

# Site Master™

## S331D/S332D

### Cable and Antenna Analyzer

Site Master is the preferred cable and antenna analyzer of wireless providers, contractors and installers.

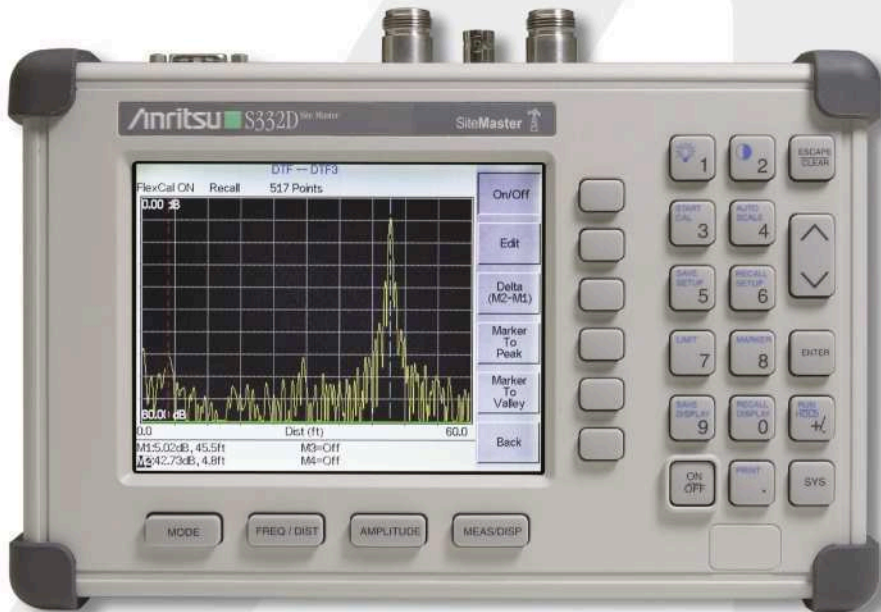

Color display option shown



## User's Guide

## WARRANTY

The Anritsu product(s) listed on the title page is (are) warranted against defects in materials and workmanship for one year from the date of shipment. Anritsu's obligation covers repairing or replacing products which prove to be defective during the warranty period. Buyers shall prepay transportation charges for equipment returned to Anritsu for warranty repairs. Obligation is limited to the original purchaser. Anritsu is not liable for consequential damages.

## LIMITATION OF WARRANTY

The foregoing warranty does not apply to Anritsu connectors that have failed due to normal wear. Also, the warranty does not apply to defects resulting from improper or inadequate maintenance by the Buyer, unauthorized modification or misuse, or operation outside the environmental specifications of the product. No other warranty is expressed or implied, and the remedies provided herein are the Buyer's sole and exclusive remedies.

## TRADEMARK ACKNOWLEDGMENTS

Windows, Windows 95, Windows NT, Windows 98, Windows 2000, Windows ME and Windows XP are registered trademarks of the Microsoft Corporation. Anritsu, FlexCal, InstaCal and Site Master are trademarks of Anritsu Company.

## NOTICE

Anritsu Company has prepared this manual for use by Anritsu Company personnel and customers as a guide for the proper installation, operation and maintenance of Anritsu Company equipment and computer programs. The drawings, specifications, and information contained herein are the property of Anritsu Company, and any unauthorized use or disclosure of these drawings, specifications, and information is prohibited; they shall not be reproduced, copied, or used in whole or in part as the basis for manufacture or sale of the equipment or software programs without the prior written consent of Anritsu Company.

## UPDATES

Updates to this manual, if any, may be downloaded from the Anritsu internet site at: <http://www.us.anritsu.com>.

Equipment marked with the Crossed-out Wheelie Bin symbol complies with the European Parliament and Council Directive 2002/96/EC (the "WEEE Directive") in the European Union.



For Products placed on the EU market after August 13, 2005, please contact your local Anritsu representative at the end of the product's useful life to arrange disposal in accordance with your initial contract and the local law.

# DECLARATION OF CONFORMITY

**Manufacturer's Name:** ANRITSU COMPANY

**Manufacturer's Address:** Microwave Measurements Division  
490 Jarvis Drive  
Morgan Hill, CA 95037-2809  
USA

declares that the product specified below:

**Product Name:** Site Master

**Model Number:** S331D, S332D, MS2711D

conforms to the requirement of:

EMC Directive 89/336/EEC as amended by Council Directive 92/31/EEC & 93/68/EEC  
Low Voltage Directive 73/23/EEC as amended by Council directive 93/68/EEC

## **Electromagnetic Interference:**

**Emissions:** CISPR 11:1990/EN55011: 1991 Group 1 Class A  
EN 61000-3-2:1995 Class A  
EN 61000-3-3:1995 Class A

**Immunity:** EN 61000-4-2:1995/EN50082-1: 1997 - 4kV CD, 8kV AD  
EN 61000-4-3:1997/EN50082-1: 1997 - 3V/m  
ENV 50204/EN50082-1: 1997 - 3V/m  
EN 61000-4-4:1995/EN50082-1: 1997 - 0.5kV SL, 1kV PL  
EN 61000-4-5:1995/EN50082-1: 1997 - 1kV L-L, 2kV L-E  
EN 61000-4-6:1994/EN61326: 1998 - 3V  
EN 61000-4-8:1994/EN61326: 1998 - 3A/m  
EN 61000-4-11:1994/EN61326: 1998 - 1 cycle@100%

## **Electrical Safety Requirement:**

**Product Safety:** The Product Complies when used with Company supplied Power  
Supply (tested to EN 60950)

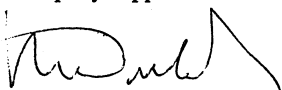
  
Corporate Quality Director

Morgan Hill, CA

12-06-03

Date

European Contact: For Anritsu product EMC & LVD information, contact Anritsu LTD, Rutherford Close,  
Stevenage Herts, SG1 2EF UK, (FAX 44-1438-740202)

# Table of Contents

---

## Chapter 1 - General Information

Introduction . . . . .	1-1
Description . . . . .	1-1
Standard Accessories . . . . .	1-1
Options . . . . .	1-2
Printers . . . . .	1-3
External Detectors . . . . .	1-3
Optional Accessories . . . . .	1-4
Performance Specifications . . . . .	1-6
Preventive Maintenance . . . . .	1-12
Calibration . . . . .	1-12
InstaCal Module . . . . .	1-13
Annual Verification . . . . .	1-13
ESD Precautions . . . . .	1-13
Mode References . . . . .	1-13

## Chapter 2 - Functions and Operations

Introduction . . . . .	2-1
Test Connector Panel . . . . .	2-1
Display Overview . . . . .	2-3
Front Panel Overview . . . . .	2-4
Function Hard Keys . . . . .	2-5
Keypad Hard Keys . . . . .	2-6
Soft Keys . . . . .	2-8
Power Monitor, External Detector (Option 5) . . . . .	2-38
Transmission Measurement (Option 21) . . . . .	2-39
Interference Analyzer Mode (Option 25) . . . . .	2-46
Channel Scanner Mode (Option 27) . . . . .	2-55
CW Signal Generator Mode (Option 28) . . . . .	2-58
Power Meter Menus (Option 29) . . . . .	2-61
T1 Tester Mode Menus (Option 50) . . . . .	2-63
E1 Tester Mode Menus (Option 50) . . . . .	2-66
Symbols . . . . .	2-68
Self Test . . . . .	2-69
Error Messages . . . . .	2-70
Battery Information . . . . .	2-75
Charging a New Battery . . . . .	2-75
Determining Remaining Battery Life . . . . .	2-76
Important Battery Information . . . . .	2-79

## Chapter 3 - Getting Started

Introduction . . . . .	3-1
Power On Procedure . . . . .	3-1
Cable and Antenna Analyzer Mode . . . . .	3-2
Spectrum Analyzer Mode . . . . .	3-11
All Modes . . . . .	3-15
Save and Recall a Setup . . . . .	3-15
Save and Recall a Display . . . . .	3-15

Changing the Units . . . . .	3-16
Changing the Language. . . . .	3-16
Adjusting Markers . . . . .	3-16
Adjusting Limits . . . . .	3-17
Adjusting the Display Brightness. . . . .	3-18
Printing . . . . .	3-19
Using the Soft Carrying Case. . . . .	3-20

## **Chapter 4 - Cable and Antenna Analyzer Measurements**

Introduction . . . . .	4-1
Line Sweep Fundamentals . . . . .	4-1
CW Mode/RF Immunity . . . . .	4-2
Information Required for a Line Sweep . . . . .	4-3
Typical Line Sweep Test Procedures . . . . .	4-3

## **Chapter 5 - Spectrum Analyzer Measurements**

Introduction . . . . .	5-1
Measurement Fundamentals . . . . .	5-1
Preamplifier . . . . .	5-3
Preamplifier Operation. . . . .	5-3
Preamplifier Measurement Example. . . . .	5-4
Dynamic Attenuation Control . . . . .	5-6
Frequency Converter Interface (Option 6). . . . .	5-7
Introduction . . . . .	5-7
Selecting the Signal Standard and Channel . . . . .	5-8
Field Strength Measurements . . . . .	5-9
Occupied Bandwidth . . . . .	5-10
Channel Power Measurement. . . . .	5-12
Adjacent Channel Power Ratio. . . . .	5-14
Interference Analysis . . . . .	5-16
AM/FM Demodulation . . . . .	5-17
Demodulation Procedure . . . . .	5-17
Carrier to Interference Ratio (C/I) . . . . .	5-19
Procedure . . . . .	5-19

## **Chapter 6 - Internal Power Meter Mode**

Introduction . . . . .	6-1
Power Measurement . . . . .	6-1
Offset Calibration . . . . .	6-2

## **Chapter 7 - Power Monitor Mode**

Introduction . . . . .	7-1
Power Measurement . . . . .	7-1

## **Chapter 8 - High Accuracy Power Meter**

Introduction . . . . .	8-1
Power Measurement . . . . .	8-2

## **Chapter 9 - T1 Measurements**

Introduction . . . . .	9-1
T1 Fundamentals . . . . .	9-1
G.821 Measurement Definitions . . . . .	9-2
Network Equipment . . . . .	9-2
Testing T1 Circuits . . . . .	9-4
In Service Testing . . . . .	9-4
Out-Of-Service Testing . . . . .	9-7
DS0 Testing . . . . .	9-12

## **Chapter 10 - E1 Measurements**

Introduction . . . . .	10-1
E1 Fundamentals . . . . .	10-1
G.821 Measurement Definitions . . . . .	10-2
Network Equipment . . . . .	10-2
Testing E1 Circuits . . . . .	10-3
In Service Testing . . . . .	10-3
Out-Of-Service Testing . . . . .	10-8
VF Channel Access Testing . . . . .	10-11

## **Chapter 11 - Transmission Measurement**

Introduction . . . . .	11-1
Measuring Active Devices . . . . .	11-1
Calibration . . . . .	11-1
Transmission Measurement Procedure . . . . .	11-3
Bias Tee (Option 10A) . . . . .	11-4

## **Chapter 12 - GPS Feature**

Introduction . . . . .	12-1
Activating the GPS Feature . . . . .	12-1
Saving with GPS Information . . . . .	12-3
Recalling GPS Information . . . . .	12-3

## **Chapter 13 - Interference Analyzer Mode**

Introduction . . . . .	13-1
Interference Analysis . . . . .	13-1
Spectrogram . . . . .	13-1
Signal Strength . . . . .	13-3
RSSI . . . . .	13-4
Signal ID . . . . .	13-5

## **Chapter 14 - Channel Scanner Mode**

Introduction . . . . .	14-1
Channel Scanner . . . . .	14-1

## **Chapter 15 - Signal Generator Mode**

Introduction . . . . .	15-1
Required Equipment . . . . .	15-1
Procedure . . . . .	15-1
Softkeys . . . . .	15-2

## Chapter 16 - Handheld Software Tools

Introduction . . . . .	16-1
Features . . . . .	16-1
System Requirements . . . . .	16-1
Installation . . . . .	16-2
Using Handheld Software Tools . . . . .	16-3
Downloading Traces . . . . .	16-3
Plot Capture to the PC . . . . .	16-4
Plot Upload to the Instrument . . . . .	16-4
Plot Properties . . . . .	16-4
Signal Standards Editor . . . . .	16-11

## Appendix A - Reference Data

Coaxial Cable Technical Data. . . . .	A-1
---------------------------------------	-----

## Appendix B - Windowing

Introduction . . . . .	B-1
Examples . . . . .	B-1

## Appendix C - Signal Standards

Introduction . . . . .	C-1
------------------------	-----

## Index

产品中有毒有害物质或元素的名称及含量 For Chinese Customers Only YLYB

部件名称	有毒有害物质或元素					
	铅 (Pb)	汞 (Hg)	镉 (Cd)	六价铬 [Cr(VI)]	多溴联苯 (PBB)	多溴二苯醚 (PBDE)
印刷线路板 (PCA)	×	○	×	×	○	○
机壳、支架 (Chassis)	×	○	×	×	○	○
LCD	×	×	×	×	○	○
其他(电缆、风扇、 连接器等) (Appended goods)	×	○	×	×	○	○

○：表示该有毒有害物质在该部件所有均质材料中的含量均在 SJ/T11363-2006 标准规定的限量要求以下。  
 ×：表示该有毒有害物质至少在该部件的某一均质材料中的含量超出 SJ/T11363-2006 标准规定的限量要求。

### 环保使用期限



这个标记是根据 2006/2/28 公布的「电子信息产品污染控制管理办法」以及 SJ/T 11364-2006 「电子信息产品污染控制标识要求」的规定，适用于在中国销售的电子信息产品的环保使用期限。仅限于在遵守该产品的安全规范及使用注意事项的基础上，从生产日起算的该年限内，不会因产品所含有害物质的泄漏或突发性变异，而对环境污染、人身及财产产生深刻地影响。  
 注) 电池的环保使用期限是 5 年。生产日期标于产品序号的前四码 (如 S/N 0728XXXX 为 07 年第 28 周生产)。

# Chapter 1

## General Information

### Introduction

This chapter provides a description, performance specifications, optional accessories, preventive maintenance, and calibration requirements for the Site Master™ models S331D and S332D. Throughout this manual, the term Site Master will refer to the S331D and S332D.

<u>Model</u>	<u>Frequency Range</u>
S331D	Cable and Antenna Analyzer Mode: 25 to 4000 MHz
S332D	Cable and Antenna Analyzer Mode: 25 to 4000 MHz Spectrum Analyzer Mode: 100 kHz to 3000 MHz

### Description

The Site Master model S331D is a hand held cable and antenna analyzer. The Site Master model S332D is a handheld cable, antenna, and spectrum analyzer. Both models include a keypad to enter data and a standard daylight-viewable color TFT display to provide graphic indications of various measurements.

The Site Master is capable of up to 1.5 hours of continuous operation from a fully charged field-replaceable battery and can be operated from a 12.5 Vdc source. Built-in energy conservation features can be used to extend battery life.

The Site Master is designed for measuring Return Loss, SWR, and Cable Loss of cable and antenna systems from 25 MHz to 4 GHz. Option 2 and Option 16 extend the frequency range of the cable and antenna analyzer to 2 MHz and 6 GHz respectively. Distance-To-Fault (DTF) measurements can be used to locate the precise location of a fault within the feedline system. The Site Master model S332D includes Spectrum Analysis (100 kHz - 3 GHz) and has dedicated routines for common one-button measurements. Options available with the S331D or S332D include 2-port Transmission Measurements, Bias Tee, narrow band or wide band power meter, Channel Scanner, Interference Analyzer, GPS, and T1/E1 Analyzer measurements.

The displayed trace can be scaled or enhanced with frequency markers or limit lines. A menu option provides for an audible “beep” when the limit value is exceeded. To permit use in low-light environments, the LCD contrast and backlight intensity can be adjusted.

### Standard Accessories

The Handheld Software Tools PC-based software program provides a database record for storing measurement data. Software Tools can also convert the Site Master display to a Microsoft Windows™ 95/98/NT4/2000/ME/XP workstation graphic. Measurements stored in the Site Master internal memory can be downloaded to the PC using the included null-modem serial cable. Once stored, the graphic trace can be displayed, scaled, or enhanced with markers and limit lines. Historical graphs can be overlaid with current data, and underlying data can be extracted and used in spreadsheets or for other analytical tasks.



The Handheld Software Tools program can display measurements made with the Site Master (SWR, return loss, cable loss, distance-to-fault, field strength, occupied bandwidth, channel power, adjacent channel power and interference analysis) as well as providing other functions, such as converting display modes and Smith charts. Refer to Chapter 11, Handheld Software Tools, for more information.

The following items are supplied with the basic hardware:

- 10580-00079 S331D/S332D Site Master User's Guide
- 2300-347 Anritsu Handheld Software Tools CDROM
- 48258 Soft Carrying Case
- 633-27 Rechargeable NiMH Battery
- 40-168 AC-DC Adapter with Power Cord
- 806-141 Automotive Cigarette Lighter/12 Volt DC Adapter
- 800-441 Serial Interface Cable (null modem type)
- 551-1691-R USB to RS232 Adapter Cable
- One year Warranty (includes battery, firmware, and software)

## Options

- Option 2 2 MHz Frequency Extension (S331D/S332D)
- Option 5 Power Monitor - (S331D/S332D, requires external detector)
- Option 6 Frequency Converter Control Module Interface (S332D)
- Option 10A Bias Tee (S332D)
- Option 16 6 GHz Frequency Extension, Cable and Antenna Analyzer (S331D/S332D)
- Option 19 High Accuracy Power Meter (S331D/S332D, sensor not included)
- Option 21 Transmission Measurement (S332D)
- Option 25 Interference Analyzer - (S332D, requires directional antenna)
- Option 27 Channel Scanner (S332D)
- Option 28 CW Signal Generator - (S332D, requires CW Signal Generator Kit)
- Option 29 Power Meter, Internal (S331D/S332D)
- Option 31 GPS - Requires GPS Antenna (S331D/S332D)
- Option 50 T1/E1 Analyzer (S331D)

*NOTE: For the Site Master S331D, Options 5 and 50 are mutually exclusive. That is, the Site Master S331D can be configured with either Option 5, Power Monitor, or Option 50, T1/E1, but not both.  
For the Site Master S332D, Options 5 and 6 are mutually exclusive. That is, the Site Master S332D can be configured with either Option 5, Power Monitor, or Option 6, Frequency Converter Interface, but not both.*

## Printers

The following printer and accessories are available for use with the Site Master S33xD.

- 2000-1214 HP DeskJet Printer, Model 450 w/Interface Cable, Black Print Cartridge, and U.S. Power Cable
- 2000-1215 Color Print Cartridge for HP450 DeskJet
- 2000-1216 Black Print Cartridge for HP450 DeskJet
- 2000-1217 Rechargeable Battery Pack for HP450 DeskJet
- 2000-1218 Power Cable (U.K.) for DeskJet Printer
- 2000-663 Power Cable (Europe) for DeskJet Printer
- 2000-664 Power Cable (Australia) for DeskJet Printer
- 2000-667 Power Cable (S. Africa) for DeskJet Printer
- 2000-753 Serial-to-Parallel Converter Cable, DB9 (f) to Centronics (m)

## External Detectors

The following Anritsu detectors can be used with the Site Master S33xD when equipped with Option 5, Power Monitor.

Model	Frequency Range	Impedance	Return Loss	Input Conn.	Frequency Response
5400-71N50	0.001 to 3 GHz	50Ω	26 dB	N(m)	±0.2 dB, <1 GHz ±0.3 dB, <3 GHz
5400-71N75	0.001 to 3 GHz	75Ω	26 dB, <2 GHz 20 dB, <3 GHz	N(m)	±0.2 dB, <1 GHz ±0.5 dB, <3 GHz
560-7N50B	0.01 to 20 GHz	50Ω	15 dB, <0.04 GHz 22 dB, <8.00 GHz 17 dB, <18.0 GHz 14 dB, <20.0 GHz	N(m)	±0.5 dB, <18 GHz ±1.25 dB, <20 GHz
560-7S50B	0.01 to 20 GHz	50Ω	15 dB, <0.04 GHz 22 dB, <8.00 GHz 17 dB, <18.0 GHz 14 dB, <20.0 GHz	WSMA (m)	±0.5 dB, <18 GHz ±2.0 dB, <20 GHz
560-7K50	0.01 to 40 GHz	50Ω	12 dB, <0.04 GHz 22 dB, <8.00 GHz 17 dB, <18.0 GHz 15 dB, <26.5 GHz 14 dB, <32.0 GHz 13 dB, <40.0 GHz	K(m)	±0.5 dB, <18 GHz ±1.25 dB, <26.5 GHz ±2.2 dB, <32 GHz ±2.5 dB, <40 GHz
560-7VA50	0.01 to 50 GHz	50Ω	12 dB, <0.04 GHz 19 dB, <20.0 GHz 15 dB, <40.0 GHz 10 dB, <50.0 GHz	V(m)	±0.8 dB, <20 GHz ±2.5 dB, <40 GHz ±3.0 dB, <50 GHz

## Optional Accessories

<u>Part Number</u>	<u>Description</u>
10580-00100	S33xD Programming Manual (available on disk or at <a href="http://www.us.anritsu.com">www.us.anritsu.com</a> )
10580-00101	S331D Maintenance Manual
10580-00102	S332D Maintenance Manual
760-243-R	Transit Case
633-27	Rechargeable Battery, NiMH
2000-1029	Battery Charger with universal power supply, NiMH only
48258	Soft Carrying Case
40-168	AC-DC Adapter Power Supply
806-141	Automotive Cigarette Lighter 12 Volt DC Adapter
800-441	Serial Interface Cable Assembly
551-1691-R	USB Adapter Cable
2300-347	Handheld Software Tools CD
FCN4760	4.7 GHz to 6 GHz Frequency converter for S332D only
ICN50	InstaCal™ Calibration Module, 50Ω, 25 MHz to 4 GHz, N (m)
65701	Offset Cal Kit consisting of one each: 3-1010-119, 10 dB Attenuator, DC to 6 GHz, 2W 3-806-151, 4 GHz Cable, 18" (46 cm)
OSLN50-1	Anritsu Precision N (m) Open/Short/Load, 42 dB, 6 GHz
OSLNF50-1	Anritsu Precision N (f) Open/Short/Load, 42 dB, 6 GHz
22N50	Anritsu Precision N (m) Short/Open
22NF50	Anritsu Precision N (f) Short/Open
SM/PL-1	Anritsu Precision N (m) Load, 42 dB, 6 GHz
SM/PLNF-1	Anritsu Precision N (f) Load, 42 dB, 6 GHz
2000-767	7/16 (m) Precision Open/Short/Load
2000-768	7/16 (f) Precision Open/Short/Load
12N50-75B	Matching Pad, DC to 3 GHz, 50 Ohm N(m) to 75 Ohm N(f)
22N75	Open/Short, DC to 3 GHz, N(m) 75 Ohm
22NF75	Open/Short, DC to 3 GHz, N(f) 75 Ohm
26N75A	Precision Termination, DC to 3 GHz, N(m)
26NF75A	Precision Termination, DC to 3 GHz, N(f) 75 Ohm
510-90	Adapter, 7/16 (f) to N (m) 6.0 GHz
510-91	Adapter, 7/16 (f) to N (f) 6.0 GHz
510-92	Adapter, 7/16 (m) to N (m) 6.0 GHz
510-93	Adapter, 7/16 (m) to N (f) 6.0 GHz
510-96	Adapter, 7/16 DIN (m) to 7/16 DIN (m) 6.0 GHz
510-97	Adapter, 7/16 DIN (f) to 7/16 DIN (f) 6.0 GHz
1091-27	Adapter, Type-N male to SMA(f)
1091-26	Adapter, Type-N male to SMA(n)
1091-80	Adapter, N(f) to SMA(m), DC to 18 GHz, 50 Ohm
1091-81	Adapter, N(f) to SMA(f), DC to 18 GHz, 50 Ohm
1091-172	Adapter, N(m) to BNC(f), DC to 1.3 GHz, 50 Ohm
34NN50A	Adapter, Precision N (m) to N (m) 18 GHz
34NFN50	Adapter, Precision N (f) to N (f) 18 GHz
15NNF50-1.5C	Armored Test Port Extension Cable, 1.5 meter, N (m) to N (f) 6 GHz
15NNF50-3.0C	Armored Test Port Extension Cable, 3.0 meter, N (m) to N (f) 6 GHz
15NNF50-5.0C	Armored Test Port Extension Cable, 5.0 meter, N (m) to N (f) 6 GHz
15NN50-1.5C	Armored Test Port Extension Cable, 1.5 meter, N (m) to N (m) 6 GHz
15NN50-3.0C	Armored Test Port Extension Cable, 3.0 meter, N (m) to N (m) 6 GHz
15NN50-5.0C	Armored Test Port Extension Cable, 5.0 meter, N (m) to N (m) 6 GHz

<u>Part Number</u>	<u>Description</u>
15NDF50-1.5C	Armored Test Port Extension Cable, 1.5 meter, N (m) to 7/16 DIN (f) 6 GHz
15ND50-1.5C	Armored Test Port Extension Cable, 1.5 meter, N (m) to 7/16 DIN (m) 6 GHz
2000-1030	Portable Antenna SMA (m), 50Ω, 1.71 to 1.88 GHz
2000-1031	Portable Antenna SMA (m), 50Ω, 1.85 to 1.99 GHz
2000-1032	Portable Antenna SMA (m), 50Ω, 2.4 to 2.5 GHz
2000-1035	Portable Antenna SMA (m), 50Ω, 896 to 941 MHz
2000-1200	Portable Antenna SMA (m), 50Ω, 806 to 866 MHz
2000-1361	Portable Antenna SMA(m), 50Ω, 5725-5825 MHz
2000-1410	Magnet Mount GPS Antenna with 15 ft. cable
61532	Antenna Kit, consisting of one each: 2000-1030, 2000-1031, 2000-1032, 2000-1035, 2000-1200, and 2000-1361
2000-1411	Portable YAGI Antenna, N(f), 822-900 MHz, 10 dBd
2000-1412	Portable YAGI Antenna, N(f), 885-975 MHz, 10 dBd
2000-1413	Portable YAGI Antenna, N(f), 1.71-1.88 GHz, 10 dBd
2000-1414	Portable YAGI Antenna, N(f), 1.85-1.99 GHz, 9.3 dBd
2000-1415	Portable YAGI Antenna, N(f), 2.4-2.5 GHz, 12 dBd
2000-1416	Portable YAGI Antenna, N(f), 1.92-2.23 GHz, 12 dBd
806-16	Bantam Plug to Bantam Plug
806-116	Bantam Plug to BNC
806-117	Bantam "Y" Plug to RJ48
1030-86	Band Pass Filter, 806-869 MHz, 1.7 dB loss, N(m) to SMA(f), 50Ω
1030-87	Band Pass Filter, 902-960 MHz, 1.7 dB loss, N(m) to SMA(f), 50Ω
1030-88	Band Pass Filter, 1.85-1.99 GHz, 1.8 dB loss, N(m) to SMA(f), 50Ω
1030-89	Band Pass Filter, 2.4-2.5 GHz, 1.4 dB loss, N(m) to SMA(f), 50Ω
PSN50	High Accuracy Power Sensor, 50 MHz to 6 GHz
3-1010-122	Attenuator, 20dB, 5 Watt, DC to 12.4 GHz, N(m)-N(f)
3-1010-123	Attenuator, 30 dB, 50 Watt, DC to 8.5 GHz, N(m)-N(f)
3-1010-124	Attenuator (Uni-directional), 40 dB, 100 Watt, DC to 8.5 GHz, N(m)-N(f)
42N50-20	20 dB, 5W, DC to 18 GHz, N(m)-N(f)
42N50A-30	30 dB, 50W, DC to 18 GHz, N(m)-N(f)
1010-121	40 dB, 100W, DC to 18 GHz, N(m)-N(f)

## Performance Specifications

Performance specifications are provided in Table 1-1. All specifications apply when calibrated at ambient temperature after a five minute warm up. Typical values are given for reference, and are not guaranteed.

Table 1-1. Performance Specifications (1 of 6)

---

### Cable and Antenna Analyzer

Frequency Range:	25 MHz to 4000 MHz
Frequency Accuracy:	$\leq \pm 75$ ppm @ +25°C
Frequency Resolution:	100 kHz
Output Power:	< 0 dBm (–10 dBm nominal)
Immunity to Interfering Signals:	on-channel +17 dBm on-frequency –5 dBm
Measurement speed:	$\leq 3.5$ msec / data point (CW ON)
Number of data points:	130 or 259 or 517
Return Loss:	
Range:	0.00 to 60.00 dB
Resolution:	0.01 dB
VSWR:	
Range:	1.00 to 65.00
Resolution:	0.01
Cable Loss:	
Range:	0.00 to 30.00 dB
Resolution:	0.01 dB
Measurement Accuracy:	> 42 dB corrected directivity after calibration
Distance-To-Fault	
Vertical Range:	
Return Loss:	0.00 to 60.00 dB
VSWR:	1.00 to 65.00
Horizontal Range:	0 to (# of data pts –1) x Resolution to a maximum of 1197m (3929 ft) # of data pts = 130 or 259 or 517
Horizontal Resolution (rectangular windowing):	
Resolution (meters) =	$(1.5 \times 10^8) \times (Vp)/DF$
Where Vp is the relative propagation velocity of the cable and DF is the stop frequency minus the start frequency (in Hz).	

### Spectrum Analyzer (S332D only)

Frequency Range:	100 kHz to 3000 MHz (tunable to 9 kHz)
Frequency Reference (internal timebase):	
Aging:	$\pm 1$ ppm/yr
Accuracy:	$\pm 2$ ppm
Frequency Span:	10 Hz to 2.99 GHz in 1, 2, 5 step selections in auto mode, plus zero span

---

Table 1-1. Performance Specifications (2 of 6)

Sweep Time:	≤1.1 seconds, full span; ≤ 50 μseconds to 20 seconds, zero span
Resolution Bandwidth (–3 dB):	100 Hz to 1 MHz in 1-3 sequence ± 5% Accuracy
Video Bandwidth (–3 dB):	3 Hz to 1 MHz in 1-3 sequence ± 5% Accuracy
SSB Phase Noise (1 GHz) @ 30 kHz Offset:	≤ –75 dBc/Hz
Spurious Responses:	≤ –45 dBc
Spurious Residual Responses:	≤ –90 dBm >10 MHz, ≤ –80 dBm ≤10 MHz (10 kHz RBW, pre-amp on)
Amplitude Total Level Accuracy:	± 1 dB typical (±1.5 dBm), ≥10MHz to 3 GHz ± 2 dB, typical <10 MHz for input signal levels ≥ –60 dBm (excludes input VSWR mismatch)
Measurement Range:	+20 dBm to –135 dBm
Input Attenuator Range:	0 to 51 dB, selected manually or automatically coupled to the reference level. Resolution in 1 dB steps.
Displayed Average Noise Level:	≤ –135 dBm typical, ≥10 MHz (preamp on) ≤ –115 dBm typical, <10 MHz (preamp on) for input terminated, 0 dB attenuation, RMS detection, 100 Hz RBW
Dynamic Range:	>65 dB
Display Range:	1 to 15 dB/division, in 1 dB steps, 10 divisions displayed
Scale Units:	dBm, dBV, dBmV, dBμV, V, W
RF Input VSWR:	1.5:1 typical (10 MHz to 2.4 GHz with ≥20 dB attenuation), 10 MHz to 2.4 GHz)

**2 MHz Frequency Extension (Option 2)**

Cable and Antenna Analyzer

Frequency Range: 2 MHz to 4 GHz

(All other specifications remain the same as standard S33XD)

**Power Monitor (Option 5, with external detector)**

Detector Range: 1A peak 150 ms, 300 mA max steady state

Offset Range: –50 to +20 dBm, 10 nW to 100 nW

Display Range: –80 to 80 dBm

Resolution: 0.1 dB, 0.1 xW

Measurement Accuracy: ±1 dB maximum for >–40 dBm and <18 GHz using 560-7N50B  
(see uncertainty curves)**6 GHz Frequency Extension, Cable and Antenna Analyzer (Option 16)**

Cable and Antenna Analyzer

Frequency Range: 25 MHz to 6 GHz

(All other specifications remain the same as standard S33XD)

Table 1-1. Performance Specifications (3 of 6)

---

**High Accuracy Power Meter (Option 19, with PSN50 Power Sensor)**

**Sensor:**

Measurement Range:	-30 to +20 dBm
Frequency Range:	50 MHz to 6 GHz
Input Connector:	Type N, male, 50Ω
Max Input Without Damage:	+33 dBm, ± 25 VDC
Input Return Loss :	50 MHz to 2 GHz: ≥26 dB 2 GHz to 6 GHz: ≥20 dB

**Accuracy:**

Total RSS Meas. Uncertainty:	CW signals: ± 0.16 dB (0 to 50°C)*
Noise:	20 nW max
Zero Set:	20 nW
Zero Drift:	10 nW max**
Instrumentation Accuracy:	0.00 dB
Sensor Linearity:	± 0.13 dB max
Sensor Cal Factor Uncertainty:	± 0.06 dB
Temperature Compensation:	± 0.06 dB max
Continuous digital modulation uncertainty:	+0.06 dB (+17 to +20 dBm)

**System:**

Measurement Resolution:	0.01 dB
Offset Range:	± 60dB

**Power Requirements:**

Supply Voltage:	8 to 18 Vdc
Supply Current:	<100 mA

\*Excludes mismatch errors. Excludes noise, zero set, zero drift for levels <-20 dBm. Excludes digital modulation uncertainty between +17 and +20 dBm.

\*\*After 30 min warm-up

**Transmission Measurement (Option 21)**

RF Source:	
Frequency Range:	25 MHz to 3 GHz
Frequency Resolution:	10 Hz
Output Power Level:	-10 dBm typical
Dynamic Range:	80 dB, 25 MHz to 2 GHz 60 dB, >2 GHz to 3 GHz
Output Impedance:	50Ω

**Interference Analysis (Option 25)**

- Audible tone - identify interference type
  - Strength of the Interferer
  - RSSI
  - Spectrogram
-

Table 1-1. Performance Specifications (4 of 6)

**Channel Scanner (Option 27)**

Frequency Range:	100 kHz to 3.0 GHz
Frequency Accuracy:	$\pm 10$ Hz + Time base error, 99% confidence level
Measurement Range:	+20 dBm to -110 dBm
Channel Power:	$\pm 1$ dB typical ( $\pm 1.5$ dB max)
Adjacent Channel Pwr Accuracy:	$\pm 0.75$ dBc

**Power Meter (Option 29)**

Frequency Range:	3 MHz to 3000 MHz
Detection Range:	-80 dBm to +80 dBm
Offset Range:	0 to +60 dB
Accuracy:	$\pm 1$ dB typical ( $\pm 1.5$ dBm max), $\geq 10$ MHz to 3 GHz $\pm 2$ dB, typical, 3 MHz to <10 MHz
VSWR:	1.5:1 typical ( $P_{in} > -30$ dBm, 10 MHz to 2.4 GHz)
Maximum Input Power without damage:	+43 dBm without external attenuator

**GPS (Option 31)**

GPS Location Indicator	
Latitude, Longitude and Altitude on Display	
Latitude, Longitude and Altitude with Trace Storage	

**T1 Analyzer (Option 50, S331D only)**

Line Coding:	AMI, B8ZS
Framing Modes:	D4 (Superframe), ESF (Extended Superframe)
Connection Configurations:	Terminate (100 $\Omega$ ) Bridge ( $\geq 1000\Omega$ ) Monitor (Connect via 20 dB pad in DSX)
Receiver Sensitivity:	0 to -36 dBdsx
Transmit Level:	0 dB, -7.5 dB, and -15 dB
Clock Sources:	External Internal: 1.544 MHz $\pm$ 30 ppm
Pulse Shapes:	Conform to ANSI T1.403
Pattern Generation & Detection:	PRBS: 2-9, 2-11, 2-15, 2-20, 2-23 Inverted and non-inverted, QRSS, 1-in-8 (1-in-7), 2-in-8, 3-in-24, All ones, All zeros, T1-Daly, User defined ( $\leq 32$ bits)
Circuit Status Reports:	Carrier present, Frame ID and Sync., Pattern ID and Sync.
Alarm Detection:	AIS (Blue Alarm), RAI (Yellow Alarm)
Error Detection:	Frame Bits, Bit, BER, BPV, CRC, Error secretary
Error Insertion:	Bit, BPV, Framing Bits, RAI, AIS
Loopback Modes:	Self loop, CSU, NIU, user defined, In-band or Data Link
Level Measurements:	Vp-p ( $\pm 5\%$ ), dBdsx
Data Log:	Continuous, up to 48 hrs



Table 1-1. Performance Specifications (5 of 6)

---

**E1 Analyzer (Option 50, S331D only)**

Line Coding:	AMI, HDB3
Framing Modes:	PCM30, PCM30CRC, PCM31, PCM31CRC
Connection Configurations:	Terminate (75Ω, 120Ω) Bridge (≥1000Ω) Monitor (Connect via 20 dB pad in DSX)
Receiver Sensitivity:	0 to -43 dB
Clock Sources:	External Internal, 2.048 MHz ± 30 ppm
Pulse Shapes:	Conform to ITU G.703
Pattern Generation and Detection:	PRBS: 2-9, 2-11, 2-15, 2-20, 2-23 Inverted and non-inverted, QRSS, 1-in-8 (1-in-7), 2-in-8, 3-in-24, All ones, All zeros, T1-Daly, User defined (≤ 32 bits)
Circuit Status Reports:	Carrier present, Frame ID and Sync., Pattern ID and Sync.
Alarm Detection:	AIS, RAI, MMF
Error Detection:	Frame Bits, Bit, BER, BPV, CRC, E-Bits, Error secretary
Error Insertion:	Bit, BPV, Framing Bits, RAI, AIS
Loopback Modes:	Self loopback
Level Measurements:	Vp-p (± 5%), dBdsx
Data Log:	Continuous, up to 48 hrs

**FCN4760 Frequency Converter (for use with Option 6, S332D only)**

Frequency Range	4.7 GHz to 6.0 GHz
Frequency Resolution*	10 Hz
Frequency Reference	Aging: ± 1 ppm/yr Accuracy: ± 2 ppm
SSB Phase Noise (6 GHz) @ 30 kHz Offset	≤-65 dBc/Hz
Spurious Responses Input Related	≤-45 dBc
Spurious Residual Responses*	≤-90 dBm
Measurement Range	-40 dBm to -100 dBm
Sensitivity* (displayed average noise level)	≤-100 dBm
Accuracy	± 1.75 dBm typ. (± 2.25 dBm max.)*
Maximum Input Level without damage	-5 dBm
Input and Output Ports:	
RF In	Type N, female, 50Ω
RF Out	Type N, male, 50Ω

---

Table 1-1. Performance Specifications (6 of 6)

Electromagnetic	Meets European community requirements for CE marking Compatibility
Safety	Conforms to EN 61010-1 for Class 1 portable equipment
Temperature:	
Operating	-10°C to 50°C, 85% humidity or less
Storage	-50°C to +80°C
Power Dissipation	850 mW maximum
Dimensions	
W x H x D	6.6 cm x 10.9 cm x 3.3 cm (2.6 in x 4.3 in x 1.3 in)
Weight	<0.45 kg (< 1 lb.)
* Specifications apply when connected to the Site Master.	
<b>General</b>	
Language Support:	English, Spanish, French, German, Chinese, Japanese
Internal Trace Memory:	Up to 300 traces
Setup Configurations:	S331D: 10 to 30 setups (VNA-10, T1-5, E1-5, High Accuracy Power Meter-5, Power Meter-5) S332D: 15 to 40 setups (VNA-10, SPA/TM-5, Power Meter-5, High Accuracy Power Meter-5, IA-5, Channel Scanner-5)
Display:	Standard color TFT (640x480) display with variable brightness control
Inputs and Outputs Ports:	
RF Out:	Type N, female, 50Ω
Maximum Input without Damage:	+23 dBm, ± 50 VDC
RF In:	Type N, female, 50Ω
Maximum Input without Damage:	+43 dBm (Peak), ± 50 VDC
Ext. Trig In:	BNC, female (5 V TTL)
Ext. Freq Ref In (2 to 20 MHz):	Shared BNC, female, 50Ω, (-15 dBm to +10 dBm)
Serial Interface:	RS-232 9 pin D-sub, three wire serial
Electromagnetic Compatibility:	Meets European Community requirements for CE marking
Safety:	Conforms to EN 61010-1 for Class 1 portable equipment
Temperature:	
Operating:	-10°C to 55°C, humidity 85% or less
Non-operating:	-51°C to +71°C (store battery separately between 0°C and +40°C for any prolonged non-operating storage period)
Power Supply:	
External DC Input:	+12.5 to +15 volt dc, 3A maximum
Internal:	NiMH battery: 10.8 volts, 1800 mAh
Dimensions:	
Size (w x h x d):	25.4 cm x 17.8 cm x 6.1 cm (10.0 in x 7.0 in x 2.4 in)
Weight:	< 2.28 kg (< 5 lbs) including battery

## Preventive Maintenance

Site Master preventive maintenance consists of cleaning the unit and inspecting and cleaning the RF connectors on the instrument and all accessories.

Clean the Site Master with a soft, lint-free cloth dampened with water or water and a mild cleaning solution.

**CAUTION:** To avoid damaging the display or case, do not use solvents or abrasive cleaners.

Clean the RF connectors and center pins with a cotton swab dampened with denatured alcohol. Visually inspect the connectors. The fingers of the N (f) connectors and the pins of the N (m) connectors should be unbroken and uniform in appearance. If you are unsure whether the connectors are good, gauge the connectors to confirm that the dimensions are correct.

Visually inspect the test port cable(s). The test port cable should be uniform in appearance, not stretched, kinked, dented, or broken.

## Calibration

The Site Master is a field portable unit operating in the rigors of the test environment. An Open-Short-Load (OSL) calibration, InstaCal calibration, FlexCal calibration with open-short-load, or FlexCal calibration with an InstaCal module should be performed prior to making a measurement in the field (see Calibration, page 3-2). Note that the frequency range of the InstaCal module, 25 MHz to 4 GHz, makes it not suitable for use with Option 2 or Option 16. A built-in temperature sensor in the Site Master advises the user when the internal temperature has exceeded a measurement accuracy window, and the user is advised to perform another calibration in order to maintain the integrity of the measurement.

**NOTES:**

*For best calibration results—compensation for all measurement uncertainties—ensure that the Open/Short/Load is at the end of the test port or optional extension cable; that is, at the same point that you will connect the antenna or device to be tested.*

*For best results, use a phase stable Test Port Extension Cable (see Optional Accessories). If you use a typical laboratory cable to extend the Site Master test port to the device under test, cable bending subsequent to the OSL calibration will cause uncompensated phase reflections inside the cable. Thus, cables which are NOT phase stable may cause measurement errors that are more pronounced as the test frequency increases.*

*For optimum calibration, Anritsu recommends using precision calibration components.*

## InstaCal Module

The Anritsu InstaCal module can be used in place of discrete components to calibrate the Site Master. The InstaCal module can be used to perform an Open, Short and Load (OSL) or a FlexCal calibration procedure. Calibration of the Site Master with the InstaCal takes approximately 45 seconds (see Calibration, page 3-2). Unlike a discrete calibration component, the InstaCal module can not be used at the top of the tower to conduct load or insertion loss measurements. The module operates from 25 MHz to 4 GHz and weighs eight ounces.

Anritsu recommends annual verification of the InstaCal module to verify performance with precision instrument data. The verification may be performed at a local Anritsu Service Center or at the Anritsu factory.

## Annual Verification

Anritsu recommends an annual calibration and performance verification of the Site Master and the OSL calibration components and InstaCal module by local Anritsu service centers. Anritsu service centers are listed in Table 1-2 on the following page.

The Site Master itself is self-calibrating, meaning that there are no field-adjustable components. However, the OSL calibration components are crucial to the integrity of the calibration and therefore, must be verified periodically to ensure performance conformity. This is especially important if the OSL calibration components have been accidentally dropped or over-torqued.

## ESD Precautions

The Site Master, like other high performance instruments, is susceptible to ESD damage. Very often, coaxial cables and antennas build up a static charge, which, if allowed to discharge by connecting to the Site Master, may damage the Site Master input circuitry. Site Master operators should be aware of the potential for ESD damage and take all necessary precautions. Operators should exercise practices outlined within industry standards like JEDEC-625 (EIA-625), MIL-HDBK-263, and MIL-STD-1686, which pertain to ESD and ESDS devices, equipment, and practices.

As these apply to the Site Master, it is recommended to dissipate any static charges that may be present before connecting the coaxial cables or antennas to the Site Master. This may be as simple as temporarily attaching a short or load device to the cable or antenna prior to attaching to the Site Master. It is important to remember that the operator may also carry a static charge that can cause damage. Following the practices outlined in the above standards will insure a safe environment for both personnel and equipment.

## Mode References

The term “VNA” in reference to the Site Master denotes cable and antenna analyzer modes. The term “SPA” in reference to the Site Master denotes Spectrum Analyzer mode. All other modes are referenced individually.

## Chapter 1 General Information

---

Table 1-2. Anritsu Service Centers

---

### UNITED STATES

ANRITSU COMPANY  
490 Jarvis Drive  
Morgan Hill, CA 95037-2809  
Telephone: (408) 776-8300  
1-800-ANRITSU  
FAX: 408-776-1744

ANRITSU COMPANY  
10 New Maple Ave., Unit 305  
Pine Brook, NJ 07058  
Telephone: (973) 227-8999  
1-800-ANRITSU  
FAX: 973-575-0092

ANRITSU COMPANY  
1155 E. Collins Blvd  
Richardson, TX 75081  
Telephone: 1-800-ANRITSU  
FAX: 972-671-1877

### AUSTRALIA

ANRITSU PTY. LTD.  
Unit 3, 170 Foster Road  
Mt Waverley, VIC 3149  
Australia  
Telephone: 03-9558-8177  
FAX: 03-9558-8255

### BRAZIL

ANRITSU ELECTRONICA LTDA.  
Praia de Botafogo, 440, Sala 2401  
CEP22250-040, Rio de Janeiro, RJ  
Brasil  
Telephone: 021-527-6922  
FAX: 021-53-71-456

### CANADA

ANRITSU INSTRUMENTS LTD.  
700 Silver Seven Road, Suite 120  
Kanata, Ontario K2V 1C3  
Telephone: (613) 591-2003  
FAX: (613) 591-1006

### CHINA

ANRITSU ELECTRONICS (SHANGHAI)  
CO. LTD.  
2F, Rm B, 52 Section Factory Building  
No. 516 Fu Te Rd (N)  
Shanghai 200131 P.R. China  
Telephone: 21-58680226, 58680227,  
58680228  
FAX: 21-58680588

### FRANCE

ANRITSU S.A  
9 Avenue du Quebec  
Zone de Courtaboeuf  
91951 Les Ulis Cedex  
Telephone: 016-09-21-550  
FAX: 016-44-61-065

### GERMANY

ANRITSU GmbH  
Grafenberger Allee 54-56  
D-40237 Dusseldorf, Germany  
Telephone: 0211-968550  
FAX: 0211-9685555

### INDIA

MEERA AGENCIES PVT. LTD.  
23 Community Centre  
Zamroodpur, Kailash Colony Extension,  
New Delhi, India 110 048  
Phone: 011-2-6442700/6442800  
FAX : 011-2-644250023

### ISRAEL

TECH-CENT, LTD.  
4 Raul Valenberg St  
Tel-Aviv 69719  
Telephone: (03) 64-78-563  
FAX: (03) 64-78-334

### ITALY

ANRITSU Sp.A  
Roma Office  
Via E. Vittorini, 129  
00144 Roma EUR  
Telephone: (06) 50-99-711  
FAX: (06) 50-22-4252

### JAPAN

ANRITSU CUSTOMER SERVICE LTD.  
1800 Onna Atsugi-shi  
Kanagawa-Prf. 243 Japan  
Telephone: 0462-96-6688  
FAX: 0462-25-8379

### KOREA

ANRITSU CORPORATION LTD.  
Service Center:  
8F Hyunjuk Building  
832-41, Yeoksam Dong  
Kangnam-Gu  
Seoul, South Korea 135-080  
Telephone: 82-2-553-6603  
FAX: 82-2-553-6605

### SINGAPORE

ANRITSU (SINGAPORE) PTE LTD.  
10, Hoe Chiang Road  
#07-01/02 Keppel Towers  
Singapore 089315  
Telephone: 282-2400  
FAX: 6282-2533

### SOUTH AFRICA

ETECSA  
12 Surrey Square Office Park  
330 Surrey Avenue  
Ferndale, Randburg, 2194  
South Africa  
Telephone: 27-11-787-7200  
FAX: 27-11-787-0446

### SWEDEN

ANRITSU AB  
Fagelviksvagen 9A  
145 84 Stockholmn  
Telephone: (08) 534-707-00  
FAX: (08) 534-707-30

### TAIWAN

ANRITSU CO., INC.  
7F, No. 316, Section 1  
NeiHu Road  
Taipei, Taiwan, R.O.C.  
Telephone: 886-2-8751-1816  
FAX: 886-2-8751-2126

### UNITED KINGDOM

ANRITSU LTD.  
200 Capability Green  
Luton, Bedfordshire  
LU1 3LU, England  
Telephone: 015-82-433200  
FAX: 015-82-731303

# Chapter 2

## Functions and Operations

### Introduction

This chapter provides a brief overview of the Site Master functions and operations, providing the user with a starting point for making basic measurements. For more detailed information, refer to the specific chapters for the measurements being made.

The Site Master is designed specifically for field environments and applications requiring mobility. As such, it is a lightweight, handheld, battery operated unit which can be easily carried to any location, and is capable of up to 1.5 hours of continuous operation from a field replaceable battery for extended time in the field. Built-in energy conservation features allow battery life to be further extended. The Site Master can also be powered by a 12.5 Vdc external source. The external source can be either the Anritsu AC-DC Adapter (P/N 40-168) or 12.5 Vdc Automotive Cigarette Lighter Adapter (P/N 806-141). Both items are standard accessories.

### Test Connector Panel

The connectors and indicators located on the test panel (Figure 2-1) are listed and described below. The illustration depicts an S331D with Option 50, T1/E1 installed.

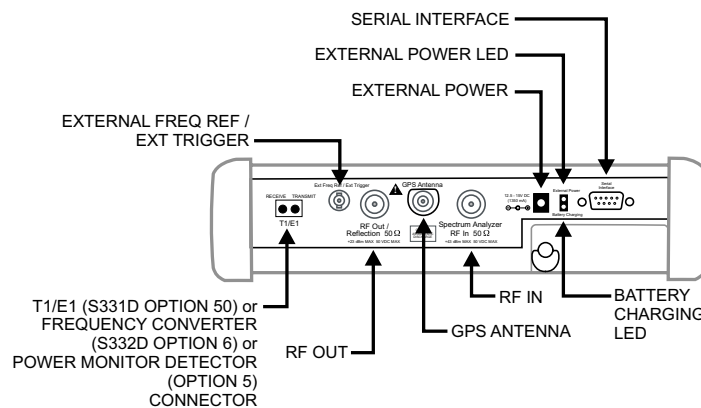

Figure 2-1. S331D Test Connector Panel (with Option 50)

**12.5-15VDC (3A)** 12.5 to 15 Vdc @ 3A input to power the unit or for battery charging.

#### WARNING

*When using the AC-DC Adapter, always use a three-wire power cable connected to a three-wire power line outlet. If power is supplied without grounding the equipment in this manner, there is a risk of receiving a severe or fatal electric shock, or damaging the equipment.*

<b>Battery Charging</b>	Illuminates when the battery is being charged. The indicator automatically shuts off when the battery is fully charged.
<b>External Power</b>	Illuminates when the Site Master is being powered by the external charging unit.
<b>Serial Interface</b>	RS232 DB9 interface to a COM port on a personal computer (for use with the Anritsu Handheld Software Tools program) or to a supported printer.
<b>RF Out/Reflection 50Ω</b>	RF output, 50 Ω impedance, for reflection measurements. Maximum input is +23 dBm at ±50 Vdc.
<b>Spectrum Analyzer RF In 50Ω</b>	RF input, 50 Ω impedance, for spectrum analysis measurements. Maximum input is +43 dBm at ±50 Vdc.
<b>Ext Freq Ref/Ext Trigger</b>	Input for an external reference signal or trigger in Spectrum Analyzer mode.
<b>GPS Antenna (Option 31)</b>	GPS antenna connection. Do not connect anything other than the Anritsu GPS antenna to this port.
<b>T1/E1 Receive/Transmit (Option 50)</b>	Transmit and Receive connectors for T1 and E1 measurements (S331D only)
<b>RF Detector (Option 5)</b>	RF detector connector for Power Monitor measurements using an external detector. Refer to the table of available RF Detectors on page 1-3.
<b>Frequency Converter Interface (Option 6)</b>	Ten pin D-style connector providing an interface to control and communicate with an Anritsu frequency conversion module (S332D only).
<b>Headphone Jack</b>	Provides audio output for the built-in AM/FM demodulator for testing and troubleshooting wireless communication systems.

*NOTE: For the Site Master S331D, Options 5 and 50 are mutually exclusive. That is, the Site Master S331D can be configured with either Option 5, Power Monitor, or Option 50, T1/E1, but not both. For the Site Master S332D, Options 5 and 6 are mutually exclusive. That is, the Site Master S332D can be configured with either Option 5, Power Monitor, or Option 6, Frequency Converter Interface, but not both.*

# Display Overview

Figure 2-2 illustrates some of the key information areas of the S331D display.

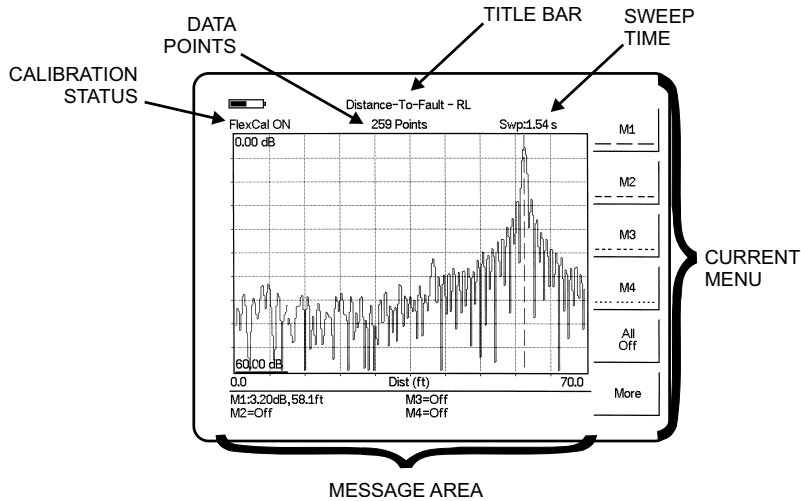

Figure 2-2. S331D Display Overview

Figure 2-3 illustrates some of the key information areas of the S332D display.

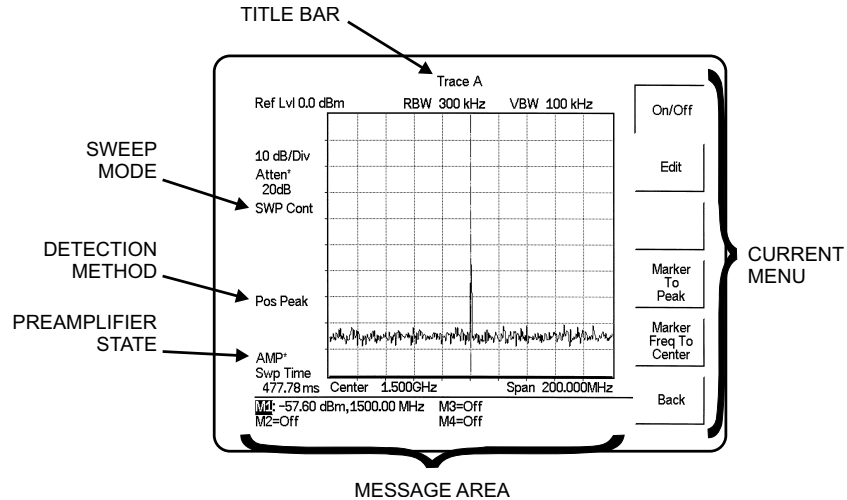

Figure 2-3. S332D Display Overview



## Front Panel Overview

The Site Master menu-driven user interface is easy to use and requires little training. Hard keys on the front panel are used to initiate function-specific menus. There are four function hard keys located below the status window: Mode, Frequency/Distance, Amplitude and Measure/Display.

There are seventeen keypad hard keys located to the right of the status window. Twelve of the keypad hard keys perform more than one function, depending on the current mode of operation. The dual purpose keys are labeled with one function in black, the other in blue.

There are also six soft keys that change function depending upon the current mode selection. The current soft key function is indicated in the soft key menu area to the right of the status window. The locations of the different keys are illustrated in Figure 2-4.

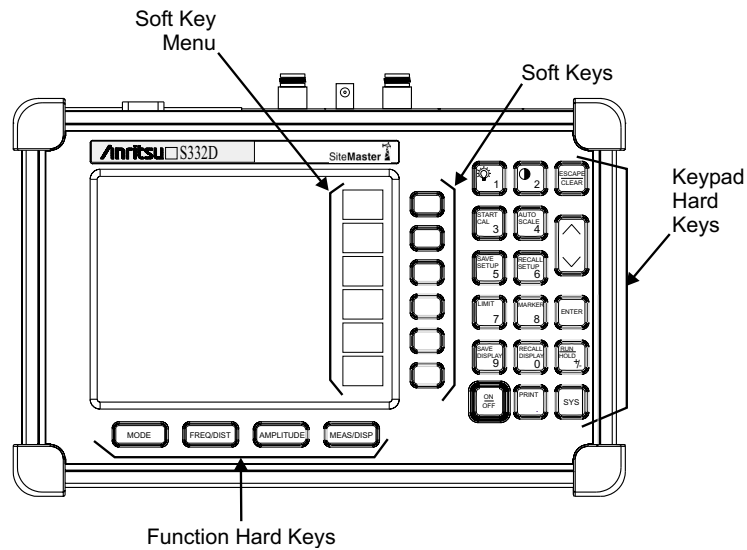

Figure 2-4. Site Master Front Panel

The following sections describe the various key functions.

## Function Hard Keys

**MODE** Opens the mode selection box (below). Use the Up/Down arrow key to select a mode. Press the ENTER key to implement.

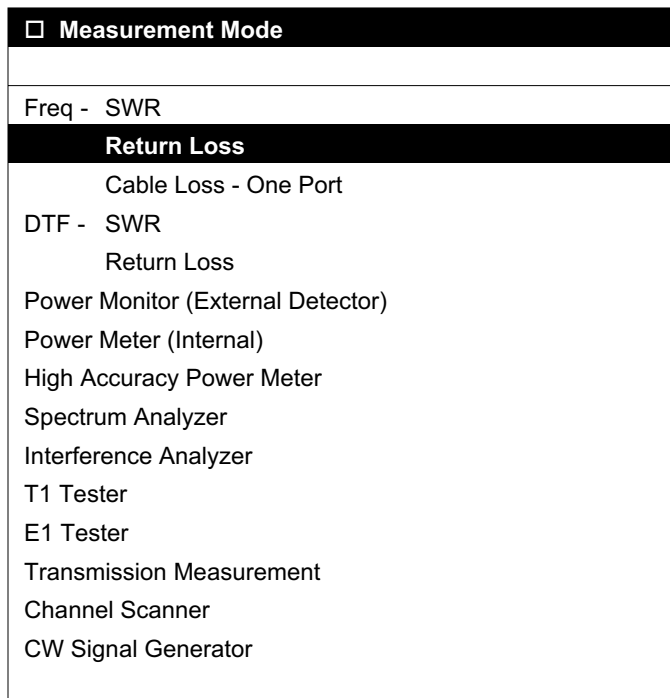

Figure 2-5. Mode Selection Box

*NOTE: Available mode selections will vary according to model number and options installed.*

**FREQ/DIST** Displays the Frequency or Distance to Fault soft key menus depending on the measurement mode (see page 2-18).

**AMPLITUDE** Displays the amplitude soft key menu for the current operating mode (see page 2-20).

**MEAS/DISP** Displays the measurement and display soft key menus for the current operating mode (see page 2-21).

## Keypad Hard Keys

This section contains an alphabetical listing of the Site Master front panel keypad controls along with a brief description of each. More detailed descriptions of the major function keys follow.

The following keypad hard key functions are printed in **black** on the keypad keys.

<b>0-9</b>	These keys are used to enter numerical data as required to setup or perform measurements.
<b>+/-</b>	The plus/minus key is used to enter positive or negative values as required to setup or perform measurements.
<b>.</b>	The decimal point is used to enter decimal values as required to setup or perform measurements.
<b><u>ESCAPE</u> CLEAR</b>	Exits the present operation or clears the status window. If a parameter is being edited, pressing this key will clear the value currently being entered and restore the last valid entry. Pressing this key again will close the parameter. During normal sweeping, pressing this key will move up one menu level.
<b>Up/Down Arrows</b>	Increments or decrements a parameter value. The specific parameter value affected typically appears in the message area of the LCD.
<b>ENTER</b>	Implements the current action or parameter selection.
<b><u>ON</u> OFF</b>	Turns the Anritsu Site Master on or off. When turned on, the saved system state at the last turn-off is restored. If the <b>ESCAPE/CLEAR</b> key is held down while the <b>ON/OFF</b> key is pressed, the factory preset state will be restored.
<b>SYS</b>	Allows selection of system and application setup parameters and the display language.

The following keypad hard key functions are printed in **blue** on the keypad keys.



This key is used to adjust the display brightness. Use the Up/Down arrow key and **ENTER** to adjust the brightness.

**AUTO  
SCALE**

Automatically scales the status window for optimum resolution in cable and antenna analyzer mode.

**LIMIT**

Displays the limit line menu for the current operating mode when in cable, antenna analyzer or spectrum analyzer mode.

**MARKER**

Displays the marker menu of the current operating mode when in cable, antenna analyzer or spectrum analyzer mode.

**PRINT**

Prints the current display to the selected printer via the RS232 serial port.

**RECALL  
DISPLAY**

Recalls a previously saved trace from memory. When the key is pressed, a Recall Trace selection box appears on the display. Select a trace using the Up/Down arrow key and press the **ENTER** key to implement.

**RECALL  
SETUP**

Recalls a previously saved setup from a memory location. When the key is pressed, a Recall Setup selection box appears on the display. Select a setup using the Up/Down arrow key and press the **ENTER** key to implement. Setup 0 recalls the factory preset state for the current mode.

**RUN  
HOLD**

When in the Hold mode, this key starts the Site Master sweeping and provides a Single Sweep Mode trigger; when in the Run mode, it pauses the sweep. When in the Hold mode, the hold symbol (page 2-68) appears on the display. Hold mode can be used to conserve battery power.

**SAVE  
DISPLAY**

Saves up to 300 displayed traces to non-volatile memory. When the key is pressed, the Trace Name: box appears. Use the soft keys to enter up to 16 alphanumeric characters for that trace name and press the **ENTER** key to save the trace.

**SAVE  
SETUP**

Saves the current system setup to an internal non-volatile memory location. The number of locations available varies with the model number and installed options. There are ten available locations in cable and antenna analyzer mode (S331D and S332D), and five in SPA mode (S332D only). There are five available locations in Power Meter mode (Option 29, S331D and S332D) and five each in T1/E1 modes (Option 50, S331D only). When the key is pressed, a Save Setup selection box appears on the status window. Use the Up/Down arrow key to select a setup and press the **ENTER** key to implement.

**START  
CAL**

Starts the calibration in SWR, Return Loss, Cable Loss, or DTF measurement modes (not available in Spectrum Analyzer or Power Meter modes).



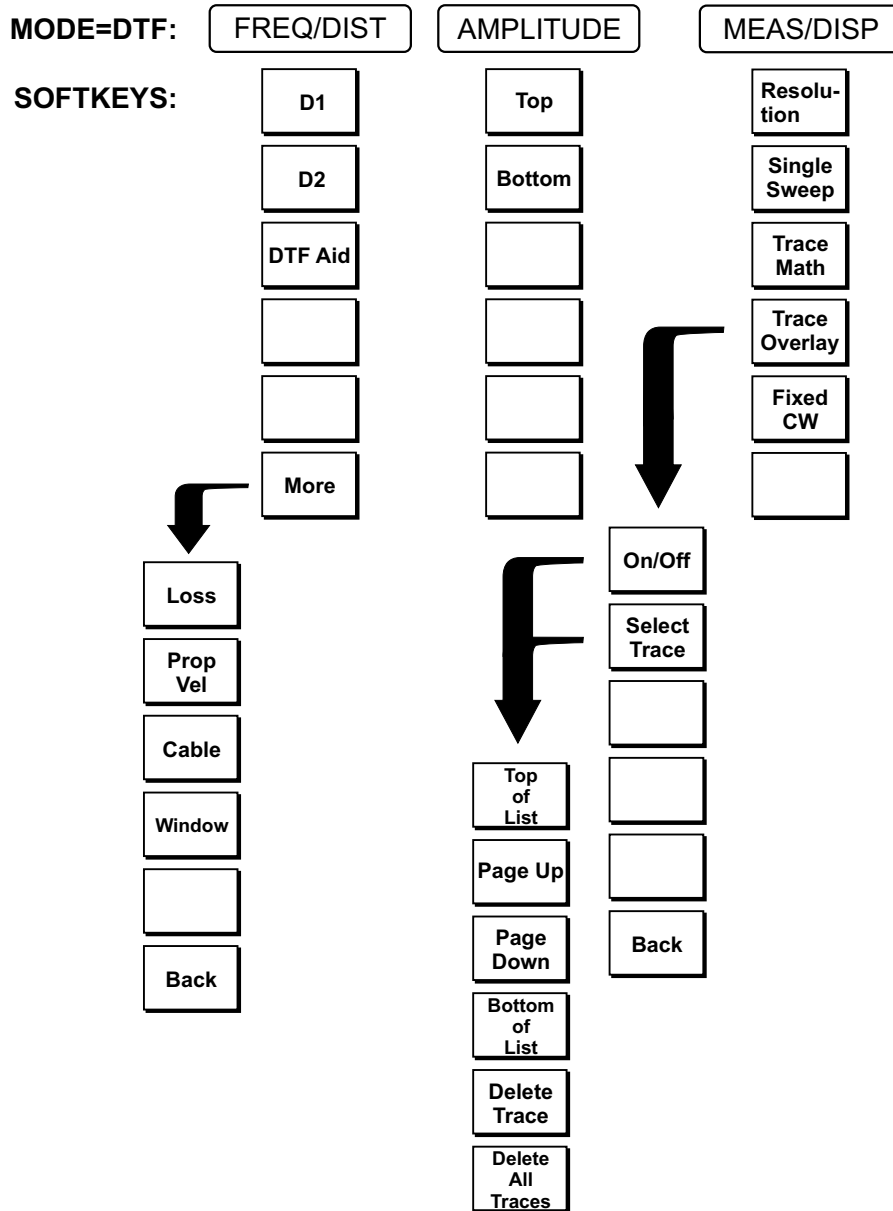

Figure 2-7. Distance to Fault Mode Soft Key Labels

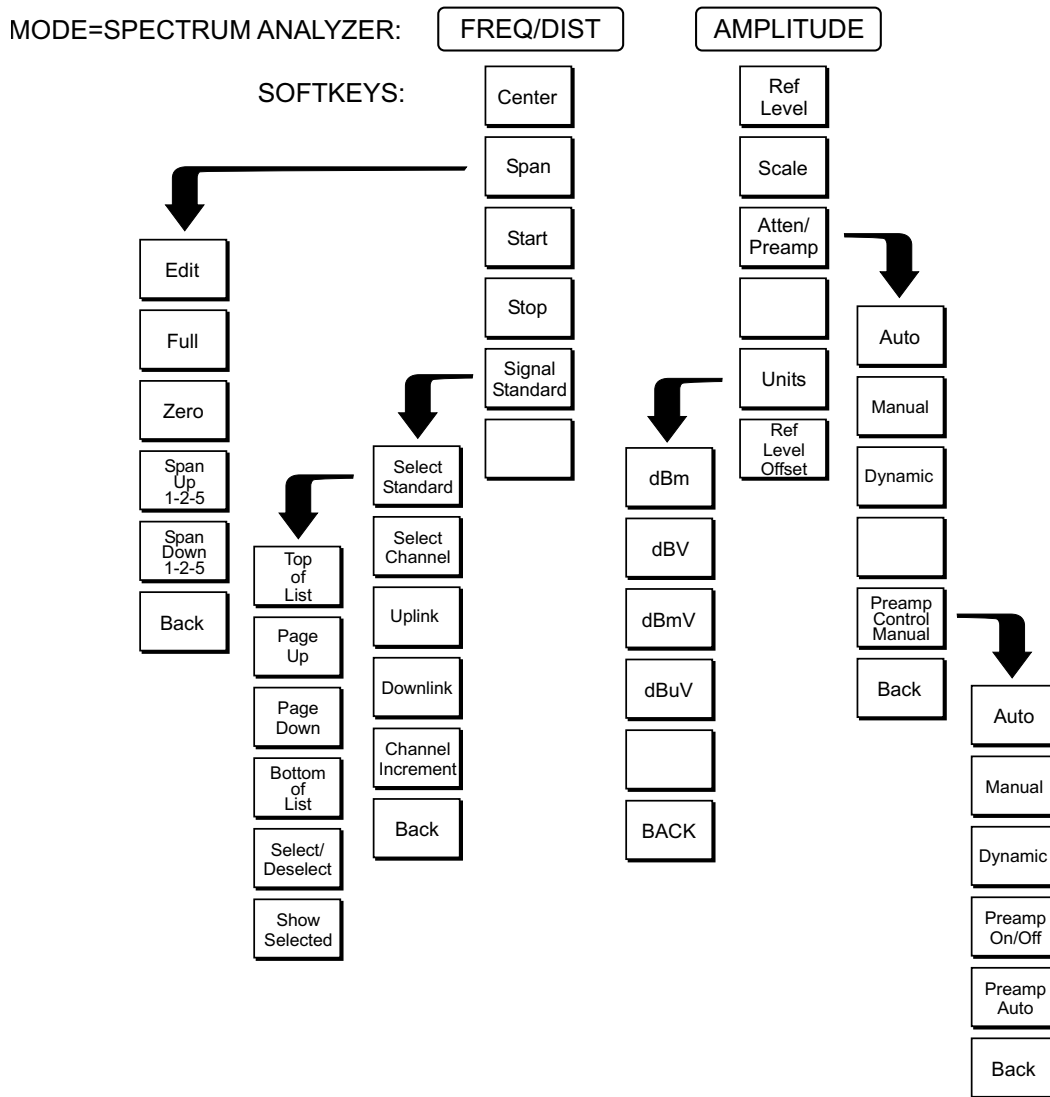

Figure 2-8. Spectrum Analyzer Mode Soft Key Labels (S332D only)

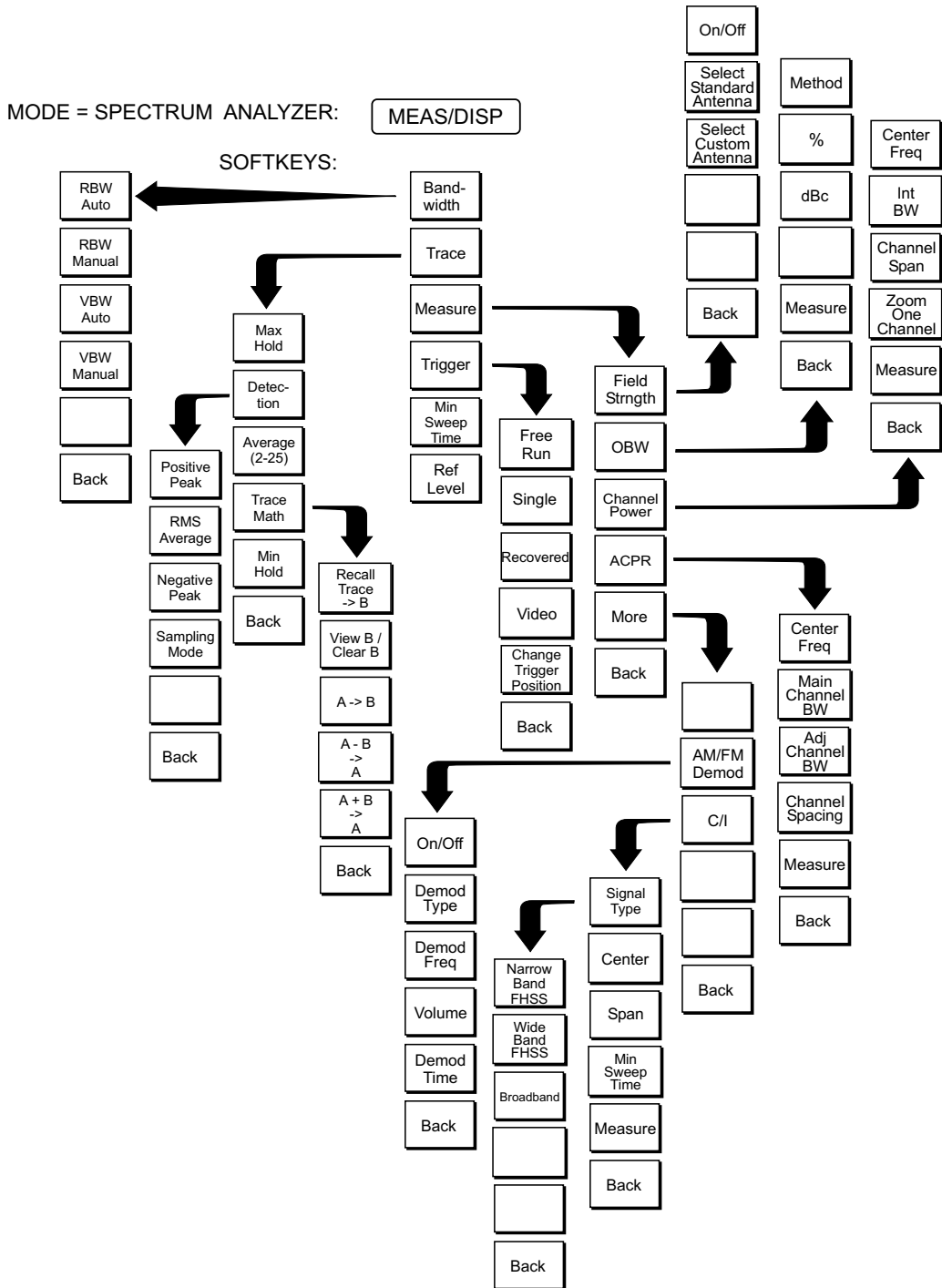

Figure 2-9. Spectrum Analyzer Mode Soft Key Labels (S332D only) (continued)



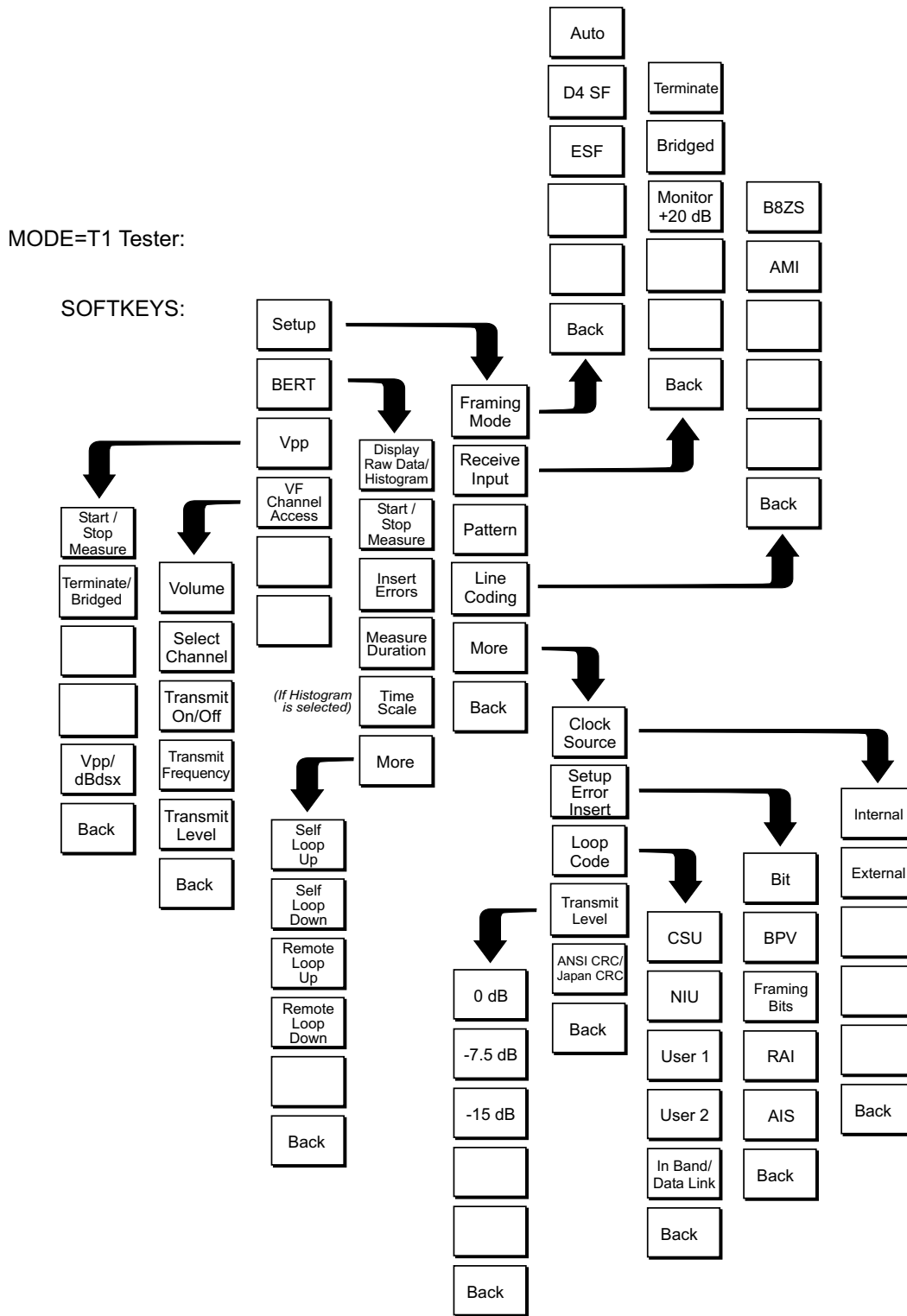

Figure 2-10. T1 Tester Mode Soft Keys

MODE=T1 Tester:

SOFTKEYS:

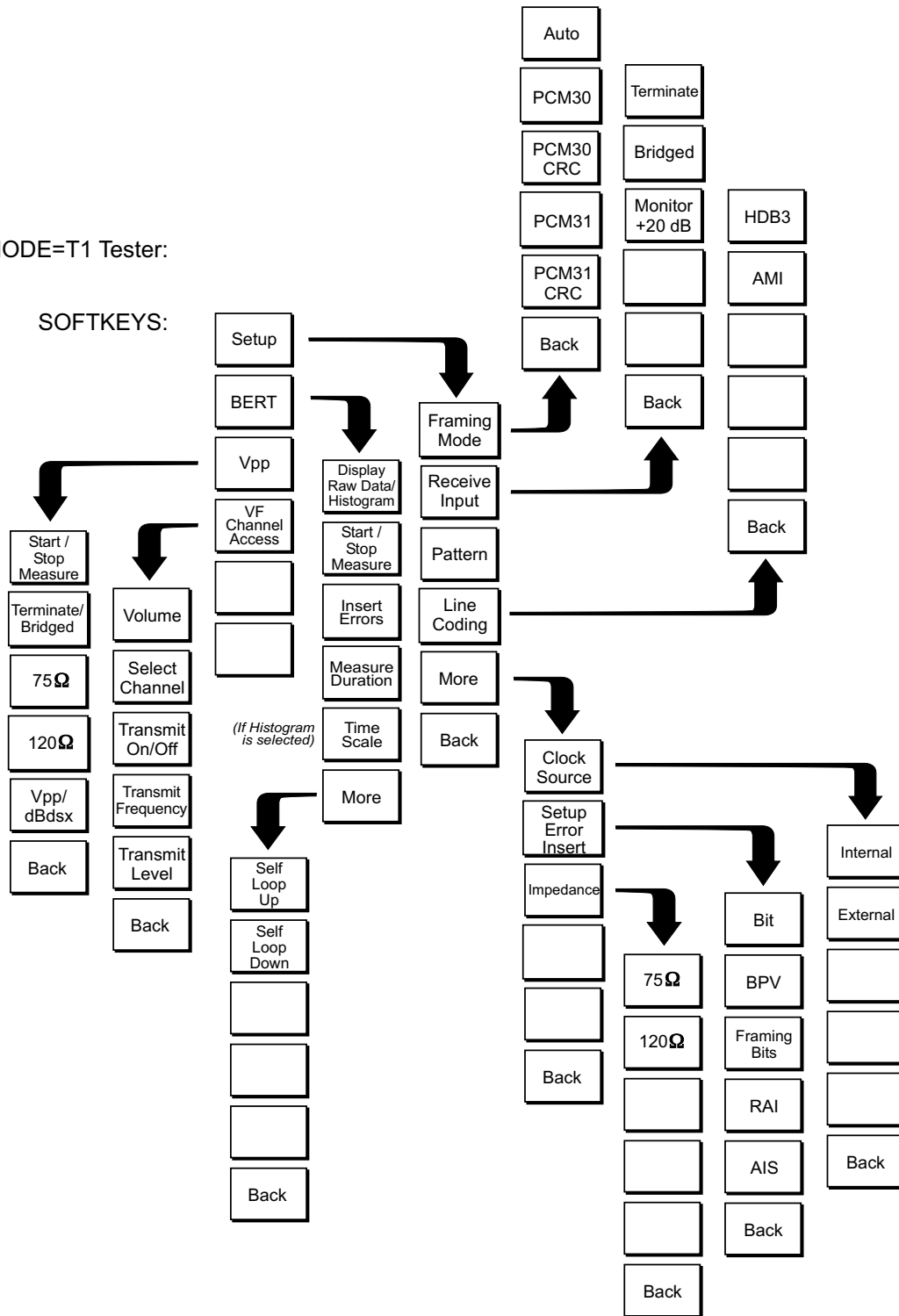

Figure 2-11. E1 Tester Mode Soft Keys

MODE = TRANSMISSION MEASUREMENT

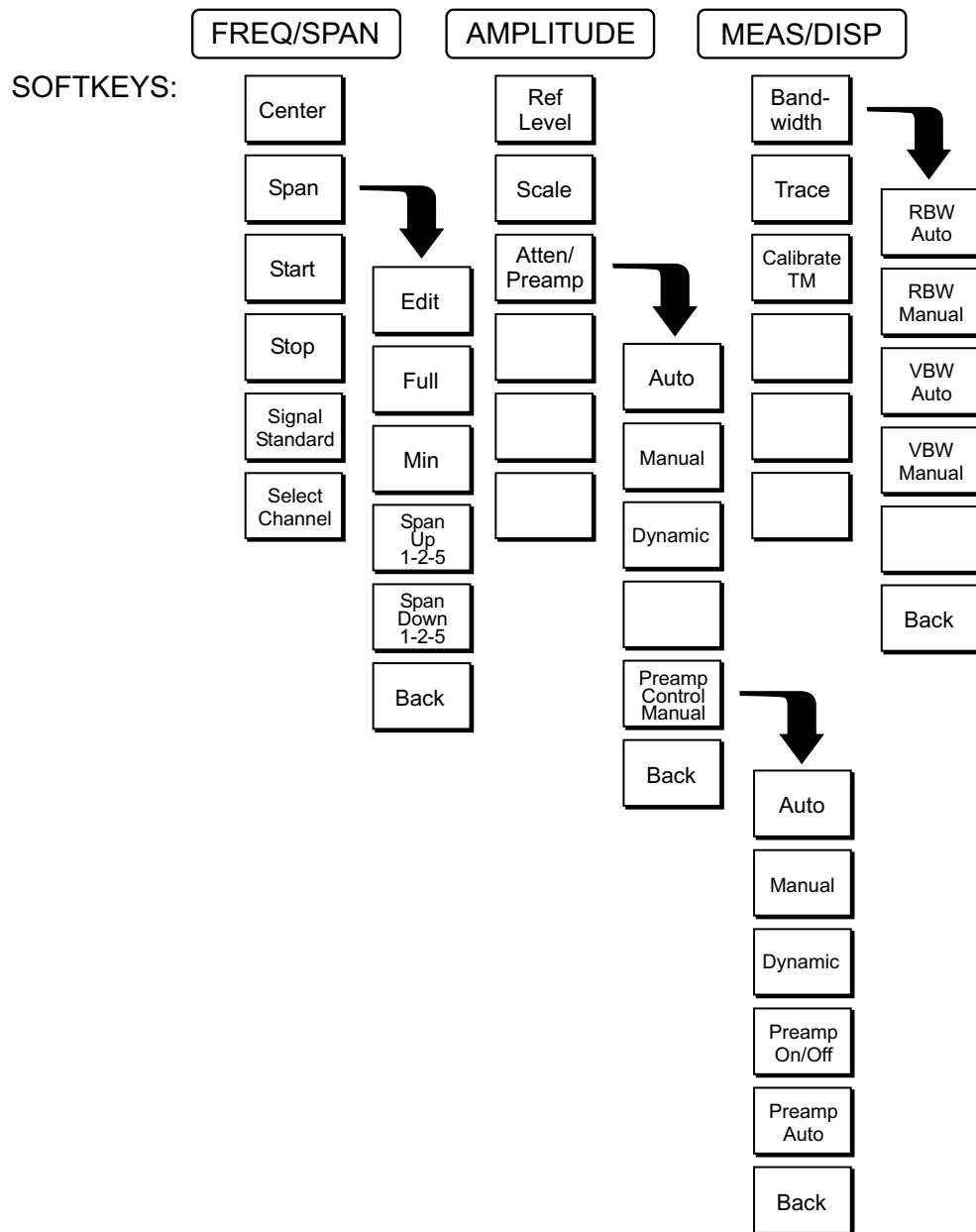

Figure 2-12. Transmission Measurement Mode Soft Keys

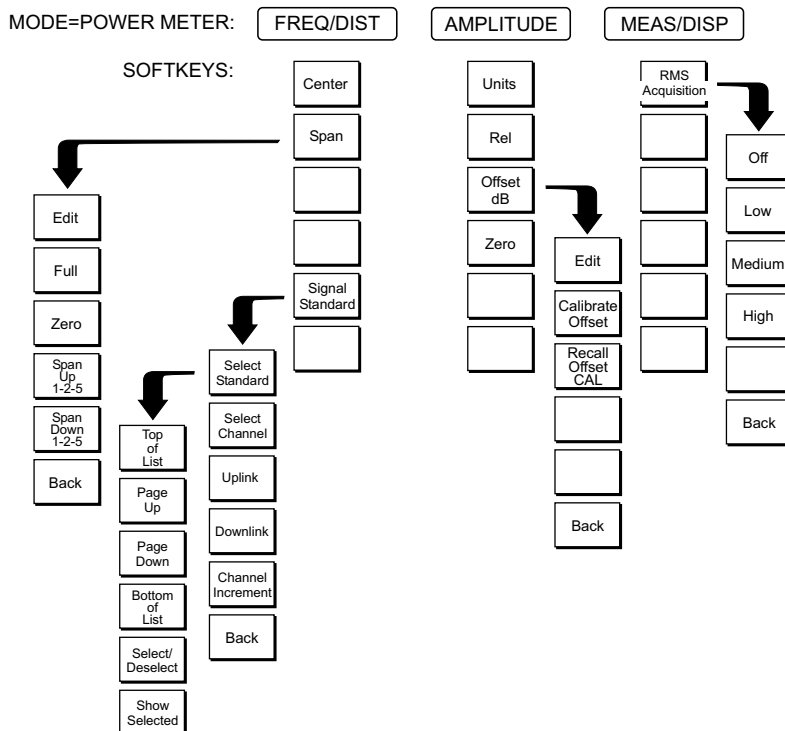

Figure 2-13. Power Meter Mode Soft Key Labels (Option 29)

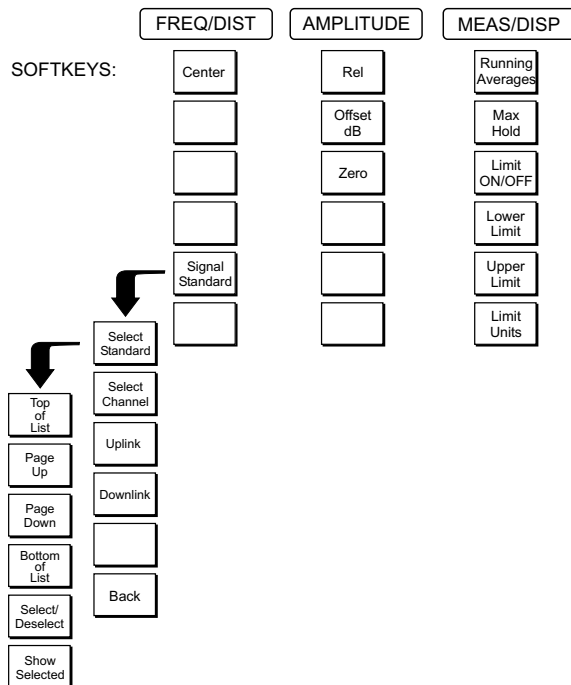

Figure 2-14. High Accuracy Power Sensor Mode (Option 19) Soft Keys

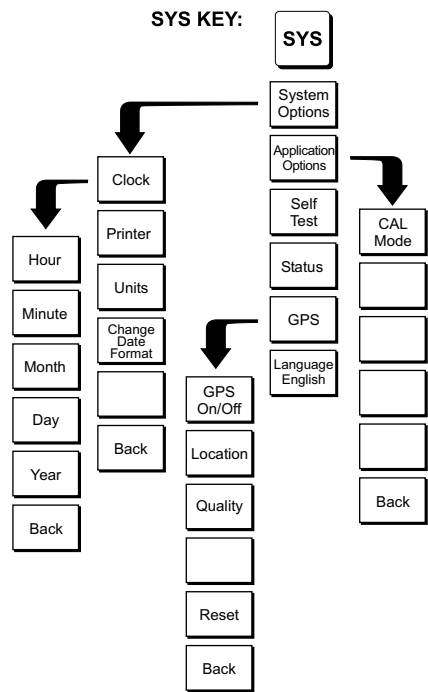

Figure 2-16. SYS Key Menu in Cable and Antenna Analyzer Mode

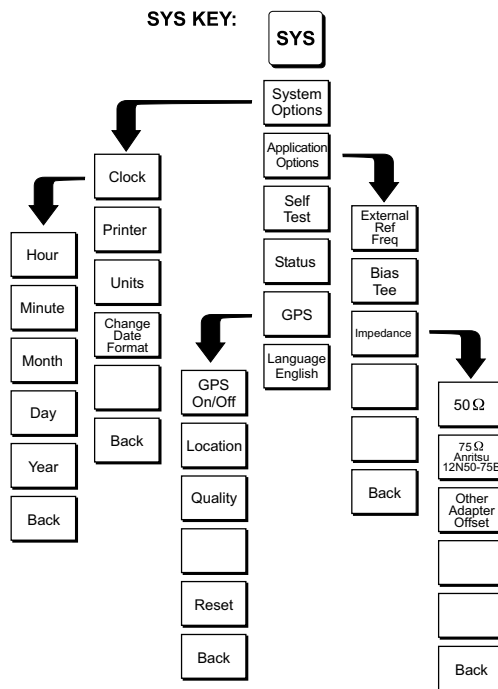

Figure 2-15. SYS Key Menu in Spectrum Analyzer and Transmission Measurement Modes

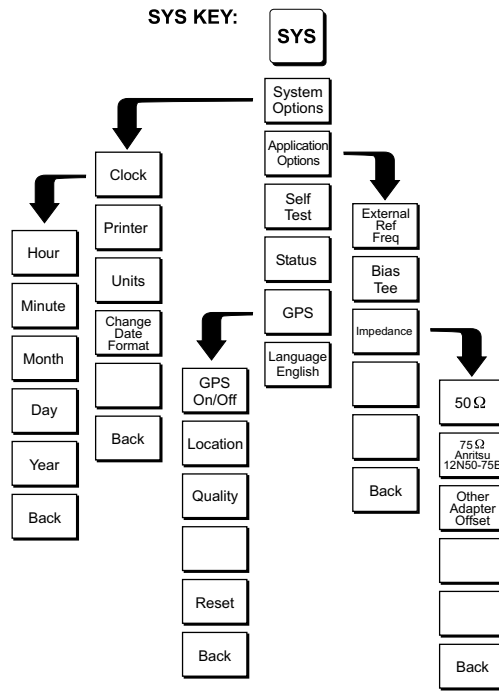

Figure 2-18. SYS Key Menu in Power Meter Mode (Option 29)

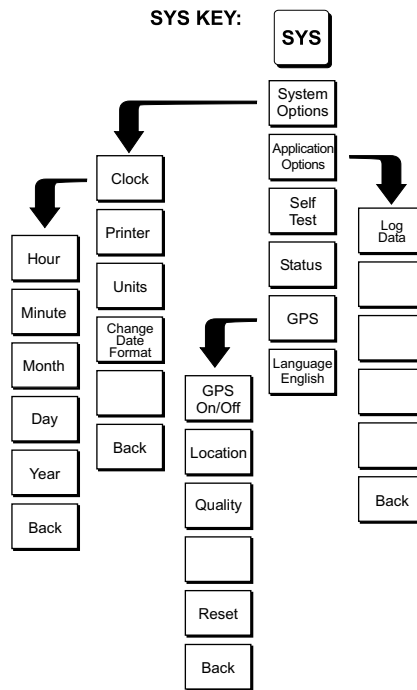

Figure 2-17. SYS Key in T1/E1 Mode (Option 50)

**FREQ/DIST** Displays the frequency and distance menu depending on the measurement mode.

**Frequency Menu** The frequency and distance menu for cable and antenna analyzer measurements provides for setting sweep frequency end points when Freq mode is selected. Selected frequency values may be changed using the keypad or Up/Down arrow key.

- F1 — Opens the F1 parameter for data entry. This is the start value for the frequency sweep. Press **ENTER** when data entry is complete.
- F2 — Opens the F2 parameter for data entry. This is the stop value for the frequency sweep. Press **ENTER** when data entry is complete.
- Signal Standard — Allows selection of the signal standard to be used. Select from the available international standards (Appendix C).

**Distance Menu** Provides for setting Distance to Fault parameters when a DTF mode is selected. Choosing DIST causes the soft keys, below, to be displayed and the corresponding values to be shown in the message area. Selected distance values may be changed using the keypad or Up/Down arrow key.

- D1 — Opens the start distance (D1) parameter for data entry. This is the start value for the distance range (D1 default = 0). Press **ENTER** when data entry is complete.
- D2 — Opens the end distance (D2) parameter for data entry. This is the end value for the distance range. Press **ENTER** when data entry is complete.
- DTF Aid — Provides interactive help to optimize DTF set up parameters. Use the Up/Down arrow key to select a parameter to edit. Press **ENTER** when data entry is complete.
- More — Selects the Distance Sub-Menu, detailed below.
  - Loss — Opens the Cable Loss parameter for data entry. Enter the loss per meter (or foot) for the type of transmission line being tested. Press **ENTER** when data entry is complete. (Range is 0.5 to 5.0 dB/m, 1.524 dB/ft)
  - Prop Vel (relative propagation velocity) — Opens the Propagation Velocity parameter for data entry. Enter the propagation velocity for the type of transmission line being tested. Press **ENTER** when data entry is complete. (Range is 0.010 to 1.000)
  - Cable — Opens a list of cable three common coaxial folders (1000 MHz, 2000 MHz, and 2500 MHz) and one custom folder. Select either folder and use the Up/Down arrow key and **ENTER** to make a selection. This feature provides a rapid means of setting both cable loss and propagation velocity. (Refer to Appendix A for a listing of common coaxial cables showing values for Relative Propagation Velocity and Nominal Attenuation in dB/m or dB/ft @ 1000 MHz, 2000 MHz and 2500 MHz.) The custom cable folder can consist of up to 49 user-defined cable parameters uploaded via the Handheld Software Tools program.
  - Window — Opens a menu of FFT windowing types for the DTF calculation. Scroll the menu using the Up/Down arrow key and make a selection with the **ENTER** key. Refer to Appendix B for more details on windowing.

- ❑ Back — Returns to the Distance Menu.

Choosing **FREQ/DIST** in Spectrum Analyzer mode causes the soft keys, below, to be displayed and the corresponding values to be shown in the message area.

- ❑ Center — Sets the center frequency of the Spectrum Analyzer. Enter a value using the Up/Down arrow key or keypad, press **ENTER** to accept, **ESCAPE** to restore previous value.
- ❑ Span — Sets the user-defined frequency span. Use the Up/Down arrow key or keypad to enter a value in MHz. Also brings up Full and Zero soft keys.
  - ❑ Edit allows editing of the frequency span. Enter a value using the number keys.
  - ❑ Full span sets the Spectrum Analyzer to its maximum frequency span.
  - ❑ Zero span sets the span to 0 Hz. This displays the input signal in an amplitude versus time mode, which is useful for viewing modulation.
  - ❑ Span Up 1-2-5 activates the span function so that the span may be increased quickly in a 1-2-5 sequence.
  - ❑ Span Down 1-2-5 activates the span function so that the span may be reduced quickly in a 1-2-5 sequence.
  - ❑ Back returns to the previous menu level.
- ❑ Start — Sets the Spectrum Analyzer in the START-STOP mode. Enter a start frequency value (in kHz, MHz, or GHz) using the Up/Down arrow key or keypad, press **ENTER** to accept, **ESCAPE** to restore.
- ❑ Stop — Sets the Spectrum Analyzer in the START-STOP mode. Enter a stop frequency value (in kHz, MHz, or GHz) using the Up/Down arrow key or keypad, press **ENTER** to accept, **ESCAPE** to restore.
- ❑ Signal Standard — Allows selection of the signal standard to be used. Select from the available international standards. For more information, refer to Appendix C.
- ❑ Select Channel — Sets the channel information for the available standard from a minimum of 0 to a maximum of 1199.



**AMPLITUDE** Displays the amplitude or scale menu depending on the measurement mode.

**Amplitude Menu** Provides for changing the status window scale. Selected values may be changed using the Up/Down arrow key or keypad.

Choosing **AMPLITUDE** in cable and antenna analyzer measurement modes causes the soft keys, below, to be displayed and the corresponding values to be shown in the message area.

- Top** — Opens the top parameter for data entry and provides for setting the top scale value. Press **ENTER** when data entry is complete.
- Bottom** — Opens the bottom parameter for data entry and provides for setting the bottom scale value. Press **ENTER** when data entry is complete.

Choosing **AMPLITUDE** in Spectrum Analyzer mode causes the soft keys, below, to be displayed and the corresponding values to be shown in the message area.

- Ref Level** — Activates the amplitude reference level function. Valid reference levels are from +20 to -120 dBm.
- Scale** — Activates the scale function in a 1 through 15 dB logarithmic amplitude scale. This soft key is not active if the units are set to linear.
- Atten/Preamp** — Sets the internal input attenuator so that it is either coupled automatically to the reference level (**Auto**), manually adjustable (**Manual**), dynamically coupled to the input signal (**Dynamic**) and provides control for the preamplifier.
  - Auto** — Sets the input attenuator so that it is coupled automatically to the reference level.
  - Manual** — Sets the input attenuator manually from 0 to 51 dB.
  - Dynamic** — Sets the input attenuator so that it is dynamically coupled to the input signal and turns the preamp on or off as necessary.
  - Preamp Control Manual** — Activates the preamp menu.
    - Preamp On/Off** — Sets the preamplifier on or off.
    - Preamp Auto** — Automatically adjusts the preamplifier according to the reference level.
  - Back** — Returns to the previous menu level.
- Units** — Choose from the menu of amplitude related units. When **Linear** is selected, the available selections are Volts or Watts. When **Log** is selected, the selection of dBm sets absolute decibels relative to 1 mW as the amplitude unit. Selection of dBV, dBmV or dB $\mu$ V sets absolute decibels relative to 1 volt, 1 millivolt, or 1 microvolt respectively as the amplitude unit.
- Ref Level Offset** — Sets the reference level offset. This feature allows measurement of high gain devices in combination with an attenuator. It is used to offset the reference level to view the correct output level. For example, to measure a high gain amplifier with an output of 70 dBm, an external 50 dB attenuator must be inserted between the Site Master and the device. To compensate, set the reference level offset to -50 dB.

- MEAS/DISP** Displays the Meas/Disp soft key menu for the current operating mode.
- Meas/Disp Menu** Provides for changing the status window resolution, single or continuous sweep, and access to the Trace Math functions.
- Choosing **MEAS/DISP** in cable and antenna analyzer freq or DTF measurement modes causes the soft keys below to be displayed.
- Resolution — Opens the status window to change the resolution. Choose 130, 259, or 517 data points. (In DTF mode, resolution can only be adjusted through the DTF Aid table.)
  - Single Sweep — Toggles the sweep between single sweep and continuous sweep. In single sweep mode, each sweep must be activated by the **RUN/HOLD** button.
  - Trace Math — Opens up the Trace Math functions (trace-memory or trace+memory) for comparison of the real time trace in the status window with any of the traces from memory. (Not available in DTF mode.)
  - Trace Overlay — Opens up the Trace Overlay functions menu to allow the current trace to be displayed with a trace in memory overlaid on it. Choose On or Off and Select Trace to select the trace from memory to be overlaid.
  - Fixed CW — Toggles the fixed CW function ON or OFF. When OFF, a narrow band of frequencies around the selected frequency is generated. This enhances the immunity of the Site Master to an interfering signal. When CW is ON, only a single frequency with a very narrow band width is generated by the Site Master. The sweep speed is somewhat faster in CW ON mode. If CW is ON during normal RL or SWR measurements, it will be more susceptible to interfering signals, so use this feature with caution. Interfering signals can make the measurement look better or worse than it really is.
- Choosing **MEAS/DISP** in Spectrum Analyzer mode causes the soft keys below to be displayed.
- Bandwidth — Activates a menu that allows the resolution and video bandwidths to be either coupled automatically to the span (Auto) or manually adjustable (Manual).
    - RBW Auto — Sets the resolution bandwidth so that it is automatically coupled to the span.
    - RBW Manual — Sets the resolution bandwidth manually, independent of the span.
    - VBW Auto — Sets the video bandwidth so that it is automatically coupled to the RBW.
    - VBW Manual — Sets the video bandwidth manually, independent of the RBW.
    - Back — Returns to the previous menu level.
  - Trace — Activates a menu of trace related functions. Use the corresponding soft key to select the desired trace function.
    - Max Hold — Displays and holds the maximum responses of the input signal.
    - Detection — Accesses a menu of detector modes including Positive Peak detection, RMS Average detection, Negative Peak detection, and Sampling Mode.

- Positive Peak — The unit reads and displays the highest measured data point within a display point.
- RMS Average — The unit reads and displays the RMS average of the measured data. RMS average is calculated by taking the log of the average power within a display point and the power is calculated from the voltage.
- Negative Peak — The unit reads and displays the lowest measured data point within a display point.
- Sampling Mode — The unit reads and displays a sampled measured point at each display point.
- Average (2-25) — The display will be an average of the number of sweeps specified here. For example, if the number four is entered here, the data displayed will be an average of the four most recent sweeps.
- Trace Math — Opens up the Trace Math functions for comparison of the real time trace in the graph with any of the traces from memory.
  - Recall Trace → B — Recalls the selected saved trace to trace B.
  - View B / Clear B — Views the recalled trace as trace B, or clears trace B from the status window.
  - A → B — Moves trace A to trace B.
  - A – B → A — Moves the results of trace A minus trace B to trace A.
  - A + B → A — Moves the results of trace A plus trace B to trace A.
  - Back — Returns to the previous menu level.
- Min Hold — Displays and holds the minimum responses of the input signal.
  - Back — Returns to the previous menu level.
- Measure — Activates a menu of measurement related functions. Use the corresponding soft key to select the measurement function.
  - Field Strength — Accesses a menu of field strength measurement options.
    - On/Off — Turns field strength measurements on or off.
    - Select Standard Antenna — Select from the list of antenna profiles provided.
    - Select Custom Antenna — Select a custom antenna profile as uploaded to the Site Master using the Handheld Software Tools program.
    - Back — Returns to the previous menu.
  - OBW — Activates the occupied bandwidth menu.
    - Method — Allows selection of either % of power or dB Down.
    - % — Allows entry of the desired % of occupied bandwidth to be measured.
    - dBc — Allows entry of the desired power level (dBc) to be measured.
    - Measure — Enables and disables the OBW measurement.
    - Back — Returns to the previous menu level.
  - Channel Power — Activates Channel Power measurement. Channel power is measured in dBm. Channel Power density is measured in dBm/Hz. The displayed units is determined by the setting of the Units soft key in the **AMPLITUDE** menu.

- ❑ Center Freq - Activates the center frequency function and sets the Site Master to the center frequency. A specific center frequency can be entered using the keypad or Up/Down arrow key.
- ❑ Int BW — Enter the integration bandwidth frequency appropriate for the application. Integration bandwidth must be at least one tenth of the channel span.
- ❑ Channel Span — Sets the channel span to a value appropriate for the application.
- ❑ Zoom One Channel — Automatically sets the span to cover one channel as defined by the selected signal standard.
- ❑ Measure — Enables and disables the channel power measurement.
- ❑ Back — Returns to the previous menu level.
- ❑ ACPR — Accesses a menu of Adjacent Channel Power Ratio measurement options:
  - ❑ Center Freq - Activates the center frequency function and sets the Site Master to the center frequency. A specific center frequency can be entered using the keypad or Up/Down arrow key.
  - ❑ Main Channel BW - Sets the bandwidth of the main channel.
  - ❑ Adjacent Channel BW - Sets the bandwidth of the adjacent channel.
  - ❑ Channel Spacing - Sets the channel spacing.
  - ❑ Measure -Enables and disables the ACPR measurement.
  - ❑ Back - Returns to the previous menu.
- ❑ More — Opens more measurement menus in spectrum analyzer mode.
  - ❑ Int. Analysis — Opens the interference analysis measurement menu.
    - ❑ Set IA Freq. — Set the interference analysis frequency from 9 kHz to 3000 MHz to measure the interference.
    - ❑ Measure — Measures the interference.
    - ❑ IA Freq. To Center — Set the interference analysis frequency to the center of the interference frequency.
    - ❑ IA Freq as Marker M1 — Set the interference analysis frequency as marker M1.
    - ❑ Back — Returns to the previous menu.
  - ❑ AM/FM Demod — Select AM, Narrow Band FM (300 ms de-emphasis), Wide Band FM (50 ms de-emphasis), USB or LSB.
    - ❑ On/Off — Turns AM/FM Demodulation on or off.
    - ❑ Demod Type — Select either AM, FM Wide Band, FM Narrow Band, SSB Lower or SSB Upper demodulation.
    - ❑ Demod Freq — Use the Up/Down arrow key or the keypad to increase or decrease the demodulation frequency. Select the GHz, MHz, kHz, or Hz soft key to accept the frequency input.
    - ❑ Volume — The current volume setting is displayed at the lower right of the screen. Use the Up/Down arrow key to increase or decrease the volume, and press the **ENTER** key to select.
    - ❑ Demod Time — Use the Up/Down arrow key or the keypad to increase or decrease the demodulation time, and press the **ENTER** key to select.
    - ❑ Back — Returns to the previous menu.

- C/I — Opens carrier to interference measurement menu.
  - Signal Type - Opens a menu to select the signal type. Selections are narrow band FHSS, wide band FHSS or a broadband signal.
  - Center - Activates the center frequency function and sets the Site Master to the center frequency. A specific center frequency can be entered using the keypad or Up/Down arrow key.
  - Span - Sets the user-defined frequency span. Use the Up/Down arrow key or keypad to enter a value in MHz.
  - Min Sweep Time - Sets a sweep time of one second or more to improve the ability to capture instances of the interfering signal.
  - Measure - Starts the carrier to interference measurement.
  - Back - Returns to the previous menu.
- Back — Returns to the previous menu.
- Trigger — Select the method used to trigger the sweep.
  - Free Run — The sweep is continuous.
  - Single — A single sweep will be performed with each press of the **Run/Hold** key.
  - Video — Sets the video trigger level if the span is set to zero.
  - Change Trigger Position — Changes the trigger sweep position from 5 msec to 2000 msec.
  - Back - Returns to the previous menu.

**MARKER**

Choosing **MARKER** in cable and antenna analyzer freq and dist mode causes the soft keys, below, to be displayed and the corresponding values to be shown in the message area. Selected frequency marker or distance marker locations may be changed using the keypad or Up/Down arrow key.

- M1 — Selects the M1 marker parameter and opens the M1 marker second level menu.
  - On/Off — Turns the selected marker on or off.
  - Edit — Opens the selected marker parameter for data entry. Press **ENTER** when data entry is complete or **ESCAPE** to restore the previous value.
  - Marker To Peak — Places the selected marker at the frequency or distance with the maximum amplitude value.
  - Marker To Valley — Places the selected marker at the frequency or distance with the minimum amplitude value.
  - Back — Returns to the Main Markers Menu.
- M2 through M4 — Selects the marker parameter and opens the marker second level menu.
  - On/Off — Turns the selected marker on or off.
  - Edit — Opens the selected marker parameter for data entry. Press **ENTER** when data entry is complete or **ESCAPE** to restore the previous value.
  - Delta (Mx-M1) — Displays delta amplitude value as well as delta frequency or distance for the selected marker with respect to the M1 marker.

- Marker To Peak — Places the selected marker at the frequency or distance with the maximum amplitude value.
- Marker To Valley — Places the selected marker at the frequency or distance with the minimum amplitude value.
- Back — Returns to the Main Markers Menu.
- All Off — Turns all markers off.
- More — Opens the continuation of the Marker Menus.
  - M5 — Selects the M5 marker parameter and opens the M5 second level menu.
    - On/Off — Turns the selected marker on or off.
    - Edit — Opens the selected marker parameter for data entry. Press **ENTER** when data entry is complete or **ESCAPE** to restore the previous value.
    - Peak Between M1 & M2 — Places the selected marker at the frequency or distance with the maximum amplitude value between marker M1 and marker M2.
    - Valley Between M1 & M2 — Places the selected marker at the frequency or distance with the minimum amplitude value between marker M1 and marker M2.
    - Back — Returns to the Main Markers Menu.
  - M6 — Selects the M6 marker parameter and opens the M6 second level menu.
    - On/Off — Turns the selected marker on or off.
    - Edit — Opens the selected marker parameter for data entry. Press **ENTER** when data entry is complete or **ESCAPE** to restore the previous value.
    - Peak Between M3 & M4 — Places the selected marker at the peak between marker M3 and marker M4.
    - Valley Between M3 & M4 — Places the selected marker at the valley between marker M3 and marker M4.
    - Back — Returns to the Main Markers Menu.
- All Off — Turns all markers off
- Back — Returns to the Main Markers Menu.

Choosing **MARKER** in Spectrum Analyzer mode causes the soft keys, below, to be displayed and the corresponding values to be shown in the message area.

- M1 — Selects the M1 marker parameter and opens the M1 marker second level menu.
  - On/Off — Turns the selected marker on or off.
  - Edit — Opens the selected marker parameter for data entry. Press **ENTER** when data entry is complete or **ESCAPE** to restore the previous value.
  - Marker To Peak — Places the selected marker at the frequency with the maximum amplitude value.
  - Marker Freq To Center — Makes the center frequency of the Site Master equal to the frequency of the selected marker.

- Back — Returns to the Main Markers Menu.
- M2 through M4 — Selects the marker parameter and opens the marker second level menu.
  - On/Off — Turns the selected marker on or off.
  - Edit — Opens the selected marker parameter for data entry. Press **ENTER** when data entry is complete or **ESCAPE** to restore the previous value.
  - Delta (Mx-M1) — Displays delta amplitude value as well as delta frequency for the selected marker with respect to the M1 marker.
  - Marker To Peak — Places the selected marker at the frequency with the maximum amplitude value.
  - Marker Freq To Center — Makes the center frequency of the Site Master equal to the frequency of the selected marker.
  - Back — Returns to the Main Markers Menu.
- All Off — Turns all markers off.
- More — Opens the continuation of the Marker Menus.
  - M5 — Selects the M5 marker parameter and opens the M5 second level menu.
    - On/Off — Turns the selected marker on or off.
    - Edit — Opens the selected marker parameter for data entry. Press **ENTER** when data entry is complete or **ESCAPE** to restore the previous value.
    - Marker Freq To Center — Makes the center frequency of the Site Master equal to the frequency of the selected marker.
    - Peak Between M1 & M2 — Places the selected marker at the frequency with the maximum amplitude value between marker M1 and marker M2.
    - Valley Between M1 & M2 — Places the selected marker at the frequency with the minimum amplitude value between marker M1 and marker M2.
    - Back — Returns to the Main Markers Menu.
  - M6 — Selects the M6 marker parameter and opens the M6 second level menu.
    - On/Off — Turns the selected marker on or off.
    - Edit — Opens the selected marker parameter for data entry. Press **ENTER** when data entry is complete or **ESCAPE** to restore the previous value.
    - Marker Freq To Center — Makes the center frequency of the Site Master equal to the frequency of the selected marker.
    - Peak Between M3 & M4 — Places the selected marker at the frequency with the maximum amplitude value between marker M3 and marker M4.
    - Valley Between M3 & M4 — Places the selected marker at the frequency with the minimum amplitude value between marker M3 and marker M4.
    - Back — Returns to the Main Markers Menu.

- Regular Marker — Measures the signal level at the point of the marker in the unit type selected in the Amplitude - Units menu. When the regular marker option is selected, all markers are regular markers.
- Noise Marker — Measures noise level normalized to a 1 Hz bandwidth. The unit of measure is dBm/Hz only. When Noise Marker is selected, the detection type is automatically changed to RMS average. When the Noise Marker option is selected, all markers are noise markers.
- All Off — Turns all markers off.
- Back — Returns to the Main Markers Menu.

## LIMIT

Pressing **LIMIT** in cable and antenna analyzer frequency and distance mode activates a menu of limit related functions. Use the corresponding soft key to select the desired limit function. Then use the Up/Down arrow key to change its value, which is displayed in the message area at the bottom of the status window.

Choosing **LIMIT** in Freq or DTF measurement modes causes the soft keys below to be displayed.

- Single Limit — Sets a single limit value in dBm. Menu choices are:
  - On/Off — Turns the single limit function on or off
  - Edit — Allows entry of the limit amplitude.
  - Back — Returns to the previous menu.
- Multiple Limits — Sets multiple user defined limits, and can be used to create a limit mask for quick pass/fail measurements.
  - Segment 1 through Segment 5 — Opens the segment menu.
    - On/Off — Turns the segment on or off.
    - Edit — Opens the parameter for data entry.
    - Prev Segment — Edit or view the parameters of the previous segment.
    - Next Segment — Edit or view the parameters of the next segment. If the next segment is off when this button is pressed, the starting point of the next segment will be set equal to the ending point of the current segment.
    - Back — Returns to the previous menu.
  - Back — Returns to the previous menu.
- Limit Beep — Turns the audible limit beep indicator on or off.

Choosing **LIMIT** in Spectrum Analyzer measurement mode causes the soft keys below to be displayed.

- Single Limit — Sets a single limit value in dBm. Menu choices are:
  - On/Off — Turns the limit on or off.
  - Edit — Opens the parameter for data entry.
  - Upper / Lower Limit — Activate the upper and lower limit lines by toggling this soft key. The unit beeps if the data is above or below the set limit lines and the status is displayed in the message area.
  - Back — Returns to the previous menu.



- ❑ Multiple Upper Limits — Sets multiple user-defined upper limits, and can be used to create an upper limit mask for quick pass/fail measurements. An upper limit will result in a failure when the data falls above the limit line. Menu choices are:
  - ❑ Segment 1 through Segment 5 — Opens the segment menu.
    - ❑ On/Off — Turns the segment on or off.
    - ❑ Edit — Opens the parameter for data entry.
    - ❑ Prev Segment — Edit or view the parameters of the previous segment.
    - ❑ Next Segment — Edit or view the parameters of the next segment. If the next segment is off when this button is pressed, the starting point of the next segment will be set equal to the ending point of the current segment.
    - ❑ Back — Returns to the previous menu.
  - ❑ Back — Returns to the previous menu.
- ❑ Multiple Lower Limits — Set multiple user defined lower limits, and can be used to create a lower limit mask for quick pass/fail measurements. A lower limit will result in a failure when the data falls below the limit line. Menu choices are:
  - ❑ Segment 1 through Segment 5 — Opens the segment menu.
    - ❑ On/Off — Turns the segment on or off.
    - ❑ Edit — Opens the parameter for data entry.
    - ❑ Prev Segment — Edit or view the parameters of the previous segment.
    - ❑ Next Segment — Edit or view the parameters of the next segment. If the next segment is off when this button is pressed, the starting point of the next segment will be set equal to the ending point of the current segment.
    - ❑ Back — Returns to the previous menu.
  - ❑ Back — Returns to the previous menu.
- ❑ Limit Beep — Turns the audible limit beep indicator on or off.

**SYS**

In cable and antenna analyzer or optional power meter mode, pressing the **SYS** key displays the following System menu soft key selections:

- ❑ System Options — Displays a second level of system option functions:
  - ❑ Clock — Displays a second level of functions:
    - ❑ Hour — Enter the hour (0-23) using the Up/Down arrow key or the keypad. Press **ENTER** when data entry is complete or **ESCAPE** to restore the previous value.
    - ❑ Minute — Enter the minute (0-59) using the Up/Down arrow key or the keypad. Press **ENTER** when data entry is complete or **ESCAPE** to restore the previous value.
    - ❑ Month — Enter the month (1-12) using the Up/Down arrow key or the keypad. Press **ENTER** when data entry is complete or **ESCAPE** to restore the previous value.
    - ❑ Day — Enter the day using the Up/Down arrow key or the keypad. Press **ENTER** when data entry is complete or **ESCAPE** to restore the previous value.
    - ❑ Year — Enter the year (2003-2036) using the Up/Down arrow key or the keypad. Press **ENTER** when data entry is complete or **ESCAPE** to restore the previous value.
    - ❑ Back — Returns to the top-level SYS menu.
  - ❑ Printer — Displays a menu of supported printers. Use the Up/Down arrow key and **ENTER** key to make the selection.
  - ❑ Units — Select the unit of measurement (metric or English).
  - ❑ Change Date Format — Toggles the date format between MM/DD/YYYY, DD/MM/YYYY, and YYYY/MM/DD.
    - ❑ Back — Returns to the top-level SYS menu.
- ❑ Application Options — Application options displays options applicable to particular mode.
  - ❑ CAL Mode — In cable and antenna analyzer modes, selects either OSL Cal or FlexCal™. FlexCal is a broadband frequency calibration valid from 25 MHz to 4 GHz. Refer to Calibration, page 3-2, for more information.
  - ❑ Back — Returns to the top-level SYS menu.
- ❑ Self Test — Start an instrument self test.
- ❑ Status — In cable and antenna analyzer freq or dist measurement mode, displays the current instrument status, including calibration status, temperature, and battery charge state. Press **ESCAPE** to return to operation.
- ❑ GPS — Opens the GPS soft key menu.
  - ❑ Press the GPS On/Off soft key to turn the GPS feature on or off.
  - ❑ Press the Location soft key to view the latitude, longitude and altitude information and UTC timing.
  - ❑ Press the Quality soft key to display the number of tracked satellites and the GPS quality.
  - ❑ Press the Reset soft key to reset the GPS.
  - ❑ Back — Returns to the previous menu.
- ❑ Language — Pressing this soft key immediately changes the language used to display messages on the Site Master status window. Choices are English,

French, German, Spanish, Chinese, and Japanese. The default language is English.

In Spectrum Analyzer mode, pressing the **SYS** key displays the following System menu soft key selections:

- System Options — Displays a second level of system option functions:
  - Clock — Displays a second level of functions:
    - Hour — Enter the hour (0-23) using the Up/Down arrow key or the keypad. Press **ENTER** when data entry is complete or **ESCAPE** to restore the previous value.
    - Minute — Enter the minute (0-59) using the Up/Down arrow key or the keypad. Press **ENTER** when data entry is complete or **ESCAPE** to restore the previous value.
    - Month — Enter the month (1-12) using the Up/Down arrow key or the keypad. Press **ENTER** when data entry is complete or **ESCAPE** to restore the previous value.
    - Day — Enter the day using the Up/Down arrow key or the keypad. Press **ENTER** when data entry is complete or **ESCAPE** to restore the previous value.
    - Year — Enter the year (2003-2036) using the Up/Down arrow key or the keypad. Press **ENTER** when data entry is complete or **ESCAPE** to restore the previous value.
    - Back — Returns to the top-level SYS menu.
  - Printer — Displays a menu of supported printers. Use the Up/Down arrow key and **ENTER** key to make the selection.
  - Units — Select the unit of measurement (metric or English).
  - Change Date Format — Toggles the date format between MM/DD/YYYY, DD/MM/YYYY, and YYYY/MM/DD.
    - Back — Returns to the top-level SYS menu.
- Application Options — Application options displays options applicable to particular mode.
  - External Ref Freq — Set the external reference frequency from 2 MHz to 20 MHz.
  - Bias Tee — Selects Bias Tee on or off.
  - Impedance — Sets the input impedance of the instrument
    - 50 $\Omega$  — Sets the input impedance of the instrument to 50 $\Omega$ , which is the default setting.
    - 75 $\Omega$  Anritsu 12N50-75B — Displays measurements as if the input impedance was 75 $\Omega$ . The actual input impedance is still 50 $\Omega$ , but the displayed information is transformed to the equivalent 75 $\Omega$  value based on the offset value specified by the adapter used in the measurement. This setting is commonly used for cable TV-related measurements. Pressing this soft key will also compensate 7.5 dB for the loss of the Anritsu 12N50-75B adapter.
    - Other adapter Offset — This key allows the user to enter other adapter offset values. Enter the desired loss using the keypad or Up/Down arrow key and press the **ENTER** key to accept.
    - Back — Returns to the previous menu.
  - Back — Returns to the top-level SYS menu.

- ❑ Self Test — Start an instrument self test.
- ❑ Status — In cable and antenna analyzer freq or dist measurement mode, displays the current instrument status, including calibration status, temperature, and battery charge state. Press **ESCAPE** to return to operation.
- ❑ GPS — Opens the GPS soft key menu.
  - ❑ Press the GPS On/Off soft key to turn the GPS feature on or off.
  - ❑ Press the Location soft key to view the latitude, longitude and altitude information and UTC timing.
  - ❑ Press the Quality soft key to display the number of tracked satellites and the GPS quality.
  - ❑ Press the Reset soft key to reset the GPS.
  - ❑ Back — Returns to the previous menu.
- ❑ Language — Pressing this soft key immediately changes the language used to display messages on the Site Master status window. Choices are English, French, German, Spanish, Chinese, and Japanese. The default language is English.

In Transmission Measurement mode, pressing the **SYS** key displays the following System menu soft key selections:

- ❑ System Options — Displays a second level of system option functions:
  - ❑ Clock — Displays a second level of functions:
    - ❑ Hour — Enter the hour (0-23) using the Up/Down arrow key or the keypad. Press **ENTER** when data entry is complete or **ESCAPE** to restore the previous value.
    - ❑ Minute — Enter the minute (0-59) using the Up/Down arrow key or the keypad. Press **ENTER** when data entry is complete or **ESCAPE** to restore the previous value.
    - ❑ Month — Enter the month (1-12) using the Up/Down arrow key or the keypad. Press **ENTER** when data entry is complete or **ESCAPE** to restore the previous value.
    - ❑ Day — Enter the day using the Up/Down arrow key or the keypad. Press **ENTER** when data entry is complete or **ESCAPE** to restore the previous value.
    - ❑ Year — Enter the year (2003-2036) using the Up/Down arrow key or the keypad. Press **ENTER** when data entry is complete or **ESCAPE** to restore the previous value.
    - ❑ Back — Returns to the top-level SYS menu.
  - ❑ Printer — Displays a menu of supported printers. Use the Up/Down arrow key and **ENTER** key to make the selection.
  - ❑ Units — Select the unit of measurement (metric or English).
  - ❑ Change Date Format — Toggles the date format between MM/DD/YYYY, DD/MM/YYYY, and YYYY/MM/DD.
    - ❑ Back — Returns to the top-level SYS menu.
- ❑ Application Options — Application options displays options applicable to particular mode.
  - ❑ External Ref Freq — Set the external reference frequency from 2 MHz to 20 MHz.

- ❑ Bias Tee — Selects Bias Tee on or off.
- ❑ Impedance — Sets the input impedance of the instrument
  - ❑ 50Ω — Sets the input impedance of the instrument to 50Ω, which is the default setting.
  - ❑ 75Ω Anritsu 12N50-75B — Displays measurements as if the input impedance was 75Ω. The actual input impedance is still 50Ω, but the displayed information is transformed to the equivalent 75Ω value based on the offset value specified by the adapter used in the measurement. This setting is commonly used for cable TV-related measurements. Pressing this soft key will also compensate 7.5 dB for the loss of the Anritsu 12N50-75B adapter.
  - ❑ Other adapter Offset — This key allows the user to enter other adapter offset values. Enter the desired loss using the keypad or Up/Down arrow key and press the **ENTER** key to accept.
  - ❑ Back — Returns to the previous menu.
- ❑ Back — Returns to the top-level SYS menu.
- ❑ Self Test — Start an instrument self test.
- ❑ Status — In cable and antenna analyzer freq or dist measurement mode, displays the current instrument status, including calibration status, temperature, and battery charge state. Press **ESCAPE** to return to operation.
- ❑ GPS — Opens the GPS soft key menu.
  - ❑ Press the GPS On/Off soft key to turn the GPS feature on or off.
  - ❑ Press the Location soft key to view the latitude, longitude and altitude information and UTC timing.
  - ❑ Press the Quality soft key to display the number of tracked satellites and the GPS quality.
  - ❑ Press the Reset soft key to reset the GPS.
  - ❑ Back — Returns to the previous menu.
- ❑ Language — Pressing this soft key immediately changes the language used to display messages on the Site Master status window. Choices are English, French, German, Spanish, Chinese, and Japanese. The default language is English.

In T1/E1 measurement mode, pressing the **SYS** key displays the following System menu soft key selections:

- ❑ System Options — Displays a second level of system option functions:
  - ❑ Clock — Displays a second level of functions:
    - ❑ Hour — Enter the hour (0-23) using the Up/Down arrow key or the keypad. Press **ENTER** when data entry is complete or **ESCAPE** to restore the previous value.
    - ❑ Minute — Enter the minute (0-59) using the Up/Down arrow key or the keypad. Press **ENTER** when data entry is complete or **ESCAPE** to restore the previous value.
    - ❑ Month — Enter the month (1-12) using the Up/Down arrow key or the keypad. Press **ENTER** when data entry is complete or **ESCAPE** to restore the previous value.
    - ❑ Day — Enter the day using the Up/Down arrow key or the keypad. Press **ENTER** when data entry is complete or **ESCAPE** to restore the previous value.

- ❑ Year — Enter the year (2003-2036) using the Up/Down arrow key or the keypad. Press **ENTER** when data entry is complete or **ESCAPE** to restore the previous value.
- ❑ Back — Returns to the top-level SYS menu.
- ❑ Printer — Displays a menu of supported printers. Use the Up/Down arrow key and **ENTER** key to make the selection.
- ❑ Units — Select the unit of measurement (metric or English).
- ❑ Change Date Format — Toggles the date format between MM/DD/YYYY, DD/MM/YYYY, and YYYY/MM/DD.
- ❑ Back — Returns to the top-level SYS menu.
- ❑ Application Options — Application options displays options applicable to particular mode.
  - ❑ Log Data — Logs the data.
  - ❑ Back — Returns to the top-level SYS menu.
- ❑ Self Test — Start an instrument self test.
- ❑ Status — In cable and antenna analyzer freq or dist measurement mode, displays the current instrument status, including calibration status, temperature, and battery charge state. Press **ESCAPE** to return to operation.
- ❑ GPS — Opens the GPS soft key menu.
  - ❑ Press the GPS On/Off soft key to turn the GPS feature on or off.
  - ❑ Press the Location soft key to view the latitude, longitude and altitude information and UTC timing.
  - ❑ Press the Quality soft key to display the number of tracked satellites and the GPS quality.
  - ❑ Press the Reset soft key to reset the GPS.
  - ❑ Back — Returns to the previous menu.
- ❑ Language — Pressing this soft key immediately changes the language used to display messages on the Site Master status window. Choices are English, French, German, Spanish, Chinese, and Japanese. The default language is English.

In Power Monitor mode, pressing the **SYS** key displays the following System menu soft key selections:

- ❑ System Options — Displays a second level of system option functions:
  - ❑ Clock — Displays a second level of functions:
    - ❑ Hour — Enter the hour (0-23) using the Up/Down arrow key or the keypad. Press **ENTER** when data entry is complete or **ESCAPE** to restore the previous value.
    - ❑ Minute — Enter the minute (0-59) using the Up/Down arrow key or the keypad. Press **ENTER** when data entry is complete or **ESCAPE** to restore the previous value.
    - ❑ Month — Enter the month (1-12) using the Up/Down arrow key or the keypad. Press **ENTER** when data entry is complete or **ESCAPE** to restore the previous value.
    - ❑ Day — Enter the day using the Up/Down arrow key or the keypad. Press **ENTER** when data entry is complete or **ESCAPE** to restore the previous value.

- Year — Enter the year (2003-2036) using the Up/Down arrow key or the keypad. Press **ENTER** when data entry is complete or **ESCAPE** to restore the previous value.
- Back — Returns to the top-level SYS menu.
- Printer — Displays a menu of supported printers. Use the Up/Down arrow key and **ENTER** key to make the selection.
- Units — Select the unit of measurement (metric or English).
- Change Date Format — Toggles the date format between MM/DD/YYYY, DD/MM/YYYY, and YYYY/MM/DD.
- Back — Returns to the top-level SYS menu.
- Self Test — Start an instrument self test.
- Status — In cable and antenna analyzer freq or dist measurement mode, displays the current instrument status, including calibration status, temperature, and battery charge state. Press **ESCAPE** to return to operation.
- GPS — Opens the GPS soft key menu.
  - Press the GPS On/Off soft key to turn the GPS feature on or off.
  - Press the Location soft key to view the latitude, longitude and altitude information and UTC timing.
  - Press the Quality soft key to display the number of tracked satellites and the GPS quality.
  - Press the Reset soft key to reset the GPS.
  - Back — Returns to the previous menu.
- Language — Pressing this soft key immediately changes the language used to display messages on the Site Master status window. Choices are English, French, German, Spanish, Chinese, and Japanese. The default language is English.

In Interference Analyzer mode, pressing the **SYS** key displays the following System menu soft key selections:

- System Options — Displays a second level of system option functions:
  - Clock — Displays a second level of functions:
    - Hour — Enter the hour (0-23) using the Up/Down arrow key or the keypad. Press **ENTER** when data entry is complete or **ESCAPE** to restore the previous value.
    - Minute — Enter the minute (0-59) using the Up/Down arrow key or the keypad. Press **ENTER** when data entry is complete or **ESCAPE** to restore the previous value.
    - Month — Enter the month (1-12) using the Up/Down arrow key or the keypad. Press **ENTER** when data entry is complete or **ESCAPE** to restore the previous value.
    - Day — Enter the day using the Up/Down arrow key or the keypad. Press **ENTER** when data entry is complete or **ESCAPE** to restore the previous value.
    - Year — Enter the year (2003-2036) using the Up/Down arrow key or the keypad. Press **ENTER** when data entry is complete or **ESCAPE** to restore the previous value.
    - Back — Returns to the top-level SYS menu.

- ❑ Printer — Displays a menu of supported printers. Use the Up/Down arrow key and **ENTER** key to make the selection.
- ❑ Units — Select the unit of measurement (metric or English).
- ❑ Change Date Format — Toggles the date format between MM/DD/YYYY, DD/MM/YYYY, and YYYY/MM/DD.
- ❑ Back — Returns to the top-level SYS menu.
- ❑ Application Options — Application options displays options applicable to particular mode.
  - ❑ External Ref Freq — Set the external reference frequency from 2 MHz to 20 MHz.
  - ❑ Bias Tee — Selects Bias Tee on or off.
  - ❑ Impedance — Sets the input impedance of the instrument
    - ❑ 50 $\Omega$  — Sets the input impedance of the instrument to 50 $\Omega$ , which is the default setting.
    - ❑ 75 $\Omega$  Anritsu 12N50-75B — Displays measurements as if the input impedance was 75 $\Omega$ . The actual input impedance is still 50 $\Omega$ , but the displayed information is transformed to the equivalent 75 $\Omega$  value based on the offset value specified by the adapter used in the measurement. This setting is commonly used for cable TV-related measurements. Pressing this soft key will also compensate 7.5 dB for the loss of the Anritsu 12N50-75B adapter.
    - ❑ Other adapter Offset — This key allows the user to enter other adapter offset values. Enter the desired loss using the keypad or Up/Down arrow key and press the **ENTER** key to accept.
    - ❑ Back — Returns to the previous menu.
  - ❑ Back — Returns to the top-level SYS menu.
- ❑ Self Test — Start an instrument self test.
- ❑ Status — In cable and antenna analyzer freq or dist measurement mode, displays the current instrument status, including calibration status, temperature, and battery charge state. Press **ESCAPE** to return to operation.
- ❑ GPS — Opens the GPS soft key menu.
  - ❑ Press the GPS On/Off soft key to turn the GPS feature on or off.
  - ❑ Press the Location soft key to view the latitude, longitude and altitude information and UTC timing.
  - ❑ Press the Quality soft key to display the number of tracked satellites and the GPS quality.
  - ❑ Press the Reset soft key to reset the GPS.
  - ❑ Back — Returns to the previous menu.
- ❑ Language — Pressing this soft key immediately changes the language used to display messages on the Site Master status window. Choices are English, French, German, Spanish, Chinese, and Japanese. The default language is English.



In Channel Scanner mode, pressing the **SYS** key displays the following System menu soft key selections:

- ❑ System Options — Displays a second level of system option functions:
  - ❑ Clock — Displays a second level of functions:
    - ❑ Hour — Enter the hour (0-23) using the Up/Down arrow key or the keypad. Press **ENTER** when data entry is complete or **ESCAPE** to restore the previous value.
    - ❑ Minute — Enter the minute (0-59) using the Up/Down arrow key or the keypad. Press **ENTER** when data entry is complete or **ESCAPE** to restore the previous value.
    - ❑ Month — Enter the month (1-12) using the Up/Down arrow key or the keypad. Press **ENTER** when data entry is complete or **ESCAPE** to restore the previous value.
    - ❑ Day — Enter the day using the Up/Down arrow key or the keypad. Press **ENTER** when data entry is complete or **ESCAPE** to restore the previous value.
    - ❑ Year — Enter the year (2003-2036) using the Up/Down arrow key or the keypad. Press **ENTER** when data entry is complete or **ESCAPE** to restore the previous value.
    - ❑ Back — Returns to the top-level SYS menu.
  - ❑ Printer — Displays a menu of supported printers. Use the Up/Down arrow key and **ENTER** key to make the selection.
  - ❑ Units — Select the unit of measurement (metric or English).
  - ❑ Change Date Format — Toggles the date format between MM/DD/YYYY, DD/MM/YYYY, and YYYY/MM/DD.
    - ❑ Back — Returns to the top-level SYS menu.
- ❑ Application Options — Application options displays options applicable to particular mode.
  - ❑ External Ref Freq — Set the external reference frequency from 2 MHz to 20 MHz.
  - ❑ Impedance — Sets the input impedance of the instrument
    - ❑ 50 $\Omega$  — Sets the input impedance of the instrument to 50 $\Omega$ , which is the default setting.
    - ❑ 75 $\Omega$  Anritsu 12N50-75B — Displays measurements as if the input impedance was 75 $\Omega$ . The actual input impedance is still 50 $\Omega$ , but the displayed information is transformed to the equivalent 75 $\Omega$  value based on the offset value specified by the adapter used in the measurement. This setting is commonly used for cable TV-related measurements. Pressing this soft key will also compensate 7.5 dB for the loss of the Anritsu 12N50-75B adapter.
    - ❑ Other adapter Offset — This key allows the user to enter other adapter offset values. Enter the desired loss using the keypad or Up/Down arrow key and press the **ENTER** key to accept.
      - ❑ Back — Returns to the previous menu.
  - ❑ Back — Returns to the top-level SYS menu.
- ❑ Self Test — Start an instrument self test.
- ❑ Status — In cable and antenna analyzer freq or dist measurement mode, displays the current instrument status, including calibration status, temperature, and battery charge state. Press **ESCAPE** to return to operation.

- ❑ **GPS** — Opens the GPS soft key menu.
  - ❑ Press the **GPS On/Off** soft key to turn the GPS feature on or off.
  - ❑ Press the **Location** soft key to view the latitude, longitude and altitude information and UTC timing.
  - ❑ Press the **Quality** soft key to display the number of tracked satellites and the GPS quality.
  - ❑ Press the **Reset** soft key to reset the GPS.
  - ❑ **Back** — Returns to the previous menu.
- ❑ **Language** — Pressing this soft key immediately changes the language used to display messages on the Site Master status window. Choices are English, French, German, Spanish, Chinese, and Japanese. The default language is English.

## Power Monitor, External Detector (Option 5)

Selecting Power Monitor (External Detector) from the mode menu causes the soft keys, described below, to be displayed and the corresponding values shown in the message area.

- Units — Toggles between dBm and Watts.
- Rel — Turns relative mode OFF, if currently ON. If relative mode is currently OFF, turns it ON and causes the power level to be measured and saved as the base level. Subsequent measurements are then displayed relative to this saved value. With units of dBm, relative mode displays dB<sub>r</sub>; with units of Watts, relative mode displays % (percent).
- Offset dB — Turns Offset OFF, if currently ON. If Offset is currently OFF, turns it ON and opens the Offset parameter for data entry (0-60). Press ENTER when data entry is complete.  
Offset is the attenuation (in dB) inserted in the line between the DUT and the RF detector. The attenuation is added to the measured input level prior to display.
- Zero — Turns Zero OFF, if currently ON. If Zero is currently OFF, this soft key turns it ON and initiates collection of a series of power level samples, which are averaged and saved. This saved value is then subtracted from subsequent measurements prior to display.

## Transmission Measurement (Option 21)

Selecting Transmission Measurement from the mode menu causes the soft keys, described below, to be displayed and the corresponding values shown in the message area.

- FREQ/DIST** Pressing the **FREQ/DIST** key in Transmission Measurement mode activates a menu of frequency-related choices in the active function block. Use the corresponding soft key to select the desired function, explained below. Use the keypad or Up/Down arrow key to change or enter values shown in the edit box. Complete the entry by pressing the appropriate soft key frequency terminator.
- Center — Sets the center frequency. A specific center frequency can be entered using the Up/Down arrow key, or the keypad and the GHz, MHz, kHz, or Hz soft keys.
  - Span — Pressing the Span soft key activates a menu of span related choices in the active function block.
    - Edit — Allows direct entry of a specific frequency span. Use the keypad or Up/Down arrow key to select the span.
    - Full — Sets the Anritsu Spectrum Master to its maximum frequency span, 2.975 GHz.
    - Min — Sets the span to the minimum frequency.
    - Span Up 1-2-5 — Activates the span function so that the span may be increased quickly in a 1-2-5 sequence.
    - Span Down 1-2-5 — Activates the span function so that the span may be reduced quickly in a 1-2-5 sequence.
    - Back — Returns to the previous menu level.
  - Start — Activates the start frequency and sets the Anritsu Spectrum Master in the Start/Stop mode. Use the keypad to enter the desired start frequency and complete the entry by pressing the GHz, MHz, kHz, or Hz soft key to accept the start frequency input.
  - Stop — Activates the stop frequency and sets the Anritsu Spectrum Master in the Start/Stop mode. Use the keypad to enter the desired stop frequency and complete the entry by pressing the GHz, MHz, kHz, or Hz soft key to accept the stop frequency input.
  - Signal Standard — Allows selection of the signal standard to be used. Select a standard using the Up/Down arrow key and press the **ENTER** key to implement.
  - Select Channel — Sets the channel for the selected signal standard. Select a channel using the Up/Down arrow key and press the **ENTER** key to implement.
- AMPLITUDE** Pressing **AMPLITUDE** in Transmission Measurement mode activates a menu of amplitude-related functions.
- Ref Level — Activates the amplitude reference level function. A specific reference level can be entered using the keypad or Up/Down arrow key. Press **ENTER** to accept the reference level value. Valid reference levels are +100 dBm to -120 dBm.

- ❑ Scale — Activates the scale function in a 1 through 15 dB per division logarithmic amplitude scale. Enter the desired scale using the keypad or Up/Down arrow key. Press **ENTER** to accept.
- ❑ Atten/Preamp — Sets the Anritsu Spectrum Master input attenuator so that it is either coupled automatically to the reference level (Auto), manually adjustable (Manual), or dynamically controlled (Dynamic).
  - ❑ Auto — Press this soft key to automatically couple the attenuation to the reference level. The automatic attenuation value is displayed to the left of the display below the Atten.
  - ❑ Manual — Sets the attenuation to manual mode. The attenuation can be adjusted from 0 to 51 dB, in 1 dB increments, using the keypad or Up/Down arrow key. Press **ENTER** to accept the selected value. The value is displayed to the left of the display below the Atten\*.

**IMPORTANT!** Attenuation is normally a coupled function and is automatically adjusted when the reference level changes. The reference level will not change however, when the attenuator changes. The attenuator should be adjusted so that the maximum signal amplitude at the input mixer is  $-30$  dBm or less. For example, if the reference level is  $+20$  dBm, the attenuation should be  $50$  dB for an input signal of  $-30$  dBm at the mixer ( $+20 - 50 = -30$ ). This prevents signal compression. (This is with the preamplifier off.)

- ❑ Dynamic — Turns on the dynamic attenuation control feature. Dynamic attenuation tracks the input signal level, automatically adjusting the attenuation and preamp to give the maximum dynamic range without compressing the input mixer.  
Dynamic attenuation is based on a broadband detector. This means that an out of band signal may interfere and force the need to use a bandpass filter to eliminate the out of band interference and enable accurate measurements.
- ❑ Preamp Control Manual — Allows manual control of the preamplifier on/off state. The Preamp On/Off soft key turns the preamplifier on or off. The Preamp Auto soft key returns to automatic control of the preamplifier.
- ❑ Back — Returns to the previous menu level.

#### MEAS/DISP

Pressing **MEAS/DISP** in Transmission Measurement mode activates a menu of bandwidth- and sweep-related functions. Use the corresponding soft key to select the desired function.

- ❑ Bandwidth — Activates a menu that allows the resolution and video bandwidths to be either coupled automatically to the span (Auto) or manually adjustable (Manual).
  - ❑ RBW Auto — Sets the resolution bandwidth so that it is automatically coupled to the span.
  - ❑ RBW Manual — Sets the resolution bandwidth manually, independent of the span.
  - ❑ VBW Auto — Sets the video bandwidth so that it is automatically coupled to the RBW.

- ❑ VBW Manual — Sets the video bandwidth manually, independent of the RBW.
- ❑ Back — Returns to the previous menu level.
- ❑ Trace — Activates a menu of trace related functions. Use the corresponding soft key to select the desired trace function.
  - ❑ Max Hold — Displays and holds the maximum responses of the input signal.
  - ❑ Average (2-25) — Sets the number of the sweeps to be averaged. The number of the sweeps can be adjusted from 2 to 25 using the Up/Down arrow key, or entered directly with the keypad number keys. Select OFF, or enter 1 to turn off averaging. Press **ENTER** to accept the selected value.  
This feature uses a measurement routine that averages samples over a user-defined number of successive sweeps. The averaging is done on a point-by-point basis. Each displayed point reflects the current measurement associated with that point averaged with the measurements associated with that point from previous sweeps. This feature can be used to minimize the impact of transients on the displayed signal and noise.
  - ❑ Min Hold — Displays and holds the minimum responses of the input signal over multiple sweeps. This feature is useful for detecting small, discrete, stable signals in the presence of noise.
  - ❑ Trace Math — Pressing the **Trace Math** key in Transmission Measurement mode activates a menu of trace-related functions. Use the corresponding soft key to select the desired trace function.

*NOTE: For this function, Trace A is always the runtime trace, and Trace B is always a saved trace. Trace A is displayed as a yellow trace, and Trace B is displayed as a magenta trace. Some adjustment of the display brightness may be required for optimal viewing. Refer to page 3-15 for information on saving and recalling traces.*

- ❑ Recall Trace → B — Recalls a stored trace into the Trace B buffer.
- ❑ View B /Clear B — Overlays a stored trace over the current trace. If there is no trace in the Trace B buffer, the Recall Trace list will display. Select a trace from the menu of saved traces to recall to the Trace B buffer. Pressing the soft key again turns off the trace overlay.
- ❑ A → B — Moves the currently displayed trace into the Trace B buffer.
- ❑ A - B → A — Subtracts Trace B from Trace A and displays the result as Trace A.
- ❑ A + B → A — Adds Trace B to Trace A and displays the result as Trace A.
- ❑ Calibrate TM — Calibrates the Spectrum Master for transmission measurements.

**SYS**

Pressing **SYS** on the data keypad in Transmission Measurement mode activates a menu of system-related functions. Use the corresponding soft key to select the system function.

- ❑ System Options — Displays a second level of system option functions:
  - ❑ Clock — Displays a second level of functions:
    - ❑ Hour — Enter the hour (0-23) using the Up/Down arrow key or the keypad. Press **ENTER** when data entry is complete or **ESCAPE** to restore the previous value.
    - ❑ Minute — Enter the minute (0-59) using the Up/Down arrow key or the keypad. Press **ENTER** when data entry is complete or **ESCAPE** to restore the previous value.
    - ❑ Month — Enter the month (1-12) using the Up/Down arrow key or the keypad. Press **ENTER** when data entry is complete or **ESCAPE** to restore the previous value.
    - ❑ Day — Enter the day using the Up/Down arrow key or the keypad. Press **ENTER** when data entry is complete or **ESCAPE** to restore the previous value.
    - ❑ Year — Enter the year (2003-2036) using the Up/Down arrow key or the keypad. Press **ENTER** when data entry is complete or **ESCAPE** to restore the previous value.
    - ❑ Back — Returns to the top-level SYS menu.
  - ❑ Printer — Displays a menu of supported printers. Use the Up/Down arrow key and **ENTER** key to make the selection.
  - ❑ Units — Select the unit of measurement (metric or English).
  - ❑ Change Date Format — Toggles the date format between MM/DD/YYYY, DD/MM/YYYY, and YYYY/MM/DD.
  - ❑ Back — Returns to the top-level SYS menu.
- ❑ Application Options — Application options displays options applicable to particular mode.
  - ❑ External Ref Freq — Set the external reference frequency from 2 MHz to 20 MHz.
  - ❑ Bias Tee — Selects Bias Tee on or off.
  - ❑ Impedance — Sets the input impedance of the instrument
    - ❑ 50 $\Omega$  — Sets the input impedance of the instrument to 50 $\Omega$ , which is the default setting.
    - ❑ 75 $\Omega$  Anritsu 12N50-75B — Displays measurements as if the input impedance was 75 $\Omega$ . The actual input impedance is still 50 $\Omega$ , but the displayed information is transformed to the equivalent 75 $\Omega$  value based on the offset value specified by the adapter used in the measurement. This setting is commonly used for cable TV-related measurements. Pressing this soft key will also compensate 7.5 dB for the loss of the Anritsu 12N50-75B adapter.
    - ❑ Other adapter Offset — This key allows the user to enter other adapter offset values. Enter the desired loss using the keypad or Up/Down arrow key and press the **ENTER** key to accept.
    - ❑ Back — Returns to the previous menu.
  - ❑ Back — Returns to the top-level SYS menu.
- ❑ Self Test — Start an instrument self test.

- ❑ Status — In cable and antenna analyzer freq or dist measurement mode, displays the current instrument status, including calibration status, temperature, and battery charge state. Press **ESCAPE** to return to operation.
- ❑ GPS — Opens the GPS soft key menu.
  - ❑ Press the GPS On/Off soft key to turn the GPS feature on or off.
  - ❑ Press the Location soft key to view the latitude, longitude and altitude information and UTC timing.
  - ❑ Press the Quality soft key to display the number of tracked satellites and the GPS quality.
  - ❑ Press the Reset soft key to reset the GPS.
  - ❑ Back — Returns to the previous menu.
- ❑ Language — Pressing this soft key immediately changes the language used to display messages on the Site Master status window. Choices are English, French, German, Spanish, Chinese, and Japanese. The default language is English.

## LIMIT

Pressing **LIMIT** on the data keypad in Transmission Measurement mode activates a menu of limit-related functions. Use the corresponding soft key to select the desired limit function. Then use the Up/Down arrow key to change its value, which is displayed in the message area at the bottom of the display.

- ❑ Single Limit — Sets a single limit value. Menu choices are:
  - ❑ On/Off — Turns the single limit function on or off.
  - ❑ Edit — Allows entry of the limit amplitude using the keypad or Up/Down arrow key. Press **ENTER** to accept the entered value.
  - ❑ Upper / Lower Limit — Selects whether the measurement will fail if the data is above the limit line or below the limit line, as indicated in the message area of the display.
  - ❑ Back — Returns to the previous menu level.
- ❑ Multiple Upper Limits — Sets multiple user-defined upper limits, and can be used to create an upper limit mask for quick pass/fail measurements. An upper limit will result in a failure when the data falls above the limit line. Menu choices are:
  - ❑ Segment 1-5 — View/edit upper limit segment 1-5.
    - ❑ On/Off — Turns the segment on or off.
    - ❑ Edit — Opens the segment parameters for editing (see Adjusting Segmented Limits, page 3-17).
    - ❑ Prev Segment — Edit or view the parameters of the previous segment.
    - ❑ Next Segment — Edit or view the parameters of the next segment. If the next segment is off when this button is pressed, the starting point of the next segment will be set equal to the ending point of the current segment (if the current segment is on).
    - ❑ Back — Returns to the previous menu level
  - ❑ Back — Returns to the previous menu level
- ❑ Multiple Lower Limits — Set multiple user-defined lower limits, and can be used to create a lower limit mask for quick pass/fail measurements. A lower limit will result in a failure when the data falls below the limit line. Menu choices are:



- ❑ Segment 1-5 — View/edit lower limit segment 1-5.
  - ❑ On/Off — Turns the segment on or off.
  - ❑ Edit — Opens the segment parameters for editing (see Adjusting Segmented Limits, page 3-17).
  - ❑ Prev Segment — Edit or view the parameters of the previous segment.
  - ❑ Next Segment — Edit or view the parameters of the next segment. If the next segment is off when this button is pressed, the starting point of the next segment will be set equal to the ending point of the current segment (if the current segment is on).
  - ❑ Back — Returns to the previous menu level
- ❑ Back — Returns to the previous menu level.
- ❑ Limit Beep — Turns the audible limit beep indicator on or off. When the limit beep indicator is on, an audible beep will occur at every data point that appears above the upper limit or below the lower limit.

**MARKER**

Pressing **MARKER** on the data keypad in Transmission Measurement mode activates a menu for the six different markers. Use the corresponding soft key to select the desired marker. Then use the marker second level menu to turn the markers on or off, and to edit marker parameters and values.

- ❑ M1 — Selects the M1 marker parameter and opens the Markers second level menu with M1 highlighted.
  - ❑ On/Off — Turns the selected marker on or off.
  - ❑ Edit — Opens the selected marker parameter for data entry. Enter the desired marker frequency using the keypad or Up/Down arrow key. Select the GHz, MHz, kHz, or Hz soft key to accept the marker frequency input.
  - ❑ Delta (Mx-M1) — Displays delta frequency and amplitude for the selected marker Mx (M2, M3 or M4) with respect to the M1 marker.
  - ❑ Marker To Peak — Places the selected marker at the maximum amplitude of a trace (M1 - M4 only).
  - ❑ Marker Freq To Center — Makes the center frequency equal to the frequency of the selected marker.
  - ❑ Back — Returns to the previous menu level.

*NOTE: The markers second-level menu above is identical for markers M2-M4.*

- ❑ M2 — Selects the M2 marker parameter and opens the Markers second level menu with M2 highlighted.
- ❑ M3 — Selects the M3 marker parameter and opens the Markers second level menu with M3 highlighted.
- ❑ M4 — Selects the M4 marker parameter and opens the Markers second level menu with M4 highlighted.
- ❑ All Off — Turns off all markers.
- ❑ More — Press to access additional marker functions:
  - ❑ M5 — Selects the M5 marker parameter and opens the M5 marker second level menu with M5 highlighted.

- ❑ On/Off — Turns the selected marker on or off.
- ❑ Edit — Opens the selected marker parameter for data entry. Enter the desired marker frequency using the keypad or Up/Down arrow key. Select the GHz, MHz, kHz, or Hz soft key to accept the marker frequency input.
- ❑ Marker Freq To Center — Makes the center frequency equal to the frequency of the selected marker.
- ❑ Peak Between M1& M2 — Places the selected marker at the frequency with maximum amplitude value between marker M1 and M2.
- ❑ Valley Between M1& M2 — Places the selected marker at the frequency with minimum amplitude value between marker M1 and M2.
- ❑ Back — Returns to the previous menu level.

*NOTE: If markers M1 and/or M2 are off, the Peak and Valley functions above are executed across the entire span.*

- ❑ M6 — Selects the M6 marker parameter and opens the M6 marker second level menu with M6 highlighted.
  - ❑ On/Off — Turns the selected marker on or off.
  - ❑ Edit — Opens the selected marker parameter for data entry. Enter the desired marker frequency using the keypad or Up/Down arrow key. Select the GHz, MHz, kHz, or Hz soft key to accept the marker frequency input.
  - ❑ Marker Freq To Center — Makes the center frequency equal to the frequency of the selected marker.
  - ❑ Peak Between M3 & M4 — Places the selected marker at the frequency with maximum amplitude value between marker M1 and M2.
  - ❑ Valley Between M3 & M4 — Places the selected marker at the frequency with minimum amplitude value between marker M1 and M2.
  - ❑ Back — Returns to the previous menu level.
- ❑ Regular Marker — Measures the signal level at the point of the marker in the unit type selected in the Amplitude - Units menu. When the regular marker option is selected, all markers are regular markers.
- ❑ Noise Marker — Measures noise level normalized to a 1 Hz bandwidth. The unit of measure is dBm/Hz only. When Noise Marker is selected, the detection type is automatically changed to RMS average. When the Noise Marker option is selected, all markers are noise markers.
- ❑ All Off — Turns off all markers.
- ❑ Back — Returns to the previous menu level.

*NOTE: If either marker M3 or marker M4 is off, the Peak and Valley functions above are executed across the entire span.*

## Interference Analyzer Mode (Option 25)

The Interference Analyzer option provides several different ways to determine the nature and source of an interfering signal. Selecting Interference Analyzer from the mode menu causes the soft keys, described below, to be displayed and the corresponding values shown in the message area.

- FREQ/DIST**
- Center — Sets the frequency at the center of the display. Frequencies can be entered in units of GHz, MHz, kHz or Hz. When the center frequency is entered, the labeling below the grid shows the center frequency and the span in the most appropriate units based on the value.
  - Span — Sets the width of the measurement window in GHz, MHz, kHz or Hz. The center frequency and span are displayed in the message area at the bottom of the status window.
  - Start — Enter a start frequency value (in GHz, MHz, kHz or Hz) using the Up/Down arrow key or keypad, press **ENTER** to accept, **ESCAPE** to restore. If the entered start frequency is greater than the current stop frequency, the stop frequency is automatically adjusted to be the same as the start frequency (zero span).
  - Stop — Enter a stop frequency value (in GHz, MHz, kHz or Hz) using the Up/Down arrow key or keypad, press **ENTER** to accept, **ESCAPE** to restore. If the entered stop frequency is lower than the current start frequency, the start frequency is automatically adjusted to be the same as the stop frequency (zero span).
  - Signal Standard — Opens a menu of soft keys used to select the signal standard to be used.
    - Select Standard — Opens the signal standard menu, showing the currently selected signal standards. Use the soft keys to navigate the list. Press the Show All soft key to show the complete signal standard list. When the complete list is displayed, the currently selected signal standards are marked with an asterisk. Press the Show Selected soft key to show only the currently selected signal standards.
    - Select Channel — Sets the channel information for the available standard. If the particular standard has not been used before, the channel number will default to the lowest legal channel number for that standard. If that standard has been used before, the last used channel will be the default.
    - Uplink — Selects the bank of frequencies that correspond to signals sent from the client transmitter to the base station.
    - Downlink — Selects the bank of frequencies that correspond to the signals sent from the base station to the client receivers.
    - Back — Returns to the previous menu.
- AMPLITUDE** Choosing **AMPLITUDE** causes the soft keys, below, to be displayed and the corresponding values to be shown in the message area.
- Ref Level — Activates the amplitude reference level function which sets the amplitude at the top of the display. Valid reference levels are from +20 to -120 dBm.

- ❑ **Scale** — Activates the scale function which sets the dB/division value from 1 dB/div to 15 dB/div in 1 dB steps. This soft key is not active if the units are set to linear.
- ❑ **Atten/Preamp** — Sets the internal input attenuator so that it is either coupled automatically to the reference level (*Auto*), manually adjustable (*Manual*) or dynamically coupled to the input signal (*Dynamic*) and provides control for the preamplifier.
  - ❑ **Auto** — Sets the input attenuator so that it is coupled automatically to the reference level.
  - ❑ **Manual** — Sets the input attenuator manually from 0 to 51 dB. Choose a value that does not overload the instrument.
  - ❑ **Dynamic** — Sets the value of the input attenuator so that it is dynamically coupled to the input signal and turns the preamp on or off based on the overall signal conditions across the entire frequency range of the instrument. The instrument will set the lowest input attenuation consistent with the need to not saturate the front end.

*NOTE: A large signal that is not displayed on-screen can sometimes cause the instrument to turn off the preamplifier or add input attenuation, causing the noise floor to jump up or down suddenly as the large signal turns on or off.*

- ❑ **Preamp Control Manual** — Activates the preamp menu for manual control of the preamplifier.
    - ❑ **Preamp On/Off** — Sets the preamplifier on or off.
    - ❑ **Preamp Auto** — Automatically adjusts the preamplifier according to the reference level.
  - ❑ **Back** — Returns to the previous menu level.
- ❑ **Units** — Choose from the menu of amplitude related units. When *Linear* is selected, the available selections are Volts or Watts. When *Log* is selected, the selection of dBm sets absolute decibels relative to 1 mW as the amplitude unit. Selection of dBV, dBmV or dB $\mu$ V sets absolute decibels relative to 1 volt, 1 millivolt, or 1 microvolt respectively as the amplitude unit.
- ❑ **Ref Level Offset** — Sets the reference level offset, which is a value, in dB, of gain or loss external to the instrument. Negative values represent external attenuation. This feature allows measurement of high gain devices in combination with an attenuator, and is used to offset the reference level to view the correct output level. For example, to measure a high gain amplifier with an output of 70 dBm, an external 50 dB attenuator must be inserted between the instrument and the device. To compensate, set the reference level offset to -50 dB.

**MEAS/DISP**

- Pressing **MEAS/DISP** activates a menu of bandwidth and sweep-related functions. Use the corresponding soft key to select the desired function.
- ❑ **Spectrum** — Spectrum selects a traditional spectrum analyzer display.
  - ❑ **Spectrogram** — Selecting Spectrogram provides a three dimensional representation of frequency, time and power to aid in the identification of intermittent signals. The bottom portion of the display shows a traditional spectrum analyzer plot while the upper portion shows the power level in color with the most recent trace placed at the bottom of the display. A color scale on the left

side of the display translates color into power level. The highest power level is displayed in red with the lowest power levels in dark blue and black.

- ❑ Sweep Interval — Sweep Interval allows for the amount of time between sweeps to be set from a minimum of zero seconds up to 660 seconds (11 minutes). Enter the number using the Up/Down arrow key or use the keypad and select the appropriate soft key for minutes, seconds, milliseconds or microseconds. The current setting will be displayed in the message area. A sweep interval of 0 seconds will display as Auto and the instrument will sweep as fast as possible. Setting this value also determines the time span.
- ❑ Time Span — Time Span sets the total time that will be taken to fill the waterfall display, from 0 to 4320 minutes (72 hours). Enter the number using the Up/Down arrow key or use the keypad and select the appropriate soft key for days, hours, minutes, seconds, milliseconds or microseconds. The current setting will be displayed in the message area. A time span of 0 seconds will display as Auto and the instrument will sweep as fast as possible. Setting this value also determines the sweep interval.
- ❑ Auto Save — Auto Save saves the screen when the waterfall display is full. Select the **RECALL DISPLAY** (0) key to view and recall the saved displays (page 3-15).
- ❑ Cursor — The cursor controls enable the user to look through the waterfall display and read the power level at a selected frequency and time. The time, frequency and power level at the measurement point are shown in the message block at the bottom of the screen. Selecting the Cursor soft key turns the cursors on.
  - ❑ Time Cursor — The Time Cursor is a white horizontal line that can be positioned anywhere in the waterfall display. Select Time Cursor and use the Up/Down arrow key to move the cursor to the desired time. The time the trace was taken is shown in the bottom message block. If the cursor is moved into a portion of the display where there is no data, the date is shown as January 1, 1970 at midnight.
  - ❑ Freq Cursor — The Frequency Cursor is a vertical white line that can be positioned at any frequency in the span range using the Up/Down arrow key. Pressing the Up arrow key moves the cursor to a higher frequency while pressing the Down arrow key moves the cursor to a lower frequency. The frequency is shown in the bottom message block.
  - ❑ Back — Returns to the previous menu level.
- ❑ Spectrum — Selecting Spectrum returns to the traditional spectrum analyzer display and **MEAS/DISP** soft key menu.
- ❑ Signal Strength — Selecting Signal Strength displays the power at a single frequency (in dBm) along with an optional audible indicator. The frequency of the audible indicator increases as the measured signal strength increases. This mode is especially useful when attempting to locate an emitter using a directional antenna.
  - ❑ Volume — Select the Volume soft key to adjust the sound level of the audible signal strength indicator using the Up/Down arrow key. The current volume setting is shown in the lower measurement block.
  - ❑ Speaker Tone On/Off — The Speaker Tone On/Off soft key toggles the audible indicator on or off. The default is On.
  - ❑ Back — Returns to the previous menu level.

- ❑ **RSSI** — RSSI provides a way to see the scrolling display of received signal strength in zero span. Once a full screen of data has been acquired, the oldest data disappears off the left edge of the display.
  - ❑ **Time Interval** — Time Interval sets the time between data points. The interval can be set from 150 ms to 1 minute. Enter the number using the Up/Down arrow key or use the keypad and select the appropriate soft key for minutes, seconds, or milliseconds.
  - ❑ **Time Span** — Time Span sets the total duration of measurements. This value can be set from 1 minute to 7 days. A setting of zero (MANUAL) can also be entered if no limit on the time span is desired.
  - ❑ **Auto Scale Data** — Auto Scale Data sets the reference level and scale factor to values that spread the data vertically over as much of the screen as possible, with the reference level set in 0.1 dB steps and vertical scaling set in 1 dB steps from 1 dB to 15 dB per division.
  - ❑ **Log Data Off/On** — Log Data Off/On selects if data will be automatically logged. When data logging is on, information is stored after each full screen of data has been captured. Saved data is named by using the word "LOG" and a dash followed by the time to the nearest second in 24-hour clock format, such as "LOG - 14:43:01. Select the **RECALL DISPLAY** (0) key to view and recall the saved data (page 3-15).
  - ❑ **Back** — Returns to the previous menu level.
- ❑ **Signal ID** — Signal Identification is used to determine, if possible, the air interface standard of a signal. If the instrument is unable to determine the modulation format, it will display the estimated bandwidth of the signal.
  - ❑ **Set IA Freq** — Set IA Freq is used to enter the center frequency of the interfering signal to be identified. Enter the frequency using the Up/Down arrow key or use the keypad and select the appropriate soft key for GHz, MHz, kHz, or Hz.
  - ❑ **Measure** — Pressing the Measure soft key starts the signal identification process. This process takes approximately one minute to complete. At the end of the measurement process, a dialog box displays the results. The results are also shown in the message area at the bottom of the display.
  - ❑ **IA Freq to Center** — The IA Freq to Center soft key moves the interference analysis frequency to the center of the screen.
  - ❑ **IA Freq As Marker M1** — The IA Freq As Marker M1 soft key sets the interference analysis frequency to be the frequency of marker M1. This is the easiest way to enter the measurement frequency. Refer to the Marker key section on the next page for information on setting the markers.
  - ❑ **Back** — Returns to the previous menu level.
- ❑ **Setup** — Sets the parameters for IA measurements.
  - ❑ **Bandwidth** — Activates a menu that allows the resolution and video bandwidths to be either coupled automatically to the span (Auto) or manually adjustable (Manual).
    - ❑ **RBW Auto** — Sets the resolution bandwidth so that it is automatically coupled to the span.
    - ❑ **RBW Manual** — Sets the resolution bandwidth manually, independent of the span, from 30 kHz to 1 MHz in zero span mode, 100 Hz to 1 MHz for a span greater than zero.

- VBW Auto — Sets the video bandwidth so that it is automatically coupled to the RBW.
- VBW Manual — Sets the video bandwidth manually, independent of the RBW, from 3 Hz to 1 MHz.
- Back — Returns to the previous menu level.
- Detection — Detection brings up a group of choices that change how the instrument deals with the multiple RF measurements that are made for each display point.
  - Positive Peak — Positive Peak displays the largest signal in each display point.
  - RMS Average — RMS Average causes the instrument to calculate the RMS average of all measurements done for each display point and display that average.
  - Negative Peak — Negative Peak displays the smallest value for each display point.
  - Sampling Mode — Sampling Mode displays a single frequency point for each display point. This is the fastest mode, but may miss displaying narrow signals.
  - Back — Returns to the previous menu level.
- Volume — Select the Volume soft key to adjust the sound level of the audible signal strength indicator using the Up/Down arrow key. The current volume setting is shown in the lower measurement block.

**MARKER**

Pressing **MARKER** on the data keypad activates a menu for the six different markers. Use the corresponding soft key to select the desired marker. Then use the marker second level menu to turn the markers on or off, and to edit marker parameters and values.

*NOTE: Markers are only available in IA-Spectrum mode.*

- M1 — Selects the M1 marker parameter and opens the Markers second level menu with M1 highlighted.
  - On/Off — Turns the selected marker on or off.
  - Edit — Opens the selected marker parameter for data entry. Enter the desired marker frequency using the keypad or Up/Down arrow key. Select the GHz, MHz, kHz, or Hz soft key to accept the marker frequency input.
  - Delta (Mx-M1) — Displays delta frequency and amplitude for the selected marker Mx (M2, M3 or M4) with respect to the M1 marker.
  - Marker To Peak — Places the selected marker at the maximum amplitude of a trace (M1 - M4 only).
  - Marker Freq To Center — Makes the center frequency equal to the frequency of the selected marker.
  - Back — Returns to the previous menu level.

*NOTE: The markers second-level menu above is identical for markers M2-M4.*

- M2 — Selects the M2 marker parameter and opens the Markers second level menu with M2 highlighted.

- ❑ M3 — Selects the M3 marker parameter and opens the Markers second level menu with M3 highlighted.
- ❑ M4 — Selects the M4 marker parameter and opens the Markers second level menu with M4 highlighted.
- ❑ All Off — Turns off all markers.
- ❑ More — Press to access additional marker functions:
  - ❑ M5 — Selects the M5 marker parameter and opens the M5 marker second level menu with M5 highlighted.
    - ❑ On/Off — Turns the selected marker on or off.
    - ❑ Edit — Opens the selected marker parameter for data entry. Enter the desired marker frequency using the keypad or Up/Down arrow key. Select the GHz, MHz, kHz, or Hz soft key to accept the marker frequency input.
    - ❑ Marker Freq To Center — Makes the center frequency equal to the frequency of the selected marker.
    - ❑ Peak Between M1 & M2 — Places the selected marker at the frequency with maximum amplitude value between marker M1 and M2.
    - ❑ Valley Between M1 & M2 — Places the selected marker at the frequency with minimum amplitude value between marker M1 and M2.
    - ❑ Back — Returns to the previous menu level.

*NOTE: If markers M1 and/or M2 are off, the Peak and Valley functions above are executed across the entire span.*

- ❑ M6 — Selects the M6 marker parameter and opens the M6 marker second level menu with M6 highlighted.
  - ❑ On/Off — Turns the selected marker on or off.
  - ❑ Edit — Opens the selected marker parameter for data entry. Enter the desired marker frequency using the keypad or Up/Down arrow key. Select the GHz, MHz, kHz, or Hz soft key to accept the marker frequency input.
  - ❑ Marker Freq To Center — Makes the center frequency equal to the frequency of the selected marker.
  - ❑ Peak Between M3 & M4 — Places the selected marker at the frequency with maximum amplitude value between marker M1 and M2.
  - ❑ Valley Between M3 & M4 — Places the selected marker at the frequency with minimum amplitude value between marker M1 and M2.
  - ❑ Back — Returns to the previous menu level.
- ❑ Regular Marker — Measures the signal level at the point of the marker in the unit type selected in the Amplitude - Units menu. When the regular marker option is selected, all markers are regular markers.
- ❑ Noise Marker — Measures noise level normalized to a 1 Hz bandwidth. The unit of measure is dBm/Hz only. When Noise Marker is selected, the detection type is automatically changed to RMS average. When the Noise Marker option is selected, all markers are noise markers.
- ❑ All Off — Turns off all markers.
- ❑ Back — Returns to the previous menu level.



*NOTE: If either marker M3 or marker M4 is off, the Peak and Valley functions above are executed across the entire span.*

## LIMIT

Pressing the **LIMIT** key activates a menu of limit related functions. Use the corresponding soft key to select the desired limit function. Then use the Up/Down arrow key to change its value, which is displayed in the message area at the bottom of the status window.

*NOTE: Limit is only available in IA-Spectrum mode.*

- Single Limit — Sets a single limit value. Menu choices are:
  - On/Off — Turns the single limit function on or off.
  - Edit — Allows entry of the limit amplitude using the keypad or Up/Down arrow key. Press **ENTER** to accept the entered value.
  - Upper / Lower Limit — Selects whether the measurement will fail if the data is above the limit line or below the limit line, as indicated in the message area of the display.
  - Back — Returns to the previous menu level.
- Multiple Upper Limits — Sets multiple user-defined upper limits, and can be used to create an upper limit mask for quick pass/fail measurements. An upper limit will result in a failure when the data falls above the limit line. Menu choices are:
  - Segment 1-5 — View/edit upper limit segment 1-5.
    - On/Off — Turns the segment on or off.
    - Edit — Opens the segment parameters for editing (see Adjusting Segmented Limits, page 3-17).
    - Prev Segment — Edit or view the parameters of the previous segment.
    - Next Segment — Edit or view the parameters of the next segment. If the next segment is off when this button is pressed, the starting point of the next segment will be set equal to the ending point of the current segment (if the current segment is on).
    - Back — Returns to the previous menu level
  - Back — Returns to the previous menu level
- Multiple Lower Limits — Set multiple user-defined lower limits, and can be used to create a lower limit mask for quick pass/fail measurements. A lower limit will result in a failure when the data falls below the limit line. Menu choices are:
  - Segment 1-5 — View/edit lower limit segment 1-5.
    - On/Off — Turns the segment on or off.
    - Edit — Opens the segment parameters for editing (see Adjusting Segmented Limits, page 3-17).
    - Prev Segment — Edit or view the parameters of the previous segment.
    - Next Segment — Edit or view the parameters of the next segment. If the next segment is off when this button is pressed, the starting point of the next segment will be set equal to the ending point of the current segment (if the current segment is on).
    - Back — Returns to the previous menu level

- Back — Returns to the previous menu level.

Limit Beep — Turns the audible limit beep indicator on or off. When the limit beep indicator is on, an audible beep will occur at every data point that appears above the upper limit or below the lower limit.

## SYS

In Interference Analyzer mode, pressing the **SYS** key displays the following System menu soft key selections:

- System Options — Displays a second level of system option functions:
  - Clock — Displays a second level of functions:
    - Hour — Enter the hour (0-23) using the Up/Down arrow key or the keypad. Press **ENTER** when data entry is complete or **ESCAPE** to restore the previous value.
    - Minute — Enter the minute (0-59) using the Up/Down arrow key or the keypad. Press **ENTER** when data entry is complete or **ESCAPE** to restore the previous value.
    - Month — Enter the month (1-12) using the Up/Down arrow key or the keypad. Press **ENTER** when data entry is complete or **ESCAPE** to restore the previous value.
    - Day — Enter the day using the Up/Down arrow key or the keypad. Press **ENTER** when data entry is complete or **ESCAPE** to restore the previous value.
    - Year — Enter the year (2003-2036) using the Up/Down arrow key or the keypad. Press **ENTER** when data entry is complete or **ESCAPE** to restore the previous value.
    - Back — Returns to the top-level SYS menu.
  - Printer — Displays a menu of supported printers. Use the Up/Down arrow key and **ENTER** key to make the selection.
  - Units — Select the unit of measurement (metric or English).
  - Change Date Format — Toggles the date format between MM/DD/YYYY, DD/MM/YYYY, and YYYY/MM/DD.
  - Back — Returns to the top-level SYS menu.
- Application Options — Application options displays options applicable to particular mode.
  - External Ref Freq — Set the external reference frequency from 2 MHz to 20 MHz.
  - Bias Tee — Selects Bias Tee on or off.
  - Impedance — Sets the input impedance of the instrument
    - 50Ω — Sets the input impedance of the instrument to 50Ω, which is the default setting.
    - 75Ω Anritsu 12N50-75B — Displays measurements as if the input impedance was 75Ω. The actual input impedance is still 50Ω, but the displayed information is transformed to the equivalent 75Ω value based on the offset value specified by the adapter used in the measurement. This setting is commonly used for cable TV-related measurements. Pressing this soft key will also compensate 7.5 dB for the loss of the Anritsu 12N50-75B adapter.
    - Other adapter Offset — This key allows the user to enter other adapter offset values. Enter the desired loss using the keypad or Up/Down arrow key and press the **ENTER** key to accept.
    - Back — Returns to the previous menu.

- ❑ Back — Returns to the top-level SYS menu.
- ❑ Self Test — Start an instrument self test.
- ❑ Status — In cable and antenna analyzer freq or dist measurement mode, displays the current instrument status, including calibration status, temperature, and battery charge state. Press **ESCAPE** to return to operation.
- ❑ GPS — Opens the GPS soft key menu.
  - ❑ Press the GPS On/Off soft key to turn the GPS feature on or off.
  - ❑ Press the Location soft key to view the latitude, longitude and altitude information and UTC timing.
  - ❑ Press the Quality soft key to display the number of tracked satellites and the GPS quality.
  - ❑ Press the Reset soft key to reset the GPS.
  - ❑ Back — Returns to the previous menu.

Language — Pressing this soft key immediately changes the language used to display messages on the Site Master status window. Choices are English, French, German, Spanish, Chinese, and Japanese. The default language is English.

## Channel Scanner Mode (Option 27)

The Channel Scanner option provides the choice of a bar graph or a text display showing the amplitude of selected channels for a given air interface standard. The interface settings can be manually entered if none of the available air interface standards meet the measurement need.

To select Channel Scanner mode, press the **MODE** key and use the up and down arrows to highlight Channel Scanner and press **ENTER**.

- FREQ/DIST** The operating frequency range for Channel Scanner mode can either be set manually, or the desired air interface standard can be selected from the Signal Standard list in the instrument. When the frequency range is selected from the Signal Standard list, all frequency related parameters are automatically set to the appropriate values for that particular standard.
- Start Freq** — Enter a start frequency from 9 kHz to 3000 MHz using the Up/Down arrow key, or the keypad and the appropriate soft key for Hz, kHz, MHz or GHz. Press **ENTER** to accept the input.
  - Freq Step Size** — The value entered here is the channel spacing. Enter a step size from 0 to 3000 MHz using the Up/Down arrow key, or the keypad and the appropriate soft key for Hz, kHz, MHz or GHz. Press **ENTER** to accept the input.
  - Signal Standard** — Opens a menu of soft keys used to select the signal standard to be used.
    - Select Standard** — Opens the signal standard menu, showing the currently selected signal standards. Use the soft keys to navigate the list. Press the Show All soft key to show the complete signal standard list. When the complete list is displayed, the currently selected signal standards are marked with an asterisk. Press the Show Selected soft key to show only the currently selected signal standards.
    - Start Channel** — Sets the channel information for the available standard. If the particular standard has not been used before, the channel number will default to the lowest legal channel number for that standard. If that standard has been used before, the last used channel will be the default.
    - Uplink** — Selects the bank of frequencies that correspond to signals sent from the client transmitter to the base station.
    - Downlink** — Selects the bank of frequencies that correspond to the signals sent from the base station to the client receivers.
    - Back** — Returns to the previous menu.
  - Channel Step Size** — This integer value tells the system how many channels to skip when scanning. Enter a step size from 1 to 1023 using the Up/Down arrow key or the keypad and press **ENTER** to accept the input. Channel Step Size is especially useful when channels overlap, such as CDMA and WiFi channels.
  - Channel Span** — Channel Span sets the width of each channel. Enter a Channel Span from 0 to 3000 MHz using the Up/Down arrow key, or the keypad and the appropriate soft key for Hz, kHz, MHz or GHz. Press **ENTER** to accept the input.

**AMPLITUDE** Choosing **AMPLITUDE** causes the soft keys, below, to be displayed and the corresponding values to be shown in the message area.

- ❑ **Ref Level** — Reference Level sets the power level at the top of the display. Enter a value from +20.0 to -120.0 dBm, in 0.1 dB steps, using the Up/Down arrow key or the keypad and press **ENTER** to accept the input. The currently selected reference level is shown in the message area at the bottom of the display.
- ❑ **Scale** — Scale sets the number of dB per division. Enter a value from 1 dB per division to 15 dB per division using the Up/Down arrow key or the keypad and press **ENTER** to accept the input. The currently selected scale is shown in the message area at the bottom of the display.

**MEAS/DISP** Pressing **MEAS/DISP** activates a menu of channel and display functions. Use the corresponding soft key to select the desired function.

- ❑ **Number of Channels** — Number of Channels sets how many channels are simultaneously shown on the display. Enter a value from 1 to 20 channels using the Up/Down arrow key or the keypad and press **ENTER** to accept the input.
- ❑ **Display Channel/Freq** — Display Channel/Frequency toggles between displaying the channel number or the channel frequency (with a resolution of 100 MHz).

**Display Graph/Text** — Display Graph/Text toggles between displaying a bar chart showing power levels, or a table showing channel number or frequency (depending upon the current setting of Display Channel Freq) and the power level.

**SYS** In Channel Scanner mode, pressing the **SYS** key displays the following System menu soft key selections:

- ❑ **System Options** — Displays a second level of system option functions:
  - ❑ **Clock** — Displays a second level of functions:
    - ❑ **Hour** — Enter the hour (0-23) using the Up/Down arrow key or the keypad. Press **ENTER** when data entry is complete or **ESCAPE** to restore the previous value.
    - ❑ **Minute** — Enter the minute (0-59) using the Up/Down arrow key or the keypad. Press **ENTER** when data entry is complete or **ESCAPE** to restore the previous value.
    - ❑ **Month** — Enter the month (1-12) using the Up/Down arrow key or the keypad. Press **ENTER** when data entry is complete or **ESCAPE** to restore the previous value.
    - ❑ **Day** — Enter the day using the Up/Down arrow key or the keypad. Press **ENTER** when data entry is complete or **ESCAPE** to restore the previous value.
    - ❑ **Year** — Enter the year (2003-2036) using the Up/Down arrow key or the keypad. Press **ENTER** when data entry is complete or **ESCAPE** to restore the previous value.
    - ❑ **Back** — Returns to the top-level SYS menu.
  - ❑ **Printer** — Displays a menu of supported printers. Use the Up/Down arrow key and **ENTER** key to make the selection.
  - ❑ **Units** — Select the unit of measurement (metric or English).

- ❑ Change Date Format — Toggles the date format between MM/DD/YYYY, DD/MM/YYYY, and YYYY/MM/DD.
- ❑ Back — Returns to the top-level SYS menu.
- ❑ Application Options — Application options displays options applicable to particular mode.
  - ❑ External Ref Freq — Set the external reference frequency from 2 MHz to 20 MHz.
  - ❑ Impedance — Sets the input impedance of the instrument
    - ❑ 50 $\Omega$  — Sets the input impedance of the instrument to 50 $\Omega$ , which is the default setting.
    - ❑ 75 $\Omega$  Anritsu 12N50-75B — Displays measurements as if the input impedance was 75 $\Omega$ . The actual input impedance is still 50 $\Omega$ , but the displayed information is transformed to the equivalent 75 $\Omega$  value based on the offset value specified by the adapter used in the measurement. This setting is commonly used for cable TV-related measurements. Pressing this soft key will also compensate 7.5 dB for the loss of the Anritsu 12N50-75B adapter.
    - ❑ Other adapter Offset — This key allows the user to enter other adapter offset values. Enter the desired loss using the keypad or Up/Down arrow key and press the **ENTER** key to accept.
    - ❑ Back — Returns to the previous menu.
  - ❑ Back — Returns to the top-level SYS menu.
- ❑ Self Test — Start an instrument self test.
- ❑ Status — In cable and antenna analyzer freq or dist measurement mode, displays the current instrument status, including calibration status, temperature, and battery charge state. Press **ESCAPE** to return to operation.
- ❑ GPS — Opens the GPS soft key menu.
  - ❑ Press the GPS On/Off soft key to turn the GPS feature on or off.
  - ❑ Press the Location soft key to view the latitude, longitude and altitude information and UTC timing.
  - ❑ Press the Quality soft key to display the number of tracked satellites and the GPS quality.
  - ❑ Press the Reset soft key to reset the GPS.
  - ❑ Back — Returns to the previous menu.
- ❑ Language — Pressing this soft key immediately changes the language used to display messages on the Site Master status window. Choices are English, French, German, Spanish, Chinese, and Japanese. The default language is English.

## CW Signal Generator Mode (Option 28)

To select CW Signal Generator mode, press the **MODE** key and use the down arrow to highlight CW Signal Generator and press **ENTER**.

The CW Signal Generator option provides a CW signal from the instrument. The primary purpose of this signal is for sensitivity testing of receivers. To use this feature, the signal is connected directly to the receiver being measured and the output amplitude is reduced until the receiver drops the signal.

The external splitter feeds the signal into the instrument's RF input. The display shows the output power and frequency. The amplitude is set using an external step attenuator.

The external splitter and attenuator are customer-supplied.

### Soft Keys

The following soft keys are available when entering CW Signal Generator mode, or by pressing the **FREQ/DIST** function key while in CW Signal Generator mode:

- ❑ **Freq** — Enter a CW frequency from 25 MHz to 3000 MHz using the Up/Down arrow key, or the keypad and the appropriate soft key for Hz, kHz, MHz or GHz. Press **ENTER** to accept the input.
- ❑ **Display Setup Help** — Selecting this soft key displays a diagram of the recommended setup to use this option.
- ❑ **Signal Standard** — Opens a menu of soft keys used to select the signal standard to be used.
  - ❑ **Select Standard** — Opens the signal standard menu, showing the currently selected signal standards. Use the soft keys to navigate the list. Press the **Show All** soft key to show the complete signal standard list. When the complete list is displayed, the currently selected signal standards are marked with an asterisk. Press the **Show Selected** soft key to show only the currently selected signal standards.
  - ❑ **Start Channel** — Sets the channel information for the available standard. If the particular standard has not been used before, the channel number will default to the lowest legal channel number for that standard. If that standard has been used before, the last used channel will be the default.
  - ❑ **Uplink** — Selects the bank of frequencies that correspond to signals sent from the client transmitter to the base station.
  - ❑ **Downlink** — Selects the bank of frequencies that correspond to the signals sent from the base station to the client receivers.
  - ❑ **Back** — Returns to the previous menu.

### **SYS**

In CW Signal Generator mode, pressing the **SYS** key displays the following System menu soft key selection

- ❑ **System Options** — Displays a second level of system option functions:
  - ❑ **Clock** — Displays a second level of functions:
    - ❑ **Hour** — Enter the hour (0-23) using the Up/Down arrow key or the keypad. Press **ENTER** when data entry is complete or **ESCAPE** to restore the previous value.

- Minute — Enter the minute (0-59) using the Up/Down arrow key or the keypad. Press **ENTER** when data entry is complete or **ESCAPE** to restore the previous value.
- Month — Enter the month (1-12) using the Up/Down arrow key or the keypad. Press **ENTER** when data entry is complete or **ESCAPE** to restore the previous value.
- Day — Enter the day using the Up/Down arrow key or the keypad. Press **ENTER** when data entry is complete or **ESCAPE** to restore the previous value.
- Year — Enter the year (2003-2036) using the Up/Down arrow key or the keypad. Press **ENTER** when data entry is complete or **ESCAPE** to restore the previous value.
- Back — Returns to the top-level SYS menu.
- Printer — Displays a menu of supported printers. Use the Up/Down arrow key and **ENTER** key to make the selection.
- Units — Select the unit of measurement (metric or English).
- Change Date Format — Toggles the date format between MM/DD/YYYY, DD/MM/YYYY, and YYYY/MM/DD.
- Back — Returns to the top-level SYS menu.
- Application Options — Application options displays options applicable to particular mode.
  - External Ref Freq — Set the external reference frequency from 2 MHz to 20 MHz.
  - Bias Tee — Selects Bias Tee on or off.
  - Impedance — Sets the input impedance of the instrument
    - 50 $\Omega$  — Sets the input impedance of the instrument to 50 $\Omega$ , which is the default setting.
    - 75 $\Omega$  Anritsu 12N50-75B — Displays measurements as if the input impedance was 75 $\Omega$ . The actual input impedance is still 50 $\Omega$ , but the displayed information is transformed to the equivalent 75 $\Omega$  value based on the offset value specified by the adapter used in the measurement. This setting is commonly used for cable TV-related measurements. Pressing this soft key will also compensate 7.5 dB for the loss of the Anritsu 12N50-75B adapter.
    - Other adapter Offset — This key allows the user to enter other adapter offset values. Enter the desired loss using the keypad or Up/Down arrow key and press the **ENTER** key to accept.
    - Back — Returns to the previous menu.
  - Back — Returns to the top-level SYS menu.
- Self Test — Start an instrument self test.
- Status — In cable and antenna analyzer freq or dist measurement mode, displays the current instrument status, including calibration status, temperature, and battery charge state. Press **ESCAPE** to return to operation.
- GPS — Opens the GPS soft key menu.
  - Press the GPS On/Off soft key to turn the GPS feature on or off.
  - Press the Location soft key to view the latitude, longitude and altitude information and UTC timing.



- ❑ Press the Quality soft key to display the number of tracked satellites and the GPS quality.
- ❑ Press the Reset soft key to reset the GPS.
- ❑ Back — Returns to the previous menu.
- ❑ Language — Pressing this soft key immediately changes the language used to display messages on the Site Master status window. Choices are English, French, German, Spanish, Chinese, and Japanese. The default language is English.

## Power Meter Menus (Option 29)

Selecting Power Meter from the mode menu causes the soft keys, described below, to be displayed and the corresponding values shown in the message area.

The following soft keys are available when the **FREQ/DIST** key is pressed.

- Center — Activates the center frequency function and sets the power meter to the center frequency. A frequency from 4.5 MHz to 2.9985 MHz can be entered.
- Span — Opens the parameter for editing and activates a menu of span related choices.
  - Edit — Allows editing of the span to enter specific frequency.
  - Full — Sets the power meter to its maximum frequency span.
  - Min — Minimum span in Power Meter mode is 3 MHz.
  - Span Up 1-2-5 — Activates the span function so that the span may be increased quickly in a 1-2-5 sequence.
  - Span Down 1-2-5 — Activates the span function so that the span may be reduced quickly in a 1-2-5 sequence.
  - Back — Returns to the previous menu level.
- Signal Standard — Opens a menu of soft keys used to select the signal standard to be used.
  - Select Standard — Opens the signal standard menu, showing the currently selected signal standards. Use the soft keys to navigate the list. Press the Show All soft key to show the complete signal standard list. When the complete list is displayed, the currently selected signal standards are marked with an asterisk. Press the Show Selected soft key to show only the currently selected signal standards.
  - Start Channel — Sets the channel information for the available standard. If the particular standard has not been used before, the channel number will default to the lowest legal channel number for that standard. If that standard has been used before, the last used channel will be the default.
  - Uplink — Selects the bank of frequencies that correspond to signals sent from the client transmitter to the base station.
  - Downlink — Selects the bank of frequencies that correspond to the signals sent from the base station to the client receivers.
  - Back — Returns to the previous menu.

The following soft keys are available when the **AMPLITUDE** key is pressed.

- Units — Choose either Watts or dBm.
- Rel — Selects whether relative power is on or off. When on, the message Relative: On will show in the message area.
- Offset — Turns offset on or off. When on, a value from 0-60 dB can be entered.
- Zero — Turns zero adjust on or off.

The following soft key is available when the **MEAS/DISP** key is pressed.

- ❑ RMS Acquisition — The RMS Acquisition menu adjusts the number of acquisitions the instrument will collect.
  - ❑ Off — Turns off RMS Acquisition.
  - ❑ Low
  - ❑ Medium
  - ❑ High
  - ❑ Back — Returns to the previous menu.
- ❑ Running Averages — Activates the RMS Averaging menu. The RMS average is calculated by taking the log of the average power and the power is calculated from voltage. The number of points to average can be set to low, medium, or high.

## T1 Tester Mode Menus (Option 50)

In T1 Tester mode (Option 50, S331D only), the **FREQ/DIST** and **AMPLITUDE** hard keys are not used. Pressing the **MEAS/DISP** key in T1 Tester mode causes the soft keys, below, to be displayed:

- BERT — Activates menus that are used Bit Error Rate Testing (BERT).
  - Setup BERT — Activates menus that are used to set BERT testing options.
    - Framing Mode — Selects the framing mode to be used.
      - Auto — Automatically detects the received framing mode.
      - D4 SF — Sets the T1 framing mode to Super Frame.
      - ESF — Sets the T1 framing mode to Extended Super Frame.
      - Back — Returns to the previous menu.
    - Receive Input
      - Terminate — Terminates the circuit under test with 100Ω. Terminate mode is used to test out of service or newly installed T1 lines when there is no traffic data.
      - Bridged — Bridged mode provides greater than 1 kΩ impedance to test the in-service line by bridging the receiver input across T1 lines.
      - Monitor +20 dB — Monitor mode adds 20 dB of gain, and is used when the connection to the circuit under test is through a 20 dB pad. In the monitor mode the Site Master sensitivity is increased by 20 dB to account for the resistive loss at the port, and is set for 100Ω nominal input impedance. In this mode the technician should be careful not to disturb the signal by using the wrong connector.
      - Back — Returns to the previous menu.
    - Pattern — Opens a list of available BERT patterns. Use the soft keys or the Up/Down arrow key to highlight a pattern and press **ENTER** to select.
    - Line Coding — Selects the line coding to be used.
      - B8ZS — Bipolar with eight-zero substitution. A T1 code in which bipolar violations are deliberately inserted if the user data contains a string of eight or more consecutive zeros. B8ZS is used to ensure a sufficient number of transitions to maintain system synchronization.
      - AMI — Alternate Mark Inversion. A bipolar signal in which ones are encoded as pulses with alternating polarity, and zeros are encoded as zero amplitude.
      - Back — Returns to the previous menu.
  - More
    - Clock Source — Selects the clock source.
      - Internal — Uses the internal clock.
      - External — The Site Master clock is synchronized with the received signal clock.
      - Back — Returns to the previous menu.

- ❑ Setup Error Insert — Opens the error insert menu which allows insertion of the following errors in the transmitting signal.
  - ❑ Bit — Configures the unit to insert bit errors.
  - ❑ BPV — Configures the unit to insert Bipolar Violations.
  - ❑ Framing Bits — Configures the unit to insert framing bit errors.
  - ❑ RAI — Configures the unit to send a Remote Alarm Indication (yellow alarm).
  - ❑ AIS — Configures the unit to send an Alarm Indication Signal (blue alarm).
  - ❑ Back
- ❑ Loop Code — Selects the loop code to be used.
  - ❑ CSU — Channel Service Unit. Configures the unit to send CSU loopback codes.
  - ❑ NIU — Network Interface Unit. Configures the unit to send NIU loopback codes.
  - ❑ User 1 — Configures the unit to send a user-defined loopback code.
  - ❑ User 2 — Configures the unit to send a user-defined loopback code.
  - ❑ In Band/Data Link — Configures the unit to send the loopback code either in the data stream or in the Facility Data Link. The Data Link mode cannot be selected with D4SF framing.
  - ❑ Back
- ❑ Transmit Level — Selects the T1 transmit level.
  - ❑ 0 dB
  - ❑ -7.5 dB
  - ❑ -15 dB
  - ❑ Back
- ❑ ANSI CRC/Japan CRC — Selects either the ANSI or Japanese methods for calculating CRC. Also selects between the ANSI and Japanese methods of generating RAI.
  - ❑ Back
- ❑ Measure BERT — Activates menus that are used to control the BERT measurement.
  - ❑ Display Raw Data/Histogram — Selects whether to display the raw data or a histogram.
  - ❑ Start/Stop Measure — Starts or stops the measurement.
  - ❑ Insert Errors — Injects the selected error(s) into the data stream, or sends the selected alarm when in transmitting mode.
  - ❑ Measure Duration — Selects the duration of the measurement. The duration can be 3 minutes, 15 minutes, 30 minutes, 1 hour, 3 hours, 6 hours, 12 hours, 1 day, 2 days or the duration can be manually set. Use the Up/Down arrow key to display the desired duration and press **ENTER** to select, or **ESCAPE** to restore the previous value.

- ❑ Time Scale — When histogram is selected, the time scale can be set from one second to one hour in the following steps: 1 second, 15 seconds, 30 seconds, 45 seconds, 1 minute, 15 minutes, 30 minutes, 45 minutes, 60 minutes, or AUTO. When AUTO is selected, the time scale is adjusted so that the measurement duration will fill the status window. Use the Up/Down arrow key to display the desired duration and press **ENTER** to select, or **ESCAPE** to restore the previous value.
- ❑ More — Opens the loop code menu.
  - ❑ Self Loop Up — Loops the received signal to the transmitted signal.
  - ❑ Self Loop Down — Turns off the internal loopback.
  - ❑ Remote Loop Up — Transmits the selected loopback activate code. After the loop activate code has been transmitted for the specified time, the circuit is tested to see if the attempt was successful and the result is reported.
  - ❑ Remote Loop Down — Transmits the selected loopback deactivate code. After the loopback deactivate code has been transmitted for the specified time, the circuit is tested to see if the attempt was successful and the result is reported.
  - ❑ Back — Returns to the previous menu.
- ❑ Vpp — Measures and displays the peak-to-peak voltage.
  - ❑ Start/Stop Measure — Starts or stops the measurement.
  - ❑ Terminate/Bridged — Select terminated or bridged measurement.
  - ❑ Vpp/dBdsx — Toggles between a voltage peak-to-peak measurement and dBdsx measurement.
  - ❑ Back — Returns to the previous menu.

## E1 Tester Mode Menus (Option 50)

In E1 Tester mode (Option 50, S331D only), the **FREQ/DIST** and **AMPLITUDE** hard keys are not used. Pressing the **MEAS/DISP** key in E1 Tester mode causes the soft keys, below, to be displayed:

- ❑ BERT — Activates menus that are used Bit Error Rate Testing (BERT).
  - ❑ Setup BERT — Activates menus that are used to set BERT testing options.
    - ❑ Framing Mode — Selects the framing mode to be used.
      - ❑ Auto — Automatically detects the received framing mode.
      - ❑ PCM30 — Sets the E1 framing mode to PCM30.
      - ❑ PCM30 CRC — Sets the E1 framing mode to PCM30 with CRC.
      - ❑ PCM31 — Sets the E1 framing mode to PCM31.
      - ❑ PCM31 CRC — Sets the E1 framing mode to PCM31 with CRC.
      - ❑ Back
    - ❑ Receive Input
      - ❑ Terminate — Terminates the circuit under test with either 75 or 120 ohms. Terminate mode is used to test out of service or newly installed E1 lines when there is no traffic data.
      - ❑ Bridged — Bridged mode provides greater than 1 k $\Omega$  impedance to test the in-service line by bridging the receiver input across E1 lines.
      - ❑ Monitor +20 dB — Monitor mode adds 20 dB of gain, and is used when the connection to the circuit under test is through a 20 dB pad.
      - ❑ Back — Returns to the previous menu.
  - ❑ Pattern — Opens a list of available BERT patterns. Use the soft keys or the Up/Down arrow key to highlight a pattern and press **ENTER** to select.
  - ❑ Line Coding — Selects the line coding to be used.
    - ❑ HDB3 — High Density Bipolar. An E1 code in which bipolar violations are inserted if the user data contains more than three consecutive zeros.
    - ❑ AMI — Alternate Mark Inversion. A bipolar signal in which ones are encoded as pulses with alternating polarity, and zeros are encoded as zero amplitude.
  - ❑ More
    - ❑ Clock Source — Selects the clock source.
      - ❑ Internal — Uses the internal clock.
      - ❑ External — The clock is recovered from the receiver signal.
      - ❑ Back — Returns to the previous menu.
    - ❑ Setup Error Insert — Opens the error insert menu.
      - ❑ Bit — Configures the unit to insert bit errors.
      - ❑ BPV — Configures the unit to insert Bipolar Violations.
      - ❑ Framing Bits — Configures the unit to insert framing bit errors.









- RAI — Configures the unit to send a Remote Alarm Indication (yellow alarm).
- AIS — Configures the unit to send an Alarm Indication Signal (blue alarm).
- Back — Returns to the previous menu.
- Impedance — Sets the Tx and Rx impedance.
  - 75 $\Omega$  — Select 75 ohm impedance.
  - 120 $\Omega$  — Select 120 ohm impedance.
  - Back — Returns to the previous menu.
- Back — Returns to the previous menu.
- Measure BERT — Activates menus that are used to control the BERT measurement.
  - Display Raw Data/Histogram — Selects whether to display the raw data or a histogram.
  - Start/Stop Measure — Starts or stops the measurement.
  - Insert Errors — Injects the selected error(s) into the data stream when transmitting, or sends the selected alarm.
  - Measure Duration — Selects the duration of the measurement. The duration can be 3 minutes, 15 minutes, 30 minutes, 1 hour, 3 hours, 6 hours, 12 hours, 1 day, 2 days or manual. Use the Up/Down arrow key to display the desired duration and press **ENTER** to select, or **ESCAPE** to restore the previous value.
  - Time Scale — When histogram is selected, the time scale can be set from one second to one hour in the following steps: 1 second, 15 seconds, 30 seconds, 45 seconds, 1 minute, 15 minutes, 30 minutes, 45 minutes, 60 minutes, or AUTO. Use the Up/Down arrow key to display the desired time scale and press **ENTER** to select, or **ESCAPE** to restore the previous value.
- More
  - Self Loop Up — Loops the received signal to the transmitted signal.
  - Self Loop Down — Turns off the internal loopback.
  - Back — Returns to the previous menu.
- Vpp — Measures and displays the peak-to-peak voltage.
  - Start/Stop Measure — Starts or stops the measurement.
  - Terminate/Bridged — Select terminate or bridging for the Vpp measurement.
  - 75 $\Omega$  — Select 75 $\Omega$  impedance.
  - 120 $\Omega$  — Select 120 $\Omega$  impedance.
  - Vpp/dBdsx — Toggles between a voltage peak-to-peak measurement and dBdsx measurement.
  - Back — Returns to the previous menu.



## Symbols

Table 2-1 provides a listing of the symbols used as condition indicators on the LCD status window.

Table 2-1. LCD Icon Symbols

<u>Icon</u>	<u>Symbol</u>
	Site Master is in Hold for power conservation. To resume sweeping, press the RUN/HOLD key. When running on battery power, after 10 minutes without a key press, the Site Master will automatically activate the power conservation mode.
	GPS is on and locked to the satellites.
	This symbol displayed in red means GPS is on and is searching for satellites. The same symbol in green means the Site Master has stored the GPS location information but is not currently locked to the satellites. The data will remain stored until the unit is turned off.
	Integrator Failure. Intermittent integrator failure may be caused by interference from another antenna. Persistent integrator failure indicates a need to return the Site Master to the nearest Anritsu service center for repair.
	Lock fail indication. Check battery. (If the Site Master fails to lock with a fully charged battery, call your Anritsu Service Center.)
	When calibration is performed, the Site Master stores the temperature. If the temperature drifts outside the specified range, this icon will appear at the top of the status window, and the Cal Off message will be displayed. A recalibration at the current temperature is recommended.
	Indicates the remaining charge on the battery. The inner white rectangle grows longer as the battery charge depletes.
	Indicates internal data processing.
Cal On	The Site Master has been calibrated with discrete Open, Short and Load components.
Cal On!	The Site Master has been calibrated with the InstaCal Module.
Cal Off	The Site Master has not been calibrated.
FlexCal On	The Site Master has been calibrated with discrete Open, Short and Load components for the frequency supported by the unit (25 MHz to 4000 MHz).
FlexCal On!	The Site Master has been calibrated with the InstaCal Module for the frequency supported by the unit (25 MHz to 4000 MHz).

## **Self Test**

At turn-on, the Site Master runs through a series of quick checks to ensure the system is functioning properly. Note that the voltage and temperature are displayed in the lower left corner below the self test message. If the battery is low, or if the ambient temperature is not within the specified operational range, Self Test will fail. If Self Test fails and the battery is fully charged and the Site Master is within the specified operating temperature range, call your Anritsu Service Center.

## Error Messages

### Self Test Error Messages

A listing of Self Test Error messages is provided in Table 2-2.

Table 2-2. Self Test Error Messages

<u>Error Message</u>	<u>Description</u>
Battery Low	Battery voltage is less than 9.5 volts. Charge battery. <i>If condition persists, call your Anritsu Service Center.</i>
External Power Low	External supply voltage is less than 10 volts. <i>Call your Anritsu Service Center</i>
PLL Failed	Phase-locked loops failed to lock. Charge battery. <i>If condition persists with a fully charged battery, call your Anritsu Service Center</i>
Integrator Failed	Integration circuit could not charge to a valid level. Charge battery. <i>If condition persists with a fully charged battery, call your Anritsu Service Center.</i>
EEPROM R/W Failed	Non-volatile memory system has failed. <i>Call your Anritsu Service Center.</i>
Out Of Temp. Range	Ambient temperature is not within the specified operating range. <i>If the temperature is within the specified operating range and the condition persists, call your Anritsu Service Center.</i>
RTC Battery Low	The internal real-time clock battery is low. A low or drained clock battery will affect the date stamp on saved traces. <i>Contact your nearest Anritsu Service Center.</i>
LO Lock Fail	The local oscillator in the spectrum analyzer has phase lock loop errors. <i>If condition persists with a fully charged battery, call your Anritsu Service Center.</i>
Battery Cal Lost	Battery communication failed. The indicated battery charge status may be invalid. <i>If condition persists, call your Anritsu Service Center.</i>
Memory Fail	The EEPROM test on the Site Master main board has failed. <i>If condition persists, call your Anritsu Service Center.</i>
The time and date Have not been set on this Site Master. To set it, after exiting here press the <SYS> [Clock] keys. Press ENTER or ESC to continue	The time and date are not properly set in the Site Master. <i>If condition persists, call your Anritsu Service Center.</i>

*Note: A listing of Anritsu Service Centers is provided on page 1-14.*

## Range Error Messages

A listing of Range Error messages is provided in Table 2-3.

Table 2-3. Range Error Messages

<u>Error Message</u>	<u>Description</u>
RANGE ERROR:F1 > F2	The start (F1) frequency is greater than the stop (F2) frequency.
RANGE ERROR:D1 > D2	The start (D1) distance is greater than the stop (D2) distance.
RANGE ERROR:D2 > DMax=xx.x ft (m)	The stop distance (D2) exceeds the maximum unaliased range. This range is determined by the frequency span, number of points, and relative propagation velocity:  $\text{Maximum Unaliased Range} = \frac{(1.5 \times 10^8)(dp - 1)(V_f)}{F2 - F1}$ <p>Where: <i>dp</i> is the number of data points (130, 259, or 517)  <i>V<sub>f</sub></i> is the relative propagation velocity  <i>F2</i> is the stop frequency in Hz  <i>F1</i> is the start frequency in Hz  Maximum Unaliased Range is in meters</p>
RANGE ERROR: TOP<=BOTTOM	The SWR scale parameter top value is less than or equal to its bottom value.
RANGE ERROR: TOP>=BOTTOM	The RL scale parameter top value is greater than or equal to its bottom value.

## Spectrum Analyzer Error Messages

A listing of Spectrum Analyzer Error Messages is provided in Table 2-4.

Table 2-4. *Spectrum Analyzer Error Messages*

<u>Error Message</u>	<u>Description</u>
OVER LOAD Decrease Input Power	This error message is displayed when there is too much input power.
OVER RANGE! Increase Attenuation	The ADC is over range.
Mixer Saturation! Increase Atten	The Mixer has saturated.
Ext Ref Not Locked	This error is displayed when a signal is present at the external reference port, but is not locked to the specified frequency.
External reference unavailable Using internal reference.	This error is displayed when there is no signal detected at the External Reference port.
Must be in Zero Span to perform this operation	This error is displayed when the user attempts to change the following parameters when not in zero span: CHANGE TRIGGER POSITION – (MEAS/DISP/TRIGGER) VIDEO TRIGGER – (MEAS/DISP/TRIGGER)
Cannot Perform Operation in Zero Span	This error is displayed when the user tries to do field strength, occupied bandwidth, channel power and adjacent channel power measurements when in Zero Span.
Xref N MHz	The internal reference is locked to an N MHz external clock.
Min RBW for Zero Span is 30 kHz. RBW has been adjusted.	The RBW in Zero Span mode must be at least 30 kHz. If it is not, it will automatically be adjusted to 30 kHz and this message will be displayed.
Over Power Condition! Remove signals connected to RF In port and re-enter Spectrum Analyzer mode.	This error message is displayed when the spectrum analyzer mode cannot be properly calibrated due to too much signal power. The power must be removed, and the mode re-entered in order to calibrate the unit.

---

## InstaCal Error Messages

If the serial number of the connected InstaCal module does not match the serial number stored in the Site Master, the following message is displayed:

*The InstaCal characterization data stored in the Site Master is for a module different than the one currently connected. Site Master contains data for InstaCal module S/N: xxxxx Currently connected InstaCal Module S/N: xxxxx Would you like to overwrite the previously loaded InstaCal characterization?*

Press the YES soft key to update the stored InstaCal characterization to use the currently connected module.

Press the NO soft key to keep the stored InstaCal characterization.

A listing of possible InstaCal error messages is provided in Table 2-5.

Table 2-5. *InstaCal Error Messages*

<b><u>Error Message</u></b>	<b><u>Description</u></b>
Failed to read serial number of InstaCal module	The Site Master was unable to read the InstaCal module serial number.
Failed to successfully transfer instacal module data to Site Master	The Site Master was unable to transfer all necessary data between the InstaCal module and the Site Master.
Failed to set baud with InstaCal module	The Site Master was unable to establish communication with the InstaCal module.

## High Accuracy Power Meter (Option 19) Error Messages

The following error messages could be displayed on the Site Master when using the High Accuracy Power Meter mode with Power Sensor PSN50. If any error condition persists, contact your local Anritsu Service Center.

Table 2-6. Option 19 Error Messages

<b><u>Error Message</u></b>	<b><u>Description</u></b>
Warning! Power Supply Error	Verify that the supply is connected properly.
Warning! RF Power Level is too high	The specified upper measurement range is +20 dBm. Do not exceed the specification.
Warning! Sensor not zeroed properly. Zero sensor again	The sensor must be zeroed with nothing connected to it.
Warning! Specified temperature range (0 to 50°C) exceeded	The PSN50 sensor temperature range is 0 to 50°C.
Warning! Temperature has changed. Zero sensor again	The temperature changed more than the allowable limit after the sensor was zeroed.

## General Error Messages

A listing of General Error Messages is provided below.

Table 2-7. General Error Messages

<b><u>Error Message</u></b>	<b><u>Description</u></b>
CAL Incomplete	A complete open, short, and load calibration must be performed before calibration can be turned on.
Dist Requires F1 < F2	Valid distance to fault plots require a non-zero frequency span.
Invalid Sweep Data	The sweep data is invalid.
Use Options menu to select a printer	Attempting to print a display with no printer selected. Select a printer, then retry.
Flexcal is not suitable for this case, Change To OSL CAL mode (SYS-Options)	The cable is too long or too reflective for FlexCal to work. OSL cal must be used instead.
Cannot zero input signal too high	Attempting to perform a Power Meter zero adjust function with an input of greater than -20 dBm.

---

## Battery Information

### Charging a New Battery

The NiMH battery supplied with the Site Master has already completed three charge and discharge cycles at the factory and full battery performance should be realized after your first charge.

*NOTE: Use only Anritsu approved batteries, adapters and chargers with this instrument. The battery will not charge if the battery temperature is above 45° C or below 0° C.*

### Charging the Battery in the Site Master

The battery can be charged while installed in the Site Master.

- Step 1.** Turn the Site Master off.
- Step 2.** Connect the AC-DC adapter (Anritsu part number: 40-168) to the Site Master charging port.
- Step 3.** Connect the AC adapter to a 120 VAC or 240 VAC power source as appropriate for your application.

The green external power indicator on the Site Master will illuminate, indicating the presence of external DC power, the battery charge indicator will light, and the battery will begin fast charging. If the battery fails to charge, contact your nearest Anritsu service center.

*NOTES: If the battery temperature exceeds 50° C while charging, the charging will stop and the charge indicator will turn off. Charging will resume automatically when the temperature drops below 50° C.*

### Charging the Battery in the Optional Charger

Up to two batteries can be charged sequentially in the optional battery charger.

- Step 1.** Remove the NiMH battery from your Site Master and place it in the optional charger (Anritsu part number 2000-1029).
- Step 2.** Connect the lead from the AC-DC adapter to the charger.
- Step 3.** Connect the AC-DC adapter to a 120 VAC or 240 VAC power source as appropriate for your application.

Each battery holder in the optional charger has an LED charging status indicator. The LED color changes as the battery is charged:

- Red indicates the battery is charging
- Green indicates the battery is fully charged
- Yellow indicates the battery is in a waiting state (see below).

A yellow light may occur because the battery became too warm during the charge cycle. The charger will allow the battery to cool off before continuing the charge. A yellow light may also indicate that the charger is alternating charge to each of the two batteries.



A blinking red light indicates less than 13 VDC is being supplied to the charger stand. Check that the correct AC charger adapter is connected to the charger stand. If the battery fails to charge, contact your nearest Anritsu Service Center.

## Determining Remaining Battery Life

When the AC-DC adapter is unplugged from the Site Master, the battery indicator symbol will be continuously displayed at the top left corner of the Site Master display (Figure 2-19). A totally black bar within the battery icon indicates a fully charged battery. When LOW BATT replaces the battery indicator bar at the top left corner, a couple of minutes of measurement time remains. If a flashing LOW BATT is accompanied by an audio beep at the end of each trace, the battery has approximately one minute of useable time remaining.

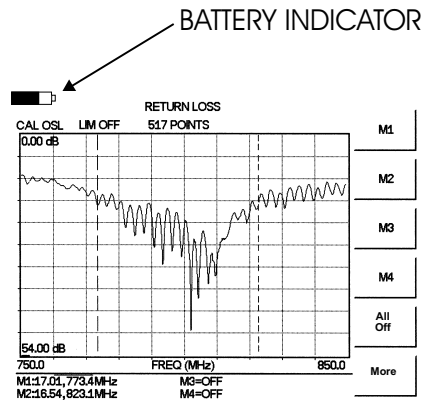

Figure 2-19. Site Master Battery Indicator

Once all the power has drained from the battery, the Site Master LCD will fade. At this point, your Site Master will switch itself off and the battery will need to be recharged.

During operation, the battery condition can be viewed by pressing the **SYS** key and selecting the Self Test soft key (Figure 2-20). The battery condition will be displayed as a percentage of charge remaining.

---

Selftest

Temperature . . . . .	24°C
Memory . . . . .	PASSED
RTC Battery. . . . .	3.1V
Voltage . . . . .	Battery (11.1V)
Battery Cal . . . . .	PASSED
Battery Charge. . . . .	84% (I = -743mA)
VNA PLL . . . . .	PASSED
VNA Integrator . . . . .	PASSED
SPA LO . . . . .	PASSED

Press **ESCAPE** to return.

---

Figure 2-20. Self Test Display (S332D shown)

## Battery Life

The NiMH battery will last longer and perform better if allowed to completely discharge before recharging. For maximum battery life, it is recommended that the NiMH battery be completely discharged and recharged once every three months.

The charging circuitry inside the Site Master is designed to optimize the life of the battery. If the temperature inside the instrument exceeds 50°C, the current charge cycle will be suspended and a new charge cycle will not start until the temperature has come down to 50°C.

The Site Master is also equipped with an automatic charging process that changes the charging level based on the battery capacity. If the battery has been completely discharged to zero volts, a pre-charge at a low DC current will be applied until the battery reaches a level which is safe for a faster charge cycle. Similarly, the charging level will change when the battery is close to fully charged. This charging process helps maximize the number of recharge cycles available from the battery.

It is normal for NiMH batteries to self-discharge during storage (Figure 2-21) and to degrade to 80% of original capacity after 12 months of continuous use.

---

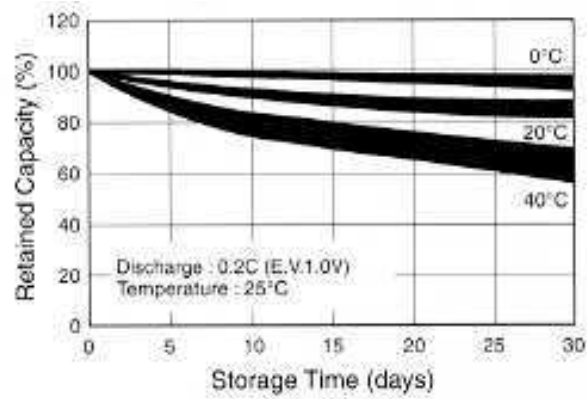

*Figure 2-21. NiMH Battery Storage Characteristics*

The battery can be charged and discharged 300 to 500 times, but it will eventually wear out. The battery may need to be replaced when the operating time between charging is noticeably shorter than normal.

## **Important Battery Information**

- The NiMH battery supplied with the Site Master has already completed three charge and discharge cycles at the factory and full battery performance should be realized after the first charge.
- Recharge the battery only in the Site Master, or in an Anritsu approved charger.
- If left unused, a fully charged battery will discharge itself over time.
- Storing the battery in extreme hot or cold places will reduce the capacity and lifetime of the battery. The battery will discharge faster at higher ambient temperatures (see Figure 2-21).
- Discharge an NiMH battery from time to time to improve battery performance and battery life.
- The battery can be charged and discharged hundreds of times, but it will eventually wear out.
- The battery may need to be replaced when the operating time between charging is noticeably shorter than normal.
- If a battery is allowed to totally discharge, the smart-memory capability of the battery may be lost, resulting in incorrect battery capacity readings or loss of communication with the battery.
- Do not short-circuit the battery terminals.
- Do not drop, mutilate or attempt to disassemble the battery.
- Never use a damaged or worn out charger or battery.
- Always use the battery for its intended purpose only.
- Temperature extremes will affect the ability of the battery to charge. Allow the battery to cool down or warm up as necessary before use or charging.
- Battery storage is recommended at less than 45° C.
- Batteries must be recycled or disposed of properly. Do not place batteries in the trash.
- Do not dispose of batteries in a fire!

# Chapter 3

## Getting Started

### Introduction

This chapter provides a brief overview of the Anritsu Site Master. The intent of this chapter is to provide the user with a starting point for making basic cable and antenna analyzer, spectrum analyzer, and power meter measurements. Procedures that are specific to cable and antenna analyzer mode (page 3-2), Spectrum Analyzer mode (page 3-11), and common to all modes (page 3-15) are presented.

### Power On Procedure

The Anritsu Site Master is capable of up to 1.5 hours of continuous operation from a fully charged, field-replaceable battery. Built-in energy conservation features allow battery life to be extended.

The Site Master can also be operated from a 12.5 Vdc source (which will also simultaneously charge the battery). This can be achieved with either the Anritsu AC-DC Adapter (P/N 40-168) or 12.5 Vdc Automotive Cigarette Lighter Adapter (P/N 806-141). Both items are included as standard accessories (see Chapter 1).

To power on the Site Master:

- Step 1.** Press the **ON/OFF** front panel key (Figure 3-1).

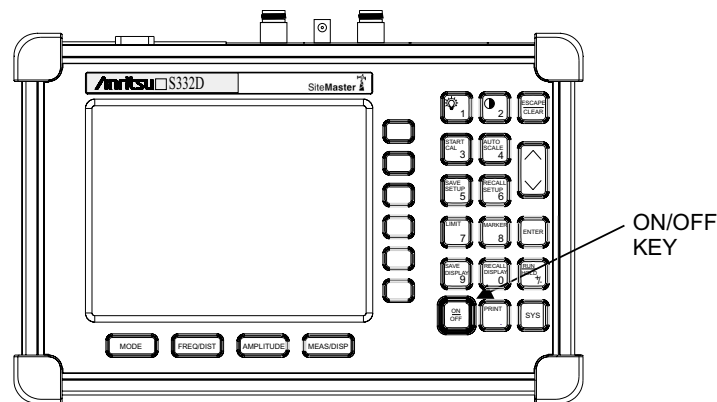

Figure 3-1. Site Master On/Off Key

- Step 2.** The Site Master will display the model number, the firmware revision, the internal temperature and voltage, and then perform a five second self test. At completion of the self-test, the screen displays a prompt to press **ENTER** to continue. If enter is not pressed, the Site Master will continue after a five second timeout.

- Step 3.** Press **ENTER** to continue.

The Site Master is now ready for operation.

## Cable and Antenna Analyzer Mode

### Selecting the Frequency

For the OSL or FlexCal calibration method the frequency range for the desired measurement must be set. The Site Master will automatically set the frequency when a particular signal standard is selected, or the frequency can be manually set using the F1 and F2 soft keys.

To set the frequency to a specific signal standard for an OSL or FlexCal calibration:

- Step 1.** Press the **FREQ/DIST** key.
- Step 2.** Press the Signal Standard soft key.
- Step 3.** Use the Up/Down arrow key to highlight the desired standard, then press the **ENTER** key to select.

To manually select the frequency range for an OSL or FlexCal calibration:

- Step 1.** Press the **FREQ/DIST** key.
- Step 2.** Press the F1 soft key.
- Step 3.** Enter the desired start frequency using the key pad or the Up/Down arrow key.
- Step 4.** Press **ENTER** to set F1 to the desired frequency.
- Step 5.** Press the F2 soft key.
- Step 6.** Enter the desired stop frequency using the keypad or the Up/Down arrow key.
- Step 7.** Press **ENTER** to set F2 to the desired frequency.
- Step 8.** Check that the start and stop frequencies displayed match the desired measurement range.

### Calibration

#### Calibration Methods

For accurate results, the Site Master must be calibrated before making any measurements. The Site Master must be re-calibrated whenever the setup frequency changes, the temperature exceeds the calibration temperature range or when the test port extension cable is removed or replaced.

The two methods of calibrating the Site Master, FlexCal and OSL calibration, can each be accomplished with either discrete components or with the InstaCal Module, providing four calibration techniques for maximum user flexibility. FlexCal is a broadband frequency calibration that remains valid if the frequency is changed. An OSL calibration is an Open, Short and Load calibration for a selected frequency range, and is no longer valid if the frequency is changed. The default calibration mode is OSL.

With either calibration method, the Site Master may be calibrated manually with Open, Short, Load (OSL) calibration components, or by using the InstaCal module (25 MHz to 4000 MHz).

If a Test Port Extension Cable is to be used, the Site Master must be calibrated with the Test Port Extension Cable in place. The Test Port Extension Cable is a phase stable cable and is used as an extension cable on the test port to ensure accurate and repeatable measurements. This phase stable cable can be moved and bent while making a measurement without causing errors in the measurement.

*NOTE: The test port extension cable should have the appropriate connectors for the measurement. Use of additional connector adapters after the test port extension cable can contribute to measurement errors not compensated for during calibration.*

## Calibration Verification

During the calibration process in Return Loss mode, either with discrete calibration components or with the InstaCal module, there are typical measurement levels expected. Verifying the measurement levels displayed on the screen during calibration can save valuable time in the field.

### Trace Characteristics in Return Loss Mode

As the discrete calibration components are connected to the Site Master RF out port, the following measurement levels will be displayed on the screen:

- ❑ When an OPEN is connected, a trace will be displayed between 0-10 dB.
- ❑ When a SHORT is connected, a trace will be displayed between 0-10 dB.
- ❑ When a LOAD is connected, a trace will be displayed between 0-50 dB.

When an InstaCal module is connected to the Site Master RF out port, the following measurement levels will be displayed on the screen:

- ❑ When the Site Master is measuring an equivalent OPEN, a trace will be displayed between 0-20 dB.
- ❑ When the Site Master is measuring an equivalent SHORT, a trace will be displayed between 0-20 dB.
- ❑ When the Site Master is measuring an equivalent LOAD, a trace will be displayed between 0-50 dB.

The following procedures explain standard OSL, FlexCal, and InstaCal calibration methods. Refer to Figure 3-2 for a calibration setup diagram.

## OSL Calibration Procedures

In Cable and Antenna Analyzer Mode, if the Cal Off message is displayed, or the test port cable has been changed, a new calibration is required. The following procedures detail how to perform the OSL calibration.

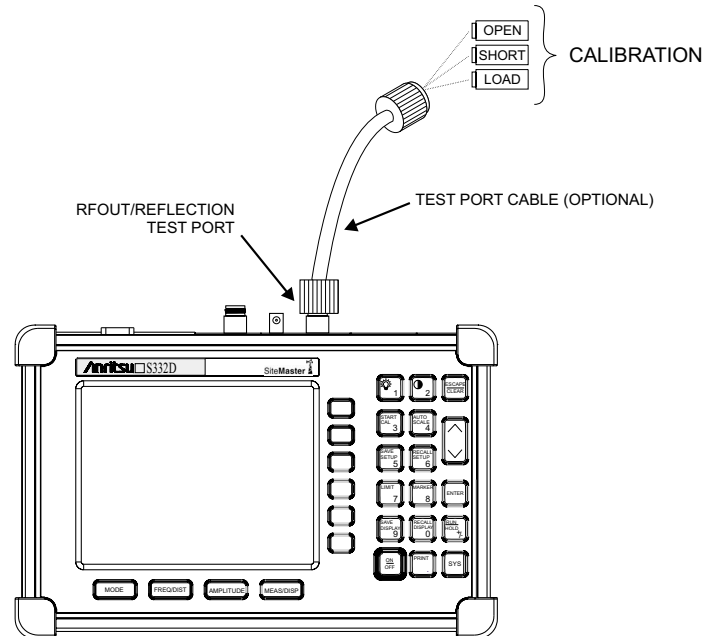

Figure 3-2. Calibration Setup

### Standard OSL Calibration

- Step 1.** Select OSL Cal by pressing the **SYS** key, followed by the Application Options soft key. The currently selected calibration method is indicated at the bottom of the status window. Use the CAL Mode soft key to select the OSL calibration method.
- Step 2.** Select the appropriate frequency range, as described on page 3-2.
- Step 3.** Press the **START CAL** key. The message “Connect OPEN or INSTACAL module to RF Out Port” will appear in a message box, with the calibration type in the message box title bar.
- Step 4.** Connect the calibrated Open and press the **ENTER** key. The messages “Measuring OPEN” and “Connect SHORT to RF Out” will appear.
- Step 5.** Remove the Open, connect the calibrated Short and press the **ENTER** key. The messages “Measuring SHORT” and “Connect LOAD to RF Out” will appear.
- Step 6.** Remove the Short, connect the calibrated Termination and press the **ENTER** key. The message “Measuring LOAD” will appear. An audible tone will sound when the calibration is complete.
- Step 7.** Verify that the calibration has been properly performed by checking that the Cal ON message is now displayed in the upper left corner of the display.



### FlexCal OSL Calibration

- Step 8.** The currently selected calibration method can be viewed by pressing the **SYS** key, followed by the Status soft key. To change the calibration method, select the **SYS** key, followed by the Application Options soft key. Use the CAL Mode soft key to select the FlexCal calibration mode.
- Step 9.** Press the **START CAL** key. The message “Connect OPEN or INSTACAL module to RF Out Port” will appear in a message box, with the calibration type in the message box title bar.
- Step 10.** Connect the calibrated Open and press the **ENTER** key. The messages “Measuring OPEN” and “Connect SHORT to RF Out” will appear and the frequency is automatically set by the Site Master from 25 MHz to 4000 MHz.
- Step 11.** Remove the Open, connect the calibrated Short and press the **ENTER** key. The messages “Measuring SHORT” and “Connect LOAD to RF Out” will appear.
- Step 12.** Remove the Short, connect the calibrated Termination and press the **ENTER** key. The message “Measuring LOAD” will appear. An audible tone will sound when the calibration is complete.
- Step 13.** Verify that the calibration has been properly performed by checking that the FlexCal ON message is now displayed in the upper left corner of the LCD.

### InstaCal Module Verification

Verifying the InstaCal module before any line sweeping measurements is critical to the measured data. InstaCal module verification identifies any failures in the module due to circuitry damage or failure of the control circuitry. This test does not attempt to characterize the InstaCal module, which is performed at the factory or the service center.

The performance of the InstaCal module can be verified by the Termination method or the Offset method. The termination method is the preferred method in the field, and is similar to testing a bad load against a known good load.

*NOTE: The InstaCal module is designed for frequencies from 25 MHz to 4 GHz. The InstaCal module should not be used to calibrate the instrument if the upper frequency range exceeds 4 GHz, or if the lower frequency range is below 25 MHz.*

### Termination Method

The Termination method compares a precision load against the InstaCal module and provides a baseline for other field measurements. A precision load provides better than 42 dB directivity.

- Step 1.** Set the frequency according to the device under test (cellular, PCS, GSM).
- Step 2.** Press the **MODE** key and select Freq-Return Loss mode.
- Step 3.** Connect the InstaCal module to the Site Master RF Out port and calibrate the Site Master using the InstaCal module (page 3-7).
- Step 4.** Remove the InstaCal module from the RF Out port and connect the precision load to the RF Out port.
- Step 5.** Measure the return loss of the precision load. The level should be less than 35 dB across the calibrated frequency range.

**Step 6.** Press the **MARKER** key and set the M1 marker to Marker To Peak. The M1 value should be less than 35 dB return loss.

**Step 7.** Press **SAVE DISPLAY** (page 3-15) name the trace, and press **ENTER**.

### Offset Method

An alternative to the termination method is to measure the return loss of a 20 dB offset. This is similar to measuring an antenna that has been specified to have a 20 dB return loss across the frequency of operation. A 20 dB offset provides a 20 dB return loss across a very wide frequency range. Measuring the return loss with the 20 dB offset will provide a relatively flat response across the operating frequency range of the Site Master.

- Step 1.** Set the frequency according to the device under test (cellular, PCS, GSM).
- Step 2.** Press the **MODE** key and select Freq-Return Loss mode.
- Step 3.** Connect the InstaCal module to the Site Master RF Out port and calibrate the Site Master using the InstaCal module (page 3-7).
- Step 4.** Remove the InstaCal module from the RF Out port and connect the 20 dB Offset to the RF Out port.
- Step 5.** Measure the return loss of the 20 dB Offset. The level should be 20 dB,  $\pm 2$  dB across the calibrated frequency range.
- Step 6.** Press the **MARKER** key and set the M1 marker to Marker To Peak. The M1 value should be approximately 20 dB return loss.
- Step 7.** Press **SAVE DISPLAY** (page 3-15) name the trace, and press **ENTER**.

### InstaCal Module Calibration Procedures

*NOTE: The InstaCal module is not a discrete calibration component and it can not be used at the top of the tower to perform line sweep measurements.*

Check that the CAL Off message is displayed in the upper left corner of the status window. This indicates that the Site Master has not been calibrated. The following procedures detail how to perform a calibration using the InstaCal module.

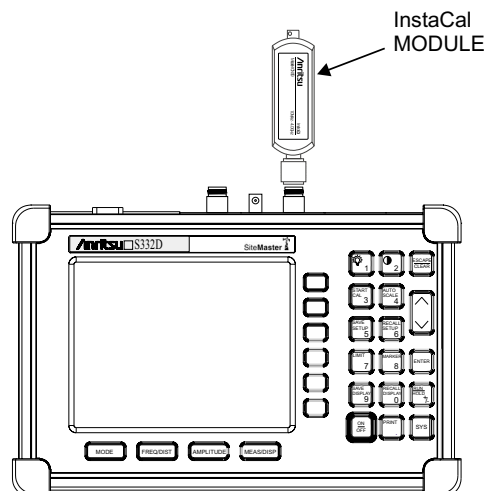

Figure 3-3. InstaCal Module Calibration

### Standard InstaCal Calibration

- Step 1.** Select OSL Cal by pressing the **SYS** key, followed by the Application Options soft key. The currently selected calibration method is indicated at the bottom of the status window. Use the CAL Mode soft key to select the OSL calibration method.
- Step 2.** Select the appropriate frequency range, as described on page 3-2.
- Step 3.** Press the **START CAL** key. The message “Connect OPEN or InstaCal to RF Out port” will appear in a message box, with the calibration type in the message box title bar.
- Step 4.** Connect the InstaCal module to the RF Out port (Figure 3-3).
- Step 5.** Press the **ENTER** key. The Site Master senses the InstaCal module and automatically calibrates the unit using the OSL procedure. The calibration should take about 45 seconds. An audible tone will sound when the calibration is complete.
- Step 6.** Verify that the calibration has been properly performed by checking that the Cal On! message is displayed in the upper left corner of the status window.

### FlexCal InstaCal Calibration

- Step 1.** Select FlexCal by pressing the **SYS** key, followed by the Application Options soft key. The currently selected calibration method is indicated at the bottom of the status window. Use the CAL Mode soft key to select the FlexCal calibration method.
- Step 2.** Press the **START CAL** key. The message “Connect OPEN or InstaCal to RF Out port” will appear in a message box, with the calibration type in the message box title bar.
- Step 3.** Connect the InstaCal module to the RF Out port (Figure 3-3). The Site Master automatically sets the frequency from 25 MHz to 4000 MHz.
- Step 4.** Press the **ENTER** key. The Site Master senses the InstaCal module and automatically calibrates the unit using the OSL procedure. The calibration should take about 45 seconds. An audible tone will sound when the calibration is complete.
- Step 5.** Verify that the calibration has been properly performed by checking that the FlexCal On! message is displayed in the upper left corner of the status window.

### Calibration with the Test Port Extension Cable

If a Test Port Extension Cable is to be used, the Site Master must be calibrated with the Test Port Extension Cable in place. Follow the same calibration procedures as above with the OSL components or the InstaCal module in place at the end of the test port extension cable.

## Auto Scale

The Site Master can automatically set the scale to the minimum and maximum values of the measurement on the y-axis of the graph. This function is particularly useful for measurements in SWR mode. To automatically set the scale, press the **AUTO SCALE** key. The Site Master will automatically set the top and bottom scales to the minimum and maximum values of the measurement with some margin on the y-axis of the LCD.

## Amplitude Scale

The following procedure sets the top and bottom scale display.

- Step 1.** Press the **AMPLITUDE** key to call up the Scale Menu.
- Step 2.** Press the Top soft key and use the keypad or Up/Down arrow key to edit the top scale value. Press **ENTER** to set.
- Step 3.** Press the Bottom soft key and use the keypad or Up/Down arrow key to edit the bottom scale value. Press **ENTER** to set.

*NOTE: Typically the y-axis scale of the graph is 0-60 dB (return loss) but for some measurements (for example, insertion loss) the scale may be changed to 0-10 dB. If the scale is not changed, some measurement results may not be easily viewed on the screen.*

## Set the Distance and Cable Type

In Distance-To-Fault (DTF) mode, the length of the transmission line (distance) and cable type are selected. The cable type determines the velocity propagation and cable attenuation factor. The following procedure can be used to set the distance and select the appropriate cable type.

*NOTE: Selecting the correct cable is very important for accurate measurements and for identifying faults in the transmission line. Selecting the incorrect cable, or using the correct cable out of its proper frequency characteristics type, will shift the DTF trace vertically and horizontally making it difficult to accurately locate faults.*

- Step 1.** Press the **MODE** key.
- Step 2.** Select DTF Return Loss or DTF SWR mode. The Site Master automatically sets D1 to zero.
- Step 3.** Press the D2 soft key.
- Step 4.** Enter the appropriate D2 value for the maximum length of the transmission line and press the **ENTER** key to set the D2 value.
- Step 5.** Press the DTF Aid soft key.

- Step 6.** Using the Up/Down arrow key, select the Cable = and press **ENTER**. Use the Up/Down arrow key to select the Standard cable types stored in the standard Site Master cable lists (which cannot be edited) or choose Custom, for additional cables. A custom cable list can be created and uploaded using the Handheld Software Tools application provided with the Site Master (Chapter 10).
- Step 7.** Using the Up/Down arrow key, select the appropriate type of cable and press the **ENTER** key. The selected cable type, Prop Vel and Cable Loss in dB/m (or dB/ft) will be displayed on the DTF parameters screen.
- Step 8.** Press **ENTER**.

# Spectrum Analyzer Mode

## Selecting Spectrum Analyzer Mode

- Step 1.** Press the **ON/OFF** key.
- Step 2.** Press the **MODE** key and use the Up/Down arrow key to select Spectrum Analyzer mode. Press **ENTER** to set the mode.

## Making a Measurement

- Step 1.** Connect the input cable to the **RF In** test port.
- Step 2.** Locate and display the signal(s) of interest by selecting the desired frequency, span, and amplitude value.

## Selecting the Frequency

### Selecting the Start and Stop Frequencies

- Step 1.** To set a specific frequency band, select the Start soft key and enter the desired start frequency using the Up/Down arrow key or the keypad and press **ENTER** to accept the input.
- Step 2.** Select the Stop soft key and enter the desired stop frequency using the Up/Down arrow key or the keypad and press **ENTER** to accept the input.

### Selecting the Center Frequency and Span

**NOTE:** Changing the center frequency and span will change the start and stop frequencies. Conversely, changing the Start and Stop frequencies will change the center frequency and span.

- Step 1.** To enter a center frequency, select the Center soft key and enter the desired center frequency using the Up/Down arrow key or the keypad and press **ENTER** to accept the input.
- Step 2.** Press the Span soft key to display the Span menu.
- Step 3.** To set a specific span, enter the desired span using the Up/Down arrow key or the keypad and press **ENTER** to accept the input.
  - or*
  - For a full span, select the Full soft key.
  - or*
  - For a single frequency measurement, select the Zero soft key.

**NOTE:** To quickly move the span value up or down, select the Span Up 1-2-5 or Span Down 1-2-5 soft keys. These keys facilitate a zoom-in, zoom-out in a 1-2-5 sequence.

### Selecting the Signal Standard and Channel

- Step 1.** Press the Signal Standard soft key and select the appropriate signal standard for the measurement.
- Step 2.** Press the Select Channel soft key and select the appropriate channel for the measurement.

### Selecting the Amplitude

- Step 1.** Press the **AMPLITUDE** key.
- Step 2.** Press the Units soft key and select the desired units from the soft keys presented (Volts or Watts in Linear, dBm, dBV, dBmV, or dB $\mu$ V in Log). Press the Back soft key to return to the Amplitude menu.
- Step 3.** Press the Ref Level soft key and use the Up/Down arrow key or directly enter the desired reference level from the keypad. Press **ENTER** to set the amplitude level.
- Step 4.** Press the Scale soft key and use the Up/Down arrow key or directly enter the desired scale from the keypad. Press **ENTER** to set the scale. Note that the Scale soft key is not active when Units is set to Linear.

**NOTE:** Press the Atten/Preamp soft key and select Auto coupling of the attenuator setting to the reference level to help insure that harmonics and spurs are not introduced into the measurements.

### Selecting Bandwidth Parameters

Both resolution bandwidth (RBW) and video bandwidth (VBW) can be automatically or manually coupled. Auto coupling of the RBW links the RBW to the span. That is, the wider the span, the wider the RBW. Auto coupling is indicated on the display as RBW XXX. When the RBW is manually coupled, it can be adjusted independently of the span. Manual RBW coupling is indicated on the status window as RBW\* XXX.

Auto coupling of the VBW links the VBW to the RBW. That is, the wider the RBW, the wider the VBW. Auto coupling is indicated on the display as VBW=Auto. When the VBW is manually coupled, it can be adjusted independently of the RBW. Manual VBW coupling is indicated on the display as VBW\* XXX.

- Step 1.** Press the **MEAS/DISP** key and the Bandwidth soft key to display the bandwidth menu.
- Step 2.** Press RBW Auto for automatic resolution bandwidth selection, or press RBW Manual and use the Up/Down arrow key to select the resolution bandwidth. Press **ENTER** to set the resolution bandwidth.
- Step 3.** Press VBW Auto for automatic video bandwidth selection, or press VBW Manual and use the Up/Down arrow key to select the video bandwidth. Press **ENTER** to set the video bandwidth. Press the Back soft key to return to the bandwidth menu.



## Selecting Sweep Parameters

### Max Hold

To toggle maximum hold on or off, press the **MEAS/DISP** key, the Trace soft key and the Max Hold soft key. Maximum hold displays the maximum response of the input signal over multiple sweeps.

### Min Hold

To toggle minimum hold on or off, press the **MEAS/DISP** key, the Trace soft key and the Min Hold soft key. Min Hold displays the minimum response of the input signal over multiple sweeps.

### Detection Method

Each display point represents some number of measurements combined by a detection method. The number of measurements per display point is affected by the span and the resolution bandwidth. The four available detection methods are Positive Peak, RMS Average, Negative Peak, and Sampling Mode. Positive peak display the maximum value of all the measurements associated with that display point. RMS Average detection displays the RMS average power of all the measurements associated with that display point. Negative peak displays the minimum value of all the measurements associated with that display point. Sampling mode displays one measured value for the measurements associated with the display point.

To set the detection method, press the **MEAS/DISP** key, the Trace soft key, and press the Detection soft key and select either Positive Peak, RMS Average, Negative Peak or Sampling Mode detection.

### Minimum Sweep Time

The minimum sweep time allows a value from .05 ms to 200 seconds to be entered. The actual sweep time will be either the Min Sweep Time entered, or the time necessary to achieve accurate results, whichever is greater.

### Sweep Average

In order to reduce the effects of noise, it may be desirable to average the results of several sweeps and display that average rather than the results of individual sweeps.

To set the number of sweeps to average, press the Average (2-25) soft key and use the Up/Down arrow key or directly enter the desired number of sweeps from the keypad. Press **ENTER** to set the sweep average.

**NOTE:** Max Hold, Min Hold, and Average are mutually exclusive.

## Adjusting Attenuator Settings

The spectrum analyzer attenuation can be automatically coupled, manually coupled, or dynamically adjusted.

- Step 1.** Press the **AMPLITUDE** key.
- Step 2.** Press the Atten/Preamp soft key.
- Step 3.** Select the soft key corresponding to the desired coupling mode, as described below.

### Auto Coupling

Auto coupling of the attenuation links the attenuation to the reference level. That is, the higher the reference level, the higher the attenuation. Auto coupling is indicated on the display as Atten XX dB.

### Manual Coupling

When manually coupled, the attenuation can be adjusted independently of the reference level. Manual attenuation coupling is indicated on the display as Atten\* XX dB.

#### **IMPORTANT!**

*The attenuation should be adjusted such that the maximum signal amplitude at the input mixer is  $-25$  dBm or less. For example, if the reference level is  $+20$  dBm, the attenuation should be  $45$  dB such that the input signal at the mixer is  $-25$  dBm ( $+20 - 45 = -25$ ). This prevents signal compression.*

### Dynamic Attenuation

Dynamic attenuation tracks the input signal level, automatically adjusting the attenuation and preamp to give the maximum dynamic range without compressing the input mixer.

Dynamic attenuation is indicated on the display as Atten=Dynamic.

### Setting the System Impedance

The RF In and RF Out ports both have  $50\Omega$  impedance. The Site Master can compensate for a  $50\Omega$  to  $75\Omega$  adapter on the RF In port.

- Step 1.** Press the **SYS** key.
- Step 2.** Press the Impedance soft key.
- Step 3.** If using the Anritsu 12N50-75B adapter, press the  $75\Omega$  Anritsu 12N50-75B soft key.
- Step 4.** If using a different adapter, press the Other Adapter Offset soft key and enter the loss value using the numeric keypad or the Up/Down arrow key. Press the **ENTER** key to set the loss value.

## All Modes

### Save and Recall a Setup

#### Saving a Setup

Saving a cable and antenna analyzer setup configuration in memory will preserve the calibration information.

- Step 1.** To save the configuration in one of the available user setup locations, press **SAVE SETUP**. There are ten locations in cable and antenna analyzer modes, and five in Spectrum Analyzer mode.
- Step 2.** Use the key pad or the Up/Down arrow key to select a location.
- Step 3.** Press **ENTER** to save the setup.

**NOTE:** For cable and antenna analyzer modes, an OSL calibration is saved with an OSL designation, an InstaCal OSL calibration is saved with an OSL!, a FlexCal OSL calibration is saved with an FLX, and an InstaCal FlexCal calibration is saved with an FLX!.

#### Recalling a Setup

The following procedure recalls a setup from memory.

- Step 1.** Press the **RECALL SETUP** key.
- Step 2.** Select the desired setup using the Up/Down arrow key.
- Step 3.** Press **ENTER** to recall the setup.

**NOTE:** Only setups from the current mode are displayed.

### Save and Recall a Display

#### Saving a Display

The following procedure saves a display to memory.

- Step 1.** Press the **SAVE DISPLAY** key to activate the alphanumeric menu for trace storage.
- Step 2.** Use the soft keys to enter a label for the saved trace.

For example, to save a display with the name “TX1 RETURN LOSS” press the soft key group that contains the letter “T” then press the “T” soft key. Press the soft key group that contains the letter “X” then press the “X” soft key. Press the number “1” key on the numeric keypad. Use the soft keys and keypad as necessary to enter the entire name, then press **ENTER** to complete the process.

**NOTES:** More than one trace can be saved using the same alphanumeric name, as traces are stored chronologically, using the time/date stamp.

Pressing the **SAVE DISPLAY** key will bring up the last saved trace name on the input line. Pressing the Delete soft key will erase the entire trace name. To erase only one character of a trace name, press the Up/Down arrow key to select the character, then press the Delete soft key. This feature can be useful when naming traces sequentially, such as: Trace 1, Trace 2, etc.

## Recalling a Display

The following procedure recalls a previously saved display from memory.

- Step 1.** Press the **RECALL DISPLAY** key.
- Step 2.** Select the desired display using the Up/Down arrow key.
- Step 3.** Press **ENTER** to recall the display.

## Changing the Units

By default, the Site Master displays information in metric units. Use the following procedure to change the display to English units when in cable and antenna analyzer mode.

- Step 1.** Press the **SYS** key.
- Step 2.** Select the System Options soft key.
- Step 3.** Press the Units soft key to change from metric to English measurement units, or vice versa. The current selection is displayed at the bottom left corner of the screen.

## Changing the Language

By default, the Site Master displays messages in English. To change the display language:

- Step 1.** Press the **SYS** key.
- Step 2.** Select the Language soft key.
- Step 3.** Select the desired language. Choices are English, French, German, Spanish, Chinese, and Japanese. The default language is English.

## Adjusting Markers

- Step 1.** Press the **MARKER** key to call up the Markers menu.
- Step 2.** Press the M1 soft key to select the M1 marker function.
- Step 3.** Press the Edit soft key and enter an appropriate value using the keypad or Up/Down arrow key to move the marker without redrawing the trace. Pressing the **ON/OFF** soft key activates or deactivates the M1 marker function.
- Step 4.** Press the Back soft key to return to the Markers Menu.
- Step 5.** Repeat the steps for markers M2, M3, M4, M5 and M6.

## Adjusting Limits

The Site Master offers two types of limits: a single horizontal limit line and segmented limits.

### Adjusting a Single Limit

- Step 1.** Press the **LIMIT** key.
- Step 2.** Press the Single Limit soft key.
- Step 3.** Press the Edit soft key.
- Step 4.** Either enter the value using the numeric keypad or scroll the limit line using the Up/Down arrow key.
- Step 5.** Press **ENTER** to set the location of the limit line.

**NOTE:** The single limit line can be defined as either an upper limit or a lower limit in Spectrum Analyzer mode only.

### Defining an Upper Limit

An upper limit in Spectrum Analyzer mode is one where the measurement fails if the data appears above the limit line.

Press the Upper/Lower Limit soft key, if necessary, so that the status window says:  
Fail if data is: Above Line.

### Defining a Lower Limit

A lower limit in Spectrum Analyzer mode is one where the measurement fails if the data appears below the limit line.

Press the Upper/Lower Limit soft key, if necessary, so that the status window says:  
Fail if data is: Below Line.

### Adjusting Segmented Limits

Segmented limit lines are defined separately as five upper limit segments and five lower limit segments. This allows the definition of a spectral mask.

A limit segment is defined by its end points. That is, starting frequency, starting amplitude, ending frequency, and ending amplitude. This procedure describes the setting of two upper limit segments. The steps can be carried over to the other upper limit segments as well as to the lower limit segments.

- Step 1.** Press the **LIMIT** key.
- Step 2.** Press the Multiple Upper Limits soft key.
- Step 3.** Press the Segment 1 soft key.
- Step 4.** Press the Edit soft key. The status window will successively display the value of the segment endpoints: Start Freq, Start Limit, End Freq, End Limit.
- Step 5.** Edit each value using the numeric keypad or scroll the limit line using the Up/Down arrow key and press **ENTER** to set.

- Step 6.** Press the Next Segment soft key to move on to Segment 2. If the status of Segment 2 is OFF, pressing the Next Segment soft key will automatically set the start point of segment 2 equal to the end point of Segment 1.
- Step 7.** Repeat these steps for the remaining segments.
- Step 8.** When the final segment is defined, press the Back soft key to end the editing process.

**NOTES:** *The Site Master does not allow overlapping limit segments of the same type. That is, two upper limit segments cannot overlap and two lower limit segments cannot overlap.*

*The Site Master also does not allow vertical limit segments. A limit segment in which the start and end frequencies are the same, but the limit values are different, cannot be specified.*

### **Enabling the Limit Beep**

Both limit types can indicate a limit violation by enabling the Limit Beep. An audible "beep" will sound at each data point that violates the defined limit.

- Step 1.** Press the **LIMIT** key (numeric keypad number 7).
- Step 2.** Press the Limit Beep soft key. The status window will indicate that the status of the limit beep is On, and the soft key will remain in the "down" state. Press the Limit Beep soft key again to disable the limit beep.

## **Adjusting the Display Brightness**

The brightness of the display can be adjusted to accommodate varying light conditions and to help discern traces.

- Step 1.** Press the light bulb key (numeric keypad number 1).
- Step 2.** Adjust the brightness using the Up/Down arrow key.
- Step 3.** Press **ENTER** to save the new setting.

# Printing

Printing is accomplished by selecting an available printer and pressing the print key as described below. Refer to the particular printer operating manual for specific printer settings.

## Printing a Screen

- Step 1.** Obtain the desired measurement display.
- Step 2.** Press the **SYS** key and the System Options soft key.
- Step 3.** Press the Printer soft key and select from the displayed menu of supported printers.
- Step 4.** Press the **PRINT** key.
- Step 5.** Connect the printer as shown in Figure 3-4.

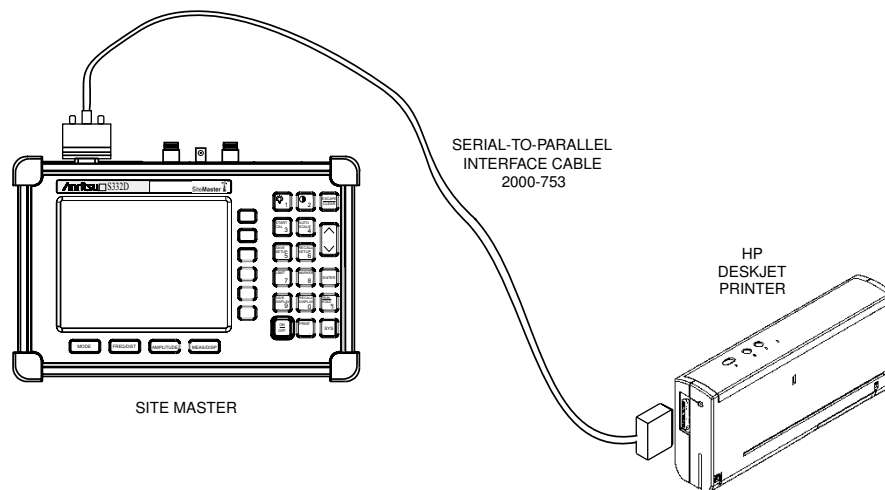

Figure 3-4-. Site Master Printer Setup

## Printer Switch Settings

Set the switches on the serial-to-parallel interface cable to the HP Deskjet 450 ink jet printer as follows:

<b><u>SW1</u></b>	<b><u>SW2</u></b>	<b><u>SW3</u></b>	<b><u>SW4</u></b>	<b><u>SW5</u></b>	<b><u>SW6</u></b>	<b><u>SW7</u></b>	<b><u>SW8</u></b>
OFF	ON	OFF	OFF	OFF	OFF	ON	OFF

## Using the Soft Carrying Case

The soft carrying case has been designed such that the strap can be unsnapped to allow the case to be easily oriented horizontally; thus allowing the Anritsu controls to be more easily accessed (Figure 3-5).

---

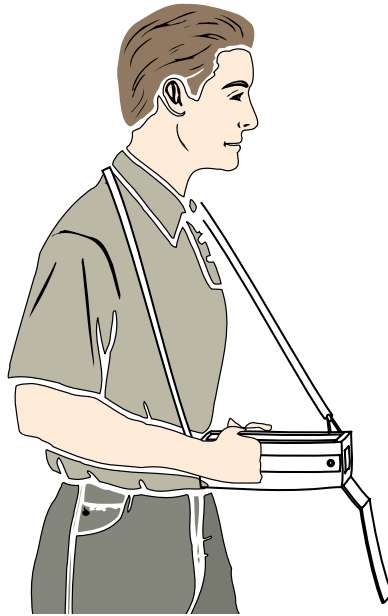

---

*Figure 3-5. Using the Site Master Soft Carrying Case*



# Chapter 4

## Cable and Antenna Analyzer Measurements

### Analyzer Measurements

#### Introduction

This chapter provides a description of cable and antenna analyzer measurements, including line sweeping fundamentals and line sweeping measurement procedures, available when the Site Master is in frequency or DTF mode.

#### Line Sweep Fundamentals

In wireless communication, the transmit and receive antennas are connected to the radio through a transmission line. This transmission line is usually a coaxial cable or waveguide. This connection system is referred to as a transmission feed line system. Figure 4-1 shows an example of a typical transmission feed line system.

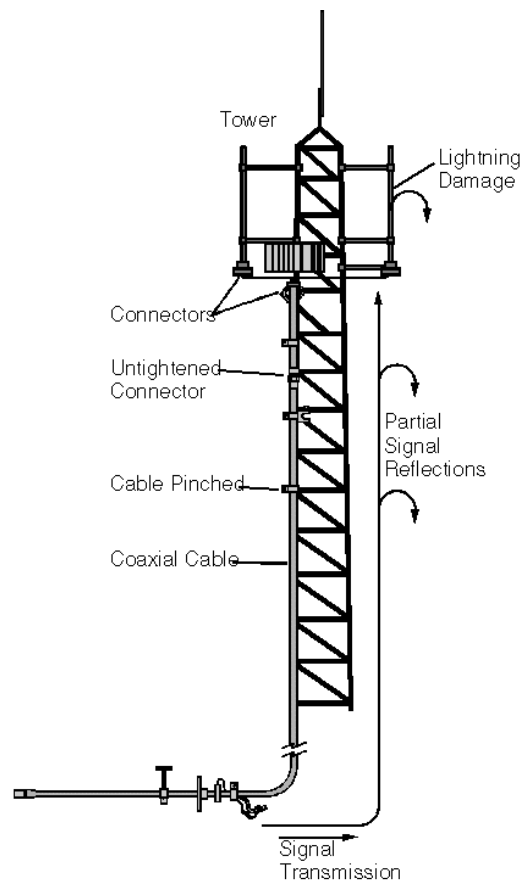

Figure 4-1. A Typical Transmission Feed Line System

The performance of a transmission feed line system may be affected by excessive signal reflection and cable loss. Signal reflection occurs when the RF signal reflects back due to an impedance mismatch or change in impedance caused by excessive kinking or bending of the transmission line. Cable loss is caused by attenuation of the signal as it passes through the transmission line and connectors.

To verify the performance of the transmission feed line system and analyze these problems, three types of line sweeps are required:

**Return Loss Measurement**—Measures the reflected power of the system in decibels (dB). This measurement can also be taken in the Standing Wave Ratio (SWR) mode, which is the ratio of the transmitted power to the reflected power.

**Cable Loss Measurement**—Measures the energy absorbed, or lost, by the transmission line in dB/meter or dB/ft. Different transmission lines have different losses, and the loss is frequency and distance specific. The higher the frequency or longer the distance, the greater the loss.

**Distance-To-Fault (DTF) Measurement**—Reveals the precise fault location of components in the transmission line system. This test helps to identify specific problems in the system, such as connector transitions, jumpers, kinks in the cable or moisture intrusion.

The different measurements are defined as:

**Return Loss - System Sweep**—A measurement made when the antenna is connected at the end of the transmission line. This measurement provides an analysis of how the various components of the system are interacting and provides an aggregate return loss of the entire system.

**Distance To Fault - Load Sweep**—A measurement is made with the antenna disconnected and replaced with a 50Ω precision load at the end of the transmission line. This measurement allows analysis of the various components of the transmission feed line system in the DTF mode.

**Cable Loss Sweep**—A measurement made when a short is connected at the end of the transmission line. This condition allows analysis of the signal loss through the transmission line and identifies the problems in the system. High insertion loss in the feed line or jumpers can contribute to poor system performance and loss of coverage.

This whole process of measurements and testing the transmission line system is called Line Sweeping.

## **CW Mode/RF Immunity**

CW mode can be used to maximize sweep speeds of both frequency and DTF measurements. With CW on, sweep times can be twice as fast as with CW off. However, making measurements with CW on will reduce the instrument's immunity to interfering signals. In a controlled environment, this reduced immunity should not be a problem. In the field however, there can be stray signals from nearby or co-located transmitters that can affect frequency and DTF measurements. Turning CW on and off can verify that the Site Master is reducing the interfering signals. If there is no appreciable difference, then it should be safe to make measurements with CW on.

Use this feature with caution, as the later introduction of an interfering signal might be mistaken for a problem with the antenna or cable run.

If CW is on during a normal RL or SWR measurement, the Site Master will be more susceptible to interfering signals. Interfering signals can make the measurement look better or worse than it really is.

## Information Required for a Line Sweep

The following information must be determined before attempting a line sweep measurement:

- System Frequency Range, to set the sweep frequency
- Cable Type, to set the cable characteristics for DTF measurements
- Distance of the Cable Run, to set the distance for DTF measurements

## Typical Line Sweep Test Procedures

This section provides typical line sweep measurements used to analyze the performance of a transmission feed line system.

### System Return Loss Measurement

System return loss measurement verifies the performance of the transmission feed line system with the antenna connected at the end of the transmission line. To measure the system return loss:

#### Required Equipment

- Site Master Model S331D/S332D
- Precision Open/Short, Anritsu 22N50 *or*  
Precision Open/Short/Load, Anritsu OSLN50-1 *or*  
InstaCal Module ICN50
- Precision Load, Anritsu SM/PL-1
- Test Port Extension Cable, Anritsu 15NNF50-1.5C
- Optional 510-90 Adapter, DC to 7.5 GHz, 50 ohm, 7/16(F)-N(M)

#### Device Under Test

- Transmission Feed Line with Antenna

#### Procedure

- Step 1.** Press the **MODE** key.
- Step 2.** Select Freq-Return Loss using the Up/Down arrow key and press **ENTER**.
- Step 3.** Set the start and stop frequencies, automatically by selecting a signal standard or manually using the F1 and F2 soft keys, as described on page 3-2.
- Step 4.** Calibrate the Site Master as described on page 3-2.
- Step 5.** Connect the Device Under Test to the Site Master. A trace will be displayed on the screen when the Site Master is in the sweep mode.
- Step 6.** Press **SAVE DISPLAY** (page 3-15) name the trace, and press **ENTER**.

**NOTE:** The antenna must be connected at the end of the transmission feed line when conducting a System Return Loss measurement.

Figure 4-2 is an example of a typical system return loss measurement trace using a FlexCal calibration:

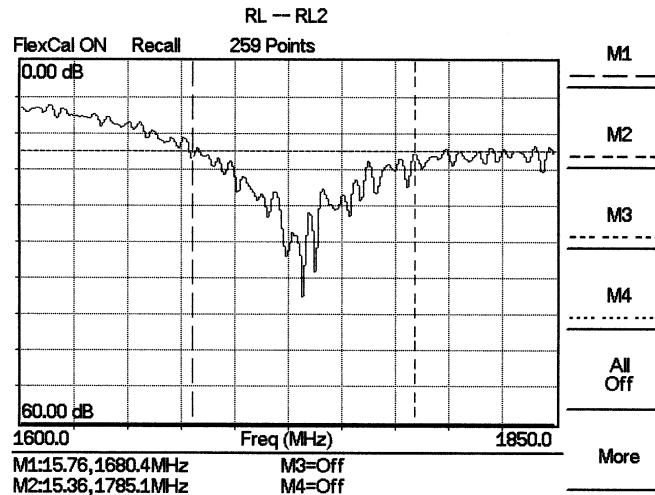

Figure 4-2. Typical System Return Loss Trace

**NOTE:** The system sweep trace should appear at an approximate return loss of 15 dB ( $\pm 3$  dB) in the status window. Typically, greater than a 15 dB return loss is measured in the passband of the antenna system.

## Cable Loss Measurement

The transmission feed line insertion loss test verifies the signal attenuation level of the cable system in reference to the specification. This test can be conducted with the Site Master in Freq-Cable Loss mode.

### Required Equipment

- Site Master Model S331D/S332D
- Precision Open/Short, Anritsu 22N50 *or*  
Precision Open/Short/Load, Anritsu OSLN50-1 *or*  
Anritsu InstaCal Module, ICN50
- Precision Load, Anritsu SM/PL-1
- Test Port Extension Cable, Anritsu 15NNF50-1.5C
- Optional 510-90 Adapter, DC to 7.5 GHz, 50 ohm, 7/16(F)-N(M)

### Device Under Test

- Transmission Feed Line with Short

**Procedure - Cable Loss Mode**

- Step 1.** Press the **MODE** key.
- Step 2.** Select Freq-Cable Loss using the Up/Down arrow key and press **ENTER**.
- Step 3.** Set the start and stop frequencies, automatically by selecting a signal standard or manually using the F1 and F2 soft keys, as described on page 3-2.
- Step 4.** Connect the Test Port Extension cable to the RF port and calibrate the Site Master as described on page 3-2.
- Step 5.** Save the calibration set up (page 3-15).
- Step 6.** Connect the Device Under Test to the Site Master phase stable Test Port Extension cable. A trace will be displayed on the screen as long as the Site Master is in sweep mode.
- Step 7.** Cable loss is displayed in the status window.
- Step 8.** Press **SAVE DISPLAY** (page 3-15) name the trace, and press **ENTER**.

Figure 4-3 is an example of a typical transmission line cable loss measurement trace using a standard calibration.

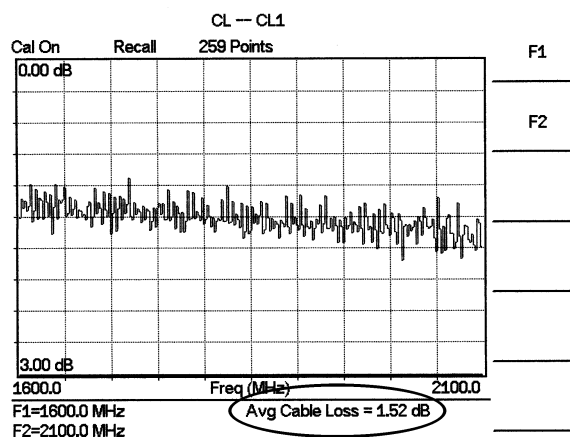

Figure 4-3. Typical Transmission Line Cable Loss Trace

## Distance-To-Fault (DTF) Transmission Line Test

The Distance-To-Fault transmission line test verifies the performance of the transmission line assembly and its components and identifies the fault locations in the transmission line system. This test determines the return loss value of each connector pair, cable component and cable to identify the problem location. This test can be performed in the DTF–Return Loss or DTF–SWR mode. Typically, for field applications, the DTF–Return Loss mode is used. To perform this test, disconnect the antenna and connect the load at the end of the transmission line.

### Required Equipment

- ❑ Site Master Model S331D/S332D
- ❑ Precision Open/Short, Anritsu 22N50 *or* Precision Open/Short/Load, Anritsu OSLN50-1 *or* Anritsu InstaCal Module, ICN50
- ❑ Precision Load, Anritsu SM/PL-1
- ❑ Test Port Extension Cable, Anritsu 15NNF50-1.5C
- ❑ Optional 510-90 Adapter, DC to 7.5 GHz, 50 ohm, 7/16(F)-N(M)

### Device Under Test

- ❑ Transmission Feed Line with Load

### Procedure - Return Loss Mode

The following steps explain how to make a DTF measurement in return loss mode.

- Step 1.** Press the **MODE** key.
- Step 2.** Select DTF-Return Loss using the Up/Down arrow key and press **ENTER**.
- Step 3.** Connect the Test Port Extension cable to the RF port and calibrate the Site Master as described on page 3-2.
- Step 4.** Save the calibration set up (page 3-15).
- Step 5.** Connect the Device Under Test to the Site Master phase stable Test Port Extension cable. A trace will be displayed on the screen as long as the Site Master is in sweep mode.
- Step 6.** Press the **FREQ/DIST** key.
- Step 7.** Set the D1 and D2 values. The Site Master default for D1 is zero.
- Step 8.** Press the DTF Aid soft key and select the appropriate Cable Type to set the correct propagation velocity and attenuation factor.

*NOTE: Selecting the right propagation velocity, attenuation factor and distance is very important for accurate measurements, otherwise the faults can not be identified accurately.*

**Step 9.** Press **SAVE DISPLAY** (page 3-15) name the trace, and press **ENTER**.

**Step 10.** Record the connector transitions.

Figure 4-4 shows an example of a typical DTF return loss measurement trace using a FlexCal calibration.

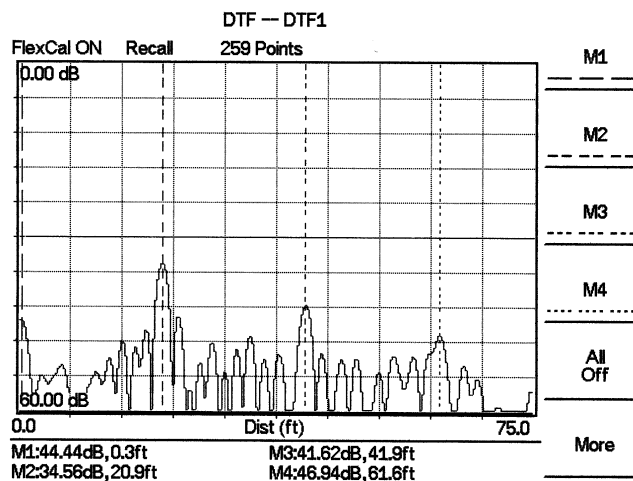

Figure 4-4. Typical DTF Return Loss Trace

In the above example:

- Marker M1 marks the first connector, the end of the Site Master phase stable Test Port Extension cable.
- Marker M2 marks the first jumper cable.
- Marker M3 marks the end of the main feeder cable.
- Marker M4 is the load at the end of the entire transmission line.

#### Procedure - DTF-SWR Mode

The following steps explain how to measure DTF in SWR mode.

- Step 1.** Press the MODE key.
- Step 2.** Select the DTF-SWR using the Up/Down arrow key and press **ENTER**.
- Step 3.** Follow the same procedure as DTF-Return Loss mode, above.

#### Resolution

There are three sets of data points (130, 259 and 517) available in the Site Master. The factory default is 259 data points. By increasing the number of data points the measurement accuracy and transmission line distance to measure will increase.

$$\text{Step size} = \frac{(1.5 \times 10^8)(V_p)}{\Delta F}$$

Where  $V_p$  is the relative propagation velocity of the cable and  $\Delta F$  is the stop frequency minus the start frequency (Hz).

The maximum distance is:  $D_{\max} = \text{step size} \times (\# \text{ of datapoints} - 1)$

Increasing the data points increases the sweep time and increases the accuracy of the measurement. CW mode On or Off can also affect sweep speed (see CW Mode, page 4-2 for details).

## **Antenna Subsystem Return Loss Test**

Antenna Subsystem return loss measurement verifies the performance of the transmit and receive antennas. This measurement can be used to analyze the performance of the antenna before installation. The antenna can be tested for the entire frequency band, or tested to a specific frequency range. Transmit and receive frequency measurements are conducted separately. The following steps explain how to measure the antenna loss in return loss mode.

### **Required Equipment**

- Site Master Model S331D/S332D
- Precision Open/Short, Anritsu 22N50 *or*  
Precision Open/Short/Load, Anritsu OSLN50-1 *or*  
Anritsu InstaCal Module, ICN50
- Precision Load, Anritsu SM/PL-1
- Test Port Extension Cable, Anritsu 15NNF50-1.5C
- Optional 510-90 Adapter, DC to 7.5 GHz, 50 ohm, 7/16(F)-N(M)

### **Device Under Test**

- Antenna Sub Assembly

### **Procedure**

- Step 1.** Press the MODE key.
- Step 2.** Select Freq-Return Loss using the Up/Down arrow key and press **ENTER**.
- Step 3.** Connect the Test Port Extension cable to the RF port and calibrate the Site Master as described on page 3-2.
- Step 4.** Press **SAVE SETUP** and save the calibration set up (page 3-15).
- Step 5.** Connect the Device Under Test to the Site Master phase stable Test Port Extension cable.
- Step 6.** Press the **MARKER** key.
- Step 7.** Set markers M1 and M2 to the desired frequencies.
- Step 8.** Record the lowest return loss over the specified frequency range.
- Step 9.** Press **SAVE DISPLAY** (page 3-15) name the trace, and press **ENTER**.



The following trace is an example of an antenna return loss measurement trace using a FlexCal calibration..

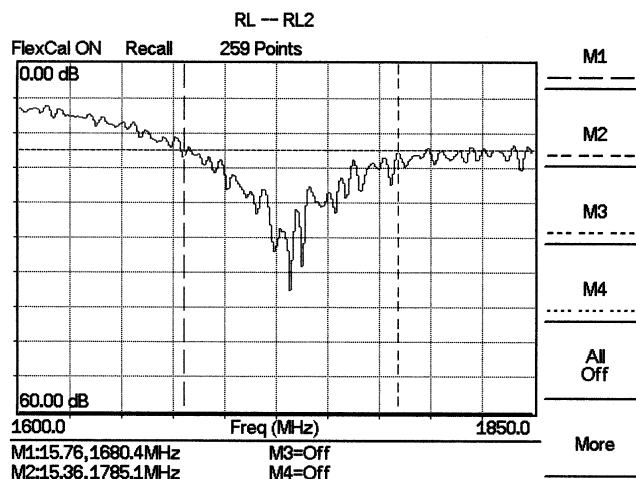

Figure 4-5. Antenna Return Loss Trace

Calculate the threshold value and compare the recorded Lowest Return Loss to the calculated threshold value.

$$\text{Maximum Return Loss} = \frac{-20 \log(VSWR - 1)}{(VSWR + 1)}$$

**NOTES:**

*VSWR is the antenna manufacturer's specified VSWR.*

*Use Handheld Software Tools to convert VSWR to Return Loss, or Return Loss to VSWR.*

If the measured return loss is less than the calculated threshold value, the test fails and the antenna must be replaced.

# ***Chapter 5***

## ***Spectrum Analyzer***

### ***Measurements***

## **Introduction**

This chapter provides a description of Spectrum Analyzer measurements and procedures when the Site Master S332D is in Spectrum Analyzer Mode.

## **Measurement Fundamentals**

Measurement fundamentals include the use of additional spectrum analyzer functions beyond frequency, span, amplitude and marker functions. In particular, this section focuses on resolution bandwidth, video bandwidth, sweep, and attenuator functions.

### **Effect of Resolution Bandwidth**

Resolution Bandwidth is determined by the intermediate frequency (IF) filter bandwidth. The spectrum analyzer traces the shape of its IF filter as it tunes past a signal. If more than one IF filter is used in a spectrum analyzer, the narrowest one dominates and is considered the resolution bandwidth.

The choice of resolution bandwidth depends on several factors. Filters take time to settle. That is, when a signal first appears at the input of the filter, it will take a while before the signal appears at the output. Additionally, the output of the filter will take some time to settle to the correct value, so that it can be measured. The narrower the filter bandwidth (resolution bandwidth) the longer the settling time.

The choice of resolution bandwidth will depend on the signal being measured. If two closely-spaced signals are to be measured individually, then a narrow bandwidth is required. If a wider bandwidth is used, then the energy of both signals will be included in the measurement. Thus, the wider bandwidth does not have the ability to look at frequencies selectively but instead simultaneously measures all signals falling within the resolution bandwidth.

Therefore, a broadband measurement would aggregate all signals and noise within the measurement bandwidth into a single measurement. On the other hand a narrow-band measurement will separate the frequency components, resulting in a measurement that includes separate peaks for each signal. There are advantages to each. The ultimate decision will be dependent on the type of measurement required by the user.

There is always some amount of noise present in a measurement. Noise is often broadband in nature; that is, it exists at a broad range of frequencies. If the noise is included in the measurement, the measured value will be in error (too large) depending on the noise level.

With a wide bandwidth, more noise is included in the measurement. With a narrow bandwidth, less noise enters the resolution bandwidth filter, and the measurement is more accurate. If the resolution bandwidth is narrower, the noise floor will drop on the display of the spectrum analyzer. This is because the IF filter of the analyzer has been made narrower in bandwidth, which lets in less noise. As the measured noise level drops, smaller signals that were previously obscured by the noise can now be measured.

### Effect of Video Bandwidth

Spectrum analyzers typically use another type of filtering after the detector called video filtering. This filter also affects the noise on the display but in a different manner than the resolution bandwidth. In video filtering, the average level of the noise remains the same but the variation in the noise is reduced. Hence, the effect of video filtering is a “smoothing” of the signal noise. The resultant effect on the analyzer’s display is that the noise floor compresses into a thinner trace, while the position of the trace remains the same. Thus, changing the video bandwidth (VBW) does not improve sensitivity; however, it does improve discernability and repeatability when making low-level measurements.

As a general rule of thumb, most field spectrum analyzer measurements are made at a video bandwidth that is a factor of 10 to 100 less than the resolution bandwidth. Thus, for a resolution bandwidth of 30 kHz, the typical video bandwidth setting options are either 3 kHz or 300 Hz.

### Sweep Limitations

With some spectrum analyzers, the user has control over sweep time (the elapsed time of each sweep, sometimes called scan time). An analyzer cannot be swept arbitrarily fast while maintaining its specified accuracy, but will have a sweep rate limitation depending on the resolution bandwidth, video bandwidth, and frequency range selected. The sweep rate is not usually chosen by the user but is determined by the frequency range swept divided by the sweep time. The limitation on sweep rate comes from the settling or response time of the resolution and video bandwidth filters. If an analyzer is swept too quickly, the filters do not have time to respond, and the measurement is inaccurate. Under such conditions, the analyzer display tends to have a “smeared” look to it, with the spectral lines being wider than normal and shifted to the right.

Fortunately, the Anritsu Handheld Spectrum Analyzer has mechanisms designed into it that relieve the user from having to calculate the sweep rate. When changing the RBW and VBW, the sweep rate will change accordingly. The sweep rate will be faster for a wide RBW or VBW and slower for a narrow RBW or VBW. The sweep rate can also be changed manually, by pressing the **MEAS/DISP** key and selecting the Min Sweep Time soft key. Enter a sweep time from 0.05 ms to 2000 seconds. If the minimum sweep time entered by the user is less than the value calculated by the Site Master to assure accurate results, the calculated value will prevail. Regardless of the minimum sweep time setting, the Site Master will never sweep faster than the RBW and VBW settings will allow.

### Attenuator Functions

Attenuation adjusts the hand held spectrum analyzer input attenuator. In Auto mode, as the reference level is increased, the attenuation is increased. In Manual mode, the input attenuation can be adjusted using the keypad or the Up/Down arrow key. The attenuator range is 0 to 51 dB, in 1 dB steps. When Dynamic attenuation is selected, the instrument automatically sets the input attenuation and preamplifier to achieve the best possible dynamic range.

**IMPORTANT!** Attenuation is normally a coupled function and is automatically adjusted when the reference level changes. The reference level does not change however, when the attenuator changes. The attenuator should be adjusted so that the maximum signal amplitude at the input mixer is  $-25$  dBm or less. For example, if the reference level is  $+20$  dBm, the attenuation should be  $50$  dB for an input signal of  $-25$  dBm at the mixer ( $+20 - 45 = -25$ ). This prevents signal compression. The nominal gain of the preamplifier is  $+25$  dB, therefore always select attenuation values so that the input to the preamp does not exceed  $-50$  dBm.

**NOTE:** It is best to begin all measurements in AUTO attenuation mode.

## Preamplifier

The S332D includes a built-in preamplifier which provides the S332D with an additional  $20$  dB of sensitivity. The preamplifier is a broadband preamplifier and thus the use of discrete filters should be considered when using it. Four different bandpass filters have been added to the list of optional accessories to accommodate this need (see Table 1-1, Optional Accessories). This chapter provides an overview of preamplifier operation. A measurement example is included.

### Preamplifier Operation

To turn the preamplifier on or off:

- Step 1.** Reset the S332D to the factory default settings for the current mode by pressing the **RECALL SETUP** key on the data keypad. When the key is pressed, a Recall Setup selection box appears on the display. Select setup location  $0$  <Default> to recall the factory preset state for the currently selected mode.
- Step 2.** Press the **AMPLITUDE** function hard key.
- Step 3.** Select the Atten/Preamp soft key, then the Preamp Control Manual soft key. Press the Preamp On/Off soft key to turn the preamplifier on or off. When the preamplifier is on, the word AMP will be displayed on the left side of the display.

**NOTES:** The preamplifier is a broadband amplifier. It can become saturated by a signal outside of the defined frequency span.

The dynamic attenuation feature will automatically activate the preamplifier when the S332D detects that the input signal level is below a certain level. This condition could result in the preamplifier being automatically turned back on even after it has been manually turned off.

When dynamic attenuation is on, Atten=Dynamic appears to the left of the display.

## Preamplifier Measurement Example

This section provides an overview of how to detect a low-level signal with the help of the preamplifier of a S332D Site Master.

### Required Equipment

- ❑ S332D Site Master
- ❑ Test Port extension cable, Anritsu 15NNF50 – 1.5C
- ❑ A signal source (Anritsu 69xxxB Synthesized Signal Generator or equivalent)

### Procedure

- Step 1.** Press the **MODE** key and use the Up/Down arrow key to select the Spectrum Analyzer mode. Press the **ENTER** key to select.
- Step 2.** Connect the RF output of the signal source to the RF In port of the S332D.
- Step 3.** Press the Center soft key. Enter the center frequency of the measurement using the Up/Down arrow key or the keypad. Select the GHz, MHz, kHz, or Hz soft key to accept the center frequency input.
- Step 4.** Press the Span soft key and use the Up/Down arrow key or the keypad to enter a span of 1 MHz.
- Step 5.** Set the signal source output level to –120 dBm.
- Step 6.** Press the **AMPLITUDE** key and select the Ref Level soft key to set the reference level to –80 dBm.
- Step 7.** Press the Scale soft key and set the scale to 10 dB/division.
- Step 8.** Press the Atten/Preamp soft key and set the attenuation to Auto and press the Back soft key.
- Step 9.** Press the **MEAS/DISP** key, the Trace soft key, and the Detection soft key and set the detection mode to Positive Peak.
- Step 10.** Press the Back soft key twice, then the Bandwidth soft key. Select the RBW Manual soft key and set the RBW to 100 Hz.
- Step 11.** Select the VBW Auto soft key.
- Step 12.** Press the **AMPLITUDE** function hard key.
- Step 13.** Select the Atten/Preamp soft key, then the Preamp Control Manual soft key. Press the Preamp On/Off soft key to turn the preamplifier on or off.

Figure 5-1 shows the measurement results with the preamplifier off.

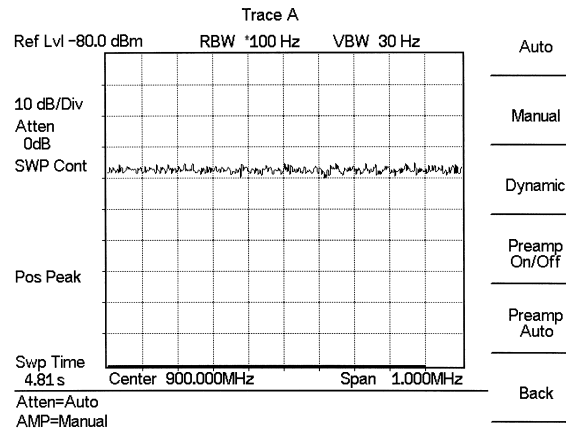

Figure 5-1. Preamplifier Off

- Step 14.** Turn the preamplifier on. When the preamplifier is ON, the word AMP should appear in the lower left corner of the display. The displayed noise level should be lowered by approximately 20 dB on the display, and the signal should appear on top of the displayed noise. The noise level will drop further if the RBW is reduced.

Figure 5-2 shows the measurement results with the preamplifier on.

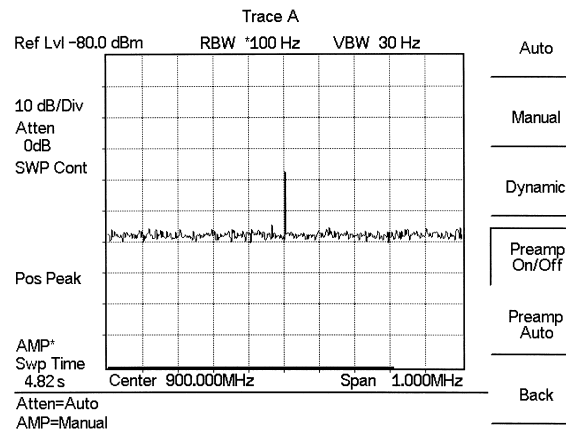

Figure 5-2. Preamplifier On

## Dynamic Attenuation Control

The dynamic attenuation control feature tracks the peak input signal level and automatically adjusts the attenuator to protect the S332D in situations of high RF signal levels. This feature also enhances the instrument sensitivity in situations of low-level RF signals by deactivating and activating the internal preamplifier resulting in improved measurement accuracy.

When dynamic attenuation is on, the S332D is in control of the attenuation and preamp. Manual settings will be overwritten based on the input signal. To manually control these parameters, set the attenuation to Manual.

The following is an example identifying interference in a PCS 900 MHz band with the aid of the preamplifier and dynamic attenuation control.

### Required Equipment

- ❑ S332D Handheld Site Master
- ❑ A PCS band Pass Filter, such as K & L Electronics 5DR30-921 or equivalent
- ❑ A PCS band antenna

### Procedure

- Step 1.** If necessary, press the **MODE** key and use the Up/Down arrow key to select the Spectrum Analyzer mode. Press the **ENTER** key to select.
- Step 2.** Reset the S332D to the factory default settings for the current mode by pressing the **RECALL SETUP** key on the data keypad. When the key is pressed, a Recall Setup selection box appears on the display. Select setup location 0 <Default> to recall the factory preset state for the currently selected mode.
- Step 3.** Connect the PCS antenna to the input of the band pass filter, and the output of the band pass filter to the RF In connector of the S332D.
- Step 4.** Press the **FREQ/DIST** key.
- Step 5.** Press the Start soft key and enter 1.93 MHz.
- Step 6.** Press the Stop soft key and enter 1.935 MHz.
- Step 7.** Press the **AMPLITUDE** key and select the Scale key. Set the scale to 10 dB/division.
- Step 8.** Press the Atten/Preamp soft key and set the attenuation to Dynamic.

As the S332D sweeps, it continually monitors the overall input signal level and, as required, adjusts the input attenuation value and the preamplifier on/off state to achieve the best possible sensitivity.

## Frequency Converter Interface (Option 6)

### Introduction

Option 6 provides added circuitry and a connector to provide power, control signals and a local oscillator signal to a frequency converter.

The Anritsu FCN4760 4.7 GHz to 6.0 GHz Frequency Converter can be used with this option. When the frequency converter is attached to the Site Master, the frequency range of the combination becomes 4.7 GHz to 6.0 GHz.

*NOTE: The frequency converter interface (Option 6) and the FCN4760 frequency converter apply to Spectrum Analyzer mode only.*



## Selecting the Signal Standard and Channel

Before making measurements, the Site Master must be set to the appropriate wireless network air interface standard and channel number. The most common standards and channel numbers are stored in the Site Master and, when selected, the Site Master automatically selects the correct frequency and span. The frequency and span can also be manually entered if necessary.

The following procedure sets the signal standard and channel number automatically by selecting from the standards stored in the Site Master:

### Procedure

- Step 1.** On the Site Master, press the **MODE** key.
- Step 2.** Use the Up/Down arrow key to select the Spectrum Analyzer mode and press **ENTER**.
- Step 3.** Select the Signal Standard soft key, use the Up/Down arrow key to select a signal standard, and press **ENTER**.
- Step 4.** Select the Select Channel soft key and use the Up/Down arrow key or the numeric keypad to enter a valid channel number. Press **ENTER** to accept the value, or **ESCAPE** to restore the previous value.

The currently selected Center Frequency, Span, Signal Standard, and Channel are displayed at the bottom of the status window.

## Field Strength Measurements

All antennas have loss or gain that can cause errors in measurements. The Site Master can correct for antenna loss or gain errors using Field Strength Measurements. The antenna factors must be uploaded to the Site Master using the Anritsu Handheld Software Tools provided with the unit.

- Step 1.** For a custom antenna, enter the antenna factor information for the specific antenna into the Antenna Editor of the Software Tools (see page 16-7).
- Step 2.** On the Site Master, press the **MODE** key.
- Step 3.** Use the Up/Down arrow key to select the Spectrum Analyzer mode and press **ENTER**.
- Step 4.** Select the measurement frequency by using Center and Span soft keys or Start and Stop keys or Signal Standard and Select Channel keys
- Step 5.** Upload the antenna factors to the Site Master.
- Step 6.** Press the **MEAS/DISP** key and select the Measure soft key.
- Step 7.** Select the Field Strength soft key from the measurement menu.
- Step 8.** Press the Select Standard Antenna or Select Custom Antenna soft key and use the Up/Down arrow key to select the desired antenna factor file from the standard or custom antenna list. Press the **ENTER** key to select.

The Site Master will now automatically adjust the measurement results based on the antenna factors entered. Field Str appears to the left of the trace and indicates that the measurement is enabled. The measurement status also appears in the lower status window along with the name of the selected antenna.

Figure 5-3 shows the results of a measurement.

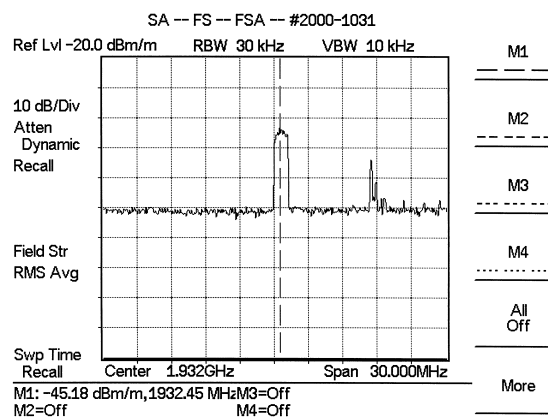

Figure 5-3. Field Strength Measurements

## Occupied Bandwidth

A common measurement performed on radio transmitters is that of occupied bandwidth (OBW). This measurement calculates the bandwidth containing the total integrated power occupied in a given signal bandwidth. There are two different methods of calculation depending on the technique to modulate the carrier.

### Percent of Power Method

The occupied frequency bandwidth is calculated as the bandwidth containing the specified percentage of the transmitted power.

### XdB Down Method

The occupied frequency bandwidth is defined as the bandwidth between the upper and lower frequency points at which the signal level is XdB below the peak carrier level.

### Required Equipment

- Site Master S332D
- Portable antenna for the selected signal frequency

### Procedure

- Step 1.** Connect the antenna to the Spectrum Analyzer connector.
- Step 2.** On the Site Master, press the **MODE** key, use the Up/Down arrow key to select the Spectrum Analyzer mode and press **ENTER**.
- Step 3.** Press the **FREQ/DIST** key, select the frequency for the measurement by using Center and Span soft keys, the Start and Stop soft keys or the Signal Standard and Select Channel soft keys.
- Step 4.** Press the **AMPLITUDE** key and select the Ref Level soft key to set the appropriate reference level.
- Step 5.** Select the Atten/Preamp soft key to set the input attenuation level to automatic, manual or dynamic.
- Step 6.** Press Preamp On/Off or Preamp Auto to activate the preamplifier manually or automatically. The default preamplifier mode is auto.
- Step 7.** Press the Back soft key to return to the previous menu.
- Step 8.** Select the Scale soft key to set the scale. Choose a value from 1dB/div to 15 dB/div and press **ENTER**.
- Step 9.** Press the **MEAS/DISP** key and select the Bandwidth soft key to set the resolution bandwidth and video bandwidth automatically or manually. Press the Back soft key to return to the previous menu.
- Step 10.** Press the Measure soft key and press the OBW soft key. Select the measurement method (dB Down or % of Power) by pressing the Method soft key. The currently selected method is shown in the lower left of the status window.
- Step 11.** Press the dBc or % soft keys to adjust the settings as appropriate.
- Step 12.** Press the Measure soft key to initiate the measurement.

Figure 5-4 shows the occupied bandwidth results using the % of power method of a CDMA signal.

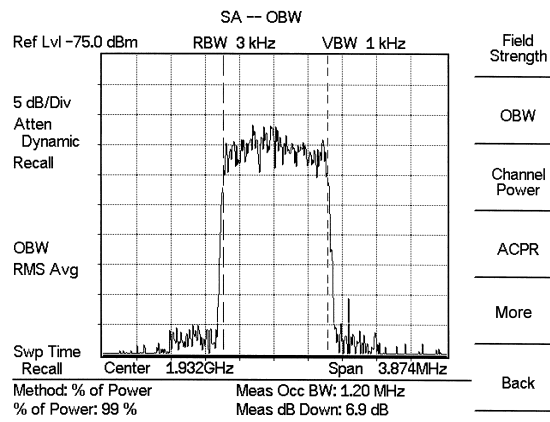

Figure 5-4. Occupied Bandwidth

Occupied bandwidth is calculated at the end of a sweep. An hourglass is displayed as the calculations are performed.

Markers M1 and M2 indicate the occupied band on the graph. The measurement results appear beneath the graph.

## Channel Power Measurement

Channel power measurement is one of most common measurements for a radio transmitter. This test measures the output power, or channel power, of a transmitter over the frequency range in a specific time interval. Out-of-specification power measurements indicate system faults, which can be in the power amplifiers and in filter circuits. Channel Power measurements can be used to:

- ❑ Validate transmitter performance
- ❑ Comply with FCC or local regulations
- ❑ Keep overall system interference at a minimum

### Required Equipment

- ❑ Site Master S332D
- ❑ Portable antenna for the selected signal frequency

### Procedure

- Step 1.** On the Site Master, press the **MODE** key, use the Up/Down arrow key to select the Spectrum Analyzer mode and press **ENTER**.
- Step 2.** Press the Signal Standard soft key, select the appropriate network standard, and press **ENTER**.
- Step 3.** Press the Select Channel soft key, enter a value and press **ENTER**.
- Step 4.** Press the **AMPLITUDE** key and select the Ref Level soft key to set the reference level.
- Step 5.** Press the Scale soft key and set the scale to 10 dB/division.
- Step 6.** Press the Atten/Preamp soft key and set the attenuation to an appropriate attenuation setting using automatic, manual, or dynamic.
- Step 7.** Press Preamp On/Off or Preamp Auto to activate the preamplifier manually or automatically. The default preamplifier mode is automatic.
- Step 8.** Press the Back soft key to return to the previous menu.
- Step 9.** Press the **MEAS/DISP** key, select the Bandwidth soft key and set the resolution bandwidth and the video bandwidth to Auto.
- Step 10.** Press the Back soft key to return to the previous menu.
- Step 11.** Press the Trace soft key and the Max Hold soft key to set max hold to ON as indicated to the left of the graph.
- Step 12.** Press the Back soft key to return to the previous menu.
- Step 13.** Press the Measure soft key and press the Channel Power soft key.
- Step 14.** Select the Int BW soft key and enter the integration bandwidth frequency appropriate for the particular application and press **ENTER**.
- Step 15.** Press Center Freq and Channel Span to set the signal frequency and span if the signal standard and channel are not selected as in steps 2 and 3.
- Step 16.** Make the measurement by pressing the Measure soft key. The detection method is automatically changed to RMS. The Site Master will display the measurement results.

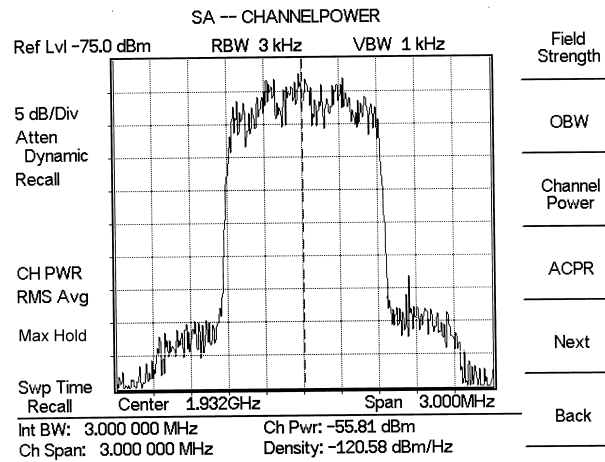

Figure 5-5. Channel Power Measurement

When the channel power measurement is on, a CH PWR icon appears to the left of the graph. Channel power is calculated at the end of a sweep. An hourglass is displayed as the calculations are performed.

*NOTE: The channel span must be set equal to or larger than the integration bandwidth. If not, the Site Master will set the channel span equal to the integration bandwidth. When the integration bandwidth and channel span are set to the same value, the Site Master uses all the sampling points for integration, providing the most accurate measurements. The ratio of the integration bandwidth to channel span is kept constant. When the integration bandwidth is changed, the ratio remains the same. The ratio can be changed by changing the channel span. For example, when the integration bandwidth is doubled, the Site Master will double the channel span. Integration Bandwidth must be at least one tenth of the channel span.*

## Adjacent Channel Power Ratio

Another common transmitter measurement is that of adjacent channel leakage power. This is defined as the ratio of the amount of leakage power in an adjacent channel to the total transmitted power in the main channel. This measurement can be used to replace the traditional two-tone intermodulation distortion (IMD) test for system non-linear behavior.

The result of an ACPR measurement can be expressed either as a power ratio or a power density. In order to calculate the upper and lower adjacent channel values, the Site Master requires the specification of four parameters:

- Main Channel Frequency
- Measurement Channel Bandwidth
- Adjacent Channel Bandwidth
- Channel Spacing

### Required Equipment

- Site Master S332D
- Portable antenna for the selected signal frequency

### Procedure

- Step 1.** On the Site Master, press the **MODE** key, use the Up/Down arrow key to select the Spectrum Analyzer mode and press **ENTER**.
- Step 2.** Press the Signal Standard soft key, select the appropriate network standard, and press **ENTER**.
- Step 3.** Press the Select Channel soft key, enter a value and press **ENTER**.

**NOTE:** For ACPR measurements, when the appropriate Channel is selected, the Main channel bandwidth, Adjacent channel bandwidth and channel spacing are automatically set.

- Step 4.** Press the **AMPLITUDE** key and select the Ref Level soft key to set the reference level to an appropriate value.
- Step 5.** Press the Atten/Preamp soft key and set the attenuation to Auto.
- Step 6.** Press the **MEAS/DISP** key and select the Bandwidth soft key to set the resolution bandwidth and the video bandwidth to Auto.
- Step 7.** Press the Back soft key to return to the previous menu.
- Step 8.** Press the Trace soft key and the Max Hold soft key to set max hold to On as indicated to the left of the graph.
- Step 9.** Press the Measure soft key and press the ACPR soft key.
- Step 10.** Make the measurement by pressing the Measure soft key. The detection method is automatically changed to RMS Average. Solid vertical lines are drawn on the display to indicate the main channel. Dashed vertical lines define the adjacent channels. The Site Master will display the measurement results.

Figure 5-6 shows the results of the measurement.

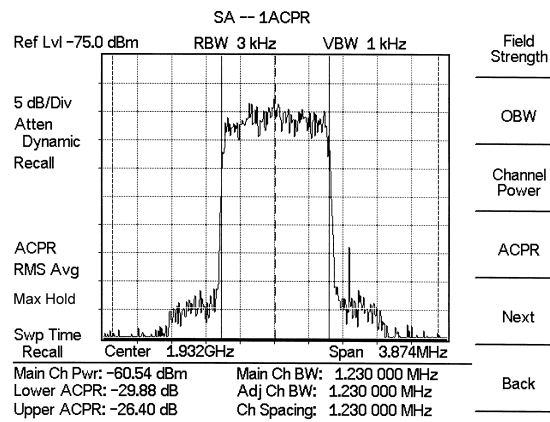

Figure 5-6. Adjacent Channel Power Measurement

Adjacent Channel Power Ratio is a continuous measurement. Once it is turned on, it will remain on until it is turned off by pressing the Measure key again. When the ACPR measurement is on, an ACPR icon appears to the left of the graph. ACPR is calculated at the end of a sweep. An hourglass is displayed as the calculations are performed.



## Interference Analysis

Multiple wireless networks often operate in complicated signal environments. Three or four base station antennas may be located on the same tower, and can create interference problems. Interference is one of the most common problems affecting wireless network systems capacity and coverage. The Site Master captures and analyzes a received signal and displays the air interface standard and estimated bandwidth of the received signal, which is critical in recognizing and analyzing the interfering signals.

### Procedure

- Step 1.** On the Site Master, press the **MODE** key, use the Up/Down arrow key to select the Spectrum Analyzer mode and press **ENTER**.
- Step 2.** Press the **MEAS/DISP** key and select the Measure soft key.
- Step 3.** Press the More soft key and the Int. Analysis soft key.
- Step 4.** Press the Set IA Freq soft key, enter the appropriate frequency to analyze the interfering signal, and press **ENTER**. Alternatively, press the IA Frequency as Marker M1 soft key when marker M1 is on to set the IA frequency to the current M1 frequency.
- Step 5.** Press the Measure soft key to start the measurement. A message box on the screen states that the analysis is in process, then, when the measurement is complete, displays the Cell Standard and estimated bandwidth of the interfering signal.

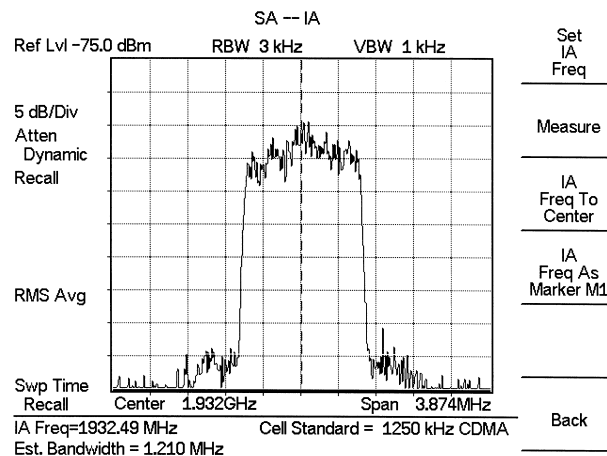

Figure 5-7. Interference Analysis

**NOTE:** Use IA Freq To Center to center the frequency on the display.

## AM/FM Demodulation

The Spectrum Master built-in demodulator for AM, narrowband FM, wideband FM and single sideband (selectable USB and LSB) allows a technician to hear an interfering signal for easy identification. The demodulated signal can be heard using either the built-in speaker, or through a monaural headset connected to the 1/8-inch jack on the test panel.

### Demodulation Procedure

- Step 1.** Press the **MEAS** key followed by the More soft key and the AM/FM Demod soft key.
- Step 2.** Press the Demod Type soft key and select AM, FM Wide Band, FM Narrow Band, SSB Lower, or SSB Upper to match the modulation format of the signal.

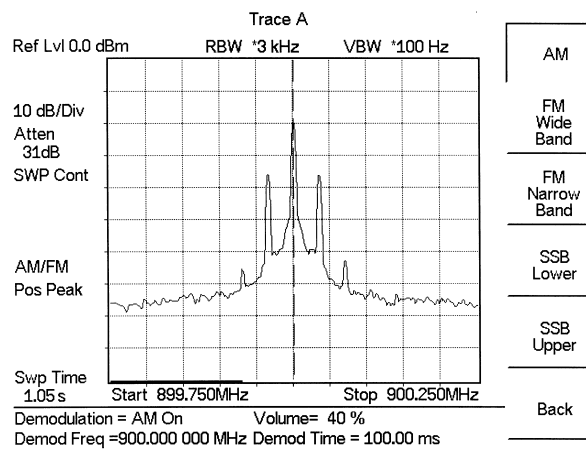

Figure 5-8. Select Demodulation Type

- Step 3.** Press the Back soft key.
- Step 4.** For AM or FM signals, press the Demod Freq soft key and use the keypad to enter the center frequency of the signal to be demodulated. By default, the demodulation frequency is the center of the frequency span.

For SSB Upper and SSB Lower signals, press the Demod Freq/BFO Adj. soft key. By default the demodulation frequency is the center of the frequency span. If the demodulation frequency needs to be changed, press the Demod Freq soft key and enter the correct demodulation frequency. The BFO Adjust soft key allows adjustment of the beat frequency oscillator to fine tune the signal through a span of  $\pm 10000$  Hz.

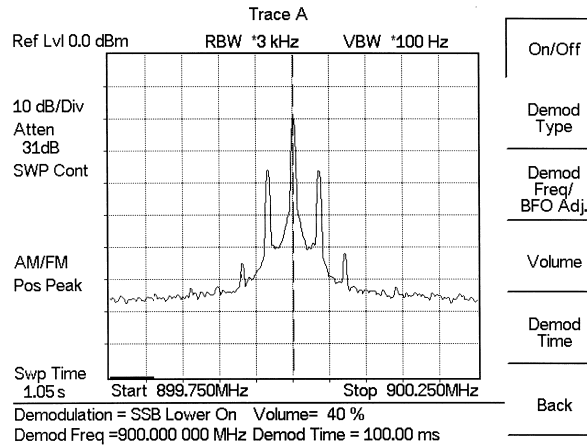

Figure 5-9. SSB Demodulation

**Step 5.** Press the On/Off soft key to enable the measurement. AM/FM will appear to the left of the graph.

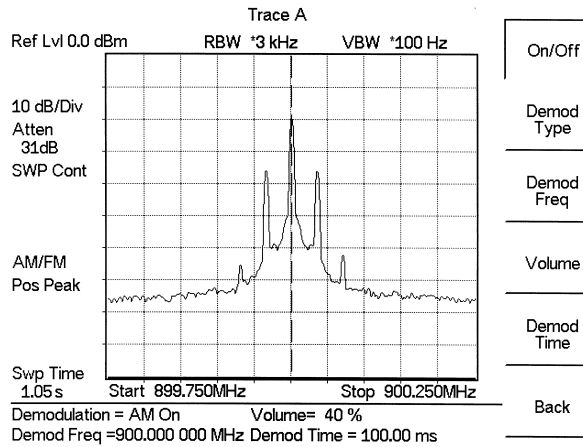

Figure 5-10. AM Demodulation

**Step 6.** Use the Volume soft key and the Up/Down arrow key to change the audio volume from 0% to 100%. For most headsets a volume of 40% is adequate.

**Step 7.** The Demod Time soft key sets the time the Spectrum Master will demodulate the signal. Enter a value from 100 ms to 500 seconds.

## Carrier to Interference Ratio (C/I)

Carrier to Interference Ratio (C/I) Measurement is a two-step process, first measuring the carrier level and then, with the carrier turned off, measuring the remaining signals and noise in the band of interest. After the two measurements are complete, the ratio of the carrier level to the noise plus interference is displayed using three assumptions:

- ❑ The interferer is a narrowband frequency hopping signal source (NB FHSS)
- ❑ The interferer is a wideband frequency hopping signal source (WB FHSS)
- ❑ The interferer is a broadband signal (BB)

The primary application for this type of measurement is determining the magnitude of interference problems for 802.11b, 802.11g and 802.11a access points (hot spots).

### Procedure

- Step 1.** If necessary, press the **MODE** key and use the Up/Down arrow key to select the Spectrum Analyzer mode. Press the **ENTER** key to select.
- Step 2.** Press the Signal Standard soft key. Select the appropriate signal standard based on the signal to be measured and press **ENTER**.
- Step 3.** Press the Select Channel soft key, select the operating channel of the access point being measured and press **ENTER**.

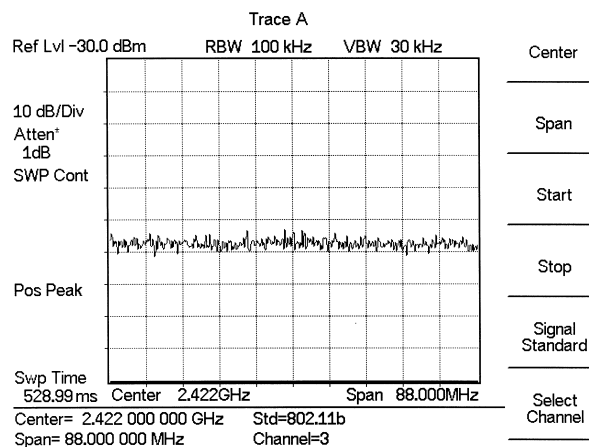

Figure 5-11. Signal Standard and Channel Selected

- Step 4.** Press the **MEAS/DISP** key followed by the Measure soft key, the More soft key and the C/I soft key.

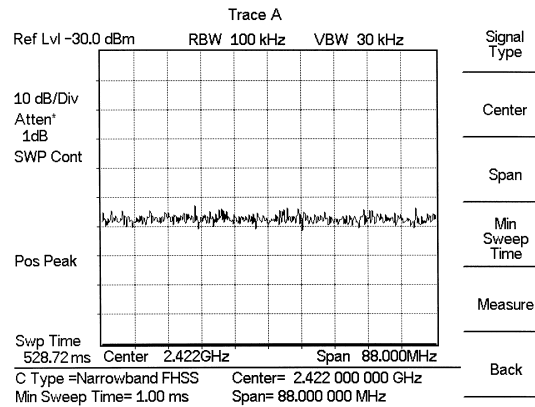

Figure 5-12. Carrier to Interference Ratio Measurement Screen

- Step 5.** Press the Signal Type soft key and select the correct carrier signal type from the three choices, Narrow Band FHSS, Wide Band FHSS, or Broadband.

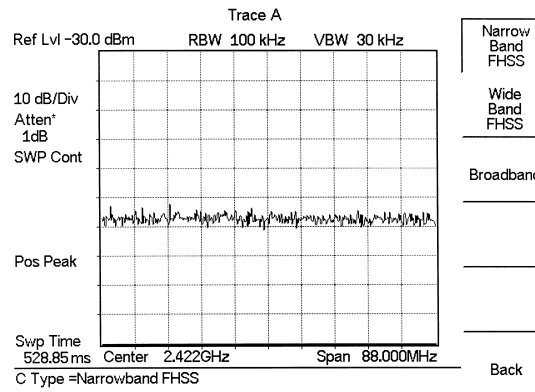

Figure 5-13. Select Signal Type

- Step 6.** Press the Back soft key to return to the previous menu.
- Step 7.** Unless a Signal Standard and Channel have already been selected, press the Center soft key and enter the desired frequency.
- Step 8.** If needed, press the Span soft key and set an appropriate span width for the signal to be measured.
- Step 9.** If the signal environment includes slow frequency hopping signals, such as cordless telephones, press the Min Sweep Time soft key to set a sweep time of one second or more to give a good chance of capturing instances of the interfering signal.

**Step 10.** Press the Measure soft key and follow the on-screen prompts to complete the measurement.

*NOTE: Access to the transmitter is required to complete this procedure as the transmitted carrier must be turned off for the second portion of the measurement.*

**Step 11.** After the measurement is complete, a message box will give results for the three different signal types. Some measurement results may show as N/A, and this is to be expected. Press the **ENTER** key to continue. All of the information in the message box will still be available.

**Step 12.** Press the appropriate soft key for the signal type being measured to view the measurement results. The results are shown at the bottom of the screen.

**Step 13.** Press the Save C/I Meas soft key to save both traces. Select the alphanumeric characters for the trace name and press the **ENTER** key to save the traces. The Site Master will save both the carrier and interferer traces with the same name, and automatically append a “-C” to the saved carrier trace, and a “-I” to the saved interference trace.

**Step 14.** Press the C/I Done soft key to return to normal sweeping mode.

**Step 15.** To recall the carrier and interferer traces, select the **RECALL DISPLAY** key and use the Up/Down arrow key to select either the -C or -I trace. Both traces will be displayed, with the selected trace data shown at the bottom of the display. The selected trace is displayed as a yellow trace, and the other as a magenta trace. (Some adjustment of the display brightness may be required for optimal viewing.)

**Step 16.** To review the specific data for the measurement, select the **MEAS/DISP** key followed by the Measure soft key, the More soft key and the C/I soft key. Select either the C Data, I Data, or C/I Data soft keys to view the corresponding data at the bottom of the display.

**Step 17.** Press the **ESCAPE** key to return to normal sweep mode.

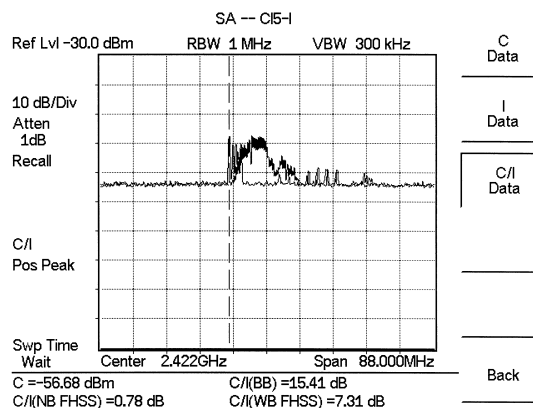

Figure 5-14. Recalled C/I Trace

# Chapter 6

## Internal Power Meter Mode

### Introduction

The Site Master S33xD can make power measurements based on the spectrum analyzer measurements, and can display the measured power in dBm or Watts.

### Power Measurement

#### Required Equipment

The following equipment is required to make a power measurement with the Site Master.

- ❑ Site Master Model S331D/S332D with Option 29
- ❑ Test Port Extension Cable, Anritsu 15NNF50 – 1.5C

#### Procedure

The following procedure details making a power measurement with the Site Master.

- Step 1.** Press the **ON/OFF** key on the Site Master.
- Step 2.** Press the **MODE** key.
- Step 3.** Use the Up/Down arrow key to select the Power Meter (Internal) mode and press **ENTER**.
- Step 4.** Press Span to activate a menu of span related choices:
  - Edit — Allows editing of the span to enter specific frequency.
  - Full — Sets the power meter to its maximum frequency span.
  - Min — Sets the power meter span to minimum.
  - Span Up 1-2-5 — Activates the span function so that the span may be increased quickly in a 1-2-5 sequence.
  - Span Down 1-2-5 — Activates the span function so that the span may be reduced quickly in a 1-2-5 sequence.
  - Back — Returns to the previous menu level.
- Step 5.** Press the Center soft key to set the power meter to the desired center frequency. A center frequency from 4.5 MHz to 2998.5 MHz can be entered.  
*or*  
Press the Signal Standard and Select Standard soft keys and choose the appropriate signal standard for the network, and press the Select Channel soft key and choose the appropriate channel for the selected standard.
- Step 6.** Press the **MEAS/DISP** key to activate the RMS Averaging menu. The RMS average is calculated by taking the log of the average power, and the power is calculated from voltage. The number of points to average can be set to low, medium or high.

## Offset Calibration

One of the main contributors to measurement error when measuring the power coming out of a base station is to assume that the combined loss of the phase stable cable and the attenuator connected to the output of the instrument is exactly the same as the specified value of the attenuator. An offset calibration can be used to measure the loss of the attenuator and cable using a scalar measurement.

The instrument measures the loss of the phase stable cable and the attenuator and uses this value to subtract the loss for the selected frequency range. The original characterization is done over the entire frequency range, so there is no need to perform additional calibrations when the frequency range is changed. The calibration automatically disappears when the instrument is rebooted. It is possible to recall the last calibration and it is also possible to apply this offset cal feature to other modes as well (SPA, Interference Analyzer, Channel Scanner).

## Required Equipment

- Site Master S33xD
- Test Port Extension Cable, Anritsu 15NNF50 – 1.5C
- 18" (46cm) Test Port Extension Cable, Anritsu 3-806-151
- 10 dB Attenuator, Anritsu 3-1010-119
- 30 dB, 50W, bi-directional, DC–18 GHz, N(m) – N(f), Attenuator, Anritsu 42N50A-30

## Procedure

- Step 1.** Press the **ON/OFF** key on the Site Master.
- Step 2.** Press the **MODE** key.
- Step 3.** Use the Up/Down arrow key to select the Power Meter mode and press **ENTER**.
- Step 4.** Press the **START CAL** (3) key.
- Step 5.** Connect the 10 dB Attenuator to the RF Out connector.
- Step 6.** Connect the 18" (46cm) Test Port Extension Cable to the RF In connector and the 10 dB Attenuator.

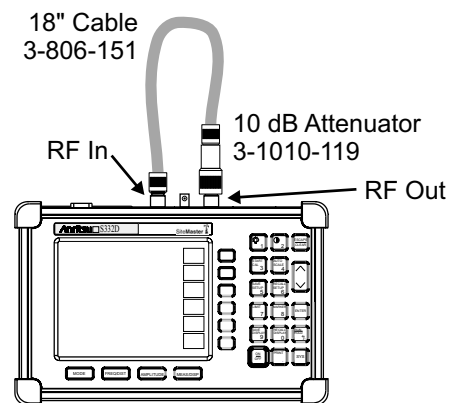

Figure 6-1. Setup for Normalizing the Trace



- Step 7.** Press the **ENTER** key.
- Step 8.** Disconnect the 18" (46cm) Test Port Extension Cable from the RF In connector and connect the phase stable cable and attenuator between the RF In connector and the 18" (46cm) Test Port Extension Cable.

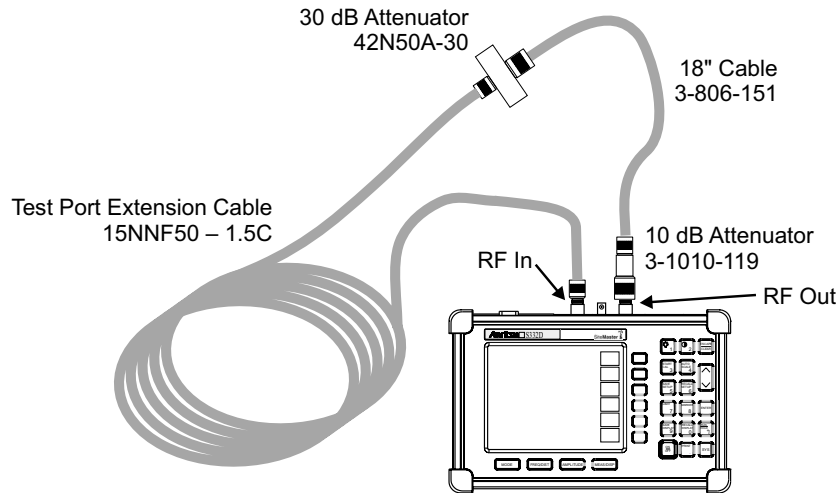

Figure 6-2. Measuring Insertion Loss of the Test Port Extension Cable and 30 dB Attenuator

- Step 9.** Press the **ENTER** key.
- Step 10.** A message will appear confirming that the Offset Calibration is done and showing the offset value to be applied. Press the **ENTER** key to accept the offset value, or press **ESCAPE** to cancel. The message Offset Cal On (# dB) will show at the bottom of the display.

### Recall an Offset Calibration

The offset calibration will be turned off when the system is rebooted. However, the last calibration is always saved and can be recalled and applied again without performing another calibration.

- Step 1.** Press the **Amplitude** key.
- Step 2.** Press the Offset dB soft key.
- Step 3.** Press the Recall Offset CAL soft key.

### Turn Off an Offset Calibration

The Offset Calibration can be turned off by rebooting the Site Master. To turn off the Offset CAL without rebooting the instrument:

- Step 1.** Press the **Amplitude** key.
- Step 2.** Press the Offset dB soft key.

*NOTE: The Offset Calibration can be applied to the amplitude offset in Spectrum Analyzer, Interference Analyzer, and Channel Scanner modes as well. For Power Meter, Spectrum Analyzer, or Interference Analyzer mode, the average insertion loss value of the span will be shown.*

## Changing the Display Units

The power reading can be displayed in dBm or Watts.

- Step 1.** Press the **AMPLITUDE** key.
- Step 2.** Press the Units soft key to toggle the display between Watts and dBm.
- Step 3.** Press the **FREQ/DIST** key to return to the Power Meter menu.

## Displaying Relative Power

Relative power can be selected through the **AMPLITUDE** menu.

- Step 1.** With the desired base power level input to the Site Master, press the **AMPLITUDE** key, then the Rel soft key. The message Relative: On will show in the lower left of the status window.
- Step 2.** Pressing the UNITS soft key will toggle the display between dB and %. When the units are dBm, the Rel soft key toggles from dB to dBm. When the units are Watts, the Rel soft key will toggle between % and nW.
- Step 3.** Choose Offset or Zero depending upon the measurement (see Chapter 2).

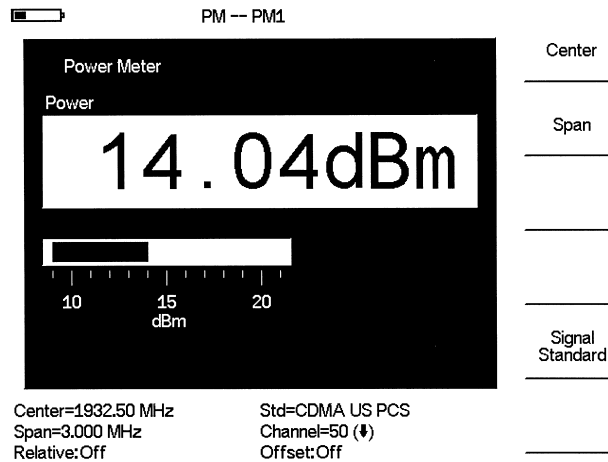

Figure 6-3. Sample Power Meter Display

# Chapter 7

## Power Monitor Mode

### Introduction

The Site Master with Option 5 installed can be used for making power measurements with broadband RF detectors, such as the 10 MHz to 20 GHz Anritsu 560-7N50B. See the table of available RF detectors on page 1-3. The power monitor displays the measured power results in dBm or Watts.

### Power Measurement

#### Required Equipment

- ❑ Site Master Model S331D or S332D with Power Monitor option
- ❑ Broadband RF detector, Anritsu P/N 5400-71N50
- ❑ 30 dB, 50 Watt, bi-directional, DC –18 GHz, N(m) – N(f), Attenuator, 42N50A-30

#### Procedure

- Step 1.** Press the **ON/OFF** key on the Site Master.
- Step 2.** Press the **MODE** key.
- Step 3.** Use the Up/Down arrow key to select the Power Monitor mode and press **ENTER**.

#### Zeroing the Power Monitor

- Step 4.** With no power applied to the DUT, press the **ZERO** soft key from the Power menu. Wait for a few seconds while the Site Master accumulates data samples of the quiescent power. When complete, **ZERO ADJ: On** is displayed in the message area.

#### Measuring High Input Power Levels

- Step 5.** Insert an attenuator between the DUT and the RF detector to protect the Site Master so that the input power level is less than or equal to 20 dBm.
- Step 6.** Press the **OFFSET** soft key.
- Step 7.** Enter the attenuation in dB using the keypad. Press the **ENTER** key to complete the entry. The message area will show **REL: ON** along with the entered value in dB.

#### Displaying Power in dBm and Watts

- Step 8.** Press the **UNITS** soft key to display power in Watts.

**Displaying Relative Power**

- Step 9.** With the desired base power level input to the Site Master, press the **REL** soft key. The message area will show **REL: ON** and the power reading will indicate 100%.
- Step 10.** Press the **UNITS** soft key to display power in dBm. Since REL is ON, the power reading will be in dB<sub>r</sub>, relative to the base power level.

# Chapter 8

## High Accuracy Power Meter

### Introduction

The S33XD Site Master with Option 19 and sensor PSN50 can be used to make High Accuracy Power Measurements from 50 MHz to 6 GHz. This high performance sensor provides true RMS measurements from -30 to +20 dBm providing accurate measurements for both CW and complex digitally modulated signals.

The display shows the power values in both dBm and Watts. The Relative Power feature displays power changes with respect to a reference value in both dB and %.

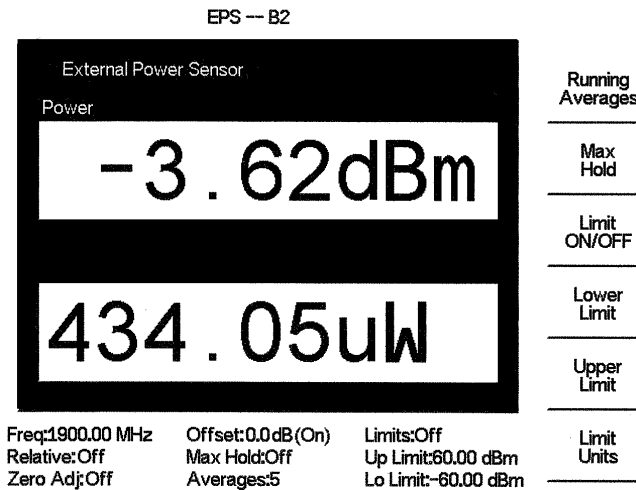

Figure 8-1. High Accuracy Power Measurement Display

Limits can be used to determine if a measurement is within specified limits, and running averaging is available along with Max/Hold and Run/Hold.

The Option 19 High Accuracy Power Meter connects to the PSN50 High Accuracy Power Sensor using an RS232 cable (Anritsu part number 800-441). A 9-18 VDC (<100 mA) power supply is needed to power the sensor. Anritsu power supply (40-168), supplied with the Site Master, is recommended.

The zero feature improves accuracy between -20 and -30 dBm by removing measured system noise. Cal Factors correct both efficiency and mismatch loss. The frequency information must be entered to obtain the correct calibration factor.

When necessary, attenuators should be used to ensure that the power does not exceed the specified measurement range. The Offset dB feature can be used to enter the value of any cables and attenuators. It is possible to measure the loss of a cable or attenuator, up to 3 GHz, using Option 21 (Transmission Measurement) or the Offset Cal Kit, 65701 (S331D with Option 29 and S332D). See page 6-2 for more details on Offset Calibration.

## Power Measurement

### Required Equipment

- ❑ S33XD Site Master
- ❑ RS232 Serial Cable, Anritsu P/N 800-441
- ❑ Power Supply, Anritsu P/N 40-168
- ❑ High Accuracy Power Sensor Anritsu P/N PSN50
- ❑ 30 dB, 50W, bi-directional, DC-8.5 GHz, N(m)-N(f), Attenuator, 3-1010-123

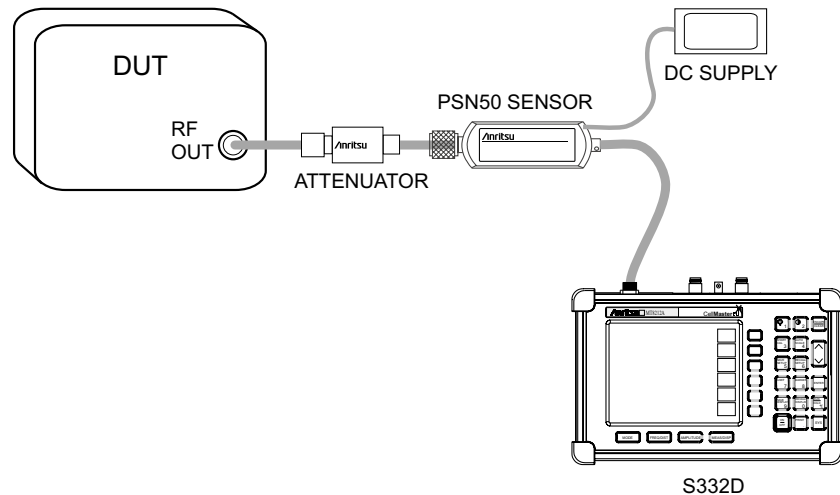

Figure 8-2. High Accuracy Power Meter Setup

### Procedure

- Step 1.** Connect the RS232 serial cable between the PSN50 High Accuracy Power Sensor and the Site Master serial port.
- Step 2.** Connect the DC power supply to the DC input of the PSN50 sensor.
- Step 3.** Press the **ON/OFF** key on the Site Master.
- Step 4.** Press the **MODE** key.
- Step 5.** Use the Up/Down arrow key to select High Accuracy Power Meter mode and press **ENTER**.

### Zero and Cal

- Step 6.** Press the **FREQ/DIST** key.
- Step 7.** To enter the frequency manually using the number keys, select the Center soft key. To select a known signal standard, press the Signal Standard soft key and use the Up/Down arrow key to select the desired standard. The Cal Factors will be derived for the corresponding center frequency.

*NOTE: The channel number is not required because the cal factor frequencies are rounded to the nearest 500 MHz.*

- Step 8.** With no power applied to the sensor, press the **AMPLITUDE** key then the Zero soft key to zero the sensor. Zeroing the sensor is recommended when making power measurements below  $-20$  dBm.

### Using Attenuators

- Step 9.** Press the **AMPLITUDE** key and select the Offset dB soft key.
- Step 10.** Connect the phase stable cable and the attenuator between the DUT and the sensor.
- Step 11.** Enter the combined offset value of the attenuator and the pad, or select the Measure Offset soft key to use the Offset Cal Kit (65701) to measure the offset. See page 6-2 for more details.

### Averaging/Max Hold/Run Hold

- Step 12.** Press the **MEAS/DISP** key.
- Step 13.** Press the Running Averages soft key and use the keypad to enter the number of averages to use (up to 50).
- Step 14.** Press the Max Hold soft key to display the maximum value. If Averaging is selected, Max/Hold will display the maximum value of the non-averaged data.
- Step 15.** Press the **RUN/HOLD** key to hold the display in the current condition.

### Setting Limits

- Step 16.** Press the **MEAS/DISP** key.
- Step 17.** Press the Limit Units soft key to select the units.
- Step 18.** Press the Lower Limit soft key and enter the lower limit value in dBm or in Watts.
- Step 19.** Press the Upper Limit soft key and enter the upper limit value in dBm or in Watts.
- Step 20.** Press the Limit ON/OFF soft key to turn on the limits. The number display will turn green if the measurement is passing, or red if the measurement is failing. The word PASS or FAIL will also be displayed in between the logarithmic and linear display windows.

### Displaying Relative Power

- Step 21.** Press the **AMPLITUDE** key.
- Step 22.** With the desired base power level input to the sensor, press the Rel soft key. The message area will show Relative On and the power reading will show 0 dB and 100%. If measuring a 10 dBm signal with the Rel key selected, a drop to 7 dBm will show  $-3$ dB and 50%.

### Saving the Measurement

- Step 23.** Press the **SAVE DISPLAY** key.
- Step 24.** Use the soft keys to enter a Trace Name.

### **Transferring Data to Handheld Software Tools**

The Site Master has only one serial port, so it is not possible to communicate with both the PSN50 sensor and a PC running Handheld Software Tools (HHST) at the same time. Therefore, only saved measurements can be viewed in HHST when using the PSN50. To view saved measurements, disconnect the serial cable from the PSN50 and connect it to the serial port of the PC running HHST. Refer to the Handheld Software Tools chapter in this manual for further information.



# Chapter 9

## T1 Measurements

### Introduction

This chapter provides a brief description of a T1 circuit and T1 measurements, and also explains how to setup and measure T1 performance using the Anritsu Site Master S331D with Option 50 installed.

### T1 Fundamentals

Wireless service providers use wired T1 circuits as the backhaul links to connect a Base Transceiver Station (BTS) to a Mobile Switching Center (MSC). The quality of the service provided over those T1 lines has a direct effect on the quality of service experienced by the wireless service provider customers. Call setup failures, dropped calls, data errors and noise can often be attributed to the T1 backhaul facilities. An example of a typical wireless network backhaul T1 link is shown in the Figure 9-1.

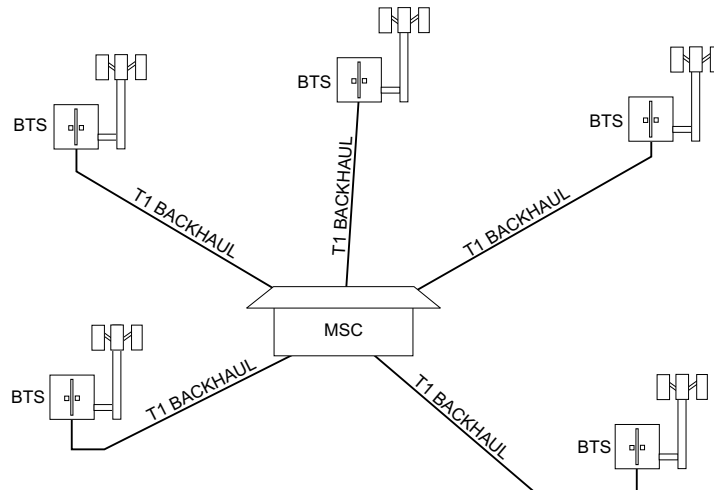

Figure 9-1. Typical Wireless Network T1 Backhaul Link

In the United States, wireless service providers generally lease T1 lines from a Local Exchange Carrier (LEC), so it often requires a joint effort to analyze and troubleshoot a T1 line.

T1 is an American National Standard Institute (ANSI) standard, used mostly in North America, parts of Japan and some Asian countries. Technically, a T1 line is a digital transmission facility consisting of wire pairs and regenerators, or optical media, carrying a DS1 signal. T1 refers to the physical properties of the line, for example, 1.544 MHz with a specific pulse shape, etc. DS1 refers to the digital signal carrying the information at a rate of 1.544 Mb/s. The DS1 signal may be formatted using various framing patterns, most commonly (but not always) divided into 24 channels each carrying encoded voice or data.

## G.821 Measurement Definitions

**Available Seconds (AS)**—The count of available seconds since the beginning of the test. Available seconds equals the total test time minus any unavailable seconds.

**Degraded Minutes (DGRM)**—The count of Degraded Minutes since the start of the test. A Degraded Minute occurs when there is a  $10^{-6}$  bit error rate during 60 available, non-severely bit errored seconds.

**Error Free Seconds (EFS)**—The count of error free seconds since the beginning of the test. Error free seconds equals the total test time minus the number of errored seconds.

**Errored Second (ES)**—The number of seconds with at least one error.

**Severely Errored Seconds (SES)**—This is the count of Severely Errored Seconds since the beginning of the test. A second with a bit error rate of  $10^{-3}$  or higher is a severely errored second. Severely errored seconds are not counted during unavailable time. Loss of signal (LOS), loss of frame (LOF) and loss of pattern synchronization (LOP) are treated as severely errored seconds

**Unavailable Seconds (UAS)**—This is the count of UnAvailable Seconds that have occurred since the beginning of the test. Unavailable time begins at the onset of 10 consecutive severely errored seconds, and ends after 10 consecutive non-severely errored seconds. The onset of unavailable seconds cause the SES count to be adjusted downward by 10. When unavailable time ends, the UAS count is adjusted downward by 10.

## Network Equipment

One possible network topology is shown in Figure 9-2.

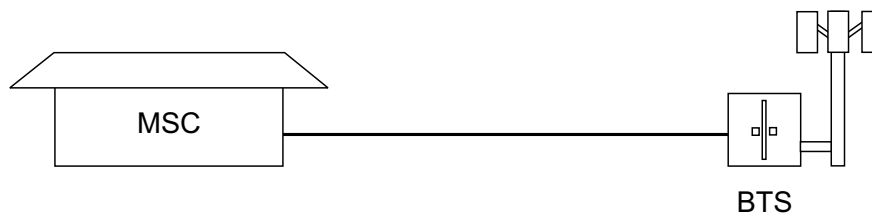

Figure 9-2. One Possible T1 Network Topology

The circuit between the MSC and BTS passes through the LEC central office, and in fact may pass through multiple central offices. Within each office, it will in turn pass through multiple pieces of transmission equipment. The Network Interface Unit (NIU) at the MSC and the BTS may be a very simple device having only a remote loop back capability, or it may provide very sophisticated performance monitoring capabilities. Its capabilities may or may not be accessible to the wireless service provider technician. Some repeaters may exist in the circuit when the signal is traveling long distances. Repeaters are full duplex devices that regenerate or restore the pulse shape and amplitude.

Another possible configuration between BTS and MSC is shown in Figure 9-3.

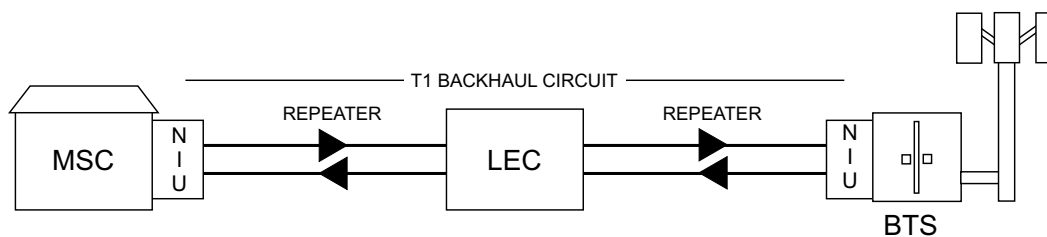

Figure 9-3. BTS and MSC Configuration

This configuration uses a High-speed Digital Subscriber Line (HDSL) in the T1 circuit, which enables full duplex T1 service over a single pair of wires without repeaters. In most cases the wireless service provider technician may not be concerned with the repeaters or HDSL.

## Testing T1 Circuits

T1 circuit testing can be done with either of two methods: In service and Out of service testing.

In service testing is done during routine maintenance and troubleshooting phase. This can be done on live data without removing the T1 circuit from service or done on live data. Monitoring live data allows wireless service provider technicians to detect alarms, bipolar violations (BPV) and frame errors but bit errors cannot be measured. However they may be estimated by measuring CRC errors or frame errors.

Out of Service testing is done when T1 is initially installed and before final acceptance from the LEC. At that time the circuit should be subjected to critical testing to guarantee the level of service per contract. Out of service testing may also be performed when the circuit performance is very poor. For Out of service testing T1 should be removed from service which allows detailed performance testing of the T1 circuit.

### In Service Testing

In service testing can only be done when the equipment has a test port. When testing a T1 circuit in service it is always better to perform a bridged or monitoring test, to avoid disrupting service. Even when the T1 circuit is down these tests will help to verify and identify the correct fault circuit. The following measurements can be used to check the T1 performance during regular maintenance:

- $V_{pp}$  Measurement
- Carrier
- Frame Sync
- CRC Errors, for Extended Super Frame (ESF)

#### Required Equipment

- S33xD Site Master with Option 50
- Bantam Cables, Anritsu Part Number 806-16 (2)

#### Vpp Measurement Procedure

- Step 1.** Press the **MODE** key, select T1 Tester, and press **ENTER**.
- Step 2.** Select the Vpp soft key.
- Step 3.** Press the Terminate/Bridged soft key and select Bridged mode.
- Step 4.** Press the Start/Stop Measure soft key to start or stop the peak to peak voltage measurement.

If the measurement meets the customer requirements for this system, proceed to the BERT measurement.

*NOTE: Vpp measurement can be displayed in dBdsx format by pressing the Vpp/dBdsx soft key.*

**BERT Measurement Setup**

- Step 1.** Press the **MODE** key, select T1 Tester, and press **ENTER**.
- Step 2.** Select the Setup soft key.
- Step 3.** Press the Framing Mode soft key and choose the Auto, D4 SF or ESF framing type. Press Back to return to the previous menu.

*NOTE: The Site Master will attempt auto-framing in two situations only:*  
 1. When the unit is initially set for auto-detect, and  
 2. When a new measurement is started and loss of frame or pattern sync is detected. The Site Master will not attempt to auto detect in mid-measurement.

- Step 4.** Press the Receive Input soft key and select Bridged mode. Press Back to return to the previous menu.
- Step 5.** Press the Line Coding soft key and select B8ZS or AMI coding. Press Back to return to the previous menu.
- Step 6.** Select the More soft key to access more menu selections.
- Step 7.** Press the Clock Source soft key and select External to synchronize to the transmitting equipment. Press Back to return to the previous menu.
- Step 8.** Press the ANSI CRC/Japan CRC soft key and choose the appropriate CRC error scheme soft key. Press Back to return to the previous menu.

Figure 9-4 illustrates some of the key information of the T1 setup measurement display.

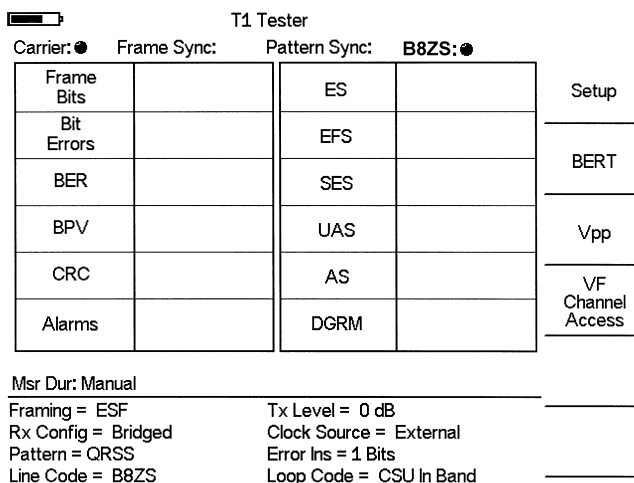

Figure 9-4. T1 Setup Measurement Display

**BERT Measurement**

- Step 1.** Press the **MEAS/DISP** key and then the BERT soft key.
- Step 2.** Press the Measure Duration soft key and use the Up/Down arrow key to select the duration of the measurement, and press **ENTER**. Figure 7-5 shows the T1 measurement display.

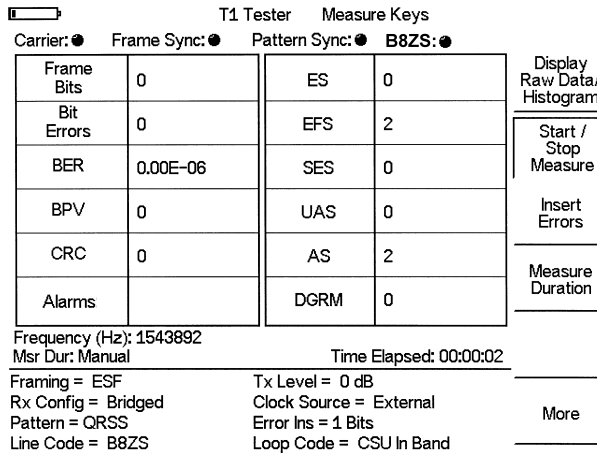

Figure 9-5. T1 BERT Measurement Display

- Step 3.** To display the measurement data in a histogram format, press the Display Raw Data/Histogram soft key.
- Step 4.** Press the Measure Duration soft key to set the duration of the measurement, and press **ENTER**. The maximum measurement duration is two days.
- Step 5.** Press the Time Scale soft key and use the Up/Down arrow key to select the histogram resolution, and press **ENTER**. The maximum time scale is 60 minutes.

**NOTE:** The unit sets the histogram display and collects and displays the data based on the selected time scale. For example, if the time scale is set to 30 minutes, the unit collects and updates the histogram display data every 30 minutes. When the time scale is set to Auto, the unit automatically sets the histogram display to collect the data based on the selected measurement duration.

- Step 6.** Press the Start/Stop Measure soft key to begin the measurement.
- Step 7.** Press the **SYS** key, then the Application Options and Log Data soft keys to save the data. A message window will display if there is insufficient memory to log the complete duration. Adjust the Measurement Duration and Time Scale as necessary to log the data.

**NOTE:** The **RUN/HOLD** key can also be used to start or stop the measurement.

Figure 7-6 displays the T1 measurement data in Histogram mode.

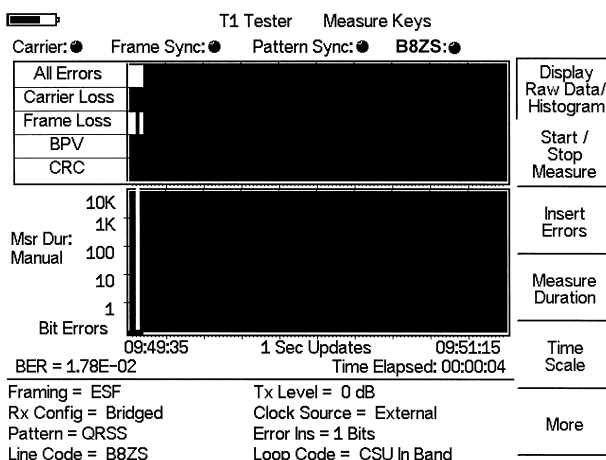

Figure 9-6. T1 BERT Measurement Display with Histogram

## Out-Of-Service Testing

Out-of-service measurements are performed when the T1 circuit is not in service or inactive. Typically these tests are done during initial installation, during circuit acceptance by the wireless service provider or when the results of the in-service measurements indicate errors. These measurements provide detailed information on the T1 circuit.

There are two methods of performing out-of-service testing: end-to-end and loopback testing. End-to-end testing requires a technician and a unit at each end of the circuit. Loopback testing requires a loopback at one end of the circuit and a unit and technician at the other end to measure the round trip of the T1 performance.

The ANSI T1 standard defines in-band and out-of-band loop codes. In-band codes are transmitted in place of payload data and are repeated continuously for a period of five seconds. They can be used either with D4 SF or ESF. Out-of-band loop codes can only be used with the ESF framing format as an out of band communication link does not exist for D4 SF.

The following measurements can be used to check T1 performance during out of service testing:

- V<sub>pp</sub>
- Carrier
- Insert Errors/Alarms
- Frame Sync
- Pattern Sync
- Remote/Self Loop Codes

### Required Equipment

- S331D Site Master with Option 50
- Bantam Cables, Anritsu Part Number 806-16 (2)

### **V<sub>pp</sub> Measurement Procedure**

- Step 1.** Press the **MODE** key, select T1 Tester, and press **ENTER**.
- Step 2.** Select the Vp-p soft key.
- Step 3.** Press the Terminate/Bridged soft key and select Terminate mode.
- Step 4.** Press the Start/Stop Measure soft key to start or stop the peak to peak voltage measurement.

*NOTE: The Vpp measurement can be displayed in dBdsx format by pressing the Vpp/dBdsx soft key.*

### **BERT Setup Procedure**

- Step 1.** Press the **MODE** key, select T1 Tester, and press **ENTER**.
- Step 2.** Select the Setup soft key.
- Step 3.** Press the Framing Mode soft key and choose the Auto, D4 SF or ESF framing type. Press Back to return to the previous menu.

*NOTE: The Site Master will attempt auto-framing in two situations only:*  
*1. When the unit is initially set for auto-detect, and*  
*2. When a new measurement is started and loss of frame or pattern sync is detected. The Site Master will not attempt to auto detect in mid-measurement.*

- Step 4.** Press the Receive Input soft key and select Terminate. Press Back to return to the previous menu.
- Step 5.** Press the Pattern soft key and select Auto, or the appropriate pattern for this test, and press **ENTER**.
- Step 6.** Press the Line Coding soft key and select either the B8ZS or AMI soft key, as appropriate. Press Back to return to the previous menu.
- Step 7.** Press the Transmit Level soft key and select either the 0 dB, -7.5 dB or -15 dB transmitter signal level soft key as appropriate for this measurement. Press Back to return to the previous menu.
- Step 8.** Select the More soft key to access more menu selections.
- Step 9.** Press the Clock Source soft key and select External for an external clock source or Internal to use the internal clock. Press Back to return to the previous menu.
- Step 10.** Press the Setup Error Insert soft key and set the appropriate error or alarm type by selecting the Bit, BPV, Framing Bits, RAI or AIS soft key. Press Back to return to the previous menu.
- Step 11.** Press the Loop Code soft key and select the appropriate loop code by selecting the CSU, NIU, User defined or In-Band/Data Link soft key. Press Back to return to the previous menu.
- Step 12.** Press the ANSI CRC/Japan CRC soft key and choose the appropriate CRC error scheme soft key. Press Back to return to the previous menu.



Figure 9-7 illustrates some of the key information of the T1 measurement setup.

T1 Tester Setup Keys

Carrier: ● Frame Sync: Pattern Sync: B8ZS: ●

Frame Bits		ES		Framing Mode
Bit Errors		EFS		Receive Input
BER		SES		
BPV		UAS		Pattern
CRC		AS		Line Coding
Alarms		DGRM		
Msr Dur: Manual				More
Framing = ESF		Tx Level = 0 dB		Back
Rx Config = Terminate		Clock Source = External		
Pattern = QRSS		Error Ins = 50 Bits		
Line Code = B8ZS		Loop Code = CSU In Band		

Figure 9-7. T1 Out-of-Service Measurement

### BERT Measurement Procedure

- Step 1.** Press the **MEAS/DISP** key and then the BERT soft key.
- Step 2.** Press the Measure Duration soft key and use the Up/Down arrow key to select the duration of the measurement, and press **ENTER**. Figure 7-8 displays the T1 measurement in raw data mode.

Carrier: ●		Frame Sync: ●		Pattern Sync: ●		B8ZS: ●		Measure Keys	
Frame Bits	0	ES	0	Display Raw Data/Histogram					
Bit Errors	0	EFS	42	Start / Stop Measure					
BER	0.00E-08	SES	0	Insert Errors					
BPV	0	UAS	0	Measure Duration					
CRC	0	AS	42						
Alarms		DGRM	0						
Frequency (Hz): 1543891		Time Elapsed: 00:00:43							
Msr Dur: Manual									
Framing = ESF		Tx Level = 0 dB							
Rx Config = Terminate		Clock Source = External							
Pattern = QRSS		Error Ins = 50 Bits							
Line Code = B8ZS		Loop Code = CSU In Band						More	

Figure 9-8. T1 BERT Measurement Display

- Step 3.** To display the measurement data in a histogram format, press the Display Raw Data/Histogram soft key.
- Step 4.** Press the Measure Duration soft key to set the duration of the measurement, and press **ENTER**. The maximum measurement duration is two days.
- Step 5.** Press the Time Scale soft key and use the Up/Down arrow key to select the histogram resolution, and press **ENTER**. The maximum time scale is 60 minutes.

**NOTE:** The unit sets the histogram display and collects and displays the data based on the selected time scale. For example, if the time scale is set to 30 minutes, the unit collects and updates the histogram display data every 30 minutes. When the time scale is set to Auto, the unit automatically sets the histogram display to collect the data based on the selected measurement duration.

- Step 6.** Press the Start/Stop Measure soft key to begin the measurement.
- Step 7.** Press the **SYS** key, then the Application Options and Log Data soft keys to save the data. A message window will display if there is insufficient memory to log the complete duration. Adjust the Measurement Duration and Time Scale as necessary to log the data.
- Step 8.** Press the Start/Stop Measure soft key to begin the measurement.

**NOTE:** The **RUN/HOLD** key can also be used to start or stop the measurement.

## Inserting Errors

- Step 9.** To insert a setup error, press the Insert Errors soft key to inject errors in the transmit signal. Figure 7-9 displays the T1 measurement when errors are inserted. The errors are displayed on the right side at the bottom of the display.

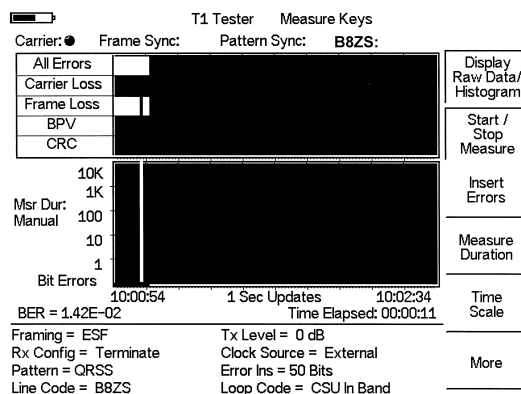

Figure 9-9. T1 BERT Measurement Display with Errors Inserted

## Activating Loopback Code

- Step 10.** Press the More soft key to activate the Loopback menu.
- Step 11.** Press the Self Loop Up or the Remote Loop Up soft key depending on the location to activate the loopback code.
- Step 12.** Press the Self Loop Down or Remote Loop Down soft key to stop the loopback code.

## **DS0 Testing**

The DS0 test feature enables testing on each of the 24 channels of the T1 line. The receive channel is decoded and the VF level and frequency are measured and displayed. The signal is also connected to a speaker, enabling the tester to make an audible assessment of the signal quality of the circuit. If the circuit is out of service, the tester can insert a test tone on the transmit channel for measurement at a remote location with another test set, or locally with a loopback.

### **Configuration**

Before conducting channel tests, the T1 interface must be properly configured. From the Setup menu, select the correct Framing Mode, Line Coding and Clock Source. If the testing is in-service, the Receive Input must be configured for either Bridged or Monitor modes. The receive mode should be set up before connecting to the circuit to avoid creating a "hit" on the customer data. If the testing is in-service, the Site Master transmit pair should not be connected to the circuit.

If the measurement is out-of-service, the Receive Input mode should be Terminate, and the Site Master transmitter can be connected to the circuit. The current configuration of the T1 interface is displayed in the status window at the bottom of the screen.

### **Channel Tests**

Once the unit is correctly configured, press the VF Channel Access soft key and select the DS0 menu to perform tests at the channel level. Press the Select Channel soft key to select specific channels. Either enter a specific channel number from the keypad, or scroll through the channels with the Up/Down arrow keys. The received VF level and frequency on the selected channel are displayed, and the decoded signal is connected to a speaker for audio monitoring. When a test tone is present on the channel, the level and frequency report will indicate whether the channel is healthy. If speech is present on the channel, the channel performance can be judged from the audio quality. A picture of channel utilization can also be formed by quickly scrolling through the channels.

If the circuit is out-of-service, the user can also connect to the transmit pair and insert a test tone on the selected channel (note that transmit and receive must be on the same channel). Two menus enable selection of transmit level and frequency. The frequency can be entered from the keypad, or scrolled to common test frequencies (404 Hz, 1004 Hz, 1804 Hz, 2713 Hz, and 2804 Hz) with the Up/Down arrow keys. To check the performance of channel level equipment, the test tone can be measured at a remote location with another VF channel test set, or locally with a loopback. To establish a loopback, use the loopback menus in the BERT test suite.

# Chapter 10

## E1 Measurements

### Introduction

This chapter provides a brief description of an E1 circuit and E1 measurements, and also explains how to setup and measure E1 performance using the Anritsu Site Master S331D with Option 50 installed.

### E1 Fundamentals

Wireless service providers use wired E1 circuits as the backhaul links to connect a Base Transceiver Station (BTS) to a Mobile Switching Center (MSC). The quality of the service provided over those E1 lines has a direct effect on the quality of service experienced by the wireless service provider customers. Call setup failures, dropped calls, data errors and noise can often be attributed to the E1 backhaul facilities. An example of a typical wireless network backhaul E1 link is shown in the Figure 10-1.

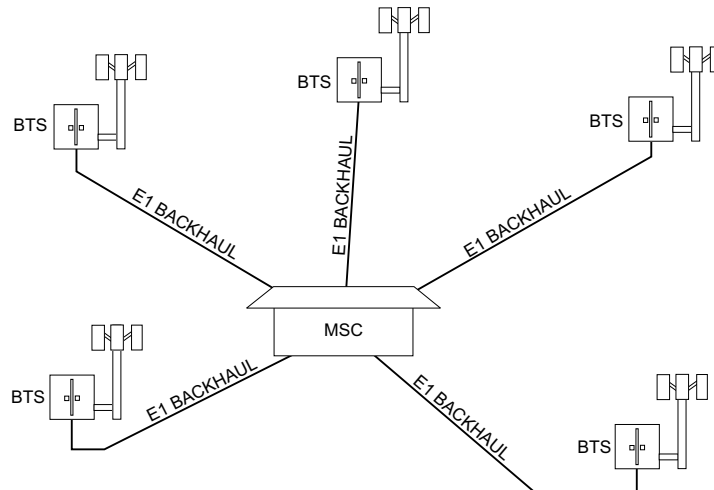

Figure 10-1. Typical Wireless Network Backhaul E1 Link

E1 is an International Telecommunication Union, Telecommunication Standardization Sector standard for E1 and is widely used in Europe and Asian countries. E1 is a digital signal carrying the information at a rate of 2 Mbps, with each 2 Mbps frame containing 256 bits in 32 time slots. Each slot has 8 bits at a repetition rate of exactly 8 kHz. The first time slot is reserved for framing, error checking and alarm signals.

ITU-T G.704 specifies a CRC-4 cyclic redundancy check for E1 performance. CRC-4 framing provides monitoring for a Bit Error Rate (BER) during normal operation. When the equipment detects an incoming CRC-4 error, it transmits an E-bit error which is received by the measuring equipment. Counting E-bit changes is equivalent to counting CRC errors, which provides BER information for the data.

## G.821 Measurement Definitions

**Available Seconds (AS)**—The count of available seconds since the beginning of the test. Available seconds equals the total test time minus any unavailable seconds.

**Degraded Minutes (DGRM)**—The count of Degraded Minutes since the start of the test. A Degraded Minute occurs when there is a  $10^{-6}$  bit error rate during 60 available, non-severely bit errored seconds.

**Error Free Seconds (EFS)**—The count of error free seconds since the beginning of the test. Error free seconds equals the total test time minus the number of errored seconds.

**Errored Second (ES)**—The number of seconds with at least one error.

**Severely Errored Seconds (SES)**—This is the count of Severely Errored Seconds since the beginning of the test. A second with a bit error rate of  $10^{-3}$  or higher is a severely errored second. Severely errored seconds are not counted during unavailable time. Loss of signal (LOS), loss of frame (LOF) and loss of pattern synchronization (LOP) are treated as severely errored seconds

**Unavailable Seconds (UAS)**—This is the count of UnAvailable Seconds that have occurred since the beginning of the test. Unavailable time begins at the onset of 10 consecutive severely errored seconds, and ends after 10 consecutive non-severely errored seconds. The onset of unavailable seconds cause the SES count to be adjusted downward by 10. When unavailable time ends, the UAS count is adjusted downward by 10.

## Network Equipment

One possible network topology is shown in Figure 10-2.

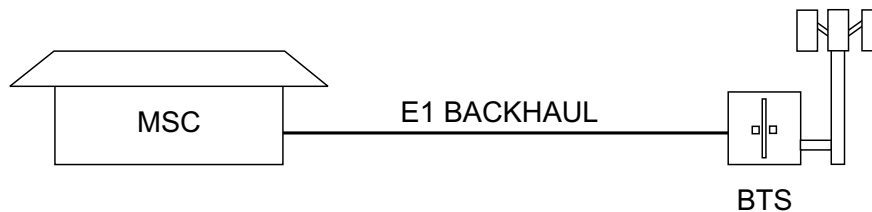

Figure 10-2. One Possible E1 Network Topology

The circuit between the MSC and BTS passes through the central office, or through multiple central offices. Within each office it may in turn pass through multiple pieces of transmission equipment. An interface unit is located at the MSC and the BTS. The interface unit may be a very simple device having only a remote loop back capability, or it may provide very sophisticated performance monitoring capabilities. Its capabilities may or may not be accessible to the wireless service provider technician.

## Testing E1 Circuits

E1 circuit testing can be done with either of two methods: In Service and Out of Service testing.

In Service testing is done during a routine maintenance and troubleshooting phase. This can be accomplished without removing the E1 circuit from service on live data. Monitoring live data allows the wireless service provider technician to detect alarms, bipolar violations (BPV) and frame errors, but bit errors cannot be measured. However, bit errors may be estimated by measuring CRC errors and E-bit errors.

Out of Service testing is done when the E1 is initially installed and before final acceptance from the service provider. At that time the circuit should be subjected to critical testing to guarantee the level of service per contract. Out of service testing may also be performed when the circuit performance is very poor. For Out of service testing, the E1 circuit should be removed from service to allow detailed performance testing.

### In Service Testing

The Bridged mode must be used when testing a E1 circuit in service to avoid disrupting service. Even when the E1 circuit is down, these tests will help to verify and identify the correct fault circuit. E-bits and CRC are very useful for in service testing to monitor E1 performance. When the equipment detects an incoming CRC-4 error, it will transmit an E-bit error toward the equipment at other end which will be seen by the test unit. E-bits determine the trouble location of the circuit. Without E-bits, the entire circuit will be determined as failure by loss of signal or alarm indication, so E-bits are critical to analyze the performance of the circuit and point to the trouble locations.

The following measurements are used to check the E1 performance during regular maintenance:

- Vpp measurement
- Carrier
- Frame Sync
- CRC errors and E-bits

#### Required Equipment

- S33xD Site Master with Option 50
- Bantam Cables, Anritsu Part Number 806-16 (2)

#### Vpp Measurement Procedure

- Step 1.** Press the **MODE** key, select E1 Tester, and press **ENTER**.
- Step 2.** Select the Vpp soft key.
- Step 3.** Press the Terminate/Bridged soft key and select Bridged mode, as indicated on the bottom left of the status window.
- Step 4.** Press the 75  $\Omega$  or 120  $\Omega$  soft key, depending on the requirements for the system impedance value. The selection will be indicated at the bottom left of the status window.

*NOTE: The Vpp measurement can be displayed in dBdsx format by pressing the Vpp/dBdsx soft key.*

**Step 5.** Press the Start/Stop Measure soft key to start or stop the peak to peak voltage measurement.

**BERT Measurement Setup**

**Step1.** Press the **MODE** key, select E1 Tester, and press **ENTER**.

**Step2.** Select the Setup soft key.

**Step3.** Press the Framing Mode soft key and choose Auto, PCM30, PCM30CRC, PCM31 or PCM31CRC framing type. Press Back to return to the previous menu.

*NOTE: The Site Master will attempt auto-framing in two situations only:*  
*1. When the unit is initially set for auto-detect, and*  
*2. When a new measurement is started and loss of frame or pattern sync is detected. The Site Master will not attempt to auto detect in mid-measurement.*

**Step4.** Press the Receive Input soft key and select Bridged mode. Press Back to return to the previous menu.

**Step5.** Press the Line Coding soft key and select HDB3 or AMI coding. Press Back to return to the previous menu.

**Step6.** Select the More soft key to access more menu selections.

**Step7.** Press the Clock Source soft key and select External clock. Press Back to return to the previous menu.

**Step8.** Press the Impedance soft key and choose 75Ω or 120Ω. Press Back to return to the previous menu.



Figure 10-3 illustrates some of the key information of the E1 setup measurement display.

E1 Tester Setup Keys			
Carrier: ●	Frame Sync:	Pattern Sync:	Alarms: None
Frame Bits		ES	
Bit Errors		EFS	
BER		SES	
BPV		UAS	
CRC		AS	
E Bits		DGRM	
Msr Dur: Manual			
Framing = PCM31 CRC		Impedance = 120 Ω	
Rx Config = Bridged		Clock Source = External	
Pattern = QRSS		Error Ins = 1 Bits	
Line Code = HDB3			

Figure 10-3. E1 BERT Setup Measurement Display

### BERT Measurement

- Step 1.** Press the **MEAS/DISP** key and then the BERT soft key.
- Step 2.** Press the Measure Duration soft key and use the Up/Down arrow key to select the duration of the measurement, and press **ENTER**. Figure 9-4 displays the E1 measurement display in raw data mode.

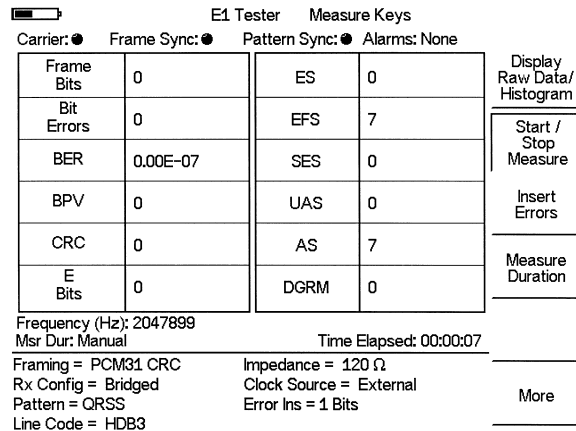

Figure 10-4. E1 BERT Measurement Display

- Step 3.** To display the measurement data in a histogram format, press the Display Raw Data/Histogram soft key.
- Step 4.** Press the Measure Duration soft key to set the duration of the measurement, and press **ENTER**. The maximum measurement duration is two days.
- Step 5.** Press the Time Scale soft key and use the Up/Down arrow key to select the histogram resolution, and press **ENTER**. The maximum time scale is 60 minutes.

**NOTE:** The unit sets the histogram display and collects and displays the data based on the selected time scale. For example, if the time scale is set to 30 minutes, the unit collects and updates the histogram display data every 30 minutes. When the time scale is set to Auto, the unit automatically sets the histogram display to collect the data based on the selected measurement duration.

- Step 6.** Press the Start/Stop Measure soft key to begin the measurement.
- Step 7.** Press the **SYS** key, then the Application Options and Log Data soft keys to save the data. A message window will display if there is insufficient memory to log the complete duration. Adjust the Measurement Duration and Time Scale as necessary to log the data.

Figure 8-5 shows the E1 measurement display in histogram mode.

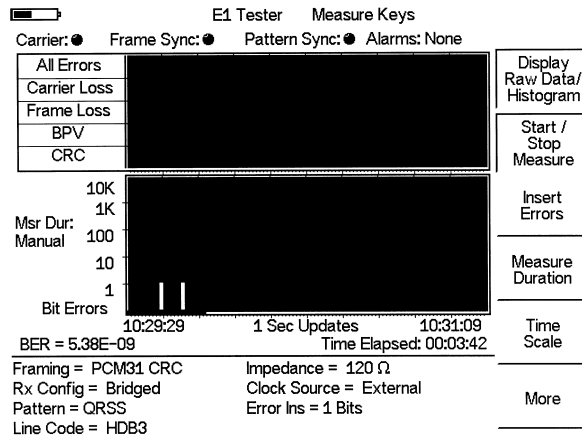

Figure 10-5. E1 BERT Measurement Display with Histogram

## Out-Of-Service Testing

Out-of-service measurements are performed when the E1 circuit is not in service or inactive. Typically these tests are done during initial installation, during circuit acceptance by the wireless service provider or when the performance of the in service measurements indicates extensive errors. These measurements provide detailed information about the E1 circuit.

Out-of-service testing is performed using end-to-end testing, which requires a technician and a unit at each end of the circuit.

The following measurements are used to check the E1 performance during out of service testing:

- Vpp
- Carrier
- CRC Errors
- Frame Sync
- Pattern Sync
- E-Bits
- Insert Errors/Alarms
- Self Loop Code

### Required Equipment

- S33xD Site Master with Option 50
- Bantam Cables, Anritsu Part Number 806-16 (2)

### Procedure

- Step 1.** Press the **MODE** key, select E1 Tester, and press **ENTER**.
- Step 2.** Select the BERT soft key.
- Step 3.** Press the Framing Mode soft key and choose Auto, PCM30, PCM30CRC, PCM31 or PCM31CRC framing type. Press Back to return to the previous menu.
- Step 4.** Press the Receive Input soft key and select Terminate. Press Back to return to the previous menu.
- Step 5.** Press the Pattern soft key and select Auto, or use the Up/Down arrow key to select the appropriate pattern for the test.

*NOTE: The Site Master will attempt auto-framing in two situations only:*

- 1. When the unit is initially set for auto-detect, and*
- 2. When a new measurement is started and loss of frame or pattern sync is detected. The Site Master will not attempt to auto detect in mid-measurement.*

- Step 6.** Press the Line Coding soft key and select HDB3 or AMI coding. Press Back to return to the previous menu.

- Step 7.** Press the Impedance soft key and choose 75Ω or 120Ω. Press Back to return to the previous menu.
- Step 8.** Select the More soft key to access more menu selections.
- Step 9.** Press the Clock Source soft key and select External clock. Press Back to return to the previous menu.
- Step 10.** Press the Setup Error Insert soft key and select Bit, BPV, Framing Bits, RAI or AIS as appropriate for the measurement.

Figure 10-7 illustrates some of the key information of the E1 measurement Setup.

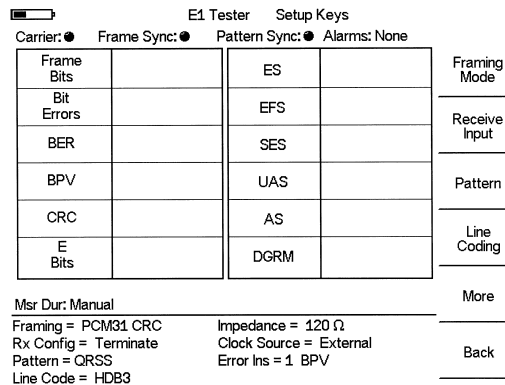

Figure 10-7. Key Information of the E1 Measurement Setup

### BERT Measurement

- Step 1.** Press the **MEAS/DISP** key and then the BERT soft key.
- Step 2.** Press the Measure Duration soft key and use the Up/Down arrow key to select the duration of the measurement, and press **ENTER**. Figure 9-7 illustrates an E1 measurement in raw data mode.

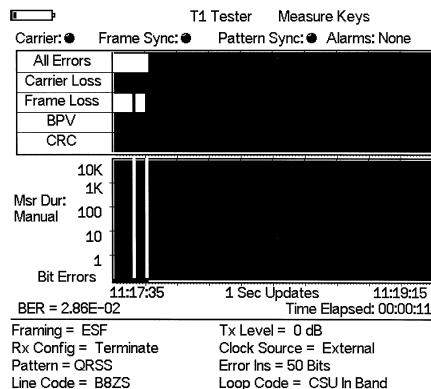

Figure 10-6. E1 Measurement Display

**NOTE:** The **RUN/HOLD** key can also be used to start or stop the measurement.

- Step 3.** To display the measurement data in a histogram format, press the Display Raw Data/Histogram soft key.
- Step 4.** Press the Measure Duration soft key to set the duration of the measurement, and press **ENTER**. The maximum measurement duration is two days.
- Step 5.** Press the Time Scale soft key and use the Up/Down arrow key to select the histogram resolution, and press **ENTER**. The maximum time scale is 60 minutes.

**NOTE:** The unit sets the histogram display and collects and displays the data based on the selected time scale. For example, if the time scale is set to 30 minutes, the unit collects and updates the histogram display data every 30 minutes. When the time scale is set to Auto, the unit automatically sets the histogram display to collect the data based on the selected measurement duration.

- Step 6.** Press the Start/Stop Measure soft key to begin the measurement.
- Step 7.** Press the **SYS** key, then the Application Options and Log Data soft keys to save the data. A message window will display if there is insufficient memory to log the complete duration. Adjust the Measurement Duration and Time Scale as necessary to log the data.
- Step 8.** Press the Start/Stop Measure soft key to begin the measurement.

**NOTE:** The **RUN/HOLD** key can also be used to start or stop the measurement.

**To Insert Setup Errors**

Press the Insert Errors soft key to inject errors in the transmit signal while performing the is E1 measurements. Figure 10-8 illustrates the E1 measurement when the errors are inserted and it is displayed on the right side at the bottom of the display.

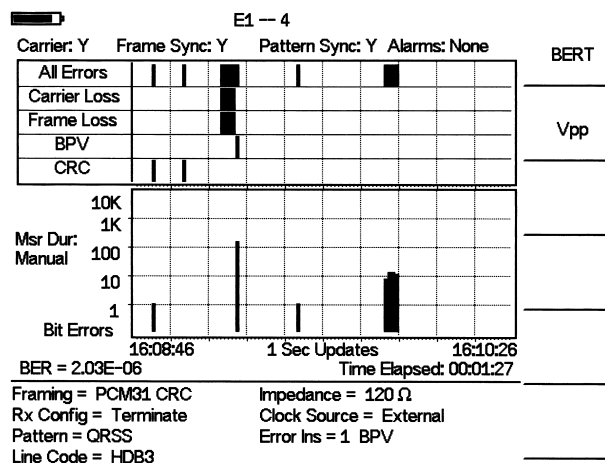

Figure 10-8. E1 Measurement Display with Errors Inserted

## VF Channel Access Testing

The VF Channel Access test feature enables testing on each of the 32 channels of the E1 line. The receive channel is decoded and the VF level and frequency are measured and displayed. The signal is also connected to a speaker, enabling the tester to make an audible assessment of the signal quality of the circuit. If the circuit is out of service, the tester can insert a test tone on the transmit channel for measurement at a remote location with another test set, or locally with a loopback.

### Configuration

Before conducting channel tests, the E1 interface must be properly configured. From the Setup menu, select the correct Framing Mode, Line Coding and Clock Source. If the testing is in-service, the Receive Input must be configured for either Bridged or Monitor modes. The receive mode should be set up before connecting to the circuit to avoid creating a "hit" on the customer data. If the testing is in-service, the Site Master transmit pair should not be connected to the circuit.

If the measurement is out-of-service, the Receive Input mode should be Terminate, and the Site Master transmitter can be connected to the circuit. The current configuration of the E1 interface is displayed in the status window at the bottom of the screen.

### Channel Tests

Once the unit is correctly configured, select the VF Channel Access menu to perform tests at the channel level. Press the Select Channel soft key to select specific channels. Either enter a specific channel number from the keypad, or scroll through the channels with the Up/Down arrow keys. The received VF level and frequency on the selected channel are displayed, and the decoded signal is connected to a speaker for audio monitoring. When a test tone is present on the channel, the level and frequency report will indicate whether the channel is healthy. If speech is present on the channel, the channel performance can be judged from the audio quality. A picture of channel utilization can also be formed by quickly scrolling through the channels.

If the circuit is out-of-service, the user can also connect to the transmit pair and insert a test tone on the selected channel (note that transmit and receive must be on the same channel). Two menus enable selection of transmit level and frequency. The frequency can be entered from the keypad, or scrolled to common test frequencies (404 Hz, 1004 Hz, 1804 Hz, 2713 Hz, and 2804 Hz) with the Up/Down arrow keys. To check the performance of channel level equipment, the test tone can be measured at a remote location with another VF channel test set.

# Chapter 11

## Transmission Measurement

### Introduction

The Transmission Measurement option (Option 21) provides the capability to perform two-port measurements of passive devices over the 25 MHz to 3 GHz frequency range. Transmission Measurement can also be used to make antenna isolation measurements and repeater measurements. The signal source provided by Option 21 is unlevelled, with a power output of approximately  $-10$  dBm. Figure 11-1 shows the typical signal level of the Option 21 signal source.

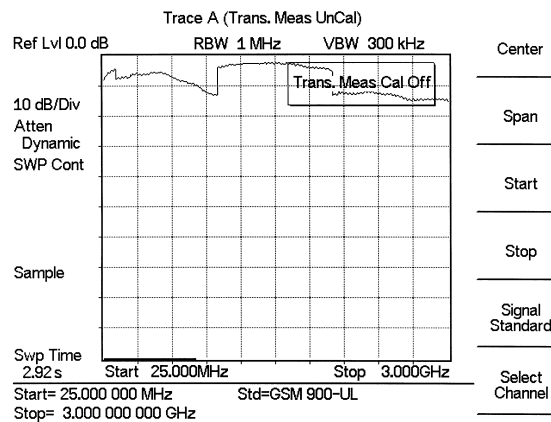

Figure 11-1. Option 21 Signal Source Typical Signal Level

**NOTE:** Ripple can be reduced by including a 6 dB attenuator in the transmission path during both calibration and measurement.

### Measuring Active Devices

Amplifiers can also be measured with Option 21, provided an external attenuator is installed between the **RF Out** port of the S33xD and the input of the amplifier. The value of this attenuator depends on the required input signal level into the amplifier. Note that the output power of the signal source is not leveled, making it most suitable for gain measurements in the linear region of an amplifier.

### Calibration

- Step 1.** Press the **MODE** key, select Transmission Measurement, and press **ENTER**.
- Step 2.** Use the Start and Stop soft keys to select the desired frequency.
- Step 3.** Press the **MEAS/DISP** key, and then the Calibrate TM soft key to calibrate the S33xD.



NOTE: The START CAL key (number 3 on the keypad) does not start calibration when the unit is in Transmission Measurement mode.

- Step 4.** Following the on-screen prompt, connect a phase-stable cable between the **RF Out** port and the **RF In** port. If an attenuator is required for the measurement, connect it directly to the **RF Out** port and connect the cable to the attenuator

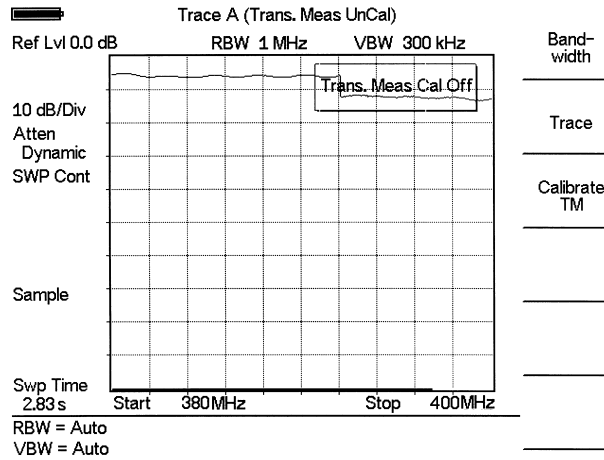

Figure 11-2. Uncalibrated Narrowband Trace

- Step 5.** Press the **ENTER** key.

The unit will sweep once and store transmission correction information. On the next sweep, the trace should be flat at the zero dB reference line and ready for measurements. The calibration information is lost when the instrument is turned off.

## Transmission Measurement Procedure

**Step 1.** Connect the filter between the Site Master RF In and RF Out ports.

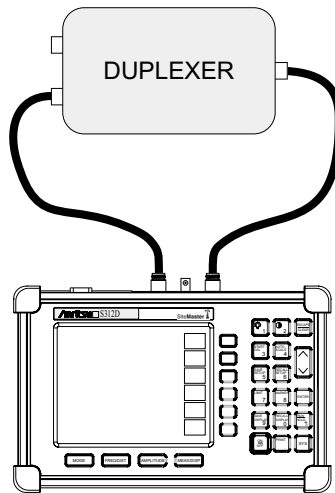

Figure 11-3. Transmission Measurement Connections

- Step 2.** Connect a load to the other end.
- Step 3.** Set the start and stop frequencies to cover the frequency range of the duplexer.
- Step 4.** Disconnect the duplexer and connect a cable to the Site Master RF In and RF Out ports.
- Step 5.** Calibrate the Site Master for transmission measurements as described in the previous section.
- Step 6.** Connect the duplexer and make the measurements.

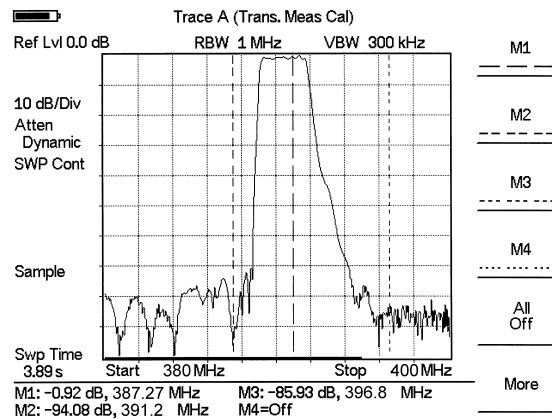

Figure 11-4. Transmission Measurement

## **Bias Tee (Option 10A)**

Option 10A provides a bias tee installed inside the S33xD Site Master. The bias arm is connected to a 12-24 Vdc (variable in 1V increments) power source that can be turned on as needed to place the voltage on the center conductor of the RF In port. This voltage can be used to provide power to block down-converters in satellite receivers, and to power some tower mounted amplifiers.

The bias can be turned on when the instrument is in either Spectrum Analyzer or Transmission Measurement (Option 21) mode. When bias is turned on, the bias voltage and current are displayed in the upper left corner of the display. The 12-24 Vdc power supply is designed to deliver 6 Watts maximum, continuously.

### **Procedure**

- Step 1.** Press the **SYS** key, then the Application Options soft key.
- Step 2.** Select the Bias Tee soft key.
- Step 3.** Select the Bias Tee Voltage soft key and use the number keys or the Up/Down arrow keys to set the bias tee voltage between 12 and 24 Vdc, in 1V increments.
- Step 4.** Select the Bias Tee On/Off soft key to turn the bias voltage on. The state of the bias tee will be saved with the runtime setup.
- Step 5.** Press the Bias Tee On/Off soft key again to turn the bias tee voltage off.

*NOTE: If power to the Bias Tee exceeds 6 Watts maximum continuous operation, the Bias Tee relay will open and a fault message will be displayed.*

# Chapter 12

## GPS Feature

### Introduction

The S331D/S332D Site Master is available with a built-in GPS receiver feature (Option 31) that can provide latitude, longitude and altitude information and UTC timing. The following GPS antennas and accessories are available from Anritsu:

- 2000-1410 Magnet Mount GPS Antenna with 15-foot cable

### Activating the GPS Feature

To activate the GPS feature:

- Step 1.** Install the Anritsu GPS antenna to the GPS antenna connection on the Site Master connector panel.

*NOTE: The GPS antenna connection on the Site Master is fitted with a reverse BNC connector to help prevent damage to the GPS circuitry. There is a DC voltage present on this connector. Do not connect anything other than the Anritsu GPS antenna to this port.*

- Step 2.** Press the **SYS** key.

- Step 3.** Select the GPS soft key.

- Step 4.** Press the GPS On/Off soft key to turn the GPS feature on or off. When GPS is first turned on, the GPS icon below will be displayed in red:



When the GPS receiver has tracked at least three satellites, the GPS icon will change to:



- Step 5.** Press the Location soft key to view the latitude, longitude and altitude information and UTC timing.

- Step 6.** Press the Quality soft key to display the number of tracked satellites and the GPS quality.

*NOTE: Press the Reset soft key to reset the GPS.*

NOTE: The Site Master retains the current GPS location information until the unit is turned off. This feature allows measurement traces to be saved with the retained GPS location information even when the GPS is inactive or the instrument is indoors.

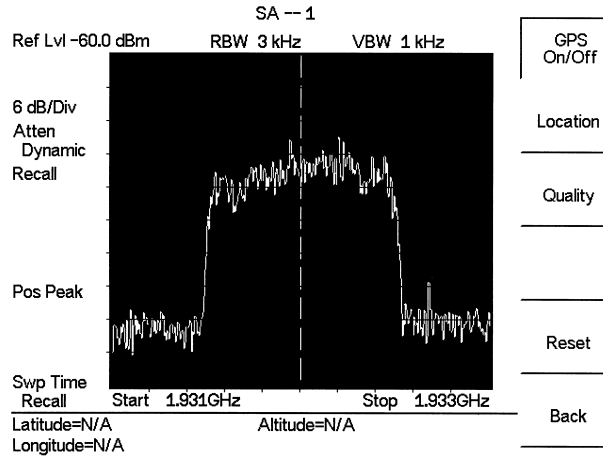

Figure 12-1. GPS Location Display

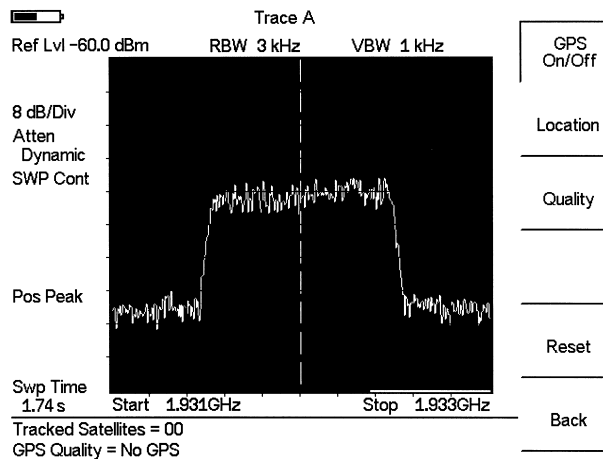

Figure 12-2. GPS Quality Display

## Saving with GPS Information

Site Master measurement traces can be saved with the GPS coordinates of the location where the measurement was taken. The following procedure saves a display to memory.

- Step 1.** Press the **SAVE DISPLAY** key to activate the alphanumeric menu for trace storage.
- Step 2.** Use the soft keys to enter a label for the saved trace.

For example, to save a display with the name “TX1 GPS” press the soft key group that contains the letter “T” then press the “T” soft key. Press the soft key group that contains the letter “X” then press the “X” soft key. Press the number “1” key on the numeric keypad. Use the soft keys and keypad as necessary to enter the entire name, then press **ENTER** to complete the process.

**NOTES:** More than one trace can be saved using the same alphanumeric name, as traces are stored chronologically, using the time/date stamp.

Pressing the **SAVE DISPLAY** key will bring up the last saved trace name on the input line. Pressing the Delete soft key will erase the entire trace name. To erase only one character of a trace name, press the Up/Down arrow key to select the character, then press the Delete soft key. This feature can be useful when naming traces sequentially, such as: Trace 1, Trace 2, etc.

The measurement traces will be saved with the GPS coordinates when GPS is active. GPS data is also automatically saved in the instrument memory until the unit is turned off, so measurement traces can be saved with the saved GPS coordinates even when the GPS is inactive. The GPS icon on the display will stay green to indicate that the GPS data is saved.

## Recalling GPS Information

The following procedure recalls a previously saved display from memory.

- Step 1.** Press the **RECALL DISPLAY** key.
- Step 2.** Select the desired display using the Up/Down arrow key.
- Step 3.** Press **ENTER** to recall the display.

To view the GPS information associated with the recalled display:

- Step 1.** Press the **SYS** key.
- Step 2.** Select the GPS soft key. The GPS coordinates will be displayed at the bottom of the trace.
- Step 3.** Press the **ESCAPE** key to return to normal sweeping.

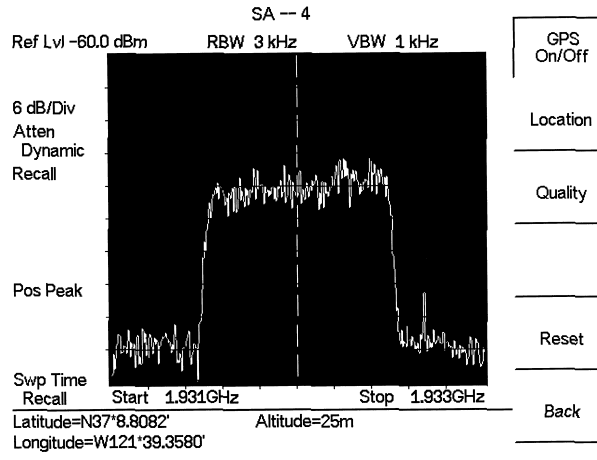

Figure 12-3. Saved GPS Location Information

# Chapter 13

## Interference Analyzer Mode

### Introduction

This chapter presents Interference Analyzer (Option 25) information and procedures.

### Interference Analysis

Multiple wireless networks often operate in complicated signal environments. Three or four base station antennas may be located on the same tower, and can create interference problems. Interference is one of the most common problems affecting wireless network systems capacity and coverage. The Site Master captures and analyzes a received signal and displays the air interface standard and estimated bandwidth of the received signal, which is critical in recognizing and analyzing the interfering signals.

The Interference Analyzer option adds four measurements to the capability of the S331D/S332D:

- ❑ Spectrogram
- ❑ Signal Strength
- ❑ RSSI
- ❑ Signal ID

### Spectrogram

Spectrogram is a three dimensional representation of frequency, time and power useful for identifying intermittent interference.

### Procedure

The following procedure demonstrates common Interference Analyzer Spectrogram setup options. To select Interference Analyzer mode:

- Step 1.** On the Site Master, press the **MODE** key, use the Up/Down arrow key to select the Interference Analyzer mode and press **ENTER**.
- Step 2.** Press the **MEAS/DISP** key followed by the Spectrogram soft key.
- Step 3.** Press the **FREQ/DIST** key to set up the desired frequency sweep. Choose the appropriate soft keys and enter the start and stop frequency, the center frequency and the span, or select the Signal Standard soft key and select the channel and Uplink or Downlink.
- Step 4.** To get the most effective spectrogram display, press the **AMPLITUDE** key, select the Ref Level soft key and set the reference level such that the largest signal to be displayed will be near the top of the spectrum analyzer area of the screen. The reference value required can be determined by observing the color of the highest signal and changing the reference level to place that value near the top of the spectrum analyzer area.
- Step 5.** Select the Scale soft key and set the scale value to place the lowest signal near the bottom of the screen. In general, 4 or 5 dB/division will be good values.



- Step 1.** Press the **MEAS/DISP** key followed by the Spectrogram soft key to set the spectrogram sweep parameters. There are two ways to set up spectrogram time parameters: set the time between sweeps or set the total time for a full spectrogram display.
- Step 2.** To change the time between sweeps, press the Sweep Interval soft key and use the keypad to set the time from 0 seconds to 660 seconds. Entering the time interval value causes the corresponding time span value to be automatically computed. The time span can be viewed or changed by selecting the Time Span soft key and using the keypad to set the span. As expected, changing the time span will automatically change the sweep interval.
- Step 3.** To set the total time span for a complete display, press the Time Span soft key and use the keypad to enter a time between 0 and 4320 minutes (72 hours.) Entering a time span value causes the corresponding sweep interval value to be automatically computed and shown when the Sweep Interval soft key is pressed.
- Step 4.** Spectrogram plots may be automatically saved when the waterfall display is full by pressing the Auto Save soft key, which toggles between OFF and ON as shown at the bottom of the screen.
- Step 5.** There are two cursors that can be used to investigate the frequency and time of any spot in the spectrogram display. Before using the cursors, press the **RUN/HOLD** key to suspend the acquisition of new data to avoid having the point of interest scroll off the top of the screen. Press the Cursor soft key to turn on the time cursor and frequency cursor.
- Step 6.** Press the Time Cursor soft key to turn on the horizontal time cursor. Use the Up/Down arrow key to move the cursor vertically through the spectrogram. The date and time that the measurement at the cursor position was taken is displayed in the message area below the graph.
- Step 7.** Press the Freq Cursor soft key to turn on the vertical frequency cursor. Use the Up/Down arrow key to move the cursor through the spectrogram. The frequency and corresponding amplitude level of the measurement at the cursor position is displayed in the message area below the graph.
- Step 8.** Press the Back soft key to turn off the cursors and return to the previous menu.

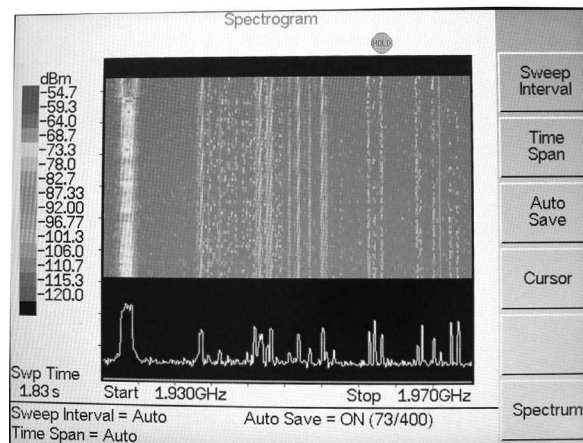

Figure 13-1. Spectrogram Display

## Signal Strength

Signal Strength is useful for tracking down the source of an interfering signal. This measurement is done at a single frequency in zero span. Signal Strength displays the power at a single frequency (in dBm) along with an optional audible indicator. Connect a directional antenna and the frequency of the audible indicator increases as the measured signal strength increases. This mode is especially useful when attempting to locate an emitter using a directional antenna.

### Procedure:

The following procedure demonstrates a common Interference Analyzer Signal Strength setup. To select Interference Analyzer mode:

- Step 1.** On the Site Master, press the **MODE** key, use the Up/Down arrow key to select the Interference Analyzer mode and press **ENTER**.
- Step 2.** Press the **MEAS/DISP** key and select the Spectrum soft key.
- Step 3.** Press the **FREQ/DIST** key, select the Center soft key, and use the soft keys to tune the center frequency to place the signal of interest in the center of the display.
- Step 4.** Connect the appropriate directional antenna to the RF In port and press the **MEAS/DISP** key.
- Step 5.** Press the Signal Strength soft key.
- Step 6.** Press the **AMPLITUDE** key.
- Step 7.** Press the Ref Level soft key and set the top of the measurement range to place the measured signal level near the right side of the bar chart.
- Step 8.** Press the Scale soft key and set the sensitivity of the audio output frequency to amplitude changes. For most signal strength application, a value of 4 dB/division works well.
- Step 9.** Press the **MEAS/DISP** key followed by the Signal Strength soft key.
- Step 10.** Press the Speaker Tone On/Off soft key to turn on the audio output.
- Step 11.** If necessary, press the Volume soft key to set the speaker or headphone volume to a comfortable level. Use the Up/Down arrow keys to adjust the volume.

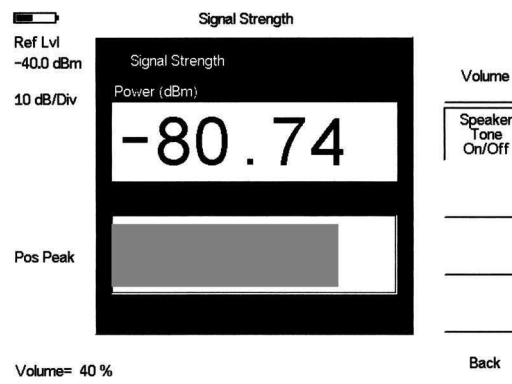

Figure 13-2. Signal Strength Displ.ay

## RSSI

RSSI is useful to observe signal strength at a single frequency over time.

### Procedure:

The following procedure demonstrates a common Interference Analyzer RSSI setup. To select Interference Analyzer mode:

- Step 1.** On the Site Master, press the **MODE** key, use the Up/Down arrow key to select the Interference Analyzer mode and press **ENTER**.
- Step 2.** Press the **MEAS/DISP** key and select the Spectrum soft key.
- Step 3.** Press the **FREQ/DIST** key, select the Center soft key, and use the soft keys to tune the center frequency to place the signal of interest in the center of the display.
- Step 4.** Press the **MEAS/DISP** key and select the RSSI soft key.
- Step 5.** Press the Time Interval soft key to set the time between adjacent measurement points. This time may be set from 150 ms to 1 minute.
- Step 6.** Press the Time Span soft key to set the overall time span for the RSSI measurement. This time can be set from zero, to give manual control of the time span, to a maximum of seven days. After the specified time span, measurement is halted. Depending on the time interval selected, the data will scroll to the left once the trace fills the screen.
- Step 7.** Press the **AMPLITUDE** key to set the reference level and scale factor to place the trace on the screen. Alternatively, the data may be scaled to place it all on screen by pressing the **MEAS/DISP** key, the RSSI soft key then the Auto Scale Data soft key.
- Step 8.** To store the RSSI data, press the Log Data On/Off soft key to turn on data logging. The data is named Log - followed by the time at which the data was stored. Each screen full of 401 data points will be stored as a separate display, and can be saved for up to seven days.

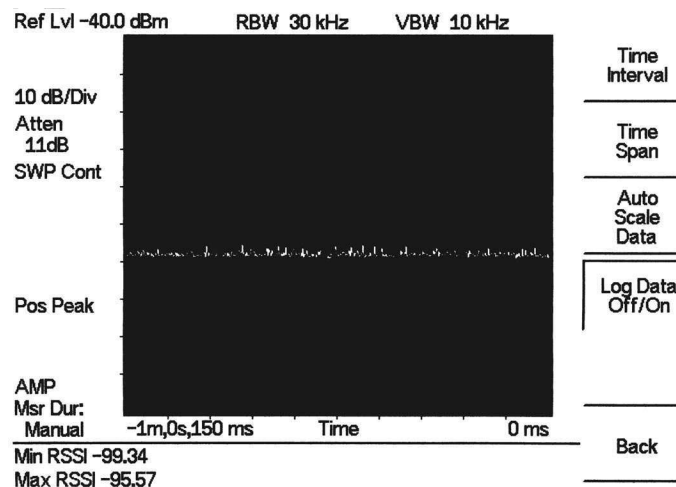

Figure 13-3. RSSI Display

## Signal ID

Signal Identification is used to determine, if possible, the air interface standard of a signal. If the instrument is unable to determine the modulation format, it will display the estimated bandwidth of the signal.

### Procedure:

The following procedure demonstrates a common Interference Analyzer Signal ID setup. To select Interference Analyzer mode:

- Step 1.** On the Site Master, press the **MODE** key, use the Up/Down arrow key to select the Interference Analyzer mode and press **ENTER**.
- Step 2.** Press the **MEAS/DISP** key and select the Signal ID soft key.
- Step 3.** Press the Set IA Freq soft key, enter the appropriate frequency to analyze the interfering signal, and press **ENTER**. Alternatively, if marker M1 is on, press the IA Frequency as Marker M1 soft key to set the IA frequency to the current M1 frequency.
- Step 4.** Press the Measure soft key to start the measurement. A message box on the screen states that the analysis is in process, then, when the measurement is complete, displays the cell standard and estimated bandwidth of the interfering signal.

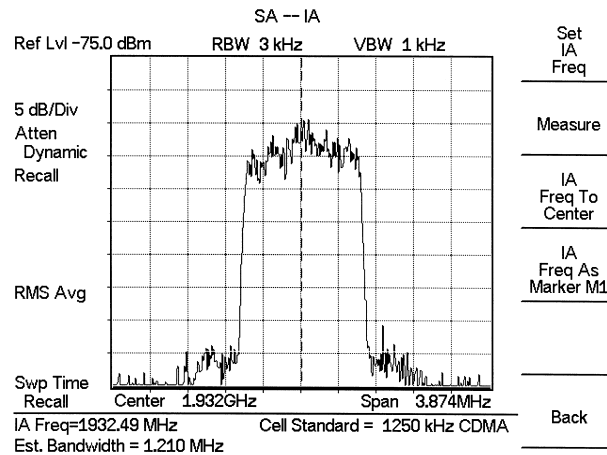

Figure 13-4. Signal ID Display

**NOTE:** Use IA Freq To Center to center the frequency on the display.

# Chapter 14

## Channel Scanner Mode

### Introduction

This chapter presents Channel Scanner (Option 27) information and procedures.

### Channel Scanner

The Channel Scanner option measures the output power of multiple transmitted signals. The output power can be displayed as a bar graph or a text display showing the amplitude of selected channels for a given air interface standard. Up to 20 channels can be measured.

The operating frequency range for Channel Scanner mode can either be set manually, or the desired air interface standard can be selected from the Signal Standard list in the instrument. When the frequency range is selected from the Signal Standard list, all frequency related parameters are automatically set to the appropriate values for the selected standard.

The Channel Scanner option provides the choice of a bar graph or a text display showing the amplitude of selected channels for a given air interface standard. The interface settings can be manually entered if none of the available air interface standards meet the measurement need.

### Procedure

The following procedure demonstrates a common channel scanner setup. To select Channel Scanner mode:

- Step 1.** Press the **MODE** key and use the up and down arrows to highlight Channel Scanner and press **ENTER**.
- Step 2.** Press the Signal Standard soft key, the Select Standard soft key, and use the Up/Down arrow key to highlight the CDMA US PCS standard. Press the **ENTER** key to select.
- Step 3.** Press the Start Channel soft key, use the keypad to enter 50 and press the **ENTER** key.

**Chapter 14 Channel Scanner Mode**

**Step 4.** Press the **MEAS/DISP** key and select the Number of Channels soft key. Use the keypad to enter 20 and press the **ENTER** key. The channels will be displayed as bar graphs.

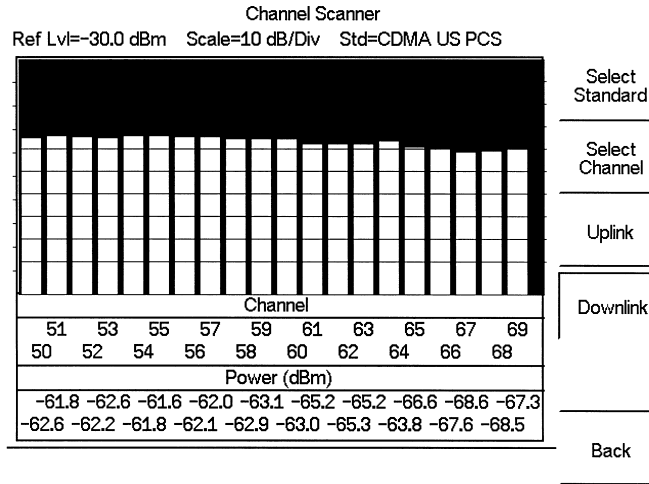

Figure 14-1. Example of Channels Displayed as Bar Graphs

**Step 5.** Press the Display/Graph Text soft key and the data will be displayed in text format.

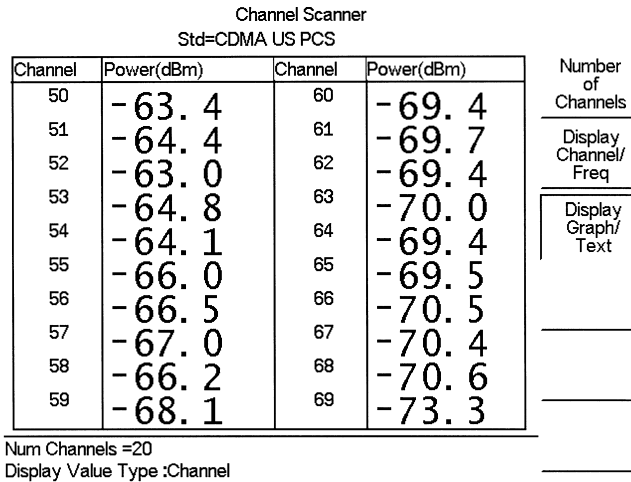

Figure 14-2. Example of Channels Displayed in Text Format

**NOTE:** The measurement can be made when the base station is either in service, out of service, or over the air.

**Step 6.** To set up the channel step size, press the **FREQ/DIST** key and select the Channel Step Size soft key. Use the keypad to enter 5 and press the **ENTER** key.

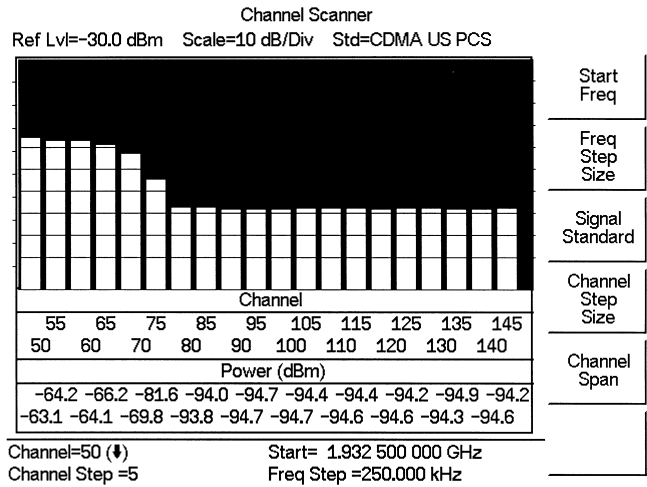

Figure 14-3. Example of Channels Displayed as Bar Graphs with Channel Step Size = 5

**Step 7.** Press the **MEAS/DISP** key and select the Display/Graph Text soft key and the data will be displayed in text format.

Channel	Power(dBm)	Channel	Power(dBm)
50	-62.5	100	-94.8
55	-63.6	105	-94.1
60	-65.2	110	-94.0
65	-67.0	115	-94.5
70	-71.0	120	-94.4
75	-83.7	125	-94.9
80	-92.8	130	-94.0
85	-94.1	135	-94.6
90	-94.6	140	-94.9
95	-94.3	145	-94.2

Num Channels =20  
Display Value Type :Channel

Figure 14-4. Example of Channels Displayed in Text Format with Channel Step Size = 5

**NOTE:** Follow the same procedure for frequency step size as used for channel step size.

# Chapter 15

## Signal Generator Mode

### Introduction

This chapter presents information and procedures to make measurements using the optional CW signal generator mode (Option 28). The CW Signal Generator provides a CW signal from the RF Out port of the instrument. The CW signal is primarily used for sensitivity testing of receivers. To test receiver sensitivity, connect the signal directly to the receiver being measured, and then reduce the output amplitude until the receiver drops the signal. The external splitter feeds the signal into the RF input of the instrument. The display shows the output power and frequency.

### Required Equipment

- ❑ Site Master S331D/S332D with Option 28
- ❑ Attenuator
- ❑ Splitter

### Procedure

- Step 1.** On the Site Master, press the **MODE** key, use the Up/Down arrow key to select the CW Signal Generator mode and press **ENTER**.
- Step 2.** Press the Freq soft key, use the Up/Down arrow key to change the desired frequency, or use the keypad to enter the desired frequency and select the MHz soft key.
- Step 3.** Connect the attenuator to the RF Out port and the splitter to the RF In port.

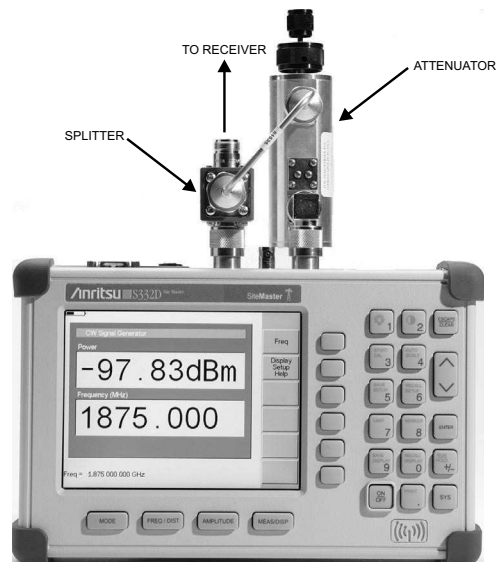

Figure 15-1. CW Signal Generator Mode Setup



- Step 4.** Connect the receiver cable to the output of the power splitter.
- Step 5.** Adjust the power using the attenuator knobs until the receiver being tested drops the signal.

## **Softkeys**

The following soft keys are available in CW Signal Generator mode:

- Freq** — Enter a CW frequency from 25 MHz to 3000 MHz using the Up/Down arrow key, or the keypad and the appropriate soft key for Hz, kHz, MHz or GHz. Press **ENTER** to accept the input.
- Display Setup Help** — Selecting this soft key displays a diagram of the recommended setup to use this option.

# Chapter 16

## Handheld Software Tools

### Introduction

This chapter provides a description of the Anritsu Handheld Software Tools program. Handheld Software Tools is a Windows 95/98/NT4/2000/ME/XP/Vista program for transferring measured traces, along with markers and limit lines, to the PC display. The program help function provides on screen instructions on display modification, trace overlay, uploading and downloading traces, and multiple plot printing.

### Features

Handheld Software Tools provides the following features:

- Download traces saved in the instrument memory to the PC for storage and analysis
- Upload traces from the PC to the instrument memory
- Trace Overlay allows the viewing of three plots simultaneously
- Ability to save captured plots as data files (.dat file format) or as records representing site information in a database file
- Ability to export plot data as text files for use in a spreadsheet (.txt file format)
- Ability to save captured plots as graphic files (.wmf file format)
- Ability to zoom in or out to analyze a particular region of the plot
- Ability to modify Plot Properties
- Ability to output plots to a printer for hard copy records
- Capture the current trace on the unit
- Create antenna factor files to be uploaded to the instrument
- Create custom cables to be uploaded to the instrument
- Create new signal standards to be uploaded to the instrument
- Create new waveguides to be uploaded to the instrument

### System Requirements

The Handheld Software Tools program will run on most any computer running Windows 95/98/NT4/2000/ME/XP/Vista. Minimum requirements and recommendations are:

- Intel Pentium 100 MHz microprocessor (Pentium II 350 MHz or better recommended)
- 16 MB of RAM (64 MB or above recommended)
- Hard disk drive with approximately 15 MB of available space (An additional 20 MB free space for storage of captured plots is recommended.)

- ❑ A serial (COM) port or a USB port and USB power adapter cable for communication with the instrument

*NOTE: It is recommended that Windows NT 4.0 users install NT 4.0 Service Pack 3 (SP3) or above. In addition, Windows 2000 (SP1 or higher) and Windows ME may require installation of the latest Service Pack. Please contact Microsoft Corporation for further information on obtaining and installing service packs.*

## Installation

To install the Handheld Software Tools program:

- Step1.** Insert the Anritsu Handheld Software Tools disk in the CDROM drive.
- Step2.** From the Windows Start menu, select **Run**.
- Step3.** Type: **X:\Setup.exe** where X is the drive letter of your CDROM drive.
- Step4.** When prompted, press the **Enter** key to accept the default directory C:\Program Files\ Software Tools and the installation will begin.

The *readme.doc* file on the disk provides updated information about the program, and the Help function provides detailed operating information.

## Communication Port Setting

The Handheld Software Tools communicates with the instrument through a standard serial COM port on the PC. Set the baud rate of the COM port to 115200.

- Step1.** Select **Start, Programs** and select **Software Tools**.
- Step2.** When the program has loaded, select **Settings, Communication**.
- Step3.** Select the appropriate PC COM port and Transfer Baud Rate for your system, and click **OK**. (For the optional USB Adapter Cable (551-1691) set the COM port to COM 4, and the baud rate to 38400.)

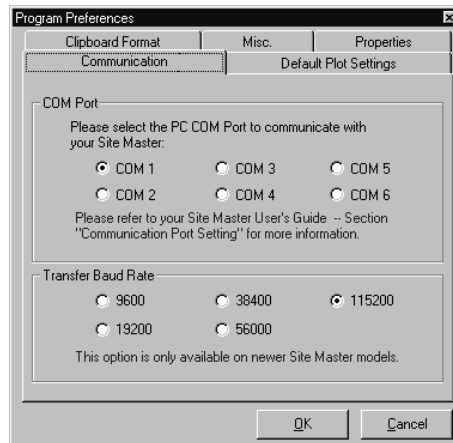

Figure 16-1. Communication Setting Dialog Box

## Interface Cable Installation

Communication between the instrument and the PC is accomplished over a null modem serial cable provided with the instrument (Anritsu part number 800-441, and optional USB to serial adapter, part number 551-1691, if required).

- Step1.** Install the null modem serial interface cable to the RS232 Serial Interface connector on the test connector panel.
- Step2.** Connect the other end of the serial interface cable to the appropriate COM port connector on the PC.
- Step3.** Turn on both the instrument and the PC.

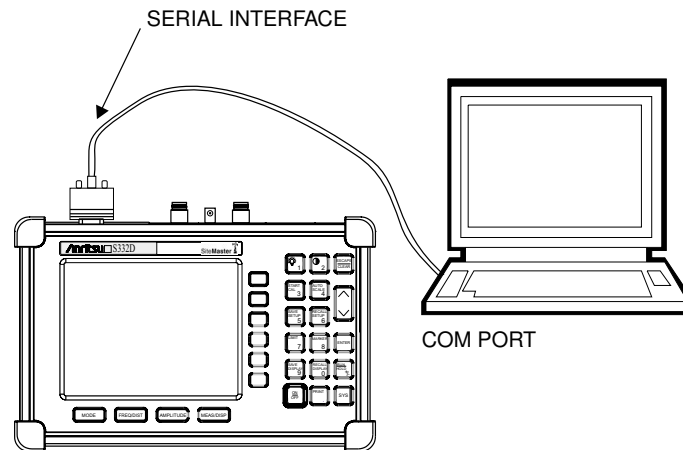

Figure 16-2. Serial Cable Connection

## Using Handheld Software Tools

Select **Start, Programs** and select **Software Tools**.

### Downloading Traces

Traces that can be downloaded from the instrument are grouped by the date on which they were saved. They are further organized in chronological order for each date, with the oldest trace at the top of the list. Each trace listing displays the trace name and measurement type for that trace. Available measurement types are:

SA (Spectrum Analyzer)	Insertion Loss	Power Monitor
TG (Tracking Generator)	Insertion Gain	Spectrogram
TGF (TG Fast Tune)	Power Meter	RSSI
Return Loss	CDMA	Channel Scanner
SWR	GSM	
Cable Loss	T1	
DTF (Distance to Fault)	E1	
Transmission Measurement	EVDO	

*NOTE: Not all selections apply to every Anritsu Handheld instrument.*

## Plot Capture to the PC

To open the plot capture menus, select the capture icon on the button bar, or select the **Capture** drop down menu from the menu bar.

Select **Capture to Screen** to download traces to the PC.

Select a folder, or individual traces within a folder, to be downloaded to the PC. The traces will appear on the PC display as they are downloaded.

When Software Tools is communicating with the instrument, REMOTE will be displayed to the left of the graph.

## Plot Upload to the Instrument

Open a plot to be uploaded to the instrument. Plot properties can be modified on the PC before it is uploaded if desired.

Select the **Capture** drop down menu from the menu bar.

Select **Upload the Current Plot** to upload the plot to the instrument. The plot will be stored in the instrument non-volatile memory with the original date and time that the plot was saved. The uploaded trace can be viewed on the instrument by pressing the **RECALL DISPLAY** button on the instrument keypad.

## Plot Properties

After downloading, certain plot properties and information can be modified. Select the Plot Properties or Plot Information icon.

Plot Properties that can be changed include:

- Graph Titles
- Display Mode
- Scale/Limit
- Markers
- Misc. (Plot Display Parameters)

### Graph Titles

After downloading the plot, the **Main Title** can be changed to reflect the site name or other descriptive information. The **Sub Title** field can be used to describe the specifics of the measurement and configuration.

### Display Mode

Display Mode allows changing the display type without having to retest. Measurements can be changed to dBm, dBV, dBmV, dB $\mu$ V, V or W with a single click of mouse button.

### Scale/Limit

The scale of the displayed plot can be modified to help analyze whether the plot meets pass/fail criteria. The Scale/Limit sub menu activates options to manually enter the scale limits, or to use the Auto Scale mode.

**Manual** adjustment sets the upper and lower limits of the display under the Scale/Limit Submenu.

**Auto Scale** automatically adjusts the scale for maximum and minimum measurement readings.

**Limit Line Off** turns off all limit lines.

**Single Limit Line** can be activated to help identify faults.

**Multi-Segment Limit Lines** can be activated to set different limits within the same measurement display for specification requirements.

### Markers

Markers M1 through M6 can be activated from the Plot Properties menu.

The six active markers can be displayed on the plot to help identify faults from the line sweep data.

### Misc.

The Miscellaneous tab allows adjustment of the Plot/Limit Line Width, the setting of the Plot Footer, and the date format.

**Plot/Limit Line Width** can be used when preparing reports for the carrier, service providers, and network operators where the trace data must be visible and legible for documentation. The line density of the trace can be set to **Normal (Thin Line)** or **Thick Line** to make the data appear easily when copies are made.

**Plot Footer** allows selection of information to be displayed in the trace display. Selections are:

- |   |   |
|---|---|
| <input type="checkbox"/> Time/Date  | <input type="checkbox"/> Impedance      |
| <input type="checkbox"/> Model and Serial Number                                | <input type="checkbox"/> Measurements   |
| <input type="checkbox"/> Bias Tee   | <input type="checkbox"/> DTF Parameters |
| <input type="checkbox"/> Date Format:<br>mm/dd/yyyy<br>dd/mm/yyyy<br>yyyy/mm/dd |   |

*NOTE: While all possible selections are displayed, some of these selections apply only to specific models of Anritsu hand held instruments.*

### Trace Overlay or Plot Overlay

Trace Overlay is activated by the Mouse Function icon. Single-click on the Mouse Function icon to toggle. Toggling this icon switches the mouse function between Marker/Limit/Zoom and Plot Overlaying.

To overlay two plots, click-and-drag from one plot to the other plot. The final display will be the two plots superimposed on one another.

Refer to the Handheld Software Tools **HELP** function for more information on the steps necessary to perform a trace overlay.

## **Saving Traces**

Once the plots are captured to the PC they can be saved as individual files or as a block of files to a database.

### **Saving a Plot as a Windows Metafile or to a Spreadsheet**

Plots can be saved as a Windows metafile (.wmf), a Handheld Software Tools .dat file, a text file (.txt) or an .mdb database. The metafile may be imported into graphic programs and the text file can be imported into a spreadsheet. The .dat and .mdb files are used exclusively by Handheld Software Tools.

To save a plot as a Windows metafile, click on the **File** menu and select **Export to Metafile** from the pull down menu. Once the trace is saved as a metafile, it can be copied and transferred into other applications as a picture or graphic file.

To copy a metafile:

- Step1.** Select the trace to be copied with the mouse cursor.
- Step2.** Select **Edit** and then **Copy**. The file will copied to the clipboard, or select **File** and then **Export** to a Windows metafile.
- Step3.** Open the target application (Microsoft Word, etc.).
- Step4.** Select **Edit** and then **Paste**. The file will be inserted as a graphic file or a bitmap.

### **Saving a Plot to a Spreadsheet**

Plots can be saved as a text file (.txt) which can then be imported into a spreadsheet program.

To save a plot as a text file:

- Step1.** Select the trace to be copied with the mouse cursor.
- Step2.** Click on the **File** menu and select **Export to Text File for a Spreadsheet** from the pull down menu.
- Step3.** Save the file to a local directory.
- Step4.** Exit the Handheld Software Tools program and open the spreadsheet application.
- Step5.** Import the .txt file into the spreadsheet program.

## Creating a Database

A single trace or a block of traces can be transferred from the instrument to the PC. A separate database can be created for each cellular site. The site name can be used as the database name.

**Step1.** Select the **File** menu and select the **Database**.

**Step2.** Open an existing database or create a new database with a descriptive filename that represents the site name.

Once the database has been created, files can be saved and site information can be added, such as Plot Description, Date/Time, Operator, record/trace number and session description (transmitter type, etc.)

Individual plots will be labeled with the Database Site Name. Each record has its own plot description and measurement type.

## Printing Formats

One to multiple plots per page can be set up under the print format in Handheld Software Tools. Orientation of how the plots are printed on the page can be changed from vertical to horizontal.

## Entering Antenna Factors in Handheld Software Tools

*NOTE: The Antenna Factor parameter is only applicable to Anritsu Hand Held Spectrum Analyzers.*

The Antenna Factor (AF) is a fundamental parameter of an antenna used in field measurements. AF is used in the calculation of field strength during radiated emissions measurements, and relates the value of the incident electric or electromagnetic field to the voltage at the output of the antenna. For an electric field antenna, this is expressed as:

$$AF = \frac{E}{V_1}$$

Where AF = Antenna Factor, m<sup>-1</sup>

E = Electric field in Volts per meter

V<sub>1</sub> = Voltage at the antenna terminals in Volts

It also can be shown that in a 50 ohm system:

$$AF = \frac{9.73}{\lambda \sqrt{G_r}}$$

Where G<sub>r</sub> = the gain of the receiving antenna in dB

λ = wave length in meters



Antenna used for radiated emissions testing are individually calibrated (the antenna factors can be measured directly) at all appropriate distances. The calibrations produce values that are defined the “equivalent free space antenna factor.” The calibration procedure corrects for the presence of the reflection of the antenna in the ground plane, giving the value that would be measured if the antenna were in “free space.”

**Antenna Editor**

- Step1.** Once Software Tools has been opened, select **Antenna Editor** from the **Tools** menu on the tool bar. A pop-up box will appear on the screen of the PC.
- Step2.** Click on “Edit Antenna” to enter an antenna name, description, frequencies, and antenna factors. Enter the frequencies in ascending order, starting with lowest frequency first. A maximum of 60 antenna factors may be entered. Use the arrow keys on the keyboard to move between entries. Enter an antenna frequency and gain only, and Software Tools will automatically calculate the antenna factor.

*NOTE: Only one input of frequency and antenna factor is allowed per row. Multiple antenna factors for a single antenna must be entered individually. For example, an antenna having an antenna factor of 5 from 2.0 to 2.25 GHz and an antenna factor of 4 from 2.25 to 2.5 GHz should be entered as follows:*

Frequency (MHz)	Antenna Factor
2000	5
2251	4
2500	4

*If necessary, an antenna factor of zero (0) may be entered.*

- Step3.** Select **Save** from the **File** menu to save the antenna factors to the hard disk.

**Uploading Antenna Factors**

All 10 available antennas are transferred to the instrument at the same time. To modify only a single antenna in the instrument, first download the current antennas (see below) then modify the appropriate antenna, then re-upload the antennas to the instrument.

To upload antenna information from Handheld Software Tools to the instrument:

- Step1.** Connect the RS232 cable between the PC and the instrument.
- Step2.** Click on the **Upload** button on the tool bar (or select **Upload** from the **Tools** menu). It is important to note that the instrument must sweep very quickly during the data transfer, at least every 5 seconds, or the Handheld Software Tools program may “time-out.” To improve the chances of a successful upload, increase the RBW and VBW settings to the maximum, or set the span to 0, temporarily.
- Step3.** The antennas available can be viewed by pressing the **MEAS/DISP** key, then the Measure, Field Strength and Select Custom Antenna soft keys.

## Downloading Antennas

All ten antennas can be downloaded to the PC from the instrument. This allows for modifications to the antenna factors of an antenna or the addition or deletion of available antennas from the list. The antennas can then be uploaded to the instrument.

To download the antennas:

- Step1.** Connect the RS232 cable between the PC and the instrument.
- Step2.** Verify that the instrument is sweeping at a minimum sweep rate of 5 seconds/sweep.
- Step3.** Select the **Query Antenna Factors** button in the Antenna Editor.
- Step4.** Modify the desired antenna(s), then upload again as required.

## Cable List

A custom cable list can be created in Software Tools and uploaded to the Site Master. Some standard 1000 MHz, 2000 MHz, and 2500 MHz cables are stored in the Site Master and are listed in Appendix A of this User's Guide.

The cable list contains vital information such as propagation velocity ( $V_p$ ) and insertion loss (dB/m or dB/ft). These parameters are important when identifying faults and discontinuities of transmission lines.

*NOTE: Values for the cable list are taken from manufacturers specifications. Complex digital communications systems may require adjustment to attenuation values at the higher frequencies. Contact the manufacturer for the appropriate cable losses.*

The Cable Editor is specifically designed to provide contractors, service providers, and network operators with a list of cable types that are tailored to their use.

To open the Cable Editor, select the Tools menu and select Cable Editor.

To open an existing cable list file, select File and Open. Select the desired cable list and press Enter.

## Creating a Custom Cable List

To create a custom cable list:

- Step1.** Select the File menu and select New.
- Step2.** Type in or cut and paste the cable types and specifications for the desired cables.

## Uploading a Cable List

After custom cable list has been created in Handheld Software Tools, it can be uploaded to the Site Master. The serial communication null modem cable must be connected from the Site Master to the PC.

In the Cable Editor, select Tools and Upload Cable List. The software will confirm the upload with a message "Upload Complete" when the operation is finished.

## Querying the Site Master Cable List

Query Cable List allows the user to check and review the contents of the custom cable list in the Site Master.

In the Cable Editor, select Tools and Query Cable List. The software will download the cable list from the Site Master to the PC.

## DTF Plots

Handheld Software Tools can convert Return Loss in Frequency Domain (Freq-RL) plots and SWR in Frequency Domain (Freq-SWR) plots to DTF plots.

To convert from Frequency Domain to Distance to Fault, follow these steps:

- Step1.** Capture a plot or load a previously saved plot.
- Step2.** Click the Distance-to-fault button on the toolbar (or choose Distance-to-Fault from the Tools menu). A dialog will open allowing you to specify the cable parameters, start distance, and stop distance. The cable type may be selected from the pull-down list. Selecting a cable from the list automatically sets the propagation velocity and insertion loss. To manually enter the dielectric constant and insertion loss, select the Custom cable type from the top of the list. Click OK when finished. A new window will open showing the converted plot.
- Step3.** Use the cursor to read out values shown in the bottom tray of the PC screen, at each point along the DTF trace. Maximize the plot window for best cursor resolution.

*NOTES: The distance units (meters or feet) can be changed by selecting Default Plot Settings from the Settings menu.*

*The stop distance entry must be less than or equal to the maximum un-aliased range (D-Max), and the start distance must be less than the stop distance.*

## Smith Chart

The Smith Chart is a commonly used graphical format for the analysis of the impedance of transmission lines. It can be a useful tool for fine tuning an antenna system.

Handheld Software Tools can convert the following types of plots to Smith Charts:

- Return Loss (Frequency Domain)
- VSWR (Frequency Domain)

To convert a plot to a Smith Chart:

- Step1.** Capture a plot or load a previously saved Return Loss or VSWR plot.
- Step2.** Click the Smith Chart button on the toolbar (or choose Convert to Smith Chart from the Tools menu). A new window will open showing the plot in Smith Chart form.
- Step3.** To read values from a Smith Chart, move the mouse pointer over a data point. When the mouse pointer turns into a hand, click once with the left button. A pop-up window will appear with various measurement data.

## Signal Standards Editor

The Signal Standards Editor is a software application for viewing, editing and creating signal standards files. Select a signal standard entry from the list to make it active.

The Signal Standards Editor can:

- Create new signal standards files
- View and edit the signal standard definitions
- Copy and paste signal standard definitions
- Retrieve the signal standards file from a test unit
- Store an updated signal standards file back onto the test unit
- Generate a report of the signal standards file

### Creating a New Signal Standards File

To create a new signal standards file, select New Signal Standards File from the File drop-down menu. An empty signal standards file will be displayed. To add a signal standard, select Add Signal Standard from the Edit menu.

To add an existing signal standard from a different signal standards file, use the Cut, Copy and Paste icons, or select Cut, Copy and Paste from the Edit menu.

### Editing a Signal Standard

A signal standard definition can be changed by editing the name and parameters. The active line of the current signal standard is displayed in the text entry box under the main toolbar. If this box is disabled, the selected signal standard can not be edited.

All changes are temporary until saved as a disk file. To save the signal standards file on the local PC, select Save from the File menu.

### Cut, Copy and Paste

Use the Cut, Copy and Paste icons, or select Cut, Copy and Paste from the Edit menu to add, copy or remove signal standards.

Cut moves the currently selected signal standard onto the clipboard and the signal standard is deleted from the Signal Standards list. If the signal standards file is saved, the cut signal standard will be permanently deleted from that list.

Copy puts a copy of the signal standard on the clipboard, but does not delete it from the current Signal Standards list.

Paste copies a signal standard from the clipboard into the current Signal Standards list.

### Retrieving Signal Standards Files

Connection Manager must be connected to a test unit before retrieving a Signal Standards file. An active connection is indicated in the Status Bar at the bottom right corner of the application window.

To retrieve a Signal Standards file, select Retrieve Signal Standards from the Connection menu, or use the short-cut icon on the button bar. The retrieved Signal Standards data will replace all existing Signal Standards data in the Signal Standards Editor. To store the current Signal Standards data locally, select Save from the File menu and save the current Signal Standards file before retrieving another the Signal Standards file from a test unit.

### **Storing Signal Standards Files**

To upload the Signal Standards file to a test unit, select Upload Signal Standards from the Connection menu, or press the short-cut icon on the button bar. This will upload the current Signal Standards file to the test unit, overwriting any data already on the test unit.

### **Signal Standards Reports**

A signal standards report is generated by selecting the Report function from the File menu. A signal standards report is an HTML file and can be opened inside the default web-browser of the PC, where it can be printed if desired.

# Appendix A

## Reference Data

### Coaxial Cable Technical Data

Table A-1 provides a standard listing of common coaxial cables along with their Relative Propagation Velocity and Nominal Attenuation values in dB/m @1000, 2000, and 2500 MHz. (N/A indicates that the specification is not applicable to the listed cable.)

Table A-1. Coaxial Cable Technical Data (1 of 4)

Manufacturer	Cable Type	Relative Propagation Velocity (Vf)	Nominal Attenuation dB/m @ 1000 MHz	Nominal Attenuation dB/m @ 2000 MHz	Nominal Attenuation dB/m @ 2500 MHz
Andrew	FSJ1-50A	0.84	0.197	0.285	0.313
Andrew	FSJ2-50	0.83	0.134	0.196	0.222
Andrew	FSJ4-50B	0.81	0.119	0.176	0.201
Andrew	LDF4-50A	0.88	0.073	0.107	0.121
Andrew	LDF5-50A	0.89	0.041	0.061	0.070
Andrew	LDF6-50	0.89	0.029	0.044	0.051
Andrew	LDF7-50A	0.88	0.024	0.037	0.043
Andrew	LDF12-50	0.88	0.021	0.033	N/A
Andrew	LDF4.5-50	0.89	0.054	0.08	0.091
Andrew	LDF5-50B	0.91	0.041	0.061	0.07
Andrew	HJ4-50	0.914	0.087	0.137	0.15
Andrew	HJ4.5-50	0.92	0.054	0.079	0.084
Andrew	HJ5-50	0.916	0.042	0.063	0.07
Andrew	HJ7-50A	0.921	0.023	0.034	0.04
Andrew	HJ12-50	0.931	0.019	0.029	N/A
Andrew	VXL5-50	0.88	0.045	0.066	0.075
Andrew	VXL6-50	0.88	0.032	0.048	0.055
Andrew	VXL7-50	0.88	0.024	0.037	0.043
Andrew	AVA5-50 7/8"	0.91	0.0115	0.0168	0.0191
Andrew	AVA7-50 1 5/8"	0.92	0.0068	0.0102	0.0117
Andrew	VXL5-50 7/8"	0.88	0.0136	0.0201	0.0229
Andrew	VXL6-50 1 1/4"	0.88	0.0097	0.0147	0.0169
Andrew	VXL7-50 1 5/8"	0.88	0.0074	0.0113	0.013
Andrew	EFX2-50	0.85	0.0368	0.0541	0.0615
Andrew	HL4RP-50A	0.88	0.0226	0.0331	0.0376

**Appendix A Reference Data**

Table A-1. Coaxial Cable Technical Data (2 of 4)

Manufacturer	Cable Type	Relative Propagation Velocity (Vf)	Nominal Attenuation dB/m @ 1000 MHz	Nominal Attenuation dB/m @ 2000 MHz	Nominal Attenuation dB/m @ 2500 MHz
Belden	RG8, 8A	0.659	0.262	N/A	N/A
Belden	RG9, 9A	0.659	0.289	N/A	N/A
Belden	RG17, 17A	0.659	0.18	N/A	N/A
Belden	RG55, 55A, 55B	0.659	0.541	N/A	N/A
Belden	RG58, 58B	0.659	0.558	N/A	N/A
Belden	RG58A, 58C	0.659	0.787	N/A	N/A
Belden	RG142	0.659	0.443	N/A	N/A
Belden	RG174	0.659	0.984	N/A	N/A
Belden	RG178B	0.659	1.509	N/A	N/A
Belden	RG188	0.659	1.017	N/A	N/A
Belden	RG213	0.659	0.292	N/A	N/A
Belden	RG214	0.659	0.292	N/A	N/A
Belden	RG223	0.659	0.535	N/A	N/A
Cablewave	HCC12-50J	0.915	0.087	0.126	0.137
Cablewave	HCC78-50J	0.915	0.041	0.061	0.066
Cablewave	HCC158-50J	0.95	0.022	0.031	0.033
Cablewave	HCC300-50J	0.96	0.015	N/A	N/A
Cablewave	HCC312-50J	0.96	0.013	N/A	N/A
Cablewave	HF 4-1/8" Cu2Y	0.97	0.01	N/A	N/A
Cablewave	HF 5" Cu2Y	0.96	0.007	N/A	N/A
Cablewave	HF 6-1/8" Cu2Y	0.97	0.006	N/A	N/A
Cablewave	FLC 38-50J	0.88	0.115	0.169	0.19
Cablewave	FLC 12-50J	0.88	0.072	0.11	0.134
Cablewave	FLC 78-50J	0.88	0.041	0.061	0.072
Cablewave	FLC 114-50J	0.88	0.033	0.05	0.059
Cablewave	FLC158-50J	0.88	0.025	0.038	0.042
Comscope	CR50 540 PE	0.88	0.069	0.103	0.116
Comscope	CR50 1070PE	0.88	0.037	0.055	0.064
Comscope	CR50 1873PE	0.88	0.022	0.0344	0.04
Eupen	EC4-50 1/2	0.88	0.074	0.109	0.124
Eupen	EC4.5-50 5/8	0.88	0.056	0.083	0.094
Eupen	EC5-50 7/8	0.88	0.041	0.061	0.069
Eupen	EC6-50 1-1/4	0.88	0.03	0.045	0.052

Table A-1. Coaxial Cable Technical Data (3 of 4)

Manufacturer	Cable Type	Relative Propagation Velocity (Vf)	Nominal Attenuation dB/m @ 1000 MHz	Nominal Attenuation dB/m @ 2000 MHz	Nominal Attenuation dB/m @ 2500 MHz
Eupen	EC7-50 1-5/8	0.88	0.025	0.038	0.043
Eupen	EC12-50 2-1/4	0.88	0.022	0.034	0.039
NK Cables	RF 1/2" -50	0.88	0.0757	0.112	0.127
NK Cables	RF 1/2" -50 GHF	0.88	0.0757	0.112	0.127
NK Cables	RF 1/2" -50 BHF	0.88	0.0757	0.112	0.127
NK Cables	RF 5/8" -50	0.88	0.0518	0.0768	0.087
NK Cables	RF 5/8" -50 GHF	0.88	0.0518	0.0768	0.087
NK Cables	RF 5/8" -50 BHF	0.88	0.0518	0.0768	0.087
NK Cables	RF 7/8" -50	0.88	0.0413	0.062	0.07
NK Cables	RF 7/8" -50 GHF	0.88	0.0413	0.062	0.07
NK Cables	RF 7/8" -50 BHF	0.88	0.0413	0.062	0.07
NK Cables	RF 1 5/8" -50	0.88	0.0248	0.038	0.044
NK Cables	RF 1 5/8" -50 GHF	0.88	0.0248	0.038	0.044
NK Cables	RF 1 5/8" -50 BHF	0.88	0.0248	0.038	0.044
NK Cables	RF 2 1/4" -50	0.88	0.021	0.034	N/A
NK Cables	RF 2 1/4" -50 GHF	0.88	0.021	0.034	N/A
NK Cables	RF 2 1/4" -50 BHF	0.88	0.021	0.034	N/A
NK Cables	RFF 3/8" -50	0.81	0.147	0.218	0.25
NK Cables	RFF 3/8" -50 GHF	0.81	0.147	0.218	0.25
NK Cables	RFF 3/8" -50 BHF	0.81	0.147	0.218	0.25
NK Cables	RFF 1/2" -50	0.82	0.112	0.167	0.19
NK Cables	RFF 1/2" -50 GHF	0.82	0.112	0.167	0.19
NK Cables	RFF 1/2" -50 BHF	0.82	0.112	0.167	0.19
NK Cables	RFF 7/8" -50	0.84	0.052	0.078	0.089
NK Cables	RFF 7/8" -50 GHF	0.84	0.052	0.078	0.089
NK Cables	RFF 7/8" -50 BHF	0.84	0.052	0.078	0.089



*Appendix A Reference Data*

---

Table A-1. Coaxial Cable Technical Data (4 of 4)

<b>Manufacturer</b>	<b>Cable Type</b>	<b>Relative Propagation Velocity (Vf)</b>	<b>Nominal Attenuation dB/m @ 1000 MHz</b>	<b>Nominal Attenuation dB/m @ 2000 MHz</b>	<b>Nominal Attenuation dB/m @ 2500 MHz</b>
Times	LMR100	0.8	0.792	1.15	1.31
Times	LMR200	0.83	0.344	0.49	0.554
Times	LMR240	0.84	0.262	0.377	0.424
Times	LMR400	0.85	0.135	0.196	0.222
Times	LMR500	0.86	0.109	0.159	0.18
Times	LMR600	0.87	0.087	0.128	0.145
Times	LMR900	0.87	0.056	0.086	0.098
Times	LMR1200	0.88	0.044	0.065	0.074
Times	LMR1700	0.89	0.033	0.049	0.056
-	310801	0.821	0.115	N/A	N/A
-	311201	0.82	0.18	N/A	N/A
-	311501	0.8	0.23	N/A	N/A
-	311601	0.8	0.262	N/A	N/A
-	311901	0.8	0.377	N/A	N/A
-	352001	0.8	0.377	N/A	N/A

# Appendix B

## Windowing

### Introduction

The **FREQ/DIST** menu (page 2-18) provides for setting the cable loss and relative propagation velocity of the coaxial cable. The Window key opens a menu of FFT windowing types for the DTF calculation.

The theoretical requirement for inverse FFT is for the data to extend from zero frequency to infinity. Side lobes appear around a discontinuity due to the fact that the spectrum is cut off at a finite frequency. Windowing reduces the side lobes by smoothing out the sharp transitions at the beginning and at the end of the frequency sweep. As the side lobes are reduced the main lobe widens thereby reducing the resolution.

In situations where there may be a small discontinuity close to a large one, side lobe reduction windowing should be used. When distance resolution is critical windowing can be reduced.

### Examples

The types of windowing in order of increasing side lobe reduction are: rectangular, nominal side lobe, low side lobe, and minimum side lobe. Figures B-1 thru B-4 show examples of the types of windowing.

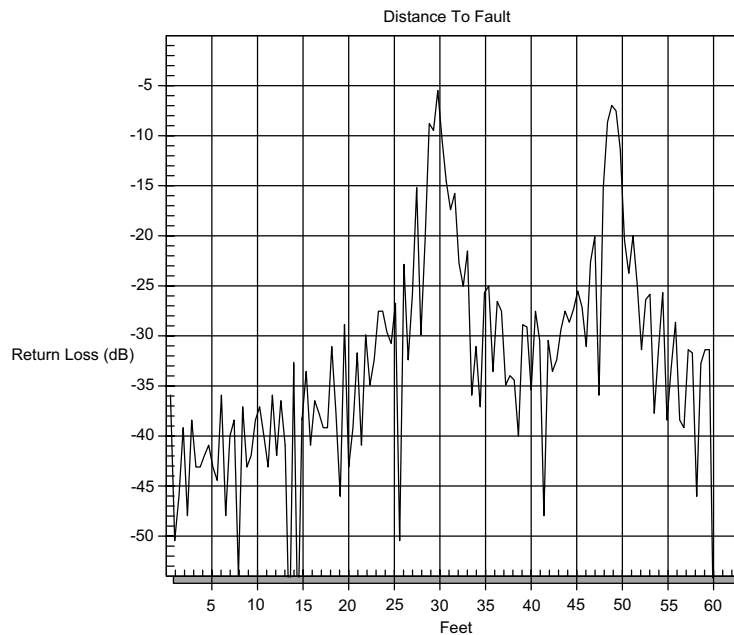

Figure B-1. Rectangular Windowing Example

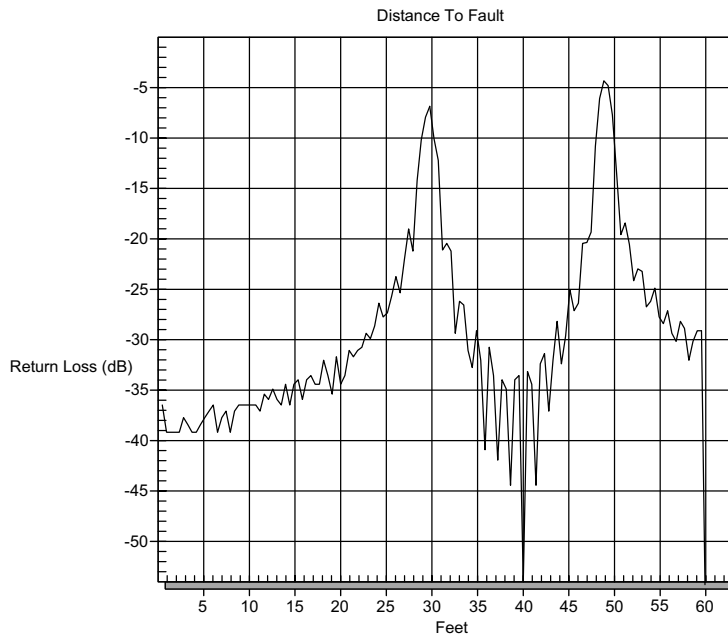

Figure B-2. Nominal Side Lobe Windowing Example

---

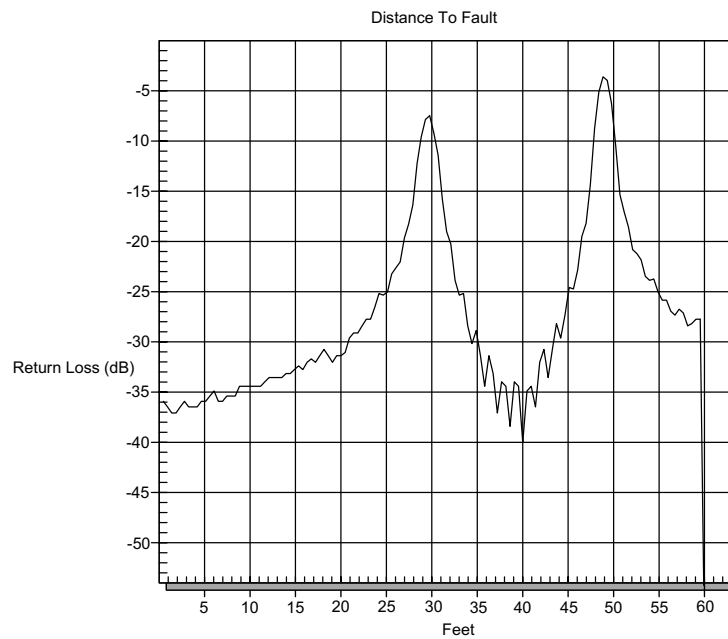

Figure B-3. Low Side Lobe Windowing Example

---

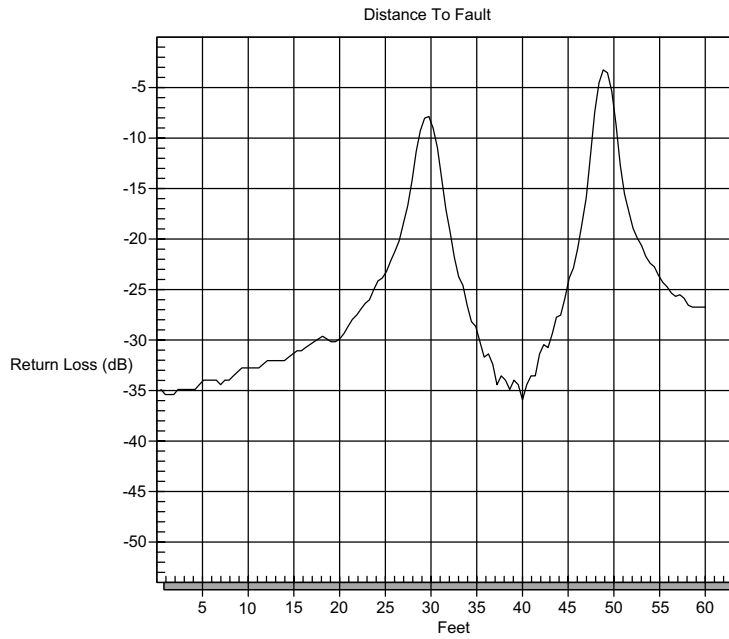

Figure B-4. Minimum Side Lobe Windowing Example

# Appendix C

## Signal Standards

### Introduction

Table C-1 provides a listing of common Spectrum Analyzer signal standards.

*Table C-1. Spectrum Analyzer Signal Standards*

AMPS / EIA 553 - Uplink  
C-450(P) - Uplink  
C-450(P) - Downlink  
C-450(SA) - Uplink  
C-450(SA) - Downlink  
CDMA China 1 - Uplink  
CDMA China 1 - Downlink  
CDMA China 2 - Uplink  
CDMA China 2 - Downlink  
CDMA Japan - Uplink  
CDMA Japan - Downlink  
CDMA Korea PCS - Uplink  
CDMA Korea PCS - Downlink  
CDMA US Cellular - Uplink  
CDMA US Cellular - Downlink  
CDMA US PCS - Uplink  
CDMA US PCS - Downlink  
CDMA2000 Class 0 Korea Cellular - Uplink  
CDMA2000 Class 0 Korea Cellular - Downlink  
CDMA2000 Class 0 N.A. Cellular - Uplink  
CDMA2000 Class 0 N.A. Cellular - Downlink  
CDMA2000 Class 1 N.A. PCS - Uplink  
CDMA2000 Class 1 N.A. PCS - Downlink  
CDMA2000 Class 2 (TACS Band) - Uplink  
CDMA2000 Class 2 (TACS Band) - Downlink  
CDMA2000 Class 3 (JTACS Band) - Uplink  
CDMA2000 Class 3 (JTACS Band) - Downlink  
CDMA2000 Class 4 Korea PCS - Uplink  
CDMA2000 Class 4 Korea PCS - Downlink  
CDMA2000 Class 5 (NMT-450-20 kHz)- Uplink  
CDMA2000 Class 5 (NMT-450-20 kHz)- Downlink  
CDMA2000 Class 5 (NMT-450-25 kHz)- Uplink  
CDMA2000 Class 5 (NMT-450-25 kHz)- Downlink  
CDMA2000 Class 6 IMT-2000- Uplink  
CDMA2000 Class 6 IMT-2000- Downlink  
CDMA2000 Class 7 N.A. 700 MHz Cellular - Uplink  
CDMA2000 Class 7 N.A. 700 MHz Cellular - Downlink  
DCS 1800 - Uplink  
DCS 1800 - Downlink  
Digital Multimedia Broadcasting  
ETACS - Uplink  
ETACS - Downlink

GSM 450 - Uplink  
GSM 450 - Downlink  
GSM 480 - Uplink  
GSM 480 - Downlink  
GSM 850 - Uplink  
GSM 850 - Downlink  
GSM 900 - Uplink  
GSM 900 - Downlink  
P-GSM 900 - Uplink  
P-GSM 900 - Downlink  
E-GSM 900 - Uplink  
E-GSM 900 - Downlink  
R-GSM 900 - Uplink  
R-GSM 900 - Downlink  
GSM 1800 - Uplink  
GSM 1800 - Downlink  
GSM 1900 - Uplink  
GSM 1900 - Downlink  
JTACS - Uplink  
JTACS - Downlink  
MATS-E - Uplink  
MATS-E - Downlink  
N-AMPS / IS-88L - Uplink  
N-AMPS / IS-88L - Downlink  
N-AMPS / IS-88M - Uplink  
N-AMPS / IS-88M - Downlink  
N-AMPS / IS-88U - Uplink  
N-AMPS / IS-88U - Downlink  
NADC IS136 Cellular - Uplink  
NADC IS136 Cellular - Downlink  
NADC IS136 PCS - Uplink  
NADC IS136 PCS - Downlink  
NMT-411-25kHz - Uplink  
NMT-411-25kHz - Downlink  
NMT-450-20kHz - Uplink  
NMT-450-20kHz - Downlink  
NMT-450-25kHz - Uplink  
NMT-450-25kHz - Downlink  
NMT-470-20kHz - Uplink  
NMT-470-20kHz - Downlink  
NMT-900 - Uplink  
NMT-900 - Downlink  
NMT-900(Offset) - Uplink  
NMT-900(Offset) - Downlink  
NTACS - Uplink  
NTACS - Downlink  
PCS 1900 - Uplink  
PCS 1900 - Downlink  
PDC 800 Analog - Uplink  
PDC 800 Analog - Downlink  
PDC 1500 (JDC) - Uplink  
PDC 1500 (JDC) - Downlink  
PHS - Uplink

PHS - Downlink  
SMR 800 - 12.5 kHz - Uplink  
SMR 800 - 12.5 kHz - Downlink  
SMR 800 - 25 kHz - Uplink  
SMR 800 - 25 kHz - Downlink  
SMR 1500 - Uplink  
SMR 1500 - Downlink  
TACS - Uplink  
TACS - Downlink  
Digital Terrestrial TV Japan  
Terrestrial TV Japan  
Terrestrial TV USA  
Terrestrial TV Eur. UHF-8MHz  
UMTS Band I Uplink 9612-9888 Europe  
UMTS Band I Downlink 10562-10838 Europe  
UMTS Band II Uplink(General) 9262-9538 US  
UMTS Band II Uplink(Additional) 12-287 US  
UMTS Band II Downlink(General) 9662-9938 US  
UMTS Band II Downlink(Additional) 412-687 US  
UMTS Band III Uplink 8562-8913 Europe  
UMTS Band III Downlink 9037-9388 Europe  
UMTS Band IV Uplink(General) 8562-8763  
UMTS Band IV Uplink(Additional) 1162-1362  
UMTS Band IV Downlink(General) 10562-10763  
UMTS Band IV Downlink(Additional) 1462-1662  
UMTS Band V Uplink(General) 4132-4233 US  
UMTS Band V Uplink(Additional) 782-782 US  
UMTS Band V Downlink(General) 4357-4458 US  
UMTS Band V Downlink(Additional) 1007-1007 US  
UMTS Band VI Uplink(General) 4162-4188 Japan  
UMTS Band VI Uplink(Additional) 812-837 Japan  
UMTS Band VI Downlink(General) 4387-4413 Japan  
UMTS Band VI Downlink(Additional) 1037-1062 Japan  
802.11a  
802.11b  
802.11 FH  
802.11 DS  
802.11g

# Index

## A

accessories . . . . . 1-1, 1-4  
ACPR . . . . . 2-23, 5-14  
aging . . . . . 1-6  
AIS . . . . . 2-64  
AM/FM. . . . . 5-17  
AMI . . . . . 2-63, 2-66  
amplitude. . . . . 3-12  
ANSI. . . . . 9-1  
antenna factors  
    downloading . . . . . 16-9  
    entering . . . . . 16-7  
    uploading . . . . . 16-8  
attenuation . . . . . 3-13  
    dynamic . . . . . 5-3, 5-6  
attenuator . . . . . 2-20, 2-47, 3-12 - 3-13, 5-2  
average  
    RMS . . . . . 2-50

## B

B8ZS . . . . . 2-63, 9-5  
bandwidth . . . . . 2-21, 2-40, 2-49, 3-12  
battery . . . . . 2-75  
BER . . . . . 10-1  
BERT. . . . . 2-63  
bias tee . . . . . 11-4  
blue alarm . . . . . 2-64  
BPV . . . . . 2-64, 2-66, 9-4, 10-3  
bridged . . . . . 2-63, 2-66  
brightness . . . . . 2-41, 3-18, 5-21  
BTS . . . . . 9-1, 10-1

## C

C/I . . . . . 2-24, 5-19  
cable loss . . . . . 4-2, 4-4  
calibration . . . . . 1-12, 3-2  
carrier to interference ratio. . . . . 5-19

case . . . . . 3-20  
channel . . . . . 2-19, 2-39, 2-46, 2-55, 2-58, 2-61,  
3-12, 5-8, 6-1  
    scanner . . . . . 14-1  
channel power . . . . . 5-12  
channel spacing . . . . . 2-23  
channel span . . . . . 2-23, 5-12  
clock 2-29 - 2-34, 2-36, 2-42, 2-53, 2-56, 2-58  
clock source . . . . . 2-63  
connectors . . . . . 2-1  
CRC. . . . . 2-64, 2-66, 9-5, 10-3  
CRC-4 . . . . . 10-1  
CSU . . . . . 2-64  
CW. . . . . 4-2  
    signal generator . . . . . 2-58, 15-1

## D

D4 . . . . . 9-7  
D4 SF. . . . . 2-63  
date format . . . . . 2-29 - 2-31, 2-33 - 2-36, 2-42,  
2-53, 2-57, 2-59  
demodulation. . . . . 5-17  
detection . . . . . 3-13  
detector. . . . . 2-21  
DS1 . . . . . 9-1  
DTF . . . . . 2-18, 3-9, 4-2, 4-6, 16-3, 16-10  
DTF Aid. . . . . 2-18, 2-21, 3-9  
dynamic attenuation . . . . . 5-6

## E

error insertion . . . . . 2-64  
error messages . . . . . 2-70  
ESD . . . . . 1-13  
ESF . . . . . 2-63, 9-4, 9-7  
external  
    attenuator . . . . . 11-1



## F

FFT . . . . . B-1  
field strength. . . . . 5-9  
fixed CW . . . . . 2-21  
FlexCal . . . . . 2-29, 2-74  
framing. . . . . 2-63, 2-66  
frequency. . . . . 2-18  
frequency range . . . . . 1-1

## G

G.821 . . . . . 9-2, 10-2  
grounding . . . . . 2-1

## H

hard keys. . . . . 2-5  
HDB3. . . . . 2-66  
HDSL . . . . . 9-3  
histogram. . . . . 2-64  
hold . . . . . 2-7, 2-21, 2-41, 2-68, 3-13

## I

In Service Testing  
    E1 . . . . . 10-3  
    T1 . . . . . 9-4  
InstaCal . . . . . 1-13, 2-73, 3-2  
integration bandwidth . . . . . 2-23, 5-13  
interference analysis . . . . . 1-2, 2-23, 5-16, 13-1  
interference analyzer . . . . . 13-1  
isolation . . . . . 11-1  
ITU-T. . . . . 10-1

## K

keys  
    hard . . . . . 2-5  
    soft . . . . . 2-8

## L

language . 2-29, 2-31 - 2-35, 2-37, 2-43, 2-54,  
2-57, 2-60, 3-16

LEC . . . . . 9-1  
limits . . . . . 2-27, 2-43, 3-17  
line sweep . . . . . 4-1  
loopback . . . . . 2-65, 9-11

## M

maintenance . . . . . 1-12  
markers. . . . . 3-16, 16-5  
Markers. . . . . 2-44  
measurements  
    cable and antenna . . . . . 4-1  
    channel power . . . . . 5-12  
    E1. . . . . 10-1  
    field strength. . . . . 5-9  
    power . . . . . 6-1, 8-1  
    Spectrum Analyzer . . . . . 3-11  
    T1 . . . . . 9-1  
memory . . . . . 2-7  
metafile. . . . . 16-6  
MSC. . . . . 9-1, 10-1

## N

NIU . . . . . 2-64, 9-2

## O

OBW . . . . . 5-10  
occupied bandwidth . . . . . 5-10  
offset . . . . . 2-20, 2-47, 2-61, 3-7  
OSL . . . . . 2-29, 3-2  
Out-Of-Service Testing  
    E1 . . . . . 10-8  
    T1 . . . . . 9-7

## P

pattern  
    sync . . . . . 9-2, 9-7, 10-2  
PCM30 . . . . . 2-66  
PCM30 CRC . . . . . 2-66  
PCM31 . . . . . 2-66  
PCM31 CRC . . . . . 2-66  
plot overlay. . . . . 16-5

## Index-2

power indicator . . . . . 2-75

power meter  
    high accuracy . . . . . 1-2, 1-8, 2-74, 8-1  
    internal . . . . . 1-2, 1-9, 2-61, 6-1

power monitor . . . . . 1-2, 1-7, 2-2, 2-38, 7-1

power sensor . . . . . 1-5

preamplifier . . . . . 2-20, 2-47, 5-3

printers . . . . . 1-3, 3-19

propagation velocity . . . . . 2-18

**R**

RAI . . . . . 2-64

RBW . . . . . 2-21, 2-40, 2-49, 3-12

reference level . . . . . 2-20, 2-39, 2-46, 5-2

relative power . . . . . 2-61, 6-4

repeater . . . . . 11-1

resolution . . . . . 2-21, 4-7

resolution bandwidth . 2-21, 2-40, 2-49, 3-12, 5-1

return loss . . . . . 4-2, 4-8

RMS . . . . . 2-22, 2-62, 3-13, 5-12, 6-1

RS232 . . . . . 2-2 - 16-3

**S**

sampling . . . . . 2-22

scale . . . . . 2-20, 3-9

self test . . 2-29, 2-31 - 2-36, 2-42, 2-54, 2-57, 2-59, 2-69, 2-76, 3-1

serial interface . . . . . 16-3

service centers . . . . . 1-14

signal generator . . . . . 15-1

signal standard . 2-19, 2-39, 2-46, 2-55, 2-58, 2-61, 3-12, 5-8, 6-1

Smith Chart . . . . . 1-2, 16-10

soft keys . . . . . 2-8

Software Tools . . . . . 16-1

span . . . . . 2-19, 2-23, 2-61, 3-11, 5-13, 6-1

specifications . . . . . 1-6

spectrogram . . . . . 2-47, 13-1

spreadsheet . . . . . 16-1

SSB . . . . . 5-17

static . . . . . 1-13

sweep . . . . . 3-13, 5-2

SWR . . . . . 2-71, 3-9, 4-2, 4-6, 16-3

symbols . . . . . 2-68

sync  
    frame . . . . . 9-4, 9-7, 10-3  
    pattern . . . . . 9-5, 9-7

**T**

trace overlay . . . . . 2-21, 16-1, 16-5

transmission measurement . . . . . 11-1

trigger . . . . . 2-24  
    external . . . . . 2-2  
    single sweep . . . . . 2-7  
    video . . . . . 2-72

trigger  
    video . . . . . 2-24

**U**

units . . . . . 2-20, 2-47, 3-16, 6-4

USB . . . . . 1-4, 16-2

UTC . . . . . 12-1

**V**

VBW . . . . . 2-21, 2-40, 2-50, 3-12  
    See video bandwidth

verification . . . . . 1-13

video bandwidth . 2-21, 2-40, 2-50, 3-12, 5-2

volume . . . . . 2-48, 13-3

Vpp . . . . . 9-4, 10-3

**W**

windowing . . . . . 2-18, B-1

Windows . . . . . 1-1, 16-1 - 16-2

**X**

XdB . . . . . 5-10

**Y**

yellow alarm . . . . . 2-64

**Z**

zero span . . . . . 1-6, 2-19, 2-72

zoom . . . . . 2-23