

# Anritsu

## Site Master Model S251C Antenna and Cable Analyzer

---

*User's Guide*



Hand-Held Tester for Transmission Lines  
and other RF Components



## **WARRANTY**

The Anritsu product(s) listed on the title page is (are) warranted against defects in materials and workmanship for one year from the date of shipment. Anritsu's obligation covers repairing or replacing products which prove to be defective during the warranty period. Buyers shall prepay transportation charges for equipment returned to Anritsu for warranty repairs. Obligation is limited to the original purchaser. Anritsu is not liable for consequential damages.

## **LIMITATION OF WARRANTY**

The foregoing warranty does not apply to Anritsu connectors that have failed due to normal wear. Also, the warranty does not apply to defects resulting from improper or inadequate maintenance by the Buyer, unauthorized modification or misuse, or operation outside the environmental specifications of the product. No other warranty is expressed or implied, and the remedies provided herein are the Buyer's sole and exclusive remedies.

## **TRADEMARK ACKNOWLEDGMENTS**

MS-DOS, Windows, Windows 95, Windows 98, Windows NT, Windows ME, and Windows 2000 are registered trademarks of the Microsoft Corporation. Anritsu and Site Master are trademarks of Anritsu Company.

## **NOTICE**

Anritsu Company has prepared this manual for use by Anritsu Company personnel and customers as a guide for the proper installation, operation and maintenance of Anritsu Company equipment and computer programs. The drawings, specifications, and information contained herein are the property of Anritsu Company, and any unauthorized use or disclosure of these drawings, specifications, and information is prohibited; they shall not be reproduced, copied, or used in whole or in part as the basis for manufacture or sale of the equipment or software programs without the prior written consent of Anritsu Company.

# DECLARATION OF CONFORMITY

**Manufacturer's Name:** ANRITSU COMPANY

**Manufacturer's Address:** Microwave Measurements Division  
490 Jarvis Drive  
Morgan Hill, CA 95037-2809  
USA

declares that the product specified below:

**Product Name:** Site Master

**Model Number:** S113C, S331C, S114C, S332C, S251C

conforms to the requirement of:

EMC Directive 89/336/EEC as amended by Council Directive 92/31/EEC & 93/68/EEC  
Low Voltage Directive 73/23/EEC as amended by Council directive 93/68/EEC

## **Electromagnetic Interference:**

**Emissions:** CISPR 11:1990/EN55011: 1991 Group 1 Class A  
EN 61000-3-2:1995 Class A  
EN 61000-3-3:1995 Class A

**Immunity:** EN 61000-4-2:1995/EN50082-1: 1997 - 4kV CD, 8kV AD  
EN 61000-4-3:1997/EN50082-1: 1997 - 3V/m  
ENV 50204/EN50082-1: 1997 - 3V/m  
EN 61000-4-4:1995/EN50082-1: 1997 - 0.5kV SL, 1kV PL  
EN 61000-4-5:1995/EN50082-1: 1997 - 1kV L-L, 2kV L-E  
EN 61000-4-6:1994/EN61326: 1998 - 3V  
EN 61000-4-8:1994/EN61326: 1998 - 3A/m  
EN 61000-4-11:1994/EN61326: 1998 - 1 cycle@100%

## **Electrical Safety Requirement:**

**Product Safety:** The Product Complies when used with Company supplied Power  
Supply (tested to EN 60950)

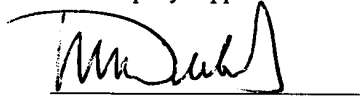
  
Corporate Quality Director

Morgan Hill, CA

25-SEP-01  
Date

European Contact: For Anritsu product EMC & LVD information, contact Anritsu LTD, Rutherford Close,  
Stevenage Herts, SG1 2EF UK, (FAX 44-1438-740202)

# Table of Contents

---

## Chapter 1 - General Information

Introduction . . . . .	1-1
Description . . . . .	1-1
Standard Accessories . . . . .	1-1
Options . . . . .	1-2
Optional Accessories . . . . .	1-2
Performance Specifications . . . . .	1-3
Preventive Maintenance . . . . .	1-6
ESD Precautions . . . . .	1-6
Annual Verification . . . . .	1-7

## Chapter 2 - Functions and Operations

Introduction . . . . .	2-1
Test Connector Panel . . . . .	2-1
Front Panel Overview . . . . .	2-2
Function Hard Keys . . . . .	2-3
Keypad Hard Keys . . . . .	2-4
Soft Keys . . . . .	2-6
Power Monitor Menu (Option 5) . . . . .	2-10
RF Source Menu . . . . .	2-11
Symbols . . . . .	2-15
Self Test . . . . .	2-15
Error Codes . . . . .	2-16
Self Test Errors . . . . .	2-16
Range Errors . . . . .	2-17
Battery Information . . . . .	2-18
Charging a New Battery . . . . .	2-18
Charging the Battery in the Site Master . . . . .	2-18
Charging the Battery in the Optional Charger . . . . .	2-18
Battery Charge Indicator . . . . .	2-19
Battery Life . . . . .	2-19
Important Battery Information . . . . .	2-20

## Chapter 3 - Getting Started

Introduction . . . . .	3-1
Power On Procedure . . . . .	3-1
Select the Frequency or Distance . . . . .	3-2
Calibration . . . . .	3-2
Calibration Procedure - Single Port . . . . .	3-3
Calibration Procedure - Dual Port . . . . .	3-4
Setting the Scale . . . . .	3-5
Auto Scale . . . . .	3-5
Amplitude Scale . . . . .	3-5
Save and Recall a Setup . . . . .	3-5

Saving a Setup . . . . .	3-5
Recalling a Setup. . . . .	3-5
Save and Recall a Display . . . . .	3-5
Saving a Display . . . . .	3-5
Recalling a Display . . . . .	3-6
Set the Distance and Cable Type . . . . .	3-7
Changing the Units . . . . .	3-7
Changing the Display Language . . . . .	3-7
Printing. . . . .	3-8
Printing a Screen. . . . .	3-8
Printer Switch Settings. . . . .	3-9
Using the Soft Carrying Case. . . . .	3-10

## **Chapter 4 - Cable & Antenna Analysis**

Introduction . . . . .	4-1
One Port Measurements . . . . .	4-1
Line Sweep Fundamentals . . . . .	4-1
Information Required for a Line Sweep . . . . .	4-2
Typical Line Sweep Test Procedures . . . . .	4-3
System Return Loss Measurement. . . . .	4-3
Insertion Loss Measurement . . . . .	4-5
Distance-To-Fault (DTF) Transmission Line Test. . . . .	4-8
Antenna Subsystem Return Loss Test . . . . .	4-10
Two Port Measurements . . . . .	4-12
Introduction. . . . .	4-12
TMA Measurements . . . . .	4-13
Antenna to Antenna Isolation. . . . .	4-19
Introduction. . . . .	4-19
Antenna-to-Antenna Isolation Measurement. . . . .	4-20

## **Chapter 5 - Site Master Software Tools**

Introduction . . . . .	5-1
Features . . . . .	5-1
System Requirements . . . . .	5-1
Installation . . . . .	5-2
Communication Port Setting. . . . .	5-2
Interface Cable Installation . . . . .	5-3
Using Software Tools . . . . .	5-3
Downloading Traces from the Site Master . . . . .	5-3
Plot Capture . . . . .	5-4
Plot Properties . . . . .	5-4
Trace Overlay or Plot Overlay . . . . .	5-5
Saving Traces . . . . .	5-5
Custom Cable List . . . . .	5-6
Creating a Database . . . . .	5-7
Printing Formats . . . . .	5-7

**Appendix A - Reference Data**

Coaxial Cable Technical Data. . . . . A-1

**Appendix B - Windowing**

Introduction . . . . . B-1  
Examples . . . . . B-1

# Chapter 1

## General Information

### Introduction

This chapter provides a description, performance specifications, optional accessories, preventive maintenance, and calibration requirements for the Site Master model S251C. Throughout this manual, the term Site Master will refer to the S251C.

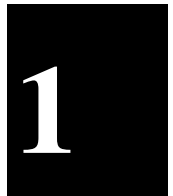

<b>Model</b>	<b>Frequency Range</b>	<b>Ports</b>
S251C	625 to 2500 MHz	2

### Description

The Site Master is a hand held SWR/RL (standing wave ratio/return loss), transmission gain/loss and Distance-To-Fault (DTF) measurement instrument that includes a built-in synthesized signal source. The S251C includes a keypad to enter data and a VGA (640 × 480) liquid crystal display (LCD) to provide graphic indications of SWR, RL (dB) over the selected frequency range and distance. The Site Master is capable of up to 2.5 hours of continuous operation from a fully charged field-replaceable battery and can be operated from a 12.5 VDC source. Built-in energy conservation features can be used to extend battery life over an eight-hour work day.

The Site Master is designed for measuring SWR, return loss, or one-port cable insertion loss and fault locations of RF components in antenna systems. Power monitoring is available as an option. Site Master model S251C includes transmission gain or loss (S21) measurements and an optional built-in bias tee. The displayed trace can be scaled or enhanced with frequency markers or a limit lines. A menu option provides for an audible “beep” when the limit value is exceeded. To permit use in low-light environments, the LCD can be back lit using a front panel key.

### Standard Accessories

The Software Tools PC-based software program provides a database record for storing measurement data. Site Master Software Tools can also convert the Site Master display to a Microsoft Windows™ 95/98/2000/ME/NT workstation graphic. Measurements stored in the Site Master internal memory can be downloaded to the PC, and vice versa, using the included null-modem serial cable. Once stored, the graphic trace can be displayed, scaled, or enhanced with markers and limit lines. Historical graphs can be overlaid with current data, and underlying data can be extracted and used in spreadsheets or for other analytical tasks.

The Site Master Software Tools program can display all of the measurements made with the Site Master (SWR, return loss, cable loss, distance-to-fault) as well as providing other functions, such as converting display modes and Smith charts. Refer to Chapter 5, Software Tools, for more information.



The following items are supplied with the basic hardware.

- Soft Carrying Case
- AC-DC Adapter
- Automotive Cigarette Lighter 12 Volt DC Adapter,
- CDROM disk containing the Software Tools program. This program contains Fault Location (DTF) and Smith Chart functions
- Serial Interface Cable (null modem type)
- One year Warranty (includes battery, firmware, and software)
- User's Guide

## Options

- Option 5 — Add RF Wattmeter Power Monitor
- Option 10A — Add Bias Tee

## Optional Accessories

- Anritsu Precision N (m) Open/Short/Load, 42 dB, Part No. OSLN50LF
- Anritsu Precision N (f) Open/Short/Load, 42 dB, Part No. OSLNF50LF
- Anritsu Precision N (m) Short/Open, Part No. 22N50
- Anritsu Precision N (f) Short/Open, Part No. 22NF50
- Site Master Precision N (m) Load, 42 dB, Part No. SM/PL
- Site Master Precision N (f) Load, 42 dB, Part No. SM/PLNF
- 7/16 (m) Precision Open/Short/Load, Part No. 2000-767
- 7/16 (f) Precision Open/Short/Load, Part No. 2000-768
- Adapter, Precision N (m) to N (m), Part No. 34NN50A
- Adapter, Precision N (f) to N (f), Part No. 34NFnF50
- Adapter, 7/16 (f) to N (m), Part No. 510-90
- Adapter, 7/16 (f) to N (f), Part No. 510-91
- Adapter, 7/16 (m) to N (m), Part No. 510-92
- Adapter, 7/16 (m) to N (f), Part No. 510-93
- Adapter, 7/16 DIN (m) to 7/16 DIN (m), Part No. 510-96
- Adapter, 7/16 DIN (f) to 7/16 DIN (f), Part No. 510-97
- Armored Test Port Extension Cable, 1.5 meter, N (m) to N (f), Part No. 15NNF50-1.5C
- Armored Test Port Extension Cable, 3.0 meter, N (m) to N (f), Part No. 15NNF50-3.0C
- Armored Test Port Extension Cable, 5.0 meter, N (m) to N (f), Part No. 15NNF50-5.0C

- Armored Test Port Extension Cable, 1.5 meter, N (m) to N (m), Part No. 15NN50-1.5C
- Armored Test Port Extension Cable, 3.0 meter, N (m) to N (m), Part No. 15NN50-3.0C
- Armored Test Port Extension Cable, 5.0 meter, N (m) to N (m), Part No. 15NN50-5.0C
- Armored Test Port Extension Cable, 1.5 meter, N (m) to 7/16 DIN (f), Part No. 15NDF50-1.5C
- Armored Test Port Extension Cable, 1.5 meter, N (m) to 7/16 DIN (m), Part No. 15ND50-1.5C
- RF Detector, 1 to 3000 MHz, N(m) input connector, 50 Ohms, Part No. 5400-71N50
- RF Detector, 0.01 to 20 GHz, N(m) input connector, 50 Ohms, Part No. 560-7N50B
- Transit Case for Site Master, Part No. 760-215A
- HP Deskjet 350 Printer, Part No. 2000-766
- Serial-to-Parallel Converter Cable (use with the HP 350 Printer), Part No. 2000-753
- Seiko DPU-414 Thermal Printer, Part No. 2000-754 (U.S.) or 2000-761 (Europe)
- US Adapter (use with the DPU-414 Printer), Part No. 2000-1002
- Europe Adapter (use with the DPU-414 Printer) Part No. 2000-1003
- Japan Adapter (use with the DPU-414 Printer) Part number 2000-1194
- Battery Pack (use with the DPU-414 Printer) Part No. 2000-1004
- Serial Interface Cable (use with the DPU-414 Printer), Part No. 2000-10012
- Thermal Paper (use with the DPU-411/DPU-414 Printer), Part No. 2000-755
- Rechargeable Battery, NiMH Part No. 633-27
- Battery Charger, NiMH only Part No. 2000-1029



## **Performance Specifications**

Performance specifications are provided in Table 1-1, on the following page.

## Chapter 1 General Information

Table 1-1. Performance Specifications (1 of 2)

Specifications are valid when the unit is calibrated at ambient temperature after a 5 minute warmup.

<u>Description</u>	<u>Value</u>
<b>Site Master:</b>	Frequency Range:
S251C	625 to 2500 MHz
Frequency Accuracy (RF Source Mode):	≤75 parts per million @ 25°C*
Frequency Resolution:	10 kHz
SWR:	
Range	1.00 to 65.00
Resolution	0.01
Return Loss:	
Range	0.00 to 54.00 dB
Resolution	0.01 dB
**Distance-To-Fault (DTF):	
Range (in meters)	0 to (Resolution x (dp-1)) a maximum of
Resolution (in meters)	1000m (3281 ft.) with a maximum of 517 points
(Rectangular Windowing)	resolution, # of data pts. = 130, 259, 517
	$\frac{(1.5 \times 10^8)(V_f)}{\Delta F}$
	Where $V_f$ is the relative propagation velocity of the cable .
	dp is the number of data points (130, 259, 517).
	$\Delta F$ is $F_2 - F_1$ (in Hz.)
Insertion Loss/Gain	
Range:	-90.00 to +50.00 dB
Resolution	0.01 dB
RF Source	
Frequency	625 to 2500 MHz @ 10 kHz step
Power Output (nominal)	selectable, - 30 dBm or + 6 dBm
RF Power Monitor:	
Range	-80.0 to +80 dBm or 10.0 pW to 100.0 kW
Offset Range	0 to +60.0 dB
Resolution	0.1 dB or 0.1 xW
Test Port, Type N	50 Ohms
***Immunity to Interfering signals up to the level of:	
on-frequency	RF out      +10 dBm, reflection RF in      +30 dBc, transmission
on-channel	RF out      +17 dBm, reflection
Maximum Input (Damage Level):	
Test Port, Type N	+22 dBm
RF Detector	+20 dBm
Measurement Accuracy:	
Measurement accuracy depends on calibration components. Precision calibration load provides a corrected directivity of 42 dB.	

Table 1-2. Performance Specifications (2 of 2)

Cable Insertion Loss:	
Range	0.00 to 54.00 dB
Resolution	0.01 dB
Bias Tee	
input voltage:	12.5 to 15.0 Vdc
output current:	270 ma maximum surge, 25 ms 240 ma maximum steady
General	
Internal Memory:	
Trace Memory	200 maximum
Instrument config.	10 setup locations with associated calibration
RS-232	9 pin D-sub, three wire serial
Electromagnetic Compatibility	Meets European Community requirements for CE marking
Power Supply:	
External DC Input	+11 to +15 Vdc, 1250 mA max.
Temperature:	
Storage	-20° C to 75° C
Operation	0° C to 50° C
Weight:	1.82 kg (4.0 pounds)
Dimensions:	25.4 x 17.8 x 6.1 cm (10 x 7 x 2.4 inches)

\*  $\pm 2$  ppm/ $\Delta$ C from 25°C

\*\* Fault location is accomplished by inverse Fourier Transformation of data taken with the Site Master. Resolution and maximum range depend on the number of frequency data points, frequency sweep range and relative propagation velocity of the cable being tested.

\*\*\* Immunity measurement is made in CW mode with incoming interfering signal exactly at the same frequency (worst case situation). Typical immunity is better when swept frequency is used.

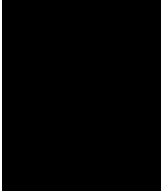

## Preventive Maintenance

Site Master preventive maintenance consists of cleaning the unit and inspecting and cleaning the RF connectors on the instrument and all accessories.

Clean the Site Master with a soft, lint-free cloth dampened with water or water and a mild cleaning solution.

**CAUTION:** To avoid damaging the display or case, do not use solvents or abrasive cleaners.

Clean the RF connectors and center pins with a cotton swab dampened with denatured alcohol. Visually inspect the connectors. The fingers of the N (f) connectors and the pins of the N (m) connectors should be unbroken and uniform in appearance. If you are unsure whether the connectors are good, gauge the connectors to confirm that the dimensions are correct.

Visually inspect the test port cable(s). The test port cable should be uniform in appearance, not stretched, kinked, dented, or broken.

## ESD Precautions

The Site Master, like other high performance instruments, is susceptible to ESD damage. Very often, coaxial cables and antennas build up a static charge, which, if allowed to discharge by connecting to the Site Master, may damage the Site Master input circuitry. Site Master operators should be aware of the potential for ESD damage and take all necessary precautions. Operators should exercise practices outlined within industry standards like JEDEC-625 (EIA-625), MIL-HDBK-263, and MIL-STD-1686, which pertain to ESD and ESDS devices, equipment, and practices.

As these apply to the Site Master, it is recommended to dissipate any static charges that may be present before connecting the coaxial cables or antennas to the Site Master. This may be as simple as temporarily attaching a short or load device to the cable or antenna prior to attaching to the Site Master. It is important to remember that the operator may also carry a static charge that can cause damage. Following the practices outlined in the above standards will insure a safe environment for both personnel and equipment.

## **Annual Verification**

Anritsu recommends an annual calibration and performance verification of the Site Master and the OSL calibration components by local Anritsu service centers. Anritsu service centers are listed in Table 1-2 on the following page.

The Site Master itself is self-calibrating, meaning that there are no field-adjustable components. However, the OSL calibration components are crucial to the integrity of the calibration and therefore, must be verified periodically to ensure performance conformity. This is especially important if the OSL calibration components have been accidentally dropped or over-torqued.

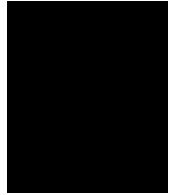

*Table 1-2. Anritsu Service Centers*

---

**UNITED STATES**

ANRITSU COMPANY  
685 Jarvis Drive  
Morgan Hill, CA 95037-2809  
Telephone: (408) 776-8300  
FAX: 408-776-1744

ANRITSU COMPANY  
10 NewMaple Ave., Suite 305  
Pine Brook, NJ 07058  
Telephone: 973-227-8999  
FAX: 973-575-0092

ANRITSU COMPANY  
1155 E. Collins Blvd  
Richardson, TX 75081  
Telephone: 1-800-ANRITSU  
FAX: 972-671-1877

**AUSTRALIA**

ANRITSU PTY. LTD.  
Unit 3, 170 Foster Road  
Mt Waverley, VIC 3149  
Australia  
Telephone: 03-9558-8177  
FAX: 03-9558-8255

**BRAZIL**

ANRITSU ELECTRONICA LTDA.  
Praia de Botafogo 440. Sala 2401  
CEP22250-040, Rio de Janeiro, RJ,  
Brasil  
Telephone: 021-527-6922  
FAX: 021-53-71-456

**CANADA**

ANRITSU INSTRUMENTS LTD.  
700 Silver Seven Road, Suite 120  
Kanata, Ontario K2V 1C3  
Telephone: (613) 591-2003  
FAX: (613) 591-1006

**CHINA (SHANGHAI)**

ANRITSU ELECTRONICS CO LTD  
2F,Rm.B, 52 Section Factory Bldg.  
NO 516 Fu Te Road (N)  
Waigaoqiao Free Trade Zone  
Pudong, Shanghai 200131  
PR CHINA  
Telephone: 86-21-58680226  
FAX: 86-21-58680588

**FRANCE**

ANRITSU S.A  
9 Avenue du Quebec  
Zone de Courtaboeuf  
91951 Les Ulis Cedex  
Telephone: 016-09-21-550  
FAX: 016-44-61-065

**GERMANY**

ANRITSU GmbH  
Grafenberger Allee 54-56  
D-40237 Dusseldorf  
Germany  
Telephone: 0211-968550  
FAX: 0211-9685555

**INDIA**

MEERA AGENCIES (P) LTD  
A-23 Hauz Khas  
New Delhi, India 110 016  
Telephone: 011-685-3959  
FAX: 011-686-6720

**ISRAEL**

TECH-CENT, LTD  
4 Raul Valenberg St.  
Tel-Aviv, Israel 69719  
Telephone: 972-36-478563  
FAX: 972-36-478334

**ITALY**

ANRITSU Sp.A  
Rome Office  
Via E. Vittorini, 129  
00144 Roma EUR  
Telephone: (06) 50-2299-711  
FAX: 06-50-22-4252

**JAPAN**

ANRITSU CUSTOMER SERVICE LTD.  
1800 Onna Atsugi—shi  
Kanagawa-Prf. 243 Japan  
Telephone: 0462-96-6688  
FAX: 0462-25-8379

**KOREA**

ANRITSU SERVICE CENTER  
8F Sanwon Bldg.  
1329-8 Seocho-Dong  
Seocho-Ku  
Seoul, Korea 137-070  
Telephone: 82-2-581-6603  
FAX: 82-2-582-6603

**SINGAPORE**

ANRITSU (SINGAPORE) PTE LTD  
10, Hoe Chiang Road  
#07-01/02  
Keppel Towers  
Singapore 089315  
Telephone: 65-282-2400  
FAX: 65-282-2533

**SOUTH AFRICA**

ETESCSA  
12 Surrey Square Office Park  
330 Surrey Avenue  
Ferndale, Randburt, 2194  
South Africa  
Telephone: 011-27-11-787-7200  
Fax: 011-27-11-787-0446

**SWEDEN**

ANRITSU AB  
Botvid Center  
Fittja Backe 13A  
145 84  
Stockholm, Sweden  
Telephone: (08) 534-707-00  
FAX: (08)534-707-30

**TAIWAN**

ANRITSU CO., LTD.  
6F, No. 96, Section 3  
Chien Kuo N. Road  
Taipei, Taiwan, R.O.C.  
Telephone: (02) 515-6050  
FAX: (02) 509-5519

**UNITED KINGDOM**

ANRITSU LTD.  
200 Capability Green  
Luton, Bedfordshire  
LU1 3LU, England  
Telephone: 015-82-43-3200  
FAX: 015-82-73-1303

# Chapter 2

## Functions and Operations

### Introduction

This chapter provides a brief overview of the Site Master functions and operations, providing the user with a starting point for making basic measurements. For more detailed information, refer to Chapter 4, *Measurements* and Chapter 5, *Software Tools*.

The Site Master is designed specifically for field environments and applications requiring mobility. As such, it is a lightweight, handheld, battery operated unit which can be easily carried to any location, and is capable of up to 2.5 hours of continuous operation from a fully charged battery. Built-in energy conservation features allow battery life to be extended over an eight-hour workday. The Site Master can also be powered by a 12.5 VDC external source. The external source can be either the Anritsu AC-DC Adapter (P/N 40-115) or 12.5 Vdc Automotive Cigarette Lighter Adapter (P/N 806-62). Both items are standard accessories.

2

### Test Connector Panel

The connectors and indicators located on the test panel are listed and described below.

**12.5-15VDC (1100 mA)** 12.5 to 15 Vdc @ 1100 mA input to power the unit or for battery charging.

#### WARNING

*When using the AC-DC Adapter, always use a three-wire power cable connected to a three-wire power line outlet. If power is supplied without grounding the equipment in this manner, there is a risk of receiving a severe or fatal electric shock.*

<b>Battery Charging</b>	Illuminates when the battery is being charged. The indicator automatically shuts off when the battery is fully charged.
<b>External Power</b>	Illuminates when the Site Master is being powered by the external charging unit.
<b>Serial Interface</b>	RS232 DB9 interface to a COM port on a personal computer (for use with the Anritsu Software Tools program) or to a supported printer.
<b>RF Out</b>	RF output, 50 $\Omega$ impedance, for reflection measurements.
<b>RF In</b>	RF input 50 $\Omega$ impedance for transmission loss or gain measurement.
<b>RF Detector</b>	RF detector input for the Power Monitor.



## Front Panel Overview

The Site Master menu-driven user interface is easy to use and requires little training. Hard keys on the front panel are used to initiate function-specific menus. There are four function hard keys located below the display, Mode, Frequency/Distance, Amplitude and Sweep.

There are seventeen keypad hard keys located to the right of the display. Twelve of the keypad hard keys are dual purpose, depending on the current mode of operation. The dual purpose keys are labeled with one function in black, the other in blue.

There are also six soft keys that change function depending upon the current mode selection. The current soft key function is indicated in the active function block to the right of the display. The locations of the different keys are illustrated in Figure 2-1.

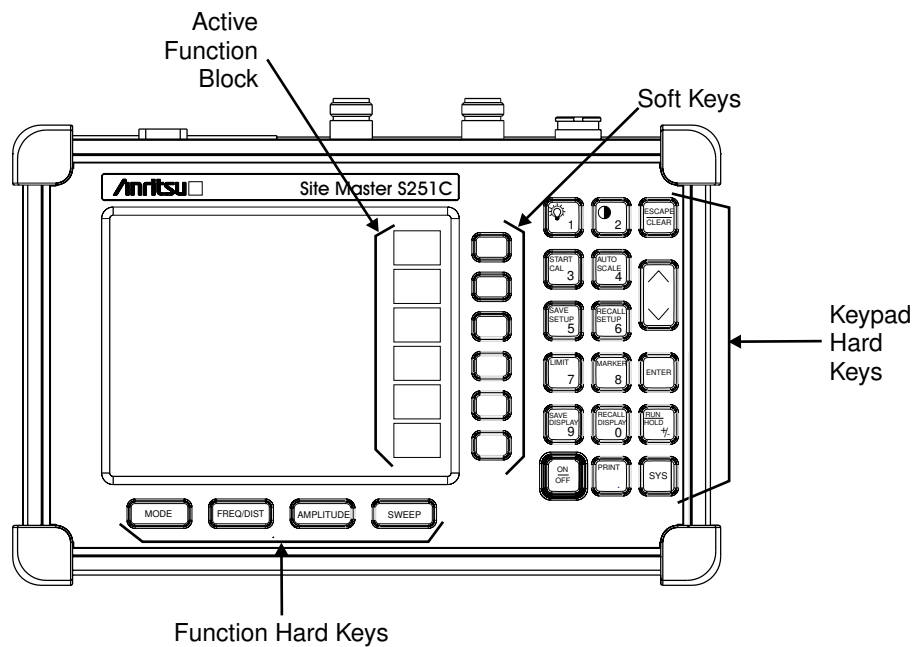

Figure 2-1. Site Master Soft Keys

The following sections describe the various key functions.

## Function Hard Keys

**MODE** Opens the mode selection box (below). Use the Up/Down arrow key to select a mode. Press the **ENTER** key to implement.

<b>MEASUREMENT MODE</b>	
FREQ -	SWR
<b>RETURN LOSS</b>	
	CABLE LOSS - ONE PORT
	INSERTION LOSS (+6 dBm)
	INSERTION GAIN (-30 dBm)
DTF -	SWR
	RETURN LOSS
	POWER MONITOR
	RF SOURCE

Figure 2-2. Mode Selection Box

- FREQ/DIST** Displays the Frequency or Distance to Fault softkey menus depending on the measurement mode.
- AMPLITUDE** Displays the amplitude softkey menu for the current operating mode.
- SWEEP** Displays the Sweep function softkey menu for the current operating mode.

## Keypad Hard Keys

This section contains an alphabetical listing of the Site Master front panel keypad controls along with a brief description of each. Where necessary, more detailed descriptions of the major function keys follow.

The following keypad hard key functions are printed in **black** on the keypad keys.

- 
- 0-9** These keys are used to enter numerical data as required to setup or perform measurements.
  - +/-** The plus/minus key is used to enter positive or negative values as required to setup or perform measurements.
  - The decimal point is used to enter decimal values as required to set up or perform measurements.
  - ESCAPE  
CLEAR** Exits the present operation or clears the display. If a parameter is being edited, pressing this key will clear the value currently being entered and restore the last valid entry. Pressing this key again will close the parameter. During normal sweeping, pressing this key will move up one menu level.
  - UP/DOWN  
ARROWS** Increments or decrements a parameter value. The specific parameter value affected typically appears in the message area of the LCD.

*NOTE: At turn on, before any other keys are pressed, the Up/Down arrow key may be used to adjust the display contrast. Press **ENTER** to return to normal operation.*

- ENTER** Implements the current action or parameter selection.
- ON  
OFF** Turns the Anritsu Site Master on or off. When turned on, the system state at the last turn-off is restored. If the **ESCAPE/CLEAR** key is held down while the **ON/OFF** key is pressed, the factory preset state will be restored.
- SYS** Allows selection of display language and system setup parameters. Choices are OPTIONS, CLOCK, SELF TEST, STATUS and LANGUAGE.

The following keypad hard key functions are printed in **blue** on the keypad keys.



Turns the liquid crystal display (LCD) back-lighting ON or OFF. (Leaving back lighting off conserves battery power.)



LCD Contrast adjust. Use the Up/Down arrow key and **ENTER** to adjust the display contrast.

**AUTO SCALE**

Automatically scales the display for optimum resolution.

**LIMIT**

Displays the limit menu of the current operating mode.

**MARKER**

Displays the marker menu of the current operating mode.

**PRINT**

Prints the current display to the selected printer via the RS232 serial port.

**RECALL DISPLAY**

Recalls a previously saved trace from memory. When the key is pressed, a Recall Trace selection box appears on the display. Select a trace using the Up/Down arrow key and press the **ENTER** key to implement.

To erase a saved trace, highlight the trace and select the **DELETE TRACE** softkey. To erase all saved traces, select the **DELETE ALL TRACES** softkey.

**RECALL SETUP**

Recalls a previously saved setup from memory location 1 through 10. When the key is pressed, a **RECALL SETUP** selection box appears on the display. Select a setup using the Up/Down arrow key and press the **ENTER** key to implement. Setup 0 recalls the factory preset state.

**RUN HOLD**

When in the Run mode, this key starts the Site Master sweeping and provides a sweep measurement trigger; when in the Hold mode, it pauses the sweep and the hold symbol (page 2-15) appears on the LCD. Hold mode conserves battery power.

**SAVE DISPLAY**

Saves up to 200 displayed traces to non-volatile memory. When the key is pressed, **TRACE NAME:** appears in the lower left of the display. Save the display with up to 16 alphanumeric characters for that trace name and press the **ENTER** key to implement.

**SAVE SETUP**

Saves the current system setup to 1 of 10 internal non-volatile memory locations. When the key is pressed, a **SAVE SETUP** selection box appears on the display. Use the Up/Down arrow key to select a setup and press the **ENTER** key to implement.

**START CAL**

Starts the calibration in SWR, Return Loss, Cable Loss, or DTF measurement modes.

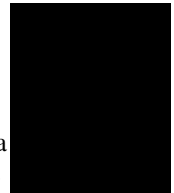

# Soft Keys

Each function key opens a set of soft key selections. Each of the soft keys has a corresponding soft key label area on the display. The label identifies the function of the soft key for the current Mode selection.

Figures 2-3 and 2-4 show the soft key labels for each Mode selection. Where necessary, more detailed descriptions of the function keys follow.

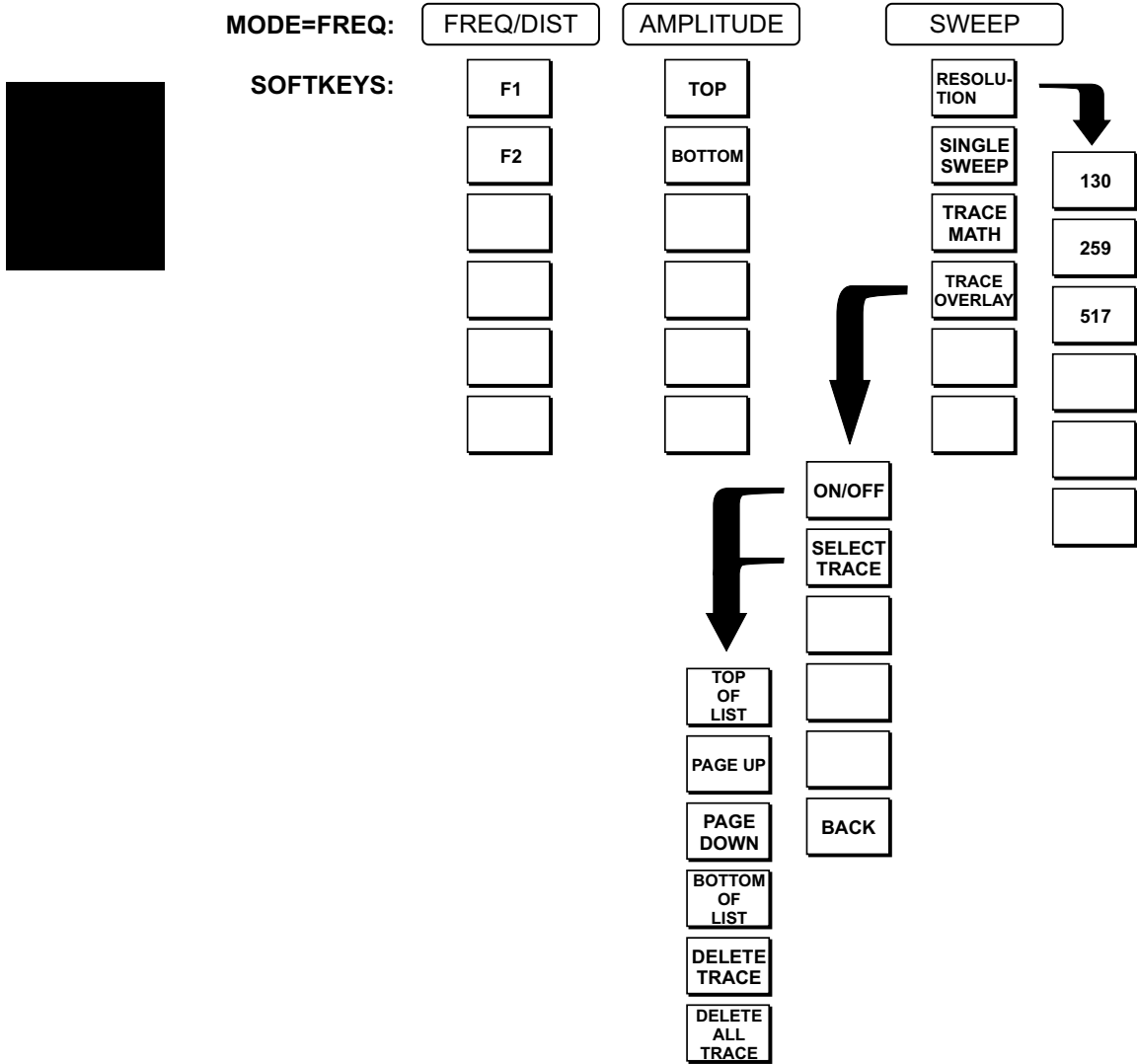

Figure 2-3. Frequency Mode Soft Key Labels

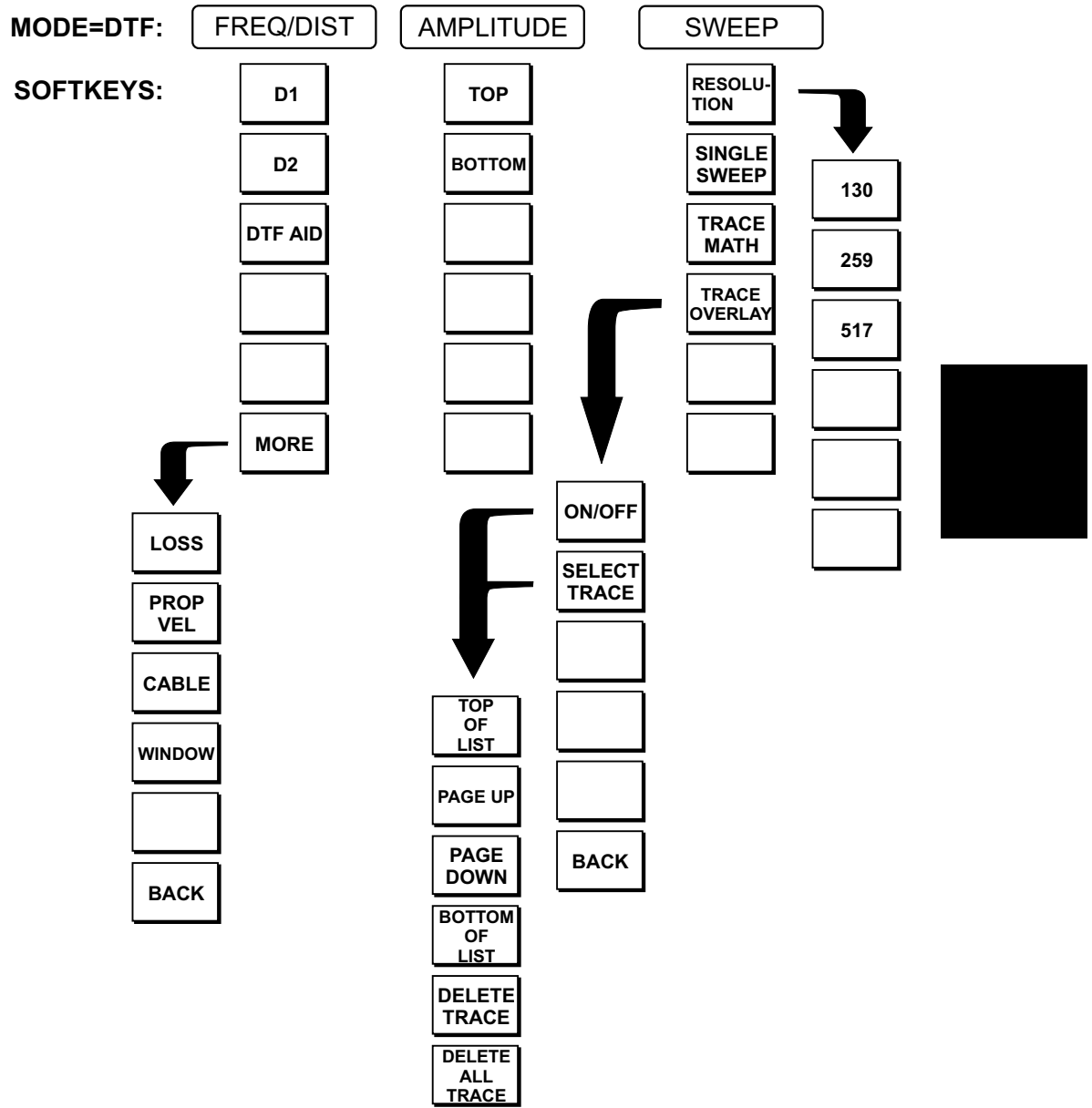

Figure 2-4. Distance to Fault Mode Soft Key Labels

**FREQ/DIST** Displays the frequency and distance menu depending on the measurement mode.

**Frequency Menu** Provides for setting sweep frequency end points when **FREQ** mode is selected. Selected frequency values may be changed using the keypad or Up/Down arrow key.

- ❑ **F1** — Opens the F1 parameter for data entry. This is the start value for the frequency sweep. Press **ENTER** when data entry is complete.
- ❑ **F2** — Opens the F2 parameter for data entry. This is the stop value for the frequency sweep. Press **ENTER** when data entry is complete.

**Distance Menu** Provides for setting Distance to Fault parameters when a DTF mode is selected. Choosing **DIST** causes the soft keys, below, to be displayed and the corresponding values to be shown in the message area. Selected distance values may be changed using the keypad or Up/Down arrow key.

- ❑ **D1** — Opens the start distance (D1) parameter for data entry. This is the start value for the distance range (D1 default = 0). Press **ENTER** when data entry is complete.
- ❑ **D2** — Opens the end distance (D2) parameter for data entry. This is the end value for the distance range. Press **ENTER** when data entry is complete.
- ❑ **DTF AID** — Provides interactive help to optimize DTF set up parameters. Use the Up/Down arrow key to select a parameter to edit. Press **ENTER** when data entry is complete.
- ❑ **MORE** — Selects the Distance Sub-Menu, detailed below.

**Distance Sub-Menu** Provides for setting the cable loss and relative propagation velocity of the coaxial cable. Selected values may be changed using the Up/Down arrow key or keypad.

- ❑ **LOSS** — Opens the Cable Loss parameter for data entry. Enter the loss per foot (or meter) for the type of transmission line being tested. Press **ENTER** when data entry is complete. (Range is 0.000 to 5.000 dB/m, 1.524 dB/ft)
- ❑ **PROP VEL** (relative propagation velocity) — Opens the Propagation Velocity parameter for data entry. Enter the propagation velocity for the type of transmission line being tested. Press **ENTER** when data entry is complete. (Range is 0.010 to 1.000)
- ❑ **CABLE** — Opens a common coaxial cable folder and custom coaxial cable folder. Select either folder and use the Up/Down arrow key and **ENTER** to make a selection. This feature provides a rapid means of setting both cable loss and propagation velocity. (Refer to Appendix A for a listing of common coaxial cables showing values for Relative Propagation Velocity and Nominal Attenuation in dB/m @ 1000 MHz, 2000 MHz and 2500 MHz.) The custom cable folder can consist of up to 24 user-defined cable parameters downloaded via the Site Master Software Tools program.
- ❑ **WINDOW** — Opens a menu of FFT windowing types for the DTF calculation. Scroll the menu using the Up/Down arrow key and make a selection with the **ENTER** key.
- ❑ **BACK** — Returns to the Distance Menu.

- AMPLITUDE** Displays the amplitude or scale menu depending on the measurement mode.
- Amplitude Menu** Provides for changing the display scale. Selected values may be changed using the Up/Down arrow key or keypad.
- Choosing **AMPLITUDE** in **FREQ** or **DTF** measurement modes causes the soft keys, below, to be displayed and the corresponding values to be shown in the message area.
- TOP** — Opens the top parameter for data entry and provides for setting the top scale value. Press **ENTER** when data entry is complete.
  - BOTTOM** — Opens the bottom parameter for data entry and provides for setting the bottom scale value. Press **ENTER** when data entry is complete.
- SWEEP** Displays the Sweep function soft key menu for the current operating mode.
- Sweep Menu** Provides for changing the display resolution, single or continuous sweep, and access to the Trace Math functions.
- Choosing **SWEEP** in **FREQ** or **DTF** measurement modes causes the soft keys below to be displayed.
- RESOLUTION** — Opens the display to change the resolution. Choose 130, 259, or 517 data points. (In DTF mode, resolution can be adjusted through the DTF-AID table.)
  - SINGLE SWEEP** — Toggles the sweep between single sweep and continuous sweep. In single sweep mode, each sweep must be activated by the **RUN/HOLD** button.
  - TRACE MATH** — Opens up the Trace Math functions (trace-memory or trace+memory) for comparison of the real time trace in the display with any of the traces from memory. (Not available in DTF mode.)
  - TRACE OVERLAY** — Opens up the Trace Overlay functions menu to allow the current trace to be displayed at the same time as a trace in memory. Choose ON or OFF and **SELECT TRACE** to select the trace from memory to perform trace overlay.

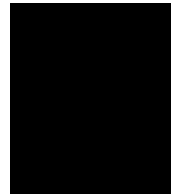



## Power Monitor Menu (Option 5)

Selecting **POWER MONITOR** from the Mode menu causes the soft keys, described below, to be displayed and the corresponding values shown in the message area.

---

**MODE=POWER MONITOR:**

**SOFTKEYS:**

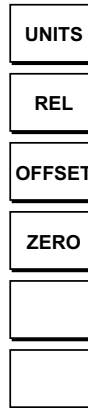

---

Figure 2-5. Power Monitor Mode Soft Key Labels

- ❑ **UNITS** — Toggles between dBm and Watts.
- ❑ **REL** — Turns relative mode OFF, if currently ON. If relative mode is currently OFF, turns it ON and causes the power level to be measured and saved as the base level. Subsequent measurements are then displayed relative to this saved value. With units of dBm, relative mode displays dB<sub>r</sub>; with units of Watts, relative mode displays % (percent).
- ❑ **OFFSET** — Turns Offset OFF, if currently ON. If Offset is currently OFF, turns it ON and opens the Offset parameter for data entry. Press **ENTER** when data entry is complete.  
Offset is the attenuation (in dB) inserted in the line between the DUT and the RF detector. The attenuation is added to the measured input level prior to display.
- ❑ **ZERO** — Turns Zero OFF, if currently ON. If Zero is currently OFF, this softkey turns it ON and initiates collection of a series of power level samples, which are averaged and saved. This saved value is then subtracted from subsequent measurements prior to display.

## RF Source Menu

RF Source mode provides an RF Out source that can be used, for example, in the alignment of dish antennas. Selecting **RF SOURCE** from the Mode menu causes the soft keys, described below, to be displayed:

**MODE=RF SOURCE:**

**SOFTKEYS:**

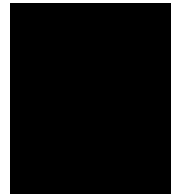

Figure . RF Source Softkeys

- ❑ **FREQ** — Allows setting of the RF source frequency. Use the keypad number keys to enter a frequency, or use the Up/down arrow key to adjust the frequency in 10 kHz steps. Press **ENTER** to accept, or **ESCAPE** to restore the previous value.
- ❑ **POWER** — Selects the RF source output power level. Choose either +6.0 dBm or -30.0 dBm.

## LIMIT

Pressing **LIMIT** on the data keypad activates a menu of limit related functions. Use the corresponding softkey to select the desired limit function. Then use the Up/Down arrow key to change its value, which is displayed in the message area at the bottom of the display.

Choosing **LIMIT** causes the soft keys below to be displayed.

- SINGLE LIMIT** — Sets a single limit value in dBm. Menu choices are:
  - ON/OFF
  - EDIT
  - BACK
- MULTIPLE UPPER LIMITS** — Sets multiple user defined upper limits, and can be used to create an upper limit mask for quick pass/fail measurements. Menu choices are:
  - SEGMENT 1
  - SEGMENT 2
  - SEGMENT 3
  - SEGMENT 4
  - SEGMENT 5
  - BACK
- MULTIPLE LOWER LIMITS** — Set multiple user defined lower limits, and can be used to create a lower limit mask for quick pass/fail measurements. Menu choices are:
  - SEGMENT 1
  - SEGMENT 2
  - SEGMENT 3
  - SEGMENT 4
  - SEGMENT 5
  - BACK
- LIMIT BEEP** — Turns the audible limit beep indicator on or off.

## MARKER

Choosing **MARKER** causes the soft keys, below, to be displayed and the corresponding values to be shown in the message area. Selected frequency marker or distance marker values may be changed using the keypad or Up/Down arrow key.

- M1** — Selects the M1 marker parameter and opens the M1 marker second level menu.
  - ON/OFF** — Turns the selected marker on or off.
  - EDIT** — Opens the selected marker parameter for data entry. Press **ENTER** when data entry is complete or **ESCAPE** to restore the previous value.
  - MARKER TO PEAK** — Places the selected marker at the frequency or distance with the maximum amplitude value.
  - MARKER TO VALLEY** — Places the selected marker at the frequency or distance with the minimum amplitude value.
  - BACK** — Returns to the Main Markers Menu.
- M2 through M4** — Selects the marker parameter and opens the marker second level menu.
  - ON/OFF** — Turns the selected marker on or off.

- **EDIT** — Opens the selected marker parameter for data entry. Press **ENTER** when data entry is complete or **ESCAPE** to restore the previous value.
- **DELTA (Mx-M1)** — Displays delta amplitude value as well as delta frequency or distance for the selected marker with respect to the M1 marker.
- **MARKER TO PEAK** — Places the selected marker at the frequency or distance with the maximum amplitude value.
- **MARKER TO VALLEY** — Places the selected marker at the frequency or distance with the minimum amplitude value.
- **BACK** — Returns to the Main Markers Menu.
- **M5** — Selects the M5 marker parameter and opens the M5 second level menu.
  - **ON/OFF** — Turns the selected marker on or off.
  - **EDIT** — Opens the selected marker parameter for data entry. Press **ENTER** when data entry is complete or **ESCAPE** to restore the previous value.
  - **PEAK BETWEEN M1 & M2** — Places the selected marker at the frequency or distance with the maximum amplitude value between marker M1 and marker M2.
  - **VALLEY BETWEEN M1 & M2** — Places the selected marker at the frequency or distance with the minimum amplitude value between marker M1 and marker M2.
  - **BACK** — Returns to the Main Markers Menu.
- **M6** — Selects the M6 marker parameter and opens the M6 second level menu.
  - **ON/OFF** — Turns the selected marker on or off.
  - **EDIT** — Opens the selected marker parameter for data entry. Press **ENTER** when data entry is complete or **ESCAPE** to restore the previous value.
  - **PEAK BETWEEN M3 & M4** — Places the selected marker at the peak between marker M3 and marker M4.
  - **VALLEY BETWEEN M3 & M4** — Places the selected marker at the valley between marker M3 and marker M4.
  - **BACK** — Returns to the Main Markers Menu.

Choosing **LIMIT** in **FREQ** or **DTF** measurement modes causes the soft keys below to be displayed.

- **SINGLE LIMIT** — Sets a single limit value in dBm. Menu choices are:
  - ON/OFF
  - EDIT
  - BACK
- **MULTIPLE LIMITS** — Sets multiple user defined limits, and can be used to create a limit mask for quick pass/fail measurements. Menu choices are:
  - SEGMENT 1
  - SEGMENT 2



SEGMENT 3  
SEGMENT 4  
SEGMENT 5  
BACK

- **LIMIT BEEP** — Turns the audible limit beep indicator on or off.

## SYS







Displays the System menu softkey selections.

- **OPTIONS** — Displays a second level of functions:
  - **UNITS** — Select the unit of measurement (English or metric).
  - **PRINTER** — Displays a menu of supported printers. Use the Up/Down arrow key and **ENTER** key to make the selection.
  - **FIXED CW** — Toggles the fixed CW function ON or OFF. When ON, F1 is set equal to F2 and a CW frequency is fixed at the selected value. When OFF, a narrow band of frequencies centered on the selected frequency is generated.
  - **CHANGE DATE FORMAT** — Toggles the date format between MM/DD/YY, DD/MM/YY, and YY/MM/DD.
  - **BACK** — Returns to the top-level SYS Menu.
- **CLOCK** — Displays a second level of functions:
  - **HOUR** — Enter the hour (0-23) using the Up/Down arrow key or the keypad. Press **ENTER** when data entry is complete or **ESCAPE** to restore the previous value.
  - **MINUTE** — Enter the minute (0-59) using the Up/Down arrow key or the keypad. Press **ENTER** when data entry is complete or **ESCAPE** to restore the previous value.
  - **MONTH** — Enter the month (1-12) using the Up/Down arrow key or the keypad. Press **ENTER** when data entry is complete or **ESCAPE** to restore the previous value.
  - **DAY** — Enter the day using the Up/Down arrow key or the keypad. Press **ENTER** when data entry is complete or **ESCAPE** to restore the previous value.
  - **YEAR** — Enter the year (1997-2036) using the Up/Down arrow key or the keypad. Press **ENTER** when data entry is complete or **ESCAPE** to restore the previous value.
  - **BACK** — Returns to the top-level SYS menu.
- **SELF TEST** — Start an instrument self test.
- **STATUS** — Displays the current instrument status, including calibration status, temperature, and battery charge state. Press **ESCAPE** to return to normal operation.
- **Language** — Pressing this soft key immediately changes the language used to display messages on the Site Master display. Choices are English, French, German, Spanish, Chinese, and Japanese. The default language is English.

## Symbols

Table 2-1 provides a listing of the symbols used as condition indicators on the LCD display.

Table 2-1. LCD Icon Symbols

<u>Icon</u>	<u>Symbol</u>
	Site Master is in Hold for power conservation. To resume sweeping, press the <b>RUN/HOLD</b> key. After 10 minutes without a key press, the Site Master will automatically activate the power conservation mode.
	Integrator Failure. Intermittent integrator failure may be caused by interference from another antenna. Persistent integrator failure indicates a need to return the Site Master to the nearest Anritsu service center for repair.
	Lock fail indication. Check battery. (If the Site Master fails to lock with a fully charged battery, call your Anritsu Service Center.)
	When calibration is performed, the Site Master stores the ambient temperature. If the temperature drifts outside the specified range, this indicator will flash. A recalibration at the current temperature is recommended.
	Indicates the remaining charge on the battery. The inner white rectangle grows longer as the battery charge depletes.
	Indicates internal data processing.
<b>CAL ON</b>	The Site Master has been calibrated.
<b>CALL OFF</b>	The Site Master has not been calibrated.

## Self Test

At turn-on, the Site Master runs through a series of quick checks to ensure the system is functioning properly. Note that the battery voltage and temperature are displayed in the lower left corner below the self test message. If the battery is low, or if the ambient temperature is not within the specified operational range, Self Test will fail. If Self Test fails and the battery is fully charged and the Site Master is within the specified operating temperature range, call your Anritsu Service Center.

## Error Codes

### Self Test Errors

A listing of Self Test Error messages is given in Table 2-2.

Table 2-2. Self Test Error Messages

<u>Error Message</u>	<u>Description</u>
BATTERY LOW	Battery voltage is less than 10 volts. Charge battery. <i>If condition persists, call your Anritsu Service Center.</i>
EXTERNAL POWER LOW	External supply voltage is less than 10 volts. <i>Call your Anritsu Service Center</i>
PLL FAILED	Phase-locked loops failed to lock. Charge battery. <i>If condition persists with a fully charged battery, call your Anritsu Service Center</i>
INTEGRATOR FAILED	Integration circuit could not charge to a valid level. Charge battery. <i>If condition persists with a fully charged battery, call your Anritsu Service Center.</i>
EEPROM R/W FAILED	Non-volatile memory system has failed. <i>Call your Anritsu Service Center.</i>
OUT OF TEMP. RANGE	Ambient temperature is not within the specified operating range. <i>If the temperature is within the specified operating range and the condition persists, call your Anritsu Service Center.</i>
RTC BATTERY LOW	The internal real-time clock battery is low. A low or drained clock battery will affect the date stamp on saved traces. <i>Contact your nearest Anritsu Service Center.</i>
POWER MONITOR FAIL	Failure of the power monitor system board voltages. <i>If condition persists, call your Anritsu Service Center.</i>
BATTERY CAL LOST	Battery communication failed. The indicated battery charge status may be invalid. <i>If condition persists, call your Anritsu Service Center.</i>
MEMORY FAIL	The EEPROM test on the Site Master main board has failed. <i>If condition persists, call your Anritsu Service Center.</i>

*Note:* A listing of current Anritsu service centers is given in Table 1-2, page 1-8.

---

## Range Errors

A listing of Range Error messages is given in Table 2-3.

Table 2-3. Range Error Messages (1 of 2)

<u>Error Message</u>	<u>Description</u>
RANGE ERROR:F1 > F2	The start (F1) frequency is greater than the stop (F2) frequency.
RANGE ERROR:D1 > D2	The start (D1) distance is greater than the stop (D2) distance.
RANGE ERROR:D2 > DMax=xx.x ft (m)	The stop distance (D2) exceeds the maximum unaliased range. This range is determined by the frequency span, number of points, and relative propagation velocity:  $\text{Maximum Unaliased Range} = \frac{(1.5 \times 10^8)(dp - 1)(V_f)}{F2 - F1}$ <p>Where: <i>dp</i> is the number of data points (130, 259, or 517)  <i>V<sub>f</sub></i> is the relative propagation velocity  <i>F2</i> is the stop frequency in Hz  <i>F1</i> is the start frequency in Hz  <i>Maximum Unaliased Range</i> is in meters</p> Refer to Figure -, page , for a plot of maximum range versus frequency span.
RANGE ERROR: TOP<=BOTTOM	The SWR scale parameter top value is less than or equal to its bottom value.
RANGE ERROR: TOP>=BOTTOM	The RL scale parameter top value is greater than or equal to its bottom value.
CAL INCOMPLETE	A complete open, short, and load calibration must be performed before calibration can be turned on.
DIST REQUIRES F1 < F2	Valid distance to fault plots require a non-zero frequency span.
DIST REQUIRES CAL	Distance-to-fault measurements cannot be performed with CAL OFF.
USE OPTIONS MENU TO SELECT A PRINTER	Attempting to print a display with no printer selected. Select a printer, then retry.
CANNOT ZERO NO DETECTOR INSTALLED	Attempting to perform a Power Monitor zero adjust function with no RF detector connected to the Site Master.
CANNOT ZERO INPUT SIGNAL TOO HIGH	Attempting to perform a Power Monitor zero adjust function with an input of greater than -20 dBm.
POWER MONITOR OPTION NOT INSTALLED	Attempting to enter Power Monitor mode with no Option 5 installed.



## Battery Information

### Charging a New Battery

The NiMH battery supplied with the Site Master has already completed three charge and discharge cycles at the factory and full battery performance should be realized after your first charge.

*NOTE: The battery will not charge if the battery temperature is above 45° C or below 0° C.*

### Charging the Battery in the Site Master

The battery can be charged while installed in the Site Master.

- Step 1.** Turn the Site Master off.
- Step 2.** Connect the AC-DC adapter (Anritsu part number: 40-115) to the Site Master charging port.
- Step 3.** Connect the AC adapter to a 120 VAC or 240 VAC power source as appropriate for your application.

The green external power indicator on the Site Master will illuminate, indicating the presence of external DC power and the battery will begin charging. The indicator will remain lit as long as the battery is charging. Once the battery is fully charged, the battery indicator will turn off. If the battery fails to charge, contact your nearest Anritsu service center.

### Charging the Battery in the Optional Charger

Up to two batteries can be charged simultaneously in the optional battery charger.

- Step 1.** Remove the NiMH battery from your Site Master and place it in the optional charger (Anritsu part number 2000-1029).
- Step 2.** Connect the lead from the AC-DC adapter to the charger.
- Step 3.** Connect the AC-DC adapter to a 120 VAC or 240 VAC power source as appropriate for your application.

Each battery holder in the optional charger has an LED charging status indicator. The LED color changes as the battery is charged:

- Red indicates the battery is charging
- Green indicates the battery is fully charged
- Yellow indicates the battery is in a waiting state (see below).

A yellow light may occur because the battery became too warm during the charge cycle. The charger will allow the battery to cool off before continuing the charge. A yellow light may also indicate that the charger is alternating charge to each of the two batteries.

A blinking red light indicates less than 13 VDC is being supplied to the charger stand. Check that the correct AC charger adapter is connected to the charger stand. If the battery fails to charge, contact your nearest Anritsu Service Center.

The NiMH battery will last longer and perform better if allowed to completely discharge before recharging. For maximum battery life, it is recommended that the NiMH battery be completely discharged and recharged once every three months.

### Battery Charge Indicator

When the AC-DC adapter is unplugged from the Site Master, the battery indicator symbol will be continuously displayed at the top left corner of the Site Master display (Figure ).

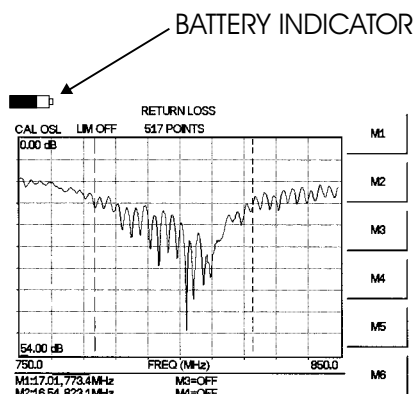

Figure . Site Master Battery Indicator

A totally black bar indicates a fully charged battery. When LOW BATT replaces the battery indicator bar at the top left corner, a couple of minutes of measurement time remains. If a flashing LOW BATT is accompanied by an audio beep at the end of each trace, the battery has approximately one minute of useable time remaining.

Once all the power has drained from the battery, the Site Master display will fade. At this point, your Site Master will switch itself off and the battery will need to be recharged.

### Battery Life

It is normal for NiMH batteries to self-discharge during storage, and to degrade to 80% of original capacity after 12 months of continuous use.

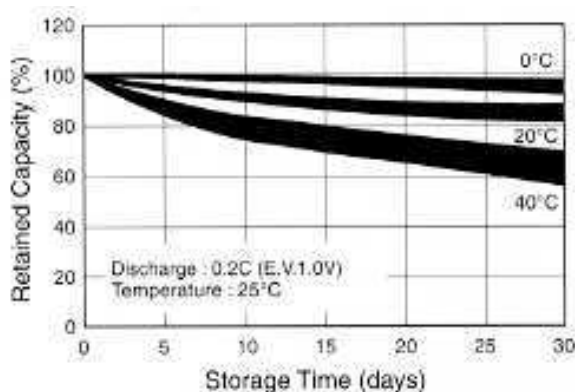

Figure . NiMH Battery Storage Characteristics

The battery can be charged and discharged 300 to 500 times, but it will eventually wear out. The battery may need to be replaced when the operating time between charging is noticeably shorter than normal.

### **Important Battery Information**

- With a new NiMH battery, full performance is achieved after three to five complete charge and discharge cycles. The NiMH battery supplied with the Site Master has already completed three charge and discharge cycles at the factory.
- Recharge the battery only in the Site Master or in an Anritsu approved charger.
- When the Site Master or the charger is not in use, disconnect it from the power source.
- Do not charge batteries for longer than 24 hours; overcharging may shorten battery life.
- If left unused a fully charged battery will discharge itself over time. Storing the battery in extreme hot or cold places will reduce the capacity and lifetime of the battery. The battery will discharge faster at higher ambient temperatures.
- Discharge an NiMH battery from time to time to improve battery performance and battery life.
- The battery can be charged and discharged hundreds of times, but it will eventually wear out.
- The battery may need to be replaced when the operating time between charging is noticeably shorter than normal.
- Do not short-circuit the battery terminals.
- Do not drop, mutilate or attempt to disassemble the battery.
- Never use a damaged or worn out charger or battery.
- Always use the battery for its intended purpose only.
- Temperature extremes will affect the ability of the battery to charge: allow the battery to cool down or warm up as necessary before use or charging.
- Batteries must be recycled or disposed of properly. Do not place batteries in garbage.
- Do not dispose of batteries in a fire!

# Chapter 3

## Getting Started

### Introduction

This chapter provides a brief overview of the Anritsu Site Master. The intent of this chapter is to provide the user with a starting point for making basic measurements.

### Power On Procedure

The Anritsu Site Master is capable of up to 2.5 hours of continuous operation from a fully charged, field-replaceable battery. Built-in energy conservation features allow battery life to be extended over an eight-hour workday.

The Site Master can also be operated from a 12.5 Vdc source (which will also simultaneously charge the battery). This can be achieved with either the Anritsu AC-DC Adapter (P/N 40-115) or 12.5 Vdc Automotive Cigarette Lighter Adapter (P/N 806-62). Both items are included as standard accessories (see Chapter 1).

To power on the Site Master:

**Step 1.** Press the **ON/OFF** front panel key (Figure 3-1).

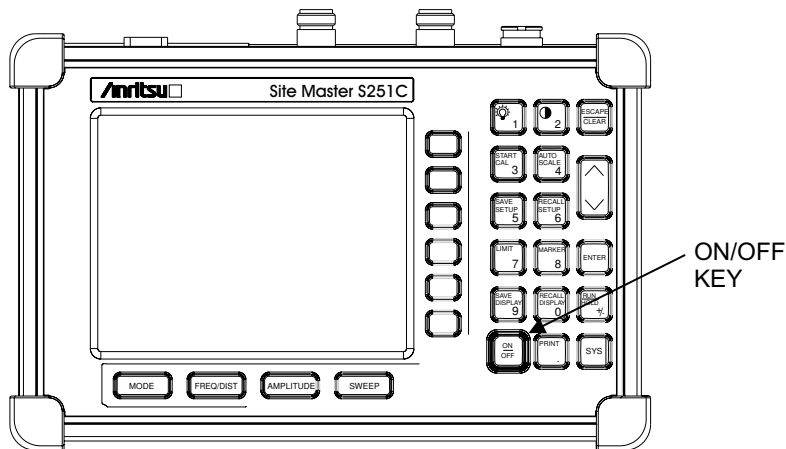

Figure 3-1. Site Master On/Off Key

The screen displays the Anritsu logo, the Site Master model number, and the firmware version. The Site Master then takes about five seconds to perform a series of self-diagnostic and adjustment routines, then displays:

**Step 2.** Press **ENTER** to continue.

If **ENTER** is not pressed, the Site Master will continue after a 10 second time-out. The Site Master is now ready for operation.

## Select the Frequency or Distance

Regardless of the calibration method used, the frequency range for the desired measurements must be set before calibrating the Site Master. The following procedure selects the frequency range for the calibration.

- Step 1.** Press the **FREQ/DIST** key.
- Step 2.** Press the **F1** soft key.
- Step 3.** Enter the desired frequency using the key pad or the Up/Down arrow key.
- Step 4.** Press **ENTER** to set F1 to the desired frequency.
- Step 5.** Press the **F2** soft key.
- Step 6.** Enter the desired frequency using the keypad or the Up/Down arrow key.
- Step 7.** Press **ENTER** to set F2 to the desired frequency.

Check that the start and stop frequencies displayed match the desired measurement range..



## Calibration

For accurate results, the Site Master must be calibrated at the ambient temperature before making any measurements. The Site Master must be re-calibrated whenever the setup frequency changes, the temperature exceeds the initial calibration temperature or when the test port extension cable is removed or replaced.

The Site Master may be calibrated manually with Open, Short, Load (OSL) calibration components. Two port calibration requires two Load components.

If a Test Port Extension Cable is to be used, the Site Master must be calibrated with the Test Port Extension Cable in place. The Test Port Extension Cable is a phase stable cable and is used as an extension cable on the test port to ensure accurate and repeatable measurements. This phase stable cable can be moved and bent while making a measurement without causing errors in the measurement.

*NOTE: The test port extension cable should have the appropriate connectors for the measurement. Use of additional connector adapters after the test port extension cable can contribute to measurement errors not compensated for during calibration.*

The following procedure explains the calibration methods. Refer to Figure 3-2 for a calibration setup diagram.

## Calibration Procedure - Single Port

Check that the “CAL OFF” message is displayed in the upper left corner of the display. This indicates that the Site Master has not been calibrated. The following procedure details how to perform the calibration.

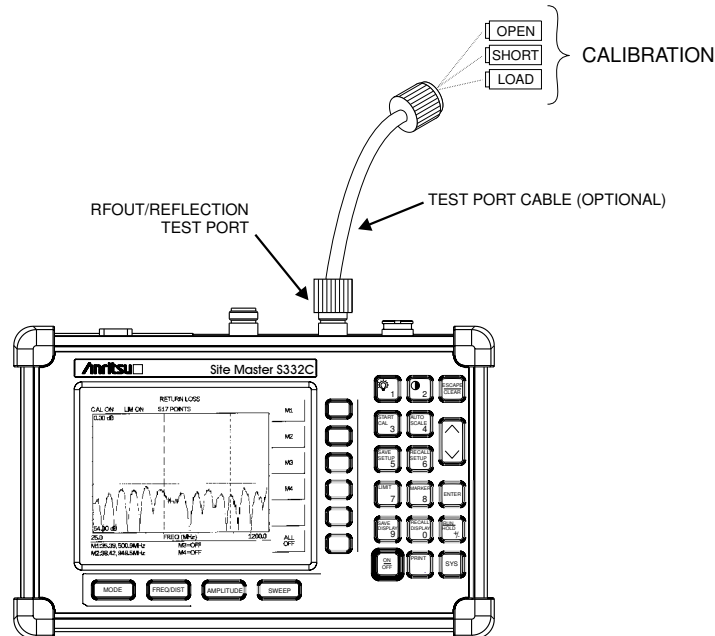

Figure 3-2. Calibration Setup

- Step 1.** Select the appropriate frequency range, as described in the procedure on page 3-2.
- Step 2.** Press the **START CAL** key. The message **CONNECT OPEN TO RF Out PORT** will appear in the display.
- Step 3.** Connect the calibrated Open and press the **ENTER** key. The messages **Measuring OPEN** and then **CONNECT SHORT TO RF Out PORT** will appear.
- Step 4.** Remove the Open, connect the calibrated Short and press the **ENTER** key. The messages **Measuring SHORT** and then **CONNECT TERMINATION TO RF Out** will appear.
- Step 5.** Verify that the calibration has been properly performed by checking that the **CAL ON** message is now displayed in the upper left corner of the display.

## Calibration Procedure - Dual Port

Check that the “CAL OFF” message is displayed in the upper left corner of the display. This indicates that the Site Master has not been calibrated. The following procedure details how to perform the calibration. Two port calibration requires two Load components.

- Step 1.** Select the appropriate frequency range, as described in the procedure on page 3-2.
- Step 2.** Press the **START CAL** key. The message **CONNECT OPEN TO RF Out PORT** will appear in the display.
- Step 3.** Connect the calibrated Open and press the **ENTER** key. The messages **Measuring OPEN** and then **CONNECT SHORT TO RF Out PORT** will appear.
- Step 4.** Remove the Open, connect the calibrated Short and press the **ENTER** key. The messages **Measuring SHORT** and then **CONNECT LOAD TO RF Out PORT** will appear.
- Step 5.** Remove the Short, connect the calibrated Load and press the **ENTER** key. The messages **Measuring LOAD** and then **CONNECT LOADS TO RF Out AND RF In PORTS** will appear.
- Step 6.** Connect the calibrated Loads to the RF Out and RF In ports and press the **ENTER** key. The messages **Measuring ISOLATION** and then **CONNECT RF Out PORT TO RF In PORT** will appear.
- Step 7.** Remove the Loads, connect the RF Out PORT extension cable to the RF In PORT extension cable, using the proper adapter for the cable connector type, and press the **ENTER** key. The message **Measuring THRU** will appear.
- Step 8.** Verify that the calibration has been properly performed by checking that the **CAL ON** message is now displayed in the upper left corner of the display.

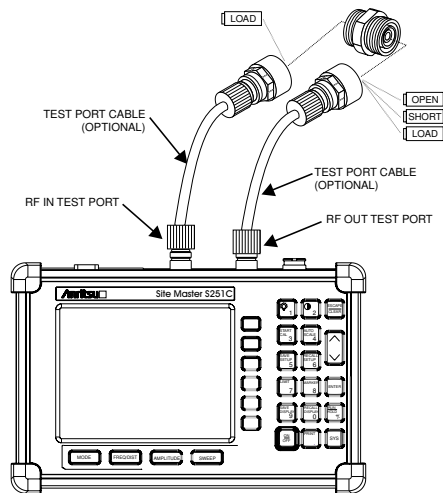
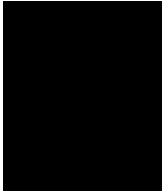

Figure 3-3. Two-Port Measurement Calibration Setup

## Setting the Scale

### Auto Scale

The Site Master can automatically set the scales to the minimum and maximum values of the measurement on the y-axis of the display. This function is particularly useful for measurements in SWR mode. To automatically set the scales:

- Step 1.** Press the **AUTO SCALE** key.  
The Site Master will automatically set the top and bottom scales to the minimum and maximum values of the measurement on the y-axis of the display.

### Amplitude Scale

The following procedure sets the top and bottom scale display.

- Step 2.** Press the **AMPLITUDE** key to call up the Scale Menu.
- Step 3.** Press the **TOP** soft key and use the keypad or Up/Down arrow key to edit the top scale value.
- Step 4.** Press the **BOTTOM** soft key and use the keypad or Up/Down arrow key to edit the bottom scale value.

*NOTE: Typically the y-axis scale of the display is 0-54 dB (return loss) but for some measurements (for example, insertion loss) the scale should be changed to 0-10 dB. If the scale is not changed, some measurement results may not be easily displayed on the screen.*

## Save and Recall a Setup

### Saving a Setup

Saving a setup configuration in memory will preserve the calibration information.

- Step 1.** To save the configuration in one of the 10 available user setup locations, press **SAVE SETUP**.
- Step 2.** Use the key pad or the Up/Down arrow key to select a location (1 - 10).
- Step 3.** Press **ENTER** to save the setup.

### Recalling a Setup

The following procedure recalls a setup from memory.

- Step 1.** Press the **RECALL SETUP** key.
- Step 2.** Select the desired setup using the Up/Down arrow key.
- Step 3.** Press **ENTER** to recall the setup.

## Save and Recall a Display

### Saving a Display

The following procedure saves a display to memory.





- Step 1.** Press the **SAVE DISPLAY** key to activate the alphanumeric menu for trace storage.
- Step 2.** Use the soft keys to enter a label for the saved trace.

For example, to save a display with the name “TX1 RETURN LOSS” press the soft key group that contains the letter “T” then press the “T” soft key. Press the soft key group that contains the letter “X” then press the “X” soft key. Press the number “1” key on the numeric keypad. Use the softkeys and keypad as necessary to enter the entire name, then press **ENTER** to complete the process.

*NOTE: More than one trace can be saved using the same alphanumeric name, as traces are stored chronologically, using the time/date stamp.*

*NOTE: Pressing the **SAVE DISPLAY** key will bring up the last saved trace name on the input line. Pressing the **BACK SPACE** soft key will erase the last character in that trace name. This feature can be useful when naming traces sequentially, such as: Trace 1, Trace 2, etc.*



### Recalling a Display

The following procedure recalls a previously saved display from memory.

- Step 1.** Press the **RECALL DISPLAY** key.
- Step 2.** Select the desired display using the Up/Down arrow key.
- Step 3.** Press **ENTER** to recall the display.

## Set the Distance and Cable Type

In Distance-To-Fault (DTF) mode, the length of the transmission line (distance) and cable type are selected. The cable type determines the velocity propagation and cable attenuation factor. The following procedure can be used to set the distance and select the appropriate cable type.

*NOTE: Selecting the correct cable is very important for accurate measurements and for identifying faults in the transmission line. Selecting the incorrect cable type will allow the DTF trace to be shifted in vertical and horizontal displays and make it difficult to accurately locate faults.*

- Step 1.** Press the **MODE** key.
- Step 2.** Select **DTF RETURN LOSS** or **DTF SWR** mode. The Site Master automatically sets D1 to zero.
- Step 3.** Press the **D2** soft key.
- Step 4.** Enter the appropriate D2 value for the maximum length of the transmission line and press the **ENTER** key to set the D2 value.
- Step 5.** Press the **DTF AID** soft key.
- Step 6.** Using the **Up/Down** arrow key, select **CABLE TYPE**. Standard cable types are stored in the Site Master cable list. This standard list may not be edited. A custom cable list can also be created.
- Step 7.** Using the **Up/Down** arrow key, select the appropriate list and select the type of cable. The selected cable type, PROP VEL and CABLE LOSS in dB/ft (or dB/m) will be displayed.
- Step 8.** Press **ENTER**.

## Changing the Units

By default, the Site Master displays information in metric units. Use the following procedure to change the display to English units.

- Step 1.** Press the **SYS** key.
- Step 2.** Select the **OPTIONS** soft key.
- Step 3.** Press **UNITS** to change from metric to English measurement units, or vice versa. The current selection is displayed at the bottom left corner of the screen.

## Changing the Display Language

By default, the Site Master displays messages in English. To change the display language:

- Step 1.** Press the **SYS** key.
- Step 2.** Select the **Language** soft key.
- Step 3.** Select the desired language. Choices are English, French, German, Spanish, Chinese, and Japanese. The default language is English.

## Printing

Printing is accomplished by selecting an available printer and pressing the print key as described below. Refer to the particular printer operating manual for specific printer settings.

### Printing a Screen

**Step 1.** Connect the printer as shown in Figure 3-4.

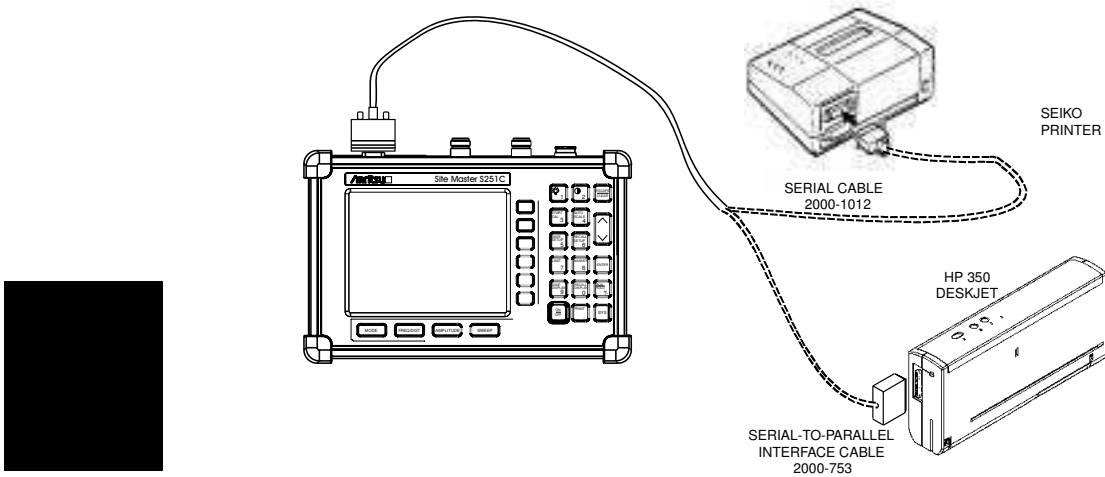

Figure 3-4-. Site Master Printer Setup

**Step 2.** Obtain the desired measurement display

**Step 3.** Press the **SYS** key and the **OPTIONS** soft key (Figure 3-5) .

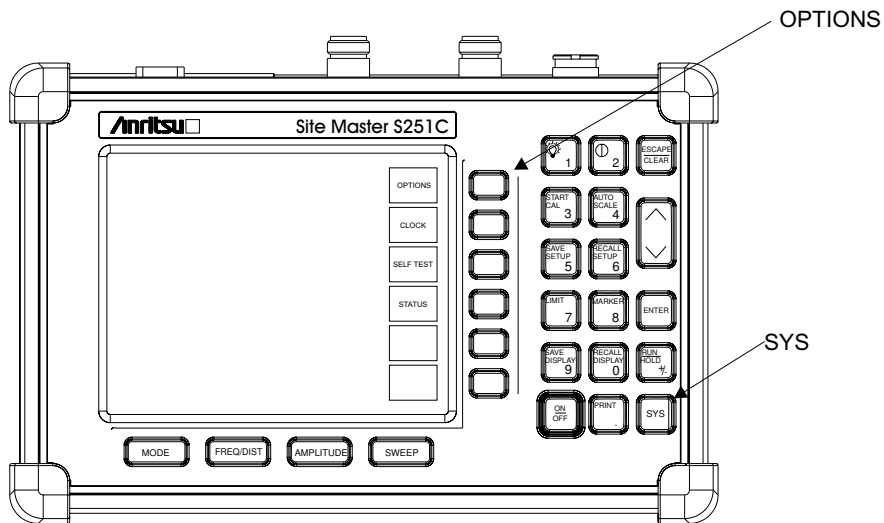

Figure 3-5-. SYS Key and OPTIONS Soft Key

- Step 4.** Press the **PRINTER** soft key and select from the displayed menu of supported printers.
- Step 5.** Press the **PRINT** key. (Figure 3-6).

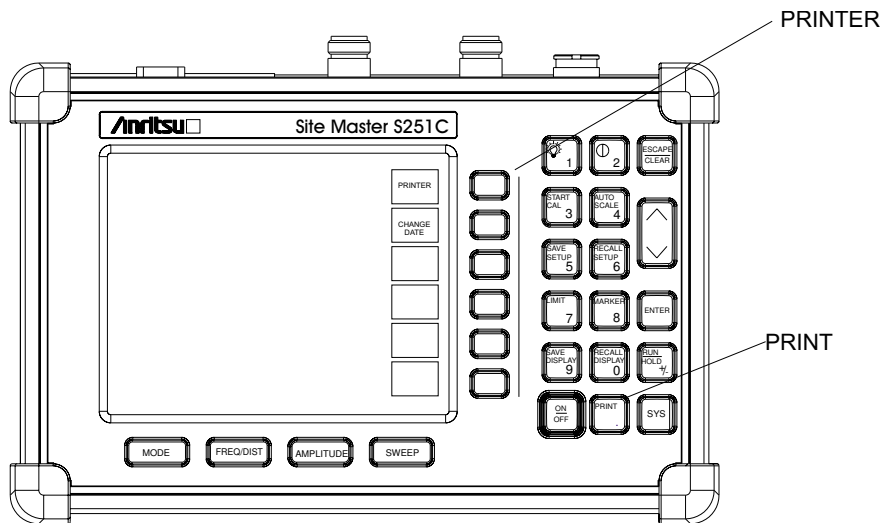

Figure 3-6-. PRINTER Soft Key and PRINT Key

### Printer Switch Settings

Set the switches, SW1, SW2, and SW3, on the Seiko DPU-414 thermal printer as follows:

<u>Switch</u>	<u>1</u>	<u>2</u>	<u>3</u>	<u>4</u>	<u>5</u>	<u>6</u>	<u>7</u>	<u>8</u>
SW1	OFF	ON	ON	ON	ON	OFF	ON	ON
SW2	ON	ON	ON	ON	ON	ON	ON	OFF
SW3	ON	ON	ON	OFF	OFF	ON	ON	ON

Set the switches on the serial-to-parallel interface cable to the HP Deskjet 350 ink jet printer as follows:

<u>SW1</u>	<u>SW2</u>	<u>SW3</u>	<u>SW4</u>	<u>SW5</u>	<u>SW6</u>	<u>SW7</u>	<u>SW8</u>
OFF	ON	OFF	OFF	OFF	OFF	ON	OFF

## Using the Soft Carrying Case

The soft carrying case has been designed such that the strap can be unsnapped to allow the case to be easily oriented horizontally; thus allowing the Anritsu controls to be more easily accessed (Figure 3-7).

---

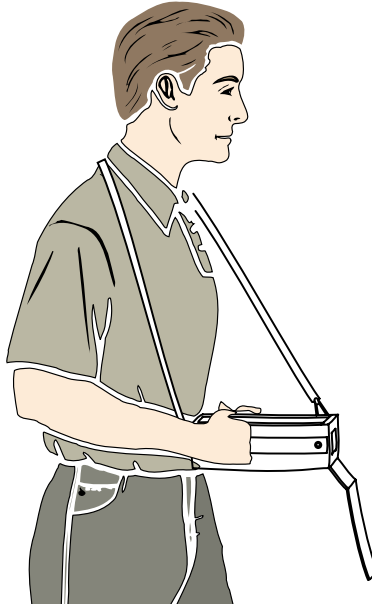

---

*Figure 3--7. Using the Site Master Soft Carrying Case*

# Chapter 4

## Cable & Antenna Analysis

### Introduction

This chapter provides a description of cable and antenna measurements in one port and two port modes. Measurements include line sweeping fundamentals and line sweeping measurement procedures, available when the Site Master is in frequency or DTF mode.

### One Port Measurements

#### Line Sweep Fundamentals

In wireless communication, the transmit and receive antennas are connected to the radio through a transmission line. This transmission line is usually a coaxial cable or waveguide. This connection system is referred to as a transmission feed line system. Figure 4-1 shows an example of a typical transmission feed line system.

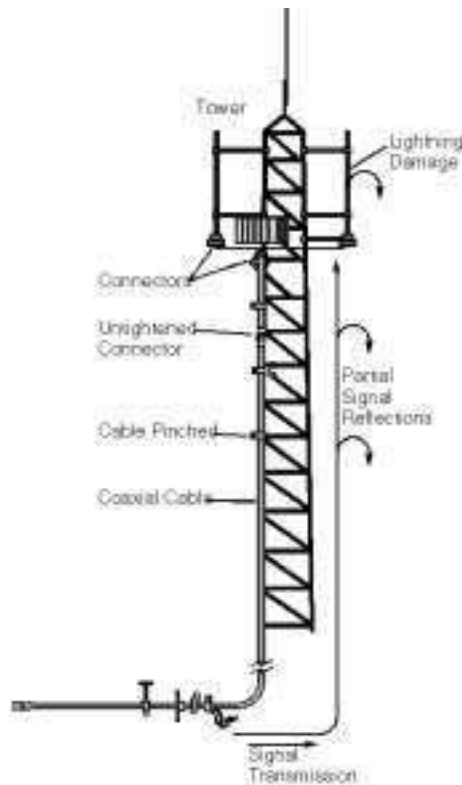

Figure 4-1. A Typical Transmission Feed Line System

The performance of a transmission feed line system may be affected by excessive signal reflection and cable loss. Signal reflection occurs when the RF signal reflects back due to an impedance mismatch or change in impedance caused by excessive kinking or bending of the transmission line. Cable loss is caused by attenuation of the signal as it passes through the transmission line and connectors.

To verify the performance of the transmission feed line system and analyze these problems, three types of line sweeps are required:

**Return Loss Measurement**—Measures the reflected power of the system in decibels (dB). This measurement can also be taken in the Voltage Standing Wave Ratio (VSWR) mode, which is the ratio of the transmitted power to the reflected power. However, the return loss measurement is typically used for most field applications.

**Insertion Loss Measurement**—Measures the energy absorbed, or lost, by the transmission line in dB/ft or dB/meter. Different transmission lines have different losses, and the loss is frequency and distance specific. The higher the frequency or longer the distance, the greater the loss.

**Distance-To-Fault (DTF) Measurement**—Reveals the precise fault location of components in the transmission line system. This test helps to identify specific problems in the system, such as connector transitions, jumpers, kinks in the cable or moisture intrusion.

The different measurements are defined as:

**Return Loss - System Sweep**—A measurement made when the antenna is connected at the end of the transmission line. This measurement provides an analysis of how the various components of the system are interacting and provides an aggregate return loss of the entire system.

**Distance To Fault - Load Sweep**—A measurement made with the antenna disconnected and replaced with a 50Ω precision load at the end of the transmission line. This measurement allows analysis of the various components of the transmission feed line system in the DTF mode.

**Cable Loss - Insertion Loss Sweep**—A measurement made when a short is connected at the end of the transmission line. This condition allows analysis of the signal loss through the transmission line and identifies the problems in the system. High insertion loss in the feed line or jumpers can contribute to poor system performance and loss of coverage.

This whole process of measurements and testing the transmission line system is called Line Sweeping.

### Information Required for a Line Sweep

The following information must be determined before attempting a line sweep measurement:

- System Frequency Range, to set the sweep frequency
- Cable Type, to set the cable characteristics for DTF measurements
- Distance of the Cable Run, to set the distance for DTF measurements

## Typical Line Sweep Test Procedures

This section provides typical line sweep measurements used to analyze the performance of a transmission feed line system.

### System Return Loss Measurement

System return loss measurement verifies the performance of the transmission feed line system with the antenna connected at the end of the transmission line. To measure the system return loss:

#### Required Equipment

- Site Master Model S251C
- Precision Open/Short, Anritsu 22N50 *or*  
Precision Open/Short/Load, Anritsu OSLN50LF
- Precision Load, Anritsu SM/PL
- Test Port Extension Cable, Anritsu 15NNF50-1.5C
- Optional 510-90 Adapter, DC to 7.5 GHz, 50 ohm, 7/16 (F)-N (M)

#### Device Under Test

- Transmission Feed Line with Antenna

#### Procedure

- Step 1.** Press the **MODE** key.
- Step 2.** Select **FREQ-RETURN LOSS** using the Up/Down arrow key and press **ENTER**.
- Step 3.** Set the start and stop frequencies, F1 and F2, as described on page 3-2.
- Step 4.** Calibrate the Site Master as described on page 3-2.
- Step 5.** Connect the Device Under Test to the Site Master. A trace will be displayed on the screen when the Site Master is in the sweep mode.
- Step 6.** Press **SAVE DISPLAY** (page 3-5) name the trace, and press **ENTER**.

*NOTE: The antenna must be connected at the end of the transmission feed line when conducting a System Return Loss measurement.*



Figure 4-2 is an example of a typical system return loss trace:

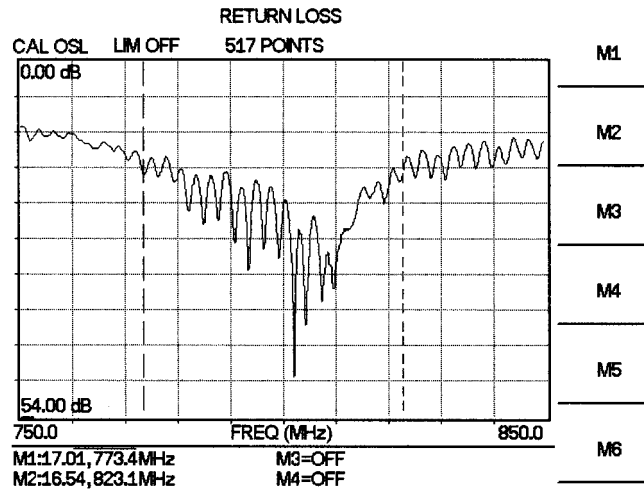

Figure 4-2. Typical System Return Loss Trace

*NOTE: The system sweep trace should appear at an approximate return loss of 15 dB ( $\pm 3$  dB) on the display. In general, a 15 dB return loss is measured in the passband of the antenna system.*

If the TMA is in the transmission feed line system, switch off the TMA bypass switch, if equipped. If the TMA does not have a bypass switch, disconnect the cables leading to and from the TMA and connect the adapter between the antenna jumper and the TMA jumper.

## Insertion Loss Measurement

The transmission feed line insertion loss test verifies the signal attenuation level of the cable system in reference to the specification. This test can be conducted with the Site Master in either **FREQ-CABLE LOSS** or **FREQ-RETURN LOSS** mode. In Cable Loss mode, the Site Master automatically considers the signal traveling in both directions when calculating the insertion loss, making the measurement easier for the user in the field. Both methods are explained below.

### Required Equipment

- ❑ Site Master Model S251C
- ❑ Precision Open/Short, Anritsu 22N50 *or*  
Precision Open/Short/Load, Anritsu OSLN50LF
- ❑ Precision Load, Anritsu SM/PL
- ❑ Test Port Extension Cable, Anritsu 15NNF50-1.5C
- ❑ Optional 510-90 Adapter, DC to 7.5 GHz, 50 ohm, 7/16(F)-N(M)

### Device Under Test

- ❑ Transmission Feed Line with Short

### Procedure - Cable Loss Mode

- Step 1.** Press the **MODE** key.
- Step 2.** Select **FREQ-CABLE LOSS** using the Up/Down arrow key and press **ENTER**.
- Step 3.** Set the start and stop frequencies, F1 and F2, as described on page 3-2.
- Step 4.** Connect the Test Port Extension cable to the RF Out port and calibrate the Site Master as described on page 3-2.
- Step 5.** Save the calibration set up (page 3-5).
- Step 6.** Connect the Device Under Test to the Site Master phase stable Test Port Extension cable. A trace will be displayed on the screen as long as the Site Master is in sweep mode.
- Step 7.** Press the **AMPLITUDE** key and set the **TOP** and **BOTTOM** values of the display. In the example below, the **TOP** is set to 2, and the **BOTTOM** is set to 5.
- Step 8.** Press the **MARKER** key.
- Step 9.** Set M1 to **MARKER TO PEAK**.
- Step 10.** Set M2 to **MARKER TO VALLEY**.
- Step 11.** Calculate the measured insertion loss by averaging M1 (marker to peak) and M2 (marker to valley) as follows:
- Step 12.**  $Insertion\ Loss = \frac{M1 + M2}{2}$
- Step 13.** Press **SAVE DISPLAY** (page 3-5) name the trace, and press **ENTER**.

Step 14. Verify the measured insertion loss against the calculated insertion loss:

	Type	Attenuation (dB/ft)	× Length (ft)	= Loss (dB)
First Jumper	LDF4-50A	0.0325	20	0.65
Main Feeder	LDF5-50A	0.0186	150	2.79
Top Jumper	LDF4-50A	0.0325	10	0.325

The number of connector pairs (3) times the loss per pair (in dB) equals the connector loss:  $3 \times 0.14 = 0.42$ .

The insertion loss of the transmission system is equal to:

$$\begin{array}{rcccccc} \text{First Jumper loss} & + & \text{Main Feeder Loss} & + & \text{Top Jumper Loss} & + & \text{Connector Loss} & = & \text{Insertion Loss} \\ 0.65 & & 2.79 & & 0.325 & & 0.42 & & = 4.19 \text{ dB} \end{array}$$

Figure 4-3 is an example of a typical transmission line cable loss trace.

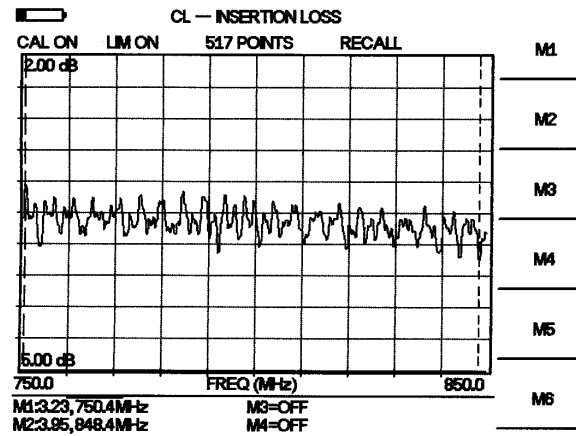

Figure 4-3. Typical Transmission Line Cable Loss Trace

**Procedure - Return Loss Mode**

- Step 1.** Press the **MODE** key.
- Step 2.** Select **FREQ-RETURN LOSS** using the Up/Down arrow key and press **ENTER**.
- Step 3.** Set the start and stop frequencies, F1 and F2, as described on page 3-2.
- Step 4.** Connect the Test Port Extension cable to the RF Out port and calibrate the Site Master as described on page 3-2.
- Step 5.** Save the calibration set up (page 3-5).
- Step 6.** Connect the Device Under Test to the Site Master phase stable Test Port Extension cable. A trace will be displayed on the screen as long as the Site Master is in sweep mode.
- Step 7.** Press the **AMPLITUDE** key and set **TOP** and **BOTTOM** values of the display. In the example below, the **TOP** is set to 4, and the **BOTTOM** is set to 10.
- Step 8.** Press the **MARKER** key.
- Step 9.** Set M1 to **MARKER TO PEAK**.
- Step 10.** Set M2 to **MARKER TO VALLEY**.
- Step 11.** Calculate the insertion loss by averaging M1 (marker to peak) and M2 (marker to valley) and dividing by two as follows:
- Step 12.**

$$\text{Insertion Loss} = \frac{\frac{M1 + M2}{2}}{2} = \frac{\text{Avg.}}{2} \quad (\text{where Avg. is one way loss})$$

- Step 13.** Press **SAVE DISPLAY** (page 3-5) name the trace, and press **ENTER**.

Figure 4-4 is an example of a typical insertion loss measurement in return loss mode.

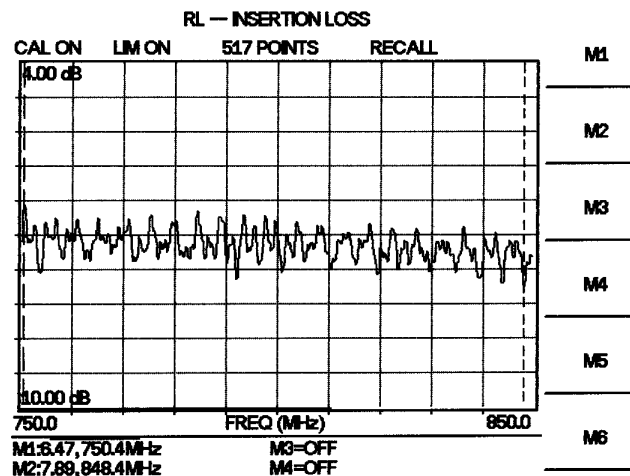

Figure 4-4. Typical Insertion Loss Measurement in Return Loss Mod

## Distance-To-Fault (DTF) Transmission Line Test

The Distance-To-Fault transmission line test verifies the performance of the transmission line assembly and its components and identifies the fault locations in the transmission line system. This test determines the return loss value of each connector pair, cable component and cable to identify the problem location. This test can be performed in the DTF-RETURN LOSS or DTF-SWR mode. Typically, for field applications, the DTF-RETURN LOSS mode is used. To perform this test, disconnect the antenna and connect the load at the end of the transmission line.

### Required Equipment

- ❑ Site Master Model S251C
- ❑ Precision Open/Short, Anritsu 22N50 *or*  
Precision Open/Short/Load, Anritsu OSLN50LF
- ❑ Precision Load, Anritsu SM/PL
- ❑ Test Port Extension Cable, Anritsu 15NNF50-1.5C
- ❑ Optional 510-90 Adapter, DC to 7.5 GHz, 50 ohm, 7/16(F)-N(M)

### Device Under Test

- ❑ Transmission Feed Line with Load

### Procedure - DTF-Return Loss Mode

The following steps explain how to make a DTF measurement in return loss mode.

- Step 1.** Press the **MODE** key.
- Step 2.** Select DTF-RETURN LOSS using the Up/Down arrow key and press **ENTER**.
- Step 3.** Set the start and stop frequencies, F1 and F2, as described on page 3-2.
- Step 4.** Connect the Test Port Extension cable to the RF Out port and calibrate the Site Master as described on page 3-2.
- Step 5.** Save the calibration set up (page 3-5).
- Step 6.** Connect the Device Under Test to the Site Master phase stable Test Port Extension cable. A trace will be displayed on the screen as long as the Site Master is in sweep mode.
- Step 7.** Press the **FREQ/DIST** key.
- Step 8.** Set the **D1** and **D2** values. The Site Master default for D1 is zero.
- Step 9.** Press the **DTF AID** soft key and select the appropriate **CABLE TYPE** to set the correct propagation velocity and attenuation factor.

*NOTE: Selecting the right propagation velocity, attenuation factor and distance is very important for accurate measurements, otherwise the faults can not be identified accurately and insertion loss will be incorrect.*

**Step 10.** Press **SAVE DISPLAY** (page 3-5) name the trace, and press **ENTER**.

**Step 11.** Record the connector transitions.

Figure 4-5 shows an example of a typical DTF return loss trace.

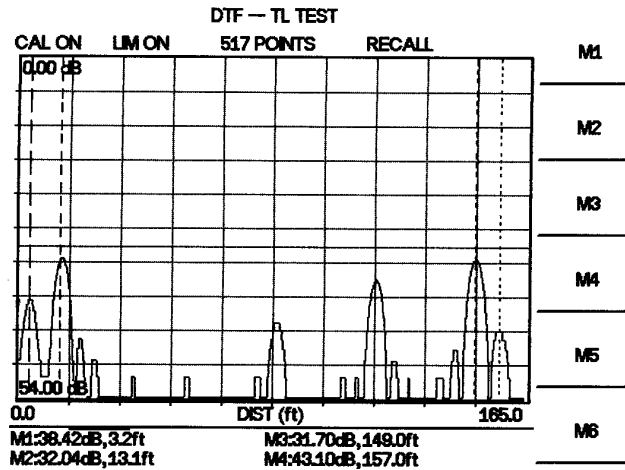

Figure 4-5. Typical DTF Return Loss Trace

In the above example:

- ❑ Marker M1 marks the first connector, the end of the Site Master phase stable Test Port Extension cable. (M1 = 38.42 dB, 3.2 ft.)
- ❑ Marker M2 marks the first jumper cable. (M2 = 32.04 dB, 13.1 ft.)
- ❑ Marker M3 marks the end of the main feeder cable. (M3 = 31.70 dB, 149.0 ft.)
- ❑ Marker M4 is the load at the end of the entire transmission line. (M4 = 43.10 dB, 157.0 ft.)

#### Procedure - DTF-SWR Mode

The following steps explain how to measure DTF in SWR mode.

- Step 1.** Press the **MODE** key.
- Step 2.** Select the DTF-SWR using the Up/Down arrow key and press **ENTER**.
- Step 3.** Follow the same procedure as DTF-Return Loss Mode, above.

## Antenna Subsystem Return Loss Test

Antenna Subsystem return loss measurement verifies the performance of the transmit and receive antennas. This measurement can be used to analyze the performance of the antenna before installation. The antenna can be tested for the entire frequency band, or tested to a specific frequency range. Transmit and receive frequency measurements are conducted separately. The following steps explain how to measure the antenna loss in return loss mode.

### Required Equipment

- ❑ Site Master Model S251C
- ❑ Precision Open/Short, Anritsu 22N50 *or*  
Precision Open/Short/Load, Anritsu OSLN50LF
- ❑ Precision Load, Anritsu SM/PL
- ❑ Test Port Extension Cable, Anritsu 15NNF50-1.5C
- ❑ Optional 510-90 Adapter, DC to 7.5 GHz, 50 ohm, 7/16(F)-N(M)

### Device Under Test

- ❑ Antenna Sub Assembly

### Procedure

- Step 1.** Press the **MODE** key.
- Step 2.** Select **FREQ-RETURN LOSS** using the Up/Down arrow key and press **ENTER**.
- Step 3.** Set the start and stop frequencies, F1 and F2, as described on page 3-2.
- Step 4.** Connect the Test Port Extension cable to the RF port and calibrate the Site Master as described on page 3-2.
- Step 5.** Press **SAVE SETUP** and save the calibration set up (page 3-5).
- Step 6.** Connect the Device Under Test to the Site Master phase stable Test Port Extension cable.
- Step 7.** Press the **MARKER** key.
- Step 8.** Set marker M1 to 750 MHz and M2 to 829 MHz.
- Step 9.** Record the lowest return loss over the specified frequency.
- Step 10.** Press **SAVE DISPLAY** (page 3-5) name the trace, and press **ENTER**.

The following trace is an example of an antenna return loss trace.

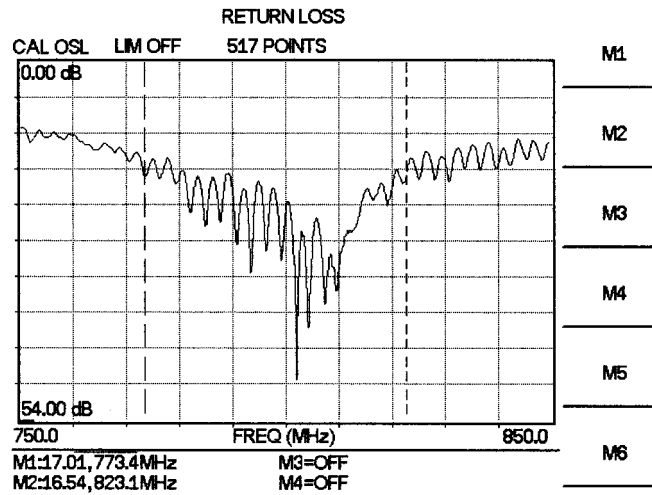

Figure 4-6. Antenna Return Loss Trace

Calculate the threshold value and compare the recorded Lowest Return Loss to the calculated threshold value.

$$\text{Maximum Return Loss} = \frac{-20 \log (VSWR - 1)}{(VSWR + 1)}$$

*NOTE: VSWR is the antenna manufacturer's specified VSWR.*

If the measured return loss is less than the calculated threshold value, the test fails and the antenna must be replaced.



## Two Port Measurements

### Introduction

A Tower Mounted Amplifier (TMA) can be used to amplify the received signal. There are different types of TMA depending on the system requirements. Three commonly used types are:

- ❑ TMA-D—A duplex tower mounted amplifier that combines transmit and receive ports from the radio system and connects to a single antenna. This configuration is specific to systems that use a single antenna configuration.
- ❑ TMA-S—A receive-only tower mounted amplifier is installed between the receiving antenna and the radio to boost weak signals. This configuration is common on systems that implement separate antennas for transmitting and receiving.
- ❑ TMA-DD—A dual-duplex tower mounted amplifier used for radios systems with a single transmission line connection for transmit and receive. These systems are commonly called transceivers.

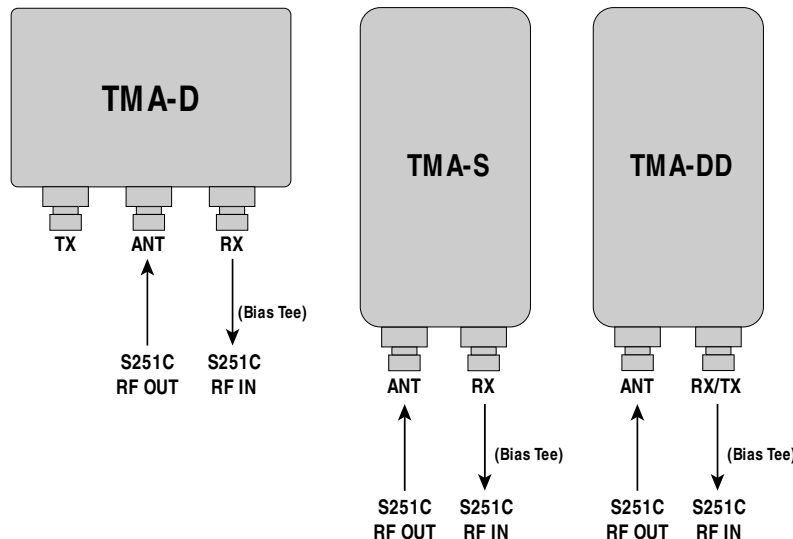

Figure 4-7. Types of Tower Mounted Amplifiers

During installation of the TMA, the following tests should be conducted:

- ❑ Antenna Subsystem Return Loss Testing to verify antenna performance.
- ❑ TMA performance testing to verify the tower mounted amplifier performance.
- ❑ Insertion Loss Measurement Test to verify the transmission line performance before TMA installation and connecting the antenna.

When troubleshooting TMA problems, the following test should be conducted:

- ❑ Insertion Loss Measurement Test to verify the transmission line performance after TMA insertion.
- ❑ DTF-Return Loss with the TMA removed from the configuration.

## TMA Measurements

### Required Equipment

- ❑ Site Master Model S251C
- ❑ Option 10A, Bias Tee
- ❑ External Power Supply 40-115
- ❑ Test Port Extension Cable, Anritsu 15NNF50-1.5C
- ❑ N (m) to  $\frac{7}{16}$  (m) Adapters

### Device Under Test

- ❑ TMA-S

### Procedure

- Step 1.** Connect the External Power Supply (40-115) to the Site Master.
- Step 2.** Turn on the Site Master and press the **MODE** key.
- Step 3.** Select **INSERTION GAIN** (–30 dBm) using the Up/Down arrow key and press **ENTER**.
- Step 4.** Press the **FREQ/DIST** key to set the frequency limits. For a TMA-S amplifier, set F1 to 800 MHz and F2 to 925 MHz.
- Step 5.** Perform a two-port calibration of the Site Master (page 3-4).
- Step 6.** Connect the RF Out port of the Site Master to the ANT connector of the TMA.
- Step 7.** Connect the RF In port of the Site Master to the RX connector of the TMA.

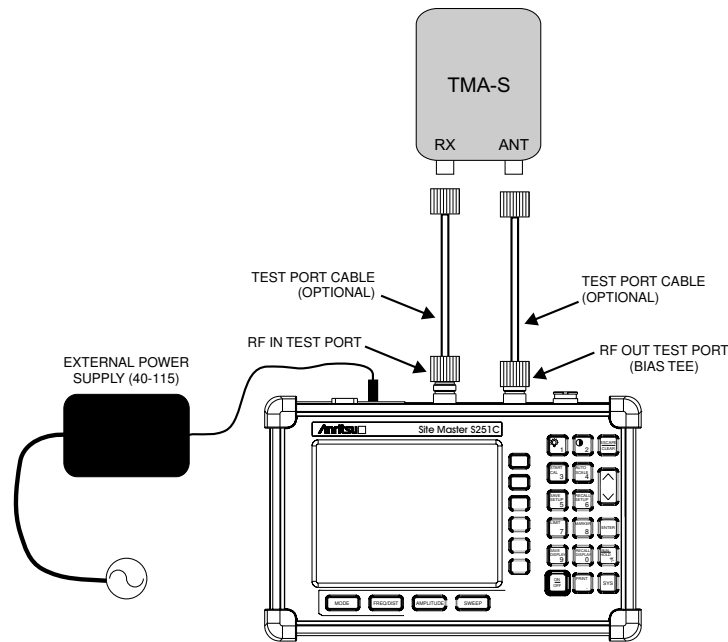

Figure 4-8. TMA-S Measurement Setup

## Chapter 4 Measurements

- Step 8.** Press the **SYS** key, then **OPTIONS**, then **BIAS TEE** to turn on the bias tee voltage. The gain is the level change before and after the bias tee voltage is turned on.
- Step 9.** Press the **AUTO SCALE** key, or press the **AMPLITUDE** key to adjust the top and bottom scale, to display the gain level.
- Step 10.** Press the **MARKER** key and set marker set M1 to 834 MHz and marker M2 to 883 MHz.

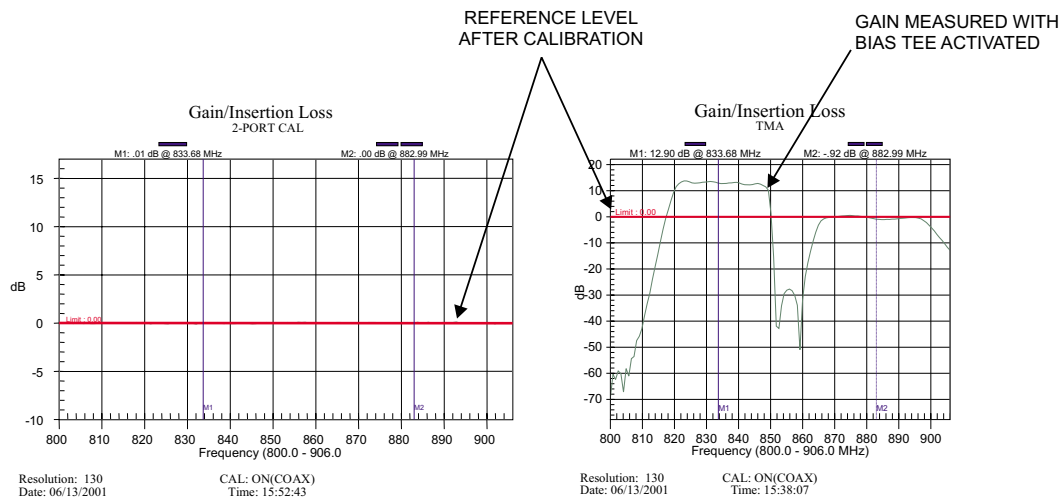

Figure 4-9. TMA Gain Measurement After Calibration

Marker M1 set at 834 MHz indicates the receive band of the tower mounted amplifier. The level above the 0 dB reference level is the gain of the TMA. Marker M2 set at 883 MHz indicates the transmit band of the amplifier where there is no gain.

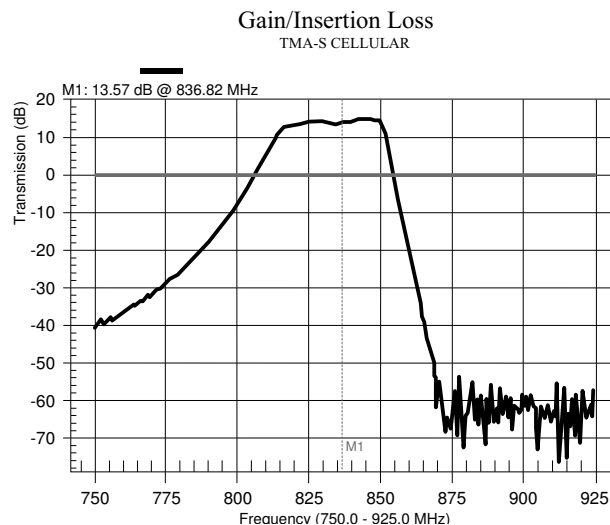

Figure 4-10. TMA-S Gain Measurement

**Device Under Test**

- TMA-DD

**Procedure**

- Step 1.** Connect the External Power Supply (40-115) to the Site Master.
- Step 2.** Turn on the Site Master and press the **MODE** key.
- Step 3.** Select **INSERTION GAIN** ( $-30$  dBm) using the Up/Down arrow key and press **ENTER**.
- Step 4.** Press the **FREQ/DIST** key to set the frequency limits. For a TMA-DD amplifier, set F1 to 1800 MHz and F2 to 1990 MHz.
- Step 5.** Perform a two-port calibration of the Site Master (page 3-4).
- Step 6.** Connect the RF Out port of the Site Master to the ANT connector of the TMA.
- Step 7.** Connect the RF In port of the Site Master to the RX/TX connector of the TMA

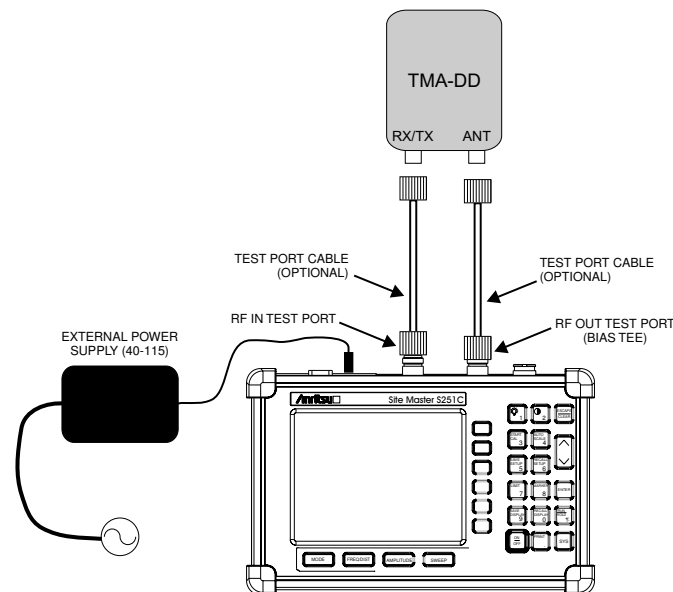

Figure 4-11. TMA-DD Measurement Setup

- Step 8.** Press the **MARKER** key and set marker set M1 to 1849 MHz and marker M2 to 1891 MHz
- Step 9.** Press the **SYS** key, then **OPTIONS**, then **BIAS TEE** to turn on the bias tee voltage. The gain is the level change before and after the bias tee voltage is turned on.

**Chapter 4 Measurements**

---

Marker M1 indicates the receive band of the tower mounted amplifier. The level above the 0 dB reference level is the gain of the TMA. Marker M2 indicates the transmit band of the amplifier where there is no gain.

---

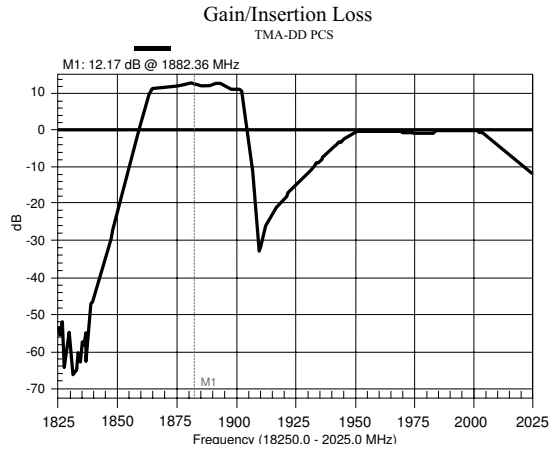
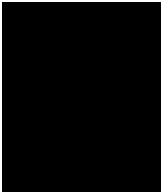

Figure 4-12. TMA-DD Gain Measurement



**Device Under Test**

- TMA-D

**Procedure**

- Step 1.** Connect the External Power Supply (40-115) to the Site Master.
- Step 2.** Turn on the Site Master and press the **MODE** key.
- Step 3.** Select **INSERTION GAIN** (−30 dBm) using the Up/Down arrow key and press **ENTER**.
- Step 4.** Press the **FREQ/DIST** key to set the frequency limits. For a TMA-D amplifier, set F1 to 1800 MHz and F2 to 1990 MHz.
- Step 5.** Perform a two-port calibration of the Site Master (page 3-4).
- Step 6.** Connect the RF Out port of the Site Master to the ANT connector of the TMA.
- Step 7.** Connect the RF In port of the Site Master to the RX connector of the TMA

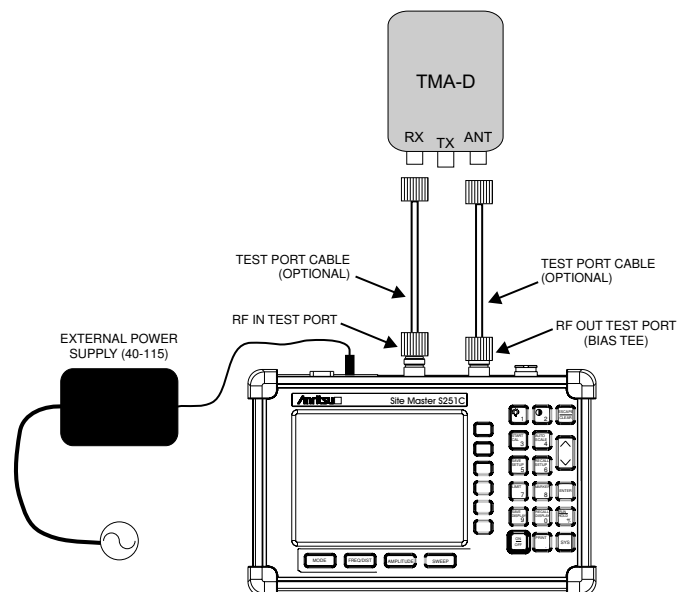

Figure 4-13. TMA-D Measurement Setup

- Step 8.** Press the **MARKER** key and set marker set M1 to 1834 MHz and marker M2 to 1871 MHz
- Step 9.** Press the **SYS** key, then **OPTIONS**, then **BIAS TEE** to turn on the bias tee voltage. The gain is the level change before and after the bias tee voltage is turned on.

**Chapter 4 Measurements**

---

Marker M1 indicates the receive band of the tower mounted amplifier. The level above the 0 dB reference level is the gain of the TMA. Marker M2 indicates the transmit band of the amplifier where there is no gain.

---

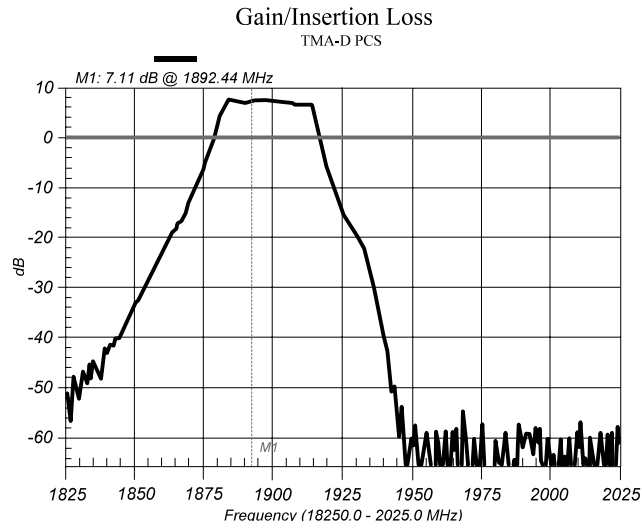
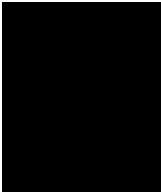

Figure 4-14. TMA-D Gain Measurement



# Antenna to Antenna Isolation

## Introduction

Measuring antenna-to-antenna isolation between adjacent systems is very important when deploying multiple systems on the same tower. It helps to determine the potential threat of interfering signals and maximizes the capacity of the base station.

An example of adjacent PCS systems is shown in Figure 4-15. Antenna 1 transmits a signal in a specific direction, but some of the signal is received by Antenna 2. Any excessive signal level from System 1 can cause poor performance, loss of communication, and system degradation in the adjacent System 2.

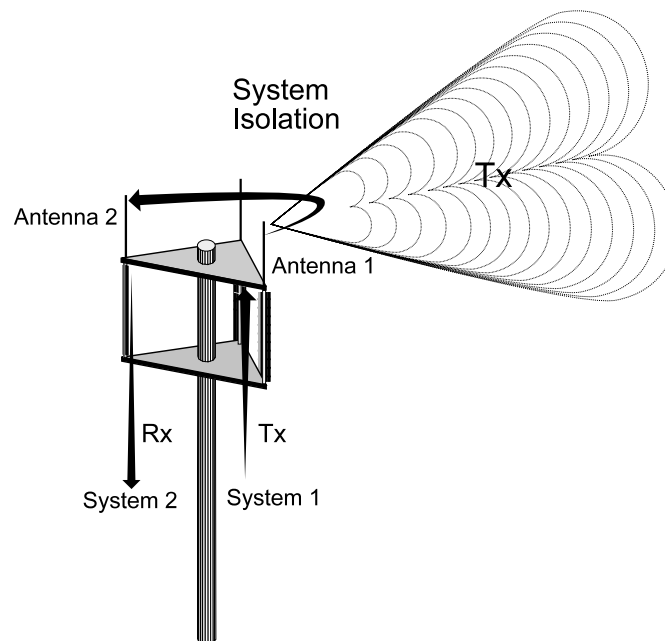

Figure 4-15. System Isolation

Antenna-to-Antenna isolation, more commonly known, as system isolation, is the difference between the output level transmitted by System 1 and the signal level received by System 2.

System isolation is equivalent to the reduction in the signal level (attenuation) of Transmitter 1. Typical levels for isolation between systems can vary from 50 dB to 100 dB.



## Antenna-to-Antenna Isolation Measurement

Antenna-to-Antenna isolation measurement is accomplished in Insertion Loss Mode. Insertion Loss Mode (+6 dBm) is used to drive the signal level large enough to be detected by the second antenna system. The Insertion Gain Mode (-30 dBm level) does not output enough power to provide an accurate measurement of Antenna-to-Antenna isolation .

### Required Equipment

- ❑ Site Master Model S251C
- ❑ Test Port Extension Cable, Anritsu 15NNF50-1.5C (2 each)
- ❑ Adapter, Anritsu 36NN50A

### Procedure

- Step 1.** Press the **MODE** key.
- Step 2.** Select **INSERTION LOSS (+6 dBm)** using the Up/Down arrow key and press **ENTER**.
- Step 3.** Set the frequency range for the antenna system. The table below indicates frequency settings for common systems.

Operation Mode	System	F1 - Start Frequency (MHz)	F2 - Stop Frequency (MHz)
Insertion Loss (+6 dBm)	CELLULAR	806	960
	PCS	1850	1990
	GSM	1800	1900

- Step 4.** Perform a full two port calibration of the Site Master (see page 3-4). The calibration will provide a 0 dB reference level as shown in Figure 4-16.

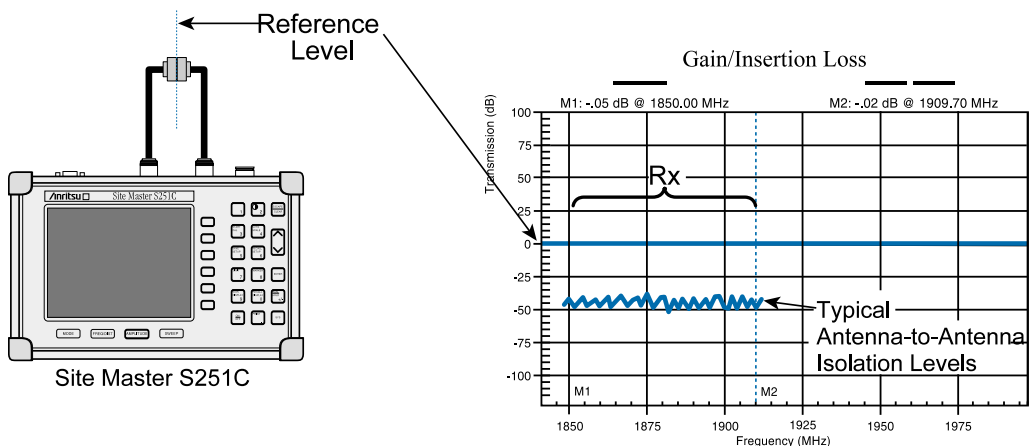

Figure 4-16. Calibration Reference Level

- Step 5.** Disconnect the Tx (Transmit) coax from System 1 and connect it to the RF Out port of the Site Master.
- Step 6.** Disconnect the Rx (Receive) coax from System 2 and connect it to the RF In port of the Site Master.
- Step 7.** Adjust the scale, either manually or by using the **AUTO SCALE** key, to display the isolation level in the center of the display.
- Step 8.** Press the **MARKER** key and set markers M1 and M2 to identify the receive band of the amplifier.
- Step 9.** Press the **LIMIT** key and set the limit line to the estimated average signal level. Figure 4-17 displays a typical antenna isolation measurement display.

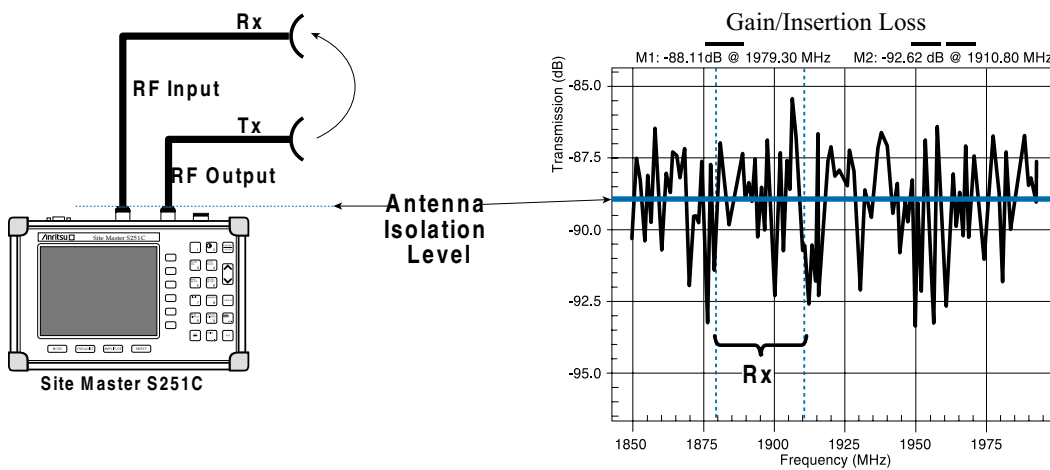

Figure 4-17. Typical Antenna Isolation Measurement Display

Typical antenna-to antenna isolation measurements are made between  $-50$  dB and  $-100$  dB below the 0 dB reference line established by the 2-port calibration.

# Chapter 5

## Site Master Software Tools

### Introduction

This chapter provides a description of the Site Master Software Tools provided with the Site Master. Site Master Software Tools (SMST) is a Windows 95/98/NT4/2000/ME program for cable and antenna trace analysis. The program help function provides on screen instructions on display modification, trace overlay, and multiple plot printing.

### Features

Site Master Software Tools provides the following features:

- Download traces saved in the Site Master memory to the PC for storage and analysis
- DTF and Smith Chart analysis capability
- Trace Overlay allows the viewing of two plots simultaneously
- Ability to save captured plots as data files (.dat file format) or as records representing site information in a database file
- Ability to convert Return Loss measurements to Distance-To-Fault measurements
- Ability to zoom in or out to analyze a particular region of the plot
- Ability to modify Plot Properties
- Ability to output plots to a printer for hard copy records
- Capture of the current trace in the unit

### System Requirements

The Site Master Software Tools program will run on most any computer running Windows 95/98/NT4/2000/ME. Minimum requirements and recommendations are:

- Intel Pentium 100 MHz microprocessor (Pentium II 350 MHz or better recommended)
- 16 MB of RAM (64 MB or above recommended)
- Hard disk drive with approximately 15 MB of available space (An additional 20 MB free space for storage of captured plots is recommended.)
- A serial (COM) port for communication with the Site Master

*NOTE: It is recommended that Windows NT 4.0 users install NT 4.0 Service Pack 3 (SP3) or above. In addition, Windows 2000 and Windows ME may require installation of the latest Service Pack. Please contact Microsoft Corporation for further information on obtaining and installing service packs.*

5

## Installation

To install the Site Master Software Tools program:

- Step 1.** Insert the Anritsu Site Master Software Tools disk in the CDROM drive.
- Step 2.** From the Windows Start menu, select **Run** .
- Step 3.** Type: **X:\Setup.exe** where X is the drive letter of your CDROM drive.
- Step 4.** When prompted, press the **Enter** key to accept the default directory C:\Program Files\Site Master Software Tools and the installation will begin.
- Step 5.** When the installation is complete, pres **Enter** to restart Windows.

The *readme.doc* file on the disk provides updated information about the program, and the Help function provides detailed operating information.

## Communication Port Setting

The Site Master Software Tools communicates with the Site Master through a standard serial COM port on the PC. Set the baud rate of the COM port to 115200.

- Step 1.** Select **Start, Programs** and select **Site Master Software Tools**.
- Step 2.** When the program has loaded, select **Settings, Communication**.
- Step 3.** Select the appropriate PC COM port and Transfer Baud Rate for your system, and click **OK**.



Figure 5-1. Communication Setting Dialog Box

## Interface Cable Installation

Communication between the Site Master and the PC is accomplished over a null modem serial cable provided with the Site Master (Anritsu part number 800-441).

- Step 1.** Install the null modem serial interface cable to the Serial Interface connector on the Site Master Test Connector Panel.
- Step 2.** Connect the other end of the serial interface cable to the appropriate COM port connector on the PC.
- Step 3.** Turn on both the Site Master and the PC.

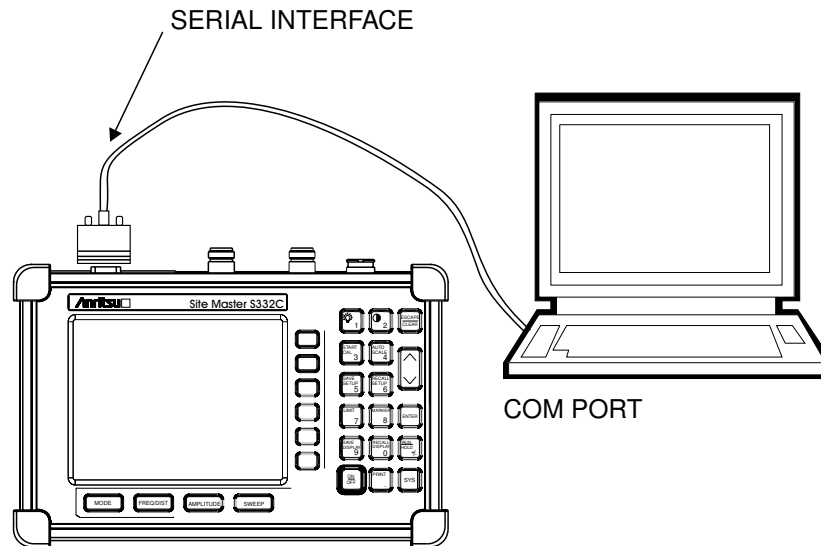

Figure 5-2. Serial Cable Connection

## Using Software Tools

Select **Start, Programs** and select **Site Master Software Tools**.

When communication is established between the Site Master and the PC a “Remote” status message will be displayed on the Site Master display.

## Downloading Traces from the Site Master

Downloaded traces from the Site Master can be selected as a entire block or as individual files. Files are categorized by measurement type:

- Return Loss
- VSWR
- DTF (Distance-to-Fault)
- Time/Date stamp

## Plot Capture

To open the plot capture menus, select the capture icon on the button bar, or select the **Capture** drop down menu from the menu bar.

Select **Capture to Screen** to download traces to the PC.

Highlight a folder, or highlight individual traces within a folder, to be downloaded to the PC. The traces will appear on the PC display as they are downloaded.

## Plot Properties

After downloading, certain plot properties and information can be modified. Select the Plot Properties or Plot Information icon, or right click on the graph area of the trace.

Plot Properties that can be changed include:

- Graph Titles
- Display Mode
- Scale/Limit
- Markers
- Misc.

### Graph Titles

After downloading the plot, the **Main Title** can be changed to reflect the site name or other descriptive information. The **Sub Title** field can be used to describe the specifics of the measurement and configuration.

### Display Mode

Display Mode allows changing the display type without having to retest. Plots can be changed from **Return Loss** to **VSWR** with single click of mouse button.

### Scale/Limit

The scale of the displayed plot can be modified to help analyze whether the plot meets pass/fail criteria. The Scale/Limit sub menu activates options to manually enter the scale limits, or to use the Auto Scale mode.

**Manual** adjustment sets the upper and lower limits of the display under the Scale/Limit Submenu.

**Auto Scale** automatically adjusts the scale for maximum and minimum measurement readings.

**Limit Line Off** turns off all limit lines.

**Single Limit Line** can be activated to help identify faults. Typical antenna specifications require better than  $-15$  dB return loss.

**Multi-Segment Limit Lines** can be activated to set different limits within the same measurement display for specification requirements.

## Markers

**Markers** M1 through M6 can be activated from the Plot Properties menu.

The six active markers can be displayed on the plot to help identify faults from the line sweep data.

## Misc.

The Miscellaneous tab allows adjustment of the Plot/Limit Line Width and the setting of the Plot Footer.

**Plot/Limit Line Width** can be used when preparing reports for the carrier, service providers, and network operators where the trace data must be visible and legible for documentation. The line density of the trace can be set to **Normal (Thin Line)** or **Thick Line** to make the data appear easily when copies are made.

**Plot Footer** allows selection of information to be displayed in the trace display. Selections are:

- |  |  |
|--|--|
| <input type="checkbox"/> Bias Tee                | <input type="checkbox"/> Impedance         |
| <input type="checkbox"/> Time/Date               | <input type="checkbox"/> Measurements      |
| <input type="checkbox"/> Model and Serial Number | <input type="checkbox"/> DTF Parameters    |
| <input type="checkbox"/> Date Format             | <input type="checkbox"/> Overlay Indicator |

## Trace Overlay or Plot Overlay

Trace Overlay is activated by the Mouse Function icon. Single-click on the Mouse Function icon to toggle. Toggling this icon switches the mouse function between Marker/Limit/Zoom and Plot Overlaying.

To overlay two plots, click-and-drag from one plot to the other plot. The final display will be the two plots superimposed on one another.

Refer to the SMST **HELP** function for more information on the steps necessary to perform a trace overlay.

## Saving Traces

Once the plots are captured to the PC they can be save as individual files, as a block of files to a database, exported as a graphic Windows metafile (.wmf) or text data file (.txt).

### Saving a Plot as a Windows Metafile or to a Spreadsheet

Plots can be saved as a Windows metafile (.wmf) or as a text file (.txt). The metafile may be imported into graphic programs and the text file can be imported into spreadsheet.

To save a plot as a Windows metafile, click on the **File** menu and select **Save as Metafile** from the pull down menu. Once the trace is saved as a metafile, it can be copied and transferred into other applications as a picture or graphic file.

To copy a metafile:

- Step 1.** Select the trace to be copied with the mouse cursor.
- Step 2.** Select **Edit** and then **Copy**. The file will copied to clipboard.

- Step 3.** Exit the Site Master Software Tools program and open the target application (Microsoft Word, etc.).
- Step 4.** Select **Edit** and then **Paste**. The file will be inserted as a low-resolution graphic file or a bitmap.

### **Saving a Plot to a Spreadsheet**

Plots can be saved as a text file (.txt) which can then be imported into a spreadsheet program.

To save a plot as a text file:

- Step 1.** Select the trace to be copied with the mouse cursor.
- Step 2.** Click on the **File** menu and select **Export to Text File for a Spreadsheet** from the pull down menu.
- Step 3.** Save the file to a local directory.
- Step 4.** Exit the Site Master Software Tools program and open the spreadsheet application.
- Step 5.** Import the .txt file into the spreadsheet program.

### **Custom Cable List**

A custom cable list can be created in Site Master Software Tools and uploaded to the Site Master. Some standard 1000 MHz, 2000 MHz, and 2500 MHz cables are stored in the Site Master and are listed in Appendix A of this User's Guide.

The cable list contains vital information such as propagation velocity ( $V_p$ ) and insertion loss (dB/m or dB/ft). These parameters are important when identifying faults and discontinuities of transmission lines.

**NOTE:** Values for the cable list are taken from manufacturers specifications and are normalized for a sweep frequency setting of 1 GHz. Complex digital communications systems may require adjustment to attenuation values at the higher frequencies. Contact the manufacturer for the appropriate cable losses.

The Cable Editor is specifically designed to provide contractors, service providers, and network operators with a list of cable types that are tailored to their use.

To open the Cable Editor, select the **Tools** menu and select **Cable Editor**.

To open an existing cable list file, select **File** and **Open**. Select the desired cable list and press **Enter**.

### **Creating a Custom Cable List**

To create a custom cable list:

- Step 1.** Select the File menu and select New.
- Step 2.** Type in or cut and paste the cable types and specifications for the desired cables.



### Uploading a Cable List

After custom cable list has been created in Site Master Software Tools it can upload it to the Site Master. The serial communication null modem cable must be connected from the Site Master to the PC.

In the Cable Editor, select **Tools** and **Upload Cable List**. The software will confirm the upload with a message " Upload Complete" when the operation is finished.

### Querying the Site Master Cable List

Query Cable List allows the user to check and review the contents of the custom cable list in the Site Master.

In the Cable Editor, select **Tools** and **Query Cable List**. The software will download the cable list from the Site Master to the PC.

### Creating a Database

A single trace or a block of traces can be transferred from the Site Master to the PC. A separate database can be created for each cellular site. The site name can be used as the database name.

- Step 1.** Select the **File** menu and select the **Database**.
- Step 2.** Open an existing database or create a new database with a descriptive filename that represents the site name.

Once the database has been created, files can be saved and site information can be added, such as Plot Description, Date/Time, Operator, record/trace number and session description (Transmitter type etc.)

Individual plots will be labeled with the Database Site Name. Each record has its own plot description and measurement type (for example, Return Loss-antenna, Return Loss-cable, and DTF-Return Loss).

### Printing Formats

One to multiple plots per page can be set up under the print format in Site Master Software Tools. Orientation of how the plots are printed on the page can be changed from vertical to horizontal.

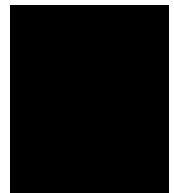

# Appendix A

## Reference Data

### Coaxial Cable Technical Data

Table A-1 provides a standard listing of common coaxial cables along with their Relative Propagation Velocity and Nominal Attenuation values in dB/m @1000, 2000, and 2500 MHz.

*Table A-1. Coaxial Cable Technical Data (1 of 3)*

Manufacturer	Cable Type	Relative Propagation Velocity (Vf)	Nominal Attenuation dB/m @ 1000 MHz	Nominal Attenuation dB/m @ 2000 MHz	Nominal Attenuation dB/m @ 2500 MHz
Andrew	FSJ1-50A	0.84	0.197	0.285	0.323
Andrew	FSJ2-50	0.83	0.134	0.196	0.224
Andrew	FSJ4-50B	0.81	0.119	0.176	0.202
Andrew	LDF4-50A	0.88	0.077	0.113	0.133
Andrew	LDF5-50A	0.89	0.043	0.064	0.077
Andrew	LDF6-50	0.89	0.032	0.048	0.056
Andrew	LDF7-50A	0.88	0.027	0.041	0.047
Andrew	LDF12-50	0.88	0.022	0.035	N/A
Andrew	HJ4-50	0.914	0.087	0.126	0.15
Andrew	HJ4.5-50	0.92	0.054	0.079	0.084
Andrew	HJ5-50	0.916	0.042	0.063	0.07
Andrew	HJ7-50A	0.921	0.023	0.034	0.04
Andrew	HJ12-50	0.931	0.019	0.029	N/A
Belden	RG8, 8A	0.659	0.262	N/A	N/A
Belden	RG9, 9A	0.659	0.289	N/A	N/A
Belden	RG17, 17A	0.659	0.18	N/A	N/A
Belden	RG55, 55A, 55B	0.659	0.541	N/A	N/A
Belden	RG58, 58B	0.659	0.558	N/A	N/A
Belden	RG58A, 58C	0.659	0.787	N/A	N/A
Belden	RG142	0.659	0.443	N/A	N/A
Belden	RG174	0.659	0.984	N/A	N/A
Belden	RG178B	0.659	1.509	N/A	N/A
Belden	RG188	0.659	1.017	N/A	N/A
Belden	RG213	0.659	0.292	N/A	N/A

**Appendix A Reference Data**

Table A-1. Coaxial Cable Technical Data (2 of 3)

Manufacturer	Cable Type	Relative Propagation Velocity (Vf)	Nominal Attenuation dB/m @ 1000 MHz	Nominal Attenuation dB/m @ 2000 MHz	Nominal Attenuation dB/m @ 2500 MHz
Belden	RG214	0.659	0.292	N/A	N/A
Belden	RG223	0.659	0.535	N/A	N/A
Cablewave	HCC12-50J	0.915	0.087	0.126	0.137
Cablewave	HCC78-50J	0.915	0.041	0.061	0.066
Cablewave	HCC158-50J	0.95	0.022	0.031	0.033
Cablewave	HCC300-50J	0.96	0.015	N/A	N/A
Cablewave	HCC312-50J	0.96	0.013	N/A	N/A
Cablewave	HF 4-1/8" Cu2Y	0.97	0.01	N/A	N/A
Cablewave	HF 5" Cu2Y	0.96	0.007	N/A	N/A
Cablewave	HF 6-1/8" Cu2Y	0.97	0.006	N/A	N/A
Cablewave	FLC 38-50J	0.88	0.115	0.169	0.19
Cablewave	FLC 12-50J	0.88	0.072	0.11	0.134
Cablewave	FLC 78-50J	0.88	0.041	0.061	0.072
Cablewave	FLC 114-50J	0.88	0.033	0.05	0.059
Cablewave	FLC158-50J	0.88	0.025	0.038	0.042
Comscope	CR50 540 PE	0.88	0.069	0.103	0.116
Comscope	CR50 1070PE	0.88	0.037	0.055	0.064
Comscope	CR50 1873PE	0.88	0.022	0.0344	0.04
NK Cables	RF 1/2" -50	0.88	0.0757	0.112	0.127
NK Cables	RF 1/2" -50 GHF	0.88	0.0757	0.112	0.127
NK Cables	RF 1/2" -50 BHF	0.88	0.0757	0.112	0.127
NK Cables	RF 5/8"-50	0.88	0.0518	0.0768	0.087
NK Cables	RF 5/8"-50 GHF"	0.88	0.0518	0.0768	0.087
NK Cables	RF 5/8"-50 BHF"	0.88	0.0518	0.0768	0.087
NK Cables	RF 7/8"-50	0.88	0.0413	0.062	0.07
NK Cables	RF 7/8"-50 GHF"	0.88	0.0413	0.062	0.07
NK Cables	RF 7/8"-50 BHF"	0.88	0.0413	0.062	0.07
NK Cables	RF 1 5/8" -50	0.88	0.0248	0.038	0.044
NK Cables	RF 1 5/8" -50 GHF"	0.88	0.0248	0.038	0.044
NK Cables	RF 1 5/8" -50 BHF"	0.88	0.0248	0.038	0.044

Table A-1. Coaxial Cable Technical Data (3 of 3)

Manufacturer	Cable Type	Relative Propagation Velocity (Vf)	Nominal Attenuation dB/m @ 1000 MHz	Nominal Attenuation dB/m @ 2000 MHz	Nominal Attenuation dB/m @ 2500 MHz
NK Cables	RF 2 1/4" -50	0.88	0.021	0.034	N/A
NK Cables	RF 2 1/4" -50 GHF	0.88	0.021	0.034	N/A
NK Cables	RF 2 1/4" -50 BHF	0.88	0.021	0.034	N/A
NK Cables	RFF 3/8" -50	0.81	0.147	0.218	0.25
NK Cables	RFF 3/8" -50 GHF	0.81	0.147	0.218	0.25
NK Cables	RFF 3/8" -50 BHF	0.81	0.147	0.218	0.25
NK Cables	RFF 1/2" -50	0.82	0.112	0.167	0.19
NK Cables	RFF 1/2" -50 GHF	0.82	0.112	0.167	0.19
NK Cables	RFF 1/2" -50 BHF	0.82	0.112	0.167	0.19
NK Cables	RFF 7/8" -50	0.84	0.052	0.078	0.089
NK Cables	RFF 7/8" -50 GHF	0.84	0.052	0.078	0.089
NK Cables	RFF 7/8" -50 BHF	0.84	0.052	0.078	0.089
Times	LMR100	0.8	0.792	1.15	1.31
Times	LMR200	0.83	0.344	0.49	0.554
Times	LMR240	0.84	0.262	0.377	0.424
Times	LMR400	0.85	0.135	0.196	0.222
Times	LMR500	0.86	0.109	0.159	0.18
Times	LMR600	0.87	0.087	0.128	0.145
Times	LMR900	0.87	0.056	0.086	0.098
Times	LMR1200	0.88	0.044	0.065	0.074
Times	LMR1700	0.89	0.033	0.049	0.056
-	310801	0.821	0.115	N/A	N/A
-	311201	0.82	0.18	N/A	N/A
-	311501	0.8	0.23	N/A	N/A
-	311601	0.8	0.262	N/A	N/A
-	311901	0.8	0.377	N/A	N/A
-	352001	0.8	0.377	N/A	N/A

# Appendix B

## Windowing

### Introduction

The Distance sub-menu (page 2-8) provides for setting the cable loss and relative propagation velocity of the coaxial cable. The WINDOW key opens a menu of FFT windowing types for the DTF calculation.

The theoretical requirement for inverse FFT is for the data to extend from zero frequency to infinity. Side lobes appear around a discontinuity due to the fact that the spectrum is cut off at a finite frequency. Windowing reduces the side lobes by smoothing out the sharp transitions at the beginning and at the end of the frequency sweep. As the side lobes are reduced the main lobe widens thereby reducing the resolution.

In situations where there may be a small discontinuity close to a large one, side lobe reduction windowing should be used. When distance resolution is critical windowing can be reduced.

### Examples

The types of windowing in order of increasing side lobe reduction are: rectangular, nominal side lobe, low side lobe, and minimum side lobe. Figures B-1 thru B-4 show examples of the types of windowing.

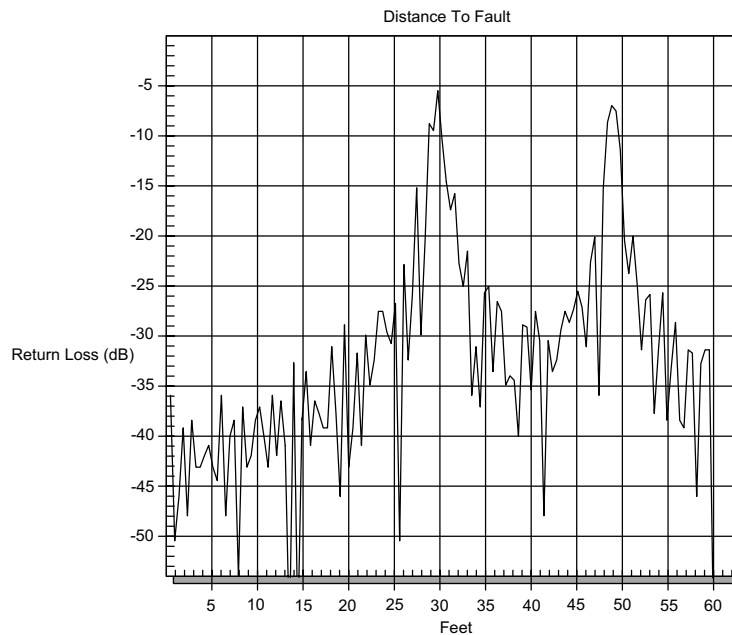

Figure B-1. Rectangular Windowing Example

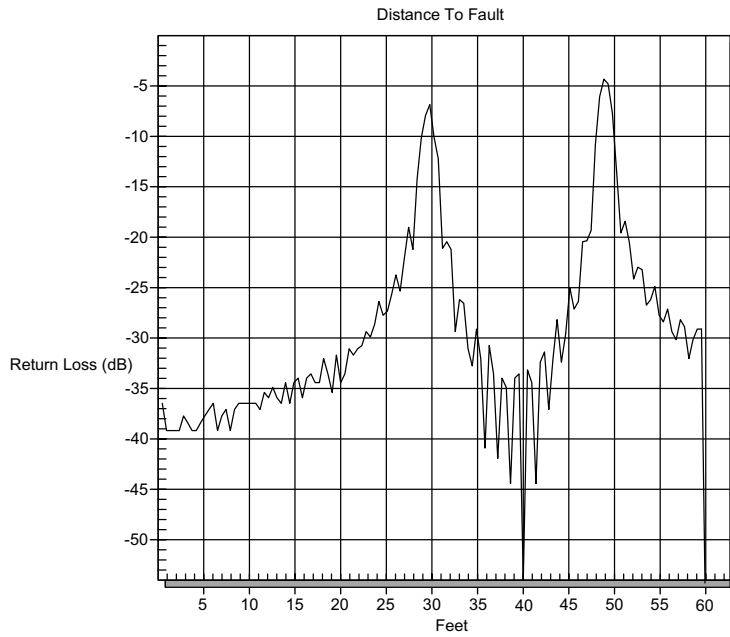

Figure B-2. Nominal Side Lobe Windowing Example

---

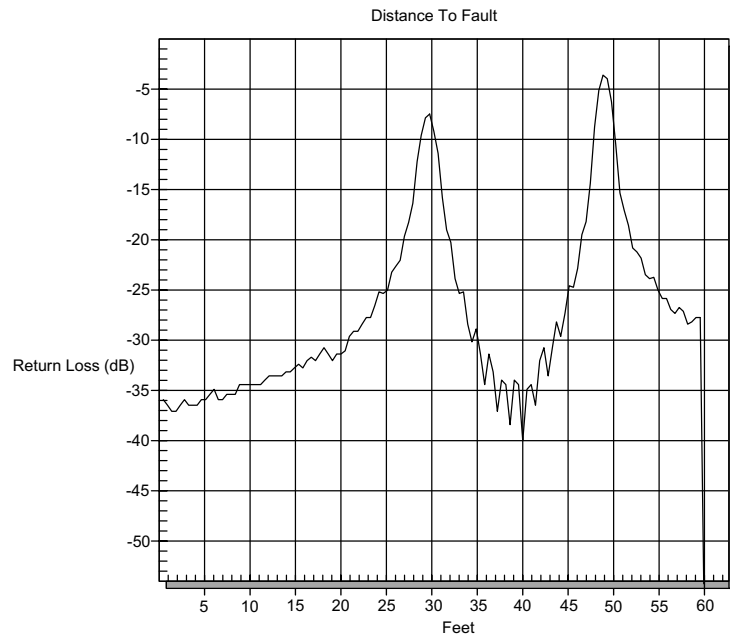

Figure B-3. Low Side Lobe Windowing Example

---

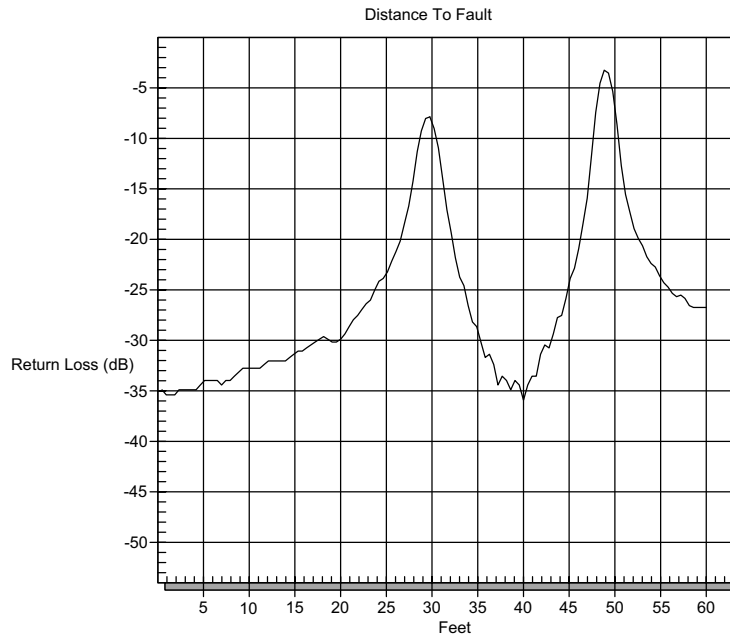

Figure B-4. Minimum Side Lobe Windowing Example





**Anritsu**