

MS2690A/MS2691A/MS2692A
Signal Analyzer
Option 020: Vector Signal Generator
Operation Manual
Operation

Sixth Edition

- For safety and warning information, please read this manual before attempting to use the equipment.
- Additional safety and warning information is provided within the MS2690A/MS2691A/MS2692A Signal Analyzer Operation Manual (Mainframe Operation). Please also refer to this document before using the equipment.
- Keep this manual with the equipment.

ANRITSU CORPORATION

Document No.: M-W2856AE-6.0

Safety Symbols

To prevent the risk of personal injury or loss related to equipment malfunction, Anritsu Corporation uses the following safety symbols to indicate safety-related information. Ensure that you clearly understand the meanings of the symbols BEFORE using the equipment. Some or all of the following symbols may be used on all Anritsu equipment. In addition, there may be other labels attached to products that are not shown in the diagrams in this manual.

Symbols used in manual

 **DANGER** This indicates a very dangerous procedure that could result in serious injury or death if not performed properly.

 **WARNING** This indicates a hazardous procedure that could result in serious injury or death if not performed properly.

 **CAUTION** This indicates a hazardous procedure or danger that could result in light-to-severe injury, or loss related to equipment malfunction, if proper precautions are not taken.

Safety Symbols Used on Equipment and in Manual

The following safety symbols are used inside or on the equipment near operation locations to provide information about safety items and operation precautions. Ensure that you clearly understand the meanings of the symbols and take the necessary precautions BEFORE using the equipment.



This indicates a prohibited operation. The prohibited operation is indicated symbolically in or near the barred circle.



This indicates an obligatory safety precaution. The obligatory operation is indicated symbolically in or near the circle.



This indicates a warning or caution. The contents are indicated symbolically in or near the triangle.



This indicates a note. The contents are described in the box.



These indicate that the marked part should be recycled.

MS2690A/MS2691A/MS2692A

Signal Analyzer Option 020: Vector Signal Generator

Operation Manual Operation

14 May 2007 (First Edition)

23 October 2012 (Sixth Edition)

Copyright © 2007-2012, ANRITSU CORPORATION.

All rights reserved. No part of this manual may be reproduced without the prior written permission of the publisher.

The contents of this manual may be changed without prior notice.

Printed in Japan

Equipment Certificate

Anritsu Corporation certifies that this equipment was tested before shipment using calibrated measuring instruments with direct traceability to public testing organizations recognized by national research laboratories, including the National Institute of Advanced Industrial Science and Technology, and the National Institute of Information and Communications Technology, and was found to meet the published specifications.

Anritsu Warranty

Anritsu Corporation will repair this equipment free-of-charge if a malfunction occurs within one year after shipment due to a manufacturing fault, under the condition that this warranty is void when:

- The fault is outside the scope of the warranty conditions separately described in the operation manual.
- The fault is due to mishandling, misuse, or unauthorized modification or repair of the equipment by the customer.
- The fault is due to severe usage clearly exceeding normal usage.
- The fault is due to improper or insufficient maintenance by the customer.
- The fault is due to natural disaster, including fire, wind, flooding, earthquake, lightning strike, or volcanic ash, etc.
- The fault is due to damage caused by acts of destruction, including civil disturbance, riot, or war, etc.
- The fault is due to explosion, accident, or breakdown of any other machinery, facility, or plant, etc.
- The fault is due to use of non-specified peripheral or applied equipment or parts, or consumables, etc.
- The fault is due to use of a non-specified power supply or in a non-specified installation location.
- The fault is due to use in unusual environments^(Note).
- The fault is due to activities or ingress of living organisms, such as insects, spiders, fungus, pollen, or seeds.

In addition, this warranty is valid only for the original equipment purchaser. It is not transferable if the equipment is resold.

Anritsu Corporation shall assume no liability for injury or financial loss of the customer due to the use of or a failure to be able to use this equipment.

Note:

For the purpose of this Warranty, "unusual environments" means use:

- In places of direct sunlight
- In dusty places
- Outdoors
- In liquids, such as water, oil, or organic solvents, and medical fluids, or places where these liquids may adhere
- In salty air or in places where chemically active gases (SO₂, H₂S, Cl₂, NH₃, NO₂, or HCl, etc.) are present
- In places where high-intensity static electric charges or electromagnetic fields are present
- In places where abnormal power voltages (high or low) or instantaneous power failures occur
- In places where condensation occurs
- In the presence of lubricating oil mists
- At low atmospheric pressure
- In the presence of frequent vibration or mechanical shock, such as in cars, ships, or airplanes

Anritsu Corporation Contact

In the event that this equipment malfunctions, contact an Anritsu Service and Sales office. Contact information can be found on the last page of the printed version of this manual, and is available in a separate file on the CD version.

Notes On Export Management

This product and its manuals may require an Export License/Approval by the Government of the product's country of origin for re-export from your country.

Before re-exporting the product or manuals, please contact us to confirm whether they are export-controlled items or not.

When you dispose of export-controlled items, the products/manuals need to be broken/shredded so as not to be unlawfully used for military purpose.

Trademark and Registered Trademark

IQproducer™ is a registered trademark of Anritsu Corporation.

Notice

The following actions are strictly prohibited for all of the software installed in this product or otherwise provided by Anritsu:

1. Copying, except for archival purposes.
2. Transferring to a third party separately from this product.
3. Analyzing the incorporated software including but not limited to modifying, decompiling, disassembling, and reverse engineering.

CE Conformity Marking

Anritsu affixes the CE Conformity marking on the following product(s) in accordance with the Council Directive 93/68/EEC to indicate that they conform to the EMC and LVD directive of the European Union (EU).

CE marking



1. Product Model

Option: MS2690A/MS2691A/MS2692A-020 Vector Signal Generator

2. Applied Directive and Standards

When the MS2690A/MS2691A/MS2692A-020 Vector Signal Generator is installed in the MS2690A/MS2691A/MS2692A, the applied directive and standards of this Option conform to those of the MS2690A/MS2691A/MS2692A main frame.

PS: About main frame

Please contact Anritsu for the latest information on the main frame types that MS2690A/MS2691A/MS2692A-020 can be used with.

C-tick Conformity Marking

Anritsu affixes the C-tick marking on the following product(s) in accordance with the regulation to indicate that they conform to the EMC framework of Australia/New Zealand.

C-tick marking



1. Product Model

Option: MS2690A/MS2691A/MS2692A-020 Vector Signal Generator

2. Applied Directive and Standards

When the MS2690A/MS2691A/MS2692A-020 Vector Signal Generator is installed in the MS2690A/MS2691A/MS2692A, the applied directive and standards of this Option conform to those of the MS2690A/MS2691A/MS2692A main frame.

PS: About main frame

Please contact Anritsu for the latest information on the main frame types that MS2690A/MS2691A/MS2692A-020 can be used with.

About This Manual

■ Composition of Operation Manuals

The operation manuals for the MS2690A/MS2691A/MS2692A Signal Analyzer are comprised as shown in the figure below.

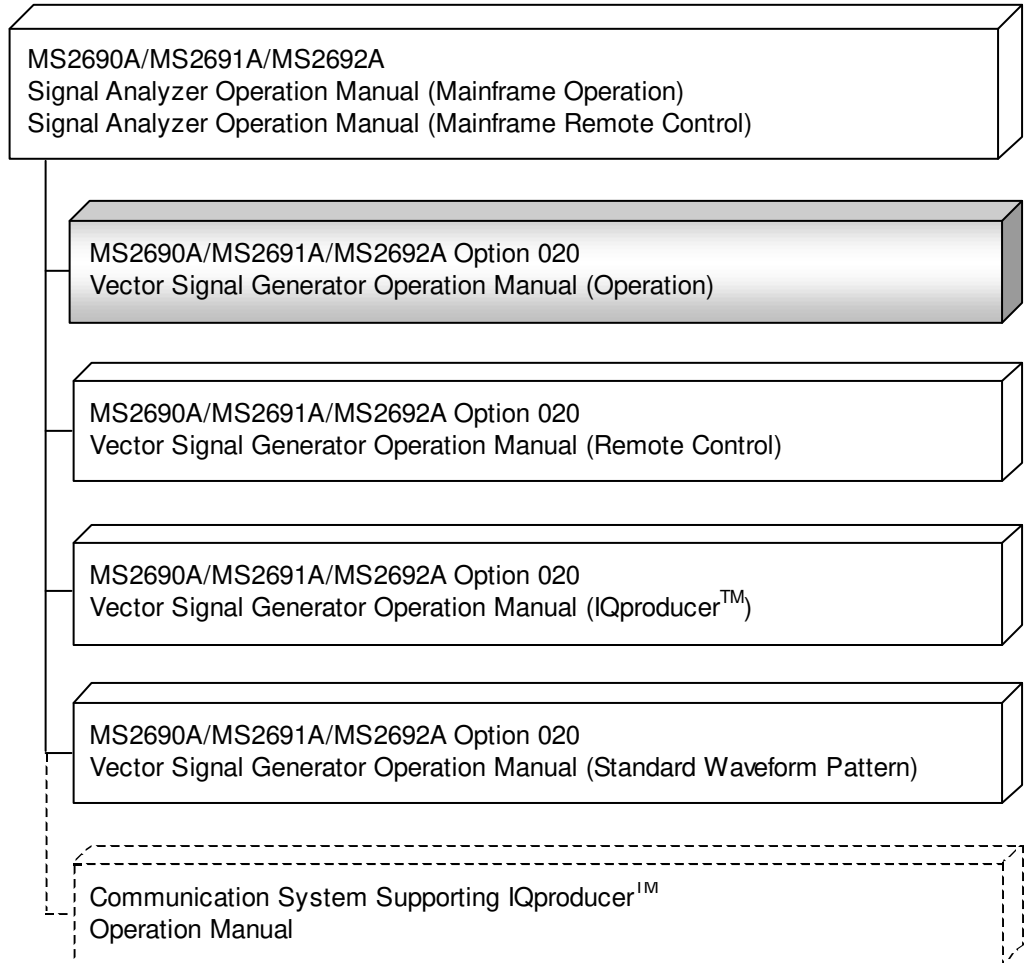

- **Signal Analyzer Operation Manual (Mainframe Operation)**
- **Signal Analyzer Operation Manual (Mainframe Remote Control)**

These manuals describe basic operating methods, maintenance procedures, common functions, and common remote control of the signal analyzer mainframe.

- **Vector Signal Generator Operation Manual (Operation)**

<This document>

This manual describes functions, operating methods, and so on of the vector signal generator (option).

- **Vector Signal Generator Operation Manual (Remote Control)**

This manual describes remote control of the vector signal generator (option).

- **Vector Signal Generator Operation Manual (IQproducer™)**

This manual describes functions, operating methods, and so on of the IQproducer, which is application software used with the vector signal generator (option).

- **Vector Signal Generator Operation Manual (Standard Waveform Pattern)**

This manual describes details on the standard waveform pattern data used with the vector signal generator (option).

In this document,  indicates a panel key.

Table of Contents

About This Manual.....	I
Chapter 1 Outline	1-1
1.1 Product Overview.....	1-2
1.2 Product Configuration	1-3
1.3 Specifications.....	1-4
Chapter 2 Operation (Signal Generator Function)	2-1
2.1 Displaying Signal Generator Screen.....	2-3
2.2 Setting Frequency.....	2-7
2.3 Setting Output Level	2-15
2.4 Setting Modulation Function	2-29
2.5 AWGN Addition Function	2-41
2.6 Setting External I/O.....	2-48
2.7 BER Measurement Function.....	2-70
2.8 Selecting SA Trigger.....	2-72
2.9 Auto Calibration	2-73
2.10 Other Functions	2-77
Chapter 3 Operation (BER Measurement Function)	3-1
3.1 Outline of BER Measurement	3-2
3.2 Display Description	3-5
3.3 BER Measurement Function Menu.....	3-9
3.4 Connecting MS2690A-020/MS2691A-020/ MS2692A-020 to External System.....	3-11
3.5 Performing BER Measurement.....	3-12
3.6 Setting Automatic Resynchronization Function	3-23
3.7 Setting Input Interface.....	3-28
3.8 Setting PN_Fix Pattern	3-29
3.9 Setting User-defined Pattern	3-35
3.10 Description of BER Measurement Operation.....	3-43

1
2
3
4
Appendix
Index

Chapter 4 Performance Test	4-1
4.1 Overview of Performance Test	4-2
4.2 Frequency Performance Test	4-4
4.3 Output Level Performance Test.....	4-6
4.4 Vector Modulation Performance Test	4-8
Appendix A Message Display.....	A-1
Appendix B Initial Value List	B-1
Appendix C AUX Connector	C-1
Appendix D Performance Test Result Form.....	D-1
Index	Index-1

Chapter 1 Outline

This chapter provides an overview of the MS2690A/MS2691A/MS2692A Option 020 Vector Signal Generator and describes the product configuration.

1

Outline

1.1	Product Overview	1-2
1.2	Product Configuration	1-3
1.3	Specifications	1-4

1.1 Product Overview

The MS2690A/MS2691A/MS2692A Option 020 Vector Signal Generator (hereinafter, referred to as “MS2690A-020/MS2691A-020/MS2692A-020”) is an optional product which adds an arbitrary waveform based vector signal output function and a BER (Bit Error Rate) function to the MS2690A/MS2691A/MS2692A Signal Analyzer (hereinafter, referred to as “MS2690A/MS2691A/MS2692A”). It can be used for a wide range of applications, from R&D to manufacturing of digital mobile communication systems, devices, and equipment.

The following are characteristics of the MS2690A-020/MS2691A-020/MS2692A-020.

- Covered frequency range: 125 to 6000 MHz
- RF modulation bandwidth: 120 MHz
- Large internal waveform memory: 256 M samples
- AWGN addition function
- BER test function for external input signals

The supplied CD-ROM contains application software. This application software allows baseband waveform data generation supporting communication systems and external data conversion.

1.2 Product Configuration

Table 1.2-1 lists the configuration of the MS2690A-020/MS2691A-020/MS2692A-020. First, after opening the packaging, check that all listed products are included. Contact an Anritsu Service and Sales office or agent about missing or damaged parts.

Table 1.2-1 Configuration of MS2690A-020/MS2691A-020/MS2692A-020

Item	Model Name/Symbol	Product	Q'ty	Remarks
Accessories	---	Installation CD-ROM	1	Application software, Operation Manual CD-ROM

1.3 Specifications

The specifications of the MS2690A-020/MS2691A-020/MS2692A-020 are defined under the following conditions unless otherwise specified.

Table 1.3-1 shows the specifications.

<Common to CW and modulation modes>

- Level Auto CAL: On
- Frequency switching speed: Normal
- Pulse modulation: Off

<Only in modulation mode>

- After SG level calibration

Table 1.3-1 Specifications for MS2690A-020/MS2691A-020/MS2692A-020

Item	Specification Value
Frequency	
Range	125 MHz to 6 GHz
Resolution	0.01 Hz steps
Output Level	
Setting range	-140 to +10 dBm (during CW) -140 to 0 dBm (during modulation)
Unit	dBm, dB μ V (terminated, open)
Resolution	0.01 dB
Output level accuracy	In CW mode, at 18 to 28°C Output level p [dBm] $-120 \leq p \leq +5$ ± 0.5 dB (≤ 3 GHz) $-110 \leq p \leq +5$ ± 0.8 dB (> 3 GHz) $-127 \leq p < -120$ ± 0.7 dB (≤ 3 GHz) $-127 \leq p < -110$ ± 2.5 dB typ. (> 3 GHz) $-136 \leq p < -127$ ± 1.5 dB typ. (≤ 3 GHz)
Output level linearity	In CW mode, at 18 to 28°C, with -5 dBm output as reference Output level p [dBm] $-120 \leq p \leq -5$ ± 0.2 dB typ. (≤ 3 GHz) $-110 \leq p \leq -5$ ± 0.3 dB typ. (> 3 GHz)
Output connector	N-J connector, 50 Ω (Front panel, SG Output (Opt))
VSWR	Output level: -5 dBm or lower in CW mode, with -15 dBm or lower in modulation mode 1.3 (≤ 3 GHz) 1.9 (> 3 GHz)
Maximum reverse input Reverse input power	1 W peak (≥ 300 MHz), 0.25 W peak (< 300 MHz)
Signal Purity	
Harmonic spurious	Output level $\leq +5$ dBm, in CW mode, at 300 MHz or higher output frequency < -30 dBc
Non-harmonic spurious	Output level $\leq +5$ dBm, in CW mode, at 15 kHz or higher offset from output frequency < -68 dBc (125 MHz \leq Frequency \leq 500 MHz) < -62 dBc (500 MHz $<$ Frequency \leq 1 GHz) < -56 dBc (1 GHz $<$ Frequency \leq 2 GHz) < -50 dBc (2 GHz $<$ Frequency \leq 6 GHz)

Table 1.3-1 Specifications of the MS2690A-020/MS2691A-020/MS2692A-020 (Cont'd)

Item	Specification Value
Vector Modulation	
Vector accuracy	W-CDMA (DL1code), SG Level Auto CAL = On, with -5 dBm or lower output level, 800 to 2700 MHz output frequency, at 18 to 28°C ≤ 2% (rms)
Carrier leak	300 MHz or higher output frequency, SG Level Auto CAL = On, at 18 to 28°C ≤ -40 dBc
Image rejection	300 MHz or higher output frequency, SG Level Auto CAL = On, at 18 to 28°C, when using sine wave of 10 MHz or lower ≤ -40 dBc
ACLR	At 18 to 28°C, SG Level Auto CAL = On, with -5 dBm or lower output level, when W-CDMA (TestModel 1 64DPCH) signal is used, 300 MHz ≤ Output frequency ≤ 2.4 GHz 5 MHz offset: ≤ -64 dBc/3.84 MHz 10 MHz offset: ≤ -67 dBc/3.84 MHz
Level error from CW during vector modulation	AWGN signal with 5 MHz bandwidth, SG Level Auto CAL = On, at 300 MHz or higher output frequency, 18 to 28°C, output level p [dBm], p ≤ -15 ±0.2 dB -15 < p ≤ -5 ±0.4 dB typ.
Spectrum reversal function	Spectrum reverse is possible.
Pulse Modulation	
On/Off ratio	≥ 60 dB
Rising/falling time	≤ 90 ns (10 to 90%)
Pulse repetition frequency	DC to 1 MHz (Duty 50%)
External pulse modulation signal input	Rear panel Aux connector, 600 Ω, 0 to 5 V, approx. 1 V threshold value
Arbitrary Waveform Generator	
Waveform resolution	14 bits
Marker output	3 signals (3 signals within waveform pattern, or 3 signals generated in real-time), TTL, polarity reversal function
Internal baseband reference clock	
Range	20 kHz to 160 MHz
Resolution	0.001 Hz
External baseband reference clock input	
Range	20 kHz to 40 MHz
Divisional and multiplication function	Input frequency multiplied by 1, 2, 4, 8, 16, 1/2, 1/4, 1/8, 1/16
Input connector	Rear panel Aux connector, 0.7 V p-p or higher (AC/50Ω), or TTL

Table 1.3-1 Specifications of the MS2690A-020/MS2691A-020/MS2692A-020 (Cont'd)

Item	Specification Value
Waveform memory Memory capacity	256 M samples
AWGN addition function Absolute value of CN ratio	≤ 40 dB
BER Test	
Connector	Rear panel Aux connector
Input level	TTL level
Input signal	Data, Clock, Enable
Input bit rate	100 bps to 10 Mbps
Measurable patterns	PN9, PN11, PN15, PN20, PN23, ALL0, ALL1, repetition of 01 PN9Fix, PN11Fix, PN15Fix, PN20Fix, PN23Fix, UserDefine
Synchronization establishing condition	PN signal: No error has been detected for (PN stage count \times 2) bits PNFix signal: Synchronization with the PN signal is established if no error has been detected for (PN stage count \times 2) bits. Next, the cycle and synchronization of the PNFix signal are established if no error has been detected for PN stage count bits beginning with the start bit of the PNFix signal. ALL0, ALL1, repetition of 01: No error has been detected for 10 bits. UserDefine: No error has been detected for 8 to 1024 bits (variable). The start bit used for synchronization detection can also be selected.
Re-synchronization judgment condition	x/y (Resynchronization is executed if x bits out of y bits are errors.) y (Measurement bit count): Selected from 500 bits, 5000 bits, and 50000 bits x (Error bit count out of y bits): 1 to y/2 bits
Measurable bit count	$\leq 2^{32} - 1$ bit
Measurable error bit count	$\leq 2^{31} - 1$ bit
Measurement termination condition	Measurement bit count, measurement error bit count
Auto Resync function	Can be switched between enable/disable.
Count operation at resynchronization	Can be selected from Count Clear and Count Keep.
Measurement mode	Continuous, Single, Endless
Display	Status, Error, Sync Loss, Error Rate, Error Count, SyncLoss Count Measurement bit count
Polarity reversal function	Data, Clock, and Enable polarities can be reversed.
Measured value clear function	It is possible to clear the measured values to 0 while retaining synchronization during BER measurement, and start the measurement again from 0.

Chapter 2 Operation (Signal Generator Function)

This chapter describes the basic operation methods for the signal generation function of the MS2690A-020/MS2691A-020/MS2692A-020 (hereinafter, referred to as “Signal Generator function”).

2.1	Displaying Signal Generator Screen.....	2-3
2.1.1	Display description	2-4
2.2	Setting Frequency.....	2-7
2.2.1	Display description	2-8
2.2.2	Using numeric keypad to set frequency	2-10
2.2.3	Using rotary knob to set frequency.....	2-11
2.2.4	Using step keys to set frequency	2-12
2.2.5	Reversing RF signal spectrum	2-13
2.2.6	Changing frequency switching speed.....	2-14
2.3	Setting Output Level	2-15
2.3.1	Display description	2-17
2.3.2	Using numeric keypad to set output level	2-19
2.3.3	Using rotary knob to change output level	2-20
2.3.4	Using step keys to change output level.....	2-21
2.3.5	Setting output level offset	2-22
2.3.6	Displaying relative level	2-24
2.3.7	Selecting automatic calibration function on/off	2-25
2.3.8	Switching output level display unit.....	2-26
2.3.9	Displaying current amplitude	2-27
2.3.10	Correcting RF output level.....	2-27
2.3.11	Turning RF output on/off	2-28
2.4	Setting Modulation Function	2-29
2.4.1	Loading waveform pattern(s) to memory.....	2-30
2.4.2	Selecting waveform pattern(s).....	2-33
2.4.3	Deleting waveform file(s) from waveform memory	2-35
2.4.4	Copying waveform file(s) to hard disk	2-37
2.4.5	Deleting waveform file(s) from hard disk	2-39
2.4.6	Turning modulation signal on/off	2-40
2.4.7	Re-outputting Pattern Beginning at Head.....	2-40
2.4.8	Displaying information of selected waveform pattern	2-40
2.5	AWGN Addition Function.....	2-41
2.5.1	Display description	2-44
2.5.2	Setting AWGN on/off	2-46
2.5.3	Inputting Carrier Power	2-46
2.5.4	Inputting C/N.....	2-47

2.6	Setting External I/O.....	2-48
2.6.1	Display description	2-48
2.6.2	Setting Start/Frame trigger	2-50
2.6.3	Setting reference clock.....	2-58
2.6.4	Setting marker output	2-62
2.6.5	Setting pulse modulation	2-68
2.7	BER Measurement Function.....	2-70
2.7.1	Display description	2-70
2.8	Selecting SA Trigger	2-72
2.9	Auto Calibration	2-73
2.10	Other Functions	2-77
2.10.1	Display description	2-77
2.10.2	Entering application title	2-79

2.1 Displaying Signal Generator Screen

After the MS2690A/MS2691A/MS2692A has been powered on, the Signal Generator screen can be displayed from the Application Switch menu.

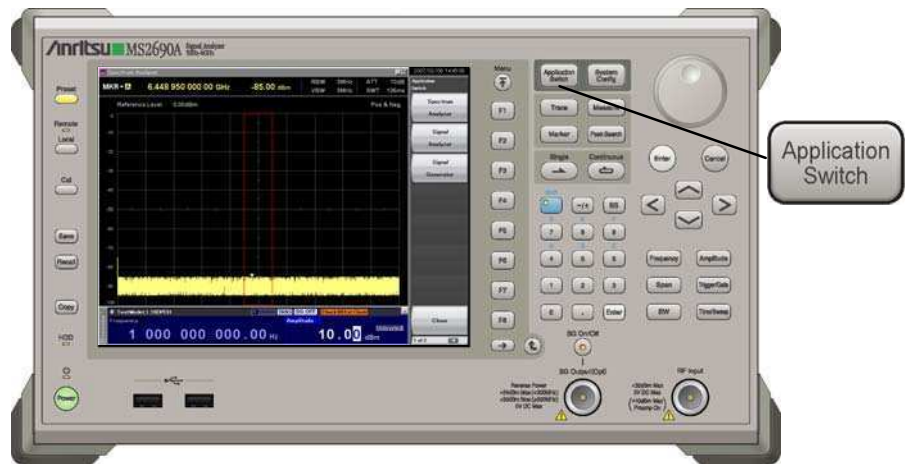



Fig. 2.1-1 Application Switch key

<Procedure>

1. Press  to display the Application Switch menu.
2. Select "Signal Generator" from the Application Switch menu to display the Signal Generator main screen.

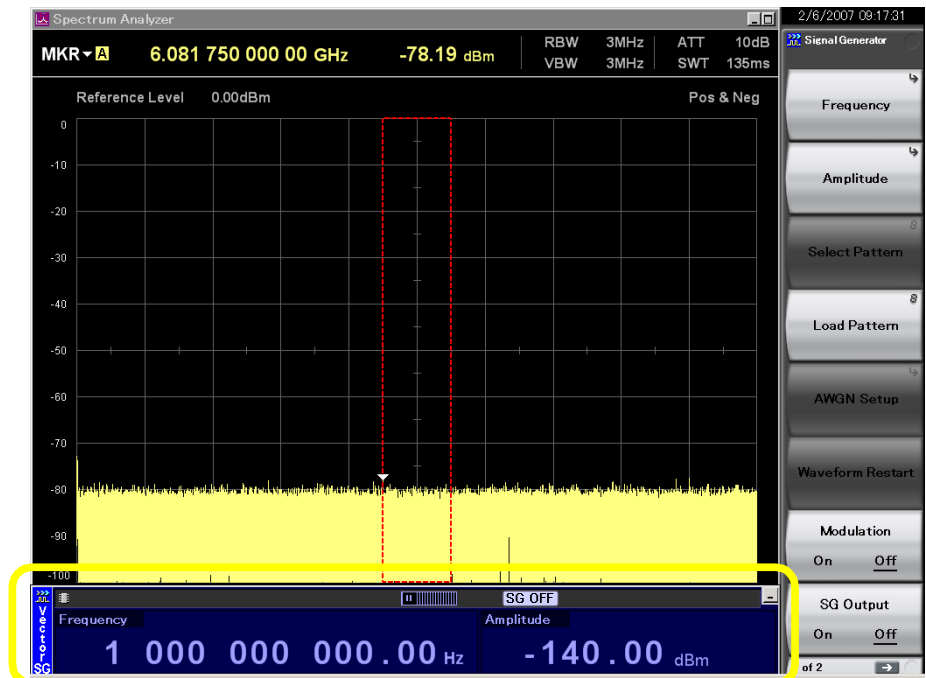



Fig. 2.1-2 Signal Generator main screen

2.1.1 Display description

This section describes the Signal Generator main screen.

Press  when the Signal Generator main screen is displayed to display the main function menu.

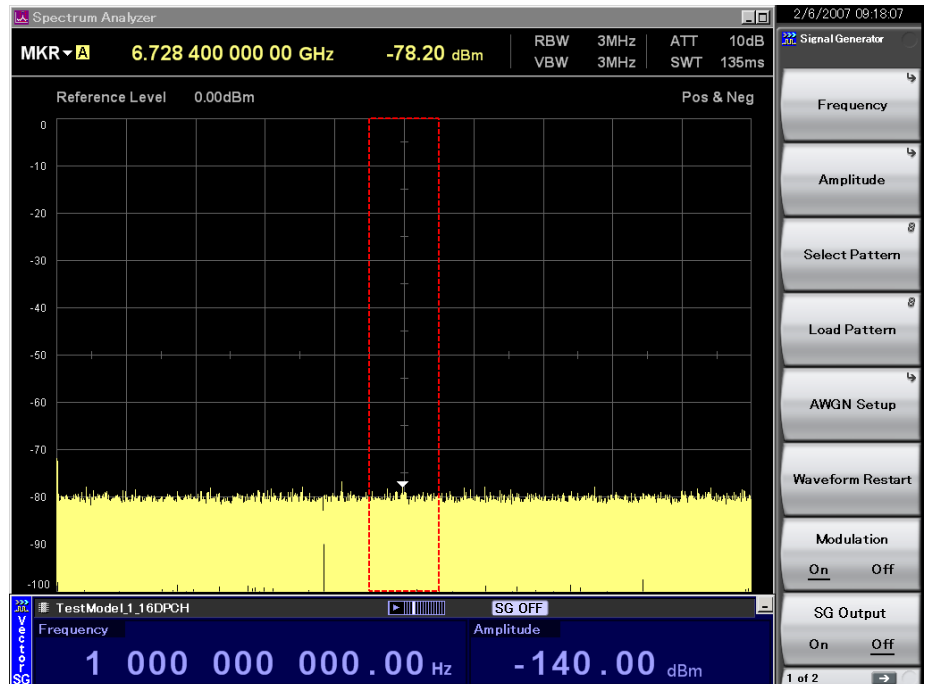

Fig. 2.1.1-1 Signal Generator main screen

2.1 Displaying Signal Generator Screen

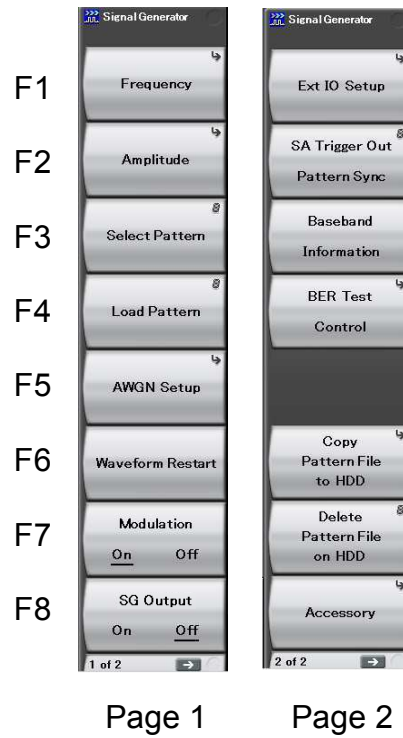

















Fig. 2.1.1-2 Main function menu

Table 2.1.1-1 Main Function Menu

Menu Display	Function
Frequency	Sets the frequency.  2.2 "Setting Frequency"
Amplitude	Sets the output level.  2.3 "Setting Output Level"
Select Pattern	Selects the waveform pattern to be output.  2.4.2 "Selecting waveform pattern(s)"
Load Pattern	Loads the waveform pattern to the memory.  2.4.1 "Loading waveform pattern(s) to memory"
AWGN Setup	Sets AWGN.  2.5 "AWGN Addition Function"
Waveform Restart	Re-outputs the waveform pattern, beginning at the head.  2.4.7 "Re-outputting Pattern Begging at Head"
Modulation (On/Off)	Selects between turning modulation On and Off.  2.4.6 "Turning modulation signal on/off"
SG Output (On/Off)	Selects between turning RF output On and Off.  2.3.11 "Turning RF output on/off"
Ext I/O Setup	Sets the external I/O.  2.6 "Setting External I/O"
SA Trigger Out Pattern Sync	Selects the trigger type to be output for other applications such as the Signal Analyzer function.  2.8 "Selecting SA Trigger"
Baseband Information	Displays information of the selected waveform pattern.  2.4.8 "Displaying information of selected waveform pattern"
BER Test Control	Performs control related to the BER test function.  2.7 "BER Measurement Function"
Copy Pattern File to HDD	Copies the waveform pattern to the hard disk.  2.4.4 "Copying waveform file(s) to hard disk"
Delete Pattern File on HDD	Deletes waveform patterns on the hard disk.  2.4.5 "Deleting waveform file(s) from hard disk"
Accessory	Sets other functions.  2.9 "Other Functions"

2.2 Setting Frequency

Pressing **F1** from page 1 of the main function menu, or pressing **Frequency** (Frequency) displays the Frequency function menu. A cursor will be displayed on one of the digits displaying the frequency. This section describes operation methods for when the Frequency function menu is displayed, unless otherwise specified.

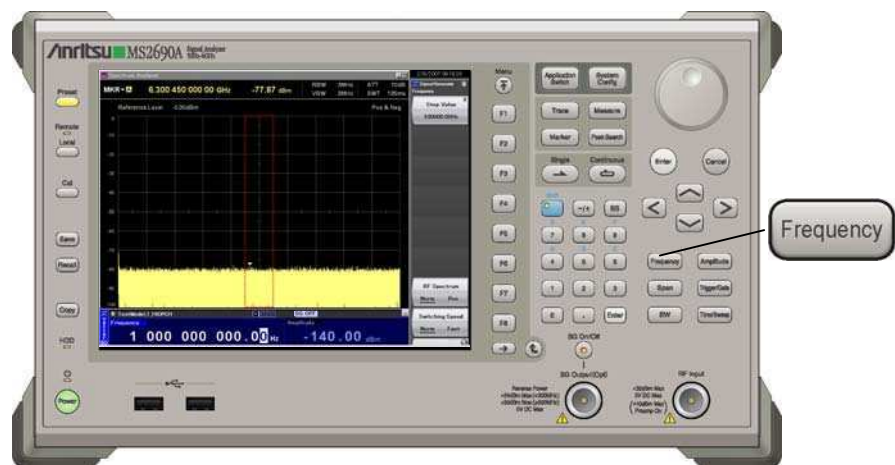

Fig. 2.2-1 Frequency key

Setting range, maximum resolution setting, and minimum resolution setting of the frequency

Frequency setting range: 125 to 6000 MHz

Maximum resolution setting of frequency: 1000000000.00 Hz

Minimum resolution setting of frequency: 0.01 Hz

If the frequency setting exceeds the above range an error message will be displayed.

The frequency can be set using the following.

- Numeric keypad
- Rotary knob
- Step keys

2.2.1 Display description

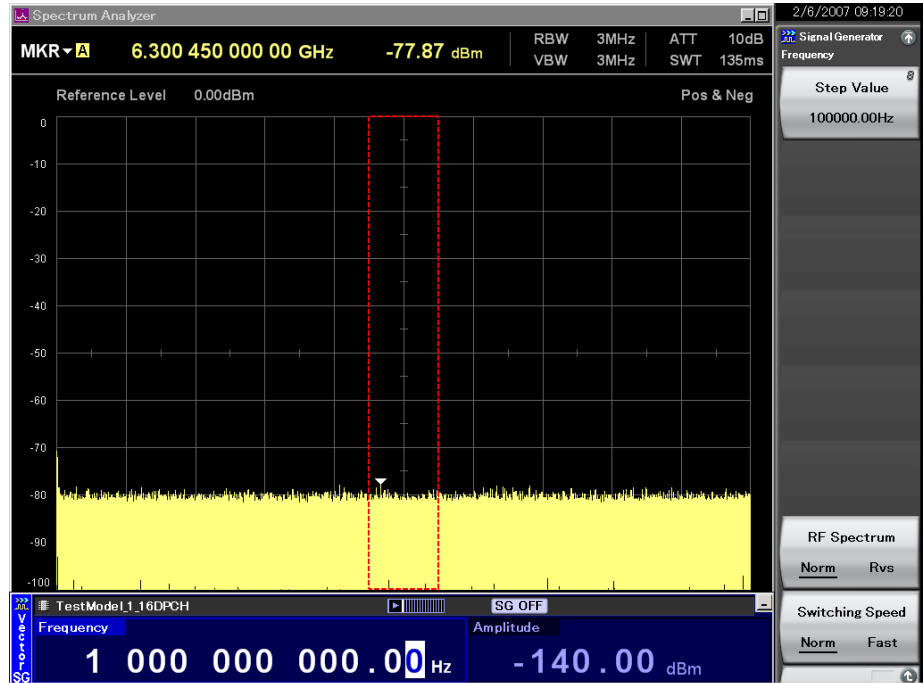

Fig. 2.2.1-1 Frequency setup screen

This section describes the frequency setup screen display.

Table 2.2.1-1 Status display

Actual View	Display	Description
Switching Fast	Switching Fast	Indicates that the frequency switching speed is set to Fast.
RF Reverse	RF Reverse	Indicates that it is set to reverse the spectrum of RF output.

Table 2.2.1-2 Alarm display

Actual View	Display	Description
Check BB Ext Clock	Check BB Ext Clock	Indicates that the frequency is not locked when the external reference signal source is valid.

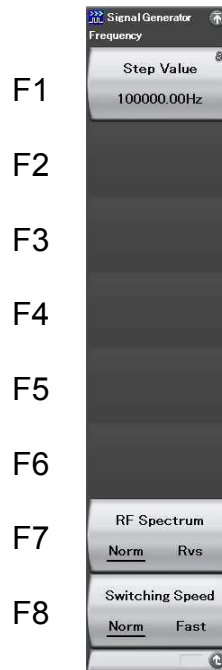





Fig. 2.2.1-2 Frequency function menu

Table 2.2.1-3 Frequency function menu

Menu Display	Function
Step Value	Sets the incremental or decremental value of the frequency that is used when a step key (⏮) or (⏭) is pressed.  2.2.4 “Using step keys to set frequency”
RF Spectrum (Norm/Rvs)	Reverses an RF output spectrum.  2.2.5 “Reversing RF signal spectrum”
Switching Speed (Norm/Fast)	Switches the frequency switching speed.  2.2.6 “Changing frequency switching speed”

2.2.2 Using numeric keypad to set frequency

The numeric keypad can be used to set numeric values and their units for the frequency.

Example: Setting the frequency to 360.3 MHz

<Procedure>

1. Press one of the numeric keypad numeric keys (3 is pressed in this example). The frequency setup window (Freq. Value) opens with the numeric character “3” displayed.



Fig. 2.2.2-1 Frequency setup window



2. After pressing 3 6 0 . 3, press F2 (MHz) to set the frequency to 360.3 MHz.
3. When the unit function key (F2 in this example) is pressed, the numeric value and its unit are set, and at the same time, the frequency setup window closes. The frequency setup screen displays “360 300 000.00 Hz.”



Fig. 2.2.2-2 Frequency setup window

All digits past 0.01 Hz are rounded down.

2.2.3 Using rotary knob to set frequency

Use of the rotary knob makes it possible to increment or decrement the numeric value of the resolution digit (cursor position) that has been selected using  . To use the rotary knob to set a frequency, follow the procedure below:

Initial setting of resolution digit (cursor position): 0.01 Hz digit

Example: Changing the frequency from the current value (360.3 MHz) to 360.7 MHz in steps of 100 kHz

<Procedure>





1. Move the cursor to the 100 kHz digit using   (pressing  seven times moves it to that digit).



Fig. 2.2.3-1 Frequency display

2. Turning the rotary knob clockwise increments the frequency in steps of 100 kHz. Turning it counterclockwise decrements the frequency in 100 kHz steps. Turn the knob clockwise in this manner to set the frequency to 360.7 MHz.

2.2.4 Using step keys to set frequency

  can be used to increment or decrement the frequency in steps of the preset frequency.

Initial setting of frequency step: 100 kHz

Example: Setting the frequency to 360.3 MHz and incrementing or decrementing it in steps of 12.5 kHz

<Procedure>

















1. After pressing     , press  (MHz) to set the frequency to 360.3 MHz.
2. Press  (Step Value) to display the frequency step setup window.



Fig. 2.2.4-1 Frequency step setup window

3. After pressing    , press  (kHz) to set the frequency step to 12.5 kHz. The window closes after the setup.
4. In the frequency setup window, pressing  once increments the frequency by 12.5 kHz, changing it to 360.3125 MHz. Pressing  once in this state decrements the frequency by 12.5 kHz, returning it to 360.3 MHz. The frequency can be incremented or decremented in the specified steps (12.5 kHz in this example) by using   in this manner.

2.2.5 Reversing RF signal spectrum

This function reverses an RF signal spectrum when modulation is On.

Initial setting of RF Spectrum: Normal

Example: Reversing and restoring an RF signal spectrum

<Procedure>



1. Press  (RF Spectrum) to switch the mode from Normal to Reverse.



Fig. 2.2.5-1 RF Reverse display

“RF Reverse” is displayed on the right side of the frequency display to indicate that the RF signal spectrum is reversed.

2. Press  (RF Spectrum) again to switch the mode back from Reverse to Normal.

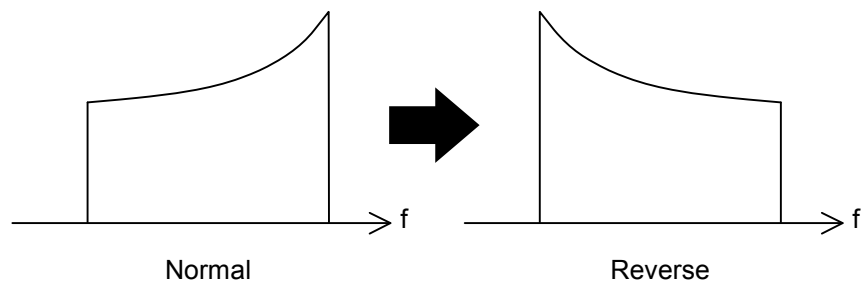

Fig. 2.2.5-2 Status of RF signal spectrum

2.2.6 Changing frequency switching speed

The frequency switching speed can be changed by switching the loop characteristic of the PLL synthesizer circuit in the MS2690A/MS2691A/MS2692A.

Normal: With an offset frequency of 50 kHz or more, this mode offers phase noise performance at least as high as that of the Fast mode. Suitable for ordinary communication.

Fast: The frequency switching speed becomes faster and the adjacent phase noises are improved in this mode. Suitable for narrow-band communications.

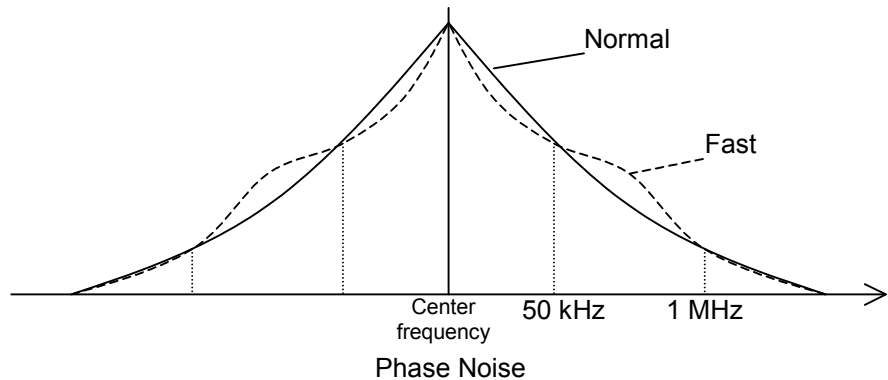

Fig. 2.2.6-1 Phase noise

Initial setting of frequency switching speed: Normal

Example: Switching the frequency switching speed to Fast, and then returning it to Normal

<Procedure>

1. Press **F8** (Switching Speed) to switch the mode from Normal to Fast. The “Switching Fast” message is displayed on the right of the frequency display to indicate that the frequency switching speed has switched to Fast.
2. Press **F8** again to switch back the mode from Fast to Normal.

2.3 Setting Output Level

Pressing **F2** (Amplitude) from page 1 of the main function menu, or pressing **Amplitude** displays the Amplitude function menu. A cursor will be displayed on one of the digits displaying the output level. This section describes operation methods for when the Amplitude function menu is displayed, unless otherwise specified.

2

Operation (Signal Generator Function)

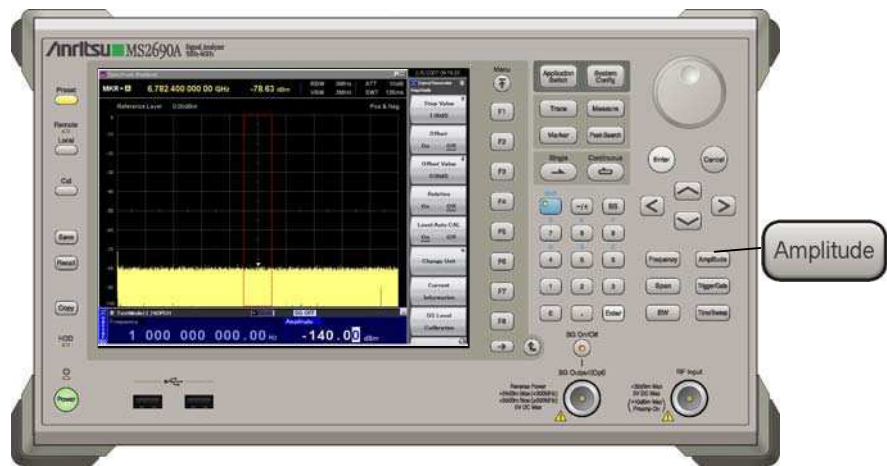

Fig. 2.3-1 Amplitude key

The output level can be set using the following:

- Numeric keypad
- Rotary knob
- Step keys

Setting range, maximum resolution setting, and minimum resolution setting of the output level

Table 2.3-1 shows the output level setting range.

Table 2.3-1 Output level setting range

Units	Range
Power units	-140 to +10 dBm (modulation Off) -140 to +0 dBm (modulation On)
Voltage units (Open voltage display)	-26.99 to +123.01 dB μ V (modulation Off) -26.99 to +113.01 dB μ V (modulation On)
Voltage units (Termination voltage display)	-33.01 to +116.99 dB μ V (modulation Off) -33.01 to +106.99 dB μ V (modulation On)

Maximum resolution for output level: 100.00 dB
 Minimum resolution for output level: 0.01 dB

Tables 2.3-2 and 2.3-3 show the output level performance guarantee ranges.

Table 2.3-2 Output level performance guarantee range (in CW mode)

Frequency	Typical
$125 \text{ MHz} \leq f \leq 3 \text{ GHz}$	-136 to +5 dBm
$3 \text{ GHz} < f \leq 6 \text{ GHz}$	-127 to +5 dBm

Table 2.3-3 Performance guarantee range for output level error with CW during vector modulation

Frequency	Typical
$125 \text{ MHz} \leq f \leq 6 \text{ GHz}$	$\leq -15 \text{ dBm}$

2.3.1 Display description

This section describes the screen display in the output level setup mode.

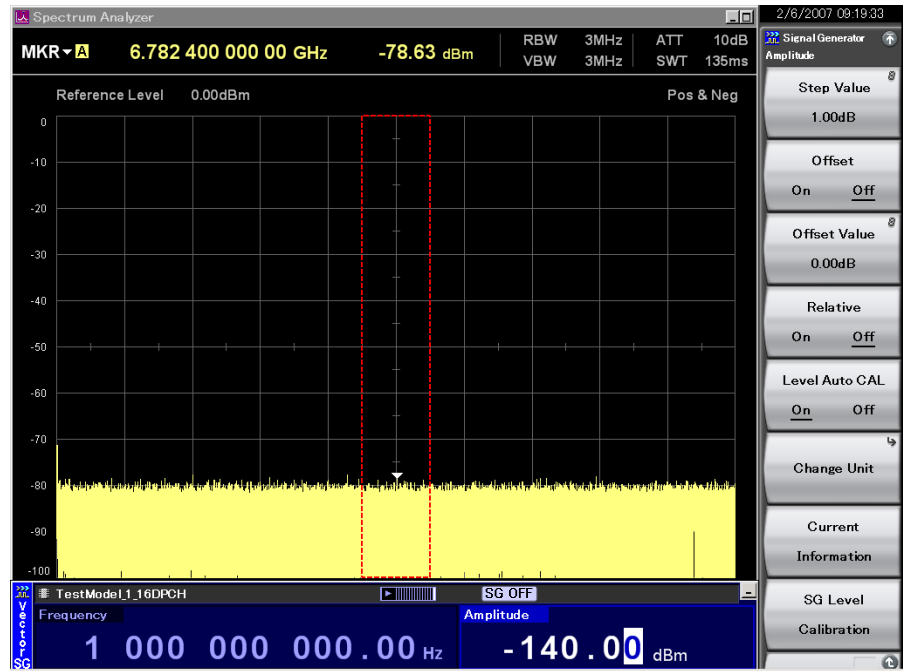

Fig. 2.3.1-1 Output level setup screen

Table 2.3.1-1 Status display

Actual View	Display	Description
EMF	EMF	Indicates that the output level is set to open voltage display.
Term	Term	Indicates that the output level is set to termination voltage display.
Offset	Offset	Indicates that level offset is valid.
Relative	Relative	Indicates that the relative output level is displayed.
CAL OFF	Level Auto CAL	Indicates that the Auto Level Calibration function is Off.
Unleveled	Unleveled	Indicates that the current output level is outside the performance guarantee range.

Table 2.3.1-2 Alarm display

Actual View	Display	Description
ALC Alarm	ALC Alarm	Indicates that the output level may not be a predetermined value.

2

Operation (Signal Generator Function)

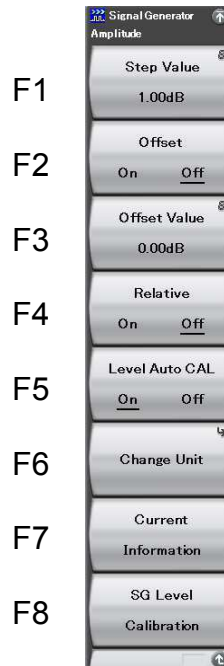

Fig. 2.3.1-2 Amplitude function menu

Table 2.3.1-3 Amplitude function menu

Menu Display	Function
Step Value	Sets the incremental or decremental value (of the output level) that is used when a step key (▲ ▼) is pressed. 2.3.4 “Using step keys to change output level”
Offset (On/Off)	Selects level offset function On/Off. 2.3.5 “Setting output level offset”
Offset Value	Sets the level offset function offset value. 2.3.5 “Setting output level offset”
Relative (On/Off)	Selects relative output level display function On/Off. 2.3.6 “Displaying relative level”
Level Auto CAL (On/Off)	Selects automatic level calibration function On/Off. 2.3.7 “Selecting automatic calibration function on/off”
Change Unit	Selects output level display unit (dBm, open voltage (EMF), termination voltage (Term)). 2.3.8 “Switching output level display unit”
Current Information	Displays the RF output level (used when setting the offset or when the relative level is displayed). Also displays the reason when the status is “Unleveled.” 2.3.9 “Displaying current amplitude”
SG Level Calibration	Corrects the output level. 2.3.10 “Correcting RF output level”

2.3.2 Using numeric keypad to set output level

The numeric keypad can be used to set numeric values and their units for the output level.

Example: Setting the output level to -47 dBm

<Procedure>

1. Press one of the numeric keypad keys (first \ominus/\oplus in this example) to display the Level Value window. A $[-]$ is displayed in the window at the same time. Each time \ominus/\oplus is pressed, switching between $[+]$ (not shown) and $[-]$ takes place. If a “-” is not displayed, press \ominus/\oplus again to display it.





Fig. 2.3.2-1 Output level setup window

2. Press 4 7 to display “-47” in the window.
3. Press $F7$ (Set) to set the numeric value and unit. The Level Value window closes at the same time. The output level setup screen displays the output level as “-47.00 dBm”.

The digits past 0.01 dB are rounded down.

2.3.3 Using rotary knob to change output level

The rotary knob can be used to increment or decrement the numeric value of the resolution digit (at the cursor position) that has been selected using  .

Initial setting of resolution digit (cursor position): 0.01 dB digit

Example: Changing the output level from the current value, -47 to -37 dBm in 1 dB steps.

<Procedure>



1. Move the cursor to the 1 dB digit using   (pressing  twice moves the cursor to that digit).



Fig. 2.3.3-1 Output level display

2. Turning the rotary knob clockwise increments the output level in 1 dB steps. Turning the knob counter-clockwise decrements the output level in 1 dB steps. Turn the rotary knob clockwise in this way to set the output level to -37 dBm.

2.3.4 Using step keys to change output level

▲ ▼ can be used to increment or decrement the output level in steps of the preset output level.

Initial setting of output level step: 1 dB

Example: Setting the output level to -47 dBm, and incrementing or decrementing it in 6 dB steps.

<Procedure>

1. After pressing ▲ ▼ 4 7, press F7 (Set) to set the output level to -47 dBm.
2. Press F1 (Step Value) to display the output level step setup window.



Fig. 2.3.4-1 Output level step setup window

3. Press 6 and then F7 (Set) to set the level step to 6 dB. The window closes at the same time the setup completes.
4. In the output level setup screen, pressing ▲ once increments the output level by 6 dB, changing it to -41 dBm. Pressing ▼ once in this state decrements the output level by 6 dB, returning it to -47 dBm. The output level can be incremented or decremented in the specified steps (6 dB in this example) by using ▲ ▼ in this manner.

2.3.5 Setting output level offset

The output level offset setting function offsets the RF output level by the offset level and displays the resulting level on the screen. This function is useful to correct the attenuation of the RF cable externally connected to the MS2690A/MS2691A/MS2692A.

$$[\text{Resulting output level}] = [\text{Actual RF output level}] + [\text{Offset level}]$$

Press **F7** (Current Information) from the Amplitude function menu while the level offset function is On, to display and check the actual RF output level.

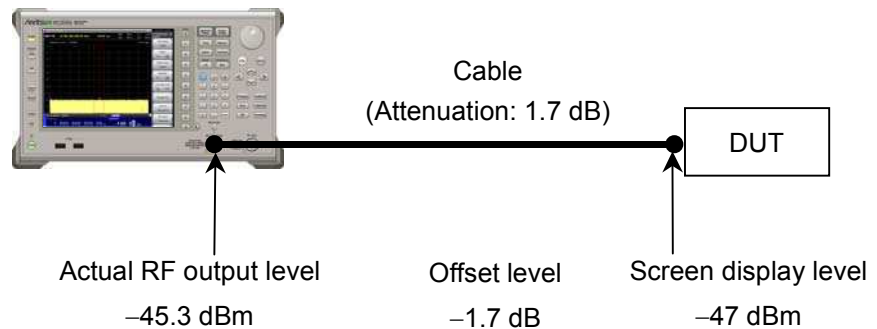

Fig. 2.3.5-1 Outline of offset level

Setting range: -100.00 to +100.00 dB
Minimum resolution for offset level: 0.01 dB

Example: Setting the offset level to -1.7 dB and the output level after offset to -47 dBm

<Procedure>

1. Press **F3** (Offset Value) to display the offset level setup window.



Fig. 2.3.5-2 Offset level setup window

2. After pressing **←** **1** **.** **7**, press **F7** (Set) to set the offset level to -1.7 dB. The window closes at the same time the setup completes.
3. Press **F2** (Offset On/Off) to turn on the offset mode, unless the cursor is already moved to the On portion. “Offset” is displayed above the output level display, to indicate the offset setting state.
4. After pressing **←** **4** **.** **7**, press **F7** (Set) to set the output level to -47 dBm. “ -47.00 dBm” is displayed on the screen. At this time, the actual output level is -45.3 dBm.

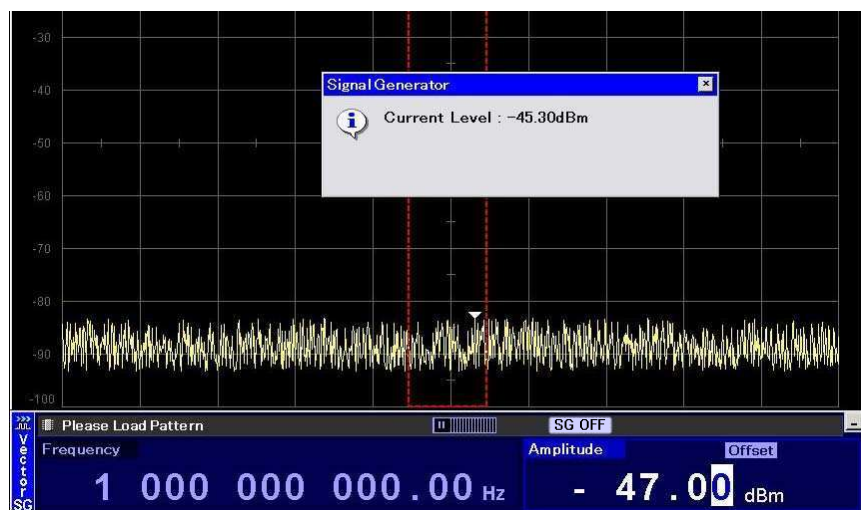

Fig. 2.3.5-3 Output level confirmation window

2.3.6 Displaying relative level

The relative output level display function displays the output level as a relative value based on a reference output level regarded as 0 dB.

$$[\text{RF output level}] = [\text{Screen display level}] + [\text{Output level for change to relative level display}]$$

Example: Increasing the level by 7.5 dB in relation to -47 dBm

<Procedure>

1. After pressing [-/+] [4] [7] , press [F7] (Set) to set the output level to -47 dBm.
2. Press [F4] (Relative On/Off) to turn on relative level display. The MS2690A/MS2691A/MS2692A enters the relative level display mode with the current output level (-47 dBm) as the reference level. The displayed output level, -47.00 dBm, changes to +0.00 dB. In addition, "Relative" is displayed on the right of the output level display, to indicate that the relative level is currently displayed.



Fig. 2.3.6-1 "Relative" display

3. After pressing [7] [.] [5] , press [F7] (Set) to set the relative level to 7.5 dB. Although the level displayed is 7.50 dB, the actual output level is -47 dBm + 7.5 dB, i.e., -39.5 dBm.

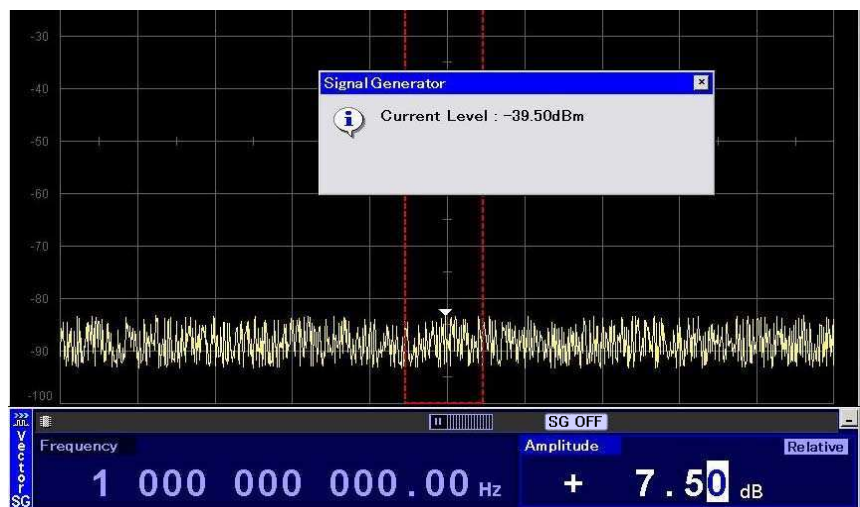

Fig. 2.3.6-2 Output level confirmation window

2.3.7 Selecting automatic calibration function on/off

The automatic level calibration function operates when the output level or frequency has been changed.

If this function is turned on, calibration is automatically executed when the level has been changed. At that time, a signal loss of a few milliseconds may occur.

If this function is turned off, calibration is not executed when the level is changed. Therefore, almost no signal loss occurs in this event.

This function can only be turned off under the following conditions.

- Modulation is on
- Output level is less than -5 dBm

Example: Turning the automatic calibration function off

<Procedure>

1. Press  (Level Auto CAL On/Off) to turn off the Auto Calibration display. The automatic calibration function is then invalid.

Level Auto Cal is automatically changed to On when any of the following operations are performed.

- Modulation is changed from On to Off.
- A pattern is selected.
- The selected pattern is deleted from the memory.

2.3.8 Switching output level display unit

The output level display unit (dBm, open voltage (EMF), or termination voltage (Term)) can be selected.

Example: Setting the output level to -83.01 dBm in dBm display and then switching it to open voltage or termination voltage display

<Procedure>

1. After pressing [-/+] [8] [3] [.] [0] [1] , press [F7] (Set) to set the output level to -83.01 dBm.
2. Press [F6] (Change Unit) to display the Change Unit function menu.



Fig. 2.3.8-1 Change Unit function menu

3. Press [F3] (dB μ V (EMF)) to change the output level display to the open voltage display (" 30.00 dB μ V" is displayed in this example). "EMF" (abbreviation of Electro Motive Force) is displayed on the right of the output level display.

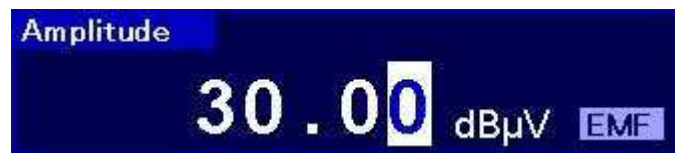

Fig. 2.3.8-2 EMF display

4. Press [F6] (Change Unit) to display the Change Unit function menu.
5. Press [F2] (dB μ V (Term)) to change the output level display to the termination voltage display (" 23.98 dB μ V" is displayed in this example). "Term" is displayed on the right of the output level display.



Fig. 2.3.8-3 Term display

2.3.9 Displaying current amplitude

The current output level is displayed. The output level display unit will however be dBm, even if display unit switching, offset change, or relative change have been performed. In addition, the reason will be displayed if the Amplitude status is “Unleveled.”



Fig. 2.3.9-1 Output level display window

2.3.10 Correcting RF output level

In a normal operation status, signals are always output at a stable level thanks to the ALC loop circuit. If modulation is on, the ALC loop circuit will be held, but performing any of the following operations will enable automatic level calibration.

- Changing the frequency
- Changing the output level (only when Level Auto CAL is on)
- Selecting a pattern

If the MS2690A/MS2691A/MS2692A is used with the same settings for a long time, level calibration is useful for removing temperature drifts. Pressing  (SG Level Calibration) starts output level calibration.

The output level will not be calibrated for the following case.

- Level Auto CAL is off and the output level is greater than -5 dBm.

2.3.11 Turning RF output on/off

Pressing the On/Off key on the front panel, or pressing  (SG Output) from page 1 of the main function menu switches the RF output between On and Off. Once the RF output is turned on, the red SG On/Off key lamp lights up and the currently set signal is output.



Note:

It is recommended that the setting process of the MS2690A/MS2691A/MS2692A parameters be completed, with the RF output off, before the RF output be turned on. This prevents damage of the measured target that is connected to the RF output.

Initial setting of RF Output: Off

Example: Turning the RF output on and then off again

<Procedure>

1. Press  (SG Output) to turn on the RF output (the lamp lights up).
2. Press  (SG Output) to turn off the RF output (the lamp goes off).

2.4 Setting Modulation Function

The MS2690A-020/MS2691A-020/MS2692A-020 is capable of reproducing waveform patterns and performing vector modulation with those patterns.

Waveform patterns are stored in the pattern files on the MS2690A/MS2691A/MS2692A internal hard disk. A folder that contains patterns classified by type is called a package.

To reproduce a waveform pattern, first, a package and patterns sorted on the internal hard disk must be loaded into the waveform memory.

Next, select the patterns to be output from the patterns expanded on the waveform memory.

AWGN can be added to the selected waveform patterns.

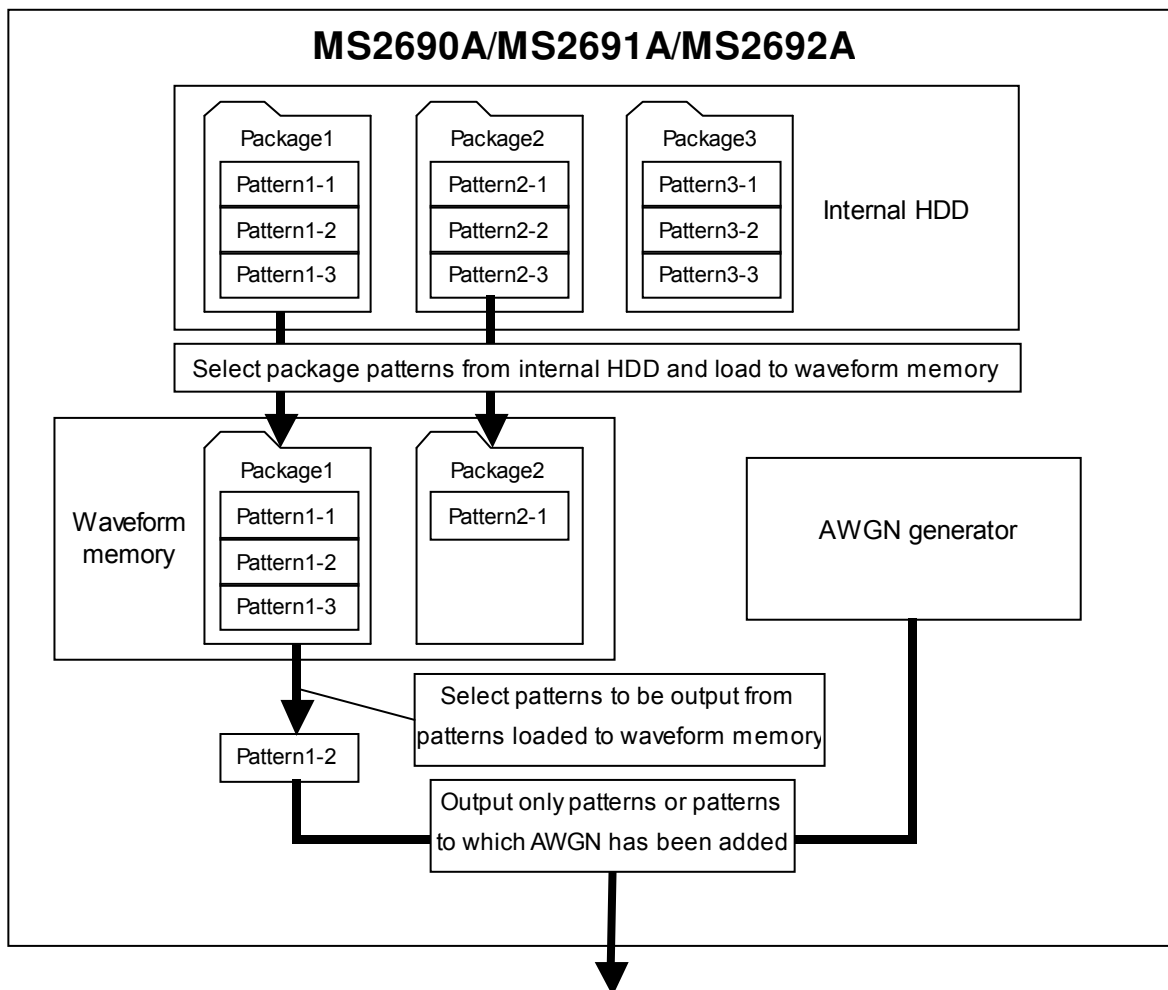



Fig. 2.4-1 Outline of waveform pattern output

2.4.1 Loading waveform pattern(s) to memory

This section describes how to load waveform patterns to the waveform memory.

Note:

To load waveform patterns to the waveform memory, license files associated with each pattern must be installed. For installing license files, refer to the MS2690A/MS2691A/MS2692A Signal Analyzer Operation Manual (Mainframe Operation).

Pressing  (Load Pattern) displays the waveform file load window. In this window, waveform files stored on the internal hard disk are loaded to the waveform memory integrated in the MS2690A/MS2691A/MS2692A.

This section describes operation methods for when the waveform file load window is displayed, unless otherwise specified.

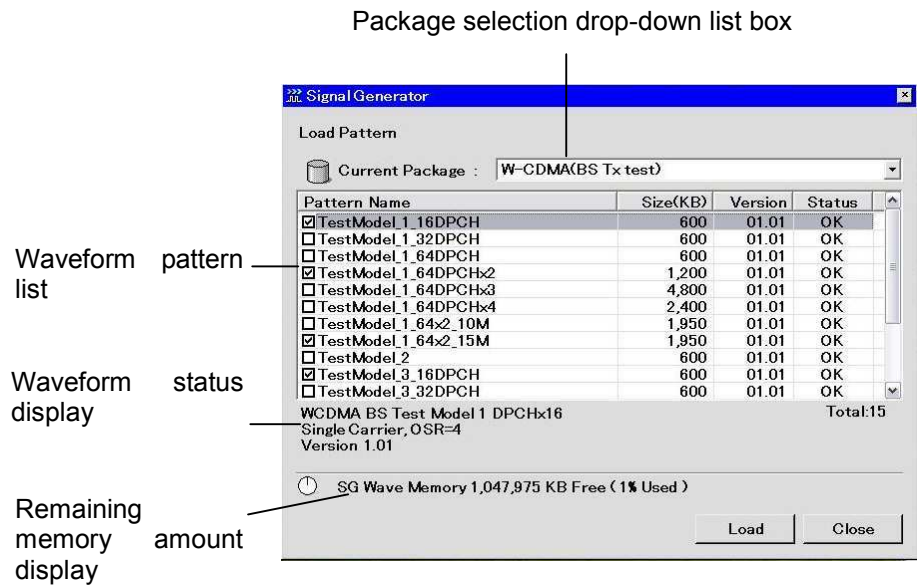

Fig. 2.4.1-1 Waveform file load window

Table 2.4.1-1 Display items on waveform file load window

Display	Description
Package selection drop-down list box	Selects the package.
Waveform pattern list	Displays a list of the waveform patterns in the package.
Waveform status display	Displays comments and statuses of the waveform pattern.
Remaining memory amount display	Displays the amount of free memory space.

Example: Loading waveform files to the waveform memory of the MS2690A/MS2691A/MS2692A

<Procedure>

1. Press **F4** (Load Pattern) from page 1 of the main function menu to display the waveform file load window.
2. Select from the package selection drop-down list box the package in which the desired waveform pattern is stored.
3. A list of waveform patterns will be displayed. Move the cursor to the waveform pattern to be loaded, and press **Enter** to select the check box. Pressing **F2** (Select All) selects all waveforms.

2

Operation (Signal Generator Function)

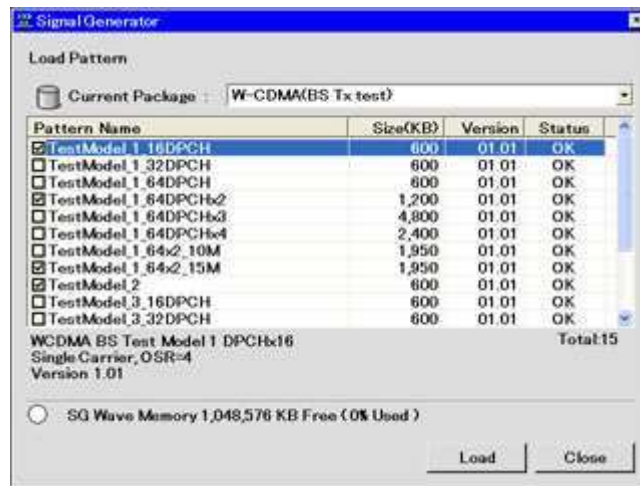

Fig. 2.4.1-2 Checking waveform pattern check boxes

4. Press **F7** (Load) to load patterns to the waveform memory.
5. During the loading of pattern files, the progress bar window is displayed.
If **Cancel** is pressed while the progress bar window is displayed, the loading of pattern files is aborted.
6. Once the loading of waveform files is complete, the progress bar window closes. The remaining memory amount display changes according to the total amount of loaded waveform files.

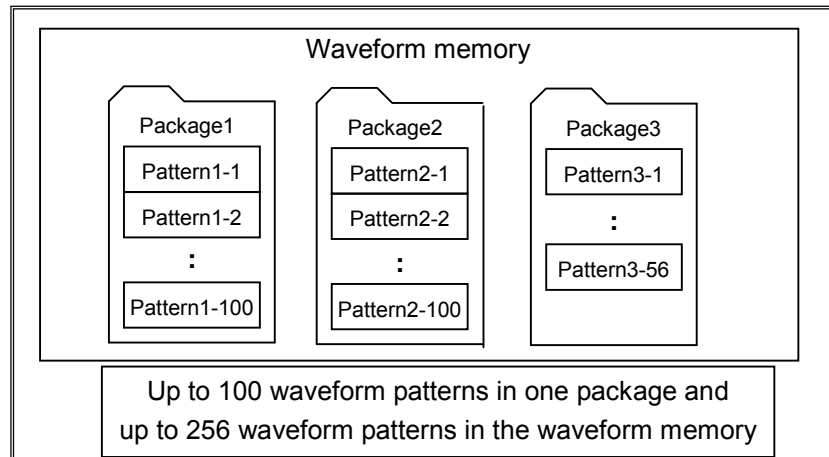

Fig. 2.4.1-3 Remaining memory amount display

Up to 256 pattern files and 100 packages can be loaded to the waveform memory.

Up to 100 waveform files can be stored in one package on the waveform memory.

If the total amount of the waveform patterns to be loaded is larger than the remaining amount of waveform memory, loading fails and an error message will be displayed. In such a case, delete waveform patterns from the waveform memory to secure the required amount of waveform memory space.



Note:

Do not insert or remove the USB memory during waveform pattern loading.

2.4.2 Selecting waveform pattern(s)

This section describes how to select waveform patterns loaded to the waveform memory.

Pressing **F3** (Select Pattern) from page 1 of the main function menu displays the waveform file selection window. In this window, select the desired waveform patterns loaded to the waveform memory. The selected waveform patterns will then be output.

This section describes operation methods for when the waveform file load window is displayed, unless otherwise specified.

2

Operation (Signal Generator Function)

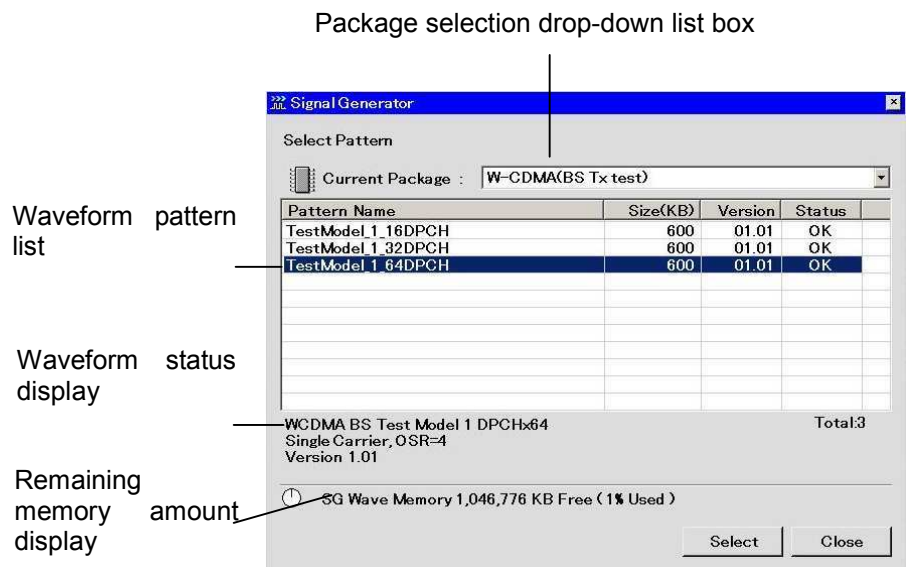

Fig. 2.4.2-1 Waveform file selection window

Table 2.4.2-1 Display items on waveform file selection window

Display	Description
Package selection drop-down list box	Selects the package.
Waveform pattern list	Displays a list of the waveform patterns in the package.
Waveform status display	Displays comments and statuses of the waveform pattern.
Remaining memory amount display	Displays the amount of free memory space.

Example: Selecting waveform files from waveform memory of the MS2690A/MS2691A/MS2692A

<Procedure>

1. Press **F3** (Select Pattern) to display the waveform file selection window. Select the package in which the desired waveform patterns are stored.
2. A list of waveform patterns will be displayed. Move the cursor to a waveform to be selected and press **F7** (Select).
3. Once a waveform is selected, the status of the waveform pattern selected in the waveform list changes from “OK” to “Selected.”

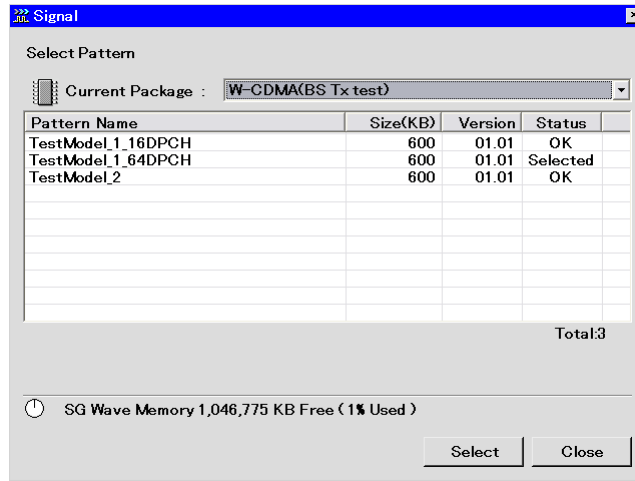

Fig. 2.4.2-2 Status display of selected waveform patterns

AWGN can be added to a waveform pattern when outputting it. Refer to Section 2.5 “AWGN Addition Function” for details of the AWGN function. After preset operations have been performed, the selection of waveform patterns is released and waveform patterns are left unselected. Waveform patterns that have been loaded to the waveform memory, however, are retained.

2.4.3 Deleting waveform file(s) from waveform memory

This section describes how to delete waveform files loaded to the waveform memory.

Pressing **F3** (Select Pattern) from page 1 of the main function menu displays the waveform file selection window, and pressing **F4** (Load Pattern) displays the waveform file load window. The deletion of waveform patterns from the waveform memory can be performed in the waveform file selection window or the waveform file load window.

This section describes operation methods for when the waveform file selection window is displayed, unless otherwise specified.

Example: Deleting a selected waveform file from the waveform memory
<Procedure>

1. Press **F3** (Select Pattern) from page 1 of the main function menu to display the waveform file selection window.
2. Select from the package selection drop-down list box the package in which the desired waveform pattern is stored.
3. A list of waveform patterns will be displayed. Move the cursor to the waveform which is to be deleted.

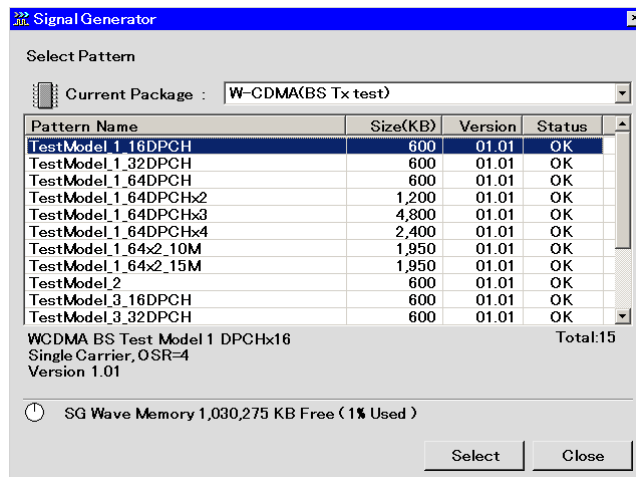



Fig. 2.4.3-1 Selecting waveform pattern to be deleted

4. Press **F3** (Delete Pattern) to delete the selected waveform pattern from the waveform memory.

Even if a waveform pattern is deleted from the waveform memory, it can be reloaded as long as the deleted waveform file is stored on the hard disk.

Example: Deleting all waveform files from the waveform memory

<Procedure>

1. Press  (Select Pattern) from page 1 of the main function menu to display the waveform selection window.
2. Press  (Clear Wave Memory) to delete all waveform patterns from the waveform memory.

Even if a waveform pattern is deleted from the waveform memory, it can be reloaded as long as the deleted waveform file is stored on the hard disk.

2.4.4 Copying waveform file(s) to hard disk

The patterns to be used with the MS2690A-020/MS2691A-020/MS2692A-020 are stored in the C drive of the MS2690A/MS2691A/MS2692A internal hard disk. Patterns can be copied from other devices to this drive.







The D drive (of the MS2690A/MS2691A/MS2692A internal hard disk) and subsequent drives (assigned to an external device, such as USB memory) can be used as a pattern copy source.

Store the pattern to be copied in the device as follows.

```
<Device root folder>
|
+--<Folder with the same name as the package>
|
+<Waveform pattern (*.wvi, *.wvd)>
```







Example: Copying a waveform file from USB memory to the internal hard disk

<Procedure>

1. Insert the USB memory containing the waveform pattern into the USB slot of the MS2690A/MS2691A/MS2692A.
2. Press  (Copy Pattern File to HDD) from page 2 of the main function menu.
3. Press  (Device) to display the Device selection screen.
4. Select the Device corresponding to the USB memory and press  (Set).
5. Press  (Select Copy Package) to display the “Copy Package to HDD” screen.
6. Move the cursor to the package to be copied and press  to select the check box. Pressing  (Select All) selects all check boxes.
7. Press  (Copy).

Example: Copying a waveform file from the D drive of the MS2690A/MS2691A/MS2692A to the internal hard disk

<Procedure>

1. Press  (Device) to display the Device selection screen.
2. Select the drive (D:) and press  (Set).
3. Press  (Select Copy Package) to display the “Copy Package to HDD” screen.
4. Move the cursor to the package to be copied and press  to select the check box. Pressing  (Select All) selects all check boxes.
5. Press  (Copy).

2.4.5 Deleting waveform file(s) from hard disk

This section describes how to delete waveform files from the hard disk.

Example: Deleting a waveform file from the internal hard disk

<Procedure>

1. Press **F7** (Delete Pattern File on HDD) from page 2 of the main function menu to display the internal hard disk edit window.
2. Select the package in which the waveform file to be deleted is stored from the package selection drop-down list box.

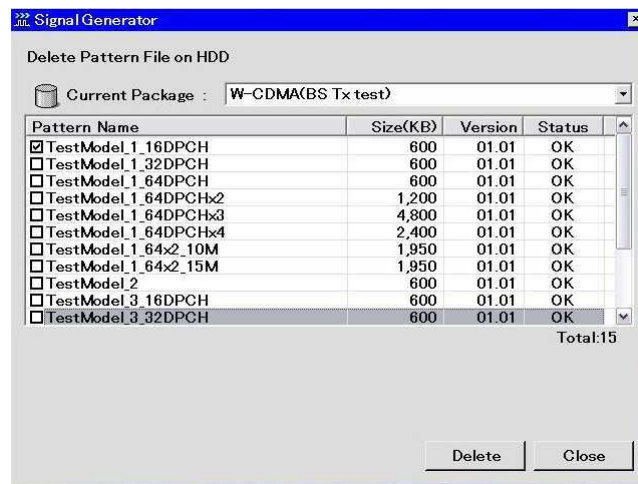

Fig. 2.4.5-1 Internal hard disk edit window

3. Move the cursor to the package to be deleted and press **Enter** to select the check box. Pressing **F2** (Select All) selects all check boxes.
4. Press **F7** (Delete) to display the confirmation window. Click [OK] to delete the checked waveform files from the internal hard disk.

Do not power off the MS2690A/MS2691A/MS2692A while deleting waveform files.

Note that the waveform files deleted from the internal hard disk cannot be restored.

2.4.6 Turning modulation signal on/off

Pressing **F7** (Modulation) from page 1 of the main function menu switches between turning modulation on and off.

Initial setting value of Modulation: Off

Example: Turning Modulation on and then off again
<Procedure>

1. Press **F7** (Modulation) to turn Modulation on.
2. Press **F7** (Modulation) again to turn Modulation off.

2.4.7 Re-outputting Pattern Beginning at Head

When the tail of the waveform pattern is reached, control automatically returns to the head and the waveform pattern is output repeatedly if no trigger signal is input from the external system. By pressing **F6** (Waveform Restart), the waveform pattern can be re-output, beginning at the head, at any time.

Condition for using Waveform Restart

This function can only be used when a waveform pattern is selected.

2.4.8 Displaying information of selected waveform pattern

Pressing **F3** (Baseband Information) from page 1 of the main function menu displays the information of the currently selected waveform pattern. A blank will be displayed if no waveform is selected.



Comments about the waveform pattern

Fig. 2.4.8-1 Information of selected waveform pattern

Table 2.4.8-1 Status display

Actual Display	Display	Description
Modulation	Modulation	Indicates that Modulation is turned on. Nothing will be displayed if Modulation is turned off.
Pulse Mod Int Pulse Mod Ext	Pulse Mod Int Pulse Mod Ext	Indicates the pulse modulation setting. Nothing will be displayed if pulse modulation is turned off.

2.5 AWGN Addition Function

AWGN can be digitally added to the selected waveform pattern. This function is useful when testing reception sensitivity.

This section describes how to use the AWGN addition function. In this section, the waveform currently selected is handled as the desired waveform.

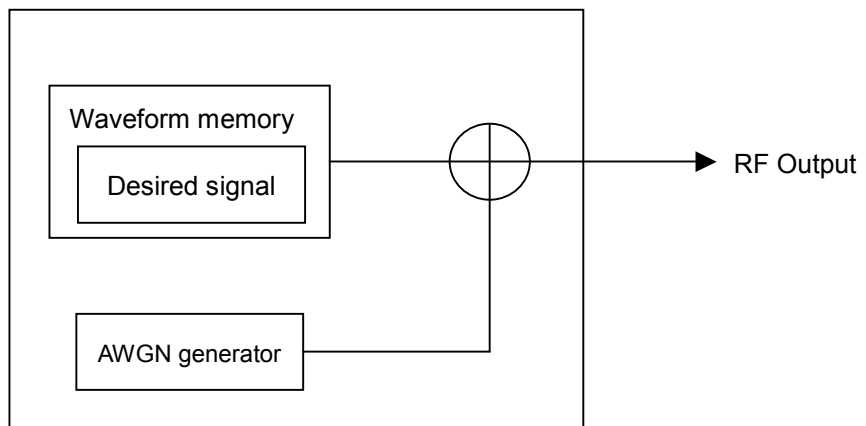
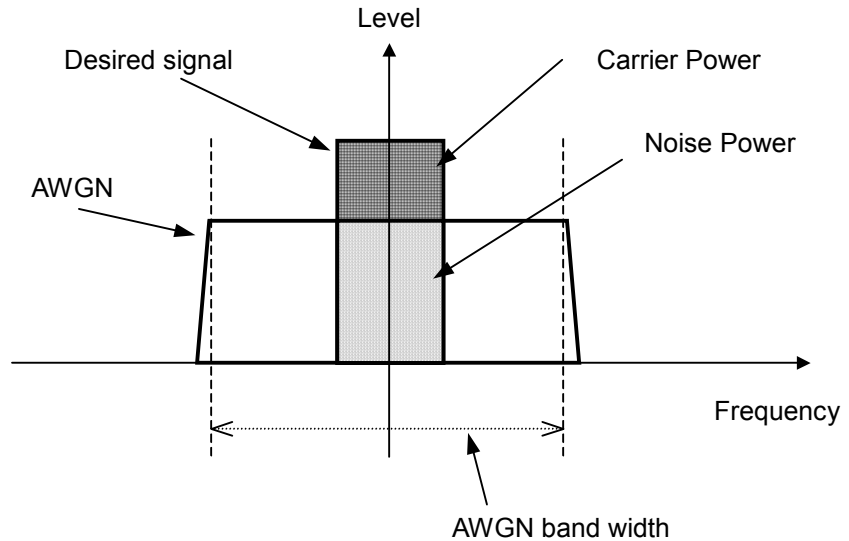

Fig. 2.5-1 Outline of AWGN addition function

Specifications of AWGN to be added



- Carrier Power: Output level of the desired signal
- Noise Power: Value of the AWGN output level converted by the signal band of the desired signal (not displayed on the screen)
- C/N Ratio: Level ratio between Carrier Power and Noise Power
- Amplitude: Sum of the output level of the desired signal and the AWGN output level

Fig. 2.5-2 AWGN specifications

The AWGN bandwidth is the sampling clock value of the desired signal.

Example:

If the conditions of the desired signal are as follows:

- WCDMA
- Band width = 3.84 MHz
- Over sampling = 4 times

AWGN band width

= Sampling clock

= 3.84 MHz × 4

= 15.36 MHz

Restrictions on the AWGN addition function

The settable range of each parameter of the AWGN addition function is restricted as follows.

- $-40 \text{ dB} \leq \text{C/N Ratio} \leq +40 \text{ dB}$
- Amplitude = Output level of desired signal + AWGN output level $\leq 0 \text{ dBm}$

If the Amplitude is around 0 dBm, the settable range of the C/N Ratio will be restricted to a range in which the Amplitude does not exceed 0 dBm.

2.5.1 Display description

Pressing **F5** (AWGN Setup) from page 1 of the main function menu displays the AWGN setup screen.

This section describes the AWGN addition function screen display.

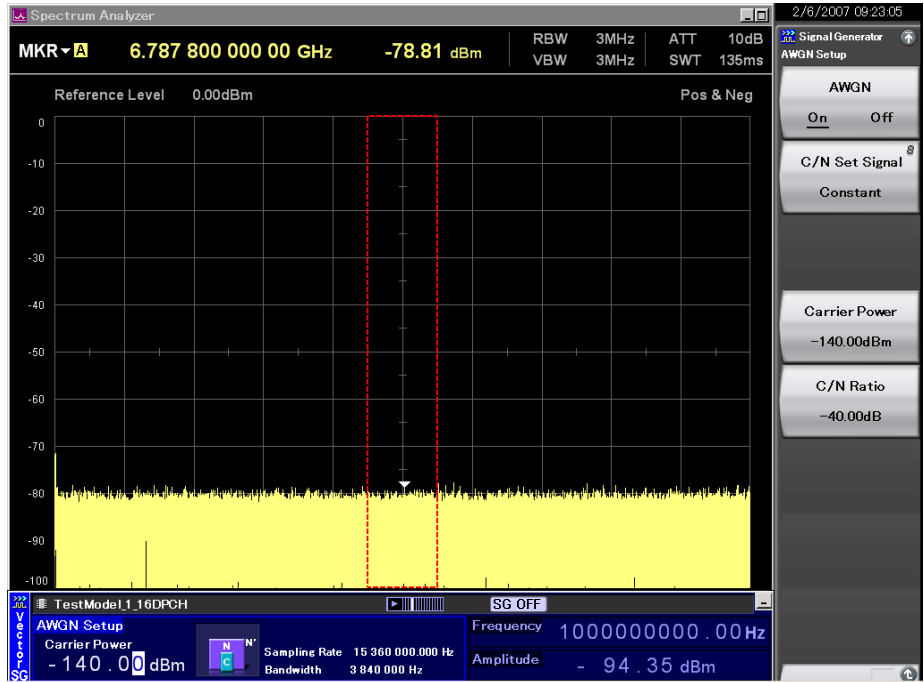

Fig. 2.5.1-1 AWGN setup screen

Table 2.5.1-1 Display items on AWGN setup screen

Display	Description
Carrier Power display	Displays the output level of the desired signal.
C/N Ratio display	Displays the level ratio between the desired signal and band-converted AWGN.

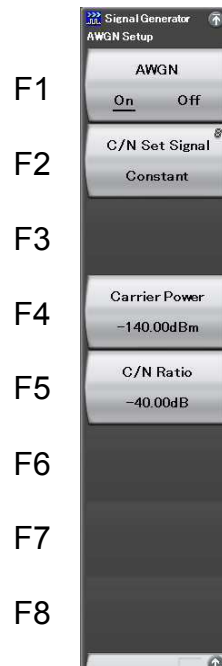





Fig. 2.5.1-2 AWGN function menu

Table 2.5.1-2 AWGN function menu

Menu Display	Function
AWGN (On/Off)	Switches between AWGN On and Off.  2.5.2 "Setting AWGN on/off"
C/N Set Signal	Sets whether the C/N value is applied to Constant, Carrier, or Noise.  2.5.4 "Inputting C/N"
Carrier Power	Sets the Carrier Power value.  2.5.3 "Inputting Carrier Power"
C/N Ratio	Sets the C/N value.  2.5.4 "Inputting C/N"

2.5.2 Setting AWGN on/off

To add AWGN, set AWGN to On.

<Procedure>

1. Press **F1** (AWGN On/Off) to select “On.”
2. AWGN will be added to the desired signal and output.

To stop AWGN output, select Off in step 1 above.

The AWGN addition function can only be used if the following condition is met.

- Modulation is turned On

When AWGN is switched to On, the current RF output level value (Amplitude) is the output level value of the desired signal (Carrier Power). In addition, the RF output level itself increases because the AWGN output level value (Noise Power) has been added.

When AWGN is switched to Off, the current output level value of the desired signal (Carrier Power) is the RF output level value (Amplitude). The RF output level value itself, therefore, decreases.

2.5.3 Inputting Carrier Power

This function sets the output level of the desired signal.

Example: Setting Carrier Power to -100 dBm

<Procedure>

1. Press **F4** (Carrier Power).
2. Then, press **-/+** **1** **0** **0** to display the Carrier Power input window and press **F7** (Set).



Fig. 2.5.3-1 Carrier Power input window

2.5.4 Inputting C/N

This function sets the level ratio between Carrier Power and Noise Power. Depending on the C/N Set Signal setting, the input value will be reflected to the output level differently.

- C/N Set Signal: Carrier
When the C/N Ratio is changed, Noise Power is fixed, and Carrier Power and the Amplitude change.
- C/N Set Signal: Noise
When the C/N Ratio is changed, Carrier Power is fixed, and Noise Power and the Amplitude change.
- C/N Set Signal: Constant
When the C/N Ratio is changed, the Amplitude is fixed, and Carrier Power and Noise Power change.

Note:

Noise Power will not be displayed on the screen.

Example: Setting C/N Set Signal Carrier to Carrier and C/N Ratio to -10 dB

<Procedure>

1. Press **F2** (C/N Set Signal) to select Carrier.
2. Press **F5** (C/N Ratio).
3. Then press **-/+** **1** **0** to display the C/N setup window and press **F7** (Set).

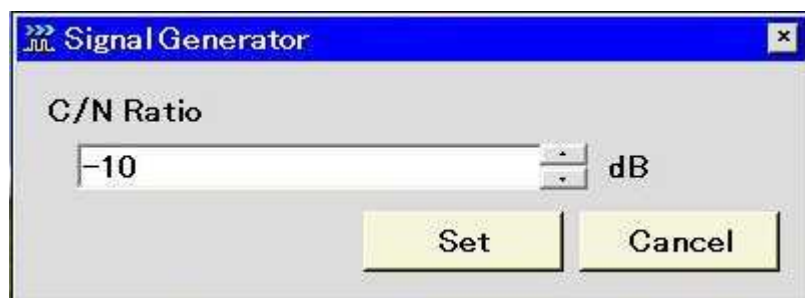

Fig. 2.5.4-1 C/N setup window

2.6 Setting External I/O

Pressing **F1** (Ext I/O Setup) from page 2 of the main function menu displays the Ext I/O Setup function menu, which is used to set the external I/O to be used for modulation or pattern reproduction.

2.6.1 Display description

This section describes the external I/O Setup screen display.

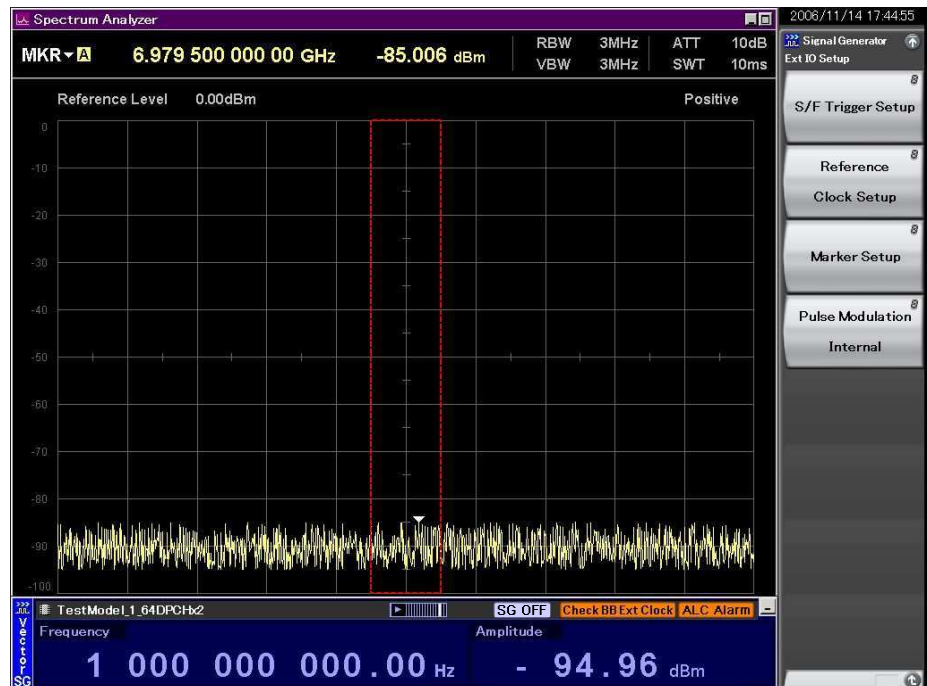

Fig. 2.6.1-1 Ext I/O Setup screen

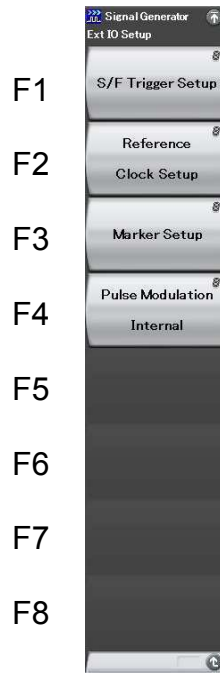





Fig. 2.6.1-2 Ext I/O Setup function menu

Table 2.6.1-1 Ext I/O Setup function menu

Menu display	Function
S/F Trigger Setup	Sets the Start/Frame trigger.  2.6.2 "Setting Start/Frame trigger"
Reference Clock Setup	Sets the reference clock.  2.6.3 "Setting reference clock"
Marker Setup	Sets the marker signal.  2.6.4 "Setting marker output"
Pulse Modulation	Sets pulse modulation.  2.6.5 "Setting pulse modulation"

2.6.2 Setting Start/Frame trigger

The MS2690A-020/MS2691A-020/MS2692A-020 can output a waveform pattern in sync with a trigger signal incoming from an external system. Either of two signals can be selected for the external trigger signal. One is Start Trigger, which specifies the output start position of the waveform pattern. The other is Frame Trigger, which specifies the output timing for each of the bursts when a burst signal is selected. The external trigger signal is input to the Trigger Input connector on the rear panel.

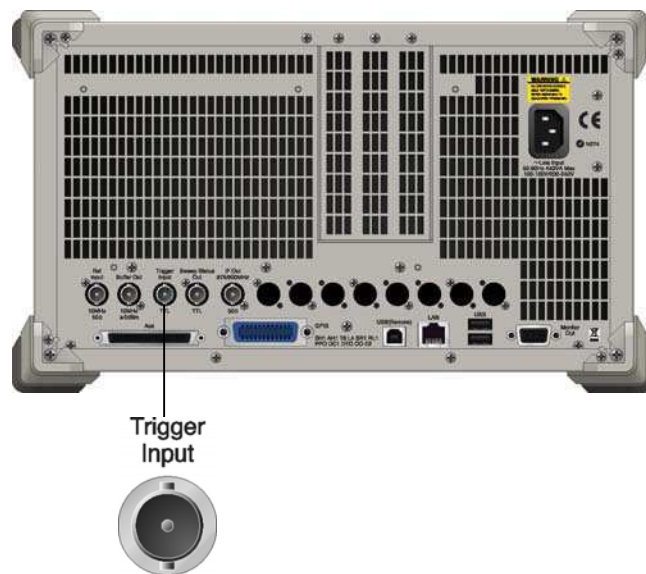

Fig. 2.6.2-1 Connector connection location

Pressing **F1** (S/F Trigger Setup) from page 2 of the main function menu displays the S/F Trigger Setup window. In this window, set the trigger. This section describes operation methods for when the Start/Frame Trigger Setup window is displayed, unless otherwise specified.

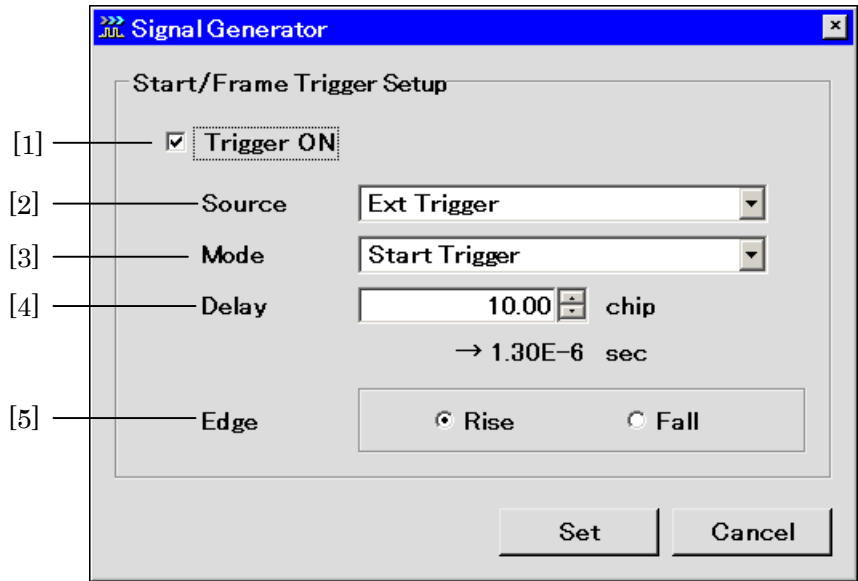

Fig. 2.6.2-2 Start/Frame Trigger Setup window

2

Operation (Signal Generator Function)

This section describes each parameter.

The following are only valid when a waveform pattern is selected.

- [1] Trigger (On/Off)
Enables the trigger input incoming from the external system.

The following are all enabled only when Trigger is set to [On].

- [2] Source (Ext Trigger/(Trigger Signal of Option))
Selects whether to use the external trigger signal or the optical trigger signal of the MS2690A/MS2691A/MS26592A.
“Application Sync Trigger” can be selected when the MX269030A W-CDMA BS Measurement Software is installed.
“Baseband I/F” can be selected when the MS2690A/MS2691A/MS2692A Option 040 Baseband Interface Unit is installed.

- [3] Mode (Start/Frame)
Selects whether the trigger is used as a start or frame trigger.

- [4] Delay
Sets the trigger delay amount.
Setting range: Depends on the selected pattern.
Minimum resolution setting: Depends on the waveform.
Displays the value calculated by converting the delay amount to the delay time.

- [5] Edge (Rise/Fall)
Sets the trigger detection edges, and switches between rising and falling operations.

When the Mode or Delay setting is changed, the pattern operation will restart and await trigger inputs from the external system.

Trigger signal input conditions

The following are input conditions for the trigger signal that is used.

External trigger signal input conditions

- Input level: TTL level
- Polarity: Rise or Fall can be selected.
- Waveform: Fig. 2.6.2-3 shows a waveform for the rising edge.
 - T1: 40 ns or more
 - T2: 40 ns or more

Reference values T1 and T2 vary depending on the drive current impedance of the outputting source, the quality and length of the cable connected to the MS2690A/MS2691A/MS2692A.

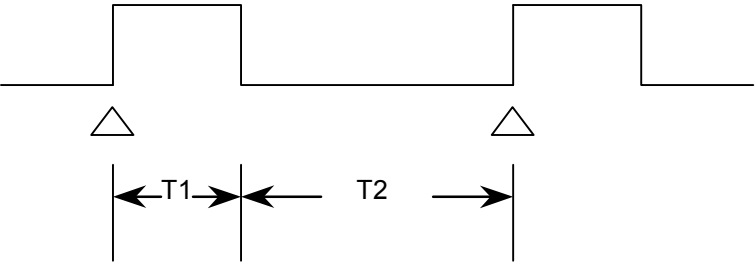

Fig. 2.6.2-3 Trigger signal input conditions

Start Trigger Operation

Output of the Start Trigger operation starts with the rising timing of the first external trigger signal after the waveform pattern is selected. Any trigger signal being input from the second time or later will be disabled. The relationship between the external trigger signal and the waveform pattern output can be set in the Delay field. If Delay is set to [0], output of the waveform pattern is delayed by the one-frame* period (relative to the rise of the external trigger signal) that depends on the waveform pattern.

*: One-frame period refers to the following value:

- (1) If the waveform pattern was generated using the IQproducer™ Convert function:

The number of samples of one frame is determined according to the Frame Length (L_f) and Gap Length (L_g) settings of Burst Setting. One-frame period indicates the number of samples within one frame, which equals $L_f + L_g$.

Example: If over sampling data of four times of W-CDMA is to be converted, set the following:

$$\text{Frame Length} = 3.84 \times 10^6 [\text{sample/s}] \times 0.01 [\text{s}] \times 4 [\text{Over sample ratio}] = 153600$$

For details, refer to the MS2690A/MS2691A/MS2692A Signal Analyzer Option 020 Vector Signal Generator Operation Manual (IQproducer™).

- (2) If the waveform pattern is generated using any of a number of IQproducer™ option signal generation applications:

The frame length matching each communication system is set automatically. In this case, the L_f and L_g values vary as follows, depending on whether your system is using continuous or burst signals.

- If the system is using continuous signals
 L_f = The number of samples of one frame for the system is set.
 L_g = 0 is set.
- If the system is using burst signals
 L_f = The number of samples of one slot or frame is set.
 L_g = [Number of samples of one frame] – [number of samples of one slot] or 0 is set.

Although the above details depend on the system, the resulting value is the number of samples of one frame where the value of [$L_f + L_g$] is determined depending on the system.

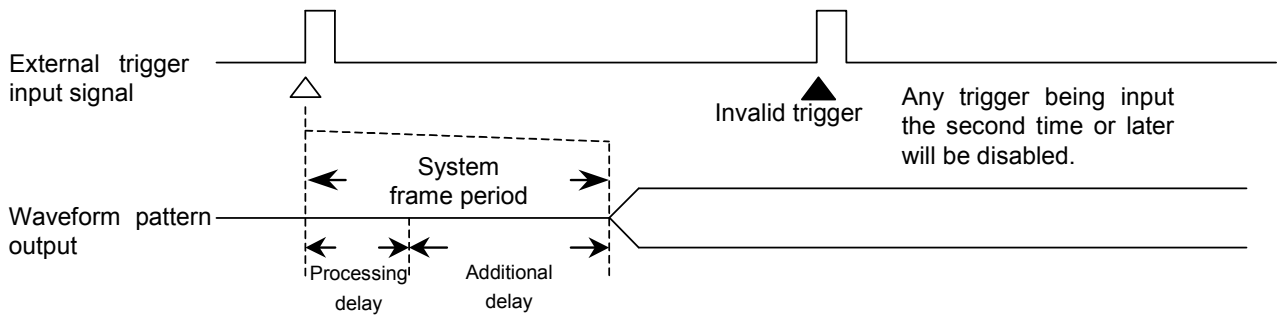

Fig. 2.6.2-4 Start Trigger operation

Notes:

1. If Delay is set to 0, some delay is internally added to the processing delay that is generated during the period from trigger input to output of the waveform pattern (additional delay), and the signal is output one frame period late.
2. The Frame period varies depending on the system. Refer to the operation manual of the currently selected waveform pattern.

Frame Trigger Operation

The Frame Trigger operation outputs one burst of the waveform pattern with the rising timing of the external trigger signal. The relationship between the external trigger signal and the waveform pattern output is the same as Start Trigger. The following figure shows operation that takes place when the external trigger signal is input with the frame period, with Delay set to [0].

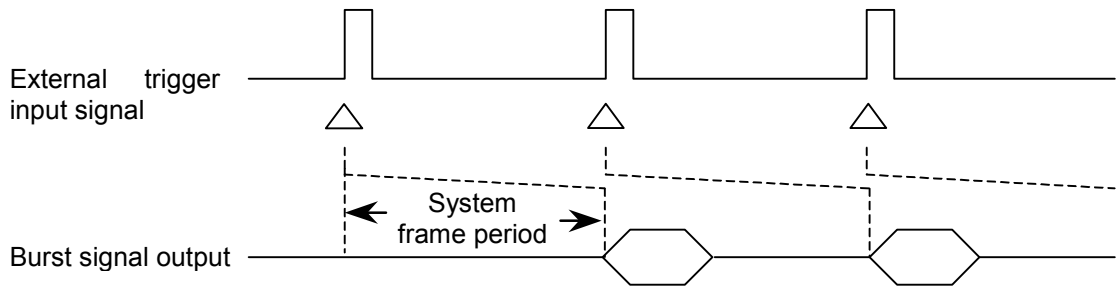

Fig. 2.6.2-5 Frame Trigger operation

If the input period of the external trigger signal is N samples shorter than the frame period, it is masked to be a disabled trigger. A burst signal matching the trigger signal cannot be obtained in this case.

$$N \text{ [samples]} = (L_f + L_g) - (L_f + 1)$$

Notes:

1. For L_f , and L_g , refer to the “Start Trigger Operation” description.
2. If Delay is set to the positive side, the frame period will increase by the number of samples set in Delay.
3. The maximum value of N (N_{max}) can be calculated from the expression shown below, in accordance with the interpolation ratio (IPLR) that is determined by the sampling clock (f_s).
4. If N exceeds N_{max} as the result of the above expression, assign N_{max} to it.

$$N_{max} = 28/IPLR$$

IPLR: Power of 2 (2^n) that meets $160 \text{ MHz} \geq IPLR \times f_s > 80 \text{ MHz}$ (n is an integer greater than 3)

For example, suppose that $L_f = 140$ symbols, $L_g = 280$ symbols, and the sampling clock = 50 MHz. In this case, because the right-hand side of the N formula above exceeds N_{max} , $N = 28$. In Fig. 2.6.2-6, if a trigger signal is input with a period 28 samples shorter than the frame period ($L_f + L_g$), it will be disabled.

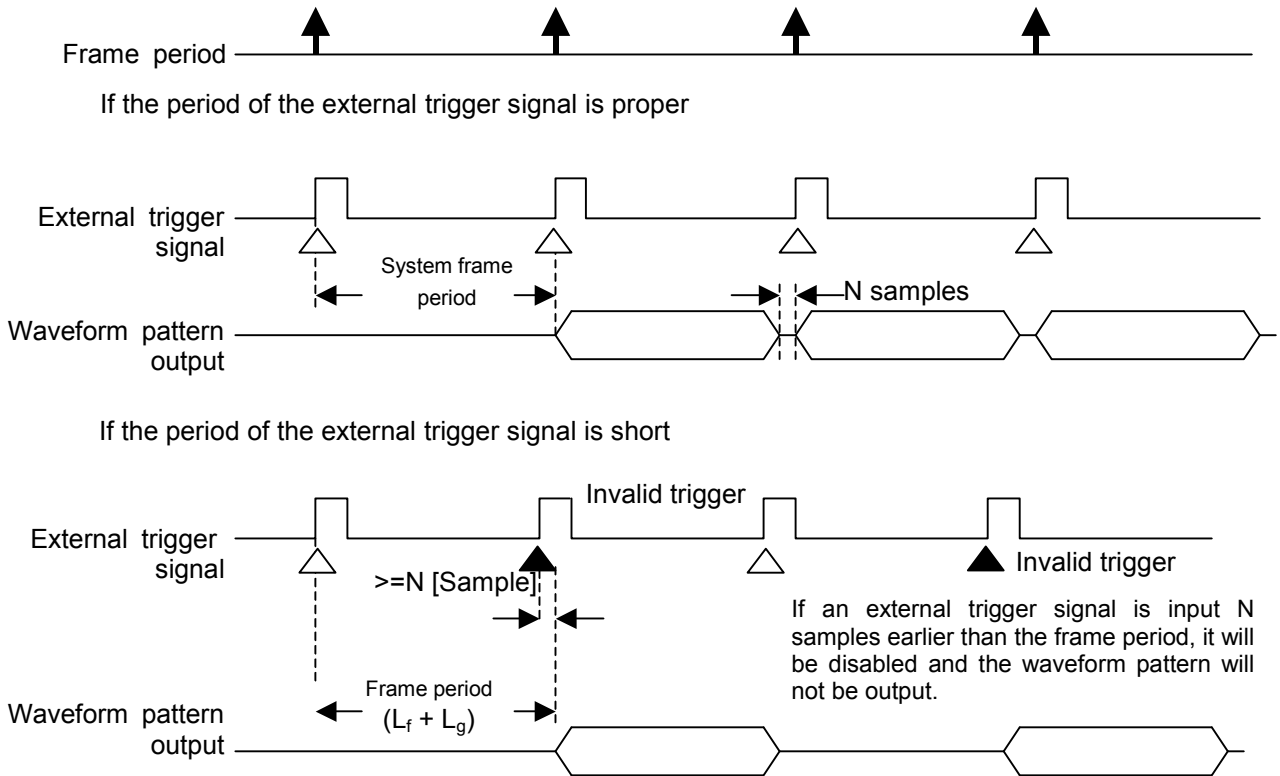

Fig. 2.6.2-6 Example of Frame Trigger operation

2.6.3 Setting reference clock

This function sets the reference clock of the internal arbitrary waveform generator of the MS2690A/MS2691A/MS2692A.

For the reference clock of the internal arbitrary waveform generator, select either the same reference signal source that is used for the carrier or the signal that is input externally. When using an external signal, input it to BB_REF_CLK of the AUX connector on the rear panel. Refer to Appendix C “AUX Connector” for details on pin assignment.



Fig. 2.6.3-1 Connector connection location

Pressing **F2** (Reference Clock Setup) from the Ext I/O Setup function menu displays the Reference Clock Setup window. In this window, set the reference clock. This section describes operation methods for when the Reference Clock Setup window is displayed, unless otherwise specified.

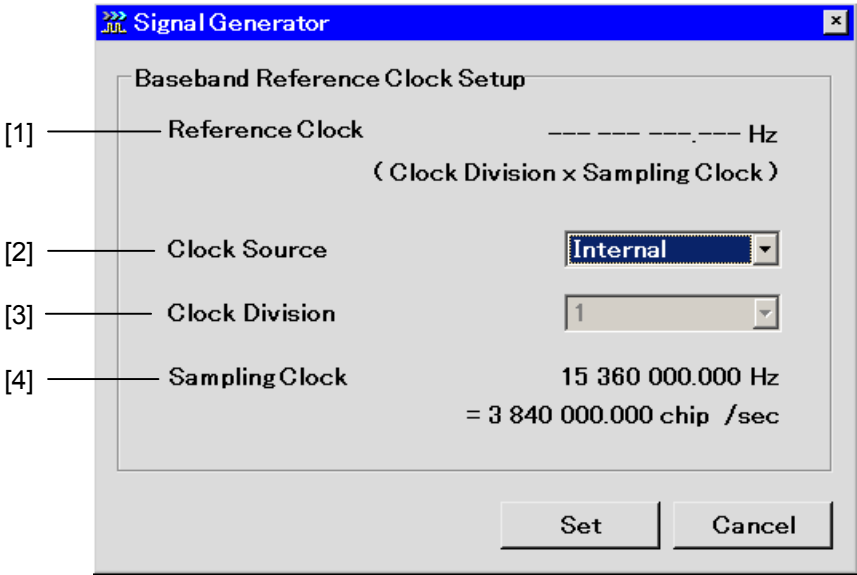

Fig. 2.6.3-2 Reference Clock Setup window

2

Operation (Signal Generator Function)

This section describes each parameter.

The following are only valid when a waveform is selected.

[1] Reference Clock

The current reference clock value is displayed only when External is selected for Clock Source.

[2] Clock Source

For the reference clock of the MS2690A/MS2691A/MS2692A, select either the same reference signal source that is used for the carrier or the signal that is input to the baseband reference clock signal input connector. If Internal is selected for the Clock Source, use the same reference signal source that is used for the carrier. The signal from this signal source will be a 10 or 5 MHz external input signal that will be input to the 10 MHz internal reference oscillator or the reference frequency signal input connector (Ref Input).

If External is selected for Clock Source, the input signal to the baseband reference clock signal input pin of the AUX connector will be used as the reference signal source.

In addition, if External is selected for Clock Source, either the TTL level or AC coupling can be selected as a specification of the input signal.

[3] Clock Division

Determined from the currently set sampling clock and the factor that is set here.

$$[\text{Reference clock}] = [\text{Sampling clock}] \times [\text{Factor}]$$

↑ To be set here.

The selectable factor range varies with the sampling clock value.

[4] Sampling Clock

The current sampling rate is displayed only when a waveform is selected. The value converted in time will also be displayed at the same time.

Table 2.6.3-1 Selectable factor range

Sampling clock f (Hz)	Baseband Reference Clock setting								
	16	8	4	2	1	1/2	1/4	1/8	1/16
$20 \text{ k} \leq f \leq 24414.062$	√	√	√	√	√				
$24414.062 < f \leq 48828.125$	√	√	√	√	√	√			
$48828.125 < f \leq 97656.25$	√	√	√	√	√	√	√		
$97656.25 < f \leq 195312.5$	√	√	√	√	√	√	√	√	
$195312.5 < f \leq 2.5 \text{ M}$	√	√	√	√	√	√	√	√	√
$2.5 \text{ M} < f \leq 5 \text{ M}$		√	√	√	√	√	√	√	√
$5 \text{ M} < f \leq 10 \text{ M}$			√	√	√	√	√	√	√
$10 \text{ M} < f \leq 20 \text{ M}$				√	√	√	√	√	√
$20 \text{ M} < f \leq 40 \text{ M}$					√	√	√	√	√
$40 \text{ M} < f \leq 80 \text{ M}$						√	√	√	√
$80 \text{ M} < f \leq 160 \text{ M}$							√	√	√

2.6.4 Setting marker output

This section describes how to set marker signals output by the MS2690A-020/MS2691A-020/MS2692A-020. There are two types of marker signals output by the MS2690A-020/MS2691A-020/MS2692A-020: one based on information described in waveform patterns and another set by this setting. Marker signals are output from MARKER 1 to 3 of the AUX connector on the rear panel. Refer to Appendix C “AUX Connector” for details on pin assignment.



Fig. 2.6.4-1 Output connector location

Modulation must be on and a waveform must be selected to perform this setting.

Pressing **F3** (Marker Setup) from the Ext I/O Setup function menu displays the Marker Setup window. In this window, set the trigger. This section describes operation methods for when the Marker Setup window is displayed, unless otherwise specified.

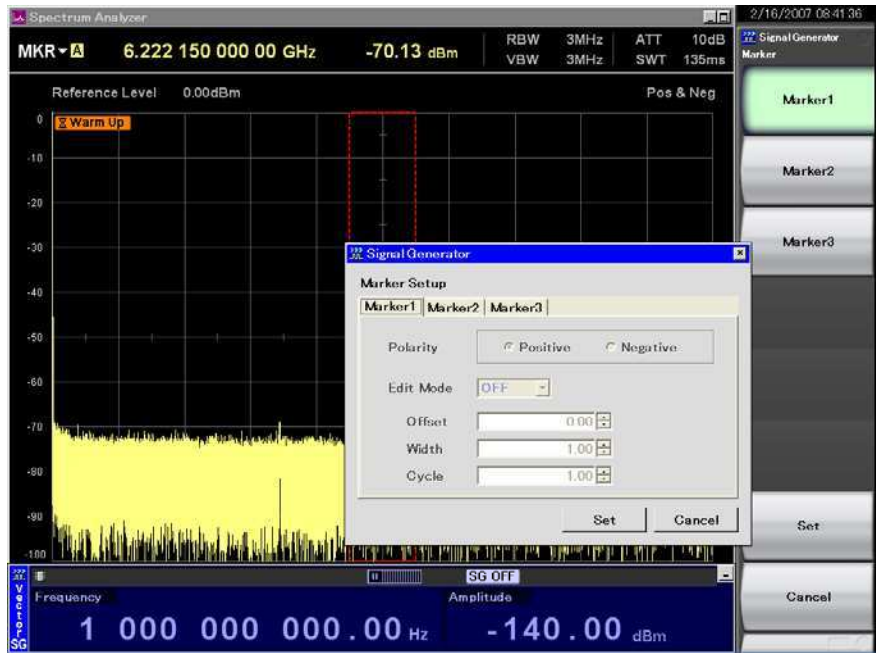

Fig. 2.6.4-2 Marker output setup screen

2

Operation (Signal Generator Function)

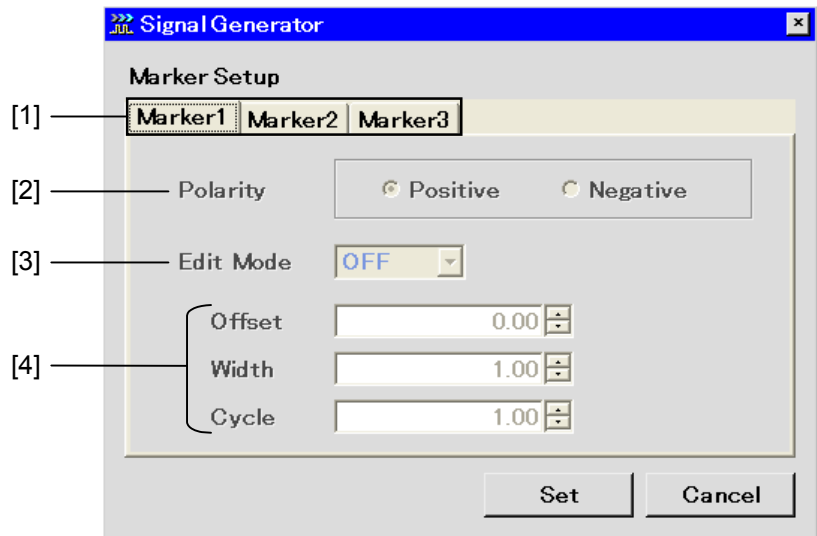

Fig. 2.6.4-3 Marker Setup window

This section describes each parameter.

[1] Markers 1 to 3

Selects the number of the marker to be edited. This can be performed from the tabs in the Marker Setup window or using the function keys. The settings in steps [2] to [4] below are to be set separately for Markers 1 to 3.

[2] Polarity

Selects the polarity of the marker signal selected in [1].

[3] Edit Mode

Switches the marker signal to be output. When Edit Mode is set to Off, a marker signal based on information described in waveform patterns is output. When Edit Mode is set to On, the marker signal set with this setting is output. When Edit Mode is set to SYNC, the marker signal set with this setting is output from the beginning of a frame.

[4] Offset/Width/Cycle

Set the marker signal to be output. These settings are valid when Edit Mode is set to On or SYNC. When Edit Mode is set to SYNC, however, Cycle is invalid. Parameter details are described later.

Marker signal based on information in waveform pattern

When Edit Mode is set to Off, marker signals based on information in waveform patterns, such as clocks and gate signals are output. At this time, the marker signal depends on the content of the currently selected waveform pattern. Refer to the operation manual of the selected waveform pattern for details.

Marker signal to be set with this setting

Set Edit Mode to On or SYNC to define the marker signal with this setting. The following are parameters to set the marker signal.

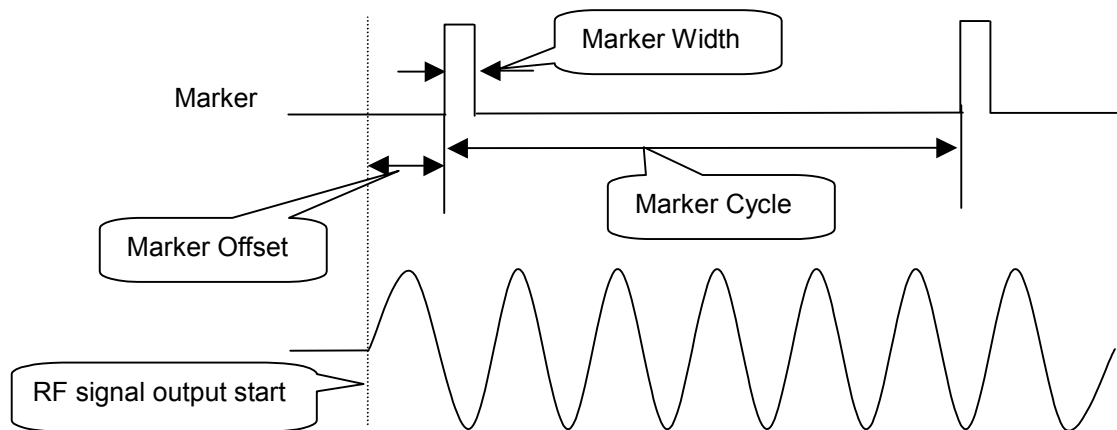

Fig. 2.6.4-4 Outline of marker parameters

This section describes the details of each parameter. Set each parameter in Chip/Over Sampling units.

<1> Offset

Delays the marker signal by the set value from the head of the waveform pattern.

<3> Width

Sets the pulse width of the marker signal.

<3> Cycle

















Sets the cycle of the marker signal. This cannot be set when Edit Mode is set to SYNC.

Conditions when inputting Edit Mode, Offset, Width, or Cycle

To set Offset, Width, or Cycle, Edit Mode must be set to On or SYNC.

Example: Setting Edit Mode to On, Offset to 1000 chips, Width to 1000 chips, and Cycle to 1000 chips

<Procedure>

1. Press  (Marker Setup) to display the Marker Setup screen. This is valid only when a waveform pattern is selected.
2. Move the cursor to Edit Mode and set it to On.
3. Move the cursor to Offset, press    , and then press .
4. Move the cursor to Cycle, press    , and then press .
5. Move the cursor to Width, press    , and then press .
6. Press  (Set).

The operation in each Edit Mode setting is as follows.

When Edit Mode is set to Off

Offset, Width, and Cycle cannot be set.

When Edit Mode is set to On

Offset, Width, and Cycle can be set.

Tables 2.6.4-1 and 2.6.4-2 show the setting range and set resolution of Offset, Width, and Cycle.

Table 2.6.4-1 Setting range of Offset, Width, and Cycle

Item	Setting Range
Offset	0.00 to $(2^{24} - 1)/\text{Over Sampling}$
Width	$1/\text{Over Sampling}$ to $(2^{24} - 1)/\text{Over Sampling}^*$
Cycle	$1/\text{Over Sampling}$ to $(2^{24} - 1)/\text{Over Sampling}$

*: The maximum value of Width varies depending on the value of Cycle. The actual setting range is “ $1/\text{Over Sampling}$ to Cycle value.”

Table 2.6.4-2 Setting resolution of Offset, Width, and Cycle

Item	Setting Resolution
Offset	$1/\text{Over Sampling}$
Width	$1/\text{Over Sampling}$
Cycle	$1/\text{Over Sampling}$

When Edit Mode is set to SYNC

Offset and Width can be set.

Tables 2.6.4-3 and 2.6.4-4 show the setting range and setting resolution of Offset and Width.

Table 2.6.4-3 Setting range of Offset and Width

Item	Setting Range
Offset	0.00 to $(2^{24} - 1)/\text{Over Sampling}$
Width	$1/\text{Over Sampling}$ to Data Point/ Over Sampling

Table 2.6.4-4 Setting resolution of Offset and Width

Item	Setting resolution
Offset	$1/\text{Over Sampling}$
Width	$1/\text{Over Sampling}$

2.6.5 Setting pulse modulation

For pulse modulation, use an internal or external signal.

By default, it is designed to use an internal signal to perform pulse modulation. It is possible to modify it so that an external signal is used for modulation, or so that no pulse modulation is performed.

Pressing  (Pulse Modulation) from the Ext I/O Setup function menu displays the pulse modulation setup window. In this window, set pulse modulation.

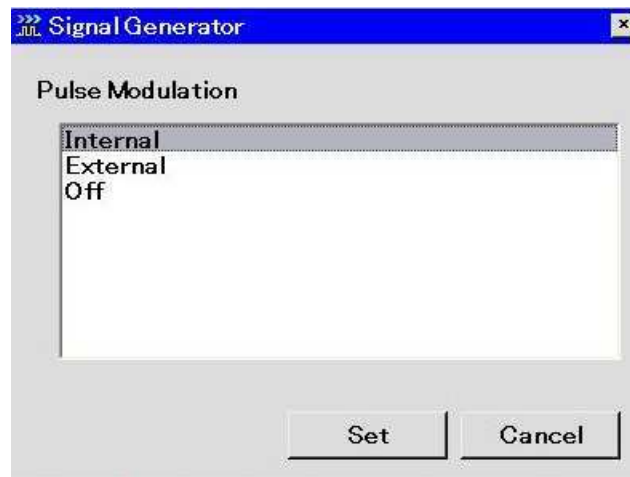

Fig. 2.6.5-1 Pulse modulation setup window

This section describes the parameter.

<1> Pulse Modulation

Selects the pulse modulation reference.

Using Internal signal

This function is useful to load patterns for pulse modulation. When an internal signal is generated, the pulse modulator is controlled by the pulse modulation control bit (RF Gate), which has been added to the waveform pattern. Refer to the MS2690A/MS2691A/MS2692A Signal Analyzer Option 020 Vector Signal Generator Operation Manual (IQproducer™) for details.

Using External Signal

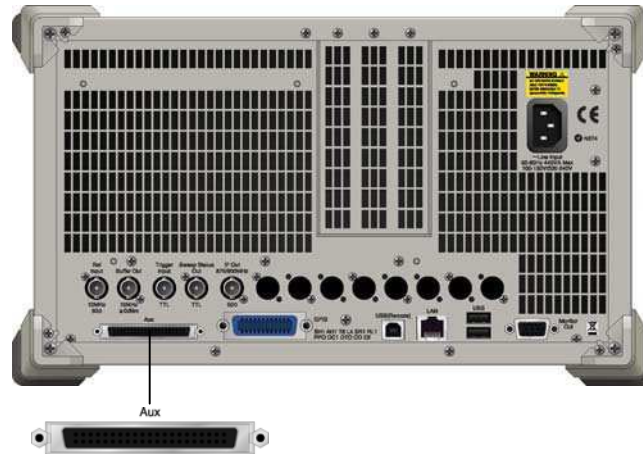

Fig. 2.6.5-2 Input connector

To perform pulse modulation using an external signal, input the external signal to PULS_MOD of the AUX connector. Refer to Appendix C “AUX Connector” for the details on pin assignment. The external input impedance is 50 Ω and the pulse modulation polarity is fixed to Positive. That is, if the external modulation signal is at High level, the RF signal is output; if it is at Low level, that signal is not output. The threshold by which the level (High or Low) is determined is 1 V.

Disabling Pulse Modulation

Select Off for Pulse Modulation to disable pulse modulation.

2.7 BER Measurement Function

Pressing **F4** (BER Test Control) from page 2 of the main function menu displays the BER measurement control function menu, which is used to control the starting and stopping of BER measurement.

2.7.1 Display description

This section describes the BER measurement control screen display.

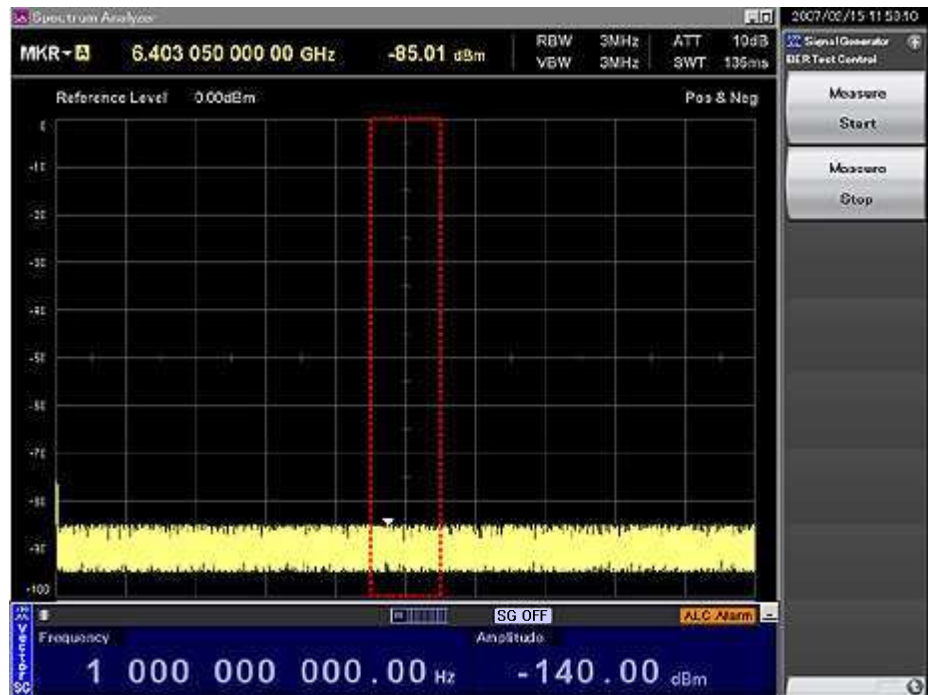

Fig. 2.7.1-1 BER measurement control screen

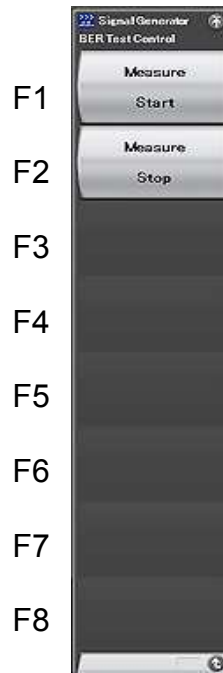

Fig. 2.7.1-2 BER measurement control function menu

Table 2.7.1-1 BER measurement control function menu

Menu Display	Function
Measure Start	Starts BER measurement.
Measure Stop	Stops BER measurement.

2.8 Selecting SA Trigger

Select the type of the trigger to be output for the Spectrum Analyzer function (hereinafter referred to as “SPA”) or the Signal Analyzer function (hereinafter referred to as “SA”).

Operate SA/SPA at the head of the waveform pattern or in sync with Markers 1 to 3 as set in Section 2.6.4 “Setting maker output.”

To enable this function, Trigger Source of Trigger/Gate must be set to SG Marker on the SA/SPA side. Refer to the MS2690A/MS2691A/MS2692A Signal Analyzer Operation Manual (Mainframe Operation), MS2690A/MS2691A/MS2692A Signal Analyzer Operation Manual (Spectrum Analyzer Function Operation), or MS2690A/MS2691A/MS2692A Signal Analyzer Operation Manual (Signal Analyzer Function Operation) for details.

Pressing  (SA Trigger Out) from page 2 of the main function menu displays the SA Trigger Out setup window.

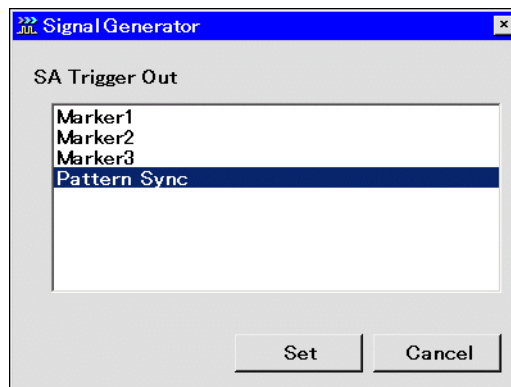

Fig. 2.8-1 SA Trigger Out setup window

This section describes the parameters.

<1> SA Trigger Out

- Marker1: Outputs Marker 1 for SA/SPA.
- Marker2: Outputs Marker 2 for SA/SPA.
- Marker3: Outputs Marker 3 for SA/SPA.
- Pattern Sync: Outputs the trigger at the head of the waveform pattern.

2.9 Auto Calibration

An auto calibration function that uses an internal calibrating oscillator is provided to minimize measurement errors of the MS2690A/MS2691A/MS2692A.

CAUTION

Do not input signals to RF input when calibrating. Correct calibration values cannot be obtained when the auto calibrating function is executed while signals are being input.

Press  (Cal) to display the Cal function menu.



Fig. 2.9-1 Cal key

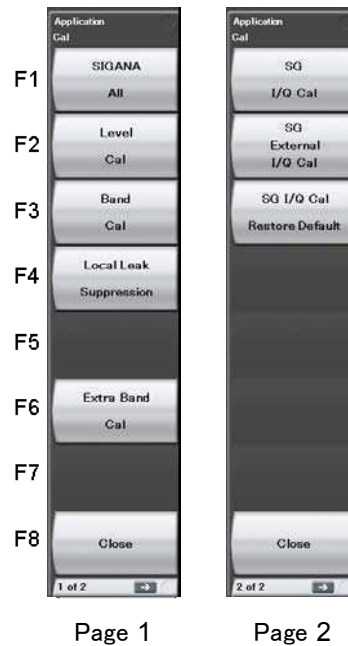

Fig. 2.9-2 Cal function menu

Table 2.9-1 Description of Cal function menu

Menu	機能
Page 1	
SIGANA All	Executes all calibrations (Level Cal, Band Cal, Local Leak Suppression) except Extra Band Cal.
Level Cal	Executes Level Calibration.
Band Cal	Executes analysis Band Calibration.
Local Leak Suppression	Executes Local Leak Suppression.
Extra Band Cal	Executes analysis Bandwidth Calibration within the current frequency.
Close	Returns to the application screen.
Page 2	Displayed only when the Vector Signal Generator option is installed.
SG I/Q Cal	Calibrates Vector Signal Generator option. SG Output and RF Input do not need to be connected by cable.
SG External I/Q Cal	Calibrates Vector Signal Generator option. SG Output and RF Input need to be connected by cable. Do not input signals in RF Input.
SG I/Q Cal Restore Default	Deletes the values calibrated by SG I/Q Cal and SG External I/Q Cal and restores the defaults.

The auto calibration function in Page 1 includes the following four calibration functions and a function to execute functions (1) to (3) at one time.

- (1) Level calibration (Level Cal)
- (2) Analysis band calibration (Band Cal)
- (3) Local Leak Suppression
- (4) Extra Band Cal

For details, refer to Section 3.3 “Auto Calibration” in *MS2690A/MS2691A/MS2692A Signal Analyzer Operation Manual (Operation)*.

The auto calibration function for signal generator in Page 2 includes the following two calibration functions (5) and (6), and a function (7) to delete the values calibrated by (5) and (6).

(5) SG I/Q Cal



Calibrate the signal generator in the specified frequency. Controls effectively the image level generated in the band when outputting broadband signals.

The calibrated values can be stored up to 100 points including the values from SG External I/Q Cal. If the center frequency of the signal generator matches a stored frequency point, the existing calibrated value is applied. When the calibrated values in different frequencies exceed 100 points, the old values are deleted in chronological order. Also, if calibration is performed for the same frequency, the old value is overwritten.

Calibrated values can fluctuate depending on temperature change. Perform calibration at stable ambient temperature after warming up for at least 30 minutes.

Example: Executes SG I/Q calibration within the current frequency.

<Procedure>

1. Press  (Cal).
2. Press .
3. Press  (SG I/Q Cal) to execute calibration.

(6) SG External I/Q Cal



Calibrate the signal generator in the specified frequency. SG Output and RF Input need to be connected by cable before calibration. Controls effectively the image level generated in the band when outputting broadband signals.

The calibrated values can be stored up to 100 points including the values from SG I/Q Cal. When the calibrated values in different frequencies exceed 100 points, the old values are deleted in chronological order. Also, if calibration is performed for the same frequency, the old value is overwritten.

Calibrated values can fluctuate depending on temperature change. Perform calibration at stable ambient temperature after warming up for at least 30 minutes.

Example: Executes SG External I/Q calibration within the current frequency.

<Procedure>

1. Press  (Cal).
2. Press .
3. Press  () to execute calibration.

(7) SG I/Q Cal Restore Default

Deletes the values calibrated by SG I/Q Cal and SG External I/Q Cal and restores the factory defaults.

Example: Delete all the values calibrated by SG I/Q Cal and SG External I/Q Cal.

<Procedure>

1. Press  (Cal).
2. Press .
3. Press  (SG I/Q Cal Restore Default) to execute calibration.

2.10 Other Functions

This section describes other functions that can be executed from the main function menu.

2.10.1 Display description

Pressing  (Accessory) from page 2 of the main function menu displays the Accessory setup screen.

2

Operation (Signal Generator Function)

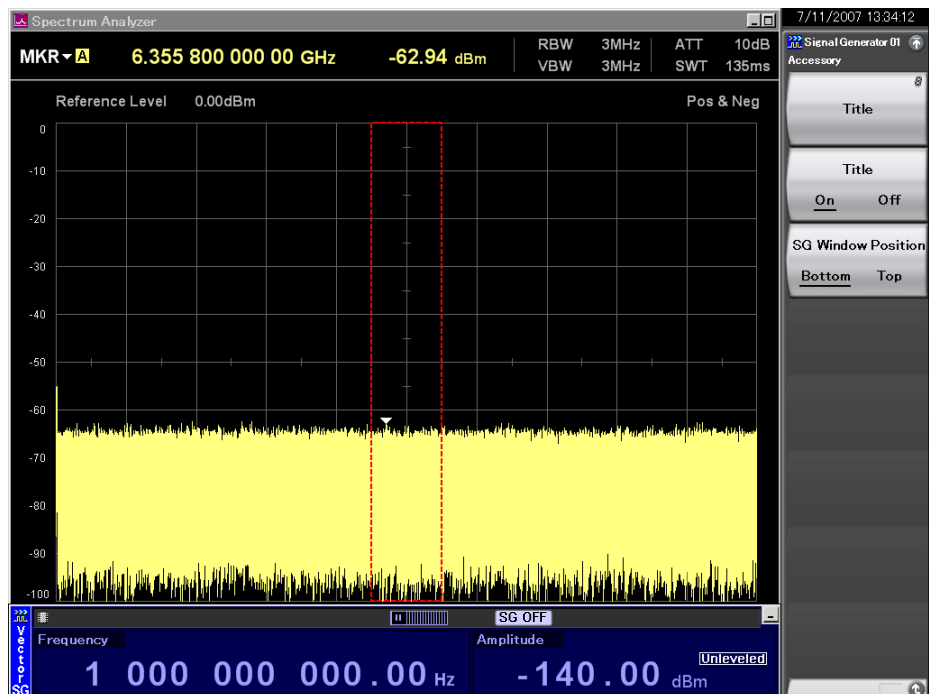



Fig. 2.10.1-1 Accessory setup screen



Fig. 2.10.1-2 Accessory function menu

Table 2.10.1-1 Accessory function menu

Menu Display	Function
Title	For entering the application title.  2.10.2 “Entering application title”
Title (On/Off)	Selects between displaying and not displaying the application title.  2.10.2 “Entering application title”
SG Window Position (Bottom/Top)	Switches the display position of the Signal Generator screen. The Signal Generator screen is displayed at the lower portion when Bottom is selected, and displayed at the upper portion when Top is selected.

2.10.2 Entering application title

This is for setting the application title. The character string entered will be displayed on the top part of the function menu (17 characters maximum).

Example: Entering the application title

<Procedure>

1. Press **F1** (Title) to display the Title Entry window.
2. Enter the title character string and press **F7** (Set).



Fig. 2.10.2-1 Title Entry window

3. The title entered will be displayed on the top part the function menu.

Title display





Fig. 2.10.2-2 Title display

This section describes the procedure for switching between displaying and hiding the application title.

Example: Setting the title display to On/Off

<Procedure>

1. Press  (Title On/Off) to select Off. The title will be hidden.
2. Press  (Title On/Off) to select On. The title will be displayed.

Even if the title is hidden, the set title character string will be retained.

Chapter 3 Operation (BER Measurement Function)

This chapter describes the operation methods for the BER measurement function of the MS2690A-020/MS2691A-020/MS2692A-020.

3.1	Outline of BER Measurement.....	3-2
3.2	Display Description	3-5
3.3	BER Measurement Function Menu.....	3-9
3.4	Connecting MS2690A-020/MS2691A-020/ MS2692A-020 to External System.....	3-11
3.5	Performing BER Measurement.....	3-12
3.6	Setting Automatic Resynchronization Function	3-23
3.7	Setting Input Interface.....	3-28
3.8	Setting PN_Fix Pattern	3-29
3.9	Setting User-defined Pattern	3-35
3.10	Description of BER Measurement Operation	3-43

3.1 Outline of BER Measurement

The MS2690A-020/MS2691A-020/MS2692A-020 can measure the bit error rate (BER) of signals incoming from external systems. By pressing the Application Switch and then BER Test, the MS2690A-020/MS2691A-020/MS2692A-020 can be switched to BER measurement mode.

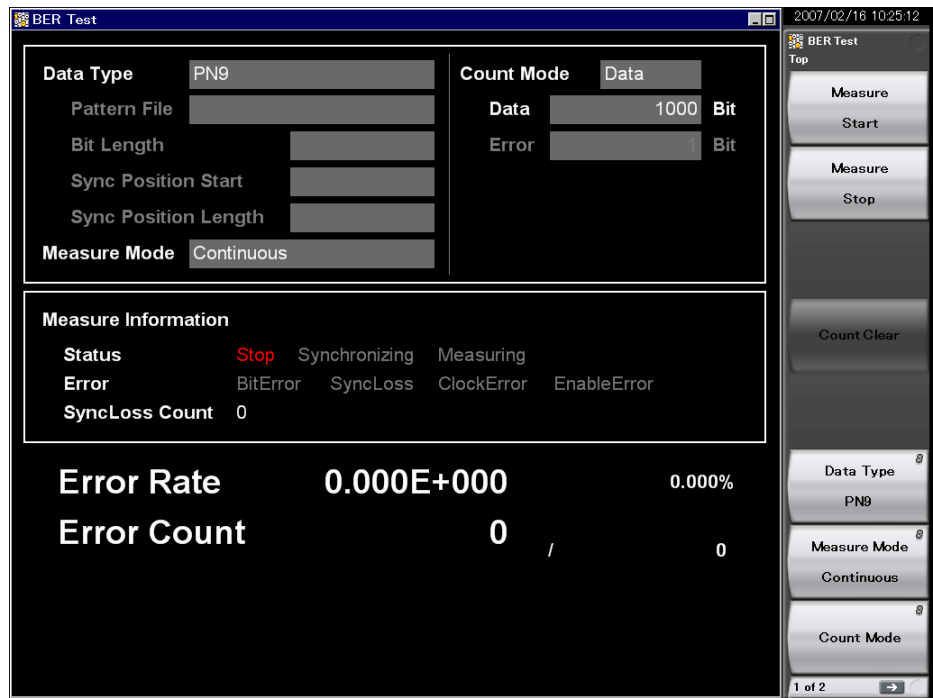

Fig. 3.1-1 BER function main screen

Features of the MS2690A-020/MS2691A-020/MS2692A-020 BER measurement function are as listed below:

Input signals

Data, Clock, Enable

(Polarity inversion is enabled.)

Input level

0 to 5 V

Measurement bit rate

100 bps to 10 Mbps

Measured pattern

PN9, PN11, PN15, PN20, PN23, ALL0, ALL1, repetition of 01, PN9Fix, PN11Fix, PN15Fix, PN20Fix, PN23Fix, and user-defined patterns

Measurement bit count

1000 to 4294967295 bits ($2^{32} - 1$ bits)

Measurement error bit count

1 to 2147483647 bits ($2^{31} - 1$ bits)

The maximum value that can be set as the measurement error bit count is ($2^{31} - 1$ bits). If Count Mode is set to Data, however, counting of the error bit count will continue even if ($2^{31} - 1$ bits) is exceeded.

Operation modes

- Auto Resync: On, Off
- Measure Mode: Continuous, Single, Endless
- Count Mode: Data, Error

Synchronization conditions

Depends on the measurement pattern.

- PN 9, 11, 15, 20, 23: No errors occur for (PN stage count × 2) consecutive bits
- ALL0, ALL1, repetition of 01: No errors occur for 10 consecutive bits
- PN_Fix pattern: See Section 3.1.8.
- User-defined pattern: No errors occur during the period that is set for synchronization judgment

Synchronization probability

The condition required for the MS2690A-020/MS2691A-020/MS2692A-020 to synchronize with a PN signal is that no error occurs for (PN stage count × 2) consecutive bits. The table below lists the probabilities that no error will occur for (PN stage count × 2) consecutive bits for a PN signal that includes random errors. These probabilities thus can be referred to as the probabilities that the MS2690A-020/MS2691A-020/MS2692A-020 synchronizes with a PN signal at a certain error rate in one cycle.

Table 3.1-1 Probabilities that MS2690A-020/MS2691A-020/MS2692A-020 synchronizes with PN signal

PN stage counts Error rate of PN signal (%)	PN9	PN15	PN23
10	15.0	4.2	0.79
3	57.8	40.1	24.6
1	83.5	74.0	63.0
0.1	98.2	97.0	95.5

SyncLoss detection condition

The SyncLoss detection condition can be changed. However, SyncLoss detection is not executed if Auto Resync is set to Off.

3.2 Display Description

This section describes the BER measurement function display items.

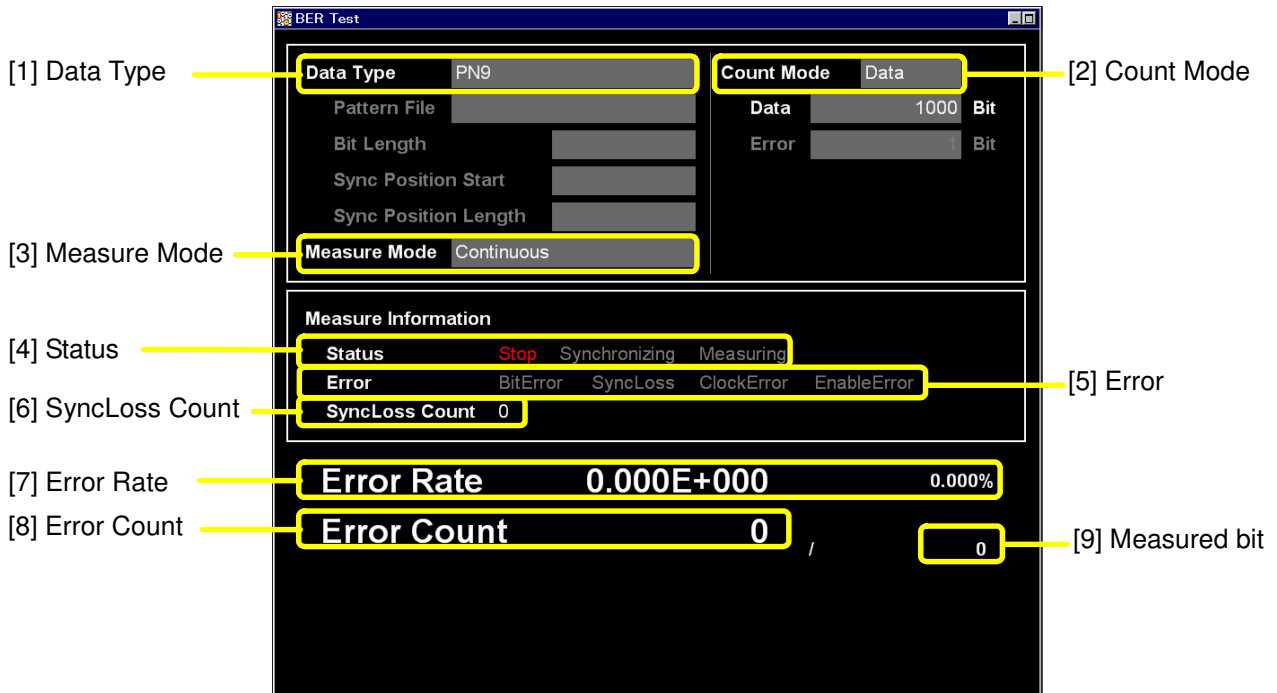

Fig. 3.2-1 BER main screen

3

Operation (BER Measurement Function)

Table 3.2-1 Display items in BER measurement mode

No.	Display	Description
[1]	Data Type	<p>Displays the names of data selected on the list selection popup screen. Characters cannot be directly entered. Displays the data set on the data input screen.</p> <p>When User Pattern is selected in the data settings, parameters related to the loaded User Pattern are displayed.</p> <ol style="list-style-type: none"> 1) Pattern File Displays the name of the loaded User Pattern. 2) Bit Length Displays the length (bit count) of the loaded User Pattern. 3) Sync Position Start Displays the bit at which synchronization of the User Pattern will be started. 4) Sync Position Length Displays the length (bit count) which is compared when synchronizing the User Pattern.
[2]	Count Mode	<p>Characters cannot be directly entered. The count mode set in the setup screen will be displayed.</p> <ol style="list-style-type: none"> 1) Count Mode Displays the count mode set on the input screen. 2) Bit length Displays the bit length of Data and Error set on the input screen.
[3]	Measure Mode	<p>Displays the measurement mode selected in the list selection popup screen. Characters cannot be directly entered. Displays the data set in the data setup screen.</p>

Table 3.2-2 Display items in Measure Information area

No.	Display	Description
[4]	Status	Displays Stop, Synchronizing, and Measuring.
[5]	Error	<p>These messages light up when the following errors occur.</p> <p>BitError: Error bit occurrence SyncLoss: SyncLoss occurrence ClockError: Input clock signal failure EnableError: Input enable signal failure</p> <p>Displays OverflowDataCount or OverflowSyncLoss when the following errors occur.</p> <p>OverflowDataCount: The number of received bits exceeds the maximum value ($2^{32} - 1$ bits).</p> <p>OverflowSyncLoss: The number of SyncLoss errors exceeds the maximum value (65535).</p>
[6]	SyncLoss Count	Displays the number of SyncLoss errors.



Table 3.2-3 Error rate display

No.	Display	Description
[7]	Error Rate	Displays the error rate.
[8]	Error Count	Displays the error count.
[9]	Bit	Displays the number of measured bits.

Error Rate display

Error Rate may be displayed in either floating-point form or fixed-point percentage, which complies with the following rules:

- Floating-point display

Rounding down to the 1/10000th digit from the maximum significant value, the digits up to the 1/1000th digit are displayed.

Example: For 0.00978495
→ Displayed as 9.785E-003.

- Fixed-point percentage display

The value is displayed in percentage. With the fourth digit of the fraction part rounded, the digits down to the third digit of the fraction part are displayed.

Example: For 0.00978495
→ Displayed as 0.978%.

If BER measurement has not yet been performed, the error rate, error count, and received bits count are all displayed as 0.

3.3 BER Measurement Function Menu

This section describes the main function menu on the BER measurement screen.

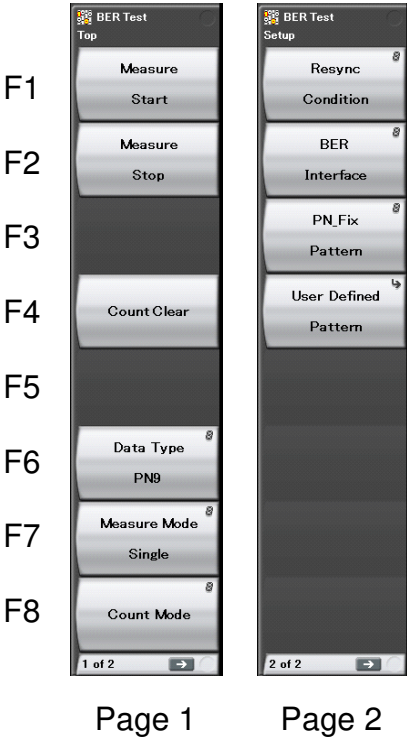











Fig. 3.3-1 Main function menu

Table 3.3-1 Top function menu

Menu Display	Function
Measure Start	Starts BER measurement.  3.5 “Performing BER Measurement”
Measure Stop	Stops BER measurement.  3.5 “Performing BER Measurement”
Count Clear	Clears the count operation.  3.5 “Performing BER Measurement”
Data Type	Selects the data type.  3.5 “Performing BER Measurement”
Measure Mode	Selects the BER measurement mode.  3.5 “Performing BER Measurement”
Count Mode	Selects the measurement termination condition and specifies the bit count.  3.5 “Performing BER Measurement”
Resync Condition	Sets the automatic resynchronization function.  3.6 “Setting Automatic Resynchronization Function”
BER Interface	Performs settings related to the BER measurement interface.  3.7 “Setting Input Interface”
PN_Fix Pattern	Sets PN fix.  3.8 “Setting PN_Fix Pattern”
User Defined Pattern	Displays the Pattern Load function menu.  3.9 “Setting User-defined Pattern”

3.4 Connecting MS2690A-020/MS2691A-020/MS2692A-020 to External System

To perform BER measurement, signals must be input from an external system. Signals can be input from the AUX connector on the rear panel.

Details of BER signal input

The following are signal pins used for BER measurement.

- BER_CLK Inputs a clock signal that is generated in sync with data.
- BER_DATA Inputs the data signal.
- BER_EN Inputs the gate (enable) signal.

Refer to Appendix C “AUX Connector” for details on pin assignment.



Fig. 3.4-1 Input connector

If the enable signal is not used, set “Enable Active” to “Disable.”

Change the settings of the MS2690A-020/MS2691A-020/MS2692A-020 in accordance with the specifications of the input signal.

 3.7 “Setting Input Interface”

3.5 Performing BER Measurement

This function performs various BER measurement settings, and executes the measurement.

BER measurement

<Procedure>

1. Input the signals from the external system according to the instructions in Section 3.4 “Connecting MS2690A-020/MS2691A-020/MS2692A-020 to External System.”
2. Select the data type. Press **F6** (Data Type) to display the Data Type selection window. Move the cursor to the pattern to be used for the measurement and press **F7** (Set) to select a pattern.

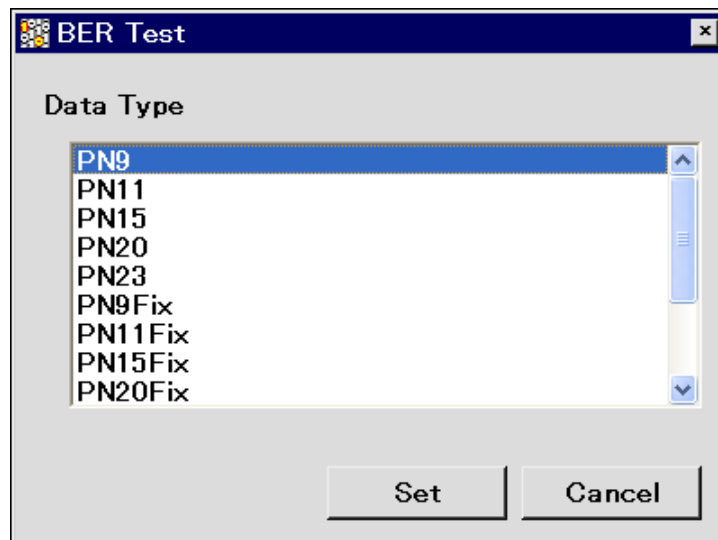



Fig. 3.5-1 Data Type selection window

The following patterns can be selected.

PN9, PN11, PN15, PN20, PN23,
PN9Fix, PN11Fix, PN15Fix, PN20Fix, PN23Fix,
ALL0, ALL1, ALT(0/1), UserDefine

ALT(0/1) indicates a repetition pattern of 0 and 1.

For details on PN_Fix and UserDefine, refer to the following sections respectively:

 3.8 “Setting PN_Fix Pattern”

 3.9 “Setting User-defined Pattern”

- 3. Select BER measure mode. Press **F7** (Measure Mode) to display the Measurement Mode selection window. Move the cursor to the desired measurement mode and press **F7** (Set) to select it.

One of the following three types can be selected for the measurement mode:

- Continuous Performs the measurement continuously for the set bit count or set error bit count.
- Single Performs the measurement for the set bit count or set error bit count.
- Endless Performs the measurement for 4294967295 bits.

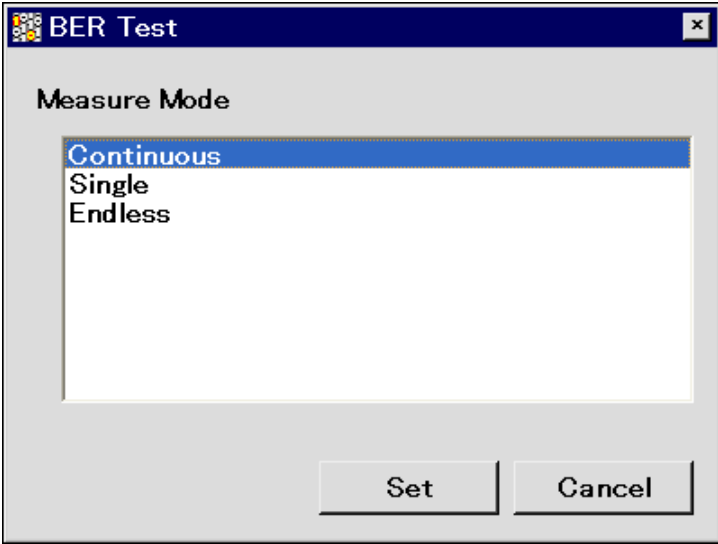

Fig. 3.5-2 Measure Mode selection window

When “Endless” is selected for the measurement mode, the count mode (Count Mode), data bit (Data), and the display of error bit (Error) setting items is darkened.

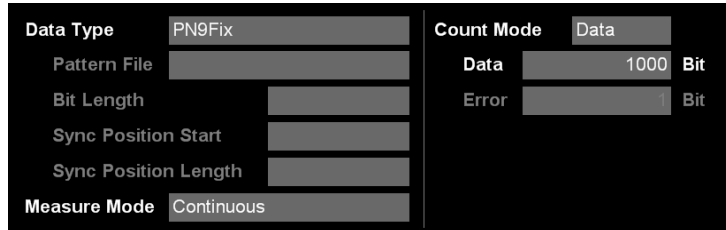

Fig 3.5-3 When Single or Continuous is selected

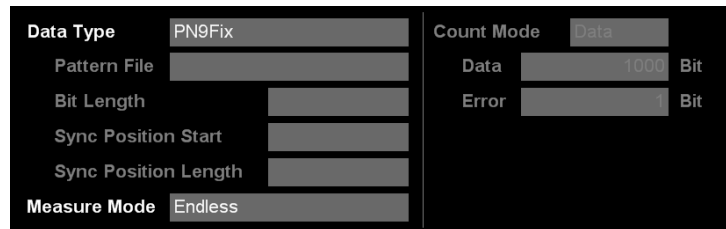

Fig. 3.5-4 When Endless is selected

- 4. Select the measurement termination condition.
This item cannot be set when Endless is selected.
Press **F8** (Count Mode) to display the Measurement termination condition setup window. Move the cursor to the desired measurement termination condition and press **F7** (Set) to select it.
Either of the following two types can be selected for the measurement termination condition:
Data Specify measurement bit count. → Go to Step 5.
Error Specify measurement error bit count. → Go to Step 6.

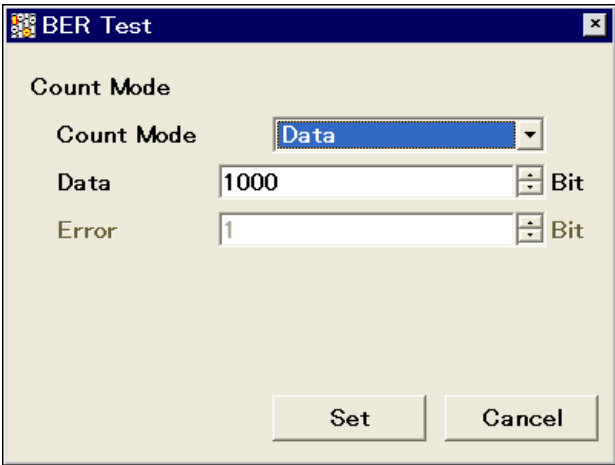

Fig. 3.5-5 Measurement termination condition selection window

- 5. Set the measurement bit count.
This item cannot be set when Endless is selected.
When Count Mode is set to Data, the value in Data Bit can be changed. Set the measurement bit count using the numeric keypad, rotary knob, or **↑** **↓**. Then press **F7** (Set) to set the measurement bit count. The measurement is stopped when the accumulated measurement bit count reaches the set bit count. → Go to Step 7.

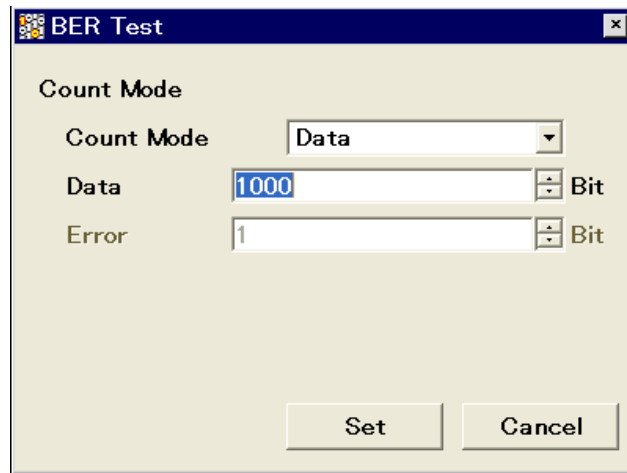





Fig. 3.5-6 Measurement bit count setup window

Measurement bit count setting range: 1000 to 4294967295 bits

6. Set the measurement error bit count.
This item cannot be set when Endless is selected.
When Count Mode is set to Error, the value in Error Bit can be changed. Specify the measurement error bit count using the numeric keypad, rotary knob, or  . Then press  (Set) to count the measurement error bit count. The measurement is stopped when the accumulated measurement error bit count reaches the set bit count.

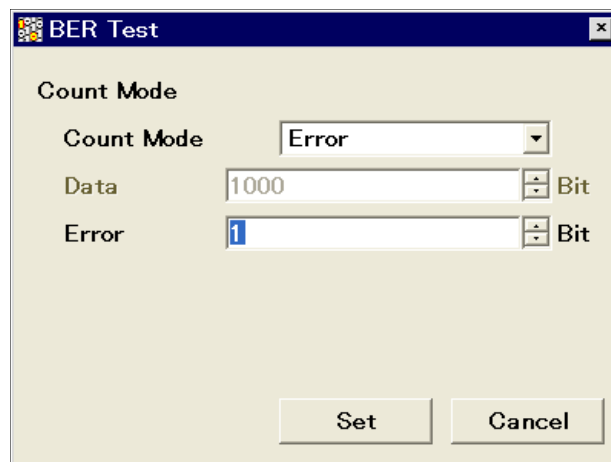



Fig. 3.5-7 Measurement error bit count setup window

Measurement error bit count setting range: 1 to 2147483647 bits

- 7. Configure settings for the automatic resynchronization function. The automatic resynchronization function can be enabled/disabled and the SyncLoss error judgment condition can be set. Refer to the following section for details on the settings.

 3.6 “Setting Automatic Resynchronization Function”

- 8. Press the  (Measure Start) panel key to start BER measurement. If  (Measure Stop) is pressed while BER measurement is in progress, the operation is stopped.

Operation termination conditions differ depending on the operation mode.



Press  to perform BER measurement in Single measurement mode. Press  to perform BER measurement in Continuous measurement mode. If measurement is started using these panel keys, the BER measurement mode settings will be switched automatically.

Table 3.5-1 Operation termination conditions for BER measurement (Single measurement mode)

Auto Resync Count Mode	On	Off
Data	<ul style="list-style-type: none"> • The set measurement bit count is reached. • The SyncLoss count reaches the maximum value (65535). 	<ul style="list-style-type: none"> • The set measurement bit count is reached.
Error	<ul style="list-style-type: none"> • The set measurement error bit count is reached. • The measurement bit count reaches the maximum value ($2^{32} - 1$ bits). • The SyncLoss count reaches the maximum value (65535). 	<ul style="list-style-type: none"> • The set measurement error bit count is reached. • The measurement bit count reaches the maximum value ($2^{32} - 1$ bits).

Measurement is stopped when setting parameters (except for BER Interface).

If a condition listed in Table 3.5-1 above is met in the Continuous measurement mode, measurement is stopped once and then started again.

Measurement continues even if the view moves to another screen while BER measurement is in progress.

If the power is turned off while BER measurement is in progress, the measurement will remain stopped.

When measurement is started with a 10 Mbps signal, the upper limit of the measurement bit count is reached about 430 seconds (max.) later, and measurement is stopped.

BER measurement will be stopped if any of the following operations is performed when the Option 004/104 Wideband Analysis Hardware is installed in the MS2690A/MS2691A/MS2692A.

- Switching the frequency span of the signal analyzer function to 31.25 MHz or less (lower) and to 50 MHz or more (upper).

3.5 Performing BER Measurement

- Switching the application to/from the spectrum analyzer function when the frequency span of the signal analyzer is set to 50 MHz or more.
- Switching the application to/from measurement software when the frequency span of the signal analyzer is set to 50 MHz or more.

Display in each BER measurement mode

The following figures show the difference in the measurement display among BER measurement modes. For the progress state and error rate display during measurement, see Fig. 3.2-1 BER main screen.

Measurement Mode: Continuous

The Measured result is not updated during measurement. When the measurement is completed, the measured result is updated and the measurement then starts again.

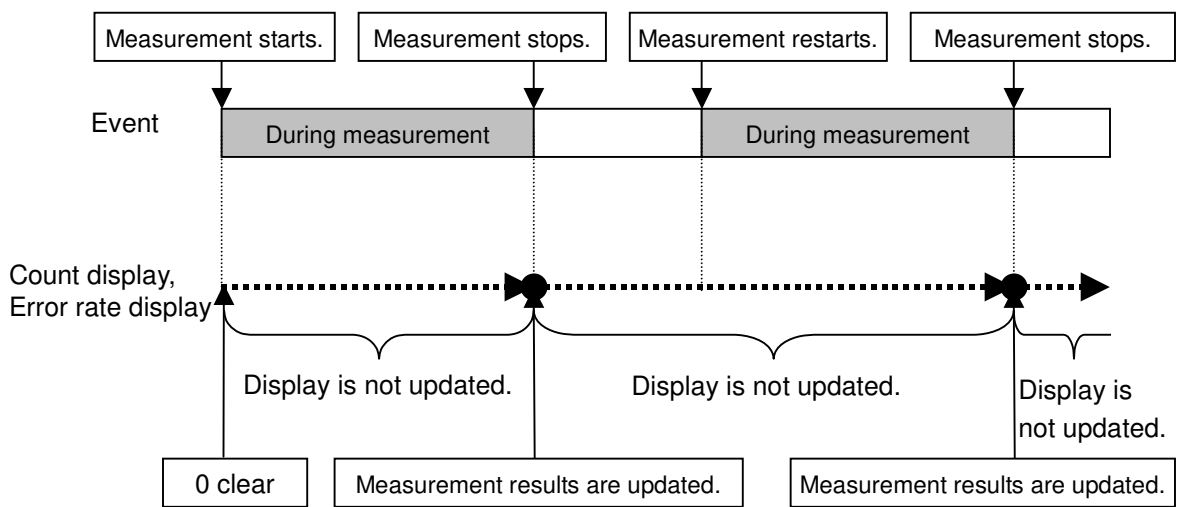

Fig. 3.5-8 Measure Mode Continuous

Measure Mode: Single and Endless

The received bit count, error bit count, error rate are updated as needed during measurement. When the measurement is completed, the display update is stopped.

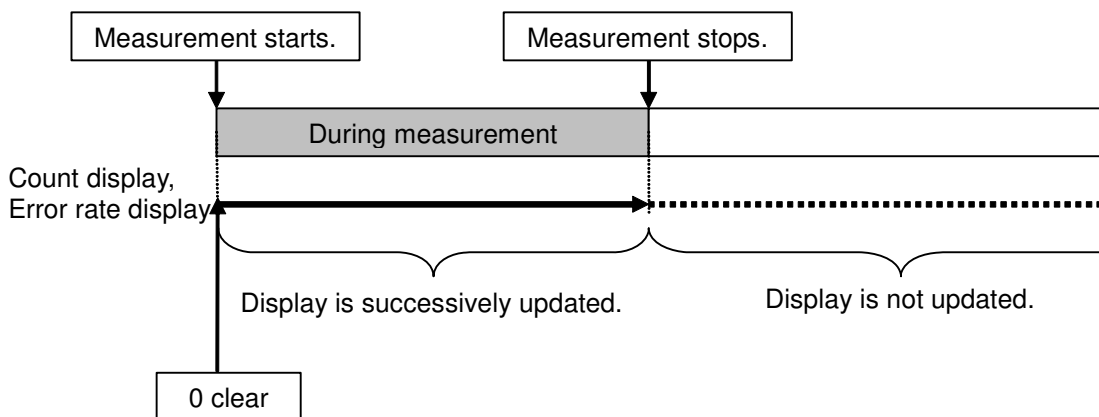

Fig. 3.5-9 Measure Mode: Single and Endless

Count Clear operation

The operation when **F4** (Count Clear) is pressed is described below. The Count Clear operation is disabled when Continuous is selected for the measurement mode.

During measurement (Synchronizing or Measuring):
The received bit count, error rate, and SyncLoss count are cleared during measurement while the synchronization state is held. Therefore, if Count Clear is executed during measurement, the received bit count at the end of measurement is smaller than the set measurement bit count. The same applies to the error bit count.

Example: Display when Count Clear is pressed when measuring 100000 bits

[1] Start the measurement.

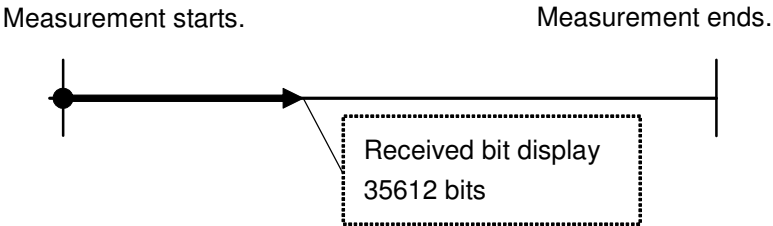

[2] Press Count Clear. The count bit count when the switch is pressed is 35612, however the display is 0 bits.

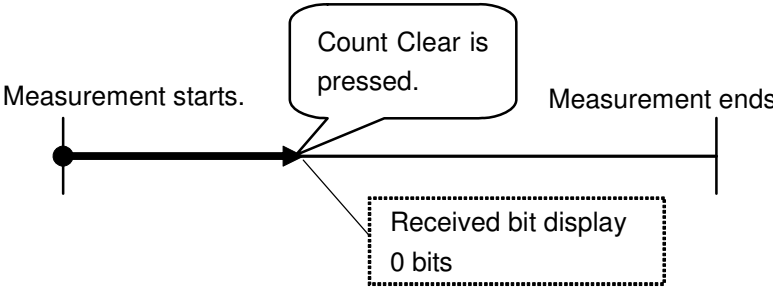

[3] The total count bit count is 100000 bits upon measurement completion, however the display is 64388 bits (100000 - 35612).

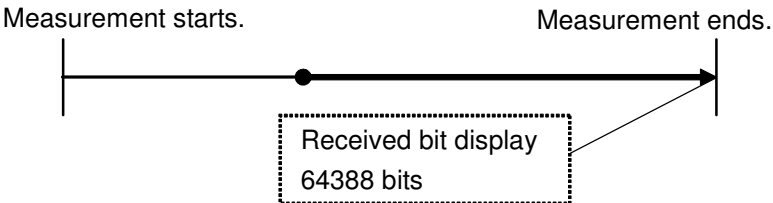

Fig. 3.5-10 Count Clear operation

When measurement is stopped (Stop):

The received bit count, error rate, and progress state displays are cleared.

3.6 Setting Automatic Resynchronization Function

This section describes the settings for the automatic resynchronization function of BER measurement.

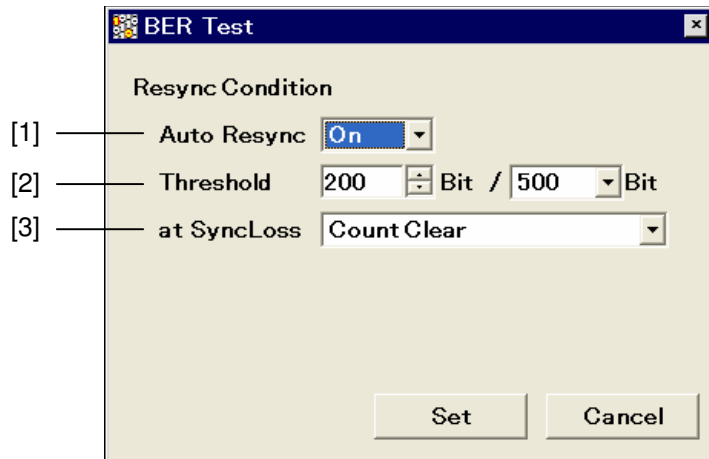

Fig. 3.6-1 Resync Condition setup screen

Setting procedure for automatic resynchronization function

Press **F1** (Resync Condition) from page 2 of the main function menu to perform various settings for the automatic resynchronization function of BER measurement. Use the cursor to select the item to be set and press **F7** (Set) to display the setting window associated with that item.

The following items can be set in this menu.

[1] Auto Resync

Sets the resynchronization operation when SyncLoss occurs.

On SyncLoss is detected. Resynchronization is automatically performed when SyncLoss occurs.

Off SyncLoss is not detected.

The following items are enabled only when Auto Resync is set to On.

[2] Threshold

Sets the SyncLoss detection conditions. When X bits out of Y bits are errors, it is judged as SyncLoss. The values of X and Y can be set here.

Setting range of X (numerator): 1 to (Y/2) bits

Setting range of Y (denominator): 500, 5000, 50000 bits

Any value within the setting range can be set for X, while one of the three preset value should be set for Y.

[3] at SyncLoss

Sets whether to clear the measurement bit count when SyncLoss occurs.

Count Clear Clears the measurement bit count to 0.

Count Keep Retains the measurement bit count.

Details of Auto Resync

The difference in operation when Auto Resync is set to On and Off is described below.

Auto Resync On

If the number of occurred errors exceeds the set Threshold value when synchronization is established, it is judged as SyncLoss, the measurement is stopped, and resynchronization is executed. When Threshold is set to 200/500 (default) and the number of error bits out of 500 bits is 200 or less, measurement can be performed without SyncLoss being detected.

When measuring a signal with a high error rate, a high Threshold value, such as 200/500, can be set to suppress the detection of SyncLoss when block errors occur due to phasing.

When measuring a signal with a low error rate, a low Threshold setting, such as 50/500, can be set to enable resynchronization by quickly detecting SyncLoss when errors occur.

Auto Resync Off

SyncLoss is not detected during measurement. When a signal with a high error rate is measured, the measurement is performed without interruption with this setting. Note, however, that the clock and data may be out of synchronization when the clock is not regenerated on the DUT side. In such a case, set Auto Resync to On for measurement.

The correspondence between the error rate of the measurement target and the recommended setting is shown in the table below.

Table 3.6-1 Error rate of measurement target and recommended setting

Settings Error Rate of Measurement target	AutoResync On		AutoResync Off
	Threshold value: 50/500	Threshold value: 200/500	
Lower than 0.3%	Optimum	Applicable	Applicable
0.3% or Higher	Not recommended	Optimum	Applicable

- Optimum: Most suitable setting
- Applicable: Measurement is possible with this setting.
- Not recommended: SyncLoss may occur frequently with this setting.

Reference:	
Default Threshold value of the MG3700A:	200/500
Threshold setting value of the MP1201C:	200/512
Default Threshold value of the MD6420A:	200/512
Threshold setting value of the MT8820A (WCDMA) BER function:	23/64

The differences between the Auto Resync operation supported in the MS2690A/MS2691A/MS2692A and the Auto Sync operation supported in the MP1201C and MD6420A are described below.

Details of Auto Resync operation

The details of the Auto Resync operation supported in the MS2690A/MS2691A/MS2692A are as follows.

Auto Resync On

Synchronization is executed at the start of measurement, and the measurement is started when synchronization is established. If SyncLoss is detected during measurement, resynchronization is automatically executed.

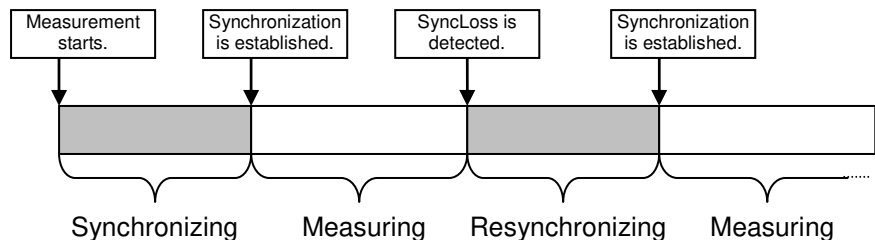

Fig. 3.6-2 Auto Resync On

Auto Resync Off

Synchronization is executed at the start of measurement, and the measurement is started when synchronization is established. SyncLoss is not detected during measurement.

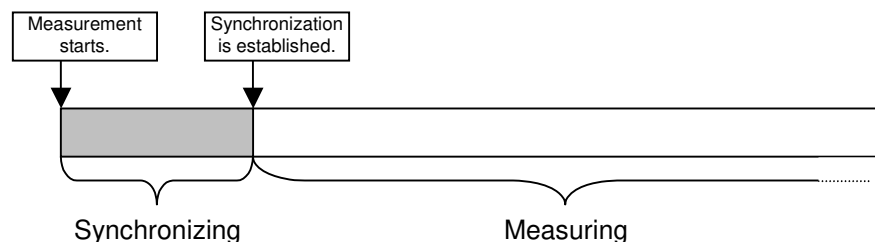

Fig. 3.6-3 Auto Resync Off

Details of Auto Sync operation

The Auto Sync operation supported in the MP1201C and MD6420A is as follows.

Auto Sync On

Synchronization is executed at the start of measurement, and the measurement is started when synchronization is established. If SyncLoss is detected during measurement, resynchronization is automatically executed.

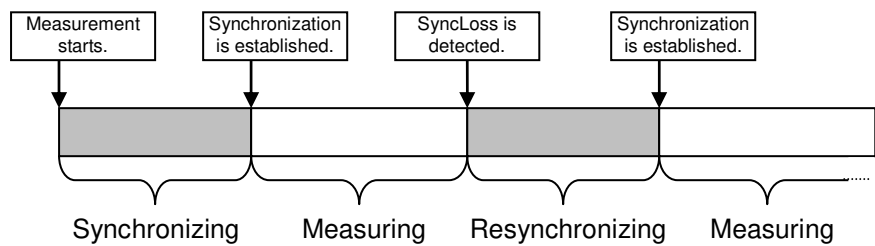

Fig. 3.6-4 Auto Sync On

Auto Sync Off

Measurement is performed on the assumption that synchronization is established at the start of measurement. SyncLoss is not detected during measurement.

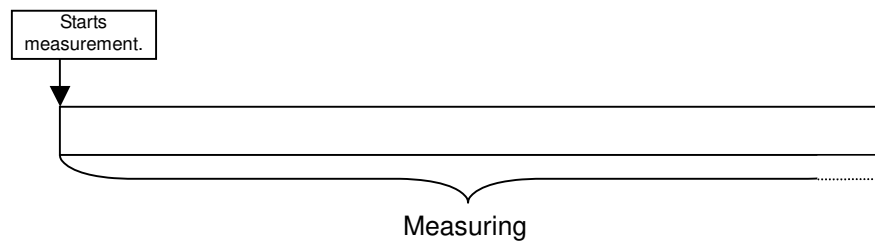

Fig. 3.6-5 Auto Sync Off

Note:

To obtain a BER curve, set Auto Sync to On so as to establish synchronization with superior S/N, and then switch Auto Sync to Off to change S/N and start the measurement.

3.7 Setting Input Interface

This section describes the settings of the input interface used for BER measurement. BER measurement will not stop even if this setting is changed.

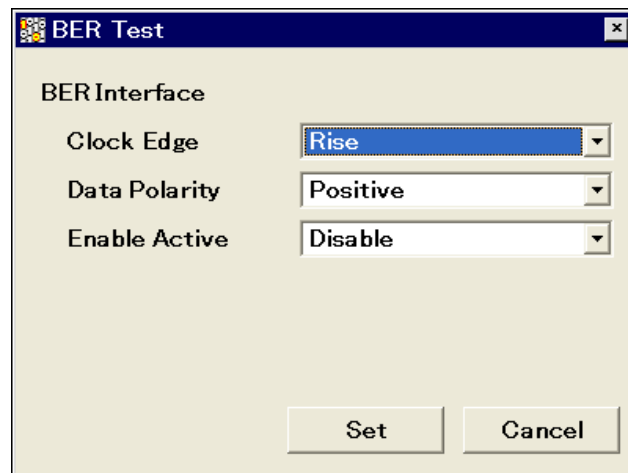

Fig. 3.7-1 Input interface setup screen

Input interface setting procedure

Press **F2** (BER Interface) from page 2 of the main function menu to set the input interface to be used for BER measurement. Use the cursor to select the item to be set and press **F7** (Set) to display the setting window associated with that item. The settings for the input interface can be configured while continuing measurement.

The following items can be set in this menu.

- **Clock Edge (Rise/Fall)**
Switches the Clock signal detection edge between rising-edge detection and falling-edge detection.
- **Data Polarity (Positive/Negative)**
Switches the logic of the Data signal between positive and negative logic.
- **Enable Active (Disable/High/Low)**
Switches the logic of the Enable signal between unused, high active, and low active.

3.8 Setting PN_Fix Pattern

Special PN patterns called PN_Fix patterns can be used for BER measurement.

Details of PN_Fix pattern

A PN_Fix pattern consists of a repetitive part of a PN pattern and a PN pattern shorter than one period.

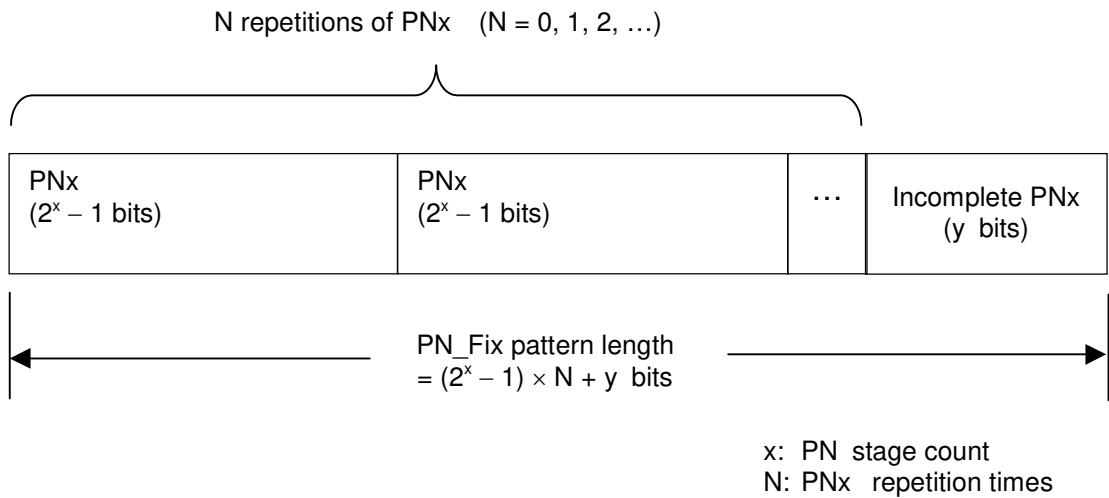

Fig. 3.8-1 PN_Fix pattern

PN_Fix pattern setting procedure

To use a PN_Fix pattern, one of the following PN Fix patterns must be selected via Data Type selection.

PN9Fix, PN11Fix, PN15Fix, PN20Fix, PN23Fix

After the PN Type has been selected, press **F2** (PN_Fix Pattern) from page 2 of the main function menu to enable detailed settings for PN_Fix. Use the cursor to select the item to be set and set a value. The following items can be set in this menu.

3
Operation (BER Measurement Function)

[1] PN Pattern Initial

Sets the initial bit pattern of the PN_Fix pattern.

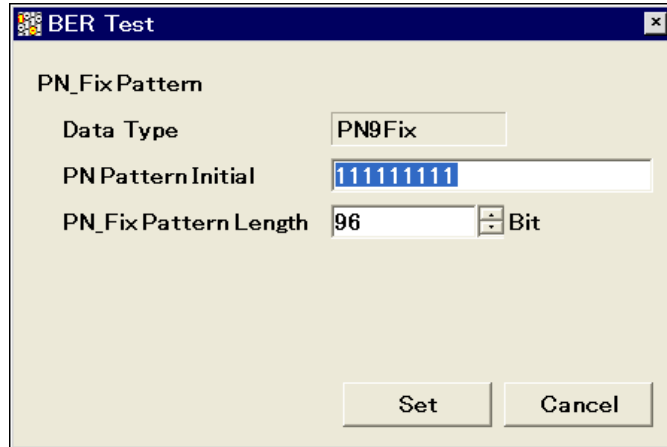

Fig. 3.8-2 PN Pattern Initial setup screen

1. Enter the initial bit pattern of the PN_Fix pattern. Enter the initial bit pattern in binary. Use the numeric key pad (only 0 and 1) to enter numeric values.
2. The settable bit count varies depending on the selected PN type:
PN9Fix: 9 bits
PN11Fix: 11 bits
PN15Fix: 15 bits
PN20Fix: 20 bits
PN23Fix: 23 bits

[2] PN_Fix Pattern Length

Specifies the length of the entire PN_Fix pattern.

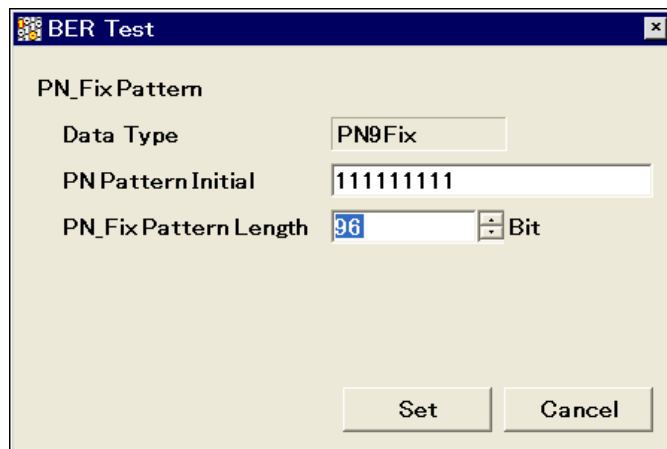

Fig. 3.8-3 PN_Fix Pattern Length setup screen

Setting range: 96 to 134217728 bits

<Note on setting PN_Fix>

When the initial value of PN_Fix is set to All0, the following signals are output:

PN9, PN11, PN20: ALL0 signal

PN15, PN23: ALL1 signal

Synchronization establishing condition for PN_Fix patterns

The synchronization establishing conditions for the PN_Fix pattern are described below.

In the description below, x is assumed as “PN stage count” (x = 9 for PN9).

Synchronization establishment is performed in the following three steps:

- [1] Synchronization with the PN pattern is established if no error is detected for $(x \times 2)$ bits.
- [2] The last bit of the PNxFix pattern is detected from the set initial bit pattern length of the PN pattern.
- [3] Synchronization with the entire PN_Fix pattern is established if no error is detected for x bits beginning with the head of the PN_Fix pattern.

An example of synchronization establishment with the PN9Fix pattern is shown below.

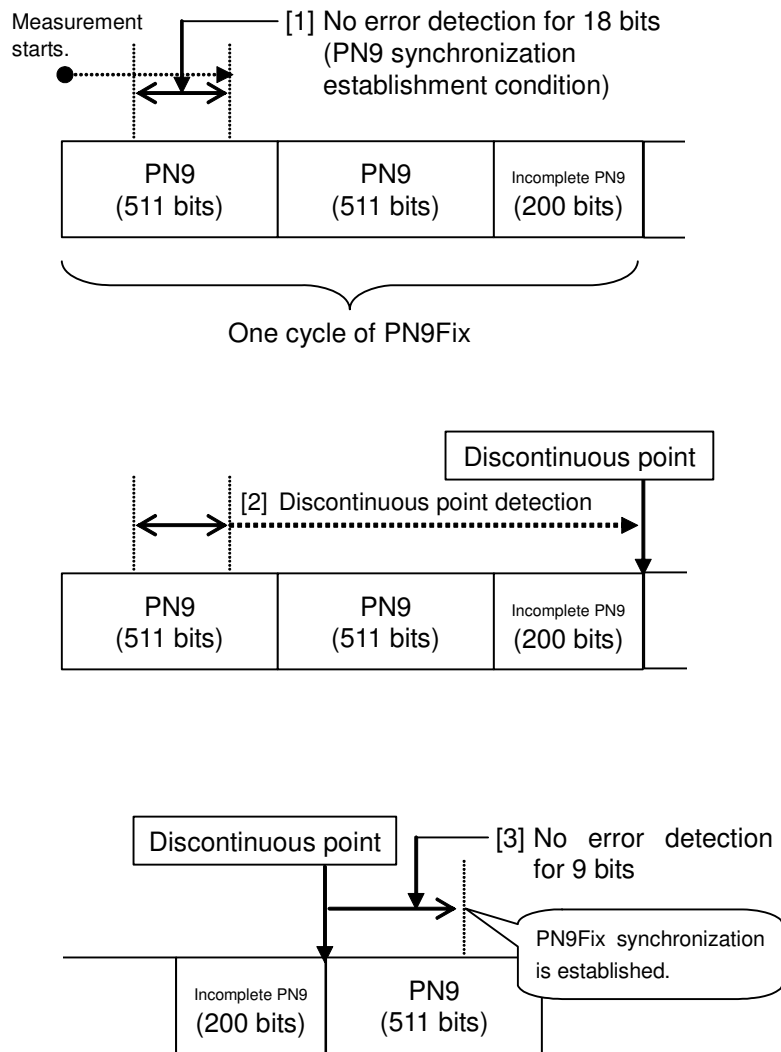

Fig. 3.8-4 Example of synchronization establishment operation for PN9Fix pattern

PN_Fix pattern use example

A specific example of using a PN_Fix pattern is described below.

The following is described on the assumption that the frame format in a communication system is configured with fixed bits A (10 bits) and communication channels B (1000 bits) as shown in Fig. 3.8-5 below.

If PN9 is used for the communication channel, the bit count per frame (1000 bits) does not match the PN9 period (511 bits). In this event, therefore, a period of 511 frames is required to retain the continuity of the PN9 signal of the communication channel.

In the case of a signal generator that uses an arbitrary waveform generator such as the MS2690A/MS2691A/MS2692A, however, the number of patterns that can be stored in the waveform memory may decrease or exceed the capacity of the waveform memory if the number of samples of the waveform pattern becomes larger due to an increase in the number of frames, as described above.

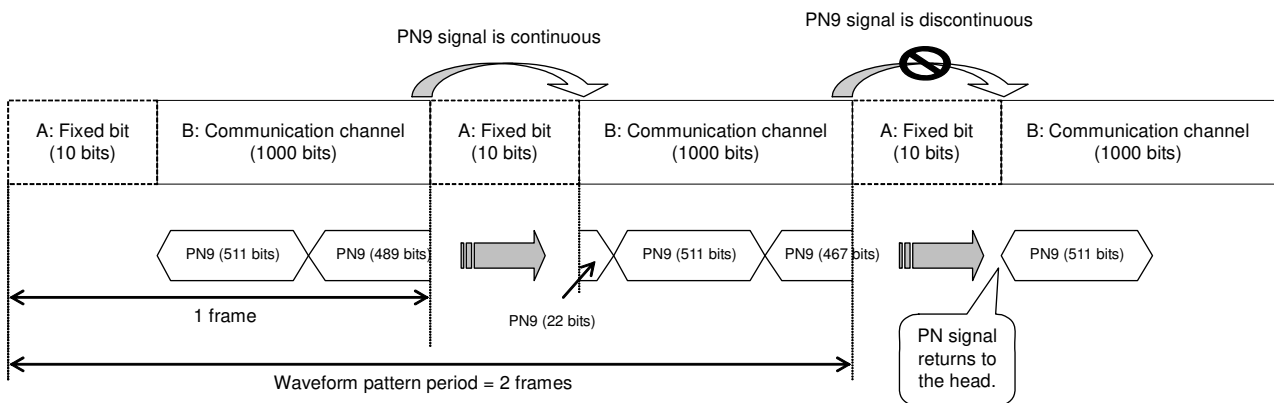

Fig. 3.8-5 PN9Fix pattern example

In such a case, use a signal with a short period, such as a two-frame period signal generated by IQproducer™, and select “PNFix” for “Data Type” (see Fig. 3.8-6 below). BER measurement can then be performed even for signals whose PN9 signal is discontinued in the middle of a frame, as shown in Fig. 3.8-5 above.

Refer to the operation manual of each IQproducer™ for how to set the PN_Fix signal for the IQproducer™.

Note, however, that the random nature of a pseudo random signal may partially be lost during measurement using a PN_Fix signal.



Fig. 3.8-6 BER measurement using PN_Fix data

3.9 Setting User-defined Pattern

The MS2690A-020/MS2691A-020/MS2692A-020 allows the use of patterns created by the user (user-defined patterns) for BER measurement.

Details of user-defined pattern files

User-defined patterns are arbitrary binary sequences with 8- to 1024-bit length.

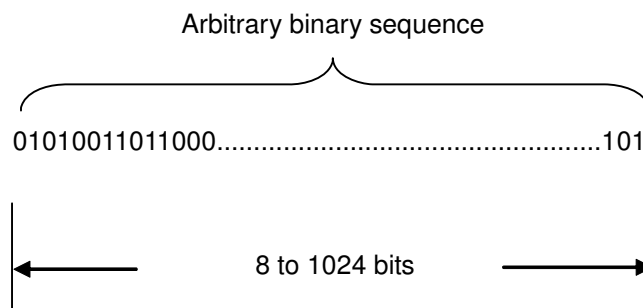

Fig. 3.9-1 User-defined pattern

A user-defined pattern can be created in text file format using a PC. That file is then loaded from USB memory or the internal hard disk of the MS2690A/MS2691A/MS2692A. Create the file as described below and set the extension as “bpn.”

Table 3.9-1 shows the content that can be described in a user-defined pattern.

Table 3.9-1 Content that can be described in user-defined pattern

Character	Description
0, 1	Single-byte numbers. This portion is read as bit data. Numbers must be continuous using characters including spaces and line feeds.
Space	Single-byte space. These are used to make it easier to view bit data editing.
Line feed	CR/LF. This character is used to facilitate the view during bit data editing.
#	Single-byte sharp. Indicates comment lines.

The following shows examples of file content that can be loaded.

Example 1:

```
#20070216 Marked by Anritsu Co.  
0010 0111 0110 0011 0000 1111 0101
```

Example 2:

```
#UserPattern Start  
0000 0000 1111 1111  
#mark001  
0101 0101  
#mark002  
1111 1111 0000 0000
```

Displaying user-defined patterns

To use a user-defined pattern, select UserDefine for Data Type. The parameters for the loaded user-defined pattern will be displayed on the main screen. Blanks will be displayed if no user-defined pattern is loaded.

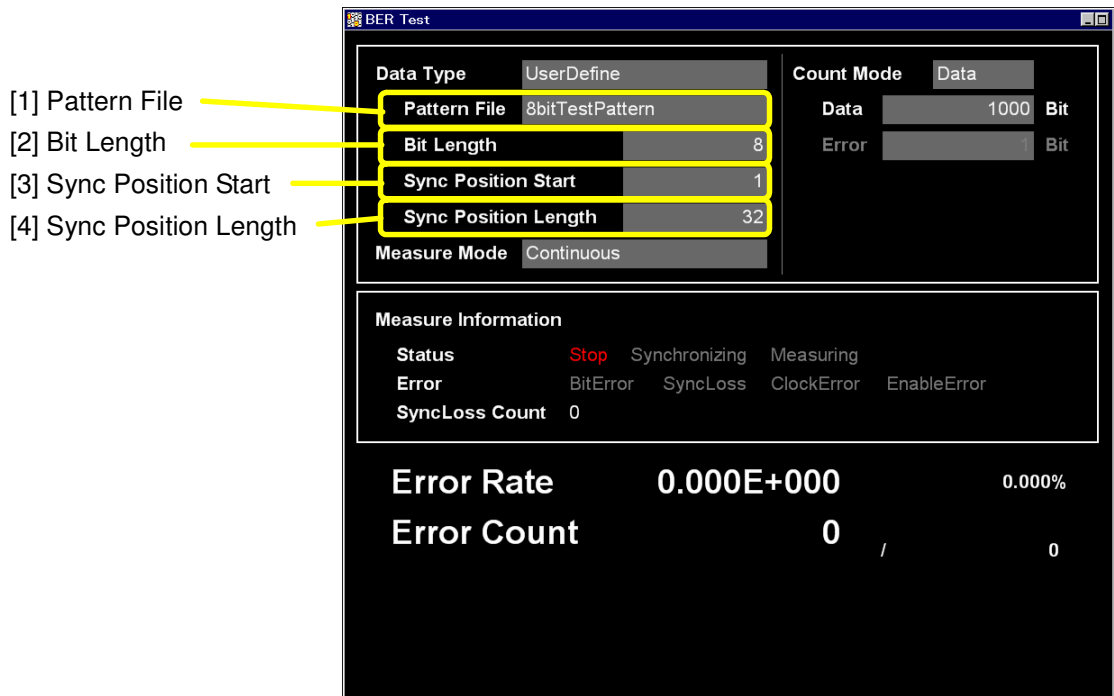

Operation (BER Measurement Function)

Fig. 3.9-2 User-defined pattern parameter display

- [1] Pattern File
Displays the name of the loaded user pattern.
- [2] Bit Length
Displays the length (number of bits) of the loaded user pattern.
- [3] Sync Position Start
Displays the bit at which synchronizing the user pattern is to be started.
- [4] Sync Position Length
Displays a length (number of bits) to be compared with when synchronizing a user pattern.

User-defined pattern function menu

Select User Pattern for Data Type and press **F2** (User Defined Pattern) from page 2 of the main function menu to display the user-defined pattern file function menu.

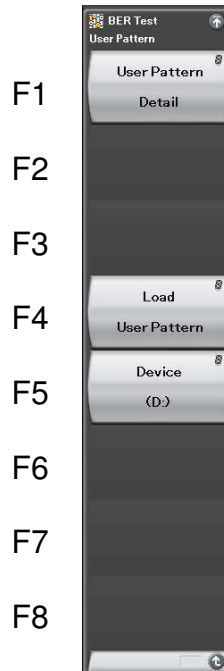

Fig. 3.9-3 User-defined pattern function menu

Table 3.9-2 User-defined pattern function menu

Menu Display	Function
User Pattern Detail	Performs settings related for synchronizing loaded user-defined patterns.
Load User Pattern	Loads user-defined patterns from the USB memory or the internal hard disk of the MS2690A/MS2691A/MS2692A.
Device	Selects the media among the USB memory and internal hard disk from which user-defined patterns are to be loaded.

Procedure for loading User-defined patterns

This section describes the procedure for loading user-defined patterns.

<Procedure>

1. Press **F5** (Device) to select among the USB memory and internal hard disk, the device in which user-defined pattern files to be loaded are stored. Place user-defined pattern files in the root directory of the device.

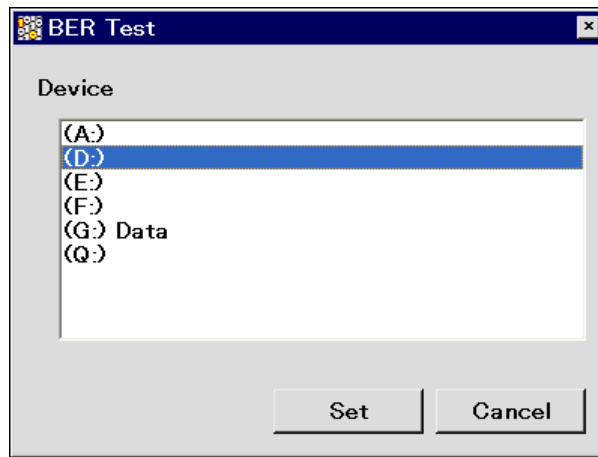

Fig. 3.9-4 Device selection window

2. Press **F4** (Load User Pattern) to display the file selection window.

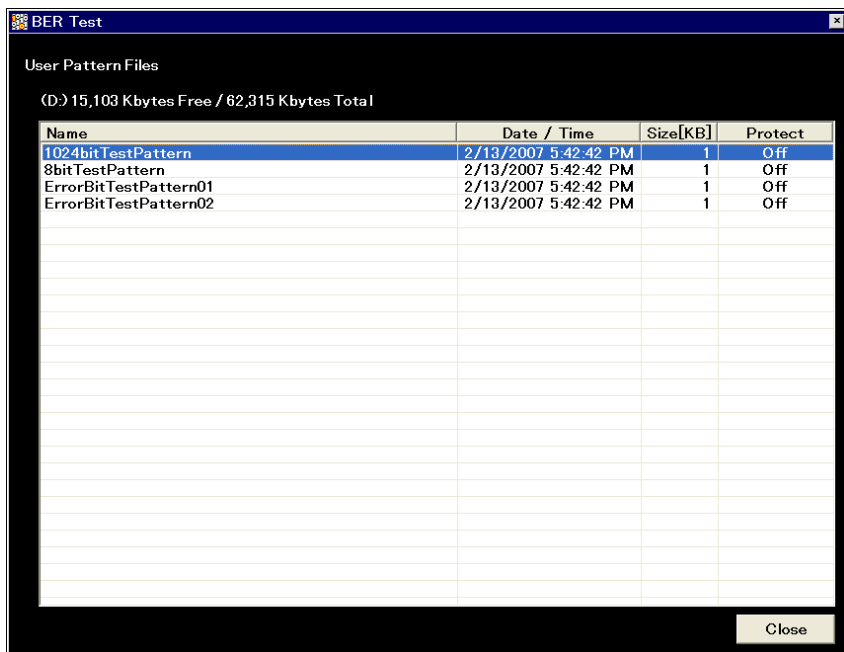





Fig. 3.9-5 File selection window

3. Use the rotary knob or   to select the user-defined pattern file to be loaded.
4. Press  (Set) to load the selected user-defined pattern files.
If  (Cancel) is pressed, loading of the user-defined pattern file is cancelled and the file selection window is closed.

Only files with extension “.bpn” are displayed in the file selection window.

User-defined pattern files must be placed in the root directory of the USB memory or internal hard disk.

File names are displayed in ascending order for numbers and alphabetical characters.

Up to 100 files can be displayed in the file selection window. The 101st and subsequent files will not be displayed.

Up to 32 characters can be used for file names. Files with names consisting of 33 or more characters cannot be loaded.

If no user-defined pattern file exists in the media, the message “No file to read” will be displayed.

Either of the following messages will be displayed if the length of the user-defined pattern is out of the range supported by the MS2690A-020/MS2691A-020/MS2692A-020.

If shorter than 8 bits: “Bit pattern is too short.”

If longer than 1024 bits: “Bit pattern is too long.”

The error message “Illegal character exists.” will be displayed if the user-defined pattern file contains a character other than “0,” “1,” a line feed character, or “#.”

Synchronization establishing condition setting for user-defined patterns

When the user-defined pattern is loaded, set the conditions for synchronization establishment.

Set the start bit and the length of the section to be used for judging the synchronization establishment. If no error is detected in the specified part, it is judged that synchronization is established.

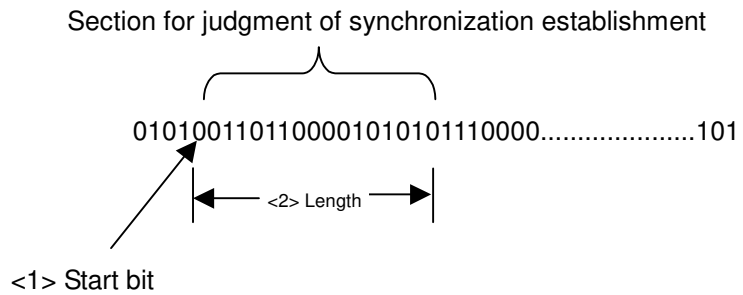

Fig. 3.9-6 Setting method for section judged for synchronization establishment

Example: Setting synchronization for a user-defined pattern

<Procedure>

1. Press (User Pattern Detail) from the user-defined pattern function menu to display the User Pattern Detail setting window.

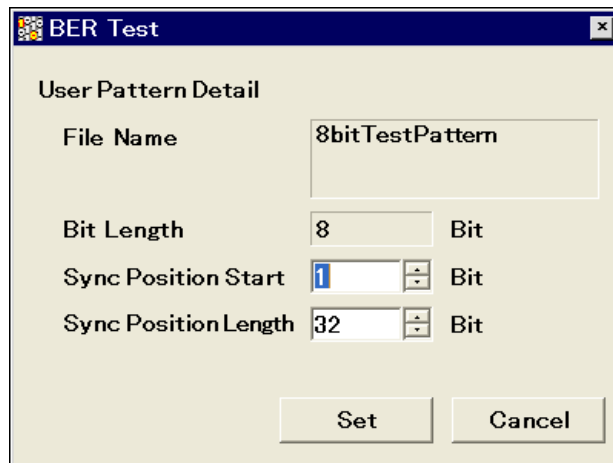



Fig. 3.9-7 User pattern Detail setting window

2. Move the cursor to Sync Position Start and use the numeric key pad, rotary knob, or to set the start bit of the section judged for synchronization establishment.

Range: 1 to the length of the user-defined pattern

3. Move the cursor to Sync Position Length and use the numeric key pad, rotary knob, or   to set the length of the section judged for synchronization establishment.

Range: 8 to 1024

3.10 Description of BER Measurement Operation

This section describes the BER measurement operation, from synchronization to measurement termination.

When Auto Resync is set to Off

The following flowchart summarizes BER measurement operation when Auto Resync is set to Off. In this mode, the error rate is checked immediately after synchronization in order to judge whether synchronization is correctly established. If the error rate is 30% or higher, it is judged as a synchronization failure, and re-synchronization is executed.

3

Operation (BER Measurement Function)

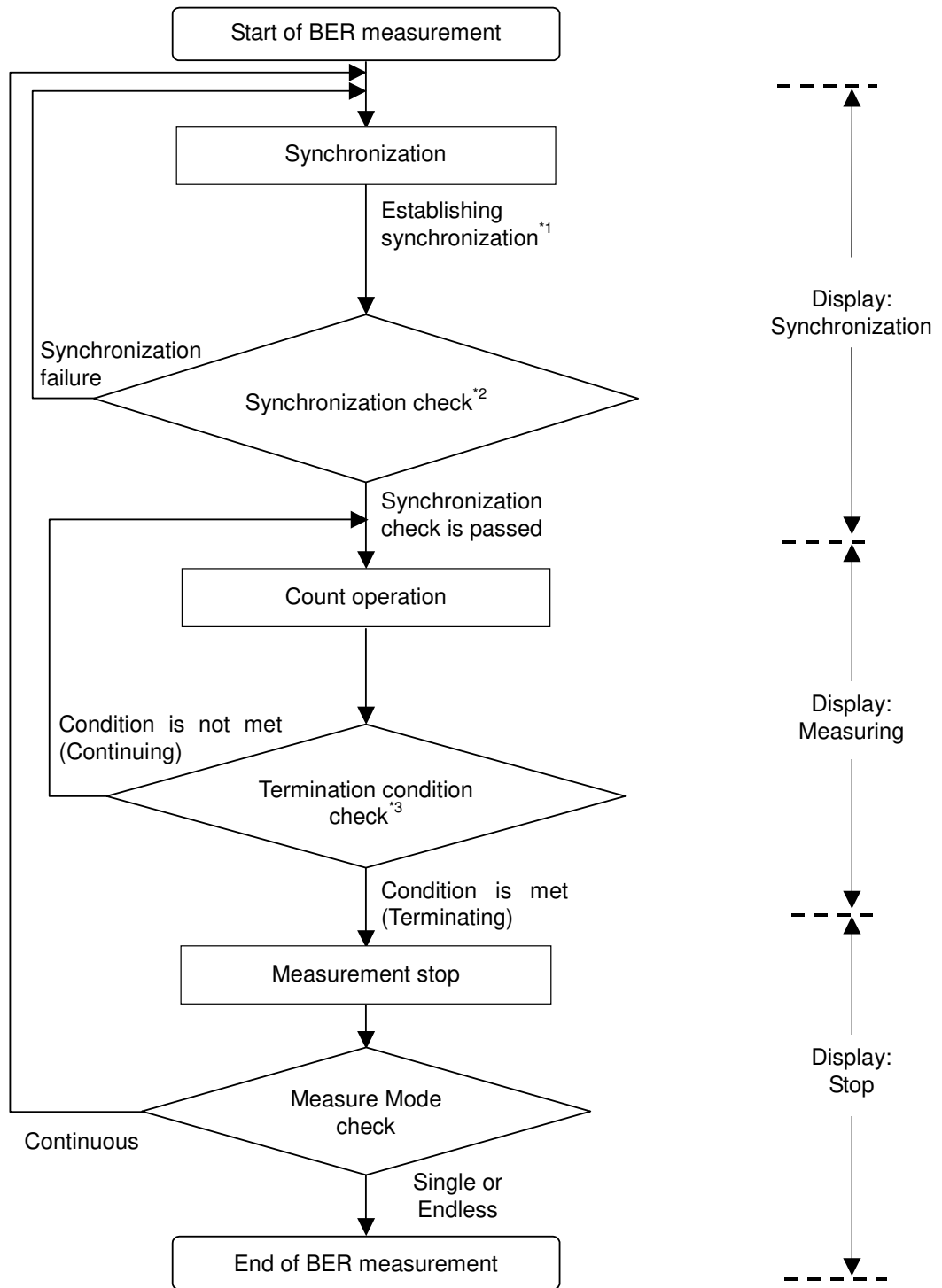

Fig. 3.10-1 When Auto Resync is set to Off

3.10 Description of BER Measurement Operation

- *1: The error rate is not checked if the measurement is terminated with a measurement bit count of less than 1000 bits. The measured values may be incorrect in this event.
- *2: If the error rate when the measurement bit count reaches 1000 bits is 30% or higher, it is judged as a synchronization failure.
- *3: The measurement termination conditions are as follows:
 - The accumulated measurement bit count or measurement error bit count reaches the set bit count.
 - The measurement bit count exceeds the maximum value.
 - The number of SyncLoss errors exceeds the maximum value.

When Auto Resync is set to On

The following flowchart summarizes the BER measurement operation when Auto Resync is set to On. In this mode, resynchronization is automatically executed when SyncLoss occurs.

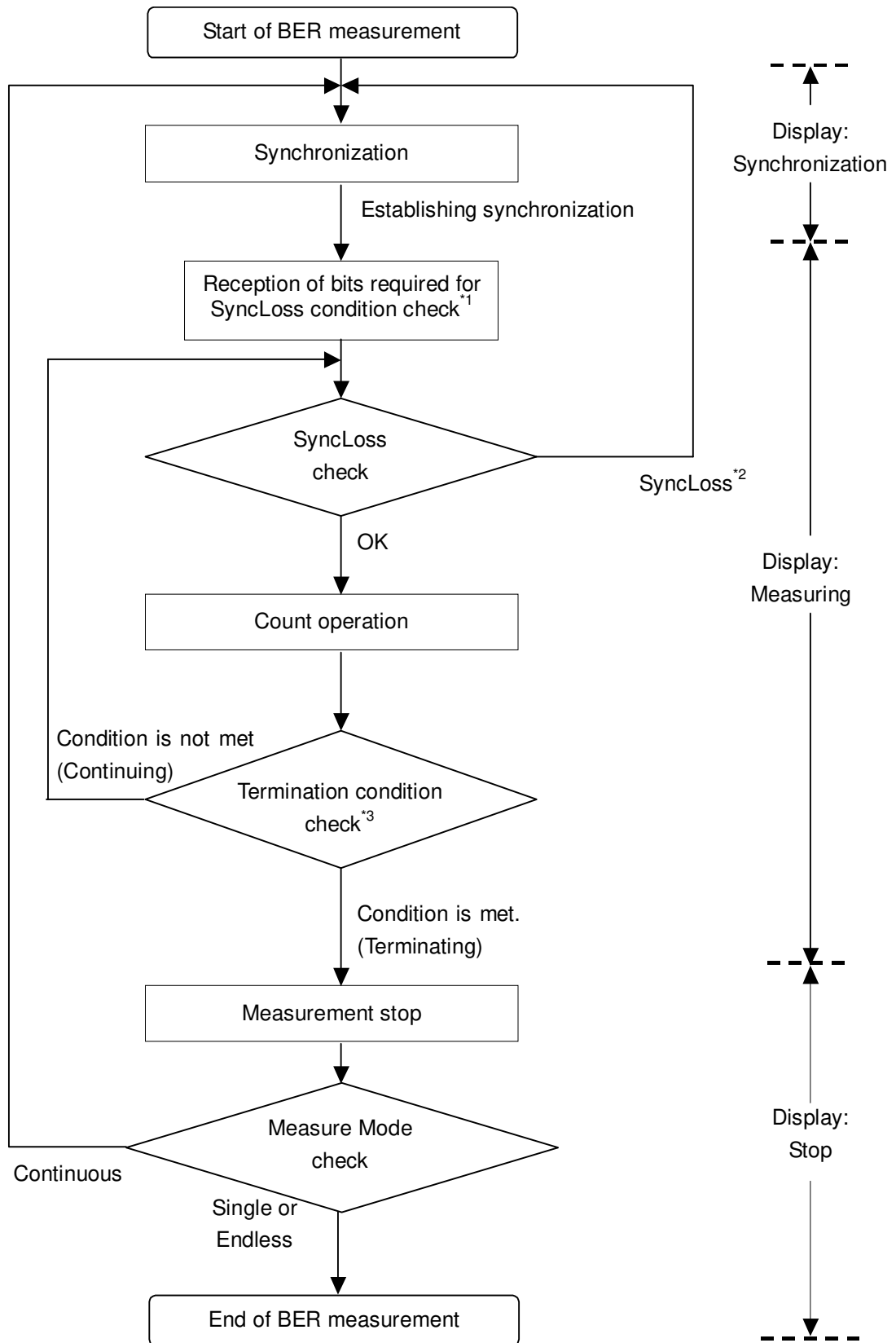

Fig. 3.10-2 When Auto Resync is set to On

- *1: The SyncLoss condition check is not executed until the number of received bits reaches the number of bits set as the denominator of the SyncLoss threshold set in [Threshold] on the Resync Condition Setup screen. Therefore, it may take some time to start the count operation after synchronization is established.
- *2: Operation after SyncLoss occurrence is performed according to the setting specified in “at SyncLoss” on the Resync Condition Setup screen.
- *3: The measurement termination conditions are as follows:
 - The accumulated measurement bit count or measurement error bit count reaches the set bit count.
 - The measurement bit count exceeds the maximum value.
 - The number of SyncLoss errors exceeds the maximum value.

Chapter 4 Performance Test

This chapter describes measurement devices, setup methods, configuration procedures, and performance test procedures required for performing performance tests as preventive maintenance of the MS2690A/MS2691A/MS2692A.

4.1	Overview of Performance Test	4-2
4.1.1	Performance Test	4-2
4.1.2	Performance test items and instruments used	4-3
4.2	Frequency Performance Test	4-4
4.2.1	Frequency	4-4
4.3	Output Level Performance Test	4-6
4.3.1	Output level frequency characteristics	4-6
4.4	Vector Modulation Performance Test	4-8
4.4.1	Vector accuracy	4-8

4.1 Overview of Performance Test

4.1.1 Performance Test

Performance tests are performed as part of preventive maintenance in order to prevent the performance of the MS2690A/MS2691A/MS2692A from being degraded before it occurs. Use performance tests when required for acceptance inspection, routine inspection and performance verification after repairs.

If items that do not meet the required level are detected during performance testing, contact an Anritsu Service and Sales office. Contact information can be found on the last page of the printed version of this manual, and is available in a separate file on the CD version.

CAUTION

Warm up the subject testing device and measuring instruments for at least 30 minutes, in order to stabilize them sufficiently before running performance tests. Demonstrating maximum measurement accuracy requires, in addition to the above, conducting performance tests under ambient temperatures, little AC power supply voltage fluctuations (100 to 120 VAC, 200 to 240 VAC), as well as the absence of noise, vibrations, dust, humidity or other problems.

4.1.2 Performance test items and instruments used

Table 4.1.2-1 lists the performance test items for the MS2690A/MS2691A /MS2692A and measuring instruments used for testing each of these test items.

Table 4.1.2-1 List of performance test items and measuring instruments

Test Items		Summary	Main Instruments Used (Anritsu Model Name)
Frequency	Frequency	A frequency is set and the output frequency is measured.	Counter (MF2412B)
Output level	Output level frequency characteristics	The absolute accuracy is measured using a power meter (frequency characteristics).	Power meter (ML2437A) Power sensor (MA2421A)
Vector modulation	Vector accuracy	A modulation pattern signal is generated through internal modulation, and the vector accuracy is measured using a transmitter tester.	Transmitter tester (MS8609A) W-CDMA measurement software (MX860901B)

Perform items deemed critical at regular intervals as preventive maintenance. A recommended cycle for routine tests of once or twice a year is desirable.

4.2 Frequency Performance Test

4.2.1 Frequency

This test consists of setting the frequency of the MS2690A/MS2691A/MS2692A in the range of 125 to 6,000 MHz, and counting the frequency with a counter (MF2412B) in order to check that the set frequency is output normally.

Test standards

Frequency Range 125 to 6,000 MHz

Frequency setting resolution 0.01 Hz

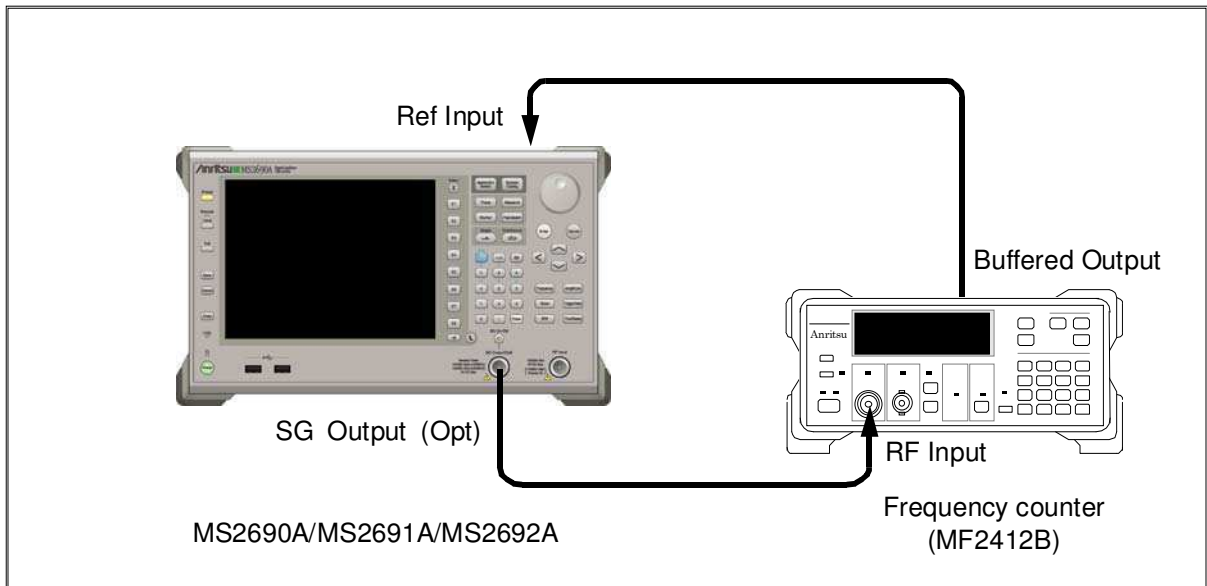



Fig. 4.2.1-1 Frequency test

Test procedure

Set the frequency of the MS2690A/MS2691A/MS2692A in the range of 125 to 6,000 MHz.

1. Connect the reference signal output (10 MHz) of the MF2412B to the external reference input connector (Ref input) of the MS2690A/MS2691A/MS2692A to establish frequency synchronization.
2. Set the measuring resolution of the MF2412B to 10 MHz.
3. Press  to preset the MS2690A/MS2691A/MS2692A.
4. Set the output level of the MS2690A/MS2691A/MS2692A to 0 dBm.
5. Set the output frequency of the MS2690A/MS2691A/MS2692A to the FR(1) value in Table 4.2.1-1.

6. Check that the frequency set for the MS2690A/MS2691A/MS2692A is the same as the frequency displayed by the MF2412B.
7. Repeat the above measuring sequence, changing the frequency FR(x) according to Table 4.2.1-1.

Table 4.2.1-1 Frequency settings

x	FR(x) (MHz)
1	125
2	200
3	300
4	600
5	1000
6	1500
7	2000
8	2500
9	3000
10	3000.001
11	3500
12	4000
13	4500
14	5000
15	5500
16	6000

4.3 Output Level Performance Test

4.3.1 Output level frequency characteristics

Using a power meter (ML2437A) and a power sensor (MA2421A), measure the level for each frequency of the MS2690A/MS2691A/MS2692A at the reference level.

The measurement result is the absolute accuracy for the reference level, and the absolute accuracy below the reference level is obtained through combination with the linearity error measurement result at each frequency.

Test standards

Absolute accuracy ($23 \pm 5^\circ\text{C}$, in CW mode)

Table 4.3.1-1 Test specifications

Output Level	Frequency	
	125 to 3000 MHz	3000 to 6000 MHz
-5 dBm	± 0.5 dB	± 0.8 dB

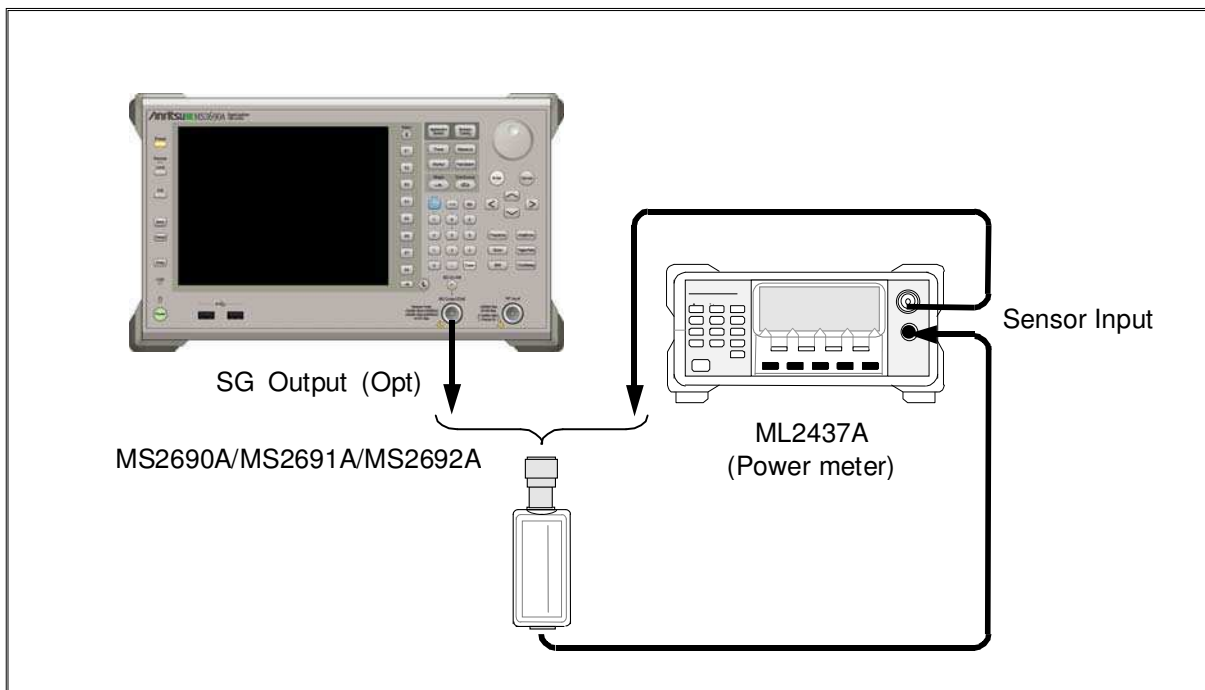

Fig. 4.3.1-1 Output level frequency characteristics test

Perform level measurement according to the frequency table shown in Table 4.3.1-2.

Test procedure

1. Turn on the RF output of the MS2690A/MS2691A/MS2692A.
2. Set the output level of the MS2690A/MS2691A/MS2692A to -5 dBm.
3. Execute sensor calibration (zero point, sensitivity) for the ML2437A.
4. Set the frequencies of the MS2690A/MS2691A/MS2692A and the ML2437A to the FR(1) value in Table 4.3.1-2.
5. Measure the level with the ML2437A.
6. Repeat Step 4, changing the frequency setting FR(x) according to Table 4.3.1-2, to obtain measurement values.

Table 4.3.1-2 Frequency settings for absolute accuracy measurement

x	FR(x) (MHz)
1	125
2	200
3	500
4	1000
5	1500
6	2000
7	2500
8	3000
9	3000.001
10	3500
11	4000
12	4500
13	5000
14	5500
15	6000

4.4 Vector Modulation Performance Test

4.4.1 Vector accuracy

This test consists of generating a baseband signal from the internal waveform pattern, and performance the vector modulation with the MS2690A/MS2691A/MS2692A. The vector error of the modulated RF signal is measured with the transmitter tester (MS8609A) onto which signal analysis software has been installed.

Test standards ($23 \pm 5^{\circ}\text{C}$)

Vector accuracy

$\leq 2\%$ (rms) (Output frequency: 800 to 1000 MHz, 1800 to 2400 MHz•
At W-CDMA 1code modulation)

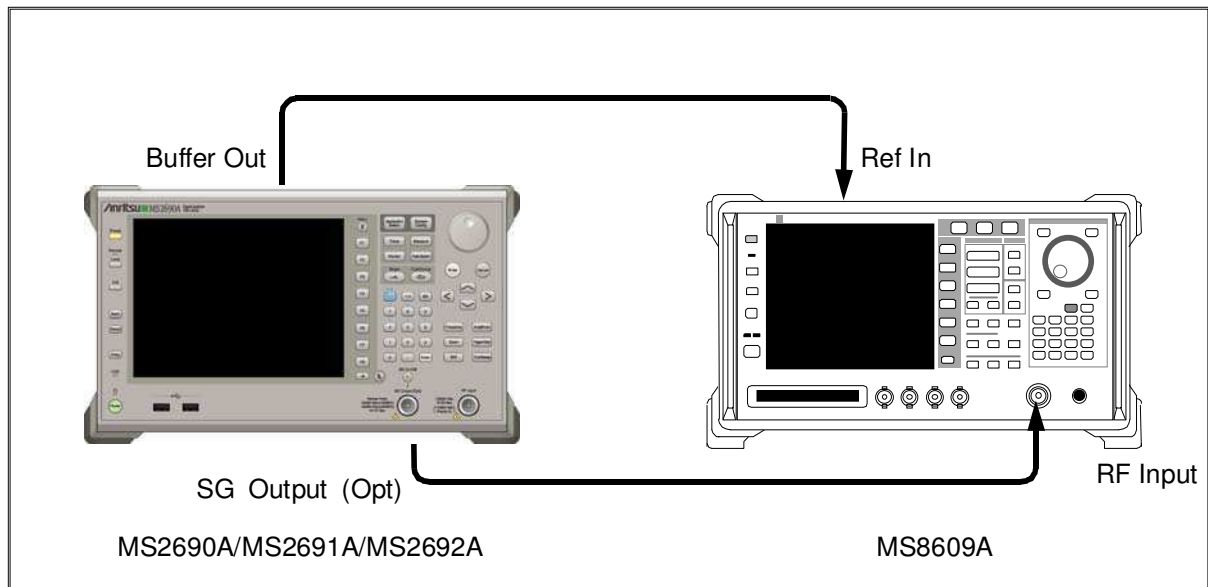

Fig. 4.4.1-1 Vector accuracy test

Test procedure (W-CDMA 1code)

1. Turn on the RF output of the MS2690A/MS2691A/MS2692A and set the output level to -5 dBm.
2. Turn on the vector modulation of the MS2690A/MS2691A/MS2692A and perform modulation with the W-CDMA DL_CPICH of the standard waveform pattern.
3. Set the measurement condition according to the waveform pattern of W-CDMA 1code with the MS8609A mode as TX Tester and System as WCDMA.
4. Set the frequencies of the MS2690A/MS2691A/MS2692A and MS8609A to the FR(1) value in Table 4.4.1-1.
5. Measure the vector error with the MS8609A.

- Repeat Step 3 to obtain the measurement values, changing the frequency setting FR(x) according to Table 4.4.1-1.

Table 4.4.1-1 W-CDMA 1code modulation accuracy measurement frequencies

x	FR(x) (MHz)
1	800
2	1000
3	1800
4	2000
5	2200
6	2400

Appendix

Appendix A Message Display..... A-1
Appendix B Initial Value List..... B-1
Appendix C AUX Connector C-1
Appendix D Performance Test Result Form..... D-1



Appendix

Appendix A Message Display

A.1	Error Messages.....	A-2
A.2	Confirmation Messages.....	A-5

A.1 Error Messages

Table A.1-1 Signal Generator function errors

Message	Description
Out of range	The settable range is exceeded.
Invalid parameter	Invalid parameter
Invalid status	Invalid status
Invalid status Not available in Relative Off.	This operation is invalid when Relative is set to Off.
Invalid status Not available in AWGN Off.	This operation is invalid when AWGN is set to Off.
Invalid status Not available in Modulation Off.	This operation is invalid when Modulation is set to Off (CW).
Invalid status Not available in Reference Clock Source Internal.	This operation is invalid when Reference Clock Source is set to Internal.
Invalid status Not available in Current Level > -5.00dBm.	This operation is invalid when the output level is greater than -5.00 dBm.
Invalid status Not available in Start/Frame Trigger Off.	This operation is invalid when Start/Frame Trigger is set to Off.
Invalid status Not available in Marker Edit Mode Off.	This operation is invalid when Edit Mode in the Marker Setup screen is set to Off.
Invalid status Not available in Marker Edit Mode Pattern Sync.	This operation is invalid when Edit Mode in the Marker Setup screen is set to Pattern Sync.
Invalid status Not available if no Pattern is loaded.	This operation is invalid when no pattern is loaded.
Invalid status Not available if no Pattern is selected.	This operation is invalid when no pattern is selected.
Cannot find checked pattern	The specified pattern cannot be found.
Invalid status Not available if not selected valid pattern	The specified pattern cannot be loaded.
Cannot find pattern on HDD	The specified pattern cannot be found.
Pattern not found The pattern is not found on memory.	The specified pattern cannot be found on memory.
Pattern not found The pattern is not found on HDD.	The specified pattern cannot be found on the hard disk.
Pattern not found The pattern is not found on the device.	The specified pattern cannot be found on the device.
Invalid pattern information file	The pattern information file is invalid.

Table A.1-1 Signal Generator function errors (Cont'd)

Message	Description
Invalid pattern file name	The pattern file name is invalid.
Insufficient pattern information parameter	The pattern parameters are insufficient.
Invalid pattern information parameter	The pattern parameter is invalid.
Invalid pattern license	The pattern license is invalid.
Not match pattern version	The pattern version does not match.
Invalid pattern data size	The pattern data size is invalid.
Pattern data file not found	The pattern data file cannot be found.
The number of pattern files is full in the package.	The maximum number of patterns loadable in one package is exceeded.
The number of pattern files is full on memory.	The maximum number of patterns loadable in waveform memory is exceeded.
The number of packages is full on memory.	The maximum number of packages loadable in waveform memory is exceeded.
Pattern load is finished. Some problems occurred.	An error occurred when loading a pattern.
BER Test application is not found.	BER test application cannot be found.
No function	Invalid function with Signal Generator.
Pattern data over waveform memory size. Free area of the waveform memory is not enough.	Free space in waveform memory is insufficient.
Invalid character	—

Table A.1-2 Load Pattern screen errors

Message	Description
Invalid pattern data size	The pattern data size is invalid.
Pattern information file is not found on HDD.	The pattern information file cannot be found on the hard disk.
Pattern data file is not found on HDD.	The pattern data file cannot be found on the hard disk.
Not available because of mismatch licensed version	Invalid because the license version does not match.
No pattern license	The required license is not installed in the mainframe.
Invalid pattern license	The pattern license is invalid.
Invalid pattern information parameter	The pattern parameter is invalid.
Insufficient pattern information parameter	The pattern parameters are insufficient.
Invalid pattern file name	The pattern file name is invalid.
Invalid pattern information file	The pattern information file is invalid.
Invalid format	The format cannot be analyzed.
Unknown error!	Unknown error

Table A.1-3 BER function errors

Message	Description
Out of Range.	The settable range is exceeded.
This can't be used because it is in Continuous Mode.	This function cannot be used because Continuous mode is selected for MeasureMode.
This can't be used because PNxFix isn't selected.	This function cannot be used because PN_Fix is selected for DataType.
This can't be used because user defined pattern isn't loaded.	This function cannot be used because a user-defined pattern file is not loaded.
This can't be used because user defined pattern isn't selected.	This function cannot be used because a user-defined pattern file is not selected.
No file to read.	No readable file can be found.
Bit pattern is too long.	Cannot be read because the user-defined pattern length is larger than 1024 bits.
Bit pattern is too short.	Cannot be read because the user-defined pattern length is smaller than 8 bits.
Illegal character exists.	Cannot be read because the user-defined pattern contains characters other than "0", "1", a line feed, or a comment marker.
This can't be used because Data is Invalid status.	This function cannot be used when Data is invalid.
This can't be used because MeasureMode is Invalid status.	This function cannot be used when MeasureMode is invalid.
This can't be used because CountMode is Invalid status.	This function cannot be used when CountMode is invalid.
This can't be used because AutoResync is Invalid status.	This function cannot be used when AutoResync is set to Off.
This can't be used because UserDefine isn't selected.	This function cannot be used when UserDefine is selected for Data Type.

A.2 Confirmation Messages

Table A.2-1 Confirmation messages

Message	Description
Overwrite the current pattern data in the waveform memory?	Prompts the user to load and overwrite the currently selected pattern.
Clear all pattern data in the waveform memory?	Prompts the user to delete all patterns loaded in memory.
Delete checked pattern data in the HDD?	Prompts the user to delete the selected pattern from the hard disk.
Delete checked pattern data in the waveform memory?	Prompts the user to delete the selected pattern from memory.
Cancel loading?	Prompts the user to cancel loading the pattern.
Cancel copying?	Prompts the user to cancel copying the pattern.

Appendix B Initial Value List

<Frequency functions>

Frequency	1 GHz
Cursor display digits	0.01 Hz (least significant digit)
Frequency step	100 kHz
RF spectrum	Normal
Frequency switching speed	Normal

<Output level main functions>

Output level	-140.00 dBm
Display unit	dBm
Cursor display digits	0.01 dB (least significant digit)
Output level step	1 dB
Offset On/Off	Off
Offset level	0 dB
Relative display On/Off	Off
RF output On/Off	Off

<Modulation main functions>

Mod On/Off	Off
Output pattern	Not selected
AWGN	
AWGN	Off
C/N Set Signal	Constant
Carrier Power	-140.00 dBm
C/N Ratio	40.00 dB

Appendix B Initial Value List

Ext I/O Setup

Start/Frame Trigger

On/Off	Off
Mode	Start
Delay	0.00
Edge	Rise

Reference Clock

Clock Source	Internal
Clock Division	1

Markers 1 to 3

Polarity	Positive
Edit Mode	Off
Offset	0.00
Width	1.00
Cycle	1.00

(The values given here for Start/Frame Trigger, Reference Clock, and Markers 1 to 3 are initial values before a waveform is selected.)

Pulse Modulation	Internal
SA Trigger Out	Pattern Sync

<BER measurement functions>

Data type	PN9
Measurement termination condition	Data
Measurement mode	Continuous
Measurement bit count	1000 bits
Measurement bit error count	1 bit
Auto Resync	On
Threshold	200/500
at SyncLoss	Count Clear
PN Pattern Initial	ALL1
PN_Fix_Pattern Length	96 bits
User-defined pattern	ALL0
Start bit of the section for judging synchronization establishment	1 bit
Length of the section for judging synchronization establishment	32 bits
User-defined pattern loading source	D drive
Data polarity Pos/Neg	Pos
Clock polarity Rise/Fall	Rise
Enable polarity High/Low/Disable	Disable

Appendix C AUX Connector

Figure C-1 and Table C-1 show the pin configuration and the signals output from each pin for the AUX connector located on the rear panel of the MS2690A/MS2691A/MS2692A.

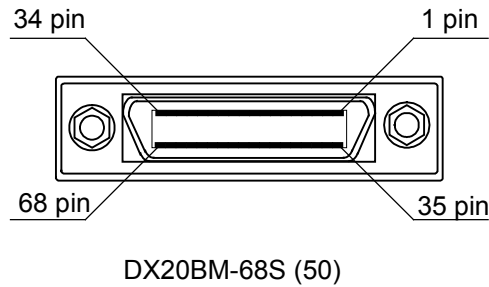

Fig. C-1 AUX connector

Table C-1 AUX connector

Function	Pin No.	Signal name	Function
BER	18	GND	Grounding
	19	GND	Grounding
	20	GND	Grounding
	51	BER_CLK	Inputs Data Clock signals for BER measurement.
	52	BER_EN	Inputs Enable signals for BER measurement.
	53	BER_DATA	Inputs data for BER measurement.
SG	21	GND	Grounding
	22	GND	Grounding
	26	GND	Grounding
	27	MARKER1	Outputs Marker1.
	28	MARKER3	Outputs Marker3.
	30	GND	Grounding
	54	PULS_MOD	Output signals for pulse modulation.
	55	BBvREF_CLK	Inputs the baseband reference clock.
	61	MARKER2	Outputs Marker2.
	62	GND	Grounding

Do not connect anything to connectors not listed in Table C-1 because they are interfaces for equipment maintenance.

The adapter to convert the AUX connector to BNC is sold separately.

Model name: J1373A

Product name: AUX conversion adapter

Refer to Section 1.2.4 “Applicable parts” in the MS2690A/MS2691A/MS2692A Signal Analyzer Operation Manual (Mainframe Operation).

Appendix D Performance Test Result Form

Performance Test Result Form

Test Location _____

Report No. _____
 Date _____
 Test person in charge _____

Equipment Name: MS2690A/MS2691A/MS2692A Signal Analyzer Option 020: Vector Signal Generator

Serial No. _____
 Power frequency _____

Ambient temperature _____ °C
 Relative humidity _____ %

Remarks: _____

Output Frequency (Section 4.2.1)

Setting	Results	
125 MHz	<input type="checkbox"/> OK	<input type="checkbox"/> NG
200 MHz	<input type="checkbox"/> OK	<input type="checkbox"/> NG
300 MHz	<input type="checkbox"/> OK	<input type="checkbox"/> NG
600 MHz	<input type="checkbox"/> OK	<input type="checkbox"/> NG
1000 MHz	<input type="checkbox"/> OK	<input type="checkbox"/> NG
1500 MHz	<input type="checkbox"/> OK	<input type="checkbox"/> NG
2000 MHz	<input type="checkbox"/> OK	<input type="checkbox"/> NG
2500 MHz	<input type="checkbox"/> OK	<input type="checkbox"/> NG
3000 MHz	<input type="checkbox"/> OK	<input type="checkbox"/> NG
3000.001 MHz	<input type="checkbox"/> OK	<input type="checkbox"/> NG
3500 MHz	<input type="checkbox"/> OK	<input type="checkbox"/> NG
4000 MHz	<input type="checkbox"/> OK	<input type="checkbox"/> NG
4500 MHz	<input type="checkbox"/> OK	<input type="checkbox"/> NG
5000 MHz	<input type="checkbox"/> OK	<input type="checkbox"/> NG
5500 MHz	<input type="checkbox"/> OK	<input type="checkbox"/> NG
6000 MHz	<input type="checkbox"/> OK	<input type="checkbox"/> NG

Appendix D

Output Level Frequency Characteristics (Section 4.3.1)

Setting		Minimum Rating	Results	Maximum Rating	Measurement Uncertainty
Frequency	Output Level				
125 MHz 200 MHz 500 MHz 1000 MHz 1500 MHz 2000 MHz 2500 MHz 3000 MHz	-5 dBm	-5.5 dBm	_____	-4.5 dBm	±0.2 dB
3000.001 MHz 3500 MHz 4000 MHz 4500 MHz 5000 MHz 5500 MHz 6000 MHz	-5 dBm	-5.8 dBm	_____	-4.2 dBm	±0.3 dB

Vector Accuracy (Section 4.4.1)

Setting		Maximum Rating	Results	Measurement Uncertainty
Frequency	Output Level			
800 MHz 1000 MHz 1800 MHz 2000 MHz 2200 MHz 2400 MHz	-5 dBm	W-CDMA 1 code 2% (rms)	_____	±0.0%

A	
Accessory	2.1.1
ALC Alarm	2.3.1
Amplitude	2.1.1, 2.3
Application Switch	2.1, 3.1
Auto Resync	3.1, 3.6, 3.10
AUX connector	2.6.3, 2.6.4, 3.4, Appendix C
AWGN Setup	2.1.1, 2.5.1
AWGN	2.1.1, 2.5
B	
Baseband Information	2.1.1, 2.4.8
BER	Section 3
BER Interface	3.3
BER measurement	Section 3
BER Test Control	2.1.1, 2.7
Bit Length	3.9
C	
C/N Ratio	2.5.1
C/N Set Signal	2.5.1
Carrier Power	2.5.3
Change Unit	2.3.1
Check BB Ext Clock	2.2.1
Clear Wave Memory	2.4.3
Clock Division	2.6.3
Clock Edge	3.7
Clock Source	2.6.3
Clock	3.1
Continuous	3.5
Copy Pattern File to HDD	2.1.1, 2.4.4
Count Clear	3.3, 3.5, 3.6
Count Keep	3.6
Count Mode	3.1, 3.2, 3.3
Current Information	2.3.1
Cycle	2.6.4
D	
Data Polarity	3.7
Data Type	3.2, 3.3, 3.5
Data	3.1
Delay	2.6.2
Delete Pattern File on HDD	2.1.1, 2.4.5
Delete Pattern	2.4.3
E	
Edge	2.6.2
Edit Mode	2.6.4
EMF	2.3.1, 2.3.8
Enable Active	3.7
Enable	3.1
Endless	3.5
Error Count	3.2
Error Rate	3.2
Ext I/O Setup	2.1.1, 2.6
External I/O	2.1.1, 2.6
F	
Frame Trigger	2.6.2
Frequency switching speed	2.2.1, 2.2.6
Frequency	2.1.1, 2.2
L	
Level Auto CAL	2.3.1
Level calibration	2.3.10
License file	2.4.1
Load Pattern	2.1.1, 2.4.1
Load User Pattern	3.9
M	
Marker	2.6.4, 2.8
Marker Setup	2.6, 2.6.4
Marker signal	2.6.4
Measure Mode	3.1, 3.2, 3.3, 3.5
Measure Start	2.7.1, 3.3, 3.5
Measure Stop	2.7.1, 3.3, 3.5
Mode	2.6.2
Modulation	2.1.1, 2.4, 2.4.6, 2.4.8
O	
Offset	2.3.1, 2.6.4
Open voltage	2.3.8
Output level	2.3

Index

P

Package	2.4.1, 2.4.2, 2.4.3, 2.4.4, 2.4.5
Pattern File	3.9
Pattern Sync	2.8
PN	3.1, 3.5
PN Pattern Initial	3.8
PN_Fix Pattern Length	3.8
PN_Fix Pattern	3.3
PN_Fix	3.8
Polarity	2.6.4
Pulse Mod	2.4.8
Pulse modulation	2.6.1, 2.6.5

R

Reference Clock Setup	2.6.1, 2.6.3
Reference clock	2.6, 2.6.3
Relative	2.3.1
Resync Condition	3.6
SG Output	2.1.1, 2.3.10, 2.3.11
RF Reverse	2.2.1
RF Spectrum	2.2.1

S

S/F Trigger Setup	2.6.1, 2.6.2
SA Trigger Out	2.8
SA Trigger Out Pattern Sync	2.1.1
Sampling Clock	2.6.3
Select Copy Package	2.4.4
Select Pattern	2.1.1, 2.4.2
SG External I/Q Cal	2.9
SG I/Q Cal	2.9
SG Level Calibration	2.3.1
SG Marker	2.8
Single	3.5
Start Trigger	2.6.2
Start/Frame trigger	2.6
Step Value	2.2.1, 2.3.1
Switching Fast	2.2.1
Switching Speed	2.2.1
SyncLoss Count	3.2
SyncLoss	3.1, 3.5, 3.6
Sync Position Length	3.9
Sync Position Start	3.9

T

Term	2.3.1, 2.3.8
Termination voltage	2.3.8
Threshold	3.6
Title	2.10.1
Trigger	2.6.2, 2.8
Trigger Input	2.6.2

U

Unleveled	2.3.1
User-defined pattern	3.3, 3.9
User Pattern Detail	3.9

W

Waveform pattern	2.1.1, 2.4
Waveform Restart	2.1.1, 2.4.7
Width	2.6.4