

**ML2430A SERIES
POWER METER**

MAINTENANCE MANUAL

The Anritsu logo is rendered in a bold, black, sans-serif font. The letter 'A' is stylized with a diagonal slash through it. The logo is centered horizontally and is flanked by two horizontal lines on each side, which are part of a larger decorative graphic consisting of multiple parallel lines.

490 JARVIS DRIVE • MORGAN HILL, CA 95037-2809

P/N: 10585-00003
REVISION: E
PRINTED: April 2009
COPYRIGHT 1998 - 2009 ANRITSU CO.

WARRANTY

The ANRITSU product(s) listed on the title page is (are) warranted against defects in materials and workmanship for one year from the date of shipment.

ANRITSU's obligation covers repairing or replacing products which prove to be defective during the warranty period. Buyers shall prepay transportation charges for equipment returned to ANRITSU for warranty repairs. Obligation is limited to the original purchaser. ANRITSU is not liable for consequential damages.

LIMITATION OF WARRANTY

The foregoing warranty does not apply to ANRITSU connectors that have failed due to normal wear. Also, the warranty does not apply to defects resulting from improper or inadequate maintenance by the Buyer, unauthorized modification or misuse, or operation outside of the environmental specifications of the product. No other warranty is expressed or implied, and the remedies provided herein are the Buyer's sole and exclusive remedies.

TRADEMARK ACKNOWLEDGMENTS

V Connector and K Connector are registered trademarks of ANRITSU Company. HP 437B, HP 438A, Deskjet, and HP 340 Deskjet are registered trademarks of Hewlett-Packard Company. Adobe Acrobat and Acrobat Reader are trademarks of Adobe Systems Incorporated. Microsoft Excel and Windows are trademarks of Microsoft Corporation.

NOTICE

ANRITSU Company has prepared this manual for use by ANRITSU Company personnel and customers as a guide for the proper installation, operation and maintenance of ANRITSU Company equipment and computer programs. The drawings, specifications, and information contained herein are the property of ANRITSU Company, and any unauthorized use or disclosure of these drawings, specifications, and information is prohibited; they shall not be reproduced, copied, or used in whole or in part as the basis for manufacture or sale of the equipment or software programs without the prior written consent of ANRITSU Company.

Safety Symbols

To prevent the risk of personal injury or loss related to equipment malfunction, ANRITSU Company uses the following symbols to indicate safety-related information. For your own safety, please read this information carefully BEFORE operating the equipment.

Symbols used in manuals

DANGER

Indicates a very dangerous procedure that could result in serious injury or death if not performed properly.

WARNING

Indicates a hazardous procedure that could result in serious injury or death if not performed properly.

CAUTION

Indicates a hazardous procedure or danger that could result in light-to-severe injury, or loss related to equipment malfunction, if proper precautions are not taken.

Safety Symbols Used on Equipment and in Manuals

(Some or all of the following five symbols may or may not be used on all ANRITSU equipment. In addition, there may be other labels attached to products that are not shown in the diagrams in this manual.)

The following safety symbols are used inside or on the equipment near operation locations to provide information about safety items and operation precautions. Ensure that you clearly understand the meanings of the symbols and take the necessary precautions BEFORE operating the equipment.



This symbol indicates a prohibited operation. The prohibited operation is indicated symbolically in or near the barred circle.



This symbol indicates a compulsory safety precaution. The required operation is indicated symbolically in or near the circle.



This symbol indicates warning or caution. The contents are indicated symbolically in or near the triangle.



This symbol indicates a note. The contents are described in the box.



These symbols indicate that the marked part should be recycled.

For Safety

WARNING



Always refer to the operation manual when working near locations at which the alert mark, shown on the left, is attached. If the operation, etc., is performed without heeding the advice in the operation manual, there is a risk of personal injury. In addition, the equipment performance may be reduced.

Moreover, this alert mark is sometimes used with other marks and descriptions indicating other dangers.

WARNING



or



When supplying AC power to this equipment, connect the accessory 3-pin power cord to a 3-pin grounded power outlet. If a grounded 3-pin outlet is not available, use a conversion adapter and ground the green wire, or connect the frame ground on the rear panel of the equipment to ground. If power is supplied without grounding the equipment, there is a risk of receiving a severe or fatal electric shock.

WARNING

Repair

WARNING



This equipment cannot be repaired by the operator. DO NOT attempt to remove the equipment covers or to disassemble internal components. Only qualified service technicians with a knowledge of electrical fire and shock hazards should service this equipment. There are high-voltage parts in this equipment presenting a risk of severe injury or fatal electric shock to untrained personnel. In addition, there is a risk of damage to precision components.

WARNING

If this equipment is used in a manner not specified by the manufacturer, the protection provided by the equipment may be impaired.

Table of Contents

Chapter 1 General Information

1-1	SCOPE OF THIS MANUAL	1-1
1-2	INTRODUCTION	1-1
1-3	RELATED MANUALS	1-1
1-4	IDENTIFICATION NUMBER	1-2
1-5	MODELS, OPTIONS, AND ACCESSORIES.	1-2
1-6	SERVICE POLICY	1-3
1-7	SPARE PARTS LISTING	1-3
1-8	COMPONENT HANDLING	1-4

Chapter 2 Performance Verification

2-1	INTRODUCTION	2-1
2-2	TEST CONDITIONS	2-1
2-3	INPUT RANGE	2-1
2-4	RANGE DATA INTERPRETATION	2-5
2-5	RANGE CALIBRATOR DIAGNOSTICS.	2-6
2-6	CALIBRATOR FREQUENCY	2-7
2-7	CALIBRATOR POWER LEVEL	2-13

Chapter 3 Calibration Procedures

3-1	INTRODUCTION	3-1
3-2	REQUIRED TEST EQUIPMENT	3-1
3-3	TEST CONDITIONS	3-2
3-4	PRE-TEST SETUP	3-2
3-5	DC REFERENCE	3-5
3-6	CALIBRATOR FREQUENCY	3-6
3-7	CALIBRATOR POWER LEVEL	3-7

Chapter 4 Theory of Operation

4-1	INTRODUCTION	4-1
4-2	PRODUCT OVERVIEW	4-1
4-3	GENERAL OPERATION	4-2
4-4	HUMAN INTERFACE	4-2
4-5	GPIB OPERATION	4-3
4-6	PRINTER	4-3
4-7	CASE CONSTRUCTION	4-3
4-8	INTERNAL CONSTRUCTION	4-3
4-9	FRONT PANEL	4-4

4-10	FRONT PANEL CONNECTORS	4-4
4-11	REAR PANEL CONNECTORS.	4-5
4-12	POWER SUPPLY OPERATION	4-6
4-13	BATTERY OPERATION	4-6

Chapter 5 Firmware Updates

5-1	INTRODUCTION	5-1
5-2	CODE LOADER PROGRAM	5-1
5-3	BOOTLOAD MODE.	5-3
5-4	SERIAL INTERFACE CABLE	5-4

Chapter 6 Troubleshooting

6-1	INTRODUCTION	6-1
6-2	FRONT PANEL	6-2
6-3	REAR PANEL	6-4
6-4	BATTERY	6-5
6-5	GENERAL FAULTS	6-6

Chapter 7 Removal and Replacement Procedures

7-1	INTRODUCTION	7-1
7-2	FRONT PANEL	7-2
7-3	POWER SUPPLY	7-4
7-4	MAIN PCB	7-5
7-5	REAR PANEL	7-7

Chapter 8 Service Mode

8-1	INTRODUCTION	8-1
8-2	ACCESSING SERVICE MODE	8-1
8-3	SENSOR SERVICE MODE.	8-2
8-4	GPIB SERVICE COMMANDS	8-4

Appendix A Connector Care and Handling

A-1	INTRODUCTION.	A-1
A-2	CONNECTOR CARE AND HANDLING	A-1

Index

Chapter 1

General Information

1-1 SCOPE OF THIS MANUAL

This manual provides general information, performance verification, calibration, theory, and service information for the Anritsu ML2430A Series Power Meter. The ML2430A Series Power Meters are shown below in Figure 1-1.



Figure 1-1. ML2430A Series Power Meters

1-2 INTRODUCTION

This chapter provides information on other related manuals, the unit identification number, instrument options, service policies, and component handling precautions.

1-3 RELATED MANUALS

This manual is one of a two manual set consisting of this Maintenance Manual, and the *ML2430A Series Power Meter Operation Manual* (ANRITSU part number 10585-00001).

These manuals are available as Adobe Acrobat™ (*.pdf) files from <http://www.us.anritsu.com>. The files can be viewed using Acrobat Reader™, a freeware program provided from Adobe.

**1-4 IDENTIFICATION
NUMBER**

The ML2430A Series ID number is affixed to the rear panel. Please use the complete ID number when ordering parts or corresponding with the ANRITSU Customer Service department.

**1-5 MODELS, OPTIONS, AND
ACCESSORIES**

The ML2430A Series Power Meter is available with either one or two sensor inputs. Model numbers, options, and accessories are listed below.

Models

<u>Model No.</u>	<u>Number of Sensor Channels</u>
ML2437A	Single Channel
ML2438A	Dual Channel

Options

<u>Model No.</u>	<u>Option</u>
ML2400A-01	Rack Mount, single unit
ML2400A-03	Rack Mount, side-by-side
ML2400A-05	Front Bail Handle (Options -01 thru -05 are mutually exclusive.)
ML2400A-06	Rear Panel Mounted Input A
ML2400A-07	Rear Panel Mounted Input A and Reference
ML2400A-08	Rear Panel Mounted Inputs A, B, & Reference
ML2400A-09	Rear Panel Mounted Inputs A and B (Options -06 thru -09 are mutually exclusive.)
ML2400A-11	3000 mA-h, NiMH Battery
ML2400A-12	Front Panel Cover (Can not be used with rack mounted units.)
ML2400A-13	External Battery Charger

Accessories

<u>Part No.</u>	<u>Item</u>
760-206	Hard Sided Transit Case
D41310	Soft Sided Carry Case with shoulder strap
ML2419A	Range Calibrator
MA2418A	50 MHz, 0 dBm Reference Source
B41323	Serial Interface Cable

1-6 SERVICE POLICY

The preferred ML2430A Series Power Meter service policy is to exchange the complete unit. This policy ensures minimum down time for the customer.

**Unit Exchange
Policy**

The customer returns the power meter to the nearest Anritsu Customer Service Center and an identical meter is issued in exchange. The original unit is repaired, calibrated and returned to the customer, whereupon the customer returns the exchange unit to the Anritsu Customer Service Center. The original power meter is returned with the same identification marks and serial number as it had before the repair.

**Spares Kit
Program**

Under circumstances where unit exchange is not possible, a spares kit made up of major modular subassemblies is available from any Anritsu Sales Center.

**1-7 SPARE PARTS
LISTING**

The following spare parts are available for the ML2430A Series Power Meter. Refer to Chapter 7 for Removal and Replacement procedures. Contact your nearest Anritsu Customer Service or Sales Center for price and availability information.

Part Number	Description
ND41357	Power Supply Assembly (w/ power switch)
ND41358	Top Case Assembly
ND41359	Bottom Case Assembly
ND41401	Rear Panel Assembly (no power switch)
ND41474	Rear Panel Assembly (no power switch, rear mounted A, B, and Cal)
ND41402	Power Supply Assembly (no power switch)
ND44172	Front Panel Assembly, ML2438A
ND45354	Main PCB Assembly, ML2437A
ND45361	Rear Panel Assembly (w/ power switch)
ND45365	Main PCB Assembly, ML2438A
ND45368	Front Panel Assembly, ML2437A
ND41469	Battery Cover with fasteners
B41294	Feet, green (as used before Feb 1998)
B41411	Feet, green (as used after Feb 1998)
B41319	Non-slip Pad, Foot Insert, Black
B41256	RF Calibrator Cable Assembly and N Connector, Front Panel
B41257	RF Calibrator Cable Assembly and N Connector, Rear Panel
551-577	Two-pin jumper for use during firmware boot loading

1-8 COMPONENT HANDLING

The ML2430A Series contains components that can be damaged by static electricity. The following figures illustrate the precautions that should be followed when handling static-sensitive subassemblies and components. If followed, these precautions will minimize the possibilities of static-shock damage to these items.

NOTE

Use of a grounded wrist strap when removing and/or replacing subassemblies or parts is strongly recommended.



1. Do not touch exposed contacts on any static sensitive component.

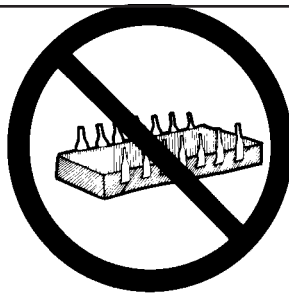

2. Do not slide static sensitive component across any surface.



3. Do not handle static sensitive components in areas where the floor or work surface covering is capable of generating a static charge.

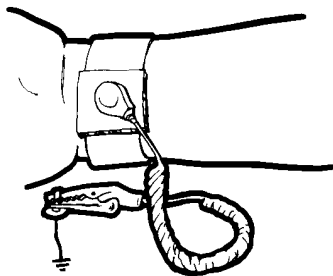

4. Wear a static-discharge wristband when working with static sensitive components.



5. Label all static sensitive devices.

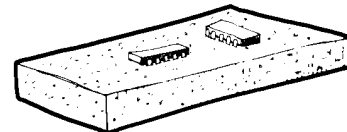

6. Keep component leads shorted together whenever possible.

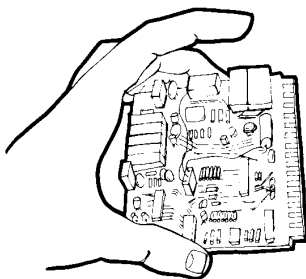

7. Handle PCBs only by their edges. Do not handle by the edge connectors.

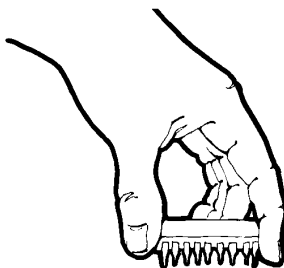

8. Lift & handle solid state devices by their bodies—never by their leads.

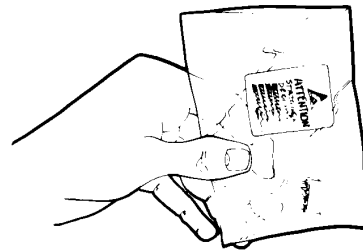

9. Transport and store PCBs and static sensitive devices in static-shielded containers.

ADDITIONAL PRECAUTIONS

Keep workspaces clean and free of any objects capable of holding or storing a static charge.
Connect soldering tools to an earth ground.
Use only special anti-static suction or wick-type desoldering tools.

Chapter 2

Performance Verification

2-1 INTRODUCTION

Performance of the Anritsu ML2430A Series Power Meter can be verified using the procedures in this chapter.

2-2 TEST CONDITIONS

The equipment is intended for use as calibration instruments, and as such must be operated under controlled conditions of temperature and humidity in order to meet its specified precision and stability.

All tests must be performed at a temperature of 25° C (77° F) ± 10° C and a relative humidity of less than 75% at 40° C (104° F), non-condensing.

Prior to making any precision measurements, allow the equipment to warm up for the manufacturer's specified time period (at least 15 minutes from power on for the ML2430A), or as indicated in the procedures. If the power supply is interrupted for any reason, allow a similar settling period.

2-3 INPUT RANGE

The Anritsu ML2419A Range Calibrator is required for this procedure as it provides a traceable series of voltages to facilitate accuracy measurements for the power meter signal channels. The voltages are produced by means of a precision voltage reference and a series of switchable attenuators, operated by a microcontroller. All voltages produced are accurate, stable and low-noise such that errors inherent in the Range Calibrator itself do not contribute significantly to the error measurements of the signal channel.

The Range Calibrator is controlled remotely using the power meter menu system, via the sensor cable(s). On connection of a sensor cable, the meter automatically senses the presence of the Range Calibrator. From this point, the Range Calibrator is controlled using the ML2430A keyboard and displayed menus.

The performance of the ANRITSU ML2430A Series Power Meter's individual signal channel inputs are verified using the following procedure. References in this procedure to sensor input B apply to model ML2438A (dual-channel) power meters only.

1. Connect the Range Calibrator to the Power Meter using 1.5m sensor cables. The input(s) to be verified must be connected to the corresponding connector(s) on the Range Calibrator; that is, connect Power Meter connector A to Range Calibrator connector A, and connector B to connector B (ML2438A only).

2. On connection of the sensor cable(s), the meter automatically detects a Range Calibrator is present and displays the performance verification menus.

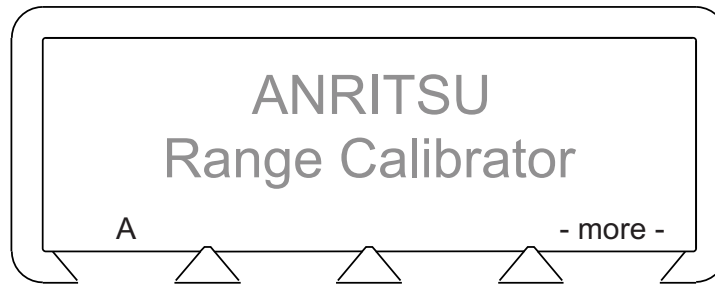

Figure 2-1. ML2419A Top Level Menu (single-channel)

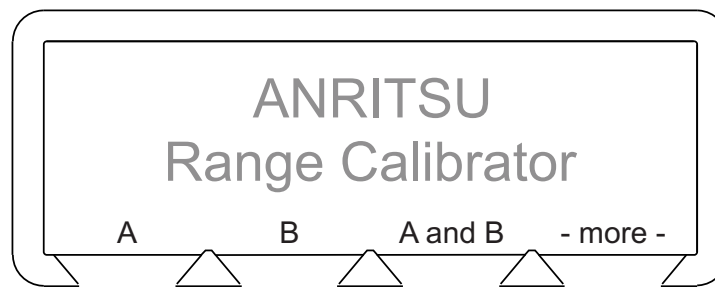

Figure 2-2. ML2419A Top Level Menu (dual-channel)

3. The performance verification tests will begin when the soft key for the sensor input to be verified is selected. For single-channel power meters (ML2437A), press the **A** soft key. For dual-channel models (ML2438A), press **A**, **B**, or **A and B**. If the **A and B** softkey is selected, all measurements are first taken on sensor input A, then repeated for sensor input B. Performance verification tests for each sensor input are performed in the following sequence:
 - ❑ The signal channel input is zeroed
 - ❑ The Power Meter signal channel(s) are checked at the upper and lower levels of each measurement range. A null is performed at each range setting prior to every measurement.

4. When all measurements have been performed on the selected inputs, the results are presented on the screen and the following soft keys are displayed:

Range calibrator results		Sensor A	
Range (upper)		Range (lower)	
1	6.996	1	-11.822
2	-11.822	2	-25.771
3	-25.864	3	-41.808
4	-41.806	4	-57.814
5	-57.805	5	-61.727
SENSOR		PRINT	REPEAT
- exit -			

Figure 2-3. ML2419A Verification Results Menu Example

SENSOR

Toggles the display to show the data for each sensor channel verified. If only one channel has been verified, the SENSOR soft key shown in Figure 2-3 will not be displayed.

PRINT

The verification data can be printed using the PRINT selection. The data is output through the ML2430A Series Power Meter rear panel printer port. The printer parameters will be the same as those selected when operating the meter in stand-alone mode. Refer to the *ML2430A Series Power Meter Operation Manual* (10585-00001) for information on print commands and supported printers.

See Figure 2-4 for an example of a printed Range Calibrator Report.

NOTE

The results of the Range Calibrator tests are available from the power meter via the GPIB, once the Range Calibrator is disconnected from the power meter. Refer to the description of the RCD command in the *ML2430A Series Power Meter Operation Manual*, Chapter 6, GPIB Operation.

REPEAT

The last selected performance verification sequence is repeated.

- exit -

Returns the user to the top-level menu (Figure 2-1 or 2-2).

ANRITSU Power Meter ML2438A s/n: 97310026
Range Calibrator Report

Firmware: 2.01

Date:

Time:

Operator:

Range Calibrator s/n:

Range	Input A	Input B
	Zeroed	Zeroed
Zero	-84.790dB	-86.864dB
Range 1 upper	6.990dB	6.990dB
Range 1 lower	-11.834dB	-11.834dB
Range 2 upper	-11.834dB	-11.834dB
Range 2 lower	-25.774dB	-25.774dB
Range 3 upper	-25.860dB	-25.860dB
Range 3 lower	-41.803dB	-41.803dB
Range 4 upper	-41.803dB	-41.803dB
Range 4 lower	-57.812dB	-57.812dB
Range 5 upper	-57.812dB	-57.812dB
Range 5 lower	-61.732dB	-61.732dB

Figure 2-4. Example Range Calibrator Report

5. To exit the Range Calibrator mode, disconnect the sensor cables. The Power Meter will reset to the default mode.

2-4 RANGE DATA INTERPRETATION

The tabular data presented by the Range Calibrator consist of the values read by the meter for each range, with one measurement taken at each end of each range. For each of these measurements, there is an expected value. These measured values must meet the specification limits defined in the *ML2419A Range Calibrator Operation and Maintenance Manual* (10585-00007).

dB Error Figure

The Range Calibrator measures the “Zero” level, and the “Upper” and “Lower” limits of each of the five ranges (both channels on a dual-channel meter). To calculate the dB Error Figure for each level, subtract the expected level from the measured level.

Pass/Fail Criteria

The meter should be accepted as PASSED if it meets the following conditions applied to the error figures calculated by the above method. Note that the Excel™ spreadsheet form provided with the ML2419A Range Calibrator can also be used to determine pass/fail status.

Range 1 and Range 3 Absolute Error and Linearity:

- The calculated absolute errors for Range 1 Upper and Range 3 Upper should each be ≤ 0.021 dBm.
- The calculated absolute error for Range 1 Lower should differ from the Range 1 Upper error by ≤ 0.021 dBm.
- The calculated absolute error for Range 3 Lower should differ from the Range 3 Upper error by ≤ 0.021 dBm.

Ranges 2, 4 and 5 Linearity:

- For Ranges 2 and 4 the absolute error (calculated as above) for the range Lower Level should differ from that range's Upper Level error by ≤ 0.021 dBm.
- For Range 5, the absolute error (calculated as above) for the range Lower Level should differ from the Upper Level by ≤ 0.033 dB.

Range Change Error

The Range Change Error is defined as the difference between the errors for the two dB levels at the overlap between any two ranges. The maximum Range Change Error between ranges is specified below:

- Range 1 Lower - Range 2 Upper: 0.021 dB
- Range 2 Lower - Range 3 Upper: 0.021 dB
- Range 3 Lower - Range 4 Upper: 0.021 dB
- Range 4 Lower - Range 5 Upper: 0.046 dB

If any of the Range figures are outside of specification, then proceed to the *DC Reference* calibration procedure in Chapter 3.

2-5 RANGE CALIBRATOR DIAGNOSTICS

The Range Calibrator Diagnostics mode allows the user to investigate meter problems by holding on any of the fixed level outputs to examine the results of a particular measurement. From the top-level menu press -more- and DIAGS. When the Diagnostics option is selected, the SENSOR, LEVEL, and ZERO soft keys become available.

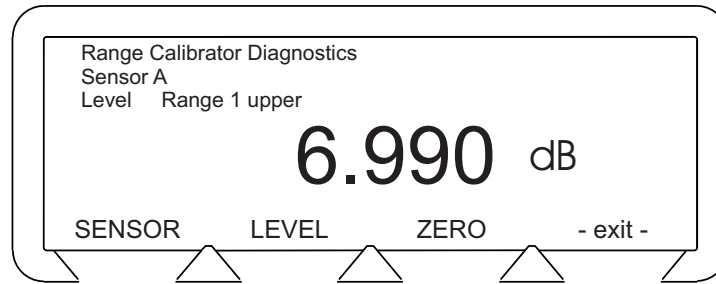

Figure 2-5. Diagnostic Mode Menu

SENSOR Toggles the display to show the measurements for each channel. If only one channel is connected, the SENSOR soft key shown in Figure 2-5 will not be displayed.

LEVEL Selects the level to be verified.

ZERO The selected sensor input is zeroed.

When a SENSOR and LEVEL are selected, the range calibrator outputs the required signal to the appropriate sensor input on the meter, and the meter continuously measures it.

The reading obtained for a particular range should be the same as when the full set of tests were run. To obtain an accurate measurement, it is important to ZERO at each selection of SENSOR and LEVEL.

2-6 CALIBRATOR FREQUENCY

The following procedure is used to measure the Calibrator output frequency of the ML2430A Series Power Meter.

Equipment Required:

- ❑ Anritsu MF2412B Frequency Counter or equivalent
- ❑ RF Cable with BNC male connection at one end and an N-type male connection at other end.

Procedure:

1. Power on the ML243xA and MF2412B. Allow to warm up for 15 minutes before taking any measurements.
2. On the MF2412B, press the **Preset** key.



Figure 2-6. MF2412B

- On the MF2412B, press the **Input** key (also the number **0** key).



Figure 2-7. MF2412B

- On the MF2412B, press the **Left Arrow** key to highlight **Input CH** area.



Figure 2-8. MF2412B

5. On the MF2412B, press the **Enter** key until **Input 2** is selected.

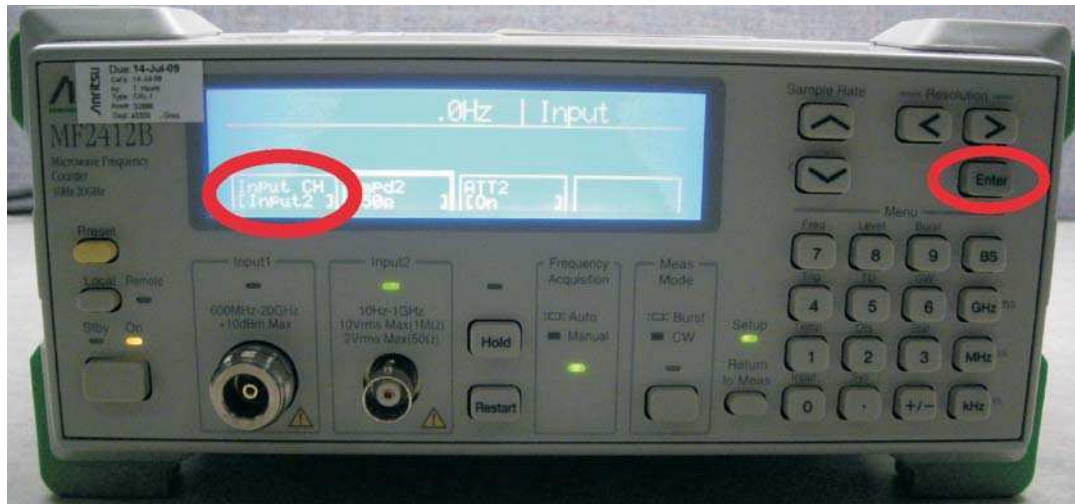

Figure 2-9. MF2412B

6. On the MF2412B, press the **Right Arrow** key to highlight the **Impd2** area.



Figure 2-10. MF2412B

7. On the MF2412B, press the **Enter** key until **50 Ω** is selected.



Figure 2-11. MF2412B

8. On the MF2412B, press the **Return to Meas** key.



Figure 2-12. MF2412B

9. Connect an RF cable from **Input 2** of the MF2412B to the **Calibrator** output of the ML243xA.



Figure 2-13. MF2412B and ML243xA

10. On the ML243xA, turn on the RF calibrator by pressing the **Cal / Zero** key, then the More soft key, then press the RF Off soft key so RF ON is displayed.
11. Now, the ML243xA Calibrator output should be turned on and the MF2412B frequency counter should be reading the frequency of the Calibrator output. Record the frequency below:

$$F_{meas} = \text{_____ MHz}$$

**Calibrator Frequency
Uncertainty:**

The sources of uncertainties of the frequency counter measurement at 50 MHz include:

- ❑ One Count: Least significant digits (LSD) of the frequency counter
- ❑ Time base accuracy from either of the following:
 - ❑ GPS Disciplined Oscillator
 - ❑ MF2412B Frequency Counter
- ❑ Residual error of the frequency counter:
 - ❑ Normal-Mode Measurement Frequency / 1×10^{10}
 - ❑ Fast-Mode Measurement Frequency / 2×10^9

Use the following equation to determine the expanded measurement uncertainty (U_f) with coverage factor $K=2$, 95% level of confidence.

For the MF2412B, use the following numbers to determine U_f :

- ❑ $I_{count} = 1$
- ❑ Time base accuracy for the MF2412:
 - $TBA = 7.5 \times 10^{-8}$ with option 1
 - $TBA = 4.5 \times 10^{-8}$ with option 2
 - $TBA = 1.5 \times 10^{-8}$ with option 3
- ❑ Measurement Frequency:
 - $F_{meas} =$ Frequency reading from the MF2412B (in Hz)
- ❑ Residual Error:
 - $ERR_{Res} = \frac{F_{meas}}{1 \times 10^{10}}$

$$U_f = \pm 2 \sqrt{\left(\frac{I_{count}}{\sqrt{3}}\right)^2 + (F_{meas} \times TBA)^2 + (ERR_{Res})^2}$$

$$U_f = \text{_____ Hz}$$

Verify the frequency of the calibrator $F_{meas} \pm U_f$ is within the range of 50 MHz ± 10 kHz.

If the frequency is outside the 50 MHz ± 10 kHz limits, then proceed to the *Calibrator Frequency* calibration procedure in Chapter 3.

2-7 CALIBRATOR POWER LEVEL

The following procedure is used to measure the Calibrator output power level of the ML2430A Series Power Meter.

Equipment Required:

- ❑ Agilent 432A Analog Power Meter
- ❑ Agilent 34420A Nano Volt / Micro Ohm Meter or equivalent
- ❑ Agilent 8478B Power Sensor

Procedure:

1. Connect the Agilent 34420A to the Agilent 432A using the 4-wire cable provided with the Agilent 34420A.

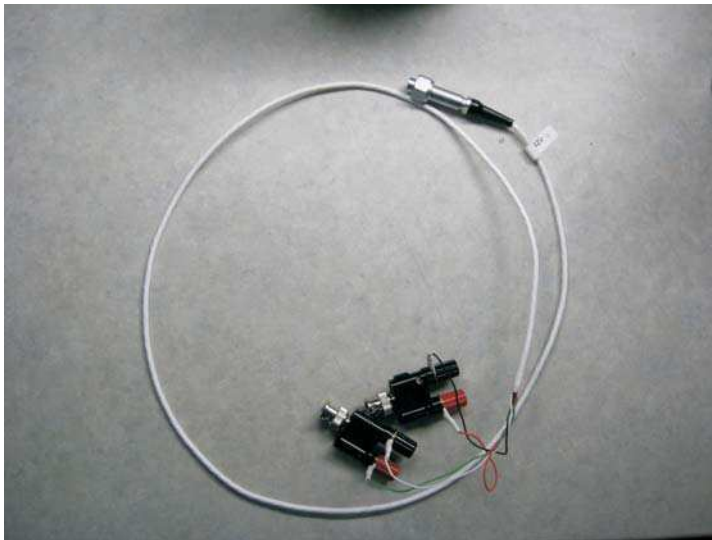

4-wire cable provided with the Agilent 34420A, along with two BNC to binding-posts adapters needed to connect the four wires to the rear of the 432A power meter.

Figure 2-14. 34420A Volt Meter, 4-Wire Cable



Connection shown to the Agilent 34420A volt meter.

Figure 2-15. 34420A Volt Meter



Connection shown to the rear of the 432A power meter:

- Green = V_{rf}
- White = GND of V_{rf}
- Red = V_{comp}
- Black = GND of V_{comp}

Figure 2-16. 432A Power Meter, Rear Panel

2. Connect the Agilent Power Sensor 8478B to the Agilent 432A Power Meter.



432A Power Meter
shown connected to the 8478B
power sensor.

Figure 2-17. 432A Power Meter

3. Power on the 432A power meter and the 34420A voltmeter. Allow the units to warm up for 15 minutes before taking any measurements.

4. On the front panel of the 432A power meter, set the mount resistance to 200 Ω .



Figure 2-18. 432A Power Meter

5. On the front panel of the 432A power meter, set the calibration factor to 100.



Figure 2-19. 432A Power Meter

6. After the 432A and 34420A have warmed up for 15 minutes, perform a zero of the 432A power meter according to the instructions listed in the 432A user manual.

- On the front panel of the 432A power meter, set the Range to 0 dBm.



Figure 2-20. 432A Power Meter

- On the ML243xA, set the RF Calibrator to **RF OFF**. This can be done by pressing the **Cal/Zero** hard key, then the **More** soft key, and then verify the left-most soft key shows **RF OFF**. If it shows RF ON, then press it once to show **RF OFF**.



Figure 2-21. ML243xA Power Meter

9. Connect the 8478B power sensor to the ML243xA Calibrator.

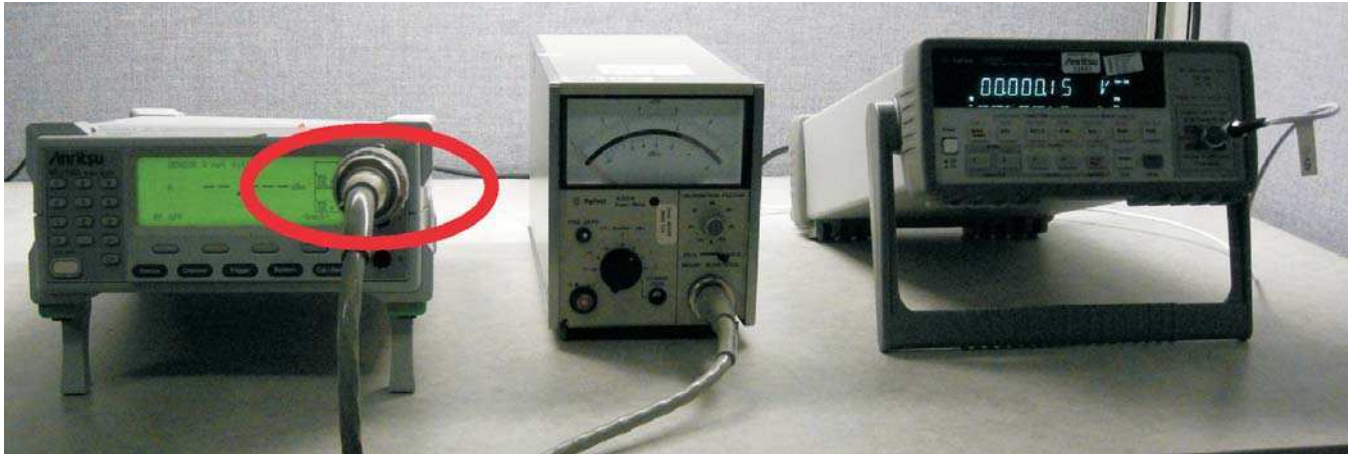

Figure 2-22. ML243xA and 432A Power Meters and 34420A Volt Meter

10. Select DCV 1-2 on the Agilent 34420A. Record the number shown in the display of the 34420A as V_0 .

$$V_0 = \text{_____} \text{ V}$$

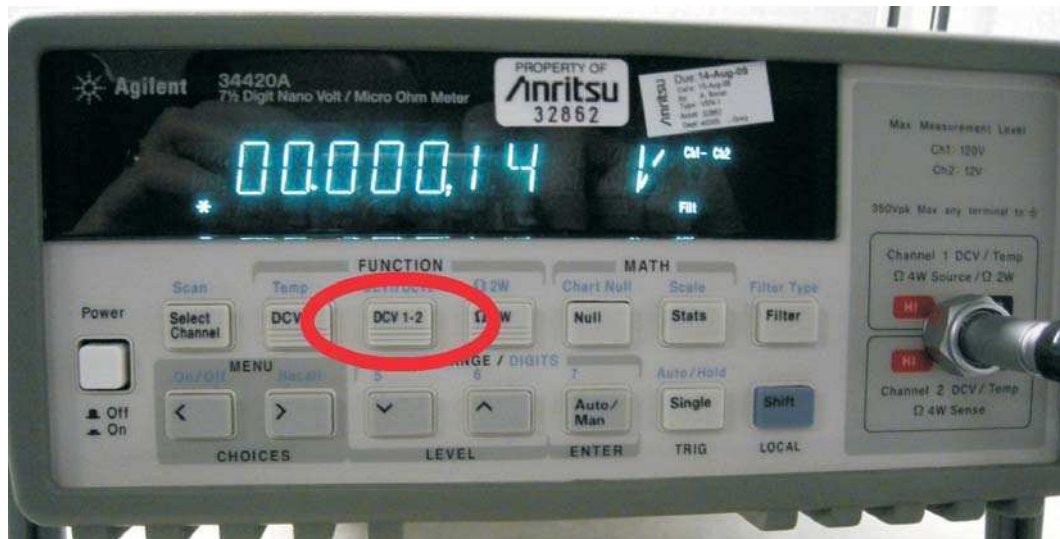

Figure 2-23. 34420A Volt Meter

- On the ML243xA, set the RF Calibrator to **RF ON**, by pressing the left-most soft key to change it from RF OFF to **RF ON**.

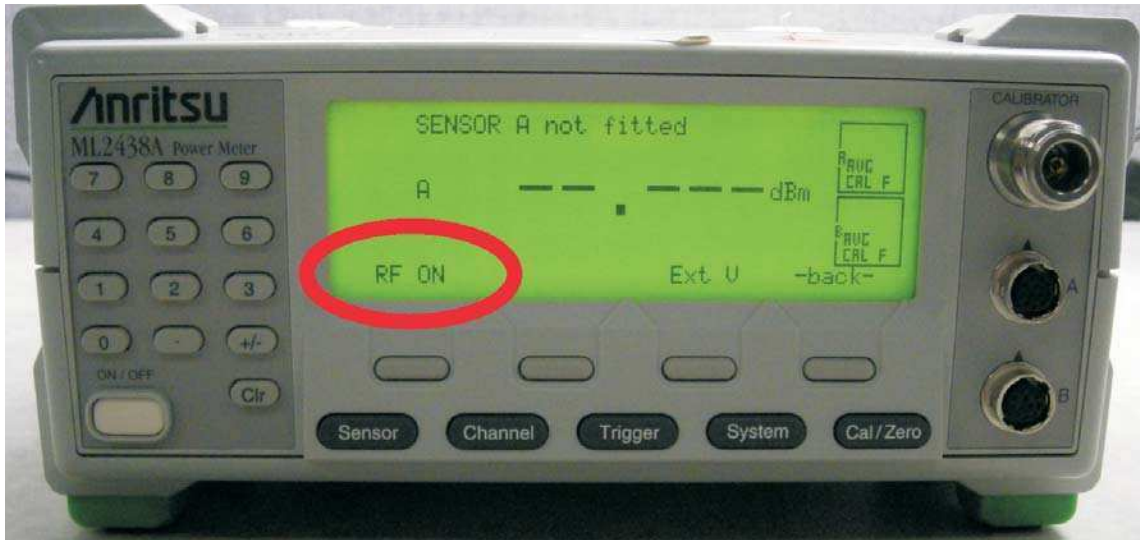

Figure 2-24. ML243xA Power Meter

- Record the new number on the Agilent 34420A as V_I .

$$V_I = \text{_____ Volts}$$

- While the RF is still ON, press the **DCV** key on the 34420A and record this number as V_{comp} .

$$V_{comp} = \text{_____ Volts}$$

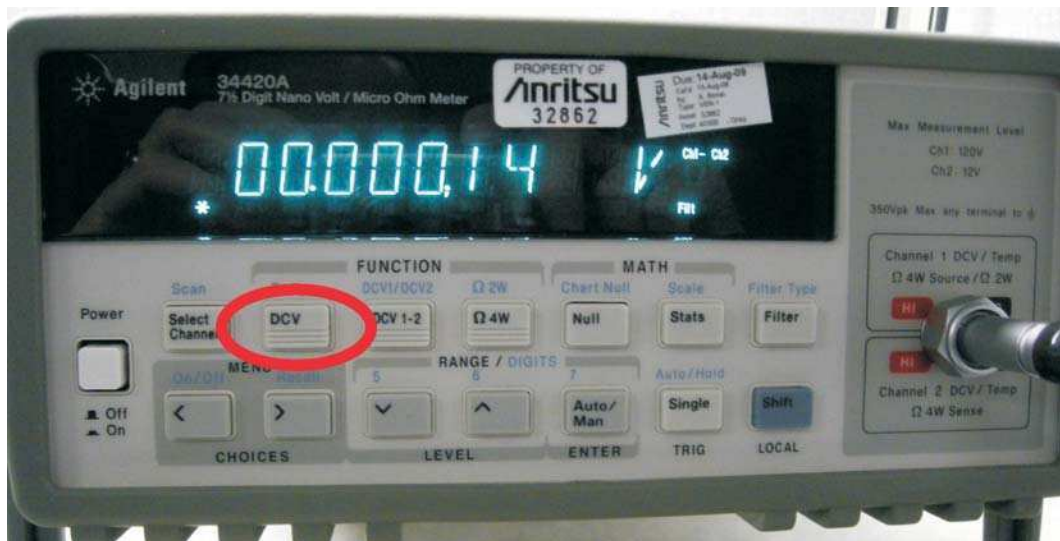

Figure 2-25. 34420A Volt Meter

14. Use the below equation to determine P_{meas} (the Reference Calibrator output power in Watts). Start by finding the Mismatch (M), then using this number, along with V_0 , V_1 , V_{comp} , R , and EE to solve for P_{meas} .

$$P_{meas} = \left[\frac{2 \times V_{comp} \times (V_1 - V_0) + V_0^2 - V_1^2}{4 \times R \times EE \times M} \right]$$

$$M = \frac{1 - |\Gamma_d|^2}{|(1 \pm \Gamma_s \times \Gamma_d)|^2} \cong 1 - |\Gamma_d|^2$$

Where:

- $M = 1 - |\Gamma_d|^2$ Worst case value for M
(should be used in the P_{meas} equation above)
- $\Gamma_d = \underline{\hspace{2cm}}$ Reflection coefficient of the 8478B sensor
(found in the 8478B calibration data)
- $EE = \underline{\hspace{2cm}}$ Effective Efficiency of the 8478B sensor
(found in the 8478B calibration data)
- $U_e = \underline{\hspace{2cm}}$ Effective Efficiency uncertainty of the 8478B sensor
(found in the 8478B calibration data; needed for
uncertainty calculation in Step 15)
- $\Gamma_s = 0.019$ Reflection coefficient of the ML243XA Reference
Calibrator output.
(needed for uncertainty calculation in Step 15)
- $R = \underline{\hspace{2cm}}$ Mount Resistance of the 432A Power Meter
- $V_{comp} = \underline{\hspace{2cm}}$ From Step 13, above
- $V_1 = \underline{\hspace{2cm}}$ From Step 12, above
- $V_0 = \underline{\hspace{2cm}}$ From Step 10, above
- $P_{meas} = \underline{\hspace{2cm}}$ Calculated from the P_{meas} equation, above

15. After P_{meas} is determined, the next step is to calculate the expanded uncertainty with coverage factor $K = 2$. This is done by using the equations below to get a value for the Expanded Uncertainty ($K = 2$).

Table 2-1, following page, shows an uncertainty calculation of an ML243xA Reference Calibrator Power Level. The table shows the resulting expanded uncertainty and each source of uncertainty.

Calibrator Power Level Uncertainty:

The formula for standard uncertainty is:

$$\text{Standard Uncertainty } X_{unc} = \frac{1}{(\text{Divisor})} \times (\text{Uncertainty } y) \times (\text{Sensitivity } C_{ix})$$

The divisor of each source of uncertainty is determined by the type of probability distribution of each uncertainty source.

The uncertainty equations of V_0 , V_1 , V_{comp} and R are obtained from the Agilent 33420A multimeter’s accuracy specifications for 1 year, 23±5 °C as stated in the product’s datasheet. The uncertainties of V_0 , V_1 , V_{comp} and R vary model to model of the multimeter used. The uncertainty of Effective Efficiency, EE , is obtained from the thermistor mount 8478B calibration data. The uncertainty of Mismatch, M , is obtained by taking twice the product of the reflection coefficient of the 8478B, Γ_d , and the reflection coefficient of the ML243XA Reference Calibrator, Γ_s . The uncertainty of connector repeatability, CR , is set to 0.1% (for example, 60 dB for precision connectors).

The sensitivity, C_{ix} , of each source of uncertainty, except for connector repeatability CR , is the first partial derivative of the P_{meas} equation with respect to the uncertainty source variable. The equation below shows how the sensitivity of V_{comp} and C_{iVcomp} is obtained:

$$C_{iVcomp} = \frac{d}{dV_{comp}} [P_{meas}] = \frac{d}{dV_{comp}} \left[\frac{2 \times V_{comp} \times (V_1 - V_0) + V_0^2 - V_1^2}{4 \times R \times EE \times M} \right] = \frac{2 \times (V_1 - V_0)}{4 \times R \times EE \times M}$$

Taking the partial first derivative of P_{meas} with respect to the variable uncertainty source needs to be done to obtain sensitivity C_{ix} for the rest of the sources of uncertainty, except for connector repeatability CR , which has a sensitivity set to 0.001 W.

Table 2-1. Uncertainty Calculation of an ML243XA Reference Calibrator Output Power Level

Sources of Uncertainty	Units	Readings	Uncertainty	Units	Divisor	Sensitivity	Units	Standard Uncertainty (W)	Standard Uncertainty (µW)
V_{comp}	(V)	5.1627784	1.949×10^{-4}	(V)	1.732	1.950×10^{-4}	(V/Ω)	2.194×10^{-8}	0.0219
V_0	(V)	0.0009813	2.756×10^{-4}	(V)	1.732	-1.300×10^{-2}	(V/Ω)	-2.068×10^{-6}	-2.0680
V_1	(V)	0.0784392	2.756×10^{-4}	(V)	1.732	1.280×10^{-2}	(V/Ω)	2.037×10^{-6}	2.0369
R	(Ω)	200	1.400×10^{-2}	(Ω)	1.732	-4.996×10^{-6}	(W/Ω)	-4.038×10^{-8}	-0.0404
EE	-	99.36%	1.700×10^{-3}	-	1.000	1.006×10^{-3}	W	-1.709×10^{-6}	-1.7094
M	-	0.999345	9.728×10^{-4}	-	1.414	-9.998×10^{-4}	W	-6.877×10^{-7}	-0.6877
CR	-	0	1.000×10^{-3}	-	1.000	1.000×10^{-3}	W	1.000×10^{-6}	1.0000
Combined Uncertainty (µW)									3.5809
Expanded Uncertainty (K = 2) (mW)									0.00716
Expanded Uncertainty (K = 2) (%)									0.716

The standard uncertainty of each source of uncertainty in Table 2-1 is calculated as follows:

$$V_{comp\ Unc} = \frac{1}{\sqrt{3}} \times \left[0.000003 \times V_{comp} + 0.000004 \times 10\text{V} \right] \times \left[\frac{2(V_1 - V_0)}{4 \times R \times EE \times M} \right]$$

$$V_{0\ Unc} = \frac{1}{\sqrt{3}} \times \sqrt{2(0.000003 \times V_{comp} + 0.000004 \times 10\text{V})^2} \times \left[\frac{-2(V_{comp} - V_0)}{4 \times R \times EE \times M} \right]$$

$$V_{1\ Unc} = \frac{1}{\sqrt{3}} \times \sqrt{2(0.000003 \times V_{comp} + 0.000004 \times 10\text{V})^2} \times \left[\frac{2(V_{comp} - V_1)}{4 \times R \times EE \times M} \right]$$

$$R_{Unc} = \frac{1}{\sqrt{3}} \times (0.000006 \times R + 0.000002 \times 1000) \times \left[\frac{-2V_{comp} (V_1 - V_0) - V_0^2 + V_1^2}{4 \times R^2 \times EE \times M} \right]$$

$$EE_{Unc} = \frac{1}{1} \times \left[\frac{U_e}{2} \right] \times \left[\frac{-2V_{comp} (V_1 - V_0) - V_0^2 + V_1^2}{4 \times R \times EE^2 \times M} \right]$$

$$M_{Unc} = \frac{1}{\sqrt{2}} \times [2 \times \Gamma_s \times \Gamma_d] \times \left[\frac{-2V_{comp} (V_1 - V_0) - V_0^2 + V_1^2}{4 \times R \times EE \times M^2} \right]$$

$$CR_{Unc} = \frac{1}{1} \times (0.1\%) \times (0.001\text{W}) = 0.000001\text{W}$$

$$\text{Combined Uncertainty} = \sqrt{V_{comp\ Unc}^2 + V_{1\ Unc}^2 + V_{0\ Unc}^2 + R_{Unc}^2 + EE_{Unc}^2 + M_{Unc}^2 + CR_{Unc}^2}$$

Expanded Uncertainty (K = 2) = 2 x Combined Uncertainty x 1000
(95% level of confidence)

Expanded Uncertainty (K = 2) = _____
(determined from the above equations)

Now that you have P_{meas} and Expanded Uncertainty (K = 2), you can calculate lower and upper limits with the below equation:

$$P_{actual} = P_{meas} \pm P_{meas} \times \text{Expanded Uncertainty (K = 2)}$$

$$P_{actual\ Lower} = \text{_____ mW}$$

$$P_{actual\ Upper} = \text{_____ mW}$$

The accuracy specification for the Reference Calibrator output power level is 1 mW ±0.012 mW/mW per year. The maximum permissible error for the power output level, P_{actual}, should be within the range of 1 mW ±0.0015 mW/mW (for example: 0.9985 mW to 1.0015 mW). If P_{actual} is outside of the 1 mW ±0.0015 mW/mW limit, then continue to the Calibrator Power Level calibration procedure in Chapter 3.

Chapter 3

Calibration Procedures

3-1 INTRODUCTION

This chapter details the process of calibrating an ANRITSU ML2430A Series Power Meter. This calibration entails adjusting the Reference Calibrator's 50 MHz output frequency and 1 mW output power level.

The Power Meter is warmed up for 15 minutes and adjustments are made to the internal DC reference and the RF calibrator.

NOTE

Procedures in this section should be performed by qualified technical personnel only. These procedures require access to internal test points and adjustment potentiometers, and care should be taken to avoid contact with potentially hazardous voltages.

3-2 REQUIRED TEST EQUIPMENT

The following test equipment is required to perform the procedures in this chapter.

- ❑ Anritsu MF2412B Frequency Counter
- ❑ Agilent 432A Analog Power Meter
- ❑ Agilent 34420A Nano Volt / Micro Ohm Meter or equivalent (Insure that the Agilent 34420A Meter is warmed up for two hours prior to use)
- ❑ Agilent 8478B Power Sensor (The calibration data including measurement uncertainty for the Agilent 8478B must be available to obtain the reflection coefficient and effective efficiency.)
- ❑ RF Cable with BNC male connection at one end and an N-type male connection at other end
- ❑ Adjustment tools (flat-head and hex screwdrivers)

NOTE

Ensure all test equipment is within its calibration period and is traceable to national standards. An example of traceable national standards is NIST or through an internationally recognized accredited laboratory.

3-3 TEST CONDITIONS

The ML2430A Series Power Meter must be operated under controlled conditions of temperature and humidity in order to meet its specified precision and stability.

All tests should ideally be performed at a temperature of 25° C (77° F) ± 5° C and a relative humidity of less than 75%, non-condensing.

3-4 PRE-TEST SETUP**CAUTION**

Procedures in this and the following sections should be performed by qualified technical personnel only. These procedures require access to internal test points and adjustment pots, and care should be taken to avoid contact with potentially hazardous voltages.

Some of the procedures in this chapter require removal of the instrument's top cover to gain access to adjustment points. With power disconnected, open the unit by loosening the six captive screws on the underside (see Figure 3-1, page 3-3) and separating the top half of the case from the base. Ensure that the front and rear panels remain firmly in place during this operation.

Apply power to the unit using the AC inlet on the rear panel and verify that the meter has completed the Power On Self Test (POST).

Prior to making any precision measurements, allow the Power Meter to warm up for a period of 15 minutes from power on. If the power supply is interrupted for any reason, allow a similar settling period.

Refer to the Main PCB drawing (Figure 3-2, page 3-4) for the location of test points and components.

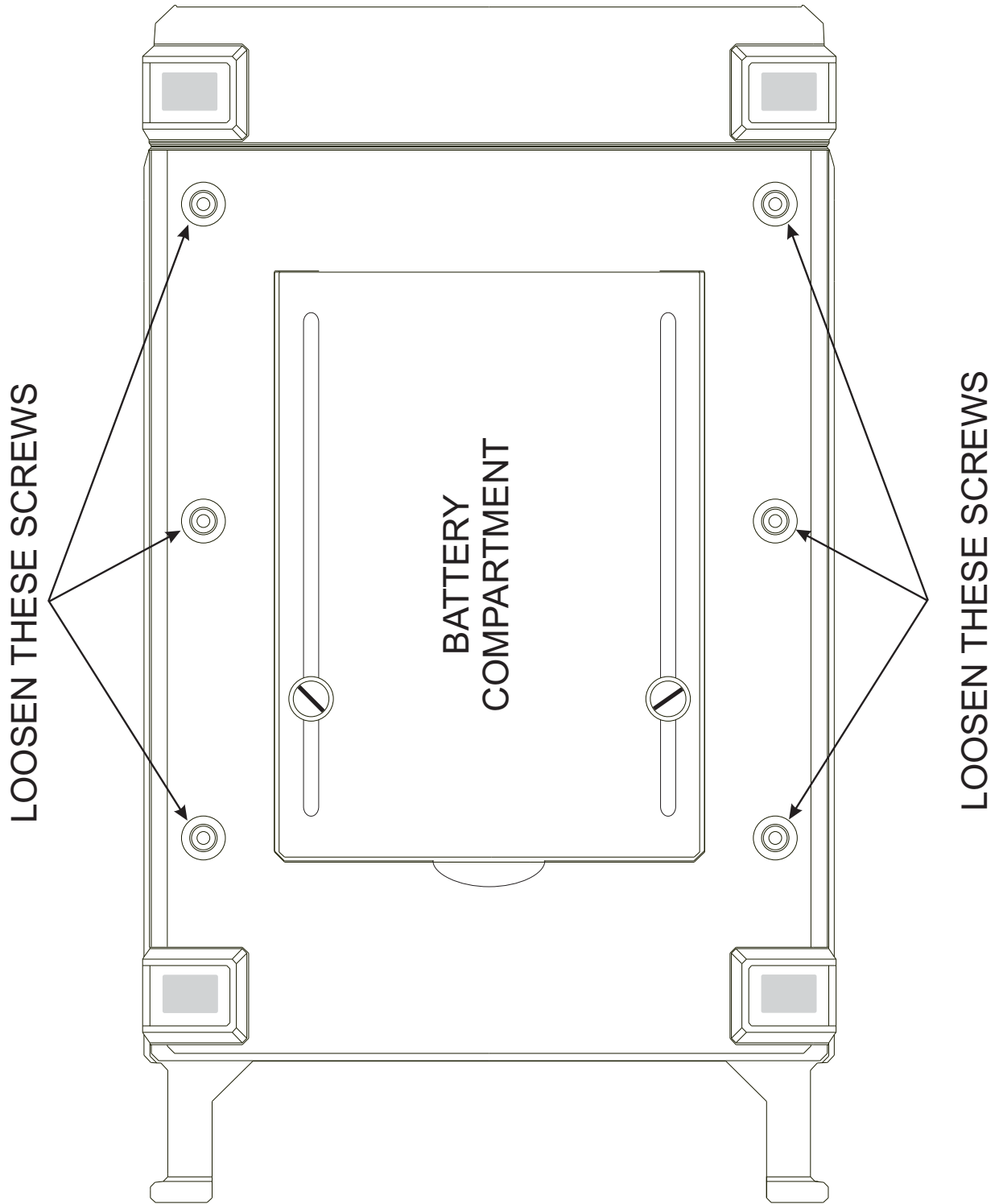

Figure 3-1. ML2430A Series Top Cover Removal

3-5 DC REFERENCE

To calibrate the DC Reference:

1. Connect a sensor via a 1.5m sensor cable to input A.
2. Connect the DVM between TP 113 (gnd) and TP 1 (+5.000V).
3. Enter the ML2430A Service Mode by pressing the front panel keys as follows:

Press System

Press -more-

Press -more-

Press -more-

Press the blank soft key to the left of the -back- soft key

Press the number 0 on the numeric keypad

Press the blank soft key to the left of the -back- soft key

4. Press CONTROL.
5. Press DSP CAL.
6. Press the number 1 key on the numeric keypad.
7. Press Enter.
8. Adjust pot R94 for a reading of 5.000V \pm 2 mV on the DVM.

3-6 CALIBRATOR FREQUENCY

The following procedure is used to adjust the Calibrator output frequency of the ML2430A Series Power Meter.

Equipment Required:

- ❑ Anritsu MF2412B Frequency Counter
- ❑ RF Cable with BNC male connection at one end and an N-type male connection at other end
- ❑ Adjustment tool

NOTE

When making adjustments to the reference calibrator output frequency, make sure that the area where the following steps will be performed is ESD protected.

Procedure:

If the 50 MHz calibrator output frequency is outside the ± 10 kHz limit, proceed as follows:

1. Power down and disconnect the AC power cord from the ML243xA.
2. Remove the six screws from the bottom of the ML243xA and remove the top cover.
3. Power the ML243xA on and allow 15 minutes for it to warm up.
4. Adjust the inductor core L401 so the frequency counter reads 50 MHz, ± 10 kHz.

NOTE

If a metal adjustment tool is used, it must be removed from the inductor core L401 before reading the counter, as the metal tool could affect the frequency.



Figure 3-3 L401 Adjustment

3-7 CALIBRATOR POWER LEVEL

The following procedure is used to adjust the Calibrator output power level of the ML2430A Series Power Meter.

Equipment Required:

- ❑ Agilent 432A Analog Power Meter
- ❑ Agilent 34420A Nano Volt / Micro Ohm Meter
- ❑ Agilent 8478B Power Sensor
- ❑ Adjustment tool

NOTE

When making adjustments to the reference calibrator output power level, make sure that the area where the following steps will be performed is ESD-protected.

Procedure:

1. If the Reference Calibrator output power level is outside of the 1 mW ± 0.0015 mW limits, adjust R409 and recalculate $P_{actual\ Upper}$ and $P_{actual\ Lower}$ with the new V_o , V_I , and V_{comp} numbers using the same equations in the previous section.
2. Continue doing the previous step until $P_{actual\ Upper}$ and $P_{actual\ Lower}$ are both within specification.

NOTE

If a metal adjustment tool is used, it must be removed from the varistor R409 before reading the counter, as the metal tool could affect the frequency.



Figure 3-4. R409 Adjustment

Chapter 4

Theory of Operation

4-1 INTRODUCTION

This chapter contains a general theory of operation and an operational block diagram for the ML2430A Series Power Meter.

4-2 PRODUCT OVERVIEW

The ML2430A Series Power Meter is a light weight, portable instrument featuring high accuracy and fast measurement speeds. The large front panel LCD provides a simultaneous two channel readout with an available graphical display of pulse power measurements.

Measurement Channels

The ML2437A Power Meter features a single measurement channel. The ML2438A Power Meter adds an optional second measurement channel. Each channel has a linear amplifier chain coupled to a DSP (Digital Signal Processor) via an ADC (Analogue to Digital Converter). Each channel has a dynamic range of +20 to -70 dBm with one sensor.

Sensors

Two types of sensors are available: diode and thermal. Diode sensors provide fast response speed and a wide dynamic range (+20 dBm to -70 dBm for example). Thermal sensors provide high accuracy and stable averaged readings, with a dynamic range of +20 dBm to -30 dBm.

Internal 50 MHz Reference

A high accuracy and stable 50 MHz reference is provided within the meter for convenient sensor calibration.

Battery

The optional rechargeable battery offers portable operation for up to nine hours.

Measurement Modes

Readout Mode: Power measurement is displayed digitally in dBm (dB milliwatts), dB μ V (dB micro Volts), dBmV (dB milli Volts), or W (Watts). Resolution can be set to 1, 2, or 3 decimal points.

Profile Mode: Power level is plotted against time in a graphical form. This allows measurement of power pulses with nanosecond pulse width resolution. Triggering may be manual, external or internal. Display scaling is available with cursor measurement.

Power vs. Time Mode: Similar to Profile mode but with wider dynamic range (+20 dBm to -70 dBm) and longer time periods (approximately 20 seconds).

Source Sweep Mode: This feature allows the ML2430A Series Power Meter to be synchronized to an RF source using the Horizontal ramp (to Analog Input) and Sequential Sync (Digital Input).

Ratio: When two channels are fitted, a ratio of A/B or B/A can be made.

External DC Volts: DC volts from 0-20V can be measured via a BNC connector on the rear panel. Resolution to mV level.

4-3 GENERAL OPERATION

The ML2430A Series Power Meter operation is controlled by a Siemens 80C165 16-bit RISC processor clocked at 20 MHz. The operating program is stored in FLASH memory which can be updated through an RS232 serial link. Static RAM memory is provided for storage of unit set up status when no power is applied. A small lithium battery with a 10 year life span provides power to the RAM memory. All unit functions including the front panel keys, display, power supply, rear panel functions, signal processing and battery operation are coordinated by the main processor.

Digital Signal Processor (DSP)

A dedicated processor is used to control all signal processing including measurement timing (triggering), sensor interface, internal channel calibration, zeroing, averaging and communication to the main processor. The DSP receives a digital output from the signal channel ADC via a direct link. At power on, the main processor downloads the DSP operating program which runs a self test and confirms all hardware is operational.

Signal Channel

There are two available signal channels, one is standard and the second optional. Both channels are independent allowing ratio measurements. The sensor output is fed via a linear amplifier chain to the internal ADCs. There are five amplifier ranges, the top two ranges are DC and the bottom three ranges are AC. AC modulation (chopping) is used on the lower ranges to give measurement stability and noise immunity. The signal channel automatically changes range as the level being measured varies. This range changing is transparent.

4-4 HUMAN INTERFACE

The ML2430A Series Power Meter front panel has a large LCD unit, 240 pixels wide by 64 pixels high, used to show measurement readouts and display soft key menus. The intensity of the display can be varied from just visible to blooming by a contrast control menu. A display backlight is permanently on when using AC or external DC power. Under battery power the backlight can be turned off to extend battery life. The display can be configured to show a single channel or a dual channel readout.

The operations menus are driven by five main system keys. Each one of these keys produces a soft key menu on the LCD which can be accessed by the four soft menu keys directly below the display.

On the left of the display is a key pad used to enter numeric data. The power meter may be switched to "stand by" mode by the white ON/OFF key in the bottom left corner of the front panel.

4-5 GPIB OPERATION

The ML2430A Series Power Meter GPIB operation is provided by a fully integrated National Instruments TNT4882 IC. Most power meter front panel functions are available by GPIB command. The Anritsu Power Meter offers five modes of GPIB operation; ML24XXA Native mode, HP 436A emulation mode, HP 437B mode, HP 438A mode, and ML4803 mode.

GPIB is not available when the unit is battery powered due to the high power requirement of the GPIB IC.

4-6 PRINTER

The ML2430A Series Power Meter is equipped with a standard parallel printer interface. Compatible printers include the HP 340 Deskjet (and most other 300 and 500 Series HP Deskjet printers) and the Canon BJC80. Many desk top Centronics printers are also compatible. Data print outs are available in all measurement modes.

4-7 CASE CONSTRUCTION

The ML2430A Series Power Meter has a clam shell case structure. The top and bottom covers are of a rugged molded plastic construction. The top case has raised slots which align with the feet of the bottom case to allow unit stacking. The front and rear panels are fitted into slots in the top and bottom cases. The bottom case features a battery compartment with a cover plate secured with two quarter-turn fasteners.

Front Panel

The front panel assembly is made up of a conductive contact rubber key pad sandwiched between the molded plastic front panel and the LCD PCB assembly. Depending upon the option configuration selected, the front panel may contain the signal channel input connectors and the RF calibrator reference output. Connection to the main PCB is by ribbon cable.

Rear Panel

The rear panel is made from sheet aluminum and contains the ground stud, line power input module, printer output connector, RS232 I/O connector, GPIB connector, four BNC I/O connectors, and the external DC Input connector. The rear panel is attached to the main PCB and fits into slots in the top and bottom cases.

Handle and Rack Mount

An optional handle can be fitted using the two circular mounting points on each side of the unit. A special top and bottom case are available to provide rack mounting capability.

4-8 INTERNAL CONSTRUCTION

The ML2430A Series Power Meter contains the main PCB, the power supply unit, and the battery compartment.

Main PCB

The main PCB is thicker than normally required in order to add strength to the unit construction. The multi-layer PC board is 95% surface mount with some components through-hole mounted. One common PCB is used for the ML2438A (dual channel) and ML2437A (single channel) units. For the ML2437A, components are omitted from the PCB. The board is mounted on six pillars in the bottom case and secured by one centrally located screw.

Power Supply

The power supply unit is mounted on top of the main PCB on four nylon standoffs. Connection to the main PCB is by two 20-pin connectors. Line power is fed through an input filter module mounted on the rear panel. The heat sink of the PSU has thermal conductive material that contacts a heat spreader mounted on the underside of the top case.

**Battery
Compartment**

In the lower case is a compartment where the optional battery is installed. The compartment has an access panel secured by two quarter-turn fasteners. The battery connects to five contacts mounted in the lower case, which in turn make contact with five spring connectors mounted on the underside of the main PCB. The battery is firmly secured in the compartment by foam pads.

4-9 FRONT PANEL

This section describes the ML2430A Series Power Meter front panel functional description.

LCD

The large front panel Liquid Crystal Display presents measurements and operations menus. Ninety percent of the top section of the display is for measurement readouts. The bottom 10% is a single text line for the menus.

System Keys

The operation of the ML2430A Series Power Meter is controlled by five system keys: Sensor, Channel, Trigger, System, and Cal/Zero. Each of these keys generates a soft key menu on the bottom line of the display.

Soft Keys

The four soft keys either apply functions directly, or access second or third level menus. Each key is related to the text displayed directly above it.

Data Entry Key Pad

The data entry key pad features the numbers 0 through 9, +/-, decimal point and clear keys. These keys are used to enter numeric data, such as a sensor cal factor frequency.

ON/OFF Key

The soft ON/OFF key is used to turn the unit on from standby mode. The switch is a software control switch which indicates to the PSU control circuitry what state the unit should be in. The power meter is in standby mode when either AC line power or external DC is applied.

**4-10 FRONT PANEL
CONNECTORS**

This section describes the ML2430A Series Power Meter front panel connectors.

**Signal Channel
Inputs**

On standard model ML2430A Series Power Meters, the signal channel A and B input connectors are mounted on the front panel. The connectors are 12-pin Hirose type. A sensor cable, provided with the meter, is used to connect an Anritsu power sensor to the signal channel. The connectors are snap push fit and require the outer body to be pulled to enable removal. The A and B signal channel connectors may optionally be fitted on the rear panel (refer to section 1-5, page 1-2).

***RF Reference
Calibrator***

The internal 50 MHz, 0 dBm reference provides a high stability, high accuracy level for signal channel calibration. The output connector is a flange mounted female 'N' type. With the power sensor connected to the calibrator output, a "Zero/Cal" will automatically zero the signal channel and then perform a 0 dBm calibration. All measurements are then referenced to the 0 dBm level.

**4-11 REAR PANEL
CONNECTORS**

This section describes the ML2430A Series Power Meter rear panel connectors.

Line Power Input

The AC line power input module is mounted on the rear panel and the supplied line power cable connects to it. The module contains filtering elements to ensure immunity to external noise and reduce emissions. The ML2430A Series Power Meter automatically senses the line level and internally configures itself accordingly. The specified line power requirement is 85-264V AC, 50-440Hz. An internally mounted 2A slow blow fuse provides fault protection. Note this fuse can NOT be changed by the operator.

External DC Input

An External DC jack connector is mounted on the main PCB and is accessed via a hole in the rear panel. The specified External DC level is +12 to +24V. Greater than +21V is required to charge the internal battery. An internally mounted diode protects against reverse connection of the supply, and a 3A slow blow fuse provides fault protection. Damage may occur if the input voltage level exceeds +28V. Note this fuse can NOT be changed by the operator.

Ground Stud

A ground stud provides a ground for External DC operation or an additional ground connection.

RS232 Port

A PC standard 9-pin D connector provides connection to the serial port. The serial port can be used to update the power meter operating firmware, and to control operation of the power meter from a PC or terminal. The hardware handshake lines RTS and CTS are used to control the flow of data. Serial control and data output commands are entered using the same format as the GPIB interface.

GPIB

Standard General Purpose Interface Bus connector used to connect through GPIB to other test equipment and a host computer. The ML2430A Series is compatible with IEEE-488.1/2 requirements. Refer to the *ML2430A Series Power Meter Operation Manual* for information on using GPIB.

BNC I/O Ports

There are four BNC connectors mounted on the rear panel. Two are multi function outputs and two are inputs.

Printer Port

A PC standard 25-pin D connector provides an interface to a standard parallel printer. Compatible printers include the HP 340 Deskjet and most other 300 and 500 Series HP Deskjet printers, and the Canon BJC80. Many desk top Centronics printers are also compatible. Full data print outs are available in all measurement modes.

4-12 POWER SUPPLY OPERATION

This section describes the ML2430A Series Power Meter power supply operation.

Auto Sequencing

The power supply automatically determines what types of power are available and then configures itself to use the most suitable. This sensing is fully automatic and requires no action by the operator. If more than one type of power is connected and the one being used is interrupted, the PSU will automatically switch to the next available power source. Early power meters will reset and restart when switching from line or external DC to battery power. If the power is restored the PSU automatically stops using the battery.

Supply Priority

The power meter will operate from supplied power in the following order of priority, AC line power, external DC, and battery power.

On Off Control

There are three ways to control the operation of the ML2430A Series Power Meter. To turn the power meter on or off:

- Connect or remove the AC line power cord, external DC power cord, or the battery.
- Use the soft ON/OFF key on the front panel of the unit.
- Use the line power switch fitted on the early model power meter rear panels.

4-13 BATTERY OPERATION

This section describes the ML2430A Series Power Meter battery operation.

Battery

The battery used in the ML2430A Series Power Meter is the 3000 mAh Duracell DR36S or 3500 mAh Energizer NJ1020. The battery is intelligent and contains information on charge status.

Operating Time

The ML2430A Series Power Meter can operate for a maximum of nine hours on battery power with the battery fully charged to at least 90% of maximum capacity. The display backlight must be turned off to achieve this operating time.

Intelligent Operation

The battery retains a charge and discharge history which ensures correct charging and discharging is performed. This is vital to ensure the maximum capacity and life of the battery is retained. The intelligent link also allows current battery status data to be available at the operators request.

Fast Charge

The battery can be charged in the power meter in approximately two hours. The charge control is accessed from a front panel menu. The unit can not be operated while the unit is charging. An external battery charger is available as an option if required.

Battery Life Indicator

When operating under battery power, a battery charge indicator is displayed on the front panel LCD. If the battery charge falls too low, the unit will automatically power down.

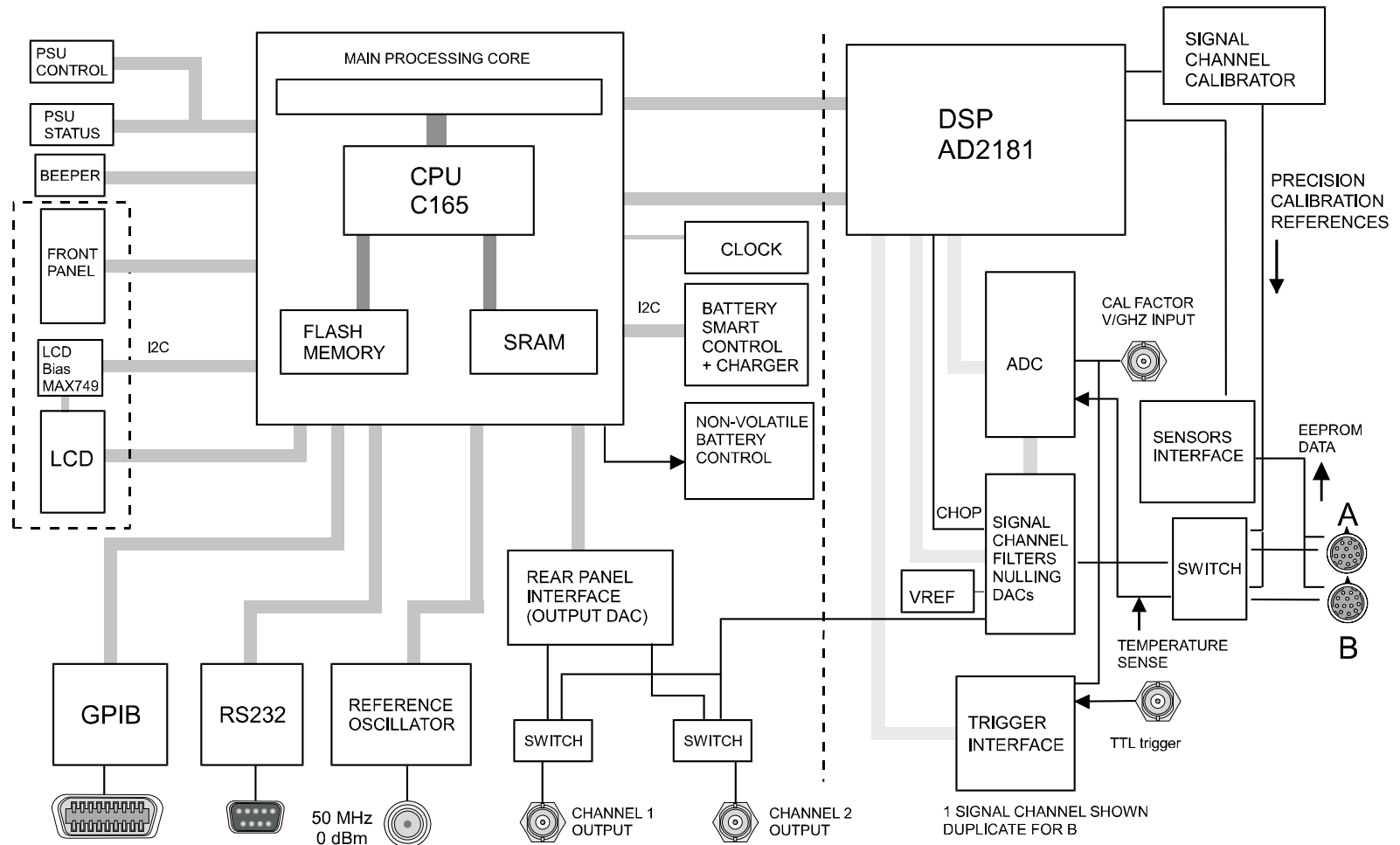

Figure 4-1. ML2430A Series Power Meter Functional Block Diagram

Chapter 5

Firmware Updates

5-1 INTRODUCTION

The ML2430A Series Power Meters use a Flash EPROM to store the operating program. New versions of the operating program can be installed using a personal computer connected through the Power Meter serial interface. Firmware updates are available on disk (part number 2300-233) from your nearest ANRITSU Customer Service Center. This chapter describes the use of the Code Loader Program and the configuration of the required RS232 cable.

5-2 CODE LOADER PROGRAM

The Power Meter Code Loader Program is a DOS based program used to transfer updated firmware into the Power Meter EPROM. The Power Meter Code Loader program requires about 1 Mb of hard drive space.

Installation

1. On the personal computer hard drive, create a directory to contain the Code Loader Program files (ML2430A for example).
2. Copy the BOOT.EXE file from the Code Loader Program floppy disk into this directory.
3. From within the designated directory, type: `BOOT ↵`

This will unzip the Code Loader Program files into the above designated directory. There will be seven files, including the original BOOT.EXE.

The installation on the personal computer is now complete.

Running the Program

1. Connect the personal computer serial COM port to the ML2430A Series Power Meter back panel RS232 Serial Connector, using the ANRITSU Serial Interface cable (PN: B41323) or equivalent (see section 5-4).
2. Apply power to the Power Meter and allow it to complete the POST. Power sensors need not be connected at this time.
3. On the Power Meter front panel, press:
System
-more-
-more-
-more-
4. Press the blank softkey just to the left of the -back- softkey.
5. Press the 0 key on the numeric keypad.
6. Press the blank softkey just to the left of the -back- softkey.

7. Press the softkey labeled BOOT LOAD.

The LCD will display:

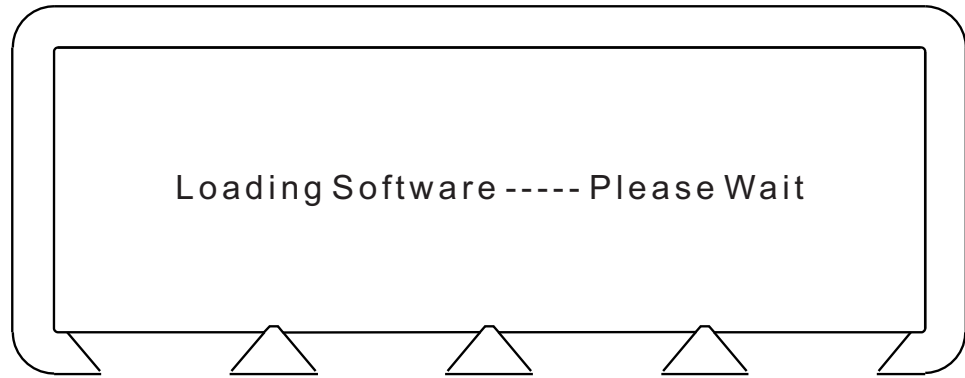

CAUTION

Disable Windows™ screen savers before attempting to run the code loader program.

8. From a DOS prompt on the computer, select the drive and directory where the Code Loader Program was installed.
9. Type:

```
BOOTLOAD n QUART_FL ↵
```

Where *n* is the PC COM port used (usually 1 or 2). Note the space before and after the COM port number.

The program will proceed to download the new operating system to the Power Meter.

The program takes about eight minutes to complete the update, during which time the Power Meter LCD screen will be dark.

When the downloading is complete, the Power Meter will reboot and be ready for normal use.

10. Disconnect the serial interface cable from the computer and the Power Meter.
11. Verify that the new firmware version was successfully installed by pressing:

```
System
-more-
-more-
-more-
Identity
```

The new firmware version will be displayed on the front panel.

CAUTION

Do not interrupt the downloading process as corruption of the EPROM program may result (see section 5-3).

5-3 BOOTLOAD MODE

CAUTION

The procedure in this section should be performed by qualified technical personnel only. This procedure requires access to internal components, and care should be taken to avoid contact with potentially hazardous voltages.

If power is lost during programming, or the Power Meter EPROM has been corrupted in some other way, the Power Meter can be forced into a special “bootload” mode and reprogrammed.

Refer to the Main PCB drawing (Figure 3-2, page 3-4) for the location of test points and components.

1. With AC power disconnected, open the unit by loosening the six captive screws on the underside (see Figure 3-1, page 3-3) and separating the top half of the case from the base. Ensure that the front and rear panels remain firmly in place during this step.
2. Remove the optional Ni-Mh battery, if so equipped (Refer to the *ML2430A Series Power Meter Operation Manual*, PN 10585-00001).
3. Connect the personal computer serial COM port to the ML2430A Series Power Meter back panel RS232 Serial Connector, using the ANRITSU Serial Interface cable (ANRITSU PN B41323) or equivalent (see section 5-4).
4. Fit a jumper (ANRITSU PN 551-577) to J501 (BOOT) located to the right of the power supply on the main PCB board. This will force the Power Meter into the Bootload Mode when power is applied.
5. Apply AC power to the Power Meter.
6. Go to Step 8 of the *Running the Program* instructions (page 5-1) and load the program as described.
7. Remove power from the meter and remove the jumper.
8. Replace the top cover, taking care not to over tighten the captive screws.
9. Replace the battery (if so equipped).

5-4 SERIAL INTERFACE CABLE

The 9-pin null-modem serial interface cable necessary for upgrading the ML2430A Series Power Meter firmware is available from the ANRITSU Customer Service department. Order part number B41323.

The cable can also be assembled from the following readily available components:

- ❑ 2 meters of 8-conductor cable (ANRITSU PN: 800-365)
- ❑ 2 each, 9-pin female D-connectors

Assemble the cable according to the following connection diagram and description:

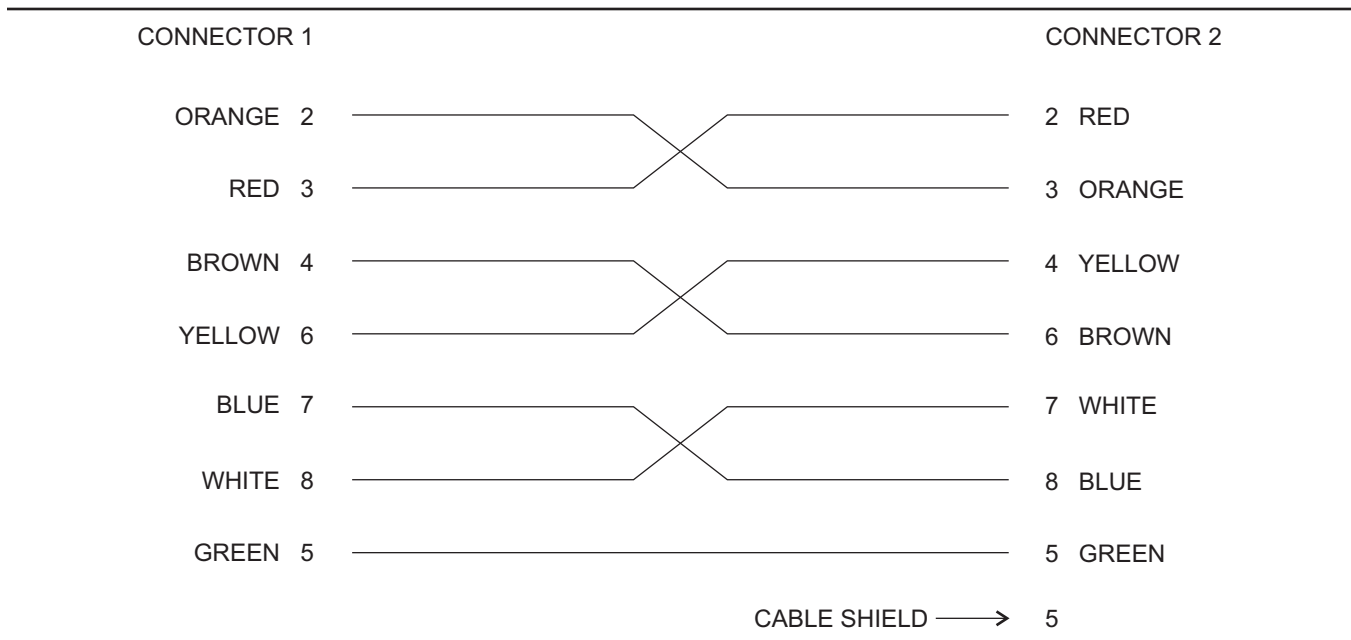

Figure 5-1 Serial Interface Cable Example Diagram using Anritsu 800-365 Cable

Description:

- Connector 1, pin 2 connected to pin 3 on connector 2
- Connector 1, pin 3 connected to pin 2 on connector 2
- Connector 1, pin 4 connected to pin 6 on connector 2
- Connector 1, pin 5 connected to pin 5 on connector 2
- Connector 1, pin 6 connected to pin 4 on connector 2
- Connector 1, pin 7 connected to pin 8 on connector 2
- Connector 1, pin 8 connected to pin 7 on connector 2
- Connector 2, pin 5 connected to the cable shield

Chapter 6

Troubleshooting

6-1 INTRODUCTION

CAUTION

The procedures in this chapter should be performed by qualified technical personnel only. These procedures may require access to internal components, and care should be taken to avoid contact with potentially hazardous voltages.

It is strongly recommend that ML2430A Series Power Meter repair be performed by qualified technical personnel only. The preferred ML2430A Series Power Meter service policy is the unit exchange program (see section 1-6, page 1-3). This policy ensures minimum down time for the customer. Only when the unit exchange method is not possible should the fault finding and repair work detailed below be used.

Refer to Chapter 1, section 1-7, page 1-3, for a listing of spare parts mentioned in this chapter. Contact your nearest Anritsu Customer Service or Sales Center for price and availability information. See Chapter 7 for specific module removal and replacement instructions.

The procedures in this chapter suggest the most likely remedies in a logical order of severity. It is best to follow the steps as presented in order to properly isolate the fault. Refer to the *ML2430A Series Power Meter Operation Manual* (10585-00001) for the specific operating instructions referred to in these procedures.

6-2 FRONT PANEL

The following procedures refer to possible faults with the power meter front panel.

Fault No measurement display.

When External DC or line power is applied, no measurement display is seen.

Recommended Action

1. Press the front panel ON/OFF key. If the unit now starts up, but did not when line power was applied, replace the PSU.
2. If the unit has recently been reprogrammed, remove the top cover (see Figure 3-1, page 3-3) and confirm that the jumper at J501 has been removed. If not, remove the jumper and reapply power.
3. If the unit still does not start up, remove the top cover and measure the voltage on the PSU connector PL1, pins 15 (+) to 14 (gnd). Confirm a reading of +5.25V, ± 160 mV. If no voltage is present, replace the PSU.
4. If the +5V is present, reprogram the power meter using the bootload method described in section 5-3, page 5-3.
5. If the unit still fails to start, replace the front panel assembly.
6. If the unit still fails to start, replace the main PCB.

Fault Front Panel display is working, but the buttons are not working.

The front panel LCD operates normally during start up and displays a normal measurement display, but one or all of the front panel buttons do not work.

Recommended Action

1. Reprogram the power meter using the bootload method described in section 5-3 on page 5-3.
2. Replace the front panel assembly.
3. Replace the main PCB assembly.

Fault Measurement problems with Input A or Input B.

Problems are encountered when calibrating, zeroing, or making power measurements with the Power Meter on Input A or B.

Recommended Action

1. Remove the top cover and confirm the two flexible cables are correctly seated in J1 and J2 on the right hand side of the main PCB. Note that to re-seat these connectors correctly the main PCB must be removed from the lower case.
2. Confirm that the flexible cable has not become disconnected from the front panel Input A and B connectors.

3. If the display indicates Sensor A or B are not fitted when sensors are connected to the front panel Inputs A or B, replace the front panel assembly including the flexible signal channel cable.
4. Connect the sensor to another 0 dBm, 50 MHz source and verify proper operation. If both inputs A and B perform a sensor zero, but will not perform a 0 dBm calibration, see Fault : RF Calibrator below.
5. For all other measurement problems with Input A and B, replace the front panel assembly.
6. If replacing the front panel assembly does not fix the problem, replace the main PCB assembly.

Fault RF Calibrator

The frequency or power level is out of specification or the RF level is not present at all.

***Recommended
Action***

1. If the RF Calibrator is ON, yet no power is present at the Calibrator connector, replace the N-type connector cable assembly from the main PCB to the front panel.
2. Calibrate the RF Reference and output power as per sections 3-10 and 3-11, on page . If calibration is not possible, replace the main PCB.

6-3 REAR PANEL

The following procedures refer to possible faults with the power meter rear panel.

Fault The power meter does not print.

When a compatible printer is connected and a print is started, no printout is generated or an incorrect printout is made.

Recommended Action

1. Reset the unit back to factory default and try again.
2. Replace the main PCB.

Fault The power meter will not load firmware.

It is not possible to load a firmware update or bootload firmware into the unit.

Recommended Action

1. Check that the PC configuration is correct for firmware transfer (refer to Chapter 5, Firmware Updates).
2. Confirm that the serial cable is correctly wired (refer to Figure 5-1, page 5-4) and not damaged .
3. Replace the main PCB.

Fault No GPIB communication

When connected to a compatible GPIB controller no communication occurs.

Recommended Action

1. Reset the unit back to factory defaults and try again.
2. Replace the main PCB.

Fault Incorrect operation of the rear panel BNC Inputs or Outputs

One or more of the BNC connector fails to operate correctly.

Recommended Action

1. Visually inspect all of the BNC connectors. If any physical damage is observed, replace the main PCB.
2. If there is no physical damage, yet the BNC Inputs or Outputs do not work correctly, replace the main PCB.

6-4 BATTERY

The following procedures refer to possible faults with the optional power meter battery.

Fault

Battery incorrectly detected or not detected, battery will not charge, or battery operating time is too short.

The unit will not power up when a battery is fitted. The battery status is not correct, for example, the battery type is not shown. When a fully discharged battery is installed, it will not charge.

Recommended Action

1. Confirm the battery being used has some charge by press the charge indicator on the battery. If no charge is shown, replace the battery.
2. If the battery is charged and still the unit will not run when the battery is installed, confirm that the battery contacts on the lower case are mated correctly with the PCB connector. To do this, remove the top cover and lift the left hand corner of the front panel up slightly. Shine a bright light down into the case and verify that the contacts are mated correctly.
3. If the battery status is not shown on the front panel display, but the unit does operate with the battery, there is a failure of the intelligent link to the battery. Confirm that the battery contacts on the lower case are mated correctly with the PCB connector, as described above.
4. If the battery case connections are correct and the battery is charged, but the unit still does not operate correctly, replace the PSU.
5. If the battery case connections are correct, the battery is charged, and the PSU has been replaced, but the unit still does not operate correctly, replace the main PCB.
6. If a battery will not charge, replace the battery, PSU, or main PCB in that order.
7. If the battery operating time is too short, confirm that after charging the battery status indicates at least 80% charged. If not, discharge the battery and recharge the battery fully five times. If the battery does not recover after this conditioning process, replace it. To extend battery operation time, turn the backlight off during use.

6-5 GENERAL FAULTS The following procedures refer to general system faults.

Fault The power meter loses non-volatile memory.

The power meter loses all non-volatile memory (stored setups, cal factors, cal factor tables, etc.) when powered off for more than two minutes.

- Recommended Action**
1. Confirm the jumper is fitted to J500 on the two pins nearest the on-board Lithium battery (the RUN position, as silkscreened on the PCB).
 2. Measure the DC voltage of the Lithium battery mounted to the center of the main PCB. This battery should measure 3.7V. If the voltage is less than 3.5V, replace the battery or the main PCB.

Fault The buzzer does not sound.

The noise generator does not make any sound or the sound is too low.

- Recommended Action**
1. Reset the unit to the factory defaults and try again.
 2. Replace the main PCB.

Chapter 7

Removal and Replacement Procedures

7-1 INTRODUCTION

CAUTION

The procedures in this chapter should be performed by qualified technical personnel only. These procedures may require access to internal components, and care should be taken to avoid contact with potentially hazardous voltages or damage from static electricity.

It is strongly recommend that ML2430A Series Power Meter repair be performed by qualified technical personnel only. The preferred ML2430A Series Power Meter service policy is the unit exchange program (see section 1-6, page 1-3), as this policy ensures minimum down time for the customer. Only when the unit exchange method is not possible should the removal and replacement procedures described in this chapter be used.

Always verify the need for a component replacement using the troubleshooting guidelines presented in Chapter 6. Repair or replacement in the field to a level beyond the subassemblies listed in this chapter is not recommended.

Refer to Chapter 1, section 1-7, page 1-3, for a listing of spare parts mentioned in this chapter. Contact your nearest Anritsu Customer Service or Sales Center for price and availability information.

7-2 FRONT PANEL

The ML2430A Series Power Meter front panel removal instructions will vary depending upon the various connector options installed (see section 1-5, page 1-2). Complete only those steps that apply to the specific unit under repair.

Tools Required

- Phillips screwdriver
- 3/16" nut driver

Procedure

1. Remove the AC or DC power cord, and the battery if fitted.
2. Remove the top cover (see Figure 3-1, page 3-3).
3. Disconnect the Display Panel ribbon cable from J510 on the main PCB.
4. Disconnect the Sensor Input A flex cable from J1 on the main PCB.
5. Disconnect the Sensor Input B flex cable from J2 on the main PCB.
6. Disconnect the RF Calibrator cable assembly from J400 on the main PCB.

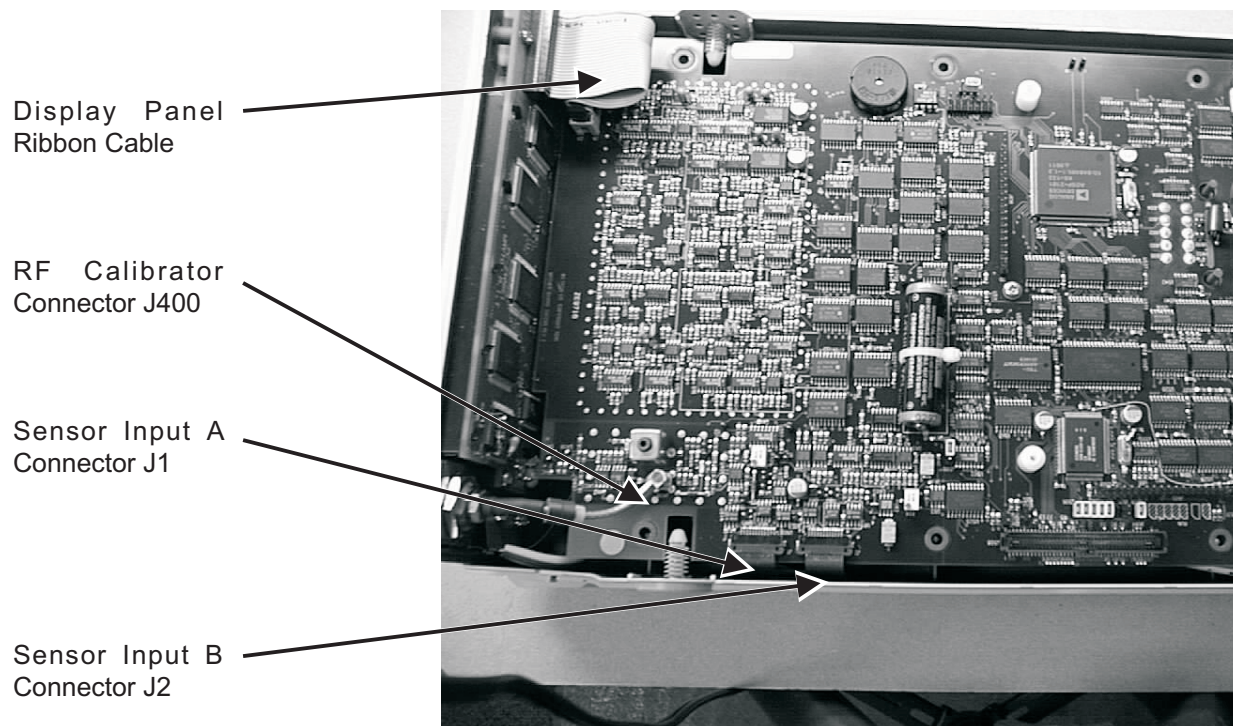

Figure 7-1. Front Panel Connections

7. On the inside of the rear panel, remove the front panel ground wire (green/yellow) from the ground stud.

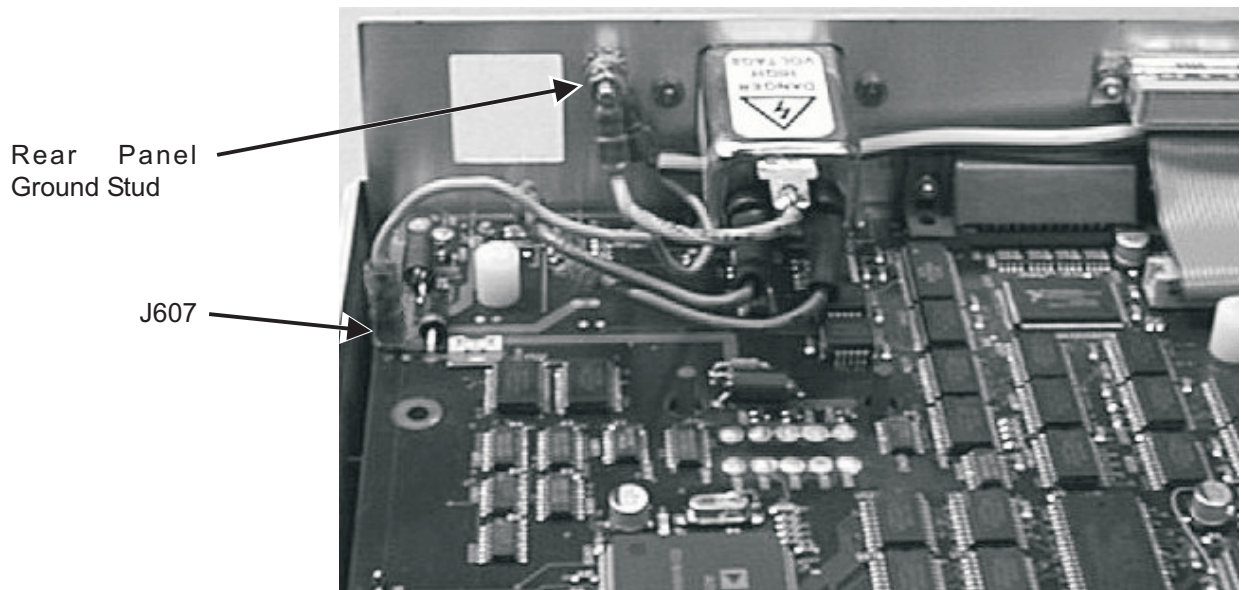

Figure 7-2. Front Panel Ground Wire Connection to Rear Panel Ground Stud

8. Disconnect the green/yellow ground wire from J607 on the main PCB.
9. Gently pull straight up on the front panel assembly and remove. Take care to pull the ground wire free of the back panel and under the main PCB.

Replacement is the opposite of removal.

7-3 POWER SUPPLY

The PSU is mounted on top of the main PCB on four nylon standoffs. Connection to the main PCB is by two 20-pin connectors.

Tools Required □ Phillips screwdriver

Procedure

1. Remove the AC or DC power cord, and the battery if fitted.
2. Remove the top cover (see Figure 3-1, page 3-3).
3. Disconnect the BLUE and BROWN wires connecting the AC input module to the PSU.

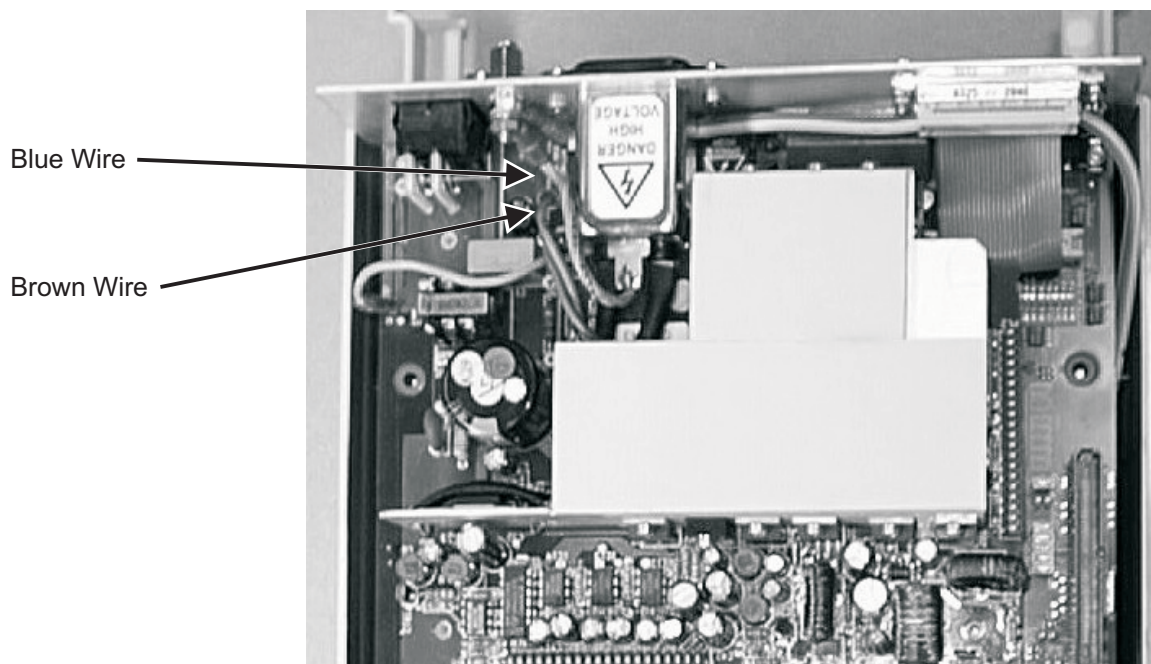

Figure 7-3. Power Supply Unit Connections

4. Remove the four Phillips screws and nylon washers securing the PSU to the Main PCB.
5. Gently lift up on the PSU to disengage the through board connector pins at PL1 and PL2. Take care not to damage the pins.
6. Angle the PSU so as to pull it up and away from the rear panel and remove.

Replacement is the opposite of removal.

7-4 MAIN PCB

The main PCB is mounted on six pillars in the bottom case and secured by one centrally located screw. Removal of the ML2430A Series Power Meter main PCB requires removal of the PSU. The front and rear panels can be removed in concert with the main PCB, and detached after the assembly is clear of the case.

Tools Required

- Phillips screwdriver

Removal Procedure

1. Remove the AC or DC power cord, and the battery if fitted.
2. Remove the top cover (see Figure 3-1, page 3-3).
3. Remove the PSU (see section 7-3).
4. Remove the Phillips screw and nylon washer that secures the main PCB to the bottom case.

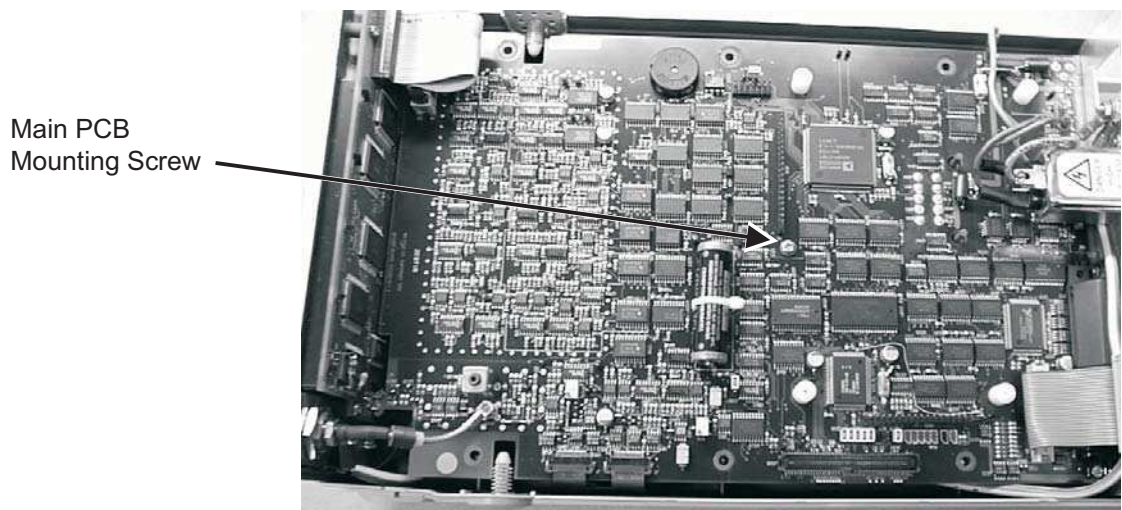

Figure 7-4. Main PCB Mounting Screw

5. Carefully lift the main PCB, with front and rear panels attached, straight up and clear of the bottom case.
6. Remove the front panel (section 7-2) and rear panel (section 7-5) as required.

***Replacement
Procedure***

1. Install the front panel (section 7-2) and rear panel (section 7-5) to the main PCB.
2. Carefully lift the assembly and position the front panel into the case.
3. Lower the main PCB onto the positioning pillars in the bottom case.

NOTE

The battery spring connectors on the underside of the main PCB must mate correctly with the connectors in the bottom case. Confirm that the battery connectors are correctly aligned by half lifting the front panel out on the left hand side of the bottom case. Shine a light down into the lower case and verify that the battery contacts fit into the main PCB connectors. Correct alignment is most easily achieved if the 'front' mounting pillars are correctly engaged first.

4. Fully lower the PCB and ensure that it fits onto all six mounting pillars and that the rear panel is correctly positioned. The mounting pillars should be level with the top surface of the PCB.
5. Install the mounting screw with nylon washer in the center of the PCB and torque to 27 CNm (2.39 in/lbs).
6. Replace the PSU (see section 7-3).
7. Replace the top cover (see Figure 3-1, page 3-3).

7-5 REAR PANEL

Removal of the ML2430A Series Power Meter rear panel first requires removal of the PSU and the main PCB. The rear panel can then be detached from the main PCB.

The ML2430A Series Power Meter rear panel removal instructions will vary depending upon the various connector options installed (see section 1-5, page 1-2). Complete only those steps that apply to the specific unit under repair.

Tools Required

- Phillips screwdriver
- Slotted screwdriver
- 3/16" nut driver
- 9/16" deep socket

Procedure

1. Remove the AC or DC power cord, and the battery if fitted.
2. Remove the top cover (see Figure 3-1, page 3-3).
3. Remove the PSU (see section 7-3).
4. Remove the main PCB with the front and rear panels attached (section 7-4).
5. Disconnect the rear panel Sensor Input A flex cable from J1 on the main PCB.
6. Disconnect the rear panel Sensor Input B flex cable from J2 on the main PCB.
7. Disconnect the rear panel RF Calibrator cable assembly from J400 on the main PCB.
8. On the inside of the rear panel, remove the front panel and AC input module ground wires (green/yellow) from the ground stud.
9. Remove the BNC connector nuts using the 9/16" deep socket.
10. Remove the jack screws from the RS232, parallel printer, and GPIB connectors. Retain all hardware for reuse.
11. Remove the rear panel.
12. Remove the AC input module, if necessary.

Replacement is the opposite of removal.

Chapter 8

Service Mode

8-1 INTRODUCTION

It is strongly recommend that ML2430A Series Power Meter service be performed by qualified technical personnel only. The preferred ML2430A Series Power Meter service policy is the unit exchange program (see section 1-6, page 1-3), as this policy ensures minimum down time for the customer.

This chapter describes the use of the Service Mode menus and GPIB commands.

8-2 ACCESSING SERVICE MODE

The service mode is accessed through the System front panel key, using the following key press sequence:

1. On the Power Meter front panel, press:
System
-more-
-more-
-more-
2. Press the blank softkey just to the left of the -back- softkey.
3. Press the 0 key on the numeric keypad.
4. Press the blank softkey just to the left of the -back- softkey.

The service menu will be displayed as shown below:

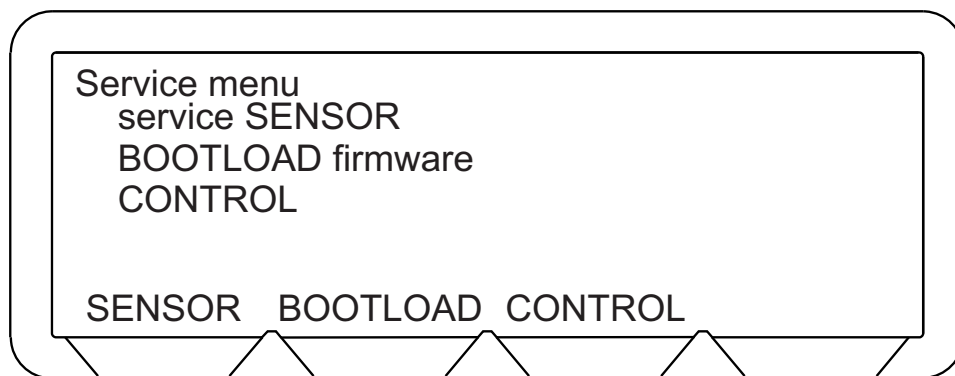

The SENSOR service mode is detailed in the following section of this chapter. BOOTLOAD mode is covered in Chapter 5, and the CONTROL mode is used in manufacturing and not required by service personnel.

8-3 **SENSOR SERVICE MODE**

Pressing the SENSOR softkey selection will bring up the Service sensor menu:

NOTE
A single channel meter (ML2437A) will only show the Sensor A information.

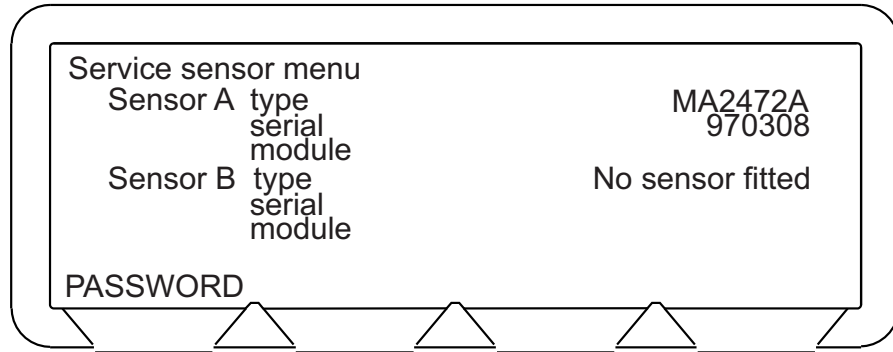

The example display above shows an ML2438A (dual channel) meter with an MA2472A power sensor connected to input A, and no sensor connected to input B. A single channel meter (ML2437A) will only show the Sensor A information.

Entering the Password

The sensor serial number and other parameters are protected by a password. The default password is "1234." To enter the password:

1. Select the PASSWORD softkey.
2. Enter the current numeric password.
3. Press the PASSWORD softkey again.

This will bring up the Service sensor menu with the EDIT A, EDIT B, and EDIT PASSWD options. Pressing the -more- key will bring up the FACTOR A, FACTOR B, PRINT A, and PRINT B options.

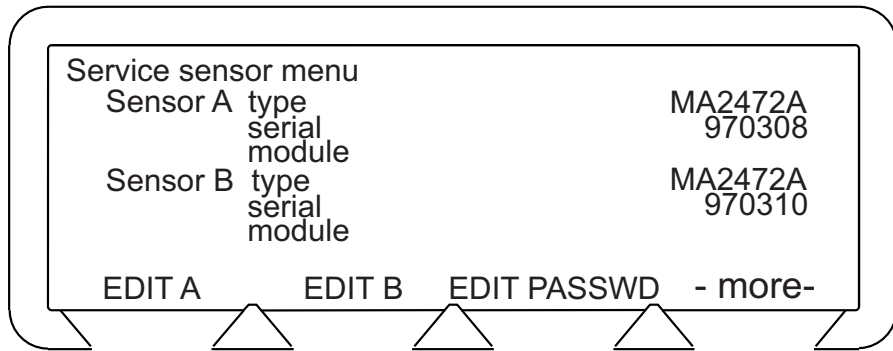

Changing the Password

NOTE

The password will not be reset when a RESET or FACTORY reset is selected from the front panel System menu, or through the GPIB commands *RST or FRST.

To edit the password:

1. Select EDIT PASSWD.
2. Enter the old password and press Enter.
3. Enter the new password (1 to 4 digits) and press Enter.
4. Enter the new password again to confirm and press Enter.

The CLR key on the numeric keypad will clear the current entry. The Abort softkey will abort the password changing process and exit this menu.

Sensor Serial Number

To edit the sensor serial number:

1. Select EDIT A (or EDIT B if appropriate).

Enter the new sensor serial number using the front panel numeric keypad. Press Delete to delete entries, Enter to accept the new serial number, or Cancel to quit without changing the sensor serial number.

When Enter is pressed to accept the new serial number, a warning message is displayed to remind the user not to remove the sensor while the serial number is being saved. Ignoring this message and removing the sensor while programming could corrupt the sensor data.

Cal Factor Edit Menu

Pressing the -more- softkey will bring up the FACTOR A (or FACTOR B) softkeys. With this selection, cal factors, but not frequencies, can be changed in the factory cal factor tables stored in the sensor EEPROM. To edit the factory cal factor tables:

1. Select the FACTOR A (or FACTOR B) softkey.
2. Use the down and up softkeys to select the frequency/factor to change. The current selection is marked by the >>.
3. Press the CHANGE softkey.
4. Use the numeric keypad to enter the new cal factor value.
5. Select dB or % as appropriate.
6. Use the down and up softkeys to select the next cal factor to change, or select the -exit- softkey if finished.
7. Select the SAVE softkey to save the changes to the sensor EEPROM, or select the DISCARD softkey to discard the changes and return to the Service sensor menu. Press the CANCEL softkey to return to the cal factor edit menu.

Printing the EEPROM Data

Pressing the -more- softkey again will bring up the PRINT A (or PRINT B) softkeys. Selecting one of these softkeys will print the first 2048 words of data from the selected sensor EEPROM to the currently selected attached printer.

8-4 GPIB SERVICE COMMANDS

The following GPIB service commands can be used to change or save factory cal factor data, and to output the instrument serial number history.

CFFCHG Change factory cal factor values

Syntax: CFFCHG <password>, <sensor>, <frequency> [suffix], <cal factor>, <units>
password: Password for the Service mode sensor edit control
sensor: 'A' or 'B'
frequency: A Factory table frequency entry.
suffix: 'MHz' or 'GHz'
cal factor: The new cal factor value for the factory frequency entry
units: '%' or 'DB'

Remarks: This command will change the cal factor value for a frequency entry in the factory cal factor table.

WARNING

Cal factors, once entered, will be available for use by the DSP. They will NOT be saved to the sensor though, until the save command CFFSAV is executed. If the sensor is changed or power is lost before saving, then all changes since the last save will be lost.

CFFSAV Save the changed factory cal factor table

Syntax: CFFSAV <password>, <sensor>
password: Password for the Service mode sensor edit control.
sensor: A or B

Remarks: This command saves the changed factory cal factor table to the sensor EEPROM.

SERHIST Outputs the serial number history

Syntax: SERHIST

Remarks: This command returns the instrument serial number history data in a binary format.

Response: SERHIST #3272,<first ever serial number><serial numbers>...

All serial numbers are terminated with a null character and padded with 0xFF to 16 characters. All unused serial number positions are filled with 0xFF. The last valid serial number in the list is the current serial number.

Appendix A

Connector Care and Handling

A-1 INTRODUCTION

This appendix provides information on the proper care and handling of RF sensor connectors.

A-2 CONNECTOR CARE AND HANDLING

ANRITSU Power Meters are high-quality, precision laboratory devices and should receive the care and respect normally afforded such devices. Follow the precautions listed below when handling or connecting these devices. Complying with these precautions will guarantee longer component life and less equipment downtime due to connector or device failure. Also, such compliance will ensure that Power Meter failures are not due to misuse or abuse—two failure modes not covered under the ANRITSU warranty.

Beware of Destructive Pin Depth of Mating Connectors.

Based on RF components returned for repair, destructive pin depth of mating connectors is the major cause of failure in the field. When a RF component connector is mated with a connector having a destructive pin depth, damage will usually occur to the RF component connector. A destructive pin depth is one that is too long in respect to the reference plane of the connector (Figure A-).

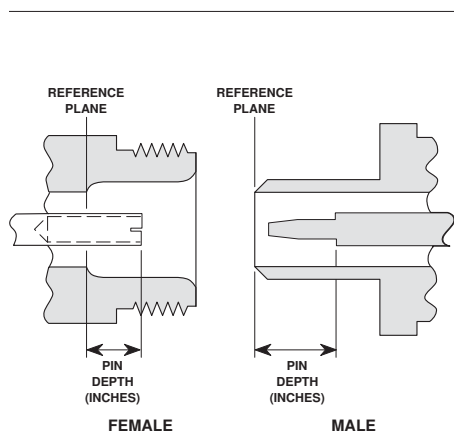

Figure A-2. N Connector Pin Depth Definition

The center pin of a precision RF component connector has a precision tolerance measured in mils (1/1000 inch). The mating connectors of various RF components may not be precision types. Consequently, the center pins of these devices may not have the proper depth. The pin depth of DUT connectors should be measured to assure compatibility before attempting to mate them with Power Meter or sensor connectors. An ANRITSU Pin Depth Gauge (Figure A-), or equivalent, can be used for this purpose.

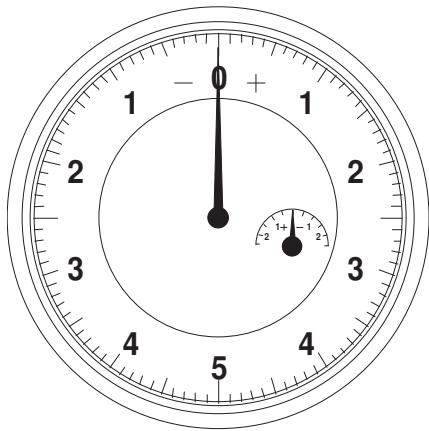

Figure A-3. Pin Depth Gauge

If the measured connector is out of tolerance in the “+” region of the outer scale, the center pin is too long (see Table A-1). Mating under this condition will likely damage the precision RF component connector. If the test device connector measures out of tolerance in the “-” region, the center pin is too short. This should not cause damage, but it will result in a poor connection and a consequent degradation in performance.

Table A-1. Allowable Mating Connector Pin Depth

Test Port Connector Type	Pin Depth (Inches)	Pin Depth Gauge Reading
N-Male	0.207–0.000 +0.003	0.207 +0.000 –0.003
K-Male, K-Female	+0.000 –0.002	Same as Pin Depth
V-Male, V-Female	+0.000 –0.002	

Avoid Over-Torquing Connectors.

Over-torquing connectors may damage the connector center pin. Finger-tight is usually sufficient for Type N connectors. Always use a connector torque wrench (8 inch-pounds) when tightening K, or V type connectors. Never use pliers to tighten connectors.

Cleaning Connectors

The precise geometry that makes possible the RF component's high performance can easily be disturbed by dirt and other contamination adhering to the connector interfaces. To clean the connector interfaces, use a clean cotton swab that has been dampened with denatured alcohol.

NOTE

Most cotton swabs are too large to fit in the smaller connector types. In these cases it is necessary to peel off most of the cotton and then twist the remaining cotton tight. Be sure that the remaining cotton does not get stuck in the connector. Cotton swabs of the appropriate size can be purchased through a medical laboratory-type supply center.

The following are some important tips on cleaning connectors:

- ❑ Use only denatured alcohol as a cleaning solvent.
- ❑ Do not use excessive amounts of alcohol as prolonged drying of the connector may be required.
- ❑ Never put lateral pressure on the center pin of the connector.
- ❑ If installed, do not disturb the Teflon washer on the center conductor pin.
- ❑ Verify that no cotton or other foreign material remains in the connector after cleaning it.
- ❑ If available, carefully use compressed air to remove foreign particles and to dry the connector.
- ❑ After cleaning, verify that the center pin has not been bent or damaged.

Index

A

accessories
 power meter 1-2
Adobe 1-1

B

battery 1-2,4-1,4-4,4-6,5-3,6-5 - 7-6

C

calibrate
 calibrator frequency 3-6
 calibrator level. 3-7
 DC reference 3-5
calibrator
 frequency verification 2-7
 level verification 2-13
case 1-2
charger, battery 1-2,4-6
component handling 1-4
connectors
 care and handling A-1
cover, front panel. 1-2

D

data interpretation 2-5
diagnostic mode 2-6
DSP. 4-2

E

EPROM. 5-1

F

firmware updates 5-1
frequency, of calibrator 2-7

G

General Information. 1-1
GPIB 2-3,4-3,4-5,6-4,7-7

H

handle. 1-2 - 4-3
humidity 3-2

I

identification number 1-2

L

level, of calibrator 2-13
limits 2-5
linearity 2-5

M

main PCB 3-2,3-4,4-3,6-2,7-5
models 1-2

O

options
 power meter 1-2

P

performance verification. 2-1
power supply. 4-4,4-6,7-4
print 2-3
printer 4-3,4-5

R

rack mount 1-2 - 4-3
range calibrator 1-2,2-1
range change error. 2-5
related manuals 1-1
RF reference 3-7,4-5,6-3
RS232 4-5,5-1

S	
Safety	1-1 - 1-2
Scope of the Manual	1-1
sensor	
care	A-1
handling	A-1
serial	
cable	1-2,5-4
service policy.	1-3,6-1,7-1,8-1
spares	1-3,7-1
spreadsheet	2-5
 T	
test	
conditions	2-1
equipment	3-1
theory of operation.	4-1
 U	
uncertainty	2-12,2-21
 V	
verification	
calibrator frequency	2-7
calibrator level	2-13
calibrator menus.	2-2
calibrator results	2-3
performance	2-1
range	2-1 - 2-4
 W	
warm up	2-1
WARRANTY	1-2