

**SERIES
680XXC
SYNTHESIZED CW GENERATOR
OPERATION MANUAL**



490 JARVIS DRIVE
MORGAN HILL, CA 95037-2809

P/N: 10370-10330
REVISION: B
PRINTED: APRIL 2001
COPYRIGHT 1999 ANRITSU CO.

www.valuetronics.com

WARRANTY

The Anritsu product(s) listed on the title page is (are) warranted against defects in materials and workmanship for one year from the date of shipment.

Anritsu's obligation covers repairing or replacing products which prove to be defective during the warranty period. Buyers shall prepay transportation charges for equipment returned to Anritsu for warranty repairs. Obligation is limited to the original purchaser. Anritsu is not liable for consequential damages.

LIMITATION OF WARRANTY

The foregoing warranty does not apply to Anritsu connectors that have failed due to normal wear. Also, the warranty does not apply to defects resulting from improper or inadequate maintenance by the Buyer, unauthorized modification or misuse, or operation outside of the environmental specifications of the product. No other warranty is expressed or implied, and the remedies provided herein are the Buyer's sole and exclusive remedies.

TRADEMARK ACKNOWLEDGEMENTS

Adobe Acrobat is a registered trademark of Adobe Systems Incorporated.

NOTICE

Anritsu Company has prepared this manual for use by Anritsu Company personnel and customers as a guide for the proper installation, operation, and maintenance of Anritsu Company equipment and computer programs. The drawings, specifications, and information contained herein are the property of Anritsu Company, and any unauthorized use or disclosure of these drawings, specifications, and information is prohibited; they shall not be reproduced, copied, or used in whole or in part as the basis for manufacture or sale of the equipment or software programs without the prior written consent of Anritsu Company.

DECLARATION OF CONFORMITY

Manufacturer's Name: ANRITSU COMPANY

Manufacturer's Address: Microwave Measurements Division
490 Jarvis Drive
Morgan Hill, CA 95037-2809
USA

declares that the product specified below:

Product Name: Synthesized CW / Sweep / Signal Generator

Model Number: 690XXB; 691XXB; 693XXB
680XXC; 681XXC; 683XXC

conforms to the requirement of:

EMC Directive 89/336/EEC as amended by Council Directive 92/31/EEC & 93/68/EEC
Low Voltage Directive 73/23/EEC as amended by Council directive 93/68/EEC

Electromagnetic Interference:

Emissions: CISPR 11:1990/EN55011: 1991 Group 1 Class A

Immunity: EN 61000-4-2:1995/EN50082-1: 1997 - 4kV CD, 8kV AD
EN 61000-4-3:1997/EN50082-1: 1997 - 3V/m
ENV 50204/EN50082-1: 1997 - 3V/m
EN 61000-4-4:1995/EN50082-1: 1997 - 0.5kV SL, 1kV PL
EN 61000-4-5:1995/EN50082-1: 1997 - 1kV L-L, 2kV L-E

Electrical Safety Requirement:

Product Safety: IEC 1010-1:1990 + A1/EN61010-1: 1993

Marcel Dubois, Corporate Quality Director

Morgan Hill, CA

JAN 8, 99
Date

European Contact: For Anritsu product EMC & LVD information, contact Anritsu LTD, Rutherford Close,
Stevenage Herts, SG1 2EF UK, (FAX 44-1438-740202)

Safety Symbols

To prevent the risk of personal injury or loss related to equipment malfunction, Anritsu Company uses the following symbols to indicate safety-related information. For your own safety, please read the information carefully BEFORE operating the equipment.

WARNING

WARNING indicates a hazard. It calls attention to a procedure that could result in personal injury or loss of life if not performed properly. Do not proceed beyond a WARNING notice until the indicated conditions are fully understood and met.

CAUTION

CAUTION indicates a hazard. It calls attention to a procedure which, if not performed properly, could result in damage to or destruction of a component of the instrument. Do not proceed beyond a CAUTION note until the indicated conditions are fully understood and met.



The instrument is marked with this symbol to indicate that it is necessary for the user to refer to the instructions in the operation manual.



Indicates ground.



Indicates heavy weight equipment.

For Safety



WARNING

When supplying power to this equipment, **always** use a three-wire power cable connected to a three-wire power line outlet. If power is supplied without grounding the equipment in this manner, there is a risk of receiving a severe or fatal electric shock.



WARNING

Before changing the fuse, **always** remove the power cord from the power outlet. There is the risk of receiving a fatal electric shock if the fuse is replaced with the power cord connected.

Always use a new fuse of the type and rating specified by the fuse markings on the rear panel of the instrument.

WARNING

There are no operator serviceable components inside. Refer servicing of the instrument to qualified service technicians.

To prevent the risk of electrical shock or damage to precision components, **do not** remove the equipment covers.



WARNING

Use two or more people to lift and move this equipment, or use an equipment cart. There is a risk of back injury, if this equipment is lifted by one person.

WARNING

If the equipment is used in a manner not specified by the manufacturer, the protection provided by the equipment may be impaired.

Table of Contents

Chapter 1 General Information

1-1	SCOPE OF MANUAL	1-3
1-2	INTRODUCTION	1-3
1-3	DESCRIPTION	1-3
1-4	IDENTIFICATION NUMBER	1-5
1-5	ELECTRONIC MANUAL	1-5
1-6	RELATED MANUALS	1-5
	GPIB Programming Manual	1-5
	SCPI Programming Manual	1-5
	Maintenance Manual	1-6
1-7	OPTIONS	1-6
1-8	PERFORMANCE SPECIFICATIONS	1-7
1-9	RECOMMENDED TEST EQUIPMENT	1-8

Chapter 2 Installation

2-1	INTRODUCTION	2-3
2-2	INITIAL INSPECTION	2-3
2-3	PREPARATION FOR USE	2-4
	Power Requirements	2-4
	Line Voltage Selection	2-4
	Power Connection	2-4
	Standby Operation	2-5
	Warmup Time	2-6
	Operating Environment	2-6
2-4	GPIB SETUP AND INTERCONNECTION	2-7
	Interface Connector	2-7
	Cable Length Restrictions	2-7
	GPIB Interconnection	2-7
	Setting the GPIB Address	2-7
	Selecting the Line Terminator	2-9
	Selecting the Interface Language	2-9
2-5	RACK MOUNTING KIT INSTALLATION	2-10
	Preliminary	2-10
	Procedure	2-10

Table of Contents (Continued)

2-6	PREPARATION FOR STORAGE/SHIPMENT . . .	2-13
	Preparation for Storage	2-13
	Preparation for Shipment	2-13

Chapter 3 Local (Front Panel) Operation

3-1	INTRODUCTION	3-5
3-2	FRONT PANEL LAYOUT	3-6
	Line Key	3-6
	Data Display Area	3-6
	Data Entry Area	3-7
	RF Output Control Key	3-7
	Connectors	3-7
3-3	DATA DISPLAY AREA	3-8
	Menu Display Format	3-9
	Menu Keys	3-10
3-4	DATA ENTRY AREA	3-12
3-5	INSTRUMENT START-UP	3-14
	Powering Up the 680XXC	3-14
	Start-Up Display	3-14
	Standby Operation	3-14
	Self-Testing the 680XXC	3-15
	Resetting to Default Parameters	3-15
3-6	ENTERING DATA	3-18
	Opening the Parameter	3-18
	Editing the Current Value	3-19
	Entering a New Value	3-20
3-7	CW FREQUENCY OPERATION	3-21
	Selecting CW Mode	3-21
	Selecting a CW Frequency	3-22
	Selecting a Power Level	3-24
	CW Ramp	3-25
3-8	SWEEP FREQUENCY OPERATION	3-26
	Step Sweep Mode	3-26
	Selecting Step Sweep Mode	3-26
	Setting Step Size, Dwell Time, and Sweep Time	3-27
	Selecting a Sweep Trigger	3-30
	Manual Sweep Mode	3-31
	Selecting Manual Sweep Mode	3-31

Table of Contents (Continued)

	Selecting a Sweep Range	3-32
	Selecting a Power Level.	3-34
	Frequency Markers.	3-35
	Selecting Alternate Sweep Mode	3-37
	List Sweep Mode	3-40
	Selecting List Sweep Mode	3-41
	Editing the List	3-42
	Selecting a List Sweep Range.	3-45
	Selecting a List Sweep Trigger	3-46
3-9	FIXED POWER LEVEL OPERATION	3-48
	Selecting Fixed Power Level Mode	3-48
	Selecting a Power Level.	3-48
	Level Offset	3-51
3-10	POWER LEVEL SWEEP OPERATION.	3-52
	Selecting CW Power Sweep Mode	3-52
	Setting CW Power Sweep Step Size and Dwell Time.	3-53
	Selecting a CW Power Sweep Trigger	3-54
	Selecting a Power Level Sweep Range.	3-55
	Selecting a Sweep Frequency / Step Power Mode.	3-57
	Setting Power Level Step Size	3-58
3-11	LEVELING OPERATIONS	3-59
	Selecting a Leveling Mode	3-59
	Attenuator Decoupling	3-63
	ALC Power Slope.	3-64
	User Cal (User Level Flatness Calibration)	3-66
3-12	SYSTEM CONFIGURATION	3-72
	Configuring the Front Panel	3-73
	Configuring the Rear Panel.	3-74
	Configuring the RF.	3-75
	Configuring the GPIB	3-77
	Setting Increment Sizes	3-79
3-13	SAVING/RECALLING INSTRUMENT SETUPS	3-80
	Saving Setups	3-80
	Recalling Setups	3-80
	Erasing Stored Setups	3-81
3-14	SECURE OPERATION	3-82
3-15	REFERENCE OSCILLATOR CALIBRATION	3-83

Table of Contents (Continued)

Chapter 4 Local Operation–Menu Maps

4-1	INTRODUCTION	4-3
4-2	MENU MAP DESCRIPTION	4-3

Chapter 5 Operation Verification

5-1	INTRODUCTION	5-3
5-2	TEST EQUIPMENT.	5-3
5-3	TEST RECORDS	5-3
5-4	INITIAL 680XXC CHECKOUT.	5-4
	Power Up	5-4
	Self Test.	5-4
	Resetting the 680XXC	5-4
	Warmup Time	5-4
5-5	CW FREQUENCY ACCURACY TEST.	5-5
	Test Setup	5-5
	Test Procedure.	5-6
5-6	POWER LEVEL ACCURACY AND FLATNESS TESTS	5-13
	Test Setup	5-13
	Power Level Accuracy Test Procedure	5-14
	Power Level Flatness Test Procedure	5-15

Chapter 6 Operator Maintenance

6-1	INTRODUCTION	6-3
6-2	ERROR AND WARNING/STATUS MESSAGES.	6-3
	Self-Test Error Messages.	6-3
	Normal Operation Error and Warning/ Status Messages	6-8
6-3	TROUBLESHOOTING	6-10
6-4	ROUTINE MAINTENANCE	6-13
	Cleaning the Fan Filter.	6-13
	Cleaning the Data Display	6-13
	Replacing the Line Fuse	6-14

Chapter 7 Use With Other Instruments

7-1	INTRODUCTION	7-3
-----	------------------------	-----

Table of Contents (Continued)

7-2	MASTER-SLAVE OPERATION	7-4
	Connecting the Instruments	7-4
	Initiating Master-Slave Operation	7-5
	Master-Slave Operation	7-7
	Master-Slave Operation in VNA Mode	7-7
	Terminating Master-Slave Operation	7-9
7-3	USE WITH A 56100A SCALAR NETWORK ANALYZER.	7-10
	Connecting the 680XXC to the 56100A	7-10
7-4	USE WITH A 360B VECTOR NETWORK ANALYZER.	7-11
	Connecting the 680XXC to the 360B	7-11
	Configuring the 680XXC	7-12
	Initiating 360B Tracking Mode	7-13
	Terminating 360B Tracking Mode	7-13

Appendix A Rear Panel Connectors

A-1	INTRODUCTION	A-1
A-2	REAR PANEL CONNECTORS	A-1
A-3	CONNECTOR PINOUT DIAGRAMS	A-1

Appendix B Performance Specifications

Chapter 1

General Information

Table of Contents

1-1	SCOPE OF MANUAL	1-3
1-2	INTRODUCTION	1-3
1-3	DESCRIPTION	1-3
1-4	IDENTIFICATION NUMBER	1-6
1-5	ELECTRONIC MANUAL	1-6
1-6	RELATED MANUALS	1-6
	GPIB Programming Manual	1-6
	SCPI Programming Manual	1-6
	Maintenance Manual	1-7
1-7	OPTIONS	1-7
1-8	PERFORMANCE SPECIFICATIONS	1-8
1-9	RECOMMENDED TEST EQUIPMENT	1-8



Figure 1-1. Series 680XXC Synthesized CW Generator

Chapter 1

General Information

1-1 SCOPE OF MANUAL

This manual provides general information, installation, and operating information for the Anritsu Series 680XXC Synthesized CW Generator. (Throughout this manual, the terms *680XXC* and *CW generator* will be used interchangeably to refer to the instrument.) Manual organization is shown in the table of contents.

1-2 INTRODUCTION

This chapter contains general information about the series 680XXC CW generators. It includes a general description of the instrument and information on its identification number, related manuals, options, and performance specifications. A listing of recommended test equipment is also provided.

1-3 DESCRIPTION

The Series 680XXC Synthesized CW Generators are microprocessor-based, synthesized signal sources with high resolution phase-lock capability. They generate both discrete CW frequencies and broad (full range) and narrow band step sweeps across the frequency range of 10 MHz to 65 GHz. All functions of the CW generator are fully controllable locally from the front panel or remotely (except for power on/standby) via the IEEE-488 General Purpose Interface Bus (GPIB).

The series presently consists of seven models covering a variety of frequency and power ranges. Table 1-1, page 1-4, lists models, frequency ranges, and maximum leveled output.

Table 1-1. Series 680XXC Models

680XXC Model	Frequency	Output Power	Output Power w/Step Attenuator	Output Power w/Electronic Step Attenuator
68017C	0.01 – 8.4 GHz	+13.0 dBm	+11.0 dBm	+9.0 dBm
68037C	2.0 – 20.0 GHz	+13.0 dBm	+11.0 dBm	+3.0 dBm
68047C	0.01 – 20.0 GHz	+13.0 dBm	+11.0 dBm	+3.0 dBm
68067C	0.01 – 2.0 GHz	+13.0 dBm	+11.0 dBm	Not Available
	2.0 – 20.0 GHz	+9.0 dBm	+7.0 dBm	
	20.0 – 40.0 GHz	+6.0 dBm	+3.0 dBm	
68077C	0.01 – 2.0 GHz	+11.0 dBm	+10.0 dBm	Not Available
	2.0 – 20.0 GHz	+10.0 dBm	+8.5 dBm	
	20.0 – 40.0 GHz	+2.5 dBm	0.0 dBm	
	40.0 – 50.0 GHz	+2.5 dBm	-1.0 dBm	
68087C	0.01 – 2.0 GHz	+11.0 dBm	+10.0 dBm	Not Available
	2.0 – 20.0 GHz	+10.0 dBm	+8.5 dBm	
	20.0 – 40.0 GHz	+2.5 dBm	0.0 dBm	
	40.0 – 50.0 GHz	+2.0 dBm	-1.5 dBm	
	50.0 – 60.0 GHz	+2.0 dBm	-2.0 dBm	
68097C	0.01 – 2.0 GHz	+11.0 dBm	Not Available	Not Available
	2.0 – 20.0 GHz	+10.0 dBm		
	20.0 – 40.0 GHz	+2.5 dBm		
	40.0 – 50.0 GHz	0.0 dBm		
	50.0 – 65.0 GHz	-2.0 dBm		
With Option 15A (High Power) Installed				
68017C	0.01 – 2.0 GHz	+13.0 dBm	+11.0 dBm	+11.0 dBm
	2.0 – 8.4 GHz	+17.0 dBm	+15.0 dBm	+11.0 dBm
68037C	2.0 – 20.0 GHz	+17.0 dBm	+15.0 dBm	+7.0 dBm
68047C	0.01 – 2.0 GHz	+13.0 dBm	+11.0 dBm	+11.0 dBm
	2.0 – 20.0 GHz	+17.0 dBm	+15.0 dBm	+7.0 dBm
68067C	0.01 – 20.0 GHz	+13.0 dBm	+11.0 dBm	Not Available
	20.0 – 40.0 GHz	+6.0 dBm	+3.0 dBm	
68077C	0.01 – 50.0 GHz	Standard	Standard	Not Available
68087C	0.01 – 60.0 GHz	Standard	Standard	Not Available

Note: In models with Option 22 that have a high-end frequency of ≤ 20 GHz, rated output power is reduced by 1 dB
 In models with Option 22 that have a high-end frequency of > 20 GHz, rated output power is reduced by 2 dB.

**1-4 IDENTIFICATION
NUMBER**

All Anritsu instruments are assigned a unique six-digit ID number, such as “875012”. The ID number is imprinted on a decal that is affixed to the rear panel of the unit. Special-order instrument configurations also have an additional *special* serial number tag attached to the rear panel of the unit.

When ordering parts or corresponding with Anritsu Customer Service, please use the correct serial number with reference to the specific instrument's model number (i.e., Model 68047C Synthesized CW Generator, Serial No. 875012).

1-5 ELECTRONIC MANUAL

This manual is available on CD ROM as an Adobe Acrobat Portable Document Format (*.pdf) file. The file can be viewed using Acrobat Reader, a free program that is also included on the CD ROM. The file is “linked” such that the viewer can choose a topic to view from the displayed “bookmark” list and “jump” to the manual page on which the topic resides. The text can also be word-searched. Contact Anritsu Customer Service for price and availability.

1-6 RELATED MANUALS

This is one of a four manual set that consists of an Operation Manual, a GPIB Programming Manual, a SCPI Programming Manual, and a Maintenance Manual.

***GPIB Pro-
gramming
Manual***

This manual provides information for remote operation of the CW generator with Product Specific commands sent from an external controller via the IEEE 488 General Purpose Interface Bus (GPIB). It contains a general description of the GPIB and bus data transfer and control functions, a complete listing and description of all 680XXC GPIB Product Specific commands, and several programming examples. The Anritsu part number for the GPIB Programming Manual is 10370-10331.

***SCPI Pro-
gramming
Manual***

This manual provides information for remote operation of the CW generator with Standard Commands for Programmable Instruments (SCPI) commands sent from an external controller via the IEEE 488 General Purpose Interface Bus (GPIB). It contains a general description of the GPIB and bus data transfer and control functions, a complete listing and description of each command in the 680XXC SCPI command set, and examples of command usage. The Anritsu part number for the SCPI Programming Manual is 10370-10332.

**Maintenance
Manual**

The Maintenance Manual supplies service information for all models in the 680XXC series. The service information includes functional circuit descriptions, block diagrams, performance verification tests, calibration procedures, troubleshooting data, and assembly and component removal/replacement procedures. The Anritsu part number for the Maintenance Manual is 10370-10336.

1-7 OPTIONS

The following options are available.

Option 1, Rack Mounting. Rack mount kit containing a set of track slides (90° tilt capability), mounting ears, and front panel handles for mounting the instrument in a standard 19-inch equipment rack.

Option 2A, 110 dB Step Attenuator. Adds a 10 dB per step attenuator with a 110 dB range for models having a high-end frequency of ≤ 8.4 GHz and ≤ 20 GHz. Output power is selected directly in dBm on the front panel (or via GPIB). Rated RF output power is reduced.

Option 2B, 110 dB Step Attenuator. Adds a 10 dB per step attenuator with a 110 dB range for models having a high-end frequency of ≤ 40 GHz. Output power is selected directly in dBm on the front panel (or via GPIB). Rated RF output power is reduced.

Option 2C, 90 dB Step Attenuator. Adds a 10 dB per step attenuator with a 90 dB range for models having a high-end frequency of ≤ 50 GHz. Output power is selected directly in dBm on the front panel (or via GPIB). Rated RF output power is reduced.

Option 2D, 90 dB Step Attenuator. Adds a 10 dB per step attenuator with a 90 dB range for models having a high-end frequency of ≤ 60 GHz. Output power is selected directly in dBm on the front panel (or via GPIB). Rated RF output power is reduced.

Option 2E, 120 dB Electronic Step Attenuator. Adds a 10 dB per step attenuator with a 120 dB range for models having a high-end frequency of ≤ 8.4 GHz. Output power is selected directly in dBm on the front panel (or via GPIB). Rated RF output power is reduced.

Option 2F, 120 dB Electronic Step Attenuator. Adds a 10 dB per step attenuator with a 120 dB range for models having a high-end frequency of ≤ 20 GHz. Output power is selected directly in dBm on the front panel (or via GPIB). Rated RF output power is reduced.

Option 9, Rear Panel RF Output. Moves the RF output connector to the rear panel.

Option 11, 0.1 Hz Frequency Resolution. Provides frequency resolution of 0.1 Hz.

Option 14, Rack Mounting without Chassis Slides. Modifies rack mounting hardware to install unit in a console that has mounting shelves. Includes mounting ears and front panel handles.

Option 15A, High Power Output. Adds high-power RF components to the instrument providing increased RF output power in the 2–20 GHz frequency range. Option 15A is standard in models having a high-end frequency that is >40 GHz.

Option 16, High-Stability Time Base. Adds an ovenized, 10 MHz crystal oscillator with $<5 \times 10^{-10}$ /day frequency stability.

Option 17B, No Front Panel. Deletes the front panel for use in remote control applications where a front panel display or keyboard control are not needed.

Option 18, mmWave Module Bias Output. Provides bias output for 54000-xWRxx Millimeter Wave Source Modules. BNC Twinax connector, rear panel.

Option 19, SCPI Programmability. Adds GPIB command mnemonics complying with Standard Commands for Programmable Instruments (SCPI), Version 1993.0. SCPI programming complies with IEEE 488.2-1987.

Option 22, 0.1 Hz to 10 MHz Audio Frequency. Adds frequency coverage below 10 MHz. In models having a high-end frequency of ≤ 20 GHz, rated output power is reduced by 1 dB; in models having a high-end frequency > 20 GHz, rated output power is reduced by 2 dB.

1-8 PERFORMANCE SPECIFICATIONS

Series 680XXC Synthesized CW Generator performance specifications are provided in Appendix B.

**1-9 RECOMMENDED TEST
EQUIPMENT**

Table 1-2 lists the recommended test equipment for performing the Series 680XXC Synthesized CW Generator operation verification tests in Chapter 5.

Table 1-2. Recommended Test Equipment

Instrument	Critical Specification	Recommended Manufacturer/Model
Frequency Counter, with Cable Kit and External Mixer	<i>Range:</i> 0.01 to 65 GHz <i>Input Z:</i> 50Ω <i>Resolution:</i> 1 Hz <i>Other:</i> External Time Base Input	EIP Microwave, Inc. Models 538B, 548B, or 578B, with Cable Kit: Option 590 and External Mixer: Option 91 (26.5 to 40 GHz) Option 92 (40 to 60 GHz) Option 93 (60 to 90 GHz)
Power Meter, with Power Sensors	<i>Range:</i> -30 to +20 dBm (1μW to 100 mW)	Anritsu Model ML2437A or ML2438A, with Power Sensors: MA2474A (0.01 to 40 GHz) MA2475A (0.01 to 50 GHz)
Oscilloscope	<i>Bandwidth:</i> DC to 150 MHz <i>Vertical Sensitivity:</i> 2 mV/division <i>Horiz Sensitivity:</i> 50 ns/division	Tektronix, Inc. Model TAS485

Chapter 2

Installation

Table of Contents

2-1	INTRODUCTION	2-3
2-2	INITIAL INSPECTION	2-3
2-3	PREPARATION FOR USE	2-4
	Power Requirements	2-4
	Line Voltage Selection	2-4
	Power Connection	2-4
	Standby Operation	2-5
	Warmup Time	2-6
	Operating Environment	2-6
2-4	GPIB SETUP AND INTERCONNECTION	2-7
	Interface Connector	2-7
	Cable Length Restrictions	2-7
	GPIB Interconnection	2-7
	Setting the GPIB Address	2-7
	Selecting the Line Terminator	2-9
	Selecting the Interface Language	2-9
2-5	RACK MOUNTING KIT INSTALLATION	2-10
	Preliminary	2-10
	Procedure	2-10
2-6	PREPARATION FOR STORAGE/SHIPMENT	2-13
	Preparation for Storage	2-13
	Preparation for Shipment	2-13

Chapter 2

Installation

2-1 INTRODUCTION

This chapter provides installation instructions for the Series 680XXC Synthesized CW Generator. It includes information on initial inspection, preparation for use, storage, and reshipment, and General Purpose Interface Bus (GPIB) setup and interconnections.



WARNING

Use two or more people to lift and move this equipment, or use an equipment cart. There is a risk of back injury, if this equipment is lifted by one person.

2-2 INITIAL INSPECTION

Inspect the shipping container for damage. If the shipping container or cushioning material is damaged, retain until the contents of the shipment have been checked against the packing list and the CW generator has been checked for mechanical and electrical operation.

If the shipment is incomplete or if the CW generator is damaged mechanically or electrically, notify your local sales representative or Anritsu Customer Service. If either the shipping container is damaged or the cushioning material shows signs of stress, notify the carrier as well as Anritsu. Keep the shipping materials for the carrier's inspection.

2-3 PREPARATION FOR USE

Preparation for use consists of (1) checking that the rear panel line voltage selector switch is set for the correct line voltage and (2) connecting the CW generator to the power source. The following paragraphs provide these procedures along with information about power requirements, warmup times, and the operating environment.

Power Requirements The CW generator accepts 90 to 132 Vac and 180 to 264 Vac, 48 to 440 Hz, single-phase power. Power consumption is 400 VA maximum. The CW generator is intended for Installation Category (Overvoltage Category) II.



CAUTION

Before applying power, verify that the unit is set to match the available line voltage and that the installed fuse is of the correct type and rating.

Line Voltage Selection

The line voltage selector switch on the rear panel can be set for either 110 Vac or 220 Vac operation (Figure 2-1). When the switch is set to 110 Vac, the 680XXC accepts 90 to 132 Vac line voltage. When the switch is set to 220 Vac, the 680XXC accepts 180 to 264 Vac line voltage. If the selector setting is incorrect for the line voltage available, change it to the correct setting.

Whenever the selector setting is changed, the line fuse must be changed to the correct value for the line voltage selected. Line fuse values for the line voltages are printed on the rear panel next to the fuse holder.



WARNING

When supplying power to this equipment, *always* use a three-wire power cable connected to a three-wire power line outlet. If power is supplied without grounding the equipment in this manner, there is a risk of receiving a severe or fatal electric shock.

Power Connection

Connecting the 680XXC to line power automatically places it in operation (front panel OPERATE LED on). To connect it to the power source, plug the female end of the power cable into the input line voltage receptacle on the rear panel (Figure 2-1). Then plug the male end of the power cord into a three-wire power line outlet.

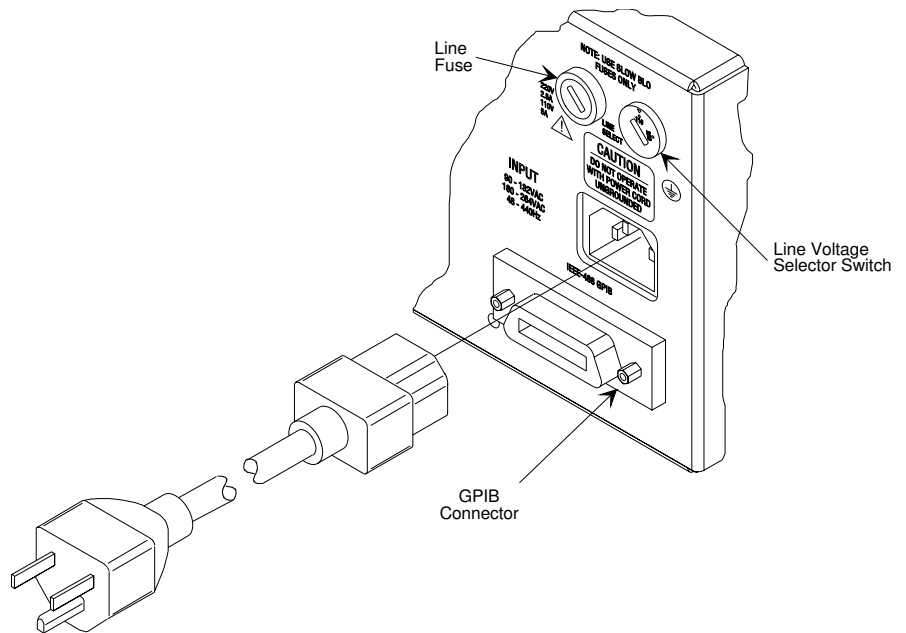
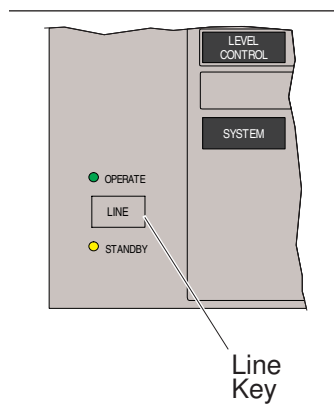

Figure 2-1. CW Generator Rear Panel showing Power Connection



Standby Operation

Whenever the CW generator is not being used it should be left connected to the power source and placed in standby. This keeps the internal timebase frequency reference at operating temperature.

On the front panel, press **LINE** to switch the 680XXC from OPERATE (green LED on) to STANDBY (orange LED on).

NOTE

During standby operation, the fan runs continuously.

Warmup Time **From Standby**—When placing the 680XXC in operation from stand-by, allow 30 minutes warmup to assure stable operation.

From a Cold Start (0°C)—The CW generator requires approximately 120 hours (5 days) of warm up to achieve specified frequency stability with aging.

NOTE

Instruments disconnected from AC power for more than 72 hours require 30 days to return to specified aging.

Operating Environment The 680XXC can be operated within the following environmental limits.

- ❑ **Temperature.** 0°C to 50°C.
- ❑ **Humidity.** 5 to 95% relative at 40°C.
- ❑ **Altitude.** Up to 4600 meters.
- ❑ **Cooling.** Internal cooling is provided by forced airflow from the fan mounted on the rear panel.

CAUTION

Before installing the 680XXC in its operating environment, ensure that all airflow passages at the sides and rear of the instrument are clear. This is of particular importance whenever the unit is being rack-mounted.

Keep the cooling fan filter clean so that the ventilation holes are not obstructed. A blocked fan filter can cause the instrument to overheat and shut down.

2-4 GPIB SETUP AND INTERCONNECTION

The 680XXC provides automated microwave signal generation via the GPIB. The following paragraphs provide information about interface connections, cable requirements, setting the GPIB operating parameters, and selecting the external interface language.

Interface Connector

Interface between the CW generator and other devices on the GPIB is via a 24-wire interface cable. This cable uses connector shells having two connector faces. These double-faced connectors allow for the parallel connection of two or more cables to a single device. Figure 2-1 shows the location of the rear panel GPIB connector.

Cable Length Restrictions

The GPIB can accommodate up to 15 instruments at any one time. To achieve design performance on the bus, proper timing and voltage level relationships must be maintained. If either the cable length between separate instruments or the cumulative cable length between all instruments is too long, the data and control lines cannot be driven properly and the system may fail to perform. Cable length restrictions are as follows:

- ❑ No more than 15 instruments may be installed on the bus.
- ❑ Total cumulative cable length in meters may not exceed two times the number of bus instruments or 20 meters—whichever is less.

NOTE

For low EMI applications, the GPIB cable should be a fully shielded type, with well-grounded metal-shell connectors

GPIB Interconnection

The only interconnection required for GPIB operation is between the CW generator and the controller. This interconnection is via a standard GPIB cable. The Anritsu Part number for such a cable is 2000-1, -2, or -4 (1, 2, or 4 meters in length).

Setting the GPIB Address

The default GPIB address is 5. If a different GPIB address is desired, it can be set from the front panel using the Configure GPIB Menu.

To change the GPIB address, first press the front panel main menu key labeled **SYSTEM**. The System Menu (shown on the following page) is displayed.

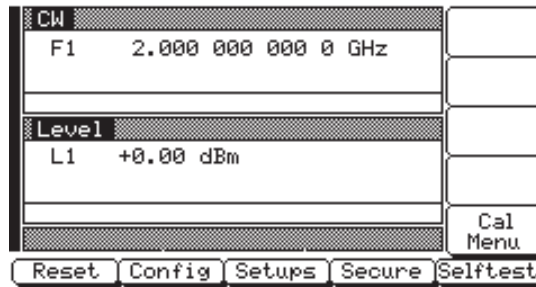

Now press the menu soft-key **Config**. The System Configuration Menu (shown below) is displayed.

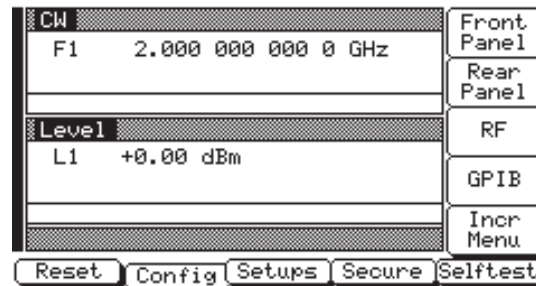

To go to the Configure GPIB menu from this menu, press the menu soft-key **GPIB**. The Configure GPIB Menu (shown below) is displayed.

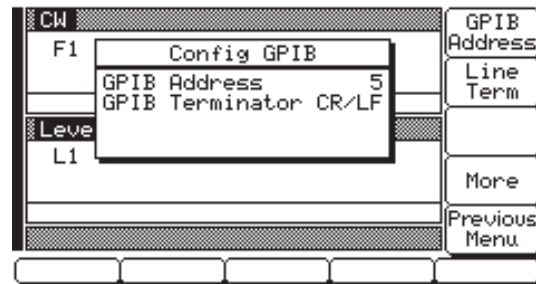

Press the menu soft-key **GPIB Address** to change the current GPIB address of the CW generator. Enter a new address using the cursor control key or the data entry keypad and the terminator key



The new GPIB address will now appear on the display. The entry must be between 1 and 30 to be recognized as a valid GPIB address.

Selecting the Line Terminator

Data is delimited on the GPIB by either the carriage return (CR) ASCII character or both the carriage return and line feed (CR/LF) ASCII characters. Which character is used depends upon the requirements of the system controller. Most modern controllers can use either CR or CR/LF, while many older controllers require one or the other. Consult the controller's manual for its particular requirements.

From the Configure GPIB Menu display, you can select which GPIB terminator to use by pressing the menu soft-key **Line Term**. This menu soft-key toggles the GPIB terminator between CR and CR/LF. The current selection appears on the display.

Selecting the Interface Language

Series 680XXC Synthesized CW Generators can be remotely operated via the GPIB using one of two external interface languages—Native or SCPI (Option 19). The Native interface language uses a set of 680XXC GPIB Product Specific commands to control the instrument; the SCPI interface language uses a set of the Standard Commands for Programmable Instruments commands to control the unit.

The Configure GPIB Menu has an additional menu display. For instruments with Option 19, selection of which external interface language is to be used is made from this additional menu. From the Configure GPIB Menu display, you can access the additional menu by pressing **More**. The Additional Configure GPIB Menu (below) is displayed.

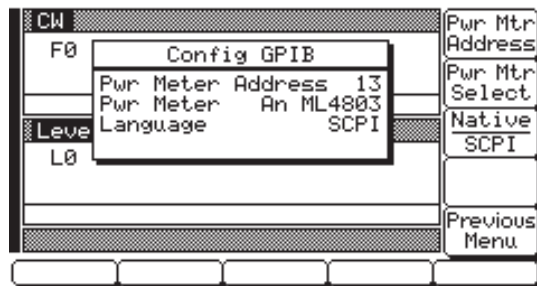

Press **Native/SCPI** to select the external interface language to be used. This menu soft-key toggles the language selection between Native and SCPI. The current selection appears on the display.

**2-5 RACK MOUNTING KIT
INSTALLATION**

The rack mounting kit (Option 1) contains a set of track slides (90° tilt capability), mounting ears, and front panel handles for mounting the CW generator in a standard equipment rack. The following procedure provides instructions for installing the rack mounting hardware on to the instrument. Refer to Figures 2-2 and 2-3 during this procedure.

Preliminary Disconnect the power cord and any other cables from the instrument.

Procedure Install the rack mounting hardware as follows:

- Step 1** Using a Phillips screwdriver, remove the screws and the front handle assemblies from the instrument. (For instruments not having front handles, remove the screws and the front top and bottom feet from the instrument.) Retain the screws.
- Step 2** Remove the four feet from the rear of the instrument. Retain the screws.
- Step 3** Remove the screws and the carrying handle from the side handle cover. (The two screws fastening the carrying handle through the side handle cover to the chassis are accessible by lifting up the rubber covering at each end of the handle.)

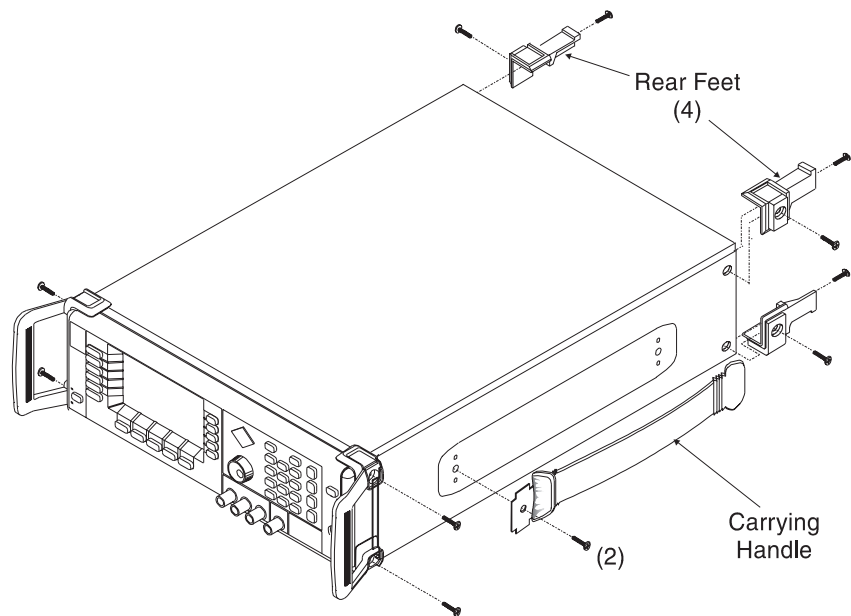

Figure 2-2. Front Handle, Feet, and Carrying Handle Removal

NOTE

The screws with green heads have metric threads. When it becomes necessary to replace any of these screws, *always* use the exact replacement green-headed screws (Anritsu P/N 2000-560) to avoid damage to the instrument.

- Step 4** Remove the inner slide assemblies from the outer slide assemblies.
- Step 5** Place the left side inner slide assembly onto the instrument case with the handle towards the front of the instrument (Figure 2-3).
- Step 6** Insert two green-headed screws through the holes in the slide assembly behind the handle and into the metric tapped holes in the side of the instrument.
- Step 7** Insert two green-headed screws through the holes near the rear of the slide assembly and into the metric tapped holes in the side of the instrument.
- Step 8** Insert the two SAE threaded screws (removed from the feet) through the 90° tabs on the rear of the slide assembly and into the rear panel of the instrument.
- Step 9** Using the Phillips screwdriver, tighten all screws holding the left side slide assembly to the instrument chassis.

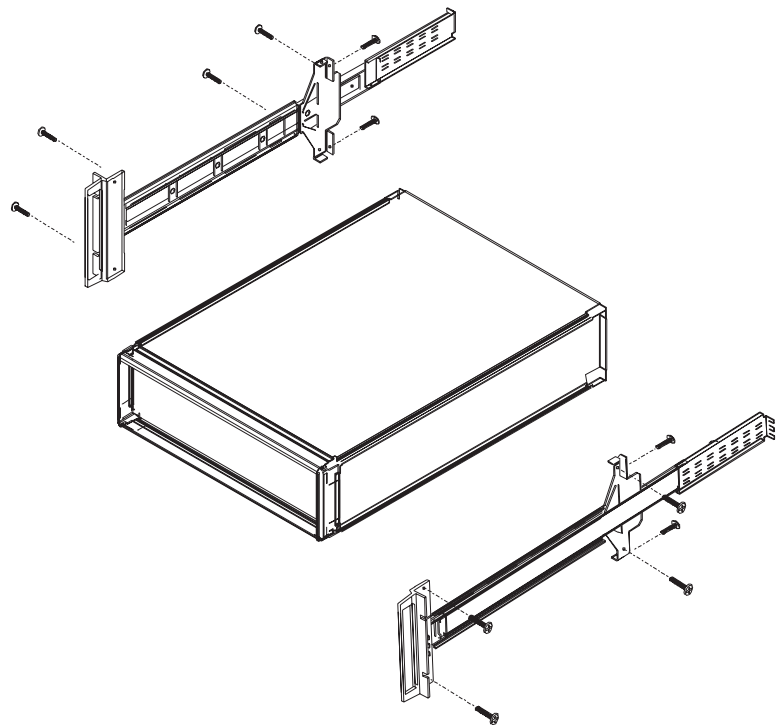

Figure 2-3. Rack Mounting Hardware Installation

- Step 10** Place the right side inner slide assembly onto the instrument case with the handle towards the front of the instrument.
- Step 11** Insert two green-headed screws through the holes in the slide assembly behind the handle and into the metric tapped holes in the side of the instrument.
- Step 12** Insert two green-headed screws through the holes near the rear of the slide assembly and into the metric tapped holes in the side of the instrument.
- Step 13** Insert the two SAE threaded screws (removed from the feet) through the 90° tabs on the rear of the slide assembly and into the rear panel of the instrument.
- Step 14** Using the Phillips screwdriver, tighten all screws holding the right side slide assembly to the instrument chassis.
- Step 15** With the appropriate hardware, install the outer slide assemblies onto the equipment rack.
- Step 16** Lift the CW generator into position. Align the inner and outer slide assemblies and slide the instrument into the rack. Realign the hardware as needed for smooth operation.



WARNING

Use two or more people to lift and move this equipment, or use an equipment cart. There is a risk of back injury, if this equipment is lifted by one person.

**2-6 PREPARATION FOR
STORAGE/SHIPMENT**

The following paragraphs give instructions for preparing the 680XXC for storage or shipment.

***Preparation
for Storage***

Preparing the CW generator for storage consists of cleaning the unit, packing the inside with moisture-absorbing desiccant crystals, and storing the unit in a temperature environment that is maintained between -40°C and $+75^{\circ}\text{C}$.

***Preparation
for Shipment***

To provide maximum protection against damage in transit, the CW generator should be repackaged in the original shipping container. If this container is no longer available and the unit is being returned to Anritsu for repair, advise Anritsu Customer Service; they will send a new shipping container free of charge. In the event neither of these two options is possible, instructions for packaging and shipment are given below.

Use a Suitable Container.

Obtain a corrugated cardboard carton with a 125 kg test strength. This carton should have inside dimensions of no less than 15 cm larger than the unit dimensions to allow for cushioning.

Protect the Instrument.

Surround the unit with polyethylene sheeting to protect the finish.

Cushion the Instrument.

Cushion the instrument on all sides by tightly packing dunnage or urethane foam between the carton and the unit. Provide at least three inches of dunnage on all sides.

Seal the Container.

Seal the carton by using either shipping tape or an industrial stapler.

Address the Container.

If the instrument is being returned to Anritsu for service, mark the address of the appropriate Anritsu service center (Table 2-1) and your return address on the carton in one or more prominent locations.

Table 2-1. ANRITSU Service Centers

UNITED STATES

ANRITSU COMPANY
490 Jarvis Drive
Morgan Hill, CA 95037-2809
Telephone: (408) 776-8300
1-800-ANRITSU
FAX: 408-776-1744

ANRITSU COMPANY
10 New Maple Ave., Unit 305
Pine Brook, NJ 07058
Telephone: (201) 227-8999, 1-800-ANRITSU
FAX: 201-575-0092

ANRITSU COMPANY
1155 E. Collins Blvd
Richardson, TX 75081
Telephone: 1-800-ANRITSU
FAX: 972-671-1877

AUSTRALIA

ANRITSU PTY. LTD.
Unit 3, 170 Foster Road
Mt Waverley, VIC 3149
Australia
Telephone: 03-9558-8177
FAX: 03-9558-8255

BRAZIL

ANRITSU ELECTRONICA LTDA.
Praia de Botafogo, 440, Sala 2401
CEP22250-040, Rio de Janeiro, RJ, Brasil
Telephone: 021-527-6922
FAX: 021-53-71-456

CANADA

ANRITSU INSTRUMENTS LTD.
215 Stafford Road, Unit 102
Nepean, Ontario K2H 9C1
Telephone: (613) 828-4090
FAX: (613) 828-5400

CHINA

ANRITSU ELECTRONICS (SHANGHAI) CO.
LTD.
2F, Rm B 52 Section Factory Building
No. 516 Fu Te Rd (W)
Shanghi 200131 China
Telephone: 21-58680226, 58680227
FAX: 21-58680588

FRANCE

ANRITSU S.A
9 Avenue du Quebec
Zone de Courtaboeuf
91951 Les Ulis Cedex
Telephone: 016-09-21-550
FAX: 016-44-61-065

GERMANY

ANRITSU GmbH
Grafenberger Allee 54-56
D-40237 Dusseldorf, Germany
Telephone: 0211-968550
FAX: 0211-968555

INDIA

MEERA AGENCIES (P) LTD.
23 Community Center
Kailash Colony Extension
New Delhi, India
Telephone: 91-11-6442700
FAX: 91-11-6442500

ISRAEL

TECH-CENT, LTD.
4 Raul Valenberg St
Tel-Aviv 69719
Telephone: (03) 64-78-563
FAX: (03) 64-78-334

ITALY

ANRITSU Sp.A
Roma Office
Via E. Vittorini, 129
00144 Roma EUR
Telephone: (06) 50-99-711
FAX: (06) 50-22-4252

KOREA

ANRITSU CORPORATION LTD.
8F, Seocho-Dong, Secho-Ku
Seoul, 137-070
South Korea
Telephone: 2-581-6603
FAX: 2-582-6603

JAPAN

ANRITSU CUSTOMER SERVICE LTD.
1800 Onna Atsugi-shi
Kanagawa-Prf. 243 Japan
Telephone: 0462-96-6688
FAX: 0462-25-8379

SINGAPORE

ANRITSU (SINGAPORE) PTE LTD.
6 New Industrial Road #06-01/02
Hoe Huat Industrial Bldg
Singapore 536199
Telephone: 282-2400
FAX: 282-2533

SOUTH AFRICA

ETEC SA
12 Surrey Square Office Park
330 Surrey Avenue
Ferndale, Randburt, 2194
South Africa
Telephone: 011-27-11-787-7200
FAX: 011-27-11-787-0446

SWEDEN

ANRITSU AB
Botivid Center
Fittja Backe 13A
S145 84 Stockholm
Telephone: (08) 534-707-00
FAX: (08) 534-707-30

TAIWAN

ANRITSU CO., LTD.
6F, No. 96, Section 3
Chien Kuo N. Road
Taipei, Taiwan, R.O.C.
Telephone: (02) 515-6050
FAX: (02) 509-5519

UNITED KINGDOM

ANRITSU LTD.
200 Capability Green
Luton, Bedfordshire
LU1 3LU, England
Telephone: 015-82-433200
FAX: 015-82-731303

Chapter 3

Local (Front Panel) Operation

Table of Contents

3-1	INTRODUCTION	3-5
3-2	FRONT PANEL LAYOUT.	3-6
	Line Key	3-6
	Data Display Area	3-6
	Data Entry Area.	3-7
	RF Output Control Key	3-7
	Connectors	3-7
3-3	DATA DISPLAY AREA	3-8
	Menu Display Format	3-9
	Menu Keys	3-10
3-4	DATA ENTRY AREA.	3-12
3-5	INSTRUMENT START-UP	3-14
	Powering Up the 680XXC.	3-14
	Start-Up Display	3-14
	Standby Operation	3-14
	Self-Testing the 680XXC	3-15
	Resetting to Default Parameters	3-15
3-6	ENTERING DATA	3-18
	Opening the Parameter.	3-18
	Editing the Current Value	3-19
	Entering a New Value	3-20
3-7	CW FREQUENCY OPERATION	3-21
	Selecting CW Mode.	3-21
	Selecting a CW Frequency	3-22
	Selecting a Power Level.	3-24
	CW Ramp	3-25

Table of Contents (Continued)

3-8	SWEEP FREQUENCY OPERATION	3-26
	Step Sweep Mode	3-26
	Selecting Step Sweep Mode	3-26
	Setting Step Size, Dwell Time, and Sweep Time .	3-27
	Selecting a Sweep Trigger	3-30
	Manual Sweep Mode	3-31
	Selecting Manual Sweep Mode	3-31
	Selecting a Sweep Range	3-32
	Selecting a Power Level.	3-34
	Frequency Markers.	3-35
	Selecting Alternate Sweep Mode	3-37
	List Sweep Mode	3-40
	Selecting List Sweep Mode	3-41
	Editing the List	3-42
	Selecting a List Sweep Range.	3-45
	Selecting a List Sweep Trigger	3-46
3-9	FIXED POWER LEVEL OPERATION	3-48
	Selecting Fixed Power Level Mode	3-48
	Selecting a Power Level.	3-48
	Level Offset	3-51
3-10	POWER LEVEL SWEEP OPERATION.	3-52
	Selecting CW Power Sweep Mode	3-52
	Setting CW Power Sweep Step Size and Dwell Time	3-53
	Selecting a CW Power Sweep Trigger	3-54
	Selecting a Power Level Sweep Range.	3-55
	Selecting a Sweep Frequency/Step Power Mode .	3-57
	Setting Power Level Step Size	3-58
3-11	LEVELING OPERATIONS	3-59
	Selecting a Leveling Mode	3-59
	Attenuator Decoupling	3-63
	ALC Power Slope.	3-64
	User Level Flatness Calibration	3-66

Table of Contents (Continued)

3-12	SYSTEM CONFIGURATION	3-72
	Configuring the Front Panel	3-73
	Configuring the Rear Panel	3-74
	Configuring the RF	3-75
	Configuring the GPIB	3-77
	Setting Increment Sizes	3-79
3-13	SAVING/RECALLING INSTRUMENT SETUPS	3-80
	Saving Setups	3-80
	Recalling Setups	3-80
	Erasing Stored Setups	3-81
3-14	SECURE OPERATION	3-82
3-15	REFERENCE OSCILLATOR CALIBRATION	3-83

Chapter 3

Local (Front Panel) Operation

3-1 INTRODUCTION

This chapter provides information and instructions on operating the Series 680XXC Synthesized CW Generator using the front panel controls. It contains the following:

- ❑ Illustrations and diagrams of the front panel, data display area, and data entry area that identify and describe all front panel controls, inputs, and outputs.
- ❑ An annotated diagram of the menu display format showing where the current frequency and power level information is displayed.
- ❑ Instructions for performing CW generator operations; namely, frequency and frequency sweep, fixed power level and power level sweep, leveling, system configuration, and saving and recalling instrument setups.

3-2 FRONT PANEL LAYOUT

The 680XXC front panel is divided into two main areas—the data display area and the data entry area. The following paragraphs provide a brief description of the front panel controls, inputs, outputs, and data display and data entry areas as shown in Figure 3-1. Detailed descriptions of the data display and data entry areas are contained in paragraphs 3-3 and 3-4.

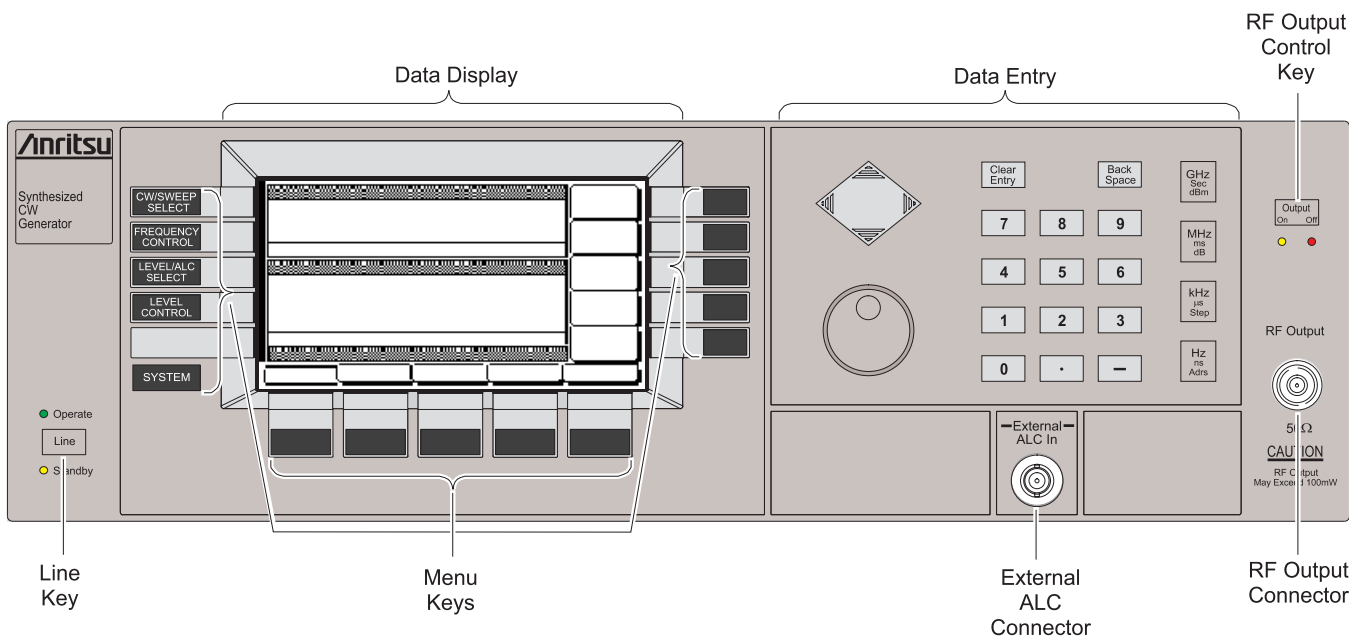

Figure 3-1. Front Panel, 680XXC Synthesized CW Generator

Line Key

The line key provides for turning the CW generator on and off. STANDBY (off) is indicated by an orange LED; OPERATE (on) by a green LED.

Data Display Area

The data display area consists of the data display and the surrounding menu keys.

Data Display

The data display provides information about the current status of the 680XXC in a menu display format. This information includes the operating mode of the instrument and the value of the active frequency and power level parameters.

Menu Keys

Menu keys provide for selecting the operating mode, parameters, and configuration of the CW generator.

***Data Entry
Area***

The data entry area consists of data entry keys and controls that provide for (1) changing values for each 680XXC parameter, and (2) terminating the value entry and assigning the appropriate units (GHz, MHz, dBm, etc.).

***RF Output
Control Key***

The RF output control key provides for turning the RF output power on and off. OUTPUT OFF is indicated by a red LED; OUTPUT ON by a yellow LED.

Connectors

The front panel has both an input connector and an output connector.

External ALC Connector

The external ALC connector provides for leveling the RF output signal externally using either a detector or a power meter.

RF Output Connector

The RF output connector provides RF output from a 50Ω source.

NOTE

To prevent power losses due to an impedance mismatch, the mating connector and cable should also be rated at 50Ω.

3-3 DATA DISPLAY AREA

The data display area consists of the data display and the surrounding menu keys. The data display is a dot matrix liquid crystal display (LCD) that provides 16 lines of 40 characters each. Information is presented on the LCD in the form of menu displays. The menu keys either select the main menu to be displayed, select a sub-menu of the current menu display, or control a function on the current menu display.

Figure 3-2 shows the format of the menu display and identifies the display elements. It also shows the placement of the menu keys in relation to the display. The paragraphs that follow provide descriptions of the menu display elements and the menu keys.

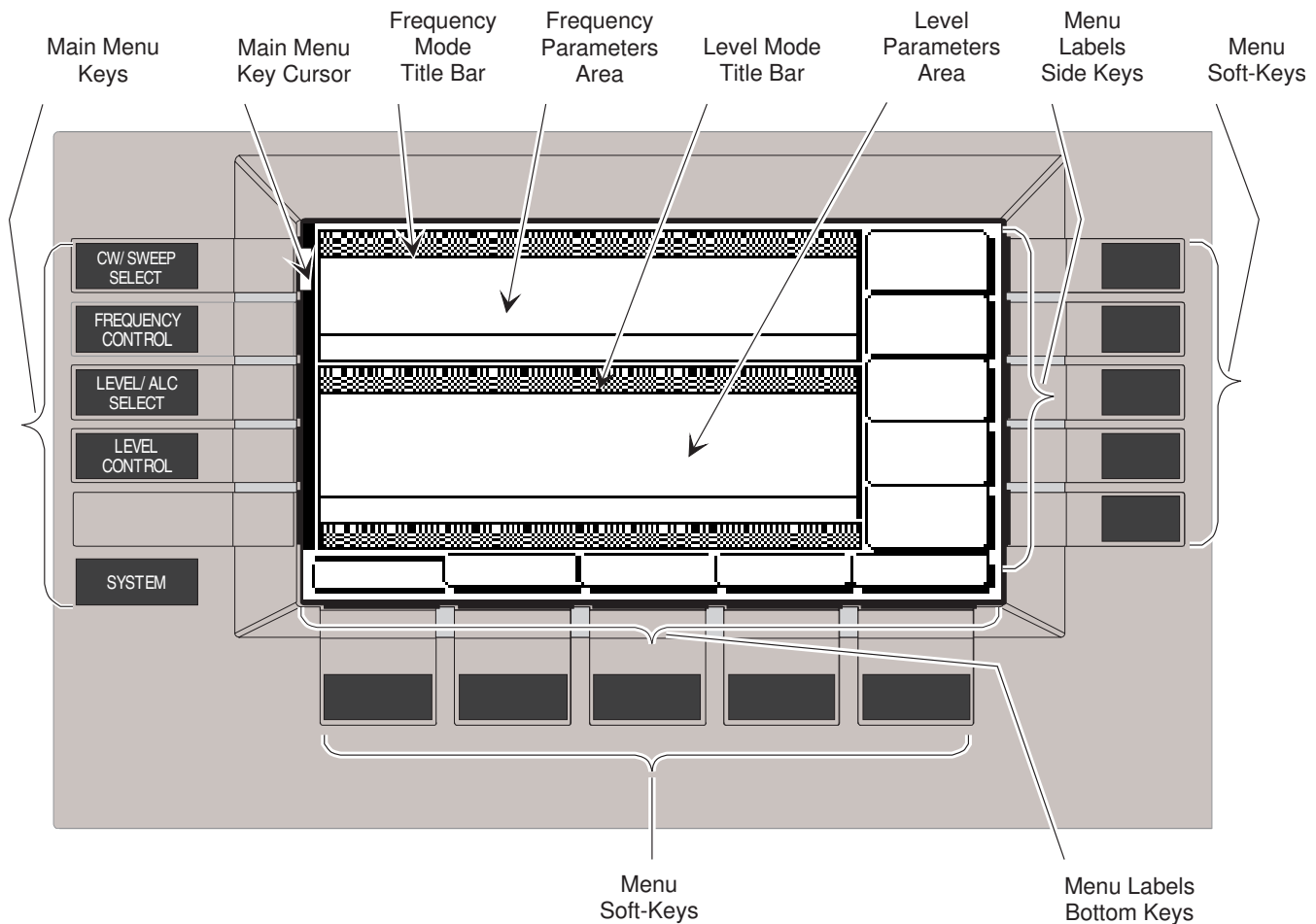

Figure 3-2. Front Panel Data Display Area

***Menu Display
Format***

The menu display is divided into specific areas that show the frequency and power level information for the current CW generator setup. Menu labels for the current menu's soft-keys appear along the bottom and right side of the display.

Title Bars

A shaded title bar identifies each parameter area. Mode information is displayed in reverse video on the title bars.

- ❑ **Frequency Mode Title Bar**—The current frequency mode (CW, Step Sweep, Manual Sweep, or List Sweep) appears on the left side of the bar. In the step and list sweep mode, the type of sweep trigger appears on the right side.
- ❑ **Level Mode Title Bar**—The current power level mode (Level or Level Sweep) appears on the left side of the bar. In a level sweep mode, the type of sweep trigger appears on the right side of the bar.

Parameter Areas

The parameter areas show the frequency and power level information for the current 680XXC setup.

- ❑ **Frequency Parameters Area**—The current CW frequency in GHz, the start and stop frequencies of the current frequency sweep range in GHz, the current list index and frequency, or the start and stop indexes for the list sweep are displayed in this area.
- ❑ **Power Level Parameters Area**—The current power level in dBm or mV, or the start and stop levels of the current power level sweep range in dBm or mV are displayed in this area.

Menu Labels

Each of the menu soft-keys, located below and to the right of the display, has a corresponding menu label area on the display. These labels identify the function of the soft-keys for the current menu display. In most cases, when a menu soft-key is pressed, its menu label changes appearance to visually show the On/Off condition.

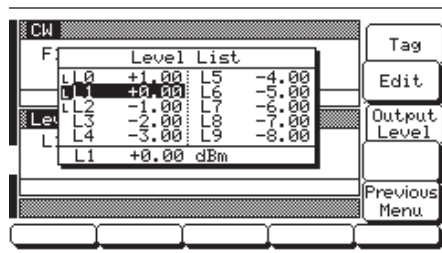

Menu Keys



Window Display

A window display that overlays a portion of the current menu display is used to (1) show the parameter being edited; (2) display selection lists of preset frequencies, power levels, markers, etc.; (3) show the system configuration choices and current selections; or (4) show self-test error messages. A typical window display is shown on the left.

As shown in Figure 3-2, there are two types of menu keys that surround the data display—main menu keys and menu soft-keys. The main menu keys are positioned to the left of the data display. The menu soft-keys are located at the bottom and to the right of the data display.

Main Menu Keys

Each of the main menu keys, shown on the left, selects a main (top-level) menu display. These menus let you select the operating mode, operating parameters, and configuration of the instrument. A brief functional description of each main menu follows.

- ❑ **CW/SWEEP SELECT**—This menu lets you select between CW, Step, Manual, and List Sweep frequency modes.
- ❑ **FREQUENCY CONTROL**—In CW frequency mode, this menu lets you select the CW frequency parameter (F0-F9 or M0-M9) to use. In the Step or Manual Sweep frequency mode, this menu lets you select the sweep range parameters (Full, F1-F2, F3-F4, F5-dF, or F6-dF) to use. In Step Sweep frequency mode, the menu also lets you select up to 20 independent, pre-settable frequency markers.
- ❑ **LEVEL/ALC SELECT**—This menu lets you select power level and ALC modes (Level, Level Sweep, Level Offset, ALC on or off, internal or external ALC, ALC/attenuator decoupling, ALC slope, and user level flatness correction).
- ❑ **LEVEL CONTROL**—In Level mode, this menu lets you select the level parameter (L0-L9) to use for a CW frequency or a frequency sweep. In the Level Sweep mode, this menu lets you select the power sweep range parameters to use.

- ❑ **SYSTEM**—This menu provides you with access to sub-menus that let you (1) reset the instrument to factory-selected default values; (2) configure the front panel, rear panel, RF, and GPIB; (3) set incremental sizes for editing frequency, power level, and time parameters; (4) save or recall instrument setups; (5) disable front panel data display; (6) perform instrument self-test; and (7) perform reference oscillator calibration.

Main Menu Key Cursor

With the exception of the **SYSTEM** key, when any main menu key is pressed, the main menu that is displayed contains a cursor positioned adjacent to the pressed key (Figure 3-2). The cursor is displayed on all sub-menus of the current menu until a different main menu key is pressed.

When the **SYSTEM** key is pressed, the System menu is displayed. The System menu and its sub-menus do *not* contain a main menu key cursor.

Menu Soft-Keys

As shown on the left, five menu soft-keys are located below the data display and five menu soft-keys are located to the right of the data display. In general, the menu soft-keys located below the data display select a sub-menu of the current main (top-level) menu display; the menu soft-keys located to the right of the data display either control a function on the current menu display or select an additional sub-menu. Menu labels that identify the current function of each soft-key are shown on the menu display adjacent to the soft-keys.

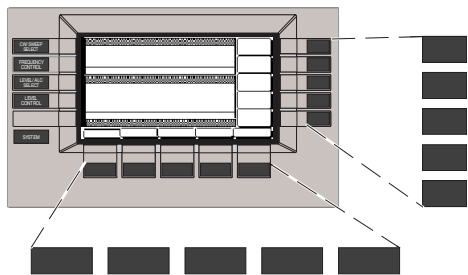

3-4 DATA ENTRY AREA

The value of a selected 680XXC parameter can be changed using the rotary data knob and/or keys of the data entry area. Each element of the data entry area is identified in Figure 3-3 and described in the following paragraphs.

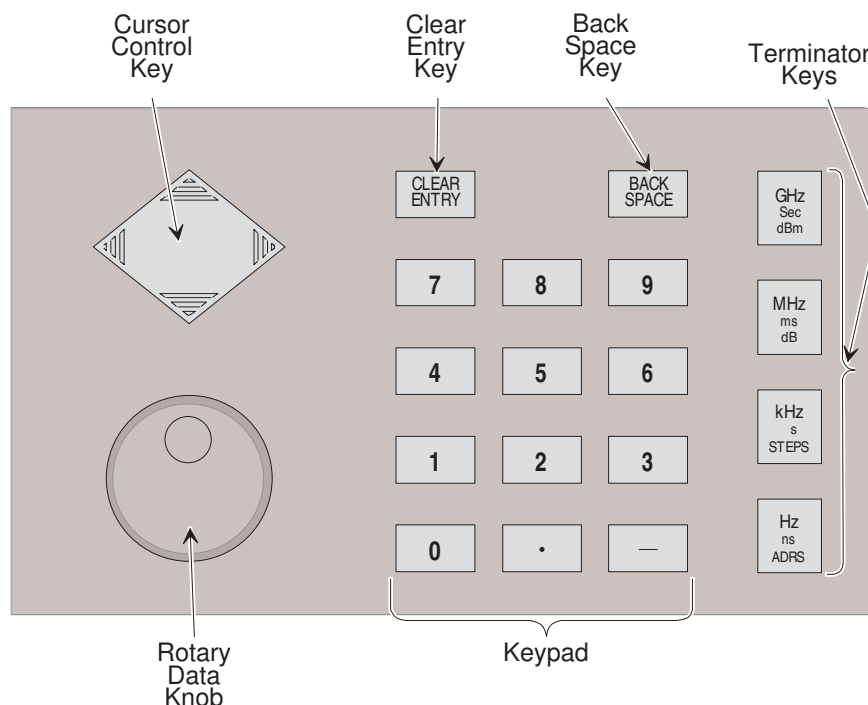

Figure 3-3. Front Panel Data Entry Area

Cursor Control Key

In general, this diamond-shaped key controls the movement of the cursor on the display. When a parameter is opened for editing, a cursor appears under the open parameter. Each time the < or > pad is pressed, the cursor moves left or right by one digit. The \wedge or \vee pad can then be used to increase or decrease the value of the parameter. The unit size of the increase or decrease that occurs each time the \wedge or \vee pad is pressed is determined by the cursor position.

In addition, when editing frequency, power level, and time parameters, the incremental size can be set to a specific value using the system configuration increment menu (paragraph 3-12). Once set and activated, each time the \wedge or \vee pad is pressed, the parameter's value increases or decreases by the set amount.

Rotary Data Knob

The rotary data knob can be used to change the value of a parameter that is open for editing. The cursor is moved under the open parameter using the < and > pads of the cursor control key. Then, by slowly turning the knob clockwise or counter-clockwise the value of the parameter is increased or decreased by the unit size. The unit size is determined by the cursor placement. Turning the knob rapidly changes the value of the parameter in larger steps.

When editing frequency, power level, and time parameters, the incremental size can be set to a specific value using the system configuration increment menu (paragraph 3-12). Once set and activated, each time the knob is turned clockwise or counter-clockwise, the parameter's value increases or decreases by the set amount.

KEYPAD

The numeric keypad provides for entering frequency, power level, time, and number-of-steps parameters and GPIB address values. The “-” key functions as a “change sign” key during any keypad entry.

CLEAR ENTRY Key

When a parameter is open for editing, the CLEAR ENTRY key is used to clear the parameter entry.

BACK SPACE Key

The BACK SPACE key is used to correct keypad data entry errors by deleting the last number, “-”, or decimal point entered.

Terminator Keys

The terminator keys are used to terminate keypad data entries and change the parameter values in memory. If the entered value is outside the allowable range of the open parameter, an error message will be displayed along with an audible “beep”. The terminator keys are as follows:

GHz / Sec / dBm
MHz / ms / dB
kHz / μ s / STEPS
Hz / ns / ADRS

NOTE

When Linear power level units are selected, use the following terminator keys for power level data entries:

GHz / Sec / dBm for V
MHz / ms / dB for mV
kHz / μ s / STEPS for μ V

3-5 INSTRUMENT START-UP

Now that you have familiarized yourself with the layout of the CW generator's front panel controls and data display, you are ready to begin operating the instrument. Begin by powering it up.

Powering Up the 680XXC

Connect the 680XXC to an ac power source by following the procedure in the Installation chapter. This automatically places the instrument in operation (front panel OPERATE LED on).

Start-Up Display

During power up, the message **Please Wait... LOADING PROGRAMS** appears on the data display. When all programs have been loaded, the start-up screen (below) is displayed. It provides you with the model number of the CW generator and the revision level of the installed firmware.

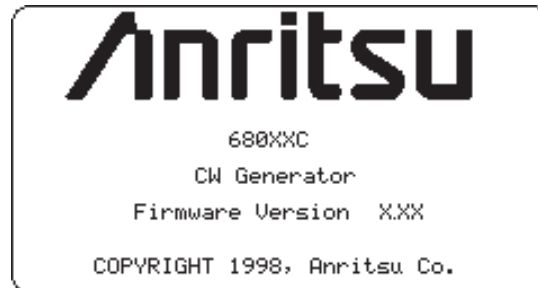

The 680XXC then returns to the exact configuration it was in when last turned off.

Standby Operation

Whenever the CW generator is not being used, it should be left connected to the power source and placed in standby. Standby operation provides power to keep the internal time base at operating temperature. This assures specified frequency accuracy and stability when the 680XXC is placed in operation.

NOTE

During standby operation, the fan runs continuously.

Press **LINE** to switch the 680XXC from OPERATE (green LED on) to STANDBY (orange LED on).

NOTE

When switching to operate from standby, allow at least a *30-minute warmup* before beginning CW generator operations.

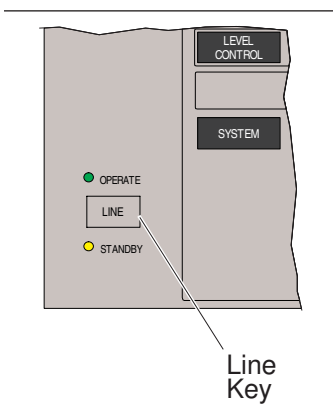

***Self-Testing
the 680XXC***

The 680XXC firmware includes internal diagnostics that self-test the instrument. These self-test diagnostics perform a brief go/no-go test of most of the PCBs and other internal assemblies. If the CW generator fails self-test, an error message is displayed on the data display. Error messages and descriptions are listed in the Operator Maintenance chapter of this manual.

CAUTION

During self-test with RF OUTPUT set to ON, the output power level is set to 0 dBm. Always disconnect sensitive equipment from the unit before performing self-test.

You can perform a self-test of the CW generator at any time during normal operation. To perform a self-test from any menu, press **SYSTEM**. Then, when the System Menu (shown below) is displayed, press **Selftest**.

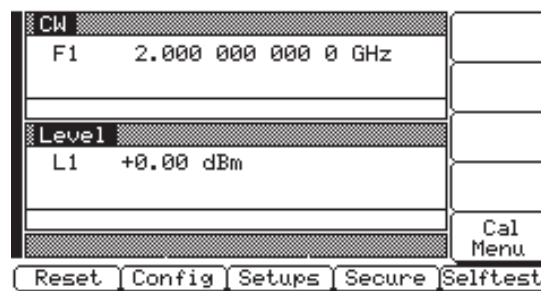

***Resetting to
Default
Parameters***

You can reset the 680XXC to the factory-selected default parameter values at any time during normal operation. Table 3-1, page 3-14, lists the default parameters for all 680XXC models.

NOTE

Resetting the instrument clears the setup presently in place. If these parameter values are needed for future testing, save them as a stored setup before resetting the CW generator. (For information on saving/recalling instrument setups, refer to paragraph 3-13.)

To reset the CW generator, press **SYSTEM**. When the System Menu (above) is displayed, press **Reset**.

Table 3-1. *Reset (Default) Parameters (1 of 2)*

680XXC MODEL NUMBER	FREQUENCY PARAMETERS (GHz)																				
	F0	F1	F2	F3	F4	F5	F6	F7	F8	F9	M0	M1	M2	M3	M4	M5	M6	M7	M8	M9	ΔF
68017C	3.5	2.0	8.4	2.0	5.0	8.0	8.4	8.4	8.4	8.4	3.5	2.0	8.4	2.0	5.0	8.0	8.4	8.4	8.4	8.4	1.0
68037C	3.5	2.0	20.0	2.0	5.0	8.0	11.0	14.0	17.0	20.0	3.5	2.0	20.0	2.0	5.0	8.0	11.0	14.0	17.0	20.0	1.0
68047C	3.5	2.0	20.0	2.0	5.0	8.0	11.0	14.0	17.0	20.0	3.5	2.0	20.0	2.0	5.0	8.0	11.0	14.0	17.0	20.0	1.0
68067C	3.5	2.0	40.0	2.0	5.0	8.0	11.0	14.0	17.0	20.0	3.5	2.0	40.0	2.0	5.0	8.0	11.0	14.0	17.0	20.0	1.0
68077C	3.5	2.0	50.0	2.0	5.0	8.0	11.0	14.0	17.0	20.0	3.5	2.0	50.0	2.0	5.0	8.0	11.0	14.0	17.0	20.0	1.0
68087C	3.5	2.0	60.0	2.0	5.0	8.0	11.0	14.0	17.0	20.0	3.5	2.0	60.0	2.0	5.0	8.0	11.0	14.0	17.0	20.0	1.0
68097C	3.5	2.0	65.0	2.0	5.0	8.0	11.0	14.0	17.0	20.0	3.5	2.0	65.0	2.0	5.0	8.0	11.0	14.0	17.0	20.0	1.0

680XXC MODEL NUMBER	POWER LEVEL PARAMETERS (dBm)									
	L0	L1	L2	L3	L4	L5	L6	L7	L8	L9
68017C	+1.0	0.0	-1.0	-2.0	-3.0	-4.0	-5.0	-6.0	-7.0	-8.0
68037C	+1.0	0.0	-1.0	-2.0	-3.0	-4.0	-5.0	-6.0	-7.0	-8.0
68047C	+1.0	0.0	-1.0	-2.0	-3.0	-4.0	-5.0	-6.0	-7.0	-8.0
68067C	+1.0	0.0	-1.0	-2.0	-3.0	-4.0	-5.0	-6.0	-7.0	-8.0
68077C	+1.0	0.0	-1.0	-2.0	-3.0	-4.0	-5.0	-6.0	-7.0	-8.0
68087C	+1.0	0.0	-1.0	-2.0	-3.0	-4.0	-5.0	-6.0	-7.0	-8.0
68097C	+1.0	0.0	-1.0	-2.0	-3.0	-4.0	-5.0	-6.0	-7.0	-8.0

Table 3-1. *Reset (Default) Parameters (2 of 2)*

680XXC MODEL NUMBER	SWEEP TIME	STEP SWEEP		LEVEL SWEEP		LEVEL OFFSET
		DWELL TIME	NUMBER OF STEPS	DWELL TIME	NUMBER OF STEPS	
68017C	50 ms	1 ms	50	50 ms	50	0.0 dB
68037C	50 ms	1 ms	50	50 ms	50	0.0 dB
68047C	50 ms	1 ms	50	50 ms	50	0.0 dB
68067C	50 ms	1 ms	50	50 ms	50	0.0 dB
68077C	50 ms	1 ms	50	50 ms	50	0.0 dB
68087C	50 ms	50 ms	50	50 ms	50	0.0 dB
68097C	50 ms	50 ms	50	50 ms	50	0.0 dB

3-6 ENTERING DATA

Before proceeding to the various modes of CW generator operation, you need to know how to enter data from the front panel. Entering data refers to changing a parameter's value by editing its current value or entering a new value to replace the current value. The following instructions describe how to (1) open a parameter, (2) edit its current value, and (3) enter a new value.

A typical 680XXC menu display (below) is used throughout the data entry instructions. At this menu display, you can edit both the CW frequency and the output power level parameters.

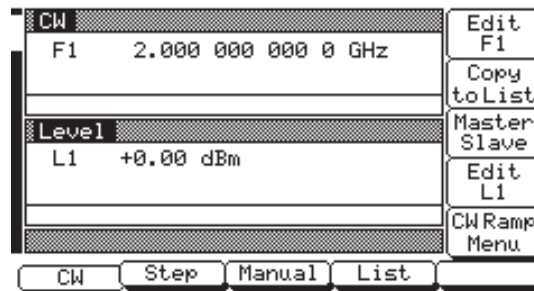

If you wish to follow along on your 680XXC, you can obtain this same menu display by resetting your instrument (press **SYSTEM**, then press **Reset**).

Opening the Parameter

In order for the value of a parameter to be changed, the parameter must first be opened.

To open the frequency parameter from the above menu, press **Edit F1**. The menu display now changes to show that the menu soft-key **Edit F1** has been pressed and that the frequency parameter has been opened. An open parameter is indicated by placing it in a window with a movable cursor under its digits.

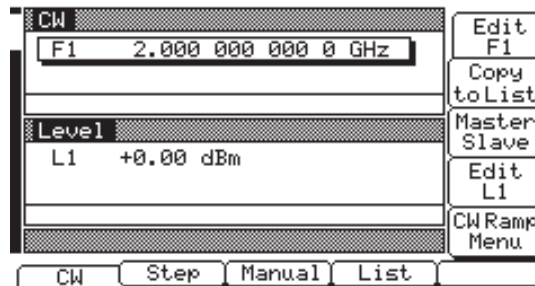

Only one parameter can be open at a time. If you press **Edit L1**, then the frequency parameter will close and the power level parameter will open.

**Editing the
Current Value**

To change the current value of a parameter by editing, you can use either the cursor control key or the rotary data knob.

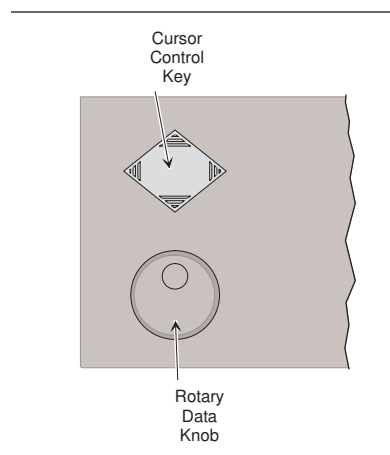

Using the Cursor Control Key

Using the < and > pads of the cursor control key, move the cursor under the digit where you want to begin editing. Then increase or decrease the value of the parameter using the ^ or v pad of the cursor control key. The unit size of the increase or decrease that occurs each time the ^ or v pad is pressed is determined by the cursor position.

Using the Rotary Data Knob

You can also increase or decrease the value of the parameter using the rotary data knob. Once you have positioned the cursor under the digit where you want to begin editing, slowly turn the knob clockwise or counter-clockwise to increase or decrease the value of the parameter by the unit size. Turning the knob rapidly changes the value of the parameter in larger steps.

Using a Set Increment

When editing frequency, power level, and time parameters, you can increase or decrease the parameter's value by a set amount each time the ^ or v pad is pressed or the rotary data knob is turned clockwise or counter-clockwise. For instructions on setting the increment size, refer to paragraph 3-12.

Now, try changing the current value of the CW frequency displayed on your 680XXC from 2.0 GHz to 6.395 GHz. Use both the cursor control key's ^ and v pads and the rotary data knob to make the value changes. When you are finished, your menu display should look like the example below.

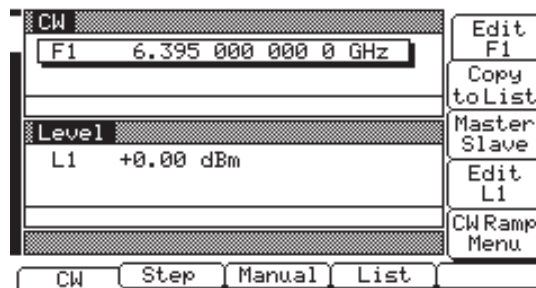

To close the open parameter when you are finished editing, press **Edit F1** or make another menu selection.

***Entering a
New Value***

To change the current value of a parameter by entering a new value for the parameter, use the data entry keypad and termination keys.

As soon as you press one of the keys on the data entry keypad, the current parameter display clears for entry of a new value. Enter the new value for the parameter, then press the appropriate terminator key to store it in memory. If the entered value is outside the allowable range of the open parameter, the entry is not accepted and the previous value for the parameter is displayed.

NOTE

A frequency entry may be terminated in GHz, MHz, kHz, or Hz; however, it is always displayed on the data display in GHz. A time entry may be terminated in Sec, ms, μ s, or ns; however it is always displayed on the data display in Sec.

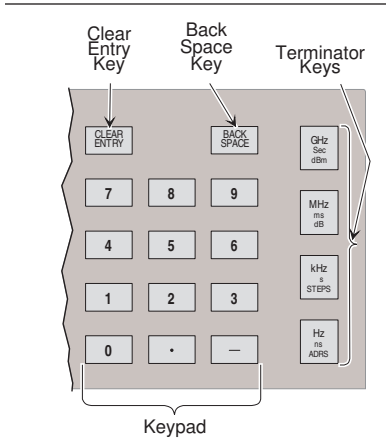

If you make an error during data entry, either (1) press **BACK SPACE** to delete the entry one character at a time starting from the last character entered, or (2) delete the entire entry by pressing **CLEAR ENTRY**. Then, re-enter the correct value.

Now, try entering a new value for the CW frequency displayed on your 680XXC using the data entry keypad and termination keys.

To close the open parameter when you are finished entering data, press **Edit F1** or make another menu selection.

3-7 CW FREQUENCY OPERATION

One of the CW generator's major functions is to produce discrete CW frequencies across the frequency range of the instrument. The following paragraphs describe how to place the 680XXC in the CW frequency mode, select a CW frequency and power level for output, and activate the CW ramp. Use the CW Frequency Mode menu map (Chapter 4, Figure 4-2) to follow the menu sequences.

Selecting CW Mode To place the 680XXC in the CW frequency mode, press the main menu key

**CW/SWEEP
SELECT**

At the resulting menu display, press **CW**. The CW Menu (below) is displayed.

NOTE
When the CW generator is reset, it automatically comes up operating in the CW frequency mode.

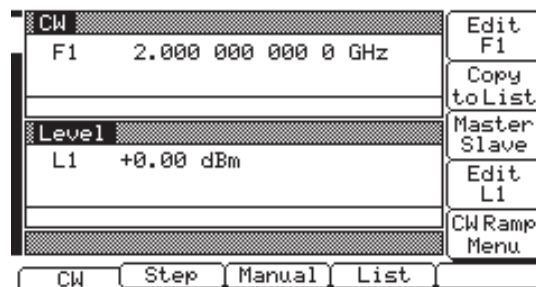

This menu lets you perform the following:

- Select a CW frequency for output.
- Copy the current frequency and power information to the current list index. (Refer to page 3-40 for the list sweep frequency mode operating instructions.)
- Go to the master-slave menu. (Refer to Chapter 7, paragraph 7-2 for Master-Slave mode operating instructions.)
- Select an output power level for the CW frequency.
- Go to the CW ramp menu (set the ramp sweep time and turn the CW ramp on/off).

**Selecting a
CW
Frequency**

There are several ways to select a CW frequency for output. You can (1) edit the current frequency, (2) enter a new frequency, or (3) select one of the 20 preset frequency parameters.

Editing the Current Frequency

Press **Edit F1** to open the frequency parameter, then edit the current CW frequency using the cursor control key or the rotary data knob. To close the open frequency parameter, press **Edit F1** or make another menu selection.

Entering a New Frequency

Press **Edit F1** to open the frequency parameter, then enter the new CW frequency using the keypad and appropriate terminator key. To close the open frequency parameter, press **Edit F1** or make another menu selection.

Selecting a Preset Frequency

To select one of the preset frequencies for output, press the main menu key

**FREQUENCY
CONTROL**

The CW Frequency Control Menu (below) is displayed.

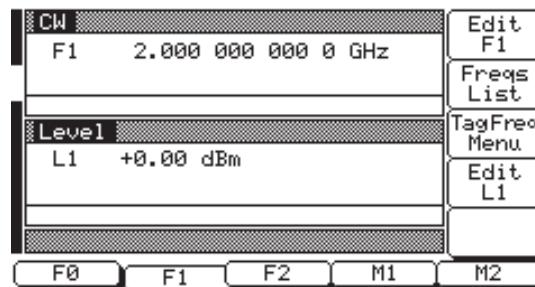

This menu lets you perform the following:

- Select preset frequencies F0, F1, F2, M1, or M2 for output.
- Go to the frequency list menu (to tag, edit, or output a frequency from the list).
- Go to the tagged frequencies menu (select a tagged frequency for output).

Frequency List—To go to the Frequency List Menu (below), press **Freqs List**. This menu lets you tag, edit, or output a frequency from the list.

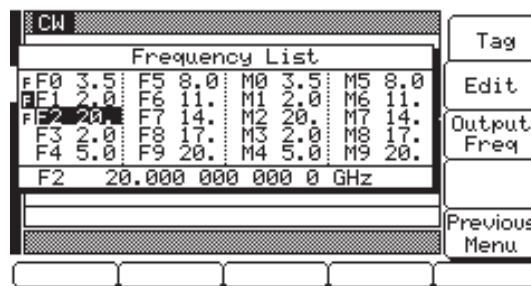

Use the cursor control key to select a frequency from the frequency list. The selected frequency is highlighted in reverse video and displayed in full below the frequency list.

Press **Tag** to mark a selected frequency (place an **F** in front of it). If the frequency is already tagged, pressing **Tag** will untag it (remove the **F**). Tagging selected frequencies lets you quickly switch between them using the scan keys of the Tagged Frequencies menu.

Press **Edit** to edit the selected frequency or enter a new frequency.

Press **Output Freq** to output the selected frequency. This frequency is output until you select another frequency from the list and press **Output Freq**. On the frequency list, the output frequency selection is marked by a black square or, if tagged, an **F** highlighted in reverse video.

Press **Previous Menu** to return to the CW Frequency Control Menu display.

Scanning Tagged Frequencies—To go to the Tagged Frequencies Menu (below) from the CW Frequency Control menu, press **Tag Freq Menu**.

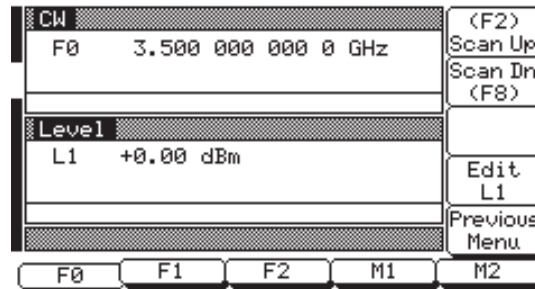

This menu lets you select the tagged frequencies for output using the **Scan Up** and **Scan Dn** keys.

Return to the CW Frequency Control Menu display by pressing **Previous Menu**.

**Selecting a
Power Level**

While in the CW frequency mode, you can edit the current CW frequency output power level or enter a new output power level.

Editing the Current Power Level

Press **Edit L1** to open the power level parameter, then edit the current power level using the cursor control key or rotary data knob. To close the open power level parameter, press **Edit L1** or make another menu selection.

Entering a New Power Level

Press **Edit L1** to open the power level parameter, then enter the new power level using the keypad and appropriate terminator key. To close the open power level parameter, press **Edit L1** or make another menu selection.

NOTE

You can also select any of the preset power levels or a power level sweep for a CW frequency. For instructions, refer to paragraphs 3-9 (Fixed Power Level Operation) and 3-10 (Power Level Sweep Operation).

CW Ramp

When active, the 680XXC's CW ramp provides a repetitive 0V to 10V ramp output to the rear panel HORIZ OUT BNC connector and AUX I/O connector. The CW ramp is used to drive a scalar analyzer display.

To go to the CW Ramp Menu (below) from the CW menu, press **CW Ramp Menu**.

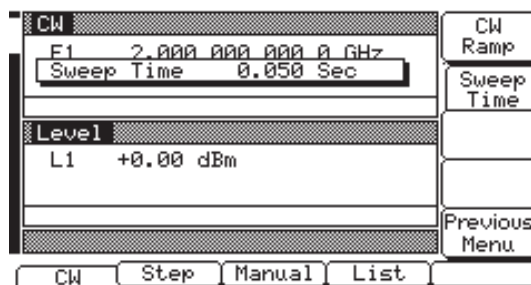

This menu lets you set the ramp speed and turn the CW ramp on/off.

To set ramp speed, press **Sweep Time**. The sweep time parameter opens for editing. Edit the current sweep time using the cursor control key or rotary data knob or enter a new sweep time using the key pad and appropriate termination key. The sweep time entered must be in the range of 30 ms to 99 sec. To close the open sweep time parameter when you are done, press **Sweep Time** or make another menu selection.

Press **CW Ramp** to turn the CW ramp on. While the CW ramp is on, the message **CW Ramp** appears on the right side of frequency title bar on all CW menus.

Press **Previous Menu** to return to the CW Menu display.

**3-8 SWEEP FREQUENCY
OPERATION**

The CW generator can generate broad (full range) and narrow band sweeps across the frequency range of the instrument. The 680XXC has three sweep frequency modes—step sweep, manual sweep, and list sweep. Descriptions and operating instructions for the step and manual sweep frequency modes begin on this page. List sweep frequency mode descriptions and operating instructions begin on page 3-40. Use the Step Sweep, Manual Sweep, and List Sweep Frequency Mode menu maps (Chapter 4, Figures 4-3, 4-4, and 4-5) to follow the menu sequences.

**Step Sweep
Mode**

In step sweep frequency mode, the output frequency changes in discrete, synthesized steps between selected start and stop frequencies. Step sweeps can be from a low frequency to a high frequency and from a high frequency to a low frequency. Step sweeps can be selected to be linear or logarithmic. Sweep width can be set from 1 kHz (0.1 Hz with Option 11) to the full frequency range of the instrument.

The step size or number of steps between the start and stop frequencies, the dwell time-per-step, the sweep time, and the type of step sweep (linear or logarithmic) and sweep trigger are controllable from step sweep menus.

**Selecting
Step Sweep
Mode**

To place the 680XXC in step sweep frequency mode, press the main menu key

**CW/SWEEP
SELECT**

At the resulting menu display, press **Step**. The Step Sweep Menu (below) is then displayed.

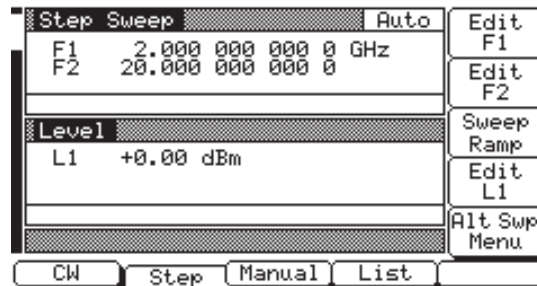

This menu lets you perform the following:

- ❑ Select a sweep range (edit the sweep start and stop frequency parameters).
- ❑ Go to the sweep ramp menu (set the dwell-time-per-step, the step size or number of steps, set the sweep time, select log or linear sweep, and select a sweep trigger).
- ❑ Select an output power level for the sweep.
- ❑ Go to the alternate sweep menu.

***Setting Step
Size, Dwell
Time, and
Sweep Time***

In linear step sweep the sweep is linearly incremented (or decremented) by the step size from the start frequency to the stop frequency. There are two ways to set the size of each step of the linear step sweep—set the step size or set the number of steps. The step size range is 1 kHz (0.1 Hz with Option 11) to the full frequency range of the CW generator; the number of steps range is 1 to 10,000. If the step size does not divide into the frequency range, the last step is truncated.

In logarithmic step sweep, step size increases logarithmically with the frequency and is determined by a logarithmic curve fitted between the sweep start and stop frequencies and the number of steps. The number of steps range is 1 to 10,000.

The dwell-time-per-step of the step sweep can be set for any time in the range of 1 ms to 99 sec. When dwell-time-per-step and step size or number of steps is set, the sweep time equals the dwell-time-per-step times the number of steps plus the total phase-locking time for all step frequencies. If sweep time is set, then dwell-time-per-step is the result of the sweep time divided by the number of steps. In this case, the resultant minimum dwell time must be ≥ 10 ms to allow for phase-locking of each step frequency. The sweep time of the step sweep can be set for any time in the range of 20 ms to 99 sec.

To go to the Step Sweep Ramp Menu (below) from the Step Sweep menu, press **Sweep Ramp**.

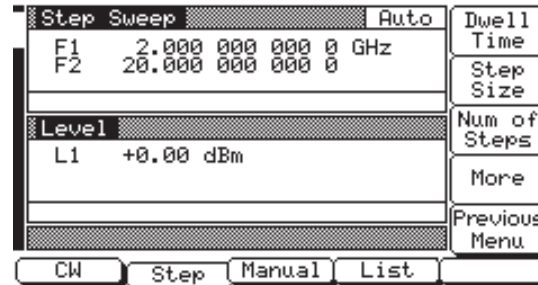

This menu lets you set the dwell time, the step size in linear step sweep, the number of steps, and go to the additional step sweep ramp menu (to set the sweep time, select log or linear sweep, and select a sweep trigger).

Press **Dwell Time** to open the dwell time-per-step parameter.

Press **Step Size** to open the step size parameter.

Press **Num of Steps** to open the number of steps parameter.

Open the parameter you wish to change, then edit the current value using the cursor control key or the rotary data knob or enter a new value using the key pad and appropriate termination key. When you have finished setting the open parameter, close it by pressing its menu soft-key or make another menu selection.

Press **More** to go to the additional Step Sweep Ramp Menu display.

Press **Previous Menu** to return to the Step Sweep Menu display.

RANGE

This error message is displayed when (1) the step size value entered is greater than the sweep range, (2) the number of steps entered results in a step size of less than 1 kHz (0.1 Hz with Option 11), or (3) the sweep time entered divided by the number of steps entered results in a dwell time of <10 ms. Entering valid values will clear the error.

Additional Step Sweep Ramp Menu

When you press **More**, the Additional Step Sweep Ramp Menu (below) is displayed.

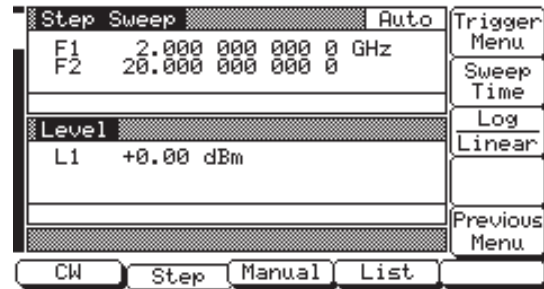

This menu lets you set the sweep time, select logarithmic or linear step sweep, and go to the trigger menu.

To open the sweep time parameter for editing, press **Sweep Time**. Edit the current sweep time using the cursor control key or the rotary data knob or enter a new sweep time using the keypad and appropriate termination key. To close the open sweep time parameter once you have set the desired time, press **Sweep Time** or make another menu selection.

Press **Log/Linear** to select logarithmic or linear step sweep operation. The soft-key label is highlighted (in reverse video) to reflect your selection.

Press **Trigger Menu** to go to the Step Sweep Trigger menu. The trigger menu lets you select a sweep trigger.

Press **Previous Menu** to return to the Step Sweep Ramp Menu display.

**Selecting a
Sweep
Trigger**

There are three modes of sweep triggering for step frequency sweep—automatic, external, and single. The sweep trigger is selectable from the trigger menu. The following is a description of each mode.

- ❑ **Auto (Automatic)**—The sweep continually sweeps from its start frequency to its stop frequency with optimal retrace time.
- ❑ **External**—The sweep recurs when triggered by an external TTL-compatible clock pulse to the rear panel AUX I/O connector.
- ❑ **Single**—A single sweep starts when the trigger key is pressed. If a sweep is in progress when the key is pressed, it aborts and resets.

To go to the Step Sweep Trigger Menu (below) from the Additional Step Sweep Ramp Menu, press **Trigger Menu**.

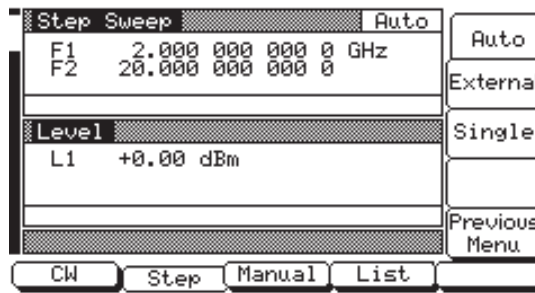

To select a sweep trigger mode, press its menu soft-key. A message showing the sweep trigger mode selected appears on the right side of frequency title bar. When you are finished, press **Previous Menu** to return to the Additional Step Sweep Ramp Menu display.

If you select the single sweep trigger mode, the menu display adds the menu soft-key **Trig**. Pressing **Trig** starts a single sweep. If a single sweep is in progress, pressing **Trig** causes the sweep to abort and reset.

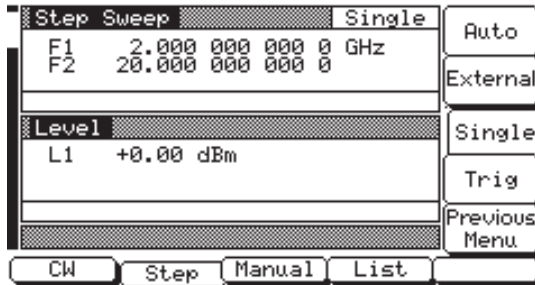

**Manual
Sweep Mode**

In manual sweep frequency mode, the output frequency can be manually tuned in phase-locked steps between the selected start and stop frequencies using the rotary data knob. As the knob is turned, the current output frequency is displayed on the data display as Fm. The step size or number of steps between the start and stop frequencies are controllable from the manual sweep menu. The step size range is 1 kHz (0.1 Hz with Option 11) to the full frequency range of the instrument; the number of steps range is 1 to 10,000.

**Selecting
Manual
Sweep Mode**

To place the 680XXC in manual sweep frequency mode, press the main menu key



At the resulting menu display, press **Manual**. The Manual Sweep Menu (below) is then displayed.

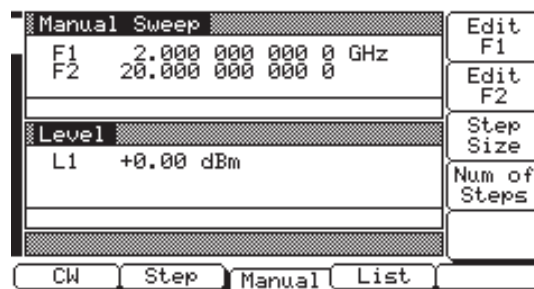

This menu lets you perform the following:

- Select a sweep range (edit the start and stop frequency parameters).
- Set the step size or number of steps (previously described on page 3-28).

**Selecting a
Sweep Range**

Selecting a sweep range involves choosing a start and a stop frequency for the frequency sweep. The sweep range selection process is identical for both the step and manual sweep frequency modes. There are several ways you can select a sweep range, including:

- ❑ Editing the current start and stop frequency parameter values.
- ❑ Entering new start and stop frequency parameter values.
- ❑ Selecting one of the preset sweep range parameters (F1-F2, F3-F4, F5-dF, or F6-dF).

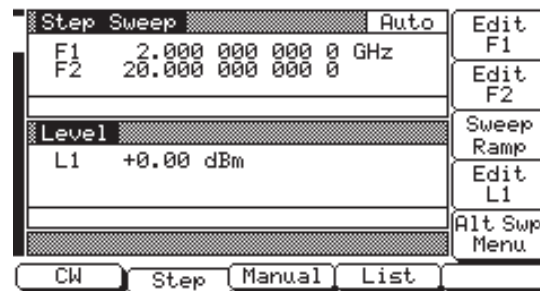

Editing the Current Start / Stop Frequencies

To edit the current frequency sweep range, open either the start or stop frequency parameter. In the display above, **Edit F1** opens the start frequency parameter and **Edit F2** opens the stop frequency parameter.

Edit the open frequency parameter using the cursor control key or the rotary data knob. When you are finished, close the open parameter by pressing its menu edit soft-key or by making another menu selection.

Entering New Start / Stop Frequencies

To enter a new frequency sweep range, open either the start or stop frequency parameter (press **Edit F1** or **Edit F2**).

Enter a new frequency using the keypad and appropriate terminator key. When you are finished, close the open parameter by pressing its menu edit soft-key or by making another menu selection.

Selecting a Preset Sweep Range

There are four preset sweep range parameters, selectable in the step sweep and manual sweep frequency modes. The following is a description of each preset sweep range.

- ❑ **F1-F2**—provides a frequency sweep between the start frequency, F1, and the stop frequency, F2.
- ❑ **F3-F4**—provides a frequency sweep between the start frequency, F3, and the stop frequency, F4.
- ❑ **F5-dF**—provides a symmetrical frequency sweep about the center frequency, F5. The sweep width is determined by the dF frequency parameter.
- ❑ **F6-dF**—provides a symmetrical frequency sweep about the center frequency, F6. The sweep width is determined by the dF frequency parameter.

To select one of the preset sweep ranges from any sweep frequency mode menu, press the main menu key

**FREQUENCY
CONTROL**

The Sweep Frequency Control Menu (below) is displayed.

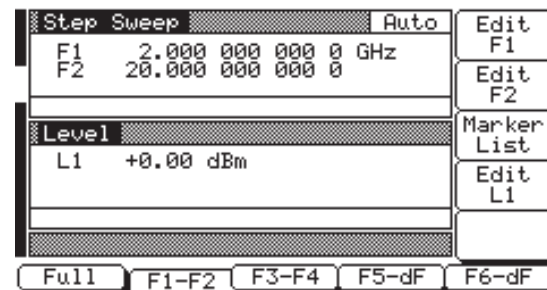

This menu lets you perform the following:

- ❑ Select a full range sweep (Fmin–Fmax) or one of the preset sweep ranges for the sweep frequency mode.
- ❑ Select the frequency parameters for each preset sweep range.
- ❑ Select an output power level for the sweep.
- ❑ Go to the marker list menu (described on page 3-35).

RANGE

This error message is displayed when the dF value entered results in a sweep outside the range of the 680XXC. Entering a valid value will clear the error.

**Selecting a
Power Level**

Setting a Preset Sweep Range—At the menu, select the sweep range (F1-F2, F3-F4, F5-dF, or F6-dF) that you wish to set. The menu then displays the current frequency parameters for the selected sweep range. Now, use the menu edit soft-keys to open the frequency parameters for editing.

Edit the current frequency parameters or enter new frequency parameter values for the sweep range. To close the open frequency parameter when you are finished, press its menu edit soft-key or make another menu selection.

You can set all the preset sweep ranges in this manner.

While at the Sweep Frequency Control menu, you can edit the current output power level or enter a new output power level for the frequency sweep.

Editing the Current Power Level

Press **Edit L1** to open the power level parameter, then edit the current power level using the cursor control key or rotary data knob. To close the open power level parameter, press **Edit L1** or make another menu selection.

Entering a New Power Level

Press **Edit L1** to open the power level parameter, then enter the new power level using the keypad and appropriate terminator key. To close the open power level parameter, press **Edit L1** or make another menu selection.

NOTE

You can also select any of the preset power levels for a frequency sweep or a power level step for a step sweep. For instructions, refer to paragraphs 3-9 (Fixed Power Level Operation) and 3-10 (Power Level Sweep Operation).

**Frequency
Markers**

The CW generator provides up to 20 independent, pre-settable markers, F0-F9 and M0-M9, that can be used in the step sweep frequency mode for precise frequency identification. Marker frequency accuracy is the same as sweep frequency accuracy. The markers are visible on a CRT display.

The 680XXC generates video markers that produce a pulse on a CRT display at each marker frequency. The video marker is either a +5V or a -5V pulse at the rear panel AUX I/O connector. Pulse polarity is selectable from a system configuration menu.

To output markers during a sweep you must first select (tag) the marker frequencies from the Marker List menu, then turn on the marker output.

To go to the Marker List menu from a step sweep frequency menu, press

**FREQUENCY
CONTROL**

The Step Sweep Frequency Control Menu (below) is displayed.

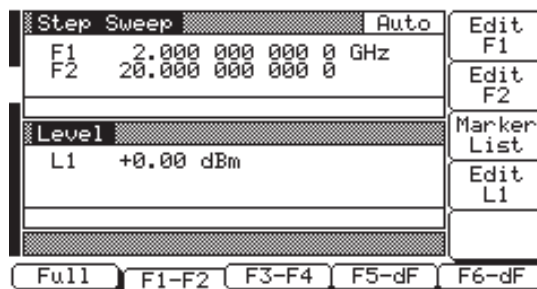

To go to the Marker List menu from this menu, press **Marker List**. The Marker List menu, shown on the next page, is displayed. This menu lets you tag or edit marker list frequencies and turn the markers on/off.

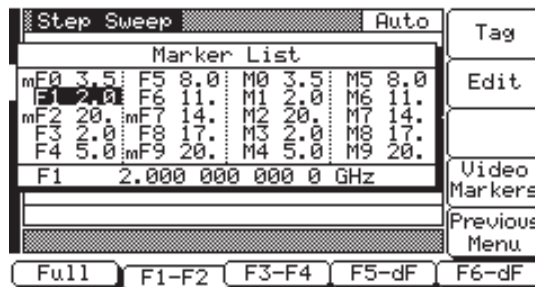

Use the cursor control key to select a frequency parameter from the marker list. The selected frequency parameter is highlighted in reverse video and displayed in full below the marker list.

Editing a Marker List Frequency

If you want to change a selected marker list frequency parameter's value, press **Edit** to open the frequency parameter, then edit the current frequency or enter a new frequency.

Tagging a Marker List Frequency

Only frequencies on the marker list that have been tagged can be output as markers during a sweep. Press **Tag** to tag a selected frequency parameter (place an **m** in front of it). If a frequency parameter is already tagged, pressing **Tag** will untag it (remove the **m**).

Activating Markers

Press **Video Markers** to output the tagged marker frequencies as video markers during a step sweep. Video markers will be displayed on the CRT for all tagged marker frequencies that are within the sweep frequency range.

To turn the markers off, press **Video Markers** again.

Press **Previous Menu** to return to the Sweep Frequency Control Menu display.

**Selecting
Alternate
Sweep Mode**

In alternate sweep frequency mode, the CW generator's output frequency sweeps alternately between any two sweep ranges in step sweep.

To select the alternate sweep mode, start with the Step Sweep Menu display (below).

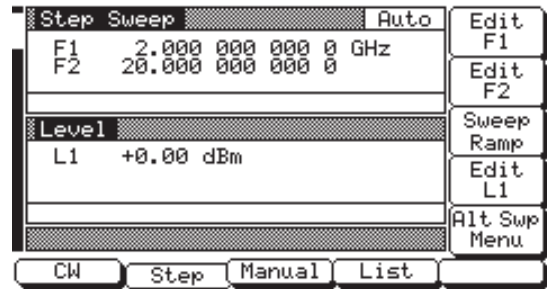

To go to the Alternate Sweep menu (below) from the Step Sweep menu, press **Alt Swp Menu**.

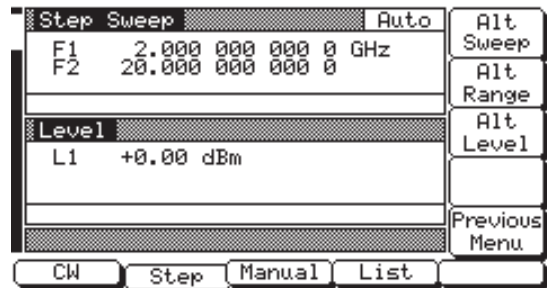

This menu lets you perform the following:

- Turn the alternate sweep mode on/off.
- Go to the alternate range menu to select a sweep range for the alternate sweep.
- Go to the alternate level menu to select a power level for the alternate sweep.

Activating the Alternate Sweep

The Alternate Sweep menu soft-key **Alt Sweep** toggles the alternate sweep mode on and off.

Press **Alt Sweep** to turn on the alternate sweep mode. Notice that the Alternate Sweep menu (on the following page) changes to show that the alternate sweep is now active.

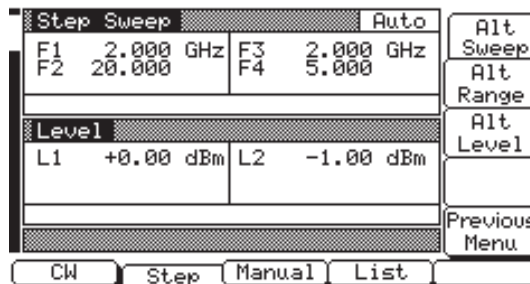

Now, press **Previous Menu** to return to the Step Sweep Menu display.

Notice the changes to the Step Sweep Menu display (below). These changes indicate that the alternate sweep frequency mode is active.

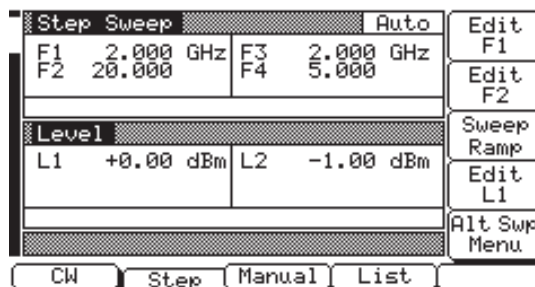

Now, press **Alt Swp Menu** to return to the Alternate Sweep menu.

Selecting an Alternate Sweep Range

To go to the Alternate Range menu (below) from the Alternate Sweep menu, press **Alt Range**.

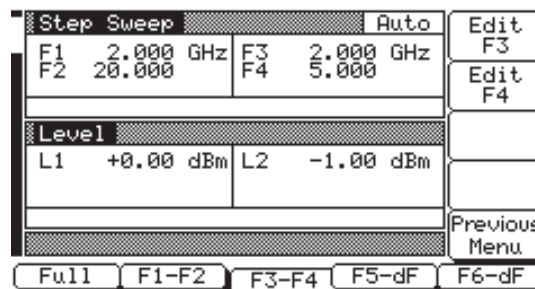

Select the alternate sweep range (Full, F1-F2, F3-F4, F5-dF, or F6-dF). The menu then displays the current frequency parameters for the selected sweep range. If you wish to change a frequency parameter, use the menu edit soft-key to open the parameter, then edit it.

When you are done selecting the alternate sweep range, press **Previous Menu** to return to the Alternate Sweep Menu display.

Selecting an Alternate Sweep Power Level

To go to the Alternate Level menu (below) from the Alternate Sweep menu, press **Alt Level**.

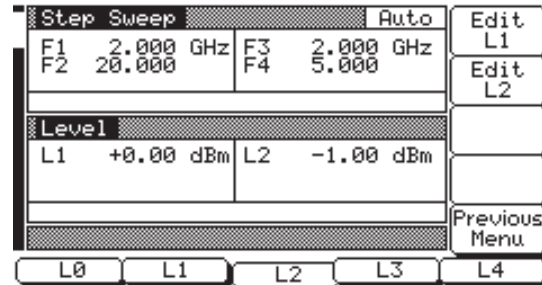

Select the power level for the alternate sweep range (L0, L1, L2, L3, or L4). The menu then displays the current level parameter for the selected power level. If you wish to change the level, use the menu edit soft-key to open the parameter, then edit it.

A menu edit soft-key is also provided to let you change the power level of the main sweep.

CAUTION

Performing alternate sweeps using power levels that cross step attenuator switch points can cause excessive wear on the switches and reduce the life expectancy of the step attenuator.

When you are done selecting the power level for the alternate sweep range and editing the power level of the main sweep, press **Previous Menu** to return to the Alternate Sweep Menu display.

***List Sweep
Mode***

In list sweep frequency mode, the output is a step sweep of up to 2000 phase-locked, non-sequential frequencies. Each frequency can have a different power level setting. The list index (0 to 1999) identifies each frequency/power level set in the list. The list sweep is defined by a list start index and list stop index.

There are four modes of sweep triggering in list sweep—automatic, external, single, and manual. When automatic, external, or single trigger mode is selected, the output sweeps between the specified list start and stop indexes, dwelling at each list index for the specified dwell time. When manual trigger mode is selected, the list start index, list stop index, and dwell time parameter are not used. Instead, the list index is incremented or decremented by using the front panel cursor control key. In manual trigger mode, the list index can also be incremented by using an external trigger input. Each TTL trigger increments the list index by one.

After a reset, the list sweep defaults to manual trigger mode. The data display shows the trigger mode, the list index, current frequency, and current power level. The list index specifies the current location within the list. The current frequency is preceded by the text “Fr”. The current power level is preceded by the text “Lv”. When automatic, external, or single trigger mode is selected, the data display changes to show the trigger mode and list sweep start and stop index values only.

The list of up to 2000 frequency/power level sets is stored in non-volatile RAM to preserve any settings after the instrument is powered off. The list is *not* stored with the other setup information in the instrument. After a master reset, the list is reset to its default state of 2000 index entries of 5 GHz at 0 dBm.

**Selecting List
Sweep Mode**

To place the 680XXC in list sweep frequency mode, press the main menu key

**CW/SWEEP
SELECT**

At the resulting menu display, press **List**. The List Sweep Menu (below) is displayed.

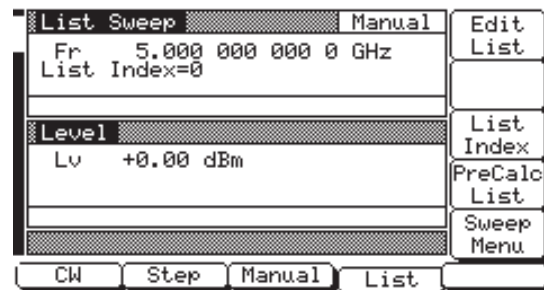

This menu lets you perform the following:

- ❑ Go to the Edit List menus (edit list index frequency and power level parameters and insert and delete list index entries).
- ❑ Edit the list index parameter.
- ❑ Calculate all list index frequency and power level settings.
- ❑ Go to the Sweep menu (set sweep start index, stop index, and dwell time and select a sweep trigger).

Editing the List Index

Press **List Index** to open the list index parameter for editing. Edit the current list index value using the cursor control key or rotary data knob or enter a new value using the key pad and any termination key. When you have finished setting the open parameter, close it by pressing **List Index** again or by making another menu selection.

The **List Index** soft-key is not the only way to change the list index. In the list sweep mode with manual trigger selected, each time the \wedge or \vee pad of the cursor control key is pressed the list index increments or decrements by one. The **List Index** soft-key is used if a larger change in the list index is desired. The only time the cursor control key will not change the list index is when a different parameter, such as frequency, power level, etc., is open. The cursor control key will then change the value of the open parameter. Once the open parameter is closed, the cursor control key will again change the list index.

Performing List Calculations

The **PreCalc List** soft-key initiates a process that examines every index in the list and performs all the calculations necessary to set the frequency and power levels. The soft-key does *not* have to be pressed every time the list changes. The instrument will perform the calculations to set the frequency and power levels as it performs the initial list sweep. This causes the initial list sweep to take longer than each subsequent sweep. Using the **PreCalc List** soft-key lets the initial list sweep be as fast as each subsequent sweep. The calculations are stored in volatile RAM and are lost at instrument power-off.

Press **PreCalc List** to perform list calculations. The soft-key image depresses to show that calculations are in progress. When the calculations are completed, the soft-key returns to normal appearance.

Editing the List

List editing consists of editing list index frequency and power level parameters and inserting and deleting list index entries.

To go to the Edit List Menu (below) from the List Sweep menu, press **Edit List**.

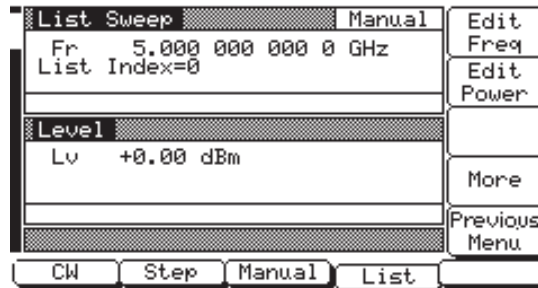

This menu lets you perform the following:

- Go to the List Frequency Edit menu (edit list index frequency parameters).
- Go to the List Power Edit menu (edit list index power level parameters).
- Go to the additional Edit List menu (insert and delete list index entries).

Press **Edit** to edit the highlighted power level or enter a new power level.

Press **Page Up** to scroll the displayed power levels to the next 10 in the list. Press **Page Down** to scroll the displayed power levels to the previous 10 in the list.

Press **Previous Menu** to return to the Edit List Menu display.

Additional Edit List Menu

At the Edit List menu, press **More** to go to the Additional Edit List Menu (below).

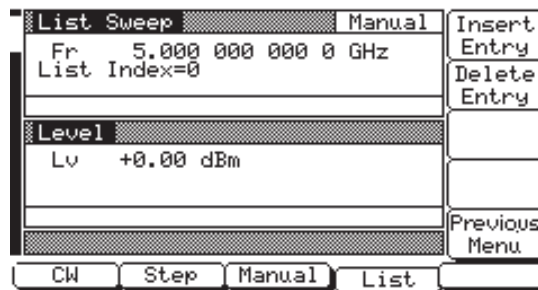

This menu lets you insert and delete entries from the list.

Press **Insert Entry** to insert the default frequency (5 GHz) and power level (0 dBm) at the current list index.

NOTE

Because the list size is fixed, inserting a new index will cause the last index to be lost. Whatever frequency and power level are at list index 1999 will be deleted and cannot be recovered.

Press **Delete Entry** to delete the current list index.

NOTE

Delete entry cannot be undone. Once a list index is deleted, the only recovery is to re-enter the deleted frequency and power level.

Press **Previous Menu** to return to the main Edit List Menu display.

Copying Data from the CW Menu

An easy method of entering frequency and power level information into the current list index is to copy the data from the CW menu.

First, go to the main List Sweep menu and press the **List Index** soft-key to open the list index parameter. Then, select the list index that you want the data to be added to.

Next, press the **CW** soft-key at the bottom of the display. The CW Menu (below) is displayed.

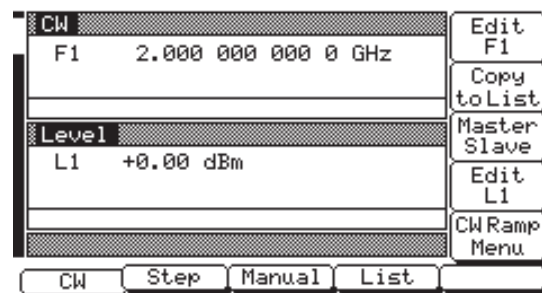

Use the **Edit F1** and **Edit L1** soft-keys to set the frequency and power level to the values you wish to enter into the current list index.

Press the **Copy to List** soft-key to copy the data to the current list index.

Once the frequency and power level information has been entered into the current list index, the list index is incremented by one.

**Selecting a
List Sweep
Range**

Selecting a sweep range involves choosing a start index and a stop index for the list sweep.

To go to the Sweep Menu (below) from the main List Sweep menu, press **Sweep Menu**.

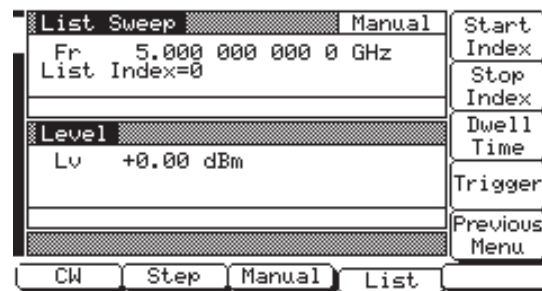

This menu lets you select the list sweep range, set the dwell-time-per-step, and go to the trigger menu.

Press **Start Index** to open the list sweep start index parameter.

Press **Stop Index** to open the list sweep stop index parameter.

Press **Dwell Time** to open the dwell-time-per-step parameter.

Open the parameter you wish to change, then edit the current value using the cursor control key or rotary data knob or enter a new value using the key pad and appropriate termination key. When you have finished setting the open parameter, close it by pressing its menu soft-key or by making another menu selection.

To go to the List Sweep Trigger menu from this menu, press **Trigger**. The trigger menu lets you select a list sweep trigger.

Press **Previous Menu** to return to the main List Sweep Menu display.

Selecting a List Sweep Trigger

There are four modes of sweep triggering in list sweep frequency mode, each selectable from the trigger menu. The following is a description of each mode.

- ❑ **Auto (Automatic)**—The output sweeps between the specified list start and stop indexes, dwelling at each list index for the specified dwell time.
- ❑ **External**—The output sweep recurs when triggered by an external TTL-compatible clock pulse to the rear panel AUX I/O connector.
- ❑ **Single (Trig)**—A single output sweep starts when the trigger key is pressed. If a sweep is in progress when the key is pressed, it aborts and resets.
- ❑ **Manual**—(*list sweep default trigger mode*) The list index is incremented or decremented by using the front panel cursor control key. The list index can also be incremented using an external trigger input. Each trigger increments the list index by one.

To go to the List Sweep Trigger Menu (below) from the Sweep menu, press **Trigger**.

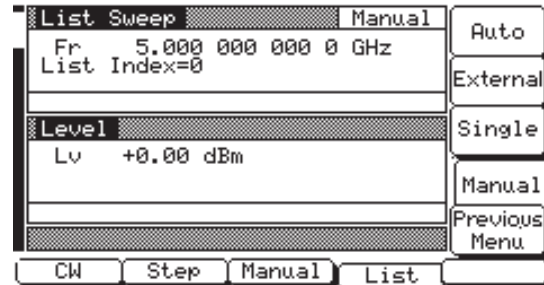

To select a sweep trigger mode, press its menu soft-key. A message showing the trigger mode selected appears on the right side of the frequency title bar. When you are finished, press **Previous Menu** to return to the Sweep Menu display.

If you select a single trigger mode, the **Single** soft-key is replaced by the **Trig** soft-key. Pressing **Trig** starts a single sweep. If a single sweep is in progress, pressing **Trig** causes the sweep to abort and reset.

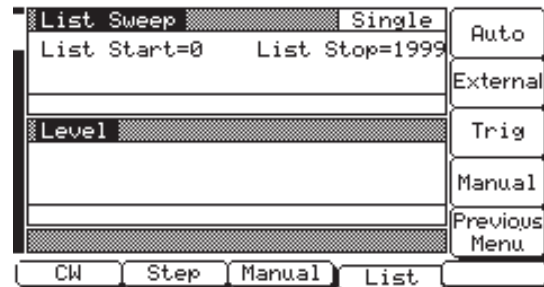

NOTE

With Auto trigger selected and the dwell-time-per-step set to a small value, display updating slows down. This ensures that sweep speed is not adversely affected. Because of this potential display update slow down, when leaving List Sweep mode with Auto trigger selected for another mode, Auto trigger is automatically turned off and Manual trigger is selected. Thus, when List Sweep mode is entered, the display updating will be back to normal speed.

**3-9 FIXED POWER LEVEL
OPERATION**

The CW generator provides leveled output power over a maximum range of up to 33 dB (up to 149 dB with option 2) for CW and sweep frequency operations. Instruments with option 15A provide leveled output power over a maximum range of up to 27 dB (up to 141 dB with option 2). The following paragraphs describe how to place the CW generator in fixed (non-swept) power level mode, select a power level for output, select logarithmic or linear units, and activate level offset. Use the Fixed (Non-Swept) Power Level Mode menu map (Chapter 4, Figure 4-6) to follow the menu sequences.

**Selecting
Fixed Power
Level Mode**

To place the 680XXC in a fixed power level mode from a CW or sweep (step or manual) frequency menu, press the main menu key

**LEVEL/ALC
SELECT**

At the resulting menu display, press **Level**. The Level Menu (below) is displayed.

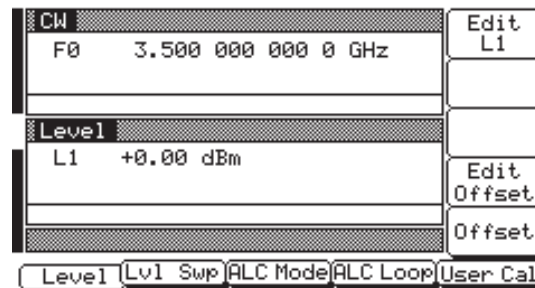

This menu lets you perform the following:

- Edit the power level parameter.
- Edit the level offset parameter.
- Turn level offset on/off.

**Selecting a
Power Level**

There are several ways to select a power level for output. You can (1) edit the current power level, (2) enter a new power level, or (3) select one of the 10 preset power level parameters.

Editing the Current Power Level

Press **Edit L1** to open the power level parameter, then edit the current power level using the cursor control key or the rotary data knob. To close the open power level parameter, press **Edit L1** or make another menu selection.

Entering a New Power Level

Press **Edit L1** to open the power level parameter, then enter the new power level using the keypad

NOTE

When Linear power level units are selected, use the following terminator keys for power level data entries:

- GHz / Sec / dBm for V
- MHz / ms / dB for mV
- kHz / μ s / STEPS for μ V

and appropriate terminator key. To close the open power level parameter, press **Edit L1** or make another menu selection.

Selecting a Preset Power Level

To select one of the preset power levels for output, press the main menu key

LEVEL CONTROL

The Level Control Menu (below) is displayed.

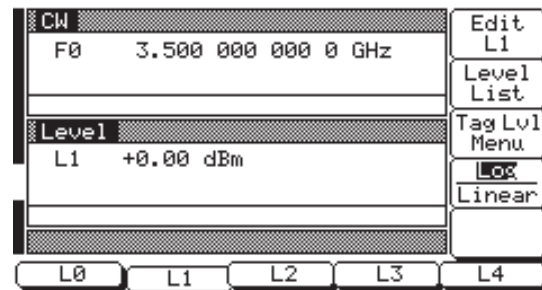

This menu lets you perform the following:

- Select preset power levels L0, L1, L2, L3, or L4 for output.
- Go to the Level List menu.
- Go to the Tagged Levels menu.
- Select Logarithmic or Linear units.

Press **Log/Linear** to select power level units. When Log is selected, units are dBm; when Linear is selected, units are mV. The soft-key label is highlighted (in reverse video) to reflect your selection.

Level List– To go to the Level List Menu (below), press **Level List**.

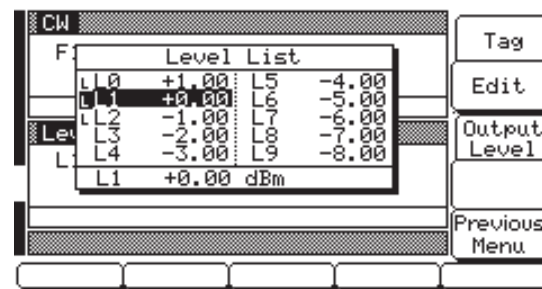

This menu lets you select a power level from the list to tag, edit, or output.

Use the cursor control key to select a power level from the level list. The selected power level is highlighted in reverse video and displayed in full below the level list.

Press **Tag** to mark a selected power level (place an **L** in front of it). If a power level is already tagged, pressing **Tag** will untag it (remove the **L**). Tagging selected power levels lets you quickly switch between them using the scan keys of the Tagged Levels menu.

Press **Edit** to edit the selected power level or enter a new power level.

Press **Output Level** to output the selected level. This power level is output until you select another level from the list and press **Output Level**. On the level list, the output power level selection is marked by a black square or, if tagged, an **L** highlighted in reverse video.

When you are finished, press **Previous Menu** to return to the Level Control Menu display.

Scanning Tagged Levels—To go to the Tagged Levels Menu (below) from the Level Control menu, press **Tag Lvl Menu**.

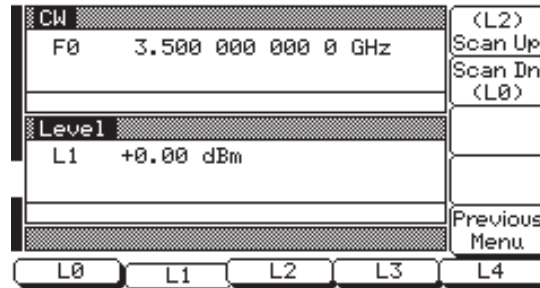

This menu lets you select the tagged power levels for output using the **Scan Up** and **Scan Dn** keys.

Return to the Level Control Menu display by pressing **Previous Menu**.

Level Offset

Level offset lets you compensate for a device on the CW generator's output that alters the RF output power level at the point of interest. For example, the power level at the test device may be less or more than the displayed power level because of the loss through an external transmission line or the gain of an amplifier located between the 680XXC RF output and the test device. Using the level offset function, you can apply a constant to the displayed power level that compensates for this loss or gain. The displayed power level will then reflect the actual power level at the test device.

To enter an offset value and apply it to the displayed power level, go to the Level Menu. Then press **Edit Offset**. As shown in the following menu, this opens the offset parameter for editing.

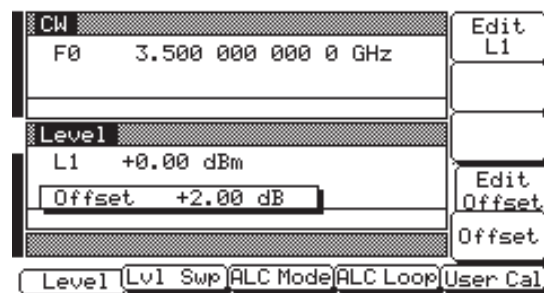

Edit the current offset value using the cursor control key or rotary data knob or enter a new offset value using the keypad and appropriate terminator key. To close the open offset parameter when you are done, press **Edit Offset** or make another menu selection.

Press **Offset** to apply the offset to the displayed power level. In this example, a +2.00 dB offset is applied to L1. L1 then displays a power level of +2.00 dBm.

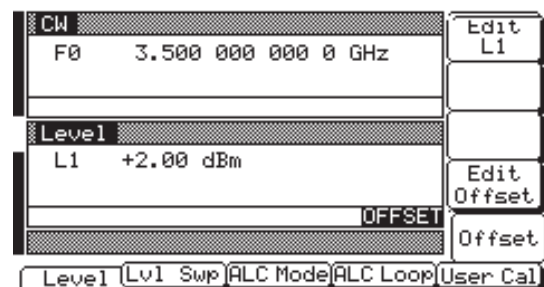

OFFSET

When Offset is selected ON, this status message is displayed on all menu displays to remind the operator that a constant (offset) has been applied to the displayed power level.

3-10 POWER LEVEL SWEEP OPERATION

The 680XXC provides leveled output power sweeps at CW frequencies and in conjunction with step frequency sweeps. Power level sweeps can be from a high level to a low level or vice versa. Power level sweeps can be selected to be linear or logarithmic. The following paragraphs provide descriptions and operating instructions for the CW power sweep mode and the sweep frequency/step power modes. Use the CW Power Sweep Mode and Sweep Frequency/Step Power Mode menu maps (Chapter 4, Figures 4-7 and 4-8) to follow the menu sequences.

CAUTION

Performing power level sweeps that cross step attenuator switch points can cause excessive wear on the switches and reduce the life expectancy of the step attenuator.

Selecting CW Power Sweep Mode

In the CW power sweep mode, output power steps between any two power levels at a single CW frequency. Menus provided let you set or select the sweep range, the step size, the dwell time-per-step, and the sweep trigger.

To place the 680XXC in a CW power sweep mode from a CW frequency menu, press the main menu key

**LEVEL/ALC
SELECT**

At the resulting menu display, press **Lvl Swp**. The CW Level Sweep Menu (below) is displayed.

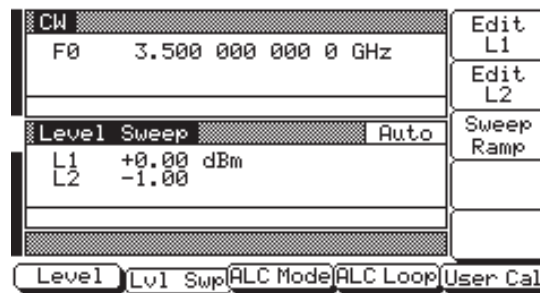

This menu lets you perform the following:

- Select a power level sweep range (edit the sweep start and stop power level parameters).
- Go to the sweep ramp menu (set the dwell time-per-step, the step size or number of steps, and select a sweep trigger).

**Setting CW
Power Sweep
Step Size and
Dwell Time**

There are two ways to set the size of each step of the CW power sweep—set the step size or set the number of steps. The step size range is 0.01 dB (Log) or 0.001 mV (Linear) to the full power range of the instrument; the number of steps range is 1 to 10,000. The dwell-time-per-step of the CW power sweep can be set for any time in the range of 1 ms to 99 sec. If the sweep crosses a step attenuator setting, there will be a sweep dwell of approximately 20 ms to allow setting of the step attenuator. The step size and dwell-time-per-step are set from the CW Level Sweep Ramp menu (below).

To go to the CW Level Sweep Ramp Menu from the CW Level Sweep menu, press **Sweep Ramp**.

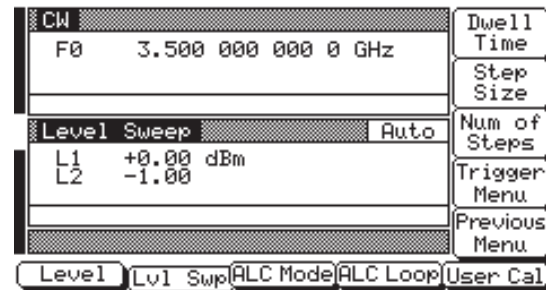

This menu lets you set the dwell time, the step size, the number of steps, and go to the trigger menu.

Press **Dwell Time** to open the dwell time-per-step parameter.

Press **Step Size** to open the step size parameter.

Press **Num of Steps** to open the number of steps parameter.

Open the parameter you wish to change, then edit the current value using the cursor control key or rotary data knob or enter a new value using the key pad and appropriate termination key. When you have finished setting the open parameter, close it by pressing its menu soft-key or by making another menu selection.

To go to the CW Level Sweep Trigger menu from this menu, press **Trigger Menu**. The trigger menu is described on the following page.

Press **Previous Menu** to return to the CW Level Sweep Menu display.

RANGE

This error message is displayed when (1) the step size value entered is greater than the level sweep range or (2) the number of steps entered results in a step size of less than 0.01 dB (Log) or 0.001 mV (Linear). Entering a valid step size will clear the error.

**Selecting a
CW Power
Sweep
Trigger**

There are three modes of triggering provided for the CW power sweep—automatic, external, and single. The sweep trigger is selectable from the CW Level Sweep Trigger menu. The following is a description of each trigger mode.

- ❑ **Auto (Automatic)**—The CW power sweep continually sweeps from its start power level to its stop power level with optimal retrace time.
- ❑ **External**—The CW power sweep recurs when triggered by an external TTL-compatible clock pulse to the rear panel AUX I/O connector.
- ❑ **Single**—A single CW power sweep starts when the trigger key is pressed. If a sweep is in progress when the key is pressed, it aborts and resets.

To go to the CW Level Sweep Trigger Menu (below) from the CW Level Sweep Ramp menu, press **Trigger Menu**.

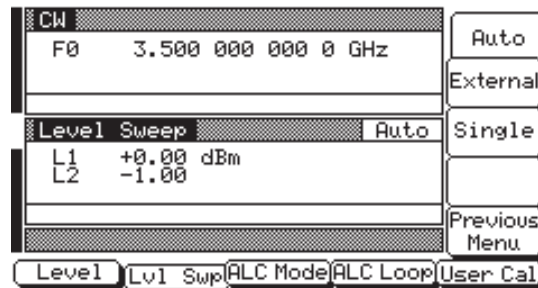

To select a CW power sweep trigger mode, press its menu soft-key. A message showing the CW power sweep trigger mode selected appears on the right side of the level mode title bar.

If you select the single sweep trigger mode, the menu display changes, adding the menu soft-key labeled **Trig**. Pressing **Trig** starts a single CW power sweep. If a single CW power sweep is in progress, pressing **Trig** causes the sweep to abort and reset.

Press **Previous Menu** to return to the CW Level Sweep Ramp Menu display.

**Selecting a
Power Level
Sweep Range**

Selecting a power level sweep range consists of choosing a start and stop level for the power level sweep. The power level sweep range selection process is identical for all power level sweep modes—CW power sweep and step sweep frequency/step power. You can select a power level sweep range as follows:

- ❑ Edit the current start and stop power level parameter values.
- ❑ Enter new start and stop power level parameter values.
- ❑ Select one of the preset power level sweep range parameters (L1-L2, L3-L4, L5-L6, L7-L8, or L9-L0).

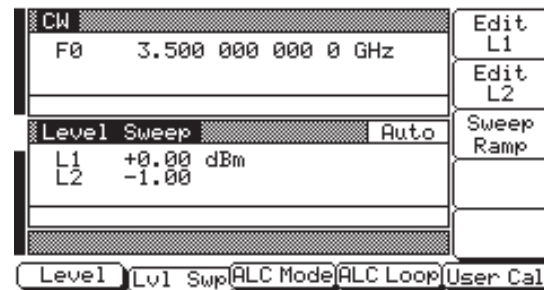

Editing the Current Start / Stop Power Levels

To edit the current power level sweep range, open either the start or stop power level parameter. In the display above, **Edit L1** opens the start power level parameter and **Edit L2** opens the stop power level parameter).

Edit the open power level parameter using the cursor control key or the rotary data knob. When you are finished, close the open parameter by pressing its menu edit soft-key or by making another menu selection.

Entering New Start / Stop Power Levels

To enter a new power level sweep range start by opening either the start or stop power level parameters (press **Edit L1** or **Edit L2**).

Enter a new power level using the keypad and appropriate terminator key. When you are finished, close the open parameter by pressing its menu edit soft-key or by making another menu selection.

NOTE

When Linear power level sweep is selected, use the following terminator keys for power level data entries:

- GHz / Sec / dBm for V
- MHz / ms / dB for mV
- kHz / μ s / STEPS for μ V

Selecting a Preset Power Level Sweep Range

There are five preset power level sweep range parameters selectable in the power level sweep modes. These preset power level sweep range parameters are L1-L2, L3-L4, L5-L6, L7-L8, and L9-L0.

To select one of the preset power level sweep ranges from a Level Sweep menu, press the main menu key

**LEVEL
CONTROL**

The Level Sweep Control Menu (below) is displayed.

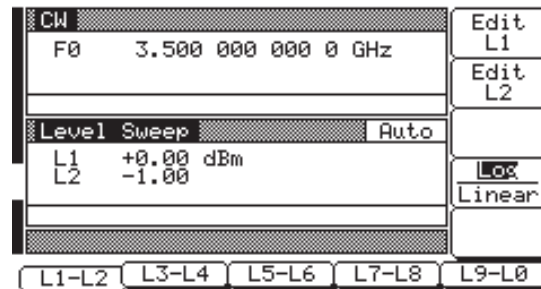

In addition to letting you select one of the preset sweep ranges for the power level sweep, this menu lets you set the start and stop power level parameters for each preset sweep range.

Setting a Preset Power Level Sweep Range

At the Level Sweep Control menu, select the power level sweep range (L1-L2, L3-L4, L5-L6, L7-L8, or L9-L0) that you wish to set. The menu then displays the current frequency parameters for the selected power level sweep range. Now, use the menu edit soft-keys to open the power level parameters for editing.

Edit the current power level parameter values or enter new power level parameter values for the power level sweep range. To close the open power level parameter when you are finished, press its menu edit soft-key or make another menu selection.

Selecting Type of Power Level Sweep

Press **Log/Linear** to select logarithmic or linear power level sweep. When Log is selected, power levels are in dBm; when Linear is selected, power levels are in mV. The soft-key label is highlighted (in reverse video) to reflect your selection.

**Selecting a
Sweep Fre-
quency / Step
Power Mode**

In step sweep frequency/step power mode, a power level step occurs after each frequency sweep. The power level remains constant for the length of time required to complete each frequency sweep. Available menus let you control the type of power level sweep (linear or logarithmic), the power level sweep range, and step size.

To select a step sweep frequency/step power mode, start with a step sweep menu display. Then press the main menu key

**LEVEL/ALC
SELECT**

At the resulting menu display, press **Lvl Swp**. The Level Sweep Menu (below) is displayed.

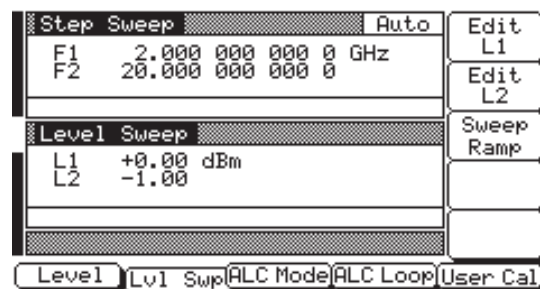

This menu lets you perform the following:

- ❑ Select a power level sweep range (edit the sweep start and stop power level parameters).
- ❑ Go to the sweep ramp menu (set the step size or number of steps).

NOTE

To select logarithmic or linear power level sweep or to select a power level sweep range, refer to the procedures on pages 3-55 and 3-56.

**Setting Power
Level Step
Size**

There are two ways to set the step size of the power level step that occurs after each frequency sweep—set the step size or set the number of steps. The step size range is 0.01 dB(Log) or 0.001 mV (Linear) to the full power range of the CW generator; the number of steps range is 1 to 10,000. The power level step size is set from the Level Sweep Ramp menu.

To go to the Level Sweep Ramp Menu (below) from the Level Sweep menu, press **Sweep Ramp**.

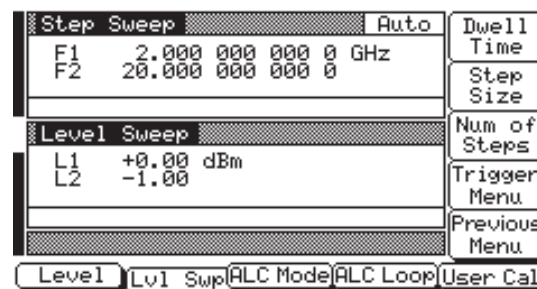

This menu lets you set the step size and the number of steps.

Press **Step Size** to open the step size parameter.

Press **Num of Steps** to open the number of steps parameter.

Open the parameter you wish to change, then edit the current value using the cursor control key or rotary data knob or enter a new value using the keypad and appropriate termination key. When you have finished setting the open parameter, close it by pressing its menu soft-key or by making another menu selection.

Press **Previous Menu** to return to the Level Sweep Menu display.

RANGE

This error message is displayed when (1) the step size value entered is greater than the level sweep range or (2) the number of steps entered results in a step size of less than 0.01 dB (Log) or 0.001 mV (Linear). Entering a valid step size will clear the error.

**3-11 LEVELING
OPERATIONS**

The 680XXC generates leveled output power over a maximum range of up to 33 dB (up to 149 dB with option 2). Instruments with option 15A provide leveled output power over a maximum range of up to 27 dB (up to 141 dB with option 2). An automatic level control (ALC) system controls the amplitude and power level of the RF output. The operator can select the ALC mode of operation—internal, external (detector or power meter), or fixed gain (ALC off). In addition, the 680XXC provides (1) an ALC power slope function that provides compensation for high frequency system or cable losses, (2) a decouple function that allows decoupling of the step attenuator (if equipped) from the ALC system, and (3) a user level (flatness correction) calibration function that provides for calibrating out path-variations-with-frequency in a test setup.

The following paragraphs provide descriptions and operating instructions for the power leveling modes and functions. Use the Leveling Modes menu map (Chapter 4, Figure 4-9) to follow the menu sequences.

**Selecting a
Leveling
Mode**

The ALC system is a feedback control system, in which the output power is measured at a detector and compared with the expected power level. If the output and desired power levels do not equal, the ALC adjusts the power output until they do. The ALC feedback signal can come from either the internal detector or an external detector or power meter. Alternatively, the output power can be set to a fixed level without using the normal feedback (ALC off). The ALC mode menu lets you make the selection of a leveling mode.

To go to the ALC Mode menu, first press the main menu key

**LEVEL/ALC
SELECT**

At the Level/ALC Select Menu display, press **ALC Mode**. The ALC Mode Menu (below) is displayed.

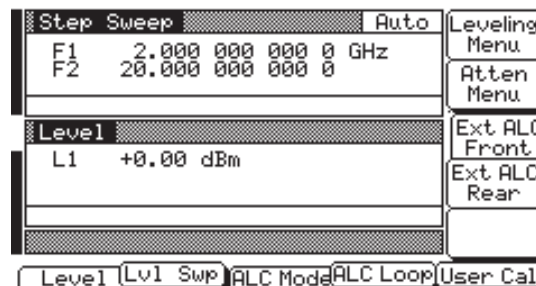

The ALC Mode menu lets you perform the following:

- ❑ Go to the leveling menu (select the ALC mode of operation).
- ❑ Go to the attenuation menu (decouple the attenuator, if equipped, from the ALC system and set the power level and attenuation).
- ❑ Select either the front panel or rear panel external ALC input.

Internal Leveling

This is the normal (default) leveling mode. Output power is sensed by the internal detector in the 680XXC. The detector output signal is fed back to the ALC circuitry to adjust the output power level. Internal ALC is selected from the leveling menu.

To go to the Leveling menu from the ALC Mode menu, press **Leveling Menu**. The Leveling Menu (below) is displayed.

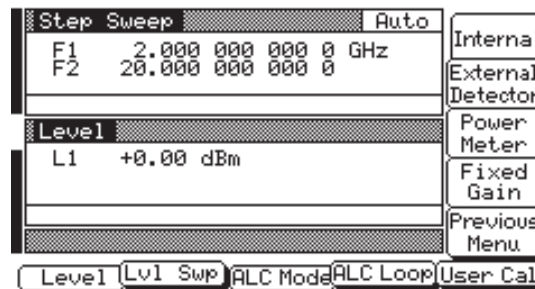

To select internal ALC, press **Internal**.

Pressing one of the other leveling menu soft-keys **External Detector**, **Power Meter**, or **Fixed Gain** will turn off internal leveling.

Press **Previous Menu** to return to the ALC Mode Menu display.

External Leveling

In external leveling, the output power from the 680XXC is detected by an external detector or power meter. The signal from the detector or power meter is returned to the ALC circuitry. The ALC adjusts the output power to keep the power level constant at the point of detection. The external ALC source input is selected from the leveling menu.

Before going to the Leveling menu from the ALC Mode menu, select whether the external ALC signal is to be connected to the front- or rear-panel EXT ALC IN connector.

At the ALC Mode menu, press **Ext ALC Front** to select front panel input, or **Ext ALC Rear** to select rear panel input.

Now, press **Leveling Menu** to go to the Leveling Menu (below).

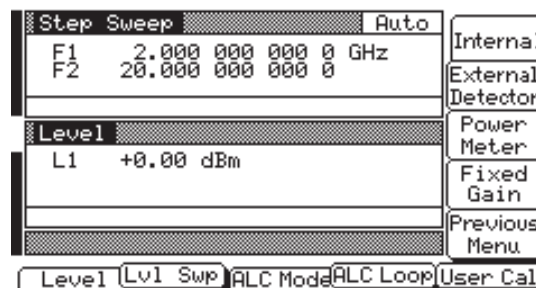

Next, select the type of external sensor you are using to detect the output power.

To select the external ALC input from an external detector, press **External Detector**.

To select the external ALC input from a power meter, press **Power Meter**.

After you have made the external ALC input connection and selected the sensor type, press **ALC Loop**. The ALC Loop Menu (below) is displayed.

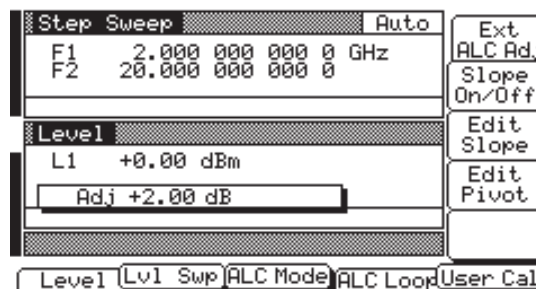

While monitoring the power level at the external detection point, first press **Ext ALC Adj**, then use the cursor control key or rotary data knob to adjust the ALC signal to obtain the set power level.

To return to the Leveling menu, press **ALC Mode** then press **Leveling Menu**.

At the Leveling menu, pressing either **Internal** or **Fixed Gain** will turn off external leveling.

Press **Previous Menu** to return to the ALC Mode Menu display.

Fixed Gain

In the fixed gain mode, the ALC is disabled. The RF Level DAC and step attenuator (if installed) are used to control the relative power level. Power is not detected at any point, and the absolute power level is uncalibrated. Fixed gain mode is selected from the leveling menu.

To go to the Leveling Menu (below) from the ALC Mode menu, press **Leveling Menu**.

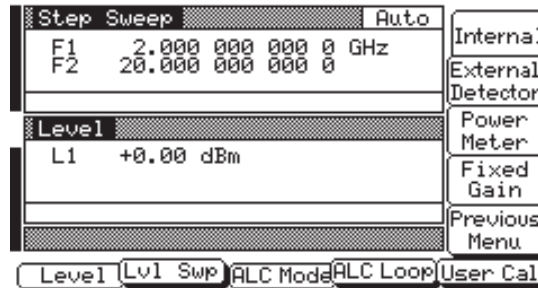

To select fixed gain mode, press **Fixed Gain**.

To return to normal ALC operation, press **Internal**.

Press **Previous Menu** to return to the ALC Mode Menu display.

***Attenuator
Decoupling***

In 680XXCs equipped with option 2 step attenuators, the ALC and attenuator work in conjunction to provide leveled output power down to -140 dBm. In the normal (coupled) leveling mode, when the desired power level is set, the correct combination of ALC level and attenuator setting is determined by the instrument firmware. In some applications, such as receiver sensitivity testing, it is desirable to control the ALC level and attenuator setting separately by decoupling the step attenuator from the ALC. The ALC mode menu lets you select attenuator decoupling.

At the ALC Mode menu, press **Atten Menu**. The Attenuator Menu (below) is displayed.

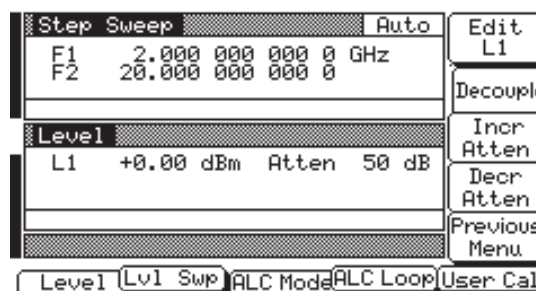

This menu lets you decouple the step attenuator from the ALC, set the power level, and set the attenuation in 10 dB steps.

Press **Decouple** to decouple the step attenuator from the ALC.

Press **Edit L1** to open the power level parameter for editing. Edit the current level using the cursor control key or rotary data knob or enter a new value using the key pad and appropriate termination key. When you have finished setting the power level, press **Edit L1** to close the open parameter.

To change the attenuation setting, press **Incr Atten** or **Decr Attn**. Pressing these soft-keys changes the attenuation in 10 dB steps.

Press **Previous Menu** to return to the ALC Mode Menu display.

NOTE

The set power level may not be maintained when switching between attenuator coupling modes.

**ALC Power
Slope**

The ALC power slope function lets you compensate for system, cable, and waveguide variations due to changes in frequency, by linearly increasing or decreasing power output as the frequency increases. As shown in the following illustration, the power slope function provides you with the ability to set both the power slope and the pivot point. The ALC Loop menu lets you activate the ALC power slope function.

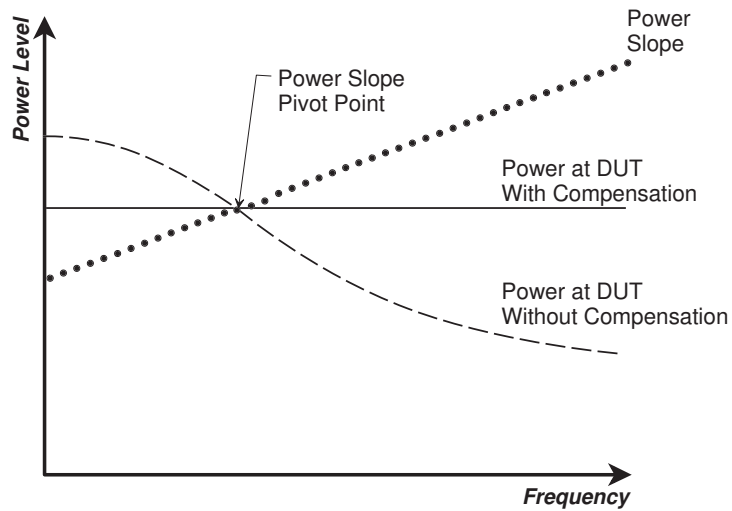

To go to the ALC Loop Menu (below) from the Level/ALC Control Menu display, press **ALC Loop**.

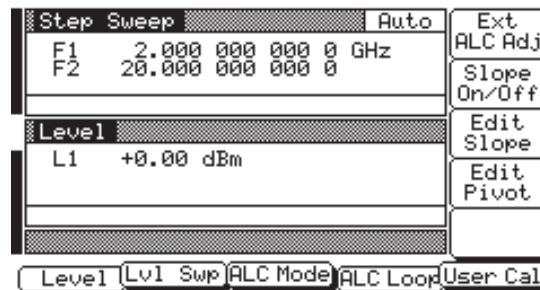

This menu lets you turn the power slope on or off and edit the slope value and pivot point frequency.

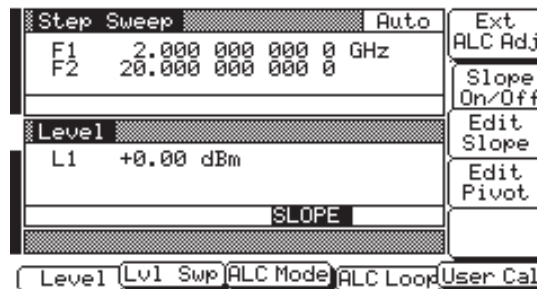

Press **Slope On/Off** to activate the ALC power slope function.

Press **Edit Pivot** to open the pivot point frequency parameter for editing. Edit the current frequency using the cursor control key or rotary data knob or enter a new value using the keypad and appropriate termination key. When you have finished setting the open parameter, close it by pressing **Edit Pivot** again or by making another menu selection.

Press **Edit Slope** to open the slope parameter for editing. Edit the current slope value using the cursor control key or rotary data knob or enter a new value using the key pad and the STEPS termination key. When you have finished setting the open parameter, close it by pressing **Edit Slope** again or by making another menu selection.

While monitoring the power level at the device-under-test (DUT), adjust the power slope and pivot point to level the power at the DUT.

SLOPE

When Power Slope is selected ON, this status message is displayed on all menu displays to remind the operator that a power slope correction has been applied to the ALC.

***User Cal
(User Level
Flatness
Calibration)***

The User Cal (user level flatness correction) function lets you compensate for path-variations-with-frequency that are caused by external switching, amplifiers, couplers, and cables in the test setup. This is done by means of an entered power-offset table from a GPIB power meter or calculated data. When user level flatness correction is activated, the set power level is delivered at the point in the test setup where the calibration was performed. This “flattening” of the test point power level is accomplished by summing a power-offset word (from the power-offset table) with the CW generator's normal power level DAC word at each frequency point.

Up to five user level flatness correction power-offset tables from 2 to 801 frequency points/table can be created and stored in 680XXC memory for recall. The GPIB power meters supported are the Anritsu Model ML2437A, ML2438A, and ML4803A and the Hewlett-Packard Models 437B, 438A, and 70100A.

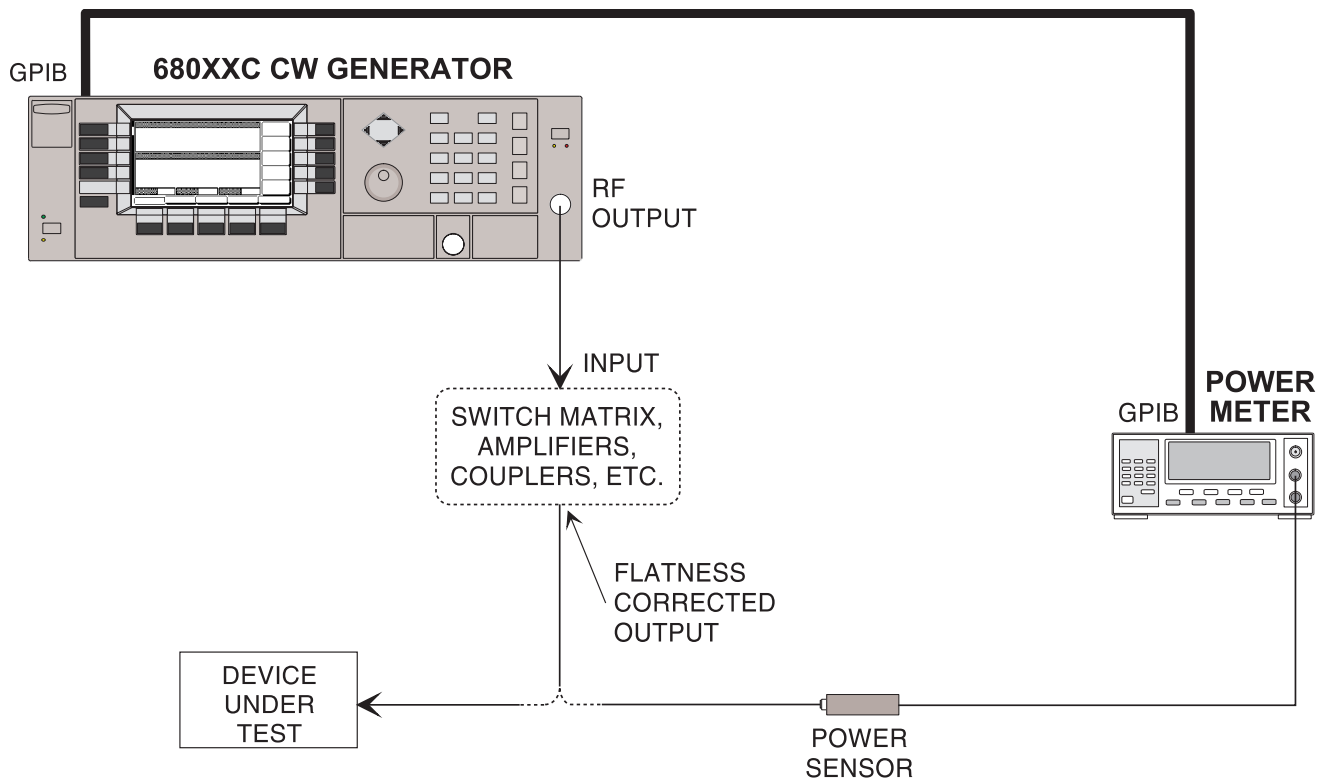

Figure 3-4 Setup for Creating a Power-Offset Table (User Level Flatness Correction)

Equipment Setup

To create a power-offset table for user level flatness correction, connect the equipment (shown in Figure 3-4) as follows:

- Step 1** Using a GPIB cable, connect the Power Meter to the 680XXC.
- Step 2** Calibrate the Power Meter with the Power Sensor.
- Step 3** Connect the Power Sensor to the point in the test setup where the corrected power level is desired.

Power Meter Model and GPIB Address

In order for the 680XXC to control the power meter, the GPIB address and power meter model must be selected from the Configure GPIB menu.

Press **SYSTEM** to go to the System Menu display. At the System Menu display, press **Config**. The System Configuration Menu (below) is displayed.

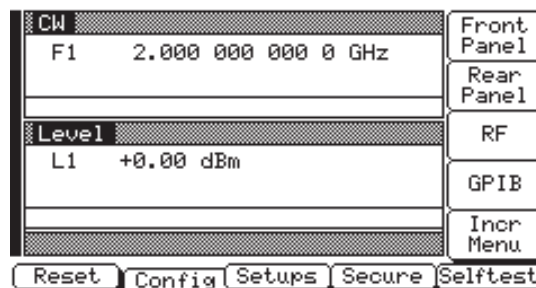

Next, press **GPIB**. The Configure GPIB Menu (below) is displayed.

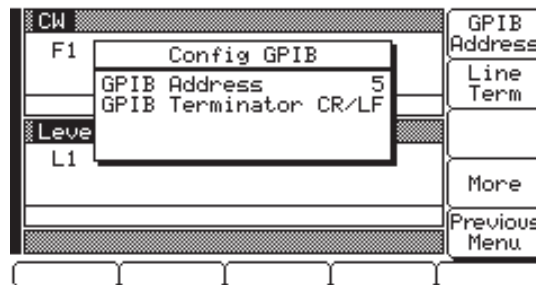

At the Configure GPIB menu, press **More** to go to the Additional Configure GPIB Menu (below).

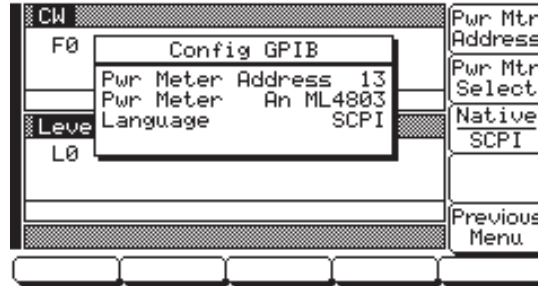

Press **Pwr Mtr Address** to change the address of the power meter on the GPIB (the power meter's default address is 13). Enter the new address, between 1 and 30, using the cursor control key or the data entry key pad and the terminator key



The new GPIB address will appear on the display.

Press **Pwr Mtr Select** to select the power meter model being used. (Supported power meters are the Anritsu ML2437A, ML2438A, and ML4803A and Hewlett-Packard 437B, 438A, and 70100A.)

Press **Previous Menu** to return to the main Configure GPIB Menu display.

At the Configure GPIB menu, press **Previous Menu** to return to the System Configuration Menu display.

Creating a Power-Offset Table

The 680XXC must be in CW frequency mode and fixed (non-swept) power level mode in order to create a power-offset table for user level flatness correction.

Place the CW generator in CW frequency mode by pressing the main menu key



At the resulting menu display, press **CW**. The 680XXC is now in CW frequency mode.

Place the CW generator in a fixed power level mode by pressing the main menu key

**LEVEL/ALC
SELECT**

At the resulting menu display, press **Level**. The 680XXC is now in fixed (non-swept) power level mode.

At the Level Menu, press **User Cal**. The User Level Cal Menu (below) is displayed.

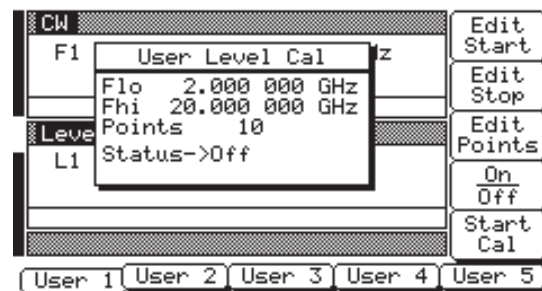

This menu lets you perform the following:

- Create a power-offset table.
- Select a measurement frequency range (edit the start and stop frequency parameters).
- Select the number of points at which correction information is to be taken.
- Apply a power-offset table to the test setup.

First, press the menu soft-key to select the power-offset table (User 1, User 2, User 3, User 4, or User 5) that you wish to create.

Next, set the measurement frequency range by pressing **Edit Start** or **Edit Stop** to open the start (Flo) or stop (Fhi) frequency parameter for editing. Edit the current frequency using the cursor control key or rotary data knob or enter a new value using the keypad and appropriate termination key. When you have finished setting the open parameter, close it by pressing its menu edit soft-key again or by making another menu selection.

Then, select the number of frequency points at which correction information is to be taken by pressing **Edit Points** to open the number-of-points parameter for editing. Edit the current number-of-points using the cursor control key or rotary data knob or enter a new value using the keypad and the STEPS termination key. (The number of points

range is 2 to 801.) When you have finished setting the open number-of-points parameter, close it by pressing **Edit Points** again or by making another menu selection.

Now, press **Start Cal** to begin automatically taking power level correction information at each frequency point. During this process the menu displays the status: Calibrating along with the current measurement frequency point.

NOTE

To terminate the measurement process at any time before completion, press **Abort**.

Once the power-offset table has been created, it is stored in non-volatile memory. The power-offset table is now ready to be applied to the test setup. Disconnect the Power Sensor and Power Meter from the test setup.

Applying User Level Flatness Correction

Whenever user level flatness correction is applied to the test setup by activating the power-offset table, the set power level is delivered at the point where the calibration was performed.

To activate the selected power-offset table and apply user level flatness correction to the test setup, press **On/Off**. The User Level Cal menu will display the status: On.

To turn off the selected power-offset table and remove user level flatness correction from the test setup, press **On/Off** again. The User Level Cal menu will display the status: Off.

Entering a Power-Offset Table via GPIB

User level flatness correction can be applied to the test setup using a power-offset table created from calculated data and entered via the GPIB. Refer to the 680XXC Programming Manual (P/N 10370-10331) for information and instructions on creating a power-offset table and entering it via the GPIB.

USER 1...5

When a power-offset table is selected ON, this status message is displayed on all menu displays to remind the operator that user level flatness correction has been applied to the ALC.

NOTE

The master reset function overwrites all information stored in the non-volatile memory with default values. This includes the nine stored front panel setups and the table of 2000 frequency/power level sets used for list sweep mode.

Erasing the Power-Offset Tables from Memory

The power-offset tables are stored in non-volatile memory. A master reset is required to erase the contents of the tables and reprogram them with default data.

To perform a master reset, proceed as follows:

- Step 1** With the 680XXC in standby, press and hold the RF OUTPUT ON/OFF key.
- Step 2** Press the LINE OPERATE/STANDBY key to turn the instrument on.
- Step 3** When the first menu is displayed (after the start-up display), release the RF OUTPUT ON/OFF key.

The contents of non-volatile memory have now been erased and reprogrammed with default data.

3-12 SYSTEM CONFIGURATION

The system configuration function provides menus that let you set or select instrument configuration items; for example, display intensity, polarity of blanking and video marker outputs, RF on or off during retrace or between steps, frequency scaling, GPIB operating parameters, external interface language, and increment sizes for frequency, power level, and time parameters. Use the System Configuration menu map (Chapter 4, Figure 4-10) to follow the menu sequences.

To go to the System Configuration menu, first press **SYSTEM**. At the System Menu display, press **Config**. The System Configuration Menu (below) is displayed.

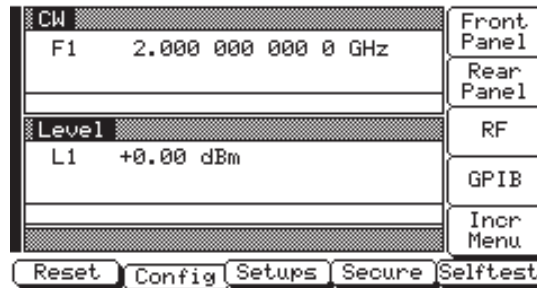

This menu lets you go to the Front Panel, Rear Panel, RF, GPIB, and Increment Configuration menus.

***Configuring
the Front
Panel***

Configuring the front panel of the CW generator involves adjusting the intensity level of the data display for ease of viewing.

To go to the Configure Front Panel menu from the System Configuration menu, press **Front Panel**. The Configure Front Panel Menu (below) is displayed.

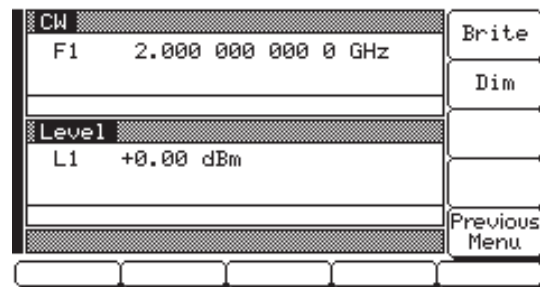

Press **Brite** (repeatedly) to increase the intensity of the data display to the desired level.

Press **Dim** (repeatedly) to decrease the intensity of the data display.

When done, press **Previous Menu** to return to the System Configuration Menu display.

***Configuring
the Rear
Panel***

Configuring the rear panel of the CW generator consists of selecting the polarity of the retrace blanking, bandswitch blanking, retrace penlift, and video marker outputs.

To go to the Configure Rear Panel Menu (below) from the System Configuration menu, press **Rear Panel**.

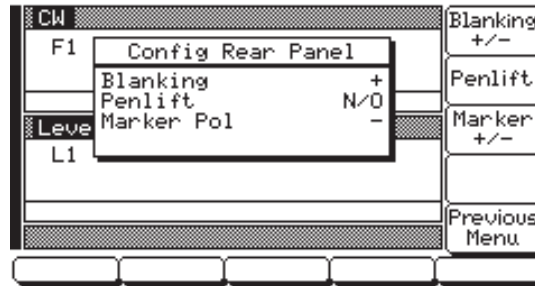

Press **Blanking +/-** to select a +5V or -5V level for the retrace and bandswitch blanking outputs. The retrace and bandswitch blanking signal outputs are both available at the rear panel AUX I/O connector. The display will reflect your selection.

Press **Penlift** to select normally-open (N/O) or normally-closed (N/C) contacts on the internal penlift relay. The penlift relay output, optionally available at the rear panel, is used to lift a plotter pen during retrace. The display will reflect your selection.

Press **Marker +/-** to select a +5V or -5V level for the video marker output when video markers are selected ON. The video marker signal output is available at the rear panel AUX I/O connector. The display will reflect your selection.

Press **Previous Menu** to return to the System Configuration Menu display.

**Configuring
the RF**

Configuring the RF of the 680XXC involves the following:

- ❑ Selecting whether the RF should be on or off during retrace.
- ❑ Selecting whether the RF should be on or off during frequency switching in CW, step sweep, and list sweep modes.
- ❑ Selecting whether a sweep triggered by a single or external trigger should rest at the top or bottom of the sweep ramp.
- ❑ Selecting whether the RF should be on or off at reset.
- ❑ Setting the reference multiplier value for frequency scaling.
- ❑ Selecting 40 dB or 0 dB of attenuation when RF is switched off in units with a step attenuator (Option 2) installed.

To go to the Configure RF Menu (below) from the System Configuration menu, press **RF**.

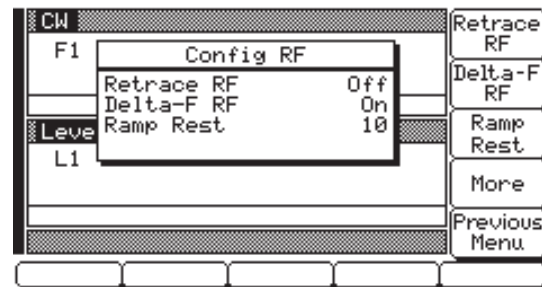

Press **Retrace RF** to select RF On or Off during retrace. The display will reflect your selection.

Press **Delta-F RF** to select RF On or Off during frequency switching in CW, step sweep, and list sweep modes. The display will reflect your selection.

Press **Ramp Rest** to select 0 or 10 for the ramp rest point for sweeps that are triggered by a single trigger or external trigger. 0 indicates that the sweep will rest at the bottom of the sweep ramp; 10 indicates that the sweep will rest at the top of the sweep ramp. The display will reflect your selection.

Press **More** to go to the Additional Configure RF menu for more selections.

Press **Previous Menu** to return to the System Configuration Menu display.

Additional Configure RF Menu

When you press **More**, the Additional Configure RF Menu (below) is displayed.

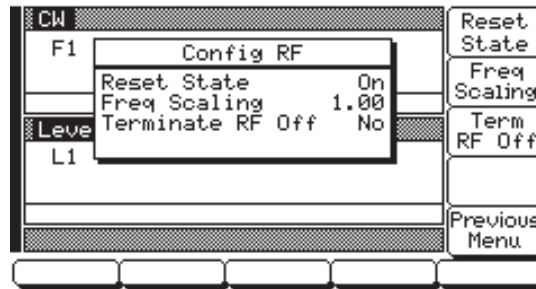

Press **Reset State** to select RF On or Off at reset. The display will reflect your selection.

Frequency Scaling – Lets you set a reference multiplier value and apply it to all frequency parameters. The reference multiplier can be any value between 0.1 and 14. Changing the multiplier value changes the entered and displayed frequencies, but it does not affect the output of the CW generator.

For example:

Frequency scaling set to 4

CW frequency set to 20 GHz

680XXC output frequency is 5 GHz (20 GHz ÷ 4)

Press **Freq Scaling** to open the reference multiplier parameter, then edit the current value using the cursor control key or rotary data knob or enter a new value using the data entry key pad and any terminator key. To close the open multiplier parameter, press **Freq Scaling** or make another menu selection.

Press **Term RF Off** to select 40 dB (minimum) of attenuation when RF is switched off in units with a step attenuator (Option 2) installed. This provides a better output source match. The display will reflect Yes to indicate the 40 dB of attenuation is applied. Press **Term RF Off** again to select 0 dB of attenuation when RF is switched off. The display will reflect No to indicate 0 dB of attenuation is applied.

Press **Previous Menu** to return to the main Configure RF Menu display.

NOTE

Resetting the 680XXC sets the frequency scaling reference multiplier value to 1.

NOTE

The Term RF Off selection is *only* available in those 680XXC models having Option 2 and Firmware Version 1.01 and above.

***Configuring
the GPIB***

The GPIB configuration menus let you perform the following:

- ❑ Set the GPIB address and select the GPIB line terminator for the CW generator.
- ❑ Select the model and set the GPIB address for the power meter that is used to create a user level flatness correction power-offset table.
- ❑ Select the external interface language for remote operation of units with Option 19.

To go to the Configure GPIB Menu (below) from the System Configuration menu, press **GPIB**.

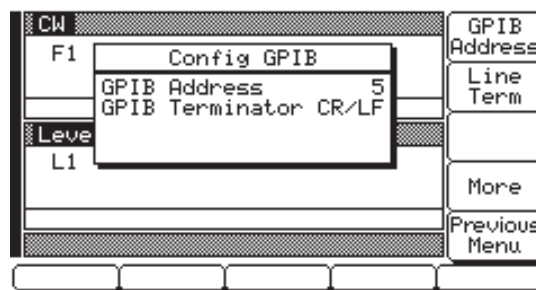

Press **GPIB Address** to change the address of the 680XXC on the bus (the CW generator's default GPIB address is 5). Enter a new address, between 1 and 30, using the cursor control key or the data entry keypad and the terminator key



The new GPIB address will appear on the display.

Press **Line Term** to select a carriage return (CR) or a carriage return and line feed (CR/LF) as the GPIB data delimiter. Consult the GPIB controller's manual to determine which data delimiter is required.

Press **More** to go to the Additional Configure GPIB menu for more selections.

Press **Previous Menu** to return to the System Configuration Menu display.

Additional Configure GPIB Menu

When you press **More** the Additional Configure GPIB Menu (below) is displayed.

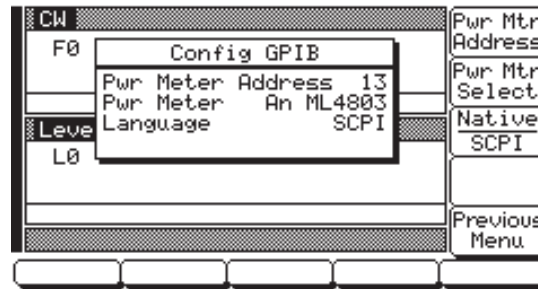

This menu lets you perform the following:

- ❑ Select the model and set the GPIB address for the power meter that is used to create a user level flatness correction power-offset table. (Refer to page 3-66 for a description of this function.)
- ❑ Select the external interface language for remote operation of 680XXCs with Option 19 installed. (Refer to page 2-9 for more information.)

Press **Pwr Mtr Address** to change the address of the power meter on the GPIB (the power meter's default GPIB address is 13). Enter a new address, between 1 and 30, using the cursor control key or the data entry keypad and the terminator key

Hz
ns
ADRS

The new GPIB address will appear on the display.

Press **Pwr Mtr Select** to select the power meter model being used. (Supported power meters are the Anritsu ML2437A, ML2438A, and ML4803A and Hewlett-Packard 437B, 438A, and 70100A.)

Press **Native/SCPI** to select the external interface language to be used for remote operation of the 680XXC. (Language selection is only available on instruments that have Option 19 installed.)

Press **Previous Menu** to return to the main Configure GPIB Menu display.

**Setting
Increment
Sizes**

The Increment menu lets you set the incremental size for editing frequency, power level, and time parameters. When the increment mode is selected on, these parameter values will increase or decrease by the set amount each time the \wedge or \vee pad is pressed or the rotary data knob is turned clockwise or counter-clockwise. The menu also lets you turn the increment mode on and off.

To go to the Increment menu from the System Configuration menu, press **Incr Menu**. The Increment Menu (below) is displayed.

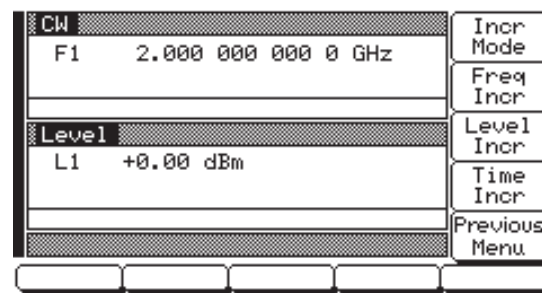

Press **Freq Incr** to open the frequency increment parameter.

Press **Level Incr** to open the power level increment parameter.

Press **Time Incr** to open the time increment parameter.

Open the parameter you wish to change, then edit the current value using the cursor control key or rotary data knob or enter a new value using the keypad and appropriate termination key. When you have finished setting the open parameter, close it by pressing its menu soft-key or by making another menu selection.

Press **Incr Mode** to turn the increment mode on. Press again to turn it off.

Press **Previous Menu** to return to the System Configuration Menu display.

**3-13 SAVING/RECALLING
INSTRUMENT SETUPS**

The 680XXC offers the capability to store up to ten complete front panel setups. The setups are numbered 0 through 9. The following paragraphs describe how to save and recall front panel setups.

***Saving
Setups***

Once you have decided that an 680XXC setup should be retained for future use, follow the procedure below to save it.

First, press **SYSTEM** to display the System Menu.

Now, press **Setups**. The Setups Menu (below) is displayed.

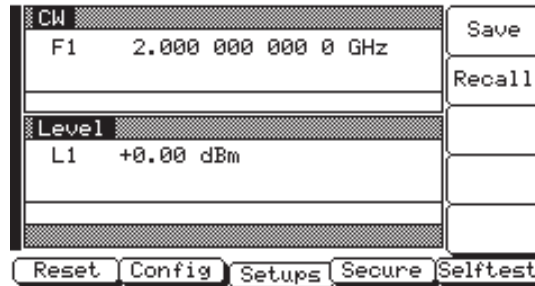

Press **Save**, then enter the desired setup number (between 0 and 9) on the keypad. The setup is now saved.

NOTE

Setup #0 automatically saves the current front panel settings when the instrument is shutdown using the front panel LINE key. Therefore, it is recommended that you use only setups #1 through #9 to save front panel setups.

When 680XXC shutdown occurs because of main power interruptions, the current front panel settings are not saved.

***Recalling
Setups***

To recall a previously saved setup, first access the Setups Menu as described above.

At the Setups Menu, press **Recall**, then enter the setup number on the keypad.

The 680XXC resets itself to the recalled configuration.

***Erasing
Stored Setups***

The front panel setups are stored in non-volatile memory. A master reset is required to erase the contents of the setups and reprogram them with default data.

To perform a master reset, proceed as follows:

- Step 1** With the 680XXC in standby, press and hold the RF OUTPUT ON/OFF key.
- Step 2** Press the LINE OPERATE/STANDBY key to turn the instrument on.
- Step 3** When the first menu is displayed (after the start-up display), release the RF OUTPUT ON/OFF key.

The contents of non-volatile memory have now been erased and reprogrammed with default data.

NOTE

The master reset function overwrites all information stored in the non-volatile memory with default values. This includes the table of 2000 frequency/power level sets used for the list sweep mode and the five power-offset tables used for the user level flatness correction function.

3-14 SECURE OPERATION

The 680XXC can be operated in a secure mode of operation. In this secure mode, the display of all frequency and power level parameters is disabled during both local (front panel) and remote (GPIB) operations. The instrument will continue to function normally in all other respects. The following paragraphs describe how to place the CW generator in secure mode and how to return to normal operation.

To place the 680XXC in the secure mode, first press **SYSTEM** to display the System Menu.

Next, press **Secure**. This places the CW generator in the secure mode and the Secure Menu (below) is displayed.

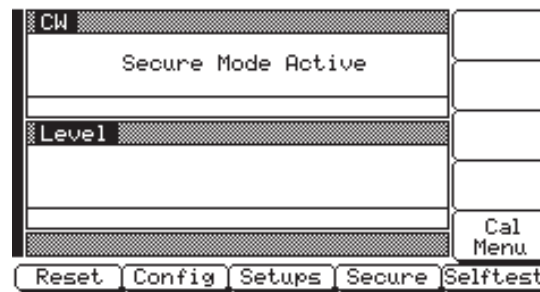

NOTE

During secure mode, all main menu keys and menu soft-keys operate normally. The menu soft-key labels are displayed and change with menu selections. Only the parameter display is disabled.

To return the 680XXC to unsecured (normal) operation, press **SYSTEM**, then press **Reset**.

3-15 REFERENCE OSCILLATOR CALIBRATION

The reference oscillator calibration function lets you calibrate the internal 100 MHz crystal reference oscillator of the 680XXC using an external 10 MHz, 0 to +10 dBm reference signal.

NOTE

Before beginning calibration, always let the 680XXC warm up for a minimum of 120 hours.

NOTE

This calibration is not applicable to units having Option 16, High Stability Time Base, installed.

To perform calibration of the internal reference oscillator, first connect the external 10 MHz reference signal to the 680XXC rear panel 10 MHz REF IN connector.

Next press the **SYSTEM** main menu key. At the System Menu display, press **Cal Menu** to go to the Calibration Menu (below).

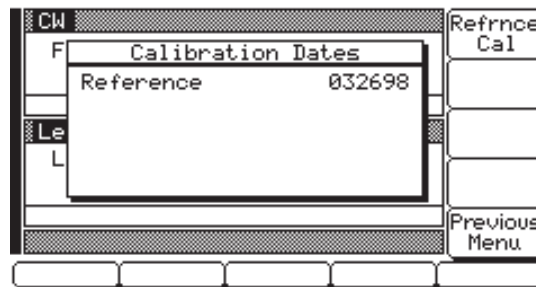

Press **Refnrnce Cal** to begin calibration.

Press **Previous Menu** to return to the System Menu display.

When **Refnrnce Cal** is pressed, the Calibration Status Menu (below) is displayed.

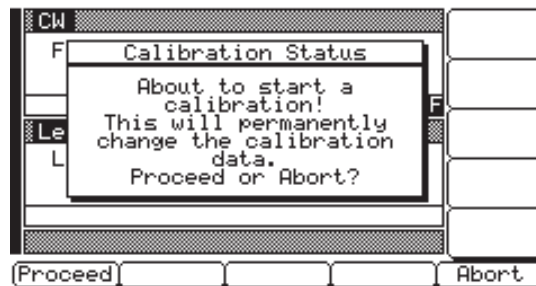

Press **Proceed** to start the calibration.

Press **Abort** to cancel the calibration and return to the Calibration Menu display.

When **Proceed** is pressed, the date parameter opens for data entry.

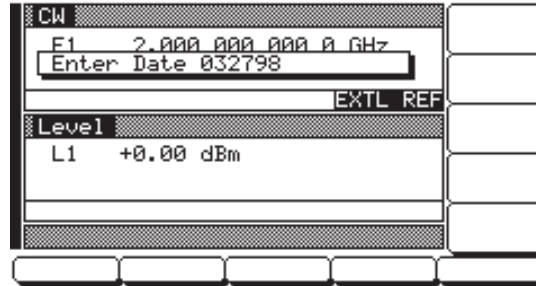

Using the key pad, enter the current date (in any desired format). Then, press any terminator key. The Calibration Status Menu display changes to indicate calibration is in progress.

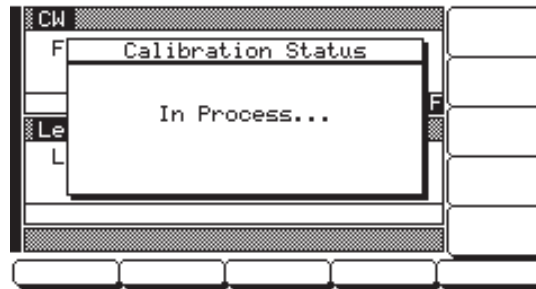

When the reference calibration is complete, the Calibration Menu is displayed.

External Reference Not Connected

If calibration is attempted without an external 10 MHz reference signal connected to the rear panel 10 MHz REF IN connector, the Calibration Status Menu displays the following.

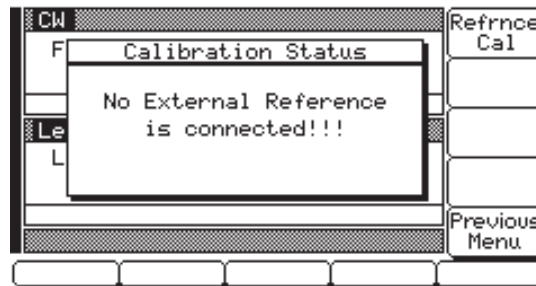

Chapter 4

Local Operation–Menu Maps

Table of Contents

4-1	INTRODUCTION	4-3
4-2	MENU MAP DESCRIPTION	4-3

Chapter 4

Local Operation–Menu Maps

4-1 INTRODUCTION

This chapter provides menu maps that support the 680XXC front panel operating instructions found in Chapter 3. It includes menu maps for all of the frequency and power level modes of operation. In addition, a menu map for system configuration is also provided.

4-2 MENU MAP DESCRIPTION

A menu map shows the menu key selections and instrument menu displays for a particular mode of CW generator operation. The menu displays are shown as they appear on the instrument and are linked together to show the sequence of menu selection. A brief description of the function of each menu's soft-keys is provided. If a menu soft-key selects another menu, then it is shown linked to that menu. Figure 4-1, on page 4-5, is a sample menu map annotated to identify the key elements.

The following is a list of the menu maps contained in this chapter.

Figure	Title	Page
4-1	Sample Menu Map	4-5
4-2	CW Frequency Mode Menu Map	4-6
4-3	Step Sweep Frequency Mode Menu Map	4-7
4-4	Manual Sweep Frequency Mode Menu Map	4-8
4-5	List Frequency Mode Menu Map	4-9
4-6	Fixed Power Level Mode Menu Map	4-10
4-7	CW Power Sweep Mode Menu Map	4-11
4-8	Sweep Frequency/Step Power Mode Menu Map	4-12
4-9	Leveling Modes Menu Map	4-13
4-10	System Configuration Menu Map	4-14

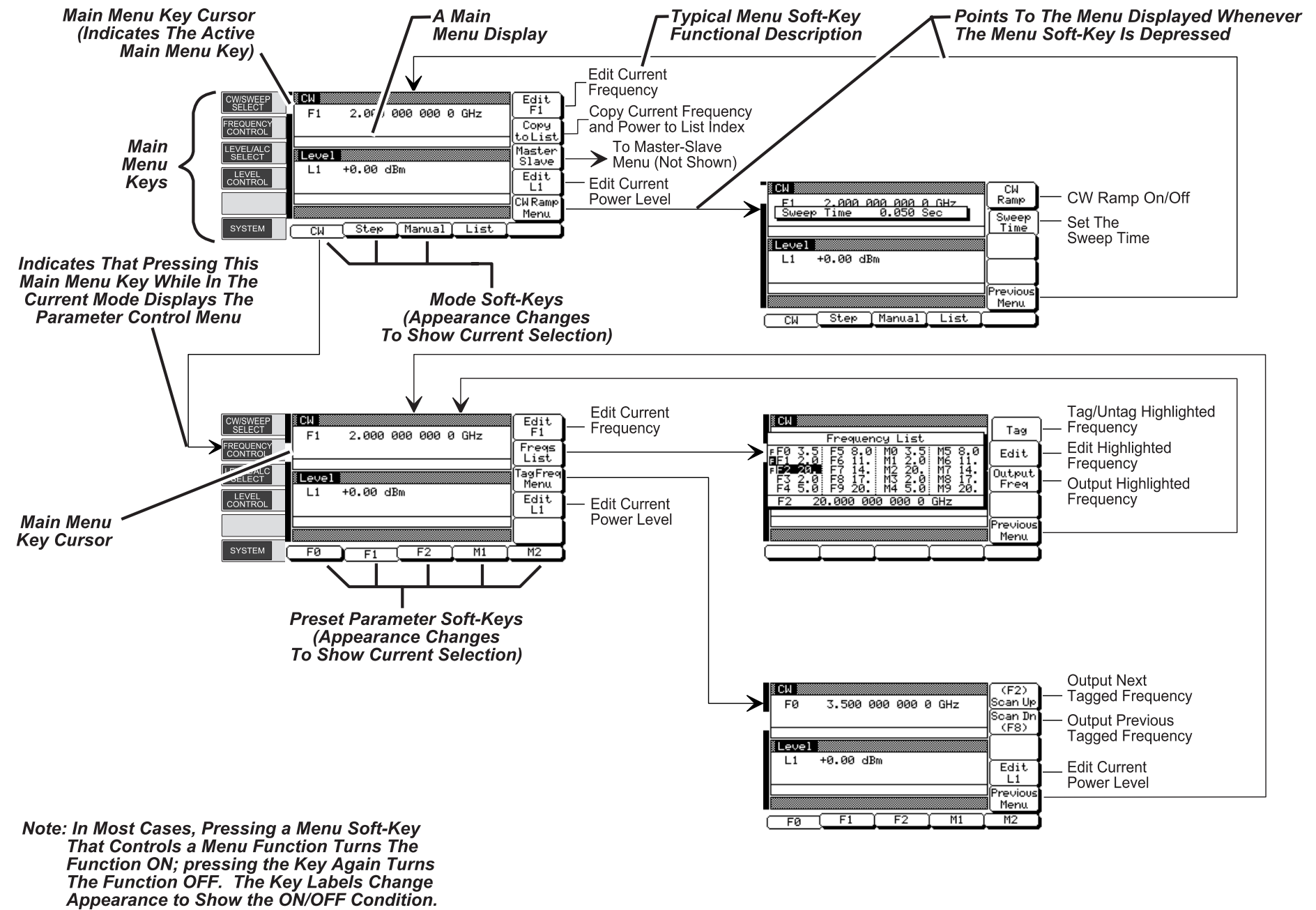
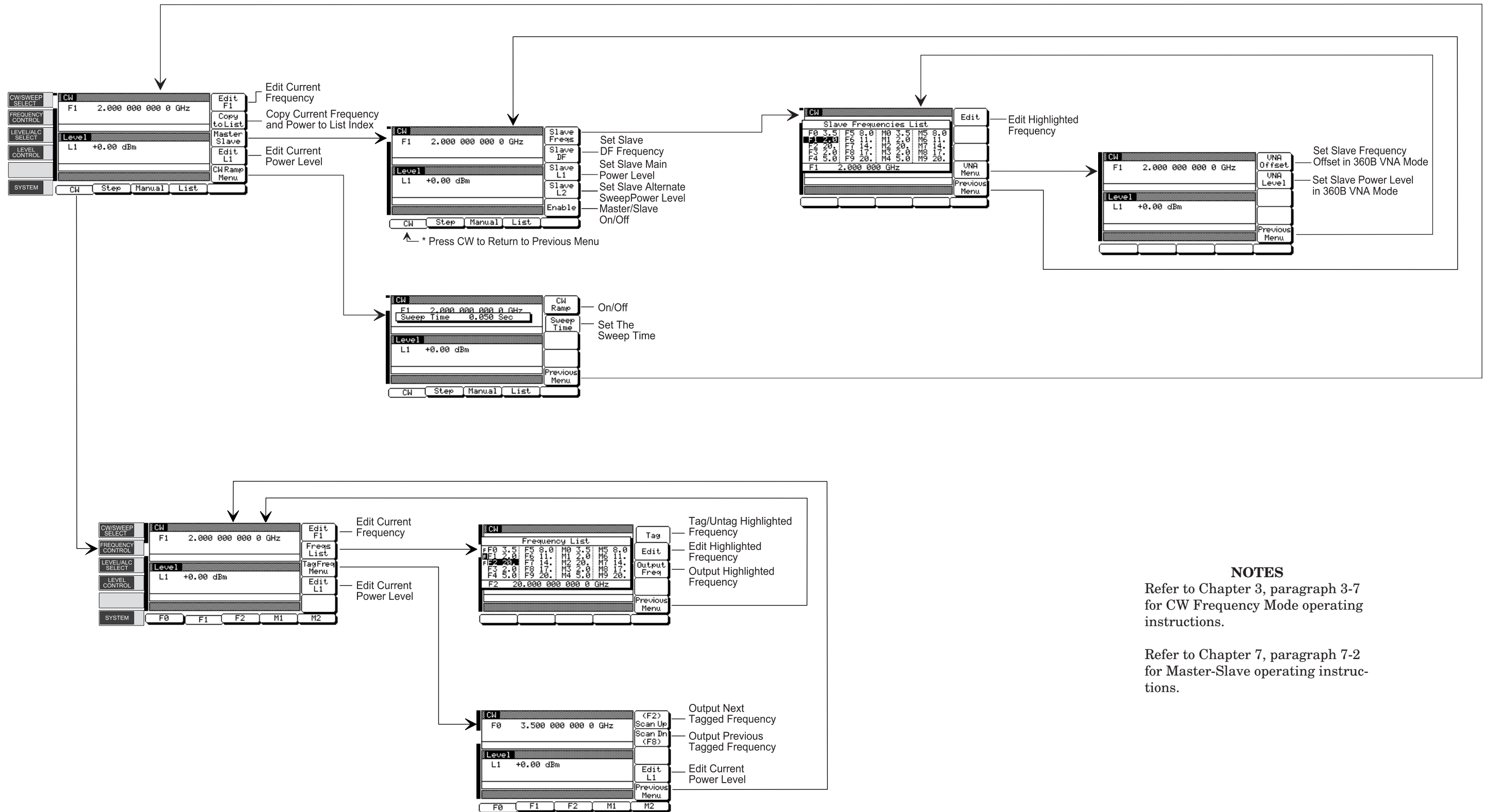

Figure 4-1. Sample Menu Map (Annotated)



NOTES
Refer to Chapter 3, paragraph 3-7 for CW Frequency Mode operating instructions.

Refer to Chapter 7, paragraph 7-2 for Master-Slave operating instructions.

Figure 4-2. CW Frequency Mode Menu Map

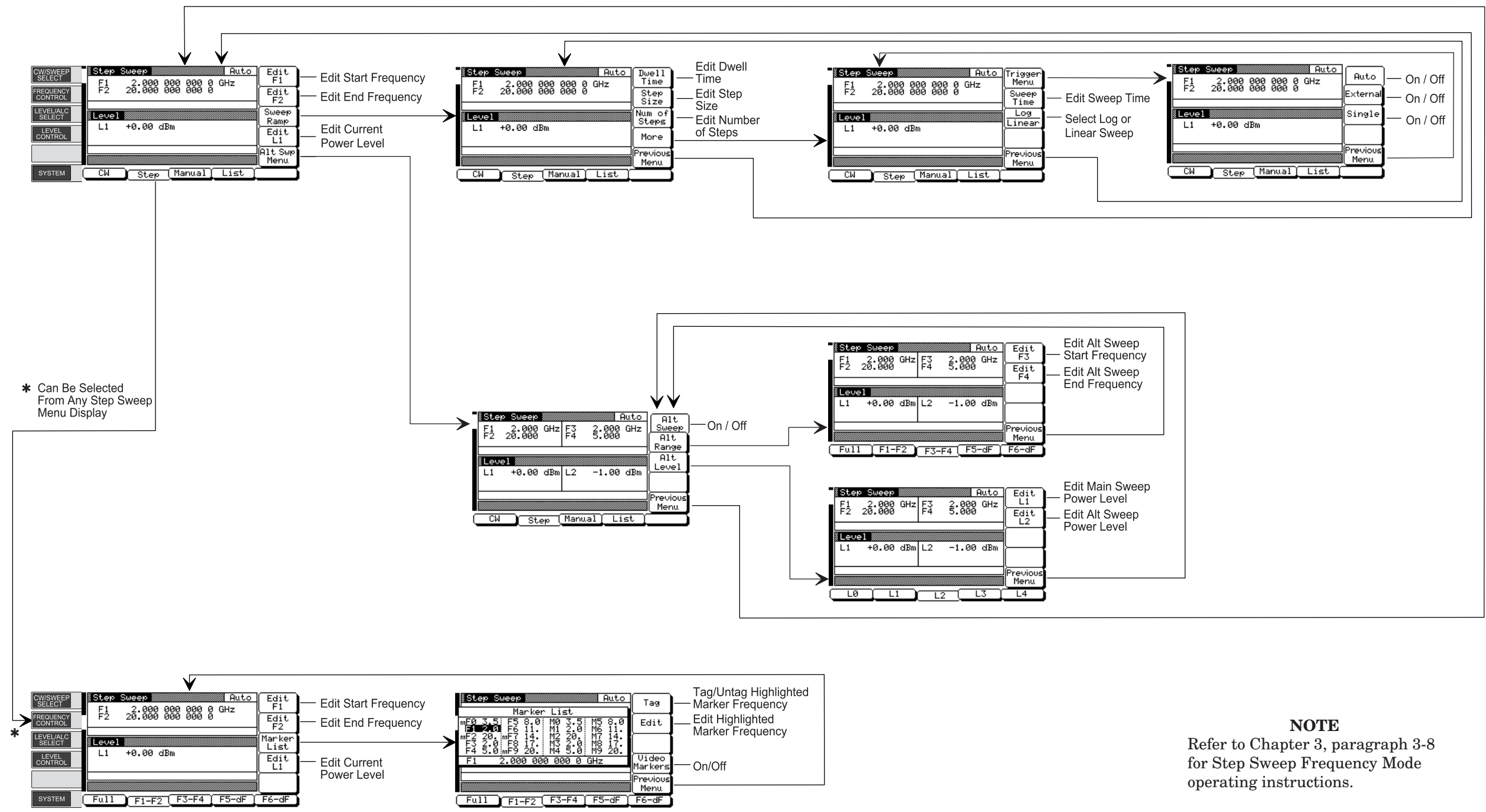

NOTE
Refer to Chapter 3, paragraph 3-8 for Step Sweep Frequency Mode operating instructions.

Figure 4-3. Step Sweep Frequency Mode Menu Map

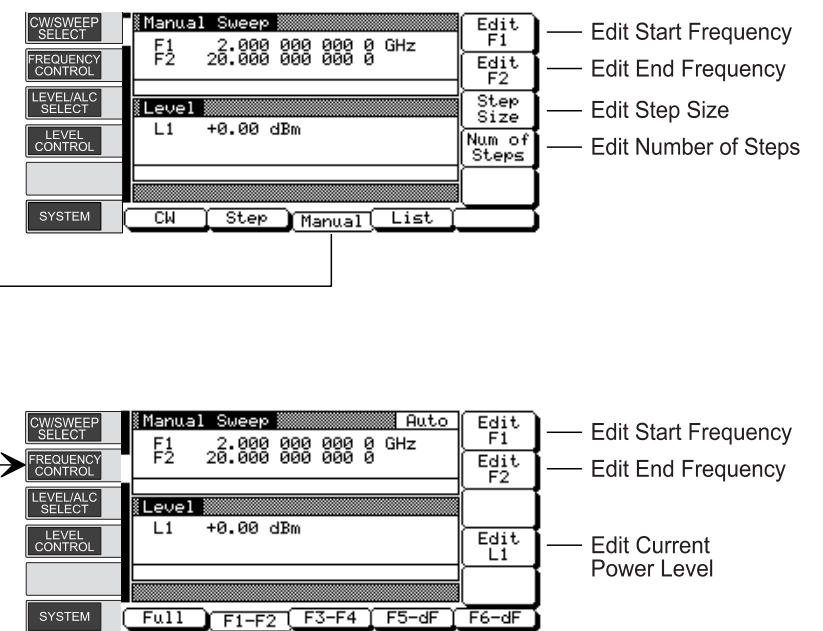

NOTE
Refer to Chapter 3, paragraph 3-8
for Manual Sweep Frequency Mode
operating instructions.

Figure 4-4. Manual Sweep Frequency Mode
Menu Map

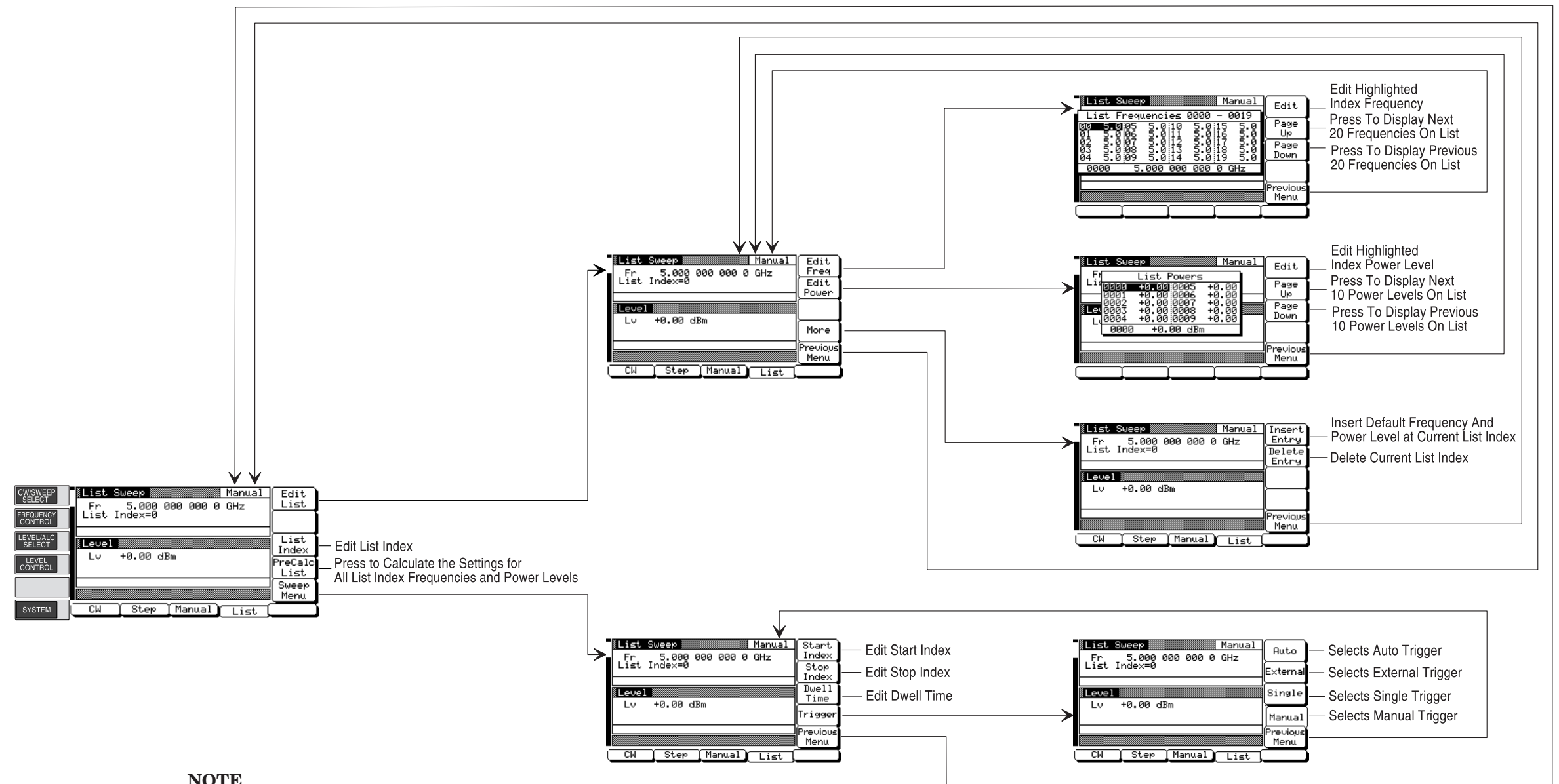
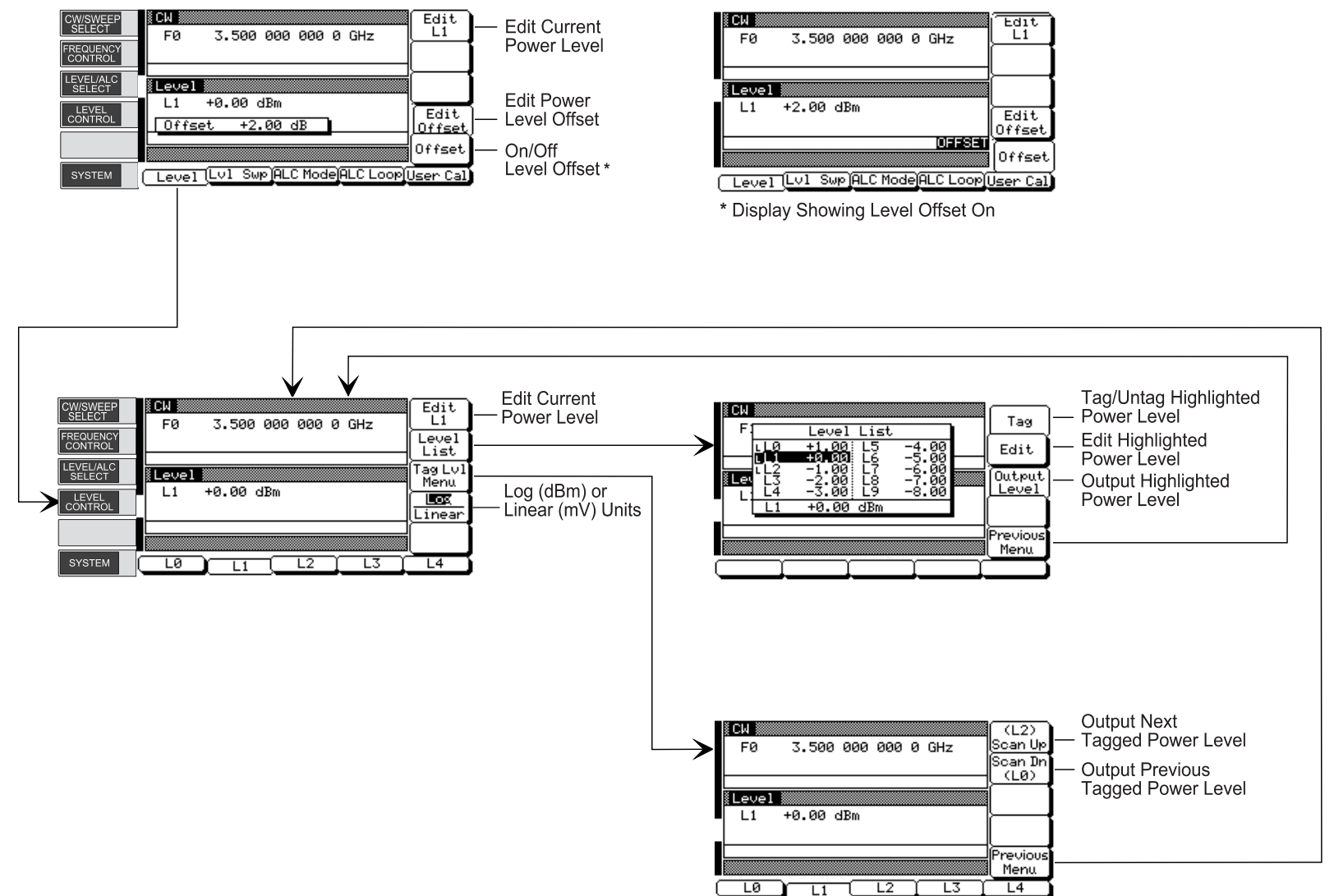
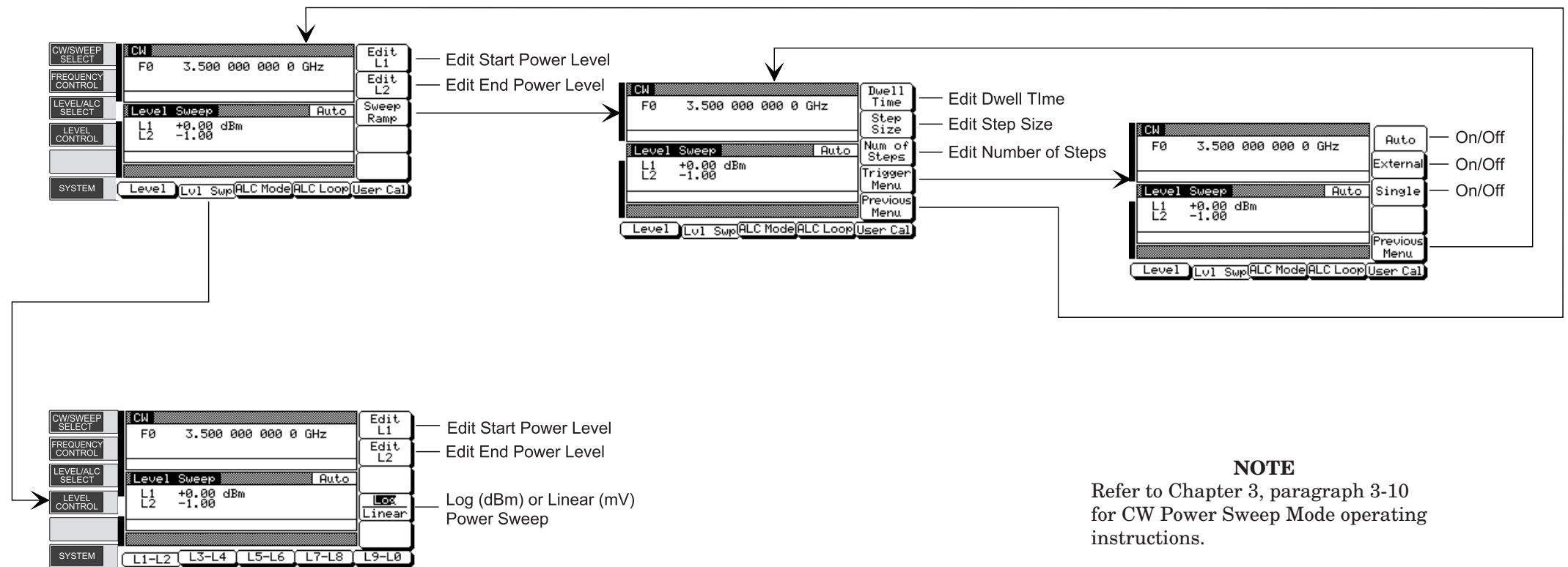

Figure 4-5. List Sweep Frequency Mode Menu Map



NOTE
Refer to Chapter 3, paragraph 3-9 for Fixed Power Level Mode operating instructions.

Figure 4-6. Fixed Power Level Mode Menu Map



NOTE
Refer to Chapter 3, paragraph 3-10
for CW Power Sweep Mode operating
instructions.

Figure 4-7. CW Power Sweep Mode Menu Map

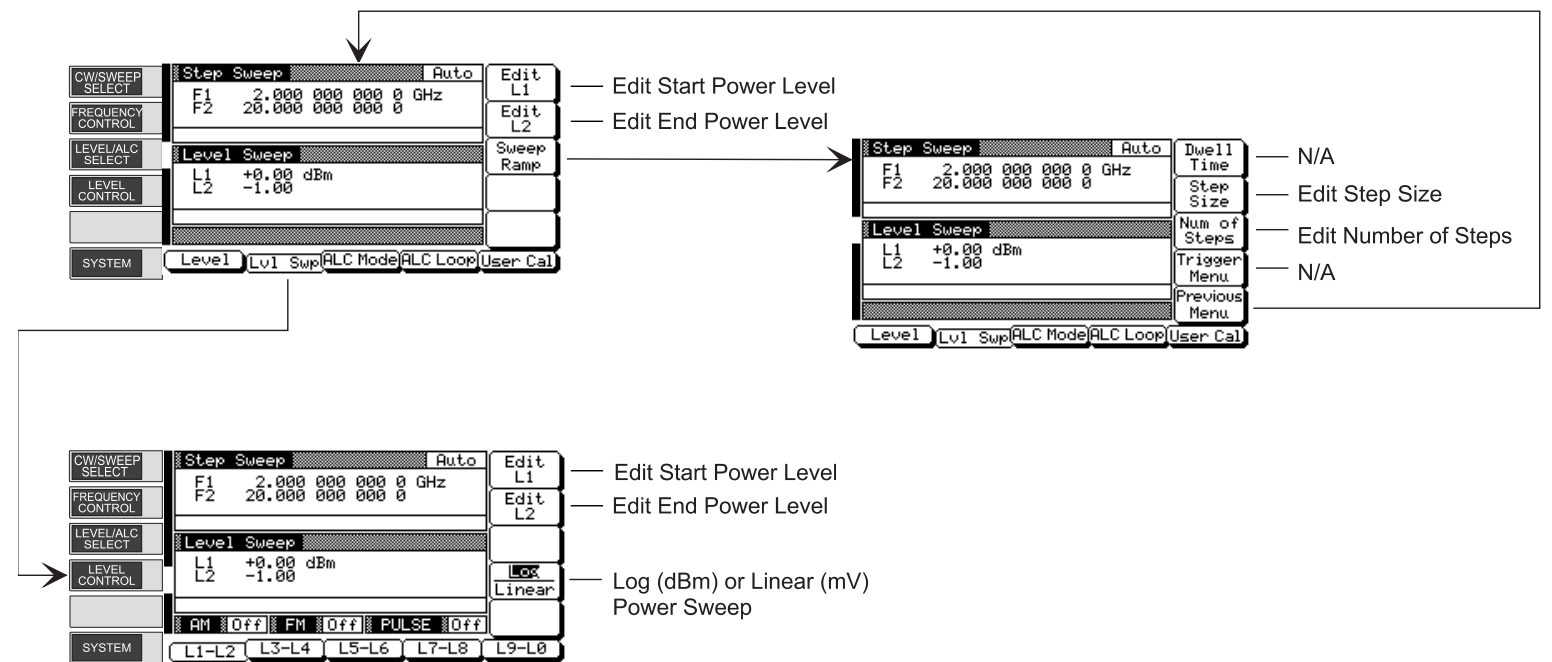

NOTE

Refer to Chapter 3, paragraph 3-10 for Sweep Frequency/Step Power Mode operating instructions.

Figure 4-8. Sweep Frequency/Step Power Mode Menu Map

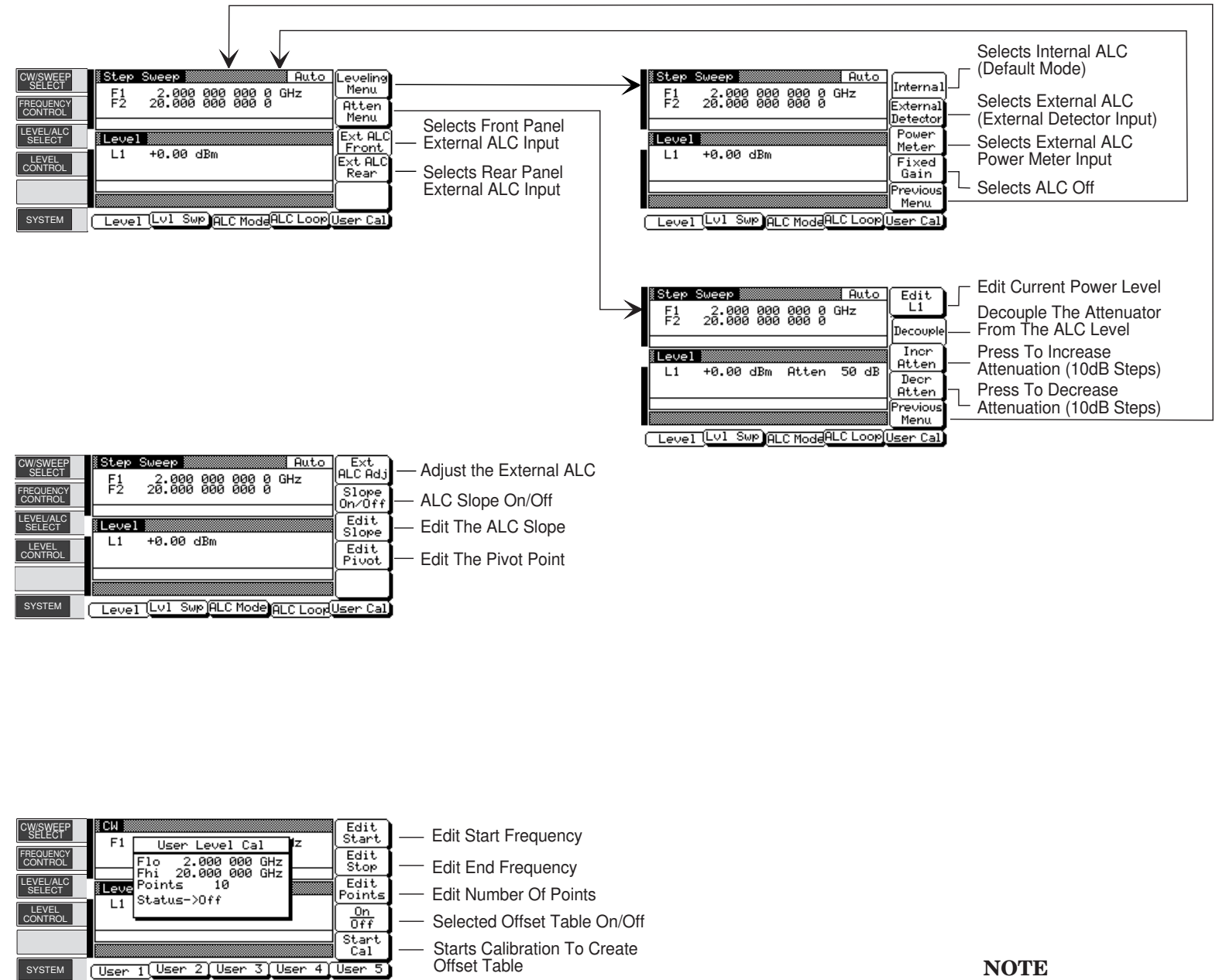

NOTE
Refer to Chapter 3, paragraph 3-11 for Leveling Modes operating instructions.

Figure 4-9. Leveling Modes Menu Map

Chapter 5

Operation Verification

Table of Contents

5-1	INTRODUCTION	5-3
5-2	TEST EQUIPMENT.	5-3
5-3	TEST RECORDS	5-3
5-4	INITIAL 680XXC CHECKOUT.	5-4
	Power Up	5-4
	Self Test.	5-4
	Resetting the 680XXC	5-4
	Warmup Time	5-4
5-5	CW FREQUENCY ACCURACY TEST.	5-5
	Test Setup	5-5
	Test Procedure.	5-6
5-6	POWER LEVEL ACCURACY AND FLATNESS TESTS.	5-13
	Test Setup	5-13
	Power Level Accuracy Test Procedure	5-14
	Power Level Flatness Test Procedure	5-15

Chapter 5

Operation Verification

5-1 INTRODUCTION

This chapter contains three operation verification tests that can be used to verify Series 680XXC Synthesized CW Generator operation.

Setup instructions and performance procedures are included for each test. The results can be compared with the specified limits that are shown on the test record forms that are provided for each test.

5-2 TEST EQUIPMENT

Table 5-1 lists the recommended test equipment for performing the operation verification tests in this chapter.

Table 5-1. Recommended Test Equipment

Instrument	Critical Specification	Recommended Manufacturer/Model
Frequency Counter, with Cable Kit and External Mixer	<i>Range:</i> 0.01 to 65 GHz <i>Input Z:</i> 50Ω <i>Resolution:</i> 1 Hz <i>Other:</i> External Time Base Input	EIP Microwave, Inc. Models 538B, 548B, or 578B, with Cable Kit: Option 590 and External Mixer: Option 91 (26.5 to 40 GHz) Option 92 (40 to 60 GHz) Option 93 (60 to 90 GHz)
Power Meter, with Power Sensors	<i>Range:</i> -30 to +20 dBm (1μW to 100 mW)	Anritsu Model ML2437A or ML2438A, with Power Sensors: MA2474A (0.01 to 40 GHz) MA2475A (0.01 to 50 GHz)
Oscilloscope	<i>Bandwidth:</i> DC to 150 MHz <i>Vertical Sensitivity:</i> 2 mV/division <i>Horiz Sensitivity:</i> 50 ns/division	Tektronix, Inc. Model TAS485

5-3 TEST RECORDS

Tables 5-2 and 5-3 contain test record forms that can be photocopied and used to record the results of operational verification testing of your 680XXC. These tables are included as part of the operational verification test procedures and contain test information for all 680XXC models.

**5-4 INITIAL 680XXC
CHECKOUT**

Before starting the operation verification tests in this chapter, perform an initial checkout of the 680XXC to be tested. This initial checkout consists of applying power to the CW generator, verifying that it passes self-test, and resetting it to the factory default parameters.

Power Up

First, verify that the rear panel line voltage selector is set for the correct line voltage, then connect the 680XXC to the power source. This automatically places the CW generator in operation (front panel OPERATE LED on).

During power up, the CW generator loads its operating program then returns to the exact setup it was in when last turned off.

Self Test

Next, perform a self-test of the 680XXC to insure proper operation of the instrument PCBs and other internal assemblies.

To self-test the CW generator, press **SYSTEM**. Then, press the System Menu soft-key **Selftest**. When the self-test is complete, the instrument displays the main CW menu.

NOTE

Error conditions detected during self-test are displayed as error messages on the data display. They should be corrected before continuing. Refer to Chapter 6 for a listing of error messages and descriptions.

**Resetting the
680XXC**

The CW generator should be reset to the factory-selected default parameters before commencing operation verification testing.

To reset the 680XXC, first press **SYSTEM**, then press **Reset**. The CW generator resets to the CW frequency mode and displays the CW Menu.

Warmup Time

When the CW generator is turned on, allow one hour of warmup time before performing operational verification testing. This will assure stable operation of the instrument.

5-5 CW FREQUENCY
ACCURACY TEST

The following test verifies that the CW frequency output of the 680XXC is within accuracy specifications. Table 5-2, beginning on page 5-7, contains test records that you can copy and use to record test results for this test. Test records for standard 680XXC models are contained in Table 5-2A ; test records for 680XXC models with Option 11 are contained in Table 5-2B.

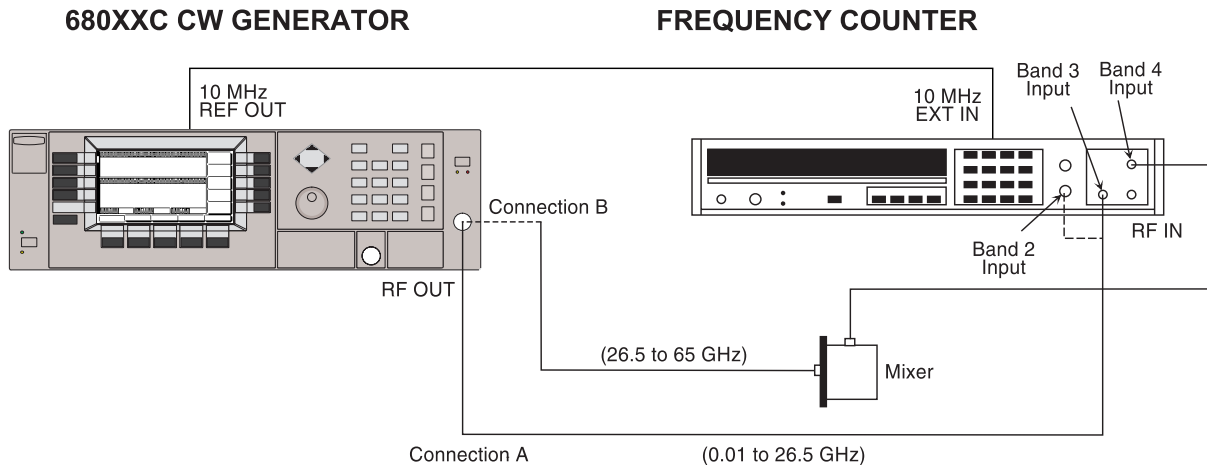

Figure 5-1. Equipment Setup for CW Frequency Accuracy Test

Test Setup

Connect the equipment, shown in Figure 5-1, as follows:

- Step 1** Connect the 680XXC rear panel 10 MHz REF OUT to the Frequency Counter 10 MHz External Reference input. If the Frequency Counter has an INT/EXT toggle switch, ensure the switch is set to EXT.
- Step 2** Connect the 680XXC RF OUTPUT to the Frequency Counter RF Input as follows:
- a. For measuring frequencies of 0.01 to 1.0 GHz, connect to the Band 2 input (Connection A).
 - b. For measuring frequencies of 1.0 to 26.5 GHz, connect to the Band 3 input (Connection A).
 - c. For measuring frequencies of 26.5 to 65.0 GHz, connect to the Band 4 input as shown in Connection B using the appropriate waveguide mixer; Option 91 (26.5 to 40 GHz), Option 92 (40 to 60 GHz), or Option 93 (60 to 90 GHz).

**Test
Procedure**

The following procedure tests both the coarse and fine loops to verify the accuracy of the CW frequency output.

Step 1 Set up the 680XXC as follows:

- a. Reset the instrument by pressing **SYSTEM**, then **Reset**. Upon reset, the CW Menu is displayed.

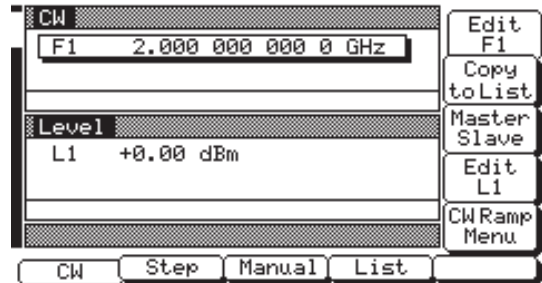

- b. Press **Edit F1** to open the current frequency parameter for editing.
- c. Set F1 to the first test frequency for the model being tested (see Table 5-2A for standard models; see Table 5-2B for models with Option 11).

Step 2 Verify that the Frequency Counter reading meets specifications (± 100 Hz of the value shown on the test record for standard models; ± 10 Hz for instruments with Option 11).

Step 3 Record the Frequency Counter reading on the test record (Table 5-2A or Table 5-2B).

NOTE

The Frequency Counter reading is typically within ± 1 Hz. Differences of a few Hertz can be caused by noise or counter limitations. Differences of $\geq \pm 100$ Hz ($\geq \pm 10$ Hz for instruments with Option 11) indicate a frequency synthesis problem.

Step 4 Set F1 to the next test frequency on the test record and record the Frequency Counter reading.

Step 5 Repeat step 4 until all frequencies listed on the test record have been recorded.

**OPERATION
VERIFICATION**

**CW FREQUENCY
ACCURACY TEST**

Table 5-2A. CW Frequency Accuracy Test Record (for Standard Models) (1 of 3)

Model 680 __ C	Serial No. _____	Date _____
	68017C	68037C / 68047C
1.000 000 000*	_____	2.000 000 000* _____
2.000 000 000	_____	5.000 000 000 _____
4.000 000 000	_____	8.000 000 000 _____
6.000 000 000	_____	11.000 000 000 _____
8.000 000 000	_____	14.000 000 000 _____
		17.000 000 000 _____
		20.000 000 000 _____
2.000 001 000	_____	2.000 001 000 _____
2.000 002 000	_____	2.000 002 000 _____
2.000 003 000	_____	2.000 003 000 _____
2.000 004 000	_____	2.000 004 000 _____
2.000 005 000	_____	2.000 005 000 _____
2.000 006 000	_____	2.000 006 000 _____
2.000 007 000	_____	2.000 007 000 _____
2.000 008 000	_____	2.000 008 000 _____
2.000 009 000	_____	2.000 009 000 _____
2.000 010 000	_____	2.000 010 000 _____

* Specification for all frequencies listed above is ± 100 Hz. All frequencies are in GHz.

**OPERATION
VERIFICATION**

**CW FREQUENCY
ACCURACY TEST**

Table 5-2A. CW Frequency Accuracy Test Record (for Standard Models) (2 of 3)

Model 680 __ C	Serial No. _____	Date _____
	68067C	68077C
2.000 000 000*	_____	2.000 000 000* _____
5.000 000 000	_____	6.000 000 000 _____
8.000 000 000	_____	10.000 000 000 _____
11.000 000 000	_____	14.000 000 000 _____
14.000 000 000	_____	18.000 000 000 _____
17.000 000 000	_____	22.000 000 000 _____
20.000 000 000	_____	26.000 000 000 _____
23.000 000 000	_____	30.000 000 000 _____
26.000 000 000	_____	34.000 000 000 _____
29.000 000 000	_____	38.000 000 000 _____
32.000 000 000	_____	42.000 000 000 _____
35.000 000 000	_____	46.000 000 000 _____
38.000 000 000	_____	50.000 000 000 _____
40.000 000 000	_____	
2.000 001 000	_____	2.000 001 000 _____
2.000 002 000	_____	2.000 002 000 _____
2.000 003 000	_____	2.000 003 000 _____
2.000 004 000	_____	2.000 004 000 _____
2.000 005 000	_____	2.000 005 000 _____
2.000 006 000	_____	2.000 006 000 _____
2.000 007 000	_____	2.000 007 000 _____
2.000 008 000	_____	2.000 008 000 _____
2.000 009 000	_____	2.000 009 000 _____
2.000 010 000	_____	2.000 010 000 _____

* Specification for all frequencies listed above is ± 100 Hz. All frequencies are in GHz.

Table 5-2A. CW Frequency Accuracy Test Record (for Standard Models) (3 of 3)

Model 680 __ C	Serial No. _____	Date _____
	68087C	68097C
2.000 000 000*	_____	2.000 000 000* _____
6.000 000 000	_____	6.000 000 000 _____
10.000 000 000	_____	10.000 000 000 _____
14.000 000 000	_____	14.000 000 000 _____
18.000 000 000	_____	18.000 000 000 _____
22.000 000 000	_____	22.000 000 000 _____
26.000 000 000	_____	26.000 000 000 _____
30.000 000 000	_____	30.000 000 000 _____
34.000 000 000	_____	34.000 000 000 _____
38.000 000 000	_____	38.000 000 000 _____
42.000 000 000	_____	42.000 000 000 _____
46.000 000 000	_____	46.000 000 000 _____
50.000 000 000	_____	50.000 000 000 _____
54.000 000 000	_____	54.000 000 000 _____
58.000 000 000	_____	58.000 000 000 _____
60.000 000 000	_____	62.000 000 000 _____
		65.000 000 000 _____
2.000 001 000	_____	2.000 001 000 _____
2.000 002 000	_____	2.000 002 000 _____
2.000 003 000	_____	2.000 003 000 _____
2.000 004 000	_____	2.000 004 000 _____
2.000 005 000	_____	2.000 005 000 _____
2.000 006 000	_____	2.000 006 000 _____
2.000 007 000	_____	2.000 007 000 _____
2.000 008 000	_____	2.000 008 000 _____
2.000 009 000	_____	2.000 009 000 _____
2.000 010 000	_____	2.000 010 000 _____

* Specification for all frequencies listed above is ± 100 Hz. All frequencies are in GHz.

**OPERATION
VERIFICATION**

**CW FREQUENCY
ACCURACY TEST**

Table 5-2B. CW Frequency Accuracy Test Record (for Models with Option 11) (1 of 3)

Model 680 __ C	Serial No. _____	Date _____
	68017C	68037C / 68047C
1.000 000 000 0*	_____	2.000 000 000 0* _____
2.000 000 000 0	_____	5.000 000 000 0 _____
4.000 000 000 0	_____	8.000 000 000 0 _____
6.000 000 000 0	_____	11.000 000 000 0 _____
8.000 000 000 0	_____	14.000 000 000 0 _____
		17.000 000 000 0 _____
		20.000 000 000 0 _____
2.000 000 100 0	_____	2.000 000 100 0 _____
2.000 000 200 0	_____	2.000 000 200 0 _____
2.000 000 300 0	_____	2.000 000 300 0 _____
2.000 000 400 0	_____	2.000 000 400 0 _____
2.000 000 500 0	_____	2.000 000 500 0 _____
2.000 000 600 0	_____	2.000 000 600 0 _____
2.000 000 700 0	_____	2.000 000 700 0 _____
2.000 000 800 0	_____	2.000 000 800 0 _____
2.000 000 900 0	_____	2.000 000 900 0 _____
2.000 001 000 0	_____	2.000 001 000 0 _____

* Specification for all frequencies listed above is ± 10 Hz. All frequencies are in GHz.

**OPERATION
VERIFICATION**

**CW FREQUENCY
ACCURACY TEST**

Figure 5-2B. CW Frequency Accuracy Test Record (for Models with Option 11) (2 of 3)

Model 680 __ C	Serial No. _____	Date _____
	68067C	68077C
2.000 000 000 0*	_____	2.000 000 000 0* _____
5.000 000 000 0	_____	6.000 000 000 0 _____
8.000 000 000 0	_____	10.000 000 000 0 _____
11.000 000 000 0	_____	14.000 000 000 0 _____
14.000 000 000 0	_____	18.000 000 000 0 _____
17.000 000 000 0	_____	22.000 000 000 0 _____
20.000 000 000 0	_____	26.000 000 000 0 _____
23.000 000 000 0	_____	30.000 000 000 0 _____
26.000 000 000 0	_____	34.000 000 000 0 _____
29.000 000 000 0	_____	38.000 000 000 0 _____
32.000 000 000 0	_____	42.000 000 000 0 _____
35.000 000 000 0	_____	46.000 000 000 0 _____
38.000 000 000 0	_____	50.000 000 000 0 _____
40.000 000 000 0	_____	
2.000 000 100 0	_____	2.000 000 100 0 _____
2.000 000 200 0	_____	2.000 000 200 0 _____
2.000 000 300 0	_____	2.000 000 300 0 _____
2.000 000 400 0	_____	2.000 000 400 0 _____
2.000 000 500 0	_____	2.000 000 500 0 _____
2.000 000 600 0	_____	2.000 000 600 0 _____
2.000 000 700 0	_____	2.000 000 700 0 _____
2.000 000 800 0	_____	2.000 000 800 0 _____
2.000 000 900 0	_____	2.000 000 900 0 _____
2.000 001 000 0	_____	2.000 001 000 0 _____

* Specification for all frequencies listed above is ±10 Hz. All frequencies are in GHz.

**OPERATION
VERIFICATION**

**CW FREQUENCY
ACCURACY TEST**

Table 5-2B. CW Frequency Accuracy Test Record (for Models with Option 11) (3 of 3)

Model 680 __ C	Serial No. _____	Date _____
	68087C	68097C
2.000 000 000 0*	_____	2.000 000 000 0* _____
6.000 000 000 0	_____	6.000 000 000 0 _____
10.000 000 000 0	_____	10.000 000 000 0 _____
14.000 000 000 0	_____	14.000 000 000 0 _____
18.000 000 000 0	_____	18.000 000 000 0 _____
22.000 000 000 0	_____	22.000 000 000 0 _____
26.000 000 000 0	_____	26.000 000 000 0 _____
30.000 000 000 0	_____	30.000 000 000 0 _____
34.000 000 000 0	_____	34.000 000 000 0 _____
38.000 000 000 0	_____	38.000 000 000 0 _____
42.000 000 000 0	_____	42.000 000 000 0 _____
46.000 000 000 0	_____	46.000 000 000 0 _____
50.000 000 000 0	_____	50.000 000 000 0 _____
54.000 000 000 0	_____	54.000 000 000 0 _____
58.000 000 000 0	_____	58.000 000 000 0 _____
60.000 000 000 0	_____	62.000 000 000 0 _____
		65.000 000 000 0 _____
2.000 000 100 0	_____	2.000 000 100 0 _____
2.000 000 200 0	_____	2.000 000 200 0 _____
2.000 000 300 0	_____	2.000 000 300 0 _____
2.000 000 400 0	_____	2.000 000 400 0 _____
2.000 000 500 0	_____	2.000 000 500 0 _____
2.000 000 600 0	_____	2.000 000 600 0 _____
2.000 000 700 0	_____	2.000 000 700 0 _____
2.000 000 800 0	_____	2.000 000 800 0 _____
2.000 000 900 0	_____	2.000 000 900 0 _____
2.000 001 000 0	_____	2.000 001 000 0 _____

* Specification for all frequencies listed above is ± 10 Hz. All frequencies are in GHz.

**5-6 POWER LEVEL
ACCURACY AND
FLATNESS TESTS**

These tests verify that the power level accuracy and flatness of the 680XXC meet specifications. Table 5-3, beginning on page 5-17, contains test records that you can copy and use to record test results for these tests. Test records are provided for each 680XXC model configuration.

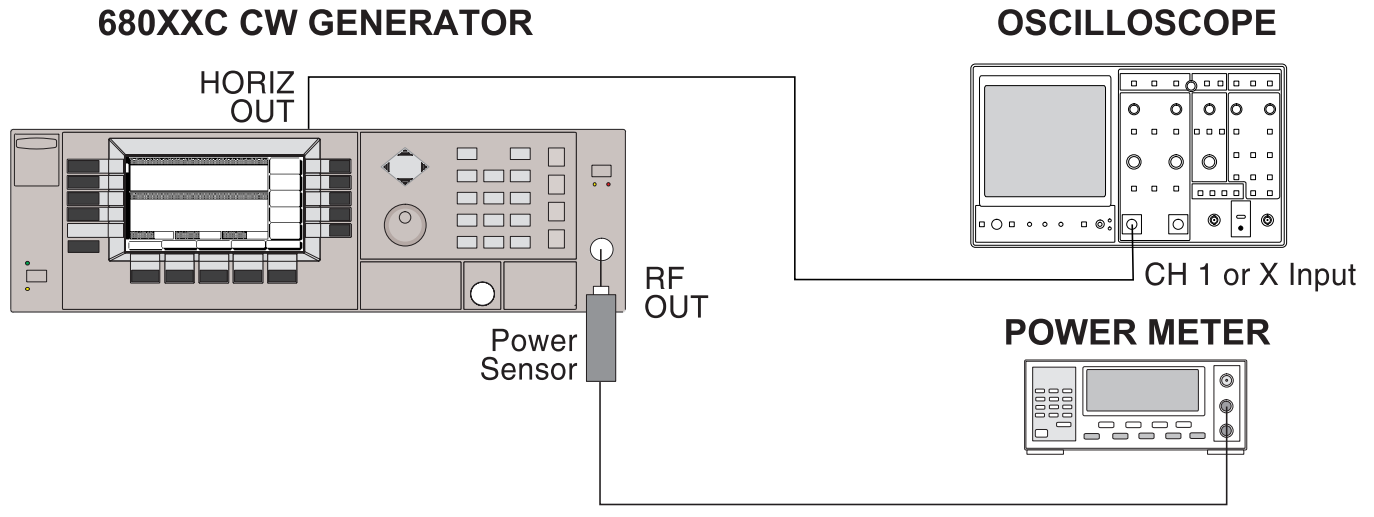

Figure 5-2. Equipment Setup for Power Level Accuracy and Flatness Tests

Test Setup

Connect the equipment, shown in Figure 5-2, as follows:

Step 1 Calibrate the Power Meter with the Power Sensor.

NOTE

For ≤ 40 GHz models, use the MA2474A power sensor; for > 40 GHz models use the MA2475A power sensor.

Step 2 Connect the Power Sensor to the RF OUTPUT of the 680XXC.

Step 3 Connect the 680XXC rear panel HORIZ OUT to the Oscilloscope CH.1 input (X input).

NOTE

Before starting these procedures, locate the test record in Table 5-3 for the particular 680XXC model configuration being tested.

***Power Level
Accuracy Test
Procedure***

Power level accuracy is checked by stepping the power down in 1 dB increments from its maximum rated power level.

Step 1 Set up the 680XXC as follows:

- a. Reset the instrument by pressing **SYSTEM**, then **Reset**. The CW Menu is displayed.

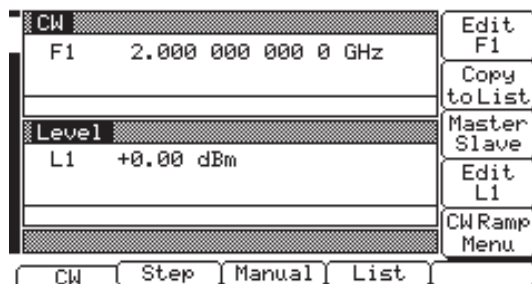

- b. Press **Edit F1** to open the current frequency parameter for editing.
- c. Set F1 to the CW frequency noted on the test record for the model being tested.
- d. Press **Edit L1** to open the current power level parameter for editing.
- e. Set L1 to the power level noted on the test record.

Step 2 Measure the output power level with the Power Meter and record the reading on the test record.

Step 3 Verify that the Power Meter reading meets the specifications stated on the test record.

Step 4 Set L1 to the next test power level. Record the Power Meter reading on the test record.

Step 5 Repeat step 4 for the other levels listed on the test record for the current CW frequency.

Step 6 Repeat steps 1 thru 5 for all CW frequencies listed on the test record.

NOTE

In models with Option 22 that have a high-end frequency of ≤ 20 GHz, rated output power is reduced by 1 dB. In models with Option 22 that have a high-end frequency of > 20 GHz, rated output power is reduced by 2 dB.

***Power Level
Flatness Test
Procedure***

Power level flatness is checked by measuring the power level variation during a full band step sweep.

- Step 1** Set up the 680XXC as follows for a step sweep power level flatness test:
- Reset the instrument by pressing **SYSTEM**, then **Reset**. The CW Menu is displayed.
 - Press **Step** to place the 680XXC in the step sweep frequency mode and display the Step Sweep Menu.

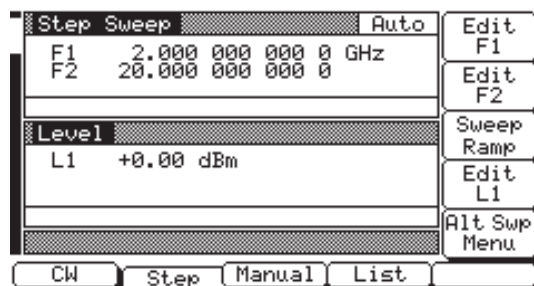

- With the Step Sweep menu displayed, press the main menu key

FREQUENCY CONTROL

The Sweep Frequency Control Menu, shown below, is displayed.

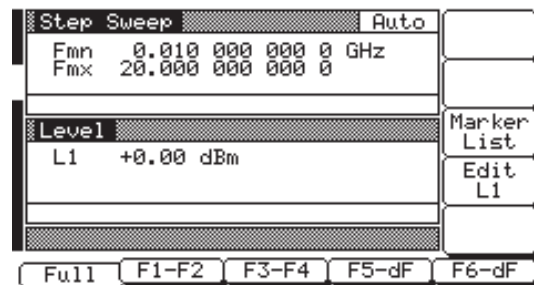

- Press **Full** to select a full range frequency sweep.
- Press **Edit L1** to open the current power level parameter for editing.
- Set L1 to the power level noted on the test record.

- g. Now, return to the Step Sweep menu by pressing the main menu key

**CW/SWEEP
SELECT**

- h. At the Step Sweep menu, press **Sweep Ramp** to go to the Step Sweep Ramp Menu.

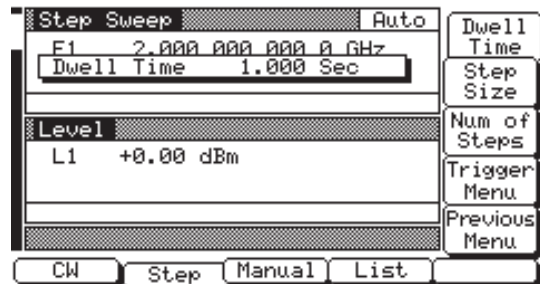

- i. Press **Dwell Time** to open the dwell time-per-step parameter for editing.
- j. Set the dwell time to 1 second.

NOTE

Monitor the 680XXC's Horizontal Output on the Oscilloscope to determine sweep start and stop.

- Step 2** As the 680XXC steps through the full frequency range, measure the maximum and minimum Power Meter readings and record the values on the test record. Verify that the variation (difference between the maximum and minimum readings) does not exceed the value noted on the test record.

Table 5-3. Power Level Accuracy and Flatness Test Record (1 of 27)

Model 68017C		Serial No. _____		Date _____	
Model 68017C (without Option 2 Step Attenuator)					
Power Level Accuracy * (CW Frequency = 1.0 GHz)			Power Level Accuracy * (CW Frequency = 5.0 GHz)		
Set Power	Measured Power	Set Power	Measured Power		
+13 dBm	_____dBm	+13 dBm	_____dBm		
+12 dBm	_____dBm	+12 dBm	_____dBm		
+11 dBm	_____dBm	+11 dBm	_____dBm		
+10 dBm	_____dBm	+10 dBm	_____dBm		
+ 9 dBm	_____dBm	+ 9 dBm	_____dBm		
+ 8 dBm	_____dBm	+ 8 dBm	_____dBm		
+ 7 dBm	_____dBm	+ 7 dBm	_____dBm		
+ 6 dBm	_____dBm	+ 6 dBm	_____dBm		
+ 5 dBm	_____dBm	+ 5 dBm	_____dBm		
+ 4 dBm	_____dBm	+ 4 dBm	_____dBm		
+ 3 dBm	_____dBm	+ 3 dBm	_____dBm		
+ 2 dBm	_____dBm	+ 2 dBm	_____dBm		
+ 1 dBm	_____dBm	+ 1 dBm	_____dBm		
* Specification is ± 1.0 dB.			* Specification is ± 1.0 dB.		
Power Level Flatness (Step Sweep)					
Set Power	Max Power	Min Power	Variation **		
+13 dBm	_____dBm	_____dBm	_____dB		
** Maximum variation is 4.0 dB (0.01 to 0.05 GHz); 1.6 dB (0.05 to 8.4 GHz).					

Table 5-3. Power Level Accuracy and Flatness Test Record (2 of 27)

Model 68017C		Serial No. _____		Date _____	
Model 68017C (with Option 2A Step Attenuator)					
Power Level Accuracy * (CW Frequency = 1.0 GHz)			Power Level Accuracy * (CW Frequency = 5.0 GHz)		
Set Power	Measured Power	Set Power	Measured Power		
+11 dBm	_____ dBm	+11 dBm	_____ dBm		
+10 dBm	_____ dBm	+10 dBm	_____ dBm		
+ 9 dBm	_____ dBm	+ 9 dBm	_____ dBm		
+ 8 dBm	_____ dBm	+ 8 dBm	_____ dBm		
+ 7 dBm	_____ dBm	+ 7 dBm	_____ dBm		
+ 6 dBm	_____ dBm	+ 6 dBm	_____ dBm		
+ 5 dBm	_____ dBm	+ 5 dBm	_____ dBm		
+ 4 dBm	_____ dBm	+ 4 dBm	_____ dBm		
+ 3 dBm	_____ dBm	+ 3 dBm	_____ dBm		
+ 2 dBm	_____ dBm	+ 2 dBm	_____ dBm		
+ 1 dBm	_____ dBm	+ 1 dBm	_____ dBm		
+ 0 dBm	_____ dBm	+ 0 dBm	_____ dBm		
- 1 dBm	_____ dBm	- 1 dBm	_____ dBm		
* Specification is ± 1.0 dB.			* Specification is ± 1.0 dB.		
Power Level Flatness (Step Sweep)					
Set Power	Max Power	Min Power	Variation **		
+11 dBm	_____ dBm	_____ dBm	_____ dB		
** Maximum variation is 4.0 dB (0.01 to 0.05 GHz); 1.6 dB (0.05 to 8.4 GHz).					

Table 5-3. Power Level Accuracy and Flatness Test Record (3 of 27)

Model 68017C		Serial No. _____		Date _____	
Model 68017C (with Option 2E Step Attenuator)					
Power Level Accuracy * (CW Frequency = 1.0 GHz)			Power Level Accuracy * (CW Frequency = 5.0 GHz)		
Set Power	Measured Power	Set Power	Measured Power		
+9 dBm	_____ dBm	+9 dBm	_____ dBm		
+8 dBm	_____ dBm	+8 dBm	_____ dBm		
+7 dBm	_____ dBm	+7 dBm	_____ dBm		
+6 dBm	_____ dBm	+6 dBm	_____ dBm		
+5 dBm	_____ dBm	+5 dBm	_____ dBm		
+4 dBm	_____ dBm	+4 dBm	_____ dBm		
+3 dBm	_____ dBm	+3 dBm	_____ dBm		
+2 dBm	_____ dBm	+2 dBm	_____ dBm		
+1 dBm	_____ dBm	+1 dBm	_____ dBm		
0 dBm	_____ dBm	0 dBm	_____ dBm		
-1 dBm	_____ dBm	-1 dBm	_____ dBm		
-2 dBm	_____ dBm	-2 dBm	_____ dBm		
-3 dBm	_____ dBm	-3 dBm	_____ dBm		
* Specification is ± 1.0 dB.			* Specification is ± 1.0 dB.		
Power Level Flatness (Step Sweep)					
Set Power	Max Power	Min Power	Variation **		
+9 dBm	_____ dBm	_____ dBm	_____ dB		
** Maximum variation is 4.0 dB (0.01 to 0.05 GHz); 1.6 dB (0.05 to 8.4 GHz).					

Table 5-3. Power Level Accuracy and Flatness Test Record (4 of 27)

Model 68017C w/Option 15A		Serial No. _____	Date _____	
Model 68017C with Option 15A High Power (without Option 2 Step Attenuator)				
Power Level Accuracy * (CW Frequency = 1.0 GHz)		Power Level Accuracy * (CW Frequency = 5.0 GHz)		
Set Power	Measured Power	Set Power	Measured Power	
+13 dBm	_____dBm	+17 dBm	_____dBm	
+12 dBm	_____dBm	+16 dBm	_____dBm	
+11 dBm	_____dBm	+15 dBm	_____dBm	
+10 dBm	_____dBm	+14 dBm	_____dBm	
+ 9 dBm	_____dBm	+13 dBm	_____dBm	
+ 8 dBm	_____dBm	+12 dBm	_____dBm	
+ 7 dBm	_____dBm	+11 dBm	_____dBm	
+ 6 dBm	_____dBm	+10 dBm	_____dBm	
+ 5 dBm	_____dBm	+ 9 dBm	_____dBm	
+ 4 dBm	_____dBm	+ 8 dBm	_____dBm	
+ 3 dBm	_____dBm	+ 6 dBm	_____dBm	
+ 2 dBm	_____dBm	+ 5 dBm	_____dBm	
+ 1 dBm	_____dBm	+ 4 dBm	_____dBm	
* Specification is ±1.0 dB.		* Specification is ±1.0 dB.		
Power Level Flatness (Step Sweep)				
Set Power	Max Power	Min Power	Variation **	
+13 dBm	_____dBm	_____dBm	_____dB	
** Maximum variation is 4.0 dB (0.01 to 0.05 GHz); 1.6 dB (0.05 to 8.4 GHz).				

Table 5-3. Power Level Accuracy and Flatness Test Record (5 of 27)

Model 68017C w/Option 15A		Serial No. _____		Date _____	
Model 68017C with Option 15A High Power (with Option 2A Step Attenuator)					
Power Level Accuracy * (CW Frequency = 1.0 GHz)		Power Level Accuracy * (CW Frequency = 5.0 GHz)			
Set Power	Measured Power	Set Power	Measured Power		
+11 dBm	_____dBm	+15 dBm	_____dBm		
+10 dBm	_____dBm	+14 dBm	_____dBm		
+ 9 dBm	_____dBm	+13 dBm	_____dBm		
+ 8 dBm	_____dBm	+12 dBm	_____dBm		
+ 7 dBm	_____dBm	+11 dBm	_____dBm		
+ 6 dBm	_____dBm	+10 dBm	_____dBm		
+ 5 dBm	_____dBm	+ 9 dBm	_____dBm		
+ 4 dBm	_____dBm	+ 8 dBm	_____dBm		
+ 3 dBm	_____dBm	+ 7 dBm	_____dBm		
+ 2 dBm	_____dBm	+ 6 dBm	_____dBm		
+ 1 dBm	_____dBm	+ 5 dBm	_____dBm		
+ 0 dBm	_____dBm	+ 4 dBm	_____dBm		
- 1 dBm	_____dBm	+ 3 dBm	_____dBm		
* Specification is ±1.0 dB.		* Specification is ±1.0 dB.			
Power Level Flatness (Step Sweep)					
Set Power	Max Power	Min Power	Variation **		
+11 dBm	_____dBm	_____dBm	_____dB		
** Maximum variation is 4.0 dB (0.01 to 0.05 GHz); 1.6 dB (0.05 to 8.4 GHz).					

Table 5-3. Power Level Accuracy and Flatness Test Record (6 of 27)

Model 68017C w/Option 15A		Serial No. _____	Date _____	
Model 68017C with Option 15A High Power (with Option 2E Step Attenuator)				
Power Level Accuracy * (CW Frequency = 1.0 GHz)		Power Level Accuracy * (CW Frequency = 5.0 GHz)		
Set Power	Measured Power	Set Power	Measured Power	
+11 dBm	_____dBm	+11 dBm	_____dBm	
+10 dBm	_____dBm	+10 dBm	_____dBm	
+ 9 dBm	_____dBm	+ 9 dBm	_____dBm	
+ 8 dBm	_____dBm	+ 8 dBm	_____dBm	
+ 7 dBm	_____dBm	+ 7 dBm	_____dBm	
+ 6 dBm	_____dBm	+ 6 dBm	_____dBm	
+ 5 dBm	_____dBm	+ 5 dBm	_____dBm	
+ 4 dBm	_____dBm	+ 4 dBm	_____dBm	
+ 3 dBm	_____dBm	+ 3 dBm	_____dBm	
+ 2 dBm	_____dBm	+ 2 dBm	_____dBm	
+ 1 dBm	_____dBm	+ 1 dBm	_____dBm	
+ 0 dBm	_____dBm	+ 0 dBm	_____dBm	
- 1 dBm	_____dBm	- 1 dBm	_____dBm	
* Specification is ± 1.0 dB.		* Specification is ± 1.0 dB.		
Power Level Flatness (Step Sweep)				
Set Power	Max Power	Min Power	Variation **	
+11 dBm	_____dBm	_____dBm	_____dB	
** Maximum variation is 4.0 dB (0.01 to 0.05 GHz); 1.6 dB (0.05 to 8.4 GHz).				

Table 5-3. Power Level Accuracy and Flatness Test Record (7 of 27)

Model 68037C	Serial No. _____	Date _____	
Model 68037C (without Option 2 Step Attenuator)			
Power Level Accuracy * (CW Frequency = 5.0 GHz)			
Set Power	Measured Power		
+13 dBm	_____dBm		
+12 dBm	_____dBm		
+11 dBm	_____dBm		
+10 dBm	_____dBm		
+ 9 dBm	_____dBm		
+ 8 dBm	_____dBm		
+ 7 dBm	_____dBm		
+ 6 dBm	_____dBm		
+ 5 dBm	_____dBm		
+ 4 dBm	_____dBm		
+ 3 dBm	_____dBm		
+ 2 dBm	_____dBm		
+ 1 dBm	_____dBm		
* Specification is ± 1.0 dB.			
Power Level Flatness (Step Sweep)			
Set Power	Max Power	Min Power	Variation **
+13 dBm	_____dBm	_____dBm	_____dB
** Maximum variation is 1.6 dB.			

Table 5-3. Power Level Accuracy and Flatness Test Record (8 of 27)

Model 68037C	Serial No. _____	Date _____
---------------------	-------------------------	-------------------

**Model 68037C
(with Option 2A Step Attenuator)**

**Power Level Accuracy *
(CW Frequency = 5.0 GHz)**

Set Power	Measured Power
+11 dBm	_____ dBm
+10 dBm	_____ dBm
+ 9 dBm	_____ dBm
+ 8 dBm	_____ dBm
+ 7 dBm	_____ dBm
+ 6 dBm	_____ dBm
+ 5 dBm	_____ dBm
+ 4 dBm	_____ dBm
+ 3 dBm	_____ dBm
+ 2 dBm	_____ dBm
+ 1 dBm	_____ dBm
+ 0 dBm	_____ dBm
- 1 dBm	_____ dBm

* Specification is ± 1.0 dB.

Power Level Flatness (Step Sweep)

Set Power	Max Power	Min Power	Variation **
+11 dBm	_____ dBm	_____ dBm	_____ dB

** Maximum variation is 1.6 dB.

Table 5-3. Power Level Accuracy and Flatness Test Record (9 of 27)

Model 68037C	Serial No. _____	Date _____																												
<p>Model 68037C (with Option 2F Step Attenuator)</p> <p>Power Level Accuracy * (CW Frequency = 5.0 GHz)</p> <table style="margin-left: auto; margin-right: auto;"> <thead> <tr> <th style="text-align: left;">Set Power</th> <th style="text-align: left;">Measured Power</th> </tr> </thead> <tbody> <tr><td>+ 3 dBm</td><td>_____dBm</td></tr> <tr><td>+ 2 dBm</td><td>_____dBm</td></tr> <tr><td>+ 1 dBm</td><td>_____dBm</td></tr> <tr><td>+ 0 dBm</td><td>_____dBm</td></tr> <tr><td>- 1 dBm</td><td>_____dBm</td></tr> <tr><td>- 2 dBm</td><td>_____dBm</td></tr> <tr><td>- 3 dBm</td><td>_____dBm</td></tr> <tr><td>- 4 dBm</td><td>_____dBm</td></tr> <tr><td>- 5 dBm</td><td>_____dBm</td></tr> <tr><td>- 6 dBm</td><td>_____dBm</td></tr> <tr><td>- 7 dBm</td><td>_____dBm</td></tr> <tr><td>- 8 dBm</td><td>_____dBm</td></tr> <tr><td>- 9 dBm</td><td>_____dBm</td></tr> </tbody> </table> <p style="text-align: center;">* Specification is ± 1.0 dB.</p>			Set Power	Measured Power	+ 3 dBm	_____dBm	+ 2 dBm	_____dBm	+ 1 dBm	_____dBm	+ 0 dBm	_____dBm	- 1 dBm	_____dBm	- 2 dBm	_____dBm	- 3 dBm	_____dBm	- 4 dBm	_____dBm	- 5 dBm	_____dBm	- 6 dBm	_____dBm	- 7 dBm	_____dBm	- 8 dBm	_____dBm	- 9 dBm	_____dBm
Set Power	Measured Power																													
+ 3 dBm	_____dBm																													
+ 2 dBm	_____dBm																													
+ 1 dBm	_____dBm																													
+ 0 dBm	_____dBm																													
- 1 dBm	_____dBm																													
- 2 dBm	_____dBm																													
- 3 dBm	_____dBm																													
- 4 dBm	_____dBm																													
- 5 dBm	_____dBm																													
- 6 dBm	_____dBm																													
- 7 dBm	_____dBm																													
- 8 dBm	_____dBm																													
- 9 dBm	_____dBm																													
<p>Power Level Flatness (Step Sweep)</p> <table style="margin-left: auto; margin-right: auto;"> <thead> <tr> <th style="text-align: left;">Set Power</th> <th style="text-align: left;">Max Power</th> <th style="text-align: left;">Min Power</th> <th style="text-align: left;">Variation **</th> </tr> </thead> <tbody> <tr> <td>+ 3 dBm</td> <td>_____dBm</td> <td>_____dBm</td> <td>_____dB</td> </tr> </tbody> </table> <p>** Maximum variation is 1.6 dB.</p>			Set Power	Max Power	Min Power	Variation **	+ 3 dBm	_____dBm	_____dBm	_____dB																				
Set Power	Max Power	Min Power	Variation **																											
+ 3 dBm	_____dBm	_____dBm	_____dB																											

Table 5-3. Power Level Accuracy and Flatness Test Record (10 of 27)

Model 68037C w/Option 15A **Serial No.** _____ **Date** _____

**Model 68037C with Option 15A High Power
(without Option 2 Step Attenuator)**

Power Level Accuracy *
(CW Frequency = 5.0 GHz)

Set Power	Measured Power
+17 dBm	_____dBm
+16 dBm	_____dBm
+15 dBm	_____dBm
+14 dBm	_____dBm
+13 dBm	_____dBm
+12 dBm	_____dBm
+11 dBm	_____dBm
+10 dBm	_____dBm
+ 9 dBm	_____dBm
+ 8 dBm	_____dBm
+ 7 dBm	_____dBm
+ 6 dBm	_____dBm
+ 5 dBm	_____dBm

* Specification is ± 1.0 dB.

Power Level Flatness (Step Sweep)

Set Power	Max Power	Min Power	Variation **
+ 17 dBm	_____dBm	_____dBm	_____dB

** Maximum variation is 1.6 dB.

Table 5-3. Power Level Accuracy and Flatness Test Record (11 of 27)

Model 68037C w/Option 15A	Serial No. _____	Date _____	
Model 68037C with Option 15A High Power (with Option 2A Step Attenuator)			
Power Level Accuracy * (CW Frequency = 5.0 GHz)			
Set Power	Measured Power		
+15 dBm	_____dBm		
+14 dBm	_____dBm		
+13 dBm	_____dBm		
+12 dBm	_____dBm		
+11 dBm	_____dBm		
+10 dBm	_____dBm		
+ 9 dBm	_____dBm		
+ 8 dBm	_____dBm		
+ 7 dBm	_____dBm		
+ 6 dBm	_____dBm		
+ 5 dBm	_____dBm		
+ 4 dBm	_____dBm		
+ 3 dBm	_____dBm		
* Specification is ± 1.0 dB.			
Power Level Flatness (Step Sweep)			
Set Power	Max Power	Min Power	Variation **
+ 15 dBm	_____dBm	_____dBm	_____dB
** Maximum variation is 1.6 dB.			

Table 5-3. Power Level Accuracy and Flatness Test Record (12 of 27)

Model 68037C w/Option 15A	Serial No. _____	Date _____	
Model 68037C with Option 15A High Power (with Option 2F Step Attenuator)			
Power Level Accuracy * (CW Frequency = 5.0 GHz)			
Set Power	Measured Power		
+ 7 dBm	_____dBm		
+ 6 dBm	_____dBm		
+ 5 dBm	_____dBm		
+ 4 dBm	_____dBm		
+ 3 dBm	_____dBm		
+ 2 dBm	_____dBm		
+ 1 dBm	_____dBm		
+ 0 dBm	_____dBm		
- 1 dBm	_____dBm		
- 2 dBm	_____dBm		
- 3 dBm	_____dBm		
- 4 dBm	_____dBm		
- 5 dBm	_____dBm		
* Specification is ± 1.0 dB.			
Power Level Flatness (Step Sweep)			
Set Power	Max Power	Min Power	Variation **
+ 7 dBm	_____dBm	_____dBm	_____dB
** Maximum variation is 1.6 dB.			

Table 5-3. Power Level Accuracy and Flatness Test Record (13 of 27)

Model 68047C		Serial No. _____		Date _____	
Model 68047C (without Option 2 Step Attenuator)					
Power Level Accuracy * (CW Frequency = 1.0 GHz)		Power Level Accuracy * (CW Frequency = 5.0 GHz)			
Set Power	Measured Power	Set Power	Measured Power		
+13 dBm	_____ dBm	+13 dBm	_____ dBm		
+12 dBm	_____ dBm	+12 dBm	_____ dBm		
+11 dBm	_____ dBm	+11 dBm	_____ dBm		
+10 dBm	_____ dBm	+10 dBm	_____ dBm		
+ 9 dBm	_____ dBm	+ 9 dBm	_____ dBm		
+ 8 dBm	_____ dBm	+ 8 dBm	_____ dBm		
+ 7 dBm	_____ dBm	+ 7 dBm	_____ dBm		
+ 6 dBm	_____ dBm	+ 6 dBm	_____ dBm		
+ 5 dBm	_____ dBm	+ 5 dBm	_____ dBm		
+ 4 dBm	_____ dBm	+ 4 dBm	_____ dBm		
+ 3 dBm	_____ dBm	+ 3 dBm	_____ dBm		
+ 2 dBm	_____ dBm	+ 2 dBm	_____ dBm		
+ 1 dBm	_____ dBm	+ 1 dBm	_____ dBm		
* Specification is ± 1.0 dB.		* Specification is ± 1.0 dB.			
Power Level Flatness (Step Sweep)					
Set Power	Max Power	Min Power	Variation **		
+ 13 dBm	_____ dBm	_____ dBm	_____ dB		
** Maximum variation is 4.0 dB (0.01 to 0.05 GHz); 1.6 dB (0.05 to 20 GHz).					

Table 5-3. Power Level Accuracy and Flatness Test Record (14 of 27)

Model 68047C		Serial No. _____		Date _____	
Model 68047C (with Option 2A Step Attenuator)					
Power Level Accuracy * (CW Frequency = 1.0 GHz)			Power Level Accuracy * (CW Frequency = 5.0 GHz)		
Set Power	Measured Power	Set Power	Measured Power		
+11 dBm	_____dBm	+11 dBm	_____dBm		
+10 dBm	_____dBm	+10 dBm	_____dBm		
+ 9 dBm	_____dBm	+ 9 dBm	_____dBm		
+ 8 dBm	_____dBm	+ 8 dBm	_____dBm		
+ 7 dBm	_____dBm	+ 7 dBm	_____dBm		
+ 6 dBm	_____dBm	+ 6 dBm	_____dBm		
+ 5 dBm	_____dBm	+ 5 dBm	_____dBm		
+ 4 dBm	_____dBm	+ 4 dBm	_____dBm		
+ 3 dBm	_____dBm	+ 3 dBm	_____dBm		
+ 2 dBm	_____dBm	+ 2 dBm	_____dBm		
+ 1 dBm	_____dBm	+ 1 dBm	_____dBm		
+ 0 dBm	_____dBm	+ 0 dBm	_____dBm		
- 1 dBm	_____dBm	- 1 dBm	_____dBm		
* Specification is ± 1.0 dB.			* Specification is ± 1.0 dB.		

Power Level Flatness (Step Sweep)

Set Power	Max Power	Min Power	Variation **
+11 dBm	_____dBm	_____dBm	_____dB

** Maximum variation is 4.0 dB (0.01 to 0.05 GHz); 1.6 dB (0.05 to 20 GHz).

Table 5-3. Power Level Accuracy and Flatness Test Record (15 of 27)

Model 68047C		Serial No. _____		Date _____	
Model 68047C (with Option 2F Step Attenuator)					
Power Level Accuracy * (CW Frequency = 1.0 GHz)			Power Level Accuracy * (CW Frequency = 5.0 GHz)		
Set Power	Measured Power	Set Power	Measured Power		
+ 3 dBm	_____ dBm	+ 3 dBm	_____ dBm		
+ 2 dBm	_____ dBm	+ 2 dBm	_____ dBm		
+ 1 dBm	_____ dBm	+ 1 dBm	_____ dBm		
+ 0 dBm	_____ dBm	+ 0 dBm	_____ dBm		
- 1 dBm	_____ dBm	- 1 dBm	_____ dBm		
- 2 dBm	_____ dBm	- 2 dBm	_____ dBm		
- 3 dBm	_____ dBm	- 3 dBm	_____ dBm		
- 4 dBm	_____ dBm	- 4 dBm	_____ dBm		
- 5 dBm	_____ dBm	- 5 dBm	_____ dBm		
- 6 dBm	_____ dBm	- 6 dBm	_____ dBm		
- 7 dBm	_____ dBm	- 7 dBm	_____ dBm		
- 8 dBm	_____ dBm	- 8 dBm	_____ dBm		
- 9 dBm	_____ dBm	- 9 dBm	_____ dBm		
* Specification is ± 1.0 dB.			* Specification is ± 1.0 dB.		
Power Level Flatness (Step Sweep)					
Set Power	Max Power	Min Power	Variation **		
+ 3 dBm	_____ dBm	_____ dBm	_____ dB		
** Maximum variation is 4.0 dB (0.01 to 0.05 GHz); 1.6 dB (0.05 to 20 GHz).					

Table 5-3. Power Level Accuracy and Flatness Test Record (16 of 27)

Model 68047C w/Option 15A		Serial No. _____	Date _____	
Model 68047C with Option 15A High Power (without Option 2 Step Attenuator)				
Power Level Accuracy * (CW Frequency = 1.0 GHz)		Power Level Accuracy * (CW Frequency = 5.0 GHz)		
Set Power	Measured Power	Set Power	Measured Power	
+ 13 dBm	_____dBm	+17 dBm	_____dBm	
+ 12 dBm	_____dBm	+16 dBm	_____dBm	
+ 11 dBm	_____dBm	+15 dBm	_____dBm	
+ 10 dBm	_____dBm	+14 dBm	_____dBm	
+ 9 dBm	_____dBm	+13 dBm	_____dBm	
+ 8 dBm	_____dBm	+12 dBm	_____dBm	
+ 7 dBm	_____dBm	+11 dBm	_____dBm	
+ 6 dBm	_____dBm	+10 dBm	_____dBm	
+ 5 dBm	_____dBm	+ 9 dBm	_____dBm	
+ 4 dBm	_____dBm	+ 8 dBm	_____dBm	
+ 3 dBm	_____dBm	+ 7 dBm	_____dBm	
+ 2 dBm	_____dBm	+ 6 dBm	_____dBm	
+ 1 dBm	_____dBm	+ 5 dBm	_____dBm	
* Specification is ± 1.0 dB.		* Specification is ± 1.0 dB.		
Power Level Flatness (Step Sweep)				
Set Power	Max Power	Min Power	Variation **	
+ 13 dBm	_____dBm	_____dBm	_____dB	
** Maximum variation is 4.0 dB (0.01 to 0.05 GHz); 1.6 dB (0.05 to 20 GHz).				

Table 5-3. Power Level Accuracy and Flatness Test Record (17 of 27)

Model 68047C w/Option 15A		Serial No. _____	Date _____	
Model 68047C with Option 15A High Power (with Option 2A Step Attenuator)				
Power Level Accuracy * (CW Frequency = 1.0 GHz)		Power Level Accuracy * (CW Frequency = 5.0 GHz)		
Set Power	Measured Power	Set Power	Measured Power	
+11 dBm	_____dBm	+15 dBm	_____dBm	
+10 dBm	_____dBm	+14 dBm	_____dBm	
+ 9 dBm	_____dBm	+13 dBm	_____dBm	
+ 8 dBm	_____dBm	+12 dBm	_____dBm	
+ 7 dBm	_____dBm	+11 dBm	_____dBm	
+ 6 dBm	_____dBm	+10 dBm	_____dBm	
+ 5 dBm	_____dBm	+ 9 dBm	_____dBm	
+ 4 dBm	_____dBm	+ 8 dBm	_____dBm	
+ 3 dBm	_____dBm	+ 7 dBm	_____dBm	
+ 2 dBm	_____dBm	+ 6 dBm	_____dBm	
+ 1 dBm	_____dBm	+ 5 dBm	_____dBm	
+ 0 dBm	_____dBm	+ 4 dBm	_____dBm	
- 1 dBm	_____dBm	+ 3 dBm	_____dBm	
* Specification is ±1.0 dB.		* Specification is ±1.0 dB.		
Power Level Flatness (Step Sweep)				
Set Power	Max Power	Min Power	Variation **	
+11 dBm	_____dBm	_____dBm	_____dB	
** Maximum variation is 4.0 dB (0.01 to 0.05 GHz); 1.6 dB (0.05 to 20 GHz).				

Figure 5-3. Power Level Accuracy and Flatness Test Record (18 of 27)

Model 68047C w/Option 15A		Serial No. _____		Date _____	
Model 68047C with Option 15A High Power (with Option 2F Step Attenuator)					
Power Level Accuracy * (CW Frequency = 1.0 GHz)			Power Level Accuracy * (CW Frequency = 5.0 GHz)		
Set Power	Measured Power	Set Power	Measured Power		
+11 dBm	_____dBm	+ 7 dBm	_____dBm		
+10 dBm	_____dBm	+ 6 dBm	_____dBm		
+ 9 dBm	_____dBm	+ 5 dBm	_____dBm		
+ 8 dBm	_____dBm	+ 4 dBm	_____dBm		
+ 7 dBm	_____dBm	+ 3 dBm	_____dBm		
+ 6 dBm	_____dBm	+ 2 dBm	_____dBm		
+ 5 dBm	_____dBm	+ 1 dBm	_____dBm		
+ 4 dBm	_____dBm	+ 0 dBm	_____dBm		
+ 3 dBm	_____dBm	- 1 dBm	_____dBm		
+ 2 dBm	_____dBm	- 2 dBm	_____dBm		
+ 1 dBm	_____dBm	- 3 dBm	_____dBm		
+ 0 dBm	_____dBm	- 4 dBm	_____dBm		
- 1 dBm	_____dBm	- 5 dBm	_____dBm		
* Specification is ±1.0 dB.			* Specification is ±1.0 dB.		
Power Level Flatness (Step Sweep)					
Set Power	Max Power	Min Power	Variation **		
+ 7 dBm	_____dBm	_____dBm	_____dB		
** Maximum variation is 4.0 dB (0.01 to 0.05 GHz); 1.6 dB (0.05 to 20 GHz).					

Table 5-3. Power Level Accuracy and Flatness Test Record (19 of 27)

Model 68067C		Serial No. _____		Date _____	
Model 68067C (without Option 2B Step Attenuator)					
Power Level Accuracy * (CW Frequency = 1.0 GHz)		Power Level Accuracy * (CW Frequency = 5.0 GHz)		Power Level Accuracy * (CW Frequency = 25.0 GHz)	
Set Power	Measured Power	Set Power	Measured Power	Set Power	Measured Power
+13 dBm	_____ dBm	+ 9 dBm	_____ dBm	+ 6 dBm	_____ dBm
+12 dBm	_____ dBm	+ 8 dBm	_____ dBm	+ 5 dBm	_____ dBm
+11 dBm	_____ dBm	+ 7 dBm	_____ dBm	+ 4 dBm	_____ dBm
+10 dBm	_____ dBm	+ 6 dBm	_____ dBm	+ 3 dBm	_____ dBm
+ 9 dBm	_____ dBm	+ 5 dBm	_____ dBm	+ 2 dBm	_____ dBm
+ 8 dBm	_____ dBm	+ 4 dBm	_____ dBm	+ 1 dBm	_____ dBm
+ 7 dBm	_____ dBm	+ 3 dBm	_____ dBm	+ 0 dBm	_____ dBm
+ 6 dBm	_____ dBm	+ 2 dBm	_____ dBm	- 1 dBm	_____ dBm
+ 5 dBm	_____ dBm	+ 1 dBm	_____ dBm	- 2 dBm	_____ dBm
+ 4 dBm	_____ dBm	+ 0 dBm	_____ dBm	- 3 dBm	_____ dBm
+ 3 dBm	_____ dBm	- 1 dBm	_____ dBm	- 4 dBm	_____ dBm
+ 2 dBm	_____ dBm	- 2 dBm	_____ dBm	- 5 dBm	_____ dBm
+ 1 dBm	_____ dBm	- 3 dBm	_____ dBm	- 6 dBm	_____ dBm
* Specification is ±1.0 dB.		* Specification is ±1.0 dB.		* Specification is ±1.0 dB.	

Power Level Flatness (Step Sweep)

Set Power	Max Power	Min Power	Variation **
+ 6 dBm	_____ dBm	_____ dBm	_____ dB

** Maximum variation is 4.0 dB (0.01 to 0.05 GHz); 1.6 dB (0.05 to 40 GHz).

Table 5-3. Power Level Accuracy and Flatness Test Record (20 of 27)

Model 68067C		Serial No. _____		Date _____	
Model 68067C (with Option 2B Step Attenuator)					
Power Level Accuracy * (CW Frequency = 1.0 GHz)		Power Level Accuracy * (CW Frequency = 5.0 GHz)		Power Level Accuracy * (CW Frequency = 25.0 GHz)	
Set Power	Measured Power	Set Power	Measured Power	Set Power	Measured Power
+11 dBm	_____dBm	+ 7 dBm	_____dBm	+ 3 dBm	_____dBm
+10 dBm	_____dBm	+ 6 dBm	_____dBm	+ 2 dBm	_____dBm
+ 9 dBm	_____dBm	+ 5 dBm	_____dBm	+ 1 dBm	_____dBm
+ 8 dBm	_____dBm	+ 4 dBm	_____dBm	+ 0 dBm	_____dBm
+ 7 dBm	_____dBm	+ 3 dBm	_____dBm	- 1 dBm	_____dBm
+ 6 dBm	_____dBm	+ 2 dBm	_____dBm	- 2 dBm	_____dBm
+ 5 dBm	_____dBm	+ 1 dBm	_____dBm	- 3 dBm	_____dBm
+ 4 dBm	_____dBm	+ 0 dBm	_____dBm	- 4 dBm	_____dBm
+ 3 dBm	_____dBm	- 1 dBm	_____dBm	- 5 dBm	_____dBm
+ 2 dBm	_____dBm	- 2 dBm	_____dBm	- 6 dBm	_____dBm
+ 1 dBm	_____dBm	- 3 dBm	_____dBm	- 7 dBm	_____dBm
+ 0 dBm	_____dBm	- 4 dBm	_____dBm	- 8 dBm	_____dBm
- 1 dBm	_____dBm	- 5 dBm	_____dBm	- 9 dBm	_____dBm
* Specification is ±1.0 dB.		* Specification is ±1.0 dB.		* Specification is ±1.0 dB.	
Power Level Flatness (Step Sweep)					
Set Power	Max Power	Min Power	Variation **		
+ 3 dBm	_____dBm	_____dBm	_____dB		
** Maximum variation is 4.0 dB (0.01 to 0.05 GHz); 1.6 dB (0.05 to 40 GHz).					

Table 5-3. Power Level Accuracy and Flatness Test Record (21 of 27)

Model 68067C w/Option 15A		Serial No. _____		Date _____	
Model 68067C with Option 15A High Power (without Option 2B Step Attenuator)					
Power Level Accuracy * (CW Frequency = 1.0 GHz)		Power Level Accuracy * (CW Frequency = 5.0 GHz)		Power Level Accuracy * (CW Frequency = 25.0 GHz)	
Set Power	Measured Power	Set Power	Measured Power	Set Power	Measured Power
+13 dBm	_____dBm	+13 dBm	_____dBm	+ 6 dBm	_____dBm
+12 dBm	_____dBm	+12 dBm	_____dBm	+ 5 dBm	_____dBm
+11 dBm	_____dBm	+11 dBm	_____dBm	+ 4 dBm	_____dBm
+10 dBm	_____dBm	+10 dBm	_____dBm	+ 3 dBm	_____dBm
+ 9 dBm	_____dBm	+ 9 dBm	_____dBm	+ 2 dBm	_____dBm
+ 8 dBm	_____dBm	+ 8 dBm	_____dBm	+ 1 dBm	_____dBm
+ 7 dBm	_____dBm	+ 7 dBm	_____dBm	+ 0 dBm	_____dBm
+ 6 dBm	_____dBm	+ 6 dBm	_____dBm	- 1 dBm	_____dBm
+ 5 dBm	_____dBm	+ 5 dBm	_____dBm	- 2 dBm	_____dBm
+ 4 dBm	_____dBm	+ 4 dBm	_____dBm	- 3 dBm	_____dBm
+ 3 dBm	_____dBm	+ 3 dBm	_____dBm	- 4 dBm	_____dBm
+ 2 dBm	_____dBm	+ 2 dBm	_____dBm	- 5 dBm	_____dBm
+ 1 dBm	_____dBm	+ 1 dBm	_____dBm	- 6 dBm	_____dBm
* Specification is ±1.0 dB.		* Specification is ±1.0 dB.		* Specification is ±1.0 dB.	
Power Level Flatness (Step Sweep)					
Set Power	Max Power	Min Power	Variation **		
+ 6 dBm	_____dBm	_____dBm	_____dB		
** Maximum variation is 4.0 dB (0.01 to 0.05 GHz); 1.6 dB (0.05 to 40 GHz).					

Table 5-3. Power Level Accuracy and Flatness Test Record (22 of 27)

Model 68067C w/Option 15A		Serial No. _____		Date _____	
Model 68067C with Option 15A High Power (with Option 2B Step Attenuator)					
Power Level Accuracy * (CW Frequency = 1.0 GHz)		Power Level Accuracy * (CW Frequency = 5.0 GHz)		Power Level Accuracy * (CW Frequency = 25.0 GHz)	
Set Power	Measured Power	Set Power	Measured Power	Set Power	Measured Power
+11 dBm	_____dBm	+11 dBm	_____dBm	+ 3 dBm	_____dBm
+10 dBm	_____dBm	+10 dBm	_____dBm	+ 2 dBm	_____dBm
+ 9 dBm	_____dBm	+ 9 dBm	_____dBm	+ 1 dBm	_____dBm
+ 8 dBm	_____dBm	+ 8 dBm	_____dBm	+ 0 dBm	_____dBm
+ 7 dBm	_____dBm	+ 7 dBm	_____dBm	- 1 dBm	_____dBm
+ 6 dBm	_____dBm	+ 6 dBm	_____dBm	- 2 dBm	_____dBm
+ 5 dBm	_____dBm	+ 5 dBm	_____dBm	- 3 dBm	_____dBm
+ 4 dBm	_____dBm	+ 4 dBm	_____dBm	- 4 dBm	_____dBm
+ 3 dBm	_____dBm	+ 3 dBm	_____dBm	- 5 dBm	_____dBm
+ 2 dBm	_____dBm	+ 2 dBm	_____dBm	- 6 dBm	_____dBm
+ 1 dBm	_____dBm	+ 1 dBm	_____dBm	- 7 dBm	_____dBm
+ 0 dBm	_____dBm	+ 0 dBm	_____dBm	- 8 dBm	_____dBm
- 1 dBm	_____dBm	- 1 dBm	_____dBm	- 9 dBm	_____dBm
* Specification is ± 1.0 dB.		* Specification is ± 1.0 dB.		* Specification is ± 1.0 dB.	

Power Level Flatness (Step Sweep)

Set Power	Max Power	Min Power	Variation **
+ 3 dBm	_____dBm	_____dBm	_____dB

** Maximum variation is 4.0 dB (0.01 to 0.05 GHz); 1.6 dB (0.05 to 40 GHz).

Table 5-3. Power Level Accuracy and Flatness Test Record (23 of 27)

Model 68077C		Serial No. _____		Date _____	
Model 68077C (without Option 2C Step Attenuator)					
Power Level Accuracy * (CW Frequency = 5.0 GHz)		Power Level Accuracy * (CW Frequency = 25.0 GHz)		Power Level Accuracy * (CW Frequency = 45.0 GHz)	
Set Power	Measured Power	Set Power	Measured Power	Set Power	Measured Power
+10 dBm	_____dBm	+ 2.5 dBm	_____dBm	+ 2.5 dBm	_____dBm
+ 9 dBm	_____dBm	+ 1.5 dBm	_____dBm	+ 1.5 dBm	_____dBm
+ 8 dBm	_____dBm	+ 0.5 dBm	_____dBm	+ 0.5 dBm	_____dBm
+ 7 dBm	_____dBm	- 0.5 dBm	_____dBm	- 0.5 dBm	_____dBm
+ 6 dBm	_____dBm	- 1.5 dBm	_____dBm	- 1.5 dBm	_____dBm
+ 5 dBm	_____dBm	- 2.5 dBm	_____dBm	- 2.5 dBm	_____dBm
+ 4 dBm	_____dBm	- 3.5 dBm	_____dBm	- 3.5 dBm	_____dBm
+ 3 dBm	_____dBm	- 4.5 dBm	_____dBm	- 4.5 dBm	_____dBm
+ 2 dBm	_____dBm	- 5.5 dBm	_____dBm	- 5.5 dBm	_____dBm
+ 1 dBm	_____dBm	- 6.5 dBm	_____dBm	- 6.5 dBm	_____dBm
+ 0 dBm	_____dBm	- 7.5 dBm	_____dBm	- 7.5 dBm	_____dBm
- 1 dBm	_____dBm	- 8.5 dBm	_____dBm	- 8.5 dBm	_____dBm
- 2 dBm	_____dBm	- 9.5 dBm	_____dBm	- 9.5 dBm	_____dBm
* Specification is ±1.0 dB.		* Specification is ±1.0 dB.		* Specification is ±1.5 dB.	
Power Level Flatness (Step Sweep)					
Set Power	Max Power	Min Power	Variation **		
+ 2.5 dBm	_____dBm	_____dBm	_____dB		
** Maximum variation is 4.0 dB (0.01 to 0.05 GHz); 1.6 dB (0.05 to 40 GHz); 2.2 dB (40 to 50 GHz).					

Table 5-3. Power Level Accuracy and Flatness Test Record (24 of 27)

Model 68077C		Serial No. _____		Date _____	
Model 68077C (with Option 2C Step Attenuator)					
Power Level Accuracy * (CW Frequency = 5.0 GHz)		Power Level Accuracy * (CW Frequency = 25.0 GHz)		Power Level Accuracy * (CW Frequency = 45.0 GHz)	
Set Power	Measured Power	Set Power	Measured Power	Set Power	Measured Power
+ 8.5 dBm	_____ dBm	+ 0 dBm	_____ dBm	- 1 dBm	_____ dBm
+ 7.5 dBm	_____ dBm	- 1 dBm	_____ dBm	- 2 dBm	_____ dBm
+ 6.5 dBm	_____ dBm	- 2 dBm	_____ dBm	- 3 dBm	_____ dBm
+ 5.5 dBm	_____ dBm	- 3 dBm	_____ dBm	- 4 dBm	_____ dBm
+ 4.5 dBm	_____ dBm	- 4 dBm	_____ dBm	- 5 dBm	_____ dBm
+ 3.5 dBm	_____ dBm	- 5 dBm	_____ dBm	- 6 dBm	_____ dBm
+ 2.5 dBm	_____ dBm	- 6 dBm	_____ dBm	- 7 dBm	_____ dBm
+ 1.5 dBm	_____ dBm	- 7 dBm	_____ dBm	- 8 dBm	_____ dBm
+ 0.5 dBm	_____ dBm	- 8 dBm	_____ dBm	- 9 dBm	_____ dBm
- 0.5 dBm	_____ dBm	- 9 dBm	_____ dBm	- 10 dBm	_____ dBm
- 1.5 dBm	_____ dBm	- 10 dBm	_____ dBm	- 11 dBm	_____ dBm
- 2.5 dBm	_____ dBm	- 11 dBm	_____ dBm	- 12 dBm	_____ dBm
- 3.5 dBm	_____ dBm	- 12 dBm	_____ dBm	- 13 dBm	_____ dBm
* Specification is ± 1.0 dB.		* Specification is ± 1.0 dB.		* Specification is ± 1.5 dB.	

Power Level Flatness (Step Sweep)

Set Power	Max Power	Min Power	Variation **
- 1 dBm	_____ dBm	_____ dBm	_____ dB

** Maximum variation is 4.0 dB (0.01 to 0.05 GHz); 1.6 dB (0.05 to 40 GHz); 2.2 dB (40 to 50 GHz).

Table 5-3. Power Level Accuracy and Flatness Test Record (25 of 27)

Model 68087C		Serial No. _____		Date _____	
Model 68087C (without Option 2D Step Attenuator)					
Power Level Accuracy * (CW Frequency = 5.0 GHz)		Power Level Accuracy * (CW Frequency = 25.0 GHz)		Power Level Accuracy * (CW Frequency = 50.0 GHz)	
Set Power	Measured Power	Set Power	Measured Power	Set Power	Measured Power
+10 dBm	_____dBm	+ 2.5 dBm	_____dBm	+ 2 dBm	_____dBm
+ 9 dBm	_____dBm	+ 1.5 dBm	_____dBm	+ 1 dBm	_____dBm
+ 8 dBm	_____dBm	+ 0.5 dBm	_____dBm	+ 0 dBm	_____dBm
+ 7 dBm	_____dBm	- 0.5 dBm	_____dBm	- 1 dBm	_____dBm
+ 6 dBm	_____dBm	- 1.5 dBm	_____dBm	- 2 dBm	_____dBm
+ 5 dBm	_____dBm	- 2.5 dBm	_____dBm	- 3 dBm	_____dBm
+ 4 dBm	_____dBm	- 3.5 dBm	_____dBm	- 4 dBm	_____dBm
+ 3 dBm	_____dBm	- 4.5 dBm	_____dBm	- 5 dBm	_____dBm
+ 2 dBm	_____dBm	- 5.5 dBm	_____dBm	- 6 dBm	_____dBm
+ 1 dBm	_____dBm	- 6.5 dBm	_____dBm	- 7 dBm	_____dBm
+ 0 dBm	_____dBm	- 7.5 dBm	_____dBm	- 8 dBm	_____dBm
- 1 dBm	_____dBm	- 8.5 dBm	_____dBm	- 9 dBm	_____dBm
- 2 dBm	_____dBm	- 9.5 dBm	_____dBm	-10 dBm	_____dBm
* Specification is ±1.0 dB.		* Specification is ±1.0 dB.		* Specification is ±1.5 dB.	
Power Level Flatness (Step Sweep)					
Set Power	Max Power	Min Power	Variation **		
+ 2 dBm	_____dBm	_____dBm	_____dB		
** Maximum variation is 4.0 dB (0.01 to 0.05 GHz); 1.6 dB (0.05 to 40 GHz); 2.2 dB (40 to 60 GHz).					

Table 5-3. Power Level Accuracy and Flatness Test Record (26 of 27)

Model 68087C		Serial No. _____		Date _____	
Model 68087C (with Option 2D Step Attenuator)					
Power Level Accuracy * (CW Frequency = 5.0 GHz)		Power Level Accuracy * (CW Frequency = 25.0 GHz)		Power Level Accuracy * (CW Frequency = 50.0 GHz)	
Set Power	Measured Power	Set Power	Measured Power	Set Power	Measured Power
+ 8.5 dBm	_____dBm	+ 0 dBm	_____dBm	- 1.5 dBm	_____dBm
+ 7.5 dBm	_____dBm	- 1 dBm	_____dBm	- 2.5 dBm	_____dBm
+ 6.5 dBm	_____dBm	- 2 dBm	_____dBm	- 3.5 dBm	_____dBm
+ 5.5 dBm	_____dBm	- 3 dBm	_____dBm	- 4.5 dBm	_____dBm
+ 4.5 dBm	_____dBm	- 4 dBm	_____dBm	- 5.5 dBm	_____dBm
+ 3.5 dBm	_____dBm	- 5 dBm	_____dBm	- 6.5 dBm	_____dBm
+ 2.5 dBm	_____dBm	- 6 dBm	_____dBm	- 7.5 dBm	_____dBm
+ 1.5 dBm	_____dBm	- 7 dBm	_____dBm	- 8.5 dBm	_____dBm
+ 0.5 dBm	_____dBm	- 8 dBm	_____dBm	- 9.5 dBm	_____dBm
- 0.5 dBm	_____dBm	- 9 dBm	_____dBm	-10.5 dBm	_____dBm
- 1.5 dBm	_____dBm	-10 dBm	_____dBm	-11.5 dBm	_____dBm
- 2.5 dBm	_____dBm	-11 dBm	_____dBm	-12.5 dBm	_____dBm
- 3.5 dBm	_____dBm	-12 dBm	_____dBm	-13.5 dBm	_____dBm
* Specification is ± 1.0 dB.		* Specification is ± 1.0 dB.		* Specification is ± 1.5 dB.	

Power Level Flatness (Step Sweep)

Set Power	Max Power	Min Power	Variation **
- 2 dBm	_____dBm	_____dBm	_____dB

** Maximum variation is 4.0 dB (0.01 to 0.05 GHz); 1.6 dB (0.05 to 40 GHz); 2.2 dB (40 to 60 GHz).

OPERATION VERIFICATION

POWER LEVEL ACCURACY AND FLATNESS TESTS

Table 5-3. Power Level Accuracy and Flatness Test Record (27 of 27)

Model 68097C		Serial No. _____		Date _____	
Model 68097C					
Power Level Accuracy * (CW Frequency = 5.0 GHz)		Power Level Accuracy * (CW Frequency = 25.0 GHz)		Power Level Accuracy * (CW Frequency = 50.0 GHz)	
Set Power	Measured Power	Set Power	Measured Power	Set Power	Measured Power
+10 dBm	_____dBm	+ 2.5 dBm	_____dBm	+ 0 dBm	_____dBm
+ 9 dBm	_____dBm	+ 1.5 dBm	_____dBm	- 1 dBm	_____dBm
+ 8 dBm	_____dBm	+ 0.5 dBm	_____dBm	- 2 dBm	_____dBm
+ 7 dBm	_____dBm	- 0.5 dBm	_____dBm	- 3 dBm	_____dBm
+ 6 dBm	_____dBm	- 1.5 dBm	_____dBm	- 4 dBm	_____dBm
+ 5 dBm	_____dBm	- 2.5 dBm	_____dBm	- 5 dBm	_____dBm
+ 4 dBm	_____dBm	- 3.5 dBm	_____dBm	- 6 dBm	_____dBm
+ 3 dBm	_____dBm	- 4.5 dBm	_____dBm	- 7 dBm	_____dBm
+ 2 dBm	_____dBm	- 5.5 dBm	_____dBm	- 8 dBm	_____dBm
+ 1 dBm	_____dBm	- 6.5 dBm	_____dBm	- 9 dBm	_____dBm
+ 0 dBm	_____dBm	- 7.5 dBm	_____dBm	-10 dBm	_____dBm
- 1 dBm	_____dBm	- 8.5 dBm	_____dBm	-11 dBm	_____dBm
- 2 dBm	_____dBm	- 9.5 dBm	_____dBm	-12 dBm	_____dBm
* Specification is ±1.0 dB.		* Specification is ±1.0 dB.		* Specification is ±1.5 dB.	

Power Level Flatness (Step Sweep)

Set Power	Max Power	Min Power	Variation **
- 2 dBm	_____dBm	_____dBm	_____dB

** Maximum variation is 4.0 dB (0.01 to 0.05 GHz); 1.6 dB (0.05 to 40 GHz); 2.2 dB (40 to 65 GHz).

Chapter 6

Operator Maintenance

Table of Contents

6-1	INTRODUCTION	6-3
6-2	ERROR AND WARNING/STATUS MESSAGES. . .	6-3
	Self-Test Error Messages.	6-3
	Normal Operation	
	Error and Warning/Status Messages	6-8
6-3	TROUBLESHOOTING	6-10
6-4	ROUTINE MAINTENANCE	6-13
	Cleaning the Fan Filter.	6-13
	Cleaning the Data Display	6-13
	Replacing the Line Fuse	6-14

Chapter 6

Operator Maintenance

6-1 INTRODUCTION

This chapter provides the information necessary for operator maintenance of the CW generator. Operator maintenance is limited to troubleshooting and repairs that can be made without removing the instrument covers.

6-2 ERROR AND WARNING/STATUS MESSAGES

During normal operation, the 680XXC generates error messages to indicate internal malfunctions, abnormal signal generator operations, or invalid signal inputs or data entries. It also displays warning messages to alert the operator to conditions that could result in inaccurate CW generator output. In addition, status messages are displayed to remind the operator of current menu selections or settings.

Self-Test Error Messages

The 680XXC firmware includes internal diagnostics that self-test the instrument. These self-test diagnostics perform a brief go/no-go test of most of the instrument PCBs and other internal assemblies.

CAUTION

During self-test with RF OUTPUT set to ON, the output power level is set to 0 dBm. Always disconnect sensitive equipment from the unit before performing self-test.

You can perform a CW generator self-test at any time during normal operation by pressing **SYSTEM** and then the System Menu soft-key **Selftest**.

If the CW generator fails self-test, an error message(s) is displayed on the front panel data display. These error messages describe the malfunction and, in most cases, provide an indication of what has failed. Table 6-1, next page, is a summary listing of the self-test error messages. Included for each is a description of the probable cause(s), whether or not the 680XXC is still operable, and if operable, what operational degradation can be expected.

WARNING

Self-test error messages normally indicate the failure of an internal component or assembly of the CW generator. There are no operator serviceable components inside. Refer servicing of the instrument to qualified service technicians.

To prevent the risk of electrical shock or damage to precision components, **do not** remove the equipment covers.

Table 6-1. Self-Test Error Messages (1 of 4)

Error Message	Description/Remarks
Error 100 DVM Ground Offset Failed	Indicates a calibration-related problem. Do Not Attempt to Operate! Refer the instrument to a qualified service technician.
Error 101 DVM Positive 10V Reference	Indicates either a calibration-related problem or a defective +10 Volt reference. Do not Attempt to Operate! Refer the instrument to a qualified service technician.
Error 102 DVM Negative 10V Reference	Indicates either a calibration-related problem or a defective –10 Volt reference. Do not Attempt to Operate! Refer the instrument to a qualified service technician.
Error 105 Power Supply Voltage(s) out of Regulation	Indicates one or more of the voltages from the power supply are out of regulation. Do Not Attempt to Operate! Refer the instrument to a qualified service technician.
Error 106 Power Supply not Locked	Indicates the power supply is not phase-locked to the 400 kHz reference frequency. The 680XXC is still operable in a degraded mode. The RF output may contain more spurious signals than normal.
Error 107 Sweep Time Check Failed	Indicates the sweep timing is out of tolerance or has failed. The 680XXC is still operable in a degraded mode.
Error 108 Crystal Oven Cold	Indicates the 100 MHz crystal oven or the Option 16 high-stability 10 MHz crystal oscillator has not reached operating temperature. The 680XXC is still operable, but frequency accuracy and stability may be degraded.
Error 109 The 100MHz Reference is not Locked to the External Reference	Indicates the reference loop is not phase-locked to the external 10 MHz reference. The reference loop may phase-lock to the internal 100 MHz time base; consequently, the 680XXC would continue to operate normally.
Error 110 The 100MHz Reference is not Locked to the High Stability 10MHz Crystal Oscillator	Indicates the reference loop is not phase-locked to the optional, high stability 10 MHz crystal oscillator. The reference loop may phase-lock to the internal 100 MHz time base; consequently, the 680XXC would continue to operate normally.
Error 111 Fine Loop Osc Failed	Indicates one or more of the oscillators within the fine loop is not phase-locked. The 680XXC is still operable but the accuracy and stability of frequency outputs are greatly reduced.

Table 6-1. *Self-Test Error Messages (2 of 4)*

Error Message	Description/Remarks
Error 112 Coarse Loop Osc Failed	Indicates the coarse loop oscillator is not phase-locked. The 680XXC is still operable but the accuracy and stability of the frequency outputs are greatly reduced.
Error 113 Yig Loop Osc Failed	Indicates the YIG loop is not phase-locked. The 680XXC is still operable but the accuracy and stability of the frequency outputs are greatly reduced.
Error 114 Down Converter LO not Locked	Indicates the local oscillator in the down converter assembly is not phase-locked. The 680XXC is still operable but the accuracy and stability of frequency outputs below 2 GHz is greatly reduced.
Error 115 Not Locked Indicator Failed	Indicates failure of the not phase-locked indicator circuit. The 680XXC is still operable but an error message will not appear on the data display when the output frequency is not phase-locked.
Error 116 FM Loop Gain Check Failed	Indicates FM loop has failed or the loop gain is out of tolerance. The 680XXC is still operable but frequency accuracy and stability are degraded.
Error 117 Linearizer Check Failed	Indicates a failure of the Linearizer DAC on the A12 PCB. The 680XXC is still operable but frequency accuracy of the RF output is degraded.
Error 118 Switchpoint DAC Failed	Indicates a failure of the Switchpoint DAC on the A12 PCB. The 680XXC is still operable but will not generate a CW Ramp.
Error 119 Center Frequency Circuits Failed	Indicates a failure of the center frequency circuitry on the A12 PCB. Do Not Attempt to Operate! Refer the instrument to a qualified service technician.
Error 121 Unleveled Indicator Failed	Indicates failure of the not leveled detector circuitry on the A10 PCB. The 680XXC is still operable but a warning message will not appear when the RF output goes unleveled.
Error 122 Level Reference Failed	Indicates a failure of the level reference circuitry on the A10 PCB. Use caution and always determine the output power level when operating the 680XXC in this condition.
Error 123 Detector Log Amp Failed	Indicates a failure of the level detector log amplifier circuitry on the A10 PCB. Use caution and always determine the output power level when operating the 680XXC in this condition.
Error 124 Full Band Unlocked and Unleveled	Indicates a failure of both YIG-tuned oscillators. Do Not Attempt to Operate! Refer the instrument to a qualified service technician.
Error 125 8.4 – 20 GHz Unlocked and Unleveled	Indicates a failure of the 8.4 to 20 GHz YIG-tuned oscillator. Do Not Attempt to Operate! Refer the instrument to a qualified service technician.
Error 126 2 – 8.4 GHz Unlocked and Unleveled	Indicates a failure of the 2 to 8.4 GHz YIG-tuned oscillator. Do Not Attempt to Operate! Refer the instrument to a qualified service technician.

Table 6-1. *Self-Test Error Messages (3 of 4)*

Error Message	Description/Remarks
Error 127 Detector Input Circuit Failed	Indicates a failure of the level detector input circuitry on the A10 PCB. Use caution and always determine the output power level when operating the 680XXC in this condition.
Error 128 .01 – 2 GHz Unleveled	Indicates a failure of the Down Converter leveling circuitry. The 680XXC operates normally but will have unleveled RF output in the 0.01 - 2 GHz frequency range.
Error 129 Switched Filter or Level Detector Failed	Indicates a failure of either the switched filter or level detector circuitry. The 680XXC may or may not produce an RF output. Use caution and always determine the output power level when operating the 680XXC in this condition.
Error 130 2 – 3.3 GH Switched Filter	Indicates a failure in the 2 - 3.3 GHz switched filter path within the switched filter assembly. The 680XXC may or may not produce an RF output in this frequency range. Use caution and always determine the output power level when operating the 680XXC in this condition.
Error 131 3.3 – 5.5 GH Switched Filter	Indicates a failure in the 3.3 - 5.5 GHz switched filter path within the switched filter assembly. The 680XXC may or may not produce an RF output in this frequency range. Use caution and always determine the output power level when operating the 680XXC in this condition.
Error 132 5.5 – 8.4 GH Switched Filter	Indicates a failure in the 5.5 - 8.4 GHz switched filter path within the switched filter assembly. The 680XXC may or may not produce an RF output in this frequency range. Use caution and always determine the output power level when operating the 680XXC in this condition.
Error 133 8.4 – 13.25 GH Switched Filter	Indicates a failure in the 8.4 - 13.25 GHz switched filter path within the switched filter assembly. The 680XXC may or may not produce an RF output in this frequency range. Use caution and always determine the output power level when operating the 680XXC in this condition.
Error 134 13.25 – 20 GH Switched Filter	Indicates a failure in the 13.25 - 20 GHz switched filter path within the switched filter assembly. The 680XXC may or may not produce an RF output in this frequency range. Use caution and always determine the output power level when operating the 680XXC in this condition.
Error 135 Modulator or Driver Failed	Indicates a failure of the modulator in the switched filter assembly or the modulator driver circuitry on the A9 PCB. The 680XXC may or may not produce an RF output. Use caution and always determine the output power level when operating the 680XXC in this condition.
Error 138 SDM Unit or Driver Failed	Indicates a failure of the switched doubler module (SDM) or SDM bias regulator circuitry on the A14 PCB. The 680XXC is still operable but it will not produce an RF output in the 20 - 40 GHz frequency range.

Table 6-1. *Self-Test Error Messages (4 of 4)*

Error Message	Description/Remarks
Error 139 32 – 40 GHz SDM Section Failed	Indicates a failure in the 32 - 40 GHz switched doubler filter path within the SDM. The 680XXC is still operable but it will not produce an RF output in the 32 - 40 GHz frequency range.
Error 140 25 – 32 GHz SDM Section Failed	Indicates a failure in the 25 - 32 GHz switched doubler filter path within the SDM. The 680XXC is still operable but it will not produce an RF output in the 25 - 32 GHz frequency range.
Error 141 20 – 25 GHz SDM Section Failed	Indicates a failure in the 20 - 25 GHz switched doubler filter path within the SDM. The 680XXC is still operable but it will not produce an RF output in the 20 - 25 GHz frequency range.
Error 143 Slope DAC Failed	Indicates a failure of the level slope DAC on the A10 PCB. The 680XXC still operates normally but RF output level flatness may be affected during frequency sweeps.

***Normal
Operation
Error and
Warning/
Status
Messages***

When an abnormal condition is detected during operation, the 680XXC displays an error message to indicate that the output is abnormal or that a signal input or data entry is invalid. It also displays warning messages to alert the operator to conditions that could cause an inaccurate signal generator output. Status messages to remind the operator of current menu selections or settings are also generated.

Table 6-2 is a summary list of possible error messages that can be displayed during normal operations. Table 6-3 is a summary list of possible warning/status messages.

Table 6-2. *Possible Error Messages during Normal Operations*

Error Message	Description
ERROR	Displayed (on the frequency mode title bar) when (1) the output frequency is not phase-locked or (2) an invalid entry causes a frequency range error.
LOCK ERROR	Displayed (in the frequency parameters area) when the output frequency is not phase-locked. The frequency accuracy and stability of the RF output is greatly reduced. Normally caused by an internal component failure. Run self-test to verify malfunction.
RANGE	Displayed (in the frequency parameters area) when (1) the dF value entered results in a sweep outside the range of the instrument, (2) the step size value entered is greater than the sweep range, (3) the number of steps entered results in a step size of less than 1 kHz (0.1 Hz with Option 11) or 0.1 dB (0.001 mV), or (4) the step sweep time entered divided by the number of steps entered does not result in a dwell time of <10 ms. Entering valid values usually clears the error.
SLAVE	Displayed (in the frequency parameters area of the Master 68XXXC) during master-slave operation in VNA mode when the slave frequency offset value entered results in a CW frequency or frequency sweep outside the range of the slave 68XXXC. Entering a valid offset value clears the error.

Table 6-3. *Possible Warning /Status Messages during Normal Operation*

Warning/Status Message	Description
OVN COLD	This warning message indicates that the 100 MHz Crystal oven (or the 10 MHz Crystal oven if Option 16 is installed) has not reached operating temperature. Normally displayed during a cold start of the 680XXC. If the message is displayed during normal operation, it could indicate a malfunction. Run self-test to verify.
UNLEVELED	Displayed when the RF output goes unlevelled. Normally caused by exceeding the specified leveled-power rating. Reducing the power level usually clears the warning message.
EXTL REF	This status message indicates that an external 10 MHz signal is being used as the reference signal for the 680XXC.
OFFSET	This status message indicates that a constant (offset) has been applied to the displayed power level.
SLOPE	This status message indicates that a power slope correction has been applied to the ALC.
USER 1...5	This status message indicates that a user level flatness correction power-offset table has been applied to the ALC.

6-3 TROUBLESHOOTING

Table 6-4 provides procedures for troubleshooting common malfunctions encountered during operation of the CW generator. Included are procedures for troubleshooting faults that do not produce error messages, such as, failure to power up and unexpected shutdown.

Table 6-4. *Troubleshooting (1 of 3)*

**CW Generator will not turn on
(OPERATE light is OFF)**

Normal Operation: When the 680XXC is connected to the power source, the OPERATE light should illuminate and the instrument should power up.

Step 1 Disconnect the 680XXC from the power source, then check the line fuse on the rear panel.

- If the fuse is defective, replace (see page 6-14).
- If the fuse is good, go to the next step.

Step 2 Check to see if power is available at the power receptacle.

- If not, move to a working receptacle.
- If power is available, go to the next step.

Step 3 Check the power cable.

- If defective, replace.
- If good, call a service technician.

**CW Generator will not turn on
(OPERATE light is ON)**

Normal Operation: When the 680XXC is connected to the power source, the OPERATE light should illuminate and the instrument should power up.

- If the OPERATE light illuminates but the unit fails to power up, the 680XXC has an internal component failure. Call a service technician.
-

Table 6-4. Troubleshooting (2 of 3)

CW Generator Quits During Operation (OPERATE light remains on)

Trouble Description: The CW generator operates for some time, then shuts down (OPERATE light remains on). After a short period, the CW generator resumes normal operation. This is an indication that the 680XXC has reached an excessive operating temperature.

- Step 1** Check that the fan is still operating during the time that the instrument is shut down.
- If the fan is still operating, clean the air filter (see page 6-13).
 - If the fan is not operating, call a service technician.

LOCK ERROR is Displayed

Trouble Description: This message is displayed in the frequency parameters area to indicate that the output frequency is not phase-locked. It is normally caused by an internal component failure.

- Step 1** Perform a self-test of the CW generator by pressing the System Menu soft-key **Selftest**.
- If self-test does not result in an error message(s), resume normal operation.
 - If an error message(s) is displayed, call a service technician.
-

Table 6-4. Troubleshooting (3 of 3)

UNLEVELED is Displayed

Trouble Description: This message is displayed to indicate that the RF output is unlevelled.

- Step 1** Check that the output power does not exceed the specified levelled-power rating and that the RF OUTPUT connector is terminated into a 50Ω load.
- Reduce the power level to not exceed the specified levelled-power rating or terminate the RF OUTPUT connector with a 50Ω load.
 - If error message remains displayed, call a service technician.

RANGE is Displayed

Trouble Description: This message is displayed in the frequency parameters area to indicate that (1) the dF value entered results in a sweep outside the range of the instrument, (2) the step size value entered is greater than the sweep range, (3) the number of steps entered results in a step size of less than 1 kHz (0.1 Hz with Option 11) or 0.1 dB (0.001 mV), or (4) the step sweep time entered divided by the number of steps entered does not result in a dwell time of <10 ms.

- Step 1** Check that (1) the dF value entered does not try to set the frequency sweep outside the range of the 680XXC, (2) the step size entered is not greater than F2 minus F1, (3) the number of steps entered does not result in a step size that is smaller than the resolution of the instrument, or (4) the step sweep time and number of steps does not result in a dwell time of <10 ms.
- Enter a valid dF value, step size, or number of steps.
 - If the error message remains displayed, call a service technician.
-

6-4 ROUTINE MAINTENANCE

Routine maintenance that can be performed by the operator consists of cleaning the fan filter, cleaning the data display, and replacing a defective line fuse.

***Cleaning the
Fan Filter***

The CW generator must always receive adequate ventilation. A blocked fan filter can cause instrument overheating and shut down. Check and clean the rear panel fan honeycomb filter periodically. Clean the fan honeycomb filter more frequently in dusty environments. Clean the filter as follows:

- Step 1** Remove the filter guard from the rear panel by pulling out on the four panel fasteners holding it in place (Figure 6-1).
- Step 2** Vacuum the honeycomb filter to clean it.
- Step 3** Install the filter guard back on the rear panel.
- Step 4** Press in on the panel fasteners to secure the filter guard to the rear panel.

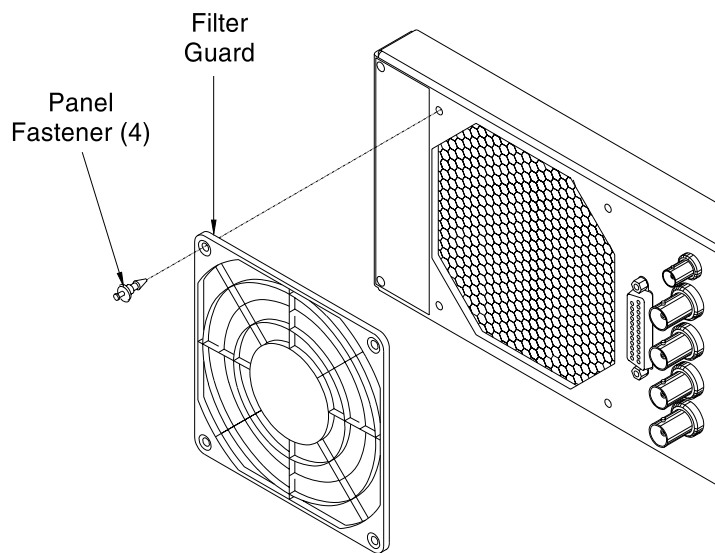

Figure 6-1. Removing/Replacing the Filter Guard

***Cleaning the
Data Display***

The data display of the CW generator is protected by a plastic display filter. To clean the display filter, use mild soap or detergent and water, or a commercial window cleaner. When cleaning use a soft, lint-free cloth. Do *not* use abrasive cleaners, tissues, or paper towels which can scratch the plastic surface.

**Replacing the
Line Fuse**

The value of the line fuse used in the 680XXC is determined by the line voltage selection—a 5A, type T fuse for 110 Vac line voltage; a 2.5A, type T fuse for 220 Vac line voltage. These line fuse values are printed on the rear panel next to the fuse holder.



WARNING

Before changing the fuse, **always** remove the power cord from the power outlet. There is the risk of receiving a fatal electric shock if the fuse is replaced with the power cord connected.

Always use a new fuse of the type and rating specified by the fuse markings on the rear panel of the instrument.

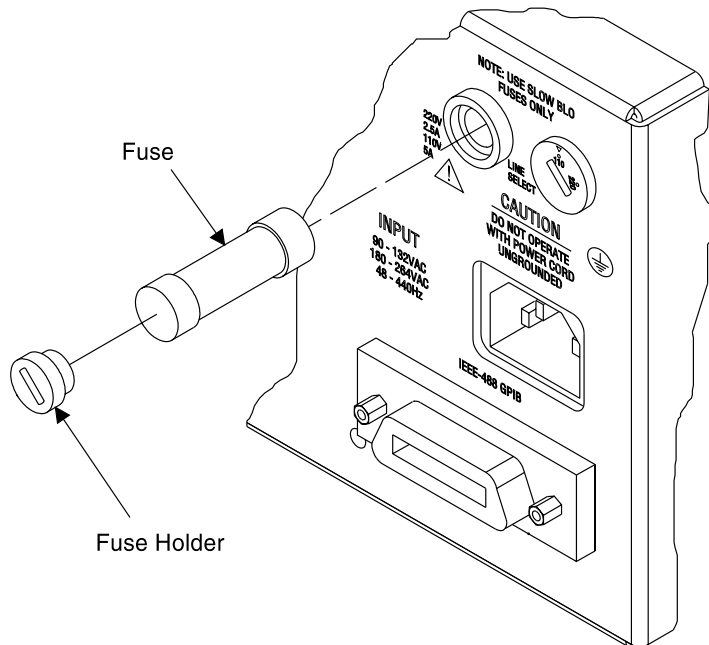

Figure 6-2. Replacing the Line Fuse

- Step 1** Disconnect the 680XXC from the power source.
- Step 2** Using a small flat-blade screwdriver, turn the fuse cap counter-clockwise and remove the fuse holder.
- Step 3** Replace the fuse in the fuse holder.

- Step 4** Install the fuse holder in the rear panel. Using the screwdriver, rotate the fuse cap clockwise to secure the fuse holder in place.
- Step 5** Reconnect the CW generator to the power source.

Chapter 7

Use With Other Instruments

Table of Contents

7-1	INTRODUCTION	7-3
7-2	MASTER-SLAVE OPERATION	7-4
	Connecting the 68XXCs	7-4
	Initiating Master-Slave Operation	7-5
	Master-Slave Operation	7-7
	Master-Slave Operation in VNA Mode	7-7
	Terminating Master-Slave Operation	7-9
7-3	USE WITH A 56100A SCALAR NETWORK ANALYZER	7-10
	Connecting the 680XXC to the 56100A	7-10
7-4	USE WITH A 360B VECTOR NETWORK ANALYZER	7-11
	Connecting the 680XXC to the 360B	7-11
	Configuring the 680XXC	7-12
	Initiating 360B Tracking Mode	7-13
	Terminating 360B Tracking Mode	7-13

Chapter 7

Use With Other Instruments

7-1 INTRODUCTION

This chapter provides information and instructions for using the Series 680XXC Synthesized CW Generator with other Anritsu instruments. It contains the following:

- ❑ Instructions for interconnecting and operating any two 68XXXC and/or 68XXXB instruments in a master-slave configuration.
- ❑ Instructions for connecting the 680XXC to a Anritsu Model 56100A Scalar Network Analyzer so that it can be used as a signal source for the analyzer.
- ❑ Instructions for connecting the 680XXC to a Anritsu Model 360B Vector Network Analyzer so that it can be used as a signal source for the analyzer operating in the tracking receiver mode.

**7-2 MASTER-SLAVE
OPERATION**

Master-slave operation consists of connecting any two 68XXXC and/or 68XXXB instruments together and configuring them so that they produce CW and synchronized, swept output signals at an operator-selectable frequency offset. One instrument (the Master) controls the other (the Slave) via interface cables between their rear panel AUX I/O and SERIAL I/O connectors. The two units are phase-locked together by connecting them to the same 10 MHz reference time base.

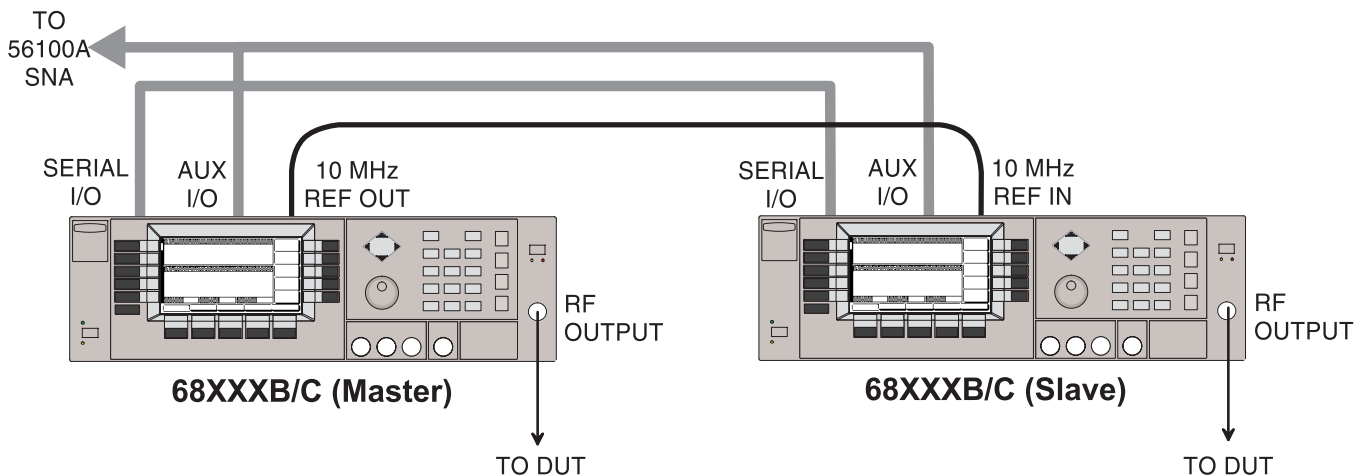

Figure 7-1. 68XXXC Configuration for Master-Slave Operation

**Connecting
the
Instruments**

Connect the two instruments, shown in Figure 7-1, as follows:

NOTES

When connecting two instruments together for Master-Slave operations, **always** use an Anritsu Master-Slave interface cable set, Part No. ND36329.

If a Model 56100A Scalar Network Analyzer is being used with the master-slave configuration, (1) connect the AUX I/O cable end labeled "SNA" to the rear panel AUX I/O connector on the 56100A SNA and (2) connect a dedicated system bus cable (P/N 2100-1) between the Master instrument rear panel IEEE-488 GPIB connector and the 56100A SNA rear panel DEDICATED GPIB connector.

- Step 1** Connect the 3-port AUX I/O cable end labeled "MASTER" to the rear panel AUX I/O connector on the Master instrument. Connect the AUX I/O cable labeled "SLAVE" to the rear panel AUX I/O connector on the Slave instrument.
- Step 2** Connect the ends of the flat interface cable to the rear panel Serial I/O connectors on the Master and Slave instruments.
- Step 3** Connect one end of a coaxial cable to the rear panel 10 MHz REF OUT connector on the Master instrument. Connect the other end to the rear panel 10 MHz REF IN connector on the Slave instrument.

Step 4 Connect the Master instrument RF OUTPUT and the Slave instrument RF OUTPUT to the appropriate connections on the DUT.

**Initiating
Master-Slave
Operation**

The following paragraphs describe how to set up both instruments to perform master-slave operations. Use the CW Frequency Mode menu map (Chapter 4, Figure 4-2) to follow the menu sequences.

To initiate master-slave operation, turn on both instruments and place them in CW mode. The CW Menu (below) is displayed.

NOTE

Master-slave operations are always initiated in the CW frequency mode. Once initiated, you then can change to a sweep frequency mode of operation by selecting the desired frequency mode on the Master instrument.

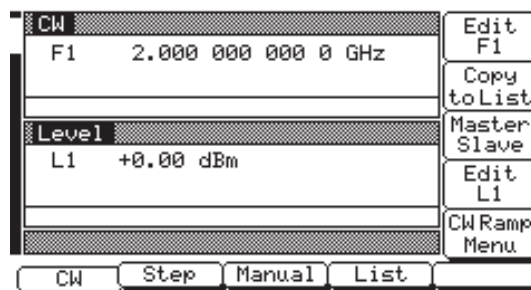

On the Master instrument, press **Master Slave** to go to the Master-Slave Menu display (below).

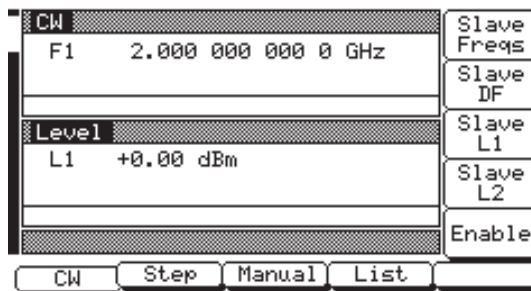

This menu lets you perform the following:

- Go to the Slave Frequencies List menu.
- Set the dF frequency for the Slave unit.
- Set the Slave unit's main power level (L1).
- Set the alternate sweep power level (L2) for the Slave unit.
- Turn master-slave operation on and off.

Press **Slave Freqs** to go to the Slave Frequencies List Menu display (next page).

NOTE
Upon reset, the slave frequencies (F0 - F9 and M0 - M9) return to the default values shown here.

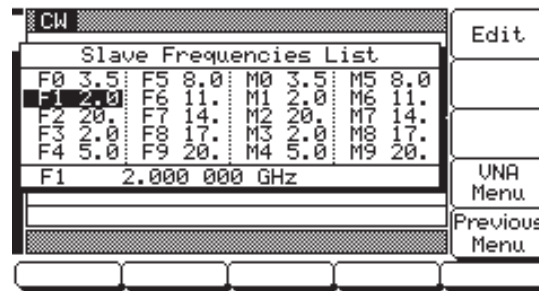

This menu lets you edit the listed frequencies for the Slave instrument.

Use the cursor control key to select a frequency parameter from the list, then press **Edit** to edit its value. Edit the current frequency parameter value using the cursor control key or rotary data knob or enter a new value using the key pad and appropriate termination key. Press **Edit** again to close the open frequency parameter.

When you are finished editing the slave frequencies, press **Previous Menu** to return to the Master-Slave Menu (below).

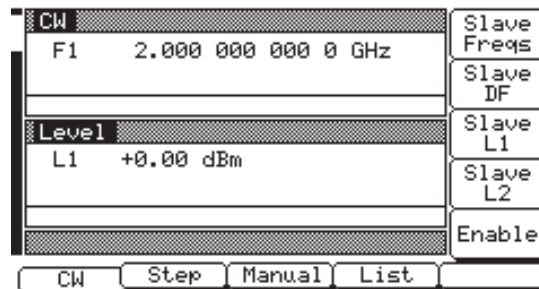

The Master-Slave menu lets you set the dF frequency and L1 and L2 power level parameters for the Slave unit.

Press **Slave DF** to open the dF frequency parameter.

Press **Slave L1** to open the main power level parameter.

Press **Slave L2** to open the alternate sweep power level parameter.

Open the parameter you wish to change, then edit the current value using the cursor control key or rotary data knob or enter a new value using the key pad and appropriate termination key. When you

have finished setting the open parameter, close it by pressing its menu soft-key or by making another menu selection.

Press **Enable** to begin master-slave operation.

Press **CW** to return to the CW Menu display.

***Master-Slave
Operation***

During master-slave operation, the Slave unit is in remote mode under the direct control of the Master unit. The Slave unit displays the following:

- ❑ Its output CW frequency or sweep frequency range.
- ❑ Its output power level.
- ❑ The messages Remote and Local Lockout.

NOTE

The 56100A SNA, when being used with the master-slave configuration, will not display markers.

The CW/sweep frequency settings on the Master unit define the master sweep, and the corresponding frequency settings on the Slave unit define the slave sweep. For example, if slave frequency F1 is set to 4 GHz and slave frequency F2 is set to 12 GHz, then the Slave unit will sweep from 4 to 12 GHz whenever the F1-F2 sweep range is selected on the Master unit. The Master unit will sweep from F1-F2 with the values of F1 and F2 defined in the Master units's frequency list.

***Master-Slave
Operation in
VNA Mode***

In the VNA mode of master-slave operation, a Slave unit is coupled to a Master instrument that is connected to a Model 360B Vector Network Analyzer in a source or dual source configuration. (Operating instructions for the vector network analyzer can be found in the Model 360B VNA Operation Manual, P/N 10410-00110.) The following paragraphs describe how to set up both instruments to perform master-slave operations in the VNA mode.

Place both units in CW mode. Then, on the Master unit, press **Master Slave** to go to the Master-Slave Menu display (page 7-5).

At the Master-Slave menu, press **Slave Freqs** to go to the Slave Frequencies List Menu display (next page).

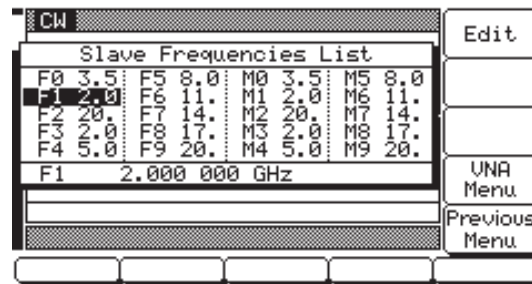

Press **VNA Menu** to go to the VNA Menu display (below).

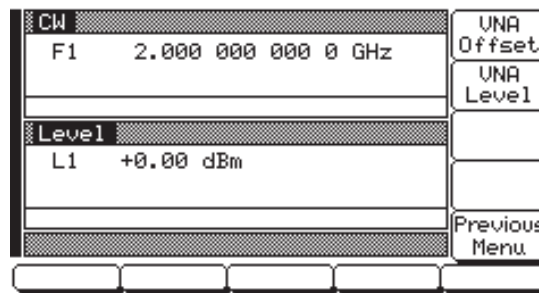

This menu lets you set the frequency offset and output power level for the Slave 68XXXX in the VNA mode.

Press **VNA Offset** to open the slave frequency offset parameter.

Press **VNA Level** to open the slave output power level parameter.

Open the parameter you wish to change, then edit the current value using the cursor control key or rotary data knob or enter a new value using the keypad and appropriate termination key. When you have finished setting the open parameter, close it by pressing its menu soft-key or by making another menu selection.

Press **Previous Menu** to return to the Slave Frequencies List Menu display.

Return to the Master-Slave menu and press **Enable** to begin master-slave operation.

SLAVE

During master-slave operations in VNA mode, this error message is displayed on the Master instrument when the slave offset value entered results in a CW frequency or frequency sweep outside the range of the Slave unit. Entering a valid offset value clears the error.

***Terminating
Master-Slave
Operation***

The following describes how to terminate master-slave operation and return the Slave instrument to local (front panel) control.

On the Master instrument, select CW mode.

At the CW Menu, press **Master Slave** to go to the Master Slave Menu display.

At the Master Slave Menu display, press **Enable**. This terminates master-slave operation and returns the Slave instrument to local (front panel) control.

**7-3 USE WITH A 56100A
SCALAR NETWORK
ANALYZER**

The 680XXC is directly compatible with the Anritsu Model 56100A Scalar Network Analyzer (SNA). The following paragraphs provide instructions for connecting the CW generator to the 56100A SNA so that it can be used as a signal source for the analyzer. Operating instructions for the network analyzer can be found in the Model 56100A Scalar Network Analyzer Operation Manual, P/N 10410-00193.

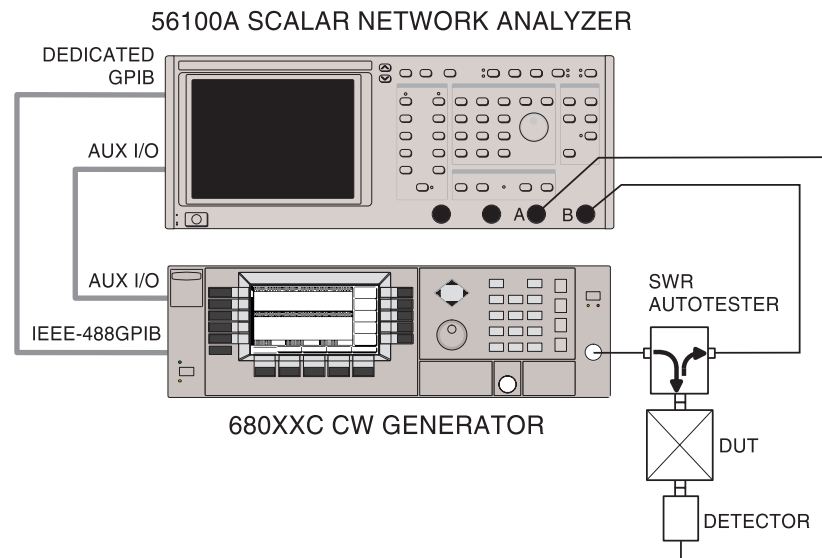

Figure 7-2. 680XXC CW Generator to 56100A SNA Connections

**Connecting
the 680XXC to
the 56100A**

Connect the 680XXC CW generator to the 56100A scalar network analyzer as shown in Figure 7-2.

Step 1 Connect one end of the Auxiliary I/O cable (P/N 806-7) to the 56100A rear panel AUX I/O connector. Connect the other end of the cable to the 680XXC rear panel AUX I/O connector.

Step 2 Connect one end of the dedicated system bus cable (P/N 2100-1) to the 56100A rear panel DEDICATED GPIB connector. Connect the other end of the cable to the 680XXC rear panel IEEE-488 GPIB connector.

Step 3 Turn on the 680XXC and the 56100A. The system is now ready to operate.

NOTES

The 680XXC's GPIB address should be set to 5 (the default address setting) for operation with a 56100A SNA. To verify or change the GPIB address setting refer to Configuring the GPIB on page 3-77.

The 56100A SNA will only accept and display the nine video markers, F1 thur F9, from the 680XXC.

When performing amplifier testing *only* use the 680XXC power level, L1.

**7-4 USE WITH A 360B
VECTOR NETWORK
ANALYZER**

The 680XXC CW generator is compatible with the Anritsu Model 360B Vector Network Analyzer (VNA). The following paragraphs provide instructions for connecting the 680XXC to the 360B VNA so that it can be used as a signal source for the analyzer operating in the tracking receiver mode. Operating instructions for the vector network analyzer can be found in the Model 360B Vector Network Analyzer Operation Manual, P/N 10410-00110.

When operating in tracking receiver mode, the 360B steers its second local oscillator frequency and phase signal so as to phase-lock itself to the reference signal from the 680XXC. Frequency resolution is limited to 1 kHz intervals. This is because of the inherent resolution of the 360B's frequency readout.

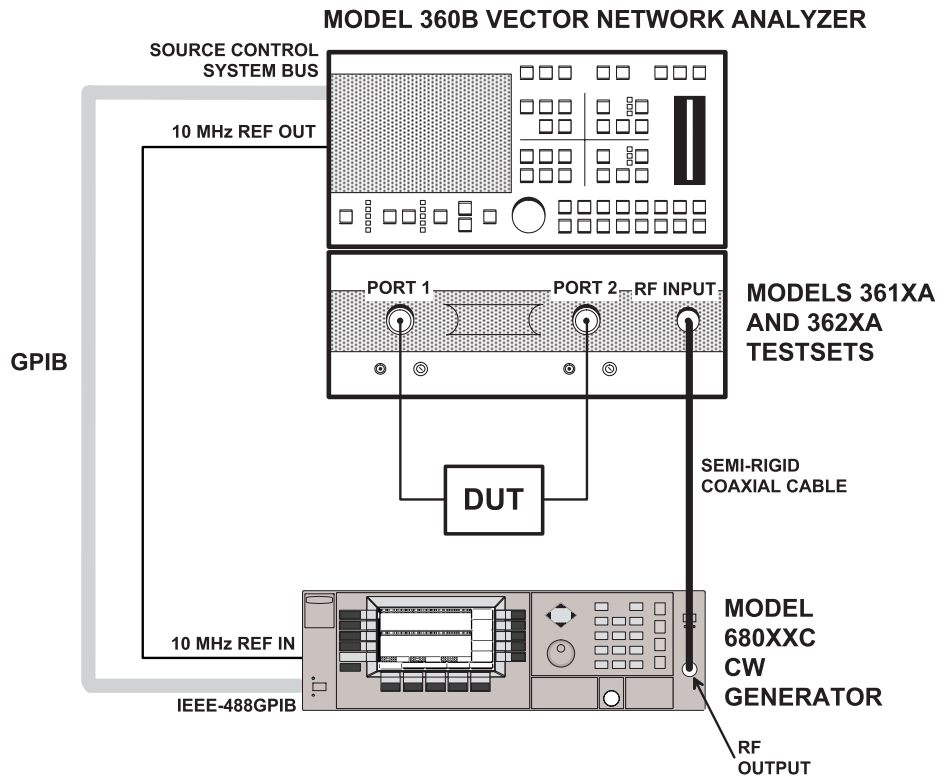

Figure 7-3. 680XXC CW Generator to 360B VNA Connections

**Connecting
the 680XXC to
the 360B**

Connect the 680XXC CW generator to the 360B vector network analyzer as shown in Figure 7-3.

- Step 1** Connect one end of a GPIB cable, 1 meter in length, to the 680XXC rear panel IEEE-488 GPIB connector. Connect the other end of the cable to the 360B rear panel

SOURCE CONTROL SYSTEM BUS connector.

Step 2 Connect one end of a coaxial cable to the 680XXC rear panel 10 MHz REF IN connector. Connect the other end to the 360B rear panel 10 MHz REF OUT connector.

If the 680XXC contains an Option 16 high-stability time base, connect the coaxial cable between the 680XXC rear panel 10 MHz REF OUT connector and the 360B rear panel 10 MHz REF IN connector.

Step 3 Turn on the 680XXC and configure it as described in the following paragraphs.

**Configuring
the 680XXC**

In order for the 680XXC to operate with a 360B in tracking receiver mode, its GPIB address and data terminator must match the System Bus source address and data terminator that are set on the 360B VNA. Verify the GPIB address and data terminator as follows:

Step 1 On the 680XXC, press **SYSTEM**. At the System Menu display, press **Config**. At the System Configuration Menu display, press **GPIB**. The Configure GPIB Menu (shown below) is displayed.

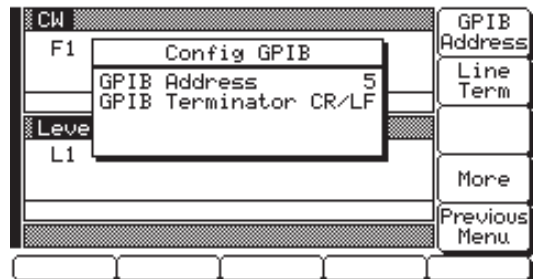

Step 2 To change the address of the 680XXC on the System Bus, press **GPIB Address**. Enter the new address using the cursor control key or the data entry keypad and the terminator key

**HZ
ms
ADRS**

The new GPIB address will appear on the display.

***Initiating
360B Track-
ing Mode***

Step 3 Press **Line Term** to select the correct GPIB data delimiter.

The CW generator is now configured for 360B tracking receiver mode operation.

Turn on the 360B VNA and configure it for tracking receiver mode operation. (Refer to the 360B VNA operation manual.) Once configured, the 360B should take control of the CW generator.

When the 360B takes control, the display of all parameters on the 680XXC is disabled and the messages Secure Mode Active and Remote appear on the front panel display.

***Terminating
360B Track-
ing Mode***

To terminate 360B VNA tracking receiver mode operation, you must first return the 680XXC to local control and then turn off the Secure mode.

Step 1 Turn off the 360B VNA. This returns the 680XXC to local control.

Step 2 On the 680XXC, press **SYSTEM**, then **Reset**. This turns off the Secure mode.

Appendix A

Rear Panel Connectors

A-1 INTRODUCTION

This appendix provides descriptions for the rear panel connectors on a typical Series 680XXC Synthesized CW Generator.

A-2 REAR PANEL CONNECTORS

Figure A-1 provides a illustration of the rear panel and describes the rear panel connectors.

A-3 CONNECTOR PINOUT DIAGRAMS

Figures A-2 and A-3 provide pinout diagrams and descriptions for the AUX I/O and IEEE-488 GPIB multipin connectors on the rear panel.

REAR PANEL CONNECTORS

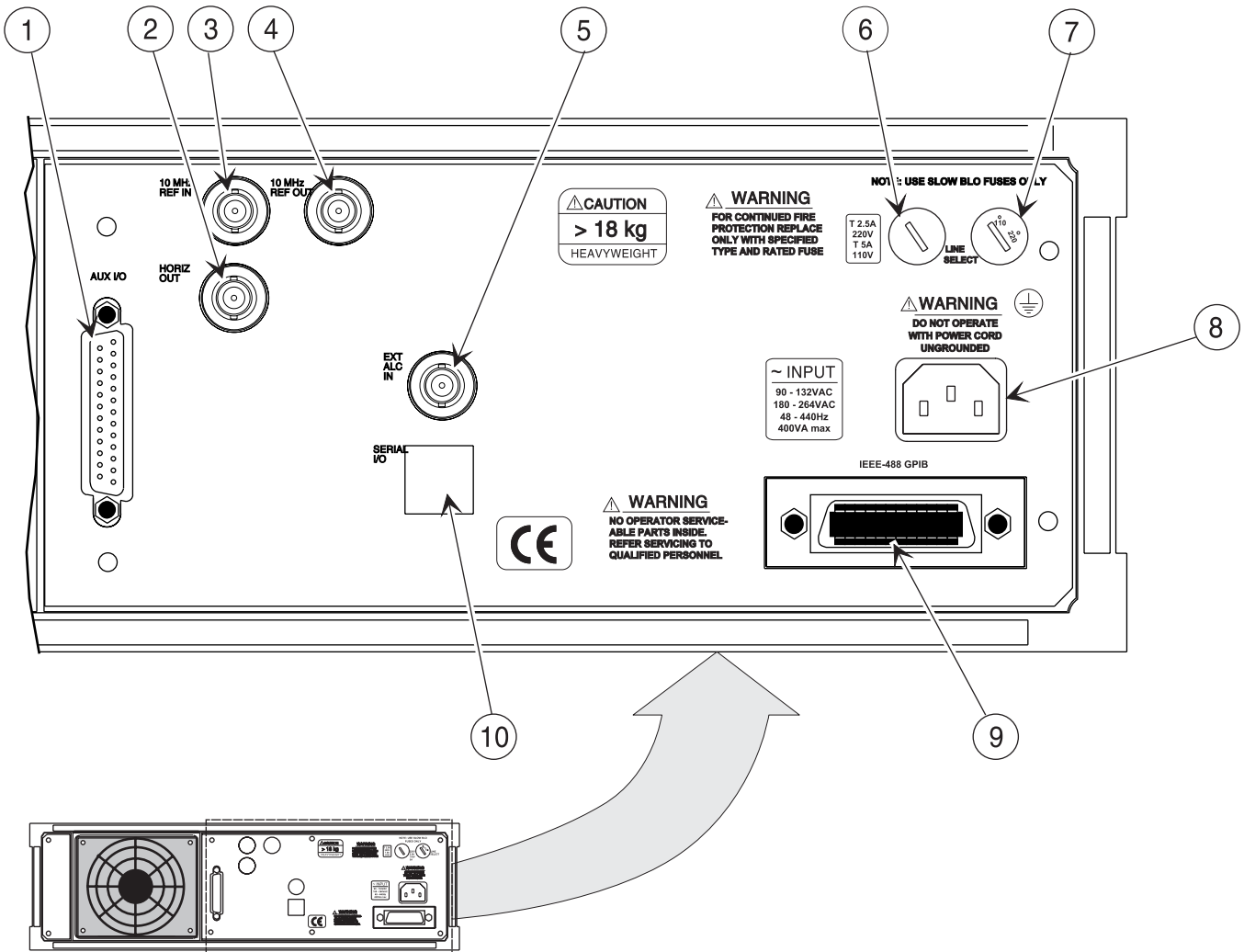
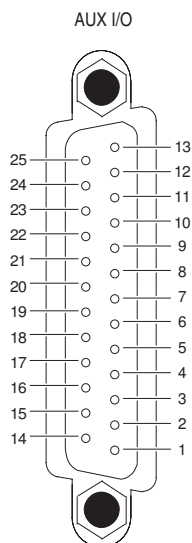

Figure A-1. Rear Panel, Series 680XXC Synthesized CW Generator (1 of 2)

REAR PANEL CONNECTORS

- ① **AUX I/O:** 25-pin connector that provides for single cable interface with another 68XXXB/C (master-slave operation) or with other Anritsu instruments such as the Anritsu 56100A Scalar Network Analyzer. A pin-out diagram for this connector is shown in Figure A-2.
- ② **HORIZ OUT:** Provides a 0V to 10V ramp during all sweep modes, regardless of sweep width. In the CW mode, provides a voltage between 0V and 10V proportional to the full frequency range of the instrument. When the CW Ramp is enabled, connector provides a repetitive 0V to 10V ramp. BNC connector, 50 Ω impedance.
- ③ **10 MHz REF IN:** Accepts an external 10 MHz \pm 100 Hz, 0 to 10 dBm time-base signal. Automatically disconnects the internal high-stability, time-base option, if installed. BNC connector, 50 Ω impedance.
- ④ **10 MHz REF OUT:** Provides a 0.5 Vp-p, AC coupled, 10 MHz signal derived from the internal frequency standard of the CW generator. BNC connector, 50 Ω impedance.
- ⑤ **EXT ALC IN:** Provides for leveling the RF output signal externally with either a remote detector or a power meter. Connector accepts a positive or negative 0.5mV to 500 mV signal from a remote detector or a \pm 1V signal from a remote power meter. BNC connector.
- ⑥ **Line Fuse:** Provides over-voltage/current protection for CW generator circuits during operation and standby. Unit requires a 5A, type T fuse for 110 Vac line voltage or a 2.5A, type T fuse for 220 Vac line voltage.
- ⑦ **LINE SELECT Switch:** Provides selection of 110 or 220 Vac line voltages. When 110 Vac is selected, the 680XXC accepts 90-132 Vac, 48-440 Hz line voltage; when 220 Vac is selected, the 680XXC accepts 180-264 Vac, 48-440 Hz line voltage.
- ⑧ **Input Line Voltage Receptacle:** Provides for connecting line voltage to the 680XXC.
- ⑨ **IEEE-488 GPIB:** 24-pin connector that provides for remotely controlling the CW generator from an external controller via the IEEE-488 bus (GPIB). A pinout diagram for this connector is shown in Figure A-3.
- ⑩ **SERIAL I/O:** Provides access to two RS-232 terminal ports to support service and calibration functions and master-slave operations. RJ45 connector.

Figure A-1. Rear Panel, Series 680XXC Synthesized CW Generator (2 of 2)



PIN	SIGNAL NAME	SIGNAL DESCRIPTION
1	HORIZ OUTPUT	<i>Horizontal Sweep Output:</i> Provides a 0V at beginning and +10V at end of sweep for all sweep modes, regardless of sweep width. In the CW mode, the voltage is proportional to frequency between 0V at low end and +10V at the high end of range. In CW mode, if CW Ramp is enabled, a repetitive, 0V to +10V ramp is provided. The ramp speed is adjusted by the Sweep Time function.
2	GND	Chassis Ground
3	SEQ SYNC	<i>Sequential Sync Output:</i> Provides a +5V signal during sweep retrace, at band-switching points, and during each frequency step in step sweep mode, -5V during markers, and -10V during the selected marker.
4	L ALT ENABLE	<i>L-Alternate Enable Output:</i> Provides a TTL low-level signal which indicates that the alternate sweep mode is active.
5	MARKER OUTPUT	<i>Marker Output:</i> Provides a +5V or -5V signal during a marker. Signal polarity selected from a front panel menu.
6	RETRACE BLANKING	<i>Retrace Blanking Output:</i> Provides a +5V or -5V signal coincident with sweep retrace. Signal polarity selected from a front panel menu.
7	L ALT SWP	<i>L-Alternate Sweep Output:</i> Provides a TTL low-level signal to indicate that the primary sweep is in progress or a TTL high-level signal to indicate that the alternate sweep is in progress.
8	Shield	Cable Shield/Chassis Ground
9	TRIGGER OUTPUT	<i>Trigger Output:</i> Provides a TTL low-level trigger signal for external devices or instruments.
10	SWP DWELL OUT	<i>Sweep Dwell Output:</i> Provides an open-collector output which goes to ground when the sweep is dwelled at the start, stop, and bandswitching frequencies, and at the markers.
11	LOCK STATUS	<i>Lock Status Output:</i> Provides a TTL high-level signal when the frequency is phase-locked.
12	RXb	<i>RXb:</i> Serial Data Input to the processor (/t1).
13	EXT TRIGGER	<i>External Trigger:</i> Accepts a TTL low-level signal of 1 μ s width to trigger a sweep.

Figure A-2. Pinout Diagram, AUX I/O Connector (1 of 2)

PIN	SIGNAL NAME	SIGNAL DESCRIPTION
14	V/GHz	<i>V/GHz Output:</i> Provides a reference voltage relative to the RF output frequency (1.0 V/GHz for Models 68017C, 68037C, and 68047C; 0.5 V/GHz for Model 68067C; 0.25 V/GHz for Models 68077C, 68087C, and 68097C).
15	EOS INPUT	<i>End-of-Sweep Input:</i> Accepts a TTL high-level signal to tell the CW generator to begin the end of sweep dwell.
16	EOS OUTPUT	<i>End-of-Sweep Output:</i> Provides a TTL high-level signal when the CW generator has begun the end of sweep dwell.
17	AUX 1	<i>Aux 1:</i> Auxiliary input/output to the processor (PB6).
18	SWP DWELL IN	<i>Sweep Dwell Input:</i> Permits a TTL low-level signal to pause the sweep. The sweep resumes when the signal is removed.
19	AUX 2	<i>Aux 2:</i> Auxiliary input/output to the processor (PC3).
20	BANDSWITCH BLANK	<i>Bandswitch Blanking Output:</i> Provides a +5V or –5V signal coincident with band-switching points. Signal polarity is selected from a front panel menu.
21	SPARE	
22	HORIZ IN	<i>Horizontal Sweep Input:</i> Accepts a 0V to 10V external sweep ramp from a Master 680XXC. This input is automatically selected when the CW generator is in the Slave Mode.
23	Return	Horizontal Sweep Input return.
24	TXb	<i>TXb:</i> Serial Data Output from the processor.
25	MEMORY SEQ	<i>Memory Sequencing Input:</i> Accepts a TTL low-level signal to sequence through ten stored, front panel setups.

Figure A-2. Pinout Diagram, AUX I/O Connector (2 of 2)

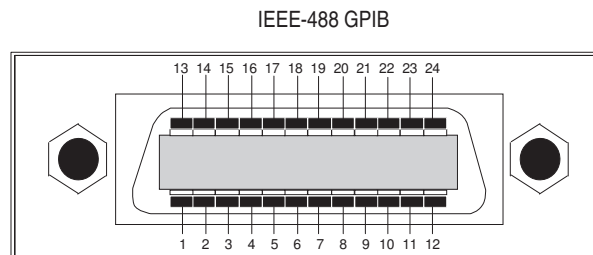

PIN	SIGNAL NAME	SIGNAL DESCRIPTION
1-4	DIO 1 thru DIO 4	<i>Data Input/Output:</i> Bits are HIGH when the data is logical 0 and LOW when the data is logical 1.
5	EOI	<i>End or Identify:</i> A low-true state indicates that the last byte of a multibyte message has been placed on the line.
6	DAV	<i>Data Valid:</i> A low-true state indicates that the active talker has (1) sensed that NRFD is high-false and NDAC is low-true, (2) placed the data byte on the bus, and (3) waited an appropriate length of time for the data to settle.
7	NRFD	<i>Not Ready For Data:</i> A high-false state indicates that all active listeners are ready to accept new data.
8	NDAC	<i>Not Data Accepted:</i> A low-true state indicates that all addressed listeners have accepted the current data byte for internal processing.
9	IFC	<i>Interface Clear:</i> A low-true state places all bus instruments in a known, quiescent state—unaddressed to talk, unaddressed to listen, and service request idle.
10	SRQ	<i>Service Request:</i> A low-true state indicates that a bus instrument desires the immediate attention of the controller.
11	ATN	<i>Attention:</i> A low-true state indicates that the bus is in the command mode (data lines are carrying bus commands). A high-false state indicates that the bus is in the data mode (data lines are carrying device-dependent instructions or data).
12	Shield	Chassis Ground
13-16	DIO5 thru DIO6	<i>Data Input/Output:</i> Bits are HIGH when the data is logical 0 and LOW when the data is logical 1.
17	REN	<i>Remote Enable:</i> A low-true state enables bus instruments to be operated remotely, when addressed.
18-24	GND	Logic Ground

Figure A-3. Pinout Diagram, IEEE-488 GPIB Connector

Appendix B

Performance Specifications

MODEL SUMMARY

Model	Frequency Range
68017C	0.01 to 8.4 GHz
68037C	2.0 to 20.0 GHz
68047C	0.01 to 20.0 GHz
68067C	0.01 to 40.0 GHz
68077C	0.01 to 50.0 GHz
68087C	0.01 to 60.0 GHz
68097C	0.01 to 65.0 GHz

FREQUENCY

CW MODE

Output: Twenty independent, presettable CW frequencies (F0 – F9 and M0 – M9).

Accuracy: Same as internal or external 10 MHz time base.

Internal Time Base Stability:

With Aging: $<2 \times 10^{-8}/\text{day}$
 ($<5 \times 10^{-10}/\text{day}$ with Option 16)

With Temperature: $<2 \times 10^{-8}/^{\circ}\text{C}$ over 0°C to 55°C
 ($<2 \times 10^{-10}/^{\circ}\text{C}$ with Option 16)

Resolution:

1 kHz (0.1 Hz with Option 11)

External 10 MHz Reference Input: Accepts external 10 MHz ± 100 Hz, -10 to $+20$ dBm time base signal. Automatically disconnects the internal high-stability time-base option, if installed. BNC, rear panel, 50Ω impedance.

10 MHz Reference Output: 0.5 Vp-p into 50Ω , AC coupled. Rear panel BNC; 50Ω impedance.

Switching Time (typical maximum):

Units having a high-end frequency of ≥ 20 GHz:
 <40 ms to be within 1 kHz of final frequency.

Units having an high-end frequency of 8.4 GHz:
 <15 ms to be within 1 KHz of final frequency.

PHASE-LOCKED STEP SWEEP MODE

Sweep Width: Independently selected, 1 kHz (0.1 Hz with Option 11) to full range. Every frequency step in sweep range is phase-locked.

Accuracy: Same as internal or external 10 MHz time base.

Resolution (Minimum Step Size):

1 kHz (0.1 Hz with Option 11)

Linear/Log Sweep: User-selectable linear or log sweep. In log sweep, step size logarithmically increases with frequency.

Steps: User-selectable number of steps or the step size.

Number of Steps: Variable from 1 to 10,000

Step Size: 1 kHz (0.1 Hz with Option 11) to the full frequency range of the instrument. (If the step size does not divide into the selected frequency range, the last step is truncated.)

Dwell Time Per Step: Variable from 1 ms to 99 seconds

Fixed Rate Sweep: Allows the user to set the total time of the sweep, including lock time. Variable from 20 ms to 99 seconds.

Switching Time (typical maximum):

Units having a high-end frequency of ≥ 20 GHz:

<15 ms + 1 ms/GHz step size or <40 ms, whichever is less, to be within 1 kHz of final frequency.

Units having a high-end frequency of 8.4 GHz:

<7 ms to be within 1 kHz of final frequency.

ALTERNATE SWEEP MODE

Sweeps alternately in step sweep between any two sweep ranges. Each sweep range may be associated with a power level.

MANUAL SWEEP MODE

Provides stepped, phase-locked adjustment of frequency between sweep limits. User-selectable number of steps or step size.

LIST SWEEP MODE

Under GPIB control or via the front panel, up to 4 tables with 2000 non-sequential frequency/power sets can be stored and then addressed as a phase-locked step sweep. One table of 2000 points is stored in non-volatile memory, all other tables are stored in volatile memory.

Switching Time (typical maximum):

Units having a high-end frequency of ≥ 20 GHz:

<25 ms to be within 1 kHz of final frequency.

Units having a high-end frequency of 8.4 GHz:

<5 ms to be within 1 kHz of final frequency.

PERFORMANCE SPECIFICATIONS

PROGRAMMABLE FREQUENCY AGILITY

Under GPIB control, up to 3202 non-sequential frequency/power sets can be stored and then addressed as a phase-locked step sweep. Data stored in volatile memory.

Switching Time (typical maximum):

Units having a high-end frequency of ≥ 20 GHz:

<25 ms to be within 1 kHz of final frequency.

Units having a high-end frequency of 8.4 GHz:

<5 ms to be within 1 kHz of final frequency.

MARKERS

Up to 20 independent, settable markers (F0 – F9 and M0 – M9).

Video Markers: +5V or –5V marker output, selectable from system menus. AUX I/O connector, rear panel.

Marker Accuracy: Same as sweep frequency accuracy.

Marker Resolution:

1 kHz (0.1 Hz with Option 11)

SWEEP TRIGGERING

Sweep triggering is provided for Step Frequency Sweep, List Frequency Sweep, and CW Power Sweep.

Auto: Triggers sweep automatically.

External: Triggers a sweep on the low to high transition of an external TTL signal. AUX I/O connector, rear panel.

Single: Triggers, aborts, and resets a single sweep. Reset sweep may be selected to be at the top or bottom of the sweep.

SPECTRAL PURITY

All specifications apply at the lesser of +10 dBm output or maximum specified leveled output power, unless otherwise noted.

SPURIOUS SIGNALS

Harmonic and Harmonic Related:

0.1 Hz to 10 MHz (Option 22): <–30 dBc

10 MHz to ≤ 50 MHz: <–30 dBc

>50 MHz to ≤ 2 GHz: <–40 dBc

>2 GHz to ≤ 20 GHz: <–60 dBc

>20 GHz to ≤ 40 GHz: <–40 dBc

Harmonic and Harmonic Related (Models having a high-end frequency of >40 GHz and units with Option 15A at maximum specified leveled output power):

10 MHz to ≤ 50 MHz: <–30 dBc

>50 MHz to ≤ 2 GHz: <–40 dBc

>2 GHz to ≤ 20 GHz: <–50 dBc

>20 GHz to ≤ 40 GHz: <–40 dBc

50 Ghz units:

>40 GHz to ≤ 50 GHz: <–40 dBc

60 Ghz units:

>40 GHz to ≤ 60 GHz: <–30 dBc

65 Ghz units:

>40 GHz to ≤ 65 GHz: <–25 dBc

Nonharmonics:

0.1 Hz to 10 MHz (Option 22): <–30 dBc

10 MHz to ≤ 2 GHz: <–40 dBc

>2 GHz to ≤ 65 GHz: <–60 dBc

PERFORMANCE SPECIFICATIONS

SINGLE-SIDEBAND PHASE NOISE (dBc/Hz)

Frequency Range	Offset From Carrier			
	100 Hz	1 kHz	10 kHz	100 kHz
0.1 Hz to <10 MHz (w/Option 22)	-90	-120	-130	-130
≥10 MHz to ≤2.0 GHz	-77	-88	-86	-100
>2.0 GHz to ≤6.0 GHz	-78	-88	-86	-102
>6.0 GHz to ≤10.0 GHz	-73	-86	-83	-102
>10.0 GHz to ≤20.0 GHz	-66	-78	-78	-100
>20.0 GHz to ≤40.0 GHz	-60	-75	-72	-94
>40.0 GHz to ≤65.0 GHz	-54	-69	-64	-88

POWER LINE and FAN ROTATION SPURIOUS EMISSIONS (dBc)

Frequency Range	Offset From Carrier		
	<300 Hz	300Hz to 1 kHz	>1 kHz
10 MHz to ≤8.4 GHz	<-50	<-60	<-60
>8.4 GHz to ≤20 GHz	<-46	<-56	<-60
>20 GHz to ≤40 GHz	<-40	<-50	<-54
>40 GHz to ≤65 GHz	<-34	<-44	<-48

RESIDUAL FM (CW and Step Sweep mode, 50 Hz - 15 kHz BW)

Frequency Range	Residual FM (Hz RMS)
10 MHz to ≤8.4 GHz	<120
>8.4 GHz to ≤20 GHz	<220
>20 GHz to ≤40 GHz	<440
>40 GHz to ≤65 GHz	<880

AM Noise Floor: Typically <-145 dBm/Hz at 0 dBm output and offsets >5 MHz from carrier.

PERFORMANCE SPECIFICATIONS

RF OUTPUT

Power level specifications apply at 25° ±10° C.

MAXIMUM LEVELED OUTPUT POWER

Model Number	Frequency Range (GHz)	Output Power (dBm)	Output Power with Step Attenuator (dBm)	Output Power with Electronic Step Attenuator (dBm)
w/Option 22	0.1 Hz to 10 MHz	+13.0	+11.0	+9.0
68017C	0.01 to ≤8.4	+13.0	+11.0	+9.0
68037C	2.0 to ≤20.0	+13.0	+11.0	+3.0
68047C	0.01 to ≤20.0	+13.0	+11.0	+3.0
68067C	0.01 to ≤2.0	+13.0	+11.0	Not Available
	>2.0 to ≤20.0	+9.0	+7.0	
	>20.0 to ≤40.0	+6.0	+3.0	
68077C	0.01 to ≤2.0	+12.0	+10.0	Not Available
	>2.0 to ≤20.0	+10.0	+8.5	
	>20.0 to ≤40.0	+2.5	0.0	
	>40.0 to ≤50.0	+2.5	-1.0	
68087C	0.01 to ≤2.0	+12.0	+10.0	Not Available
	>2.0 to ≤20.0	+10.0	+8.5	
	>20.0 to ≤40.0	+2.5	0.0	
	>40.0 to ≤50.0	+2.0	-1.5	
	>50.0 to ≤60.0	+2.0	-2.0	
68097C	0.01 to ≤2.0	+12.0	Not Available	Not Available
	>2.0 to ≤20.0	+10.0		
	>20.0 to ≤40.0	+2.5		
	>40.0 to ≤50.0	0.0		
	>50.0 to ≤65.0	-2.0		
With Option 15A (High Power) Installed				
68017C	0.01 to ≤2.0	+13.0	+11.0	+11.0
	>2.0 to ≤8.4	+17.0	+15.0	+11.0
68037C	2.0 to ≤20.0	+17.0	+15.0	+7.0
68047C	0.01 to ≤2.0	+13.0	+11.0	+11.0
	>2.0 to ≤20.0	+17.0	+15.0	+7.0
68067C	0.01 to ≤20.0	+13.0	+11.0	Not Available
	>20.0 to ≤40.0	+6.0	+3.0	

Note: In models with Option 22 that have a high-end frequency of ≤20 GHz, rated output power is reduced by 1 dB
In models with Option 22 that have a high-end frequency of >20 GHz, rated output power is reduced by 2 dB.

PERFORMANCE SPECIFICATIONS

LEVELED OUTPUT POWER RANGE

Standard Units

Without an Attenuator: Maximum leveled power to -15 dBm (-20 dBm typical).

With an Attenuator: Maximum leveled power to -120 dBm

With an Electronic Attenuator: Maximum leveled power to -140 dBm.

Units with Option 15A, High Power

Without an Attenuator: Maximum leveled power to -5 dBm (-10 dBm typical).

With an Attenuator: Maximum leveled power to -115 dBm (-120 dBm typical). For units with a high frequency limit >40 GHz and units with Option 15A, minimum settable power is -105 dBm (-110 dBm typical).

With an Electronic Attenuator: Maximum leveled power to -115 dBm (-110 dBm).

UNLEVELED OUTPUT POWER RANGE (typical)

Without an Attenuator: >40 dB below max power.

With an Attenuator: >130 dB below max power.

POWER LEVEL SWITCHING TIME (to within specified accuracy):

Without Change in Step Attenuator: <3ms typical

With Change in Step Attenuator: <20 ms typical

With Change in Electronic Step Attenuator: <3 ms typical. Power level changes across -70 dB step will result in 20 ms delay.

ACCURACY AND FLATNESS

Accuracy specifies the total worst case accuracy. Flatness is included within the accuracy specification.

Attenuation Below Max Power	Frequency (GHz)				
	0.01-20	20-40	40-50	50-60	60-65
Accuracy:					
0-25 dB ^Å	±1.0 dB	±1.0 dB	±1.5 dB	±1.5 dB	±1.5 dB
25-60 dB	±1.0 dB	±1.0 dB	±1.5 dB	±3.5 dB ^Å	N/A
>60 dB	±1.0 dB	±1.0 dB	±2.5 dB ^Å	±3.5 dB ^Å	N/A
Flatness:					
0-25 dB ^Å	±0.8 dB	±0.8 dB	±1.1 dB	±1.1 dB	±1.1 dB
25-60 dB	±0.8 dB	±0.8 dB	±1.1 dB	±3.1 dB ^Å	N/A
>60 dB	±0.8 dB	±0.8 dB	±2.1 dB ^Å	±3.1 dB ^Å	N/A

^Å Typical

^Å 0 to 25 dB or to minimum rated power, whichever is higher

OTHER OUTPUT POWER SPECIFICATIONS

Output Units: Output units selectable as either dBm or mV. Selection of mV assumes 50Ω load. All data entry and display are in the selected units.

Output Power Resolution: 0.01 dB or 0.001 mV

Source Impedance: 50Ω nominal

Source SWR (Internal Leveling): <2.0 typical

Power Level Stability with Temperature:

0.04 dB/°C typical

Level Offset: Offsets the displayed power level to establish a new reference level.

OUTPUT ON/OFF: Toggles the RF output between an Off and On state. During the Off state, the RF oscillator is turned off. The On or Off state is indicated by two LEDs located below the OUTPUT ON/OFF key on the front panel.

RF On/Off Between Frequency Steps: System menu selection of RF On or RF Off during frequency switching in CW, Step Sweep, and List Sweep modes.

RF On/Off During Retrace: System menu selection of RF On or RF Off during retrace.

Internal Leveling: Power is leveled at the output connector in all modes.

External Leveling:

External Detector: Levels output power at a remote detector location. Accepts a positive or negative 0.5 mV to 500 mV input signal from the remote detector. EXT ALC ADJ adjusts the input signal range to an optimum value. BNC connector, front and rear panel.

External Power Meter: Levels output power at a remote power meter location. Accepts a ±1V full scale input signal from the remote power meter. EXT ALC ADJ adjusts the input signal range to an optimum value. BNC connector, front and rear panel.

External Leveling Bandwidth:

30 kHz typical in Detector mode.

0.7 Hz typical in Power Meter mode.

User Level Flatness Correction:

Number of points: 2 to 801 points per table

Number of tables: 5 available

Entry modes: GPIB power meter or computed data

CW POWER SWEEP

Range: Sweeps between any two power levels at a single CW frequency.

Resolution: 0.01 dB/step (Log) or 0.001 mV (Linear)

Accuracy: Same as CW power accuracy.

Log/Linear Sweep: Power sweep selectable as either log or linear. Log sweep is in dB; linear sweep is in mV.

Step Size: User-controlled, 0.01 dB (Log) or 0.001 mV (Linear) to the full power range of the instrument.

Step Dwell Time: Variable from 1 ms to 99 seconds. If the sweep crosses a step attenuator setting, there will be a sweep dwell of approximately 20 ms to allow setting of the step attenuator.

PERFORMANCE SPECIFICATIONS

SWEEP FREQUENCY/STEP POWER

A power level step occurs after each frequency sweep. Power level remains constant for the length of time required to complete each sweep.

REMOTE OPERATION

All instrument functions, settings, and operating modes (except for power on/standby) are controllable using commands sent from an external computer via the GPIB (IEEE-488 interface bus).

GPIB Address: Selectable from a system menu

IEEE-488 Interface Function Subset:

Source Handshake: SH1

Acceptor Handshake: AH1

Talker: T6

Listener: L4

Service Request: SR1

Remote/Local: RL1

Parallel Poll: PP1

Device Clear: DC1

Device Trigger: DT1

Controller Capability: C0, C1, C2, C3, C28

Tri-State Driver: E2

GPIB Status Annunciators: When the instrument is operating in Remote, the GPIB status annunciators (listed below) will appear in a window on the front panel LCD.

REMOTE: Operating on the GPIB (all instrument front panel keys except for the SYSTEM key and the RETURN TO LOCAL soft-key will be ignored).

LLO (LOCAL LOCKOUT): Disables the RETURN TO LOCAL soft-key. Instrument can be placed in local mode only via GPIB or by cycling line power.

Emulations: The instrument responds to the published GPIB commands and responses of the Anritsu Models 6600, 6700, and 6XX00-series signal sources. When emulating another signal source, the instrument will be limited to the capabilities, mnemonics, and parameter resolutions of the emulated instrument.

GENERAL

Stored Setups: Stores front panel settings and nine additional front-panel setups in a non-volatile RAM. A system menu allows saving and recalling of instrument setups. Whenever the instrument is turned on, control settings come on at the same functions and values existing when the instrument was turned off.

Memory Sequencing Input: Accepts a TTL low-level signal to sequence through ten stored setups. AUX I/O connector, rear panel.

Self-Test: Instrument self-test is performed when Selftest soft-key is selected. If an error is detected, an error message is displayed in a window on the LCD identifying the probable cause and remedy.

Secure Mode: Disables all frequency and power level state displays. Stored setups saved in secure mode remain secured when recalled. Mode selectable from a system menu and via GPIB.

Parameter Entry: Instrument-controlled parameters can be entered in three ways—keypad, rotary data knob, or the \wedge and \vee touch pads of the cursor-control key.

The keypad is used to enter new parameter values; the rotary data knob and the cursor-control key are used to edit existing parameter values. The < and > touch pads of the cursor-control key move the cursor left and right one digit under the open parameter. The rotary data knob or the \wedge and \vee touch pads will increment or decrement the digit position over the cursor.

Controlled parameters are frequency, power level, sweep time, dwell time, and number of steps.

Keypad entries are terminated by pressing the appropriate unit key (GHz/Sec/dBm, MHz/ms/dB, kHz/ μ s/STEPS, or Hz/ns/ADRS). Edits are terminated by exiting the edit menu.

Reset: Returns all instrument parameters to predefined default states or values. Any pending GPIB I/O is aborted. Selectable from the system menu.

Master/Slave Operation: Allows two output signals (68XXB/C) to be swept with a user-selected frequency offset. One instrument controls the other via AUX I/O and SERIAL I/O connections. Requires a Master/Slave Interface Cable Set (Part No. ND36329).

User Level Flatness Correction: Allows user to calibrate out path loss due to external switching and cables via entered power table from a GPIB power meter or calculated data. When user level correction is activated, entered power levels are delivered at the point where calibration was performed. Supported power meters are Anritsu ML2437A, ML2438A, and ML4803A and HP 437B, 438A, and 70100A. Five user tables are available with up to 801 points/table.

PERFORMANCE SPECIFICATIONS

Warm Up Time:

From Standby: 30 minutes.

From Cold Start (0°C): 120 hours to achieve specified frequency stability with aging.

Instruments disconnected from ac line power for more than 72 hours require 30 days to return to specified frequency stability with aging.

Power:

90-132 Vac or 180-264 Vac, 48–440 Hz, 400 VA maximum

Standby: With ac line power connected, unit is placed in standby when front panel power switch is released from the OPERATE position.

Weight: 23 kg maximum

Dimensions:

133 H x 429 W x 597 D mm

RF Output Connector:

Type K female, ≤40 GHz models

Type V female, >40 GHz models

ENVIRONMENTAL

Storage Temperature Range: –40°C to +75°C.

Operating Temperature Range: 0°C to +50°C.

Relative Humidity: 5% to 95% at 40°C.

Altitude: 4,600 meters.

EMI

Meets the conducted and radiated emission requirements of:

EN55011:1991/CISPR-11:1990 Group 1 Class A

EN50082-1:1997/

EN 61000-4-2:1995 - 4kV CD, 8kV AD

EN 61000-4-3:1997 - 3 V/m

ENV 50204 - 3 V/m

EN 61000-4-4:1995 - 0.5 kV SL, 1 kV PL

EN 61000-4-5:1995 - 1 kV L-L, 2 kV L-E

MIL-STD-461C Part 2 RE01, RE02, CE01, CE03, CS01, CS02, CS06, RS03

INPUTS and OUTPUTS

Input/Output Connectors		
Nomenclature	Type	Location
EXT ALC IN	BNC	Front & Rear Panel
RF OUTPUT	K-Connector V-Connector	Standard-Front Panel Option 9-Rear Panel
10 MHz REF IN	BNC	Rear Panel
10 MHz REF OUT	BNC	Rear Panel
HORIZ OUT	BNC	Rear Panel
AUX I/O	25-pin D-type	Rear Panel
SERIAL I/O	RJ45	Rear Panel
IEEE-488 GPIB	Type 57	Rear Panel

EXT ALC IN (External ALC Input): Provides for leveling the RF output signal externally with either a detector or power meter. Signal requirements are shown in the RF Output specifications on page B-5.

RF OUTPUT: Provides for RF output from 50Ω source impedance. K or V Connector, female. Option 9 moves the RF Output connector to the rear panel.

10 MHz REF IN: Accepts an external 10 MHz ±100 Hz, 0 to +10 dBm time-base signal. Automatically disconnects the internal high-stability time-base option, if installed. 50Ω impedance.

10 MHz REF OUT: Provides a 0.5 V_{p-p}, AC coupled, 10 MHz signal derived from the internal frequency standard. 50Ω impedance.

HORIZ OUT (Horizontal Sweep Output): Provides 0V at beginning and +10V at end of sweep, regardless of sweep width. In CW mode, the voltage is proportional to frequency between 0V at low end and +10V at the high end of range. In CW mode, if CW RAMP is enabled, a repetitive, 0V to +10V ramp is provided.

AUX I/O (Auxiliary Input/Output): Provides for most of the rear panel BNC connections through a single, 25-pin, D-type connector. Supports master-slave operation with another 68XXXC synthesizer or allows for a single-cable interface with the Model 56100A Scalar Network Analyzer and other Anritsu instruments. For a pinout diagram and descriptions, see Appendix A, Figure A-2.

SERIAL I/O (Serial Input/Output): Provides access to RS-232 terminal ports to support service and calibration functions and master-slave operations.

IEEE-488 GPIB: Provides input/output connections for the General Purpose Interface Bus (GPIB). For a pinout diagram, see Appendix A, Figure A-3.

PERFORMANCE SPECIFICATIONS

OPTIONS

Option 1, Rack Mounting: Rack mount kit containing a set of track slides (90° tilt capability), mounting ears, and front panel handles to let the instrument be mounted in a standard 19-inch equipment rack.

Option 2A, 110 dB Step Attenuator: Adds a 10 dB/step attenuator with 110 dB range for models having a high-end frequency of ≤ 20 GHz. Rated RF output power is reduced.

Option 2B, 110 dB Step Attenuator: Adds a 10 dB/step attenuator with 110 dB range for models having a high-end frequency of ≤ 40 GHz. Rated RF output power is reduced.

Option 2C, 90 dB Step Attenuator: Adds a 10 dB/step attenuator with a 90 dB range for models having a high-end frequency of ≤ 50 GHz. Rated RF output power is reduced.

Option 2D, 90 dB Step Attenuator: Adds a 10 dB/step attenuator with a 90 dB range for models having a high-end frequency of ≤ 60 GHz. Rated RF output power is reduced.

Option 2E, 120 dB Electronic Step Attenuator: Adds a 10 dB/step electronic attenuator with a 120 dB range for models having a high-end frequency of ≤ 8.4 GHz. Rated RF output power is reduced.

Option 2F, 120 dB Electronic Step Attenuator: Adds a 10 dB/step electronic attenuator with a 120 dB range for models having a high-end frequency of ≤ 20 GHz. Rated RF output power is reduced.

Option 9, Rear Panel RF Output: Moves the RF output connector to the rear panel.

Option 11, 0.1 Hz Frequency Resolution: Provides frequency resolution of 0.1 Hz.

Option 14, Rack Mounting without Chassis Slides: Modifies rack mounting hardware to install unit in a console that has mounting shelves. Includes mounting ears and front panel handles.

Option 15A, High Power Output: Adds high-power RF components to the instrument in the 2-20 GHz frequency range. Option 15A is standard in models having a high-end frequency that is > 40 GHz.

Option 16, High-Stability Time Base: Adds an ovenized, 10 MHz crystal oscillator as a high-stability time base.

Option 17B, Delete Front Panel: Deletes the front panel for use in remote control applications where a front panel display and keyboard control are not needed.

Option 18, mmWave Bias Output: Provides bias output for 54000-xWRxx Millimeter Wave Source Modules. BNC Twinax connector, rear panel.

Option 19, SCPI Programmability: Adds GPIB command mnemonics complying with Standard Commands for Programmable Instruments (SCPI), Version 1993.0 SCPI programming complies with IEEE 488.2-1987.

Option 22, 0.1 Hz to 10 MHz Audio Frequency: Adds frequency coverage below 10 MHz. In models having a high-end frequency of ≤ 20 GHz, rated output power is reduced by 1 dB; in models having a high-end frequency of > 20 GHz, rated output power is reduced by 2 dB.

Subject Index

Number

680XXC
Front Panel Layout, 3-6
General Description, 1-3
Manual, Electronic, 1-5
Manuals, Related, 1-5
Models, List of, 1-4
Options, List of, 1-6
Performance Specifications, B-1
Rear Panel Layout, A-2

A

ALC, 3-59
Alternate Sweep Frequency Mode
Activating the Alternate Sweep, 3-37
Selecting a Power Level, 3-39
Selecting a Sweep Range, 3-38
Selecting Alternate Sweep, 3-37

C

Calibration, Reference Oscillator, 3-83
Connectors
Front Panel, 3-7
Rear Panel, A-1
CW Frequency Accuracy Test
Test Procedure, 5-6
Test Records, 5-7 - 5-12
Test Setup, 5-5
CW Frequency Mode
Menu Map, 4-6
Selecting a CW Frequency, 3-22
Selecting a Power Level, 3-24
Selecting CW Mode, 3-21
CW Power Sweep Mode
Menu Map, 4-11
Selecting a Sweep Range, 3-55
Selecting a Sweep Trigger, 3-54
Selecting CW Power Sweep Mode, 3-52
Selecting Linear or Logarithmic Sweep, 3-56
Setting Dwell Time, 3-53
Setting Step Size, 3-53
CW Ramp, 3-25

D

Data Display
Description, 3-8
Menu Display Format, 3-9
Menu Keys, 3-10
Data Entry Area
Description, 3-12
Default Parameters, 3-16 - 3-17

E

Entering Data
Editing the Current Value, 3-19
Entering a New Value, 3-20
Opening the Parameter, 3-18
Setting Increment Sizes, 3-79
Error Messages
Operation Related, 6-8
Self Test, 6-3 - 6-7

F

Fixed Power Level Mode
Menu Map, 4-10
Selecting a Power Level, 3-48
Selecting Fixed Power Level Mode, 3-48
Selecting Linear or Logarithmic Units, 3-49
Frequency Control
Frequency List, 3-23
Selecting a Preset Frequency, 3-22
Selecting a Preset Sweep Range, 3-33
Setting a Preset Sweep Range, 3-34
Frequency Markers
Marker List, 3-35
Frequency Modes
CW Frequency Mode, 3-21
List Sweep Frequency Mode, 3-26
Manual Sweep Frequency Mode, 3-26
Step Sweep Frequency Mode, 3-26
Frequency Scaling, 3-76
Front Panel
Connectors, 3-7
Data Display Area, 3-6, 3-8
Data Entry Area, 3-7, 3-12
Description, 3-6

Layout, 3-6

G

General Description, 1-3
General Purpose Interface Bus (GPIB)
 Address, 2-7
 Cable Length Restrictions, 2-7
 Interface Connector, 2-7
 Line Terminator, 2-9
 Native Interface Language, 2-9
 SCPI Interface Language, 2-9
 Setup and Interconnection, 2-7

I

Identification Number, 1-5
Initial Inspection, 2-3

L

Level Offset, 3-51
Leveling Operations
 ALC Power Slope, 3-64
 Attenuator Decoupling, 3-63
 External Leveling, 3-60
 Fixed Gain, 3-62
 Internal Leveling, 3-60
 Menu Map, 4-13
 Selecting a Leveling Mode, 3-59
 User Cal (User Level Flatness Correction), 3-66
List Sweep Frequency Mode
 Description, 3-40
 Editing the List, 3-42
 Menu Map, 4-9
 Selecting a Sweep Range, 3-45
 Selecting a Sweep Trigger, 3-46
 Selecting List Sweep Mode, 3-41

M

Maintenance, Routine
 Display Cleaning, 6-13
 Fan Filter Cleaning, 6-13
 Line Fuse Replacement, 6-14
Manual Sweep Frequency Mode
 Description, 3-31
 Menu Map, 4-8
 Selecting a Power Level, 3-34
 Selecting a Sweep Range, 3-32
 Selecting Manual Sweep Mode, 3-31
Manual, Electronic, 1-5

Manual, GPIB Programming, 1-5
Manual, Maintenance, 1-6
Manual, SCPI Programming, 1-5
Markers, Frequency, 3-35
Master Reset, 3-71, 3-81
Master-Slave Operation, 7-4
Menu Maps
 CW Frequency Mode, 4-6
 CW Power Sweep Mode, 4-11
 Description, 4-3
 Fixed Power Level Mode, 4-10
 Leveling Modes, 4-13
 List Sweep Frequency Mode, 4-9
 Manual Sweep Frequency Mode, 4-8
 Sample Menu Map, 4-5
 Step Sweep Frequency Mode, 4-7
 Sweep Frequency/Step Power Mode, 4-12
 System Configuration, 4-14
Messages
 Error, 6-3 - 6-8
 Status, 6-9
 Warning, 6-9
Models, List of, 1-4

O

Operating Environment, 2-6
Operational Verification Tests, 5-3
Operator Maintenance
 Error and Warning/Status Messages, 6-3
 Routine Maintenance, 6-13
 Troubleshooting, 6-10
Options, List of, 1-6

P

Performance Specifications, 1-7, B-1
Power Level Accuracy and Flatness Tests
 Accuracy Test Procedure, 5-14
 Flatness Test Procedure, 5-15
 Test Records, 5-17 - 5-43
 Test Setup, 5-13
Power Level Control
 Level List, 3-49
 Selecting a Preset Power Level, 3-49
 Selecting a Preset Sweep Range, 3-56
 Setting a Preset Sweep Range, 3-56
Power Level Modes
 CW Power Sweep Mode, 3-52
 Fixed Power Level Mode, 3-48
 Sweep Frequency/Step Power Mode, 3-52

Power Level Offset, 3-51
Power Requirements, 2-4
Preparation for Storage/Shipment, 2-13
Preparation for Use, 2-4
 Line Voltage Selection, 2-4
 Operating Environment, 2-6
 Power Requirements, 2-4
 Standby Operation, 2-5
 Warmup Time, 2-6

R

Rack Mounting Kit (Option 1)
 Installation Procedures, 2-10
Rear Panel Connectors, A-1
Recommended Test Equipment, 1-8
Reference Oscillator Calibration, 3-83

S

Saving/Recalling Instrument Setups, 3-80
Scope of Manual, 1-3
Secure Operation, 3-82
Self Test
 Error Messages, 6-3 - 6-7
 From System Menu, 3-15
Specifications, Performance, B-1
Start Up, 3-14
Start-Up Display, 3-14
Step Sweep Frequency Mode
 Description, 3-26
 Menu Map, 4-7
 Selecting a Power Level, 3-34
 Selecting a Sweep Range, 3-32
 Selecting Alternate Sweep, 3-37
 Selecting Linear or Logarithmic Sweep, 3-29
 Selecting Step Sweep Mode, 3-26
 Setting a Sweep Trigger, 3-30
 Setting Dwell Time, 3-27
 Setting Step Size, 3-27

 Setting Sweep Time, 3-27
 Using Frequency Markers, 3-35
Sweep Frequency Modes
 List Sweep Frequency Mode, 3-26
 Manual Sweep Frequency Mode, 3-26
 Step Sweep Frequency Mode, 3-26
Sweep Frequency/Step Power Mode
 Menu Map, 4-12
 Selecting a Sweep Frequency/Step Power Mode,
 3-57
 Selecting a Sweep Range, 3-55
 Selecting Linear or Logarithmic Sweep, 3-56
 Setting Step Size, 3-58
System Configuration
 Configuring the Front Panel, 3-73
 Configuring the GPIB, 3-77
 Configuring the Rear Panel, 3-74
 Configuring the RF, 3-75
 Frequency Scaling, 3-76
 Menu Map, 4-14
 Setting Increment Sizes, 3-79

T

Test Equipment, 1-8, 5-3
Testing, Operational Verification
 CW Frequency Accuracy, 5-5
 Initial 680XXB Checkout, 5-4
 Power Level Accuracy and Flatness, 5-13
 Test Equipment, 5-3
 Test Records, 5-3, 5-7 - 5-12, 5-17 - 5-43
Troubleshooting Tables, 6-10 - 6-12

U

Use With Other Instruments
 Master-Slave Operation, 7-4
 Use with a 360B Vector Network Analyzer, 7-11
 Use with a 56100A Scalar Network Analyzer,
 7-10