



Part No. 995758  
Rev.A

# ***DMII™ PRO***

## ***Data Logger Recorder***

---

---

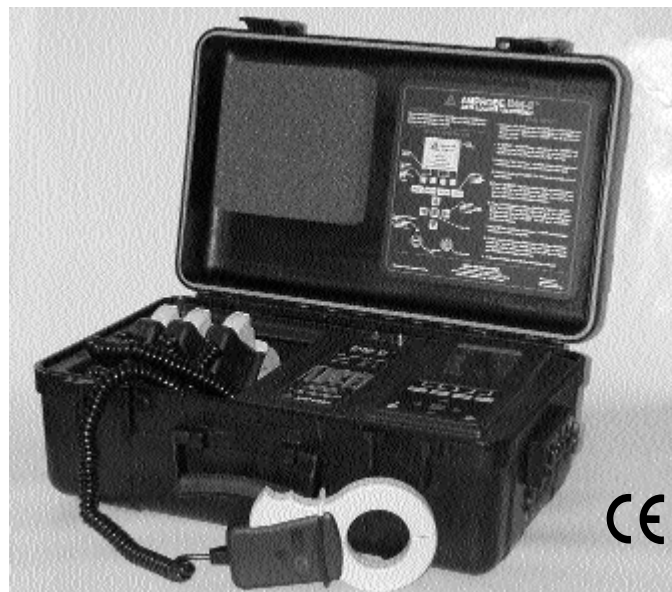

## **User's Manual**

Amprobe thanks you for purchasing the DMII PRO. For your safety, please read this instruction manual in its entirety.



## **SAFETY PRECAUTIONS & WARNINGS**



1. Read this manual in its entirety before proceeding.
2. This equipment should only be used by trained professionals who are familiar with electrical hazards.
3. In many instances you will be working with dangerous levels of voltage and/or current, therefore, it is important that you avoid direct contact with any uninsulated current-carrying surfaces. Wear lineman gloves, safety glasses and protective clothing at all times.
4. Before installing or removing batteries and/or fuses, disconnect all inputs to the instrument and remove power cord from the outlet.
5. Before applying test leads to circuit under test, make certain that leads are plugged into proper jacks.
6. Before using the DM-II PRO, always check condition of instrument and accessories. Replace any damaged parts.
7. The unit should be checked on a known live line to verify it is operating before using.

---

---

## ▶ Table of Contents

Introduction .....	4
Phase Set-up .....	.5, 6, 7
CT Set-up .....	8
Clock Set-up .....	9
Language Set-up .....	9
Communication Mode .....	10
Fund (Fundamental Frequency) Mode .....	10
Meter Mode .....	.11, 12, 13, 14, 15
Record Mode .....	.16, 17, 18, 19
Viewing Data .....	.20, 21, 22, 23, 24, 25, 26
Symbols & Definitions .....	.27
Fuse Replacement/Voltage Protection Procedure .....	.28
Total Power Quantities .....	.29
Battery Replacement .....	.30
Setting Voltage Selection Switch .....	.31
Specifications .....	.32, 33
User Interface .....	.34
Notes .....	.35

### Helpful Hints in using this manual:

All button commands will be represented in a bold typeface.

For example - Press **HOLD** button

You will be able to walk your way through the commands by following the Steps indicated in each section.

For example - Step 1, Step 2, etc.

---

---

## ► Introduction

Congratulations! You have just purchased Amprobe's DM-II (PRO) Data Logger Recorder. This instrument was designed to assist you in your work. We have written this manual in a user friendly, easy-to-follow format. Follow the steps and you will find it to be simple to use.

As you browse through the screens, you will find there are four sections. We will walk you through them with ease. First, in order to begin, you must

### Step 1 - TURN THE DM-II ON

Push the **ON/OFF** button and hold it for a second. The green or red light will come on.

- Green indicates your instrument is powered by 110V.
- Red indicates your instrument is powered by batteries. Batteries are used as a power back-up. If the power is interrupted, the DMII will continue recording using its internal batteries.

The LCD screen will briefly display an information screen, then will finally switch to a SET-UP screen.

### Step 2 - ADJUST THE BRIGHTNESS OF YOUR LCD SCREEN

Since the LCD screen is sensitive to temperature, the brightness of your screen may vary as the ambient temperature changes. If your screen is very dark or completely black, push the red **ENTER** button on your keypad and hold the key.

While holding **ENTER** button, push left **ARROW** button simultaneously and hold for a few seconds.

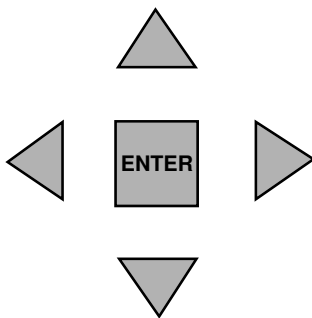

If your screen is very light, or BLANK push the red **ENTER** button and right **ARROW** button simultaneously and hold for a few seconds.

---

---

## ► Phase Set-up

In order to prepare your DM-II PRO for operation, follow the various steps indicated in the diagrams that follow:

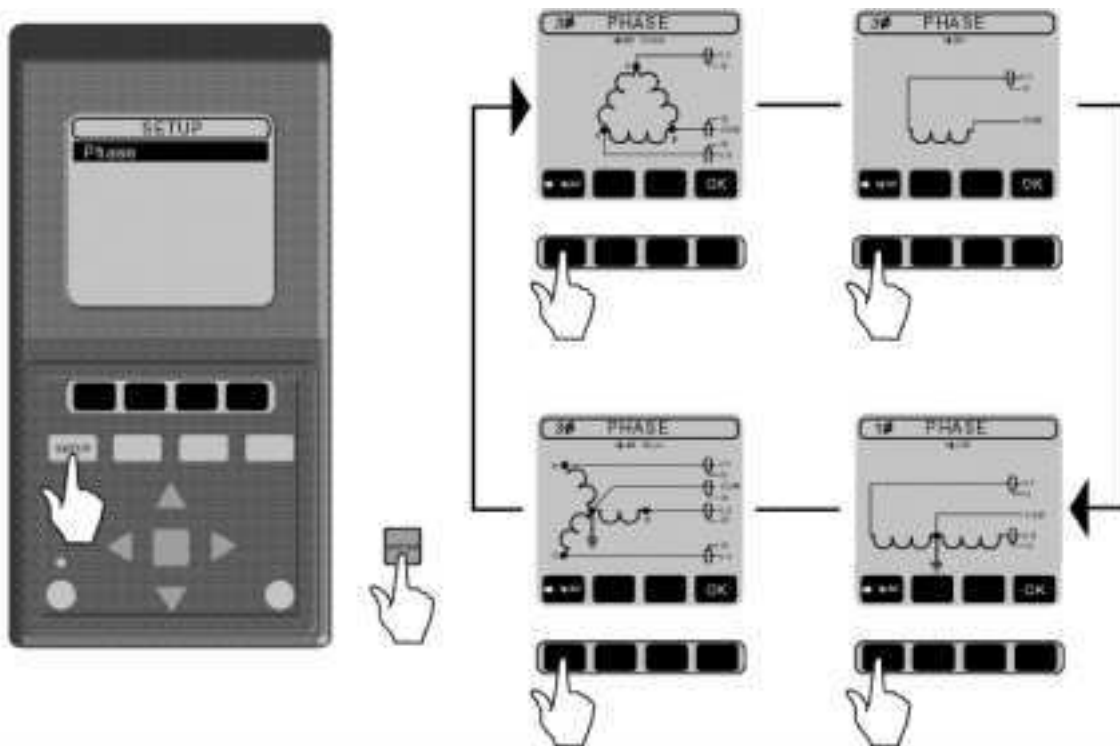

STEP 1 - Press **SET-UP** button (phase should be highlighted).

STEP 2 - Press **ENTER**

STEP 3 - Scroll through the 4 Phase screens. Before you press **OK**, check Drawings A through D (on pages 6 - 7) for instructions for connecting test leads. Press **OK** after the test leads are connected.

► Phase Set-up (cont'd.)

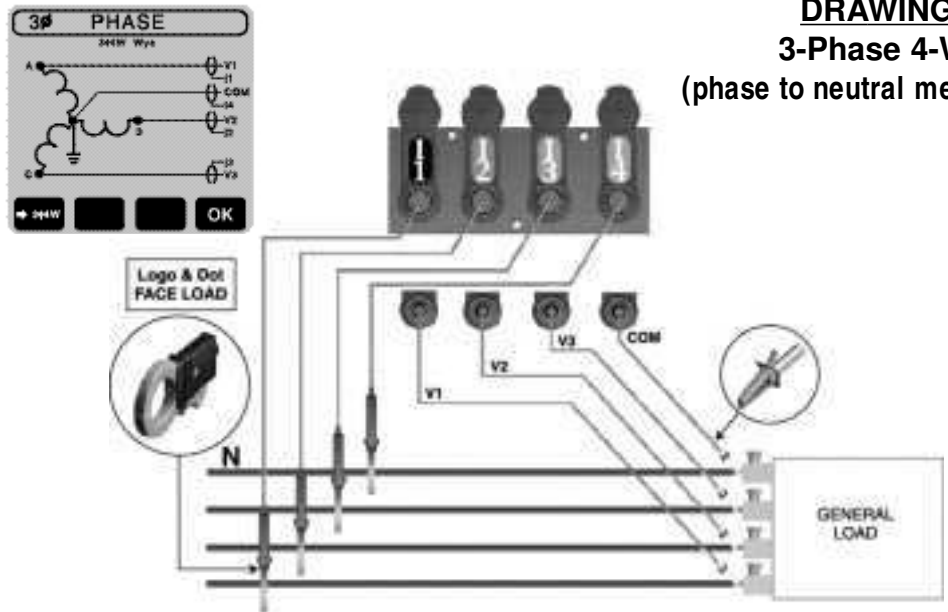

**DRAWING A**  
**3-Phase 4-Wire**  
 (phase to neutral measurement)

**NOTE:** Use 3-Phase 3-Wire set-up (below) for phase voltage measurement on 3-phase 4-wire system.

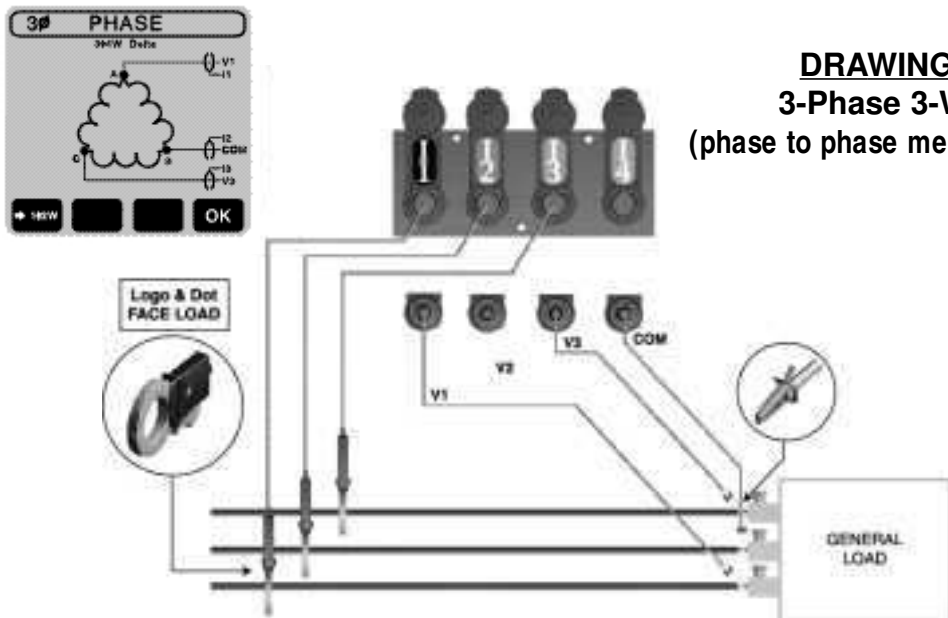

**DRAWING B**  
**3-Phase 3-Wire**  
 (phase to phase measurement)

**NOTE:** V2 and I4 inputs are NOT used.

## ► Phase Set-up (cont'd.)

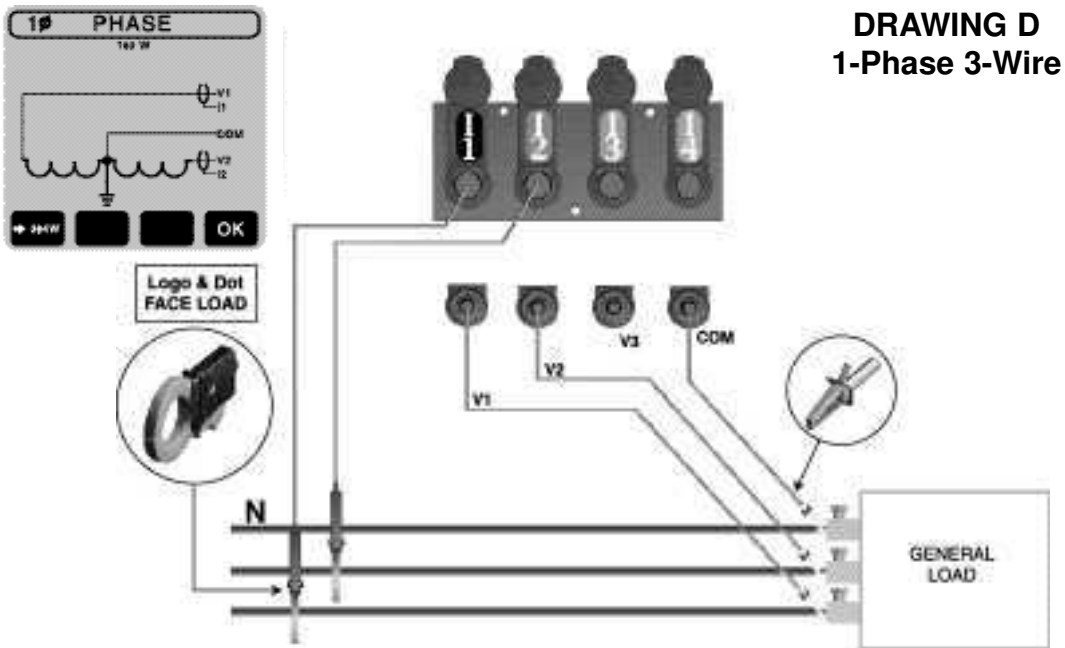
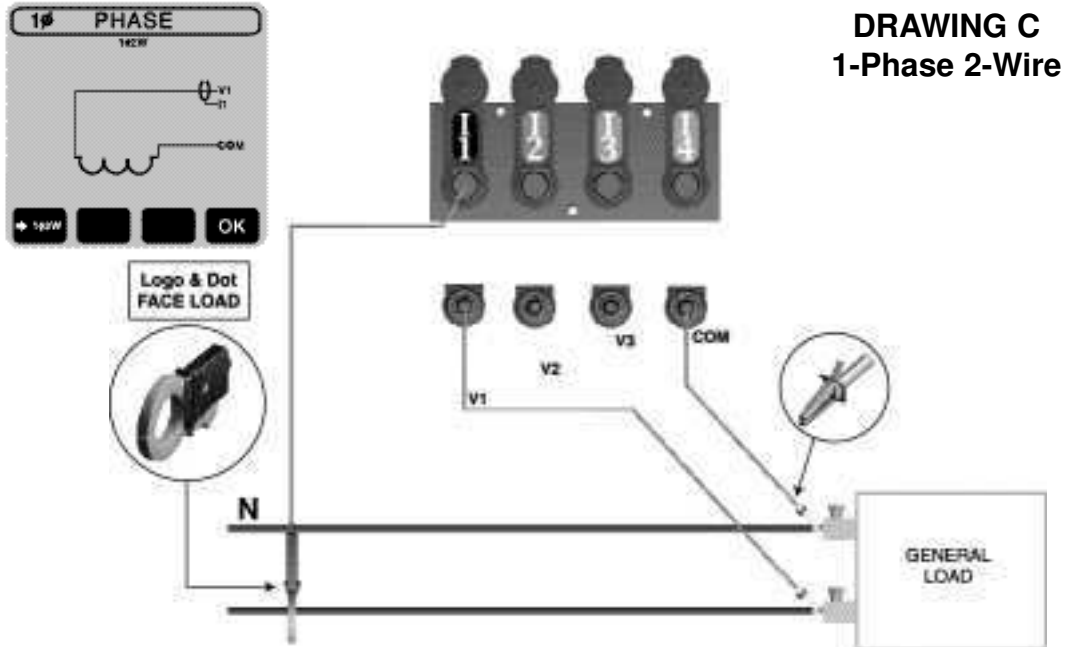

## ▶ CT Set-up

Check if the type of CT's you are using matches the set-up on the DM-II PRO.

TYPE OF CURRENT TRANSDUCERS		RANGE		PROPER SET-UP OF THE DM-II
DM-CT or DM-CT CE	Standard CTs shipped with every DM-II PRO	0-1000 amps	<b>CT</b>	DM-CT
ACF-3000DM	Optional flexible CTs set-up	30-300 amps	<b>CT</b>	ACF3000 300
ACF-3000 DM	Optional flexible CTs	300-3000 amps	<b>CT</b>	ACF3000 3000

To set up the ACF-3000 itself, please refer to the ACF-3000 DM manual.

To change a CT set-up on the DM-II

Step 1 - Simply highlight CT in Setup screen using up/down arrows on the keypad and press **ENTER** (red square).

Step 2 - Using same arrow keys, highlight desired CT.

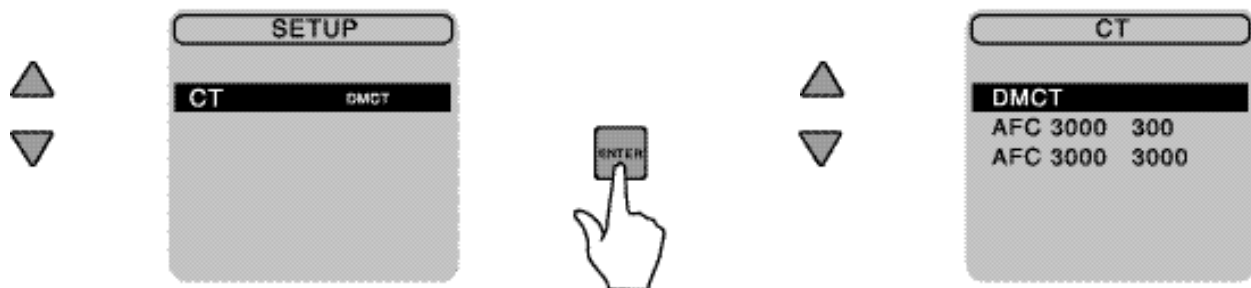

Step 3 - Press **ENTER** again.



## ► Clock Set-up

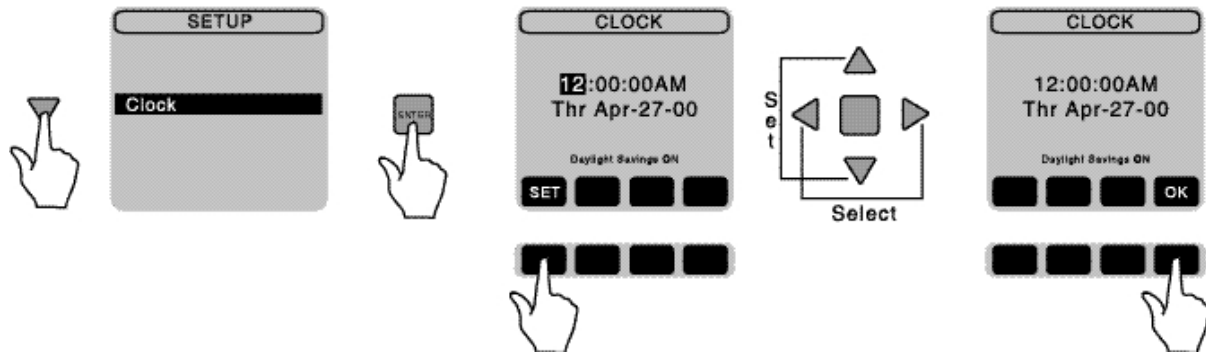

Step 1 - Under SET-UP screen, using arrows on the keypad, select clock, then press **ENTER**.

Step 2 - If clock needs to be changed, using arrow keys, change time and date.

Step 3 - Once correct information has been obtained, press OK to return to SET-UP screen.

## ► Language Set-up

If you are satisfied with the choice of language on your screen, skip this section.

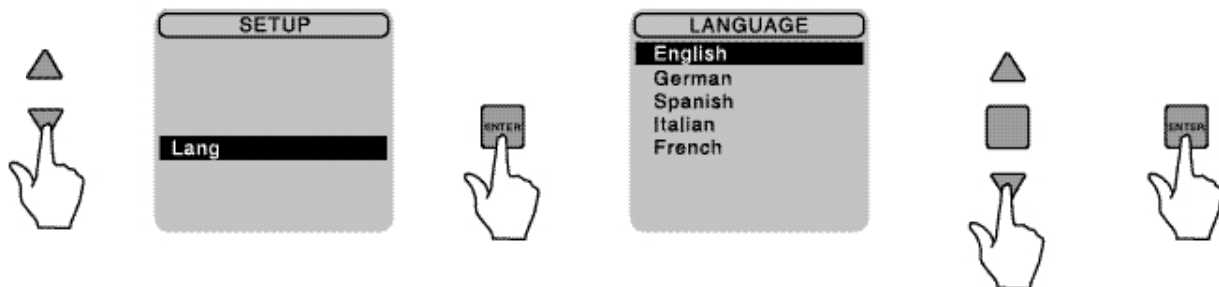

To change a language:

Step 1 - In the SET-UP screen, using arrow keys select a **lang** and press **ENTER**

Step 2 - Select your desired language.

Step 3 - Press **ENTER**.

---

---

## ► Communication Set-up

You may skip this section. *No set-up is required at this stage.* The Communication Mode is used only when downloading data to a computer. Disregard the baud rate indicated on your screen, it will be selected before you download to your PC. Please refer to the software section of your manual on how to use this feature.

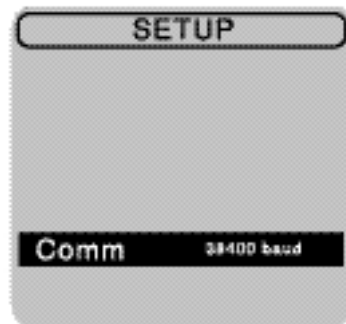

## ► Fund (Fundamental Frequency) Set-up

Step 1 - Select a FUND under SET-UP screen.

Step 2 - Using arrows on keypad, press **ENTER** to toggle between 50 or 60 Hz.

Step 3 - Once the user selects the fundamental frequency of the system, this frequency will become the default setting.

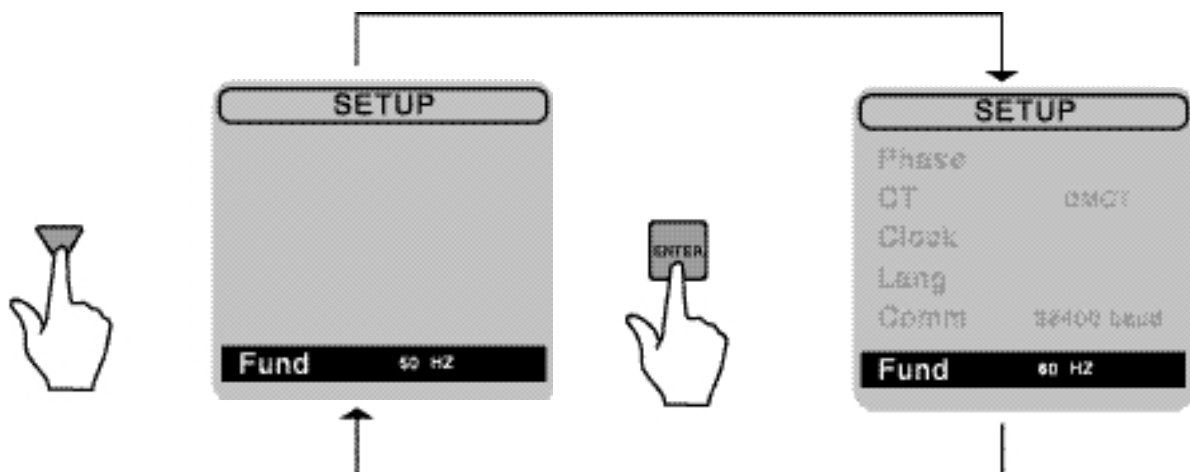

---

---

## ► Meter Mode

### VERIFYING A PROPER SET-UP OF THE DM-II PRO

#### **IMPORTANT NOTE:**

***Always perform this check. It will only take you a minute to verify a correct set-up, but you may lose weeks or months of work if the DM-II PRO was set-up improperly.***

Step 1 - Push the **METER** button. Check the following:

- **P** (Real Power) on each of the phases should be positive. If it is negative, reverse the direction of the CT to make the color dot and Amprobe logo face the opposite way.
- Check if voltage and amperage (current) ranges on each of the phases are within expected values. For example if nominal voltage of the system is 480V, but you are reading only 270V something is apparently wrong. In this case double-check the set-up of the test leads and the DM-II itself.

The meter mode allows you to view real time readings of voltage, current, power, power factor.

Step 2 - Begin meter mode by pressing **METER** button. For definitions of terms see Pages 16 & 17.

Depending on phase set-up, there are different screens for you to view data.

### METER MODE SCREENS FOR DIFFERENT PHASE SET-UPS

Meter mode for 3Ø4W - Page 12

Meter mode for 3Ø3W - Page 13

Meter mode for 1Ø2W - Page 14

Meter mode for 1Ø3W - Page 15

For details on how to scroll through the screens, refer to the drawing on Page 12.

## ► Meter Mode - 3Ø 4 Wire



Press the corresponding button labeled: either ØA, ØB, or ØC to view respectively phase A, B or C; press ►N to view current in the neutral wire, press TOTAL to view power and power factor.

### PHASE A

ØA	METER	
VAN	120.0	VRMS
I A	34.5	ARMS
S	4.5	VA
P	3.6	W
Q	1.2	VAR
PF	0.76	LAG

→ØB →ØC →N TOTAL



### PHASE B

ØB	METER	
VBN	120.0	VRMS
I B	34.5	ARMS
S	4.5	VA
P	3.6	W
Q	1.2	VAR
PF	0.76	LAG

→ØC

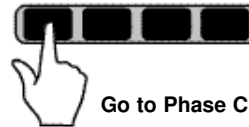

### PHASE C

ØC	METER	
VCN	120.0	VRMS
I C	34.5	ARMS
S	4.5	VA
P	3.6	W
Q	1.2	VAR
PF	0.76	LAG

→N



### NEUTRAL

N	METER	
I N	34.5	ARMS

TOTAL



### TOTAL

N	METER	
S	4.5	VA
P	3.6	W
Q	1.2	VAR
PF	0.76	LAG

→ØA →ØB →ØC TOTAL

**NOTE:** Indicated readings should be of an actual condition.

## ► Meter Mode - 3Ø 3 Wire

Using the **TOTAL** (corresponding black key), you can display the total 3-Phase power measurements from all three phases.

Use **LINE V & I** button to go back to volt and amp.

### 3Ø3W Delta Configuration

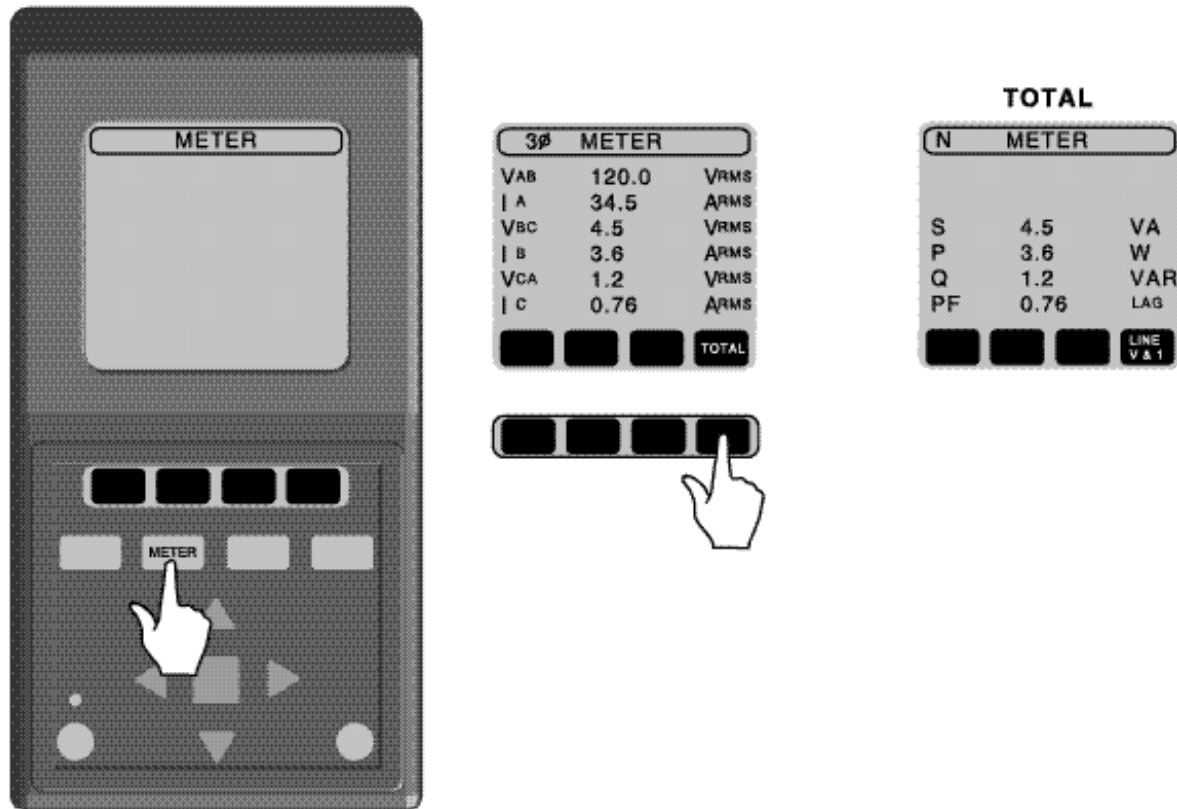

**NOTE:** Indicated readings should be of an actual condition.

---

---

► Meter Mode - 1Ø 2 Wire

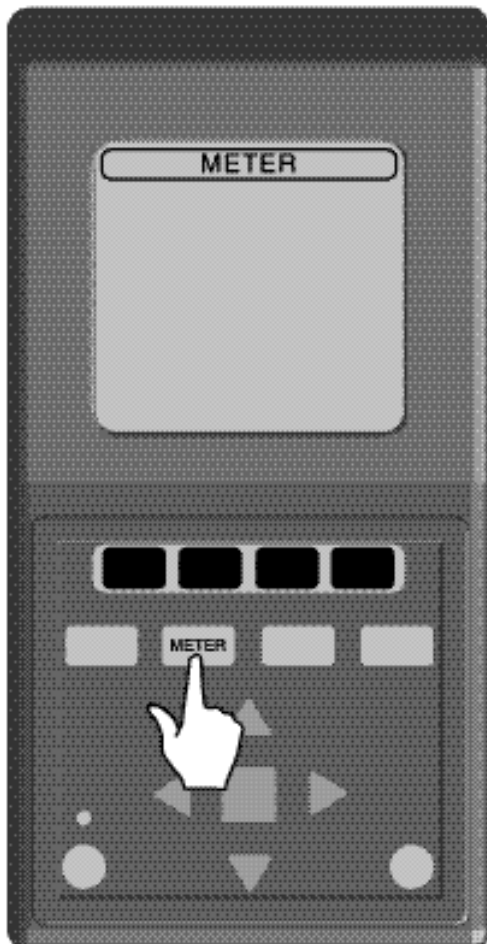

METER		
V1	120.0	VRMS
I1	34.5	ARMS
S	4.5	VA
P	3.6	W
Q	1.2	VAR
PF	0.76	LAG

**NOTE:** Indicated readings should be of an actual condition.

---

---

## ► Meter Mode 1Ø 3 Wire

Press V2I2 to view Phase 2

Press V1I1 to view Phase 1

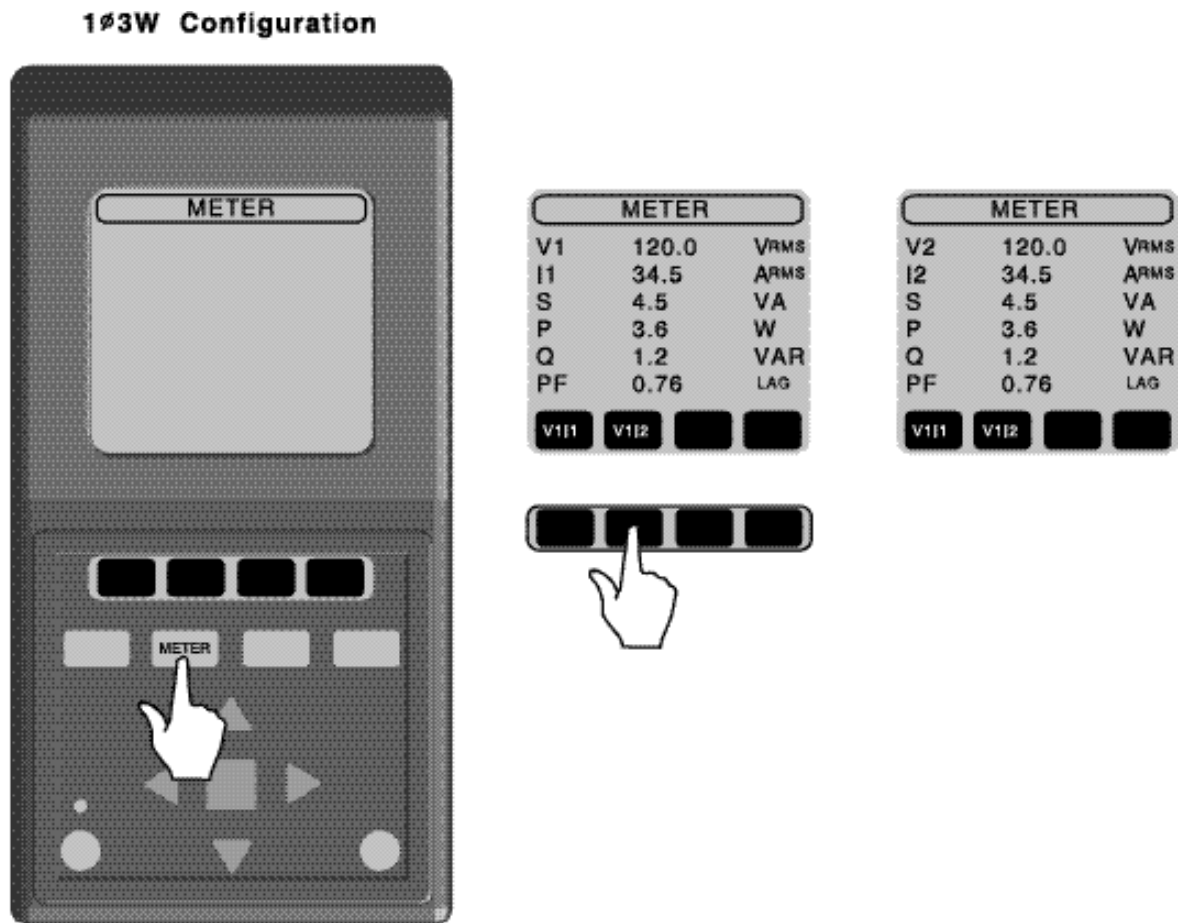

**NOTE:** Indicated readings should be of an actual condition.

---

---

## ► Record Mode

Step 1 - Press the **RECORD** button .

Step 2 - Select parameters for recording.

- **SELECT ALL** button will select all of the parameters for recording. All grid boxes will become black. The DMII™ is going to record everything.
- **CLEAR ALL** button deselects all parameters. All grid boxes will become blank. When this is selected, the DMII™ will NOT record anything.
- Selecting or deselecting one parameter at a time. Using the arrow keys, you can move the blinking cursor to one of the selection boxes.

Press the **ENTER** button, to change between blank (not record) and black (record).

For RMS voltage and current, you can change between blank, black or black with "T"  
(Threshold).

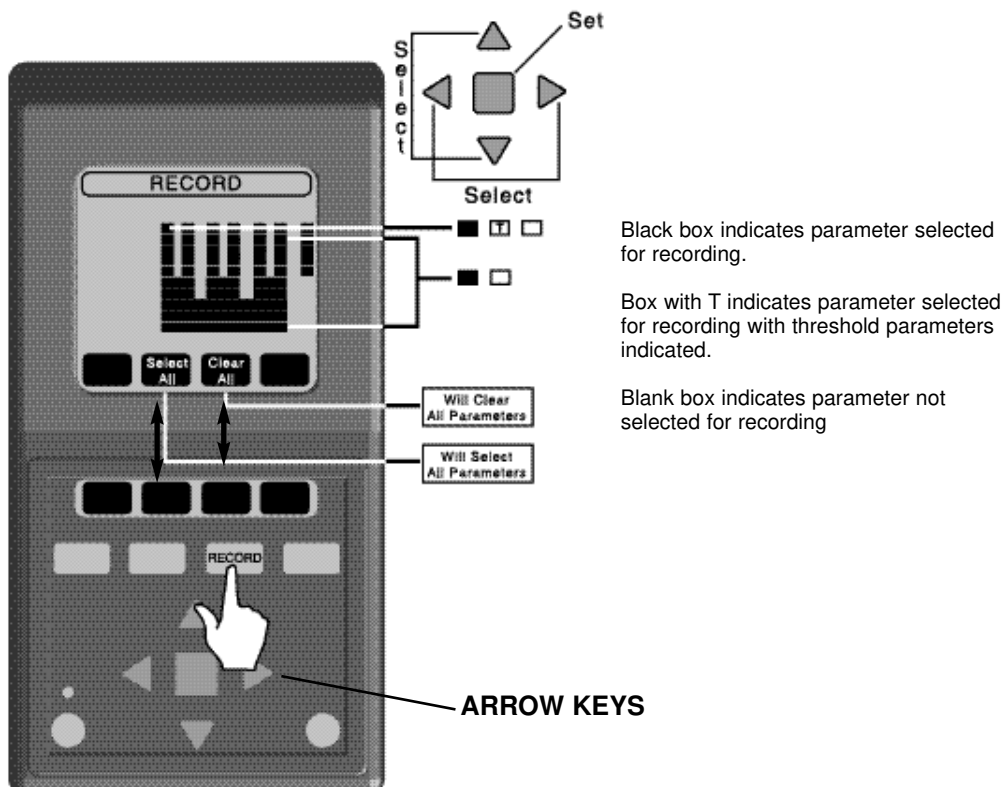



---

---

## ► Record Mode (cont'd.)

### Threshold Set-up and Features

The threshold feature is available for RMS voltage or current only (the first upper row). The DMII™ is going to record only those values, that are between threshold parameters. Any values beyond threshold will be recorded as zero. Threshold feature is not going to give any additional time for recording.

To set-up threshold, follow these steps:

- Set up RMS voltage or current selection box to black with "T" and make sure it is blinking (refer to previous section)
- Push **SET** button
- Press **ZERO** button to clear previous or current set-up of LO or HI bounds.
- Using arrow keys set LO (low) and HI (high) parameters of the threshold, RIGHT and LEFT arrows allow you to move between digits. UP and DOWN allows you to enter the values.
- Press OK to enter changes.
- Threshold LO and HI parameters will appear on the screen.

Step 3 - Press **SET SCHEDULE** to access scheduling screen (see drawing on Page 18)

In the scheduling screen there are three different recording variables that the user must set: MODE, RATE AND INTERVAL. Using the arrow keys, you can move between Mode, Rate and Interval.

### MODE

**Normal** - THE DMII will automatically stop when the memory is full.

**Loop** - THE DMII will override previously recorded data except events like:

- |            |           |
|------------|-----------|
| A) max     | D) peak   |
| B) min     | E) energy |
| C) average | F) demand |

These data values are going to be stored even if the DMII starts looping. This feature is very useful if you are interested in recording events. One of the application examples could be recording energy on demand throughout thirty days.

### Total Available Time of Recording

At the bottom section of the screen, you will find information about total available time of recording. The DMII is going to stop recording after this time. Note: It shows you a number of years, months and days before hours, minutes and seconds.

You can change the total time of recording in two ways:

- Changing rate - The lower the rate, the shorter total time of recording. If you record on demand, you will not be able to change the rate.

## ► Record Mode (cont'd.)

- Changing number of parameters selected for recording - The more parameters selected, the shorter the total time of recording.

If you are recording events like max, min, average, peak or energy only, there is no time limit for recording. The total length of recording for all parameters will be shown as zeros on the screen.

**RATE** - The recording rate is how often the DMII is going to record data. For example, within a 15 second rate, the device is going to record once every 15 seconds. The rate affects the total available time of recording. Please refer to the section "Total Available Time of Recording" for details.

You can select rate only if **INTERVAL** is set-up to **NONE**. Otherwise the rate will be locked to one second (refer to Energy on Demand section)

User selectable recording rates:

1 second, 5 seconds, 15 seconds, 30 seconds,  
1 minute, 5 minutes, 15 minutes, 30 minutes.

**INTERVAL** - You should set up **INTERVAL** either to 15 or 30 minutes if you want to measure Energy on Demand. In this case your rate will be locked to one second according to definition. For any other measurements, set-up **INTERVAL** to **NONE**, this allows you to choose one of the available rates on the DMII.

### What is Energy on Demand?

If power plant is not able to supply enough energy for customer using their regular resources, they need to produce energy on demand. The cost for using this energy will be higher than regular. To compute this amount, the power plant measures average power in 15 or 30 minute intervals with a rate of 1 second throughout 30 days time. For their energy cost computations, they take the highest average result.

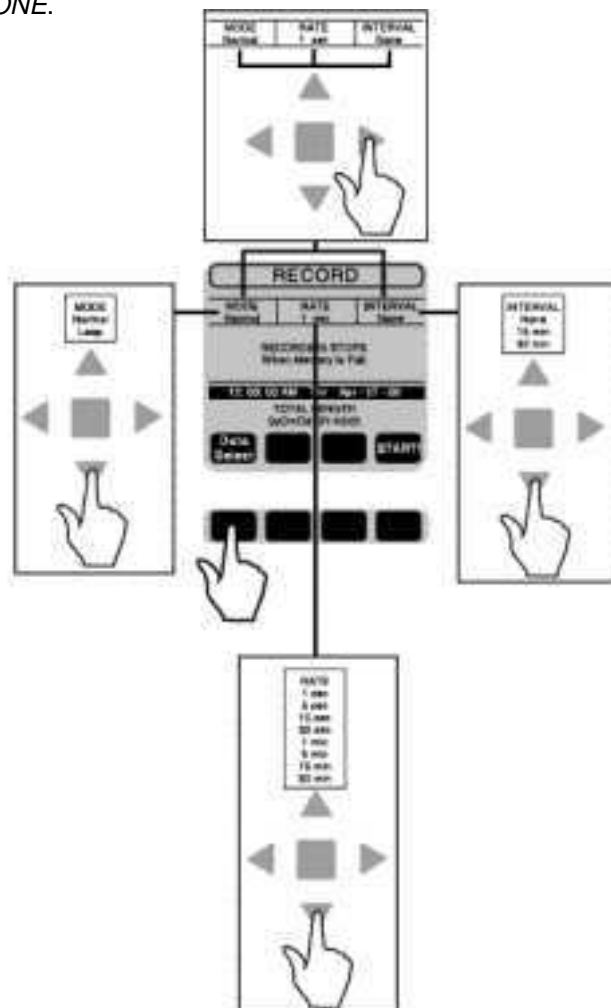

---

---

## ▶ Record Mode (cont'd.)

Step 4 - Start, Stop Recording - Press the **START** button. This will take you to the confirmation screen.

- If you press the **START** button again you will start a recording session.  
**WARNING:** All previously stored data in the memory will be erased. If you want to cancel and return to the *RECORD* selection screen, press **NO** (middle right black button). Previously recorded data will remain in the memory.
- To start a recording session, press **START**. Remember, all previously recorded data will be lost.
- To terminate the recording session, press **STOP** button.

**NOTE: YOU WILL TERMINATE THE RECORDING SESSION BY PRESSING ON/OFF BUTTON.**

At this stage you can view data being recorded by pressing view button. Please refer to the next section on Page 21.

## ► Viewing Data

It is not necessary for you to download to a PC in order to view your recorded data. You have the option of viewing the data directly on the DMII LCD screen. Note that while the data is being recorded, the scroll feature of the charts is not available. All features will be available when the recording session is complete.

Step 1 - To view data, simply push the **VIEW** button.

- A black selection box indicates that the parameter was recorded and can be viewed.
- A blank selection box indicates that the parameter was NOT recorded and cannot be viewed.

Depending on the phase set-up you will see one of the four screens:

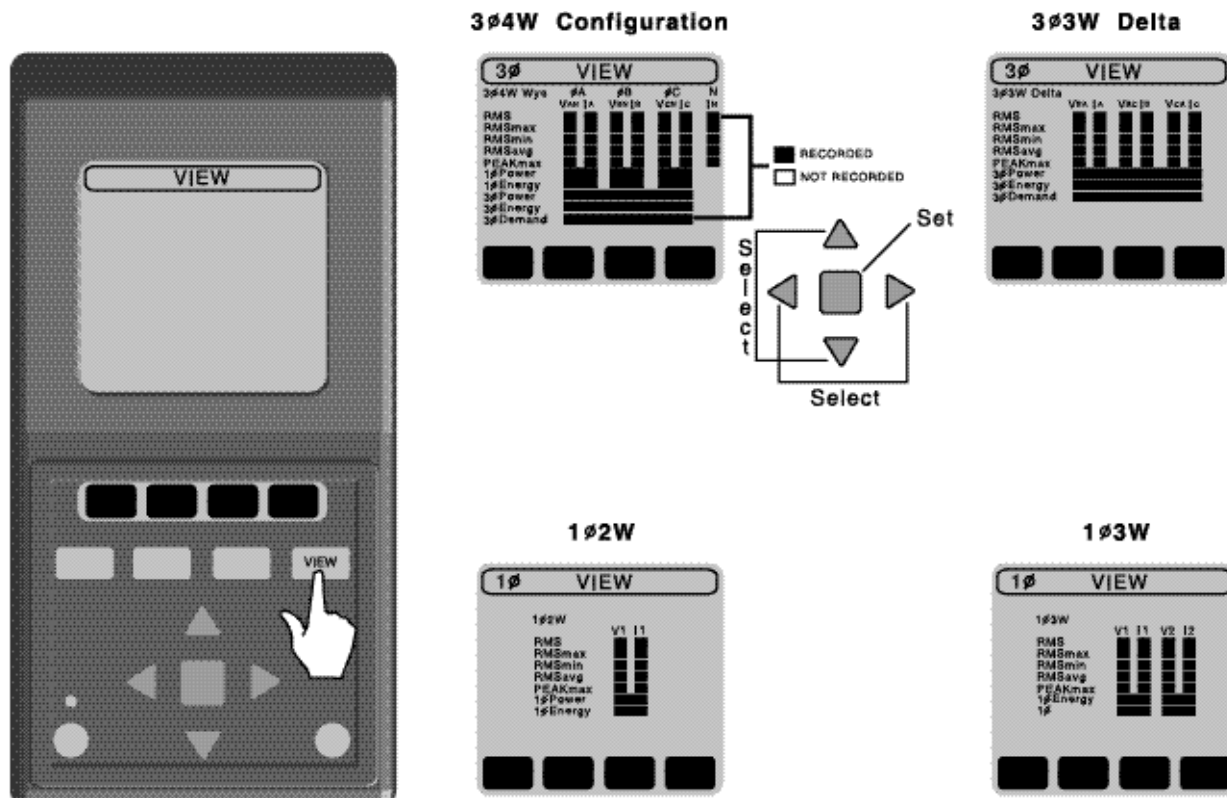

## ► Viewing Data (cont'd.)

**NON DEMAND RECORDING** (interval was set up to NONE)

*Note: If you recorded on-demand (interval was set up to 15 or 30 min.) skip this section and go to the next one.*

To view desired parameter, move blinking cursor to the parameter.

If you selected parameter other than POWER, press **ENTER**.

For events, max, min, ave, peak or energy the numerical value will be displayed.

For example:

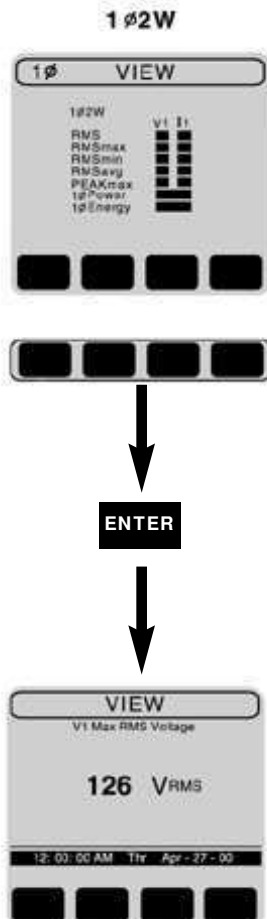

Press **VIEW** button to return to the selection screen.

For RMS value, a chart will be displayed.

For example:

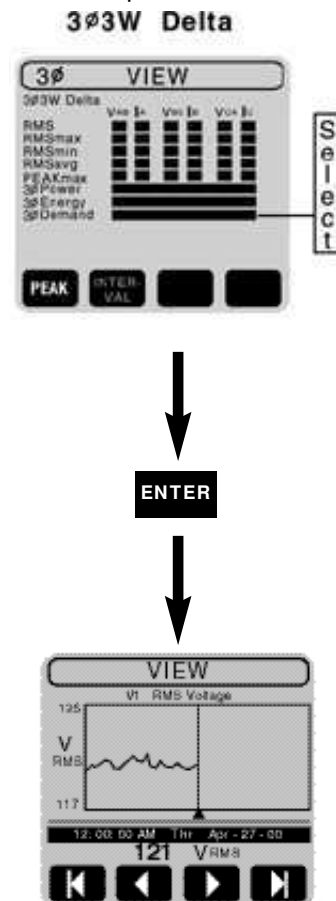

\*You will be able to scroll throughout the chart only if recording was finished.

---

---

## ► Viewing Data

If you selected power, push corresponding black button to view:

P - Real Power  
Q - Reactive Power  
S - Apparent Power  
PF - Power Factor

Press VIEW button to return to the selection screen.

Here is an example for single phase system:

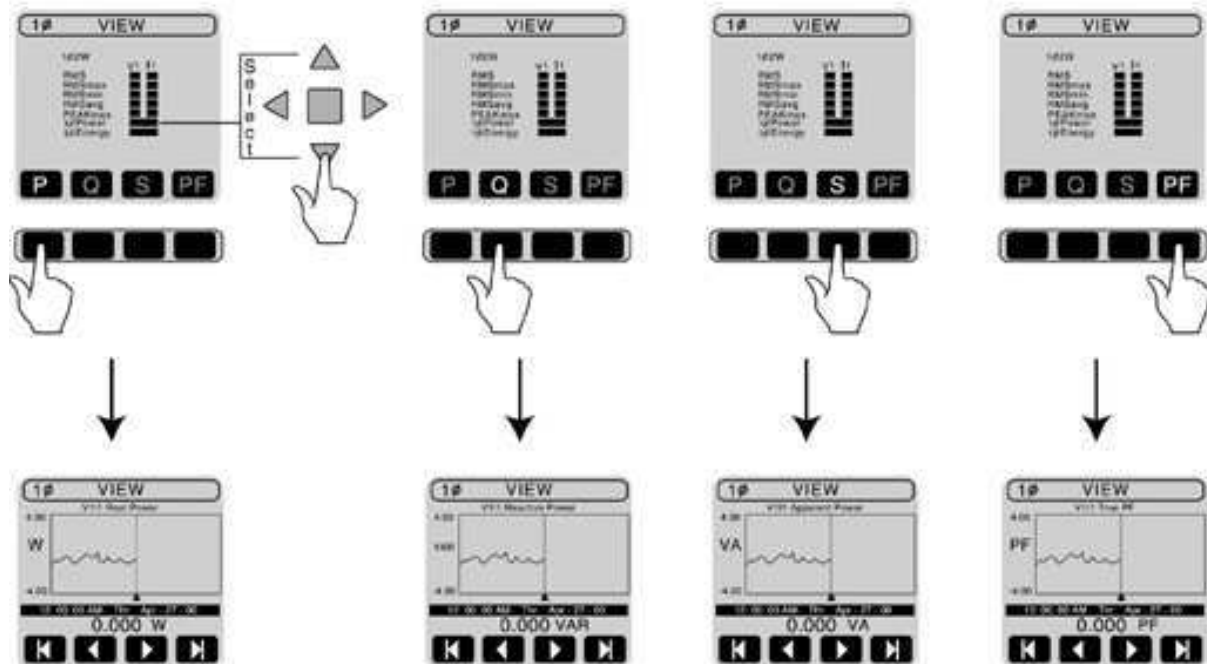

Notice that if you are viewing data while recording, you can't scroll through the data. This feature will be available after the recording is finished.

---

---

## ▶ Viewing Data (cont'd.)

**ON DEMAND RECORDING** (INTERVAL was set-up to either 15 or 20 minutes during recording).

To view desired parameter, move blinking cursor to the parameter.

- If you selected RMS, the chart on Page 21 will be shown.
- If you selected POWER, the parameters are going to be displayed the same way as on Page 22.
- If you selected events, max, min, ave, peak or energy - the total and interval selection is available (explained in the next section).



---

---

## ► Viewing Data (cont'd.)

If you selected DEMAND (available for three phase set-up only), the peak and interval selection is available (explained in the next section).

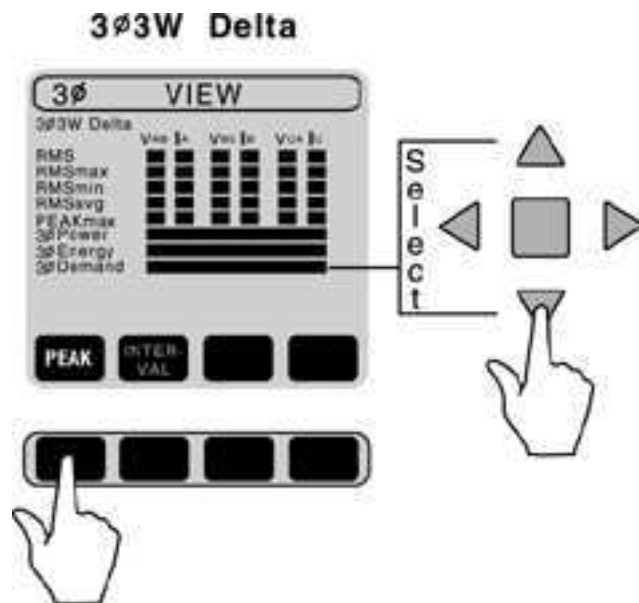



---

---

## ▶ Viewing Data (cont'd.)

Total will show the event value for entire recording session (this value is NOT GOING to be overwritten if the DM-II is looping)

### TOTAL (EVENT)

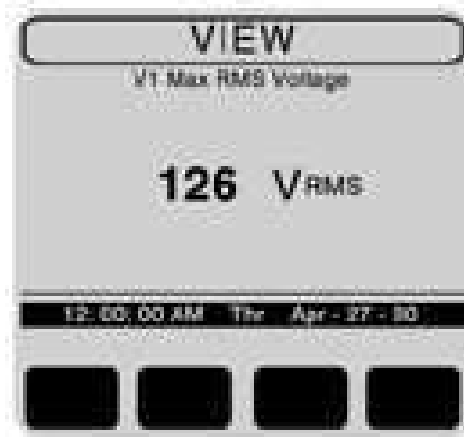

Interval - Points on the graph represent event values for each of the time intervals (these values ARE going to be overwritten if the DM-II starts looping).

### INTERVAL

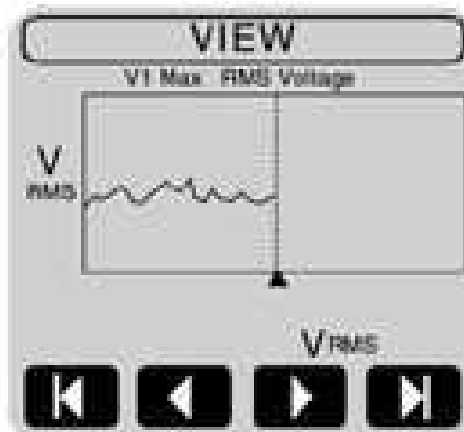

---

---

## ▶ Viewing Data (cont'd.)

DEMAND - will show the Peak Demand for entire recording session (this value is not going to be overwritten if the DM-II starts looping). For Peak Demand definition, refer to Page 18 "What is Energy on Demand?"

---

---

## ► Symbols & Definitions of Terms Used on the DM-II

### SYMBOLS AND DEFINITIONS OF TERMS USED ON THE DM-II

<b>V</b>	(V)	- Voltage RMS
<b>I</b>	(A)	- Current RMS
<b>S</b>	(VA)	- Apparent Power
<b>P</b>	(W or kW)	- Working Power
<b>Q</b>	(VAR)	- Reactive Power
<b>PF</b>		- Power Factor

#### **RMS**

Root mean square value, which is the effective value of an alternating current or voltage. Unless otherwise specified, the AC values are always RMS i.e. the typical receptacle is 110V RMS.

#### **RMS max**

Greatest, maximum value of the RMS voltage or current which occurred during the recording time.

#### **RMS min**

Lowest, minimum value of the RMS voltage or current which occurred during the recording time.

#### **RMS avg**

Average RMS value of voltage or current, which is a sum of all RMS measured values divided by the number of values

#### **PEAK max**

The greatest instantaneous value of voltage or current (the highest point of the sinusoid)

#### **1 $\emptyset$ Power**

Power in the selected phase

#### **1 $\emptyset$ Energy**

Energy in the selected phase

#### **3 $\emptyset$ Power**

Total power in all phases

#### **3 $\emptyset$ Energy**

Total energy in all phases

#### **3 $\emptyset$ Demand**

The highest average usage of energy during 15 or 30 minute intervals throughout 30 day period of time.

#### **V<sub>AN</sub>, V<sub>AB</sub>**

Letters used in a subscript describe what are the reference points for measurement i.e. V<sub>AN</sub> - Voltage between phase A and Neutral wire, V<sub>AB</sub> - Voltage between phase A and B.

## DM-II™ Fuse Replacement/Voltage Selection Procedure

**True RMS Voltage and Current (volts and amps):** True RMS is calculated by using Parseval's theorem:

$$V_{rms} = \sqrt{\sum_n V_n^2} \quad I_{rms} = \sqrt{\sum_n I_n^2}$$

**Real Power P (watts):** The real power that performs the work of creating heat, light, motion, machine output, etc.

$$P = \sum_n V_{rms_n} I_{rms_n} \cos(\theta_{DIFF_n})$$

**Apparent Volt-Amperes S (VA):** The total power required to be generated to provide the desired working power output.

$$S = V_{rms} I_{rms}$$

**Reactive Volt-Amperes Q (VAR):** The “non-working” or “phantom” power that is needed to charge capacitors and magnetize inductors, i.e. reactive power to sustain electromagnetic fields.

$$Q = \sum_n V_{rms_n} I_{rms_n} \sin(\theta_{DIFF_n})$$

**True Power Factor PF:** The ratio of working power or Real Power, P, to Apparent Power, S. It measures how effectively electrical power is being used by the system. The Displacement Power Factor has traditionally been calculated by examining the phase angle between the fundamental voltage and current and is equal to  $\cos(\theta)$ . This traditional method only works for linear, sinusoidal systems. The DM-II™, however, calculates the True Power Factor, which also works for non-linear, non-sinusoidal systems.

$$PF = \frac{P}{S}$$

Power factor can be leading or lagging, depending on the sign of the reactive Volt-Amperes Q (VAR). The following table summarizes:

<u>Power Factor</u>	<u>Sign of Q</u>	<u>Type of Load</u>	<u>Current/Voltage Relationship</u>
Lagging	Positive	Inductive	Current Lags Voltage
Leading	Negative	Capacitive	Current Leads Voltage

### **DM-II™ Total Power Quantities (P, Q, S, PF) for 3Ø Systems**

3Ø 3W Delta and 3Ø 4W Wye configurations include total calculations for P, Q, S, and PF, based upon the following formulas.

Total Power,  $P_{Total}$ :

$$P_{Total} = P_{\phi A} + P_{\phi B} + P_{\phi C}$$

Total Reactive Volt-Amperes,  $Q_{Total}$ :

$$Q_{Total} = Q_{\phi A} + Q_{\phi B} + Q_{\phi C}$$

Total Apparent Volt-Amperes,  $S_{Total}$ :

$$S_{Total} = \sqrt{P_{Total}^2 + Q_{Total}^2}$$

Total Power Factor,  $PF_{Total}$ :

$$PF_{Total} = \frac{P_{Total}}{S_{Total}}$$

## ► Battery Replacement

Step 1 - Remove the battery cover by turning the two cover screws 3/4 turn counter clockwise.

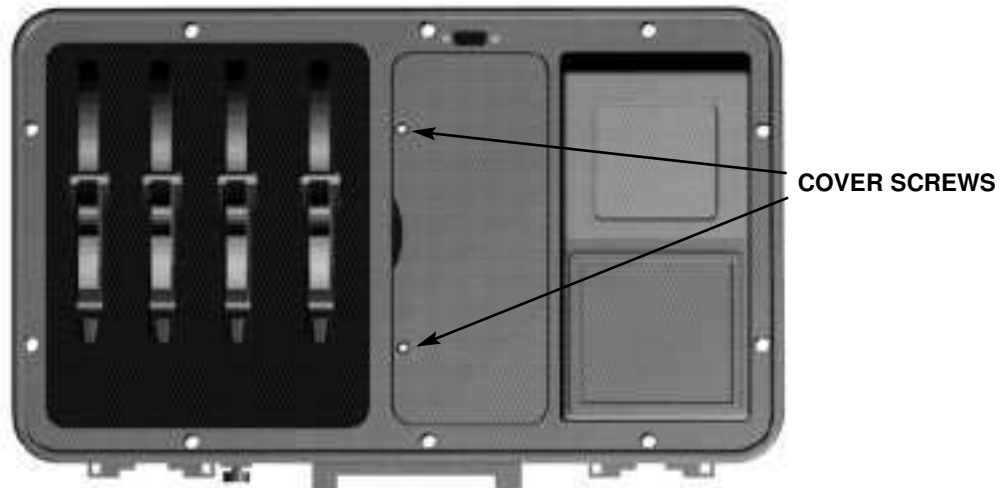

Step 2 - Remove batteries from battery compartment.

Step 3 - Install new batteries. Use six "D" size alkaline batteries. Always replace all six batteries at the same time. observe polarity symbols on battery holder.



Step 4 - Replace battery cover and tighten two lid cover screws.



**To set voltage selection switch:**

1. Disconnect the power cord from the power entry module.
2. Use a small screwdriver to open the fuse compartment door. Remove the drawer by pulling it out of the power entry module.
3. Rotate the fuse holder so that the desired voltage setting is aligned with the window. Slide the fuse holder back into the compartment until it snaps into place.
4. Snap the fuse compartment door back into place.

**Fusing:**

The fuse holder accepts the 0.25A@250V 1/4" 1/4" x 1-1/4" 5 x 20mm fuse.

**WARNING: For continued protection against fire hazard, replace only with the same type and rating of fuse as specified.**

# MODEL DM-II™

## Data Logger/Recorder

### Specifications

#### Inputs:

**Voltage:** Three voltage channels with common (V1, V2, V3, and COM). The test leads are flexible straight sheathed banana plugs on each end, rated for 1000Vrms and a length of 6 Ft. (set of four supplied). The alligator clips have a 1 in. jaw opening and are rated at 10A max. (set of four supplied).

**Current:** Four channels (I1, I2, I3, I4)  
DM-CT: 1 to 1000A ±1% of reading (four supplied)  
ACF-3000:

30A to 300A ±1% of full scale

300A to 3000A ±1% of full scale

Note: The ACF-3000 is an optional accessory. A total of three would be required for a 3Ø measurement.

#### Ranges:

AC Voltage measurements (True RMS) 5 to 600 Vrms

AC Current measurements (True RMS) 1 to 1000 Arms with four supplied DM-CTs

#### Accuracy:

Voltage measurements ±1% of reading + 3 LSDs

Current measurements ±1% of reading + 3 LSDs

#### Voltage and Current measurement selections:

True RMS voltage and current, RMS max, RMS min, RMS avg, Peak max

#### Power measurement capabilities:

Real power P (watts), Apparent Volt-amperes S (VA),

Reactive Volt-amperes Q (VAR), True Power Factor (tPF),

#### Energy measurement capabilities:

Kilowatt Hours (KWH), Demand (KW)

#### Programmable Thresholds:

User selectable high/low limits for RMS voltage and current

#### Recording Modes/Rates/Intervals:

User selectable normal and loop (wrap around) recording modes, user selectable recording rates of 1 second, 5 seconds, 15 seconds, 30 seconds, 1 minute, 5 minutes, 15 minutes, and 30 minutes. User selectable recording intervals of none, 15 minutes, and 30 minutes.



## MODEL DM-II™ PRO Data Logger/Recorder (cont'd)

### Memory:

Total of 600K RAM memory. The recording session length depends on the recording rate, the number of parameters selected for recording, recording mode, and recording interval. The memory has a lithium backup battery to preserve its contents in event of the absence of AC power and batteries.

### Real Time Clock:

User programmable real time clock, displayed in 12/24 hour format and HH:MM:SS Day Month Date Year, daylight savings option, accuracy of ±1 minute per month.

### System Configuration:

Total of four prestored setup phase configurations for 1Ø and 1Ø systems: 1Ø 2W, 1Ø 3W, 3Ø 3W Straight Delta, and 3Ø 4W Wye.

Note: Any or all parameters of a phase configuration can be recorded.

### PC Interface:

Optically isolated RS-232 serial interface. DM-II View™ PRO software for display, data analysis, and report generation. User selectable baud rates of 9600, 19200, and 38400 baud.

### Power Requirements:

AC line voltage with battery backup operation. The ON/OFF dual color LED indicates the unit's power source: green indicates AC line power, red indicates battery power.

### Safety Standards:

Designed to meet: UL3111-1, CE (LVD/EMC/EMI)

### Case:

Material: Injection molded flame retardant ABS911, rugged, water-resistant, and corrosion proof.

Case dimensions: 17.5" x 11.6" x 7.5"

Weight: 16 lbs. (7.3 kgs.) includes batteries, 4 CTs, voltage leads and alligator clips.

Important - Be sure that the pressure relieve valve located next to the handle is open when encountering atmospheric changes.

### Battery:

Six alkaline "D" cells (not supplied)

### Battery Life:

21 hours continuous with backlight OFF, 1 second recording rate, normal recording mode, all parameters elected for a 3Ø 4W Wye configuration.

### Operating Temperature Range:

32° - 122°F (0°F - 50°C), Relative humidity <85%

### Storage Temperature Range:

28° - 140°F (-2°F - 60°C), Relative humidity <90%

## **User Interface**

### **Graphic Display:**

User adjustable contrast, LED backlight, 160 x 160 pixel, STN

### **Switch Keypad:**

15 key membrane switch keypad, shielding protection, embedded dual color red/green LED indicating power from line voltage or from batteries.

### **System Requirements for DM-II View™ PRO**

Windows™ 95/98/NT/2000

Pentium Processor or higher

8 MB RAM minimum, 16 MB recommended

## **ACCESSORIES & REPLACEMENTS**

Test Leads & Alligator Clips (set of four)	DVL-4
Current Transducer (Black)	DM-CT-BL-CE
Current Transducer (Red)	DM-CT-R-CE
Current Transducer (Blue)	DM-CT-B-CE
Current Transducer (Yellow)	DM-CT-Y-CE
Output Lead	RS-232
Power Cord	PC-4
DM-II View™ PRO 3.5" Discs (set of 2)	DISC-II
Flexible Current Transducer (3000 Amps)	ACF-3000 DM
DM-II™ PRO Instruction Manual	
DM-II View™ PRO Instruction Manual	





Telephone: 305-757-8811 Fax: 305-757-2153  
[www.amprobe.com](http://www.amprobe.com)