

Agilent U3606A Multimeter | DC Power Supply

Quick Start Guide



Agilent Technologies

Notices

© Agilent Technologies, Inc., 2009, 2010

No part of this manual may be reproduced in any form or by any means (including electronic storage and retrieval or translation into a foreign language) without prior agreement and written consent from Agilent Technologies, Inc. as governed by United States and international copyright laws.

Manual Part Number

U3606-90002

Edition

Second Edition, March 31, 2010

Agilent Technologies, Inc.
5301 Stevens Creek Blvd.
Santa Clara, CA 95052 USA

Warranty

The material contained in this document is provided “as is,” and is subject to being changed, without notice, in future editions. Further, to the maximum extent permitted by applicable law, Agilent disclaims all warranties, either express or implied, with regard to this manual and any information contained herein, including but not limited to the implied warranties of merchantability and fitness for a particular purpose. Agilent shall not be liable for errors or for incidental or consequential damages in connection with the furnishing, use, or performance of this document or of any information contained herein. Should Agilent and the user have a separate written agreement with warranty terms covering the material in this document that conflict with these terms, the warranty terms in the separate agreement shall control.

Technology Licenses

The hardware and or software described in this document are furnished under a license and may be used or copied only in accordance with the terms of such license.

Restricted Rights Legend

U.S. Government Restricted Rights. Software and technical data rights granted to the federal government include only those rights customarily provided to end user customers. Agilent provides this customary commercial license in Software and technical data pursuant to FAR 12.211 (Technical Data) and 12.212 (Computer Software) and, for the Department of Defense, DFARS 252.227-7015 (Technical Data - Commercial Items) and DFARS 227.7202-3 (Rights in Commercial Computer Software or Computer Software Documentation).

Safety Notices

CAUTION





A **CAUTION** notice denotes a hazard. It calls attention to an operating procedure, practice, or the like that, if not correctly performed or adhered to, could result in damage to the product or loss of important data. Do not proceed beyond a **CAUTION** notice until the indicated conditions are fully understood and met.

WARNING

A **WARNING** notice denotes a hazard. It calls attention to an operating procedure, practice, or the like that, if not correctly performed or adhered to, could result in personal injury or death. Do not proceed beyond a **WARNING** notice until the indicated conditions are fully understood and met.

Safety Symbols

The following symbols on the instrument and in the documentation indicate precautions which must be taken to maintain safe operation of the instrument.

	Direct current (DC)		Alternating current (AC)
	Both direct and alternating current		Caution, risk of danger (refer to this manual for specific Warning or Caution information)

Environmental Conditions

This instrument is designed for indoor use and in an area with low condensation. The table below shows the general environmental requirements for this instrument.





Environmental conditions	Requirements
Operating temperature	0 °C to 55 °C
Storage temperature	-40 °C to 70 °C
Relative humidity	Up to 80% at 30 °C RH (non-condensing)

NOTE

The U3606A Multimeter | DC Power Supply complies with the following safety and EMC requirements:

- IEC 61010-1:2001/EN61010-1:2001 (2nd Edition)
- Canada: CAN/CSA-C22.2 No. 61010-1-04
- USA: ANSI/UL 61010-1:2004
- IEC 61326-1:2005/EN61326-1:2006
- CISPR11:2003/EN55011:2007, Group 1 Class A
- Canada: ICES/NMB-001:2004
- Australia/New Zealand: AS/NZS CISPR 11:2004

Regulatory Markings

 <p>ISM 1-A</p>	<p>The CE mark is a registered trademark of the European Community. This CE mark shows that the product complies with all the relevant European Legal Directives.</p>	 <p>N10149</p>	<p>The C-tick mark is a registered trademark of the Spectrum Management Agency of Australia. This signifies compliance with the Australia EMC Framework regulations under the terms of the Radio Communication Act of 1992.</p>
<p>ICES/NMB-001</p>	<p>ICES/NMB-001 indicates that this ISM device complies with the Canadian ICES-001. Cet appareil ISM est conforme a la norme NMB-001 du Canada.</p>		<p>This instrument complies with the WEEE Directive (2002/96/EC) marking requirement. This affixed product label indicates that you must not discard this electrical or electronic product in domestic household waste.</p>
 <p>C US</p>	<p>The CSA mark is a registered trademark of the Canadian Standards Association.</p>		

Additional Safety Information

For further information on safety, refer to the *U3606A User's and Service Guide*.

Contents

Introduction	1
The Front Panel at a Glance	2
The Display at a Glance	3
Connect the Power Cord	4
Adjust the Carrying Handle	5
Connect the Test Leads to the Terminals	6
Input terminal connections	6
Output terminal connections	7
Power-on the U3606A	8
Select a Function	9
Using the utility menu	10
Digital multimeter functions	11
DC power supply functions	17
Where to Go Next?	25
User references	25
Agilent support and contact information	25

1 Introduction



The Agilent U3606A Multimeter | DC Power Supply unit is a combination of a 5½ digit, 120000 count digital multimeter and a 30 W DC power supply with a square-wave generator, that is able to work simultaneously and independently.

As a digital multimeter, the U3606A is capable of making DC voltage, AC voltage, AC+DC voltage, DC current, AC current, AC+DC current, 2-wire resistance, 4-wire low-resistance, capacitance, frequency, duty cycle, and pulse width measurements. It is also capable of performing audible continuity and diode tests. The U3606A supports the following mathematical operations: null, decibel display, statistics, limit, and hold.

As a DC power supply, the U3606A is able to supply a 30 W DC output with two selectable ranges: S1 (30 V/1 A) and S2 (8 V/3 A). It is capable of generating 30 V square waves (up to 4.8 kHz) for digital circuit troubleshooting. The U3606A also supports ramp and scan capability.

This quick start guide aims to provide a quick approach to setting up the U3606A for making measurements and supplying power.

2 The Front Panel at a Glance

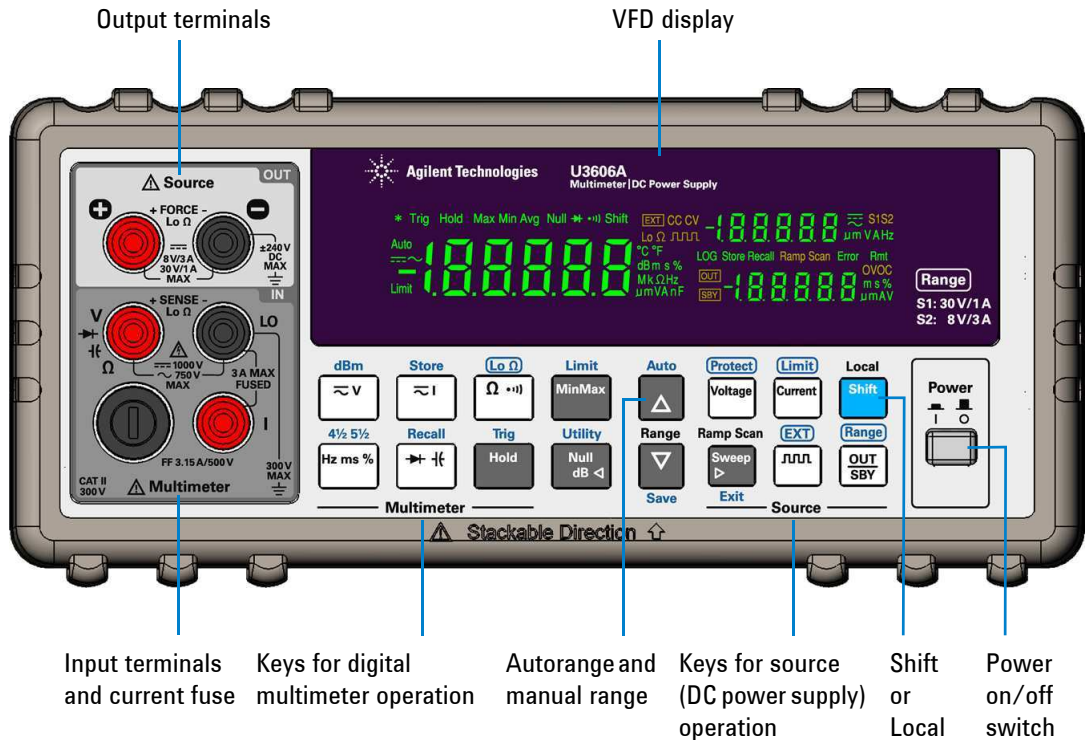

For a complete list of all the keypad functions and descriptions, see *Chapter 1, “Getting Started”* in the *U3606A User’s and Service Guide*.

The front panel has two rows of keys to select various functions and operations. Most keys have a *shifted* function printed in **blue** above the key. To perform a shifted function: first, press **Shift** (the Shift annunciator will illuminate). Then, press the key that has the desired label above it.

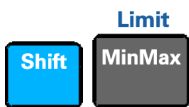

As an example, the limit math operation is *shifted* (shown in **blue**). To enable the limit math operation, press **Shift** > **Limit**. If you accidentally press **Shift**, but do not want to perform a shifted function, just press it again to turn off the Shift annunciator.

3 The Display at a Glance

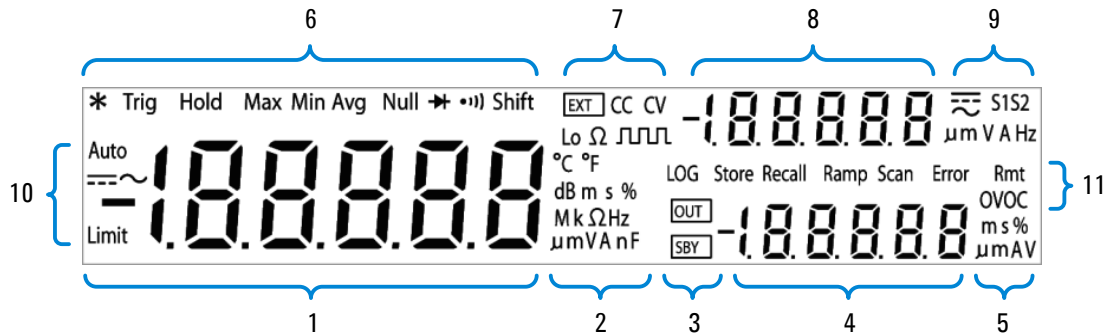

Description

1	Primary display for digital multimeter measurements
2	Measurement functions and units
3	OUT and SBY annunciators
4	Secondary display for source operations (lower secondary display)
5	Source functions and units
6	Trigger, hold, statistics, null, diode, audible continuity, and shift annunciator
7	Source operations, Lo Ω annunciator
8	Primary display for source operations (upper secondary display)
9	Calibration and source functions and units, S1 and S2 range annunciators
10	Autoranging, AC, DC, and limit annunciator
11	Log (feature currently not applicable for the U3606A), store, recall, ramp, scan, error, remote, and over-voltage/over-current annunciator

For a complete list of all the annunciator descriptions, see *Chapter 1, "Getting Started"* in the *U3606A User's and Service Guide*.

4 Connect the Power Cord

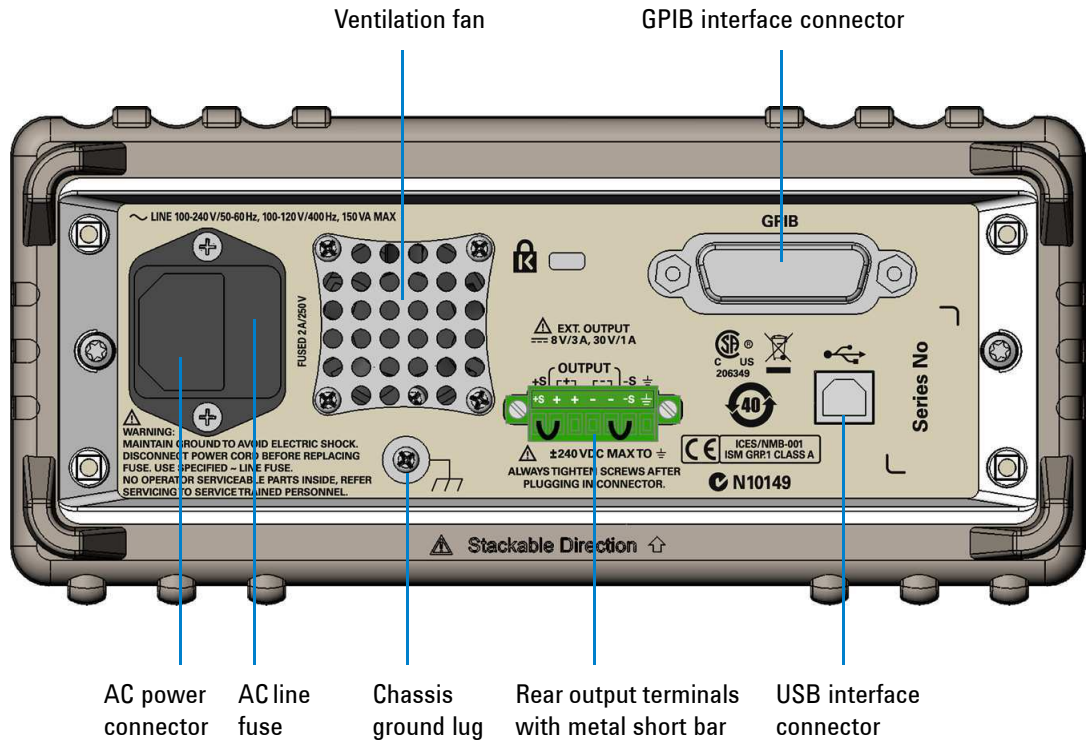

Connect the power cord to the AC power connector. The mains plug should only be inserted in a socket outlet that provides protective earth contact.

WARNING

Any interruption of the protective earth contact inside or outside the instrument makes any operation of the instrument dangerous. Intentional interruption is prohibited.

CAUTION

The U3606A is grounded only when the power-line cord is plugged into an appropriate receptacle. Do not operate your instrument without adequate ground connection.

5 Adjust the Carrying Handle

To adjust the handle, grasp the handle by the sides and pull outward. Then, rotate the handle to the desired position. The various positions available are illustrated below.

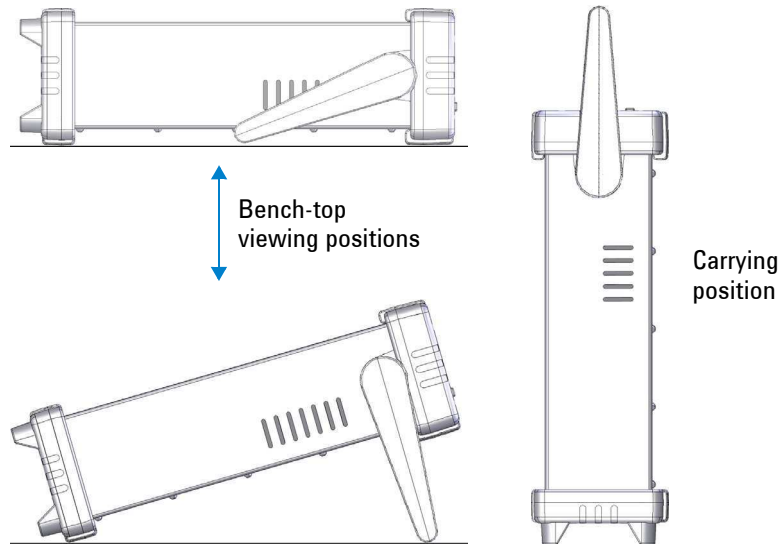

6 Connect the Test Leads to the Terminals

Input terminal connections

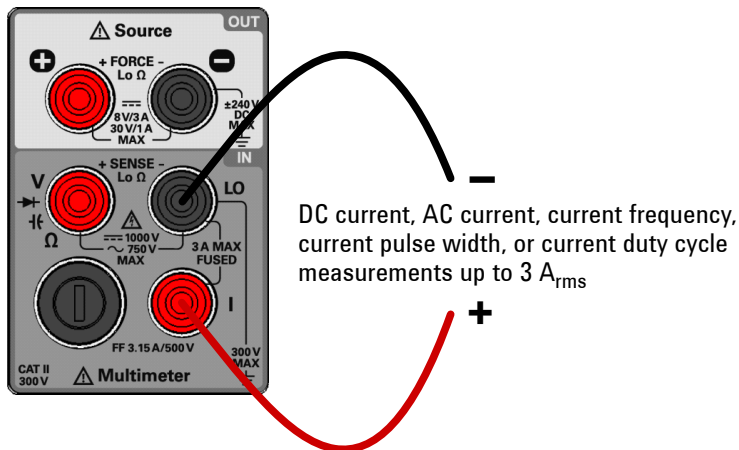
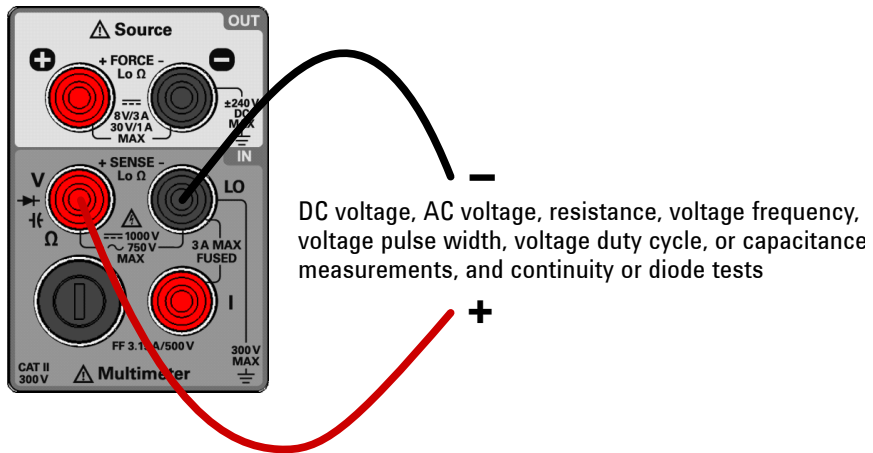

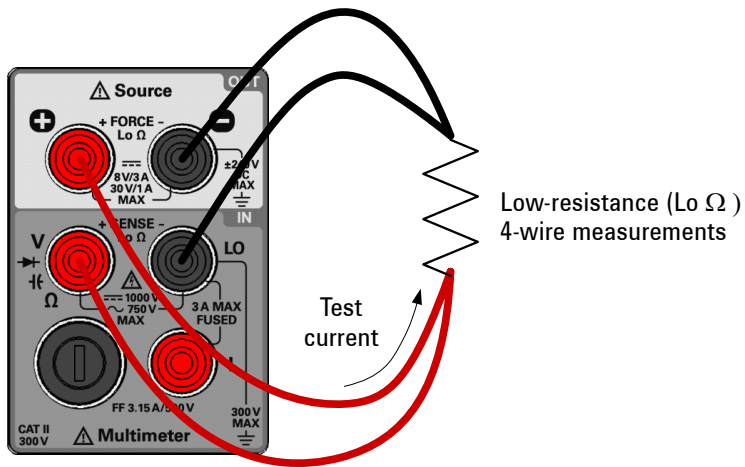

NOTE

For low-resistance ($Lo \Omega$) measurements, current is sourced from the + FORCE – terminals and measured from the + SENSE – terminals.

Output terminal connections

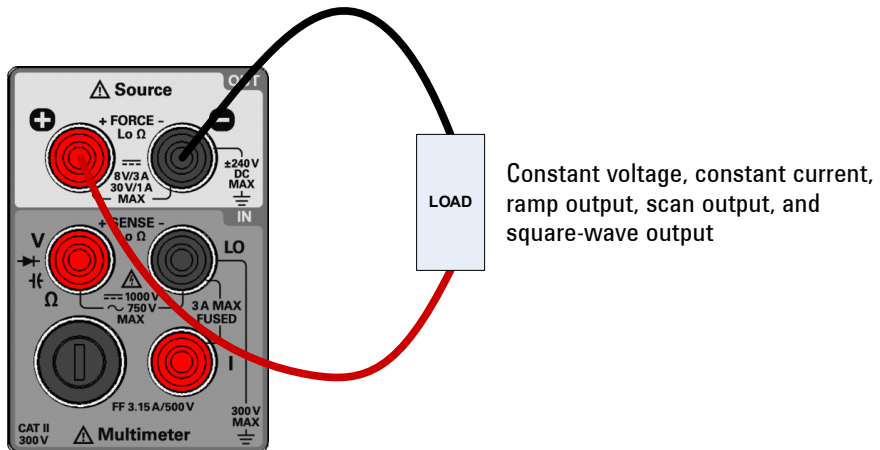

7 Power-on the U3606A

To turn on the U3606A push the power switch:



The front panel display illuminates while the U3606A performs its power-on self-test. (If the U3606A does not power-on, refer to “*Operating Checklist*” in the *U3606A User’s and Service Guide*). If self-test is successful, the U3606A goes into normal operation.

The U3606A powers up in the following modes when turned on for the first time:

- DC voltage measurement function with autoranging enabled, and
- Constant voltage (CV) mode with the output disabled (on standby).



NOTE

For subsequent power cycles, the U3606A returns to the last power-off state (when power is applied) by default. You can change this behavior in the utility menu. See *Chapter 4, “System Related Operation”* in the *U3606A User’s and Service Guide* for more details on changing the instrument power-on setting.

CAUTION

- If the self-test is unsuccessful, Error is displayed on the right side of the display. To read the error number, you will need to access the utility menu. Press **Shift** > **Utility** to access the utility menu.
- See “*Reading error messages*” in the *U3606A User’s and Service Guide* for more information. In the unlikely event that the self-test repeatedly fails, contact your nearest Agilent Sales Office.

8 Select a Function

The U3606A Multimeter|DC Power Supply has two main features: a digital multimeter, and a DC power supply with a square-wave generator, working simultaneously and independently.

- For a quick glance at measurement functions and math operations, see [“Digital multimeter functions”](#) on page 11.
 - See also [“Setting the range”](#) on page 12
 - See also [“Setting the resolution”](#) on page 12
 - See also [“Using math operations”](#) on page 13

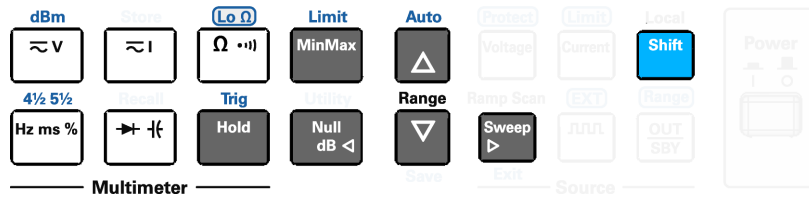

- For a quick glance at source operations and output functions, see [“DC power supply functions”](#) on page 17.
 - See also [“Generating square waves”](#) on page 17
 - See also [“Using sweep functions”](#) on page 18
 - See also [“Implementing protection features”](#) on page 20
 - See also [“Setting the range”](#) on page 21
 - See also [“Enabling the output”](#) on page 21

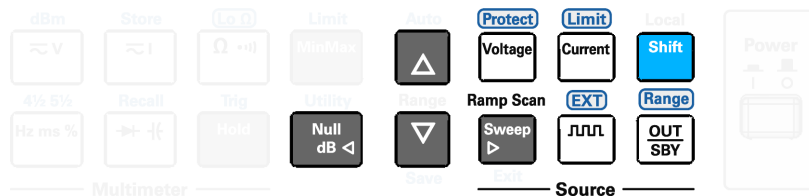











For detailed information on the various operations and functions of the U3606A, see the *U3606A User's and Service Guide*.

Using the utility menu

You can define and modify various settings in the U3606A. Modifying these settings affects the operation of your instrument across several functions.

Select a setting that you want to edit to do the following:

- Switch between two values, such as on or off,
- Select a value from the list, or
- Decrease or increase a value by using the directional keys.







Key	Description
 	Press Shift > Utility to access the utility menu.
 	Press Null dB or Sweep to step through the menu items.
 	Press Up or Down to switch between two values, to select a value from the list, or to decrease or increase a value.
 	Press Shift > Save to save a setting.
 	Press Shift > Exit to exit the edit mode without saving or to exit the utility menu.

NOTE

For more information on the various settings available in the utility menu, see *Chapter 4, "System Related Operation"* in the *U3606A User's and Service Guide*.

Digital multimeter functions

To make basic measurements, the test leads must be connected to the instrument following the input terminal connections shown in “[Connect the Test Leads to the Terminals](#)” on page 6. Most basic measurements can be made with the factory default settings.

Key	Description
	Press $\approx V$ to cycle between the DC, AC, and AC+DC voltage measurement functions.
	Press $\approx I$ to cycle between the DC, AC, and AC+DC current measurement functions.
	Press $\Omega \dots$ to select the resistance (2-wire) measurement function. Press $\Omega \dots$ again to select the continuity test function.
	Press Hz ms % to cycle between the frequency (Hz), pulse width (ms), and duty cycle (%) measurement functions related to the voltage or current path. ^[1]
	Press $\rightarrow \text{diode}$ to select the diode test function. Press $\rightarrow \text{diode}$ again to select the capacitance measurement function.
 	Press Shift > Lo Ω to select the low-resistance (4-wire) measurement function.





[1] The voltage path is the default path when you select the frequency measurement function. To switch to the current path for frequency, pulse width, and duty cycle measurements, first press $\approx I$, then press **Hz ms %**.

CAUTION

Ensure that the terminal connections are correct for the measurement function selected before making any measurements. To avoid damaging the device, do not exceed the rated input limit.



Setting the range

For most measurement functions, you can allow the U3606A to automatically select the range using autoranging, or you can select a fixed range using manual ranging.

Key	Description
	Press Δ to select a higher range and disable autoranging.
Range 	Press ∇ to select a lower range and disable autoranging.
 	Press Shift > Auto to enable autoranging and disable manual ranging.

Setting the resolution

You can select either 4½ digit or 5½ digit resolution for most measurement functions. 5½ digit resolutions have the best accuracy and noise rejection. 4½ digit resolutions provide for faster reading rates.











Key	Description
 	Press Shift > 4½ 5½ to toggle between 4½ digit and 5½ digit mode.

NOTE

The continuity and diode test functions have a fixed 4½ digit resolution. Capacitance measurement is fixed to 3½ digit resolution.

Using math operations

The U3606A provides six math operations: null measurements, dB measurements, dBm measurements, statistics (MinMax) for accumulated readings, limit testing, and a hold function.

Key	Description
	Press Null to enable the null math operation.
 	Press Shift > dBm to convert the measured voltage value to dBm.
  	Press Shift > dBm > dB to convert the measured voltage value to dB.
	Press MinMax to store statistical data for the current readings.
 	Press Shift > Limit to enable the limit math operation.
	Press Hold to capture and hold a reading within the specified variation and threshold values. ^[1]

[1] The refresh hold variation and threshold values can be configured through the utility menu. See *Chapter 4, "System Related Operation"* in the *U3606A User's and Service Guide* for more information on the utility menu.

NOTE

- All math operations can be toggled on or off by pressing **Shift** > **Exit**.
- See *"Math Operations"* in the *U3606A User's and Service Guide* for more information on each math operation.

Measurement example

The null function is commonly used to eliminate the effects of test leads from measurements. This example teaches you how to use the null math operation to increase the accuracy of a 2-wire resistance measurement – by nulling the test lead resistance – in the U3606A Multimeter|DC Power Supply.

- 1 Connect the test leads to the Ω (red) and **L0** (black) input terminals.
- 2 Press $\Omega \cdot \text{Null}$ to select the resistance function.



- 3 Directly contact the ends of the two test leads together, and measure the test lead resistance.

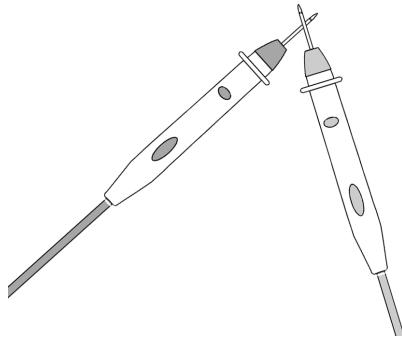

- 4 Press **Null** to enable the null function.



- The Null annunciator will illuminate and the offset value is measured and subtracted from all resistance readings in the measurement display.

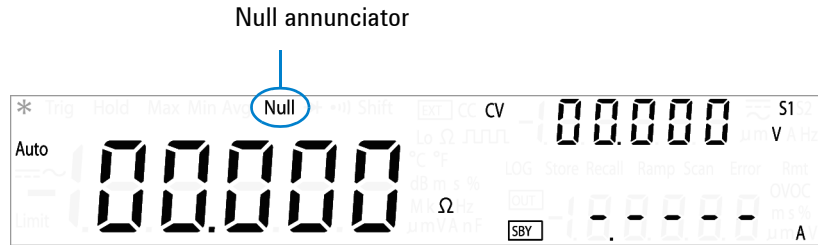

- Press **Null** again to view and edit the offset value.



- The offset value is displayed.

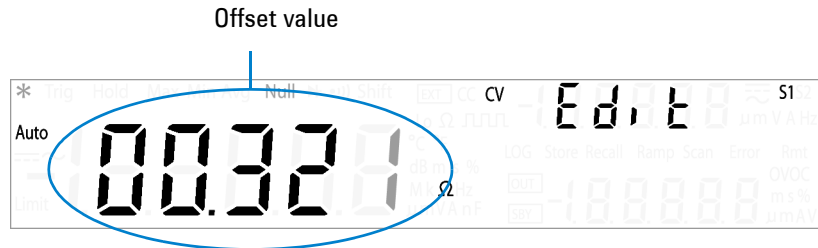

- Use the directional keys if you wish to edit the offset value.

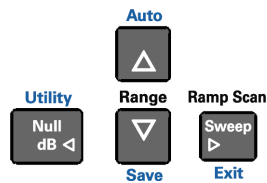

- Press **Shift** > **Save** to save and exit the edit mode. (Or press **Shift** > **Exit** to exit the edit mode without saving.)



- 10 You can now perform 2-wire resistance measurements without the effects of the test leads used.

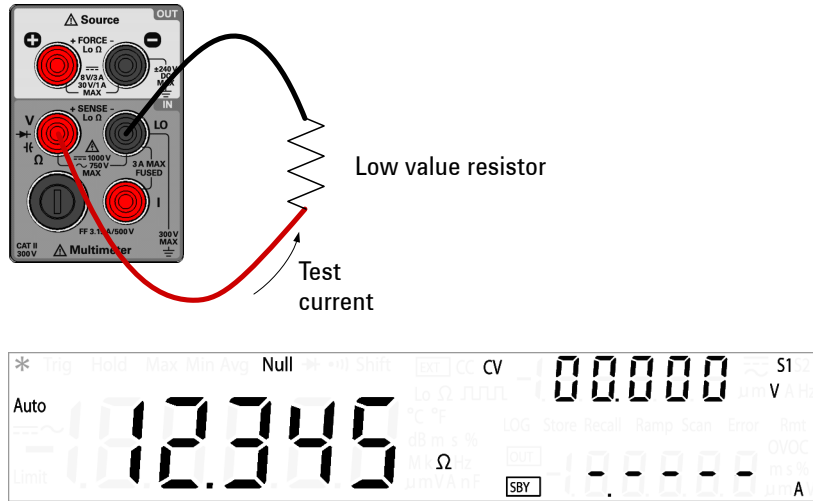



NOTE

For complete instructions on all measurement functions and math operations, see *Chapter 2, "Digital Multimeter Operation"* in the *U3606A User's and Service Guide*.









DC power supply functions

The U3606A has two basic operating DC power supply modes: constant voltage (CV) and constant current (CC).

Key	Description
	Press Voltage to select CV output. Use the directional keys to select a suitable voltage value.
	Press Current to select CC output. Use the directional keys to select a suitable current value.

Generating square waves

The U3606A is capable of generating up to 4.8 kHz square waves for digital circuit troubleshooting.

Key	Description
	Press  to select the square-wave output. Use the directional keys to set the voltage amplitude. Press  again to cycle through the duty cycle and pulse width settings.
 	While the  annunciator is flashing, use the ◀ and ▶ keys to step through the available frequencies.
 	While the  annunciator is flashing, use the ▲ and ▼ keys set the voltage amplitude, or to step through the available duty cycle values or pulse width values.

Using sweep functions

The U3606A comes equipped with ramp and scan capability.

- When the ramp function is enabled, the Ramp annunciator will illuminate.
- When the scan function is enabled, the Scan annunciator will illuminate.

Key	Description
Ramp Scan 	Press Sweep to cycle through the ramp and scan sweep functions, or to disable the sweep mode for the selected output (CV or CC). ^[1]

[1] The sweep functions can only be accessed when the U3606A is in constant voltage or constant current mode. You cannot access the sweep functions while the U3606A is in square-wave output mode.

Editing the ramp signal properties:

- 1 To edit the properties of the ramp signal, you will need to access the utility menu. Press **Shift** > **Utility** to access the utility menu.
- 2 Press **◀** or **▶** to step through the menu items until “rAMP” is shown on upper secondary display.
- 3 Use the directional keys to edit the signal properties.

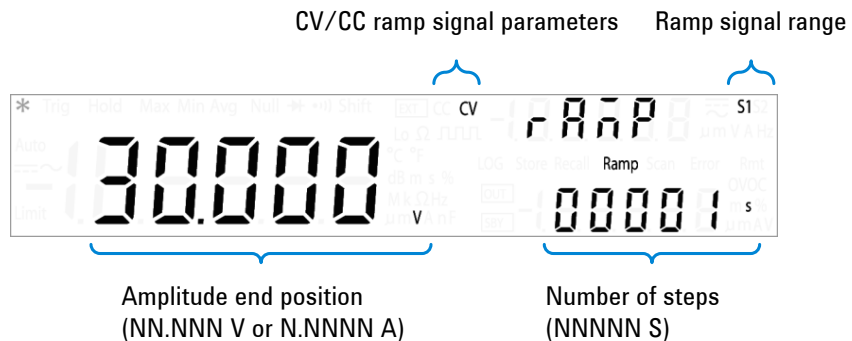

- 4 After configuring the ramp signal parameters, press **Shift** > **Save** to save, and **Shift** > **Exit** to exit the utility menu.

Editing the scan signal properties:

- 1 To edit the properties of the scan signal, you will need to access the utility menu. Press **Shift** > **Utility** to access the utility menu.
- 2 Press **◀** or **▶** to step through the menu items until “SCAN” is shown on upper secondary display.
- 3 Use the directional keys to edit the signal properties.

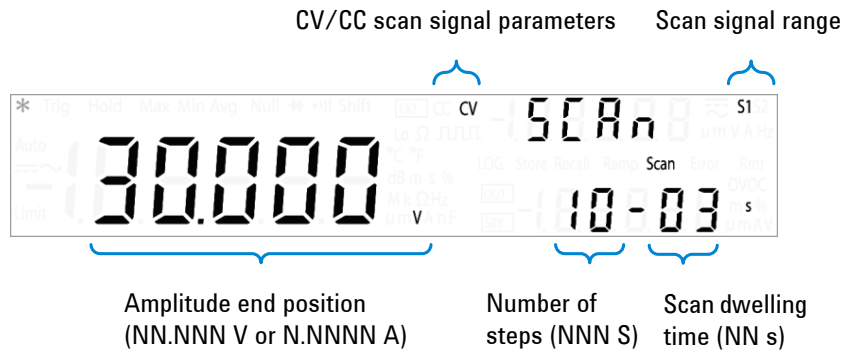

- 4 After configuring the scan signal parameters, press **Shift** > **Save** to save, and **Shift** > **Exit** to exit the utility menu.

NOTE

The ramp and scan signal amplitude end positions are limited by the range (S1 or S2) and output type (CV or CC) selected.





See Chapter 4, “System Related Operation” in the *U3606A User’s and Service Guide* for more information on changing the ramp and scan signal properties.

Implementing protection features

Protection circuits in the U3606A can limit the voltage or current to a preset level or shut down the instrument when an overvoltage or overcurrent condition occurs.

The U3606A has the following protection features:

- Overvoltage limit (OV)
- Overcurrent limit (OC)
- Overvoltage protection (OVP)
- Overcurrent protection (OCP)

Key	Description
 	Press Shift > Limit to set the overcurrent limit value for the CV output or the overvoltage limit value for the CC output.
 	Press Shift > Protect to set the overcurrent protection value for the CV output or the overvoltage protection value for the CC output ^[1] .



[1] Setting the OCP and OVP values will not activate the OCP and OVP protection features. To activate the OCP and OVP protection features, you will need to enable the output protection state from the utility menu. See *Chapter 4, "System Related Operation"* in the *U3606A User's and Service Guide* for more details.

NOTE

The U3606A protection features are set to the maximum protection limits by default. See *Chapter 3, "DC Power Supply Operation"* in the *U3606A User's and Service Guide* for more details.

Setting the range

You can select either the S1 (30 V/1 A) or S2 (8 V/3 A) range for all output operations. The S1 range has a higher voltage range, but a lower current range. The S2 range provides a higher current range, but has a lower voltage range. The S1 or S2 annunciators will illuminate respectively when selected.

Key	Description
 	Press Shift > Range select range S1 (30 V/1 A).
	Press Shift > Range again to select range S2 (8 V/3 A).

NOTE

You can only change the range when the instrument output is in the “standby” state (the SBY annunciator is illuminated).

Enabling the output

The output of the U3606A can be enabled (output state) or disabled (standby state) from the front panel.

- When the instrument is in the “standby” state, the SBY annunciator is illuminated.
- When the instrument returns to the “output” state, the OUT annunciator is illuminated.

Key	Description
	Press OUT SBY to toggle between source output (OUT) and source standby (SBY).

DC power supply example

The over-voltage limit (OV) and over-voltage protection (OVP) protection features are set to the maximum by default for the constant current output. The combination of the OV and OVP protection functions create a closed loop circuit protection for sensitive load behaviors. This example teaches you how to set the OV and OVP protection values before you source a constant current from the U3606A Multimeter | DC Power Supply.

- 1 Connect the load to the **+** (red) and **-** (black) input terminals.

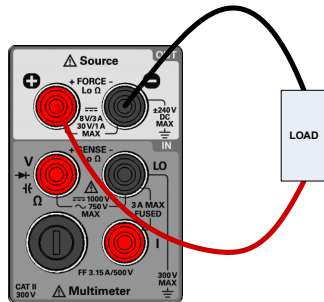

- 2 Press **Current** to select a constant current (CC) output.



- 3 Use the directional keys to select a suitable current value.

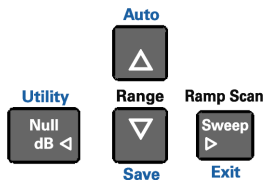

4 Press **Shift** > **Limit** to set the OV value.

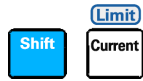

5 The OV value is displayed. (Default 30 V for range S1.)

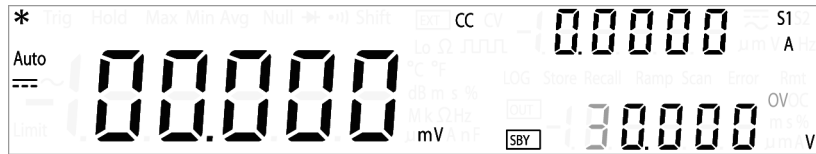

6 Use the directional keys to select a suitable OV value.

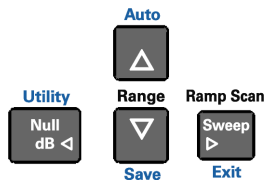

7 Press **Shift** > **Save** or **Current** (**Limit**) again to save and exit the edit mode.



8 Press **Shift** > **Protect** to set the OVP value.



9 The OVP value is displayed. (Default 33 V for range S1.)



10 Use the directional keys to select a suitable OVP value.

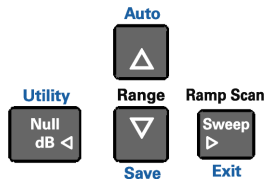

11 Press **Shift** > **Save** or **Voltage (Protect)** again to save and exit the edit mode.



12 Press **OUT|SBY** to enable the constant current output.

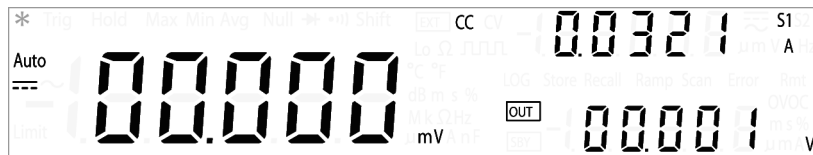

13 If the load attempts to draw more voltage than required, such that it exceeds the programmed protection value, the over-voltage protection circuit will protect the load by disabling the output.

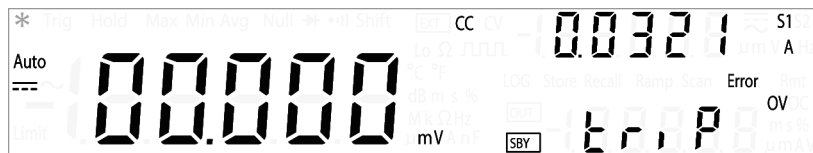

NOTE

For complete instructions on all source operations and output functions, see *Chapter 3, "DC Power Supply Operation"* in the *U3606A User's and Service Guide*.

9 Where to Go Next?

User references

User's and Service Guide The *Agilent U3606A Multimeter | DC Power Supply User's and Service Guide* contains more detailed information on the front panel, measurement functions, math operations, source operations, output functions, and the utility menu (the utility menu allows you to customize the instrument settings). It also contains information requisite to do performance tests, adjustments, troubleshooting, and repairs.

Programmer's Reference For information on remote programming and SCPI commands, see the *Agilent U3606A Multimeter | DC Power Supply Programmer's Reference*.

Product Reference CD-ROM All product documentation, software, and examples are included on the *Agilent U3606A Product Reference CD-ROM*.

Agilent support and contact information

Check www.agilent.com/find/hybrid-multimeter for the latest version of the User's and Service Guide, additional information, downloads, and services related to your Agilent product.

The web site provides information on the use of Agilent products and services. If you need to contact customer service, check the list of local Agilent contact centres on www.agilent.com/find/contactus.

For maintenance services, check your nearest Agilent Service Centre on www.agilent.com/find/assist.

www.agilent.com

Contact us

To obtain service, warranty or technical assistance, contact us at the following phone or fax numbers:

United States:

(tel) 800 829 4444 (fax) 800 829 4433

Canada:

(tel) 877 894 4414 (fax) 800 746 4866

China:

(tel) 800 810 0189 (fax) 800 820 2816

Europe:

(tel) 31 20 547 2111

Japan:

(tel) (81) 426 56 7832 (fax) (81) 426 56 7840

Korea:

(tel) (080) 769 0800 (fax) (080) 769 0900

Latin America:

(tel) (305) 269 7500

Taiwan:

(tel) 0800 047 866 (fax) 0800 286 331

Other Asia Pacific Countries:

(tel) (65) 6375 8100 (fax) (65) 6755 0042

Or visit Agilent World Wide Web at:

www.agilent.com/find/assist

Product specifications and descriptions in this document are subject to change without notice. Always refer to Agilent Web site for the latest revision.

© Agilent Technologies, Inc., 2009, 2010

Second Edition, March 31, 2010
U3606-90002



Agilent Technologies

www.valuetronics.com