

**Agilent U3402A  
5 1/2 Digit Dual Display  
Multimeter**

**User's and Service Guide**



**Agilent Technologies**

## Notices

© Agilent Technologies, Inc. 2009–2014

No part of this manual may be reproduced in any form or by any means (including electronic storage and retrieval or translation into a foreign language) without prior agreement and written consent from Agilent Technologies, Inc. as governed by United States and international copyright laws.

### Manual Part Number

U3402-90001

### Edition

Seventh Edition, July 7, 2014

Printed in Malaysia

Agilent Technologies, Inc.  
5301 Stevens Creek Blvd.  
Santa Clara, CA 95051 USA

### Warranty

**The material contained in this document is provided “as is,” and is subject to being changed, without notice, in future editions. Further, to the maximum extent permitted by applicable law, Agilent disclaims all warranties, either express or implied, with regard to this manual and any information contained herein, including but not limited to the implied warranties of merchantability and fitness for a particular purpose. Agilent shall not be liable for errors or for incidental or consequential damages in connection with the furnishing, use, or performance of this document or of any information contained herein. Should Agilent and the user have a separate written agreement with warranty terms covering the material in this document that conflict with these terms, the warranty terms in the separate agreement shall control.**

### Technology Licenses

The hardware and/or software described in this document are furnished under a license and may be used or copied only in accordance with the terms of such license.

### Restricted Rights Legend

U.S. Government Restricted Rights. Software and technical data rights granted to the federal government include only those rights customarily provided to end user customers. Agilent provides this customary commercial license in Software and technical data pursuant to FAR 12.211 (Technical Data) and 12.212 (Computer Software) and, for the Department of Defense, DFARS 252.227-7015 (Technical Data - Commercial Items) and DFARS 227.7202-3 (Rights in Commercial Computer Software or Computer Software Documentation).

### Safety Notices

#### CAUTION

A **CAUTION** notice denotes a hazard. It calls attention to an operating procedure, practice, or the like that, if not correctly performed or adhered to, could result in damage to the product or loss of important data. Do not proceed beyond a **CAUTION** notice until the indicated conditions are fully understood and met.

---











#### WARNING

A **WARNING** notice denotes a hazard. It calls attention to an operating procedure, practice, or the like that, if not correctly performed or adhered to, could result in personal injury or death. Do not proceed beyond a **WARNING** notice until the indicated conditions are fully understood and met.





---

## Safety Symbols

The following symbol on the instrument and in the documentation indicates precautions that must be taken to maintain safe operation of the instrument.

	Direct current (DC)		Caution, risk of electric shock
	Alternating current (AC)		Caution, risk of danger (refer to this manual for specific Warning or Caution information)
	Both direct and alternating current		Out position of a bi-stable push control
	Earth (ground) terminal		In position of a bi-stable push control
	Protective conductor terminal		Frame or chassis terminal
<b>CAT II 300 V</b>	IEC Measurement Category II. Inputs may be connected to mains (up to 300 VAC) under Category II overvoltage conditions.		

## Regulatory Markings

	<p>The CE mark is a registered trademark of the European Community. This CE mark shows that the product complies with all the relevant European Legal Directives.</p>		<p>The C-tick mark is a registered trademark of the Spectrum Management Agency of Australia. This signifies compliance with the Australia EMC Framework regulations under the terms of the Radio Communication Act of 1992.</p>
<p><b>ICES/NMB-001</b></p>	<p>ICES/NMB-001 indicates that this ISM device complies with the Canadian ICES-001. Cet appareil ISM est conforme a la norme NMB-001 du Canada.</p>		<p>This instrument complies with the WEEE Directive (2002/96/EC) marking requirement. This affixed product label indicates that you must not discard this electrical/electronic product in domestic household waste.</p>
	<p>The CSA mark is a registered trademark of the Canadian Standards Association.</p>		<p>This symbol indicates the time period during which no hazardous or toxic substance elements are expected to leak or deteriorate during normal use. Forty years is the expected useful life of the product.</p>

## General Safety Information

The following general safety precautions must be observed during all phases of operation, service, and repair of this instrument. Failure to comply with these precautions or with specific warnings elsewhere in this manual violates safety standards of design, manufacture, and intended use of the instrument. Agilent Technologies assumes no liability for the customer's failure to comply with these requirements.

### WARNING

- **Do not exceed any of the measurement limits defined in the specifications to avoid instrument damage and the risk of electric shock.**
- **Do not defeat power cord safety ground feature. Plug in to a grounded (earthed) outlet.**
- **Do not use instrument in any manner that is not specified by the manufacturer.**
- **Double-check the instrument's operation by measuring a known voltage.**
- **For current measurement, turn off circuit power before connecting the instrument to the circuit. Always place the instrument in series with the circuit.**
- **When connecting probes, always connect the common test probe first. When disconnecting probes, always disconnect the live test probe first.**
- **Do not measure more than the rated voltage (as marked on the multimeter) between terminals, or between terminal and earth ground.**
- **Do not use repaired fuses or short-circuited fuse-holders. For continued protection against fire, replace the line fuses only with fuses of the same voltage and current rating and recommended type.**
- **Do not service or perform adjustments alone. Under certain conditions, hazardous voltages may exist, even with the instrument switched off. To avoid dangerous electric shock, service personnel must not attempt internal service or adjustment unless another person, capable of rendering resuscitation or first aid, is present.**
- **Do not substitute parts or modify instrument to avoid the danger of introducing additional hazards. Return the instrument to Agilent Technologies Sales and Service Office for service and repair to ensure the safety features are maintained.**
- **Do not operate damaged instrument as the safety protection features built into this instrument may have been impaired, either through physical damage, excessive moisture, or any other reason. Remove power and do not use the instrument until safe operation can be verified by service-trained personnel. If necessary, return the instrument to Agilent Technologies Sales and Service Office for service and repair to ensure the safety features are maintained.**

**CAUTION**

- Turn off circuit power and discharge all high-voltage capacitors in the circuit before you perform resistance, continuity, or diode tests.
  - Use the correct terminals, functions, and range for your instrument.
  - Do not measure voltage when current measurement is selected.
  - Use the instrument with the cables provided.
  - Repair or service that is not covered in this manual should only be performed by qualified personnels.
-

## Environmental Conditions

This instrument is designed for indoor use and in an area with low condensation. The table below shows the general environmental requirements for the instrument.

Environmental Conditions	Requirements
Operating temperature	Full accuracy from 0 °C to 50°C (Operating)
Operating humidity	Full accuracy up to 80 % R.H. (relative humidity) for temperature up to 28°C
Storage temperature	-20 °C to 60 °C (Non-operating)
Altitude	Operating up to 2,000 metres (6,562 feet)
Pollution degree	Pollution Degree 2

### NOTE

The Agilent U3402A 5 1/2 digit dual display multimeter complies with the following EMC requirements:

- IEC 61010-1:2001/EN61010-1:2001 (2nd Edition)
- Canada: CAN/CSA-C22.2 No. 61010-1-04
- USA: ANSI/UL 61010-1:2004
- IEC 61326-1:2005/EN 61326-1:2006
- Canada: ICES/NMB-001: Issue 4, June 2006
- Australia/New Zealand: AS/NZS CISPR11:2004

## Waste Electrical and Electronic Equipment (WEEE) Directive 2002/96/EC

This instruction complies with the WEEE Directive (2002/96/EC) marking requirement. This affixed product label indicates that you must not discard this electrical/electronic product in domestic household waste.

Product Category:

With reference to the equipment types in the WEEE directive Annex 1, this instrument is classified as a “Monitoring and Control Instrument” product.

The affixed product label is shown as below:

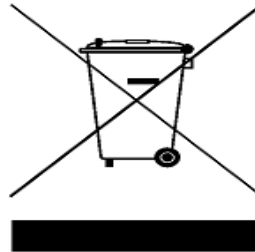

### **Do not dispose in domestic household waste**

To return this unwanted instrument, contact your nearest Agilent office, or visit

[www.agilent.com/environment/product](http://www.agilent.com/environment/product)

for more information.



## Declaration of Conformity (DoC)

The Declaration of Conformity (DoC) for this instrument is available on the Web site. You can search the DoC by its product model or description.

<http://regulations.corporate.agilent.com/DoC/search.htm>

### NOTE

If you are unable to search for the respective DoC, please contact your local Agilent representative.

---

## In This Guide ...

### **1 Getting Started Tutorial**

This chapter provides an introduction to the U3402A digital multimeter and a tutorial showing how to use the front panel in order to make measurements.

### **2 Operations and Features**

This chapter explains the various functions and features available to the U3402A digital multimeter.

### **3 Application Tutorial**

This chapter describes the advanced features and the possible applications for effective operation of the multimeter.

### **4 Performance Test**

This chapter contains performance test procedures. The performance test procedures allow you to verify that the multimeter is operating within its published specifications.

### **5 Disassembly and Repair**

This chapter will help you troubleshoot a faulty multimeter. It describes how to disassemble the multimeter, how to obtain repair services, and lists the replaceable parts.

### **6 Specifications and Characteristics**

This chapter describes the multimeter's specifications and operating specifications

# Contents

## 1 Getting Started Tutorial

Introducing the Agilent U3402A Dual Display Multimeter 2

    Checking the shipping contents 3

    Connecting power to the multimeter 4

Stacking the U3402A 5

Adjusting the Handle 6

Product at a Glance 7

    Product dimensions 7

    The front panel at a glance 8

    The display at a glance 9

    The keypad at a glance 11

    The terminals at a glance 14

    The rear panel at a glance 16

Making Measurements 17

    Performing voltage measurements 18

    Performing current measurements 21

    Performing frequency measurements 23

    Performing resistance measurements 24

    Performing diode/continuity test 26

Selecting a Range 31

Setting the Reading Rate 33

## 2 Operations and Features

Operating Math Operations 36

    dBm 37

    Rel 38

    MinMax 39

    Comp 41

Hold	42
Combination of Math Operations	43
Using the Secondary Display	45
Using the Setup Menu	47
Changing the Configurable Settings	48

### **3 Application Tutorial**

Applications for Using Dual Display	52
Dual Display Operation Examples	53
Measure DC Voltage and AC Ripple on a Rectification Circuit	53
Measure AC and DC Current on a Rectification Circuit	54
Measure AC Voltage and Frequency on an AC Circuit	55
Measure DC Voltage and DC Current on a Transistor Circuit or Load	56
Measure Resistance Using 2-Wire Mode	58
Measure Resistance Using 4-Wire Mode	59
Measure True RMS AC+DC	60

### **4 Performance Test**

Calibration Overview	62
Agilent Technologies Calibration Services	62
Calibration Interval	62
Recommended Test Equipment	63
Test Considerations	64
Performance Verification Test Overview	65
Performance Verification Test	65

### **5 Disassembly and Repair**

Operating Checklist	76
---------------------	----

Types of Service Available	77
Repackaging for Shipment	78
Cleaning	78
To Replace the Power Line Fuse	79
To Replace a Current Input Fuse	80
Electrostatic Discharge (ESD) Precautions	80
Mechanical Disassembly	81
Replaceable Parts	87
To order replaceable parts	87

## **6 Specifications and Characteristics**

DC Specifications	90
AC Specifications	93
Decibel (dB) Calculation	97
Supplemental Measurement Specifications	98
Display update rate	98
Measurement specifications	98
Reading rates	105
General Characteristics	107
To Calculate Total Measurement Error	109
Accuracy Specifications	110
Transfer Accuracy	110
One-Year Accuracy	110
Temperature Coefficients	110
Configuring for Highest Accuracy Measurements	111

**THIS PAGE HAS BEEN INTENTIONALLY LEFT BLANK.**

## List of Tables

Table 1-1	Display annunciators	9
Table 1-2	Keypad functions	11
Table 1-3	Input terminal for different measurement functions	15
Table 1-4	Range scale value in slow, medium, and fast reading rate	32
Table 1-5	Reading rates for single function measurements	33
Table 2-1	Math operations for different measurement functions	36
Table 2-2	Descriptions for combined math operations	44
Table 2-3	Description for dual display combination	46
Table 2-4	Setup menu and communication parameters	47
Table 3-1	Typical combinations and applications when using dual display	52
Table 4-1	Recommended test equipments	63
Table 4-2	DC voltage verification test	66
Table 4-3	DC current verification test	67
Table 4-4	2-wire W verification test	68
Table 4-5	4-wire W verification test	69
Table 4-6	Diode verification test	71
Table 4-7	Frequency verification test	71
Table 4-8	AC volts verification test	72
Table 4-9	AC current verification test	73
Table 5-1	Type of supplied fuse (according to country of destination)	79
Table 5-2	Type of current input fuse	80
Table 6-1	DC resolution, full scale reading, and accuracy [ $\pm$ (% of reading + count)]	90
Table 6-2	AC voltage resolution, full scale reading, and accuracy [ $\pm$ (% of reading + count)]	93
Table 6-3	AC voltage <sub>ac</sub> +dc resolution, full scale reading, and accuracy [ $\pm$ (% of reading + count)]	94
Table 6-4	AC current resolution, full scale reading, burden voltage, and accuracy [ $\pm$ (% of reading + count)]	95
Table 6-5	AC current ac+dc resolution, full scale reading, burden voltage, and accuracy [ $\pm$ (% of reading + count)]	96

<b>Table 6-6</b>	Frequency resolution and accuracy [ $\pm$ (% of reading + count)]	<b>96</b>
<b>Table 6-7</b>	Range and accuracy ( $\pm$ dB)	<b>97</b>
<b>Table 6-8</b>	Full scale display update rates	<b>98</b>
<b>Table 6-9</b>	Supplemental measurement specifications	<b>98</b>
<b>Table 6-10</b>	Reading rates for single display (readings/second (approx))	<b>105</b>
<b>Table 6-11</b>	Reading rates for the dual display (readings/second (approx))	<b>106</b>
<b>Table 6-12</b>	General characteristics	<b>107</b>



## List of Figures

- Figure 1-1 Stacking the U3402A 5
- Figure 1-2 Type of handle position 6
- Figure 1-3 Attaching and detaching the handle. 6
- Figure 1-4 U3402A dimensions 7
- Figure 1-5 Front panel 8
- Figure 1-6 VFD full display with all segments illuminated. 9
- Figure 1-7 Keypad 11
- Figure 1-8 Input terminal 14
- Figure 1-9 Rear panel 16
- Figure 1-10 ACV terminal connection and display 19
- Figure 1-11 DCV terminal connection and display 20
- Figure 1-12 ACI RMS or DCI (mA) terminal connection and display 21
- Figure 1-13 ACI RMS or DCI (A) terminal connection and display 22
- Figure 1-14 Frequency terminal connection and display 23
- Figure 1-15 2-wire W terminal connection and display 25
- Figure 1-16 4-wire W terminal connection and display 25
- Figure 1-17 Forward-biased diode/continuity test terminal connection and display 28
- Figure 1-18 Reverse-biased diode/continuity terminal connection and display 28
- Figure 1-19 2-wire/continuity test terminal connection and display 30
- Figure 1-20 Reading rate annunciator 33
- Figure 2-1 Typical dBm operation display 37
- Figure 2-2 Typical Rel operation display 38
- Figure 2-3 Typical Max operation display 39
- Figure 2-4 Typical Min operation display 40
- Figure 2-5 Typical Comp operation display 41
- Figure 2-6 Typical Hold operation display 42
- Figure 2-7 Combined math operations sequence 44
- Figure 2-8 Secondary display 45
- Figure 3-1 Terminal connection when measuring DC voltage and AC ripple on a rectification circuit 53

- Figure 3-2 Terminal connection when measuring AC and DC current on a rectification circuit 54
- Figure 3-3 Terminal connection when measuring AC voltage and frequency on an AC circuit 55
- Figure 3-4 Terminal connection when measuring DC voltage and DC current on a transistor circuit or load 57
- Figure 3-5 Terminal connection when measuring resistance using 2-wire mode 58
- Figure 3-6 Terminal connection when measuring resistance using 4-wire mode 59



# 1 Getting Started Tutorial

Introducing the Agilent U3402A Dual Display Multimeter	2
Checking the shipping contents	3
Connecting power to the multimeter	4
Stacking the U3402A	5
Adjusting the Handle	6
Product at a Glance	7
Product dimensions	7
The front panel at a glance	8
The display at a glance	9
The keypad at a glance	11
The terminals at a glance	14
The rear panel at a glance	16
Making Measurements	17
Performing voltage measurements	18
Performing current measurements	21
Performing frequency measurements	23
Performing resistance measurements	24
Performing diode/continuity test	26
Selecting a Range	31
Setting the Reading Rate	33

This chapter provides an introduction to the U3402A digital multimeter and a tutorial showing how to use the front panel in order to make measurements.



## Introducing the Agilent U3402A Dual Display Multimeter

The key features of the U3402A dual display multimeter are:

- 5 ½–digit dual display measurement
- Eleven measurement functions:
  - AC voltage
  - DC voltage
  - AC + DC voltage
  - AC current
  - DC current
  - AC+DC current
  - 2-wire resistance
  - 4-wire resistance
  - Frequency
  - Continuity test
  - Diode test
- Five math operations:
  - dBm
  - Min/Max
  - Relative (Rel)
  - Compare (Comp)
  - Hold
- True RMS measurement for both AC+DC voltage and current.
- Wide AC and DC current measurement range; from 12 mA to 12 A.
- Resistance measurement up to 120 M $\Omega$  with 1 m $\Omega$  resolution at slow reading rate or up to 300 M $\Omega$  with 10 m $\Omega$  and 100 m $\Omega$  resolution at medium and fast reading rate respectively.
- Frequency measurement up to 1 MHz.
- dBm measurement with selectable reference impedance from 2  $\Omega$  to 8000  $\Omega$  and audio power measurement capability.
- Dynamic recording for minimum and/or maximum readings.

## Checking the shipping contents

Verify that you have received the following items with your multimeter:

- Power cord
- Standard test lead kit
- Quick start guide
- Product reference CD
- Test report
- Certificate of calibration

Inspect the shipping container for damage. Signs of damage may include a dented or torn shipping container or cushioning material that shows signs of unusual stress or compacting.

Carefully remove the contents from the shipping container and verify that any options ordered are included with the shipment by checking the packing list included with the shipment.

If anything is missing, contact your nearest Agilent Sales Office.

### NOTE

- If the shipping container or packaging material is damaged, it should be kept until the contents have been checked mechanically and electrically. If there is mechanical damage, notify the nearest Agilent Technologies office. Keep the damaged shipping materials (if any) for inspection by the carrier and Agilent representative. If required, you can find a list of Agilent Sales and Service Offices on the last page of this guide.
- Ensure you have read and understand the preceding safety information before you proceed.

### Original packaging

Containers and materials identical to those used in the factory packaging are available through Agilent Technologies office. If the multimeter is being returned to Agilent Technologies for servicing, attach a tag indicating the type of service required, return address, model number, and serial number. Also mark the container FRAGILE to assure careful handling. In any correspondence, refer to the multimeter by model number and serial number.

## Connecting power to the multimeter

Connect the power cord and press the power switch to turn on the multimeter.

The front panel display illuminates while the multimeter performs its power-on self-test. (If the multimeter does not power-on, refer to the

“Operating Checklist” on page 76). During the power-on session, press to hold the full display. Press any key to resume the power-on self-test.



The multimeter powers up in the DC voltage function with autoranging enabled. If self-test is successful, the multimeter goes to normal operation. If the self-test fails, either a full annunciator or a blank display is displayed without entering the normal operation. In the unlikely event that the self-test repeatedly fails, contact your nearest Agilent Sales and Service Office.

### NOTE

The multimeter will operate at any line voltage between 90 VAC and 264 VAC when the line voltage selector is set properly with frequency range 50 Hz or 60 Hz.

### CAUTION

- Before turning on the multimeter, make sure the line voltage selector is set to the correct position for the applied line voltage to the power line cord connector.
- Do not apply a line voltage that exceeds the specified range of the line cord connector.

## Stacking the U3402A

The U3402A is shipped with specially designed anti-slip protective bumpers on the front panel and rear panel. The multimeters will not slide off when stacked on top of each other.

To be able to stack the U3402A multimeters, ensure the attached bumpers are in correct orientation. Refer to [Figure 1-1](#).

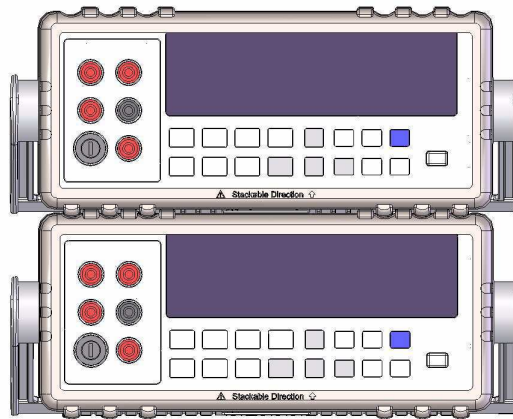

**Figure 1-1** Stacking the U3402A

## Adjusting the Handle

To adjust the handle, grasp the handle by the side and pull outward. Then, rotate the handle to the desired position. [Figure 1-2](#) below shows the possible handle positions.

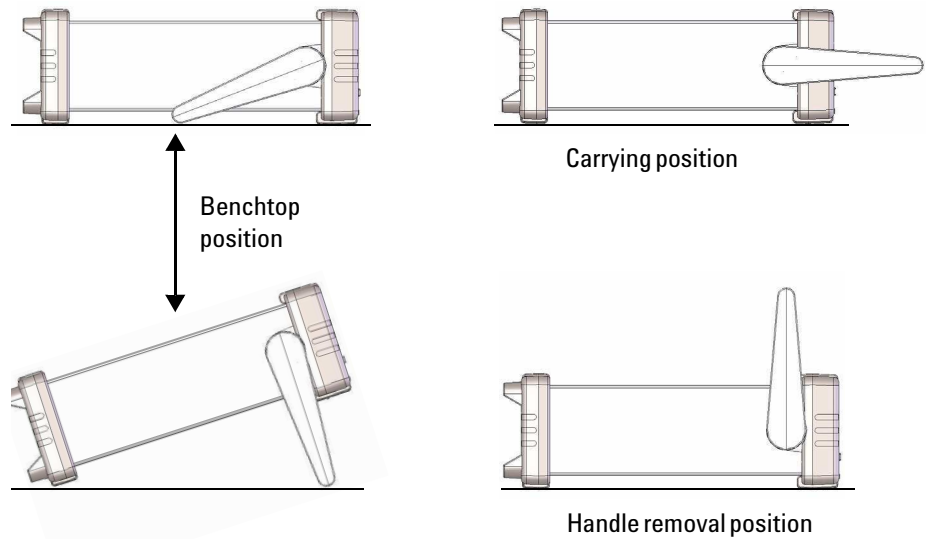

**Figure 1-2** Type of handle position

To attach or detach the handle, rotate the handle upright and pull it out from the sides of the multimeter. Refer to [Figure 1-3](#).

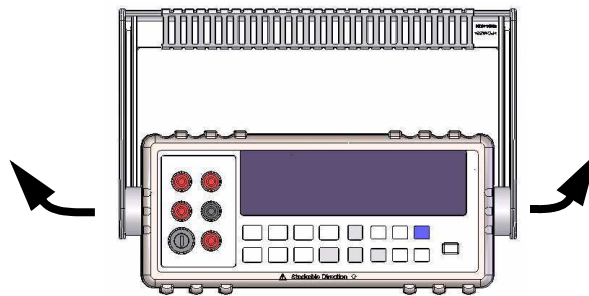

**Figure 1-3** Attaching and detaching the handle.



## Product at a Glance

### Product dimensions

#### Front view

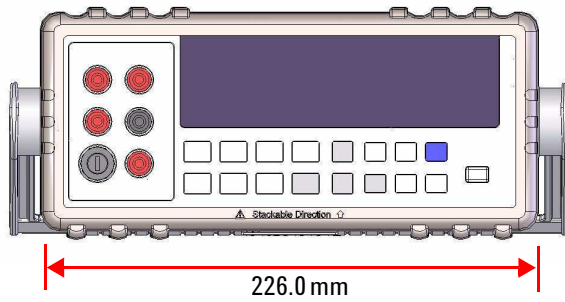

#### Side view

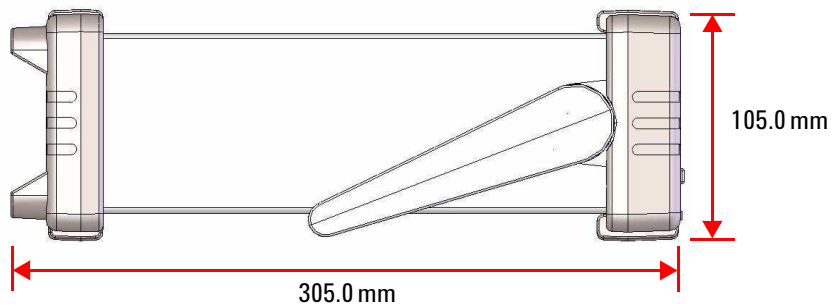

Figure 1-4 U3402A dimensions

## The front panel at a glance

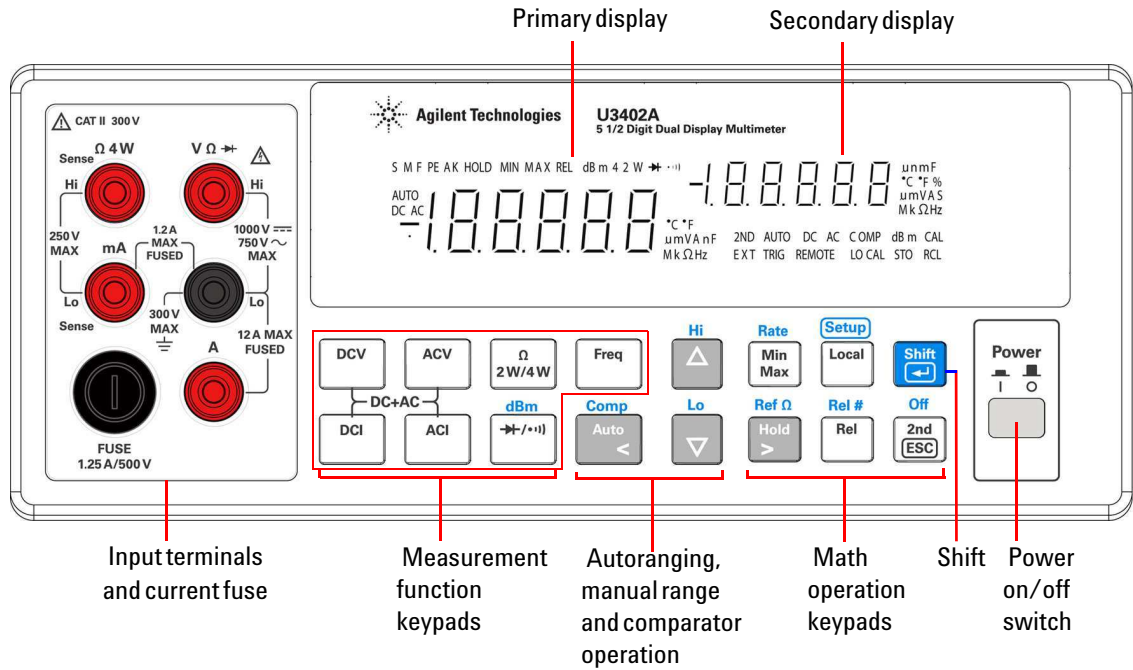
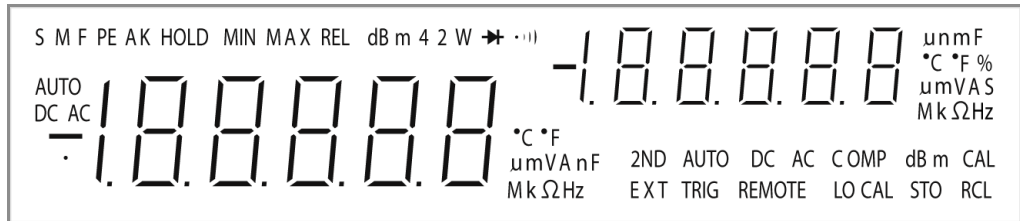

Figure 1-5 Front panel

## The display at a glance



**Figure 1-6** VFD full display with all segments illuminated.

The highly visible vacuum fluorescent display (VFD) annunciator are described in [Table 1-1](#).

**Table 1-1** Display annunciators

Annunciator	Description
<b>Primary display</b>	
S	Reading rate: Slow
M	Reading rate: Medium
F	Reading rate: Fast
PEAK	Peak measurement. Not applicable for the U3402A.
HOLD	Data hold
MIN	MinMax math operation: Minimum value shown on the primary display
MAX	MinMax math operation: Maximum value shown on the primary display
REL	Relative value
dBm	Decibel unit relative to 1 mW
4 2 W	4-wire/2-wire resistance
➔	Diode test
••))	Audible continuity test for resistance
AUTO	Autoranging
DC	Direct current
AC	Alternating current
DCAC	AC + DC
-1.00000	Polarity, digits, and decimal points for primary display

**Table 1-1** Display annunciators

<b>Annunciator</b>	<b>Description</b>
°C	Celcius temperature unit. Not applicable for the U3402A.
°F	Fahrenheit temperature unit. Not applicable for the U3402A.
mV	Voltage unit: mV, V
µmA	Current unit: µA, mA, A
µmF	Capacitance unit: nF, µF, mF. Not applicable for the U3402A.
MkΩ	Resistance unit: Ω, kΩ, MΩ
MkHz	Frequency unit: Hz, kHz, MHz
<b>Secondary display</b>	
	Polarity, digits, and decimal points for secondary display
µmF	Capacitance unit: nF, µF, mF. Not applicable for the U3402A.
°C	Celcius temperature unit. Not applicable for the U3402A.
°F	Fahrenheit temperature unit. Not applicable for the U3402A.
%	Duty cycle measurement. Not applicable for the U3402A.
mV	Voltage unit: mV, V
µmA	Current unit: µA, mA, A
S	Shift mode
MkΩ	Resistance unit: Ω, kΩ, MΩ
MkHz	Frequency unit: Hz, kHz, MHz
2ND	Secondary display is enabled
AUTO	Autoranging
DC	Direct current
AC	Alternating current
DCAC	AC + DC
COMP	Compare operation
dBm	Decibel unit relative to 1 mW
CAL	Calibration mode. Not applicable for the U3402A.
EXT	External. Not applicable for the U3402A.
TRIG	Trigger mode. Not applicable for the U3402A.
REMOTE	Remote interface control. For calibration use only.
LOCAL	Local mode
STO	Store instrument state. Not applicable for the U3402A.
RCL	Recall stored instrument state. Not applicable for the U3402A.



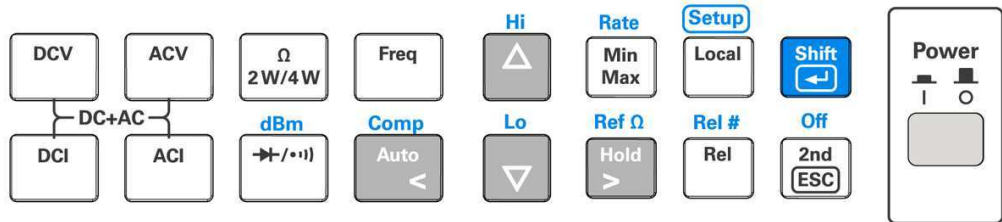

## The keypad at a glance

The operation for each key is shown in [Table 1-2](#). Pressing a key changes the current key operation, illuminates the related symbol on the display and emits a beep.

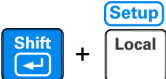

**Figure 1-7** Keypad

**Table 1-2** Keypad functions

Key	Description
<b>System related operation</b>	
	Press to power-on or power-off the U3402A multimeter.
	Press to select Shift.
	Press to return the multimeter to front panel operation when it is in remote state.
	Press to step through the Setup menu. See “Using the Setup Menu” on page 47 for more information.
	Press to enable the secondary display.
	Press to disable the secondary display.

**Table 1-2** Keypad functions





























Key	Description
<b>Measurement related operation</b>	
	Press to select the DC voltage measurement.
	Press to select the AC voltage measurement.
	Press to select the DC current measurement.
	Press to select the AC current measurement.
	Press to select the AC+DC voltage measurement.
	Press to select the AC+DC current measurement.
	Press to toggle between the 2-wire resistance or 4-wire resistance measurement.
	Press to select the frequency measurement.
	Press to toggle between the diode and continuity measurement.
	Press to select dBm measurement.
	Press to toggle between manual ranging and autoranging.
	Press to select a higher range and disable autoranging. See <a href="#">“Selecting a Range”</a> on page 31 for more information.
	Press to select a lower range and disable autoranging. See <a href="#">“Selecting a Range”</a> on page 31 for more information.

Table 1-2 Keypad functions

Key	Description
 + 	Press to select compare math operation.
 + 	Press to select and set the high limit for compare math operation.
 + 	Press to select and set the low limit for compare math operation.
	Press to enable Hold math operation. See “Hold” on page 42 for more information.
 + 	Press to select the reference impedance for dBm measurement.
	Press to enable the MinMax math operation.
 + 	Press to select the reading rate. See “Setting the Reading Rate” on page 33 for more information.
	Press to select the relative math operation.
 + 	Press to toggle in and out of the relative base (Rel#). See “Rel” on page 38 for more information.

## The terminals at a glance

**CAUTION**

To avoid damaging this multimeter, do not exceed the rated input limit.

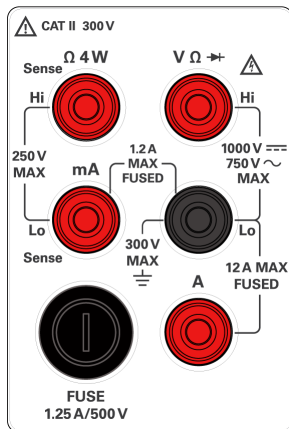

**Figure 1-8** Input terminal

**NOTE**

Voltages above 300 VAC may be measured only in circuits that are isolated from mains. However, transient overvoltages are also present on circuits that are isolated from mains. The Agilent U3402A is designed to safely withstand occasional transient overvoltages up to 2500 V PEAK. Do not use this multimeter to measure circuits where transient overvoltages could exceed this level.



**Table 1-3** Input terminal for different measurement functions

Measurement function	Input terminal		Overload protection
DC voltage (VDC)	V $\Omega$ Hz (Hi)	Lo	1000 VDC
AC voltage (VAC), frequency (Hz)			750 VAC RMS, 1100 V PEAK, 2x10 <sup>7</sup> V-Hz normal mode, or 1x10 <sup>6</sup> V-Hz common mode
Miliampere (mA), frequency (Hz)	mA		1200 mADC or AC RMS
12A, frequency (Hz)	12A		12 ADC or AC RMS for continuous 30 seconds, or 10 ADC or AC RMS
2-wire resistance ( $\Omega$ (2W))	V $\Omega$ Hz		500 VDC or AC RMS
Diode test, continuity test			
4-wire resistance ( $\Omega$ (4W))	Hi		250 VDC or AC RMS
All functions	Any terminal to earth		1000 VDC or AC PEAK

## The rear panel at a glance

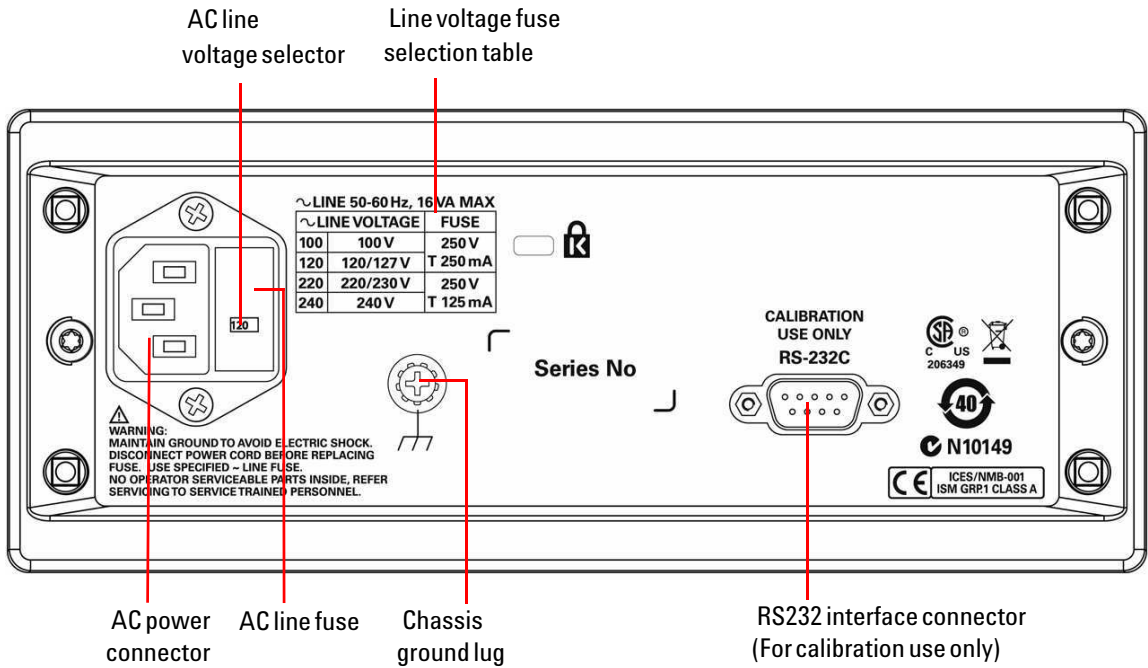

Figure 1-9 Rear panel

## Making Measurements

The following pages show you how to make measurement connections and how to select measurement functions from the front panel for each of the measurement functions.

### NOTE

- After measuring a high voltage measurement of up to 1000 VDC, you are recommended to wait for approximate two minutes before measuring a low-level measurement with 1 to 10  $\mu$ V resolutions.
  - After measuring a high current measurement using the A input terminal, you are recommended to wait for approximate ten minutes before measuring a low-level DC measurements of volts, amperes, or ohms; to achieve accurate measurement. This is due to the thermal voltages generated during the high current measurements that may cause errors when measuring the low-level measurements.
-

## Performing voltage measurements

### WARNING

Exceeding the crest factor limit may result in an incorrect or a lower reading. Do not exceed the crest factor limit to avoid instrument damage and the risk of electric shock.

---

### CAUTION

Ensure that the terminal connections are connected correctly before making any measurement. To avoid damaging the multimeter, do not exceed the rated input limit.

---

### AC voltage:

- Five ranges:
  - Slow reading rate: 120.000 mV, 1.20000 V, 12.0000 V, 120.000 V, 750.00 V.
  - Medium reading rate: 400.00 mV, 4.0000 V, 40.000 V, 400.00 V, 750.0 V.
  - Fast reading rate: 400.0 mV, 4.000 V, 40.00 V, 400.0 V, 750 V.
- Measurement method: AC coupled true RMS—measures the AC component with up to 400 VDC bias on any range
- Crest factor: Maximum 3:0 at full scale
- Input impedance:  $1\text{ M}\Omega \pm 2\%$  in parallel with  $< 120\text{ pF}$  on all ranges
- Input protection: 750 V RMS on all ranges

- 1 Press .
- 2 Connect the red and black test leads to the respective input terminals as shown in [Figure 1-10](#).
- 3 Probe the test points and read the display. In auto-ranging mode, the multimeter automatically selects the appropriate range and the measurement is displayed.



**Figure 1-10** ACV terminal connection and display

### DC voltage:

- Five ranges:
  - Slow reading rate: 120.000 mV, 1.20000 V, 12.0000 V, 120.000 V, 1000.00 V.
  - Medium reading rate: 400.00 mV, 4.0000 V, 40.000 V, 400.00 V, 1000.0 V.
  - Fast reading rate: 400.0 mV, 4.000 V, 40.00 V, 400.0 V, 1000 V.
- Measurement method: Sigma Delta A-to-D converter
- Input impedance: 10 M $\Omega$   $\pm$  2% range (typical)
- Input protection: 1000 V on all ranges

1 Press .

2 Connect the red and black test leads to the respective input terminals as shown in [Figure 1-11](#).

3 Probe the test points and read the display. In autoranging mode, the multimeter automatically selects the appropriate range and the measurement is displayed.

## 1 Getting Started

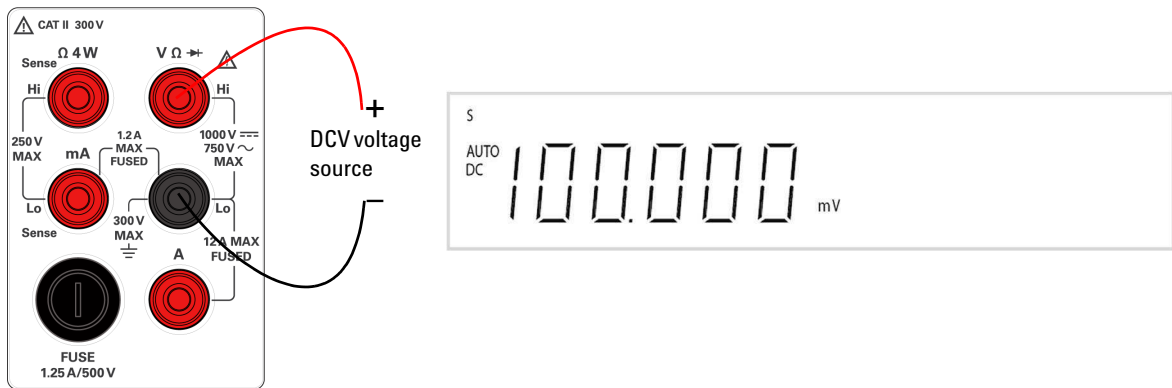

**Figure 1-11** DCV terminal connection and display

## Performing current measurements

### Measuring AC (RMS) or DC Current in mA

- Three AC current or DC current ranges:
  - Slow reading rate: 12.0000 mA, 120.000 mA, 1.20000 A
  - Medium reading rate: 40.000 mA, 120.00 mA, 1.2000 A
  - Fast reading rate: 40.00 mA, 120.0 mA, 1.200 A
- Shunt resistance: 0.1  $\Omega$  to 10  $\Omega$  for 12 mA to 1.2 A range
- Input protection: Front panel 1.25 A, 500 V FH fuse for one terminal

- 1 Press  or .
- 2 Power off the measured circuit.
- 3 Connect the red and black test leads to mA input terminal as shown in [Figure 1-12](#).
- 4 Probe the test points in series with the circuit
- 5 Power on the measured circuit and read the display.

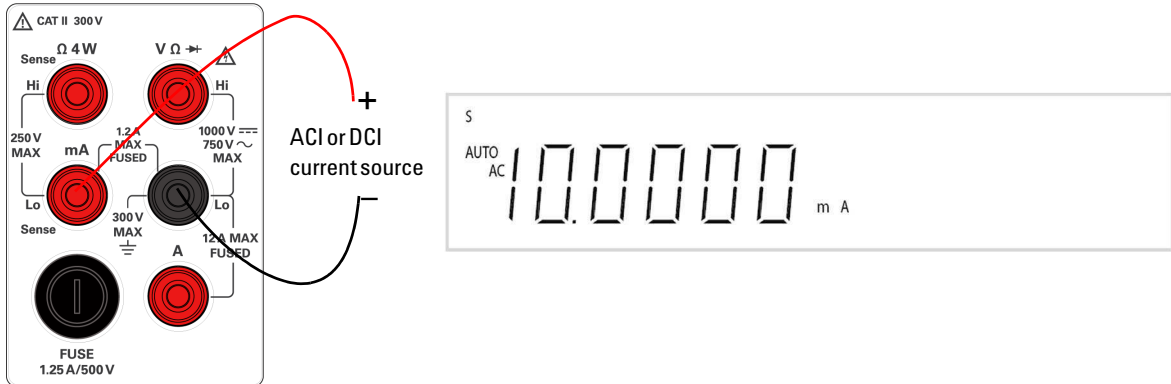

**Figure 1-12** ACI RMS or DCI (mA) terminal connection and display

## Measuring AC (RMS) or DC Current up to 12 A

- One range:
  - 12.0000A for DC or AC RMS continuous
  - 12.0000 ADC or AC RMS for maximum 30 seconds
- Shunt resistance: 0.01  $\Omega$  for 12 A range
- Input protection: Internal 15 A, 600 V fuse for 12A terminal

- 1 Press  or .
- 2 Power off the measured circuit.
- 3 Connect the red and black test leads to the A input terminal as shown in [Figure 1-13](#).
- 4 Probe the test points in series with the circuit.
- 5 Power on the measured circuit and read the display.

### NOTE

Autorangeing is not applicable for current measurement up to 12 A. You are required to select the range manually when a signal is applied to the A terminal.

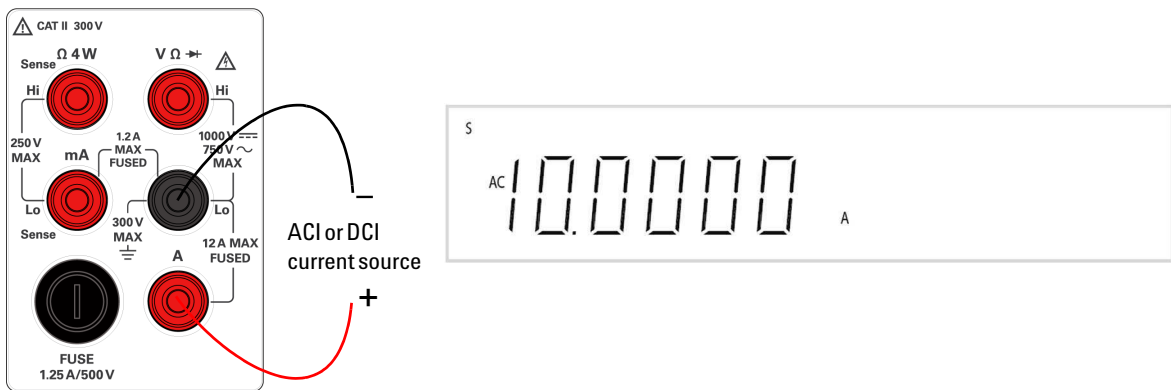

**Figure 1-13** ACI RMS or DCI (A) terminal connection and display



## Performing frequency measurements

### WARNING

Use the frequency counter for low voltage applications. Do not use the frequency counter on AC power line systems.

### Measuring frequency

- Five ranges: 120.000 mV, 1.20000 V, 12.0000 V, 120.000 V, 750.00 V — range is based on the voltage level of the signal, not frequency
- Measurement method: Reciprocal counting technique
- Signal level: 10% of range to full scale input on all ranges
- Gate time: 0.1 s or 1 period of the input signal, whichever is longer
- Input protection: 750 V RMS on all ranges

- 1 Press .
- 2 Connect the red and black test leads to the input terminal as shown in [Figure 1-14](#).
- 3 Probe the test points and read the display. In auto-ranging mode, the multimeter automatically selects the appropriate range and the measurement is displayed.

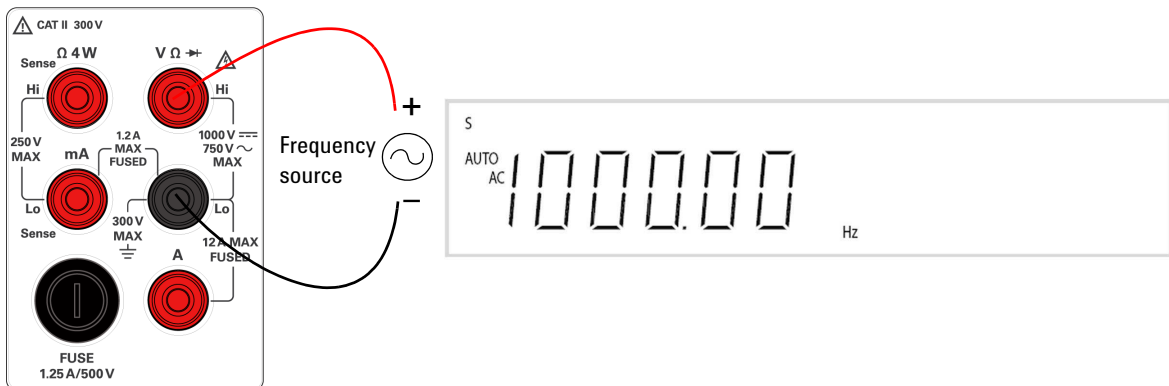

**Figure 1-14** Frequency terminal connection and display

## Performing resistance measurements

### CAUTION

Disconnect circuit power and discharge all high-voltage capacitors before measuring resistance to avoid damaging the multimeter or the device under test.

### Measuring resistance

- Seven ranges:
  - Slow reading rate: 120 .000  $\Omega$ , 1.20000 k $\Omega$ , 12.0000 k $\Omega$ , 120.000 k $\Omega$ , 1.20000 M $\Omega$ , 12.0000 M $\Omega$ , 120.000 M $\Omega$
  - Medium reading rate: 400 .00  $\Omega$ , 4.0000 k $\Omega$ , 40.000 k $\Omega$ , 400.00 k $\Omega$ , 4.0000 M $\Omega$ , 40.000 M $\Omega$ , 300.00 M $\Omega$
  - Fast reading rate: 400 .0  $\Omega$ , 4.000 k $\Omega$ , 40.00 k $\Omega$ , 400.0 k $\Omega$ , 4.000 M $\Omega$ , 40.00 M $\Omega$ , 300.0 M $\Omega$
- Measurement method: 2-wire ohms or 4-wire ohms, open circuit voltage limited to < 5 V
- Input protection: 500 V on all ranges

- 1 Press . The default function is 2-wire  $\Omega$  measurement.
- 2 Connect the red and black test leads to the input terminal as shown in [Figure 1-15](#) or [Figure 1-16](#) on page 25 respectively (according to the selected measurement method).
- 3 Probe the test points (by shunting the resistor) and read the display. In auto-ranging mode, the multimeter automatically selects the appropriate range and the measurement is displayed.

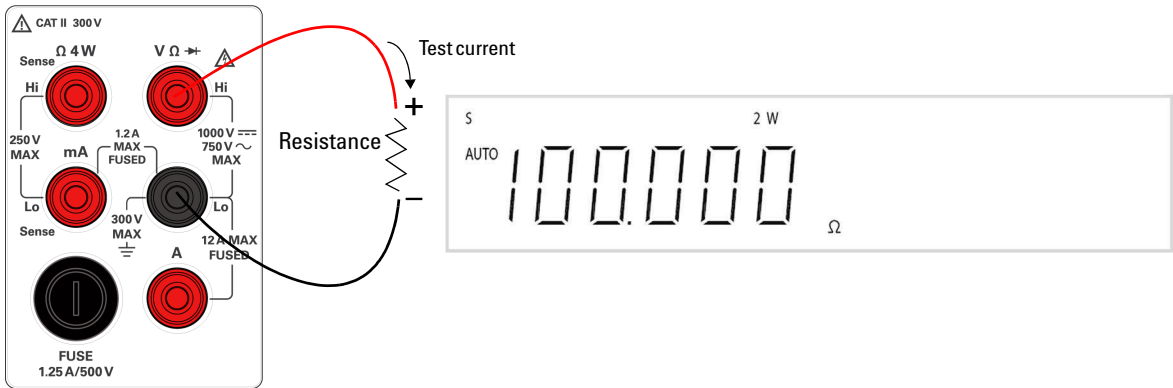

Figure 1-15 2-wire  $\Omega$  terminal connection and display

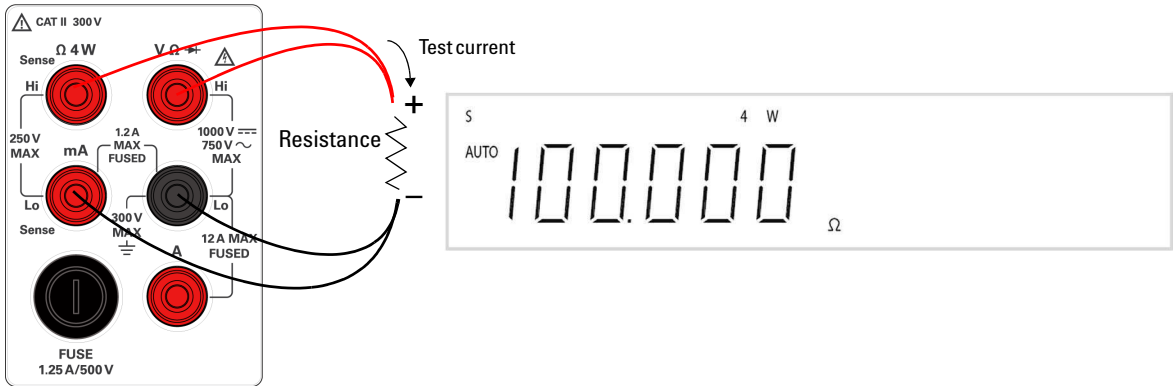

Figure 1-16 4-wire  $\Omega$  terminal connection and display

## Performing diode/continuity test

### Testing diodes

The diode test measures the forward voltage of a semiconductor junction of approximately 0.5 mA. The beeper will emit a single beep tone when the input voltage is below +0.7 V (approximately 1.4 k $\Omega$ ) and emits a continuous beep tone when the input voltage is below 50 mV (approximately 100  $\Omega$ ).

Measurements are displayed as shown below:

Reading rate	Measurement display
Slow	1.2 V range
Medium	2.5 V range
Fast	4.0 V range

#### NOTE

The measurement value will display **OL** (overload) when the voltage measured is

- > 1.2 V at slow reading rate
- > 2.5 V at medium reading rate
- > 4.0 V at fast reading rate

#### CAUTION

Disconnect circuit power and discharge all high-voltage capacitors before testing diodes to avoid damaging the multimeter.

- Measurement method: 0.5 mA  $\pm$  0.2% constant current source, open-circuit voltage limited to < 5 V
- Response time: 70 samples per seconds with audible tone
- Gate time: 0.1 s or 1 period of the input signal, whichever is longer
- Input protection: 500 V RMS on all ranges

To test a diode, switch the circuit power off, and remove the diode from the circuit. Then proceed as follows:

- 1 Press . The default function is diode measurement.
- 2 Connect the red and black test leads to the input terminal as shown in [Figure 1-17](#).
- 3 Connect the red test lead to the positive terminal (anode) of the diode and the black test lead to the negative terminal (cathode). Refer to [Figure 1-17](#).

**NOTE**

The cathode of a diode is indicated with a band.

- 4 Read the display.
- 5 Reverse the probes and measure the voltage across the diode again as shown in [Figure 1-18](#). Assess the diode according to the following guidelines:
  - A diode is considered good if the multimeter displays **OL** in reverse bias mode.
  - A diode is considered shorted if the multimeter displays approximately 0 V in both forward and reverse bias modes, and the multimeter beeps continuously.
  - A diode is considered open if the multimeter displays **OL** in both forward and reverse bias modes.

## 1 Getting Started

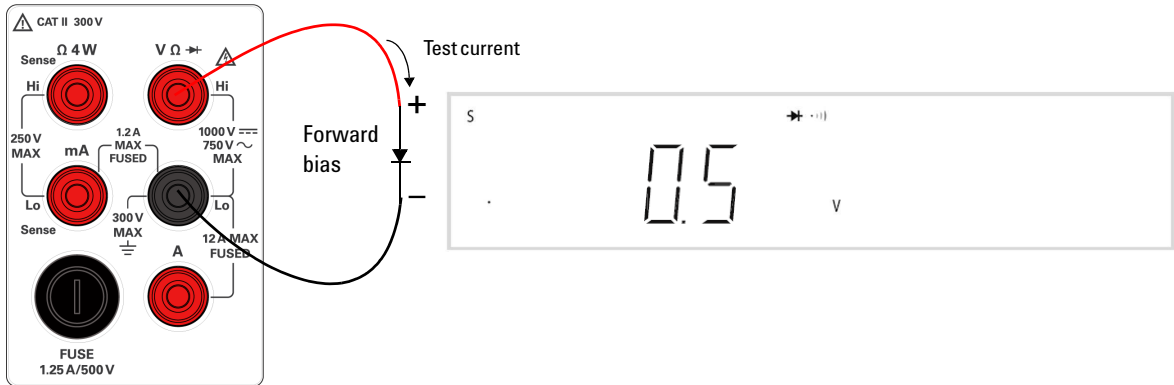

**Figure 1-17** Forward-biased diode/continuity test terminal connection and display

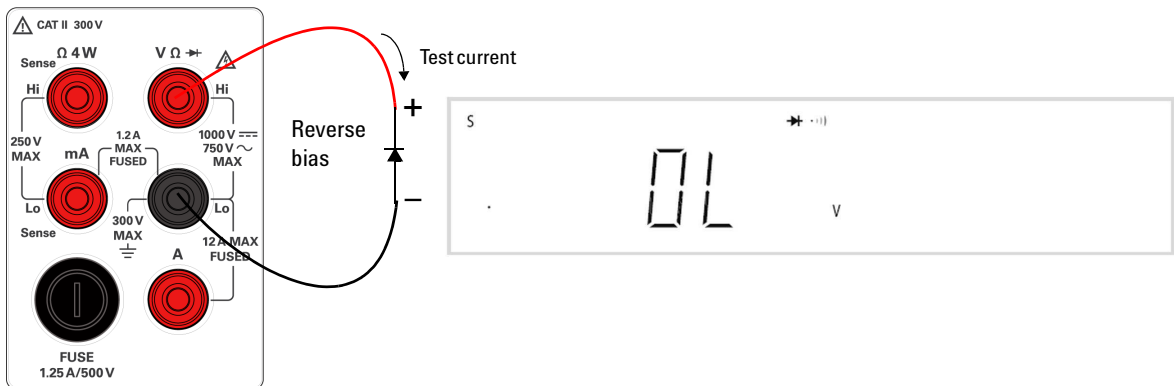

**Figure 1-18** Reverse-biased diode/continuity terminal connection and display

## Testing Continuity

The continuity test measures the resistance of a tested circuit with 2-wire method at approximately 0.5 mA and determines whether the circuit is intact. The beeper emits a continuous beep tone when the input resistance value is less than the approximate 10  $\Omega$ .

Measurement are displayed as shown below:

Reading rate	Measurement display
Slow	120.000 $\Omega$ range
Medium	400.00 $\Omega$ range
Fast	400.0 $\Omega$ range

### CAUTION

Disconnect circuit power and discharge all high-voltage capacitors before testing the circuit continuity to avoid damaging the multimeter or the device under test.

- Measurement method: 0.5 mA  $\pm$  0.2% constant current source, open circuit voltage limited to < 5 V
- Continuity threshold: 10  $\Omega$  fixed
- Input protection: 500 V RMS on all ranges

- 1 Press  to toggle to the continuity measurement function.
- 2 Connect the red and black test leads to the input terminal as shown in [Figure 1-19](#).
- 3 Probe the test points and read the display.

## 1 Getting Started

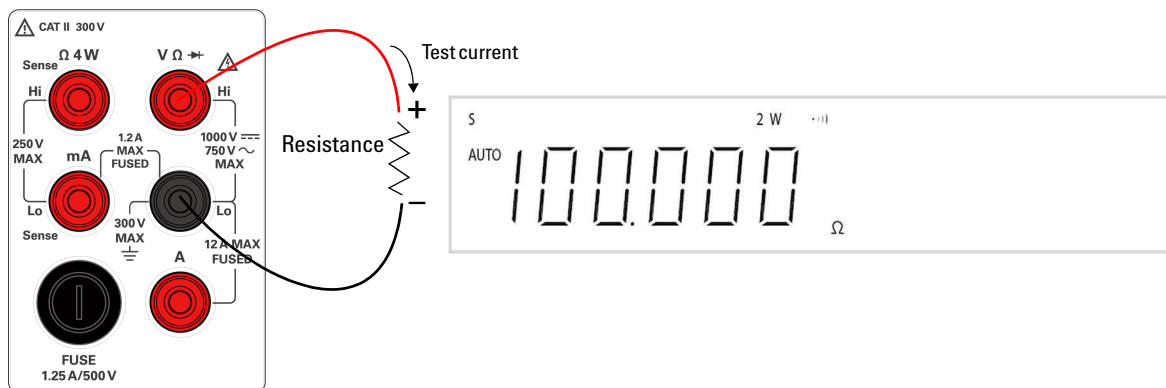

**Figure 1-19** 2-wire/continuity test terminal connection and display



## Selecting a Range

You can allow the multimeter to select the range automatically by using autoranging, or you can select a fixed range using manual ranging. Auto-ranging is convenient because the multimeter automatically selects the appropriate range for sensing and displaying each measurement. However, manual ranging results in better performance, since the multimeter does not have to determine which range to use for each measurement.



Selects autoranging and disables manual ranging. Press to toggle between the manual ranging and autoranging.



Selects a higher range and disable autoranging.



Selects a lower range and disable autoranging.

For dual display, the measurement range for primary and secondary display as stated below is similar and is unable to be changed independently.

- |               |               |
|---------------|---------------|
| • DCV/DCV     | • DCI/DCI     |
| • DCV/ACV     | • DCI/ACI     |
| • ACV/DCV     | • ACI/DCI     |
| • ACV/ACV     | • ACI/ACI     |
| • ACV+DCV/DCV | • ACI+DCI/DCI |
| • ACV+DCV/ACV | • ACI+DCI/ACI |

- Autoranging is selected at default factory power-on.
- Manual ranging – If the input signal is greater than can be measured on the selected range, the multimeter will display an overload indication, **OL** on the primary or secondary display front panel.
- The multimeter remembers the selected ranging method (auto or manual) and the selected manual range for each measurement function.

## 1 Getting Started

- Autorange thresholds – The multimeter shifts ranges as follows:
  - Down range at < 5% of current range
  - Up range at > full scale of current range
- [Table 1-4](#) shows the summary of range values for slow, medium, and fast reading rate respectively.

### NOTE

Autoranging is not applicable for current measurement up to 12 A. You are required to select the range manually when a signal is applied to the A terminal.

**Table 1-4** Range scale value in slow, medium, and fast reading rate

Measurement function	Range			Autoranging
	Slow reading rate	Medium reading rate	Fast reading rate	
DCV	120.000 mV, 1.20000 V, 12.0000 V, 120.000 V, 1000.00 V	400.00 mV, 4.0000 V, 40.000 V, 400.00 V, 1000.0 V	400.0 mV, 4.000 V, 40.00 V, 400.0 V, 1000 V	✓
ACV, DCV + ACV	120.000 mV, 1.20000 V, 12.0000 V, 120.000 V, 750.00 V	400.00 mV, 4.0000 V, 40.000 V, 400.00 V, 750.0 V	400.0 mV, 4.000 V, 40.00 V, 400.0 V, 750 V	✓
DCI, ACI, DCI + ACI	12.0000 mA, 120.000 mA, 1200.00 mA	40.000 mA, 120.00 mA, 1200.0 mA	40.00 mA, 120.0 mA, 1200 mA	✓
DCI, ACI, DCI + ACI	12.0000 A <sup>[1]</sup>	12.000 A <sup>[1]</sup>	12.00 A <sup>[1]</sup>	Manual only
Frequency	1200.00 Hz, 12.0000 kHz, 120.000 kHz, 1.00000 MHz	1200.0 Hz, 12.000 kHz, 120.00 kHz, 1.0000 MHz	1200 Hz, 12.00 kHz, 120.0 kHz, 1.000 MHz	✓
Resistance <sup>[2]</sup>	120.000 Ω, 1.20000 kΩ, 12.0000 kΩ, 120.000 kΩ, 1.20000 MΩ, 12.0000 MΩ, 120.000 MΩ	400.00 Ω, 4.0000 kΩ, 40.000 kΩ, 400.00 kΩ, 4.0000 MΩ, 40.000 MΩ, 300.00 MΩ,	400.0 Ω, 4.000 kΩ, 40.00 kΩ, 400.0 kΩ, 4.000 MΩ, 40.00 MΩ, 300.0 MΩ,	✓
Diode test	1.20000 V	2.5000 V	2.500 V	
Continuity	2-wire Ω/120 Ω (continuity mode)	2-wire Ω/400 Ω (continuity mode)	2-wire Ω/400 Ω (continuity mode)	Fixed range

#### Notes:

**1** 10 A continuous DC or AC RMS; 12 A DC or AC RMS for 30 seconds maximum.

**2** A shielded test cable is recommended when measuring resistance more than 120 kΩ to eliminate noise interference that might be induced to the test leads.

## Setting the Reading Rate

You can select three reading rates for the AC and DC voltage, AC and DC current, and resistance measurement which are Slow (**S**), Medium (**M**), and Fast (**F**)

The selected rate allows you to maximize either the measurement speed or noise rejection, which affects the measurement accuracy. Refer to [Table 1-5](#).

**Table 1-5** Reading rates for single function measurements

Reading rate	Resolution	Display counts <sup>[1][2]</sup>
Slow	5 ½	119,999
Medium	4 ½	39,999
Fast	3 ½	3,999



**Notes:**

- 1 In VDC 1000 V range, the display counts is limited up to 1200.00, 1200.0 and 1200 for slow, medium, and fast reading rate respectively.
- 2 In VAC 750 V range, 1000 V RMS is measurable.

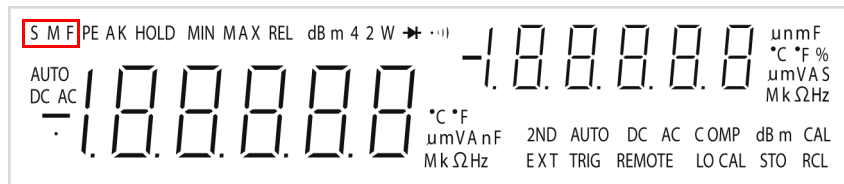
The annunciator **S**, **M**, and **F** (slow, medium and fast respectively) are located at the corner left of the display indicates the selected rate on the primary display. Refer to [Figure 1-20](#).



**Figure 1-20** Reading rate annunciator

Press   to cycle through the available reading rates (**S**, **M**, or **F**).

**NOTE**

In the dBm function, the display counts is 0.01 dBm for slow or medium reading rate and 0.1 dBm for fast reading rate.

**THIS PAGE HAS BEEN INTENTIONALLY LEFT BLANK.**

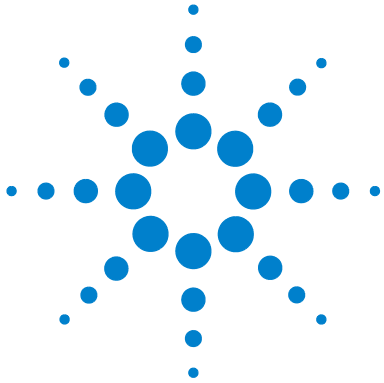

## 2 Operations and Features

Operating Math Operations	36
dBm	37
Rel	38
MinMax	39
Comp	41
Hold	42
Combination of Math Operations	43
Using the Secondary Display	45
Using the Setup Menu	47
Changing the Configurable Settings	48

This chapter explains the various functions and features available to the U3402A digital multimeter



## Operating Math Operations

Table 2-1 presents a summary of the math operations that can be used with each measurement function.

**Table 2-1** Math operations for different measurement functions

Measurement functions	Allowed math operations					
	dBm	Rel	Min	Max	Comp	Hold
DCV	✓	✓	✓	✓	✓	✓
DCI	—	✓	✓	✓	✓	✓
Resistance	—	✓	✓	✓	✓	✓
ACV	✓	✓	✓	✓	✓	✓
ACI	—	✓	✓	✓	✓	✓
Frequency	—	✓	✓	✓	✓	✓
Diode/Continuity	—	✓	✓	✓	✓	✓

- All math operations can be toggled on and off by reselecting the same math operation.
- Only one math operation can be turned-on at a time. When selecting another math operation when one is already on, you are required to turn-off the first operation and then turn-on the second math operation.
- All math operations are automatically turned-off when changing the measurement functions.
- Range changing is allowed for all math operations.

## dBm

The logarithmic dBm (decibels relative to one milliwatt) scale is often used in RF signal measurements. The multimeter's dBm operation takes a measurement and calculates the power delivered to a reference impedance (typically 50, 75, or 600  $\Omega$ ). The formula used for conversion from the voltage reading is:

$$dBm = 10 \times \text{Log}_{10} [ 1000 \times (\text{Reading}^2 / \text{reference impedance}) ]$$



**Figure 2-1** Typical dBm operation display

The default reference impedance value is 600  $\Omega$ . You can select the following 21 reference impedance values:





2  $\Omega$ , 4  $\Omega$ , 8  $\Omega$ , 16  $\Omega$ , 50  $\Omega$ , 75  $\Omega$ , 93  $\Omega$ , 110  $\Omega$ , 124  $\Omega$ , 125  $\Omega$ , 135  $\Omega$ , 150  $\Omega$ , 250  $\Omega$ , 300  $\Omega$ , 500  $\Omega$ , 600  $\Omega$ , 800  $\Omega$ , 900  $\Omega$ , 1000  $\Omega$ , 1200  $\Omega$ , or 8000  $\Omega$ .

If reference impedance 2  $\Omega$ , 4  $\Omega$ , 8  $\Omega$ , or 16  $\Omega$  is selected, the dBm operation is displayed in watt (power).







Numeric results are in the range of  $\pm 120.000$  dBm with 0.01 dBm resolution shown, independent of the number of digits setting.

The dBm operation can be applied to DCV and ACV measurement functions only. The multimeter displays the dBm operation on the primary display and displays the reference impedance selection on the secondary display.

### Procedure 1

- 1 Press   to enter dBm operation.
- 2 Use  and  to select the desired reference impedance.
- 3 Press  to store the selected value and read the display.

### Procedure 2

- 1 Press  . The reference impedance currently used will be displayed on the secondary display.
- 2 Use  and  to select the desired reference impedance.
- 3 Press  to store the selected value.
- 4 Press   to enable the dBm operation and read the display.

## Rel

When making Rel (relative) measurements, each reading is the difference between a stored relative value and the input signal. For example, this feature can be used to make more accurate resistance measurements by nulling the test lead resistance.

After you enable the Rel operation, the multimeter stores the next reading as a Rel # (relative base) and immediately displays on the primary display:

$$\text{Primary Display} = \text{Reading} - \text{Rel \#}$$

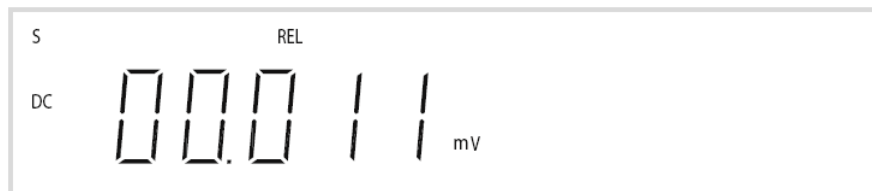









**Figure 2-2** Typical Rel operation display

The multimeter allows relative settings for the following measurement functions: DC voltage, AC voltage, DC current, AC current, resistance, and frequency.



**Procedure**

- 1 Press  to enable Rel operation.
- 2 Press   to toggle in (and out) the Rel #.
- 3 Use , , , and  to modify the Rel #.
- 4 Press  to set the Rel # and read the display.
- 5 Press  to disable the Rel operation.

**NOTE**

- In resistance measurement mode, the multimeter will read a non-zero value even when the two test leads are in direct contact, because of the resistance of these leads. Use the Rel operation to zero-adjust the display.
- In DC voltage measurement mode, the thermal effect will influence the accuracy. Short the test leads and press  once the displayed value is stable to zero-adjust the display.

**MinMax**

The MinMax (Minimum/Maximum) operation stores the minimum and maximum values of reading during a series of measurements.

When enabled, the MinMax operation turns on the **MINMAX** annunciator and begins accumulating various statistics of the readings being displayed.

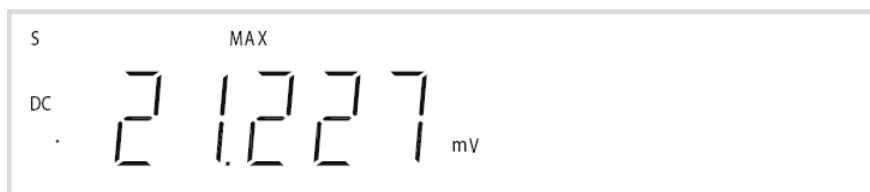

**Figure 2-3** Typical Max operation display

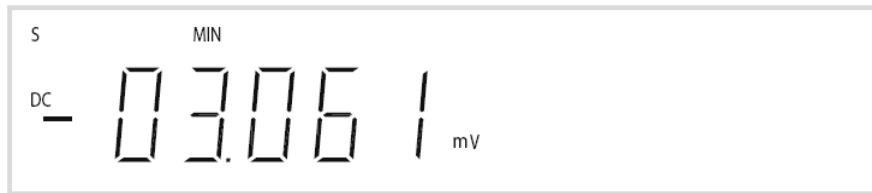

**Figure 2-4** Typical Min operation display

Each time a new minimum or maximum value is stored, the multimeter beeps once (if the beeper is enabled) and briefly turns on the appropriate **MAX** or **MIN** annunciator.





Accumulated statistics are:

- **MAX**—maximum reading since MinMax was enabled
- **MIN**—minimum reading since MinMax was enabled
- **MINMAX**—actual readings

### NOTE

When MinMax is enabled, the measurement range changed to manual ranging and the current measurement mode is locked until MinMax is disabled (with other ranges being selected or autoranging is enabled).

### Procedure

- 1 Press  to enable MinMax operation.
- 2 Press  to cycle through the available MINMAX operations (**MIN**, **MAX**, or **MINMAX**).
- 3 Press   to disable the MinMax operation.

## Comp



The Comp (compare) operation allows you to perform pass/fail testing against specified upper and lower limits. You can set the upper and lower limits to any value between 0 and  $\pm 100\%$  of the highest range for the present function.





**Figure 2-5** Typical Comp operation display

When enabled, the actual readings are shown in primary display and the comparison results such as **HI**, **LO**, or **PASS** is shown in secondary display.

- You should specify the upper limit to always be a more positive number than the lower limit. The initial factory setting for **LO** limit is 0.
- The secondary display shows **PASS** when readings are within the specified limits. The secondary display shows **HI** when the reading is outside the high limit and **LO** when the reading is outside the low limit.
- When the beeper is ON (see “Using the Setup Menu” on page 47), the beeper beeps on the transition from **PASS** to **HI** or **PASS** to **LO** or when transitioning directly from **HI** to **LO** or **LO** to **HI** (no **PASS** in between).

- Press   to enable Comp operation.



### Procedure

- 1 Press   to enter the upper limit setup mode.









The upper limit is shown on primary display while the **HI** annunciator is shown on secondary display.

- 2 Use  ,  ,  , and  to modify the upper limit.

## 2 Operations and Features

- 3 Press  to store the specified value.
- 4 Press   to enter the lower limit setup mode.

The lower limit is shown on primary display while the **LO** annunciator is shown on secondary display.

- 5 Use , , , and  to modify the lower limit.
- 6 Press  to store the specified value.
- 7 Press   to enable the Comp operation.
- 8 Press   to disable the Comp operation or exit.

## Hold

The reading hold feature allows you to capture and hold a reading on the front panel display. When enabled, the Hold operation turns on the **Hold** annunciator and hold the reading.

### Procedure

- 1 Press  to hold the reading on the display.



**Figure 2-6** Typical Hold operation display

## Combination of Math Operations







### NOTE

The math operation can be operated for primary display only.

The Agilent U3402A multimeter allows you to use multiple math operation such as dBm, MinMax, Rel, Hold, and Comp simultaneously.

### Example:

Set upper and lower limit for Comp operation using multiple math operation as below:

- 1 Press   to enable dBm operation.
- 2 Press  to take dBm readings as Rel # for new measurement.
- 3 Press  to record the Max value as the new Rel # (upper limit).
- 4 Press  to record the Min value as the new Rel # (lower limit).
- 5 Press   to enable the Comp operation.

The step-by-step sequence and readings of the combined math operations are shown in [Table 2-2](#) on page 44 when all math operations are used sequentially. Refer to [Figure 2-7](#).

**Table 2-2** Descriptions for combined math operations



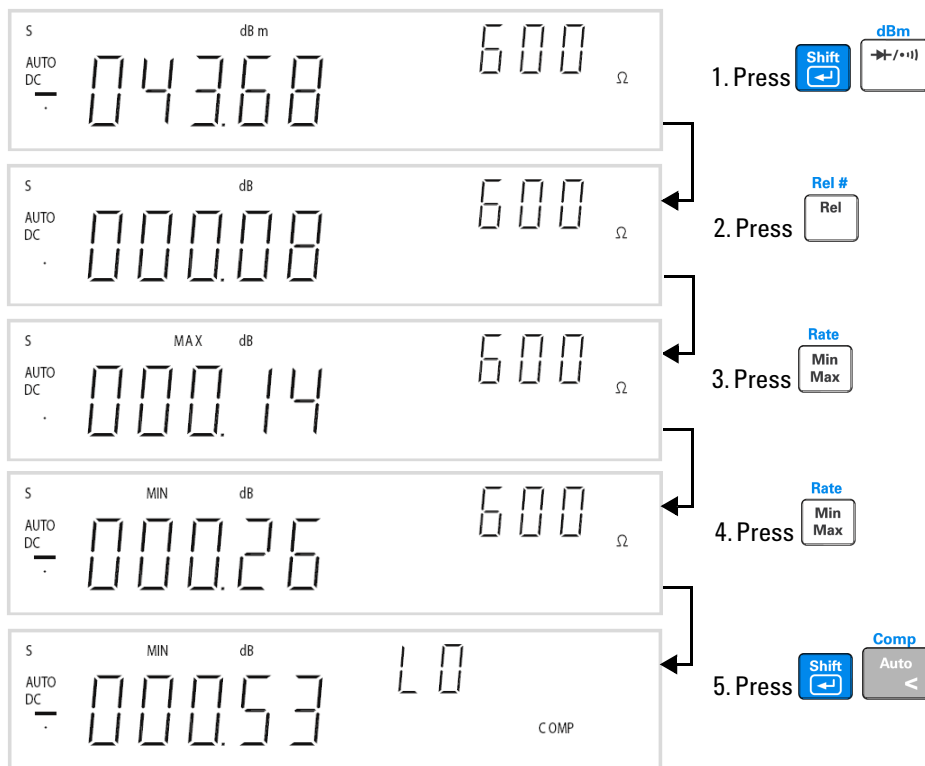



No.	Math operation sequence	Description	Readings
1	dBm	Reading is calculated to a dBm operation	"A"
2	Rel	dBm reading, "A" is taken as Rel #	"B"
3	Min	Min reading of relative dB is recorded as a new Rel #, "B"	"C"
4	Max	Max reading of relative dB is recorded as a new Rel #, "B"	"D"
5	Comp	Compare operation is performed based on the readings of "C" and "D"	"E"



**Figure 2-7** Combined math operations sequence

## Using the Secondary Display

To enable the secondary display mode:

- 1 Press  followed by a specified function keys such as , , , , or  to enable the secondary display mode.

The **2ND** annunciator is displayed along with the secondary display.

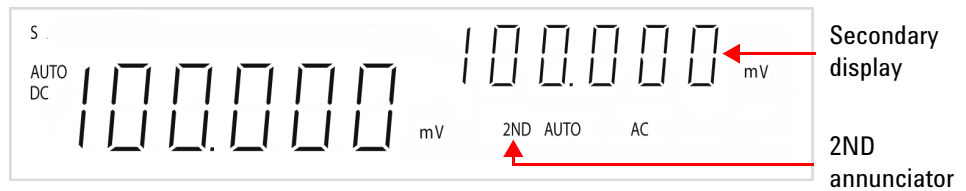

**Figure 2-8** Secondary display

To disable the secondary display mode:

- 1 Press  .

[Table 2-3](#) details the available input combinations for both primary and secondary display when dual display mode is selected.

**Table 2-3** Description for dual display combination

Primary display	Secondary display				
	DCV	ACV	DCI <sup>[4]</sup>	ACI <sup>[4]</sup>	Hz <sup>[7]</sup>
DCV	✓ <sup>[1]</sup>	✓ <sup>[1]</sup>	✓	✓	✓
ACV	✓ <sup>[1]</sup>	✓ <sup>[1]</sup>	✓	✓	✓
DCI <sup>[4]</sup>	✓	✓	✓ <sup>[1]</sup>	✓ <sup>[1]</sup>	✓ <sup>[2]</sup>
ACI <sup>[4]</sup>	✓	✓	✓ <sup>[1]</sup>	✓ <sup>[1]</sup>	✓ <sup>[2]</sup>
ACV + DCV	✓ <sup>[1]</sup>	✓ <sup>[1]</sup>	✓	✓	✓
ACI + DCI <sup>[4]</sup>	✓	✓	✓ <sup>[1]</sup>	✓ <sup>[1]</sup>	✓ <sup>[2]</sup>
Frequency <sup>[7]</sup>	✓	✓	✓ <sup>[2]</sup>	✓ <sup>[2]</sup>	✓
Resistance <sup>[3]</sup>	✓	✓ <sup>[5]</sup>	✓	✓ <sup>[5]</sup>	✓ <sup>[5]</sup>
Diode/Continuity	✓	✓ <sup>[5]</sup>	✓	✓ <sup>[5]</sup>	✓ <sup>[5]</sup>
dBm <sup>[6]</sup>	✓	✓	✓	✓	✓

**Notes:**

- 1** The range for both primary and secondary display are corresponding to the higher range of two displays (autoranging mode, while the range of secondary display are the same as the primary displays (manual range mode).
- 2** The frequency measurement corresponding to the current input signals; other measurements are corresponding to the voltage input signals.
- 3** In dual display mode, users are recommended to measure the resistance up to 1 MΩ.
- 4** At 12 A range, manual range mode is selected by default.
- 5** Measurable with non-guaranteed accuracy.
- 6** Autoranging mode by default.
- 7** The voltage or current range of the frequency function follows the voltage or current range of the other function.

**NOTE**

The multimeter has an increased key response time (0.6 s to 1 s) when in dual display mode. You may need to press the selected key until the multimeter responses.



## Using the Setup Menu

The Setup menu allows you to customize a number of non-volatile instrument configurations. The content of the Setup menu are shown in [Table 2-4](#).

**Table 2-4** Setup menu and communication parameters





First tier menu	Description	Second tier menu	Description	Default factory setting	Available settings
rS232 <sup>[1]</sup>	RS232 interface parameters	bAUd	Baud rate for remote communication with a PC (remote control).	9600	300, 600, 1200, 2400, 4800 or 9600
		PArY	Parity bit for remote communication with a PC.	None	None, odd, or even
		dAtA	Data bit length for remote communication with a PC.	8	7 or 8
		StoP	Stop bit.	1	1 or 2
		Echo	ECHO. Return a character to PC in remote communication.	OFF	ON or OFF
		Print	Printer-Only. Print measured data to a PC in remote communication.	OFF	ON or OFF
bEEP <sup>[2]</sup>	Beeper selection			ON	ON or OFF

**Notes:**





- 1 For calibration use only.
- 2 The beeper is use to simplify the multimeter operation. It is not a communication related parameter.

## Changing the Configurable Settings







The parameters in the Setup menu can be configured by using the following procedures:

- 1 Press   to access to the Setup menu.
- 2 Use  and  to select the desired configurable items in the first tier menu.

If you select **bEEP**,

- a Use  and  to select the desired parameter.
- b Press  to confirm the selected parameter.
- c Press  to quit from the Setup menu.
- d The configuration settings is saved and main display is displayed.

If you select **rS232**,

- a Press  to enter the second tier menu.
- b Use  and  to select the desired configurable items.
- c Use  and  to select the desired parameters.
- d Press  to confirm the selected parameter.
- e Press  to quit from the tier menu or quit from the Setup menu.
- f The configuration settings is saved and main display is displayed.



## 3 Application Tutorial

Applications for Using Dual Display 52

Dual Display Operation Examples 53

Measure DC Voltage and AC Ripple on a Rectification Circuit 53

Measure AC and DC Current on a Rectification Circuit 54

Measure AC Voltage and Frequency on an AC Circuit 55

Measure DC Voltage and DC Current on a Transistor Circuit or Load 56

Measure Resistance Using 2-Wire Mode 58

Measure Resistance Using 4-Wire Mode 59

Measure True RMS AC+DC 60

This chapter describes the advanced features and the possible applications for effective operation of the multimeter.



## Applications for Using Dual Display

The dual display feature in the multimeter can be used to enhance test and measurement capabilities. See [Table 3-1](#) for the available combinations and application when using dual display.

**Table 3-1** Typical combinations and applications when using dual display

No.	Primary display	Secondary display	Applications
1	DCV	ACV	• Test DC to AC or AC to DC converter circuit.
2	ACV + DCV	DCV	• Measure DC level and AC ripple of power supply.
3	DCV	DCI	• Test power supply load regulation.
4	DCV	ACI	• Check loop current and voltage drop level.
5	ACI + DCI	DCV	• Test line and load regulation.
6	ACV	DCI	• Test AC to DC or DC to AC converters.
7	ACI + DCI	ACV	• Measure DC level and AC ripple of power supply.
8	ACV	ACI	• Test transformer.
9	ACV	Frequency	• Measure AC frequency response of amplifier circuit.
10	ACI	Frequency	• Adjust AC motor control.
11	DCI	ACI	• Measure AC ripple and DC current of power supply.
12	ACI + DCI	DCI	• Measure current dissipation for power supply analysis.
13	dBm	Reference $\Omega$	• Set dB reference impedance and show dBm.
14	dBm	DCV	• Indicate DC voltage and dBm.
15	dBm	ACV	• Indicate AC voltage and dBm.
16	dBm	Frequency	• Check frequency response.

## Dual Display Operation Examples

This section describes some practical operations when using dual display feature.

### Measure DC Voltage and AC Ripple on a Rectification Circuit

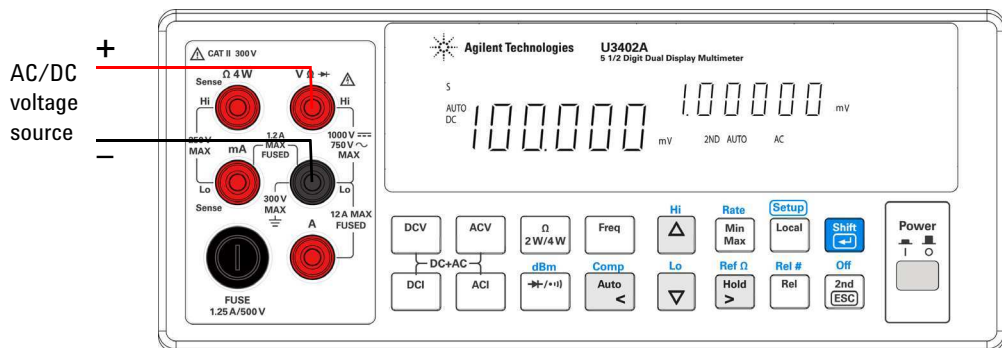

A single measurement for both DC voltage and AC ripple can be displayed through both display while testing a rectifier circuit.

- 1 Connect the red and black test leads to the input terminal and probe the test points as shown in [Figure 3-1](#).





**Figure 3-1** Terminal connection when measuring DC voltage and AC ripple on a rectification circuit

- 2 Press  to select DC voltage measurement for primary display.
- 3 Press  to enable the secondary display. The **2ND** is displayed.
- 4 Press  to select AC voltage measurement for secondary display.

- 5 Press . Use  and  to select autoranging or manual ranging for the primary and secondary display. The ranging will be the same for both displays.

**NOTE**

- Press   to disable the secondary display.
- Press  to select the suitable range if DCV+ACV ripple is above the scale of the current range.

## Measure AC and DC Current on a Rectification Circuit

A single measurement for both AC current and DC current can be displayed through both display while testing a rectifier circuit.







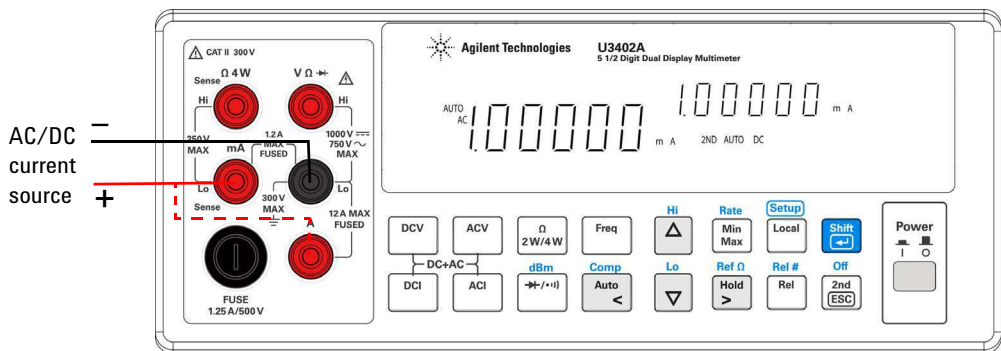

**WARNING**

- **Make sure you select the correct input terminal according to the input range used.**
- **Do not apply more than 12 A to the A input terminal to avoid the multimeter from damage.**

- 1 Connect the red and black test leads to the input terminal and probe the test points as shown in [Figure 3-2](#).



**Figure 3-2** Terminal connection when measuring AC and DC current on a rectification circuit

- 2 Press  to select AC current measurement for primary display.
  - 3 Press . Use  and  to select autoranging or manual ranging for secondary display.
  - 4 Press  to enable the secondary display. The **2ND** is displayed.
  - 5 Press  to select DC current measurement for secondary display.
- Press   to disable the secondary display.

**NOTE**

## Measure AC Voltage and Frequency on an AC Circuit

A single measurement for both AC voltage and frequency can be displayed through both display while testing a rectifier circuit.

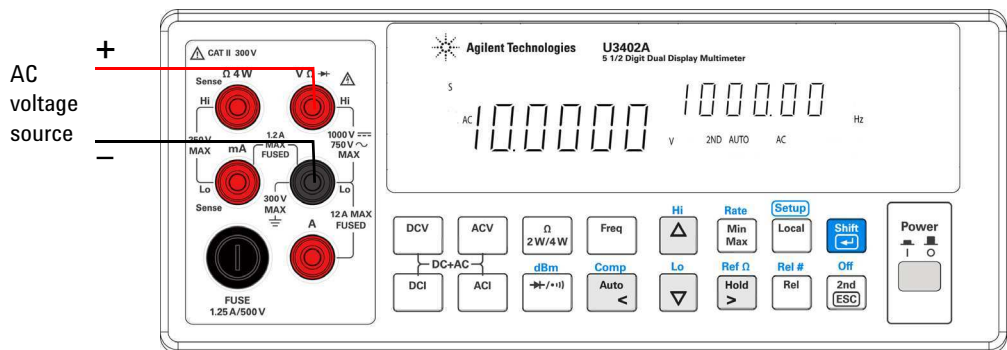

- 1 Connect the red and black test leads to the input terminal and probe the test points as shown in [Figure 3-3](#).





**Figure 3-3** Terminal connection when measuring AC voltage and frequency on an AC circuit



- 2 Press  to select AC voltage measurement for primary display.



### 3 Application Tutorial

3 Press . Use  and  to select autoranging or manual ranging for primary display.

4 Press  to enable the secondary display. The **2ND** is displayed.

5 Press  to select frequency measurement for secondary display.

6 Press . Use  and  to select autoranging or manual ranging for secondary display.

Press   to disable the secondary display.

#### NOTE

## Measure DC Voltage and DC Current on a Transistor Circuit or Load

A single measurement for both DC voltage and current can be displayed through both display while testing a transistor amplifier circuit. You may also check the  $H_{fe}$  or calculate the DC load consumption by using the dual display.

#### WARNING

- **Make sure you select the correct input terminal according to the input range used.**
- **Do not apply more than 12 A to the A input terminal to avoid the multimeter from damage.**



- 1 Connect the red and black test leads to the input terminal and probe the test points as shown in [Figure 3-4](#).

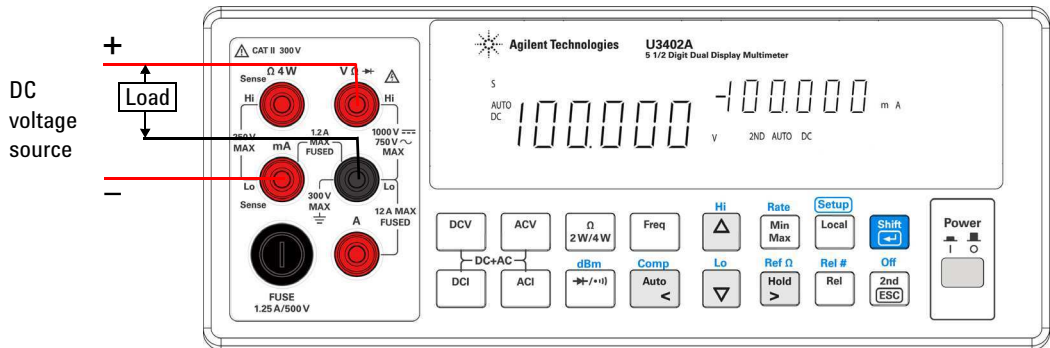

**Figure 3-4** Terminal connection when measuring DC voltage and DC current on a transistor circuit or load

- 2 Press to select DC voltage measurement for primary display.
  - 3 Press . Use and to select autoranging or manual ranging for primary display.
  - 4 Press to enable the secondary display. The **2ND** is displayed.
  - 5 Press to select DC current measurement for secondary display.
  - 6 Press . Use and to select autoranging or manual ranging for secondary display.
- Press to disable the secondary display.

#### NOTE

## Measure Resistance Using 2-Wire Mode

**WARNING**

Do not apply voltage exceeding 500 V PEAK between V.Ω.Hz and Lo input terminals.

- 1 Connect the red and black test leads to the resistor and probe the test points as shown in Figure 3-5.

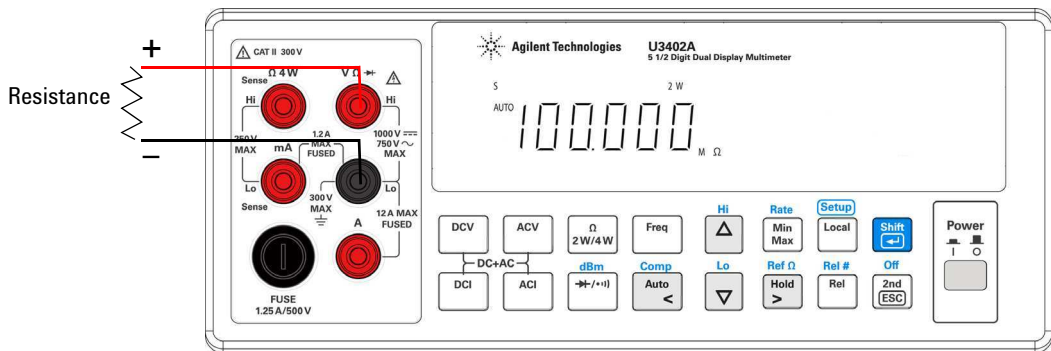

**Figure 3-5** Terminal connection when measuring resistance using 2-wire mode

- 2 Press  $\Omega$  2W/4W to select the 2-wire  $\Omega$  measurement for primary display. The 2W is displayed.
- 3 Press  $\text{Comp}$  Auto. Use  $\Delta$  Hi and  $\nabla$  Lo to select autoranging or manual ranging for primary display.

**NOTE**

When measuring low resistance, you may use the Rel operation to reduce the measurement error created by the test leads resistance and contact resistance in the test loop (0.1  $\Omega$ ~ 0.5  $\Omega$  typical)

## Measure Resistance Using 4-Wire Mode

### WARNING

Do not apply voltage exceeding 250 V PEAK between Sense Hi and Sense Lo terminals, and 500 V PEAK between V.Ω.Hz and Lo input terminals.

- 1 Connect the red and black test leads to the resistor and probe the test points as shown in Figure 3-6.

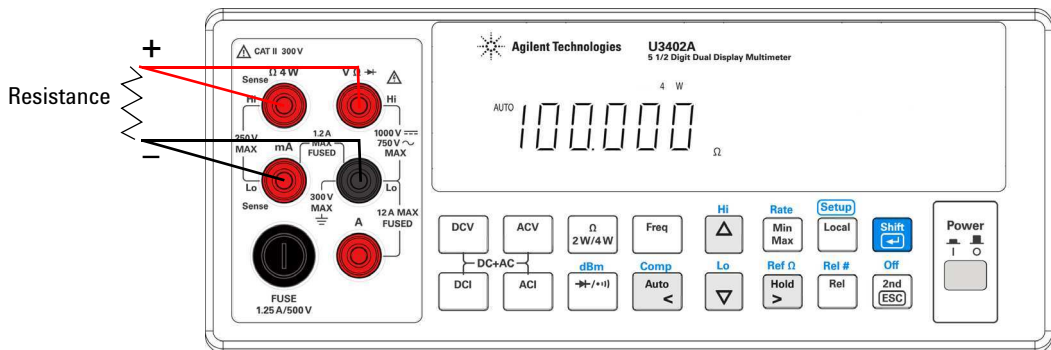

**Figure 3-6** Terminal connection when measuring resistance using 4-wire mode

- 2 Press  $\Omega$  2W/4W to select the 4-wire  $\Omega$  measurement for primary display. The 4W is displayed.
- 3 Press  $\text{Comp}$  Auto. Use  $\Delta$  Hi and  $\nabla$  Lo to select autoranging or manual ranging for primary display.

## Measure True RMS AC+DC

The multimeter can measure the true RMS value of the AC voltage and AC current.

- 1 Press  and , or  and  simultaneously. The multimeter will measure the DC and AC signals alternatively, calculate and display the AC+DC (RMS) value using the equation below:

$$\text{AC+DC (RMS)} = \sqrt{\text{DC}^2 + \text{AC}^2}$$

### NOTE

When AC+DC voltage measurement is selected, the DCV input impedance is paralleled with the AC coupled 1.1 M $\Omega$  AC divider.

---

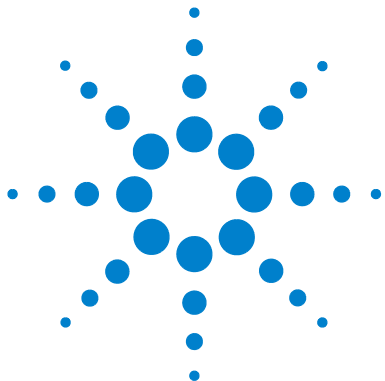

## 4 Performance Test

Calibration Overview	62
Agilent Technologies Calibration Services	62
Calibration Interval	62
Recommended Test Equipment	63
Test Considerations	64
Performance Verification Test Overview	65
Performance Verification Test	65
DC Voltage Verification Test	65
DC Current Verification Test	67
Resistance Verification Test	68
Diode Verification Test	71
Frequency Verification Test	71
AC Voltage Verification Test	72
AC Current Verification Test	73

This chapter contains performance test procedures. The performance test procedures allow you to verify that the multimeter is operating within its published specifications.

### WARNING

**Shock hazard. Only service-trained personnel who are aware of the hazards involved should perform the procedures in this chapter. To avoid electrical shock and personal injury, make sure to read and follow all test equipment safety instructions.**

**Use only completely electrically insulated test lead sets with connectors that prevent contact with test voltages.**



## Calibration Overview

**NOTE**

Make sure you have read “[Test Considerations](#)” on page 64 before calibrating the multimeter.

---

### Agilent Technologies Calibration Services

When your instrument is due for calibration, contact your local Agilent Service Center. The U3402A is supported on automated calibration systems at Agilent service centres only.

### Calibration Interval

A one-year interval is adequate for most applications. Accuracy specifications are warranted only if adjustment is made at regular calibration intervals. Accuracy specifications are not warranted beyond the one-year calibration interval. Agilent does not recommend extending calibration intervals beyond two years for any application. When an adjustment is required, contact your local Agilent Service Center.

## Recommended Test Equipment

The test equipments recommended for the performance verification procedures are listed below. If the exact instrument is not available, substitute calibration standards of equivalent accuracy.

A suggested alternate method would be to use the Agilent 3458A 8½ - digit digital multimeter to measure less accurate yet stable sources. The output value measured from the source can be entered into the instrument as the target calibration value.

**Table 4-1** Recommended test equipments

Application	Recommended equipment	Recommended accuracy requirements
Zero calibration	Shorting plug — Dual banana plug with copper wire short between the two terminals	—
DC voltage	Fluke 5520A	<1/5 instrument 1 year spec
DC current	Fluke 5520A	<1/5 instrument 1 year spec
Resistance	Fluke 5520A	<1/5 instrument 1 year spec
AC voltage	Fluke 5520A	<1/5 instrument 1 year spec
AC current	Fluke 5520A	<1/5 instrument 1 year spec
Frequency	Fluke 5520A	<1/5 instrument 1 year spec
Diode	Fluke 5520A	<1/5 instrument 1 year spec

## Test Considerations

For optimum performance, all procedures should comply with the following recommendations:

- Ensure that the calibration ambient temperature is stable and between 18 °C and 28 °C. Ideally the calibration should be performed at 23 °C ±1 °C.
- Ensure ambient relative humidity is less than 80%.
- Allow a one-hour warm-up period with a shorting plug connected to the Hi and Lo input terminals.
- Use shielded twisted pair PTFE-insulated cables to reduce settling and noise errors. Keep the input cables as short as possible.

### NOTE

Please ensure that the calibration standards and test procedures used do not introduce additional errors. Ideally, the standards used to verify and adjust the instrument should be an order of magnitude more accurate than each instrument range full-scale error specification.

---



## Performance Verification Test Overview

Performance verification test is an extensive set of tests that are recommended as an acceptance test when you first received the instrument.

Use the performance verification test to verify the measurement performance of the instrument. The performance verification test uses the instrument's specifications listed in [Chapter 6](#), “Specifications and Characteristics”.

### Performance Verification Test

The performance verification test is recommended as acceptance tests when you first received the instrument. The acceptance test results should be compared against the one-year test limits. After acceptance, you should repeat the performance verification tests at every calibration interval.

If the instrument fails performance verification, adjustment or repair is required. Contact your local Agilent Service Center for details.

#### NOTE

Make sure you have read “[Test Considerations](#)” on page 64 before doing the performance verification test.

---

This test checks the full-scale reading accuracy of the instrument.

#### DC Voltage Verification Test

- 1 Connect the calibrator to the front panel Hi and Lo input terminals.
- 2 Select each function and range in the order shown in [Table 4-2](#). Provide the input shown in [Table 4-2](#).
- 3 Make a measurement and observe the result. Compare measurement results to the appropriate test limits shown in the [Table 4-2](#). (Be certain to allow for appropriate source settling when using the Fluke 5520A.)

**Table 4-2** DC voltage verification test

Function	Reading rate	Input	Range	Error from nominal one year
DC voltage	Slow	0.000 V	120 mV	$\pm 8 \mu\text{V}$
		0.00000 V	1.2 V	$\pm 50 \mu\text{V}$
		0.0000 V	12 V	$\pm 0.5 \text{ mV}$
		0.000 V	120 V	$\pm 5 \text{ mV}$
		0.00 V	1000 V	$\pm 50 \text{ mV}$
	Medium	0.00 V	400 mV	$\pm 50 \mu\text{V}$
		0.0000 V	4 V	$\pm 500 \mu\text{V}$
		0.000 V	40 V	$\pm 5 \text{ mV}$
		0.00 V	400 V	$\pm 50 \text{ mV}$
		0.0 V	1000 V	$\pm 0.5 \text{ V}$
	Slow	100.000 mV	120 mV	$\pm 0.02 \text{ mV}$
		1.00000 V	1.2 V	$\pm 0.17 \text{ mV}$
		10.0000 V	12 V	$\pm 1.7 \text{ mV}$
		100.000 V	120 V	$\pm 17 \text{ mV}$
		1000.00 V	1000 V	$\pm 170 \text{ mV}$
	Medium	360.00 mV	400 mV	$\pm 90 \mu\text{V}$
		3.6000 V	4 V	$\pm 900 \mu\text{V}$
		36.000 V	40 V	$\pm 9 \text{ mV}$
		360.00 V	400 V	$\pm 90 \text{ mV}$
		1000.0 V	1000 V	$\pm 0.6 \text{ V}$

**CAUTION**

Set the calibrator output to 0 V before disconnecting it from the multimeter input terminals.

### DC Current Verification Test

- 1 Connect the calibrator to the front panel Hi and Lo input connectors.
- 2 Select each function and range in the order shown in [Table 4-3](#). Provide the input shown in [Table 4-3](#).
- 3 Make a measurement and observe the result. Compare measurement results to the appropriate test limits shown in [Table 4-3](#). (Be certain to allow for appropriate source settling when using the Fluke 5520A.)

**Table 4-3** DC current verification test

Function	Reading rate	Input	Range	Error from nominal one year
DC current	Slow	0.0000 mA	12 mA	$\pm 1.5 \mu\text{A}$
		0.000 mA	120 mA	$\pm 5 \mu\text{A}$
		0.00 mA	1200 mA	$\pm 50 \mu\text{A}$
		0.0000 A	12 A	$\pm 0.5 \text{ mA}$
	Medium	0.000 mA	40 mA	$\pm 6 \mu\text{A}$
		0.00 mA	120 mA	$\pm 30 \mu\text{A}$
		0.0 mA	1200 mA	$\pm 0.3 \text{ mA}$
		0.000 A	12 A	$\pm 3 \text{ mA}$
	Slow	10.0000 mA	12 mA	$\pm 6.5 \mu\text{A}$
		100.000 mA	120 mA	$\pm 55 \mu\text{A}$
		1000.00 mA	1200 mA	$\pm 2.05 \text{ mA}$
		10.0000 A	12 A	$\pm 20.5 \text{ mA}$
	Medium	36.000 mA	40 mA	$\pm 42 \mu\text{A}$
		100.00 mA	120 mA	$\pm 0.13 \text{ mA}$
		1000.0 mA	1200 mA	$\pm 2.3 \text{ mA}$
		10.000 A	12 A	$\pm 23 \text{ mA}$

#### CAUTION

Connect calibrator to multimeter's A and Lo terminals before applying 10 A.

**Resistance Verification Test**Configuration: 2-wire  $\Omega$ 

- 1 Select the resistance function.
- 2 Select each range in the order shown in [Table 4-4](#). Provide the resistance value indicated. Compare measurement results to the appropriate test limits shown in [Table 4-4](#). (Be certain to allow for appropriate source settling.)

**Table 4-4** 2-wire  $\Omega$  verification test

Function	Reading rate	Input	Range	Error from nominal one year
2-wire $\Omega$	Slow	0.000 $\Omega$	120 $\Omega$	$\pm 8$ m $\Omega$ <sup>[1]</sup>
		0.00000 $\Omega$	1.2 k $\Omega$	$\pm 50$ m $\Omega$ <sup>[1]</sup>
		0.0000 $\Omega$	12 k $\Omega$	$\pm 0.5$ $\Omega$ <sup>[1]</sup>
		0.000 $\Omega$	120 k $\Omega$	$\pm 5$ $\Omega$
		0.00000 $\Omega$	1.2 M $\Omega$	$\pm 50$ $\Omega$
		0.0000 $\Omega$	12 M $\Omega$	$\pm 0.5$ k $\Omega$
		0.000 $\Omega$	120 M $\Omega$	$\pm 8$ k $\Omega$
	Medium	0.00 $\Omega$	400 $\Omega$	$\pm 50$ m $\Omega$ <sup>[1]</sup>
		0.0000 $\Omega$	4 k $\Omega$	$\pm 0.3$ $\Omega$ <sup>[1]</sup>
		0.000 $\Omega$	40 k $\Omega$	$\pm 3$ $\Omega$ <sup>[1]</sup>
		0.00 $\Omega$	400 k $\Omega$	$\pm 30$ $\Omega$
		0.0000 $\Omega$	4 M $\Omega$	$\pm 0.3$ k $\Omega$
		0.000 $\Omega$	40 M $\Omega$	$\pm 3$ k $\Omega$
		0.00 $\Omega$	300 M $\Omega$	$\pm 50$ k $\Omega$
	Slow	100.000 $\Omega$	120 $\Omega$	$\pm 108$ m $\Omega$ <sup>[1]</sup>
		1.00000 k $\Omega$	1.2 k $\Omega$	$\pm 0.85$ $\Omega$ <sup>[1]</sup>
		10.0000 k $\Omega$	12 k $\Omega$	$\pm 6.5$ $\Omega$ <sup>[1]</sup>
		100.000 k $\Omega$	120 k $\Omega$	$\pm 65$ $\Omega$
		1.00000 M $\Omega$	1.2 M $\Omega$	$\pm 0.65$ k $\Omega$
		10.0000 M $\Omega$	12 M $\Omega$	$\pm 30.5$ k $\Omega$
		100.000 M $\Omega$	120 M $\Omega$	$\pm 3.008$ M $\Omega$

**Table 4-4** 2-wire  $\Omega$  verification test

Function	Reading rate	Input	Range	Error from nominal one year
2-wire $\Omega$	Medium	360.00 $\Omega$	400 $\Omega$	$\pm 0.41 \Omega$ <sup>[1]</sup>
		3.6000 k $\Omega$	4 k $\Omega$	$\pm 3.2 \Omega$ <sup>[1]</sup>
		36.000 k $\Omega$	40 k $\Omega$	$\pm 25 \Omega$ <sup>[1]</sup>
		360.00 k $\Omega$	400 k $\Omega$	$\pm 250 \Omega$
		3.6000 M $\Omega$	4 M $\Omega$	$\pm 5.7 \text{ k}\Omega$
		20.000 M $\Omega$	40 M $\Omega$	$\pm 303 \text{ k}\Omega$
		200.00 M $\Omega$	300 M $\Omega$	$\pm 10.05 \text{ M}\Omega$

**Notes:**

- 1 Specifications are for 2-wire ohms function using the Rel operation enabled to eliminate lead resistance.

Configuration: 4-wire  $\Omega$

- 1 Select the resistance function.
- 2 Select each range in the order shown in [Table 4-5](#). Provide the resistance value indicated. Compare measurement results to the appropriate test limits shown in [Table 4-5](#). (Be certain to allow for appropriate source settling.)

**Table 4-5** 4-wire  $\Omega$  verification test

Function	Reading rate	Input	Range	Error from nominal one year
4-wire $\Omega$	Slow	0.000 $\Omega$	120 $\Omega$	$\pm 8 \text{ m}\Omega$ <sup>[1]</sup>
		0.00000 $\Omega$	1.2 k $\Omega$	$\pm 50 \text{ m}\Omega$ <sup>[1]</sup>
		0.0000 $\Omega$	12 k $\Omega$	$\pm 0.5 \Omega$
		0.000 $\Omega$	120 k $\Omega$	$\pm 5 \Omega$
		0.00000 $\Omega$	1.2 M $\Omega$	$\pm 50 \Omega$
		0.0000 $\Omega$	12 M $\Omega$	$\pm 0.5 \text{ k}\Omega$
		0.000 $\Omega$	120 M $\Omega$	$\pm 8 \text{ k}\Omega$

**Table 4-5** 4-wire  $\Omega$  verification test

Function	Reading rate	Input	Range	Error from nominal one year
4-wire $\Omega$	Medium	0.00 $\Omega$	400 $\Omega$	$\pm 50$ m $\Omega$ <sup>[1]</sup>
		0.0000 $\Omega$	4 k $\Omega$	$\pm 0.3$ $\Omega$
		0.000 $\Omega$	40 k $\Omega$	$\pm 3$ $\Omega$
		0.00 $\Omega$	400 k $\Omega$	$\pm 30$ $\Omega$
		0.0000 $\Omega$	4 M $\Omega$	$\pm 0.3$ k $\Omega$
		0.000 $\Omega$	40 M $\Omega$	$\pm 3$ k $\Omega$
		0.00 $\Omega$	300 M $\Omega$	$\pm 50$ k $\Omega$
	Slow	100.000 $\Omega$	120 $\Omega$	$\pm 58$ m $\Omega$ <sup>[1]</sup>
		1.00000 k $\Omega$	1.2 k $\Omega$	$\pm 0.55$ $\Omega$ <sup>[1]</sup>
		10.0000 k $\Omega$	12 k $\Omega$	$\pm 5.5$ $\Omega$
		100.000 k $\Omega$	120 k $\Omega$	$\pm 55$ $\Omega$
		1.00000 M $\Omega$	1.2 M $\Omega$	$\pm 0.55$ k $\Omega$
		10.0000 M $\Omega$	12 M $\Omega$	$\pm 30.5$ k $\Omega$
		100.000 M $\Omega$	120 M $\Omega$	$\pm 3.008$ M $\Omega$
	Medium	360.00 $\Omega$	400 $\Omega$	$\pm 0.23$ $\Omega$ <sup>[1]</sup>
		3.6000 k $\Omega$	4 k $\Omega$	$\pm 2.1$ $\Omega$
		36.000 k $\Omega$	40 k $\Omega$	$\pm 21$ $\Omega$
		360.00 k $\Omega$	400 k $\Omega$	$\pm 0.21$ k $\Omega$
		3.6000 M $\Omega$	4 M $\Omega$	$\pm 5.7$ k $\Omega$
		20.000 M $\Omega$	40 M $\Omega$	$\pm 0.303$ k $\Omega$
		200.00 M $\Omega$	300 M $\Omega$	$\pm 10.05$ M $\Omega$

<sup>[1]</sup> Specifications are for 4-wire ohms function using the Rel operation enabled to eliminate lead resistance.

## Diode Verification Test

Configuration: Diode

- 1 Connect the calibrator to the front panel Hi and Lo input terminals.
- 2 Select each function and range in the order shown in [Table 4-6](#). Provide the input shown in [Table 4-6](#).
- 3 Make a measurement and observe the result. Compare measurement results to the appropriate test limits shown in [Table 4-6](#). (Be certain to allow for appropriate source settling when using the Fluke 5520A.)

**Table 4-6** Diode verification test

Function	Reading rate	Voltage	Range	Error from nominal one year
Diode	Slow	0.50000 V	1.2 V	$\pm 0.11$ mV
		1.00000 V	1.2 V	$\pm 0.17$ mV
	Medium	0.5000 V	2.5 V	$\pm 0.6$ mV
		2.0000 V	2.5 V	$\pm 0.7$ mV

## Frequency Verification Test

Configuration: Frequency

- 1 Select the frequency function.
- 2 Select each range in the order shown in [Table 4-7](#). Provide the input voltage and frequency indicated. Compare measurement results to the appropriate test limits shown in [Table 4-7](#). (Be certain to allow for appropriate source settling.)

**Table 4-7** Frequency verification test

Function	Reading rate	Voltage	Input frequency	Range	Error from nominal one year
Frequency	Slow	1 V	1000.00 Hz	1200 Hz	$\pm 0.08$ Hz

### AC Voltage Verification Test

Configuration: AC volts

- 1 Select the AC voltage function.
- 2 Select each range in the order shown in [Table 4-8](#). Provide the indicated input voltage and frequency. Compare measurement results to the appropriate test limits shown in [Table 4-8](#). (Be certain to allow for appropriate source settling.)

**Table 4-8** AC volts verification test

Function	Reading rate	V RMS	Input frequency	Range	Error from nominal one year
AC voltage	Slow	12.000 mV	1 kHz	120 mV	±0.124 mV
		100.000 mV	1 kHz	120 mV	±0.3 mV
		0.12000 V	1 kHz	1.2 V	±1.24 mV
		1.00000 V	1 kHz	1.2 V	±3 mV
		1.2000 V	1 kHz	12 V	±12.4 mV
		10.0000 V	1 kHz	12 V	±30 mV
		12.000 V	1 kHz	120 V	±124 mV
		100.000 V	1 kHz	120 V	±0.3 V
		120.00 V	1 kHz	750 V	±1.24 V
	750.00 V	1 kHz	750 V	±2.5 V	
	Medium	40.00 mV	1 kHz	400 mV	±0.48 mV
		360.00 mV	1 kHz	400 mV	±1.12 mV
		0.4000 V	1 kHz	4 V	±4.8 mV
		3.6000 V	1 kHz	4 V	±11.2 mV
		4.000 V	1 kHz	40 V	±48 mV
		36.000 V	1 kHz	40 V	±112 mV
		40.00 V	1 kHz	400 V	±480 mV
		360.00 V	1 kHz	400 V	±1.12 V
		120.0 V	1 kHz	750 V	±4.2 V
750.0 V		1 kHz	750 V	±5.5 V	

#### CAUTION

Set the calibrator output to 0 V before disconnecting it from the multimeter input terminals.



## AC Current Verification Test

Configuration: AC current

- 1 Select the AC current function.
- 2 Select each range in the order shown in [Table 4-9](#). Provide the input current and frequency indicated. Compare measurement results to the appropriate test limits shown in [Table 4-9](#). (Be certain to allow for appropriate source settling.)

**Table 4-9** AC current verification test

Function	Reading rate	Current	Input frequency	Range	Error from nominal one year
AC current	Slow	1.2000 mA	1 kHz	12 mA	±16 µA
		10.0000 mA	1 kHz	12 mA	±60 µA
		12.000 mA	1 kHz	120 mA	±0.16 mA
		100.000 mA	1 kHz	120 mA	±0.6 mA
		120.00 mA	1 kHz	1200 mA	±1.6 mA
		1000.00 mA	1 kHz	1200 mA	±6 mA
		1.2000 A	1 kHz	12 A	±22 mA
		10.000 A	1 kHz	12 A	±110 mA
	Medium	4.000 mA	1 kHz	40 mA	±60 µA
		36.000 mA	1 kHz	40 mA	±0.22 mA
		12.00 mA	1 kHz	120 mA	±0.18 mA
		100.00 mA	1 kHz	120 mA	±0.62 mA
		120.0 mA	1 kHz	1200 mA	±1.8 mA
		1000.0 mA	1 kHz	1200 mA	±6.2 mA
		1.200 A	1 kHz	12 A	±24 mA
		10.000 A	1 kHz	12 A	±112 mA

### CAUTION

Connect calibrator to multimeter's A and Lo terminals before applying 10 A.

**THIS PAGE HAS BEEN INTENTIONALLY LEFT BLANK.**



## 5 Disassembly and Repair

Operating Checklist	76
Types of Service Available	77
Repackaging for Shipment	78
Cleaning	78
To Replace the Power Line Fuse	79
To Replace a Current Input Fuse	80
Electrostatic Discharge (ESD) Precautions	80
Mechanical Disassembly	81
Replaceable Parts	87

This chapter will help you troubleshoot a faulty multimeter. It describes how to disassemble the multimeter, how to obtain repair services, and lists the replaceable parts.



## Operating Checklist

Before returning your multimeter to Agilent for service or repair check the following items:

### Is the multimeter inoperative?

- Verify the power line voltage setting.
- Verify the power line fuse is installed.
- Verify that the power cord is connected to the multimeter and to AC line power.
- Verify the front panel power switch is depressed.

See [page 79](#).

### Is the multimeter's current input inoperative?

- Verify the current input fuse.

## Types of Service Available

If your instrument fails during the warranty period, Agilent Technologies will repair or replace it under the terms of your warranty. After your warranty expires, Agilent offers repair services at competitive prices.

### Extended Service Contracts

Many Agilent products are available with optional service contracts that extend the *covered period* after the standard warranty expires. If you have such a service contract and your instrument fails during the covered period, Agilent Technologies will repair or replace it in accordance with the contract.

### Obtaining Repair Service (Worldwide)

To obtain service for your instrument (in-warranty, under service contract, or post-warranty), contact your nearest Agilent Technologies Service Center. They will arrange to have your instrument repaired or replaced, and can provide warranty or repair-cost information where applicable.

To obtain warranty, service, or technical support information you can contact Agilent Technologies at one of the following telephone numbers:

In the United States: (800) 829-4444

In Europe: 31 20 547 2111

In Japan: 0120-421-345

Or use our Web link for information on contacting Agilent worldwide:

[www.agilent.com/find/assist](http://www.agilent.com/find/assist)

Or contact your Agilent Technologies representative.

Before shipping your instrument, ask the Agilent Technologies Service Center to provide shipping instructions, including what components to ship. Agilent recommends that you retain the original shipping carton for use in such shipments.

## Repackaging for Shipment

If the instrument is to be shipped to Agilent for service or repair, be sure to:

- Attach a tag to the unit identifying the owner and indicating the required service or repair. Include the model number and full serial number.
- Place the unit in its original container with appropriate packaging material for shipping.
- Secure the container with strong tape or metal bands.
- If the original shipping container is not available, place your instrument in a container which will ensure at least 4 inches of compressible packaging material around all sides for the instrument. Use static-free packaging materials to avoid additional damage to your instrument.

*Agilent suggests that you always insure shipments.*

## Cleaning

Clean the outside of the multimeter with a soft, lint-free, slightly dampened cloth. Do not use detergent. Disassembly is not required or recommended for cleaning.

## To Replace the Power Line Fuse

The power line fuse is located within the multimeter’s fuse-holder assembly on the rear panel. The multimeter is shipped from the factory with a power-line fuse installed (according to country of destination). Refer to [Table 5-1](#). If you determine that the fuse is faulty, replace it with one of the same size and rating.

**Table 5-1** Type of supplied fuse (according to country of destination)

Type of fuse (time-lag, low breaking fuse)	Input line voltage	Part number
0.25A, 250V, 5x20 mm	100 V to 120 V	A02-62-25592-3U
0.125A, 250V, 5x20 mm	220 V to 240 V	A02-62-25648-1U

**1** Disconnect the power cord. Depress tab 1 and 2 and pull the fuse holder from rear panel.

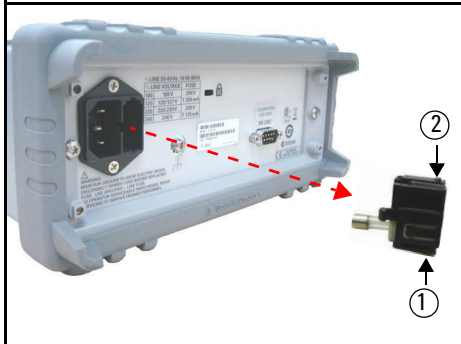

**2** Remove the line voltage selector from fuse holder assembly.

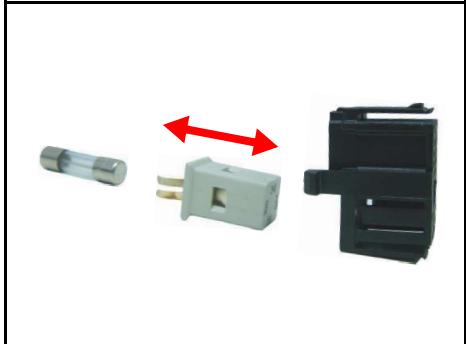

**3** Rotate the line voltage selector and reinstall it back, so that the correct voltage appears in the fuse holder window.

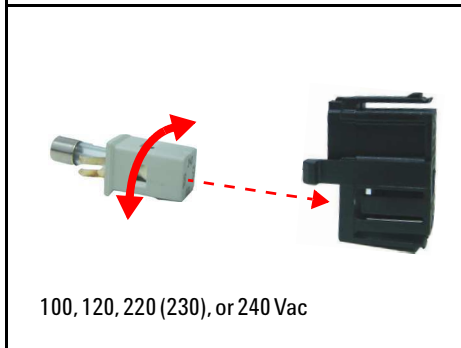

**4** Replace fuse holder assembly in rear panel.

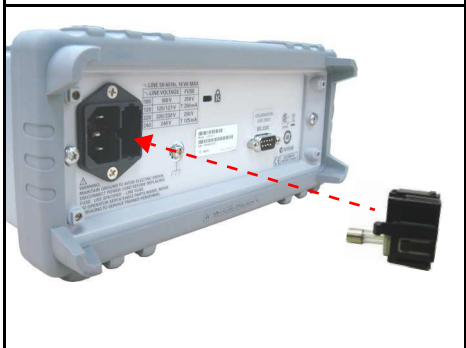

## To Replace a Current Input Fuse

Both the mA and the A current input terminals are fuse protected. The fuse for the mA input terminal is located on the front panel (see [page 14](#)). The fuse is a 1.25 A, 500 V fuse (refer to [Table 5-2](#)). If you determine that the fuse is faulty, replace it with one of the same size and rating.

The fuse for the A current input terminal is located inside the multimeter (see [page 85](#)) and requires partial disassembly of the multimeter. The fuse is a 15 A, 600 V fast-acting fuse (refer to [Table 5-2](#)). If you determine that the fuse is faulty, replace it with one of the same size and rating.

**Table 5-2** Type of current input fuse

Type of fuse	Part number
1.25 A, 500 V fuse	2110-1394
15 A, 600 V fast-acting fuse	2110-1396

## Electrostatic Discharge (ESD) Precautions

Almost all electrical components can be damaged by electrostatic discharge (ESD) during handling. Component damage can occur at electrostatic discharge voltages as low as 50 volts.

The following guidelines will help prevent ESD damage when servicing the instrument or any electronic device.

- Disassemble instruments only in a static-free work area.
- Use a conductive work area to reduce static charges.
- Use a conductive wrist strap to reduce static charge accumulation.
- Minimize handling.
- Keep replacement parts in original static-free packaging.
- Remove all plastic, foam, vinyl, paper, and other static-generating materials from the immediate work area.
- Use only anti-static solder suckers.



## Mechanical Disassembly

For procedures in this manual, the following tools are required for disassembly:

- T15 Torx driver
- T20 Torx driver
- #2 Pozi-drive screw driver

### WARNING

**Shock hazard. Only service-trained personnel who are aware of the hazards involved should remove the instrument covers. To avoid electrical shock and personal injury, make sure to disconnect the power cord from the multimeter before removing the covers. Some circuits are active and have power applied even when the power switch is turned off.**

### General Disassembly

- 1 Remove power and all cables from the multimeter.
- 2 Remove the carrying handle by rotating the handle upright and pulling it out from the sides of the multimeter.



## 5 Disassembly and Repair

- 3 Remove the multimeter's bumpers.** Pull from a corner and stretch the bumpers off the multimeter.



- 4 Remove the rear bezel.** Loosen the two captive screws in the rear bezel and remove the rear bezel.



- 5 Remove the cover.** Remove the screw at the bottom of the cover and slide the cover off the multimeter.



### Front Panel Removal

- 1 Remove on/off switch push rod.** Gently move the power switch push rod toward the front of the multimeter to disengage it from the switch. Be careful not to twist or bend the push rod.

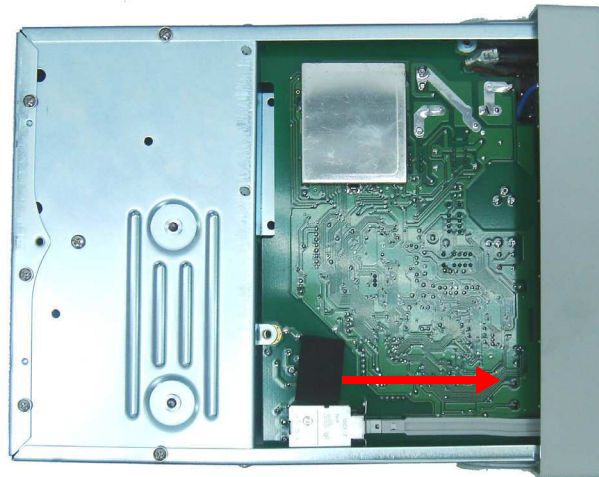

## 5 Disassembly and Repair

**2 Remove the screw holding the front panel.**



**3 Disconnect the two ribbon cable connectors from the front panel.**

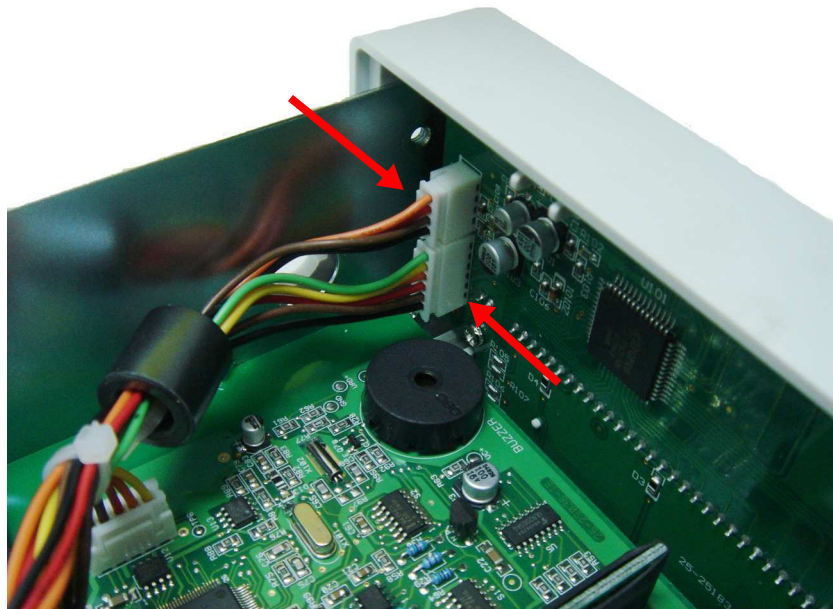

- 4 Disconnect the individual front panel wires shown below.

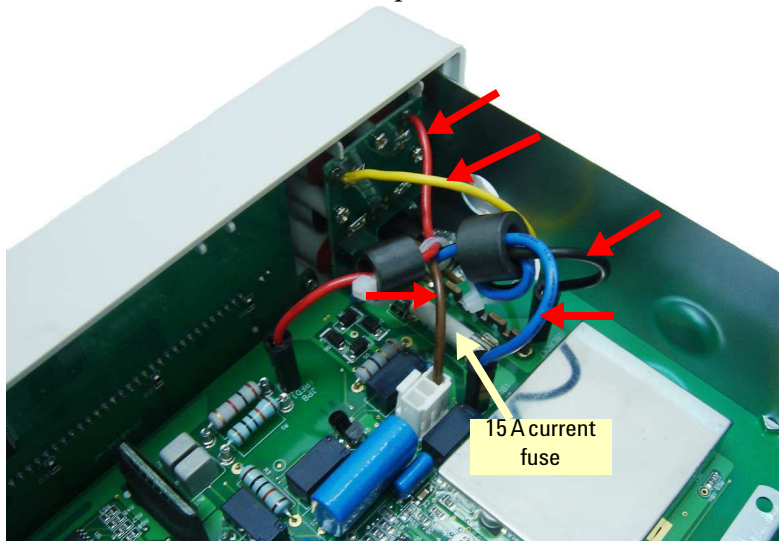

- 5 There is now enough play to allow the side of the front panel to be pried from the chassis and removed as an assembly.

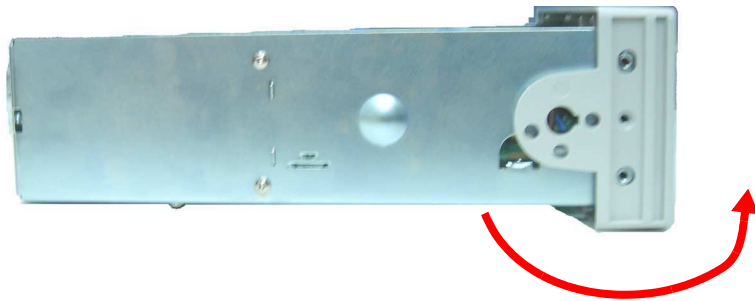

### Front Panel Disassembly

- 1 Remove the keyboard and display assembly.** Remove the two screws holding the circuit board. Lift the keyboard and display assembly from the plastic housing.

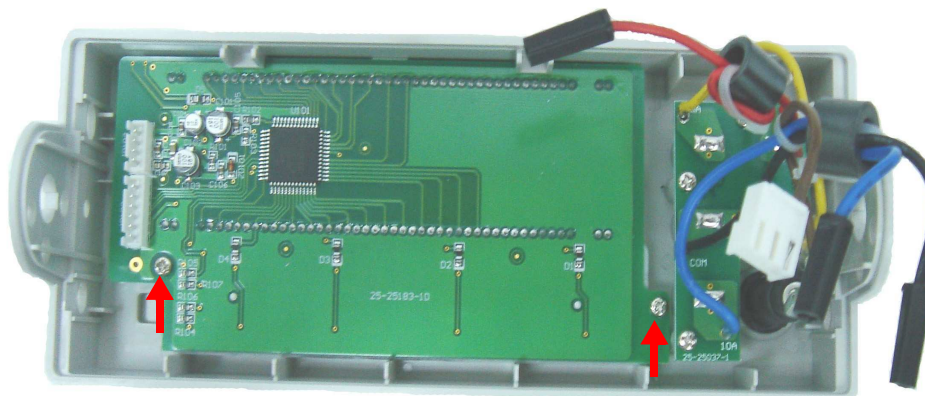

- a** The rubber keypad can now be pulled from the plastic housing.

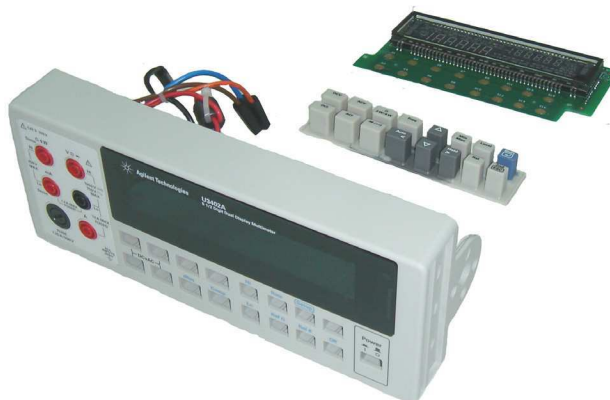

## Replaceable Parts

This section contains information for ordering replacement parts for your instrument. You can find the instrument support part list at Agilent's Test & Measurement Parts Catalog at <http://www.agilent.com/find/parts>

This parts list includes a brief description of each part with applicable Agilent part number.

### To order replaceable parts

You can order replaceable parts from Agilent using the Agilent part number. Note that not all parts listed are available as field-replaceable parts.

To order replaceable parts from Agilent, do the following:

- 1 Contact your nearest Agilent Sales Office or Service Center.
- 2 Identify the parts by the Agilent part number shown in the support parts list.
- 3 Provide the instrument model number and serial number.

**THIS PAGE HAS BEEN INTENTIONALLY LEFT BLANK.**





## 6 Specifications and Characteristics

DC Specifications	90
AC Specifications	93
True RMS AC Voltage (AC Coupling Mode)	93
True RMS AC Voltage (AC+DC Coupling Mode)	94
True RMS AC Current (AC Coupling Mode)	95
True RMS AC Current (AC+DC Coupling Mode)	96
Frequency	96
Decibel (dB) Calculation	97
Supplemental Measurement Specifications	98
Display update rate	98
Measurement specifications	98
Reading rates	105
General Characteristics	107
To Calculate Total Measurement Error	109
Accuracy Specifications	110
Configuring for Highest Accuracy Measurements	111

This chapter describes the multimeter's specifications and operating specifications



## DC Specifications

**Table 6-1** DC resolution, full scale reading, and accuracy [ $\pm$ (% of reading + count)]

Function	Rate	Range	Resolution	Maximum reading	Accuracy (One year; 23°C $\pm$ 5°C)	Typical input impedance <sup>[1]</sup>	Burden voltage <sup>[4]</sup>
Voltage	Slow	120.000 mV	0.001 mV	119.999	$\pm 0.012\% + 8$ <sup>[2]</sup>	10.0 M $\Omega$	—
		1.20000 V	0.00001 V	1.19999	$\pm 0.012\% + 5$	10.0 M $\Omega$	
		12.0000 V	0.0001 V	11.9999	$\pm 0.012\% + 5$	11.1 M $\Omega$	
		120.000 V	0.001 V	119.999	$\pm 0.012\% + 5$	10.1 M $\Omega$	
		1000.00 V	0.01 V	1000.00 <sup>[3]</sup>	$\pm 0.012\% + 5$	10.0 M $\Omega$	
	Med	400.00 mV	0.01 mV	399.99	$\pm 0.012\% + 5$	10.0 M $\Omega$	—
		4.0000 V	0.0001 V	3.9999	$\pm 0.012\% + 5$	11.1 M $\Omega$	
		40.000 V	0.001 V	39.999	$\pm 0.012\% + 5$	10.1 M $\Omega$	
		400.00 V	0.01 V	399.99	$\pm 0.012\% + 5$	10.0 M $\Omega$	
		1000.0 V	0.1 V	1000.0 <sup>[3]</sup>	$\pm 0.012\% + 5$	10.0 M $\Omega$	
	Fast	400.0 mV	0.1 mV	399.9	$\pm 0.012\% + 2$	10.0 M $\Omega$	—
		4.000 V	0.001 V	3.999	$\pm 0.012\% + 2$	11.1 M $\Omega$	
		40.00 V	0.01 V	39.99	$\pm 0.012\% + 2$	10.1 M $\Omega$	
		400.0 V	0.1 V	399.9	$\pm 0.012\% + 2$	10.0 M $\Omega$	
		1000 V	1 V	1000 <sup>[3]</sup>	$\pm 0.012\% + 2$	10.0 M $\Omega$	

**Table 6-1** DC resolution, full scale reading, and accuracy [ $\pm$ (% of reading + count)] (continued)

Function	Rate	Range	Resolution	Maximum reading	Accuracy (One year; 23°C $\pm$ 5°C)	Typical input impedance <sup>[1]</sup>	Burden voltage <sup>[4]</sup>
Current	Slow	12.0000 mA	0.0001 mA	11.9999	0.05% + 15 <sup>[2]</sup>	—	< 0.15 V
		120.000 mA	0.001 mA	119.999	0.05% + 5	—	< 1.5 V
		1200.00 mA	0.01 mA	1199.99	0.2% + 5	—	< 0.3 V
		12.0000 A	0.0001A	11.9999	0.2% + 5	—	< 0.6 V
	Med	40.000 mA	0.001 mA	39.999	0.1% + 6	—	< 0.5 V
		120.00 mA	0.01 mA	119.99	0.1% + 3	—	< 1.5 V
		1200.0 mA	0.1 mA	1199.9	0.2% + 3	—	< 0.3 V
		12.000 A	0.001 A	11.999	0.2% + 3	—	< 0.6 V
	Fast	40.00 mA	0.01 mA	39.99	0.1% + 2	—	< 0.5 V
		120.0 mA	0.1 mA	119.9	0.1% + 2	—	< 1.5 V
		1200 mA	1 mA	1199	0.2% + 2	—	< 0.3 V
		12.00 A	0.01 A	11.99	0.2% + 2	—	< 0.6 V
Diode/ Continuity	Slow	—	0.00001 V	1.19999 V	0.012% + 5	—	—
	Med	—	0.0001 V	2.4999 V	0.012% + 5	—	—
	Fast	—	0.001 V	2.499 V	0.012% + 2	—	—
Resistance / Continuity (2-wire)	Slow	120.000 $\Omega$	0.001 $\Omega$	119.999	0.1% + 8 <sup>[5]</sup>	—	—
	Med	400.00 $\Omega$	0.01 $\Omega$	399.99	0.1% + 5 <sup>[5]</sup>	—	—
	Fast	400.0 $\Omega$	0.1 $\Omega$	399.9	0.1% + 2 <sup>[5]</sup>	—	—

## 6 Specifications and Characteristics

**Table 6-1** DC resolution, full scale reading, and accuracy [ $\pm$ (% of reading + count)] (continued)

Function	Rate	Range <sup>[6]</sup>	Resolution	Maximum reading	Current source	Accuracy (One year; 23°C $\pm$ 5°C)	
						2-wire	4-wire
Resistance	Slow	120.000 $\Omega$	0.001 $\Omega$	119.999	0.5 mA	0.1% + 8 <sup>[2]</sup>	0.05% + 8 <sup>[2]</sup>
		1.20000 k $\Omega$	0.00001 k $\Omega$	1.19999	0.5 mA	0.08% + 5 <sup>[2]</sup>	0.05% + 5 <sup>[2]</sup>
		12.0000 k $\Omega$	0.0001 k $\Omega$	11.9999	100 $\mu$ A	0.06% + 5 <sup>[2]</sup>	0.05% + 5
		120.000 k $\Omega$	0.001 k $\Omega$	119.999	10 $\mu$ A	0.06% + 5	0.05% + 5
		1.20000 M $\Omega$	0.00001 M $\Omega$	1.19999	1 $\mu$ A	0.06% + 5	0.05% + 5
		12.0000 M $\Omega$	0.0001 M $\Omega$	11.9999	100 nA	0.3% + 5	0.3% + 5
		120.000 M $\Omega$	0.001 M $\Omega$	119.999	10 nA	3.0% + 8	3.0% + 8
	Med	400.00 $\Omega$	0.01 $\Omega$	399.99	0.5 mA	0.1% + 5 <sup>[2]</sup>	0.05% + 5 <sup>[2]</sup>
		4.0000 k $\Omega$	0.0001 k $\Omega$	3.9999	100 $\mu$ A	0.08% + 3 <sup>[2]</sup>	0.05% + 3
		40.000 k $\Omega$	0.001 k $\Omega$	39.999	50 $\mu$ A	0.06% + 3	0.05% + 3
		400.00 k $\Omega$	0.01 k $\Omega$	399.99	5 $\mu$ A	0.06% + 3	0.05% + 3
		4.0000 M $\Omega$	0.0001 M $\Omega$	3.9999	500 nA	0.15% + 3	0.15% + 3
		40.000 M $\Omega$	0.001 M $\Omega$	39.999	50 nA	1.5% + 3	1.5% + 3
		300.00 M $\Omega$	0.01 M $\Omega$	299.99	10 nA	5.0% + 5	5.0% + 5
	Fast	400.0 $\Omega$	0.1 $\Omega$	399.9	0.5 mA	0.1% + 2 <sup>[2]</sup>	0.05% + 2
		4.000 k $\Omega$	0.001 k $\Omega$	3.999	100 $\mu$ A	0.08% + 2	0.05% + 2
		40.00 k $\Omega$	0.01 k $\Omega$	39.99	50 $\mu$ A	0.06% + 2	0.05% + 2
		400.0 k $\Omega$	0.1 k $\Omega$	399.9	5 $\mu$ A	0.06% + 2	0.05% + 2
		4.000 M $\Omega$	0.001 M $\Omega$	3.999	500 nA	0.15% + 2	0.15% + 2
		40.00 M $\Omega$	0.01 M $\Omega$	39.99	50 nA	1.5% + 2	1.5% + 2
		300.0 M $\Omega$	0.1 M $\Omega$	299.9	10 nA	5.0% + 2	5.0% + 2

**Notes:**

- 1** Input impedance is in parallel with capacitance < 120 pF.
- 2** Use Rel operation.
- 3** In VDC 1000 V range, 5% over-range (1050 VDC) is readable.
- 4** Typical at full scale reading and voltage across the input terminals.
- 5** Use Rel operation. If Rel operation is not used, add 0.2  $\Omega$  additional error.
- 6** In order to eliminate the noise interference, which might be induced to the test leads, it is recommended to use a shielded test cable for measuring resistance above 100 k $\Omega$

## AC Specifications

### True RMS AC Voltage (AC Coupling Mode)

**Table 6-2** AC voltage resolution, full scale reading, and accuracy [ $\pm$  (% of reading + count)]

Rate	Range	Resolution	Maximum reading	Accuracy (One year; 23°C $\pm$ 5°C) <sup>[1]</sup>			
				20 Hz to 45 Hz	45 Hz to 10kHz	10 kHz to 30 kHz	30 kHz to 100 kHz <sup>[2]</sup>
Slow	120.000 mV	0.001 mV	119.999	1% + 100	0.2% + 100	1.5% + 300	5% + 300
	1.20000 V	0.00001 V	1.19999	1% + 100	0.2% + 100	1% + 100	3% + 200
	12.0000 V	0.0001 V	11.9999	1% + 100	0.2% + 100	1% + 100	3% + 200
	120.000 V	0.001 V	119.999	1% + 100	0.2% + 100	1% + 100	3% + 200
	750.00 V	0.01 V	750.00 <sup>[4]</sup>	1% + 100 <sup>[2]</sup>	0.2% + 100	1% + 100	3% + 200 <sup>[3]</sup>
Med	400.00 mV	0.01 mV	399.99	1% + 40	0.2% + 40	1.5% + 80	5% + 120
	4.0000 V	0.0001 V	3.9999	1% + 40	0.2% + 40	1% + 40	3% + 80
	40.000 V	0.001 V	39.999	1% + 40	0.2% + 40	1% + 40	3% + 80
	400.00 V	0.01 V	399.99	1% + 40 <sup>[2]</sup>	0.2% + 40	1% + 40	3% + 80
	750.0 V	0.1 V	750.0	1% + 40 <sup>[2]</sup>	0.2% + 40	1% + 40	3% + 80 <sup>[3]</sup>
Fast	400.0 mV	0.1 mV	399.9	1% + 5	0.2% + 5	1.5% + 10	5% + 15
	4.000 V	0.001 V	3.999	1% + 5	0.2% + 5	1% + 5	3% + 10
	40.00 V	0.01 V	39.99	1% + 5	0.2% + 5	1% + 5	3% + 10
	400.0 V	0.1 V	399.9	1% + 5 <sup>[2]</sup>	0.2% + 5	1% + 5	3% + 10
	750 V	1 V	750	1% + 5 <sup>[2]</sup>	0.2% + 5	1% + 5	3% + 10 <sup>[3]</sup>

**Notes:**

- 1 Specified accuracy at input > 5% of full scale.
- 2 For input < 200 V RMS.
- 3 For input < 500 V RMS.
- 4 In VAC 750 V range, 787.5 V RMS is readable.

**True RMS AC Voltage (AC+DC Coupling Mode)**

**Table 6-3** AC voltage<sub>ac+dc</sub> resolution, full scale reading, and accuracy [ $\pm$  (% of reading + count)]

Rate	Range <sup>[1]</sup>	Resolution	Maximum reading	Accuracy (One year; 23°C $\pm$ 5°C) <sup>[2]</sup>		
				45 Hz to 10kHz	10 kHz to 30 kHz	30 kHz to 100 kHz
Slow	120.000 mV	0.001 mV	119.999	0.2% + 100	1.5% + 300	5% + 300
	1.20000 V	0.00001 V	1.19999	0.2% + 100	1% + 100	3% + 200
	12.0000 V	0.0001 V	11.9999	0.2% + 100	1% + 100	3% + 200
	120.000 V	0.001 V	119.999	0.2% + 100	1% + 100	3% + 200
	750.00 V	0.01 V	750.00 <sup>[3]</sup>	0.2% + 100	1% + 100	3% + 200 <sup>[4]</sup>
Med	400.00 mV	0.01 mV	399.99	0.2% + 45	1.5% + 83	5% + 125
	4.0000 V	0.0001 V	3.9999	0.2% + 43	1% + 43	3% + 83
	40.000 V	0.001 V	39.999	0.2% + 43	1% + 43	3% + 83
	400.00 V	0.01 V	399.99	0.2% + 43	1% + 43	3% + 83
	750.0 V	0.1 V	750.0	0.2% + 43	1% + 43	3% + 83 <sup>[4]</sup>
Fast	400.0 mV	0.1 mV	399.9	0.2% + 7	1.5% + 12	5% + 18
	4.000 V	0.001 V	3.999	0.2% + 7	1% + 7	3% + 12
	40.00 V	0.01 V	39.99	0.2% + 7	1% + 7	3% + 12
	400.0 V	0.1 V	399.9	0.2% + 7	1% + 7	3% + 12
	750 V	1 V	750	0.2% + 7	1% + 7	3% + 12 <sup>[4]</sup>

**Notes:**

- 1 VDC and VAC are automatically set at the same range.
- 2 Specified accuracy at input > 5% of full scale.
- 3 In VAC 750 V range, 787.5 V RMS is readable.
- 4 For input < 500 V RMS.

### True RMS AC Current (AC Coupling Mode)

**Table 6-4** AC current resolution, full scale reading, burden voltage, and accuracy [ $\pm$  (% of reading + count)]

Rate	Range	Resolution	Maximum reading	Burden voltage <sup>[1]</sup>	Accuracy (One year; 23°C $\pm$ 5°C) <sup>[2]</sup>		
					20 Hz to 45 Hz	45 Hz to 2 kHz	2 kHz to 10 kHz
Slow	12.0000 mA	0.0001 mA	11.9999	< 0.15 V	1.5% + 100	0.5% + 100	2% + 200
	120.000 mA	0.001 mA	119.999	< 1.5 V	1.5% + 100	0.5% + 100	2% + 200
	1200.00 mA	0.01 mA	1199.99	< 0.3 V	1.5% + 100	0.5% + 100	2% + 200
	12.0000 A	0.0001 A	11.9999	< 0.6 V	2% + 100 (<1.2 A)	1% + 100	–
Med	40.000 mA	0.001 mA	39.999	< 0.5 V	1.5% + 40	0.5% + 40	2% + 80
	120.00 mA	0.01 mA	119.99	< 1.5 V	1.5% + 12	0.5% + 12	2% + 30
	1200.0 mA	0.1 mA	1199.9	< 0.3 V	1.5% + 12	0.5% + 12	2% + 30
	12.000 A	0.001 A	11.999	< 0.6 V	1.5% + 12 (<1.2 A)	1% + 12	–
Fast	40.00 mA	0.01 mA	39.99	< 0.5 V	1.5% + 5	0.5% + 5	2% + 10
	120.0 mA	0.1 mA	119.9	< 1.5 V	1.5% + 2	0.5% + 2	2% + 5
	1200 mA	1 mA	1199	< 0.3 V	1.5% + 2	0.5% + 2	2% + 5
	12.00 A	0.01 A	11.99	< 0.6 V	2% + 2 (<1.2 A)	1% + 2	–

**Notes:**

- 1 Typical at full scale reading and voltage across the input terminals.
- 2 Specified accuracy at input > 5% of full scale.

**True RMS AC Current (AC+DC Coupling Mode)**

**Table 6-5** AC current <sub>ac+dc</sub> resolution, full scale reading, burden voltage, and accuracy [ $\pm$  (% of reading + count)]

Rate	Range	Resolution	Maximum reading	Burden voltage <sup>[1]</sup>	Accuracy (one year; 23°C $\pm$ 5°C) <sup>[2]</sup>	
					45 Hz to 2 kHz	2 kHz to 10 kHz
Slow	12.0000 mA	0.0001 mA	11.9999	< 0.15 V	0.5% + 100	2% + 200
	120.000 mA	0.001 mA	119.999	< 1.5 V	0.5% + 100	2% + 200
	1200.00 mA	0.01 mA	1199.99	< 0.3 V	0.5% + 100	2% + 200
	12.0000 A	0.0001 A	11.9999	< 0.6 V	1% + 100	–
Med	40.000 mA	0.001 mA	39.999	< 0.5 V	0.5% + 42	2% + 80
	120.00 mA	0.01 mA	119.99	< 1.5 V	0.5% + 15	2% + 30
	1200.0 mA	0.1 mA	1199.9	< 0.3 V	0.5% + 15	2% + 30
	12.000 A	0.001 A	11.999	< 0.6 V	1% + 15	–
Fast	40.00 mA	0.01 mA	39.99	< 0.5 V	0.5% + 7	2% + 12
	120.0 mA	0.1 mA	119.9	< 1.5 V	0.5% + 4	2% + 7
	1200 mA	1 mA	1199	< 0.3 V	0.5% + 4	2% + 7
	12.00 A	0.01 A	11.99	< 0.6 V	1% + 4	–

**Notes:**

- 1 Typical at full scale reading and voltage across the input terminals.
- 2 Specified accuracy at input > 5% of full scale.

**Frequency**

**Table 6-6** Frequency resolution and accuracy [ $\pm$  (% of reading + count)]

Range	Measurement range	Resolution	Maximum reading	Accuracy (One year; 23°C $\pm$ 5°C) <sup>[1]</sup>	Input sensitivity (Sine wave)
1200 Hz	5 Hz to 1200 Hz	0.01 Hz	1199.99	0.005% + 3	40 mV RMS
12 kHz	10 Hz to 12 kHz	0.0001 kHz	11.9999	0.005% + 2	40 mV RMS
120 kHz	100 Hz to 120 kHz	0.001 kHz	119.999	0.005% + 2	40 mV RMS
1 MHz	1 kHz to 1 MHz	0.0001 MHz	1.1999	0.005% + 2	0.5 V RMS

**Notes:**

- 1 Specified accuracy at input > 5% of full scale.



## Decibel (dB) Calculation

**Table 6-7** Range and accuracy ( $\pm$ dB)

Rate	Voltage range [1][2]	Input voltage	dBm [3] range at 600 $\Omega$ ref	Accuracy (One year; 23°C $\pm$ 5°C) [4]		
				20 Hz to 45 Hz	45 Hz to 10 kHz	10 kHz to 100 kHz
Slow	120.000 mV	6 mV to 120 mV	-42.20 to -16.20	1.0	0.2	1.0
	1.20000 V	120 mV to 1.2 V	-16.20 to 3.80	0.8	0.1	0.8
	12.0000 V	1.2 V to 12 V	3.80 to 23.80	0.8	0.1	0.8
	120.000 V	12 V to 120 V	23.80 to 43.80	0.8	0.1	0.8
	1000.00 VDC	120 V to 1000 V	43.80 to 62.22	-	1.0 [4]	-
	750.00 VAC	120 V to 750 V	43.80 to 59.72	-	1.0 [4]	-
Medium	400.00 mV	20 mV to 400 mV	-31.76 to -5.74	1.0	0.2	1.0
	4.0000 V	400 mV to 4 V	-5.74 to 14.26	0.8	0.1	0.8
	40.000 V	4 V to 40 V	14.26 to 34.26	0.8	0.1	0.8
	400.00 V	40 V to 400 V	34.26 to 54.26	0.8	0.1	0.8
	1000.0 VDC	400 V to 1000 V	54.26 to 62.22	-	1.0 [4]	-
	750.0 VAC	400 V to 750 V	54.26 to 59.72	-	1.0 [4]	-
Fast	400.0 mV	20 mV to 400 mV	-31.76 to -5.74	1.0	0.2	1.0
	4.000 V	400 mV to 4 V	-5.74 to 14.26	0.8	0.1	0.8
	40.00 V	4 V to 40 V	14.26 to 34.26	0.8	0.1	0.8
	400.0 V	40 V to 400 V	34.26 to 54.26	0.8	0.1	0.8
	1000 VDC	400 V to 1000 V	54.26 to 62.22	-	1.0 [4]	-
	750 VAC	400 V to 750 V	54.26 to 59.72	-	1.0 [4]	-

**Notes:**

- 1 Autoranging is used when dBm operation is enabled.
- 2 In VAC 750 V range, 5% over-range is readable.
- 3 Reading displayed in dB when Rel operation is used.
- 4 For input voltage at frequency between 45 Hz to 1 kHz.

## Supplemental Measurement Specifications

### Display update rate

**Table 6-8** Full scale display update rates

Display update rates	Display counts
Slow	119,999
Medium	39,999
Fast	3,999

### Measurement specifications

**Table 6-9** Supplemental measurement specifications

#### DC voltage

- Measurement method
  - Sigma Delta A-to-D converter
- Input resistance
  - 10 M $\Omega$   $\pm$  2% range (typical)
- Maximum input voltage
  - 1000 VDC or PEAK AC on all ranges
- Input protection
  - 1000 V on all ranges
- Response time
  - Approximately 1.0 second when the displayed reading reaches 99.9% DC value of the tested input signal at the same range.

**Table 6-9** Supplemental measurement specifications (continued)**DC current**

- Shunt resistance
  - 0.1  $\Omega$  to 10  $\Omega$  for 12 mA to 1.2 A ranges
  - 0.01  $\Omega$  for 12 A range
- Maximum input and overload protection
  - **mA input terminal:** 1200 mADC or AC RMS. Protected with 1.25 A/500 V, IEC-127 sheet, FB fuse
  - **12 A input terminal:** 10 ADC or AC RMS continuous, or 12 ADC or AC RMS for 30 seconds maximum. Protected with 15 A/600 V, breaking capacity 10,000 A FB fuse
- Response time
  - Approximately 1.0 seconds when the displayed reading reaches 99.9% DC value of the tested input signal at the same range

**AC voltage (True RMS AC Coupling Mode)**

- Measurement method
  - AC coupled true RMS—measure the AC component with up to 400 VDC bias on any range
- Crest factor
  - Maximum 3:0 at full scale
- Input impedance
  - 1 M $\Omega$   $\pm$  2% in parallel with <120 pF on all ranges
- Maximum input voltage
  - 750 V RMS /1100 V PEAK
  - $2 \times 10^7$  V-Hz product on any range, normal mode input
  - $1 \times 10^6$  V-Hz product on any range, common mode input
- Overload ranging
  - Will select higher range if peak input overload is detected during autorange. Overload is reported in manual ranging
- Input protection
  - 750 V RMS on all ranges

**Table 6-9** Supplemental measurement specifications (continued)

- Response time
    - Approximately 1.5 seconds when the displayed reading reaches 99.9% AC RMS value of the tested input signal at the same range.
- 

**AC voltage (True RMS AC + DC Coupling Mode)**

- Measurement method
    - AC+DC coupled true RMS—measure the AC component with up to 400 VDC bias on any range
  - Crest factor
    - Maximum 3:0 at full scale
  - Input impedance
    - 1 M $\Omega$   $\pm$  2% in parallel with <120 pF of all ranges
  - Maximum input voltage
    - 750 V RMS /1100 V PEAK
    - 2x10<sup>7</sup> V-Hz product on any range, normal mode input
    - 1x10<sup>6</sup> V-Hz product on any range, common mode input
  - Overload ranging
    - Will select higher range if peak input overload is detected during autorange. Overload is reported in manual ranging
  - Input protection
    - 750 V RMS on all ranges
  - Response time
    - Approximately 2.5 seconds when the displayed reading reaches 99.9% AC RMS value of the tested input signal at the same range
-

**Table 6-9** Supplemental measurement specifications (continued)**AC current (True RMS, AC Coupling Mode)**

- Measurement method
  - DC coupled to the fuse and current shunt, AC coupled true RMS measurement (measures the AC component only)
- Crest factor
  - Maximum 3:0 at full scale
- Shunt resistance
  - 0.1  $\Omega$  to 10  $\Omega$  for 10 mA to 1.2 A ranges
  - 0.01  $\Omega$  for 12 A range
- Input protection
  - **mA input terminal:** 1200 mADC or AC RMS. Protected with 1.25 A/500 V, IEC-127 sheet, FH fuse
  - **12 A input terminal:** 10 ADC or AC RMS continuous, or 12 ADC or AC RMS for 30 seconds maximum. Protected with 15 A/600 V, breaking capacity 10,000 A FH fuse.
- Response time
  - Approximately 1.5 seconds when the displayed reading reaches 99.9% AC RMS value of the tested input signal at the same range

**AC current (True RMS, AC Coupling Mode)**

- Measurement method
  - AC+DC coupled to the fuse and current shunt, AC+DC coupled true RMS measurement (measures the AC component only)
- Crest factor
  - Maximum 3:0 at full scale
- Measurement range
  - VDC and VAC are automatically set at the same range.
- Response time
  - Approximately 1.5 seconds when the displayed reading reaches 99.9% AC RMS value of the tested input signal at the same range

**Table 6-9** Supplemental measurement specifications (continued)

---

**Resistance (2-wire  $\Omega$  and 4-wire  $\Omega$ )**

- Measurement method
  - 2-wire Ohms or 4-wire Ohms
- Open-circuit voltage
  - Limited to < +5 VDC
- Zeroing error
  - 0.05  $\Omega$  or less (excluding test lead resistance) in each range when Rel operation is used
- Input protection
  - 500 V on all ranges
- Response time
  - Approximately 1.5 seconds for 12 M $\Omega$  and ranges below 12 M $\Omega$
  - Approximately 5 seconds for 40 M $\Omega$
  - Approximately 10 seconds for 120 M $\Omega$
  - Approximately 23 seconds for 300 M $\Omega$

---

**Diode/continuity**

- Measurement method
  - 0.5 mA  $\pm$ 0.2% constant current source, open-circuit voltage limited to < 5 V
- Test current
  - Approximately 0.5 mADC
- Open-circuit voltage
  - Limited to < +5 VDC
- Continuity threshold
  - 10  $\Omega$  fixed
- Continuity level
  - Approximately < +50 mVDC

**Table 6-9** Supplemental measurement specifications (continued)

- Audible tone
    - Continuous beep for continuity and single tone for normal forward-biased diode or semiconductor junction
  - Input protection
    - 500 V RMS on all ranges
- 

**Resistance/continuity (2-wire  $\Omega$ )**

- Measurement method
    - 2-wire Ohms
  - Test current
    - Approximately 0.5 mADC
  - Open-circuit voltage
    - Limited to < +5 VDC
  - Audible tone
    - Continuous beep for continuity and single tone for normal forward-biased diode or semiconductor junction
  - Zeroing error
    - 0.05  $\Omega$  or less (excluding test lead resistances) in each range when Rel operation is used
  - Input protection
    - 500 V RMS on all ranges
- 

**Frequency**

- Measurement method
  - Reciprocal counting technique. AC coupled input using AC voltage function
- Crest factor
  - Maximum 3:0 at full scale
- Signal level
  - 10% of range to full scale input on all ranges
  - Auto or manual range selection

**Table 6-9** Supplemental measurement specifications (continued)

- Gate time
  - 0.1 second or 1 period of the input signal, whichever is longer
- Input impedance
  - $1\text{ M}\Omega \pm 2\%$  in parallel with  $<120\text{ pF}$  of all ranges
- Maximum input voltage
  - 750 V RMS /1100 V PEAK
  - $2 \times 10^7$  V-Hz product on any range, normal mode input
  - $1 \times 10^6$  V-Hz product on any range, common mode input
- Input protection
  - 750 V RMS on all ranges
- Response time
  - Approximately 1.5 seconds when the displayed reading reaches 99.9% of frequency value

---

### Measurement Noise Rejection

- Common mode reject ratio (CMRR) for 1 k $\Omega$  unbalanced LO lead
  - 50/60 Hz  $\pm 0.1\%$ : DC > 90 dB
- Normal mode rejection ratio (NMRR)
  - 50/60 Hz  $\pm 0.1\%$ : > 50 dB

---

### dBm Operation

- 0 dBm
  - 1 mW at 600  $\Omega$  reference impedance
- Resolution
  - Slow: 0.01 dB for all ranges
  - Medium: 0.01 dB for all ranges
  - Fast: 0.1 dB for all ranges
- Reference impedance <sup>[1]</sup>
  - 2  $\Omega$  <sup>[2]</sup>, 4  $\Omega$  <sup>[2]</sup>, 8  $\Omega$  <sup>[2]</sup>, 16  $\Omega$  <sup>[2]</sup>, 50  $\Omega$ , 75  $\Omega$ , 93  $\Omega$ , 110  $\Omega$ , 124  $\Omega$ , 125  $\Omega$ , 135  $\Omega$ , 150  $\Omega$ , 250  $\Omega$ , 300  $\Omega$ , 500  $\Omega$ , 600  $\Omega$ , 800  $\Omega$ , 900  $\Omega$ , 1000  $\Omega$ , 1200  $\Omega$ , or 8000  $\Omega$



**Table 6-9** Supplemental measurement specifications (continued)

<b>Math Operation</b>
• dBm, Rel, MinMax, Comp, Hold
<b>I/O Interface</b>
• RS232 <sup>[3]</sup>
<b>Notes:</b>
<b>1</b> Reference impedance is displayed on the secondary display.
<b>2</b> Reading displayed in watts (Audio power).
<b>3</b> For calibration use only.

**NOTE**

When  $V_{ac+dc}$  measurement function is selected, the VDC input impedance is parallel with an AC-couples 1.1 M $\Omega$  divider.

## Reading rates

**Table 6-10** Reading rates for single display (readings/second (approx))

Measurement functions	Slow	Medium	Fast
DCV	2.2	5.5	22.0
DCA	2.2	5.5	22.0
Diode	2.2	5.5	22.0
ACV	2.2	5.5	22.0
ACA	2.2	5.5	22.0
2-wire $\Omega$	2.2	5.5	22.0
4-wire $\Omega$ , 4M $\Omega$ /1.2M $\Omega$ range and below	0.7	0.9	1.0
4-wire $\Omega$ , 12M $\Omega$ range and above	1.5	1.8	2.0
Frequency (5Hz)	1.0	1.7	2.3
ACV + DCV	0.8	1.1	1.6
ACA + DCA	0.5	0.7	0.9

**Table 6-11** Reading rates for the dual display (readings/second (approx))

Measurement functions	Slow	Medium	Fast
DCV / ACV	0.8	1.1	1.6
DCA / ACA	0.5	0.7	0.9
DCV / DCA	0.7	1.1	1.6
DCV / ACA	0.1	0.4	0.5
ACV / ACA	0.1	0.4	0.5
ACV / DCA	0.8	1.1	1.6
ACV / Frequency <sup>[1]</sup>	1.0	1.7	2.3
ACA / Frequency <sup>[1]</sup>	1.2	1.7	2.5
ACV + DCV / DCV	0.7	1.1	1.6
ACA + DCA / DCV	0.1	0.3	0.4
ACA + DCA / ACV	0.1	0.3	0.4
ACA + DCA / DCA	0.5	0.7	0.9
dBm (ACV) / Reference	2.2	5.5	22.0
dBm (ACV) / ACV	2.2	4.3	11.0
dBm (ACV) / DCV	0.8	1.1	1.8
dBm (ACV) / Frequency <sup>[1]</sup>	1.0	1.7	2.4

**Notes:**

- 1 This reading rate depends on the frequency of the signal, the table itself shows the worst possible case.
- 2 This table shows the typical combinations of measurement functions for the dual display.

## General Characteristics

**Table 6-12** General characteristics

---

### Power Supply

- 100 V/120 V/220 V/240 V  $\pm$  10%
- AC line frequency 50 Hz to 60Hz

---

### Power Consumption

- 16 VA maximum

---

### Input Power Option

- Manual ranging (100 VAC to 240 VAC  $\pm$ 10%)

---

### Fuse

- Terminal:
  - 1.25 A, 500 V FB fuse
  - 15 A, 600 V FB fuse (internal)
- Power line (according to country of destination):
  - 0.25 A, 250 V SB fuse OR
  - 0125 A, 250 V SB fuse

---

### Display

- Highly visible vacuum fluorescent display (VFD)

---

### Operating Environment

- Operating temperature from 0 °C to + 50 °C
  - Relative humidity up to 80% at 28 °C RH (non-condensing)
  - Altitude up to 2000 meters
  - Pollution degree 2
  - For indoor use only
-

**Table 6-12** General characteristics

### Storage Compliance

- – 20 °C to 60 °C
  - Relative humidity at 5% to 90% RH (non-condensing)
- 

### Safety Compliance

- IEC 61010-1:2001/EN61010-1:2001 (2nd Edition)
  - Canada: CAN/CSA-C22.2 No. 61010-1-04
  - USA: ANSI/UL 61010-1:2004
- 

### EMC Compliance

- IEC 61326-1:2005/EN61326-1:2006
  - Canada: ICES/NMB-001:2004
  - Australia/New Zealand: AS/NZS CISPR11:2004
- 

### Shock and Vibration

- Tested to IEC/EN 60068-2
- 

### I/O Connector

- Output connectors
- 

### I/O Interface

- RS232 (For calibration use only)
- 

### Dimension (HxWxD)

- 226.00 × 105.00 × 305.00 mm (with bumpers)
  - 215.00 × 87.00 × 282.00 mm (without bumpers)
- 

### Weight

- 3.44 kg (with bumpers)
- 

### Warm Up Time

- 30 minutes
- 

### Calibration Cycle

- 1 year
- 

### Warranty

- 3 years
  - 3 months for standard shipped accessories
-

## To Calculate Total Measurement Error

The multimeter's accuracy specifications are expressed in the form of:

(% of reading + count)

In addition to the reading error and count error, you may need to add additional errors for certain operating conditions. Check the list below to make sure you include all measurement errors for a given function. Also, make sure you apply the conditions as described in the footnotes on the specification pages.

- If you are operating the multimeter outside the temperature range specified, apply an additional temperature coefficient error.
- For AC voltage and AC current measurements, you may need to apply an additional low frequency error or crest factor error.

## Accuracy Specifications

### Transfer Accuracy

Transfer accuracy refers to the error introduced by the multimeter due to noise and short-term drift. This error becomes apparent when comparing two nearly-equal signals for the purpose of "transferring" the known accuracy of one device to the other.

### One-Year Accuracy

These long-term accuracy specifications are valid at the calibration temperature ( $T_{cal}$ )  $\pm 5$  °C temperature range. These specifications include the initial calibration errors plus the multimeter's long-term drift errors.

### Temperature Coefficients

Accuracy is usually specified at the calibration temperature ( $T_{cal}$ )  $\pm 5$  °C temperature range. This is a common temperature range for many operating environments. You must add additional temperature coefficient errors to the accuracy specification if you are operating the multimeter at 0 °C to 18 °C and 28 °C to 50 °C temperature range (the specification is per °C).

Temperature Coefficient = add  $\pm 0.15 \times$  [the applicable accuracy]/°C]

## Configuring for Highest Accuracy Measurements

The measurement configurations shown below assume that the multimeter is in its power-on or reset state. It is also assumed that auto-ranging is enabled to ensure proper full scale range selection.

- Select 5½ digits.
- Null the test lead resistance for 2-wire ohms measurements, and to remove any interconnection offset for DC voltage measurements.

**THIS PAGE HAS BEEN INTENTIONALLY LEFT BLANK.**



**www.agilent.com**

**Contact us**

To obtain service, warranty or technical support assistance, contact us at the following phone numbers:

United States:

(tel) 800 829 4444 (fax) 800 829 4433

Canada:

(tel) 877 894 4414 (fax) 800 746 4866

China:

(tel) 800 810 0189 (fax) 800 820 2816

Europe:

(tel) 31 20 547 2111

Japan:

(tel) (81) 426 56 7832 (fax) (81) 426 56 7840

Korea:

(tel) (080) 769 0800 (fax) (080) 769 0900

Latin America:

(tel) (305) 269 7500

Taiwan:

(tel) 0800 047 866 (fax) 0800 286 331

Other Asia Pacific Countries:

(tel) (65) 6375 8100 (fax) (65) 6755 0042

Or visit the Agilent World Wide Web at:

[www.agilent.com/find/assist](http://www.agilent.com/find/assist)

Product specifications and descriptions in this document are subject to change without notice. Always refer to the English version on the Agilent Web site for the latest revision.

© Agilent Technologies, Inc. 2009–2014

Printed in Malaysia  
Seventh Edition, July 7, 2014

U3402-90001



**Agilent Technologies**

**www.valuetronics.com**