

# **Agilent U1610/20A Handheld Digital Oscilloscope**

## **User's Guide**



**Agilent Technologies**

## Notices

© Agilent Technologies, Inc., 2011–2014

No part of this manual may be reproduced in any form or by any means (including electronic storage and retrieval or translation into a foreign language) without prior agreement and written consent from Agilent Technologies, Inc., as governed by United States and international copyright laws.

### Manual Part Number

U1610-90040

### Edition

Fourth Edition, June 27, 2014

Agilent Technologies, Inc.,  
5301 Stevens Creek Blvd.  
Santa Clara, CA 95051 USA

Available in electronic format only

### Warranty

**The material contained in this document is provided “as is,” and is subject to change, without notice, in future editions. Further, to the maximum extent permitted by the applicable law, Agilent disclaims all warranties, either express or implied, with regard to this manual and any information contained herein, including but not limited to the implied warranties of merchantability and fitness for a particular purpose. Agilent shall not be liable for errors or for incidental or consequential damages in connection with the furnishing, use, or performance of this document or of any information contained herein. Should Agilent and the user have a separate written agreement with warranty terms covering the material in this document that conflict with these terms, the warranty terms in the separate agreement shall control.**

### Technology Licenses

The hardware and/or software described in this document are furnished under a license and may be used or copied only in accordance with the terms of such license.

### Restricted Rights Legend

U.S. Government Restricted Rights. Software and technical data rights granted to the federal government include only those rights customarily provided to end user customers. Agilent provides this customary commercial license in Software and technical data pursuant to FAR 12.211 (Technical Data) and 12.212 (Computer Software) and, for the Department of Defense, DFARS 252.227-7015 (Technical Data - Commercial Items) and DFARS 227.7202-3 (Rights in Commercial Computer Software or Computer Software Documentation).

### Safety Notices

#### CAUTION

A **CAUTION** notice denotes a hazard. It calls attention to an operating procedure, practice, or the likes of that, if not correctly performed or adhered to, could result in damage to the product or loss of important data. Do not proceed beyond a **CAUTION** notice until the indicated conditions are fully understood and met.

---








#### WARNING

A **WARNING** notice denotes a hazard. It calls attention to an operating procedure, practice, or the likes of that, if not correctly performed or adhered to, could result in personal injury or death. Do not proceed beyond a **WARNING** notice until the indicated conditions are fully understood and met.

---

## Safety Symbols

The following symbols on the instrument and in the documentation indicate precautions which must be taken to maintain safe operation of the instrument.

	Direct current (DC)		Equipment protected throughout by double insulation or reinforced insulation
	Alternating current (AC)		Earth (ground) terminal
	Both direct and alternating current	<b>CAT II</b>	Category II overvoltage protection
	Caution, risk of danger (refer to this manual for specific Warning or Caution information)	<b>CAT III</b>	Category III overvoltage protection
	Caution, risk of electric shock		

## General Safety Information

The following general safety precautions must be observed during all phases of operation of this instrument. Failure to comply with these precautions or with specific warnings elsewhere in this manual violates safety standards of design, manufacture, and intended use of the instrument. Agilent Technologies, Inc., assumes no liability for the customer's failure to comply with these requirements.

### WARNING

- **Remove all unused scope (oscilloscope) probes, DMM (digital multimeter) test leads, or USB cable.**
  - **Do not connect the DMM test leads and scope probes at the same time.**
  - **Disconnect the scope probe from the instrument before using the DMM functions.**
  - **Disconnect the DMM test leads from the instrument before using the scope functions.**
- 

### WARNING

**To avoid electrical shock or fire during battery replacement:**

- **Disconnect test leads, probes, power supply, and USB cable before opening case or battery cover.**
  - **Do not operate the instrument with the battery cover open.**
  - **Use only specified insulated probes and test leads.**
  - **Use only the 10.8 V Li-Ion battery pack supplied with the instrument.**
- 

### WARNING

**To prevent fire or injury:**

- **Use only the designated AC/DC adapter and test leads supplied with the instrument.**
  - **Observe all ratings and markings on the instrument before connecting to the instrument.**
  - **When performing measurements, ensure that the right safety and performance ratings of instrument and accessories are used.**
-

## WARNING

- Plug the probe or test leads to the instrument before connecting to any active circuit for testing. Before disconnecting from the instrument, remove the probe or test leads from the active circuit.
  - Do not connect the USB cable when not in use. Keep the USB cable away from any probe, test lead, or exposed circuitry.
  - Do not expose the circuit or operate the instrument without its cover or while power is being supplied.
  - Do not use exposed metal BNC or banana plug connectors. Use only the insulated voltage probes, test leads, and adapters supplied with the instrument.
  - Do not supply any voltage when measuring resistance or capacitance in multimeter mode.
  - Do not operate the instrument if it does not operate properly. Have the instrument inspected by qualified service personnel.
  - Do not operate the instrument in wet or damp environments.
  - Do not operate the instrument in any environment at risk of explosion. Do not operate the instrument in the presence of flammable gases or flames.
  - Keep the instrument surface clean and dry. Keep the BNC connectors dry especially during high-voltage testing.
- 

## WARNING



### Maximum Input Voltages

- Input CH1 and CH2 direct (1:1 probe) — CAT III 300 Vrms
- Input CH1 and CH2 via 10:1 probe — CAT III 600 Vrms<sup>[1]</sup>, CAT II 1000 Vrms<sup>[1]</sup>
- Input CH1 and CH2 via 100:1 probe — CAT III 600 Vrms<sup>[1]</sup>, CAT II 1000 Vrms<sup>[1]</sup>, CAT I 3540 Vrms<sup>[1]</sup>
- Meter input — CAT III 600 Vrms, CAT II 1000 Vrms
- Scope input — CAT III 300 Vrms
- Voltage ratings are Vrms (50 – 60 Hz) for AC sine wave and VDC for DC applications.



### Maximum Floating Voltage

- From any terminal to earth ground — CAT III 600 Vrms

---

[1] Refer to the respective probe's manual for more information on the specification.

## CAUTION

- If the instrument is used in a manner not specified by the manufacturer, the instrument protection may be impaired.
  - Always use dry cloth to clean the instrument. Do not use ethyl alcohol or any other volatile liquid.
  - It is recommended to use the instrument under ventilated condition and in the upright position to ensure adequate airflow at the rear.
  - Always cover the DC power inlet and the USB port by closing the lid when not in used.
- 

## CAUTION

### **To prevent electrostatic discharge (ESD):**

Electrostatic discharge (ESD) can result in damage to the components in the instrument and accessories.

- Select a static-free work location when installing and removing sensitive equipment.
  - Handle sensitive components to the minimum extent possible. Do not allow contacts between components and exposed connector pins.
  - Transport and store in ESD preventive bags or containers that protect sensitive components from static electricity.
  - The battery (optional) must be properly recycled or disposed.
-

## Environmental Conditions

This instrument is designed for indoor use and in an area with low condensation. The table below shows the general environmental requirements for this instrument.






Environmental conditions	Requirements
Temperature	Operating: <ul style="list-style-type: none"><li>• 0 °C to 50 °C (with battery only)</li><li>• 0 °C to 40 °C (with AC/DC adapter)</li></ul> Storage: -20 °C to 70 °C
Humidity	Operating: <ul style="list-style-type: none"><li>• Maximum: 80% RH at 40 °C (non-condensing)</li><li>• Minimum: 50% RH at 40 °C (non-condensing)</li></ul> Storage: Up to 95% RH at 40 °C (non-condensing)

### NOTE

The U1610/20A Handheld Digital Oscilloscope complies with the following safety and EMC requirements:

- IEC 61010-1:2001/EN 61010-1:2001
- Canada: CAN/CSA-C22.2 No. 61010-1-04
- USA: ANSI/UL 61010-1:2004
- IEC 61326-1:2005/EN 61326-1:2006
- Australia/New Zealand: AS/NZS CISPR 11:2004
- Canada: ICES/NMB-001: ISSUE 4, June 2006

## Regulatory Markings

	<p>The CE mark is a registered trademark of the European Community. This CE mark shows that the product complies with all the relevant European Legal Directives.</p> <p>ICES/NMB-001 indicates that this ISM device complies with the Canadian ICES-001. Cet appareil ISM est conforme a la norme NMB-001 du Canada.</p> <p>ISM GRP.1 Class A indicates that this is an Industrial Scientific and Medical Group 1 Class A product.</p>	 N10149	<p>The C-tick mark is a registered trademark of the Spectrum Management Agency of Australia. This signifies compliance with the Australia EMC Framework regulations under the terms of the Radio Communication Act of 1992.</p>
	<p>The CSA mark is a registered trademark of the Canadian Standards Association.</p>		<p>This instrument complies with the WEEE Directive (2002/96/EC) marking requirement. This affixed product label indicates that you must not discard this electrical or electronic product in domestic household waste.</p>
			<p>Product contains restricted substance(s) above maximum value, with a 40-year Environmental Protection Use Period.</p>



## Waste Electrical and Electronic Equipment (WEEE) Directive 2002/96/EC

This instrument complies with the WEEE Directive (2002/96/EC) marking requirement. This affixed product label indicates that you must not discard this electrical or electronic product in domestic household waste.

### Product Category:

With reference to the equipment types in the WEEE directive Annex 1, this instrument is classified as a “Monitoring and Control Instrument” product.

The affixed product label is as shown below.



### Do not dispose in domestic household waste.

To return this unwanted instrument, contact your nearest Agilent Service Center, or visit:

[www.agilent.com/environment/product](http://www.agilent.com/environment/product)

for more information.

## Declaration of Conformity

The Declaration of Conformity (DoC) for this instrument is available on our Web site. You can search for the DoC by the instrument model number or description.

<http://regulations.corporate.agilent.com/DoC/search.htm>

### NOTE

If you are unable to search for the respective DoC, contact your local Agilent representative.

---

## In This Guide...

### **1 Getting Started**

This chapter provides you the information to start using your handheld scope.

### **2 Product Outlook**

This chapter provides an overview of the handheld scope keys, panels, and display.

### **3 Using the Oscilloscope**

This chapter explains how to set up the oscilloscope functions.

### **4 Using the Digital Multimeter**

This chapter explains how to configure and perform multimeter measurements.

### **5 Using the Data Logger**

This chapter describes how to perform scope and meter data logging.

### **6 Using the System-Related Functions**

This chapter explains how to set up system-related settings and perform service functions.

### **7 Specifications and Characteristics**

This chapter lists the specifications, characteristics, pollution degree, and measurement category of the handheld scope.

**THIS PAGE HAS BEEN INTENTIONALLY LEFT BLANK.**

# Table of Contents

## 1 Getting Started

Introduction	2
Package Contents	3
Optional Accessories	4
Adjust the Hand Strap	4
Install the Neck Strap	4
Charge the Battery	5
Tilt the Handheld Scope	5
Power On/Off the Handheld Scope	6
Use the Function Softkeys	6
Access the Quick Help	6
Reset the Handheld Scope	7
Perform Self-Calibration	8
Set the Date and Time and Language	9
Connect Probes to Oscilloscope Terminals	10
Compensate the Scope Probe	11
Independently Isolated Scope Input Channels	13
Floating measurement with isolated probes at CAT III 600 V	17
Derating curve	18
Connect Test Leads to Meter Terminals	19

## 2 Product Outlook

Product at a Glance	22
Front Panel Key Overview	23

Oscilloscope Display Overview	25
Multimeter and Data Logger Display Overview	26

### 3 Using the Oscilloscope

Vertical Controls	28
Channel selection for waveform display	28
Vertical system setup	29
Channel coupling	30
Probe setting	30
AC current measurement	31
Invert control	31
Bandwidth limit control	32
Return to zero	32
Horizontal Controls	33
Horizontal system setup	33
Horizontal modes	35
Recording length	36
Trigger Controls	38
Trigger types	38
Edge trigger	39
Glitch trigger	40
TV trigger	41
Nth Edge trigger	42
CAN trigger	43
LIN trigger	45
Trigger modes	46
Trigger holdoff	47
Noise rejection	47
Waveform Acquisition Controls	48
Display Controls	50
Vectors display	50

Sin x/x interpolation	50
Infinite persistence	51
Automatic Measurements	52
Time measurements	53
Voltage measurements	55
Power measurements	58
Cursor Measurement Controls	60
Analyzer Controls	62
Math functions	63
FFT function	64
Autoscale and Run/Stop Controls	66
Autoscale	66
Run/Stop	67
Save and Recall Controls	69
Save control	70
Recall control	71
Print screen control	72
<b>4 Using the Digital Multimeter</b>	
Introduction	76
Voltage Measurements	77
Resistance Measurement	78
Capacitance Measurement	79
Diode Test	80
Continuity Test	81
Temperature Measurement	82
Frequency Measurement	83
Relative Measurement	84

## Table of Contents

Range	85
Restart Measurements	85

### 5 Using the Data Logger

Introduction	88
Scope Logger	89
Measurement statistics	89
Graphing mode	90
Saving the recorded data	91
Erasing the saved recorded data	91
Transferring the saved recorded data	91
Meter Logger	92
Measurement selection	92
Graphing mode	92
Saving the recorded data	92
Erasing the saved recorded data	93
Transferring the saved recorded data	93

### 6 Using the System-Related Functions

Introduction	96
General System Settings	96
USB connectivity	97
Set the language	97
Set the date and time	97
Set auto-shutdown	97
Display Settings	98
Backlight intensity	98
View mode	98
Sound Settings	99
Service Functions	100



Firmware update	100
Self-calibration	101
Antialiasing	101
System Information	101

## **7 Specifications and Characteristics**

Oscilloscope Specifications and Characteristics	104
Maximum Input Voltages and Channel Isolation	108
Digital Multimeter Specifications	110
Data Logger Specifications	113
General Specifications	114
Pollution Degree	116
Measurement Category	117

**THIS PAGE HAS BEEN INTENTIONALLY LEFT BLANK.**

## List of Figures

- Figure 1-1 Default Settings function 7
- Figure 1-2 Self-Cal notification 9
- Figure 1-3 Trimmer capacitor 12
- Figure 1-4 Pulse shape reference 12
- Figure 1-5 Floating ground reference signal and earth ground reference signal 13
- Figure 1-6 Ground loop 14
- Figure 1-7 Channel isolation block diagram 15
- Figure 1-8 Insulation cover 16
- Figure 1-9 Probing the VFD IGBT control signal and IGBT output 16
- Figure 1-10 Channel-to-channel isolation at CAT III 600 V 17
- Figure 1-11 U1560A scope probe 1:1 18
- Figure 1-12 U1561A scope probe 10:1 18
- Figure 1-13 U1562A scope probe 100:1 18
- Figure 3-1 Channel 1 submenu 28
- Figure 3-2 Waveform before and after inversion 32
- Figure 3-3 Time reference position setting 33
- Figure 3-4 Zoom mode 35
- Figure 3-5 Trigger type and settings submenu 38
- Figure 3-6 Auto trigger mode 46
- Figure 3-7 Acquire menu 48
- Figure 3-8 Display control menu 50
- Figure 3-9 Measurement function menu 52
- Figure 3-10 Cursor function menu 60
- Figure 3-11 Autoscale function menu 66
- Figure 3-12 Save/Recall menu 69
- Figure 3-13 Save submenu 70
- Figure 3-14 Recall submenu 71
- Figure 3-15 Print screen submenu 73
- Figure 4-1 Multimeter display 76
- Figure 4-2 Relative measurement display 84
- Figure 5-1 Data logger menu 88
- Figure 5-2 Scope logger display 89
- Figure 5-3 Statistics display 90
- Figure 5-4 Meter logger display 92

## List of Figures

- Figure 6-1 User function menu 96
- Figure 6-2 General system settings submenu 96
- Figure 6-3 Display settings submenu 98
- Figure 6-4 Sound settings submenu 99
- Figure 6-5 Service function submenu 100
- Figure 7-1 Maximum safety voltage for scope reference to earth 108
- Figure 7-2 Maximum input voltage 109



# 1 Getting Started

Introduction	2
Package Contents	3
Optional Accessories	4
Adjust the Hand Strap	4
Install the Neck Strap	4
Charge the Battery	5
Tilt the Handheld Scope	5
Power On/Off the Handheld Scope	6
Use the Function Softkeys	6
Access the Quick Help	6
Reset the Handheld Scope	7
Perform Self-Calibration	8
Set the Date and Time and Language	9
Connect Probes to Oscilloscope Terminals	10
Compensate the Scope Probe	11
Independently Isolated Scope Input Channels	13
Connect Test Leads to Meter Terminals	19

This chapter provides you the information to start using your handheld scope.



## Introduction

The U1610/20A Handheld Digital Oscilloscope is a mobile high-performance troubleshooting tool for multi-industrial automation, process control, facility maintenance, and automotive-service industries.

The U1610A and U1620A models have 100 MHz and 200 MHz bandwidths with maximum real-time sample rates of 1 GSa/s and 2 GSa/s respectively.

With its 5.7-inch LCD color display, the U1610/20A oscilloscope is capable of clearly distinguishing waveforms from two channels. The U1610/20A allows you to perform up to 30 types of automatic measurements. Waveform math and Fast Fourier Transform (FFT) functions are available for performing quick waveform analyses in both time and frequency domains.

The U1610/20A can also function as a digital multimeter (DMM) and a data logger. The autorange function provided allows you to perform quick and accurate DMM measurements. Using the data logger function, you can perform automatic data logging for DMM and scope measurements.

## Package Contents

When you receive your shipping container, unpack and inspect the container for damage.

If the shipping container is damaged, or the cushioning materials show signs of stress, notify the carrier and your nearest Agilent Sales Office. Keep the damaged shipping container or cushioning material until you have inspected the contents of the shipment for completeness and have checked the handheld scope mechanically and electrically.

Verify that you have received the following items in the handheld scope packaging:

- ✓ 1 × Handheld scope
- ✓ 1 × Power cable
- ✓ 1 × Li-Ion battery pack, 10.8 V (included in the handheld scope)
- ✓ 1 × AC/DC adapter
- ✓ 2 × 10:1 CAT III 600 V scope probe
- ✓ 1 × BNC-to-probe adapter
- ✓ 1 × DMM test lead kit
- ✓ 1 × USB cable
- ✓ 1 × Hand strap (attached on the handheld scope)
- ✓ 1 × Neck strap
- ✓ 1 × Printed Quick Start Guide
- ✓ 1 × Certificate of Calibration

If anything is missing, contact your nearest Agilent Sales Office.

### NOTE

The above items are available for purchase separately if you require more quantities.

### Inspect the handheld scope

If there is mechanical damage or a defect, or if the handheld scope does not operate properly or does not pass performance tests, notify your nearest Agilent Sales Office.

## Optional Accessories

The following accessories are available for purchase separately.

- 1:1 CAT III 300 V scope probe
- 100:1 CAT III 600 V scope probe
- Temperature module
- Desktop charger
- Soft carrying case

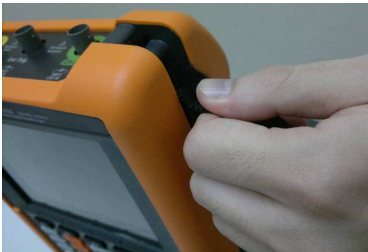
## Adjust the Hand Strap

For better grip, peel open the strap and adjust the two velcro strips as shown below.



## Install the Neck Strap


Thread the velcro strip through the strap hole. Adjust the strap to the maximum length and secure it as shown below.





## Charge the Battery

Before using the handheld scope for the first time or after a prolonged storage period, fully charge the battery for at least 3 hours, with the handheld scope turned off, using the AC/DC adapter provided. If the battery is fully discharged after subsequent use, charge the battery with the handheld scope turned on.

The power key  will turn constant yellow when the battery is fully charged.



## Tilt the Handheld Scope


For proper handling during operation, tilt the handheld scope as shown below.





## Power On/Off the Handheld Scope

### NOTE


Hook up all cables and accessories before applying power. You can connect/disconnect probes while the handheld scope is turned on.

Press and hold  for approximately 3 seconds to power on the handheld scope. When the handheld scope display appears, the scope is ready for use.



Press and hold  for approximately 3 seconds to power off the handheld scope. The display will take some time to turn off.

Press and hold  for approximately 10 seconds to power cycle the handheld scope.




### NOTE

If the handheld scope is not able to power cycle after pressing and holding  for approximately 10 seconds, remove and reinsert the battery.

## Use the Function Softkeys

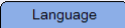
Press the softkey (  to  ) that corresponds to the label shown above it on the display.


## Access the Quick Help

Press any function key/softkey followed by  to display its respective Help information. Use the  or  key to navigate within Help.


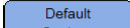
To view Help in another language, press  >  >

 and use the   keys to select the language. Press



 again to exit the selection menu.

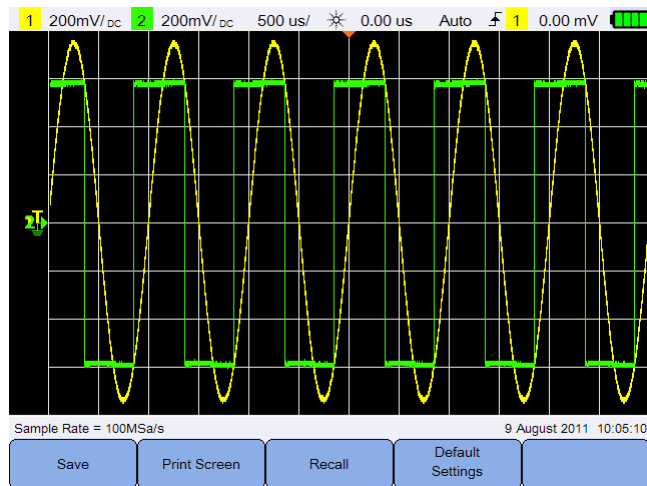
To access information on using Help, press and hold  for approximately 3 seconds.

## Reset the Handheld Scope

Reset the handheld scope to its default settings by pressing  > . This removes all previous user-defined configurations.

### NOTE

Before resetting the handheld scope, you may want to save the current configuration for later use by pressing  > . See [Chapter 3, “Save and Recall Controls”](#) on page 69.



**Figure 1-1** Default Settings function

## Perform Self-Calibration

When performing self-calibration, no signal is injected into the handheld scope. During the self-calibration process, the firmware will perform zero, offset, and TDC calibration.

- For zero calibration, the firmware will acquire samples for a fixed period of time corresponding to the zero input condition. The acquired data contains channel noise and DC offset. The firmware determines this channel DC offset and upon completion of self-calibration, uses the determined DC offset to subtract from ADC samples, producing offset-compensated samples. This feature is useful for removing channel DC offset due to temperature changes and component aging, thus providing better accuracy.
- Offset calibration (performed after completion of the zero calibration) calibrates the system offset DAC for gain accuracy. During calibration, the firmware determines the offset DAC code settings required to offset the zero input signal trace to +4 divisions and -4 divisions (vertical). The codeword range for the offset DAC to move the zero input trace across  $\pm 4$  division range will represent the offset DAC gain. This gain changes due to temperature variation and component aging. Offset calibration corrects for this drift in the offset DAC gain.
- TDC calibration calibrates and corrects for errors (due to temperature variation) in the time interval measurement performed by the TDC circuit.

Allow the handheld scope to warm up for at least 30 minutes before performing self-calibration. It is recommended that you perform self-calibration in the following situations:

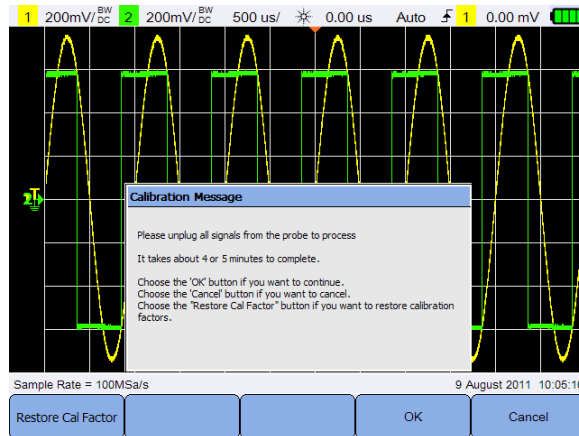
- Every 12 months or after 2000 hours of operation.
- If the ambient temperature is  $>10$  °C from the calibration temperature.
- To maximize the measurement accuracy.
- After experiencing abnormal operation.
- To verify proper operation after repairing.

### WARNING

**Disconnect all probe and meter connections to the input terminals of the handheld scope before performing self-calibration.**

Press **User** > **Service** > **Self Cal** to start self-calibration.

If you want to restore factory calibration constants, press **Restore Cal Factor**.



**Figure 1-2** Self-Cal notification

## Set the Date and Time and Language

Press **User** > **System Settings** to access the general system settings.

Press **Set Date & Time** to set the current date and time of day (24-hour format). Press any softkey and use the ▲ or ▼ key to set the year, month, day, hour, or minute.

### NOTE

- The real-time clock only allows selection of valid dates. If a day is selected and the month or year is changed so the day is invalid, the day is automatically adjusted.

- **Set Date & Time** is only accessible when in the Scope mode.

Press **Language <English>** and use the ◀▶ keys to set any of the 10 languages (English, Spanish, French, Italian, German, Portuguese, Simplified Chinese, Traditional Chinese, Japanese, and Korean). Press **Language <English>** again to exit the selection menu.

## Connect Probes to Oscilloscope Terminals

Connect the handheld scope in either single channel or dual channels with scope probes as shown below.

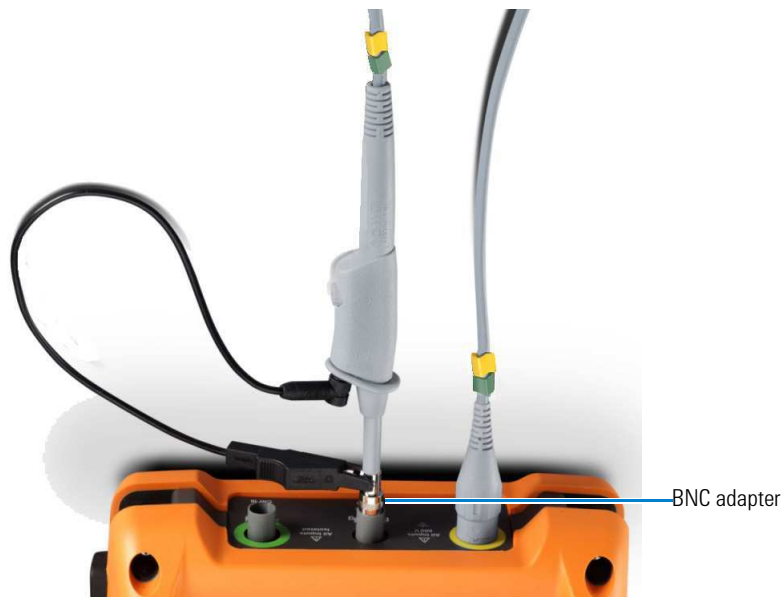


## Compensate the Scope Probe

Perform scope probe compensation whenever you attach a passive scope probe to any input channel for the first time. This is important to match the probe characteristic to the handheld scope. A poorly compensated probe can introduce significant measurement errors.

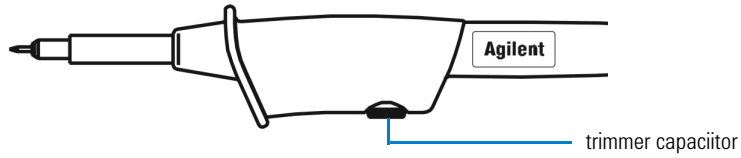
To adjust the probe compensation for a channel as example:

- 1 Connect the passive probe to the channel terminal and the probe contact to the external trigger terminal using a BNC adapter as shown below.
- 2 Press **Scope**, then toggle **Probe Comp <Off>** to turn on the compensation signal for a channel.
- 3 Press **Probe <1:1>** repeatedly to set the probe attenuation factor.
- 4 The input signal is 5 Vpp, 1 kHz from the external trigger.

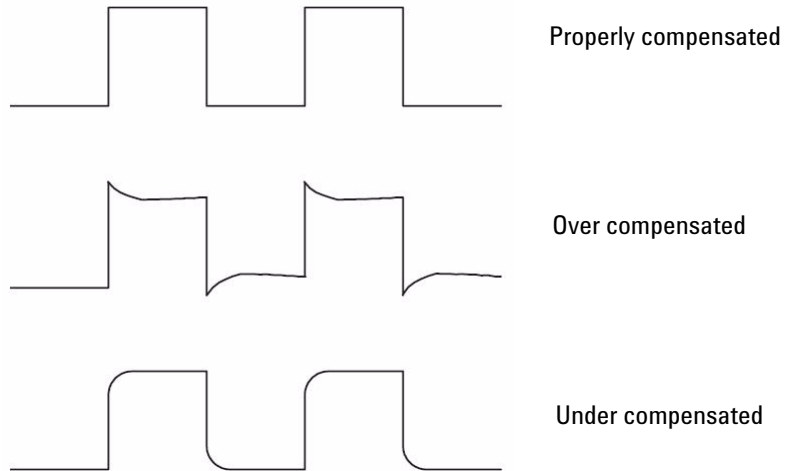


## 1 Getting Started

Use a nonmetallic tool to adjust the trimmer capacitor on the probe for the flattest pulse possible.



**Figure 1-3** Trimmer capacitor



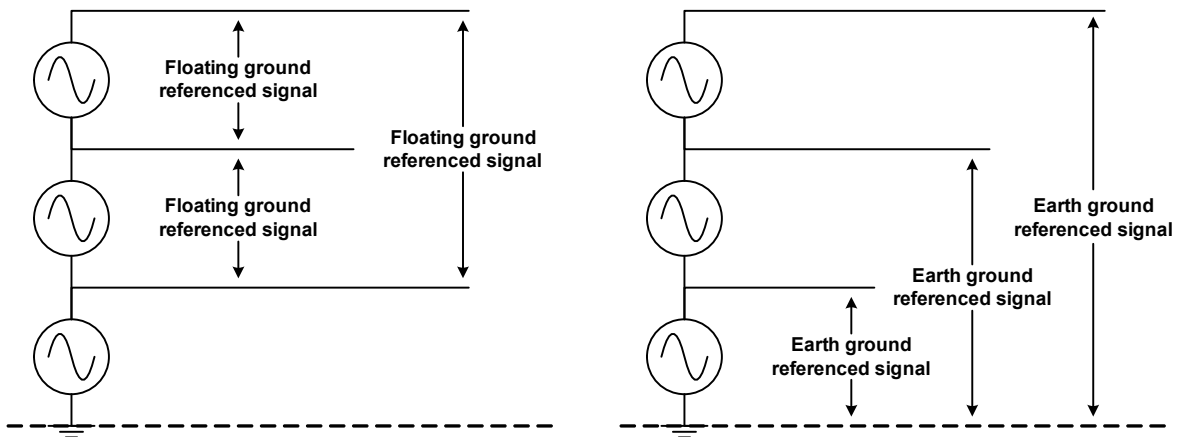
**Figure 1-4** Pulse shape reference



## Independently Isolated Scope Input Channels

There are two main categories of signal sources:

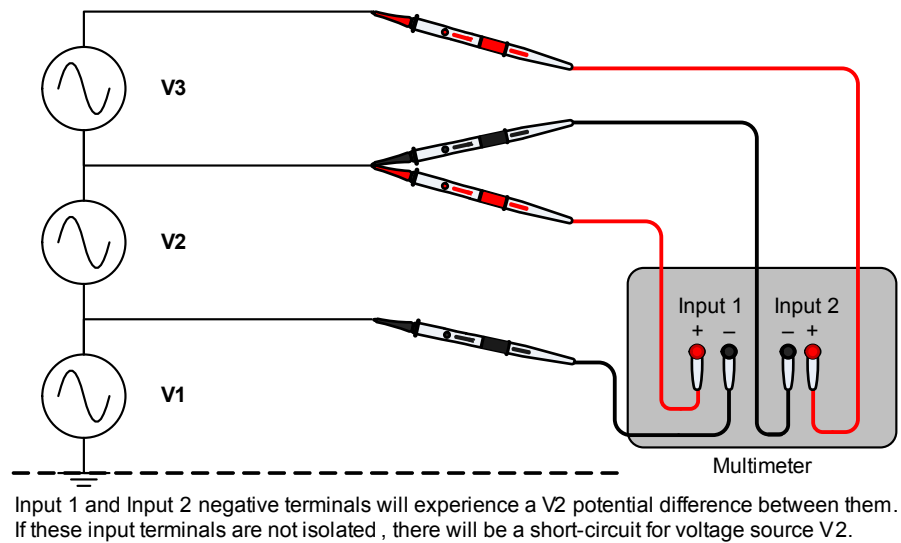
- Earth ground referenced signal—the voltage signals are referenced to a system ground, such as earth ground.
- Floating ground referenced signal—a floating signal in which the voltage signal is not referenced to earth ground.



**Figure 1-5** Floating ground reference signal and earth ground reference signal

When measuring floating signals with instruments that have multiple inputs, unwanted ground loops may occur. These ground loops can induce measurement errors and cause electrical shock or power surges. Ground loop occurs between the negative terminals of two inputs as shown in [Figure 1-6](#).

Instruments with channel-to-channel isolation can be used to eliminate the ground loops. Isolated channels separate the two signal path effectively from each other by eliminating any potential common circuit path between the two inputs.

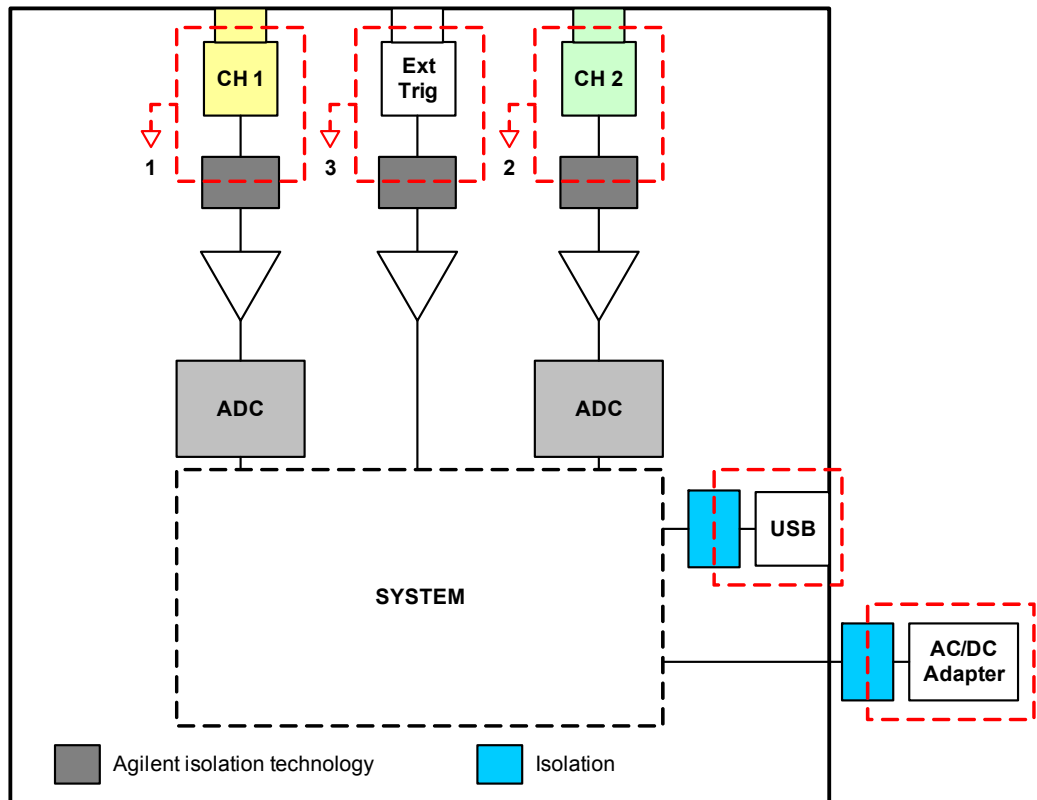


**Figure 1-6** Ground loop

The handheld scope input channels, external trigger, USB, and AC/DC adapter are electrically isolated from each other. This level of isolation allows you to:

- measure floating signal between channels without any unwanted ground loops.
- latch trigger points freely on the circuit.
- connect to the PC using the USB port for monitoring as the port is isolated from the handheld scope.
- monitor your device-under-test while charging the handheld scope.

[Figure 1-7](#) outlines the handheld scope channel isolation. The chassis and the controls of an isolated-input channel are designed with plastic, rubber, or other types of insulating material. Each input channel (CH1, CH2, and Ext. Trig) is isolated with Agilent isolation technology architecture and the ground leads are referred to any ground potential as shown in [Figure 1-7](#).



**Figure 1-7** Channel isolation block diagram

As there are no direct connections between the measurement probes and the inputs to the scope, you are protected from the measured voltages. Each input is connected to its reference voltage point and not to the earth reference point.

The handheld scope input channels are fully isolated and provide channel-to-power line isolation, channel-to-USB connectivity isolation, and channel-to-keypad isolation. You can connect to signals with different voltage reference levels safely and obtain accurate measurements.

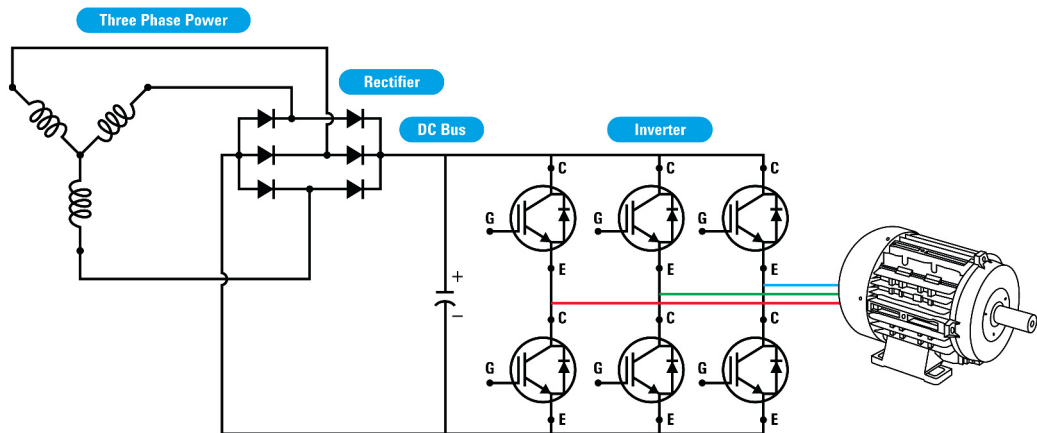
**WARNING**

Connect the insulation cover over the probe tip when the hook clip is not used to prevent any electrical shock. This also helps to avoid unwanted interconnection between the two probes when both ground clips are connected.



**Figure 1-8** Insulation cover

An example of how a fully isolated input channels handheld scope monitors the output voltage of a PWM inverter drive and the gate control signals of an Insulated Gate Bipolar Transistor (IGBT) is shown in [Figure 1-9](#). Channel 1 is connected to the output voltage of the PWM AC drive and Channel 2 is connected to the transistor input, where the signals come from the control board. For a complete floating measurement, the probe reference lead for each channel is connected to the circuitry.



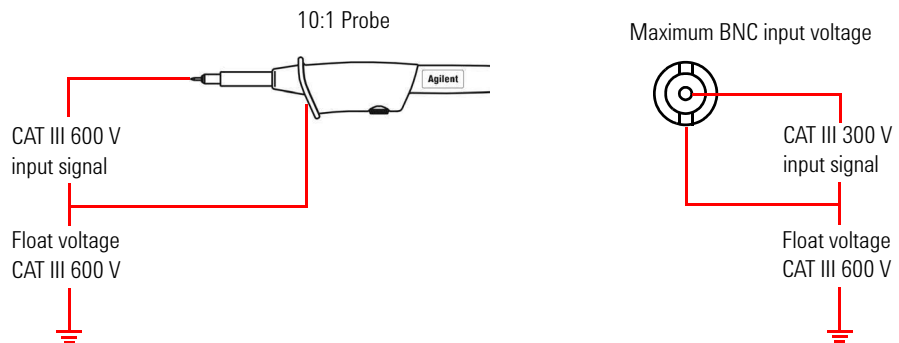
**Figure 1-9** Probing the VFD IGBT control signal and IGBT output

## Floating measurement with isolated probes at CAT III 600 V

### NOTE

Before performing floating measurements with the handheld scope, ensure that the measured signal is within the voltage range specified on the probe and input terminals, and the floating voltage from any terminal to ground as shown in [Figure 1-10](#).

The differential signal in each channel is referenced to a reference point that is not connected to the earth ground. This helps in eliminating ground loop errors.



**Figure 1-10** Channel-to-channel isolation at CAT III 600 V

The maximum input voltage on each BNC input is CAT III 300 V (referenced to non-earth grounding) and CAT III 600 V (referenced to earth-grounding). If you are measuring an input floating voltage of CAT III 600 V with a 10:1 probe, the signal will be attenuated 10 times. The actual voltage flow into the BNC input will be CAT III 60 V which is within the maximum input voltage rating.

## Derating curve

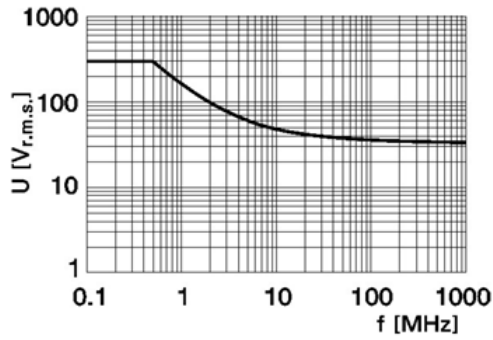


Figure 1-11 U1560A scope probe 1:1

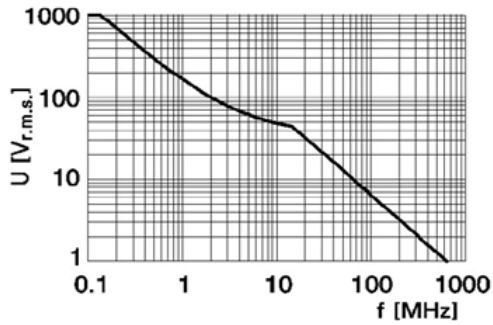


Figure 1-12 U1561A scope probe 10:1

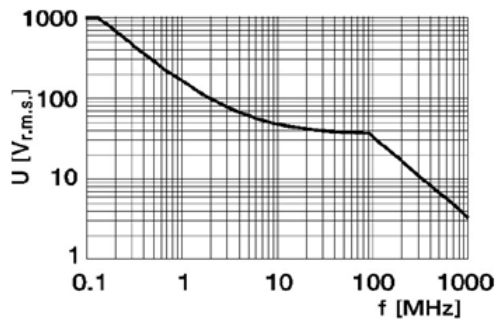


Figure 1-13 U1562A scope probe 100:1

## Connect Test Leads to Meter Terminals

Connect the test leads to the meter terminals on the handheld scope as shown below.



**THIS PAGE HAS BEEN INTENTIONALLY LEFT BLANK.**





## 2 Product Outlook

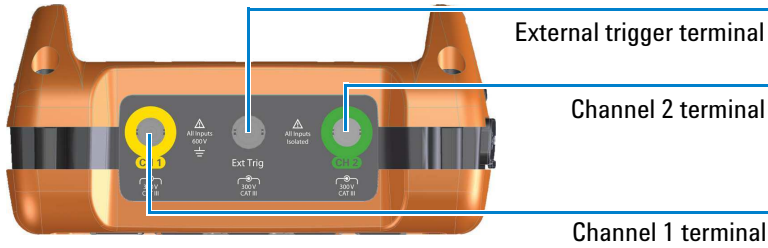
Product at a Glance	22
Front Panel Key Overview	23
Oscilloscope Display Overview	25
Multimeter and Data Logger Display Overview	26

This chapter provides an overview of the handheld scope keys, panels, and display.



# Product at a Glance

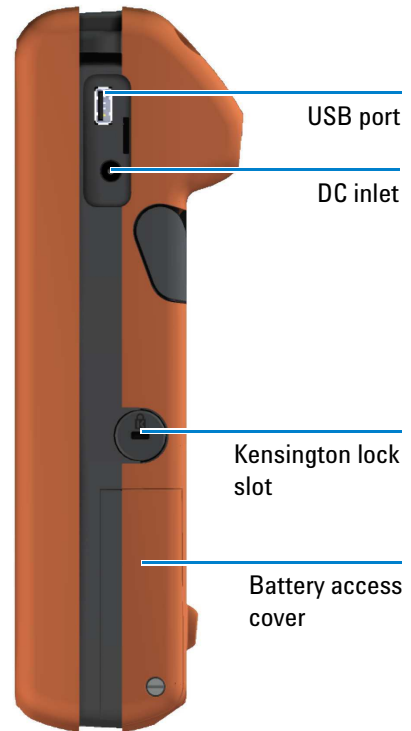
Top view



Front view



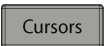
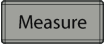







Side view



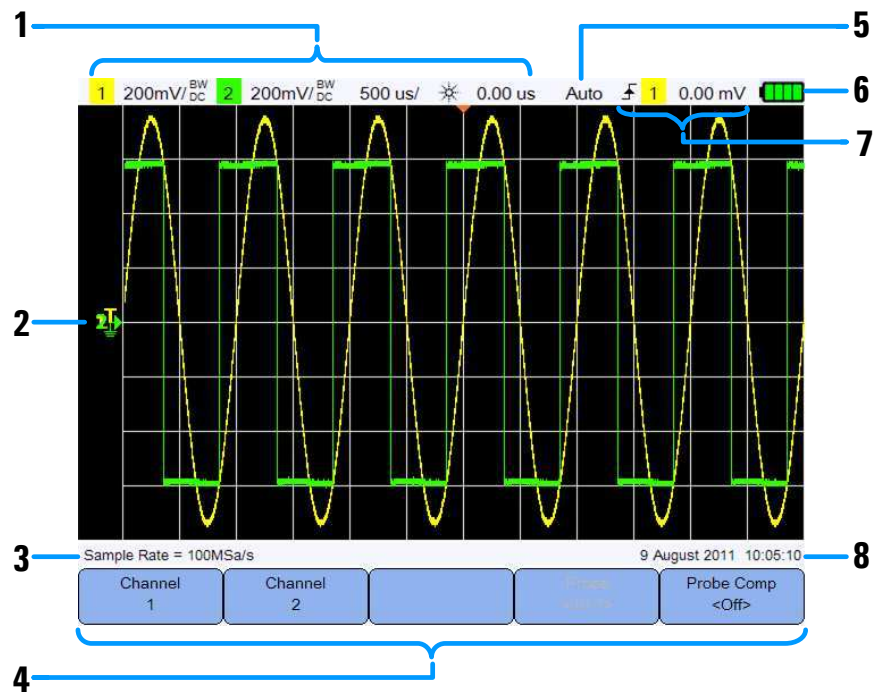
## Front Panel Key Overview

Key	Description
F1 F2 F3 F4 F5	To access the submenus related to the main function when a main function key is pressed.
Trigger	To configure the trigger settings. Pressing and holding this key will change the triggering mode.
Acquire	To select the waveform acquisition mode.
Run/Stop	To toggle between continuous running mode or stopped mode. Pressing and holding this key will change the triggering mode to the Single acquisition.
Autoscale	To perform autoscaling and configure the autoscale settings.
Meter	To access the multimeter mode.
Scope	To access the oscilloscope mode.
User	To access the system-related settings.
Help	To access the built-in quick help.
Logger	To access the data logger mode.
Analyzer	To perform mathematical operations and Fast Fourier Transform (FFT) function.
Save/Recall	To access the save and recall, print screen, and default settings functions. Pressing and holding this key will enable the quick print function.
Display	To configure the display settings.

## 2 Product Outlook

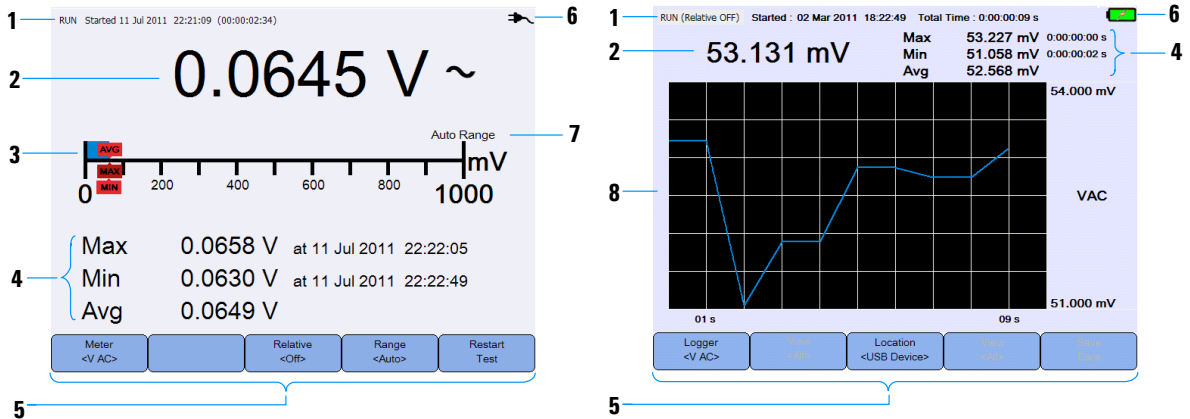
Key	Description
	To access the X or Y cursor functions.
	To select and perform automatic measurements.
	To select softkey functions and values.
	To adjust the vertical sensitivity (gain) in voltage per vertical division (volt/div).
	To adjust the waveform and ground level positions.
	To access the horizontal modes.
	To change the sweep speed in time per horizontal division (time/div).
	To set the delay time (horizontal position).
	<p>Press and hold this key for:</p> <ul style="list-style-type: none"> <li>• <math>\approx 3</math> seconds to turn on the handheld scope.</li> <li>• <math>\approx 1</math> second to turn off the handheld scope.</li> <li>• <math>\approx 10</math> seconds to power cycle the handheld scope.</li> </ul> <p>During power-off battery charging, this key will show the following status:</p> <ul style="list-style-type: none"> <li>• blinking red (capacity &lt; 60%)</li> <li>• blinking yellow (60% &lt; capacity &lt; 90%)</li> <li>• constant yellow (90% – 100% capacity)</li> </ul> <p>During power-on battery charging, this key will always turn constant yellow. The charging status is indicated on the top right of the display.</p>

## Oscilloscope Display Overview



No.	Description
1	Displays the channel and timebase setup information.
2	Displays the channel input waveforms with channel identifiers and indicators for trigger level, signal ground level, analyzer waveforms, time reference, and trigger point.
3	Displays the sample rate.
4	Displays the function menus of the keys and softkeys.
5	Displays the signal acquisition mode.
6	Displays the battery status and AC connectivity for battery charging.
7	Displays the trigger type, source, and level.
8	Displays the date and time.

## Multimeter and Data Logger Display Overview



No.	Description
1	Displays the acquisition, start date and time, and duration status.
2	Displays the measurement reading.
3	Displays the virtual measurement scale.
4	Displays the resulting average, maximum, and minimum readings.
5	Displays the function menus of the keys and softkeys.
6	Displays the battery status and AC connectivity for battery charging.
7	Indicates the auto or manual ranging mode.
8	Displays the logging graph.




## 3 Using the Oscilloscope



Vertical Controls	28
Horizontal Controls	33
Trigger Controls	38
Waveform Acquisition Controls	48
Display Controls	50
Automatic Measurements	52
Cursor Measurement Controls	60
Analyzer Controls	62
Autoscale and Run/Stop Controls	66
Save and Recall Controls	69

This chapter explains how to set up the oscilloscope functions.



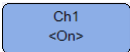
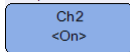
## Vertical Controls

Press  to access the vertical channel control menu.

Press  /  to access the respective channel submenu.

## Channel selection for waveform display

You can enable either one channel or two channels simultaneously.

Turn on/off the channel by toggling  / .

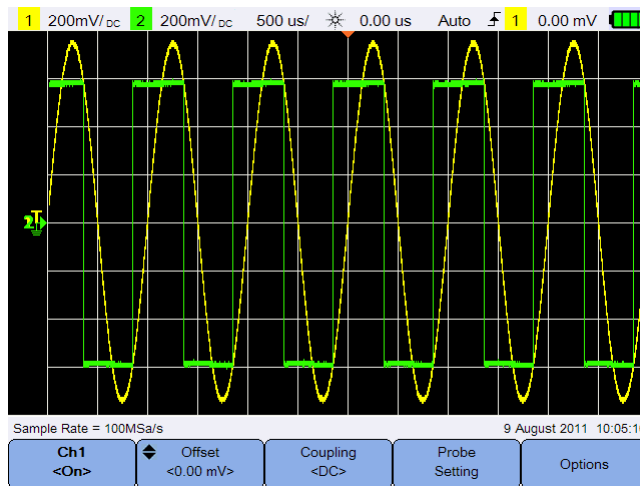



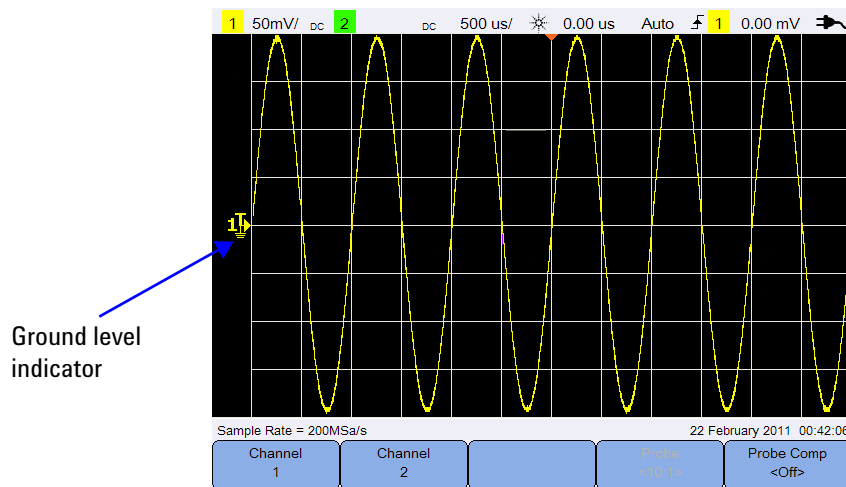
Figure 3-1 Channel 1 submenu





## Vertical system setup

### Adjust the ground level position



The signal ground level is identified by the position of the  icon on the display.



Move both  and the waveform vertically by:

- pressing  , or

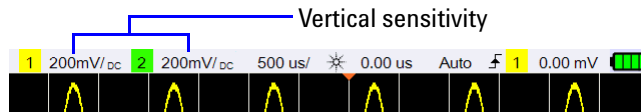


- pressing  and using the  or  key.

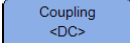
Moving the waveform to the top offsets the waveform with a negative voltage value, while moving to the bottom offsets it with a positive voltage value.

#### Adjust the vertical sensitivity

You can increase or decrease the vertical sensitivity (Volt/div) of a waveform by pressing

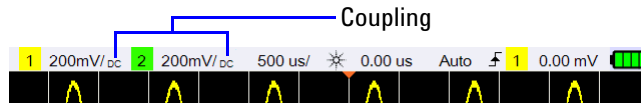


#### Channel coupling

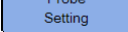
Toggle  to set the channel coupling.

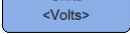
AC coupling blocks any DC component in the waveform and allows only the AC component of the signal to be viewed.

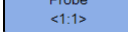
DC coupling allows both AC and DC components to pass into the handheld scope.



#### Probe setting

Press  to access the probe setup submenu.



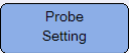
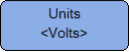
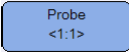
Toggle  to set the Volts unit for a voltage probe or Amps for a current probe. Channel sensitivity and offset, trigger level, measurement results, and math functions will reflect the unit you have selected.

Press  repeatedly to set the attenuation factor/sensitivity for measuring voltage/current values with a voltage/current probe. The attenuation factor/sensitivity must be set according to the probe being used to ensure the measurement results reflect the actual voltage/current level.

## AC current measurement

AC current measurement can be performed by using an AC current clamp. Agilent recommends the U1583B AC current clamp.

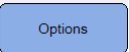
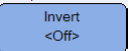
To measure AC current:

- 1 Connect the AC current clamp to channel 1 or channel 2.
- 2 Press  /  to access the connected channel submenu.
- 3 Press  to access the probe setup submenu.
- 4 Toggle  to set the unit to Amps.
- 5 Press  repeatedly to select the required V/A range for the AC current clamp.

## Invert control

This control inverts the displayed waveform with respect to the ground level. Invert affects how a channel is displayed, but does not affect triggering. Inverting a channel also changes the result of any function selected in the [Analyzer Controls](#) menu.

To invert a channel waveform:

- 1 Press  to access the invert and bandwidth limit control submenu.
- 2 Toggle .

### 3 Using the Oscilloscope

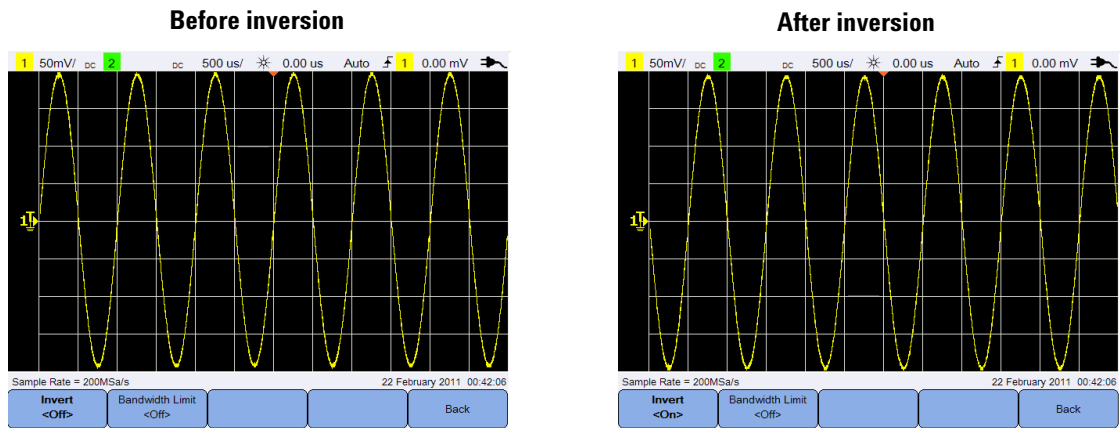


Figure 3-2 Waveform before and after inversion

### Bandwidth limit control

Press **Options** and press **Bandwidth Limit <Off>** repeatedly to set the maximum bandwidth for a channel to 10 kHz or 20 MHz. For waveforms with frequencies below the bandwidth limit, turning on this control removes unwanted high-frequency noise from the waveform.



### Return to zero

Press **Save/Recall** > **Return to zero** to return the vertical offset to zero for both channels.

## Horizontal Controls

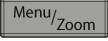
The horizontal controls adjust the horizontal scale and position of the waveforms.

### Horizontal system setup

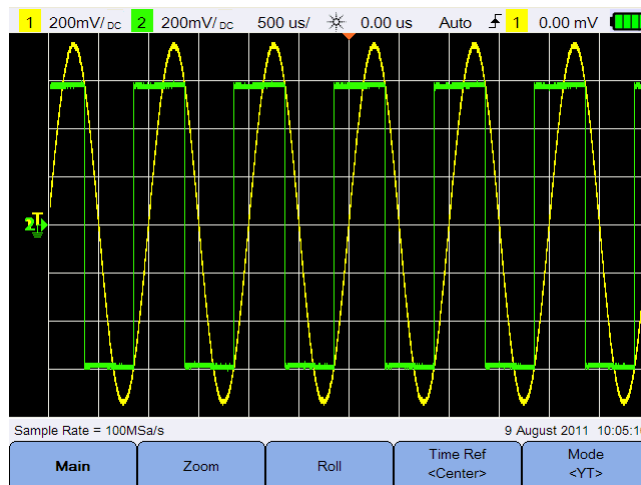
#### Select the time reference position

Time reference is the point on the display where the trigger point is referenced. Time reference can be set to one grid line from left to right, or to the center of the display.

▼ at the top of the graticule marks the position of the time reference. When delay time is set to zero, the delay time indicator (▼) overlays the time reference indicator.

Set the time reference position by pressing  and pressing

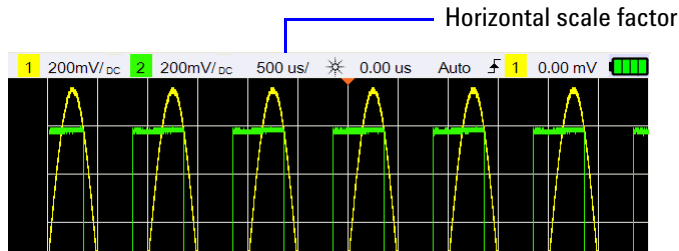
 repeatedly.



**Figure 3-3** Time reference position setting

#### Adjust the horizontal scale factor (time/div)

You can increase or decrease the horizontal scale factor or sweep speed of a waveform by pressing



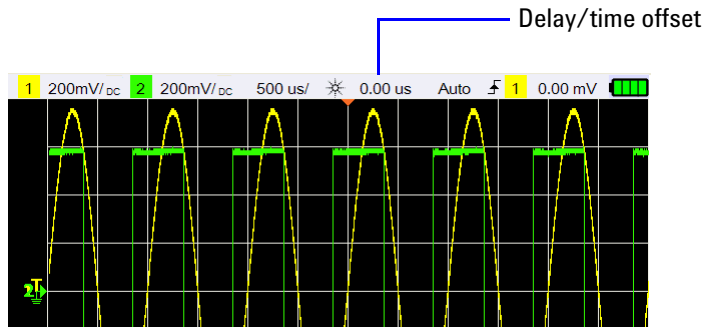
#### Set the waveform delay

The delay setting sets the specific location of the trigger event with respect to the time reference position.

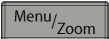
You can move the delay time indicator (▼) by pressing




Negative delay values indicate that you are looking at a portion of the waveform before the trigger event, and positive values indicate that you are looking at the waveform after the trigger event.



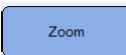
## Horizontal modes

Press  to access the horizontal mode menu.



### Main mode

Press  to access the Main mode, which is the normal viewing mode for the oscilloscope.

### Zoom mode

Press  to access the Zoom mode, which is a horizontally expanded version of the normal display. When Zoom is enabled, the display divides in half, where the top half shows the normal sweep and the bottom half displays the zoom sweep.




The area of the normal display that is expanded is outlined with a box.

 controls the size of the box and  sets the position of the zoom sweep.

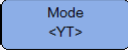


**Figure 3-4** Zoom mode

#### Roll mode

Press  to access the Roll mode, which causes the waveform to roll across the display from right to left. To pause the display, press . To clear the display and restart an acquisition, press  again.

#### XY mode

Press  to access the XY mode, which changes the display from a volts-versus-time display to a volts-versus-volts display. The timebase is turned off and Channel 1 amplitude is plotted on the X-axis and Channel 2 amplitude is plotted on the Y-axis. The Z-axis input (Ext Trigger) turns the trace on and off. When Z is low (<1.4 V), Y versus X is displayed; when Z is high (>1.4 V), the trace is turned off.

You can use XY mode to compare frequency and phase relationships between two signals.


## Recording length

Time/div	Non-interleave			Interleave		
	Sampling rate	Recording length (points)		Sampling rate	Recording length (points)	
		U1610A	U1620A		U1610A	U1620A
50 s	1 kSa/s	60 k	600 k	2 kSa/s	120 k	1.2 M
20 s	2.5 kSa/s	60 k	600 k	5 kSa/s	120 k	1.2 M
10 s	5 kSa/s	60 k	600 k	10 kSa/s	120 k	1.2 M
5 s	10 kSa/s	60 k	600 k	20 kSa/s	120 k	1.2 M
2 s	25 kSa/s	60 k	600 k	50 kSa/s	120 k	1.2 M
1 s	50 kSa/s	60 k	600 k	100 kSa/s	120 k	1.2 M
500 ms	100 kSa/s	60 k	600 k	200 kSa/s	120 k	1.2 M
200 ms	250 kSa/s	60 k	600 k	500 kSa/s	120 k	1.2 M





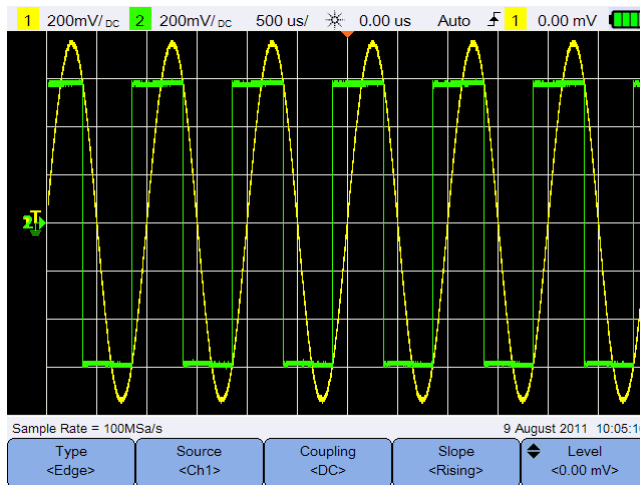
Time/div	Non-interleave			Interleave		
	Sampling rate	Recording length (points)		Sampling rate	Recording length (points)	
		U1610A	U1620A		U1610A	U1620A
100 ms	500 kSa/s	60 k	600 k	1 MSa/s	120 k	1.2 M
50 ms	1 MSa/s	60 k	600 k	2 MSa/s	120 k	1.2 M
20 ms	2.5 MSa/s	60 k	1 M	5 MSa/s	120 k	2 M
10 ms	5 MSa/s	60 k	1 M	10 MSa/s	120 k	2 M
5 ms	10 MSa/s	60 k	1 M	20 MSa/s	120 k	2 M
2 ms	25 MSa/s	60 k	1 M	50 MSa/s	120 k	2 M
1 ms	50 MSa/s	60 k	1 M	100 MSa/s	120 k	2 M
500 $\mu$ s	100 MSa/s	60 k	1 M	200 MSa/s	120 k	2 M
200 $\mu$ s	250 MSa/s	60 k	1 M	500 MSa/s	120 k	2 M
100 $\mu$ s	500 MSa/s	60 k	1 M	1 GSa/s	120 k	2 M
50 $\mu$ s	1 GSa/s	60 k	1 M	2 GSa/s	120 k	2 M
20 $\mu$ s	1 GSa/s	60 k	1 M	2 GSa/s	120 k	2 M
10 $\mu$ s	1 GSa/s	60 k	1 M	2 GSa/s	120 k	2 M
5 $\mu$ s	1 GSa/s	60 k	1 M	2 GSa/s	120 k	2 M
2 $\mu$ s	1 GSa/s	60 k	1 M	2 GSa/s	120 k	2 M
1 $\mu$ s	1 GSa/s	60 k	1 M	2 GSa/s	120 k	2 M
500 ns	1 GSa/s	60 k	1 M	2 GSa/s	120 k	2 M
200 ns	1 GSa/s	60 k	1 M	2 GSa/s	120 k	2 M
100 ns	1 GSa/s	60 k	1 M	2 GSa/s	120 k	2 M
50 ns	1 GSa/s	60 k	1 M	2 GSa/s	120 k	2 M
20 ns	1 GSa/s	60 k	1 M	2 GSa/s	120 k	2 M
10 ns	1 GSa/s	60 k	1 M	2 GSa/s	120 k	2 M
5 ns	1 GSa/s	60 k	1 M	2 GSa/s	120 k	2 M

## Trigger Controls


Press  to access the trigger function which determines when the oscilloscope starts to acquire data and display a waveform. A triggered waveform is one in which the oscilloscope begins tracing the waveform, from the left side of the display to the right, each time a particular trigger condition is met.

### Trigger types

You can select the trigger type by pressing  and pressing  repeatedly.



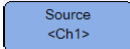
**Figure 3-5** Trigger type and settings submenu

The  icon on the left of the display indicates the position of the trigger level for the analog channel.

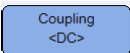
## Edge trigger

The Edge trigger identifies a trigger by looking for a specified edge (slope) and voltage level on a waveform.

### Source

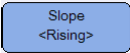
Press  repeatedly to select the trigger source.

### Coupling

Press  repeatedly to select either:

- DC coupling – allows DC and AC signals into the trigger path.
- AC coupling – removes any DC offset voltage from the trigger waveform.
- LF (low frequency) reject coupling – removes any unwanted low-frequency components from the trigger waveform.
- HF (high frequency) reject coupling – removes high-frequency components from the trigger waveform.

### Slope

Press  repeatedly to select the Rising (↕) edge, Falling (↘) edge, Alternate (↕↗) edges, or Either (↕↔) edge.

All modes operate up to the oscilloscope bandwidth except the Either edge mode, which has a limitation. The Either edge mode will trigger on constant wave signals up to 100 MHz, but can trigger on isolated pulses down to  $1/(2 \times \text{oscilloscope bandwidth})$ .

### Level

Press  and use the ▲ or ▼ key to set the trigger level.

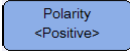
## Glitch trigger

A glitch is a rapid change in the waveform that is usually narrow as compared to the waveform. The [Peak Detect mode](#) can be used to more easily view glitches or narrow pulses.

### Source

See “[Source](#)” on page 39.

### Polarity

Toggle  to select the positive ( $\sqcup$ ) polarity or negative ( $\sqcap$ ) polarity for the glitch you want to capture.

### Level

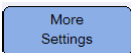
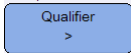
See “[Level](#)” on page 39.

### Qualifier

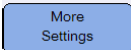
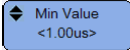
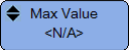
The time qualifier sets the oscilloscope to trigger on a channel pattern whose time duration is:

- less than a time value (<)
- greater than a time value (>)
- within a range of time values (><)
- outside a range of time values (<>)

To select the qualifier:

- 1 Press  to access more trigger parameters.
- 2 Press  repeatedly.

### Minimum and Maximum values

Press  >  /  and use the  $\blacktriangle$  or  $\blacktriangledown$  key to set the minimum or maximum time value respectively for the selected qualifier.

## Coupling

See “Coupling” on page 39.

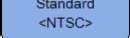
## TV trigger

TV triggering can be used to capture the complicated waveforms of most standard and high-definition analog video signals.

### Source

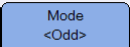
See “Source” on page 39.

### Standard

Press  repeatedly to select the NTSC, SECAM, PAL, PAL-M, HDTV 720p, HDTV 1080p, or HDTV 1080i standard.

NTSC, SECAM, PAL, and PAL-M are broadcast standards used throughout the world. HDTV is a high-definition TV standard.

### Mode

Press  repeatedly to select the portion of the video signal to trigger on:

- All Field – triggers on the rising edge of the first pulse in the vertical sync interval.
- All Line – triggers on all horizontal sync pulses.
- Line – triggers on the selected line # (HDTV standard only).
- Odd – triggers on the rising edge of the first serration pulse of the odd field.
- Even – triggers on the rising edge of the first serration pulse of the even field.
- Line:Odd – triggers on the selected line # in the odd field.
- Line:Even – triggers on the selected line # in the even field.

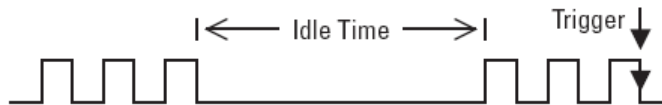
Not all of the above modes are available for all standards. The mode selection changes according to the standard you select.

#### Custom Line

Press  and use the ▲ or ▼ key to select the line number on which you want to trigger. This is only applicable for the Line trigger mode.

#### Nth Edge trigger

The Nth Edge trigger allows you to trigger on the Nth edge of a burst that occurs after a specified idle time.



#### Source

See “Source” on page 39.

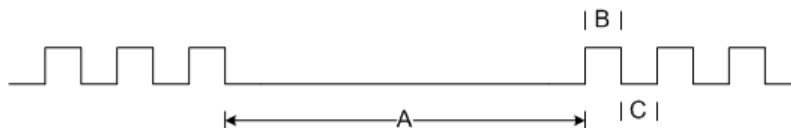
#### Slope

Toggle  to select the Rising (↗) edge or Falling (↘) edge to make the oscilloscope count the waveform rising or falling edges. The oscilloscope will trigger when the Nth edge has been detected after the idle time has been satisfied.

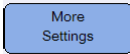

#### Idle time

Press  and use the ▲ or ▼ key to set an idle time which must be greater than the largest width of the burst, and smaller than the longest idle time (high or low).

In the example below, the idle time must be less than A and greater than B or C. The idle time is considered whether it is low (as shown) or high.



**Edge**

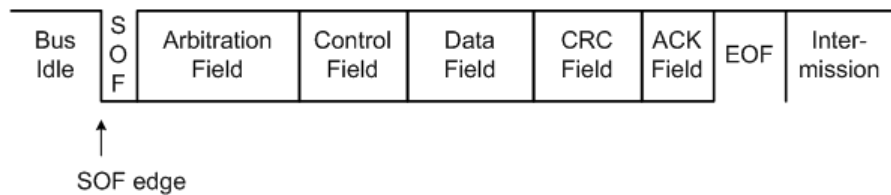
Press  >  and use the ▲ or ▼ key to set the edge count from 1 to 65535.

**Level**

See “[Level](#)” on page 39.

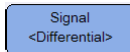
**CAN trigger**

The Controller Area Network (CAN) trigger allows triggering on CAN version 2.0A and 2.0B signals. The basic CAN trigger will trigger on the Start of Frame (SOF) bit of a Data frame. A CAN message frame in the CAN\_L signal type is shown below:

**Source**

See “[Source](#)” on page 39.

**Signal**

Press  repeatedly to set the type and polarity of the CAN signal. This also automatically sets the channel label for the source channel that can be connected as follows:

- CAN\_H – actual CAN\_H differential bus signal.

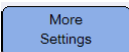

Dominant low signals:

- CAN\_L – actual CAN\_L differential bus signal.
- Rx – Receive signal from the CAN bus transceiver.
- Tx – Transmit signal from the CAN bus transceiver.
- Differential – CAN differential bus signals connected to an analog source channel using a differential probe.

#### Level

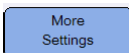
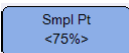
See “Level” on page 39.

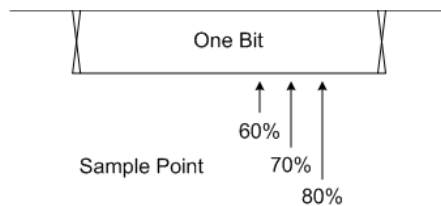
#### Baud rate

Press  and press  repeatedly to set the baud rate to match the bus signal.

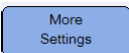
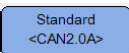
If the selected baud rate does not match the system baud rate, false triggers may occur.

#### Sample point

Press  and press  repeatedly to set the sample point which represents the percentage of time between the beginning of the bit time to the end of the bit time.

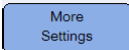
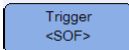


#### Standard

Press  and toggle  to select Standard CAN (2.0A) or Extended CAN (2.0B).

Standard CAN has an 11-bit long identifier while Extended CAN has a 29-bit long identifier.

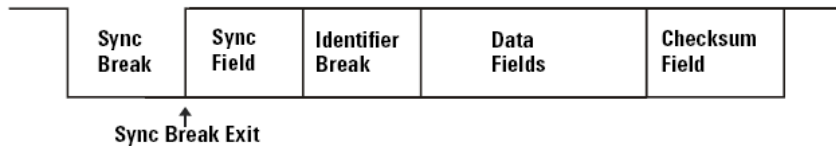
#### Trigger

Press  >  to trigger on the SOF bit of a Data frame.



## LIN trigger

Local Interconnect Network (LIN) triggering will trigger on the rising edge at the Sync Break exit of the LIN single-wire bus signal that marks the beginning of the message frame.



### Source

See “[Source](#)” on page 39.

### Sync break

Press  repeatedly to select the minimum number of clocks that define a sync break in the LIN signal.

### Level

See “[Level](#)” on page 39.

### Baud rate

See “[Baud rate](#)” on page 44.

### Sample point

See “[Sample point](#)” on page 44.

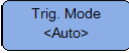
### Standard


Press  and press  repeatedly to select the LIN standard of 1.3, 2.0, or 2.1.

### Trigger

Press  >  to trigger on the rising edge at the Sync Break exit of the LIN single-wire bus signal that marks the beginning of the message frame.

## Trigger modes

Press  repeatedly to select the trigger mode which affects the way the oscilloscope searches for the trigger.

- Normal – displays a waveform when the trigger conditions are met, otherwise the oscilloscope does not trigger and the display is not updated. “Trig’d” is shown on the status line when this trigger mode is set and a trigger is found. “Trig’d (blinking)” is shown when a trigger has not been found.
- Auto – displays a waveform when the trigger conditions are met. If the trigger conditions are not met, it forces the oscilloscope to trigger anyway. “Auto” is shown on the status line when this trigger mode is set and a trigger is found. “Auto (blinking)” is shown when a trigger has not been found.
- Single – displays single-shot events without subsequent waveform data overwriting the display. When the oscilloscope triggers, the single acquisition is displayed and the oscilloscope is stopped (“Stop” is shown on the status line). Press  again to acquire another waveform.

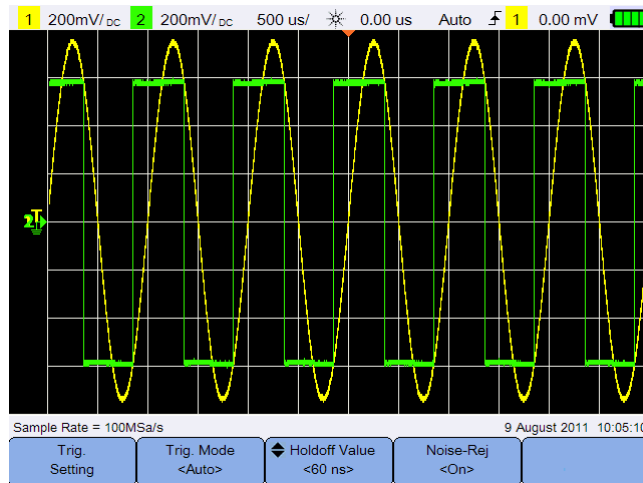
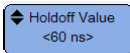
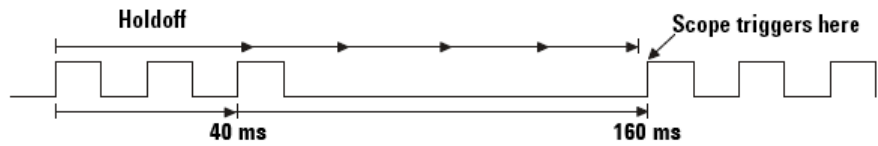


Figure 3-6 Auto trigger mode

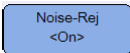
## Trigger holdoff

Press  and use the ▲ or ▼ key to set the amount of time that the oscilloscope waits before re-arming the trigger circuitry.

To get a stable trigger on the pulse burst shown below, set the holdoff time to be >40 ms but <160 ms.



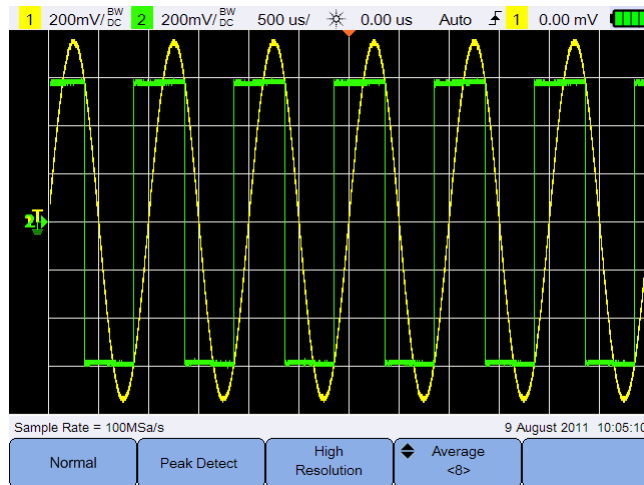
## Noise rejection

Toggle  to turn on/off noise rejection which adds additional hysteresis to the trigger circuitry and reduces the possibility of triggering on noise.

## Waveform Acquisition Controls

The real-time sampling of the handheld scope can be used with either repetitive signals or single-shot signals. This means the waveform display is produced from samples collected during one trigger event and all samples from previous trigger events are erased.

Press  to access the acquisition mode menu.



**Figure 3-7** Acquire menu

- Normal mode  
Used for most waveforms with normal decimating and no averaging. This mode provides the best display for most waveforms. You are allowed to capture up to 1.2 kpts of data in the CSV format.
- Peak Detect mode  
Evaluates all sample points at the maximum sample rate, selects the minimum and maximum points, and stores them into memory. This ensures that narrow glitches will always be displayed regardless of sweep speed. You are allowed to capture up to 1.2 kpts of data in the CSV format.

- High Resolution mode

Averages extra samples at slower sweep speeds to reduce random noise, produce a smoother trace, and effectively increase vertical resolution. You are allowed to capture up to 12 kpts of data in the CSV format.

- Average mode

Averages multiple acquisitions to reduce random noise and increase vertical resolution. The average numbers can be set from 2 to 8192 in powers-of-2 increments using the ▲ or ▼ key. You are allowed to capture up to 1.2 kpts of data in the CSV format.

## Display Controls

Press  to access the display control menu.

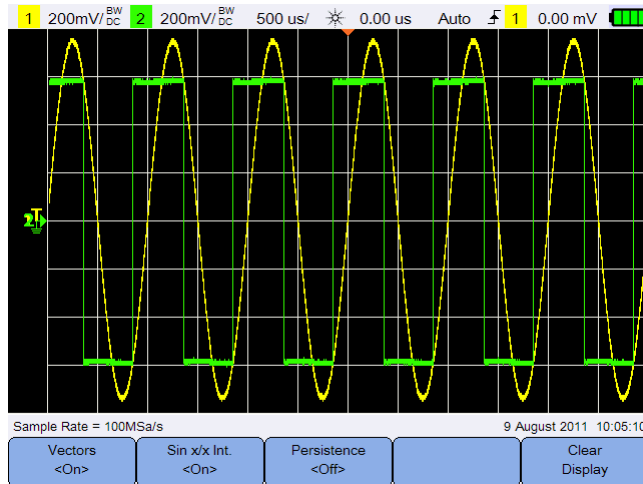


Figure 3-8 Display control menu

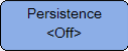
### Vectors display

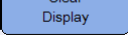
Toggle  to enable the vectors mode which draws a line between consecutive waveform data points. This mode produces the most insightful waveforms for most situations.



### Sin x/x interpolation

Toggle  to enable sin x/x interpolation which reproduces the exact waveform as displayed on the oscilloscope. You can use this process to reaffirm the behavior of a signal between samples.

## Infinite persistence

Toggle  to enable infinite persistence which updates the display with new acquisitions, but does not erase the results of previous acquisitions. This can be used to measure noise and jitter, observe the worst case of a varying waveform, look for timing violations, and capture events that occur irregularly.


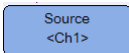
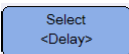



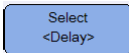
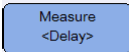
To erase previous acquisitions, press . The display will start to accumulate acquisitions again if the oscilloscope is running. Turn off

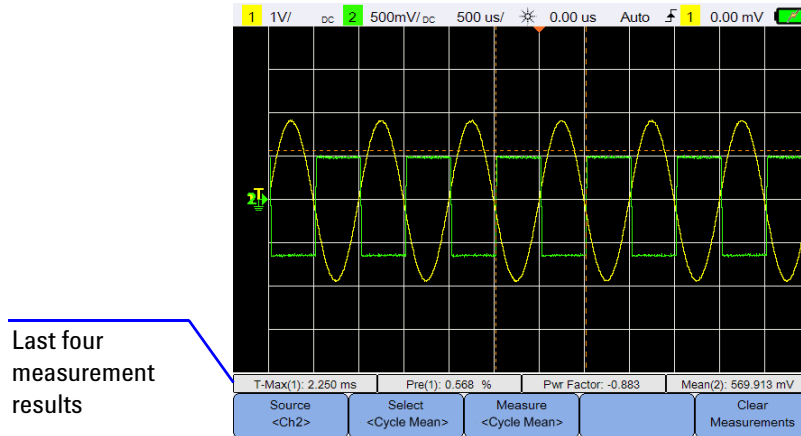
, then press  to return to the normal display mode.

## Automatic Measurements

You can perform up to 30 automatic measurements (time, voltage, and power) on any channel source or running math function.

To make a quick measurement:

- 1 Press  to access the measurement function menu.
- 2 Press  repeatedly to select a channel or math source. The math source is applicable only when [Analyzer Controls](#) are enabled.
- 3 Press  and use the    keys to select a measurement type. Press  again to exit the selection menu.
- 4 Press  to make the selected measurement.



**Figure 3-9** Measurement function menu

Cursors are turned on to show the portion of the waveform being measured for the most recently selected measurement.

If a portion of the waveform required for a measurement is not displayed or does not display enough resolution to make the measurement, the result will be displayed as no signal, no edges, greater than a value, or less than a value.



If you select the delay or phase shift measurement, press **Setting** to select the source channels or running math functions. Press **Source 1 <Ch1>** and **Source 2 <Ch2>** repeatedly to select the first and second sources respectively.

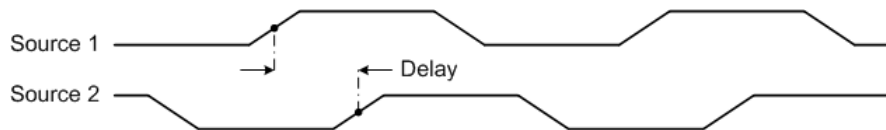
If you select any power measurement, press **Sensitivity** to set the channel input and probe attenuation factor or sensitivity. Toggle **Volt/Amp. <Ch1/Ch2>** to assign channel 1 or 2 as the voltage input or current input. Press **Volt Probe <1:1>** or **Sensitivity <1.00V/A>** repeatedly to set the attenuation factor or sensitivity for the connected voltage or current probe respectively. Changing the attenuation or sensitivity will also change the vertical scale of the assigned channel.

To clear all measurements, press **Clear Measurements**.

## Time measurements

### Delay

Delay measures the time difference from the selected edge on Source 1 and the selected edge on Source 2 closest to the trigger reference point at the middle threshold points on the waveforms.



**Duty Cycle (-), Duty Cycle (+), Fall Time, Rise Time, Frequency, Period, Width (-), Width (+)**

The duty cycle (-) and (+) of a repetitive pulse train are expressed as follows:

$$\text{Duty Cycle } (-) = \frac{-\text{Width}}{\text{Period}} \times 100 \qquad \text{Duty Cycle } (+) = \frac{+\text{Width}}{\text{Period}} \times 100$$

The fall time is the time difference between the crossing of the upper threshold and the crossing of the lower threshold for a negative-going edge.

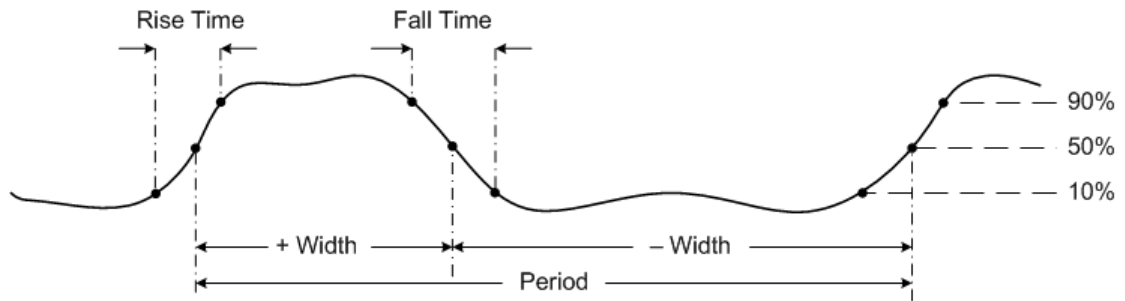
The rise time is the time difference between the crossing of the lower threshold and the crossing of the upper threshold for a positive-going edge.

Frequency is defined as 1/Period.

Period is the time period of the complete waveform cycle.

Width (-) is the time from the middle threshold of the falling edge to the middle threshold of the next rising edge.

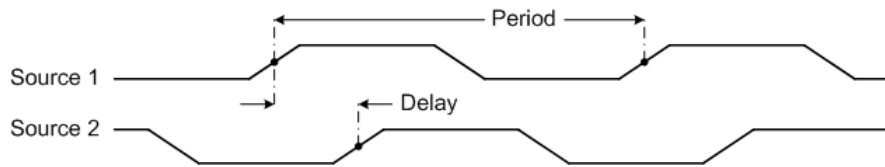
Width (+) is the time from the middle threshold of the rising edge to the middle threshold of the next falling edge.



**Phase Shift**

Phase shift is expressed as follows:

$$\text{Phase Shift} = \frac{\text{Delay}}{\text{Source 1 Period}} \times 360$$



### T-Max and T-Min

T-Max and T-Min are X-axis time values at the first displayed occurrence of the waveform Maximum and Minimum respectively, starting from the left side of the display.

## Voltage measurements

### Amplitude, Base, Maximum, Minimum, Peak to Peak, Top

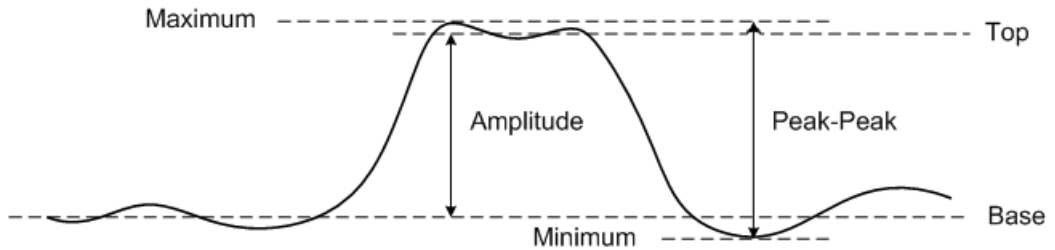
The amplitude of a waveform is the difference between its Top and Base values.

The base is the mode (most common value) of the lower part of the waveform, or if the mode is not well defined, the base is the same as Minimum.

Maximum and Minimum are the highest and lowest values in the waveform display respectively.

The peak-to-peak value is the difference between Maximum and Minimum values.

The top is the mode of the upper part of the waveform, or if the mode is not well defined, the top is the same as Maximum.



#### Average

Average is the sum of the levels of the waveform samples divided by the number of samples over one or more full periods.

$$\text{Average} = \frac{\sum x_i}{n}$$

#### CREST

The crest factor is computed by dividing the peak amplitude of a waveform by the waveform RMS value.

$$C = \frac{|x|_{\text{peak}}}{|x|_{\text{rms}}}$$

#### Cycle Mean

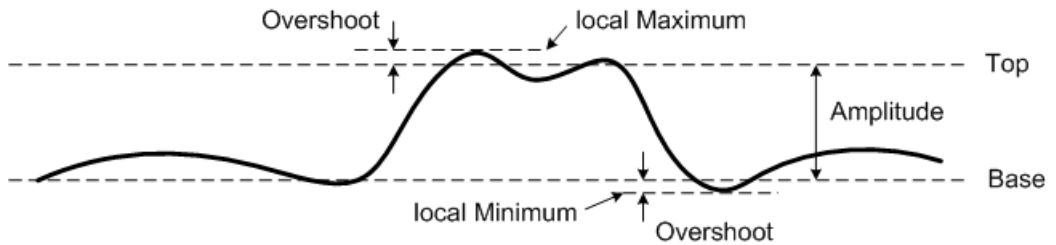
The mean cycle value is the statistical average of the measurement within a cycle period.

#### Overshoot

Overshoot is distortion that follows a major edge transition expressed as a percentage of amplitude.

$$\text{Rising edge overshoot} = \frac{\text{local Maximum} - \text{Top}}{\text{Amplitude}} \times 100$$

$$\text{Falling edge overshoot} = \frac{\text{Base} - \text{local Minimum}}{\text{Amplitude}} \times 100$$

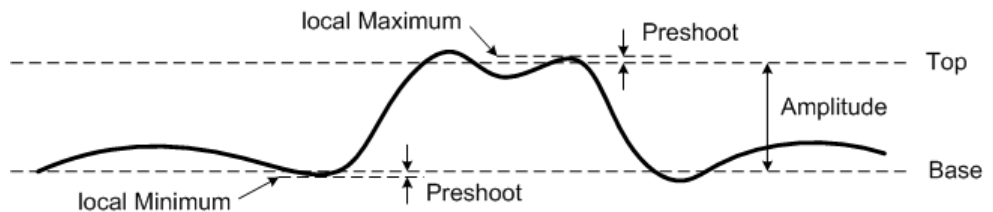


### Preshoot

Preshoot is distortion that precedes a major edge transition expressed as a percentage of amplitude.

$$\text{Rising edge preshoot} = \frac{\text{Base} - \text{local Minimum}}{\text{Amplitude}} \times 100$$

$$\text{Falling edge preshoot} = \frac{\text{local Maximum} - \text{Top}}{\text{Amplitude}} \times 100$$



### Std Deviation

The standard deviation ( $\sigma$ ) of a data collection is the amount that the data varies from the mean value.

$$\sigma = \sqrt{\frac{\sum(x_i - \bar{x})^2}{N - 1}}$$

#### RMS (AC)

AC voltage is normally expressed as a root-mean-square (RMS) value, represented as  $V_{rms}$ . For a sinusoidal voltage,  $V_{rms}$  is equivalent to  $V_{peak}/\sqrt{2}$ .

#### RMS (DC)

VRMS (DC) is the RMS value of the waveform over one or more full periods.

$$VRMS (DC) = \sqrt{\frac{\sum_{i=1}^n x_i^2}{n}}$$

## Power measurements

Power measurement is a point-by-point multiplication of the voltage and current waveforms measured by the voltage and current probes.

The U1610/20A is designed to measure power factor, active power, reactive power, and apparent power in the electrical power distribution system in factories or commercial and residential areas. It is ideally suited to measure power in the 50 Hz or 60 Hz cycle commonly found in the power distribution system.

For higher frequency applications such as those found in switch mode power supplies, a deskewing mechanism is needed in order to compensate for the time delay between the voltage and current probes. This is important as a small offset in the timing of the high frequency voltage and current traces can cause a large error in the instantaneous power reading. The U1610/20A is not able to support this high frequency power measurement application.

#### NOTE

Ensure that the correct attenuation factor/sensitivity is set for the connected voltage/current probe respectively. Refer to [page 53](#) for more information in setting up the probes.

**Active Pwr**

Active power (real or true power) is measured in watts (W) by averaging a portion of power over a complete cycle of the AC waveform which produces a net transfer of energy in one direction. It is the power drawn by the electrical resistance of a system.

**Apparent Pwr**

Apparent power is measured in volt-amperes (VA) and by the vector sum of the active and reactive power. It is the voltage on an AC system multiplied by all the current that flows in it.

**Reactive Pwr**

Reactive power is measured in volt-amperes reactive (VAR) and is the portion of power stored and discharged by inductive motors, transformers, and solenoids.

**Pwr Factor**


Power factor is a measurement of how effectively the electrical power is being used. A high power factor (near 1.0), indicates the efficient utilization of the electrical power, while a low power factor indicates the poor utilization of the electrical power. If the power factor falls below 0.90, some utility companies charge a power factor penalty. Power factor is the ratio of real power (watts) and the apparent power (volt-amperes). It is calculated by dividing the real power with the apparent power.

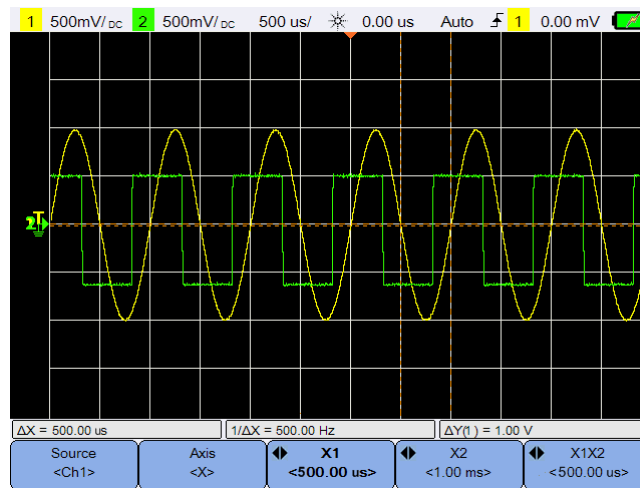
**NOTE**

Agilent recommends the U1583B AC current clamp for the power measurement.

## Cursor Measurement Controls

Cursors are horizontal and vertical markers that indicate X-axis values for timebase measurements and Y-axis values for voltage measurements respectively. You can use cursors to make custom voltage or time measurements on oscilloscope signals.

Press  to access the cursor function menu.



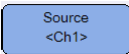

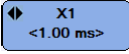
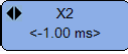
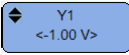
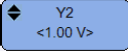
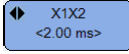
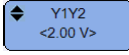
**Figure 3-10** Cursor function menu

The X-cursor measurement places two vertical lines across the displayed waveform which adjust horizontally and indicate time relative to the trigger point for all sources except math FFT (frequency is indicated).

The Y-cursor measurement places two horizontal lines across the displayed waveform which adjust vertically and indicate values relative to the waveform ground point.



To set up the cursor measurement:

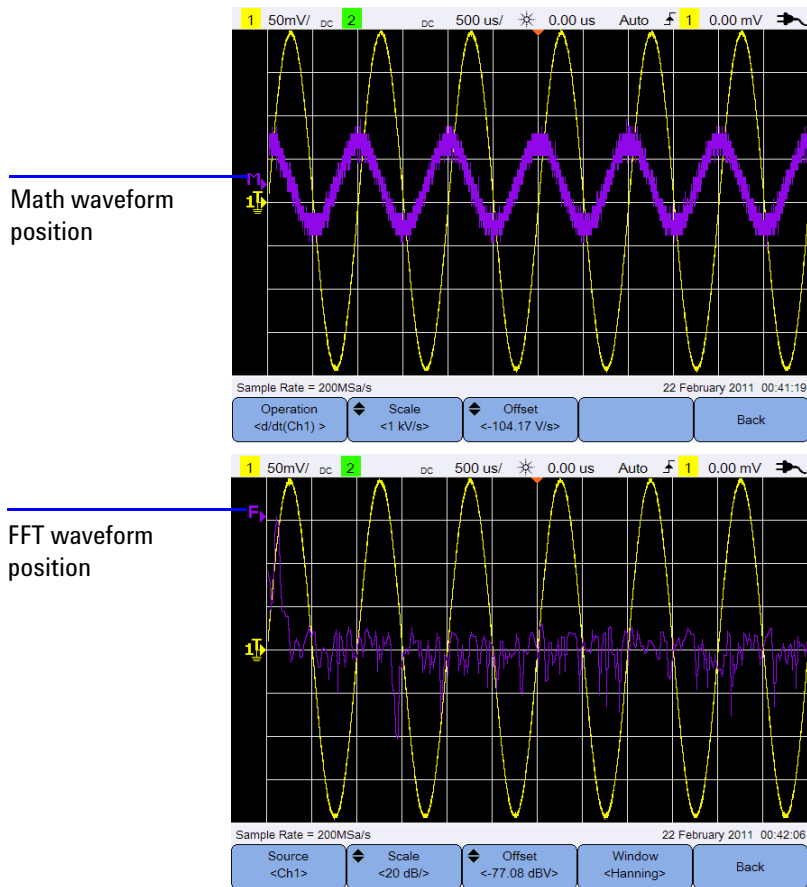
- 1 Press  repeatedly to select a channel or analyzer source, or to turn off the cursors. The analyzer source is applicable only when [Analyzer Controls](#) are enabled.
- 2 Toggle  to select the X or Y cursor.
- 3 Press  or  and use the ◀ or ▶ key to adjust the X1 or X2 cursor respectively. The X1 cursor is displayed as a short-dashed vertical line while the X2 cursor is displayed as a long-dashed vertical line.  
Press  or  and use the ▲ or ▼ key to adjust the Y1 or Y2 cursor respectively. The Y1 cursor is displayed as a short-dashed horizontal line while the Y2 cursor is displayed as a long-dashed horizontal line.
- 4 Press  and use the ◀ or ▶ key to adjust the X1 and X2 cursors together.  
Press  and use the ▲ or ▼ keys to adjust the Y1 and Y2 cursors together.

## Analyzer Controls

Press **Analyzer** > **Math** / **FFT** to perform mathematical operations or Fast Fourier Transform (FFT) function on the waveforms.

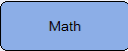
Press **Analyzer** > **Display Channel** <Both> repeatedly to display either channel 1, channel 2, both channels 1 and 2, or turn off all the channels waveform on the screen.

The resulting math and FFT waveforms are displayed in purple.



To turn off the analyzer functions, press **Turn Off Analyzer**.

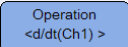
## Math functions

Press  to perform math functions on analog channels.

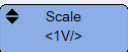
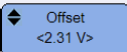



### Select the math operations

Press  and use the   keys to select a math operation.

<b>Ch1 + Ch2</b>	Adds channel 2 voltage values to channel 1 voltage values point by point.
<b>Ch1 - Ch2</b> or <b>Ch2 - Ch1</b>	Subtracts channel 2/channel 1 voltage values from channel 1/channel 2 voltage values point by point.
<b>Ch1 * Ch2</b>	Multiplies channel 1 and channel 2 voltage values, point by point.
<b>Ch1/Ch2</b> or <b>Ch2/Ch1</b>	Divides channel 2/channel 1 voltage values by channel 1/channel 2 voltage values point by point.
<b>d/dt(Ch1)</b> or <b>d/dt(Ch2)</b>	Calculates the discrete time derivative of channel 1 or channel 2.
<b>∫(Ch1)dt</b> or <b>∫(Ch2)dt</b>	Calculates the integral of channel 1 or channel 2.

Press  again to exit the selection menu.

### Adjust the math waveform scale or offset

Press  /  and use the  or  key to set the scale factor (unit/division) or offset respectively for the selected math operation. Set the Volts or Amps unit for the scale/offset via [Probe setting](#) ( menu). The units are:

Ch1 + Ch2 : V or A



Ch1 - Ch2 : V or A

Ch2 - Ch1 : V or A

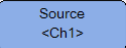


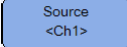
Ch1 \* Ch2 :  $V^2$ ,  $A^2$ , or W  
Ch1/Ch2 : -  
Ch2/Ch1 : -  
d/dt : V/sec or A/sec  
 $\int dt$  : Vsec or Asec

A unit of U (undefined) will be displayed for Ch1 + Ch2, Ch1 - Ch2, and Ch2 - Ch1 if the channels are set to dissimilar units.

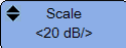



## FFT function

Press  >  to access the FFT function which converts a time-domain waveform into a frequency-domain waveform.

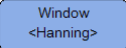
### Select the source

Press  and use the   keys to select any analog channel or math operation as the FFT source. Press  again to exit the selection menu.

### Adjust the FFT waveform scale or offset

Press  /  and use the  or  key to set the scale factor (dB/division) or offset (dB or dBV) respectively.

### Select the window function

Press  repeatedly to select a window function to apply to your FFT input signal based on the signal characteristics and measurement priorities.

- Hanning – used for making accurate frequency measurements or for resolving two frequencies that are close together.
- Rectangular – provides good frequency resolution and amplitude accuracy, but can be used only where there will be no leakage effects.

- Hamming – provides better frequency resolution but less amplitude accuracy compared to the Rectangular window. The Hamming window has a slightly better frequency resolution than the Hanning window.
- B. Harris – reduces time resolution compared to the Rectangular window, but improves the capacity to detect smaller impulses due to lower secondary lobes.
- Flattop – used for making accurate amplitude measurements of frequency peaks.

## Autoscale and Run/Stop Controls

### Autoscale

Pressing  automatically configures the handheld scope to best display the input signals by analyzing any waveforms present at each channel and at the external trigger input.

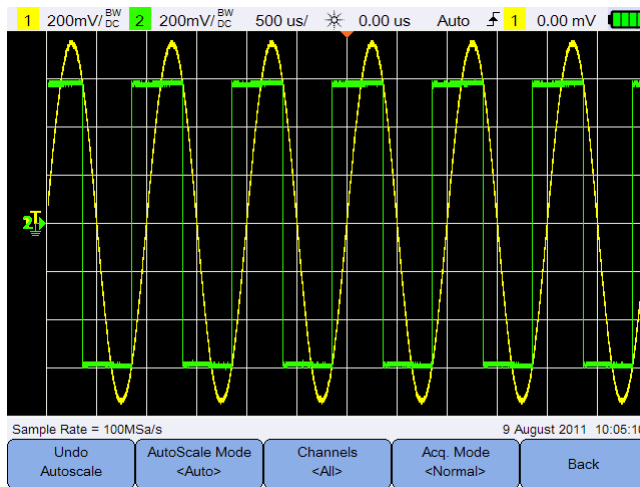


Figure 3-11 Autoscale function menu

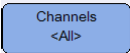
### Undo autoscale

Press  to return to the settings that existed before pressing . This is useful if you have unintentionally pressed  or do not like the settings Autoscale has selected and want to return to your previous settings.


### Select the autoscale mode

Toggle  to select between the auto or manual range mode to apply on the waveforms.

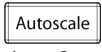
### Specify the channels displayed after autoscale

Toggle  to set which channels will be displayed on subsequent autoscales.

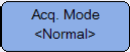
- All

The next time you press , all channels that meet the autoscale requirements will be displayed.


- Displayed Ch.

The next time you press , only the channels that are turned on will be examined for signal activity.


### Preserve the acquisition mode during autoscale

Toggle  to choose whether to allow the acquisition mode to be switched to Normal or left unchanged when autoscale is performed.

- Normal

The handheld scope will switch to the Normal acquisition mode whenever  is pressed.


- Preserve

The handheld scope will remain in the acquisition mode you have chosen when  is pressed.

### Return to the previous menu

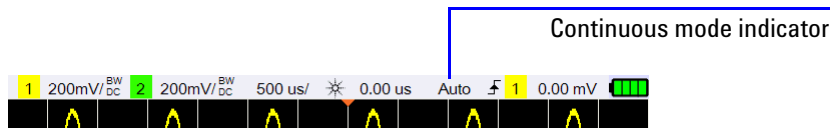
Press  to return to the previous menu.


## Run/Stop

Press  to toggle between continuous running mode or stopped mode.

- Continuous mode – You are viewing multiple acquisitions of the same signal similar to the way an analog oscilloscope displays waveforms. “Trig’d” is indicated on the status line if the triggering mode is set to the Normal or Single acquisition.

### 3 Using the Oscilloscope




- Stopped mode – You can pan and zoom the stored waveform by pressing the horizontal and vertical control keys. The stopped display may contain several triggers worth of information, but only the last trigger acquisition is available for pan and zoom. To ensure the display does not change, change the triggering mode to the Single acquisition to be sure you have acquired only one trigger. Pressing and holding  also allows you to change to the Single acquisition.




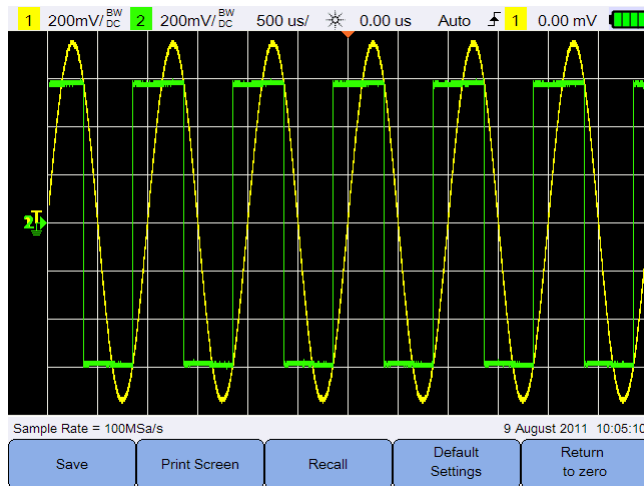


## Save and Recall Controls

Pressing  allows you to perform save, recall, print screen, default settings, and return to zero functions.


### NOTE

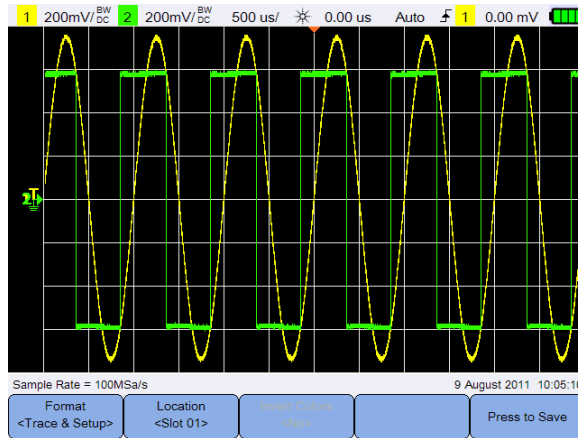
 is only accessible when in the Scope mode.



**Figure 3-12** Save/Recall menu


## Save control

Press  to access the save functions.



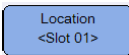

**Figure 3-13** Save submenu

### Select the save file format

Press  repeatedly to select the file format to save. The waveform trace and setup is saved to the handheld scope internal memory, while the rest of the formats are saved to a connected USB storage device.

- Trace & Setup – save the waveform image and setup file.
- csv data – save the data points in the CSV format.
- bmp (8-bit) – save the waveform image in the BMP (8-bit) format.
- bmp (24-bit) – save the waveform image in the BMP (24-bit) format.
- png (24-bit) – save the waveform image in the PNG (24-bit) format.
- RAW – save the waveform image in the raw format.

### Select the save location

Press  and use the  keys to select any of the internal memory slots (for the trace and setup format) or any location in your connected USB storage device (for other file formats) to save to.

Press  again to exit the selection menu.

For USB, you need to first ensure that your USB storage device is connected to the handheld scope. Then, press  > . Press  repeatedly to select <Host> for the handheld scope to detect the USB device.

### Invert image colors

Toggle  to invert all colors on the screen image you want to save. This is only applicable for image formats.

### Save the file

Press  to save the selected file format into the selected memory location.

## Recall control

Press  to access the recall functions.

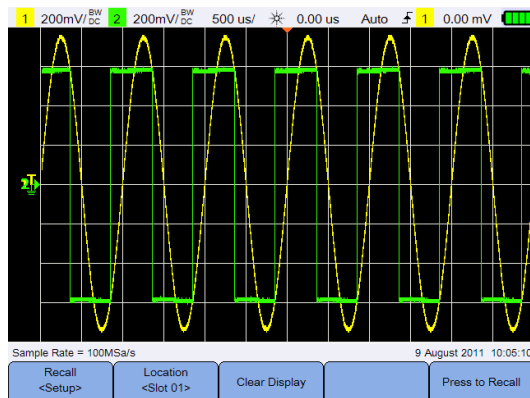
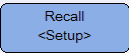
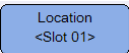



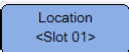


Figure 3-14 Recall submenu


#### Select the recall file format

Press  repeatedly to select the waveform trace, setup, or both to recall from the internal memory.

#### Select the recall location

Press  and use the    keys to select an internal memory location to recall a saved file. Press  again to exit the selection menu.

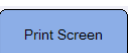

#### Clear the display

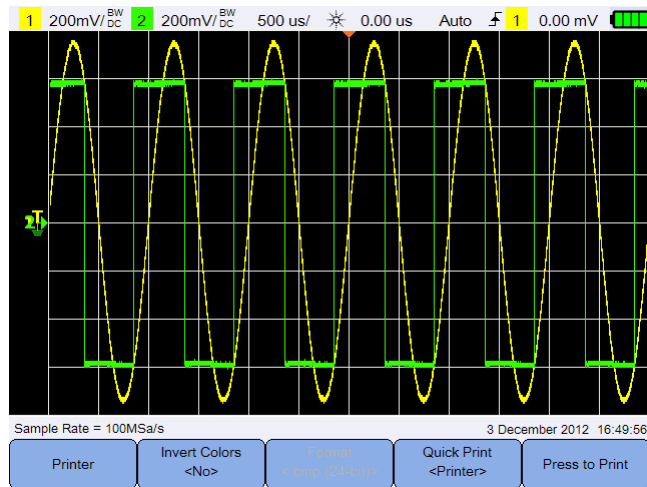
Press  to clear the current displayed waveform from the screen. If the handheld scope is running, the display will begin to accumulate waveform data again.

#### Recall the file

Press  to recall the saved file from the selected memory location.

### Print screen control

Press  to print a hardcopy of the current screen image via a supported USB printer connected to the handheld scope. You can also perform a quick print by pressing and holding .



**Figure 3-15** Print screen submenu

### Invert image colors

Toggle  to invert all colors on the screen image you want to print.

### Print the screen image

Press  to print the current screen image via a supported USB printer connected to the handheld scope.

Press  repeatedly to set the quick print option to the printer, USB, or internal storage.

Press  repeatedly to select the print screen file format for the USB or internal storage quick print option.

- bmp (8-bit) – save the waveform image in the BMP (8-bit) format.
- bmp (24-bit) – save the waveform image in the BMP (24-bit) format.
- png (24-bit) – save the waveform image in the PNG (24-bit) format.

**THIS PAGE HAS BEEN INTENTIONALLY LEFT BLANK.**




## 4 Using the Digital Multimeter

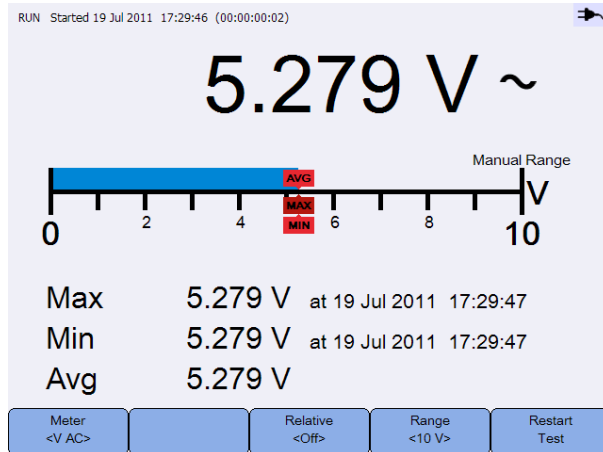
Introduction	76
Voltage Measurements	77
Resistance Measurement	78
Capacitance Measurement	79
Diode Test	80
Continuity Test	81
Temperature Measurement	82
Frequency Measurement	83
Relative Measurement	84
Range	85
Restart Measurements	85

This chapter explains how to configure and perform multimeter measurements.




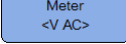

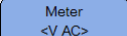
## Introduction





Press  to select and perform multimeter measurements.



**Figure 4-1** Multimeter display

To run or stop multimeter measurements, press .

To select the measurement function, press  and use the  keys. Press  again to exit the selection menu.

When you measure voltage, the AC () , DC () , or AC+DC () indicator is displayed. A voltage warning sign () will appear whenever a potentially hazardous voltage is being measured.

The virtual scale indicates the measured value and the average, maximum, and minimum values. This allows you to quickly estimate different attributes of the input, such as variability (difference between min and max) and stability (average reading versus current reading).

If there is an input overload, OVERLOAD will be shown and no readings will be displayed.

### NOTE

For accurate measurement results, allow the multimeter to warm up for 30 minutes.



## Voltage Measurements

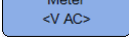

### WARNING

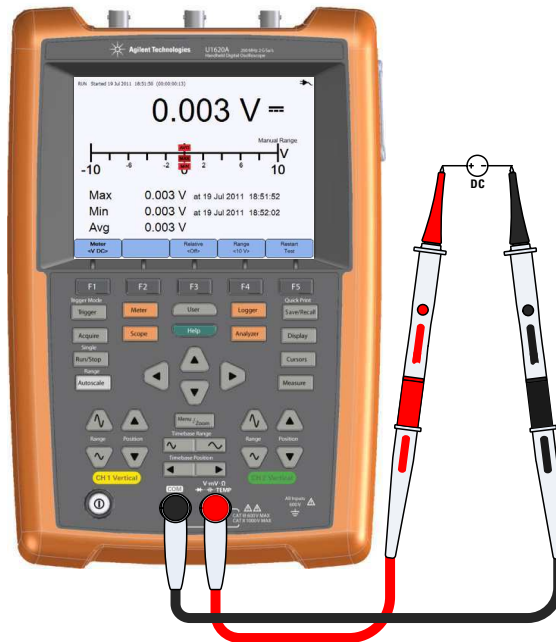
Ensure that the probe tips are in contact with the metal contacts inside the outlet. Improper contact may lead to inaccurate voltage measurement. Poor contact will cause inaccurate readings and poses a risk of electrocution.

Voltage measurements consist of:

- V AC – Measurements are returned as true RMS readings which are accurate for sine waves and other waveforms (with no DC offset).
- V DC – Measurements are returned with their polarity.
- V AC+DC – Both AC and DC signal components are measured as one AC+DC (RMS) value combined.

To measure voltage:

- 1 Press  and use the  keys to select the voltage measurement function. Set up the following connections:



- 2 Read the voltage reading from the display.

- 3 See "Relative Measurement", "Range", and "Restart Measurements" for the respective functions.

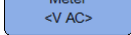

## Resistance Measurement

### WARNING

Disconnect power to the device-under-test and discharge all high voltage capacitors to avoid electric shock and damage to the handheld scope or device-under-test while taking resistance measurement.

Resistance ( $\Omega$ ) is measured by sending a small current out through the test leads to the device or circuit-under-test.

To measure resistance:

- 1 Press  and use the  keys to select the resistance measurement function. Set up the following connections:



- 2 Read the resistance reading from the display.

- 3 See "Relative Measurement", "Range", and "Restart Measurements" for the respective functions.

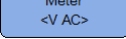

## Capacitance Measurement

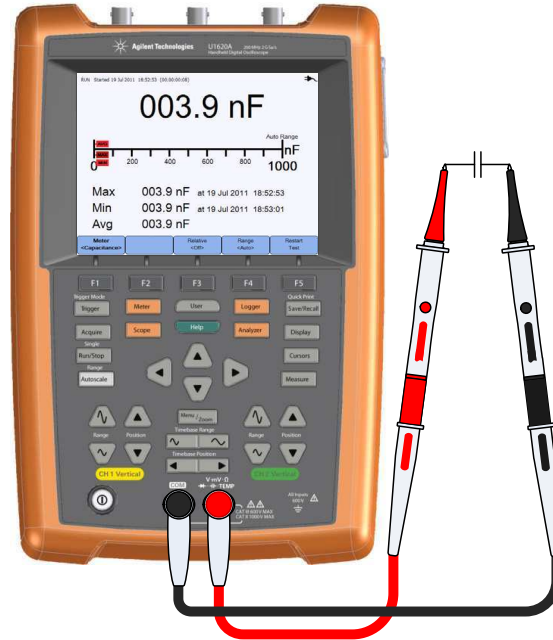
### WARNING

**Disconnect circuit power and discharge all high voltage capacitors before performing capacitance measurement to avoid electric shock and damage to the handheld scope. Use the V DC function to confirm that the capacitor is fully discharged.**

Capacitance is measured by charging the capacitor with a known current for a known period of time, measuring the resulting voltage, and then calculating the capacitance.

To measure capacitance:

- 1 Press  and use the  keys to select the capacitance measurement function. Set up the following connections:



- 2 Read the capacitance reading from the display.

- 3 See "Relative Measurement", "Range", and "Restart Measurements" for the respective functions.

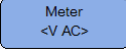

## Diode Test

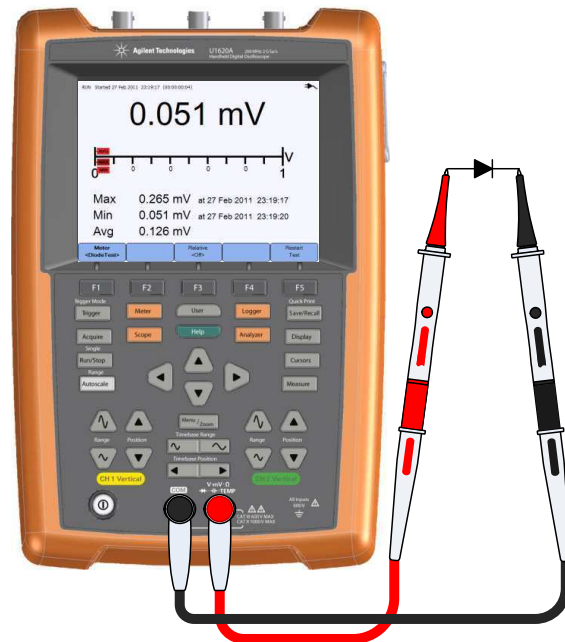
### WARNING

**Disconnect circuit power and discharge all high voltage capacitors before performing diode test to avoid electric shock and damage to the handheld scope.**

The diode test sends a current through a semiconductor junction, and then measures the junction voltage drop.

To perform the diode test:

- 1 Press  and use the  keys to select the diode test function. Set up the following connections:




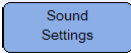
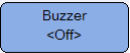
- 2 Read the voltage reading from the display.
- 3 Reverse the polarity of the probes and measure the voltage across the diode again. Read the voltage reading from the display.

- 4 See "Relative Measurement" and "Restart Measurements" for the respective functions.

## Continuity Test

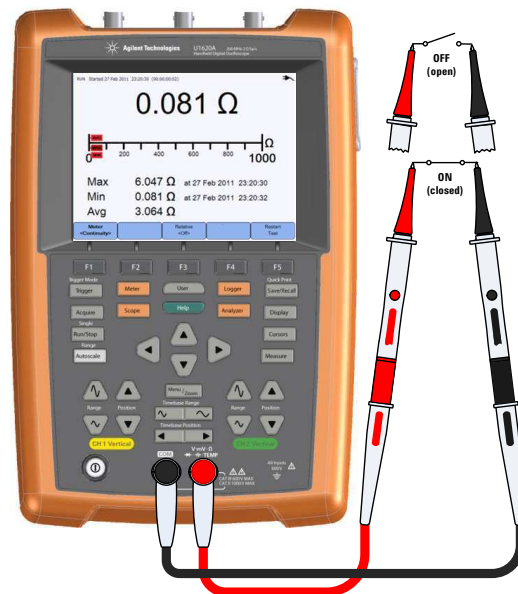
### WARNING

**Disconnect circuit power and discharge all high voltage capacitors before measuring continuity on circuits or wires to avoid electric shock and damage to the handheld scope.**

The continuity test emits a continuous beep (press  >  >  to enable the beeper) when a circuit is complete; otherwise the circuit is broken.

To perform the continuity test:

- 1 Press  and use the  keys to select the continuity test function. Set up the following connections:



- 2 Read the resistance reading from the display.

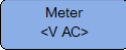

## 4 Using the Digital Multimeter

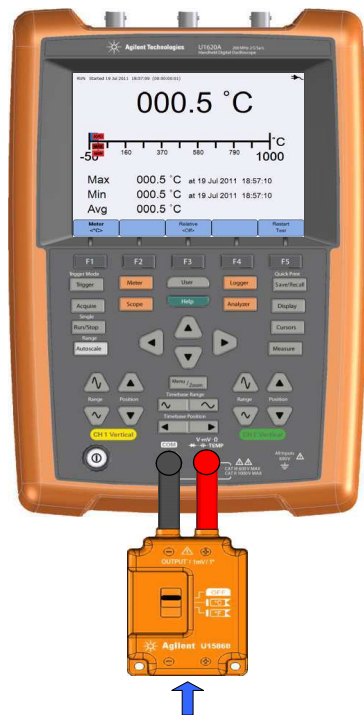
- 3 See "Relative Measurement" and "Restart Measurements" for the respective functions.

# Temperature Measurement

The temperature measurement works in the autorange mode with a temperature module. Agilent recommends using the U1586B temperature adapter.

To measure temperature:

- 1 Press  and use the  keys to select the °C or °F temperature measurement function. Set up the following connections:



- 2 Touch the material-under-test with the thermocouple probe tip.
- 3 Read the temperature reading from the display.

- See "Relative Measurement" and "Restart Measurements" for the respective functions.

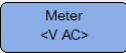


**WARNING**

**Do not connect the thermocouple to electrically live circuits to avoid fire or electric shock.**

## Frequency Measurement

Frequency of a signal is measured by counting the number of times the signal crosses a threshold level within a specified period of time.

To measure frequency:

- Press  and use the   keys to select the frequency measurement function. Set up the following connections:

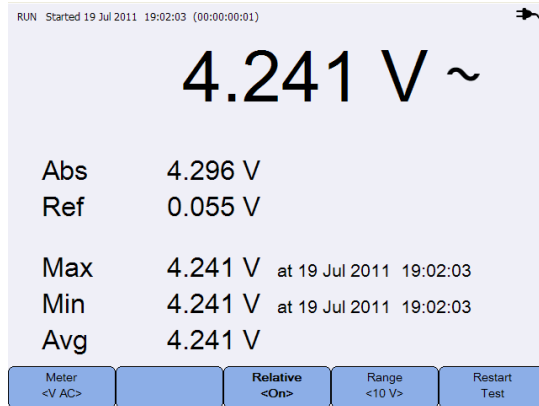


- Read the frequency reading from the display.
- See "Relative Measurement", "Range", and "Restart Measurements" for the respective functions.

## Relative Measurement

Toggle  to enable the relative function.

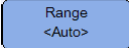
Relative value = Measured value – Reference value.

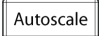


**Figure 4-2** Relative measurement display



## Range

Press  repeatedly to let the meter select the best range (Auto range) for the current reading, or select your own range to work with (manual range).

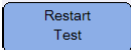
You can also activate Auto range by pressing .

Range is only applicable for the voltmeter, resistance, capacitance, and frequency functions.

### NOTE

- Frequency measurement works in the autorange mode, and the range that you select applies for V AC.
- In the V AC+DC mode, the meter will default to the 1000 V range and only manual range is available.

## Restart Measurements

Press  to restart and retest measurement functions.

**THIS PAGE HAS BEEN INTENTIONALLY LEFT BLANK.**




## 5 Using the Data Logger

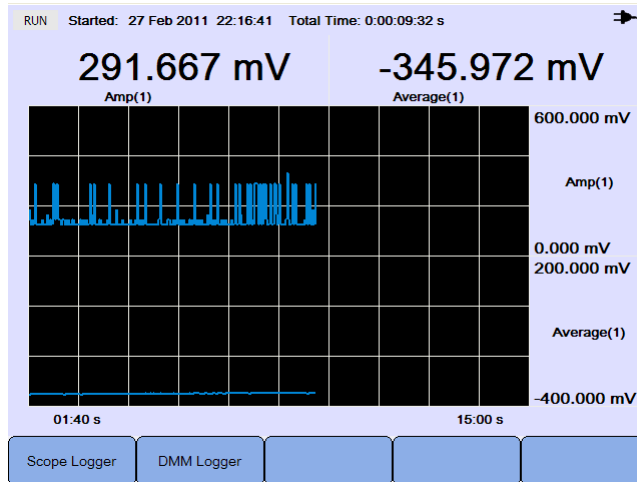
Introduction	88
Scope Logger	89
Measurement statistics	89
Graphing mode	90
Saving the recorded data	91
Erasing the saved recorded data	91
Transferring the saved recorded data	91
Meter Logger	92
Measurement selection	92
Graphing mode	92
Saving the recorded data	92
Erasing the saved recorded data	93
Transferring the saved recorded data	93

This chapter describes how to perform scope and meter data logging.



## Introduction


Press  to access the data logger functions for scope and multimeter measurements.



**Figure 5-1** Data logger menu

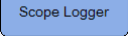
Once the data logger function is activated, it takes measurements at a fixed rate of 1 reading/second. All the measured samples are stored into a buffer memory. The buffer memory can hold up to 691200 samples. At the rate of 1 reading/second, this is equivalent to a continuous measurement of up to 8 days. Once the buffer memory is full, the logger will stop.

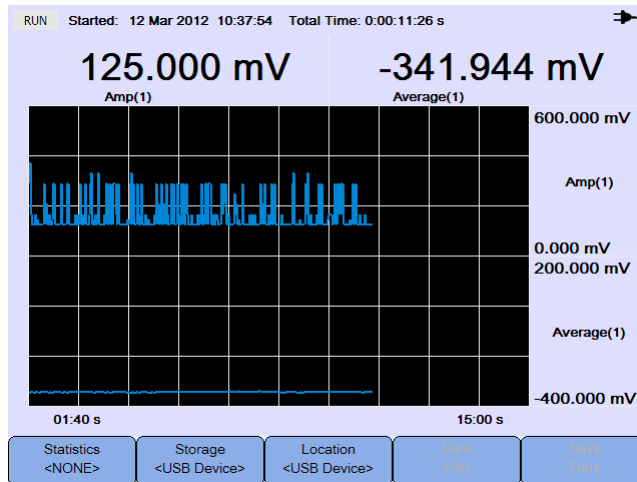
The data logger function provides an on-screen chart which plots the selected measurement parameter (for example, VDC or VAC). The chart is updated every second as a new sample arrives. Once the number of accumulated samples is more than the number of horizontal screen pixels on the chart area, the data logger will change the horizontal axis (time) scale while the measurement and chart updating process continues uninterrupted.

To start or stop the data recording, press  .

When the data logger is stopped, you can zoom in to the graph. The zoom bar operates the same way as for the scope. See “[Zoom mode](#)” on page 35.

## Scope Logger

Press  to access the scope logger which logs the first two scope measurement results.

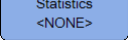


**Figure 5-2** Scope logger display

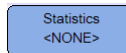
Each measurement reading has a label below it indicating “measurement(channel number)”.

The upper half of the logging graph contains the logged graph for the first measurement, and the lower half contains the logged graph for the second measurement.

## Measurement statistics

Press  repeatedly to display the maximum, minimum, and average measurements for the first or second scope measurement.

If there is only one scope measurement selected, automatically selects that measurement.



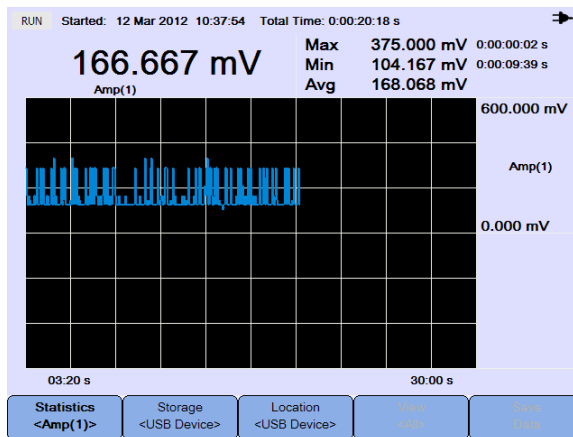
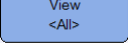


Figure 5-3 Statistics display

## Graphing mode

When the logger is stopped, toggle  to select the graphing mode.


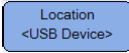



- View Latest

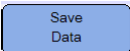
Only the latest 12 data points are shown. After that, new data is added to the right and previous data is moved to the left. This gives a clear view of the recent input.

- View All

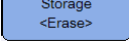
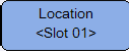



Allows you to view all the plotted data since the logger was started/restarted. All the data is compressed into the grid, allowing you to view long-term trends.

## Saving the recorded data

When the logger is stopped, press  to select either the USB storage device or internal memory as the storage location. Press  and use the    keys to select the USB location or the internal memory slot to save the recorded data to. Ensure that your USB storage device is connected and ready for use (see [“Select the save location”](#) on page 70).

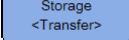
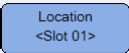



Press  to save the recorded data.


## Erasing the saved recorded data

When the logger is stopped, press  repeatedly to select the erase function. Press  and use the    keys to select the internal memory slot to be erased.

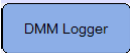
Press  to erase the recorded data in the selected memory slot.

## Transferring the saved recorded data

When the logger is stopped, press  repeatedly to select the transfer function. Press  and use the    keys to select the internal memory slot to be transferred to the USB storage device. The USB location will be the previous location selected.

Press  to transfer the selected recorded data to the USB storage device.

## Meter Logger

Press  to access the meter logger which logs the multimeter measurement results. This allows you to notice trends over a long period of time.

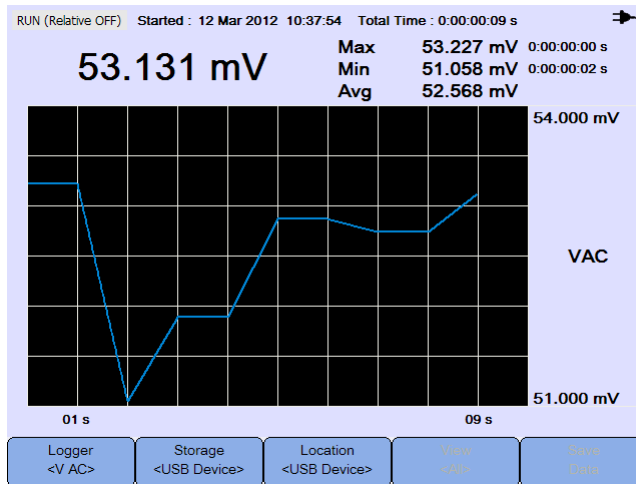
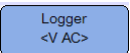

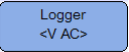


Figure 5-4 Meter logger display

## Measurement selection

Press  and use the  keys to select a multimeter measurement function to be logged. Press  again to exit the selection menu.

## Graphing mode

See “Graphing mode” on page 90.

## Saving the recorded data

See “Saving the recorded data” on page 91.



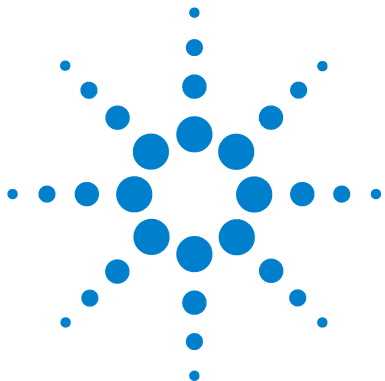
## **Erasing the saved recorded data**

See “Erasing the saved recorded data” on page 91.

## **Transferring the saved recorded data**

See “Transferring the saved recorded data” on page 91.

**THIS PAGE HAS BEEN INTENTIONALLY LEFT BLANK.**




## 6 Using the System-Related Functions

Introduction	96
General System Settings	96
USB connectivity	97
Set the language	97
Set the date and time	97
Set auto-shutdown	97
Display Settings	98
Backlight intensity	98
View mode	98
Sound Settings	99
Service Functions	100
Firmware update	100
Self-calibration	101
Antialiasing	101
System Information	101

This chapter explains how to set up system-related settings and perform service functions.



## Introduction

Press  to access the system configurations and functions.

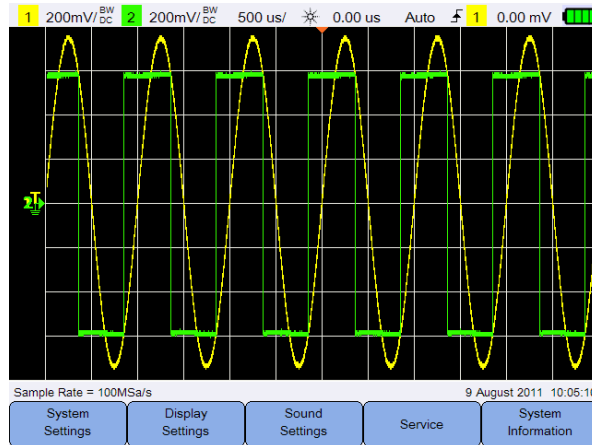
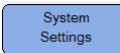


Figure 6-1 User function menu

## General System Settings

Press  to access the general system settings.

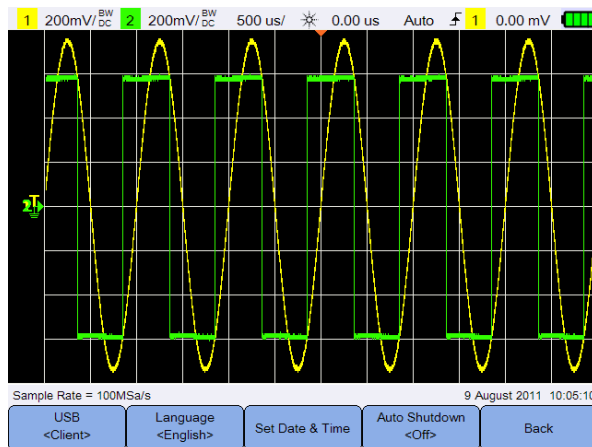
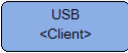


Figure 6-2 General system settings submenu

## USB connectivity

Press  repeatedly to select the USB connectivity type when you connect a USB device to the handheld scope. Select **<Host>** when a USB storage device is connected to the handheld scope, or **<Client>** when the handheld scope is connected to the PC.

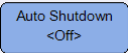
## Set the language

See “Set the Date and Time and Language” on page 9.

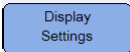
## Set the date and time

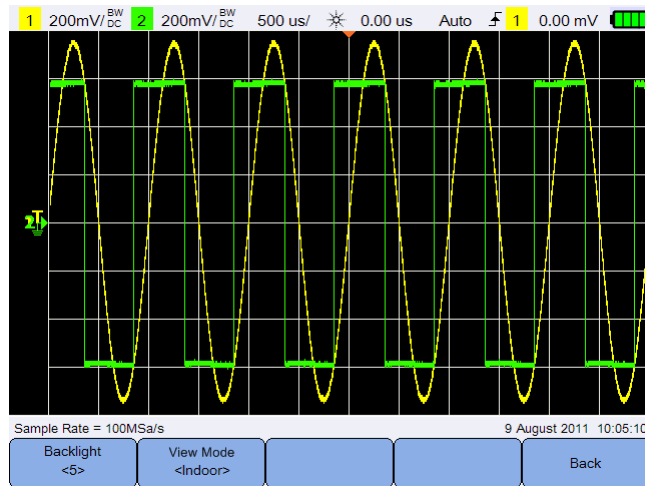
See “Set the Date and Time and Language” on page 9.

## Set auto-shutdown

Press  repeatedly to adjust the length of time the display can be left idle before the handheld scope is powered down automatically. Enabling this option helps you save the battery life of your handheld scope.

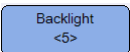
## Display Settings

Press  to configure the handheld scope display.

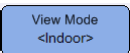


**Figure 6-3** Display settings submenu

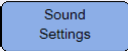
### Backlight intensity

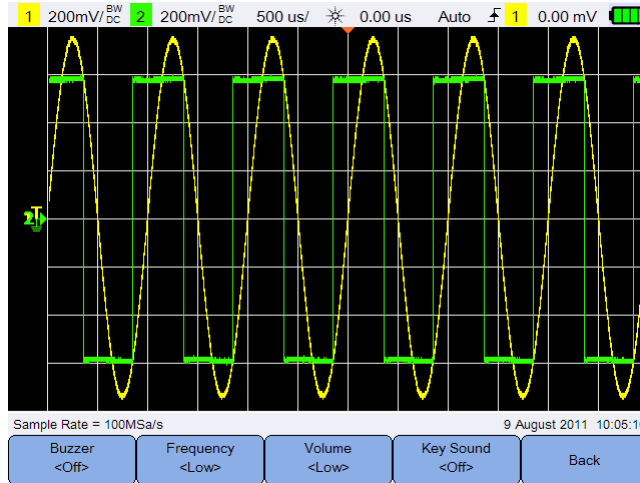
Press  repeatedly to increase/decrease the backlight brightness.

### View mode

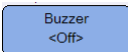
Press  repeatedly to select a suitable view mode for the display to obtain the best views in different environments.

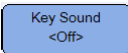
## Sound Settings

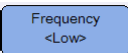
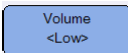
Press  to configure the buzzer and key sounds.



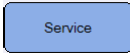
**Figure 6-4** Sound settings submenu

Toggle  to turn on/off the buzzer which emits a beep for warnings and alerts.

Toggle  to turn on/off the key sound which produces the sound for the keypad when any of the keys is pressed.

Press  or  repeatedly to set the sound frequency or volume level respectively.

## Service Functions

Press  to access the service functions.

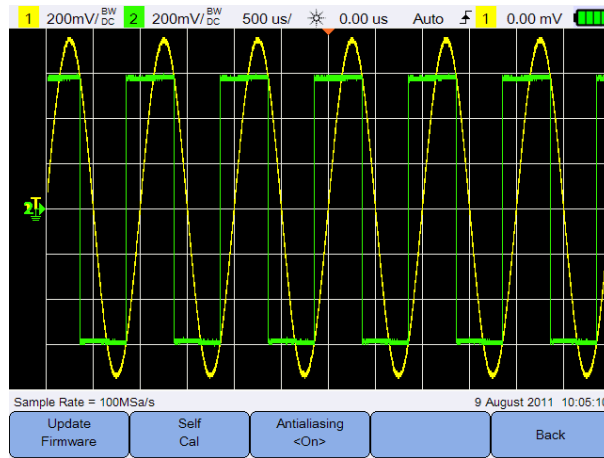



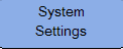
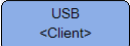
Figure 6-5 Service function submenu

## Firmware update

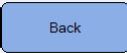

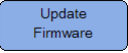
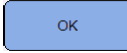
### NOTE

From time to time Agilent releases software and firmware updates for the U1610/20A. To search for firmware updates, go to the Agilent U1610/20A firmware update Web site at [www.agilent.com/find/U1600\\_installers](http://www.agilent.com/find/U1600_installers).

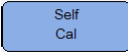
Use the following procedure to update the firmware:

- 1 Download the firmware update file from the Web page: [www.agilent.com/find/U1600\\_installers](http://www.agilent.com/find/U1600_installers)
- 2 Save the firmware file to the root directory on your USB storage device.
- 3 On the handheld scope, press  >  and press  repeatedly to select **<Host>**.



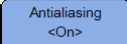
- 4 Connect your USB storage device to the handheld scope.
- 5 Press  >  >  >  to start updating the firmware.
- 6 Once completed, the handheld scope will automatically restart for the firmware updating to take effect.

## Self-calibration

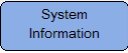
Press  to perform self-calibration. (See “Perform Self-Calibration” on page 8).

## Antialiasing

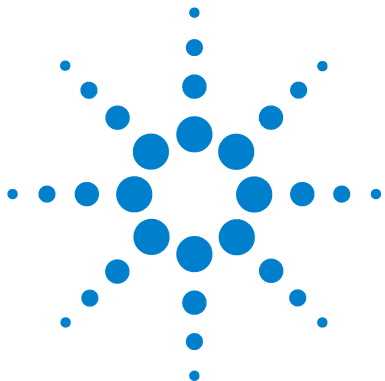
Aliasing can occur when the oscilloscope sampling rate is not at least twice as fast as the highest frequency component in the sampled waveform. When the antialiasing function is turned on, the handheld scope randomizes the time between the samples at a low sweep rate. This prevents the high frequency aliased signals to be misinterpreted as low frequency signals when displayed on the screen.

Toggle  to turn on/off antialiasing.

## System Information

Press  to view the current system information of the handheld scope.

**THIS PAGE HAS BEEN INTENTIONALLY LEFT BLANK.**




## 7 Specifications and Characteristics


Oscilloscope Specifications and Characteristics	104
Maximum Input Voltages and Channel Isolation	108
Digital Multimeter Specifications	110
Data Logger Specifications	113
General Specifications	114
Pollution Degree	116
Measurement Category	117

This chapter lists the specifications, characteristics, pollution degree, and measurement category of the handheld scope.



## Oscilloscope Specifications and Characteristics

	U1610A	U1620A
<b>SPECIFICATION</b>		
<b>Vertical system</b>		
Bandwidth (-3 dB) <sup>[1]</sup>	100 MHz	200 MHz
DC vertical gain accuracy <sup>[1]</sup>	±4% of full scale Full scale is equivalent to 8 div	
Dual cursor accuracy <sup>[1]</sup>	±{DC vertical gain accuracy + 0.4% full scale (~1 least significant bit (LSB))} ±{4% full scale + 0.4% full scale (~1 LSB)}	
<b>CHARACTERISTIC</b>		
<b>Acquisition</b>		
Maximum sampling rate		
<ul style="list-style-type: none"> <li>• Single channel operation</li> <li>• Dual channel operation</li> </ul>	1 GSa/s interleaved 500 MSa/s per channel	2 GSa/s interleaved 1 GSa/s per channel
Maximum recording length		
<ul style="list-style-type: none"> <li>• Single channel operation</li> <li>• Dual channel operation</li> </ul>	120 kpts/channel (interleaved) 60 kpts/channel (non-interleaved)	2 Mpts/channel (interleaved) 1 Mpts/channel (non-interleaved)
Vertical resolution	8 bits	
Peak detection	>10 ns	>5 ns
Average	Selectable from 2 to 8192 in powers-of-2 increments	
Filter	10 kHz and 20 MHz bandwidth limiters	
Interpolation	(Sin x)/x	
<b>Vertical system</b>		
Analog channels	Channel 1 and Channel 2 simultaneous acquisition	
Calculated rise time	3.50 ns typical	1.75 ns typical
Vertical scale	2 mV/div to 50 V/div	
Maximum input 	CAT III 600 Vrms <sup>[2]</sup> , CAT II 1000 Vrms <sup>[2]</sup> (with 10:1 probe) CAT III 300 Vrms (direct/1:1 probe)	
Offset (position) range	±4 div	

	U1610A	U1620A
<b>Vertical system</b>		
Dynamic range	±8 div	
Input impedance	1 MΩ ± 1% ≈ 22 pF ± 3 pF	
Coupling	DC, AC	
Bandwidth limit	10 kHz and 20 MHz (selectable)	
Channel-to-channel isolation (with channels at the same V/div) 	CAT III 600 Vrms	
Probes	U1560-60002 1:1 passive probe U1561-60002 10:1 passive probe U1562-60002 100:1 passive probe	
Probe attenuation factors	1×, 10×, 100×	
Probe compensation output	5 Vpp, 1 kHz	
Noise peak-to-peak (typical)	3% of full scale or 5 mVpp, whichever is greater	
DC vertical offset (position) accuracy	±0.1 div ±2 mV ±1.6% offset value	
Single cursor accuracy	±{DC vertical gain accuracy + DC vertical offset accuracy + 0.2% full scale (~1/2 LSB)} ±{4% full scale ±0.1 div ±2 mV ±1.6% offset value + 0.2% full scale (~1/2 LSB)}	
<b>Horizontal system</b>		
Range	5 ns/div to 50 s/div	2 ns/div to 50 s/div
Resolution	100 ps for 5 ns/div	40 ps for 2 ns/div
Timebase accuracy	25 ppm	
Reference position	Left, center, right	
Delay range (pre-trigger)	1 screen width or 120 μs (whichever is less)	1 screen width or 1 ms (whichever is less)
Delay range (post-trigger)	50 ms to 500 s	20 ms to 500 s
Delay resolution	100 ps for 5 ns/div	40 ps for 2 ns/div
Delta time measurement accuracy	Same channel: ±0.0025% reading ±0.17% screen width ±60 ps Channel-to-channel: ±0.0025% reading ±0.17% screen width ±120 ps	

## 7 Specifications and Characteristics

	U1610A	U1620A
<b>Horizontal system</b>		
Modes	Main, zoom, XY, roll	
Horizontal pan and zoom	Dual window zoom	
<b>Trigger system</b>		
Sources	Channel 1, Channel 2, External	
Modes	Normal, Single, Auto	
Types	Edge, Glitch, TV, Nth Edge, CAN, LIN	
Autoscale	<p>Finds or displays active channels, sets the edge trigger type on the highest numbered channel, and sets the vertical sensitivity on the scope channel timebase to display ~2 periods</p> <p>Requires &gt;10 mVpp minimum voltage, 0.5% duty cycle, and &gt;50 Hz minimum frequency</p>	
Holdoff time	60 ns to 10 s	
Range	±6 div from center of screen	
Sensitivity	≥10 mV/div: 0.5 div <10 mV/div: greater of 1 div or 5 mV	
Trigger level accuracy	±0.6 div	
Coupling modes	AC (~10 Hz), DC, LF-Reject (~35 kHz), HF-Reject (~35 kHz)	
External trigger		
<ul style="list-style-type: none"> <li>Input impedance</li> </ul>	1 MΩ ≈ 10 pF	
<ul style="list-style-type: none"> <li>Maximum input</li> </ul>	CAT III 300 Vrms	
<ul style="list-style-type: none"> <li>Range</li> </ul>	DC coupling: trigger level ±5 V	
<ul style="list-style-type: none"> <li>Bandwidth</li> </ul>	100 kHz	
<b>Measurement</b>		
Automatic measurements	Delay, duty cycle (+/-), fall/rise time, frequency, period, phase shift, T-max, T-min, width (+/-), amplitude, average, base, crest, cycle mean, maximum, minimum, overshoot, peak-to-peak, preshoot, standard deviation, top, Vrms (AC/DC), active/apparent/reactive power, power factor, AC current (with U1583B/1146A), DC current (with 1146A)	



	U1610A	U1620A
<b>Measurement</b>		
Waveform math functions	CH1 + CH2, CH1 – CH2, CH2 – CH1, CH1 × CH2, CH1/CH2, CH2/CH1, d/dt (CH1), d/dt (CH2), ∫(CH1)dt, ∫(CH2)dt, FFT	
Cursors	Delta V: Voltage difference between cursors Delta T: Time difference between cursors	
FFT points	1024	
FFT windows	Rectangular, Hamming, Hanning, Blackman-Harris, Flattop	
<b>Display system</b>		
Display	5.7" TFT LCD VGA Color (outdoor readable)	
Resolution	VGA (screen area): 640 vertical by 480 horizontal	
Control	Vectors on/off, sin x/x interpolation on/off, infinite persistence on/off, backlight intensity, color scheme, clear display	
Real-time clock	Date and time (adjustable)	
Language	10 languages (selectable)	
Built-in help system	Functional quick help displayed by pressing the [Help] key	
<b>Storage system</b>		
Save/recall (non-volatile)	10 setups and waveforms can be saved and recalled internally	
Storage mode	USB 2.0 full-speed host port <sup>[3]</sup> Image formats: .bmp (8-bit, 24-bit) and .png (24-bit) Data format: .csv	
I/O	USB 2.0 full-speed host, USB 2.0 full-speed client	
Printer languages and standards	PCL 3 GUI, PCL 5 Enhanced, PCL 5 Color, PCL 6	

[1] Denotes warranted specifications, all others are typical. Specifications are valid after a 30-minute warm-up period and within 23 ±10 °C of last calibration temperature.

[2] Refer to the respective probe's manual for more information on the specification.

[3] Only USB storage device formatted in FAT is supported.

## Maximum Input Voltages and Channel Isolation

U1610A and U1620A	
<b>Maximum input voltages</b>	
Input CH1 and CH2 direct (1:1 probe)	CAT III 300 Vrms
Input CH1 and CH2 (10:1 probe)	CAT III 600 Vrms <sup>[1]</sup> , CAT II 1000 Vrms <sup>[1]</sup>
Input CH1 and CH2 (100:1 probe)	CAT III 600 Vrms <sup>[1]</sup> , CAT II 1000 Vrms <sup>[1]</sup> , CAT I 3540 Vrms <sup>[1]</sup>
Meter input	CAT III 600 Vrms, CAT II 1000 Vrms
Scope input	CAT III 300 Vrms
<b>Channel isolation</b>	
From any terminal to earth ground	CAT III 600 Vrms

[1] Refer to the respective probe's manual for more information on the specification.

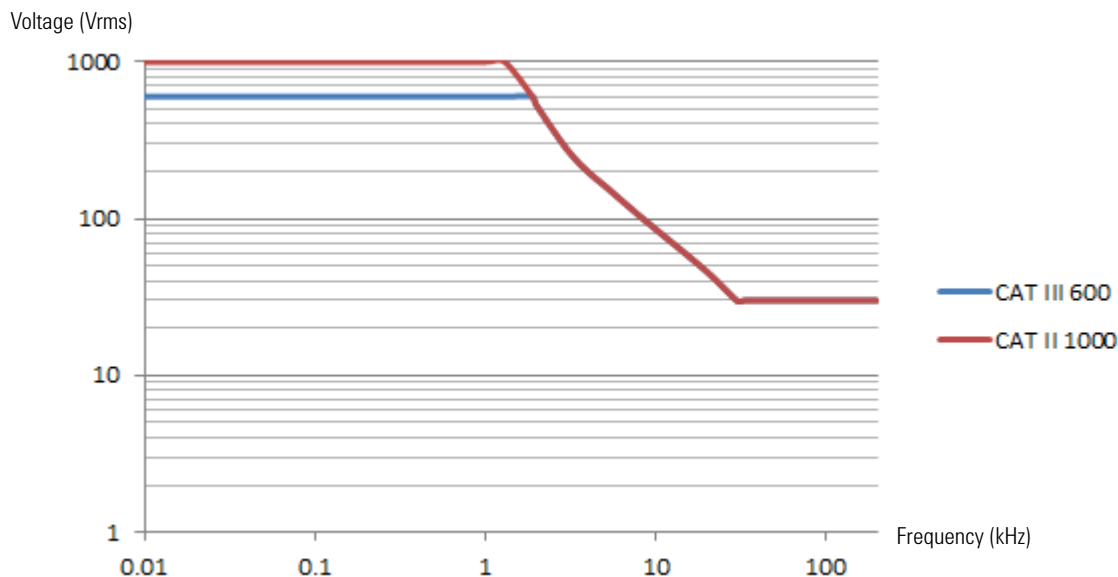


Figure 7-1 Maximum safety voltage for scope reference to earth



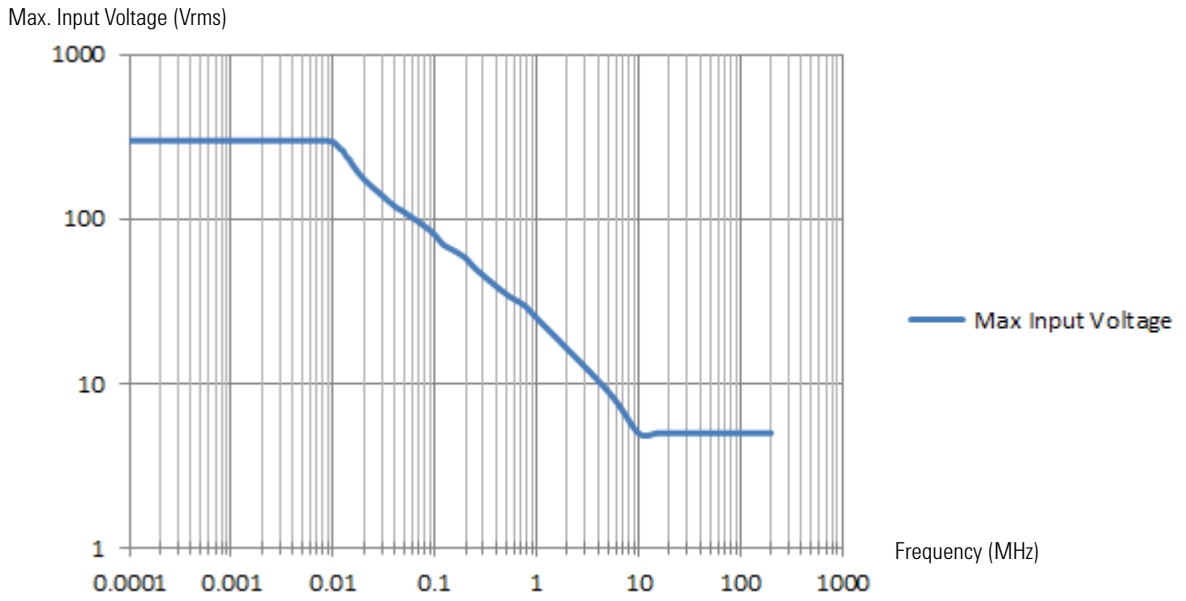


Figure 7-2 Maximum input voltage

## Digital Multimeter Specifications

### NOTE

- Accuracy is given as  $\pm$ (% of reading + counts of least significant digit) at  $23\text{ }^{\circ}\text{C} \pm 5\text{ }^{\circ}\text{C}$ , with relative humidity  $<80\text{ RH}$ .
- AC V specifications are AC coupled, true RMS and are valid from 5% to 100% of range.
- Temperature coefficient is given as  $0.1 \times$  (specified accuracy) /  $^{\circ}\text{C}$  (from  $0\text{ }^{\circ}\text{C}$  to  $18\text{ }^{\circ}\text{C}$  or  $28\text{ }^{\circ}\text{C}$  to  $50\text{ }^{\circ}\text{C}$ ).
- Common mode rejection ratio (CMRR) is  $>90\text{ dB}$  at DC,  $50/60\text{ Hz} \pm 0.1\%$  ( $1\text{ k}\Omega$  unbalanced).
- Normal mode rejection ratio (NMRR) is  $>60\text{ dB}$  at  $50/60\text{ Hz} \pm 0.1\%$ .

Maximum reading	10000 counts with automatic polarity indication				
Voltage <sup>[1]</sup>	CAT II 1000 V or CAT III 600 V				
Function	Range	Resolution	Accuracy	Input impedance (nominal)	Test current
DC V	100.00 mV <sup>[2]</sup>	0.01 mV	0.1% + 5	>1 G $\Omega$	
	1000.0 mV	0.1 mV	0.09% + 5	11.11 M $\Omega$	
	10.000 V	0.001 V	0.09% + 2	10.10 M $\Omega$	
	100.00 V	0.01 V		10.01 M $\Omega$	
	1000.0 V <sup>[3]</sup>	0.1 V	0.15% + 5		
AC V	100.00 mV	0.01 mV	1% + 5 (40 Hz – 2 kHz)	>1 G $\Omega$	
	1000.0 mV	0.1 mV	1% + 5 (40 Hz – 500 Hz) 2% + 5 (500 Hz – 1 kHz)		
	10.000 V	0.001 V	1% + 5 (40 Hz – 500 Hz)	10.00 M $\Omega$	
	100.00 V	0.01 V	1% + 5 (500 Hz – 1 kHz) 2% + 5 (1 kHz – 2 kHz)		
	1000.0 V <sup>[3]</sup>	0.1 V	1% + 5 (40 Hz – 500 Hz) 1% + 5 (500 Hz – 1 kHz)		

Function	Range	Resolution	Accuracy	Input impedance (nominal)	Test current
AC+DC V	100.00 mV <sup>[2]</sup>	0.01 mV	1.1% + 5 (40 Hz – 2 kHz)	>1 GΩ	
	1000.0 mV	0.1 mV	1.1% + 10 (40 Hz – 500 Hz) 2.1% + 10 (500 Hz – 1 kHz)		
	10.000 V	0.001 V	1.1% + 7 (40 Hz – 500 Hz)	10.00 MΩ	
	100.00 V	0.01 V	1.1% + 7 (500 Hz – 1 kHz) 2% + 5 (1 kHz – 2 kHz)		
	1000.0 V <sup>[3]</sup>	0.1 V	1.2% + 10 (40 Hz – 500 Hz) 1.2% + 10 (500 Hz – 1 kHz)		
Diode <sup>[4]</sup>	1 V	0.001 V	0.3% + 2		~0.5 mA
	Beeper <~50 mV, Single tone for normal forward-biased diode or semiconductor junction of $0.3\text{ V} \leq \text{reading} \leq 0.8\text{ V}^{[5]}$ Overload protection: 1000 Vrms for short circuit with <0.3 A Open voltage: <+2.8 VDC				
Instant continuity <sup>[4]</sup>	Continuous beep when resistance <10 Ω <sup>[5]</sup>				
Resistance	1000.0 Ω <sup>[6]</sup>	0.1 Ω	0.3% + 3		0.5 mA
	10.000 kΩ <sup>[6]</sup>	0.001 kΩ			50 μA
	100.00 kΩ	0.01 kΩ			4.91 μA
	1000.0 kΩ	0.1 kΩ		447 nA	
	10.000 MΩ	0.001 MΩ	0.8% + 3		112 nA
	100.00 MΩ <sup>[7]</sup>	0.01 MΩ	1.5% + 3		112 nA
Capacitance	1000.0 nF	0.1 nF	1.2% + 4 <sup>[8]</sup>		
	10.000 μF	0.001 μF			
	100.00 μF	0.01 μF	2% + 4 <sup>[8]</sup>		
	1000.0 μF	0.1 μF			
	10.000 mF	0.001 mF			

## 7 Specifications and Characteristics

Function	Range	Resolution	Accuracy	Input impedance (nominal)	Test current
Frequency <sup>[4]</sup>	100.00 Hz	0.01 Hz	0.03% + 3		
	1000.0 Hz	0.1 Hz			
	10.000 kHz	0.001 kHz			
	100.00 kHz	0.01 kHz			
	1000.0 kHz	0.1 kHz			

[1] Only allowed to measure up to CAT III 600 V if referring to GND.

[2] In an open connection, the reading shown on the display is noise pickup due to the high input impedance at the input terminal.

[3] Only allowed for floating voltage.

[4] Denotes typical specifications, all others are warranted.

[5] Denotes characteristics.

[6] The accuracy is specified after the Null function is used to subtract the test lead resistance and thermal effect.

[7] RH is specified for <60%. The temperature coefficient is  $0.15 \times$  specified accuracy as  $>50 \text{ M}\Omega$ .

[8] The accuracy is based on film capacitors or better and uses the Relative mode for residual values.

### NOTE

Agilent recommends using the U1586B temperature adapter for temperature measurement. Refer to <http://cp.literature.agilent.com/litweb/pdf/U1586-90101.pdf> for more information on the U1586B specifications.

## Data Logger Specifications

<b>Scope and meter logger</b>	
Range	1 s/div – 86400 s/div (1 day/div)
Recording time span	8 days
Memory depth	691200 points
Recording mode	Continuous (Range will change according to the time elapsed)
Sampling rate	1 sample/s

## General Specifications

---

### POWER SUPPLY

AC/DC adapter:

- Line voltage range: 50/60 Hz, 100 – 240 VAC, 1.6 A
- Output voltage: 15 VDC, 4 A
- Installation Category II

Battery:

- Li-Ion rechargeable battery pack, 10.8 V
- Operating time: Up to 3 hours

---

### OPERATING ENVIRONMENT

Temperature:

- 0 °C to 50 °C (with battery only)
- 0 °C to 40 °C (with AC/DC adapter)

Humidity:

- Maximum: 80% RH at 40 °C (non-condensing)
- Minimum: 50% RH at 40 °C (non-condensing)

Altitude up to 2000 m

Pollution degree 2

---

### STORAGE COMPLIANCE

Temperature: –20 °C to 70 °C

Humidity: Up to 95% RH at 40 °C (non-condensing)

Altitude up to 15000 m

---

### SHOCK

Tested to IEC 60068-2-27

---

### VIBRATION

Tested to IEC 60068-2-6, IEC 60068-2-64

---

### SAFETY COMPLIANCE

IEC 61010-1:2001/EN 61010-1:2001

Canada: CAN/CSA-C22.2 No. 61010-1-04

USA: ANSI/UL 61010-1:2004

---

---

**EMC COMPLIANCE**

IEC 61326-1:2005/EN 61326-1:2006

Australia/New Zealand: AS/NZS CISPR 11:2004

Canada: ICES/NMB-001: ISSUE 4, June 2006

---

**IP RATING**

IP41 ingress protection according to IEC 60529

The rating only applies when the cover (for DC power inlet and USB port) is in place

---

**DIMENSIONS (W × H × D)**

183 mm × 270 mm × 65 mm

---

**WEIGHT**

<2.5 kg

---

**WARRANTY**

3 years for main unit

3 months for standard shipped accessories unless otherwise stated

---

## Pollution Degree

This instrument may be operated in a pollution degree 2 environment.

### **Pollution degree 1**

No pollution or only dry, non-conductive pollution occurs. The pollution has no influence. Example is a clean room or climate-controlled office environment.

### **Pollution degree 2**

Normally only dry, non-conductive pollution occurs. Occasionally a temporary conductivity caused by condensation may occur. Example is a general indoor environment.

### **Pollution degree 3**

Conductive pollution occurs, or dry, non-conductive pollution occurs which becomes conductive due to condensation which is expected. Example is a sheltered outdoor environment.



## Measurement Category

This instrument is intended to be used for measurement in Measurement Category II and III.

### Measurement CAT I

Measurements performed on circuits not directly connected to MAINS. Examples are measurements on circuits not derived from MAINS, and specially protected (internal) mains-derived circuits.

### Measurement CAT II

Measurements performed on circuits directly connected to the low voltage installation. Examples are measurements on household appliances, portable tools, and similar equipment.

### Measurement CAT III

Measurements performed in the building installation. Examples are measurements on distribution boards, circuit-breakers, wiring, including cables, bus-bars, junction boxes, switches, socket-outlets in the fixed installation, and equipment for industrial use and some other equipment including stationary motors with permanent connection to the fixed installation.

### Measurement CAT IV

Measurements performed at the source of the low-voltage installation. Examples are electricity meters and measurements on primary over current protection devices and ripple control units.

**THIS PAGE HAS BEEN INTENTIONALLY LEFT BLANK.**

**www.agilent.com**

**Contact us**

To obtain service, warranty, or technical assistance, contact us at the following phone or fax numbers:

United States:

(tel) 800 829 4444 (fax) 800 829 4433

Canada:

(tel) 877 894 4414 (fax) 800 746 4866

China:

(tel) 800 810 0189 (fax) 800 820 2816

Europe:

(tel) 31 20 547 2111

Japan:

(tel) (81) 426 56 7832 (fax) (81) 426 56 7840

Korea:

(tel) (080) 769 0800 (fax) (080) 769 0900

Latin America:

(tel) (305) 269 7500

Taiwan:

(tel) 0800 047 866 (fax) 0800 286 331

Other Asia Pacific Countries:

(tel) (65) 6375 8100 (fax) (65) 6755 0042

Or visit the Agilent World Wide Web at:

[www.agilent.com/find/assist](http://www.agilent.com/find/assist)

Product specifications and descriptions in this document are subject to change without notice. Always refer to the English version on the Agilent Web site for the latest revision.

© Agilent Technologies, Inc., 2011–2014

Fourth Edition, June 27, 2014  
U1610-90040



**Agilent Technologies**

**www.valuetronics.com**