

Agilent Part Number 37718-90219

Printed in U.K. September 2000

OmniBER 718

In This Book

This manual contains all the information necessary for remote control of the OmniBER 718.

1 Methods of Remote Control

Methods of Remote Control	1-2
Connecting the OmniBER 718 via GPIB (HP-IB).....	1-3
Operating Distances.....	1-3
Communication with the System Controller	1-3
Connecting the OmniBER 718 to RS-232-C	1-4
OmniBER 718 RS-232-C Port	1-4
Controller Type.....	1-5
Terminal Mode.....	1-6
Computer Mode.....	1-6
Connecting the OmniBER 718 to a LAN.....	1-7
Current Settings	1-8
New Settings (BOOTP)	1-8
New Settings (Keyboard Entry)	1-9
Controlling the OmniBER 718	1-10
To Initialize the OmniBER 718.....	1-12
Remote Control Hints & Tips	1-13
Default Settings	1-13
Instrument Coupling	1-13
Error Checking	1-13
Command Completion.....	1-14
Setup Delays	1-14
Status Registers.....	1-14
Gating Control	1-15
Frequency Offsets.....	1-16
User Locks.....	1-16

2 SCPI Backwards Compatibility Differences

SCPI Backwards Compatibility Differences	2-2
--	-----

3 Common Commands

SCPI Command Format.....	3-2
Command Syntax	3-2
SCPI Long Form Command Headers.....	3-3
Linking Command Statements	3-3
Parameters	3-3
Remote Control Commands	3-5
Instrument Options	3-6
INSTRument subsystem	3-7
SOURce subsystem	3-8
SOURce subsystem - Transmitter Common Commands	3-9
INPut subsystem	3-12
SENSe subsystem	3-13
SENSe subsystem - Receiver Common Commands	3-15
SENSe subsystem - Test Timing	3-18
SENSe subsystem - Analysis Control	3-20
SENSe subsystem - Result Returning Commands	3-21
Common Results	3-21
SENSe subsystem - Trouble Scan Results.....	3-23
Common System Commands	3-25
SENSe subsystem - Configuring Stored Measurements and Graphics .	3-26
SENSe subsystem - Managing Graphics Stores	3-28
SENSe subsystem - Retrieving Graphics Store Data	3-30
SENSe subsystem - Retrieving Data for a Single Graph Element	3-34
SENSe subsystem -Obtaining Graphics End of Measurement Results .	3-36
STATus subsystem.....	3-43
SYSTem Subsystem.....	3-46
IEEE common capabilities	3-63

4 PDH/DSn Command Reference

PDH/DSn Command Reference	4-2
OUTPut subsystem	4-3
SOURce subsystem - Transmitter Structured PDH Commands	4-7
DS1/DS3 PDH Thru mode settings	4-14
SOURce subsystem - Transmitter SPDH Test Signal Settings Commands	4-20
SOURce subsystem - Transmitter SPDH Test Function Commands	4-29
INPut subsystem	4-47
SENSE subsystem - Receiver Structured PDH Settings	4-51
SENSE subsystem - Receiver SPDH Test Signal Settings Commands	4-54
SENSE subsystem - Receiver SPDH Test Function Commands	4-60
SENSE subsystem - Analysis Control	4-61
SENSE subsystem - Alarm Scan Control	4-66
SENSE subsystem - SPDH Round Trip Delay Control	4-67
SENSE subsystem - SPDH Loop Codes Control	4-68
SENSE subsystem - Result Returning Commands	4-70
Frequency Results (SPDH)	4-70
Structured PDH Short Term Results	4-70
Structured PDH Cumulative Results	4-71
Structured PDH and Payload G.821 Analysis Results	4-72
Structured PDH 140 Mb/s G.826 Analysis Results	4-73
Structured PDH 34 Mb/s G.826 Analysis Results	4-74
Structured PDH 8 Mb/s G.826 Analysis Results	4-75
Structured PDH 2 Mb/s G.826 Analysis Results	4-76
Structured PDH DS1 G.826 Analysis Results	4-77
Structured PDH DS3 G.826 Analysis Results	4-78
PDH BIT G.826	4-79
Structured PDH M.2100 Analysis Results	4-79
Structured PDH M.2110 Analysis Results	4-81
Structured PDH M.2120 ANALYSIS Results	4-82
Structured PDH 2 Mb/S FAS Error Analysis Results	4-82
Structured PDH 8 Mb/S FAS Error Analysis Results	4-83

Structured PDH 34 Mb/S FAS Error Analysis Results	4-83
Structured PDH 140 Mb/S FAS Error Analysis Results	4-84
Structured PDH CRC Error Analysis Results	4-84
Structured PDH REBE Error Analysis Results	4-85
Structured PDH Alarm Seconds Results	4-86
Structured PDH Round Trip Delay Results.....	4-87
FETCh subsystem.....	4-89

5 SDH Command Reference

SDH Command Reference	5-2
OUTPut subsystem	5-3
SOURce subsystem - Transmitter SDH Settings Commands	5-9
SDH Clock settings	5-9
Thru mode settings	5-11
SDH Mapping Settings.....	5-14
Tandem Connection Monitoring (TCM) - SDH ONLY	5-15
AU Layer Selection	5-16
TU Layer Selection	5-17
Payload Layer Selection	5-17
TUG Channel	5-18
TU Payload and Test Pattern	5-19
Background Settings.....	5-23
SOURce subsystem - Transmitter SDH OVERHEAD SETUP	5-27
SOURce subsystem - Transmitter SDH Test Function Commands	5-40
INPut subsystem	5-69
SENSe subsystem - Receiver SDH Settings.....	5-73
SDH Mapping settings	5-73
Tandem Connection Monitoring (TCM) - SDH ONLY	5-74
AU Layer Selection	5-75
TU Layer Selection	5-75

Payload Layer Selection	5-76
TUG Channel.....	5-77
TU Payload and Test Pattern	5-78
SENSE subsystem - Receiver SDH Test Function Commands.....	5-83
SENSE subsystem - Alarm Scan Control.....	5-89
SENSE subsystem - SDH Tributary Scan Control	5-91
SENSE subsystem - MS-REI Measurements Enable/Disable.....	5-92
SENSE subsystem - Result Returning Commands	5-93
Frequency Results (SDH).....	5-93
SDH Short Term Results	5-93
TCM Short Term Results.....	5-94
SDH Cumulative Results.....	5-94
TCM Cumulative Results	5-95
SDH RS B1 BIP Analysis Results.....	5-96
SDH MS B2 BIP Analysis Results.....	5-96
SDH Path MS FEBE Analysis Results.....	5-97
SDH Path B3 BIP Analysis Results	5-97
SDH Path FEBE Analysis Results.....	5-98
SDH Tributary Path BIP Analysis Results	5-98
SDH Tributary Path FEBE Analysis Results.....	5-99
SDH Block Based Bit Analysis Results	5-100
TCM Path IEC Analysis Results	5-100
TCM REI Analysis Results	5-101
TCM OEI Analysis Results	5-101
TCM Errors Analysis Results.....	5-102
SDH M.2101 Analysis Results	5-102
SDH Service Disruption Results	5-104
SDH Optical Power Result.....	5-104
SDH Pointer Activity Results.....	5-104
SDH Alarm Seconds Results.....	5-105
TCM Alarm Seconds Results	5-106
FETCh subsystem	5-107

6 SONET Command Reference

SONET Command Reference	6-2
OUTPut subsystem	6-3
SOURce subsystem - Transmitter SONET Settings Commands	6-9
SONET Clock settings	6-9
Thru mode settings	6-11
SONET Mapping Settings.....	6-14
SPE Layer Selection	6-15
VT Layer Selection	6-15
Payload Layer Selection.....	6-16
VT Group	6-17
VT Payload and Test Pattern	6-18
Background Settings.....	6-22
SOURce subsystem - Transmitter SONET OVERHEAD SETUP	6-24
:SOURce subsystem - Transmitter SONET Test Function Commands	6-35
INPut subsystem	6-63
SENSe subsystem - Receiver SONET Settings.....	6-67
SONET Mapping settings	6-67
SPE Layer Selection	6-68
VT Layer Selection	6-68
Payload Layer Selection.....	6-69
VT Group	6-70
VT Payload and Test Pattern	6-71
SENSe subsystem - Receiver SONET Test Function Commands.....	6-76
SENSe subsystem - Alarm Scan Control	6-82
SENSe subsystem - SONET Tributary Scan Control.....	6-84
SENSe subsystem - REI-L Result Enable/Disable	6-85
SENSe subsystem - Result Returning Commands	6-86
Frequency Results (SONET).....	6-86
SONET Short Term Results	6-86
SONET Cumulative Results.....	6-87
SONET Section B1 BIP (CV-S) Analysis Results	6-88

SONET Line B2 BIP (CV-L) Analysis Results	6-88
SONET Line FEBE (REI-L) Analysis Results.....	6-88
SONET Path B3 BIP (CV-P) Analysis Results	6-89
SONET Path FEBE (REI-P) Analysis Results	6-89
SONET Virtual Tributary Path BIP (CV-V) Analysis Results	6-90
SONET Virtual Tributary Path FEBE (REI-V) Analysis Results	6-90
SONET Block Based Bit Analysis Results	6-91
SONET M.2101 Analysis Results	6-91
SONET Service Disruption Results	6-93
SONET Optical Power Result	6-93
SONET Pointer Activity Results	6-93
SONET Alarm Seconds Results	6-94
FETCh subsystem	6-97

7 Jitter Command Reference

Jitter Command Reference.....	7-2
OUTPut subsystem	7-3
SOURce subsystem - Transmitter Jitter Commands.....	7-5
Mask Selections	7-7
Auto Tolerance.....	7-8
Auto Transfer Function.....	7-10
Wander	7-14
User Masks	7-15
SENSE subsystem - Receiver Jitter Settings.....	7-21
SENSE subsystem Result Returning Commands	7-24
Jitter/Wander Results	7-24
FETCh subsystem	7-26

8 ATM Command Reference

ATM Command Reference.....	8-2
SOURce subsystem -Transmitter ATM Commands	8-3
SENSE subsystem - Receiver ATM Settings	8-19
SENSE subsystem - Result Returning Commands	8-27
ATM Cumulative Term Results	8-27
Alarm Seconds Results.....	8-29
ATM Service Disruption Results	8-30

9 POS Command Reference

SOURce subsystem -Transmitter POS Commands.....	9-2
SENSE subsystem - Receiver POS Settings	9-11
SENSE subsystem - Result Returning Commands	9-14
PoS Short Term Results.....	9-14
PoS Cumulative Results	9-14
PoS Alarm Seconds Results	9-15
PoS Service Disruption Results.....	9-15

10 Status Reporting

Status Reporting.....	10-2
Status Byte.....	10-5
Standard Event Status Register	10-6
QUESTionable Status Register.....	10-7
OPERation Status Register.....	10-8
INSTRument Status Register.....	10-9
DATA Status Register.....	10-10
ISUMmary Status Register.....	10-11

ISUMmary Status Register Sources	10-12
SDH Status Register	10-13
SDH2 Status Register	10-14
SDH3 Status Register	10-15
SONet Status Register	10-16
SONet2 Status Register	10-17
SONet3 Status Register	10-18
ATM Status Register.....	10-19
IPOS Status Register.....	10-20
JITTer Status Register.....	10-21
SPDH Status Register	10-22
M140 Status Register.....	10-23
M34 Status Register.....	10-24
M8 Status Register.....	10-25
M2 Status Register.....	10-26
DS3 Status Register	10-27
DS2 Status Register	10-28
DS1 Status Register	10-29
DISK Status Register.....	10-30
Programmed Status Reporting.....	10-33

11 General Information

General Information.....	11-2
SCPI Overview.....	11-2
GPIB (HP-IB) Universal Commands.....	11-3
Device Clear (CLEAR)	11-3
Serial Poll (SPOLL).....	11-3
Remote Enable (REMOTE).....	11-3
Local Lockout (LOCAL LOCKOUT).....	11-4

Local (LOCAL)..... 11-4

12 Application Program Examples

Initializing the OmniBER 718 12-2
Setup the OmniBER 718 PDH Tx (Main Settings) 12-3
Setup the OmniBER 718 PDH Rx (Main Settings) 12-4
Setup the OmniBER 718 PDH Tx (Main & Structured Settings)..... 12-5
Setup the OmniBER 718 PDH Rx (Main & Structured Settings) 12-7
Setup the OmniBER 718 PDH Tx to add Errors & Alarms..... 12-8
Setup the OmniBER 718 PDH Rx to perform Bit Error Measurements12-9
Setup the OmniBER 718 SDH Tx 12-10
Setup the OmniBER 718 SDH Rx 12-12
Setup the OmniBER 718 SDH Tx to add Errors & Alarms..... 12-13
Setup the OmniBER 718 SDH Tx Overhead Bytes..... 12-14
Setup the OmniBER 718 SDH Tx for Overhead Byte Sequencing.... 12-15
Perform OmniBER 718 SDH Rx Measurements..... 12-16
Setup the OmniBER 718 SDH Rx to retrieve Overhead Monitor Bytes12-17
Setup the OmniBER 718 SDH Rx to perform Overhead Byte Capture12-18
Setup the OmniBER 718 SONET Tx 12-19
Setup the OmniBER 718 SONET Rx 12-21
Setup the OmniBER 718 SONET Tx to add Errors & Alarms..... 12-22
Setup the OmniBER 718 SONET Tx Overhead Bytes..... 12-23
Setup the OmniBER 718 SONET Tx for Overhead Byte Sequencing12-24
Perform OmniBER 718 SONET Rx Measurements..... 12-25
Setup the OmniBER 718 SONET Rx to retrieve Overhead Monitor Bytes12-26
Setup the OmniBER 718 SONET Rx to perform Overhead Byte Capture12-27
Setup the OmniBER 718 to generate Jitter 12-28
Setup the OmniBER 718 to generate a PDH Jitter Swept Mask 12-29
Setup the OmniBER 718 to generate a SDH/SONET Jitter Swept Mask12-30
Setup the OmniBER 718 to generate a PDH Jitter Mask Spot Frequency12-31

Setup the OmniBER 718 to generate an SDH/SONET Jitter Mask Spot Frequency
12-32

Perform OmniBER 718 Jitter Rx Measurements 12-33

Setup the OmniBER 718 to generate Wander 12-35

Setup the OmniBER 718 to generate a Wander Mask Spot Frequency 12-36

Perform OmniBER 718 Wander Rx Measurements..... 12-37

Perform OmniBER 718 Jitter Auto-Tolerance Measurement 12-38

Perform OmniBER 718 Jitter Transfer Function Measurement 12-39

Setup the OmniBER 718 ATM Tx 12-40

Setup the OmniBER 718 ATM Rx 12-42

Setup the OmniBER 718 Tx to add ATM Errors and Alarms..... 12-43

Perform OmniBER 718 ATM Rx Measurements 12-44

Setup the OmniBER 718 POS Tx 12-45

Setup the OmniBER 718 POS Rx 12-47

Setup the OmniBER 718 Tx to add POS Errors and Alarms..... 12-48

Perform OmniBER 718 POS Rx Measurements..... 12-49

13 SCPI Error Messages

SCPI Error Messages 13-2

General Index

Methods of Remote Control

Methods of Remote Control

Methods of Remote Control

The OmniBER 718 can be remotely controlled in one of four ways:

- GPIB (HP-IB)** Provides a parallel interface that allows the connection of other devices to the system for example: Frequency Counter; Printer; Signal Generator. Allows great flexibility in communicating data and controlling data and provides one of the easiest methods of constructing automatic systems. If long distance communication is required, suitable GPIB Extenders must be connected within the test system at both ends of the communication link.
- RS-232-C** Provides a serial interface that can be connected directly to the RS-232-C port of a terminal or computer. Only the controller and the OmniBER 718 can be connected within the system. If long distance communication is required, the OmniBER 718 can be connected directly to the RS-232-C port of a Modem and controlled via a telephone line.
- LAN** Provides a parallel interface that allows the connection of other instruments and controllers to the system for example: workstations; other OmniBER 718's; other test sets that have a LAN interface.
- DNA** Provides control via a Front Panel displayed on a PC connected to a LAN. Other test sets that have the Virtual Remote capability can be connected to the LAN and controlled via the same PC. *See HP E4540A Manual, HP part number E4540-90004.*
- UID's** OmniBER Universal Instrument Drivers - please refer to the UID sales flyer (part number 5968-5608E) provided with your instrument for information on OmniBER UID's which are provided on a CD-ROM with your instrument.

Methods of Remote Control

Connecting the OmniBER 718 via GPIB (HP-IB)

The following points should be considered when connecting the OmniBER 718 via GPIB:

- Operating distances
- Communication with the system controller

Operating Distances

1. The total length of GPIB cable must not exceed 2 meters (6 feet) × the number of devices in the system.
2. The total length of GPIB cable, used to interconnect all devices in the system, must not exceed 20 meters (65 feet).

Operating distances can be increased by using GPIB Extenders, as follows:

Up to 1250 meters use HP 37204A.

Over 1250 meters use two HP 37201A and two suitable Modems.

Communication with the System Controller

Each device in the system must have a unique address to allow the controller to access each one individually. On the OmniBER 718 the address is set on the OTHER display under REMOTE CONTROL:

To set the GPIB (HP-IB) Address press



OTHER; **REMOTE CONTROL** and set the display as shown opposite. Address 5 has been selected but any Address in the range 0 to 30 can be selected.

FUNCTION	[REMOTE CONTROL]
REMOTE CONTROL PORT	[HP-IB]
PRINTER PORT	[DISK]
ADDRESS	[5]
SRQ STATE	
ERROR NUMBER	
STATUS:	
HP-IB	RS232
LAN	MULTIPLE WINDOW

Methods of Remote Control

Connecting the OmniBER 718 to RS-232-C

Remote control via RS-232-C requires that the OmniBER 718 RS-232-C interface settings match those of the terminal/computer. These settings are made on the OTHER display under REMOTE CONTROL.

Using ,  and the display softkeys set REMOTE CONTROL PORT [RS232]. Set CONTROLLER TYPE, XON/XOFF, SPEED, PARITY and STOP BITS to match the settings on your terminal/computer.

FUNCTION	[REMOTE CONTROL]
REMOTE CONTROL PORT	[RS232]
PRINTER PORT	[DISK]
CONTROLLER TYPE	[TERMINAL]
XON/XOFF	[RX & TX]
SPEED	[9600 BAUD]
PARITY (? BIT DATA)	[ODD]
STOP BITS	[1]
ERROR NUMBER			
STATUS:			
COMPUTER	TERMINAL	MULTIPLE WINDOW	

Refer to the following pages for a list of instrument RS-232-C port connections, cable connections between the instrument and a PC, Modem or Terminal, and an explanation of controller type.

OmniBER 718 RS-232-C Port

The OmniBER 718 acts as DTE (Data Terminal Equipment), see Table 1-1 for a list of port connections.

The RS-232-C Port is an IBM PC style port which can be connected to a serial device using the same type of cable as would be used to connect the device to a standard IBM PC.

Methods of Remote Control

Table 1-1 **OmniBER 718 RS-232-C port connections**

37718 Pin #	Signal	Input/Output
1	DCD	Input
2	RXD	Input
3	TXD	Output
4	DTR	Output
5	GND	GND
6	DSR	Input
7	RTS	Output
8	CTS	Input
9	N/A	N/A

Controller Type

Two methods of controlling the OmniBER 718 via RS-232-C are available:

- Terminal** Simple method of control when commands are issued manually on a command by command basis.
- Computer** Typically used when commands are issued via a program.

Methods of Remote Control

Terminal Mode

Terminal mode is provided to allow the OmniBER 718 to be controlled by a "dumb" terminal and provides the following features:

When connection is established via RS-232-C the OmniBER 718 responds with a "prompt".

Characters sent to the OmniBER 718 are echoed back to the terminal.

If a mistake is made in the command, the appropriate SCPI Error Message and the "entered" command is returned to the terminal to provide a local record.

A command history buffer is provided with a capacity of 20 commands. This allows frequently used commands to be retransmitted without having to retype the command:

To list the history buffer contents type: **!l** (lower case L)

To retransmit the last Command sent type : **!!**

To retransmit a previously sent command, type: **!n** where n = the commands listed number. If "n" is negative, the number is relative to the last command sent.

Computer Mode

Computer mode is provided to allow the OmniBER 718 to be controlled by a computer allowing programs to be run. Unlike Terminal mode commands are not echoed back and SCPI Error Messages are not returned unless the appropriate query command is issued.

Methods of Remote Control

Connecting the OmniBER 718 to a LAN

The following information should be obtained from the LAN System Administrator before connecting to the LAN:

- Internet address (Example 015.144.180.205)
- Subnet Mask (Example 255.255.248.0).
- Default Gateway IP Address (Example 15.144.176.1).

The PORT NUMBER and MAC ADDRESS are assigned to the OmniBER 718 at the time of shipment.

Connect the OmniBER 718 LAN interface to the LAN network.

The OmniBER 718 must now be configured to accept the IP address, Subnet Mask and Default Gateway IP Address.

Press **OTHER**, **REMOTE CONTROL**

and set up the display as shown opposite.
The OmniBER 718 can be configured to accept the IP address, Subnet Mask and Default Gateway IP Address in one of two ways:

FUNCTION [REMOTE CONTROL]	
REMOTE CONTROL PORT	[LAN]
PRINTER PORT	DISK
CONFIGURATION [CURRENT SETTINGS]	
IP ADDRESS	15.144.181.41
PORT NUMBER	5001
SUBNET MASK	255.255.248.000
GATEWAY IP ADDRESS	15.144.175.181
MAC ADDRESS	080090000000
ERROR NUMBER	
STATUS:	
HP1B	RS232
LAN	MULTIPLE WINDOW

Methods of Remote Control

Current Settings

The IP Address, Subnet Mask and Gateway IP Address will adopt the current settings.

The Port Number and MAC Address are displayed for information.

FUNCTION	[REMOTE CONTROL]
REMOTE CONTROL PORT	[LAN]
PRINTER PORT	DISK
CONFIGURATION	<input checked="" type="radio"/> CURRENT SETTINGS
IP ADDRESS	15.144.181.41
PORT NUMBER	5001
SUBNET MASK	255.255.248.000
GATEWAY IP ADDRESS	15.144.175.181
MAC ADDRESS	080090000000
ERROR NUMBER	

STATUS: CURRENT SETTINGS NEW SETTINGS MULTIPLE WINDOW

New Settings (BOOTP)

To use BOOTP your system administrator must set up a BOOTP server on the network.

When YES is selected the power must be cycled on the OmniBER 718 to allow for a change of settings.

When power is restored the OmniBER 718 will issue BOOTP requests until it receives a reply from a suitably configured BOOTP server.



FUNCTION	[REMOTE CONTROL]
REMOTE CONTROL PORT	[LAN]
PRINTER PORT	DISK
CONFIGURATION	[NEW SETTINGS]
USE BOOTP	<input checked="" type="radio"/> YES
NEW Settings take effect on next power up	
ERROR NUMBER	



STATUS: NO YES MULTIPLE WINDOW

The Settings of IP Address, Subnet Mask and Gateway IP Address will be adopted as the Current Settings.

Methods of Remote Control



New Settings (Keyboard Entry)

Use **DECREASE DIGIT**  **INCREASE DIGIT**  and **INCREASE DIGIT** to set the IP Address, Subnet Mask and Gateway IP Address.

Use  and  to move between the IP Address, Subnet Mask and Gateway IP Address.

The New Settings will not become active until the power is cycled (power off/ power on) on the OmniBER 718.

FUNCTION	[REMOTE CONTROL]
REMOTE CONTROL PORT	[LAN]
PRINTER PORT	[DISK]
CONFIGURATION	[NEW SETTINGS]
USE BOOTP	[NO]
IP ADDRESS	[15 144 180 205]
SUBNET MASK	[15 144 180 205]
GATEWAY IP ADDRESS	[15 144 180 205]
NEW Settings take effect on next power up	
ERROR NUMBER	

STATUS:
DECREASE DIGIT **INCREASE DIGIT**   **MULTIPLE WINDOW**

The entered New settings are checked to ensure they conform to the relationships that should exist between the IP Address, Subnet Mask and Gateway IP Address. If the entered data contravenes these relationships, the OmniBER 718 will change the data to more sensible values.

Configuration

The OmniBER 718 can only accept one tcp connection at a time and it cannot establish an outgoing call. The connection has to be directed to port 5001.

For Example (from a UNIX system):

```
telnet <IP address> 5001
```

If ping <IP address> is issued (from a UNIX system), commands issued will be echoed at the local end of the connection.

Methods of Remote Control

Controlling the OmniBER 718

The simplest way to verify the connection and become familiar with remote RS-232-C operation is to send a few commands and observe their effect. In this example using a terminal we will:

- Take the OmniBER 718 under remote control
- Initialize the OmniBER 718
- Read the contents of the error register
- Start a test period
- Add errors
- Obtain the result (Option dependent)
- Return the OmniBER 718 to local operation

NOTE

Connect the PDH OUT port to the PDH IN port for the duration of this exercise.

Table 1-2 **OmniBER 718 to RS-232-C Computer**

Terminal Input	Comment
:SYST:REM	Takes the OmniBER under remote control. On the instrument the indicator above LOCAL is lit.
*RST	Default settings, registers cleared.
:SYST:ERR?	The SCPI Error Message and number can be read, even in local operation mode. (+0, "No error")
:SENS:DATA:TEL:TEST :TYPE MAN	Selects a manual test period.
:SENS:DATA:TEL:TEST ON	Starts the manual test period. On the instrument the indicator above RUN/STOP is lit.
:SOUR:DATA:TEL:ERR :BIT ONCE	Adds a single bit error.
:SOUR:DATA:TEL:ERR :BIT ONCE	Adds a single bit error.
:SOUR:DATA:TEL:ERR :BIT ONCE	Adds a single bit error.
:SENS:DATA:TEL:TEST OFF	Halts the manual test period. On the instrument the indicator above RUN/STOP is extinguished.

Methods of Remote Control

Table 1-2 **OmniBER 718 to RS-232-C Computer**

Terminal Input	Comment
:SENS:DATA? "ECO:SPDH :BIT"	Structured PDH -Returns the bit error count in numeric form, in this example 3.
:SYST:LOC	Returns the OmniBER 718 to local control. On the instrument the indicator above LOCAL is extinguished.

Methods of Remote Control

To Initialize the OmniBER 718

Regardless of the current setup the following command will initialize the OmniBER 718. It sets the OmniBER 718 to the factory default settings and clears all registers.

*RST

It is recommended that you do not rely on default settings but program each setting to what you require.

Remote Control Hints & Tips

Remote Control Hints & Tips

The following section gives some Hints & Tips on how to control the OmniBER 718 via remote control. Before writing any program to control the OmniBER 718 it may help to manually go through the steps required to setup the desired configuration. The order in which you should send the corresponding SCPI commands will usually follow the order in which you set up the OmniBER 718's Front Panel. This can be seen in the Application Examples listed in the Manual. These could be used as a starting point in order to find the SCPI commands that correspond to particular OmniBER 718 Front Panel settings.

Default Settings

In general, default settings should not be assumed. It is recommended that each instrument setting should be explicitly programmed to the desired value.

Also commands that affect higher level settings such as Signal Rate or Payload Type should be sent before commands to set up lower level settings e.g. Pattern. This is because, in some cases, higher level setting changes can affect the values of lower settings.

Instrument Coupling

If you wish to set the OmniBER 718 Transmitter and Receiver to the same settings then you can save time by selecting Transmitter/Receiver Coupling and then programming the Receiver only.

To turn coupling on use the :INSTRument:COUPLE RTTX command.

Error Checking

It is recommended that, when sending SCPI commands to the OmniBER 718, you also periodically send the SYSTem:ERRor? command to check for any Remote Control Errors reported by the instrument. This command returns 0, "No Error" if there are no errors in the error queue. If the SYSTem:ERRor? command is sent after every setup command then it makes debugging any reported errors much easier since you will know exactly which command caused the error.

The actual error queue within the OmniBER 718 can be cleared by sending the *CLS command.

Remote Control Hints & Tips

Command Completion

When programming the instrument over RS-232, it is important to realize that a buffer (of 128 bytes) exists in the OmniBER 718 between the RS-232 port and the SCPI parser.

The effect of this is that even if the OmniBER 718 accepts the last character of a command, it cannot be assumed that it will immediately be executed - there could be several commands ahead of this one waiting in the buffer.

If you need to know when a command, or sequence of commands has been accepted by the instrument, follow them with a query command. When the response to the query command is returned, then you know that all commands prior to that have been executed.

Suitable query commands to use are *OPC? or SYST:ERRor? (which also gives the additional benefit of error checking as described above).

Note that this effect does not apply with GPIB. When GPIB is used to remotely control the OmniBER 718 then, after the last character of a SCPI command has been accepted by the instrument, its execution is imminent. However, it is still good practice to send a SYSTem:ERRor? after each command in order to check for error free completion.

Setup Delays

Even after the OmniBER 718 has accepted a SCPI command it may take some time for it to execute the requested operation (e.g. payload change, single error add). It is therefore recommended that at least 250ms is allowed after the command has completed before expecting the instrument operation to occur. One way of determining if such delays exist is to perform the desired operation manually using the OmniBER 718's Front Panel and checking if there is any noticeable delay in execution.

Status Registers

Status registers in general are only updated every 100ms by the OmniBER 718. Therefore you should avoid reading them any faster than that since, although it does not do any harm if they are read faster, it means that less processing power will be available to update the display.

If you need to detect a status register bit that is momentarily changing state, avoid using the condition register in the hope of catching both states. Instead it is much better to program the PTRansition and NTRansition registers to catch the event of interest, and then use the event register to monitor for the event.

Remote Control Hints & Tips

For example, say you wished to detect when the K1 and K2 bytes in the Multiplex Section Line Overhead of a STM-1/STS-3 signal have changed. There is a K1K2 bit defined (DB6) in the SDH2/SONet2 Status Register that is set when these bytes change value.

However, if you monitored the SDH2/SONet2 status register simply by sending the STATus:SDH2:CONDition? or STATus:SON2:CONDition? command then it is very likely that you would miss any transition in the K1K2 bit.

A better method is as follows.

```
Set transition filter to pass positive      : STATus:SDH2:PTR 64;NTR 0
transitions in K1K2 (DB6)
```

```
Periodically read SDH2 event register.    : STATus:SDH2:EVENT?
Periodically read SONet2 event register   : STATus:SONet2:EVENT?
Check for K1K2 (DB6) being set.
```

Using this technique you will detect any changes in the K1 and K2 bytes.

If you needed to monitor a number of status bits then using this method would not be ideal since it would have the disadvantage of having to regularly read a number of status registers. A general rule is to minimize the number of status register reads required and, to achieve this, use can be made of the Summary register. For details on how to use the Summary register and also the SRQ mechanism see Programmed Status Reporting on page 8-33.

Gating Control

There are a number of status register bits that can be used to indicate the state of the OmniBER 718's measurement system.

When you send the start gating command to the OmniBER 718 you should check the MEAS bit (DB4) in the OPERation status register. This is because the OmniBER 718 takes a finite period of time (the actual length of time can be affected by factors such as whether Stored Measurement Graphics is selected or not) to start gating. When the MEAS bit is set to one it means that the OmniBER 718 is gating.

If it is required to retrieve Short Term results while the OmniBER 718 is gating then the STP bit (DB6) in the INSTRument status register can be used to determine when short term results can read i.e. when the first short term test period has completed.

The EOT bit (DB2) in the INSTRument status register can be used to determine when the OmniBER 718 gating period is complete.

Remote Control Hints & Tips

Frequency Offsets

If the OmniBER 718 Transmitter's PDH signal rate or frequency offset is changed it will take some time for the Internal VCXO's to settle. This is indicated on the OmniBER 718's Front Panel by a flashing status message. The state of the VCXO's can also be checked by monitoring the LOC Bit (DB8) in the SPDH Status Register.

User Locks

User locks are a mechanism used within the OmniBER 718 to prevent the user selecting a particular instrument feature when some other selection takes priority. An example of this would be if you tried to modify the value of a SDH/SONET Overhead byte using the `:SOURCE:DATA:TELEcom:SDHSONet:OVERhead:DATA` command at the same time as a sequence was being generated in the same byte. If you tried to do this manually via the OmniBER 718's Front PANEL than a status message warns you that this operation is not possible. If you tried to do it via remote control then a "-200, Execution Error" would result. The solution is to switch of the particular feature (in this example sequence generation) that has priority before sending the command.

**SCPI Backwards
Compatibility Differences**

SCPI Backwards Compatibility Differences

SCPI Backwards Compatibility Differences

This chapter lists those commands for which it has not been possible to continue from a previous version of instrument software to the current version.

SCPI forward compatibility is treated with high priority when instrument features evolve. Thus, SCPI commands are written with the following prioritized guidelines:

- 1 Wherever possible, existing SCPI commands will be used and expanded to cover altered and new functionality.
- 2 The query form of an existing configuration command may be sacrificed in order to map the configuration form to both old and new capability. For example, where two “discrete” configuration parameters map to a single choice on the instrument display, the new choice will invariably be returned by the query.
- 3 If all else fails, the default is to create a new command.

The following chapter is organized by functionality differences which may affect commands across a number of subsystems. Listed are those commands which have been altered in such a way that they are incompatible with previously released versions of instrument software.

Also listed are commands which have been retained for backward compatibility but have been replaced by newer commands, the use of which is recommended.

Option Identification Query

The ATM options 300, 301 and 302 have been merged into one ATM option 300. A new option 350 has also been added to indicate if the Advanced payload Engine is fitted. These changes apply to instruments with Revision Codes above (but not including) A.05.79.

Structured Payload Type

Change applies to 37718/19 and 37717C instruments with Revision Code A.03.41 and above.

```
:SOURce:DATA:TELEcom:SPDH:PAYLoad:TYPE  
:SENSe:DATA:TELEcom:SPDH:PAYLoad:TYPE  
:SOURce:DATA:TELEcom:SDH:PAYLoad:TYPE  
:SENSe:DATA:TELEcom:SDH:PAYLoad:TYPE
```

The parameter ‘STRuctured’ has been removed from both command and query. New commands has been created for this alone:

SCPI Backwards Compatibility Differences

:SOURce | SENSE:DATA:TELEcom:SPDH:PAYLoad:STRucture

:SOURce | SENSE:DATA:TELEcom:SDH:PAYLoad:STRucture

Use their query form to determine if the signal is structured.

Mixed Backgrounds - Change applies to 37717C instruments with Revision Code A.03.41 and above:

:SOURce:DATA:TELEcom:SDH:TUG3:BACKground:PAYLoad[:PATTERN]

Once, all three backgrounds could be programmed and only the two in context at any time would be in effect. The other would be masked by the foreground selection. Now, there are only two background channels, called LO and HI. LO can be channel 1 (if the foreground is not in channel 1) or 2. HI can be channel 2 or 3, depending on which channel is the foreground. Changing which channel is the foreground will change the channel selections of LO and/or HI.

The mapping selections and user words associated with HI and LO will be unaffected by such a change, but they may apply to a different channel.

For correct operation, it is recommended that the backgrounds are setup after each change of foreground channel number.

Furthermore, the TU3 background is now always of the user selectable word form instead of fixed word for the cases where TU3 was a mixed background. The effect of this is that the parameter UWORD will be converted to TU3. The effect is the same for the command, but the query will return TU3 instead of the previous behavior of returning UWORD.

Sequences and Overheads - Change applies to all 37718/19/20 instruments.

:SOURce:DATA:TELEcom:SDH:SEquence:CHANnel

Command retained for backward compatibility only. The following new command is recommended: :SOURce:DATA:TELEcom:SDH:SEquence:OHBYte

DCC Interface - Change applies to all 37718/19/20 instruments

:SOURce:DATA:TELEcom:SDH | SONet:IDCC:POLarity

:SENse:DATA:TELEcom:SDH | SONet:IDCC:POLarity

Now only accepts NORMal as a parameter - REVERsed is no longer supported.

SCPI Backwards Compatibility Differences

Thru Mode - Change applies to 37718/19/20 instruments with Revision Code A.04.70 and above.

The following command/query pair is affected.

:SOURce:DATA:TELEcom:SDH:THRumode:POVerwrite

This command both sets up and enables the thru-mode payload overwrite. This has been retained for backwards compatibility only. Thru-mode has been enhanced, such that the payload overwrite is set up and enabled separately. The recommended commands are shown below.

:SOURce:DATA:TELEcom:SDH:THRumode:PAYLoad:OVERwrite
<discrete>

:SOURce:DATA:TELEcom:SDH:THRumode:PAYLoad:OVERwrite:ENABLE
<boolean>

Jitter Auto tolerance - Change applies to 37718/19 instruments with Revision Code A.05.11 and above.

SOURce:DATA:TELEcom:JITTer:ATOLerance:THReshold<numeric>

This command has been superceded by the ERRor:TYPe & ERRor:THReshold commands.

Fixed Jitter Masks - Change applies to 37718/19 instruments with Revision Code A.05.11 and above.

SOURce:DATA:TELEcom:JITTer:SDHMask | SONMask
SOURce:DATA:TELEcom:JITTer:TRANSfer:MASK:INPut
SOURce:DATA:TELEcom:JITTer:TRANSfer:MASK:PASS

Parameters ATYPE and BTYPE are replaced by G958A and G958B respectively.

SOURce:DATA:TELEcom:JITTer:QFACTOR
SOURce:DATA:TELEcom:JITTer:PDHMask
SOURce:DATA:TELEcom:JITTer:SDHMask
SOURce:DATA:TELEcom:JITTer:SDHMask:MRANge
SOURce:DATA:TELEcom:JITTer:SONMask
SOURce:DATA:TELEcom:JITTer:SONMask:MRANge

With the introduction of the User Mask selection for Auto Tolerance, the above commands have been replaced by newer commands. They will continue to be maintained for backwards compatibility.

SCPI Backwards Compatibility Differences

User Jitter Masks - Change applies to 37718/19 instruments with Revision Code A.05.11 and above.

:SOURce:DATA:TELecom:JITTer:TRANsfer:MASK:INPut:A1
:SOURce:DATA:TELecom:JITTer:TRANsfer:MASK:INPut:A2
:SOURce:DATA:TELecom:JITTer:TRANsfer:MASK:INPut:F1
:SOURce:DATA:TELecom:JITTer:TRANsfer:MASK:INPut:F2
:SOURce:DATA:TELecom:JITTer:TRANsfer:MASK:INPut:F3
:SOURce:DATA:TELecom:JITTer:TRANsfer:MASK:INPut:F4

The feature and hence the commands which defined the Jitter Transfer Function user jitter mask have been deleted from the instrument. A new all encompassing user jitter mask feature is now provided.

Jitter Module Obsolescence - Change applies to all 37718/19 instruments.

1 :SOURce:CLOCK:JITTer:FORMat

2 :SOURce:CLOCK:JITTer:BALanced

3 :INPut:TELecom:JITTer:...

4 JITTER Status Register:

DB3: WRS - Wander Reference Unlock.

DB4: EXW - Excess wander (>5 UI).

DB11: JLOS - SDH Loss of Signal. (Jitter optical Rx only).

DB12: JLOL - SDH Optical Loss of Light. (Jitter optical Rx only).

5 :SENSe:DATA:TELecom:JITTer:SETTings

6 :SENSe:DATA? "PEAK:JITTer:WANDer:SECond:PK15"

7 :SENSe:DATA? "PEAK:JITTer:WANDer:SECond:PK24"

Due to jitter module obsolescence, the above commands and status bits are amended as follows:

- 1 Only the parameter CLOCK is supported.
- 2 Only the parameter UNBalanced is supported.
- 3 There are no primary inputs on the upgraded jitter module and hence all of these commands are obsolete.
- 4 There are no primary inputs on the upgraded jitter module and hence all of these status bits are obsolete.
- 5 Obsolete command. No longer required.
- 6 New module returns results in units of nanoseconds.
- 7 New module returns results in units of nanoseconds.

SCPI Backwards Compatibility Differences

Jitter External Clock - Change applies to 37718/19 instruments with Revision Code A.05.11 and above.

:SOURce:CLOCK:SPDH:SOURce
:SOURce:CLOCK:JITTer:EXTernal:SOURce
:SOURce:CLOCK:JITTer:EXTernal:FORMat

Due to PDH jitter module obsolescence, there is no longer an external reference clock input on a PDH jitter module. Consequently, the commands :SOUR:CLOC:JITT:EXT:SOUR and :SOUR:CLOC:JITT:EXT:FORM are now obsolete but are retained for backwards compatibility.

The existing command, :SOUR:CLOC:SPDH:SOUR is now extended in line with the :SOUR:CLOC:SDH | SON:SOUR commands. The obsolete parameter JITTer is retained for backwards compatibility.

Tandem Connection Monitoring Feature

The introduction of the SDH Tandem Connection Monitoring (TCM) feature has impacted the following areas:

- Removal of SONET CV-IEC functionality. This affects CV-IEC error generation [see :SOURce:DATA:TELEcom:SONet:ERRor:TYPE <discrete>] and the error/analysis results containing CVIec in the parameter.
- SDH Path IEC errors are only offered when a TCM path is selected.
- SDH Path IEC results should now use the relevant TCM SCPI parameters [See TCM sections in “SENSe subsystem - Result Returning Commands” on page 93 of Chapter 5.]

Common SCPI Command Reference

SCPI Command Format, see page 3-2.

Remote Control Commands, see page 3-5.

Instrument Options, see page 3-6.

INSTRument subsystem, see page 3-7.

SOURce subsystem, see page 3-8.

SOURce subsystem - Transmitter Common Commands, see page 3-9.

INPut subsystem, see page 3-12.

SENSE subsystem, see page 3-13.

SENSE subsystem - Receiver Common Commands, see page 3-15.

SENSE subsystem - Test Timing, see page 3-18.

SENSE subsystem - Analysis Control, see page 3-20.

SENSE subsystem - Trouble Scan Results, see page 3-23.

SENSE subsystem - Configuring Graphics, see page 3-26.

SENSE subsystem - Managing Graphics Stores, see page 3-28.

SENSE subsystem - Retrieving Graphics Store Data, see page 3-30.

SENSE subsystem - Retrieving Data for a Single Graph, see page 3-34.

SENSE subsystem - Obtaining Graphics End of Measurement Results, see page 3-36.

STATus Subsystem, see page 3-43.

SYSTEM Subsystem, see page 3-46.

Common Commands

This chapter contains general information on SCPI commands, and detailed information on the commands that are common for all types of instrument operation, i.e. PDH, SDH, SONET and Jitter.

SCPI Command Format

Instrument functions such as making measurements, retrieving data, and querying status, are performed by stringing together SCPI "nodes" into commands. The SCPI commands are based on a hierarchical structure called a "subsystem" that comprises a top level "root" node and one or more lower-level nodes and their parameters as follows:

:INPut:TELEcom:SPDH:CODE <CMI> or <AMI> or <HDB3>

:INPut is the root node

:TELEcom is a second level node

:SPDH is a third level node

:CODE is a fourth level node

CMI, AMI and HDB3 are parameters of the fourth-level :CODE node.

Command Syntax

Commands are shown as a mix of upper and lowercase characters.

Commands can be abbreviated for shorter program line lengths. The uppercase characters define the abbreviated form of the command.

Commands are formed by linking the root node with lower-level nodes. A colon (:) is used to link nodes.

If the command requires a parameter, a space must separate the lowest level node and the parameter. If there is more than one parameter, a comma (,) is used to separate the parameters.

An example of typical commands and their abbreviated form are shown below :

:INPut:TELEcom:SPDH:CODE AMI	full form
:INP:TEL:SPDH:CODE AMI	abbreviated form
:SOURce:DATA:TELEcom:SPDH:PAYLoad:PATTern PRBS23	- full form
:SOUR:DATA:TEL:SPDH:PAYL:PATT PRBS23	- abbreviated form

Common Commands

SCPI Command Format

SCPI Long Form Command Headers

The general rule for SCPI long form command headers that are greater than four characters in length is as follows:

- Abbreviated short form mnemonics - the first four characters from the long form command header are used unless the fourth character is a vowel. In such cases, the vowel is dropped and only the first three characters are used.
- If the command is four characters long then all four characters are used, irrespective of whether the fourth character is a vowel or not.

Linking Command Statements

Command statements can be linked using semicolons (;). For example :

```
:INPut:TELEcom:SPDH:CODE AMI;;SOURce:DATA:TELEcom:SPDH:  
PAYLoad:PATtern PRBS23
```

Parameters

In this manual, parameters are shown in angled brackets < >. There are five parameter types used in commands as listed in table 3-1.

Table 3-1

Parameter Types

Parameter Types	Description
<numeric>	All commonly used decimal numbers including optional signs, decimal points, and scientific notation. Examples are 123, 123E2, -123, -1.23E2, .123, .123E2 and 1.2300E-01. Special cases include MINimum and MAXimum. A numeric parameter can also be specified in hex, octal, and/or binary. Examples are #H7B, #Q173 and #B11110111.
<boolean>	A single binary condition that is either true or false. Examples are ON, OFF, 1 and 0.
<discrete>	Values that are represented by a string of alphanumeric characters. Examples are INTernal and EXTernal.

Common Commands
SCPI Command Format

Table 3-1

Parameter Types

Parameter Types	Description
<string>	Any set of ASCII characters enclosed within single quotes or double quotes. Examples are '1111111111111111' and "0000000000000000".
<block>	Used to transfer large quantities of related data. Blocks can be sent as definite length blocks (#<numeric><numeric>) or indefinite length blocks (#0).

Occasionally, a command may use more than one parameter of the same type. When this occurs, the order of the parameters used in the command will map to the order of the individual parameter descriptions.

Common Commands
Remote Control Commands

Remote Control Commands

The remote control commands in this manual have been grouped into Sections that relate to instrument functions. These have then been split into Subsystems

The Subsystems used in the OmniBER 718 are listed in table 3-2.

Table 3-2

SCPI Subsystems

Instrument Functions	Subsystem
To control SIGNAL OUT port, STM-0/STS-1, STM-1/STS-3 OUT port/ Optical OUT port .	:OUTPut
To control instrument coupling.	:INSTrument
To control the transmitter.	:SOURce
To control the SIGNAL IN port, STM-0/STS-1, STM-1/STS-3 IN port/ Optical IN port.	:INPut
To control the receiver, results and graphics	:SENSe
To obtain results directly accumulated by the instrument.	:FETCh
To control the instrument OTHER functions.	:SYSTem
To control Status Reporting.	:STATus

Instrument Options

The OmniBER 718 Communications Performance Analyzer is a modular product allowing a wide range of test options to be fitted. SCPI commands with the following node names need the appropriate options to be fitted.

SPDH - needs structured PDH option

SDH - needs SDH option

SONET - needs SONET option

JITTER - needs Jitter option

ATM - needs ATM option

Commands are not valid unless the correct option has been fitted e.g.

:SOURCE:DATA:TELEcom:SONet:VTGRoup <numeric> only works if the SONET option is fitted.

Common Commands
INSTrument subsystem

INSTrument subsystem

The INSTrument subsystem is used to control the coupling between the transmitter and the receiver as provided on the OTHER SETTINGS CONTROL display.

:INSTrument:COUPlE <mode>

<discrete> =	OFF	Independent
	RTTX	Coupled

After a reset the receiver and transmitter coupling will be OFF. If the instrument is testing and the receiver and transmitter are coupled, changing certain transmitter settings will generate an error because the coupled receiver setting cannot be changed because of testing lock.















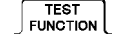

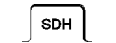
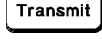

The corresponding query returns the Coupling state in discrete form as listed above.

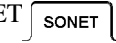
:INSTrument:COUPlE?

Returns : <discrete>

SOURce subsystem

The SOURce subsystem contains commands that allow the transmitter settings to be set. The commands within the SOURce subsystem have been arranged as follows:

<i>Chapter 3</i>	SOURce subsystem - Transmitter Common Commands		PDH	
<i>Chapter 4</i>	SOURce subsystem -Transmitter Structured PDH Commands		PDH	
	SOURce subsystem - Transmitter SPDH Test Signal Settings Commands		PDH	
	SOURce subsystem - Transmitter SPDH Test Function Commands		SDH	
<i>Chapter 5</i>	SOURce subsystem - Transmitter SDH Settings Commands		SDH	
	SOURce subsystem - Transmitter SDH OVERHEAD SETUP		SDH	
	SOURce subsystem - Transmitter SDH Test Function Commands		SONET	
<i>Chapter 6</i>	SOURce subsystem - Transmitter SONET Settings Commands		SONET	
	SOURce subsystem - Transmitter SONET OVERHEAD SETUP		SONET	
	:SOURce subsystem - Transmitter SONET Test Function Commands		PDH	
<i>Chapter 7</i>	SOURce subsystem - Transmitter Jitter Commands		ATM SETTINGS	
<i>Chapter 8</i>	SOURce subsystem -Transmitter ATM Commands		POS SETTINGS	
<i>Chapter 9</i>	SOURce subsystem -Transmitter POS Commands			

Where commands are applicable to more than one category these are included in all the applicable categories.

SOURce subsystem - Transmitter Common Commands

:SOURce:DATA:TELEcom:SOURce <discrete>

<discrete> =	PDH	PDH Outputs
	SDH	STM- 0/STM-1 Electrical
	SONet	STS-1/STS-3 electrical
	OPT1	STM-0/STM-1 Optical
	OC3	OC-1/OC-3
	OPT4	STM-0/STM-1/STM-4 Optical
	OC12	OC-1/OC-3/OC-12
	OPT16	STM-0/STM-1/STM-4/STM16 Optical
	OC48	OC-1/OC-3/OC-12/OC-48

Selects the output port. The output characteristics of each port are controlled by the :OUTPut subsystem.

Recommended use: This command selects which transmitter output port is in use, and also selects the TRANSMITTER OUTPUT selection on the transmitter page. The parameters refer to the physical ports on the instrument but do not select the interface rate. There are a number of different optical port parameters, one for each optical module option available. The correct optical parameter must be selected based on the optical module option fitted to the instrument.

After this command has been used to select the applicable port and interface, the interface rate commands should be used to set the required line rate. See the Associated Commands.

Associated Commands: For each parameter of this command, the command to set the interface rate is listed here.

(SPDH) :OUTPut:TELEcom:SPDH:RATE <discrete>

(SDH) :OUTPut:TELEcom:SPDH:RATE <discrete>

(SONET) :OUTPut:TELEcom:SONet:RATE <discrete>

(OPT1) :OUTPut:TELEcom:OPT1:RATE <discrete>

Common Commands

SOURce subsystem - Transmitter Common Commands

(OC3) :OUTPut:TELEcom:OC3:RATE <discrete>

(OPT4) :OUTPut:TELEcom:OPT4:RATE <discrete>

(OC12) :OUTPut:TELEcom:OC12:RATE <discrete>

(OPT16) :OUTPut:TELEcom:OPT16:RATE <discrete>

(OC48) :OUTPut:TELEcom:OC48:RATE <discrete>

:SOURce:DATA:TELEcom:SOURce?

Returns : <discrete>

:SOURce:DATA:TELEcom:TFUNction <discrete>

<discrete> =	NONE	Test function off
	SDH	
	SONet	
	PDHPayload	requires an SDH or SONET option
	PDH	
	SDISruption	Service Disruption
	ATM	
	POS	

Selects the transmitter test function source.

The corresponding query returns the transmitter test function source in discrete form as shown above.

:SOURce:DATA:TELEcom:TFUNction?

Returns: <discrete>

:SOURce:DATA:TELEcom:ERRor:BIT <discrete>

<discrete> = NONE Off

Common Commands

SOURce subsystem - Transmitter Common Commands

ONCE	Single Error Add
RATE	1E-3

Selects the required bit error add rate.

This command is retained for backwards compatibility only. The recommended commands are:

- :SOURce:DATA:TELEcom:SDH:ERRor:TYPE <discrete> and :SOURce:DATA:TELEcom:SDH:ERRor:RATE <discrete> for SDH errors.
- :SOURce:DATA:TELEcom:SONet:ERRor:TYPE <discrete> and :SOURce:DATA:TELEcom:SONet:ERRor:RATE <discrete> for SONET errors.
- :SOURce:DATA:TELEcom:SDH:PDHPayload:ERRor:TYPE <discrete> and :SOURce:DATA:TELEcom:SDH:PDHPayload:ERRor:RATE <discrete> for SDH PDH payload errors.
- :SOURce:DATA:TELEcom:SONet:PDHPayload:ERRor:TYPE <discrete> and :SOURce:DATA:TELEcom:SONet:PDHPayload:ERRor:RATE <discrete> for SONET PDH payload errors
- :SOURce:DATA:TELEcom:SPDH:ERRor:TYPE <discrete> and :SOURce:DATA:TELEcom:SPDH:ERRor:RATE <discrete> for SPDH errors.

The corresponding query returns NONE or RATE.

:SOURce:DATA:TELEcom:ERRor:BIT?

Returns : <discrete>

INPut subsystem

INPut subsystem

This subsystem controls the characteristics of the instrument's input ports.

:INPut:TELEcom:LEVel <discrete>

<discrete> = TERMinate
 MONitor

Sets the input level for the SPDH or SDH or SONET electrical input port when that port is selected by :SENSE:DATA:TELEcom:SENSE <discrete> , type= SDH or SONET or PDH.

The corresponding query returns the input level in discrete form, as listed above.

:INPut:TELEcom:LEVel?

Returns : <discrete>

SENSe subsystem

SENSe subsystem

The SENSe subsystem contains the commands that control the Receiver. These have been arranged in the following manner:

<i>Chapter 2</i>	SENSe subsystem - Receiver Common Commands	Receive	PDH	MAIN SETTINGS
<i>Chapter 3</i>	SENSe subsystem - Receiver Structured PDH Settings	Receive	PDH	STRUCT'D PAYLOAD
	SENSe subsystem - Receiver SPDH Test Signal Settings Commands	Receive	PDH	TEST FUNCTION
	SENSe subsystem - Receiver SPDH Test Function Commands	Receive	PDH	TEST FUNCTION
<i>Chapter 4</i>	SENSe subsystem - Receiver SDH Settings	Receive	SDH	SDH
	SENSe subsystem - Receiver SDH Test Function Commands	Receive	SDH	TEST FUNCTION
<i>Chapter 5</i>	SENSe subsystem - Receiver SONET Settings	Receive	SONET	SONET
	SENSe subsystem - Receiver SONET Test Function Commands	Receive	SONET	TEST FUNCTION
<i>Chapter 6</i>	SENSe subsystem - Receiver Jitter Commands	Receive	PDH	JITTER
<i>Chapter 7</i>	SENSe subsystem - Receiver ATM Settings	Receive	ATM SETTINGS	
<i>Chapter 2</i>	SENSe subsystem - Test Timing	Receive	TIMING CONTROL	
	SENSe subsystem - Analysis Control	Other	MISC	
<i>Chapter 3</i>	SENSe subsystem - Alarm Scan Control	Results	PDH ALM SCAN	

Common Commands

SENSe subsystem

<i>Chapter 4</i>	SENSe subsystem - SDH Tributary Scan Control	Transmit	SDH	TEST FUNCTION
<i>Chapter 5</i>	SENSe subsystem - SONET Tributary Scan Control	Transmit	SONET	TEST FUNCTION
<i>Chapter 3</i>	SENSe subsystem - SPDH Round Trip Delay Control	Results	PDH TRIP DELAY	
<i>Chapter 4</i>	SENSe subsystem - Result Returning Commands	Results	SDH	
<i>Chapter 2</i>	SENSe subsystem - Trouble Scan Results	Results		
	SENSe subsystem - Result Returning Commands			
	SENSe subsystem - Configuring Stored Measurements and Graphics			
	SENSe subsystem - Managing Graphics Stores			
	SENSe subsystem - Retrieving Graphics Store Data			
	SENSe subsystem - Retrieving Data for a Single Graph Element			
	SENSe subsystem - Obtaining Graphics End of Measurement Results			

SENSe subsystem - Receiver Common Commands

:SENSe:DATA:TELEcom:SENSe <discrete>

<discrete> =	PDH	SPDH
	SDH	SDH Electrical (STM-0, STM-1)
	SONet	STS-1/STS-3
	OPT1	STM-0/STM-1 Optical
	OC3	OC-1/OC-3
	OPT4	STM-0/STM-1/STM-4 Optical
	OC12	OC-1/OC-3/OC-12
	OPT16	STM-0/STM-1/STM-4/STM-16 Optical
	OC48	OC-1/OC-3/OC-12/OC-48

Selects the input port. The input characteristics of each port are controlled by the INPut subsystem.

Recommended use: This command selects which receiver input port is in use, and also selects the top level field on the receiver page. The parameters refer to the physical ports on the instrument but do not select the interface rate. After this command has been used to select the applicable port and interface, the interface rate commands should be used to set the required line rate. See the Associated Commands. There are a number of different optical port parameters, one for each optical module option available. The correct optical parameter must be selected based on the optical module option fitted to the instrument.

Associated Commands: For each parameter of this command, the command to set that interface's rate is listed here.

(PDH) :INPut:TELEcom:SPDH:RATE <discrete>

(SDH) :INPut:TELEcom:SDH:RATE <discrete>

(SONet) :INPut:TELEcom:SONet:RATE <discrete>

(OPT1) :INPut:TELEcom:OPT1:RATE <discrete>

(OC3) :INPut:TELEcom:OC3:RATE <discrete>

Common Commands

SENSe subsystem - Receiver Common Commands

(OPT4) :INPut:TELEcom:OPT4:RATE <discrete>

(OC12) :INPut:TELEcom:OC12:RATE <discrete>

(OPT16) :INPut:TELEcom:OPT16:RATE <discrete>

(OC48) :INPut:TELEcom:OC48:RATE <discrete>

The corresponding query returns the selected input port in discrete form, as listed above.

:SENSe:DATA:TELEcom:SENSe?

Returns : <discrete>

:SENSe:DATA:TELEcom:TEST <boolean>

<boolean> =	0 or OFF	Stop the current test
	1 or ON	Start a new test

Start/Stop the test as **RUN/STOP**.

The corresponding query returns the test state as 0 or 1.

:SENSe:DATA:TELEcom:TEST?

Returns : <boolean>

:SENSe:DATA:TELEcom:TFUNction <discrete>

<discrete>=	NONE	
	SDH	
	SONet	
	SDISruption	Service Disruption

Sets the Receiver test function.

The corresponding query returns the receiver test function in discrete form as listed above.

Common Commands

SENSe subsystem - Receiver Common Commands

:SENSe:DATA:TELEcom:TFUNction?

Returns: <discrete>

SENSe subsystem - Test Timing

SENSe subsystem - Test Timing

:SENSe:DATA:TELeCom:TEST:TYPE <discrete>

<discrete> =	MANual	Manual Test period
	SINGle	Single Test period
	TIMed	Timed Start Test period

Selects the type of test period. If SING or TIM is selected, the duration is set using :SENS:DATA:TEL:TEST:PER. If TIM is selected, the start time is selected using :SENS:DATA:TEL:TEST:STAR.

The corresponding query returns the type of test period in discrete form, as listed above.

:SENSe:DATA:TELeCom:TEST:TYPE?

Returns : <discrete>

:SENSe:DATA:TELeCom:TEST:PERiod <numeric> <suffix>

<numeric> =	1 to 99	
<suffix> =	d	Days
	h	Hours
	m	Minutes
	s	Seconds

Sets the duration of the test period. Is only valid when :SENS:DATA:TEL:TEST:TYPE SING or TIM is selected.

The corresponding query returns the test duration.

:SENSe:DATA:TELeCom:TEST:PERiod?

Returns : <numeric> <suffix>

Common Commands

SENSe subsystem - Test Timing

:SENSe:DATA:TELEcom:TEST:STARt <numeric>,<numeric>,<numeric>,<numeric>, <numeric>

<numeric> =	1970 to 2069	Year
<numeric> =	1 to 12	Month
<numeric> =	1 to 31	Day
<numeric> =	0 to 23	Hour
<numeric> =	0 to 59	Minute

Sets the test period start time when :SENS:DATA:TEL:TEST:TYPE <TIM> is selected.

The corresponding query returns the test period start time in numeric form.

:SENSe:DATA:TELEcom:TEST:STARt?

Returns <numeric>,<numeric>,<numeric>,<numeric>,<numeric>

:SENSe:DATA:TELEcom:STERm:PERiod <numeric> <suffix>

<numeric> =	1 to 100	
<suffix> =	s	Seconds

Sets the short term results calculation period.

The corresponding query returns the short term results period.

:SENSe:DATA:TELEcom:STERm:PERiod?

Returns : <numeric> <suffix>

SENSe subsystem - Analysis Control

SENSe subsystem - Analysis Control

:SENSe:DATA:TELEcom:TEST:SUSPend <boolean>

<boolean> = 0 or OFF G821 Analysis
 1 or ON Suspend test during Signal Loss

Sets the state of Analysis Control.

The corresponding query returns the state of Analysis Control as 0 or 1.

:SENSe:DATA:TELEcom:TEST:SUSPend?

Returns : <boolean>

SENSE subsystem - Result Returning Commands

SENSE subsystem - Result Returning Commands

Common Results

:SENSE:DATA? <string>

<string> =	"ETIME"	Returns the elapsed Time
	"ASEConds:PLOSS"	Power loss
	"ASEConds:PSL"	Pattern Sync Loss

NOTE

It is recommended that for Pattern Sync Loss this result is used in preference to the SDH/SONET, SPDH, ATM and POS pattern Sync Loss results, as this removes any dependency on Rx Payload selection.

<string> =	"ECOut:BIT"	Cumulative Bit error count
	"ERATio:BIT"	Cumulative Bit error ratio
	"ECOut:STERm:BIT"	Short Term Bit error count
	"ERATio:STERm:BIT"	Short Term Bit error ratio
	"ESEConds:BIT:ANALysis"	G.821 Error Seconds
	"PESEConds:BIT:ANALysis"	G.821 % Error Seconds (Annex D)
	"EFSEConds:BIT:ANALysis"	G.821 Error Free Seconds
	"PEFSEConds:BIT:ANALysis"	G.821 % Error Free Seconds
	"SESEConds:BIT:ANALysis"	G.821 Severely Errored Sec- onds
	"PSESEConds:BIT:ANALysis"	G.821 % Severely Errored Seconds

Common Commands

SENSe subsystem - Result Returning Commands

"UASeconds:BIT:ANALysis"	G.821 Unavailable Seconds
PUASeconds:BIT:ANALysis"	G.821 % Unavailable Seconds
"DMINutes:BIT:ANALysis"	G.821 Degraded Minutes
"PDMinutes:BIT:ANALysis"	G.821 % Degraded Minutes

SENSe subsystem - Trouble Scan Results

SENSe subsystem - Trouble Scan Results

:SENSe:DATA:TELEcom:TSCan:TYPE?

Returns:	<discrete>	NTR	No Trouble
		ADET	Alarms Detected
		ERR	Errors Detected

Returns the Trouble Scan state.

:SENSe:DATA:TELEcom:TSCan:ERRors?

Returns:	<numeric>,<result>	
<numeric> =	0 to 4	Number of Troublescan error messages
<discrete> =	See Table below	Error name and number of errors

Returns the number of active Trouble Scan error messages. If no error messages are active, returns 0. If error message is active, returns the type of error and the error count separated by a comma e.g

2
FAS140 ERR, 6
BIT ERROR, 1

This indicates that 2 trouble scan error messages are active and 6 140 Mb/s frame errors and 1 bit error have occurred.

Common Commands

SENSe subsystem - Trouble Scan Results

Trouble Scan Results and Priority

SDH	RS B1 BIP MS B2 BIP PATH B3 BIP TCM ERR TU BIP A1A2 FRAME MS-REI HP-REI TCM PATH IEC TCM OEI TCM REI LP REI BIT
SONET	CV-S (B1) CV-L (B2) CV-P (B3) CV-V (V5) A1A2 FRAME (DSn near-end errors except BIT) REI-L REI-P REI-V BIT (DSn far-end errors)
SPDH	CRC BIT CODE FAS 140M FAS 34M FAS 8M FAS 2M REBE EM-BIP FEBE
ATM	Corrected HEC Non-corrected HEC Lost cells Misinserted cells Errored cells Non-conforming cells BIT PLCP BIP

Common System Commands

SENSe subsystem - Configuring Graphics,
SENSe subsystem - Managing Graphics Stores,
SENSe subsystem - Retrieving Graphics Store Data,
SENSe subsystem - Retrieving Data for a Single Graph,
SENSe subsystem -Obtaining Graphics End of Measurement Results,
STATus Subsystem,
SYSTem Subsystem,
IEEE common capabilities

SENSe subsystem - Configuring Stored Measurements and Graphics

:SENSe:DATA:TELEcom:SMG <discrete>

<discrete> =	OFF	Storage Off
	ON or T1Second	1 Second resolution
	T1Minute	1 Minute resolution
	T15Minute	15 Minute resolution
	T1Hour	1 Hour resolution

Sets the resolution of the stored measurements and graphics (SMG).

The corresponding query returns the SMG resolution in discrete form.

:SENSe:DATA:TELEcom:SMG?

Returns: <discrete>

:SENSe:DATA:TELEcom:SMG:RESolution <discrete>

<discrete> =	COMPRESS	Storage capacity 20,000 Events
	FULL	Storage capacity 10,000 Events

Sets the resolution of the graphics storage.

The corresponding query returns the storage resolution in discrete form.

:SENSe:DATA:TELEcom:SMG:RESolution?

Returns: <discrete>

:SENSe:DATA:TELEcom:SMG:STORe <discrete>

<discrete> =	INTernal	Graphics store location
	DISK	Disk storage

Selects the storage location for the stored measurements and graphics (SMG).

Common Commands

SENSe subsystem - Configuring Stored Measurements and Graphics

The corresponding query returns the storage location in discrete form.

:SENSe:DATA:TELEcom:SMG:STORe?

Returns: <discrete>

SENSe subsystem - Managing Graphics Stores

SENSe subsystem - Managing Graphics Stores

:SENSe:DATA:TELEcom:SMG:CATalog?

Requests a catalogue of the SMG store data. A record, as described, is produced for each SMG store being used.

Returns: <record-1>
<record-2>
|
<record-10>
EOI

<record-n> = <numeric>,<numeric>,<numeric>,<numeric>,<numeric>,
<numeric>,<numeric>,<numeric>,<numeric>

<numeric> =	-9 to 0	Graphics Store Location
<numeric> =	1	Unused
<numeric> =	1970 to 2069	Year
<numeric> =	1 to 12	Month
<numeric> =	1 to 31	Day
<numeric> =	0 to 23	Hour
<numeric> =	0 to 59	Minute
<numeric> =	1 to 20000	Number of samples in use
<numeric> =	1, 60, 900 or 3600	Sample period in seconds

Common Commands

SENSe subsystem - Managing Graphics Stores

:SENSe:DATA:TELEcom:SMG:SIZE?

Requests the capacity of the graphics store and the number of store locations in use. The store size is a constant for a given instrument.

Returns: <numeric>,<numeric>

<numeric> =	702000	Store size
<numeric> =	0 to 702000	Stores used

:SENSe:DATA:TELEcom:SMG:DELeTe <numeric>

<numeric> =	-9 to 0	Graphics Store Location
-------------	---------	-------------------------

Deletes the given store.

:SENSe:DATA:TELEcom:SMG:DELeTe:ALL

Deletes all stores.

:SENSe:DATA:TELEcom:SMG:SINFormation? <numeric>

<numeric> =	-9 to 0	Graphics Store Location
-------------	---------	-------------------------

This command returns details of the specified SMG store.

Returns: <numeric>,<discrete>,<special>,<numeric>

<numeric> =	1, 60, 900 or 3600	Sample period in seconds
<discrete> =	COMP	Compressed format
	UNCOMP	Full resolution
<special>	00:00:00 1-JAN-1970 to 23:59:59 31-DEC-2069	Start time and date
<numeric>	1 to 86400000	Seconds since start of test

SENSe subsystem - Retrieving Graphics Store Data

The data used to construct all the graphs within a given store location can be extracted from the instrument and processed by a PC. The following glossary is applicable to the commands within the following sections.

graph element: The stored graphics application presents two selectable graph elements for viewing on the display. These elements are either histograms or alarm bar graphs.

histogram : A graph element used to represent discrete counts, such as errors, versus real time. On the instrument graph display, the horizontal axis represents real time and the vertical axis represents counts obtained within that real time period.

alarm bar graph : A graph element used to represent the presence of up to eight time based events, such as alarm seconds, versus real time. On the instrument graph display, the horizontal axis represents real time and the vertical axis represents the occurrence of event(s) within that real time period.

graph label : Each graph element (histogram or alarm bar graph) is identified by a label.

alarm label : Each alarm bar graph has up to eight individual alarms/events with their own individual labels.

graph number: The ordinal value of a graph element. The total number 'n' and order being determined from the command:

:SENSe:DATA:TELEcom:SMG:LABels? <numeric>.

:SENSe:DATA:TELEcom:SMG:LABels? <numeric>

<numeric> =	-9 to 0	Graphics Store Location
	-10	Disk Storage

Returns all possible graph labels from the given SMG store even if some of those graph elements are not applicable to the particular instrument configuration at the time the measurement was made. The numerical order of the returned labels is termed the graph number and starts from '0'. This is used in some commands which make reference to specific graph elements by graph number.

Common Commands

SENSe subsystem - Retrieving Graphics Store Data

Do not rely upon the order or the total number of these labels from one version of the instrument to the next.

Returns: <numeric> {,<string> {,<string> {...}}}

<numeric> Number of strings to follow.

<string> Graph label string.

:SENSe:DATA:TELEcom:SMG:HDATa:NORMAL? <numeric>

<numeric> =	-9 to 0	Graphics Store Location
	-10	Disk Storage

Returns a series of numerics (histogram data) and 8 bit binary strings (alarm bar graph data), separated by commas. All results are returned even if some of those graph elements are not applicable to the particular instrument configuration at the time the measurement was made.

One complete record is returned for each SMG measurement sample in the selected store location. The ordinal position of the data within this record corresponds to the order of the graph labels obtained from :SENSe:DATA:TELEcom:SMG:LABeLs? <numeric> :

Returns:	<record-1>	Data from sample period-1
	<record-2>	Data from sample period-2
	<record-n>	Data from final sample period
	EOI	End of data indicator.

<record> = <numeric|string> {,<numeric|string> {,<numeric|string> {...}}}

Where each data point in the record is one of :

<numeric> Histogram data value for sample period

<string> Alarm bar data value for sample period.

Non-zero alarm bar graph data, e.g. "01000000", indicates that an alarm or event has occurred within the sample period.

Common Commands

SENSe subsystem - Retrieving Graphics Store Data

:SENSe:DATA:TELEcom:SMG:HDATa:PACKed? <numeric>

<numeric> =	-9 to 0	Graphics Store Location
	-10	Disk Storage

Returns a series of numerics (number of unchanged samples and histogram data) and 8 bit binary strings (alarm bar graph data), separated by commas. All results are returned even if some of those graph elements are not applicable to the particular instrument configuration at the time the measurement was made.

One complete record is returned for each SMG measurement sample in the selected store location unless the data in consecutive samples is the same. In that case only one record is returned and the first numeric value in each record indicates the number of SMG measurement samples in which the data was unchanged. The ordinal position of the data within this record corresponds to the order of the graph labels obtained from :SENSe:DATA:TELEcom:SMG:LABels? <numeric> :

Returns:	<numeric>,<record-1>	Data from first group of <numeric> sample periods.
	<numeric>,<record-2>	Data from second group of <numeric> sample periods.
	<numeric>,<record-n>	Data from final group of <numeric> sample periods.
	EOI	End of data indicator.

<record> =

<numeric or string> {,<numeric or string> {,<numeric or string> {...}}}

Where each data point in the record is one of :

<numeric>	Histogram data value for sample period
<string>	Alarm bar data value for sample period.

Non-zero alarm bar graph data, e.g. "01000000", indicates that an alarm or event has occurred within the sample period.

Common Commands

SENSe subsystem - Retrieving Graphics Store Data

:SENSe:DATA:TELEcom:SMG:ALABels? <numeric>,<numeric>

<numeric> =	-9 to 0	Graphics Store Location
	-10	Disk Storage
<numeric> =	0 to n	Graph number

Requests the alarm labels from the selected SMG store and graph number.

Do not rely upon the order or the total number of these labels from one version of the instrument to the next.

Returns: <numeric> {,<string> {,<string> {...}}}

<numeric> Number of strings to follow.

<string> Alarm label string.

SENSe subsystem - Retrieving Data for a Single Graph Element

SENSe subsystem - Retrieving Data for a Single Graph Element

The data associated with each individual graph element may be obtained using one of the following commands:

:SENSe:DATA:TELEcom:SMG:EDATa? <numeric>,<numeric>

<numeric> =	-9 to 0	Graphics Store Location
	-10	Disk Storage
<numeric> =	0 to n	Graph number

Returns the number of data points that contributed to the graph element, followed by pairs of data points which include the elapsed time since the start of the measurement and either the histogram count or binary weighted alarm data value at that elapsed time.

Returns:

<numeric> {,<numeric>,<numeric> {,<numeric>,<numeric> {...}}}

<numeric> =	0 to 20,000	Number of events to follow
{ <numeric> =	1 to 86,400,000	Seconds since start of test
<numeric> } =	0 to n	Histogram count or binary weighted alarm value

Common Commands

SENSe subsystem - Retrieving Data for a Single Graph Element

:SENSe:DATA:TELEcom:SMG:VDATA? <numeric>,<numeric>

<numeric> =	-9 to 0	Graphics Store Location
	-10	Disk Storage
<numeric> =	0 to n	Graph number

Returns the number of data points that contributed to the graph element, followed by pairs of data points which include the elapsed time since the start of the measurement absolute to January 1 1970, and either the histogram count or binary weighted alarm data value at that elapsed time.

NOTE

PCs calculate time based on January 1st 1970.

Returns:

<numeric> {,<numeric>,<numeric> {,<numeric>,<numeric> {...}}}

<numeric> =	0 to 20,000	Number of data point pairs to follow
{ <numeric> =	1 to 2,147,483,647	Seconds since January 1 st 1970
<numeric> } =	0 to n	Histogram count or binary weighted alarm value

:SENSe:DATA:TELEcom:SMG:TINFormation? <numeric>,<numeric>

<numeric> =	-9 to 0	Graphics Store Location
	-10	Disk Storage
<numeric> =	0 to n	Graph number

Returns, for the graph element corresponding to the passed graph number, the validity, the number of samples and the type of graph element.

Returns:	<boolean> =	0	Graph element not valid.
		1	Graph element valid.
	<numeric> =	0 to 20000	Number of samples.
	<discrete> =	ALAR	Alarm bar graph element.
		HIST	Histogram graph element.

SENSe subsystem -Obtaining Graphics End of Measurement Results

:SENSe:DATA:TELEcom:SMG:DATA? <numeric>,<string>

<numeric> =	-9 to 0	Graphics Store Location
	-10	Disk Storage
<string> =	"ASEConds:PLOSs"	Power Loss seconds
	"ECOut:SPDH:BIT"	SPDH bit error count
	"ECOut:SPDH:CODE"	SPDH code error count
	"ECOut:SPDH:EMBip"	SPDH EM-BIP error count
	"ECOut:SPDH:REI"	SPDH REI error count
	"ECOut:SPDH:M2:FAS"	SPDH 2 Mb/s FAS error count
	"ECOut:SPDH:M8:FAS"	SPDH 8 Mb/s FAS error count
	"ECOut:SPDH:M34:FAS"	SPDH 34 Mb/s FAS error count
	"ECOut:SPDH:M140:FAS"	SPDH 140 Mb/s FAS error count
	"ECOut:SPDH:PBITS"	SPDH P Parity error count
	"ECOut:SPDH:CPBits"	SPDH CP Parity error count
	"ECOut:SPDH:DS3:FAS"	SPDH DS3 FAS error count
	"ECOut:SPDH:DS1:FAS"	SPDH DS1 FAS error count
	"ECOut:SPDH:CRC"	SPDH CRC6 error count
	"ECOut:SPDH:REBE"	SPDH FAS REBE error count
	"ECOut:SPDH:FEBE"	DS3 FEBE error count
	"ERATio:SPDH:BIT"	SPDH bit error ratio
	"ERATio:SPDH:CODE"	SPDH code error ratio
	"ERATio:SPDH:EMBip"	SPDH EM-BIP error ratio
	"ERATio:SPDH:REI"	SPDH REI error ratio
	"ERATio:SPDH:M2:FAS"	SPDH 2 Mb/s FAS error ratio

Common Commands

SENSe subsystem -Obtaining Graphics End of Measurement Results

"ERATio:SPDH:M8:FAS"	SPDH 8 Mb/s FAS error ratio
"ERATio:SPDH:M34:FAS"	SPDH 34 Mb/s FAS error ratio
"ERATio:SPDH:M140:FAS"	SPDH 140 Mb/s FAS error ratio
"ERATio:SPDH:PBITs"	SPDH P Parity error ratio
"ERATio:SPDH:CPBits"	SPDH CP Parity error ratio
"ERATio:SPDH:DS3:FAS"	SPDH DS3 FAS error ratio
"ERATio:SPDH:DS1:FAS"	SPDH DS1 FAS error ratio
"ERATio:SPDH:CRC"	SPDH CRC error ratio
"ERATio:SPDH:REBE"	SPDH REBE error ratio
"ERATio:SPDH:FEBE"	DS3 FEBE error ratio
"ASECnds:SPDH:LOS"	Loss of Signal seconds
"ASECnds:SPDH:M2:LOF"	Loss of frame seconds 2 Mb/s
"ASECnds:SPDH:M8:LOF"	Loss of frame seconds 8 Mb/s
"ASECnds:SPDH:M34:LOF"	Loss of frame seconds 34 Mb/s
"ASECnds:SPDH:M140:LOF"	Loss of frame seconds 140 Mb/s
"ASECnds:SPDH:DS1:OOF"	Out of frame seconds DS1
"ASECnds:SPDH:DS3:OOF"	Out of frame seconds DS3
"ASECnds:SPDH:DS3:EXZ"	DS3 Excess zeros
"ASECnds:SPDH:DS1:EXZ"	DS1 Excess zeros
"ASECnds:SPDH:DS3:IDLE"	DS3 Idle
"ASECnds:SPDH:MFM"	M' frame loss seconds
"ASECnds:SPDH:AIS"	AIS seconds
"ASECnds:SPDH:RAI"	Remote loss seconds
"ASECnds:SPDH:RDI"	Remote defect indication seconds
"ASECnds:SPDH:RMFR"	Remote m' frame loss seconds
"ASECnds:SPDH:PSL"	Pattern sync loss seconds
"TR1:SPDH:TRANsmit:ANALysis:M2120"	15 minute TX threshold report
"TR1:SPDH:RECeive:ANALysis:M2120"	15 minute RX threshold report

Common Commands

SENSe subsystem -Obtaining Graphics End of Measurement Results

"TR2:SPDH:TRANsmit:ANALysis:M2120"	24 hour TX threshold report
"TR2:SPDH:RECeive:ANALysis:M2120"	24 hour RX threshold report
"ECOunt:SDH:FRAMe"	SDH Frame error count
"ECOunt:SDH:RSBip"	B1 RS BIP error count
"ECOunt:SDH:MSBip"	MS B2 BIP error count
"ECOunt:SDH:MFEBe" or "ECOunt:SDH:MSRei"	MS FEBE/MS REI error count
"ECOunt:SDH:PBIP"	Path B3 BIP error count
"ECOunt:SDH:FEBE" or "ECOunt:SDH:REI"	Path FEBE/HP-REI error count
"ECOunt:SDH:TRIB:FEBE" or "ECOunt:SDH:TRIB:REI"	TU FEBE/LP-REI error count
"ECOunt:SDH:TRIB:PBIP"	TU path BIP error count
"ECOunt:SDH:TCM:PIEC"	TCM Path IEC error count
"ECOunt:SDH:TCM:REI"	TCM REI error count
"ECOunt:SDH:TCM:OEI"	TCM OEI error count
"ECOunt:SDH:TCM:ERR"	TCM Error error count
"ERATio:SDH:FRAMe"	SDH Frame error ratio
"ERATio:SDH:RSBip"	B1 RS BIP error ratio
"ERATio:SDH:MSBip"	MS B2 BIP error ratio
"ERATio:SDH:MFEBe" or "ERATio:SDH:MSRei"	MS FEBE/RS-REI error ratio
"ERATio:SDH:PBIP"	Path B3 BIP error ratio
"ERATio:SDH:FEBE" or "ERATio:SDH:REI"	Path FEBE/HP-REI error ratio
"ERATio:SDH:TRIB:FEBE" or "ERATio:SDH:TRIB:REI"	TU FEBE/LP-REI error ratio
"ERATio:SDH:TRIB:PBIP"	TU path BIP error ratio
"ERATio:SDH:TCM:PIEC"	TCM Path IEC error ratio

Common Commands

SENSe subsystem -Obtaining Graphics End of Measurement Results

"ERATio:SDH:TCM:REI"	TCM REI error ratio
"ERATio:SDH:TCM:OEI"	TCM OEI error ratio
"ERATio:SDH:TCM:ERR"	TCM Error error ratio
"PACTivity:SDH:NDFSeconds"	AU Pointer NDF seconds
"PACTivity:SDH:MNDFseconds"	AU Pointer MNDF seconds
"PACTivity:SDH:PCOunt"	AU Pointer +ve Adj Count
"PACTivity:SDH:NCOunt"	AU Pointer -ve Adj Count
"PACTivity:SDH:TRIButary:NDFSeconds"	TU Pointer NDF seconds
"PACTivity:SDH:TRIButary:MNDFseconds"	TU Pointer MNDF seconds
"PACTivity:SDH:TRIButary:PCOunt"	TU Pointer +ve Adj Count
"PACTivity:SDH:TRIButary:NCOunt"	TU Pointer -ve Adj Count
"ASEConds:SDH:LOS"	Loss of signal seconds
"ASEConds:SDH:LOF"	Loss of frame seconds
"ASEConds:SDH:OOF"	Out of frame seconds
"ASEConds:SDH:H4MF"	H4 multiframe loss seconds
"ASEConds:SDH:LOP"	Loss of pointer seconds
"ASEConds:SDH:MSAis"	MS AIS seconds
"ASEConds:SDH:PAIS"	Path AIS seconds
"ASEConds:SDH:PSLoss"	Pattern Sync Loss seconds
"ASEConds:SDH:MSFerf" or "ASEConds:SDH:MSRDi"	MS FERF/MS-RDI seconds
"ASEConds:SDH:K1K2"	K1K2 change seconds
"ASEConds:SDH:PFERf" or "ASEConds:SDH:RDI"	STM Path FERF/HP-RDI seconds
"ASEConds:SDH:TRIB:LOP"	TU Loss of pointer seconds
"ASEConds:SDH:TRIB:PAIS"	TU Path AIS seconds
"ASEConds:SDH:TRIB:PFERf" or "ASEConds:SDH:TRIB:RDI"	TU Path FERF/LP-RDI seconds
"ASEConds:SDH:TRIB:P1P0"	P1P0 Frame Synchronization Loss

Common Commands

SENSe subsystem -Obtaining Graphics End of Measurement Results

"ASECond:SDH:TCM:LOM"	TCM Loss of Multiframe seconds
"ASECond:SDH:TCM:IAIS"	TCM Incoming AIS seconds
"ASECond:SDH:TCM:RDI"	TCM Remote Defect Indication seconds
"ASECond:SDH:TCM:ODI"	TCM Outgoing Defect Indication seconds
"ECOunt:SONet:FRAMe"	SONET Frame error count
"ECOunt:SONet:CVS"	CV-S (Section B1 BIP) error count
"ECOunt:SONet:CVL"	CV-L (Section B2 BIP) error count
"ECOunt:SONet:REIL"	REI-L (Line FEBE) error count
"ECOunt:SONet:CVP"	CV-P (Path B3 BIP) error count
"ECOunt:SONet:REIP"	REI-P (Path FEBE) error count
"ECOunt:SONet:TRIB:REIV"	REI-V (VT FEBE) error count
"ECOunt:SONet:TRIB:CVV"	CV-V (VT path BIP) error count
"ERATio:SONet:FRAMe"	SONET Frame error ratio
"ERATio:SONet:CVS"	CV-S (Section B1 BIP) error ratio
"ERATio:SONet:CVL"	CV-L (Line B2 BIP) error ratio
"ERATio:SONet:REIL"	REI-L (Line FEBE) error ratio
"ERATio:SONet:CVP"	CV-P (Path B3 BIP) error ratio
"ERATio:SONet:REIP"	REI-P (Path FEBE) error ratio
"ERATio:SONet:TRIB:REIV"	REI-V (VT FEBE) error ratio
"ERATio:SONet:TRIB:CVV"	CV-V (VT path BIP) error ratio
"PACTivity:SONet:NDFSeconds"	SPE Pointer NDF seconds
"PACTivity:SONet:MNDFseconds"	SPE Pointer MNDF seconds
"PACTivity:SONet:PCOunt"	SPE Pointer +ve Adj Count
"PACTivity:SONet:NCOunt"	SPE Pointer -ve Adj Count
"PACTivity:SONet:TRIButary:NDFSeconds"	VT Pointer NDF seconds
"PACTivity:SONet:TRIButary:MNDFseconds"	VT Pointer MNDF seconds
"PACTivity:SONet:TRIButary:PCOunt"	VT Pointer +ve Adj Count

Common Commands

SENSe subsystem -Obtaining Graphics End of Measurement Results

"PACTivity:SONet:TRIButary:NCOunt"	VT Pointer -ve Adj Count
"ASECnds:SONet:LOS"	Loss of signal seconds
"ASECnds:SONet:LOF"	Loss of frame seconds
"ASECnds:SONet:SEF"	Severely Errored Frame Defect seconds
"ASECnds:SONet:H4MF"	H4 multiframe loss seconds
"ASECnds:SONet:LOPP"	LOP-P (Loss of pointer) seconds
"ASECnds:SONet:AISL"	AIS-L (Line AIS) seconds
"ASECnds:SONet:AISP"	AIS-P (Path AIS) seconds
"ASECnds:SONet:PSLoss"	Pattern Sync Loss seconds
"ASECnds:SONet:RDIL"	RDI-L (Line FERF) seconds
"ASECnds:SONet:K1K2"	K1K2 change seconds
"ASECnds:SONet:RDIP"	RDI-P (Path FERF) seconds
"ASECnds:SONet:TRIB:LOPV"	LOP-V (VT Loss of pointer) seconds
"ASECnds:SONet:TRIB:AISV"	AIS-V (VT Path AIS) seconds
"ASECnds:SONet:TRIB:RDIV"	RDI-V (VT Path FERF) seconds
"ASECnds:SONet:TRIB:P1P0"	P1P0 Frame Synchronization Loss
"ECOunt:ATM:CHEC"	Corrected HEC count
"ECOunt:ATM:NCHeC"	Non Corrected HEC count
"ECOunt:ATM:ECeLI"	Errored cell count
"ECOunt:ATM:LCeLI"	Cell loss count
"ECOunt:ATM:MCeLI"	Misinserted cell count
"ECOunt:ATM:NCCeLl"	Non-conforming Cell count
"ECOunt:ATM:BIT"	Bit error count
"ECOunt:ATM:PLCP:BIP"	PLCP BIP error count
"ERATio:ATM:CHEC"	Corrected HEC ratio
"ERATio:ATM:NCHeC"	Non Corrected HEC ratio
"ERATio:ATM:ECeLI"	Errored cell ratio

Common Commands

SENSe subsystem -Obtaining Graphics End of Measurement Results

"ERATio:ATM:LCELI"	Cell loss ratio
"ERATio:ATM:MCELI"	Misinserted cell ratio
"ERATio:ATM:NCCell"	Non-conforming Cell ratio
"ERATio:ATM:BIT"	Bit error ratio
"ERATio:ATM:PLCP:BIP"	PLCP BIP error ratio
"ASECnds:ATM:LCD"	Loss of Cell Delineation seconds
"ASECnds:ATM:SCNReceived"	Selected cell not received seconds
"ASECnds:ATM:VPAis"	Virtual Path AIS second
"ASECnds:ATM:VPRDi"	Virtual Path RDI seconds
"ASECnds:ATM:VPLoc"	Virtual Path Loss of continuity seconds
"ASECnds:ATM:CEXPerienced"	Congestion experienced seconds
"ASECnds:ATM:VCAis"	Virtual Channel AIS seconds
"ASECnds:ATM:VCRDi"	Virtual Channel RDI seconds
"ASECnds:ATM:VGLoc"	Virtual Channel Loss of continuity seconds
"ASECnds:ATM:TCLoss"	Test Cell Loss seconds
"ASECnds:ATM:PSLoss"	Pattern Sync Loss seconds
"ASECnds:ATM:PLCP:OOF"	PLCP out of frame seconds
"ASECnds:ATM:PLCP:RAI"	PLCP RAI seconds
"ECOunt:IPOS:FCS"	HDLC FCS error count
"ECOunt:IPOS:IPHeader"	IP Header error count
"ECOunt:IPOS:BIT"	BIT error count
"ERATio:IPOS:FCS"	HDLC FCS error ratio
"ERATio:IPOS:IPHeader"	IP Header error ratio
"ERATio:IPOS:BIT"	BIT error ratio
"ASECnds:IPOS:LNKLoss"	HDLC Link Loss
"ASECnds:IPOS:IPNReceived"	IP Not Received

Common Commands

STATus subsystem

"ASEConds:IPOS:PSLoss"	Pattern Loss
"COUNT:JITT:HITS"	Jitter Hit count
"SLIPs:JITT:WANDer:FRAMe"	estimated frame slips
"SLIPs:JITT:WANDer:BIT"	estimated bit slips

STATus subsystem

This subsystem controls the status reporting registers. SCPI defined status registers QUEStionable, OPERation and INSTRument are provided. In addition instrument defined status registers DATA, SPDH, SDH, SDH2, SDH3, SON, SON2, SON3, JITT and ATM are provided. For detailed information on status reporting refer to Section 7 of this manual.

:STATus:CHIStory

Clear the contents of all History registers, and the front panel led history.

:STATus:PRESet

Sets all Status registers to the default state.

Common Commands

STATUS subsystem

For each of the <Status Registers>'s listed in Table 10-1 (excluding the Standard Event Register) the following commands exist:

:STATUS:<Status Register>:ENABLE <numeric>

Sets the Event Enable register mask which allows true conditions in the Event register to be reported in the <Status Register>'s summary bit. If a bit is 1 in the Event Enable register and its associated event bit makes the transition to true, a positive transition will occur in the <Status Register>'s summary bit.

The corresponding query returns the current mask setting.

:STATUS:<Status Register>:ENABLE?

Returns : <numeric>

:STATUS:<Status Register>:PTRANSITION <numeric>

Sets the positive Transition Filter. Setting a bit in the positive Transition filter shall cause a 0 to 1 transition in the corresponding bit of the <Status Register>'s Condition register to cause a 1 to be written in the corresponding bit of the <Status Register>'s Event register.

The corresponding query returns the current setting.

:STATUS:<Status Register>:PTRANSITION?

Returns : <numeric>

:STATUS:<Status Register>:NTRANSITION <numeric>

Sets the negative Transition filter. Setting a bit in the negative Transition Filter shall cause a 1 to 0 transition in the corresponding bit of the <Status Register>'s Condition register to cause a 1 to be written in the corresponding bit of the <Status Register>'s Event register.

The corresponding query returns the current setting.

:STATUS:<Status Register>:NTRANSITION?

Returns : <numeric>

:STATUS:<Status Register>:EVENT?

Returns : <numeric>

SYSTEM Subsystem

SYSTEM Subsystem

:SYSTEM:WINDow<type>

Selects the display type, Single or Multiple. Selection of SINGLE results in faster remote operation.

<type> =	SINGLE	Selects single window display
	MULTiple	Selects multiple window display

The corresponding query returns the display type.

:SYSTEM:WINDow?

Returns : <type>

:SYSTEM:DATE <year>,<month>,<day>

<year> =	<numeric>	1970 to 2069
<month> =	<numeric>	1 to 12
<day> =	<numeric>	1 to 31

Sets the date within the OTHER TIME & DATE function.

The corresponding query returns the date in numeric form.

:SYSTEM:DATE?

Returns : <year>,<month>,<day>

:SYSTEM:TIME <hour>,<minute>,<second>

<hour> =	<numeric>	0 to 23
<minute> =	<numeric>	0 to 59
<second> =	<numeric>	0 to 59

Sets the time within the OTHER TIME & DATE function.

Common Commands

SYSTem Subsystem

The corresponding query returns the time in numeric form.

:SYSTem:TIME?

Returns : <hour>,<minute>,<second>

:SYSTem:TRIGger <trig_source>

Where <trig_source> = NONE
 TXFRame
 RXFRame
 RSBip
 MSBip
 PBIP

:SYSTem:KLOCK <boolean>

<boolean> = 0 or OFF Keyboard unlocked
 1 or ON Keyboard locked

Selects the state of the OTHER KEYBOARD LOCK function.

The corresponding query returns the state of KEYBOARD LOCK as 0 or 1.

:SYSTem:KLOCK?

Returns : <boolean>

:SYSTem:LOCAL

Set the OmniBER 718 to Local (keyboard) control.

:SYSTem:REMOte

Set the OmniBER 718 to Remote control.

:SYSTem:PRESet

Sets the instrument to the same state as the front panel reset key (power). This command is similar to *RST but differs in that it duplicates the action of the front panel power on/off key.

Common Commands

SYSTEM Subsystem

:SYSTEM:SERial?

The serial number is returned as a string in the form "GBnnnnnnnn". GB signifies the country of origin (Great Britain).

:SYSTEM:CONF <block>

<block> = #0 type Block

Sets the OmniBER 718 to the state defined by the Block data.

The corresponding query returns the instrument state in block form.

:SYSTEM:CONF?

Returns : #0<block>

:SYSTEM:VERSion?

Requests the revision state of the SCPI remote control.

The revision state is returned in the form YYYY.V. YYYY signifies the year and V signifies the revision number.

Returns : <version> = YYYY.V

:SYSTEM:ERRor?

Requests the OmniBER 718 remote control Error status.

The error status is returned as a numeric value and a string containing a description of the error.

Returns : <numeric>,<string>

:SYSTEM:PRINt

The current results are logged to the selected printer.

:SYSTEM:PRINt:AUTO <boolean>

<boolean> = 0 or OFF
1 or ON

Common Commands

SYSTEM Subsystem

Determines whether the selected results are logged to the selected logging device. If OFF is selected results can only be logged using :SYSTEM:PRINT. If ON is selected further selection of :SYSTEM:PRINT:PERiod <period> is required.

The corresponding query returns the logging state as 0 or 1.

:SYSTEM:PRINT:AUTO?

Returns : <boolean>

:SYSTEM:PRINT:PERiod <period>

<period> =	OFF	Log at end of test
	MIN10	Log at 10 minute intervals
	HR1	Log at 1 hour intervals
	HR24	Log at 24 hour intervals
	USER	User defined Logging interval

Determines the interval at which the results are logged to the selected logging device. If anything other than OFF is selected further selection of :SYSTEM:PRINT:RESults <type> is required. If USER is selected further selection of :SYSTEM:PRINT:UPERiod <numeric>, <discrete> is required.

The corresponding query returns the logging interval in discrete form, as listed above.

:SYSTEM:PRINT:PERiod?

Returns : <period>

:SYSTEM:PRINT:UPERiod <numeric>, <discrete>

<numeric> =	1 to 99	
<discrete> =	HR	Hours (1 - 99)
	MIN	Minutes (10 - 99)

Sets the USER defined logging period in the range 10 to 99 minutes or 1 to 99 hours.

The corresponding query returns the User defined period in numeric, discrete form, as listed above.

Common Commands

SYSTEM Subsystem

:SYSTEM:PRINT:UPERiod?

Returns : <numeric>,<discrete>

:SYSTEM:PRINT:RESults <type>

<type> =	ALL	Print All results
	SElect	Print selected results

Determines which results are logged to the selected logging device. If SEL is selected further selections of :SYSTEM:PRINT:CONTent <content> , :SYSTEM:PRINT:WHEN <select> and :SYSTEM:PRINT:SPAN <content> are required.

The corresponding query returns the logged results selection in discrete form, as listed above.

:SYSTEM:PRINT:RESults?

Returns : <type>

:SYSTEM:PRINT:CONTent <content>

<content> =	ERATio	Error Ratio results
	ANALysis	Analysis results
	BOTH	Error Ratio & Analysis results

In conjunction with :SYSTEM:PRINT:SPAN <content> determines the type of selected results to be logged to the selected logging device. Please note that this command is retained for backward compatibility reasons only. It is recommended that the individual :SYSTEM:PRINT:CONTent:<TYPE> <boolean> commands are used in order to select which results are logged.

The corresponding query returns the result content in discrete form, as listed above.

:SYSTEM:PRINT:CONTent?

Returns :	<content>=	ERATio	Error Ratio results
		ANALysis	Analysis results
		BOTH	Error Ratio & Analysis results

Common Commands

SYSTEM Subsystem

SElected Selected results

:SYSTEM:PRINT:CONTENT:ERRORs <boolean>

<boolean> = 0 or OFF

 1 or ON

Determines whether or not the Error Results are to be logged to the selected logging device.

The corresponding query returns the state of the boolean.

:SYSTEM:PRINT:CONTENT:ERRORs?

Returns : <boolean>

:SYSTEM:PRINT:CONTENT:JITTer <boolean>

<boolean> = 0 or OFF

 1 or ON

Determines whether or not the Jitter Results are to be logged to the selected logging device.

The corresponding query returns the state of the boolean.

:SYSTEM:PRINT:CONTENT:JITTer?

Returns : <boolean>

:SYSTEM:PRINT:CONTENT:G821 <boolean>

<boolean> = 0 or OFF

 1 or ON

Common Commands

SYSTEM Subsystem

Determines whether or not the G.821 Measurement Analysis Results are to be logged to the selected logging device.

The corresponding query returns the state of the boolean.

:SYSTEM:PRINT:CONTent:G821?

Returns : <boolean>

:SYSTEM:PRINT:CONTent:G826 <boolean>

<boolean> = 0 or OFF

1 or ON

Determines whether or not the G.826 Measurement Analysis Results are to be logged to the selected logging device.

The corresponding query returns the state of the boolean.

:SYSTEM:PRINT:CONTent:G826?

Returns : <boolean>

:SYSTEM:PRINT:CONTent:M2100 <boolean>

<boolean> = 0 or OFF

1 or ON

Determines whether or not the M.2100 Measurement Analysis Results are to be logged to the selected logging device.

The corresponding query returns the state of the boolean.

:SYSTEM:PRINT:CONTent:M2100?

Returns : <boolean>

Common Commands

SYSTEM Subsystem

:SYSTEM:PRINT:CONTent:M2101 <boolean>

<boolean> = 0 or OFF

1 or ON

Determines whether or not the M.2101 Measurement Analysis Results are to be logged to the selected logging device.

The corresponding query returns the state of the boolean.

:SYSTEM:PRINT:CONTent:M2101?

Returns : <boolean>

:SYSTEM:PRINT:CONTent:M2110 <boolean>

<boolean> = 0 or OFF

1 or ON

Determines whether or not the M.2110 Measurement Analysis Results are to be logged to the selected logging device.

The corresponding query returns the state of the boolean.

:SYSTEM:PRINT:CONTent:M2110?

Returns : <boolean>

:SYSTEM:PRINT:CONTent:M2120 <boolean>

<boolean> = 0 or OFF

1 or ON

Determines whether or not the M.2120 Measurement Analysis Results are to be logged to the selected logging device.

The corresponding query returns the state of the boolean.

Common Commands

SYSTEM Subsystem

:SYSTEM:PRINT:CONTENT:M2120?

Returns : <boolean>

:SYSTEM:PRINT:SPAN <content>

<content> =	PERiod	Period results
	CUMulative	Cumulative results
	BOTH	Period & Cumulative results

In conjunction with the :SYSTEM:PRINT:CONTENT:<TYPE> <boolean> commands determines the type of selected results to be logged to the selected logging device.

The corresponding query returns the result content in discrete form, as listed above.

:SYSTEM:PRINT:SPAN?

Returns : <content>

:SYSTEM:PRINT:WHEN <select>

<select> =	ALWays	Logged at specified interval
	ECOUNT	Logged if bit error count is > 0

Determines the conditions for logging results when :SYSTEM:PRINT:RESULTS <type> is set to <SEL>.

The corresponding query returns the logging conditions in discrete form, as listed above.

:SYSTEM:PRINT:WHEN?

Returns : <select>

:SYSTEM:PRINT:MODE <mode>

<mode> =	NORMAL	Normal print format
	COMPRESSED	Compressed print format

Only valid when RS232 or Parallel printer is selected. Determines the column width of the printed results.

Common Commands

SYSTem Subsystem

The corresponding query returns the print mode in discrete form, as listed above.

:SYSTem:PRINt:MODE?

Returns : <mode>

:SYSTem:SELFtest:WAVelength <discrete>

<discrete> =	NM1310	1310nm
	NM1550	1550nm

Selects the relevant optical output port to be used during selftest. Only valid for dual wavelength options (option 106).

The corresponding query returns the port selected in discrete form, as listed above

:SYSTem:PRINt:ESEConds <boolean>

<boolean> =	0 or OFF
	1 or ON

Determines whether occurrences of error seconds are logged on the selected logging device. The corresponding query returns the error second logging state as 0 or 1.

:SYSTem:PRINt:ESEConds?

Returns : <boolean>

:SYSTem:LOGGing:DEVice <type>

<type> =	INTernal	Internal printer (option 602)
	GPIB	GPIB external printer
	RS232	RS-232-C external printer
	DISK	Internal Disc Drive
	PARAllel	Centronics external printer

Selects the logging device for results logging.

The corresponding query returns the logging device selected in discrete form as listed above.

:SYSTem:LOGGing:DEVice?

Returns : <type>

Common Commands
SYSTEM Subsystem

:SYSTEM:PRINT:DEMAND <mode>

<mode> =	RESults	Print results snapshot
	OVERhead	Print overhead snapshot
	OCAPture	Print overhead capture results
	PGRaph	Print pointer graph
	TRIBscan	Print SDH/SONET tributary scan
	SDUMp	Copies the current display to the internal disc drive
	ALMScan	Print alarm scan information

Selects the Log on Demand item to be printed.

The corresponding query returns the log on demand item selected in discrete short form.

:SYSTEM:PRINT:DEMAND?

Returns: <mode>

:SYSTEM:PRINT:SDUMp:DESTination <destination>

Destination=	LID	Send screen dump information to in-lid printer
	DISK	Send screen dump information to floppy disk

Selects the destination of screen dump information.

The corresponding query returns the current selection

:SYSTEM:PRINT:SDUMp:COMPression <boolean>

<boolean> =	0 or OFF	Deselect compression of screen dump information
	1 or ON	Select compression of screen dump information

Common Commands

SYSTEM Subsystem

:SYSTEM:DISK:FORMat

Format a Disk.

:SYSTEM:DISK:LABel <string>

Label the disk with a string of up to 11 alphanumeric characters e.g. "SiteB 28/5"

The corresponding query returns the filename as a string.

:SYSTEM:DISK:LABel?

Returns : <string>

:SYSTEM:DISK:SAVE <extension>,<filename>,<overwrite>

<extension> =	CNF	Instrument Configuration
	SMG	Stored Measurement Graphics
	PRN	Data Logging

<filename> = Up to 8 Alphanumeric character string

<overwrite> =	0	If file exists will not overwrite
	1	Will overwrite automatically

Saves required information to disk. If PRN is selected further selection of :SYSTEM:DISK:SAVE:MODE <discrete> is required.

:SYSTEM:DISK:SAVE:MODE <discrete>

<discrete> =	APPend	Add to file
	OVERwrite	Overwrite existing file

Designates the position within the file to which the results are saved if the file type is PRN.

The corresponding query returns the save mode in discrete form as listed above.

:SYSTEM:DISK:SAVE:MODE?

Returns : <discrete>

Common Commands

SYSTEM Subsystem

:SYSTEM:DISK:RECall <extension>,<filename>,<confirm>

<extension> =	CNF	Instrument Configuration
	SMG	Stored Measurement Graphics

<filename> = Up to 8 Alphanumeric character string

<confirm> = 0 If Option structure is different from stored configuration will not recall.
1 Will recall stored configuration automatically.

Recalls stored measurement graphics or instrument configuration from Disk to instrument.

**:SYSTEM:DISK:FILE:COPY:CNF
<to>,<store>,<directory>,<filename>,<overwrite>**

<to> =	DISK	Copy to Disk
	MEMory	Copy to Instrument store
<store> =	1 to 4	Instrument store number

<directory> = Up to 256 Alphanumeric character string

<filename> = Up to 8 Alphanumeric character string

<overwrite> = 0 **Copying to Disk:** If file exists will not overwrite.
Copying to Instrument: If Option structure is different from stored configuration will not copy.
1 **Copying to Disk:** Will copy automatically.
Copying to Instrument: Will copy automatically.

Copy instrument configuration from Disk to instrument store or from instrument store to Disk. When TO = MEMory OVERWRITE must be 1.

Common Commands

SYSTem Subsystem

:SYSTem:DISK:FILE:COPIY:SMG:FORMat <type>

<type> =	NORMal	Normal SMG format
	CSV	Comma Separated Variable

Sets the format of the SMG data to be copied to Disk. This should be set before the :SYST:DISK:FILE:COPIY:SMG command is issued.

:SYSTem:DISK:FILE:COPIY:SMG:FORMat?

Returns : <discrete>

:SYSTem:DISK:FILE:COPIY:SMG <store>,<directory>,<filename>,<overwrite>

<store> =	-9 to 0	Instrument store number
<directory> =	Up to 256 Alphanumeric character string	
<filename> =	Up to 8 Alphanumeric character string	
<overwrite> =	0	If file exists will not overwrite
	1	Will overwrite automatically

Copy stored measurement graphics from instrument store to Disk. Set :SYSTem:DISK:FILE:COPIY:SMG:FORMat <type> to NORM or CSV before issuing this command.

:SYSTem:DISK:FILE:DELEte <filename>

<filename> = Up to 12 Alphanumeric character string including extension

:SYSTem:DISK:DIRectory:DELEte

Delete current directory.

:SYSTem:DISK:FILE:REName <from_filename>,<to_dir>,<filename>,<overwrite>

<from_filename> =	Up to 12 Alphanumeric character string including extension
<to_dir> =	Up to 256 Alphanumeric character string
<to_filename> =	Up to 12 Alphanumeric character string including extension

Common Commands

SYSTEM Subsystem

<overwrite> =	0	If file exists will not overwrite
	1	Will overwrite automatically

Rename file. Cannot rename directories.

:SYSTEM:DISK:DIRectory:CREate <filename>

<filename> Up to 8 Alphanumeric character string

Create a directory.

:SYSTEM:DISK:DIRectory? <extension>,<format>

<extension> =	ALL	List all files
	CNF	List only files with CNF extension
	SMG	List only files with SMG extension
	PRN	List only files with PRN extension
<format> =	SHORT	List file name only
	LONG	List file name, file size, date & time modified
	DESCRiption	list file name, file description

Returns directory list.

:SYSTEM:DISK:PWD?

Returns : <string>

Returns directory name.

:SYSTEM:DISK:FREE?

Returns : <numeric>

Returns free space on disk in bytes.

:SYSTEM:DISK:CD <string>

<directory> =	"dir_name"	Up to 8 alphanumeric characters
	".."	CD to parent directory

Common Commands

SYSTEM Subsystem

"\" CD to root directory

Change directory.

:SYSTEM:SSETting:LOCK <boolean>

<boolean> =	0 or OFF	Lock Off
	1 or ON	Lock On

Selects the state of OTHER Stored Settings lock.

The corresponding query returns the state of Stored Settings lock as 0 or 1.

:SYSTEM:SSETting:LOCK?

Returns : <boolean>

:SYSTEM:SSETting:LABel <numeric>,<string>

<numeric> =	1 to 4	Stored Setting number
<string> =	1 to 24 characters	Stored Settings store label

Titles the Store Setting location with the contents of the string.

The corresponding query returns the title of the selected Stored Setting location as a string.

:SYSTEM:SSETting:LABel? <numeric>

Returns : <string> 1 to 24 characters

:SYSTEM:BEEPPer:STATe <boolean>

<boolean> =	0 or OFF	Beep Off
	1 or ON	Beep On

Selects the state of the OTHER BEEP ON ERROR function.

The corresponding query returns the state of the BEEP ON ERROR function as 0 or 1.

Common Commands

SYSTEM Subsystem

:SYSTEM:BEEPper:STATe?

Returns :

<boolean>

Common Commands
IEEE common capabilities

IEEE common capabilities

***CLS**

Clear Status - Clears all status registers and the error queue.

***ESE <numeric>**

Event Status Enable - Sets the mask of the Event Status Register.

<numeric> =	1	Operation Complete
	2	Request Control
	4	Query Error
	8	Device Dependent Error
	16	Execution Error
	32	Command Error
	64	User Request
	128	Power On

***ESE?**

Event Status Enable Query - Returns the current mask setting.

***ESR?**

Event Status Register Query - Returns the state of the Event Status Register in numeric form.

***IDN?**

Identification Query - Returns the Manufacture Name, Model Number & Name, Serial Number, Firmware Revision Number as a string. For example:-

Instrument Revision Code A.04.70 to A.05.30. "HEWLETT-PACKARD, 37718 OMNIBER, GBnnnnnnnn, A.nn.nn"
GB signifies the country of origin (Great Britain).

Instrument Revision Code A.05.38 and above. "AGILENT TECHNOLOGIES, 37718A OMNIBER, GBnnnnnnnn, A.nn.nn"
GB signifies the country of origin (Great Britain). This string would be returned by an OmniBER 37718A, an OmniBER 37718C (for example) would return 37718C.

Common Commands

IEEE common capabilities

Please use the *OPT? command to determine options installed and the instrument Line Rate.

***LRN?**

Learn Query - Returns the instrument settings configuration in <#0 Block> form.

***OPC**

Operation Complete - Masks the OPC bit in the Event Status Register.

***OPC?**

Operation Complete Query - Returns a 1 when the OPC bit in the Event Status Register is set to 1 (true).

***OPT?**

Option Identification Query - Returns the Options fitted in the instrument as a comma separated list of option numbers. For example: B, 104, 200, 300 returned indicates that your instrument Line Rate is 622 Mb/s and that 1310 nm, BER Analysis, Jitter Generation and Measurement, and ATM are all fitted

Option/Plug-In Fitted	Returned Result
None	0
Test capability up to 2.5 Gb/s	A
Test capability up to 622 Mb/s	B
Test capability up to 155 Mb/s	C
SDH (ITU-T)	001
SONET/SDH (ANSI/ITU-T)	002
2.5 Gb/s, 1310 nm, BER analysis	104
2.5 Gb/s, 1550 nm, BER analysis	105
2.5 Gb/s, 1310/1550 nm, BER analysis	106
Jitter Generation and Measurement	200
ATM payloads	300
POS	310
Advanced Payload Engine	350

Common Commands
IEEE common capabilities

Option/Plug-In Fitted	Returned Result
RS-232-C, GP-IB and LAN remote control interfaces	601
80-column in-lid graphics printer	602

If more than one Option/Plug-In combination is fitted a complete list is returned with each list item separated by a comma.

***PSC <numeric>**

Sets the value of the Power On Status Clear flag. Controls the automatic clearing of SRQ Enable register, Standard ESR & Parallel Poll Enable register after power on. See IEE 488.2 Section 10.25.

***PSC?**

Returns the status of the PSC flag.

***RCL <numeric>**

Recall Stored Settings - Sets the instrument to a set of previously stored settings. Numeric is in the range 0 to 4 and determines which set of stored settings is recalled.

***RST**

Set the instrument to the Default settings listed.

***SAV <numeric>**

Save Stored Settings - Stores the current instrument settings. Numeric is in the range 1 to 4 and determines the store location.

***SRE <numeric>**

Service Request Enable - Sets the status byte mask.

<numeric> =	8	QUES Status Summary
	16	Message Available
	32	Event Status Summary
	64	Request Service
	128	OPER Status Summary

Common Commands
IEEE common capabilities

***SRE?**

Service Request Enable Query - Returns the current mask setting in numeric form.

***STB?**

Status Byte Query - Returns the value of the status byte in numeric form.

***TRG**

Trigger - Not implemented on OmniBER 718 .

***TRG?**

Trigger Query - Not implemented on OmniBER 718 .

***WAI**

Wait To Continue - Not implemented on the OmniBER 718.

***TST**

Initiate Self Test

***TST?**

Self Test Query

PDH/DSn SCPI Command Reference

OUTPut subsystem, see page 4- 3.

SOURce subsystem - Transmitter Structured PDH Commands, see page 4- 7.

SOURce subsystem - Transmitter SPDH Test Signal Settings Commands, see page 4- 20.

SOURce subsystem - Transmitter SPDH Test Function Commands, see page 4- 29.

INPut subsystem, see page 4-47.

SENSe subsystem - Receiver Structured PDH Settings, see page 4-51.

SENSe subsystem - Receiver SPDH Test Signal Settings Commands, see page 4- 54.

SENSe subsystem - Receiver SPDH Test Function Commands, see page 4- 60.

SENSe subsystem - Analysis Control, see page 4- 61.

SENSe subsystem - Alarm Scan Control, see page 4-66.

SENSe subsystem - SPDH Round Trip Delay Control, see page 4- 67.

SENSe subsystem - Result Returning Commands, see page 4-70.

FETCh subsystem, see page 4- 89.

PDH/DSn Command Reference

PDH/DSn Command Reference

This chapter contains detailed information on the SCPI (Standard Commands for Programming Instruments) and IEEE 488.2 common commands you will use when writing programs to control your OmniBER 718 for PDH/DSn operation.

Please also refer to chapter 2 Common Commands for general information on SCPI command formats and for a list of commands that are common to PDH/DSn, SDH, SONET, ATM, or Jitter operation; they are as follows:

SCPI Command Format

Remote Control Commands

Instrument Options

INSTRument subsystem

SOURce subsystem

SOURce subsystem - Transmitter Common Commands

INPut subsystem

SENSE subsystem

SENSE subsystem - Receiver Common Commands

SENSE subsystem - Test Timing

SENSE subsystem - Analysis Control

SENSE subsystem - Trouble Scan Results

SENSE subsystem - Configuring Graphics,

SENSE subsystem - Managing Graphics Stores

SENSE subsystem - Retrieving Graphics Store Data

SENSE subsystem - Retrieving Data for a Single Graph

SENSE subsystem - Obtaining Graphics End of Measurement Results

STATus Subsystem

SYSTem Subsystem

IEEE common capabilities

OUTPut subsystem

OUTPut subsystem

This subsystem controls the characteristics of the instrument's output ports.

:OUTPut:TELEcom:SPDH:RATE <discrete>

<discrete>	M140	140Mb/s
	M34	34Mb/s
	M8	8Mb/s
	M2	2Mb/s
	DS1	1.544 Mb/s
	DS3	44.736 Mb/s

Sets the output rate for the PDH electrical output port. This command is only valid when :SOURce:DATA:TELEcom:SOURce <discrete> is set to PDH .

The corresponding query returns the Structured PDH rate in discrete form as listed above.

:OUTPut:TELEcom:SPDH:RATE?

Returns : <discrete>

:OUTPut:TELEcom:SPDH:CODE <discrete>

<discrete> =	AMI	8 Mb/s, 2 Mb/s, DS1
	HDB3	34 Mb/s, 8 Mb/s, 2 Mb/s
	CMI	140 Mb/s only
	B3ZS	DS3
	B8ZS	DS1

Selects the Structured PDH interface line code for the transmitter.

The corresponding query returns the Structured PDH code in discrete form as listed above.

OUTPut subsystem

:OUTPut:TELEcom:SPDH:CODE?

Returns : <discrete>

:OUTPut:TELEcom:SPDH:DROP:CODE <discrete>

<discrete> =	AMI	2Mb/s, DS1
	HDB3	2Mb/s only
	B8ZS	DS1 only

Selects the Structured PDH drop port interface line code for the receiver.
The corresponding query returns the line code in discrete form as listed above.

:OUTPut:TELEcom:SPDH:DROP:CODE?

Returns: <discrete>

:OUTPut:TELEcom:SPDH:LEVel <discrete>

<discrete> =	DSX	
	HIGH	DS3 only
	FT900	
	LOW	DS1 only

Sets the DS3/DS1 output level. The corresponding query command returns the current setting.

:OUTPut:TELEcom:SPDH:LEVel?

Returns <discrete>

:OUTPut:TELEcom:SPDH:BALance <discrete>

<discrete> =	UNBalanced	75Ω Unbalanced
	BALanced	120Ω Balanced

OUTPut subsystem

Selects the Structured PDH transmitter termination level. 120 Ω Balanced is only allowed when :OUTPut:TELEcom:SPDH:RATE <discrete> is set to M2 .

The corresponding query returns the Structured PDH level in discrete form as listed above.

:OUTPut:TELEcom:SPDH:BALance?

Returns : <discrete>

:OUTPut:TELEcom:SPDH:STATe <boolean>

<boolean> = 0 or OFF
1 or ON

Disable or enable the transmitter output, equivalent to generating or disabling Loss Of Signal. Disabling the output is only permitted when :SOURce:DATA:TELEcom:TFUNction <discrete> is set to PDH or PDHPayload, and :SOURce:DATA:TELEcom:SPDH:TFUNction:TYPE <discrete> is set to ERRor.

The corresponding query command returns the current state of the output.

NOTE

Issuing command :OUTPut:TELEcom:SPDH:STATe <boolean> has the effect of disabling any active SPDH alarm. Similarly, issuing any SPDH alarm command, for example, :SOURce:DATA:TELEcom:SPDH:M140:ALARm <discrete> has the effect of automatically enabling the transmitter output.

:OUTPut:TELEcom:SPDH:STATe?

Returns: <boolean>

SOURce subsystem -Transmitter Structured PDH Commands

SOURce subsystem -Transmitter Structured PDH Commands

:SOURce:CLOCK:SPDH:SOURce <discrete>

<discrete> =	INTernal	Internal Clock
	EXTernal	External MTS Clock/Data
	RSTM0 or RSTS1	52Mb/s Electrical Rx
	ROPT0 or ROC1	52Mb/s Optical Rx
	RMON0 or RMN1	52Mb/s Monitor Rx
	RSTM1 or RSTS3	155Mb/s Electrical Rx
	ROPT1 or ROC3	155Mb/s Optical Rx
	RMON1 or RMN3	155Mb/s Monitor Rx
	ROPT4 or ROC12	622Mb/s Optical Rx
	RMON4 or RMN12	622Mb/s Monitor Rx
	ROPT16 or ROC48	2.4Gb/s Optical Rx
	RM140	140Mb/s Rx
	RM34	34Mb/s Rx
	RM8	8Mb/s Rx
	RM2	2Mb/s Rx
	RDS3	DS3 Rx
	RDS1	DS1 Rx

Selects the clock source for the Structured PDH transmitter.

When EXTernal is selected as the clock source, a further selection is required using :SOURce:CLOCK:SPDH:FORMat <discrete> in order to specify from where the External Reference is to be derived.

The corresponding query returns the Structured PDH clock source in discrete form as listed above.

SOURce subsystem -Transmitter Structured PDH Commands

:SOURce:CLOCK:SPDH:SOURce?

Returns : <discrete>

:SOURce:CLOCK:SPDH:FORMat <discrete>

<discrete> =	CLOCK	Clock Format
	DATA	Data Format
	K64	64 kb/s data
	DS1Bits	DS1 bit rate
	M10Ref	10 MHz Reference

Sets the format of the SPDH external timing reference signal. This command is only valid when :SOURce:CLOCK:SPDH:SOURce <discrete> is EXTERNAL.

The corresponding query returns the SDH external timing reference format in discrete form as listed above.

:SOURce:CLOCK:SPDH:FORMat?

Returns : <discrete>

:SOURce:CLOCK:SPDH:M2:FOFFset <discrete>

<discrete> =	NONE	Off
	PMAX	CCITT max +50 ppm
	NMAX	CCITT max -50 ppm
	USER	± 100 ppm

Selects the Structured PDH transmitter 2.048 MHz clock offset type. If USER is selected, the amount of offset is set using

:SOURce:CLOCK:SPDH:M2:FOFFset:OFFSet <numeric>.

The corresponding query returns the Structured PDH 2.048 MHz clock offset type in discrete form as listed above.

SOURce subsystem -Transmitter Structured PDH Commands

:SOURce:CLOCK:SPDH:M2:FOFFset?

Returns : <discrete>

:SOURce:CLOCK:SPDH:M2:FOFFset:OFFSet <numeric>

<numeric> = -100 to +100 parts per million

Sets the USER frequency offset for the Structured PDH transmitter 2.048 MHz clock if :SOURce:CLOCK:SPDH:M2:FOFFset <discrete> is set to USER is selected.

The corresponding query returns the USER 2.048 MHz clock offset in parts per million.

:SOURce:CLOCK:SPDH:M2:FOFFset:OFFSet?

Returns : <numeric>

:SOURce:CLOCK:SPDH:M8:FOFFset <discrete>

<discrete> =	NONE	Off
	PMAX	CCITT maximum +30 ppm
	NMAX	CCITT maximum -30 ppm
	USER	± 100 ppm

Selects the Structured PDH transmitter 8.448 MHz clock offset type. If USER is selected, the amount of offset is set using

:SOURce:CLOCK:SPDH:M8:FOFFset:OFFSet <numeric>.

The corresponding query returns the Structured PDH 8.448 MHz clock offset type in discrete form as listed above.

:SOURce:CLOCK:SPDH:M8:FOFFset?

Returns : <discrete>

:SOURce:CLOCK:SPDH:M8:FOFFset:OFFSet <numeric>

<numeric> = -100 to +100 parts per million

SOURce subsystem -Transmitter Structured PDH Commands

Sets the USER frequency offset for the Structured PDH transmitter 8.448 MHz clock if :SOURce:CLOCK:SPDH:M8:FOFFset <discrete> is set to USER.

The corresponding query returns the USER 8.448 MHz clock offset in parts per million.

:SOURce:CLOCK:SPDH:M8:FOFFset:OFFSet?

Returns : <numeric>

:SOURce:CLOCK:SPDH:M34:FOFFset <discrete>

<discrete> =	NONE	Off
	PMAX	CCITT max +20 ppm; DS3
	NMAX	CCITT max -20 ppm; DS3
	USER	± 100 ppm

Selects the Structured PDH transmitter 34.368 MHz clock offset type. If USER is selected, the amount of offset is set using

:SOURce:CLOCK:SPDH:M34:FOFFset:OFFSet <numeric>.

The corresponding query returns the Structured PDH 34.368 MHz clock offset type in discrete form as listed above.

:SOURce:CLOCK:SPDH:M34:FOFFset?

Returns : <discrete>

:SOURce:CLOCK:SPDH:M34:FOFFset:OFFSet <numeric>

<numeric> = -100 to +100 parts per million

Sets the USER frequency offset for the Structured PDH transmitter 34.368 MHz clock if :SOURce:CLOCK:SPDH:M34:FOFFset <discrete> is set to USER .

The corresponding query returns the USER 34.368 MHz clock offset in parts per million.

:SOURce:CLOCK:SPDH:M34:FOFFset:OFFSet?

Returns : <numeric>

SOURce subsystem -Transmitter Structured PDH Commands

:SOURce:DATA:TELEcom:SPDH:M34:TTRace:PATtern_<discrete>

<discrete> =	TEST	(serial number)
	USER	User Defined

Selects the type of Trail Trace string to be transmitted. TEST contains the instrument’s serial number with added CRC7 byte. USER allows user selection of a message containing 15 ASCII characters with added CRC7 byte (calculated by instrument).

The corresponding query returns the type of trail trace in discrete form as listed above

:SOURce:DATA:TELEcom:SPDH:M34:TTRace:PATtern?

Returns: <discrete>

:SOURce:DATA:TELEcom:SPDH:M34:TTRace:PATtern:USER <string>

Sets the user defined pattern that is to be transmitted in the Trail Trace string. The string can be up to 15 ASCII characters in length. If less than 15 characters are input the instrument will pad with the required number of NULL characters. If the string contains any non printing characters ~ is substituted.

The corresponding query returns the type of trail trace as a string.

:SOURce:DATA:TELEcom:SPDH:M34:TTRace:PATtern:USER?

Returns: <string>

:SOURce:DATA:TELEcom:SPDH:M34:TTRace:PATtern:USER:HEXadecimal?

Returns: <block>

Returns a 15 byte block of data. Each byte represents the hexadecimal value of an ASCII character “00” to “FF”. The 15 hexadecimal numbers are preceded by the header “#125”.

SOURce subsystem -Transmitter Structured PDH Commands

:SOURce:CLOCK:SPDH:M140:FOFFset <discrete>

<discrete> =	NONE	Off
	PMAX	CCITT maximum +15 ppm
	NMAX	CCITT maximum -15 ppm
	USER	± 100 ppm

Selects the Structured PDH transmitter 139.264 MHz clock offset type. If USER is selected, the amount of offset is set using :SOURce:CLOCK:SPDH:M140:FOFFset:OFFSet <numeric>.

The corresponding query returns the Structured PDH 139.264 MHz clock offset type in discrete form as listed above.

:SOURce:CLOCK:SPDH:M140:FOFFset?

Returns : <discrete>

:SOURce:CLOCK:SPDH:M140:FOFFset:OFFSet <numeric>

<numeric> = -100 to +100 parts per million

Sets the USER frequency offset for the Structured PDH transmitter 139.264 MHz clock if :SOUR:CLOC:SPDH:M140:FOFF <discrete> is set to USER.

The corresponding query returns the USER 139.264 MHz clock offset in parts per million.

:SOURce:CLOCK:SPDH:M140:FOFFset:OFFSet?

Returns : <numeric>

:SOURce:CLOCK:SPDH:DS3:FOFFset <discrete>

<discrete> =	NONE	Off
	PMAX	ANSI maximum +20 ppm
	NMAX	ANSI maximum - 20 ppm
	USER	± 100 ppm

SOURce subsystem -Transmitter Structured PDH Commands

:SOURce:CLOCK:SPDH:DS1:FOFFset:OFFSet <numeric>

<numeric> = -100 to +100 parts per million

Sets the USER frequency offset for the Structured PDH transmitter DS1 clock if :SOURce:CLOCK:SPDH:DS1:FOFFset <discrete> is set to USER.

The corresponding query returns the USER DS1 clock offset in parts per million.

:SOURce:CLOCK:SPDH:DS1:FOFFset:OFFSet?

Returns : <numeric>

DS1/DS3 PDH Thru mode settings

:SOURce:DATA:TELEcom:SPDH:THRumode <discrete>

<discrete> =	INTernal	Select Normal SDH Mode
	THRu	Select DS1/DS3 PDH Thru Mode

Selects/Deselects DS1/DS3 PDH THRU mode.

The corresponding query returns the THRu mode state in discrete form as listed above.

:SOURce:DATA:TELEcom:SPDH:THRumode?

Returns : <discrete>

:SOURce:DATA:TELEcom:SPDH:THRumode:ERRor:RATE <discrete>

<discrete> =	NONE	Errors off
	E_3	1E-3 Error rate
	E_4	1E-4 Error rate
	E_5	1E-5 Error rate
	E_6	1E-6 Error rate
	E_7	1E-7 Error rate

SOURce subsystem -Transmitter Structured PDH Commands

USER	User error rate
ONCE	Add single error

Sets the DS1/DS3 PDH Thru Mode Entire Frame Error Add rate. ONCE will add a single error if the current rate is NONE. This command is applicable when :SOURce:DATA:TELEcom:SPDH:THRumode <discrete> is set to THRU. Setting a preset rate will also force the user rate to be the same value.

Associated commands:

:SOURce:DATA:TELEcom:SPDH:THRumode:ERRor:RATE:USER <numeric>

The corresponding query returns the error add rate in discrete form. Note that if this query returns USER, then :SOUR:DATA:TEL:SPDH:THR:ERR:RATE:USER? must be used to discover the currently injected error rate.

:SOURce:DATA:TELEcom:SPDH:THRumode:ERRor:RATE?

Returns : <discrete>

:SOURce:DATA:TELEcom:SPDH:THRumode:ERRor:RATE:USER <numeric>

<numeric> 1.1E-3 to 1.0E-9 mantissa resolution 0.1, exponent resolution 1

Sets the user defined DS1/DS3 PDH Thru Mode Entire Frame Error Add rate. Note that if :SOURce:DATA:TELEcom:SPDH:THRumode:ERRor:RATE <discrete> is not already set to USER, then this command will automatically set it to USER.

Associated commands:

:SOURce:DATA:TELEcom:SPDH:THRumode:ERRor:RATE <discrete>

The corresponding query returns the user defined SPDH Error Add rate in numeric form.

:SOURce:DATA:TELEcom:SPDH:THRumode:ERRor:RATE:USER?

Returns: <numeric>

SOURce subsystem -Transmitter Structured PDH Commands

:SOURce:DATA:TELEcom:SPDH:PATtern <discrete>

<discrete> =	PRBS9	$2^9 - 1$
	PRBS11	$2^{11} - 1$
	PRBS15	$2^{15} - 1$
	PRBS20	$2^{20} - 1$
	QRSS	$2^{20} - 1$ with 14 zero limit (DS1 only)
	PRBS23	$2^{23} - 1$
	AZERo	All zeros
	AONE	All ones
	STRes	3-in-24 stress pattern (DS1 only)
	P1010	word 1010
	P1IN8	1-in-8 test pattern
	P2IN8	2-in-8 test pattern
	OCT55	55 octet test pattern (uses Daly pattern as per ANSI T1.403)
	P1000	word 1000
	UWORD	16 bit user word

Selects the Structured PDH transmitter data pattern. If UWORD is selected the word is set using :SOURce:DATA:TELEcom:SPDH:UWORD <string>.

The corresponding query returns the data pattern in discrete form as listed above.

:SOURce:DATA:TELEcom:SPDH:PATtern?

Returns : <discrete>

:SOURce:DATA:TELEcom:SPDH:UWORD <string>

Sets the Structured PDH transmitter user word pattern in the range "000000000000000" to "1111111111111111".

SOURce subsystem -Transmitter Structured PDH Commands

The corresponding query returns the user word pattern as a string as listed above.

:SOURce:DATA:TELEcom:SPDH:UWORD?

Returns : <string>

:SOURce:DATA:TELEcom:SPDH:PRBS:POLarity <discrete>

<discrete> =	INVerted	CCITT conformity
	NORMal	Non CCITT

Sets the polarity of the PRBS pattern of the Structured PDH transmitter.

The corresponding query returns the polarity in discrete form as listed above.

:SOURce:DATA:TELEcom:SPDH:PRBS:POLarity?

Returns: <discrete>

:SOURce:DATA:TELEcom:SPDH:PAYLoad:TYPE <discrete>

<discrete> =	UNFRamed	No Framing
	FRAMed	8, 34 and 140Mb/s
	G832	34Mb/s only
	PCM30	2Mb/s only
	PCM31	2Mb/s only
	PCM30CRC	2Mb/s only
	PCM31CRC	2Mb/s only
	D4	DS1 only
	ESF	DS1 only
	SLC96	DS1 only
	M13	DS3 only
	CBIT	DS3 only

SOURce subsystem -Transmitter Structured PDH Commands

Selects the Structured PDH transmitter interface rate framing.

Note that this command is not backwards compatible. To set the payload to be structured, use the command

:SOURce:DATA:TELEcom:SPDH:PAYLoad:STRucture <discrete>

The corresponding query returns the framing in discrete form as listed above.

:SOURce:DATA:TELEcom:SPDH:PAYLoad:TYPE?

Returns: <discrete>

:SOURce:DATA:TELEcom:SPDH:PAYLoad:STRucture <discrete>

<discrete> =	UNSTructured	All rates
	STRuctured	All framed formats
	ATM	Valid only for :- DS3 CBIT 34M G.832 2M PCM30/ PCM30CRC DS1 ESF

Selects whether or not the PDH signal is to have any further structure or not.

The corresponding query returns the type in discrete form as listed above.

:SOURce:DATA:TELEcom:SPDH:PAYLoad:STRucture?

Returns: <discrete>

:SOURce:DATA:TELEcom:SPDH:TSLot:SIGNaling:DATA:M2 <string>

<string> = 4 bit string

Selects the signaling bits for 2Mb/s CAS framing to be transmitted.

The corresponding query returns the signaling bits selected as a 4 bit binary string.

SOURce subsystem -Transmitter Structured PDH Commands

:SOURce:DATA:TELEcom:SPDH:TSLot:SIGNaling:DATA:M2?

Returns: <string>

**SOURce subsystem - Transmitter SPDH Test Signal Settings
Commands**

K64 or K64XN: determines whether the 64 kb/s timeslot(s) are mapped into a 2 Mb/s or DS1 signal within a structured DS3 signal.

The corresponding query returns the test signal mapping in discrete form as listed above.

:SOURce:DATA:TELEcom:SPDH:TSIGnal:MAPPing?

Returns : <discrete>

:SOURce:DATA:TELEcom:SPDH:TSIGnal:PAYLoad <discrete>

<discrete> =	UNFRamed	2, 8 & 34 Mb/s
	FRAMed	8 & 34 Mb/s
	PCM30	2 Mb/s & 64 kb/s
	PCM31	2 Mb/s & 64 kb/s
	PCM30CRC	2 Mb/s & 64 kb/s
	PCM31CRC	2 Mb/s & 64 kb/s
	IM2	2 Mb/s
	D4	DS1
	ESF	DS1
	SLC96	DS1
	IDS1	Insert DS1

Selects the Structured PDH transmitter test signal framing.

The corresponding query returns the framing in discrete form as listed above.

:SOURce:DATA:TELEcom:SPDH:TSIGnal:PAYLoad?

Returns : <discrete>

**SOURce subsystem - Transmitter SPDH Test Signal Settings
Commands**

:SOURce:DATA:TELEcom:SPDH:TSIGnal:TRIButary:M34 <discrete>

<discrete> = TRIB1
 TRIB2
 TRIB3
 TRIB4

Selects the Structured PDH transmitter 34 Mb/s tributary test signal.

The corresponding query returns the 34 Mb/s tributary test signal in discrete form.

:SOURce:DATA:TELEcom:SPDH:TSIGnal:TRIButary:M34?

Returns : <discrete>

:SOURce:DATA:TELEcom:SPDH:TSIGnal:TRIButary:M8 <discrete>

<discrete> = TRIB1
 TRIB2
 TRIB3
 TRIB4

Selects the Structured PDH transmitter 8 Mb/s tributary test signal.

The corresponding query returns the 8 Mb/s tributary test signal in discrete form.

:SOURce:DATA:TELEcom:SPDH:TSIGnal:TRIButary:M8?

Returns : <discrete>

:SOURce:DATA:TELEcom:SPDH:TSIGnal:TRIButary:M2 <discrete>

<discrete> = TRIB1
 TRIB2
 TRIB3
 TRIB4

**SOURce subsystem - Transmitter SPDH Test Signal Settings
Commands**

Selects the Structured PDH transmitter 2 Mb/s tributary test signal.

The corresponding query returns the 2 Mb/s tributary test signal in discrete form.

:SOURce:DATA:TELEcom:SPDH:TSIGnal:TRIButary:M2?

Returns : <discrete>

:SOURce:DATA:TELEcom:SPDH:TSIGnal:TRIButary:DS1 <discrete>

<discrete> = TRIB1
 TRIB2
 TRIB3
 TRIB4

Selects the Structured PDH transmitter DS1 tributary test signal. The corresponding query returns the tributary in discrete form as listed above.

:SOURce:DATA:TELEcom:SPDH:TSIGnal:TRIButary:DS1?

Returns: <discrete>

:SOURce:DATA:TELEcom:SPDH:TSIGnal:TRIButary:DS2 <discrete>

<discrete> = TRIB1
 TRIB2
 TRIB3
 TRIB4
 TRIB5
 TRIB6
 TRIB7

Selects the Structured PDH transmitter DS2 tributary test signal.

SOURce subsystem - Transmitter SPDH Test Signal Settings Commands

The corresponding query returns the tributary in discrete form as listed above.

:SOURce:DATA:TELEcom:SPDH:TSIGnal:TRIButary:DS2?

Returns: <discrete>

:SOURce:DATA:TELEcom:SPDH:TSIGnal:TSLot:DS1:K56 <numeric>

<numeric> 1 to 24 Any framing

Selects the PDH transmitter 56kb/s timeslot.

The corresponding query returns the 56kb/s timeslot in numeric form.

:SOURce:DATA:TELEcom:SPDH:TSIGnal:TSLot:DS1:K56?

Returns: <numeric>

:SOURce:DATA:TELEcom:SPDH:TSIGnal:TSLot:DS1:K64 <numeric>

<numeric> 1 to 24 Any framing

Selects the PDH transmitter 56kb/s timeslot.

The corresponding query returns the 56kb/s timeslot in numeric form.

:SOURce:DATA:TELEcom:SPDH:TSIGnal:TSLot:DS1:K64?

Returns: <numeric>

:SOURce:DATA:TELEcom:SPDH:TSIGnal:TSLot:M2:K64 <numeric>

<numeric> 1 to 31 PCM31 & PCM31CRC
1 to 15 & 17 PCM30 & PCM30CRC
to 31

PDH Command Reference

**SOURce subsystem - Transmitter SPDH Test Signal Settings
Commands**

Selects the PDH transmitter 64kb/s timeslot.

The corresponding query returns the 64kb/s timeslot in numeric form.

:SOURce:DATA:TELEcom:SPDH:TSIGnal:TSLot:M2:K64?

Returns: <numeric>

:SOURce:DATA:TELEcom:SPDH:TSIGnal:TSLot:M2:K64XN <string>

<string> = 31 bit string

Selects the 64XN kb/s timeslots of the 2mb/s test signal. a "1" in the nth position signifies selection of timeslot n. A "0" signifies deselection. E.g. to select timeslots 1,8,15,22,29 "1000000100000010000001000000100".

The corresponding query returns the 64XNkb/s timeslot as a 31 bit binary string.

:SOURce:DATA:TELEcom:SPDH:TSIGnal:TSLot:M2:K64XN?

Returns: <string>

:SOURce:DATA:TELEcom:SPDH:TSIGnal:TSLot:DS1:K64XN <string>

<string> = 24 bit string

Selects the 64XN kb/s timeslots of the DS1 signal. a "1" in the nth position signifies selection of timeslot n. A "0" signifies deselection e.g. to select timeslots 1,8,15,22 "100000010000001000000100".

The corresponding query returns the 64XNkb/s timeslot as a 24 bit binary string.

:SOURce:DATA:TELEcom:SPDH:TSIGnal:TSLot:DS1:K64XN?

Returns: <string>

**SOURce subsystem - Transmitter SPDH Test Signal Settings
Commands**

:SOURce:DATA:TELEcom:SPDH:TSIGnal:TSLot:DS1:K56XN <string>

<string> = 24 bit string

Selects the 56XN kb/s timeslots. a "1" in the nth position signifies selection of timeslot n. A "0" signifies deselection e.g. to select timeslots 1,8,15,22 "100000010000001000000100".

The corresponding query returns the 56XNkb/s timeslot as a 24 bit binary string.

:SOURce:DATA:TELEcom:SPDH:TSIGnal:TSLot:DS1:K56XN?

Returns: <string>

:SOURce:DATA:TELEcom:SPDH:TSIGnal:BACKground <discrete>

<discrete> =	AIS	Alarm Indication Sequence
	PRBS9	2 ⁹ -1 PRBS
	AS_FG	As foreground pattern

Selects the pattern to fill the non test signal tributaries.

The corresponding query returns the background pattern type in discrete form as listed above.

:SOURce:DATA:TELEcom:SPDH:TSIGnal:BACKground?

Returns : <discrete>

:SOURce:DATA:TELEcom:SPDH:TSLot:SIGNaling:DATA:DS1:D4 <string>

<string> = 2 bit string

Selects the signaling bits for DS1 D4 framing to be transmitted.

The corresponding query returns the signaling bits selected as a 2 bit binary string.

**SOURce subsystem - Transmitter SPDH Test Signal Settings
Commands**

:SOURce:DATA:TELEcom:SPDH:TSLot:SIGNaling:DATA:DS1:D4?

Returns: <string>

**:SOURce:DATA:TELEcom:SPDH:TSLot:SIGNaling:DATA:DS1:ESF
<string>**

<string> = 4 bit binary string

Selects the signaling bits for DS1 ESF framing to be transmitted.

The corresponding query returns the signaling bits selected as a 4 bit binary string.

:SOURce:DATA:TELEcom:SPDH:TSLot:SIGNaling:DATA:DS1:ESF?

Returns: <string>

**:SOURce:DATA:TELEcom:SPDH:TSLot:SIGNaling:DATA:DS1:NOFBit
<string>**

<string> = 4 bit string

Selects the signaling bits for DS1 'No Frame Bit' framing to be transmitted. In this case, the framing bit position associated with the mapping will be set to '0'.

The corresponding query returns the signaling bits selected as a 4 bit binary string.

:SOURce:DATA:TELEcom:SPDH:TSLot:SIGNaling:DATA:DS1:NOFBit?

Returns: <string>

**:SOURce:DATA:TELEcom:SPDH:TSLot:SIGNaling:DATA:DS1:SLC96
<string>**

<string> = 2 character string comprising 'A',
'1' or '0'.

**SOURce subsystem - Transmitter SPDH Test Signal Settings
Commands**

Selects the signaling bits for DS1 SLC96 framing to be transmitted. To select 'alternating' for either bit use the character 'A'.

The corresponding query returns the signaling bits selected as a 2 character string.

:SOURce:DATA:TELEcom:SPDH:TSLot:SIGNaling:DATA:DS1:SLC96?

Returns: <string>

See also:

:SOURce:DATA:TELEcom:SPDH:PATtern <discrete>

:SOURce:DATA:TELEcom:SPDH:UWORD <string>

:SOURce:DATA:TELEcom:SPDH:PRBS:POLarity <discrete>

SOURCE subsystem - Transmitter SPDH Test Function Commands

See also common commands:

:SOURCE:DATA:TELEcom:TFUNCTION <discrete>

:SOURCE:DATA:TELEcom:TFUNCTION:SDISruption <boolean>

<boolean> = 0 or OFF
 1 or ON

Selects the Structured PDH transmitter special service disruption mode. This command is only valid if the test function is set to service disruption with **:SOURCE:DATA:TELEcom:TFUNCTION** <discrete>.

The corresponding query returns the special service disruption mode setting in boolean form as listed above.

:SOURCE:DATA:TELEcom:TFUNCTION:SDISruption?

Returns: <boolean>

:SOURCE:DATA:TELEcom:SPDH:TFUNCTION:TYPE <discrete>

<discrete> = ERROR Errors & Alarms
 SBITS Spare Bits

Sets the Structured PDH transmitter test function type.

The corresponding query returns the current Structured PDH test function type as listed above.

:SOURCE:DATA:TELEcom:SPDH:TFUNCTION:TYPE?

Returns: <discrete>

SOURce subsystem - Transmitter SPDH Test Function Commands

:SOURce:DATA:TELEcom:SPDH:ERRor:TYPE <discrete>

<discrete> =	BIT	Bit Errors
	CODE	Code Errors
	FAS	Frame Errors
	MFAS	MFAS Errors (DS3)
	FASmfas	Frame & MFAS Errors (DS3)
	CRC	CRC-4 for 2M, CRC-6 for DS1
	EXZ	Excess zeros (DSn)
	FEBE	FEBE Errors (DS3)
	REBE	REBE Errors
	PBITs	P bit Errors (DS3)
	CPBits	CP bit errors (DS3)
	EMBip	EM-BIP errors (34M G832)

Selects the Structured PDH transmitter error add type. Bit errors are injected at the test rate. FAS errors are injected at the line rate. The corresponding query returns the error add type in discrete form.

:SOURce:DATA:TELEcom:SPDH:ERRor:TYPE?

Returns : <discrete>

:SOURce:DATA:TELEcom:SPDH:ERRor:RATE <discrete>

<discrete> =	NONE	Errors off
	E_3	1E-3 Error rate
	E_4	1E-4 Error rate
	E_5	1E-5 Error rate
	E_6	1E-6 Error rate
	E_7	1E-7 Error rate

SOURce subsystem - Transmitter SPDH Test Function Commands

USER	User error rate
ONCE	Add single error

Sets the SPDH Error Add rate of the error type selected by :SOURce:DATA:TELEcom:SPDH:ERRor:TYPE <discrete> . ONCE will add a single error if the current rate is NONE. As ONCE is a transient case, the query form will return NONE.

This command is applicable when :SOURce:DATA:TELEcom:SPDH:TFUNction:TYPE <discrete> is set to PDH. Setting a preset rate will also force the user rate to be the same value.

Associated commands:

:SOURce:DATA:TELEcom:SPDH:ERRor:RATE:USER <numeric>

The corresponding query returns the error add rate in discrete form. Note that if this query returns USER, then :SOURce:DATA:TELEcom:SPDH:ERRor:RATE:USER? must be used to discover the currently injected error rate.

:SOURce:DATA:TELEcom:SPDH:ERRor:RATE?

Returns : <discrete>

:SOURce:DATA:TELEcom:SPDH:ERRor:RATE:USER <numeric>

<numeric> 0.1E-3 to 9.9E-9 mantissa resolution 0.1, exponent resolution 1

Sets the user defined SPDH Error Add rate. (Requires a SPDH module to be fitted). Note that if :SOURce:DATA:TELEcom:SPDH:ERRor:RATE <discrete> is not already set to USER, then this command will automatically set it to USER.

Associated commands:

:SOURce:DATA:TELEcom:SPDH:ERRor:RATE <discrete>

The corresponding query returns the user defined SPDH Error Add rate in numeric form.

SOURce subsystem - Transmitter SPDH Test Function Commands

:SOURce:DATA:TELEcom:SPDH:ERRor:RATE:USER?

Returns: <numeric>

:SOURce:DATA:TELEcom:SPDH:ERRor:FRAMe:NERRored <discrete>

<discrete> =	ONE	1 frame
	TWO	2 frames
	THRee	3 frames
	FOUR	4 frames
	FIVE	5 frames
	SIX	6 frames

Frame Error Add only. Selects the number of frames to be errored in the Structured PDH transmitter.

The corresponding query returns the number of frames errored in discrete form.

:SOURce:DATA:TELEcom:SPDH:ERRor:FRAMe:NERRored?

Returns : <discrete>

:SOURce:DATA:TELEcom:SPDH:ERRor:MFRame:NERRored <discrete>

<discrete> =	ONE	1 DS3 Multiframe errored
	TWO	2 DS3 Multiframes errored
	THRee	3 DS3 Multiframes errored
	FOUR	4 DS3 Multiframes errored
	FIVE	5 frames
	SIX	6 frames

Sets the number of DS3 multi-frames to error.

The corresponding query command returns the current setting.

SOURce subsystem - Transmitter SPDH Test Function Commands

:SOURce:DATA:TELEcom:SPDH:ERRor:MFRame:NERRored?

Returns : <discrete>

:SOURce:DATA:TELEcom:SPDH:ERRor:EXZ:NUMBer <numeric>

<numeric> = 3 to 16

Sets the number of DS3/DS1 excess zeros sent. The corresponding query command returns the current setting.

:SOURce:DATA:TELEcom:SPDH:ERRor:EXZ:NUMBer?

Returns : <numeric>

:SOURce:DATA:TELEcom:SPDH:FEAC <discrete>

<discrete> =	OFF	No Action
	ON	Alarm burst switched to continuous
	BURSt	Selected burst length transmitted

Sets the transmitter FEAC action. Only valid if :SENSe:DATA:TELEcom:TFUNction <discrete> is set to SPDH and :SOURce:DATA:TELEcom:SPDH:DS3:ALARm <discrete> is set to FEAC . If set to 'ON' then the alarm burst will be switched to continuous. If 'BURSt' then the alarm burst length set up will be transmitted. The corresponding query command returns the current setting.

:SOURce:DATA:TELEcom:SPDH:FEAC?

Returns <discrete>

:SOURce:DATA:TELEcom:SPDH:FEAC:BURSt <numeric>

<numeric> = 0 to 15

Sets the transmitter FEAC alarm burst length. Only valid if :SOURce:DATA:TELEcom:TFUNction <discrete> is set to SPDH and :SOURce:DATA:TELEcom:SPDH:DS3:ALARm <discrete> is set to FEAC. If set to 0 then the alarm burst will be switched to continuous. Any other value (1 to 15) will set the alarm burst length to that value. The corresponding query command returns the current setting.

SOURce subsystem - Transmitter SPDH Test Function Commands

:SOURce:DATA:TELEcom:SPDH:FEAC:BURSt?

Returns : <numeric> = 0 (Indicates continuous)
 1 to 15 (Indicates burst length)

:SOURce:DATA:TELEcom:SPDH:FEAC:CODE <string>

<string> = "nnnnnn" (n = 0,1)

Sets the user configurable section of the FEAC code. Range "000000" to "111111". The corresponding query command returns the current setting.

:SOURce:DATA:TELEcom:SPDH:FEAC:CODE?

Returns : <string> = "000000" to "111111"

:SOURce:DATA:TELEcom:SPDH:FEAC:LOOPback:ACTion <discrete>

<discrete> =	DS1Deactivat	Deactivate DS1 Loopback
	DS1Activat	Activate DS1 Loopback
	DS3Deactivat	Deactivate DS3 Loopback
	DS3Activat	Activate DS3 Loopback

Sets the transmitter FEAC loopback action. Only valid if :SOURce:DATA:TELEcom:TFUNction <discrete> is set to SPDH and :SOURce:DATA:TELEcom:SPDH:DS3:ALARm <discrete> is set to FEAC. The corresponding query command returns the current setting.

:SOURce:DATA:TELEcom:SPDH:FEAC:LOOPback:ACTion?

Returns : <discrete>

:SOURce:DATA:TELEcom:SPDH:FEAC:LOOPback:MESSAge <numeric>

<numeric> = 0 to 28 Sets the transmitter FEAC DS1 channel for loopback

SOURce subsystem - Transmitter SPDH Test Function Commands

Only valid if :SOURce:DATA:TELEcom:TFUNction <discrete> is set to SPDH and :SOURce:DATA:TELEcom:SPDH:DS3:ALARm <discrete> is set to FEAC. If set to 0 then ALL will be selected. Any other value (1 to 28) will set the DS1 channel for loopback to that value. The corresponding query command returns the current setting.

:SOURce:DATA:TELEcom:SPDH:FEAC:LOOPback:MESSAge?

Returns : <numeric> = 0 (Indicates ALL)
 1 to 28 (Indicates channel number)

**:SOURce:DATA:TELEcom:SPDH:FEAC:LOOPback:BURSt
 <numeric>,<numeric>**

<numeric> = 1 to 15 Sets the FEAC loopback command durations
 <numeric> = 1 to 15 Sets the FEAC loopback message durations

Only valid if :SOURce:DATA:TELEcom:TFUNction <discrete> is set to SPDH and :SOURce:DATA:TELEcom:SPDH:DS3:ALARm <discrete> is set to FEAC. The corresponding query command returns the current setting.

:SOURce:DATA:TELEcom:SPDH:FEAC:LOOPback:BURSt?

Returns : <numeric>,<numeric>

:SOURce:DATA:TELEcom:SPDH:M140:ALARm <discrete>

<discrete> =	NONE	
	LOS	Loss of Signal
	AIS	Alarm Indication Signal
	LOFRame	Loss Of Framing
	RAI	Remote Alarm Indication
	RDI	Remote Defect Indication

Set a 140 Mb/s transmit alarm. Command node :M139 can be used in place of :M140. Activating an alarm is only permitted when :SOURce:DATA:TELEcom:TFUNction <discrete> is set to PDH or PDHPayload,

SOURce subsystem - Transmitter SPDH Test Function Commands

and :SOURce:DATA:TELEcom:SPDH:TFUNction:TYPE <discrete> is set to ERRor.

The corresponding query command returns the current 140 Mb/s transmit alarm as listed above.

:SOURce:DATA:TELEcom:SPDH:M140:ALARm?

Returns: <discrete>

:SOURce:DATA:TELEcom:SPDH:M34:ALARm <discrete>

<discrete> =	NONE	
	LOS	Loss of Signal
	AIS	Alarm Indication Signal
	LOFRame	Loss Of Framing
	RAI	Remote Alarm Indication

Sets a 34Mb/s transmit alarm. Activating an alarm is only permitted when :SOURce:DATA:TELEcom:TFUNction <discrete> is set to PDH or PDHPayload, and :SOURce:DATA:TELEcom:SPDH:TFUNction:TYPE <discrete> is set to ERRor.

The corresponding query command returns the current 34 Mb/s transmit alarm as listed above.

:SOURce:DATA:TELEcom:SPDH:M34:ALARm?

Returns: <discrete>

:SOURce:DATA:TELEcom:SPDH:M8:ALARm <alarm>

<discrete> =	NONE	
	LOS	Loss of Signal
	AIS	Alarm Indication Signal
	LOFRame	Loss Of Framing
	RAI	Remote Alarm Indication

SOURce subsystem - Transmitter SPDH Test Function Commands

Set an 8 Mb/s transmit alarm. Activating an alarm is only permitted when :SOURce:DATA:TELEcom:TFUNction <discrete> is set to PDH or PDHPayload, and :SOURce:DATA:TELEcom:SPDH:TFUNction:TYPE <discrete> is set to ERRor.

The corresponding query command returns the current 8 Mb/s transmit alarm as listed above.

:SOURce:DATA:TELEcom:SPDH:M8:ALARm?

Returns: <discrete>

:SOURce:DATA:TELEcom:SPDH:M2:ALARm <discrete>

<discrete> =	NONE	
	LOS	Loss of Signal
	AIS	Alarm Indication Signal
	LOFRame	Loss Of Framing
	RAI	Remote Alarm Indication
	RMFR	Remote Multiframe Alarm
	CMFL	CAS Multiframe Loss

Set a 2 Mb/s transmit alarm. RMFR and CMFL are only valid when timeslot-16 CAS multiframe has been selected. Activating an alarm is only permitted when :SOURce:DATA:TELEcom:TFUNction is set to PDH or PDHPayload, and :SOURce:DATA:TELEcom:TFUNction:TYPE is set to ERRor.

The corresponding query command returns the current 2 Mb/s transmit alarm as listed above.

:SOURce:DATA:TELEcom:SPDH:M2:ALARm?

Returns: <discrete>

:SOURce:DATA:TELEcom:SPDH:DS3:ALARm <discrete>

<alarm> =	NONE	
	LOS	Loss of signal
	AIS	Alarm Indication Signal

SOURce subsystem - Transmitter SPDH Test Function Commands

OOFrAmE	Out Of Framing
RAI	Remote Alarm Indication
FEAC	FEAC alarm
IDLE	Idle

Sets a DS3 transmit alarm. Activating an alarm is only permitted when :SOURce:DATA:TELEcom:TFUNction <discrete> is set to PDH or PDHPayload, and :SOURce:DATA:TELEcom:SPDH:TFUNction:TYPE <discrete> is set to ERRor.

The corresponding query command returns the current DS3 transmit alarm as listed above.

:SOURce:DATA:TELEcom:SPDH:DS3:ALARm?

Returns: <discrete>

:SOURce:DATA:TELEcom:SPDH:DS1:ALARm <discrete>

<discrete> =	NONE	
	LOS	Loss of Signal
	AIS	Alarm Indication Signal
	OOFrAmE	Out Of Framing
	RAI	Remote Alarm Indication

Sets a DS1 transmit alarm. Activating an alarm is only permitted when :SOURce:DATA:TELEcom:TFUNction <discrete> is set to PDH or PDHPayload, and :SOURce:DATA:TELEcom:SPDH:TFUNction:TYPE <discrete> is set to ERRor.

The corresponding query returns the framing in discrete form as listed above.

:SOURce:DATA:TELEcom:SPDH:DS1:ALARm?

Returns: <discrete>

:SOURce:DATA:TELEcom:SPDH:M140:SPARe <string>

<string> = "000" to "111"

SOURce subsystem - Transmitter SPDH Test Function Commands

Set the 140 Mb/s spare bits. This action is only permitted when :SOURce:DATA:TELEcom:TFUNction <discrete> is set to PDH or PDHPayload, and :SOURce:DATA:TELEcom:SPDH:TFUNction:TYPE <discrete> is set to SBITs. Command node :M139 can be used in place of :M140.

The corresponding query command returns the current 140 Mb/s spare bit values.

:SOURce:DATA:TELEcom:SPDH:M140:SPARe?

Returns: <string>

:SOURce:DATA:TELEcom:SPDH:M34:SPARe <string>

<string> = "0" to "1"

Set the 34Mb/s spare bit. This action is only permitted when :SOURce:DATA:TELEcom:TFUNction <discrete> is set to PDH or PDHPayload, and :SOURce:DATA:TELEcom:SPDH:TFUNction:TYPE <discrete> is set to SBITs.

The corresponding query command returns the current 34 Mb/s spare bit value.

:SOURce:DATA:TELEcom:SPDH:M34:SPARe?

Returns: <string>

:SOURce:DATA:TELEcom:SPDH:M8:SPARe <string>

<string> = "0" to "1"

Set the 8 Mb/s spare bit. This action is only permitted when :SOURce:DATA:TELEcom:TFUNction <discrete> is set to PDH or PDHPayload, and :SOURce:DATA:TELEcom:SPDH:TFUNction:TYPE <discrete> is set to SBITs.

The corresponding query command returns the current 8 Mb/s spare bit value.

:SOURce:DATA:TELEcom:SPDH:M8:SPARe?

Returns: <string>

SOURce subsystem - Transmitter SPDH Test Function Commands

:SOURce:DATA:TELEcom:SPDH:M2:SI <string>

<string> = "0" to "1"

Set the 2 Mb/s Spare International bit, valid for non-CRC4 multiframe. This action is only permitted when :SOURce:DATA:TELEcom:TFUNction <discrete> is set to PDH or PDHPayload, and :SOURce:DATA:TELEcom:SPDH:TFUNction:TYPE <discrete> is set to SBITs.

The corresponding query command returns the current 2 Mb/s Spare International bit.

:SOURce:DATA:TELEcom:SPDH:M2:SI?

Returns: <string>

:SOURce:DATA:TELEcom:SPDH:M2:SIE <string>

<string> = "00" to "11"

Set the 2 Mb/s E-bits, valid for CRC4 multiframe. This action is only permitted when :SOURce:DATA:TELEcom:TFUNction <discrete> is set to PDH or PDHPayload, and :SOURce:DATA:TELEcom:SPDH:TFUNction:TYPE <discrete> is set to SBITs.

The corresponding query command returns the current 2 Mb/s E-bits.

:SOURce:DATA:TELEcom:SPDH:M2:SIE?

Returns: <string>

:SOURce:DATA:TELEcom:SPDH:M2:NFAS <string>

<string> = "00000" to "11111"

Set the 2 Mb/s NFAS Sa bits 4 to 8. This action is only permitted when :SOURce:DATA:TELEcom:TFUNction <discrete> is set to PDH or PDHPayload, and :SOURce:DATA:TELEcom:SPDH:TFUNction:TYPE <discrete> is set to SBITs. The command will generate an error if the Sa sequence is active.

The corresponding query command returns the current 2 Mb/s NFAS Sa bit values.

SOURce subsystem - Transmitter SPDH Test Function Commands

:SOURce:DATA:TELEcom:SPDH:M2:NFASt?

Returns: <string>

If the Sa sequence is active, the underlying user-defined value of the affected bit is returned rather than the "X" that appears on the instrument display.

:SOURce:DATA:TELEcom:SPDH:M2:SASequence <boolean>

<boolean> = 0 or OFF
1 or ON

Set the 2 Mb/s NFAS Sa sequence generation ON or OFF, valid for CRC4 multiframe. The sequence that is generated is controlled by :SASequence:PATtern and the bit that it is inserted into is controlled by :SASequence:BIT. This action is only permitted when :SOURce:DATA:TELEcom:TFUNction <discrete> is set to PDH or PDHPayload, and :SOURce:DATA:TELEcom:SPDH:TFUNction:TYPE <discrete> is set to SBITs.

The corresponding query command returns the current sequence generation state.

:SOURce:DATA:TELEcom:SPDH:M2:SASequence?

Returns: <boolean>

:SOURce:DATA:TELEcom:SPDH:M2:SASequence:PATtern <string>

<string> = "00000000" to "11111111"

Set the 2 Mb/s NFAS Sa sequence pattern. The command will generate an error if the Sa sequence is active.

The corresponding query command returns the current 2 Mb/s NFAS Sa sequence pattern.

:SOURce:DATA:TELEcom:SPDH:M2:SASequence:PATtern?

Returns: <string>

SOURce subsystem - Transmitter SPDH Test Function Commands

:SOURce:DATA:TELEcom:SPDH:M2:SASequence:BIT <numeric>

<numeric> = 4 to 8

Set the bit in the 2 Mb/s NFAS timeslot into which the Sa sequence will be inserted. The command will generate an error if the Sa sequence is active.

The corresponding query command returns the currently selected bit.

:SOURce:DATA:TELEcom:SPDH:M2:SASequence:BIT?

Returns: <numeric>

:SOURce:DATA:TELEcom:SPDH:M2:CASMfm <string>

<string> = "000" to "111"

Set the 2 Mb/s MFAS spare bits 5, 7 and 8. This action is only permitted when :SOURce:DATA:TELEcom:TFUNction <discrete> is set to PDH or PDHPayload, and :SOURce:DATA:TELEcom:SPDH:TFUNction:TYPE <discrete> is set to SBITs.

The corresponding query command returns the current 2 Mb/s MFAS spare bit values.

:SOURce:DATA:TELEcom:SPDH:M2:CASMfm?

Returns: <string>

SOURce subsystem - Transmitter SPDH Test Function Commands

:SOURce:DATA:TELEcom:SPDH:INBand <discrete>

<discrete> =	OFF	Transmission of the Inband loop code is disabled.
	BURSt	Transmission of the Inband loop code is enabled.

Enables or disables transmission of the Inband loop code. When BURSt is selected, the Inband loop code is transmitted for a nominal 8 seconds.

The corresponding query returns the state of the Inband loop code transmission in the discrete form given above.

:SOURce:DATA:TELEcom:SPDH:INBand?

Returns: <discrete>

:SOURce:DATA:TELEcom:SPDH:INBand:CODE <discrete>

<discrete> =	LINact	Activate Line
	LINDeact	Deactivate Line
	PAYact	Activate Payload
	PAYDeact	Deactivate Payload
	NETact	Activate Network
	NETDeact	Deactivate Network
	USER	User Loop Code

Selects the Structured PDH transmitter Inband loop code. The corresponding query returns the Inband loop code in discrete form.

:SOURce:DATA:TELEcom:SPDH:INBand:CODE? :

Returns : <discrete>

SOURce subsystem - Transmitter SPDH Test Function Commands

SOURce:DATA:TELEcom:SPDH:OUTBand <discrete>

<discrete> =	OFF	Transmission of the Inband loop code is disabled.
	ON	Transmission of the Inband loop code is enabled.
	BURSt	Transmission of the Inband loop code is enabled.

Enables or disables transmission of the Outband loop code. When the Outband burst length is set to CONTinuous (see below), the ON selection enables transmission and OFF disables transmission. When the Outband burst length is set to BURSt, the Outband loop code is transmitted for the specified burst count.

The corresponding query returns the state of the Outband loop code transmission in the discrete form given above.

:SOURce:DATA:TELEcom:SPDH:OUTBand?

Returns: <discrete>

:SOURce:DATA:TELEcom:SPDH:OUTBand:CODE <discrete>

<discrete> =	LINact	Activate Line
	LINDeact	Deactivate Line
	PAYact	Activate Payload
	PAYDeact	Deactivate Payload
	NETact	Activate Network
	UNIDeact	Deactivate Universal
	USER	User Loop Code

Selects the Structured PDH transmitter Outband loop code. The corresponding query returns the Outband loop code in discrete form.

SOURce subsystem - Transmitter SPDH Test Function Commands

:SOURce:DATA:TELEcom:SPDH:OUTBand:CODE? :

Returns : <discrete>

:SOURce:DATA:TELEcom:SPDH:OUTBand:BURSt <numeric>

<numeric> = 0 to 15

Sets the transmitter Outband loop code burst length. If set to 0 then the Outband loop code burst will be switched to continuous. Any other value (1 to 15) will set the alarm burst length to that value. The corresponding query command returns the current setting.

:SOURce:DATA:TELEcom:SPDH:OUTBand:BURSt?

Returns : <numeric> = 0 (Indicates continuous)
1 to 15 (Indicates burst length)

:SOURce:DATA:TELEcom:SPDH:OUTBand:USER <string>

<string> = "000000" to "111111"

Sets the Outband loop code user word pattern.

The corresponding query command returns the current Outband loop code user word pattern.

:SOURce:DATA:TELEcom:SPDH:OUTBand:USER?

Returns: <string>

INPut subsystem

The corresponding query returns the line code in discrete form, as listed above.

:INPut:TELEcom:SPDH:CODE?

Returns : <discrete>

:INPut:TELEcom:SPDH:INSert:CODE <discrete>

<discrete> =	AMI	2Mb/s, DS1
	HDB3	2Mb/s only
	B8ZS	DS1 only

Selects the Structured PDH insert port interface line code for the transmitter.

The corresponding query returns the line code in discrete form as listed above.

:INPut:TELEcom:SPDH:INSert:CODE?

Returns: <discrete>

:INPut:TELEcom:SPDH:BALance <discrete>

<discrete> =	UNBalanced	75 Ω unbalanced
	BALanced	120 Ω balanced

Selects the Structured PDH receiver termination levels. BALanced is only valid when :INPut:TELEcom:SPDH:RATE <discrete> is set to M2.

The corresponding query returns the termination level in discrete form, as listed above.

:INPut:TELEcom:SPDH:BALance?

Returns : <discrete>

:INPut:TELEcom:SPDH:GAIN <discrete>

<discrete> =	DB20	All rates
--------------	------	-----------

INPut subsystem

DB26	All rates
DB30	DS1, 2Mb/s, 8Mb/s

Selects the Monitor gain for the Structured PDH receiver. Only valid when :INPut:TELEcom:LEVel <discrete> is set to MON.

The corresponding query returns the Monitor gain in discrete form, as listed above.

:INPut:TELEcom:SPDH:GAIN?

Returns : <discrete>

:INPut:TELEcom:SPDH:EQUalisation <boolean>

<boolean> = 0 or OFF
1 or ON

Selects the Monitor equalization for Structured PDH receiver. Only valid when :INPut:TELEcom:LEVel <discrete> is set to MON.

The corresponding query returns the Monitor equalization state in numeric form.

:INPut:TELEcom:SPDH:EQUalisation?

Returns : <boolean>

SENSe subsystem - Receiver Structured PDH Settings

SENSe subsystem - Receiver Structured PDH Settings

:SENSe:DATA:TELEcom:SPDH:PATtern <discrete>

<discrete> =	PRBS9	2^9-1
	PRBS11	$2^{11}-1$
	PRBS15	$2^{15}-1$
	PRBS20	$2^{20}-1$
	QRSS	$2^{20}-1$ with 14 zero limit
	PRBS23	$2^{23}-1$
	AZERo	All Zero's
	AONE	All One's
	STRess	3-in-24 stress pattern
	P1IN8	1-in-8 test pattern
	P2IN8	2-in-8 test pattern
	OCT55	55 octet test pattern (uses Daly pattern as per ANSI T1.403)
	P1010	Word 1010
	P1000	Word 1000
	UWORD	16 Bit User Word
	LIVE	Live Traffic

Selects the Structured PDH receiver data pattern. If UWORD is selected the word is set using :SENSe:DATA:TELEcom:SPDH:UWORD <string>.

The corresponding query returns the reference data pattern in discrete form, as listed above.

SENSe subsystem - Receiver Structured PDH Settings

:SENSe:DATA:TELEcom:SPDH:PATtern?

Returns : <discrete>

:SENSe:DATA:TELEcom:SPDH:UWORD <string>

Sets the user word pattern, of the Structured PDH receiver, in the range "00000000 00000000" to "1111111111111111".

The corresponding query returns the user word pattern as a string.

:SENSe:DATA:TELEcom:SPDH:UWORD?

Returns : <string>

:SENSe:DATA:TELEcom:SPDH:PRBS:POLarity <discrete>

<discrete> =	NORMAL	Non CCITT
	INVERTed	CCITT

Selects the Structured PDH receiver PRBS pattern polarity.

The corresponding query returns the PRBS pattern polarity in discrete form as listed above.

:SENSe:DATA:TELEcom:SPDH:PRBS:POLarity?

Returns : <discrete>

:SENSe:DATA:TELEcom:SPDH:PAYLoad:TYPE <discrete>

<discrete> =	UNFRamed	No framing
	FRAMed	8, 34 & 140 Mb/s
	G832	34Mb/s only
	PCM30	2 Mb/s Only
	PCM31	2 Mb/s Only
	PCM30CRC	2 Mb/s Only
	PCM31CRC	2 Mb/s Only

SENSe subsystem - Receiver Structured PDH Settings

D4	DS1 only
ESF	DS1 only
SLC96	DS1 only
M13	DS3 only
CBIT	DS3 only

Selects the Structured PDH receiver interface rate framing.

Note: This command is not backwards compatible, to set the framing type to be structured, use the command :SENSe:DATA:TELEcom:SPDH:PAYLoad:STRucture <discrete>.

The corresponding query returns the interface frame type in discrete form, as listed above.

:SENSe:DATA:TELEcom:SPDH:PAYLoad:TYPE?

Returns : <discrete>

:SENSe:DATA:TELEcom:SPDH:PAYLoad:STRucture <discrete>

<discrete> =	UNSTructured	All rates
	STRuctured	All framed formats
	ATM	Valid only for :- DS3 CBIT 34M G.832 2M PCM30/ PCM30CRC DS1 ESF

Selects whether or not the PDH receiver is to have any further structure or not.

The corresponding query returns the type in discrete form as listed above.

:SENSe:DATA:TELEcom:SPDH:PAYLoad:STRucture?

Returns: <discrete>

SENSe subsystem - Receiver SPDH Test Signal Settings Commands

K64XN: determines whether the 64 kb/s timeslot(s) is mapped into a 2 Mb/s or DS1 signal within a structured DS3 signal.

The corresponding query returns the test signal mapping in discrete form as listed above.

:SENSe:DATA:TELEcom:SPDH:TSIGnal:MAPPING?

Returns : <discrete>

:SENSe:DATA:TELEcom:SPDH:TSIGnal:PAYLoad <discrete>

<discrete> =	UNFRamed	2, 8 & 34 Mb/s
	FRAMed	8 & 34 Mb/s
	PCM30	2 Mb/s
	PCM31	2 Mb/s
	PCM30CRC	2 Mb/s
	PCM31CRC	2 Mb/s
	DM2	2 Mb/s Drop
	D4	DS1
	ESF	DS1
	SLC96	DS1
	DDS1	Drop DS1

Selects the Structured PDH receiver test signal framing.

The corresponding query returns the framing in discrete form as listed above.

:SENSe:DATA:TELEcom:SPDH:TSIGnal:PAYLoad?

Returns : <discrete>

:SENSe:DATA:TELEcom:SPDH:TSIGnal:TRIButary:M34 <discrete>

<discrete> =	TRIB1
	TRIB2

SENSe subsystem - Receiver SPDH Test Signal Settings Commands

TRIB3

TRIB4

Selects the Structured PDH receiver 34 Mb/s tributary test signal.

The corresponding query returns the 34 Mb/s tributary test signal in discrete form.

:SENSe:DATA:TELEcom:SPDH:TSIGnal:TRIButary:M34?

Returns : <discrete>

:SENSe:DATA:TELEcom:SPDH:TSIGnal:TRIButary:M8 <discrete>

<discrete> = TRIB1

TRIB2

TRIB3

TRIB4

Selects the Structured PDH receiver 8 Mb/s tributary test signal.

The corresponding query returns the 8 Mb/s tributary test signal in discrete form.

:SENSe:DATA:TELEcom:SPDH:TSIGnal:TRIButary:M8?

Returns : <discrete>

:SENSe:DATA:TELEcom:SPDH:TSIGnal:TRIButary:M2 <discrete>

<discrete> = TRIB1

TRIB2

TRIB3

TRIB4

Selects the Structured PDH receiver 2 Mb/s tributary test signal.

The corresponding query returns the 2 Mb/s tributary test signal in discrete form.

SENSe subsystem - Receiver SPDH Test Signal Settings Commands

:SENSe:DATA:TELEcom:SPDH:TSIGnal:TRIButary:M2?

Returns : <discrete>

:SENSe:DATA:TELEcom:SPDH:TSIGnal:TRIButary:DS1 <discrete>

<discrete> = TRIB1
TRIB2
TRIB3
TRIB4

Selects the Structured PDH receiver DS1 tributary test signal.

The corresponding query returns the tributary in discrete form as listed above.

:SENSe:DATA:TELEcom:SPDH:TSIGnal:TRIButary:DS1?

Returns: <discrete>

:SENSe:DATA:TELEcom:SPDH:TSIGnal:TRIButary:DS2 <discrete>

<discrete> = TRIB1
TRIB2
TRIB3
TRIB4
TRIB5
TRIB6
TRIB7

Selects the Structured PDH receiver DS2 tributary test signal.

The corresponding query returns the tributary in discrete form as listed above.

:SENSe:DATA:TELEcom:SPDH:TSIGnal:TRIButary:DS2?

Returns: <discrete>

SENSe subsystem - Receiver SPDH Test Signal Settings Commands

:SENSe:DATA:TELEcom:SPDH:TSIGnal:TSLot:DS1:K64 <numeric>

<numeric> 1 to 24 Any framing

Selects the PDH receiver 64kb/s timeslot.

The corresponding query returns the 64kb/s timeslot in numeric form.

:SENSe:DATA:TELEcom:SPDH:TSIGnal:TSLot:DS1:K64?

Returns: <numeric>

:SENSe:DATA:TELEcom:SPDH:TSIGnal:TSLot:DS1:K64XN <string>

<string> = 24 bit string

Selects the NX64 kb/s timeslots of the DS1 signal. a "1" in the nth position signifies selection of timeslot n. A "0" signifies deselection e.g. to select timeslots 1,8,15,22 "100000010000001000000100".

The corresponding query returns the NX64kb/s timeslot as a 24 bit binary string.

:SENSe:DATA:TELEcom:SPDH:TSIGnal:TSLot:DS1:K64XN? <string>

Returns: <string>

:SENSe:DATA:TELEcom:SPDH:TSIGnal:TSLot:DS1:K56XN <string>

<string> = 24 bit string

Selects the 56XN kb/s timeslots of the DS1 signal. a "1" in the nth position signifies selection of timeslot n. A "0" signifies deselection e.g. to select timeslots 1,8,15,22 "100000010000001000000100".

The corresponding query returns the NX64 kb/s timeslot as a 24 bit binary string.

:SENSe:DATA:TELEcom:SPDH:TSIGnal:TSLot:DS1:K56XN? <string>

Returns: <string>

SENSe subsystem - Receiver SPDH Test Function Commands

:SENSe:DATA:TELEcom:TFUNction:SDISruption <discrete>

<discrete>= OFF
 ON

Sets the receiver service disruption mode.

The corresponding query returns the service disruption mode setting in discrete form as listed above.

:SENSe:DATA:TELEcom:TFUNction:SDISruption?

Returns: <discrete>

SENSe subsystem - Analysis Control

simultaneously, but only one path is measured and analysed for M.2110 and M.2120. This command selects that path.

The corresponding query returns the current path under test in discrete form as listed above.

:SENSe:DATA:TELEcom:SPDH:ANALysis:M2110:PATH?

Returns: <discrete>

:SENSe:DATA:TELEcom:SPDH:ANALysis:M2110 :PALLocation <numeric>

<numeric> = 0.5 to 63 Percentage

Sets the Structured PDH M2110 path allocation percentage.

The corresponding query returns the current path allocation percentage in numeric form.

:SENSe:DATA:TELEcom:SPDH:ANALysis:M2110: PALLocation?

Returns : <numeric>

:SENSe:DATA:TELEcom:SPDH:ANALysis:M2110:USER: ESECond <discrete>, <numeric>

<discrete> =	S1H2	S1, 2 Hours
	S2H2	S2, 2 Hours
	S1D1	S1, 24 Hours
	S2D1	S2 24 Hours
	S1D7	S1, 7 Days
	S1M15	S1, 15 Minutes
	S2M15	S2, 15 Minutes
	S1H1	S1, 1 Hour
	S2H1	S2, 1 Hour
<numeric> =	0 to 720	S1H2 & S2H2

SENSe subsystem - Analysis Control

0 to 8640	S1D1 & S2D1
0 to 60480	S1D7
0 to 90	S1M15 & S2M15
0 to 360	S1H1 & S2H1

Sets the Structured PDH user programmable M.2110 Error Second thresholds. The corresponding query returns the selected M.2110 Error Second threshold in numeric form.

:SENSe:DATA:TELEcom:SPDH:ANALysis:M2110:USER: ESECond? <discrete>

Returns : <numeric>

:SENSe:DATA:TELEcom:SPDH:ANALysis:M2110:USER: SESecond <discrete>, <numeric>

<discrete> =	S1H2	S1, 2 Hours
	S2H2	S2, 2 Hours
	S1D1	S1, 24 Hours
	S2D1	S2, 24 Hours
	S1D7	S1, 7 Days
	S1M15	S1, 15 Minutes
	S2M15	S2, 15 Minutes
	S1H1	S1, 1 Hour
	S2H1	S2, 1 Hour
	<numeric> =	0 to 720
0 to 8640		S1D1 & S2D1
0 to 60480		S1D7
0 to 90		S1M15 & S2M15
0 to 360		S1H1 & S2H1

SENSe subsystem - Analysis Control

Sets the Structured PDH user programmable M.2110 Severely Errored Seconds thresholds.

The corresponding query returns the selected user programmable M.2110 Severely Errored Seconds threshold in numeric form.

:SENSe:DATA:TELEcom:SPDH:ANALysis:M2110:USER: SESecond? <discrete>

Returns : <numeric>

:SENSe:DATA:TELEcom:SPDH:ANALysis:M2120 <discrete>

<discrete> =	PALlocation	Path Allocation
	USER	User Defined

Selects the Structured PDH M.2120 threshold control source.

The corresponding query returns the current control source in discrete form.

:SENSe:DATA:TELEcom:SPDH:ANALysis:M2120?

Returns : <discrete>

:SENSe:DATA:TELEcom:SPDH:ANALysis:M2120:MFACTOR <numeric>

<numeric> =	50 to 150	% Maintenance Factor
-------------	-----------	----------------------

Sets the Structured PDH M.2120 maintenance factor percentage.

The corresponding query returns the current maintenance factor value in numeric form.

:SENSe:DATA:TELEcom:SPDH:ANALysis:M2120:MFACTOR?

Returns : <numeric>

:SENSe:DATA:TELEcom:SPDH:ANALysis:M2120:USER: ESECond <discrete>, <numeric>

<discrete> =	TR1	15 Minute period
	TR2	24 Hour period

SENSe subsystem - Analysis Control

<numeric> =	0 to 900	TR1
	0 to 86400	TR2

Sets the Structured PDH user programmable M.2120 Error Seconds thresholds.

The corresponding query returns the selected user programmable M.2120 Error Second threshold in numeric form.

:SENSe:DATA:TELEcom:SPDH:ANALysis:M2120:USER: ESECond?
<discrete>

Returns : <numeric>

:SENSe:DATA:TELEcom:SPDH:ANALysis:M2120:USER: SESecond
<discrete>, <numeric>

<discrete> =	TR1	15 Minute period
	TR2	24 Hour period
<numeric> =	0 to 900	TR1
	0 to 86400	TR2

Sets the Structured PDH user programmable M.2120 Severely Errored Seconds thresholds.

The corresponding query returns the selected user programmable M.2120 Severely Errored Seconds threshold in numeric form.

:SENSe:DATA:TELEcom:SPDH:ANALysis:M2120:USER: SESecond?
<discrete>

Returns : <numeric>

SENSe subsystem - Alarm Scan Control

SENSe subsystem - Alarm Scan Control

:SENSe:DATA:TELEcom:SPDH:ASCan <boolean>

<boolean> =	0 or OFF	Stop the current alarm scan
	1 or ON	Start a new alarm scan

Start/Stop the structured PDH alarm scan. The corresponding query returns the alarm scan state as 0 or 1.

:SENSe:DATA:TELEcom:SPDH:ASCan?

Returns : <boolean> 0 or 1

SENSe subsystem - SPDH Round Trip Delay Control

SENSe subsystem - SPDH Round Trip Delay Control

:SENSe:DATA:TELEcom:SPDH:RTDelay <boolean>

<boolean> = 0 or OFF Stop the round trip delay measurement

1 or ON Start a new round trip delay measurement

Start/Stop the structured PDH round trip delay measurement.

The corresponding query returns the round trip delay state as 0 or 1.

:SENSe:DATA:TELEcom:SPDH:RTDelay?

Returns : <boolean> 0 or 1

SENSe subsystem - Result Returning Commands

SENSe subsystem - Result Returning Commands

Frequency Results (SPDH)

:SENSe:DATA? <"result">

Result =	"FREQUency:SPDH"	RX SPDH clock frequency
	"FOFPpm:SPDH"	RX SPDH clock offset in ppm
	"FOFHz:SPDH"	RX SPDH clock offset in Hz

Structured PDH Short Term Results

:SENSe:DATA?<"result">

Result =	"ECOut:SPDH:STERm:BIT"	Bit error count
	"ERATio:SPDH:STERm:BIT"	Bit error ratio
	"ECOut:SPDH:STERm:CODE"	Code error count
	"ERATio:SPDH:STERm:CODE"	Code error ratio
	"ECOut:SPDH:STERm:M2:FAS"	2 Mb/s FAS error count
	"ERATio:SPDH:STERm:M2:FAS"	2 Mb/s FAS error ratio
	"ECOut:SPDH:STERm:M8:FAS"	8 Mb/s FAS error count
	"ERATio:SPDH:STERm:M8:FAS"	8 Mb/s FAS error ratio
	"ECOut:SPDH:STERm:M34:FAS"	34 Mb/s FAS error count
	"ERATio:SPDH:STERm:M34:FAS"	34 Mb/s FAS error ratio
	"ECOut:SPDH:STERm:EMBip"	PDH M34 EM-BIP error count
	"ERATio:SPDH:STERm:EMBip"	PDH M34 EM-BIP error count
	"ECOut:SPDH:STERm:M140:FAS"	140 Mb/s FAS error count
	"ERATio:SPDH:STERm:M140:FAS"	140 Mb/s FAS error ratio

SENSe subsystem - Result Returning Commands

"ECOunt:SPDH:STERm:FEBe"	PDH FEBe error count
"ERATio:SPDH:STERm:FEBe"	PDH FEBe error ratio
"ECOunt:SPDH:STERm:PBITs"	PDH DS3 P-BITs error count
"ERATio:SPDH:STERm:PBITs"	PDH DS3 P-BITs error ratio
"ECOunt:SPDH:STERm:CPBits"	PDH DS3 CP-Bits error count
"ERATio:SPDH:STERm:CPBits"	PDH DS3 CP-Bits error ratio
"ECOunt:SPDH:STERm:DS1:FAS"	PDH Frame short term error count
"ERATio:SPDH:STERm:DS1:FAS"	PDH Frame short term error ratio
"ECOunt:SPDH:STERm:DS3:FAS"	PDH Frame short term error count
"ERATio:SPDH:STERm:DS3:FAS"	PDH Frame short term error ratio
"ECOunt:SPDH:STERm:CRC"	CRC error count
"ERATio:SPDH:STERm:CRC"	CRC error ratio
"ECOunt:SPDH:STERm:REBE"	REBE error count
"ERATio:SPDH:STERm:REBE"	REBE error ratio

Structured PDH Cumulative Results

:SENSe:DATA? <"result">

Result = "ECOunt:SPDH:BIT"	Bit error count
"ERATio:SPDH:BIT"	Bit error ratio
"ECOunt:SPDH:CODE"	Code error count
"ERATio:SPDH:CODE"	Code error ratio
"ECOunt:SPDH:M2:FAS"	2 Mb/s FAS error count
"ERATio:SPDH:M2:FAS"	2 Mb/s FAS error ratio
"ECOunt:SPDH:M8:FAS"	8 Mb/s FAS error count
"ERATio:SPDH:M8:FAS"	8 Mb/s FAS error ratio

PDH Command Reference

SENSe subsystem - Result Returning Commands

"ECOunt:SPDH:M34:FAS"	34 Mb/s FAS error count
"ERATio:SPDH:M34:FAS"	34 Mb/s FAS error ratio
"ECOunt:SPDH:STERm:EMBip"	PDH M34 EM-BIP error count
"ERATio:SPDH:STERm:EMBip"	PDH M34 EM-BIP error ratio
"ECOunt:SPDH:M140:FAS"	140 Mb/s FAS error count
"ERATio:SPDH:M140:FAS"	140 Mb/s FAS error ratio
"ECOunt:SPDH:FEBE"	PDH / DS _n FEBE error count
"ERATio:SPDH:FEBE"	PDH / DS _n FEBE error ratio
"ECOunt:SPDH:STERm:REI"	PDH M34 REI error count
"ERATio:SPDH:STERm:REI"	PDH M34 REI error ratio
"ECOunt:SPDH:PBITs"	DS3 P-BITs error count
"ERATio:SPDH:PBITs"	PDH DS3 P-BITs error ratio
"ECOunt:SPDH:CPBits"	DS3 CP-Bits error count
"ERATio:SPDH:CPBits"	DS3 CP-Bits error ratio
"ECOunt:SPDH:DS1:FAS"	DS1 Frame error count
"ERATio:SPDH:DS1:FAS"	DS1 Frame error ratio
"ECOunt:SPDH:DS3:FAS"	DS3 Frame error count
"ERATio:SPDH:DS3:FAS"	DS3 Frame error ratio
"ECOunt:SPDH:REBE"	REBE error count
"ERATio:SPDH:REBE"	REBE error ratio
"ECOunt:SPDH:CRC"	CRC error count
"ERATio:SPDH:CRC"	CRC error ratio

Structured PDH and Payload G.821 Analysis Results

:SENSe:DATA? <"result">

SENSe subsystem - Result Returning Commands

Result = "ECOUNT:SPDH:BIT"	Error Count
"ESECOnDs:SPDH:BIT:ANALySis"	Error Seconds
"PESECOnDs:SPDH:BIT:ANALySis"	% Error Seconds
"PESD:SPDH:BIT:ANALySis"	% Error Seconds (Annex D)
"EFSECOnDs:SPDH:BIT:ANALySis"	Error Free Seconds
"PEFSECOnDs:SPDH:BIT:ANALySis"	% Error Free Seconds
"SESECOnDs:SPDH:BIT:ANALySis"	Severely Errored Seconds
"PSESECOnDs:SPDH:BIT:ANALySis"	% Severely Errored Seconds
"UASECOnDs:SPDH:BIT:ANALySis"	Unavailable Seconds
"PUASECOnDs:SPDH:BIT:ANALySis"	% Unavailable Seconds
"DMINutes:SPDH:BIT:ANALySis"	Degraded Minutes
"PDMInutes:SPDH:BIT:ANALySis"	% Degraded Minutes
"ESECOnDs:SPDH:CODE:ANALySis"	Code-errored seconds

Structured PDH 140 Mb/s G.826 Analysis Results

:SENSe:DATA? <"result">

Result = "ESECOnDs:SPDH:M140:TRANsmit:ANALySis:G826"	TX Errored Seconds
"SESECOnDs:SPDH:M140:TRANsmit:ANALySis:G826"	TX Severely Errored Seconds
"UASECOnDs:SPDH:M140:TRANsmit:ANALySis:G826"	TX Unavailable Seconds
"PUASECOnDs:SPDH:M140:TRANsmit:ANALySis:G826"	TX Path Unavailable Seconds
"ESRatio:SPDH:M140:TRANsmit:ANALySis:G826"	TX Errored Second Ratio
"SESRatio:SPDH:M140:TRANsmit:ANALySis:G826"	TX Severely Errored Second Ratio

SENSe subsystem - Result Returning Commands

"ESECONDS:SPDH:M140:RECEIVE:ANALYSIS:G826"	RX Errored Seconds
"SESECONDS:SPDH:M140:RECEIVE:ANALYSIS:G826"	RX Severely Errored Seconds
"UASECONDS:SPDH:M140:RECEIVE:ANALYSIS:G826"	RX Unavailable Seconds
"PUASECONDS:SPDH:M140:RECEIVE:ANALYSIS:G826"	RX Path Unavailable Seconds
"ESRATIO:SPDH:M140:RECEIVE:ANALYSIS:G826"	RX Errored Second Ratio
"SESRATIO:SPDH:M140:RECEIVE:ANALYSIS:G826"	RX Severely Errored Second Ratio

Structured PDH 34 Mb/s G.826 Analysis Results

:SENSe:DATA? <"result">

Result = "ESECONDS:SPDH:M34:TRANSMIT:ANALYSIS:G826"	TX Errored Seconds
"SESECONDS:SPDH:M34:TRANSMIT:ANALYSIS:G826"	TX Severely Errored Seconds
"UASECONDS:SPDH:M34:TRANSMIT:ANALYSIS:G826"	TX Unavailable Seconds
"PUASECONDS:SPDH:M34:TRANSMIT:ANALYSIS:G826"	TX Path Unavailable Seconds
"ESRATIO:SPDH:M34:TRANSMIT:ANALYSIS:G826"	TX Errored Second Ratio
"SESRATIO:SPDH:M34:TRANSMIT:ANALYSIS:G826"	TX Severely Errored Second Ratio
"ESECONDS:SPDH:M34:RECEIVE:ANALYSIS:G826"	RX Errored Seconds
"SESECONDS:SPDH:M34:RECEIVE:ANALYSIS:G826"	RX Severely Errored Seconds
"UASECONDS:SPDH:M34:RECEIVE:ANALYSIS:G826"	RX Unavailable Seconds

SENSe subsystem - Result Returning Commands

"PUASeconds:SPDH:M34:RECeive:ANALysis:G826"	RX Path Unavailable Seconds
"ESRatio:SPDH:M34:RECeive:ANALysis:G826"	RX Errored Second Ratio
"SESRatio:SPDH:M34:RECeive:ANALysis:G826"	RX Severely Errored Second Ratio

Structured PDH 8 Mb/s G.826 Analysis Results

:SENSe:DATA? <"result">

Result = "ESEconds:SPDH:M8:TRANsmit:ANALysis:G826"	TX Errored Seconds
"SESeconds:SPDH:M8:TRANsmit:ANALysis:G826"	TX Severely Errored Seconds
"UASeconds:SPDH:M8:TRANsmit:ANALysis:G826"	TX Unavailable Second Counts
"PUASeconds:SPDH:M8:TRANsmit:ANALysis:G826"	TX Path Unavailable Seconds
"ESRatio:SPDH:M8:TRANsmit:ANALysis:G826"	TX Errored Second Ratio
"SESRatio:SPDH:M8:TRANsmit:ANALysis:G826"	TX Severely Errored Second Ratio
"ESEconds:SPDH:M8:RECeive:ANALysis:G826"	RX Errored Seconds
"SESeconds:SPDH:M8:RECeive:ANALysis:G826"	RX Severely Errored Seconds
"UASeconds:SPDH:M8:RECeive:ANALysis:G826"	RX Unavailable Seconds
"PUASeconds:SPDH:M8:RECeive:ANALysis:G826"	RX Path Unavailable Seconds

SENSe subsystem - Result Returning Commands

"ESRatio:SPDH:M8:RECeive:ANALysis:G826"	RX Errored Second Ratio
"SESRatio:SPDH:M8:RECeive:ANALysis:G826"	RX Severely Errored Second Ratio

Structured PDH 2 Mb/s G.826 Analysis Results

:SENSe:DATA? <"result">

Result = "EBCount:SPDH:M2:TRANsmit:ANALysis:G826"	TX Errored Block Count
"ESEConds:SPDH:M2:TRANsmit:ANALysis:G826"	TX Errored Seconds
"SESeconds:SPDH:M2:TRANsmit:ANALysis:G826"	TX Severely Errored Seconds
"UASeconds:SPDH:M2:TRANsmit:ANALysis:G826"	TX Unavailable Seconds
"PUASeconds:SPDH:M2:TRANsmit:ANALysis:G826"	TX Path Unavailable Seconds
"BBECount:SPDH:M2:TRANsmit:ANALysis:G826"	TX Background Block Error Count
"ESRatio:SPDH:M2:TRANsmit:ANALysis:G826"	TX Errored Second Ratio
"SESRatio:SPDH:M2:TRANsmit:ANALysis:G826"	TX Severely Errored Second Ratio
"BBERatio:SPDH:M2:TRANsmit:ANALysis:G826"	TX Background Block Error Ratio
"EBCount:SPDH:M2:RECeive:ANALysis:G826"	RX Errored Block Count
"ESEConds:SPDH:M2:RECeive:ANALysis:G826"	RX Errored Seconds
"SESeconds:SPDH:M2:RECeive:ANALysis:G826"	RX Severely Errored Seconds
"UASeconds:SPDH:M2:RECeive:ANALysis:G826"	RX Unavailable Seconds
"PUASeconds:SPDH:M2:RECeive:ANALysis:G826"	RX Path Unavailable Seconds
"BBECount:SPDH:M2:RECeive:ANALysis:G826"	RX Background Block Error Count
"ESRatio:SPDH:M2:RECeive:ANALysis:G826"	RX Errored Second Ratio

SENSe subsystem - Result Returning Commands

"SESRatio:SPDH:M2:RECeive:ANALysis:G826"	RX Severely Errored Second Ratio
"BBERatio:SPDH:M2:RECeive:ANALysis:G826"	RX Background Block Error Ratio

Structured PDH DS1 G.826 Analysis Results

:SENSe:DATA? <"result">

Result = "ESECONDS:SPDH:DS1:TRANsmit:ANALysis:G826"	TX Errored Seconds
"SESECONDS:SPDH:DS1:TRANsmit:ANALysis:G826"	TX Severely Errored Seconds
"UASECONDS:SPDH:DS1:TRANsmit:ANALysis:G826"	TX Unavailable Seconds
"PUASECONDS:SPDH:DS1:TRANsmit:ANALysis:G826"	TX Path Unavailable Seconds
"ESRatio:SPDH:DS1:TRANsmit:ANALysis:G826"	TX Errored Second Ratio
"SESRatio:SPDH:DS1:TRANsmit:ANALysis:G826"	TX Severely Errored Second Ratio
"EBCOUNT:SPDH:DS1:RECeive:ANALysis:G826"	RX Errored Block Count
"ESECONDS:SPDH:DS1:RECeive:ANALysis:G826"	RX Errored Seconds
"SESECONDS:SPDH:DS1:RECeive:ANALysis:G826"	RX Severely Errored Seconds
"UASECONDS:SPDH:DS1:RECeive:ANALysis:G826"	RX Unavailable Seconds
"PUASECONDS:SPDH:DS1:RECeive:ANALysis:G826"	RX Path Unavailable Seconds
"BBECOUNT:SPDH:DS1:RECeive:ANALysis:G826"	RX Background Block Error Count
"ESRatio:SPDH:DS1:RECeive:ANALysis:G826"	RX Errored Second Ratio

SENSe subsystem - Result Returning Commands

"SESRatio:SPDH:DS1:RECEive:ANALysis:G826"	RX Severely Errored Second Ratio
"BBERatio:SPDH:DS1:RECEive:ANALysis:G826"	RX Background Block Error Ratio

Structured PDH DS3 G.826 Analysis Results

:SENSe:DATA? <"result">

Result = "EBCount:SPDH:DS3:TRANsmit:ANALysis:G826"	TX Errored Block Count
"ESECONDS:SPDH:DS3:TRANsmit:ANALysis:G826"	TX Errored Seconds
"SESeconds:SPDH:DS3:TRANsmit:ANALysis:G826"	TX Severely Errored Seconds
"UASeconds:SPDH:DS3:TRANsmit:ANALysis:G826"	TX Unavailable Seconds
"PUASeconds:SPDH:DS3:TRANsmit:ANALysis:G826"	TX Path Unavailable Seconds
"BBECOUNT:SPDH:DS3:TRANsmit:ANALysis:G826"	TX Background Block Error Count
"ESRatio:SPDH:DS3:TRANsmit:ANALysis:G826"	TX Errored Second Ratio
"SESRatio:SPDH:DS3:TRANsmit:ANALysis:G826"	TX Severely Errored Second Ratio
"BBERatio:SPDH:DS3:TRANsmit:ANALysis:G826"	TX Background Block Error Ratio
"EBCount:SPDH:DS3:RECEive:ANALysis:G826"	RX Errored Block Count
"ESECONDS:SPDH:DS3:RECEive:ANALysis:G826"	RX Errored Seconds
"SESeconds:SPDH:DS3:RECEive:ANALysis:G826"	RX Severely Errored Seconds
"UASeconds:SPDH:DS3:RECEive:ANALysis:G826"	RX Unavailable Seconds
"PUASeconds:SPDH:DS3:RECEive:ANALysis:G826"	RX Path Unavailable Seconds
"BBECOUNT:SPDH:DS3:RECEive:ANALysis:G826"	RX Background Block Error Count

PDH Command Reference

SENSe subsystem - Result Returning Commands

"ESRatio:SPDH:DS3:RECeive:ANALysis:G826"	RX Errored Second Ratio
"SESRatio:SPDH:DS3:RECeive:ANALysis:G826"	RX Severely Errored Second Ratio
"BBERatio:SPDH:DS3:RECeive:ANALysis:G826"	RX Background Block Error Ratio

PDH BIT G.826

:SENSe:DATA? <"result">

Result = "EBCount:SPDH:BIT:RECeive:ANALysis:G826"	RX Errored Block Count
"ESECONDS:SPDH:BIT:RECeive:ANALysis:G826"	RX error seconds
"SESeconds:SPDH:BIT:RECeive:ANALysis:G826"	RX severely errored seconds
"UASeconds:SPDH:BIT:RECeive:ANALysis:G826"	RX unavailable seconds
"BBECount:SPDH:BIT:RECeive:ANALysis:G826"	RX Background Block Error Count
"ESRatio:SPDH:BIT:RECeive:ANALysis:G826"	RX Errored Second Ratio
"SESRatio:SPDH:BIT:RECeive:ANALysis:G826"	RX Severely Errored Second Ratio
"BBERatio:SPDH:BIT:RECeive:ANALysis:G826"	RX Background Block Error Ratio

Structured PDH M.2100 Analysis Results

:SENSe:DATA? <"result">

Result = "ESECONDS:SPDH:M140:TRANsmit:ANALysis:M2100"	TX error seconds
"ESECONDS:SPDH:M140:RECeive:ANALysis:M2100"	RX error seconds
"SESeconds:SPDH:M140:TRANsmit:ANALysis:M2100"	TX severely errored seconds
"SESeconds:SPDH:M140:RECeive:ANALysis:M2100"	RX severely errored seconds

SENSe subsystem - Result Returning Commands

"UASeconds:SPDH:M140:TRANsmit:ANALysis:M2100"	TX unavailable seconds
"UASeconds:SPDH:M140:RECeive:ANALysis:M2100"	RX unavailable seconds
"ESEConds:SPDH:M34:TRANsmit:ANALysis:M2100"	TX error seconds
"ESEConds:SPDH:M34:RECeive:ANALysis:M2100"	RX error seconds
"SESeconds:SPDH:M34:TRANsmit:ANALysis:M2100"	TX severely errored seconds
"SESeconds:SPDH:M34:RECeive:ANALysis:M2100"	RX severely errored seconds
"UASeconds:SPDH:M34:TRANsmit:ANALysis:M2100"	TX unavailable seconds
"UASeconds:SPDH:M34:RECeive:ANALysis:M2100"	RX unavailable seconds
"ESEConds:SPDH:M8:TRANsmit:ANALysis:M2100"	TX error seconds
"ESEConds:SPDH:M8:RECeive:ANALysis:M2100"	RX error seconds
"SESeconds:SPDH:M8:TRANsmit:ANALysis:M2100"	TX severely errored seconds
"SESeconds:SPDH:M8:RECeive:ANALysis:M2100"	RX severely errored seconds
"UASeconds:SPDH:M8:TRANsmit:ANALysis:M2100"	TX unavailable seconds
"UASeconds:SPDH:M8:RECeive:ANALysis:M2100"	RX unavailable seconds
"ESEConds:SPDH:M2:TRANsmit:ANALysis:M2100"	TX error seconds
"ESEConds:SPDH:M2:RECeive:ANALysis:M2100"	RX error seconds
"SESeconds:SPDH:M2:TRANsmit:ANALysis:M2100"	TX severely errored seconds
"SESeconds:SPDH:M2:RECeive:ANALysis:M2100"	RX severely errored seconds
"UASeconds:SPDH:M2:TRANsmit:ANALysis:M2100"	TX unavailable seconds

SENSe subsystem - Result Returning Commands

"UASeconds:SPDH:M2:RECeive:ANALysis:M2100"	RX unavailable seconds
"ESEConds:SPDH:DS1:TRANsmit:ANALysis:M2100"	TX error seconds
"ESEConds:SPDH:DS1:RECeive:ANALysis:M2100"	RX error seconds
"SESeconds:SPDH:DS1:TRANsmit:ANALysis:M2100"	TX severely errored seconds
"SESeconds:SPDH:DS1:RECeive:ANALysis:M2100"	RX severely errored seconds
"UASeconds:SPDH:DS1:TRANsmit:ANALysis:M2100"	TX unavailable seconds
"UASeconds:SPDH:DS1:RECeive:ANALysis:M2100"	RX unavailable seconds
"ESEConds:SPDH:DS3:TRANsmit:ANALysis:M2100"	TX error seconds
"ESEConds:SPDH:DS3:RECeive:ANALysis:M2100"	RX error seconds
"SESeconds:SPDH:DS3:TRANsmit:ANALysis:M2100"	TX severely errored seconds
"SESeconds:SPDH:DS3:RECeive:ANALysis:M2100"	RX severely errored seconds
"UASeconds:SPDH:DS3:TRANsmit:ANALysis:M2100"	TX unavailable seconds
"UASeconds:SPDH:DS3:RECeive:ANALysis:M2100"	RX unavailable seconds

Structured PDH M.2110 Analysis Results

:SENSe:DATA? <"result">

Result = "MIN15:SPDH:ANALysis:M2110"	M.2110 15 minute BIS Result
"HOUR1:SPDH:ANALysis:M2110"	M.2110 1 hour BIS Result
"HOUR2:SPDH:ANALysis:M2110"	M.2110 2 hour BIS Result
"HOUR24:SPDH:ANALysis:M2110"	M.2110 24 hour BIS Result
"DAY7:SPDH:ANALysis:M2110"	M.2110 7 day BIS Result

SENSe subsystem - Result Returning Commands

Structured PDH M.2120 ANALysis Results

:SENSe:DATA? <"result">

Result =	"TR1:SPDH:TRANsmit:ANALysis:M2120"	15 minute TX threshold report
	"TR2:SPDH:TRANsmit:ANALysis:M2120"	24 hour TX threshold report
	"TR1:SPDH:RECeive:ANALysis:M2120"	15 minute RX threshold report
	"TR2:SPDH:RECeive:ANALysis:M2120"	24 hour RX threshold report

Structured PDH 2 Mb/S FAS Error Analysis Results

:SENSe:DATA? <"result">

Result =	"ECOunt:SPDH:M2:FAS"	Error count
	"ESEConds:SPDH:M2:FAS:ANALysis"	Error Seconds
	"PESEconds:SPDH:M2:FAS:ANALysis"	% Error Seconds
	"EFSEconds:SPDH:M2:FAS:ANALysis"	Error Free Seconds
	"PEFSEconds:SPDH:M2:FAS:ANALysis"	% Error Free Seconds
	"SESEconds:SPDH:M2:FAS:ANALysis"	Severely Errored Seconds
	"PSESEconds:SPDH:M2:FAS:ANALysis"	% Severely Errored Seconds
	"UASEconds:SPDH:M2:FAS:ANALysis"	Unavailable Seconds
	"PUASEconds:SPDH:M2:FAS:ANALysis"	% Unavailable Seconds
	"DMINutes:SPDH:M2:FAS:ANALysis"	Degraded Minutes
	"PDMinutes:SPDH:M2:FAS:ANALysis"	% Degraded Minutes
	"ESEConds:SPDH:CODE:ANALysis"	Code errored seconds

SENSe subsystem - Result Returning Commands

Structured PDH 8 Mb/S FAS Error Analysis Results

:SENSe:DATA? <"result">

Result =	"ECount:SPDH:M8:FAS"	Error count
	"ESECONDS:SPDH:M8:FAS:ANALYSIS"	Error Seconds
	"PESECONDS:SPDH:M8:FAS:ANALYSIS"	% Error Seconds
	"EFSECONDS:SPDH:M8:FAS:ANALYSIS"	Error Free Seconds
	"PEFSECONDS:SPDH:M8:FAS:ANALYSIS"	% Error Free Seconds
	"SESECONDS:SPDH:M8:FAS:ANALYSIS"	Severely Errored Seconds
	"PSESECONDS:SPDH:M8:FAS:ANALYSIS"	% Severely Errored Seconds
	"UASECONDS:SPDH:M8:FAS:ANALYSIS"	Unavailable Seconds
	"PUASECONDS:SPDH:M8:FAS:ANALYSIS"	% Unavailable Seconds
	"DMINUTES:SPDH:M8:FAS:ANALYSIS"	Degraded Minutes
	"PDMINUTES:SPDH:M8:FAS:ANALYSIS"	% Degraded Minutes
	"ESECONDS:SPDH:CODE:ANALYSIS"	Code errored seconds

Structured PDH 34 Mb/S FAS Error Analysis Results

:SENSe:DATA? <"result">

Result =	"ECount:SPDH:M34:FAS"	Error count
	"ESECONDS:SPDH:M34:FAS:ANALYSIS"	Error Seconds
	"PESECONDS:SPDH:M34:FAS:ANALYSIS"	% Error Seconds
	"EFSECONDS:SPDH:M34:FAS:ANALYSIS"	Error Free Seconds
	"PEFSECONDS:SPDH:M34:FAS:ANALYSIS"	% Error Free Seconds
	"SESECONDS:SPDH:M34:FAS:ANALYSIS"	Severely Errored Seconds
	"PSESECONDS:SPDH:M34:FAS:ANALYSIS"	% Severely Errored Seconds
	"UASECONDS:SPDH:M34:FAS:ANALYSIS"	Unavailable Seconds
	"PUASECONDS:SPDH:M34:FAS:ANALYSIS"	% Unavailable Seconds

SENSe subsystem - Result Returning Commands

"DMINutes:SPDH:M34:FAS:ANALysis"	Degraded Minutes
"PDMinutes:SPDH:M34:FAS:ANALysis"	% Degraded Minutes
"ESEConds:SPDH:CODE:ANALysis"	Code errored seconds

Structured PDH 140 Mb/S FAS Error Analysis Results

:SENSe:DATA? <"result">

Result =	"ECOut:SPDH:M140:FAS"	Error count
	"ESEConds:SPDH:M140:FAS:ANALysis"	Error Seconds
	"PESeconds:SPDH:M140:FAS:ANALysis"	% Error Seconds
	"EFSeconds:SPDH:M140:FAS:ANALysis"	Error Free Seconds
	"PEFSeconds:SPDH:M140:FAS:ANALysis"	% Error Free Seconds
	"SESeconds:SPDH:M140:FAS:ANALysis"	Severely Errored Seconds
	"PSESeconds:SPDH:M140:FAS:ANALysis"	% Severely Errored Seconds
	"UASSeconds:SPDH:M140:FAS:ANALysis"	Unavailable Seconds
	"PUASSeconds:SPDH:M140:FAS:ANALysis"	% Unavailable Seconds
	"DMINutes:SPDH:M140:FAS:ANALysis"	Degraded Minutes
	"PDMinutes:SPDH:M140:FAS:ANALysis"	% Degraded Minutes
	"ESEConds:SPDH:CODE:ANALysis"	Code errored seconds

Structured PDH CRC Error Analysis Results

:SENSe:DATA? <"result">

Result =	"ECOut:PDH:CRC"	Error Count
	"ESEConds:SPDH:CRC:ANALysis"	Error Seconds
	"PESeconds:SPDH:CRC:ANALysis"	% Error Seconds
	"EFSeconds:SPDH:CRC:ANALysis"	Error Free Seconds

SENSe subsystem - Result Returning Commands

"PEFSeconds:SPDH:CRC:ANALysis"	% Error Free Seconds
"SESeconds:SPDH:CRC:ANALysis"	Severely Errored Seconds
"PSESeconds:SPDH:CRC:ANALysis"	% Severely Errored Seconds
"UASeconds:SPDH:CRC:ANALysis"	Unavailable Seconds
"PUASeconds:SPDH:CRC:ANALysis"	% Unavailable Seconds
"DMINutes:SPDH:CRC:ANALysis"	Degraded Minutes
"PDMInutes:SPDH:CRC:ANALysis"	% Degraded Minutes
"ESEConds:SPDH:CODE:ANALysis"	Code errored seconds

Structured PDH REBE Error Analysis Results

:SENSe:DATA? <"result">

Result =	"ECOunt:SPDH:REBE"	Error Count
	"ESEConds:SPDH:REBE:ANALysis"	Error Seconds
	"PESeconds:SPDH:REBE:ANALysis"	% Error Seconds
	"EFSeconds:SPDH:REBE:ANALysis"	Error Free Seconds
	"PEFSeconds:SPDH:REBE:ANALysis"	% Error Free Seconds
	"SESeconds:SPDH:REBE:ANALysis"	Severely Errored Seconds
	"PSESeconds:SPDH:REBE:ANALysis"	% Severely Errored Seconds
	"UASeconds:SPDH:REBE:ANALysis"	Unavailable Seconds
	"PUASeconds:SPDH:REBE:ANALysis"	% Unavailable Seconds
	"DMINutes:SPDH:REBE:ANALysis"	Degraded Minutes
	"PDMInutes:SPDH:REBE:ANALysis"	% Degraded Minutes
	"ESEConds:SPDH:CODE:ANALysis"	Code errored seconds

SENSe subsystem - Result Returning Commands

Structured PDH Alarm Seconds Results

:SENSe:DATA? <"result">

Result =	"ASEConds:SPDH:LOS"	Loss Of Signal
	"ASEConds:SPDH:M2:LOF"	2 Mb/s Frame Loss
	"ASEConds:SPDH:M8:LOF"	8 Mb/s Frame Loss
	"ASEConds:SPDH:M34:LOF"	34 Mb/s Frame Loss
	"ASEConds:SPDH:M140:LOF"	140 Mb/s Frame Loss
	"ASEConds:SPDH:DS1:OOF"	DS1 Out Of Frame
	"ASEConds:SPDH:DS3:OOF"	DS3 Out Of Frame
	"ASEConds:SPDH:OOF"	DS1/DS3 Out of Frame
	"ASEConds:SPDH:DS3:EXZ"	DS3 Excess zeros
	"ASEConds:SPDH:DS1:EXZ"	DS1 Excess zeros
	"ASEConds:SPDH:DS3:IDLE"	DS3 Idle
	"ASEConds:SPDH:DS3:FMM"	DS3 Frame Mismatch
	"ASEConds:SPDH:FERF"	FERF
	"ASEConds:SPDH:AIS"	AIS
	"ASEConds:SPDH:MFM"	Multiframe Loss
	"ASEConds:SPDH:RAI"	Remote Alarm
	"ASEConds:SPDH:RMFR"	Remote Multiframe Alarm
	"ASEConds:SPDH:PSL"	Pattern Sync Loss (see Note on page 3-21.

Structured PDH Round Trip Delay Results

:SENSe:DATA? <"result">

Result = "RTDelay:SPDH:COUNT" Round Trip Delay

FETCh subsystem

FETCh subsystem

The FETCh subsystem is used to retrieve data directly accumulated by the instrument.

:FETCh:STRing:DATA:TELEcom:SPDH:FEAC?

Returns: <numeric>

Returns the currently detected FEAC code as a 6 bit binary string.

:FETCh:STRing:DATA:TELEcom:SPDH:FEAC:TEXT?

Returns: <string>

Returns the currently detected FEAC code decoded as the message types defined in ANSI T1.107-1995. Note that two additional codes which are undefined by the ANSI spec have been decoded as follows:

Code	Message
00010010 11111111	NIU Loop Up
00100100 11111111	NIU Loop Down

:FETCh:STRing:DATA:TELEcom:SPDH:FEAC:LAST?

Returns: <numeric>

Returns the last detected non-idle FEAC code as a 6 bit binary string.

:FETCh:STRing:DATA:TELEcom:SPDH:FEAC:LAST:TEXT?

Returns: <string>

Returns the last detected non-idle FEAC code decoded as the message types defined in ANSI T1.107-1995. Note that two additional codes which are undefined by the ANSI spec have been decoded as follows:

Code	Message
------	---------

PDH Command Reference

FETCh subsystem

00010010 11111111

NIU Loop Up

00100100 11111111

NIU Loop Down

FETCh subsystem

INBAND LOOP CODES

:FETCh:STRing:DATA:TELEcom:SPDH:INBand:LAST?

Code	Message
Expected loop up code is detected	DETECTED
Expected loop up code is not detected

Returns: <numeric>

:FETCh:STRing:DATA:TELEcom:SPDH:INBand:LAST:TEXT?

Code	Message
Expected loop down code is detected	DETECTED
Expected loop down code is not detected

Returns: <string>

Returns the last valid Structured PDH receiver Inband Loop Code as a decode message as follows:-

Code	Message
00001	ACTIVATE LINE
001	DEACTIVATE LINE
1100	ACTIVATE PAYLOAD
1110	DEACTIVATE PAYLOAD
11000	ACTIVATE NETWORK
11100	DEACTIVATE UNIVERSAL

FETCh subsystem

Unrecognised preset code from USER CODE
above list

OUT-OF-BAND LOOP CODES

:FETCh:STRing:DATA:TELEcom:SPDH:OUTBand:CURRent?

Returns: <numeric>

Returns the current Structured PDH receiver Out-of-band loop code as a 6 bit binary string.

:FETCh:STRing:DATA:TELEcom:SPDH:OUTBand:CURRent:TEXT?

Returns: <string>

Returns the current Structured PDH receiver Out-of-band loop code as a decode message as follows :-

Code	Message
111000	ACTIVATE LINE
100110	DEACTIVATE LINE
010100	ACTIVATE PAYLOAD
100110	DEACTIVATE PAYLOAD
100100	ACTIVATE NETWORK
010010	DEACTIVATE UNIVERSAL
Unrecognised preset code from above list	USER CODE

:FETCh:STRing:DATA:TELEcom:SPDH:OUTBand:LAST?

Returns: <numeric>

Returns the last valid Structured PDH receiver Out-of-band loop code as a 6 bit binary string.

PDH Command Reference

FETCh subsystem

:FETCh:STRing:DATA:TELEcom:SPDH:OUTBand:LAST:TEXT?

Returns: <string>

Returns the last valid Structured PDH receiver Out-of-band loop code as a decode message as follows :-

Code	Message
111000	ACTIVATE LINE
100110	DEACTIVATE LINE
010100	ACTIVATE PAYLOAD
100110	DEACTIVATE PAYLOAD
100100	ACTIVATE NETWORK
010010	DEACTIVATE UNIVERSAL
Unrecognised preset code from above list	USER CODE

:FETCh:STRing:DATA:TELEcom:SPDH:M34:TTRace?

Returns: <string>

Returns the 15 or 16 byte Trail Trace as a string. The OmniBER 718 aligns the received trace by detecting the CRC7 byte. If the CRC7 byte is detected a 15 byte string is returned. If the CRC7 byte is not detected a 16 byte string is returned. If the string contains any not-printing characters then ~ is substituted. This is a snapshot of the received trail trace and is only updated once per second.

:FETCh:STRing:DATA:TELEcom:SPDH:M34:TTRace:HEXadecimal?

Returns: <block>

Returns the value of the Trail Trace as 15 or 16 hexadecimal numbers. The OmniBER 718 aligns the received trace by detecting the CRC7 byte. If the CRC7 byte is detected 15 hexadecimal numbers are returned. If the CRC7 byte is not detected 16 hexadecimal numbers are returned. Each number is in the range "00" to

FETCh subsystem

“FF”. The block header is “#215” if 15 Hex numbers and “#216” if 16 Hex numbers. This is a snapshot of the overhead byte and is captured once per second.

FETCh subsystem

:FETCh:SCALar:DATA:TELEcom:SPDH:TSLot:SIGNaling? <numeric>

Returns: <string>

<numeric> = 1 - 31 Timeslot number
1 to 24 Timeslot Number (DS1 Signalling Bits)

Returns: <string>

Returns the signalling bits for the specified timeslot as a string.

:FETCh:ARRay:DATA:TELEcom:SPDH:ASCan:M140?

Returns : <numeric>

Retained for backwards compatibility. Returns a number indicating the status of the 140 Mb/s Alarm Scan. For new developments the command :FETCh:ARRay:DATA:TELEcom:SPDH:ASCan? is recommended.

:FETCh:ARRay:DATA:TELEcom:SPDH:ASCan:M34?

Returns : <numeric>,<numeric>,<numeric>,<numeric>

Retained for backwards compatibility. Returns 4 numbers, separated by commas, indicating the status of the 34 Mb/s Alarm Scan. For new developments the command :FETCh:ARRay:DATA:TELEcom:SPDH:ASCan? is recommended.

:FETCh:ARRay:DATA:TELEcom:SPDH:ASCan:M8?

Returns (each of <numeric>,<numeric>,<numeric>,<numeric>
rows 1 to 4):

Retained for backwards compatibility. Returns 4 rows of 4 numbers, separated by commas, indicating the status of the 8 Mb/s Alarm Scan. For new developments the command :FETCh:ARRay:DATA:TELEcom:SPDH:ASCan? is recommended.

FETCh subsystem

:FETCh:ARRay:DATA:TELEcom:SPDH:ASCan:M2?

Returns (each of <numeric>,<numeric>,<numeric>,<numeric>
rows 1 to 16):

Retained for backwards compatibility. Returns 16 rows of 4 numbers separated by commas, indicating the status of the 2 Mb/s Alarm Scan. For new developments the command

:FETCh:ARRay:DATA:TELEcom:SPDH:ASCan? is recommended.

:FETCh:ARRay:DATA:TELEcom:SPDH:ASCan?

Returns (each of one or <numeric>{,<numeric>}
more rows):

The results returned are those for the last FULL scan. Results from partial scans are not available. If no full scan has been completed since the instrument was powered up, this command will return -1.

If data is available it is returned as a set of string arrays. The arrays are separated by a CR/LF pair. The arrays consist of comma separated numerics, one for each scanned tributary. The numeric is a boolean flag which is used as follows.

Value	State
0	No Problems detected
1	Alarms Detected

For specific signal structures, the format of the returned strings are shown below:

1) 140Mb/s Interface Rate, Structured, 2Mb/s Test Signal

Each level of the structure scanned returns its results in one array apart from the fourth level, in this case 2Mb/s, where its results are split into 4 arrays.

140Mb/s	0
34Mb/s	0,0,1,0
8Mb/s	0,1,0,1,1,0,0,1,1,1,1,0,0,0,0,0
2Mb/s	1,1,1,0,0,1,0,0,0,0,0,1,1,1,1,0

FETCh subsystem

0,1,1,1,1,1,0,0,0,0,0,0,0,0,0

1,1,1,1,0,0,1,0,0,0,1,1,1,1,0,0

0,0,0,0,0,0,0,0,0,0,0,0,0,0,0,0

2) STM-1 Interface Rate, DS3 Payload, Structured, Nx64kb/s Test Signal

When there are less than four levels in the structure, each levels results are returned in one array.

DS3 0

DS2 0,0,1,0,1,1,1

DS1 0,1,0,1,1,0,0,1,1,1,1,0,0,0,0,0,1,0,1,1,1,0,0,0,0,0,1,1

SDH SCPI Command Reference

OUTPut subsystem, see page 5- 3.

SOURce subsystem - Transmitter SDH Settings Commands, see page 5- 9.

SDH Mapping Settings, see page 5-14.

SOURce subsystem - Transmitter SDH OVERHEAD SETUP, see page 5- 27.

SOURce subsystem - Transmitter SDH Test Function Commands, see page 5-40.

INPut subsystem, see page 5- 69.

SENSe subsystem - Receiver SDH Settings, see page 5- 73.

SENSe subsystem - Receiver SDH Test Function Commands, see page 5-83.

SENSe subsystem - Alarm Scan Control, see page 5-89.

SENSe subsystem - SDH Tributary Scan Control, see page 5- 91.

SENSe subsystem - Result Returning Commands, see page 5- 93.

FETCh subsystem, see page 5- 107.

SDH Command Reference

This chapter contains detailed information on the SCPI (Standard Commands for Programming Instruments) and IEEE 488.2 common commands you will use when writing programs to control your OmniBER 718 for SDH operation.

Please also refer to chapter 2 Common Commands for general information on SCPI command formats and for a list of commands that are common to PDH, SDH, SONET, Jitter or ATM operation; they are as follows:

SCPI Command Format

Remote Control Commands

Instrument Options

INSTRument subsystem

SOURce subsystem

SOURce subsystem - Transmitter Common Commands

INPut subsystem

SENSE subsystem

SENSE subsystem - Receiver Common Commands

SENSE subsystem - Test Timing

SENSE subsystem - Analysis Control

SENSE subsystem - Trouble Scan Results

SENSE subsystem - Configuring Graphics

SENSE subsystem - Managing Graphics Stores

SENSE subsystem - Retrieving Graphics Store Data

SENSE subsystem - Retrieving Data for a Single Graph

SENSE subsystem - Obtaining Graphics End of Measurement Results

STATus Subsystem

SYSTEM Subsystem

IEEE common capabilities

OUTPut subsystem

OUTPut subsystem

This subsystem controls the characteristics of the instrument's output ports.

:OUTPut:TELEcom:SDH:RATE <discrete>

<discrete> =	STM0	STM-0 Electrical
	STM1	STM-1 Electrical

Is only valid when :SOURce:DATA:TELEcom:SOURce <discrete> is set to SDH.

:OUTPut:TELEcom:SDH:RATE?

Returns: <discrete>

:OUTPut:TELEcom:SDH:LEVel <discrete>

<discrete> =	XCON	450 feet simulated cable
	HIGH	0 feet simulated cable
	LOW	900 feet simulated cable

Selects the signal level for the STM-0 output.

The corresponding query returns the STM-0 signal level in discrete short form.

:OUTPut:TELEcom:SDH:LEVel?

Returns: <discrete>

:OUTPut:TELEcom:OPT1:RATE <discrete>

<discrete> =	STM0	STM-0 optical
	STM1	STM-1 Optical

Selects the output rate for the STM-0/STM-1 optical output port. This command is only valid when :SOURce:DATA:TELEcom:SOURce <discrete> is set to OPT1.

The corresponding query returns the STM-0/STM-1 output rate in discrete form as listed above. If the OPT1 port is not selected, STM1 will be returned as the default.

OUTPut subsystem

:OUTPut:TELEcom:OPT1:RATE?

Returns : <discrete>

:OUTPut:TELEcom:OPT1:INTerface?

Returns: <discrete>

Returns the selected output port interface in discrete form - always OPTical.

:OUTPut:TELEcom:OPT1:WAVelength <discrete>

<discrete> =	NM1310	1310 nm
	NM1550	1550 nm

Selects the wavelength of the output optical signal on the Optical module.

The corresponding query returns the output optical wavelength in discrete form, as listed above.

:OUTPut:TELEcom:OPT1:WAVelength?

Returns : <discrete>

:OUTPut:TELEcom:OPT1:LASer <boolean>

<boolean> =	0 or OFF
	1 or ON

Controls the state of the laser (ON or OFF) on the Optical module.

The corresponding query returns the state of the laser as 0 or 1.

:OUTPut:TELEcom:OPT1:LASer?

Returns : <boolean> 0 or 1

OUTPut subsystem

:OUTPut:TELEcom:OPT4:RATE <discrete>

<discrete> =	STM0	STM-0 optical
	STM1	STM-1 Optical
	STM4	STM-4 Optical

Selects the output rate for the STM-0/STM-1/STM-4 optical output port. This command is only valid when :SOURce:DATA:TELEcom:SOURce <discrete> is set to OPT4.

The corresponding query returns the STM-0/STM-1/STM-4 output rate in discrete form as listed above. If the OPT4 port is not selected, STM4 will be returned as the default.

:OUTPut:TELEcom:OPT4:RATE?

Returns : <discrete>

:OUTPut:TELEcom:OPT4:INTerface?

Returns: <discrete>

Returns the selected output port interface in discrete form - always OPTical.

:OUTPut:TELEcom:OPT4:WAVelength <discrete>

<discrete> =	NM1310	1310 nm
	NM1550	1550 nm

Selects the wavelength of the output optical signal on the Optical module.

The corresponding query returns the output optical wavelength in discrete form, as listed above.

:OUTPut:TELEcom:OPT4:WAVelength?

Returns : <discrete>

OUTPut subsystem

NM1550 1550 nm

Selects the wavelength of the output optical signal on the Optical module. Only valid for Dual Wavelength options.

The corresponding query returns the output optical wavelength in discrete form, as listed above.

:OUTPut:TELEcom:OPT16:WAVelength?

Returns : <discrete>

:OUTPut:TELEcom:OPT16:LASer <boolean>

<boolean> = 0 or OFF

1 or ON

Controls the state of the laser (ON or OFF) on the Optical module. Only valid for Dual Wavelength options.

The corresponding query returns the state of the laser as 0 or 1.

:OUTPut:TELEcom:OPT16:LASer?

Returns : <boolean> 0 or 1

SDH Command Reference
OUTPut subsystem

SOURce subsystem - Transmitter SDH Settings Commands**SDH Clock settings****:SOURce:CLOCK:SDH:SOURce <discrete>**

<discrete> =	INTernal	Internal
	EXTernal	External MTS Clock/Data
	RSTM0	STM-0 Electrical
	ROPT0	STM-0 Optical
	RMON0	STM-0 Monitor
	RSTM1	STM-1 Electrical
	ROPT1	STM-1 Optical
	RMON1	STM-1 Monitor
	ROPT4	STM-4 Optical
	RMON4	STM-4 Monitor
	ROPT16	STM-16 Optical

Selects the SDH transmitter clock sync source. If the RX is set to an SDH rate, then the only received clock rate that may be selected is the one in use. This restriction does not apply if the RX is set to a non SDH rate. If EXT is selected, the Format is set using :SOURce:CLOCK:SDH:FORMat <discrete>.

The corresponding query returns the transmitter SDH clock sync source in discrete form as listed above.

:SOURce:CLOCK:SDH:SOURce?

Returns : <discrete>

:SOURce:CLOCK:SDH:LEVel <discrete>

<discrete> =	TERMinate	Terminated
	MONitor	Monitor

Selects the transmitter SDH clock sync source level.

SOURce subsystem - Transmitter SDH Settings Commands

The corresponding query returns the transmitter SDH clock sync source level in discrete form as listed above.

:SOURce:CLOCK:SDH:LEVel?

Returns : <discrete>

:SOURce:CLOCK:SDH:FORMat <discrete>

<discrete> =	CLOCK	Clock Format
	DATA	Data Format
	K64	64kb/s data
	DS1Bits	DS1 bit rate
	M10Ref	10 MHz Reference

Selects the transmitter SDH EXT MTS clock sync source format.

The corresponding query returns the EXT MTS clock sync source format in discrete form as listed above.

:SOURce:CLOCK:SDH:FORMat?

Returns : <discrete>

:SOURce:CLOCK:SDH:FOFFset <boolean>

<boolean> =	0 or OFF
	1 or ON

Enables/disables the SDH Frequency Offset. The amount of Offset is set using :SOURce:CLOCK:SDH:FOFFset:OFFSet <numeric><suffix>.

The corresponding query returns the SDH Frequency Offset state as 0 or 1.

:SOURce:CLOCK:SDH:FOFFset?

Returns : <boolean>

SOURce subsystem - Transmitter SDH Settings Commands

:SOURce:DATA:TELEcom:SDH:THRumode:PAYLoad:OVERwrite
<discrete>

<discrete> =	OFF	Payload Overwrite Off
	AU4	Overwrite AU-4 payload
	AU3	Overwrite AU-3 payload
	TU3	Overwrite TU-3 payload
	TU2	Overwrite TU-2 payload
	TU12	Overwrite TU-12 payload
	TU11	Overwrite TU-11 payload

Selects the type of thru-mode payload to overwrite. The payload is not overwritten until explicitly enabled by

:SOURce:DATA:TELEcom:SDH:THRumode:PAYLoad:OVERwrite:ENABle
<boolean> .

The corresponding query returns the payload overwrite state in discrete form as listed above.

:SOURce:DATA:TELEcom:SDH:THRumode:PAYLoad:OVERwrite?

Returns : **<discrete>**

:SOURce:DATA:TELEcom:SDH:THRumode:PAYLoad:OVERwrite:ENABle
<boolean>

<boolean> =	0 or OFF
	1 or ON

Enable the thru-mode payload overwrite.

The corresponding query returns the payload overwrite enable state in discrete form as listed above.

:SOURce:DATA:TELEcom:SDH:THRumode:PAYLoad:OVERwrite:ENABle?

Returns : **<boolean>** **0 or 1**

SOURCE subsystem - Transmitter SDH Settings Commands

:SOURCE:DATA:TELEcom:SDH:THRumode:COVerwrite <boolean>

<boolean> =	0 or OFF	Overhead Overwrite Off
	1 or ON	Overhead Overwrite On

Enables/disables section overhead overwrite.

The corresponding query returns the section overhead overwrite state in discrete form as listed above.

:SOURCE:DATA:TELEcom:SDH:THRumode:COVerwrite?

Returns : <boolean>

SOURce subsystem - Transmitter SDH Settings Commands

:SOURce:DATA:TELEcom:SDH:TCM:APID:PATtern?

Returns : <discrete>

:SOURce:DATA:TELEcom:SDH:TCM:APID:DATA <string>

Sets the user defined pattern that is to be transmitted in the TC-APId message. The pattern should be 15 characters long. If less than 15 characters are input, the instrument will pad with the required number of NULL characters and a frame marker byte with CRC7 is added to the string. The pattern repeats every 16 characters and is transmitted byte by byte in subsequent multiframes.

The corresponding query returns the value of the user defined pattern as a string, as defined above. If the string contains any non printing characters, ~ is substituted.

:SOURce:DATA:TELEcom:SDH:TCM:APID:DATA?

Returns : <string>

AU Layer Selection

:SOURce:DATA:TELEcom:SDH:AU:TYPE <discrete>

<discrete> = AU4
AU3
AU4_4C
AU4_16C

Set the AU mapping into an STM-N frame.

The corresponding query returns the AU layer in discrete form as listed above.

:SOURce:DATA:TELEcom:SDH:AU:TYPE?

Returns: <discrete>

:SOURce:DATA:TELEcom:SDH:AU3 <numeric>

<numeric> = 1 to 3 AU3 Number

SOURce subsystem - Transmitter SDH Settings Commands

ATM	ATM (C4-16C, C4-4C, C-4 or C-3)
IPOS	POS (C4-16C, C4-4C, C-4, or C-3)

This command controls the transmitter SDH payload for single payload cases.

Only valid if :SOURce:DATA:TELEcom:SDH:PAYLoad <discrete> is set to VC3, VC4, VC4-4c or VC4-16c.

The corresponding query returns the low order mapping in discrete form as listed above.

:SOURce:DATA:TELEcom:SDH:MAPPING?

Returns: <discrete>

:SOURce:DATA:TELEcom:SDH:TRIButary:MAPPING <discrete>

<discrete> =	ASYNc or ASM2	Asynchronous 2 Mb/s
	FBYTe or FLM2	2 Mb/s Floating Byte
	M34 or ASM34	34 Mb/s
	DS1 or ASDS1	Asynchronous 1.544Mb/s DS1
	FLDS1	DS1 Floating Byte
	DS3 or ASDS3	Asynchronous 44.736 Mb/s DS3
	BULK	Bulk Filled

Selects the transmitter low order mapping. Only valid if :SOURce:DATA:TELEcom:SDH:PAYLoad <discrete> is set to TU3, TU12 or TU11.

The corresponding query returns the low order mapping in discrete short form.

:SOURce:DATA:TELEcom:SDH:TRIButary:MAPPING?

Returns: <discrete>

TUG Channel**:SOURce:DATA:TELEcom:SDH:TUG3 <numeric>**

<numeric> = 1 to 3 TUG3 Number

SOURce subsystem - Transmitter SDH Settings Commands**:SOURce:DATA:TELEcom:SDH:PAYLoad:STRucture?**

Returns: <discrete>

:SOURce:DATA:TELEcom:SDH:PAYLoad:PATtern <discrete>

<discrete> =	PRBS9	2^9-1
	PRBS11	$2^{11}-1$
	PRBS15	$2^{15}-1$
	PRBS20	$2^{20}-1$
	PRBS23	$2^{23}-1$
	QRSS	$2^{20}-1$ with 14 consecutive zero limit
	AZERo	All Zeros
	AONE	All Ones
	STRess	3-in-24 stress pattern (DS1 only)
	P1IN8	1-in-8 test pattern
	P2IN8	2-in-8 test pattern
	OCT55	55 octet test pattern (uses Daly pattern as per ANSI T1.403)
	P1010	Word 1010
	P1000	Word 1000
	UWORD	16 Bit User Word

Selects the transmitter SDH payload data pattern.

See: :SOURce:DATA:TELEcom:SDH:PAYLoad:TYPE <discrete>. If UWORD is selected, the word pattern is set using

:SOURce:DATA:TELEcom:SDH:PAYLoad:UWORD <string>.

The corresponding query returns the transmitter SDH payload data pattern in discrete form, as listed above.

:SOURce:DATA:TELEcom:SDH:PAYLoad:PATtern?

Returns : <discrete>

SOURce subsystem - Transmitter SDH Settings Commands

:SOURce:DATA:TELEcom:SDH:PAYLoad:UWORD <string>

Sets the SDH transmitter user word pattern in the range "0000000000000000" to "1111111111111111".

The corresponding query returns the user word pattern as a string.

:SOURce:DATA:TELEcom:SDH:PAYLoad:UWORD?

Returns : <string>

:SOURce:DATA:TELEcom:SDH:PRBS:POLarity <discrete>

<discrete> = INVerted
 NORMal

Selects the PRBS pattern polarity.

The corresponding query returns the polarity in discrete form as listed above.

:SOURce:DATA:TELEcom:SDH:PRBS:POLarity?

Returns: <discrete>

:SOURce:DATA:TELEcom:SDH:PAYLoad:OFFSet <numeric>

<numeric> = -100 to +100 Parts per Million
 -0.000100 to 0.000100 % or Ratio
<suffix> = PPM Parts per Million
 PCT Percentage

Sets the 140, 34, 2 Mb/s, DS3 or DS1 payload frequency offset in parts per million (ppm).

The corresponding query returns the offset in numeric form.

:SOURce:DATA:TELEcom:SDH:PAYLoad:OFFSet?

Returns: <numeric> ppm

SOURce subsystem - Transmitter SDH Settings Commands

:SOURce:DATA:TELEcom:SDH:TRIButary:CONCatenate <numeric>, <numeric>

<numeric> = (first parameter)	0	Concatenation Off
	2	TU2-2C
	3	TU2-3C
	4	TU2-4C
	5	TU2-5C
	6	TU2-6C
<numeric> = (second parameter)	1 to 6	TU2-2C selected
	1 to 5	TU2-3C selected
	1 to 4	TU2-4C selected
	1 to 3	TU2-5C selected
	1 to 2	TU2-6C selected

Selects the TU2 concatenation (first parameter) and starting at TU (second parameter).

The corresponding query returns the TU2 concatenation and starting at TU in numeric form as listed above.

:SOURce:DATA:TELEcom:SDH:TRIButary:CONCatenate?

Returns : <numeric>, <numeric>

Background Settings

:SOURce:DATA:TELEcom:SDH:AU3:BACKground <discrete>

<discrete> =	UNEQuipped	Fixed at 00000000
	AS_FG	As Foreground

Selects the payload in the background (non test) AU-3s. This command only applies if the selected mapping is AU3.

SOURce subsystem - Transmitter SDH Settings Commands

The corresponding query returns the type of payload in the background AU-3s in discrete short form.

:SOURce:DATA:TELEcom:SDH:AU3:BACKground?

Returns: <discrete>

:SOURce:DATA:TELEcom:SDH:AU4:BACKground <discrete>

<discrete> =	UNEQuipped	Fixed at 00000000
	AS_FG	As Foreground

Selects the payload in the background (non test) AU-4s. This command only applies if the selected mapping is AU4.

The corresponding query returns the type of payload in the background AU-4s in discrete short form.

:SOURce:DATA:TELEcom:SDH:AU4:BACKground?

Returns: <discrete>

:SOURce:DATA:TELEcom:SDH:AU4C:BACKground <discrete>

<discrete> =	UNEQuipped	Fixed at 00000000
	AS_FG	As Foreground

Selects the payload in the background (non test) AU-4-4Cs. This command only applies if the selected mapping is AU4-4C.

The corresponding query returns the type of payload in the background AU-4-4Cs in discrete short form.

:SOURce:DATA:TELEcom:SDH:AU4C:BACKground?

Returns: <discrete>

:SOURce:DATA:TELEcom:SDH:PRIMary:BACKground:PAYLoad:PATtern <discrete>

<discrete> =	PRBS9	2^9-1
	PRBS15	$2^{15}-1$

SOURce subsystem - Transmitter SDH Settings Commands

NUMBered	(TU2 or framed TU12/TU11)
P1100	word 1100

Selects the background payload pattern for TUs within the foreground TUG3 or AU3.

The corresponding query returns the background pattern in discrete form as listed above.

:SOURce:DATA:TELEcom:SDH:PRIMary:BACKground:PAYLoad:PATtern?

Returns: <discrete>

:SOURce:DATA:TELEcom:SDH:TUG3:BACKground:PAYLoad:PATtern <numeric> <discrete>

<numeric> =	1 to 3	TUG 3 to be configured
<discrete>	TU3	TU-3 structure
	TU12	TU-12 structure
	UWORD	User Defined

Selects the structure in a background TUG3. This command is only valid if the selected TUG3 is not the current foreground.

The corresponding query returns the specified TUG3 background structure in discrete form as listed above.

:SOURce:DATA:TELEcom:SDH:TUG3:BACKground:PAYLoad:PATtern? <numeric>

<numeric> = 1 to 3

:SOURce:DATA:TELEcom:SDH:TUG3:BACKground:PAYLoad:PATtern:UWORD <numeric> <string>

<numeric> =	1 to 3	TUG 3 to be configured
<string>	8 bit	00000000 to 11111111

Sets the user pattern to be transmitted in the specified background TUG3. This command is only valid if the TUG3 selected is not the current foreground.

The corresponding query returns the background word pattern in the TUG 3 selected by numeric.

SOURce subsystem - Transmitter SDH Settings Commands

**:SOURce:DATA:TELEcom:SDH:TUG3:BACKground:PAYLoad:PATtern:U
WORD? <numeric>**

<numeric> = 1 to 3

SOURce subsystem - Transmitter SDH OVERHEAD SETUP**SOURce subsystem - Transmitter SDH OVERHEAD SETUP**

Lists the settings for the commands associated with the TRANSMIT OVERHEAD SETUP display.

:SOURce:DATA:TELEcom:SDH:OVERhead:DEFault

Sets all overhead bytes to their default value:

Byte	Value	Byte	Value	Byte	Value	Byte	Value
A1	11110110	A2	00101000	J0/Z0	00000001	B1	xxxxxxxx
E1	00000000	F1	00000000	D1	00000000	D2	00000000
D3	00000000	E2	00000000	H1	xxxx10xx	H2	xxxxxxxx
H3	xxxxxxxx	B2	xxxxxxxx	K1	00000000	K2	00000000
D4	00000000	D5	00000000	D6	00000000	D7	00000000
D8	00000000	D9	00000000	D10	00000000	D11	00000000
D12	00000000	S1/Z1	00000000	Z2/M1	00000000	J1	Default
B3	xxxxxxxx	C2	00000001	G1	00000000	F2	00000000
H4	00000000	F3	00000000	K3	00000000	N1	00000000

:SOURce:DATA:TELEcom:SDH:OVERhead:DATA <numeric>, <numeric>, <discrete>, <string>

<numeric> = STM-1 Number: range 1 to 16
(first parameter)

<numeric> = Column Number: range 1 to 3
(second parameter)

<discrete> = A1|A2|J0/Z0|E1|F1|D1|D2|D3|H1|K1
K2|D4|D5|D6|D7|D8|D9|D10|D11
D12|S1/Z1|M1/Z2|E2
X11|X12|X13|X21|X22|X23|X31|X32|X33|
X41|X42|X52|X53|X61|X62|X63|
X71|X72|X73|X81|X82|X83|X91|X92|X93

<string> = "00000000" to "11111111"

SOURce subsystem - Transmitter SDH OVERHEAD SETUP

:SOURce:DATA:TELEcom:SDH:OVERhead:DATA:HEXadecimal<numeric>, <numeric>, <discrete>, <string>

<numeric> = (first parameter)	STM-1 Number: range 1 to 16
<numeric> = (second parameter)	Column Number: range 1 to 3
<discrete> =	A1 A2 J0/Z0 E1 F1 D1 D2 D3 H1 K1 K2 D4 D5 D6 D7 D8 D9 D10 D11 D12 S1/Z1 M1/Z2 E2 X11 X12 X13 X21 X22 X23 X31 X32 X33 X41 X42 X52 X53 X61 X62 X63 X71 X72 X73 X81 X82 X83 X91 X92 X93
<string> =	"00" to "FF"

Sets the hexadecimal value for the selected transmitter transport overhead byte. All overhead bytes in the transmitted signal can be configured. The required byte is specified by 3 command parameters

The first parameter, STM-1 Number, identifies an STM-1 within the signal. The acceptable range for this parameter will depend on the selected transmit signal rate. For the STM-0 signal rate only 1 is valid.

The second parameter identifies a set of columns within the selected STM-1. A Value of 1 selects Columns 1,4,&7, a value of 2 selects Columns 2,5,&8. and a value of 3 selects Columns 3,6,&9. For the STM-0 signal rate only 1 is valid.

The third parameter identifies the specific byte in the selected set of columns. There are two ways of specifying this byte. The first is to use standard names where these are valid. The set of valid names is shown in the table above. The second method is to use a "Xrc" notation, where r is the numerical value of the bytes row in the transport overhead and c is the numerical value of the bytes column in the transport overhead. This method allows access to ANY byte in the selected STM-1 / Column set.

The fourth command parameter is a 2 character string representing the hex value which should be transmitted in the specified byte.

Where a set of H1 and H2 bytes in the overhead represent an active pointer, only the SS bits in H2 can be set. In this case the fourth parameter is still specified as an 2 bit string but has the unsettable nibble set to 'x' and the nibble containing the SS bits set

SOURce subsystem - Transmitter SDH OVERHEAD SETUP

to a value which assumes that the other 2 bits are zero. For example, to set bits 2 and 3 to '11' send the value 'xC'.

The K1 and K2 bytes can not be programmed when the MSP Message topology protection mode is set to Active.

The corresponding query returns the hexadecimal value of the byte named within the selected STM-1 column.

:SOURce:DATA:TELEcom:SDH:OVERhead:DATA:HEXadecimal?
<numeric>, <numeric>, <discrete>

Returns: <string>

:SOURce:DATA:TELEcom:SDH:POVerhead:DATA <discrete>,<string>

<discrete> = C2|G1|F2|H4|Z3/F3|Z4/K3|Z5/N1|V5

<string> = "xx00xxx0" to "xx11xxx1" for V5
 "xxxx00xx" to "xxxx11xx" for N1 (TCM HO Path)
 "00000000" to "11111111" otherwise

Sets the binary value of the specified VC-4-NC/VC-4/VC-3 High Order POH overhead byte. The corresponding query returns the value of the specified STM-1 path overhead byte as a string, as described above.

:SOURce:DATA:TELEcom:SDH:POVerhead:DATA? <discrete>

Returns: <string>

:SOURce:DATA:TELEcom:SDH:POVerhead:SLABel <discrete>

<discrete> =	UNEQuipped	Unequipped (00000000)
	EQUipped	Equipped (00000001)
	TUGStructure	TUG structure (00000010)
	LOCKed	Locked TU (00000011)
	ASYN34	Asynchronous 34 /45 Mb/s (00000100)
	ASYN140	Asynchronous 140 Mb/s (00010010)

SOURce subsystem - Transmitter SDH OVERHEAD SETUP

ATM	ATM (00010011)
DQDB	DQDB (00010100)
FDDI	FDDI (00010101)
PPPScram	PPP Scrambling On (00010110)
PPPNoscram	PPP Scrambling Off (11001111)
BULK	Bulk Filled (11111110)
VCAis	VCAIS
USER	User Defined

Sets the value of the HP path label (C2 Byte) of the foreground High Order POH. To update the USER byte value use the
:SOURce:DATA:TELEcom:SDH:POVerhead:DATA <discrete>, <string> command.

The corresponding query returns the value of the C2 byte in discrete short form.

:SOURce:DATA:TELEcom:SDH:POVerhead:SLABel?

Returns: <discrete>

:SOURce:DATA:TELEcom:SDH:POVerhead:J1:PATtern <discrete>

<discrete> =	Default	64 NULL characters
	TEST	Test Message
	USER	User Defined
	CRC7Test	GB(serial number)
	CRC7User	User Defined

Sets the type of pattern that is to be transmitted in the J1 byte of the STM path overhead. The pattern repeats every 64 characters (16 chars in CRC7 case) and is transmitted byte by byte in subsequent frames.

The corresponding query returns the type of pattern being transmitted in STM-1 path overhead byte J1 in discrete form as listed above.

:SOURce:DATA:TELEcom:SDH:POVerhead:J1:PATtern?

Returns : <discrete>

SOURce subsystem - Transmitter SDH OVERHEAD SETUP

:SOURce:DATA:TELEcom:SDH:POVerhead:J1 <string>

Sets the user defined pattern that is to be transmitted in the J1 byte of the STM path overhead. The pattern should be 64 characters long, terminated with CR/LF. If less than 64 characters are input, the instrument will pad with the required number of NULL characters and terminate with CR/LF. The pattern repeats every 64 characters and is transmitted byte by byte in subsequent frames.

The corresponding query returns the value of the user defined pattern as a string, as defined above. If the string contains any non printing characters, ~ is substituted.

If CRC7 was returned in response to

:SOURce:DATA:TELEcom:SDH:POVerhead:J1:PATtern? , this query command is not valid.

:SOURce:DATA:TELEcom:SDH:POVerhead:J1?

Returns : <string>

:SOURce:DATA:TELEcom:SDH:POVerhead:J1:CRC7 <string>

This command sets the CRC7 based user defined string that is to be transmitted using the J1 byte and configures the instrument to use this string. The string can be up to 15 characters in length; remaining characters are set to NULLs. A frame marker byte with CRC7 is added to this string.

The string is transmitted byte by byte in subsequent frames. The string repeats every 16 characters. The corresponding query returns the current value of the string. If the string contains any non printing characters, ~ is substituted.

:SOURce:DATA:TELEcom:SDH:POVerhead:J1:CRC7?

Returns : <string>

:SOURce:DATA:TELEcom:SDH:POVerhead:J1:HEXadecimal?

Returns : <block>

Returns a 64 byte block of data. Each byte represents the hexadecimal value of an ASCII character of STM path overhead byte J1 in the range "00" to "FF". The 64 hexadecimal numbers are preceded by the header "#264".

If CRC7 was returned in response to

:SOURce:DATA:TELEcom:SDH:POVerhead:J1:PATtern?, this query command is not valid.

SOURce subsystem - Transmitter SDH OVERHEAD SETUP

:SOURce:DATA:TELEcom:SDH:TRIButary:POVerhead:DATA <discrete>,<string>

<discrete>= C2|G1|F2|H4|F3|K3|N1|N2|K4|V5

<string>= "xx00xxx0" to "xx11xxx1" for V5
 "xxxx00xx" to "xxxx11xx" for N1/N2 (TCM LO Path)
 "00000000" to "11111111" otherwise

Sets the binary value of the specified VC-3/VC-2/VC-12/VC-11 Low Order POH overhead byte. The corresponding query returns the byte specified by type in string form, as described above.

:SOURce:DATA:TELEcom:SDH:TRIButary:POVerhead:DATA? <discrete>

Returns: <string>

:SOURce:DATA:TELEcom:SDH:OVERhead:J0:PATtern <discrete>

<discrete> =	FIXed	Fixed Byte
	TEST	GB(serial number)
	USER	User Defined

Sets the type of pattern that is to be transmitted in the J0 byte of the STM regenerator section overhead. The pattern repeats every 16 characters and is transmitted character by character in subsequent frames. Default = FIX.

The corresponding query returns the type of pattern being transmitted in overhead byte J0 in discrete short form.

:SOURce:DATA:TELEcom:SDH:OVERhead:J0:PATtern?

Returns: <discrete>

:SOURce:DATA:TELEcom:SDH:OVERhead:J0 <string>

Sets the user defined pattern that is to be transmitted in the J0 byte of the regenerator overhead. The pattern should be 15 characters long. The instrument automatically appends a E.164 CRC character to make up a 16 character sequence. If less than 15 characters are input, the instrument will pad with the required number of NULL characters. The pattern repeats every 16 characters and is transmitted character by character in subsequent frames.

The corresponding query returns the value of the user defined pattern as a string, as defined above. If the string contains any non printing characters, ~ is substituted.

SOURce subsystem - Transmitter SDH OVERHEAD SETUP

If FIXed was returned in response to: **SOURce:DATA:TELEcom:SDH:OVERhead:J0:PATtern?**, this query command is not valid.

:SOURce:DATA:TELEcom:SDH:OVERhead:J0?

Returns: <string>

:SOURce:DATA:TELEcom:SDH:OVERhead:J0:HEXAdecimal?

Returns: <block>

Returns a 15 byte block of data. Each byte represents the hexadecimal value of an ASCII character "00" to "FF". The 15 hexadecimal numbers are preceded by the header "#215".

If FIXed was returned in response to: **SOURce:DATA:TELEcom:SDH:OVERhead:J0:PATtern?**, this query command is not valid.

:SOURce:DATA:TELEcom:SDH:TRIButary:POVerhead:J1:PATtern <discrete>

<discrete> =	DEFault	64 NULL characters
	TEST	Test message
	USER	User Defined
	CRC7Test	GB(serial number)
	CRC7User	User Defined

Sets the type of pattern that is to be transmitted in the J1 byte of the TU3 path overhead. The pattern repeats every 64 characters (16 chars in CRC7 case) and is transmitted byte by byte in subsequent frames.

The corresponding query returns the type of pattern being transmitted in TU3 path overhead byte J1 in discrete form as listed above.

:SOURce:DATA:TELEcom:SDH:TRIButary:POVerhead:J1:PATtern?

Returns : <discrete>

SOURce subsystem - Transmitter SDH OVERHEAD SETUP

:SOURce:DATA:TELEcom:SDH:TRIButary:POVerhead:J1 <string>

Sets the user defined pattern that is to be transmitted in the J1 byte of the TU3 path overhead. The pattern should be 64 characters long, terminated with CR/LF. If less than 64 characters are input, the instrument will pad with the required number of NULL characters and terminate with CR/LF. The pattern repeats every 64 characters and is transmitted byte by byte in subsequent frames.

The corresponding query returns the value of the user defined pattern as a string, as defined above. If the string contains any non printing characters, ~ is substituted.

If CRC7T or CRC7U was returned in response to

:SOURce:DATA:TELEcom:SDH:POVerhead:J1:PATtern?, this query command is not valid.

:SOURce:DATA:TELEcom:SDH:TRIButary:POVerhead:J1?

Returns : <string>

:SOURce:DATA:TELEcom:SDH:TRIButary:POVerhead:J1:CRC7 <string>

This command sets the CRC7 based user defined string that is to be transmitted using the J1 byte of the TU3 path overhead, and configures the instrument to use this string. The string can be up to 15 characters in length; remaining characters are set to NULLs. A frame marker byte with CRC7 is added to this string. The string is transmitted byte by byte in subsequent frames. The string repeats every 16 characters. The corresponding query returns the current value of the string. If the string contains any non printing characters, ~ is substituted.

:SOURce:DATA:TELEcom:SDH:TRIButary:POVerhead:J1:CRC7?

Returns : <string>

:SOURce:DATA:TELEcom:SDH:TRIButary:POVerhead:J1:HEXadecimal?

Returns : <block>

Returns a 64 byte block of data. Each byte represents the hexadecimal value of an ASCII character of TU3 byte J1 in the range "00" to "FF". The 64 hexadecimal numbers are preceded by the header "#264".

If CRC7T or CRC7U was returned in response to

:SOURce:DATA:TELEcom:SDH:POVerhead:J1:PATtern?, this query command is not valid.

SOURce subsystem - Transmitter SDH OVERHEAD SETUP

:SOURce:DATA:TELEcom:SDH:TRIButary:POVerhead:J2:PATtern
<discrete>

<discrete> =	DEFault	15 NULL characters
	TEST	GB(serial number)
	USER	User Defined
	FIXed	Fixed Byte

Sets the type of pattern that is to be transmitted in the J2 byte of the VC-2, VC-11 or VC-12 path overhead. The pattern repeats every 16 characters and is transmitted byte by byte in subsequent frames.

The corresponding query returns the type of pattern being transmitted in VC-2, VC-11 or VC-12 path overhead byte J2 in discrete form as listed above.

:SOURce:DATA:TELEcom:SDH:TRIButary:POVerhead:J2:PATtern?

Returns : **<discrete>**

:SOURce:DATA:TELEcom:SDH:TRIButary:POVerhead:J2 <string>

Sets the user defined pattern that is to be transmitted in the J2 byte of the VC-2, VC-11 or VC-12 path overhead. The pattern should be 15 characters long. If less than 15 characters are input, the instrument will pad with the required number of NULL characters and a frame marker byte with CRC7 is added to the string. The pattern repeats every 16 characters and is transmitted byte by byte in subsequent frames.

The corresponding query returns the value of the user defined pattern as a string, as defined above. If the string contains any non printing characters, ~ is substituted.

:SOURce:DATA:TELEcom:SDH:TRIButary:POVerhead:J2?

Returns : **<string>**

:SOURce:DATA:TELEcom:SDH:TRIButary:POVerhead:J2:HEXadecimal?

Returns : **<block>**

Returns a 16 byte block of data. Each byte represents the hexadecimal value of an ASCII character of VC-2 or VC12 byte J2 in the range "00" to "FF". The 15 hexadecimal numbers are preceded by the header "#215".

SOURce subsystem - Transmitter SDH OVERHEAD SETUP

:SOURce:DATA:TELEcom:SDH:TRIButary:POVerhead:J2:FIXed <string>

<string> = "00000000" to "11111111"

Sets the user defined fixed byte that is to be transmitted in the J2 byte of the VC-2, VC-11 or VC-12 path overhead. The value is a binary string.

The corresponding query returns the value of the user defined fixed byte as a binary string, as defined above.

:SOURce:DATA:TELEcom:SDH:TRIButary:POVerhead:J2:FIXed?

Returns : <string>

:SOURce:DATA:TELEcom:SDH:TRIButary:POVerhead:V5:SLABel <numeric>

<numeric> = 0 to 7

Sets the VC-2, VC-12 or VC-11 signal label (Byte V5) value.

The corresponding query returns the signal label value in numeric form.

:SOURce:DATA:TELEcom:SDH:TRIButary:POVerhead:V5:SLABel?

Returns : <numeric>

:SOURce:DATA:TELEcom:SDH:TRIButary:POVerhead:C2:SLABel <discrete>

<discrete> =	UNEQuipped	Unequipped (00000000)
	EQUipped	Equipped (00000001)
	TUGStructure	TUG structure (00000010)
	LOCKed	Locked TU (00000011)
	ASYN34	Asynchronous 34 /45 Mb/s (00000100)
	ASYN140	Asynchronous 140 Mb/s (00010010)
	ATM	ATM (00010011)
	DQDB	DQDB (00010100)
	FDDI	FDDI (00010101)
	BULK	Bulk Filled (11111110)

SOURce subsystem - Transmitter SDH OVERHEAD SETUP

VCAis	VCAIS
USER	User Defined

Sets the LP Path Signal Label (C2 byte) if foreground payload TU-3 into an VC-4 is selected.

The corresponding query returns the C2 byte value in discrete short form.

:SOURce:DATA:TELEcom:SDH:TRIButary:POV:C2:SLABel?

Returns: <discrete>

:SOURce:DATA:TELEcom:SDH:POVerhead:H4Sequence <discrete>

<discrete> =	LONG	Long Sequence
	SHORt	Short Sequence
	C0C1	COC1 Sequence

Sets the H4 path overhead byte sequence length when :SOURce:DATA:TELEcom:SDH:PAYLoad <discrete> is set to TU2, TU11 or TU12.

The corresponding query returns the H4 byte sequence length in discrete form as listed above.

:SOURce:DATA:TELEcom:SDH:POVerhead:H4Sequence?

Returns : <discrete>

:SOURce:DATA:TELEcom:SDH:OVERhead:SBYTe <discrete>

<discrete> =	QUALUnknown	(0000)
	G811	(0010)
	G812Transit	(0100)
	G812Local	(1000)
	SETS	(1011)
	DONTusesync	(1111)

Selects the SDH SYNC message type (S1 Byte Bits 5 to 8).

SOURce subsystem - Transmitter SDH OVERHEAD SETUP

The corresponding query returns the Sync Message type in discrete form as listed above.

:SOURce:DATA:TELEcom:SDH:OVERhead:SBYTe?

Returns : <discrete>

SOURce subsystem - Transmitter SDH Test Function Commands

OEI	TCM Outgoing Error Indication
TCBip	TCM BIP
TUBip	Tributary BIP
LPRei	Tributary FEBE
FRAME	Frame

* TCM errors are only available in SDH mode

Selects SDH transmit test function error type when

:SOURce:DATA:TELEcom:SDH:TFUNction:TYPE <discrete> is set to ERR .

Further selection of :SOURce:DATA:TELEcom:SDH:ERRor:RATE <discrete> is required.

The corresponding query returns the SDH error type in discrete form as listed above.

:SOURce:DATA:TELEcom:SDH:ERRor:TYPE?

Returns : <discrete>

:SOURce:DATA:TELEcom:SDH:ERRor:RATE <discrete>

<discrete> =	NONE	Errors Off
	ONCE	Single Error Add, Not Frame errors
	EALL	Error All (Not Frame)
	MSPThreshold	MSP Threshold (MS Bip only)
	E_3	Line rate dependent
	E_4	All except Frame errors (Line rate dependent)
	E_5	All except Frame errors (Line rate dependent)
	E_6	All except Frame errors
	E_7	All except Frame errors
	E_8	All except Frame errors

SOURce subsystem - Transmitter SDH Test Function Commands

E_9	All except Frame errors
USER	User error rate
ONE	Frame Errors only
TWO	Frame Errors only
THRee	Frame Errors only
FOUR	Frame Errors only

Selects the transmitter SDH Error rate of the error type selected by :SOURce:DATA:TELEcom:SDH:ERRor:TYPE <discrete>. This command is applicable when :SOURce:DATA:TELEcom:TFUNction <discrete> is set to SDH.

If bit errors are to be added to the PDH payload then :SOURce:DATA:TELEcom:TFUNction <discrete> must be set to "PDH."

Associated commands:

:SOURce:DATA:TELEcom:SDH:ERRor:RATE:USER <numeric>

The corresponding query returns the selected transmitter SDH error rate in discrete form, as listed above. Note that if this query returns USER, then :SOURce:DATA:TELEcom:SDH:ERRor:RATE:USER? must be used to discover the currently injected error rate.

:SOURce:DATA:TELEcom:SDH:ERRor:RATE?

Returns : <discrete>

:SOURce:DATA:TELEcom:SDH:ERRor:RATE:USER <numeric>

<numeric>= 9.9E-3 to 0.1E-9 mantissa resolution 0.1, exponent resolution 1

Sets the user defined SDH Error Add rate. Note that if :SOURce:DATA:TELEcom:SDH:ERRor:RATE <discrete> is not already set to USER, then this command will automatically set it to USER.

Associated commands:

:SOURce:DATA:TELEcom:SDH:ERRor:RATE <discrete>

SOURce subsystem - Transmitter SDH Test Function Commands

Note that the maximum user defined error rate is dependent on both error type and line rate.

The corresponding query returns the user defined SDH Error Add rate in numeric form.

:SOURce:DATA:TELEcom:SDH:ERRor:RATE:USER?

Returns: <numeric>

:SOURce:DATA:TELEcom:SDH:PDHPayload:ERRor:TYPE <discrete>

<discrete> =	BIT	Bit Errors
	FAS	PDH Frame Errors
	MFAS	Multiframe errors
	FASMfas	PDH frame and multiframe errors
	CRC	
	PBITS	Parity bits errors
	FEBE	
	REBE	
	CPBits	
	EXZ	Excess zeroes

Selects the TX PDH Payload error type.

The corresponding query returns the error type in discrete form as listed above.

:SOURce:DATA:TELEcom:SDH:PDHPayload:ERRor:TYPE?

Returns : <discrete>

:SOURce:DATA:TELEcom:SDH:PDHPayload:ERRor:RATE <discrete>

<discrete> =	NONE	No errors added
	ONCE	single error added

SOURce subsystem - Transmitter SDH Test Function Commands

E_3	1.0E-3 error rate
E_4	1.0E-4 error rate
E_5	1.0E-5 error rate
E_6	1.0E-6 error rate
E_7	1.0E-7 error rate
USER	User defined error rate

Sets the PDH Payload error rate for the error type selected by

:SOURce:DATA:TELEcom:SDH:PDHPayload:ERROR:TYPE <discrete>.

The corresponding query returns the error rate in discrete form as listed above.

:SOURce:DATA:TELEcom:SDH:PDHPayload:ERROR:RATE?

Returns: <discrete>

:SOURce:DATA:TELEcom:SDH:PDHPayload:ERROR:RATE:USER
<numeric>

<numeric>= 1.1E-3 to 0.1E-9 mantissa resolution 0.1,
exponent resolution 1

Sets the user defined SDH PDH payload Error Add rate of the error type selected by

:SOURce:DATA:TELEcom:SDH:PDHPayload:ERROR:TYPE <discrete>. This command is applicable when **:SOURce:DATA:TELEcom:SOURce** <discrete> is set to PDHPayload.

The corresponding query returns the user defined SDH PDH Error Add rate in numeric form.

:SOURce:DATA:TELEcom:SDH:PDHPayload:ERROR:RATE:USER?

Returns: <numeric>

SOURce subsystem - Transmitter SDH Test Function Commands

:SOURce:DATA:TELEcom:SDH:ERRor:MSPTThreshold:NERRors <numeric>

<numeric> =	0 to 640	for STM-0
	0 to 1920	for STM-1
	0 to 7680	for STM-4
	0 to 30720	for STM-16

Sets the number of errors for the MSP Threshold when

:SOURce:DATA:TELEcom:SDH:ERRor:RATE <discrete> is set to MSPT. Default = 0.

The corresponding query returns the number of errors selected for the MSP Threshold in numeric form.

:SOURce:DATA:TELEcom:SDH:ERRor:MSPTThreshold:NERRors?

Returns : <numeric>

:SOURce:DATA:TELEcom:SDH:ERRor:MSPTThreshold:EINterval<discrete>

<discrete> =	MS10	10 milliseconds
	MS100	100 milliseconds
	S1	1 second
	S10	10 seconds
	S100	100 seconds
	S1000	1,000 seconds
	S10000	10,000 seconds

Sets the interval between MSP Threshold errors when

:SOURce:DATA:TELEcom:SDH:ERRor:RATE <discrete> is set to MSPT .

The corresponding query returns the MSP Threshold error interval in discrete form as listed above.

:SOURce:DATA:TELEcom:SDH:ERRor:MSPTThreshold:EINterval?

Returns : <discrete>

SOURce subsystem - Transmitter SDH Test Function Commands**:SOURce:DATA:TELEcom:SDH:ALARm <discrete>**

<discrete> =	NONE	Alarms Off
	LOS	Loss of Signal
	LOF	Loss of Frame
	OOF	Out of Frame
	MSAis	Multiplexer Section AIS
	MSRD _i	Multiplexer Section FERF
	LOP	Loss of Pointer
	PAIS	Path AIS
	HPRD _i	Path FERF
	PUNequipped	Path Unequipped
	TCLom*	TCM Loss of Multiframe
	IAIS*	TCM Incoming AIS
	TCRD _i *	TCM Remote Defect Indication
	ODI*	TCM Outgoing Defect Indication
	TULop	TU Loss of Pointer
	TUPais	TU Path AIS
	LPRD _i	TU Path FERF
	LOMultiframe	Multiframe (H4) Loss
	TUUNequipped	TU Path Unequipped

* TCM alarms are only available in SDH mode.

Selects the TX Test Function alarm type when

:SOURce:DATA:TELEcom:SDH:TFUNction:TYPE <discrete> is set to ERR.

The corresponding query returns the SDH alarm type in discrete form as listed above.

SOURce subsystem - Transmitter SDH Test Function Commands

:SOURce:DATA:TELEcom:SDH:ALARm?

Returns : <discrete>

:SOURce:DATA:TELEcom:SDH:ALARm:SOOFrame

Generates a single Out Of Frame alarm.

:SOURce:DATA:TELEcom:SDH:POINter <discrete>

<discrete> =	BURSt	Adds bursts
	NPOinter	New Pointer
	OFFSet	Adds offset in ppm
	G783	Adds G.783 sequence

Selects the Pointer adjustment type when

:SOURce:DATA:TELEcom:SDH:TFUNction:TYPE <discrete> is set to POIN.

The corresponding query returns the pointer adjustment type in discrete form as listed above.

:SOURce:DATA:TELEcom:SDH:POINter?

Returns : <discrete>

:SOURce:DATA:TELEcom:SDH:POINter:TYPE <discrete>

<discrete> =	AU
	TU

Selects the TX pointer type when

:SOURce:DATA:TELEcom:SDH:TFUNction:TYPE <discrete> is set to POIN.

The corresponding query returns the pointer type in discrete form as listed above.

:SOURce:DATA:TELEcom:SDH:POINter:TYPE?

Returns : <discrete>

SOURce subsystem - Transmitter SDH Test Function Commands**:SOURce:DATA:TELEcom:SDH:POINter:DIRection <discrete>**

<discrete> =	INCRement
	DECRement
	ALTErnate

Selects the direction of the pointer burst adjustment when

:SOURce:DATA:TELEcom:SDH:TFUNction:TYPE <discrete> is set to POIN and
:SOURce:DATA:TELEcom:SDH:POINter <discrete> is set to BURS .

The corresponding query returns the pointer burst direction in discrete form as listed above.

:SOURce:DATA:TELEcom:SDH:POINter:DIRection?

Returns :	<discrete>
-----------	------------

:SOURce:DATA:TELEcom:SDH:POINter:IDECrement <numeric>

<numeric> =	1 to 10	TU-3, AU-3, AU-4, AU-4Nc
	1 to 5	TU-2, TU-12, TU-11

Selects the number of places by which the pointer is to be incremented or decremented when :SOURce:DATA:TELEcom:SDH:TFUNction:TYPE <discrete> is set to POIN and :SOURce:DATA:TELEcom:SDH:POINter <discrete> is set to BURS .

The corresponding query returns the number of places in numeric form.

:SOURce:DATA:TELEcom:SDH:POINter:IDECrement?

Returns :	<numeric>
-----------	-----------

:SOURce:DATA:TELEcom:SDH:POINter:TRANsmitted?

Returns:	<numeric>
----------	-----------

Returns the currently transmitted value of the AU pointer in numeric form.

SOURce subsystem - Transmitter SDH Test Function Commands

:SOURce:DATA:TELEcom:SDH:POINter:ACTion

Forces the new pointer value defined by
:SOURce:DATA:TELEcom:SDH:POINter:VALue <numeric> to be adopted.

:SOURce:DATA:TELEcom:SDH:POINter:VALue <numeric>

<numeric> = 0 to 782

Selects the AU New Pointer value when
:SOURce:DATA:TELEcom:SDH:TFUNction:TYPE <discrete> is set to POIN and
:SOURce:DATA:TELEcom:SDH:POINter <discrete> is set to NPO.

The corresponding query returns the new pointer value in numeric form as listed above.

:SOURce:DATA:TELEcom:SDH:POINter:VALue?

Returns : <numeric>

:SOURce:DATA:TELEcom:SDH:TRIButary:POINter:TRANsmitted?

Returns: <numeric>

Returns the currently transmitted value of the TU pointer in numeric form.

:SOURce:DATA:TELEcom:SDH:TRIButary:POINter:VALue <numeric>

<numeric> =	0 to 764	for TU-3
	0 to 427	for TU-2
	0 to 139	for TU-12
	0 to 103	for TU-11

Selects the TU New Pointer value when
:SOURce:DATA:TELEcom:SDH:TFUNction:TYPE <discrete> is set to POIN and
:SOURce:DATA:TELEcom:SDH:POINter <discrete> is set to NPO.

The corresponding query returns the new pointer value in numeric form as listed above.

SOURce subsystem - Transmitter SDH Test Function Commands

:SOURce:DATA:TELEcom:SDH:TRIButary:POINter:VALue?

Returns : <numeric>

:SOURce:DATA:TELEcom:SDH:POINter:NPOinter <discrete>

<discrete> = NDF With New Data Flag
 NNDF Without New Data Flag

Selects the type of new pointer when

:SOURce:DATA:TELEcom:SDH:TFUNction:TYPE <discrete> is set to POIN and
:SOURce:DATA:TELEcom:SDH:POINter <discrete> is set to NPO.

The corresponding query returns the type of new pointer in discrete form as listed above.

:SOURce:DATA:TELEcom:SDH:POINter:NPOinter?

Returns : <discrete>

:SOURce:DATA:TELEcom:SDH:POINter:ADJust

Adjust pointer to new settings if :SOURce:DATA:TELEcom:SDH:POINter
<discrete> is set to BURS or NPO .

:SOURce:DATA:TELEcom:SDH:POINter:OFFSet <discrete>

<discrete> = SIGNal Line offset
 VC4 VC-4 rate offset
 TU TU rate offset

Determines whether the Output signal rate, VC Rate or TU rate is offset.

The corresponding query returns the signal Rate, which is offset, in discrete form as listed above.

:SOURce:DATA:TELEcom:SDH:POINter:OFFSet?

Returns : <discrete>

SOURce subsystem - Transmitter SDH Test Function Commands

Selects the G.783 Pointer sequence adjustment type when :SOURce:DATA:TELEcom:SDH:TFUNction:TYPE <discrete> is set to POIN and :SOURce:DATA:TELEcom:SDH:POINter <discrete> is set to G783 .This command is only valid if an SDH option is fitted.

The corresponding query returns the G.783 adjustment type in discrete form as listed above.

:SOURce:DATA:TELEcom:SDH:POINter:G783?

Returns : <discrete>

:SOURce:DATA:TELEcom:SDH:POINter:G783:SINGle <discrete>

<discrete> =	APOLarity	Periodic alternate single
	WCANcelled	With Cancelled
	WADDed	With Added

(Obsolete) Set the type of G.783 pointer sequence when :SOURce:DATA:TELEcom:SDH:TFUNction:TYPE <discrete> is set to POIN and :SOURce:DATA:TELEcom:SDH:POINter <discrete> is set to G783 and :SOURce:DATA:TELEcom:SDH:POINter:G783 <discrete> :is set to SING.

The corresponding query returns the type in discrete form as listed above.

:SOURce:DATA:TELEcom:SDH:POINter:G783:SINGle?

Returns : <discrete>

:SOURce:DATA:TELEcom:SDH:POINter:G783:PATTern <discrete>

<discrete> =	CONTInuous	No pattern
	P873	87:3 pattern
	P261	26:1 pattern

Selects the pattern of the G.783 pointer sequence when :SOURce:DATA:TELEcom:SDH:TFUNction:TYPE <discrete> is set to POIN and :SOURce:DATA:TELEcom:SDH:POINter <discrete> is set to G783 and :SOURce:DATA:TELEcom:SDH:POINter:G783 <discrete> is set to PNOR, PADD or PCAN.

SOURce subsystem - Transmitter SDH Test Function Commands

The corresponding query returns the G.783 pattern in discrete form as listed above.

:SOURce:DATA:TELEcom:SDH:POINter:G783:PATtern?

Returns : <discrete>

:SOURce:DATA:TELEcom:SDH:POINter:G783:POLarity <discrete>

<discrete> = NEGative
 POSitive

Selects the polarity of the G.783 pointer sequence when

:SOURce:DATA:TELEcom:SDH:TFUNction:TYPE <discrete> is set to POIN and
 :SOURce:DATA:TELEcom:SDH:POINter <discrete> is set to G783 and
 :SOURce:DATA:TELEcom:SDH:POINter:G783 <discrete> is set to SING . Default
 = NEG.

The corresponding query returns the G.783 polarity in discrete form as listed above.

:SOURce:DATA:TELEcom:SDH:POINter:G783:POLarity?

Returns : <discrete>

:SOURce:DATA:TELEcom:SDH:POINter:G783:INTerval <numeric><suffix>

<numeric> =	1 to 500	See text
<suffix> =	MS	milliseconds
	S	seconds

Selects the interval between G.783 adjustments.

(AU-4, AU-4-NC, AU-3, TU-3) Range is 7.5ms, 10ms, 20ms, 30ms, 34ms, 40ms to 100ms in 10ms steps. 100 ms to 1s in 100ms steps. 1s, 2s, 5s and 10s.

(TU-2, TU-12, TU-11) Range is 200ms, 500ms, 1s, 2s, 5s and 10s.

The corresponding query returns the G.783 interval as listed above.

The default suffix unit is seconds.

SOURce subsystem - Transmitter SDH Test Function Commands

:SOURce:DATA:TELEcom:SDH:POINter:G783:INTerval?

Returns : <numeric>,<suffix>

:SOURce:DATA:TELEcom:SDH:POINter:G783:SEQuence <discrete>

<discrete> =	STOP	Stop the current G.783 pointer sequence
	START	Start a G.783 pointer sequence
	INITialize	Start a G.783 pointer sequence preceded by initialization and cooldown

Stops/Starts the G.783 pointer sequence.

The corresponding query returns the sequence start state in discrete form as listed above. See also STAT:SDH2.

:SOURce:DATA:TELEcom:SDH:POINter:G783:SEQuence?

Returns : <discrete>

:SOURce:DATA:TELEcom:SDH:SEQuence <discrete>

<discrete> =	STOP	Stop current sequence
	START	Start new sequence

Starts/Stops a Single or Repeat run Sequence.

The corresponding query returns the Sequence mode in discrete form as listed above.

:SOURce:DATA:TELEcom:SDH:SEQuence?

Returns : <discrete>

:SOURce:DATA:TELEcom:SDH:SEQuence:MODE <discrete>

<discrete> =	SINGle	Single Run
	REPeat	Repeat Run

SOURce subsystem - Transmitter SDH Test Function Commands

Selects the type of SEQUENCE when

:SOURce:DATA:TELEcom:SDH:TFUNction:TYPE <discrete> is set to SEQ.

The corresponding query returns the type of Sequence in discrete form as listed above.

:SOURce:DATA:TELEcom:SDH:SEQuence:MODE?

Returns : <discrete>

:SOURce:DATA:TELEcom:SDH:SEQuence:OHBYte <discrete>

<discrete> =	A1A2 J0 Z0 E1 F1	Regenerator Overhead
	D1D3	
	BNDA1A2 X22 X23 X32	
	X33	
	K1K2 D4D12 S1 Z1	Multiplexer Overhead
	Z2 M1 E2	
	J1 C2 G1 F2 H4 F3	Path Overhead
	K3 N1	

Selects the overhead byte into which the overhead sequence is to be inserted when :SOURce:DATA:TELEcom:SDH:TFUNction:TYPE <discrete> is set to SEQ. Some of the parameters are only available in certain columns or STM-1 channels.

BNDA1A2 selects the 6 middle A1A2 boundary bytes.

N1 is invalid when :SOURce:DATA:TELEcom:SDH:TCM:PATH <discrete> is set to HIGH.

K1K2 is invalid when :SOURce:DATA:TELEcom:SDH:MSPMessages:TOPology <discrete> is set to LIN and :SOURce:DATA:TELEcom:SDH:MSPMessages:TOPology:TYPE <discrete> is set to ACT.

The corresponding query returns the sequenced byte in discrete form as listed above.

:SOURce:DATA:TELEcom:SDH:SEQuence:OHBYte?

Returns: <discrete>

SOURce subsystem - Transmitter SDH Test Function Commands

:SOURce:DATA:TELEcom:SDH:SEQuence:COLumn <numeric>

<numeric> 1 to 9 Column in Section overhead of byte to sequence.

Sets the column of the Section Overhead of the byte to be sequenced.

The corresponding query returns the column in numeric form.

:SOURce:DATA:TELEcom:SDH:SEQuence:COLumn?

Returns: <numeric>

:SOURce:DATA:TELEcom:SDH:SEQuence:CHANnel:SElect <numeric>

<numeric> = 1 to 16

Selects STM-1 number for channels that occur in more than one STM-1:

The corresponding query returns the STM-1 number in numeric form.

:SOURce:DATA:TELEcom:SDH:SEQuence:CHANnel:SElect?

Returns: <numeric>

:SOURce:DATA:TELEcom:SDH:SEQuence:DATA <discrete>,<string>

<discrete> = A | B | C | D | E

<string> = "00" to "FFFFFFFFFFFFFFFFFFFF"

Sets the Sequence data pattern for the designated block to the hexadecimal value contained in the string. The number of hexadecimal characters is dependent on the overhead byte or bytes selected. Two hexadecimal characters are required per byte, for Example:

E1 - 1 byte "00" to "FF"

D4D12 - 9 bytes "000000000000000000" to "FFFFFFFFFFFFFFFFFFFF"

The corresponding query returns the hexadecimal value of the designated block as a string.

:SOURce:DATA:TELEcom:SDH:SEQuence:DATA? <discrete>

Returns : <string>

SOURce subsystem - Transmitter SDH Test Function Commands

:SOURce:DATA:TELEcom:SDH:SEQuence:ORDer <discrete>, <discrete>, <discrete>, <discrete>, <discrete>

<discrete> = A | B | C | D | E

Selects the order of transmission for the blocks of data used in the Sequence.

The corresponding query returns the block order in discrete form as listed above.

:SOURce:DATA:TELEcom:SDH:SEQuence:ORDer?

Returns : <discrete>, <discrete>, <discrete>, <discrete>, <discrete>

:SOURce:DATA:TELEcom:SDH:SEQuence:FCOunt <numeric>, <numeric>

<numeric> = 1 to 5 Block number
(first parameter)

<numeric> = 0 to 64000 Frame count
(second parameter)

Selects the number of frames in which the block of data, designated by the block_no, is to be transmitted.

The corresponding query returns the frame_count in numeric form.

:SOURce:DATA:TELEcom:SDH:SEQuence:FCOunt? <numeric>

Returns : <numeric> Frame count

:SOURce:DATA:TELEcom:SDH:STESt:SPATtern <discrete>

<discrete> = AZERos All Zero's pattern

 AONes All Ones pattern

 G958 G.958 sequence

Selects the pattern used in the Optical stress test when

:SOURce:DATA:TELEcom:SDH:TFUNction:TYPE <discrete> is set to STES.

The corresponding query returns the selected pattern in discrete form as listed above.

SOURce subsystem - Transmitter SDH Test Function Commands**:SOURce:DATA:TELEcom:SDH:STES:SPATtern?**

Returns : <discrete>

:SOURce:DATA:TELEcom:SDH:STES:BLENght <numeric>

<numeric> =	2 to 85	Bytes	for STM-0
	2 to 259	Bytes	for STM-1
	2 to 1042	Bytes	for STM-4
	2 to 4174	Bytes	for STM-16

Selects the block length used in the Optical stress test when
:SOURce:DATA:TELEcom:SDH:TFUNction:TYPE <discrete> is set to STES.

The corresponding query returns the block length in numeric form.

:SOURce:DATA:TELEcom:SDH:STES:BLENght?

Returns : <numeric>

:SOURce:DATA:TELEcom:SDH:MSPMessages:TOPology <discrete>

<discrete> =	LINear	Linear protection
	RING	Ring protection

Selects the type of protection topology.

The corresponding query returns the selected protection topology in discrete short form.

:SOURce:DATA:TELEcom:SDH:MSPMessages:TOPology?

Returns: <discrete>

:SOURce:DATA:TELEcom:SDH:MSPMessages:TOPology:TYPE <discrete>

<discrete> =	PASSive	Passive protection type
	ACTive	Active protection type

Selects the type of MSP Message topology protection.

SOURCE subsystem - Transmitter SDH Test Function Commands

Only valid if :SOURCE:DATA:TELEcom:SDH:MSPMessages:TOPology <discrete> is set to LIN.

The corresponding query returns the selected MSP Message topology protection type in discrete short form.

:SOURCE:DATA:TELEcom:SDH:MSPMessages:TOPology:TYPE?

Returns: <discrete>

:SOURCE:DATA:TELEcom:SDH:MSPMessages:TOPology:MODE <discrete>

<discrete> =	UNIDirection	Unidirectional mode
	BIDirection	Bidirectional mode

Selects the mode of MSP Message topology protection.

Only valid if :SOURCE:DATA:TELEcom:SDH:MSPMessages:TOPology <discrete> is set to LIN and :SOURCE:DATA:TELEcom:SDH:MSPMessages:TOPology:TYPE <discrete> is set to ACT.

The corresponding query returns the selected MSP Message topology protection mode in discrete short form.

:SOURCE:DATA:TELEcom:SDH:MSPMessages:TOPology:MODE?

Returns: <discrete>

:SOURCE:DATA:TELEcom:SDH:MSPMessages:REQuest <discrete>

<discrete> =	NREQuest	No Request (0000)
	DNRevert	Do Not Revert (0001)
	RREQuest	Reverse Request (0010)
	THRee	Not Used (0011)
	EXERcise	Exercise (0100)
	FIVE	Not Used (0101)
	WTRestore	Wait To Restore (0110)
	SEVen	Not Used (0111)

SOURce subsystem - Transmitter SDH Test Function Commands

MSWitch	Manual Switch (1000)
NINE	Not Used (1001)
SDLPriority	Signal Degrade Low Priority (1010)
SDHPriority	Signal Degrade High Priority (1011)
SFLPriority	Signal Fail Low Priority (1100)
SFHPriority	Signal Fail High Priority (1101)
FSWitch	Forced Switch (1110)
LOPRotectio	Lockout Of Protection (1111)

Selects the transmitter SDH MSP message to be transmitted (K1 Byte, Bits 1 to 4). Only valid if :SOURce:DATA:TELEcom:SDH:MSPMessages:TOPology <discrete> is set to LIN and :SOURce:DATA:TELEcom:SDH:MSPMessages:TOPology:TYPE <discrete> is set to PASS.

SDHP and SFHP are only valid when :SOURce:DATA:TELEcom:SDH:MSPMessages:ARCHitecture <discrete> is set to OTN.

The corresponding query returns the selected transmitter SDH MSP message type in discrete form, as listed above.

:SOURce:DATA:TELEcom:SDH:MSPMessages:REQuest?

Returns : <discrete>

:SOURce:DATA:TELEcom:SDH:MSPMessages:CHANnel <numeric>

<numeric> =	0	NULL Channel
	1	Working Channel 1
	2	Working Channel 2
	3	Working Channel 3
	4	Working Channel 4
	5	Working Channel 5
	6	Working Channel 6

SOURce subsystem - Transmitter SDH Test Function Commands

The corresponding query returns the MSP messages bridged channel as a string as listed above.

:SOURce:DATA:TELEcom:SDH:MSPMessages:BRIDGE?

Returns : <string>

:SOURce:DATA:TELEcom:SDH:MSPMessages:ARCHitecture <discrete>

<discrete> =	OTONE	1+1
	OTN	1:N

Selects the SDH transmitter Linear MSP architecture (K2 Byte, Bit 5). Only valid if :SOURce:DATA:TELEcom:SDH:MSPMessages:TOPology <discrete> is set to LIN.

The corresponding query returns the selected transmitter SDH MSP message architecture in discrete form, as listed above.

:SOURce:DATA:TELEcom:SDH:MSPMessages:ARCHitecture?

Returns : <discrete>

:SOURce:DATA:TELEcom:SDH:MSPMessages:REServed <numeric>

<numeric> =	0	000
	1	001
	2	010
	3	011
	4	100
	5	101

Selects the SDH transmitter Linear MSP messages reserved bits (K2 Byte, Bits 6 to 8) in numeric form. Only valid if

:SOURce:DATA:TELEcom:SDH:MSPMessages:TOPology <discrete> is set to LIN and :SOURce:DATA:TELEcom:SDH:MSPMessages:TOPology:TYPE <discrete> is set to PASS.

SOURce subsystem - Transmitter SDH Test Function Commands

The corresponding query returns the selected transmitter SDH MSP message reserved bits in numeric form.

:SOURce:DATA:TELEcom:SDH:MSPMessages:REServed?

Returns: <numeric>

:SOURce:DATA:TELEcom:SDH:MSPMessages:RCODE <discrete>

<discrete> =	NREQuest	No Request (0000)
	RRRIng	Reverse Request - Ring (0001)
	RRSPan	Reverse Request - Span (0010)
	ERIng	Exerciser - Ring (0011)
	ESPan	Exerciser - Span (0100)
	WTRestore	Wait to Restore (0101)
	MSRing	Manual Switch - Ring (0110)
	MSSPan	Manual Switch - Span (0111)
	SDRIng	Signal Degrade - Ring (1000)
	SDSPan	Signal Degrade - Span (1001)
	SDPProtection	Signal Degrade - Protection (1010)
	SFRing	Signal Fail - Ring (1011)
	SFSPan	Signal Fail - Span (1100)
	FSRing	Forced Switch Ring (1101)
	FSSPan	Forced Switch - Span(1110)
	LOPProtection	Lockout Of Protection (1111)

Selects the transmitter Ring MSP message to be transmitted (K1 Byte, Bits 1 to 4). Only valid if :SOURce:DATA:TELEcom:SDH:MSPMessages:TOPology <discrete> is set to RING.

The corresponding query returns the selected transmitter SDH MSP message type in discrete short form.

:SOURce:DATA:TELEcom:SDH:MSPMessages:RCODE?

Returns: <discrete>

SOURce subsystem - Transmitter SDH Test Function Commands

:SOURce:DATA:TELEcom:SDH:MSPMessages:DNODE <string>

<string> = "0000" to "1111"

Selects the SDH transmitter Ring MSP message destination node (K1 Byte, Bits 5 to 8). Only valid if :SOURce:DATA:TELEcom:SDH:MSPMessages:TOPology <discrete> is set to RING.

The corresponding query returns the MSP messages destination node as a string as listed above.

:SOURce:DATA:TELEcom:SDH:MSPMessages:DNODE?

Returns: <string>

:SOURce:DATA:TELEcom:SDH:MSPMessages:SNODE <string>

<string> = "0000" to "1111"

Selects the SDH transmitter Ring MSP message source node (K2 Byte, Bits 1 to 4) . Only valid if :SOURce:DATA:TELEcom:SDH:MSPMessages:TOPology <discrete> is set to RING.

The corresponding query returns the MSP messages source node as a string as listed above.

:SOURce:DATA:TELEcom:SDH:MSPMessages:SNODE?

Returns: <string>

:SOURce:DATA:TELEcom:SDH:MSPMessages:PCODE <discrete>

<discrete> =	SHORT	Short path
	LONG	Long path

Selects the SDH transmitter Ring MSP message path type (K2 bit 5). Only valid if :SOURce:DATA:TELEcom:SDH:MSPMessages:TOPology <discrete> is set to RING.

The corresponding query returns the Ring MSP messages path type in discrete short form.

SOURce subsystem - Transmitter SDH Test Function Commands**:SOURce:DATA:TELEcom:SDH:MSPMessages:PCODE?**

Returns: <discrete>

:SOURce:DATA:TELEcom:SDH:MSPMessages:SCODE <discrete>

<discrete> =	IDLE	Idle (000)
	BRIDged	Bridged (001)
	BASWitched	Bridged & Switched (010)
	P011	011
	P100	100
	P101	101

Selects the SDH transmitter Ring MSP messages status code (K2 Byte, Bits 6 to 8). Only valid if :SOURce:DATA:TELEcom:SDH:MSPMessages:TOPology <discrete> is set to RING.

The corresponding query returns the selected transmitter SDH MSP message status code in discrete form as listed above.

:SOURce:DATA:TELEcom:SDH:MSPMessages:SCODE?

Returns: <discrete>

:SOURce:DATA:TELEcom:SDH:MSPMessages:DOWNload

Start transmission of the SDH transmitter MSP message.

:SOURce:DATA:TELEcom:SDH:IDCC <discrete>

<discrete> =	RDCC	Regenerator DCC
	MDCC	Multiplexer DCC

Selects the Data Communication Channel Insert port when :SOURce:DATA:TELEcom:SDH:TFUNction:TYPE <discrete> is set to IDCC . The corresponding query returns the selected port in discrete form as listed above.

:SOURce:DATA:TELEcom:SDH:IDCC?

Returns : <discrete>

SOURce subsystem - Transmitter SDH Test Function Commands**:SOURce:DATA:TELEcom:SDH:OBERTest:CHANnel <discrete>**

<discrete> =	C1/J0 Z0 E1 F1 D1 D2 D3	Regenerator Overhead
	K1 K2 D4 D5 D6 D7	Multiplexer Overhead
	D8 D9 D10 D11 D12 X22 X	Multiplexer Overhead
	23 X32 X33	
	S1/Z1 Z1 M1/Z2 E2	Multiplexer Overhead
	J1 C2 G1 F2 H4 Z3/F3	Path Overhead
	Z4/K3 Z5/N1	

Selects the TX overhead byte used for the overhead BER test when :SOURce:DATA:TELEcom:SDH:TFUNction:TYPE <discrete> is set to OBER.

N1 is invalid when :SOURce:DATA:TELEcom:SDH:TCM:PATH <discrete> is set to HIGH.

K1,K2 are invalid when :SOURce:DATA:TELEcom:SDH:MSPMessages:TOPology <discrete> is set to LIN and :SOURce:DATA:TELEcom:SDH:MSPMessages:TOPology:TYPE <discrete> is set to ACT.

The corresponding query returns the overhead byte identity in discrete form as listed above.

:SOURce:DATA:TELEcom:SDH:OBERTest:CHANnel?

Returns	<discrete>
---------	------------

:SOURce:DATA:TELEcom:SDH:OBERTest:CHANnel:SElect <numeric>

<numeric> =	1-16
-------------	------

Selects STM-1 number for channels that occur in more than one STM-1.

The corresponding query returns the STM-1 number in numeric form.

The command is only valid if :SOURce:DATA:TELEcom:SDH:TFUNction:TYPE <discrete> is set to OBER. It is only applicable when Z0 is selected by :SOURce:DATA:TELEcom:SDSt:OBERTest:CHANnel <discrete>

SOURCE subsystem - Transmitter SDH Test Function Commands

:SOURCE:DATA:TELEcom:SDH:OBERtest:CHANnel:SElect?

Returns: <numeric>

:SOURCE:DATA:TELEcom:SDH:OBERtest <discrete>

<discrete> = ONCE Single error

Injects a single overhead BER error when

:SOURCE:DATA:TELEcom:SDH:TFUNction:TYPE <discrete> is set to OBER.

INPut subsystem

INPut subsystem

This subsystem controls the characteristics of the instrument's input ports.

:INPut:TELEcom:SDH:RATE <discrete>

<discrete> =	STM0	STM-0 Electrical
	STM1	STM-1 Electrical

Is only valid when the SDH Module is fitted and :SENSe:DATA:TELEcom:SENSe <discrete> is set to SDH.

The corresponding query returns the SDH rate in discrete short form.

:INPut:TELEcom:SDH:RATE?

Returns : <discrete>

:INPut:TELEcom:SDH:GAIN <discrete>

<discrete> =	DB20	20 dB Gain
	DB26	26 dB Gain

Selects the Monitor gain for the SDH receiver. Only valid when :INPut:TELEcom:LEVel <discrete> is set to MON.

The corresponding query returns the Monitor gain in discrete short form.

:INPut:TELEcom:SDH:GAIN?

Returns: <discrete>

:INPut:TELEcom:OPT1:RATE <discrete>

<discrete> =	STM0	STM-0 optical
	STM1	STM-1 Optical

Selects the input rate for the STM-0/STM-1 optical input port. Is only valid when Option STM-0/STM-1 Optical Interface is fitted and :SENSe:DATA:TELEcom:SENSe <discrete> is set to OPT1.

INPut subsystem

The corresponding query returns the STM-0/STM-1 input rate in discrete form as listed above. I

:INPut:TELEcom:OPT1:RATE?

Returns : <discrete>

:INPut:TELEcom:OPT1:INTerface <discrete>

<discrete> =	OPTical	Optical input
	MONitor	Protected Monitor Input

Selects the input interface on the Optical modules.

The corresponding query returns the input interface in discrete form, as listed above.

:INPut:TELEcom:OPT1:INTerface?

Returns: <discrete>

:INPut:TELEcom:OPT4:RATE <discrete>

<discrete> =	STM0	STM-0 optical
	STM1	STM-1 Optical
	STM4	STM-4 Optical

Selects the input rate for the STM-0/STM-1/STM-4 optical input port. Is only valid when Option STM-0/STM-1/STM-4 Optical Interface is fitted and :SENSe:DATA:TELEcom:SENSe <discrete> is set to OPT4.

The corresponding query returns the STM-0/STM-1/STM-4 input rate in discrete form as listed above. I

:INPut:TELEcom:OPT4:RATE?

Returns : <discrete>

INPut subsystem

:INPut:TELEcom:OPT4:INTerface <discrete>

<discrete> =	OPTical	Optical input
	MONitor	Protected Monitor Input

Selects the input interface on the Optical modules.

The corresponding query returns the input interface in discrete form, as listed above.

:INPut:TELEcom:OPT4:INTerface?

Returns: <discrete>

:INPut:TELEcom:OPT16:RATE <discrete>

<discrete> =	STM0	STM-0 Optical
	STM1	STM-1 Optical
	STM4	STM-4 Optical
	STM16	STM-16 Optical

Sets the input rate for the STM-0/STM-1/STM-4/STM-16 optical input port. Is only valid when Option STM-0/STM-1/STM-4/STM-16 Optical Interface is fitted and :SENSe:DATA:TELEcom:SENSe <discrete> is set to OPT16.

The corresponding query returns the STM-0/STM-1/STM-4/STM-16 input rate in discrete form, as listed above.

:INPut:TELEcom:OPT16:RATE?

Returns : <discrete>

:INPut:TELEcom:OPT16:INTerface <discrete>

<discrete> =	OPTical	Optical input
	MONitor	Protected Monitor Input

Selects the input interface on the Optical modules.

The corresponding query returns the input interface in discrete form, as listed above.

INPut subsystem

:INPut:TELEcom:OPT16:INTerface?

Returns: <discrete>

SENSe subsystem - Receiver SDH Settings

SDH Mapping settings

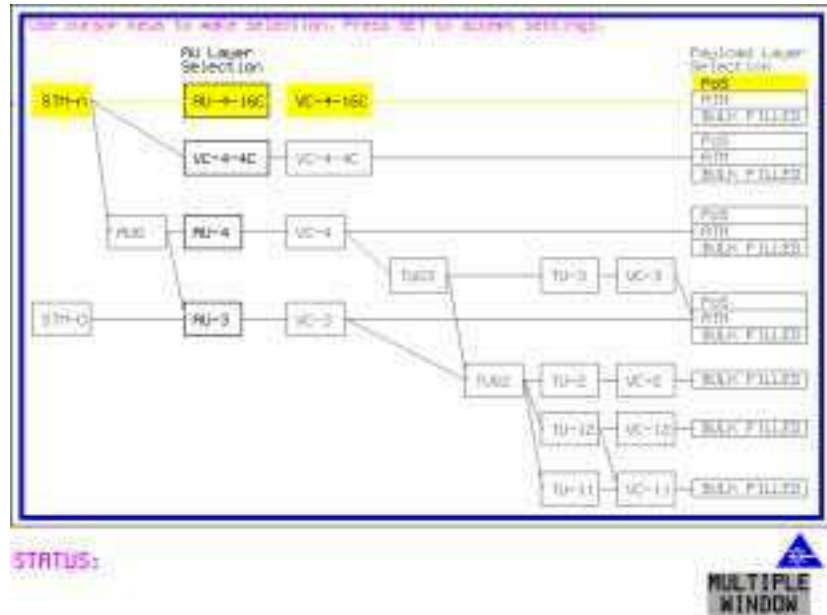

:SENSe:DATA:TELEcom:SDH:AU4 <numeric>

<numeric> = <numeric> 1 to 16 AU-4 under test

Selects the AU-4 within an STM-N for test. Only valid if :INPut:TELEcom:OPT1:RATE <discrete> is set a rate higher than STM1.

The corresponding query returns the test AU-4 number.

:SENSe:DATA:TELEcom:SDH:AU4?

Returns : <numeric>

SENSe subsystem - Receiver SDH Settings

:SENSe:DATA:TELEcom:SDH:AU3 <numeric>

<numeric> = <numeric> 1 to 3 AU-3 under test

Selects the AU-3 within an AUG for test.
Only valid if the selected mapping is AU-3.

The corresponding query returns the test AU-3 number.

:SENSe:DATA:TELEcom:SDH:AU3?

Returns : <numeric>

:SENSe:DATA:TELEcom:SDH:AU4C <numeric>

<numeric> = <numeric> 1 to 4 AU-4 under test

Selects the AU-4-4C within an STM-16 for test. Only valid if
:INPut:TELEcom:OPT1:RATE <discrete> is set to STM16 and selected mapping is
AU-4-4C.

The corresponding query returns the test AU-4-4C number.

:SENSe:DATA:TELEcom:SDH:AU4C?

Returns : <numeric>

Tandem Connection Monitoring (TCM) - SDH ONLY

:SENSe:DATA:TELEcom:SDH:TCM:PATH <discrete>

<discrete> = OFF
HIGH High-Order TCM path
LOW Low-Order TCM path

Set the Tandem Connection path

The corresponding query returns the Tandem Connection path in discrete form as
listed above

:SENSe:DATA:TELEcom:SDH:TCM:PATH?

Returns: <discrete>

AU Layer Selection

:SENSe:DATA:TELEcom:SDH:AU:TYPE <discrete>

<discrete> = AU4
AU3
AU4_4c
AU4_16c

Set the AU mapping into an STM-N frame.

The corresponding query returns the AU type in discrete form as listed above.

:SENSe:DATA:TELEcom:SDH:AU:TYPE?

Returns: <discrete>

TU Layer Selection

:SENSe:DATA:TELEcom:SDH:PAYLoad <discrete>

<discrete> = VC4 *or* M140 140 Mb/s
VC3 STM-0
TU3 *or* M34 34 Mb/s
TU12 *or* M2 2 Mb/s
TU2 VC-2
TU11 *or* DS1 TU-11
VC4_4c VC-4-4c
VC4_16c VC-4-16c

This command selects the SDH receiver mapping

The corresponding query returns the mapping in discrete form, as listed above.

SENSe subsystem - Receiver SDH Settings**:SENSe:DATA:TELEcom:SDH:PAYLoad?**

Returns : <discrete>

Payload Layer Selection**:SENSe:DATA:TELEcom:SDH:MAPPING <discrete>**

<discrete> =	M140	140 Mb/s - AU-4 (C-4 only)
	M34	34 Mb/s - VC-3 (C-3 only)
	DS3	DS3 - VC-3 (C-3 only)
	BULK	Bulk Filled (C-4 or C-3)
	ATM	ATM (C4-16C, C4-4C, C4 or C3)
	IPOS	POS (C4-16C, C4-4C, C-4, or C-3)

Selects the Receiver SDH payload for single payload cases. Only valid if :SENSe:DATA:TELEcom:SDH:PAYLoad <discrete> is set to VC3, VC4, VC4-4c or VC4-16c.

The corresponding query returns the payload in discrete form as listed above.

:SENSe:DATA:TELEcom:SDH:MAPPING?

Returns: <discrete>

:SENSe:DATA:TELEcom:SDH:TRIButary:MAPPING <discrete>

<discrete> =	ASYNc or ASM2	Asynchronous 2 Mb/s
	FBYTe or FLM2	2 Mb/s Floating Byte
	M34 or ASM34	34 Mb/s
	DS1 or ASDS1	Asynchronous 1.544 Mb/s DS1
	FLDS1	DS1 Floating Byte
	DS3 or ASDS3	Asynchronous 44.736 Mb/s DS3
	BULK	Bulk Filled

Selects the low order mapping. Only valid if :SENSe:DATA:TELEcom:SDH:PAYLoad <discrete> is set to TU3, TU12 or TU11.

The corresponding query returns the low order mapping in discrete short form.

SENSe subsystem - Receiver SDH Settings

:SENSe:DATA:TELEcom:SDH:TRIButary:MAPPING?

Returns: <discrete>

:SENSe:DATA:TELEcom:SDH:PRIMary:TS0 <boolean>

<boolean> = 0 or OFF Data in TS0
 1 or ON Signaling in TS0

Determines the content of TS0 as Data/Signaling.

The corresponding query returns the TS0 state in numeric form.

:SENSe:DATA:TELEcom:SDH:PRIMary:TS0?

Returns : <boolean>

TUG Channel

:SENSe:DATA:TELEcom:SDH:TUG3 <numeric>

<numeric> = 1 to 3

Selects the SDH Receiver active TUG3 within the AU4.

The corresponding query returns the active TUG-3 number in numeric form.

:SENSe:DATA:TELEcom:SDH:TUG3?

Returns : <numeric>

:SENSe:DATA:TELEcom:SDH:TUG2 <numeric>

<numeric> = 1 to 7

Selects the SDH Receiver active TUG2 within the selected TUG3 or AU3.

The corresponding query returns the TUG2 number in numeric form.

SENSe subsystem - Receiver SDH Settings

:SENSe:DATA:TELEcom:SDH:TUG2?

Returns : <numeric>

:SENSe:DATA:TELEcom:SDH:TRIButary <numeric>

<numeric> = 1 to 3 Tributary number for TU-12
1 to 4 Tributary number for TU-11

Selects the SDH Receiver active TU within the selected TUG2.

The corresponding query returns the receiver test tributary in numeric form.

:SENSe:DATA:TELEcom:SDH:TRIButary?

Returns : <numeric>

TU Payload and Test Pattern

:SENSe:DATA:TELEcom:SDH:PAYLoad:TYPE <discrete>

<discrete> =	UNFRamed	No framing
	FRAMed	8, 34 & 140 Mb/s
	PCM30	2 Mb/s
	PCM31	2 Mb/s
	PCM30CRC	2 Mb/s
	PCM31CRC	2 Mb/s
	DM2	Drop 2 Mb/s
	DM34	Drop 34 Mb/s
	DM140	Drop 140 Mb/s
	D4	DS1 Framing
	ESF	DS1 Framing
	SLC96	DS1 Framing

SENSe subsystem - Receiver SDH Settings

M13	DS3 Framing
M23	
CBIT	DS3 Framing
DDS1	Drop DS1
DDS3	Drop DS3
NOFBit	No Framing Bit (set to '0')

Only valid if a Structured PDH receiver is fitted.

The corresponding query returns the framing in discrete form as listed above.

:SENSe:DATA:TELEcom:SDH:PAYLoad:TYPE?

Returns : <discrete>

:SENSe:DATA:TELEcom:SDH:PAYLoad:STRucture <discrete>

<discrete> =	UNSTRuctured	All rates
	STRuctured	All framed formats

Determines whether the receiver is to expect any structure in the PDH payload.

The corresponding query returns the receiver structure setting in discrete form as listed above.

:SENSe:DATA:TELEcom:SDH:PAYLoad:STRucture?

Returns: <discrete>

:SENSe:DATA:TELEcom:SDH:PAYLoad:PATtern <discrete>

<discrete> =	PRBS9	2^9-1
	PRBS11	$2^{11}-1$
	PRBS15	$2^{15}-1$

SENSe subsystem - Receiver SDH Settings

PRBS20	$2^{20}-1$
QRSS	$2^{20}-1$ with 14 consecutive zero limit (DS1 only)
PRBS23	$2^{23}-1$
AZERo	All Zero's
AONE	All One's
STRes	3-in-24 stress pattern (DS1 only)
P1IN8	1-in-8 test pattern
P2IN8	2-in-8 test pattern
OCT55	55 octet test pattern (uses Daly pattern as per ANSI T1.403)
P1010	Word 1010
P1000	Word 1000
UWORD	16 Bit User Word
LIVE	Live Traffic

Selects the receiver SDH payload data pattern. If UWORD is selected, the word pattern is set using :SENSe:DATA:TELEcom:SDH:PAYLoad:UWORD <string>.

The corresponding query returns the receiver SDH payload data pattern in discrete form as listed above.

:SENSe:DATA:TELEcom:SDH:PAYLoad:PATtern?

Returns : <discrete>

:SENSe:DATA:TELEcom:SDH:PAYLoad:UWORD <string>

Sets the receiver user word pattern in the range "0000000000000000" to "1111111111111111".

The corresponding query returns the user word pattern as a string.

SENSe subsystem - Receiver SDH Settings**:SENSe:DATA:TELEcom:SDH:PAYLoad:UWORD?**

Returns : <string>

:SENSe:DATA:TELEcom:SDH:PRBS:POLarity <discrete>

<discrete> = NORMAL
 INVerted

Selects the PRBS pattern polarity.

The corresponding query returns the PRBS pattern polarity in discrete form as listed above.

:SENSe:DATA:TELEcom:SDH:PRBS:POLarity?

Returns : <discrete>

**:SENSe:DATA:TELEcom:SDH:TRIButary:CONCatenate
<numeric>,<numeric>**

<numeric> =	0	Concatenation Off
	2	TU2-2c
	3	TU2-3c
	4	TU2-4c
	5	TU2-5c
	6	TU2-6c
<numeric> =	1 to 6	TU2-2c selected
	1 to 5	TU2-3c selected
	1 to 4	TU2-4c selected
	1 to 3	TU2-5c selected
	1 to 2	TU2-6c selected

SDH Command Reference

SENSe subsystem - Receiver SDH Settings

Selects the TU2 concatenation level (first parameter) and starting at the TU (second parameter).

The corresponding query returns the TU2 concatenation and starting TU in numeric form as listed above.

:SENSe:DATA:TELEcom:SDH:TRIButary:CONCatenate?

Returns : <numeric>,<numeric>

SENSe subsystem - Receiver SDH Test Function Commands**:SENSe:DATA:TELEcom:SDH:OCAPture:CHANnel <discrete>**

```

<discrete> =  A1A2 | C1/J0 | Z0 | E1 | F1 |          RS Overhead
                D1D3

                H1H2 | K1K2 | D4D12 | S1 |          MS Overhead
                Z1_1|Z1_2 | Z1_3 | Z2_4 | Z2_5 |
                M1 | Z2_5 | Z2_6 | E2

                J1 | C2 | G1 | F2 | H4 | Z3/F3 |      Path Overhead
                Z4/K3 | Z5/N1

```

Selects the overhead byte or bytes to be captured. Is only valid when :SENSe:DATA:TELEcom:SDH:TFUNction:TYPE <discrete> is set to OCAP. Z0 is only valid when a rate higher than STM-1 is selected.

The corresponding query returns the overhead byte or bytes currently selected, in discrete form as listed above.

:SENSe:DATA:TELEcom:SDH:OCAPture:CHANnel?

Returns : <discrete>

:SENSe:DATA:TELEcom:SDH:OCAPture:OHBYte <discrete>

```

<discrete> =  A1A2 | J0/Z0 | E1 | F1 | D1D3|      Regenerator Overhead
                BNDA1A2|X22|X23|X32|X33

                H1H2 | K1K2 | D4D12 | S1/ Z1      Multiplexer Overhead
                | M1/Z2| E2

                J1 | C2 | G1 | F2 | H4 | F3 | K3 |  Path Overhead
                N1

```

Selects the overhead byte or bytes to be captured. Is only valid when :SENSe:DATA:TELEcom:SDH:TFUNction:TYPE <discrete> is set to OCAP. Z0 is only valid when STM-4 or higher is selected.

BNDA1A2 selects the 6 middle A1A2 boundary bytes

The corresponding query returns the byte(s) to be captured in discrete form as listed above.

SENSe subsystem - Receiver SDH Test Function Commands

:SENSe:DATA:TELEcom:SDH:OCAPture:OHBYte?

Returns: <discrete>

:SENSe:DATA:TELEcom:SDH:OCAPture:COLumn <numeric>

<numeric> = 1 to 9

Selects the Section overhead column from which to capture. This only applies to Z1 and Z2.

The corresponding query returns the column to be captured in numeric form.

:SENSe:DATA:TELEcom:SDH:OCAPture:COLumn?

<numeric>= 1 to 9

:SENSe:DATA:TELEcom:SDH:OCAPture:CHANnel:SElect <numeric>

<numeric> = 1 to 16

Only valid if a rate higher than STM-1 is selected.

The corresponding query returns the STM-1 number in numeric form.

:SENSe:DATA:TELEcom:SDH:OCAPture:CHANnel:SElect?

Returns: <numeric>

:SENSe:DATA:TELEcom:SDH:OCAPture:TRIGger <discrete>

<discrete> = OFF
ON
ONNot On Not

Selects the Overhead Capture Trigger mode. If OFF is selected, capture begins immediately. If ON is selected, capture begins when the received data matches the pattern defined by :SENSe:DATA:TELEcom:SDH:OCAPture:TRIGger:PATtern <string>. If ONN is selected, capture begins when the received data does not match

SENSe subsystem - Receiver SDH Test Function Commands

the pattern defined by

:SENSe:DATA:TELEcom:SDH:OCAPture:TRIGger:PATtern <string>.

The corresponding query returns the selected Trigger mode, in discrete form as listed above.

:SENSe:DATA:TELEcom:SDH:OCAPture:TRIGger?

Returns : <discrete>

:SENSe:DATA:TELEcom:SDH:OCAPture:TRIGger:PATtern <string>

Sets the Overhead Capture Trigger Pattern to the hexadecimal value contained in the string. The number of hexadecimal characters in the string is dependent on the overhead byte or bytes selected.

Two hexadecimal characters are required per byte, for example:

E1 - 1 Byte - "00" to "FF"

D4D12 - 9 Bytes - "000000000000000000" to "FFFFFFFFFFFFFFFFFFFF"

Is only valid when :SENSe:DATA:TELEcom:SDH:TFUNction:TYPE <discrete> is set to OCAP and :SENSe:DATA:TELEcom:SDH:OCAPture:TRIGger <discrete> is set to ON or ONN.

The corresponding query returns the Trigger Pattern selected, as a string as described above.

:SENSe:DATA:TELEcom:SDH:OCAPture:TRIGger:PATtern?

Returns : <string>

:SENSe:DATA:TELEcom:SDH:DDCC <discrete>

<discrete> = RDCC Regenerator Section DCC

MDCC Multiplexer Section DCC

Selects the DataCommunications channel to be dropped via the rear panel DROP port. Is only valid when :SENSe:DATA:TELEcom:SDH:TFUNction:TYPE <discrete> is set to DDCC.

The corresponding query returns the selected DCC, in discrete form as listed above.

:SENSe:DATA:TELEcom:SDH:DDCC?

Returns : <discrete>

SENSe subsystem - Receiver SDH Test Function Commands**:SENSe:DATA:TELEcom:SDH:PGRaph:PTYPe <discrete>**

<discrete> =	AU4
	AU3
	TU3
	TU2
	TU12
	TU11
	AU4_4c
	AU4_16c

Selects the type of pointer to be captured for pointer graph.

The corresponding query returns the type of pointer, in discrete short form.

:SENSe:DATA:TELEcom:SDH:PGRaph:PTYPe?

Returns: <discrete>

:SENSe:DATA:TELEcom:SDH:PGRaph:CINterval <discrete>

<discrete> =	SEC1	1 second interval
	SEC5	5 second interval
	SEC20	20 second interval
	MIN1	1 minute interval
	MIN5	5 minute interval
	MIN20	20 minute interval

Selects the pointer graph capture interval.

The corresponding query returns the pointer graph capture interval, in discrete form as listed above.

:SENSe:DATA:TELEcom:SDH:PGRaph:CINterval?

Returns: <discrete>

SENSe subsystem - Receiver SDH Test Function Commands**:SENSe:DATA:TELEcom:SDH:OBERTest:CHANnel <discrete>**

<discrete> = C1/J0 | Z0 | E1 | F1 | D1 | D2 | RS Overhead
 D3 |
 K1 | K2 | D4 | D5 | D6 | D7 | D8 | MS Overhead
 D9 | D10 | D11 | D12 | S1/Z1 |
 M1/Z1 | E2 |
 J1 | C2 | G1 | F2 | H4 | Z3/F3 | Path Overhead
 Z4/K3 | Z5/N1

Selects the overhead byte used for the overhead BER test. Is only valid when :SENSe:DATA:TELEcom:SDH:TFUNction:TYPE <discrete> is set to OBER . Z0 is only valid when a rate above STM-1 is selected.

The corresponding query returns the Overhead byte name in discrete form as listed above.

:SENSe:DATA:TELEcom:SDH:OBERTest:CHANnel?

Returns <discrete>

:SENSe:DATA:TELEcom:SDH:OBERTest:CHANnel:SElect <numeric>

<numeric> = 1 to 16

Selects STM-1 number for channels that occur in more than one STM-1.

The corresponding query returns the STM-1 number in numeric form.

:SENSe:DATA:TELEcom:SDH:OBERTest:CHANnel:SElect?

Returns: <numeric>

SENSe subsystem - Alarm Scan Control

:SENSe:DATA:TELEcom:SDH:ASCan:MODE <discrete>

<discrete> =	AUTomatic	Automatic receiver configuration
	RSETtings	Fixed receiver configuration

Selects the SDH alarm scan mode.

The corresponding query returns the alarm scan mode in discrete short form.

:SENSe:DATA:TELEcom:SDH:ASCan:MODE?

Returns: <discrete>

:SENSe:DATA:TELEcom:SDH:ASCan:BIP <discrete>

<discrete> =	OFF	Fail if Alarm
	GTE0	Fail if alarm or any BIP error
	GTEE_6	Fail if alarm or BIP ER > 10E-6
	GTEE_3	Fail if alarm or BIP ER > 10E-3

Selects the SDH alarm scan BIP error threshold.

The corresponding query returns the alarm scan BIP error threshold in discrete short form.

:SENSe:DATA:TELEcom:SDH:ASCan:BIP?

Returns: <discrete>

:SENSe:DATA:TELEcom:SDH:ASCan <boolean>

<boolean> =	0 or OFF	Stop the current alarm scan
	1 or ON	Start a new alarm scan

Start/Stop the SDH alarm scan.

The corresponding query returns the alarm scan state as 0 or 1.

SDH Command Reference

SENSE subsystem - Alarm Scan Control

:SENSe:DATA:TELEcom:SDH:ASCan?

Returns: <boolean>

SENSE subsystem - SDH Tributary Scan Control

:SENSE:DATA:TELEcom:SDH:TSCan:PERiod <numeric>, <suffix>

<numeric> =	1 to 99	
<suffix> =	d	Days
	h	Hours
	m	Minutes
	s	Seconds

Sets the test duration for each tributary.

The corresponding query returns the test duration for each tributary.

:SENSE:DATA:TELEcom:SDH:TSCan:PERiod?

Returns: <numeric>,<suffix>

:SENSE:DATA:TELEcom:SDH:TSCan:BIP <discrete>

<discrete> =	GTE0	Fail if any BIP error
	GTEE_6	Fail if BIP ER > 10E-6
	GTEE_3	Fail if BIP ER > 10E-3

Selects the SDH tributary scan BIP error threshold.

The corresponding query returns the alarm scan BIP error threshold in discrete short form.

:SENSE:DATA:TELEcom:SDH:TSCan:BIP?

Returns: <discrete>

:SENSE:DATA:TELEcom:SDH:TSCan <boolean>

<boolean> =	0 or OFF	Stop the current tributary scan
	1 or ON	Start a new tributary scan

Start/Stop the SDH tributary scan.

SENSe subsystem - MS-REI Measurements Enable/Disable

The corresponding query returns the alarm scan state as 0 or 1.

:SENSe:DATA:TELEcom:SDH:TSCan?

Returns: <boolean>

SENSe subsystem - MS-REI Measurements Enable/Disable

:SENSe:DATA:TELEcom:SDH:MSRei <boolean>

<boolean> = 0 or OFF MS REI measurements off
1 or ON MS REI measurements on

Allows measurement of MS-REI to be suppressed.

The corresponding query returns the MS-REI state as 0 or 1.

:SENSe:DATA:TELEcom:SDH:MSRei?

Returns: <boolean>

SENSe subsystem - Result Returning Commands

Frequency Results (SDH)

:SENSe:DATA? <"result">

Result =	"FREQuency:SDH:GATE1S"	RX SDH clock frequency (1s gate)
	"FREQuency:SDH[:GATE16S]"	RX SDH clock frequency (16s gate)
	"FOFPpm:SDH[:GATE16S]"	RX SDH clock offset in ppm (16s gate)
	"FOFHz:SDH[:GATE16S]"	RX SDH clock offset in Hz (16s gate)

SDH Short Term Results

:SENSe:DATA? <"result">

Result =	"ECOunt:SDH:STERm:FRAMe"	Frame error count
	"ERATio:SDH:STERm:FRAMe"	Frame error ratio
	"ECOunt:SDH:STERm:RSBip"	RS B1 BIP error count
	"ERATio:SDH:STERm:RSBip"	RS B1 BIP error ratio
	"ECOunt:SDH:STERm:MSBip"	MS B2 BIP error count
	"ERATio:SDH:STERm:MSBip"	MS B2 BIP error ratio
	"ECOunt:SDH:STERm:MFEBe" or "ECOunt:SDH:STERm:MSRei"	MS FEBE/MS REI error count. See page 4-92.
	"ERATio:SDH:STERm:MFEBe" or "ERATio:SDH:STERm:MSRei"	MS FEBE/MS REI error ratio. See page 4-92.
	"ECOunt:SDH:STERm:PBIP"	Path B3 BIP error count
	"ERATio:SDH:STERm:PBIP"	Path B3 BIP error ratio
	"ECOunt:SDH:STERm:FEBE" or "ECOunt:SDH:STERm:REI"	FEBE/REI error count

SENSe subsystem - Result Returning Commands

"ERATio:SDH:STERm:FEBe" or "ERATio:SDH:STERmREI"	FEBe/REI error ratio
"ECOut:SDH:STERm:TRIB:PBIP"	TU path BIP error count
"ERATio:SDH:STERm:TRIB:PBIP"	TU path BIP error ratio
"ECOut:SDH:STERm:TRIB:FEBe" or "ECOut:SDH:STERm:TRIB:REI"	TU FEBe/LP REI error count
"ERATio:SDH:STERm:TRIB:FEBe" or "ERATio:SDH:STERm:TRIB:REI"	TU FEBe/LP REI error ratio

TCM Short Term Results

:SENSe:DATA? <"result">

Result = "ECOut:SDH:STERm:TCM:PIEC"	TCM PIEC error count
"ERATio:SDH:STERm:TCM:PIEC"	TCM PIEC error ratio
"ECOut:SDH:STERm:TCM:REI"	TCM REI error count
"ERATio:SDH:STERm:TCM:REI"	TCM REI error ratio
"ECOut:SDH:STERm:TCM:OEI"	TCM OEI error count
"ERATio:SDH:STERm:TCM:OEI"	TCM OEI error ratio
"ECOut:SDH:STERm:TCM:ERR"	TCM Error error count
"ERATio:SDH:STERm:TCM:ERR"	TCM Error error ratio

SDH Cumulative Results

:SENSe:DATA? <"result">

Result = "ECOut:SDH:FRAMe"	Frame error count
"ERATio:SDH:FRAMe"	Frame error ratio
"ECOut:SDH:RSBip"	RS B1 BIP error count
"ERATio:SDH:RSBip"	RS B1 BIP error ratio

SENSe subsystem - Result Returning Commands

"ECOut:SDH:MSBip"	MS B2 BIP error count
"ERATio:SDH:MSBip"	MS B2 BIP error ratio
"ECOut:SDH:MFEBe" or "ECOut:SDH:MSRei"	MS FEBE/MS REI error count. See page 4-92.
"ERATio:SDH:MFEBe" or "ERATio:SDH:MSRei"	MS FEBE/MS REI error ratio. See page 4-92.
"ECOut:SDH:PBIP"	Path B3 BIP error count
"ERATio:SDH:PBIP"	Path B3 BIP error ratio
"ECOut:SDH:FEBE" or "ECOut:SDH:REI"	FEBE/REI error count
"ERATio:SDH:FEBE" or "ERATio:SDH:REI"	FEBE/REI error ratio
"ECOut:SDH:TRIB:PBIP"	TU path BIP error count
"ERATio:SDH:TRIB:PBIP"	TU path BIP error ratio
"ECOut:SDH:TRIB:FEBE" or "ECOut:SDH:TRIB:REI"	TU FEBE/LP REI error count
"ERATio:SDH:TRIB:FEBE" or "ERATio:SDH:TRIB:REI"	TU FEBE/LP REI error ratio
"ECOut:SDH:OVERhead"	Overhead error count

TCM Cumulative Results

:SENSe:DATA? <"result">

Result =	"ECOut:SDH:TCM:PIEC"	TCM PIEC error count
	"ERATio:SDH:TCM:PIEC"	TCM PIEC error ratio
	"ECOut:SDH:TCM:REI"	TCM REI error count
	"ERATio:SDH:TCM:REI"	TCM REI error ratio
	"ECOut:SDH:TCM:OEI"	TCM OEI error count
	"ERATio:SDH:TCM:OEI"	TCM OEI error ratio

SENSe subsystem - Result Returning Commands

"ECount:SDH:TCM:ERR"	TCM Error error count
"ERATio:SDH:TCM:ERR"	TCM Error error ratio

SDH RS B1 BIP Analysis Results

:SENSe:DATA? <"result">

Result= "ESECONDS:SDH:RSBip:ANALYSIS"	Error Seconds
"SESECONDS:SDH:RSBip:ANALYSIS"	Severely Errored Seconds
"EBCOUNT:SDH:RSBip:ANALYSIS"	Errored block count
"BBECOUNT:SDH:RSBip:ANALYSIS"	Background block error count
"ESRATIO:SDH:RSBip:ANALYSIS"	Error Second Ratio
"SESRATIO:SDH:RSBip:ANALYSIS"	Severely Errored Second Ratio
"BBERATIO:SDH:RSBip:ANALYSIS"	Background Block Error ratio
"UASECONDS:SDH:RSBip:ANALYSIS"	Unavailable seconds

SDH MS B2 BIP Analysis Results

:SENSe:DATA? <"result">

Result= "ESECONDS:SDH:MSBip:ANALYSIS"	Error Seconds
"SESECONDS:SDH:MSBip:ANALYSIS"	Severely Errored Seconds
"EBCOUNT:SDH:MSBip:ANALYSIS"	Errored block count
"BBECOUNT:SDH:MSBip:ANALYSIS"	Background block error count
"ESRATIO:SDH:MSBip:ANALYSIS"	Error Second Ratio
"SESRATIO:SDH:MSBip:ANALYSIS"	Severely Errored Second Ratio
"BBERATIO:SDH:MSBip:ANALYSIS"	Background Block Error ratio
"UASECONDS:SDH:MSBip:ANALYSIS"	Unavailable seconds
"PUASECONDS:SDH:MSBip:ANALYSIS"	Path Unavailable seconds

SDH Command Reference
SENSe subsystem - Result Returning Commands

SDH Path MS FEBe Analysis Results

:SENSe:DATA? <"result">

If you wish to disable the MSRei measurement, see page 4-92.

Result=	"ESECONDS:SDH:MFEBE:ANALYSIS" or "ESECONDS:SDH:MSREI:ANALYSIS"	Error Seconds
	"SECONDS:SDH:MFEBE:ANALYSIS" or "SECONDS:SDH:MSREI:ANALYSIS"	Severely Errored Seconds
	"EBCOUNT:SDH:MFEBE:ANALYSIS" or "EBCOUNT:SDH:MSREI:ANALYSIS"	Errored block count
	"BBECOUNT:SDH:MFEBE:ANALYSIS" or "BBECOUNT:SDH:MSREI:ANALYSIS"	Background block error count
	"ESRATIO:SDH:MFEBE:ANALYSIS" or "ESRATIO:SDH:MSREI:ANALYSIS"	Error Second Ratio
	"SESRATIO:SDH:MFEBE:ANALYSIS" or "SESRATIO:SDH:MSREI:ANALYSIS"	Severely Errored Second Ratio
	"BBERATIO:SDH:MFEBE:ANALYSIS" or "BBERATIO:SDH:MSREI:ANALYSIS"	Background Block Error ratio
	"UASECONDS:SDH:MFEBE:ANALYSIS" or "UASECONDS:SDH:MSREI:ANALYSIS"	Unavailable seconds
	"PUASECONDS:SDH:MFEBE:ANALYSIS" or "PUASECONDS:SDH:MSREI:ANALYSIS"	Path Unavailable seconds

SDH Path B3 BIP Analysis Results

:SENSe:DATA? <"result">

Result=	"ESECONDS:SDH:PBIP:ANALYSIS"	Error Seconds
	"SECONDS:SDH:PBIP:ANALYSIS"	Severely Errored Seconds
	"EBCOUNT:SDH:PBIP:ANALYSIS"	Errored block count
	"BBECOUNT:SDH:PBIP:ANALYSIS"	Background block error count

SENSe subsystem - Result Returning Commands

"ESRatio:SDH:PBIP:ANALysis"	Error Second Ratio
"SESRatio:SDH:PBIP:ANALysis"	Severely Errored Second Ratio
"BBERatio:SDH:PBIP:ANALysis"	Background Block Error ratio
"UASeconds:SDH:PBIP:ANALysis"	Unavailable seconds
"PUASeconds:SDH:PBIP:ANALysis"	Path Unavailable seconds

SDH Path FEBE Analysis Results

:SENSe:DATA? <"result">

Result= "ESECONDS:SDH:FEBE:ANALysis" or "ESECONDS:SDH:REI:ANALysis"	Error Seconds
"SESECONDS:SDH:FEBE:ANALysis" or "SESECONDS:SDH:REI:ANALysis"	Severely Errored Seconds
"EBCount:SDH:FEBE:ANALysis" or "EBCount:SDH:REI:ANALysis"	Errored block count
"BBECount:SDH:FEBE:ANALysis" or "BBECount:SDH:REI:ANALysis"	Background block error count
"ESRatio:SDH:FEBE:ANALysis" or "ESRatio:SDH:REI:ANALysis"	Error Second Ratio
"SESRatio:SDH:FEBE:ANALysis" or "SESRatio:SDH:REI:ANALysis"	Severely Errored Second Ratio
"BBERatio:SDH:FEBE:ANALysis" or "BBERatio:SDH:REI:ANALysis"	Background Block Error ratio
"UASeconds:SDH:FEBE:ANALysis" or "UASeconds:SDH:REI:ANALysis"	Unavailable seconds
"PUASeconds:SDH:FEBE:ANALysis" or "PUASeconds:SDH:REI:ANALysis"	Path Unavailable seconds

SDH Tributary Path BIP Analysis Results

:SENSe:DATA? <"result">

SENSe subsystem - Result Returning Commands

Result=	"ESECONDS:SDH:TRIB:PBIP:ANALYSIS"	Error Seconds
	"SECONDS:SDH:TRIB:PBIP:ANALYSIS"	Severely Errored Seconds
	"EBCOUNT:SDH:TRIB:PBIP:ANALYSIS"	Errored block count
	"BBECOUNT:SDH:TRIB:PBIP:ANALYSIS"	Background block error count
	"ESRATIO:SDH:TRIB:PBIP:ANALYSIS"	Error Second Ratio
	"SESRATIO:SDH:TRIB:PBIP:ANALYSIS"	Severely Errored Second Ratio
	"BBERATIO:SDH:TRIB:PBIP:ANALYSIS"	Background Block Error ratio
	"UASECONDS:SDH:TRIB:PBIP:ANALYSIS"	Unavailable seconds
	"PUASECONDS:SDH:TRIB:PBIP:ANALYSIS"	Path Unavailable seconds

SDH Tributary Path FEBE Analysis Results

:SENSe:DATA? <"result">

Result =	"ESECONDS:SDH:TRIB:FEBE:ANALYSIS" or "ESECONDS:SDH:TRIB:REI:ANALYSIS"	Error Seconds
	"SECONDS:SDH:TRIB:FEBE:ANALYSIS" or "SECONDS:SDH:TRIB:REI:ANALYSIS"	Severely Errored Seconds
	"EBCOUNT:SDH:TRIB:FEBE:ANALYSIS" or "EBCOUNT:SDH:TRIB:REI:ANALYSIS"	Errored block count
	"BBECOUNT:SDH:TRIB:FEBE:ANALYSIS" or "BBECOUNT:SDH:TRIB:REI:ANALYSIS"	Background block error count
	"ESRATIO:SDH:TRIB:FEBE:ANALYSIS" or "ESRATIO:SDH:TRIB:REI:ANALYSIS"	Error Second Ratio
	"SESRATIO:SDH:TRIB:FEBE:ANALYSIS" or "SESRATIO:SDH:TRIB:REI:ANALYSIS"	Severely Errored Second Ratio
	"BBERATIO:SDH:TRIB:FEBE:ANALYSIS" or "SESRATIO:SDH:TRIB:REI:ANALYSIS"	Background Block Error ratio

SENSe subsystem - Result Returning Commands

"UASeconds:SDH:TRIB:FEBE:ANALysis" or "UASeconds:SDH:TRIB:REI:ANALysis"	Unavailable seconds
"PUASeconds:SDH:TRIB:FEBE:ANALysis" or "PUASeconds:SDH:TRIB:REI:ANALysis"	Path Unavailable seconds

SDH Block Based Bit Analysis Results

:SENSe:DATA? <"result">

Result = "ESECONDS:SDH:BLKBit:ANALysis"	Error Seconds
"SESeconds:SDH:BLKBit:ANALysis"	Severely Errored Seconds
"EBCount:SDH:BLKBit:ANALysis"	Errored block count
"BBECount:SDH:BLKBit:ANALysis"	Background block error count
"ESRatio:SDH:BLKBit:ANALysis"	Error Second Ratio
"SESRatio:SDH:BLKBit:ANALysis"	Severely Errored Second Ratio
"BBERatio:SDH:BLKBit:ANALysis"	Background Block Error ratio
"UASeconds:SDH:BLKBit:ANALysis"	Unavailable seconds

TCM Path IEC Analysis Results

:SENSe:DATA? <"result">

Result= "ESECONDS:SDH:TCM:PIEC:ANALysis"	Error Seconds
"SESeconds:SDH:TCM:PIEC:ANALysis"	Severely Errored Seconds
"EBCount:SDH:TCM:PIEC:ANALysis"	Errored block count
"BBECount:SDH:TCM:PIEC:ANALysis"	Background block error count
"ESRatio:SDH:TCM:PIEC:ANALysis"	Error Second Ratio
"SESRatio:SDH:TCM:PIEC:ANALysis"	Severely Errored Second Ratio
"BBERatio:SDH:TCM:PIEC:ANALysis"	Background Block Error ratio
"UASeconds:SDH:TCM:PIEC:ANALysis"	Unavailable seconds

SDH Command Reference
SENSe subsystem - Result Returning Commands

TCM REI Analysis Results

:SENSe:DATA? <"result">

Result=	"ESECONDS:SDH:TCM:REI:ANALYSIS"	Error Seconds
	"SESECONDS:SDH:TCM:REI:ANALYSIS"	Severely Errored Seconds
	"EBCOUNT:SDH:TCM:REI:ANALYSIS"	Errored block count
	"BBECOUNT:SDH:TCM:REI:ANALYSIS"	Background block error count
	"ESRATIO:SDH:TCM:REI:ANALYSIS"	Error Second Ratio
	"SESRATIO:SDH:TCM:REI:ANALYSIS"	Severely Errored Second Ratio
	"BBERATIO:SDH:TCM:REI:ANALYSIS"	Background Block Error ratio
	"UASECONDS:SDH:TCM:REI:ANALYSIS"	Unavailable seconds
	"PUASECONDS:SDH:TCM:REI:ANALYSIS"	Path Unavailable seconds

TCM OEI Analysis Results

:SENSe:DATA? <"result">

Result=	"ESECONDS:SDH:TCM:OEI:ANALYSIS"	Error Seconds
	"SESECONDS:SDH:TCM:OEI:ANALYSIS"	Severely Errored Seconds
	"EBCOUNT:SDH:TCM:OEI:ANALYSIS"	Errored block count
	"BBECOUNT:SDH:TCM:OEI:ANALYSIS"	Background block error count
	"ESRATIO:SDH:TCM:OEI:ANALYSIS"	Error Second Ratio
	"SESRATIO:SDH:TCM:OEI:ANALYSIS"	Severely Errored Second Ratio
	"BBERATIO:SDH:TCM:OEI:ANALYSIS"	Background Block Error ratio
	"UASECONDS:SDH:TCM:OEI:ANALYSIS"	Unavailable seconds

SENSe subsystem - Result Returning Commands**TCM Errors Analysis Results**

:SENSe:DATA? <"result">

Result=	"ESECONDS:SDH:TCM:ERR:ANALYSIS"	Error Seconds
	"SECONDS:SDH:TCM:ERR:ANALYSIS"	Severely Errored Seconds
	"EBCOUNT:SDH:TCM:ERR:ANALYSIS"	Errored block count
	"BBECOUNT:SDH:TCM:ERR:ANALYSIS"	Background block error count
	"ESRATIO:SDH:TCM:ERR:ANALYSIS"	Error Second Ratio
	"SESRATIO:SDH:TCM:ERR:ANALYSIS"	Severely Errored Second Ratio
	"BBERATIO:SDH:TCM:ERR:ANALYSIS"	Background Block Error ratio
	"UASECONDS:SDH:TCM:ERR:ANALYSIS"	Unavailable seconds
	"PUASECONDS:SDH:TCM:ERR:ANALYSIS"	Path Unavailable seconds

SDH M.2101 Analysis Results

:SENSe:DATA? <"result">

Result =	"ESECONDS:SDH:LOW:RECEIVE:ANALYSIS:M2101"	Low Order Path Receive Direction Errored Seconds
	"SECONDS:SDH:LOW:RECEIVE:ANALYSIS:M2101"	Low Order Path Receive Direction Severely Errored Seconds
	"UASECONDS:SDH:LOW:RECEIVE:ANALYSIS:M2101"	Low Order Path Receive Direction Unavailable Seconds
	"ESECONDS:SDH:LOW:TRANSMIT:ANALYSIS:M2101"	Low Order Path Transmit Direction Errored Seconds
	"SECONDS:SDH:LOW:TRANSMIT:ANALYSIS:M2101"	Low Order Path Transmit Direction Severely Errored Seconds
	"UASECONDS:SDH:LOW:TRANSMIT:ANALYSIS:M2101"	Low Order Path Transmit Direction Unavailable Seconds

SENSe subsystem - Result Returning Commands

"ESECONDS:SDH:HIGh:RECEIVE:ANALYSIS:M2101"	High Order Path Receive Direction Errored Seconds
"SECONDS:SDH:HIGh:RECEIVE:ANALYSIS:M2101"	High Order Path Receive Direction Severely Errored Seconds
"UASECONDS:SDH:HIGh:RECEIVE:ANALYSIS:M2101"	High Order Path Receive Direction Unavailable Seconds
"ESECONDS:SDH:HIGh:TRANSMIT:ANALYSIS:M2101"	High Order Path Transmit Direction Errored Seconds
"SECONDS:SDH:HIGh:TRANSMIT:ANALYSIS:M2101"	High Order Path Transmit Direction Severely Errored Seconds
"UASECONDS:SDH:HIGh:TRANSMIT:ANALYSIS:M2101"	High Order Path Transmit Direction Unavailable Seconds
"ESECONDS:SDH:SECTIon:RECEIVE:ANALYSIS:M2101"	Section Layer Path Receive Direction Errored Seconds
"SECONDS:SDH:SECTIon:RECEIVE:ANALYSIS:M2101"	Section Layer Path Receive Direction Severely Errored Seconds
"UASECONDS:SDH:SECTIon:RECEIVE:ANALYSIS:M2101"	Section Layer Path Receive Direction Unavailable Seconds
"ESECONDS:SDH:SECTIon:TRANSMIT:ANALYSIS:M2101"	Section Layer Path Transmit Direction Errored Seconds
"SECONDS:SDH:SECTIon:TRANSMIT:ANALYSIS:M2101"	Section Layer Path Transmit Direction Severely Errored Seconds
"UASECONDS:SDH:SECTIon:TRANSMIT:ANALYSIS:M2101"	Section Layer Path Transmit Direction Unavailable Seconds

SENSe subsystem - Result Returning Commands**SDH Service Disruption Results**

:SENSe:DATA? <"result">

Result =	"SDTest:COUNt:LONG"	Longest error burst
	SDTest:COUNt:SHORT"	Shortest error burst
	"SDTest:COUNt:LAST"	Last error burst

Returns: <range>,<value>

<range> =	0	Result invalid due to receiver configuration
	1	Result valid
	2	Result out of range

Value is returned in milliseconds. If the value is > 2000 or no result is available or the result is not applicable then 9.91E+37 is returned.

SDH Optical Power Result

:SENSe:DATA? <"result">

Result =	"OPOWer:SDH"	Optical power (dBm)
----------	--------------	---------------------

SDH Pointer Activity Results

:SENSe:DATA? <"result">

Result=	"PACTivity:SDH:PVALue"	AU Pointer value
	"PACTivity:SDH:NDFSeconds"	AU Pointer NDF seconds
	"PACTivity:SDH:MNDFseconds"	AU Pointer MNDF seconds
	"PACTivity:SDH:PCOunt"	AU Pointer +ve Adj Count
	"PACTivity:SDH:PSEConds"	AU Pointer +ve Adj Seconds
	"PACTivity:SDH:NCOunt"	AU Pointer -ve Adj Count

SENSe subsystem - Result Returning Commands

"PACTivity:SDH:NSEConds"	AU Pointer -ve Adj Seconds
"PACTivity:SDH:IOFFset"	Implied VC4 Offset
"PACTivity:SDH:TRIButary:PVALue"	TU Pointer Value
"PACTivity:SDH:TRIButary:NDFSeconds"	TU Pointer NDF seconds
"PACTivity:SDH:TRIButary:MNDFseconds"	TU Pointer MNDF seconds
"PACTivity:SDH:TRIButary:PCOunt"	TU Pointer +ve Adj Count
"PACTivity:SDH:TRIButary:PSEConds"	TU Pointer +ve Adj Seconds
"PACTivity:SDH:TRIButary:NCOunt"	TU Pointer -ve Adj Count
"PACTivity:SDH:TRIButary:NSEConds"	TU Pointer -ve Adj Seconds
"PACTivity:SDH:TRIButary:IOFFset"	Implied TU VC Offset

SDH Alarm Seconds Results

:SENSe:DATA? <"result">

Result =	"ASEConds:SDH:LOS"	Loss Of Signal
	"ASEConds:SDH:LOF"	Loss Of Frame
	"ASEConds:SDH:OOF"	Out Of Frame
	"ASEConds:SDH:H4MF"	H4 Multiframe Loss
	"ASEConds:SDH:LOP"	Loss Of Pointer
	"ASEConds:SDH:MSAis"	Multiplexer Section AIS
	"ASEConds:SDH:PAIS"	Path AIS
	"ASEConds:SDH:PSLoss"	Pattern Synchronization Loss (see Note on page 3-21.)
	"ASEConds:SDH:MSRDi"	Multiplexer Section Remote Defect
	"ASEConds:SDH:PFERf" or "ASEConds:SDH:RDI"	STM Path FERF/HP-RDI
	"ASEConds:SDH:K1K2"	K1K2 byte change
	"ASEConds:SDH:TRIB:LOP"	TU Loss Of Pointer
	"ASEConds:SDH:TRIB:PAIS"	TU Path AIS

SDH Command Reference

SENSe subsystem - Result Returning Commands

"ASEConds:SDH:TRIB:PFERf"	TU Path FERF/LP-RDI
or	
"ASEConds:SDH:TRIB:RDI"	
"ASEConds:SDH:TRIB:P1P0"	P1P0 Frame Synchronization Loss
"ASEConds:SDH:OPSL"	Overhead Pattern Sync Loss

TCM Alarm Seconds Results

:SENSe:DATA? <"result">

Result =	"ASEConds:SDH:TCM:LOM"	Loss Of Multiframe
	"ASEConds:SDH:TCM:IAIS"	Incoming AIS
	"ASEConds:SDH:TCM:RDI"	Remote Defect Indication
	"ASEConds:SDH:TCM:ODI"	Outgoing Defect Indication

FETCh subsystem

FETCh subsystem

The FETCh subsystem is used to retrieve data directly accumulated by the instrument.

:FETCh:STRing:DATA:TELEcom:SDH:TCM:APID?

Returns: <string>

Returns the Tandem Connection Monitoring (TCM) Access Point Identifier as a 16 ASCII character string if CRC7 is not detected, 15 ASCII character string if CRC7 is detected. If the string contains any non printing characters then ~ is substituted. This is a snapshot of the TCM multiframe and is captured once per second.

:FETCh:STRing:DATA:TELEcom:SDH:J0?

Returns: <string>

The value of the STM-N regenerator overhead J0 byte is returned as a 16 ASCII character string if CRC7 is not detected, 15 ASCII character string if CRC7 is detected. If the string contains any non printing characters then ~ is substituted. This is a snapshot of the overhead byte and is captured once per second.

:FETCh:STRing:DATA:TELEcom:SDH:J0:HEXadecimal?

Returns: <block>

Returns the value of the STM-N regenerator overhead J0 byte as 16 hexadecimal numbers if CRC7 is not detected, 15 hexadecimal numbers if CRC7 is detected. Each number is in the range "00" to "FF". The block header is "#216" if CRC7 not detected, "#215" if CRC7 is detected. This is a snapshot of the overhead byte and is captured once per second.

:FETCh:STRing:DATA:TELEcom:SDH:J1?

Returns : <string>

If interfacing at STM-1/4/16, the value of the VC-3, VC-4, VC-4-NC J1 path trace byte is returned as a, 64 ASCII character, string (15 ASCII characters if CRC7 is detected). If interfacing at STM-0, the value of the VC-3 J1 path trace byte is

SDH Command Reference

FETCh subsystem

returned as a string. If the string contains any non printing characters then ~ is substituted. This is a snapshot of the overhead byte and is captured once per second.

:FETCh:STRing:DATA:TELEcom:SDH:J1:HEXadecimal?

Returns : <block>

If interfacing at STM-1/4/16, returns the value of the VC-3, VC-4, VC-4-NC J1 path trace byte as 64 hexadecimal numbers (15 if CRC7 is detected). If interfacing at STM-0, the value of the VC-3 J1 path trace byte is returned as 64 hexadecimal numbers (15 if CRC7 is detected).

Each number is in the range "00" to "FF". The block header is "#264" (" #215" if CRC7 is detected). This is a snapshot of the overhead byte and is captured once per second.

:FETCh:STRing:DATA:TELEcom:SDH:TRIButary:J1?

Returns : <string>

When the VC-3 is mapped into a higher level container such as VC-4 the value of the VC-3 J1 path trace byte is returned as a, 64 ASCII character, string (15 ASCII characters if CRC7 is detected). If the string contains any non printing characters then ~ is substituted. This is a snapshot of the overhead byte and is captured once per second.

:FETCh:STRing:DATA:TELEcom:SDH:TRIButary:J1:HEXadecimal?

Returns : <block>

When the VC-3 is mapped into a higher level container such as VC-4 returns the value of the VC-3 J1 path trace byte as 64 hexadecimal numbers (15 if CRC7 is detected). Each number is in the range "00" to "FF". The block header is "#264" (" #215" if CRC7 is detected). This is a snapshot of the overhead byte and is captured once per second.

:FETCh:STRing:DATA:TELEcom:SDH:TRIButary:J2?

Returns: <string>

Returns the 15 or 16 byte J2 path trace as a string. The OmniBER 718 attempts to align the received pattern by detecting the CRC7 byte. If the CRC7 byte is detected, a 15 byte pattern is returned. If the CRC7 byte is not detected, a 16 byte pattern is

FETCh subsystem

returned. If the string contains any non-printing characters then ~ is substituted. This is a snapshot of the received path trace and is only updated once per second.

:FETCh:STRing:DATA:TELEcom:SDH:TRIButary:J2:HEXadecimal?

Returns: <block>

Returns the value of the J2 path trace byte as 15 or 16 hexadecimal numbers. The OmniBER 718 attempts to align the received pattern by detecting the CRC7 byte. If the CRC7 byte is detected, 15 hexadecimal numbers are returned. If the CRC7 byte is not detected, 16 hexadecimal numbers are returned. Each number is in the range "00" to "FF". The block header is "#215" if 15 Hex numbers and "#216" if 16 Hex numbers. This is a snapshot of the overhead byte and is captured once per second.

:FETCh:STRing:DATA:TELEcom:SDH:K1?

Returns : <string>

The value of the MPS K1 byte is returned as an 8 bit string in the range "00000000" to "11111111".

:FETCh:STRing:DATA:TELEcom:SDH:K2?

Returns : <string>

The value of the MPS K2 byte is returned as an 8 bit string in the range "00000000" to "11111111".

:FETCh:STRing:DATA:TELEcom:SDH:S1?

Returns : <string>

The value of the SYNC S1 byte (bits 5-8) is returned as a 4 bit string in the range "0000" to "1111".

:FETCh:SCALar:DATA:TELEcom:SDH:OVERhead? <numeric>,<numeric>,<discrete>

<numeric> = 1 to 16

VC4 Number

<numeric> = 1 to 3

Column Number

SDH Command Reference

FETCh subsystem

<discrete> =	Byte Name
A1 A2 C1 J0/ Z0 B1 E1 F1 D1 D2 D3 H1 H2 H3 B2 K1 K2 D11 D12 Z1 S1 Z2/ M1 E2 X13 X21 X22 X23 X31 X32 X33 X52 X53 X61 X62 X63 X71 X72 X73 X81 X82 X83 X93	

Returns the selected overhead byte as an 8 bit binary string in the range "00000000" to "11111111". The byte number is given by its defined name if it has one.

Undefined bytes are represented by <Xrc>, where r is the numerical value of the bytes row in the transport overhead and c is the numerical value of the bytes column in the transport overhead.

If an STM-1 signal is being transmitted, the only applicable value of VC4 is 1.

Notice that column number 1 is actually columns 1,4 & 7, 2 is columns 2,5 & 8 and 3 is columns 3,6 & 9.

C1/J0 byte: The J0 capability is available at STM-0 and STM-1 only.

Z2/M1 byte: If any other SDH option is fitted, the Z2 capability is available and M1 is not available.

Z0 byte is available when STM-4 is selected.

Returns: <string>

:FETCh:SCALAr:DATA:TELEcom:SDH:POVerhead:H4Sequence?

Obtains the length of the H4 byte sequence.

Returns :	<discrete> =	LONG	Long sequence
		SHORT	Short sequence
		UNKNOWN	Unknown sequence

FETCh subsystem**:FETCh:SCALar:DATA:TELEcom:SDH:POVerhead? <discrete>**

<discrete> = J1|B3|C2|G1|F2|H4|Z3/F3|Z4/
K3|Z5/N1

Obtains the value of the named path overhead byte. The value of the named byte is returned as a string in the range "00000000" to "11111111". This is a snapshot of the overhead byte and is captured once per second.

:FETCh:SCALar:DATA:TELEcom:SDH:TRIButary:POVerhead? <discrete>

<discrete> = C2|G1|F2|H4|Z3/F3|Z4/K3|Z5/N1| TU-3
V5|J2|N2|K4 TU-2/TU-12/TU11

Obtains the value of the specified path overhead byte. The value of the named byte is returned as a string in the range "00000000" to "11111111". This is a snapshot of the overhead byte and is captured once per second.

:FETCh:SCALar:DATA:TELEcom:SDH:TRIButary:POVerhead:SLABel?

Returns the TU-2/TU-12/TU-11 signalling label of the selected tributary in numeric form.

:FETCh:ARRay:DATA:TELEcom:SDH:ASCan?

Returns (each of one or <numeric>{,<numeric>
more rows):

The results returned are those for the last FULL scan. Results from partial scans are not available. If no full scan has been completed since the instrument was powered up, this command will return -1.

If data is available it is returned as a set of string arrays one for each scanned group. The arrays are separated by a CR/LF pair. A group is defined as a set of scanned paths at either the AU or TU level. The arrays consist of comma separated numerics,

FETCh subsystem

one for each path scanned. The value of the numeric indicates the status of the scanned path. The following values are valid.

Value	State
0	No Problems Detected
1	Alarms or Errors Detected
2	Path Unequipped
3	Loss of Pointer
4	AIS
5	RDI
6	H4 Multiframe Loss
?	Invalid

For a specific signal structure, the format of the returned strings are shown below:

a) STM-1 AU-4 TU-2

This signal consists of 1 AU-4 containing 3 TUG-3's each of which contains 7 TUG-2s. The TUG-2's in turn each contain a TU-2. From the perspective of the Alarm Scan function the paths are 1 at the AU-4 level and 21 at the TU level. The single AU path is defined as a group on its own while the 21 TU's are arranged as 3 groups of 7 paths with the groups corresponding to the TUG-2 allocation. For this configuration, four arrays are returned with formats shown below:

```
AU-4 GROUP -> AU4
TUG-3 #1 -> TU#1, TU#2, TU#3, TU#4, TU#5, TU#6, TU#7
TUG-3 #2 -> TU#1, TU#2, TU#3, TU#4, TU#5, TU#6, TU#7
TUG-3 #3 -> TU#1, TU#2, TU#3, TU#4, TU#5, TU#6, TU#7
```

For Example, the output could look like:

```
0
1, 1, 1, 0, 0, 1, 0
2, 2, 2, 2, 2, 2, 2
0, 0, 0, 0, 1, 0, 0
```

FETCh subsystem**b) STM-1 AU-4 TU-3**

This signal consists of 1 AU-4 containing 3 TUG-3's each of which contains 1 TU-3. In this configuration there are 4 paths, 1 at the AU-4 level and 3 at the TU-3 level. Again, the single AU path is defined as a group on its own. The TU paths in this instance are also defined as groups corresponding to their allocation within the TUG-3's. For this configuration, four arrays are returned with the following format:

```
AU-4 Group -> AU-4
TUG-3 #1    -> TU-3 #1
TUG-3 #2    -> TU-3 #2
TUG-3 #3    -> TU-3 #3
```

The output will look something like:

```
0
1
2
2
```

c) STM-1 AU-4 TU-12

This signal again consists of 1 AU-4 containing 3 TUG-3's. In this case however, the TUG-3's each contain 7 TUG-2's. These TUG-2's each contain 3 TU-12's. In terms of paths the signal comprises 1 path at the AU-4 level and 63 paths at the TU-12 level. Again the single AU-4 is defined as a group on its own. The 63 TU-12 paths are split into 3 groups corresponding to their allocation with the 3 TUG-3's. For this configuration, four arrays are returned with the following format:

NOTE: TU-12's designated thus [TUG-3# - TUG-2# - TU#]

```
AU-4 Group -> AU-4
TUG-3 #1    -> [1-1-1], [1-1-2], [1-1-3], [1-2-1], [1-2-2], [1-2-3],
                [1-3-1], [1-3-2], [1-3-3], [1-4-1], [1-4-2], [1-4-3],
                [1-5-1], [1-5-2], [1-5-3], [1-6-1], [1-6-2], [1-6-3],
                [1-7-1], [1-7-2], [1-7-3]
TUG-3 #2    -> As Above
TUG-3 #3    -> As Above
```

The output will look like:

SDH Command Reference

FETCh subsystem

```
AUG      -> AU3#1, AU3#2, AU3#3
AU-3 #1  -> TU#1,TU#2,TU#3,TU#4,TU#5,TU#6,TU#7
AU-3 #2  -> TU#1,TU#2,TU#3,TU#4,TU#5,TU#6,TU#7
AU-3 #3  -> TU#1,TU#2,TU#3,TU#4,TU#5,TU#6,TU#7
```

For Example, the output could look like:

```
0,1,1
1,1,1,0,0,1,0
2,2,2,2,2,2,2
0,0,0,0,1,0,0
```

f) STM-1 AU-3 VC-3

This signal consists of 3 AU-3s each containing 1 VC-3. In this configuration there are 3 paths, 3 at the AU-3 level and no lower paths. For this configuration, 3 arrays are returned with the following format:

```
AUG -> AU3#1, AU3#2, AU3#3
```

The output will look something like:

```
0,1,2
```

g) STM-1 AU-3 TU-12

This signal again consists of 3 AU-3's. In this case however, the AU-3's each contain 7 TUG-2's. These TUG-2's each contain 3 TU-12's. In terms of paths the signal comprises 3 paths at the AU-3 level and 63 paths at the TU-12 level. Again the AU-3s are defined as a group on their own. The 63 TU-12 paths are split into 3 groups corresponding to their allocation with the 3 AU-3's. For this configuration, four arrays are returned with the following format:

NOTE: TU-12's designated thus [AU-3# - TUG-2# - TU#]

```
AUG -> AU-3#1, AU-3#2, AU-3#3
AU-3 #1  -> [1-1-1], [1-1-2], [1-1-3], [1-2-1], [1-2-2], [1-
2-3],
           [1-3-1], [1-3-2], [1-3-3], [1-4-1], [1-4-2], [1-
4-3],
           [1-5-1], [1-5-2], [1-5-3], [1-6-1], [1-6-2], [1-
6-3],
           [1-7-1], [1-7-2], [1-7-3]
AU-3 #2  -> As Above
```

SDH Command Reference

FETCh subsystem

defined as one group. For this configuration, 2 groups are returned with the following format:

```
AU-3 Group -> AU-3
AU-3#1 -> TU-2#1,TU-2#2,TU-2#3,TU-2#4,TU-2#5,TU-2#6,TU-2#7
```

The output will look like:

```
0
1, 1, 1, 0, 0, 0, 0
```

j) STM-0 AU-3 TU-12

This signal again comprises 1 AU-3 containing 7 TUG-2's. However, this time the TUG-2's each contain 3 TU-12's. As before, the AU-3 path is defined as a group on its own, while the 7 TU-2 paths are also defined as one group. For this configuration, 2 groups are returned with the following format:

NOTE: TU-12's designated thus [TUG-2# - TU-12#]

```
AU-3 Group -> AU-3
TUG-2      -> [1-1], [1-2], [1-3], [2-1], [2-2], [2-3], [3-1],
               [3-2], [3-3], [4-1], [4-2], [4-3], [5-1], [5-2],
               [5-3], [6-1], [6-2], [6-3], [7-1], [7-2], [7-3]
```

The output will look like:

```
0
1, 1, 1, 0, 0, 0, 0, 1, 1, 1, 1, 1, 1, 1, 1, 0, 0, 2, 0, 0, 0, 0
```

k) STM-0 AU-3 TU-11

This signal again comprises 1 AU-3 containing 7 TUG-2's. However, this time the TUG-2's each contain 4 TU-11's. As before, the AU-3 path is defined as a group on its own, while the 7 TU-2 paths are also defined as one group. For this configuration, 2 groups are returned with the following format:

NOTE: TU-11's designated thus [TUG-2# - TU-11#]

```
AU-3 Group -> AU-3
TUG-2      -> [1-1], [1-2], [1-3], [1-4], [2-1], [2-2], [2-
3], [2-4], [3-1], [3-2], [3-3], [3-4], [4-1], [4-2], [4-3], [4-
4], [5-1], [5-2], [5-3], [5-4], [6-1], [6-2], [6-3], [6-4], [7-
```

FETCh subsystem

1], [7-2], [7-3], [7-4]

The output will look like:

0

1,1,1,1,0,0,0,0,0,1,1,1,1,1,1,1,1,1,0,0,0,2,0,0,0,0,0,1

l) Unrecognized Structure

When Alarm Scan is operating in AUTO mode, it is possible that due to various signal alarm conditions, it may not be able to determine the structure for a particular group of paths. When this occurs that group is marked as an “Unrecognized Structure”. The string returned for such a group is the SCPI NAN - “9.91E+37”

:FETCh:ARRay:DATA:TELEcom:SDH:TSCan?

Returns (each of one or more rows): <numeric>{,<numeric>

The results returned are those for the last FULL scan. Results from partial scans are not available. If no full scan has been completed since the instrument was powered up, this command will return -1.

If data is available it is returned as a set of string arrays one for each scanned group. The arrays are separated by a CR/LF pair. A group is defined as a set of scanned paths at either the AU or TU level. The arrays consist of comma separated numerics, one for each tributary scanned. The value of the numeric indicates the status of the scanned tributary. The following values are valid.

Value	State
0	No Problems Detected
1	Alarms or Errors Detected

For a specific signal structure, the format of the returned strings are shown below:

FETCh subsystem**a) STM-1 AU-4 TU-2**

This signal consists of 1 AU-4 containing 3 TUG-3's each of which contains 7 TUG-2s. The TUG-2's in turn each contain a TU-2. There are therefore 21 (7*3) tributaries in this signal which must be scanned. The 21 tributaries are arranged as 3 groups of 7 paths with the groups corresponding to the TUG-2 allocation. For this configuration, three arrays are returned with formats shown below:

```
TUG-3 #1    -> TU#1, TU#2, TU#3, TU#4, TU#5, TU#6, TU#7
TUG-3 #2    -> TU#1, TU#2, TU#3, TU#4, TU#5, TU#6, TU#7
TUG-3 #3    -> TU#1, TU#2, TU#3, TU#4, TU#5, TU#6, TU#7
```

For Example, the output could look like:

```
1, 1, 1, 0, 0, 1, 0
1, 1, 1, 0, 0, 1, 1
0, 0, 0, 0, 1, 0, 0
```

b) STM-1 AU-4 TU-3

This signal consists of 1 AU-4 containing 3 TUG-3's each of which contains 1 TU-3. There are therefore 3 tributaries which must be scanned. The three tributaries are defined as groups corresponding to their allocation within the TUG-3's. For this configuration, three arrays are returned with the following format:

```
TUG-3 #1    -> TU-3 #1
TUG-3 #2    -> TU-3 #2
TUG-3 #3    -> TU-3 #3
```

The output will look something like:

```
0
1
1
```

c) STM-1 AU-4 TU-12

This signal again consists of 1 AU-4 containing 3 TUG-3's. In this case however, the TUG-3's each contain 7 TUG-2's. These TUG-2's each contain 3 TU-12's. There are therefore 63 (3*7*3) tributaries which must be scanned. The 63 TU-12 paths are arranged in 3 groups corresponding to their allocation with the 3 TUG-3's. For this configuration, three arrays are returned with the following format:

NOTE: TU-12's designated thus [TUG-3# - TUG-2# - TU#]

```
TUG-3 #1    -> [1-1-1], [1-1-2], [1-1-3], [1-2-1], [1-2-
```

SDH Command Reference

FETCh subsystem

1, 1, 1, 0, 0, 0, 0

f) STM-0 AU-3 TU-12

This signal again comprises 1 AU-3 containing 7 TUG-2's. However, this time the TUG-2's each contain 3 TU-12's. There are therefore 21 (7*3) tributaries to be scanned. These are defined as one group and are returned in the following format:

NOTE: TU-12's designated thus [TUG-2# - TU-12#]

TUG-2 -> [1-1], [1-2], [1-3], [2-1], [2-2], [2-3], [3-1],
 [3-2], [3-3], [4-1], [4-2], [4-3], [5-1], [5-2],
 [5-3], [6-1], [6-2], [6-3], [7-1], [7-2], [7-3]

The output will look like:

1, 1, 1, 0, 0, 0, 0, 1, 1, 1, 1, 1, 1, 1, 0, 0, 1, 0, 0, 0, 0

g) STM-0 AU-3 TU-11

This signal again comprises 1 AU-3 containing 7 TUG-2's. However, this time the TUG-2's each contain 4 TU-11's. There are therefore 28 (7*4) tributaries to be scanned. These are defined as one group and are returned in the following format:

NOTE: TU-11's designated thus [TUG-2# - TU-11#]

TUG-2 -> [1-1], [1-2], [1-3], [1-4], [2-1], [2-2], [2-
3], [2-4], [3-1], [3-2], [3-3], [3-4], [4-1], [4-2], [4-3], [4-
4], [5-1], [5-2], [5-3], [5-4], [6-1], [6-2], [6-3], [6-4], [7-
1], [7-2], [7-3], [7-4]

The output will look like:

1, 1, 1, 0, 0, 0, 0, 1, 1, 1, 1, 1, 1, 1, 0, 0, 1, 0, 0, 0, 0

2) STM-4

For the STM-4 situation, the formats are similar to those defined above for STM-1 except that there will be data returned for all four STM-1's in the signal.

A case which is not described in the formats for STM-1 signals is that of an STM-4 signal with a VC-4 structure. In the STM-1 case this structure is not considered since there is only one tributary in the signal. However in the STM-4 case there are 4 tributaries and the scan is carried out.

In this case each VC-4 is treated as a separate group, hence 4 arrays are returned from the SCPI command:

SDH Command Reference

FETCh subsystem

```
STM-1 #1 VC-4
STM-1 #2 VC-4
STM-1 #3 VC-4
STM-1 #4 VC-4
```

The output will look like:

```
0
0
1
1
```

:FETCh:ARRay:DATA:TELEcom:SDH:PGRaph?

Returns: <array>

Returns an array of 576 bytes, 2 bytes for each of the possible 288 points on the displayed pointer graph. The 2 bytes at each point indicate the maximum and minimum offset at that point. Each byte has 3 numeric entries separated by commas.

The value of the 3 numeric entries, <range bit>,<validity bit>,<offset value>, provide the following information:

Range bit	Validity Bit	Offset Value	Description
1	1	-18 to +18	Valid in range result
1	0	0	No measurement
1	1	9.91E+37	Alarms during measurement
2	1	0	Offset out of range > +18
0	1	0	Offset out of range < -18

The graph entries are arranged as shown below. Each entry has the format previously described above:

```
<max offset 1>,<min offset 1>,<max offset 2>,<min offset 2>,  
<max offset 3>,<min offset 3>,<max offset 4>,<min offset 4>,  
<max offset 5>,<min offset 5>,<max offset 6>,<min offset 6>,  
.....  
.....  
<max offset 287>,<min offset 287>,<max offset 288>,<min offset 288>
```

Range of valid offset values is -18 thru +18

SDH Command Reference

FETCh subsystem

A typical return array might look like:

1,1,9.91E+37,1,1,9.91E+37,1,1, 0,1,1, 0,1,1, +1,1,1, -2, etc....

:FETCh:ARRAy:DATA:TELEcom:SDH:OCAPture? <numeric>

<numeric> = 1 to 16 Overhead channels

Returns: <array>

Returns an array with the number of entries determined by <numeric> and separated by CR/LF.

Each entry consists of an alphanumeric string and a numeric separated by commas. The alphanumeric string provide the hexadecimal value of the captured data. The length of the string depends upon the overhead channel selected for capture, two hexadecimal characters/overhead byte. The numeric indicates the number of frames for which the captured data existed. If this command is issued when a capture is being performed, some entries will contain no data. In this case 9.91E+37 is returned.

The overhead byte or bytes to be captured is specified by
:SENS:DATA:TEL:OCAP: CHAN <channel>.

:FETCh:SCALAr:DATA:TELEcom:SDH:POVerhead? <byte name>

<byte name> = C2|G1|F2|H4|F3|K3|N1

Returns: <string>

Returns the value of the selected path overhead byte as an 8 bit string in the range "00000000" to "11111111".

:FETCh:ARRAy:DATA:TELEcom:SDH:POVerhead? <numeric>

<numeric> = 1 to 9

Returns the value of the selected path overhead bytes as an array of strings. Each string is in the range "00000000" to "11111111". This is a snapshot of the overhead byte and is captured once per second.

The array always begins with byte 1 of the path overhead and ends with the byte number specified by <bytes>.

Byte Order: (1) J1 (2) B3 (3) C2 (4) G1 (5) F2 (6) H4 (7) F3 (8) K3 (9) N1.

FETCh subsystem**:FETCh:SCALar:DATA:TELEcom:SDH:TRIButary:POVerhead:SLABel?**

Returns the signalling label of the selected tributary in numeric form.

:FETCh:ARRAy:DATA:TELEcom:SDH:OVERhead? <numeric>,<numeric>,<numeric>

<numeric> =	1 to 27	(Byte)
<numeric> =	1 to 16	(STM-1 Number)
<numeric> =	1	(Columns 1,4,7)
	2	(Columns 2,5,8)
	3	(Columns 3,6,9)

Returns the value of the selected transport overhead bytes as an array of strings. Each string is in the range "00000000" to "11111111". This is a snapshot of the overhead byte and is captured once per second.

The array always begins with byte 1 of the transport overhead and ends with the byte number specified by the first parameter.

Number	Name	Number	Name	Number	Name
1	A1	10	H1	19	D7
2	A2	11	H2	20	D8
3	J0/Z0/C1	12	H3	21	D9
4	B1	13	B2	22	D10
5	E1	14	K1	23	D11
6	F1	15	K2	24	D12
7	D1	16	D4	25	S1
8	D2	17	D5	26	Z2/M1
9	D3	18	D6	27	E2

SONET SCPI Command Reference

OUTPut subsystem, see page 6-3.

SOURce subsystem - Transmitter SONET Settings Commands, see page 6-9.

SONET Mapping Settings, see page 6-14.

SOURce subsystem - Transmitter SONET OVERHEAD SETUP, see page 6-24.

SOURce subsystem - Transmitter SONET Test Function Commands, see page 6-35.

INPut subsystem, see page 6-63.

SENSe subsystem - Receiver SONET Settings, see page 6-67.

SENSe subsystem - Receiver SONET Test Function Commands, see page 6-76.

SENSe subsystem - Alarm Scan Control, see page 6-82.

SENSe subsystem - SONET Tributary Scan Control, see page 6-84.

SENSe subsystem - Result Returning Commands, see page 6-86.

FETCh subsystem, see page 6-97.

SONET Command Reference

SONET Command Reference

This chapter contains detailed information on the SCPI (Standard Commands for Programming Instruments) and IEEE 488.2 common commands you will use when writing programs to control your OmniBER 718 for SONET operation.

Please also refer to chapter 2 Common Commands for general information on SCPI command formats and for a list of commands that are common to PDH, SDH, SONET, Jitter or ATM operation; they are as follows:

SCPI Command Format

Remote Control Commands

Instrument Options

INSTRument subsystem

SOURce subsystem

SOURce subsystem - Transmitter Common Commands

INPut subsystem

SENSE subsystem

SENSE subsystem - Receiver Common Commands

SENSE subsystem - Test Timing

SENSE subsystem - Analysis Control

SENSE subsystem - Trouble Scan Results

SENSE subsystem - Configuring Graphics

SENSE subsystem - Managing Graphics Stores

SENSE subsystem - Retrieving Graphics Store Data

SENSE subsystem - Retrieving Data for a Single Graph

SENSE subsystem - Obtaining Graphics End of Measurement Results

STATus Subsystem

SYSTEM Subsystem

IEEE common capabilities

OUTPut subsystem

OUTPut subsystem

This subsystem controls the characteristics of the instrument's output ports.

:OUTPut:TELEcom:SONet:RATE <discrete>

<discrete> =	STS1	STS-1 Electrical
	STS3	STS-3 Electrical

Is only valid when :SOURce:DATA:TELEcom:SOURce <discrete> is set to SONet.

:OUTPut:TELEcom:SONet:RATE?

Returns: <discrete>

:OUTPut:TELEcom:SONet:LEVel <discrete>

<discrete> =	XCON	450 feet simulated cable
	HIGH	0 feet simulated cable
	LOW	900 feet simulated cable

Selects the signal level for the STS-1 output.

The corresponding query returns the STS-1 signal level in discrete short form.

:OUTPut:TELEcom:SONet:LEVel?

Returns: <discrete>

:OUTPut:TELEcom:OC3:RATE <discrete>

<discrete> =	OC1	OC-1 optical
	OC3	OC-3 Optical

Selects the output rate for the OC-1/OC-3 optical output port. This command is only valid when :SOURce:DATA:TELEcom:SOURce <discrete> is set to OC3.

The corresponding query returns the OC-1/OC-3 output rate in discrete form as listed above. If the OC-3 port is not selected, OC3 will be returned as the default.

OUTPut subsystem

:OUTPut:TELEcom:OC3:RATE?

Returns: <rate>

:OUTPut:TELEcom:OC3:INTerface?

Returns: <discrete>

Returns the selected output port interface in discrete form - always OPTical.

:OUTPut:TELEcom:OC3:WAVelength <discrete>

<discrete> =	NM1310	1310 nm
	NM1550	1550 nm

Selects the wavelength of the output optical signal on the Optical module.

The corresponding query returns the output optical wavelength in discrete form, as listed above.

:OUTPut:TELEcom:OC3:WAVelength?

Returns : <discrete>

:OUTPut:TELEcom:OC3:LASer <boolean>

<boolean> =	0 or OFF
	1 or ON

Controls the state of the laser (ON or OFF) on the Optical module.

The corresponding query returns the state of the laser as 0 or 1.

:OUTPut:TELEcom:OC3:LASer?

Returns : <boolean> 0 or 1

:OUTPut:TELEcom:OC12:RATE <discrete>

<discrete> =	OC1	OC-1 optical
--------------	-----	--------------

SONET Command Reference

OUTPut subsystem

OC3	OC-3 Optical
OC12	OC-12 Optical

Selects the output rate for the OC-1/OC-3/OC-12 optical output port. This command is only valid when :SOURCE:DATA:TELEcom:SOURCE <discrete> is set to OC12.

The corresponding query returns the OC-1/OC-3/OC-12 output rate in discrete form as listed above. If the OC-12 port is not selected, OC12 will be returned as the default.

:OUTPut:TELEcom:OC12:RATE?

Returns : <discrete>

:OUTPut:TELEcom:OC12:INTerface?

Returns: <discrete>

Returns the selected output port interface in discrete form - always OPTical.

:OUTPut:TELEcom:OC12:WAVelength <discrete>

<discrete> =	NM1310	1310 nm
	NM1550	1550 nm

Selects the wavelength of the output optical signal on the Optical module.

The corresponding query returns the output optical wavelength in discrete form, as listed above.

:OUTPut:TELEcom:OC12:WAVelength?

Returns : <discrete>

:OUTPut:TELEcom:OC12:LASer <boolean>

<boolean> =	0 or OFF
	1 or ON

Controls the state of the laser (ON or OFF) on the Optical module.

SONET Command Reference

OUTPut subsystem

The corresponding query returns the state of the laser as 0 or 1.

:OUTPut:TELEcom:OC12:LASer?

Returns : <boolean> 0 or 1

:OUTPut:TELEcom:OC48:RATE <discrete>

<discrete> =	OC1	OC-1 optical
	OC3	OC-3 Optical
	OC12	OC-12 Optical
	OC48	OC-48 Optical

Selects the output rate for the OC-1/OC-3/OC-12/OC-48 optical output port. This command is only valid when :SOURce:DATA:TELEcom:SOURce <discrete> is set to OC48.

The corresponding query returns the OC-1/OC-3/OC-12/OC-48 output rate in discrete form as listed above. If the OC-48 port is not selected, OC-48 will be returned as the default.

:OUTPut:TELEcom:OC48:RATE?

Returns : <discrete>

:OUTPut:TELEcom:OC48:INTerface?

Returns: <discrete>

Returns the selected output port interface in discrete form - always OPTical.

:OUTPut:TELEcom:OC48:WAVelength <discrete>

<discrete> =	NM1310	1310 nm
	NM1550	1550 nm

Selects the wavelength of the output optical signal on the Optical module.

SONET Command Reference

OUTPut subsystem

The corresponding query returns the output optical wavelength in discrete form, as listed above.

:OUTPut:TELEcom:OC48:WAVelength?

Returns : <discrete>

:OUTPut:TELEcom:OC48:LASer <boolean>

<boolean> = 0 or OFF

 1 or ON

Controls the state of the laser (ON or OFF) on the Optical module.

The corresponding query returns the state of the laser as 0 or 1.

:OUTPut:TELEcom:OC48:LASer?

Returns : <boolean> 0 or 1

SOURce subsystem - Transmitter SONET Settings Commands

The corresponding query returns the transmitter SONET clock sync source level in discrete form as listed above.

:SOURce:CLOCK:SONet:LEVel?

Returns : <discrete>

:SOURce:CLOCK:SONet:FORMat <discrete>

<discrete> =	CLOCK	Clock Format
	DATA	Data Format
	K64	64kb/s data
	DS1Bits	DS1 bit rate
	M10Ref	10 MHz Reference

Selects the transmitter SONET EXT clock sync source format.

The corresponding query returns the EXT clock sync source format in discrete form as listed above.

:SOURce:CLOCK:SONet:FORMat?

Returns : <discrete>

:SOURce:CLOCK:SONet:FOFFset <boolean>

<boolean> =	0 or OFF
	1 or ON

Enables/disables the SONET Frequency Offset. The amount of Offset is set using :SOURce:CLOCK:SONet:FOFFset:OFFSet <numeric><suffix>.

The corresponding query returns the SONET Frequency Offset state as 0 or 1.

:SOURce:CLOCK:SONet:FOFFset?

Returns : <boolean>

SOURce subsystem - Transmitter SONET Settings Commands**:SOURce:CLOCK:SONet:FOFFset:OFFSet <numeric><suffix>**

<numeric> =	-999 to +999	Parts per Million
	-0.0999 to 0.0999	% or Ratio
<suffix> =	PPM	Parts per Million
	PCT	Percentage

Sets the amount of SONET Frequency Offset when Frequency Offset is enabled by setting :SOURce:CLOCK:SONet:FOFFset <boolean> to ON. If Ratio is chosen as the method of specifying Offset, no suffix is required.

The corresponding query returns the amount of SONET Frequency Offset in ppm.

:SOURce:CLOCK:SONet:FOFFset:OFFSet?

Returns : <numeric>

Thru mode settings**:SOURce:DATA:TELEcom:SONet:THRumode <discrete>**

<discrete> =	INTernal	Select Normal SONET Mode
	THRU	Select SONET Thru Mode

Selects/Deselects SONET THRU mode.

The corresponding query returns the THRU mode state in discrete form as listed above.

:SOURce:DATA:TELEcom:SONet:THRumode?

Returns : <discrete>

SOURce:DATA:TELEcom:SONet:THRumode:PAYLoad:OVERwrite <discrete>

<discrete> =	OFF	Payload Overwrite Off
	STS3c	Overwrite STS-3C payload
	STS1	Overwrite STS-1 payload

:SOURce:DATA:TELEcom:SONet:THRumode:COVerwrite?

Returns : <boolean>

SONET Mapping Settings

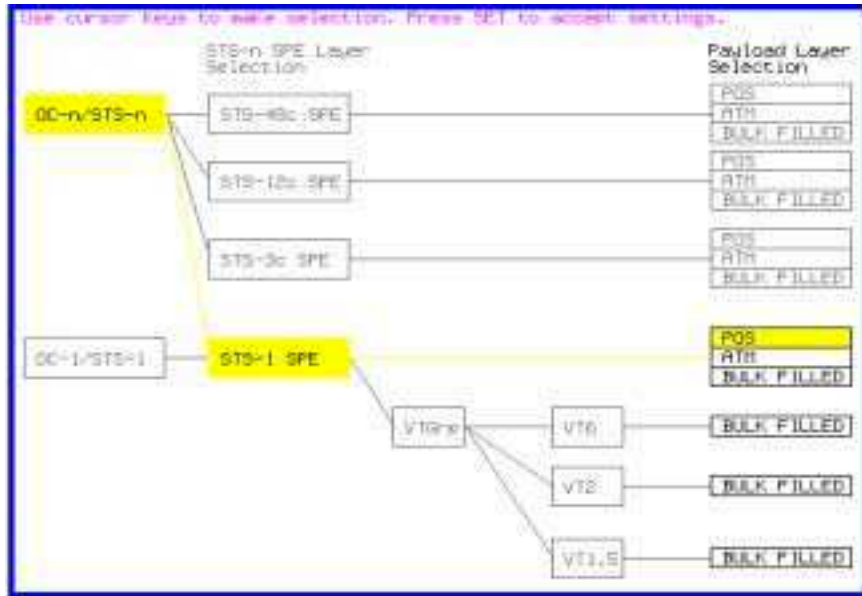

:SOURce:DATA:TELEcom:SONet:STS3 <numeric>

<numeric> = 1 to 16 STS3 number under test.

Only valid if :OUTPut:TELEcom:OC48:RATE <discrete> is set to a rate higher than STS-3. Selects the transmitted STS-3 that is selected for test.

The corresponding query returns the STS-3 selected for test in numeric form, as listed above.

:SOURce:DATA:TELEcom:SONet:STS3?

Returns : <numeric>

:SOURce:DATA:TELEcom:SONet:STS12c <numeric>

<numeric> = 1 to 4 STS12 number under test.

SOURce subsystem - Transmitter SONET Settings Commands

:SOURce:DATA:TELEcom:SONet:STS12c?

Returns : <numeric>

SPE Layer Selection

:SOURce:DATA:TELEcom:SONet:SPE:TYPE <discrete>

<discrete> = STS3c
STS1
STS12c
STS48c

Set the SPE mapping into an STS-N frame.

The corresponding query returns the SPE layer in discrete form as listed above.

:SOURce:DATA:TELEcom:SONet:SPE:TYPE?

Returns: <discrete>

:SOURce:DATA:TELEcom:SONet:STS1 <numeric>

<numeric> = 1 to 3 STS1 Number

Selects the SONET Transmitter active STS-1 within the STS-3.

The corresponding query returns the active STS-1 in numeric form.

:SOURce:DATA:TELEcom:SONet:STS1?

Returns : <numeric>

VT Layer Selection

:SOURce:DATA:TELEcom:SONet:PAYLoad <discrete>

<discrete> = STS3c or M140 140 Mb/s
STS1 STS-1
VT2 or M2 2 Mb/s
VT6 VT-6

SOURce subsystem - Transmitter SONET Settings Commands

STS12c	STS-12c
STS48c	STS-48c
VT15 or DS1	VT-1.5

This command selects the SONET transmitter mapping.

The corresponding query returns the SONET mapping in discrete form, as listed above.

:SOURce:DATA:TELEcom:SONet:PAYLoad?

Returns : <discrete>

Payload Layer Selection**:SOURce:DATA:TELEcom:SONet:MAPPING <discrete>**

<discrete> =	M140	140 Mb/s (STS3c only)
	M34	34 Mb/s (STS1 Full SPE only)
	DS3	DS3 (STS1 Full SPE only)
	BULK	Bulk Filled (STS1, STS3c STS12c and STS48c)
	ATM	ATM (STS1, STS3c STS12c and STS48c)
	IPOS	POS (STS1, STS3c, STS12c, or STS48c)

This command controls the transmitter SONET payload for single payload cases.

Only valid if :SOURce:DATA:TELEcom:SONet:PAYLoad <discrete> is set to STS1, STS3C, STS12c or STS48c.

The corresponding query returns the low order mapping in discrete form as listed above.

:SOURce:DATA:TELEcom:SONet:MAPPING?

Returns: <discrete>

SOURce subsystem - Transmitter SONET Settings Commands**:SOURce:DATA:TELEcom:SONet:TRIButary?**

Returns : <numeric>

VT Payload and Test Pattern**:SOURce:DATA:TELEcom:SONet:PAYLoad:TYPE <discrete>**

<discrete> =	UNFRamed	No framing
	FRAMed	8, 34 & 140 Mb/s
	PCM30	2 Mb/s Only
	PCM31	2 Mb/s Only
	PCM30CRC	2 Mb/s Only
	PCM31CRC	2 Mb/s Only
	IM2	2 Mb/s Insert
	IM34	34 Mb/s Insert
	IM140	140 Mb/s Insert
	D4	DS1 Framing Only
	ESF	DS1 Framing Only
	SLC96	DS1 Framing Only
	M13	DS3 Framing Only
	CBIT	DS3 Framing Only
	IDS1	Insert DS1
	IDS3	Insert DS3
	NOFBit	No Framing Bit (set to '0')

To set the framing type to be structured use the command

:SOURce:DATA:TELEcom:SONet:PAYLoad:STRucture <discrete>.

Only valid if a Structured PDH transmitter is fitted.

The corresponding query returns the framing in discrete form as listed above.

:SOURce:DATA:TELEcom:SONet:PAYLoad:TYPE?

Returns : <discrete>

SOURce subsystem - Transmitter SONET Settings Commands

:SOURce:DATA:TELEcom:SONet:PAYLoad:STRucture <discrete>

<discrete> =	UNSTRuctured	All rates
	STRuctured	All framed formats

Selects whether or not the PDH payload signal is to have any further structure or not.

The corresponding query returns the transmitter PDH payload structure setting in discrete form as listed above.

:SOURce:DATA:TELEcom:SONet:PAYLoad:STRucture?

Returns: <discrete>

:SOURce:DATA:TELEcom:SONet:PAYLoad:PATtern <discrete>

<discrete> =	PRBS9	2^9-1
	PRBS11	$2^{11}-1$
	PRBS15	$2^{15}-1$
	PRBS20	$2^{20}-1$
	PRBS23	$2^{23}-1$
	QRSS	$2^{20}-1$ with 14 consecutive zero limit
	AZERo	All Zeros
	AONE	All Ones
	STRess	3-in-24 stress pattern (DS1 only) (requires option 110)
	P1010	Word 1010
	P1000	Word 1000
	UWORD	16 Bit User Word

Selects the transmitter SONET payload data pattern.

If UWORD is selected, the word pattern is set using
:SOURce:DATA:TELEcom:SONet:PAYLoad:UWORD <string>.

SOURce subsystem - Transmitter SONET Settings Commands

The corresponding query returns the transmitter SONET payload data pattern in discrete form, as listed above.

:SOURce:DATA:TELEcom:SONet:PAYLoad:PATtern?

Returns : <discrete>

:SOURce:DATA:TELEcom:SONet:PAYLoad:UWORD <string>

Sets the SONET transmitter user word pattern in the range "0000000000000000" to "1111111111111111".

The corresponding query returns the user word pattern as a string.

:SOURce:DATA:TELEcom:SONet:PAYLoad:UWORD?

Returns : <string>

:SOURce:DATA:TELEcom:SONet:PRBS:POLarity <discrete>

<discrete> = INVerted
 NORMAl

Selects the PRBS pattern polarity.

The corresponding query returns the polarity in discrete form as listed above.

:SOURce:DATA:TELEcom:SONet:PRBS:POLarity?

Returns: <discrete>

:SOURce:DATA:TELEcom:SONet:PAYLoad:OFFSet <numeric>

<numeric> =	-100 to +100	Parts per Million
	-0.0100 to 0.0100	% or Ratio
<suffix> =	PPM	Parts per Million
	PCT	Percentage

Sets the 140, 34, 2 Mb/s, DS3 or DS1 payload frequency offset in parts per million (ppm).

The corresponding query returns the offset in numeric form.

SOURCE subsystem - Transmitter SONET Settings Commands**:SOURCE:DATA:TELEcom:SONet:PAYLoad:OFFSet?**

Returns: <numeric> ppm

:SOURCE:DATA:TELEcom:SONet:TRIButary:CONCatenate <numeric>, <numeric>

<numeric> = (first parameter)	0	Concatenation Off
	2	VT6-2c
	3	VT6-3c
	4	VT6-4c
	5	VT6-5c
	6	VT6-6c
<numeric> = (second parameter)	1 to 6	VT6-2c selected
	1 to 5	VT6-3c selected
	1 to 4	VT6-4c selected
	1 to 3	VT6-5c selected
	1 to 2	VT6-6c selected

Selects the VT6 concatenation (first parameter) and starting at VT (second parameter).

The corresponding query returns the VT6 concatenation and starting at VT in numeric form as listed above.

:SOURCE:DATA:TELEcom:SONet:TRIButary:CONCatenate?

Returns : <numeric>, <numeric>

SOURce subsystem - Transmitter SONET Settings Commands**Background Settings**

**:SOURce:DATA:TELEcom:SONet:PRIMary:BACKground:PAYLoad
:PATtern <discrete>**

<discrete> =	PRBS9	2^9-1
	PRBS15	$2^{15}-1$
	NUMBERed	(VT-6 or framed VT-2/VT-1.5)
	P1100	word 1100

Selects the background payload pattern for VTs within the foreground VT Group. The corresponding query returns the background pattern in discrete form as listed above.

**:SOURce:DATA:TELEcom:SONet:PRIMary:BACKground:PAYLoad
:PATtern?**

Returns: <discrete>

:SOURce:DATA:TELEcom:SONet:STS1:BACKground <discrete>

<discrete> =	UNEQuipped	Fixed at 00000000
	AS_FG	As Foreground

Selects the payload in the background (non test) STS-1s. This command only applies if the interface rate is higher than STS-1. The corresponding query returns the type of payload in the background STS-1s in discrete short form.

:SOURce:DATA:TELEcom:SONet:STS1:BACKground?

Returns: <discrete>

:SOURce:DATA:TELEcom:SONet:STS3:BACKground <discrete>

<discrete> =	UNEQuipped	Fixed at 00000000
	AS_FG	As Foreground

Selects the payload in the background (non test) STS-3s. This command only applies if the interface rate is higher than STS-3.

SOURce subsystem - Transmitter SONET Settings Commands

The corresponding query returns the type of payload in the background STS-3s in discrete short form.

:SOURce:DATA:TELEcom:SONet:STS3:BACKground?

Returns: <discrete>

:SOURce:DATA:TELEcom:SONet:STS12c BACKground <discrete>

<discrete> =	UNEQuipped	Fixed at 00000000
	AS_FG	As Foreground

Selects the payload in the background (non test) STS-12c's. This command only applies if the interface rate is higher than STS-12c.

The corresponding query returns the type of payload in the background STS-12c in discrete short form.

:SOURce:DATA:TELEcom:SONet:STS12c:BACKground?

Returns: <discrete>

SOURce subsystem - Transmitter SONET OVERHEAD SETUP**SOURce subsystem - Transmitter SONET OVERHEAD SETUP**

Lists the settings for the commands associated with the TRANSMIT OVERHEAD SETUP display.

:SOURce:DATA:TELEcom:SONet:OVERhead:DEFault

Sets all overhead bytes to their default value :

Byte	Value	Byte	Value	Byte	Value	Byte	Value
A1	11110110	A2	00101000	J0/Z0	00000001	B1	xxxxxxxx
E1	00000000	F1	00000000	D1	00000000	D2	00000000
D3	00000000	E2	00000000	H1	xxxx10xx	H2	xxxxxxxx
H3	xxxxxxxx	B2	xxxxxxxx	K1	00000000	K2	00000000
D4	00000000	D5	00000000	D6	00000000	D7	00000000
D8	00000000	D9	00000000	D10	00000000	D11	00000000
D12	00000000	S1/Z1	00000000	M0/M1/Z2	00000000	J1	Default
B3	xxxxxxxx	C2	00000001	G1	00000000	F2	00000000
H4	00000000	Z3	00000000	Z4	00000000	N1	00000000

:SOURce:DATA:TELEcom:SONet:OVERhead:DATA <numeric>, <numeric>, <discrete>, <string>

<numeric> = STS-3 Number: range 1 to 16
(first parameter)

<numeric> = STS-1 Number: range 1 to 3
(second parameter)

<discrete> = A1|A2|J0/Z0|E1|F1|D1|D2|D3|H1|K1
K2|D4|D5|D6|D7|D8|D9|D10|D11
D12|S1/Z1|M0/M1/
Z2|E2|X11|X12|X13|X21|X22|X23|X31
X32|X33|X41|X42|X52|X53|X61|X62|X63
X71|X72|X73|X81|X82|X83|X91|X92|X93

<string> = "00000000" to "11111111"

SOURce subsystem - Transmitter SONET OVERHEAD SETUP

Sets the binary value for the selected transmitter section overhead byte. The byte number is given by its defined name if it has one. Undefined bytes are represented by "Xrc", where r is the numerical value of the bytes row in the transport overhead and c is the numerical value of the bytes column in the transport overhead.

If an STS-3 signal is being transmitted, the only applicable value of STS-3 number is 1.

The byte is set to the binary representation of the given 8 character string.

In the case of STS-1 #1 only bits 2 and 3 of H1 may be set. The value sent must however still be 8 bits long. The unused bits should be marked 'x', i.e. to set bits 2 and 3 to '11' send the value 'xxxx11xx'.

The corresponding query returns the binary value of the byte named within the selected STS-3 column.

The K1 and K2 bytes can not be programmed when Active APS messages mode is selected.

:SOURce:DATA:TELEcom:SONet:OVERhead:DATA? <numeric>, <numeric>, <discrete>

Returns : <string>

:SOURce:DATA:TELEcom:SONet:OVERhead:DATA:HEXadecimal <numeric>, <numeric>, <discrete>, <string>

<numeric> = STS-3 Number: range 1 to 16

<numeric> = STS-1 Number: range 1 to 3

<discrete> = A1|A2|J0/Z0|E1|F1|D1|D2|D3|H1|K1

K2|D4|D5|D6|D7|D8|D9|D10|D11

D12|S1/Z1|M0/M1/

Z2|E2|X11|X12|X13|X21|X22|X23|X31

X32|X33|X41|X42|X52|X53|X61|X62|X63

X71|X72|X73|X81|X82|X83|X91|X92|X93

<string> = "00" to "FF"

Sets the hexadecimal value for the selected transmitter transport overhead byte. The byte number is given by its defined name if it has one. Undefined bytes are represented by "Xrc", where r is the numerical value of the bytes row in the

SOURce subsystem - Transmitter SONET OVERHEAD SETUP

transport overhead and c is the numerical value of the bytes column in the transport overhead.

If an STS-3 signal is being transmitted, the only applicable value of STS-3 is 1.

The byte is set to the hexadecimal representation of the given 2 character string.

In the case of STS-1 #1 only bits 2 and 3 of H1 may be set. Any hexadecimal value can be sent but only bits 2 and 3 will be set and all other bits will remain unchanged.

The corresponding query returns the hexadecimal value of the specified byte.

The K1 and K2 bytes can not be programmed when Active APS messages mode is selected.

:SOURce:DATA:TELEcom:SONet:OVERhead:DATA:HEXadecimal?
<numeric>, <numeric>, <discrete>

Returns: <string>

:SOURce:DATA:TELEcom:SONet:POVerhead:DATA <discrete>, <string>

<discrete> = C2|G1|F2|H4|Z3|Z4|N1

<string> = "xx00xxx0" to "xx11xxx1" for V5

"00000000 to 11111111 not V5

Sets the binary value of the specified STS-3, STS-12C and STS-48C path overhead byte.

The corresponding query returns the value of the specified high order path overhead byte as a string, as described above.

:SOURce:DATA:TELEcom:SONet:POVerhead:DATA? <discrete>

Returns: <string>

:SOURce:DATA:TELEcom:SONet:POVerhead:SLABel <discrete>

<discrete> =	UNEQuipped	Unequipped (00000000)
	EQUipped	Equipped (00000001)
	VTStructure	VT structure STS-1 SPE (00000010)
	LOCKed	Locked VT (00000011)

SOURce subsystem - Transmitter SONET OVERHEAD SETUP

DS3asyn	Asynchronous DS3 (00000100)
DS4Naasyn	Asynchronous DS4NA (00010010)
ATM	ATM (00010011)
DQDB	DQDB (00010100)
FDDI	FDDI (00010101)
PPPScram	
PPPNocram	
USER	User Defined

Sets the value of the STS POH path label (C2 Byte). To update the USER byte value use the :SOURce:DATA:TELEcom:SONet:POVerhead:DATA <discrete>, <string> command.

The corresponding query returns the value of the C2 byte in discrete short form.

:SOURce:DATA:TELEcom:SONet:POVerhead:SLAbel?

Returns: <discrete>

:SOURce:DATA:TELEcom:SONet:POVerhead:J1:PATtern <discrete>

<discrete> =	Default	64 NULL characters
	TEST	Test message
	USER	User Defined
	CRC7Test	GB(Serial Number)
	CRC7User	User Defined

Sets the type of pattern that is to be transmitted in the J1 byte of the STS path overhead. The pattern repeats every 64 characters (16 chars in CRC7 case) and is transmitted byte by byte in subsequent frames.

The corresponding query returns the type of pattern being transmitted in STS path overhead byte J1 in discrete form as listed above.

:SOURce:DATA:TELEcom:SONet:POVerhead:J1:PATtern?

Returns : <discrete>

SOURce subsystem - Transmitter SONET OVERHEAD SETUP

:SOURce:DATA:TELEcom:SONet:POVerhead:J1 <string>

Sets the user defined pattern that is to be transmitted in the J1 byte of the STS path overhead. The pattern should be 64 characters long, terminated with CR/LF. If less than 64 characters are input, the instrument will pad with the required number of NULL characters and terminate with CR/LF. The pattern repeats every 64 characters and is transmitted byte by byte in subsequent frames.

The corresponding query returns the value of the user defined pattern as a string, as defined above. If the string contains any non printing characters, ~ is substituted.

If CRC7 was returned in response to

:SOURce:DATA:TELEcom:SONet:POVerhead:J1:PATtern? , this query command is not valid.

:SOURce:DATA:TELEcom:SONet:POVerhead:J1?

Returns : <string>

:SOURce:DATA:TELEcom:SONet:POVerhead:J1:CRC7 <string>

This command sets the CRC7 based user defined string that is to be transmitted using the J1 byte and configures the instrument to use this string. The string can be up to 15 characters in length; remaining characters are set to NULLs. A frame marker byte with CRC7 is added to this string.

The string is transmitted byte by byte in subsequent frames. The string repeats every 16 characters. The corresponding query returns the current value of the string. If the string contains any non printing characters, ~ is substituted.

:SOURce:DATA:TELEcom:SONet:POVerhead:J1:CRC7?

Returns : <string>

:SOURce:DATA:TELEcom:SONet:POVerhead:J1:HEXadecimal?

Returns : <block>

Returns a 64 byte block of data. Each byte represents the hexadecimal value of an ASCII character of STS path overhead byte J1 in the range "00" to "FF". The 64 hexadecimal numbers are preceded by the header "#264".

If CRC7 was returned in response to

:SOURce:DATA:TELEcom:SONet:POVerhead:J1:PATtern?, this query command is not valid.

SOURce subsystem - Transmitter SONET OVERHEAD SETUP

:SOURce:DATA:TELEcom:SONet:TRIButary:POVerhead:DATA <discrete>, <string>

<discrete>= V5|Z6|Z7

Sets the value of the specific VT-2, VT-1.5 or VT-6 path overhead byte to the value specified by string (in the range "00000000" to "11111111"). The byte is specified by the first parameter.

Only bits 3, 4 and 8 of V5 can be set but an 8 bit string must be sent with the unsettable bits set to x. To set bits 3, 4 and 8 to "1" send "xx11xxx1".

The corresponding query returns the byte specified by type in string form, as described.

:SOURce:DATA:TELEcom:SONet:TRIButary:POVerhead:DATA? <discrete>

Returns: <string>

:SOURce:DATA:TELEcom:SONet:OVERhead:J0:PATtern <discrete>

<discrete> =	FIXed	Fixed Byte
	TEST	GB(Serial Number)
	USER	User Defined

Sets the type of pattern that is to be transmitted in the J0 byte of the STS section overhead. The pattern repeats every 16 characters and is transmitted character by character in subsequent frames.

The corresponding query returns the type of pattern being transmitted in overhead byte J0 in discrete short form.

:SOURce:DATA:TELEcom:SONet:OVERhead:J0:PATtern?

Returns: <discrete>

:SOURce:DATA:TELEcom:SONet:OVERhead:J0 <string>

Sets the user defined pattern that is to be transmitted in the J0 byte of the regenerator overhead. The pattern should be 15 characters long. The instrument automatically appends a E.164 CRC character to make up a 16 character sequence. If less than 15 characters are input, the instrument will pad with the required number of NULL characters. The pattern repeats every 16 characters and is transmitted character by character in subsequent frames.

SOURce subsystem - Transmitter SONET OVERHEAD SETUP

The corresponding query returns the value of the user defined pattern as a string, as defined above. If the string contains any non printing characters, ~ is substituted.

If FIXed was returned in response

to: **SOURce:DATA:TELEcom:SONet:OVERhead:J0:PATtern?**, this query command is not valid.

:SOURce:DATA:TELEcom:SONet:OVERhead:J0?

Returns: <string>

:SOURce:DATA:TELEcom:SONet:OVERhead:J0:HEXadecimal?

Returns: <block>

Returns a 15 byte block of data. Each byte represents the hexadecimal value of an ASCII character "00" to "FF". The 15 hexadecimal numbers are preceded by the header "#215".

If FIXed was returned in response to

to: **SOURce:DATA:TELEcom:SONet:OVERhead:J0:PATtern?**, this query command is not valid.

:SOURce:DATA:TELEcom:SONet:TRIButary:POVerhead:J1:PATtern <discrete>

<discrete> =	DEFault	64 NULL characters
	TEST	Test message
	USER	User Defined
	CRC7Test	GB(Serial Number)
	CRC7User	User Defined

Sets the type of pattern that is to be transmitted in the J1 byte of the STS SPE path overhead. The pattern repeats every 64 characters (16 chars in CRC7 case) and is transmitted byte by byte in subsequent frames.

The corresponding query returns the type of pattern being transmitted in STS SPE path overhead byte J1 in discrete form as listed above.

SOURce subsystem - Transmitter SONET OVERHEAD SETUP

:SOURce:DATA:TELEcom:SONet:TRIButary:POVerhead:J1:PATtern?

Returns : <discrete>

:SOURce:DATA:TELEcom:SONet:TRIButary:POVerhead:J1 <string>

Sets the user defined pattern that is to be transmitted in the J1 byte of the STS SPE path overhead. The pattern should be 64 characters long, terminated with CR/LF. If less than 64 characters are input, the instrument will pad with the required number of NULL characters and terminate with CR/LF. The pattern repeats every 64 characters and is transmitted byte by byte in subsequent frames.

The corresponding query returns the value of the user defined pattern as a string, as defined above. If the string contains any non printing characters, ~ is substituted.

If CRC7T or CRC7U was returned in response to

:SOURce:DATA:TELEcom:SONet:POVerhead:J1:PATtern <discrete>, this query command is not valid.

:SOURce:DATA:TELEcom:SONet:TRIButary:POVerhead:J1?

Returns : <string>

:SOURce:DATA:TELEcom:SONet:TRIButary:POVerhead:J1:CRC7 <string>

This command sets the CRC7 based user defined string that is to be transmitted using the J1 byte of the STS SPE path overhead, and configures the instrument to use this string. The string can be up to 15 characters in length; remaining characters are set to NULLs. A frame marker byte with CRC7 is added to this string. The string is transmitted byte by byte in subsequent frames. The string repeats every 16 characters. The corresponding query returns the current value of the string. If the string contains any non printing characters, ~ is substituted.

:SOURce:DATA:TELEcom:SONet:TRIButary:POVerhead:J1:CRC7?

Returns : <string>

:SOURce:DATA:TELEcom:SONet:TRIButary:POVerhead:J1:HEXadecimal?

Returns : <block>

Returns a 64 byte block of data. Each byte represents the hexadecimal value of an ASCII character of TU3 byte J1 in the range "00" to "FF". The 64 hexadecimal numbers are preceded by the header "#264".

SOURce subsystem - Transmitter SONET OVERHEAD SETUP

If CRC7T or CRC7U was returned in response to :SOURce:DATA:TELEcom:SONet:POVerhead:J1:PATtern <discrete>, this query command is not valid.

:SOURce:DATA:TELEcom:SONet:TRIButary:POVerhead:J2:PATtern <discrete>

<discrete> =	DEFault	15 NULL characters
	TEST	GB(Serial Number)
	USER	User Defined
	FIXed	Fixed Byte

Sets the type of pattern that is to be transmitted in the J2 byte of the VT-6, VT-2 or VT-1.5 path overhead. The pattern repeats every 16 characters and is transmitted byte by byte in subsequent frames.

The corresponding query returns the type of pattern being transmitted in VT-6 or VT-2 path overhead byte J2 in discrete form as listed above.

:SOURce:DATA:TELEcom:SONet:TRIButary:POVerhead:J2:PATtern?

Returns : <discrete>

:SOURce:DATA:TELEcom:SONet:TRIButary:POVerhead:J2 <string>

Sets the user defined pattern that is to be transmitted in the J2 byte of the VT-6, VT-2 or VT-1.5 path overhead. The pattern should be 15 characters long. If less than 15 characters are input, the instrument will pad with the required number of NULL characters and a frame marker byte with CRC7 is added to the string. The pattern repeats every 16 characters and is transmitted byte by byte in subsequent frames.

The corresponding query returns the value of the user defined pattern as a string, as defined above. If the string contains any non printing characters, ~ is substituted.

:SOURce:DATA:TELEcom:SONet:TRIButary:POVerhead:J2?

Returns : <string>

:SOURce:DATA:TELEcom:SONet:TRIButary:POVerhead:J2:HEXadecimal?

Returns : <block>

SOURce subsystem - Transmitter SONET OVERHEAD SETUP

Returns a 16 byte block of data. Each byte represents the hexadecimal value of an ASCII character of VT-6, VT-2 or VT-1.5 byte J2 in the range "00" to "FF". The 15 hexadecimal numbers are preceded by the header "#215".

:SOURce:DATA:TELEcom:SONet:TRIButary:POVerhead:J2:FIXed <string>

<string> = "00000000" to "11111111"

Sets the user defined fixed byte that is to be transmitted in the J2 byte of the VT-6, VT-2 or VT-1.5 path overhead. The value is a binary string.

The corresponding query returns the value of the user defined fixed byte as a binary string, as defined above.

:SOURce:DATA:TELEcom:SONet:TRIButary:POVerhead:J2:FIXed?

Returns : <string>

:SOURce:DATA:TELEcom:SONet:TRIButary:POVerhead:V5:SLABel <numeric>

<numeric> = 0 to 7

Sets the VT-6, VT-2 or VT-1.5 signal label (Byte V5) value.

The corresponding query returns the signal label value in numeric form.

:SOURce:DATA:TELEcom:SONet:TRIButary:POVerhead:V5:SLABel?

Returns : <numeric>

:SOURce:DATA:TELEcom:SONet:POVerhead:H4Sequence <discrete>

<discrete> =	LONG	Long Sequence
	SHORT	Short Sequence
	COC1	COC1 Sequence

Sets the H4 path overhead byte sequence length when

:SOURce:DATA:TELEcom:SONet:PAYLoad <discrete> is set to VT6 or VT2 or VT1.5.

The corresponding query returns the H4 byte sequence length in discrete form as listed above.

SOURce subsystem - Transmitter SONET OVERHEAD SETUP**:SOURce:DATA:TELEcom:SONet:POVerhead:H4Sequence?**

Returns : <discrete>

:SOURce:DATA:TELEcom:SONet:OVERhead:SBYTe <discrete>

<discrete> =	SYNChronized	Synchronized - traceability unknown (0000)
	STRatum1	Stratum 1 traceable (0001)
	STRatum2	Stratum 2 traceable (0111)
	STRatum3	Stratum 3 traceable (1010)
	SONet	SONET minimum clock traceable (1100)
	NETWork	Network synchronization (1110)
	DONTusesync	Do not use for synchronization (1111)
	USER	

Selects the SONET SYNC message type (S1 Byte Bits 5 to 8). To update the USER byte value use either the :SOURce:DATA:TELEcom:SONet:OVERhead:DATA <numeric>, <numeric>, <discrete>, <string> or the :SOURce:DATA:TELEcom:SONet:OVERhead:DATA:HEXadecimal <numeric>, <numeric>, <discrete>, <string> command.

The corresponding query returns the Sync Message type in discrete form as listed above.

:SOURce:DATA:TELEcom:SONet:OVERhead:SBYTe?

Returns : <discrete>

:SOURCE subsystem - Transmitter SONET Test Function Commands**:SOURCE:DATA:TELEcom:SONet:TFUNCTION:TYPE <discrete>**

<discrete> =	ERRor	Errors & Alarms
	POINter	Pointer
	SEQuence	Overhead sequences
	STESt	Optical Stress
	APSMessages	APS messages
	IDCC	Insert Datacomm
	OBERtest	Overhead BER test

Selects the SONET transmit test function type. STESt is only valid when an optical line rate selected.

The corresponding query returns the test function type in discrete form as listed above.

:SOURCE:DATA:TELEcom:SONet:TFUNCTION:TYPE?

Returns : <discrete>

:SOURCE:DATA:TELEcom:SONet:ERROR:TYPE <discrete>

<discrete> =	FRAMe	A1A2 frame errors
	EFRame	Entire frame or data errors
	CVS	CV-S (Section B1 BIP)
	CVL	CV-L (Line B2 BIP)
	REIL	REI-L (Line FEBE)
	CVP	CV-P (Path B3 BIP)
	REIP	REI-P (Path FEBE)

:SOURCE subsystem - Transmitter SONET Test Function Commands

CVV	CV-V (VT Path BIP)
REIV	REI-V (VT Path FEBE)

Selects SONET transmit test function error type when

:SOURCE:DATA:TELEcom:SONet:TFUNCTION:TYPE <discrete> is set to ERR .

Further selection of :SOURCE:DATA:TELEcom:SONet:ERROR:RATE <discrete> is required.

The corresponding query returns the SONET error type in discrete form as listed above.

:SOURCE:DATA:TELEcom:SONet:ERROR:TYPE?

Returns : <discrete>

:SOURCE:DATA:TELEcom:SONet:ERROR:RATE <discrete>

<discrete> =	NONE	Errors Off
	ONCE	Single Error Add, Not Frame errors
	EALL	Error All (Not Frame)
	APSThreshold	APS Threshold (CV-L only)
	E_3	Bit, CV-L, REI-L, CV-V & REI-V only
	E_4	All except Frame errors
	E_5	All except Frame errors
	E_6	All except Frame errors
	E_7	All except Frame errors
	E_8	All except Frame errors
	E_9	All except Frame errors
	USER	User defined error rate
	ONE	Frame Errors only
	TWO	Frame Errors only

:SOURce subsystem - Transmitter SONET Test Function Commands

THRee	Frame Errors only
FOUR	Frame Errors only

Selects the transmitter SONET Error rate of the error type selected by :SOURce:DATA:TELEcom:SONet:ERRor:TYPE <discrete>. This command is applicable when :SOURce:DATA:TELEcom:TFUNction <discrete> is set to SONet.

If bit errors are to be added to the PDH payload then :SOURce:DATA:TELEcom:TFUNction <discrete> must be set to PDHP.

The corresponding query returns the selected transmitter SONET error rate in discrete form, as listed above.

:SOURce:DATA:TELEcom:SONet:ERRor:RATE?

Returns : <discrete>

:SOURce:DATA:TELEcom:SONet:ERRor:RATE:USER <numeric>

<numeric>= 9.9E-3 to 0.1E-9 mantissa resolution 0.1,
exponent resolution 1

Sets the user defined SONET Error Add rate. Note that if :SOURce:DATA:TELEcom:SONet:ERRor:RATE <discrete> is not already set to USER, then this command will automatically set it to USER.

Associated commands:

:SOURce:DATA:TELEcom:SONet:ERRor:RATE <discrete>

Note that the maximum user defined error rate is dependent on both error type and line rate.

The corresponding query returns the user defined SONet Error Add rate in numeric form.

:SOURce:DATA:TELEcom:SONet:ERRor:RATE:USER?

Returns: <numeric>

:SOURce subsystem - Transmitter SONET Test Function Commands

E_7	1.0E-7 error rate
USER	User defined error rate

Sets the PDH Payload error rate for the error type selected by :SOURce:DATA:TELEcom:SONet:PDHPayload:ERROR:TYPE <discrete>. This command is applicable when :SOURce:DATA:TELEcom:SOURce <discrete> is set to PDHPayload.

The corresponding query returns the error rate in discrete form as listed above.

:SOURce:DATA:TELEcom:SONet:PDHPayload:ERROR:RATE?

Returns: <discrete>

**:SOURce:DATA:TELEcom:SONet:PDHPayload:ERROR:RATE:USER
<numeric>**

<numeric> 1.1E-3 to 0.1E-9 mantissa resolution 0.1,
exponent resolution 1

Sets the user defined SONET PDH payload Error Add rate of the error type selected by :SOURce:DATA:TELEcom:SONet:PDHPayload:ERROR:TYPE <discrete>. This command is applicable when :SOURce:DATA:TELEcom:SOURce <discrete> is set to PDHPayload.

The corresponding query returns the user defined SPDH Error Add rate in numeric form.

:SOURce:DATA:TELEcom:SONet:PDHPayload:ERROR:RATE:USER?

Returns: <numeric>

**:SOURce:DATA:TELEcom:SONet:ERROR:APSThreshold:NERRORs
<numeric>**

<numeric> = 0 to 640 for STS 0
0 to 1920 for STS1

:SOURce subsystem - Transmitter SONET Test Function Commands

:SOURce:DATA:TELEcom:SONet:ALARm <discrete>

<discrete> =	NONE	Alarms Off
	LOS	Loss of Signal
	LOF	Loss of Frame
	SEF	Severely Errored Frame Defect
	AISL	Line AIS (AIS-L)
	RDIL	Line FERF (RDI-L)
	LOPP	Loss of Pointer (LOP-P)
	AISP	Path AIS (AIS-P)
	RDIP	Path FERF (RDI-P)
	PUNequipped	Path Unequipped (UNEQ-P)
	LOPV	VT Loss of Pointer (LOP-V)
	AISV	VT Path AIS (AIS-V)
	RDIV	VT Path FERF (RDI-V)
	LOMultiframe	Multiframe (H4) Loss
	VTUNequipped	VT Unequipped

Selects the TX Test Function alarm type when

:SOURce:DATA:TELEcom:SONet:TFUNction:TYPE <discrete> is set to ERR.

The corresponding query returns the SONET alarm type in discrete form as listed above.

:SOURce:DATA:TELEcom:SONet:ALARm?

Returns : <discrete>

:SOURce:DATA:TELEcom:SONet:ALARm:SSEFrame

Generates a single Severely Errored Frame alarm.

:SOURCE subsystem - Transmitter SONET Test Function Commands

:SOURCE:DATA:TELEcom:SONet:POINter <discrete>

<discrete> =	BURSt	Adds bursts
	NPOinter	New Pointer
	OFFSet	Adds offset in ppm
	T1105	Adds T1.105/GR-253 sequence

Selects the Pointer adjustment type when

:SOURCE:DATA:TELEcom:SONet:TFUNction:TYPE <discrete> is set to POIN.

The corresponding query returns the pointer adjustment type in discrete form as listed above.

:SOURCE:DATA:TELEcom:SONet:POINter?

Returns : <discrete>

:SOURCE:DATA:TELEcom:SONet:POINter:TYPE <discrete>

<discrete> =	SPE
	VT

Selects the TX pointer type when

:SOURCE:DATA:TELEcom:SONet:TFUNction:TYPE <discrete> is set to POIN.

The corresponding query returns the pointer type in discrete form as listed above.

:SOURCE:DATA:TELEcom:SONet:POINter:TYPE?

Returns : <discrete>

:SOURCE:DATA:TELEcom:SONet:POINter:DIRection <discrete>

<discrete> =	INCRement
	DECRement
	ALTErnate

Selects the direction of the pointer burst adjustment when

:SOURCE:DATA:TELEcom:SONet:TFUNction:TYPE <discrete> is set to POIN.

:SOURCE subsystem - Transmitter SONET Test Function Commands

The corresponding query returns the pointer burst direction in discrete form as listed above.

:SOURCE:DATA:TELEcom:SONet:POINter:DIRection?

Returns : <discrete>

:SOURCE:DATA:TELEcom:SONet:POINter:IDECrement <numeric>

<numeric> =	1 to 10	SPE
	1 to 5	VT-6, VT-2, VT-1.5

Selects the number of places by which the pointer is to be incremented or decremented when :SOURCE:DATA:TELEcom:SONet:TFUNction:TYPE <discrete> is set to POIN and :SOURCE:DATA:TELEcom:SONet:POINter <discrete> is set to BURS .

The corresponding query returns the number of places in numeric form.

:SOURCE:DATA:TELEcom:SONet:POINter:IDECrement?

Returns : <numeric>

:SOURCE:DATA:TELEcom:SONet:POINter:TRANsmitted?

Returns: <numeric>

Returns the currently transmitted value of the SPE pointer in numeric form.

:SOURCE:DATA:TELEcom:SONet:POINter:ACTion

Forces the new pointer value defined by :SOURCE:DATA:TELEcom:SONet:POINter:VALue <numeric> to be adopted.

:SOURCE:DATA:TELEcom:SONet:POINter:VALue <numeric>

<numeric> = 0 to 782

Selects the SPE New Pointer value when :SOURCE:DATA:TELEcom:SONet:TFUNction:TYPE <discrete> is set to POIN and :SOURCE:DATA:TELEcom:SONet:POINter <discrete> is set to NPO.

:SOURCE subsystem - Transmitter SONET Test Function Commands

The corresponding query returns the new pointer value in numeric form as listed above.

:SOURCE:DATA:TELEcom:SONet:POINter:VALue?

Returns : <numeric>

:SOURCE:DATA:TELEcom:SONet:TRIButary:POINter:TRANsmitted?

Returns: <numeric>

Returns the currently transmitted value of the VT pointer in numeric form.

:SOURCE:DATA:TELEcom:SONet:TRIButary:POINter:VALue <numeric>

0 to 427	for VT-6
0 to 139	for VT-2
0 to 103	for VT-1.5

Selects the VT New Pointer value when

:SOURCE:DATA:TELEcom:SONet:TFUNction:TYPE <discrete> is set to POIN and
:SOURCE:DATA:TELEcom:SONet:POINter <discrete> is set to NPO.

The corresponding query returns the new pointer value in numeric form as listed above.

:SOURCE:DATA:TELEcom:SONet:TRIButary:POINter:VALue?

Returns : <numeric>

:SOURCE:DATA:TELEcom:SONet:POINter:NPOinter <discrete>

<discrete> =	NDF	With New Data Flag
	NNDF	Without New Data Flag

Selects the type of new pointer when

:SOURCE:DATA:TELEcom:SONet:TFUNction:TYPE <discrete> is set to POIN and
:SOURCE:DATA:TELEcom:SONet:POINter <discrete> is set to NPO.

:SOURce subsystem - Transmitter SONET Test Function Commands

The corresponding query returns the type of new pointer in discrete form as listed above.

:SOURce:DATA:TELEcom:SONet:POINter:NPOinter?

Returns : <discrete>

:SOURce:DATA:TELEcom:SONet:POINter:ADJust

Adjust pointer to new settings if :SOURce:DATA:TELEcom:SONet:POINter <discrete> is set to BURS or NPO .

:SOURce:DATA:TELEcom:SONet:POINter:OFFSet <discrete>

<discrete> =	SIGNal	Line offset
	SPE	SPE rate offset
	VT	VT rate offset

Determines whether the Output signal rate, SPE Rate or VT rate is offset.

The corresponding query returns the signal Rate, which is offset, in discrete form as listed above.

:SOURce:DATA:TELEcom:SONet:POINter:OFFSet?

Returns : <discrete>

:SOURce:DATA:TELEcom:SONet:POINter:OFFSet:RATE <numeric>, <suffix>

<numeric> =	-100 to +100	parts per million
	-0.010 to +0.010	percent
<suffix> =	PPM	parts per million
	PCT	percent

Selects the amount of offset applied to the Output Signal Rate or the SPE Rate or the VT Rate when :SOURce:DATA:TELEcom:SONet:TFUNction:TYPE <discrete> is set to POIN and :SOURce:DATA:TELEcom:SONet:POINter <discrete> is set to OFFS.

:SOURCE subsystem - Transmitter SONET Test Function Commands

The default suffix unit is percent.

The corresponding query returns the offset in PPM.

:SOURCE:DATA:TELEcom:SONet:POINter:OFFSet:RATE?

Returns : <numeric>

:SOURCE:DATA:TELEcom:SONet:POINter:T1105 <discrete>

<discrete>=	RSINgle	Repeating single (e)
	RBURst	Repeating burst (f)
	RPTRansient	Repeating phase transient
	PNORmal	Periodic normal (g/h)
	PADDED	Periodic added (g/h)
	PCANcelled	Periodic cancelled (g/h)

Selects the T1.105/GR-253 Pointer sequence adjustment type when :SOURCE:DATA:TELEcom:SONet:TFUNction:TYPE <discrete> is set to POIN and :SOURCE:DATA:TELEcom:SONet:POINter <discrete> is set to T1105 .

The corresponding query returns the T1.105/GR-253 adjustment type in discrete form as listed above.

:SOURCE:DATA:TELEcom:SONet:POINter:T1105?

Returns : <discrete>

:SOURCE:DATA:TELEcom:SONet:POINter:T1105:PATTern <discrete>

<discrete> =	CONTInuous	No pattern
	P873	87:3 pattern
	P261	26:1 pattern

Selects the pattern of the T1.105/GR-253 pointer sequence when :SOURCE:DATA:TELEcom:SONet:TFUNction:TYPE <discrete> is set to POIN and :SOURCE:DATA:TELEcom:SONet:POINter <discrete> is set to T1105 and

:SOURCE subsystem - Transmitter SONET Test Function Commands

:SOURCE:DATA:TELEcom:SONet:POINter:T1105:INTerval?

Returns : <numeric>, <suffix>

:SOURCE:DATA:TELEcom:SONet:POINter:T1105:SEQUence <discrete>

<discrete> =	STOP	Stop the current T1.105/GR-253 pointer sequence
	START	Start a T1.105/GR-253 pointer sequence
	INITialize	Start a T1.105/GR-253 pointer sequence preceded by initialization and cooldown

Stops/Starts the T1.105/GR-253 pointer sequence.

The corresponding query returns the sequence start state in discrete form as listed above. See also STAT:SONet2.

:SOURCE:DATA:TELEcom:SONet:POINter:T1105:SEQUence?

Returns : <discrete>

:SOURCE:DATA:TELEcom:SONet:SEQUence <discrete>

<discrete> =	STOP	Stop current sequence
	START	Start new sequence

Starts/Stops a Single or Repeat run Sequence.

The corresponding query returns the Sequence mode in discrete form as listed above.

:SOURCE:DATA:TELEcom:SONet:SEQUence?

Returns : <discrete>

:SOURCE:DATA:TELEcom:SONet:SEQUence:MODE <discrete>

<discrete> =	SINGLE	Single Run
	REPeat	Repeat Run

:SOURCE subsystem - Transmitter SONET Test Function Commands

Selects the type of SEQUENCE when

:SOURCE:DATA:TELEcom:SONet:TFUNction:TYPE <discrete> is set to SEQ.

The corresponding query returns the type of Sequence in discrete form as listed above.

:SOURCE:DATA:TELEcom:SONet:SEQuence:MODE?

Returns : <discrete>

:SOURCE:DATA:TELEcom:SONet:SEQuence:OHBYte <discrete>

<discrete> =	A1A2 J0 Z0 E1 F1	Section Overhead
	D1D3	
	BNDA1A2 X22 X23 X32	
	X33	
	K1K2 D4D12 S1 Z1	Line Overhead
	Z2 M1 M0 E2	
	J1 C2 G1 F2 H4 Z3	Path Overhead
	Z4 N1	

Selects the overhead byte into which the overhead sequence is to be inserted when

:SOURCE:DATA:TELEcom:SONet:TFUNction:TYPE <discrete> is set to SEQ.

Some of the parameters are only available in certain STS-1's or STS-3's.

BNDA1A2 selects the 6 middle A1A2 boundary bytes.

K1K2 is invalid when :SOURCE:DATA:TELEcom:SONet:APSMessages:TOPology

<discrete> is set to LIN and

:SOURCE:DATA:TELEcom:SONet:APSMessages:TOPology:TYPE <discrete> is set to ACT.

The corresponding query returns the sequenced byte in discrete form as listed above.

:SOURCE:DATA:TELEcom:SONet:SEQuence:OHBYte?

Returns: <discrete>

:SOURCE:DATA:TELEcom:SONet:SEQuence:STS1 <numeric>

<numeric> 1 to 3 STS-1 Number of byte to sequence.

Sets the STS-1 Number of the byte to be sequenced.

:SOURce subsystem - Transmitter SONET Test Function Commands

The corresponding query returns the STS-1 Number in numeric form.

:SOURce:DATA:TELEcom:SONet:SEQuence:STS1?

Returns: <numeric>

:SOURce:DATA:TELEcom:SONet:SEQuence:STS3:SElect <numeric>

<numeric> = 1 to 16

Selects STS-3 number for channels that occur in more than one STS-3.

The corresponding query returns the STS-3 number in numeric form.

:SOURce:DATA:TELEcom:SONet:SEQuence:STS3:SElect?

Returns: <numeric>

:SOURce:DATA:TELEcom:SONet:SEQuence:DATA <discrete>, <string>

<discrete> = A | B | C | D | E

<string> = "00" to "FFFFFFFFFFFFFFFFFFFF"

Sets the Sequence data pattern for the designated block to the hexadecimal value contained in the string. The number of hexadecimal characters is dependent on the overhead byte or bytes selected. Two hexadecimal characters are required per byte, for Example:

E1 - 1 byte "00" to "FF"

D4D12 - 9 bytes "000000000000000000" to "FFFFFFFFFFFFFFFFFFFF"

The corresponding query returns the hexadecimal value of the designated block as a string.

:SOURce:DATA:TELEcom:SONet:SEQuence:DATA? <discrete>

Returns : <string>

:SOURce:DATA:TELEcom:SONet:SEQuence:ORder <discrete>, <discrete>, <discrete>, <discrete>, <discrete>

<discrete> = A | B | C | D | E

Selects the order of transmission for the blocks of data used in the sequence.

:SOURCE subsystem - Transmitter SONET Test Function Commands

The corresponding query returns the block order in discrete form as listed above.

:SOURCE:DATA:TELEcom:SONet:SEQuence:ORDer?

Returns : <discrete>, <discrete>, <discrete>, <discrete>, <discrete>

:SOURCE:DATA:TELEcom:SONet:SEQuence:FCOunt <numeric>, <numeric>

<numeric> = 1 to 5 Block number
(first parameter)

<numeric> = 0 to 64000 Frame count
(second parameter)

Selects the number of frames in which the block of data, designated by the block_no, is to be transmitted.

The corresponding query returns the frame count of the block specified in numeric form.

:SOURCE:DATA:TELEcom:SONet:SEQuence:FCOunt? <numeric>

<numeric>= 1 to 5 Block number

Returns : <numeric> Frame count

:SOURCE:DATA:TELEcom:SONet:STESt:SPATtern <discrete>

<discrete> = AZERos All Zero's pattern

AONes All Ones pattern

G958 G.958 sequence

Selects the pattern used in the OC-3 Optical stress test when is set to STES.

The corresponding query returns the selected pattern in discrete form as listed above.

:SOURCE:DATA:TELEcom:SONet:STESt:SPATtern?

Returns : <discrete>

:SOURce subsystem - Transmitter SONET Test Function Commands

:SOURce:DATA:TELEcom:SONet:STESt:BLENght <numeric>

<numeric> =	2 to 85	OC-1
	2 to 259	OC-3
	2 to 1042	OC-12
	2 to 4174	OC-48

Selects the block length used in the SONET Optical stress test when :SOURce:DATA:TELEcom:SONet:TFUNction:TYPE <discrete> is set to STES.

The corresponding query returns the block length in numeric form.

:SOURce:DATA:TELEcom:SONet:STESt:BLENght?

Returns : <numeric>

:SOURce:DATA:TELEcom:SONet:APSMessages:TOPology <discrete>

<discrete> =	LINear	Linear protection
	RING	Ring protection

Selects the type of protection topology.

The corresponding query returns the selected protection topology in discrete short form.

:SOURce:DATA:TELEcom:SONet:APSMessages:TOPology?

Returns: <discrete>

:SOURce:DATA:TELEcom:SONet:APSMessages:TOPology:TYPe <discrete>

<discrete> =	PASSive	Passive protection type
	ACTive	Active protection type

Selects the type of APS Message topology protection.

Only valid if :SOURce:DATA:TELEcom:SONet:APSMessages:TOPology <discrete> is set to LIN.

The corresponding query returns the selected APS Message topology protection type in discrete short form.

:SOURce subsystem - Transmitter SONET Test Function Commands

:SOURce:DATA:TELEcom:SONet:APSMessages:TOPology:TYPe?

Returns: <discrete>

:SOURce:DATA:TELEcom:SONet:APSMessages:TOPology:MODE <discrete>

<discrete> =	UNIDirection	Unidirectional mode
	BIDirection	Bidirectional mode

Selects the mode of APS Message topology protection.

Only valid if :SOURce:DATA:TELEcom:SONet:APSMessages:TOPology <discrete> is set to LIN and

:SOURce:DATA:TELEcom:SONet:APSMessages:TOPology:TYPe <discrete> is set to ACT.

The corresponding query returns the selected APS Message topology protection mode in discrete short form.

:SOURce:DATA:TELEcom:SONet:APSMessages:TOPology:MODE?

Returns: <discrete>

:SOURce:DATA:TELEcom:SONet:APSMessages:REQuest <discrete>

<discrete> =	NREQuest	No Request (0000)
	DNRevert	Do Not Revert (0001)
	RREQuest	Reverse Request (0010)
	THRee	Not Used (0011)
	EXERcise	Exercise (0100)
	FIVE	Not Used (0101)
	WTRestore	Wait To Restore (0110)
	SEVen	Not Used (0111)
	MSWitch	Manual Switch (1000)
	NINE	Not Used (1001)

:SOURce subsystem - Transmitter SONET Test Function Commands

SDLPriority	Signal Degrade Low Priority (1010)
SDHPriority	Signal Degrade High Priority (1011)
SFLPriority	Signal Fail Low Priority (1100)
SFHPriority	Signal Fail High Priority (1101)
FSWitch	Forced Switch (1110)
LOPRotectio	Lockout Of Protection (1111)

Selects the transmitter SONET APS message to be transmitted (K1 Byte, Bits 1 to 4). Only valid if :SOURce:DATA:TELEcom:SONet:APSMessages:TOPology <discrete> is set to LIN and :SOURce:DATA:TELEcom:SONet:APSMessages:TOPology:TYPE <discrete> is set to PASS.

SDHPriority and SFHPriority are only valid when :SOURce:DATA:TELEcom:SONet:APSMessages:ARCHitecture <discrete> is set to OTN.

The corresponding query returns the selected transmitter SONET APS message type in discrete form, as listed above.

:SOURce:DATA:TELEcom:SONet:APSMessages:REQuest?

Returns : <discrete>

:SOURce:DATA:TELEcom:SONet:APSMessages:CHANnel <numeric>

<numeric> =	0	NULL Channel
	1	Working Channel 1
	2	Working Channel 2
	3	Working Channel 3
	4	Working Channel 4
	5	Working Channel 5
	6	Working Channel 6
	7	Working Channel 7

:SOURce subsystem - Transmitter SONET Test Function Commands

8	Working Channel 8
9	Working Channel 9
10	Working Channel 10
11	Working Channel 11
12	Working Channel 12
13	Working Channel 13
14	Working Channel 14
15	Extra Traffic Channel

Selects the transmitter SONET APS message channel (K1 Byte, Bits 5 to 8).

Only valid if :SOURce:DATA:TELEcom:SONet:APSMessages:TOPology <discrete> is set to LIN and

:SOURce:DATA:TELEcom:SONet:APSMessages:TOPology:TYPe <discrete> is set to PASS.

Working Channels 2 to 14 are only valid if

:SOURce:DATA:TELEcom:SONet:APSMessages:ARCHitecture <discrete> is set to OTN.

The corresponding query returns the selected transmitter SONET APS message channel in numeric form, as listed above.

:SOURce:DATA:TELEcom:SONet:APSMessages:CHANnel?

Returns : <numeric>

:SOURce:DATA:TELEcom:SONet:APSMessages:BRIDge <string>

<string> = "0000" to "1111"

Selects the SONET transmitter Linear APS message bridged channel (K2 Byte, Bits 1 to 4). Only valid if :SOURce:DATA:TELEcom:SONet:APSMessages:TOPology <discrete> is set to LIN and

:SOURce:DATA:TELEcom:SONet:APSMessages:TOPology:TYPe <discrete> is set to PASS.

The corresponding query returns the APS messages bridged channel as a string as listed above.

:SOURce subsystem - Transmitter SONET Test Function Commands

:SOURce:DATA:TELEcom:SONet:APSMessages:BRIDGE?

Returns : <string>

:SOURce:DATA:TELEcom:SONet:APSMessages:ARCHitecture <discrete>

<discrete> =	OTONE	1+1
	OTN	1:N

Selects the SONET transmitter Linear APS architecture (K2 Byte, Bit 5). Only valid if :SOURce:DATA:TELEcom:SONet:APSMessages:TOPology <discrete> is set to LIN.

The corresponding query returns the selected transmitter SONET APS message architecture in discrete form, as listed above.

:SOURce:DATA:TELEcom:SONet:APSMessages:ARCHitecture?

Returns : <discrete>

:SOURce:DATA:TELEcom:SONet:APSMessages:REServed <numeric>

<numeric> =	0	000
	1	001
	2	010
	3	011
	4	100
	5	101

Selects the SONET transmitter Linear APS messages reserved bits (K2 Byte, Bits 6 to 8) in numeric form.

Only valid if :SOURce:DATA:TELEcom:SONet:APSMessages:TOPology <discrete> is set to LIN and

:SOURce:DATA:TELEcom:SONet:APSMessages:TOPology:TYPE <discrete> is set to PASS.

The corresponding query returns the selected transmitter SONET APS message reserved bits in numeric form.

:SOURCE subsystem - Transmitter SONET Test Function Commands**:SOURCE:DATA:TELEcom:SONet:APSMessages:RESERVED?**

Returns: <numeric>

:SOURCE:DATA:TELEcom:SONet:APSMessages:RCODE <discrete>

<discrete> =	NREQuest	No Request (0000)
	RRRing	Reverse Request - Ring (0001)
	RRSPan	Reverse Request - Span (0010)
	ERIng	Exerciser - Ring (0011)
	ESPan	Exerciser - Span (0100)
	WTRestore	Wait to Restore (0101)
	MSRing	Manual Switch - Ring (0110)
	MSSPan	Manual Switch - Span (0111)
	SDRing	Signal Degrade - Ring (1000)
	SDSPan	Signal Degrade - Span (1001)
	SDPProtection	Signal Degrade - Protection (1010)
	SFRing	Signal Fail - Ring (1011)
	SFSPan	Signal Fail - Span (1100)
	FSRing	Forced Switch Ring (1101)
	FSSPan	Forced Switch - Span(1110)
	LOPProtection	Lockout Of Protection (1111)

Selects the transmitter Ring APS message to be transmitted (K1 Byte, Bits 1 to 4). Only valid if :SOURCE:DATA:TELEcom:SONet:APSMessages:TOPology <discrete> is set to RING.

The corresponding query returns the selected transmitter SONET APS message type in discrete short form.

:SOURCE:DATA:TELEcom:SONet:APSMessages:RCODE?

Returns: <discrete>

:SOURCE:DATA:TELEcom:SONet:APSMessages:DNODE <string>

<string> = "0000" to "1111"

:SOURCE subsystem - Transmitter SONET Test Function Commands

Selects the SONET transmitter Ring APS message destination node (K1 Byte, Bits 5 to 8). Only valid if :SOURCE:DATA:TELEcom:SONet:APSMessages:TOPology <discrete> is set to RING.

The corresponding query returns the APS messages destination node as a string as listed above.

:SOURCE:DATA:TELEcom:SONet:APSMessages:DNODE?

Returns: <string>

:SOURCE:DATA:TELEcom:SONet:APSMessages:SNODE <string>

<string> = "0000" to "1111"

Selects the SONET transmitter Ring APS message source node (K2 Byte, Bits 1 to 4) . Only valid if :SOURCE:DATA:TELEcom:SONet:APSMessages:TOPology <discrete> is set to RING.

The corresponding query returns the APS messages source node as a string as listed above.

:SOURCE:DATA:TELEcom:SONet:APSMessages:SNODE?

Returns: <string>

:SOURCE:DATA:TELEcom:SONet:APSMessages:PCODE <discrete>

<discrete> =	SHORT	Short path
	LONG	Long path

Selects the SONET transmitter Ring APS message path type (K2 bit 5). Only valid if :SOURCE:DATA:TELEcom:SONet:APSMessages:TOPology <discrete> is set to RING.

The corresponding query returns the Ring APS messages path type in discrete short form.

:SOURCE:DATA:TELEcom:SONet:APSMessages:PCODE?

Returns: <discrete>

:SOURCE subsystem - Transmitter SONET Test Function Commands

:SOURCE:DATA:TELEcom:SONet:APSMessages:SCODE <discrete>

<discrete> =	IDLE	Idle (000)
	BRIDged	Bridged (001)
	BASWitched	Bridged & Switched (010)
	P011	011
	P100	100
	P101	101

Selects the SONET transmitter Ring APS messages status code (K2 Byte, Bits 6 to 8). Only valid if :SOURCE:DATA:TELEcom:SONet:APSMessages:TOPology <discrete> is set to RING.

The corresponding query returns the selected transmitter SONET APS message status code in discrete form as listed above.

:SOURCE:DATA:TELEcom:SONet:APSMessages:SCODE?

Returns: <discrete>

:SOURCE:DATA:TELEcom:SONet:APSMessages:DOWNload

Start transmission of the SONET transmitter APS message.

:SOURCE:DATA:TELEcom:SONet:IDCC <discrete>

<discrete> =	SDCC	Section DCC
	LDCC	Line DCC

Selects the Data Communication Channel Insert port when :SOURCE:DATA:TELEcom:SONet:TFUNCTION:TYPE <discrete> is set to IDCC .

The corresponding query returns the selected port in discrete form as listed above.

:SOURCE:DATA:TELEcom:SONet:IDCC?

Returns : <discrete>

:SOURce subsystem - Transmitter SONET Test Function Commands

:SOURce:DATA:TELEcom:SONet:OBERTest:CHANnel <discrete>

<discrete> =	C1 J0 Z0 E1 F1 D1 D2 D3	Section Overhead
	K1 K2 D4 D5 D6 D7	Line Overhead
	D8 D9 D10 D11 D12 X22	
	X23 X32 X33	
	S1 Z1 M0/M1/Z2 E2	
	J1 C2 G1 F2 H4 Z3	Path Overhead
	Z4 N1	

Selects the TX overhead byte used for the overhead BER test when :SOURce:DATA:TELEcom:SONet:TFUNCTION:TYPE <discrete> is set to OBER. M0 is valid at STS-1 only.

K1,K2 are invalid when :SOURce:DATA:TELEcom:SONet:APSMessages:TOPology <discrete> is set to LIN and :SOURce:DATA:TELEcom:SONet:APSMessages:TOPology:TYPE <discrete> is set to ACT.

The corresponding query returns the overhead byte identity in discrete form as listed above.

:SOURce:DATA:TELEcom:SONet:OBERTest:CHANnel?

Returns	<discrete>
---------	------------

:SOURce:DATA:TELEcom:SONet:OBERTest:STS1 <numeric>

<numeric>	1 to 3
-----------	--------

Sets the STS-1 Number (within the currently selected STS-3) of the Section Overhead byte currently selected for the overhead bit transmitter error rate test function.

The command is only valid if :SOURce:DATA:TELEcom:SONet:TFUNCTION:TYPE <discrete> is set to OBER. It is only applicable when Z0 is selected by :SOURce:DATA:TELEcom:SONet:OBERTest:CHANnel <discrete>

The corresponding query returns the STS-1 Number in numeric form as described above.

:SOURCE subsystem - Transmitter SONET Test Function Commands

:SOURCE:DATA:TELEcom:SONet:OBERtest:STS1?

Returns: <numeric>

:SOURCE:DATA:TELEcom:SONet:OBERtest:STS3:SElect <numeric>

<numeric> = 1 to 16

Selects STS-3 number for channels that occur in more than one STS-3:

It is only applicable when Z0 is selected by

:SOURCE:DATA:TELEcom:SONet:OBERtest:CHANnel <discrete>

The corresponding query returns the STS-3 number in numeric form.

:SOURCE:DATA:TELEcom:SONet:OBERtest:STS3:SElect?

Returns: <numeric>

:SOURCE:DATA:TELEcom:SONet:OBERtest <discrete>

<discrete> = ONCE Single error

Injects a single overhead BER error when

SOURCE:DATA:TELEcom:SONet:TFUNction:TYPE <discrete> is set to OBER.

INPut subsystem

INPut subsystem

This subsystem controls the characteristics of the instrument's input ports.

:INPut:TELEcom:SONet:RATE <discrete>

<discrete> =	STS1	STS-1 Electrical
	STS3	STS-3 Electrical

Is only valid when the SONET Module is fitted and
:SENSe:DATA:TELEcom:SENSe <discrete> is set to SONet.

The corresponding query returns the SONET rate in discrete short form.

:INPut:TELEcom:SONet:RATE?

Returns : <discrete>

:INPut:TELEcom:SONet:GAIN <discrete>

<discrete> =	DB20	20 dB Gain
	DB26	26 dB Gain

Selects the Monitor gain for the SONET receiver. Only valid when
:INPut:TELEcom:LEVel <discrete> is set to MON.

The corresponding query returns the Monitor gain in discrete short form.

:INPut:TELEcom:SONet:GAIN?

Returns: <discrete>

:INPut:TELEcom:OC3:RATE <discrete>

<discrete> =	OC1	OC-1 optical
	OC3	OC-3 Optical

Sets the input rate for the optical input port. :SENSe:DATA:TELEcom:SENSe
<discrete> is set to OC3.

INPut subsystem

The corresponding query returns the OC-3 input rate in discrete form, as listed above.

:INPut:TELEcom:OC3:RATE?

Returns : <discrete>

:INPut:TELEcom:OC3:INTerface <discrete>

<discrete> =	OPTical	Optical input
	MONitor	Protected Monitor Input

Selects the input interface on the Optical modules.

The corresponding query returns the input interface in discrete form, as listed above.

:INPut:TELEcom:OC3:INTerface?

Returns: <discrete>

:INPut:TELEcom:OC12:RATE <discrete>

<discrete> =	OC1	OC-1 optical
	OC3	OC-3 Optical
	OC12	OC-12 Optical

Sets the input rate for the optical input port. :SENSE:DATA:TELEcom:SENSE <discrete> is set to OC12.

The corresponding query returns the OC-12 input rate in discrete form, as listed above.

:INPut:TELEcom:OC12:RATE?

Returns : <discrete>

:INPut:TELEcom:OC12:INTerface <discrete>

<discrete> =	OPTical	Optical input
	MONitor	Protected Monitor Input

SONET Command Reference

INPut subsystem

Selects the input interface on the Optical modules.

The corresponding query returns the input interface in discrete form, as listed above.

:INPut:TELEcom:OC12:INTerface?

Returns: <discrete>

:INPut:TELEcom:OC48:RATE <discrete>

<discrete> =	OC1	OC-1 optical
	OC3	OC-3 Optical
	OC12	OC-12 Optical
	OC48	OC-48 Optical

Sets the input rate for the optical input port.

:SENSe:DATA:TELEcom:SENSe <discrete> is set to OC48.

The corresponding query returns the OC-48 input rate in discrete form, as listed above.

:INPut:TELEcom:OC48:RATE?

Returns : <discrete>

:INPut:TELEcom:OC48:INTerface <discrete>

<discrete> =	OPTical	Optical input
	MONitor	Protected Monitor Input

Selects the input interface on the Optical modules.

The corresponding query returns the input interface in discrete form, as listed above.

:INPut:TELEcom:OC48:INTerface?

Returns: <discrete>

SONET Command Reference
INPut subsystem

SENSe subsystem - Receiver SONET Settings

SONET Mapping settings

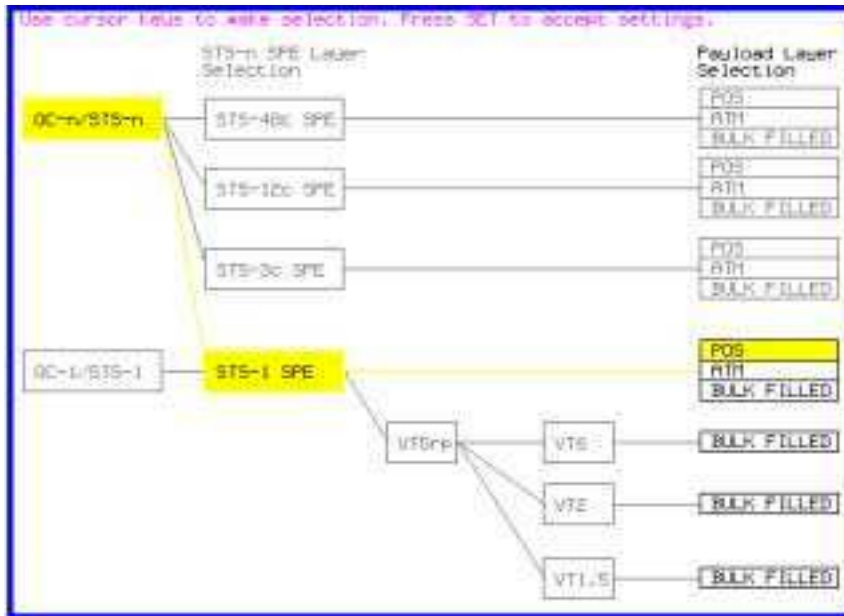

:SENSe:DATA:TELEcom:SONet:STS3 <numeric>

<numeric> = 1 to 16 STS-3 Number under test

Selects the STS-3 number under test. Only valid if :INPut:TELEcom:OC3:RATE <discrete> is set a rate higher than STS3.

The corresponding query returns the test STS3 number.

:SENSe:DATA:TELEcom:SONet:STS3?

Returns : <numeric>

SENSe subsystem - Receiver SONET Settings

:SENSe:DATA:TELEcom:SONet:STS12c <numeric>

<numeric> = 1 to 4 STS-12c Number under test

SPE Layer Selection

:SENSe:DATA:TELEcom:SONet:SPE:TYPE <discrete>

<discrete> = STS3c
STS1
STS12c
STS48c

Set the SPE mapping into an STS-N frame.

The corresponding query returns the SPE layer in discrete form as listed above.

:SENSe:DATA:TELEcom:SONet:SPE:TYPE?

Returns: <discrete>

:SENSe:DATA:TELEcom:SONet:STS1 <numeric>

<numeric> = 1 to 3 STS1 Number

Selects the SONET Receiver active STS-1 within the STS-3.

The corresponding query returns the active STS-1 in numeric form.

:SENSe:DATA:TELEcom:SONet:STS1?

Returns : <numeric>

VT Layer Selection

:SENSe:DATA:TELEcom:SONet:PAYLoad <discrete>

<discrete> = STS3C or M140 140 Mb/s
STS1 STM-0
VT2 or M2 2 Mb/s

SENSe subsystem - Receiver SONET Settings

VT6	VT-6
STS12c	
STS48c	
VT15 <i>or</i> DS1	VT-1.5

This command selects the SONET receiver mapping

The corresponding query returns the mapping in discrete form, as listed above.

:SENSe:DATA:TELEcom:SONet:PAYLoad?

Returns : <discrete>

Payload Layer Selection**:SENSe:DATA:TELEcom:SONet:MAPPing <discrete>**

<discrete> =	M140	140 Mb/s (STS3c only)
	M34	34 Mb/s (STS1 Full SPE only)
	DS3	DS3 - (STS1 Full SPE only)
	BULK	Bulk Filled (STS1, STS3c STS12c and STS48c)
	ATM	ATM (STS1, STS3c STS12c and STS48c)
	IPOS	POS (STS1, STS3c, STS12c, or STS48c)

Selects the Receiver SONET payload for single payload cases. Only valid if :SENSe:DATA:TELEcom:SONet:PAYLoad <discrete> is set to STS1, STS3c, STS12c or STS48c.

The corresponding query returns the payload in discrete form as listed above.

:SENSe:DATA:TELEcom:SONet:MAPPing?

Returns: <discrete>

:SENSe:DATA:TELEcom:SONet:TRIButary:MAPPing <discrete>

<discrete> =	ASYNc or ASM2	Asynchronous 2 Mb/s
--------------	------------------	---------------------

SENSe subsystem - Receiver SONET Settings

FBYTe or FLM2	2 Mb/s Floating Byte
DS1 or ASDS1	Asynchronous 1.544 Mb/s DS1
FLDS1	DS1 Floating Byte
BULK	Bulk Filled

Selects the low order mapping. Only valid if
:SENSe:DATA:TELEcom:SONet:PAYLoad <discrete> is set to VT2 or VT15.
The corresponding query returns the low order mapping in discrete short form.

:SENSe:DATA:TELEcom:SONet:TRIButary:MAPPING?

Returns: <discrete>

:SENSe:DATA:TELEcom:SONet:PRIMary:TS0 <boolean>

<boolean> = 0 or OFF Data in TS0
1 or ON Signaling in TS0

Determines the content of TS0 as Data/Signaling.
The corresponding query returns the TS0 state in numeric form.

:SENSe:DATA:TELEcom:SONet:PRIMary:TS0?

Returns : <boolean>

VT Group

:SENSe:DATA:TELEcom:SONet:VTGRoup <numeric>

<numeric> = 1 to 7

Selects the SONET Receiver active VT Group within the selected STS-1.
The corresponding query returns the active VT Group in numeric form.

SENSe subsystem - Receiver SONET Settings

:SENSe:DATA:TELEcom:SONet:VTGRoup?

Returns : <numeric>

:SENSe:DATA:TELEcom:SONet:TRIButary <numeric>

<numeric> = 1 to 3 Tributary number for VT-2
1 to 4 Tributary number for VT-15

Selects the SONET Receiver active VT within the selected VT Group.
The corresponding query returns the receiver test tributary in numeric form.

:SENSe:DATA:TELEcom:SONet:TRIButary?

Returns : <numeric>

VT Payload and Test Pattern

:SENSe:DATA:TELEcom:SONet:PAYLoad:TYPE <discrete>

<discrete> =	UNFRamed	No framing
	FRAMed	8, 34 & 140 Mb/s
	PCM30	2 Mb/s
	PCM31	2 Mb/s
	PCM30CRC	2 Mb/s
	PCM31CRC	2 Mb/s
	DM2	Drop 2 Mb/s
	DM34	Drop 34 Mb/s
	DM140	Drop 140 Mb/s
	D4	DS1 Framing
	ESF	DS1 Framing
	SLC96	DS1 Framing

SENSe subsystem - Receiver SONET Settings

M13	DS3 Framing
CBIT	DS3 Framing
DDS1	Drop DS1
DDS3	Drop DS3
NOFBit	No Framing Bit (set to '0')

To set the framing type to be structured use the command
:SENSe:DATA:TELEcom:SONet:PAYLoad:STRucture <discrete>.

Only valid if a Structured PDH receiver is fitted.

The corresponding query returns the framing in discrete form as listed above.

:SENSe:DATA:TELEcom:SONet:PAYLoad:TYPE?

Returns : <discrete>

:SENSe:DATA:TELEcom:SONet:PAYLoad:STRucture <discrete>

<discrete> =	UNSTRuctured	All rates
	STRuctured	All framed formats

Determines whether the receiver is to expect any structure in the PDH payload.

The corresponding query returns the receiver structure setting in discrete form as listed above.

:SENSe:DATA:TELEcom:SONet:PAYLoad:STRucture?

Returns: <discrete>

:SENSe:DATA:TELEcom:SONet:PAYLoad:PATtern <discrete>

<discrete> =	PRBS9	2^9-1
	PRBS11	$2^{11}-1$

SENSe subsystem - Receiver SONET Settings

PRBS15	$2^{15}-1$
PRBS20	$2^{20}-1$
QRSS	$2^{20}-1$ with 14 consecutive zero limit (DS1 only)
PRBS23	$2^{23}-1$
AZERo	All Zero's
AONE	All One's
STResS	3-in-24 stress pattern (DS1 only)
P1IN8	1-in-8 test pattern
P2IN8	2-in-8 test pattern
OCT55	55 octet test pattern (uses Daly pattern as per ANSI T1.403)
P1010	Word 1010
P1000	Word 1000
UWORd	16 Bit User Word
LIVE	Live Traffic

Selects the receiver SONET payload data pattern.

If UWORd is selected, the word pattern is set using
:SENSe:DATA:TELEcom:SONet:PAYLoad:UWORd <string>

The corresponding query returns the receiver SONET payload data pattern in discrete form as listed above.

:SENSe:DATA:TELEcom:SONet:PAYLoad:PATtern?

Returns : <discrete>

:SENSe:DATA:TELEcom:SONet:PAYLoad:UWORd <string>

Sets the receiver user word pattern in the range "0000000000000000" to "1111111111111111".

The corresponding query returns the user word pattern as a string.

SONET Command Reference
SENSe subsystem - Receiver SONET Settings

:SENSe:DATA:TELEcom:SONet:PAYLoad:UWORD?

Returns : <string>

:SENSe:DATA:TELEcom:SONet:PRBS:POLarity <discrete>

<discrete> = NORMAL
 INVerted

Selects the PRBS pattern polarity.

The corresponding query returns the PRBS pattern polarity in discrete form as listed above.

:SENSe:DATA:TELEcom:SONet:PRBS:POLarity?

Returns : <discrete>

**:SENSe:DATA:TELEcom:SONet:TRIButary:CONCatenate
<numeric>,<numeric>**

<numeric> =	0	Concatenation Off
	2	VT6-2c
	3	VT6-3c
	4	VT6-4c
	5	VT6-5c
	6	VT6-6c
<numeric> =	1 to 6	VT6-2c selected
	1 to 5	VT6-3c selected
	1 to 4	VT6-4c selected
	1 to 3	VT6-5c selected
	1 to 2	VT6-6c selected

Selects the VT6 concatenation level (first parameter) and starting at the VT (second parameter).

SONET Command Reference

SENSe subsystem - Receiver SONET Settings

The corresponding query returns the VT6 concatenation and starting VT in numeric form as listed above.

:SENSe:DATA:TELEcom:SONet:TRIButary:CONCatenate?

Returns : <numeric>,<numeric>

SENSe subsystem - Receiver SONET Test Function Commands

:SENSe:DATA:TELEcom:SONet:OCAPture:OHBYte <discrete>

<discrete> =	A1A2 J0/Z0 E1 F1 D1D3	Section Overhead
	BND A1A2 X22 X23 X32 X33	
	H1H2 K1K2 D4D12 S1/Z1	Line Overhead
	M1/Z2 E2	
	J1 C2 G1 F2 H4 Z3 Z4	Path Overhead
	N1	

Selects the overhead byte or bytes to be captured. Is only valid when :
SENSe:DATA:TELEcom:SONet:TFUNction:TYPE <discrete> is set to OCAP.

BND A1A2 selects the 6 middle A1A2 boundary bytes.

The corresponding query returns the byte(s) to be captured in discrete form as listed above.

:SENSe:DATA:TELEcom:SONet:OCAPture:OHBYte?

Returns: <discrete>

:SENSe:DATA:TELEcom:SONet:OCAPture:STS1 <numeric>

<numeric> = 1 to 3

Selects the Section overhead column from which to capture. This only applies to Z1 and Z2.

The corresponding query returns the column to be captured in numeric form.

:SENSe:DATA:TELEcom:SONet:OCAPture:STS1?

<numeric>= 1 to 3

:SENSe:DATA:TELEcom:SONet:OCAPture:STS3:SElect <numeric>

<numeric> = 1 to 16

Only valid if a rate higher than STS-3 is selected. Selects STS-3 number for channels that occur in more than one STS-3.

SENSe subsystem - Receiver SONET Test Function Commands

The corresponding query returns the STS-3 number in numeric form.

:SENSe:DATA:TELEcom:SONet:OCAPture:STS3:SElect?

Returns: <numeric>

:SENSe:DATA:TELEcom:SONet:OCAPture:TRIGger <discrete>

<discrete> = OFF
ON
ONNot On Not

Selects the Overhead Capture Trigger mode. If OFF is selected, capture begins immediately. If ON is selected, capture begins when the received data matches the pattern defined by :SENSe:DATA:TELEcom:SONet:OCAPture:TRIGger:PATtern <string>. If ONN is selected, capture begins when the received data does not match the pattern defined by

:SENSe:DATA:TELEcom:SONet:OCAPture:TRIGger:PATtern <string>.

The corresponding query returns the selected Trigger mode, in discrete form as listed above.

:SENSe:DATA:TELEcom:SONet:OCAPture:TRIGger?

Returns : <discrete>

:SENSe:DATA:TELEcom:SONet:OCAPture:TRIGger:PATtern <string>

Sets the Overhead Capture Trigger Pattern to the hexadecimal value contained in the string. The number of hexadecimal characters in the string is dependent on the overhead byte or bytes selected.

Two hexadecimal characters are required per byte, for example:

E1 - 1 Byte - "00" to "FF"

D4D12 - 9 Bytes - "000000000000000000" to "FFFFFFFFFFFFFFFFFFFF"

Is only valid when : SENSe:DATA:TELEcom:SONet:TFUNction:TYPE <discrete> is set to OCAP and :SENSe:DATA:TELEcom:SONet:OCAPture:TRIGger <discrete> is set to ON or ONN

The corresponding query returns the Trigger Pattern selected, as a string as described above.

SENSe subsystem - Receiver SONET Test Function Commands

:SENSe:DATA:TELEcom:SONet:OCApTure:TRIGger:PATtern?

Returns : <string>

:SENSe:DATA:TELEcom:SONet:DDCC <discrete>

<discrete> = SDCC Section DCC
LDCC Line DCC

Selects the DataCommunications channel to be dropped via the rear panel DROP port. Is only valid when :SENSe:DATA:TELEcom:SONet:TFUNction:TYPE <discrete> is set to DDCC.

The corresponding query returns the selected DCC, in discrete form as listed above.

:SENSe:DATA:TELEcom:SONet:DDCC?

Returns : <discrete>

:SENSe:DATA:TELEcom:SONet:PGRaph:PTYPE <discrete>

<discrete> = STS3c
STS1
STS12c
STS48c
VT6
VT2
VT15

Selects the type of pointer to be captured for pointer graph.

The corresponding query returns the type of pointer, in discrete short form.

:SENSe:DATA:TELEcom:SONet:PGRaph:PTYPE?

Returns: <discrete>

:SENSe:DATA:TELEcom:SONet:PGRaph:CINterval <discrete>

<discrete> = SEC1 1 second interval

SENSe subsystem - Receiver SONET Test Function Commands

SEC5	5 second interval
SEC20	20 second interval
MIN1	1 minute interval
MIN5	5 minute interval
MIN20	20 minute interval

Selects the pointer graph capture interval.

The corresponding query returns the pointer graph capture interval, in discrete form as listed above.

:SENSe:DATA:TELEcom:SONet:PGRaph:CINterval?

Returns: <discrete>

:SENSe:DATA:TELEcom:SONet:OBERtest:STS3 <discrete>

<discrete> = C1/J0 | Z0 | E1 | F1 | D1 | D2 | Section Overhead
D3
K1 | K2 | D4 | D5 | D6 | D7 | D8 | Line Overhead
D9 | D10 | D11 | D12 | S1/Z1 |
M1/Z2 | M0 |
E2|X22|X23|X32|X33
J1 | C2 | G1 | F2 | H4 | Z3 | Z4 | Path Overhead
N1

Selects the overhead byte used for the overhead BER test. Is only valid when :SENSe:DATA:TELEcom:SONet:TFUNction:TYPE <discrete> is set to OBER .

The corresponding query returns the Overhead byte name in discrete form as listed above.

:SENSe:DATA:TELEcom:SONet:OBERtest:STS3?

Returns: <discrete>

:SENSe:DATA:TELEcom:SONet:OBERtest:STS1 <numeric>

<numeric>= 1 to 3

SENSe subsystem - Receiver SONET Test Function Commands

Sets the STS-1 Number (within the currently selected STS-3) of the Section overhead of the channel for the receiver overhead BER test function. This command is only valid if :SENSe:DATA:TELEcom:SONet:TFUNction:TYPE <discrete> is set to OBER and it is only applicable when Z0 is selected by :SENSe:DATA:TELEcom:SONet:OBERtest:CHANnel <discrete>.

The corresponding query returns the STS-1 Number in numeric form as listed above

:SENSe:DATA:TELEcom:SONet:OBERtest:STS1?

Returns: <numeric>

:SENSe:DATA:TELEcom:SONet:OBERtest:STS3:SElect <numeric>

<numeric> = 1 to 16

Only valid if a rate higher than STS-3 is selected. Selects STS-3 number for channels that occur in more than one STS-3. This command is only applicable when Z0 is selected by

:SENSe:DATA:TELEcom:SONet:OBERtest:CHANnel <discrete>.

The corresponding query returns the STS-3 number in numeric form.

:SENSe:DATA:TELEcom:SONet:OBERtest:STS3:SElect?

Returns: <numeric>

SONET Command Reference
SENSe subsystem - Alarm Scan Control

SENSe subsystem - Alarm Scan Control

:SENSe:DATA:TELEcom:SONet:ASCan:MODE <discrete>

<discrete> = AUTomatic Automatic receiver configuration
 RSEttings Fixed receiver configuration

Selects the SONET alarm scan mode.

The corresponding query returns the alarm scan mode in discrete short form.

:SENSe:DATA:TELEcom:SONet:ASCan:MODE?

Returns: <discrete>

:SENSe:DATA:TELEcom:SONet:ASCan:BIP <discrete>

<discrete> = OFF Fail if Alarm
 GTE0 Fail if alarm or any BIP error
 GTEE_6 Fail if alarm or BIP ER > 10E-6
 GTEE_3 Fail if alarm or BIP ER > 10E-3

Selects the SONET alarm scan BIP error threshold.

The corresponding query returns the alarm scan BIP error threshold in discrete short form.

:SENSe:DATA:TELEcom:SONet:ASCan:BIP?

Returns: <discrete>

:SENSe:DATA:TELEcom:SONet:ASCan <boolean>

<boolean> = 0 or OFF Stop the current alarm scan
 1 or ON Start a new alarm scan

Start/Stop the SONET alarm scan.

The corresponding query returns the alarm scan state as 0 or 1.

SONET Command Reference
SENSe subsystem - Alarm Scan Control

:SENSe:DATA:TELEcom:SONet:ASCan?

Returns: <boolean>

SENSe subsystem - SONET Tributary Scan Control**SENSe subsystem - SONET Tributary Scan Control**

:SENSe:DATA:TELEcom:SONet:TSCan:PERiod <numeric>, <suffix>

<numeric> =	1 to 99	
<suffix> =	d	Days
	h	Hours
	m	Minutes
	s	Seconds

Sets the test duration for each tributary.

The corresponding query returns the test duration for each tributary.

:SENSe:DATA:TELEcom:SONet:SONet:TSCan:PERiod?

Returns: <numeric>,<suffix>

:SENSe:DATA:TELEcom:SONet:TSCan:BIP <discrete>

<discrete> =	GTE0	Fail if any BIP error
	GTEE_6	Fail if BIP ER > 10E-6
	GTEE_3	Fail if BIP ER > 10E-3

Selects the SONET tributary scan BIP error threshold.

The corresponding query returns the alarm scan BIP error threshold in discrete short form.

:SENSe:DATA:TELEcom:SONet:TSCan:BIP?

Returns: <discrete>

:SENSe:DATA:TELEcom:SONet:TSCan <boolean>

<boolean> =	0 or OFF	Stop the current tributary scan
	1 or ON	Start a new tributary scan

Start/Stop the SONET tributary scan.

SENSe subsystem - REI-L Result Enable/Disable

The corresponding query returns the alarm scan state as 0 or 1.

:SENSe:DATA:TELEcom:SONet:TSCan?

Returns: <boolean>

SENSe subsystem - REI-L Result Enable/Disable

:SENSe:DATA:TELEcom:SONet:REIL

<discrete> OFF- don't measure REI-L
 ON - measure REI-L

Allows measurement of REI-L to be suppressed. The default value is ON.

:SENSe:DATA:TELEcom:SONet:REIL?

Returns: <boolean>

The corresponding query returns the REI-L status as listed above.

SENSe subsystem - Result Returning Commands

Frequency Results (SONET)

:SENSe:DATA? <"result">

Result =	"FREQUency:SONet:GATE1S"	RX SONET clock frequency (1s gate)
	"FREQUency:SONet[:GATE16S]"	RX SONET clock frequency (16s gate)
	"FOFPpm:SONet[:GATE16S]"	RX SONET clock offset in ppm (16s gate)
	"FOFHZ:SONet[:GATE16S]"	RX SONET clock offset in Hz (16s gate)

SONET Short Term Results

:SENSe:DATA? <"result">

Result =	"ECount:SONet:STERm:FRAME"	Frame error count
	"ERATio:SONet:STERm:FRAME"	Frame error ratio
	"ECount:SONet:STERm:CVS"	Section B1 BIP error count
	"ERATio:SONet:STERm:CVS"	Section B1 BIP error ratio
	"ECount:SONet:STERm:CVL"	Line B2 BIP error count
	"ERATio:SONet:STERm:CVL"	Line B2 BIP error ratio
	"ECount:SONet:STERm:REIL"	REI-L (Line FEBE) error count. See page 5-85.
	"ERATio:SONet:STERm:REIL"	REI-L (Line FEBE) error ratio. See page 5-85.
	"ECount:SONet:STERm:CVP"	Path B3 BIP error count
	"ERATio:SONet:STERm:CVP"	Path B3 BIP error ratio
	"ECount:SONet:STERm:REIP"	REI-P (Path FEBE) error count
	"ERATio:SONet:STERm:REIP"	REI-P (Path FEBE) error ratio
	"ECount:SONet:STERm:TRIB:CVV"	VT Path BIP error count

SONET Command Reference

SENSe subsystem - Result Returning Commands

"ERATio:SONet:STERm:TRIB:CVV"	VT Path BIP error ratio
"ECOut:SONet:STERm:TRIB:REIV"	VT FEBE error count
"ERATio:SONet:STERm:TRIB:REIV"	VT FEBE error ratio

SONET Cumulative Results

:SENSe:DATA? <"result">

Result = "ECOut:SONet:FRAME"	Frame error count
"ERATio:SONet:FRAME"	Frame error ratio
"ECOut:SONet:CVS"	Section B1 BIP error count
"ERATio:SONet:CVS"	Section B1 BIP error ratio
"ECOut:SONet:CVL"	Line B2 BIP error count
"ERATio:SONet:CVL"	Line B2 BIP error ratio
"ECOut:SONet:REIL"	REI-L (Line FEBE) error count. See page 5-85.
"ERATio:SONet:REIL"	REI-L (Line FEBE) error ratio. See page 5-85.
"ECOut:SONet:CVP"	Path B3 BIP error count
"ERATio:SONet:CVP"	Path B3 BIP error ratio
"ECOut:SONet:REIP"	REI-P (Path FEBE) error count
"ERATio:SONet:REIP"	REI-P (Path FEBE) error ratio
"ECOut:SONet:TRIB:CVV"	VT Path BIP error count
"ERATio:SONet:TRIB:CVV"	VT Path BIP error ratio
"ECOut:SONet:TRIB:REIV"	VT FEBE error count
"ERATio:SONet:TRIB:REIV"	VT FEBE error ratio
"ECOut:SONet:OVERhead"	Overhead error count

SONET Command Reference
SENSe subsystem - Result Returning Commands

SONET Section B1 BIP (CV-S) Analysis Results

:SENSe:DATA? <"result">

Result=	"ESECONDS:SONet:CVS:ANALYSIS"	Error Seconds
	"SESECONDS:SONet:CVS:ANALYSIS"	Severely Errored Seconds
	"EBCOUNT:SONet:CVS:ANALYSIS"	Errored block count
	"BBECOUNT:SONet:CVS:ANALYSIS"	Background block error count
	"ESRATIO:SONet:CVS:ANALYSIS"	Error Second Ratio
	"SESRATIO:SONet:CVS:ANALYSIS"	Severely Errored Second Ratio
	"BBERATIO:SONet:CVS:ANALYSIS"	Background Block Error ratio
	"UASECONDS:SONet:CVS:ANALYSIS"	Unavailable seconds

SONET Line B2 BIP (CV-L) Analysis Results

:SENSe:DATA? <"result">

Result=	"ESECONDS:SONet:CVL:ANALYSIS"	Error Seconds
	"SESECONDS:SONet:CVL:ANALYSIS"	Severely Errored Seconds
	"EBCOUNT:SONet:CVL:ANALYSIS"	Errored block count
	"BBECOUNT:SONet:CVL:ANALYSIS"	Background block error count
	"ESRATIO:SONet:CVL:ANALYSIS"	Error Second Ratio
	"SESRATIO:SONet:CVL:ANALYSIS"	Severely Errored Second Ratio
	"BBERATIO:SONet:CVL:ANALYSIS"	Background Block Error ratio
	"UASECONDS:SONet:CVL:ANALYSIS"	Unavailable seconds
	"PUASECONDS:SONet:CVL:ANALYSIS"	Path Unavailable seconds

SONET Line FEBE (REI-L) Analysis Results

:SENSe:DATA? <"result">

If you wish to disable the REI-L measurement, see page 5-85.

SONET Command Reference

SENSe subsystem - Result Returning Commands

Result=	"ESECONDS:SONet:REIL:ANALYSIS"	Error Seconds
	"SESECONDS:SONet:REIL:ANALYSIS"	Severely Errored Seconds
	"EBCOUNT:SONet:REIL:ANALYSIS"	Errored block count
	"BBECOUNT:SONet:REIL:ANALYSIS"	Background block error count
	"ESRATIO:SONet:REIL:ANALYSIS"	Error Second Ratio
	"SESRATIO:SONet:REIL:ANALYSIS"	Severely Errored Second Ratio
	"BBERATIO:SONet:REIL:ANALYSIS"	Background Block Error ratio
	"UASECONDS:SONet:REIL:ANALYSIS"	Unavailable seconds
	"PUASECONDS:SONet:REIL:ANALYSIS"	Path Unavailable seconds

SONET Path B3 BIP (CV-P) Analysis Results

:SENSe:DATA? <"result">

Result=	"ESECONDS:SONet:CVP:ANALYSIS"	Error Seconds
	"SESECONDS:SONet:CVP:ANALYSIS"	Severely Errored Seconds
	"EBCOUNT:SONet:CVP:ANALYSIS"	Errored block count
	"BBECOUNT:SONet:CVP:ANALYSIS"	Background block error count
	"ESRATIO:SONet:CVP:ANALYSIS"	Error Second Ratio
	"SESRATIO:SONet:CVP:ANALYSIS"	Severely Errored Second Ratio
	"BBERATIO:SONet:CVP:ANALYSIS"	Background Block Error ratio
	"UASECONDS:SONet:CVP:ANALYSIS"	Unavailable seconds
	"PUASECONDS:SONet:CVP:ANALYSIS"	Path Unavailable seconds

SONET Path FEBE (REI-P) Analysis Results

:SENSe:DATA? <"result">

Result=	"ESECONDS:SONet:REIP:ANALYSIS"	Error Seconds
	"SESECONDS:SONet:REIP:ANALYSIS"	Severely Errored Seconds

SENSe subsystem - Result Returning Commands

"EBCount:SONet:REIP:ANALysis"	Errored block count
"BBECount:SONet:REIP:ANALysis"	Background block error count
"ESRatio:SONet:REIP:ANALysis"	Error Second Ratio
"SESRatio:SONet:REIP:ANALysis"	Severely Errored Second Ratio
"BBERatio:SONet:REIP:ANALysis"	Background Block Error ratio
"UASeconds:SONet:REIP:ANALysis"	Unavailable seconds
"PUASeconds:SONet:REIP:ANALysis"	Path Unavailable seconds

SONET Virtual Tributary Path BIP (CV-V) Analysis Results

:SENSe:DATA? <"result">

Result=	"ESECONDS:SONet:TRIB:CVV:ANALysis"	Error Seconds
	"SESECONDS:SONet:TRIB:CVV:ANALysis"	Severely Errored Seconds
	"EBCount:SONet:TRIB:CVV:ANALysis"	Errored block count
	"BBECount:SONet:TRIB:CVV:ANALysis"	Background block error count
	"ESRatio:SONet:TRIB:CVV:ANALysis"	Error Second Ratio
	"SESRatio:SONet:TRIB:CVV:ANALysis"	Severely Errored Second Ratio
	"BBERatio:SONet:TRIB:CVV:ANALysis"	Background Block Error ratio
	"UASeconds:SONet:TRIB:CVV:ANALysis"	Unavailable seconds
	"PUASeconds:SONet:TRIB:CVV:ANALysis"	Path Unavailable seconds

SONET Virtual Tributary Path FEBE (REI-V) Analysis Results

:SENSe:DATA? <"result">

Result =	"ESECONDS:SONet:TRIB:REIV:ANALysis"	Error Seconds
	"SESECONDS:SONet:TRIB:REIV:ANALysis"	Severely Errored Seconds
	"EBCount:SONet:TRIB:REIV:ANALysis"	Errored block count
	"BBECount:SONet:TRIB:REIV:ANALysis"	Background block error count

SONET Command Reference

SENSe subsystem - Result Returning Commands

"ESRatio:SONet:TRIB:REIV:ANALysis"	Error Second Ratio
"SESRatio:SONet:TRIB:REIV:ANALysis"	Severely Errored Second Ratio
"BBERatio:SONet:TRIB:REIV:ANALysis"	Background Block Error ratio
"UASeconds:SONet:TRIB:REIV:ANALysis"	Unavailable seconds
"PUASeconds:SONet:TRIB:REIV:ANALysis"	Path Unavailable seconds

SONET Block Based Bit Analysis Results

:SENSe:DATA? <"result">

Result = "ESEConds:SONet:BLKBit:ANALysis"	Error Seconds
"SESeconds:SONet:BLKBit:ANALysis"	Severely Errored Seconds
"EBCount:SONet:BLKBit:ANALysis"	Errored block count
"BBECount:SONet:BLKBit:ANALysis"	Background block error count
"ESRatio:SONet:BLKBit:ANALysis"	Error Second Ratio
"SESRatio:SONet:BLKBit:ANALysis"	Severely Errored Second Ratio
"BBERatio:SONet:BLKBit:ANALysis"	Background Block Error ratio
"UASeconds:SONet:BLKBit:ANALysis"	Unavailable seconds

SONET M.2101 Analysis Results

:SENSe:DATA? <"result">

Result = "ESEConds:SONet:LOW:RECeive:ANALysis:M2101"	Low Order Path Receive Direction Errored Seconds
"SESeconds:SONet:LOW:RECeive:ANALysis:M2101"	Low Order Path Receive Direction Severely Errored Seconds
"UASeconds:SONet:LOW:RECeive:ANALysis:M2101"	Low Order Path Receive Direction Unavailable Seconds

SONET Command Reference

SENSe subsystem - Result Returning Commands

"ESECONDS:SONet:LOW:TRANSMIT:ANALYSIS:M2101"	Low Order Path Transmit Direction Errored Seconds
"SECONDS:SONet:LOW:TRANSMIT:ANALYSIS:M2101"	Low Order Path Transmit Direction Severely Errored Seconds
"UASECONDS:SONet:LOW:TRANSMIT:ANALYSIS:M2101"	Low Order Path Transmit Direction Unavailable Seconds
"ESECONDS:SONet:HIGH:RECEIVE:ANALYSIS:M2101"	High Order Path Receive Direction Errored Seconds
"SECONDS:SONet:HIGH:RECEIVE:ANALYSIS:M2101"	High Order Path Receive Direction Severely Errored Seconds
"UASECONDS:SONet:HIGH:RECEIVE:ANALYSIS:M2101"	High Order Path Receive Direction Unavailable Seconds
"ESECONDS:SONet:HIGH:TRANSMIT:ANALYSIS:M2101"	High Order Path Transmit Direction Errored Seconds
"SECONDS:SONet:HIGH:TRANSMIT:ANALYSIS:M2101"	High Order Path Transmit Direction Severely Errored Seconds
"UASECONDS:SONet:HIGH:TRANSMIT:ANALYSIS:M2101"	High Order Path Transmit Direction Unavailable Seconds
"ESECONDS:SONet:SECTION:RECEIVE:ANALYSIS:M2101"	Section Layer Path Receive Direction Errored Seconds
"SECONDS:SONet:SECTION:RECEIVE:ANALYSIS:M2101"	Section Layer Path Receive Direction Severely Errored Seconds
"UASECONDS:SONet:SECTION:RECEIVE:ANALYSIS:M2101"	Section Layer Path Receive Direction Unavailable Seconds
"ESECONDS:SONet:SECTION:TRANSMIT:ANALYSIS:M2101"	Section Layer Path Transmit Direction Errored Seconds
"SECONDS:SONet:SECTION:TRANSMIT:ANALYSIS:M2101"	Section Layer Path Transmit Direction Severely Errored Seconds
"UASECONDS:SONet:SECTION:TRANSMIT:ANALYSIS:M2101"	Section Layer Path Transmit Direction Unavailable Seconds

SENSe subsystem - Result Returning Commands**SONET Service Disruption Results**

:SENSe:DATA? <"result">

Result =	"SDTest:COUNT:LONG"	Longest error burst
	"SDTest:COUNT:SHORT"	Shortest error burst
	"SDTest:COUNT:LAST"	Last error burst

Returns: <range>,<value>

<range> =	0	Result invalid due to receiver configuration
	1	Result valid
	2	Result out of range

Value is returned in milliseconds. If the value is > 2000 or no result is available or the result is not applicable then 9.91E+37 is returned.

SONET Optical Power Result

:SENSe:DATA? <"result">

Result =	"OPOWer:SONet"	Optical power (dBm)
----------	----------------	---------------------

SONET Pointer Activity Results

:SENSe:DATA? <"result">

Result	"PACTivity:SONet:PVALue"	SPE Pointer value
	"PACTivity:SONet:NDFSeconds"	SPE Pointer NDF seconds
	"PACTivity:SONet:MNDFseconds"	SPE Pointer MNDF seconds
	"PACTivity:SONet:PCOunt"	SPE Pointer +ve Adj Count

SENSe subsystem - Result Returning Commands

"PACTivity:SONet:PSEConds"	SPE Pointer +ve Adj Seconds
"PACTivity:SONet:NCOut"	SPE Pointer -ve Adj Count
"PACTivity:SONet:NSEConds"	SPE Pointer -ve Adj Seconds
"PACTivity:SONet:IOFFset"	Implied SPE Offset
"PACTivity:SONet:TRIButary:PVALue"	VT Pointer Value
"PACTivity:SONet:TRIButary:NDFSeconds"	VT Pointer NDF seconds
"PACTivity:SONet:TRIButary:MNDFseconds"	VT Pointer MNDF seconds
"PACTivity:SONet:TRIButary:PCOut"	VT Pointer +ve Adj Count
"PACTivity:SONet:TRIButary:PSEConds"	VT Pointer +ve Adj Seconds
"PACTivity:SONet:TRIButary:NCOut"	VT Pointer -ve Adj Count
"PACTivity:SONet:TRIButary:NSEConds"	VT Pointer -ve Adj Seconds

SONET Alarm Seconds Results

:SENSe:DATA? <"result">

Result =	"ASEConds:SONet:LOS"	Loss Of Signal
	"ASEConds:SONet:LOF"	Loss Of Frame
	"ASEConds:SONet:SEF"	Severely Errored Frame Defect
	"ASEConds:SONet:H4MF"	H4 Multiframe Loss
	"ASEConds:SONet:LOPP"	Loss Of Pointer (LOP-P)
	"ASEConds:SONet:AISL"	Line AIS (AIS-L)
	"ASEConds:SONet:AISP"	Path AIS (AIS-P)
	"ASEConds:SONet:PSLoss"	Pattern Synchronization Loss (see Note on page 3-21.)
	"ASEConds:SONet:RDIL"	Line FERF (RDI-L)
	"ASEConds:SONet:RDIP"	Path FERF (RDI-P)
	"ASEConds:SONet:K1K2"	K1K2 byte change
	"ASEConds:SONet:TRIB:LOPV"	VT Loss Of Pointer (LOP-V)

SONET Command Reference

SENSE subsystem - Result Returning Commands

"ASECnds:SONet:TRIB:AISV"	VT Path AIS (AIS-V)
"ASECnds:SONet:TRIB:RDIV"	VT Path FERF (RDI-V)
"ASECnds:SONet:TRIB:P1P0"	P1P0 Frame Synchronization Loss
"ASECnds:SONet:OPSL"	Overhead Pattern Sync Loss

FETCh subsystem

FETCh subsystem

The FETCh subsystem is used to retrieve data directly accumulated by the instrument.

:FETCh:STRing:DATA:TELEcom:SONet:J0?

Returns: <string>

The value of the STS-N Section overhead J0 byte is returned as a 16 ASCII character string if CRC7 is not detected, 15 ASCII character string if CRC7 is detected. If the string contains any non printing characters then ~ is substituted. This is a snapshot of the overhead byte and is captured once per second.

:FETCh:STRing:DATA:TELEcom:SONet:J0:HEXadecimal?

Returns: <block>

Returns the value of the STS-N Section overhead J0 byte as 16 hexadecimal numbers if CRC7 is not detected, 15 hexadecimal numbers if CRC7 is detected. Each number is in the range "00" to "FF". The block header is " #216" if CRC7 not detected, " #215" if CRC7 is detected. This is a snapshot of the overhead byte and is captured once per second.

:FETCh:STRing:DATA:TELEcom:SONet:J1?

Returns : <string>

The value of the SPE J1 path trace byte is returned as a, 64 ASCII character, string (15 ASCII characters if CRC7 is detected). If the string contains any non printing characters then ~ is substituted. This is a snapshot of the overhead byte and is captured once per second.

:FETCh:STRing:DATA:TELEcom:SONet:J1:HEXadecimal?

Returns : <block>

Returns the value of the SPE J1 path trace byte as 64 hexadecimal numbers (15 if CRC7 is detected).

SONET Command Reference

FETCh subsystem

Each number is in the range "00" to "FF". The block header is " #264" (" #215" if CRC7 is detected). This is a snapshot of the overhead byte and is captured once per second.

:FETCh:STRing:DATA:TELEcom:SONet:TRIButary:J2?

Returns: <string>

Returns the 15 or 16 byte J2 path trace as a string. The OmniBER 71819 attempts to align the received pattern by detecting the CRC7 byte. If the CRC7 byte is detected, a 15 byte pattern is returned. If the CRC7 byte is not detected, a 16 byte pattern is returned. If the string contains any non-printing characters then ~ is substituted. This is a snapshot of the received path trace and is only updated once per second.

:FETCh:STRing:DATA:TELEcom:SONet:TRIButary:J2:HEXadecimal?

Returns: <block>

Returns the value of the J2 path trace byte as 15 or 16 hexadecimal numbers. The OmniBER 718 attempts to align the received pattern by detecting the CRC7 byte. If the CRC7 byte is detected, 15 hexadecimal numbers are returned. If the CRC7 byte is not detected, 16 hexadecimal numbers are returned. Each number is in the range "00" to "FF". The block header is " #215" if 15 Hex numbers and " #216" if 16 Hex numbers. This is a snapshot of the overhead byte and is captured once per second.

:FETCh:STRing:DATA:TELEcom:SONet:K1?

Returns : <string>

The value of the MPS K1 byte is returned as an 8 bit string in the range "00000000" to "11111111".

:FETCh:STRing:DATA:TELEcom:SONet:K2?

Returns : <string>

The value of the MPS K2 byte is returned as an 8 bit string in the range "00000000" to "11111111".

:FETCh:STRing:DATA:TELEcom:SONet:S1?

Returns : <string>

FETCh subsystem**:FETCh:SCALAr:DATA:TELEcom:SONet:POVerhead? <discrete>**

<discrete> = J1|B3|C2|G1|F2|H4|Z3|Z4|N1

Obtains the value of the named path overhead byte. The value of the named byte is returned as a string in the range "00000000" to "11111111". This is a snapshot of the overhead byte and is captured once per second.

Returns: <string>

:FETCh:SCALAr:DATA:TELEcom:SONet:TRIButary:POVerhead? <discrete>

<discrete> = V5|Z6|Z7 VT-6|VT-2|VT-1.5

Obtains the value of the specified path overhead byte. The value of the named byte is returned as a string in the range "00000000" to "11111111". This is a snapshot of the overhead byte and is captured once per second.

Returns: <string>

:FETCh:SCALAr:DATA:TELEcom:SONet:TRIButary:POVerhead:SLABel?

Returns the VT-6/VT-2/VT-1.5 signalling label of the selected tributary in numeric form.

Returns: <numeric>

:FETCh:ARRAy:DATA:TELEcom:SONet:ASCan?

Returns (each of one or more rows): <numeric>{,<numeric>}

The results returned are those for the last FULL scan. Results from partial scans are not available. If no full scan has been completed since the instrument was powered up, this command will return -1.

If data is available it is returned as a set of string arrays one for each scanned group. The arrays are separated by a CR/LF pair. A group is defined as a set of scanned paths at either the SPE or VT level. The arrays consist of comma separated numerics, one for each path scanned. The value of the numeric indicates the status of the scanned path. The following values are valid.

FETCh subsystem

Value	State
0	No Problems Detected
1	Alarms or Errors Detected
2	Path Unequipped
3	Loss of Pointer
4	AIS
5	RDI
6	H4 Multiframe Loss
?	Invalid

For a specific signal structure, the format of the returned strings are shown below:

a) STS-3 STS-1 VT-6

This signal consists of 3 STS-1s each of which contains 7 VT-Groups. The VT-Groups's in turn each contain 1 VT-6. From the perspective of the Alarm Scan function the paths are 3 at the STS-1 level and 21 at the VT level. The STS-1 paths are defined as a group on their own while the 21 VTs are arranged as 3 groups of 7 paths with the groups corresponding to the STS-1 allocation. For this configuration, four arrays are returned with fomats shown below:

```

STS-3      -> STS1#1, STS1#2, STS1#3
STS-1 #1  -> VT#1,VT#2,VT#3,VT#4,VT#5,VT#6,VT#7
STS-1 #2  -> VT#1,VT#2,VT#3,VT#4,VT#5,VT#6,VT#7
STS-1 #3  -> VT#1,VT#2,VT#3,VT#4,VT#5,VT#6,VT#7

```

For Example, the output could look like:

```

0,1,1
1,1,1,0,0,1,0
2,2,2,2,2,2,2
0,0,0,0,1,0,0

```

FETCh subsystem**b) STS-3 STS-1 Full SPE**

This signal consists of 3 STS-1s each containing 1 Full SPE. In this configuration there are 3 paths, 3 at the STS-1 level and no lower paths. For this configuration, 3 arrays are returned with the following format:

```
STS-3 -> STS1#1, STS1#2, STS1#3
```

The output will look something like:

```
0, 1, 2
```

c) STS-3 STS-1 VT-2

This signal again consists of 3 STS-1's. In this case however, the STS-1's each contain 7 VT-Groups's. These VT-Groups's each contain 3 VT-2's. In terms of paths the signal comprises 3 path at the STS-1 level and 63 paths at the VT-2 level. Again the STS-1s are defined as a group on their own. The 63 VT-2 paths are split into 3 groups corresponding to their allocation with the 3 STS-1's. For this configuration, four arrays are returned with the following format:

NOTE: VT-2's designated thus [STS-1# - VT-Grp# - VT#]

```
STS-3      -> STS-1#1, STS-1#2, STS-1#3
STS-1 #1   -> [1-1-1], [1-1-2], [1-1-3], [1-2-1], [1-2-2], [1-
2-3],
                [1-3-1], [1-3-2], [1-3-3], [1-4-1], [1-4-2], [1-
4-3],
                [1-5-1], [1-5-2], [1-5-3], [1-6-1], [1-6-2], [1-
6-3],
                [1-7-1], [1-7-2], [1-7-3]
STS-1 #2   -> As Above
STS-1 #3   -> As Above
```

The output will look like:

```
1, 2, 0
0, 0, 0, 0, 0, 0, 0, 0, 0, 0, 0, 0, 0, 0, 0, 0, 0, 0, 0
1, 1, 1, 0, 0, 1, 0, 0, 0, 0, 0, 0, 0, 0, 0, 1, 1, 0, 0, 0, 0
2, 2, 2, 2, 2, 2, 2, 2, 2, 2, 2, 2, 2, 2, 2, 2, 2, 2, 2, 2, 2
```

FETCh subsystem**f) STS-1 VT-2**

This signal again comprises 1 STS-1 containing 7 VT-Groups's. However, this time the VT-Groups's each contain 3 VT-2's. As before, the STS-1 path is defined as a group on its own, while the 7 VT-2 paths are also defined as one group. For this configuration, 2 groups are returned with the following format:

NOTE: VT-2's designated thus [VT-Grp# - VT-2#]

```
STS-1      -> STS-1
VT-Group   -> [1-1], [1-2], [1-3], [2-1], [2-2], [2-3], [3-1],
               [3-2], [3-3], [4-1], [4-2], [4-3], [5-1], [5-2],
               [5-3], [6-1], [6-2], [6-3], [7-1], [7-2], [7-3]
```

The output will look like:

```
0
1,1,1,0,0,0,0,0,1,1,1,1,1,1,1,1,0,0,2,0,0,0,0
```

g) STS-1 VT-1.5

This signal again comprises 1 STS-1 containing 7 VT Groups. However, this time the VT Groups each contain 4 VT-1.5's. As before, the STS-1 path is defined as a group on its own, while the 7 VT-1.5 paths are also defined as one group. For this configuration, 2 groups are returned with the following format:

NOTE: VT-1.5's designated thus [VT-Group# - VT-1.5#]

```
STS-1      -> STS-1
VT-Group   -> [1-1], [1-2], [1-3], [1-4], [2-1], [2-2], [2-
3], [2-4], [3-1], [3-2], [3-3], [3-4], [4-1], [4-2], [4-3], [4-
4], [5-1], [5-2], [5-3], [5-4], [6-1], [6-2], [6-3], [6-4], [7-
1], [7-2], [7-3], [7-4]
```

The output will look like:

```
0
1,1,1,1,0,0,0,0,0,0,1,1,1,1,1,1,1,1,0,0,0,2,0,0,0,0,0,1
```

h) Unrecognized Structure

When Alarm Scan is operating in AUTO mode, it is possible that due to various signal alarm conditions, it may not be able to determine the structure for a particular group of paths. When this occurs that group is marked as an "Unrecognized Structure". The string returned for such a group is the SCPI NAN - "9.91E+37"

SONET Command Reference

FETCh subsystem

:FETCh:ARRay:DATA:TELEcom:SONet:TSCan?

Returns (each of one or more rows): <numeric>{,<numeric>}

The results returned are those for the last FULL scan. Results from partial scans are not available. If no full scan has been completed since the instrument was powered up, this command will return -1.

If data is available it is returned as a set of string arrays one for each scanned group. The arrays are separated by a CR/LF pair. A group is defined as a set of scanned paths at either the STS or VT level. The arrays consist of comma separated numerics, one for each tributary scanned. The value of the numeric indicates the status of the scanned tributary. The following values are valid.

Value	State
0	No Problems Detected
1	Alarms or Errors Detected

For a specific signal structure, the format of the returned strings are shown below:

a) STS-1 VT-6

This signal consists of 1 STS-1 containing 7 VT-Groups. Each VT-Group contains 1 VT-6. There are therefore 7 tributaries to be scanned. These are defined as one group and hence for this configuration, 1 array is returned with the following format:

STS-1 -> VT6#1, VT6#2, VT6#3, VT6#4, VT6#5, VT6#6, VT6#7

The output will look like:

1,1,1,0,0,0,0

b) STS-1 VT-2

This signal again comprises 1 STS-1 containing 7 VT-Groups. However, this time the VT-Groups each contain 3 VT-2's. There are therefore 21 (7*3) tributaries to be scanned. These are defined as one group and are returned in the following format:

NOTE: VT-2's designated thus [VT-Group# - VT-2#]

SONET Command Reference

FETCh subsystem

```
STS-1    -> [1-1], [1-2], [1-3], [2-1], [2-2], [2-3], [3-1],  
            [3-2], [3-3], [4-1], [4-2], [4-3], [5-1], [5-2],  
            [5-3], [6-1], [6-2], [6-3], [7-1], [7-2], [7-3]
```

The output will look like:

```
1, 1, 1, 0, 0, 0, 0, 1, 1, 1, 1, 1, 1, 1, 0, 0, 1, 0, 0, 0, 0
```

c) STS-1 VT-1.5

This signal again comprises 1 STS-1 containing 7 VT-Groups. However, this time the VT-Groups each contain 4 VT-1.5's. There are therefore 28 (7*4) tributaries to be scanned. These are defined as one group and are returned in the following format:

NOTE: VT-1.5's designated thus [VT-Group# - VT-1.5#]

```
STS-1    -> [1-1], [1-2], [1-3], [1-4], [2-1], [2-2], [2-  
3], [2-4], [3-1], [3-2], [3-3], [3-4], [4-1], [4-2], [4-3], [4-  
4], [5-1], [5-2], [5-3], [5-4], [6-1], [6-2], [6-3], [6-4], [7-  
1], [7-2], [7-3], [7-4]
```

The output will look like:

```
1, 1, 1, 0, 0, 0, 0, 1, 1, 1, 1, 1, 1, 1, 0, 0, 1, 0, 0, 0, 0
```

2) STS-12/OC-12

For the STS-12/OC-12 situation, the formats are similar to those defined above for STS-1/STS-3 except that there will be data returned for all four STS-3's in the signal.

Consider a STS-12 signal with a STS-3C structure. In the STS-3 case this structure would not be considered since there is only one tributary in the signal. However in the STS-12/OC-12 case there are 4 tributaries and the scan is carried out.

In this case each STS-3C is treated as a separate group, hence 4 arrays are returned from the SCPI command:

```
STS-3 #1 STS-3C  
STS-3 #2 STS-3C  
STS-3 #3 STS-3C  
STS-3 #4 STS-3C
```

The output will look like:

```
0  
0
```

FETCh subsystem

1

1

:FETCh:ARRay:DATA:TELEcom:SONet:PGRaph?

Returns: <numeric>,<numeric>, <numeric>,...
 <numeric>,<numeric>, <numeric>

Returns an array of 576 bytes, 2 bytes for each of the possible 288 points on the displayed pointer graph. The 2 bytes at each point indicate the maximum and minimum offset at that point. Each byte has 3 numeric entries separated by commas.

The value of the 3 numeric entries, <range bit>,<validity bit>,<offset value>, provide the following information:

Range bit	Validity Bit	Offset Value	Description
1	1	-18 to +18	Valid in range result
1	0	0	No measurement
1	1	9.91E+37	Alarms during measurement
2	1	0	Offset out of range > +18
0	1	0	Offset out of range < -18

The graph entries are arranged as shown below. Each entry has the format previously described above:

<max offset 1>,<min offset 1>,<max offset 2>,<min offset 2>,
 <max offset 3>,<min offset 3>,<max offset 4>,<min offset 4>,
 <max offset 5>,<min offset 5>,<max offset 6>,<min offset 6>,

 <max offset 287>,<min offset 287>,<max offset 288>,<min offset 288>

Range of valid offset values is -18 thru +18

A typical return array might look like:

1,1,9.91E+37,1,1,9.91E+37,1,1, 0,1,1, 0,1,1, +1,1,1, -2, etc....

:FETCh:ARRay:DATA:TELEcom:SONet:OCAPture? <numeric>

<numeric> = 1 to 16 Overhead channels

FETCh subsystem

Returns: <array>

Returns an array with the number of entries determined by <numeric> and separated by CR/LF.

Each entry consists of an alphanumeric string and a numeric separated by commas. The alphanumeric string provide the hexadecimal value of the captured data. The length of the string depends upon the overhead channel selected for capture, two hexadecimal characters/overhead byte. The numeric indicates the number of frames for which the captured data existed. If this command is issued when a capture is being performed, some entries will contain no data. In this case 9.91E+37 is returned.

The overhead byte or bytes to be captured is specified by :SENS:DATA:TEL:OCAP: CHAN <channel>.

:FETCh:ARRAy:DATA:TELEcom:SONet:POVerhead? <numeric>

<numeric> = 1 to 9

Returns the value of the selected path overhead bytes as an array of strings. Each string is in the range "00000000" to "11111111". This is a snapshot of the overhead byte and is captured once per second.

The array always begins with byte 1 of the path overhead and ends with the byte number specified by <numeric>.

Byte Order: (1) J1 (2) B3 (3) C2 (4) G1 (5) F2 (6) H4 (7) Z3 (8) Z4 (9) N1.

Returns: <string>{,<string>}

:FETCh:ARRAy:DATA:TELEcom:SONet:OVERhead? <numeric><numeric><numeric>

<numeric> = 1 to 27 (Byte Number)
(first parameter)

<numeric> = 1 to 16 (STS-3 number)
(second parameter)

<numeric> = 1 to 3 (STS-1 number)
(third parameter)

SONET Command Reference

FEtCh subsystem

Returns the value of the selected transport overhead bytes as an array of strings. Each string is in the range "00000000" to "11111111". This is a snapshot of the overhead byte and is captured once per second.

The array always begins with byte 1 of the transport overhead and ends with the byte number specified by the first parameter.

Number	Name	Number	Name	Number	Name
1	A1	10	H1	19	D7
2	A2	11	H2	20	D8
3	J0/Z0	12	H3	21	D9
4	B1	13	B2	22	D10
5	E1	14	K1	23	D11
6	F1	15	K2	24	D12
7	D1	16	D4	25	S1/Z1
8	D2	17	D5	26	M0/M1/Z2
9	D3	18	D6	27	E2

Returns (each of one or more rows): <string>,{<string>}

SONET Command Reference
FETCH subsystem

Jitter SCPI Command Reference

OUTPut subsystem, see page 7-3.

SOURce subsystem - Transmitter Jitter Commands, see page 7-5.

SENSE subsystem - Receiver Jitter Settings, see page 7-21.

SENSE subsystem - Result Returning Commands, see page 7-24.

FETCh subsystem, see page 7-26.

Jitter Command Reference

Jitter Command Reference

This chapter contains detailed information on the SCPI (Standard Commands for Programming Instruments) and IEEE 488.2 common commands you will use when writing programs to control your OmniBER 718 for Jitter operation.

Please also refer to chapter 2 Common Commands for general information on SCPI command formats and for a list of commands that are common to PDH, SDH, SONET ATM or Jitter operation; they are as follows:

SCPI Command Format

Remote Control Commands

Instrument Options

INSTRument subsystem

SOURce subsystem

SOURce subsystem - Transmitter Common Commands

INPut subsystem

SENSE subsystem

SENSE subsystem - Receiver Common Commands

SENSE subsystem - Test Timing

SENSE subsystem - Analysis Control

SENSE subsystem - Trouble Scan Results

SENSE subsystem - Configuring Graphics

SENSE subsystem - Managing Graphics Stores

SENSE subsystem - Retrieving Graphics Store Data

SENSE subsystem - Retrieving Data for a Single Graph

SENSE subsystem -Obtaining Graphics End of Measurement Results

STATus Subsystem

SYSTem Subsystem

IEEE common capabilities

Jitter Command Reference
OUTPut subsystem

OUTPut subsystem

This subsystem controls the characteristics of the instrument's output ports.

:OUTPut:TELEcom:JITTer <discrete>

<discrete> =	OFF	Jitter Disabled
	ON	Jitter Enabled
	AUTotal	Auto Tolerance Mode
	TRANSfer	Jitter Transfer (Requires Jitter Measurement option)

Selects the jitter modulation operating mode. When AUTotal is selected a further selection of :OUTPut:TELEcom:JITTer:AUTotal <boolean> is required. When TRANSfer is selected further selections of :OUTPut:TELEcom:JITTer:TRANSfer <boolean> and :OUTPut:TELEcom:JITTer:TRANSfer:CALibrate? are required.

The corresponding query command returns the jitter modulation mode in discrete short form.

:OUTPut:TELEcom:JITTer?

Returns: <discrete>

:OUTPut:TELEcom:JITTer:AUTotal <boolean>

<boolean> = 0 or OFF
1 or ON

Start or stop the jitter auto tolerance mode. Before ON is selected, further selections under :SOURCE:DATA:TELEcom:JITTer:ATOLerance:DELay <numeric> and other AUTotal commands are required.

The corresponding query command returns the jitter auto tolerance mode as 0 or 1.

:OUTPut:TELEcom:JITTer:AUTotal?

Returns : <boolean>

OUTPut subsystem

:OUTPut:TELEcom:JITTer:TRANsfer <boolean>

<boolean> =	0 or OFF	Jitter Transfer disabled
	1 or ON	Jitter Transfer enabled

Requires a Jitter Measurement option also. Enable/Disable the jitter transfer mode. When ON is selected further selections under :SOURce:DATA:TELEcom:JITTer:TRANsfer:MODE <discrete> and related commands are required.

The corresponding query command returns the jitter transfer mode as 0 or 1.

:OUTPut:TELEcom:JITTer:TRANsfer?

Returns: 0 or 1

:OUTPut:TELEcom:JITTer:TRANsfer:CALibrate?

Returns:	INV	Calibration invalid
	VAL	Calibration valid

Requires a Jitter Measurement option also. Returns the validity of the jitter transfer calibration. To initiate a jitter transfer Calibration or measurement further selections under :SOURce:DATA:TELEcom:JITTer:TRANsfer:MODE <discrete> and related commands are required.

:OUTPut:TELEcom:JITTer:WANDer <boolean>

<boolean> =	0 or OFF
	1 or ON

Enables or disables wander generation. Jitter generation is automatically disabled when wander generation is enabled.

The corresponding query command returns the wander generation state as 0 or 1.

:OUTPut:TELEcom:JITTer:WANDer?

Returns : 0 or 1

Jitter Command Reference
SOURce subsystem - Transmitter Jitter Commands

Mask Selections

:SOURce:DATA:TELEcom:JITTer:MASK:TYPE <discrete>

<discrete> =	G823	G.823
	QHIGh	G.823 High-Q
	QLOW	G.823 Low-Q
	G824	G.824
	GR499CAT1	GR.499 Cat 1
	GR499CAT2	GR.499 Cat 2
	G958A	G.958 Type A
	G958B	G.958 Type B
	G825	G.825
	GR253	GR.253
	USER	User selectable mask

Selects the mask for jitter sweep, spot and auto tolerance.

The corresponding query returns the selected mask in discrete short form.

:SOURce:DATA:TELEcom:JITTer:MASK:TYPE?

Returns: <discrete>

:SOURce:DATA:TELEcom:JITTer:MASK:TYPE:USER <numeric>

<numeric>= 1 .. 5 User Jitter Mask number

Selects which User Jitter Mask is to be used when the

:SOURce:DATA:TELEcom:JITTer:MASK:TYPE <discrete> command is set to USER.

The corresponding query returns the selected User Jitter Mask.

:SOURce:DATA:TELEcom:JITTer:MASK:TYPE:USER?

Returns: <numeric>

SOURCE subsystem - Transmitter Jitter Commands

:SOURCE:DATA:TELEcom:JITTer:MASK:TYPE:MRANge <discrete>

<discrete> =	HFReq	High frequency
	LFReq	Low frequency

Selects the mask range when generating jitter with a G.825 mask.

The corresponding query returns the selected jitter G.825 mask range in discrete form, as listed above.

:SOURCE:DATA:TELEcom:JITTer:MASK:TYPE:MRANge?

Returns : <discrete>

Auto Tolerance

:SOURCE:DATA:TELEcom:JITTer:ATOLerance:DELay <numeric>

<numeric> = 0.0 .. 99.9

Set the delay in seconds between each autotolerance modulation frequency and amplitude setting. During this delay the output is not jittered. This delay does not include transmitter settling times. The corresponding query returns the delay in numeric form.

:SOURCE:DATA:TELEcom:JITTer:ATOLerance:DELay?

Returns : <numeric>

:SOURCE:DATA:TELEcom:JITTer:ATOLerance:DWELI <numeric>

<numeric> = 1.0 .. 99.9

Set the time in seconds spent gating at each autotolerance, modulation frequency and amplitude, setting.

The corresponding query returns the dwell time in numeric form.

:SOURCE:DATA:TELEcom:JITTer:ATOLerance:DWELI?

Returns : <numeric>

SOURce subsystem - Transmitter Jitter Commands

:SOURce:DATA:TELEcom:JITTer:ATOLerance:ERRor:TYPE <discrete>

<discrete> = ANY Any Errors
 BIT Bit Errors

Selects the type to be used by the auto tolerance feature.

The corresponding query returns the selected error type, as listed above.

:SOURce:DATA:TELEcom:JITTer:ATOLerance:ERRor:TYPE?

Returns : <discrete>

:SOURce:DATA:TELEcom:JITTer:ATOLerance:THREshold <numeric>

<numeric> = 0 .. 1000000

Set the number of bit errors that constitute an error for each autotolerance gating period as specified by the dwell time. When this value is 0 any errors are assumed to constitute an error otherwise only bit errors are tested. If an alarm that suppresses bit error measurements is present then it is assumed that this threshold has been exceeded. The corresponding query returns the threshold value in numeric form.

:SOURce:DATA:TELEcom:JITTer:ATOLerance:THREshold?

Returns : <numeric>

:SOURce:DATA:TELEcom:JITTer:ATOLerance:POINts <numeric>

<numeric> = 3 .. 55

Set the number of frequency points at which autotolerance is tested.

This command should only be used to select points for fixed autotolerance masks. If a User Mask is selected, the command

:SOURce:DATA:TELEcom:JITTer:UMASK:POINts <numeric>, <numeric> should be used.

The corresponding query returns the number of frequency points.

:SOURce:DATA:TELEcom:JITTer:ATOLerance:POINts?

Returns : <numeric>

SOURce subsystem - Transmitter Jitter Commands

Auto Transfer Function

:SOURce:DATA:TELEcom:JITTer:TRANSfer:MODE <discrete>

<discrete> =	CALib	Start Jitter Transfer Calibration
	MEASure	Start Jitter Transfer Measurement

Selects the jitter transfer mode.

The corresponding query returns the selected jitter transfer mode in discrete short form.

:SOURce:DATA:TELEcom:JITTer:TRANSfer:MODE?

Returns: <discrete>

:SOURce:DATA:TELEcom:JITTer:TRANSfer:POINts <numeric>

<numeric> = 1 .. 55

Set the number of frequency points at which jitter transfer is tested.

This command should only be used to select points for fixed transfer masks. If a User Mask is selected, the command :SOURce:DATA:TELEcom:JITTer:UMASk:POINts <numeric>, <numeric> should be used.

The corresponding query returns the number of frequency points.

:SOURce:DATA:TELEcom:JITTer:TRANSfer:POINts?

Returns: <numeric>

:SOURce:DATA:TELEcom:JITTer:TRANSfer:DELay <numeric>

<numeric> = 5.0 .. 99.9

Set the delay in seconds between each jitter transfer modulation frequency and amplitude setting. During this delay the output is not jittered. This delay does not include transmitter settling times.

The corresponding query returns the delay in numeric form.

:SOURce:DATA:TELEcom:JITTer:TRANSfer:DELay?

Returns: <numeric>

SOURce subsystem - Transmitter Jitter Commands

:SOURce:DATA:TELEcom:JITTer:TRANsfer:DWELl <numeric>

<numeric> = 5 .. 99

Set the data acquisition time, at each jitter transfer point, in 1 second steps. The corresponding query returns the dwell time in numeric form.

:SOURce:DATA:TELEcom:JITTer:TRANsfer:DWELl?

Returns: <numeric>

:SOURce:DATA:TELEcom:JITTer:TRANsfer:MASK:INPut <discrete>

<discrete> =	QLOW	G.823 Low-Q
	QHIGh	G.823 High-Q
	G823	G.823
	G958A	G.958 Type A
	G958B	G.958 Type B
	GR253A	GR-253-core part A
	GR253B	GR-253-core part B
	G824	G.824
	GR499CAT1	GR.499 Cat 1
	GR499CAT2	GR.499 Cat 2
	USER	User selectable mask

Selects the input mask for jitter transfer.

The corresponding query returns the selected input mask in discrete short form.

:SOURce:DATA:TELEcom:JITTer:TRANsfer:MASK:INPut?

Returns: <discrete>

:SOURce:DATA:TELEcom:JITTer:TRANsfer:MASK:INPut:USER <numeric>

<numeric>= 1 .. 5 User Jitter Mask number

SOURce subsystem - Transmitter Jitter Commands

Selects which User Jitter Mask is to be used when the :SOURce:DATA:TELEcom:JITTer:TRANsfer:MASK:INPut <discrete> command is set to USER.

The corresponding query returns the selected User Jitter Mask.

:SOURce:DATA:TELEcom:JITTer:TRANsfer:MASK:INPut:USER?

Returns: <numeric>

:SOURce:DATA:TELEcom:JITTer:TRANsfer:MASK:PASS <discrete>

<discrete> =	G823	G.823
	G958A	G.958 Type A
	G958B	G.958 Type B
	GR253	GR-253-core
	G823HIQ	G.823 High-Q
	G823LOQ	G.823 Low-Q
	G824	G.824
	GR499CAT1	GR.499 Cat 1
	GR499CAT2	GR.499 Cat 2
	NONE	No pass mask

Selects the pass mask for jitter transfer.

The corresponding query returns the selected pass mask in discrete short form.

:SOURce:DATA:TELEcom:JITTer:TRANsfer:MASK:PASS?

Returns: <discrete>

:SOURce:DATA:TELEcom:JITTer:TRANsfer:MASK:PASS[:ADJust] <boolean>

<boolean> =	0 or OFF	Disable JTF pass mask adjustment
	1 or ON	Enable JTF pass mask adjustment

Enables the jitter transfer function pass mask adjustment control.

The corresponding query returns the setting in discrete short form.

SOURce subsystem - Transmitter Jitter Commands

:SOURce:DATA:TELEcom:JITTer:TRANsfer:MASK:PASS[:ADJust]?

Returns: <boolean>

**:SOURce:DATA:TELEcom:JITTer:TRANsfer:MASK:PASS:ADJust:OFFSet
<numeric>**

<numeric> = -2.00 .. 2.00 dB

Sets the adjustment to be added to the Pass Mask.

The corresponding query returns the adjustment value.

:SOURce:DATA:TELEcom:JITTer:TRANsfer:MASK:PASS:ADJust:OFFSet?

Returns: <numeric>

:SOURce:DATA:TELEcom:JITTer:MODulation <discrete>

<discrete> = INTERNAL
EXTERNAL

Selects the source of the jitter/wander modulation signal. If INTERNAL is selected, then the modulation frequency and amplitude can be set on the instrument. If EXTERNAL modulation is selected, frequency and amplitude are determined by the supplied signal.

The corresponding query returns the selected jitter/wander modulation source in discrete form, as listed above.

:SOURce:DATA:TELEcom:JITTer:MODulation?

Returns : <discrete>

:SOURce:DATA:TELEcom:JITTer:ERANge <discrete>

<discrete> = UI2 2 UI range
UI10 10 UI range

Selects the transmitter output range when using externally modulated jitter.

The corresponding query returns the selected output range in discrete form, as listed above.

SOURce subsystem - Transmitter Jitter Commands

:SOURce:DATA:TELEcom:JITTer:ERANge?

Returns : <discrete>

Wander

:SOURce:DATA:TELEcom:JITTer:WANDer:MASK <discrete>

<discrete> =	OFF	No mask
	SPOT	Spot frequency

If OFF is selected, further selections of

:SOURce:DATA:TELEcom:JITTer:WANDer:FREQuency <numeric> and

:SOURce:DATA:TELEcom:JITTer:WANDer:AMPLitude <numeric> are required. If

SPOT is selected, further selection of

:SOURce:DATA:TELEcom:JITTer:WANDer:FREQuency <numeric> is required and the amplitude value is derived from the ITU-T G.823/G.825 mask.

The corresponding query returns the selected mask state in discrete form, as listed above.

:SOURce:DATA:TELEcom:JITTer:WANDer:MASK?

Returns : <discrete>

:SOURce:DATA:TELEcom:JITTer:WANDer:FREQuency <numeric>

<numeric> =	10 ..125000	micro Hertz
-------------	-------------	-------------

Sets the wander modulation or spot frequency in micro Hz .

The corresponding query returns the wander modulation or spot frequency.

:SOURce:DATA:TELEcom:JITTer:WANDer:FREQuency?

Returns : <numeric>

:SOURce:DATA:TELEcom:JITTer:WANDer:AMPLitude <numeric>

<numeric> =	0.5 .. 57600	UI
-------------	--------------	----

SOURce subsystem - Transmitter Jitter Commands

Sets the wander modulation amplitude if

:SOURce:DATA:TELEcom:JITTer:WANDer:MASK <discrete> is set to OFF. The absolute maximum value is dependant upon line rate and modulation frequency.

Any values exceeding the allowed ranges will result in the amplitude being set to the maximum permitted value for that frequency.

The corresponding query returns the wander modulation amplitude.

:SOURce:DATA:TELEcom:JITTer:WANDer:AMPLitude?

Returns : <numeric>

:SOURce:DATA:TELEcom:JITTer:SETTings <discrete>

<discrete> =	OFF	Jitter settings display disabled
	ON	Jitter settings display enabled

Enables/disables display of the jitter settings page.

The corresponding query returns an indication of whether the jitter settings page is displayed in discrete form as listed above.

:SOURce:DATA:TELEcom:JITTer:SETTings?

Returns : <discrete>

User Masks

:SOURce:DATA:TELEcom:JITTer:UMASK:LOCK <boolean>

<boolean> =	0 or OFF
	1 or ON

User jitter mask editing lock control.

The corresponding query command returns the current setting:

SOURce subsystem - Transmitter Jitter Commands

:SOURce:DATA:TELEcom:JITTer:UMASk:AMPLitude[:MULTiple] <numeric>, <numeric>, <numeric>, {<numeric>,{...} }

<numeric> =	1 .. 5	User Jitter Mask number
<numeric> =	1 .. 55	Number of following amplitudes
<numeric>, [<numeric>, {...}] =	0.01 .. 800.00	UIpp Jitter amplitude (upto 55-values)

Updates one or more consecutive amplitude values in the nominated user jitter mask, and also set the number of points in the mask. No update is permitted if the user jitter mask lock is on.

:SOURce:DATA:TELEcom:JITTer:UMASk:AMPLitude[:MULTiple]? <numeric>

<numeric> = 1 .. 5 User Jitter Mask number

The number of amplitude values in the nominated mask is returned, followed by the actual amplitude values themselves.

Returns :	<numeric>	Number of following amplitudes
	<numeric>	UIpp Jitter amplitudes (upto 55 values)

:SOURce:DATA:TELEcom:JITTer:UMASk:AMPLitude:SINGLE <numeric>, <numeric>, <numeric>

<numeric> =	1 .. 5	User Jitter Mask number
<numeric> =	1 .. 55	Index of amplitude value to update
<numeric> =	0.01 .. 800.00	UIpp Jitter amplitude

Updates a single amplitude value in the nominated user jitter mask. No update is permitted if the user jitter mask lock is on.

:SOURce:DATA:TELEcom:JITTer:UMASk:AMPLitude:SINGLE? <numeric>,<numeric>

<numeric> = 1 .. 5 User Jitter Mask number

SOURce subsystem - Transmitter Jitter Commands

<numeric> = 1 .. 55 Index of amplitude value

The indexed amplitude value in the nominated mask is returned.

Returns : <numeric>

**:SOURce:DATA:TELEcom:JITTer:UMASk:FREQUency[:MULTiple]
<numeric>, <numeric>, <numeric>, {<numeric>},...,}}**

<numeric> = 1 .. 5 User Jitter Mask number
 <numeric> = 1 .. 55 Number of Frequency points
 <numeric>, 2 .. 20000000 Frequency in Hz (up to 55-values)
 [<numeric>,{...}] =

Updates one or more consecutive frequency values in the nominated user jitter mask, and also updates the number of points in the mask. No change is permitted if the user jitter mask lock is on.

**:SOURce:DATA:TELEcom:JITTer:UMASk:FREQUency[:MULTiple]?
<numeric>**

<numeric> = 1 .. 5 User Jitter Mask number

The number of frequency values in the nominated mask is returned, followed by the actual amplitude values themselves.

Returns <numeric> Number of following frequencies
 :
 <numeric> Jitter frequencies in Hz (upto 55 values)

**:SOURce:DATA:TELEcom:JITTer:UMASk:FREQUency:SINGLE <numeric>,
<numeric>, <numeric>**

<numeric> = 1 .. 5 User Jitter Mask number
 <numeric> = 1 .. 55 Index of frequency value to update
 <numeric> = 2 .. 20000000 Frequency in Hz

SOURce subsystem - Transmitter Jitter Commands

Updates a single frequency value in the nominated user jitter mask. No change is permitted if the user jitter mask lock is on.

:SOURce:DATA:TELEcom:JITTer:UMASk:FREQuency:SINGLE?
<numeric>,<numeric>

<numeric> = 1 .. 5 User Jitter Mask number

<numeric> = 1 .. 55 Index of frequency value

The indexed frequency value in the nominated mask is returned.

Returns : <numeric>

:SOURce:DATA:TELEcom:JITTer:UMASk:GENErator [:PARAmeters]
<numeric>,<numeric>,<numeric>,<numeric>,<numeric>,<numeric>,<numeric>

<numeric> = 1 .. 55 number of points

<numeric> = 0.01 .. 800.00 Amplitude at A1 in UIpp

<numeric> = 0.01 .. 800.00 Amplitude at A2 in UIpp

<numeric> = 2 .. 20000000 Hz frequency at fa

<numeric> = 2 .. 20000000 Hz frequency at f0

<numeric> = 2 .. 20000000 Hz frequency at ft

<numeric> = 2 .. 20000000 Hz frequency at fb

Presets the parameters of the jitter mask generator prior to the generation of a user jitter mask. Simple range checking is applied to the parameters - more rigorous checking is performed when a subsequent :SOURce:DATA:TELEcom:JITTer:UMASk:GENErator :ACTion <numeric> command is issued.

The corresponding query command returns the current settings:

:SOURce:DATA:TELEcom:JITTer:UMASk:GENErator [:PARAmeters]?

Returns : <numeric>,<numeric>,
 <numeric>,<numeric>,
 <numeric>,<numeric>,
 <numeric>

SOURce subsystem - Transmitter Jitter Commands

:SOURce:DATA:TELEcom:JITTer:UMASk:GENerator :ACTion <numeric>

<numeric> = 1 .. 5 User Jitter Mask number

Generates a jitter mask based on the parameters supplied by the :SOURce:DATA:TELEcom:JITTer:UMASk:GENerator [:PARAmeters] <numeric>, <numeric>, <numeric>, <numeric>, <numeric>, <numeric>, <numeric> command. The generated frequency/amplitude pairs will overwrite those of the selected user jitter mask.

No action is permitted if the user jitter mask lock is on. An execution error will result if the mask profile frequency values are not in ascending order.

SENSe subsystem - Receiver Jitter Settings

:SENSe:DATA:TELEcom:JITTer:FILTer?

Returns : <discrete>

:SENSe:DATA:TELEcom:JITTer:HP1 <discrete>

<discrete> =	O171	O.171
	O172	O.172
	GR499	GR.499 (same as O.172)

Selects the HP1 (High Pass 1) filter version used for jitter measurement. GR499 is offered as an alternative name for O172.

The corresponding query returns the HP1 filter version selection in discrete form as listed above.

:SENSe:DATA:TELEcom:JITTer:HP1?

Returns : <discrete>

:SENSe:DATA:TELEcom:JITTer:RANGe <discrete>

<discrete> =	UI1_6	1.6 UI range
	UI16	16 UI range
	UI64	64 UI range

Selects the jitter measurement range. Range UI1_6 is available at all line rates. Range UI16 is available at all line rates except 2.4Gb/s. Range UI64 is available only at the 2.4Gb/s line rate.

In extended jitter measurement mode there is a fixed range of up to 1024UI, determined by the line rate. This cannot be selected or queried.

The corresponding query returns the jitter measurement range in discrete form as listed above.

Jitter Command Reference
SENSe subsystem - Receiver Jitter Settings

:SENSe:DATA:TELEcom:JITTer:RANGe?

Returns : <discrete>

:SENSe:DATA:TELEcom:JITTer:THReshold <numeric>

<numeric> =	0.05 to 1.60 step 0.01	1.6 UI range
	0.5 to 16.0 step 0.1	16 UI range
	1.0 to 64.0 step 0.2	64 UI range
	5 to 256 step 1	256 UI range
	10 to 1024 step 5	1024 UI range

Selects the jitter hits measurement threshold. The limits and step size are determined by the range setting in effect.

The corresponding query returns the jitter hits measurement threshold in numeric form as listed above.

:SENSe:DATA:TELEcom:JITTer:THReshold?

Returns : <numeric>

SENSe subsystem Result Returning Commands

Jitter/Wander Results

:SENSe:DATA? <"result">

Result = "COUNT:JITT:HITS"	Hit count
"SECONDS:JITT:HITS"	Hit seconds
"FSECONDS:JITT:HITS"	Hit free seconds
"PEAK:JITT:POSitive"	+ve peak Jitter
"PEAK:JITT:NEGative"	-ve peak Jitter
"PEAK:JITT:PKPK"	pk-to-pk Jitter
"PEAK:JITT:STERm:POSitive"	+ve peak Jitter Short Term
"PEAK:JITT:STERm:NEGative"	-ve peak Jitter Short Term
"PEAK:JITT:STERm:PKPK"	pk-to-pk Jitter Short Term
"RMS:JITT"	RMS jitter
"RMS:JITT:STERm"	Short TermRMS jitter
"COUNT:JITT:WANDer:TIERror"	Wander time interval error
"COUNT:JITT:WANDer:SECONDS:TIERror"	Wander time interval error nanoseconds
"PEAK:JITT:WANDer:POSitive"	+ve peak Wander
"PEAK:JITT:WANDer:SECONDS:POSitive"	+ve peak Wander nanoseconds
"PEAK:JITT:WANDer:NEGative"	-ve peak Wander
"PEAK:JITT:WANDer:SECONDS:NEGative"	-ve peak Wander nanoseconds
"PEAK:JITT:WANDer:PKPK"	pk-to-pk Wander
"PEAK:JITT:WANDer:SECONDS:PKPK"	pk-to-pk Wander nanoseconds
"PEAK:JITT:WANDer:PK15"	pk-to-pk15 min Wander
"PEAK:JITT:WANDer:SECONDS:PK15"	pk-to-pk 15 min Wander nanoseconds

Jitter Command Reference

SENSE subsystem Result Returning Commands

"PEAK:JITT:WANDer:PK24"	pk-to-pk 24 hour Wander
"PEAK:JITT:WANDer:SECOnds:PK24"	pk-to-pk 24 hour Wander nanoseconds
"SLIPs:JITT:WANDer:FRAMe"	Estimated frame slips
"SLIPs:JITT:WANDer:BIT"	Estimated bit slips
"FOFPm:JITT:WANDer:IMPLied"	Wander implied frequency offset

FETCh subsystem

FETCh subsystem

The FETCh subsystem is used to retrieve data directly accumulated by the instrument.

:FETCh:ARRay:DATA:TELEcom:JITTer:ATOLerance?

Returns: <array-1>
 <array-2>
 |
 <array-n>
 EOI

<array> = <numeric>, <numeric>, <boolean>

Where:

<numeric> = Frequency (Hz)

<numeric> = Amplitude (UI). Can include '>' symbol

<boolean> = 0 (fail) or 1 (fail)

Returns the jitter tolerance results as shown. The number of array rows, n, depends upon the number of points selected at the beginning of the measurement.

If no bit errors have been detected when the transmit jitter amplitude is a maximum, then the symbol '>' (greater than) is prepended to the <amplitude> value.

FETCh subsystem

:FETCh:ARRAy:DATA:TELEcom:JITTer:TRANsfer?

Returns: <array-1>
 <array-2>
 |
 <array-n>
 EOI

<array> = <numeric>, <numeric>, <numeric> ,<numeric>, <boolean>

Where:

<numeric> = JTF point number

<numeric> = Frequency (Hz)

<numeric> = Mask value (UI)

<numeric> = JTF result (dB)

<boolean> = 0 (fail) or 1 (pass)

Returns the jitter transfer results in numerical form as shown. The number of array rows , n, depends upon the number of points selected at the beginning of the measurement.

Jitter Command Reference
FEtCh subsystem

SOURce subsystem -Transmitter ATM Commands, see page 8-3.

SENSE subsystem - Receiver ATM settings, see page 8-19.

SENSE subsystem - Result Returning Commands, see page 8-27.

ATM Command Reference

ATM Command Reference

This chapter contains detailed information on the SCPI (Standard Commands for Programming Instruments) and IEEE 488.2 common commands you will use when writing programs to control your OmniBER 718 for ATM operation.

Please also refer to chapter 2 Common Commands for general information on SCPI command formats and for a list of commands that are common to PDH, SDH, SONET, Jitter or ATM operation; they are as follows:

SCPI Command Format

Remote Control Commands

Instrument Options

INSTRument subsystem

SOURce subsystem

SOURce subsystem - Transmitter Common Commands

INPut subsystem

SENSE subsystem

SENSE subsystem - Receiver Common Commands

SENSE subsystem - Test Timing

SENSE subsystem - Analysis Control

SENSE subsystem - Trouble Scan Results

SENSE subsystem - Configuring Graphics

SENSE subsystem - Managing Graphics Stores

SENSE subsystem - Retrieving Graphics Store Data

SENSE subsystem - Retrieving Data for a Single Graph

SENSE subsystem - Obtaining Graphics End of Measurement Results

STATus Subsystem

SYSTEM Subsystem

IEEE common capabilities

SOURCE subsystem -Transmitter ATM Commands

SOURCE subsystem -Transmitter ATM Commands

:SOURCE:DATA:TELEcom:ATM:NINterface <discrete>

<discrete> = UNI
 NNI

Sets ATM Layer Network Interface to User-Network Interface or Network-Network Interface.

The corresponding query returns the interface selection in discrete form as listed above.

:SOURCE:DATA:TELEcom:ATM:NINterface?

Returns: <discrete>

:SOURCE:DATA:TELEcom:ATM:CONVergence <discrete>

<discrete> = DIRect
 PLCP

Sets the Tx convergence sublayer mapping type.

The corresponding query returns the Tx convergence sublayer mapping type in discrete form as listed above.

:SOURCE:DATA:TELEcom:ATM:CONVergence?

Returns: <discrete>

:SOURCE:DATA:TELEcom:ATM:CONVergence:PLCP:C1 <discrete>

<discrete> = MINimum 13 14 13 13 14 13 (minumum rate adaption)

SOURCE subsystem -Transmitter ATM Commands

NOMinal 13 14 13 13 14 14 (nominal rate adaption)

MAXimum 13 14 14 13 14 14 (maximum rate adaption)

Sets the stuffing rate for the PLCP mapping.

The corresponding query returns the PLCP stuffing rate in discrete form as listed above.

:SOURCE:DATA:TELEcom:ATM:CONVergence:PLCP:C1?

Returns: <discrete>

:SOURCE:DATA:TELEcom:ATM:SCRambling <boolean>

<boolean> = 0 or OFF

 1 or ON

Sets the ATM Layer Scrambling On/Off.

The corresponding query returns the scrambling state in discrete form as listed above.

:SOURCE:DATA:TELEcom:ATM:SCRambling?

Returns: <boolean>

:SOURCE:DATA:TELEcom:ATM:HEADer:GFC <numeric>

<numeric> = 0 to 15

Sets the foreground channel header GFC field.

The corresponding query returns the GFC value in numeric form.

:SOURCE:DATA:TELEcom:ATM:HEADer:GFC?

Returns: <boolean>

SOURce subsystem -Transmitter ATM Commands

:SOURce:DATA:TELEcom:ATM:HEADer:VPI <numeric>

<numeric> = 0 to 255 when interface is UNI
 0 to 4095 when interface is NNI

Sets the foreground channel header VPI field.

The corresponding query returns the VPI value in numeric form.

:SOURce:DATA:TELEcom:ATM:HEADer:VPI?

Returns: <numeric>

:SOURce:DATA:TELEcom:ATM:HEADer:VCI <numeric>

<numeric> = 0 to 65535

Sets the foreground channel header VCI field.

The corresponding query returns the VPI value in numeric form.

:SOURce:DATA:TELEcom:ATM:HEADer:VCI?

Returns: <numeric>

:SOURce:DATA:TELEcom:ATM:HEADer:PTI <string>

<string> = "000" No Congestion
 "010" Congestion
 "nnn" n = 0, 1 or X

Sets the foreground channel header PTI field.

The corresponding query returns the PTI field in string form.

SOURce subsystem -Transmitter ATM Commands

:SOURce:DATA:TELEcom:ATM:HEADer:PTI?

Returns: <string>

:SOURce:DATA:TELEcom:ATM:HEADer:CLP <string>

<string> = "0"
"1"

Sets the foreground channel header CLP field.

The corresponding query returns the foreground channel CLP field in string form.

:SOURce:DATA:TELEcom:ATM:HEADer:CLP?

Returns: <string>

:SOURce:DATA:TELEcom:ATM:PAYLoad <discrete>

<discrete> =	TCELL	Test Cell
	PRBS15	PRBS15 Cross Cell
	PRBS23	PRBS23 Cross Cell
	UWORD	User Word

Sets foreground channel payload type.

The corresponding query returns the foreground channel payload type in discrete form as listed above.

:SOURce:DATA:TELEcom:ATM:PAYLoad?

Returns: <discrete>

SOURce subsystem -Transmitter ATM Commands

:SOURce:DATA:TELEcom:ATM:PAYLoad:UWORD <string>

<string> = "00000000" to
"11111111"

Sets the foreground channel pattern user defined byte.

The corresponding query returns the foreground channel pattern user defined byte in string form.

:SOURce:DATA:TELEcom:ATM:PAYLoad:UWORD?

Returns: <string>

:SOURce:DATA:TELEcom:ATM:DISTRibution:SERVice <discrete>

<discrete> = CBR
VBR
BURSt

Sets the ATM Layer foreground cell stream distribution type.

The corresponding query returns the ATM Layer foreground channel distribution type in discrete form as listed above.

:SOURce:DATA:TELEcom:ATM:DISTRibution:SERVice:BURSt

Causes a burst of ATM cells to be generated according to the parameters for the burst distribution type.

:SOURce:DATA:TELEcom:ATM:DISTRibution:SERVice?

Returns: <discrete>

:SOURce:DATA:TELEcom:ATM:DISTRibution:PCR <numeric>

<numeric> = 0 to 5656963 Cells per second

SOURce subsystem -Transmitter ATM Commands

Sets the foreground channel Peak Cell Rate in cells per second.

The corresponding query returns the foreground channel Peak Cell Rate in cells per second in numeric form.

:SOURce:DATA:TELEcom:ATM:DISTRibution:PCR?

Returns: <numeric>

:SOURce:DATA:TELEcom:ATM:DISTRibution:PCR:KBITs?

This queries the foreground channel Peak Cell Rate in Kilobits per second, returning the value in numeric form.

Returns: <numeric>

:SOURce:DATA:TELEcom:ATM:DISTRibution:PCR:PCTBw?

This queries the foreground channel Peak Cell Rate in terms of percentage bandwidth, returning the value in numeric form.

Returns: <numeric>

:SOURce:DATA:TELEcom:ATM:DISTRibution:SCR <numeric>

<numeric> = 0 to 5656963 Cells per second

Sets the foreground channel Sustainable Cell Rate in cells per second in numeric form.

The corresponding query returns the foreground cell Sustainable Cell Rate in cells per second in numeric form.

:SOURce:DATA:TELEcom:ATM:DISTRibution:SCR?

Returns: <numeric>

:SOURce:DATA:TELEcom:ATM:DISTRibution:SCR:KBITs?

This queries the foreground channel Sustainable Cell Rate in Kilobits per second, returning the value in numeric form.

Returns: <numeric>

SOURce subsystem -Transmitter ATM Commands

:SOURce:DATA:TELEcom:ATM:DISTRibution:SCR:PCTBw?

This queries the foreground channel Sustainable Cell Rate in Kilobits per second, returning the value in numeric form.

Returns: <numeric>

:SOURce:DATA:TELEcom:ATM:DISTRibution:MBS <numeric>

<numeric> = 1 to 2047

Sets the foreground channel Maximum Burst Size.

The corresponding query returns the foreground channel Maximum Burst Size in numeric form.

:SOURce:DATA:TELEcom:ATM:DISTRibution:MBS?

Returns: <numeric>

:SOURce:DATA:TELEcom:ATM:DISTRibution:CDVT <numeric>

<numeric> = 0 to 100000

Sets the foreground channel Cell Delay Variation Tolerance in microseconds in numeric form.

The corresponding query returns the foreground channel Cell Delay Variation Tolerance in microseconds in numeric form.

:SOURce:DATA:TELEcom:ATM:DISTRibution:CDVT?

Returns: <numeric>

SOURCE subsystem -Transmitter ATM Commands

:SOURCE:DATA:TELEcom:ATM:BACKground:HEADer:GFC <numeric>, <numeric>

<numeric> #1 = 1 to 7 Background channel No.

<numeric> #2 = 0 to 15

Sets a background channel cell header Generic Flow Control field in numeric form.

The corresponding query returns a background channel cell header Generic Flow Control field in numeric form.

:SOURCE:DATA:TELEcom:ATM:BACKground:HEADer:GFC? <numeric>

<numeric> 1 to 7 Background channel

Returns: <numeric>

:SOURCE:DATA:TELEcom:ATM:BACKground:HEADer:VPI <numeric>, <numeric>

<numeric> #1 = 1 to 7 Background channel No.

<numeric> #2 = 0 to 255 VPI when in UNI mode

0 to 4095 VPI when in NNI mode

Sets a background channel header Virtual Path Indicator.

The corresponding query returns a background channel header Virtual Path Indicator in numeric form.

:SOURCE:DATA:TELEcom:ATM:BACKground:HEADer:VPI? <numeric>

<numeric> 1 to 7 Background channel

Returns: <numeric> VPI

SOURce subsystem -Transmitter ATM Commands

:SOURce:DATA:TELEcom:ATM:BACKground:HEADer:VCI <numeric>, <numeric>

<numeric> #1 = 1 to 7 Background channel No.

<numeric> #1= 0 to 65535 VCI

Sets a background channel cell header Virtual Channel Indicator field.

The corresponding query returns a background channel cell header Virtual Channel Indicator field in numeric form.

:SOURce:DATA:TELEcom:ATM:BACKground:HEADer:VCI? <numeric>

<numeric> 1 to 7 Background channel

Returns: <numeric> VCI

:SOURce:DATA:TELEcom:ATM:BACKground:HEADer:PTI <numeric>, <string>

<numeric> = 1 to 7 Background channel No.

<string> = "nnn" n = 0, 1 or X

Sets a background channel cell header Payload Type Indicator field in string form.

The corresponding query returns a background channel cell header Payload Type Indicator field in string form.

:SOURce:DATA:TELEcom:ATM:BACKground:HEADer:PTI? <numeric>

<numeric> 1 to 7 Background channel

Returns: <numeric> PTI

SOURce subsystem -Transmitter ATM Commands

:SOURce:DATA:TELEcom:ATM:BACKground:HEADer:CLP <numeric>, <string>

<numeric> = 1 to 7 Background channel No.

<string> = "0" or "1"

Sets a background channel cell header CLP flag..

The corresponding query returns the a background channel cell header CLP flag in string form.

:SOURce:DATA:TELEcom:ATM:BACKground:HEADer:CLP <numeric>

<numeric> 1 to 7 Background channel

Returns: <numeric> CLP

:SOURce:DATA:TELEcom:ATM:BACKground:DISTriBution:SERvice?

Returns: CBR

Queries the ATM Layer background channels' cell stream distribution type.

:SOURce:DATA:TELEcom:ATM:BACKground:DISTriBution:PCR <numeric>,<numeric>

<numeric> #1 = 1 to 7 Background channel No.

<numeric> = 0 to 5656963 Cells per second

Set ATM Layer background cell peak cell rate in cells per second.

The corresponding query returns a background cell peak cell rate in cells per second in numeric form.

SOURce subsystem -Transmitter ATM Commands

:SOURce:DATA:TELEcom:ATM:BACKground:DISTRibution:PCR?
<numeric>

<numeric> 1 to 7 Background channel

Returns: <numeric> PCR

:SOURce:DATA:TELEcom:ATM:BACKground:DISTRibution:PCR:KBITs?
<numeric>

<numeric> 1 to 7 Background channel

Returns: <numeric> PCR

Queries a background channel peak cell rate in kilobits per second and returns the value in numeric form.

:SOURce:DATA:TELEcom:ATM:BACKground:DISTRibution:PCR:PCTBw?
<numeric>

<numeric> 1 to 7 Background channel

Returns: <numeric> PCR

Queries a background channel peak cell rate in percentage bandwidth and returns the value in numeric form.

:SOURce:DATA:TELEcom:ATM:BACKground:PAYLoad:UWORD
<numeric>,<string>

<numeric> = 1 to 7 Background channel

<string> = "00000000" to
 "11111111"

Set background cell pattern user defined byte

The corresponding query returns a background channel payload user word in string form.

SOURce subsystem -Transmitter ATM Commands

**:SOURce:DATA:TELEcom:ATM:BACKground:PAYLoad:UWORD?
<numeric>**

<numeric> = 1 to 7 Background channel

Returns: <string>

:SOURce:DATA:TELEcom:ATM:FILL <discrete>

<discrete> = IDLE

UNASsigned

Set type of cells used to fill surplus bandwidth.

The corresponding query returns the type of cells used to fill surplus bandwidth in discrete form as listed above.

:SOURce:DATA:TELEcom:ATM:FILL?

Returns: <discrete>

:SOURce:DATA:TELEcom:ATM:ERRor:TYPE <discrete>

<discrete> = SHEC Single HEC

DHEC Double HEC

BIT

BIPPlcp DS3 PLCP BIP

ECELL Errored Cells

LCELL Lost Cells

MCELL Misinserted Cells

Sets the ATM error add type.

The corresponding query returns the ATM error add type in discrete form as listed above.

SOURce subsystem -Transmitter ATM Commands

:SOURce:DATA:TELEcom:ATM:ERRor:TYPE?

Returns: <discrete>

:SOURce:DATA:TELEcom:ATM:ERRor:STReam <discrete>

<discrete> = FG Errors added to Foreground stream
ALL Errors added to All Cells

Sets the ATM stream into which errors are to be added.

The corresponding query returns the ATM stream into which errors are to be added in discrete form.

:SOURce:DATA:TELEcom:ATM:ERRor:STReam?

Returns: <discrete>

:SOURce:DATA:TELEcom:ATM:ERRor:RATE <discrete>

<discrete> = NONE No errors
ONCE Single error
E_3 1E-3 Error rate
E_4 1E-4 Error rate
E_5 1E-5 Error rate
E_6 1E-6 Error rate
E_7 1E-7 Error rate
E_8 1E-8 Error rate
E_9 1E-9 Error rate
USER User error rate

Sets the ATM error add rate.

SOURce subsystem -Transmitter ATM Commands

The corresponding query returns the ATM error rate in discrete form as listed above.

:SOURce:DATA:TELEcom:ATM:ERRor:RATE?

Returns: <discrete>

:SOURce:DATA:TELEcom:ATM:ERRor:RATE:USER <numeric>

<numeric> = 1.1E-3 to mantissa resolution 0.1, exponent resolution 1
1.0E-9

The corresponding query returns the ATM user error add rate in numeric form.

:SOURce:DATA:TELEcom:ATM:ERRor:RATE:USER?

Returns: <numeric>

:SOURce:DATA:TELEcom:ATM:ERRor:BSIZE <numeric>

<numeric> = 1 to 8 Single and Double HEC
1 to 999 Errored Cells, Lost Cells and
Misinserted Cells

Sets the ATM error add burst size.

The corresponding query returns the ATM error add burst size in numeric form.

:SOURce:DATA:TELEcom:ATM:ERRor:BSIZE?

Returns: <numeric>

:SOURce:DATA:TELEcom:ATM:ERRor:BURSt

Adds a burst of the currently selected ATM errors.

SOURce subsystem -Transmitter ATM Commands

:SOURce:DATA:TELEcom:ATM:ALARm <discrete>

<discrete> =	OFF	No Alarms
	VPAis	Virtual Path AIS
	VPRDi	Virtual Path RDI
	VPCC	Virtual Path Continuity Check
	VCAis	Virtual Channel AIS
	VCRDi	Virtual Channel RDI
	VCCC	Virtual Channel Continuity Check
	RAIPlcp	DS3 PLCP Remote Alarm Indication

Sets the ATM TX Test Function alarm type

The corresponding query returns the ATM TX Test Function alarm type in discrete form as listed above.

:SOURce:DATA:TELEcom:ATM:ALARm?

Returns: <discrete>

ATM Command Reference

SOURce subsystem -Transmitter ATM Commands

ATM Operation
SENSe subsystem - Receiver ATM Settings

SENSe subsystem - Receiver ATM Settings

:SENSe:DATA:TELEcom:ATM:NINTerface <discrete>

<discrete> = UNI
 NNI

Sets the ATM Layer Network Interface to User-Network Interface or Network-Network Interface.

The corresponding query returns the interface selection in discrete form as listed above.

:SENSe:DATA:TELEcom:ATM:NINTerface?

Returns: <discrete>

:SENSe:DATA:TELEcom:ATM:CONVergence <discrete>

<discrete> = DIRect
 PLCP

Sets the ATM receiver convergence sublayer mapping type.

The corresponding query returns the ATM receiver convergence sublayer mapping type in discrete form as listed above.

:SENSe:DATA:TELEcom:ATM:CONVergence?

Returns: <discrete>

:SENSe:DATA:TELEcom:ATM:SCRambling <boolean>

<boolean> = ON
 OFF

Sets the receive ATM Layer Scrambling On/Off

ATM Operation

SENSe subsystem - Receiver ATM Settings

The corresponding query returns the ATM receiver scrambling state in boolean form as listed above.

:SENSe:DATA:TELEcom:ATM:SCRambling?

Returns: <boolean>

:SENSe:DATA:TELEcom:ATM:HEC <boolean>

<boolean> = ON
OFF

Sets the receive ATM Header Error Correction On/Off

The corresponding query returns the receive Header Error Correction control state in boolean form as listed above.

:SENSe:DATA:TELEcom:ATM:HEC?

Returns: <boolean>

:SENSe:DATA:TELEcom:ATM:CELLs <discrete>

<discrete> =	AUSer	All User
	VPATH	Virtual Path
	VCHannel	Virtual Channel
	EXPertmode	User Defined

Set the ATM Cell Selected For Test in the Receive Filter. This selection determines what values can be configured for the ATM Cell Header.

The corresponding query returns the scrambling state in discrete form as listed above.

ATM Operation
SENSe subsystem - Receiver ATM Settings

:SENSe:DATA:TELEcom:ATM:CELLs?

Returns: <discrete>

:SENSe:DATA:TELEcom:ATM:HEADer:GFC <discrete>

<discrete> = X Don't Care
VALue User Defined

Sets the Receive Filter GFC mode.

The corresponding query returns the Receive GFC mode in discrete form.

:SENSe:DATA:TELEcom:ATM:HEADer:GFC?

Returns: <discrete>

:SENSe:DATA:TELEcom:ATM:HEADer:GFC:VALue <numeric>

<numeric> = 0 to 15

Sets the Receive Filter GFC value.

The corresponding query returns the Receive GFC value in numeric form.

:SENSe:DATA:TELEcom:ATM:HEADer:GFC:VALue?

Returns: <numeric>

:SENSe:DATA:TELEcom:ATM:HEADer:VPI <discrete>

<discrete> = X Don't Care
VALue User Defined

Sets the Receive Filter VPI mode.

The corresponding query returns the Receive VPI mode in discrete form.

ATM Operation

SENSe subsystem - Receiver ATM Settings

:SENSe:DATA:TELEcom:ATM:HEADer:VPI?

Returns: <discrete>

:SENSe:DATA:TELEcom:ATM:HEADer:VPI:VALue <numeric>

<numeric> = 0 to 255 UNI

0 to 4095 NNI

Sets the Receive Filter VPI value.

The corresponding query returns the Receive VPI value in numeric form.

:SENSe:DATA:TELEcom:ATM:HEADer:VPI:VALue?

Returns: <numeric>

:SENSe:DATA:TELEcom:ATM:HEADer:VCI <discrete>

<discrete> = VALue User Defined

UCELls Filters VCIs of 1, 2, 5, & > 15

Sets the Receive Filter VCI mode.

The corresponding query returns the Receive VCI mode in discrete form.

:SENSe:DATA:TELEcom:ATM:HEADer:VCI?

Returns: <discrete>

:SENSe:DATA:TELEcom:ATM:HEADer:VCI:VALue <numeric>

<numeric> = 0 to 65535 EXPertmode

32 to 65535 VCHannel

Sets the Receive Filter VCI value.

ATM Operation

SENSe subsystem - Receiver ATM Settings

The corresponding query returns the Receive VCI value in numeric form.

:SENSe:DATA:TELEcom:ATM:HEADer:VCI:VALue?

Returns: <numeric>

:SENSe:DATA:TELEcom:ATM:HEADer:PTI <string>

<string> = "nnn" n = 0, 1 or X

Sets the Receive Filter PTI field.

The corresponding query returns the PTI field in string form.

:SENSe:DATA:TELEcom:ATM:HEADer:PTI?

Returns: <string>

:SENSe:DATA:TELEcom:ATM:HEADer:CLP <string>

<string> = "0"
"1"
"X" Don't Care

Sets the Receive Filter CLP field.

The corresponding query returns the CLP field in string form.

:SENSe:DATA:TELEcom:ATM:HEADer:CLP?

Returns: <string>

:SENSe:DATA:TELEcom:ATM:PAYLoad <discrete>

<discrete> = TCELI Test Cell
PRBS15 PRBS15 Cross Cell

ATM Operation

SENSe subsystem - Receiver ATM Settings

PRBS23	PRBS23 Cross Cell
UWORD	User Word
LIVE	Live Traffic

Sets the ATM receiver payload type.

The corresponding query returns the ATM receiver payload type in discrete form as listed above.

:SENSe:DATA:TELEcom:ATM:PAYLoad?

Returns: <discrete>

:SENSe:DATA:TELEcom:ATM:PAYLoad:UWORD <string>

<string> = "00000000" to "11111111"

Sets the ATM receiver user defined payload byte.

The corresponding query returns the ATM receiver user defined payload byte in string form.

:SENSe:DATA:TELEcom:ATM:PAYLoad:UWORD?

Returns: <string>

:SENSe:DATA:TELEcom:ATM:POLicing:SERVice <discrete>

<discrete> = NONE
CBR
VBR

Sets the ATM receiver Non-conforming Cell Policing Service. Selecting NONE will disable the non-conforming cell measurement.

The corresponding query returns the ATM Policing Service in discrete form as listed above.

ATM Operation
SENSe subsystem - Receiver ATM Settings

:SENSe:DATA:TELEcom:ATM:POLicing:SERvice?

Returns: <discrete>

:SENSe:DATA:TELEcom:ATM:POLicing:SCR <numeric>

<numeric> = 1 to 5656964 Cells per second

Sets the ATM receiver Sustainable Cell Rate for the policing of Non-conforming Cells. Only valid when the Policing Service is configured for VBR.1. The maximum Sustainable Cell Rate is line rate dependant.

The corresponding query returns the ATM reciever Sustainable Cell Rate in cells per second in numeric form.

:SENSe:DATA:TELEcom:ATM:POLicing:SCR?

Returns: <numeric>

:SENSe:DATA:TELEcom:ATM:POLicing:PCR <numeric>

<numeric> = 1 to 5656964 Cells per second

Sets the ATM receiver Peak Cell Rate for the policing of Non-conforming Cells. Only valid when the Policing Service is configured for CBR or VBR.1. The minimum Peak Cell Rate is always >= Sustainable Cell Rate for VBR.1 policing. The maximum Peak Cell Rate is line rate dependant.

The corresponding query returns the ATM reciever Peak Cell Rate in cells per second in numeric form.

:SENSe:DATA:TELEcom:ATM:POLicing:PCR?

Returns: <numeric>

ATM Operation

SENSe subsystem - Receiver ATM Settings

:SENSe:DATA:TELEcom:ATM:POLicing:CDVT <numeric>

<numeric> = 0 to 100000

Sets the ATM receiver Cell Delay Variation Tolerance in microseconds for the policing of Non-conforming cells. Only valid when the Policing Service is configured for CBR or VBR.1.

The corresponding query returns the ATM receiver Cell Delay Variation Tolerance in microseconds in numeric form.

:SENSe:DATA:TELEcom:ATM:POLicing:CDVT?

Returns: <numeric>

:SENSe:DATA:TELEcom:ATM:POLicing:MBS <numeric>

<numeric> = 1 to 2047

Sets the ATM receiver Maximum Burst Size for the policing of Non-conforming cells. Only valid when the Policing Service is configured for VBR.1.

The corresponding query returns the ATM receiver Maximum Burst Size in numeric form.

:SENSe:DATA:TELEcom:ATM:POLicing:MBS?

Returns: <numeric>

SENSe subsystem - Result Returning Commands

ATM Cumulative Term Results

:SENSe:DATA? <“result”>

Result =	ECOUNT:ATM:CHEC	Corrected HEC error count
	ERATIO:ATM:CHEC	Corrected HEC error ratio
	ECOUNT:ATM:NCHEC	Non Corrected HEC error count
	ERATIO:ATM:NCHEC	Non Corrected HEC error ratio
	ECOUNT:ATM:RCELL	Received Cell Count all cells
	ERATIO:ATM:RCELL	Received Cell rate all cells
	ECOUNT:ATM:RCELL:CLP0	Received Cell Count CLP 0
	ERATIO:ATM:RCELL:CLP0	Received Cell rate CLP 0
	ECOUNT:ATM:RCELL:CLP1	Received Cell Count CLP 1
	ERATIO:ATM:RCELL:CLP1	Received Cell rate CLP 1
	ECOUNT:ATM:ECELL	Errored Cell count
	ERATIO:ATM:ECELL	Errored Cell ratio
	ECOUNT:ATM:LCELL	Cell Loss count
	ERATIO:ATM:LCELL	Cell Loss ratio
	ECOUNT:ATM:MCELL	Misinserted Cell count
	ERATIO:ATM:MCELL	Misinserted Cell ratio
	ECOUNT:ATM:NCCell	Non-conforming Cell count
	ERATIO:ATM:NCCell	Non-conforming Cell ratio
	ECOUNT:ATM:BIT	Bit Error count
	ERATIO:ATM:BIT	Bit Error ratio

ATM Operation

SENSe subsystem - Result Returning Commands

ECOUNT:ATM:MCTDelay	Mean Cell Transfer Delay count
ECOUNT:ATM:MXCTdelay	Maximum Cell Transfer Delay count
ECOUNT:ATM:PCDV	Peak-to-peak 2-point CDV
ECOUNT:ATM:PLCP:BIP	DS3 PLCP BIP Error count
ERATIO:ATM:PLCP:BIP	DS3 PLCP BIP Error ratio

ATM Short Term Results

:SENSe:DATA? <“result”>

Result =	ECOUNT:ATM:STERm:CHEC	Corrected HEC error count
	ERATIO:ATM:STERm:CHEC	Corrected HEC error ratio
	ECOUNT:ATM:STERm:NChec	Non Corrected HEC Error count
	ERATIO:ATM:STERm:NChec	Non Corrected HEC Error ratio
	ECOUNT:ATM:STERm:RCELI	Received Cell Count all cells
	ERATIO:ATM:STERm:RCELI	Received Cell rate all cells
	ECOUNT:ATM:STERm:RCELI:CLP0	Received Cell Count CLP 0
	ERATIO:ATM:STERm:RCELI:CLP0	Received Cell rate CLP 0
	ECOUNT:ATM:STERm:RCELI:CLP1	Received Cell Count CLP 1
	ERATIO:ATM:STERm:RCELI:CLP1	Received Cell rate CLP 1
	ECOUNT:ATM:STERm:ECELI	Errored Cell count
	ERATIO:ATM:STERm:ECELI	Errored Cell ratio
	ECOUNT:ATM:STERm:LCELI	Cell Loss count
	ERATIO:ATM:STERm:LCELI	Cell Loss ratio
	ECOUNT:ATM:STERm:MCELI	Misinserted cell count
	ERATIO:ATM:STERm:MCELI	Misinserted cell ratio

ATM Operation

SENSe subsystem - Result Returning Commands

ECOUNT:ATM:STERm:NCCell	Non-conforming Cell count
ERATIO:ATM:STERm:NCCell	Non-conforming Cell ratio
ECOUNT:ATM:STERm:BIT	Bit Error count
ERATIO:ATM:STERm:BIT	Bit Error ratio
ECOUNT:ATM:STERm:MCTDelay	Mean Cell Transfer Delay count
ECOUNT:ATM:STERm:MXCTdelay	Maximum Cell Transfer Delay count
ECOUNT:ATM:STERm:PCDV	Peak-to-peak 2-point CDV
ECOUNT:ATM:STERm:PLCP:BIP	DS3 PLCP BIP Error count
ERATIO:ATM:STERm:PLCP:BIP	DS3 PLCP BIP Error ratio

Alarm Seconds Results

:SENSe:DATA? <“result”>

Result =	ASEconds:ATM:LCD	Loss of Cell Delineation seconds
	ASEconds:ATM:SCNReceived	Selected Cell not received seconds
	ASEconds:ATM:VPAis	VP AIS seconds
	ASEconds:ATM:VPRDi	VP-RDI seconds
	ASEconds:ATM:VPLoc	VP Loss of Continuity seconds
	ASEconds:ATM:CEXperienced	Congestion experienced seconds
	ASEconds:ATM:VCAis	VC AIS seconds
	ASEconds:ATM:VCRDi	VC-RDI seconds
	ASEconds:ATM:VCLoc	VC Loss of Continuity
	ASEconds:ATM:TCLoss	Test Cell Loss seconds
	ASEconds:ATM:PSLoss	Pattern Sync Loss seconds (see Note on page 3- 21.)

ATM Operation

SENSe subsystem - Result Returning Commands

ASEConds:ATM:PLCP:OOF	DS3 PLCP Out of Frame seconds
ASEConds:ATM:PLCP:RAI	DS3 PLCP RAI seconds

ATM Service Disruption Results

:SENSe:DATA? <“result”>

Result =	SDTest:ATM:COUNt:LONG	Longest Burst size in milliseconds
	SDTest:ATM:COUNt:SHORT	Shortest Burst size in milliseconds
	SDTest:ATM:COUNt:LAST	Last Burst size in milliseconds
	ASEConds:ATM:VPRDi	VP-RDI seconds
	ASEConds:ATM:VPLoc	VP Loss of Continuity seconds
	ASEConds:ATM:CEXPerienced	Congestion experienced seconds
	ASEConds:ATM:VCAis	VC AIS seconds
	ASEConds:ATM:VCRDi	VC-RDI seconds
	ASEConds:ATM:VCLoc	VC Loss of Continuity
	ASEConds:ATM:TCLoss	Test Cell Loss seconds
	ASEConds:ATM:PSLoss	Pattern Sync Loss seconds
	ASEConds:ATM:PLCP:OOF	DS3 PLCP Out of Frame seconds
	ASEConds:ATM:PLCP:RAI	DS3 PLCP RAI seconds

SOURce subsystem -Transmitter POS Commands, see page 9-2.

SENSE subsystem - Receiver POS Settings, see page 9-11.

SENSE subsystem -Result Returning Commands, see page 9-14.

POS Command Reference

SOURce subsystem -Transmitter POS Commands

SOURce subsystem -Transmitter POS Commands

:SOURce:DATA:TELEcom:IPOS:HDLC:FRAMing <discrete>

<discrete>	PPP	PPP in HDLC framing as per RFC 1662
	CISCO	CISCO HDLC - Cisco's proprietary frame structure

Selects the POS HDLC Framing type.

The corresponding query returns the HDLC Framing type in discrete form as listed above.

:SOURce:DATA:TELEcom:IPOS:HDLC:FRAMing?

Returns : <discrete>

:SOURce:DATA:TELEcom:IPOS:HDLC:SCRambling <discrete>

<discrete>	OFF	Disables the scrambler
	ON	Scrambling on

Selects the POS HDLC Scrambling setting.

The corresponding query returns the HDLC Scrambling setting in discrete form as listed above.

:SOURce:DATA:TELEcom:IPOS:HDLC:SCRambling?

Returns : <discrete>

:SOURce:DATA:TELEcom:IPOS:HDLC:FCS <discrete>

<discrete>	CRC32	32-bit CRC check
	CRC16	16-bit CRC check

Selects the POS HDLC Field Check Sequence type.

SOURce subsystem -Transmitter POS Commands

The corresponding query returns the HDLC Field Check Sequence type in discrete form as listed above.

:SOURce:DATA:TELEcom:IPOS:HDLC:FCS?

Returns : <discrete>

:SOURce:DATA:TELEcom:IPOS:ADDResSes:SOURce <string>

Selects the transmitters POS IP Source address in the range “0.0.0.0” to “255.255.255.255”.

The corresponding query returns the transmitters POS IP Source address as a string.

:SOURce:DATA:TELEcom:IPOS:ADDResSes:SOURce?

Returns : <string>

:SOURce:DATA:TELEcom:IPOS:ADDResSes:DESTination <string>

Selects the transmitters POS IP Destination address in the range “0.0.0.0” to “255.255.255.255”.

The corresponding query returns the transmitters POS IP Destination address as a string.

:SOURce:DATA:TELEcom:IPOS:ADDResSes:DESTination?

Returns : <string>

:SOURce:DATA:TELEcom:IPOS:PACKet:LENGth <discrete>

<discrete> =	L741	7,4,1 distribution
	USER	User packet length from 20 to 65535
	RANDom	Random distribution

Selects the transmitters POS IP packet stream length. If USER is selected, the user length is set using :SOURce:DATA:TELEcom:IPOS:PACKet:LENGth:USER <integer>.

The corresponding query returns the transmitters POS IP packet stream length in discrete form as listed above.

SOURce subsystem -Transmitter POS Commands

:SOURce:DATA:TELEcom:IPOS:PACKet:LENGth?

Returns : <discrete>

:SOURce:DATA:TELEcom:IPOS:PACKet:LENGth:USER <integer>

Sets the transmitter POS IP User packet stream length in the range 20 to 65535.

The corresponding query returns the user packet length as an integer.

:SOURce:DATA:TELEcom:IPOS:PACKet:LENGth:USER?

Returns : <integer>

**:SOURce:DATA:TELEcom:IPOS:PACKet:LENGth:RANDom:MAX
<discrete>**

<discrete> =	MAX0	Maximum value of 127
	MAX1	Maximum value of 511
	MAX2	Maximum value of 1023
	MAX3	Maximum value of 8191
	MAX4	Maximum value of 65535

Selects the transmitters POS IP maximum packet stream length for the random distribution.

The corresponding query returns the transmitters POS IP maximum packet stream length in discrete form as listed above.

:SOURce:DATA:TELEcom:IPOS:PACKet:LENGth:RANDom:MAX?

Returns : <discrete>

:SOURce:DATA:TELEcom:IPOS:PACKet:LENGth:RANDom:MIN <integer>

Sets the transmitter POS IP minimum packet stream length in the range 20 to 63.

The corresponding query returns the POS IP minimum packet stream length as an integer.

SOURce subsystem -Transmitter POS Commands

:SOURce:DATA:TELEcom:IPOS:PACKet:LENGth:RANDom:MIN?

Returns : <integer>

:SOURce:DATA:TELEcom:IPOS:PACKet:GAP <discrete>

<discrete> = USER User Inter-Packet Gap length
RANDOM Random Inter-Packet Gap lengths

Selects the transmitter POS IP Inter-packet Gap length.

The corresponding query returns the transmitters POS IP Inter-Packet Gap length in discrete form as listed above.

:SOURce:DATA:TELEcom:IPOS:PACKet:GAP?

Returns : <discrete>

:SOURce:DATA:TELEcom:IPOS:PACKet:GAP:USER <integer>

Sets the transmitter POS IP User Inter-packet gap length in the range 1 to $2^{30}-1$ (1073741823).

The corresponding query returns the inter-packet gap length as an integer.

:SOURce:DATA:TELEcom:IPOS:PACKet:GAP:USER?

Returns : <integer>

:SOURce:DATA:TELEcom:IPOS:PACKet:GAP:RANDom:MAX <discrete>

<discrete> = MAX0 Maximum value of 4
MAX1 Maximum value of 32
MAX2 Maximum value of 1024
MAX3 Maximum value of 2^{20}
MAX4 Maximum value of $2^{30}-1$

Selects the transmitters POS IP maximum inter-packet gap length for the random distribution.

SOURce subsystem -Transmitter POS Commands

The corresponding query returns the transmitters POS IP maximum inter-packet gap length in discrete form as listed above.

:SOURce:DATA:TELEcom:IPOS:PACKet:GAP:RANDom:MAX?

Returns : <discrete>

:SOURce:DATA:TELEcom:IPOS:PACKet:RATE?

Returns : <integer>

The above command returns the transmitted packet rate in packets per second. When there is less than 1 packet per second being transmitted the result will be equal to one when the HDLC header is detected and will go to zero 1 second later and will remain at zero until the next HDLC header is detected.

:SOURce:DATA:TELEcom:IPOS:HEADer:PROTOcol <discrete>

<discrete> =	ICMP	ICMP Protocol
	IP	IP Protocol
	TCP	TCP Protocol (Default)
	UDP	UDP Protocol
	USER	User program from 0 to 255

Selects the transmitters POS IP Protocol Header Field. If USER is selected, the user length is set using :SOURce:DATA:TELEcom:IPOS:HEADer:PROTOcol:USER <integer>.

The corresponding query returns the transmitters POS IP Protocol Header Field in discrete form as listed above.

:SOURce:DATA:TELEcom:IPOS:HEADer:PROTOcol?

Returns : <discrete>

:SOURce:DATA:TELEcom:IPOS:HEADer:PROTOcol:USER <integer>

Sets the transmitter POS IP Protocol Header Field User value in the range 0 to 255.

The corresponding query returns the user protocol header field as an integer.

SOURce subsystem -Transmitter POS Commands

:SOURce:DATA:TELEcom:IPOS:HEADer:PROToCol:USER?

Returns : <integer>

:SOURce:DATA:TELEcom:IPOS:HEADer:TOSerVice <string>

Selects the transmitters POS IP Type of Service Header Field in the range “00000000” to “11111111”.

The corresponding query returns the transmitters POS IP Type of Service header Field as a string.

:SOURce:DATA:TELEcom:IPOS:HEADer:TOSerVice?

Returns : <string>

:SOURce:DATA:TELEcom:IPOS:HEADer:FLAG <string>

Selects the transmitters POS IP Flags Header Field in the range “000” to “111”.

The corresponding query returns the transmitters POS IP Flags Header Field as a string.

:SOURce:DATA:TELEcom:IPOS:HEADer:FLAG?

Returns : <string>

:SOURce:DATA:TELEcom:IPOS:HEADer:TTLive <integer>

Sets the transmitter POS IP Time to Live Header Field in the range 0 to 255.

The corresponding query returns the time to live header field as an integer.

:SOURce:DATA:TELEcom:IPOS:HEADer:TTLive?

Returns : <integer>

:SOURce:DATA:TELEcom:IPOS:PAYLoad:PATtern <discrete>

<discrete> =	PRBS23	$2^{23}-1$
	AA55	0xAA55 pattern
	AZERo	All Zero's
	AONE	All One's

SOURce subsystem -Transmitter POS Commands

UWORD 16 Bit User Word

Selects the transmitters POS payload data pattern. If UWORD is selected, the word pattern is set using :SOURce:DATA:TELEcom:IPOS:PAYLoad:UWORD[:BIN16] <string>.

The corresponding query returns the transmitters POS payload data pattern in discrete form as listed above.

:SOURce:DATA:TELEcom:IPOS:PAYLoad:PATtern?

Returns : <discrete>

:SOURce:DATA:TELEcom:IPOS:PAYLoad:UWORD[:BIN16] <string>

Sets the transmitters user word pattern in the range "0000000000000000" to "1111111111111111". Optional node BIN16.

The corresponding query returns the user word pattern as a quoted string.

:SOURce:DATA:TELEcom:IPOS:PAYLoad:UWORD[:BIN16]?

Returns : <string>

:SOURce:DATA:TELEcom:IPOS:PAYLoad:UWORD:BIN32 <string>

Sets the transmitters user word pattern in the range "00000000000000000000000000000000" to "11111111111111111111111111111111".

The corresponding query returns the user word pattern as a quoted string.

:SOURce:DATA:TELEcom:IPOS:PAYLoad:UWORD:BIN32?

Returns : <string>

:SOURce:DATA:TELEcom:IPOS:PAYLoad:UWORD:HEX16 <string>

Sets the transmitters user word pattern in the range "0000" to "FFFF".

The corresponding query returns the user word pattern as a quoted string.

:SOURce:DATA:TELEcom:IPOS:PAYLoad:UWORD:HEX16?

Returns : <string>

SOURce subsystem -Transmitter POS Commands

:SOURce:DATA:TELEcom:IPOS:ERRor:RATE <discrete>

<discrete> =	NONE	No errors
	ONCE	Single error
	E_3	1E-3 Error rate
	E_4	1E-4 Error rate
	E_5	1E-5 Error rate
	E_6	1E-6 Error rate
	E_7	1E-7 Error rate
	E_8	1E-8 Error rate
	E_9	1E-9 Error rate

Sets the POS error add rate.

The corresponding query returns the POS error rate in discrete form as listed above.

:SOURce:DATA:TELEcom:IPOS:ERRor:RATE?

Returns: <discrete>

:SOURce:DATA:TELEcom:IPOS:ALARm <discrete>

<discrete> =	OFF	No Alarms
	LNKLoss	HDLC Link Loss

Sets the POS TX Test Function alarm type

The corresponding query returns the POS TX Test Function alarm type in discrete form as listed above.

:SOURce:DATA:TELEcom:IPOS:ALARm?

Returns: <discrete>

SENSe subsystem - Receiver POS Settings

SENSe subsystem - Receiver POS Settings

:SENSe:DATA:TELEcom:IPOS:HDLC:FRAMing <discrete>

<discrete>	PPP	PPP in HDLC framing as per RFC 1662
	CISCO	CISCO HDLC - Cisco's proprietary frame structure

Selects the POS HDLC Framing type.

The corresponding query returns the HDLC Framing type in discrete form as listed above.

:SENSe:DATA:TELEcom:IPOS:HDLC:FRAMing?

Returns : <discrete>

:SENSe:DATA:TELEcom:IPOS:HDLC:DESCrambling <discrete>

<discrete>	OFF	Disables the scrambler
	ON	Descrambling on

Selects the POS HDLC Descrambling setting.

The corresponding query returns the HDLC Descrambling setting in discrete form as listed above.

:SENSe:DATA:TELEcom:IPOS:HDLC:DESCrambling?

Returns : <discrete>

:SENSe:DATA:TELEcom:IPOS:HDLC:FCS <discrete>

<discrete>	CRC32	32-bit CRC check
	CRC16	16-bit CRC check

Selects the POS HDLC Field Check Sequence type.

SENSe subsystem - Receiver POS Settings

The corresponding query returns the HDLC Field Check Sequence type in discrete form as listed above.

:SENSe:DATA:TELEcom:IPOS:HDLC:FCS?

Returns : <discrete>

:SENSe:DATA:TELEcom:IPOS:PAYLoad:PATtern <discrete>

<discrete> =	PRBS23	$2^{23}-1$
	AA55	0xAA55 pattern
	AZERo	All Zero's
	AONE	All One's
	UWORD	16 Bit User Word
	LIVE	Live Traffic

Selects the receiver POS payload data pattern. If UWORD is selected, the word pattern is set using :SENSe:DATA:TELEcom:POS:PAYLoad:UWORD<string>.

The corresponding query returns the receiver POS payload data pattern in discrete form as listed above.

:SENSe:DATA:TELEcom:IPOS:PAYLoad:PATtern?

Returns : <discrete>

:SENSe:DATA:TELEcom:IPOS:PAYLoad:UWORD[:BIN16] <string>

Sets the receivers user word pattern in the range "0000000000000000" to "1111111111111111". Optional node BIN16.

The corresponding query returns the user word pattern as a quoted string.

:SENSe:DATA:TELEcom:IPOS:PAYLoad:UWORD[:BIN16]?

Returns : <string>

SENSe subsystem - Receiver POS Settings

:SENSe:DATA:TELEcom:IPOS:PAYLoad:UWORD:BIN32 <string>

Sets the receivers user word pattern in the range "00000000000000000000000000000000" to "11111111111111111111111111111111".

The corresponding query returns the user word pattern as a quoted string.

:SENSe:DATA:TELEcom:IPOS:PAYLoad:UWORD:BIN32?

Returns : <string>

:SENSe:DATA:TELEcom:IPOS:PAYLoad:UWORD:HEX16 <string>

Sets the receivers user word pattern in the range "0000" to "FFFF".

The corresponding query returns the user word pattern as a quoted string.

:SENSe:DATA:TELEcom:IPOS:PAYLoad:UWORD:HEX16?

Returns : <string>

:SENSe:DATA:TELEcom:IPOS:PAYLoad:UWORD:HEX32 <string>

Sets the receivers user word pattern in the range "00000000" to "FFFFFFFF".

The corresponding query returns the user word pattern as a quoted string.

:SENSe:DATA:TELEcom:IPOS:PAYLoad:UWORD:HEX32?

Returns : <string>

:SENSe:DATA:TELEcom:IPOS:PRBS:POLarity <discrete>

<discrete> = NORMAL
 INVERTed

Selects the PRBS pattern polarity.

The corresponding query returns the PRBS pattern polarity in discrete form as listed above.

:SENSe:DATA:TELEcom:IPOS:PRBS:POLarity?

Returns : <discrete>

SENSe subsystem - Result Returning Commands

PoS Short Term Results

:SENSe:DATA? <"result">

Result =	ECOUNT:IPOS:STERM:HDLCFRAME	HDLC frame count
	ERATIO:IPOS:STERM:HDLCFRAME	HDLC frame rate
	ECOUNT:IPOS:STERM:FCS	HDLC FCS error count
	ERATIO:IPOS:STERM:FCS	HDLC FCS error ratio
	ECOUNT:IPOS:STERM:IPDATAGRAM	IP Datagram count
	ERATIO:IPOS:STERM:IPDATAGRAM	IP Datagram rate
	ECOUNT:IPOS:STERM:IPHEADER	IP Header error count
	ERATIO:IPOS:STERM:IPHEADER	IP Header error ratio
	ECOUNT:IPOS:STERM:BIT	BIT error count
	ERATIO:IPOS:STERM:BIT	BIT error ratio

PoS Cumulative Results

:SENSe:DATA? <"result">

Result =	ECOUNT:IPOS:HDLCFRAME	HDLC frame count
	ERATIO:IPOS:HDLCFRAME	HDLC frame rate
	ECOUNT:IPOS:FCS	HDLC FCS error count
	ERATIO:IPOS:FCS	HDLC FCS error ratio
	ECOUNT:IPOS:IPDATAGRAM	IP Datagram count
	ERATIO:IPOS:IPDATAGRAM	IP Datagram rate
	ECOUNT:IPOS:IPHEADER	IP Header error count
	ERATIO:IPOS:IPHEADER	IP Header error ratio

POS Command Reference

SENSe subsystem - Result Returning Commands

ECOUNT:IPOS:BIT	BIT error count
ERATIO:IPOS:BIT	BIT error ratio

PoS Alarm Seconds Results

:SENSe:DATA? <"result">

Result =	"ASECONDS:IPOS:LNKLoss"	HDLC Link Loss
	"ASECONDS:IPOS:IPNReceived"	IP Not Received
	"ASECONDS:IPOS:PSLoss"	Pattern Loss

PoS Service Disruption Results

:SENSe:DATA? <"result">

Result =	"SDTEST:IPOS:COUNT:LONG"	Longest Burst size in milliseconds
	"SDTEST:IPOS:COUNT:SHORT"	Shortest Burst size in millisecond
	"SDTEST:IPOS:COUNT:LAST"	Last Burst size in milliseconds

Status Reporting

Status Reporting

Status Reporting

The status reporting capability of the OmniBER 718 is provided by the Status Registers and the Status Byte. The STATUS subsystem and some IEEE common capability commands control the status registers and the status byte.

Table 10-1 **Status Registers**

The following status registers are provided in the OmniBER 718 and conform to IEEE 488.2:

Status Register	Description
Standard Event	This register is accessed by issuing the *ESR? common capability command.
QUESTionable	Defined by SCPI.
OPERation	Defined by SCPI.
INSTrument	Monitors general instrument conditions and summarizes the DISK status register.
DATA	Summarizes the PDH, FAS, SPDH, SDH, SDH2, SDH3, SONet, SONet2, SONet3 and JIT status registers.
ISUMmary	Summarizes alarm indications from SDH/SONET, SPDH, ATM and POS status registers.
FAS	Monitors the condition of the Unstructured PDH FAS signal (UPDH option)
SPDH	Summarizes the M140, M34, M8, M2, DS3, DS2 and DS1 status registers. (SPDH option).
M140	Monitors the condition of the Structured PDH 140 Mb/s signal. (SPDH option).
M34	Monitors the condition of the Structured PDH 34 Mb/s signal. (SPDH option).

Status Reporting

Status Register	Description
M8	Monitors the condition of the Structured PDH 8 Mb/s signal. (SPDH option).
M2	Monitors the condition of the Structured PDH 2 Mb/s signal. (SPDH option).
DS1	Monitors the condition of the Structured PDH DS1 signal. (SPDH option).
DS2	Monitors the condition of the Structured PDH DS2 signal. (SPDH option).
DS3	Monitors the condition of the Structured PDH DS3 signal. (SPDH option).
SDH/SONet	Monitors the primary conditions of the SDH/SONET signal. (SDH/SONET option).
SDH2/SONet2	Monitors miscellaneous SDH/SONET conditions. (SDH/SONET option).
SDH3/SONet3	Monitors miscellaneous SDH/SONET conditions. (SDH/SONET option).
ATM	Monitors the condition of the ATM Cell Layer
IPOS	Monitors the condition of the POS Link and IP Layers
JITTer	Monitors the condition of the Jitter/Wander signal. (Jitter/Wander option).
DISK	Monitors the disk activity.

Status Reporting

General Status Register

The status registers conform to IEEE 488.2 and each comprises 4 registers as shown in Figure 10-1. For the commands which access and control these registers, see “STATus subsystem” on page 3-43

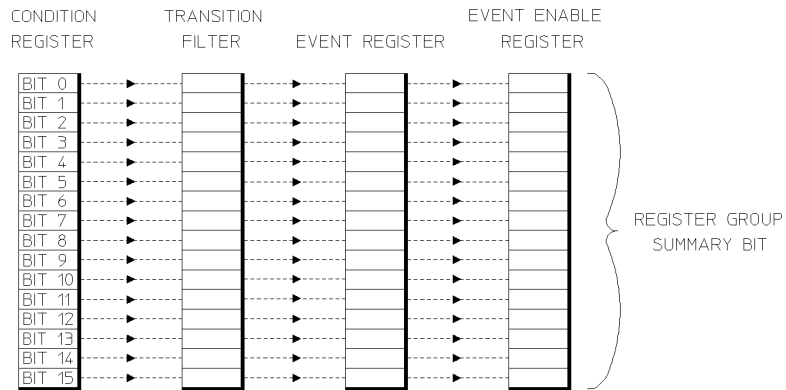

Figure 8-1

General Status Register

Condition

Register

Monitors the defined status conditions. There is no latching of conditions in this register, it is updated in real time.

Transition Filter

Determines whether positive or negative transitions (true or false) in the Condition register sets the Event register.

Event Register

Latches the transient states that occur in the Condition register as specified by the Transition Filter.

Event Enable

Register

Acts like a mask on the Event register. It determines which bits in the Event register set the summary bit in the Status Byte.

Status Reporting

Status Byte

*STB? or a serial poll - Returns the value of the Status Byte in numeric form.

*SRE <numeric> - Sets the Status Byte mask.

*SRE? - Returns the current mask setting in numeric form.

DB7	DB6	DB5	DB4	DB3	DB2	DB1	DB0
OPER	RQS	ESR	MAV	QUES	-	-	-

DB0 - DB2 Not used, always read as 0.

DB3 QUES - QUEStionable status register summary. Indicates that a bit has been set in the QUEStionable status register.

DB4 MAV - Message Available. Remains set until all output messages are read from the OmniBER 71819.

DB5 ESR - Event status register summary. Indicates that a bit has been set in the Event status register.

DB6 RQS - Request Service. Set when an SRQ is generated for whatever reason. Cleared by SPOLL or *STB?.

DB7 OPER - OPERation status register summary. Indicates that a bit has been set in the OPERation status register.

Status Reporting

Standard Event Status Register

*ESR? - Returns the Standard Event Status Register value in numeric form.

*ESE <numeric> - Sets the event enable register mask.

*ESE? - Returns the current mask setting.

DB7	DB6	DB5	DB4	DB3	DB2	DB1	DB0
PWR	URQ	CME	EXE	DDE	QUE	RQC	OPC

DB0 OPC - Operation Complete.

DB1 RQC - Request Control.

DB2 QUE - Query Error.

DB3 DDE - Device Dependent Error.

DB4 EXE - Execution Error.

DB5 CME - Command Error.

DB6 URQ - User Request.

DB7 PWR - Power On.

Status Reporting

QUEStionable Status Register

Provides a summary of the DATA status register.

For related commands, see “STATus subsystem” on page 3-43

Example: STATus:QUEStionable:EVENT?

DB15	DB14	DB13	DB12	DB11	DB10	DB9	DB8
-	CMW	-	-	-	-	DATA	-

DB7	DB6	DB5	DB4	DB3	DB2	DB1	DB0
-	-	-	-	-	-	-	-

DB0 - DB8 Not used, always read as 0.

DB9 DATA - DATA status register summary.

DB10 - DB13 Not used, always read as 0.

DB14 CMW - Command Warning

DB15 Not used, always reads as 0.

Status Reporting

OPERation Status Register

Provides a summary of the INSTRument status register, and reports when a measurement is being made.

For related commands, see “STATus subsystem” on page 3-43

Example: STATus:OPERation:EVENT?

DB15	DB14	DB13	DB12	DB11	DB10	DB9	DB8
-	-	INST	-	-	-	-	-

DB7	DB6	DB5	DB4	DB3	DB2	DB1	DB0
-	-	-	MEAS	-	-	-	-

DB0 - DB3 Not used, always reads as 0.

DB4 MEAS - Measuring. Currently making a measurement.

DB5 - DB12 Not used, always read as 0.

DB13 INST - INSTRument status register summary.

DB14 - DB15 Not used, always read as 0.

Status Reporting

INSTRUMENT Status Register

Reports the instrument status.

For related commands, see “STATUS subsystem” on page 3-43

Example: STATUS:INSTRUMENT:EVENT?

DB15	DB14	DB13	DB12	DB11	DB10	DB9	DB8
-	-	-	-	-	-	-	-

DB7	DB6	DB5	DB4	DB3	DB2	DB1	DB0
DISK	STP	STC	-	-	EOT	LQE	SMG

DB0 SMG - Graphics Results enabled.

DB1 LQE - Logging Queue Empty.

DB2 EOT - End Of Test period.

DB3 Not used, always read as 0.

DB4 Not used, always read as 0.

DB5 STC - Self Test complete.

DB6 STP - Short Term Period complete.

DB7 DISK - Disk status register summary.

DB8 - DB15 Not used, always read as 0.

Status Reporting

DATA Status Register

Summarizes the alarm status registers shown. In addition provides a Power Failed alarm indication.

For related commands, see “STATus subsystem” on page 3-43

Example: STATus:DATA:EVENT?

DB15	DB14	DB13	DB12	DB11	DB10	DB9	DB8
-	ISUM	-	-	IPOS	SDH3	-	-

DB7	DB6	DB5	DB4	DB3	DB2	DB1	DB0
-	ATM	SPDH	JITT	SDH2	SDH	FAS	-

DB0	Reserved for future use, always read as 0.
DB1	FAS - FAS status register summary.
DB2	SDH - SDH status register summary.
DB3	SDH2 - SDH2 status register summary.
DB4	JITT - JITTter status register summary.
DB5	SPDH - SPDH status register summary.
DB6	ATM - ATM status register summary.
DB7 - DB9	Reserved for future use, always read as 0.
DB10	SDH3 - SDH3 status register summary
DB11	POS - POS status register summary.
DB12 - DB13	Not used, always read as 0.
DB14	ISUM - ISUM status register summary.
DB15	Not used, always read as 0.

Status Reporting

ISUMmary Status Register

Provides alarm indications summarised from SDH/SONET, SPDH, ATM and POS status registers and should be used in preference to the SDH/SONET, SPDH, ATM and POS status registers.

This register provides a summary of the SDH/SONET, SPDH, ATM and POS status registers for each of the conditions shown below. Use this register to determine the status of the instrument independent of its configuration.

NOTE: It is recommended that for pattern loss in particular this register is used in preference to the SDH/SONET, SPDH, ATM and POS registers as this removes the dependence on Receiver payload selection.

DB15	DB14	DB13	DB12	DB11	DB10	DB9	DB8
-	ERR	PSL	-	-	-		IPOS

DB7	DB6	DB5	DB4	DB3	DB2	DB1	DB0
ATM	-	LOP	FAR	AIS	LOF	LOS	PLO

DB0	PLO - Power Loss.
DB1	LOS - Loss of Signal.
DB2	LOF - Loss of frame.
DB3	AIS - Alarm indication signal.
DB4	FAR - Far end alarms.
DB5	LOP - Loss of Pointer.
DB6	Not used
DB7	ATM - LCD, SCNR, CEXP, VPLOC, VCLOC
DB8	POS - LNKL, IPNR
DB9	Not used
DB10	Not used
DB11	Not used
DB12	Not used
DB13	PSL - Pattern sync loss.
DB14	ERR - Errors detected.

Status Reporting

DB15

Not used

ISUMmary Status Register Sources

Refer to the following Table for an indication of the source of common alarm conditions

ISUM		SDH	SPDH	ATM	POS	JITTER
Data Bit	Name	Reg - Data Bit - Name	Reg - Data Bit - Name	Reg - Data Bit - Name	Reg - Data Bit - Name	Reg - Data Bit - Name
0	PLO					
1	LOS	SDH - 0 - LOS	M140/M34/M8/M2 - 0 - LOS DS3/DS1 - 0 - LOS			
2	LOF	SDH - 1 - LOF SDH - 2 - OOF	M140/M34/M8/M2 - 1 - LOF M2 - 3 - CAS DS3/DS2/DS1 - 2 - OOF	ATM - 12 - PLCP OOF		
3	AIS	SDH - 4 - MSAIS SDH - 5 - AUAIS SDH -12 - TUAIS	M140/M34/M8/M2 - 5 - AIS DS3/DS1 - 5 - AIS	ATM - 2 - VP-AIS ATM - 6 - VC-AIS		
4	FAR	SDH - 9 - MSRDI SDH - 10 - HPRDI SDH - 13 - LPRDI	M140/M34/M8/M2 - 10 - RAI DS3/DS1 - 10 - RAI	ATM - 3 - VP-RDI ATM - 7 - VC-RDI ATM - 9 - PLCP RAI		
5	LOP	SDH - 3 - LOP SDH - 8 - H4 SDH -11 - TULOP				
6	JITT					JITT - 0 - JSL JITT - 2 - WSL JITT - 5 - JOVR
7	ATM			ATM - 0 - LCD ATM - 1 - SCNR ATM - 4 - VP-LOC ATM - 5 - CEXP ATM - 8 - VC-LOC		
8	IPOS				IPOS - 0 - LNKL IPOS - 1 - IPNR	
9-12						
13	PSL	SDH - 6 - PSL	SPDH - 13 - PSL	ATM - 9 - TCL	IPOS - 2 - PSL	
14	ERR	SDH - 14 - ERR	SPDH - 14 - ERR	AT - 11 - ERR	IPOS - 3 - ERR	
15						

Status Reporting

SDH Status Register

Provides primary alarm indications related to the SDH signal.

For related commands, see “STATus subsystem” on page 3-43

Example: STATus:SDH:EVENT?

DB15	DB14	DB13	DB12	DB11	DB10	DB9	DB8
-	ERR	LPRDI	TUAIS	TULOP	HPRDI	MSRDI	H4

DB7	DB6	DB5	DB4	DB3	DB2	DB1	DB0
CSL	PSL	AUAIS	MSAIS	LOP	OOF	LOF	LOS

DB0	LOS - Loss Of Signal.
DB1	LOF - Loss Of Frame.
DB2	OOF - Out Of Frame.
DB3	LOP - Loss Of Pointer.
DB4	MSAIS - Multiplexer Section AIS.
DB5	AUAIS - AU AIS. (Formerly Path AIS).
DB6	PSL - Pattern Synchronization Loss (see Note on page 10-12).
DB7	CSL - Clock Synchronization Loss.
DB8	H4 - H4 LOM.
DB9	MSRDI - Multiplexer Section RDI. (Formerly MS FERF).
DB10	HPRDI - High Order Path RDI. (Formerly Path FERF).
DB11	TULOP - Tributary Loss Of Pointer.
DB12	TUAIS - Tributary Path AIS.
DB13	LPRDI - Low Order Path FERF. (Formerly TU FERF).
DB14	ERR - Errors Alarm.
DB15	Not used, always read as 0.

Status Reporting

SDH2 Status Register

Provides miscellaneous SDH monitoring.

For related commands, see “STATus subsystem” on page 3-43

Example:

STATus:SDH2:EVENT?

DB15	DB14	DB13	DB12	DB11	DB10	DB9	DB8
-	BDL	BCL	PSA	RAS	TAS	PSI	FMU

DB7	DB6	DB5	DB4	DB3	DB2	DB1	DB0
ALSC	K1K2	TMNDF	TNDF	TPADJ	MNDF	NDF	PADJ

DB0	PADJ - AU Pointer Adjust.
DB1	NDF - AU Pointer New Data Flag.
DB2	MNDF - AU Pointer Missing New Data Flag.
DB3	TPADJ - TU Pointer Adjust.
DB4	TNDF - TU Pointer New Data Flag.
DB5	TMNDF - TU Pointer Missing New Data Flag.
DB6	K1K2 - K1K2 change.
DB7	ALSC - SDH Alarm/Trib scan in progress.
DB8	FMU - Frequency Measurement Updated. (16s gate).
DB9	PSI - TX pointer sequence initialization.
DB10	TAS - TX Async 2 Mb/s Settling.
DB11	RAS - RX Async 2 Mb/s Settling.
DB12	PSA - TX pointer sequence active.
DB13	BCL - SDH Binary Clock Loss.
DB14	BDL - SDH Binary Data Loss.
DB15	Not used, always read as 0.

Status Reporting

SDH3 Status Register

Provides miscellaneous SDH monitoring.

For related commands, see “STATus subsystem” on page 3-43

Example:

STATus:SDH3:EVENT?

DB15	DB14	DB13	DB12	DB11	DB10	DB9	DB8
-	-	-	-	-	-	-	FMU_1S

DB7	DB6	DB5	DB4	DB3	DB2	DB1	DB0
-	-	-	ODI	TC_RDI	TC_IAIS	TC_LOM	P1P0

DB0	P1P0 LOM
DB1	TCM Loss Of Multiframe
DB2	TCM Incoming AIS
DB3	TCM Remote Defect Indication
DB4	TCM Outgoing Defect Indication
DB5 - DB7	Not used, always read as 0.
DB8	FMU_1S - Frequency Measurement Updated. (1s gate). Cleared when the corresponding frequency result is read.
DB9 - DB15	Not used, always read as 0.

Status Reporting

SONet Status Register

Provides primary alarm indications related to the SONET signal.

For related commands, see “STATus subsystem” on page 3-43

Example: STATus:SONet:EVENT?

DB15	DB14	DB13	DB12	DB11	DB10	DB9	DB8
-	ERR	RDIV	AISV	LOPV	RDIP	RDIL	H4

DB7	DB6	DB5	DB4	DB3	DB2	DB1	DB0
CSL	PSL	AISP	AISL	LOPP	SEF	LOF	LOS

DB0	LOS - Loss Of Signal.
DB1	LOF - Loss Of Frame.
DB2	SEF - Severely Errored Frame Defect.
DB3	LOPP - Loss Of Pointer (LOP-P).
DB4	AISL - Line AIS (AIS-L).
DB5	AISP - Path AIS (AIS-P).
DB6	PSL - Pattern Synchronization Loss.
DB7	CSL - Clock Synchronization Loss.
DB8	H4 - H4 LOM.
DB9	RDIL - Line FERF (RDI-L).
DB10	RDIP - Path FERF (RDI-P).
DB11	LOPV - VT Loss Of Pointer (LOP-V).
DB12	AISV - VT Path AIS (AIS-V).
DB13	RDIV - VT Path FERF. (RDI-V).
DB14	ERR - Errors Alarm.
DB15	Not used, always read as 0.

Status Reporting

SONet2 Status Register

Provides miscellaneous SONET monitoring.

For related commands, see “STATus subsystem” on page 3-43

Example: STATus:SONet2:EVENT?

DB15	DB14	DB13	DB12	DB11	DB10	DB9	DB8
-	BDL	BCL	PSA	RAS	TAS	PSI	FMU

DB7	DB6	DB5	DB4	DB3	DB2	DB1	DB0
ALSC	K1K2	TMNDF	TNDF	TPADJ	MNDF	NDF	PADJ

DB0	PADJ - SPE Pointer Adjust.
DB1	NDF - SPE Pointer New Data Flag.
DB2	MNDF - SPE Pointer Missing New Data Flag.
DB3	TPADJ - VT Pointer Adjust.
DB4	TNDF - VT Pointer New Data Flag.
DB5	TMNDF - VT Pointer Missing New Data Flag.
DB6	K1K2 - K1K2 change.
DB7	ALSC - SONET Alarm/Trib scan in progress.
DB8	FMU - Frequency Measurement Updated. (16s gate).
DB9	PSI - TX pointer sequence initialization.
DB10	TAS - TX Async 2 Mb/s Settling.
DB11	RAS - RX Async 2 Mb/s Settling.
DB12	PSA - TX pointer sequence active.
DB13	BCL - SONET Binary Clock Loss.
DB14	BDL - SONET Binary Data Loss.
DB15	Not used, always read as 0.

Status Reporting

SONet3 Status Register

Provides miscellaneous SONET monitoring.

For related commands, see “STATus subsystem” on page 3-43

Example: STATus:SONet3:EVENT?

DB15	DB14	DB13	DB12	DB11	DB10	DB9	DB8
-	-	-	-	-	-	-	FMU_1S

DB7	DB6	DB5	DB4	DB3	DB2	DB1	DB0
-	-	-	-	-	-	-	P1P0

- DB0** P1P0 LOM
- DB1 - DB7** Not used, always read as 0.
- DB8** FMU_1S - Frequency Measurement Updated. (1s gate).
- DB9 - DB15** Not used, always read as 0.

Status Reporting

ATM Status Register

Provides alarm indications related to the ATM Cell Layer.

For related commands, see “STATus subsystem” on page 3-43.

Example:STATus:ATM:EVENT? - Returns the ATM Status Register value in numeric form..

DB15	DB14	DB13	DB12	DB11	DB10	DB9	DB8
-	-	PLCP RAI	PLCP OOF	ERR	PSL	TCL	VC- LOC
DB7	DB6	DB5	DB4	DB3	DB2	DB1	DB0
VC- RDI	VC- AIS	CEXP	VP- LOC	VP- RDI	VP- AIS	SCNR	LCD

DB0	LCD - Loss of Cell Deliniation
DB1	SCNR - Selected Cell not Received.
DB2	VP-AIS - Virtual Path AIS.
DB3	VP-RDI - Virtual Path RDI.
DB4	VP-LOC - Virtual Path LOC.
DB5	CEXP - Congestion Experienced.
DB6	VC-AIS - Virtual Channel AIS.
DB7	VC-RDI - Virtual Channel RDI.
DB8	VC-LOC - Virtual Channel LOC.
DB9	TCL - Test Cell Loss.
DB10	PSL - Pattern Synchronization Loss.
DB11	ERR - Errors Present.
DB12	PLCP OOF - Physical Layer Convergence Protocol Out of Frame.
DB13	PLCP RAI - Physical Layer Convergence Protocol Remote Alarm Indicator.
DB14	Not used, always read as 0.
DB15	Not Used, always read as 0.

Status Reporting

IPOS Status Register

Provides alarm indications related to the POS Link and IP Layers.

For related commands, see “STATus subsystem” on page 3-43.

Example: STATus:IPOS:EVENT? - Returns the IPOS Status Register value in numeric form.

DB15	DB14	DB13	DB12	DB11	DB10	DB9	DB8
-	-	-	-	-	-	-	-
DB7	DB6	DB5	DB4	DB3	DB2	DB1	DB0
-	-	-	-	ERR	PSL	IPNR	LNKL

DB0	LNKL - Link Loss
DB1	IPNR - IP Not Received.
DB2	PSL - Pattern Synchronization Loss.
DB3	ERR - Errors Present
DB4	Not used, always read as 0.
DB5	Not used, always read as 0.
DB6	Not used, always read as 0.
DB7	Not used, always read as 0.
DB8	Not used, always read as 0.
DB9	Not used, always read as 0.
DB10	Not used, always read as 0.
DB11	Not used, always read as 0.
DB12	Not used, always read as 0.
DB13	Not used, always read as 0.
DB14	Not used, always read as 0.
DB15	Not Used, always read as 0.

Status Reporting

JITTer Status Register

Provides alarm indications related to the Jitter measurement.

For related commands, see “STATus subsystem” on page 3-43

Example: STATus:JITTer:EVENT?

DB15	DB14	DB13	DB12	DB11	DB10	DB9	DB8
-	JTF	-			JAT	JSWP	TSET

DB7	DB6	DB5	DB4	DB3	DB2	DB1	DB0
ORCL	XCL	JOVR			WSL	JHT	JSL

DB0	JSL - Jitter Unlock.
DB1	JHT - Jitter Hits.
DB2	WSL - Wander Unlock.
DB3	Not Used, always 0.
DB4	Not Used, always 0.
DB5	JOVR - Jitter out of range.
DB6	XCL - Loss of External Timing Reference.
DB7	ORCL - External Timing Reference Out of Range.
DB8	TSET - Jitter transmitter settling.
DB9	JSWP - Jitter sweep in progress.
DB10	JAT - Jitter Autotolerance in progress.
DB11	Not Used, always 0
DB12	Not Used, always 0
DB13	Not Used, always 0.
DB14	JTF - Jitter Transfer in progress.
DB15	Not Used, always 0.

Status Reporting

SPDH Status Register

Provides alarm indications related to the Structured PDH signal.

For related commands, see “STATus subsystem” on page 3-43

Example: STATus:SPDH:EVENT?

DB15	DB14	DB13	DB12	DB11	DB10	DB9	DB8
-	ERR	PSL	ILOS	IPES	DPES	FMU	LOC

DB7	DB6	DB5	DB4	DB3	DB2	DB1	DB0
DS2	ALSC	DS1	DS3	M2	M8	M34	M140

DB0	M140 - M140 status register summary.
DB1	M34 - M34 status register summary.
DB2	M8 - M8 status register summary.
DB3	M2 - M2 status register summary.
DB4	DS3 - DS3 status register summary.
DB5	DS1 - DS1 status register summary.
DB6	ALSC - PDH Alarm Scan in progress.
DB7	DS2 - DS2 status register summary.
DB8	LOC - VCXO Lock Loss. Cleared when the VCXO has locked
DB9	FMU - Frequency Measurement in progress. Cleared when the frequency measurement result has updated.
DB10	DPES - 2 Mb/s Drop Port Elastic Store settled.
DB11	IPES - 2 Mb/s Insert Port Elastic Store settled.
DB12	ILOS - 2 Mb/s Insert Port Loss of Signal.
DB13	PSL - Pattern Synchronization loss.
DB14	ERR - Errors present.
DB15	Not used, always read as 0.

Status Reporting

M140 Status Register

Provides alarm indications related to the Structured PDH 140 Mb/s signal.

For related commands, see “STATus subsystem” on page 3-43

Example: STATus:M140:EVENT?

DB15	DB14	DB13	DB12	DB11	DB10	DB9	DB8
-	-	DEFO	IEFO	MIN	RAI	-	-

DB7	DB6	DB5	DB4	DB3	DB2	DB1	DB0
-	-	AIS	-	-	-	LOF	LOS

DB0 LOS - Loss Of Signal.

DB1 LOF - Loss Of Frame.

DB2 -DB4 Not used, always read as 0.

DB5 AIS - Alarm Indication Sequence.

DB6 - DB9 Not used, always read as 0.

DB10 RAI - Remote Alarm.

DB11 MIN - Minor Alarm.

DB12 IEFO - Insert port Excess Frequency Offset.

DB13 DEFO - Drop port Excess Frequency Offset.

DB14 - DB15 Not used, always read as 0.

Status Reporting

M34 Status Register

Provides alarm indications related to the Structured PDH 34 Mb/s signal.

For related commands, see “STATus subsystem” on page 3-43

Example: STATus:M34:EVENT?

DB15	DB14	DB13	DB12	DB11	DB10	DB9	DB8
-	-	DEFO	IEFO	MIN	RAI	-	-

DB7	DB6	DB5	DB4	DB3	DB2	DB1	DB0
-	-	AIS	-	-	-	LOF	LOS

- DB0** LOS - Loss Of Signal.
- DB1** LOF - Loss Of Frame.
- DB2 -DB4** Not used, always read as 0.
- DB5** AIS - Alarm Indication Sequence.
- DB6 - DB9** Not used, always read as 0.
- DB10** RAI - Remote Alarm.
- DB11** MIN - Minor Alarm.
- DB12** IEFO - Insert port Excess Frequency Offset.
- DB13** DEFO - Drop port Excess Frequency Offset.
- DB14 - DB15** Not used, always read as 0.

Status Reporting

M8 Status Register

Provides alarm indications related to the Structured PDH 8 Mb/s signal.

For related commands, see “STATus subsystem” on page 3-43

Example: STATus:M8:EVENT?

DB15	DB14	DB13	DB12	DB11	DB10	DB9	DB8
-	-	-	-	MIN	RAI	-	-

DB7	DB6	DB5	DB4	DB3	DB2	DB1	DB0
-	-	AIS	-	-	-	LOF	LOS

DB0 LOS - Loss Of Signal.

DB1 LOF - Loss Of Frame.

DB2 -DB4 Not used, always read as 0.

DB5 AIS - Alarm Indication Sequence.

DB6 - DB9 Not used, always read as 0.

DB10 RAI - Remote Alarm.

DB11 MIN - Minor Alarm.

DB12 - DB15 Not used, always read as 0.

Status Reporting

M2 Status Register

Provides alarm indications related to the Structured PDH 2 Mb/s signal.

For related commands, see “STATus subsystem” on page 3-43

Example: STATus:M2:EVENT?

DB15	DB14	DB13	DB12	DB11	DB10	DB9	DB8
-	-	-	-	MIN	RAI	-	-

DB7	DB6	DB5	DB4	DB3	DB2	DB1	DB0
-	-	AIS	CRC	CAS	RMFR	LOF	LOS

- DB0** LOS - Loss Of Signal.
- DB1** LOF - Loss Of Frame.
- DB2** RMFR - Remote Multiframe Alarm.
- DB3** CAS - CAS Multiframe Loss.
- DB4** CRC - CRC4 Multiframe Loss.
- DB5** AIS - Alarm Indication Sequence.
- DB6 - DB9** Not used, always read as 0.
- DB10** RAI - Remote Alarm.
- DB11** MIN - Minor Alarm.
- DB12 - DB15** Not used, always read as 0.

Status Reporting

DS3 Status Register

Provides alarm indications related to the Structured PDH DS3 signal.

For related commands, see “STATus subsystem” on page 3-43

Example: STATus:DS3:EVENT?

DB15	DB14	DB13	DB12	DB11	DB10	DB9	DB8
-	FMM	IDLE	EXZ	-	RAI	DEFO	IEFO

DB7	DB6	DB5	DB4	DB3	DB2	DB1	DB0
-	-	AIS	MFM	-	OOF	-	LOS

DB0	LOS - Loss Of Signal.
DB1	Not used, always read as 0.
DB2	OOF - Out Of Frame.
DB3	Not used, always read as 0.
DB4	MFM - Multiframe Loss.
DB5	AIS - Alarm Indication Sequence.
DB6 - DB7	Not used, always read as 0.
DB8	IEFO - Insert port Excess Frequency Offset.
DB9	DEFO - Drop port Excess Frequency Offset.
DB10	RAI - Remote Alarm. (FERF)
DB11	Not used, always read as 0
DB12	EXZ - Excess Zeros
DB13	IDLE - Idle
DB14	FMM - Frame Mismatch
DB15	Not Used, always read as 0.

Status Reporting

DS2 Status Register

Provides alarm indications related to the Structured PDH DS2 signal.

For related commands, see “STATus subsystem” on page 3-43

Example: STATus:DS2:EVENT?

DB15	DB14	DB13	DB12	DB11	DB10	DB9	DB8
-	-	-	-	-	-	-	-

DB7	DB6	DB5	DB4	DB3	DB2	DB1	DB0
-	-	-	-	-	OOF	-	-

DB2 OOF - Out Of Frame.

Status Reporting

DS1 Status Register

Provides alarm indications related to the Structured PDH DS1 signal.

For related commands, see “STATus subsystem” on page 3-43

Example: STATus:DS1:EVENT?

DB15	DB14	DB13	DB12	DB11	DB10	DB9	DB8
LPDN	LPUP	IDLE	EXZ	-	RAI	-	-

DB7	DB6	DB5	DB4	DB3	DB2	DB1	DB0
-	-	AIS	-	-	OOF	-	LOS

DB0	LOS - Loss Of Signal.
DB1	Not used, always read as 0.
DB2	OOF - Out Of Frame
DB3 - DB4	Not used, always read as 0.
DB5	AIS - Alarm Indication Sequence.
DB6 - DB9	Not used, always read as 0.
DB10	RAI - Remote Alarm. (FERF).
DB11	Not used, always read as 0.
DB12	EXZ - Excess Zeros.
DB13	IDLE - Idle.
DB14	DS1 Inband Loop Up code detected.
DB15	DS1 Inband Loop Down code detected.

Status Reporting

DISK Status Register

Provides miscellaneous floppy disk monitoring.

For related commands, see “STATus subsystem” on page 3-43

Example: STATus:DISK:EVENT?

DB15	DB14	DB13	DB12	DB11	DB10	DB9	DB8
-	-	-	-	-	-	-	-

DB7	DB6	DB5	DB4	DB3	DB2	DB1	DB0
-	-	-	-	-	-	-	FMT

DB0 FMT - Formatting Disk.

DB1 - DB15 Not used, always read as 0.

Status Reporting

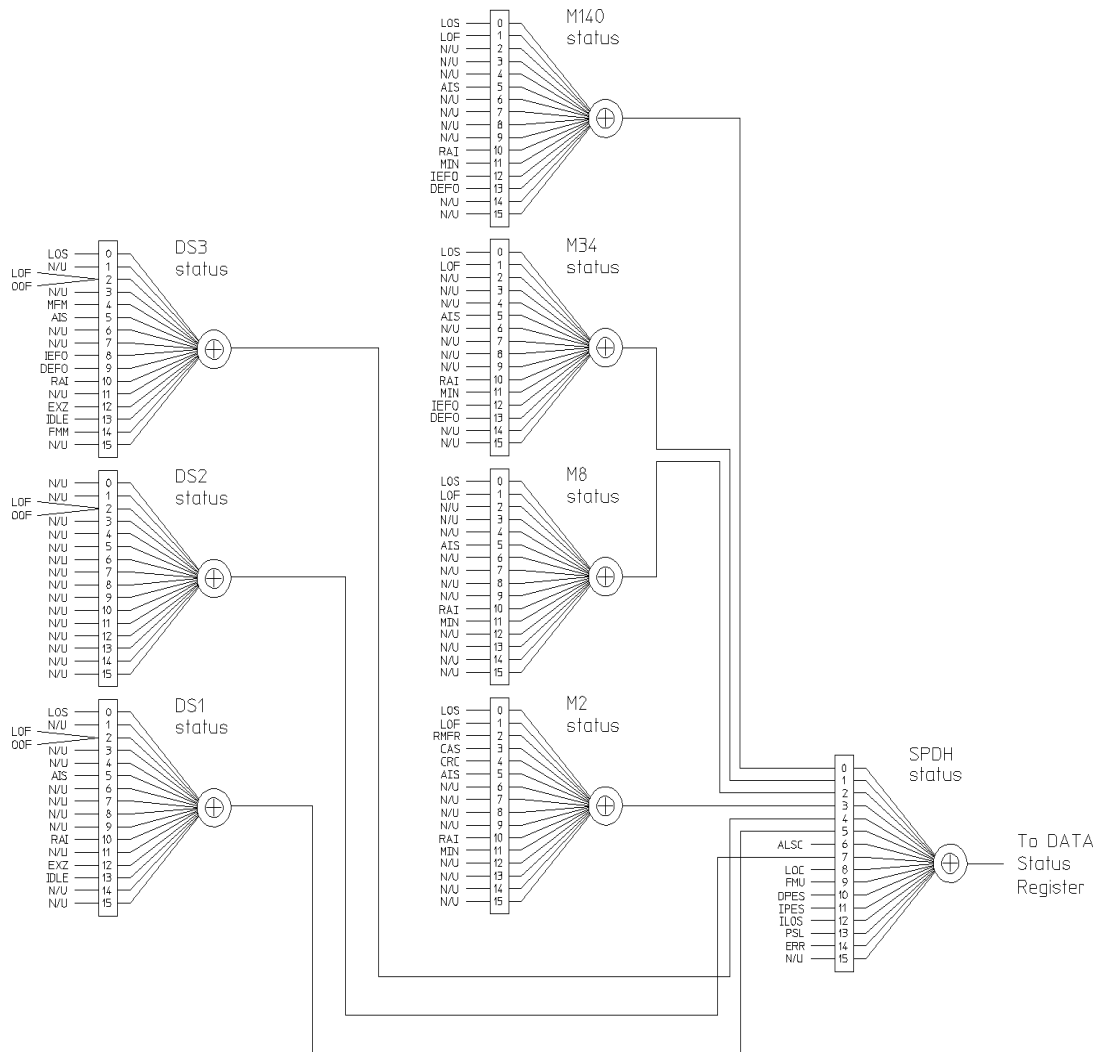

Figure 10-2

Status Registers Relationship 1

Status Reporting

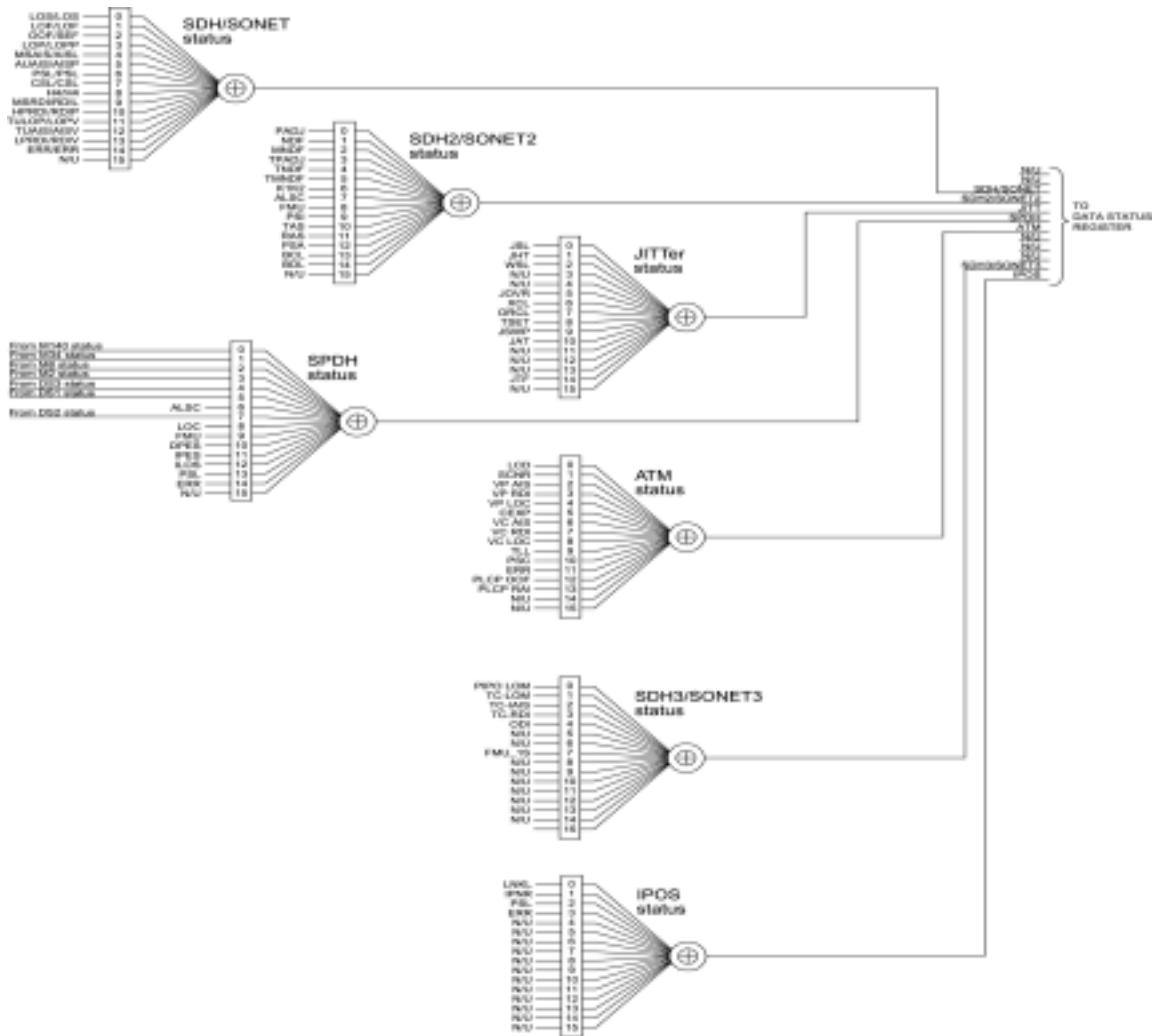

Figure 10-3

Status Registers Relationship 2

Status Reporting

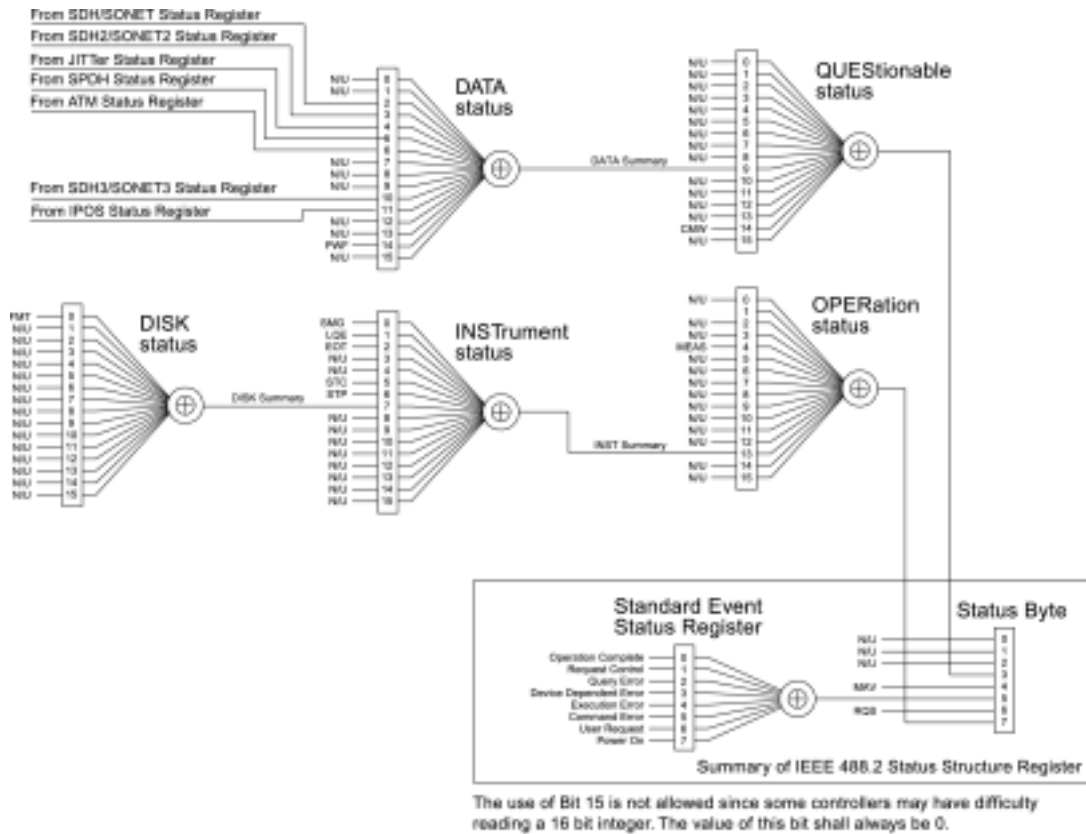

Figure 10-4 Status Registers Relationship 3

Programmed Status Reporting

When a condition is detected, a summary bit is generated by the Status Register which detects the condition. The summary bit in most cases passes through other Status Registers before affecting the Status Byte. These other Status Registers also generate a summary bit, therefore to report a condition requires the setting of the Event Enable Register mask in all registers in the chain.

When implementing status reporting into your programming, consider the following with reference to the Status Registers Relationship diagram, Figure 10-2 to Figure 10-4:

Status Reporting

Programming Interrupts

1) Define which conditions you want reported. To do this, set the Event Enable Register mask of the Status Register that first detects the defined conditions. Set the Event Enable Register mask of all subsequent Status Registers between the reporting Status Register and the Status Byte. Using an example from the SDH Status Register :

LOS + LOF

:STAT:SDH :ENAB 3	Set the SDH event enable register to summarize for LOF(2) + LOS (1)
:STAT:SDH :PTR 3;NTR 0	Transition filter passes positive transitions bits 0 and 1.
:STAT:DATA:ENAB 4	Set the DATA event enable register to summarize for SDH(4)
:STAT:DATA:PTR 4;NTR 0	Transition filter passes positive transitions bit 2.
:STAT:QUES:ENAB 512	Set the QUES event enable register to summarize for DATA(512)
:STAT:QUES:PTR 512;NTR 0	Transition filter passes positive transitions bit 9.

2) If you are implementing a service request/serial poll operation, set the mask of the Status Byte, for example :

***SRE 40** QUES summary + Standard Event summary

The Status Byte register will initiate a service request (RQS) when either of the masked conditions are detected.

Interpreting Interrupts

1) Check the content of the Status Byte register using the service request/serial poll operation (SPOLL) or by issuing the *STB? common capabilities command, for example :

***STB?** Returns 8 - QUES summary

Status Reporting

2) If a condition has been detected, determine which Status Register is responsible for issuing the summary bit, then use the appropriate STATus commands to interrogate the appropriate registers, for example :

:STAT:QUES:EVENT?	Returns 512 - DATA summary
:STAT:DATA:EVENT?	Returns 4 - SDH summary
:STAT:SDH :EVENT?	Returns 3 - LOF (2) + LOS (1)

The following program example is written in Rocky Mountain Basic and utilises a combination of SRQ and Status Register filtering.

Example Program

```
10 ! Program Name : 21SRQ_DEMO
20 !
30 ! Program to illustrate the use of the Service Request Routine
31 ! in the OmniBER .
40 !
50 !
60 ! The program starts a 10 second BER measurement on the OmniBER
70 ! then continually reads and displays the OmniBER Short-Term
80 ! BER until a Service Request is received from the OmniBER .
90 ! When this happens, the Controller will suspend current activity
100 ! and read registers to determine the cause of the SRQ.
110 ! The maskable registers are set in the program to generate SRQ at
120 ! end of a measurement or when an OmniBER Alarm condition occurs.
130 ! If the SRQ is found to be caused by End of Measurement then the
140 ! the program will read and print the measurement result before
150 ! continuing to read and display the received Short-Term BER.
160 ! If the SRQ is found to be caused by a masked alarm condition then
170 ! the program will read and print the alarm status then stop as it
```

Status Reporting

```
180 ! is invalid to return results when a recognized Alarm condition
190 ! exists.
191 !
200 PRINT CHR$(12) !Clear screen
210 PRINT TABXY(27,1);"Service Request - Demo Program"
220 !
230 COM Hp37718 !Common variable(s)
240 Hp37718=705 ! assign variable to default address
250 CALL Init_instr ! Sub to initialize the OmniBER
260 !
270 CALL Config_regs_14 ! Sub to configure OmniBER regs for SRQ
280 !
290 ON INTR 7 CALL Read_stat_byte ! Specify interrupt routine
300 !
310 CALL Tx_setup ! Sub to set up OmniBER Transmitter
320 !
330 CALL Rx_setup ! Sub to set up OmniBER Receiver
340 !
350 CALL Results_setup ! Sub to setup results display
360 !
370 OUTPUT Hp37718;"*CLS" ! Clear any existing SRQ/ Remote errors
380 WAIT 3
390 ENABLE INTR 7;2 ! Enable computer to recognize interrupt
400 !
410 CALL Run_meas
420 !
430 CALL Read_short_rslt
440 END
```

Status Reporting

450 !
460 !
470 !
480 !
490 SUB Config_regs_14
500 ! This sub sets up the conditions for generating an SRQ.
510 ! In this case, an SRQ will occur when Signal Loss or FFrame Loss
520 ! alarms are detected.
530 ! An SRQ is also set to occur at the end of the Measurement period.
540 !
550 !
560 COM Hp37718
570 !OUTPUT Hp37718;"*CLS" ! Clear any existing SRQ/Remote errors
580 !
590 OUTPUT Hp37718;"STAT:M34:PTR 3;NTR 0"
600 ! Set the Transition Filter to pass positive transitions in
610 ! Bits 0,1 of the M34 Register
620 !
630 OUTPUT Hp37718;"STAT:M34:ENAB 3"
640 !Enable LOF and LOS bits in the M34 status register
650 !to set the telecom summary bit in the Data status register
660 !on occurrence of any of these events.
661 !
662 OUTPUT Hp37718;"STAT:SPDH:PTR 2;NTR 0"
663 ! Set the Transition Filter to pass positive transitions in Bit 0
664 !of the SPDH Data Status register.
665 OUTPUT Hp37718;"STAT:SPDH:ENAB 2"
666 !Enable the M34 data bit in the SPDH Status register to set

Status Reporting

667 !the SPDH summary bit in the Data status register
670 !
680 OUTPUT Hp37718;":STAT:DATA:PTR 32;NTR 0"
690 ! Set the Transition Filter to pass positive transitions in Bit 5
700 !of the Data Status register.
710 OUTPUT Hp37718;":STAT:DATA:ENAB 32"
720 !Enable the SPDH data bit in the Data Status register to set
730 !the data summary bit in the Questionable status register
740 !
750 !
760 OUTPUT Hp37718;":STAT:QUES:PTR 512;NTR 0"
770 !Set the transition filter to pass positive transitions in bit 9 of
780 !the Questionable status register
790 OUTPUT Hp37718;":STAT:QUES:ENAB 512"
800 !Enable the data summary bit in the Questionable status register
810 !to set the questionable data summary bit in the status byte
820 !
830 !
840 !
850 OUTPUT Hp37718;":STAT:INST:PTR 4;NTR 0"
860 ! Set the Transition Filter to pass positive transitions in Bit 4
870 ! (End of Test) in the Instrument Status Register
880 OUTPUT Hp37718;":STAT:INST:ENAB 4"
890 !Enable the EOT data bit in the Instrument Status register to set
900 !the data summary bit in the Operation status register
910 !
920 !
930 OUTPUT Hp37718;":STAT:OPER:PTR 8192;NTR 0"

Status Reporting

```
940 !Set the transition filter to pass positive transitions in bit 13
950 !of the Operation status register
960 OUTPUT Hp37718;":STAT:OPER:ENAB 8192"
970 !Enable the instrument summary bit in Operation status register
980 !to set the Operation register summary bit in the status byte
990 !
1000 !
1010 OUTPUT Hp37718;"*SRE 200"
1020 !Set the SRQ mask to cause an SRQ on occurrence of Bit 3 (Ques Reg)
1030 !Bit 6 (RQS) or 7 (Oper reg) being set in the Status byte.
1040 !
1050 !
1060 SUBEND
1070 !
1080 SUB Read_stat_byte
1090 !This subroutine reads the Telecom status register to determine the
1100 !reason(s) for the SRQ.
1110 COM Hp37718
1120 BEEP 700,.5
1130 DISP "SRQ detected"
1140 WAIT 1 ! allow time for registers to be updated
1150 DISP
1160 Intr_check=SPOLL(Hp37718) ! Interrogate Primary Status Byte register
1170 ! using Serial Poll method - returns value Intr_check
1180 ! DISP "interrupt check number is ";Intr_check
1190 SELECT Intr_check ! read the value of Primary Status Byte to see
1200 ! cause of interrupt
1201 !
```

Status Reporting

```
1210 CASE 0 ! interrupt from unspecified device
1220 PRINT CHR$(12)          !Clear screen
1229 PRINT TABXY(20,10);"The Controller has received an interrupt from"
1230 PRINT TABXY(20,11);"Remove all unspecified equipment from HP-IB"
1231 STOP
1232 !
1240 CASE 192 ! End of Test Period (rqs[64]+oper[128])
1250 CALL Read_meas_rslt ! measurement has ended, so read back result.
1260 !
1270 CASE 72,200 ! masked Alarm condition has occurred (with EOT?)
1280 CALL Read_m34_reg
1290 !
1300 CASE ELSE
1305 PRINT TABXY(20,10);"The Controller has received an unspecified"
1310 PRINT TABXY(20,11);"interrupt from the OmniBER - check cause"
1311 STOP
1312 !
1320 END SELECT
1330 SUBEND
1340 !
1350 !
1360 SUB Init_instr
1370 ! sub to initialize the OmniBER
1380 !
1390 !
1400 COM Hp37718
1410 DISP "Initializing HP37718 " !
1420 OUTPUT Hp37718;"*CLS"      ! Clear any existing SRQ/Remote errors
```

Status Reporting

1430 WAIT 2 ! allow time for initialization
1440 OUTPUT Hp37718;"*RST" ! set instrument to default settings
1450 WAIT 2 ! allow time for initialization
1460 DISP
1470 SUBEND
1480 !
1490 !
1500 SUB Tx_setup
1510 !
1520 !sub to setup the OmniBER transmitter
1530 COM Hp37718 !Common variable(s)
1540 OUTPUT Hp37718;"OUTP:TEL:SPDH:RATE M34"
1550 !
1560 !OUTPUT Hp37718;"OUTP:TEL:SPDH:LEV UNB"
1570 ! Set up PDH Output conditions
1580 !
1590 !
1600 OUTPUT Hp37718;"INST:COUP RTTX"
1610 ! Setup Instrument Subsystem
1620 !
1630 !
1640 OUTPUT Hp37718;"SOUR:DATA:TEL:SOUR PDH"
1650 !SOUR:DATA:TEL:SPDH:PAYL:TYPE FRAM
1660 OUTPUT Hp37718;" SOUR:DATA:TEL:SPDH:PATT PRBS23"
1670 ! Setup transmit (Source) conditions
1680 !
1690 !
1700 SUBEND

Status Reporting

1710 !
1720 !
1730 SUB Rx_setup
1740 !
1750 !sub to setup the OmniBER Receiver
1760 COM Hp37718 !Common variable(s)
1770 ! Use default
1780 SUBEND
1790 !
1800 !
1810 SUB Results_setup
1820 !
1830 ! Sub to setup the Results page
1840 COM Hp37718 !Common variable(s)
1850 OUTPUT Hp37718;"SENS:DATA:TEL:TEST:TYPE SING"
1860 OUTPUT Hp37718;"SENS:DATA:TEL:TEST:PER 10s" !Set Test Period
1870 !
1880 SUBEND
1890 !
1900 !
1910 SUB Run_meas
1920 !
1930 ! Sub to start and run the measurement
1940 COM Hp37718 !Common variable(s)
1950 !
1960 OUTPUT Hp37718;"SENS:DATA:TEL:TEST ON"
1970 SUBEND
1980 !

Status Reporting

2110 SUB Read_meas_rslt
2120 !
2130 ! Sub to read back the 37718 result
2140 COM Hp37718 !Common variable(s)
2150 !
2160 WAIT 2
2170 OUTPUT Hp37718;"SENS:DATA? ""ERAT:SPDH:BIT""
2180 ! Return the measurement result BER Ratio
2190 ENTER Hp37718;Ber_ratio ! Read back bit error results
2200 PRINT TABXY(27,12); "MEASURED BER RATIO IS ";Ber_ratio
2210 CALL Run_meas
2220 OUTPUT Hp37718;"*CLS" ! Clear any existing SRQ/Remote errors
2230 WAIT 3
2240 ENABLE INTR 7;2 ! Re-enable computer to recognize interrupt
2250 PRINT TABXY(25,12);"
2260 SUBEND
2270 !
2280 !
2290 SUB Read_short_rslt
2300 !
2310 ! Sub to read back the OmniBER Short Term Results
2320 WAIT 2 ! Allow time for Short Term results update
2330 !
2340 COM Hp37718 !Common variable(s)
2350 REPEAT
2360 OUTPUT Hp37718;"SENS:DATA? ""ECO:SPDH:STER:BIT""
2370 ! Returns the short-term BER Result
2380 ENTER Hp37718;Short_rate ! Readback Short Term BER result

Status Reporting

```
2390 !
2400 PRINT TABXY(27,10);"SHORT-TERM BER COUNT IS ";Short_rate
2410 WAIT 1
2420 PRINT TABXY(25,10);"
2430 !PRINT CHR$(12) !Clear screen
2440 UNTIL Forever
2450 SUBEND
2460 !
2470 !
2480 SUB Read_m34_reg
2490 !
2500 ! Sub to read the M34 register
2510 COM Hp37718 !Common variable(s)
2520 !
2530 !
2540 OUTPUT Hp37718;" :STATUS:M140:EVENT?" !Read PDH Status register
2550 ENTER Hp37718;Alrm_reg_value
2570 SELECT Alrm_reg_value
2580 CASE 1 ! LOS detected
2590 PRINT CHR$(12) !Clear screen
2600 PRINT TABXY(20,10); "Signal loss has been detected on OmniBER "
2601 PRINT TABXY(30,11); "Results invalid"
2602 !
2610 CASE 2 ! LOF detected
2620 PRINT CHR$(12) !Clear screen
2630 PRINT TABXY(20,10); "140MFrame Loss has been detected on
HPOmniBER "
2660 !
2820 CASE ELSE ! unknown SRQ
```

Status Reporting

```
2830 PRINT CHR$(12)           !Clear screen
2840 PRINT TABXY(20,10);"A Status Alarm has occurred on the OmniBER "
2843 PRINT TABXY(20,11);"Check instrument Front Panel to see cause "
2860 END SELECT
2870 !
2871 STOP
2880 !
2920 !
2930 SUBEND
```

Figure 10-5 **Status Reporting Program Example**

Status Reporting

General Information

General Information

General Information

This chapter contains general remote control information.

- **SCPI Overview** - Gives a brief overview of the SCPI Standard.
 - **HP-IB Universal Commands** - Describes the HP-IB Universal commands.
-

SCPI Overview

Standard Commands for Programmable Instruments (SCPI) is a standard of the SCPI Consortium that provides guidelines for remote programming commands for instruments. The goal of SCPI is to reduce Automatic Test Equipment (ATE) program development time. It accomplishes this by providing a consistent programming environment for instrument control and data usage. This programming environment uses defined programming messages, instrument responses, and data formats across all SCPI instruments, regardless of manufacturer.

SCPI is based on two IEEE standards:

- ANSI/IEEE Standard 488.1-1987, *IEEE Standard Digital Interface for Programmable Instrumentation*
- ANSI/IEEE Standard 488.2-1987, *IEEE Standard Codes, Formats, Protocols, and Common Commands. For use with ANSI/IEEE Standard 488.1-1987, IEEE Standard Digital Interface for Programmable Instrumentation*

General Information

GPIB (HP-IB) Universal Commands

The Required Commands perform the most basic remote functions over GPIB and are common to all GPIB controllable instruments. The commands are as follows:-

- DEVICE CLEAR
- SERIAL POLL
- REMOTE ENABLE
- LOCAL LOCKOUT
- GO TO LOCAL

Device Clear (CLEAR)

This command will initialize the instrument HP-IB hardware.

The command format using HP 200/300 Series Basic, for example is:

CLEAR 705 (where 7 is the Bus I/O select code and 05 is the device address).

Serial Poll (SPOLL)

A serial poll will retrieve the value of the primary status byte. This byte contains useful information about the current state of the instrument.

for example :

SPOLL(705) (where 7 is the Bus I/O select code and 05 is the device address).

Remote Enable (REMOTE)

The Remote command instructs the instrument to enter the REMOTE state and be ready to accept instructions via GP-IB.

When the OmniBER 718 receives this command it illuminates the front panel REMOTE indicator.

for example:

REMOTE 705 (where 7 is the Bus I/O select code and 05 is the device address).

General Information

Local Lockout (LOCAL LOCKOUT)

It is recommended that the Local Lockout command is sent after the Remote command. This disables the front panel local key preventing the return to local mode and thus any interference to the instrument settings.

It should always be preceded by the REMOTE command.

for example:

LOCAL LOCKOUT 7 (will configure all the instruments on the bus to the Local Lockout condition.)

NOTE

If the instrument has been set to the LOCAL LOCKOUT condition, then the front panel LOCAL key is disabled. The instrument can only be returned to LOCAL operation by the controller sending the LOCAL command or by cycling power to the instrument.

Local (LOCAL)

The Local command returns the instrument from Remote operation to local front panel control.

for example:

LOCAL 7 or LOCAL 705 (where 7 is the Bus I/O select code and 05 is the device address).

Application Program Examples

The following application program examples are intended only as a guide to which SCPI Remote Control commands can be used to configure the OmniBER 718 for a particular application. The examples do not describe how to send and receive these commands - please refer to Chapter 1 Methods of Remote Control for further information.

Initializing the OmniBER 718

The following commands can be used to initialize the OmniBER 718. They setup the OmniBER 718 for remote operation, retrieve various instrument details and couple the transmitter to the receiver.

Table 12-1

OmniBER 718 Initialization

Comment	SCPI Command	Ref.
Takes the 37718 under remote control.	:SYSTem:REMOte	3-47
Reset 37718 to Default settings	*RST	3-65
Read SCPI Error Message & Number (+0, "No error")	:SYSTem:ERRor?	3-48
Read Model Name, Serial No., Firmware Rev.etc	*IDN?	3-63
Retrieve 37718 Option structure	*OPT?	3-64
Retrieve 37718 Serial Number	:SYSTem:SERial?	3-48
Couple the 37718 Receiver to the Transmitter	:INSTrument:COUple RTTX	3-7
Return the 37718 to local control.	:SYSTem:LOCal	3-47

Setup the OmniBER 718 PDH Tx (Main Settings)

The following commands can be used to setup the OmniBER 718 PDH Transmitter to generate a 2Mb/s Unframed signal with a $2^{15}-1$ Inverted PRBS.

Table 12-2

OmniBER 718 PDH Tx Setup

Comment	SCPI Command	Ref.
Set Tx Output to PDH	SOURce:DATA:TELEcom:SOURce PDH	3-9
Set Tx Line Rate to 2Mb/s	OUTPut:TELEcom:SPDH:RATE M2	3-3
Set Clock Sync to Internal	SOURce:CLOCK:SPDH:SOURce INTernal	3-7
Set Termination to 75Ohm Unbalanced	OUTPut:TELEcom:SPDH:BALance UNBalanced	3-4
Set Line Code to HDB3	OUTPut:TELEcom:SPDH:CODE HDB3	3-3
Ensure Frequency Offset is OFF	SOURce:CLOCK:SPDH:M2:FOFFset NONE	3-8
Set Payload Type to Unframed	SOURce:DATA:TELEcom:SPDH:PAYLoad:TYPE UNFRamed	3-17
Set Payload Type to Unstructured	SOURce:DATA:TELEcom:SPDH:PAYLoad:STRucture UNSTRuctured	3-18
Set Pattern to $2^{15}-1$ PRBS	SOURce:DATA:TELEcom:SPDH:PATTern PRBS15	3-16
Set PRBS Polarity to be Inverted	SOURce:DATA:TELEcom:SPDH:PRBS:POLarity INVerted	3-17

Setup the OmniBER 718 PDH Rx (Main Settings)

The following commands can be used to setup the OmniBER 718 PDH Receiver to receive a 2Mb/s Unframed signal with a $2^{15}-1$ Inverted PRBS.

Table 12-3

OmniBER 718 PDH Rx Setup

Comment	SCPI Command	Ref.
Set Rx Input to PDH	SENSE:DATA:TELEcom:SENSe PDH	3-15
Set Rx Line Rate to 2Mb/s	INPut:TELEcom:SPDH:RATE M2	4-47
Set Termination to 75 Ohm Unbalanced	INPut:TELEcom:SPDH:BALance UNBalanced	4-48
Set Line Code to HDB3	INPut:TELEcom:SPDH:CODE HDB3	4-47
Set the Level to Monitor	INPut:TELEcom:LEVel MONitor	3-12
Set the Monitor Equalisation ON	INPut:TELEcom:SPDH:EQUalisation ON	4-49
Set the Monitor Equalisation to 26 dB	INPut:TELEcom:SPDH:GAIN DB26	4-48
Set Payload Type to Unframed	SENSE:DATA:TELEcom:SPDH:PAYLoad:TYPE UNFRamed	4-53
Set Payload Type to Unstructured	SENSE:DATA:TELEcom:SPDH:PAYLoad:STRUcture UNSTRUctured	4-53
Set Pattern to $2^{15}-1$ PRBS	SENSE:DATA:TELEcom:SPDH:PATTern PRBS15	4-51
Set PRBS Polarity to be Inverted	SENSE:DATA:TELEcom:SPDH:PRBS:POLarity INVerted	4-52

Setup the OmniBER 718 PDH Tx (Main & Structured Settings)

The following commands can be used to setup the OmniBER 718 PDH Transmitter to generate a fully structured DS3 signal with M13 framing.

Table 12-4 **OmniBER 718 PDH Tx Setup**

Comment	SCPI Command	Ref.
Setup ‘Main Settings’		
Set Tx Output to PDH	<code>SOURce:DATA:TELEcom:SOURce PDH</code>	3-9
Set Tx Line Rate to DS3	<code>OUTPut:TELEcom:SPDH:RATE DS3</code>	4-3
Set Clock Sync to Internal	<code>SOURce:CLOCK:SPDH:SOURce INTernal</code>	4-7
Set Output Level to DS3-HI	<code>OUTPut:TELEcom:SPDH:LEVel HIGH</code>	4-4
Ensure Frequency Offset is OFF	<code>SOURce:CLOCK:SPDH:DS3:FOFFset NONE</code>	4-12
Set Payload Type to M13 Framing	<code>SOURce:DATA:TELEcom:SPDH:PAYLoad:TYPE M13</code>	4-17
Set Payload Type to Unstructured	<code>SOURce:DATA:TELEcom:SPDH:PAYLoad:STRUcture STRUctured</code>	4-18

Table 12-4**OmniBER 718 PDH Tx Setup, continued**

Comment	SCPI Command	Ref.
Setup 'Struct'd Settings'		
Set Structured Test Signal to be 56 kb/s timeslot	SOURce:DATA:TELEcom:SPDH:TSIGnal:RATE K56	4-20
Set DS1 Framing to be D4	SOURce:DATA:TELEcom:SPDH:TSIGnal:PAYLoad D4	4-21
Set DS2 Tributary Number to 1	SOURce:DATA:TELEcom:SPDH:TSIGnal:TRIButary:DS2 TRIB1	4-22
Set DS1 Tributary Number to 1	SOURce:DATA:TELEcom:SPDH:TSIGnal:TRIButary:DS1 TRIB1	4-22
Set 56 kb/s Timeslot Number to 1	SOURce:DATA:TELEcom:SPDH:TSIGnal:TSLot:DS1:K56 1	4-24
Set Pattern to 2 ¹¹ -1 PRBS	SOURce:DATA:TELEcom:SPDH:PATTern PRBS11	4-16
Set PRBS Polarity to be Normal	SOURce:DATA:TELEcom:SPDH:PRBS:POLarity NORMal	4-17
Set the non-test Tributary Pattern to AIS	SOURce:DATA:TELEcom:SPDH:TSIGnal:BACKground AIS	4-26
Set DS1 D4 Signaling Bits to be '11'	SOURce:DATA:TELEcom:SPDH:TSLot:SIGNaling:DATA:DS1:D4 "11"	4-26

Setup the OmniBER 718 PDH Rx (Main & Structured Settings)

The following commands can be used to setup the OmniBER 718 PDH Receiver to receive a fully structured DS3 signal with M13 framing.

Table 12-5 OmniBER 718 PDH Rx Setup

Comment	SCPI Command	Ref.
Setup 'Main Settings'		
Set Rx Input to PDH	SENSE:DATA:TELEcom:SENSe PDH	3-15
Set Rx Line Rate to DS3	INPut:TELEcom:SPDH:RATE DS3	4-47
Set the Level to Terminate	INPut:TELEcom:LEVel TERMinate	3-12
Set Payload Type to M13 Framing	SENSE:DATA:TELEcom:SPDH:PAYLoad:TYPE M13	4-52
Set Payload Type to Unstructured	SENSE:DATA:TELEcom:SPDH:PAYLoad:STRUcture STRUctured	4-53
Setup 'Struct'd Settings'		
Set Structured Test Signal to be 56 kb/s timeslot	SENSE:DATA:TELEcom:SPDH:TSIGnal:RATE K56	4-54
Set DS1 Framing to be D4	SENSE:DATA:TELEcom:SPDH:TSIGnal:PAYLoad D4	4-54
Set DS2 Tributary Number to 1	SENSE:DATA:TELEcom:SPDH:TSIGnal:TRIButary:DS2 TRIB1	4-55
Set DS1 Tributary Number to 1	SENSE:DATA:TELEcom:SPDH:TSIGnal:TRIButary:DS1 TRIB1	4-56
Set 56 kb/s Timeslot Number to 1	SENSE:DATA:TELEcom:SPDH:TSIGnal:TSLot:DS1:K56 1	4-58
Set Pattern to 2 ¹¹ -1 PRBS	SENSE:DATA:TELEcom:SPDH:PATTern PRBS11	4-51
Set Normal PRBS Polarity	SENSE:DATA:TELEcom:SPDH:PRBS:POLarity NORMal	4-52

Setup the OmniBER 718 PDH Tx to add Errors & Alarms

The following commands can be used to setup the OmniBER 718 PDH Transmitter to add errors & alarms.

Table 12-6 OmniBER 718 PDH Tx Error & Alarm Add

Comment	SCPI Command	Ref.
Select PDH Test Function. See Note 1.	SOURce:DATA:TELEcom:TFUNction PDH	3-16
Set Test Function to be Errors & Alarms	SOURce:DATA:TELEcom:SPDH:TFUNction:TYPE ERRor	4-29
Set Error Add type to Bit	SOURce:DATA:TELEcom:SPDH:ERRor:TYPE BIT	4-30
Add a single Bit error. Repeat if required.	SOURce:DATA:TELEcom:SPDH:ERRor:RATE ONCE	4-30
Add a Bit error rate of 1E-4	SOURce:DATA:TELEcom:SPDH:ERRor:RATE E_4	4-30
Add a Bit error rate of 3.8E-4. See Note 2.	SOURce:DATA:TELEcom:SPDH:ERRor:RATE:USER 3.8E-4	4-31
Switch Bit error rate OFF	SOURce:DATA:TELEcom:SPDH:ERRor:RATE NONE	4-30
Generate a 2 Mb/s AIS alarm	SOURce:DATA:TELEcom:SPDH:M2:ALARm AIS	4-37
Switch alarm OFF	SOURce:DATA:TELEcom:SPDH:M2:ALARm NONE	4-37

Note 1: If the Tx Output is set to PDH then the PDH Test Function should be selected as shown. However, if the Tx Output is set to SDH then the Test Function selection should be PDHPayload and the corresponding commands used.

Note 2: When selecting a user error rate via SCPI it is not necessary to send any command to switch the selected user rate ON. It is switched ON by default when the user error rate SCPI command is received.

Setup the OmniBER 718 PDH Rx to perform Bit Error Measurements

The following commands can be used to setup the OmniBER 718 PDH Receiver to do bit error measurements.

Table 12-7 OmniBER 718 PDH Rx Bit Error Measurements

Comment	SCPI Command	Ref.
Setup Results Timing Control		
Set Short Term Period to 10 seconds	SENSe:DATA:TELecom:STERm:PERiod 10s	3-19
Set Test Timing to Single	SENSe:DATA:TELecom:TEST:TYPE SINGLE	3-18
Set Test Period to 1 minute	SENSe:DATA:TELecom:TEST:PERiod 1m	4-18
Start gating	SENSe:DATA:TELecom:TEST ON	4-16
Wait for measurement to complete		
Retrieve Results		
Read back Cumulative Bit Error Count	SENSe:DATA? "ECOUNT:SPDH:BIT"	3-71
Read back Short Term Bit Error Count	SENSe:DATA? "ECOUNT:SPDH:STERm:BIT"	3-70
Read back G.821 Analysis Results	SENSe:DATA? "ESECONDS:SPDH:BIT:ANALYSIS" SENSe:DATA? "EFSECONDS:SPDH:BIT:ANALYSIS" SENSe:DATA? "SESECONDS:SPDH:BIT:ANALYSIS" SENSe:DATA? "UASECONDS:SPDH:BIT:ANALYSIS" SENSe:DATA? "DMINUTES:SPDH:BIT:ANALYSIS"	3-72

Setup the OmniBER 718 SDH Tx

The following commands can be used to setup the OmniBER 718 SDH Transmitter to generate a STM-1 Optical signal with a TU-12 PCM31 Framed payload.

Table 12-8

OmniBER 718 SDH Tx Setup

Comment	SCPI Command	Ref.
Set Tx Output to STM-16/4/1/0 Optical	<code>SOURce:DATA:TELEcom:SOURce OPT16</code>	3-9
Set Tx Line Rate to STM-1 Optical	<code>OUTPut:TELEcom:OPT16:RATE STM1</code>	5-6
Set Tx Optical Wavelength to be 1310 nm	<code>OUTPut:TELEcom:OPT16:WAVelength NM1310</code>	5-6
Ensure that Thru Mode is not selected	<code>SOURce:DATA:TELEcom:SDH:THRumode INTernal</code>	5-11
Set Clock Sync to Internal	<code>SOURce:CLOCK:SDH:SOURce INTernal</code>	5-10
Ensure Frequency Offset is OFF	<code>SOURce:CLOCK:SDH:FOFFset OFF</code>	5-11
Setup F/G Mappings		
Set AU Layer Selection to AU-4	<code>SOURce:DATA:TELEcom:SDH:AU:TYPE AU4</code>	5-16
Set TU Layer Selection to TU-12	<code>SOURce:DATA:TELEcom:SDH:PAYLoad TU12</code>	5-17
Set the TU-12 Mapping to Asynchronous 2 Mb/s	<code>SOURce:DATA:TELEcom:SDH:TRIButary:MAPPING ASYNc</code>	5-18
Ensure 2M Payload Offset is 0 ppm	<code>SOURce:DATA:TELEcom:SDH:PAYLoad:OFFset 0</code>	5-22
Set TUG3 Number to 1	<code>SOURce:DATA:TELEcom:SDH:TUG3 1</code>	5-18
Set TUG2 Number to 1	<code>SOURce:DATA:TELEcom:SDH:TUG2 1</code>	5-19

Table 12-8

OmniBER 718 SDH Tx Setup, continued

Comment	SCPI Command	Ref.
Set TU Number to 1	SOURce:DATA:TELEcom:SDH:TRIB 1	5-19
Set TU Payload Framing to PCM31	SOURce:DATA:TELEcom:SDH:PAYLoad:TYPE PCM31	5-19
Set TU Payload Type to Unstructured	SOURce:DATA:TELEcom:SDH:PAYLoad:STRUcture UNSTRUctured	5-20
Set Pattern to 2 ¹⁵ -1 PRBS	SOURce:DATA:TELEcom:SDH:PAYLoad:PATtern PRBS15	5-21
Set PRBS Polarity to be Inverted	SOURce:DATA:TELEcom:SDH:PRBS:POLarity INVERTed	5-22
Setup B/G Mappings		
Set Background TUG3 #2 to TU-12 Mapping	SOURce:DATA:TELEcom:SDH:TUG3:BACKground:PAYLoad:PATtern 2, TU12	5-25
Set Background TUG3 #3 to TU-12 Mapping	SOURce:DATA:TELEcom:SDH:TUG3:BACKground:PAYLoad:PATtern 3, TU12	5-25
Set Pattern in Background TU-12's within TUG3 #1 to be "1100" Word	SOURce:DATA:TELEcom:SDH:PRIMary:BACKground:PAYLoad:PATtern P1100	5-24

Setup the OmniBER 718 SDH Rx

The following commands can be used to setup the OmniBER 718 SDH Receiver to receive a STM-4 Optical signal with a TU-12 Unframed payload.

Table 12-9

OmniBER 718 SDH Rx Setup

Comment	SCPI Command	Ref.
Set Rx Input to STM-16/4/1/0 Optical	SENSe:DATA:TELEcom:SENSe OPT16	3-15
Set Rx Line Rate to STM-4 Optical	INPut:TELEcom:OPT16:RATE STM4	5-69
Set AU Layer Selection to AU-4	SENSe:DATA:TELEcom:SDH:AU:TYPE AU4	5-75
Set TU Layer Selection to TU-12	SENSe:DATA:TELEcom:SDH:PAYLoad TU12	5-75
Set the TU-12 Mapping to Asynchronous 2 Mb/s	SENSe:DATA:TELEcom:SDH:TRIButary:MAPPING ASYNc	5-76
Set STM-1 Number Under Test to 1	SENSe:DATA:TELEcom:SDH:VC4 1	4-73
Set TUG3 Number to 1	SENSe:DATA:TELEcom:SDH:TUG3 1	5-77
Set TUG2 Number to 1	SENSe:DATA:TELEcom:SDH:TUG2 1	5-77
Set TU Number to 1	SENSe:DATA:TELEcom:SDH:TRIB 1	5-78
Set TU Payload to be Unframed	SENSe:DATA:TELEcom:SDH:PAYLoad:TYPE UNFRamed	5-78
Set TU Payload Type to Unstructured	SENSe:DATA:TELEcom:SDH:PAYLoad:STRUcture UNSTRUctured	5-79
Set Pattern to 2 ¹⁵ -1 PRBS	SENSe:DATA:TELEcom:SDH:PAYLoad:PATTern PRBS15	5-79
Set PRBS Polarity to be Inverted	SENSe:DATA:TELEcom:SDH:PRBS:POLarity INVERTed	5-81

Setup the OmniBER 718 SDH Tx to add Errors & Alarms

The following commands can be used to setup the OmniBER 718 SDH Transmitter to generate errors and alarms using the SDH Test Function.

Table 12-10

OmniBER 718 SDH Tx Error & Alarm Add

Comment	SCPI Command	Ref.
Select SDH Test Function	SOURCE:DATA:TELEcom:TFUNCTION SDH	3-10
Set Test Function to be Errors & Alarms	SOURCE:DATA:TELEcom:SDH:TFUNCTION:TYPE ERROR	5-40
Set Error Add type to B3 Path BIP	SOURCE:DATA:TELEcom:SDH:ERROR:TYPE PBIP	5-40
Add a single B3 error. Repeat if required.	SOURCE:DATA:TELEcom:SDH:ERROR:RATE ONCE	5-41
Add a B3 error rate of 1E-4	SOURCE:DATA:TELEcom:SDH:ERROR:RATE E_4	5-41
Switch B3 error rate OFF	SOURCE:DATA:TELEcom:SDH:ERROR:RATE NONE	5-41
Generate a MS FERF alarm	SOURCE:DATA:TELEcom:SDH:ALARm MSRDl	5-46
Switch alarm OFF	SOURCE:DATA:TELEcom:SDH:ALARm NONE	5-46

Setup the OmniBER 718 SDH Tx Overhead Bytes

The following commands can be used to setup the OmniBER 718 SDH Transmitter Overhead bytes. It is assumed that a STM-4 signal is selected.

Table 12-11

OmniBER 718 SDH Tx Overhead Setup

Comment	SCPI Command	Ref.
Set the Overhead bytes to their default values	SOURce:DATA:TELEcom:SDH:OVERhead:DEFault	5-27
Update the D1 byte in STM-1 #1	SOURce:DATA:TELEcom:SDH:OVERhead:DATA 1,1,D1,"11111111"	5-27
Update the M1 byte in STM-1 #3	SOURce:DATA:TELEcom:SDH:OVERhead:DATA:HEXadecimal 3,1,M1,"FF"	5-29
Update F2 byte in the VC-4 POH of the selected STM-1	SOURce:DATA:TELEcom:SDH:POVerhead:DATA F2,"11111111"	5-30
Update J1 trace in VC-4 POH of selected STM-1 to be HP37718 Test string	SOURce:DATA:TELEcom:SDH:POVerhead:J1:PATtern TEST	5-31
Update F2 byte in VC-3 POH of selected STM-1	SOURce:DATA:TELEcom:SDH:TRIButary:POVerhead:DATA F2,"11111111"	5-30
Update J1 trace in VC-3 POH of selected STM-1 to be HP37718A Test string	SOURce:DATA:TELEcom:SDH:TRIButary:POVerhead:J1:PATtern TEST	5-33

Setup the OmniBER 718 SDH Tx for Overhead Byte Sequencing

The following commands can be used to setup the OmniBER 718 SDH Transmitter to generate an Overhead byte sequence. It is assumed that a STM-4 signal is selected.

Table 12-12

OmniBER 718 SDH Tx Overhead Sequence

Comment	SCPI Command	Ref.
Select SDH Test Function.	SOURce:DATA:TELEcom:TFUNction SDH	3-10
Set Test Function to be Overhead Sequences	SOURce:DATA:TELEcom:SDH:TFUNction:TYPE SEquence	5-40
Set Sequence Mode to be Repeat Run	SOURce:DATA:TELEcom:SDH:SEquence:MODE REPEAT	5-54
Select J0 Byte in RSOH	SOURce:DATA:TELEcom:SDH:SEquence:OHBYte J0	5-55
Set Sequence byte values to "00","01","02","03","04"	SOURce:DATA:TELEcom:SDH:SEquence:DATA A, "00" SOURce:DATA:TELEcom:SDH:SEquence:DATA B, "01" SOURce:DATA:TELEcom:SDH:SEquence:DATA C, "02" SOURce:DATA:TELEcom:SDH:SEquence:DATA D, "03" SOURce:DATA:TELEcom:SDH:SEquence:DATA E, "04"	5-56
Set the Sequence order to be A,B,C,D,E	SOURce:DATA:TELEcom:SDH:SEquence:ORDER A,B,C,D,E"	5-57
Set the Frame Count for each value to be 10	SOURce:DATA:TELEcom:SDH:SEquence:FCOUNT 1,10 SOURce:DATA:TELEcom:SDH:SEquence:FCOUNT 2,10 SOURce:DATA:TELEcom:SDH:SEquence:FCOUNT 3,10 SOURce:DATA:TELEcom:SDH:SEquence:FCOUNT 4,10 SOURce:DATA:TELEcom:SDH:SEquence:FCOUNT 5,10	5-57
Start Sequence	SOURce:DATA:TELEcom:SDH:SEquence START	5-54

Perform OmniBER 718 SDH Rx Measurements

The following commands can be used to setup the OmniBER 718 SDH Receiver to perform B3 measurements.

Table 12-13

OmniBER 718 SDH Rx Measurements

Comment	SCPI Command	Ref.
Setup Results Timing Control		
Set Short Term Period to 10 seconds	SENse:DATA:TELEcom:STERm:PERiod 10s	3-19
Set Test Timing to Single	SENse:DATA:TELEcom:TEST:TYPE SINGLE	3-18
Set Test Period to 1 minute	SENse:DATA:TELEcom:TEST:PERiod 1m	3-18
Start gating	SENse:DATA:TELEcom:TEST ON	3-16
Wait for measurement to complete		
Retrieve Results		
Read back Cumulative B3 Error Count	SENse:DATA? "ECOUNT:SDH:PBIP"	5-94
Read back Short Term B3 Error Count	SENse:DATA? "ECOUNT:SDH:STERm:PBIP"	5-94
Read back some G.826 Analysis Results	SENse:DATA? "ESECONDS:SDH:PBIP:ANALYSIS" SENse:DATA? "SECONDS:SDH:PBIP:ANALYSIS" SENse:DATA? "UASECONDS:SDH:PBIP:ANALYSIS"	5-94

Setup the OmniBER 718 SDH Rx to retrieve Overhead Monitor Bytes

The following commands can be used to retrieve the OmniBER 718 SDH Receiver's Overhead Monitor byte values.

Table 12-14

OmniBER 718 SDH Rx Overhead Monitor

Comment	SCPI Command	Ref.
Retrieve the D1 byte in STM-1 #1	<code>FETCh:SCALar:DATA:TELEcom:SDH:OVERhead? 1,1,D1</code>	5-109
Retrieve the M1 byte in STM-1 #3	<code>FETCh:SCALar:DATA:TELEcom:SDH:OVERhead? 3,1,M1</code>	5-109
Retrieve F2 byte in VC-4 POH of selected STM-1	<code>FETCh:SCALar:TELEcom:SDH:POVerhead? F2</code>	5-110
Retrieve J1 trace in VC-4 POH of selected STM-1	<code>FETCh:STRing:DATA:TELEcom:SDH:J1?</code>	5-107
Fetch F2 byte in VC-3 POH of selected STM-1	<code>FETCh:SCALar:TELEcom:SDH:TRIButary:POVerhead? F2</code>	5-111
Fetch J1 trace in VC-3 POH of selected STM-1	<code>FETCh:STRing:DATA:TELEcom:SDH:TRIButary:J1?</code>	5-108

Setup the OmniBER 718 SDH Rx to perform Overhead Byte Capture

The following commands can be used to setup the OmniBER 718 SDH Receiver to capture selected Overhead bytes.

Table 12-15 **OmniBER 718 SDH Rx Overhead Byte Capture**

Comment	SCPI Command	Ref.
Select SDH Test Function.	<code>SENSe:DATA:TELEcom:TFUNction SDH</code>	3-16
Set Test Function to be Overhead Sequences	<code>SENSe:DATA:TELEcom:SDH:TFUNction:TYPE OCAPture</code>	5-83
Select J0 Byte for Sequence Capture	<code>SENSe:DATA:TELEcom:SDH:OCAPture:OHBYte J0</code>	5-83
Set Overhead Capture to trigger on value.	<code>SENSe:DATA:TELEcom:SDH:OCAPture:TRIGger ON</code>	5-85
Set Overhead Capture trigger value to "02"	<code>SENSe:DATA:TELEcom:SDH:OCAPture:TRIGger:PATtern "02"</code>	5-86
Start Overhead Capture	<code>SENSe:DATA:TELEcom:SDH:OCAPture START</code>	5-83
Retrieve Overhead Capure data	<code>FETCh:ARRAy:DATA:TELEcom:SDH:OCAPture? 16</code>	5-83

Setup the OmniBER 718 SONET Tx

The following commands can be used to setup the OmniBER 718 SONET Transmitter to generate a OC-3 Optical signal with a VT-2 PCM31 Framed payload.

Table 12-16

OmniBER 718 SONET Tx Setup

Comment	SCPI Command	Ref.
Set Tx Output to OC-48/12/3/1 Optical	<code>SOURce:DATA:TELEcom:SOURce OC48</code>	3-9
Set Tx Line Rate to OC-3 Optical	<code>OUTPut:TELEcom:OC48:RATE OC3</code>	5-6
Set Tx Optical Wavelength to be 1310 nm	<code>OUTPut:TELEcom:OC48:WAVelength NM1310</code>	5-6
Ensure that Thru Mode is not selected	<code>SOURce:DATA:TELEcom:SONet:THRumode INTernal</code>	6-11
Set Clock Sync to Internal	<code>SOURce:CLOCK:SONet:SOURce INTernal</code>	6-9
Ensure Frequency Offset is OFF	<code>SOURce:CLOCK:SONet:FOFFset OFF</code>	6-10
Setup F/G Mappings		
Set SPE Layer Selection to STS-1	<code>SOURce:DATA:TELEcom:SONet:SPE:TYPE STS1</code>	6-15
Set VT Layer Selection to VT-2	<code>SOURce:DATA:TELEcom:SONet:PAYLoad VT2</code>	6-15
Set the VT-2 Mapping to Asynchronous 2 Mb/s	<code>SOURce:DATA:TELEcom:SONet:TRIButary:MAPPING ASYNc</code>	6-17
Ensure 2M Payload Offset is 0 ppm	<code>SOURce:DATA:TELEcom:SONet:PAYLoad:OFFset 0</code>	6-20
Set STS-1 Number to 1	<code>SOURce:DATA:TELEcom:SONet:STS1 1</code>	6-15
Set VT Group Number to 1	<code>SOURce:DATA:TELEcom:SONet:VTGRoup 1</code>	6-17

Table 12-16

OmniBER 718 SONET Tx Setup, continued

Comment	SCPI Command	Ref.
Set VT Number to 1	SOURce:DATA:TELEcom:SONet:TRIButary 1	6-17
Set VT Payload Framing to PCM31	SOURce:DATA:TELEcom:SONet:PAYLoad:TYPE PCM31	6-18
Set VT Payload Type to Unstructured	SOURce:DATA:TELEcom:SONet:PAYLoad:STRUcture UNSTRUctured	6-19
Set Pattern to 2 ¹⁵ -1 PRBS	SOURce:DATA:TELEcom:SONet:PAYLoad:PATTern PRBS15	6-19
Set PRBS Polarity to be Inverted	SOURce:DATA:TELEcom:SONet:PRBS:POLarity INVerted	6-20
Setup B/G Mappings		
Set Background STS-1 #2 to VT-2 Mapping	SOURce:DATA:TELEcom:SONet:STS1:BACKground:PAYLoad:PATTern 2,VT2	6-22
Set Background STS-1 #3 to VT-2 Mapping	SOURce:DATA:TELEcom:SONet:STS1:BACKground:PAYLoad:PATTern 3,VT2	6-22
Set Pattern in Background VT-2's within STS-1 #1 to be "1100" Word	SOURce:DATA:TELEcom:SONet:PRIMary:BACKground:PAYLoad:PATTern P1100	6-22

Setup the OmniBER 718 SONET Rx

The following commands can be used to setup the OmniBER 718 SONET Receiver to receive a OC-12 Optical signal with a VT-2 Unframed payload.

Table 12-17

OmniBER 718 SONET Rx Setup

Comment	SCPI Command	Ref.
Set Rx Input to OC-48/12/3/1 Optical	SENSe:DATA:TELEcom:SENSe OC48	3-15
Set Rx Line Rate to OC-12 Optical	INPut:TELEcom:OC48:RATE OC12	6-63
Set SPE Layer Selection to STS-1	SENSe:DATA:TELEcom:SONet:SPE:TYPE STS1	6-68
Set VT Layer Selection to VT-2	SENSe:DATA:TELEcom:SONet:PAYLoad VT2	6-68
Set the VT-2 Mapping to Asynchronous 2 Mb/s	SENSe:DATA:TELEcom:SONet:TRIButary:MAPPING ASYNc	6-69
Set STS-3 Number Under Test to 1	SENSe:DATA:TELEcom:SONet:STS3 1	6-67
Set STS-1 Number to 1	SENSe:DATA:TELEcom:SONet:STS1 1	6-68
Set VT Group Number to 1	SENSe:DATA:TELEcom:SONet:VTGRoup 1	6-70
Set VT Number to 1	SENSe:DATA:TELEcom:SONet:TRIButary 1	6-71
Set VT Payload to be Unframed	SENSe:DATA:TELEcom:SONet:PAYLoad:TYPE UNFRamed	6-71
Set VT Payload Type to Unstructured	SENSe:DATA:TELEcom:SONet:PAYLoad:STRUcture UNSTRUctured	6-72
Set Pattern to 2 ¹⁵ -1 PRBS	SENSe:DATA:TELEcom:SONet:PAYLoad:PATTern PRBS15	6-72
Set PRBS Polarity to be Inverted	SENSe:DATA:TELEcom:SONet:PRBS:POLarity INVERTed	6-74

Setup the OmniBER 718 SONET Tx to add Errors & Alarms

The following commands can be used to setup the OmniBER 718 SONET Transmitter to generate errors and alarms using the SONET Test Function.

Table 12-18

OmniBER 718 SONET Tx Error & Alarm Add

Comment	SCPI Command	Ref.
Select SONET Test Function	<code>SOURce:DATA:TELEcom:TFUNction SONet</code>	3-10
Set Test Function to be Errors & Alarms	<code>SOURce:DATA:TELEcom:SONet:TFUNction:TYPE ERROr</code>	6-35
Set Error Add type to CV-P (B3)	<code>SOURce:DATA:TELEcom:SONet:ERRor:TYPE CVP</code>	6-35
Add a single CV-P error. Repeat if required.	<code>SOURce:DATA:TELEcom:SONet:ERRor:RATE ONCE</code>	6-36
Add a CV-P error rate of 1E-4	<code>SOURce:DATA:TELEcom:SONet:ERRor:RATE E_4</code>	6-36
Switch CV-P error rate OFF	<code>SOURce:DATA:TELEcom:SONet:ERRor:RATE NONE</code>	6-36
Generate a Line FERF (RDI-L) alarm	<code>SOURce:DATA:TELEcom:SONet:ALARm RDIL</code>	6-41
Switch alarm OFF	<code>SOURce:DATA:TELEcom:SONet:ALARm NONE</code>	6-41

Setup the OmniBER 718 SONET Tx Overhead Bytes

The following commands can be used to setup the OmniBER 718 SONET Transmitter Overhead bytes. It is assumed that a OC-12 signal is selected. .

Table 12-19

OmniBER 718 SONET Tx Overhead Setup

Comment	SCPI Command	Ref.
Set the Overhead bytes to their default values	<code>SOURce:DATA:TELEcom:SONet:OVERhead:DEFault</code>	6-24
Update the D1 byte in STS-3 #1	<code>SOURce:DATA:TELEcom:SONet:OVERhead:DATA 1,1,D1,"11111111"</code>	6-24
Update the M1 byte in STS-3 #3	<code>SOURce:DATA:TELEcom:SONet:OVERhead:DATA:HEXadecimal 3,1,M1,"FF"</code>	6-25
Update F2 byte in the POH of the selected STS-3	<code>SOURce:DATA:TELEcom:SONet:POVerhead:DATA F2,"11111111"</code>	6-26
Update J1 trace in POH of selected STS-3 to be HP37718A Test string	<code>SOURce:DATA:TELEcom:SONet:POVerhead:J1:PATtern TEST</code>	6-27

Setup the OmniBER 718 SONET Tx for Overhead Byte Sequencing

The following commands can be used to setup the OmniBER 718 SONET Transmitter to generate an Overhead byte sequence. It is assumed that an OC-12 signal is selected.

Table 12-20 **OmniBER 718 SONET Tx Overhead Sequence**

Comment	SCPI Command	Ref.
Select SONET Test Function.	<code>SOURce:DATA:TELEcom:TFUNction SONet</code>	3-10
Set Test Function to be Overhead Sequences	<code>SOURce:DATA:TELEcom:SONet:TFUNction:TYPE SEquence</code>	6-35
Set Sequence Mode to be Repeat Run	<code>SOURce:DATA:TELEcom:SONet:SEquence:MODE REPeat</code>	6-48
Select J0 Byte in SOH	<code>SOURce:DATA:TELEcom:SONet:SEquence:OHBYte J0</code>	6-49
Set Sequence byte values to "00","01","02","03","04"	<code>SOURce:DATA:TELEcom:SONet:SEquence:DATA A, "00 "</code> <code>SOURce:DATA:TELEcom:SONet:SEquence:DATA B, "01 "</code> <code>SOURce:DATA:TELEcom:SONet:SEquence:DATA C, "02 "</code> <code>SOURce:DATA:TELEcom:SONet:SEquence:DATA D, "03 "</code> <code>SOURce:DATA:TELEcom:SONet:SEquence:DATA E, "04 "</code>	6-50
Set the Sequence order to be A,B,C,D,E	<code>SOURce:DATA:TELEcom:SONet:SEquence:ORDER A,B,C,D,E"</code>	6-50
Set the Frame Count for each value to be 10	<code>SOURce:DATA:TELEcom:SONet:SEquence:FCOUNT 1,10</code> <code>SOURce:DATA:TELEcom:SONet:SEquence:FCOUNT 2,10</code> <code>SOURce:DATA:TELEcom:SONet:SEquence:FCOUNT 3,10</code> <code>SOURce:DATA:TELEcom:SONet:SEquence:FCOUNT 4,10</code> <code>SOURce:DATA:TELEcom:SONet:SEquence:FCOUNT 5,10</code>	6-51
Start Sequence	<code>SOURce:DATA:TELEcom:SONet:SEquence START</code>	6-48

Perform OmniBER 718 SONET Rx Measurements

The following commands can be used to setup the OmniBER 718 SONET Receiver to perform B3 measurements. .

Table 12-21

OmniBER 718 SONET Rx Measurements

Comment	SCPI Command	Ref.
Setup Results Timing Control		
Set Short Term Period to 10 seconds	SENSe:DATA:TELEcom:STERm:PERiod 10s	3-19
Set Test Timing to Single	SENSe:DATA:TELEcom:TEST:TYPE SINGLE	3-18
Set Test Period to 1 minute	SENSe:DATA:TELEcom:TEST:PERiod 1m	3-18
Start gating	SENSe:DATA:TELEcom:TEST ON	3-16
Wait for measurement to complete		
Retrieve Results		
Read back Cumulative CV-P Error Count	SENSe:DATA? "ECOUNT:SONet:CVP"	6-86
Read back Short Term CV-P Error Count	SENSe:DATA? "ECOUNT:SONet:STERm:CVP"	6-86
Read back some G.826 Analysis Results	SENSe:DATA? "ESECONDS:SONet:CVP:ANALYSIS" SENSe:DATA? "SECONDS:SONet:CVP:ANALYSIS" SENSe:DATA? "UASECONDS:SONet:CVP:ANALYSIS"	6-91

Setup the OmniBER 718 SONET Rx to retrieve Overhead Monitor Bytes

The following commands can be used to retrieve the OmniBER 718 SONET Receiver's Overhead Monitor byte values. .

Table 12-22 **OmniBER 718 SONET Rx Overhead Monitor**

Comment	SCPI Command	Ref.
Retrieve the D1 byte in STS-3 #1	<code>FETCh:SCALar:DATA:TELEcom:SONet:OVERhead? 1,1,D1</code>	6-99
Retrieve the M1 byte in STS-3 #3	<code>FETCh:SCALar:DATA:TELEcom:SONet:OVERhead? 3,1,M1</code>	6-99
Retrieve F2 byte in POH of selected STS-3	<code>FETCh:SCALar:TELEcom:SONet:POVerhead? F2</code>	6-99
Retrieve J1 trace in POH of selected STS-3	<code>FETCh:STRing:DATA:TELEcom:SONet:J1?</code>	6-97

Setup the OmniBER 718 SONET Rx to perform Overhead Byte Capture

The following commands can be used to setup the OmniBER 718 SONET Receiver to capture selected Overhead bytes.

Table 12-23

OmniBER 718 SONET Rx Overhead Byte Capture

Comment	SCPI Command	Ref.
Select SONET Test Function.	<code>SENSe:DATA:TELEcom:TFUNction SONet</code>	3-16
Set Test Function to be Overhead Sequences	<code>SENSe:DATA:TELEcom:SONet:TFUNction:TYPE OCAPture</code>	6-76
Select J0 Byte for Sequence Capture	<code>SENSe:DATA:TELEcom:SONet:OCAPture:OHBYte J0</code>	6-77
Set Overhead Capture to trigger on value.	<code>SENSe:DATA:TELEcom:SONet:OCAPture:TRIGger ON</code>	6-78
Set Overhead Capture trigger value to "02"	<code>SENSe:DATA:TELEcom:SONet:OCAPture:TRIGger:PATtern "02"</code>	6-78
Start Overhead Capture	<code>SENSe:DATA:TELEcom:SONet:OCAPture START</code>	6-76
Retrieve Overhead Capure data	<code>FETCh:ARRay:DATA:TELEcom:SONet:OCAPture? 16</code>	6-107

Setup the OmniBER 718 to generate Jitter

The following commands can be used to set up an internally generated jitter modulation frequency of 1.3MHz with a jitter amplitude of 0.59UI on an SDH/SONET signal.

Table 12-24

OmniBER 718 Jitter Tx Setup

Comment	SCPI Command	Ref.
Set Jitter on	:OUTPut:TELEcom:JITTer ON	7-3
Set Modulation Source	:SOURce:DATA:TELEcom:JITTer:MODulation INTERNAL	7-13
Switch off Jitter Mask	:SOURce:DATA:TELEcom:JITTer:MASK OFF	7-5
Set Tx Jitter Range	:SOURce:DATA:TELEcom:JITTer:RANGE UI20	7-6
Set Tx Jitter Modulation Frequency	:SOURce:DATA:TELEcom:JITTer:FREQuency 1300000	7-5
Set Tx Jitter Amplitude	:SOURce:DATA:TELEcom:JITTer:AMPLitude 0.59	7-5
Wait for Tx to Settle	:STAT:JITT:COND? Tx amplitude settled when bit 8 is false	7-21/2-44

NOTE

The Tx amplitude settled bit should be queried after any transmitter setting change.

Setup the OmniBER 718 to generate a PDH Jitter Swept Mask

The following commands can be used to set up an internally generated PDH G.823 swept jitter mask with LOW Q-factor. This applies to both 2Mb/s and 8Mb/s.

Table 12-25

OmniBER 718 PDH Jitter Tx Swept Mask Setup

Comment	SCPI Command	Ref.
Set Jitter on	:OUTPut:TELEcom:JITTer ON	7-3
Set Modulation Source	:SOURce:DATA:TELEcom:JITTer:MODulation INTernal	7-13
Set PDH Jitter Q-Factor	:SOUR:DATA:TEL:JITTer:MASK:TYPE QLOW	7-7
Set Swept Jitter Mask	:SOURce:DATA:TELEcom:JITTer:MASK SWEPT	7-5

Setup the OmniBER 718 to generate a SDH/SONET Jitter Swept Mask

The following commands can be used to set up an internally generated SDH/SONET GR-253 swept jitter mask.

Table 12-26

OmniBER 718 SDH/SONET Jitter Tx Swept Mask Setup

Comment	SCPI Command	Ref.
Set Jitter on	:OUTPut:TELEcom:JITTer ON	7-3
Set Modulation Source	:SOURce:DATA:TELEcom:JITTer:MODulation INTernal	7-13
Set Jitter Mask type	:SOURce:DATA:TELEcom:JITTer:MASK:TYPE GR253	7-7
Set Swept Jitter Mask	:SOURce:DATA:TELEcom:JITTer:MASK SWEPT	7-5

Setup the OmniBER 718 to generate a PDH Jitter Mask Spot Frequency

The following commands can be used to set up an internally generated jitter modulation SPOT frequency of 1.6kHz on a PDH G823 mask.

Table 12-27

OmniBER 718 PDH Jitter Mask Spot Frequency Setup

Comment	SCPI Command	Ref.
Set Jitter on	:OUTPut:TELEcom:JITTer ON	6-3
Set Modulation Source	:SOURce:DATA:TELEcom:JITTer:MODulation INTernal	6-13
Set Jitter Mask Type	:SOURce:DATA:TELEcom:JITTer:MASK:TYPE G823	
Set Tx Jitter Modulation Frequency	:SOURce:DATA:TELEcom:JITTer:FREQuency 1600	6-5
Set Spot Jitter Mask	:SOURce:DATA:TELEcom:JITTer:MASK SPOT	6-5
Wait for Tx to Settle	:STAT:JITT:COND? Tx amplitude settled when bit 8 is false	7-21/3-39

Setup the OmniBER 718 to generate an SDH/SONET Jitter Mask Spot Frequency

The following commands can be used to set up an internally generated jitter modulation SPOT frequency of 1MHz on an SDH/SONET G958 Type B mask.

Table 12-28

OmniBER 718 SDH/SONET Jitter Mask Spot Frequency Setup

Comment	SCPI Command	Ref.
Set Jitter on	:OUTPut:TELEcom:JITTer ON	7-3
Set Modulation Source	:SOURce:DATA:TELEcom:JITTer:MODulation INTernal	7-13
Set Jitter Mask type	:SOURce:DATA:TELEcom:JITTer:MASK:TYPE G958B	7-7
Set Tx Jitter Modulation Frequency	:SOURce:DATA:TELEcom:JITTer:FREQuency 1000000	7-5
Set Spot Jitter Mask	:SOURce:DATA:TELEcom:JITTer:MASK SPOT	7-5
Wait for Tx to Settle	:STAT:JITT:COND? Tx amplitude settled when bit 8 is false	7-21/3-39

Perform OmniBER 718 Jitter Rx Measurements

The following commands can be used to setup the OmniBER 718 Jitter Receiver to perform some jitter hit/amplitude measurements. The Jitter Receiver measurement range is 1.6UI, using the HP1 filter selection with a HIT threshold of 1.4UI.

Table 12-29

OmniBER 718 Jitter Rx Measurements

Comment	SCPI Command	Ref.
Jitter Receiver Setting		
Set Jitter Measurement Type	:SENSe:DATA:TELEcom:JITTer:TYPE JITTer	7-21
Set Jitter Receiver Range	:SENSe:DATA:TELEcom:JITTer:RANGe UI1_6	7-22
Set Jitter Receiver Hit Threshold	:SENSe:DATA:TELEcom:JITTer:THReshold 1.4	7-23
Set Jitter Receiver Filter	:SENSe:DATA:TELEcom:JITTer:FILTer HP1	7-21
Wait for Jitter Rx to settle	:STAT:JITT:COND? Rx locked up when bit 0 is false	7-21
Setup Results Timing Control		
Set Short Term Period to 10 seconds	:SENSe:DATA:TELEcom:STERm:PERiod 10s	3-19
Set Test Timing to Single	:SENSe:DATA:TELEcom:TEST:TYPE SINGLE	3-18
Set Test Period to 1 minute	:SENSe:DATA:TELEcom:TEST:PERiod 1m	3-18
Start gating	:SENSe:DATA:TELEcom:TEST ON	3-16
Wait for measurement to complete		
Retrieve Results		
Read back Cumulative Jitter Hit Counts	:SENSe:DATA? "COUNT:JITT:HITS"	7-24

Table 12-29

OmniBER 718 Jitter Rx Measurements, continued

Comment	SCPI Command	Ref.
Read back Cumulative Jitter PK-PK Amplitude	:SENSe:DATA? "PEAK:JITT:PKPK"	7-24
Read back Short-Term RMS Jitter result	:SENSe:DATA? "RMS:JITT:STERm"	7-24

Setup the OmniBER 718 to generate Wander

The following commands can be used to set up a wander modulation frequency of 0.125 Hz with a wander modulation amplitude of 50UI

Table 12-30

OmniBER 718 Wander Tx Setup

Comment	SCPI Command	Ref.
Set Wander on	:OUTPut:TELEcom:JITTer:WANDer ON	7-4
Switch off Wander Mask	:SOURce:DATA:TELEcom:JITTer:WANDer:MASK OFF	7-14
Set Tx Wander Modulation Frequency	:SOURce:DATA:TELEcom:JITTer:WANDer:FREQuency 125000	7-14
Set Tx Wander Modulation Amplitude	:SOURce:DATA:TELEcom:JITTer:WANDer:AMPLitude 50	7-14

Setup the OmniBER 718 to generate a Wander Mask Spot Frequency

The following commands can be used to set up a wander modulation SPOT frequency of 1.6mHz on an ITU-T G.823/G.825 mask

Table 12-31 **OmniBER 718 Wander Mask Spot Frequency Setup**

Comment	SCPI Command	Ref.
Set Wander on	:OUTPut:TELEcom:JITTer:WANDer ON	7-4
Set Tx Jitter Modulation Frequency	:SOURce:DATA:TELEcom:JITTer:WANDer:FREQuency 1600	7-14
Set Spot Jitter Mask	:SOURce:DATA:TELEcom:JITTer:MASK SPOT	7-5

Perform OmniBER 718 Wander Rx Measurements

The following commands can be used to setup the OmniBER 718 Jitter Receiver to perform some wander measurements. The Jitter Receiver HIT threshold is set at 15UI.

Table 12-32

OmniBER 718 Jitter Rx Measurements

Comment	SCPI Command	Ref.
Wander Receiver Setting		
Set Wander Measurement Type	:SENSe:DATA:TELEcom:JITTer:TYPE WANDer	7-21
Set Jitter Receiver Hit Threshold	:SENSe:DATA:TELEcom:JITTer:THReshold 15	7-23
Wait for Jitter Rx locked	:STAT:JITT:COND? Rx locked when bit 0 and bit 2 are false	7-21
Setup Results Timing Control		
Set Test Timing to Single	:SENSe:DATA:TELEcom:TEST:TYPE SINGLE	3-18
Set Test Period to 1 minute	:SENSe:DATA:TELEcom:TEST:PERiod 1m	3-18
Start gating	:SENSe:DATA:TELEcom:TEST ON	3-16
Wait for measurement to complete		
Retrieve Results		
Read back +ve peak Wander	:SENSe:DATA? "PEAK:JITT:WANDer:POSitive"	7-24
Read back pk-to-pk Wander	:SENSe:DATA? "PEAK:JITT:WANDer:PKPK"	7-24

Perform OmniBER 718 Jitter Auto-Tolerance Measurement

The following commands can be used to setup the OmniBER 718 to perform a jitter auto-tolerance measurement. The auto-tolerance measurement is carried out for 9 frequency points, using a delay time of 2 seconds and a dwell time of 1 second for each point. Any error during the auto-tolerance gating period will cause a fail at that particular point.

Table 12-33 OmniBER 718 Jitter Auto-Tolerance Measurement

Comment	SCPI Command	Ref.
Select Auto-Tolerance	:OUTPut:TELEcom:JITTer AUTotol	7-3
Setup Auto-Tolerance Parameters		
Set Number of Points	:SOURce:DATA:TELEcom:JITTer:ATOLerance:POINTs 9	7-9
Set Dwell Time	:SOURce:DATA:TELEcom:JITTer:ATOLerance:DWELL 1	7-8
Set Delay Time	:SOURce:DATA:TELEcom:JITTer:ATOLerance:DELay 2	7-8
Set Threshold	:SOURce:DATA:TELEcom:JITTer:ATOLerance:THReshold 0	7-9
Start Auto-Tolerance	:OUTPut:TELEcom:JITTer:AUTotol ON	7-3
Wait for Auto-Tolerance to complete	:STAT:JITT:COND? Jitter Auto-Tolerance complete when bit 10 is false	7-21/3-39
Retrieve Results	:FETCh:ARRAy:DATA:TELEcom:JITTer:ATOLerance?	7-26

NOTE If a jitter auto-tolerance mask selection is available, this should be set up prior to running the auto-tolerance measurement. The relevant commands is:-
:SOURce:DATA:TELEcom:JITTer:MASK:TYPE Ref 6-7

Perform OmniBER 718 Jitter Transfer Function Measurement

The following commands can be used to setup the OmniBER 718 to perform an SDH/SONET jitter transfer function measurement. The transfer function measurement is carried out for 55 frequency points, using a delay time of 5 seconds and a dwell time of 6 second for each point. The G.958 Type A transfer function input mask is selected for the test.

Table 12-34 OmniBER 718 Jitter Transfer Function Measurement

Comment	SCPI Command	Ref.
Select Transfer Function	:OUTPut:TELEcom:JITTer TRANSfer	7-3
Setup Transfer Function Parameters		
Set Number of Points	:SOURce:DATA:TELEcom:JITTer:TRANSfer:POINTs 55	7-10
Set Dwell Time	:SOURce:DATA:TELEcom:JITTer:TRANSfer:DWELl 6	7-11
Set Delay Time	:SOURce:DATA:TELEcom:JITTer:TRANSfer:DELay 5	7-10
Set Input Mask	:SOURce:DATA:TELEcom:JITTer:TRANSfer:MASK:INPut G958A	7-11
Perform Calibration Run		
Select Calibration Mode	:SOURce:DATA:TELEcom:JITTer:TRANSfer:MODE CALib	7-10
Initiate Calibration Run	:OUTPut:TELEcom:JITTer:TRANSfer ON	7-4
Wait for Calibration Run to complete	:STAT:JITT:COND? Calibration Run complete when bit 14 is false	7-21/3-39
Perform Measurement Run		
Select Measurement Mode	:SOURce:DATA:TELEcom:JITTer:TRANSfer:MODE MEASure	7-10
Initiate Measurement Run	:OUTPut:TELEcom:JITTer:TRANSfer ON	7-4
Wait for Measurement Run to complete	:STAT:JITT:COND? Measurement Run complete when bit 14 is false	7-21/3-39
Retrieve Results	:FETCh:ARRAy:DATA:TELEcom:JITTer:TRANSfer?	7-27

Setup the OmniBER 718 ATM Tx

The following commands can be used to setup the OmniBER 718 Transmitter to generate an ATM cell stream mapped into a VC-4 at STM-1 optical.

Table 12-35

OmniBER 718 ATM Tx Setup

Comment	SCPI Command	Ref.
Set Tx Output to STM-16/4/1/0 Optical	<code>SOURce:DATA:TELEcom:SOURce OPT16</code>	3-9
Set Tx Line Rate to STM-1 Optical	<code>OUTPut:TELEcom:OPT16:RATE STM1</code>	5-6
Set Tx Optical Wavelength to be 1310 nm	<code>OUTPut:TELEcom:OPT16:WAVelength NM1310</code>	5-6
Ensure that Thru Mode is not selected	<code>SOURce:DATA:TELEcom:SDH:THRumode INTernal</code>	5-11
Set Clock Sync to Internal	<code>SOURce:CLOCK:SDH:SOURce INTernal</code>	5-10
Ensure Frequency Offset is OFF	<code>SOURce:CLOCK:SDH:FOFFset OFF</code>	5-11
Setup F/G Mapping		
Set AU Layer Selection to AU-4	<code>SOURce:DATA:TELEcom:SDH:AU:TYPE AU4</code>	5-16
Set the Mapping to ATM	<code>SOURce:DATA:TELEcom:SDH:MAPPING ATM</code>	5-17
Setup ATM Convergence Sublayer		
Set Network Interface to UNI	<code>SOURce:DATA:TELEcom:ATM:NINTerface UNI</code>	8-3
Set ATM Scrambling to ON	<code>SOURce:DATA:TELEcom:ATM:SCRambling ON</code>	8-4
Setup ATM Distribution		
Set ATM PCR to 100000 cells/s	<code>SOURce:DATA:TELEcom:ATM:DISTRibution:PCR 100000</code>	8-7

Table 12-35

OmniBER 718 ATM Tx Setup, continued

Comment	SCPI Command	Ref.
Setup ATM Payload		
Set ATM Payload to PRBS23	SOURce:DATA:TELEcom:ATM:PAYLoad PRBS23	8-6

Setup the OmniBER 718 ATM Rx

The following commands can be used to setup the OmniBER 718 Receiver to receive an ATM cell stream mapped into an AU-4-4c at STM-4 Optical.

Table 12-36

OmniBER 718 ATM Rx Setup

Comment	SCPI Command	Ref.
Set Rx Input to STM-16/4/1/0 Optical	SENSe:DATA:TELEcom:SENSe OPT16	3-15
Set Rx Line Rate to STM-4 Optical	INPut:TELEcom:OPT16:RATE STM4	5-69
Set AU Layer Selection to AU-4-4c	SENSe:DATA:TELEcom:SDH:AU:TYPE AU4_4C	5-75
Set the Mapping to ATM	SENSe:DATA:TELEcom:SDH:MAPPING ATM	5-76
Setup ATM Convergence Sublayer		
Set Network Interface to UNI	SENSe:DATA:TELEcom:ATM:NINTerface UNI	8-19
Set ATM Descrambling to ON	SENSe:DATA:TELEcom:ATM:SCRambling ON	8-19
Setup ATM Payload		
Set ATM Payload to PRBS23	SENSe:DATA:TELEcom:ATM:PAYLoad PRBS23	8-23

Setup the OmniBER 718 Tx to add ATM Errors and Alarms

The following commands can be used to setup the OmniBER 718 Transmitter to generate errors and alarms using the ATM Test Function.

Table 12-37

OmniBER 718 ATM Tx Error and Alarm Add

Comment	SCPI Command	Ref.
Select ATM Test Function	SOURCE:DATA:TELECOM:TFUNCTION ATM	3-10
Set Error Add type to Single HEC	SOURCE:DATA:TELECOM:ATM:ERROR:TYPE SHEC	8-14
Add a single correctable HEC error. Repeat if required.	SOURCE:DATA:TELECOM:ATM:ERROR:RATE ONCE	8-15
Add a correctable HEC error rate of 1E-4	SOURCE:DATA:TELECOM:ATM:ERROR:RATE E_4	8-15
Switch correctable HEC error rate OFF	SOURCE:DATA:TELECOM:ATM:ERROR:RATE NONE	8-15
Switch on a VP-AIS OAM alarm	SOURCE:DATA:TELECOM:ATM:ALARM VPAIS	8-17
Switch alarm OFF	SOURCE:DATA:TELECOM:ATM:ALARM NONE	8-17

Perform OmniBER 718 ATM Rx Measurements

The following commands can be used to setup the OmniBER 718 Receiver to perform ATM Correctable HEC measurements and Loss of Cell Delineation alarm seconds.

Table 12-38

OmniBER 718 ATM Rx Measurements

Comment	SCPI Command	Ref.
Setup Results Timing Control		
Set Short Term Period to 10 seconds	SENSe:DATA:TELEcom:STERm:PERiod 10s	3-19
Set Test Timing to Single	SENSe:DATA:TELEcom:TEST:TYPE SINGLE	3-18
Set Test Period to 1 minute	SENSe:DATA:TELEcom:TEST:PERiod 1m	3-18
Start gating	SENSe:DATA:TELEcom:TEST ON	3-16
Wait for measurement to complete		
Retrieve Results		
Read back Cumulative Correctable HEC Error Count	SENSe:DATA? "ECOUNT:ATM:CHEC"	8-27
Read back Short Term Correctable HEC Error Count	SENSe:DATA? "ECOUNT:ATM:STERm:CHEC"	8-28
Read back Loss of Cell Delineation Alarm Seconds	SENSe:DATA? "ASECnds:ATM:LCD"	8-29

Setup the OmniBER 718 POS Tx

The following commands can be used to setup the OmniBER 718 Transmitter to generate an POS payload mapped into a VC-4 at STM-1 optical.

Table 12-39

OmniBER 718 POS Tx Setup

Comment	SCPI Command	Ref.
Set Tx Output to STM-16/4/1/0 Optical	<code>SOURce:DATA:TELEcom:SOURce OPT16</code>	3-9
Set Tx Line Rate to STM-1 Optical	<code>OUTPut:TELEcom:OPT16:RATE STM1</code>	5-6
Set Tx Optical Wavelength to be 1310 nm	<code>OUTPut:TELEcom:OPT16:WAVelength NM1310</code>	5-6
Ensure that Thru Mode is not selected	<code>SOURce:DATA:TELEcom:SDH:THRumode INTernal</code>	5-11
Set Clock Sync to Internal	<code>SOURce:CLOCK:SDH:SOURce INTernal</code>	5-10
Ensure Frequency Offset is OFF	<code>SOURce:CLOCK:SDH:FOFFset OFF</code>	5-11
Setup F/G Mapping		
Set AU Layer Selection to AU-4	<code>SOURce:DATA:TELEcom:SDH:AU:TYPE AU4</code>	5-16
Set the Mapping to POS	<code>SOURce:DATA:TELEcom:SDH:MAPPING IPOS</code>	5-17
Setup POS Link Layer		
Set POS HDLC Framing type to be PPP	<code>:SOURce:DATA:TELEcom:IPOS:HDLC:FRAMing PPP</code>	9-2
Set POS Scrambling to ON	<code>:SOURce:DATA:TELEcom:IPOS:HDLC:SCRambling ON</code>	9-2
Set POS HDLC Field Check Sequence to CRC-32	<code>:SOURce:DATA:TELEcom:IPOS:HDLC:FCS CRC32</code>	
Setup POS IP Packet Size and Inter-Packet Gap		

Table 12-39**OmniBER 718 POS Tx Setup, continued**

Comment	SCPI Command	Ref.
Set Packet Size to 7:4:1 distribution	:SOURce:DATA:TELEcom:IPOS:PACKet:LENGth L741	9-4
Set Inter-Packet Gap to Random	:SOURce:DATA:TELEcom:IPOS:PACKet:GAP RANDom	9-5
Set Maximum Random Inter-Packet Gap to be 32.	:SOURce:DATA:TELEcom:IPOS:PACKet:GAP:RANDom:MAX MAX1	9-5
Setup POS IP Header		
Set Type of Service to be 00000000.	:SOURce:DATA:TELEcom:IPOS:HEADer:TOService "00000000"	9-7
Set Flags to be 000.	:SOURce:DATA:TELEcom:IPOS:HEADer:FLAG "000"	9-7
Set Time To Live to be 64.	:SOURce:DATA:TELEcom:IPOS:HEADer:TTLive 64	9-7
Set Protocol to be TCP.	:SOURce:DATA:TELEcom:IPOS:HEADer:PROTOcol TCP	9-6
Setup POS IP Addresses		
Set IP Source Address to be 15.144.180.205	:SOURce:DATA:TELEcom:IPOS:ADDResses:SOURce "15.144.180.205"	9-3
Set IP Destination Address to be 15.144.180.215	:SOURce:DATA:TELEcom:IPOS:ADDResses:DESTination "15.144.180.215"	9-3
Setup POS IP Payload		
Set POS IP Payload to PRBS23	SOURce:DATA:TELEcom:IPOS:PAYLoad:PATTern PRBS23	9-8
Set PRBS Polarity to Invert	:SOURce:DATA:TELEcom:IPOS:PRBS:POLarity INVerted	9-9

Setup the OmniBER 718 POS Rx

The following commands can be used to setup the OmniBER 718 Receiver to receive an POS payload mapped into an AU-4-4c at STM-4 Optical.

Table 12-40

OmniBER 718 POS Rx Setup

Comment	SCPI Command	Ref.
Set Rx Input to STM-16/4/1/0 Optical	:SENSe:DATA:TELEcom:SENSe OPT16	3-15
Set Rx Line Rate to STM-4 Optical	:INPut:TELEcom:OPT16:RATE STM4	5-69
Set AU Layer Selection to AU-4-4c	:SENSe:DATA:TELEcom:SDH:AU:TYPE AU4_4C	5-75
Set the Mapping to POS	:SENSe:DATA:TELEcom:SDH:MAPPing IPOS	5-76
Setup POS Link Layer		
Set POS HDLC Framing type to be PPP	:SENSe:DATA:TELEcom:IPOS:HDLC:FRAMing PPP	9-11
Set POS Descrambling to ON	:SENSe:DATA:TELEcom:IPOS:HDLC:DESCrambling ON	9-11
Set POS HDLC Field Check Sequence to CRC-32	:SENSe:DATA:TELEcom:IPOS:HDLC:FCS CRC32	9-11
Setup POS IP Payload		
Set POS IP Payload to PRBS23	:SENSe:DATA:TELEcom:IPOS:PAYLoad:PATtern PRBS23	9-12
Set PRBS Polarity to Invert	:SENSe:DATA:TELEcom:IPOS:PRBS:POLarity INVerted	9-13

Setup the OmniBER 718 Tx to add POS Errors and Alarms

The following commands can be used to setup the OmniBER 718 Transmitter to generate errors and alarms using the POS Test Function.

Table 12-41 **OmniBER 718 ATM Tx Error and Alarm Add**

Comment	SCPI Command	Ref.
Select POS Test Function	<code>SOURce:DATA:TELEcom:TFUNction IPOS</code>	3-10
Set Error Add type to HDLC FCS	<code>SOURce:DATA:TELEcom:IPOS:ERRor:TYPE FCS</code>	9-9
Add a single HDLC FCS error. Repeat if required.	<code>SOURce:DATA:TELEcom:IPOS:ERRor:RATE ONCE</code>	9-10
Add a HDLC FCS error rate of 1E-4	<code>SOURce:DATA:TELEcom:IPOS:ERRor:RATE E_3</code>	9-10
Switch HDLC FCS error rate OFF	<code>SOURce:DATA:TELEcom:IPOS:ERRor:RATE NONE</code>	9-10
Switch on a HDLC Link Loss alarm	<code>SOURce:DATA:TELEcom:IPOS:ALARm LNKLoss</code>	9-10
Switch alarm OFF	<code>SOURce:DATA:TELEcom:IPOS:ALARm NONE</code>	9-10

Perform OmniBER 718 POS Rx Measurements

The following commands can be used to setup the OmniBER 718 Receiver to perform POS measurements.

Table 12-42

OmniBER 718 POS Rx Measurements

Comment	SCPI Command	Ref.
Setup Results Timing Control		
Set Short Term Period to 10 seconds	SENSE:DATA:TELEcom:STERm:PERiod 10s	3-19
Set Test Timing to Single	SENSE:DATA:TELEcom:TEST:TYPE SINGLE	3-18
Set Test Period to 1 minute	SENSE:DATA:TELEcom:TEST:PERiod 1m	3-18
Start gating	SENSE:DATA:TELEcom:TEST ON	3-16
Wait for measurement to complete		
Retrieve Results		
Read back Cumulative HDLC FCS Error Count	SENSE:DATA? "ECOUNT:IPOS:FCS"	9-14
Read back Short Term HDLC FCS Error Count	SENSE:DATA? "ECOUNT:IPOS:STERm:FCS"	9-14
Read back HDLC Link Loss Alarm Seconds	SENSE:DATA? "ASECnds:IPOS:LNKLoss"	9-15

SCPI Error Messages

SCPI Error Messages

SCPI Error Messages

The system-defined error/event numbers are chosen on an enumerated (“1 of N”) basis. The SCPI defined error/event numbers and the error description portions of the ERROR query response are listed here. The first error/event described in each class (for example, –100, –200, –300, –400) is a “generic” error. In selecting the proper error/event number to report, more specific error/event codes are preferred, and the generic error/event is used only if the others are inappropriate.

No Error

This message indicates that the device has no errors.

No Error

The queue is completely empty. Every error/event in the queue has been read or the queue was purposely cleared by power-on, *CLS, etc.

Command Errors [–199, –100]

An < error/event number > in the range [–199, –100] indicates that an *IEEE 488.2* syntax error has been detected by the instrument’s parser. The occurrence of any error in this class should cause the command error bit (bit 5) in the event status register (*IEEE 488.2*, section 11.5.1) to be set. One of the following events has occurred:

- An *IEEE 488.2* system error has been detected by the parser. That is, a controller-to-device message was received which is in violation of the *IEEE 488.2* standard. Possible violations include a data element which violates the device listening formats or whose type is unacceptable to the device.
- An unrecognized header was received. Unrecognized headers include incorrect device-specific headers and incorrect or not implemented *IEEE 488.2* common commands.
- A Group Execute Trigger (GET) was entered into the input buffer inside of an

SCPI Error Messages

IEEE 488.2 < PROGRAM MESSAGE >.

Events that generate command errors shall not generate execution errors, device-specific errors, or query errors.

-100

Command error

This is the generic syntax error for devices that cannot detect more specific errors. This code indicates only that a Command Error as defined in *IEEE 488.2*, 11.5.1.1.4 has occurred.

-101

Invalid character

A syntactic element contains a character which is invalid for that type; for example, a header containing an ampersand, SETUP&. This error might be used in place of errors -114, -121, -141, and perhaps some others.

-102

Syntax error

An unrecognized command or data type was encountered; for example, a string was received when the device does not accept strings.

-103

Invalid separator

The parser was expecting a separator and encountered an illegal character; for example, the semicolon was omitted after a program message unit, *ESE 1 :OUTP1:TEL:RATE 140 Mb/s

-104

Data type error

The parser recognized a data element different than one allowed; for example, numeric or string data was expected but block data was encountered.

-105

GET not allowed

A Group Execute Trigger was received within a program message (see *IEEE 488.2*, 7.7).

-108

Parameter not allowed

More parameters were received than expected for the header; for example, the *RCL common command only accepts one parameter, so receiving *RCL 0,1 is not allowed.

SCPI Error Messages

- 109 **Missing parameter**
- Fewer parameters were received than required for the header; for example, the *ESE common command requires one parameter, so receiving *ESE is not allowed.
- 110 **Command header error**
- An error was detected in the header. This error message should be used when the device cannot detect the more specific errors described for errors –111 through –119.
- 111 **Header separator error**
- A character which is not a legal header separator was encountered while parsing the header; for example, no white space followed the header, thus *ESE1 is an error.
- 112 **Program mnemonic too long**
- The header contains more than twelve characters (see *IEEE 488.2*, 7.6.1.4.1).
- 113 **Undefined header**
- The header is syntactically correct, but it is undefined by this specific device; for example, *XYZ is not defined for any device.
- 114 **Header suffix out of range**
- Indicates that a non-header character has been encountered in what the parser expects is a header element.
- 120 **Numeric data error**
- This error, as well as errors –121 through –129, are generated when parsing a data element which appears to be numeric, including the non-decimal numeric types. This particular error message should be used if the device cannot detect a more specific error.
- 121 **Invalid character in number**
- An invalid character for the data type being parsed was encountered; for example, an alpha in a decimal numeric or a “9” in octal data.

SCPI Error Messages

- 123 **Exponent too large**
The magnitude of the exponent was larger than 32000 (see *IEEE 488.2, 7.7.2.4.1*).
- 124 **Too many digits**
The mantissa of a decimal numeric data element contained more than 255 digits excluding leading zeros (see *IEEE 488.2, 7.7.2.4.1*).
- 128 **Numeric data not allowed**
A legal numeric data element was received, but the device does not accept one in this position for the header.
- 130 **Suffix error**
This error, as well as errors -131 through -139, are generated when parsing a suffix. This particular error message should be used if the device cannot detect a more specific error.
- 131 **Invalid suffix**
The suffix does not follow the syntax described in *IEEE 488.2, 7.7.3.2*, or the suffix is inappropriate for this device.
- 134 **Suffix too long**
The suffix contained more than 12 characters (see *IEEE 488.2, 7.7.3.4*).
- 138 **Suffix not allowed**
A suffix was encountered after a numeric element which does not allow suffixes.
- 140 **Character data error**
This error, as well as errors -141 through -149, are generated when parsing a character data element. This particular error message should be used if the device cannot detect a more specific error.
- 141 **Invalid character data**
Either the character data element contains an invalid character or the particular element received is not valid for the header.

SCPI Error Messages

- 144 **Character data too long**
The character data element contains more than twelve characters (see *IEEE 488.2*, 7.7.1.4).
- 148 **Character data not allowed**
A legal character data element was encountered where prohibited by the device.
- 150 **String data error**
This error, as well as errors -151 through -159, are generated when parsing a string data element. This particular error message should be used if the device cannot detect a more specific error.
- 151 **Invalid string data**
A string data element was expected, but was invalid for some reason (see *IEEE 488.2*, 7.7.5.2); for example, an END message was received before the terminal quote character.
- 158 **String data not allowed**
A string data element was encountered but was not allowed by the device at this point in parsing.
- 160 **Block data error**
This error, as well as errors -161 through -169, are generated when parsing a block data element. This particular error message should be used if the device cannot detect a more specific error.
- 161 **Invalid block data**
A block data element was expected, but was invalid for some reason (see *IEEE 488.2*, 7.7.6.2); for example, an END message was received before the length was satisfied.
- 168 **Block data not allowed**
A legal block data element was encountered but was not allowed by the device at this point in parsing.

SCPI Error Messages

- 170 **Expression error**
- This error, as well as errors –171 through –179, are generated when parsing an expression data element. This particular error message should be used if the device cannot detect a more specific error.
- 171 **Invalid expression**
- The expression data element was invalid (see *IEEE 488.2, 7.7.7.2*); for example, unmatched parentheses or an illegal character.
- 178 **Expression data not allowed**
- A legal expression data was encountered but was not allowed by the device at this point in parsing.
- 180 **Macro error**
- This error, as well as errors –181 through –189, are generated when defining a macro or executing a macro. This particular error message should be used if the device cannot detect a more specific error.
- 181 **Invalid outside macro definition**
- Indicates that a macro parameter placeholder ($\$<number>$) was encountered outside of a macro definition.
- 183 **Invalid inside macro definition**
- Indicates that the program message unit sequence, sent with a *DDT or *DMC command, is syntactically invalid (see 10.7.6.3).
- 184 **Macro parameter error**
- Indicates that a command inside the macro definition had the wrong number or type of parameters.

SCPI Error Messages

Execution Errors [-299, -200]

An < error/event number > in the range [-299, -200] indicates that an error has been detected by the instrument's execution control block. The occurrence of any error in this class should cause the execution error bit (bit 4) in the event status register (*IEEE 488.2*, section 11.5.1) to be set. One of the following events has occurred:

- A < PROGRAM DATA > element following a header was evaluated by the device as outside of its legal input range or is otherwise inconsistent with the device's capabilities.
- A valid program message could not be properly executed due to some device condition.

Execution errors shall be reported by the device after rounding and expression evaluation operations have taken place. Rounding a numeric data element, for example, shall not be reported as an execution error. Events that generate execution errors shall not generate Command Errors, device-specific errors, or Query Errors.

-200

Execution error

This is the generic syntax error for devices that cannot detect more specific errors. This code indicates only that an Execution Error as defined in *IEEE 488.2*, 11.5.1.1.5 has occurred.

-201

Invalid while in local

Indicates that a command is not executable while the device is in local due to a hard local control (see *IEEE 488.2*, 5.6.1.5); for example, a device with a rotary switch receives a message which would change the switches state, but the device is in local so the message can not be executed.

-202

Settings lost due to rtl

Indicates that a setting associated with a hard local control (see *IEEE 488.2*, 5.6.1.5) was lost when the device changed to LOCS from REMS or to LWLS from RWLS.

-210

Trigger error

SCPI Error Messages

- 211 **Trigger ignored**
- Indicates that a GET, *TRG, or triggering signal was received and recognized by the device but was ignored because of device timing considerations; for example, the device was not ready to respond. Note: a DT0 device always ignores GET and treats *TRG as a Command Error.
- 212 **Arm ignored**
- Indicates that an arming signal was received and recognized by the device but was ignored.
- 213 **Init ignored**
- Indicates that a request for a measurement initiation was ignored as another measurement was already in progress.
- 214 **Trigger deadlock**
- Indicates that the trigger source for the initiation of a measurement is set to GET and subsequent measurement query is received. The measurement cannot be started until a GET is received, but the GET would cause an INTERRUPTED error.
- 215 **Arm deadlock**
- Indicates that the arm source for the initiation of a measurement is set to GET and subsequent measurement query is received. The measurement cannot be started until a GET is received, but the GET would cause an INTERRUPTED error.
- 220 **Parameter error**
- Indicates that a program data element related error occurred. This error message should be used when the device cannot detect the more specific errors described for errors -221 through -229.
- 221 **Setting conflict**
- Indicates that a legal program data element was parsed but could not be executed due to the current device state (see *IEEE 488.2*, 6.4.5.3 and 11.5.1.1.5.)

SCPI Error Messages

- 222 **Data out of range**
- Indicates that a legal program data element was parsed but could not be executed because the interpreted value was outside the legal range as defined by the device (see *IEEE 488.2*, 11.5.1.1.5.)
- 223 **Too much data**
- Indicates that a legal program data element of block, expression, or string type was received that contained more data than the device could handle due to memory or related device-specific requirements.
- 224 **Illegal parameter value**
- Used where exact value, from a list of possibles, was expected.
- 230 **Data corrupt or stale**
- Possibly invalid data; new reading started but not completed since last access.
- 231 **Data questionable**
- Indicates that measurement accuracy is suspect.
- 240 **Hardware error**
- Indicates that a legal program command or query could not be executed because of a hardware problem in the device. Definition of what constitutes a hardware problem is completely device-specific. This error message should be used when the device cannot detect the more specific errors described for errors –241 through –249.
- 241 **Hardware missing**
- Indicates that a legal program command or query could not be executed because of missing device hardware; for example, an option was not installed. Definition of what constitutes missing hardware is completely device-specific.
- 250 **Mass storage error**
- Indicates that a mass storage error occurred. This error message should be used when the device cannot detect the more specific errors described for errors –251 through –259.

SCPI Error Messages

-251

Missing mass storage

Indicates that a legal program command or query could not be executed because of missing mass storage; for example, an option that was not installed. Definition of what constitutes missing mass storage is device-specific.

-252

Missing media

Indicates that a legal program command or query could not be executed because of a missing media; for example, no disk. The definition of what constitutes missing media is device-specific.

-253

Corrupt media

Indicates that a legal program command or query could not be executed because of corrupt media; for example, bad disk or wrong format. The definition of what constitutes corrupt media is device-specific.

-254

Media full

Indicates that a legal program command or query could not be executed because the media was full; for example, there is no room on the disk. The definition of what constitutes a full media is device-specific.

-255

Directory full

Indicates that a legal program command or query could not be executed because the media directory was full. The definition of what constitutes a full media directory is device-specific.

-256

File name not found

Indicates that a legal program command or query could not be executed because the file name on the device media was not found; for example, an attempt was made to read or copy a nonexistent file. The definition of what constitutes a file not being found is device-specific.

-257

File name error

Indicates that a legal program command or query could not be executed because the file name on the device media was in error; for example, an attempt was made to copy to a duplicate file name. The definition of what constitutes a file name error is device-specific.

SCPI Error Messages

- 258 **Media protected**
- Indicates that a legal program command or query could not be executed because the media was protected; for example, the write-protect tab on a disk was present. The definition of what constitutes protected media is device-specific.
- 260 **Expression error**
- Indicates that an expression program data element related error occurred. This error message should be used when the device cannot detect the more specific errors described for errors –261 through –269.
- 261 **Math error in expression**
- Indicates that a syntactically legal expression program data element could not be executed due to a math error; for example, a divide-by-zero was attempted. The definition of math error is device-specific.
- 270 **Macro error**
- Indicates that a macro-related execution error occurred. This error message should be used when the device cannot detect the more specific errors described for errors –271 through –279.
- 271 **Macro syntax error**
- Indicates that a syntactically legal macro program data sequence, according to *IEEE 488.2, 10.7.2*, could not be executed due to a syntax error within the macro definition (see *IEEE 488.2, 10.7.6.3*.)
- 272 **Macro execution error**
- Indicates that a syntactically legal macro program data sequence could not be executed due to some error in the macro definition (see *IEEE 488.2, 10.7.6.3*.)
- 273 **Illegal macro label**
- Indicates that the macro label defined in the *DMC command was a legal string syntax but could not be accepted by the device (see *IEEE 488.2, 10.7.3* and *10.7.6.2*); for example, the label was too long, the same as a common command header, or contained invalid header syntax.

SCPI Error Messages

- 274 **Macro parameter error**
Indicates that the macro definition improperly used a macro parameter placeholder (see *IEEE 488.2*, 10.7.3).
- 275 **Macro definition too long**
Indicates that a syntactically legal macro program data sequence could not be executed because the string or block contents were too long for the device to handle (see *IEEE 488.2*, 10.7.6.1).
- 276 **Macro recursion error**
Indicates that a syntactically legal macro program data sequence could not be executed because the device found it to be recursive (see *IEEE 488.2*, 10.7.6.6).
- 277 **Macro redefinition not allowed**
Indicates that a syntactically legal macro label in the *DMC command could not be executed because the macro label was already defined (see *IEEE 488.2*, 10.7.6.4).
- 278 **Macro header not found**
Indicates that a syntactically legal macro label in the *GMC? query could not be executed because the header was not previously defined.
- 280 **Program error**
Indicates that a downloaded program-related execution error occurred. This error message should be used when the device cannot detect the more specific errors described for errors –281 through –289.
-
- NOTE** A downloaded program is used to add algorithmic capability to a device. The syntax used in the program and the mechanism for downloading a program is device-specific.
-
- 281 **Cannot create program**
Indicates that an attempt to create a program was unsuccessful. A reason for the failure might include not enough memory.

SCPI Error Messages

-282

Illegal program name

The name used to reference a program was invalid; for example, redefining an existing program, deleting a nonexistent program, or in general, referencing a nonexistent program.

-283

Illegal variable name

An attempt was made to reference a nonexistent variable in a program.

-284

Program currently running

Certain operations dealing with programs may be illegal while the program is running; for example, deleting a running program might not be possible.

-285

Program syntax error

Indicates that a syntax error appears in a downloaded program. The syntax used when parsing the downloaded program is device-specific.

-286

Program runtime error

SCPI Error Messages

Query Errors [–399, –300]

An < error/event number > in the range [–399, –300] indicates that the instrument has detected an error which is not a command error, a query error, or an execution error; some device operations did not properly complete, possibly due to an abnormal hardware or firmware condition. These codes are also used for self-test response errors. The occurrence of any error in this class should cause the device-specific error bit (bit 3) in the event status register (IEEE 488.2, section 11.5.1) to be set. The meaning of positive error codes is device-dependent and may be enumerated or bit mapped; the <error message> string for positive error codes is not defined by SCPI and available to the device engineer. Note that the string is not optional; if the designer does not wish to implement a string for a particular error, the null string should be sent (for example 42," "). The occurrence of any error in this class should cause the device-specific error bit (bit 3) in the event status register (IEEE 488.2, section 11.5.1) to be set. Events that generate device-specific errors shall not generate command errors, execution errors, or query errors; see the other error definitions in this section.

–300

Device-specific error

This is the generic device-dependent error for devices that cannot detect more specific errors. This code indicates only that a Device-Dependent Error as defined in *IEEE 488.2*, 11.5.1.1.6 has occurred.

–310

System error

Indicates that some error, termed “system error” by the device has occurred. This code is device dependent.

–311

Memory error

Indicates that an error was detected in the device’s memory. The scope of this error is device-dependent.

–312

PUD memory lost

Indicates that the protected user data saved by the *PUD command has been lost.

SCPI Error Messages

- 313 **Calibration memory lost**
Indicates that nonvolatile calibration data used by the *CAL? command has been lost.
- 314 **Save/Recall memory lost**
Indicates that the nonvolatile data saved by the *SAV? command has been lost.
- 315 **Configuration memory lost**
Indicates that the nonvolatile data saved by the device has been lost. The meaning of this error is device-specific.
- 330 **Self-test failed**
- 350 **Queue overflow**
A specific code entered into the queue in lieu of the code that caused the error. This code indicates that there is no room in the queue and an error occurred but was not recorded.
- 360 **Communication error**
This is the generic communication error for devices that cannot detect the more specific errors described for errors -361 through -363.
- 361 **Parity error in program message**
Parity bit not correct when data received for example, on a serial port (for example, a baud rate mismatch).
- 362 **Framing error in program message**
A stop bit was not detected when data was received for example, on a serial port.
- 363 **Input buffer overrun**
Software or hardware input buffer on serial port overflows with data caused by improper or nonexistent pacing.

SCPI Error Messages

Query Errors [–499, –400]

An < error/event number > in the range [–499, –400] indicates that the output queue control of the instrument has detected a problem with the message exchange protocol described in *IEEE 488.2*, chapter 6. The occurrence of any error in this class should cause the query error bit (bit 2) in the event status register (*IEEE 488.2*, section 11.5.1) to be set. These errors correspond to message exchange protocol errors described in *IEEE 488.2*, section 6.5. One of the following is true:

- An attempt is being made to read data from the output queue when no output is either present or pending;
- Data in the output queue has been lost.

Events that generate query errors shall not generate command errors, execution errors, or device-specific errors; see the other error definitions in this section.

–400

Query error

This is the general query error for devices that cannot detect more specific errors. This code indicates only that a Query Error as defined in *IEEE 488.2*, 11.5.1.1.7 and 6.3 has occurred.

–410

Query INTERRUPTED

Indicates that a condition causing an INTERRUPTED Query error occurred (see *IEEE 488.2*, 6.3.2.3); for example, a query followed by DAB or GET before a response was completely sent.

–420

Query UNTERMINATED

Indicates that a condition causing an UNTERMINATED Query error occurred (see *IEEE 488.2*, 6.3.2.2); for example, the device was addressed to talk and an incomplete program message was received.

–430

Query DEADLOCKED

Indicates that a condition causing a DEADLOCKED Query error occurred (see *IEEE 488.2*, 6.3.1.7); for example, both input buffer and output buffer are full and the device cannot continue.

SCPI Error Messages

-440

Query UNTERMINATED after indefinite response

Indicates that a query was received in the same program message after a query requesting an indefinite response was executed (see *IEEE 488.2*, 6.5.7.5.7.)

General Index

A

Alarm Seconds Results, 8-29

Alarms

SDH, 5-46

SONET, 6-41

Application Program Examples, 12-1

ATM commands

transmitter, 8-3

ATM Cumulative Term Results, 8-27

ATM Service Disruption Results, 8-30

ATM settings

receiver, 8-19

ATM Short Term Results, 8-28

B

Backwards Compatibility, 2-1

BOOTP, 1-8

C

Command Errors, 13-2

Command Reference, 5-2, 6-2

Command Syntax, 3-2

Communication with the System Controller, 1-3

Condition Register, 10-4

Connecting the LAN to the Instrument Remote Control Interface, 1-9

Connecting to a LAN, 1-7

Connecting to GP-IB, 1-3

Connecting to RS-232-C, 1-4

D

DATE, 3-46

DCC port, 5-65, 5-86, 6-59

Default Gateway IP Address, 1-7

Default Settings, 1-13

Device Clear (CLEAR), 11-3

DNA Option USS, 1-2

E

Error Checking, 1-13

Errors

SDH, 5-40

SONET, 6-35

Event Enable Register, 10-4

Event Register, 10-4

General Index

Example Program, 10-35

Execution Errors, 13-8

F

FETCh subsystem, 4-89, 5-107, 6-97, 7-26

Fixed Jitter Masks

 Backwards Compatibility, 2-4

Frequency Offsets, 1-16

G

Gating Control, 1-15

General Information, 11-2

Graphics

 Configuring, 3-26

 Managing Stores, 3-28

 Obtaining End of Measurement Results, 3-36

 Retrieving Data for a Single Graph, 3-34

 Retrieving Store Data, 3-30

H

Hints & Tips, 1-13

HP-IB Universal Commands, 11-3

I

IEEE common capabilities, 3-63

Initialization, 1-12

Initializing the HP 37718A, 12-2

INPut subsystem, 3-12, 4-47, 5-69, 6-63

Instrument Coupling, 1-13

INSTRument subsystem, 3-7

Internet address, 1-7

Interpreting Interrupts, 10-34

J

Jitter Auto tolerance

 BackwardsCompatibility, 2-4

K

KLOCK, 3-47

L

LAN

 BOOTP, 1-8

 Current Settings, 1-8

 New Settings, 1-9

General Index

Linking Command Statements, 3-3
LOCAl, 3-47
Local (LOCAL), 11-4
Local Lockout (LOCAL LOCKOUT), 11-4

M

Methods of Remote Control, 1-2
Mixed Backgrounds, 2-5
 Backwards Compatibility, 2-3
MSP messages, 5-58, 6-52

O

Operating Distances, 1-3
Option Identification Query
 Backwards Compatibility, 2-2
OUTPut subsystem, 4-3, 5-3, 6-3, 7-3
Overhead BER test, SDH, 5-88

P

Pointer Graph, SDH, 5-87
Pointer moves, SDH, 5-47
Pointer moves, SONET, 6-42
Program examples, 12-3
Programming Interrupts, 10-34

Q

Query Errors, 13-15

R

Receiver
 Common Commands, 3-15
 Jitter Settings, 7-21
 SDH AU Layer Selection, 5-75
 SDH Mapping settings, 5-73
 SDH overhead capture, 5-83
 SDH Settings, 5-73, 9-11
 SDH Test Function Commands, 5-83
 SDH TUG Channel, 5-77
 SONET Settings, 6-67
 SONET SPE Layer Selection, 6-68
 SONET Test Function Commands, 6-76
 SONET VT Group, 6-70
 SPDH Test Function Commands, 4-60
 Structured PDH Settings, 4-51, 8-19
Receiver ATM Settings, 8-19

General Index

Remote Control Commands, 3-5
Remote Control Hints & Tips, 1-13
Remote Control, Methods of, 1-2
Remote Enable (REMOTE), 11-3
Results
 common, 3-21
 Frequency, 4-70, 5-93
 Frequency (Sonet), 6-86
 Jitter/Wander, 7-24
 SDH Alarm Seconds, 5-105, 9-15
 SDH Cumulative, 5-94, 9-14
 SDH MS B2 BIP Analysis, 5-96
 SDH Optical Power, 5-104, 9-15
 SDH Path B3 BIP Analysis, 5-97
 SDH Path FEBE Analysis, 5-98
 SDH Path IEC Analysis, 5-98
 SDH Path MS FEBE Analysis, 5-97
 SDH Pointer Activity, 5-104
 SDH RS B1 BIP Analysis, 5-96
 SDH Service Disruption, 5-104, 9-15
 SDH Short Term, 5-93, 8-27, 8-28, 9-14
 SDH Tributary Path BIP Analysis, 5-98
 SDH Tributary Path FEBE Analysis, 5-99, 5-100
 SONET Alarm Seconds, 6-94
 SONET Block Based Bit Analysis, 6-91
 SONET Cumulative, 6-87
 SONET CV-IEC Analysis, 6-90
 SONET CV-L Analysis, 6-88
 SONET CV-S Analysis, 6-88
 SONET Line RE-L Analysis, 6-88
 SONET Optical Power, 6-93
 SONET Path CV-P Analysis, 6-89
 SONET Pointer Activity, 6-93
 SONET REI-P Analysis, 6-89
 SONET Service Disruption, 6-93
 SONET Short Term, 6-86
 SONET Tributary Path CV-V Analysis, 6-90
 SONET Tributary Path REI-V Analysis, 6-90
 Structured PDH 140 Mb/S FAS Error Analysis, 4-84
 Structured PDH 140 Mb/s G.826 Analysis, 4-73
 Structured PDH 2 Mb/S FAS Error Analysis, 4-82
 Structured PDH 2 Mb/s G.826 Analysis, 4-76, 4-77, 4-78
 Structured PDH 34 Mb/S FAS Error Analysis, 4-83
 Structured PDH 34 Mb/s G.826 Analysis, 4-74
 Structured PDH 8 Mb/S FAS Error Analysis, 4-83
 Structured PDH 8 Mb/s G.826 Analysis, 4-75
 Structured PDH Alarm Seconds, 4-86

General Index

Structured PDH and Payload G.821 Analysis, 4-72
Structured PDH CRC Error Analysis, 4-84
Structured PDH Cumulative, 4-71
Structured PDH M.2100 Analysis, 4-79
Structured PDH M.2110 Analysis, 4-81
Structured PDH M.2120 ANALysis, 4-82
Structured PDH REBE Error Analysis, 4-85
Structured PDH Round Trip Delay, 4-87
Structured PDH Short Term, 4-70
RS232 port conections, 1-5
RS-232-C Communication with the Terminal/Computer, 1-5
RS-232-C Computer Mode, 1-6
RS-232-C Terminal Mode, 1-6

S
SCPI Command Format, 3-2
SCPI Error Messages, 13-2
SCPI Long Form Command Headers, 3-3
SCPI Overview, 11-2
SENSe subsystem, 3-13
Sequences and Overheads
 Backwards Compatibility, 2-3
Sequences, SDH overhead, 5-54
Sequences, SONET overhead, 6-48
Serial Poll (SPOLL), 11-3
Setup Delays, 1-14
Signaling bits
 2M CAS, 4-11, 4-18
 DS1, 4-26
SONET Mapping Settings, 6-67
SOURce subsystem, 3-8
SOURce subsystem - Transmitter SDH OVERHEAD SETUP, 5-27
SOURce subsystem - Transmitter SONET OVERHEAD SETUP, 6-24
Status Byte, 10-5
Status Register
 DATA, 10-10
 INSTrument, 10-9
 JITTer, 10-19, 10-20, 10-21
 M140, 10-23
 M2, 10-26
 M34, 10-24
 M8, 10-25
 OPERation, 10-8
 QUEStionable, 3-44, 10-7
 SDH, 10-13

General Index

- SDH2, 10-14, 10-15, 10-18
- SONET, 10-16
- SONET2, 10-17
- SPDH, 10-22
 - Standard Event, 10-6
- Status Registers, 1-14
- Status Registers Relationship, 10-31
- Status Reporting, 10-2
- STATus subsystem, 3-43
- Structured Payload Type
 - Backwards Compatibility, 2-2
- Subnet Mask, 1-7
- SYSTEM Subsystem, 3-46

T

- Test Timing, 3-18
- Thru Mode
 - Backwards Compatibility, 2-4
- Transition Filter, 10-4
- Transmitter
 - Common Commands, 3-9
 - Jitter, 7-5
 - SDH AU Layer Selection, 5-15, 5-74
 - SDH Clock settings, 5-9
 - SDH overhead, 5-66
 - SDH Payload Layer Selection, 5-17
 - SDH Settings, 4-42, 5-9
 - SDH Test Function, 5-40
 - SDH Thru mode settings, 5-11
 - SDH TU Payload and Test Pattern, 5-19
 - SDH TUG Channel, 5-18
 - SONET Clock settings, 6-9
 - SONET overhead, 6-60
 - SONET Payload Layer Selection, 6-16
 - SONET Settings, 6-9
 - SONET SPE Layer Selection, 6-15
 - SONET Test Function, 6-35
 - SONET Thru mode settings, 6-11
 - SONET VT Group, 6-17
 - SONET VT Payload and Test Pattern, 6-18
 - Structured PDH, 4-7, 8-3, 9-2
 - Wander, 7-14
- Transmitter ATM Commands, 8-3
- TRIGger, 3-47
- Trouble Scan, 3-23

General Index

U

User Locks, 1-16

V

VT Layer Selection, 6-68

W

WINDow, 3-46

General Index

Command Index

*CLS 3-63
*ESE <numeric> 3-63
*ESE? 3-63
*ESR? 3-63
*IDN? 3-63
*LRN? 3-64
*OPC 3-64
*OPT? 3-64
*PSC <numeric> 3-65
*RCL <numeric> 3-65
*RST 3-65
*SAV <numeric> 3-65
*SRE <numeric> 3-65
*SRE? 3-66
*STB? 3-66
*TRG 3-66
*TRG? 3-66
*TST 3-66
*TST? 3-66
*WAI 3-66
: FETCh:SCALAr:DATA:TELEcom:SONet:POVerhead:H4Sequence? 6-99
: SENSE:DATA:TELEcom:SONet:TFUNction:TYPE <discrete> 6-76
::SOURce:DATA:TELEcom:SONet:THRumode:COVerwrite <boolean> 6-12
:FETCh:ARRAy:DATA:TELEcom:JITTer:ATOLerance? 7-26
:FETCh:ARRAy:DATA:TELEcom:JITTer:TRANsfer? 7-27
:FETCh:ARRAy:DATA:TELEcom:SDH:ASCan? 5-111
:FETCh:ARRAy:DATA:TELEcom:SDH:OCApTure? <numeric> 5-123
:FETCh:ARRAy:DATA:TELEcom:SDH:OVERhead? <numeric>,<numeric>, <numeric> 5-124
:FETCh:ARRAy:DATA:TELEcom:SDH:PGRaph? 5-122
:FETCh:ARRAy:DATA:TELEcom:SDH:POVerhead? <numeric> 5-123
:FETCh:ARRAy:DATA:TELEcom:SDH:TSCan? 5-118
:FETCh:ARRAy:DATA:TELEcom:SONet:ASCan? 6-100
:FETCh:ARRAy:DATA:TELEcom:SONet:OCApTure? <numeric> 6-107
:FETCh:ARRAy:DATA:TELEcom:SONet:OVERhead? <numeric><numeric> <numeric> 6-108
:FETCh:ARRAy:DATA:TELEcom:SONet:PGRaph? 6-107
:FETCh:ARRAy:DATA:TELEcom:SONet:POVerhead? <numeric> 6-108
:FETCh:ARRAy:DATA:TELEcom:SONet:TSCan? 6-105
:FETCh:ARRAy:DATA:TELEcom:SPDH:ASCan:M140? 4-95
:FETCh:ARRAy:DATA:TELEcom:SPDH:ASCan:M2? 4-96

Command Index

:FETCh:ARRAy:DATA:TELEcom:SPDH:ASCan:M34? 4-95
:FETCh:ARRAy:DATA:TELEcom:SPDH:ASCan:M8? 4-95
:FETCh:ARRAy:DATA:TELEcom:SPDH:ASCan? 4-96
:FETCh:SCALAr:DATA:TELEcom:SDH:OVERhead? <numeric>,<numeric>, <discrete> 5-109
:FETCh:SCALAr:DATA:TELEcom:SDH:POVerhead:H4Sequence? 5-110
:FETCh:SCALAr:DATA:TELEcom:SDH:POVerhead? <byte name> 5-123
:FETCh:SCALAr:DATA:TELEcom:SDH:POVerhead? <discrete> 5-111
:FETCh:SCALAr:DATA:TELEcom:SDH:TRIButary:POVerhead:SLABel? 5-111
:FETCh:SCALAr:DATA:TELEcom:SDH:TRIButary:POVerhead:SLABel? 5-124
:FETCh:SCALAr:DATA:TELEcom:SDH:TRIButary:POVerhead? <discrete> 5-111
:FETCh:SCALAr:DATA:TELEcom:SONet:OVERhead? <numeric>,<numeric>, <discrete> 6-99
:FETCh:SCALAr:DATA:TELEcom:SONet:POVerhead? <discrete> 6-100
:FETCh:SCALAr:DATA:TELEcom:SONet:TRIButary:POVerhead:SLABel? 6-100
:FETCh:SCALAr:DATA:TELEcom:SONet:TRIButary:POVerhead? <discrete> 6-100
:FETCh:SCALAr:DATA:TELEcom:SPDH:TSLot:SIGNaling? <numeric> 4-95
:FETCh:STRing:DATA:TELEcom:SDH:J0:HEXadecimal? 5-107
:FETCh:STRing:DATA:TELEcom:SDH:J0? 5-107
:FETCh:STRing:DATA:TELEcom:SDH:J1:HEXadecimal? 5-108
:FETCh:STRing:DATA:TELEcom:SDH:J1? 5-107
:FETCh:STRing:DATA:TELEcom:SDH:K1? 5-109
:FETCh:STRing:DATA:TELEcom:SDH:K2? 5-109
:FETCh:STRing:DATA:TELEcom:SDH:S1? 5-109
:FETCh:STRing:DATA:TELEcom:SDH:TCM:APID? 5-107
:FETCh:STRing:DATA:TELEcom:SDH:TRIButary:J1:HEXadecimal? 5-108
:FETCh:STRing:DATA:TELEcom:SDH:TRIButary:J1? 5-108
:FETCh:STRing:DATA:TELEcom:SDH:TRIButary:J2:HEXadecimal? 5-109
:FETCh:STRing:DATA:TELEcom:SONet:J0:HEXadecimal? 6-97
:FETCh:STRing:DATA:TELEcom:SONet:J0? 6-97
:FETCh:STRing:DATA:TELEcom:SONet:J1:HEXadecimal? 6-97
:FETCh:STRing:DATA:TELEcom:SONet:J1? 6-97
:FETCh:STRing:DATA:TELEcom:SONet:K1? 6-98
:FETCh:STRing:DATA:TELEcom:SONet:K2? 6-98
:FETCh:STRing:DATA:TELEcom:SONet:S1? 6-98
:FETCh:STRing:DATA:TELEcom:SONet:TRIButary:J2:HEXadecimal? 6-98
:FETCh:STRing:DATA:TELEcom:SONet:TRIButary:J2? 6-98
:FETCh:STRing:DATA:TELEcom:SPDH:FEAC:LAST:TEXT? 4-89
:FETCh:STRing:DATA:TELEcom:SPDH:FEAC:LAST? 4-89
:FETCh:STRing:DATA:TELEcom:SPDH:FEAC:TEXT? 4-89
:FETCh:STRing:DATA:TELEcom:SPDH:FEAC? 4-89

Command Index

:FETCh:STRing:DATA:TELEcom:SPDH:INBand:LAST:TEXT? 4-91
:FETCh:STRing:DATA:TELEcom:SPDH:INBand:LAST? 4-91
:FETCh:STRing:DATA:TELEcom:SPDH:M34:TTRace:HEXadecimal? 4-93
:FETCh:STRing:DATA:TELEcom:SPDH:M34:TTRace? 4-93
:FETCh:STRing:DATA:TELEcom:SPDH:OUTBand:CURRent:TEXT? 4-92
:FETCh:STRing:DATA:TELEcom:SPDH:OUTBand:CURRent? 4-92
:FETCh:STRing:DATA:TELEcom:SPDH:OUTBand:LAST:TEXT? 4-93
:INPut:TELEcom:LEVel <discrete> 3-12
:INPut:TELEcom:OC12:INTErface <discrete> 6-64
:INPut:TELEcom:OC12:RATE <discrete> 6-64
:INPut:TELEcom:OC3:INTErface <discrete> 6-64
:INPut:TELEcom:OC3:RATE <discrete> 6-63
:INPut:TELEcom:OC48:INTErface <discrete> 6-65
:INPut:TELEcom:OC48:RATE <discrete> 6-65
:INPut:TELEcom:OPT1:INTErface <discrete> 5-70
:INPut:TELEcom:OPT1:RATE <discrete> 5-69
:INPut:TELEcom:OPT16:INTErface <discrete> 5-71
:INPut:TELEcom:OPT16:RATE <discrete> 5-71
:INPut:TELEcom:OPT4:INTErface <discrete> 5-71
:INPut:TELEcom:OPT4:RATE <discrete> 5-70
:INPut:TELEcom:SDH:GAIN <discrete> 5-69
:INPut:TELEcom:SDH:RATE <discrete> 5-69
:INPut:TELEcom:SONet:GAIN <discrete> 6-63
:INPut:TELEcom:SONet:RATE <discrete> 6-63
:INPut:TELEcom:SPDH:BALance <discrete> 4-48
:INPut:TELEcom:SPDH:CODE <discrete> 4-47
:INPut:TELEcom:SPDH:EQUalisation <boolean> 4-49
:INPut:TELEcom:SPDH:GAIN <discrete> 4-48
:INPut:TELEcom:SPDH:INSert:CODE <discrete> 4-48
:INPut:TELEcom:SPDH:RATE <discrete> 4-47
:INSTrument:COUPle <mode> 3-7
:OUTPut:TELEcom:JITTer <discrete> 7-3
:OUTPut:TELEcom:JITTer:AUTotol <boolean> 7-3
:OUTPut:TELEcom:JITTer:TRANsfer <boolean> 7-4
:OUTPut:TELEcom:JITTer:TRANsfer:CALibrate? 7-4
:OUTPut:TELEcom:JITTer:WANDer <boolean> 7-4
:OUTPut:TELEcom:OC12:LASer <boolean> 6-5
:OUTPut:TELEcom:OC12:RATE <discrete> 6-4
:OUTPut:TELEcom:OC12:WAVelength <discrete> 6-5

Command Index

:OUTPut:TELEcom:OC3:LASer <boolean> 6-4
:OUTPut:TELEcom:OC3:RATE <discrete> 6-3
:OUTPut:TELEcom:OC3:RATE? 6-4
:OUTPut:TELEcom:OC3:WAVelength <discrete> 6-4
:OUTPut:TELEcom:OC48:LASer <boolean> 6-7
:OUTPut:TELEcom:OC48:RATE <discrete> 6-6
:OUTPut:TELEcom:OC48:WAVelength <discrete> 6-6
:OUTPut:TELEcom:OPT1:LASer <boolean> 5-4
:OUTPut:TELEcom:OPT1:RATE <discrete> 5-3
:OUTPut:TELEcom:OPT1:WAVelength <discrete> 5-4
:OUTPut:TELEcom:OPT16:LASer <boolean> 5-7
:OUTPut:TELEcom:OPT16:RATE <discrete> 5-6
:OUTPut:TELEcom:OPT16:WAVelength <discrete> 5-6
:OUTPut:TELEcom:OPT4:LASer <boolean> 5-6
:OUTPut:TELEcom:OPT4:RATE <discrete> 5-5
:OUTPut:TELEcom:OPT4:WAVelength <discrete> 5-5
:OUTPut:TELEcom:SDH:LEVel <discrete> 5-3
:OUTPut:TELEcom:SDH:RATE <discrete> 5-3
:OUTPut:TELEcom:SONet:LEVel <discrete> 6-3
:OUTPut:TELEcom:SONet:RATE <discrete> 6-3
:OUTPut:TELEcom:SPDH:BALance <discrete> 4-4
:OUTPut:TELEcom:SPDH:CODE <discrete> 4-3
:OUTPut:TELEcom:SPDH:DROP:CODE <discrete> 4-4
:OUTPut:TELEcom:SPDH:LEVel <discrete> 4-4
:OUTPut:TELEcom:SPDH:RATE <discrete> 4-3
:OUTPut:TELEcom:SPDH:STATe <boolean> 4-5
:SENSe:DATA:TELEcom:ATM:CELLs <discrete> 8-20
:SENSe:DATA:TELEcom:ATM:CONVergence <discrete> 8-19
:SENSe:DATA:TELEcom:ATM:HEADer:CLP <string> 8-23
:SENSe:DATA:TELEcom:ATM:HEADer:GFC <discrete> 8-21
:SENSe:DATA:TELEcom:ATM:HEADer:GFC:VALue <numeric> 8-21
:SENSe:DATA:TELEcom:ATM:HEADer:PTI <string> 8-23
:SENSe:DATA:TELEcom:ATM:HEADer:VCI <discrete> 8-22
:SENSe:DATA:TELEcom:ATM:HEADer:VCI:VALue <numeric> 8-22
:SENSe:DATA:TELEcom:ATM:HEADer:VPI <discrete> 8-21
:SENSe:DATA:TELEcom:ATM:HEADer:VPI:VALue <numeric> 8-22
:SENSe:DATA:TELEcom:ATM:HEC <boolean> 8-20
:SENSe:DATA:TELEcom:ATM:NINTerface <discrete> 8-19
:SENSe:DATA:TELEcom:ATM:PAYLoad <discrete> 8-23

Command Index

:SENSe:DATA:TELEcom:ATM:PAYLoad:UWORD <string> 8-24
:SENSe:DATA:TELEcom:ATM:POLicing:CDVT <numeric> 8-26
:SENSe:DATA:TELEcom:ATM:POLicing:MBS <numeric> 8-26
:SENSe:DATA:TELEcom:ATM:POLicing:PCR <numeric> 8-25
:SENSe:DATA:TELEcom:ATM:POLicing:SCR <numeric> 8-25
:SENSe:DATA:TELEcom:ATM:POLicing:SERVice <discrete> 8-24
:SENSe:DATA:TELEcom:ATM:SCRambling <boolean> 8-19
:SENSe:DATA:TELEcom:IPOS:HDLC:DESCrambling <discrete> 9-11
:SENSe:DATA:TELEcom:IPOS:HDLC:FCS <discrete> 9-11
:SENSe:DATA:TELEcom:IPOS:HDLC:FRAMing <discrete> 9-11
:SENSe:DATA:TELEcom:IPOS:PAYLoad:PATtern <discrete> 9-12
:SENSe:DATA:TELEcom:IPOS:PAYLoad:UWORD:BIN32 <string> 9-13
:SENSe:DATA:TELEcom:IPOS:PAYLoad:UWORD:HEX16 <string> 9-13
:SENSe:DATA:TELEcom:IPOS:PAYLoad:UWORD:HEX32 <string> 9-13
:SENSe:DATA:TELEcom:IPOS:PAYLoad:UWORD[:BIN16] <string> 9-12
:SENSe:DATA:TELEcom:IPOS:PRBS:POLarity <discrete> 9-13
:SENSe:DATA:TELEcom:JITTer:FILTer <discrete> 7-21
:SENSe:DATA:TELEcom:JITTer:HP1 <discrete> 7-22
:SENSe:DATA:TELEcom:JITTer:RANGe <discrete> 7-22
:SENSe:DATA:TELEcom:JITTer:THReshold <numeric> 7-23
:SENSe:DATA:TELEcom:JITTer:TYPE <discrete> 7-21
:SENSe:DATA:TELEcom:SDH:ASCan <boolean> 5-89
:SENSe:DATA:TELEcom:SDH:ASCan:BIP <discrete> 5-89
:SENSe:DATA:TELEcom:SDH:ASCan:MODE <discrete> 5-89
:SENSe:DATA:TELEcom:SDH:AU:TYPE <discrete> 5-75
:SENSe:DATA:TELEcom:SDH:AU3 <numeric> 5-74
:SENSe:DATA:TELEcom:SDH:AU4 <numeric> 5-73
:SENSe:DATA:TELEcom:SDH:AU4C <numeric> 5-74
:SENSe:DATA:TELEcom:SDH:DDCC <discrete> 5-86
:SENSe:DATA:TELEcom:SDH:MAPPing <discrete> 5-76
:SENSe:DATA:TELEcom:SDH:MSRei <boolean> 5-92
:SENSe:DATA:TELEcom:SDH:OBERtest:CHANnel <discrete> 5-88
:SENSe:DATA:TELEcom:SDH:OBERtest:CHANnel:SElect <numeric> 5-88
:SENSe:DATA:TELEcom:SDH:OCAPture <discrete> 5-83
:SENSe:DATA:TELEcom:SDH:OCAPture:CHANnel <discrete> 5-84
:SENSe:DATA:TELEcom:SDH:OCAPture:CHANnel:SElect <numeric> 5-85
:SENSe:DATA:TELEcom:SDH:OCAPture:COLumn <numeric> 5-85
:SENSe:DATA:TELEcom:SDH:OCAPture:OHBYte <discrete> 5-84
:SENSe:DATA:TELEcom:SDH:OCAPture:TRIGger <discrete> 5-85

Command Index

:SENSe:DATA:TELEcom:SDH:OCAPture:TRIGger:PATTern <string> 5-86
:SENSe:DATA:TELEcom:SDH:PAYLoad <discrete> 5-75
:SENSe:DATA:TELEcom:SDH:PAYLoad:PATTern <discrete> 5-79
:SENSe:DATA:TELEcom:SDH:PAYLoad:STRUcture <discrete> 5-79
:SENSe:DATA:TELEcom:SDH:PAYLoad:TYPE <discrete> 5-78
:SENSe:DATA:TELEcom:SDH:PAYLoad:UWORD <string> 5-80
:SENSe:DATA:TELEcom:SDH:PGRaph:CINTerval <discrete> 5-87
:SENSe:DATA:TELEcom:SDH:PGRaph:PTYPE <discrete> 5-87
:SENSe:DATA:TELEcom:SDH:PRBS:POLarity <discrete> 5-81
:SENSe:DATA:TELEcom:SDH:PRIMary:TS0 <boolean> 5-77
:SENSe:DATA:TELEcom:SDH:TCM:PATH <discrete> 5-74
:SENSe:DATA:TELEcom:SDH:TFUNction:TYPE <discrete> 5-83
:SENSe:DATA:TELEcom:SDH:TRIButary <numeric> 5-78
:SENSe:DATA:TELEcom:SDH:TRIButary:CONCatenate <numeric>,<numeric> 5-81
:SENSe:DATA:TELEcom:SDH:TRIButary:MAPPing <discrete> 5-76
:SENSe:DATA:TELEcom:SDH:TSCan <boolean> 5-91
:SENSe:DATA:TELEcom:SDH:TSCan:BIP <discrete> 5-91
:SENSe:DATA:TELEcom:SDH:TSCan:PERiod <numeric>,<suffix> 5-91
:SENSe:DATA:TELEcom:SDH:TUG2 <numeric> 5-77
:SENSe:DATA:TELEcom:SDH:TUG3 <numeric> 5-77
:SENSe:DATA:TELEcom:SENSe <discrete> 3-15
:SENSe:DATA:TELEcom:SMG <discrete> 3-26
:SENSe:DATA:TELEcom:SMG:ALABels? <numeric>,<numeric> 3-33
:SENSe:DATA:TELEcom:SMG:CATalog? 3-28
:SENSe:DATA:TELEcom:SMG:DATA? <numeric>,<string> 3-36
:SENSe:DATA:TELEcom:SMG:DELeTe <numeric> 3-29
:SENSe:DATA:TELEcom:SMG:DELeTe:ALL 3-29
:SENSe:DATA:TELEcom:SMG:EDATa? <numeric>,<numeric> 3-34
:SENSe:DATA:TELEcom:SMG:HDATa:NORMal? <numeric> 3-31
:SENSe:DATA:TELEcom:SMG:HDATa:PACKed? <numeric> 3-32
:SENSe:DATA:TELEcom:SMG:LABels? <numeric> 3-30
:SENSe:DATA:TELEcom:SMG:RESolution <discrete> 3-26
:SENSe:DATA:TELEcom:SMG:SINformation? <numeric> 3-29
:SENSe:DATA:TELEcom:SMG:SIZE? 3-29
:SENSe:DATA:TELEcom:SMG:STORe <discrete> 3-26
:SENSe:DATA:TELEcom:SMG:TINformation? <numeric>,<numeric> 3-35
:SENSe:DATA:TELEcom:SMG:VDATa? <numeric>,<numeric> 3-35
:SENSe:DATA:TELEcom:SONet:ASCan <boolean> 6-82
:SENSe:DATA:TELEcom:SONet:ASCan:BIP <discrete> 6-82

Command Index

:SENSe:DATA:TELEcom:SONet:ASCan:MODE <discrete> 6-82
:SENSe:DATA:TELEcom:SONet:DDCC <discrete> 6-79
:SENSe:DATA:TELEcom:SONet:MAPPing <discrete> 6-69
:SENSe:DATA:TELEcom:SONet:OBERtest:STS1 <numeric> 6-80
:SENSe:DATA:TELEcom:SONet:OBERtest:STS3 <discrete> 6-80
:SENSe:DATA:TELEcom:SONet:OBERtest:STS3:SELEct <numeric> 6-81
:SENSe:DATA:TELEcom:SONet:OCAPture <discrete> 6-76
:SENSe:DATA:TELEcom:SONet:OCAPture:OHBYte <discrete> 6-77
:SENSe:DATA:TELEcom:SONet:OCAPture:STS1 <numeric> 6-77
:SENSe:DATA:TELEcom:SONet:OCAPture:STS3:SELEct <numeric> 6-77
:SENSe:DATA:TELEcom:SONet:OCAPture:TRIGger <discrete> 6-78
:SENSe:DATA:TELEcom:SONet:OCAPture:TRIGger:PATTern <string> 6-78
:SENSe:DATA:TELEcom:SONet:PAYLoad <discrete> 6-68
:SENSe:DATA:TELEcom:SONet:PAYLoad:PATTern <discrete> 6-72
:SENSe:DATA:TELEcom:SONet:PAYLoad:STRucture <discrete> 6-72
:SENSe:DATA:TELEcom:SONet:PAYLoad:TYPE <discrete> 6-71
:SENSe:DATA:TELEcom:SONet:PAYLoad:UWORD <string> 6-73
:SENSe:DATA:TELEcom:SONet:PGRaph:CINTerval <discrete> 6-79
:SENSe:DATA:TELEcom:SONet:PGRaph:PTYPE <discrete> 6-79
:SENSe:DATA:TELEcom:SONet:PRBS:POLarity <discrete> 6-74
:SENSe:DATA:TELEcom:SONet:PRIMary:TS0 <boolean> 6-70
:SENSe:DATA:TELEcom:SONet:SPE:TYPE <discrete> 6-68
:SENSe:DATA:TELEcom:SONet:STS1 <numeric> 6-68
:SENSe:DATA:TELEcom:SONet:STS12c <numeric> 6-68
:SENSe:DATA:TELEcom:SONet:STS3 <numeric> 6-67
:SENSe:DATA:TELEcom:SONet:TRIButary <numeric> 6-71
:SENSe:DATA:TELEcom:SONet:TRIButary:CONCatenate <numeric>,<numeric> 6-74
:SENSe:DATA:TELEcom:SONet:TRIButary:MAPPing <discrete> 6-69
:SENSe:DATA:TELEcom:SONet:TSCan <boolean> 6-84
:SENSe:DATA:TELEcom:SONet:TSCan:BIP <discrete> 6-84
:SENSe:DATA:TELEcom:SONet:TSCan:PERiod <numeric>,<suffix> 6-84
:SENSe:DATA:TELEcom:SONet:VTGRoup <numeric> 6-70
:SENSe:DATA:TELEcom:SPDH:ANALysis:M2110 <discrete> 4-61
:SENSe:DATA:TELEcom:SPDH:ANALysis:M2110:PATH <discrete> 4-61
:SENSe:DATA:TELEcom:SPDH:ANALysis:M2110:USER: ESECond <discrete>,<numeric> 4-62
:SENSe:DATA:TELEcom:SPDH:ANALysis:M2110:USER: SESECond <discrete>,<numeric> 4-63
:SENSe:DATA:TELEcom:SPDH:ANALysis:M2120 <discrete> 4-64
:SENSe:DATA:TELEcom:SPDH:ANALysis:M2120:MFACTor <numeric> 4-64
:SENSe:DATA:TELEcom:SPDH:ANALysis:M2120:USER: ESECond <discrete>,<numeric> 4-64

Command Index

:SENSe:DATA:TELEcom:SPDH:ANALysis:M2120:USER: SESecond <discrete>, <numeric> 4-65
:SENSe:DATA:TELEcom:SPDH:ASCan <boolean> 4-66
:SENSe:DATA:TELEcom:SPDH:INBand:LPDN:CODE <discrete> 4-69
:SENSe:DATA:TELEcom:SPDH:INBand:LPUP:CODE <discrete> 4-68
:SENSe:DATA:TELEcom:SPDH:PATtern <discrete> 4-51
:SENSe:DATA:TELEcom:SPDH:PAYLoad:STRucture <discrete> 4-53
:SENSe:DATA:TELEcom:SPDH:PAYLoad:TYPE <discrete> 4-52
:SENSe:DATA:TELEcom:SPDH:PRBS:POLarity <discrete> 4-52
:SENSe:DATA:TELEcom:SPDH:RTDelay <boolean> 4-67
:SENSe:DATA:TELEcom:SPDH:TSIGnal:MAPPing <discrete> 4-54
:SENSe:DATA:TELEcom:SPDH:TSIGnal:PAYLoad <discrete> 4-55
:SENSe:DATA:TELEcom:SPDH:TSIGnal:RATE <discrete> 4-54
:SENSe:DATA:TELEcom:SPDH:TSIGnal:TRIButary:DS1 <discrete> 4-57
:SENSe:DATA:TELEcom:SPDH:TSIGnal:TRIButary:DS2 <discrete> 4-57
:SENSe:DATA:TELEcom:SPDH:TSIGnal:TRIButary:M2 <discrete> 4-56
:SENSe:DATA:TELEcom:SPDH:TSIGnal:TRIButary:M34 <discrete> 4-55
:SENSe:DATA:TELEcom:SPDH:TSIGnal:TRIButary:M8 <discrete> 4-56
:SENSe:DATA:TELEcom:SPDH:TSIGnal:TSLot:DS1:K56 <numeric> 4-58
:SENSe:DATA:TELEcom:SPDH:TSIGnal:TSLot:DS1:K56XN <string> 4-59
:SENSe:DATA:TELEcom:SPDH:TSIGnal:TSLot:DS1:K64 <numeric> 4-59
:SENSe:DATA:TELEcom:SPDH:TSIGnal:TSLot:DS1:K64XN <string> 4-59
:SENSe:DATA:TELEcom:SPDH:TSIGnal:TSLot:M2:K64 <numeric> 4-58
:SENSe:DATA:TELEcom:SPDH:TSIGnal:TSLot:M2:K64XN <string> 4-58
:SENSe:DATA:TELEcom:SPDH:UWORd <string> 4-52
:SENSe:DATA:TELEcom:STERm:PERiod <numeric> <suffix> 3-19
:SENSe:DATA:TELEcom:TEST <boolean> 3-16
:SENSe:DATA:TELEcom:TEST:PERiod <numeric> <suffix> 3-18
:SENSe:DATA:TELEcom:TEST:STARt <numeric>, <numeric>, <numeric>, <numeric>, <numeric> 3-19
:SENSe:DATA:TELEcom:TEST:SUSPend <boolean> 3-20
:SENSe:DATA:TELEcom:TEST:TYPE <discrete> 3-18
:SENSe:DATA:TELEcom:TFUNction <discrete> 3-16
:SENSe:DATA:TELEcom:TFUNction:SDISruption <discrete> 4-60
:SENSe:DATA:TELEcom:TSCan:ERRors? 3-23
:SENSe:DATA:TELEcom:TSCan:TYPE? 3-23
:SENSe:DATA? <"result"> 8-27
:SENSe:DATA? <"result"> 8-28
:SENSe:DATA? <"result"> 8-29
:SENSe:DATA? <"result"> 8-30

Command Index

:SOURce:CLOCK:SDH:FOFFset <boolean> 5-10
:SOURce:CLOCK:SDH:FOFFset:OFFSet <numeric><suffix> 5-11
:SOURce:CLOCK:SDH:FORMat <discrete> 5-10
:SOURce:CLOCK:SDH:LEVel <discrete> 5-9
:SOURce:CLOCK:SDH:SOURce <discrete> 5-9
:SOURce:CLOCK:SONet:FOFFset <boolean> 6-10
:SOURce:CLOCK:SONet:FOFFset:OFFSet <numeric><suffix> 6-11
:SOURce:CLOCK:SONet:FORMat <discrete> 6-10
:SOURce:CLOCK:SONet:LEVel <discrete> 6-9
:SOURce:CLOCK:SONet:SOURce <discrete> 6-9
:SOURce:CLOCK:SPDH:DS1:FOFFset <discrete> 4-13
:SOURce:CLOCK:SPDH:DS1:FOFFset:OFFSet <numeric> 4-14
:SOURce:CLOCK:SPDH:DS3:FOFFset <discrete> 4-12
:SOURce:CLOCK:SPDH:DS3:FOFFset:OFFSet <numeric>, <discrete> 4-13
:SOURce:CLOCK:SPDH:FORMat <discrete> 4-8
:SOURce:CLOCK:SPDH:M140:FOFFset <discrete> 4-12
:SOURce:CLOCK:SPDH:M140:FOFFset:OFFSet <numeric> 4-12
:SOURce:CLOCK:SPDH:M2:FOFFset <discrete> 4-8
:SOURce:CLOCK:SPDH:M2:FOFFset:OFFSet <numeric> 4-9
:SOURce:CLOCK:SPDH:M34:FOFFset <discrete> 4-10
:SOURce:CLOCK:SPDH:M34:FOFFset:OFFSet <numeric> 4-10
:SOURce:CLOCK:SPDH:M8:FOFFset <discrete> 4-9
:SOURce:CLOCK:SPDH:M8:FOFFset:OFFSet <numeric> 4-9
:SOURce:CLOCK:SPDH:SOURce <discrete> 4-7
:SOURce:DATA:TELEcom:ATM:ALARm <discrete> 8-17
:SOURce:DATA:TELEcom:ATM:BACKground:DISTRibution:PCR <numeric>,<numeric> 8-12
:SOURce:DATA:TELEcom:ATM:BACKground:DISTRibution:PCR:KBITS? <numeric> 8-13
:SOURce:DATA:TELEcom:ATM:BACKground:DISTRibution:PCR:PCTBw? <numeric> 8-13
:SOURce:DATA:TELEcom:ATM:BACKground:DISTRibution:SERVice? 8-12
:SOURce:DATA:TELEcom:ATM:BACKground:HEADer:CLP <numeric>, <string> 8-12
:SOURce:DATA:TELEcom:ATM:BACKground:HEADer:GFC <numeric>, <numeric> 8-10
:SOURce:DATA:TELEcom:ATM:BACKground:HEADer:PTI <numeric>, <string> 8-11
:SOURce:DATA:TELEcom:ATM:BACKground:HEADer:VCI <numeric>, <numeric> 8-11
:SOURce:DATA:TELEcom:ATM:BACKground:HEADer:VPI <numeric>, <numeric> 8-10
:SOURce:DATA:TELEcom:ATM:BACKground:PAYLoad:UWORD <numeric>,<sting> 8-13
:SOURce:DATA:TELEcom:ATM:CONVergence <discrete> 8-3
:SOURce:DATA:TELEcom:ATM:CONVergence:PLCP:C1 <discrete> 8-3
:SOURce:DATA:TELEcom:ATM:CONVergence:PLCP:C1? 8-4
:SOURce:DATA:TELEcom:ATM:DISTRibution:CDVT <numeric> 8-9

Command Index

:SOURCE:DATA:TELEcom:ATM:DISTRibution:MBS <numeric> 8-9
:SOURCE:DATA:TELEcom:ATM:DISTRibution:PCR <numeric> 8-7
:SOURCE:DATA:TELEcom:ATM:DISTRibution:PCR:KBITs? 8-8
:SOURCE:DATA:TELEcom:ATM:DISTRibution:PCR:PCTBw? 8-8
:SOURCE:DATA:TELEcom:ATM:DISTRibution:SCR <numeric> 8-8
:SOURCE:DATA:TELEcom:ATM:DISTRibution:SCR:KBITs? 8-8
:SOURCE:DATA:TELEcom:ATM:DISTRibution:SCR:PCTBw? 8-9
:SOURCE:DATA:TELEcom:ATM:DISTRibution:SERVice <discrete> 8-7
:SOURCE:DATA:TELEcom:ATM:DISTRibution:SERVice:BURSt 8-7
:SOURCE:DATA:TELEcom:ATM:ERRor:BSIZe <numeric> 8-16
:SOURCE:DATA:TELEcom:ATM:ERRor:BURSt 8-16
:SOURCE:DATA:TELEcom:ATM:ERRor:RATE <discrete> 8-15
:SOURCE:DATA:TELEcom:ATM:ERRor:RATE:USER <numeric> 8-16
:SOURCE:DATA:TELEcom:ATM:ERRor:STReam <discrete> 8-15
:SOURCE:DATA:TELEcom:ATM:ERRor:TYPE <discrete> 8-14
:SOURCE:DATA:TELEcom:ATM:FILL <discrete> 8-14
:SOURCE:DATA:TELEcom:ATM:HEADer:CLP <string> 8-6
:SOURCE:DATA:TELEcom:ATM:HEADer:GFC <numeric> 8-4
:SOURCE:DATA:TELEcom:ATM:HEADer:PTI <string> 8-5
:SOURCE:DATA:TELEcom:ATM:HEADer:VCI <numeric> 8-5
:SOURCE:DATA:TELEcom:ATM:HEADer:VPI <numeric> 8-5
:SOURCE:DATA:TELEcom:ATM:NINTerface <discrete> 8-3
:SOURCE:DATA:TELEcom:ATM:PAYLoad <discrete> 8-6
:SOURCE:DATA:TELEcom:ATM:PAYLoad:UWORD <string> 8-7
:SOURCE:DATA:TELEcom:ATM:SCRambling <boolean> 8-4
:SOURCE:DATA:TELEcom:ERRor:BIT <discrete> 3-10
:SOURCE:DATA:TELEcom:IPOS:ADDReses:DESTination <string> 9-3
:SOURCE:DATA:TELEcom:IPOS:ADDReses:SOURce <string> 9-3
:SOURCE:DATA:TELEcom:IPOS:ALARm <discrete> 9-10
:SOURCE:DATA:TELEcom:IPOS:ERRor:RATE <discrete> 9-10
:SOURCE:DATA:TELEcom:IPOS:ERRor:TYPE <discrete> 9-9
:SOURCE:DATA:TELEcom:IPOS:HDLC:FCS <discrete> 9-2
:SOURCE:DATA:TELEcom:IPOS:HDLC:FRAMing <discrete> 9-2
:SOURCE:DATA:TELEcom:IPOS:HDLC:SCRambling <discrete> 9-2
:SOURCE:DATA:TELEcom:IPOS:HEADer:PROTOcol:USER <integer> 9-6
:SOURCE:DATA:TELEcom:IPOS:HEADer:TTLive <integer> 9-7
:SOURCE:DATA:TELEcom:IPOS:PACKet:GAP:USER <integer> 9-5
:SOURCE:DATA:TELEcom:IPOS:PACKet:LENGth <discrete> 9-3
:SOURCE:DATA:TELEcom:IPOS:PACKet:LENGth:RANDom:MIN <integer> 9-4

Command Index

:SOURce:DATA:TELEcom:IPOS:PACKet:LENGth:USER <integer> 9-4
:SOURce:DATA:TELEcom:IPOS:PAYLoad:UWORD:BIN32 <string> 9-8
:SOURce:DATA:TELEcom:IPOS:PAYLoad:UWORD:HEX16 <string> 9-8
:SOURce:DATA:TELEcom:IPOS:PAYLoad:UWORD:HEX32 <string> 9-9
:SOURce:DATA:TELEcom:IPOS:PAYLoad:UWORD[:BIN16] <string> 9-8
:SOURce:DATA:TELEcom:IPOS:PRBS:POLarity <discrete> 9-9
:SOURce:DATA:TELEcom:JITTer:AMPLitude <numeric> 7-5
:SOURce:DATA:TELEcom:JITTer:ATOLerance:DELay <numeric> 7-8
:SOURce:DATA:TELEcom:JITTer:ATOLerance:DWELl <numeric> 7-8
:SOURce:DATA:TELEcom:JITTer:ATOLerance:ERRor:TYPe <discrete> 7-9
:SOURce:DATA:TELEcom:JITTer:ATOLerance:POINts <numeric> 7-9
:SOURce:DATA:TELEcom:JITTer:ATOLerance:THReshold <numeric> 7-9
:SOURce:DATA:TELEcom:JITTer:ERANge <discrete> 7-13
:SOURce:DATA:TELEcom:JITTer:FREQuency <numeric> 7-5
:SOURce:DATA:TELEcom:JITTer:MASK <discrete> 7-5
:SOURce:DATA:TELEcom:JITTer:MASK:TYPe <discrete> 7-7
:SOURce:DATA:TELEcom:JITTer:MASK:TYPe:MRANge <discrete> 7-8
:SOURce:DATA:TELEcom:JITTer:MASK:TYPe:USER <numeric> 7-7
:SOURce:DATA:TELEcom:JITTer:MODulation <discrete> 7-13
:SOURce:DATA:TELEcom:JITTer:RANGe <discrete> 7-6
:SOURce:DATA:TELEcom:JITTer:SETTings <discrete> 7-15
:SOURce:DATA:TELEcom:JITTer:TRANsfer:DELay <numeric> 7-10
:SOURce:DATA:TELEcom:JITTer:TRANsfer:DWELl <numeric> 7-11
:SOURce:DATA:TELEcom:JITTer:TRANsfer:MASK:INPut <discrete> 7-11
:SOURce:DATA:TELEcom:JITTer:TRANsfer:MASK:INPut:USER <numeric> 7-11
:SOURce:DATA:TELEcom:JITTer:TRANsfer:MASK:PASS <discrete> 7-12
:SOURce:DATA:TELEcom:JITTer:TRANsfer:MASK:PASS:ADJust:OFFSet <numeric> 7-13
:SOURce:DATA:TELEcom:JITTer:TRANsfer:MASK:PASS[:ADJust] <boolean> 7-12
:SOURce:DATA:TELEcom:JITTer:TRANsfer:MODE <discrete> 7-10
:SOURce:DATA:TELEcom:JITTer:TRANsfer:POINts <numeric> 7-10
:SOURce:DATA:TELEcom:JITTer:UMASK:AMPLitude:SINGle <numeric>, <numeric>, <numeric> 7-17
:SOURce:DATA:TELEcom:JITTer:UMASK:AMPLitude[:MULtiple] <numeric>, <numeric>, <numeric>,
{<numeric>,...} 7-17
:SOURce:DATA:TELEcom:JITTer:UMASK:FREQuency:SINGle <numeric>, <numeric>, <numeric> 7-18
:SOURce:DATA:TELEcom:JITTer:UMASK:FREQuency[:MULtiple] <numeric>, <numeric>, <numeric>,
{<numeric>,...} 7-18
:SOURce:DATA:TELEcom:JITTer:UMASK:GENerator :ACTion <numeric> 7-20
:SOURce:DATA:TELEcom:JITTer:UMASK:GENerator [:PARAmeters] <numeric>, <numeric>,<numeric>,
<numeric>, <numeric>, <numeric>, <numeric> 7-19

Command Index

:SOURce:DATA:TELEcom:JITTer:UMASK:LABel <numeric>, <string> 7-16
:SOURce:DATA:TELEcom:JITTer:UMASK:LOCK <boolean> 7-15
:SOURce:DATA:TELEcom:JITTer:UMASK:POINts <numeric>, <numeric> 7-16
:SOURce:DATA:TELEcom:JITTer:WANDer:AMPLitude <numeric> 7-14
:SOURce:DATA:TELEcom:JITTer:WANDer:FREQuency <numeric> 7-14
:SOURce:DATA:TELEcom:JITTer:WANDer:MASK <discrete> 7-14
:SOURce:DATA:TELEcom:SDH:ALARm <discrete> 5-46
:SOURce:DATA:TELEcom:SDH:ALARm:SOOFrAm 5-47
:SOURce:DATA:TELEcom:SDH:AU:TYPE <discrete> 5-16
:SOURce:DATA:TELEcom:SDH:AU3 <numeric> 5-16
:SOURce:DATA:TELEcom:SDH:AU3:BACKground <discrete> 5-23
:SOURce:DATA:TELEcom:SDH:AU4 <numeric> 5-14
:SOURce:DATA:TELEcom:SDH:AU4:BACKground <discrete> 5-24
:SOURce:DATA:TELEcom:SDH:AU4C <numeric> 5-14
:SOURce:DATA:TELEcom:SDH:AU4C:BACKground <discrete> 5-24
:SOURce:DATA:TELEcom:SDH:ERRor:MSPThreshold:EINterval <discrete> 5-45
:SOURce:DATA:TELEcom:SDH:ERRor:MSPThreshold:NERRors <numeric> 5-45
:SOURce:DATA:TELEcom:SDH:ERRor:RATE <discrete> 5-41
:SOURce:DATA:TELEcom:SDH:ERRor:RATE:USER <numeric> 5-42
:SOURce:DATA:TELEcom:SDH:ERRor:TYPE <discrete> 5-40
:SOURce:DATA:TELEcom:SDH:IDCC <discrete> 5-65
:SOURce:DATA:TELEcom:SDH:MAPPing <discrete> 5-17
:SOURce:DATA:TELEcom:SDH:MSPMessages:ARCHitecture <discrete> 5-62
:SOURce:DATA:TELEcom:SDH:MSPMessages:BRIDge <string> 5-61
:SOURce:DATA:TELEcom:SDH:MSPMessages:CHANnel <numeric> 5-60
:SOURce:DATA:TELEcom:SDH:MSPMessages:DNODE <string> 5-64
:SOURce:DATA:TELEcom:SDH:MSPMessages:PCODE <discrete> 5-64
:SOURce:DATA:TELEcom:SDH:MSPMessages:RCODE <discrete> 5-63
:SOURce:DATA:TELEcom:SDH:MSPMessages:REQuest <discrete> 5-59
:SOURce:DATA:TELEcom:SDH:MSPMessages:REServed <numeric> 5-62
:SOURce:DATA:TELEcom:SDH:MSPMessages:SCODE <discrete> 5-65
:SOURce:DATA:TELEcom:SDH:MSPMessages:SNODE <string> 5-64
:SOURce:DATA:TELEcom:SDH:MSPMessages:TOPology <discrete> 5-58
:SOURce:DATA:TELEcom:SDH:MSPMessages:TOPology:MODE <discrete> 5-59
:SOURce:DATA:TELEcom:SDH:MSPMessages:TOPology:TYPE <discrete> 5-58
:SOURce:DATA:TELEcom:SDH:OBERTest <discrete> 5-67
:SOURce:DATA:TELEcom:SDH:OBERTest:CHANnel <discrete> 5-66
:SOURce:DATA:TELEcom:SDH:OBERTest:CHANnel:SElect <numeric> 5-66
:SOURce:DATA:TELEcom:SDH:OVERhead:DATA <numeric>, <numeric>, <discrete>, <string> 5-

Command Index

27

:SOURce:DATA:TELEcom:SDH:OVERhead:DATA:HEXadecimal <numeric>, <numeric>, <discrete>, <string> 5-29
:SOURce:DATA:TELEcom:SDH:OVERhead:DEFault 5-27
:SOURce:DATA:TELEcom:SDH:OVERhead:J0 <string> 5-33
:SOURce:DATA:TELEcom:SDH:OVERhead:J0:HEXadecimal? 5-34
:SOURce:DATA:TELEcom:SDH:OVERhead:J0:PATtern <discrete> 5-33
:SOURce:DATA:TELEcom:SDH:OVERhead:SBYTe <discrete> 5-38
:SOURce:DATA:TELEcom:SDH:PAYLoad <discrete> 5-17
:SOURce:DATA:TELEcom:SDH:PAYLoad:OFFSet <numeric> 5-22
:SOURce:DATA:TELEcom:SDH:PAYLoad:PATtern <discrete> 5-21
:SOURce:DATA:TELEcom:SDH:PAYLoad:STRucture <discrete> 5-20
:SOURce:DATA:TELEcom:SDH:PAYLoad:TYPE <discrete> 5-19
:SOURce:DATA:TELEcom:SDH:PAYLoad:UWORD <string> 5-22
:SOURce:DATA:TELEcom:SDH:PDHPayload:ERRor:RATE <discrete> 5-43
:SOURce:DATA:TELEcom:SDH:PDHPayload:ERRor:RATE:USER <numeric> 5-44
:SOURce:DATA:TELEcom:SDH:PDHPayload:ERRor:TYPE <discrete> 5-43
:SOURce:DATA:TELEcom:SDH:POINter <discrete> 5-47
:SOURce:DATA:TELEcom:SDH:POINter:ACTion 5-49
:SOURce:DATA:TELEcom:SDH:POINter:ADJust 5-50
:SOURce:DATA:TELEcom:SDH:POINter:DIRection <discrete> 5-48
:SOURce:DATA:TELEcom:SDH:POINter:G783 <discrete> 5-51
:SOURce:DATA:TELEcom:SDH:POINter:G783:INTerval <numeric><suffix> 5-53
:SOURce:DATA:TELEcom:SDH:POINter:G783:PATtern <discrete> 5-52
:SOURce:DATA:TELEcom:SDH:POINter:G783:POLarity <discrete> 5-53
:SOURce:DATA:TELEcom:SDH:POINter:G783:SEQuence <discrete> 5-54
:SOURce:DATA:TELEcom:SDH:POINter:G783:SINGle <discrete> 5-52
:SOURce:DATA:TELEcom:SDH:POINter:IDECrement <numeric> 5-48
:SOURce:DATA:TELEcom:SDH:POINter:NPOinter <discrete> 5-50
:SOURce:DATA:TELEcom:SDH:POINter:OFFSet <discrete> 5-50
:SOURce:DATA:TELEcom:SDH:POINter:OFFSet:RATE <numeric> <suffix> 5-51
:SOURce:DATA:TELEcom:SDH:POINter:TYPE <discrete> 5-47
:SOURce:DATA:TELEcom:SDH:POINter:VALue <numeric> 5-49
:SOURce:DATA:TELEcom:SDH:POVerhead:DATA <discrete>,<string> 5-30
:SOURce:DATA:TELEcom:SDH:POVerhead:H4Sequence <discrete> 5-38
:SOURce:DATA:TELEcom:SDH:POVerhead:J1 <string> 5-32
:SOURce:DATA:TELEcom:SDH:POVerhead:J1:CRc7 <string> 5-32
:SOURce:DATA:TELEcom:SDH:POVerhead:J1:PATtern <discrete> 5-31
:SOURce:DATA:TELEcom:SDH:POVerhead:SLABel <discrete> 5-30

Command Index

:SOURCE:DATA:TELEcom:SDH:PRBS:POLarity <discrete> 5-22
:SOURCE:DATA:TELEcom:SDH:PRIMary:BACKground:PAYLoad:PATtern <discrete> 5-24
:SOURCE:DATA:TELEcom:SDH:SEQuence <discrete> 5-54
:SOURCE:DATA:TELEcom:SDH:SEQuence:CHANnel:SElect <numeric> 5-56
:SOURCE:DATA:TELEcom:SDH:SEQuence:COLumn <numeric> 5-56
:SOURCE:DATA:TELEcom:SDH:SEQuence:DATA <discrete>,<string> 5-56
:SOURCE:DATA:TELEcom:SDH:SEQuence:FCOUNT <numeric>,<numeric> 5-57
:SOURCE:DATA:TELEcom:SDH:SEQuence:MODE <discrete> 5-54
:SOURCE:DATA:TELEcom:SDH:SEQuence:OHBYte <discrete> 5-55
:SOURCE:DATA:TELEcom:SDH:SEQuence:ORder <discrete>,<discrete>,<discrete>,<discrete>,<discrete> 5-57
:SOURCE:DATA:TELEcom:SDH:STESt:BLENgth <numeric> 5-58
:SOURCE:DATA:TELEcom:SDH:STESt:SPATtern <discrete> 5-57
:SOURCE:DATA:TELEcom:SDH:TCM:APID:DATA <string> 5-16
:SOURCE:DATA:TELEcom:SDH:TCM:APID:PATtern <discrete> 5-15
:SOURCE:DATA:TELEcom:SDH:TCM:PATH <discrete> 5-15
:SOURCE:DATA:TELEcom:SDH:TFUNction:TYPE <discrete> 5-40
:SOURCE:DATA:TELEcom:SDH:THRumode <discrete> 5-11
:SOURCE:DATA:TELEcom:SDH:THRumode:COVerwrite <boolean> 5-13
:SOURCE:DATA:TELEcom:SDH:THRumode:PAYLoad:OVERwrite <discrete> 5-12
:SOURCE:DATA:TELEcom:SDH:THRumode:PAYLoad:OVERwrite:ENABle <boolean> 5-12
:SOURCE:DATA:TELEcom:SDH:TRIButary <numeric> 5-19
:SOURCE:DATA:TELEcom:SDH:TRIButary:CONCatenate <numeric>,<numeric> 5-23
:SOURCE:DATA:TELEcom:SDH:TRIButary:MAPPing <discrete> 5-18
:SOURCE:DATA:TELEcom:SDH:TRIButary:POINter:TRANsmitted? 5-49
:SOURCE:DATA:TELEcom:SDH:TRIButary:POINter:VALue <numeric> 5-49
:SOURCE:DATA:TELEcom:SDH:TRIButary:POVerhead:C2:SLABel <discrete> 5-37
:SOURCE:DATA:TELEcom:SDH:TRIButary:POVerhead:DATA <discrete>,<string> 5-33
:SOURCE:DATA:TELEcom:SDH:TRIButary:POVerhead:J1 <string> 5-35
:SOURCE:DATA:TELEcom:SDH:TRIButary:POVerhead:J1:CRc7 <string> 5-35
:SOURCE:DATA:TELEcom:SDH:TRIButary:POVerhead:J1:HEXadecimal? 5-35
:SOURCE:DATA:TELEcom:SDH:TRIButary:POVerhead:J1:PATtern <discrete> 5-34
:SOURCE:DATA:TELEcom:SDH:TRIButary:POVerhead:J2 <string> 5-36
:SOURCE:DATA:TELEcom:SDH:TRIButary:POVerhead:J2:FIXed <string> 5-37
:SOURCE:DATA:TELEcom:SDH:TRIButary:POVerhead:J2:PATtern <discrete> 5-36
:SOURCE:DATA:TELEcom:SDH:TRIButary:POVerhead:V5:SLABel <numeric> 5-37
:SOURCE:DATA:TELEcom:SDH:TUG2 <numeric> 5-19
:SOURCE:DATA:TELEcom:SDH:TUG3 <numeric> 5-18
:SOURCE:DATA:TELEcom:SDH:TUG3:BACKground:PAYLoad:PATtern <numeric> <discrete> 5-25

Command Index

:SOURCE:DATA:TELEcom:SDH:TUG3:BACKground:PAYLoad:PATtern:UWORD <numeric> <string> 5-25

:SOURCE:DATA:TELEcom:SONet:ALARm <discrete> 6-41

:SOURCE:DATA:TELEcom:SONet:ALARm:SSEFrame 6-41

:SOURCE:DATA:TELEcom:SONet:APSMessages:ARCHitecture <discrete> 6-56

:SOURCE:DATA:TELEcom:SONet:APSMessages:BRIDge <string> 6-55

:SOURCE:DATA:TELEcom:SONet:APSMessages:CHANnel <numeric> 6-54

:SOURCE:DATA:TELEcom:SONet:APSMessages:DNODE <string> 6-57

:SOURCE:DATA:TELEcom:SONet:APSMessages:DOWNload 6-59

:SOURCE:DATA:TELEcom:SONet:APSMessages:PCODE <discrete> 6-58

:SOURCE:DATA:TELEcom:SONet:APSMessages:RCODE <discrete> 6-57

:SOURCE:DATA:TELEcom:SONet:APSMessages:REQuest <discrete> 6-53

:SOURCE:DATA:TELEcom:SONet:APSMessages:REServed <numeric> 6-56

:SOURCE:DATA:TELEcom:SONet:APSMessages:SCODE <discrete> 6-59

:SOURCE:DATA:TELEcom:SONet:APSMessages:SNODE <string> 6-58

:SOURCE:DATA:TELEcom:SONet:APSMessages:TOPology <discrete> 6-52

:SOURCE:DATA:TELEcom:SONet:APSMessages:TOPology:MODE <discrete> 6-53

:SOURCE:DATA:TELEcom:SONet:APSMessages:TOPology:TYPE <discrete> 6-52

:SOURCE:DATA:TELEcom:SONet:ERRor:APSThreshold:EINterval <discrete> 6-40

:SOURCE:DATA:TELEcom:SONet:ERRor:APSThreshold:NERRors <numeric> 6-39

:SOURCE:DATA:TELEcom:SONet:ERRor:RATE <discrete> 6-36

:SOURCE:DATA:TELEcom:SONet:ERRor:RATE:USER <numeric> 6-37

:SOURCE:DATA:TELEcom:SONet:ERRor:TYPE <discrete> 6-35

:SOURCE:DATA:TELEcom:SONet:IDCC <discrete> 6-59

:SOURCE:DATA:TELEcom:SONet:MAPPing <discrete> 6-16

:SOURCE:DATA:TELEcom:SONet:OBERTest <discrete> 6-61

:SOURCE:DATA:TELEcom:SONet:OBERTest:CHANnel <discrete> 6-60

:SOURCE:DATA:TELEcom:SONet:OBERTest:STS1 <numeric> 6-60

:SOURCE:DATA:TELEcom:SONet:OBERTest:STS3:SElect <numeric> 6-61

:SOURCE:DATA:TELEcom:SONet:OVERhead:DATA <numeric>, <numeric>, <discrete>, <string> 6-24

:SOURCE:DATA:TELEcom:SONet:OVERhead:DATA:HEXadecimal <numeric>, <numeric>, <discrete>, <string> 6-25

:SOURCE:DATA:TELEcom:SONet:OVERhead:DEFault 6-24

:SOURCE:DATA:TELEcom:SONet:OVERhead:JO <string> 6-29

:SOURCE:DATA:TELEcom:SONet:OVERhead:JO:HEXadecimal? 6-30

:SOURCE:DATA:TELEcom:SONet:OVERhead:JO:PATtern <discrete> 6-29

:SOURCE:DATA:TELEcom:SONet:OVERhead:SBYTE <discrete> 6-34

:SOURCE:DATA:TELEcom:SONet:PAYLoad <discrete> 6-15

:SOURCE:DATA:TELEcom:SONet:PAYLoad:OFFSet <numeric> 6-20

Command Index

:SOURCE:DATA:TELEcom:SONet:PAYLoad:PATtern <discrete> 6-19
:SOURCE:DATA:TELEcom:SONet:PAYLoad:STRucture <discrete> 6-19
:SOURCE:DATA:TELEcom:SONet:PAYLoad:TYPE <discrete> 6-18
:SOURCE:DATA:TELEcom:SONet:PAYLoad:UWORD <string> 6-20
:SOURCE:DATA:TELEcom:SONet:PDHPayload:ERRor:RATE <discrete> 6-38
:SOURCE:DATA:TELEcom:SONet:PDHPayload:ERRor:RATE:USER <numeric> 6-39
:SOURCE:DATA:TELEcom:SONet:PDHPayload:ERRor:TYPE <discrete> 6-38
:SOURCE:DATA:TELEcom:SONet:POINter <discrete> 6-42
:SOURCE:DATA:TELEcom:SONet:POINter:ACTion 6-43
:SOURCE:DATA:TELEcom:SONet:POINter:ADJust 6-45
:SOURCE:DATA:TELEcom:SONet:POINter:DIRection <discrete> 6-42
:SOURCE:DATA:TELEcom:SONet:POINter:IDECrement <numeric> 6-43
:SOURCE:DATA:TELEcom:SONet:POINter:NPOinter <discrete> 6-44
:SOURCE:DATA:TELEcom:SONet:POINter:OFFSet <discrete> 6-45
:SOURCE:DATA:TELEcom:SONet:POINter:OFFSet:RATE <numeric>, <suffix> 6-45
:SOURCE:DATA:TELEcom:SONet:POINter:T1105 <discrete> 6-46
:SOURCE:DATA:TELEcom:SONet:POINter:T1105:INTerval <numeric>, <suffix> 6-47
:SOURCE:DATA:TELEcom:SONet:POINter:T1105:PATtern <discrete> 6-46
:SOURCE:DATA:TELEcom:SONet:POINter:T1105:POLarity <discrete> 6-47
:SOURCE:DATA:TELEcom:SONet:POINter:T1105:SEQuence <discrete> 6-48
:SOURCE:DATA:TELEcom:SONet:POINter:TRANsmitted? 6-43
:SOURCE:DATA:TELEcom:SONet:POINter:TYPE <discrete> 6-42
:SOURCE:DATA:TELEcom:SONet:POINter:VALue <numeric> 6-43
:SOURCE:DATA:TELEcom:SONet:POVerhead:DATA <discrete>, <string> 6-26
:SOURCE:DATA:TELEcom:SONet:POVerhead:H4Sequence <discrete> 6-33
:SOURCE:DATA:TELEcom:SONet:POVerhead:J1 <string> 6-28
:SOURCE:DATA:TELEcom:SONet:POVerhead:J1:CRc7 <string> 6-28
:SOURCE:DATA:TELEcom:SONet:POVerhead:J1:HEXadecimal? 6-28
:SOURCE:DATA:TELEcom:SONet:POVerhead:J1:PATtern <discrete> 6-27
:SOURCE:DATA:TELEcom:SONet:POVerhead:SLABel <discrete> 6-26
:SOURCE:DATA:TELEcom:SONet:PRBS:POLarity <discrete> 6-20
:SOURCE:DATA:TELEcom:SONet:PRIMary:BACKground:PAYLoad
:PATtern <discrete> 6-22
:SOURCE:DATA:TELEcom:SONet:SEQuence <discrete> 6-48
:SOURCE:DATA:TELEcom:SONet:SEQuence:DATA <discrete>, <string> 6-50
:SOURCE:DATA:TELEcom:SONet:SEQuence:FCOUNT <numeric>, <numeric> 6-51
:SOURCE:DATA:TELEcom:SONet:SEQuence:MODE <discrete> 6-48
:SOURCE:DATA:TELEcom:SONet:SEQuence:OHBYte <discrete> 6-49
:SOURCE:DATA:TELEcom:SONet:SEQuence:ORDer <discrete>, <discrete>, <discrete>, <discrete>

Command Index

<discrete> 6-50
:SOURce:DATA:TELEcom:SONet:SEQuence:STS1 <numeric> 6-49
:SOURce:DATA:TELEcom:SONet:SEQuence:STS3:SELEct <numeric> 6-50
:SOURce:DATA:TELEcom:SONet:SPE:TYPE <discrete> 6-15
:SOURce:DATA:TELEcom:SONet:STESt:BLENght <numeric> 6-52
:SOURce:DATA:TELEcom:SONet:STESt:SPATtern <discrete> 6-51
:SOURce:DATA:TELEcom:SONet:STS1 <numeric> 6-15
:SOURce:DATA:TELEcom:SONet:STS1:BACKground <discrete> 6-22
:SOURce:DATA:TELEcom:SONet:STS12c <numeric> 6-14
:SOURce:DATA:TELEcom:SONet:STS12c BACKground <discrete> 6-23
:SOURce:DATA:TELEcom:SONet:STS3 <numeric> 6-14
:SOURce:DATA:TELEcom:SONet:STS3:BACKground <discrete> 6-22
:SOURce:DATA:TELEcom:SONet:TFUNction:TYPE <discrete> 6-35
:SOURce:DATA:TELEcom:SONet:THRumode <discrete> 6-11
:SOURce:DATA:TELEcom:SONet:THRumode:PAYLoad:OVERwrite:ENABLE <boolean> 6-12
:SOURce:DATA:TELEcom:SONet:TRIButary <numeric> 6-17
:SOURce:DATA:TELEcom:SONet:TRIButary:CONCatenate <numeric>, <numeric> 6-21
:SOURce:DATA:TELEcom:SONet:TRIButary:MAPPing <discrete> 6-17
:SOURce:DATA:TELEcom:SONet:TRIButary:POINter:TRANsmitted? 6-44
:SOURce:DATA:TELEcom:SONet:TRIButary:POINter:VALue <numeric> 6-44
:SOURce:DATA:TELEcom:SONet:TRIButary:POVerhead:DATA <discrete>, <string> 6-29
:SOURce:DATA:TELEcom:SONet:TRIButary:POVerhead:J1 <string> 6-31
:SOURce:DATA:TELEcom:SONet:TRIButary:POVerhead:J1:CRC7 <string> 6-31
:SOURce:DATA:TELEcom:SONet:TRIButary:POVerhead:J1:PATTern <discrete> 6-30
:SOURce:DATA:TELEcom:SONet:TRIButary:POVerhead:J2 <string> 6-32
:SOURce:DATA:TELEcom:SONet:TRIButary:POVerhead:J2:FIXed <string> 6-33
:SOURce:DATA:TELEcom:SONet:TRIButary:POVerhead:J2:HEXadecimal? 6-32
:SOURce:DATA:TELEcom:SONet:TRIButary:POVerhead:J2:PATTern <discrete> 6-32
:SOURce:DATA:TELEcom:SONet:TRIButary:POVerhead:V5:SLABel <numeric> 6-33
:SOURce:DATA:TELEcom:SONet:VTGRoup <numeric> 6-17
:SOURce:DATA:TELEcom:SOURce <discrete> 3-9
:SOURce:DATA:TELEcom:SPDH:DS1:ALARm <discrete> 4-38
:SOURce:DATA:TELEcom:SPDH:DS3:ALARm <discrete> 4-37
:SOURce:DATA:TELEcom:SPDH:ERRor:EXZ:NUMBer <numeric> 4-33
:SOURce:DATA:TELEcom:SPDH:ERRor:FRAME:NERRored <discrete> 4-32
:SOURce:DATA:TELEcom:SPDH:ERRor:MFRame:NERRored <discrete> 4-32
:SOURce:DATA:TELEcom:SPDH:ERRor:RATE <discrete> 4-30
:SOURce:DATA:TELEcom:SPDH:ERRor:RATE:USER <numeric> 4-31
:SOURce:DATA:TELEcom:SPDH:ERRor:TYPE <discrete> 4-30

Command Index

:SOURce:DATA:TELEcom:SPDH:FEAC <discrete> 4-33
:SOURce:DATA:TELEcom:SPDH:FEAC:BURSt <numeric> 4-33
:SOURce:DATA:TELEcom:SPDH:FEAC:CODE <string> 4-34
:SOURce:DATA:TELEcom:SPDH:FEAC:LOOPback:ACTion <discrete> 4-34
:SOURce:DATA:TELEcom:SPDH:FEAC:LOOPback:BURSt <numeric>,<numeric> 4-35
:SOURce:DATA:TELEcom:SPDH:FEAC:LOOPback:MESSAge <numeric> 4-34
:SOURce:DATA:TELEcom:SPDH:INBand <discrete> 4-43
:SOURce:DATA:TELEcom:SPDH:M140:ALARm <discrete> 4-35
:SOURce:DATA:TELEcom:SPDH:M140:SPARe <string> 4-38
:SOURce:DATA:TELEcom:SPDH:M2:ALARm <discrete> 4-37
:SOURce:DATA:TELEcom:SPDH:M2:CASMfm <string> 4-42
:SOURce:DATA:TELEcom:SPDH:M2:CASMfm? 4-42
:SOURce:DATA:TELEcom:SPDH:M2:NFAS <string> 4-40
:SOURce:DATA:TELEcom:SPDH:M2:SASequence <boolean> 4-41
:SOURce:DATA:TELEcom:SPDH:M2:SASequence:BIT <numeric> 4-42
:SOURce:DATA:TELEcom:SPDH:M2:SASequence:BIT? 4-42
:SOURce:DATA:TELEcom:SPDH:M2:SASequence:PATtern <string> 4-41
:SOURce:DATA:TELEcom:SPDH:M2:SI <string> 4-40
:SOURce:DATA:TELEcom:SPDH:M2:SIE <string> 4-40
:SOURce:DATA:TELEcom:SPDH:M34:ALARm <discrete> 4-36
:SOURce:DATA:TELEcom:SPDH:M34:SPARe <string> 4-39
:SOURce:DATA:TELEcom:SPDH:M34:TTRace:PATtern <discrete> 4-11
:SOURce:DATA:TELEcom:SPDH:M34:TTRace:PATtern:USER <string> 4-11
:SOURce:DATA:TELEcom:SPDH:M8:ALARm <alarm> 4-36
:SOURce:DATA:TELEcom:SPDH:M8:SPARe <string> 4-39
:SOURce:DATA:TELEcom:SPDH:OUTBand:BURSt <numeric> 4-46
:SOURce:DATA:TELEcom:SPDH:OUTBand:USER <string> 4-46
:SOURce:DATA:TELEcom:SPDH:PATtern <discrete> 4-16
:SOURce:DATA:TELEcom:SPDH:PAYLoad:TYPE <discrete> 4-17
:SOURce:DATA:TELEcom:SPDH:PRBS:POLarity <discrete> 4-17
:SOURce:DATA:TELEcom:SPDH:TFUNction:TYPE <discrete> 4-29
:SOURce:DATA:TELEcom:SPDH:THRumode <discrete> 4-14
:SOURce:DATA:TELEcom:SPDH:THRumode:ERRor:RATE <discrete> 4-14
:SOURce:DATA:TELEcom:SPDH:THRumode:ERRor:RATE:USER <numeric> 4-15
:SOURce:DATA:TELEcom:SPDH:TSIGnal:BACKground <discrete> 4-26
:SOURce:DATA:TELEcom:SPDH:TSIGnal:MAPPing <discrete> 4-20
:SOURce:DATA:TELEcom:SPDH:TSIGnal:PAYLoad <discrete> 4-21
:SOURce:DATA:TELEcom:SPDH:TSIGnal:RATE <discrete> 4-20
:SOURce:DATA:TELEcom:SPDH:TSIGnal:TRIButary:DS1 <discrete> 4-23

Command Index

:SOURce:DATA:TELEcom:SPDH:TSIGnal:TRIButary:DS2 <discrete> 4-23
:SOURce:DATA:TELEcom:SPDH:TSIGnal:TRIButary:M2 <discrete> 4-22
:SOURce:DATA:TELEcom:SPDH:TSIGnal:TRIButary:M34 <discrete> 4-22
:SOURce:DATA:TELEcom:SPDH:TSIGnal:TRIButary:M8 <discrete> 4-22
:SOURce:DATA:TELEcom:SPDH:TSIGnal:TSLot:DS1:K56 <numeric> 4-24
:SOURce:DATA:TELEcom:SPDH:TSIGnal:TSLot:DS1:K56XN <string> 4-26
:SOURce:DATA:TELEcom:SPDH:TSIGnal:TSLot:DS1:K64 <numeric> 4-24
:SOURce:DATA:TELEcom:SPDH:TSIGnal:TSLot:DS1:K64XN <string> 4-25
:SOURce:DATA:TELEcom:SPDH:TSIGnal:TSLot:M2:K64 <numeric> 4-24
:SOURce:DATA:TELEcom:SPDH:TSIGnal:TSLot:M2:K64XN <string> 4-25
:SOURce:DATA:TELEcom:SPDH:TSLot:SIGNaling:DATA:DS1:D4 <string> 4-26
:SOURce:DATA:TELEcom:SPDH:TSLot:SIGNaling:DATA:DS1:ESF <string> 4-27
:SOURce:DATA:TELEcom:SPDH:TSLot:SIGNaling:DATA:DS1:NOFBit <string> 4-27
:SOURce:DATA:TELEcom:SPDH:TSLot:SIGNaling:DATA:DS1:SLC96 <string> 4-27
:SOURce:DATA:TELEcom:SPDH:TSLot:SIGNaling:DATA:M2 <string> 4-18
:SOURce:DATA:TELEcom:SPDH:UWORd <string> 4-16
:SOURce:DATA:TELEcom:TFUNction <discrete> 3-10
:SOURce:DATA:TELEcom:TFUNction:SDISruption <boolean> 4-29
:STATus:<Status Register>:CONDition? 3-45
:STATus:<Status Register>:ENABle <numeric> 3-44
:STATus:<Status Register>:EVENt? 3-44
:STATus:<Status Register>:HISTory? 3-45
:STATus:<Status Register>:NTRansition <numeric> 3-44
:STATus:<Status Register>:NTRansition? 3-44
:STATus:<Status Register>:PTRansition <numeric> 3-44
:STATus:CHIStory 3-43
:STATus:PRESet 3-43
:SYSTem:BEEPer:STATe <boolean> 3-61
:SYSTem:CONF <block> 3-48
:SYSTem:DATE <year>,<month>,<day> 3-46
:SYSTem:DISK:CD <string> 3-60
:SYSTem:DISK:DIRectory:CREate <filename> 3-60
:SYSTem:DISK:DIRectory? <extension>,<format> 3-60
:SYSTem:DISK:FILE:COPIY:CNF <to>,<store>,<directory>,<filename>,<overwrite> 3-58
:SYSTem:DISK:FILE:COPIY:SMG <store>,<directory>,<filename>,<overwrite> 3-59
:SYSTem:DISK:FILE:COPIY:SMG:FORMAt <type> 3-59
:SYSTem:DISK:FILE:DELeTe <filename> 3-59
:SYSTem:DISK:FILE:REName <from_filename>,<to_dir>,<filename>,<overwrite> 3-59
:SYSTem:DISK:FORMAt 3-57

Command Index

:SYSTem:DISK:FREE? 3-60
:SYSTem:DISK:LABel <string> 3-57
:SYSTem:DISK:PWD? 3-60
:SYSTem:DISK:RECall <extension>,<filename>,<confirm> 3-58
:SYSTem:DISK:SAVE <extension>,<filename>,<overwrite> 3-57
:SYSTem:DISK:SAVE:MODE <discrete> 3-57
:SYSTem:ERRor? 3-48
:SYSTem:KLOCK <boolean> 3-47
:SYSTem:LOCAL 3-47
:SYSTem:LOGGing:DEVice <type> 3-55
:SYSTem:PRESet 3-47
:SYSTem:PRINt 3-48
:SYSTem:PRINt:AUTO <boolean> 3-48
:SYSTem:PRINt:CONTent <content> 3-50
:SYSTem:PRINt:CONTent:ERRors <boolean> 3-51
:SYSTem:PRINt:CONTent:G821 <boolean> 3-51
:SYSTem:PRINt:CONTent:G826 <boolean> 3-52
:SYSTem:PRINt:CONTent:JITTer <boolean> 3-51
:SYSTem:PRINt:CONTent:M2100 <boolean> 3-52
:SYSTem:PRINt:CONTent:M2101 <boolean> 3-53
:SYSTem:PRINt:CONTent:M2110 <boolean> 3-53
:SYSTem:PRINt:CONTent:M2120 <boolean> 3-53
:SYSTem:PRINt:DEMAND <mode> 3-56
:SYSTem:PRINt:ESEConds <boolean> 3-55
:SYSTem:PRINt:MODE <mode> 3-54
:SYSTem:PRINt:PERiod <period> 3-49
:SYSTem:PRINt:RESults <type> 3-50
:SYSTem:PRINt:SDUMp:COMPReSSion <boolean> 3-56
:SYSTem:PRINt:SDUMp:DESTination <destination> 3-56
:SYSTem:PRINt:SPAN <content> 3-54
:SYSTem:PRINt:UPERiod <numeric>,<discrete> 3-49
:SYSTem:PRINt:WHEN <select> 3-54
:SYSTem:REMote 3-47
:SYSTem:SELFTest:WAVelength <discrete> 3-55
:SYSTem:SERial? 3-48
:SYSTem:SSETting:LABel <numeric>,<string> 3-61
:SYSTem:SSETting:LOCK <boolean> 3-61
:SYSTem:TIME <hour>,<minute>,<second> 3-46
:SYSTem:VERSion? 3-48

Command Index

:SYSTem:WINDow<type> 3-46

INBAND LOOP CODES 4-91

OUT-OF-BAND LOOP CODES 4-92

SOURce:DATA:TELEcom:SONet:THRumode:PAYLoad:OVERwrite <discrete> 6-11

SOURce:DATA:TELEcom:SPDH:OUTBand <discrete> 4-45

Command Index
