

Agilent N9923A FieldFox RF Vector Network Analyzer 2 MHz to 4/6 GHz

Data Sheet



Anticipate — Accelerate — Achieve



Agilent Technologies

Table of Contents

| | |
|---|----|
| Definitions..... | 2 |
| FieldFox RF Vector Network Analyzer..... | 3 |
| Cable and Antenna Analyzer (Option 305)..... | 10 |
| External USB Power Sensor Support (Option 302)..... | 10 |
| Vector Voltmeter (Option 308)..... | 11 |
| Block Diagram..... | 11 |
| General Information..... | 12 |
| Remote control capability (Option 030)..... | 12 |
| N9923A FieldFox RF VNA Options..... | 14 |
| N9923A Upgrade Options..... | 15 |
| Calibration Kits..... | 15 |
| FieldFox Data Link Software..... | 16 |

Definitions

Specification (spec.)

Warranted performance. Specifications include guardbands to account for the expected statistical performance distribution, measurement uncertainties, and changes in performance due to environmental conditions. The following conditions must be met:

- FieldFox has been turned on for 10 minutes.
- FieldFox is within its calibration cycle.
- FieldFox remains at a stable surrounding environment temperature (between -10 to 55 °C) for 90 minutes prior to turn-on and during operation.

Typical (typ.)

Expected performance of an average unit at a stable temperature between 20 °C to 30 °C for 90 minutes prior to turn-on and during operation; does not include guardbands. It is not covered by the product warranty. The FieldFox must be within its calibration cycle.

Nominal (nom.)

A general, descriptive term or design parameter. It is not tested, and not covered by the product warranty.

Calibration

The process of measuring known standards to characterize an instrument's systematic (repeatable) errors.

Corrected (residual)

Indicates performance after error correction (calibration). It is determined by the quality of calibration standards and how well "known" they are, plus system repeatability, stability, and noise.

FieldFox RF Vector Network Analyzer

| Description | Specification | Supplemental Information |
|--|---|---|
| Frequency range | | |
| | 2 MHz to 4 GHz | Option 104 |
| | 2 MHz to 6 GHz | Option 106 |
| Frequency reference | | |
| Accuracy | ±2 ppm | |
| Aging rate | ±1 ppm/yr | |
| Temperature stability | ±1 ppm over -10 to 55 °C | |
| Frequency resolution | 1 Hz < 3.2 GHz 1.2 Hz > 3.2 GHz | |
| Data points | 101, 201, 401, 601, 801, 1001, 1601, 4001, 10,001 (custom number of points can be set using SCPI) | |
| Measurements | S11, S21 magnitude and phase S22, S12 magnitude and phase (option 122) | |
| Formats | Log magnitude, linear magnitude, VSWR, phase, Smith chart, polar, group delay, unwrapped phase, real, imaginary | |
| Directivity | | |
| Corrected, with full two-port calibration, N9910X-800 calibration kit (option 122) | 42 dB | |
| Corrected with QuickCal (option 112) | | 38 dB (typical) |
| System impedance | 50Ω (nominal) | 75Ω with appropriate adapter and calibration kit |
| System dynamic range¹ (IF bandwidth = 300 Hz, 32 averages) | | |
| 2 MHz to 6 GHz | 90 dB | 100 dB (typical) |
| Receiver dynamic range² (IF bandwidth = 300 Hz) | | |
| 2 MHz to 6 GHz | | 104 dB (typical) |
| Receiver compression level at 0.1 dB compression | | +10 dBm (typical) |
| Test port output power | | |
| High | | +5 dBm (nominal) |
| Low | | -40 dBm (nominal) |
| Manual | | Power settable in 1 dB steps |
| Test port 1 or 2 damage level | | |
| 2 MHz to 6 GHz | +23 dBm | |
| Trace noise (high output power, IF bandwidth = 300 Hz) | | |
| Magnitude | | < 3 GHz, 0.008 dB rms (typical) > 3 GHz, 0.01 dB rms (typical) |
| Temperature stability | | |
| Stability magnitude | | 0.01 dB/°C at 23 °C ±5 °C (typical) |
| IF bandwidths | | 300 Hz, 1 kHz, 3 kHz, 10 kHz, 30 kHz |

1. System dynamic range = source maximum output power - receiver noise floor

2. Receiver dynamic range = receiver maximum input level - receiver noise floor

FieldFox RF Vector Network Analyzer (continued)

| Description | Information |
|--------------------------|---|
| Display range | |
| Log magnitude S11 or S22 | -1000 to 1000 dB |
| Log magnitude S21 or S12 | -1000 to 1000 dB |
| Log magnitude resolution | 0.01 dB |
| Phase | -180 to +180 degrees |
| Phase resolution | 0.01 degrees |
| VSWR | 1.01 to 1000 |
| VSWR resolution | 0.01 |
| Averaging | 2 to 999 Two methods: sweep and point averaging |
| Number of traces | Four traces available. Tr1, Tr2, Tr3, Tr4 |
| Data markers | Each trace has six independent markers that can be displayed simultaneously. Delta markers are available for each marker. |
| Marker formats | Default marker format is the trace format. In Smith chart or polar format, [Real +Imag] or [Mag and Phase] formats are also available. |
| Marker functions | Peak, Next Peak, Peak Left, Peak Right, Mkr→ Center, Min Search, Peak Excursion, Peak Threshold, Target, Bandwidth, Tracking |
| Sweep type | Linear |
| Sweep time | Set sweep time in seconds |
| Sweep trigger | Continuous, single |
| Display formats | Single-trace Dual-trace overlay (both traces on one graticule) Dual-trace split (each trace on separate graticules) Three-trace overlay (all three traces on one graticule) Three-trace split (each trace on separate graticules) Quad-trace split (each trace on separate graticules) |
| Display data | Display data, memory, data and memory, or data math |
| Trace math | Vector division or subtraction of current linear measurement values and memory data. |
| Scale | Autoscale, scale, reference level, reference position Autoscale: Automatically selects scale resolution and reference value to center the trace. Autoscale all scales all visible traces. |
| Title | Add custom titles to the display. |
| Limit lines | Define test limit lines that appear on the display for go/no go testing. Lines may be any combination of horizontal, sloping lines, or discrete data points. Each trace can have its own limit line. Limit lines can be fixed or relative, and can be built from existing traces. |
| Calibration Types | |
| CalReady | Each FieldFox is calibrated at the test port. |
| Frequency response | Simultaneous magnitude and phase correction of frequency response errors for either reflection or transmission measurements. |
| Enhanced response | Corrects for frequency response and source match for transmission measurements, and corrects for reflection frequency response, directivity and source match errors for reflection measurements. |
| 1-port calibration | Corrects for directivity, frequency response, and source match errors. |

FieldFox RF Vector Network Analyzer (continued)

| Description | Information |
|---|--|
| 2-port calibration (with option 122) | Full 12-term error correction. Corrects for directivity, source match, reflection frequency response, load match, and transmission frequency response for an N9923A with option 122, full two-port S-parameters. Unknown thru and QSOLT are both available. |
| 1-port QuickCal (with option 112) | Corrects for directivity, frequency response, and source match errors, using internal and external standards. QuickCal is most accurate for DUTs with 7/16 and Type-N connectors and measurement uncertainties are provided for frequencies ≤ 6 GHz. Reduced accuracy for DUTs with 3.5 mm (m), SMA (m), or other male coaxial connectors; performance is unspecified. QuickCal is not recommended for DUTs with 3.5 mm (f), SMA (f), or other similar female connectors. QuickCal is not applicable to waveguide. |
| 2-port QuickCal (with option 112 and 122) | Full 12-term error correction. Corrects for directivity, source match, reflection frequency response, load match, and transmission frequency response. QuickCal is most accurate for DUTs with 7/16 and Type-N connectors and measurement uncertainties are provided for frequencies ≤ 6 GHz. Reduced accuracy for DUTs with 3.5 mm (m), SMA (m), or other male coaxial connectors; performance is unspecified. QuickCal is not recommended for DUTs with 3.5 mm (f), SMA (f), or other similar female connectors. QuickCal is not applicable to waveguide. |
| Guided calibration wizard | FieldFox's calibration wizard recommends a calibration type and calibration kit based on selected parameters and connector types. Alternatively, users can select their own calibration type and calibration kit. |
| Interpolated error correction | With any type of accuracy enhancement applied, interpolated mode recalculates the error coefficients when the test frequencies are changed. The number of points can be increased or decreased and the start/stop frequencies can be changed, but the resulting frequency span must be a subset of the original calibration frequency span. |

Corrected measurement uncertainty, 2-port or enhanced response cal, high port power (default power)

Applies to N9923A, N9910X-800 Type-N (m) calibration kit, full 2-port or enhanced response calibration, IF bandwidth = 300 Hz, no averaging, data based on high port power of +5 dBm, 2-port cal available only with option 122.

| | Corrected performance 2 MHz to 4 GHz | Corrected performance >4 GHz to 6 GHz |
|-----------------------|---|--|
| Directivity | 42 dB | 42 dB |
| Source match | 36 dB | 36 dB |
| Load match | 40 dB | 38 dB |
| Transmission tracking | ± 0.02 dB | ± 0.06 dB |
| Reflection tracking | ± 0.06 dB | ± 0.06 dB |

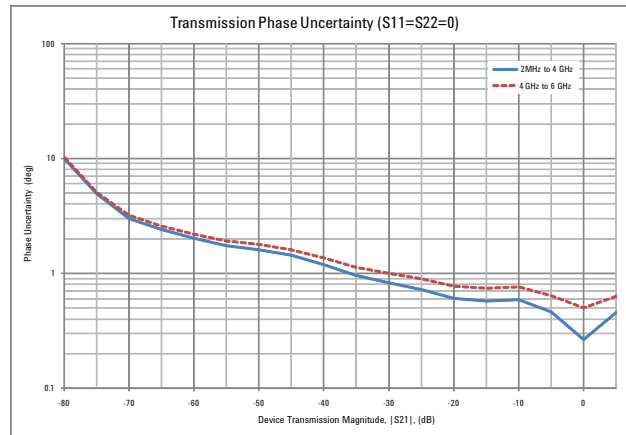
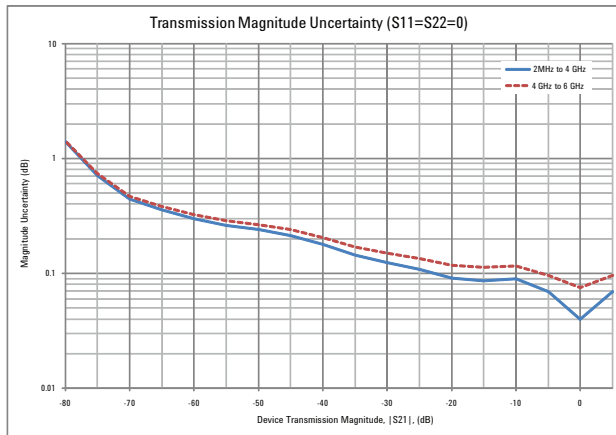

Figure 1: Transmission uncertainty (specification)

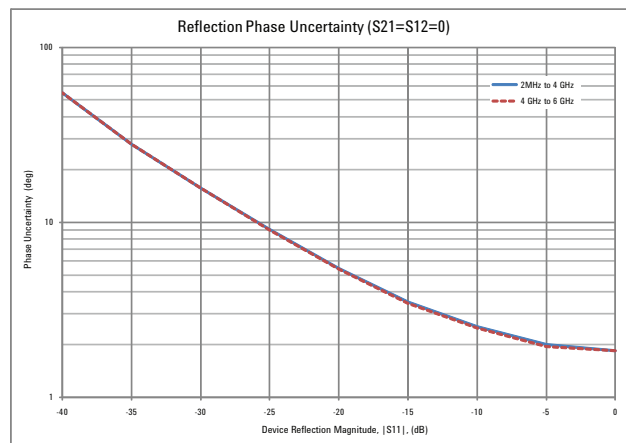
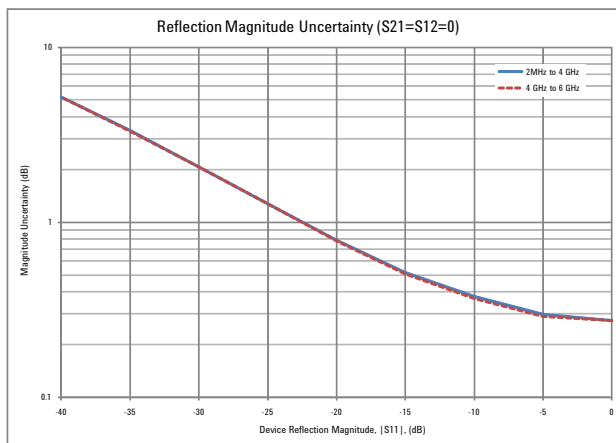

Figure 2: Reflection uncertainty (specification)

Corrected measurement uncertainty, 2-port or enhanced response cal, low port power

Applies to N9923A, N9910X-800 Type-N (m) calibration kit, full 2-port or enhanced response calibration, IF bandwidth = 300 Hz, no averaging, data based on low port power of -40 dBm, 2-port cal available only with option 122.

| | Corrected performance 2 MHz to 4 GHz | Corrected performance >4 GHz to 6 GHz |
|-----------------------|---|--|
| Directivity | 42 dB | 42 dB |
| Source match | 36 dB | 36 dB |
| Load match | 40 dB | 38 dB |
| Transmission tracking | ± 0.02 dB | ± 0.06 dB |
| Reflection tracking | ± 0.06 dB | ± 0.06 dB |

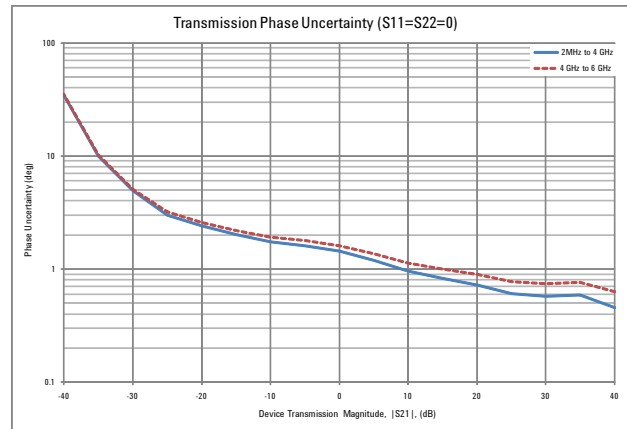
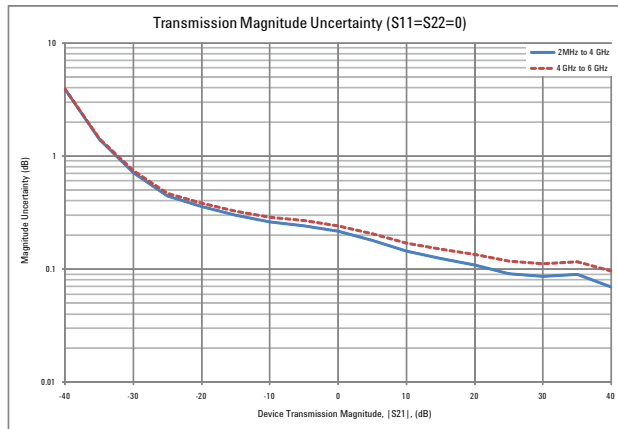

Figure 3: Transmission uncertainty (specification)

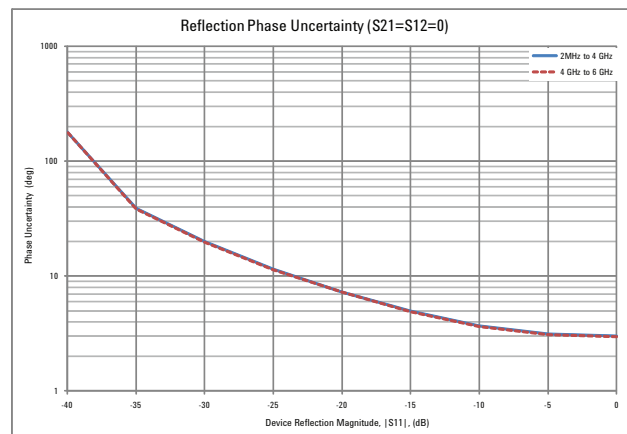
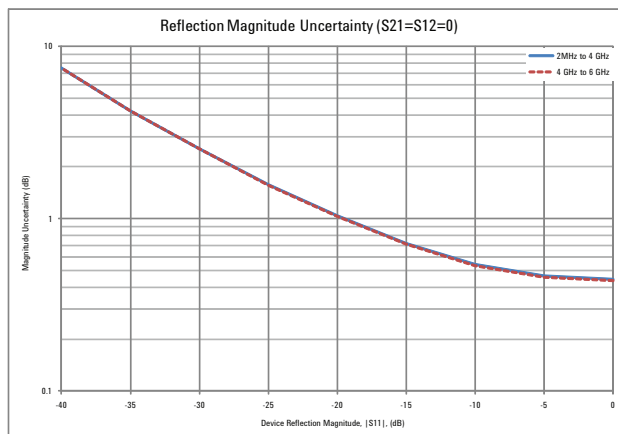

Figure 4: Reflection uncertainty (specification)

Corrected measurement uncertainty, 1- or 2-port QuickCal, high port power (default power)

Applies to N9923A with option 112, QuickCal with load, IF bandwidth = 300 Hz, no averaging, 1-port female DUT, or 2-port female-female DUT, data based on high port power of +5 dBm , 2-port QuickCal requires option 122, typical performance.

| | Corrected performance 2 MHz to 4 GHz | Corrected performance >4 GHz to 6 GHz |
|-----------------------|---|--|
| Directivity | 38 dB | 38 dB |
| Source match | 33 dB | 23 dB |
| Load match | 37 dB | 35 dB |
| Transmission tracking | ±0.04 dB | ±0.09 dB |
| Reflection tracking | ±0.06 dB | ±0.06 dB |

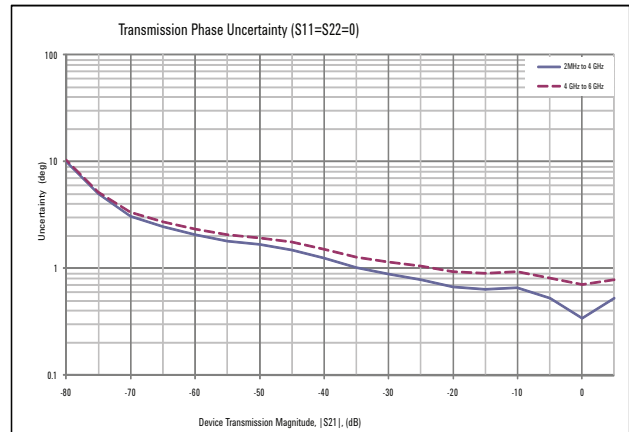
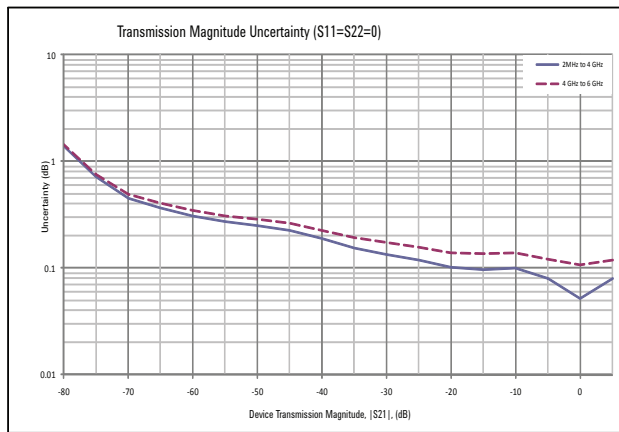

Figure 5: Transmission uncertainty

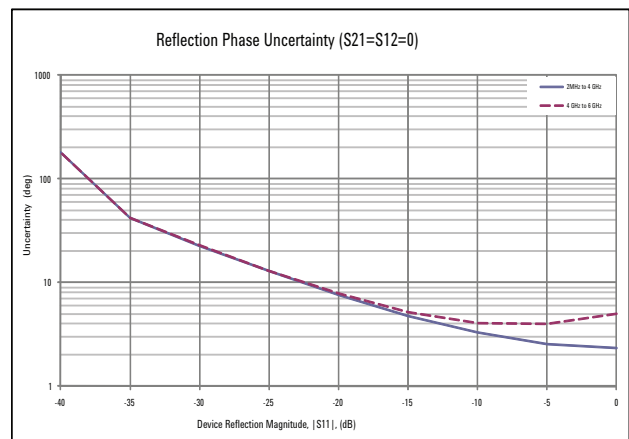
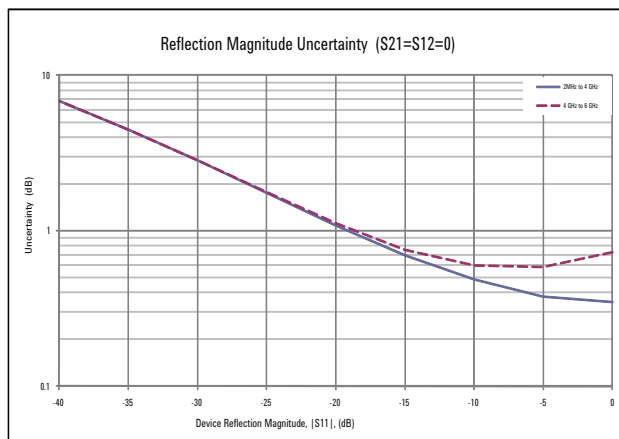

Figure 6: Reflection uncertainty

Corrected measurement uncertainty, 1- or 2-port QuickCal, low port power

Applies to N9923A with option 112, QuickCal with load, IF bandwidth = 300 Hz, no averaging, 1-port female DUT, or 2-port female-female DUT, data based on low port power of -40 dBm, 2-port QuickCal requires option 122, typical performance.

| | Corrected performance 2 MHz to 4 GHz | Corrected performance >4 GHz to 6 GHz |
|-----------------------|---|--|
| Directivity | 38 dB | 38 dB |
| Source match | 33 dB | 23 dB |
| Load match | 37 dB | 35 dB |
| Transmission tracking | ± 0.04 dB | ± 0.09 dB |
| Reflection tracking | ± 0.06 dB | ± 0.06 dB |

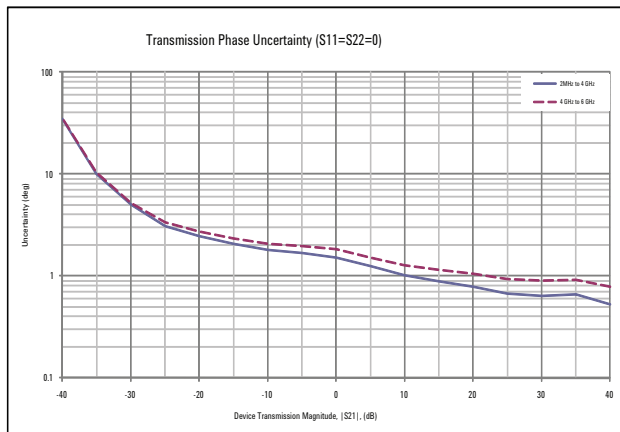
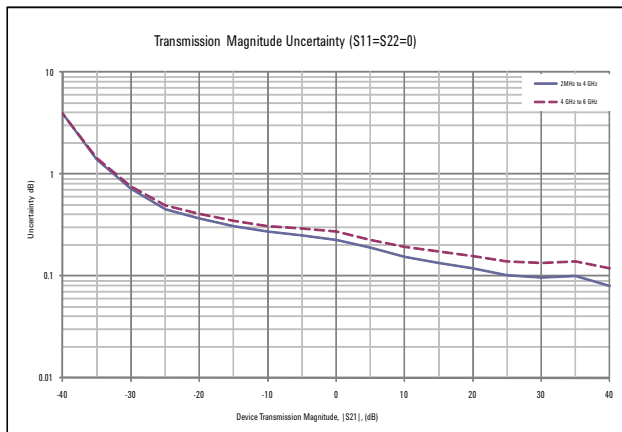

Figure 7: Transmission uncertainty

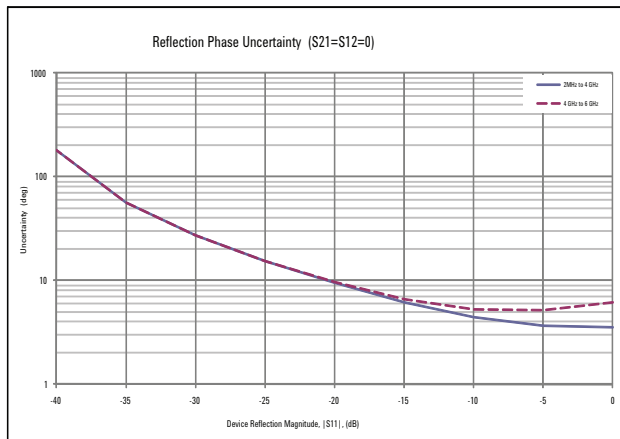
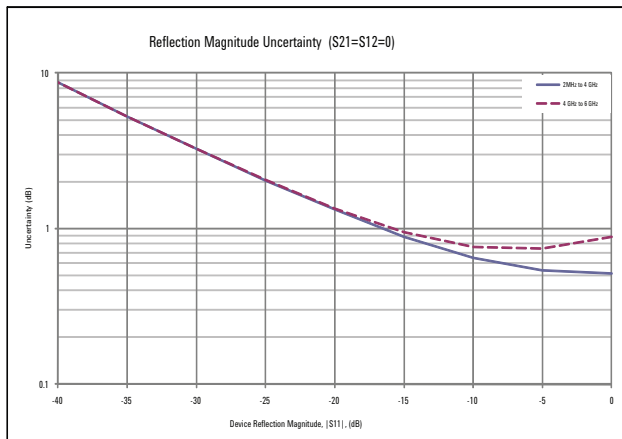

Figure 8: Reflection uncertainty

Dynamic Accuracy

Accuracy of the test port input power, relative to the specified port power.

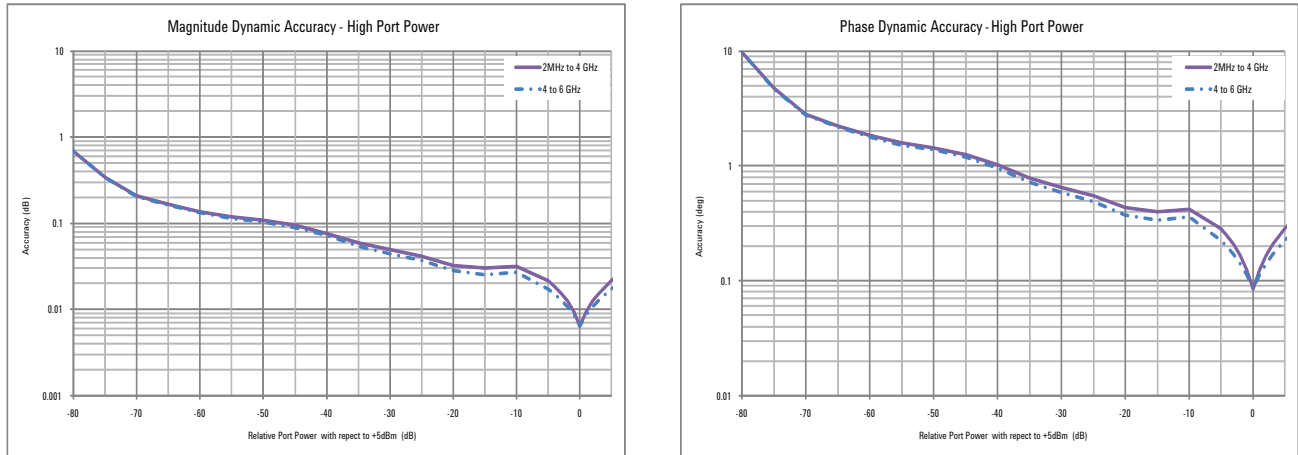

Figure 9: Dynamic accuracy (specification)

Cable and Antenna Analyzer (option 305)

The following CAT mode performance parameters are in addition to the VNA mode performance parameters specified above.

Table1: Cable and antenna analyzer specifications

| Description | Specification | Supplemental Information |
|----------------------------|--|--|
| Cable loss | | |
| Display range | 0 to 100 dB | |
| Resolution | 0.01 dB | |
| Distance-to-Fault | | |
| Horizontal range | Range = [(number of points - 1) / frequency span * 2] * velocity factor * speed of light | Number of points auto coupled according to start and stop distance entered |
| Horizontal Resolution | Resolution = Range / (number of points - 1) | Number of points settable by user |
| Bandpass mode Window types | | Maximum, medium, and minimum windows |

External USB Power Sensor Support (option 302)

The external USB power sensor option supports the Agilent Technologies USB Power Sensors. List of supported sensors available from:

<http://www.agilent.com/find/usbsensorsforfieldfox>.

Vector Voltmeter (option 308)

With vector voltmeter mode, you can characterize the difference between two measurements easily. The zeroing function allows you to create a reference signal, and characterize the difference between two device measurements.

- 1-port cable trimming - reflection or S11 measurement, magnitude and phase
- 2-port transmission - transmission or S21 measurement, magnitude and phase
- A/B and B/A - ratio of two receivers or channels, magnitude and phase –
Need an external signal generator for the A/B or B/A measurement (must order option 122).

The results are shown on a large display in digital format. Refer to the network analyzer section for magnitude and phase accuracy information.

Time domain (Option 010)

Using time domain, data from transmission or reflection measurements in the frequency domain are converted to the time domain. The time-domain response shows the measured parameter value versus time.

Time stimulus modes

- *Low-pass step*
This stimulus, similar to a traditional time domain reflectometer (TDR) stimulus waveform, is used to measure low-pass devices. The frequency-domain data should extend from DC (extrapolated value) to a higher value.
- *Low-pass impulse*
This stimulus is also used to measure low-pass devices.
- *Bandpass impulse*
The bandpass impulse stimulates a pulsed RF signal and is used to measure the time-domain response of band-limited devices.

Windows

The windowing function can be used to filter the frequency-domain data and thereby reduce overshoot and ringing in the time-domain response.

Gating

The gating function can be used to selectively remove reflection or transmission time-domain responses. In converting back to the frequency domain the effects of the responses outside the gate are removed.

Remote control capability, Option 030

Option 030 adds remote control capability to the FieldFox analyzers that allows FieldFox to be controlled via an iOS device. The FieldFox app, running on the iOS device, combined with Option 030 on the FieldFox analyzer provides full control of the instrument from a remote location. The app emulates the front panel of the unit, so users can press any FieldFox key right from their iOS device, including hardkeys or softkeys.

iOS device requirements

- iPad, iPhone, or iPod Touch
- iOS of 5.1 or higher
- A WiFi or 3G/4G connection

The FieldFox app communicates with FieldFox via a network connection, both the iOS device and FieldFox need to be on a network where both devices can reach the other. For example, a company intranet or a site installation using a wireless router. FieldFox can be directly connected to a LAN cable, or if wired LAN is not available, a user supplied wireless router can be configured to work with FieldFox. A wireless router is not included with FieldFox.

FieldFox app without Option 030

The FieldFox app can be installed on an iOS device independent of the presence of Option 030 on the analyzer. Without Option 030, users can view the live display screen of their FieldFox remotely, but cannot control the instrument. FieldFox with Option 030 installed allows users to both view and control their FieldFox. Control refers to the ability to press hardkeys, softkeys, make or change measurements, etc.

Option 030 does not include an iOS device, users must supply their own. Option 030 is a license on the FieldFox analyzer.

Option 030 and the FieldFox app are not applicable to Android, BlackBerry, or Windows phone/tablet devices.

Block Diagram

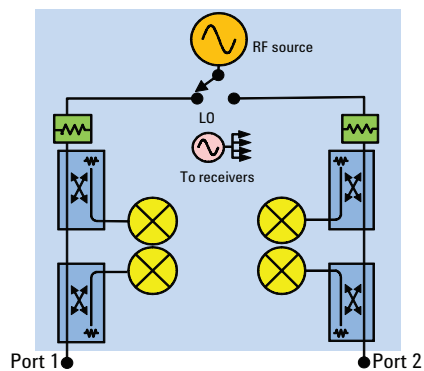

Figure 10: N9923A with option 122

Measurement throughput

Cycle time data, 1001 points, CalRdy, typical information.

Measurement speed

| | |
|-------------------|--------------|
| S11:1.75-3.85 GHz | 1.4 ms/point |
| S21:1.78-2.06 GHz | 1.4 ms/point |

General Information

| Description | Specification | Supplemental Information |
|---|--|--|
| Calibration cycle | | |
| | 1 year | |
| Environmental | | |
| | <ul style="list-style-type: none"> Agilent Technologies outdoor equipment class¹ MIL-PRF-28800F class 2 | |
| Altitude – operating | 9,144 m (30,000 ft) | Under battery operation [AC to DC adapter rated at 3,000 m (9,840 ft)] |
| Altitude – non-operating | 15,240 m (50,000 ft) | |
| Intrusion protection | IP 30 IEC/EN 60529 | |
| Temperature range | | |
| Operating | | |
| AC power | -10 to 55 °C | |
| Battery | -10 to 50 °C | -10 to 55 °C (typical) |
| Storage | -51 to 71 °C | With the battery pack removed. The battery packs should be stored in an environment with low humidity. Extended exposure to temperature above 45 °C could degrade battery performance and life. |
| EMC | | |
| Complies with European EMC Directive 2004/108/EC | <ul style="list-style-type: none"> EC/EN 61326-1 CISPR Pub 11 Group 1, class A AS/NZS CISPR 11 ICES/NMB-001 | |
| ESD | | |
| | • IEC/EN 61000-4-2 | |
| Safety | | |
| Complies with European Low Voltage Directive 2006/95/EC | <ul style="list-style-type: none"> EC/EN 61010-1 2nd Edition Canada: CSA C22.2 No. 61010-1-04 USA: UL 61010-1 2nd Edition | |
| Power | | |
| Power supply | | |
| External DC input | 15 to 19 VDC | 40 W maximum when battery charging |
| External AC power adapter | | Efficiency Level IV, 115 VAC |
| Input | 100 to 250 VAC, 50 to 60 Hz 1.25 – 0.56 A | |
| Output | 15 VDC, 4 A | |
| Power consumption | | On: 14 W (typical) |

1. Samples of this product have been type tested in accordance with the Agilent Environmental Test Manual (ETM) for outdoor equipment (OE) and verified to be robust against the environmental stresses of storage, transportation and end use; those stresses include but are not limited to temperature, humidity, shock, vibration, altitude and power line conditions

General Information (continued)

| Description | Specification | Supplemental Information |
|---|--|---|
| Battery | | |
| | 10.8 V, 4.6 A-h | Lithium ion |
| Operating time | | 3.5 hours (typical) |
| Charge time | A fully discharged battery takes about 1.5 hours to recharge to 80%, 4 hours to 100% | |
| Discharge temperature limits ¹ | -10 to 60 °C, ≤ 85% RH | |
| Charge temperature limits ¹ | 0 to 45 °C, ≤ 85% RH | |
| Storage temperature limits | -20 to 50 °C ¹ , ≤ 85% RH | The battery packs should be stored in an environment with low humidity. Extended exposure to temperature above 45 °C could degrade battery performance and life |
| Data storage | | |
| Internal | Minimum 16 MB | Up to 1000 instrument states and trace |
| External | | Supports USB 2.0 compatible memory devices; Supports microSD and microSDHC memory cards |
| Display | 6.5" transfective color VGA LED-backlit 640 x 480 with anti-glare coating | |
| Weight | 2.7 kg (6.0 lbs) including battery | |
| Dimensions (H x W x D) | 292 x 188 x 72 mm (11.5" x 7.4" x 2.8") | |
| Test ports | | |
| RF Port 1 or Port 2 | | |
| Connector | Type-N, female | |
| Impedance | 50 Ω (nominal) | |
| Damage level | > +23 dBm, > ±50 VDC | |

1. Charge and discharge temperatures are internal temperatures of the battery as measured by a sensor embedded in the battery. The Battery screen displays temperature information. To access the screen, select **System**, **Service Diagnostics** and **Battery**

General Information (continued)

| Description | Specification | Supplemental Information |
|---------------------------------|--|---|
| Headphone Jack Connector | 3.5 mm (1/8 inch) miniature audio jack | |
| USB | | |
| USB-A (2 ports) | Hi-speed USB 2.0 | |
| Mini USB (1 port) | Hi-speed USB 2.0 | Provided for future use. |
| LAN | | |
| External | RJ-45 connector | 10Base-T is NOT supported |
| Programming | The built-in LAN interface and firmware, support data transfer and control via direct connection to a LAN network. | |
| External Reference | | |
| Connector | BNC female | |
| Input frequency | 10 MHz | |
| Input amplitude range | | -5 dBm to +10 dBm (nominal) |
| Impedance | | 50 Ω (nominal) |
| Lock Range | | ±10 ppm of external reference frequency (nominal) |

N9923A FieldFox RF VNA Options

Must select 104 or 106 as a minimum. 104 and 106 are mutually exclusive.

| | |
|------------|--|
| N9923A-104 | 4 GHz RF vector network analyzer, transmission/reflection: Includes S11 and S21, mag and phase, one-port and enhanced response calibration, 2 MHz to 4 GHz. |
| N9923A-106 | 6 GHz RF vector network analyzer, transmission/reflection: Includes S11 and S21, mag and phase, one-port and enhanced response calibration, 2 MHz to 6 GHz. |
| N9923A-112 | QuickCal: Adds one-port QuickCal and two-port QuickCal (two-port QuickCal only if option 122 is ordered). |
| N9923A-122 | Full two-port S-parameters: Adds S12, S22, and full two-port calibration. |
| N9923A-302 | External USB power sensor support: Enables USB port to be used for power measurements. Power sensor not included. |
| N9923A-305 | Cable and antenna analyzer: Adds Cable and Antenna Test (CAT) mode, which allows for DTF measurements. Measurements include DTF (dB), RL & DTF, RL (dB), VSWR, DTF (VSWR), Cable loss (1-port), Insertion loss (2-port), and DTF (linear). |
| N9923A-308 | Vector voltmeter: Provides 1-port cable trimming and 2-port transmission measurements. |
| N9923A-010 | Time domain analysis and gating |
| N9923A-030 | Remote control capability for iOS device, such as iPad, iPhone, or iPod Touch. |

N9923A Upgrade Options

Agilent FieldFox Customer Support <http://www.agilent.com/find/fieldfoxsupport>

| | |
|-------------|---|
| N9923AU-122 | Add full two-port S-parameter capability to an N9923A. |
| N9923AU-112 | Add QuickCal capability to an N9923A. |
| N9923AU-305 | Add cable and antenna analysis to an N9923A. |
| N9923AU-302 | Add external USB power sensor support to an N9923A. Power sensor not included. |
| N9923AU-308 | Add vector voltmeter capability to an N9923A. |
| N9923AU-010 | Add time domain analysis and gating |
| N9923AU-030 | Add remote control capability |

Calibration Kits

The following is a list of the calibration kits that are loaded in a standard FieldFox. Users can add additional calibration kits to their unit using FieldFox Data Link Software. Note regarding QuickCal: The basic QuickCal, either 1 or 2-port does not require any standards. For higher accuracy, users can perform QuickCal with a load.

| | |
|------------|--|
| N9910X-800 | T-calibration kit, DC-6 GHz, Type-N(m) |
| N9910X-801 | T-calibration kit, DC-6 GHz, Type-N(f) |
| N9910X-802 | T-calibration kit, DC-6 GHz, 7/16 DIN(m) |
| N9910X-803 | T-calibration kit, DC-6 GHz, 7/16 DIN(f) |
| 85031B | Economy calibration kit, DC to 6 GHz, 7 mm |
| 85032E | Economy calibration kit, DC to 6 GHz, Type-N, 50-ohm |
| 85032F | Standard calibration kit, DC to 9 GHz, Type-N, 50-ohm |
| 85033E | Standard calibration kit, DC to 9 GHz, 3.5 mm |
| 85036B | Standard calibration kit, DC to 3 GHz, Type-N 75-ohm |
| 85036E | Economy calibration kit, DC to 3 GHz, Type-N 75-ohm |
| 85038A | Standard calibration kit, DC to 7.5 GHz, 7-16 |
| 85039B | Economy calibration kit, DC to 3 GHz, Type-F, 75-ohm |
| 85052D | Economy calibration kit, DC to 26.5 GHz, 3.5 mm |
| 85054B | Standard calibration kit, DC to 18 GHz, Type-N, 50-ohm |
| 85054D | Economy calibration kit, DC to 18 GHz, Type-N, 50-ohm |

FieldFox Data Link Software

FieldFox Data Link software, installed on a PC, provides the following capabilities:

- Capture of current trace and setting
- Opening of data files (.s1p, .s2p, .csv, .sta, and .png) residing on the instrument
- Editing cal kit and cable files on the instrument, or creating new cal kits and cables
- Transferring files to/from the instrument
- Annotating plots for documentation purposes
- Marker, limit line, and format changes on the PC
- Report generation
- Printing function

FieldFox Data Link Software is available from Agilent FieldFox Customer Support <http://www.agilent.com/find/fieldfoxsupport>

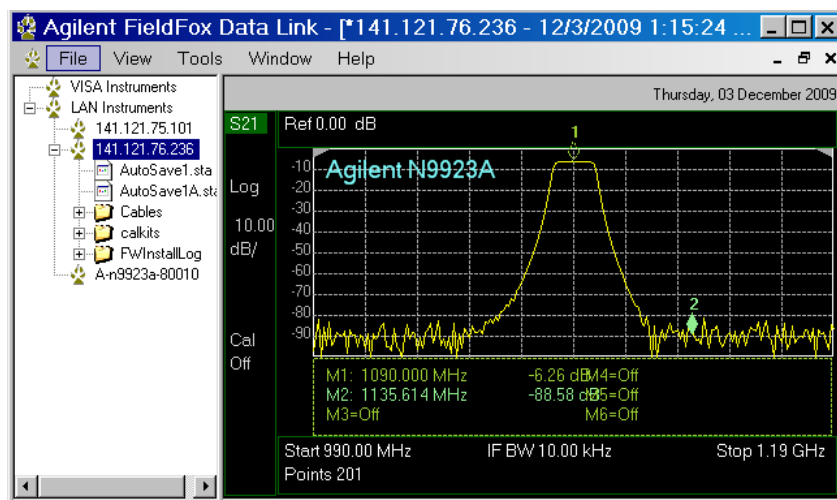

Figure 11: FieldFox Data Link Software

www.agilent.com
www.agilent.com/find/fieldfox

For more information on Agilent Technologies' products, applications or services, please contact your local Agilent office. The complete list is available at:

www.agilent.com/find/contactus

Americas

| | |
|---------------|----------------|
| Canada | (877) 894 4414 |
| Brazil | (11) 4197 3600 |
| Mexico | 01800 5064 800 |
| United States | (800) 829 4444 |

Asia Pacific

| | |
|--------------------|----------------|
| Australia | 1 800 629 485 |
| China | 800 810 0189 |
| Hong Kong | 800 938 693 |
| India | 1 800 112 929 |
| Japan | 0120 (421) 345 |
| Korea | 080 769 0800 |
| Malaysia | 1 800 888 848 |
| Singapore | 1 800 375 8100 |
| Taiwan | 0800 047 866 |
| Other AP Countries | (65) 375 8100 |

Europe & Middle East

| | |
|----------------|----------------------|
| Belgium | 32 (0) 2 404 93 40 |
| Denmark | 45 45 80 12 15 |
| Finland | 358 (0) 10 855 2100 |
| France | 0825 010 700* |
| | *0.125 €/minute |
| Germany | 49 (0) 7031 464 6333 |
| Ireland | 1890 924 204 |
| Israel | 972-3-9288-504/544 |
| Italy | 39 02 92 60 8484 |
| Netherlands | 31 (0) 20 547 2111 |
| Spain | 34 (91) 631 3300 |
| Sweden | 0200-88 22 55 |
| United Kingdom | 44 (0) 118 927 6201 |

For other unlisted countries:

www.agilent.com/find/contactus

(BP-3-1-13)

Product specifications and descriptions in this document subject to change without notice.

© Agilent Technologies, Inc. 2009-2013
 Published in USA, May 30, 2013
 5990-5363EN



www.agilent.com/find/myagilent

A personalized view into the information most relevant to you.

Agilent Channel Partners

www.agilent.com/find/channelpartners

Get the best of both worlds: Agilent's measurement expertise and product breadth, combined with channel partner convenience.



www.agilent.com/find/ThreeYearWarranty

Agilent's combination of product reliability and three-year warranty coverage is another way we help you achieve your business goals: increased confidence in uptime, reduced cost of ownership and greater convenience.



www.agilent.com/quality



Agilent Technologies