

Agilent N9310A RF Signal Generator

User's Guide



Agilent Technologies

Notices

© Agilent Technologies, Inc. 2006-2010

No part of this manual may be reproduced in any form or by any means (including electronic storage and retrieval or translation into a foreign language) without prior agreement and written consent from Agilent Technologies, Inc. as governed by United States and international copyright laws.

Edition

Third Edition, Jan. 2010

Printed in China

Agilent Technologies, Inc.
No. 116 Tuo Xin West 1st Street
Hi-Tech Industrial Zone (South)
Chengdu 611731, China

Software Revision

This guide is valid for A.02.00 revisions of the Agilent N9310A RF Signal Generator software.

Warranty

The material contained in this document is provided “as is,” and is subject to being changed, without notice, in future editions. Further, to the maximum extent permitted by applicable law, Agilent disclaims all warranties, either express or implied, with regard to this manual and any information contained herein, including but not limited to the implied warranties of merchantability and fitness for a particular purpose. Agilent shall not be liable for errors or for incidental or consequential damages in connection with the furnishing, use, or performance of this document or of any information contained herein. Should Agilent and the user have a separate written agreement with warranty terms covering the material in this document that conflict with these terms, the warranty terms in the separate agreement shall control.

Technology Licenses

The hardware and/or software described in this document are furnished under a license and may be used or copied only in accordance with the terms of such license.

Restricted Rights Legend

U.S. Government Restricted Rights. Software and technical data rights granted to the federal government include only those rights customarily provided to end user customers. Agilent provides this customary commercial license in Software and technical data pursuant to FAR 12.211 (Technical Data) and 12.212 (Computer Software) and, for the Department of Defense, DFARS 252.227-7015 (Technical Data - Commercial Items) and DFARS 227.7202-3 (Rights in Commercial Computer Software or Computer Software Documentation).

Safety Notices

CAUTION

A **CAUTION** notice denotes a hazard. It calls attention to an operating procedure, practice, or the like that, if not correctly performed or adhered to, could result in damage to the product or loss of important data. Do not proceed beyond a **CAUTION** notice until the indicated conditions are fully understood and met.

WARNING

A **WARNING** notice denotes a hazard. It calls attention to an operating procedure, practice, or the like that, if not correctly performed or adhered to, could result in personal injury or death. Do not proceed beyond a **WARNING** notice until the indicated conditions are fully understood and met.

Contents

1	Overview	1
	Agilent N9310A At a Glance	2
	Front Panel Overview	4
	Front Panel Display	7
	Rear Panel Overview	9
	Front and rear panel symbols	11
2	Getting Started	13
	Check the Shipment and Order List	14
	Safety Notice	17
	Environmental Requirements	18
	Electrical Requirements	19
	Power on and Check	22
	Turn On the Signal Generator	23
	Check for Error Messages	24
	Some Tips	25
	Enable an option	25
	Remote Control	26
	Firmware Update	27
	Connector Maintenance	28
3	Using Functions	29
	Commonly used Front-panel Elements	30
	Generating a CW Signal	31

Contents

Generating a Step Swept Signal	32
Generating an RF Sweep	35
Generating an Amplitude Sweep	37
Generating an LF Sweep	38
Generating a List Swept Signal	39
Generating a Modulated Signal	41
Preparing the Modulation Format	41
Generating an AM signal	43
Generating an FM Signal	44
Generating a Phase Modulated Signal	45
Generating a Pulse Modulated Signal	46
Generating an I/Q Modulated Signal (Option 001 Only)	47
Generating an LF Output	49
Save, Recall and Delete an Instrument State	50
4 Key Reference	53
AM	54
Amplitude	57
Arrow Keys	58
Enter	58
File	59
FM	61
Frequency	64
I/Q (Option 001 only)	64
LF Out	65
Mod On/Off	66
RF On/Off	66
Numeric Keypad	66
Phase Modulation	67
Switch	69
Preset	70
Pulse	71

Sweep	73
Trigger	83
Utility	84

5 Programming Fundamentals 89

Remotely Operating Your N9310A	90
System Requirements for Remote Operation	90
Connecting the N9310A to a PC through the USB Port	91
About USB Interface	94
Getting Started with SCPI	95
An Introduction to the SCPI Language	95
Common Terms used in this Book	96
Command Categories	97
Command Syntax	97
Program and Response Messages	101
Subsystem Command Trees	102
IEEE 488.2 common command	103

6 Subsystem Command Reference 105

Preparing for Use	106
Frequency Subsystem	109
Continuous Wave (CW) Output Frequency	109
RF Start	110
RF Stop	110
LF Start	111
LF Stop	111
Step Scale	112
Amplitude Subsystem	113
Trigger Subsystem	115
Sweep Subsystem	116

Contents

RF Sweep State	116
LF Sweep State	117
Amplitude Sweep State	118
RF Start	119
RF Stop	119
LF Start	120
LF Stop	120
Amplitude Start	121
Amplitude Stop	121
Step Points	122
Step Dwell	122
Sweep Type	123
List Power State	123
List Dwell	124
List RF	124
List Amplitude	125
List Dwell Points	125
List RF Points	125
List Amplitude Points	126
List Row Goto	126
List Row Insert	126
List Row Delete	127
List Rows	127
List Preset	127
List Dwell Type	128
Sweep Repeat	128
Sweep Trigger	129
External Sweep Trigger Slope	129
Point Trigger	130
External Point Trigger Slope	131
Sweep Direction	131
AM Subsystem	132

AM State	132
AM Depth	133
AM Rate	133
AM Source	134
AM External Coupling	134
FM Subsystem	135
FM State	135
FM Deviation	136
FM Rate	136
FM Source	137
FM External Coupling	137
Phase Modulation Subsystem	138
Pulse Modulation Subsystem	140
I/Q Modulation Subsystem	142
Utility Subsystem	143
Display Style	143
Error Messages	143
Screen Saver	144
System Date	144
System Time	145
Reference Oscillator Sources	145
Phase Noise Mode	146
Modulation State Subsystem	147
RF Output State Subsystem	148
LF Output Subsystem	149
Subsystem Command Trees	151
Symbols used in Command Trees	151
Frequency Subsystem	152
Amplitude Subsystem	153
Trigger Subsystem	153

Contents

LF Output Subsystem	153
Sweep Subsystem	154
AM Subsystem	156
FM Subsystem	157
Phase Modulation Subsystem	158
Pulse Modulation Subsystem	158
I/Q Modulation Subsystem	159
Modulation State Subsystem	159
RF Output State Subsystem	159
Utility Subsystem	160
Programming Examples	161
Programming in C using the VTL	162
Example 1 - Checking USB Connection	164
Example 2 - Generating a CW signal	166
Example 3 - Generating an AM Signal	168
Example 4 - Generating an continuous RF Sweep	170
7 Instrument Messages	173
Overview	174
Command Errors	175
Execution Conflict	178
System Errors	179
Hardware Errors	180
8 Supplementary Information	181
Check the Basics	182
Read the warranty	183
Contact Agilent Technologies	184
List of Commands	185
Index	189



1 Overview

General Features and Functions	2
Options	3
Front Panel Overview	4
Front Panel Display	7
Rear Panel Overview	9
Front and rear panel symbols	11

This chapter describes the general features and functions of the Agilent N9310A RF Signal Generator and provides an introduction to the front and rear panel.



Agilent N9310A At a Glance

The Agilent N9310A is a general purpose RF signal generator with applications in manufacturing, service, research, development and education.

The signal generator has an optional broadband I/Q modulator, able to generate digital signals in conjunction with an external I/Q source.

General Features and Functions

The Agilent N9310A RF Signal Generator provides:

- 9 kHz to 3 GHz frequency range
- -127 to +13 dBm level range (settable to +20 dBm)
- Built in AM, FM, Φ M, and pulse modulation
- RF sweep, LF sweep and amplitude sweep
- LF output: 20 Hz to 80 kHz, 0-3 V_p (into 50 Ω)
- I/Q modulator (optional)
- 6.5-inch TFT LCD
- Universal USB interface
- 1-year calibration cycle

Options

This section provides an overview of available options. For details, please refer to <http://www.agilent.com/find/n9310a>.

- Option 001: I/Q modulator
(part number: N9310A -001)

This option provides an additional internal I/Q modulator. Using this option in the signal generator generates digital signals. Option 001 also requires an external I/Q baseband signal input.

- Option 1CM: Rackmount flange kit
(part number: N9310A -1CM)



Use the rack mount kit to facilitate installation in a standard rack system.

- Option 1TC: Hard transit case
(part number: N9310A -1TC)

A hard transit case protects the signal generator during transportation and storage.

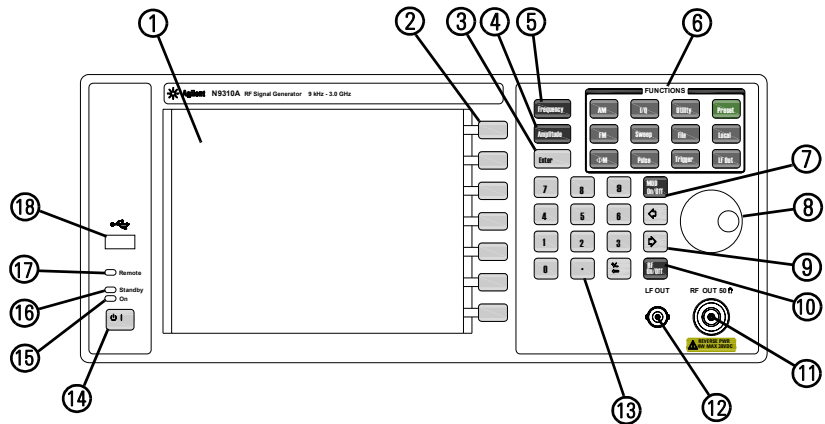
Front Panel Overview



- 1 **Display** The LCD screen shows information on the current function. Information includes status indicators, frequency and amplitude settings, and error messages. Function specific menu labels for the softkeys are shown on the right-hand side of the display. For further description of the front panel display, refer to [“Front Panel Display”](#) on page 7.
- 2 **Softkeys** Softkey menus are determined by the Function chosen. The softkey menu selections are displayed to the left of each key and activate features and functions associated with the Function hardkeys. Refer to [Chapter 4, “Key Reference,”](#) starting on page 53 for further information.
- 3 **Enter** The  hardkey terminates data entry field or parameter selection. Also functions as a single sweep trigger.
- 4 **Amplitude** Press the  hardkey to edit the CW (continuous wave) power levels.
- 5 **Frequency** Press the  hardkey to edit the CW frequency parameter.
- 6 **Function keys** These hardkey selections directly access the following main instrument functions:
 - **Preset** sets the signal generator to factory default settings.

- **AM** configures the amplitude modulation function.
- **FM** configures a frequency modulation function.
- **ΦM** configures a phase modulation function.
- **Pulse** configures a pulse modulation function.
- **I/Q** activates the I/Q modulation function.
- **Sweep** configures RF/LF/Amplitude sweep function.
- **Trigger** triggers an armed sweep.
- **Utility** sets the system configurations
- **Local** returns the control from remote to local.
- **File** saves, recalls or deletes customized configuration files.
- **LF Out** configures a low frequency signal.

- 7 **Mod On/Off** Press the  hardkey to toggle the modulator state between On and Off. A **MOD On/Off** annunciator is visible on the screen, indicating whether the modulator is enabled or not.

A user must select the modulation type and select from the menu softkeys to turn modulation on (for example,  > **AM On**), or no modulation will be applied to the output carrier signal, even though the modulator is enabled (**MOD On**).

- 8 **Knob** The front panel knob increases or decreases a value, a numeric digit, or scrolls up and down to select an item in a list.
- 9 **Arrow keys** The left and right arrow keys shift the selected digit in the active entry area of the display; Once an individual digit is selected, you can change its value by rotating the knob.
- 10 **RF On/Off** The  hardkey toggles the RF output state between On and Off. A **RF On/Off** annunciator is always visible on the display, indicating whether the RF output is enabled or not.

- 11 **RF Out connector** Female N-type connector provides the Signal Generator RF output signal. The impedance is 50 ohm. The damage level is +36 dBm maximum.
- 12 **LF Out connector** BNC (F) connector outputs the low frequency (LF) signal whenever you set the **LF Out** > **LF OUT** to on. The LF output is capable of driving a 3V_{peak} (nominal) signal into a 50 ohm load.
- 13 **Numeric Keypad** 0 through 9 numeric keys, decimal point and a backspace key. The backspace hardkey may be used to input a negative value. When entering a negative value, enter a negative sign prior to entering the numeric value.
- 14 **Standby Switch** switching to the On position activates all functions of the signal generator. When pressing this key to switch the signal generator Off, the signal generator deactivate all the functions but still remains connected to the line power, while the line power is supplied to some internal circuits.
- 15 **Switch On LED** This green LED lights when the signal generator is switched on using the front panel standby switch.
- 16 **Standby LED** This orange LED lights when the line power is switched on with the rear panel power switch.
- 17 **Remote LED** This LED lights when the signal generator is remotely controlled by a PC by way of the USB host interface located on the rear panel.
- 18 **USB Type A (Host) Connector** provides a port connection for use by external USB devices, such as a USB memory stick.

Front Panel Display

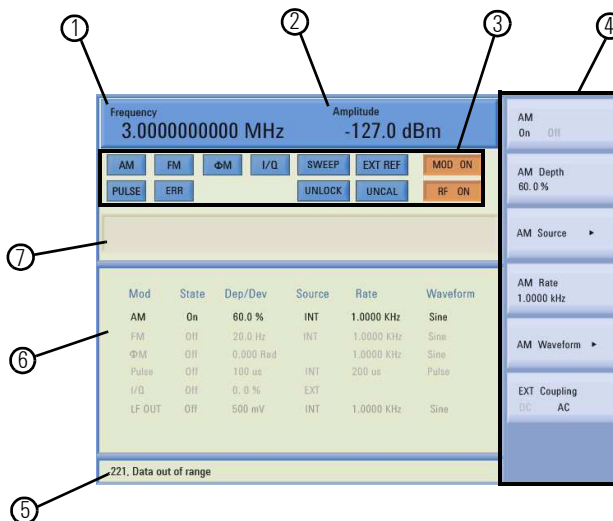

- 1 Frequency Area** displays the current CW (continuous wave) frequency.
- 2 Amplitude Area** displays the current output power level.
- 3 Annunciators** display the status of most of the signal generator functions, as well as indicating errors generated. An annunciator position may be used by more than one function.
 - Φ M becomes active when Φ M is enabled.
 - AM becomes active when an AM is enabled.
 - ARMED becomes active when a sweep mode is selected and the signal generator is waiting for a trigger to initiate sweeping.
 - ERR becomes active when an error is generated. This annunciator will not turn off until you have viewed all the error messages and cleared the error queue. You can access error messages by pressing **Utility** > **Error Info**.

- **EXT REF** becomes active when an external frequency reference is applied.
 - **FM** becomes active when an FM is enabled.
 - **I/Q** becomes active when an I/Q modulation is enabled.
 - **MOD ON/OFF** indicates when the RF carrier is modulated (**MOD ON** indicates the modulator is enabled, while **MOD OFF** indicates disabled). Either state is always visible on the screen.
 - **PULSE** becomes active when a pulse modulation is enabled.
 - **RF ON/OFF** indicates whether the RF output is enabled or disabled. RF status is always visible in the display.
 - **SWEEP** becomes active when the signal generator is sweeping.
 - **UNCAL** becomes active when the signal generator is unable to maintain the correct level.
 - **UNLOCK** becomes active when any of the phase locked loops are unable to maintain phase lock. To view further descriptions, please refer to [Chapter 7](#), “Instrument Messages,” starting on page 173.
- 4 Softkey Label** displays submenus of each function. The content of softkey labels change according to the function selected. Refer to [Chapter 4](#), “Key Reference,” starting on page 53 for further information.
 - 5 Message Area** displays abbreviated system messages. When multiple system messages occur, only the most recent message is displayed. Press **Utility** > **Error Info** to view all reported system messages along with details.
 - 6 Status Area** displays state information about the signal generator, such as the modulation status, sweep status, and file catalogs and storages.
 - 7 Active Function Area** displays the current active function. For example, if you press **Frequency** hardkey, the frequency is active and the current frequency setting is displayed.

Rear Panel Overview

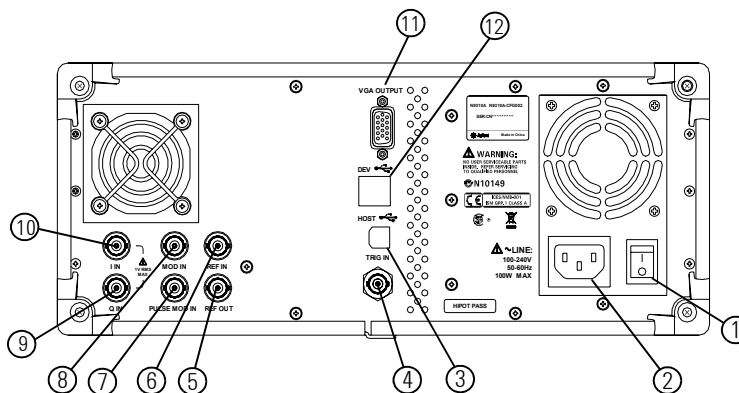

- 1 **Power switch** The power switch isolates the signal generator from the AC line power. After pressing this switch to the On position, the signal generator enters standby mode and the standby LED (orange) on the front panel indicates that line power is on.
- 2 **AC power receptacle** The power receptacle accepts a standard three-conductor plug.
- 3 **USB Type B (Device) connector** Used for connecting with a controller, such as a PC.
- 4 **TRIG IN connector** BNC (F) connector, accepts a TTL signal for triggering a sweep. Triggering occurs on either the positive or negative edge. The frequency of the external trigger source may be no greater than 100 Hz. The damage level is $\geq +10$ V or ≤ -4 V.
- 5 **REF OUT connector** BNC (F) connector for output of the internal reference frequency, which has a nominal output level greater than $0.35V_{rms}$, and an output impedance of 50 ohm.

- 6 **REF IN connector** BNC (F) connector, accepts a -3.5 to $+20$ dBm signal from an external reference oscillator that is within ± 1 ppm. The nominal input impedance is 50 ohm. The instrument will accept a 2MHz, 5MHz, or 10 MHz reference oscillator signal.
- 7 **PULSE MOD IN connector** BNC (F) input connector accepts a TTL signal for pulse modulation. The damage level is 5 Vrms.
- 8 **MOD IN connector** BNC (F) input connector accepts a $1.0 \pm 2\%$ V (peak) signal for AM, FM, and phase modulation. For all modulation types, a $+1.0$ Vpeak produces the indicated deviation or depth. The damage level is 5 Vrms.
- 9 **Q IN connector** BNC (F) input connector accepts an external quadrature-phase component of an I/Q baseband signal. The signal level is $\sqrt{I^2 + Q^2} = 0.5$ Vrms for calibrated output level. The input impedance is 50 Ohm. The damage level is 1 Vrms.
- 10 **I IN connector** BNC (F) input connector accepts an externally in-phase component of an I/Q modulation signal. It has the same characteristics as the Q baseband signal.

NOTE

The I/Q IN connectors are only available for external I/Q signal input with Option 001.

- 11 **VGA connector** outputs to an external monitor or projector.
- 12 **USB Type A (Host) connector** connect with external USB devices, such as a USB memory stick.

Front and rear panel symbols

The signal generator uses the following symbols. Before operation, familiarize yourself with each marking and its meaning.



The instruction manual symbol: indicates that the user must refer to specific instructions in the manual.



The CE mark: a registered trademark of the European Community.

ISM1-A

shows that this is an Industrial Scientific and Medical Group 1 Class A product. (CISPR 11, Clause 4)



The CSA mark: a registered trademark of the Canadian Standards Association International.

ICES/NMB-001

The ISM device complies with Canadian Interference-Causing Equipment Standard-001.
Cet appareil ISM est conforme à la norme NMB-001 du Canada.



The C-Tick Mark: a trademark registered to the Australian Communication Media Authority. It indicates compliance with all Australian EMC regulatory information.



marks the “on” position of the power line switch.



marks the “standby” position of the power line switch.



indicates that the instrument requires AC power input.

1 Overview



This product complies with the WEEE Directive(2002/96/EC) marking requirements. The affixed label indicates that you must not discard this electrical/electronic product in domestic household waste.

Product Category: With reference to the equipment types in the WEEE Directive Annex 1, this product is classed as a Monitoring and Control instrumentation product.

Do not dispose in domestic household waste. To return unwanted products, contact your local Agilent office, or see

<http://www.agilent.com/environment/product/>



2 Getting Started

Check the Shipment and Order List	14
Safety Notice	17
Environmental Requirements	18
Electrical Requirements	19
Power on and Check	22
Some Tips	25
Connectors Maintenance	28

This chapter presents information to properly configure test connections to your instruments and interfaces for correct use of the signal generator.



Check the Shipment and Order List

After receiving the product shipment, refer to the following procedures to check the shipment contents. If there is any concern about the shipment, please contact Agilent Technologies Customer Contact Center for consultation and service.

- Inspect the shipping container for physical damage. Signs of damage may include a dented or torn shipping container or cushioning material. This may indicate signs of unusual stress or compacting.
- Carefully remove the contents of the shipping container and verify that the order is complete. Each shipment includes the following standard items:

Item	Quantity	Part Number
N9310A signal generator	1	N9310A
USB cable	1	8121-1482
Three-conductor power cord	1	Specific to region
Quick Start Guide	1	N9310-90003
Help kit CD-ROM	1	N9310-84500
Calibration certificate	1	5962-0476

- If you ordered any of the following options, verify that they are in the shipment by checking the product label on the rear panel and the package check list.

Option	Name	Part number
001	I/Q modulator	N9310A-001
1CM	Rack mount kit	N9310A-1CM
1TC	Hard transit case	N9310A-1TC

Rack Mount

It is recommended to use the rack mount kit (option 1CM) if the signal generator is to be installed into an instrument rack.

Do not attempt to rack mount the signal generator using the front panel handles only. The Agilent rack mount kit will allow the signal generator to be mounted in a rack with or without the handles.

Refer to the following instructions when you rack mount the signal generator.

- 1 Remove the feet, key-locks and tilt stands, as shown below.
- 2 Remove side trim strips and a middle screw per side.

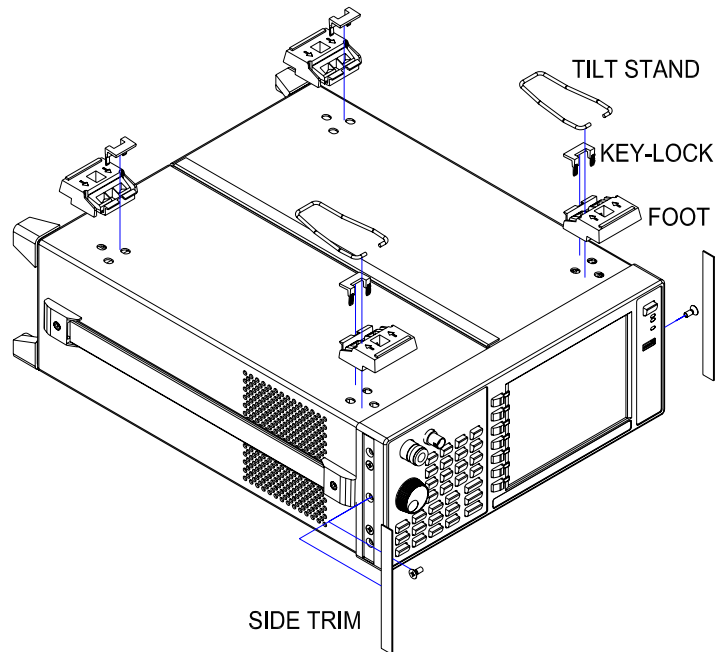

- 3 Attach the rack mount flange and front handle assembly with 3 screws per side.

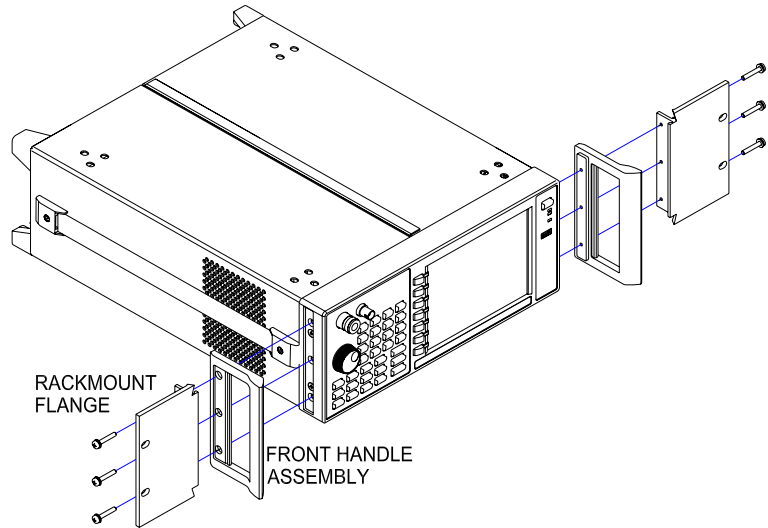

- 4 Rack mounting with two dress screws per side.

CAUTION

Installing the signal generator into a non-approved rack may promote shock hazards, overheating, dust contamination, and inferior system performance. Consult your Agilent customer engineer about installation, warranty, and support details.

Transit

The hard transit case (option 1TC) is recommended for transporting instruments.

Safety Notice

Please read the following warnings and cautions carefully before applying power to the signal generator in order to ensure personal and instrument safety.

WARNING

Always use a well-grounded, three-pin AC plug and power cord to connect to a power source. Personal injury may occur if there is any interruption of the AC power cord of the signal generator. Intentional interruption is prohibited.

WARNING

Personal injury may result if the signal generator covers are removed. There are no operator service parts inside. To avoid electrical shock, refer servicing to qualified personnel.

WARNING

Electrical shock may result if the signal generator is connected with the power supply when cleaning. Do not attempt to clean internally.

CAUTION

Installing the signal generator in non-approved rack systems may promote shock hazards, overheating, dusting contamination, and inferior system performance. Consult to your Agilent customer engineer about installation, warranty, and support details.

CAUTION

Damage to the signal generator may result when the total power dissipated in the system cabinet is greater the 800 watts. When this condition exists, forced convection must be applied.

CAUTION

Avoid turning off the signal generator when current state is changing as a result of front panel operation or remote control.

Environmental Requirements

Agilent Technologies has designed this product for use in Installation Category II, POLLUTION DEGREE 2, per IEC 61010-1. Agilent has designed the signal generator for use under the following conditions:

- Indoor use
- Altitude < 3,000 meters
- Temperature 0 to 45°C, unless otherwise specified
- 15% to 95% relative humidity for temperatures at 40°C

Ventilation

Ventilation holes are located on the rear panel and all four sides of the signal generator cover. Do not allow these holes to be obstructed, as they allow air flow through the signal generator.

When installing the signal generator in a cabinet, do not restrict the convection airflow into or out of the signal generator. The ambient temperature outside the cabinet must be less than the maximum operating temperature of the signal generator by 4°C for every 100 watts dissipated within the cabinet.

Cleaning Tips

To prevent electrical shock, disconnect the signal generator from the main AC power circuits before cleaning. Use a dry cloth or one slightly dampened with water to clean the external case parts. Do not attempt to clean internally.

WARNING

Electrical shock may result if the signal generator is connected to the AC power supply while cleaning. Disconnect from any AC power source before cleaning. Do not attempt to clean internally.

Electrical Requirements

The signal generator has an auto-ranging line voltage internal power supply input. The available AC power source must meet the following conditions:

Voltage:	100~240 volts nominal
Frequency:	50/60 Hz nominal
Power:	100 watts maximum





Connecting the AC Power Cord

This Safety Class I Product is provided with a protective earth ground incorporated into the power cord. The front panel switch is a standby switch only; it is not an AC power switch. The AC power cord is a disconnecting device that may be used to disconnect the signal generator from the main AC supply. Alternately, The rear panel switch or circuit breaker may also be used as a disconnecting device.

Perform the following steps to connect the AC power cord:

- Ensure that the power cord is not damaged.
- Install the signal generator so that you can easily reach the AC power cord or circuit breaker.
- Insert the main plug into a socket outlet provided with a protective earth grounding.

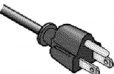
AC Power Cord Localization

Plug Type	Cable Part Number	Plug ^a Description	For Use in Country & Region
 250V 10A	8121-1466	BS 1363/A	Option 900 United Kingdom, Hong Kong, Singapore, Malaysia
 250V 10A	8120-1454	KS C8305	Option 902 Korea
 250V 10A	8120-1378	CNS 10917-2	Option 903 United States, Canada, Taiwan
 125V 12A	8120-4754	JIS C8303	Option 918 Japan
 250V 10A	8120-8377	GB 1002	Option 922 China

a. Plug identifier numbers describe the plug only. The part number is for the complete cable assembly.

Electrostatic Discharge Protection

Electrostatic discharge (ESD) damages or destroys electronic components (the possibility of unseen damage caused by ESD is present whenever transportation, store or use of components).

This product contains components that are easily damaged by Electrostatic Discharge (ESD). To help reduce ESD damage that can occur while using test equipment:

- 1** Each day, before connecting any coaxial cables to the signal generator connector, momentarily short the center and outer conductors of the cable together.
- 2** Before touching the center pin of any connector, and before removing any assembly from the signal generator, users must be grounded with a 1 M Ω resistor-isolated wrist-strap.
- 3** Be sure that all instruments are properly grounded to prevent build-up of static charges.

For more information about ESD and how to prevent ESD damage, contact the Electrostatic Discharge Association (<http://www.esda.org>). The ESD standards developed by this agency are sanctioned by the American National Standards Institute (ANSI).

Power on and Check

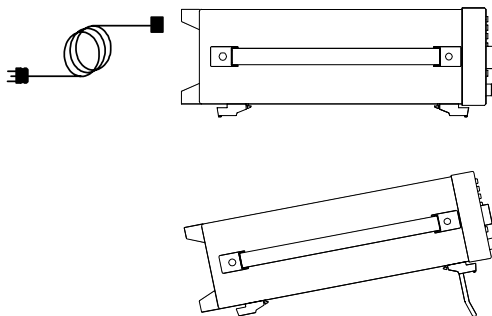

- 1 Connect the power cord. Insert the plug into a power socket provided with a protective earth ground contact. Set the tilt adjustor for your preference.

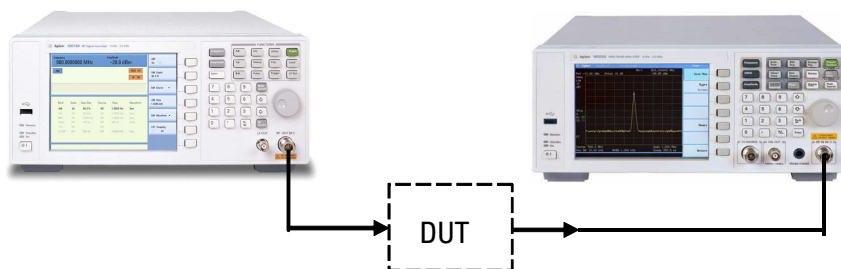

- 2 Connect a cable to the RF output connector of the signal source to the DUT (device under test).



Turn On the Signal Generator

- 1 Toggle the rear panel line switch  to the On state. The orange front panel standby LED will light and the signal generator will then have AC line power.
- 2 Pressing the standby switch  on the front panel, will turn on the signal generator and the green Switch On LED will light.

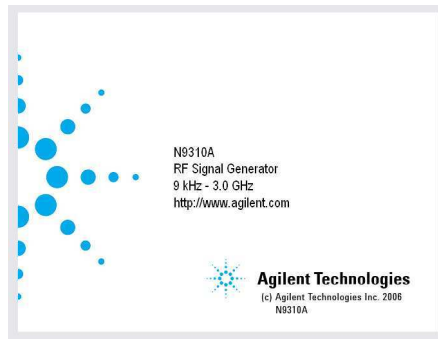

Self-initialization (boot up) will take about 30 seconds, including self-test. If an error is detected, the signal generator will report an error. The signal generator will then default to a maximum frequency of 3 GHz and a minimum amplitude of -127 dBm. The signal generator is then ready for use. After power on, the signal generator requires approximately 45 minutes for temperature stabilization.

NOTE

The front panel switch is a standby power switch only; it does not turn off AC line power. To completely disconnect the signal generator from the line power, turn off the power switch located on the rear panel.

Check for Error Messages

There are two categories of instrument messages. System messages and error messages. A system message is triggered by operation errors. For example, parameter setting conflicts or data input that is out of the parameter range. An error message may be triggered by hardware defects and will have an ERR annunciator displayed on the screen.

If an operational error occurs, the signal generator will report a message displayed at the bottom of the screen. It will indicate an operation error has occurred and that the instrument has corrected the error. The signal generator will automatically clear system messages after 30 seconds.

If a hardware defect or system error occurs, the signal generator will report a message at the bottom of the screen and will also have an ERR annunciator displayed.

Here are some tips for checking for error messages in the signal generator:

- 1 Check the display to see if the ERR annunciator is displayed. If it is, press **Utility** > **Error Info** to review each error message in the error queue (list). Refer to [Chapter 7](#), “Instrument Messages,” starting on page 173 for detailed system messages descriptions.
- 2 When you have reviewed and resolved all of the error messages, press **Utility** > **Error Info** > **Clear** softkey to delete the messages.
- 3 Cycle the AC power to the signal generator and then check again to see if the ERR annunciator has turned off.
- 4 If you can not resolve the error messages, please contact the Agilent Customer Contact Center for assistance.

Some Tips

Refer to the following hints to set up the signal generator for your preference. For more detailed description, see [Chapter 4](#), “Utility,” starting on page 84.

- Press **Utility** > **Screen Saver**> **On** to set the screen saver on. With the screen saver set to **On**, the display will turn off after 15 minutes if there is no input from the front panel. Press any front panel key to turn the display back on.
- Select a display style by pressing **Utility** > **Display Style**

NOTE

The display style and the screen saver are persistent state, pressing **Preset** hardkey will not affect these settings.

- Toggle the phase noise mode by pressing **Utility** > **Opti. Φ Noise**> **Normal/Resume Opt.**
- Save the current configuration for frequent use to either local memory or an external USB memory.
- Connect and set an external reference by pressing **Utility** > **Ref Setups**
- Connect an external display monitor to the VGA connector for educational projects or other needs.

Enable an option

You are required to enter the option license key to enable the option. Contact your nearest Agilent Office for purchasing a license. Refer to the following steps to enable the I/Q modulator (option 001):

- 1 Press **Utility** hardkey
- 2 Press **License key** softkey
- 3 Enter the license key information and the option will be enabled immediately

Remote Control

The configuration for setting up remote control for your N9310A is done very simply. You need only to connect your N9310A with a PC which has installed Agilent IO Libraries Suite using an appropriate USB cable.

If you need a more flexible remote control, you can also create your own program by using Agilent VTL (Visa Transition Library) and the SCPI commands.

For more information about N9310A SCPI commands and programming examples, refer to [Chapter 6](#), “Subsystem Command Reference,” starting on page 105.

For more information about Agilent IO Libraries Suite, refer to <http://www.agilent.com/find/iolib>

If you are new to instrument programming, please refer to [Chapter 5](#), “Programming Fundamentals,” starting on page 89.

Firmware Update

The N9310A provides a convenient firmware update service. Please refer to this procedure to finish the firmware update:

- 1 Download the firmware (ZIP file) from

<http://www.agilent.com/find/n9310a>

Refer to the following flow chart for downloading:

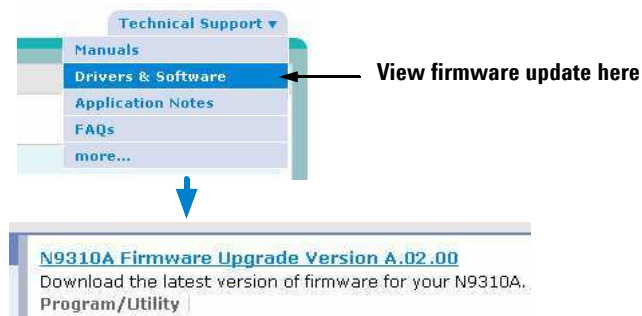

NOTE

The instrument firmware contains drivers for most USB memory sticks. Please make sure your USB memory stick is in FAT16 or FAT 32 format. The N9310A does not support USB memory sticks with self-startup partition or multi-partitions.

- 2 Extract the ZIP file, you will get the file *N9310A.update*, then copy this file into the root directory of your USB memory stick.
- 3 Power off your N9310A and insert this USB memory stick into the USB connector on the front panel.
- 4 Power on your N9310A, then press **[Enter]** to begin the upgrade process.
- 5 The entire upgrade procedure will take several minutes. Please wait until the instructions are displayed before removing the USB memory stick. The instrument will then show that new firmware is available for use after rebooting the instrument.

Press **Utility** > **Information** to view the current firmware information.

Connector Maintenance

The RF connectors should be checked every six months—more often if the instrument is in daily use on a production line or in a harsh environment.

Visually inspect the front panel connectors. The most important connectors are those to which the DUT (device under test) is connected, typically the RF cable end or the RF OUT and LF OUT connectors. All connectors should be clean and the center pins centered. The fingers of female connectors should be unbroken and uniform in appearance. If unsure whether the connectors are in good condition, gauge the RF OUT connectors to confirm their dimensions are correct.

Maximum and minimum protrusion of center conductor from mating plane

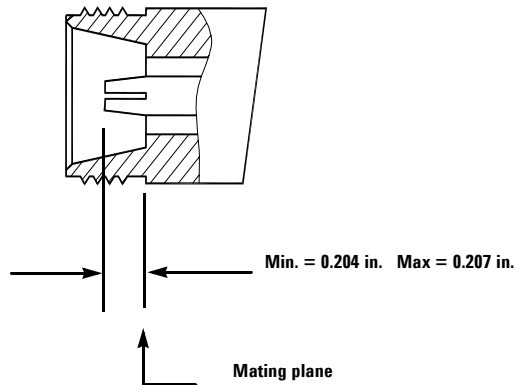



3 Using Functions

Commonly used Front-panel Elements	30
Generating a CW Signal	31
Generating a Step Swept Signal	32
Generating a List Swept Signal	39
Generating a Modulated Signal	41
Generating an LF Output	49
Save, Recall and Delete an Instrument State	50

This chapter contains procedures that illustrate how to use the major functions of your signal generator. They include setting frequency and power levels, setting up modulations, creating RF and LF sweeps, saving and recalling instrument states, and enabling options.

Commonly used Front-panel Elements

In addition to using basic function hardkeys, a user will also enter data using softkeys and selection from menu softkeys. If you are new user of the N9310A, refer to the following tips on entering data and using softkeys.

Entering Data

When setting the parameter values, there are two ways of entering or modifying values for an active function:

Using the numeric keypad and the unit softkey

Numeric Keypad Enters a specific value.

Unit softkey Terminates a data input by softkey menu keypad

Using the knob, arrow keys and the Enter hardkey



Knob Increases or decreases a parameter value

Arrow Keys Used to move to the selected item to be modified or input

Enter Confirms and terminates the data input

Using Softkeys

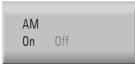
Softkeys, which are located to the right side of the display, provide access to many sub-functions. There are three types of softkeys being used in N9310A. See the table below to learn their types and functions.

Type	Function	Example
Toggle	Pressing this type of softkey toggles a parameter between two states	
Submenu	Pressing this type of softkey enter another submenu	
Modify	Pressing this type of softkey enables you to modify a parameter value	

Generating a CW Signal

Generating a CW (Continuous Wave) signal requires you to select the frequency and amplitude parameters and enable the RF output. The parameters have the following characteristics:

Character	Range	Default
Frequency	9 kHz to 3 GHz	3.0000000000 GHz, with 0.1 Hz resolution
Amplitude	-127 to +13 dBm (+20 dBm settable) -80 to +60 dBmV (+67 dBmV settable) -20 to +120 dBμV (+127 dBμV settable) 0.0001 to 1000 mV (2238.8 mV settable) 0.1 to 1000000 μV (2238800 μV settable)	-127 dBm, with 0.1 dB resolution

Operation Example

Assume you need to generate a CW signal with:

- a frequency of 700 MHz
- an amplitude of -20 dBm



Please refer to the following steps to set up the CW signal:

- 1 Press **Preset** hardkey
This returns the signal generator to the factory default state. To view the default settings of the signal generator, please check [Chapter 4](#), “Factory Default Settings,” starting on page 70.

Observe the FREQUENCY and AMPLITUDE area of the display (in the upper left-hand corner). The value displayed is the maximum frequency (3 GHz) and the minimum amplitude (-127 dBm), the default conditions.
- 2 Press **Frequency** > **700** > **MHz** to set the CW frequency to 700 MHz.
- 3 Press **Amplitude** > **-20** > **dBm** to set the CW amplitude to -20 dBm.
- 4 Toggle **RF On/Off** hardkey to enable the RF output.

Generating a Step Swept Signal

The signal generator will generate step swept signals in three sweep modes:

Sweep Mode	Sweep Range	Front-panel key access
RF	9 kHz to 3 GHz	 > Sweep Mode > RF
Amplitude	-127 to +13 dBm	 > Sweep Mode > Ampl
LF	20 Hz to 80 kHz	 > Sweep Mode > LF

NOTE

During the swept RF output or Amplitude output, the FREQUENCY and AMPLITUDE display are deactivated.

General Settings for a Step Sweep

It is necessary to set up the following parameters for a step sweep function:

- start and stop frequency/amplitude
- the number of equally spaced frequency points (steps) the RF output will dwell upon
- the dwell time at each point

For more information on how to generate a step sweep, refer to:

“Generating an RF Sweep” on page 35,

“Generating an Amplitude Sweep” on page 37,

“Generating an LF Sweep” on page 38.

Additional Settings for a Step Sweep

There four other settings that will have an effect on the sweep:

- **Sweep Trigger:**

The sweep trigger can be set to any of the following three choices: **Immediate/Trigger Key/EXT**

- **Point Trigger:**

The point trigger can be set to any of the following three choices: **Immediate/Trigger Key/EXT**

- **Sweep Repeat: Cont/Single**

The sweep repeat can be set to either **Cont** or **Single**.

If set to **Cont**, the signal generator sweeps from the start point to the stop point and repeats continuously.







If set to **Single**, the signal generator sweeps from the start point to the stop point for one sweep only.

- **Sweep Direction: Up/Down**

For example, as you enable the RF sweep by pressing



> **Sweep Mode** > **RF**, the signal generator will perform as shown below, depending on the combination of settings for sweep and point trigger.

Sweep Trigger	Point Trigger	Sweep Performance
IMM	IMM (Immediate)	Pressing  > Sweep mode > RF starts a continuous sweep mode. Pressing  > Sweep mode > Off will stop the sweep.
IMM	Key	Pressing  > Sweep mode > RF enables the RF sweep, then pressing the Trigger key will initiate manual sweeping over the defined points.
Key	IMM	Pressing  > Sweep mode > RF , the "ARMED" annunciator will be displayed, indicating the signal generator is ready for trigger instruction. Pressing Trigger key starts the signal generator sweeping over the points automatically.
Key	Key	Pressing  > Sweep mode > RF , the "ARMED" annunciator displays on the screen, indicating the sweep is ready for the trigger. Pressing  > Sweep mode > RF enables an RF sweep, then pressing the Trigger key will initiate a manual point sweep.

To use an external trigger source, a TTL signal with 100 ns as the minimum level holding time is required. The sweep trigger must be set to **Key** and the point trigger set to **EXT**, for the sweep to be set to either **Single** or **Cont**. Other combinations of sweep and point trigger will allow continuous sweep only.

Generating an RF Sweep

To generate an RF sweep with the following settings:

- frequency range from 1 GHz to 2 GHz,
at a power level of 0 dBm
- nine sweep points with a 50 ms dwell time at each point

Refer to the following procedures to configure and generate an RF sweep:

- 1 Press **Preset** hardkey
- 2 Press **Amplitude** > **0** > **dBm**
To set the RF sweep output level at 0 dBm.
- 3 Press **Sweep** hardkey
To open the sweep submenus.
- 4 Press **Step Sweep** softkey
To open a submenu for step sweep configurations.
- 5 Press **RF Start** > **1** > **GHz**
To set the start frequency of the sweep to 1 GHz.
- 6 Press **RF Stop** > **2** > **GHz**
To set the stop frequency of the sweep to 2 GHz.
- 7 Press **# Points** > **9** > **Enter**
To set the number of sweep points to nine.
- 8 Press **More(1/2)** > **Step Dwell** > **50** > **ms**
To set the dwell time at each point to 50 ms.
- 9 Press **RF On/Off** hardkey to enable the RF output.
The annunciator will change from **RF OFF** to **RF ON**.
- 10 Press **Return** > **Sweep Mode** > **RF**

This enables the RF sweep and initiates the signal generator to sweep immediately and automatically. A **SWEEP** annunciator is displayed for the duration of the sweep.

NOTE

When presetting the instrument, the sweep and point trigger settings default to **Immediate**. For more information about how to use different trigger modes, refer to [“Additional Settings for a Step Sweep”](#) on page 33.

For more information about the sweep settings, refer to [Chapter 4, “Sweep,”](#) starting on page 73.

Generating an Amplitude Sweep

To generate an amplitude sweep with the following settings:

- amplitude ranges from -80 to -60 dBm, at a frequency of 1 GHz
- 9 sweep points, 50 ms dwell time at each point

Refer to the following steps to configure and generate an amplitude sweep:

- 1 Press **Preset** hardkey
- 2 Press **Frequency** > **1** > **GHz**
- 3 Press **Sweep** hardkey
- 4 Press **Step Sweep** softkey
- 5 Press **# Points** > **9** > **Enter**
- 6 Press **More** > **Ampl Stop** > **-60** > **dBm**
- 7 Press **Ampl Stop** > **-80** > **dBm**
- 8 Press **Step Dwell** > **50** > **ms**
- 9 Press **RF On/Off** hardkey to enable the RF output.
- 10 Press **Return** > **Sweep Mode** > **Ampl** to enable the amplitude sweep immediately. A **SWEEP** annunciator displays for the duration of the sweep.

For more information about the sweep settings, please refer to [Chapter 4](#), “Sweep,” starting on page 73.

Generating an LF Sweep

To generate an LF sweep with the following settings:

- frequency range, 10 to 60 kHz, at a level of 500 mV
- six sweep points and 50 ms dwell time at each point

NOTE

Pressing **Preset** sets the sweep/point trigger to Immediate (IMM) and the LF output amplitude to 500 mV. The following procedures do not include the steps to set the sweep/point trigger and the LF output amplitude.

Refer to the following procedures to configure and generate an LF sweep:

- 1 Press **Preset** hardkey
- 2 Press **Sweep** hardkey
- 3 Press **Step Sweep** softkey
- 4 Press **LF Start > 10 > kHz**
- 5 Press **LF Stop > 60 > kHz**
- 6 Press **# Points > 6 > Enter**
- 7 Press **Step Dwell > 50 > ms**
- 8 Press **Return > Sweep State > LF**



This initiates the LF sweep output immediately via the LF OUT connector. A **SWEEP** annunciator displays for the duration of the sweep.

For more information about the sweep settings, please refer to [Chapter 4](#), “Sweep,” starting on page 73.

Generating a List Swept Signal

List sweep allows you to create a list of arbitrary frequency, amplitude, and dwell time values and sweep the output based on the entries in the **List Mode Values** table.

The signal generator allows you to generate list swept signals in three modes:

Sweep Mode	Sweep Range	Front-panel key access
RF	9 kHz to 3 GHz	 > Sweep Mode > RF
Amplitude	-127 to +13 dBm	 > Sweep Mode > Ampl
RF&Ampl	9 kHz to 3GHz &-127 to +13 dBm	 > Sweep Mode > RF&Ampl

List sweep frequencies and amplitudes can be entered at unequal intervals, nonlinear ascending/descending, or random order. Unlike a step sweep that contains linear ascending/descending frequency and amplitude values spaced at equal intervals throughout the sweep.

In List Swept Mode both the RF mode and the Amplitude mode are similar to their functions in step sweep, except for the differences stated above. Thus we will only discuss some detail operational procedures for **RF&Ampl**, which could also be referenced when you are using the **RF mode** or the **Amplitude mode**. Note that in the RF mode all signals share the same amplitude while in the Amplitude mode all signals share the same frequency.

Refer to the following procedure to configure and generate an RF&Ampl sweep:

- 1 Press **Preset** hardkey
- 2 Press **Sweep** > **Sweep Type** > **List**.
- 3 Press **List Sweep**> **Insert Row** to input your list sequence data.
- 4 Using the knob to highlight the item to edit, input the desired value and terminate that input with a unit key.
- 5 Press **Return** to go up one menu level when all data values have been entered for the testing sequence.
- 6 Press **More(1/2)** softkey, to go to the next menu page.
- 7 Press **Sweep Trigger** > **Trigger Key**
- 8 Press **Point Trigger** > **Immediate**
- 9 Press **More(2/2)** softkey, to return to the previous menu page.
- 10 Press **Sweep Mode** > **RF & Ampl**.
- 11 Press **RF On/Off** hardkey to enable the RF output.
- 12 Press the **Trigger** hardkey on the front panel.

This will enable the list sweep function and start the frequency and amplitude sweep immediately and automatically.

NOTE

When presetting the instrument, the default setting for sweep trigger and point trigger is **Immediate**. For more information about using different trigger modes and how to set **Sweep Direction** and **Sweep Repeat**, refer to [“Additional Settings for a Step Sweep”](#) on page 33. They function similar to these modes in a list sweep.

Generating a Modulated Signal

The N9310A will generate the following modulated signals: AM, FM, Φ M, Pulse Modulation. An optional I/Q modulator is also available with *Option 001*.

Preparing the Modulation Format

The modulation format can be turned before or after setting the other modulation parameters. To turn on the modulation format and output a modulated signal, perform the following steps:

- 1 For example, press the **AM** hardkey, to access the submenu for this modulation format.

This submenu shows a set of softkeys associated with the format's name. For example, AM Depth, AM Source.

- 2 Press the **Mod On/Off** hardkey until **MOD ON** is displayed. And press **RF On/Off** key to enable the RF output.

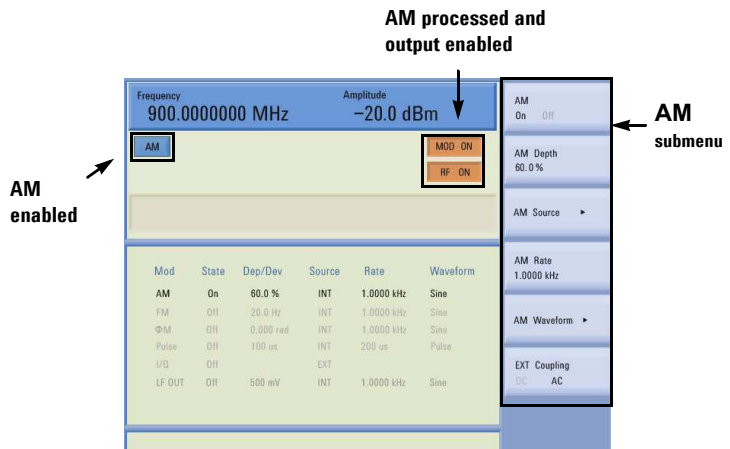

More examples about generating a modulated signal are shown on the following pages.

Simultaneous Modulations

The signal generator can generate multiple modulation formats simultaneously. The following table shows some of the capability to generate the simultaneous modulation formats.

	AM (INT)	AM (EXT)	I/Q	FM (INT)	FM (EXT)	FM	Pulse (INT)	Pulse (EXT)
AM (INT)	–	•	–	•	•	•	–	–
AM (EXT)	•	–	–	•	•	•	–	–
I/Q	–	–	–	•	•	•	•	•
FM (INT)	•	•	•	–	•	–	•	•
FM (EXT)	•	•	•	–	–	–	•	•
FM	•	•	•	–	–	–	•	•
Pulse (INT)	–	–	•	•	•	•	–	–
Pulse (EXT)	–	–	•	•	•	•	–	–

Generating an AM signal

The signal generator generates AM (amplitude modulated) signals with the following basic settings:

Character	Range	Default
AM Depth	0.0 to 100.0%	0.0
AM Source	Internal source (INT) External source (EXT) Combined INT and EXT	INT
AM Rate	20 Hz to 80 kHz (INT) DC/20 Hz to 80 kHz (EXT)	1.0000 kHz, 0.1 Hz resolution

Operation Example

To generate an AM signal with the following parameters:

- Carrier frequency of 1 GHz, amplitude of -10 dBm
- AM depth of 70%
- AM rate at 15 kHz
- Internal AM source (default by **Preset**)

Refer to the following to configure the signal generator for the above described AM output:

- 1 Press **Preset** presets the signal generator
- 2 Press **Frequency** > **1** > **GHz** sets the CW frequency to 1 GHz
- 3 Press **Amplitude** > **-10** > **dBm** sets the CW amplitude to -10 dBm
- 4 Press **AM** enters the AM submenu
- 5 Press **AM Depth** > **70** > **%** sets AM depth to 70%
- 6 Press **AM Rate** > **15** > **kHz** sets AM rate to 15 kHz
- 7 Press **AM On** enables AM
- 8 Press **RF On/Off** **On** enables the AM signal output

For key reference, please refer to “AM” on page 54.

Generating an FM Signal

The N9310A will generate FM (frequency modulated) signals with the following basic settings:





Character	Range	Default
FM Deviation	20 Hz to 100 kHz	20 Hz, 1 Hz resolution
FM Source	Internal source (INT) External source (EXT) Combined INT and EXT	INT
FM Rate	20 Hz to 80 kHz (INT) DC/20 Hz to 80 kHz (EXT)	1.0000 kHz, 0.1 Hz resolution

Operation Example

To generate an FM signal with the following parameters:

- Carrier frequency of 1 GHz, amplitude of -10 dBm
- FM deviation of 50 kHz
- FM rate at 30 kHz
- Internal FM source (default by )

Refer to the following to configure your signal generator for the above signal type:

- 1 Press  presets the signal generator
- 2 Press  > **1** > **GHz** sets the CW frequency to 1 GHz
- 3 Press  > **-10** > **dBm** sets the CW amplitude to -10 dBm
- 4 Press  enters the FM submenu
- 5 Press **FM Deviation** > **50** > **kHz** sets FM deviation to 50 kHz
- 6 Press **FM Rate** > **30** > **kHz** sets FM rate to 30 kHz
- 7 Press **FM** > **On** enables FM
- 8 Press  hardkey to **RF On** enables FM signal output.

For key reference, please refer to “FM” on page 61.

Generating a Phase Modulated Signal

The signal generator generates phase modulated (Φ M) signals with the following characteristics:

Character	Range	Default
Φ M Deviation	0 to 10 rad ($300 \text{ Hz} \leq \Phi\text{M rate} \leq 10 \text{ kHz}$) 0 to 5 rad ($10 \text{ kHz} < \Phi\text{M rate} \leq 80 \text{ kHz}$)	0.000 rad, with 0.001 rad resolution
Φ M Source	Internal source only	N/A
Φ M Rate	300 Hz to 80 kHz	1.0000 kHz, with 0.1 Hz resolution

Operation Example

To generate a Φ M signal with the following characteristics:

- Carrier frequency of 1 GHz, amplitude of -10 dBm
- Φ M deviation of 7.3 rad
- Φ M rate at 10 kHz

The following procedure will configure the N9310A to generate the above signal:

- 1 Press **Preset** presets the signal generator (default settings).
- 2 Press **Frequency** > **1** > **GHz** sets the CW frequency to 1 GHz.
- 3 Press **Amplitude** > **-10** > **dBm** sets the CW amplitude to -10 dBm.
- 4 Press **Φ M** enters the Φ M submenu.
- 5 Press **Φ M Deviation** > **7.3** > **rad** sets Φ M deviation to 7.3 rad.
- 6 Press **Φ M Rate** > **10** > **kHz** sets Φ M rate to 10 kHz.
- 7 Press **Φ M On off** enables Φ M.
- 8 Press **RF On/Off** to **On** enables Φ M signal output.

For key reference, please refer to [Chapter 4](#), “Phase Modulation,” starting on page 67.

Generating a Pulse Modulated Signal

The N9310A will generate pulse modulated signals with the following characteristics:

Character	Range	Default
Pulse Source	Internal source (INT) External source (EXT)	INT
Pulse Period	200 μ s to 2 s (INT and EXT)	200 μ s, with 1 μ s resolution
Pulse Width	100 μ s to 1 s (INT and EXT)	100 μ s, with 1 μ s resolution

Operation Example

To generate a pulse modulated signal with the following characteristics:

- Carrier frequency of 1 GHz, amplitude of -10 dBm.
- Pulse period of 10 ms.
- Pulse width of 6 ms.
- Internal pulse source (default by **Preset**).

The following procedure will configure the N9310A to generate the above signal:

- 1 Press **Preset** presets the signal generator (default settings).
- 2 Press **Frequency** > **1** > **GHz** sets the CW frequency to 1 GHz.
- 3 Press **Amplitude** > **-10** > **dBm** sets the CW amplitude to -10 dBm.
- 4 Press **Pulse** enters the Pulse modulation submenu.
- 5 Press **Pulse Period** > **10** > **ms** sets pulse period to 10 ms.
- 6 Press **Pulse width** > **6** > **ms** sets pulse width to 6 ms.
- 7 Press **Pulse On/Off** enables pulse modulation.
- 8 Press **RF On/Off** **On** enables pulse modulated signal output.

For key reference, please refer to [Chapter 4](#), “Pulse,” starting on page 71.

Generating an I/Q Modulated Signal (Option 001 Only)

The N9310A generates I/Q modulated signals with the following characteristics:

Character	Range	Default
I/Q Source	External source only	N/A
I/Q Input	50 Ω impedance VSWR < 1.5 Full scale input < 0.5 Vrms	N/A
I/Q Input Connector	EXT I and Q connector on rear panel (BNC type, female)	N/A

When using a constant sum vector modulation of $\sqrt{I^2 + Q^2} = 0.5$ V to drive the I/Q modulator, the actual RF level corresponds to the displayed RF level. To avoid over driving the I/Q modulator, the sum vector must never exceed 0.5 V when using I/Q modulation. For full-scale input, the peak envelope power of the modulated RF signal is equal to the indicated LEVEL. The average power will be less.

$$\text{Amplitude} = \frac{\sqrt{I^2 + Q^2}}{0.5V} \text{ input value LEVEL}$$

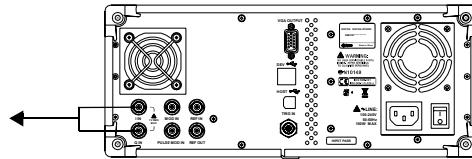
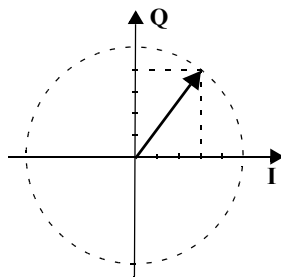

Operation Example

To generate an I/Q modulated signal with 1 GHz carrier frequency, and an amplitude of -10 dBm.

The following procedure will configure the N9310A to generate the above signal:

- 1 Connect the external I/Q source to the BNC I and Q inputs on the rear panel of the signal generator
- 2 Press **Preset** presets the signal generator
- 3 Press **Frequency** > **1** > **GHz** sets the CW frequency to 1 GHz
- 4 Press **Amplitude** > **-10** > **dBm** sets the CW amplitude to -10 dBm
- 5 Press **I/Q** enters the I/Q modulation submenu
- 6 Press **I/Q On/Off** enables I/Q modulation
- 7 Press **RF On/Off** enables I/Q modulated signal output.

Generating an LF Output

The N9310A can generate an LF (Low Frequency) signal with the following characteristics. A Low frequency signal is typically called the audio frequency.

Character	Range	Default
Frequency	20 Hz to 80 kHz	1.0000 kHz, with 0.1 Hz resolution
Amplitude	0 to 3 V (peak)	500 mV, with 1 mV resolution
Output Connection	LF OUT connector on the front panel (BNC type, 50 Ω)	N/A

Operation Example

To generate an LF signal with:

- a frequency of 10 kHz
- an amplitude of 3 V

Refer to the following steps to generate the LF signal:

- 1 Press **LF Out** enters submenu of LF output function.
- 2 Press **LF Out Freq > 10 > kHz** sets LF frequency to 10 kHz
- 3 Press **LF Out Ampl > 3 > V** sets LF amplitude to 3 V
- 4 Press **LF Out On/Off** to **On** state enables LF output.

Save, Recall and Delete an Instrument State

This section describes how to use the functions located under the front-panel **File** key. You can save the instrument state information to either local memory or external to a USB memory stick or disk. The output file format of a configuration file is *.cfg (file extension type). You can also recall the saved files from local memory or an external flash memory for a quick start of commonly used or custom (unique) instrument configurations.

NOTE

Set the file catalog to **Local** before unplugging a USB memory stick from the USB connector on the front or rear panel of the signal generator.

Saving an Instrument State

Instrument state configurations are saved in the file format of “<file name>.cfg”, such as “sample.cfg”.

The file name can be modified with the 26 lowercase letters from a to z and 10 arabic numbers from 0 to 9.

The signal generator provides up to 20 files memory spaces in the local memory.

Saving an instrument state in the local memory

Use the following steps to save an instrument state configuration to local memory:

- 1 Press  > **Catalog** > **Local** sets file catalog to local memory.
- 2 Press **Save** softkey. This will enable editing of a file name for the instrument state you are saving.
- 3 Edit or input the file name by rotating the knob and pressing **Next** softkey to enter each letter or number.
- 4 Press **Save now** softkey to confirm the file name and save the instrument state into local memory.

Refer to the example on the next page for how to editing the file name.

How to edit a file name

To save an instrument state with the filename “sample”, refer to following process:

- 1 Press **Save** to enable editing the file name. The signal generator automatically presents an “a” as the first letter.
- 2 Rotate the knob until the first letter is an “s”.
- 3 Press **Next** to confirm the first letter and the instrument will automatically present an “a” as the second letter.
- 4 Repeat step 2 and step 3, to edit the filename “sample” is completed.
- 5 Press **Save now** to confirm the filename and saves the instrument state as “sample.cfg” to the local memory.

Saving an instrument state to an external USB memory stick

Refer to the following steps to save an instrument state to a USB memory stick or disk:

- 1 Press **Catalog > USB** to set the file catalog to **USB**.
- 2 Press **Save** softkey to enable editing of the filename for the instrument state to save.
- 3 Edit the file name by rotating the knob. Select the correct letter or number, and press the **Next** softkey for entering the next letter.
- 4 Press the **Save now** softkey to confirm the file name and save the instrument state onto the external USB memory stick.

Recalling an Instrument State

You can recall a previously saved instrument state from both local memory or an external USB memory stick.

Recalling an instrument state from the local memory

Refer to the following steps to recall an instrument state from the local memory:

- 1 Press **File** > **Catalog** > **Local** to set file catalog to **Local**.
- 2 Rotate the knob to choose a file from the local directory.
- 3 Press the **Recall** softkey to recall the file.

Recalling an instrument state from an external flash memory

Refer to the following steps to recall an instrument state from the external memory:

- 1 Press **File** > **Catalog** > **USB** to set the file catalog to an external **USB** port. Insert an external memory stick or disk into one of the port on the instrument.
- 2 Rotate the knob to select the correct file.
- 3 Press **Recall now** to recall the file. The instrument will automatically set the instrument parameters per the file data.

Delete an Instrument State

Refer to the following steps to delete an instrument state (configuration file) from the local memory:

- 1 Set file catalog to **Local** or **USB**.
- 2 Rotate the knob to select the file to be deleted.
- 3 Press the **Delete** softkey.
- 4 Press the **Delete now** softkey to confirm and delete the file

NOTE

It is impossible to recover files after pressing **Delete now**. To abort the file deletion, press the **Return** softkey instead.



4 Key Reference



This chapter describes the front panel hardkeys and associated softkeys, and the default value for each key. The chapter is organized alphabetically by front panel hardkey. Each section in this chapter illustrates the softkey menus and their descriptions.



AM

Pressing  hardkey reveals a submenu for AM configurations.

AM On/Off	Toggles amplitude modulation state between on and off
AM Depth	Sets amplitude modulation depth
AM Source ▶	Enters amplitude modulation source submenu:
INT	Selects internal AM source
EXT	Selects external AM source
INT+EXT	Selects internal and external AM source
AM Rate	Sets amplitude modulation frequency
AM Waveform	Selects amplitude modulation waveform
Sine	Selects sine amplitude modulation waveform
EXT Coupling AC/DC	Toggles external coupling between AC and DC

AM On Off Pressing this softkey menu selection toggles the amplitude modulation (AM) between on and off. An  annunciator will be displayed on the screen after enabling AM. However, the amplitude modulation will only be processed when the modulation is turned on by pressing the  hardkey.

- Default value: **Off**
- Key sequence:  > **AM On Off**

AM Depth Press this softkey menu selection to enter the AM depth value. The active entry area of the display will show the current AM depth value. The AM Depth range is from 0 % to 100 %, with minimum increment of 0.1 %.

- Default value: **0.0 %**
- Key sequence:  > **AM Depth**

AM Source Pressing this softkey reveals a softkey menu of selections for amplitude modulation sources. Select from internal source, or external source from the MOD IN connector. Or select internal and external simultaneously.

Pressing **INT** connects an internally calibrated signal to the modulator. This internal AM source defaults to a sine wave at a frequency of 1.0000 kHz.



Pressing **EXT** connects an externally calibrated signal to the modulator. You need also set the **EXT Coupling**, see “[Ext Coupling](#)” on next page.

Pressing **INT+EXT** connects both an internally calibrated signal and an external calibrated signal to the modulator simultaneously.

- Default value: **INT**
- Key sequence:  > **AM Source**

AM Rate Press this softkey menu selection to modify the internal AM modulation frequency. The active entry area displays the current value of AM rate. The allowed range is 20 Hz to 80 kHz. The minimum increment is 0.1 Hz. AM source softkey is disabled when external AM is selected.

- Default value: **1 kHz**
- Key sequence:  > **AM Rate**

- AM Waveform** Press this softkey to access the softkey menu for modulating signal waveform.
- Default value: **Sine**
 - Key sequence:  > **AM waveform**
- Ext Coupling** Pressing this softkey toggles the external modulating signal input between AC (Alternating Current) to DC (Direct Current) coupling.
- Selecting **AC** isolates the DC component of the external input signal and will only allow the AC component to pass to the internal modulator. The amplitude of the signal will typically decrease without the DC component.
- Selecting **DC** will allow the entire external signal, both DC and AC component. A $1.0 V_{\text{peak}} \pm 2\%$ input level is required.
- Default value: **AC**
 - Key sequence:  > **EXT Coupling**

Amplitude

Pressing the **Amplitude** hardkey will allow modification of the RF output power level. Amplitude becomes the active function and the active entry area of the instrument display will show the current value.

The calibrated power range is -127 to $+13$ dBm leveled output (settable to $+20$ dBm max). The minimum incremental value is 0.1 dB. The amplitude area of the display shows the actual RF output power, except when an amplitude sweep is in process.

- Default value: **-127.0 dBm**

The RF output power level may be modified using the following scales:

Range	Minimum increment
-127.0 to $+13.0$ dBm, (max. $+20$ dBm settable)	0.1 dB
-80.0 to $+60.0$ dBmV, (max. $+67$ dBmV settable)	0.1 dB
-20.0 to $+120.0$ dB μ V, (max. $+127$ dB μ V settable)	0.1 dB
0.0001 to 1000.0 mV, (max. 2238.8 mV settable)	0.1 mV
0.1 to 1000000.0 μ V, (max. 2238800 μ V settable)	0.1 μ V (Ampl ≤ 999.9 μ V) 100 μ V (Ampl ≥ 1000.0 μ V)

Arrow Keys



Pressing the left/right arrow keys allows the modification of a data digit by digit, in conjunction with rotating the knob. Pressing the  hardkey will confirm the data modification.

For example, to modify 2.000 000 0000 GHz to 2.000 000 0500 GHz, follow these steps:

- 1 press the left/right arrow key to shift the focus to the digit.
- 2 rotating the knob until the “5” position is displayed.
- 3 Press  hardkey to confirm the value modification.





Enter

The  hardkey has two purposes:

- 1 Confirming data modification. Using **Enter** hardkey together with arrow keys or knob to modify a data value.
- 2 Initiate a single sweep. For example, starting an RF single sweep by pressing  > **Sweep Mode** > **RF** initiates the first run of a single RF sweep. The instrument will then stop sweeping and wait for an instruction to start another sweep. Pressing the  hardkey will then instruct the instrument to run another cycle of the single RF sweep.

File

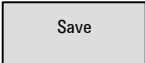
Pressing  hardkey reveals a softkey submenu for saving, recalling, or deleting a customized configuration file. For additional information, refer to “[Save, Recall and Delete an Instrument State](#)” on page 50.

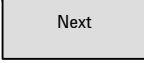
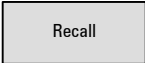
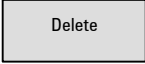
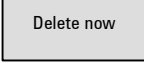
	Accesses the File Catalog submenus
	Selects local memory as the current catalog
	Selects USB device as the current catalog
	Enables editing a file name and saving a file
	Saves a file to the current catalog
	Goes to edit next letter/number
	Recalls a file from the current catalog
	Deletes a file from the current catalog
	Confirms deleting

Catalog Pressing this softkey selects the catalog for storing configuration files. **Local** means saving a configuration file in the instrument’s internal memory. **USB** means saving a configuration file to a USB memory stick by way of one of the USB device type connectors.

Insert a external memory stick into the USB connector (device). The signal generator will then detect the USB memory stick and you may set the catalog to **USB**.

- Default value: **Local**
- Key sequence:  > **Catalog**

Save Press the **Save** softkey to enable the instrument to save the current instrument status into a file and edit the file name. The instrument will save a maximum of 20 files in the local memory. Pressing the **Preset** hardkey or performing a power cycle will not affect any configuration files in local memory. See “[Saving an Instrument State](#)” on page 50 for editing a file name using **Save**, **Save now** and **Next** softkeys.

- Softkey sequence: **File** > **Save**

Recall Pressing the **Recall** softkey will access the menu selections for recalling a customized configuration file. The files may be accessed from either local or external memory.

Files to be recalled from an external USB memory stick must be in the root directory of the USB memory stick.

- Softkey sequence: **File** > **Recall**

Delete Press the **Delete** softkey to delete a configuration file that has been selected by rotating the knob. Press the **Delete now** to confirm the selection and file deletion.

- Softkey sequence: **File** > **Delete**



CAUTION

Do NOT press **Delete now** before you make sure the selected file is one not needed in the future.

FM

Press the  hardkey to access the submenu selections for FM modulation configurations and settings.

FM On/Off	Toggles frequency modulation between on and off
FM Deviation	Sets frequency modulation deviation
FM Source ▶	Enters frequency modulation source submenu:
INT	Selects internal FM source
EXT	Selects external FM source
INT+EXT	Selects internal and external FM source
FM Rate	Sets frequency modulation rate
FM Waveform	Selects frequency modulation waveform
Sine	Selects sine frequency modulation waveform
EXT Coupling AC/DC	Toggles external coupling between AC and DC

FM On Off This softkey toggles the frequency modulation on and off. Press this softkey to turn FM on, the FM annunciator will be displayed. FM is only applied to the RF carrier only after the modulation is enabled by pressing the  hardkey. The  annunciator will be displayed when Modulation has been enabled.

- Default value: **Off**
- Key sequence:  > **FM On Off**

FM Deviation Press this softkey to access the frequency modulation deviation control value setting. The active entry area of the instrument display will show the current FM deviation value. The allowable value range for FM is 20 Hz to 100 kHz. The minimum incremental value is 0.1 Hz.

- Default value: **20 Hz**
- Key sequence:  > **FM Deviation**

FM Source Press this softkey to reveal the submenu for Frequency modulation source selection. You may select an internal FM source, an external FM source input to MOD IN connector, or internal and external FM input sources simultaneously.

Pressing **INT** connects the internally generated, calibrated signal to the modulator. The internal FM source default is a sine wave at a frequency of 1.0000 kHz.



Pressing **EXT** connects an externally calibrated signal at the MOD IN connector to the internal modulator. **EXT Coupling** must also be set, see “[EXT Coupling](#)” on next page.

Press **INT+EXT** to connect both the internally calibrated signal and an externally calibrated signal to the modulator simultaneously.

- Default value: **INT**
- Key sequence:  > **FM Source**

FM Rate Pressing this softkey allows the user to enter the frequency value desired for the internal modulation source. The active entry area displays the current FM rate. The allowable value range is 20 Hz to 80 kHz. The minimum increment is 0.1 Hz. This softkey menu selection is disabled when external FM source is selected.

- Default value: **1.0000 kHz**
- Key sequence:  > **FM Rate**

- FM Waveform** Pressing this softkey reveals the submenu for FM waveform selections.
- Default value: **Sine**
 - Key sequence:  > **FM Waveform**
- EXT Coupling** Pressing this softkey toggles the external modulating signal coupling input to either AC or DC coupling. A $1.0 V_{\text{peak}} \pm 2\%$ input level is required.
- Selecting **AC** isolates the DC component in the signal allowing only the AC component to pass. The amplitude of the signal will typically decrease without the DC component.
- Selecting **DC** allows both the DC and AC components of the external mod signal to enter the modulator of the signal generator.
- Default value: **AC**
 - Key sequence:  > **EXT Coupling**

Frequency

Pressing the  hardkey allows the modification of the RF output frequency. Frequency becomes the active function and the active entry area will display the current value.

The allowable frequency range is 9 kHz to 3 GHz. The minimum incremental value is 0.1 Hz. The frequency value will be present on the display area except when an RF swept frequency sweep is in progress.

- Default value: **3 GHz**

I/Q (Option 001 only)

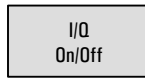

Switches I/Q modulation on/off

I/Q This softkey toggles the external I/Q modulation state
On Off between on and off. The I/Q annunciator is displayed on the screen whenever I/Q modulation is enabled.

- Default value: **Off**
- Key sequence: **I/Q > I/Q On Off**

LF Out

Pressing the **LF Out** hardkey reveals the submenu of softkeys to configure the internal LF (low frequency) generator.

LF Out On/Off	Toggles the LF output between on and off
LF Out Freq	Sets LF frequency
LF Out Ampl	Sets LF output amplitude

LF Out On/Off

This softkey toggles the LF output between on and off. Once the output is on, the signal is available at the LF OUT connector. The **Mod On/Off** and **RF On/Off** hardkeys do not apply when in this state.

- Default value: **Off**
- Key sequence: **LF Out** > **LF On/Off**

LF Out Freq

Press this softkey to set the frequency of the LF signal. The the current LF signal frequency will be displayed. The allowed frequency range is 20 Hz to 80 kHz.

- Default value: **1.0000 kHz**
- Key sequence: **LF Out** > **LF Out Freq**

LF Out Ampl

Press this softkey to set the amplitude of the LF signal. The active entry area displays the current LF signal amplitude. The allowed amplitude range is 0 to 3 V_{peak}, with 1 mV minimum increment value.

- Default value: **500 mV**
- Key sequence: **LF Out** > **LF Out Ampl**

Mod On/Off

Toggle this hardkey **On** to modulate the RF carrier with the active modulation.

The **Mod On/Off** annunciator is always displayed to indicate whether modulation is on or off.

After pressing **Preset** hardkey, the **MOD ON** annunciator will be displayed on the screen indicating the modulator is active.

- Default value: **Mod On**

RF On/Off

Pressing this hardkey toggles the RF out between on and off. An annunciator is always displayed indicating the RF is on or off.

Default Value: **RF Off**

Numeric Keypad

The front panel numeric keypad consists of the 0 to 9 digit keys, a decimal point key, and a backspace key. The backspace key has a dual function. It can backspace, or change the sign of a value to positive or negative. These keys are used any time when an active function requires a value input.



The backspace key function will change according to the operational situations outlined below:

- When modifying a previously entered value, press the backspace key to delete the entire value and replace it with a negative sign. Subsequent key pressing will change the sign between positive and negative states.
- When entering a new value, pressing the backspace key deletes the immediate left digit. If no digit remains, subsequent key pressing will change the sign between positive and negative states.

Phase Modulation

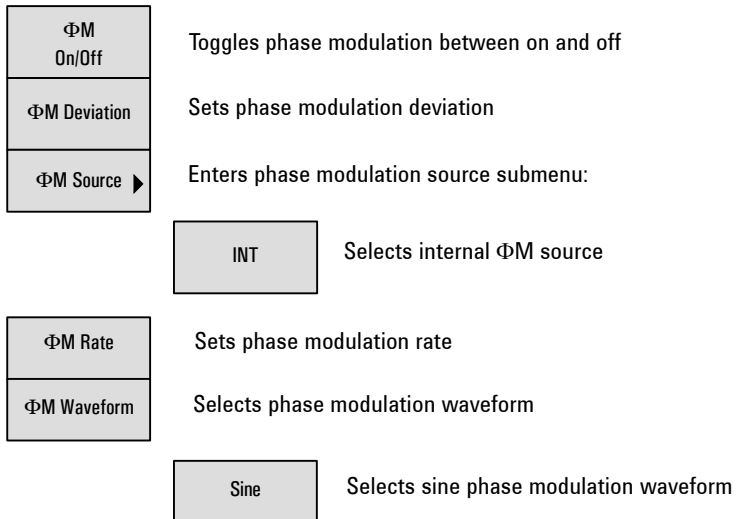
Pressing the  hardkey reveals a submenu of softkeys for phase modulation configurations.



Φ M On Off Pressing this softkey toggles the phase modulation between on and off. When phase modulation is enabled, the Φ M display annunciator is turned on. However, it is only applied to the RF carrier after the modulator is enabled by pressing  hardkey. The  annunciator will then be displayed.

- Default value: **Off**
- Key sequence:  > **Φ M On/Off**

Φ M Deviation Press this softkey to access the menu for setting the phase modulation deviation. The active entry area displays current Φ M deviation value. The allowable value ranges depend on the Φ M rate:

0 to 10 rad ($300 \text{ Hz} \leq \Phi\text{M rate} \leq 10 \text{ kHz}$)
 0 to 5 rad ($10 \text{ kHz} < \Phi\text{M rate} \leq 80 \text{ kHz}$)

- Default value: **0.000 rad**
- Key sequence:  > **Φ M Deviation**

ΦM Source Press this softkey to select a phase modulation source.

- Default value: **INT**
- Key sequence:  > **ΦM Source**

ΦM Rate Press this softkey to modify the internal modulation frequency. The current value of ΦM rate will be displayed in the active entry area. The allowable value range is 300 Hz to 80 kHz. The minimum increment is 0.1 Hz. This softkey is disabled when external ΦM source is selected.

- Default value: **1.0000 kHz**
- Key sequence:  > **ΦM Rate**

ΦM Waveform Pressing this softkey reveals a submenu of ΦM waveform choices.

- Default value: **Sine**
- Key sequence:  > **ΦM Waveform**

Switch

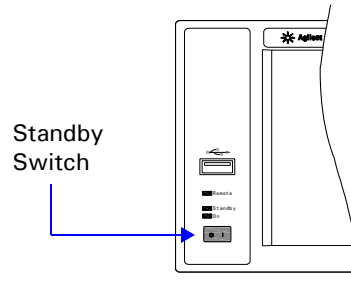

Pressing this front panel switch toggles power to the signal generator between on (green LED on) and standby (orange LED on). In standby mode, the signal generator is switched off, however the instrument is still connected to the line power. The rear panel line switch and the detachable power cord are the instrument disconnecting device. The front panel standby switch, therefore, is not, and should not be used as a power switch.

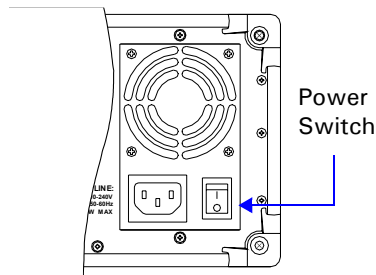

CAUTION

Avoid turning off the power to the signal generator when the current state is changing either as a result of front panel operation or remote control.

Preset

Press the **Preset** hardkey to set the signal generator to the preset factory default conditions. Pressing this hardkey will not clear the customized configuration files that have been saved. Using the preset hardkey will give the user the advantage of knowing exactly what all instrument settings will be.

Factory Default Settings

Item	Default	Item	Default
Frequency	3.000 000 0000 GHz	Sweep Scale	Linear
Amplitude	-127.0 dBm	Sweep/Point Trigger	Immediate
LF Out	Off	Sweep Direction	Up
LF Out Freq	1.0000 kHz	Trig In Polarity	Negative
LF Out Ampl	500 mV	Modulation	
Mod ON/OFF	On	Modulation State	Off
RF ON/OFF	Off	AM Depth	0.0 %
Sweep		Φ M Deviation	0.000 rad
Sweep Mode	Off	FM Deviation	20 Hz
RF Start	9.0000 kHz	Pulse Period	200 μ s
RF Stop	3.000 000 0000 GHz	Pulse Width	100 μ s
Amplitude Start	-127.0 dBm	Modulation Source	INT
Amplitude Stop	-126.0 dBm	Modulation Rate	1.0000 kHz
LF Start	20.0 Hz	Ext Coupling	AC
LF Stop	80.0000 kHz	System	
#Point	10	File Catalog	Local
Step Dwell	10.0 ms	Opt. Φ Noise	Normal
Sweep Repeat	Cont	Reference Source	Int_10 MHz

Pulse

Press the **Pulse** hardkey accesses the submenu for pulse modulation configuration settings.

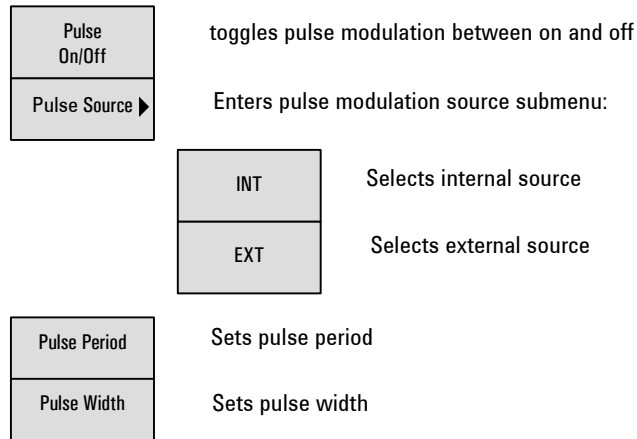

Pulse On Off Press this softkey to enable the pulse modulation. The PULSE annunciator will then be displayed. The RF carrier will be modulated only when the **Mod On/Off** hardkey is pressed and the **Mod On/Off** annunciator displays.

- Default value: **Off**
- Key sequence: **Pulse** > **Pulse On Off**

Pulse Source Press this softkey to access a menu of selections for pulse modulation sources. Select INT to connect the internally-generated, calibrated signal to the modulator. The default settings are, a 200 μ s pulse period and a 100 μ s pulse width. Selecting EXT connects an externally sourced input signal to the modulator through the PULSE MOD IN connector located on the rear panel of the instrument.

- Default value: **INT**
- Key sequence: **Pulse** > **Pulse Source**

Pulse Period Press this softkey to modify the pulse period of the internal pulse signal. The current pulse period value will show in the active function area of the display. The allowable value range is 200 μs to 2 s, with a minimum incremental value of 1 μs . The pulse period applies only to the internal pulse signal. The **Pulse Period** softkey is disabled if an external pulse source is selected,.

- Default value: 200 μs
- Key sequence:  > **Pulse Period**

Pulse Width Press this softkey to modify the pulse width of the internal pulse signal. The active entry area displays the current pulse width value. The allowed value range is 100 μs to 1 s, with the minimum incremental value of 1 μs . The **Pulse Width** softkey is disabled if an external pulse source is selected.

- Default value: 100 μs
- Key sequence: **Pulse** > **Pulse Width**

Sweep

Press the **Sweep** accesses a menu of softkeys. The softkey menu is used to define the frequency, amplitude, and dwell time information for step sweep or list sweep.

Sweep State ▶	Enters sweep state submenu:
Off	Disables a sweep
RF	Enables radio frequency sweep mode
LF	Enables low frequency sweep mode
Ampl	Enables amplitude sweep mode
RF& Ampl	Enables RF&Ampl sweep mode
Step Scaling LOG/LIN	Toggles step scale between logarithm and linear
Sweep Type Step/List	Toggles sweep type between step and list
Sweep Repeat Single/Cont	Toggles sweep repeat between single and continuous
Step Sweep ▶	Enters step sweep configuration submenu:
RF Start	Sets RF sweep start frequency
RF Stop	Sets RF sweep stop frequency
LF Start	Sets LF sweep start frequency
LF Stop	Sets LF sweep stop frequency
# Point	Sets sweep points
▼	Continued

	Ampl Start	Sets sweep stop amplitude
	Ampl Stop	Sets sweep start amplitude
	Step Dwell	Sets dwell time
List Sweep ▶		Enters list sweep configuration submenu
	Edit Item	Edits the current item
	Insert Row	Inserts a new row below the current row
	Delete Row	Deletes the current row
	Goto Row	Jumps to a certain row
	Insert Item	Inserts a new item below the current item
	Delete Item	Deletes the current item
	Recall/Save	Recalls or saves list files (Please refer to the file menu)
	Dwell Type Step/List	Toggles dwell type between step and list
	Preset List	Presets the list
Sweep Trigger ▶		Enters sweep trigger submenu
	Immediate	Initiates a sweep immediately
	Trigger Key	Triggers a sweep with trigger key



Continued

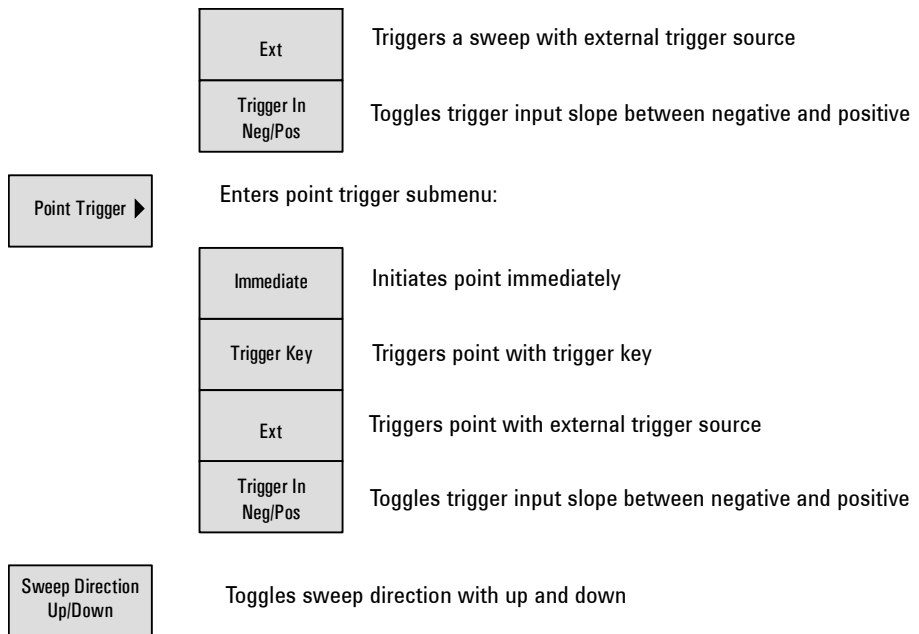

Sweep Mode Press this softkey to access a menu for selecting the sweep state and mode. Use the submenu to select an RF sweep, LF sweep, amplitude sweep, or RF&Ampl sweep. Pressing **Sweep Mode > Off** turns off the sweep. The output signal is then set according to the current **Frequency** and **Amplitude** hardkey settings.

- Default value: **Off**
- Key sequence: **Sweep > Sweep Mode**

RF Press the **Sweep Mode > RF** softkeys to enable an RF sweep output through the RF OUT port. The amplitude is at a constant level defined by the **Amplitude** hardkey.

Key sequence: **Sweep > Sweep Mode > RF**

The signal generator produces an RF sweep signal depending on the settings for sweep trigger and point trigger as outlined in the following case conditions:

Case 1. **Sweep trigger** and **Point trigger** are both set to **Immediate (IMM)**: the signal generator initiates an RF sweep over the points immediately and automatically.

Case 2. **Sweep trigger** and **Point trigger** are both set to **Key**, pressing **Sweep** > **Sweep Mode** > **RF** arms an RF sweep. The signal generator requires the **Trigger** hardkey be pressed both to start a sweep and to sweep from point to point.

Case 3. **Sweep trigger** is set to **Key** while **Point trigger** is set to **Immediate**, pressing **Sweep** > **Sweep Mode** > **RF** arms an RF sweep. The signal generator requires the **Trigger** hardkey be pressed to start the sweep. Once started, the signal generator will sweep over the points automatically. Each sweep is begun manually by pressing the **Trigger** hardkey.

Case 4. **Sweep trigger** is set to **Immediate** while **Point trigger** is set to **Key**, pressing **Sweep** > **Sweep Mode** > **RF** initiates an RF sweep immediately. However, the signal generator requires the **Trigger** hardkey be pressed to sweep from each point to the next point.

To use the external trigger source, a TTL signal with 100 ns minimum level holding time is required. Only in the case that the sweep trigger is set to **Key** and the point trigger to **EXT**, will the sweep repeat continuously when set to either **Single** or **Cont**. This is due to using an external trigger source. The other combinations of the sweep and point triggers allows continuous sweep only.

LF Pressing this softkey enables the LF sweep output through the LF OUT connector on the front panel. The amplitude is at a constant level defined by the **LF Out Ampl** softkey. This function is available only when the sweep is set to step sweep.

- Key sequence: **Sweep** > **Sweep Mode** > **LF**

Ampl Pressing this softkey enables an amplitude sweep output through the RF OUT connector. The frequency is a constant value determined by the **Frequency** hardkey.

- Key sequence: **Sweep** > **Sweep Mode** > **Ampl**

RF&Ampl Press this softkey to enable an RF & Ampl sweep output through the RF OUT connector. Both the frequency and the amplitude can be set at arbitrary values. This function is available only when the sweep type is set list sweep. See “List Sweep” on page 79

- Key sequence:  > **Sweep Mode > RF&Ampl**

NOTE

Similar to the RF sweep, the signal generator initiates an LF sweep or an amplitude sweep depending on the combination of settings for the sweep trigger and point trigger. See “RF” on page 75 for more information.

Step Scale LOG/LIN

Press this softkey to toggle the step scale between linear or logarithmic scales for RF sweep only. The LF sweep and amplitude sweep scale is default to linear scale only.

- Default value: **LIN**
- Key sequence: **Sweep > Step Scale**

Sweep Repeat Cont/Single

Press this softkey to toggle the sweep repetition between single and continuous sweep. In **Continuous** sweep mode, the signal generator automatically initiates the sweep and continuously repeats the sweep until instructed to stop. In **Single** sweep mode, the signal generator performs one sweep only and then waits until the user initiates another sweep using the  Enter key. Press the **Enter** hardkey each time to enable additional single sweeps. Sweep trigger and point trigger must both be set to **Immediate (IMM)**.

- Default value: **Cont**
- Key sequence:  > **Sweep Repeat**

Step Sweep

Press this softkey to access the softkey submenu for parameter configuration of a step sweep, to include the following:

- RF/LF start and stop frequencies
- Amplitude start and stop power levels
- Number of points in a sweep and the dwell time at each point.

- Key sequence:  > **Step Sweep**

RF Start Press this softkey to set the RF start sweep frequency. The range is 9 kHz to 3 GHz, with a 0.1 Hz minimum increment. The start frequency must always be set to a frequency less than the stop frequency in an RF sweep.

- Default value: **9.0000 kHz**
- Key sequence:  > **Step Sweep > RF Start**

RF Stop Press this softkey to set the stop sweep frequency. The range is 9 kHz to 3 GHz, with a 0.1 Hz minimum increment. The stop frequency must always be set greater than the start frequency.

- Default value: **3.000 000 0000 GHz**
- Key sequence:  > **Step Sweep > RF Stop**

LF Start Press this softkey to set the LF sweep start frequency. The allowable range is 20 Hz to 80 kHz, with a 0.1 Hz minimum increment. The start frequency must always be set to a frequency less than the stop frequency.

- Default value: **20.0 Hz**
- Key sequence:  > **Step Sweep > LF Start**

LF Stop Press this softkey to set the LF sweep stop frequency. The allowable range is 20 Hz to 80 kHz, with a 0.1 Hz minimum increment. The stop frequency must always be set to a greater frequency than the start frequency.

- Default value: **80.0000 kHz**
- Key sequence:  > **Step Sweep > LF Stop**

Points Press this softkey to set the number of points desired in a step sweep. The allowed range is 2 to 1001 points.



- Default value: **10**
- Key sequence:  > **Step Sweep > # points**

- Ampl Start** Press this softkey to set the start amplitude in an amplitude sweep. The allowable range is -127 dBm to $+13$ dBm leveled, with 0.1 dB minimum increment. In an amplitude sweep, the start amplitude value must always be set lower than the stop amplitude value.
- Default value: **-127.0 dBm**
 - Key sequence: **Sweep > Step Sweep > Ampl Start**
- Ampl Stop** Press this softkey to set the stop amplitude in an amplitude sweep. The allowed range is -127 dBm to 13 dBm, with 0.1 dB minimum increment. The stop amplitude must always be set to a greater value than the start amplitude.
- Default value: **-126.0 dBm**
 - Key sequence: **Sweep > Step Sweep > Ampl Stop**
- Step Dwell** Press this softkey to set the dwell time for each point of a step sweep. The dwell time is the amount of time the sweep maintains a frequency or power for the current sweep point. The allowable range value is 10 ms to 1 s, with 0.1 ms minimum increment.
- Default value: **10.0 ms**
 - Key sequence: **Sweep > Step Sweep > Step Dwell**
- List Sweep** Press this softkey to access the submenu for list sweep parameter configuration, to include:
- frequency at each point
 - Amplitude power level at each point
 - Number of sweep points, the dwell time at each point.
 - Key sequence: **Sweep > List Sweep**
- Edit Item** Press this softkey to edit the current highlighted item value or parameter. Use the front panel knob to select the item to edit. Use the numeric keys to input the necessary value and terminate (confirm) it with the correct unit softkey selection.
- Key sequence: **Sweep > List Sweep > Edit Item**

- Insert Row** Press this softkey to insert an additional (new) row below the current row.
- Key sequence: **Sweep** > **List Sweep** > **Insert Row**
- Delete Row** Press this softkey to delete the current row in a list sweep data table. Note that the list sweep table must have a minimum of two rows. If there are only two rows in the current table, you cannot delete any rows.
- Key sequence: **Sweep** > **List Sweep** > **Delete Row**
- Goto Row** Press this softkey to access a submenu from which you can select to jump to a specific row. Use the numeric keys to input the row number and select it with the **Enter** softkey. If the row to jump to is not visible as part of the current table, use the softkeys **Page Up** or **Page Down** to locate the row or table.
- Key sequence: **Sweep** > **List Sweep** > **Goto Row**
- Insert Item** Press this softkey to insert a new item below the current item.
- Key sequence: **Sweep** > **List Sweep** > **Insert Item**
- Delete Item** Press this softkey to delete the current highlighted item.
- Key sequence: **Sweep** > **List Sweep** > **Delete Item**
- Recall/Save** Press this softkey to recall or save list files. This process is similar to the file function.
- Key sequence: **Sweep** > **List Sweep** > **Recall/Save**
- Dwell Type Step/List** Press this softkey to toggle the dwell type selection between step and list. When in **Step** mode, the dwell time for each point in the list table is equal to the dwell time value set in step sweep. When in **List** mode, the dwell time for each point in list sweep is set independently in the list table.
- Key sequence: **Sweep** > **List Sweep** > **Dwell Type**

- Preset List** Press this softkey to preset two rows of data in the list table. The user can then edit the testing sequence data based on these two rows.
- Key sequence: **Sweep** > **List Sweep** > **Preset List**
- Sweep Trigger** Press this softkey to access a submenu of selections for triggering a full sweep. Use this softkey to select triggering immediately, triggering by the **Trigger** hardkey, or triggering on either the positive or negative edge of a external signal supplied to the TRIGGER IN connector.
- Default value: **Immediate**
 - Key sequence: **Sweep** > **Sweep Trigger**
- Point Trigger** Press this softkey to access a submenu of selections for triggering a point-by-point sweep. Use this softkey to select the process for triggering succeeding sweep points following the dwell time of the previous point. The triggering selections immediate, automatic, triggering by pressing the **Trigger** hardkey, or external triggering. External triggering is on either the positive or negative edge of a external signal supplied to the TRIGGER IN connector.
- Default value: **Immediate**
 - Key sequence: **Sweep** > **Point Trigger**
- Immediate** This softkey is a selection in both the **Sweep Trigger** and the **Point Trigger** submenu. If both the **Sweep Trigger** and the **Point Trigger** are set to **Immediate**, the signal generator initiates a sweep covering all the points, immediately upon selecting a sweep mode (**RF/LF/Ampl**).
- Key sequence: **Sweep** > **Sweep Trigger** > **Immediate**
Sweep > **Point Trigger** > **Immediate**

Trigger key This softkey is a selection in both the **Sweep Trigger** and the **Point Trigger** submenu. If both the **Sweep Trigger** and the **Point Trigger** are set to **key**, the signal generator will arm a sweep upon selecting a sweep mode. However, it requires the user to press the  hardkey to initiate a point-by-point sweep.

- Key sequence:  > **Sweep Trigger** > **Trigger Key**
 > **Point Trigger** > **Trigger Key**

EXT This softkey is a selection in both the **Sweep Trigger** and the **Point Trigger** submenus. When **EXT** is selected, the external trigger source signal is switched in and will trigger a full sweep or trigger a point to point sweep. The external trigger source must be a TTL signal with 100 ns minimum level holding time.

The signal generator can also be set to trigger on the slope of the external trigger source signal. To do this, press the **Trigger In** softkey: on either the negative or the positive edge of the TTL signal.

- Key sequence:  > **Sweep Trigger** > **EXT**
 > **Point Trigger** > **EXT**

Trigger In Pos/Neg Press this softkey to toggle the slope selection of the TTL signal between positive and negative. This softkey is available only when the **EXT** is selected.

- Default value: **Neg**
- Softkey sequence:  > **Trigger In**

Sweep Direction Up /Down Changes the direction of sweep parameters. Choose **Up** to sweep from start frequency/amplitude to the stop frequency/amplitude. Choose **Down** to reverse the direction of sweep.

- Default value: **Up**
- Key sequence:  > **Sweep Direction**

Trigger

Press the  hardkey to trigger (initiate) an armed sweep or each point in a sweep. Only active when the sweep trigger or the point trigger are set to **Key**.

Utility

Press the **Utility** hardkey to access a submenu for system configuration.

Display Style ▶

Enters the display style submenu:

Classic White	Sets display style to classic white
Modern Blue	Sets display style to Modern Blue
Jade Green	Sets display style to Jade Green

Screen Saver ▶

Enters the screen saver submenu:

On	Enables screen saver
Off	Disables screen saver

Error Info ▶

Enters error information submenu:

Page Up	Pages up the error information list
Page Down	Pages down the error information list
Clear	Clears the error information queue

Date/Time

Enters the date/time submenu:

Date	Sets date information
Time	Sets time information

▼ next page





Ref Setups ▶	Enters the reference source submenu:
INT-10 MHz	Selects 10 MHz internal reference source
EXT-2 MHz	Selects 2 MHz external reference source
EXT-5 MHz	Selects 5 MHz external reference source
EXT-10 MHz	Selects 10 MHz external reference source
Information	Displays system information
Opt. Φ Noise	Enters the phase noise optimize mode menu
Normal	Selects normal phase noise mode
ResFM Opt.	Optimizes Residual FM
License Key	Inputs License Key to enable an option

Display Style Press this softkey to select a display style (**Classic White/Modern Blue/Jade Green**).

- Default value: **Modern Blue**
- Key sequence: **Utility** > **Display style**

Screen saver Press this softkey to toggle the signal generator's screen saver between on and off. When the screen saver is on, the screen is turned off after standing by for 15 minutes. Turn on the screen again by pressing any front panel key (except the standby switch). It will also turn back on when the generator receives a remote command.

- Default value: **Off**
- Key sequence: **Utility** > **Screen Saver**

- Error Info** Press this softkey to access a selection menu for viewing error messages. Press **Page up/down** to view previous/next page. Press **Clear** will delete all the messages stored in the error message queue. You cannot recover message after performing this action; once the messages are deleted, they are permanently gone. When the error message queue is empty, the ERR annunciator is turned off.
- Key sequence:  > **Error Info**
- Date/Time** Pressing this softkey allows you to set the system date/time. Set system date with the **Set date** softkey. The data display format is YYYY-MM-DD. Set system time with the **Set time** softkey. The time display format is HH:MM.
- Key sequence:  > **Date/time**
- Ref Setup** Press this softkey to set the reference oscillator selection to either: internal 10 MHz, or external 2, 5, or 10 MHz reference oscillator.
- Default value: **INT-10 MHz**
 - Key sequence:  > **Ref Setups**
- Information** Press this softkey to display the system information of the signal generator. The displayed information includes:
- instrument model
 - instrument serial number
 - current firmware version
 - option status
 - hardware information
- Key sequence:  > **Information**

Opt. Φ Noise Press this softkey to set the desired phase noise mode: **ResFM Opt.** or **Normal**. Selecting **ResFM Opt.** improves the residual FM performance, as compared to **Normal** mode.

- Default value: **Normal**
- Key sequence:  > **Opt. Φ Noise**

License Key Press this softkey to enter a license key when adding or turning on an instrument option. Refer to “[Enable an option](#)” on page 25 for an example of using this function.

- Key sequence:  > **License Key**



5 Programming Fundamentals

Remotely Operating Your N9310A 90

Getting Started with SCPI 95

IEEE 488.2 common command 103

This chapter provides information on remote instrument operation using the USB interface, PC requirements, and use of SCPI commands.



Remotely Operating Your N9310A

The signal generator provides USB (Universal Serial Bus) connections which allows remote operation with a controller computer. A controller computer can be a personal computer (PC), or a minicomputer. Some intelligent instruments can also function as controllers.

System Requirements for Remote Operation

An IBM compatible PC or controller equivalent with the following requirements are necessary to set up a remote operation environment:

Processor:

- 450 MHz or higher required

Operating system:

- Microsoft® Windows® XP, or Windows® 2000 Professional, service pack 4 or later

Video: SGVA (800 * 600 or greater) 256 colors

Available memory:

- 64 MB required

Available disk space: 175 MB or greater required

Available Ports: A compatible interface port to connect to the USB port on the signal generator.

Connecting the N9310A to a PC through the USB Port

No additional drivers are required to connect the N9310A through the USB port to a PC. Agilent IO Libraries Suite version 14.1 or later is necessary. The IO libraries suite can be found in the documentation CD that came in the shipment along with your N9310A. Or it can be downloaded from the Agilent website at:

<http://www.agilent.com/find/iolib>

Refer to the following steps to make the PC to signal generator connection:

- 1 Install IO Libraries Suite in the PC.
- 2 Switch on the N9310A.
- 3 Connect the signal generator to a PC using a USB cable as shown below:

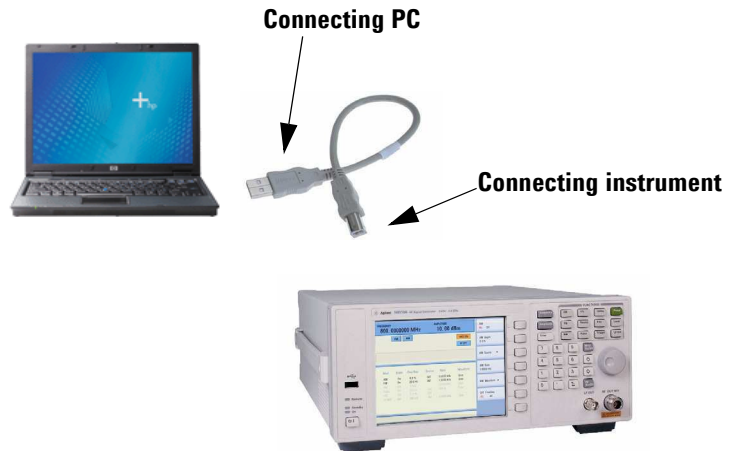

- 4 Following boot up, the PC will find the N9310A as a new hardware and will prompt a message indicating “Found new hardware...”. A **Found New Hardware Wizard** is initiated immediately.



5 Select **Display a list...**

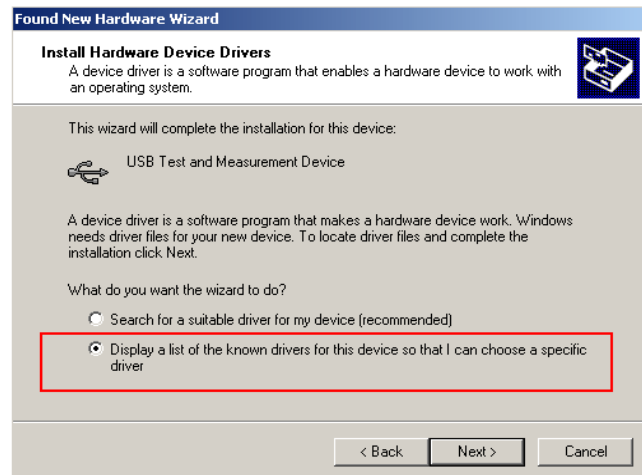

- 6 Windows should find **USB Test and Measurement Device**. Select it and press **Next**.

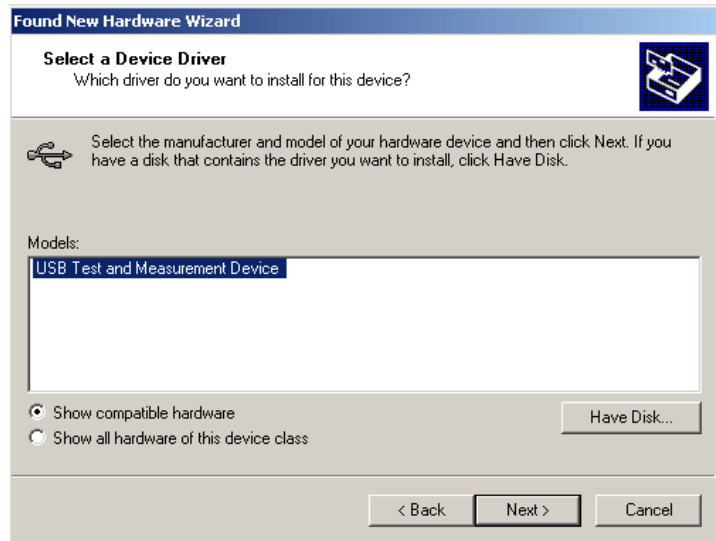

- 7 The wizard will guide you through the rest of installation until the correct driver is installed.
- 8 Open the Agilent Connection Expert in your IO Libraries Suite. The N9310A will be detected automatically. If this does not occur, press **Refresh All**.

About USB Interface

A USB connection is typically easy to setup and very cost effective. The USB specification supports a wide variety of devices that range from lower-speed devices, such as keyboards and mice to higher-speed devices, such as digital camera and intelligent instruments.

The USB interface initially offered up to 12 Mb/S. That is approximately 100 times faster than the RS-232 style serial interfaces that are used in earlier generation devices. A USB 2.0 connection is faster than both a LAN or GPIB connection.

USB Connector Types

Many USB devices come with their own built-in cable, with an “A” connection on it. If not, then the device has a socket on it that accepts a USB “B” connector. The USB standard uses “A” and “B” connectors to avoid confusion.

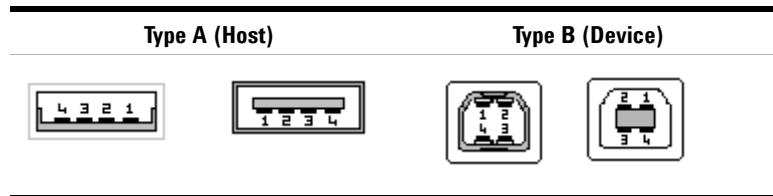

Pin Map of USB Connectors

Pin #	Pin caption	Description
1	VCC	+5 V, DC
2	D –	Data –
3	D +	Data +
4	GND	Ground

Refer to <http://www.usb.org> for additional details.

Getting Started with SCPI

Programming with SCPI (Standard Command of Programmable Instrument) requires familiarity with the following:

- Computer programming languages, such as C, C++, and Microsoft® Visual Basic®.
- The language used to remotely control your instrument. The N9310A employs SCPI as its programming language.

The semantic requirements of your controller's language determine how the programming commands and responses are handled in your application program.

An Introduction to the SCPI Language

SCPI is an ASCII-based instrument command language designed for test and measurement instruments, with the goal of reducing automatic test equipment (ATE) program development time.

SCPI accomplishes this goal by providing a consistent programming environment for instrument control and data usage. This consistent programming environment is achieved by the use of defined program messages, instrument responses, and data formats across all SCPI instruments.

By providing a consistent programming environment, replacing one SCPI instrument with another SCPI instrument in a system will usually require less effort than with non-SCPI instrument.

SCPI is not a standard which completely provides for interchangeable instrumentation. SCPI helps move toward interchangeability by defining instrument commands and responses, but it does not define instrument functionality, accuracy, resolution, connectors, etc.

Common Terms used in this Book

Terms	Description
Controller	Any computer used to communicate with an instrument. A controller can be a personal computer (PC), a minicomputer, or a plug-in card in a card cage. Some intelligent instruments can also function as controllers.
Instrument	Any device that implements SCPI. Most instruments are electronic measurement or stimulus devices, but this is not a requirement. Similarly, most instruments use a GPIB or RS-232 or USB interface for communication. The same concepts apply regardless of the instrument function or the type of interface used.
Command	An instruction. You combine commands to form messages that control instruments to complete a specified task. In general, a command consists of mnemonics (keywords), parameters and punctuation.
Query	A special type of command. Queries instruct the instrument to make response data available to the controller. Query keywords always end with a question mark, ? .

Reference material:

IEEE Standard 488.1-1987, *IEEE Standard Digital Interface for Programmable Instrumentation*, New York, NY, 1998.

IEEE Standard 488.2-1987, *IEEE Standard Codes, Formats, Protocols and Comment Commands for Use with ANSI/IEEE Std 488.1-1987*, New York, NY, 1998.

Command Categories

The SCPI command falls into two categories:

- Subsystem commands that simulate front panel keystrokes
- Common commands that are unique and have no front panel equivalent

Use a computer to control the signal generator (but operate the line power switch manually). Computer programming procedures for the signal generator involve selecting a programming statement and then adding the specified programming codes to that statement to achieve the desired operating conditions.

Command Syntax

Command syntax includes standard notations and statement rules.

Standard Notations

A command consists of mnemonics (keywords), parameters and punctuation. Before you start to program your signal generator, familiarize yourself with the standard notation of each of them. See the table on next page.

Command Mnemonics (keywords)	<p>Many commands have both a long and a short form: use either one. (a combination of the two is not allowed). Consider the :FREQuency command for example:</p> <ul style="list-style-type: none">• Short form :FREQ• Long form :FREQUENCY <p>SCPI is not case sensitive, so fREquEncy is just as valid as FREQUENCY, but FREQ and FREQUENCY are the only valid forms of the FREQuency command.</p> <p>In this documentation, upper case letters indicate the short form of the keyword. The lower case letters indicate the long form of the keyword.</p>
Punctuation	<ul style="list-style-type: none">• A vertical bar " " dictates a choice of one element from a list. For example: <A> indicates that either A or B can be selected, but not both.• Square brackets "[]" indicates that the enclosed items are optional.• Angle brackets "< >" indicates a variable items to be entered to represent user choices.• A question mark "?" after a subsystem command indicates that the command is a query. The returned information, <value> varies in format according to the type of the field.
Separator	<ul style="list-style-type: none">• A colon ":" seperates keywords of different levels.• A space separates a keyword and a parameter, as well as a parameter and a unit.

The colon before the root keyword is usually omitted.

Command Statement Rules Overview

Besides the standard notation of SCPI described in previous page, SCPI uses the following rules:

- Command statements read from left to right
- Use either long form or short form of keywords, but do not use both
- no separating space between the keywords, only use a colon to separate keywords of different levels
- always separating a keyword from a variable with a space
- always separating a variable from its unit with a space (if variable has a unit)

Take “:AM:DEPTh <val>” for example,

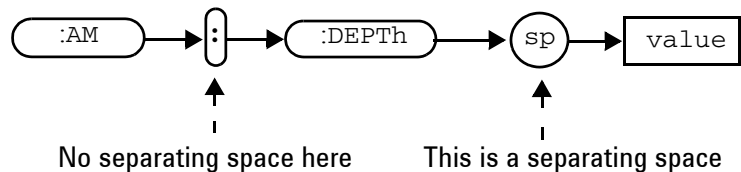

Using Valid Commands

The following examples demonstrate valid and invalid commands.

Example 1 **:FREQ: CW 900 MHz**

In this example, the keyword short form is used. The command is correct and will not cause errors.

It is equivalent to front panel key access **Frequency > 900 > MHz**

Example 2 **:AMPLITUDE: CW -85 dBm**

In this example, the keyword long form is used. The command is correct and will not cause errors.

It is equivalent to front panel key access **Amplitude > - 85 > dBm**

NOTE

Always enter the minus symbol with English language environment settled in your PC. Minus symbol of any other language is recognized as invalid symbol.

Example 3 **freq:cw 900 mhz**

In this example, the keyword lowercase is used and the leading colon is omitted. The command is correct and will not cause errors. It will have the same effect as the command message that is in uppercase.

Example 4 **fre:cw 900mhz**

The command is incorrect and will cause errors. It uses incorrect keyword “fre”, which is not the standard short form and can not be recognized by program. Another error of this program message is that there is no space between 900 and Mhz.

Program and Response Messages

To understand how your instrument and controller communicate using SCPI, you must understand the concepts of program and response messages.

Program Messages

Program messages are the formatted data sent from the controller to the instrument. Conversely, response messages are formatted data sent from the instrument to the controller. Program messages contain one or more commands, and response messages contain one or more responses.

Response Messages

The controller may send commands at any time, but the instrument sends responses only when query commands is received. All query mnemonics end with a question mark. Queries return either measured values or internal instrument settings.

Forgiving Listening and Precise Talking

SCPI uses the concept of forgiving listening and precise talking outlined in IEEE 488.2.

Forgiving listening means that instruments are very flexible in accepting various command and parameter formats. For example, the signal generator accepts either

:RFOutput:STATE ON or **:RFOutput:STATE 1**

Precise talking means that the response format for a particular query is always the same. For example, if you query RF output state when it is on (using **:RFOutput:STATE?**), the response is always 1, regardless of if you previously sent **:RFOutput:STATE 1** or **:RFOutput:STATE ON**.

1 represents logic state 1 = ON; logic state 0 = OFF

Subsystem Command Trees

Most programming tasks involve subsystem commands that are usually specified to simulate front panel keystrokes. SCPI uses a hierarchical structure for subsystem commands similar to the file system on most computers. In SCPI, this command structure is called a command tree. It helps you to understand how the subsystem commands simulate front panel operations.

How to Use a Command Tree

In the command tree example shown below, the command closest to the left is the root command, or simply “the root”. Notice that you must follow a particular path to reach lower level sub-commands.

In this example, `:LFOutput` is the root keyword of the tree, `FREQuency`, `AMPLitude` and `STATe` are second-level keywords. If you wish to access the `STATe?` command, you must follow the path `:LFOutput:STATe?`

Example 5 Low Frequency Output Subsystem

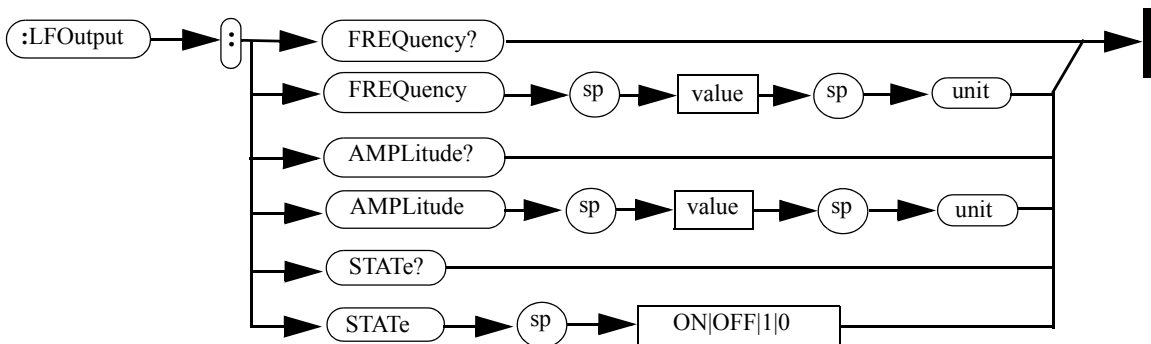

IEEE 488.2 common command

Common commands are generally not measurement related, but are used to manage macros, status registers, synchronization, and data storage. The common commands are defined by IEEE 488.2.

All common commands begin with an asterisk. The following common commands are available in N9310A.

***RST (Reset)**

Using this command resets the signal generator to factory default settings and returns the instrument to a state where it waits for a command to initiate other actions. See “Preset” on page 70 for an overview of the factory default settings of the signal generator.

***IDN? (Identification)**

This is a query only command. After sending this query, the signal generator reports the following identification information:

- Manufactory title
- Instrument module
- Instrument serial number
- Firmware version number

***CLS (Clear Status)**

Using this command clears the error queue of the signal generator. There is no equivalent front panel key access.



6 Subsystem Command Reference

Preparing for Use	106
Frequency Subsystem	109
Amplitude Subsystem	113
Trigger Subsystem	115
Sweep Subsystem	116
AM Subsystem	132
FM Subsystem	135
Phase Modulation Subsystem	138
Pulse Modulation Subsystem	140
I/Q Modulation Subsystem	142
Utility Subsystem	143
Modulation State Subsystem	147
RF Output State Subsystem	148
LF Output Subsystem	149
Subsystem Command Trees	151
Programming Examples	161

Preparing for Use

Subsystem commands include all measurement functions and some general-purpose functions.

Subsystem Commands Overview

Each of the following subsystems is a set of commands that broadly corresponds to a functional block of the instrument.

- [“Frequency Subsystem”](#) on page 109
Provides SCPI commands to configure frequency related items.
- [“Amplitude Subsystem”](#) on page 113
Provides SCPI commands to configure amplitude related items.
- [“Trigger Subsystem”](#) on page 115
Provides SCPI commands to configure a trigger event.
- [“Sweep Subsystem”](#) on page 116
Provides SCPI commands to configure an RF step sweep, or an LF step sweep, or an amplitude step sweep. It also provides configuration commands that configure the trigger mode associated with any step sweep mode.
- [“AM Subsystem”](#) on page 132
Provides SCPI commands to configure an AM signal.
- [“FM Subsystem”](#) on page 135
Provides SCPI commands to configure an FM signal.
- [“Phase Modulation Subsystem”](#) on page 138
Provides SCPI commands to configure a phase modulation signal.

- “Pulse Modulation Subsystem” on page 140
Provides SCPI commands to configure a pulse modulation signal.
- “I/Q Modulation Subsystem” on page 142
Provides SCPI command to configure the state of the I/Q modulation.
- “Utility Subsystem” on page 143
Provides SCPI commands to configure the instrument system settings.
- “Modulation State Subsystem” on page 147
Provides SCPI command to manage the modulator's state for AM, FM, Phase modulation, and Pulse modulation.
- “RF Output State Subsystem” on page 148
Provides a command to manage the RF output state for CW output, RF/Amplitude sweep output, and modulation output.
- “LF Output Subsystem” on page 149
Provides SCPI commands to configure the LF output.

Conventions used in Programming

- Use "us" instead of "μs" in your coding when describing microsecond.
- Always enter a minus symbol with English language environment settled in your PC.
- The returned data of a query keeps to the following rules:
 - a boolean variable returns 1|0. (1= On, 0= Off)
 - an enumerative variable returns its short form normally. For example, :SWEep:REPeat? returns SING, indicating the current sweep repeat is in single mode.
 - a minority of enumerative variable return their specified format. For example, :SYSTem:REFeRence:FREQUency? returns EXT10MHZ, indicating the current reference is set to external 10 MHz oscillator.
- If the variable contains a parameter and a unit, with a space between them, the returned data also consists of a parameter and a unit with the best match telling the magnitude. For example, :FREQ:CW? returns a parameter with different magnitude unit:
 - "60.0000 kHz" ($9 \text{ kHz} \leq \text{Frequency} < 1 \text{ MHz}$)
 - "450.0000000 MHz" ($1 \text{ MHz} \leq \text{Frequency} < 1 \text{ GHz}$)
 - "1.562000000 GHz" ($\text{Frequency} \geq 1 \text{ GHz}$)

Frequency Subsystem

The frequency subsystem controls the settings and parameters associated with frequency.

Continuous Wave (CW) Output Frequency

```
:FREQUENCY:CW <val> <unit>
```

```
:FREQUENCY:CW?
```

This command sets the frequency of a CW signal.

The query returns the current frequency of a CW signal.

Range	9 kHz to 3 GHz
Valid unit	GHz, MHz, kHz
Minimum increment	0.1 Hz
*RST value	3.000 000 0000 GHz
Returned data format	<val> <unit>
Front panel access	

RF Start

```
:FREQUENCY:RF:START <val> <unit>
```

```
:FREQUENCY:RF:START?
```

This command sets the start frequency in an RF sweep. The start frequency should always be lower than stop frequency in an RF sweep.

The query returns the current start frequency.

Range	9 kHz to 3 GHz
Valid unit	GHz, MHz, kHz
Minimum increment	0.1 Hz
*RST value	9.0000 kHz
Returned data format	<val> <unit>
Front panel access	Sweep > Step Sweep > RF Start

RF Stop

```
:FREQUENCY:RF:STOP <val> <unit>
```

```
:FREQUENCY:RF:STOP?
```

This command sets the stop frequency in an RF sweep. The stop frequency should always be set higher than the start frequency.

The query returns the current stop frequency.

Range	9 kHz to 3 GHz
Valid unit	GHz, MHz, kHz
Minimum increment	0.1 Hz
*RST value	3.000 000 0000 GHz
Returned data format	<val> <unit>
Front panel access	Sweep > Step Sweep > RF Stop

LF Start

```
:FREQUENCY:LF:START <val> <unit>
```

```
:FREQUENCY:LF:START?
```

This command sets the start frequency in an LF sweep. The start frequency should always be lower than the stop frequency in an LF sweep.

The query returns the current start frequency.

Range	20 Hz to 80 kHz
Valid unit	kHz, Hz
Minimum increment	0.1 Hz
*RST value	20.0 Hz
Returned data format	<val> <unit>
Front panel access	Sweep > Step Sweep > LF Start

LF Stop

```
:FREQUENCY:LF:STOP <val> <unit>
```

```
:FREQUENCY:LF:STOP?
```

This command sets the stop frequency in an LF sweep. The stop frequency should always be set higher than the start frequency.

The query returns the current stop frequency.

Range	20 Hz to 80 kHz
Valid unit	kHz, Hz
Minimum increment	0.1 Hz
*RST value	80.0000 kHz
Returned data format	<val> <unit>
Front panel access	Sweep > Step Sweep > LF Stop

Step Scale

```
:FREQuency:RF:SCALE LOG|LIN
```

```
:FREQuency:RF:SCALE?
```

This command toggles the scale of an RF sweep between logarithmic and linear.

The LOG scale is NOT applicable to amplitude sweep or LF sweep.

The query returns the current scale.

Range	LOG, LIN
*RST value	LIN
Returned data	LOG, LIN
Front panel access	Sweep > Step Scale

Amplitude Subsystem

The amplitude subsystem controls the settings and parameters associated with amplitude.

Continuous Wave Output Amplitude

```
:AMPLitude:CW <val> <unit>
```

```
:AMPLitude:CW?
```

This command sets the amplitude of CW output.

The query returns the current amplitude of CW output.

Range and unit	-127 to +13 dBm, (+20 dBm settable) -80 to +60 dBmV, (+67 dBmV settable) -20 to +120 dBμV, (+127 dBμV settable) 0.0001 to 1000 mV, (2238.8 mV settable) 0.1 to 1 000 000 μV, (2238800 μV settable)
Minimum increment	0.1 dB (When using dBm/dBmV/dBμV) 0.1 mV (When using mV) 0.1 μV (Ampl ≤ 999.9 μV) 100 μV (Ampl ≥ 1000 μV)
*RST value	-127.0 dBm
Returned data format	<val> <unit>
Front panel access	

Amplitude Start

```
:AMPLitude:START <val> <unit>
```

```
:AMPLitude:START?
```

This command sets the start amplitude in an amplitude sweep. The start amplitude should always be lower than the stop amplitude in an amplitude sweep.

The query returns the current start amplitude.

Range	-127 to +13 dBm
Valid unit	dBm
Minimum increment	0.1 dBm
*RST value	-127.0 dBm
Returned data format	<val> <unit>
Front panel access	Sweep > Step Sweep > Ampl Start

Amplitude Stop

```
:AMPLitude:STOP <val> <unit>
```

```
:AMPLitude:STOP?
```

This command sets the stop amplitude in an amplitude sweep. The stop amplitude should always be higher than the start amplitude.

The query returns the current stop amplitude.

Range	-127 to +13 dBm
Valid unit	dBm
Minimum increment	0.1 dB
*RST value	13.0 dBm
Returned data format	<val> <unit>
Front panel access	Sweep > Step Sweep > Ampl Stop

Trigger Subsystem

The trigger subsystem controls the settings and parameters associated with triggering a sweep.

Immediate Trigger

:TRIGger:IMMediate

This command has no effect unless sweep is armed. It has an equivalent function to the  hardkey in activating an armed sweep.

There is no query for this command.

Front panel access: 

Single Sweep

:TRIGger:SSWP

This command initiates a single RF/LF/Amplitude sweep when the following conditions are met:

- Sweep and point trigger are both set to IMMediate
- Sweep repeat is set to SINGLE
- An RF/LF/Amplitude sweep is enabled and first free run of the sweep is complete

There is no query for this command.

Front panel access: 

Sweep Subsystem

The sweep subsystem controls the settings and parameters associated with an RF/LF/Amplitude/RF&Ampl sweep.

NOTE

To make an RF/amplitude sweep available at the RF OUT connector, make sure you enable RF output. See “[RF Output State Subsystem](#)” on page 148

RF Sweep State

```
:SWEep:RF:STATe ON|OFF|1|0
```

```
:SWEep:RF:STATe?
```

This command initiates the signal generator to sweep in a different manner, according to the sweep trigger or point trigger settings:

- If the sweep trigger and point trigger are both set to IMMEDIATE, sending this command below initiates an RF sweep immediately:
":SWEep:RF:STATe ON"
- If either the sweep trigger or point trigger is set to KEY, sending the commands ":SWEep:RF:STATe ON" arms an RF sweep.
Sending command ":TRIGger IMMEDIATE" initiates the RF sweep.
- If either the sweep trigger or point trigger is set to EXT, sending the commands ":SWEep:RF:STATe ON" arms an RF sweep. No further command is needed to initiate the RF sweep, but a proper external signal should be input into the signal generator.

The query returns a current RF sweep state.

Range	On (1), OFF (0)
*RST value	OFF
Returned data	1, 0
Front panel access	Sweep > Sweep Mode > RF/Off

LF Sweep State

`:SWEep:LF:STATe ON|OFF|1|0`

`:SWEep:LF:STATe?`

This command initiates your signal generator to sweep in a different manner, according to the sweep trigger or point trigger settings:

- If the sweep trigger and point trigger are both set to IMMEDIATE, sending the following command initiates an LF sweep immediately:
`":SWEep:LF:STATe ON"`
- If either the sweep trigger or point trigger is set to KEY, sending the command `":SWEep:LF:STATe ON"` arms an LF sweep:
 Sending command `":TRIGger IMMEDIATE"` initiates the LF sweep.
- If either the sweep trigger or point trigger is set to EXT, sending the commands `":SWEep:LF:STATe ON"` arms an LF sweep. No further command is needed to initiate the LF sweep, but a proper external signal should be input into the signal generator.

The query returns the current LF sweep state.

Range	On (1), OFF (0)
*RST value	OFF
Returned data	1, 0
Front panel access	Sweep > Sweep Mode > LF Sweep > Sweep Mode > Off (abort an on-going LF sweep)

Amplitude Sweep State

```
:SWEep:AMPLitude:STATe ON|OFF|1|0
```

```
:SWEep:AMPLitude:STATe?
```

This command initiates your signal generator to sweep in a different manner, according to the sweep trigger or point trigger settings:

- If the sweep trigger and point trigger are set to IMMEDIATE, sending the command `":SWEep:AMPLitude:STATe ON"` initiates an immediate amplitude sweep.
- If either the sweep trigger or point trigger is set to KEY, sending the command `":SWEep:AMPLitude:STATe ON"` arms an amplitude sweep. Sending command `":TRIGger IMMEDIATE"` initiates the amplitude sweep.
- If either the sweep trigger or point trigger is set to EXT, sending the commands `":SWEep:AMPLitude:STATe ON"` arms an amplitude sweep. No further command is needed to initiate the amplitude sweep, but a proper external signal should be input into the signal generator.

The query returns the current amplitude sweep state.

Range	On (1), OFF (0)
*RST value	OFF
Returned data	1, 0
Front panel access	Sweep > Sweep Mode > Amplitude Sweep > Sweep Mode > Off

RF Start

```
:SWEep:RF:START <val> <unit>
```

```
:SWEep:RF:START?
```

This command sets the start frequency in an RF sweep. The start frequency should always be lower than the stop frequency in an RF sweep.

The query returns the current start frequency.

Range	9 kHz to 3 GHz
Valid unit	GHz, MHz, kHz
Minimum increment	0.1 Hz
*RST value	9.0000 kHz
Returned data format	<val> <unit>
Front panel access	Sweep > Step Sweep > RF Start

RF Stop

```
:SWEep:RF:STOP <val> <unit>
```

```
:SWEep:RF:STOP?
```

This command sets the stop frequency in an RF sweep. The stop frequency should always be set higher than the start frequency.

The query returns the current stop frequency.

Range	9 kHz to 3 GHz
Valid unit	GHz, MHz, kHz
Minimum increment	0.1 Hz
*RST value	3.000 000 0000 GHz
Returned data format	<val> <unit>
Front panel access	Sweep > Step Sweep > RF Stop

LF Start

```
:SWEep:LF:START <val> <unit>
```

```
:SWEep:LF:START?
```

This command sets the start frequency in an LF sweep. The start frequency should always be lower than the stop frequency in an LF sweep.

The query returns the current start frequency.

Range	20 Hz to 80 kHz
Valid unit	kHz, Hz
Minimum increment	0.1 Hz
*RST value	20.0 Hz
Returned data format	<val> <unit>
Front panel access	Sweep > Step Sweep > LF Start

LF Stop

```
:SWEep:LF:STOP <val> <unit>
```

```
:SWEep:LF:STOP?
```

This command sets the stop frequency in an LF sweep. The stop frequency should always be set higher than the start frequency.

The query returns the current stop frequency.

Range	20 Hz to 80 kHz
Valid unit	kHz, Hz
Minimum increment	0.1 Hz
*RST value	80.0000 kHz
Returned data format	<val> <unit>
Front panel access	Sweep > Step Sweep > LF Stop

Amplitude Start

```
:SWEep:AMPLitude:START <val> <unit>
```

```
:SWEep:AMPLitude:START?
```

This command sets the start amplitude in an amplitude sweep. The start amplitude should always be lower than the stop amplitude in an amplitude sweep.

The query returns the current start amplitude.

Range and unit	-127 to +13 dBm
Valid unit	dBm
Minimum increment	0.1 dB
*RST value	-127.0 dBm
Returned data format	<val> <unit>
Front panel access	Sweep > Step Sweep > Ampl Start

Amplitude Stop

```
:SWEep:AMPLitude:STOP <val> <unit>
```

```
:SWEep:AMPLitude:STOP?
```

This command sets the stop amplitude in an amplitude sweep. The stop amplitude should always be higher than the start amplitude.

The query returns the current stop amplitude.

Range and unit	-127 to +13 dBm
Valid unit	dBm
Minimum increment	0.1 dB
*RST value	13.0 dBm
Returned data format	<val> <unit>
Front panel access	Sweep > Step Sweep > Ampl Stop

Step Points

```
:SWEep:STEP:POINTs <val>
```

```
:SWEep:STEP:POINTs?
```

This command defines the number of points in a step sweep. A step sweep must always have a minimum of two points and can be configured to have as many as 1001 points.

The query returns the current number of points.

Range	2 to 1001
*RST value	10
Returned data format	<val>
Front panel access	Sweep > Step Sweep > # Points

Step Dwell

```
:SWEep:STEP:DWELl <val> <unit>
```

```
:SWEep:STEP:DWELl?
```

This command sets the dwell time for each point in a sweep. The query returns the current dwell time.

Range	10 ms to 1s
Valid unit	s, ms
Minimum increment	0.1 ms
*RST value	10.0 ms
Returned data format	<val> <unit>
Front panel access	Sweep > Step Sweep > Step Dwell

Sweep Type

```
:SWEep:TYPE STEP|LIST
```

```
:SWEep:TYPE?
```

This command toggles the sweep type between step and list. The query returns the current sweep type..

Range	STEP/LIST
*RST value	STEP
Returned data	STEP, LIST
Front panel access	Sweep > Sweep Type

List Power State

```
:LIST:POWer:STATe ON|OFF|1|0
```

```
:LIST:POWer:STATe?
```

This command toggles the RF&Ampl list between on and off. The query returns the current list power state.

Range	ON(1), OFF(0)
*RST value	OFF
Returned data	1, 0
Front panel access	Sweep > Sweep Mode > RF&Ampl Sweep > Sweep Mode > Off

List Dwell

```
:LIST:DWELL <val> <unit>
```

```
:LIST:DWELL?
```

This command sets the dwell time for the current list sweep point.

The query returns the current list sweep point's dwell time.

Range	10 ms to 1s
Valid unit	s, ms
Minimum increment	0.1 ms
*RST value	10.0 ms
Returned data format	<val> <unit>
Front panel access	Sweep > List Sweep > Edit Item

List RF

```
:LIST:RF <val> <unit>
```

```
:LIST:RF?
```

This command sets the frequency value for the current list sweep point.

The query returns the current list sweep point's frequency value.

Range	9 kHz to 3 GHz
Valid unit	GHz, MHz, kHz
Minimum increment	0.1 Hz
*RST value	9.0000 kHz
Returned data format	<val> <unit>
Front panel access	Sweep > List Sweep > Edit Item

List Amplitude

:LIST:Amplitude <val> <unit>

:LIST:Amplitude?

This command sets the amplitude value for the current list sweep point.

The query returns the current list sweep point's amplitude value.

Range and unit	-127 to +13 dBm
Valid unit	dBm
Minimum increment	0.1 dB
*RST value	13.0 dBm
Returned data format	<val> <unit>
Front panel access	Sweep > List Sweep > Edit Item

List Dwell Points

:LIST:DWELL:POINTs?

The query returns the number of dwell points in the current list sweep file.

List RF Points

:LIST:RF:POINTs?

The query returns the number of frequency points in the current list sweep file.

List Amplitude Points

```
:LIST:AMPLitude:POINTs?
```

The query returns the number of amplitude points in the current list sweep file.

List Row Goto

```
:LIST:ROW:GOTO <val>
```

```
:LIST:ROW:GOTO?
```

This command sets the list to the specified row.

The query returns the current row number.

Range	2 to 1001
*RST value	10
Returned data format	<val>
Front panel access	Sweep > List Sweep > Goto Row

List Row Insert

```
:LIST:ROW:INSert <val>
```

This command inserts a new row below the specified row.

Range	2 to 1001
*RST value	10
Front panel access	Sweep > List Sweep > Goto Row Sweep > List Sweep > Insert Row

List Row Delete

:LIST:ROW:DELeTe <val>

This command deletes the specified row in the list table.

Range	2 to 1001
*RST value	10
Front panel access	Sweep > List Sweep > Goto Row Sweep > List Sweep > Delete Row

List Rows

:LIST:ROWS?

This query returns the number of the current row in the list table.

Range	2 to 1001
Returned data format	<val>

List Preset

:LIST:PRESet

This command replaces the current list sweep data with a factory-defined file consisting of two rows.

Front panel access	Sweep > List Sweep > Preset
---------------------------	--

List Dwell Type

```
:LIST:DWELL:TYPE STEP|LIST
```

```
:LIST:DWELL:TYPE?
```

This command toggles the dwell time type between step and list.

The query returns the current list dwell type.

Range	STEP/LIST
*RST value	STEP
Returned data	STEP, LIST
Front panel access	Sweep > List Sweep > Dwell Type

Sweep Repeat

```
:SWEep:REPeat SINGLE|CONTInuous
```

```
:SWEep:REPeat?
```

This command toggles the sweep repeat between single and continuous.

The query returns the current sweep repeat state.

Range	SINGLE/CONTInuous
*RST value	CONTInuous
Returned data	SING, CONT
Front panel access	Sweep > Sweep Repeat

Sweep Trigger

```
:SWEep:STRG IMMEDIATE|KEY|EXT
:SWEep:STRG?
```

This command sets the sweep trigger mode to one of the following choices:

- IMMEDIATE - Selecting this mode immediately triggers signal generator to sweep from the first point to the final point in a sweep sequence automatically.
- KEY - Selecting this mode arms a sweep. The armed sweep will be initiated by sending the “TRIGger:IMMEDIATE” command.
- EXT - Selecting this mode enables an external trigger source to initiate an armed sweep.

The query returns the current sweep trigger mode.

Range	IMMEDIATE, KEY, EXT
*RST value	IMMEDIATE
Returned data	IMM, KEY, EXT
Front panel access	Sweep > Sweep Trigger

External Sweep Trigger Slope

```
:SWEep:STRG:SLOPe EXTN|EXTP
:SWEep:STRG:SLOPe?
```

This command toggles the slope of external trigger source between negative (EXTN) and positive (EXTP). This command is valid only when an external trigger source is properly connected and enabled.

If you have select EXT (an external trigger source), the query returns the current slope of the external trigger

source. If you have NOT select EXT or you preset the signal generator, the query returns “NA”.

Range	EXTN, EXTP
*RST value	NA
Returned data	EXTN, EXTP, NA
Front panel access	Sweep > Sweep Trigger > Trigger In Neg/Pos

Point Trigger

```
:SWEep:PTRG IMMEDIATE|KEY|EXT
```

```
:SWEep:PTRG?
```

This command sets the point trigger mode to one of the following items:

- IMMEDIATE - immediately initiates a sweep.
- KEY - arms a sweep and requires you to send the command “TRIGger:IMMEDIATE”
- EXT - enables an external trigger source to initiate each point in a sweep.

The query returns the current sweep trigger mode.

Range	IMMEDIATE, KEY, EXT
*RST value	IMMEDIATE
Returned data	IMM, KEY, EXT
Front panel access	Sweep > Point Trigger

External Point Trigger Slope

```
:SWEep:PTRG:SLOPe EXTN|EXTP
```

```
:SWEep:PTRG:SLOPe?
```

This command toggles the slope of external trigger source between negative (EXTN) and positive (EXTP). This command is valid only when an external trigger source is properly connected and enabled.

If you have selected EXT (an external trigger source), the query returns the current slope of the external trigger source. If you have NOT selected EXT or you preset the signal generator, the query returns "NA".

Range	EXTN, EXTP
*RST value	NA
Returned data	EXTN, EXTP, NA
Front panel access	Sweep > Point Trigger > Trigger In Neg/Pos

Sweep Direction

```
:SWEep:DIRection UP|DOWN
```

```
:SWEep:DIRection?
```

This command sets the sweep direction of an RF, LF or an amplitude sweep to either of the following choices:

- UP - sweeps from start point to stop point
- Down - sweeps from stop point to start point

The query returns the current sweep direction.

Range	UP, DOWN
*RST value	UP
Returned data	UP, DOWN
Front panel access	Sweep > Sweep Direction

AM Subsystem

The AM subsystem controls the settings and parameters associated with amplitude modulated signal.

AM State

```
:AM:STATE ON|OFF|1|0
```

```
:AM:STATE?
```

This command toggles the AM state between ON and OFF. However, applying an amplitude modulation to the RF carrier requires you also set MOD on.

See “[Modulation State Subsystem](#)” on page 147.

The query returns the current AM state.

Range	ON(1), OFF(0)
*RST value	OFF
Returned data	1, 0
Front panel access	AM > AM On/Off

AM Depth

:AM:DEPTH <val>

:AM:DEPTH?

This command sets the amplitude modulation depth.

The query returns the current AM depth.

Range	0 to 100
Minimum increment	0.1
*RST value	0.0 %
Returned data	<val>
Front panel access	AM > AM Depth

AM Rate

:AM:RATE <val> <unit>

:AM:RATE?

This command sets the frequency of the internal AM source. The query returns the current frequency of the internal AM source.

Range	20 Hz to 80 kHz
Minimum increment	0.1 Hz
*RST value	1.0000 kHz
Returned data format	<val> <unit>
Front panel access	AM > AM Rate

AM Source

```
:AM:SOURce INT|EXT|INT+EXT
```

```
:AM:SOURce?
```

This command sets the AM source to one of the three choices: internal source, external source or combined internal and external source.

The query returns the current AM source.

Range	INT, EXT, INT+EXT
*RST value	INT
Returned data	INT, EXT, INT+EXT
Front panel access	AM > AM Source

AM External Coupling

```
:AM:EXTCoupling AC|DC
```

```
:AM:EXTCoupling?
```

This command sets the coupling for the external AM source. The choice is either AC or DC coupling. AC coupling passes only AC signal components. DC coupling passes both the AC and DC signal components. This command is effective only when an external AM source is connected and enabled.

The query returns the current external coupling state.

Range	AC, DC
*RST value	AC
Returned data	AC, DC
Front panel access	AM > EXT Coupling

FM Subsystem

The FM subsystem controls the settings and parameters associated with frequency modulated signal.

FM State

```
:FM:STATE ON|OFF|1|0
```

```
:FM:STATE?
```

This command toggles the FM state between ON and OFF. However, applying a frequency modulation to the RF carrier requires you also set MOD on.

See “[Modulation State Subsystem](#)” on page 147

The query returns the current FM state.

Range	ON (1), OFF (0)
*RST value	OFF
Returned data	1, 0
Front panel access	FM > FM On/Off

FM Deviation

```
:FM:DEVIation <val> <unit>
```

```
:FM:DEVIation?
```

This command sets the FM deviation.

The query returns the current FM deviation.

Range	20 Hz to 100 kHz
Valid unit	kHz, Hz
Minimum increment	1 Hz
*RST value	20 Hz
Returned data format	<val> <unit>
Front panel access	FM > FM Deviation

FM Rate

```
:FM:RATE <val> <unit>
```

```
:FM:RATE?
```

This command sets the frequency of the internal FM source.

The query returns the current frequency of the internal FM source.

Range	20 Hz to 80 kHz
Minimum increment	0.1 Hz
*RST value	1.0000 kHz
Returned data format	<val> <unit>
Front panel access	FM > FM Rate

FM Source

```
:FM:SOURce INT|EXT|INT+EXT
```

```
:FM:SOURce?
```

This command sets the FM source to one of the three choices: internal source, external source or combined internal and external source.

The query returns the current FM source.

Range	INT, EXT, INT+EXT
*RST value	INT
Returned data format	INT, EXT, INT+EXT
Front panel access	FM > FM Source

FM External Coupling

```
:FM:EXTCoupling AC|DC
```

```
:FM:EXTCoupling?
```

This command sets the coupling for the external FM source. The choice is either AC or DC coupling. AC coupling passes only AC signal components. DC coupling passes both the AC and DC signal components.

This command is effective only when an external FM source is connected and enabled.

The query returns the current external coupling state.

Range	AC, DC
*RST value	AC
Returned data	AC, DC
Front panel access	FM > EXT Coupling

Phase Modulation Subsystem

The phase modulation (Φ M) subsystem controls the settings and parameters associated with phase modulated signal.

Φ M State

```
:PM:STATE ON|OFF|1|0
```

```
:PM:STATE?
```

This command toggles the Φ M state between ON and OFF. However, applying a phase modulation to the RF carrier requires you also set MOD on. See “[Modulation State Subsystem](#)” on page 147.

The query returns the current Φ M state.

Range	ON (1) / OFF (0)
*RST value	OFF
Returned data	1, 0
Front panel access	Φ M > Φ M On/Off

Φ M Deviation

```
:PM:DEVIation <val> <unit>
```

```
:PM:DEVIation?
```

This command sets the Φ M deviation.

Choices for the variables <val> depend on Φ M rate.

The query returns the current Φ M deviation.

Range	0 to 10 rad ($300 \text{ Hz} \leq \Phi\text{M rate} \leq 10 \text{ kHz}$) 0 to 5 rad ($10 \text{ kHz} < \Phi\text{M rate} \leq 20 \text{ kHz}$)
Valid unit	rad
Minimum increment	0.001 rad
*RST value	0.000 rad
Returned data format	<val> <unit>
Front panel access	$\Phi\text{M} > \Phi\text{M Deviation}$

Φ M Rate

```
:PM:RATE <val> <unit>
```

```
:PM:RATE?
```

This command sets the frequency of the internal Φ M source. The query returns the current frequency of the internal Φ M source.

Range	300 Hz to 80 kHz
Minimum increment	0.1 Hz
*RST value	1.0000 kHz
Returned data format	<val> <unit>
Front panel access	$\Phi\text{M} > \Phi\text{M Rate}$

Pulse Modulation Subsystem

The phase modulation (Φ M) subsystem controls the settings and parameters associated with phase modulated signal.

Pulse Modulation State

```
:PULM:STATe ON|OFF|1|0
```

```
:PULM:STATe?
```

This command toggles the pulse modulation state between ON and OFF.

The query returns the current pulse modulation state.

Range	ON(1), OFF(0)
*RST value	OFF
Returned data	1, 0
Front panel access	Pulse > Pulse On/Off

Pulse Source

```
:PULM:SOURce INT|EXT
```

```
:PULM:SOURce?
```

This command sets the pulse source to either internal or external source.

The query returns the current pulse modulation source.

Range	INT, EXT
*RST value	INT
Returned data	INT, EXT
Front panel access	Pulse > Pulse Source

Pulse Period

```
:PULM:WIDTh <val> <unit>
```

```
:PULM:WIDTh?
```

This command sets the pulse period of the internally generated pulse modulation signal.

The query returns the current pulse period of the internal pulse source.

Range	200 μ s to 2s
Valid unit	s, ms, us
Minimum increment	1 us
*RST value	200 us
Returned data format	<val> <unit>
Front panel access	Pulse > Pulse Period

Pulse Width

```
:PULM:PERiod <val> <unit>
```

```
:PULM:PERiod?
```

This command sets the pulse width of the internally generated pulse modulation signal.

The query returns the current pulse width of the internal pulse source.

Range	100 us to 1s
Valid unit	s, ms, us
Minimum increment	1 us
*RST value	100 us
Returned data format	<val> <unit>
Front panel access	Pulse > Pulse Width

I/Q Modulation Subsystem

The I/Q modulation subsystem controls I/Q modulation.

Enable I/Q Modulation

```
:IQ:STATE ON|OFF|1|0
```

```
:IQ:STATE?
```

This command toggles the externally generated I/Q modulation state between ON and OFF.

The external I/Q signal must meet the following restrictions, before you enable the I/Q modulation:

- input impedance 50 Ω
- VSWR < 1.5
- Full scale input voltage < 0.5 V_{rms}

The query returns the current state of I/Q modulation.

Range	ON(1), OFF(0)
*RST value	OFF
Returned data	1, 0
Front panel access	I/Q > I/Q On/Off

Utility Subsystem

The commands of the utility subsystem control the settings and parameters associated with the signal generator’s system configurations.

Display Style

```
:SYSTem:DISPlay WHITE|BLUE|GREEN
```

```
:SYSTem:DISPlay?
```

This command sets the display style to any of the following three choices: classic white, modern blue or jade green. The query returns the current display style in use.

Range	WHITE, BLUE, GREEN
*RST value	BLUE
Returned data	WHITE, BLUE, GREEN
Front panel access	Utility > Display Style

Error Messages

```
:SYSTem:ERRor?
```

This is a query only command.

It returns the a decimal value that indicates the error message code number. To interpret the error code number, please refer to “Instrument Messages” on page 173.

Screen Saver

```
:SYSTem:SSAVer ON|OFF|1|0
```

```
:SYSTem:SSAVer?
```

This command toggles the screen saver between On and Off.

If you set the screen saver On, the signal generator turns off its screen after standing by for 15 minutes. Pressing **Local** hardkey turns on screen but also returns the signal generator to Local Control.

The query returns the current screen saver state.

Range	ON (1) , OFF (0)
*RST value	OFF
Returned data	1, 0
Front panel access	Utility > Screen Saver

System Date

```
:SYSTem:DATE <year><month><day>
```

```
:SYSTem:DATE?
```

This command sets the date in the signal generator. Do NOT put a space or comma between the variables <year><month><day>.

The query returns the current date in the signal generator.

Range	<ul style="list-style-type: none"> • Year: 1980 to 2030, four-digit numeric type (YYYY) • Month: 01 to 12, two-digit numeric type (MM) • Day: 01 to 31, two-digit numeric type (DD)
Returned data	<year><month><day>
Front panel access	Utility > Date/Time > Set Date

System Time

:SYSTem:TIME <hour><minute>

:SYSTem:TIME?

This command sets time on the signal generator. Do NOT put a space or comma between the variables <hour><minute>.

The query returns the current time in the signal generator.

-
- | | |
|--------------|---|
| Range | <ul style="list-style-type: none"> • Hour: 00 to 23, two-digit numeric type numeric (HH) • Minute: 0 to 59, two-digit numeric type numeric (MM) |
|--------------|---|

Returned data	<hour><minute><second>
----------------------	------------------------

Front panel access	Utility > Date/Time > Set Time
---------------------------	---

Reference Oscillator Sources

:SYSTem:REfERENCE:FREQuency
 INT10MHZ | EXT2MHZ | EXT5MHZ | EXT10MHZ

:SYSTem:REfERENCE:FREQuency?

This command sets the reference oscillator to any of the four choices:

- internal 10 MHz reference oscillator
- external 2 MHz reference oscillator
- external 5 MHz reference oscillator
- external 10 MHz reference oscillator

The query returns the current reference source.

Range	INT10MHZ, EXT2MHZ, EXT5MHZ, EXT10MHZ
--------------	--------------------------------------

*RST value	INT10MHZ
-------------------	----------

Returned data	INT10MHZ, EXT2MHZ, EXT5MHZ, EXT10MHZ
----------------------	--------------------------------------

Front panel access	Utility > Ref Setups
---------------------------	--------------------------------

Phase Noise Mode

:SYSTem:PNMD NORMAL|RESFM

:SYSTem:PNMD?

This command sets the phase noise mode to either normal mode or optimized residual FM mode (RESFM) .

Range	NORMAL, RESFM
*RST value	NORMAL
Returned data	NORMAL, RESFM
Front panel access	Utility > Opt. Φ Noise

Modulation State Subsystem

```
:MOD:STATE ON|OFF|1|0
```

```
:MOD:STATE?
```

This command enables or disables the modulator.

The query returns the current modulator state.

Range	ON (1), OFF (0)
*RST value	ON
Returned data	1, 0
Front panel access	MOD On/Off

RF Output State Subsystem

```
:RFOutput:STATE ON|OFF|1|0
```

```
:RFOutput:STATE?
```

This command enables or disables the RF output.

The query returns the current RF output state.

Range	ON (1), OFF (0)
*RST value	OFF
Returned data	1, 0
Front panel access	RF On/Off

LF Output Subsystem

The low frequency (LF) subsystem controls the settings and parameters of an LF output signal.

LF Output State

```
:LFOutput:STATE ON|OFF|1|0
```

```
:LFOutput:STATE?
```

This command enables or disables the LF signal output. The query returns the current state of LF output signal.

Range	ON(1), OFF(0)
*RST value	OFF
Returned data	1, 0
Front panel access	LF Out > LF Out On/Off

LF Output Frequency

```
:LFOutput:FREQuency <val> <unit>
```

```
:LFOutput:FREQuency?
```

This command sets the LF output frequency.

The query returns the current LF signal frequency.

Range	20 Hz to 80 kHz
Valid unit	kHz, Hz
Resolution	0.1 Hz
*RST value	1.0000 kHz
Returned data format	<val> <unit>
Front panel access	LF Out > LF Out Freq

LF Output Amplitude

```
:LFOutput:AMPLitude <val> <unit>
```

```
:LFOutput:AMPLitude?
```

This command sets the LF output amplitude.

The query returns the current LF output amplitude.

Range	0 to 3 V
Valid unit	V, mV
Resolution	1 mV
*RST value	500 mV
Returned data format	<val> <unit>
Front panel access	LF Out > LF Out Ampl

Subsystem Command Trees

Subsystem command trees help you to understand command syntax and the hierarchal structure of each command in a subsystem.

Symbols used in Command Trees

Symbol	Caption	Utility
:	Colon	Separates different level keywords
Ⓟ	Space	Separates parameters from keywords and also separates parameters from their units
value	Numeric parameter	Requires you to customize an exact number for the variable
A B	Enumerative or Boolean parameter	Requires you to select a parameter from the list
unit	Unit	use along with numeric parameter
RF	Key word	mnemonics of different levels

Frequency Subsystem

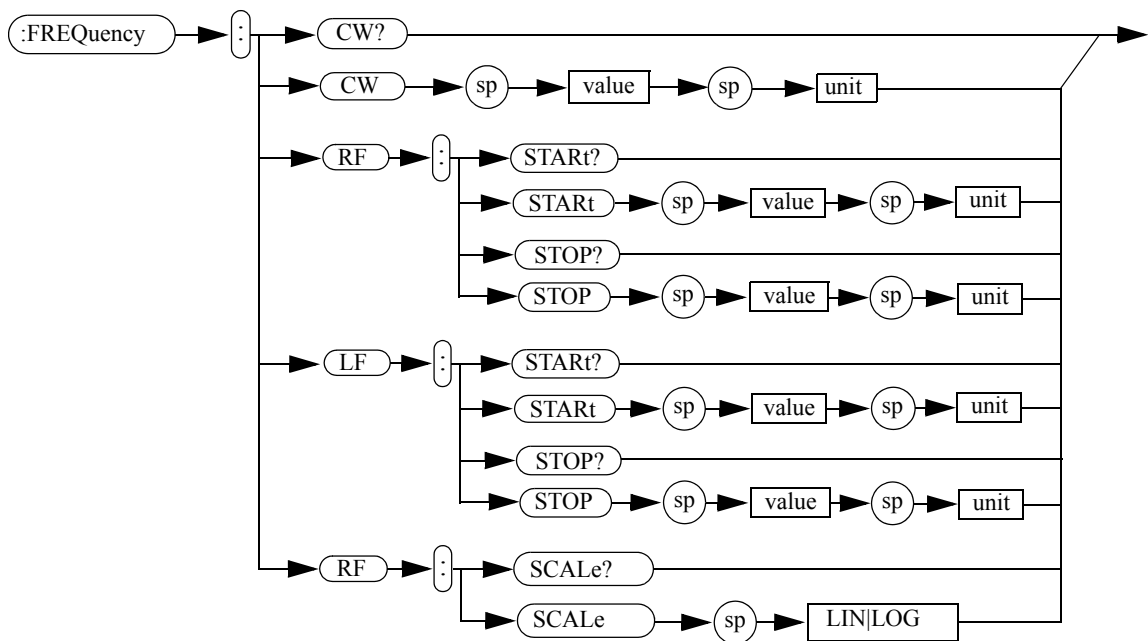

Amplitude Subsystem

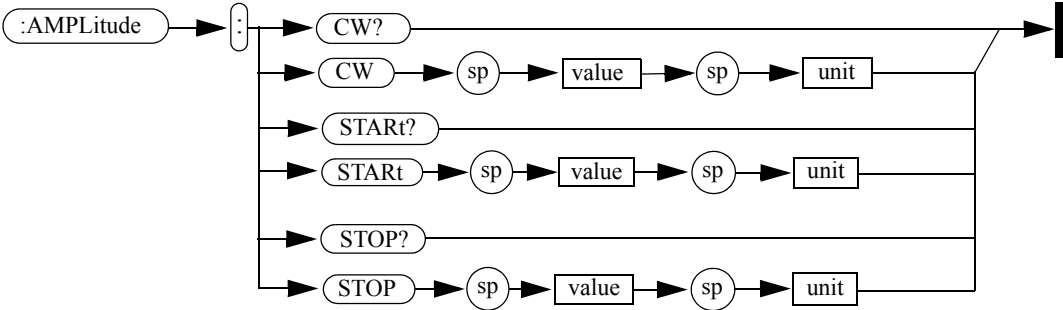

Trigger Subsystem

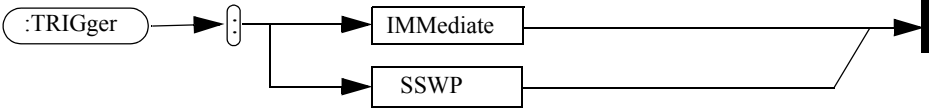

LF Output Subsystem

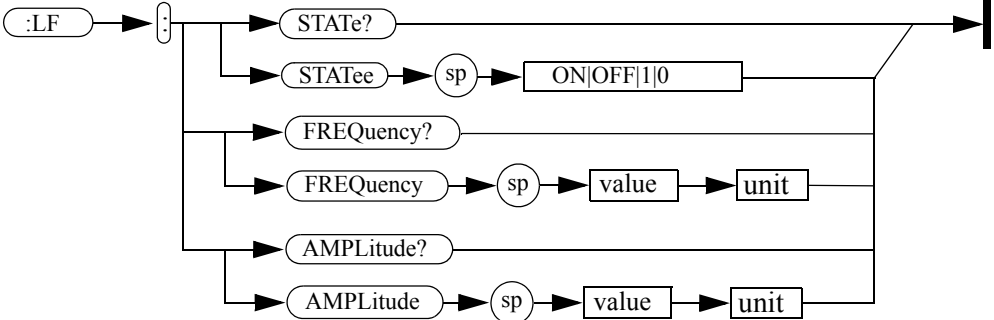

Sweep Subsystem

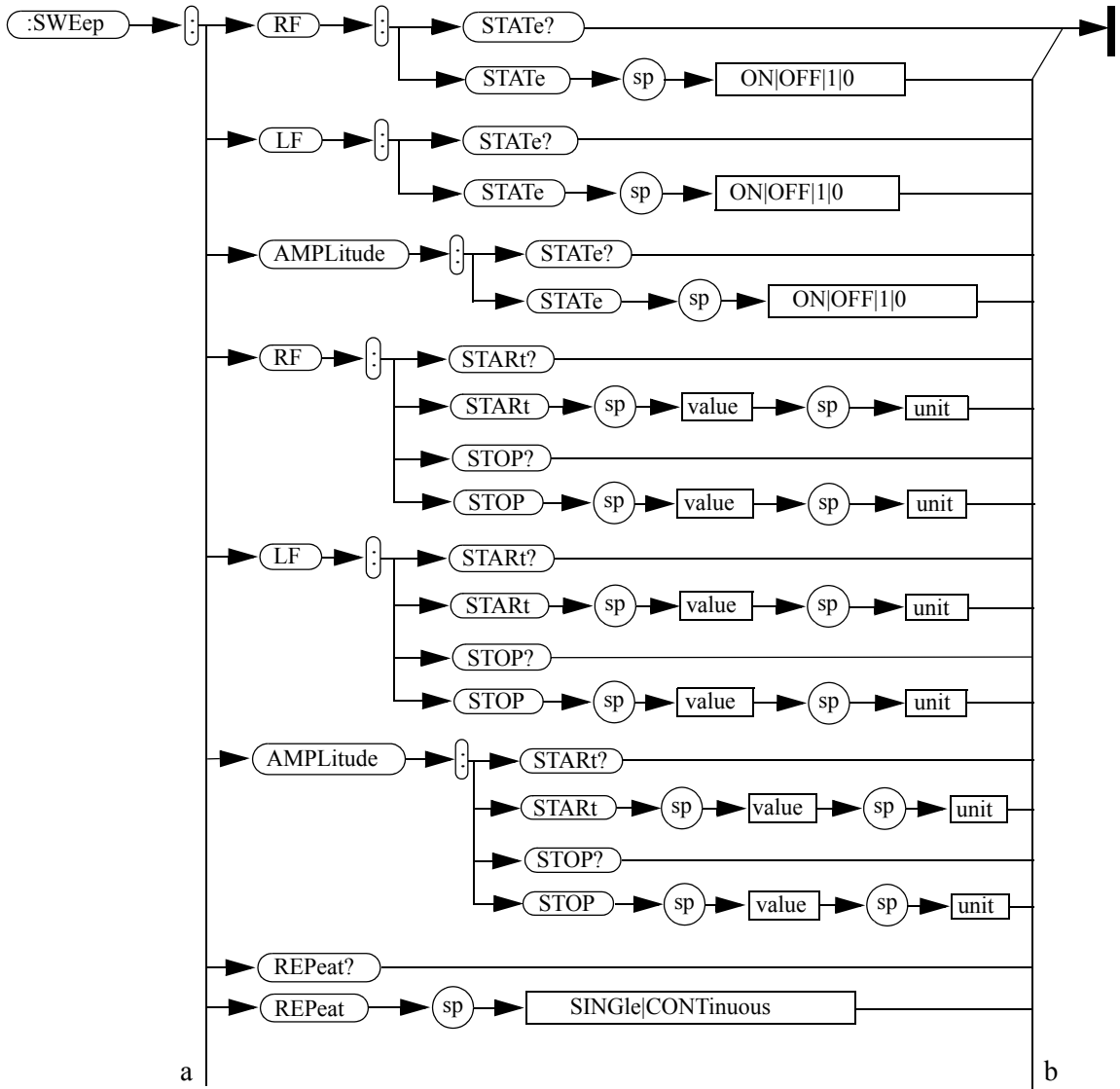

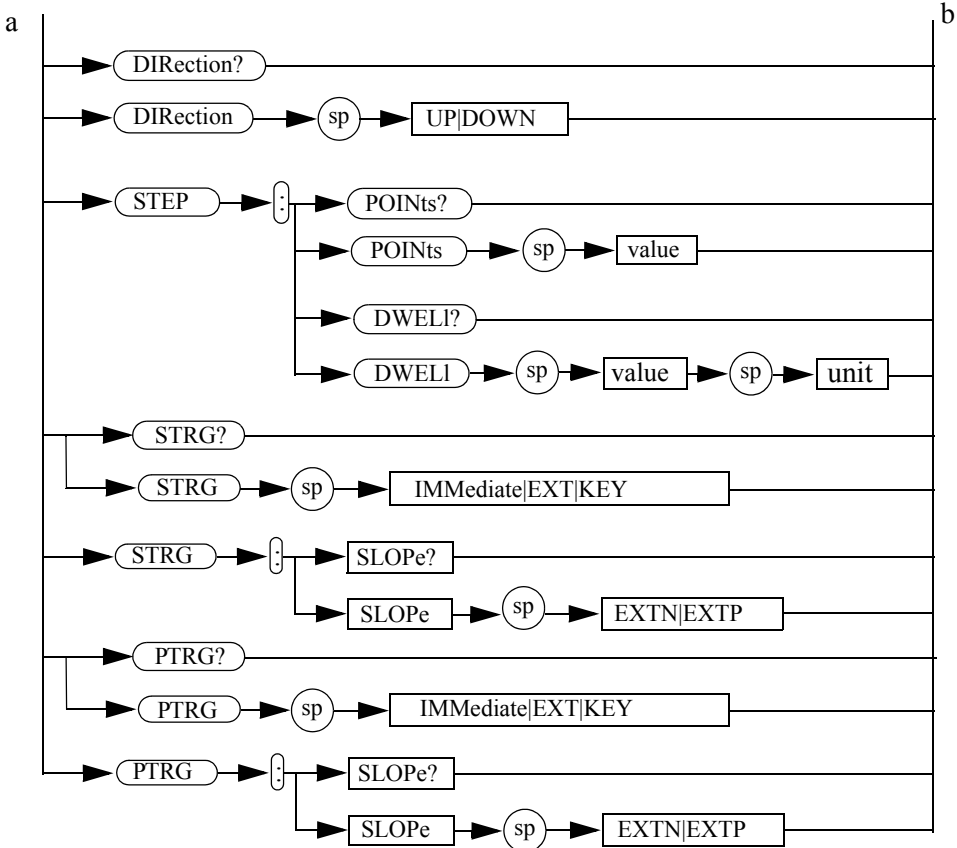

AM Subsystem

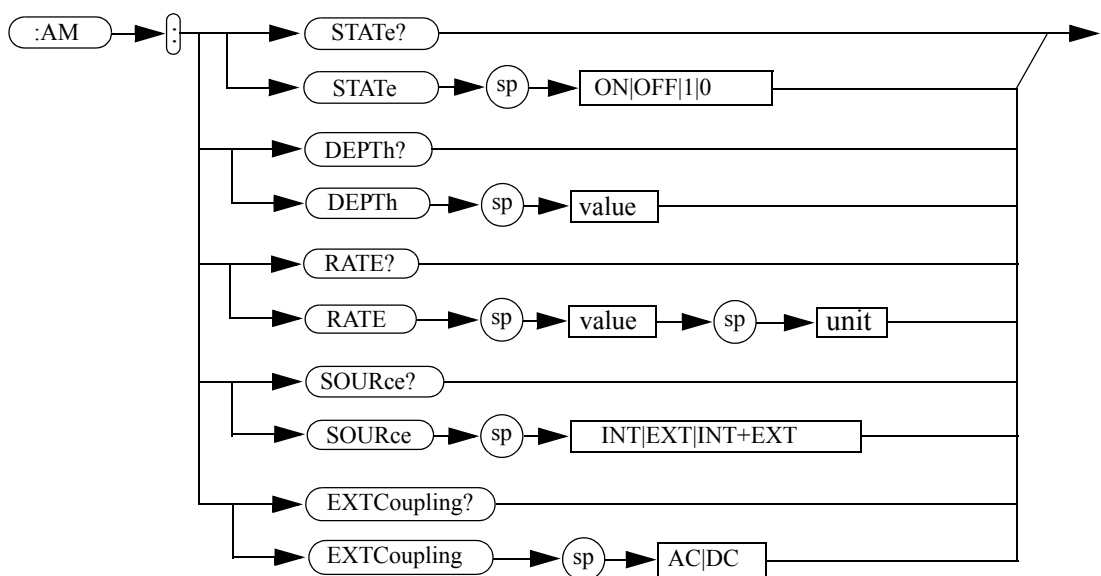

FM Subsystem

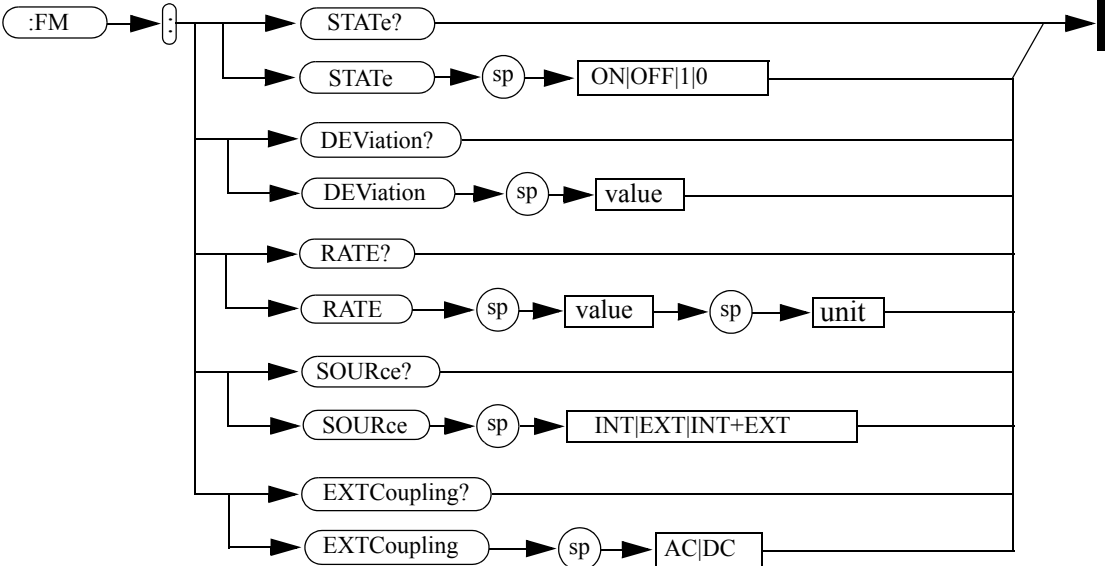

Phase Modulation Subsystem

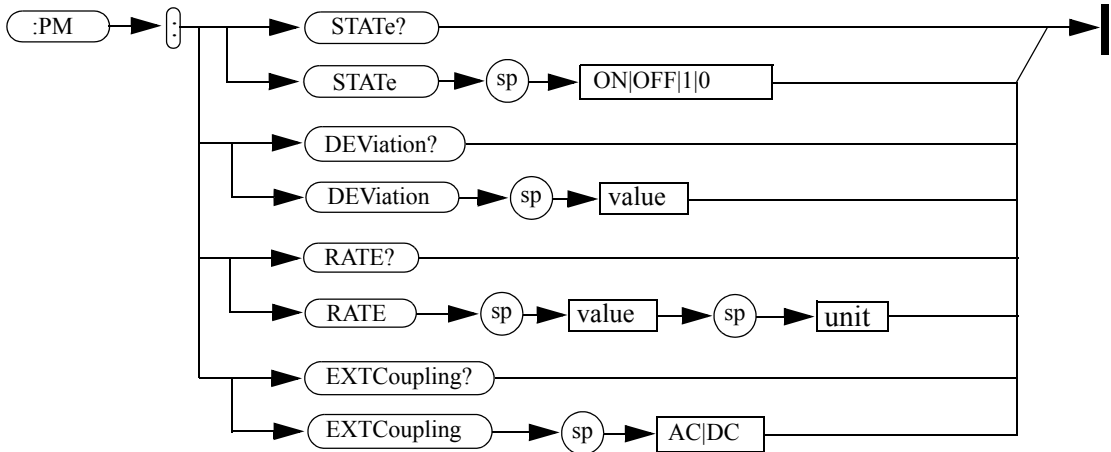

Pulse Modulation Subsystem

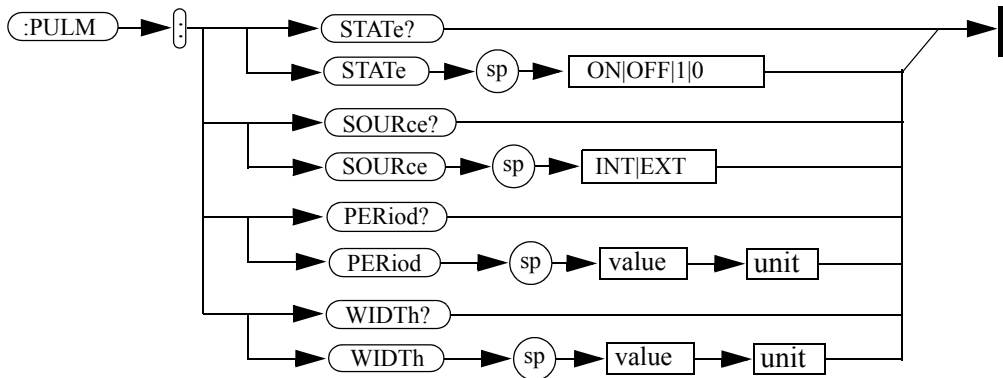

I/Q Modulation Subsystem

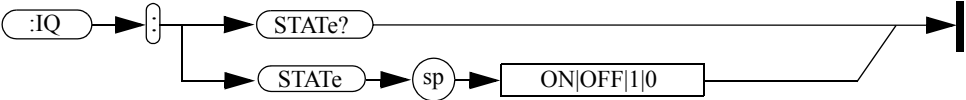

Modulation State Subsystem

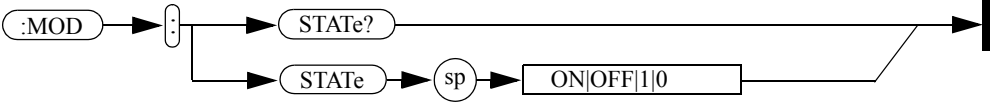

RF Output State Subsystem

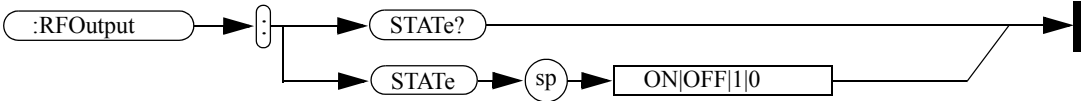

Utility Subsystem

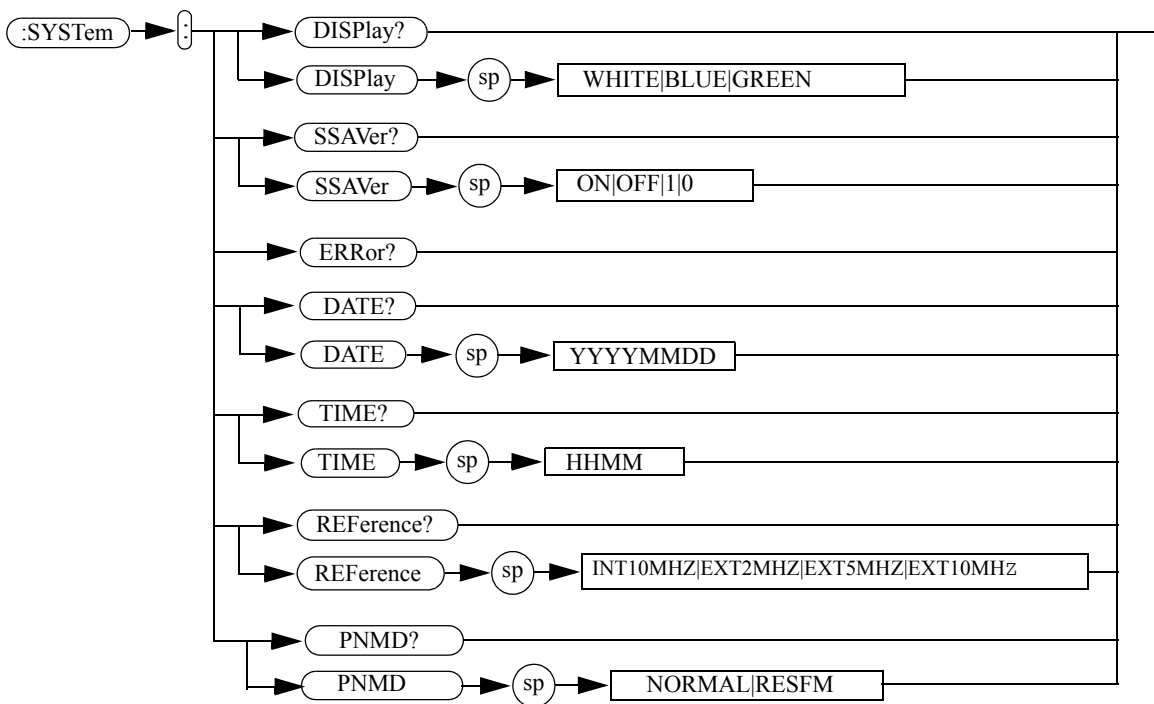

Programming Examples

The programming examples in this section keep to the following 3 conventions:

- The programming examples were written for use on an IBM compatible PC.
- The programming examples use USB interface
- The programming examples are written in C programming language and SCPI programming commands, using Agilent VISA transition library (Agilent VTL).

The Agilent VTL is installed when you installed the Agilent IO libraries suite.

The Agilent IO libraries suite contains the latest Agilent VTL and is available at:

<http://www.agilent.com/find/iolib>

NOTE

Agilent Technology provides programming examples for illustration only. All sample programs assume that you are familiar with the programming language being demonstrated and the tools used to create and debug procedures.

You have a royalty-free right to use, modify, reproduce and distribute the sample application files in any way you find useful, provided that you agree that Agilent has no warranty, obligations, or liability for any sample application files.

Programming in C using the VTL

This section includes basic information about programming in the C language using Agilent VISA transition library (VTL). Note that some of this information may not be relevant to your particular application. For example, if you are not using VXI instruments, the VXI references will not be relevant.

Typical Example Program Contents

The following table summaries the VTL function calls used in the example programs.

visa.h	This file is included at the beginning of the each file to provide the function prototypes and constants defined by VTL. For C and C++ programs, you must include the <code>visa.h</code> header file at the beginning of every file that contains VISA function calls: <code>#include "visa.h"</code>
ViSession	The <code>ViSession</code> is a VTL data type. Each object that will establish a communication channel must be defined as <code>ViSession</code> . Sessions must firstly be opened on the default resource manager, and then for each resource you will be using.
viOpenDefaultRM	You must first open a session with the default resource manager with the <code>viOpenDefaultRM</code> function, and then for each resource you will be using. This function will initialize the default resource manager and return a pointer to that resource manager session. <code>viOpenDefaultRM(&sesn)</code>

viOpen	<p>This function establishes a communication channel with the device specified. A session identifier that can be used with other VTL functions is returned. This call must be made for each device you will be using.</p> <pre>viOpenDefaultRM(&sesn) viOpen(sesn, rsrcName, accessMode, timeout, &vi)</pre>
viWrite	<p>This function synchronously sends the data pointed to by buf to the device specified by vi. Only one synchronous write operation can occur at any one time.</p> <pre>viWrite(vi, buf, count, &retCount)</pre>
viRead	<p>This function synchronously reads raw data from the session specified by the vi parameter and stores the result in location where buf is pointing. Only one synchronous read operation can occur at any one time.</p> <pre>viRead(vi, buf, count, &retCount)</pre>
viClose	<p>This function must be used to close each session. When you close a device session, all data structures that had been allocated for the session will be set free. If you close the default resource manager session, all sessions opened using that resource manager session will be closed.</p> <pre>viClose(vi); viClose(defaultRM)</pre>

Example 1 - Checking USB Connection

Usually, using “*IDN?” verifies the data transferring between the controller PC and the instrument.

```
*****
#include "visa.h"
#include <studio.h>

#define BufferSize 128

static ViStatus status;
static ViSession defaultRM;
static ViSession inst_N9310A;
static ViUInt32 rcount;
static unsigned char buffer[BufferSize];

int main(void)
{
/* Connect N9310A and read its "IDN". */
status = viOpen (defaultRM,
"USB0::2391::8216::0115000001::0::INSTR", VI_NULL,
VI_NULL, &inst_N9310A);
if (STATUS != VI_SUCCESS);
return -1; //failed to connect N9310A

/* Read "IDN" from N9310A" */
status = viWrite (inst_N9310A, "*RST\n",
StringLength("*RST\n"), &rcount);
status = viWrite (inst_N9310A, "*IDN?\n",
StringLength("*IDN?\n"), &rcount);
status = viRead (inst_N9310A, buffer, BufferSize,
&rcount);

/* Close connection to N9310A. */
status = viClose (inst_N9310A);
status = viClose (defaultRM); return 1;
}
```

Programming Comments

Thread	Relevant code
Include the visa.h header file at the beginning of every file that contains VTL function calls.	<code>#include "visa.h"</code>
Open a session on the default resource manager first, and then for the device you will be using.	<code>viOpenDefaultRM (&defaultRM) viOpen (defaultRM, "USB0::2391::8216::0115000001::0::INSTR", VI_NULL, VI_NULL, &inst_N9310A)</code>
Send a *RST command to set the instrument to its default status.	<code>viWrite (inst_N9310A, "*RST\n", StringLength ("*RST\n"), &rcount)</code>
Send a *IDN? query to the instrument.	<code>viWrite (inst_N9310A, "*IDN?\n", StringLength ("*IDN?\n"), &rcount)</code>
Fetch the instrument identity information to the buffer.	<code>viRead (inst_N9310A, buffer, BufferSize, &rcount)</code>
Close device session	<code>viClose (inst_N9310A) viClose (defaultRM)</code>

Example 2 - Generating a CW signal

Assume you wish to generate a CW signal with a frequency of 1 GHz and an amplitude of -10 dBm.

```
*****
int main(void)
{
    status = viOpenDefaultRM (&defaultRM);
    if (status != VI_SUCCESS) return -1;

    status = viOpen (defaultRM,
        "USB0::2391::8216::0115000001::0::INSTR", VI_NULL,
        VI_NULL, &INST_N9310A);
    if (status != VI_SUCCESS) return -1;

    /* Setup N9310A to generate a CW wave. */
    status = viWrite (inst_N9310A, "*RST\n",
        StringLength("*RST\n"), &rcount)

    status = viWrite (inst_N9310A, "FREQ:CW 1 GHz\n",
        StringLength("FREQ:CW 1 GHz\n"), &rcount);

    status = viWrite (inst_N9310A, "AMPL:CW -10 dBm\n",
        StringLength("AMPL:CW -10 dBm\n"), &rcount);

    status = viWrite (inst_N9310A, "RFO:STAT ON\n",
        StringLength("RFO:STAT ON\n"), &rcount);

    status = viClose (inst_N9310A);

    status = viClose (defaultRM)

    return 1;
}
```

Programming Comments

Thread	Relevant code
Open a session on the default resource manager first, and then for the device you will be using.	<pre>viOpenDefaultRM (&defaultRM) viOpen (defaultRM, "USB0::2391::8216::0115000001::0::INSTR", VI_NULL, VI_NULL, &inst_N9310A)</pre>
Preset the signal generator	<pre>viWrite (inst_N9310A, "*RST\n", StringLength("*RST\n"), &rcount)</pre>
Set the frequency and amplitude of the CW signal	<pre>status = viWrite (inst_N9310A, "FREQ:CW 1 GHz\n", StringLength("FREQ:CW 1 GHz\n"), &rcount); status = viWrite (inst_N9310A, "AMPL:CW -10 dBm\n", StringLength("AMPL:CW -10 dBm\ n"), &rcount);</pre>
Enable the RF output	<pre>viWrite (inst_N9310A, "RFO:STAT ON\n", StringLength("RFO:STAT ON\n"), &rcount);</pre>
Close device session	<pre>viClose (inst_N9310A) viClose (defaultRM)</pre>

Example 3 - Generating an AM Signal

Assume you wish to generate an AM signal, with the following characters:

- AM depth = 80 %
- AM rate = 10 kHz
- AM source = internal source
- CW. frequency = 1 GHz
- CW. amplitude = -10 dBm

```
*****
/* Setup N9310A to generate an AM wave. */
int main(void)
{
    status = viOpenDefaultRM (&defaultRM);
    if (status != VI_SUCCESS) return -1;

    status = viOpen (defaultRM,
        "USB0::2391::8216::0115000001::0::INSTR", VI_NULL,
        VI_NULL, &INST_N9310A);
    if (status != VI_SUCCESS) return -1;

    /* Configure the carrier. */
    status = viWrite (inst_N9310A, "*RST\n",
        StringLength("*RST\n"), &rcount);

    status = viWrite (inst_N9310A, "FREQ:CW 1 GHz\n",
        StringLength("FREQ:CW 1 GHz\n"), &rcount);

    status = viWrite (inst_N9310A, "AMPL:CW -10 dBm\n",
        StringLength("AMPL:CW -10 dBm\n"), &rcount);

    /* Configure the AM. */
    status = viWrite (inst_N9310A, "AM:DEPT 80\n",
        StringLength("AM:DEPT 80\n"), &rcount);

    status = viWrite (inst_N9310A, "AM:RATE 10 kHz\n",
        StringLength("AM:RATE 10 kHz\n"), &rcount);

    /* Enable AM and RF output. */
    status = viWrite (inst_N9310A, "AM:STAT ON\n",
        StringLength("AM:STAT ON\n"), &rcount);
}
```



```

status = viWrite (inst_N9310A, "RFO:STAT ON\n",
StringLength("RFO:STAT:ON"\n, &rcount);
/* Close session. */
status = viClose (inst_N9310A);
status = viClose (defaultRM)
return 1;
}

```

Programming Comments

Thread	Relevant code
Open a session on the default resource manager first, and then for the device you will be using.	<pre> viOpenDefaultRM (&defaultRM) viOpen (defaultRM, "USB0::2391::8216::0115000001::0::INSTR", VI_NULL, VI_NULL, &inst_N9310A) </pre>
Preset the signal generator	<pre> viWrite (inst_N9310A, "*RST\n", StringLength("*RST\n"), &rcount) </pre>
Set the frequency and amplitude of the CW signal	<pre> viWrite (inst_N9310A, "FREQ:CW 1 GHz\n", StringLength("FREQ:CW 1 GHz\n"), &rcount) viWrite (inst_N9310A, "AMPL:CW -10 dBm\n", StringLength("AMPL:CW -10 dBm\n"), &rcount) </pre>
Set AM depth and AM rate	<pre> viWrite (inst_N9310A, "AM:DEPT 80\n", StringLength("AM:DEPT 80\n"), &rcount) viWrite (inst_N9310A, "AM:RATE 10 kHz\n", StringLength("AM:RATE 10 kHz\n"), &rcount) </pre>
Enable AM	<pre> viWrite (inst_N9310A, "AM:STAT ON\n", StringLength("AM:STAT:ON\n"), &rcount) </pre>
Enable the RF output	<pre> viWrite (inst_N9310A, "RFO:STAT ON\n", StringLength("RFO:STAT:ON\n"), &rcount) </pre>
Close device session	<pre> viClose (inst_N9310A) viClose (defaultRM) </pre>

NOTE

After presetting the signal generator, the AM source is set to internal source and the modulation state is set to On by default. The commands to set the AM source and the Modulation state are omitted in this example.

Example 4 - Generating an continuous RF Sweep

Assume you wish to initiate an RF sweep, with the following characters:

- RF sweeps from 1 GHz to 2 GHz
- Sweeps across 90 points linearly
- Dwells for 20 ms for each point
- Repeats sweep continuously
- Triggers immediately and continuously over all points

```
*****
/* Setup N9310A to generate an continuous RF
output. */
int main(void)
{
    status = viOpenDefaultRM (&defaultRM);
    if (status != VI_SUCCESS) return -1;
    status = viOpen (defaultRM,
        "USB0::2391::8216::0115000001::0::INSTR", VI_NULL,
        VI_NULL, &INST_N9310A);
    if (status != VI_SUCCESS) return -1;
    /* Configure an RF sweep. */
    status = viWrite (inst_N9310A, "*RST\n",
        StringLength("*RST\n"), &rcount);
    status = viWrite (inst_N9310A, "SWE:RF:STAR 1 GHz\n",
        StringLength("SWE:RF:STAR 1 GHz\n"), &rcount);
    status = viWrite (inst_N9310A, "SWE:RF:STOP 2 GHz\n",
        StringLength("SWE:RF:STOP 2 GHz\n"), &rcount);
    status = viWrite (inst_N9310A, "SWE:STEP:POIN 90\n",
        StringLength("SWE:STEP:POIN 90\n"), &rcount);
    status = viWrite (inst_N9310A, "SWE:STEP:DWEL 20
ms\n", StringLength("SWE:STEP:DWEL 20 ms\n"),
        &rcount);
    /* Enable RF sweep & initiate the RF sweep. */
    status = viWrite (inst_N9310A, "RFO:STAT ON\n",
        StringLength("RFO:STAT ON\n"), &rcount);
}
```

```

status = viWrite (inst_N9310A, "SWE:RF:STAT ON\n",
StringLength("SWE:RF:STAT ON\n"), &rcount);
/* Close session. */
status = viClose (inst_N9310A);
status = viClose (defaultRM);
return 1;
}

```

Programming Comments

Thread	Relevant code
Open a session on the default resource manager first, and then for the device you will be using.	<pre> viOpenDefaultRM (&defaultRM) viOpen (defaultRM, "USB0::2391::8216::0115000001::0::INSTR", VI_NULL, VI_NULL, &inst_N9310A) </pre>
Preset the signal generator	<pre> viWrite (inst_N9310A, "*RST\n", StringLength("*RST\n"), &rcount) </pre>
Set the start frequency and the stop frequency	<pre> viWrite (inst_N9310A, "SWE:RF:STAR 1 GHz\n", StringLength("SWE:RF:STAR 1 GHz\n"), &rcount) viWrite (inst_N9310A, "SWE:RF:STOP 2 GHz\n", StringLength("SWE:RF:STOP 2 GHz\n"), &rcount) </pre>
Set the number of points and dwell time for each point	<pre> viWrite (inst_N9310A, "SWE:STEP:POIN 90\n", StringLength("SWE:STEP:POIN 90\n"), &rcount) viWrite (inst_N9310A, "SWE:STEP:DWEL 20 ms\n", StringLength("SWE:STEP:DWEL 20 ms\n"), &rcount) </pre>
Enable RF output	<pre> viWrite (inst_N9310A, "RFO:STAT ON\n", StringLength("RFO:STAT ON\n"), &rcount) </pre>
Enable RF sweep	<pre> viWrite (inst_N9310A, "SWE:RF:STAT ON\n", StringLength("SWE:RF:STAT ON\n"), &rcount) </pre>
Close device session	<pre> viClose (inst_N9310A) viClose (defaultRM) </pre>

NOTE

After presetting the signal generator, the Sweep Repeat is set to CONT, Sweep Direction is set to UP and Sweep trigger and Point trigger is set to IMMEDIATE by default. The commands to set the Sweep Repeat, Sweep Direction, Sweep trigger and Point trigger are omitted in this example.



7 Instrument Messages

Overview	174
Command Errors	175
Execution Conflict	178
System Errors	179
Hardware Errors	180



Overview

The instrument messages include system messages and error messages.

System messages

If an improper operation occurs during the instrument configuration, a system message displays in the text area of the screen, indicating the incident and the how the signal generator corrected the setting automatically. The system messages will be cleared automatically after a period of 30 seconds.

Error messages

If a system error or a hardware error occurs, the error messages will appear on the screen and an ERR annunciator displays also on the screen. Then you need to press  > **Error Info** to read the specific descriptions of those error messages.

Example

In this example, an explanation is generally included with each error to further clarify its meaning. The instrument messages in this guide are listed numerically.

<Code>

-222

Data out of range;

<Message>

Value clipped to lower limit.

<Description>

Indicates that the user has entered a deviation, depth or internal source frequency that is beyond the specified limits.

<Explanation in manual>

Command Errors

The messages listed below are command errors, which are saved into local registers. Press  > **Error Info** to read or delete them.

- 100 Command error;
An unrecognized command or data type was encountered. This message is used when the device cannot detect more specifics described for errors -101 to -109.
- 101 Invalid character;
A syntactic element contains an invalid character.
- 102 Syntax error;
An unrecognized command or data type was encountered.
- 103 Invalid separator;
The parser recognized a separator that is not allowed.
- 108 Parameter not allowed;
More parameters were received than expected for the header.
- 109 Missing parameter;
Fewer parameters were received than required for the header.
- 110 Command header error;
An error was detected in the header. This message is used when the device cannot detect more specifics described for errors -111 to -119.

- 111 Header separator error;
A character that is not a legal header separator was encountered while parsing the header.

- 112 Program mnemonic too long;
The header contains more than 12 characters.

- 113 Undefined header;
The header is correct in syntax, but it is undefined for this device.

- 120 Numeric data error;
An error occurred when parsing a data element that appears to be numeric including non-decimal numeric types. Specific details are not available.

- 121 Invalid character in numeric;
An invalid character for the data type being parsed was encountered.

- 124 Too many digits;
The mantissa of a decimal-numeric data element contained more than 20 digits excluding leading zeros.

- 128 Numeric data not allowed;
A legal numeric data element was received, but the device does not accept one in this position for the header.

- 130 Suffix error;

This error is generated when parsing a suffix. This message is used when the device cannot detect more specifics described for errors -101 to -109.

- 131 Invalid suffix;
The suffix does not follow the syntax described in *IEEE 488.2*, or the suffix is inappropriate for the device.

- 134 Suffix too long;
The suffix contained more than 12 characters.

- 138 Suffix not allowed;
A suffix was encountered after a numeric element which does not allow suffixes.

- 140 Character data error;
This error is generated when parsing a character data element. This particular error message should be used if the device cannot detect a more specific error.

- 141 Invalid character data;
Either the character data element contains an invalid character or the particular element received is not valid for the header.

- 144 Character data too long;
The character data element contains more than twelve characters.

- 148 Character data not allowed;
A legal character data element was encountered where prohibited by the device.

Execution Conflict

The system messages listed below are execution conflicts, indicating settings conflict during your operation. These messages will be cleared from the screen by the signal generator automatically 30 seconds later since they were generated.

- 221 Setting conflict;
start frequency must be smaller than stop frequency.
- 221 Setting conflict;
start amplitude must be smaller than stop amplitude.
- 221 Setting conflict;
AM cannot be enabled with I/Q or pulse.
- 221 Setting conflict;
FM cannot be enabled together with Φ M.
- 221 Setting conflict;
LF cannot be enabled together with AM/FM/ Φ M/LF sweep.
- 221 Setting conflict;
Pulse width must be narrower than pulse period.
- 221 Setting conflict;
 Φ M deviation range is decided by Φ M rate.
- 221 Setting conflict;
AM carrier frequency cannot be lower than 100 kHz.
- 221 Setting conflict;
Modulation rate must be lower than carrier frequency.
- 222 Value clipped to upper limit.
- 222 Value clipped to lower limit.
- 255 Media/Directory full.

System Errors

- 310 System error;
write file error.
An attempt to write to a file has failed.
- 310 System error;
Recall file error.
Error encountered while loading system files.
- 310 System error;
Error detecting USB peripheral device.
Error encountered while attempt to detecting USB peripheral device. For example, Set **Catalog** to **USB** without USB device inserted.
- 310 System error;
File name exists, can not save current file.
Current file can not cover the existed file with the same file name.
- 313 Calibration memory lost;
Error locating calibration file.
An expected file was not found while trying to load internal calibration.

Hardware Errors

501 Mother board +15 V power supply failed.
501 Mother board -15 V power supply failed.
501 Mother board +24 V power supply failed.
501 Mother board +5 V power supply failed.
601 Digital board +5 V power supply failed.
601 Digital board +15 V power supply failed.
601 Digital board -15V power supply failed.
601 Digital board +5 V power supply failed.
601 Digital board -5V power supply failed.
601 Digital board +17V power supply failed.
601 Digital board +8.3V power supply failed.
601 Digital board +34V power supply failed.
602 Digital VCO failed.
Digital 100M VCO failed.
702 Analog board VCO unlock.
703 Analog board VCO 4G PLL unlocked.
704 Analog board level error at 4G-7G.
705 Analog board level error at 4G.
706 Analog board level error at 9k-3G.



8 Supplementary Information

Check the Basics	182
Read the warranty	183
Contact Agilent Technologies	184
List of Commands	185

This Chapter contains information on instrument troubleshooting, service, and SCPI commands.



Check the Basics

When having difficulties with the signal generator, check its functionality using the following steps:

- Is there AC power at the power connector?
- Is the signal generator turned on? Listen for internal fan noise to determine if the cooling fan is running. Feel the right side of the signal generator to check for air flow.
- When using other equipment, cables, and connectors with the signal generator, make sure to have them connected properly, and that they are operating correctly.
- Review the operation procedures from when the problem first appeared. Are all the settings correct?
- If the signal generator is not functioning as expected, return the signal generator to a known state by pressing **Preset** hardkey.
- Are measurements and results within the specification and capabilities of the signal generator? Refer to the *Technical Overview* for your generator.
- Is the signal generator displaying an error message? If so, refer to the [Chapter 7](#), “Instrument Messages”.

WARNING

There are no serviceable components in the signal generator. To prevent Electrical shock, please do not disassemble the signal generator. Contact Agilent Technologies or a professional service provider.

NOTE

A button cell battery provides power to the real time clock of the signal generator. It is not rechargeable. If the N9310A seems to be encountering a clock defect, contact the nearest Agilent Customer Contact Center (CCC) for service.

Read the warranty

Agilent technologies provides a one year standard warranty. The warranty information for the signal generator is in the back of your *Technical Overview*. Please read it and become familiar with its terms.

If the signal generator is covered by a separate maintenance agreement, please check it and be familiar with its terms.

Agilent Technologies offers several optional maintenance plans to service the signal generator after its warranty has expired. Call the nearest Agilent Technologies sales office for full details.

To provide in house service for the signal generator after the warranty expires, a service guide can be purchased that provides all necessary test and maintenance information.

NOTE

The calibration cycle of N9310A RF signal generator is one year.

Contact Agilent Technologies

Agilent Technologies has offices around the world to provide you with complete support for your source. To obtain servicing information or to order replacement parts, contact the Agilent Technologies customer contact center listed below. In any correspondence or telephone conversations, refer to your signal generator by its product number and full serial number.

Online help: <http://www.agilent.com/find/assist>

United State

(tel) 800 829 4444
(fax) 800 829 4433

Canada

(tel) 877 894 4414
(fax) 800 746 4866

Europe

(tel) +31 20 547 2111

Korea

(tel) 080 769 0800
(fax) 080 769 0900

Japan

(tel) 0120 802 363
(fax) 0120 660 524

Latin America

(tel) +1 (305) 269 7500

China

(tel) 800 810 0189
(fax) 800 820 2816

Taiwan

(tel) 0800 047 866
(fax) 0800 286 331

Australia

(tel) 1 800 629 485
(fax) +61 (3) 9210 5947

Other Pacific Countries

(tel) +65 6375 8100
(fax) +65 6755 0042

E-mail: tm_ap@agilent.com

List of Commands

SCPI Command	Page #
:FREQuency:CW <val> <unit> :FREQuency:CW?	page 109
:FREQuency:RF:STARt <val> <unit> :FREQuency:RF:STARt?	page 110
:FREQuency:RF:STOP <val> <unit> :FREQuency:RF:STOP?	page 110
:FREQuency:LF:STARt <val> <unit> :FREQuency:LF:STARt?	page 111
:FREQuency:LF:STOP <val> <unit> :FREQuency:LF:STOP?	page 111
:FREQuency:RF:SCALe LOG LIN :FREQuency:RF:SCALe?	page 112
:AMPLitude:CW <val> <unit> :AMPLitude:CW?	page 113
:AMPLitude:STARt <val> <unit> :AMPLitude:STARt?	page 114
:AMPLitude:STOP <val> <unit> :AMPLitude:STOP?	page 114
:TRIGger:IMMediate	page 115
:TRIGger:SSWP	page 115
:SWEep:RF:STATe ON OFF 1 0 :SWEep:RF:STATe?	page 116
:SWEep:LF:STATe ON OFF 1 0 :SWEep:LF:STATe?	page 117
:SWEep:AMPLitude:STATe ON OFF 1 0 :SWEep:AMPLitude:STATe?	page 118
:SWEep:RF:STARt <val> <unit> :SWEep:RF:STARt?	page 119

SCPI Command	Page #
:SWEep:LF:START <val> <unit> :SWEep:LF:START?	page 120
:SWEep:RF:STOP <val> <unit> :SWEep:RF:STOP?	page 119
:SWEep:LF:STOP <val> <unit> :SWEep:LF:STOP?	page 120
:SWEep:AMPLitude:START <val> <unit> :SWEep:AMPLitude:START?	page 121
:SWEep:AMPLitude:STOP <val> <unit> :SWEep:AMPLitude:STOP?	page 121
:SWEep:STEP:POINTs <val> :SWEep:STEP:POINTs?	page 122
:SWEep:STEP:DWELl <val> <unit> :SWEep:STEP:DWELl?	page 122
:SWEep:REPeat SINGLE CONTInuous :SWEep:REPeat?	page 128
:SWEep:STRG IMMEDIATE EXT KEY :SWEep:STRG?	page 129
:SWEep:STRG:SLOPe EXTN EXTP :SWEep:STRG:SLOPe?	page 129
:SWEep:PTRG IMMEDIATE EXT KEY :SWEep:PTRG?	page 130
:SWEep:PTRG:SLOPe EXTN EXTP :SWEep:PTRG:SLOPe?	page 131
:SWEep:DIRectIon UP DOWN :SWEep:DIRectIon?	page 131
:AM:STATe ON OFF 1 0 :AM:STATe?	page 132
:AM:DEPTH <val> :AM:DEPTH?	page 133

SCPI Command	Page #
:AM:RATE <val> <unit> :AM:RATE?	page 133
:AM:SOURce INT EXT INT+EXT :AM:SOURce?	page 134
:AM:EXTCoupling AC DC :AM:EXTCoupling?	page 134
:FM:STATe ON OFF 1 0 :FM:STATe?	page 135
:FM:DEVIation <val> <unit> :FM:DEVIation?	page 136
:FM:RATE <val> <unit> :FM:RATE?	page 136
:FM:SOURce INT EXT INT+EXT :FM:SOURce?	page 137
:FM:EXTCoupling AC DC :FM:EXTCoupling?	page 137
:PM:STATe ON OFF 1 0 :PM:STATe?	page 138
:PM:DEVIation <val> <unit> :PM:DEVIation?	page 139
:PM:RATE <val> <unit> :PM:RATE?	page 139
:PULM:STATe ON OFF 1 0 :PULM:STATe?	page 140
:PULM:SOURce INT EXT :PULM:SOURce?	page 140
:PULM:PERIod <val> <unit> :PULM:PERIod?	page 141
:PULM:WIDTh <val> <unit> :PULM:WIDTh?	page 141

SCPI Command	Page #
:IQ:STATe ON OFF 1 0 :IQ:STATe?	page 142
:SYSTem:DISPlay WHITE BLUE GREEN :SYSTem:DISPlay?	page 143
:SYSTem:ERRor?	page 143
:SYSTem:SSAVer ON OFF 1 0 :SYSTem:SSAVer?	page 144
:SYSTem:DATE <year><month><day> :SYSTem:DATE?	page 144
:SYSTem:TIME <hour><minute> :SYSTem:TIME?	page 145
:SYSTem:REFEreNce:FREQuency INT10MHz EXT2MHz EXT5MHz EXT10MHz :SYSTem:REFEreNce:FREQuency?	page 145
:SYSTem:PNMD NORMAl RESFM	page 146
:MOD:STATe ON OFF 1 0 :MOD:STATe?	page 147
:RFOutput:STATe ON OFF 1 0 :RFOutput:STATe?	page 148
:LFOutput:STATe ON OFF 1 0 :LFOutput:STATe?	page 149
:LFOutput:FREQuency <val> <unit> :LFOutput:FREQuency?	page 150
:LFOutput:AMPLitude <val> <unit> :LFOutput:AMPLitude?	page 150

Index

Numerics

- 001,option, 3
- 1CM,option, 3
- 1TC,option, 3

A

- AC power cord
 - connection, 19
 - localization, 20
- Agilent Technologies
 - contact, 184
- AM, 54
 - annunciator, 7
 - depth, 55
 - example, 43
 - generate, 43
 - on/off, 54
 - rate, 55
 - source, 55
- Amplitude area, 7
- Amplitude hardkey, 4, 57
- annunciators, 7
- ARMED annunciator, 7
- arrow keys, 5, 58

B

- backspace, 66

C

- CE mark, 11

- check the shipment, 14
- connector, maintenance, 28

connectors

- I IN, 10
- LF Out, 6
- MOD IN, 10
- PULSE MOD IN, 10
- Q IN, 10
- REF IN, 10
- REF OUT, 9
- RF Out, 6
- TRIG IN, 9
- USB device, 10
- USB Host, 9
- VGA, 10

- continuous wave, 31
- CSA mark, 11
- c-tick mark, 11

D

- data, 30
- decimal point, 66
- display, 4
 - display style, 25
 - screen saver, 25

E

- enable option, 25
- Enter hardkey, 4, 58
- ERR annunciator, 7
- Error message, 24
- error message area, 8

- ESD, 21
- external trigger source, 34

F

- factory default settings, 70
- file, 59
 - catalog, 59
 - delete, 60
 - recall, 60
 - save, 60
- file name, 51
- firmware
 - update, 27
- FM, 61
 - deviation, 62
 - example, 44
 - ext coupling, 63
 - generate, 44
 - on/off, 61
 - rate, 62
 - source, 62
- frequency area, 7
- Frequency hardkey, 4, 64
- front panel overview, 4

H

- hardkeys
 - Preset, 70

Index

I

- I/Q, 64
 - annunciator, 8
 - example, 48
 - generate, 47
- instruction manual, 11
- instrument state, 50
- IO libraries suite, 26
- ISM1-A, 11

K

- knob, 5

L

- LF
 - example, 49
 - generate, 49
 - sweep, 38
- LF OUT, 65
 - ampl, 65
 - freq, 65
- LF Out connector, 6

M

- MOD IN, 10
- Mod On/Off, 5
- Mod On/Off hardkey, 66
- modulation, 41
 - simultaneous, 42

N

- numeric keypad, 6, 66

O

- options
 - 001, 3, 25, 64
 - 1CM, 3
 - 1TC, 3

P

- Phase
 - generate, 45
- phase, 67
 - on/off, 67
- Phase example, 45
- power on, 22
- power switch, 9
- pulse, 71
 - deviation, 67
 - example, 46
 - generate, 46
 - on/off, 71
 - period, 72
 - rate, 68
 - source, 71
 - width, 72
- PULSE MOD IN, 10

R

- rack mount, 15
- rear panel overview, 9
- requirements
 - electrical, 19
 - environmental, 18
 - ventilation, 18
- RF On/Off, 5, 66
- RF OUT connector, 6
- RF sweep, 35

S

- safety notice, 17
- save, 50
 - local, 50
 - USB, 51
- simultaneous modulation, 42
- single sweep
 - initiate, 58
- Softkeys, 4
- softkeys, 30

- sweep
 - amplitude, 37
 - configuration, 32
 - generate, 32
 - RF, 35
 - trigger, 33
- switch, 68, 69
 - power, 69
 - standby, 6, 69
- symbols, 11

T

- text area, 8
- TFT, 2
- TRIG IN, 9
- trigger
 - point, 81
 - sweep, 81

U

- update, 27
- USB Device Connectors, 6

V

- ventilation, 18
- VGA connector, 10

W

- warranty, 183
- WEEE, 12



Manufacturer's Name: Agilent Technologies (Chengdu) Co., Ltd.
Manufacturer's Address: No. 116, 1st Street Tuo Xin West
Chengdu Hi-Tech Industrial Development Zone (South),
Chengdu, 610041, China

Declares under sole responsibility that the product as originally delivered

Product Name: RF Signal Generator
Model Number: N9310A
Product Options: This declaration covers all options of the above product(s)

complies with the essential requirements of the following applicable European Directives, and carries the CE marking accordingly:

Low Voltage Directive 2006/95/EC
EMC Directive 2004/108/EC

and conforms with the following product standards:

EMC	Standard	Limit
	IEC 61326-2-1:2005 / EN 61326-2-1:2006	
	<i>Reference Standards</i>	
	CISPR 11:2003 / EN 55011:2007	Class A Group 1
	IEC 61000-4-2:2001 / EN 61000-4-2	4 kV/4 kV contact/air
	IEC 61000-4-3:2002 / EN 61000-4-3	3 V/m, 80-2000 MHz, 1 V/m, 2-2.7 GHz
	IEC 61000-4-4:2004 / EN 61000-4-4	0.5 kV signal lines, 1 kV power lines
	IEC 61000-4-5:2001 / EN 61000-4-5	0.5 kV line-line, 1 kV line-ground
	IEC 61000-4-6:2003 / EN 61000-4-6	3 V, 0.15-80 MHz
	IEC 61000-4-11:2004 / EN 61000-4-11	1 cycle, >95%

Canada: ICES/NMB-001:2006
Australia/New Zealand: AS/NZS CISPR 11:2004

The product was tested in a typical configuration with Agilent Technologies test systems.

Safety
IEC 61010-1:2001 / EN 61010-1:2001
Canada: CAN/CSA-C22.2 No. 61010-1-04,
USA: ANSI/UL 61010-1:2004,

Supplementary Information:

This DoC applies to above-listed products placed on the EU market after:

Sep 28, 2009
Date

Shi Wen
Quality Manager

For further information, please contact your local Agilent Technologies sales office, agent or distributor,
or Agilent Technologies Deutschland GmbH, Herrenberger Straße 130, D 71034 Böblingen, Germany.

www.agilent.com

© Agilent Technologies, Inc. 2006-2010

Printed in China

Jan. 2010



N9310-90001



Agilent Technologies

www.valuetronics.com