

Agilent N1913/1914A EPM Series Power Meters

Service Guide



Agilent Technologies

Notices

© Agilent Technologies, Inc., 2009–2014

No part of this manual may be reproduced in any form or by any means (including electronic storage and retrieval or translation into a foreign language) without prior agreement and written consent from Agilent Technologies, Inc. as governed by United States and international copyright laws.

Manual Part Number

N1913-90009

Edition

Ninth Edition, May 8, 2014

Agilent Technologies, Inc.
5301 Stevens Creek Blvd.
Santa Clara, CA 95052 USA

Warranty

The material contained in this document is provided “as is,” and is subject to being changed, without notice, in future editions. Further, to the maximum extent permitted by applicable law, Agilent disclaims all warranties, either express or implied, with regard to this manual and any information contained herein, including but not limited to the implied warranties of merchantability and fitness for a particular purpose. Agilent shall not be liable for errors or for incidental or consequential damages in connection with the furnishing, use, or performance of this document or of any information contained herein. Should Agilent and the user have a separate written agreement with warranty terms covering the material in this document that conflict with these terms, the warranty terms in the separate agreement shall control.

Technology Licenses

The hardware and or software described in this document are furnished under a license and may be used or copied only in accordance with the terms of such license.

Restricted Rights Legend

U.S. Government Restricted Rights. Software and technical data rights granted to the federal government include only those rights customarily provided to end user customers. Agilent provides this customary commercial license in Software and technical data pursuant to FAR 12.211 (Technical Data) and 12.212 (Computer Software) and, for the Department of Defense, DFARS 252.227-7015 (Technical Data - Commercial Items) and DFARS 227.7202-3 (Rights in Commercial Computer Software or Computer Software Documentation).

Safety Notices

CAUTION

A **CAUTION** notice denotes a hazard. It calls attention to an operating procedure, practice, or the like that, if not correctly performed or adhered to, could result in damage to the product or loss of important data. Do not proceed beyond a **CAUTION** notice until the indicated conditions are fully understood and met.

WARNING

A **WARNING** notice denotes a hazard. It calls attention to an operating procedure, practice, or the like that, if not correctly performed or adhered to, could result in personal injury or death. Do not proceed beyond a **WARNING** notice until the indicated conditions are fully understood and met.

Certification

Agilent Technologies certifies that this product met its published specifications at the time of shipment from the factory. Agilent Technologies further certifies that its calibration measurements are traceable to the United States National Institute of Standard and Technology, to the extent allowed by the Institute's calibration facility, and to the calibration facilities of other International Standard Organization members.

Limitation of Warranty

The foregoing warranty shall not apply to defects resulting from improper or inadequate maintenance by Buyer, Buyer-supplied software or interfacing, unauthorized modification or misuse, operation outside of the environmental specifications for the product, or improper site preparation or maintenance. No other warranty is expressed or implied. Agilent technologies specifically disclaims the implied warranties of merchantability and fitness for a particular purpose.

Exclusive Remedies

The remedies provided herein are buyer's sole and exclusive remedies. Agilent Technologies shall not be liable for any direct, indirect, special, incidental, or consequential damages, whether based on contract, tort, or any other legal theory.

Equipment Operation

Warnings and Cautions

This guide uses warnings and cautions to denote hazards.

WARNING

A WARNING notice denotes a hazard. It calls attention to an operating procedure, practice, or the like that, if not correctly performed or adhered to, could result in personal injury or loss of life. Do not proceed beyond a WARNING notice until the indicated conditions are fully understood and met.

CAUTION

A CAUTION notice denotes a hazard. It calls attention to an operating procedure, practice, or the like that, if not correctly performed or adhered to, could result in damage to the product or loss of important data. Do not proceed beyond a CAUTION notice until the indicated conditions are fully understood and met.

Personal Safety Considerations

This is a Safety Class I product (provided with a protective earthing ground incorporated in the power cord). The mains plug shall only be inserted in a socket outlet provided with a protective earth contact. Any interruption of the protective conductor, inside or outside the instrument, is likely to make the instrument dangerous. Intentional interruption is prohibited. If this instrument is not used as specified, the protection provided by the equipment could be impaired. This instrument must be used in a normal condition (in which all means of protection are intact) only. No operator serviceable parts inside. Refer servicing to qualified personnel. To prevent electrical shock, do not remove covers. For continued protection against fire hazard, replace the line fuse(s) only with fuses of the same type and rating (for example, normal blow, time delay, etc.). The use of other fuses or material is prohibited.

General Safety Considerations

The following general safety precautions must be observed during all phases of operation of this instrument. Failure to comply with these precautions or with specific warnings elsewhere in this manual violates safety standards of design, manufacture, and intended use of the instrument. Agilent Technologies, Inc. assumes no liability for the customer's failure to comply with these requirements.

WARNING


















Before this instrument is switched on, make sure it has been properly grounded through the protective conductor of the ac power cable to a socket outlet provided with protective earth contact. Any interruption of the protective (grounding) conductor, inside or outside the instrument, or disconnection of the protective earth terminal can result in personal injury.

CAUTION

Any adjustments or service procedures that require operation of the instrument with protective covers removed should be performed only by trained service personnel.

Safety Symbols

The following symbols on the instrument and in the documentation indicate precautions which must be taken to maintain safe operation of the instrument.

	Caution, risk of danger. The Instruction Documentation Symbol. The product is marked with this symbol when it is necessary for the user to refer to the instructions in the supplied documentation.		This symbol indicates the operating switch for 'Stand-by' mode. Note, the instrument is NOT isolated from the mains when the switch is pressed. To isolate the instrument, the mains coupler (mains input cord) should be removed from the power supply.
	Alternating current (AC)		Equipment protected throughout by double insulation or reinforced insulation
	Direct current (DC)		On (supply)
	Both direct and alternating current		Off (supply)
	Three-phase alternating current		Caution, risk of electric shock
	Earth (ground) terminal		Caution, hot surface
	Protective conductor terminal		In position of a bi-stable push control
	Frame or chassis terminal		Out position of a bi-stable push control
	Equipotentiality		

Environmental Conditions

This instrument is designed for indoor use. The table below shows the general environmental requirements for this instrument.

Environmental condition	Requirement
Temperature	Operating condition • 0 °C to 55 °C Storage condition • -40 °C to 70 °C
Humidity	Operating condition • Up to 95% RH at 40 °C (non-condensing) Storage condition • Up to 90% RH at 65 °C (non-condensing)
Altitude	Up to 4600 m
Pollution degree	2

Regulatory Information

The Agilent N1913/1914A EPM Series Power Meters comply with the following safety and Electromagnetic Compatibility (EMC) compliances:






Safety compliance

- IEC 61010-1:2010/EN 61010-1:2010 (3rd Edition)
- Canada: CAN/CSA-C22.2 No. 61010-1-12
- USA: ANSI/UL 61010-1 (3rd Edition)

EMC compliance

- IEC 61326-1:2005/EN 61326-1:2006
- CISPR11:2003/EN 55011:2007, Group 1 Class A
- Canada: ICES/NMB-001:Issue 4, June 2006
- Australia/New Zealand: AS/NZS CISPR 11:2004

Regulatory Markings

	<p>The CE mark is a registered trademark of the European Community. This CE mark shows that the product complies with all the relevant European Legal Directives.</p>		<p>The C-tick mark is a registered trademark of the Spectrum Management Agency of Australia. This signifies compliance with the Australia EMC Framework regulations under the terms of the Radio Communication Act of 1992.</p>
<p>ICES/NMB-001</p>	<p>ICES/NMB-001 indicates that this ISM device complies with the Canadian ICES-001. Cet appareil ISM est conforme a la norme NMB-001 du Canada.</p>		<p>This instrument complies with the WEEE Directive (2002/96/EC) marking requirement. This affixed product label indicates that you must not discard this electrical or electronic product in domestic household waste.</p>
	<p>The CSA mark is a registered trademark of the Canadian Standards Association.</p>		<p>This symbol indicates the time period during which no hazardous or toxic substance elements are expected to leak or deteriorate during normal use. Forty years is the expected useful life of the product.</p>

In This Guide...

1 Specifications and Characteristics

This chapter describes the specifications and characteristics of your Agilent N1913/1914A EPM Series power meter.

2 Performance Tests

This chapter contains procedures which allow you to test the power meter's electrical performance to its specifications.

3 Adjustments

This chapter contains checks and adjustments that ensure proper performance of the power meter.

4 Theory of Operation

This chapter describes how each of the power meter's individual assemblies operate.

5 Troubleshooting Guide

This chapter contains troubleshooting procedures for the Agilent N1913/1914A EPM Series power meter.

6 Repair Guide

This chapter details the power meter's replaceable parts. It also explains how to assemble and disassemble the power meter.

7 Contacting Agilent Technologies

This chapter details what to do if you have a problem with your power meter.

THIS PAGE HAS BEEN INTENTIONALLY LEFT BLANK.

Contents

1 Specifications and Characteristics

Introduction	2
Recommended Calibration Interval	3
Power Meter Specifications	4
Power Sensor Specifications	5
Power Meter Supplemental Characteristics	10
Measurement Characteristics	20
Rear Panel Inputs and Output Connections	21
1 mW Power Reference	22
Environmental Conditions	23
Physical Characteristics	24
Regulatory Information	25

2 Performance Tests

Introduction	28
Complete Equipment List	29
1 mW Power Reference Level Test	31
Output Standing Wave Ratio (SWR) Test	33
Zero Set (Average Path)	36
Linearity (Average Path)	37

3 Adjustments

Introduction	40
Power Reference Level Adjustment	40

Table of Contents

4 Theory of Operation

PPMC Assembly	44
Main Board Assembly	45
Calibrator Assembly	46
Front Panel Assembly	47
PSU Assembly	48

5 Troubleshooting Guide

Introduction	50
Power-Up Problems	50
Instrument Self-Test	51
Extended Self-Test	52
Performance Test	52
Power Reference Level Adjustment Problems	53
Communication Interface Failures	53
Additional Diagnostic Tests	53

6 Repair Guide

Introduction	56
Replaceable Parts	57
Tools Required	80
Required Torque Values for Fasteners	81
Disassembly Instructions	82
Reassembly Instructions	88
Disassembly vs Part Replacement	91
Front Panel Disassembly Instructions	93

Front Panel Reassembly Instructions	97
Additional Repair Notes	101
Main Board vs. Rear Panel Assembly	102
Replacing the PPMC Assembly	102
Replacing the Calibrator Semi-Rigid/Split Ferrite	103

7 Contacting Agilent Technologies

Introduction	106
Before Calling Agilent Technologies	107
Check the Basics	108
Instrument Serial Numbers	109
Agilent Sales and Service Offices	110
Returning Your Power Meter for Service	111
Useful Web Pages	112

THIS PAGE HAS BEEN INTENTIONALLY LEFT BLANK.

List of Tables

Table 1-1	Zero set specifications	6
Table 1-2	Zero set (Internal and External) for U2000 Series	8
Table 1-3	Noise multiplier	10
Table 1-4	Power sensor specifications	11
Table 1-5	U2000 Series power sensors specification	13
Table 1-6	8480 Series settling time	15
Table 1-7	E441x and E9300 Series settling time	16
Table 1-8	N8480 Series settling time	18
Table 1-9	U2000 Series settling time	19

THIS PAGE HAS BEEN INTENTIONALLY LEFT BLANK.

List of Figures

Figure 1-1	8480 Series settling time with auto-filter	15
Figure 1-2	E441x Series settling time with auto-filter	16
Figure 1-3	E9300 Series settling time with auto-filter	17
Figure 1-4	N8480 Series settling time with auto-filter	18
Figure 1-5	U2000 Series settling time with auto-filter	19
Figure 2-1	1 mW power reference level test setup connection diagram	31
Figure 2-2	System calibration connection diagram	34
Figure 2-3	Output SWR test setup-open connection diagram	34
Figure 2-4	Output SWR test setup-load connection diagram	35
Figure 6-1	Calibrator assembly and improved calibrator assembly	76
Figure 6-2	Separate the clamshells	82
Figure 6-3	Remove the top clamshell	83
Figure 6-4	Remove the PSU safety cover and cable guide	83
Figure 6-5	Remove the PSU	84
Figure 6-6	Top view with top clamshell removed	84
Figure 6-7	Remove the EMI earth wires	85
Figure 6-8	Disconnect the front panel cable	85
Figure 6-9	Disconnect the semi-rigid cable	86
Figure 6-10	Remove the front panel	86
Figure 6-11	Remove PPMC	86
Figure 6-12	Remove the main board	87
Figure 6-13	Remove the rear panel	87
Figure 6-14	Analog recorder output connections	88
Figure 6-15	Sensor flex connections	89
Figure 6-16	PSU screw locations	90
Figure 6-17	PSU cable routing	90
Figure 6-18	Main board revision markings	102
Figure 6-19	Separate the two halves of the ferrite	103

THIS PAGE HAS BEEN INTENTIONALLY LEFT BLANK.



1 Specifications and Characteristics

Introduction	2
Recommended Calibration Interval	3
Power Meter Specifications	4
Power Sensor Specifications	5
Power Meter Supplemental Characteristics	10
Measurement Characteristics	20
Rear Panel Inputs and Output Connections	21
1 mW Power Reference	22
Environmental Conditions	23
Physical Characteristics	24
Regulatory Information	25

This chapter describes the specifications and characteristics of your Agilent N1913/1914A EPM Series power meter.



Introduction

This chapter details the Agilent N1913/1914A EPM Series power meter specifications and supplemental characteristics.

Specification Definitions

There are two types of product specifications:

- Warranted specifications
- Characteristic specifications

Warranted specifications

Warranted specifications are covered by the product warranty and apply after a 30 minutes warm-up. These specifications are valid over the power meter's operating and environmental range unless otherwise stated and after performing a zero and calibration.

Characteristic specifications

Supplemental characteristics which are shown in italics are intended to provide information useful in applying the power meter by giving typical, but non-warranted performance parameters. These characteristics are shown in *italics* or denoted as "*typical*", "*nominal*", or "*approximate*".

Characteristic information is representative of the product. In many cases, it may also be supplemental to a warranted specification. Characteristic specifications are not verified on all power meters. The types of characteristic specifications can be placed in two groups:

- The first group of characteristic types describes 'attributes' common to all products of a given model or option.

Examples of characteristics that describe 'attributes' are product weight, and 50 Ω input N-type connector. In these examples, product weight is an *approximate* value and a 50 Ω input is *nominal*. These two terms are most widely used when describing a product's 'attributes'.

- The second group of characteristic types describes 'statistically' the aggregate performance of the population of products.

These characteristics describe the expected behavior of the population of products. They do not guarantee the performance of any individual product. No measurement uncertainty value is accounted for in the specification. These specifications are referred to as *typical*.

Conditions

The power meter and power sensor meet its specifications when:

- Stored for a minimum of two hours at a stable temperature within the operating temperature range, and turned on for at least 30 minutes.
- The power meter and power sensor are within their recommended calibration periods.
- Used in accordance to the information provided in the *Agilent N1913/1914A EPM Series Power Meter User's Guide*.

Recommended Calibration Interval

Agilent Technologies recommends a two- years calibration cycle for the N1913/1914A EPM Series power meters.

Power Meter Specifications

Frequency Range

9 kHz to 110 GHz, power sensor dependant

Power Range

-70 dBm to +44 dBm (100 pW to 25 W), power sensor dependant

Power Sensors Compatibility

- Agilent 8480 Series power sensors
- Agilent E9300 E-Series average power sensors
- Agilent E4410 E-Series average power sensors
- Agilent N8480 Series power sensors
- Agilent U2000 Series average USB power sensors

Single Sensor Dynamic Range

- 90 dB maximum (Agilent E-Series power sensors)
- 50 dB maximum (Agilent 8480 Series power sensors)
- 55 dB maximum (Agilent N8480 Series power sensors)
- 80 dB maximum (Agilent U2000 Series USB power sensors)

Display Units

Absolute: Watts (W) or dBm

Relative: Percent (%) or dB

Display Resolution

Selectable resolution of: 1.0, 0.1, 0.01, and 0.001 dB in logarithmic mode, or 1, 2, 3, and 4 significant digits in linear mode

Default Resolution

0.01 dB in logarithmic mode or three digits in linear mode

Power Sensor Specifications

Definitions

Zero Set

In any power measurement, the power meter must initially be set to zero with no power applied to the power sensor. Zero setting is accomplished within the power meter by digitally correcting for residual offsets.

Zero Drift

This parameter is also called long term stability and is the change in the power meter indication over a long time (usually one hour) for a constant input power at a constant temperature, after a defined warm-up interval.

Measurement Noise

This parameter is also known as short term stability and is specified as the change in the power meter indication over a short time interval (usually one minute) for a constant input power at a constant temperature.

Accuracy

Instrumentation

Absolute accuracy^[1]: ± 0.02 dB (Logarithmic) or $\pm 0.5\%$ (Linear). (Refer to the power sensor linearity specification in your power sensor manual to assess overall system accuracy.)

Relative accuracy^[1]: ± 0.04 dB (Logarithmic) or $\pm 1.0\%$ (Linear). (Refer to the power sensor linearity specification in your power sensor manual to assess overall system accuracy.)

[1] Refer to the power sensor linearity specification in your power sensor manual to assess overall system accuracy.

1 Specifications and Characteristics

Zero Set (digital settability of zero): Power sensor dependent (refer to [Table 1-1](#) and [Table 1-3](#)). For Agilent E-Series power sensors, this specification applies when zeroing is performed with the sensor input disconnected from the POWER REF.

Table 1-1 Zero set specifications

Power sensor	Zero set ^[i]
8481A ^[ii]	±50 nW
8481B ^[ii]	±50 mW
8481D ^[ii]	±20 pW
8481H ^[ii]	±5 mW
8482A ^[ii]	±50 nW
8482B ^[ii]	±50 mW
8482H ^[ii]	±5 mW
8483A ^[ii]	±50 nW
8485A ^[ii]	±50 nW
8485D ^[ii]	±20 pW
R8486A ^[ii]	±50 nW
R8486D ^[ii]	±30 pW
Q8486A ^[ii]	±50 nW
Q8486D ^[ii]	±30 pW
V8486A ^[ii]	±200 nW
W8486A ^[ii]	±200 nW
8487A ^[ii]	±50 nW
8487D ^[ii]	±20 pW
E4412A	±50 pW
E4413A	±50 pW
E9300A	±500 pW
E9301A	±500 pW
E9304A	±500 pW

Table 1-1 Zero set specifications (continued)

Power sensor	Zero set ^[i]
E9300B	±500 nW
E9301B	±500 nW
E9300H	±5 nW
E9301H	±5 nW
N8481A (exclude Option CFT) ^[ii]	±25 nW
N8482A (exclude Option CFT) ^[ii]	±25 nW
N8485A (exclude Option CFT) ^[ii]	±25 nW
N8486A R (exclude Option CFT) ^[ii]	±25 nW
N8486A Q (exclude Option CFT) ^[ii]	±25 nW
N8487A (exclude Option CFT) ^[ii]	±25 nW
N8488A (exclude Option CFT) ^[ii]	±25 nW
N8481B (exclude Option CFT) ^[ii]	±25 μW
N8482B (exclude Option CFT) ^[ii]	±25 μW
N8481H (exclude Option CFT) ^[ii]	±2.5 μW
N8482H (exclude Option CFT) ^[ii]	±2.5 μW
N8481A with Option CFT ^[ii]	±63 nW
N8482A with Option CFT ^[ii]	±63 nW
N8485A with Option CFT ^[ii]	±63 nW
N8486A R with Option CFT ^[ii]	±63 nW
N8486A Q with Option CFT ^[ii]	±63 nW
N8487A with Option CFT ^[ii]	±63 nW
N8481B with Option CFT ^[ii]	±63 μW
N8482B with Option CFT ^[ii]	±63 μW
N8481H with Option CFT ^[ii]	±6.3 μW
N8482H with Option CFT ^[ii]	±6.3 μW

^[i] The zero set specifications are tested with Agilent 11730A power sensor cable, 1.5 m (7.5 ft).

1 Specifications and Characteristics

[ii] The zero set specifications are tested at 50 MHz.

Table 1-2 Zero set (Internal and External) for U2000 Series

Power sensor	Range	Zero set (Internal)	Zero set (External)
U2000/1/2A	-60 dBm to -35 dBm	± 1.5 nW	± 600 pW
	-38 dBm to -15 dBm	± 2 nW	± 1.5 nW
	-20 dBm to -9 dBm	± 12 nW	± 10 nW
	-11 dBm to -5 dBm	± 2 μ W	± 500 nW
	-7 dBm to 15 dBm	± 4 μ W	± 1 μ W
	10 dBm to 20 dBm	± 6 μ W	± 5 μ W
U2004A	-60 dBm to -35 dBm	± 2.8 nW	± 600 pW
	-38 dBm to -15 dBm	± 3 nW	± 1.5 nW
	-20 dBm to -9 dBm	± 12 nW	± 10 nW
	-11 dBm to -5 dBm	± 2 μ W	± 500 nW
	-7 dBm to 15 dBm	± 4 μ W	± 1 μ W
	10 dBm to 20 dBm	± 6 μ W	± 5 μ W
U2000/1/2H	-50 dBm to -25 dBm	± 15 nW	± 8 nW
	-28 dBm to -5 dBm	± 20 nW	± 20 nW
	-10 dBm to 1 dBm	± 120 nW	± 100 nW
	-1 dBm to 5 dBm	± 20 μ W	± 20 μ W
	3 dBm to 25 dBm	± 40 μ W	± 30 μ W
	20 dBm to 30 dBm	± 60 μ W	± 60 μ W
U2000/1B	-30 dBm to -5 dBm	± 1.8 μ W	± 800 nW
	-8 dBm to 15 dBm	± 2 μ W	± 2 μ W
	10 dBm to 21 dBm	± 12 μ W	± 10 μ W
	19 dBm to 25 dBm	± 2 mW	± 1 mW
	23 dBm to 44 dBm	± 4 mW	± 2 mW

NOTE

The zero set specifications are only applicable to U2000 Series USB power sensors with serial prefix as shown below:

U2000A Serial prefix MY480/SG480 and above

U2001A Serial prefix MY481/SG481 and above

U2002A Serial prefix MY482/SG482 and above

U2004A Serial prefix MY484/SG484 and above

For power sensors with earlier prefixes, refer to the *Agilent U2000 Series USB Power Sensors Operating and Service Guide*.

Power Meter Supplemental Characteristics

Zero Drift of Sensors

This parameter is also called long term stability and is the change in the power meter indication over a long time (within one hour) at a constant temperature after a 24-hour warm-up of the power meter.

Power sensor dependent (refer to [Table 1-4](#)).

Measurement Noise

Power sensor dependent (refer to [Table 1-3](#) and [Table 1-4](#)).

Averaging effects on measurement noise. Averaging over 1 to 1024 readings is available for reducing noise. [Table 1-4](#) provides the measurement noise for a particular power sensor with the number of averages set to 16 for normal mode and 32 for x2 mode. Use the “Noise Multiplier” for the appropriate mode (normal or x2) and number of averages to determine the total measurement noise value.

For example, for an Agilent 8481D power sensor in normal mode with the number of averages set to 4, the measurement noise is equal to:

$$(<45 \text{ pW} \times 2.75) = <124 \text{ pW}$$

Table 1-3 Noise multiplier

Number of averages	1	2	4	8	16	32	64	128	256	512	1024
Noise Multiplier (Normal Mode)	5.5	3.89	2.75	1.94	1.0	0.85	0.61	0.49	0.34	0.24	0.17
Noise Multiplier (X2 Mode)	6.5	4.6	3.25	2.3	1.63	1.0	0.72	0.57	0.41	0.29	0.2

Table 1-4 Power sensor specifications

Power sensor	Zero drift ^[i]	Measurement ^[ii] noise
Agilent 8481A ^[iv]	<±10 nW	<110 nW
Agilent 8481B ^[iv]	<±10 mW	<110 mW
Agilent 8481D ^[iv]	<±4 pW	<45 pW
Agilent 8481H ^[iv]	<±1 mW	<10 mW
Agilent 8482A ^[iv]	<±10 nW	<110 nW
Agilent 8482B ^[iv]	<±10 mW	<110 mW
Agilent 8482H ^[iv]	<±1 mW	<10 mW
Agilent 8483A ^[iv]	<±10 nW	<110 nW
Agilent 8485A ^[iv]	<±10 nW	<110 nW
Agilent 8485D ^[iv]	<±4 pW	<45 pW
Agilent R8486A ^[iv]	<±10 nW	<110 nW
Agilent R8486D ^[iv]	<±6 pW	<65 pW
Agilent Q8486A ^[iv]	<±10 nW	<110 nW
Agilent Q8486D ^[iv]	<±6 pW	<65 pW
Agilent V8486A ^[iv]	<±40 nW	<450 nW
AgilentW8486A ^[iv]	<±40 nW	<450 nW
Agilent 8487A ^[iv]	<±10 nW	<110 nW
Agilent 8487D ^[iv]	<±4 pW	<45 pW
Agilent E4412A	<±15 pW	<70 pW
Agilent E4413A	<±15 pW	<70 pW
Agilent E9300A ^[iii]	<±150 nW	<700 nW
Agilent E9301A ^[iii]	<±150 nW	<700 nW
Agilent E9304A ^[iii]	<±150 nW	<700 nW
Agilent E9300B ^[iii]	<±150 nW	<700 nW
Agilent E9301B ^[iii]	<±150 nW	<700 nW

1 Specifications and Characteristics

Table 1-4 Power sensor specifications (continued)

Power sensor	Zero drift ^[i]	Measurement ^[ii] noise
Agilent E9300H ^[iii]	<±1.5 nW	<7 nW
Agilent E9301H ^[iii]	<±1.5 nW	<7 nW
Agilent N8481A (exclude Option CFT) ^[iv]	<±3 nW	<80 nW
Agilent N8482A (exclude Option CFT) ^[iv]	<±3 nW	<80 nW
Agilent N8485A (exclude Option CFT) ^[iv]	<±3 nW	<80 nW
Agilent N8486A R (exclude Option CFT) ^[iv]	<±3 nW	<80 nW
Agilent N8486A Q (exclude Option CFT) ^[iv]	<±3 nW	<80 nW
Agilent N8487A (exclude Option CFT) ^[iv]	<±3 nW	<80 nW
Agilent N8488A (exclude Option CFT) ^[iv]	<±3 nW	<80 nW
Agilent N8481B (exclude Option CFT) ^[iv]	<±3 μW	<80 μW
Agilent N8482B (exclude Option CFT) ^[iv]	<±3 μW	<80 μW
Agilent N8481H (exclude Option CFT) ^[iv]	<±0.3 μW	<8 μW
Agilent N8482H (exclude Option CFT) ^[iv]	<±0.3 μW	<8 μW
Agilent N8481A with Option CFT ^[iv]	<±7 nW	<114 nW
Agilent N8482A with Option CFT ^[iv]	<±7 nW	<114 nW
Agilent N8485A with Option CFT ^[iv]	<±7 nW	<114 nW
Agilent N8486A R with Option CFT ^[iv]	<±7 nW	<114 nW
Agilent N8486A Q with Option CFT ^[iv]	<±7 nW	<114 nW
Agilent N8487A with Option CFT ^[iv]	<±7 nW	<114 nW
Agilent N8481B with Option CFT ^[iv]	<±7 μW	<114 μW
Agilent N8482B with Option CFT ^[iv]	<±7 μW	<114 μW
Agilent N8481H with Option CFT ^[iv]	<±0.7 μW	<11.4 μW
Agilent N8482H with Option CFT ^[iv]	<±0.7 μW	<11.4 μW

^[i] Within one hour after zero set, at a constant temperature after a 24-hour warm-up of the power meter.

- [ii] The number of averages at 16 (for normal mode) and 32 (for x2 mode), at a constant temperature, measured over a one minute interval and two standard deviations. For Agilent E-Series power sensors, the measurement noise is measured within the low range. Refer to the relevant power sensor manual for further information.
- [iii] Specification applies to the low power path, 15% to 75% relative humidity.
- [iv] The zero drift and measurement noise specifications are tested at 50 MHz.

Table 1-5 U2000 Series power sensors specification

Power sensor	Range	Zero drift ^[i]	Measurement ^[ii] noise
U2000/1/2A	-60 dBm to -35 dBm	200 pW	1 nW
	-38 dBm to -15 dBm	400 pW	1.5 nW
	-20 dBm to -9 dBm	1.5 nW	15 nW
	-11 dBm to -5 dBm	50 nW	650 nW
	-7 dBm to 15 dBm	500 nW	1 μW
	10 dBm to 20 dBm	2 μW	10 μW
U2004A	-60 dBm to -35 dBm	200 pW	1 nW
	-38 dBm to -15 dBm	400 pW	1.5 nW
	-20 dBm to -9 dBm	1.5 nW	15 nW
	-11 dBm to -5 dBm	50 nW	650 nW
	-7 dBm to 15 dBm	500 nW	1 μW
	10 dBm to 20 dBm	2 μW	10 μW
U2000/1/2H	-50 dBm to -25 dBm	2 nW	10 nW
	-28 dBm to -5 dBm	4 nW	15 nW
	-10 dBm to 1 dBm	15 nW	150 nW
	-1 dBm to 5 dBm	500 nW	6.5 μW
	3 dBm to 25 dBm	5 μW	10 μW
	20 dBm to 30 dBm	20 μW	100 μW

Table 1-5 U2000 Series power sensors specification (continued)

Power sensor	Range	Zero drift ^[i]	Measurement ^[ii] noise
U2000/1B	–30 dBm to –5 dBm	200 nW	1 μW
	–8 dBm to 15 dBm	400 nW	1.5 μW
	10 dBm to 21 dBm	1.5 μW	15 μW
	19 dBm to 25 dBm	50 nW	650 μW
	23 dBm to 44 dBm	500 μW	1 mW

^[i] Within one hour after zero set, at a constant temperature after a 24-hour warm-up of the power meter.

^[ii] The number of averages at 16 (for normal mode) and 32 (for x2 mode), at a constant temperature, measured over a one minute interval and two standard deviations. For Agilent E-Series power sensors, the measurement noise is measured within the low range. Refer to the relevant power sensor manual for further information.

NOTE

The zero drift and measurement noise specifications are only applicable to U2000 Series. USB power sensors with serial prefix as shown below:

- U2000A Serial prefix MY480/SG480 and above
- U2001A Serial prefix MY481/SG481 and above
- U2002A Serial prefix MY482/SG482 and above
- U2004A Serial prefix MY484/SG484 and above

For power sensors with earlier prefixes, refer to the *U2000 Series Operating and Service Guide*.

Settling Time

For Agilent 8480 Series power sensors

0 to 99% settled readings over the GPIB.

Manual filter, 10 dB decreasing power step (refer to [Table 1-6](#)).

Auto filter, default resolution, 10 dB decreasing power step, normal and x2 speed modes (refer to [Figure 1-1](#)).

Table 1-6 8480 Series settling time

Number of averages	1	2	4	8	16	32	64	128	256	512	1024
Settling time (s) (Normal mode)	0.15	0.2	0.3	0.5	1.1	1.9	3.4	6.6	13	27	57
Settling time (s) (X2 mode)	0.15	0.18	0.22	0.35	0.55	1.1	1.9	3.5	6.9	14.5	33

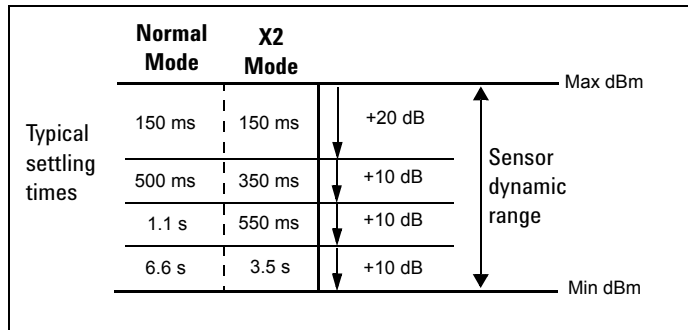


Figure 1-1 8480 Series settling time with auto-filter

1 Specifications and Characteristics

For Agilent E-Series power sensors

For E441X Series and E9300 Series power sensors in normal and x2 speed modes, manual filter, 10 dB decreasing power step (refer to [Table 1-7](#)).

Auto-filter, default resolution, 10dB decreasing power step, normal and x2 speed modes (refer to [Figure 1-2](#) for E441X Series sensors and [Figure 1-3](#) for E9300 Series sensors).

Table 1-7 E441x and E9300 Series settling time

Number of averages	1	2	4	8	16	32	64	128	256	512	1024
Settling time (s) (Normal mode)	0.08	0.13	0.24	0.45	1.1	1.9	3.5	6.7	14	27	57
Settling time (s) (X2 mode)	0.07	0.09	0.15	0.24	0.45	1.1	1.9	3.5	6.7	14	27

* E-Series power sensors in Fast mode (using free run trigger), within the range –50 dBm to +17 dBm, the settling time is:

N1913A: 10 ms

N1914A: 20 ms

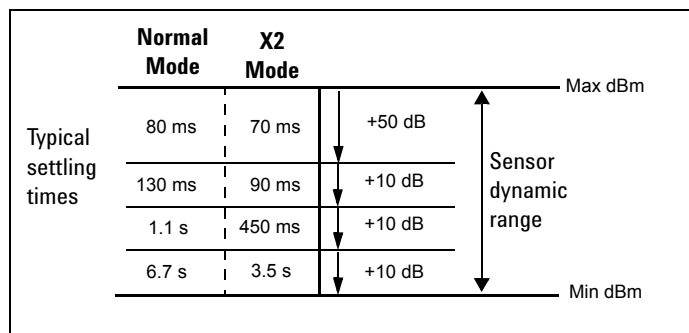


Figure 1-2 E441x Series settling time with auto-filter

	Normal Mode	X2 Mode	
	70 ms	40 ms	Max dBm
High power path	210 ms	120 ms	+10 dBm
	400 ms	210 ms	+2 dBm
	1 s	400 ms	-4 dBm
Typical settling times	70 ms	40 ms	-10 dBm
	120 ms	70 ms	-20 dBm
	1 s	400 ms	-30 dBm
Low power path	6.5 s	3.4 ms	-40 dBm
	13 s	6.8 s	-50 dBm
			Min dBm

Figure 1-3 E9300 Series settling time with auto-filter

1 Specifications and Characteristics

For Agilent N8480 Series power sensors

Typical Settling time: 0 to 99% settled readings over the GPIB.

Auto filter, default resolution, 10 dB decreasing power step, normal and x2 speed modes (refer to [Figure 1-4](#)). Manual filter, 10 dB decreasing power step (refer to [Table 1-8](#)).

Table 1-8 N8480 Series settling time

Number of averages	1	2	4	8	16	32	64	128	256	512	1024
Settling time (s) (Normal mode)	0.15	0.2	0.3	0.5	1.1	1.9	3.4	6.6	13	27	57
Settling time (s) (X2 mode)	0.15	0.18	0.22	0.35	0.55	1.1	1.9	3.5	6.9	14.5	33

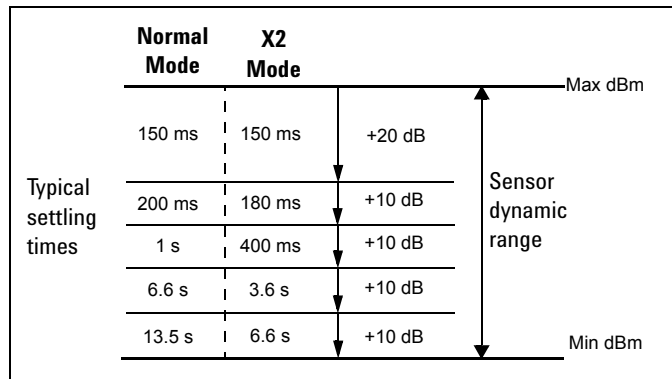


Figure 1-4 N8480 Series settling time with auto-filter

For Agilent U2000 Series power sensors

In FAST mode (using Free Run trigger), for a 10 dB decreasing power step, the settling time is $25\text{ ms}^{[1]}$.

Table 1-9 U2000 Series settling time

Number of averages	1	2	4	8	16	32	64	128	256	512	1024
Settling time ^[i] (s) (Normal mode)	0.045	0.09	0.17	0.34	0.66	1.3	2.6	5.2	10.4	20.9	41.9
Settling time ^[i] (s) (X2 mode)	0.042	0.05	0.09	0.17	0.34	0.66	1.3	2.6	5.2	10.4	20.9

^[i] Manual filter, 10 dB decreasing power step (not across the switching point)

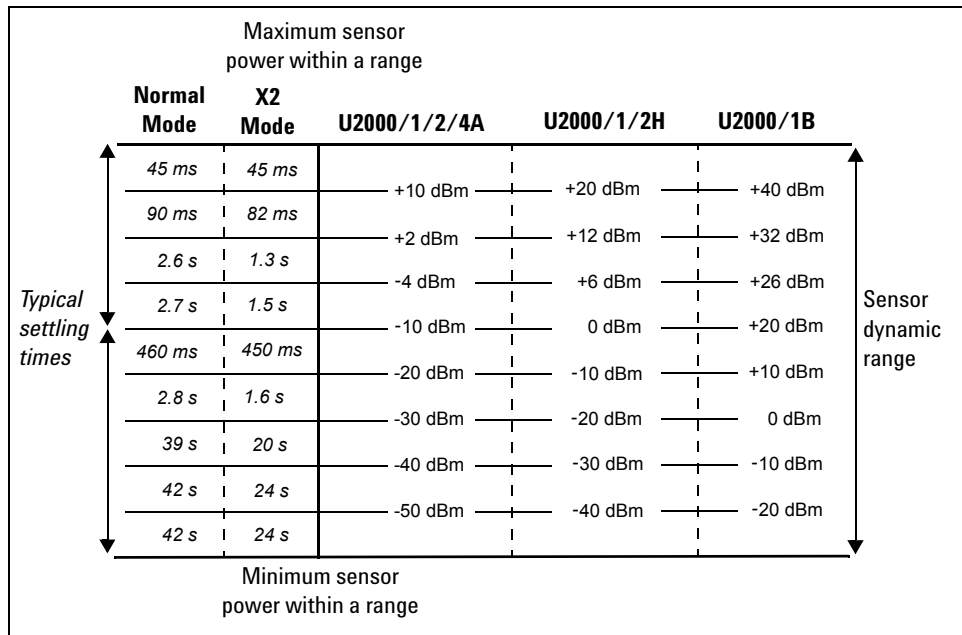


Figure 1-5 U2000 Series settling time with auto-filter

[1] When a power step crosses the auto-range switch point of the sensor, add 25 ms.

Measurement Characteristics

Measurement Speed

Over the GPIB, three measurement speed modes are available as shown, along with the typical maximum measurement speed for each mode:

- Normal: 20 readings/second
- x2: 40 readings/second
- Fast^[1]: 400 readings/second, for Agilent E-Series power sensors only

Maximum measurement speed is obtained using binary output in free run trigger mode.

[1] For N1914A, if both channels are used in the fast mode, the measurement speed will be reduced to 200 readings/second for each channel.

Rear Panel Inputs and Output Connections

Recorder output(s)	Analog 0 to 1 V, 1 k Ω output impedance, BNC connectors
GPIB USB 2.0 10/100Base T LAN	Interfaces allow communication with an external controller
Trigger input (Optional)	Input has TTL compatible logic levels and uses a BNC connector
Trigger out (Optional)	Output provides TTL compatible logic levels and uses a BNC connector
Ground	Binding post, accepts 4 mm plug or bare wire connection
USB host (Optional)	To connect U2000 Series power sensors
VGA out (Optional)	Standard 15-pin VGA connector, allows connection of external VGA monitor

Line Power

Input voltage range	100 – 240 Vac 100 – 120 Vac Automatic voltage selection Fluctuations not exceeding $\pm 10\%$
Input frequency range	50 – 60 Hz (100 to 240 Vac) 400 Hz (100 to 120 Vac)
Power requirement	70 VA (maximum)

1 mW Power Reference

NOTE

The *1mW Power Reference* is provided for calibration of the E-Series, 8480 Series, and N8480 Series power sensors.

Power output	1.00 mW (0.0 dBm) Factory set to $\pm 0.4\%$ traceable to the National Physical Laboratories (NPL), UK
Accuracy	$\pm 1.2\%$ (0 – 55 °C) $\pm 0.4\%$ (25 ± 10 °C)
Frequency	<i>50 MHz nominal</i>
SWR	1.08 (0 - 55 °C) <i>1.05 (typical)</i>
Connector type	Type N (f), 50 Ω

Environmental Conditions

General

Complies with the requirements of the EMC Directive 89/336/EEC.

Operating Environment

Temperature	0 °C to 55 °C
Maximum humidity	95% at 40 °C (non-condensing)
Minimum humidity	15% at 40 °C (non-condensing)
Maximum altitude	4,600 meters (15,000 feet)

Storage Conditions

Non-operating storage temperature	-40 °C to +70 °C
Non-operating maximum humidity	90% at 65 °C (non-condensing)
Non-operating maximum altitude	15,240 meters (50,000 feet)

Battery Storage Conditions

Storage temperature limits: -20°C to 60°C, ≤ 80% RH

NOTE

Refer to “Battery Information (Optional)” on page 90 of *Agilent N1913/1914A EPM Series Power Meters User’s Guide* for more details on the battery pack.

Physical Characteristics

Dimensions

The following dimensions exclude front and rear panel protrusions:

212.6 mm W x 88.5 mm H x 348.3 mm D

(8.5 in x 3.5 in x 13.7 in)

Weight

N1913A/1914A weight (Net)	<i>≤ 3.60 kg (approximately)</i>
N1913A/1914A weight (Shipping)	<i>≤ 8.20 kg (approximately)</i>

Regulatory Information

Electromagnetic Compatibility

This product complies with the essential requirements of the following applicable European (EC) Directives, and carries the CE marking accordingly to Low Voltage Directive (2006/95/EC) and EMC Directive (2004/108/EC).

EMC test have conforms to the IEC61326-1:2005/EN61326-1:2006 and CISPR11:2003/EN55011:2007 (Group 1, Class A). In order to preserve the EMC performance of the product, any cable which becomes worn or damaged must be replaced with the same type and specification.

The product also meets the following EMC standards:

- IEC 61326-1:2005/EN61326-1:2006
- CISPR11:2003/EN55011:2007, Group 1 Class A
- Canada: ICES/NMB-001:Issue 4, June 2006
- Australia/New Zealand: AS/NZS CISPR 11:2004

Product Safety

This product conforms to the requirements of the following safety standards:

- IEC 61010-1:2010/EN 61010-1:2010 (3rd Edition)
- Canada: CAN/CSA-C22.2 No. 61010-1-12
- USA: ANSI/UL 61010-1 (3rd Edition)

Low Voltage Directive

This product conforms to the requirements of European Council Directive "2006/95/EC".

THIS PAGE HAS BEEN INTENTIONALLY LEFT BLANK.



2 Performance Tests

Introduction	28
Complete Equipment List	29
1 mW Power Reference Level Test	31
Output Standing Wave Ratio (SWR) Test	33
Zero Set (Average Path)	36
Linearity (Average Path)	37

This chapter contains procedures which allow you to test the power meter's electrical performance to its specifications.



Introduction

The performance tests described in this chapter test the power meter's electrical performance against the specifications detailed in [Chapter 1](#). They are used for incoming inspection, during calibration cycle (also called periodic maintenance), or after repairs have been made.

NOTE

- This document does not provide a complete breakdown for these tests; it only gives a brief overview of each, in line with Agilent's recommendation that the Agilent N7800 Series calibration software should be used at all times.
- Performance testing is limited to the measurement and verification of warranted specifications.
- Some tests cannot be performed manually, and so the N7800 Series calibration software is essential.
- Measurement uncertainty will not be addressed in this document (this is handled by the N7800 Series software).

The following performance tests are described in this chapter:

- [“1 mW Power Reference Level Test”](#) on page 31
- [“Output Standing Wave Ratio \(SWR\) Test”](#) on page 33
- [“Zero Set \(Average Path\)”](#) on page 36
- [“Zero Set \(Average Path\)”](#) on page 36
- [“Linearity \(Average Path\)”](#) on page 37

Complete Equipment List

Instrument	Critical Specifications	Recommended Agilent Model Number	Alternative Agilent Model Number
Meters			
Power Meter	Dual channel Absolute accuracy: 0.5% Power reference accuracy: 0.9% – (a best capability measurement is required for the power reference output — the power level must be accurately measured, and the uncertainty of this measurement must also be known)	E4419B	E4419A
Power Sensor	Frequency: 50 MHz Amplitude range: –70 dBm to –20 dBm SWR: 1.15 at 50 MHz	8481D	
Power Sensor	Frequency: 50 MHz Amplitude range: –30 dBm to +20 dBm SWR: 1.1 at 50 MHz	N8482A	8482A
Power Sensor	Frequency: 50MHz Amplitude range: –70 dBm to +20 dBm SWR: 1.06 maximum	E4412A	
Attenuator			
20 dB Fixed Attenuator	N-type (m,f)	8491B (Option 020)	

2 Performance Tests

Instrument	Critical Specifications	Recommended Agilent Model Number	Alternative Agilent Model Number
Miscellaneous			
Power Splitter	Frequency: DC to 18 GHz insertion Loss: 7 dB Equivalent output SWR: 1.20 DC to 8 GHz	11667A (Option 001)	
Coaxial Termination	DC to 18 GHz	909A	
BNC Cable	Cable Assy-Coaxial RG/223 cable 50-Ohm straight BNC male to straight BNC 24-in LG	8120-1839	
Calibration Test Cable required for N1913A and N1914A		11730A	
Sensor Cable		85032B	
N-Type Calibration Kit		85032B	
Assorted accessories (cables and adapters) required			

1 mW Power Reference Level Test

Description

The 1 mW power reference is used for the calibration of 8480 Series, N8480 Series and E-Series power sensors, and is traceable to national standards. This test uses an N8482A power sensor to transfer the power measured on an accurately calibrated E4419B or E4417A power meter to the DUT reference.

Equipment

- Required test equipment:
 - 1 unit of E4419B or E4417A dual channel power meter
 - 1 unit of N8482A power sensor
 - 11730A power sensor cable
- Either of these E4419B or E4417A power meters can be used. This specific power meter model must be used.

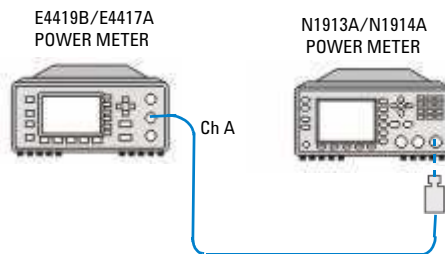


Figure 2-1 1 mW power reference level test setup connection diagram

NOTE

For rear panel options, the connections will differ from the illustration shown here. Refer to the connector identification markings on the rear panel for further details.

Test Method

- 1 Enter the recorded measurement uncertainty of the E4419B or E4417A 1mW power reference.
- 2 Using the E4419B or E4417A power meter and the N8482A sensor, measure the 1mW power reference of the E4419B or E4417A.
- 3 Using the E4419B or E4417A power meter and the N8482A sensor, measure the 1 mW power reference of the DUT.
- 4 Using all of these values, the N7800 Series software will calculate the power reference level of the DUT.

NOTE

- The 1 mW reference of the E4419B or E4417A power meter must be precisely calibrated at a standards accredited lab, and the uncertainty of this measurement known.
 - Anyone who has a basic understanding of metrology should be able to perform this test manually; it is simply the transfer of known power level with a known calibration uncertainty to the DUT.
 - An adjustment is available for this test if it fails (see [Chapter 3](#), “Adjustments”).
-

Output Standing Wave Ratio (SWR) Test

Description

Connector mismatch is the largest single contributor to measurement uncertainty, so this specification must be warranted to provide assurance of instrument accuracy. The 1 mW power reference level test must be carried out prior to this test, as the VSWR specification is only valid at 1 mW. This test measures VSWR by equating relative powers (measured by the test system power meter and its sensors) when the power reference is exercised under different load conditions.

Equipment

- Required test equipment:
 - 1 unit of 8753ES/ET network analyzer
 - 1 unit of 85032B Type N calibration kit
 - 1 unit of E4419B or E4417A dual channel power meter
 - 2 units of 8481D power sensor
 - 2 units of 11667A #001 power splitter
 - 1 unit of 20dB pad, male to female (e. g. 8491A)
 - 1 unit of 30dB pad (e. g. 11708A reference attenuator)
 - 2 units of 11730A power sensor cable
- An alternative network analyzer can be used, as long as it can measure S11 in the 45 MHz to 55 MHz range
- These specific models of power sensors and power splitters must be used
- Any type of pad can be used (as long as there are no additional mating connections, or differing pad values)
- 1 unit of 11667A, 1 unit of 8481D and the 30 dB pad combine to create the 'Calibration System'

2 Performance Tests

- 1 unit of 11667A, 1 unit of 8481D and the 20 dB pad combine to create the 'Measurement System'

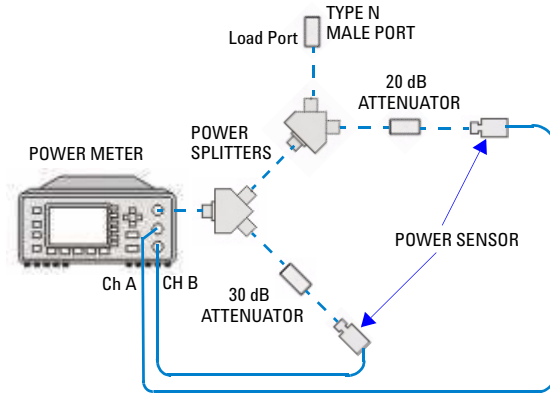


Figure 2-2 System calibration connection diagram

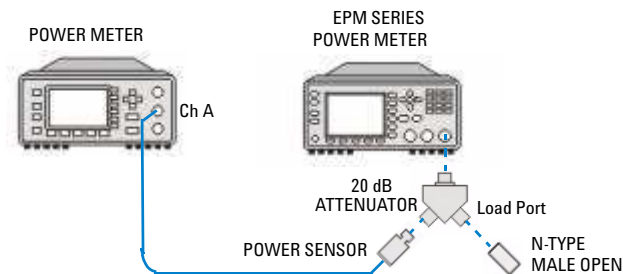


Figure 2-3 Output SWR test setup-open connection diagram

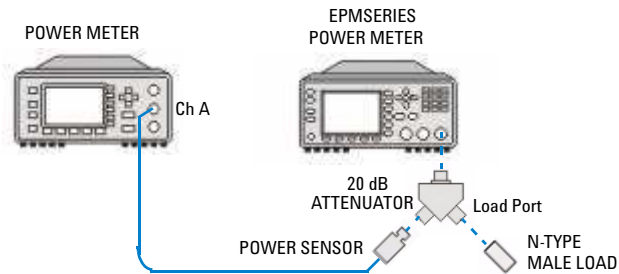


Figure 2-4 Output SWR test setup-load connection diagram

NOTE

For rear panel options, the connections will differ from the illustration shown here. Refer to the connector identification markings on the rear panel for further details.

Test Method

- 1 Obtain the S11 parameter of the calibration system.
- 2 Connect the measurement system to the calibration system and obtain its S21 (load) & S21 (open) parameters.
- 3 Using only the measurement system, terminated with the OPEN connector from the 85032B calibration kit, measure the 1 mW power reference level of the DUT.
- 4 Remove the OPEN connector from the measurement system, terminate it with the 50 R load from the 85032B calibration kit, and repeat the 1 mW power reference level measurement.
- 5 Using all of these values, the N7800A Series software will calculate the VSWR of the power reference output.

NOTE

- This test cannot be performed manually, due to the complexity of the equipment calibration procedure, and the complexity of the measurement algorithm.
- No adjustment is available for this test if it fails (see [Chapter 5](#), “Troubleshooting Guide”).

Zero Set (Average Path)

Description

Zero set is defined as the amount of residual offset error that is present following a zero operation. This offset error is caused by contamination from several sources, including circuit noise. This test measures the effectiveness of zero set by performing 15 back-to-back zero operations of the average path (with no sensor attached), after which the standard deviation of the results is calculated and returned as the measured value.

Equipment

No test equipment required

Test Method

- 1 Execute the internal zero set measurement procedure for channel A.
- 2 Read back the result of the measurement from the DUT.
- 3 If the DUT model number is N1914A, then repeat this procedure for channel B.
- 4 The test will take a few minutes to complete.
- 5 The measurement result should be less than 0.0000175. The smaller the measurement result, the smaller the amount of residual offset error.

NOTE

This test can be performed manually via the commands:

```
SERV:BIST:CW[1|2]:ZSET
```

```
SERV:BIST:CW[1|2]:ZSET:NUM?
```

(Refer to the *N1913A/1914A EPM Series Power Meters Programming Guide* for further details on the use of these commands)

Linearity (Average Path)

Description

Linearity over the full input voltage range of the measurement path is warranted to provide assurance of instrument accuracy. This test measures linearity by using a calibration DAC and a calibration ADC (built into the DUT) to stimulate and compare performance of the average path against the measurement ADC, returning the worst case percentage error.

Equipment

No test equipment required

Test Method

- 1 Execute the internal linearity measurement procedure for channel A.
- 2 Read back the result of the measurement from the DUT.
- 3 If the DUT model number is N1914A, then repeat this procedure for channel B.
- 4 The test will take a few minutes to complete.
- 5 The measurement result should be less than 0.5 and greater than -0.5. The optimum measurement result for this test is 0.

NOTE

This test can be performed manually via the commands:

```
SERV:BIST:CW[1|2]:LIN
```

```
SERV:BIST:CW[1|2]:LIN:PERR?
```

(Refer to the *N1913A/1914A EPM Series Power Meters Programming Guide* for further details on the use of these commands)

THIS PAGE HAS BEEN INTENTIONALLY LEFT BLANK.



3 Adjustments

Introduction 40

Power Reference Level Adjustment 40

This chapter contains checks and adjustments that ensure proper performance of the power meter.



Introduction

The adjustment attempts to correct the power reference level if the performance test has failed. Power reference level is controlled by the coarse and fine settings of a digital potentiometer. Adjustment of the coarse and fine settings can only be carried out via remote commands. Adjustment can be carried out without having to remove the outer covers from the DUT.

Power Reference Level Adjustment

Equipment

As per the test equipment list for the power reference level performance test.

Test Method

- 1 Set: Coarse = 834, Fine = 550
- 2 Measure power ref. level as per the performance test:
 - a If the result is > 1 mW, the increment COARSE by 1
 - b If the result is < 1 mW, the decrement COARSE by 1
- 3 Repeat step 2 until the result crosses the 1 mW boundary (in either direction)
- 4 Measure power ref. level as per the performance test:
 - a If the result is > 1 mW, then decrement FINE by 1
 - a If the result is < 1 mW, then increment FINE by 1
- 5 Repeat step 4 until the result crosses the 1 mW boundary (in either direction)
- 6 The adjustment is completed

NOTE

- This adjustment can be performed manually via the commands:

SERV:CAL:ADJ:COUR <value>

SERV:CAL:ADJ:COUR?

SERV:CAL:ADJ:FINE <value>

SERV:CAL:ADJ:FINE?

(Refer to the *Agilent N1913/1914A EPM Series Power Meters Programming Guide* for further details on the use of these commands.)

- COARSE and FINE values are valid in the range of 0 to 1023
 - If adjustment is not possible, then a fault may be present in the DUT (see [Chapter 5](#), "Troubleshooting Guide").
-

THIS PAGE HAS BEEN INTENTIONALLY LEFT BLANK.



4 Theory of Operation

PPMC Assembly	44
Main Board Assembly	45
Calibrator Assembly	46
Front Panel Assembly	47
PSU Assembly	48

This chapter describes how each of the power meter's individual assemblies operate.



PPMC Assembly

Purpose

- Provides the main processor and memory for the power meter
- Provides external interfaces for LAN and USB
- Stores the power meter firmware in flash EEPROM
- Stores the power meter serial number and option data

Inputs

- Power supplies [from PSU, via main board]
- Control and data lines [from main board and front panel]
- LAN/USB communications [from external equipment]
- GPIB communications [from external equipment, via main board]

Outputs

- Control address and datalines [to main board and front panel]

Main Board Assembly

Purpose

- Provides the average measurement path(s)
- Provides external trigger input/output and recorder output(s)
- Provides the driver and the LVDS serialiser for the LCD display
- Provides signal routing between the PPMC and front panel

Inputs

- Power supplies [from PSU]
- Sensed power level(s) [from sensor flex(s)]
- Trigger input [from external equipment]
- Control, address, and data lines [from PPMC]

Outputs

- Processed average path measurement [to PPMC]
- Trigger output & recorder output(s) [to external equipment]
- LVDS LCD display control lines [to front panel]
- Control and data lines [to PPMC]

Calibrator Assembly

Purpose

- Provides a 1 mW (0 dBm) power reference level at 50 MHz

Inputs

- Power supplies [from PSU, via main board]
- Control, address, and data lines [from PPMC]

Outputs

- 1 mW (0 dBm) power reference [to external equipment]
- Control and data lines [to PPMC, via main board]

Front Panel Assembly

Purpose

- Provides a keypad as the manual user interface
- Provides an LCD display to assist with manual setups and measurements
- Provides mounting for the sensor and power reference connectors (option 101)

Inputs

- Power supplies [from PSU, via main board]
- Front panel control interface [from the PPMC LVDS LCD control lines, via main board]
- Front USB port available for Option 008. This USB port can only be used for U2000 Series power sensors.

NOTE

Front USB port is not to be used with USB flash storage devices.

Outputs

- Keypress data [to PPMC, via main board]
- Information on the LCD display
- Control and data lines [to PPMC, via main board]

PSU Assembly

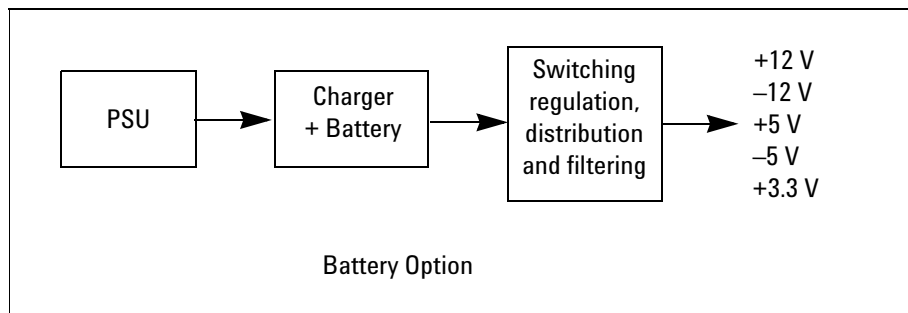
Purpose

- Provides various DC power supplies

Inputs

- 100 Vac ~240 Vac, 50 Hz ~60 Hz, 150 VA Max [from an external source]
- Control lines [from front panel, via main board]

Outputs





5 Troubleshooting Guide

Introduction	50
Power-Up Problems	50
Instrument Self-Test	51
Extended Self-Test	52
Performance Test	52
Power Reference Level Adjustment Problems	53
Communication Interface Failures	53
Additional Diagnostic Tests	53

This chapter contains troubleshooting procedures for the Agilent N1913/1914A EPM Series power meter.



Introduction

This chapter contains general troubleshooting guide to detect failures for the Agilent N1913/1914A EPM Series power meter.

Power-Up Problems

Basic External Checks

- Check the mains power source is live
- Check the mains fuse is operational
- Check the mains cable for any obvious damage
- Check the line module fuse in the instrument is operational

Basic Internal Checks

- Check/reseat the cable between the line module and the PSU
- Check/reseat the cable between the PSU and the main board
- Green LED DS1: If this is off, then the PSU may be faulty
- Green LED DS4: This should come on when the power button is pressed
- Green LEDs DS2/DS3: These will flash on and off during normal operation

Possible Faults

- PSU
- Main board
- Front panel (defective keymat, key flex circuit, or display)
- Loose front panel cable (connection to main board)

Instrument Self-Test

Instrument	Purpose	Debug Tips	Possible Faults
Test point voltages	Checks that all of the supply voltages are present	Replace the PSU to see if this clears the faults	PSU (low probability) Main board (high probability)
Calibrator	Verifies that the calibrator is working (Note: This test does not check that the calibrator meets its specifications)	Check/reseat that cable between the calibrator assembly and the main board Attempt to adjust the 1 mW power reference level	Calibrator assembly (high probability) Main board (low probability)
Fan	Verifies that the fan is working	Check/reseat the cable between the fan assembly and the main board Check visually if the fan is functioning	Fan assembly (high probability) Main board (low probability)
RTC Battery	Checks that the lithium manganese battery on the main board is working	Replace the battery to see if this clears the fault	Lithium manganese battery (high probability) Main board (low probability)
CW path/ChA CW path	Verifies that the average path of channel A is working (Note: This does not prove that the average path meets its specifications)	Not applicable	Main board
ChB CW path	Verifies that the average path of channel B is working (Note: This does not prove that the average path meets its specifications)	Not applicable	Main board

Extended Self-Test

Instrument	Purpose	Debug Tips	Possible Faults
Keypad	Verifies the operation of every key (apart from the power button)	Not applicable	Front panel (defective keymat or key flex circuit)
Bitmap display	Verifies that all pixels in the display can be illuminated in various colors	Not applicable	Front panel (defective display, display interface board, or inverter board)

Performance Test

Type of Failures	Debug Tips	Possible Faults
1 mW power reference level failures	Attempt to adjust the 1 mW power reference level	Calibrator assembly (high probability) Main board (low probability)
VSWR failures	Not applicable	Calibrator assembly
Zero set (average Path) failures	Not applicable	Main board
Linearity (average path) failures	Not applicable	Main board

Power Reference Level Adjustment Problems

Possible Faults

- Calibrator assembly (high probability)
- Main board (low probability)

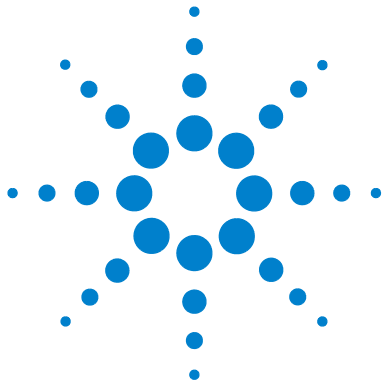
Communication Interface Failures

Type of Communication	Debug Tips	Possible Faults
GPIB communication	Check/reseat the ribbon cable connecting the PPMC to the main board	Ribbon cable (low probability) Main board (high probability)
LAN/USB communication	Check visually to see whether or not the connector is obstructed/damaged	PPMC assembly

Additional Diagnostic Tests

Type of Functionality	Reason	Recommended Test Method	Possible Faults
USB/LAN functionality	The N7800 Series software only tests functionality over GPIB	Check the DUT responds when *RST is sent to it via the USB/LAN interfaces	PPMC assembly
Sensor functionality	The N7800 Series software does not prove both paths of the sensor flex assembly	Connect an E4412A sensor to the DUT and ensure it can be zeroed/calibrated	Sensor flex assembly

THIS PAGE HAS BEEN INTENTIONALLY LEFT BLANK.



6 Repair Guide

Introduction	56
Replaceable Parts	57
Front Panel Assembly	57
Rear Panel Assembly	69
Additional Spare Parts	73
Calibrator Assembly	75
Improved calibrator assembly	76
Outer Housing Components	77
Sundries	79
Tools Required	80
Required Torque Values for Fasteners	81
Disassembly Instructions	82
Reassembly Instructions	88
Disassembly vs Part Replacement	91
Front Panel Disassembly Instructions	93
Front Panel Reassembly Instructions	97
Additional Repair Notes	101
Main Board vs. Rear Panel Assembly	102
Replacing the PPMC Assembly	102
Replacing the Calibrator Semi-Rigid/Split Ferrite	103

This chapter details the power meter's replaceable parts. It also explains how to assemble and disassemble the power meter.



Introduction

This chapter contains details of some of the higher level components and assemblies which can be ordered from Agilent Technologies. It also details how to assemble and disassemble the power meter for repair. The contents included are:

- 1 **Replaceable Parts**
- 2 **Tools Required**
- 3 **Disassembly Instructions**
- 4 **Reassembly Instructions**
- 5 **Disassembly vs Part Replacement**
- 6 **Front Panel Disassembly Instructions**
- 7 **Front Panel Reassembly Instructions**
- 8 **Additional Repair Notes**
- 9 **Replacing the PPMC Assembly**
- 10 **Replacing the Calibrator Semi-Rigid/Split Ferrite**

You can order replaceable parts from Agilent by contacting your local Agilent Technologies Sales and Service Office.



You can return your power meter for servicing at a qualified service center referring to [Chapter 7](#), “Contacting Agilent Technologies”.

Replaceable Parts

Front Panel Assembly

Main Assembly

The standard N1913A/N1914A power meter has the reference calibrator at the front panel. An option is available to move the reference calibrator to rear panel.




Agilent part number	Description	Visual
N1914-60200 N1914-60201	Front panel assembly (Front calibrator option) Front panel assembly - Front calibrator Front panel assembly - Front calibrator and USB	
N1914-60203	Front panel assembly (Rear calibrator option) Note: <ul style="list-style-type: none"> • The front panel assembly must be customized to suit the hardware configuration of the unit being repaired • Refurbished front panel assembly are not available Front panel assembly - Rear calibrator	

Customization Details


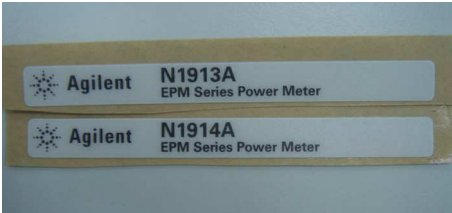
The standard Agilent N1913/1914A EPM Series power meter has a input sensor connector(s) and reference calibrator connector on the front panel. Option 003 is available to move the input sensor connector(s) and reference calibrator connector to the rear panel. Below are the customization details on Front Panel Assembly.

Connector option	Details	Part number
N1913A (Front connectors option)	1 unit of sensor flex assembly	N1913-67300
	1 unit of calibrator plug	N1912-21003
	1 unit of PLUG-HOLE TR-HD FOR .688-D-HOLE NYL	6960-0024
	1 unit of blank front panel dress label	N1912-00027
	1 unit of N1913A nameplate	N1913-34300
N1913A (Rear connectors option)	2 units of PLUG-HOLE TR-HD FOR .688-D-HOLE NYL	6960-0024
	1 unit of front panel plug (small)	N1912-21005
	1 unit of blank front panel dress label	N1914-34302
	1 unit of N1913A nameplate	N1913-34300
N1914A (Front connectors option)	2 unit of sensor flex assembly	N1913-67300
	1 unit of calibrator plug	N1912-21003
	1 unit of blank front panel dress label	N1912-00027
	1 unit of N1914A nameplate	N1914-34300
N1914A (Rear connectors option)	2 units of PLUG-HOLE TR-HD FOR .688-D-HOLE NYL	6960-0024
	1 unit of front panel plug (small)	N1912-21005
	1 unit of blank front panel dress label	N1912-00025
	1 unit of N1914A nameplate	N1914-34300


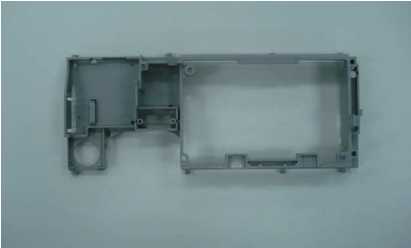

Customization Parts



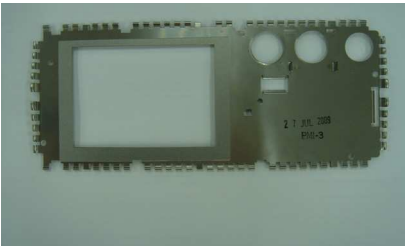
Agilent part number	Description	Visual
N1913-67300 (Front panel - Long) N1913-67301 (Rear panel - short)	Sensor flex assembly Note: <ul style="list-style-type: none"> • The same assembly is used for all four sensor positions • The sensor flex assembly is supplied straight, and so it must be folded to match the assembly being replaced (see "Additional Repair Notes" on page 101) Power sensor cable assembly - Front Power sensor cable assembly - Rear	
N1912-21003	Calibrator plug	
N1912-21005	Plug - Front panel small	




6 Repair Guide

Agilent part number	Description	Visual
N1914-34302 N1912-00027	Label dual channel - Rear cal Label - Dual	
N1913-34300 N1914-34300	N1913A name plate N1914A name plate	



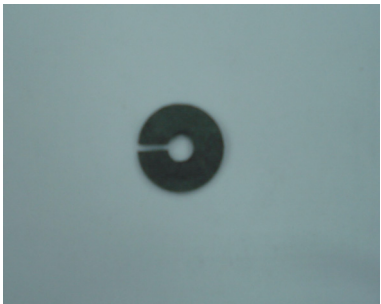
Replaceable Parts

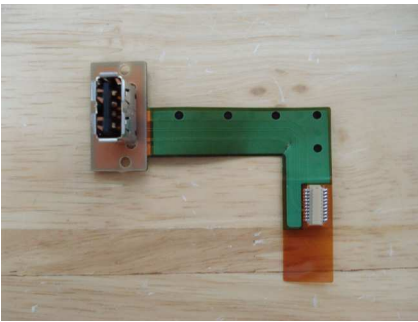


Agilent part number	Description	Visual
<p>N1913-40200</p>	<p>Front panel</p> <p>Note:</p> <p>This front panel sub-frame is used on all variants of the front panel assembly</p>	 <p>A white plastic front panel sub-frame with a central rectangular cutout for a display, a keypad area on the right, and various ports and buttons on the left and bottom edges.</p>
<p>N1913-36600</p>	<p>Display support</p> <p>Note:</p> <p>This display support molding is used on all variants of the front panel assembly</p>	 <p>A white plastic display support molding, which is a rectangular frame with a central cutout and several mounting tabs and slots around the perimeter.</p>
<p>N1913-38300</p>	<p>Keypad</p> <p>Note:</p> <p>This keypad is used on all variants of the front panel assembly</p>	 <p>A keypad assembly with a central display area, a numeric keypad on the right, and several function buttons on the left and bottom.</p>

Agilent part number	Description	Visual
N1913-66503	<p>Key flex circuit</p> <p>Note: This key flex circuit is used on all variants of the front panel assembly</p>	
N1912-20005	<p>Window EMI shield</p> <p>Note: This EMI Shielded Window is used on all variants of the Front Panel Assembly</p>	
N1913-00600	<p>EMI Screen</p> <p>Note: This EMI screen is used on all variants of the front panel assembly</p>	



Agilent part number	Description	Visual
<p>2090-0825</p>	<p>Sharp display</p> <p>Note: This display is used on all variants of the front panel assembly</p>	<p>Front view</p>  <p>Rear view</p> 
<p>N1912-60002</p>	<p>Display interface board</p> <p>Note: This display interface board is used on all variants of the front panel assembly</p>	

6 Repair Guide



Agilent part number	Description	Visual
0950-4111	Inverters 5-Watt 1-output Note: This inverter interface board is used on all variants of the front panel assembly	
N1912-61002	Cable assembly backlight Note: This backlight cable is used on all variants of the front panel assembly	
N1912-00038	EMC split washer	

Agilent part number	Description	Visual
<p>N1913-68303</p>	<p>USB assembly - Front</p> <p>Note: This USB assembly is only available for Option 105, 106, and 167</p>	
<p>N1913-68301 (Single) N1913-68302 (Dual)</p>	<p>USB assembly - Single USB assembly - Dual</p>	
<p>8121-0936</p>	<p>Flat-Ribbon-Assy- 28-AWG 30-COND 03-IN-LG</p> <p>Note: This flat ribbon cable is used on all variants of the front panel assembly</p>	


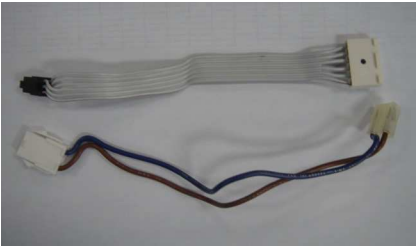
Main Board Assembly

Agilent part number	Description	Visual
N1913-66502	N1913A mother board [New]	
N1914-66502	<p>N1914A mother board [New]</p> <p>Note:</p> <ul style="list-style-type: none"> • Refurbished main boards are not available • The part number for the Lithium Manganese battery (upper- right of both photographs) is 1420-0394 	

PPMC (Processor PCI Mezzanine) Assembly


Agilent part number	Description	Visual
<ul style="list-style-type: none"> • N1913-66501 (Tested single channel processor peripheral component interconnect mezzanine card PCA) • N1914-66501 (Tested dual channel processor peripheral component interconnect mezzanine card PCA) 	<p>Note:</p> <ul style="list-style-type: none"> • The same assembly is used for both N1913A and N1914A models • N1913-66501 (Tested single channel processor peripheral component interconnect mezzanine card PCA) comes pre-programmed with N1913A firmware • N1914-66501 (Tested dual channel processor peripheral component interconnect mezzanine card PCA) comes pre-programmed with N1914A firmware • Refurbished PPMC Assemblies are not available • The PPMC assembly must be programmed once it has been installed (see “Additional Repair Notes” on page 101) • Ribbon Cable 8121-1076 is supplied separately 	
<p>N1913-00100 (Non-battery option)</p> <p>N1913-00105 (Battery option)</p> <p>0950-5015</p> <p>N1913-34102</p>	<p>PSU [New] Deck assembly</p> <p>Deck assembly - Battery option</p> <p>Power supply AC-DC Adapter 120-WATT 1-OUTPUT</p> <p>Power supply cover</p>	

6 Repair Guide

Agilent part number	Description	Visual
N1913-37900	Battery pack	
N1913-61301 N1913-61604	Ribbon cable assembly - PSU Cable assembly - PSU	

Rear Panel Assembly

Main Assembly




Agilent part number	Description	Visual
<p>N1913-00200</p>	<p>Rear panel assembly [New] Revised rear panel assembly [New]</p> <p>Note:</p> <ul style="list-style-type: none"> • The rear panel assembly must be customized to suit the hardware configuration of the unit being repaired • Refurbished rear panel assemblies are not available • The same assemblies are used for both N1913A and N1914A models 	

Customization Details



The standard Agilent N1913/1914A EPM Series power meter has a input sensor connector(s) and reference calibrator connector on the front panel. Option 003 is available to move the input sensor connector(s) and reference calibrator connector to the rear panel. Below are the customization details on rear panel assembly.

Connector option	Details	Part number
N1913A (Front connectors option)	1 unit of rear panel plug (BNC)	6960-0081
	2 units of rear panel plug (Sensor)	6960-0024
	1 unit of rear panel plug (Calibrator)	6960-0178
N1913A (Rear connectors option)	1 unit of sensor flex assembly	N1913-67300
	1 unit of N-type connector	E4418-20009
	1 unit of lock washer	E4418-00016
	1 unit of Hex nut	2950-0132
	1 unit of washer	3050-0916
	1 unit of rear panel plug (BNC)	6960-0081
	1 unit of rear panel plug (Sensor)	6960-0024
N1914A (Front connectors option)	2 units of recorder output cable	E4418-61015
	2 units of rear panel plug (Sensor)	6960-0024
	1 unit of rear panel plug (Calibrator)	6960-0178
N1914A (Rear connectors option)	2 units of sensor flex assembly	N1912-61806
	1 unit of N-type connector	E4418-20009
	1 unit of lock washer	E4418-00016
	1 unit of Hex nut	2950-0132

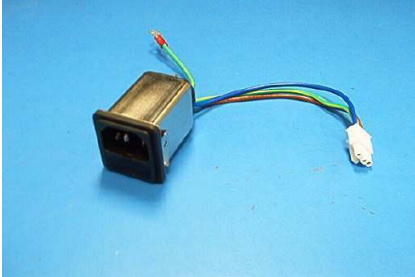

Customization Parts

Agilent part number	Description	Visual
E4418-20009 E4418-00016 2950-0132 3050-0916	N- Type connector Lock washer Hex nut Washer	
N1913-67300 N1913-67301	Sensor flex assembly	
E4418-61015	Recorder output cable	



6 Repair Guide

Agilent part number	Description	Visual
N1913-67912	BNC option	
6960-0081 6960-0024 6960-0178 N1913-36200 N1913-36201 N1913-36202	BNC plug (rear panel) Sensor plug (front and rear panels) Calibrator plug (rear panel) USB plug (front panel) USB plug (rear panel) VGA plug (rear panel)	

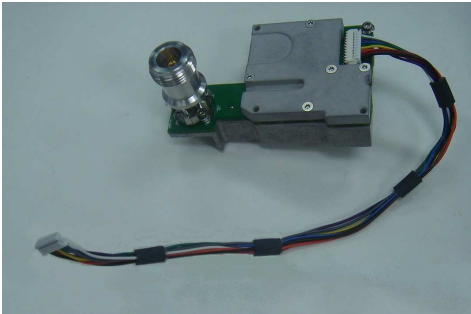
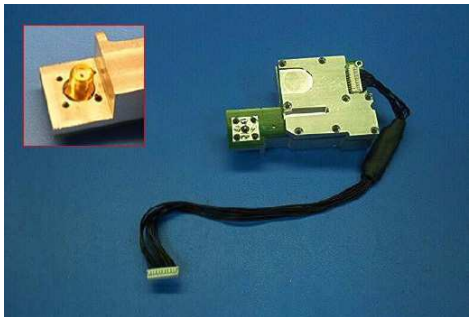
Additional Spare Parts

Agilent part number	Description	Visual
N1913-62700	Line module assembly	 <p>A photograph of a line module assembly. It is a small, rectangular, metallic component with a black plastic front panel. A multi-colored cable (red, green, blue, yellow) is connected to the back of the module, ending in a white plastic connector.</p>
N1913-67910	VGA Option	 <p>A photograph of a VGA option cable. It is a long, thin, black cable with a standard 15-pin D-sub connector at one end and a smaller, black plastic connector at the other end.</p>

6 Repair Guide

Agilent part number	Description	Visual
N1912-00016	Spring contact - Perpendicular	
N1913-61601 N1913-61600 N1913-60002	Wire Harness Assembly - 10 to 10 Pins Ribbon cable assembly - 6 to 4 Pins PCA - Battery charger	

Calibrator Assembly

Agilent part number	Description	Visual
<p>N1913-62000</p>	<p>Calibrator assembly - Front (Front connectors option)</p> <p>For more information on the improved calibrator assembly, refer to "Improved calibrator assembly" on page 76.</p>	
<p>N1911-61002</p>	<p>Calibrator assembly (Rear connectors option)</p> <p>Note:</p> <p>Semi-rigid cable N1912-61004 is not included with assembly N1911-61002; if this is required, it is available as a separate item</p>	

Improved calibrator assembly

The N1913A/N1914A calibrator assembly is improved with a new type-N calibrator connector for a better fit with the front panel assembly as shown in [Figure 6-1](#). The calibrator plug (N1912-21003) will not be needed with the improved calibrator assembly.

NOTE

The N1913A/N1914A performance will not be affected with the improved calibrator assembly.

Calibrator assembly

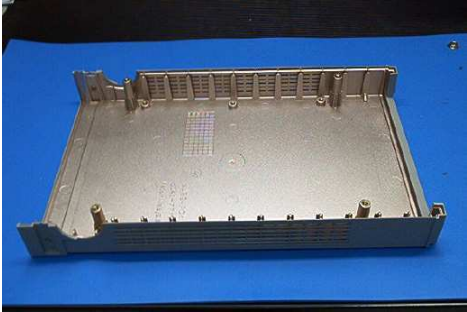
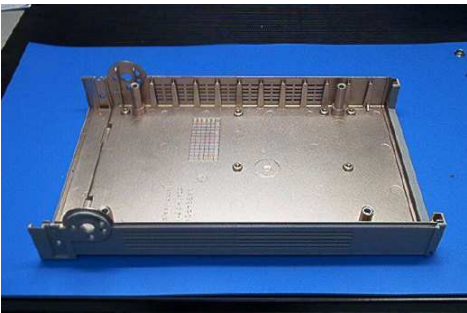
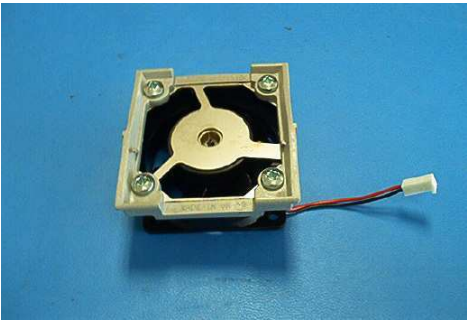


Improved calibrator assembly





Figure 6-1 Calibrator assembly and improved calibrator assembly


Outer Housing Components

Agilent part number	Description	Visual
N1913-30100 N1913-30101	Top clamshell - Non battery option Top clamshell - Battery option	 A photograph of a rectangular metal top clamshell component. It features a series of vertical slots along the top edge and several mounting points around the perimeter. The component is shown against a blue background.
5041-7718	Clamshell (Bottom)	 A photograph of a rectangular metal bottom clamshell component. It has a similar design to the top clamshell but includes a circular cutout on the left side. The component is shown against a blue background.
N1912-61005	Fan assembly	 A photograph of a small, square fan assembly. It has a central hub with four blades and is mounted on a metal frame. A red and black cable with a white connector is attached to the side. The component is shown against a blue background.

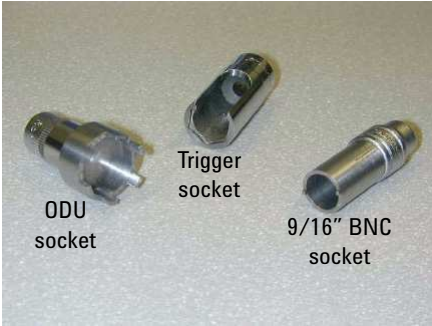
6 Repair Guide

Agilent part number	Description	Visual
34401-86020	Bumper kit	
34401-45021	Handle	

Sundries

Agilent part number	Description	Visual
<p>N1911-61004 N1912-80005 0890-2337</p> <p>Note: If the semi-rigid cable is replaced, then the split ferrite must be positioned correctly (see "Additional Repair Notes" on page 101)</p> <p>Tubing-HS 9.5MM EXP ID 4.80MM RCVD ID 0.56MM WTHKNS Split ferrite Cable assembly S-R-Rear option</p>		 <p>N1911-61004 (with N1912-80005)</p>
<p>2110-1334</p>	<p>Line module fuse, 2.5 A/250 V (time-lag)</p>	

Tools Required

Agilent part number	Description	Visual
<p>N1911-61004 N1912-80005</p>	<ul style="list-style-type: none"> • 3 unit of ¼" drive torque wrenches <ul style="list-style-type: none"> ◦ 1 unit calibrated to 2.37 Nm (21 lb-in) ◦ 1 unit calibrated to 1.02 Nm (9 lb-in) ◦ 1 unit calibrated to 0.68 Nm (6 lb-in) • 3 unit of Torque Screwdrivers <ul style="list-style-type: none"> ◦ 1 unit calibrated to 2.37 Nm (21 lb-in) ◦ 1 unit calibrated to 0.56 Nm (5 lb-in) ◦ 1 unit calibrated to 0.34 Nm (3 lb-in) • T6, T8, T10, & T20 Torx screwdriver bits • 7/16" break spanner, calibrated to 2.37 Nm (21 lb- in) • 5/16" break spanner, calibrated to 1.02 Nm (9 lb- in) • 9/32" socket 	
<p>N1912-61807</p>	<p>Special tooling kit</p> <ul style="list-style-type: none"> • Contains: <ul style="list-style-type: none"> ◦ ODU socket ◦ Trigger socket ◦ 9/16" BNC socket • Sockets must be used in conjunction with a ¼" drive torque wrench, calibrated to 2.37 Nm (21 lb-in) • The 9/16" BNC socket is required to remove the Trig In/Out fasteners for the majority of N1913A/N1914A power meters • The trigger socket is required to remove the Trig In/Out fasteners for a minority of N1913A/N1914A power meters 	 <p>The image shows three metal sockets arranged on a light-colored surface. From left to right: an ODU socket, a Trigger socket, and a 9/16" BNC socket. Each socket is labeled with its name in black text below it.</p>


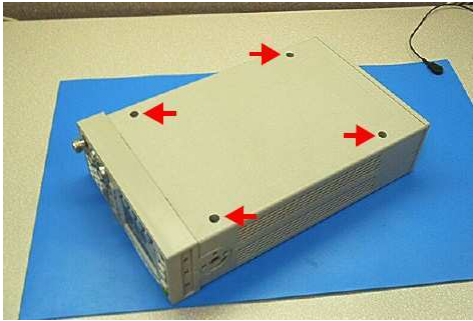
Required Torque Values for Fasteners

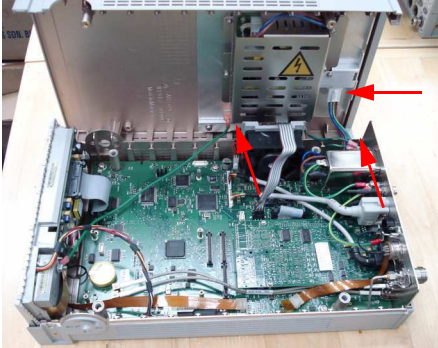
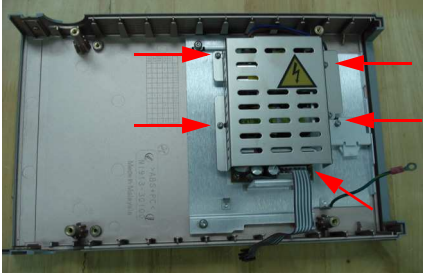
Required tools and torque values for fasteners are listed below:


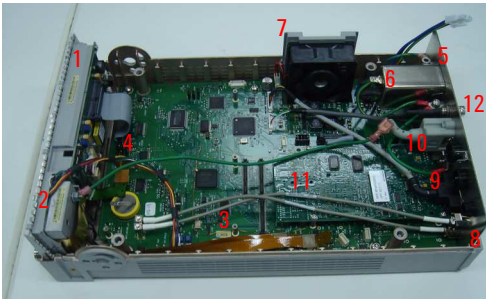
Item	Description/Default	Range of Values
Fit rear panel GPIB standoffs	9/32" socket	2.37 Nm
Fit rear panel Trig In/Out connectors	Special tooling kit (N1912-61807)	2.37 Nm
Fit rear panel recorder output connectors	7/16" spanner	2.37 Nm
Attach main board to clamshell	T20 screwdriver	2.37 Nm
Attach PPMC assemblies to main board	T8 screwdriver	0.56 Nm
Fit calibrator semi-rigid, both ends (Option 003)	5/16" spanner	1.02 Nm
Attach earth wires (nut)	9/32" socket	1.02 Nm
Attach earth wires (screw)	T20 screwdriver	2.37 Nm
Attach top clamshell to bottom clamshell	T20 screwdriver	2.37 Nm
Fit sensor connector	Circlip pliers	
Fit PSU/PSU safety cover	T10 screwdriver	2.37 Nm
Fit display to display support moulding	T6 screwdriver	0.56 Nm
Fit calibrator to display support moulding	T6 screwdriver	0.34 Nm
Fit display interface board to inverter board	T6 screwdriver	0.56 Nm

Disassembly Instructions

The guidelines in this section describe the disassembly of the major assembling in the Agilent N1913A and N1914A power meters.

Instructions	Visual
<p>This procedure focuses primarily on model N1913A & N1914A (i. e. dual channel, with front panel sensor and power reference connectors)</p>	 <p style="text-align: center;">N1913A</p> <p style="text-align: center;">N1914A</p>
<ul style="list-style-type: none"> Remove the handle. Rotate it to the vertical position. Pull both sides outwards from the body of the unit. Remove the front/rear bumpers: Pull one side of the bumper outwards to disengage it. Pull it away from the unit. Separate the clamshells (Figure 6-2): Use the T20 Torx Sscrewdriver bit to loosen the 4 captive screws. 	 <p style="text-align: center;">Figure 6-2 Separate the clamshells</p>

Instructions	Visual
<p>Remove the top clamshell (Figure 6-3). Disconnect the mains power connector from the top clamshell. Disconnect the ribbon cable from the main board. Disconnect both earth spade connectors from the top clamshell. Remove top clamshell.</p>	 <p>Figure 6-3 Remove the top clamshell</p>
<ul style="list-style-type: none"> Remove the PSU safety cover (Figure 6-4). Use the T10 Torx screwdriver bit to remove the 4 screws attaching the PSU safety cover to the top clamshell. Lift and remove the safety cover. Remove the PSU cable guide (Figure 6-4). Use the T10 Torx screwdriver bit to remove the screw attaching the cable guide to the top clamshell. Lift and remove cable guide. 	 <p>Figure 6-4 Remove the PSU safety cover and cable guide</p>

Instructions	Visual
<p>Remove the PSU (Figure 6-5). Use the T10 Torx screwdriver bit to remove the six screws attaching the PSU to the top clamshell. Lift and remove the PSU.</p>	 <p>Figure 6-5 Remove the PSU</p>
<p>Key to Figure 6-6:</p> <ol style="list-style-type: none"> 1 Front panel assembly 2 Calibrator assembly 3 Sensor flex connection(s) 4 Calibrator cable connection 5 Rear panel assembly 6 Line module 7 Fan assembly 8 Analog recorder output connection(s) 9 VGA cable 10 USB cable 11 PPMC assembly 12 Trigger BNC 	 <p>Figure 6-6 Top view with top clamshell removed</p>

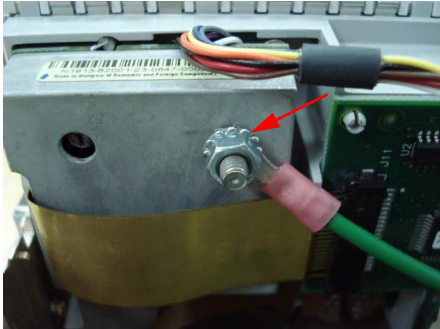
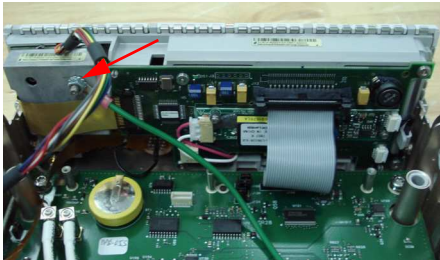

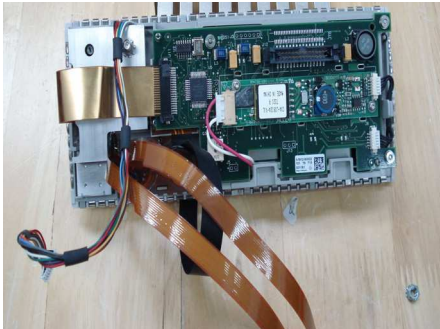
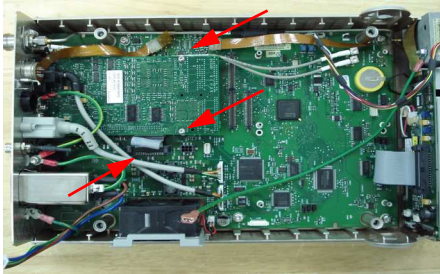
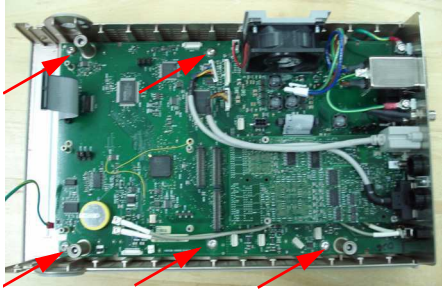

Instructions	Visual
<p>With reference to Figure 6-6:</p> <ul style="list-style-type: none"> • Lift and remove the cable clamp. • Disconnect the cable attaching the fan assembly to the main board. • Lift and remove the fan assembly • Disconnect the sensor RF connections from the main board. • Disconnect the sensor flex connection(s) from the main board. • Disconnect the calibrator cable connection from the main board. • Disconnect the analog recorder output connection(s) from the main board. 	
<p>Remove the EMI earth wires (Figure 6-7). Use the 9/32" socket to remove the Hex nut attaching the EMI earth wires to the calibrator assembly. Remove the earth wires and washers, taking note of the assembly order.</p>	
<p>Disconnect the front panel cable (Figure 6-8). Depress both sides of the connector holding the ribbon cable to eject it.</p>	

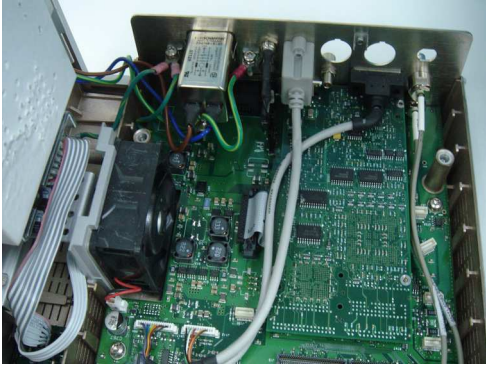
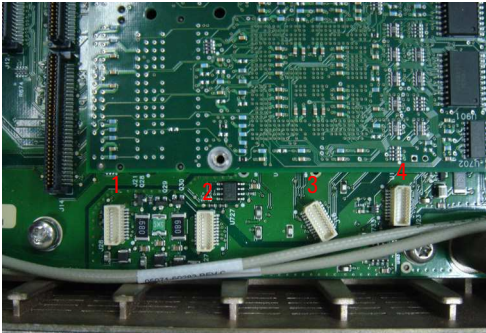
Figure 6-7 Remove the EMI earth wires

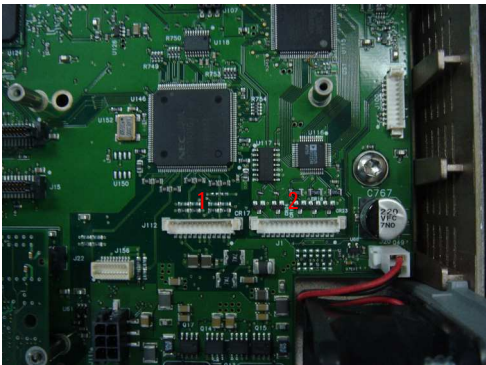

Figure 6-8 Disconnect the front panel cable

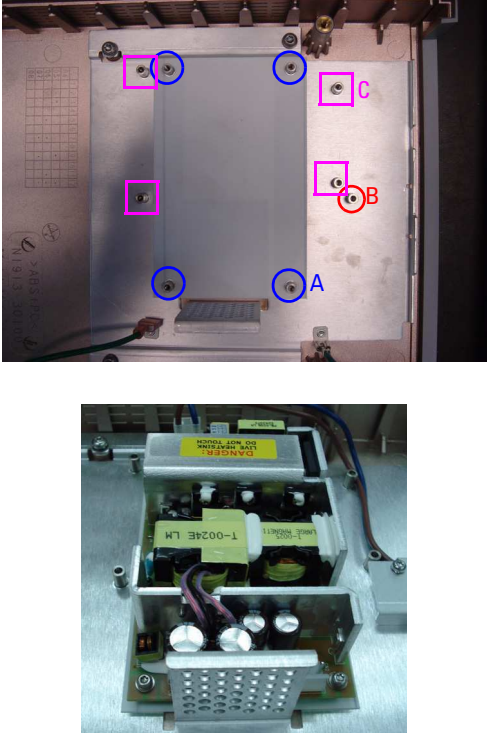
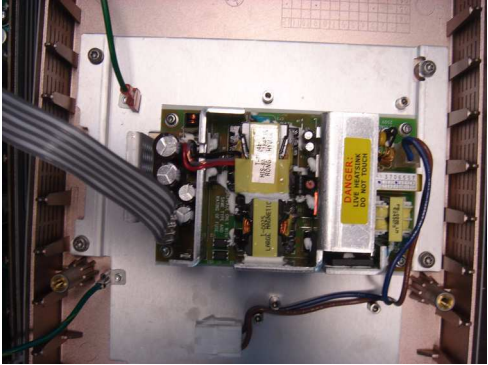
Instructions	Visual
<p>Disconnect the semi-rigid cable (Figure 6-9).</p> <p>Note:</p> <p>This only applies to Option 003 units. Use the 5/16" spanner to disconnect the semi-rigid cable from the N-type connector on the rear panel.</p>	 <p>Figure 6-9 Disconnect the semi-rigid cable</p>
<p>Remove the front panel (Figure 6-10). Carefully lift and remove the front panel assembly.</p>	 <p>Figure 6-10 Remove the front panel</p>
<p>Disconnect PPMC cables (Figure 6-11). Disconnect the service connector cable from the PPMC assembly. Disconnect the ribbon cable from the main board, whilst leaving it connected to the PPMC assembly.</p> <p>Remove PPMC (Figure 6-11). Use the T8 Torx screwdriver bit to remove the screws attaching the DAP and PPMC assemblies to the main board. Carefully remove the PPMC assembly by lifting the end closest to the DAP assembly. Carefully remove each DAP assembly by lifting the end closest to the rear panel.</p>	 <p>Figure 6-11 Remove PPMC</p>

Instructions	Visual
<p>Remove the main board (Figure 6-12). Use the T20 Torx screwdriver bit to remove the five screws attaching the main board to the bottom clamshell. Use the T20 Torx screwdriver bit to remove the screw attaching the earth wires to the line module. Remove the earth wires and washers, taking note of the assembly order. Lift and remove the main board.</p>	 <p>Figure 6-12 Remove the main board</p>
<p>Remove the rear panel (Figure 6-13). Use the N1912-61807 special tooling kit to remove the asteners on the trigger connectors. Use the 9/32" socket to remove the GPIB standoffs. Carefully pull the rear panel away from the main board.</p>	 <p>Figure 6-13 Remove the rear panel</p>

Reassembly Instructions

Instructions	Visual
<p>The reassembly process is simply the reverse of the disassembly process. However, there are various points to be aware of.</p> <ul style="list-style-type: none"> • USB/LAN connectors must rest on top of the rear panels' EMC spring fingers. • The position of the cable clamp depends on whether option 101 or 003 is fitted. • The main board connector from the PSU must be pushed firmly to fully engage it. • Take care not to trap any cables when fitting the top clamshell. • Analog recorder output connections (Figure 6-14). Ensure recorder 1 is plugged into the rear connector. Where applicable, recorder 2 is plugged into the connector nearer to the front. 	 <p>Figure 6-14 Analog recorder output connections</p>
<p>Sensor flex connections (Figure 6-15)</p> <ul style="list-style-type: none"> • A - Front, Channel A (for option 101) • B - Front, Channel B (for option 101) • C - Rear, Channel A (for option 003) • D - Rear, Channel B (for option 003) 	 <ol style="list-style-type: none"> 1 J28 - front Ch 1 2 J127 - front Ch 2 3 J23 - rear Ch 2 4 J18 - rear Ch 1

Instructions	Visual
	 <ol style="list-style-type: none"> 1 J112 - USB (rear) 2 J1 - VGA  <ol style="list-style-type: none"> 1 J109 - Calibrator 2 P71 - Trig Out 3 P70 - Trig In 4 J115 - USB (front) <p>Figure 6-15 Sensor flex connections</p>

Instructions	Visual
<p>PSU screw locations (Figure 6-16)</p> <ul style="list-style-type: none"> • A - Attach PSU to clamshell (4 screws) • B - Attach PSU cable guide (1 screw) • C - Attach PSU safety cover (4 screws) 	 <p>Figure 6-16 PSU screw locations</p>
<p>PSU cable routing (Figure 6-17). Ensure the PSU cables are positioned such that the cable guide does not trap them or pinch them.</p>	 <p>Figure 6-17 PSU cable routing</p>

Disassembly vs Part Replacement


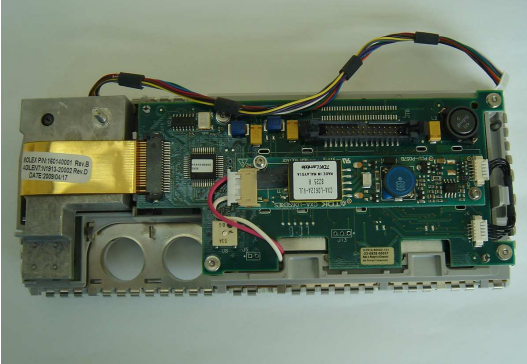
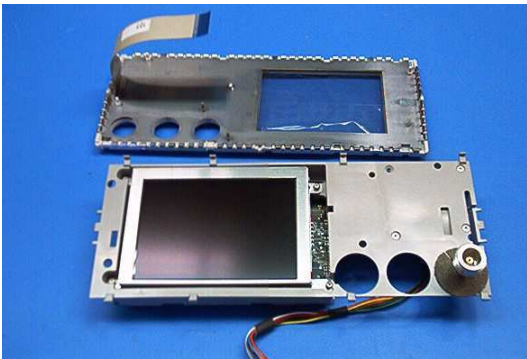
Disassembly of Replacement Part	Instructions
Main board/Rear panel assembly/Bottom clamshell	Full strip-down required
PSU/Top clamshell	<ul style="list-style-type: none"> Remove handle, bumpers, and top clamshell (including PSU) PSU can now be removed from the top clamshell
Fan assembly	<ul style="list-style-type: none"> Remove handle, bumpers, and top clamshell (including PSU) Disconnect fan assembly from the main board Fan assembly can now be removed
PPMC assembly (Front connectors option)	<ul style="list-style-type: none"> Remove handle, bumpers, and top clamshell (including PSU) Disconnect the main board ribbon cable from the PPMC Disconnect the service connector cable from the PPMC Dismantle rear USB assembly N1913-68301 or N1913-68302 (if applicable) Remove the four screws securing the PPMC to the main board PPMC Assembly can now be removed
PPMC assembly (Rear connectors option)	<ul style="list-style-type: none"> Remove handle, bumpers, and top clamshell (including PSU) Disconnect the sensor flex connection(s) from the main board Disconnect the main board ribbon cable from the PPMC Disconnect the service connector cable from the PPMC Dismantle rear USB assembly N1913-68301 or N1913-68302 (if applicable) Remove the four screws securing the PPMC to the main board PPMC assembly can now be removed

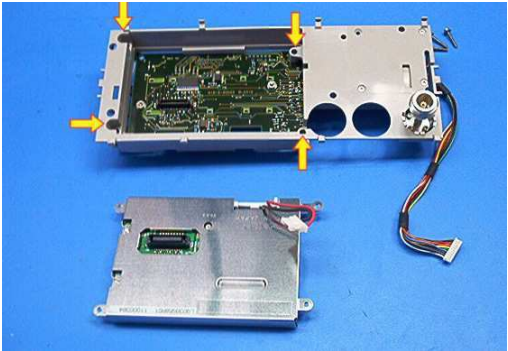

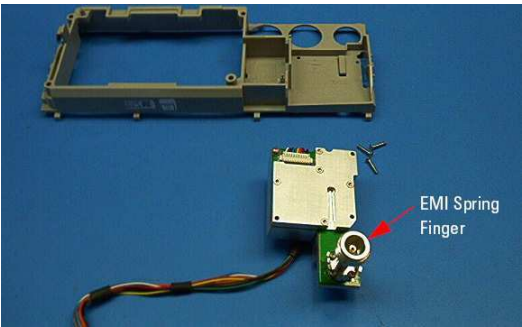
Disassembly of Replacement Part	Instructions
Front panel assembly (Front connectors option)	<ul style="list-style-type: none"> • Remove handle, bumpers, and top clamshell (including PSU) • Disconnect the sensor RF connections from the main board • Disconnect the sensor flex connection(s) from the main board • Disconnect the calibrator assembly cable connection from the main board • Disconnect the EMI earth wires from the calibrator assembly • Disconnect main board ribbon cable from the front panel assembly • Front panel assembly can now be removed
Front panel assembly (Rear connectors option)	<ul style="list-style-type: none"> • Remove handle, bumpers, and top clamshell (including PSU) • Disconnect calibrator semi-rigid from the rear panel assembly • Disconnect the calibrator assembly cable connection from the main board • Disconnect the EMI earth wires from the calibrator assembly • Disconnect main board ribbon cable from the front panel • Front panel assembly can now be removed
Sensor flex assembly (Front connectors option)	<ul style="list-style-type: none"> • Remove front panel assembly as previously described • Use the N1912-61807 special tooling kit to remove the sensor flex assembly
Sensor flex assembly (Rear connectors option)	<ul style="list-style-type: none"> • Remove handle and front/rear bumpers • Remove top clamshell (including PSU) • Disconnect the sensor RF connections from the main board • Disconnect the sensor flex connection from the main board • Use the N1912-61807 special tooling kit to remove the sensor flex assembly

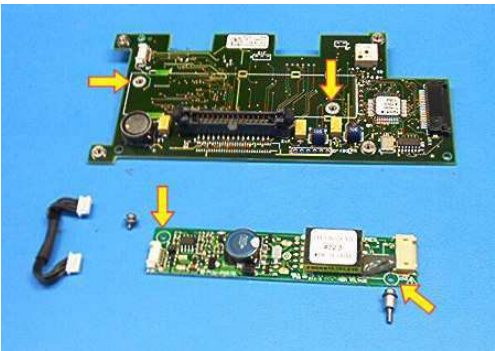


Front Panel Disassembly Instructions

CAUTION


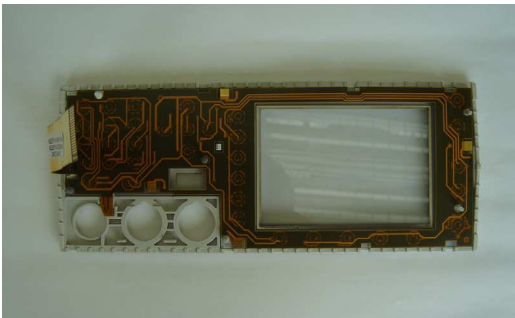
- The front panel assembly should only be repaired in a clean and dust-free environment.
 - Failure to do so may introduce contamination between the EMI shielded window and the display.
 - Also note that it may not be necessary to completely disassemble the front panel in order to repair or replace some of its parts. As such, this procedure should be tailored to suit the specific repair requirements.
-

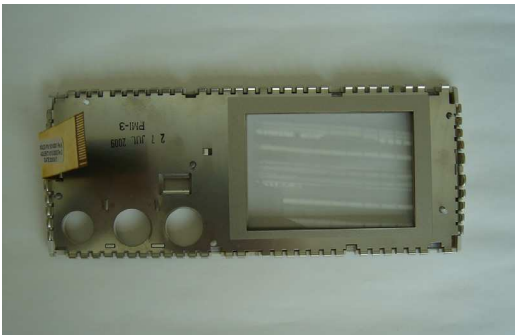


Instructions	Visual
<p>Step 1</p> <p>Carefully lift and remove the calibrator plug. [This step is not applicable to units with rear-panel connectors.]</p> <p>This step is only applicable for calibrator assembly with the calibrator plug.</p> <p>For more information on the improved calibrator assembly, refer to “Improved calibrator assembly” on page 76.</p>	 <p style="text-align: right;">Calibrator plug</p>
<p>Step 2</p> <p>Use circlip pliers to remove N1912-61806 sensor flex assembly.</p> <p>Release the tab holding the flex cable to the display interface board, and then disconnect it.</p> <p>Step 3</p> <p>Disconnect the white plastic plug from the display interface board.</p>	
<p>Step 4</p> <p>Unlock the main plastic clip that holds the front panel sub-frame and display support molding together (situated beside the key flex circuit), and carefully pull them apart to separate them.</p>	




Instructions	Visual
<p>Step 5</p> <p>Remove the four screws that are attached to the display from the display support molding, and then disconnect it from the display interface board .</p>	
<p>Step 6</p> <p>Lift the display interface board off of the plastic mounting lugs on the display support molding to separate them from one another.</p>	
<p>Step 7</p> <p>Remove the three screws that are attached to the calibrator assembly from the display support molding, and separate them from one another.</p> <p>Note:</p> <p>Take care not to damage the EMI spring fingers on the calibrator assembly.</p>	

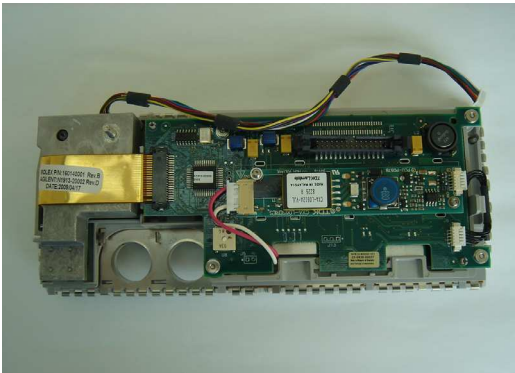

Instructions	Visual
<p>Step 8</p> <p>Disconnect the backlight cable assembly from the display interface board and inverter board.</p> <p>Step 9</p> <p>Remove the two screws that are attached to the display inter face board from the inverter board, and separate them from one another.</p>	 <p>The image shows two green printed circuit boards (PCBs) against a blue background. The top board is larger and has two yellow arrows pointing to screws on its surface. The bottom board is smaller and has two yellow arrows pointing to connectors on its edge. A small black cable with white connectors is also visible to the left of the bottom board.</p>
<p>Step 10</p> <p>Release the metal tabs holding the EMI Screen to the front panel sub-frame, and separate them from one another.</p> <p>Step 11</p> <p>Disengage the rubber tabs that are attached to the key flex circuit from the keymat, and carefully lift it out.</p>	 <p>The image shows a white front panel sub-frame with a grey EMI screen and a black keymat. The EMI screen is held in place by metal tabs. The keymat is attached to the sub-frame with rubber tabs.</p>
<p>Step 12</p> <p>Remove the EMI shielded window and the keymat from the front panel sub-frame.</p>	 <p>The image shows the front panel sub-frame with the EMI shielded window and the keymat removed. The sub-frame is white and has a rectangular cutout for the display. The EMI shielded window is a brown, flexible material with a rectangular cutout. The keymat is a black, rectangular mat with a grid of keys.</p>

Front Panel Reassembly Instructions

Instructions	Visual
<p>Step 1 Insert the keymat into the front panel sub-frame.</p> <p>Step 2 Insert the EMI shielded window into the keymat, ensuring that it is clean and free from fingerprints.</p>	 A photograph of the front panel sub-frame assembly. It features a white plastic sub-frame with a grid of circular keyholes on the left side and a large rectangular window on the right. The keymat and EMI shielded window are already in place.
<p>Step 3 Overlay the key flex circuit onto the keymat, ensuring that all of the rubber lugs are engaged to hold it securely.</p>	 A photograph of the front panel sub-frame assembly with the key flex circuit overlay. The circuit is a brown printed circuit board with gold-colored traces, overlaid on the keymat and EMI shielded window. The rubber lugs are visible at the bottom of the circuit board.

Instructions	Visual
<p>Step 4</p> <p>Overlay the EMI screen onto the key flex circuit, ensuring that all of the metal tabs are engaged to hold it securely.</p>	
<p>Step 5</p> <p>Fit the display interface board onto the plastic mounting lugs on the display support molding.</p>	
<p>Step 6</p> <p>Attach the inverter board to the display interface board using the two screws removed earlier.</p> <p>Step 7</p> <p>Connect the inverter board to the display interface board using the backlight cable assembly.</p> <p>Note</p> <p>The cable must be tucked under the plastic clip to prevent any fouling.</p>	

Instructions	Visual
<p>Step 8 Attach the calibrator assembly to the display support molding using the three screws removed earlier.</p> <p>Step 9 Carefully spread the EMI fingers outwards, ensuring they extend beyond the edges of the hole in which the calibrator assembly is fitted.</p>	
<p>Step 10 Fit the split washer to the calibrator assembly.</p> <p>Step 11 Attach the display to the display interface board using the four screws removed earlier.</p>	
<p>Step 12 Connect the white plastic plug to the display interface board.</p>	

Instructions	Visual
<p>Step 13 Attach the front panel sub-frame to the display support moulding, ensuring that all plastic clips are engaged to hold it securely.</p> <p>Step 14 Connect the flex cable to the display interface board, and then tighten the locking tab.</p>	
<p>Step 15 Re-fit the calibrator plug.</p> <p>This step is only applicable for calibrator assembly with the calibrator plug.</p> <p>For more information on the improved calibrator assembly, refer to “Improved calibrator assembly” on page 76</p>	

Additional Repair Notes


Replacing A Sensor Flex Assembly

The sensor flex assembly is supplied straight. Do not bend the sensor flex cable.

NOTE

Route and connect the sensor flex assembly. Once the sensor flex assembly has been attached to the power meter, do not bend the sensor flex cable.

Main Board vs. Rear Panel Assembly

Instructions	Visual
<ul style="list-style-type: none"> • Due to a difference in the connector positions for main board revision 102 and revision 103, there are two different rear panels. • Revision 102 main boards are not available as spares - all spare main boards will be revision 103 (or newer). • When replacing a revision 102 main board, take note that the rear panel will need to be replaced • Figure 6-18 shows the main board revision markings 	 <p data-bbox="654 687 1092 713">Figure 6-18 Main board revision markings</p>

Replacing the PPMC Assembly


- The PPMC Assembly is pre-programmed with N1914A firmware.
- Always perform a firmware upgrade to the instrument if the PPMC assembly has been replaced.

NOTE

Fitting a PPMC assembly that has been pre-programmed with N1913A firmware to an N1914A power meter will generate errors; these errors will disappear once the firmware upgrade procedure has been carried out.

- Instrument serial number:
This can be stored in the PPMC assembly via the command:
`SERV: SNUM <CHARACTER DATA>`
- Instrument option(s):
This/these can be stored in the PPMC assembly via the command:
`SERV: OPT "< CHARACTER DATA>"`
- Refer to the *Agilent N1913A/1914A EPM Series Power Meters Programming Guide* for further details on the use of these commands.

Replacing the Calibrator Semi-Rigid/Split Ferrite

Instructions	Visual
<ul style="list-style-type: none"> • Separate the two halves of the ferrite (Figure 6-19). • Position the ferrite such that it's furthest edge is 120 mm (4 ¾") from the bend of the semi-rigid. • Hold the ferrite in place by applying a coating of silicone or silicone-rubber compound (e. g. RTV) along that 20 mm (¾") section of the semi-rigid. • Join both halves of the ferrite, keeping the mating surfaces free of the silicone compound if possible. 	 <p data-bbox="654 644 1172 673">Figure 6-19 Separate the two halves of the ferrite</p>

THIS PAGE HAS BEEN INTENTIONALLY LEFT BLANK.



7 Contacting Agilent Technologies

Introduction	106
Before Calling Agilent Technologies	107
Check the Basics	108
Instrument Serial Numbers	109
Agilent Sales and Service Offices	110
Returning Your Power Meter for Service	111
Useful Web Pages	112

This chapter details what to do if you have a problem with your power meter.



Introduction

Contacting Agilent Technologies

This section details what to do if you have a problem with your power meter. If you have a problem with your power meter, first refer to “[Before Calling Agilent Technologies](#)” on page 107. This section contains a checklist that helps identify some of the most common problems. If you wish to contact Agilent Technologies about any aspect of the power meter, from service problems to ordering information, refer to “[Agilent Sales and Service Offices](#)” on page 110”. If you wish to return the power meter to Agilent Technologies, refer to “[Returning Your Power Meter for Service](#)” on page 111.

Before Calling Agilent Technologies

Before calling Agilent Technologies or returning the power meter for service, please make the checks listed in [“Check the Basics”](#) on page 108. If your power meter is covered by a separate maintenance agreement, please be familiar with the terms.

Agilent Technologies offers several maintenance plans to service your power meter after warranty expiration. Call your Agilent Technologies Sales and Service Center for full details.

If the power meter becomes faulty and you wish to return the faulty instrument, follow the description on how to return the faulty instrument in [“Returning Your Power Meter for Service”](#) on page 111.

Check the Basics

Problems can be solved by repeating what was being performed when the problem occurred. A few minutes spent in performing these simple checks may eliminate time spent waiting for instrument repair. Before calling Agilent Technologies or returning the power meter for service, please make the following checks:

- Check that the line socket has power.
- Check that the power meter is plugged into the proper ac power source.
- Check that the power meter is switched on.
- Check that the line fuse is in working condition.
- Check that the other equipment, cables, and connectors are connected properly and operating correctly.
- Check the equipment settings in the procedure that was being used when the problem occurred.
- Check that the test being performed and the expected results are within the specifications and capabilities of the power meter.
- Check the power meter display for error message.
- Check operation by performing the self tests.
- Check with a different power sensor.

Instrument Serial Numbers

Agilent Technologies makes frequent improvements to its products to enhance their performance, usability, and reliability. Agilent Technologies service personnel have access to complete records of design changes for each instrument. The information is based on the serial number and option designation of each power meter.

Whenever you contact Agilent Technologies about your power meter have a complete serial number available. This ensures you obtain the most complete and accurate service information. The serial number can be obtained by:

- Querying the power meter over a remote interface (via the *IDN? Command).
- From the front panel (via the Service menu).
- From the serial number label.

The serial number label is attached to the rear of each Agilent Technologies instrument. This label has two instrument identification entries. The first provides the instruments serial number and the second provides the identification number for each option built into the instrument.

The serial number is divided into two parts: the prefix (two letters and the first four numbers), and the suffix (the last four numbers). The prefix letters indicate the country of manufacture. This code is based on the ISO international country code standard, and is used to designate the specific country of manufacture for the individual product. The same product number could be manufactured in two different countries. In this case the individual product serial numbers would reflect different country of manufacture codes. The prefix also consists of four numbers. This is a code identifying the date of the last major design change.

The suffix indicates an alpha numeric code which is used to ensure unique identification of each product throughout Agilent Technologies.

Agilent Sales and Service Offices

In any correspondence or telephone conversations, please refer to the power meter by its model number and full serial number. With this information, the Agilent representative can quickly determine whether your unit is still within its warranty period.

UNITED STATES	Agilent Technologies (tel) 1 800 829 4444
CANADA	Agilent Technologies Canada Inc., Test & Measurement (tel) 1 877 894 4414
EUROPE	Agilent Technologies, Test & Measurement, European Marketing Organization (tel) (31 20) 547 2000
JAPAN	Agilent Technologies Japan Ltd. (tel) (81) 426 56 7832 (fax) (81) 426 56 7840
LATIN AMERICA	Agilent Technologies, Latin America Region Headquarters, USA (tel) (305) 267 4245 (fax) (305) 267 4286
AUSTRALIA and NEW ZEALAND	Agilent Technologies Australia Pty Ltd. (tel) 1-800 629 4852 (Australia) (fax) (61 3) 9272 0749 (Australia) (tel) 0-800 738 378 (New Zealand) (fax) (64 4) 802 6881 (New Zealand)
ASIA PACIFIC	Agilent Technologies, Hong Kong (tel) (852) 3197 7777
You can visit our Web site:	www.agilent.com/find/assist

Returning Your Power Meter for Service

Use the information in this section if you need to return your power meter to Agilent Technologies.

Packaging the power meter for shipment to Agilent Technologies for service

- Fill in a blue service tag (available at the end of most hardcopy *Agilent Service Guides*) and attach it to the power meter. Please be as specific as possible about the nature of the problem. Send a copy of any or all of the following information:
- Any error messages that appeared on the power meter display.
- Any information on the performance of the power meter.

CAUTION

Power meter damage can result from using packaging materials other than those specified. Never use styrene pellets in any shape as packaging materials. They do not adequately cushion the power meter or prevent it from shifting in the carton. Styrene pellets cause power meter damage by generating static electricity and by lodging in the rear panel.

-
- Use the original packaging materials or a strong shipping container that is made of double-walled, corrugated cardboard with 159 kg (350 lb) bursting strength. The carton must be both large enough and strong enough to accommodate the power meter and allow at least 3 to 4 inches on all sides of the power meter for packing material.
 - Surround the power meter with at least three to four inches of packing material, or enough to prevent the power meter from moving in the carton. If packing foam is not available, the best alternative is SD-240 Air Cap™ from Sealed Air Corporation (Commerce, CA 90001). Air Cap looks like a plastic sheet covered with 1-1/4 inch air filled bubbles. Use the pink Air Cap to reduce static electricity. Wrap the power meter several times in the material to both protect the power meter and prevent it from moving in the carton.
 - Seal the shipping container securely with strong nylon adhesive tape.
 - Mark the shipping container “FRAGILE, HANDLE WITH CARE” to ensure careful handling.
 - Retain copies of all shipping papers.

Useful Web Pages

- Main Product Page
www.agilent.com/find/EPM
- Product Manuals
www.agilent.com/find/EPMseriesmanuals
- Product Firmware
www.agilent.com/find/epmseriesfirmware
- Performance Test & Calibration Software
www.calsw.tm.agilent.com
- Service Notes
<https://litstation.marketing.agilent.com/litapp/SearchSN.do?method=openExternalSNSearch>

www.agilent.com

Contact us

To obtain service, warranty, or technical assistance, contact us at the following phone or fax numbers:

United States:

(tel) 800 829 4444 (fax) 800 829 4433

Canada:

(tel) 877 894 4414 (fax) 800 746 4866

China:

(tel) 800 810 0189 (fax) 800 820 2816

Europe:

(tel) 31 20 547 2111

Japan:

(tel) (81) 426 56 7832 (fax) (81) 426 56 7840

Korea:

(tel) (080) 769 0800 (fax) (080) 769 0900

Latin America:

(tel) (305) 269 7500

Taiwan:

(tel) 0800 047 866 (fax) 0800 286 331

Other Asia Pacific Countries:

(tel) (65) 6375 8100 (fax) (65) 6755 0042

Or visit Agilent World Wide Web at:

www.agilent.com/find/assist

Product specifications and descriptions in this document are subject to change without notice. Always refer to the Agilent Web site for the latest revision.

© Agilent Technologies, Inc., 2009–2014

Ninth Edition, May 8, 2014
N1913-90009



Agilent Technologies

www.valuetronics.com