

Agilent J2126/7A Transmission Test Set

Installation and Verification Manual



Notices

© Agilent Technologies UK Limited 2002

No part of this manual may be reproduced in any form or by any means (including electronic storage and retrieval or translation into a foreign language) without prior agreement and written consent from Agilent Technologies UK Limited as governed by international copyright laws.

Manual Part Number

J7280-90012

Edition

First edition, September 2002

Printed in UK

Agilent Technologies UK Limited
Transmission & Transport Test Operation
South Queensferry, West Lothian, Scotland
EH30 9TG

Warranty

The material contained in this document is provided “as is,” and is subject to being changed, without notice, in future editions. Further, to the maximum extent permitted by applicable law, Agilent disclaims all warranties, either express or implied, with regard to this manual and any information contained herein, including but not limited to the implied warranties of merchantability and fitness for a particular purpose. Agilent shall not be liable for errors or for incidental or consequential damages in connection with the furnishing, use, or performance of this document or of any information contained herein. Should Agilent and the user have a separate written agreement with warranty terms covering the material in this document that conflict with these terms, the warranty terms in the separate agreement shall control.

Technology Licenses

The hardware and/or software described in this document are furnished under a license and may be used or copied only in accordance with the terms of such license.

Restricted Rights Legend

If software is for use in the performance of a U.S. Government prime contract or subcontract, Software is delivered and licensed as “Commercial computer software” as defined in DFAR 252.227-7014 (June 1995), or as a “commercial item” as defined in FAR 2.101(a) or as “Restricted computer software” as defined in FAR 52.227-19 (June 1987) or any equivalent agency regulation or contract clause. Use, duplication or disclosure of Software is subject to Agilent Technologies’ standard commercial license terms, and non-DOD Departments and Agencies of the U.S. Government will receive no greater than Restricted Rights as defined in FAR 52.227-19(c)(1-2) (June

1987). U.S. Government users will receive no greater than Limited Rights as defined in FAR 52.227-14 (June 1987) or DFAR 252.227-7015 (b)(2) (November 1995), as applicable in any technical data.

Safety Notices

CAUTION

A **CAUTION** notice denotes a hazard. It calls attention to an operating procedure, practice, or the like that, if not correctly performed or adhered to, could result in damage to the product or loss of important data. Do not proceed beyond a **CAUTION** notice until the indicated conditions are fully understood and met.

WARNING

A **WARNING** notice denotes a hazard. It calls attention to an operating procedure, practice, or the like that, if not correctly performed or adhered to, could result in personal injury or death. Do not proceed beyond a **WARNING** notice until the indicated conditions are fully understood and met.

In This Guide...

You will find information for installing and verifying the performance of your instrument

1 Introduction

This chapter provides a brief description of the product and also all safety requirements the user should be aware of when using the instrument.

2 Installation (Getting Started)

This chapter provides general information on how to install and connect up the instrument.

3 Performance Tests

This chapter details the procedures to test the performance of the instrument and provides a test record table to record the results of the tests.

4 Self Test Overview

This chapter details all of the Self Test procedures.

5 ETSI/ANSI Terminology

This chapter provides a table explaining the equivalent SDH/SONET terms.

Conventions Used in this Manual

The conventions used in this manual to illustrate instrument keys and display information are as follows:

- <Menu>** This is an example of a hardkey. Hardkeys (located to the right of the display) are used to give access to different sets of instrument settings, or select dedicated instrument functions.
- Menu Items** Menu items appear in text as **bold** face with the greater than (>) symbol separating each menu level. For example, if you are instructed to choose Errors and Alarms from the Test Functions menu item, it appears as **Test Functions > Errors and Alarms**.
- Field Items** Field items you are instructed to select in a window will appear in **bold** face, for example select **Signal Rate** field.
- Drop Down Lists** The item you must select from a drop down list is also shown in **bold**. For example, select **Signal Rate** field and choose **STM-1** or **OC-3** from the drop down list.

Contents

1 Introduction

Product Description	12
SONET/SDH Capability	12
Ethernet Capability	13
Option Guide	15
Mainframes and Potential Test Rate Capability	15
Optical Interfaces	16
Optical Connectors (product options)	16
Alternative Optical Connectors (available accessories)	17
Ethernet Options	17
Other Options	17
Accessories	18
General Information	19
Responsibilities of the Customer	19
Certification	19
Assistance	19
Instruments Covered By Manual	20
Storage and Shipment	21
Temperature	21
Altitude	21
Repackaging for Shipment	21
Weight and Dimensions	22
Safety Information	23
Safety Precautions	23
Safety Symbols	24
Avoiding Problems When Making Measurements	26
Operators Maintenance	27
Cleaning Optical Connectors	27
Statement of Compliance	29
Noise Declaration (German)	30
Electromagnetic Compatibility	30
Declaration of Conformity	30

2 Installation (Getting Started)

Preparation	32
Initial Inspection	32
Operating Environment	32
Preparation for Use	33
Power Requirements	33
Connecting to the Power Supply	34
Power Cable	35
Removing the Instrument Covers	36
Connecting the Mouse Cable	36
Useful Information When Requesting Support	37
Operation Checks on Delivery	38
Power-up Sequence	38
Recalling Default Settings	39
Back-to-Back Functional Checks	40
What to do if the Test fails	45
Optical Connector Safety Information	46
Laser Warnings and Cautions	46
Laser Warning Symbols	48
Avoiding Optical Receiver Overload	48
Additional Precautions for Service Engineers	49
ESD Precautions	49
Top Panel Connectors	51
Optical Out Ports	52
Optical In Ports	53
Clock Ports	54
DCC Port	55
Electrical Test Ports	56
Ethernet Ports	57
Connectors on Instrument Front/Left Side Panel	58
Connectors on Instrument Front/Right Side Panel	59
Instrument Reboot (Cold Start)	61

3 Performance Tests

Introduction	64
Equipment Required	64
Performance Test Record	64
Calibration Check Cycle	64
Instrument Option Configuration	64
Recommended Test Equipment	65
Self Test Loopback Cables and Accessories	66
Recall Default Settings	67
Performance Self Test	68
Description of the Performance Self Test	68
Loopback Connections Required for Self Test	69
How to run the Self Test	72
What to do if the Self Test fails	72
Internal Reference Clock Accuracy	73
Specification	73
Description	73
Equipment Required	74
Procedure	74
Alternative DS1 Clock test (if suitable DS _n Test Set is not available)	78
External Clock Reference Inputs and Clock Reference Output	79
Specifications	79
Description	79
Equipment Required	79
Procedure	80
Optical Pulse Mask and Output Characteristics	86
Specifications	86
Description	86
Equipment Required	87
Procedure	87
52/155 and 622 Mb/s Optical Output Checks	88
OC-1/STM-0 Power Level and Eye Mask Tests	88
OC-3/STM-1 Power Level and Eye Mask Tests	90
OC-12/STM-4 Power Level and Eye Mask Tests	91

2.5 Gb/s Optical Output Checks	93
OC-48/STM-16 Power Level and Eye Mask Tests	93
10 Gb/s Optical Output Checks (if fitted)	95
OC-192/STM-64 Power Level and Eye Mask Tests	95
Optical Receiver Sensitivity, Optical Power and Frequency Measurement	98
Specifications	98
Description	99
Equipment Required	100
Procedure	100
Checking the Receiver Minimum Sensitivity Margin Against Laser Transmitter Extinction Ratio (ER)	113
Electrical Pulse Mask and Output Level Characteristics	114
Specifications	114
Description	115
Equipment Required	115
Procedure	115
DS1 Output Mask Test	116
2 Mb/s Balanced Output Mask Tests	118
2 Mb/s Unbalanced Output Mask Tests	121
8 Mb/s Output Mask Tests	123
34 Mb/s Output Mask Tests	125
DSX-3 Output Mask Tests	127
140 Mb/s Output Mask Tests	129
51.84 Mb/s (STS-1) Output Mask Tests	132
155 Mb/s Output Mask Tests	136
Performance Test Record	140

4 Self Test Overview

Description of the Self Test	148
List of Self Tests	149
Loopback Connections Required for Self Test	151
How to Run a Self Test	155
Error messages and codes	155
List of Self Test Sub Tests	156
What to Do if the Self Test Fails	161
Tips and Checks to Confirm Correct Optical Loopback	161

5 ETSI/ANSI Terminology

ETSI/ANSI Conversion and Equivalent Terms	164
---	-----

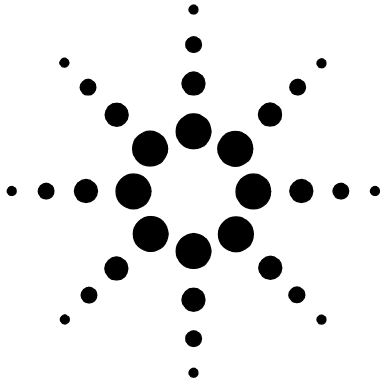

1 Introduction

Product Description	12
Option Guide	15
General Information	19
Safety Information	23
Avoiding Problems When Making Measurements	26
Operators Maintenance	28
Statement of Compliance	29

This chapter provides a brief description of the product and also all safety requirements the user should be aware of when using the instrument.



Product Description

The instrument provides all the test capability you need to install and verify the performance of today's high-capacity transmission systems and networks in one portable package.

In addition, there is an Ethernet module that can fully test the data capabilities of the new generation of multi-service network elements.



SONET/SDH Capability

- Global test coverage (SONET, SDH, PDH and T-Carrier).
- Full integrated all-rate testing:
 - 52 Mb/s to 10 Gb/s optical.
 - 52/155 Mb/s; DS1/3; 2/8/34/140 Mb/s electrical.
- Full range of standard and concatenated mappings.
- All standard error and alarm measurements, plus:
 - optical power, electrical level, pulse mask, frequency.
 - service disruption time, pointer movements, delay.
- Simultaneous all-channel testing (up to 192 STSs/AUs).
- Intrusive and non-intrusive Thru-mode.
- Comprehensive SONET/SDH overhead testing.

- Electrical interfaces
(DS1/3; 2/8/34/140 Mb/s; 52/155 Mb/s)
- VT/TU payload testing
- DS1/3 and 2/34/140 Mb/s service mappings
- DS_n and PDH (En) testing
- Pulse mask testing (up to 52 Mb/s electrical)
- Service disruption measurement
- Round trip delay measurement
- Electrical level measurement
- Graphical error and alarm result displays
- G.821, M2100, M2101, M2101.1, M2110, M.2120 performance analysis
- Fast access to key measurement tasks using Smart Test.
- Line and payload frequency offset.
- Transmit and Receive can be independently configured.
- Broad range of graphical results tools.
- Comprehensive online help facilities:
 - Online User manual.
 - Context-sensitive help for each control field.
 - Ability to add your own help documents.

See "Option Guide" on page 15, for more product details.

Ethernet Capability

- Test data services at Layer 1 and Layer 2
- Multi-port testing - 8x10/100 Mb/s and 2x1 Gigabit Ethernet
- Simultaneous operation of all ports
- Simultaneous SONET/SDH and Ethernet operation
- Extremely simple to set-up and operate
- Hot-swap GBIC modules for wavelength choice
- Automated RFC 2544 benchmark testing
- Full rate traffic generation and reception

1 Introduction

- Can be used for end-to-end or loopback testing
- Unique “Loopthru” mode allows loopback testing even at Layer 2
- Measure the “Transmission” elements of Ethernet:
 - Throughput
 - Latency
 - Frame Loss
 - Errors
- User selectable full/restricted/fixed auto negotiation
- User selectable VLAN/priority tagging and flow control
- Frame capture facility
- Comprehensive online help facilities:
 - Online User manual
 - Context-sensitive help for each control field
 - Ability to add your own help documents

See “Option Guide” on page 15, for more product details.

Option Guide

This guide explains the features offered with each instrument mainframe and its associated options.

For more information, see:

- “Mainframes and Potential Test Rate Capability” on page 15
- “Optical Interfaces” on page 16
- “Optical Connectors (product options)” on page 16
- “Alternative Optical Connectors (available accessories)” on page 17
- “Ethernet Options” on page 17
- “Other Options” on page 17
- “Accessories” on page 18

Mainframes and Potential Test Rate Capability

There are three mainframes:

- J2126A - 3-slot chassis
- J2127A - 4-slot chassis
- J2127A - 6-slot extended chassis

Mainframe	Optical Test Interfaces	Frequency Range
J2126A (see Note 1)	OC-1, OC-3, OC-12, OC-48 STM-0, STM-1, STM-4, STM-16	52 Mb/s to 2.5 Gb/s
J2127A (see Notes 1, 2 and 3)	OC-1, OC-3, OC-12, OC-48, OC-192 STM-0, STM-1, STM-4, STM-16, STM-64	52 Mb/s to 10 Gb/s

1. With option 103 fitted, maximum line rate restricted to OC-12/STM-4.

2. Can be configured with maximum line rate of OC-48/STM-16 and later upgraded to OC-192/STM-64.

3. Can have a 4-slot chassis or extended (6-slot) chassis.

Optical Interfaces

	Tx Optical Wavelength	Option
Optical interfaces operating up to 2.5 Gb/s	1310 nm	100
	1550 nm	101
	1310/1550 nm	102
Optical interfaces operating up to 10 Gb/s	1550 nm	111 (HS*), 121 (SR**)
	1310 nm	120 (SR**)

* HS - High Rx sensitivity optics.

** SR - Short reach optics.

Optical Connectors (product options)

Connector	Option
FC/PC Adapters fitted on all optical interfaces	190
SC Adapters fitted on all optical interfaces	191
ST Adapters fitted on all optical interfaces	192

Alternative Optical Connectors (available accessories)

Alternative optical connectors are available for your product, order the appropriate J7283A (FC/PC), J7284A (SC) or J7285A (ST) accessory (connector). The number of connectors required for your product is shown below.

	J7283A (FC/PC)	J7284A (SC)	J7285A (ST)
J2126A with option 100/101	2	2	2
J2126A with option 102	3	3	3
J2127A* with option 100/101 and 111/120/121	5	5	5
J2127A* with option 102 and 111/120/121	6	6	6

* Can have a 4-slot chassis or extended (6-slot) chassis.

Ethernet Options

	Option
Ethernet testing (8 x 10/100 Mb/s; 2 x 1 Gb/s)	323
1000Base-SX (850 nm) GBIC modules (two)	325
1000Base-LX (1310 nm) GBIC modules (two)	326

Other Options

Certificate of Calibration

Option UK6: Calibration certificate with test data

Warranty and Service Plans

Terms and conditions of the applicable warranty for this product are contained in the sales and related documentation supplied separately.

Please contact your nearest Agilent Technologies Sales Office for further information on warranty and extended warranty options.

For access to Agilent Product information and sales/service contacts, please visit:

<http://www.agilent.com>.

Accessories

Additional Documentation

J7280A: Full set of printed manuals: User Guide, Quick Reference Guide, Remote Control, and Installation and Verification manual.

Carrying Cases

J7286A: Hard transit case (for J2126A)

J7287A: Hard transit case (for J2127A)

J7288A: Soft carrying case (for J2126/7A)

J7289A: Hard transit case (for J2127A 6-slot extended chassis)

J7290A: Soft carrying case (for J2127A 6-slot extended chassis)

Optical Adapters and Cables

J7283A: FC/PC optical connector (exchangeable)

J7284A: SC optical connector (exchangeable)

J7285A: ST optical connector (exchangeable)

J7281A: DCC port converter cable: 9-pin miniature D-type to 37-pin D-type (RS-449, female)

General Information

Responsibilities of the Customer

The customer shall provide:

- 1 Access to the products during the specified periods of coverage to perform maintenance.
- 2 Adequate working space around the products for servicing by Agilent personnel.
- 3 Access to and use of all information and facilities determined necessary by Agilent to service and/or maintain the products. (Insofar as these items may contain proprietary or classified information, the customer shall assume full responsibility for safeguarding and protection from wrongful use.
- 4 Routine operator maintenance and cleaning as specified in the Agilent Operating and Service Manuals.
- 5 Consumables such as paper, disks, magnetic tapes, ribbons, inks, pens, gases, solvents, columns, syringes, lamps, septa, needles, filters, frits, fuses, seals, detector flow cell windows, etc.

Certification

Agilent Technologies certifies that this product met its published specifications at the time of shipment from the factory. Agilent Technologies further certifies that its calibration measurements are traceable to the United States National Bureau of Standards, to the extent allowed by the Bureau's calibration facility and to the calibration facilities of other International Standards Organization members.

Assistance

Product maintenance agreements and other customer assistance agreements are available for Agilent products.

Instruments Covered By Manual

Attached to the **rear panel** of the instrument is a serial number plate. The serial number plate has a two letter reference denoting country of origin (GB = Great Britain) and an eight digit serial number. The serial number is unique to each instrument and should be quoted in all correspondence with Agilent, especially when ordering replacement parts.

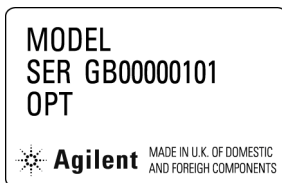

Serial Number Plate

Storage and Shipment

The instrument may be stored or shipped in environments within the following limits:

Temperature

-20 to +70 degC

Altitude

Up to 4,600 meters (15,000 feet)

The instrument should also be protected from temperature extremes which could cause condensation within the instrument.

Repackaging for Shipment

Shipping to Service Centers. You can re-use the packaging, if in its original condition, for onwards transportation and to return the instrument for calibration or servicing. If the instrument is being returned to Agilent for servicing, attach a tag indicating the type of service required, return address, model number, and full serial number. In any correspondence, refer to the instrument by model number and full serial number.

Shipping/Transit to Customer Sites Soft and hard transit cases are available as an optional accessory. (Order transit cases using part numbers listed on page 18.) It is recommended that these are used for shipping to your customer sites. The soft case should only be used if the instrument is being hand carried as it offers only light protection. The hard case should always be used when transporting the instrument in an aircraft hold.

CAUTION

The instrument cover should always be fitted when transporting the instrument.

Other Packaging. The following general instructions should be followed when repackaging with commercially available materials:

- Wrap instrument in heavy paper or plastic. If the instrument is being shipped to Agilent, attach a tag indicating the type of service required, return address, model number and full serial number.
- Use a strong shipping container. A double wall carton made of 350 pound test material is adequate.
- Use a layer of shock absorbing material 70 to 100 mm (3 to 4 inch) thick, around all sides of the instrument to provide firm cushioning and prevent movement inside the container. Protect the Front Panel controls and Top Panel connectors with cardboard.
- Seal shipping container securely.
- Mark shipping container FRAGILE to ensure careful handling.
- In any correspondence, refer to instrument by model number and full serial number.

Weight and Dimensions

Weight	
• J2126A	8.7 kg (19lb) (covers all rates to 2.5 Gb/s)
• J2127A	11.2 kg (25 lb) (covers all rates to 10 Gb/s)
• J2127A Option 006	12.5 kg (28 lb) (covers all rates to 10 Gb/s)

Dimensions	
• J2126A	180 mm x 331 mm x 224 mm (7.1 in x 13 in x 8.8 in)
• J2127A	180 mm x 331 mm x 288 mm (7.1 in x 13 in x 11.3 in)
• J2127A Option 006	180 mm x 331 mm x 400 mm (7.1 in x 13 in x 16 in)

Safety Information

For safety information, read the following sections:

- “Safety Precautions” on page 23
- “Safety Symbols” on page 24
- “Optical Connector Safety Information” on page 46
- “Additional Precautions for Service Engineers” on page 49
- “Avoiding Problems When Making Measurements” on page 26

Safety Precautions

The following general safety precautions must be observed during all phases of operation, service, and repair of this instrument. Failure to comply with these precautions or with specific warnings elsewhere in this manual violates safety standards of design, manufacture, and intended use of the instrument. Agilent Technologies assumes no liability for the customer’s failure to comply with these requirements.

In particular, the operator should note the following safety information:

- “Safety Symbols” on page 24
- “Operators Maintenance” on page 28

WARNING

DO NOT operate damaged equipment. Whenever it is possible that the safety protection features built into this product have been impaired, either through physical damage, excessive moisture, or any other reason, REMOVE POWER and do not use the product until safe operation can be verified by service-trained personnel. If necessary, return the product to an Agilent Sales and Service Office for service and repair to ensure the safety features are maintained.

Refer to “Laser Warning Symbols” on page 48 for information on the laser warning labels on the instrument.

Safety Symbols

The following symbols on the instrument and in the manual indicate precautions which must be taken to maintain safe operation of the instrument.



The Instruction Documentation Symbol. The product is marked with this symbol when it is necessary for the user to refer to the instructions in the supplied documentation.



Indicates the field wiring terminal that must be connected to earth ground before operating the equipment - protects against electrical shock in case of fault.

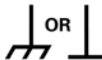

Frame or chassis ground terminal - typically connects to the equipment's metal frame.



Alternating current (AC).



Direct current (DC).



Indicates hazardous voltages.



This symbol indicates the position of the operating switch for 'Off' mode.



This symbol indicates the position of the operating switch for 'Off' mode.

WARNING

Warning denotes a hazard. It calls attention to a procedure, which if not correctly performed or adhered to could result in injury or loss of life. Do not proceed beyond a warning note until the indicated conditions are fully understood and met.

CAUTION

Caution denotes a hazard. It calls attention to a procedure, which if not correctly performed or adhered to could result in damage to or destruction of the instrument. Do not proceed beyond a caution note until the indicated conditions are fully understood and met.



Indicates that a laser is fitted. The user must refer to the manual for specific Warning or Caution information to avoid personal injury or damage to the product.

Avoiding Problems When Making Measurements

Bit errors can occur due to network defects (such as faulty network elements, damaged optical fiber or dust/dirt particles in the fiber connections) or problems with the test environment/setup. Follow the steps below to avoid problems when making measurements.

► **To avoid introducing errors when performing tests:**

- 1** Ensure that optical fibers connecting the instrument to the network are not damaged - check that fibers have not been crimped.
- 2** Avoid acute bends in the fiber. Ensure that fibers only have gentle arcs.
- 3** If the instrument is left unattended for a long term test, ensure that the equipment is not in a position where people will disturb the connecting fibers.
- 4** Ensure that all fiber connections are clean and dirt-free. Use a fiberscope to measure the cleanliness of a (unpowered) fiber. A poorly cleaned fiber results in a drop in power. Alternatively, use a power meter (e.g. the instrument's internal power meter) to measure the power at the end of a fiber, the other end of which is connected to the network.
- 5** Before connection is made, always clean the connector ferrule tip with acetone or alcohol using a cotton swab. Dry the connector with compressed air. Failure to maintain cleanliness of connectors is liable to cause excessive insertion loss.
- 6** Ensure that the correct time and date is set on the instrument.

Operators Maintenance

WARNING

No operator serviceable parts inside. Refer servicing to qualified personnel. To prevent electrical shock, do not remove covers.

Maintenance appropriate for the operator is:

- Cabinet cleaning - clean the cabinet using a dry cloth only.
- Cleaning Optical Connectors
- Ensure ventilating fan cover is clean.

Cleaning Optical Connectors

You should clean the optical connectors at regular intervals using the following materials:

Description	Agilent Part Number
Compressed Air Can or Blow Brush	
Isopropyl Alcohol	8500-5344
Lens Cleaning Paper	9300-0761
Swabs	5080-5400

CAUTION

Do not insert any tool or object into the optical IN or OUT ports of the instrument as damage to or contamination of the optical fiber may result.

► To clean the optical connectors

- 1 Disconnect the instrument from the Power Line or switch off the laser transmitter before commencing this cleaning procedure.
- 2 Remove the adapters from the optical IN and OUT ports by flipping back the lever on the optical adapter.

1 Introduction

- 3** Using the blow brush with the brush removed blow through the ferrule of the standard flexible connector and the adapter.
- 4** If the optical fiber of the fixed connector requires further cleaning this entails disassembly of the module. This should be carried out only by suitably trained service personnel.
- 5** Apply some isopropyl alcohol to a piece of the cleaning paper and clean the barrel of the adapter. Using a new piece of cleaning paper, clean the face of the adapter. Repeat this operation, using a new piece of cleaning paper each time.
- 6** Use a blow brush or compressed air to remove any particles of cleaning paper which may be present.
- 7** Replace the adapters in the optical connector. Secure in place by clicking the retaining lever back into position.

Statement of Compliance

This instrument has been designed and tested in accordance with IEC Publication 61010-1 (1990) + A1:1992 + A2(1995) Safety requirements for Electrical Equipment for Measurement, Control and Laboratory Use, and has been supplied in a safe condition. The instruction documentation contains information and warnings which must be followed by the user to ensure safe operation and to maintain the instrument in a safe condition.



The CE mark shows that the product complies with all relevant European legal Directives.

ISM 1-A

This is a symbol of an Industrial Scientific and Medical Group 1 Class A product.

ICES/NMB-001

This ISM device complies with Canadian ICES-001. Cet appareil ISM est conforme à la norme NMB-001 du Canada.



The CSA mark is a registered trademark of the Canadian Standards Association.



Australian EMC Regulations

The C-Tick mark is a registered trademark of the Australian Communications Authority. This signifies compliance with the Australian EMC Framework Regulations under the terms of the Radiocommunications Act of 1992.

Noise Declaration (German)

LpA<70dB

am Arbeitsplatz (operator position)

normaler Betrieb (normal position)

nach DIN 45635 pt.19 (per ISO 7779)

Electromagnetic Compatibility

This product conforms with the protection requirements of European Council Directive 89/336/EEC for Electromagnetic Compatibility (EMC).

The conformity assessment requirements have been met using the technical Construction file route to compliance, using EMC test specifications EN 55011:1991 (Group 1, Class A) and EN 50082-1:1992.

In order to preserve the EMC performance of the product, any cable which becomes worn or damaged must be replaced with the same type and specification.

See also "10 Base-T LAN Connection Radiated Emissions" on page 61.

Declaration of Conformity

A Declaration of Conformity is provided on the CD-ROM shipped with your instrument.

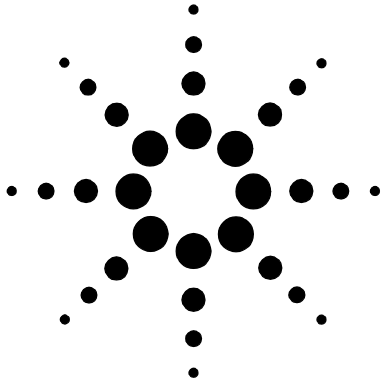

2 Installation (Getting Started)

Preparation	32
Operation Checks on Delivery	38
Optical Connector Safety Information	46
Additional Precautions for Service Engineers	49
Top Panel Connectors	51
Connectors on Instrument Front/Left Side Panel	58
Connectors on Instrument Front/Right Side Panel	59
Instrument Reboot (Cold Start)	61

This chapter provides general information on how to install and connect up the instrument, and how to check that the instrument operates correctly on delivery.



Preparation

Initial Inspection

WARNING

To avoid hazardous electrical shock, do not perform electrical tests when there are signs of shipping damage to any portion of the outer enclosure.

Inspect the shipping container for damage.

If the shipping container or cushioning material is damaged, it should be kept until the contents of the shipment have been checked for completeness and the instrument has been checked both mechanically and electrically.

Procedures for checking operation on delivery are given later in this chapter on page 38.

If the contents of the shipment are incomplete, if there is mechanical damage or defect, notify the nearest Agilent Office.

If the instrument does not pass the delivery checks given on page 38, notify the nearest Agilent office.

If the shipping container is also damaged, or the cushioning material shows signs of stress, notify the carrier as well as the nearest Agilent office. Keep the shipping materials for the carrier's inspection. The Agilent office will arrange for repair or replacement without waiting for claim settlement.

Operating Environment

DO NOT operate the product in an explosive atmosphere or in the presence of flammable gasses or fumes.

This instrument may be operated in environments within the following limits:

Temperature: 0 to +45 degC

Altitude: Up to 3050 m (10,000 ft)

Humidity: Up to 90% relative humidity to 40°C, but it should be protected from temperature extremes which may cause condensation.

To ensure adequate cooling, do not obstruct air vents in the instrument cabinet.

CAUTION

This instrument is designed for use in Installation Category II and Pollution Degree 2 per IEC 61010-1 and IEC 60664 respectively.

Ventilation Requirements: When installing the instrument in a cabinet, the convection into and out of the instrument must not be restricted. If the total power dissipated in the cabinet is greater than 800 watts, then forced convection must be used.

This product is suitable for indoor use only.

Preparation for Use

WARNING

If this instrument is not used as specified, the protection provided by the equipment could be impaired. This instrument must be used in a normal condition only (in which all means for protection are intact).

Power Requirements

The instrument requires a power source of 100 to 240 V ac at a frequency between 47 and 66 Hz (nominal).

Power consumption:

J2126A: 150 VA, J2127A: 250VA

There are no customer replaceable fuses in the instrument.

Connecting to the Power Supply

WARNING

This is a Safety Class I instrument (provided with a protective earthing ground, incorporated in the power cord). The mains plug shall only be inserted in a socket outlet provided with a protective earth contact. Any interruption of the protective conductor inside or outside of the instrument is likely to make the instrument dangerous. Intentional interruption is prohibited.

The mains switch fitted to the instrument is a single pole device and must not be used as the disconnect device. An IEC320 coupler (mains input power cord) is intended as the main disconnect device. The switch is marked I and O. The I indicates on and the O indicates off. Do not position the instrument such that access to the coupler is impaired.

Before switching on this instrument, make sure that the line supply voltage is in the specified ranges. Mains supply voltage fluctuations should not exceed +/- 10% of the nominal line voltage. Range selection is automatic.

Power Cable

WARNING

To avoid the possibility of injury or death, the following precautions must be followed before the instrument is switched on:

- (a) While this is a Class I product, provided with a protective earthing conductor in a power cord, an external protective earthing terminal has also been provided. This terminal is for use where the earthing cannot be assured. At least an 18AWG earthing conductor should be used in such an instance, to ground the instrument to an assured earth terminal. The external protective earth terminal is on the rear of the instrument as shown on page 35.
- (b) If this instrument is to be energized via an auto-transformer to reduce or increase the line voltage, make sure that the common terminal is connected to the neutral pole of the power source.
- (c) The power cable plug shall only be inserted into a socket outlet provided with a protective ground contact. The protective action must not be negated by the use of an extension cord without a protective conductor (grounding).

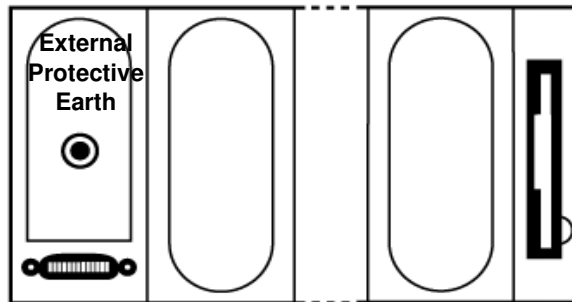







Earthing terminal - left side panel

The power cord supplied with each instrument varies with the country of destination. The following figure illustrates the standard power plug and cord configurations that are commonly used. The part number shown beneath each plug is the part number of the appropriate power cord and plug. If the

2 Installation (Getting Started)

appropriate power cord is not included with the instrument notify the nearest Agilent office and a replacement will be provided.

						
8120-2104	8120-1369	8120-1689	8120-1351	8120-1378 US 8120-4753 JAP	8120-2956	8120-4211

Power cable configurations and part numbers

Removing the Instrument Covers

The instrument covers are a press-fit. To remove them, gently lever them off.

When transporting the instrument, always replace both covers to protect the instrument connectors and display.

Connecting the Mouse Cable

CAUTION

To ensure complete compliance with the EMC regulations specified for the instrument, you must attach a ferrite bead to the connector end of the mouse cable.

Your mouse cable may not look identical to the one illustrated, but the instructions are the same. Snap open the ferrite bead (supplied with the instrument) and attach it as close to the cable plug as possible, wind the cable twice through the 28A2025-0A0 bead, then snap it shut. To stop the bead sliding along the cable attach the tie wrap (also supplied with the instrument) round the cable just after the bead.

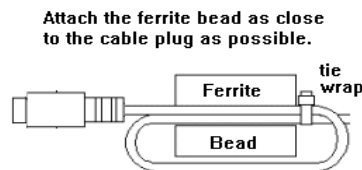

Useful Information When Requesting Support

When contacting Agilent Technologies for support it is useful to have the following instrument information available:

- Model Number
- Serial Number (on instrument base plate in the format GBXXXXXXXXXX)
- Instrument Options (These can be located on the instrument by pressing <Menu> and selecting **System >Options.**)
- Instrument Firmware Revision. (This can be located on the instrument by pressing <Menu> and selecting **System >Preferences.**)
- Self Test fail codes and messages. (These can be located on the instrument by pressing <Menu> and selecting **System >Self Test.**)

Operation Checks on Delivery

The following procedures give a quick Power-up and Back-to-Back functional test of the optical interfaces using the optical accessories provided. These checks should be done by a user or engineer familiar with making optical interface connections.

CAUTION

Safety precautions, care and connection cleanliness must be observed to ensure that the optical connections are not damaged or degraded. Ensure the recommended optical attenuation is present in all optical loopback connections as failure to do so could cause test failure or damage to the optical receivers.

Power-up Sequence

For information on how to use the instrument and navigate the graphical user interface, refer to the Quick Reference Guide supplied with the instrument.

- 1 Connect the Transmission Test Set to the AC Power Line using the Power Cord provided and set the power switch to ON (located beside power inlet).
- 2 The fans should start and after a few seconds the display will initialize and indicate the following.

Starting Instrument

Please wait.....

The Agilent Technologies splash screen will then be displayed while the unit completes initialization.

- 3 On completion (approximately 30 seconds), the display will change to the user windows with instrument settings. The Instrument is now ready for use.

NOTE

While running the instrument, a single line of text appears at the bottom of the display. This gives you helpful information relating to the area of the screen that is highlighted. In addition, online help is available on the instrument. If you require assistance at any time press the <Help> button on the front panel. This will display the online help.

To return to the normal instrument display press the <Help> button again.

Recalling Default Settings

To ensure instrument is set to a known state:

- 1 Press <Menu>, choose **Tx/Rx > Stored Settings** then press <Select>.

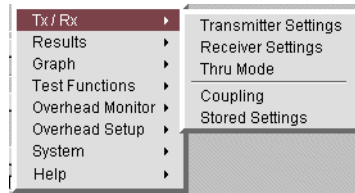

- 2 Select **Default** then **Recall**.

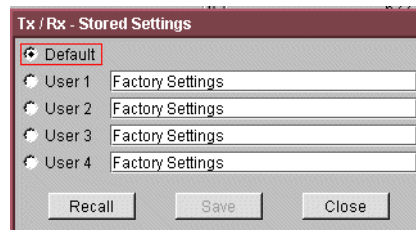

- 3 Select **OK** then wait for a few seconds for instrument to reconfigure to the default settings. Recall has completed when the dialog box clears.
- 4 Select **Close** on the Tx/Rx - Stored Settings window.

NOTE

The instrument is a dual standard SONET/SDH instrument. It should have been set to the Network Standard for the country it was shipped to, However if you need to change this, press the <Menu> key and select **System > Preferences**. Press <Select> to open the Preferences window. Select SONET or SDH as required.

- 5 Proceed with the Back-to-Back functional checks.

2 Installation (Getting Started)

Back-to-Back Functional Checks

CAUTION

When making a back-to-back connection between the optical Transmit and Receive ports, you must attenuate the signal to the receiver by 15 dB to prevent damage to the receiver. It is recommended that you use the supplied Optical Patch Cord and 15 dB Optical Attenuator assembly to make the optical connection between the Transmit and Receive ports.

For Option 120 no optical attenuation is required in the 10 Gb/s loopback.

Before connecting the optical cable, remove any dust protectors from the ends of Patch Cord and Attenuator and make sure the (white) exposed ends are not touched by fingers or otherwise they will become contaminated.

When making connections ensure full location in port key/notch then tighten/lock by hand depending on the connector type.

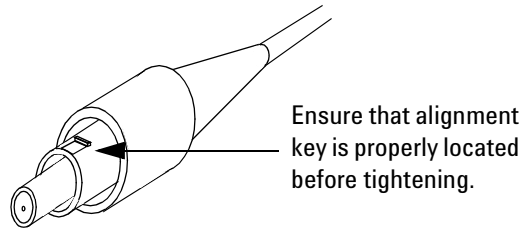

WARNING

Always ensure Optical Output Laser LEDs (adjacent to each transmit port) are OFF while making/changing optical connections.

Also refer to "Laser Warnings and Cautions" on page 46.

- 1 For J2127A models with 10 Gb/s interface, make connection as follows. If unit is J2126/7A with 2.5 Gb/s interface only, skip this step and proceed from step 8.

10 Gb/s Loopback Connections (J2127A Only)

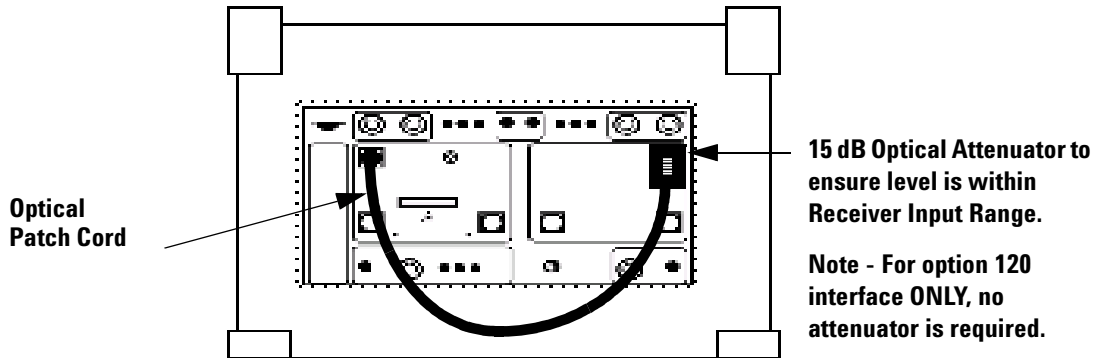

- 2 Press <Menu>, choose **Tx/Rx > Transmitter Settings** then press <Select>. Select the **Physical** tab. Select the **Laser On** checkbox (a tick appears in the box). The displayed Transmitter Settings should be similar to example below.

Note Signal rate may show either (OC-192 or STM-64) depending on instrument System preferences.

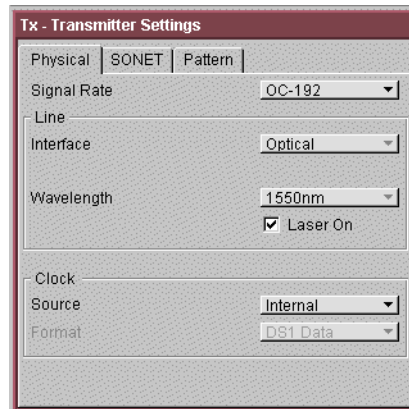

Check the laser LED is illuminated at the 10 Gb/s Output Port on the Transmission Test Set’s connector panel.

2 Installation (Getting Started)

- 3 Press <Menu>, choose **Tx/Rx > Coupling** then press <Select>. Choose **Copy Tx to Rx** to set Coupling On. Select **Close** to close dialog.

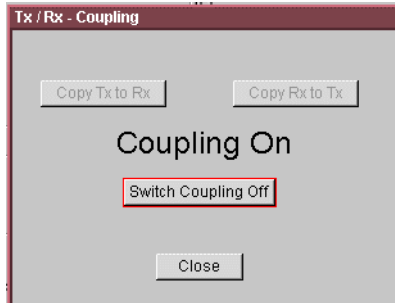

- 4 Press <Smart Test>, choose **Shortcuts > Trouble Scan** then press <Select>. Press **Run/Stop** to begin a measurement.
- 5 Check that '**No Trouble**' is displayed in the **Results** window to confirm no errors have been detected. If not then refer to "What to do if the Test fails" on page 45.

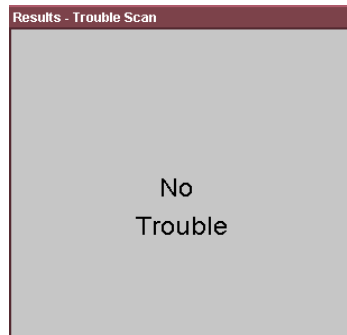

- 6 Press <Single Error> button and check that the Errors Led flashes red and some errors accumulate on the **Results - Trouble Scan** window. Then press the <Run/Stop> key to stop gating.
- 7 Press <Window> key to highlight the Tx-Transmitter Settings window and set the **Laser** to **OFF**.

- 8 Change/Make the following Optical loopback connection to check of the 2.5 Gb/s interface.

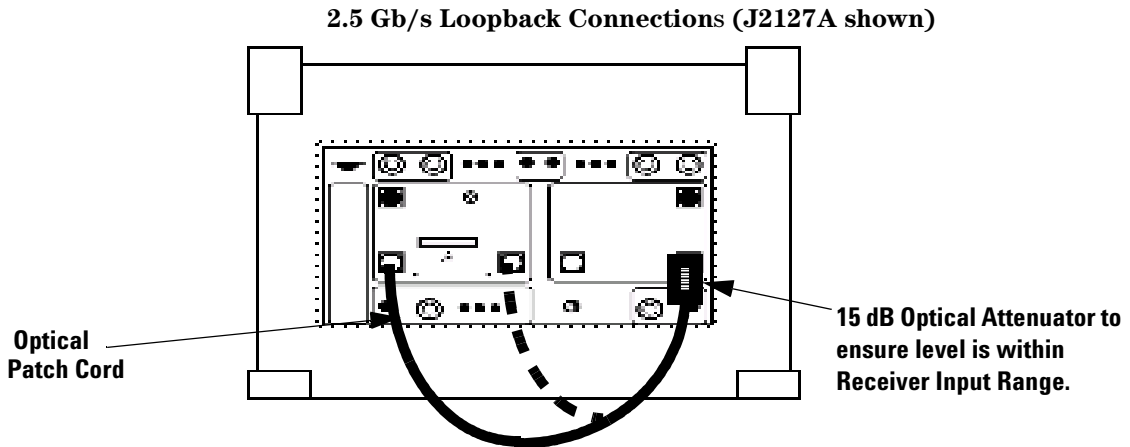

Note - Either of the [52 Mb/s - 2.5 Gb/s] Transmitter Outputs may be used if both 1310 & 1550 nm ports are fitted.

- 9 Change the Transmitter Settings **Signal Rate** to (**OC-48** or **STM-16**). and set the **Wavelength** to be the same as the Transmit Port connected in set-up, i.e. **1310nm** or **1550nm**.

NOTE

The Receiver signal rate will be the same as the Transmitter if Tx > Rx Coupling is On. The Coupling status and Transmitter & Receiver settings are shown in left lower corner of the graphical display.

- 10 Set the **Laser** to **ON** and check the laser LED is illuminated at the connected 52 Mb/s - 2.5 Gb/s Output Port on the Transmission Test Set's connector panel.
- 11 Repeat step 4 to step 6 to confirm correct operation.
- 12 Press <Window> key to highlight the **Tx-Transmitter Settings** page and set the **Laser** to **OFF**.
- 13 If the instrument has a single Receiver port covering the range 52 Mb/s to 2.5 Gb/s skip this step and resume at step 14. If the instrument has two separate Receiver ports;

2 Installation (Getting Started)

52 Mb/s - 622 Mb/s and 2.5 Gb/s continue with step 13.
Cable-up as shown below

622 Mb/s Loopback Connections (J2127A shown)

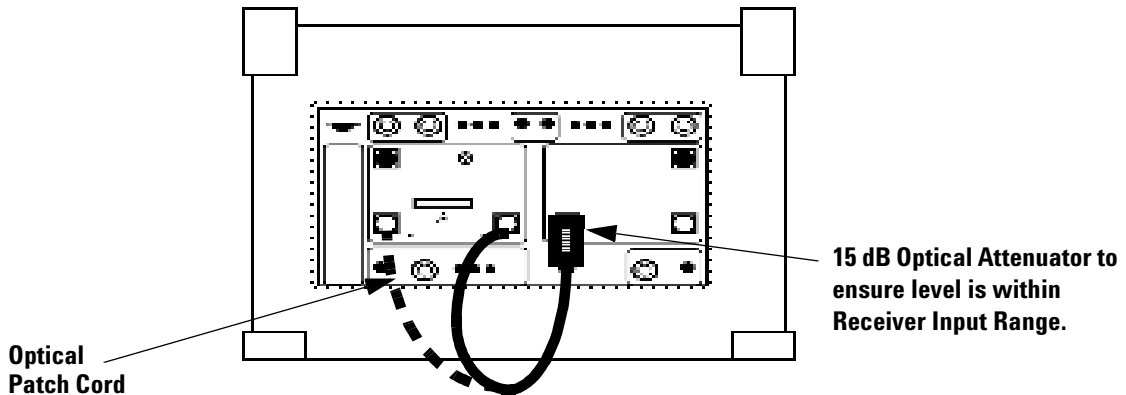

Note - Either of the [52 Mb/s - 2.5 Gb/s] Transmitter Outputs may be used if both 1310 & 1550 nm ports are fitted.

- 14** Change the Transmitter Settings **Signal Rate** to (**OC-12** or **STM-4**), and set the Wavelength to the be same as the Transmit Port connected in set-up.
- 15** Set the **Laser to ON** and check the laser LED is illuminated at the connected 52 Mb/s - 2.5 Gb/s Output Port on the instrument's connector panel.
- 16** Repeat step 4 to step 6 to confirm correct operation.
- 17** Press <Window> key to highlight the **Tx-Transmitter Settings window** and set the **Laser to OFF**.
- 18** Disconnect all loopback connections.

NOTE

The above checks are for Optical Interfaces only. Electrical and Ethernet Interfaces can be checked using Self Test if required. See Chapter 4 for more details.

What to do if the Test fails

NOTE

Always ensure Optical Output Laser LEDs beside ports are OFF while making/changing optical connections.

- 1 Check all connections and make sure that the correct loopback connection is in place for the interface being checked. Make sure connectors are located in key/notch of the port connectors to ensure full insertion.
- 2 Check Transmitter and Receiver are set to the same Signal Rate and that the correct Laser is On when test is being Run.
- 3 Press <**Smart Test**> then select **Shortcuts > Signal Power** and check the Received signal level is in the Green BER measurement power range.
- 4 Ensure all optical connections are clean and fully connected with no sharp bends or twists in the optical patch cord. Check the Optical Cord and Attenuator, if damaged substitute with equivalent.
- 5 Power down unit and use recognized cleaning kit to clean connectors before retrying the Tests.

If the problem persists then contact your local Agilent Sales/Service representative.

Optical Connector Safety Information

The connectors available for connecting to the network depend on the options fitted to your instrument.

For more information, see:

- "Avoiding Optical Receiver Overload" on page 48
- "Cleaning Optical Connectors" on page 28
- "Additional Precautions for Service Engineers" on page 49
- "Laser Warnings and Cautions" on page 46

Laser Warnings and Cautions

Before connecting, note the Warning and Caution information given.

All Connectors

CAUTION



When connecting or disconnecting, ensure that you are grounded or, make contact with the metal surface of the Mainframe with your free hand to bring you, the module, and the mainframe to the same static potential.

Modules remain susceptible to ESD damage while the module is installed in the Mainframe Additional ESD information is required when servicing, see your Verification manual for further information.

Optical Interface Connectors

For your protection, review all laser information given in this manual and the Verification manual before installing or using the instrument.

WARNING

To prevent personal injury, avoid use that may be hazardous to others, and maintain the instrument in a safe condition. Ensure the information given below is reviewed before operating the instrument.

Laser Product Classification

All optical modules are classified as Class I (non-hazardous) laser product in the USA which complies with the United States Food and Drug Administration (FDA) Standard 21 CFR Ch.1 1040.10, and are classified as Class 1 (non-hazardous) laser products in Europe which complies with EN 60825-1 (1994).

To avoid hazardous exposure to laser radiation, it is recommended that the following practices are observed during system operation:

- ALWAYS DEACTIVATE THE LASER BEFORE CONNECTING OR DISCONNECTING OPTICAL CABLES.
- When connecting or disconnecting optical cables between the instrument and device-under-test, observe the connection sequences given below.

Connecting: Connect the optical cable to the input of the device-under-test before connecting to any of the instrument's **Optical Out** connectors. When connecting to the **Optical In** ports ensure the power level never exceeds the maximum stated limit for that port. Also ensure that the power level of a signal applied to an instrument receive port is within the recommended operating level for that port. Recommended input operating power levels for each input port are printed on the connector panel adjacent to the port.

Disconnecting: Disconnect the optical cable from the **Optical Out** connector before disconnecting from the device-under-test. Always close the fiber optic connector dust caps over the laser aperture.

- NEVER examine or stare into the open end of a broken, severed, or disconnected optical cable when it is connected to one of the instrument's Optical Out connectors.
- Arrange for service-trained personnel, who are aware of the hazards involved, to repair optical cables.

Laser Warning Symbols

The instrument's connector panel has the following label:

CLASS 1 LASER PRODUCT

CLASS 1 LASER PRODUCT translates as follows:

Finnish - LUOKAN 1 LASERLAITE

Finnish/Swedish - KLASS 1 LASER APPARAT

This label indicates that the radiant energy present in this instrument is non-hazardous.

Avoiding Optical Receiver Overload

Check when connecting an optical transmitter to an optical receiver that you do not overload the receiver. This applies to elements under test and also the receiver input ports.

Check for Status messages on the instrument display warning of overload conditions.

On the connector panel the following output/input power level information is printed:

Tx Optical Out ports: Maximum available output power.

Rx Optical In ports: Maximum input power (damage level) the receiver input can accept before damage occurs. Recommended input power operating range for signals applied to the receiver.

When performing tests, it is recommended that you drive the optical receiver with a signal that has an average power in the middle of the receiver's operating range.

Additional Precautions for Service Engineers

DO NOT substitute parts or modify equipment. Because of the danger of introducing additional hazards, do not install substitute parts or perform any unauthorized modification to the product. Return the product to an Agilent Sales and Service Office for service and repair to ensure the safety features are maintained.

DO NOT service or adjust alone. Under certain conditions, dangerous voltages may exist even with the equipment switched off. To avoid dangerous electrical shock, service personnel must not attempt internal service or adjustment unless another person, capable of rendering first aid and resuscitation, is present.

Review "Safety Precautions" on page 23.

See "Optical Connector Safety Information" on page 46 before making connections to the instrument.

ESD Precautions

CAUTION



When making connections to the instrument, review "Optical Connector Safety Information" on page 46.

The instrument contains components sensitive to electrostatic discharge. To prevent component damage, carefully follow the handling precautions presented below.

The smallest static voltage most people can feel is about 3500 volts. It takes less than one tenth of that (about 300 volts) to destroy or severely damage static sensitive circuits. Often, static damage does not immediately cause a malfunction but significantly reduces the component's life.

2 Installation (Getting Started)

Adhering to the following precautions will reduce the risk of static discharge damage.

Keep the assembly in its conductive storage box/bag when not installed in the Mainframe. Save the box/bag for future storage of the assembly.

Before handling the assembly, select a work area where potential static sources are minimized. Avoid working in carpeted areas and non-conductive chairs. Keep body movement to a minimum. Agilent recommends that you use a controlled static workstation.

Avoid touching any components or edge connectors. When you install the assembly, keep one hand in contact with the protective bag as you pick up the assembly with your other hand. Then, before installing the assembly, ensure that you are grounded or make contact with the metal surface of the Mainframe with your free hand to bring you, the assembly, and the mainframe to the same static potential. This also applies whenever you connect or disconnect cables on the instrument.

CAUTION

Review "Optical Connector Safety Information" on page 46 before making connections to the instrument.



Top Panel Connectors

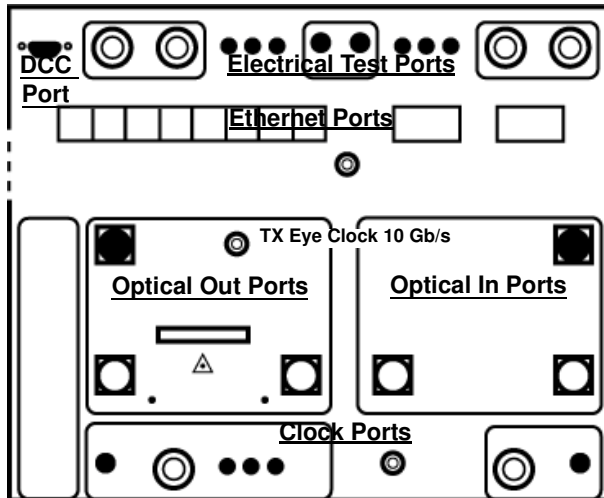

For information on the instrument's connectors, see:

- "Optical Out Ports" on page 52
- "Optical In Ports" on page 53
- "Clock Ports" on page 54
- "DCC Port" on page 55
- "Electrical Test Ports" on page 56
- "Ethernet Ports" on page 57

Optical Out Ports

Provides SONET optical signals OC-1, OC-3, OC-12, OC-48, OC-192, and SDH optical signals STM-0, STM-1, STM-4, STM-16, STM-64 at wavelength 1310 and 1550 nm, depending on instrument model and options.

52 Mb/s - 2.5 Gb/s 1310 nm Selectable optical connector (see "Optical Connectors (product options)" on page 16) for a 52 Mb/s to 2.5 Gb/s optical output. Nominal wavelength is 1310 nm. Power output is -5 to +0 dBm.

52 Mb/s - 2.5 Gb/s 1550 nm Selectable optical connector (see "Optical Connectors (product options)" on page 16) for a 52 Mb/s to 2.5 Gb/s optical output. Nominal wavelength is 1550 nm. Power output is -2 to +3 dBm.

10 Gb/s, 1550 nm Selectable optical connector (see "Optical Connectors (product options)" on page 16) for a 10 Gb/s optical output. Nominal wavelength is 1550 nm. Power output is -1 to +1 dBm.

10 Gb/s, 1550 nm (SR) Selectable optical connector (see "Optical Connectors (product options)" on page 16) for a 10 Gb/s optical output. Nominal wavelength is 1550 nm. Power output is -5 to -1 dBm.

10 Gb/s, 1310 nm (SR) Selectable optical connector (see "Optical Connectors (product options)" on page 16) for a 10 Gb/s optical output. Nominal wavelength is 1310 nm. Power output is -6 to -1 dBm.

Optical Connector	Order Option
FC/PC	190
SC	191
ST	192

Optical In Ports

Accepts SONET OC-1, OC-3, OC-12, OC-48 and OC-192 and SDH STM-0, STM-1, STM-4, STM-16, STM-64 signals, depending on the model and options fitted.

52 - 622 Mb/s Selectable optical connector (see "Optical Connectors (product options)" on page 16) for a 52 Mb/s to 622 Mb/s optical input (OC-1, OC-3, OC-12/STM-0, STM-1, STM-4 signals). Wavelength 1200 to 1600 nm. Input damage power $>+3$ dBm; never exceed maximum input power. The recommended input power operating level for OC-1, OC-3/STM-0, STM-1 signals is -33 to -10 dBm and for OC-12/STM-4 signals -28 to -8 dBm.

2.5 Gb/s Selectable optical connector (see "Optical Connectors (product options)" on page 16) for a 2.5 Gb/s optical input (OC-48/STM-16 signals). Wavelength 1200 to 1600 nm. Input damage power $>+3$ dBm; never exceed maximum input power. The recommended input power operating level for OC-48/STM-16 signals is -28 to -8 dBm.

10 Gb/s High Rx Sensitivity Optics Selectable optical connector (see "Optical Connectors (product options)" on page 16) for 10 Gb/s (OC-192/STM-64) optical input signals. Wavelength 1200 to 1600 nm. Input damage power $>+1$ dBm; never exceed maximum input power. The recommended input power operating level for OC-192/STM-64 signals is -20 to -9 dBm.

10 Gb/s (SR) Optics Selectable optical connector (see "Optical Connectors (product options)" on page 16) for 10 Gb/s (OC-192/STM-64) optical input signals. Wavelength 1200 to 1600 nm. Input damage power $>+3$ dBm; never exceed maximum input power. The recommended input power operating level for OC-192/STM-64 (1310 nm) signals is -11 to -1 dBm. The recommended input power operating level for OC-192/STM-64 (1550 nm) signals is -14 to -1 dBm.

Clock Ports

2 Mb/s, 2 MHz Clock In BNC 75 ohm (nominal) unbalanced connector for a 2 Mb/s and 2 MHz MTS external clock source input.

2 Mb/s, 2 MHz Clock In 3-pin Siemens connector for a 2 Mb/s and 2 MHz MTS external clock source input.

DS1 Clock In Bantam 100 ohm (nominal) connector for a DS1 BITS external reference clock input.

2 MHz Clock Out BNC 75 ohm (nominal) unbalanced connector for a 2 MHz MTS clock reference output. Generated relative to the selected transmit reference clock.

DS1 Clock Out Bantam 100 ohm (nominal) connector for a DS1 BITS clock reference output. Generated relative to the selected transmit reference clock.

TX Eye Clock 52 - 2.5 Mb/s SMA connector providing a TX Eye Clock signal (at 1/4 of the line rate) which can be used to trigger an oscilloscope when examining data signals.

TX Eye Clock 10 Gb/s SMA connector providing a TX Eye Clock signal (at 1/16 of the line rate) which can be used to trigger an oscilloscope when examining data signals.

DCC Port

Connector 9-pin miniature D-type.

Use this port to insert and drop either the D1-D3 DCC channel or the D4-D12 DCC channel. The first bit of data inserted will be put into the MSB of the DCC channel. The MSB of the dropped data bytes will be output first. The transmit (drop) and receive (insert) capabilities are independent, that is the transmit and receive clock rates can be set to different rates. The instrument acts as a DCE (Data Communications Equipment), supplying the clock signal for both drop and insert operation.

Rates D1-D3 DCC: 192 kb/s, D4-D12 DCC: 576 kb/s

Signal Type Unipolar differential signal as defined in ANSI EIA-422-B and EIA-423-B.

Input Termination 100 ohms differential.

Input Sensitivity 500 mV over a +/-15 V common mode range and 200 mV over a +/-7 V range.

Pin Number	RS-449/422 Circuit
1	Rx Data Output (+)
2	Rx Clock Output (+)
3	Signal ground
4	Tx Clock Output (+)
5	Tx Data Input (+)
6	Rx Data Output (-)
7	Rx Clock Output (-)
8	Tx Clock Output (-)
9	Tx Data Input (+)

Electrical Test Ports

SONET/SDH Out BNC 75 ohm unbalanced connector for an STS-1/STM-0 (B3ZS) or STS-3/STM-1 (CMI) electrical output.

SONET/ SDH In BNC 75 ohm unbalanced connector for an STS-1/STM-0 (B3ZS) or STS-3/STM-1 (CMI) electrical input. Input Mode - Terminate or Monitor. Monitor mode conforms to G.772-1993. Monitor Gain - 20 dB.

2 Mb/s Out 3-pin Siemens 120 ohm balanced connector for an E1 Transmit or E1 Drop signal output. Either this port or the 2-140 Mb/s, DS3 unbalanced Out port can be active for the E1 Transmit function.

2 Mb/s In 3-pin Siemens 120 ohm balanced connector for an E1 Receive or E1 Insert signal input. Either this port or the 2-140 Mb/s DS3 unbalanced In port can be active for the E1 Receive function.

DS1 Out Bantam 100 ohm balanced connector for a DS1 Transmit or DS1 Drop signal output.

DS1 In Bantam 100 ohm balanced connector for a DS1 Receive or DS1 Insert signal input.

2-140 Mb/s DS3 Out BNC 75 ohm unbalanced connector for E1, E2, E3, E4, DS3 transmit or E3, E4, DS3 Drop signals. Either this port or the 2 Mb/s balanced Out port can be active for the E1 Transmit function.

2-140 Mb/s DS3 In BNC 75 ohm unbalanced connector for E1, E2, E3, E4, DS3 receive or E3, E4, DS3 Insert signals. Either this part or the 2 Mb/s balanced In port can be active for E1.

Ethernet Ports

10M/100M Ethernet Ports Eight RJ-45 connectors are provided, each of which can support 10 Mb/s or 100 Mb/s data rates.

1G Ethernet Ports Two Gigabit Interface Convertors (GBICs) are provided as follows:

Instrument Option Number	Ethernet Type	GBIC Agilent Part Number
325	1000BASE-SX (850 nm)	HFBR-5601
326	1000BASE-LX (1310 nm)	HFBR-5611

Tx Eye Clock SMA connector providing a TX Eye Clock signal that can be used to trigger an oscilloscope when examining data signals.

2 Installation (Getting Started)

Connectors on Instrument Front/Left Side Panel

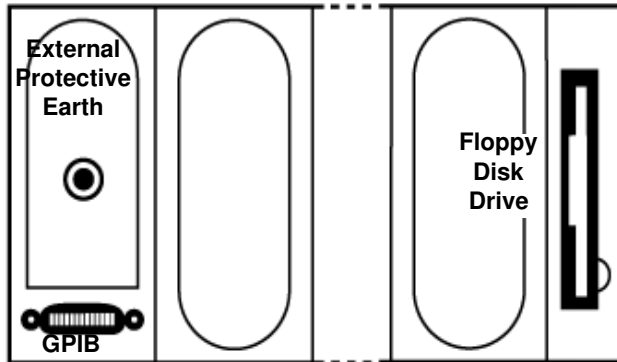

GPIB Allows test set to be remotely controlled via the GPIB control bus.

External Protective Earth Connect an external earth connection to the instrument at this point.

Floppy Disk Drive Accepts 1.44 Mb IBM formatted disks.

Connectors on Instrument Front/Right Side Panel

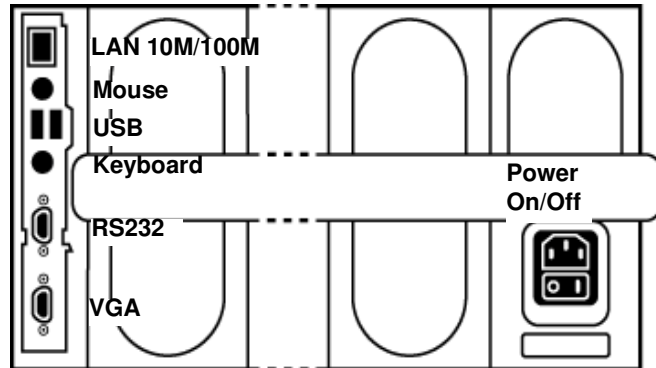

LAN 10M/100M 10/100 Base-T LAN interface port. Supports remote control of the test set and the downloading of firmware upgrades.

10 Base-T LAN Connection Radiated Emissions To ensure compliance with EN 55011 (1991) a category 5, STP patch lead, RJ45 cable should be used to connect to the LAN port.

Mouse PS/2 port for connecting a mouse. To prevent possible damage, the mouse should only be connected and disconnected when the instrument is powered off.

USB Two Universal Serial Bus ports for connecting to a Printer.

Keyboard PS/2 port for connecting an external keyboard. Can be hot-plugged for use at any time. Ensure that keyboard port is used - if connected to mouse PS/2 port in error the instrument will require to be restarted.

RS232 Remote Control port providing following configurations:

2 Installation (Getting Started)

- **Controller Type:** Computer and Terminal.
- **Protocol:** None and Xon/Xoff.
- **Speed:** 110, 300, 600, 1200, 2400, 4800, 9600, 19200, 38400 baud.
- **Parity:** Odd, Even, 1s, 0s.
- **Stop Bits:** 1, 2
- **Data Length:** 7 bits.

VGA Connector for displaying contents of instrument screen on an external display. Ensure that the external display is connected before powering up the instrument.

Instrument Reboot (Cold Start)

An instrument “cold start” routine is provided to reset the instrument in the event of an unplanned hardware or firmware event. A cold start reboots the instrument and restarts the instrument using a default configuration file. Performing a cold start erases existing configuration information. Current menu settings will be lost and the instrument will power up in its default state.

► **To perform a cold start**

- 1 Switch the instrument off and wait a few seconds.
- 2 Switch the instrument on and as the instrument boots up, look carefully at the display.
- 3 Wait for the “Starting instrument” text to be displayed. After a few seconds start to repeatedly press the **<Menu>** key until the Agilent splash screen appears with an options menu in the top left corner of the display.

The following options are available:

- 1 Reload configuration.
- 3 Cold start.
- 5 Normal start.
- 6 Upgrade software.
- 4 Press 3 on the numeric keypad to select cold start. The unit will then continue with the boot up process.
- 5 When the boot-up procedure is complete, the instrument displays a dialog box with the message: “Instrument reset to default settings.”

2 Installation (Getting Started)

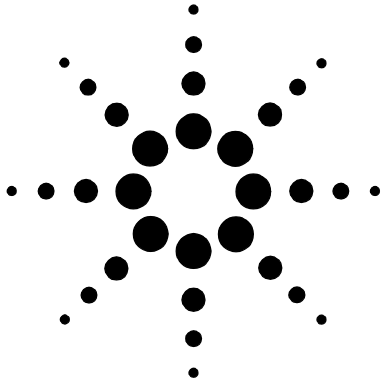

3

Performance Tests

Introduction	64
Recommended Test Equipment	65
Recall Default Settings	67
Performance Self Test	68
Internal Reference Clock Accuracy	73
External Clock Reference Inputs and Clock Reference Output	79
Optical Pulse Mask and Output Characteristics	86
Optical Receiver Sensitivity, Optical Power and Frequency Measurement	98
Electrical Pulse Mask and Output Level Characteristics	114
Performance Test Record	140



Introduction

The procedures given in this section test the performance of the J2126/7A against the instrument specifications. The tests are intended to be performed in the recommended order for a full instrument calibration check. Tests can be run individually, however it will be assumed that any preceding test would meet specifications.

Equipment Required

Equipment required for the Performance Tests is given in "Recommended Test Equipment" on page 65. Any equipment which meets or exceeds the critical specification of the equipment listed may be substituted. Recommended models are those typically used in Agilent Service Centers. Where appropriate, alternative models are also listed.

Performance Test Record

The results of the Performance Tests may be recorded in the "Performance Test Record" on page 140. The Performance Test Record lists all the tested specifications and the acceptable limits. The results recorded at incoming inspection may be used for comparison during periodic maintenance, troubleshooting or after repair or adjustment.

Calibration Check Cycle

This instrument requires periodic verification of performance. Depending on use and environmental conditions, the instrument should be checked approximately once every 2 years, using these Performance Tests.

Instrument Option Configuration

Please refer to Chapter 1 and the instrument Specifications for information on option configuration.

Recommended Test Equipment

Instrument	Critical Specification	Recommended Model
High Speed Optical Oscilloscope	Oscilloscope Mainframe 3 GHz Opt/Elect Module with STM-1/4 Filter 20 GHz Opt/Elect Module with STM-16/64 Filter.	86100A 86103A opt 201 86105A opt 202
Oscilloscope with Communications Mask Kit	> 400 MHz BW, Communications mask measurement kit with appropriate connectors/adaptors. Capability. DS1 to STS-3/STM-1e	54830B/54845B/54810A with opt 100 (option 100 provides E2625A Communication Mask test kit)
Frequency Counter	Range 0 to 200 MHz, accuracy <0.1 ppm.	53181A opt 001 or 5325A opt 010
Optical Power Meter and Sensor Module	Range -8 dBm to -33 dBm, Wavelength 1260-1600 nm	8163A & 81633A or 8153A & 81536A
Optical Attenuator	Wavelength 1200 - 1600 nm, Range 0 - 30 dB	8156A opt 100 or 8157A
FC/PC Optical Interface Connector	Unique	81000FI (Qty 4)
Optical Cables	Unique	1005-0337 (Qty 2)
PDH/DSn Structured Test Set	Unique	OmniBER 718, with option 012 or OmniBER 719 with option 013
75Ω Termination	0 to 200 MHz	15522-80010
T Connector	BNC to Dual BNC	1250-0781
Adaptor	BNC(m) to SMA(f)	E9632A
Cable	SMA to SMA	8120-4948
Balanced/Unbalanced Converter	110 ohms balanced: 75 ohms Unbalanced (nominal)	15508B
Termination Adapter Probe	Balanced 100/120 ohms to unbalanced 50 ohms	E2621A
Termination Adapter	75/50 ohms unbalanced	E2622A
Patch Cable	Bantam 110 ohms	15670A
Patch Cable	Siemens 3-pin 120 ohms	15512A

Self Test Loopback Cables and Accessories

- 1005-0337 1m fiber optic cable FC/CP connectors
- 1005-0433 FC/CP 15 dB attenuator
- 15525A 75 ohm BNC, 2 off
- 15512A Siemens 3-pin
- 15670A Bantam 110 ohm
- J2125-65011 DCC Port 9-pin loopback plug
- J2126-65021 10/100 Lan Loopback
- 1005-1110 1 G (850 nm) Ethernet Loopback,
(Tyco Electronics Corp/AMP 504971-1) or
1005-1111 1 G (1310 nm) Ethernet Loopback
(Tyco Electronics Corp/AMP 492019-1)
- Formatted floppy disk

Recall Default Settings

The Performance Tests require the Test Set to a pre-defined (default) state at the beginning of each test.

► **To recall stored settings**

- 1 Press <Menu>, choose **Tx/Rx > Stored Settings** then press <Select>.

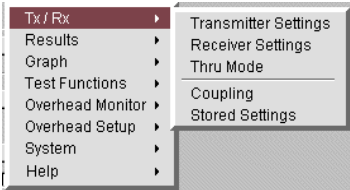

- 2 Select **Default** then **Recall**.

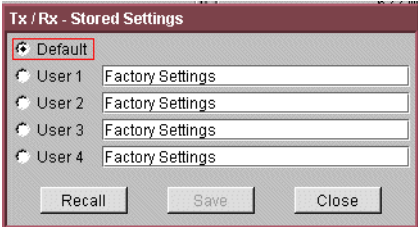

- 3 Select **OK**, then wait a few seconds for instrument to reconfigure to the default settings. Recall has completed when the dialog box clears.
- 4 Select **Close** on the Tx/Rx - Stored Settings window.

Performance Self Test

Part of the instrument Self Test is used for the Performance Tests. This provides a high degree of confidence that the relevant measurement hardware is operating correctly in advance of completing the Performance Tests.

NOTE

A full overview of the Self Test is given later in the manual.

This section gives an description of the Self Tests that are required to be completed as part of the Performance Tests and covers the following:

- "Description of the Performance Self Test" on page 68
- "Loopback Connections Required for Self Test" on page 69
- "How to run the Self Test" on page 72
- "What to do if the Self Test fails" on page 72

Description of the Performance Self Test

The Self Test comprises of a selection of tests covering different areas of hardware in the instrument. For the purposes of the Performance Self Tests, the **Confidence Test**, the **Frequency Measurement Test** and all **Ethernet Tests** (if Ethernet is fitted) should be completed. These are selected from the main Self Test menu. If a failure occurs during a test then a descriptive text message and Fail Code is returned.

The Self Test is selected by pressing the <Menu> key and selecting **System > Self Test**. An example of the Self Test page is shown.

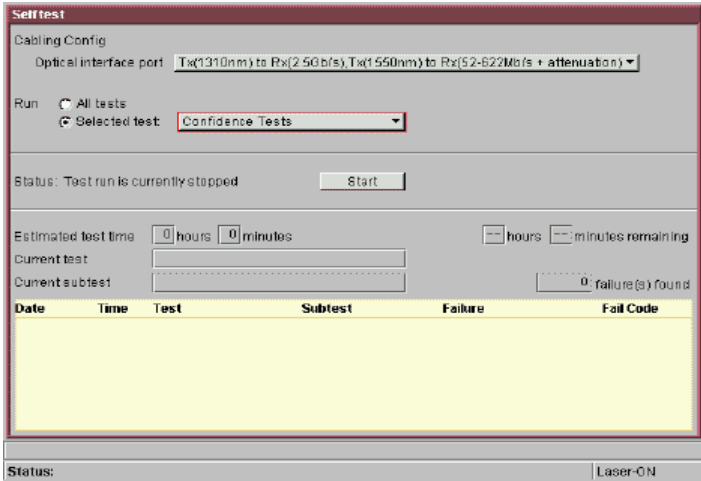

Loopback Connections Required for Self Test

The Confidence Test verifies all the optical and electrical (instruments with J2129A only) test ports on the unit therefore loopback connections are required on the instrument. The following loopback connections are required.

Optical Loopback Connections (Required on all instruments.)

Use optical cables P/N 1005-0337 and 15 dB attenuator P/N 1005-0433.

- Connect 10 Gb/s 1550 nm Optical Out <=> 15 dB Attenuator <=> 10 Gb/s Optical In. (Note attenuator is not required for Option 120 interfaces.)
- Connect 52 Mb/s - 2.5 Gb/s Optical Out <=> 15 dB Attenuator <=> 2.5 Gb/s Optical In.
- If Option 102, Dual Wavelength is installed, connect the other 52 Mb/s - 2.5 Gb/s Optical Out <=> 15 dB Attenuator <=> 52 Mb/s - 622 Mb/s Optical In.

Electrical connections 8 Mb/s to 155 Mb/s

Use BNC cable P/N 15525A

- Connect 52/155 Mb/s Out (BNC) <=> 52/155 Mb/s In (BNC)
- Connect 2 - 140 Mb/s DS3 Out (BNC) <=> 2 - 140 Mb/s DS3 In (BNC)

Unbalanced Electrical Connections PDH/DSn 2-140 Mb/s and DS3

Use BNC cable P/N 15525A

- Connect 2 - 140 Mb/s DS3 Out (BNC) <=> 2 - 140 Mb/s DS3 In (BNC)

Balanced Electrical Connections 2M/DS1

Use 3-pin Siemens cable P/N 15512A and Bantam cable P/N 15670A

- Connect 2M Out (3-pin Siemens) <=> 2M In
- Connect DS1 Out <=> DS1 In

Ethernet Loopback Connections (Option Dependent)

- Use standard category 5 patch cords for the 10/100 Mb/s Ethernet loopbacks. No crossover is required as this is handled internally. These patch cords are supplied with the instrument, Part Number J2126-65021.
- Use duplex SC optical patch cord (Tx crossed-over to Rx and Rx crossed-over to Tx). This patch cord is supplied with the instrument when 1 Gb/s Ethernet is fitted, Part Number 1005-1110 (850 nm) (Tyco Electronics Corp/AMP 504971-1), or 1005-1111 (1310 nm) (Tyco Electronics Corp/AMP 492019-1).

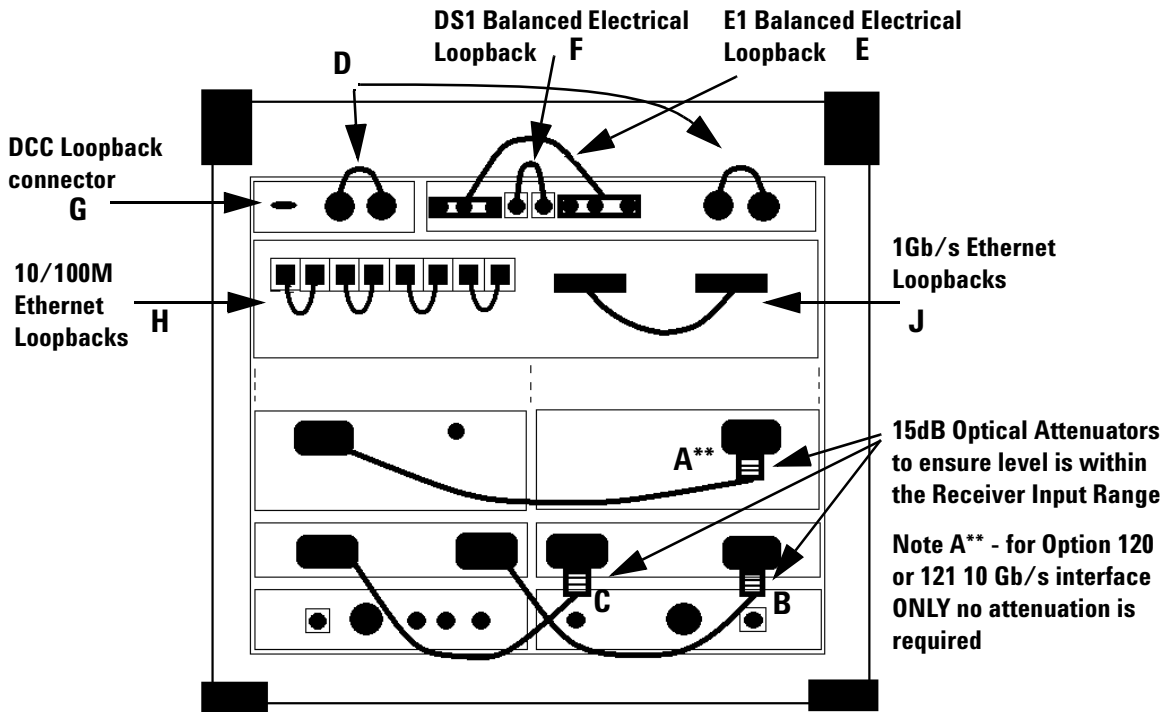

— Thick line represents Loopback Patch Cords. The connections shown are typical for J2127A fitted with Options 102 (Dual 2.5G Tx Wavelength), 111 (1550nm High Sensitivity 10G Rx optics) and 32x (Ethernet testing).

NOTE

If only a single wavelength optical port is fitted for 2.5 Gb/s - 52 Mb/s Optical Out (e.g. Option 100/101), then the Self Test should be performed twice to verify all the Optical In ports. Perform the test with the 2.5 Gb/s - 52 Mb/s Optical Out port connected to the 2.5 Gb/s Optical In port and repeat with the 2.5 Gb/s - 52 Mb/s Optical Out port connected to the 662 - 52 Mb/s Optical In port. Select the cable configuration from the test menu as appropriate.

CAUTION

Safety precautions care and connection cleanliness must be observed to ensure that the optical connections are not damaged or degraded. Ensure the recommended optical attenuation is present in all optical loopback connections as failure to do so could cause self test failure or damage to the optical receivers.

How to run the Self Test

- 1 Press <Menu>, choose **System > Self Test** then press <Select>.
- 2 Ensure all loopbacks are in place and, from the Self Test page menu, select the appropriate 1310/1550 nm 2.5 Gb/s to 52 Mb/s optical loopback Cabling Configuration.
- 3 On the Self Test page choose **Run Selected Test** and choose **Confidence Test**. Choose START to begin the test.
- 4 The Self Test will now run selecting each sub-test in sequence. The remaining test time to complete the tests is displayed on the right hand side of the Self Test page.
- 5 If any sub-test fails an error message and error code will be returned. Up to five errors are recorded.
- 6 On the Self Test page choose **Run Selected Test** and choose **Frequency Measurement**. Choose START to begin the test.
- 7 On the Self Test page choose **Run Selected Test** and choose **Ethernet Test (10/100/1G)**. Choose START to begin the test.

Further information on the Self Test can be obtained in the Self Test Overview section at the rear of this manual.

What to do if the Self Test fails

- 1 Check all connections to make sure that all the correct loopback connections are in place.
- 2 Be suspicious of any optical interface failures and if necessary clean all optical connections with a recognized cleaning kit before retrying the Self Test.
- 3 If the problem persists then contact your local Agilent Service Office or representative.

Internal Reference Clock Accuracy

Specification

Clock Output	Frequency	Accuracy
2 MHz	2.048 MHz	± 4.5 ppm
DS1 (BITS Clock)	1.544 MHz	± 4.5 ppm

Accuracy of Transmitter Internal Clock:

- Settability ± 0.5 ppm
- Stability ± 3 ppm over temperature range
- Ageing ± 1 ppm/year

NOTE

The 2 MHz output is only available when SDH or En rate is selected on the Transmitter. The DS1 output is only available when SONET or T-Carrier rate is selected on the Transmitter.

BITS Clock is not a binary format signal. Signal is a Ternary All 1s DS-1 signal with ESF Framing, clocked at 1.544 MHz.

Description

The test uses a Frequency Counter or DS_n Test Set connected to the appropriate Clock output port. When the Transmitter is set to Internal Clock the reference output is derived from the instrument internal 10 MHz reference which is also used in main signal generation.

An alternative test method using the Frequency Counter is provided for the DS1 check if a suitable DS_n Test Set is not available. However, in this case it should be noted that as this signal is a Framed All 1s Ternary signal the expected result on the Frequency Counter is offset due to the effect of Framing Bits in the signal.

Equipment Required

Frequency Counter	Agilent 53181A Option 010,015 (see Note)
DSn Test Set	Agilent 37718C with Option 012
Bantam/Bantam Cable	Agilent 15670A
75/50 ohm Matching Pad	Agilent E2629A
Bal/Unbal Converter	Agilent 15508B

NOTE

For accuracy required the counter **MUST** have high stability Internal Timebase option or be externally referenced to an in-house Standard.

Procedure

- 1 Press **<Menu>**, choose **Tx/Rx > Stored Settings** then press **<Select>**. Select **Default** then **Recall**.
- 2 Press **<Menu>**, choose **System > Preferences** then press **<Select>**. Set **Network Standard** to **SDH**.
- 3 Connect the Transmission Test Set's 2 MHz Clock Out port to the Frequency Counter Input using a 75/50Ω matching pad, set the input impedance to 50Ω. Alternatively, a 75Ω termination can be used with the input impedance set to 1 MΩ.

Transmission Test Set

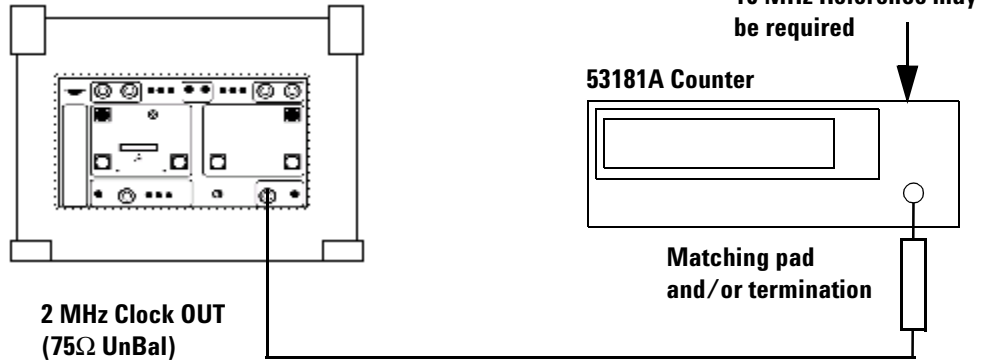

- 4 Adjust the Frequency Counter Trigger Level to obtain a stable reading and check that the Frequency Counter reads between:

2.047998 MHz and 2.0480092 MHz.

NOTE

The reading should be well within these limits. However, after several years of operation the main reference oscillator may need adjustment optimized to compensate for drift/ageing. If necessary contact your local Agilent Service for advice. Before doing so ensure the Counter being used has the appropriate internal/external reference accuracy.

- 5 Press <Menu>, choose **System > Preferences** then press <Select>. Set **Network Standard** to **SONET**.
- 6 Connect the DS1 Transmit OUT to Receive IN ports of the Test Set using a Bantam to Bantam cable. Also connect an External 10 MHz Reference signal to the Test Set 10M CLOCK Input port.

3 Performance Tests

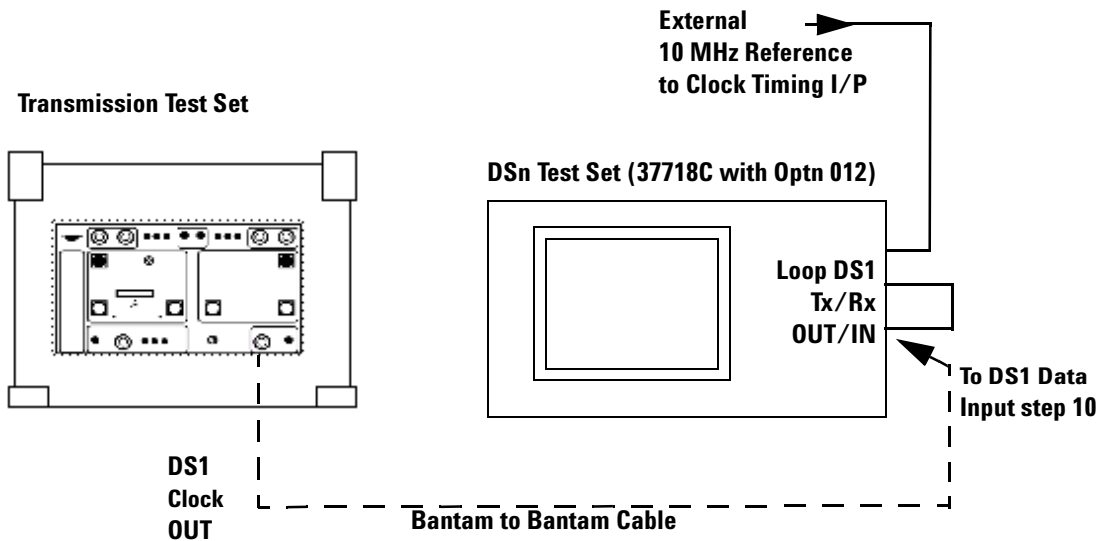

7 Setup the Test Set Settings as follows:

Tx/Rx to COUPLED mode.

SIGNAL to DS1 rate

PAYLOAD TYPE to ESF UNSTRUCTURED

PATTERN to ALL ONES

Set the Transmitter CLOCK to EXTERNAL 10 MHz REF

NOTE

This ensures the Test Set transmitter generates a DS1 signal locked to the External 10 MHz reference signal, e.g. in-house Standard. The signal is looped to the Test Set receiver to take note of the receiver frequency measurement accuracy/error.

8 Check there are no Alarms/Errors indicated by the Test Set Receiver.

NOTE

If the Test Set CLOCK LOSS LED is ON check the external reference signal.

- 9** Set the Test Set to display the Frequency Measurement and ppm Offset results and check these are between:
1543993 and 1544007 Hz.
-4.5 and +4.5 ppm
- 10** Change the test setup as follows. Disconnect the loopback connection between Test Set Tx/Rx then connect the Transmission Test Set DS1 Clock Out port to the Test Set DS1 Receive port using the Bantam to Bantam cable.
- 11** Check there are no Alarms/Errors indicated by the Test Set Receiver.
- 12** Set the Test Set to display the Frequency Offset Measurement result and check this is between:
-9 ppm and +9 ppm
- 13** Subtract the ppm Test Set error noted in step 9 from the result in step 12 to give the Transmission Test Set Transmitter DS1 Bits frequency error in ppm and check this is between:
-4.5 ppm and +4.5 ppm
- 14** Test Complete.

Alternative DS1 Clock test (if suitable DS_n Test Set is not available)

- 1 Connect the Transmission Test Set's DS1 Clock Out port to the Frequency Counter Input using a 110/75Ω Bal/Unbal Converter and 75Ω termination. Set the Frequency Counter input impedance set to 1MΩ.

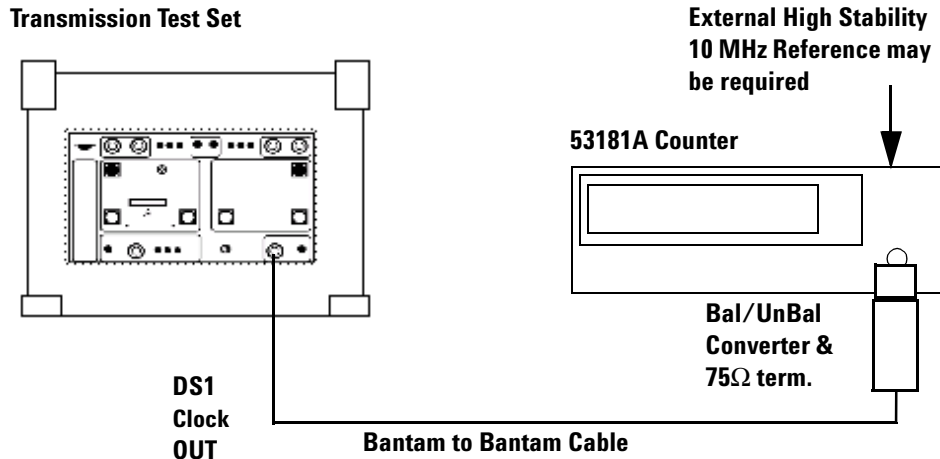

NOTE

As the DS1 Clock Output is a Framed All '1's signal the average frequency measured by the Counter will be less than expected, e.g. 1541000 Hz rather than 1544000 Hz due to the effects of Framing Bits in the signal. The Ternary format of the signal can also mean that depending on input attenuation/trigger setting the counter may trigger on exactly half the signal rate e.g. 770500 Hz.

- 2 Adjust the Frequency Counter Trigger Level to obtain a stable reading and it will also be necessary to increase the Gating time due to the effects of Framing Bits. Check that the Frequency Counter reads between:

1.540993 MHz and 1.541007 MHz

- 3 Alternative Test Complete.

External Clock Reference Inputs and Clock Reference Output

Specifications

Clock Rate	Description
2.048 Mb/s MTS	Accepts timing reference as per ITU-T G.703-1998
2.048 MHz Clock	Accepts timing reference as per ITU-T G.703-1998
1.544 Mb/s BITS	Accepts DS-1 timing reference as per TA-TSY-000378

NOTE

The 2 MHz input is only available when SDH or En rate is selected on the Transmitter. The DS1 input is only available when SONET or T-Carrier rate is selected on the Transmitter. The BITS Clock is not a binary format signal. Signal is a Ternary All 1s DS-1 signal with ESF Framing, clocked at 1.544 MHz.

Description

The test uses a PDH/DSn Test Set and a Frequency Counter connected to the appropriate external Clock input and output ports. When the Transmitter is set to external Clock the reference Clock output port timing and signal rate generation is derived from the external Clock source.

Equipment Required

Frequency Counter	Agilent 53181A Option 010,015 (see Note)
DSn Test Set	Agilent 37718C with Option 012
Bantam/Bantam Cables (2)	Agilent 15670A
75/50 ohm Matching Pad	Agilent E2629A
Bal/Unbal Converter	Agilent 15508B

NOTE

For accuracy required the counter **MUST** have high stability Internal Timebase option or be externally referenced to an in-house Standard.

Procedure

- 1 Press <Menu>, choose **Tx/Rx > Stored Settings** then press <Select>. Select **Default** then **Recall**.
- 2 Press <Menu>, choose **System > Preferences** then press <Select>. Set **Network Standard** to **SDH**.

Now set **Clock Source** to **External**, **Format** to **2 Mb/s Clock**.

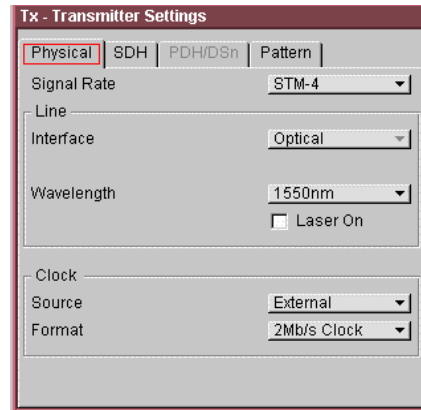

- 3 Connect the Transmission Test Set's 2 MHz Clock Out port to the Frequency Counter Input using a 75/50Ω matching pad, set the input impedance to 50Ω. Alternatively, a 75Ω termination can be used with the input impedance set to 1 MΩ.

Connect the Counter rear panel 10 MHz Reference Output to the PDH/DSn Test Set external 10M CLOCK input port.

Connect the PDH/DSn Test Set CLOCK REF OUT or TRANSMIT CLOCK OUT port to the instrument CLOCK IN 2 MHz BNC port.

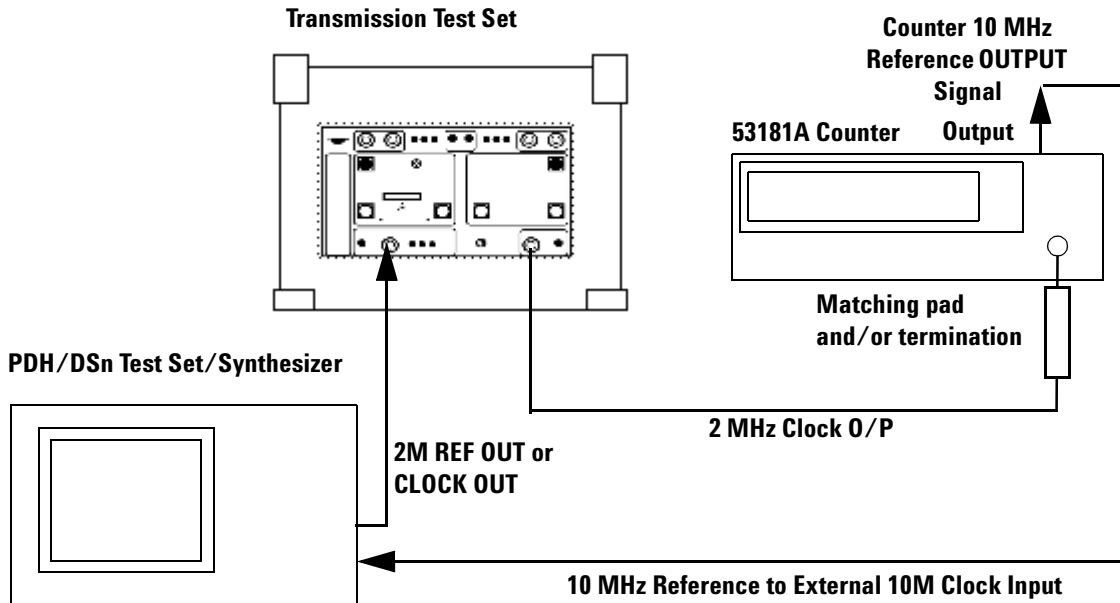

- 4 Set the PDH/DSn Test Set Transmitter as follows.
 SIGNAL to 2 Mb/s rate
 CLOCK to EXTERNAL 10 MHz REF
- 5 Check that the Test Set CLOCK LOSS Alarm Led is not lit.
- 6 Adjust the Frequency Counter Trigger Level to obtain a stable reading and check that the Frequency Counter reads between:
2.047999999 MHz and 2.048000001 MHz.
- 7 Confirm that the Transmission Test Set is locked to the External signal by disconnecting/re-connecting the BNC cable at the instrument CLOCK IN port.
- 8 Change the Transmission Test Set **External Clock, Format** setting to **2 Mb/s Data**.
- 9 Change the 2 MHz CLOCK OUT connection at the Test Set to connect the Transmit 2 Mb/s DATA out BNC to the Transmission Test Set CLOCK IN BNC port.

3 Performance Tests

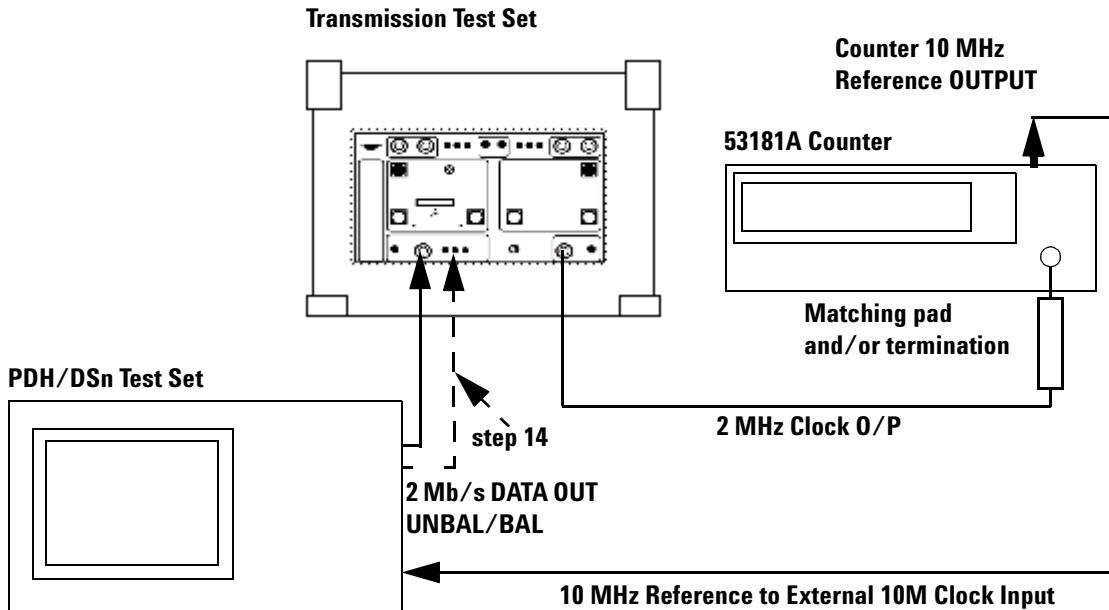

10 Ensure the PDH/DSn Test Set Transmitter is set as follows.

SIGNAL to 2 Mb/s rate

CLOCK to EXTERNAL 10 MHz REF

TERMINATION to 75 ohm UNBAL

LINE CODE to HDB3

PAYLOAD TYPE to UNFRAMED

PATTERN to 2^{23} PRBS

11 Check that the Test Set CLOCK LOSS Alarm LED is not lit.

12 Adjust the Frequency Counter Trigger Level to obtain a stable reading and check that the Frequency Counter reads between:

2.047999999 MHz and 2.048000001 MHz

- 13 Confirm that the Transmission Test Set is locked to the External signal by disconnecting/re-connecting the BNC cable at the Transmission Test Set CLOCK IN port.
- 14 Change the set-up as follows. Disconnect and remove the BNC/BNC Test Set to Transmission Test Set signal connection. Connect a Balanced 3 pin Siemens cable between Test Set Data OUT 3-pin port and Transmission Test Set CLOCK IN 3-pin port.
- 15 Change the Test Set Transmit TERMINATION to 120 ohm BALANCED.
- 16 Check that the Test Set CLOCK LOSS Alarm Led is not lit.
- 17 Adjust the Frequency Counter Trigger Level to obtain a stable reading and check that the Frequency Counter reads between.

2.047999999 MHz and 2.048000001 MHz

- 18 Confirm that the Transmission Test Set is locked to the External signal by disconnecting/re-connecting the BNC cable at the Transmission Test Set CLOCK IN port.
- 19 Press <Menu>, choose **System > Preferences** then press <Select>. Set **Network Standard** to **SONET**.

Now set **Clock Source** to **External**, **Format** to **DS1 Data**.

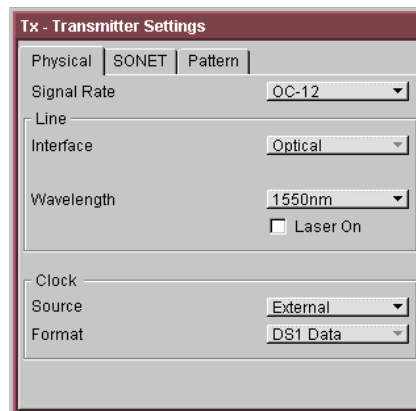

3 Performance Tests

- 20 Connect the Test Set DS1 Transmit OUT port to the Transmission Test Set Clock IN DS1 port using a Bantam cable. Connect the Transmission Test Set's DS1 Clock Out port to the Test Set DS1 Receiver IN using a Bantam cable.

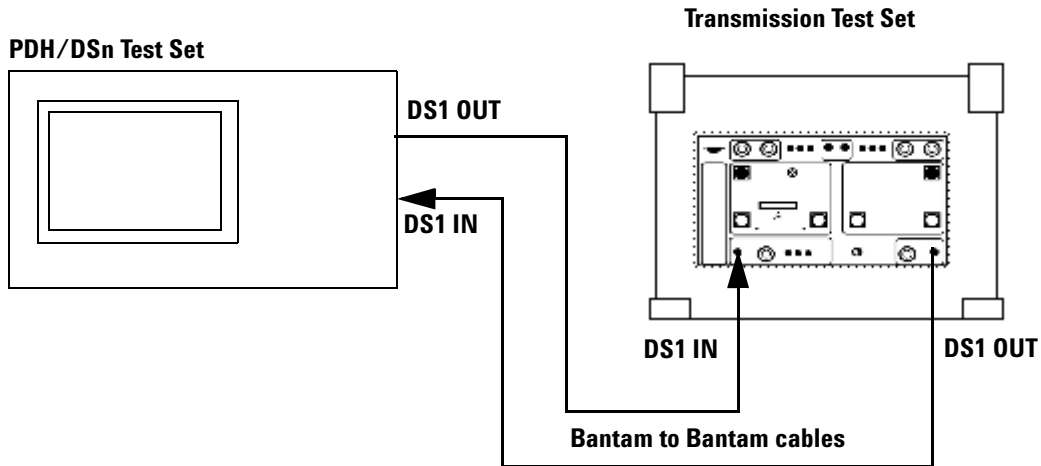

- 21 Set the PDH/DSn Test Set as follows:

TRANSMIT/RECEIVE settings to COUPLED

SIGNAL to DS1 rate

CLOCK to INTERNAL

OUTPUT LEVEL to DSX-1

LINE CODE to B8ZS

PAYLOAD TYPE to ESF UNSTRUCTURED

PATTERN to ALL ONES

- 22 Check there are no ALARMS/ERRORS detected by the Test Set Receiver.

- 23 Set the Test Set to Frequency Measurement Results and check that the displayed frequency is between:

1543999 Hz and 1544001Hz

- 24 Confirm that the Transmission Test Set is locked to the External signal by disconnecting/re-connecting the BNC cable at the Transmission Test Set CLOCK IN port.
- 25 Test Complete.

Optical Pulse Mask and Output Characteristics

Specifications

Optical Output Power

52 Mb/s to 2.5 Gb/s Output **

1310 nm	-5 to +0 dBm *
1550 nm	-2 to +3 dBm *

10 Gb/s Output **

1550 nm HS type	-1 to +1 dBm *
1310 nm SR type	-6 to -1 dBm *
1550 nm SR type	-5 to -1 dBm *

* Typical transmit power level is in the middle of the stated range.

** Output wavelength/type is dependent on options fitted. See "Option Guide" on page 15.

Extinction ratio	>8.2 dB, (>6 dB for 1310 nm 10 Gb/s SR type)
-------------------------	---

Pulse mask	Meets ITU-T G-957 (6/1999) and Telcordia GR-253-CORE Issue 3 (9/2000)
-------------------	---

Description

This test ensures the Optical Transmitter(s) output power level and waveform meet the required eye mask, extinction ratio and average power specifications. The Transmitter output is connected to an Optical Oscilloscope and the eye compared with the predefined masks stored in the Oscilloscope memory. The average signal power levels and Extinction Ratio are also measured using the Oscilloscope.

NOTE

These tests are identical for SONET or SDH modes and can be tested in either mode and should not be repeated for both.

Equipment Required

High Speed Optical Oscilloscope	Agilent Infinium 86100A Mainframe Agilent Infinium 86103A option 201, Optical Plug-in Agilent Infinium 86105A option 202, Optical Plug-in
Optical Attenuator	Agilent 8156A
Optical Patch Cord(s)	Agilent PN 1005-0337
BNC(m) to SMA(f) Adapter	Agilent E9632A
SMA(m) to SMA(m) cable	Agilent PN 8120-4948

Procedure

NOTE

This performance test uses the Infinium 86100A Optical Oscilloscope (DCA) with appropriate Optical Plug-in modules and built-in filters. If a different oscilloscope is used refer to the scope information for Optical Eye Mask measurement.

52/155 and 622 Mb/s Optical Output Checks

OC-1/STM-0 Power Level and Eye Mask Tests

- 1 Press <Menu>, choose **Tx/Rx** > **Stored Settings** then press <Select>. Select **Default** then **Recall**.
- 2 Press <Menu>, choose **System** > **Preferences** then press <Select>. Set **Network Standard** to **SONET**.

Set the transmit **Signal Rate** to **OC1**, **Wavelength** **1310 nm** (or if this is not fitted, or already tested, select **1550 nm**). Ensure the **Laser** is set to **OFF**.

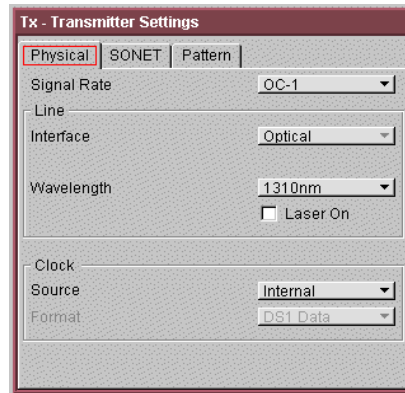

- 3 Connect the **52 Mb/s Optical Out Port** (1310/1550 nm) to the Oscilloscope via an Optical Attenuator. Set the attenuator to provide approximately 6 dB attenuation, (see Note). Also connect the **TX Eye Clock** (52 Mb/s - 2.5 Gb/s) to the scope Trigger input.

NOTE

Optical signal should be attenuated to ensure specified maximum input for 86103A (-4 dBm) is not exceeded. To ensure this, Set the 8156A to 3 dB, (typical 8156A attenuator insertion loss of approximately 3 dB), giving approximately 6 dB total attenuation.

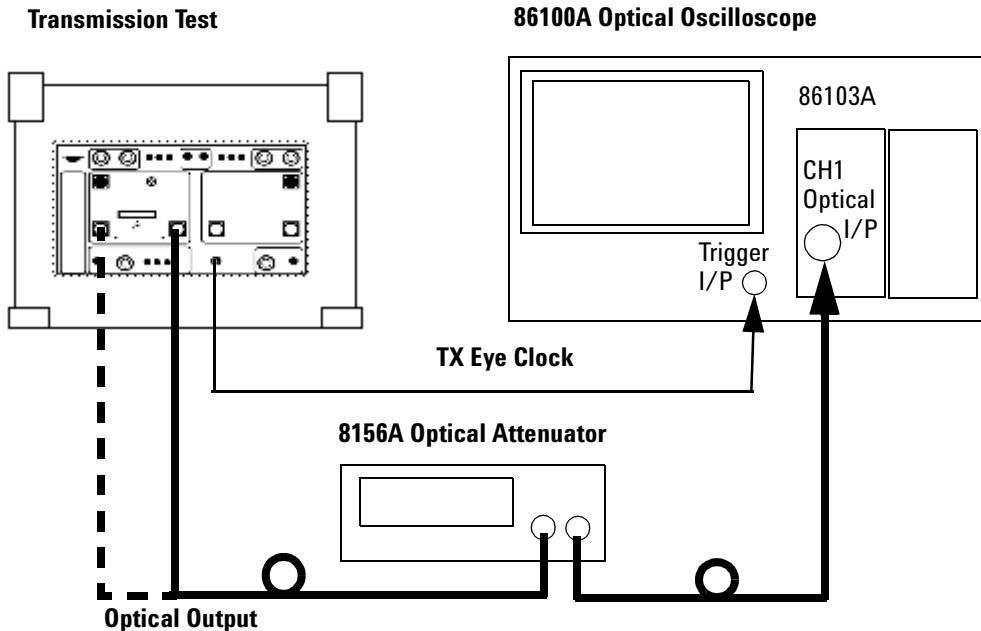

- 4 Set Transmission Test Set **Laser** to **ON** and set Optical Attenuator to Enable.
- 5 On the scope select **Setup > Channel 1 > Advanced settings**. Switch scope Channel 1 ON, set it to the correct optical wavelength for the signal being tested and set **Mask Filter** to **OC-3 (156 Mb/s)**, **ON**, see Note.

NOTE

Normally an OC-1 filter would be used, however as this may not be available, it is permissible to use the OC-3 Filter for this check. The procedures for higher bit rates using OC-3, OC-12 and OC-48 filters will give confirmation that laser overshoot response is as expected.

- 6 Set all other scope channels off.
- 7 Select **Eye/Mask Mode**, **Mask Test**. Select **Open Mask** and open the **STM000_OC1.msk**.
- 8 Select scope **Autoscale** and allow the scope to find signal and trigger inputs.

3 Performance Tests

- 9 Start **Mask Test** and check the Optical Output meets the Mask. See example below.

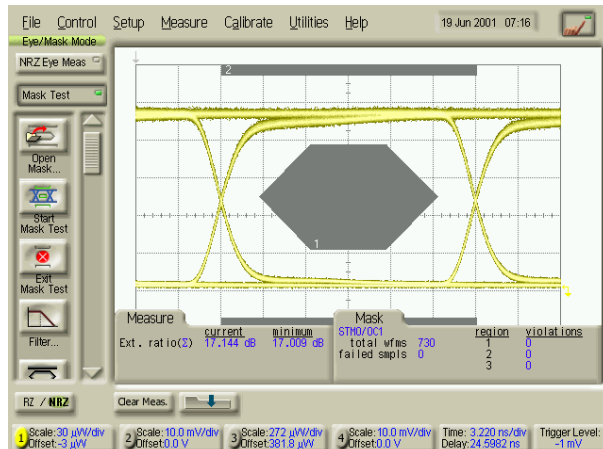

OC-1/STM-0 Eye Mask

- 10 Set the scope to **Eye Measure** mode and select **Extinction Ratio** measurement.

NOTE

Ensure Vertical Calibration and Extinction Ratio Calibration have been performed for the scope channel and vertical sensitivity range to ensure measurement accuracy. Refer to scope information/Help if necessary.

- 11 Check the Extinction Ratio is > 8.2 dB and record the value.

OC-3/STM-1 Power Level and Eye Mask Tests

- 12 Change the Transmission Test Set **Transmitter** $>$ **Signal Rate** to **OC3**.
- 13 Select **Eye/Mask Mode**, **Mask Test**. Select **Filter** and ensure it is set to **OC-3 (156 Mb/s)**, **ON**.
- 14 Select **Open Mask** and open the **STM001_OC3.msk**.
- 15 Select scope **Autoscale** and allow the scope to find signal and trigger inputs.

- 16 Start **Mask Test** and check the Optical Output meets the Mask. See example on page 91.
- 17 Set the scope to **Eye Measure** mode and select **Extinction Ratio** measurement.
- 18 Check the Extinction Ratio is greater than **8.2 dB** and record the measured value.

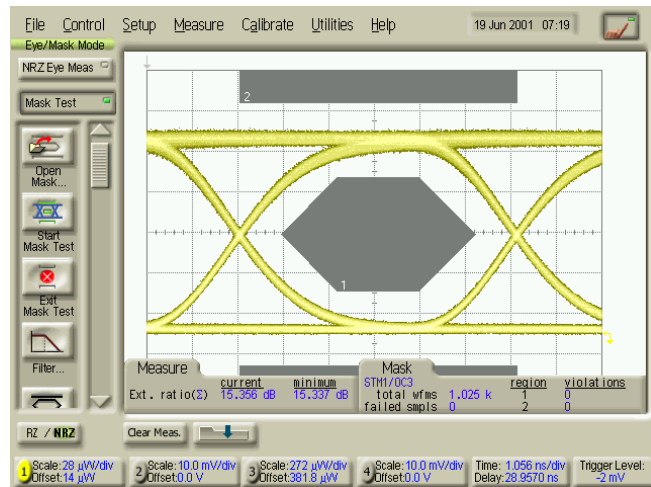

OC-3/STM-1 Eye Mask

OC-12/STM-4 Power Level and Eye Mask Tests

- 19 Change the Transmission Test Set **Transmitter > Signal Rate** to **OC12**.
- 20 Select **Eye/Mask Mode**, **Mask Test**. Select **Filter** and set it to **OC-12 (622 Mb/s)**, **ON**.
- 21 Select **Open Mask** and open the **STM004_OC12.msk**.
- 22 Select scope **Autoscale** and allow the scope to find signal and trigger inputs.
- 23 Start **Mask Test** and check the Optical Output meets the Mask. See example on page 92.

3 Performance Tests

- 24 Set the scope to **Eye Measure** mode and select **Extinction Ratio** measurement.
- 25 Check the Extinction Ratio is greater than **8.2 dB** and record the measured value.

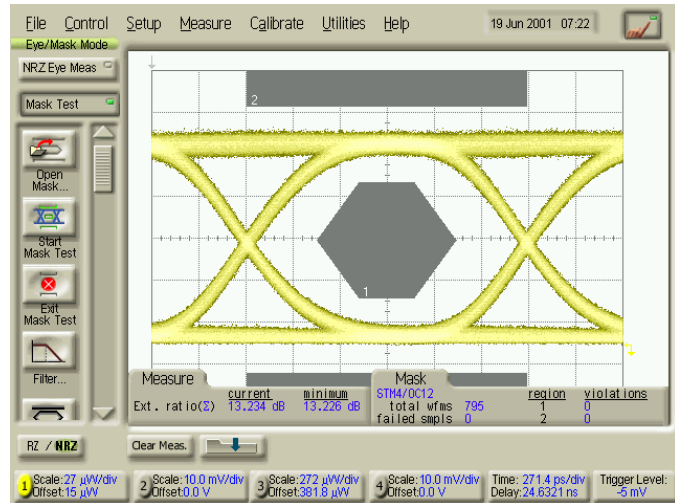

OC-12/STM-4 Eye Mask

2.5 Gb/s Optical Output Checks

OC-48/STM-16 Power Level and Eye Mask Tests

- 26** Change the Transmission Test Set **Transmitter > Signal Rate** to **OC48**. Set **Laser** to **OFF**.
- 27** Remove the Attenuator from the Setup and connect the **2.5 Gb/s Optical Out Port** (1310/1550 nm) directly to the scope Channel 3 Input as shown on the next page.

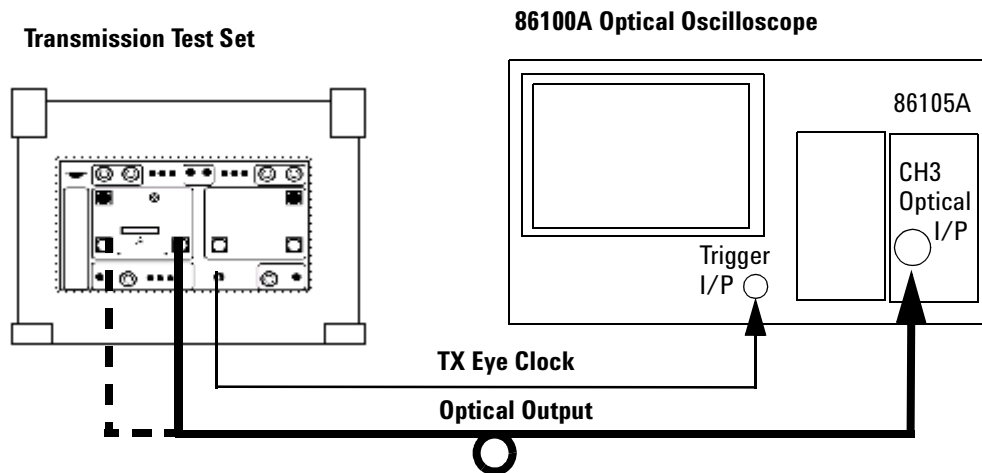

- 28** Set the Transmission Test Set Laser to ON.
- 29** On the scope select **Setup > Channel 3 > Advanced settings**. Switch scope Channel 3 ON, set it to the correct optical wavelength for the signal being tested and set **Mask Filter** to **OC-48 (2.488 Gb/s), ON**.
- 30** Set all other scope channels off.
- 31** Select **Eye/Mask Mode, Mask Test**. Select **Open Mask** and open the **STM016_OC48.msk**.
- 32** Select scope **Autoscale** and allow the scope to find signal and trigger inputs.

- 33** Start **Mask Test** and check the Optical Output meets the Mask. See example on page 94.

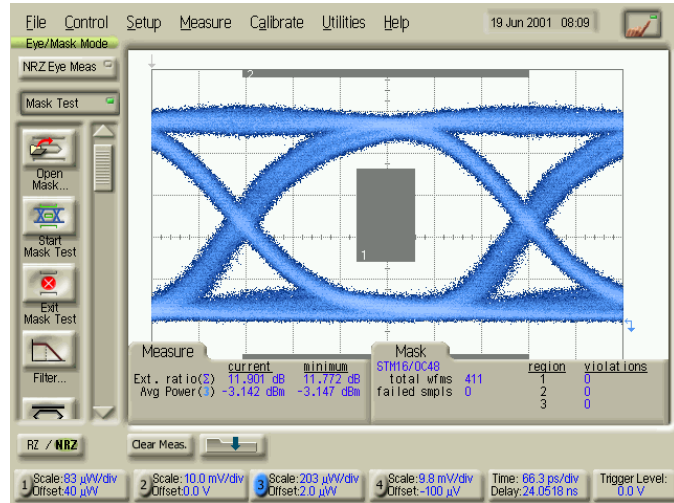

OC-48/STM-16 Eye Mask

- 34** Set the scope to **Eye Measure** mode and setup to measure the **Average Power** (in dBm) and **Extinction Ratio**.

NOTE

Ensure Vertical Calibration and Extinction Ratio Calibration have been performed for the scope channel and vertical sensitivity range to ensure measurement accuracy. Refer to scope information/Help if necessary.

- 35** Check the Average Optical Power is between:

-5 dBm to +0 dBm (for 1310 nm)

-2 dBm to +3 dBm (for 1550 nm)

- 36** Check the Extinction Ratio is greater than **8.2 dB** and record the measured value.

- 37** If the instrument has Dual Wavelength option (1310 and 1550 nm ports) for 51/155/622 Mb/s and 2.5 Gb/s, repeat step 1 to step 36 for the 1550 nm Output and use 1550 nm settings as appropriate for scope Channel inputs.

10 Gb/s Optical Output Checks (if fitted)

OC-192/STM-64 Power Level and Eye Mask Tests

- 1 Press <Menu>, choose **Tx/Rx > Stored Settings** then press <Select>. Select **Default** then **Recall**.
- 2 Press <Menu>, choose **System > Preferences** then press <Select>. Set **Network Standard** to **SONET**.

Set the transmit **Signal Rate** to **OC192**. Ensure the **Laser** is set to **OFF**.

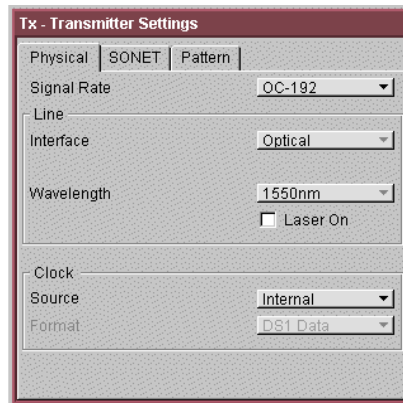

- 3 Connect the **10 Gb/s Optical Out** Port to the Oscilloscope using an Optical Patch cord. Also connect the connect the **TX Eye Clock** (10 Gb/s) to the scope Trigger input as shown.

3 Performance Tests

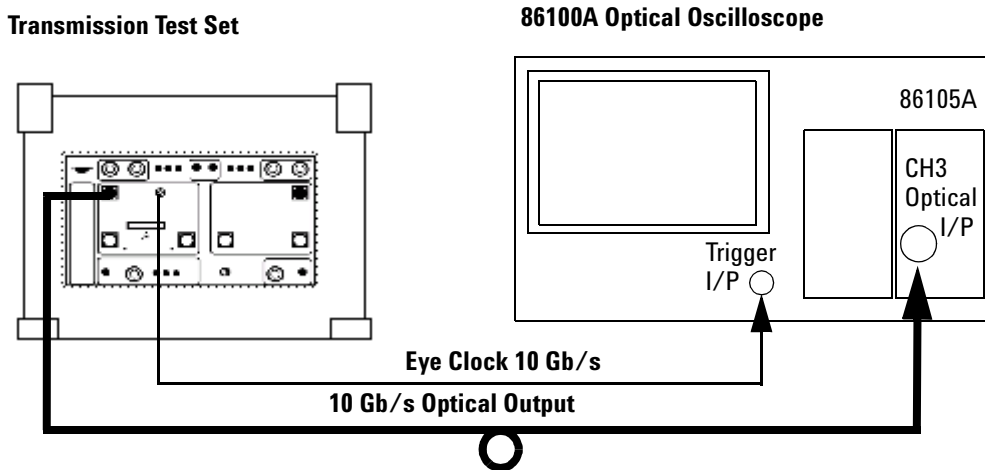

- 4 Set the Transmission Test Set **Laser** to **ON**.
- 5 On the scope select **Setup > Channel 3 > Advanced settings**. Set the correct optical wavelength for the signal being tested and set **Mask Filter** to **OC-192, ON**.
- 6 Select **Eye/Mask Mode, Mask Test**. Select **Open Mask** and open the **STM064_OC192.msk**.
- 7 Select scope **Autoscale** and allow the scope to find signal and trigger inputs.
- 8 Start **Mask Test** and check the Optical Output meets the "OC-192/STM-64 Eye Mask" on page 97.
- 9 Set the scope to **Eye Measure** mode and setup to measure the **Average Power** (in dBm) and **Extinction Ratio**.

NOTE

Ensure Vertical Calibration and Extinction Ratio Calibration have been performed for the scope channel and vertical sensitivity range to ensure measurement accuracy. Refer to scope information/Help if necessary.

10 Check the Average Optical Power (depending on option installed):

-1 to +1 dBm. (for Option 111, 1550 nm HS type)

-6 to -1 dBm. (for Option 120, 1310 nm SR type)

-5 to -1 dBm. (for Option 121, 1550 nm SR type)

11 Check the Extinction Ratio is > 8.2 dB, (> 6 dB for 1310 nm SR type) and record the measured value.

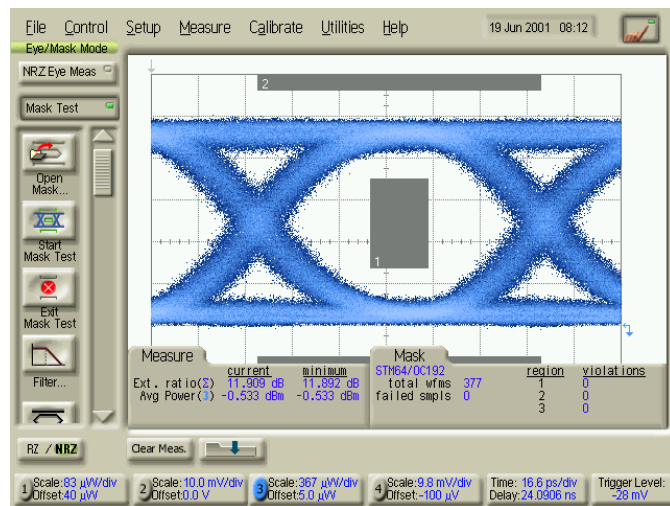

OC-192/STM-64 Eye Mask

12 Tests Complete. Set the Laser to OFF before disconnecting setup.

Optical Receiver Sensitivity, Optical Power and Frequency Measurement

Specifications

Min. sensitivity (1):

52/155 Mb/s	-33 dBm (2)
622 Mb/s	-28 dBm
2.5 Gb/s	-28 dBm
10 Gb/s HS type	-20 dBm (3)(4)
10 Gb/s SR type	-11/-14 dBm (6)

Max. input power (1):

52/155 Mb/s	-10 dBm
622 Mb/s	-8 dBm
2.5 Gb/s	-8 dBm
10 Gb/s HS type	-9 dBm (4)(5)
10 Gb/s SR type	-1dBm

1. For BER = 1×10^{-10} (input signal extinction ratio = 8.2 dB).

2. Typical: < -34 dBm.

3. Minimum sensitivity for a 1550 nm input signal (as measured at BER = 1×10^{-12} ; input signal extinction ratio = 8.2 dB). Minimum sensitivity for a 1310 nm input signal is < -19 dBm (under the same measurement conditions).

4. Specifications for the 10 Gb/s HS optical receiver apply for receive signals with 1310 and 1550 nm (nominal) wavelengths. However, the 10 Gb/s receiver is a broadband device and operates over the 1200 to 1600 nm range of wavelengths.

5. Maximum input power for a 1550 nm input (as measured at BER = 1×10^{-12} ; input signal extinction ratio = 8.2 dB). Maximum input power for a 1310 nm input is > -10 dBm (under the same measurement conditions).

6. Minimum sensitivity for 1550 nm SR type with Extinction Ratio = 8.2 dB. For 1310 nm SR type where Extinction Ratio may be = 6 dB the Min. sensitivity is -11 dBm.

Optical power measurement	<p>Supported for all optical receive rates.</p> <p>Ranges: 10 Gb/s: -3 dBm to -25 dBm. 2.5 Gb/s: 0 dBm to -28 dBm. 622 Mb/s and below: 0 dBm to -30 dBm.</p> <p>Accuracy: 10 Gb/s: ± 1.5 dB. 2.5 Gb/s: ± 2 dB. 622 Mb/s and below: ± 1 dB.</p> <p>Resolution: 0.1 dB.</p>
Line frequency measurement	<p>Supported for all optical and electrical receive rates.</p> <p>Results: Frequency (MHz), Offset (Hz and ppm).</p> <p>Accuracy: ± 4.5 ppm.</p> <p>Resolution: Frequency: 0.01 kHz (up to 622 Mb/s), 0.1 kHz (2.5 Gb/s and 10 Gb/s). Offset: 0.1 ppm.</p>

NOTE

The rates and wavelengths available are dependent on the Transmission Test Set options fitted.

Description

The Transmitter output is attenuated and set for appropriate level using an external Power meter. The receiver sensitivity is verified using the attenuated transmitter output and checking for no errors in back-to-back mode. Checks of the receiver operation at Operating Max and Min levels is performed. The Receiver Optical Power and Frequency measurements are also checked during these tests.

Sensitivity measurements are affected by the Extinction Ratio of the laser used in the test. Receiver sensitivity specifications are quoted for worst case, that is minimum laser extinction ratio specification. A table is provided at the end of these tests to check the typical additional receiver sensitivity expected against the extinction ratio of the laser used in test.

NOTE

- These tests are identical for SONET or SDH modes and can be tested in either mode and should not be repeated for both.
 - Always set the Laser to OFF before changing Optical Output Port connections.
 - It is most important that advice on Optical Cleanliness is adhered to ensure accuracy of these tests and to prevent damage to optical interfaces.
-

Equipment Required

Power Meter	Agilent 8163A
Power Meter Sensor Module	Agilent 81633A
Optical Attenuator	Agilent 8156A
FC/PC Connector Interface (qty 4)	Agilent 81000FI
Optical Cables (qty 2)	Agilent PN 1005-0337

WARNING

Safety precautions must be observed when handling the Transmission Test Set's Optical Modules as these generate laser signals which can cause serious injury. The guidelines below must be followed:

- **Check the connector configuration of the Fiber Optic Interfaces. If non FC/PC connectors are fitted then remove them, then fit the FC/PC connector interface.**
 - **Check for any damage to the Transmission Test Set's Fiber Optic Interface spring loaded aperture covers and connectors. Do not power up the instrument if in any doubt about the integrity of these connectors.**
-

Procedure

OC-1/STM-0 and OC-3/STM-1 Rates

- 1 Press <Menu>, choose **Tx/Rx** > **Stored Settings** then press <Select>. Select **Default** then **Recall**.
- 2 Press <Menu>, choose **Tx/Rx** > **Coupling** then press <Select>. Select **Copy Tx to Rx**.



- 3 Connect the test set-up as shown below depending on the wavelengths installed.

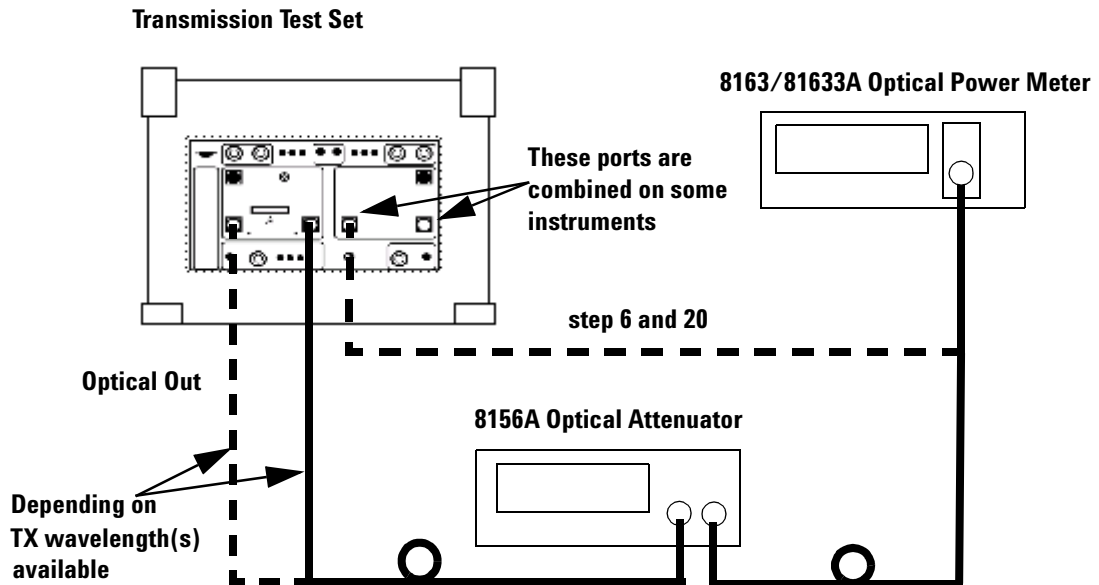

- 4 Set the Optical Attenuator to:
 - ATTEN 15 dB**
 - WAVELENGTH 1310 nm (or 1550 nm depending on wavelength used)**

3 Performance Tests

CAL=0

ENB ON

Set the Optical Power Meter to:

WAVELENGTH 1310 nm (or 1550 nm depending on wavelength used)

Connect the Optical Attenuator between the Power Meter and the Transmission Test Set's **Optical Out** port (ensure that all connections are tight and that the cable has no twists).

- 5 Press **<Menu>**, choose **System > Preferences** then press **<Select>**. Set **Network Standard** to **SONET**.

Set the transmit **Signal Rate** to **OC1**, **Wavelength 1310 nm** (or if this is not fitted, select **1550 nm**). Ensure the **Laser** is set to **ON**. Check the laser LED is illuminated at the selected Output Port on the Transmission Test Set's connector panel.

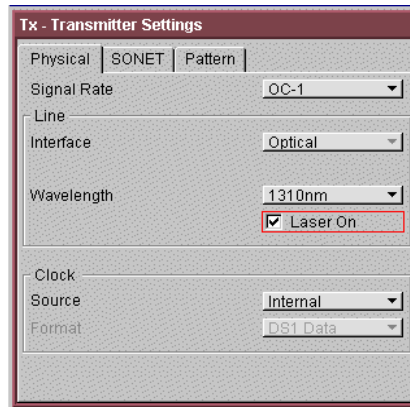

- 6 Adjust the Optical Attenuator to obtain a reading of -33 dBm on the Power Meter (that is, the Receiver minimum sensitivity for 52/155 Mb/s rates). Take note of the Attenuator setting.
- 7 Set the Optical Attenuator to Disable mode.

Note, do not switch OFF the Transmission Test Set laser.

Disconnect the Optical Attenuator Output from the Power Meter and connect to the Transmission Test Set's **Optical IN** Port (52–622 Mb/s). Ensure all optical connectors are clean and all connections are tight with no twists in the optical cable. Set the Optical Attenuator to Enable.

- 8 Press **<Smart Test>**, choose **Shortcuts > Trouble Scan** then press **<Select>**. Press **<Run/Stop>** to begin measurement.
- 9 After 1 minute check that **'No Trouble'** is displayed in the Results window to confirm no errors have been detected.

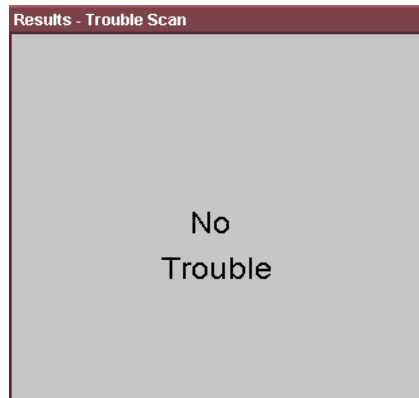

- 10 Add more attenuation by increasing the Optical Attenuator setting to find the point just before the occurrence of errors. This can be done by observing the Errors LED while adjusting attenuator. Record the additional attenuation setting (typically this will be at least 1 dB). Press **<Run/Stop>** to stop measurement.
- 11 Set the Optical Attenuator to the setting noted in step 6, then reduce setting by a further 3 dB (that is, providing –30 dBm output).

Set the Transmission Test Set's Receiver to display **Optical Power** as follows:

Press **<Smart Test>**, choose **Shortcuts > Optical Power** then press **<Select>**. Set **Wavelength** to 1310/1550 nm as appropriate.

3 Performance Tests

Check that the optical power measurement reads between:

-31 dBm and -29 dBm

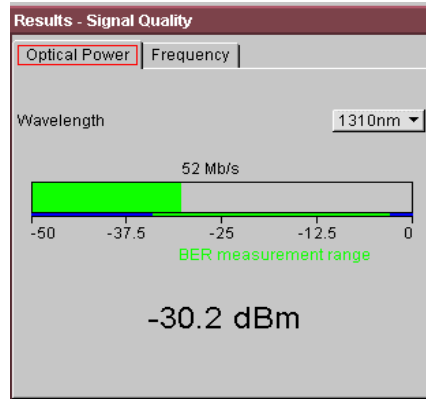

Press <Smart Test>, choose **Shortcuts > Frequency Measurement** then press <Select>. The Transmission Test Set now displays the received frequency results.

Check that the frequency measurement reads between:

51.83999 and 51.84001 MHz for [STM-0 OPT] or [OC-1]

155.51999 and 155.52001 MHz for [STM-1 OPT] or [OC-3]

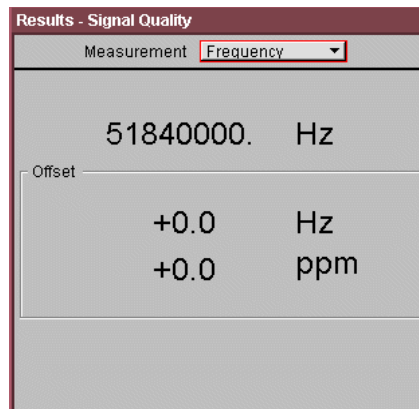

- 12** Reduce the Optical Attenuator setting by a further 20 dB and check the Receiver **Optical Power** result is between:

-11 dBm and -9 dBm

- 13** Press <**Smart Test**>, choose **Shortcuts > Trouble Scan** then press <**Select**>. Press <**Run/Stop**> to begin measurement.

After 1 minute check that '**No Trouble**' is displayed in the Results window to confirm no errors have been detected.

Press <**Run/Stop**> to stop measurement.

- 14** Disable the Optical Attenuator then disconnect the Optical signal from the Transmission Test Set **Optical IN** port and connect to the Power Meter. Re-enable the Optical Attenuator.

- 15** Check the Power Meter reading is between:

-10.5 dBm and -9.5 dBm

- 16** Repeat step 4 through step 15, substituting SIGNAL RATE [OC-3] in step 5.

OC-12/STM-4 Rate

- 17** Set the Transmission Test Set Transmitter to provide OC-12 output with PRBS bulk payload as follows:

Press <**Menu**>, choose **Tx/Rx > Transmitter Settings** then press <**Select**>. Select the **Physical** tab. Set **Signal Rate** to **OC12, Wavelength 1310 nm** (or if this is not fitted, select **1550 nm**). Ensure the **Laser** is set to **ON**.

Check the laser LED is illuminated at the selected Output Port.

Ensure the Optical Attenuator and Optical power meter are set for the Wavelength being used.

- 18** Adjust the Optical Attenuator to obtain a reading of -28 dBm on the Power Meter (that is, the Receiver minimum sensitivity for 622 Mb/s rates). Take note of the Attenuator setting.

- 19** Set the Optical Attenuator to Disable mode.

Note: do not switch OFF the Transmission Test Set laser.

Disconnect the Optical Attenuator Output from the Power Meter and connect to the Transmission Test Set's **Optical IN** Port (51–622 Mb/s). Ensure all optical connectors are clean and all connections are tight with no twists in the optical cable. Set the Optical Attenuator to Enable.

- 20** Ensure the Transmission Test Set is set to **TX>RX Coupled Mode**.
- 21** Press **<Smart Test>**, choose **Shortcuts > Trouble Scan** then press **<Select>**. Press **<Run/Stop>** to begin measurement.

After 1 minute check that **'No Trouble'** is displayed in the Results window to confirm no errors have been detected.
- 22** Increase the Optical Attenuator setting to find the point just before the occurrence of errors by observing the Errors LED while adjusting attenuator. Record the additional attenuation setting. (typically, this will be at least 1 dB). Press **<Run/Stop>** to stop measurement.
- 23** Re-set the Optical Attenuator to the setting noted in step 18 (providing –28 dBm output).

Set the Transmission Test Set's Receiver to display **Optical Power**. That is, press **<Smart Test>** then select **Shortcuts > Optical Power**. Set **Wavelength** to 1310/1550 nm as appropriate and check that the optical power measurement reads between:

–29 dBm and –27 dBm

Set the Transmission Test Set's Receiver to display **Frequency** and check that the frequency measurement reads between:

622.07999 MHz and 622.08001 MHz

- 24** Decrease the Optical Attenuator setting by a further 20 dB and check the Receiver **Optical Power** result is between:

–9 dBm and –7 dBm
- 25** Press **<Smart Test>**, choose **Shortcuts > Trouble Scan** then press **<Select>**. Press **<Run/Stop>** to begin measurement.

After 1 minute check that **'No Trouble'** is displayed in the Results window to confirm no errors have been detected.

Press **<Run/Stop>** to stop measurement.

26 Disable the Optical Attenuator then disconnect the Optical signal from the Transmission Test Set **Optical IN** port and connect to the Power Meter. Re-enable the Optical Attenuator.

27 Check the Power Meter reading is between:

-8.5 dBm and -7.5 dBm

OC-48/STM-16 Rates

1 Press **<Menu>**, choose **Tx/Rx > Stored Settings** then press **<Select>**. Select **Default** then **Recall**.

2 Connect the Test Set-up as shown below, depending on wavelengths installed:

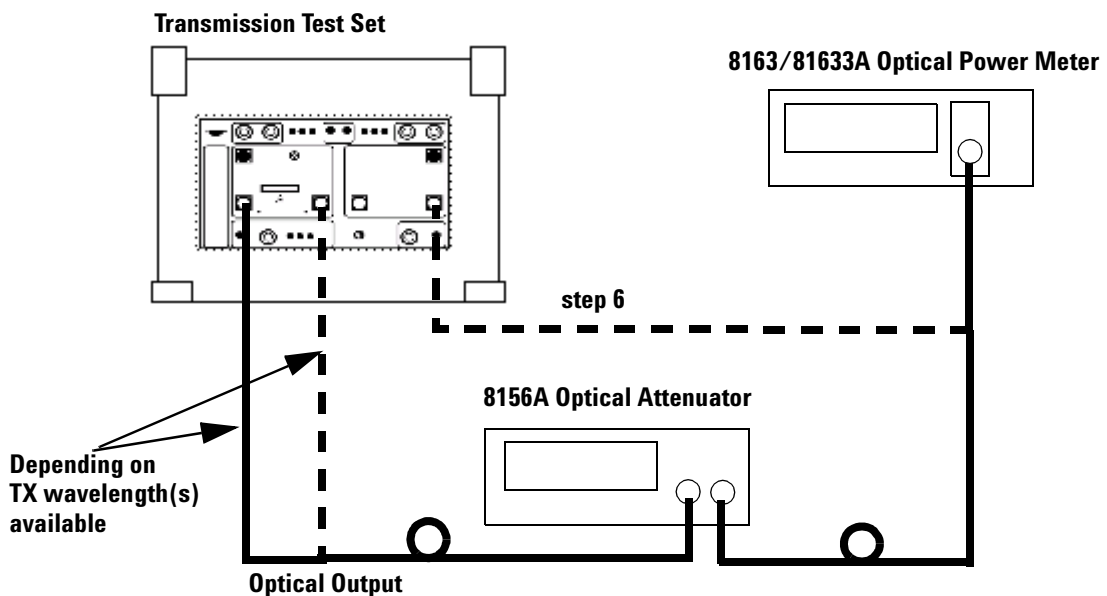

3 Set the Optical Attenuator to:

ATTEN 15 dB

WAVELENGTH 1550 nm (or 1310 nm depending on wavelength used)

CAL=0

ENB ON

Set the Optical Power Meter to:

WAVELENGTH 1550 nm (or 1310 nm depending on wavelength used)

Connect the Optical Attenuator between the Power Meter and the Transmission Test Set's **Optical Out** port (ensure that all connections are tight and that the cable has no twists).

- 4 Set the Transmission Test Set Transmitter to provide OC-48 output with PRBS bulk payload as follows:

Press **<Menu>**, choose **System > Preferences** then press **<Select>**. Set **Network Standard** to **SONET**.

Press **<Menu>**, choose **Tx/Rx > Transmitter Settings** then press **<Select>**. Select the **Physical** tab. Set **Signal Rate** to **OC48, Wavelength 1550 nm** (or if this is not fitted, select **1310 nm**). Ensure the **Laser** is set to **ON**. Check the laser LED is illuminated at the selected Output Port.

- 5 Adjust the Optical Attenuator to obtain a reading of -28 dBm on the Power Meter (that is, the Receiver minimum sensitivity for 2.5 Gb/s rate). Take note of the Attenuator setting.
- 6 Set the Optical Attenuator to Disable mode.

Note: do not switch OFF the Transmission Test Set laser.

Disconnect the Optical Attenuator Output from the Power Meter and connect to the Transmission Test Set's **Optical IN** Port (2.5 Gb/s). Ensure all optical connectors are clean and all connections are tight with no twists in the optical cable. Set the Optical Attenuator to Enable.

- 7 Set the Transmission Test Set to **TX>RX Coupled Mode**.
- 8 Press **<Smart Test>**, choose **Shortcuts > Trouble Scan** then press **<Select>**. Press **<Run/Stop>** to begin measurement.

After 1 minute check that '**No Trouble**' is displayed in the Results window to confirm no errors have been detected.

- 9 Increase the Optical Attenuator setting to find the point just before the occurrence of errors by observing the Errors LED while adjusting attenuator. Record the additional attenuation setting. (typically, this will be at least 1 dB). Press **<Run/Stop>** to stop measurement.
- 10 Re-set Optical Attenuator to the setting noted in step 5 (providing -28 dBm output).

Set the Transmission Test Set's Receiver to display **Optical Power**. Press **<Smart Test>**, choose **Shortcuts > Optical Power** then press **<Select>**. Set **Wavelength** to 1310/1550 nm as appropriate, and check that the optical power measurement reads between:

-30 dBm and -26 dBm

Set the Transmission Test Set's Receiver to display **Frequency** and check that the frequency measurement reads between:

2488.3199 MHz and 2488.3201 MHz

- 11 Reduce the Optical Attenuator setting by a further 20 dB and check the Receiver **Optical Power** result is between:

-10 dBm and -6 dBm

- 12 Press **<Smart Test>**, choose **Shortcuts > Trouble Scan** then press **<Select>**. Press **<Run/Stop>** to begin measurement.

After 1 minute check that '**No Trouble**' is displayed in the Results window to confirm no errors have been detected.

Press **<Run/Stop>** to stop measurement.

- 13 Disable the Optical Attenuator then disconnect the Optical signal from the Transmission Test Set **Optical IN** port and connect to the Power Meter. Re-enable the Optical Attenuator.

- 14 Check the Power Meter reading is between:

-8.5 dBm and -7.5 dBm

3 Performance Tests

OC-192/STM-64 Rate (if fitted)

- 1 Press <Menu>, choose **Tx/Rx > Stored Settings** then press <Select>. Select **Default** then **Recall**.
- 2 Connect the Test Set-up as shown below.

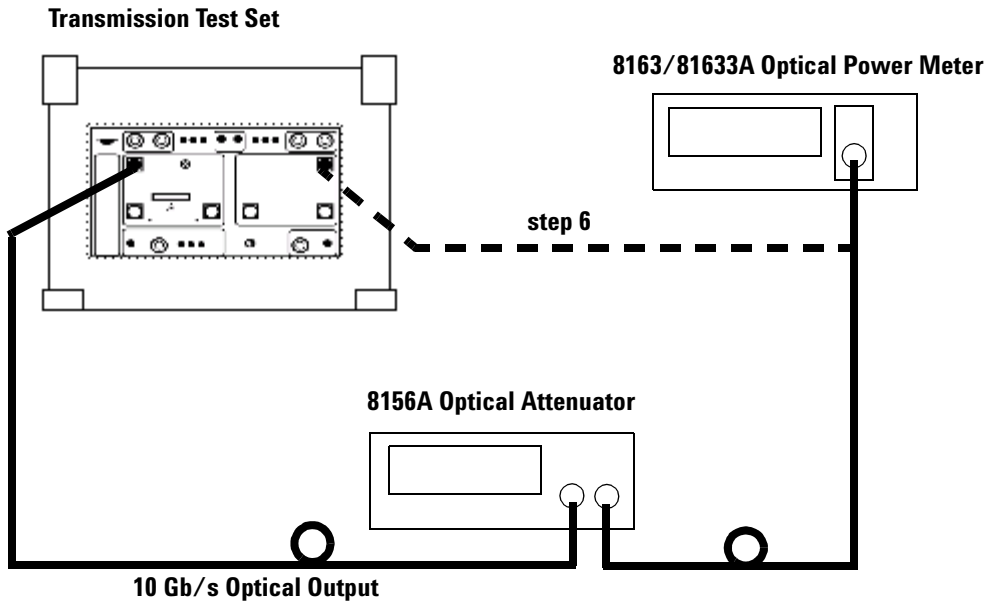

- 3 Set the Optical Attenuator to:

ATTEN 15 dB

WAVELENGTH 1550 nm or 1310 nm as required

CAL=0

ENB ON

Set the Optical Power Meter: **WAVELENGTH** as appropriate.

Connect the Optical Attenuator between the Power Meter and the Transmission Test Set's **Optical Out** port (ensure that all connections are tight and that the cable has no twists).

- 4 Set the Transmission Test Set Transmitter to provide OC-192 output with PRBS bulk payload as follows:

Press <Menu>, choose **System > Preferences** then press <Select>. Set **Network Standard** to **SONET**.

Press <Menu>, choose **Tx/Rx > Transmitter Settings** then press <Select>. Select the **Physical** tab. Set **Signal Rate** to **OC192**. Ensure the **Laser** is set to **ON**.

Check the laser LED is illuminated at the 10 Gb/s Optical Out Port.

- 5 Adjust the Optical Attenuator to obtain a reading on the Power Meter equal to the Receiver minimum sensitivity specification for the type of 10 Gb/s interface installed.

Option 111, 1550 nm HS type this is -20 dBm,

Option 120, 1310 nm SR type this is -11 dBm

Option 121, 1550 nm SR type, -14 dBm.

Take note of the Attenuator setting.

- 6 Set the Optical Attenuator to Disable mode.

Note: do not switch OFF the Transmission Test Set laser.

Disconnect the Optical Attenuator Output from the Power Meter and connect to the Transmission Test Set's **Optical IN** Port (10 Gb/s). Ensure all optical connectors are clean and all connections are tight with no twists in the optical cable. Set the Optical Attenuator to Enable.

- 7 Set the Transmission Test Set to **TX>RX Coupled Mode**.

- 8 Press <Smart Test>, choose **Shortcuts > Trouble Scan** then press <Select>. Press <Run/Stop> to begin measurement.

After 1 minute check that '**No Trouble**' is displayed in the Results window to confirm no errors have been detected.

- 9 Increase the Optical Attenuator setting to find the point just before the occurrence of errors by observing the Errors LED while adjusting attenuator. Record the additional attenuation setting. (typically, this will be at least 1 dB).

Press <Run/Stop> to stop measurement.

3 Performance Tests

- 10** Re-set Optical Attenuator to the setting noted in step 5 (providing -20dBm, -11dBm or -14dBm output depending on interface type installed).

Press <Smart Test>, choose **Shortcuts > Optical Power** then press <Select>. The Transmission Test Set now displays the received optical power result. Ensure the Optical Power measurement **Wavelength** is set to **1310/1550 nm**. Check that the optical power reads between:

-21.5 dBm and -18.5 dBm for Option 111
-12.5 dBm and -9.5 dBm for Option 120
-15.5 dBm and -11.5 dBm for Option 121

Set the Transmission Test Set's Receiver to display **Frequency** and check that the frequency measurement reads between:

9953.2799 MHz and 9953.2801 MHz

- 11** For **Option 111**, reduce the Optical Attenuator setting by 11 dB.

For Option 120 or Option 121 ONLY, set the **Laser** to **OFF**, remove the attenuator from the configuration to allow direct optical connection between the Transmitter and Receiver. Set **Laser ON** and check the Receiver **Optical Power** result is between:

-10.5 dBm and -7.5 dBm for Option 111
+0 dBm and -7.5 dBm for Option 120
+0 dBm and -6.5 dBm for Option 121

- 12** Press <Smart Test>, choose **Shortcuts > Trouble Scan** then press <Select>. Press <Run/Stop> to begin measurement.

After 1 minute check that '**No Trouble**' is displayed in the Results window to confirm no errors have been detected. Press <Run/Stop> to stop measurement.

- 13** For **Option 111**, disable the Optical Attenuator then disconnect the Optical signal from the Transmission Test Set

Optical IN port and connect to the Power Meter. Re-enable the Optical Attenuator.

For Option 120 or Option 121 ONLY, set the **Laser** to **OFF** then disconnect the Optical signal from the Transmission Test Set **Optical IN** port and connect to the Power Meter. Set **Laser** to **ON**.

14 Check the Power Meter reading is between:

-9.5 dBm and -8.5 dBm for Option 111
Value in step 11 +/- 2dB for Option 120/121.

Checking the Receiver Minimum Sensitivity Margin Against Laser Transmitter Extinction Ratio (ER)

The Transmitter Lasers used in the tests have extinction ratio significantly better than the minimum (ER) specification. The table below gives correction factors for a range (ER) values to check the additional Receiver sensitivity measured in tests.

Using the extinction ratio results from the **Optical Pulse Mask and Output Characteristics** tests for the laser used confirm the typical 'additional' margin measured in sensitivity tests exceed values in table.

Extinction Ratio measured in Optical Pulse Mask and Output Characteristics Test	Additional Sensitivity
> 8.2 dB to 9 dB	>0.4 dB
> 9 dB to 10 dB	>0.6 dB
> 10 dB to 12 dB	>0.93 dB
> 12 dB to 15 dB	>1.05 dB
> 15 dB to 20 dB	>1.2 dB

Electrical Pulse Mask and Output Level Characteristics

Specifications

Rate	Level	Waveshape
DSX-1	2.4V - 3.6V	Fits Mask T1.102-1993
DS1-LO	As DSX-1 with 655' ABAM Cable	
DS3-HI	0.9 V pk (nominal)	
DSX-3	560 mV pk (nominal)	Fits mask T1.102-1993
DS3-900	330 mV pk (nominal)	
2 Mb/s Balanced	3.00 V pk (nominal)	As per ITU rec G.703
2 Mb/s Unbalanced	2.37 V pk (nominal)	As per ITU rec G.703
8 Mb/s Unbalanced	2.37 V pk (nominal)	As per ITU rec G.703
34 Mb/s Unbalanced	1.0 V pk (nominal)	As per ITU rec G.703
140 Mb/s Unbalanced	1.0 V \pm 0.1 V pk to pkV	As per ITU rec G.703
STSX-1 (450ft)	530mV (nominal) pk.	Compliant with GR-253 Issue 3& ITU-R F.750 Appendix 1
STS-1-HI	1V pk (nominal)	
STS-1-LO (900ft)	300mV pk (nominal)	
STM-0e	1.1 V \pm 0.1 V pk	
STS-3/STM-1e	0.5 V \pm 0.05 pk	As per ITU rec G703

Description

This test ensures the Electrical Transmitter output level and pulse shape meet the required specifications. The Transmitter output is connected to an Oscilloscope and the waveshape compared with the predefined masks stored in the Oscilloscope memory. The signal levels are also measured using the Oscilloscope.

Equipment Required

Oscilloscope	54810A with Option 100 Communication Mask Kit (E2625A)
Patch Cable	15512A Siemens 3 pin
Patch Cable	15670A Bantam 110 ohm

Procedure

NOTE

This performance test uses the Infinium 54810A Oscilloscope with Option 100 (E2625A) Telecom Masks Template Kit. If any other Oscilloscope is used refer to the scope information for Mask measurement. It is assumed the appropriate Masks are installed in the Infinium.

3 Performance Tests

DS1 Output Mask Test

- 1 Press <Menu>, choose **Tx/Rx** > **Stored Settings** then press <Select>. Select **Default** then **Recall**.
- 2 Press <Menu>, choose **Tx/Rx** > **Transmitter Settings** then press <Select>. Select the **Physical** tab. Set the **Signal Rate** to **DS1** as shown in the example below.

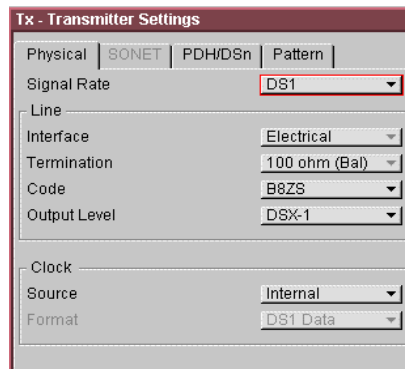

- 3 Connect the Transmission Test Set's **DS1 OUT** port to the Oscilloscope using the E2621A Termination Adapter Probe, set probe switch to **100Ω**.

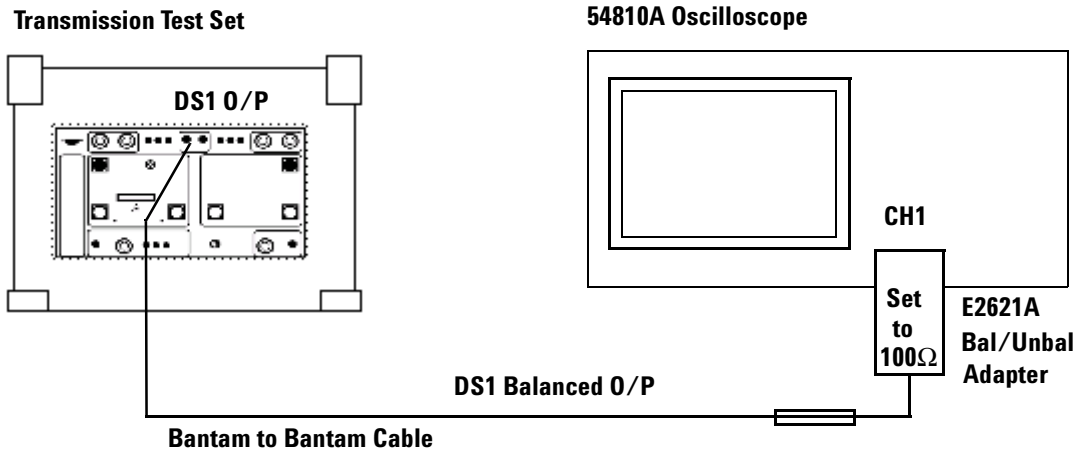

4 Load the **DS1_ANSI.msk** test mask and run the mask test. Check the Positive and Negative pulses are within the mask (see examples).

NOTE

To test Negative pulse set the Scope **Mask Test Set-up** panel to **Invert Mask**.

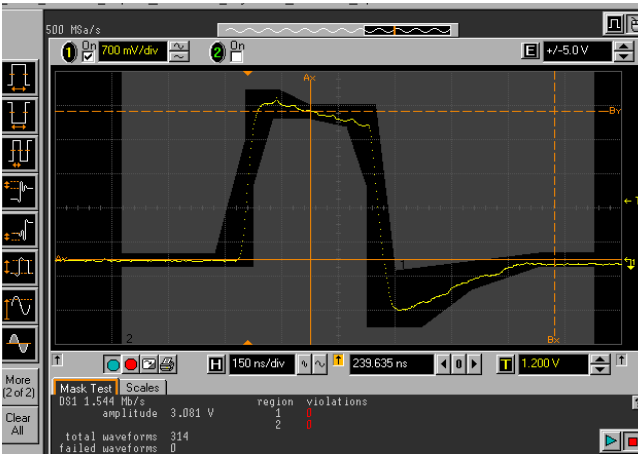

DSX-1 Positive Pulse

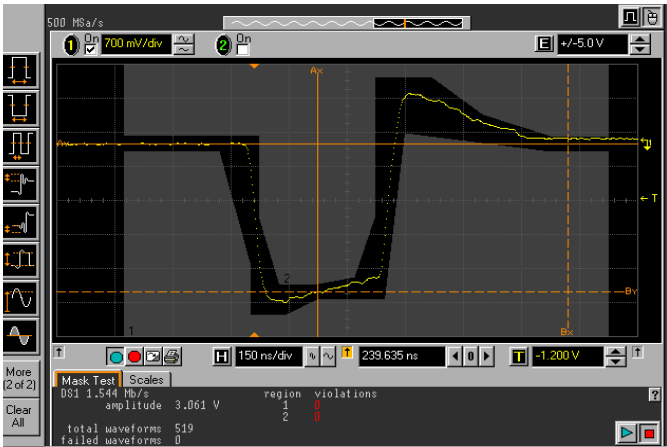

DSX-1 Negative Pulse

3 Performance Tests

- 5 Check the DSX-1 pulse amplitudes are between 2.4 - 3.6 V pk.
- 6 Set the instrument Output Level to DS-1-LO and check that the Pulse Output Amplitude decreases by approximately 20% and pulse shape has slower rise/fall edges.

NOTE

The DS1-LO Pulse mask test is not applicable to step 6 and the check is included to provide a functional confirmation of the LO selection.

2 Mb/s Balanced Output Mask Tests

- 1 Press <Menu>, choose **Tx/Rx > Stored Settings** then press <Select>. Select **Default** then **Recall**.
- 2 Press <Menu>, choose **Tx/Rx > Transmitter Settings** then press <Select>. Select the **Physical** tab. Set the **Signal Rate** to **2 Mb/s**, **Termination 120 ohm (Bal)**.

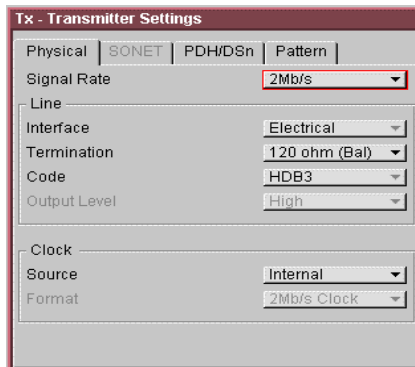

- 3 Connect the **2 Mb/s BAL OUT** port to the Oscilloscope CHAN 1, using the E2621A Termination Adapter Probe, set probe switch to **120Ω**.

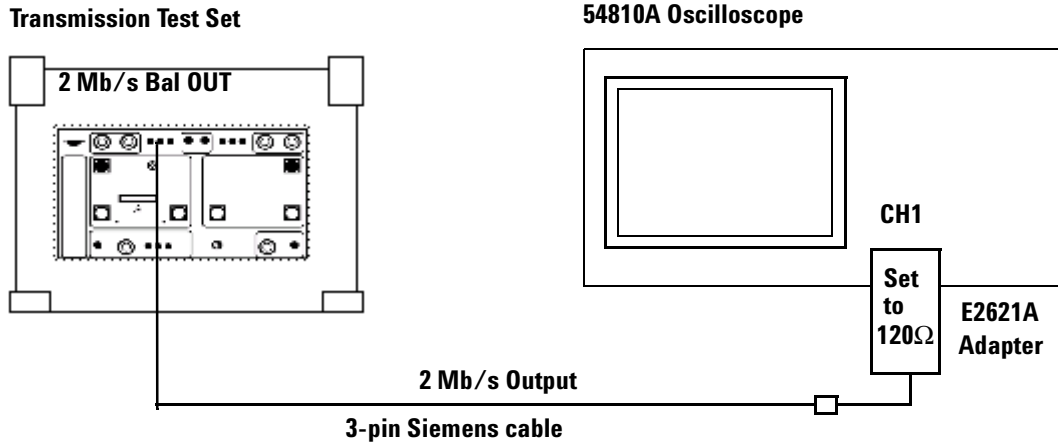

3 Performance Tests

- 4 Load the **2Mb_ITU_120.msk** test mask and check the Positive and Negative pulses are within the mask (see examples).

NOTE

To test Negative pulse set the Scope **Mask Test Set-up** panel to **Invert Mask**.

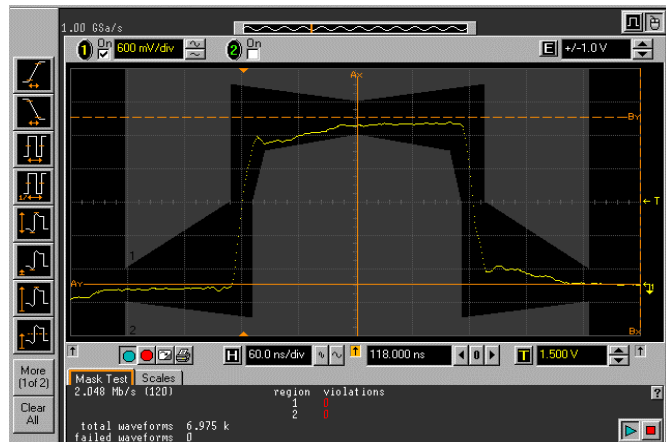

2M Balanced Positive Pulse

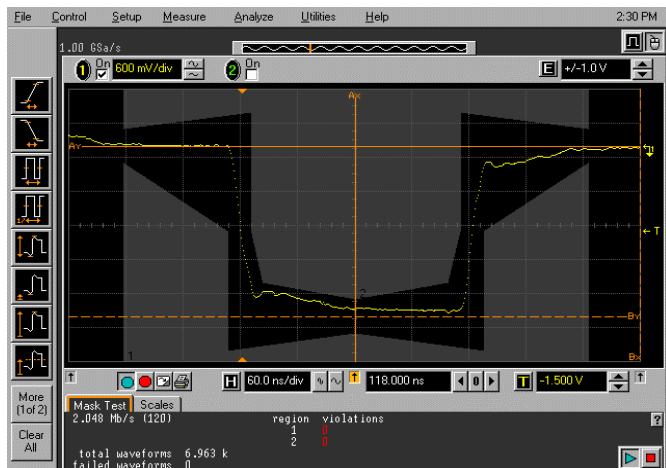

2M Balanced Negative Pulse

2 Mb/s Unbalanced Output Mask Tests

- 1 Press <Menu>, choose **Tx/Rx > Stored Settings** then press <Select>. Select **Default** then **Recall**.
- 2 Press <Menu>, choose **Tx/Rx > Transmitter Settings** then press <Select>. Select the **Physical** tab. Set the **Signal Rate** to **2 Mb/s**, **Termination 75 ohms (Unbal)**.

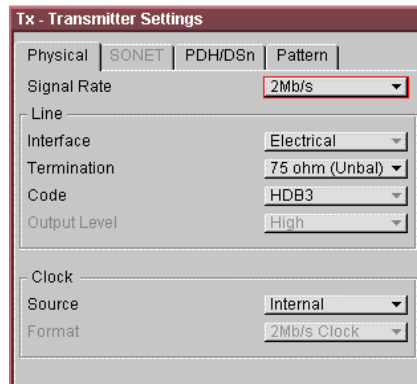

- 3 Connect the **2 Mb/s BAL OUT** port to the Oscilloscope CHAN 1, using the E2622A Termination Adapter Probe.

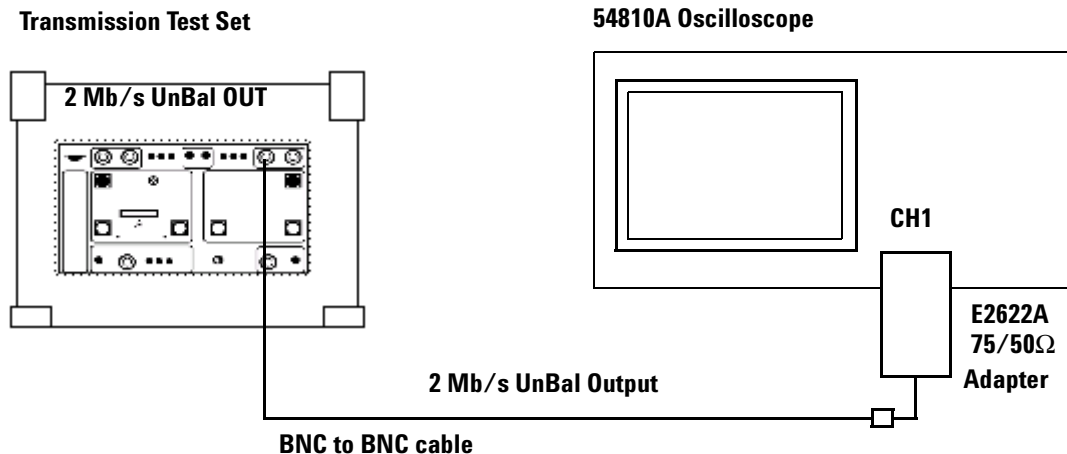

3 Performance Tests

- 4 Load the **2Mb_ITU_75.msk** test mask and check the Positive and Negative pulses are within the mask (see examples).

NOTE

To test Negative pulse set the Scope **Mask Test Set-up** panel to **Invert Mask**

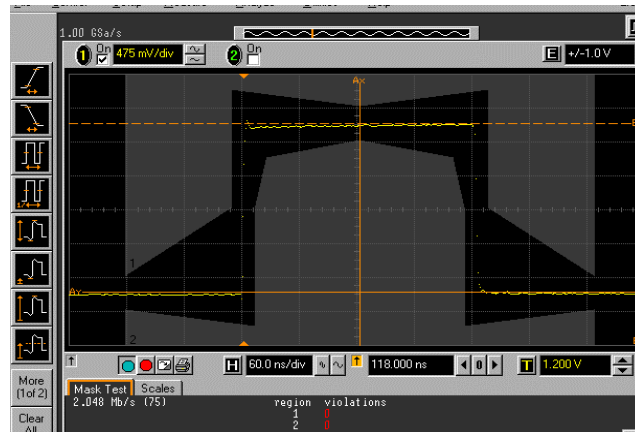

2M Unbalanced Positive Pulse

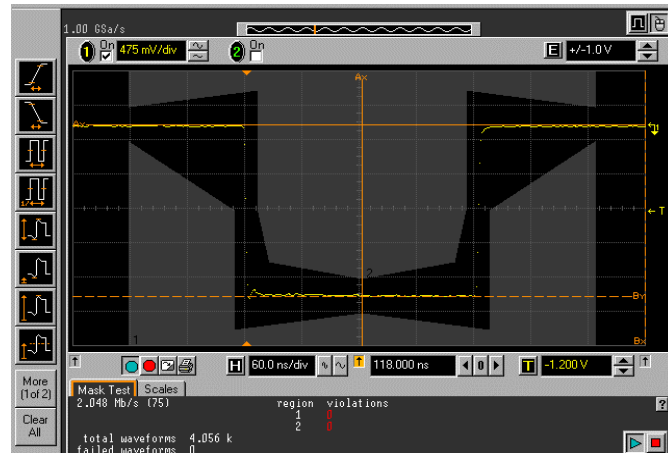

2M Unbalanced Negative Pulse

8 Mb/s Output Mask Tests

- 1 Press <Menu>, choose **Tx/Rx > Stored Settings** then press <Select>. Select **Default** then **Recall**.
- 2 Press <Menu>, choose **Tx/Rx > Transmitter Settings** then press <Select>. Select the **Physical** tab. Set the **Signal Rate** to **8 Mb/s**.

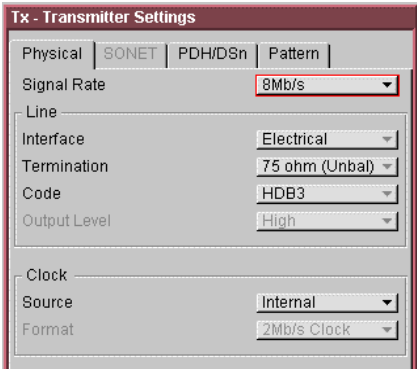

- 3 Connect the **8 Mb/s OUT** port to the Oscilloscope CHAN 1, using the E2622A Termination Adapter Probe.

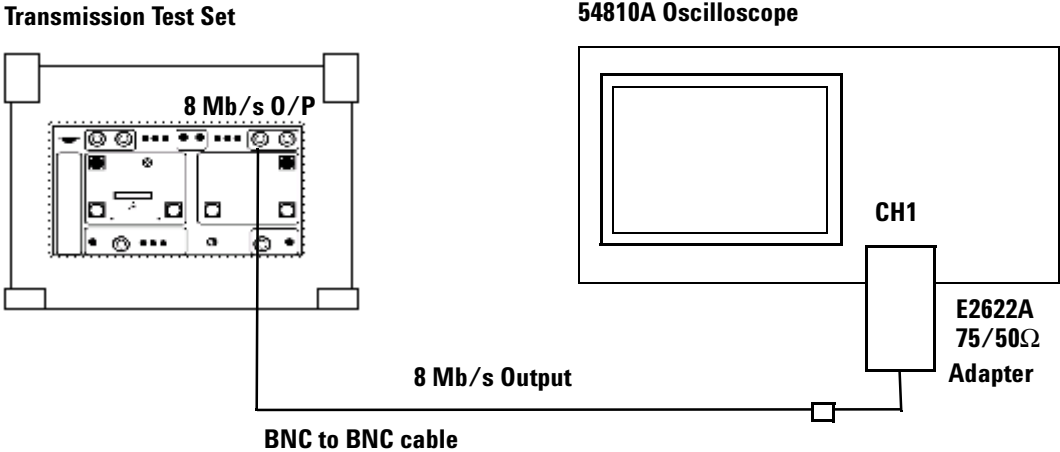

3 Performance Tests

- 4 Load the **8Mb_ITU.msk** test mask and check the Positive and Negative pulses are within the mask (see examples).

NOTE

To test Negative pulse set the Scope **Mask Test Set-up** panel to **Invert Mask**

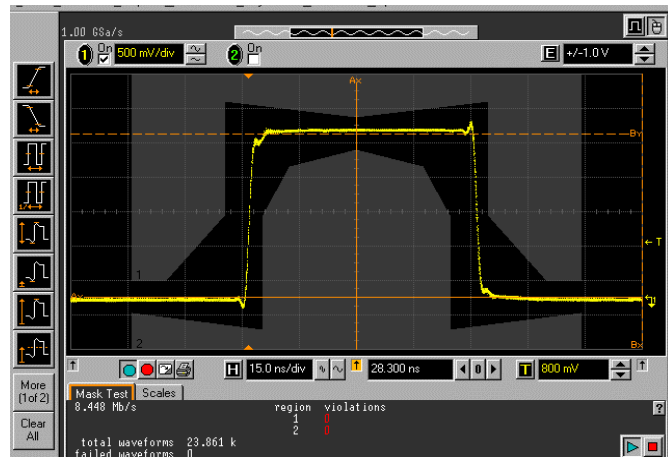

8M Unbalanced Positive Pulse

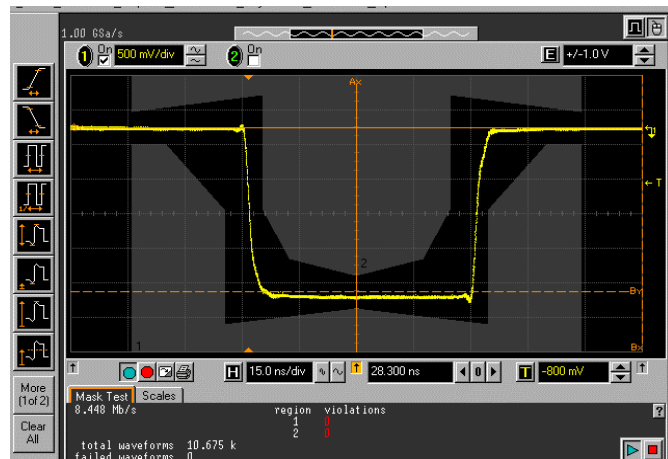

8M Unbalanced Negative Pulse

34 Mb/s Output Mask Tests

- 1 Press <Menu>, choose **Tx/Rx** > **Stored Settings** then press <Select>. Select **Default** then **Recall**.
- 2 Press <Menu>, choose **Tx/Rx** > **Transmitter Settings** then press <Select>. Select the **Physical** tab. Set the **Signal Rate** to **34 Mb/s**.

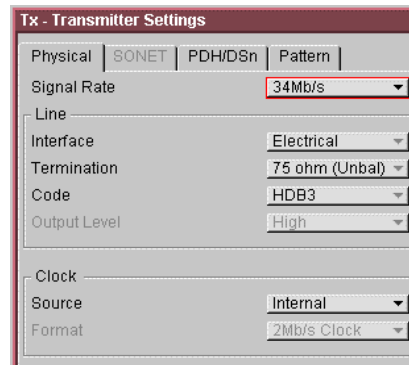

- 3 Connect the **34 Mb/s OUT** port to the Oscilloscope CHAN 1, using the E2622A Termination Adapter Probe.

Transmission Test Set

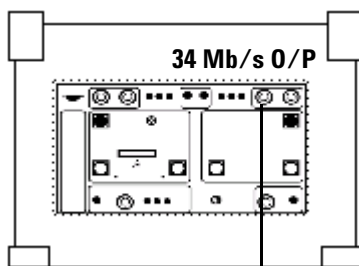

54810A Oscilloscope

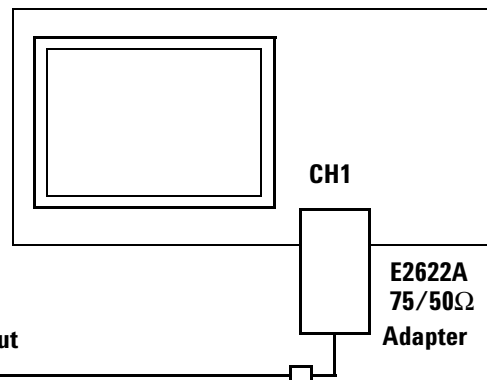

34 Mb/s Output
BNC to BNC cable

3 Performance Tests

- 4 Load the **34Mb_ITU.msk** test mask and check the Positive and Negative pulses are within the mask (see examples).

NOTE

To test Negative pulse set the Scope **Mask Test Set-up** panel to **Invert Mask**

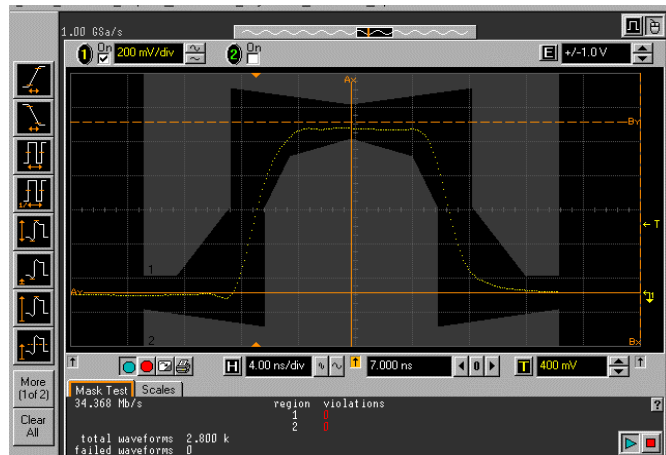

34M Unbalanced Positive Pulse

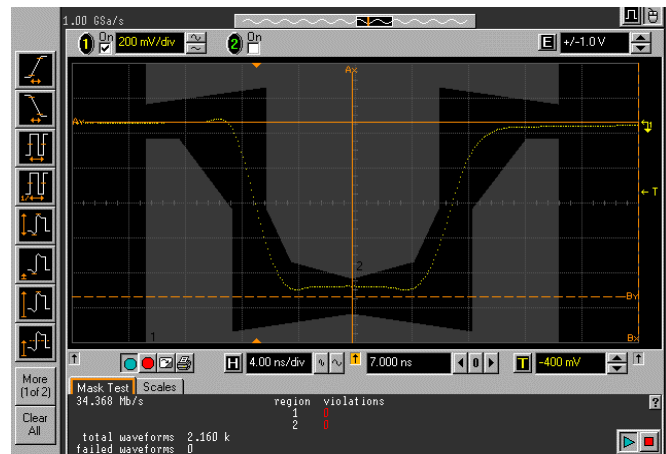

34M Unbalanced Negative Pulse

DSX-3 Output Mask Tests

- 1 Press <Menu>, choose **Tx/Rx > Stored Settings** then press <Select>. Select **Default** then **Recall**.
- 2 Press <Menu>, choose **Tx/Rx > Transmitter Settings** then press <Select>. Select the **Physical** tab. Set the **Signal Rate** to **DS3**.

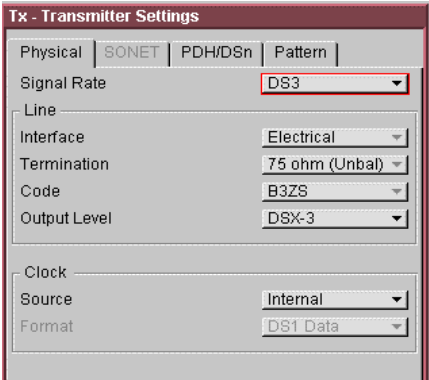

- 3 Connect the **DS-3 OUT** port to the Oscilloscope CHAN 1, using the E2622A Termination Adapter Probe.

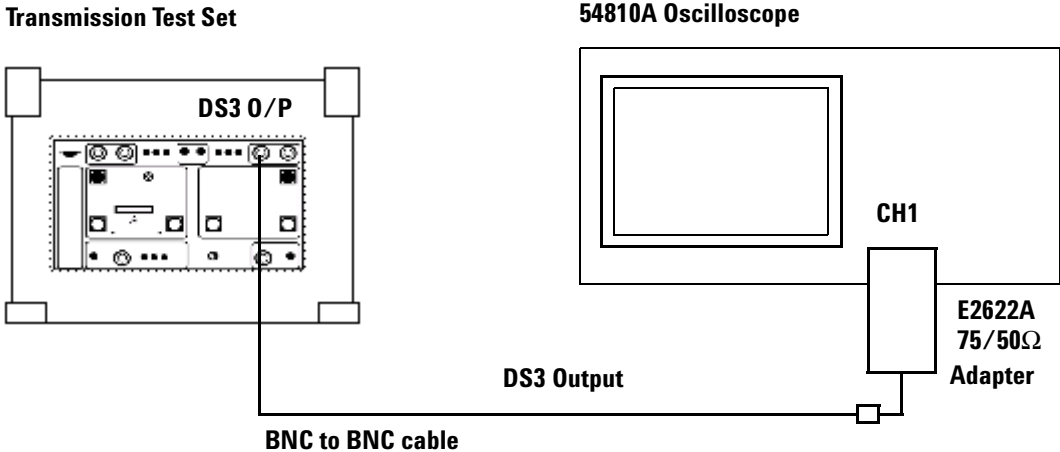

3 Performance Tests

- 4 Load the **DS3_ANSI.msk** test mask and check the Positive and Negative pulses are within the mask (see examples).

NOTE

To test Negative pulse set the Scope **Mask Test Set-up** panel to **Invert Mask**

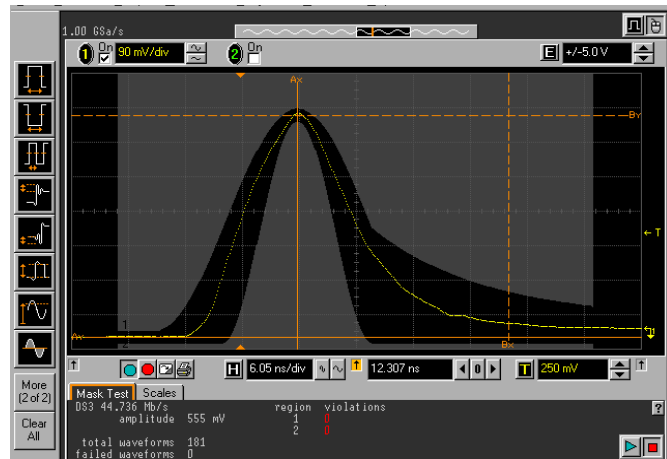

DSX-3 Positive Pulse

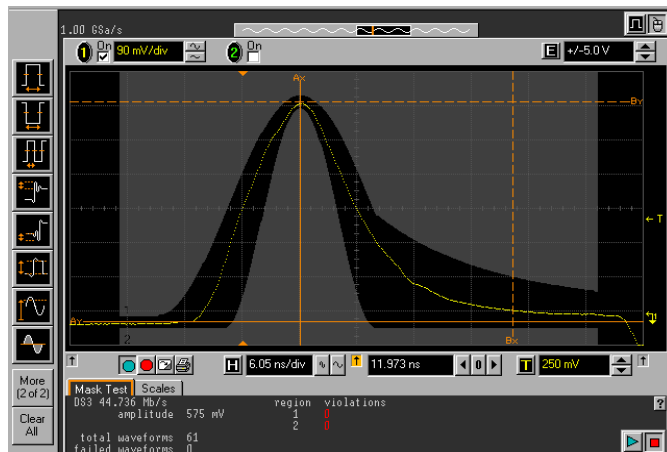

DSX-3 Negative Pulse

140 Mb/s Output Mask Tests

- 1 Press <Menu>, choose **Tx/Rx > Stored Settings** then press <Select>. Select **Default** then **Recall**.
- 2 Press <Menu>, choose **Tx/Rx > Transmitter Settings** then press <Select>. Select the **Physical** tab. Set the **Signal Rate** to **140 Mb/s**.

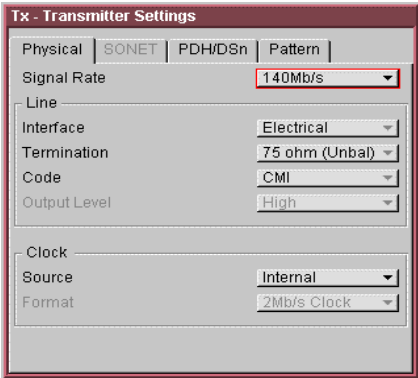

- 3 Connect the **140 Mb/s OUT** port to the Oscilloscope CHAN 1, using the E2622A Termination Adapter Probe.

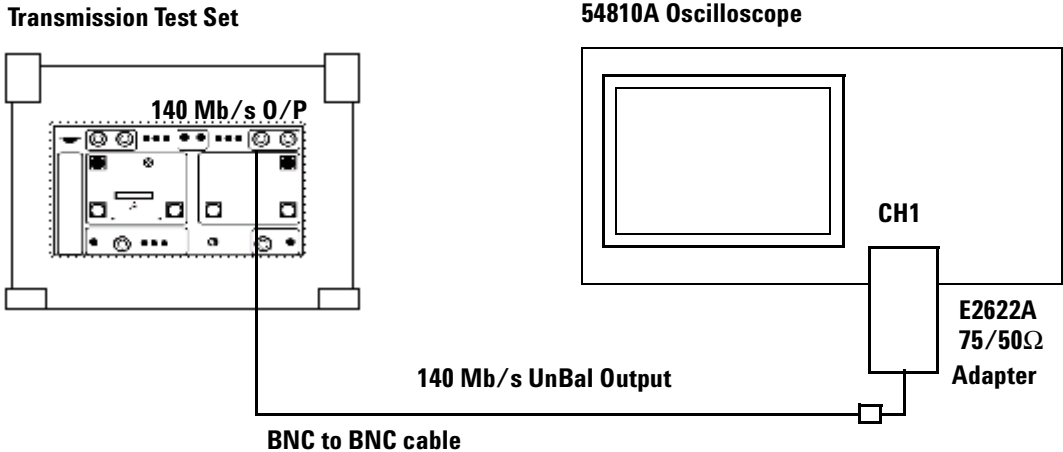

3 Performance Tests

- 4 Load the **140Mb_ITU_0.msk**, **140Mb_ITU_1.msk** and **140Mb_ITU_1_INV.msk** test masks and check each of the pulses are within the mask (see examples).

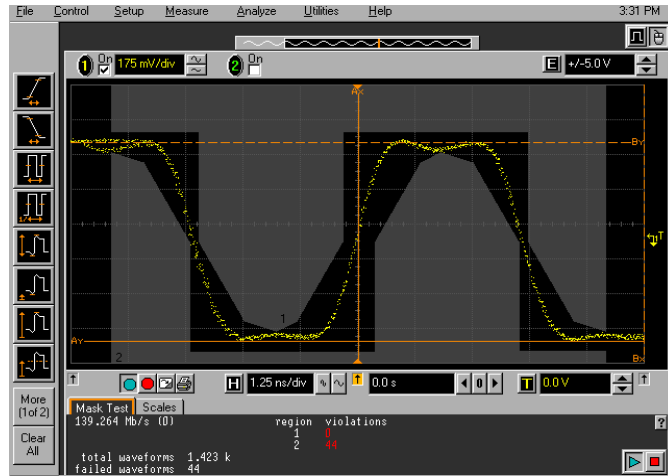

140 Mb/s All Zeros Mask Test

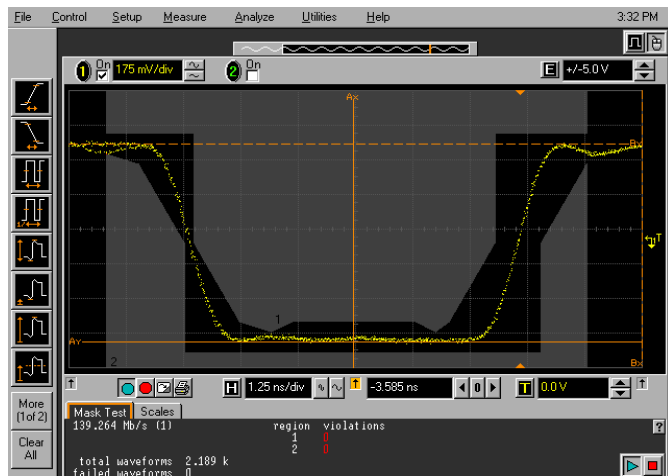

140 Mb/s All Ones Mask Test

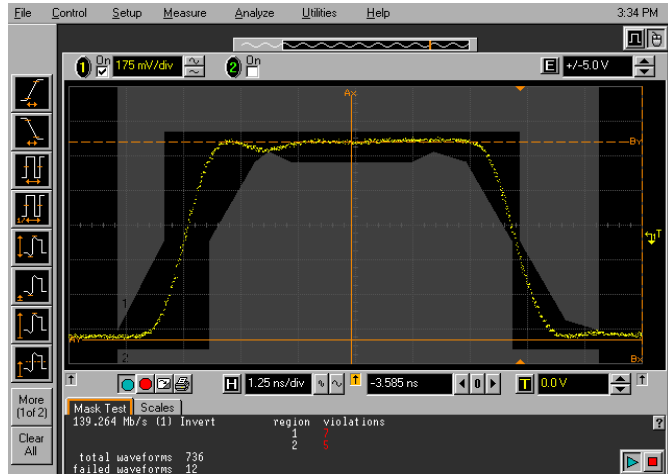

140Mb/s All Ones (inverted) Mask Test

51.84 Mb/s (STS-1) Output Mask Tests

- 1 Press <Menu>, choose **Tx/Rx > Stored Settings** then press <Select>. Select **Default** then **Recall**.
- 2 Press <Menu>, choose **Tx/Rx > Transmitter Settings** then press <Select>. Select the **Physical** tab. Set the **Signal Rate** to **STSX-1**.

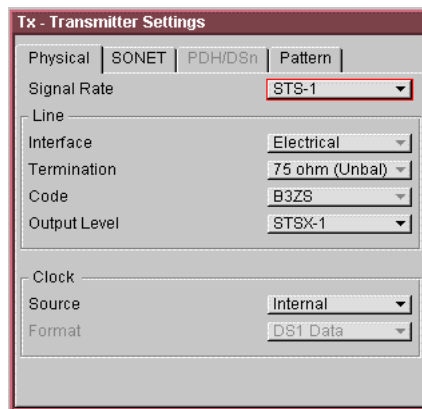

- 3 Connect the **52 Mb/s OUT** port to the Oscilloscope CHAN 1, using the E2622A Termination Adapter Probe.

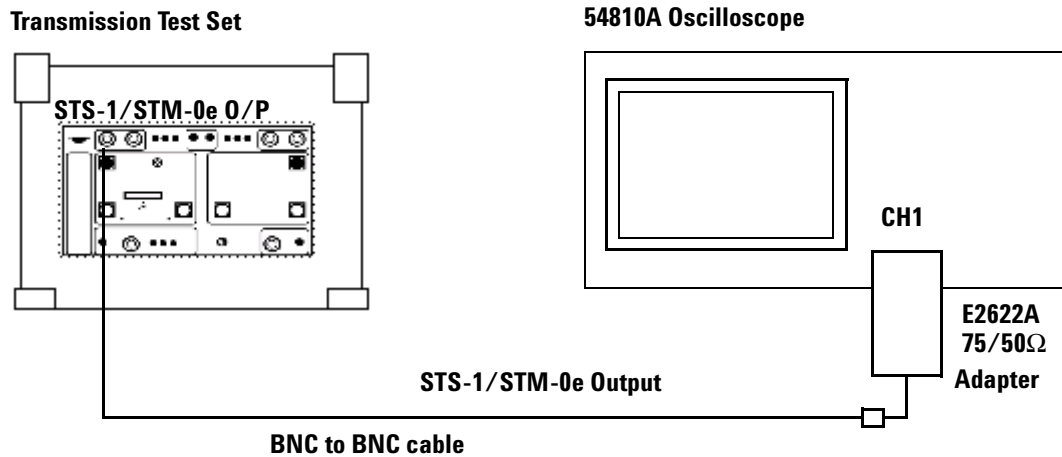

- 4 Load the **STS1_ANSI_EYE.msk** test mask and check the eye meets the mask. See examples

NOTE

It may be necessary to use Manual settings to Align this mask. If necessary change the selection in the scope Mask Test Set-up to allow manual settings rather than File Set-up for Alignment.

3 Performance Tests

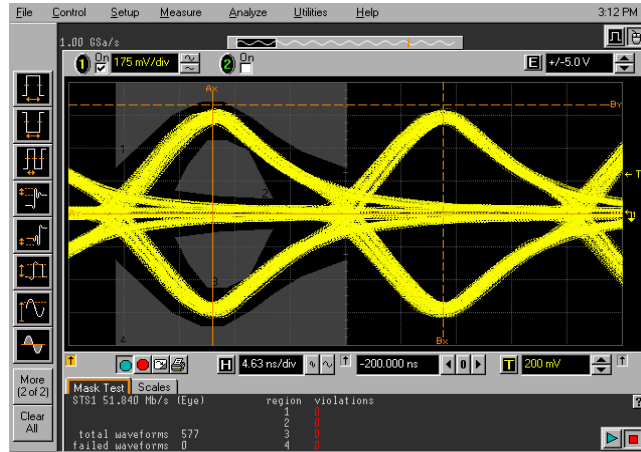

STXS-1 Mask Test

- 5 Load the **STS1_ANSI_PULSE.msk** test mask and check the positive and negative pulses meet the mask (see examples).

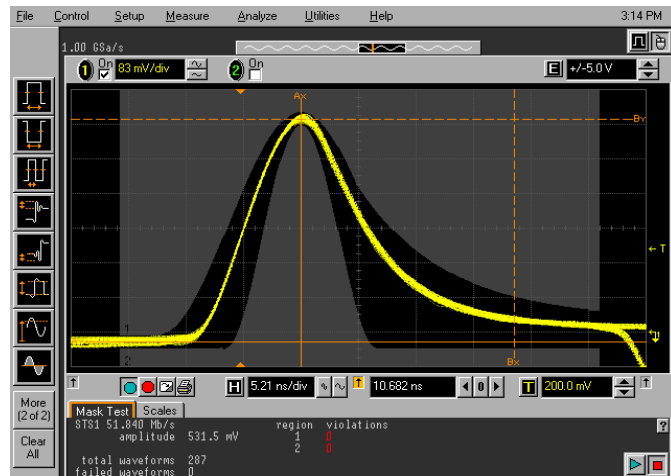

STXS-1 Positive Pulse Mask Test

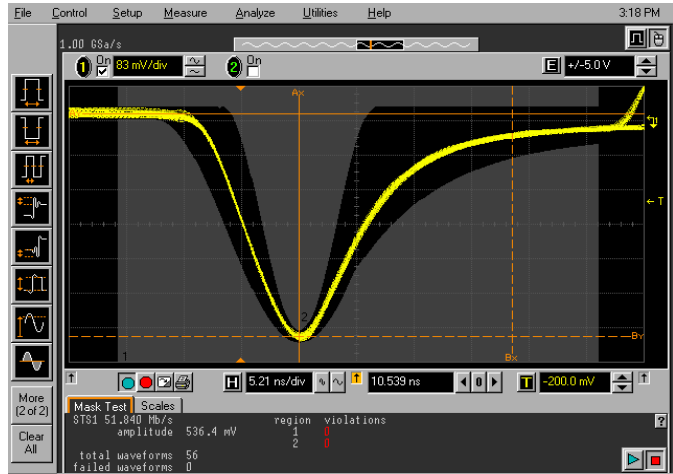

STXS-1 Negative Pulse Mask Test

3 Performance Tests

155 Mb/s Output Mask Tests

- 1 Press <Menu>, choose **Tx/Rx** > **Stored Settings** then press <Select>. Select **Default** then **Recall**.
- 2 Press <Menu>, choose **Tx/Rx** > **Transmitter Settings** then press <Select>. Select the **Physical** tab. Set the **Signal Rate** to **STS-3**.

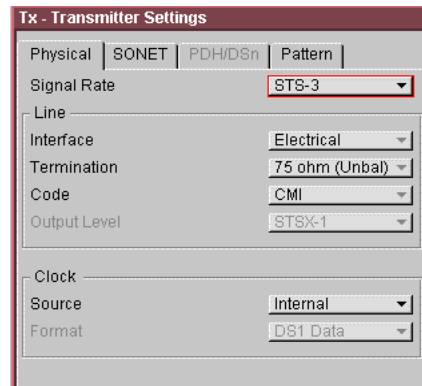

- 3 Connect the **155 Mb/s OUT** port to the Oscilloscope CHAN 1, using the E2622A Termination Adapter Probe.

Transmission Test Set

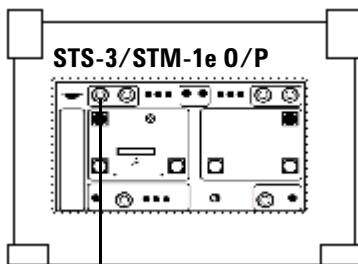

54810A Oscilloscope

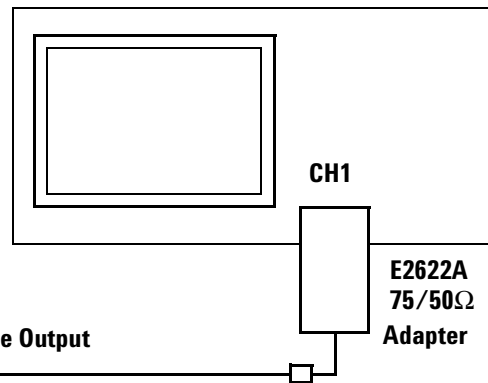

BNC to BNC cable

- 4 Load the **STS3_ANSI.msk** test mask and check the eye meets the mask (see example).

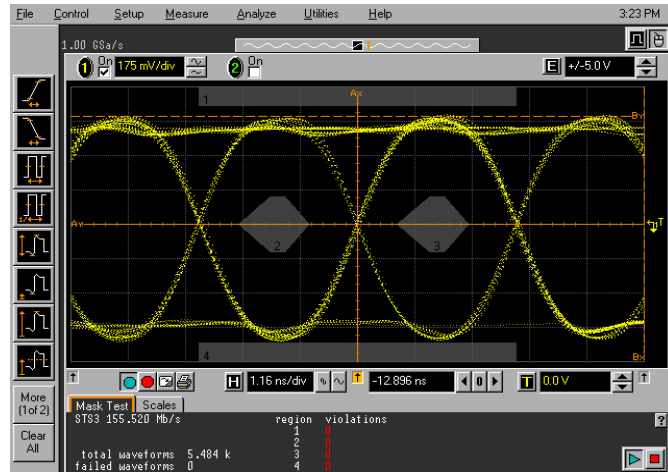

STS-3 Eye Mask Test

- 5 Press <Menu>, choose **System > Preferences** then press <Select>. Set **Network Standard** to **SDH**.
- 6 Press <Menu>, choose **Tx/Rx > Transmitter Settings** then press <Select>. Select the **Physical** tab. Set the **Signal Rate** to **STM-1**, and **Interface** to **Electrical**.
- 7 Load the **155Mb_ITU_0.msk** test mask and check the 'zero' pulses are within the mask. See examples.
- 8 Also check the 'ones' pulses (normal & inverted) by loading and checking against the **155Mb_ITU_1.msk** and **155_ITU_1_INV.msk** test masks (see examples).

3 Performance Tests

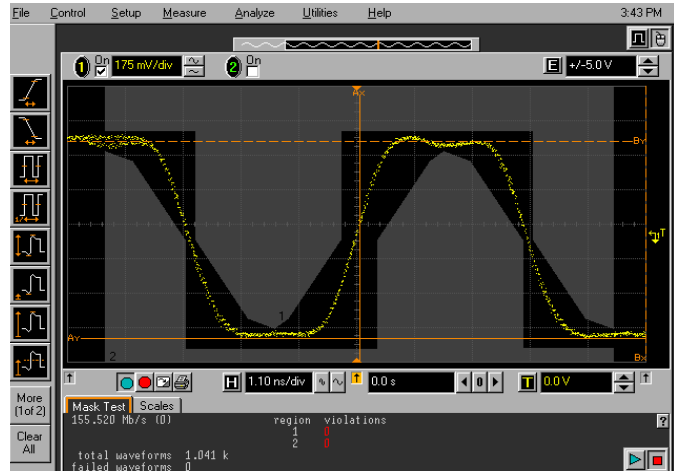

STM-1 All Zeros Mask Test



STM-1 All Ones Mask Test

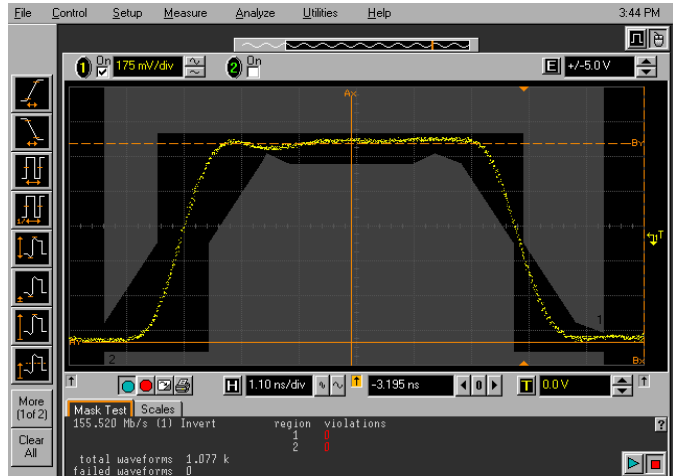

STM-1 All Ones (inverted) Mask Test

3 Performance Tests

Performance Test Record

Model: Agilent J2126/7A Transmission Test Set	
Location:	Serial No.:
Tested by:	Options:
Temperature:	Certified by:
Humidity:	Date:

NOTE

The test steps applicable are dependent on the instrument options installed. Enter N/A if a test does not apply for your instrument.

Page No.	Test Description	Min	Result Actual	Max
Performance Self Test				
72	step 3	Confidence Test	Pass/Fail	
72	step 6	Frequency Measurement	Pass/Fail	
72	step 7	Ethernet Test (10/100/1G)	Pass/Fail	
Internal Reference Clock Accuracy				
75	step 4	2 MHz Clock OUT	2.0479908 MHz	2.0480092 MHz
77	step 13	DS1 Clock OUT	-4.5 ppm	+4.5 ppm
78	step 2	Alternative DS1 Test (Counter indication for framed signal)	1.540993 MHz	1.541007 MHz
External Clock Reference Inputs and Clock Reference Output				
81	step 6	2 MHz Clock Ext	2.047999999 MHz	2.048000001 MHz
81	step 7	Signal Locked	Pass/Fail	
82	step 12	2 Mb/s Data Ext Unbal	2.047999999 MHz	2.048000001 MHz

Page No.	Test Description	Min	Result Actual	Max
83	step 13	Signal Locked	Pass/Fail	
83	step 17	2 Mb/s Data Ext Bal	2.047999999 MHz	2.048000001 MHz
83	step 18	Signal Locked	Pass/Fail	
84	step 22	No Alarm/Errors	Pass/Fail	
84	step 23	DS1 Ext	1.543999	1.544001
85	step 24	Signal Locked	Pass/Fail	
Optical Pulse Mask and Output Characteristics				
Option 100/102	1310nm Optical Port (52 Mb/s - 2.5 Gb/s)			
90	step 9	OC-1/STM-0 Mask	Pass/Fail	
90	step 11	OC-1/STM-0 (ER)	>8.2 dB	N/A
91	step 16	OC-3/STM-1 Mask	Pass/Fail	
91	step 18	OC-3/STM-1 (ER)	>8.2 dB	N/A
91	step 23	OC-12/STM-4 Mask	Pass/Fail	
92	step 25	OC-12/STM-4 (ER)	>8.2 dB	N/A
94	step 33	OC-48/STM-16 Mask	Pass/Fail	
94	step 35	OC-48/STM-16 (PWR)	-5 dBm	+0 dBm
94	step 36	OC-48/STM-16 (ER)	>8.2 dB	N/A
Option 101/102	1550nm Optical Port (52 Mb/s - 2.5 Gb/s)			
90	step 9	OC-1/STM-0 Mask	Pass/Fail	
90	step 11	OC-1/STM-0 (ER)	>8.2 dB	N/A
91	step 16	OC-3/STM-1 Mask	Pass/Fail	
91	step 18	OC-3/STM-1 (ER)	>8.2 dB	N/A
91	step 23	OC-12/STM-4 Mask	Pass/Fail	
92	step 25	OC-12/STM-4 (ER)	>8.2 dB	N/A

3 Performance Tests

Page No.	Test Description	Min	Result Actual	Max
94	step 33	OC-48/STM-16 Mask	Pass/Fail	
94	step 35	OC-48/STM-16 (PWR)	-2 dBm	+3 dBm
94	step 36	OC-48/STM-16 (ER)	>8.2 dB	Pass/Fail
1550nm Optical Port (10 Gb/s-HS type)				
Option 111				
96	step 8	OC-192/STM-64 Mask	Pass/Fail	
97	step 10	OC-192/STM-64 (PWR)	-1 dBm	+1 dBm
97	step 11	OC-192/STM-64 (ER)	>8.2 dB	Pass/Fail
1310nm Optical Port (10 Gb/s-SR type)				
Option 120				
96	step 8	OC-192/STM-64 Mask	Pass/Fail	
97	step 10	OC-192/STM-64 (PWR)	-6 dBm	-1 dBm
97	step 11	OC-192/STM-64 (ER)	>6.0 dB	Pass/Fail
1550nm Optical Port (10 Gb/s-SR type)				
Option 121				
96	step 8	OC-192/STM-64 Mask	Pass/Fail	
97	step 10	OC-192/STM-64 (PWR)	-5 dBm	-1 dBm
97	step 11	OC-192/STM-64 (ER)	>8.2 dB	Pass/Fail
Optical Receiver Sensitivity, Optical Power and Frequency Measurement				
Optical Receive Port (52 & 155 Mb/s)				
All options				
102	step 5	Laser LED ON	Pass/Fail	
102	step 6	Note Attenuator Setting	N/A	N/A
103	step 9	'No Trouble' Min Sens	Pass/Fail	
103	step 10	Additional Attenuation	Typ > 1 dB	N/A

Page No.	Test Description	Min	Result Actual	Max
103	step 11	-30 dBm PWR meas	-31 dBm	-29 dBm
103	step 11	OC-1/STM-0 Frequency	51.83999 MHz	51.84001 MHz
105	step 12	-10 dBm PWR meas	-11 dBm	-9 dBm
105	step 13	'No Trouble' Max Sens	Pass/Fail	
105	step 15	Power Meter check	-10.5	-9.5
102	step 5	Laser LED ON	Pass/Fail	
102	step 6	Note Attenuator Setting	N/A	N/A
103	step 9	'No Trouble' Min Sens	Pass/Fail	
103	step 10	Additional Attenuation	Typ > 1 dB	N/A
103	step 11	-30 dBm PWR meas	-31 dBm	-29 dBm
103	step 11	OC-3 /STM-1 Frequency	155.51999 MHz	155.52001 MHz
105	step 12	-10 dBm PWR meas	-11 dBm	-9 dBm
105	step 13	'No Trouble' Max Sens	Pass/Fail	
105	step 15	Power Meter check	-10.5	-9.5
Optical Receive Port (622 Mb/s)				
105	step 17	Laser LED ON	Pass/Fail	
105	step 18	Note Attenuator Setting	N/A	N/A
106	step 21	'No Trouble' Min Sens	Pass/Fail	
106	step 22	Additional Attenuation	Typ > 1 dB	N/A
106	step 23	-28 dBm PWR meas	-29 dBm	-27 dBm
106	step 23	OC-12/STM-4 Frequency	622.07999 MHz	622.08001 MHz
106	step 24	-8 dBm PWR meas	-9 dBm	-7 dBm
106	step 25	'No Trouble' Max Sens	Pass/Fail	
107	step 27	Power Meter check	-8.5	-7.5

3 Performance Tests

Page No.	Test Description	Min	Result Actual	Max
Optical Receive Port (2.5 Gb/s)				
108	step 4	Laser LED ON	Pass/Fail	
108	step 5	Note Attenuator Setting	N/A	N/A
108	step 8	'No Trouble' Min Sens	Pass/Fail	
109	step 9	Additional Attenuation	Typ > 1 dB	N/A
109	step 10	-28 dBm PWR meas	-30 dBm	-26 dBm
109	step 10	OC-48/STM-16 Frequency	2488.3199 MHz	2488.3201 MHz
109	step 11	-8 dBm PWR meas	-10 dBm	-6 dBm
109	step 12	'No Trouble' Max Sens	Pass/Fail	
109	step 14	Power Meter check	-8.5	-7.5
Optical Receive Port (10 Gb/s)				
Option 111				
111	step 4	Laser LED ON	Pass/Fail	
111	step 5	Note Attenuator Setting	N/A	N/A
111	step 8	'No Trouble' Min Sens	Pass/Fail	
111	step 9	Additional Attenuation	Typ > 1 dB	N/A
112	step 10	-20dBm PWR meas	-21.5 dBm	-18.5 dBm
112	step 10	OC-192/STM-64 Frequency	9953.2799 MHz	9953.2801 MHz
112	step 11	-9 dBm PWR meas	-10.5 dBm	-7.5 dBm
112	step 12	'No Trouble' Max Sens	Pass/Fail	
113	step 14	Power Meter check	-9.5 dBm	-8.5 dBm
Option 120				
111	step 4	Laser LED ON	Pass/Fail	
111	step 5	Note Attenuator Setting	N/A	N/A

Page No.	Test Description	Min	Result Actual	Max
111	step 8	'No Trouble' Min Sens	Pass/Fail	
111	step 9	Additional Attenuation	Typ > 1 dB	N/A
112	step 10	-20dBm PWR meas	-12.5 dBm	-9.5 dBm
112	step 10	OC-192/STM-64 Frequency	9953.2799 MHz	9953.2801 MHz
112	step 11	-9 dBm PWR meas	+0 dBm	-7.5 dBm
112	step 12	'No Trouble' Max Sens	Pass/Fail	
113	step 14	Power Meter check	step 11,+2 dB	step 11,-2 dB
Option 121				
111	step 4	Laser LED ON	Pass/Fail	
111	step 5	Note Attenuator Setting	N/A	N/A
111	step 8	'No Trouble' Min Sens	Pass/Fail	
111	step 9	Additional Attenuation	Typ > 1 dB	N/A
112	step 10	-20dBm PWR meas	-15.5 dBm	-11.5 dBm
112	step 10	OC-192/STM-64 Frequency	9953.2799 MHz	9953.2801 MHz
112	step 11	-9 dBm PWR meas	+0 dBm	-6.5 dBm
112	step 12	'No Trouble' Max Sens	Pass/Fail	
113	step 14	Power Meter check	step 11,+2 dB	step 11,-2 dB
All options				
113	Check Receiver Sensitivity margin v.s. Transmitter Extinction Ratio		Pass/Fail	
Electrical Pulse Mask and Output Characteristics				
DS1 Output Mask Tests				
117	step 4	DS1 ANSI Mask	Pass/Fail	
118	step 5	DSX-1 Pulse Amplitudes	Pass/Fail	

3 Performance Tests

Page No.	Test Description	Min	Result Actual	Max
118	step 6 DSX1-LO Output Level		Pass/Fail	
	2 Mb/s Balanced Output Mask Tests			
120	step 4 2 Mb/s ITU 120 Mask		Pass/Fail	
122	step 4 2 Mb/s ITU 75 Mask		Pass/Fail	
	8 Mb/s Output Mask Tests			
124	step 4 8 Mb/s ITU Mask		Pass/Fail	
	34 Mb/s Output Mask Tests			
126	step 4 34 Mb/s ITU Mask		Pass/Fail	
	DS3 Output Mask Tests			
128	step 4 DS3 ANSI Mask		Pass/Fail	
	140 Mb/s Output Mask Tests			
130	step 4 140 Mb/s ITU Masks		Pass/Fail	
	STS-1 (51 Mb/s) Output Mask Tests			
133	step 4 STS-1 Eye Mask		Pass/Fail	
134	step 5 STS-1 ANSI Mask		Pass/Fail	
	STS-3 Output Mask Tests			
137	step 4 STS-3 ANSI Mask		Pass/Fail	
137	step 7 155 Mb/s ITU_0 Mask		Pass/Fail	
137	step 8 155 Mb/s ITU_1s Mask		Pass/Fail	

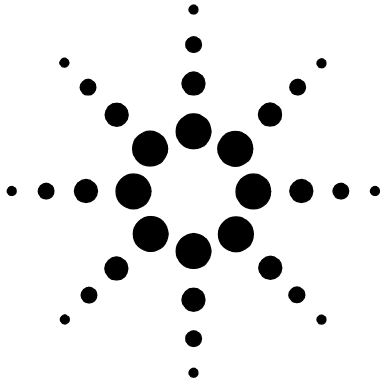

4 Self Test Overview

Description of the Self Test	148
List of Self Tests	149
Loopback Connections Required for Self Test	151
How to Run a Self Test	155
What to Do if the Self Test Fails	161

The instrument Self Test consists of a number of tests and sub-tests designed to verify the functionality of the instrument measurement and utility ports as well verify the major hardware paths within the instrument.

This section gives an overview of the instrument Self Tests available on the instrument.



Description of the Self Test

The Self Test comprises several tests each consisting of a number of sub tests (the tests available and number of sub tests within each test is option dependent). Self Test can be run as one complete sequence or an individual test may be run. If a failure occurs, then a descriptive text message and Fail Code is returned. An Error example is provided at the end of this section.

The Self Test is selected by pressing the <Menu> key then selecting **System > Self Test**. An example of the Self Test page in Selected Test mode is shown below.

The screenshot shows a software interface titled "Selftest". It contains several sections:

- Cabling Config:** Two dropdown menus. The first is "2.5G Optical interface port" with the value "Tx(1310nm) to Rx + attenuation". The second is "10G Optical interface port" with the value "Tx(1550nm) to Rx(10Gb/s) + attenuation".
- Run:** Two radio buttons: "All tests" (unselected) and "Selected test:" (selected). Next to "Selected test:" is a dropdown menu showing "Confidence Tests".
- Status:** The text "Test run is currently stopped" is displayed, with a red-bordered "Start" button to its right.
- Estimated test time:** Two digital displays showing "0 hours 2 minutes" and "0 hours 1 minutes remaining".
- Current test:** A text field containing "Confidence Tests".
- Current subtest:** A text field containing "Conf DS1" and a digital display showing "0 failure(s) found".
- Result:** A large yellow rectangular area containing the text "PASSED" followed by a timestamp "25-Aug-2008 14:18:54" in a white box.
- Footer:** A blue link "Press Select to start/stop selected test" and a "Status:" label with the value "Laser-OFF".

List of Self Tests

The Self Test comprises of several tests. Each test consists of a number of sub tests. A brief description of each test is given below.

The Self Test can be run in one of two modes **Run > All Tests** or **Run > Selected Test**.

The **Run All Tests** mode runs all the tests from the following list.

The **Run Selected Test** allows an individual test to be selected from the following list.

Test	Title	Description
1	Platform Test	This is for factory use only. It performs basic test of the CPU memory and IDE interface.
2	Confidence Test	This test checks all the optical and the electrical paths for SONET/SDH, PDH/DSn, but not for Ethernet. A basic signal continuity check is performed. This involves verifying the signal configuration by injecting/detecting a single error.
3	Optical Power Test	This test checks both the data paths and the optical power measurement circuitry.
4	DCC Add/Drop Test	The test checks the data paths associated with the DCC add/drop hardware. The DCC loopback should be fitted for this test.
5		Not currently applicable.
6		Not currently applicable.
7	Frequency Test	This test checks the data path through the clock offset and frequency measurement hardware. The test checks the absolute clock offset frequency result.
8		Not currently applicable.
9	Long Gating Test	This test is for factory use only.

4 Self Test Overview

Test	Title	Description
10		Not currently applicable.
11	Loop Back Test	This test is for factory use only.
12	Confidence Test 10 Gb/s Optics	This test performs a confidence test on the 10 Gb/s optical paths only.
13	Confidence Test 2.5 Gb/s - 52 Mb/s Optics	This test performs a confidence test on the 2.5 Gb/s - 52 Mb/s optical paths only.
14	Confidence Test Electrical Unbalanced Ports (52 Mb/s down to DS3)	This test performs a confidence test on the unbalanced electrical paths only.
15	Confidence Test E1 Balanced Ports	This test performs a confidence test on the E1 balanced port only.
16	Confidence Test DS1 Balanced Ports	This test performs a confidence test on the DS1 balanced port only.
17	Ethernet Test (10/100M)	This test performs a confidence test on the 10/100M Ethernet ports only.
18	Ethernet Test (1G)	This test performs a confidence test on the 1G Ethernet port only.
19	Ethernet Test (10/100/1G)	This test performs a confidence test on the all Ethernet ports

Loopback Connections Required for Self Test

The Self Test loopbacks required for each test are listed below. Those required are dependent on the test selected. See diagram on page 152 indicating loopback connections for a J2127A with options 102, 111 and 32x. The table indicates the minimum test loopback requirements.

Optical Loopback Connections (Option Dependent)

Use optical cables P/N 1005-0337 and 15 dB attenuator P/N 1005-0433.

- Connect 10 Gb/s 1550 nm Optical Out <=> 15 dB Attenuator <=> 10Gb/s Optical In. (Note attenuator is not required for Option 120/121 interfaces.)
- Connect 52 Mb/s - 2.5 Gb/s Optical Out <=> 15 dB Attenuator <=> 2.5 Gb/s Optical In.
- If Option 102, Dual Wavelength is installed, connect the other 52 Mb/s - 2.5 Gb/s Optical Out <=> 15 dB Attenuator <=> 52 Mb/s - 622 Mb/s Optical In.

Unbal Electrical Connections 52 - 155 Mb/s, DS3/2-140 Mb/s

Use BNC cable P/N 15525A for each loopback.

- Connect 52 - 155 Mb/s Out (BNC) <=> 52 - 155 Mb/s In (BNC).
- Connect 2 - 140 Mb/s DS3 Out (BNC) <=> 2 - 140 Mb/s DS3 In (BNC).

Balanced Electrical Connections 2M/DS1

Use 3-pin Siemens cable P/N 15512A and Bantam cable P/N 15670A.

- Connect 2M Out (3-pin Siemens) <=> 2M In.
- Connect DS1 Out <=> DS1 In.

DCC Loopback Connector (Only required if DCC ADD/DROP TEST or All tests are selected.)

- Connect DCC loopback plug to 9-pin DCC port P/N J2125-65011.

Ethernet Loopback Connections (Option Dependent)

- Use standard category 5 patch cords for the 10/100 Mb/s Ethernet loopbacks. No crossover is required as this is handled internally. These patch cords are supplied with the instrument, Part Number J2126-65021.
- Use duplex SC optical patch cord (Tx crossed-over to Rx and Rx crossed-over to Tx). This patch cord is supplied with the instrument when 1 Gb/s Ethernet is fitted, Part Number 1005-1110 (850 nm) (Tyco Electronics Corp/AMP 504971-1), or 1005-1111 (1310 nm) (Tyco Electronics Corp/AMP 492019-1).

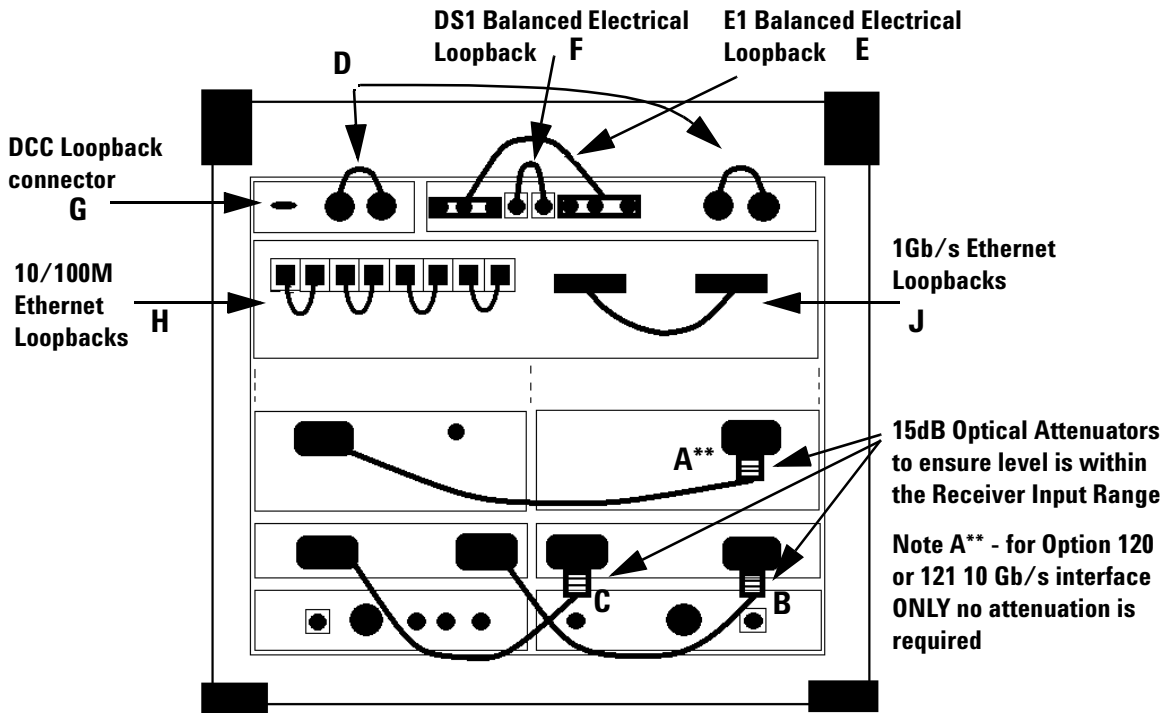

— Thick line represents Loopback Patch Cords. The connections shown are typical for J2127A fitted with Options 102 (Dual 2.5G Tx Wavelength), 111 (1550nm High Sensitivity 10G Rx optics) and 32x (Ethernet testing).

CAUTION

Safety precautions care and connection cleanliness must be observed to ensure that the optical connections are not damaged or degraded. Ensure the recommended optical attenuation is present in all optical loopback connections as failure to do so could cause self test failure or damage to the optical receivers.

Minimum test loopback requirements

Self Test	Optical Loopback (Use 15 dB attenuator when required)	Electrical Loopback	DCC Loopback plug	Ethernet Loopbacks
	Loopbacks are option dependent			Use when Ethernet Module is fitted
All tests	A**, B, C,	D, E, F	G	H, J
Confidence Tests (This runs all the confidence tests given below)	A**, B, C,	D, F	not required	
Confidence Tests (10Gb/s Optics)	A**			
Confidence Tests (2.5Gb/s - 52 Mb/s Optics)	B, C			
Confidence Tests Unbalanced Electrical Ports (52 Mb/s down to DS3)		D		
Confidence Tests (E1 Balanced Ports)		E		
Confidence Tests (DS1 Balanced Ports)		F		
Optical Power Tests	A, B, C	not required	not required	
Note - A**, for Option 120/121, 10 Gb/s interface ONLY no attenuation is required.				

4 Self Test Overview

Minimum test loopback requirements

Self Test	Optical Loopback (Use 15 dB attenuator when required)	Electrical Loopback	DCC Loopback plug	Ethernet Loopbacks
	Loopbacks are option dependent			Use when Ethernet Module is fitted
DCC Add/Drop Tests	A	not required	E	
Frequency Tests	A, B, C	D	not required	
Platform Tests	not required	not required	not required	
Ethernet Tests (10/100M)				H
Ethernet Tests (1G)				J
Ethernet Tests (10/100/1G)				H, J

Note - A**, for Option 120/121, 10 Gb/s interface ONLY no attenuation is required.

NOTE

If single wavelength optics are fitted to the 2.5 Gb/s - 52 Mb/s Optical Out port then the Self Test should be performed twice to verify all the Optical In ports. Perform the test with the 2.5 Gb/s - 52 Mb/s Optical Out port connected to the 2.5 Gb/s Optical In port and repeat with the 2.5 Gb/s - 52 Mb/s Optical Out port connected to the 662 - 52 Mb/s Optical In port. Select the cable configuration from the test menu.

How to Run a Self Test

- 1 Press <Menu>, choose **System > Self Test** then press <Select>.
- 2 Ensure all loopbacks are in place and from the Self Test page menu select the appropriate 1310/1550 nm 2.5 Gb/s to 52 Mb/s optical loopback Cabling Configuration. Loopback accordingly, taking care to ensure attenuation is provided in the Optical loopback paths.
- 3 On the Self Test page choose **Run Selected Test** and choose the selected test. Choose **START** to begin the test.
- 4 The Self Test will now run, selecting each sub test in sequence. The remaining test time to complete the tests is displayed on the right hand side of the Self Test page.
- 5 If any sub test fails an error message and error code will be returned. Up to five sub test errors can be logged before the test ends/aborts.
- 6 End of procedure.

Error messages and codes

The approximate test time for selected test is shown on the Self Test display. Most tests only take 1-2 minutes to complete. If no errors are recorded then all sub tests have passed. If any sub test fails, an error message is returned along with an error code which returns Test Number, Sub Test Number. An example of a test failure is shown in the following figure.

4 Self Test Overview

The screenshot shows the 'Selftest' window with the following configuration and results:

- Cabling Config:**
 - 2.5G Optical interface port: Tx(1310nm) to Rx + attenuation
 - 10G Optical interface port: Tx(1550nm) to Rx(10Gb/s) + attenuation
- Run:**
 - All tests:
 - Selected test: Confidence Tests
- Status:** Test run is currently stopped. **Start** button is highlighted.
- Estimated test time:** 0 hours 2 minutes. 0 hours 1 minutes remaining.
- Current test:** Confidence Tests
- Current subtest:** Conf DS1. 4 failure(s) found.
- Results Table:**

Date	Time	Test	Subtest	Failure
25-Aug-2008	14:28:45	Confidence Tests	Conf2.5Gb/s 1310nm	LOS Alarm Detected
25-Aug-2008	14:29:06	Confidence Tests	Conf022Mb/s 1310nm	LOS Alarm Detected
25-Aug-2008	14:29:26	Confidence Tests	Conf 155Mb/s 1310nm	LOS Alarm Detected
25-Aug-2008	14:29:47	Confidence Tests	Conf52Mb/s 1310nm	LOS Alarm Detected

[Press Select to start/stop selected test](#)

Status: Laser-OFF

List of Self Test Sub Tests

A list of all the possible sub tests in any given Test is shown below. Each interface is tested in sequence starting with the highest rate interface down to the lowest rate interface. The actual number of sub tests run is dependent on the instrument options fitted, for example single or dual wavelength.

Test 1 - Platform Test

This test is for factory use only. It performs a basic test of the CPU memory and IDE interface.

Test 2 - Confidence Test

Sub Test Number	Sub Test Description
1	Conf 10 Gb/s 1550 nm
2	Conf 2.5 Gb/s 1310 nm
3	Conf 2.5 Gb/s 1550 nm
4	Conf 622 Mb/s 1310 nm
5	Conf 622 Mb/s 1550 nm
6	Conf 155 Mb/s 1310 nm
7	Conf 155 Mb/s 1550 nm
8	Conf 52 Mb/s 1310 nm
9	Conf 52 Mb/s 1550 nm
10	Conf 155 Mb/s
11	Conf 52 Mb/s
12	Conf E4 Unbal
13	Conf E3 Unbal
14	Conf E2 Unbal
15	Conf E1 Unbal
16	Conf E1 Bal
17	Conf DS3 Unbal
18	Conf DS1Bal

4 Self Test Overview

Test 3 - Optical Power Test

Sub Test Number	Sub Test Description
1	10 Gb/s 1550nm
2	2.5 Gb/s 1310/1550nm
3	622 Mb/s 1310/1550nm

Test 4 - DCC Add/Drop Test

Sub Test Number	Sub Test Description
1	Performed at the maximum available DCC/GCC channel rate

Test 7 - Frequency Measurement

Sub Test Number	Sub Test Description
1	Performed at the maximum available Optical line rate
2	E4 Unbal
3	E1 Bal

Test 9- Long Gating Test

Factory use only

Test 11 - Loopback Test

Factory use only

Test 12 - Confidence Test 10 Gb/s Optical

Sub Test Number	Sub Test Description
1	Conf 10 Gb/s 1310/1550 nm

Test 13 - Confidence Test 2.5 Gb/s - 52 Mb/s Optical

Sub Test Number	Sub Test Description
2	Conf 2.5 Gb/s 1310 nm
3	Conf 2.5 Gb/s 1550 nm
4	Conf 622 Mb/s 1310 nm
5	Conf 622 Mb/s 1550 nm
6	Conf 155 Mb/s 1310 nm
7	Conf 155 Mb/s 1550 nm
8	Conf 52 Mb/s 1310 nm
9	Conf 52 Mb/s 1550 nm

Test 14 - Confidence Test Unbalanced Electrical

Sub Test Number	Sub Test Description
10	Conf 155 Mb/s
11	Conf 52 Mb/s
12	Conf E4 Unbal
13	Conf E3 Unbal
14	Conf E2 Unbal
15	Conf E1 Unbal
17	Conf DS3 Unbal

Test 15 - Confidence Test E1 Balanced

Sub Test Number	Sub Test Description
16	Conf E1 Bal

Test 16 - Confidence Test DS1 Balanced

Sub Test Number	Sub Test Description
18	Conf DS1 Bal

Test 17, 18, 19- Ethernet Tests

Sub Test Number	Sub Test Description
Many	Too many to list*

* The Ethernet subtests are abbreviated as follows:

Ext - External Loopback

IntX - Internal Xilinx Loopback

IntS - Internal Serdes Loopback

Q - Quiet mode

P - Parallel mode

FD - Full Duplex

HD - Half Duplex

Po 1->2 - Port 1 transmitting to Port 2

FS - Frame Size

An Example of an Ethernet subtest description is **10m_FD P FS64 Po1->2**. This translates to a test where Port 1 transmits to Port 2 after the link has been auto negotiated to 10 Mb/s Full Duplex. This is a parallel test (all ports transmit simultaneously), using Frame Size of 64 bytes.

What to Do if the Self Test Fails

- 1 Check all connections to make sure that all the correct loopback connections are in place and Optical Attenuators are fitted as required.
- 2 Be suspicious of any optical interface failures and if necessary clean all optical connections with a recognized cleaning kit before retrying the Self Test.
- 3 If the problem persists then contact your local Agilent Service Office or representative.

Tips and Checks to Confirm Correct Optical Loopback

- Make sure connectors are located in key/notch of the port connectors to ensure full insertion.
- Check Transmitter and Receiver are set to the same Signal Rate and that the correct Laser is On when test is being Run.
- Press <Smart Test>, choose **Shortcuts** > **Optical Power** then press <Select>. Check the Received signal level is in the Green BER measurement power range.
- Ensure all optical connections are clean and fully connected with no sharp bends or twists in the optical patch cord. Check the Optical Cord and Attenuator are not damaged and/or substitute with equivalent.

4 Self Test Overview

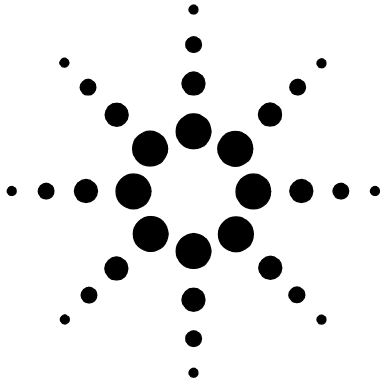

5 ETSI/ANSI Terminology

The terminology used on the instrument display can be ETSI (SDH) or ANSI (SONET). Refer to the table given in this section for an explanation of equivalent SDH/SONET terms.



ETSI/ANSI Conversion and Equivalent Terms

ETSI: European Telecommunications Standards Institute.

ANSI: American National Standards Institute.

ETSI (SDH) Term	ANSI (SONET) Term
AU-3	STS-1 SPE + H1, H2, H3
AU-4	STS-3c SPE + H1, H2, H3
BIP (Bit Interleaved parity)	CV (Code Violation)
High Order Path (HP / HO)	STS Path
I-n Intra Office, (n=STM-n level)	Intermediate Reach (IR)
L-n.1 or L-n.2 long haul	LR long reach
Low Order Path (LP / LO)	VT Path
LP-REI	REI-V
M.S.P	A.P.S
Multiplexer Section (MS)	Line
Multiplexer Section Protection	Automatic Protection Switching
MS-AIS	Line AIS / AIS-L
MS-BIP	Line CV / CV-L
MS-DCC	Line DCC / DCC-L
MS-REI	Line FEBE / REI-L
MS-RDI	Line FERF / RDI-L
Multiplexer Section Overhead	Line Overhead
Network Node Interface	Line Interface
OOF	SEF (severely errored frame defect)
Path AIS / AU-AIS	AIS-P
Path REI / HP REI	REI-P
Path FERF / HP RDI	RDI-P

ETSI (SDH) Term	ANSI (SONET) Term
Path IEC / AU-IEC	IEC-P
Path Overhead	Path Overhead
Regenerator	Repeater
Regenerator Section (RS)	Section
Regenerator Section Overhead	Section Overhead
Remote Alarm Indicator	RAI
RS-DCC	Section DCC (DCC-S)
Section Overhead (SOH)	Transport Overhead (TOH)
S-n.1 or S-n.2 short haul	Short Reach (SR)
SOH	TOH
STM-m	OC-n / STS-n (where $m = n + 3$ for $m \geq 1$)
STM-0	STS-1
STM-1	OC3c / STS-3c
STM-4	OC-12 / STS-12
STM-16	OC-48 / STS-48
STM-64	OC-192
Tributary Unit (TU)	Virtual Tributary (VT)
TU	VT
TU-11	VT 1.5
TU-12	VT 2
TU-2	VT 6
TU-3	NONE
TU BIP	VT BIP (CV-V)
TU RDI / LP-RDI	RDI-V
TUG	VT Group
TUG2	VT Group (12 columns)

5 ETSI/ANSI Conversion and Equivalent Terms

ETSI (SDH) Term	ANSI (SONET) Term
TUG3	VT Group (86 columns)
TU multiframe	VT superframe
TU PATH AIS	VT AIS (AIS-V)
VC	SPE
VC4	STS3C SPE
Virtual Container (VC)	Synchronous Payload Envelope (SPE)

NOTE: VC is an ETSI abbreviation for Virtual Container and an ETSI / ANSI abbreviation for (ATM) Virtual Channel. The context of VC must therefore be taken into account when converting between standards.

Index

Numerics

- 52/155 and 622 Mb/s Optical Output Checks, 88
- 9.95 and 10.71 Gb/s Optical Output Checks, 95

A

- Accessories, 18
 - additional documentation, 18
 - carrying cases, 18
 - optical adapters and cables, 18
- Altitude, 21
 - environment, 32
- Assistance, 19

C

- Calibration Cycle, 64
- Certification, 19
- Changing the Network Standard Setting, 39
- Clock Offset/Frequency Measurement Sub Test, 158, 159, 160
- Clock ports, 54
- Cold start, 61
- Compliance, 29
- Confidence Sub Test, 157
- Confidence Test, 68, 149

Connectors

- DCC, 55
 - electrical test ports, 56
 - ethernet ports, 57
 - external protective earth, 58
 - GPIB, 58
 - keyboard, 59
 - LAN, 59
 - left side, 58
 - mouse, 59
 - optical in, 53
 - optical interface, 46
 - optical out, 52
 - right side, 59
 - RJ45, 59
 - RS232, 59
 - top panel, 51
 - USB, 59
 - VGA, 60
- Covers - how to remove, 36
- CPU Test, 149

D

- DCC Add/Drop Sub Test, 158
- DCC Add/Drop Test, 149
- Declaration of Conformity, 30
- Default Settings, Recall of, 67
- Dimensions, 22
- DS1 Clock test
 - Alternative, 78

E

- Electromagnetic Compatibility, 30
- Electrostatic discharge (ESD)
 - precautions, 49
- Ethernet
 - ports, 57
- Ethernet Capability, 13
- External Clock Reference Inputs and Clock Reference Output, 79

F

- Floppy disk drive (location), 58
- Frequency Measurement Self Test, 149
- Frequency Measurement Test, 68
- Front panel soft recovery (cold start), 61
- Fuses, 33

G

- General Information, 19
- Getting Started, 31

H

- How to
 - remove instrument covers, 36
 - run the Self Test, 155
- Humidity, 33

I

- Initial Inspection, 32
- Installation, 31
- Instrument Covers - How to remove, 36
- Instrument Reboot, 61
- Instruments Covered By Manual, 20
- Internal Reference Clock Accuracy, 73
 - Equipment Required, 74
 - Procedure, 74

L

- Laser product classification, 47
- Laser warning symbols, 48
- Line frequency measurement, 99
- Loopback connections required for Self Test, 69, 151
- Loss of Signal/Alarm Sub Test, 156

M

- Mainframe test rate capability, 15
- Mouse connection, 36

Index

N

Network Standard Setting, Changing the, 39

Noise Declaration, 30

O

OC-1/STM-0 Power Level and Eye Mask Tests., 88, 116

OC-12/STM-4 Power Level and Eye Mask Tests, 91

OC-192/STM-64 Power Level and Eye Mask Tests, 95

OC-3/STM-1 Power Level and Eye Mask Tests, 90, 124

OC-48/STM-16 Power Level and Eye Mask Tests, 93

Operating Environment, 32

Operator maintenance
general, 27

Optical cables
connecting, 47
disconnecting, 47

Optical connectors, 16
alternatives, 17
cleaning, 27
types, 16

Optical connectors (location), 51

Optical interfaces, 16

Optical Loopback-Tips and Checks, 161

Optical Patch Cord, 40

Optical power measurement, 99

Optical Power Measurement Sub Test, 158

Optical Power Test, 149

Optical Pulse Mask and Output
Characteristics, 86, 114

Optical receiver overload, avoiding, 48

Optical Receiver Sensitivity, Optical Power
and Frequency Measurement, 98

OC-1/STM-0 and OC-3/STM-1
Rates, 100

OC-12/STM-4 Rate, 105

OC-192/STM-64 Rate, 110

OC-48/STM-16 Rates, 107

Options

certificate of calibration, warranty,
service plans, 17

enhanced testing upgrades, 17

Ethernet, 17

guide, 15

other, 17

UK6, 17

Original Packaging, 21

P

Packaging, 21

Performance Self Test

What to do if it fails, 72

Performance Test Record, 140

Performance Tests - Recommended Test
Equipment, 65

Power Cable, 35

Power Requirements, 33

Power-up Sequence, 38

Precautions for service engineers, 49

Preparation for Use, 33

Product description, 12

R

Recall Default Settings, 67

Recommended Test Equipment,
Performance Tests, 65

Removing the Instrument Covers, 36

Repackaging for Shipment, 21

Requesting support, 37

Responsibilities of the Customer, 19

S

Safety precautions, 23

Safety symbols, 24

Self Test, 68

Confidence Test, 149

CPU Test, 149

DCC Add/Drop Test, 149

Frequency Measurement, 149

How to run, 72, 155

Loopback Connections, 151

Optical Power Test, 149

sub tests, 156

What to do if it fails, 161

Self Test Loopback Cables and
Accessories, 66

Self Test, Description of, 148

Serial Number Plate, 20

Service plans, 18

Shipping/Transit to Customer Sites, 21

SONET/SDH Capability, 12

Specifications, 98

Statement of Compliance, 29

Storage and Shipment, 21

Sub Test

Clock Offset/Frequency

Measurement, 158, 159, 160

DCC Add/Drop Test, 158

Loss of Signal/Alarm Test, 156

Optical Power Measurement, 158

Sub Tests

Confidence Test, 157

T

Temperature, 21

environment, 32, 33

Tips and Checks to Confirm Correct Optical
Loopback, 161

Transit Cases, 21

V

Ventilation Requirements, 33

W

Weight, 22

What to do if the Self Test fails, 161

In this book

This book contains all the information you need to be able to verify the correct performance and installation of the Transmission Test Sets. It is aimed at both new and experienced users.

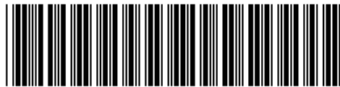

Printed in UK 09/02
J2127-90012



Agilent Technologies