

Operating and Service Manual

R85026A Detector

26.5 to 40 GHz

Serial Numbers

This manual applies directly to R85026A detectors with serial numbers 100 and above. For additional information on serial numbers, refer to *Instruments Covered by Manual* in Section 1, General Information.



Part Number 85026-90001
Printed in USA April 1986

© Agilent Technologies, Inc. 1986

Hewlett-Packard to Agilent Technologies Transition

This manual may contain references to HP or Hewlett-Packard. Please note that Hewlett-Packard's former test and measurement, semiconductor products and chemical analysis businesses are now part of Agilent Technologies. To reduce potential confusion, the only change to product numbers and names has been in the company name prefix: where a product number/name was HP XXXX the current name/number is now Agilent XXXX. For example, model number HP R85026A is now model number Agilent R85026A .

Documentation Warranty

THE MATERIAL CONTAINED IN THIS DOCUMENT IS PROVIDED "AS IS," AND IS SUBJECT TO BEING CHANGED, WITHOUT NOTICE, IN FUTURE EDITIONS. FURTHER, TO THE MAXIMUM EXTENT PERMITTED BY APPLICABLE LAW, AGILENT DISCLAIMS ALL WARRANTIES, EITHER EXPRESS OR IMPLIED WITH REGARD TO THIS MANUAL AND ANY INFORMATION CONTAINED HEREIN, INCLUDING BUT NOT LIMITED TO THE IMPLIED WARRANTIES OF MERCHANTABILITY AND FITNESS FOR A PARTICULAR PURPOSE. AGILENT SHALL NOT BE LIABLE FOR ERRORS OR FOR INCIDENTAL OR CONSEQUENTIAL DAMAGES IN CONNECTION WITH THE FURNISHING, USE, OR PERFORMANCE OF THIS DOCUMENT OR ANY INFORMATION CONTAINED HEREIN. SHOULD AGILENT AND THE USER HAVE A SEPARATE WRITTEN AGREEMENT WITH WARRANTY TERMS COVERING THE MATERIAL IN THIS DOCUMENT THAT CONFLICT WITH THESE TERMS, THE WARRANTY TERMS IN THE SEPARATE AGREEMENT WILL CONTROL.

DFARS/Restricted Rights Notice

If software is for use in the performance of a U.S. Government prime contract or subcontract, Software is delivered and licensed as "Commercial computer software" as defined in DFAR 252.227-7014 (June 1995), or as a "commercial item" as defined in FAR 2.101(a) or as "Restricted computer software" as defined in FAR 52.227-19 (June 1987) or any equivalent agency regulation or contract clause. Use, duplication or disclosure of Software is subject to Agilent Technologies' standard commercial license terms, and non-DOD Departments and Agencies of the U.S. Government will receive no greater than Restricted Rights as defined in FAR 52.227-19(c)(1-2) (June 1987). U.S. Government users will receive no greater than Limited Rights as defined in FAR 52.227-14 (June 1987) or DFAR 252.227-7015 (b)(2) (November 1995), as applicable in any technical data.

Printing Copies of Documentation from the Web

To print copies of documentation from the Web, download the PDF file from the Agilent web site:

- Go to <http://www.agilent.com>.
- Enter the document's part number (located on the title page) in the Quick Search box.
- Click GO.
- Click on the hyperlink for the document.
- When the PDF document is open, click the printer icon located in the tool bar.

Contacting Agilent

This information supersedes all prior HP contact information.			
Online assistance: www.agilent.com/find/assist			
Americas			
Brazil (tel) (+55) 11 3351 7012 (fax) (+55) 11 3351 7024	Canada (tel) 888 447 7378 (fax) 905 282 6495	Mexico (tel) 1 800 254 2440 (fax) 1 800 254 4222	United States (tel) 800 829 4444 (alt) (+1) 303 662 3998 (fax) 800 829 4433
Asia Pacific and Japan			
Australia (tel) 1 800 225 574 (fax) 1 800 681 776 (fax) 1 800 225 539	China (tel) 800 810 0508 (alt) 800 810 0510 (fax) 800 810 0507 (fax) 800 810 0362	Hong Kong (tel) 800 933 229 (fax) 800 900 701	India (tel) 1600 112 626 (fax) 1600 112 727 (fax) 1600 113 040
Japan (Bench) (tel) 0120 32 0119 (alt) (+81) 426 56 7799 (fax) 0120 01 2144	Japan (On-Site) (tel) 0120 802 363 (alt) (+81) 426 56 7498 (fax) (+81) 426 60 8953	Singapore (tel) 1 800 275 0880 (fax) (+65) 6755 1235 (fax) (+65) 6755 1214	South Korea (tel) 080 778 0011 (fax) 080 778 0013
Taiwan (tel) 0800 047 669 (fax) 0800 047 667 (fax) 886 3492 0779	Thailand (tel) 1 800 2758 5822 (alt) (+66) 2267 5913 (fax) 1 800 656 336	Malaysia (tel) 1800 880 399 (fax) 1800 801 054	
Europe			
Austria (tel) 0820 87 44 11* (fax) 0820 87 44 22	Belgium (tel) (+32) (0)2 404 9340 (alt) (+32) (0)2 404 9000 (fax) (+32) (0)2 404 9395	Denmark (tel) (+45) 7013 1515 (alt) (+45) 7013 7313 (fax) (+45) 7013 1555	Finland (tel) (+358) 10 855 2100 (fax) (+358) (0) 10 855 2923
France (tel) 0825 010 700* (alt) (+33) (0)1 6453 5623 (fax) 0825 010 701*	Germany (tel) 01805 24 6333* (alt) 01805 24 6330* (fax) 01805 24 6336*	Ireland (tel) (+353) (0)1 890 924 204 (alt) (+353) (0)1 890 924 206 (fax) (+353) (0)1 890 924 024	Israel (tel) (+972) 3 9288 500 (fax) (+972) 3 9288 501
Italy (tel) (+39) (0)2 9260 8484 (fax) (+39) (0)2 9544 1175	Luxemburg (tel) (+32) (0)2 404 9340 (alt) (+32) (0)2 404 9000 (fax) (+32) (0)2 404 9395	Netherlands (tel) (+31) (0)20 547 2111 (alt) (+31) (0)20 547 2000 (fax) (+31) (0)20 547 2190	Russia (tel) (+7) 095 797 3963 (alt) (+7) 095 797 3900 (fax) (+7) 095 797 3901
Spain (tel) (+34) 91 631 3300 (alt) (+34) 91 631 3000 (fax) (+34) 91 631 3301	Sweden (tel) 0200 88 22 55* (alt) (+46) (0)8 5064 8686 (fax) 020 120 2266*	Switzerland (French) (tel) 0800 80 5353 opt. 2* (alt) (+33) (0)1 6453 5623 (fax) (+41) (0)22 567 5313	Switzerland (German) (tel) 0800 80 5353 opt. 1* (alt) (+49) (0)7031 464 6333 (fax) (+41) (0)1 272 7373
Switzerland (Italian) (tel) 0800 80 5353 opt. 3* (alt) (+39) (0)2 9260 8484 (fax) (+41) (0)22 567 5314	United Kingdom (tel) (+44) (0)7004 666666 (alt) (+44) (0)7004 123123 (fax) (+44) (0)7004 444555		
(tel) = primary telephone number; (alt) = alternate telephone number; (fax) = FAX number; * = in country number			
			8/03/04

OPERATING AND SERVICE MANUAL

HP R85026A DETECTOR

26.5 to 40 GHz

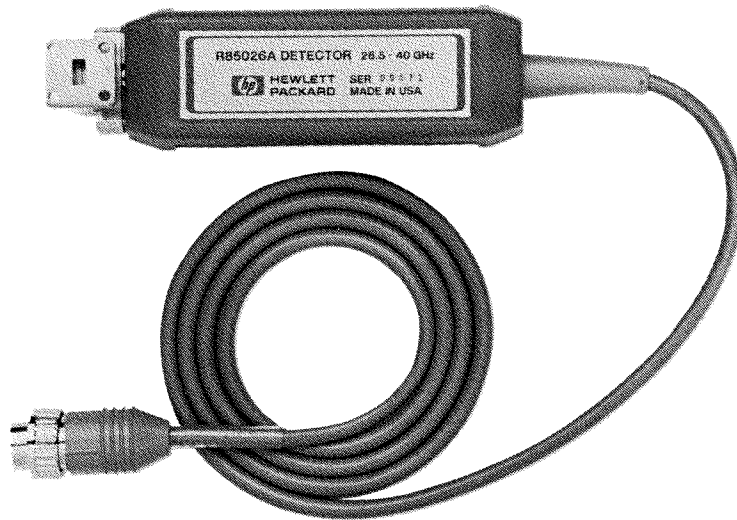

WARRANTY

This Hewlett-Packard instrument product is warranted against defects in material and workmanship for a period of one year from date of delivery. During the warranty period, Hewlett-Packard Company will, at its option, either repair or replace products which prove to be defective.

For warranty service or repair, this product must be returned to a service facility designated by HP. Buyer shall prepay shipping charges to HP and HP shall pay shipping charges to return the product to Buyer. However, Buyer shall pay all shipping charges, duties, and taxes for products returned to HP from another country.

HP warrants that its software and firmware designated by HP for use with an instrument will execute its programming instructions when properly installed on that instrument. HP does not warrant that the operation of the instrument, or software, or firmware will be uninterrupted or error free.

LIMITATION OF WARRANTY

The foregoing warranty shall not apply to defects resulting from improper handling by Buyer, Buyer-supplied software or interfacing, unauthorized modification or misuse, or operation outside of the environmental specifications for the product.

NO OTHER WARRANTY IS EXPRESSED OR IMPLIED, HP SPECIFICALLY DISCLAIMS THE IMPLIED WARRANTIES OR MERCHANTABILITY AND FITNESS FOR A PARTICULAR PURPOSE.

EXCLUSIVE REMEDIES

THE REMEDIES PROVIDED HEREIN ARE BUYER'S SOLE AND EXCLUSIVE REMEDIES, HP SHALL NOT BE LIABLE FOR ANY DIRECT, INDIRECT, SPECIAL, INCIDENTAL, OR CONSEQUENTIAL DAMAGES, WHETHER BASED ON CONTRACT, TORT, OR ANY OTHER LEGAL THEORY.

ASSISTANCE

Product maintenance agreements and other customer assistance agreements are available for Hewlett-Packard Products.

For any assistance, contact your nearest Hewlett-Packard Sales and Service Office. Addresses are provided at the back of this manual.

MANUAL CHANGES**NOTE**

Manual change supplements are revised as often as necessary to keep manuals as current and accurate as possible. Hewlett-Packard recommends that you periodically request the latest edition of this supplement. Free copies are available from all HP offices. When requesting copies, quote the manual identification information from your supplement, or the model number and print date from the title page of the manual.

MANUAL IDENTIFICATION

HP Number: R85026A
Date Printed: February 1986
Part Number: 85026-90001

This supplement contains important information for correcting manual errors and for adapting the manual to instruments containing improvements made after the printing of the manual.

Two types of information are included:

UPDATES - APPLY TO ALL SERIAL NUMBERS.

NUMBERED CHANGES - UPDATES THAT ARE SERIAL NUMBER PREFIX RELATED.

The information is in the following order: UPDATES, NUMBERED CHANGES in sequential order with applicable illustrations as close as possible to each numbered change.

To use this supplement, make all UPDATES and all appropriate serial number related CHANGES indicated in the following tables.

▶ = NEW ITEM

▶ **UPDATES**

Page 1-6. OPERATING ENVIRONMENT:

Change temperature to 0° to +55°C (+32° to +131°F).

Page 1-6. STORAGE AND SHIPMENT:

Change temperature to -40° to +75°C (-40° to +167°F).

Page 3-2. RETURN LOSS:

Under Specification, change the temperature to +20° to +30°C (+68° to +86°F).

Page 3-4. FLATNESS:

Under Specification, change the temperature to +20 to +30°C (+68° to +86°F).

Page 3-7. DYNAMIC ACCURACY:

Under Specification, change the temperature to +20° to +30°C (+68° to +86°F).

APRIL 9, 1986



**HEWLETT
PACKARD**

HP R85026A DETECTOR 26.5 to 40 GHz

SERIAL NUMBERS

This manual applies directly to HP R85026A detectors with serial number 100 and above.

For additional information about serial numbers, refer to INSTRUMENTS COVERED BY MANUAL in Section I, General Information.

©Copyright HEWLETT-PACKARD COMPANY 1986
1400 FOUNTAINGROVE PARKWAY, SANTA ROSA, CA 95401 U.S.A.

MANUAL PART NO. 85026-90001
Microfiche Part Number 85026-90002

Printed: FEBRUARY 1986



**HEWLETT
PACKARD**

TABLE OF CONTENTS

Section	Page	Section	Page
I	GENERAL INFORMATION	II	OPERATION
	Introduction		Introduction
	Instruments Covered by this Manual		Features
	Description		Operator's Check
	Specifications		Operating Precautions
	Safety Considerations		Operating Theory
	Accessories Supplied		Detection Modes
	Equipment Required but not Supplied	III	PERFORMANCE TESTS
	Equipment Available		Introduction
	Accessories Available		Return Loss
	Recommended Test Equipment		Flatness
	Initial Inspection		Dynamic Accuracy
	Preparations for Use	IV	SERVICE
	Operating Environment		Introduction
	Storage and Shipment		Cable Troubleshooting
	Adjustments		Power Cable Replacement
	Ordering Manual/Microfiche		Ordering Information
			Replaceable Parts



HP R85026A DETECTOR

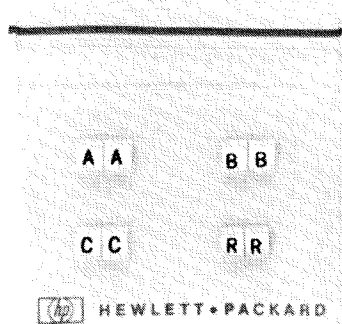

CABLE MARKER KIT

HP Part Number 5061-1044

Figure 1-1. HP R85026A and Accessories Supplied

Section I: General Information

INTRODUCTION

This manual contains information required to operate, test, and service the Hewlett-Packard R85026A detector. Figure 1-1 shows the instrument and the accessories supplied with it.

INSTRUMENTS COVERED BY THIS MANUAL

Each HP R85026A detector has a unique serial number. This manual applies to instruments with serial number 100 and above.

A detector manufactured after the printing of this manual may be different from the detector documented in this manual. The manual for newer instruments is accompanied by a yellow manual change supplement that contains serial-specific change information explaining how to adapt the manual for the newer instrument. In addition to change information, the supplement may contain replacement information that applies to all instruments, regardless of their serial number.

To keep this manual as current as possible, periodically request the latest manual change supplement. The supplement for this manual is keyed to its print date and part number, which appear on the title page. Complimentary copies of the supplement are available from your local Hewlett-Packard office.

DESCRIPTION

The HP R85026A detector is designed to be used with the HP 8757A scalar network analyzer (it is NOT compatible with the HP 8755C or 8756A scalar network analyzer). The HP R85026A enables the analyzer to measure either modulated (AC) or unmodulated (DC) test signals.

The HP R85026A detects 26.5 to 40 GHz RF signals at levels from -50 to $+10$ dBm (AC detection). The use of three HP R85026A detectors, and two waveguide directional couplers, enables simultaneous (amplitude only) transmission and reflection measurements via the analyzer CRT.

SPECIFICATIONS

Table 1-1 lists the HP R85026A specifications.

SAFETY CONSIDERATIONS

General

Become familiar with all safety instructions in this manual before you use the HP R85026A detector. This product was designed and tested in accordance with international standards.

Safety Symbols

WARNING

This indicates a personal hazard. **WARNING** calls attention to a procedure, practice, etc., that, if not performed correctly, can cause personal injury. Do not continue past a **WARNING** until you fully understand and meet the stated conditions.

CAUTION

This indicates a mechanical hazard. **CAUTION** calls attention to an operating procedure, practice, etc., that, if not correctly performed or adhered to, can cause damage to (or destruction of) part or all of the instrument. Do not continue past a **CAUTION** until you fully understand and meet the stated conditions.

ACCESSORIES SUPPLIED

The accessories supplied with the HP R85026A detector are shown in Figure 1-1.

Instrument Case

To protect the HP R85026A, when not using the detector, store it in its case.

Hex Balldriver

Use the 3/32 inch hex balldriver to tighten or loosen hex screws when making waveguide connections.

Flange Cover

When the HP R85026A is not in use, protect the waveguide with the flange cover.

Cable Markers

When you use more than one detector in a test setup, use the cable markers for identification.

EQUIPMENT REQUIRED BUT NOT SUPPLIED

To use the HP R85026A detector, you will need a network analyzer and a source.

Network Analyzer

With the HP 8757A scalar network analyzer, you can make measurements using AC detection (a 27.778 kHz amplitude modulated signal), or DC detection (an unmodulated signal). The HP 8757A, with up to four HP R85026A detectors (Opt. 001), measures amplitude levels of -50 to $+10$ dBm and amplitude ratios of up to 60 dB (AC detection). For more information, see the *HP 8757A Scalar Network Analyzer Operation Manual*.

To ensure that the HP R85026A meets its dynamic accuracy specification, the HP 8757A must have firmware revision 2.0.

Source

There are several source options:

- The HP 8350B sweep oscillator with an HP 83550A RF plug-in and an HP 83554A mm-wave source module.
- The HP 8350B sweep oscillator with an HP 83590 series RF plug-in, an HP 8349B microwave amplifier, and an HP 83554A mm-wave source module.
- The HP 8350B sweep oscillator with an HP 83572A/B RF plug-in (option 006).
- The HP 8340A or 8341A synthesized sweeper with an HP 8349B microwave amplifier, and an HP 83554A mm-wave source module.

Note: The HP 8349B microwave amplifier requires a 0.5V/GHz input from the source. See SOURCE SYSTEM GUIDES in the *HP 83554A Millimeter-Wave Source Module R-Band System Manual*.

EQUIPMENT AVAILABLE

The following equipment is available for use with the HP R85026A detector:

HP R752C/D	Directional Coupler (10 dB/20 dB)
HP R532A	Frequency Meter
HP R382A	Precision Variable Attenuator

ACCESSORIES AVAILABLE

The following accessories are available for the HP R85026A detector:

HP 11679A	7.6 metre (25 foot) extension cable
HP 11679B	61 metre (200 foot) extension cable
HP 11548A	R-Band waveguide holder (used with waveguide stand)
HP 11540A	Waveguide stand. Locks waveguide holder at any height from 70 to 133 mm (2.7 to 5.25 in)
HP R362A	Waveguide Low Pass Filter
HP R365A	Isolator. Faraday-rotation-type
HP R910A	Fixed Load
HP R896A	Standard Section
HP R897A/B	Waveguide 90° Bend (E-Plane/H Plane)
HP R898A/B	Waveguide 90° Twist (R.H./L.H.)
HP R899A/B	Waveguide Straight Section (2.5 cm, 1 in/5.0 cm, 2 in)
HP R914A	Sliding Load
HP R920B	Moving Short
HP R921A	Flat Short

RECOMMENDED TEST EQUIPMENT

The equipment required for testing and/or troubleshooting the HP R85026A is listed in Table 1-2. Other equipment may be substituted if it meets or exceeds the critical specifications indicated in the table.

INITIAL INSPECTION

If the shipping container or cushioning material is damaged, keep it until the contents of the shipment are checked for completeness, and the instrument is checked both mechanically and electrically.

1. Check the package for completeness. Figure 1-1 shows the items you should receive with each detector.
2. Check connector, cable, and body for mechanical damage.
3. Test the detector electrically. Refer to OPERATOR'S CHECK in Section II.

Notify your nearest Hewlett-Packard office if any of the following conditions exist:

- The instrument does not pass the performance tests and using the procedures in Section IV, Service, you cannot correct the problem.
- The shipping contents are incomplete.
- There is mechanical damage or defect.

Also, notify the carrier if the shipping container is damaged or if the cushioning material shows signs of stress. Keep all shipping materials for the carrier's inspection. Hewlett-Packard will arrange for repair or replacement without waiting for a claim settlement.

PREPARATIONS FOR USE

Power Requirements

Power for each detector is supplied by the HP 8757A scalar network analyzer. Each detector requires approximately 0.5 watt.

Connecting the HP R85026A Detector

Connect the detector to the analyzer as follows:

1. Insert the HP R85026A multi-pin connector into the analyzer mating connector. The detector connector is keyed; insert the plug with the key downward.
2. Secure the multi-pin connector in the analyzer by turning the outer shell clockwise.
3. Connect the HP R85026A to the RF output as follows:

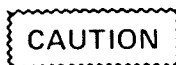

Do not apply more than +16 dBm RF power to the HP R85026A.

Using the 3/32 inch hex balldriver supplied, connect the HP R85026A to the RF output with four 4-40 socket cap screws. The HP part numbers for the two screw sizes most often used are 3030-0209 (0.5 in) and 3030-0349 (0.312 in). Use a 4-40 double chamfer hex nut where required (HP part number 2260-0001).

Mating Connector

The HP R85026A input connector is EIA size WR 28 waveguide. This waveguide should mate directly with a UG-599/U cover flange, and can be mated to a UG-318/U cover flange with the use of an HP 11516A waveguide adapter.

Detector Lead Identification

Use the furnished coded cable clips (cable marker kit) to identify detector cables when you use two or more detectors. Place matching clips on both ends of the same cable.

OPERATING ENVIRONMENT

HP R85026A detector operates within the following environmental limits:

Temperature: +20° to +30°C (+36° to +118°F).

Humidity: Up to 95%.

Altitude: Up to 7,620 m (25,000 ft).

Provide maximum protection from temperature extremes. Condensation can occur within the instrument if it is exposed to temperature extremes or to higher humidity levels.

STORAGE AND SHIPMENT

The instrument may be stored or shipped in environments within the following limits:

Temperature: -40° to +75°C (-13° to +167°F).

Humidity: Up to 95%.

Altitude: Up to 7,620 m (25,000 ft).

Provide protection from temperature extremes, which can cause condensation within the instrument.

Packaging

Containers and materials identical to those used in factory packaging are available through your local Hewlett-Packard office.

Returning Instrument for Service

If you ship the instrument to a Hewlett-Packard office or service center, please include the following information:

1. Your company name and address.
2. A technical contact person within your company, and their complete phone number.
3. The complete model and serial number of the instrument.
4. The type of service required.
5. Any other information that may expedite service.

When making inquiries, either by correspondence or by telephone, please refer to the instrument by model number and full serial number.

ADJUSTMENTS

There are no operator adjustable components on the HP R85026A detector.

ORDERING MANUAL/MICROFICHE

On the title page of this manual is a manual part number and a microfiche part number. Both can be used to order extra copies of this manual.

Microfiche are 10 × 15 cm (4 × 6 in) microfilm transparencies. Each microfiche contains reduced photocopies of the manual pages.

Also included in the microfiche package are the latest manual changes supplement and pertinent service notes.

The manual number also appears on the back cover, in the lower left hand corner.

Table 1-1. Specifications (20° to 30° C)

Frequency Range:	26.5 to 40 GHz
Flatness:	±1.5 dB
Return Loss:	≥ 12 dB (≤ 1.67 SWR)
Dynamic Accuracy:*	±0.3 dB ±.03 dB/dB Referenced to +5 dBm Typically <±0.5 dB from +10 to -40 dBm
Dynamic Range:	AC +10 to -50 dBm DC +10 to -45 dBm
Maximum Input Power:	+16 dBm
Dimensions:	Cable length is 1.22 m (48 in)
Weight:	Net 0.24 kg (0.5 lb); Shipping 1.0 kg (2.2 lb)
Input Connector:	EIA size WR 28 waveguide
Cover Flange:	UG-599/U

* With HP 8757A firmware revision 2.0 or higher.

Table 1-2. Recommended Test Equipment

Instrument	Critical Specifications	Recommended Model	Use*
Network Analyzer	R85026A AC/DC compatible	HP 8757A with firmware rev. 2.0 or higher	O,P
mm-Wave Source System: Sweep Oscillator RF Plug-In Source Module	26.5 to 40 GHz 8757A compatible WR 28	HP 8350B HP 83550A** HP 83554A	O,P
Directional Coupler	26.5 to 40 GHz WR 28	HP R752C	P
Detector	26.5 to 40 GHz	HP R85026A	P
Short	26.5 to 40 GHz WR 28	HP R921A	P
Low Pass Filter	26.5 to 40 GHz WR 28	HP R362A	P
Isolator	26.5 to 40 GHz	HP R2365A	O,P
Power Meter	With frequency compatible sensor	HP 436A	P
Power Sensor	26.5 to 40 GHz	HP R8486A	P
Variable Attenuator	0 to 50 dB; 0.5% accuracy	HP R382A Opt. 890	P
Digital Voltmeter	Accuracy: $\pm 0.01\%$ Input Impedance $\geq 10M$ ohms	HP 3456A	S
Phillips Screwdriver	Size 0 Point	HP P/N 8710-0978	S
Flat Blade Screwdriver		HP P/N 8730-0008	S
Hex Nut Wrench	1/2 x 7/16	HP P/N 8720-0009	S

* O=Operator's Check P=Performance Tests S=Service

** The HP 83550A can be replaced by an HP 83590 Series plug-in and an HP 8349B microwave amplifier.

Section II: Operation

INTRODUCTION

This section contains information concerning the operation of the HP R85026A detector.

WARNING

Never look directly into the open end of a piece of waveguide when it is connected to a source of microwave energy. Microwave energy is extremely harmful to the eye.

FEATURES

The HP R85026A features are shown in Figure 2-1.

OPERATOR'S CHECK

The OPERATOR'S CHECK (at the end of this section) verifies that the HP R85026A is functioning correctly. It does not thoroughly check all specifications to their limits, but it is an appropriate test for daily instrument verification, incoming inspection, or verification after digital circuit repair or replacement.

OPERATING PRECAUTIONS

CAUTION

Do not apply more than +16 dBm RF CW power to the HP R85026A, or damage can occur.

Do not drop the HP R85026A or subject it to mechanical shock. The detector is easily damaged.

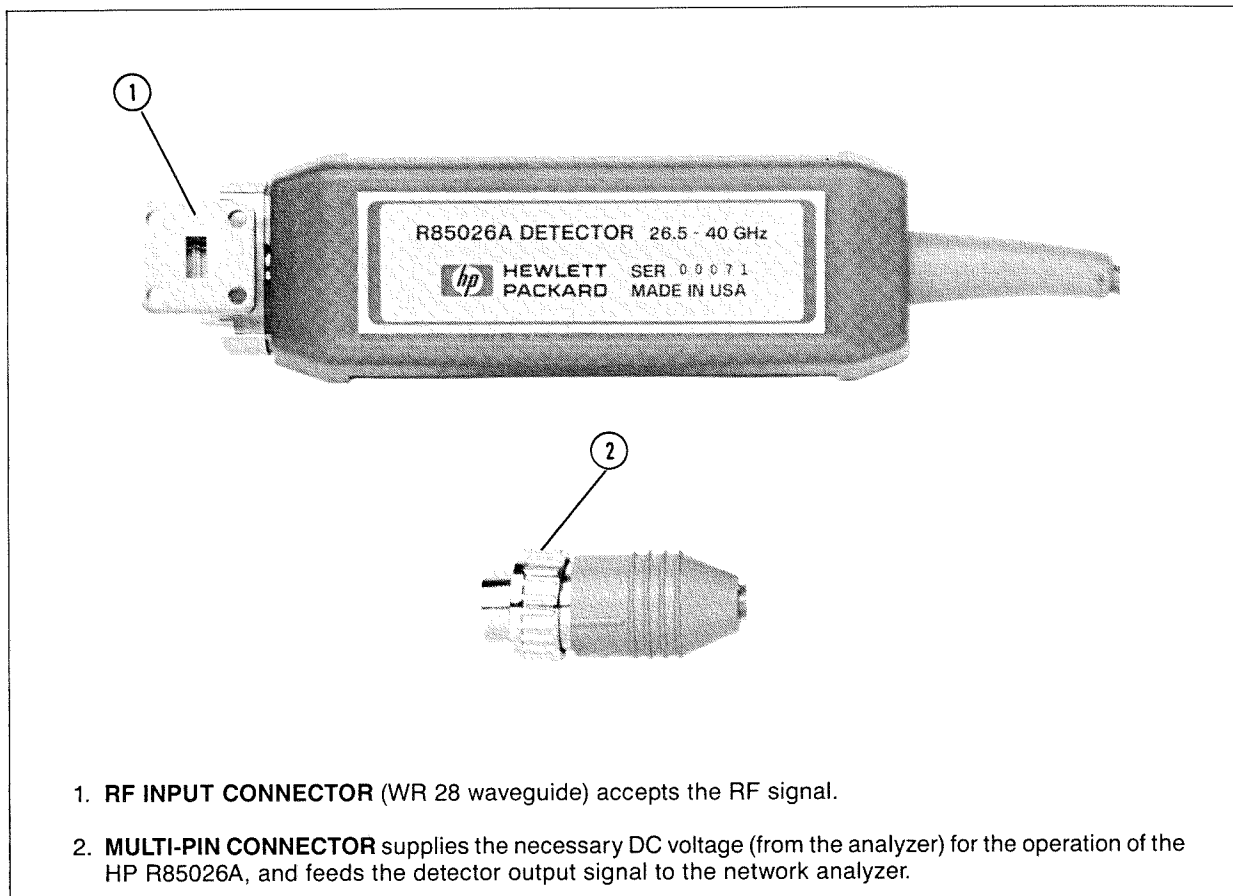

Figure 2-1. HP R85026A Features

OPERATING THEORY

The HP R85026A detects and adapts an input signal in the frequency range of 26.5 to 40 GHz that is either an unmodulated RF signal (DC detection mode) or a squarewave amplitude modulated RF signal (AC detection mode) so that it can be displayed on the HP 8757A scalar network analyzer. In either AC or DC detection mode, the detector provides a 27.778 kHz squarewave signal for the analyzer to interpret and display.

In AC detection, an RF or microwave signal is amplitude modulated with a 27.778 kHz squarewave. The HP R85026A demodulates (envelope detects) the signal to produce a 27.778 kHz squarewave whose peak-to-peak voltage corresponds to the RF signal magnitude at the detector input. This signal is amplified and passed to the analyzer.

In the DC detection mode, no modulation is required. The HP R85026A detector converts the RF signal to a proportional DC voltage that is then chopped at a 27.778 kHz rate. This chopped signal is amplified, and passed to the network analyzer.

DC Detection Mode

DC detection offers greater power measurement accuracy and the ability to characterize oscillators and modulation sensitive devices. To use DC detection, you must first set the DC measurement mode on the HP 8757A. There is also a zeroing operation used in the DC mode that compensates for the effects of DC drift and temperature fluctuations.

The ability to make DC measurements and the softkeys specific to DC mode are not automatically accessible. The HP 8757A must acknowledge the presence of an AC/DC detector either at preset, or via the **[CONFIG SYSTEM]** softkey in the CAL menu.

1. Connect the equipment as shown in Figure 2-2.

On the HP 8757A:

2. Press **[PRESET]**.

During preset:

- The analyzer reads each input port and identifies the detector or bridge connected to it (AC/DC or AC only).
- The HP 8757A enables the DC mode softkeys (when an AC/DC detector or bridge is identified). Now you can access **[DC DET ZERO]** (in the CAL menu) and **[MODE AC/DC]** (in the SYSTEM menu).

3. To turn on the DC mode, press **[SYSTEM]** and select the softkey **[MODE AC/DC]**. AC dims and DC lights up.

When you select DC mode with the softkey **[MODE AC/DC]**, the analyzer turns OFF the source internal squarewave modulation (HP 8350B) and disables the analyzer's rear panel modulation drive output (used with the HP 8340A/41A).

You can also have the analyzer read the inputs without using **[PRESET]**: Press **[CAL]** and select the softkey **[CONFIG SYSTEM]**.

If you remove and/or exchange a detector, you must reconfigure the system, using either **[PRESET]** or the softkey **[CONFIG SYSTEM]**, so that the correction factors match the port and device.

DC Zeroing. When you make a DC mode measurement, you should perform a zeroing operation to compensate for the effects of DC drift and temperature fluctuations (this is not required for AC detection). The zeroing operation eliminates small DC voltages from the diode detector that would otherwise cause amplitude measurement errors at low (–40 dBm and below) power levels.

On the HP 8757A:

1. Press **[CAL]** and select **[MORE] [DC DET ZERO]**. The analyzer displays SELECT DC DET ZERO.
2. Select **[AUTOZRO]**. The analyzer displays AUTOZERO IN PROGRESS . . . and then AUTOZERO COMPLETED.

Repeat Autozero, **[REPT AZ ON/OFF]**, repeats autozero at a selected interval (**[REPT AZ TIMER]**).

Repeat Autozero Timer, **[REPT AZ TIMER]**, allows you to set the time interval for the Repeat Autozero (from 1 to 60 minutes).

Manual Zero, **[MANUAL]**, is similar to zeroing a power meter. First, remove the RF signal from the detector. Then select **[MANUAL]** to perform the zeroing.

NOTES: If a device under test generates RF signals or noise, Autozero is not valid. Devices that can generate RF energy are microwave amplifiers and mixers with the local oscillator signal applied. If you are testing such devices, use Manual Zero.

For optimum performance, the source RF output waveguide must be electrically connected to the detector input waveguide when zeroing.

It is good practice to perform a DC zero operation every five minutes, and before making a low level measurement. This is especially important if the operating environment temperature changes significantly (several degrees centigrade).

Refer to the *HP 8757A Operating Manual* for detailed softkey information.

OPERATOR'S CHECK

DESCRIPTION

The operator's check verifies that the HP R85026A is functioning properly. It does not thoroughly check all specifications to their limits, but is an appropriate test for daily instrument verification, incoming inspection, or verification after repair or replacement of digital circuits. It consists of checking the detector over a 40 dB range.

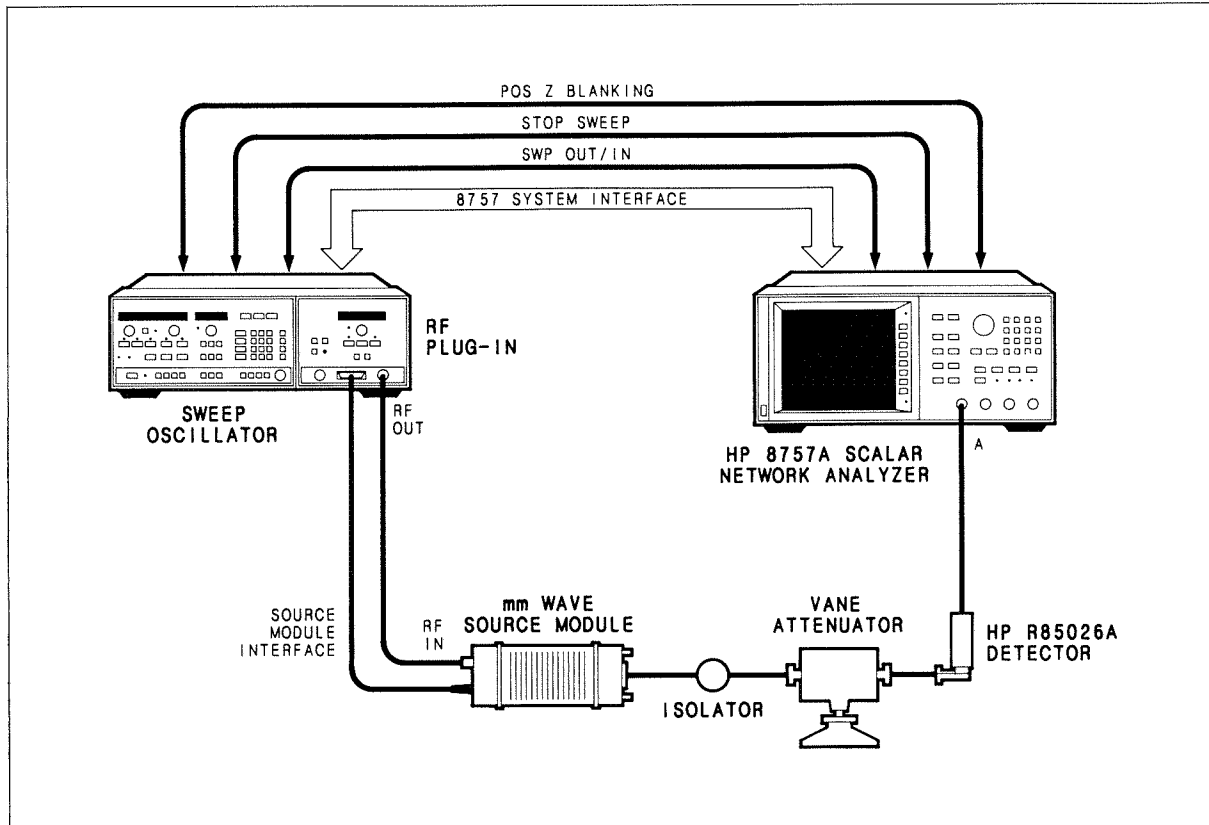

Figure 2-3. Equipment Setup for Operator's Check

EQUIPMENT

Sweep Oscillator Mainframe	HP 8350B
RF Plug-in	HP 83550A
mm-Wave Source Module	HP 83554A
Variable Attenuator	HP R382A
Isolator	HP R365A
Scalar Network Analyzer	HP 8757A

PROCEDURE

1. Connect the equipment as shown in Figure 2-3. Allow 30 minutes for warm-up.

On the HP 8757A:

2. Press **[PRESET]** to preset both the analyzer and the source.

On the HP 8350B:

3. Press **[START] [2] [6] [.] [5] [GHz]**.

4. Press **[STOP] [4] [0] [GHz]**.

On the HP 8757A:

5. Select the softkey **[CHAN 2 OFF]** to turn off the channel 2 trace.

NOTE: The first time through the procedure, you are checking the detector in the AC detection mode (AC is analyzer default condition).

6. Press **[CAL]** and select **[MORE] [DET OFFST]**. The analyzer displays SELECT DETECTOR OFFSET.

7. Select **[DET A]**. The analyzer displays A DETECTOR OFFST and the value of the offset.

8. Press **[0] [ENT]** to ensure that the detector offset is zero.

NOTE: When using DC mode, perform DC zeroing:

- a. Select **[PRIOR MENU]**.
- b. Select **[DC DET ZERO]**.
- c. Select **[AUTOZERO]**.

On the HP R382A attenuator:

9. Set the attenuation to 0 dB.

On the HP 8757A:

10. Press **[CURSOR]**. A cursor (+) appears at the center of the trace. Note the CRSR value displayed in the CRT's active entry area.

On the source:

11. Adjust the output power level until the cursor value on the CRT reads +5 dBm.

On the HP R382A attenuator:

12. Set the attenuator to 50 dB of attenuation.

On the HP 8757A:

13. Press **[AVG]** and select **[AVG ON/OFF]** to turn averaging on (ON lights up). The default average factor of 8 is displayed on the CRT. Wait approximately seven seconds for the trace to settle.

14. Press **[CURSOR]**. The active entry area should display a cursor value of $-45 \text{ dBm} \pm 3 \text{ dB}$.

15. Press **[AVG]** and **[AVG ON/OFF]** to turn averaging off.

16. Press **[SYSTEM]** and select **[MODE AC/DC]** to turn DC on.

17. Repeat steps 6 through 14 to check the detector in the DC detection mode.

If the HP R85026A does not pass the OPERATOR'S CHECK, refer to TROUBLESHOOTING in Section IV, Service.

Section III: Performance Tests

INTRODUCTION

The procedures in this section test the electrical characteristics of the HP R85026A detector against the specifications listed in Table 1-1 in Section I, General Information. These procedures do not require access to the interior of the detector.

There are three performance tests in this section:

1. Return Loss
2. Flatness
3. Dynamic Accuracy

Table 1-2 lists the recommended test equipment used in this section. Any equipment that satisfies the critical specifications given in that table may be substituted for the recommended model.

Results of the performance tests should be tabulated in *Table 3-1, Performance Test Record Card*. This record lists the tested specifications and their acceptable limits.

RETURN LOSS

Specification

26.5 to 40 GHz: ≥ 12 dB
 At +20 to +30°C (+36° to +118°F)

Description

Two HP R85026A detectors and two waveguide directional couplers comprise a reflectometer test setup for a return loss measurement. The test setup is calibrated using a short to minimize frequency response errors.

The measured return loss should be greater than or equal to the specified value listed above. There is an uncertainty range of ± 0.6 dB due to coupler directivity and mismatch uncertainty.

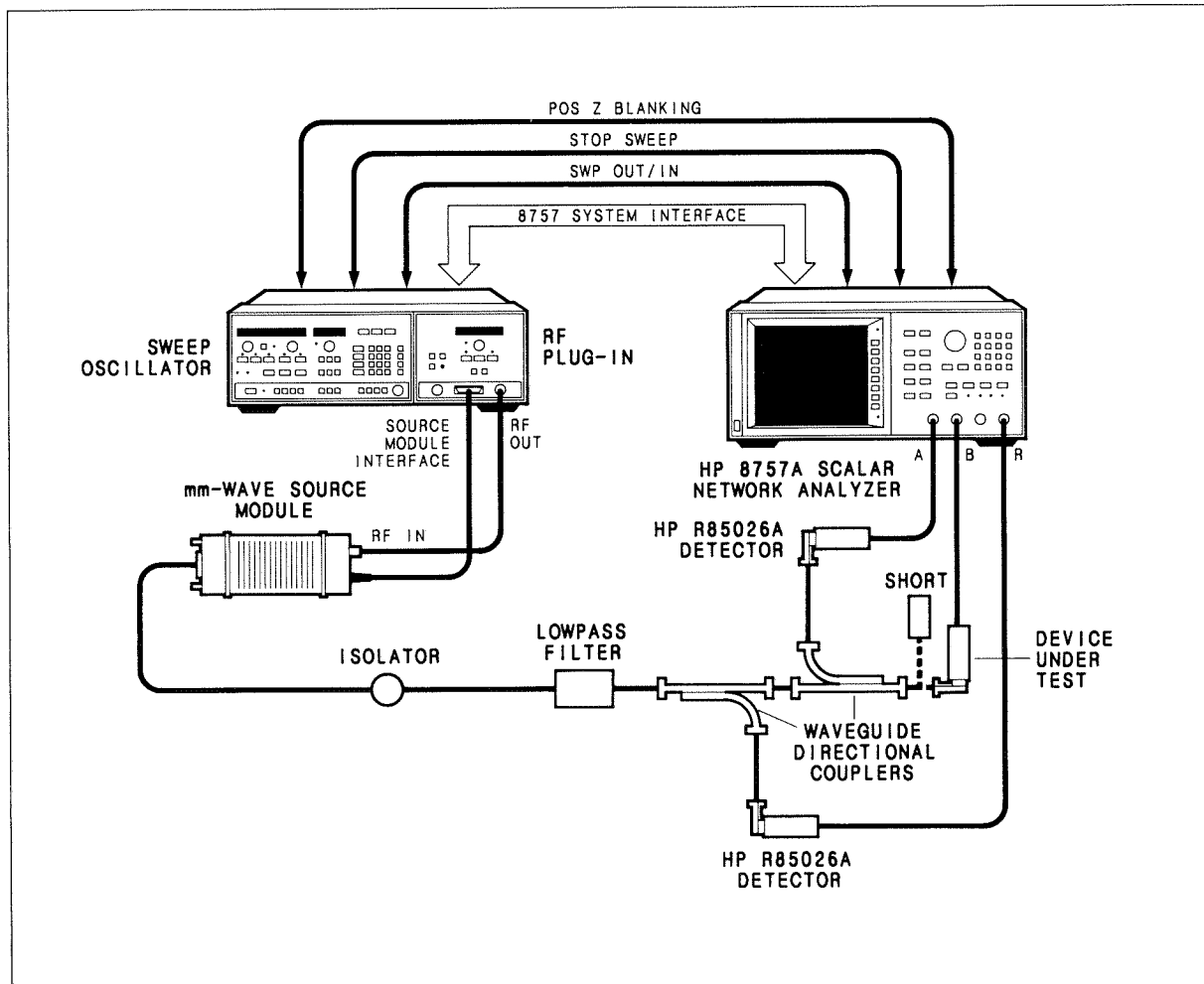

Figure 3-1. Return Loss Performance Test Setup

Equipment

Sweep Oscillator	HP 8350B
RF Plug-In	HP 83550A
Source Module	HP 83554A
Directional Coupler (two required)	HP R752C
Detector (two required plus DUT)	HP R85026A
Scalar Network Analyzer	HP 8757A
Short	HP R921A
Low Pass Filter	HP R362A
Isolator	HP R365A

Procedure

1. Connect equipment as shown in Figure 3-1, with the short connected to the coupler, and allow the equipment to warm up for 30 minutes.

On the HP 8757A:

2. Press **[PRESET]** to preset both the HP 8757A and HP 8350B.

On the HP 8350B:

3. Press:

[START] [2] [6] [.] [5] [GHz]
[STOP] [4] [0] [GHz]

This step sets the frequency range at the output of the HP 83554A source module.

On the HP 8757A:

4. Select **[CHAN 2 OFF]**.
5. Press **[MEAS]** and select **[A/R]** softkey.
6. Press **[DISPLAY]** and select **[MEAS→MEM]** to store the channel 1 display in memory.
7. Select **[MEAS–MEM]**. A flat trace is displayed on the CRT.
8. Connect the detector to be tested in place of the short in the test setup.

On the HP 8757A:

9. Press **[SCALE]** and select **[AUTOSCALE]** in the SCALE menu.
10. Press **[CURSOR]** and select the **[MAX]** softkey.
11. Read the worst case return loss from the cursor value given in the active entry area of the CRT. Record this value on the test record card.

FLATNESS

Specification

26.5 to 40 GHz: ± 1.5 dB
 At 20° to 30°C (36° to 118°F)

Description

This procedure measures the flatness of the HP R85026A detector at various CW frequencies within the detector's frequency range. The Performance Test Record Card, Table 3-1, facilitates this measurement. The measured flatness should be within the specified values listed above. There is a ± 0.2 dB uncertainty range in the flatness measurement.

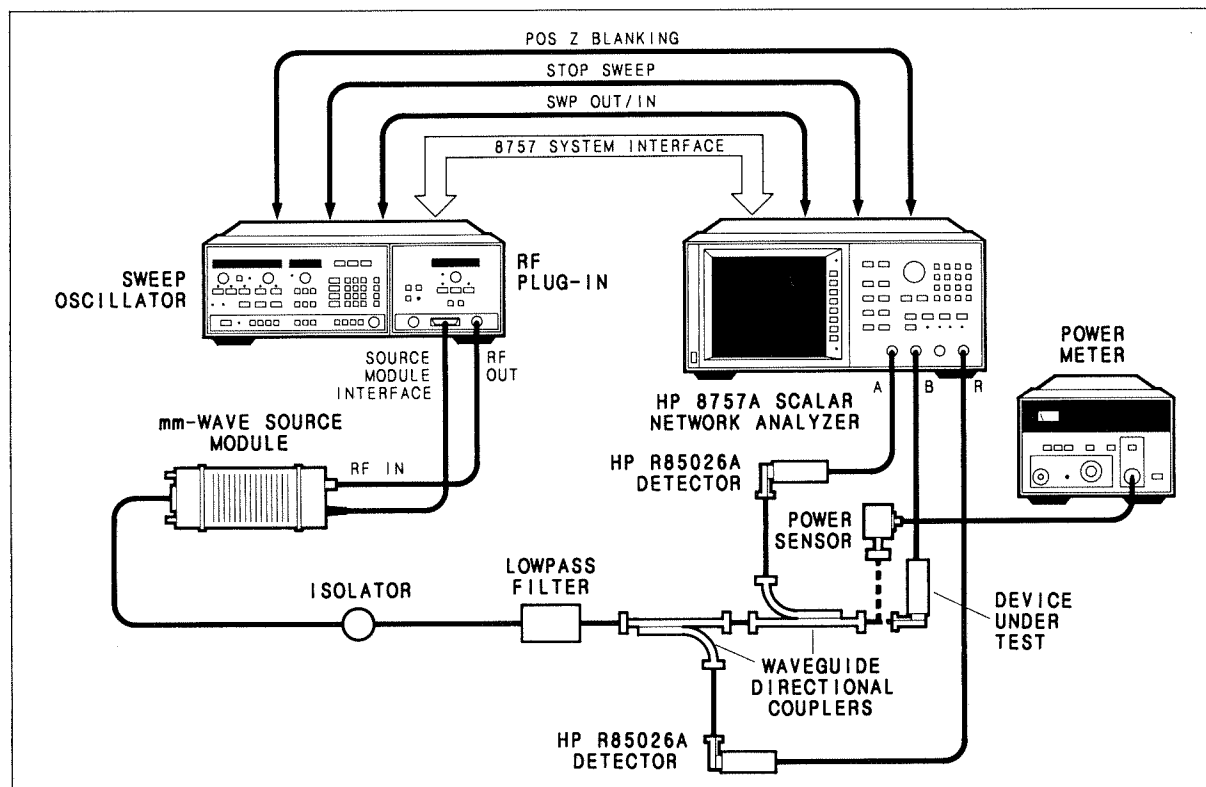

Figure 3-2. Flatness Performance Test Setup

Equipment

Sweep Oscillator	HP 8350B
RF Plug-In	HP 83550A
Source Module	HP 83554A
Network Analyzer	HP 8757A
Power Meter	HP 436A
Power Sensor	HP R8486A
Directional Coupler (two required)	HP R752C
Detector (two required plus DUT)	HP R85026A
Low-Pass Filter	HP 362A
Isolator	HP R365A

Procedure

1. Connect equipment as shown in Figure 3-2 with the power sensor connected to the coupler and allow the equipment to warm up for 30 minutes.

On the HP 8757A:

2. Press **[PRESET]** to preset both the HP 8757A and the HP 8350B.
3. Select **[CHAN 2 OFF]**.
4. Press **[SYSTEM]** and select the **[MODE AC DC]** softkey. DC lights up.

On the HP 8350B/83550A:

5. Select a CW frequency between 26.5 and 40 GHz. We recommend that you select a frequency at which your power sensor is calibrated. See the CAL FACTOR chart on your power sensor. Record this frequency in column 1 of the Performance Test Record Card (Actual Test Frequency).

On the power meter:

6. Set the CAL FACTOR dial to the value for the selected frequency (see the CAL FACTOR chart on your power sensor) and zero the power meter.
7. Reconnect the power sensor to the coupler. Read the displayed power and record this value in column 2 (Power Meter) of the Performance Test Record Card.

On the HP 8757A:

8. Press **[MEAS]** and select the **[R]** softkey.
9. Press **[CURSOR]**.
10. Read the displayed power level on the network analyzer and record this value in column 3 (R Detector) of the Performance Test Record Card.
11. Subtract column 2 from column 3 and record this new value in column 4 (R Detector — Power Meter).
12. Repeat steps 7 through 12 using several CW frequencies between 26.5 and 40 GHz. Again, we recommend that you select frequencies at which your power sensor is calibrated.
13. Disconnect the power sensor from the coupler. Connect the HP R85026A detector as shown in Figure 3-2.

On the HP 8350B:

14. Set the output to the first CW frequency listed in column 1 of the Performance Test Record Card.

On the HP 8757A:

15. Press **[MEAS]** and select the **[B/R]** softkey.



16. Read the displayed value on the network analyzer and record it in column 5 (B/R) of the Performance Test Record Card.
17. Add the value in column 4 to the value in column 5 and record this new value in column 6 (Error).
18. Repeat steps 16 through 18 using the frequencies listed in column 1 of the Performance Test Record Card.
19. After all of the frequencies have been tested, subtract the minimum error value (column 6) from the maximum error value and divide by two. The result should be within the ± 1.5 dB specification (± 0.2 dB uncertainty).

DYNAMIC ACCURACY

Specification

26.5 to 40 GHz: $\pm 0.3 \text{ dB} \pm 0.03 \text{ dB/dB}$
 Referenced to +5 dBm
 At 20° to 30°C (36° to 118°F)

Description

The performance test for dynamic accuracy is performed in both the AC and DC detection modes. In each case, the reference power is set to 5 dBm and attenuated in 5 dB steps. The results can be plotted on the accompanying graph.

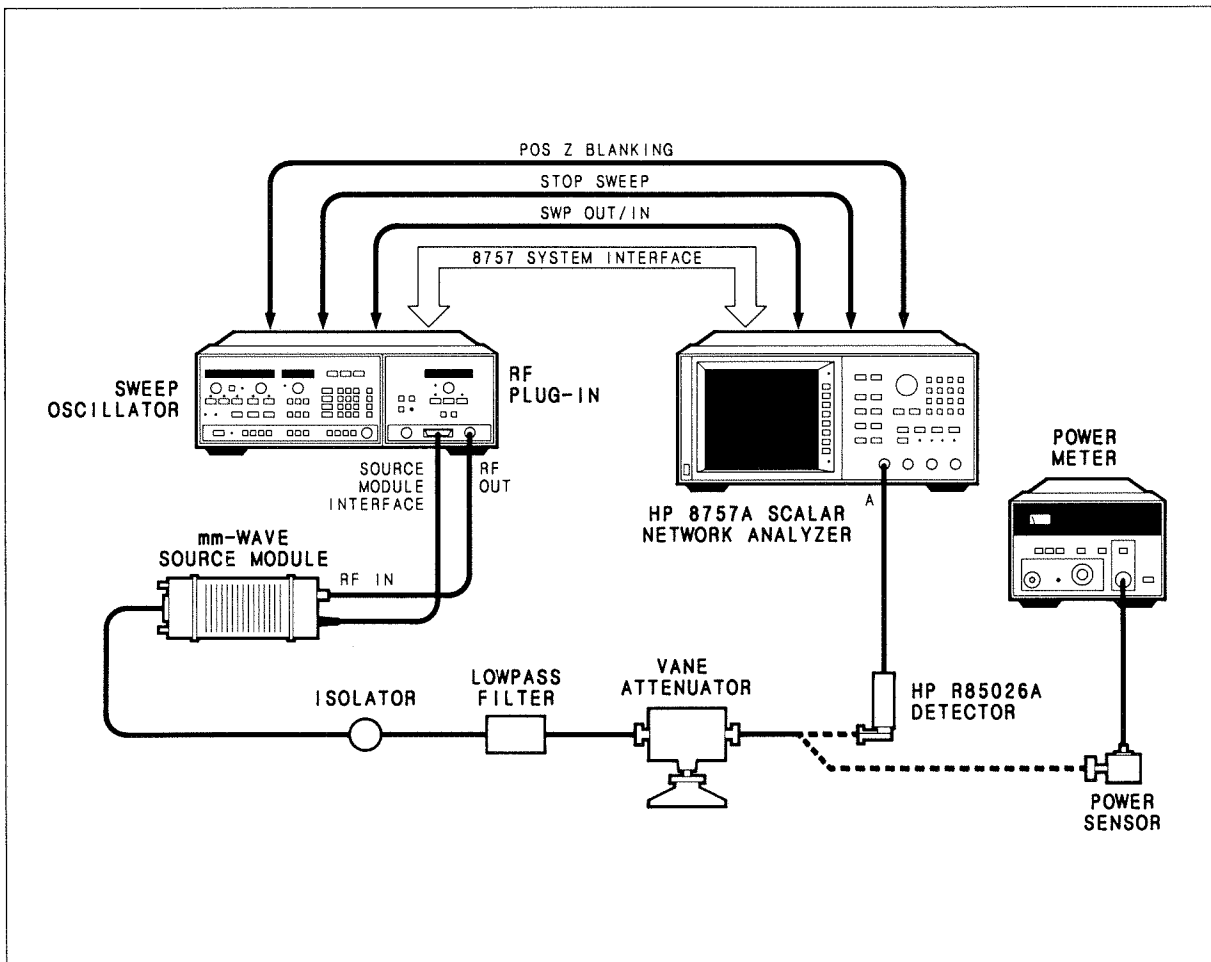

Figure 3-3. Dynamic Accuracy Test Setup

Equipment

Sweep Oscillator	HP 8350B
RF Plug-In	HP 83550A
Source Module	HP 83554A
Network Analyzer	HP 8757A
Power Meter	HP 436A
Power Sensor	HP R8486A
Isolator	HP R365A
Low-Pass Filter	HP R362A
Attenuator	HP R382A

Procedure

1. Connect the equipment as shown in Figure 3-3 with the power meter connected to the HP R382A attenuator. Allow the equipment to warm up for 30 minutes.

On the HP 8757A:

2. Press **[PRESET]** to preset both the HP 8757A and HP 8350B. Select **[CHAN 2 OFF]**.
3. Press **[SPCL]** and select **[SMOOTH ON OFF]**. ON lights up.

On the HP 8350B/HP 83550A:

4. Press **[CW] [3] [0] [GHz]**.
5. Press **[PWR LVL], [5], [dBm]**.
6. With the attenuator set to 0 dB, manually adjust the rotary knob on the RF plug-in until a +2 dBm power level is displayed on the HP 436A power meter (+5 dBm unmodulated).
7. Connect the HP R85026A detector to the attenuator.

On the HP 8757A:

8. Press **[CURSOR] [DISPLAY] [MEAS → MEM] [MEAS – MEM]**. The cursor should read 0 dB.
9. On the attenuator, increase the attenuation by 5 dB and read the power displayed on the HP 8757A CRT.
10. Add the attenuator value to the power displayed on the CRT. Plot the result on the graph in the performance test record card. For example, if the attenuator is set to 20 dB and the power indicated on the CRT is -19.8 dB, then plot +0.2 dB on the graph.
11. Repeat steps 9 and 10 until the attenuation is greater than 50 dB.

For testing in the DC detection mode, press **[SYSTEM]** and select the **[MODE AC DC]** softkey. DC lights up. Press **[CAL]** and select **[DC DET ZERO]** and **[AUTOZRO]**. Reset the attenuator to 0 dB and repeat steps 8 through 11.

Performance Test Record Card (1 of 2)

HP R85026A Detector						
					Tested By _____	
Serial No. _____			Date _____			
Humidity* _____			Temperature* _____			
* Optional						
RETURN LOSS						
Frequency Range		Minimum		Actual		
26.5 to 40 GHz		12 dB		_____ dB		
FLATNESS						
Test Frequency		2 Power Meter	3 R Detector	4 R Detector minus Power Meter	5 B/R	6 Error Column 4 + 5
Recommended	1 Actual					
26.5 GHz	_____	_____	_____	_____	_____	_____
28 GHz	_____	_____	_____	_____	_____	_____
30 GHz	_____	_____	_____	_____	_____	_____
32 GHz	_____	_____	_____	_____	_____	_____
34 GHz	_____	_____	_____	_____	_____	_____
36 GHz	_____	_____	_____	_____	_____	_____
38 GHz	_____	_____	_____	_____	_____	_____
40 GHz	_____	_____	_____	_____	_____	_____



Performance Test Record Card (2 of 2)

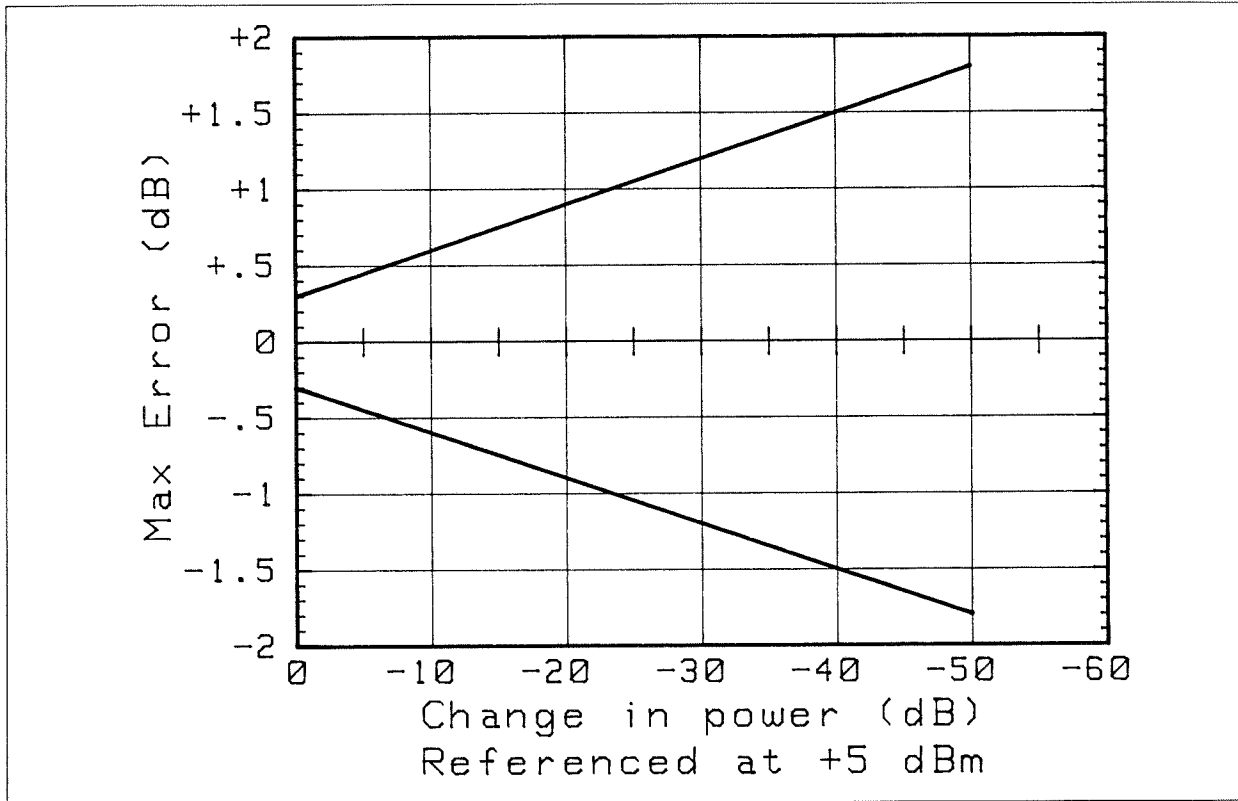

Section IV: Service

INTRODUCTION

The HP R85026A detector is not field repairable to the component level. The only replaceable part is the cable assembly (W1), with all other repairs involving a detector exchange. This section provides cable troubleshooting and replacement procedures, and the information for ordering a restored detector.

WARNING

Any servicing or repair of this product must be performed by qualified personnel. Never look directly into the open end of a piece of waveguide when it is connected to a source of microwave energy. Microwave energy is extremely harmful to the eye.

CABLE TROUBLESHOOTING

Equipment

Digital Voltmeter HP 3456A

Cover Removal Procedure

1. Place the detector so that its narrow side is on a flat surface, with the waveguide connector facing away from you. Refer to Figure 4-1.

WARNING

While removing the covers DO NOT hold the detector in the palm of your hand. Personal injury can result. READ the entire procedure before attempting cover removal.

2. Hold the sides of the detector, near the cable end.
3. At an angle, carefully insert the tip of a flat-head screwdriver into the seam of the cover assembly until it slips under the seam. Be sure your hand is not in the path of the screwdriver.
4. Turn the screwdriver to snap apart the cover assembly.

5. Turn the detector over and repeat steps 3 and 4.
6. The cover assembly can be pulled apart to expose the metal housing.
7. To remove the inner metal sleeve, remove the two screws located on the base plate next to the cable. Slide the sleeve away from the housing and over the cable to expose the circuit board.

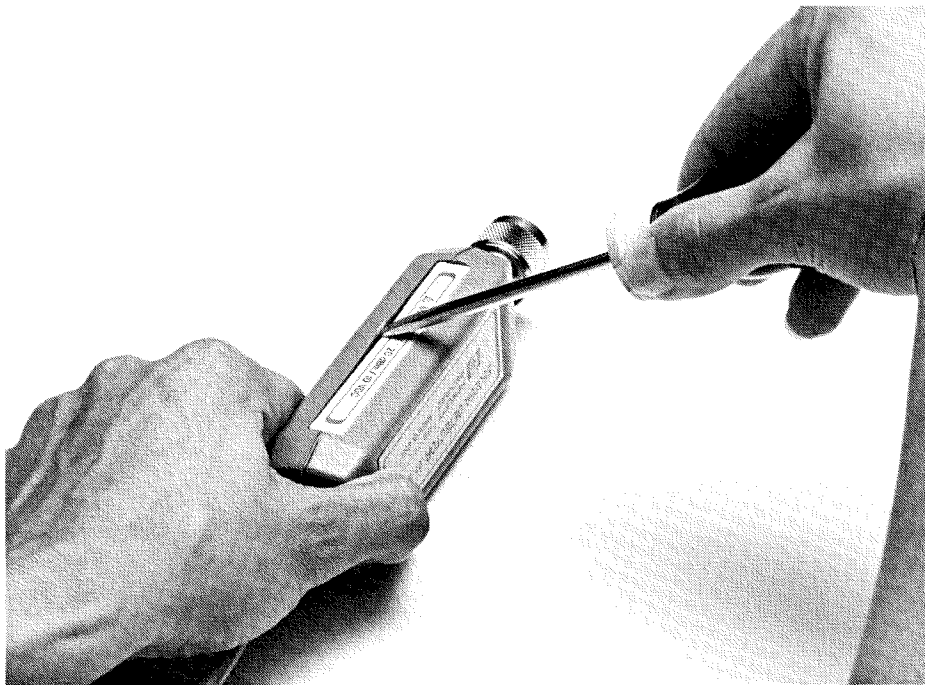
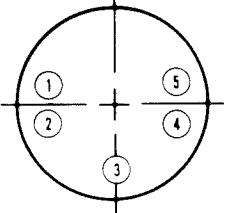

Figure 4-1. Cover Removal

Cable Continuity Check

1. Use a digital voltmeter (DVM) to check the continuity of the power cable conductors from the connector pins to the wire connections inside the detector adapter housing. Table 4-1 lists the cable connector pins and the corresponding wires.

Table 4-1. Cable Connectors and Wires

	Connector Pin	Conductor (Label)	Signal
	1	White (W)	Output
	2	Green (G)	Return
	3	Yellow (Y)	Control
	4	Blue (B)	-12.6v
	5	Red (R)	+15v

- Use the DVM to check for possible shorts between the connector pins and ground (frame).
- If there are any discontinuities, replace the cable by following the instructions in POWER CABLE REPLACEMENT.

POWER CABLE REPLACEMENT

Equipment

Phillips Screwdriver	HP 8710-0978
Flat Blade Screwdriver	HP 8730-0008
7/16 Inch Hex Nut Wrench	HP 8720-0009

Procedure

CAUTION

Electrostatic discharge (ESD) as low as 60 volts can destroy microwave diodes. If static discharge is noticed by the operator, it indicates a voltage of at least 20,000 volts. Materials conducive to static build-up include carpeting, nylon, dry air, paper, adhesive tape, styrofoam, vinyl. The best method of preventing ESD is for the operator to wear a grounding strap (HP Part Number 9300-0970) connected to a conductive bench mat (HP Part Number 9300-0797) that provides a path to ground of between 1 and 2.5 Megohms. Alternatively, the operator can ground himself by touching any grounding instrument chassis before touching the HP R85026A board assembly.

1. Remove the outer and inner covers by performing the Cover Removal under the CABLE TROUBLESHOOTING section.
2. Unsolder the wires connected to the power cable/circuit board assembly. Note that the pads to which the wires are soldered are labeled as indicated in Table 4-1.
3. Remove the 1/2 inch hex nut that fastens the cable to the end plate.
4. Remove the old cable.
5. Install the new cable by performing this procedure in reverse order.

ORDERING INFORMATION

Refer to Table 4-3 for the list of HP R85026A replaceable parts.

If your HP R85026A fails (other than W1), a restored detector is available from your nearest Hewlett-Packard sales or service office on an exchange basis, thus affording a considerable cost savings.

Exchange (factory repaired and tested) detectors are available ONLY on a trade-in basis. The defective HP R85026A MUST be returned for credit.

REPLACEABLE PARTS

Introduction

This section contains replaceable parts ordering information. Table 4-2 lists abbreviations used in the parts list, and throughout this manual. Table 4-3 lists all replaceable parts.

The following information is given for each replaceable part:

- The Hewlett-Packard part number.
- The part number check digit (CD).
- The total quantity (Qty) in the instrument.
- A description of the part.

Ordering Instructions

To order a part in Table 4-3, provide the Hewlett-Packard part number (with check digit), indicate the quantity required, and address your order to the nearest Hewlett-Packard office. The check digit ensures accurate and timely processing of your order.

To request information on a part not listed in the replaceable parts table, include the instrument model number, instrument serial number, and a description and function of the part. Address your inquiry to the nearest Hewlett-Packard office.

Table 4-2. Abbreviations

A	Assembly	m	Male; Metre
AC	Alternating Current	MISC	Miscellaneous
ADJ	Adjust	mm	Millimetre
cm	Centimetre	ns	Nanoseconds
dBm	Decibels referenced to 1 mW	pf	Picofarad
DUT	Device Under Test	P/N	Part Number
ESD	Electrostatic Discharge (static)	PP	Peak-to-Peak
F	Fahrenheit; Female	RF	Radio Frequency
GHz	Gigahertz	SM	Small
in	Inch	V	Volt; Voltage
k	Kilo (1000)	VDC	Volts, Direct Current
kg	Kilogram	W	Watt

Table 4-3. Replaceable Parts

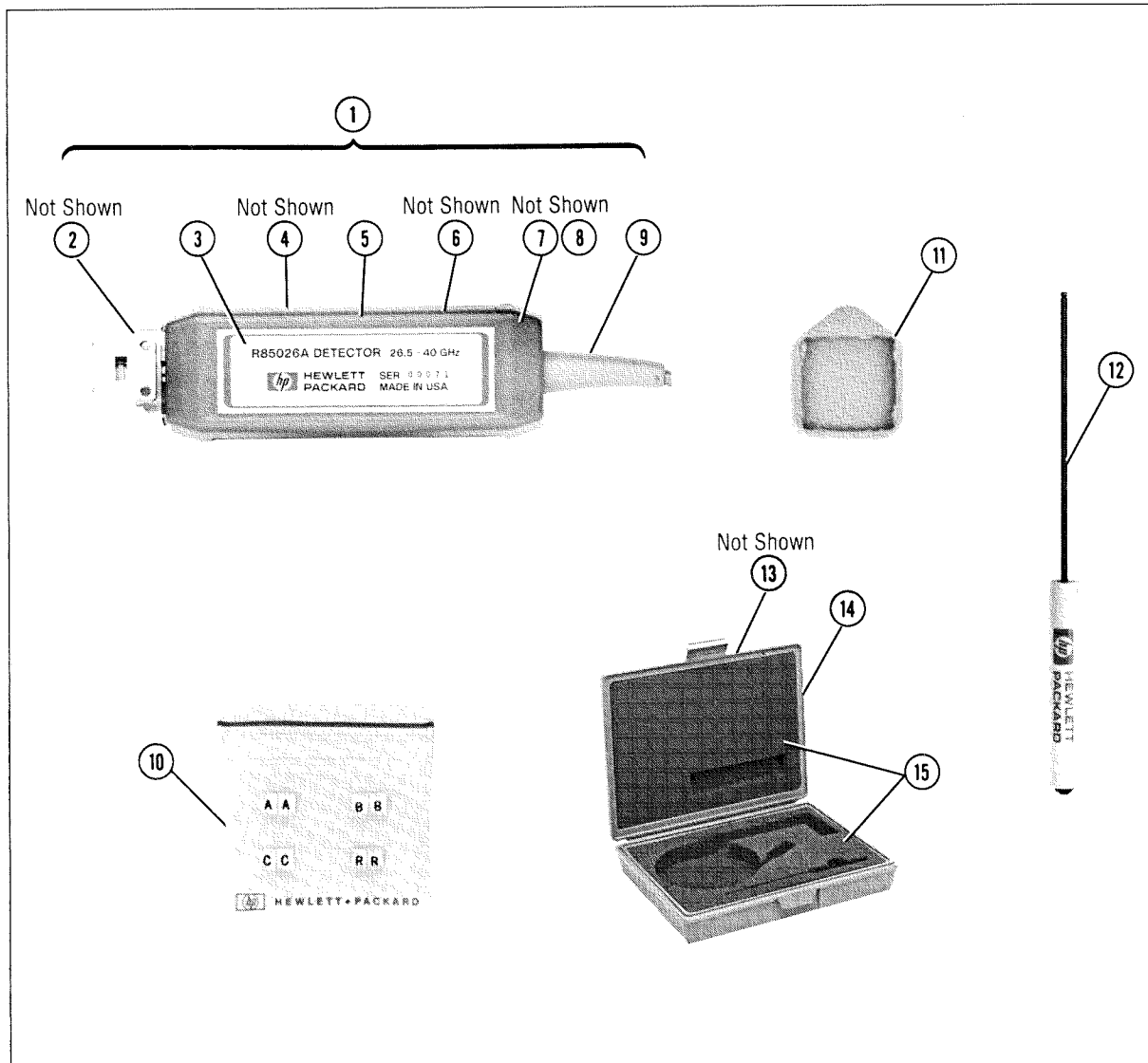

Reference Designation	HP Part Number	C D	Qty	Description
1	85026-60004	4	1	RESTORED HP R85026A
2	85026-80005	7	1	LABEL: HP TRADEMARK (Not Shown)
3	85026-80004	6	1	LABEL: ID R85026A
4	85026-80006	8	2	LABEL: WARNING MAX INPUT (Not Shown)
5	85025-40001	8	2	SOLID PLASTIC HALF-BODY
6	85025-20007	2	1	INNER METAL SLEEVE
7	0515-0061	6	2	SCREW-MACHINE M2.5×0.45 4MM-LG (Not Shown)
8	2190-0583	9	2	LOCK WASHER, 2.5MM (Not Shown)
9	85025-60003	2	1	CABLE (W1)
10	5061-1044	9	1	CABLE MARKER KIT
11	5040-0359	3	1	FLANGE COVER
12	8710-1539	7	1	3/32 INCH HEX BALLDRIVER
13	85026-80007	9	1	STORAGE BOX LABEL (Not Shown)
14	1540-0181	5	1	STORAGE BOX
15	85026-80010	4	1	TOP AND BOTTOM PACKAGING FOAM