

## Errata

**Title & Document Type:** 75000 Series C - E1410A 6-1/2 Digit Multimeter  
User's Manual

**Manual Part Number:** E1410-90002

**Revision Date:** June 1, 1992

---

### HP References in this Manual

This manual may contain references to HP or Hewlett-Packard. Please note that Hewlett-Packard's former test and measurement, semiconductor products and chemical analysis businesses are now part of Agilent Technologies. We have made no changes to this manual copy. The HP XXXX referred to in this document is now the Agilent XXXX. For example, model number HP8648A is now model number Agilent 8648A.

### About this Manual

We've added this manual to the Agilent website in an effort to help you support your product. This manual provides the best information we could find. It may be incomplete or contain dated information, and the scan quality may not be ideal. If we find a better copy in the future, we will add it to the Agilent website.

### Support for Your Product

Agilent no longer sells or supports this product. You will find any other available product information on the Agilent Test & Measurement website:

[www.tm.agilent.com](http://www.tm.agilent.com)

Search for the model number of this product, and the resulting product page will guide you to any available information. Our service centers may be able to perform calibration if no repair parts are needed, but no other support from Agilent is available.





HEWLETT  
PACKARD



**HP 75000 SERIES C**

# **HP E1410A**

## **6 $\frac{1}{2}$ Digit Multimeter**

---

**User's Manual**



Copyright© Hewlett-Packard Company, 1992

Manual Part Number: E1410-90002  
Microfiche Part Number: E1410-99002

Printed: June 1992 Edition 2  
Printed in U.S.A.

## CERTIFICATION

Hewlett-Packard Company certifies that this product met its published specifications at the time of shipment from the factory. Hewlett-Packard further certifies that its calibration measurements are traceable to the United States National Institute of Standards and Technology (formerly National Bureau of Standards), to the extent allowed by that organization's calibration facility, and to the calibration facilities of other International Standards Organization members.

## WARRANTY

This Hewlett-Packard product is warranted against defects in materials and workmanship for a period of three years from date of shipment. Duration and conditions of warranty for this product may be superceded when the product is integrated into (becomes a part of) other HP products. During the warranty period, Hewlett-Packard Company will, at its option, either repair or replace products which prove to be defective.

For warranty service or repair, this product must be returned to a service facility designated by Hewlett-Packard (HP). Buyer shall prepay shipping charges to HP and HP shall pay shipping charges to return the product to Buyer. However, Buyer shall pay all shipping charges, duties, and taxes for products returned to HP from another country.

HP warrants that its software and firmware designated by HP for use with a product will execute its programming instructions when properly installed on that product. HP does not warrant that the operation of the product, or software, or firmware will be uninterrupted or error free.

## LIMITATION OF WARRANTY

The foregoing warranty shall not apply to defects resulting from improper or inadequate maintenance by Buyer, Buyer-supplied products or interfacing, unauthorized modification or misuse, operation outside of the environmental specifications for the product, or improper site preparation or maintenance.

The design and implementation of any circuit on this product is the sole responsibility of the Buyer. HP does not warrant the Buyer's circuitry or malfunctions of HP products that result from the Buyer's circuitry. In addition, HP does not warrant any damage that occurs as a result of the Buyer's circuit or any defects that result from Buyer-supplied products.

NO OTHER WARRANTY IS EXPRESSED OR IMPLIED. HP SPECIFICALLY DISCLAIMS THE IMPLIED WARRANTIES OF MERCHANTABILITY AND FITNESS FOR A PARTICULAR PURPOSE.

## EXCLUSIVE REMEDIES

THE REMEDIES PROVIDED HEREIN ARE BUYER'S SOLE AND EXCLUSIVE REMEDIES. HP SHALL NOT BE LIABLE FOR ANY DIRECT, INDIRECT, SPECIAL, INCIDENTAL, OR CONSEQUENTIAL DAMAGES, WHETHER BASED ON CONTRACT, TORT, OR ANY OTHER LEGAL THEORY.

---

## NOTICE

The information contained in this document is subject to change without notice. HEWLETT-PACKARD (HP) MAKES NO WARRANTY OF ANY KIND WITH REGARD TO THIS MATERIAL, INCLUDING, BUT NOT LIMITED TO, THE IMPLIED WARRANTIES OF MERCHANTABILITY AND FITNESS FOR A PARTICULAR PURPOSE. HP shall not be liable for errors contained herein or for incidental or consequential damages in connection with the furnishing, performance or use of this material. This document contains proprietary information which is protected by copyright. All rights are reserved. No part of this document may be photocopied, reproduced, or translated to another language without the prior written consent of Hewlett-Packard Company. HP assumes no responsibility for the use or reliability of its software on equipment that is not furnished by HP.

---

## Restricted Rights Legend

Use, duplication, or disclosure by the Government is subject to restrictions as set forth in subdivision (b)(3)(ii) of the Rights in Technical Data and Computer Software clause at 52.227-7013. Hewlett-Packard Company; 3000 Hanover Street; Palo Alto, California 94304

---

## Declaration of Conformity

*According to ISO/IEC Guide 22 and EN 45014*

The Hewlett-Packard Company declares that the HP E1410A conforms to the following Product Specifications.

Safety: IEC 1010-1 (1990)  
CSA 234  
UL 1244

EMC: CISPR 11:1990/EN55011 (1991): Group 1 Class A  
IEC 801-2:1991/EN50082-1 (1992): 4kV CD, 8kV AD  
IEC 801-3:1984/EN50082-1 (1992): 3 V/m  
IEC 801-4:1988/EN50082-1 (1992): 1 kV

Tested in HP VXi mainframe.

  
Q.A. Manager  
June 1992

Hewlett-Packard Company  
P.O. Box 301  
815 14th Street S.W.  
Loveland, Colorado 80539 U.S.A.

## Printing History

The Printing History shown below lists all Editions and Updates of this manual and the printing date(s). The first printing of the manual is Edition 1. The Edition number increments by 1 whenever the manual is revised. Updates, which are issued between Editions, contain replacement pages to correct the current Edition of the manual. Updates are numbered sequentially starting with Update 1. When a new Edition is created, it contains all the Update information for the previous Edition. Each new Edition or Update also includes a revised copy of this printing history page. Many product updates or revisions do not require manual changes and, conversely, manual corrections may be done without accompanying product changes. Therefore, do not expect a one-to-one correspondence between product updates and manual updates.

Edition 1 (Part Number E1410-90001) ..... January 1990

Edition 2 (Part Number E1410-90002) ..... June 1992

---

## Safety Symbols



Instruction manual symbol affixed to product. Indicates that the user must refer to the manual for specific Warning or Caution information to avoid personal injury or damage to the product.



Indicates the field wiring terminal that must be connected to earth ground before operating the equipment – protects against electrical shock in case of fault.



OR



Frame or chassis ground terminal – typically connects to the equipment's metal frame.



Alternating current (AC).



Direct current (DC).



Indicates hazardous voltages.

### WARNING

Calls attention to a procedure, practice, or condition that could cause bodily injury or death.

### CAUTION

Calls attention to a procedure, practice, or condition that could possibly cause damage to equipment or permanent loss of data.

---

## WARNINGS

The following general safety precautions must be observed during all phases of operation, service, and repair of this product. Failure to comply with these precautions or with specific warnings elsewhere in this manual violates safety standards of design, manufacture, and intended use of the product. Hewlett-Packard Company assumes no liability for the customer's failure to comply with these requirements.

**Ground the equipment:** For Safety Class 1 equipment (equipment having a protective earth terminal), an uninterruptible safety earth ground must be provided from the mains power source to the product input wiring terminals or supplied power cable.

**DO NOT operate the product in an explosive atmosphere or in the presence of flammable gases or fumes.**

For continued protection against fire, replace the line fuse(s) only with fuse(s) of the same voltage and current rating and type. DO NOT use repaired fuses or short-circuited fuseholders.

**Keep away from live circuits:** Operating personnel must not remove equipment covers or shields. Procedures involving the removal of covers or shields are for use by service-trained personnel only. Under certain conditions, dangerous voltages may exist even with the equipment switched off. To avoid dangerous electrical shock, DO NOT perform procedures involving cover or shield removal unless you are qualified to do so.

**DO NOT operate damaged equipment:** Whenever it is possible that the safety protection features built into this product have been impaired, either through physical damage, excessive moisture, or any other reason, REMOVE POWER and do not use the product until safe operation can be verified by service-trained personnel. If necessary, return the product to a Hewlett-Packard Sales and Service Office for service and repair to ensure that safety features are maintained.

**DO NOT service or adjust alone:** Do not attempt internal service or adjustment unless another person, capable of rendering first aid and resuscitation, is present.

**DO NOT substitute parts or modify equipment:** Because of the danger of introducing additional hazards, do not install substitute parts or perform any unauthorized modification to the product. Return the product to a Hewlett-Packard Sales and Service Office for service and repair to ensure that safety features are maintained.

# How to Use This Manual

---

## Manual Overview

This manual shows how to operate, configure, and program the HP E1410A 6½-Digit Multimeter. This plug-in module is a VXIbus message-based device which can operate in C-Size or (with an adapter) D-Size mainframes.

If you are using the multimeter in a Hewlett-Packard Series C mainframe, refer to the “C-Size Installation and Getting Started Guide” for installation information. If you are using the multimeter in another manufacturer’s mainframe, refer to the applicable installation manual supplied by that manufacturer.

Most information in this manual applies to multimeter operations in the HP 75000 Series C mainframe with an HP E1405A Command Module. Standard Commands for Programmable Instrument (SCPI) is used as the programming language.

---

## Manual Content

This manual has five chapters and two appendixes.

- Chapters 1 and 2 provide multimeter module description and configuration information. Chapter 3 shows several ways to use the multimeter to make measurements. For basic multimeter operations using SCPI, use these chapters.
- Chapter 4 explains the more advanced multimeter operations and Chapter 5 describes the SCPI commands used to program the multimeter.
- Appendix A gives the multimeter’s specifications and Appendix B lists the SCPI error codes and messages.

---

## Suggested Sequence to Use This Manual

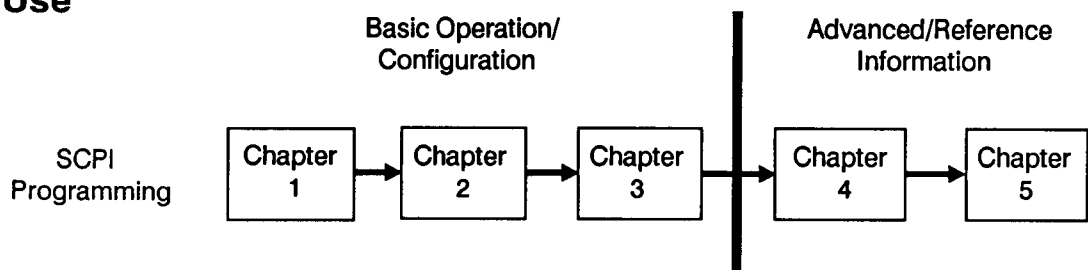

# MANUAL COMMENT SHEET

HP E1410A Multimeter User's Manual  
Manual Part Number E1410-90002  
Edition 2 (June 1992)

You can help us improve our manuals by sharing your comments and suggestions. Please complete this questionnaire after becoming familiar with the manual and then return it to us. In appreciation of your time, we will enter your name in a quarterly drawing for a Hewlett-Packard calculator.

Please describe the system controller, operating system, and programming language you are using to program this product.

---

---

---

---

Please pencil-in one circle for each statement below as it applies to this documentation:

	←-----→				
	Disagree		Agree		
● The manual is well organized.	<input type="radio"/>	<input type="radio"/>	<input type="radio"/>	<input type="radio"/>	<input type="radio"/>
● Instructions are easy to understand.	<input type="radio"/>	<input type="radio"/>	<input type="radio"/>	<input type="radio"/>	<input type="radio"/>
● The manual is clearly written.	<input type="radio"/>	<input type="radio"/>	<input type="radio"/>	<input type="radio"/>	<input type="radio"/>
● Examples are clear and useful.	<input type="radio"/>	<input type="radio"/>	<input type="radio"/>	<input type="radio"/>	<input type="radio"/>
● The manual contains enough examples.	<input type="radio"/>	<input type="radio"/>	<input type="radio"/>	<input type="radio"/>	<input type="radio"/>
● Illustrations are clear and helpful.	<input type="radio"/>	<input type="radio"/>	<input type="radio"/>	<input type="radio"/>	<input type="radio"/>
● The manual meets my overall expectations.	<input type="radio"/>	<input type="radio"/>	<input type="radio"/>	<input type="radio"/>	<input type="radio"/>

Please write any comments and/or suggestions in the space provided below. Use additional pages if you wish. The more specific your comments, the more useful they are to us.

---

---

---

---

---

Your Name: \_\_\_\_\_

Company: \_\_\_\_\_

Address: \_\_\_\_\_

Job Title: \_\_\_\_\_

City/State: \_\_\_\_\_

Telephone: \_\_\_\_\_

Zip/Postal Code: \_\_\_\_\_

Today's Date: \_\_\_\_\_

Country: \_\_\_\_\_

*Please fold and tape for mailing.*



NO POSTAGE  
NECESSARY  
IF MAILED  
IN THE  
UNITED STATES

**BUSINESS REPLY MAIL**  
FIRST CLASS / PERMIT NO. 37 / LOVELAND, COLORADO

POSTAGE WILL BE PAID BY ADDRESSEE

**HEWLETT-PACKARD COMPANY**  
VXI SYSTEM DIVISION  
Dept. 4185  
P.O. Box 301  
Loveland, CO 80539





# Contents

---

<b>1. Getting Started</b>	
About This Chapter . . . . .	1-1
Multimeter Overview . . . . .	1-1
Programming the Multimeter . . . . .	1-2
Initial Operation . . . . .	1-4
<b>2. Configuring the Multimeter</b>	
About This Chapter . . . . .	2-1
Input Terminals . . . . .	2-2
Setting the Logical Address Switch . . . . .	2-4
Selecting the Bus Request Level . . . . .	2-5
Setting the Line Frequency Reference . . . . .	2-7
Autocalibration . . . . .	2-8
Voltage Measurement Connections . . . . .	2-9
2-Wire Ohms Measurement Connections . . . . .	2-10
4-Wire Ohms Measurement Connections . . . . .	2-11
Frequency & Period Measurement Connections . . . . .	2-12
<b>3. Using the Multimeter</b>	
About This Chapter . . . . .	3-1
Programming Overview . . . . .	3-2
Making a Single Measurement . . . . .	3-3
Making a Burst of Measurements . . . . .	3-4
Making Multiple Burst Measurements . . . . .	3-5
Making Externally Triggered Measurements . . . . .	3-6
Maximizing Measurement Accuracy . . . . .	3-7
Maximizing Measurement Speed . . . . .	3-8
Synchronizing the Multimeter with a Switch Module . . . . .	3-10
Synchronizing the Multimeter with the Computer . . . . .	3-12
Checking for Errors . . . . .	3-14
Additional Measurement Functions . . . . .	3-16
<b>4. Understanding the Multimeter</b>	
About This Chapter . . . . .	4-1
Using MEASure and CONFigure . . . . .	4-1
Measurement Functions . . . . .	4-8
Multimeter Parameters . . . . .	4-13
Triggering the Multimeter . . . . .	4-23
Saving Multimeter Configurations . . . . .	4-37

**5. Multimeter Command Reference**

About This Chapter . . . . . 5-1  
Command Types . . . . . 5-1  
Multimeter Range and Resolution Tables . . . . . 5-4  
SCPI Command Reference . . . . . 5-5  
IEEE 488.2 Common Command Reference . . . . . 5-85  
Command Quick Reference . . . . . 5-87

**Appendixes**

Specifications . . . . . A-1  
Error Messages . . . . . B-1

**Index**

# Contents

---

## Chapter 1 - Getting Started

About This Chapter . . . . .	1-1
Multimeter Overview . . . . .	1-1
Programming the Multimeter . . . . .	1-2
Performing a Self-Test . . . . .	1-2
Resetting the Multimeter . . . . .	1-3
Clearing the Multimeter . . . . .	1-3
Reading the Error Queue . . . . .	1-4
Initial Operation . . . . .	1-4

## Getting Started

---

### About This Chapter

This chapter describes the HP E1410A 6½-Digit Multimeter and shows how to program the module using Standard Commands for Programmable Instruments (SCPI) commands. This chapter contains the following sections:

- Multimeter Overview
- Programming the Multimeter
- Initial Operation

---

### Multimeter Overview

This one-slot C-Size multimeter can measure DC voltage, AC voltage, AC + DC voltage, 2-wire and 4-wire resistance, frequency, period, and temperature. All measurements are made from the multimeter's front terminals. For all types of measurements, you can use the autorange function which automatically selects the measurement range or you can specify a particular measurement range. The multimeter has offset compensation for resistance measurements and autozero for all measurements.

The multimeter measures an analog signal by converting it to a digital value. Once the signal is in digital form, it can be sent to the output buffer or stored in multimeter memory. Input signals are converted to digital values by the multimeter's analog-to-digital (A/D) converter. The method of A/D conversion (integration) can provide normal mode noise rejection (rejection of noise at multiples of the power line frequency). A GUARD terminal enhances common mode noise rejection (rejection of noise common to both of the multimeter's input terminals).

**NOTE:** Refer to Appendix A for a complete listing of the multimeter's specifications.

## Programming the Multimeter

To program the multimeter using the Standard Commands for Programmable Instruments (SCPI), you must select the controller language, interface address, and SCPI commands to be used. See the “C-Size Installation and Getting Started Guide” (or equivalent) for interfacing, addressing, and controller language information.

Before continuing with the remainder of this manual, you will want to verify communication between the multimeter, the mainframe, and your computer. This section shows how to perform the multimeter self-test, how to reset and clear the multimeter, and how to read the error queue.

### Performing a Self-Test

After the multimeter completes its power-on sequence, it is ready for use. Sending the self-test command is an easy way to verify that you are properly addressing the multimeter. The self-test is also useful in locating intermittent problems that might occur during operation. The following commands perform the multimeter’s self-test:

`*TST?` or `TEST?`

These commands return a number to show whether the self-test passed or failed (Table 1-1). The number is sent to the output buffer. To return the multimeter to a known state after a self-test, you may want to reset the multimeter (see “Resetting the Multimeter”).

**Table 1-1. Multimeter Self-Test Codes**

Weighted Value	Description
0	All tests passed.
1	Inguard UART failure.
2	Inguard CPU failure.
4	Inguard link failure.
8	Integrator convergence error.
16	Front end zero measurement error.
32	Gain test error.
128	AC amplifier’s DC offset test failure.
256	AC flatness check failure.
512	Ohms precharge failure.
4096	Calibration RAM checksum failure.
8192	Autocalibration RAM checksum failure.
16384	ROM checksum failure.

**NOTE:** *If the multimeter does not respond to the self-test, the specified logical address may be incorrect. Chapter 2 in this manual reviews the multimeter addressing convention. If the multimeter responds with a number other than “0”, you may have to return the multimeter to Hewlett-Packard for repair.*

## Resetting the Multimeter

The \*RST (reset) command resets the multimeter to its power-on state. The reset function aborts any measurements in progress and clears any reading in the multimeter's internal reading buffer. Table 1-2 shows the multimeter's power-on settings.

**Table 1-2. Multimeter Power-On Settings**

Item	Related Commands	Power-On State
AC Bandwidth	SENSe:BANDwidth:DETEctor	Slow Mode
Autorange	CONFigure, MEASure, SENSE:RESistance:RANGe, or SENSE:VOLTage:RANGe	On
Autozero	CALibration:ZERO:AUTO	On
Delay Time	TRIGger:DELay	Default (see Table 4-9)
Function	CONFigure, MEASure, SENSE:FUNCTION	DC Voltage
Input Coupling	INPut:COUPLing	AC Voltage
Input Impedance	INPut:IMPedance:AUTO	On
Input Terminals	INPut:STATe	On
Integration Time	SENSe:RESistance:NPLC or SENSE:VOLTage:NPLC	1 Power Line Cycle
Offset Compensation	SENSe:RESistance:OCOMPensated	Off
Range	CONFigure, MEASure, SENSE:RESistance:RANGe, or SENSE:VOLTage:RANGe	Autorange
Readings per Trigger	SAMPlE:COUNT	1 reading
Reference Frequency	CALibration:LFRequency	Last value programmed
Sample Source	SAMPlE:SOURce	Immediate
Sample Timer Interval	SAMPlE:TIMER	1 second
Trigger Buffer	TRIGger:BUFFered	Off
Trigger Count	TRIGger:COUNT	1
Trigger Slope	TRIGger:SLOPe	Negative
Trigger Source	TRIGger:SOURce	Immediate
Voltmeter Complete	OUTput:TTLTrg	Routed to front BNC
Power-On Status Clear	*PSC	Last value programmed
Event Status Clear	*ESE	Last value programmed
Service Request Enable	*SRE, STATus:QUEStionable:ENABle, or STATus:OPERation:ENABle	Last value programmed Always 0 Always 0

## Clearing the Multimeter

The HP-IB CLEAR command clears the multimeter preparing it to receive a command. Clearing the multimeter allows you to regain control of the multimeter without cycling power. Clearing the multimeter also clears the HP-IB input and output buffers.

## Reading the Error Queue

When the multimeter detects an error condition, it stores an error number and corresponding message in its error queue. To read the error queue, send the following command:

```
SYSTem:ERRor?
```

One error is removed from the error queue each time the SYSTem:ERRor? command is executed. The errors are cleared in a first-in, first-out order. This means that if several errors are waiting in the queue, each query returns the oldest (not the most recent) error. That error is then removed from the queue.

When the error queue is empty, subsequent SYSTem:ERRor? queries return +0, "No error". To clear all errors from the queue, execute the \*CLS (clear status) command.

The error queue can hold a maximum of 30 errors. If more than 30 errors are generated, the last error in the queue will be -350, "Too many errors". No additional errors are accepted by the queue until you begin reading and removing errors.

**NOTE:** See Appendix B for a complete listing of error numbers and messages for the multimeter.

---

## Initial Operation

To verify that the multimeter is operating properly, use the following program to make a simple DC voltage measurement using the MEASure command. The example is written in the HP BASIC program language. The Hewlett-Packard Interface Bus (HP-IB) interface select code is 7, the HP-IB primary address is 09, and the multimeter's secondary address is 03.

```
10 OUTPUT 70903; "MEAS:VOLT:DC?"  Function: DC voltage;  
                                     autorange on; trigger  
                                     multimeter immediately; send  
                                     reading to output buffer  
20 ENTER 70903; Rdg                Enter reading into computer  
30 PRINT Rdg                        Print reading  
40 END
```

# Contents

---

## Chapter 2 - Configuring the Multimeter

About This Chapter . . . . .	2-1
Input Terminals . . . . .	2-2
Setting the Logical Address Switch . . . . .	2-4
Selecting the Bus Request Level . . . . .	2-5
Setting the Line Frequency Reference . . . . .	2-7
Checking the Line Frequency Reference . . . . .	2-7
Autocalibration . . . . .	2-8
Voltage Measurement Connections . . . . .	2-9
2-Wire Ohms Measurement Connections . . . . .	2-10
4-Wire Ohms Measurement Connections . . . . .	2-11
Frequency & Period Measurement Connections . . . . .	2-12



## Configuring the Multimeter

---

### About This Chapter

This chapter shows how to connect signals to the multimeter's input terminals and how to configure the module for measurements. This chapter contains the following sections:

- Input Terminals
  - Setting the Logical Address Switch
  - Selecting the Bus Request Level
  - Setting the Line Frequency Reference
  - Autocalibration
  - Voltage Measurement Connections
  - 2-Wire Ohms Measurement Connections
  - 4-Wire Ohms Measurement Connections
  - Frequency and Period Measurement Connections
- 

### Warning

**SHOCK HAZARD.** Only service-trained personnel who are aware of the hazards involved should install or configure the multimeter. Before you remove any installed module, disconnect AC power from the mainframe and other modules connected to the multimeter.

---

---

### Caution

The maximum input voltages are:

**HI to LO Terminals:**  $\pm 300\text{V DC}$  or  $300\text{V AC RMS}$  or  $\pm 450\text{V Peak}$

**Any Terminal to Guard or Chassis:**  $\pm 300\text{V DC}$  or  $300\text{V AC RMS}$  or  $\pm 450\text{V Peak}$

**Guard to Chassis:**  $\pm 300\text{V DC}$  or  $300\text{V AC RMS}$  or  $\pm 450\text{V Peak}$

**HI  $\Omega$  Sense to LO  $\Omega$  Sense Terminals:**  $\pm 250\text{V DC}$  or  $250\text{V AC RMS}$  or  $\pm 350\text{V Peak}$

**HI  $\Omega$  Sense or LO  $\Omega$  Sense to LO Terminal:**  $\pm 250\text{V DC}$  or  $250\text{V AC RMS}$  or  $\pm 350\text{V Peak}$

---

---

## Input Terminals

The multimeter's front panel contains terminals for connecting input signals, receiving external trigger signals, and accessing the *voltmeter complete* pulse (Figure 2-1).

The INPut:STATe command enables or disables the multimeter's input terminals. For example, the following command statement disables the input terminals:

```
INP:STAT OFF
```

The INPut:STATe? command returns a number to show whether the input terminals are enabled or disabled: "1" = ON (enabled), "0" = OFF (disabled). The number is sent to the output buffer.

**NOTE:** *The outer shell of the "Ext Trig" BNC connector is connected to chassis.*

There are four LEDs on the multimeter's front panel:

- The **Failed LED** turns on momentarily during the multimeter's power-on self-test. If the multimeter successfully completes its self-test, the LED turns off. If the multimeter fails its self-test, the LED remains on.
- The **Access LED** turns on only when the command module is communicating with the multimeter.
- The **Error LED** turns on only when an error is present in the multimeter's error queue.
- The **Sample LED** turns on when the multimeter is sampling the input for a measurement.

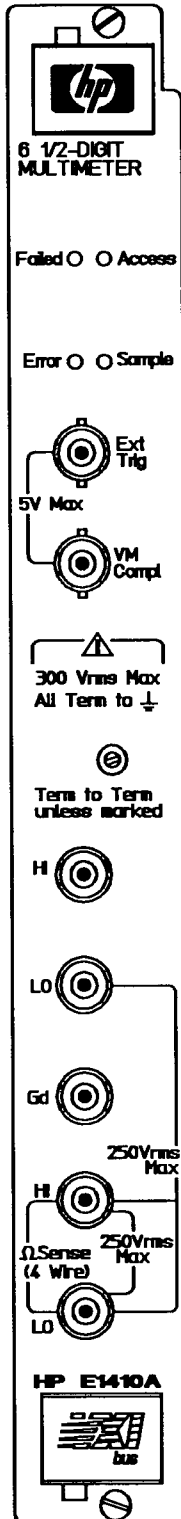

ME10) E410-F.21

Figure 2-1. Measurement Terminals



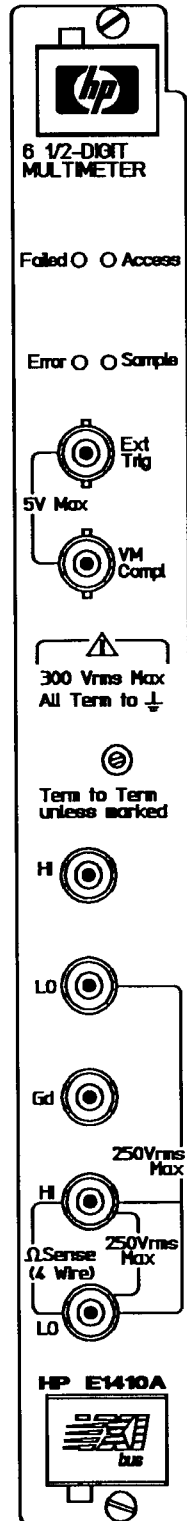

0ME101 E1410F.2.1

Figure 2-1. Measurement Terminals

## Setting the Logical Address Switch

The multimeter's logical address is set to 24 at the factory (secondary address is 03). You may have changed the settings during module installation. Valid address values are from 0 to 255. Use Figure 2-2 to change the switch settings if necessary.

If you have installed more than one multimeter, you must change one logical address to some other multiple of eight (e.g., 32, 40, 48). Each instrument must have a unique secondary address.

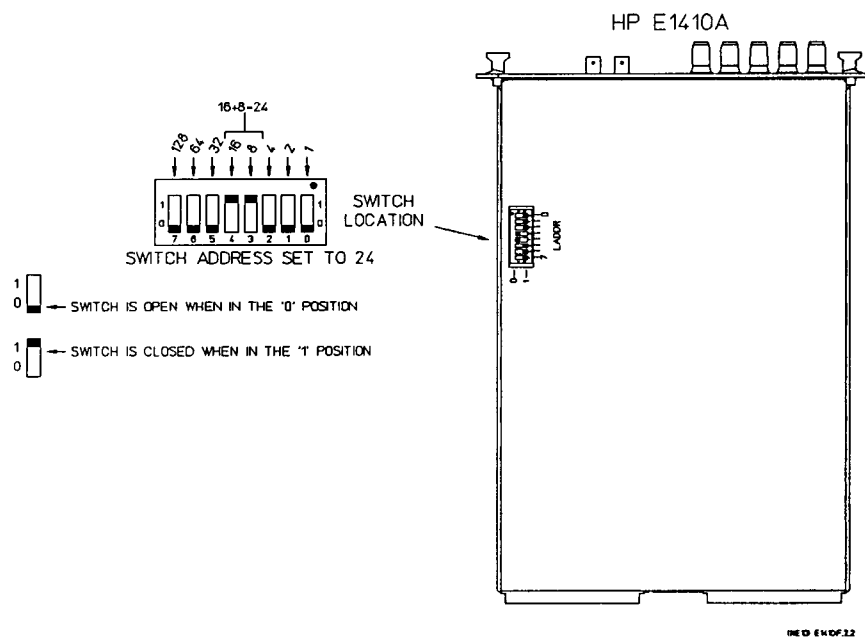

Figure 2-2. Setting the Logical Address Switch

**Static versus Dynamic Configuration:** Up to this point, we have talked about setting the logical address “statically” using the logical address switches. You can also set the multimeter’s logical address “dynamically.” By setting the logical address to 255 (all switches = “1”), the command module sets (programs) the logical address based on other modules installed in the mainframe. Refer to Chapter 2 in the “HP E1405A Command Module User’s Manual” for more information.

---

## Selecting the Bus Request Level

The VXIbus backplane implements four bus request lines (BR0 through BR3). Instruments installed in the mainframe request use of the data transfer bus (DTB) on these four lines. The mainframe grants use of the DTB on the four Bus Grant lines (BG0 through BG3). Four bus request levels (0 through 3) correspond to the four bus request lines. Level 3 has the highest priority and Level 0 has the lowest priority.

If two or more modules have the same bus request level, the module installed in the lowest slot (i.e., the leftmost slot) has priority. Once the command module grants use of the bus to a module, that module cannot request the bus again until the Bus Busy line (BBSY\*) has been released for 30 ns. This prevents the module in the lowest slot from dominating the bus.

Figure 2-3 shows the location of the Bus Request Level jumpers on the multimeter. These jumpers control the bus request level and daisy-chain the Bus Grant lines from slot to slot. The multimeter is shipped from the factory with the jumpers set at Level 3. In most applications, you will not have to change the jumper settings.

If you need to change the bus request level, you must move a total of four jumpers (the three level jumpers and one daisy-chain jumper). Figure 2-3 shows an example of the jumpers in position for Level 1.

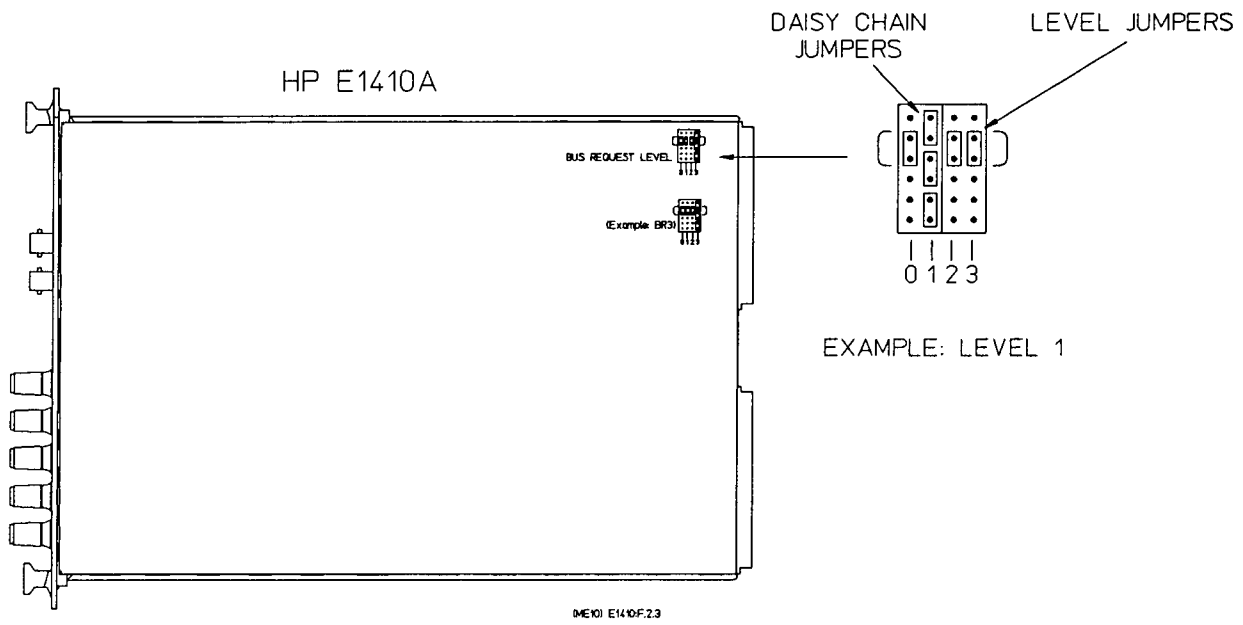

Figure 2-3. Changing the Bus Request Level



## Setting the Line Frequency Reference

Normal mode rejection (NMR) is the multimeter's ability to reject noise at the power line frequency from DC voltage or ohms measurements. For maximum NMR you should set the multimeter's line frequency reference to the exact power line frequency (50, 60, or 400 Hz). This allows the multimeter to reject unwanted signals of power line frequency from measurements.

The multimeter's line frequency reference is programmed to 60 Hz when shipped from the factory. To meet instrument specifications for 50 Hz or 400 Hz line frequencies, you must change the line frequency reference to the appropriate value if necessary.

To change the line frequency reference, use the CALibration:LFRrequency command. This is particularly useful when the multimeter is set for a different line frequency than the device being measured. The frequency setting is stored in non-volatile multimeter memory and is changed only when CALibration:LFRrequency is executed.

Suppose, for example, that the multimeter has a power line frequency of 60 Hz and the device being measured has a power line frequency of 50 Hz. You can achieve NMR by setting the multimeter's reference frequency to 50 Hz:

```
CAL:LFR 50
```

If 400 Hz is specified as the A/D converter's reference frequency, the multimeter actually uses a 50 Hz reference frequency. However, since 50 Hz is a subharmonic of 400 Hz, it provides normal mode rejection of power line related noise.

## Checking the Line Frequency Reference

The CALibration:LFRrequency? [MINimum | MAXimum] command returns one of the following numbers to the output buffer:

- The present line frequency reference (50 or 60) if MIN or MAX is not specified.
- The minimum line frequency reference available (50) if MIN is specified.
- The maximum line frequency reference available (60) if MAX is specified.

---

## Autocalibration

The multimeter has two autocalibration (autocal) routines: AC and RESistance. The autocal routines increase short term accuracy but are not substitutes for periodic calibration of the multimeter.

**NOTE:** *Always disconnect all input signals before you perform an autocal. If you leave an input signal connected to the multimeter, it may adversely affect the autocal.*

The AC autocal increases short term accuracy for AC or AC + DC voltage measurements. This routine takes approximately three seconds to complete. To perform the AC autocal routine, send:

CALibration:INTernal? AC

The RESistance autocal routine increases short term accuracy on the 3 G $\Omega$  range for 2-wire and 4-wire resistance measurements. This routine takes approximately 32 seconds to complete. To perform the RES autocal routine, send:

CALibration:INTernal? RES

You can perform both autocal routines by sending:

CALibration:INTernal? ALL

The CALibration:INTernal? command returns "0" for successful autocal. If an autocal is not successful, the command returns a number indicating the failed condition (an error is also placed in the error queue). See Chapter 5 "Multimeter Command Reference" for more information.

**NOTE:** *The \*CAL? common command also performs both autocal routines.*

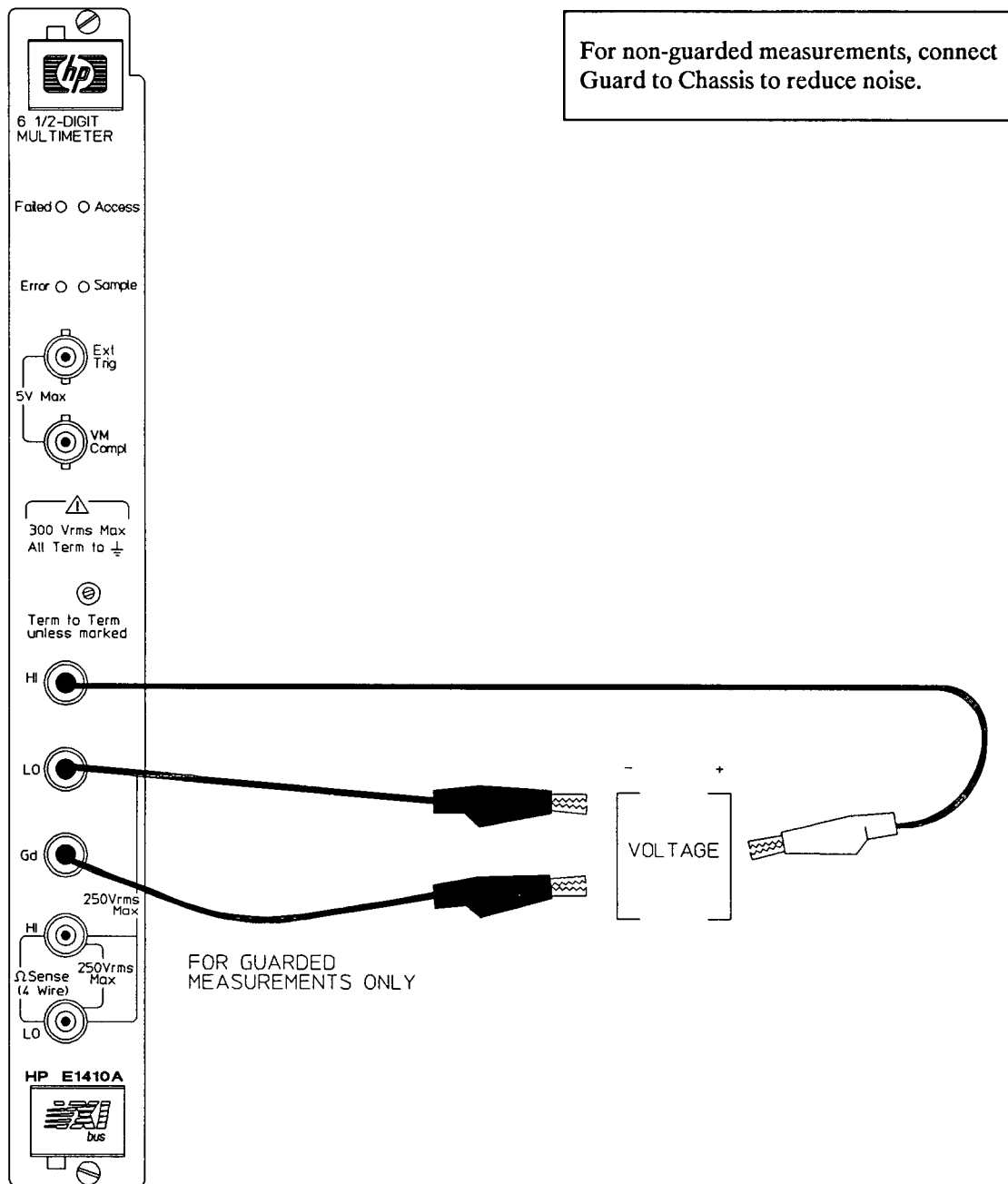

(ME10) E1410:F.2.4

Figure 2-4. Voltage Measurement Connections

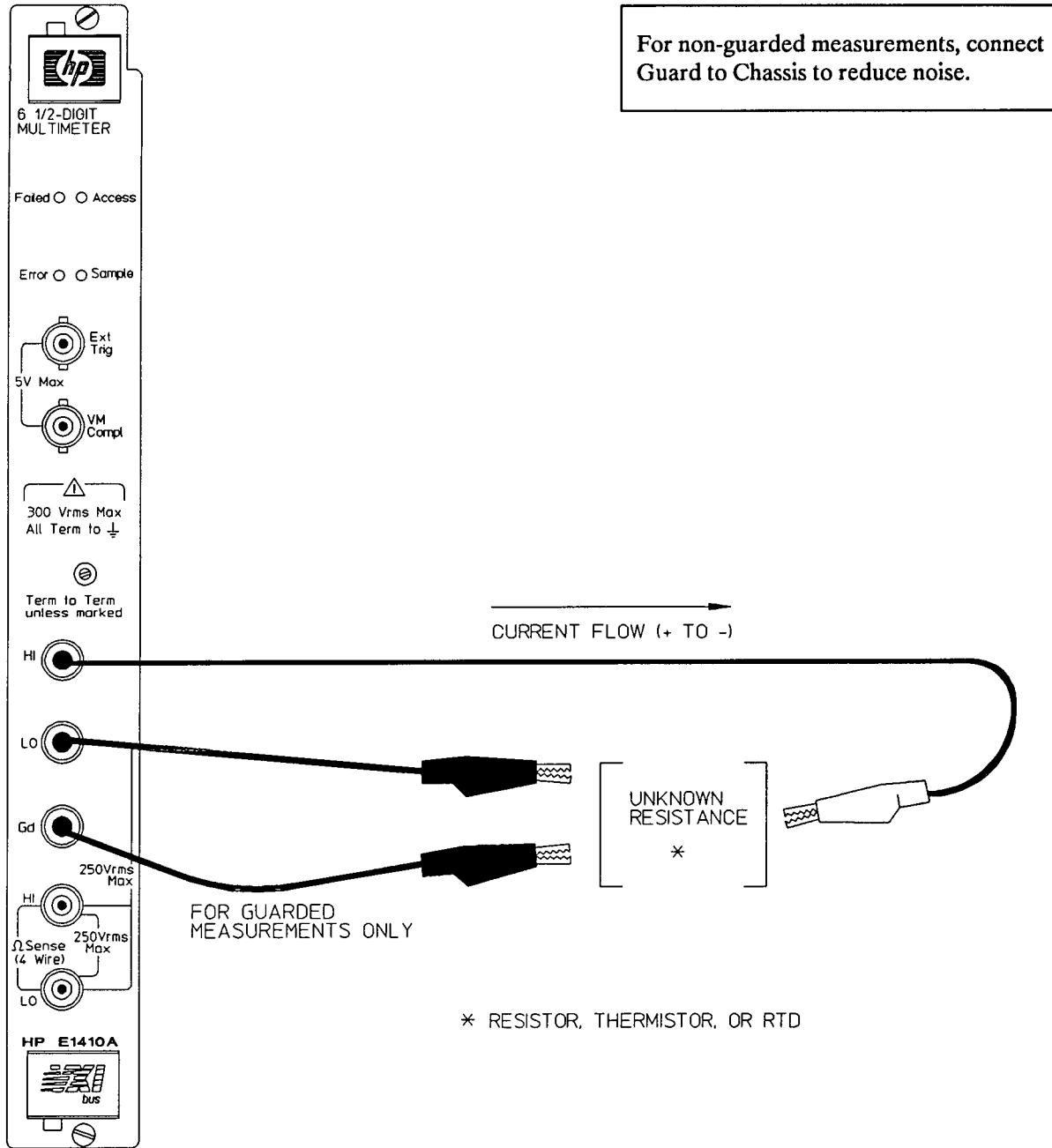

(ME10) E1410:F.2.5

Figure 2-5. 2-Wire Ohms Measurement Connections

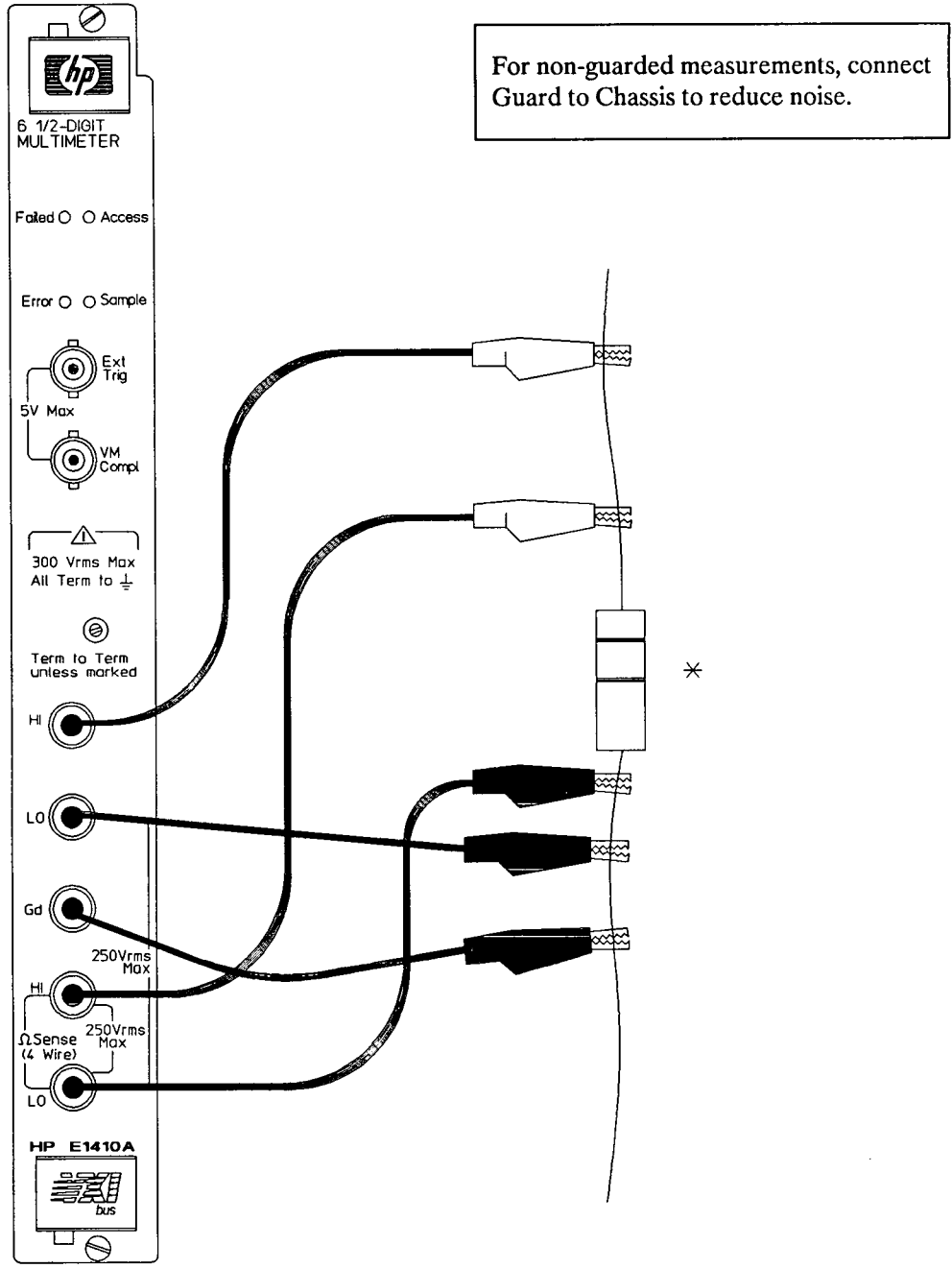

IME10) E1410.F 2.6

\* RESISTOR, THERMISTOR, OR RTD

Figure 2-6. 4-Wire Ohms Measurement Connections

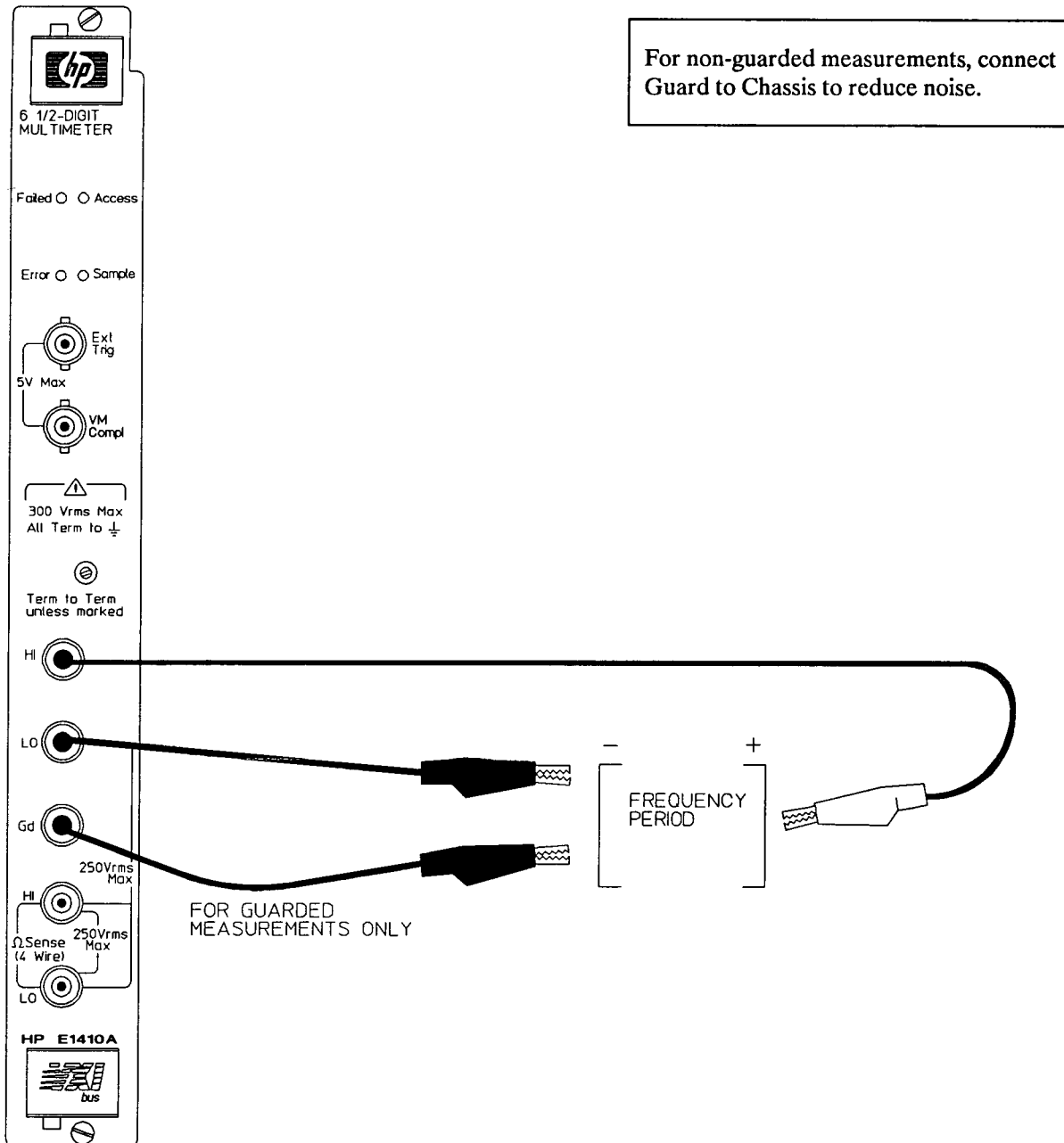

(ME10) E1410:F.2.7

Figure 2-7. Frequency and Period Measurement Connections

# Contents

---

## Chapter 3 - Using the Multimeter

About This Chapter . . . . .	3-1
Programming Overview . . . . .	3-2
Making a Single Measurement . . . . .	3-3
Making a Burst of Measurements . . . . .	3-4
Making Multiple Burst Measurements . . . . .	3-5
Making Externally Triggered Measurements . . . . .	3-6
Maximizing Measurement Accuracy . . . . .	3-7
Maximizing Measurement Speed . . . . .	3-8
Synchronizing the Multimeter with a Switch Module . . . . .	3-10
Synchronizing the Multimeter with the Computer . . . . .	3-12
Checking for Errors . . . . .	3-14
Additional Measurement Functions . . . . .	3-16

## Using the Multimeter

### About This Chapter

This chapter uses typical examples to show how to use the multimeter. Refer to Chapter 2 “Configuring the Multimeter” for information on connecting input signals to the multimeter. Refer to Chapter 4 “Understanding the Multimeter” for more information on using the full measurement capability of the multimeter. Table 3-1 lists the commands used in this chapter.

This chapter contains the following sections:

- Programming Overview
- Making a Single Measurement
- Making a Burst of Measurements
- Making Multiple Burst Measurements
- Making Externally Triggered Measurements
- Maximizing Measurement Accuracy
- Maximizing Measurement Speed
- Synchronizing the Multimeter with a Switch Module
- Synchronizing the Multimeter with the Computer
- Checking for Errors
- Additional Measurement Functions

**Table 3-1. Multimeter Commands in Chapter 3**

Command	Description
CALibration :ZERO:AUTO OFF 0 ON 1 ONCE	Enable/disable autozero mode.
CONFigure :<function> [<max. input> [, <resolution> ]]	Configure multimeter for selected function, but do not initiate or make measurement.
FETCh?	Place stored readings in output buffer.
INITiate [:IMMEDIATE]	Place multimeter in wait-for trigger state.
MEASure :<function>? [<max. input> [, <resolution> ]]	Configure multimeter for selected function, initiate the measurement, and send readings to output buffer.
READ?	Place multimeter in wait-for trigger state; place readings in output buffer.
SAMPlE :COUNt 1-16,777,215 MIN MAX	Set number of readings/trigger.
SAMPlE :SOURce IMM TIM	Set pacing source.
SAMPlE :TIMer 680 $\mu$ s-2100s MIN MAX	Define period between readings.
SYSTem :ERRor?	Read error queue.
TRIGger :COUNt 1-16,777,215 MIN MAX	Set number of triggers or scans.
TRIGger :DELay 1 $\mu$ s-2100s MIN MAX	Set delay between trigger and start of measurement.
TRIGger :SOURce BUS EXT HOLD IMM TTLT0-TTLT7	Specify trigger source.



---

## Programming Overview

The easiest way to make measurements is to use the MEASure or CONFigure command. All you have to do is specify a function, expected value, and resolution. Other measurement parameters (aperture time, integration time, trigger count, etc.) are automatically set to default values for you. The example programs in this chapter use MEASure or CONFigure to make measurements.

Executing MEASure or CONFigure is equivalent to configuring the multimeter with a series of “low-level” commands. When using CONFigure, you can change the multimeter’s default configuration by executing the low-level commands. Refer to Chapter 4 for more information.

The example programs in this chapter are written in the HP BASIC program language using SCPI commands. The example programs assume that the multimeter is controlled from an HP 9000 Series 200/300 computer over the HP-IB (IEEE-488).

When using HP BASIC as the controller language, use the OUTPUT statement to send commands from the computer to the multimeter:

```
OUTPUT 70903; "MEAS:VOLT:DC?"
```

The address specified (70903) represents the HP-IB interface select code (7) plus the HP-IB primary address of the command module (09) plus the HP-IB secondary address of the multimeter (03).

Use the ENTER statement to enter data from the multimeter into the computer:

```
ENTER 70903; Rdg
```

**NOTE:** *For simplicity, all example programs in this chapter use DC voltage as the measurement function. To select a different measurement function, simply replace the function parameter in the MEASure or CONFigure command. Refer to the last section in this chapter, “Additional Measurement Functions,” for additional information.*

## Making a Single Measurement

This example makes one DC voltage measurement using MEASure and sends the reading to the output buffer.

10 OUTPUT 70903; "*RST"	<i>Reset multimeter to its power-on state</i>
20 OUTPUT 70903; "MEAS:VOLT:DC?"	<i>Configure multimeter and make DC voltage measurement; send reading to output buffer</i>
30 ENTER 70903; Rdg	<i>Enter reading into computer</i>
40 PRINT Rdg	<i>Display reading on computer</i>
50 END	

### Comments

**Measurement Function:** DC voltage is the default function selected by MEASure and CONFigure.

**Range Selected:** Autorange (default).

**Integration Time Selected:** 1 power line cycle (default).

**Resolution Selected:** Based on function and range selected.

## Making a Burst of Measurements

This example makes 100 DC voltage measurements using CONFIGure and stores the readings in multimeter memory.

10 DIM Rdgs(1:100)	<i>Dimension computer array to store readings</i>
20 OUTPUT 70903; "*RST"	<i>Reset multimeter to its power-on state</i>
30 OUTPUT 70903; "CONF:VOLT:DC"	<i>Configure multimeter for DC voltage measurements</i>
40 OUTPUT 70903; "SAMP:COUN 100"	<i>Specify 100 readings per trigger</i>
50 OUTPUT 70903; "INIT"	<i>Place multimeter in wait-for-trigger state; store readings in multimeter memory when trigger is received</i>
60 OUTPUT 70903; "FETC?"	<i>Place readings in output buffer</i>
70 ENTER 70903; Rdgs(*)	<i>Enter readings into computer</i>
80 PRINT Rdgs(1), Rdgs(50)	<i>Display selected readings on computer</i>
90 END	

### Comments

**Measurement Function:** DC voltage is the default function selected by MEASure and CONFIGure.

**Range Selected:** Autorange (default).

**Integration Time Selected:** 1 power line cycle (default).

**Resolution Selected:** Based on function and range selected.

**Setting the Sample Count:** The CONFIGure command automatically sets the sample count (i.e., the number of readings per trigger) to 1. The SAMPLE:COUNT command sets the sample count to 100 in this example. You can specify up to 16,777,215 measurements per trigger using SAMPLE:COUNT.

**Using Multimeter Memory:** When the INITiate command follows CONFIGure, readings are stored in multimeter memory. The FETCh? command retrieves the readings from memory and places them in the output buffer. You can replace INITiate and FETCh? with the READ? command to place the readings directly in the output buffer (readings aren't stored in multimeter memory). However, when measurement speed is critical, store readings in multimeter memory using INITiate and FETCh?.

**Multimeter Memory Capacity:** The multimeter module has enough memory to store 4,096 readings. Each reading stored is eight bytes long.

## Making Multiple Burst Measurements

This example makes three burst measurements and each burst consists of 10 readings. All readings are stored in multimeter memory (INITiate command). For this example, the maximum expected value of the input signal is specified as 8.25 VDC. Based on this value, the multimeter automatically selects the 30 VDC range.

10 DIM Rdgs(1:30)	<i>Dimension computer array to store readings</i>
20 OUTPUT 70903; "**RST"	<i>Reset multimeter to its power-on state</i>
30 OUTPUT 70903; "CONF:VOLT:DC 8.25"	<i>Configure multimeter for DC voltage measurements; specify fixed range</i>
40 OUTPUT 70903; "TRIG:SOUR EXT"	<i>Trigger source is external BNC on multimeter front panel</i>
50 OUTPUT 70903; "TRIG:COUN 3"	<i>Multimeter will accept 3 external triggers (10 readings are taken per trigger)</i>
60 OUTPUT 70903; "SAMP:COUN 10"	<i>Specify 10 readings per trigger</i>
70 OUTPUT 70903; "INIT"	<i>Place multimeter in wait-for-trigger state; store readings in multimeter memory when trigger is received</i>
80 OUTPUT 70903; "FETC?"	<i>Place readings in output buffer</i>
90 ENTER 70903; Rdgs(*)	<i>Enter readings into computer</i>
100 PRINT Rdgs(10), Rdgs(20)	<i>Display selected readings on computer</i>
110 END	

### Comments

**Measurement Function:** DC voltage is the default function selected by MEASure and CONFigure.

**Range Selected:** 30 VDC

**Integration Time Selected:** 1 power line cycle (default).

**Resolution Selected:** 10  $\mu$  V (default based on 1 PLC integration time).

**Setting the Sample Count:** The CONFigure command sets the sample count (i.e., the number of readings per trigger) to 1. The SAMPlE:COUNT command sets the sample count to 10 in this example. You can specify up to 16,777,215 measurements per trigger using SAMPlE:COUNT.

**Trigger Source:** The MEASure and CONFigure commands automatically set the trigger source to the multimeter's internal trigger. For this example, the trigger source is set to external (EXT).

**Trigger Count:** The TRIGger:COUNT command sets the number of triggers the multimeter will accept before returning to the idle state. In this example, the multimeter will accept three external triggers. The maximum trigger count is 16,777,215.

## Making Externally Triggered Measurements

This example makes 10 DC voltage measurements when the multimeter's external trigger BNC connector is pulsed low. This example uses CONFIGure with the READ? command to send the readings directly to the output buffer.

10 DIM Rdgs(1:10)	<i>Dimension computer array to store readings</i>
20 OUTPUT 70903; "*RST"	<i>Reset multimeter to its power-on state</i>
30 OUTPUT 70903; "CONF:VOLT:DC"	<i>Configure multimeter for DC voltage measurements</i>
40 OUTPUT 70903; "TRIG:SOUR EXT"	<i>Trigger source is external BNC on multimeter front panel</i>
50 OUTPUT 70903; "SAMP:COUN 10"	<i>Specify 10 readings per trigger</i>
60 OUTPUT 70903; "READ?"	<i>Place multimeter in wait-for-trigger state; make measurements when external trigger is received; send readings to output buffer</i>
70 ENTER 70903; Rdgs(*)	<i>Enter readings into computer</i>
80 PRINT Rdgs(*)	<i>Display readings on computer</i>
90 END	

### Comments

**Measurement Function:** DC voltage is the default function selected by MEASure and CONFIGure.

**Range Selected:** Autorange (default).

**Integration Time Selected:** 1 power line cycle (default).

**Resolution Selected:** Based on function and range selected.

**Trigger Source:** The MEASure and CONFIGure commands automatically set the trigger source to the multimeter's internal trigger. For this example, the trigger source is set to external (EXT).

**Trigger Slope:** The TRIGger:SLOPe command determines which edge (rising or falling) of a signal input to the external trigger BNC connector will trigger the multimeter. At power-on or after a \*RST (reset) command, the multimeter is triggered on the falling edge (NEG). The MEASure and CONFIGure commands automatically set the trigger slope to NEG.

**Setting the Sample Count:** The CONFIGure command sets the sample count (i.e., the number of readings per trigger) to 1. The SAMPlE:COUNt command sets the sample count to 10 in this example. You can specify up to 16,777,215 measurements per trigger using SAMPlE:COUNt.

**Output Buffer Capacity:** The output buffer capacity is 128 bytes. Therefore, seven readings (17 bytes each) can be transferred to the output buffer at a time.

## Maximizing Measurement Accuracy

This example shows the multimeter configuration required to make measurements with the greatest possible accuracy (this program takes approximately 5 seconds to return the reading to the computer).

10	OUTPUT 70903; "*RST"	<i>Reset multimeter to its power-on state</i>
20	OUTPUT 70903; "CONF:VOLT:DC AUTO,MIN"	<i>Configure multimeter for DC voltage measurements; enable autoranging; request the best possible resolution (integration time is 1 PLC)</i>
30	OUTPUT 70903; "SENS:VOLT:NPLC MAX"	<i>Set integration time to 100 PLCs</i>
40	OUTPUT 70903; "READ?"	<i>Place multimeter in wait-for-trigger state and make measurement; send reading to output buffer</i>
50	ENTER 70903; Rdg	<i>Enter reading into computer</i>
60	PRINT Rdg	<i>Display reading on computer</i>
70	END	

### Comments

**Measurement Function:** DC voltage is the default function selected by MEASure and CONFigure.

**Range Selected:** Autorange is specified.

**Integration Time Selected:** 100 power line cycles. The MIN parameter in the CONFigure command selects the best possible resolution for the range selected by autorange (this sets the integration time to 1 PLC). The SENSE:VOLTage:NPLC MAX command selects the best integration time available (100 PLCs).

**Resolution Selected:** Based on function and range selected (the MIN parameter selects the best possible resolution for the range selected by autorange).

**Offset Compensation:** When making resistance measurements (including RTD and thermistor measurements), you can often increase accuracy by enabling offset compensation.

## Maximizing Measurement Speed

This example shows the multimeter configuration required to make measurements at the fastest possible rate (1,450 readings per second).

10 DIM Rdgs(1:500)	<i>Dimension computer array to store readings</i>
20 OUTPUT 70903; "*RST"	<i>Reset multimeter to its power-on state</i>
30 OUTPUT 70903; "CONF:VOLT:DC 8.25,MAX"	<i>Configure multimeter for DC voltage measurements; specify fixed range with the worst resolution</i>
40 OUTPUT 70903; "CAL:ZERO:AUTO OFF"	<i>Disable autozero</i>
50 OUTPUT 70903; "SAMP:COUN 500"	<i>Specify 500 readings per trigger</i>
60 OUTPUT 70903; "SAMP:SOUR TIM"	<i>Sample source is SAMPLE:TIMER command</i>
70 OUTPUT 70903; "SAMP:TIM MIN"	<i>Set minimum sample rate</i>
80 OUTPUT 70903; "INIT"	<i>Place multimeter in wait-for-trigger state; store readings in multimeter memory when trigger is received</i>
90 OUTPUT 70903; "FETC?"	<i>Place readings in output buffer</i>
100 ENTER 70903; Rdgs(*)	<i>Enter readings into computer.</i>
110 PRINT Rdgs(1), Rdgs(250)	<i>Display selected readings on computer</i>
120 END	

### Comments

**Measurement Function:** DC voltage is the default function selected by MEASure and CONFigure.

**Range Selected:** 30 VDC

**Integration Time Selected:** 1 power line cycle (default).

**Resolution Selected:** 10 mV. By specifying MAX resolution in the CONFigure command, the multimeter selects the worst resolution for the selected range.

**Setting the Sample Count:** The CONFigure command sets the sample count (i.e., the number of readings per trigger) to 1. The SAMPlE:COUNt command sets the sample count to 500 in this example. You can specify up to 16,777,215 measurements per trigger using SAMPlE:COUNt.

**Autozero:** The CALibration:ZERO:AUTO command enables or disables the autozero mode. When autozero is ON, the multimeter makes a zero measurement (measurement with input disabled) following every measured reading and subtracts the zero measurement from the reading. This doubles the time required per reading. When autozero is OFF, the multimeter makes one zero measurement and subtracts this from all subsequent measurements. A new zero measurement is made whenever the function is changed.

**Sample Rate:** The `SAMPlE:TIMer` command defines the period between readings in a burst when `SAMPlE:COUNT` is greater than 1 and the `SAMPlE:SOURce` is `TIMer`. By specifying `MIN` for `SAMPlE:TIMer`, the multimeter uses  $680 \mu\text{s}$ .

**Using Multimeter Memory:** When the `INITiate` command follows `CONFigure`, readings are stored in multimeter memory. The `FETCh?` command retrieves the readings from memory and places them in the output buffer. You can replace `INITiate` and `FETCh?` with the `READ?` command to place the readings directly in the output buffer (readings aren't stored in multimeter memory). However, when measurement speed is critical, store readings in multimeter memory using `INITiate` and `FETCh?`.

**Multimeter Memory Capacity:** The multimeter module has enough memory to store 4,096 readings. Each reading stored is eight bytes long.



## Synchronizing the Multimeter with a Switch Module

This example synchronizes the multimeter with an HP E1460A 64-Channel Relay Multiplexer Module using the VXIbus trigger lines. Connections are shown in Figure 3-1. The sequence of operation is:

1. The INITiate command sent to the switch module (line 150) closes channel number 100.
2. The switch module sends its *channel closed* pulse to trigger line TTLTRG2 which triggers to multimeter to take a reading.
3. When the reading is complete, the multimeter sends the result to the output buffer. The multimeter sends its *voltmeter complete* signal to trigger line TTLTRG1. This signals the switch module to advance to the next channel in the scan list.
4. Steps 2 and 3 are repeated until all channels have been scanned and readings taken.

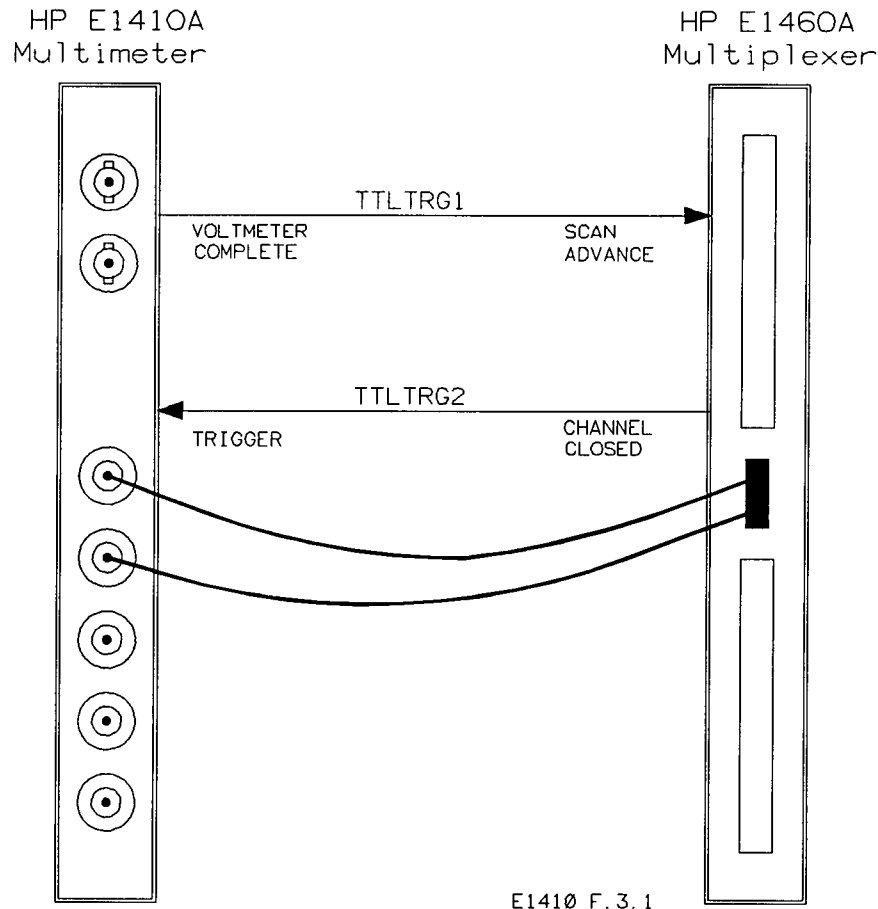

Figure 3-1. Synchronizing Multimeter/Switch Module

- |                            |   |
|----------------------------|---|
| 10 DIM Readings(0:7)       | <i>Dimension computer array to store readings</i> |
| 20 ASSIGN @Dmm to 70903    | <i>Assign address for multimeter</i>              |
| 30 ASSIGN @Switch to 70902 | <i>Assign address for switch module</i>           |
| 40 OUTPUT @Dmm; "**RST"    | <i>Reset multimeter to its power-on state</i>     |
| 50 OUTPUT @Switch; "**RST" | <i>Reset switch module to its power-on state</i>  |

Configure multimeter for DC voltage with the given range, resolution, and trigger count. Set the trigger source (TTLTRG2), and *voltmeter complete* destination (TTLTRG1).

- |  |   |
|--|---|
| 60 OUTPUT @Dmm; "ABOR"                   | <i>Place multimeter in idle trigger state</i>   |
| 70 OUTPUT @Dmm; "CONF:VOLT:DC 25,MIN"    | <i>Function: DC voltage; range selected: 30V; MIN resolution: 10 <math>\mu</math>V</i>              |
| 80 OUTPUT @Dmm; "TRIG:SOUR TTLT2;COUN 8" | <i>Accept trigger from switch module on trigger line TTLTRG2; multimeter will accept 8 triggers</i> |
| 90 OUTPUT @Dmm; "OUTP:TTLT1:STAT ON"     | <i>Route voltmeter complete signal to switch module on trigger line TTLTRG1</i>                     |
| 95 OUTPUT @Dmm; "TRIG:BUFF ON"           |   |
| 100 OUTPUT @Dmm; "READ?"                 | <i>Place multimeter in wait-for-trigger state ; send readings to output buffer</i>                  |

Select the switch module's *scan advance* source (TTLTRG1) and *channel closed* destination (TTLTRG2). Configure scan channel list and place switch module in wait-for-trigger state.

- |  |  |
|--|--|
| 110 OUTPUT @Switch; "ABOR"               | <i>Place switch module in idle trigger state</i>   |
| 120 OUTPUT @Switch; "OUTP:TTLT2:STAT ON" | <i>Route channel closed signal to multimeter on trigger line TTLTRG2</i>                             |
| 130 OUTPUT @Switch; "TRIG:SOUR TTLT1"    | <i>Accept scan advance signal from multimeter on trigger line TTLTRG1</i>                            |
| 140 OUTPUT @Switch; "SCAN (@100:107)"    | <i>Specify channel list (channels 100 through 107)</i>   |
| 150 OUTPUT @Switch; "INIT"               | <i>Place switch module in wait-for-trigger state and close first channel (starts scanning cycle)</i> |

Enter and print results.

- |                             |                                     |
|-----------------------------|-------------------------------------|
| 160 ENTER @Dmm; Readings(*) | <i>Enter readings into computer</i> |
| 170 PRINT Readings(*)       | <i>Print results</i>                |
| 180 END                     |                                     |

## Synchronizing the Multimeter with the Computer

This example shows how an HP 9000 Series 200/300 computer can monitor the multimeter to determine when data is available. This allows the computer to perform other functions while the multimeter is making measurements. When the readings are available to be read, the computer stops its present task and enters the data.

10 DIM Rdgs(1:15)	<i>Dimension computer array to store readings</i>
20 OUTPUT 70903; "**CLS"	<i>Clear all status registers</i>
30 OUTPUT 70903; "**SRE 16"	<i>Unmask the Message Available bit (bit 4) in the Status Byte Register</i>
40 OUTPUT 70903; "CONF:VOLT:DC"	<i>Configure multimeter for DC voltage measurements</i>
50 OUTPUT 70903; "TRIG:COUN 15"	<i>Multimeter will accept 15 internal triggers (1 reading is taken per trigger)</i>
60 OUTPUT 70903; "TRIG:DEL 1"	<i>Wait 1 second between each trigger and measurement</i>
70 OUTPUT 70903; "INIT"	<i>Place multimeter in wait-for-trigger state; store readings in multimeter memory</i>
80 OUTPUT 70903; "FETC?"	<i>Place readings in output buffer</i>

While the multimeter is making measurements, the computer is monitoring the Message Available bit. The computer displays a message while it waits for the bit to be set.

90 WHILE NOT BIT(SPOLL(70903),4)	<i>Monitor Message Available bit</i>
100 DISP "Waiting for Data..."	<i>Display message</i>
110 WAIT .5	<i>Display message for 0.5 seconds</i>
120 DISP " "	<i>Clear display</i>
130 WAIT 0.5	<i>Wait 0.5 seconds</i>
140 END WHILE	
150 ENTER 70903; Rdgs(*)	<i>Enter readings into computer</i>
160 FOR I = 1 TO 15	
170 PRINT Rdgs(I)	<i>Display readings on computer</i>
180 NEXT I	
190 END	

## Comments

**Using Multimeter Memory:** When the INITiate command follows CONFigure, readings are stored in multimeter memory. The FETCh? command retrieves the readings from memory and places them in the output buffer. You can replace INITiate and FETCh? with the READ? command to place the readings directly in the output buffer (readings aren't stored in multimeter memory). However, when measurement speed is critical, store readings in multimeter memory using INITiate and FETCh?.

**Multimeter Memory Capacity:** The multimeter module has enough memory to store 4,096 readings. Each reading stored is eight bytes long.

**Trigger Count:** The TRIGger:COUNT command sets the number of triggers the multimeter will accept before returning to the idle state. In this example, the multimeter will accept 15 internal triggers. The maximum trigger count is 16,777,215.

**Trigger Delay:** The TRIGger:DELAy command sets the delay period between receipt of the trigger and the start of the measurements. You can set the delay to values between 1  $\mu$ s and 2100 seconds.

**Retrieving Readings From Memory:** Readings are not retrieved from multimeter memory until all measurements are completed. The Message Available bit in the Status Byte Register is set when the first reading is retrieved from memory and is placed in the output buffer.

The data from only one command can be placed in the output buffer or in multimeter memory. Synchronizing the computer with the multimeter as shown in this example ensures that data is entered and printed before it is replaced by data from another command.

## Checking for Errors

This example shows a way to check for errors as you program the multimeter. The program monitors the multimeter's Standard Event Status Register for an error condition. If no errors occur, the multimeter operates as programmed. If errors do occur, the multimeter interrupts the computer and the error codes and messages are read from the multimeter's error queue. See the "HP E1405A Command Module User's Manual" (or equivalent) for more information on using the status registers.

Configure multimeter and computer to send/receive error interrupt:

10 OUTPUT 70903; "*CLS"	<i>Clear all status registers and the error queue</i>
20 OUTPUT 70903; "*SRE 32"	<i>Unmask the Event Status bit (bit 5) in the multimeter's Status Byte Register</i>
30 OUTPUT 70903; "*ESE 60"	<i>Unmask the multimeter error conditions in the multimeter's Standard Event Status Register (unmask bits 2, 3, 4, and 5)</i>
40 OUTPUT 70903; "*ESR?"	<i>Read and clear Standard Event Status Register</i>
50 ENTER 70903; Esr	<i>Enter result</i>
60 ON INTR 7 CALL Errmsg	<i>Call subprogram if error occurs</i>
70 ENABLE INTR 7;2	<i>Enable computer to respond to service request interrupt</i>

At this point, send commands for your specific application. In this example, we will make a measurement using the MEASure command:

80 OUTPUT 70903; "MEAS:VOLT:DC?"	<i>Configure multimeter and make DC voltage measurement; send reading to output buffer</i>
----------------------------------	--

Monitor "Message Available" bit (bit 4) and "Standard Event Status Register" summary bit (bit 5) in the Status Byte Register:

90 REPEAT	
100 Spoll_val = SPOLL(70903)	
110 UNTIL BINAND(Spoll_val,48)	
120 IF BIT(Spoll_val,5) THEN CALL Errmsg	<i>Reading Serial Poll (SPOLL) can occasionally clear the interrupt before the computer can respond</i>

Enter results from MEASure command:

130 ENTER 70903; Reading	<i>Enter measurement result if no errors occur</i>
140 PRINT Reading	<i>Display result on computer</i>
150 END	

*(Continued on next page)*

The following subprogram is executed if an error occurs while the multimeter is being configured or during the measurement:

```
500 SUB Errmsg
510  DIM Message$(256)           Dimension computer string
                                array to store error messages
520  CLEAR 70903                Clear multimeter to regain
                                control
530  B = SPOLL(70903)           Execute a serial poll to clear
                                the Service Request bit in the
                                Status Byte Register
540  REPEAT                     Read all error messages in the
                                multimeter's error queue
550    OUTPUT 70903; "SYST:ERR?" Read error queue
560    ENTER 70903; Code,Message$ Enter error code and message
570    PRINT Code,Message$      Print results
580  UNTIL Code = 0
590  OUTPUT 70903; "*CLS"       Clear all bits in the
                                multimeter's Standard Event
                                Status Register

600 STOP
610 SUBEND
```

## Comments

**The Error Queue:** As multimeter errors are detected, they are placed in its error queue. The error queue is first-in, first-out. This means that if several error messages are waiting in the queue, each SYST:ERR? command will return the oldest error message, and that message will be deleted from the queue.

If the error queue fills to 30 entries, the last error in the queue is replaced with -350, "Too many errors". No additional errors are accepted by the queue until space becomes available using SYST:ERR?, or the queue is cleared using the \*CLS command. When SYST:ERR? is sent while the error queue is empty, the multimeter responds with +0, "No error".

**Overload Condition:** An overload condition (e.g., 9.9000000E + 37) sets the Device Dependent Error bit in the Standard Event Status Register. In this example, an overload condition will interrupt the computer and execute the error subprogram. However, an overload does not generate an error message and +0, "No error" is displayed (if no other errors are in the error queue).

## Additional Measurement Functions

For simplicity, all example programs in this chapter use DC voltage as the measurement function. To select a different measurement function, simply replace the *function* parameter in the CONFigure or MEASure command. Table 3-2 lists the syntax statements for the MEASure and CONFigure commands.

*NOTE: For additional information on the MEASure and CONFigure commands and their parameters, refer to Chapter 5 “Multimeter Command Reference.”*

**Table 3-2. CONFigure and MEASure Syntax Statements**

Command	Description
<b>CONFigure</b> :FREQuency [ <expected value> [, <resolution> ] ] :FRESistance [ <expected value> [, <resolution> ] ] :PERiod [ <expected value> [, <resolution> ] ] :RESistance [ <expected value> [, <resolution> ] ] :TEMPerature <transducer> , <type> :VOLTage:AC [ <expected value> [, <resolution> ] ] :VOLTage:ACDC [ <expected value> [, <resolution> ] ] :VOLTage[:DC] [ <expected value> [, <resolution> ] ]	Configure multimeter for frequency. Configure multimeter for 4-wire ohms. Configure multimeter for period. Configure multimeter for 2-wire ohms. Configure multimeter for temperature. Configure multimeter for AC voltage. Configure multimeter for AC + DC voltage. Configure multimeter for DC voltage.
<b>MEASure</b> :FREQuency? [ <expected value> [, <resolution> ] ] :FRESistance? [ <expected value> [, <resolution> ] ] :PERiod? [ <expected value> [, <resolution> ] ] :RESistance? [ <expected value> [, <resolution> ] ] :TEMPerature? <transducer> , <type> :VOLTage:AC? [ <expected value> [, <resolution> ] ] :VOLTage:ACDC? [ <expected value> [, <resolution> ] ] :VOLTage[:DC]? [ <expected value> [, <resolution> ] ]	Make frequency measurement. Make 4-wire ohms measurement. Make period measurement. Make 2-wire ohms measurement. Make temperature measurement. Make AC voltage measurement. Make AC + DC voltage measurement. Make DC voltage measurement.

# Contents

---

## Chapter 4 - Understanding the Multimeter

About This Chapter . . . . .	4-1
Using MEASure and CONFigure . . . . .	4-1
Making Measurements Using MEASure . . . . .	4-2
Making Measurements Using CONFigure . . . . .	4-4
Storing Readings in Memory . . . . .	4-5
Retrieving Readings From Memory . . . . .	4-6
Measurement Data Format . . . . .	4-7
Overload Indication . . . . .	4-7
The Output Buffer . . . . .	4-7
Measurement Functions . . . . .	4-8
Voltage Measurements . . . . .	4-8
Resistance Measurements . . . . .	4-9
Frequency and Period Measurements . . . . .	4-11
Temperature Measurements . . . . .	4-12
Multimeter Parameters . . . . .	4-13
Enabling/Disabling the Input Terminals . . . . .	4-13
Checking the Input Terminal State . . . . .	4-13
Specifying the AC Bandwidth . . . . .	4-13
Checking the AC Bandwidth . . . . .	4-14
Specifying the AC Input Coupling Source . . . . .	4-15
Checking the AC Input Coupling Source . . . . .	4-15
Autorange . . . . .	4-15
Checking the Autorange Setting . . . . .	4-16
Specifying the Range . . . . .	4-16
Checking the Range . . . . .	4-16
Specifying the Resolution . . . . .	4-17
Checking the Resolution . . . . .	4-17
Aperture and Integration Times . . . . .	4-18
Checking the Aperture and Integration Times . . . . .	4-20



<b>Multimeter Parameters (continued)</b>	
The Autozero Function . . . . .	4-21
Checking the Autozero Function . . . . .	4-21
Offset Compensation . . . . .	4-21
Checking the Offset Compensation Setting . . . . .	4-22
Fixed Input Impedance . . . . .	4-22
Checking the Fixed Input Impedance Mode . . . . .	4-23
<b>Triggering the Multimeter . . . . .</b>	<b>4-23</b>
The Trigger Source . . . . .	4-25
Checking the Trigger Source . . . . .	4-26
The Trigger Slope . . . . .	4-26
Checking the Trigger Slope . . . . .	4-26
The Trigger Count . . . . .	4-26
Checking the Trigger Count . . . . .	4-27
Inserting a Trigger Delay . . . . .	4-27
Default Delays . . . . .	4-28
Checking the Delay Time . . . . .	4-30
The Sample Count . . . . .	4-30
Checking the Sample Count . . . . .	4-31
The Sample Rate . . . . .	4-31
Checking the Sample Source . . . . .	4-33
Checking the Sample Rate . . . . .	4-33
The Wait-For-Trigger State . . . . .	4-33
Sending a Single Trigger . . . . .	4-34
Trigger Buffering . . . . .	4-35
Checking the Trigger Buffer State . . . . .	4-35
Aborting a Measurement . . . . .	4-35
Routing Voltmeter Complete to the Trigger Lines . . . . .	4-36
Checking the Voltmeter Complete Destination . . . . .	4-36
<b>Saving Multimeter Configurations . . . . .</b>	<b>4-37</b>

## Understanding the Multimeter

---

### About This Chapter

Chapter 3 showed you how to make measurements using the MEASure and CONFigure commands without much detail about the parameters involved. Chapter 4 describes the individual measurement parameters (range, resolution, integration time, etc.) used to configure the multimeter for measurements and optimize its performance. You will also learn how to program the multimeter's trigger system and save entire multimeter configurations in memory.

This chapter is divided into the following sections:

- Using MEASure and CONFigure
- Measurement Functions
- Multimeter Parameters
- Triggering the Multimeter
- Saving Multimeter Configurations

*NOTE: Throughout this chapter, optional command parameters are shown enclosed in square brackets ([ ]). For additional information on any SCPI command discussed in this chapter, refer to Chapter 5 "Multimeter Command Reference."*

---

### Using MEASure and CONFigure

The easiest way to make measurements is to use the MEASure or CONFigure command. All you have to do is specify a function, expected value, and resolution. Other measurement parameters (aperture time, integration time, trigger count, etc.) are automatically set to default values for you.

Executing the MEASure or CONFigure command is equivalent to configuring the multimeter with the "low-level" commands shown in Table 4-1. When using CONFigure, you can change the multimeter's default configuration by executing the low-level commands. Refer to "Multimeter Parameters" and "Triggering the Multimeter," later in this chapter, for more information on using the low-level commands.

**Table 4-1. Default Configuration Using CONFIGure or MEASure**

Parameter	Command	Setting
Function	SENSe:FUNCTION:FREQuency, SENSe:FUNCTION:FRESistance, SENSe:FUNCTION:PERiod, SENSe:FUNCTION:RESistance, SENSe:FUNCTION:VOLTage:AC, or SENSe:FUNCTION:VOLTage:DC	As specified by CONFIGure.
Range	SENSe:RESistance:RANGE or SENSe:VOLTage:RANGE	As specified, or autorange.
Autozero	CALibration:ZERO:AUTO	ON (performs autozero after each measurement).
Input Terminals	INPut:STATe	ON (connects input source).
Input Coupling	INPut:COUPling	AC Voltage.
Integration Time	SENSe:RESistance:NPLC or SENSe:VOLTage:NPLC	1 Power Line Cycle (PLC), or based on specified resolution.
Aperture Time	SENSe:RESistance:APERture or SENSe:VOLTage:APERture	16.7 ms (60 Hz) or 20 ms (50 Hz), or based on specified resolution.
Offset Compensation	SENSe:RESistance:OCOMPensated	OFF (useful for resistance measurements only).
Input Impedance	INPut:IMPedance:AUTO	ON (useful for DC voltage measurements only).
AC Bandwidth	SENSe:BANDwidth:DETector	Selects slow measurement mode (useful for AC voltage, frequency, and period measurements only).
Readings per Trigger	SAMPlE:COUNT	1 reading.
Trigger Source	TRIGger:SOURce	IMMediate (trigger signal is always true).
Trigger Count	TRIGger:COUNT	1 trigger.
Trigger Delay	TRIGger:DELay	Default (see Table 4-9).

## Making Measurements Using MEASure

The MEASure command configures the multimeter to perform the specified measurement. However, unlike the CONFIGure command, MEASure immediately makes the measurement and sends the readings to the output buffer. The only measurement parameters that you can control when using MEASure are function, range, and resolution (i.e., the low-level commands cannot be used with MEASure).

You can configure the multimeter for the following functions: frequency, 4-wire resistance, period, temperature, 2-wire resistance, AC voltage, AC + DC voltage, and DC voltage. The MEASure subsystem syntax follows.

## MEASure

:FREQUency? [ < *expected value* > [, < *resolution* > ]]  
:FRESistance? [ < *expected value* > [, < *resolution* > ]]  
:PERiod? [ < *expected value* > [, < *resolution* > ]]  
:RESistance? [ < *expected value* > [, < *resolution* > ]]  
:TEMPerature? < *transducer* > , < *type* >  
:VOLTage:AC? [ < *expected value* > [, < *resolution* > ]]  
:VOLTage:ACDC? [ < *expected value* > [, < *resolution* > ]]  
:VOLTage[:DC]? [ < *expected value* > [, < *resolution* > ]]

The *expected value* parameter specifies the expected value of the input signal. The multimeter then selects the correct range. By not specifying a value for the *expected value* parameter, or by substituting “AUTO” or “DEF”, the multimeter selects the autorange mode.

By substituting “MIN” for the *expected value* parameter, the multimeter selects the minimum range available for that function. By substituting “MAX” for the *expected value* parameter, the multimeter selects the maximum range.

The *resolution* parameter specifies the desired resolution for the measurement. By not specifying a value for the *resolution* parameter, or by substituting “DEF”, the multimeter selects a resolution of 1 power line cycle (PLC).

By substituting “MIN” for the *resolution* parameter, the multimeter selects the minimum resolution available for that function. By substituting “MAX” for the *resolution* parameter, the multimeter selects the maximum resolution.

For temperature measurements, the *transducer* parameter specifies the transducer (RTD or thermistor) and *type* specifies the transducer type (5 k $\Omega$  thermistor, type 85 RTD, etc.). Range and resolution parameters are not available for temperature measurements.

**NOTE:** For a complete listing of range and resolution values available for each function, refer to “Measurement Functions” later in this chapter.

### Example: Making Measurements Using MEASure

The following program configures the multimeter to make a DC voltage measurement on the 30V range with 1 mV resolution. The measurement is taken and the reading is sent to the output buffer as soon as the MEASure command is executed.

```
MEAS:VOLT:DC? 8.25,1.0E-3
```

*Function: DC voltage;  
range selected: 30V;  
resolution selected: 1 mV;  
trigger source is IMMEDIATE  
by default*

```
enter statement
```

*Enter reading into computer*

## Making Measurements Using CONFigure

The CONFigure command configures the multimeter to perform the specified measurement but *does not* automatically make the measurement. Therefore, after initially configuring the multimeter, you can change the individual measurement parameters using low-level commands (Table 4-1).

You can configure the multimeter for the following functions: frequency, 4-wire resistance, period, temperature, 2-wire resistance, AC voltage, AC + DC voltage, and DC voltage. The CONFigure subsystem syntax follows.

### CONFigure

```
:FREQuency [ <expected value > [, <resolution > ] ]  
:FRESistance [ <expected value > [, <resolution > ] ]  
:PERiod [ <expected value > [, <resolution > ] ]  
:RESistance [ <expected value > [, <resolution > ] ]  
:TEMPerature <transducer > , <type >  
:VOLTage:AC [ <expected value > [, <resolution > ] ]  
:VOLTage:ACDC [ <expected value > [, <resolution > ] ]  
:VOLTage[:DC] [ <expected value > [, <resolution > ] ]
```

The *expected value* parameter specifies the expected value of the input signal. The multimeter then selects the correct range. By not specifying a value for the *expected value* parameter, or by substituting “AUTO” or “DEF”, the multimeter selects the autorange mode.

By substituting “MIN” for the *expected value* parameter, the multimeter selects the minimum range available for that function. By substituting “MAX” for the *expected value* parameter, the multimeter selects the maximum range.

The *resolution* parameter specifies the desired resolution for the measurement. By not specifying a value for the *resolution* parameter, or by substituting “DEF”, the multimeter selects a resolution of 1 power line cycle (PLC).

By substituting “MIN” for the *resolution* parameter, the multimeter selects the minimum resolution available for that function. By substituting “MAX” for the *resolution* parameter, the multimeter selects the maximum resolution.

For temperature measurements, the *transducer* parameter specifies the transducer (RTD or thermistor) and *type* specifies the transducer type (5 k $\Omega$  thermistor, type 85 RTD, etc.). Range and resolution parameters are not available for temperature measurements.

**NOTE:** For a complete listing of range and resolution values available for each function, refer to “Measurement Functions” later in this chapter.

## Making the Measurement

After the multimeter is configured with CONFIGure, use the READ? command to place the multimeter in the wait-for-trigger state and send the readings to the output buffer when the trigger occurs. Or, use the INITiate[:IMMediate] command to place the multimeter in the wait-for-trigger state and store readings in multimeter memory when the trigger occurs.

The READ? and INITiate commands will make the measurement when executed if the trigger source is TRIGger:SOURce IMMEDIATE. If the trigger source is changed after CONFIGure is executed, the READ? and INITiate commands place the multimeter in the wait-for-trigger state. However, a measurement is not made until the trigger is received from the specified source. For more information on triggering, refer to "Triggering the Multimeter."

### Example: Making Measurements Using CONFIGure

The following program makes eight 4-wire resistance measurements with the best possible resolution. The trigger source for the measurement is the multimeter's external trigger BNC connector. The expected value for each reading is approximately 2.5 k $\Omega$ . The readings are sent to the output buffer.

dimension array	<i>Dimension computer array</i>
CONF:FRES 2.5E + 3,MIN	<i>Function: 4-wire ohms; range selected: 3 k<math>\Omega</math>; MIN resolution: 1 m<math>\Omega</math></i>
TRIG:SOUR EXT	<i>Trigger source is external trigger BNC connector on multimeter front panel</i>
TRIG:COUN 8	<i>Multimeter will accept 8 external triggers (one measurement is taken per trigger)</i>
READ?	<i>Place multimeter in wait-for-trigger state; make measurements when external trigger is received; send readings to output buffer</i>
enter statement	<i>Enter readings into computer</i>

## Storing Readings in Memory

As described earlier, the INITiate command places the multimeter in the wait-for-trigger state and stores readings in multimeter memory. The multimeter has enough memory available to store up to 4,096 readings. Readings stored in memory from previous commands are replaced by the new readings.

Storing readings in multimeter memory using the INITiate command is faster than sending readings to the output buffer using the READ? command. Storing readings in memory also ensures that the period between readings is constant.

**NOTE:** You can also store readings on external VME memory cards. See the MEMory command subsystem in Chapter 5 "Multimeter Command Reference" for more information.

### Example: Storing Readings in Memory

The following program makes eight DC voltage measurements. The trigger source for the measurement is the multimeter's external trigger BNC connector. The expected value for each reading is approximately 25 volts. The readings are stored in multimeter memory.

dimension array	<i>Dimension computer array</i>
CONF:VOLT:DC 25,MAX	<i>Function: DC voltage; range selected: 30V; MAX resolution: 10 mV (for fastest measurements)</i>
TRIG:SOUR EXT	<i>Trigger source is external trigger BNC connector on multimeter front panel</i>
TRIG:COUN 8	<i>Multimeter will accept 8 external triggers (one measurement is taken per trigger)</i>
INIT	<i>Place multimeter in wait-for-trigger state; store readings in memory when trigger is received</i>

### Retrieving Readings From Memory

The FETCh? command retrieves readings stored in multimeter memory by the most recent INITiate command and places them in the output buffer. The following program shows how to use the FETCh? command.

dimension array	<i>Dimension computer array</i>
CONF:VOLT:DC 25,MAX	<i>Function: DC voltage; range selected: 30V; MAX resolution: 10 mV (for fastest measurements)</i>
TRIG:SOUR EXT	<i>Trigger source is external trigger BNC connector on multimeter front panel</i>
TRIG:COUN 8	<i>Multimeter will accept 8 external triggers (one measurement is taken per trigger)</i>
INIT	<i>Place multimeter in wait-for-trigger state; store readings in memory when trigger is received</i>
FETC?	<i>Place readings in output buffer</i>
enter statement	<i>Enter readings into computer</i>

## Measurement Data Format

Each reading sent to the output buffer consists of 17 bytes (characters) in Real ASCII format:

$\pm 1.23456789E \pm 123 LF$

If multiple readings are returned by a command, the readings are separated by commas. A Line Feed (*LF*) and the HP-IB End-or-Identify (EOI) signal follow the last reading returned.

## Overload Indication

The multimeter indicates an overload condition (input greater than the present range can measure) by sending  $9.9000000E + 37$  to the output buffer instead of a reading. An overload condition sets the Device Dependent Error bit (bit 3) in the Standard Event Status Register. An overload condition also sets the appropriate bits in the Questionable Data/Signal Register:

Voltage Overrange – bit 0  
Period Overrange – bit 2  
Frequency Overrange – bit 5  
Resistance Overrange – bit 9  
Temperature Overrange – bit 10

An overload condition does not generate an error message. If no other errors are present in the error queue at the time of the overload, the multimeter responds with +0, "No error".

**NOTE:** *For frequency and period measurements, an overload condition exists when the input voltage (not the input frequency) exceeds the allowable limits.*

**NOTE:** *If the inguard A/D converter does not respond to the multimeter's outguard, a reading of  $9.9100000E + 37$  is returned. This reading, which is very similar to the overload indication, is sent to the output buffer after the multimeter's internal timeout occurs. This condition sets the Device Dependent Error bit (bit 3) in the Standard Event Status Register and places +1102, "A/D timeout" in the error queue.*

## The Output Buffer

The multimeter's output buffer capacity is 128 bytes. Therefore, seven readings (17 bytes each) can be transferred to the output buffer at a time. The multimeter remains "busy" until you begin removing readings from the output buffer using your computer's enter statement. New data sent to the output buffer overwrites data sent from previous commands.



## Measurement Functions

This section describes the measurement functions (AC voltage, 2-wire ohms, frequency, etc.) and shows the ranges and resolution available for each. You can use the CONFIGure, MEASure, and SENSE commands to select the measurement function. This section gives the complete command syntax statements for each function. Refer to Chapter 5 “Multimeter Command Reference” for detailed information on each command.

## Voltage Measurements

The multimeter can make DC voltage, AC voltage, and AC + DC voltage measurements. Table 4-2 shows the voltage ranges and the resolution available for the various aperture times or integration times.

**Table 4-2. DC, AC, or AC + DC Voltage: Resolution versus Aperture or Integration Times**

Range	Maximum Reading	*Effective Resolution versus Aperture Time (seconds) or Integration Time (PLCs)					
		1.67s (2.0s) 100 PLCs	167 ms (200 ms) 10 PLCs	16.7 ms (20.0 ms) 1 PLC	1.67 ms (2.0 ms) 0.1 PLCs	100 $\mu$ s (100 $\mu$ s) 0.005 PLCs	10 $\mu$ s (10 $\mu$ s) 0.0005 PLCs
30 mV	30.30000 mV	10 nV	10 nV	10 nV	100 nV	1 $\mu$ V	10 $\mu$ V
300 mV	303.0000 mV	100 nV	100 nV	100 nV	1 $\mu$ V	10 $\mu$ V	100 $\mu$ V
3V	3.030000V	1 $\mu$ V	1 $\mu$ V	1 $\mu$ V	10 $\mu$ V	100 $\mu$ V	1 mV
30V	30.30000V	10 $\mu$ V	10 $\mu$ V	10 $\mu$ V	100 $\mu$ V	1 mV	10 mV
300V	300.0000V	100 $\mu$ V	100 $\mu$ V	100 $\mu$ V	1 mV	10 mV	100 mV

\*In 10 and 100 NPLC, more digits may be returned.

NOTE: 50 Hz aperture times are enclosed in parentheses.

## DC Voltage Measurements

The multimeter can measure DC voltage from 30 mV to 300V with resolution from 10 nV to 100  $\mu$ V depending on aperture or integration time selected. DC voltage is the multimeter’s power-on function.

Each of the following commands selects the DC voltage function:

```
MEASure:VOLTage:DC? [<expected value> [, <resolution>]]
CONFIGure:VOLTage:DC [<expected value> [, <resolution>]]
[SENSE:]FUNCTION:VOLTage[:DC]
```

## AC and AC + DC Voltage Measurements

The multimeter can measure AC or AC + DC voltages in a bandwidth of 20 Hz to 1 MHz for all ranges. The multimeter uses a true RMS-to-DC converter for AC and AC + DC voltage measurements. It can measure the true RMS value of signals that are noisy, non-periodic, or non-sinusoidal such as sawtooth, triangle, and square waveforms. It also measures the true RMS value of low repetition rate, high crest factor (ratio of peak to RMS) pulse trains. In addition, the RMS-to-DC converter can measure any of these waveforms riding on a DC voltage level and can either include the DC level in the RMS value (AC + DC voltage measurements) or block the DC component (AC voltage measurements).

Each of the following commands selects the AC voltage function:

```
MEASure:VOLTage:AC? [ < expected value > [, < resolution > ]]
CONFigure:VOLTage:AC [ < expected value > [, < resolution > ]]
[SENSe:]FUNctIon:VOLTage:AC;:INPut:COUPling AC
```

Each of the following commands selects the AC + DC voltage function:

```
MEASure:VOLTage:ACDC? [ < expected value > [, < resolution > ]]
CONFigure:VOLTage:ACDC [ < expected value > [, < resolution > ]]
[SENSe:]FUNctIon:VOLTage:AC;:INPut:COUPling DC
```

## Resistance Measurements

The multimeter can make 2-wire and 4-wire resistance measurements. Table 4-3 shows the resistance ranges and the resolution available for the various aperture times or integration times.

**Table 4-3. 2-Wire or 4-Wire Ohms: Resolution versus Aperture or Integration Times**

Range	Maximum Reading	*Effective Resolution versus Aperture Time (seconds) or Integration Time (PLCs)					
		1.67s (2.0s) 100 PLCs	167 ms (200 ms) 10 PLCs	16.7 ms (20.0 ms) 1 PLC	1.67 ms (2.0 ms) 0.1 PLCs	100 μs (100 μs) 0.005 PLCs	10 μs (10 μs) 0.0005 PLCs
30Ω	30.30000Ω	10 μΩ	10 μΩ	10 μΩ	100 μΩ	1 mΩ	10 mΩ
300Ω	303.0000Ω	100 μΩ	100 μΩ	100 μΩ	1 mΩ	10 mΩ	100 mΩ
3 kΩ	3.030000 kΩ	1 mΩ	1 mΩ	1 mΩ	10 mΩ	100 mΩ	1 Ω
30 kΩ	30.30000 kΩ	10 mΩ	10 mΩ	10 mΩ	100 mΩ	1 Ω	10 Ω
300 kΩ	303.0000 kΩ	100 mΩ	100 mΩ	100 mΩ	1 Ω	10 Ω	100Ω
3 MΩ	3.030000 MΩ	1Ω	1Ω	1 Ω	10Ω	100Ω	1 kΩ
30 MΩ	30.30000 MΩ	10Ω	10Ω	10Ω	100Ω	1 kΩ	10 kΩ
300 MΩ	303.0000 MΩ	100Ω	100Ω	100Ω	1 kΩ	10 kΩ	100 kΩ
3 GΩ	3.030000 GΩ	1 kΩ	1 kΩ	1 kΩ	10 kΩ	100 kΩ	1 MΩ

\*In 10 and 100 NPLC, more digits may be returned.

NOTE: 50 Hz aperture times are enclosed in parentheses.

The multimeter measures resistance by sourcing a known current through the unknown resistance being measured. The current passing through the resistance generates a voltage across the resistance. The multimeter measures this voltage and calculates the unknown resistance (*resistance = voltage/current*). Table 4-4 shows the nominal current sourced on each range for both 2-wire and 4-wire measurements.

**NOTE:** *The offset compensation function prevents small external offset voltages from affecting 2-wire and 4-wire resistance measurements. Refer to "Offset Compensation," later in this chapter, for more information.*

**Table 4-4. Resistance Range versus Current Sourced**

Range	Current Sourced
30Ω	1 mA
300Ω	1 mA
3 kΩ	1 mA
30 kΩ	100 μA
300 kΩ	10 μA
3 MΩ	1 μA
30 MΩ	100 nA
300 MΩ	100 nA*
3 GΩ	100 nA*

\* Current source is in parallel with 10 MΩ resistor.

### **2-Wire Resistance Measurements**

Use the 2-wire resistance function in applications where the test lead resistance is not critical. Since the multimeter measures the total resistance between its terminals, lead resistance that is large relative to the unknown resistance will cause inaccurate measurements. Therefore, for all resistance measurements and especially those on the lower ranges, make the test leads as short as possible.

Each of the following commands selects the 2-wire resistance function:

```
MEASure:RESistance? [<expected value> [, <resolution> ]]  
CONFigure:RESistance [<expected value> [, <resolution> ]]  
[SENSe:]FUNctioN:RESistance
```

### **4-Wire Resistance Measurements**

The 4-wire resistance function eliminates the measurement error caused by test lead resistance. In the 2-wire mode, the voltage measurement is made across the combined resistance of the test wiring and the unknown resistance. In the 4-wire mode, the voltage is measured across the unknown resistance only, not the combined resistance. The 4-wire resistance function is essential when the greatest accuracy is required, especially when the test lead resistance is high in comparison to the resistance being measured.

Each of the following commands selects the 4-wire resistance function:

```
MEASure:FRESistance? [<expected value> [, <resolution> ]]  
CONFigure:FRESistance [<expected value> [, <resolution> ]]  
[SENSe:]FUNctioN:FRESistance
```

## Frequency and Period Measurements

The multimeter's frequency and period counter accepts AC voltage or AC + DC voltage as inputs. You must specify whether the input is AC- or DC-coupled using the `INPut:COUPling` command. The multimeter can make frequency measurements from 10 Hz to 1.5 MHz or period measurements from 100 ms to 667 ns.

Each of the following commands selects the frequency function (AC-coupled):

```
MEASure:FREQuency? [ < expected value > [, < resolution > ]]  
CONFigure:FREQuency [ < expected value > [, < resolution > ]];  
:INPut:COUPling AC  
[SENSe:]FUNction:FREQuency;:INPut:COUPling AC
```

Each of the following commands selects the frequency function (DC-coupled):

```
CONFigure:FREQuency [ < expected value > [, < resolution > ]];  
:INPut:COUPling DC  
[SENSe:]FUNction:FREQuency;:INPut:COUPling DC
```

Each of the following commands selects the period function (AC-coupled):

```
MEASure:PERiod? [ < expected value > [, < resolution > ]]  
CONFigure:PERiod [ < expected value > [, < resolution > ]];  
:INPut:COUPling AC  
[SENSe:]FUNction:PERiod;:INPut:COUPling AC
```

Each of the following commands selects the period function (DC-coupled):

```
CONFigure:PERiod [ < expected value > [, < resolution > ]];  
:INPut:COUPling DC  
[SENSe:]FUNction:PERiod;:INPut:COUPling DC
```

## Temperature Measurements

The multimeter can measure temperature using either thermistors or RTDs. The MEASure and CONFigure commands return all temperature measurements in Degrees Celsius.

### Thermistor Measurements

The following thermistor types are supported by the MEASure and CONFigure commands: 2252 $\Omega$ , 5 k $\Omega$ , and 10 k $\Omega$ . You can make thermistor measurements using either a 2-wire or 4-wire configuration.

Each of the following commands selects the 2-wire thermistor function (specify *type* as 2252, 5000, or 10000):

```
MEASure:TEMPerature? THERmistor , <type >  
CONFigure:TEMPerature THERmistor , <type >
```

Each of the following commands selects the 4-wire thermistor function (specify *type* as 2252, 5000, or 10000):

```
MEASure:TEMPerature? FTHERmistor , <type >  
CONFigure:TEMPerature FTHERmistor , <type >
```

### RTD Measurements

The following RTD types are supported by the MEASure and CONFigure commands: 85 (0.00385  $\Omega/\Omega/^\circ\text{C}$ ) and 92 (0.00392  $\Omega/\Omega/^\circ\text{C}$ ). You can make RTD measurements using either a 2-wire or 4-wire configuration.

Each of the following commands selects the 2-wire RTD function (specify *type* as 85 or 92):

```
MEASure:TEMPerature? RTD , <type >  
CONFigure:TEMPerature RTD , <type >
```

Each of the following commands selects the 4-wire RTD function (specify *type* as 85 or 92):

```
MEASure:TEMPerature? FRTD , <type >  
CONFigure:TEMPerature FRTD , <type >
```

## Multimeter Parameters

As described earlier in this chapter (Table 4-1), executing the MEASure or CONFigure command is equivalent to configuring the multimeter with a series of low-level commands. In addition to selecting a function, range, and resolution, these low-level commands configure the multimeter's analog-to-digital (A/D) converter and other portions of its measurement circuitry.

This section describes the low-level commands and the multimeter parameters that these commands control (e.g., input terminals, AC bandwidth, frequency source, aperture and integration time, offset compensation, etc.). Refer to Chapter 5 "Multimeter Command Reference" for detailed information on each low-level command discussed in this section.

**NOTE:** *The low-level commands are most commonly used with the CONFigure and SENSE commands to change specific measurement parameters without completely reconfiguring the multimeter. Remember that the only parameters that can be changed when using MEASure are function, range, and resolution.*

### Enabling/Disabling the Input Terminals

The INPut:STATe <mode> command enables or disables the multimeter's input terminals. The input terminals are either connected (enabled) or open (disabled). To enable the input terminals (this is the power-on state), send:

```
INPut:STATe ON
```

To disconnect the HI, LO,  $\Omega$  SENSE HI, and  $\Omega$  SENSE LO terminals, send the following command. (The Guard, External Trigger, and Voltmeter Complete terminals are not affected by this command.)

```
INPut:STATe OFF
```

### Checking the Input Terminal State

The INPut:STATe? command returns a number to show whether the input terminals are connected or open: "1" = ON (connected), "0" = OFF (open). The number is sent to the output buffer.

### Specifying the AC Bandwidth

For any type of AC measurement (ACV, ACDCV, FREQ, and PER), you should specify the AC fast or slow measurement mode. The slow mode is for frequencies below 400 Hz. In the slow mode, a longer time constant is used for the input filter in ACV and ACDCV and a longer settling time (delay) is used (compared to the fast mode) for ACV, ACDCV, FREQ, and PER. The fast mode is for signals above 400 Hz and uses a shorter time constant and delay time. Table 4-9 (later in this chapter in the "Default Delays" section) shows the various delay times used in the fast and slow modes. Table 4-5 shows the measurement speeds for AC measurements made in the fast or slow mode for the various integration times or aperture times.

**Table 4-5. AC Fast versus Slow Mode (ACV or ACDCV)**

Aperture Time*	Power Line Cycles	Readings per Second			
		Slow Mode		Fast Mode	
		60 Hz	50 Hz	60 Hz	50 Hz
10 $\mu$ s (10 $\mu$ s)	0.0005	1	1	9.5	9.5
100 $\mu$ s (100 $\mu$ s)	0.005	1	1	9.5	9.5
1.67 ms (2.0 ms)	0.1	1	1	9.25	9.2
16.7 ms (20.0 ms)	1	1	1	7.25	6.9
167 ms (200 ms)	10	0.7	0.65	2.0	1.7
1.67s (2.0s)	100	0.2	0.17	0.25	0.2

\* 50 Hz aperture times are enclosed in parentheses.

The [SENSE:]BANDwidth:DETECTOR <frequency> command selects the AC fast or slow mode. You specify *frequency* as the expected frequency of the input signal. The multimeter selects the slow mode (20 Hz is used) or fast mode (400 Hz is used) based on the frequency you specify. At power-on or after a \*RST (reset), the slow mode is selected. (The MEASURE and CONFIGURE commands automatically select the slow mode.)

If you specify a frequency value greater than or equal to 400 Hz, the multimeter selects the fast mode. If you specify a value less than 400 Hz, the multimeter selects the slow mode. For example, the following program statement selects the fast mode.

```
SENSE:BANDwidth:DETECTOR 5000
```

**NOTE:** *If you are unsure of the input frequency, or if the frequency may dip below 400 Hz, use the slow mode. This takes slightly more time per measurement, but ensures accurate measurements.*

### Checking the AC Bandwidth

The SENSE:BANDwidth:DETECTOR? [MINimum | MAXimum] command returns one of the following numbers to the output buffer:

- The present bandwidth (in hertz) selected by the multimeter (either 20 or 400) if MIN or MAX is not specified.
- The minimum bandwidth available (20) if MIN is specified.
- The maximum bandwidth available (400) if MAX is specified.

## Specifying the AC Input Coupling Source

The `INPut:COUPling <source>` command selects the AC input coupling source for AC voltage, frequency, and period measurements. To select AC voltage as the input coupling source (this is the power-on configuration), send:

```
INPut:COUPling AC
```

To select AC + DC voltage as the input coupling source, send:

```
INPut:COUPling DC
```

**NOTE:** To make AC + DC voltage measurements using the `SENSe` command, send the following command sequence:

```
SENSe:FUNCTION:VOLTage:AC;:INPut:COUPling DC
```

## Checking the AC Input Coupling Source

The `INPut:COUPling?` command returns “AC” or “DC” to show the present AC input coupling source. The string is sent to the output buffer.

## Autorange

When the autorange mode is enabled, the multimeter samples the input signal before each measurement and selects the appropriate range. At power-on, the autorange mode is enabled. Therefore, if you are measuring a fairly stable input signal, you can allow autorange to select the correct range and then disable autorange. This allows you to get the automatic range selection advantage of autorange and also the speed advantage of readings made with autorange disabled.

Each of the following commands enables or disables the autorange function for resistance or voltage measurements:

```
SENSe:RESistance:RANGe:AUTO <mode>  
SENSe:VOLTage:RANGe:AUTO <mode>
```

Substituting “OFF” for the *mode* parameter disables autoranging. Substituting “ON” for the *mode* parameter enables autoranging.

You have several ways to control the autorange mode when using the `MEASure` or `CONFigure` commands. Autorange is enabled if you substitute “AUTO” or “DEF” for the *expected value* parameter (or default the parameter). Autoranging is disabled if you specify a numeric value for the *expected value* parameter.



## Checking the Autorange Setting

Each of the following commands returns a number to show whether the autorange mode is enabled or disabled: “1” = ON, “0” = OFF. The number is sent to the output buffer.

```
SENSe:RESistance:RANGe:AUTO?  
SENSe:VOLTage:RANGe:AUTO?
```

## Specifying the Range

To specify a range without reconfiguring the multimeter by sending MEASure or CONFigure, you can use one of the commands shown below. For a complete listing of the range and resolution values available, see Table 4-2 and Table 4-3 earlier in this chapter.

```
SENSe:RESistance:RANGe <expected value >  
SENSe:VOLTage:RANGe <expected value >
```

The *expected value* parameter specifies the expected value of the input signal. The multimeter then selects the correct range.

By substituting “MIN” for the *expected value* parameter, the multimeter selects the minimum range available for that function. By substituting “MAX” for the *expected value* parameter, the multimeter selects the maximum range.

**NOTE:** The multimeter indicates an overload condition (input greater than the present range can measure) by sending 9.9000000E + 37 to the output buffer instead of a reading.

**NOTE:** For frequency and period measurements, an overload condition exists when the input voltage (not the input frequency) exceeds the allowable limits.

## Checking the Range

You can use either of the following low-level commands to check the measurement range on the specified function.

```
SENSe:RESistance:RANGe? [MINimum | MAXimum]  
SENSe:VOLTage:RANGe? [MINimum | MAXimum]
```

These commands return one of the following numbers to the output buffer:

- The present range selected for the specified function if MIN or MAX is not specified.
- The minimum range available for the specified function if MIN is specified.
- The maximum range available for the specified function if MAX is specified.

## Specifying the Resolution

To specify a resolution without reconfiguring the multimeter by sending MEASure or CONFigure, you can use one of the following commands. For a complete listing of the range and resolution values available, see Table 4-2 and Table 4-3 earlier in this chapter.

```
SENSE:RESistance:RESolution <resolution >  
SENSE:VOLTage:RESolution <resolution >
```

The *resolution* parameter specifies the desired resolution for the measurement. By substituting “MIN” for the *resolution* parameter, the multimeter selects the minimum resolution available for that function. By substituting “MAX” for the *resolution* parameter, the multimeter selects the maximum resolution.

Specify a resolution only when making measurements on a fixed range. Otherwise, the resolution will change to correspond to the range selected during autorange. Resolution also affects the reading rate. The better the resolution, the slower the reading rate.

Setting the resolution also sets the aperture time and integration time. Of these three parameters (resolution, aperture time, and integration time), the settings of the other two are based on the one most recently set. For example, specifying a resolution of 10  $\mu$ V on the 3V range (Table 4-2), sets a 1.67 ms aperture time and a 0.1 PLC integration time.

## Checking the Resolution

You can use either of the following low-level commands to check the measurement resolution on the specified function.

```
SENSE:RESistance:RESolution? [MINimum | MAXimum]  
SENSE:VOLTage:RESolution? [MINimum | MAXimum]
```

These commands return one of the following numbers to the output buffer:

- The present resolution selected for the specified function and range if MIN or MAX is not specified.
- The minimum resolution available for the specified function and range if MIN is specified.
- The maximum resolution available for the specified function and range if MAX is specified.

## Aperture and Integration Times

The multimeter samples the input signal being measured for a period of time (aperture time or integration time) based on the power line frequency. Aperture time is expressed in seconds and integration time is expressed in power line cycles (PLCs).

The integration time determines the measurement speed, accuracy, maximum digits of resolution, and the amount of normal mode noise rejection (ability to reject noise at multiples of the power line frequency from the measurements). With longer integration times, the measurement resolution, accuracy, and normal mode noise rejection increase, but measurement speed decreases.

Table 4-6 shows the relationship between the integration time in PLCs to the aperture time; the maximum number of digits; the reading rate; the AC normal mode noise rejection (AC NMR); the AC effective common mode noise rejection (AC ECMR); and the DC common mode noise rejection (DC CMR) for DC measurements. Refer to Appendix A for accuracy specifications on each measurement function.

**Table 4-6. A/D Converter Relationships**

Aperture Time	Power Line Cycles	Maximum Number of Digits*	Maximum Reading Rate**		Noise Rejection (dB)***		
			60 Hz	50 Hz	AC NMR	AC ECMR	DC CMR
10 $\mu$ s (10 $\mu$ s)	0.0005	3.5	1450	1450	0 dB	86	140
100 $\mu$ s (100 $\mu$ s)	0.005	4.5	1250	1250	0 dB	86	140
1.67 ms (2.0 ms)	0.1	5.5	360	312	0 dB	86	140
16.7 ms (20.0 ms)	1	6.5	56	47	60 dB	146	140
167 ms (200 ms)	10	6.5	4.9	4.0	80 dB	160	140
1.67s (2.0s)	100	6.5	0.49	0.4	90 dB	160	140

\* Aperture times of 167 ms, 200 ms, 1.67s, and 2s may return extra digits of resolution.

\*\* Autozero off, autorange off, offset compensation off, fixed range, delay=0.

\*\*\* With 1 k $\Omega$  imbalance in the LO lead and a power line frequency of 50 or 60 Hz ( $\pm$  0.08%).

NOTE: 50 Hz aperture times are enclosed in parentheses.

Setting the aperture time or integration time also sets the resolution. Of these three parameters (aperture time, integration time, and resolution), the settings of the other two are based on the one most recently set. For example, specifying an aperture time of 1.67 ms sets the integration to 0.1 PLCs (the resolution selected is based on the present range). The MEASure and CONFigure commands set the integration time to 1 PLC and the aperture time to 16.7 ms (60 Hz) or 20 ms (50 Hz).

NOTE: Use the CALibration:LFrequency command to select the line frequency reference (see Chapter 2).

Each of the following commands sets the aperture time (in seconds) for resistance and voltage measurements.

```
SENSe:RESistance:APERture <time>  
SENSe:VOLTage:APERture <time>
```

By substituting “MIN” for the *time* parameter, the multimeter sets the aperture time to 10  $\mu$ s. By substituting “MAX” for the *time* parameter, the multimeter sets the aperture time to 2.0 seconds.

Each of the following commands set the integration time (in PLCs) for resistance and voltage measurements.

```
SENSe:RESistance:NPLC <number>  
SENSe:VOLTage:NPLC <number>
```

By substituting “MIN” for the *number* parameter, the multimeter sets the integration time to 0.0005 PLCs. By substituting “MAX” for the *number* parameter, the multimeter sets the integration time to 100 PLCs.

To set the integration time for the fastest measurements (with the lowest accuracy, lowest resolution, and no normal mode noise rejection), send:

```
SENSe:VOLTage:NPLC 0.0005
```

To specify the most accuracy, highest resolution, and 90 dB of normal mode noise rejection (with the slowest measurement speed), send:

```
SENSe:VOLTage:NPLC 100
```

The remaining four settings (0.005, 0.1, 1, and 10 PLCs) provide flexibility in the selection of measurement speed, accuracy, resolution, and normal mode noise rejection. Typically, you should select the integration time that provides adequate speed while maintaining an acceptable amount of accuracy, resolution, and normal mode noise rejection.

## Checking the Aperture and Integration Times

You can use either of the following commands to check the aperture time setting for resistance and voltage measurements.

```
SENSe:RESistance:APERture? [MINimum | MAXimum]  
SENSe:VOLTage:APERture? [MINimum | MAXimum]
```

These commands return one of the following numbers to the output buffer:

- The present aperture time in seconds if MIN or MAX is not specified.
- The minimum aperture time available (10  $\mu$ s) if MIN is specified.
- The maximum aperture time available (2.0 seconds) if MAX is specified.

You can use either of the following commands to check the integration time setting for resistance and voltage measurements.

```
SENSe:RESistance:NPLC? [MINimum | MAXimum]  
SENSe:VOLTage:NPLC? [MINimum | MAXimum]
```

These commands return one of the following numbers to the output buffer:

- The present integration time in PLCs if MIN or MAX is not specified.
- The minimum integration time available (0.0005) if MIN is specified.
- The maximum integration time available (100) if MAX is specified.

## The Autozero Function

The autozero function ensures that any offset errors *internal* to the multimeter are nulled from subsequent measurements. You can control the autozero function using the CALibration:ZERO:AUTO <mode> command. With autozero enabled, the multimeter internally disconnects the input signal and makes a zero reading following every measurement. It then subtracts the zero reading from the preceding measurement. This prevents offset voltages on the multimeter's internal circuitry from affecting measurements.

With autozero disabled, a new zero measurement is taken whenever you change the function, range, number of PLCs, input coupling source, or offset compensation mode. At power-on, the autozero function is enabled (CAL:ZERO:AUTO ON). The MEASure and CONFigure commands automatically enable autozero. To disable the autozero function, send:

CALibration:ZERO:AUTO OFF or CALibration:ZERO:AUTO ONCE

## Checking the Autozero Function

The CALibration:ZERO:AUTO? command returns a number to show whether the autozero mode is enabled or disabled: "1" = ON, "0" = OFF or ONCE. The number is sent to the output buffer.

## Offset Compensation

You can use offset compensation for both 2-wire and 4-wire resistance measurements. Offset compensation allows the multimeter to make accurate resistance measurements in the presence of small *external* offset voltages on the 30Ω, 300Ω, and 3 kΩ ranges. Offset compensation does not function on the 30 kΩ through 3 GΩ ranges.

With offset compensation enabled, the multimeter measures the offset voltage prior to each resistance reading. Next, it sources a known current and measures the combination of induced voltage and offset voltage. The multimeter subtracts the offset voltage from the combined voltage leaving only the induced voltage. The multimeter then uses this induced voltage to determine the resistance (*resistance = voltage/current*). Table 4-7 shows the maximum combined voltages that can be present for each range.

Table 4-7. Maximum Combined Voltages

Range	Maximum Offset for Full Scale Measurements	Maximum Combined Voltage
30Ω	0.001V	0.0303V
300Ω	0.01V	0.303V
3 kΩ	0.1V	3.03V

To enable offset compensation, send:

SENSe:RESistance:OCOMpensated ON

To disable offset compensation (this is the power-on configuration), send:

SENSe:RESistance:OCOMpensated OFF

## Checking the Offset Compensation Setting

The SENSe:RESistance:OCOMpensated? command returns a number to show whether offset compensation is enabled or disabled: "1" = ON, "0" = OFF. The number is sent to the output buffer.

## Fixed Input Impedance

When making DC voltage measurements, you can fix the multimeter's input resistance using the INPut:IMPedance:AUTO *<mode>* command. This is useful to prevent a change in input impedance (caused by changing ranges) from affecting the measurements. Table 4-8 shows the input impedance values for the DC voltage ranges with fixed input impedance enabled (AUTO ON) and disabled (AUTO OFF).

Table 4-8. Input Impedances

<i>mode</i> Parameter	Input Impedances	
	30 mV, 300 mV, 3V DCV ranges	30V, 300V DCV ranges
OFF or 0	10 M $\Omega$	10 M $\Omega$
ON or 1	10 G $\Omega$	10 M $\Omega$

To enable the automatic input impedance mode (this is the power-on configuration), send:

INPut:IMPedance:AUTO ON

With the fixed input impedance mode enabled, the multimeter's input impedance is 10 G $\Omega$  on the 30 mV, 300 mV, and 3V ranges.

To disable the automatic input impedance mode, send:

INPut:IMPedance:AUTO OFF

With the fixed input impedance mode disabled, the multimeter maintains its input impedance of 10 M $\Omega$  on all DC voltage ranges.

The automatic input impedance mode remains disabled (AUTO OFF) after you change from DC voltage measurements to 2-wire resistance or 4-wire resistance measurements. This can affect the resistance measurements since the 10 M $\Omega$  resistance remains connected in parallel with the input terminals. Enable the automatic input impedance mode (AUTO ON) before selecting resistance measurements.

The automatic input impedance mode is temporarily enabled (AUTO ON) when you change from DC voltage measurements to AC voltage, AC + DC voltage, frequency, or period measurements. When you return the measurement function to DC voltages, automatic input impedance is again disabled (AUTO OFF).

### Checking the Fixed Input Impedance Mode

The `INPut:IMPedance:AUTO?` command returns a number to show whether the automatic input impedance mode is enabled or disabled: “1” = ON, “0” = OFF. The number is sent to the output buffer.

---

## Triggering the Multimeter

This section discusses the multimeter’s trigger system and outlines the different triggering configurations and programming methods used to control the trigger system. Keep in mind that you do not have to program the trigger system to make measurements. By using the default trigger configuration set by `MEASure` and `CONFigure`, you can avoid having to learn the information in this chapter. However, to take advantage of the flexibility of the multimeter’s trigger system when using the `CONFigure` command, this chapter is the place to find that information.

The multimeter’s trigger system synchronizes measurements with specified internal or external events. These events include software trigger commands, positive- or negative-going edges on the VXIbus trigger lines, and pulses on the multimeter’s external trigger BNC connector. The trigger system also allows you to specify the number of triggers that will be accepted, the number of readings per trigger, and the delay between the trigger and the first reading.

Figure 4-1 summarizes the multimeter’s trigger system and the programming commands that control the trigger system. Notice that the multimeter operates in one of two trigger states. When you are configuring the multimeter for measurements, the multimeter must be in the *idle* state. After configuring the multimeter, the multimeter must be placed in the *wait-for-trigger* state.



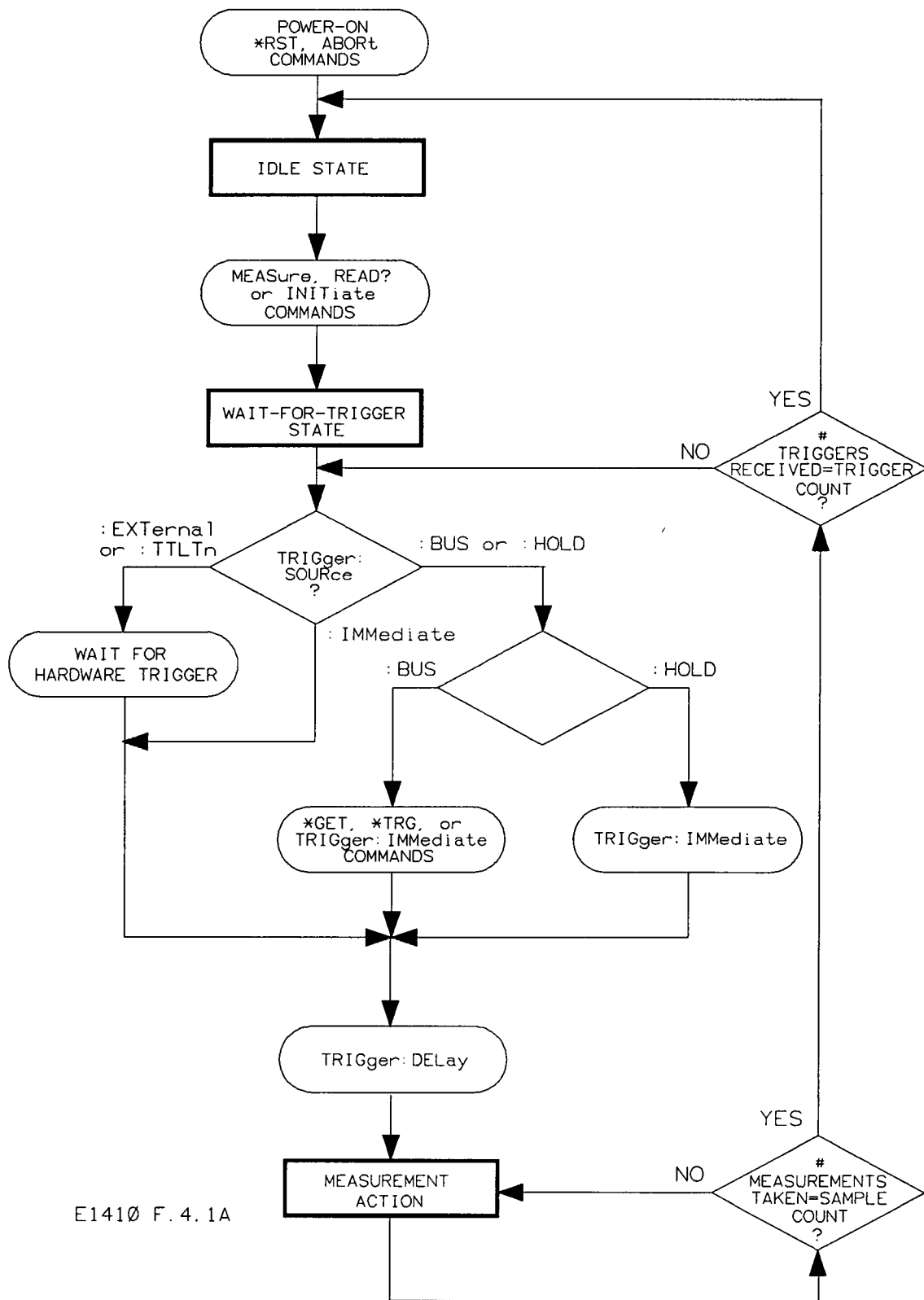

E1410 F. 4. 1A

Figure 4-1. The Multimeter Trigger System

## The Trigger Source

The TRIGger:SOURce <source > command configures the multimeter's trigger system to respond to the specified source. The following trigger sources are available:

- **BUS:** Trigger source is the HP-IB Group Execute Trigger (GET) or the \*TRG common command. Within the HP 75000 Series C mainframes, the instrument whose trigger source is "BUS" and was the last instrument addressed to listen will respond to the HP-IB Group Execute Trigger. The \*TRG is sent to a specific instrument (e.g., OUTPUT 70903; "\*TRG").
- **EXTernal:** Trigger source is the multimeter's external trigger BNC connector. At power-on or after a \*RST command, the falling (negative-going) edge of the input signal triggers the multimeter. Use the TRIGger:SLOPe command to change the trigger slope (see "The Trigger Slope" for more information).
- **HOLD:** Suspend triggering. After executing TRIGger:SOURce HOLD, only the TRIGger[:IMMEDIATE] command will trigger the multimeter.
- **IMMEDIATE:** Internal trigger is always present. If the multimeter is in the wait-for-trigger state (INITiate), TRIGger:SOURce IMMEDIATE sends the trigger. The MEASure and CONFigure commands automatically set the trigger source to IMM.
- **TTLTrg0 through TTLTrg7:** Trigger source is the VXibus TTL trigger lines. The multimeter is triggered on the falling (negative-going) edge of a TTL input signal.

For example, the following program statement selects the external trigger BNC connector as the trigger source.

```
TRIGger:SOURce EXTernal
```

You can change the trigger source only when the multimeter is in the idle state. Attempting to change the trigger source while the multimeter is in the wait-for-trigger state will generate the "Settings conflict" error.

**NOTE:** Do not confuse the levels of triggering commands containing the IMMEDIATE parameter. The TRIGger:SOURce IMMEDIATE command bypasses the trigger system so that the multimeter is triggered immediately if it is in the wait-for-trigger state. The TRIGger[:IMMEDIATE] command (see "Sending a Single Trigger" later in this section) initiates a single trigger cycle after the trigger system has been disabled (the trigger source must be TRIGger:SOURce BUS or TRIGger:SOURce HOLD).

## Checking the Trigger Source

The TRIGger:SOURce? command returns “BUS”, “EXT”, “HOLD”, “IMM”, or “TTLTn” to show the present trigger source. The string is sent to the output buffer.

## The Trigger Slope

The TRIGger:SLOPe <edge> command determines which edge (rising or falling) of a signal input to the external trigger BNC connector will trigger the multimeter. TRIGger:SLOPe POSitive selects the rising edge and TRIGger:SLOPe NEGative selects the falling edge (NEG is the power-on setting).

## Checking the Trigger Slope

The TRIGger:SLOPe? command returns “NEG” or “POS” to show the present trigger slope. The string is sent to the output buffer.

## The Trigger Count

The TRIGger:COUNt <number> command sets the number of triggers the multimeter will accept in the wait-for-trigger state before returning to the idle state. Use the *number* parameter to set the trigger count to a value between 1 and 16,777,215. The MEASure and CONFigure commands set the trigger count to 1.

Substituting MIN for the *number* parameter sets the trigger count to 1. Substituting MAX for the *number* parameter sets the trigger count to 16,777,215.

## Example: Setting the Trigger Count

In the following example, one DC voltage measurement is made each time the multimeter’s external trigger BNC connector is pulsed low (the default trigger slope is NEG). After 10 external triggers are received, the multimeter returns to the idle state.

dimension array  
CONF:VOLT:DC  
TRIG:SOUR EXT

TRIG:COUN 10

READ?

enter statement

*Dimension computer array*

*Function: DC voltage*

*Trigger source is external BNC on multimeter front panel*

*Multimeter will accept 10 external triggers (one measurement is taken per trigger)*

*Place multimeter in wait-for-trigger state; make measurements when external trigger is received; send readings to output buffer*

*Enter readings into computer*

## Checking the Trigger Count

The TRIGger:COUNT? [MINimum | MAXimum] command returns one of the following numbers to the output buffer:

- The present trigger count (1 through 16,777,215) if MIN or MAX are not specified.
- The minimum trigger count available (1) if MIN is specified.
- The maximum trigger count available (16,777,215) if MAX is specified.

## Inserting a Trigger Delay

The TRIGger:DElay <period> command inserts a delay between the trigger and the first reading (Figure 4-2). After that, only the sample time interval (SAMPLE:TIMER command) occurs between readings. The *period* parameter sets the delay to a value between 1  $\mu$ s and 2100 seconds (with 1  $\mu$ s resolution).

Substituting MIN for the *period* parameter sets the trigger delay to 1  $\mu$ s. Substituting MAX for the *period* parameter sets the trigger delay to 2100 seconds.

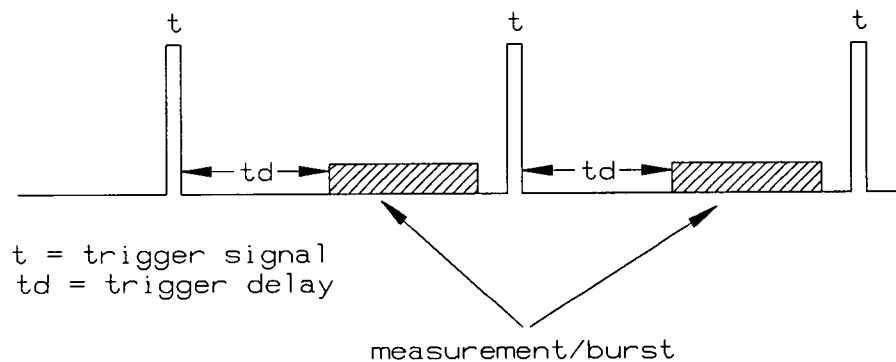

E1326\_1411:F.4.2

Figure 4-2. Inserting a Trigger Delay

### Example: Inserting a Trigger Delay

In the following example, the multimeter will accept 5 triggers from the external trigger BNC connector. One measurement is taken per trigger (this is the default sample count) and the trigger delay is 2 seconds.

dimension array	<i>Dimension computer array</i>
CONF:VOLT:DC	<i>Function: DC voltage</i>
TRIG:SOUR EXT	<i>Trigger source is external BNC on multimeter front panel</i>
TRIG:COUN 5	<i>Multimeter will accept 5 external triggers (one measurement is taken per trigger)</i>
TRIG:DEL 2	<i>Wait 2 seconds between trigger and start of each measurement</i>
READ?	<i>Place multimeter in wait-for-trigger state; make measurements when external trigger is received; send readings to output buffer</i>
enter statement	<i>Enter readings into computer</i>

### Default Delays

If you do not specify a trigger delay, the multimeter automatically determines a delay time (default delay) based on the present measurement function, range, resolution, and AC bandwidth setting. The delay time is actually the settling time allowed before measurements which ensures accurate measurements. The default delay time is automatically updated whenever you change the function or range. Once you specify a delay time value, however, the value does not change until you specify another value or reset the multimeter. Table 4-9 shows the default delay times for all functions.

**NOTE:** *You can specify a shorter delay time than the default values shown. However, the resulting settling time may not produce accurate measurements.*

The values shown in Table 4-9 (for AC measurement functions) assume the range and function have been selected for at least one reading. Whenever the range changes on an AC measurement function, the first reading after the change has an additional delay added to the default delay. This is shown in Table 4-10. Whenever you select an AC measurement function, an additional delay is added to the default delay before the first reading. This delay is shown in Table 4-11.

**Table 4-9. Default Delay Times**

Function	AC Bandwidth**	Range	Default Delay versus Aperture Time* (seconds) or Integration Time (PLCs)					
			1.67s (2.0s) 100 PLCs	167 ms (200 ms) 10 PLCs	16.7 ms (20.0 ms) 1 PLC	1.67 ms (2.0 ms) 0.1 PLCs	100 $\mu$ s (100 $\mu$ s) 0.005 PLCs	10 $\mu$ s (10 $\mu$ s) 0.0005 PLCs
DCV		30 mV	0.56 ms	0.56 ms	0.56 ms	0.46 ms	0.39 ms	0.32 ms
DCV		300 mV - 300V	0.35 ms	0.35 ms	0.35 ms	0.3 ms	0.25 ms	0.2 ms
ACV	$\geq 400$	Any	100 ms	100 ms	100 ms	100 ms	100 ms	100 ms
ACV	$< 400$	Any	1s	1s	1s	1s	1s	1s
ACDCV	$\geq 400$	Any	100 ms	100 ms	100 ms	100 ms	100 ms	100 ms
ACDCV	$< 400$	Any	1s	1s	1s	1s	1s	1s
RES FRES		30 $\Omega$	0.56 ms	0.56 ms	0.56 ms	0.46 ms	0.39 ms	0.32 ms
RES FRES		300 $\Omega$ - 30 k $\Omega$	0.35 ms	0.35 ms	0.35 ms	0.3 ms	0.25 ms	0.2 ms
RES FRES		300 k $\Omega$	2.4 ms	2.4 ms	2.4 ms	2.0 ms	1.7 ms	1.3 ms
RES FRES		3 M $\Omega$	24 ms	24 ms	24 ms	20 ms	17 ms	13 ms
RES FRES		30 M $\Omega$	240 ms	240 ms	240 ms	200 ms	170 ms	130 ms
RES FRES		300 M $\Omega$	2.4s	2.4s	2.4s	2.0s	1.7s	1.3s
RES FRES		3 G $\Omega$	2.4s	2.4s	2.4s	2.0s	1.7s	1.3s
FREQ	$\geq 400$	Any	100 ms	100 ms	100 ms	100 ms	100 ms	100 ms
FREQ	$< 400$	Any	1s	1s	1s	1s	1s	1s
PER	$\geq 400$	Any	100 ms	100 ms	100 ms	100 ms	100 ms	100 ms
PER	$< 400$	Any	1s	1s	1s	1s	1s	1s

\* 50 Hz aperture times are enclosed in parentheses.

\*\* SENSE:BANDwidth:DETECTOR command.

**Table 4-10. Added Delay for Range Change**

Function	AC Bandwidth*	Change to Range	Added Delay
ACV	$\geq 400$	30 mV	900 ms
ACV	$\geq 400$	300 mV	700 ms
ACV	$\geq 400$	Others	0 ms
ACV	$< 400$	30 mV	500 ms
ACV	$< 400$	Others	100 ms
ACDCV	$\geq 400$	Any	0 ms
ACDCV	$< 400$	Any	100 ms

\*SENSE:BANDwidth:DETECTOR command.

**Table 4-11. Added Delay for Function Change**

Change to Function	AC Bandwidth*	Range	Delay
ACV	≥ 400	30 mV	1000 ms
ACV	≥ 400	300 mV	800 ms
ACV	≥ 400	Others	100 ms
ACV	< 400	30 mV	800 ms
ACV	< 400	Others	400 ms
ACDCV	≥ 400	Any	100 ms
ACDCV	< 400	Any	400 ms

\*SENSe:BANdwidth:DETEctor command.

### Checking the Delay Time

The TRIGger:DELay? [MINimum | MAXimum] command returns one of the following numbers to the output buffer:

- The present trigger delay (1  $\mu$ s through 2100 seconds) if MIN or MAX is not specified.
- The minimum trigger delay available (1  $\mu$ s) if MIN is specified.
- The maximum trigger delay available (2100 seconds) if MAX is specified.

### The Sample Count

The SAMPlE:COUNT <number> command designates the number of readings per trigger. The *number* parameter sets the number of readings to a value between 1 and 16,777,215.

Substituting MIN for the *number* parameter sets the number of readings per trigger to 1. Substituting MAX for the *number* parameter sets the number of readings per trigger to 16,777,215.

### Example: Setting the Sample Count

In the following example, 10 DC voltage measurements are made when the multimeter's external trigger BNC connector is pulsed low (the default trigger slope is NEG). After the 10 readings are taken, the multimeter returns to the idle state.

dimension array  
CONF:VOLT:DC  
TRIG:SOUR EXT

**SAMP:COUN 10**  
**READ?**

enter statement

*Dimension computer array*  
*Function: DC voltage*  
*Trigger source is external BNC on multimeter front panel*  
*Specify 10 readings per trigger*  
*Place multimeter in wait-for-trigger state; make measurements when external trigger is received; send readings to output buffer*  
*Enter readings into computer*

### Checking the Sample Count

The **SAMPle:COUNT?** [**MIN**imum | **MAX**imum] command returns one of the following numbers to the output buffer:

- The present sample count (1 through 16,777,215) if **MIN** or **MAX** are not specified.
- The minimum sample count available (1) if **MIN** is specified.
- The maximum sample count available (16,777,215) if **MAX** is specified.

### The Sample Rate

When you set the sample count greater than 1 (e.g., **SAMPle:COUNT** 10), the multimeter allows you to set the period between readings (sample rate). The **SAMPle:SOURce** <source> command selects the source which sets sample rate. The following sources are available:

- **IMM**ediate: Initiate reading whenever multimeter is not busy. The **MEASure** and **CONF**igure commands automatically set **SAMPle:SOURce** to **IMM**.
- **TIM**er: Specify sample rate using the **SAMPle:TIMer** <period> command. The *period* parameter sets the sample rate to a value between 680  $\mu$ s and 2100 seconds (with 1  $\mu$ s resolution).

Substituting **MIN** for the *period* parameter sets the sample rate to 680  $\mu$ s. Substituting **MAX** for the *period* parameter sets the sample rate to 2100 seconds.

**NOTE:** To achieve the fastest sample rate, you must disable autoranging and autozero. Also, the sample rate will not be exact if autoranging is enabled.



The specified sample rate must be longer than the specified aperture time. Table 4-12 shows the minimum sample rates for each available aperture time setting.

**Table 4-12. Aperture Times and Minimum Sample Rates\***

Aperture Time	Minimum Sample Rate (SAMPle:TIMer)	Maximum Reading Rate (Readings/second)
2.0s	2.5s	0.4
1.67s	2.04s	0.49
200 ms	250 ms	4.0
167 ms	204 ms	4.9
20 ms	21.2 ms	47
16.7 ms	17.8 ms	56
2.0 ms	3.2 ms	312
1.67 ms	2.7 ms	360
100 $\mu$ s	800 $\mu$ s	1250
10 $\mu$ s	680 $\mu$ s	1450

\*Autozero off, fixed range.

**NOTE:** If the aperture time is longer than the sample rate, 2602 "Timer too fast" is stored in the error queue when the multimeter attempts to make the measurement.

**Example: Setting the Sample Rate**

In the following example, 10 readings are taken when the READ? command is executed (the trigger source is IMM by default). The aperture time is set to 2 ms to allow a sample rate of 10 ms (the 10 ms delay is inserted between each of the 10 readings).

dimension array	<i>Dimension computer array</i>
CONF:VOLT:DC 8.25	<i>Function: AC volts; range selected: 30V; default resolution: 10 <math>\mu</math>V</i>
VOLT:APER 0.002	<i>Set aperture time to 2.0 ms</i>
SAMP:COUN 10	<i>Specify 10 readings per trigger; trigger source is IMM by default</i>
SAMP:SOUR TIM	<i>Sample source is SAMPle:TIMer command</i>
SAMP:TIM 0.01	<i>Set 10 ms sample rate</i>
READ?	<i>Place multimeter in wait-for-trigger state and make measurements; send readings to output buffer</i>
enter statement	<i>Enter readings into computer</i>

## Checking the Sample Source

The `SAMPlE:SOURce?` command returns “IMM” or “TIM” to show the present sample source. The string is sent to the output buffer.

## Checking the Sample Rate

The `SAMPlE:TIMer? [MINimum | MAXimum]` command returns one of the following numbers to the output buffer:

- The present sample rate (680  $\mu$ s through 2100 seconds) if MIN or MAX are not specified.
- The minimum sample rate available (680  $\mu$ s) if MIN is specified.
- The maximum sample rate available (2100 seconds) if MAX is specified.

## The Wait-For-Trigger State

Before the multimeter will respond to a trigger signal, it must be moved from the idle state to the wait-for-trigger state. You can place the multimeter in the wait-for-trigger state using one of three methods:

1. Use the `INITiate` command explicitly.
2. Use the `READ?` command, which executes `INITiate` implicitly.
3. Use the `MEASure` command, which executes `INITiate` implicitly.

**NOTE:** *The multimeter returns to the idle state following each trigger cycle or after the number of triggers specified by `TRIGger:COUNT` have occurred.*

## Example: Using `INITiate` Explicitly

In the following example, the `CONFigure` command configures the multimeter for DC voltage measurements. The trigger source is the multimeter’s external trigger BNC connector (`TRIGger:SOURce EXTErnal`). The `INIT` command places the multimeter in the wait-for-trigger state. When the external trigger occurs, the measurement is taken and the reading is stored in multimeter memory. The `FETCh?` command transfers the reading from memory to the output buffer.

```
CONF:VOLT:DC
TRIG:SOUR EXT
```

```
INIT
```

```
FETCh?
enter statement
```

*Function: DC voltage*

*Trigger source is external BNC on multimeter front panel*

*Place multimeter in wait-for-trigger state; store reading in multimeter memory when trigger is received*

*Place reading in output buffer*

*Enter reading into computer*

**Example: Using INITiate  
Implicitly (READ?)**

In the following example, the CONFigure command configures the multimeter for DC voltage measurements. The trigger source is the multimeter's external trigger BNC connector (TRIGger:SOURce EXTernal). The READ? command places the multimeter in the wait-for-trigger state. When the external trigger occurs, the measurement is taken and the reading is sent to the output buffer.

CONF:VOLT:DC

*Function: DC voltage*

TRIG:SOUR EXT

*Trigger source is external BNC on multimeter front panel*

READ?

*Place multimeter in wait-for-trigger state; make measurement when external trigger is received; send reading to output buffer*

enter statement

*Enter reading into computer*

**Example: Using INITiate  
Implicitly (MEASure)**

In the following example, INITiate is executed by the MEASure command after configuring the multimeter for DC voltage measurements. The trigger source is IMM by default for the MEASure command. When MEASure is executed, the multimeter is placed in the wait-for-trigger state, the measurement is taken, and the reading is sent to the output buffer.

MEAS:VOLT:DC?

*Function: DC voltage; trigger source is IMM by default*

enter statement

*Enter reading into computer*

**Sending a  
Single Trigger**

The TRIGger[:IMMEDIATE] command sends an immediate internal trigger if the multimeter is in the wait-for-trigger state. The readings are stored in multimeter memory following the trigger. The trigger source must be BUS or HOLD (see "The Trigger Source").

*NOTE: Do not confuse the levels of triggering commands containing the IMMEDIATE parameter. The TRIGger:SOURce IMMEDIATE command bypasses the trigger system so that the multimeter is triggered immediately if it is in the wait-for-trigger state. The TRIGger[:IMMEDIATE] command initiates a single trigger cycle after the trigger system has been disabled.*

### Example: Sending a Single Trigger

In the following example, the CONFIGure command configures the multimeter for DC voltage measurements. The trigger source is HOLD and the sample count is 10. When the TRIG command is executed the multimeter makes 10 DC voltage measurements and stores them in multimeter memory.

dimension array	<i>Dimension computer array</i>
CONF:VOLT:DC	<i>Function: DC voltage</i>
TRIG:SOUR HOLD	<i>Suspend triggering</i>
SAMP:COUN 10	<i>Specify 10 readings per trigger</i>
INIT	<i>Place multimeter in wait-for-trigger state; store readings in memory when trigger is received</i>
TRIG	<i>Trigger the multimeter</i>
FETC?	<i>Place readings in output buffer</i>
enter statement	<i>Enter readings into computer</i>

### Trigger Buffering

The TRIGger:BUFFered <mode> command enables or disables the multimeter's trigger buffer and corrects for a "Trigger too fast" error. With trigger buffering enabled, any external trigger occurring during a reading generates a "Trigger too fast" error and the trigger(s) are ignored. To enable trigger buffering, send:

TRIGger:BUFFered ON

With trigger buffering disabled, the first external trigger occurring during a reading is stored and no error is generated. After the reading is complete, the stored trigger satisfies the EXTERNAL trigger event if the multimeter is so programmed. However, a second trigger occurring during a reading does generate the "Trigger too fast" error. To disable trigger buffering (this is the power-on state), send:

TRIGger:BUFFered OFF

### Checking the Trigger Buffer State

The TRIGger:BUFFered? command returns a number to show whether trigger buffering is enabled or disabled: "1" = ON, "0" = OFF. The number is sent to the output buffer.

### Aborting a Measurement

The ABORT command removes the multimeter from the wait-for-trigger state and places it in the idle state. ABORT can only be use with the following trigger sources: TRIGger:SOURce BUS or TRIGger:SOURce HOLD.

If TRIGger:SOURce BUS is selected as the trigger source, ABORT returns the multimeter to the idle state. When a Group Execute Trigger (GET) bus command or \*TRG common command is executed, the "Trigger ignored" error is generated.

If TRIGger:SOURce HOLD is selected as the trigger source, ABORt returns the multimeter to the idle state. All subsequent single triggers sent using TRIGger:IMMEDIATE are ignored and the “Trigger ignored” error is generated.

**NOTE:** If TRIGger:SOURce EXT is selected as the trigger source and the multimeter is waiting for an external trigger, send the HP-IB CLEAR command to return to the idle state.

### Routing Voltmeter Complete to the Trigger Lines

The multimeter generates a *voltmeter complete* signal after it has sampled the input for each reading. The OUTPut:TTLTrg<n> <mode> command enables or disables routing of the *voltmeter complete* signal to the specified VXIbus trigger line (TTLTRG0 through TTLTRG7) on the backplane connector P2. For example, to route the *voltmeter complete* signal to trigger line 7, send:

```
OUTPut:TTLTRG7 ON
```

To disable routing of the *voltmeter complete* signal to trigger line 7 (this is the default condition), send:

```
OUTPut:TTLTRG7 OFF
```

The *voltmeter complete* signal is always routed to the multimeter’s front panel “VM Complete” BNC connector. When enabled (ON), the OUTPut command also routes *voltmeter complete* to the specified trigger line on connector P2. When disabled (OFF), *voltmeter complete* is routed only to the multimeter’s front panel connector.

### Checking the Voltmeter Complete Destination

The OUTPut:TTLTrg<n>? command returns a number to show whether VXIbus trigger line routing of the *voltmeter complete* signal is enabled or disabled: “1” = ON, “0” = OFF. The number is sent to the output buffer.

---

## Saving Multimeter Configurations

You can store up to 10 different configurations in multimeter memory for later recall. The information stored includes:

### Measurement Parameters:

- Function
- Range
- Autozero
- Input Terminals
- Integration Time
- Aperture Time
- Offset Compensation
- Input Impedance
- Input Coupling
- AC Bandwidth
- Voltmeter Complete Destination
- External VME Memory Address
- External VME Memory Size
- External VME Memory State

### Trigger Parameters:

- Trigger Source
- Trigger Count
- Trigger Delay
- Trigger Slope
- Trigger Buffering
- Sample Count
- Sample Source
- Sample Timer

The `*SAV <state number>` common command stores the present configuration in a numbered memory location (0 through 9). The stored configurations remain in memory until power is removed. The `*RCL <state number>` common command recalls the specified configuration from memory.

**Example: Saving and Recalling a Configuration**

The following example saves a configuration in memory location 2. The \*RST command resets the multimeter to its power-on configuration. The stored configuration is then recalled using the \*RCL command.

dimension array	<i>Dimension computer array</i>
CONF:VOLT:DC 8.25	<i>Function: DC voltage; range selected: 30V</i>
VOLT:APER 1.67E-01	<i>Aperture time is 167 ms</i>
TRIG:SOUR EXT	<i>Trigger source is external BNC on multimeter front panel</i>
TRIG:COUN 10	<i>Multimeter will accept 10 external triggers (one measurement is taken per trigger)</i>
<b>*SAV 2</b>	<i>Save configuration in memory location 2</i>
<b>*RST</b>	<i>Reset multimeter</i>
<b>*RCL 2</b>	<i>Recall configuration in memory location 2</i>
READ?	<i>Place multimeter in wait-for-trigger state; make measurements when external trigger is received; send readings to output buffer</i>
enter statement	<i>Enter readings into computer</i>

# Contents

---

## Chapter 5 - Multimeter Command Reference

About This Chapter . . . . .	5-1
Command Types . . . . .	5-1
Common Command Format . . . . .	5-1
SCPI Command Format . . . . .	5-1
Linking Commands . . . . .	5-3
Multimeter Range and Resolution Tables . . . . .	5-4
SCPI Command Reference . . . . .	5-5
ABORt Subsystem . . . . .	5-5
CALibration Subsystem . . . . .	5-6
CALibration? Subsystem . . . . .	5-10
CONFigure Subsystem . . . . .	5-11
CONFigure? Subsystem . . . . .	5-22
DIAGnostic Subsystem . . . . .	5-23
FETCh? Subsystem . . . . .	5-24
INITiate Subsystem . . . . .	5-25
INPut Subsystem . . . . .	5-26
MEASure Subsystem . . . . .	5-29
MEMory Subsystem . . . . .	5-39
OUTPut Subsystem . . . . .	5-42
READ? Subsystem . . . . .	5-44
SAMPlE Subsystem . . . . .	5-45
SENSE Subsystem . . . . .	5-49
STATus Subsystem . . . . .	5-66
SYSTem Subsystem . . . . .	5-71
TEST Subsystem . . . . .	5-72
TRIGger Subsystem . . . . .	5-76
IEEE 488.2 Common Command Reference . . . . .	5-85
Command Quick Reference . . . . .	5-87
SCPI Commands Quick Reference . . . . .	5-87
IEEE 488.2 Common Commands Quick Reference . . . . .	5-89



## Multimeter Command Reference

---

### About This Chapter

This chapter describes Standard Commands for Programmable Instruments (SCPI) commands and summarizes IEEE 488.2 Common (\*) commands applicable to the HP E1410A 6½-Digit Multimeter. This chapter contains the following sections:

- Command Types
- Multimeter Range and Resolution Tables
- SCPI Command Reference
- IEEE 488.2 Common Command Reference
- Command Quick Reference

### Command Types

Commands are separated into two types: IEEE 488.2 Common Commands and SCPI Commands.

#### Common Command Format

The IEEE 488.2 standard defines the Common commands that perform functions like reset, self-test, status byte query, etc. Common commands are four or five characters in length, always begin with the asterisk character (\*), and may include one or more parameters. The command keyword is separated from the first parameter by a space character. Some examples of Common commands are shown below:

```
*RST *ESR 32 *STB?
```

#### SCPI Command Format

The SCPI commands perform functions such as making measurements, querying instrument states, or retrieving data. A command subsystem is a hierarchical structure that usually has a top level (or root) command, one or more low-level commands, and their parameters. The following example shows a typical subsystem:

CALibration

```
:INTernal? <type >
:LFRequency <frequency >
:LFRequency? [MINimum|MAXimum]
:NUMBer?
:ZERO:AUTO <mode >
:ZERO:AUTO?
```

CALibration is the root command; INTernal?, LFRequency, NUMBer?, and ZERO are second level commands; and AUTO is a third level command.

## Command Separator

A colon (:) always separates one command from the next lower level command as shown below:

```
CALibration:ZERO:AUTO?
```

Colons separate the root command from the second level command (CALibration:ZERO) and the second level from the third level (ZERO:AUTO?).

## Abbreviated Commands

The command syntax shows most commands as a mixture of upper and lower case letters. The upper case letters indicate the abbreviated spelling for the command. For shorter program lines, use the abbreviated form. For better program readability, you may use the entire command. The instrument will accept either the abbreviated form or the entire command.

For example, if the command syntax shows MEASure, then MEAS and MEASURE are both acceptable forms. Other forms of MEASure, such as MEASU or MEASUR will generate an error. You may use upper or lower case letters. Therefore, MEASURE, measure, and MeAsUrE are all acceptable.

## Implied Commands

Implied commands are those that appear in square brackets ( [ ] ) in the command syntax. (Note that the brackets are not part of the command and are not sent to the instrument.) Suppose you send a second level command but do not send the preceding implied command. In this case, the instrument assumes you intend to use the implied command and it responds as if you had sent it. Examine the partial SENSE subsystem shown below (this subsystem also contains optional *parameters* enclosed in square brackets; see “Optional Parameters” for more information).

```
[SENSe:]  
  FUNCtion[: <function > ]  
  FUNCtion?  
  RESistance  
    :APERture <time >  
    :APERture? [MINimum | MAXimum]  
    :NPLC <number >  
    :NPLC? [MINimum | MAXimum]
```

The root command SENSE is an implied command. To set the multimeter's function to AC volts, for example, you can send either of the following command statements:

```
SENS:FUNC:VOLT:AC or FUNC:VOLT:AC
```

## Parameters

**Parameter Types.** The following table contains explanations and examples of parameter types you might see later in this chapter.

Parameter Type	Explanations and Examples
Numeric	Accepts all commonly used decimal representations of numbers including optional signs, decimal points, and scientific notation.  123, 123E2, -123, -1.23E2, 0.123, 1.23E-2, 1.23000E-01. Special cases may include MIN, MAX, and INF.
Boolean	Represents a single binary condition that is either true or false.  ON, OFF, 1, 0.
Discrete	Selects from a finite number of values. These parameters use mnemonics to represent each valid setting.  An example is the TRIGger:SOURce <source> command where <i>source</i> can be BUS, EXT, HOLD, or IMM.

**Optional Parameters.** Parameters shown within square brackets ([ ]) are optional parameters. (Note that the brackets are not part of the command and are not sent to the instrument.) If you do not specify a value for an optional parameter, the instrument chooses a default value. For example, consider the TRIGger:COUNt? [MINimum|MAXimum] command. If you send the command without specifying a MIN or MAX parameter, the present TRIGger:COUNt value is returned. If you send the MIN parameter, the command returns the minimum trigger count available. If you send the MAX parameter, the command returns the maximum trigger count available. Be sure to place a space between the command and the parameter.

## Linking Commands

**Linking IEEE 488.2 Common Commands with SCPI Commands.** Use a semicolon between the commands. For example:

\*RST;RES:OCOM ON    *or*    SAMP:SOUR TIM;\*TRG

**Linking Multiple SCPI Commands.** Use both a semicolon and a colon between the commands. For example:

SENS:FUNC:VOLT:AC;;SAMP:COUN 10

## Multimeter Range and Resolution Tables

The following tables list the voltage and resistance ranges available for the multimeter. Also shown are the associated resolution values versus aperture time in seconds or integration time in power line cycles (PLCs). You will be asked to refer to these tables throughout this chapter.

**Table 5-1. DC, AC, or AC + DC Voltage: Resolution versus Aperture or Integration Times**

Range	Maximum Reading	*Effective Resolution versus Aperture Time (seconds) or Integration Time (PLCs)					
		1.67s (2.0s) 100 PLCs	167 ms (200 ms) 10 PLCs	16.7 ms (20.0 ms) 1 PLC	1.67 ms (2.0 ms) 0.1 PLCs	100 $\mu$ s (100 $\mu$ s) 0.005 PLCs	10 $\mu$ s (10 $\mu$ s) 0.0005 PLCs
30 mV	30.30000 mV	10 nV	10 nV	10 nV	100 nV	1 $\mu$ V	10 $\mu$ V
300 mV	303.0000 mV	100 nV	100 nV	100 nV	1 $\mu$ V	10 $\mu$ V	100 $\mu$ V
3V	3.030000V	1 $\mu$ V	1 $\mu$ V	1 $\mu$ V	10 $\mu$ V	100 $\mu$ V	1 mV
30V	30.30000V	10 $\mu$ V	10 $\mu$ V	10 $\mu$ V	100 $\mu$ V	1 mV	10 mV
300V	300.0000V	100 $\mu$ V	100 $\mu$ V	100 $\mu$ V	1 mV	10 mV	100 mV

\*In 10 and 100 NPLC, more digits may be returned.

NOTE: 50 Hz aperture times are enclosed in parentheses.

**Table 5-2. 2-Wire or 4-Wire Ohms: Resolution versus Aperture or Integration Time**

Range	Maximum Reading	*Effective Resolution versus Aperture Time (seconds) or Integration Time (PLCs)					
		1.67s (2.0s) 100 PLCs	167 ms (200 ms) 10 PLCs	16.7 ms (20.0 ms) 1 PLC	1.67 ms (2.0 ms) 0.1 PLCs	100 $\mu$ s (100 $\mu$ s) 0.005 PLCs	10 $\mu$ s (10 $\mu$ s) 0.0005 PLCs
30 $\Omega$	30.30000 $\Omega$	10 $\mu\Omega$	10 $\mu\Omega$	10 $\mu\Omega$	100 $\mu\Omega$	1 m $\Omega$	10 m $\Omega$
300 $\Omega$	303.0000 $\Omega$	100 $\mu\Omega$	100 $\mu\Omega$	100 $\mu\Omega$	1 m $\Omega$	10 m $\Omega$	100 m $\Omega$
3 k $\Omega$	3.030000 k $\Omega$	1 m $\Omega$	1 m $\Omega$	1 m $\Omega$	10 m $\Omega$	100 m $\Omega$	1 $\Omega$
30 k $\Omega$	30.30000 k $\Omega$	10 m $\Omega$	10 m $\Omega$	10 m $\Omega$	100 m $\Omega$	1 $\Omega$	10 $\Omega$
300 k $\Omega$	303.0000 k $\Omega$	100 m $\Omega$	100 m $\Omega$	100 m $\Omega$	1 $\Omega$	10 $\Omega$	100 $\Omega$
3 M $\Omega$	3.030000 M $\Omega$	1 $\Omega$	1 $\Omega$	1 $\Omega$	10 $\Omega$	100 $\Omega$	1 k $\Omega$
30 M $\Omega$	30.30000 M $\Omega$	10 $\Omega$	10 $\Omega$	10 $\Omega$	100 $\Omega$	1 k $\Omega$	10 k $\Omega$
300 M $\Omega$	303.0000 M $\Omega$	100 $\Omega$	100 $\Omega$	100 $\Omega$	1 k $\Omega$	10 k $\Omega$	100 k $\Omega$
3 G $\Omega$	3.030000 G $\Omega$	1 k $\Omega$	1 k $\Omega$	1 k $\Omega$	10 k $\Omega$	100 k $\Omega$	1 M $\Omega$

\*In 10 and 100 NPLC, more digits may be returned.

NOTE: 50 Hz aperture times are enclosed in parentheses.

## SCPI Command Reference

This section describes the Standard Commands for Programmable Instruments (SCPI) commands for the HP E1410A 6½-Digit Multimeter. Commands are listed alphabetically by subsystem and within each subsystem. Command guides are printed in the top margin of each page. The left guide indicates the first command listed on that page. The right guide indicates the last command listed on that page. If a single command appears on a page, the left and right guides will be the same.

### ABORt

The ABORt command subsystem removes the multimeter from the wait-for-trigger state and places it in the idle state. ABORt can only be used with the following trigger sources: TRIGger:SOURce BUS or TRIGger:SOURce HOLD.

#### Subsystem Syntax

ABORt

#### Example

#### Aborting a Measurement

CONF:VOLT:DC  
TRIG:SOUR HOLD

*Function: DC voltage  
Suspend triggering; wait for  
TRIG:IMM command*

INIT

*Place multimeter in  
wait-for-trigger state*

ABOR

*Place multimeter in  
idle state*

#### Comments

- ABORt does not affect any other settings of the trigger system. When the INITiate command is sent, the trigger system will respond as it did before ABORt was executed.
- When TRIGger:SOURce BUS is selected as the trigger source, ABORt returns the multimeter to the idle state. When a Group Execute Trigger (GET) bus command or \*TRG common command is executed after an ABORt, the “Trigger ignored” error is generated.
- When TRIGger:SOURce HOLD is selected as the trigger source, ABORt returns the multimeter to the idle state. All subsequent single triggers sent using TRIGger:IMMEDIATE are ignored and the “Trigger ignored” error is generated.
- **Related Commands:** INITiate, TRIGger
- **\*RST Condition:** After a \*RST, the multimeter acts as though an ABORt has occurred.

# CALibration

The CALibration command subsystem:

- Instructs the multimeter to perform one or both of its automatic calibrations (CALibration:INTernal?).
- Selects the multimeter’s line frequency reference (CALibration:LFRrequency).
- Returns a number indicating the number of times your multimeter has been calibrated (CALibration:NUMBer?).
- Enables or disables the autozero mode (CALibration:ZERO:AUTO).

## Subsystem Syntax

```
CALibration
:INTernal? <type>
:LFRrequency <frequency>
:LFRrequency? [MINimum|MAXimum]
:NUMBer?
:ZERO:AUTO <mode>
:ZERO:AUTO?
```

The following CALibration subsystem commands are service-related and are documented in the HP E1410A Service Manual.

```
CALibration
:SECure:CODE
:SECure[:STATe]
:VALue
:VALue?
```

## :INTernal?

**CALibration:INTernal?** <type> instructs the multimeter to perform one or both of its automatic calibrations (autocal). This command returns “0” for successful autocal.

### Parameters

Parameter Name	Parameter Type	Range of Values	Default Units
<i>type</i>	discrete	AC RESistance ALL	none

### Example

Performing the AC Autocal

```
CAL:INT? AC          Perform AC autocal
enter statement      Enter value into computer
```

### Comments

- The AC autocal performs the AC flatness and AC offset autocal. This increases short term accuracy for AC or AC + DC voltage measurements. This routine takes approximately 3 seconds to complete.
- The RES autocal performs the extended ohms and precharge autocal. This increases short term accuracy on the 3 GΩ range for 2-wire and 4-wire ohms measurements. This routine takes approximately 32 seconds to complete.
- ALL performs both the AC and RES autocal. This routine takes approximately 35 seconds to complete. The \*CAL? common command also performs both autocal routines.

- The CALibration:INTernal? command returns “0” for successful autocal. If an autocal routine is not successful, the command returns a number indicating the failed condition (an error is also placed in the error queue). Refer to the HP E1410A Service Manual for more information. The following table lists the failure codes.

Failure Code	Failed Autocal
1	AC Offset (300V)
2	AC Offset (3V)
4	AC Flatness (300 mV)
8	AC Flatness (3V)
16	Precharge
32	Extended Ohms Range
64	Timeout

- Always perform the RES autocal before making measurements on the 3 GΩ range.
- Always disconnect all input signals before you perform an autocal. If you leave an input signal connected to the multimeter, it may adversely affect the autocal.
- The autocal constants are stored in non-volatile multimeter memory (remain intact when power is removed). Therefore, it is not necessary to perform autocal after power has been removed and re-applied. A one-hour warmup is also recommended before performing an autocal.

## :LFRrequency

CALibration:LFRrequency <frequency> selects the line frequency reference used by the multimeter’s analog-to-digital (A/D) converter.

### Parameters

Parameter Name	Parameter Type	Range of Values	Default Units
frequency	numeric	50 60 400  MINimum MAXimum	hertz

### Example

Selecting the Line Frequency Reference

CAL:LFR 50

Frequency is 50 Hz

### Comments

- MIN selects the minimum line frequency reference available (50 Hz). MAX selects the maximum line frequency reference available (60 Hz).
- The line frequency reference is set to 60 Hz at the factory. The setting is stored in non-volatile multimeter memory and is changed only when CALibration:LFRrequency is executed.
- If 400 Hz is specified as the A/D converter’s reference, the multimeter actually uses a 50 Hz reference frequency. However, since 50 Hz is a subharmonic of 400 Hz, it provides normal mode rejection of power line related noise.

- The line frequency reference set by CALibration:LFRrequency can be overridden by the 50 or 60 Hz aperture time set by the SENSE:RESistance:APERture or SENSE:VOLTage:APERture commands. The last command executed has priority.
- **Related Commands:** SENSE:RESistance:APERture, SENSE:VOLTage:APERture
- **\*RST Condition:** The selected line frequency reference remains unchanged since it is stored in non-volatile multimeter memory.

**:LFRrequency?**

**CALibration:LFRrequency?** [MINimum|MAXimum] returns one of the following numbers to the output buffer:

- The present line frequency reference (50 or 60) if MIN or MAX is not specified.
- The minimum line frequency reference available (50) if MIN is specified.
- The maximum line frequency reference available (60) if MAX is specified.

**Example****Querying the Line Frequency Reference**

CAL:LFR 50	<i>Frequency is 50 Hz</i>
CAL:LFR?	<i>Query multimeter to return frequency value</i>
enter statement	<i>Enter value into computer</i>

**:NUMBer?**

**CALibration:NUMBer?** returns a decimal number indicating the number of times your multimeter has been calibrated. The number is sent to the output buffer.

**Example****Querying the Calibration Number**

CAL:NUMB?	<i>Query multimeter to return calibration number</i>
enter statement	<i>Enter value into computer</i>

**Comments**

- Your multimeter was calibrated before it left the factory. When you receive your multimeter, read the calibration number to determine its initial value.
- The calibration number is stored in non-volatile multimeter memory (remains intact when power is removed).
- The calibration number increments by one for each instrument point calibrated. A complete calibration increments the calibration number by several counts. The calibration number increments up to a maximum of 32,767 after which it wraps-around to 0.
- Automatic calibration (CALibration:INTernal?) does not affect the calibration number.



**:ZERO:AUTO**

CALibration:ZERO:AUTO <mode> enables or disables the autozero mode.

**Parameters**

Parameter Name	Parameter Type	Range of Values	Default Units
<i>mode</i>	boolean	OFF 0 ON 1 ONCE	none

**Example**

Turning Autozero OFF

**CAL:ZERO:AUTO OFF**

*Disable autozero*

**Comments**

- You can substitute decimal values for the OFF ("0") and ON ("1") parameters. The OFF and ONCE parameters have the same effect.
- When autozero is ON, the multimeter makes a zero measurement (measurement with input disabled) following every measured reading and subtracts the zero measurement from the reading. This doubles the time required per reading for most modes.
- When autozero is OFF, the multimeter makes one zero measurement and subtracts this from all subsequent measurements. A new zero measurement is made whenever you change the function, range, number of PLCs, input coupling, or offset compensation mode.
- Do not turn autozero OFF when in the 4-wire ohms function if the resistance in the LO lead can change.
- The CONFIGure and MEASure commands turn autozero ON.
- \*RST Condition: CAL:ZERO:AUTO ON

**:ZERO:AUTO?**

CALibration:ZERO:AUTO? returns a number to show whether the autozero mode is enabled or disabled: "1" = ON, "0" = OFF or ONCE. The number is sent to the output buffer.

**Example**

Querying the Autozero Mode

**CAL:ZERO:AUTO OFF**

*Disable autozero*

**CAL:ZERO:AUTO?**

*Query multimeter to return autozero mode ("0")*

enter statement

*Enter value into computer*

**CALibration?**

**CALibration?**

## **CALibration?**

The **CALibration?** command subsystem calibrates the present function and range. This is a service-related command. Refer to the HP E1410A Service Manual for details.

---



## CONFigure

The CONFigure command subsystem configures the multimeter to perform the specified measurement with the given range and resolution. CONFigure *does not* automatically make the measurement after setting the configuration.

Use the INITiate command to place the multimeter in the wait-for-trigger state and store readings in multimeter memory. Or, use the READ? command to make the measurement and send the readings to the output buffer when the trigger is received.

Executing CONFigure is equivalent to configuring the multimeter with the low-level commands shown in the following table.

Parameter	Command	Setting
Function	SENSe:FUNCTION:FREQuency, SENSe:FUNCTION:FRESistance, SENSe:FUNCTION:PERiod, SENSe:FUNCTION:RESistance, SENSe:FUNCTION:VOLTage:AC, or SENSe:FUNCTION:VOLTage:DC	As specified by CONFigure.
Range	SENSe:RESistance:RANGE or SENSe:VOLTage:RANGE	As specified, or autorange.
Autozero	CALibration:ZERO:AUTO	ON (performs autozero after each measurement).
Input Terminals	INPut:STATe	ON (connects input source).
Input Coupling	INPut:COUPLing	AC Voltage.
Integration Time	SENSe:RESistance:NPLC or SENSe:VOLTage:NPLC	1 Power Line Cycle (PLC), or based on specified resolution.
Aperture Time	SENSe:RESistance:APERture or SENSe:VOLTage:APERture	16.7 ms (60 Hz) or 20 ms (50 Hz), or based on specified resolution.
Offset Compensation	SENSe:RESistance:OCOMpensated	OFF (useful for resistance measurements only).
Input Impedance	INPut:IMPedance:AUTO	ON (useful for DC voltage measurements only).
AC Bandwidth	SENSe:BANDwidth:DETector	Selects slow measurement mode (useful for AC voltage, frequency, and period measurements only).
Readings per Trigger	SAMPlE:COUNT	1 reading.
Trigger Source	TRIGger:SOURce	IMMediate (trigger signal is always true).
Trigger Count	TRIGger:COUNT	1 trigger.
Trigger Delay	TRIGger:DELay	Default (see Table 4-9).

**Subsystem Syntax**

```

CONFigure
:FREQUENCY [ <expected value > [, <resolution > ]]
:FRESistance [ <expected value > [, <resolution > ]]
:PERiod [ <expected value > [, <resolution > ]]
:RESistance [ <expected value > [, <resolution > ]]
:TEMPerature <transducer > , <type >
:VOLTage:AC [ <expected value > [, <resolution > ]]
:VOLTage:ACDC [ <expected value > [, <resolution > ]]
:VOLTage[:DC] [ <expected value > [, <resolution > ]]
    
```

**:FREQUENCY**

CONFigure:FREQUENCY [ <expected value > [, <resolution > ]] selects the frequency function.

**Parameters**

Parameter Name	Parameter Type	Range of Values	Default Units
<i>expected value</i>	numeric	10 Hz through 1.5 MHz   AUTOMATIC   DEFAULT   MINIMUM   MAXIMUM	hertz
<i>resolution</i>	numeric	1 Hz through 1 ppm   DEFAULT   MINIMUM   MAXIMUM	hertz

**Example**

**Making Frequency Measurements**

dimension array

CONF:FREQ

INP:COUP DC

TRIG:COUN 3

READ?

enter statement

*Dimension computer array*

*Function: frequency*

*Input source is AC + DC voltage (DC-coupled)*

*Multimeter will accept 3 triggers (one measurement is taken per trigger)*

*Place multimeter in wait-for-trigger state and make measurements; send readings to output buffer*

*Enter readings into computer*

**Comments**

- Specify *expected value* as the input signal's maximum expected frequency. The multimeter verifies that the input frequency is between 10 Hz and 1.5 MHz. The multimeter automatically voltage autoranges in the frequency function.
- The AUTO, DEF, MIN, and MAX options for the *expected value* parameter are not used for frequency measurements. If you specify one of these options, the multimeter will ignore it and no errors are generated.
- The multimeter provides a constant 1 ppm of resolution (the minimum resolution is 1 Hz). Specifying a resolution greater than 1 ppm generates an error.
- The DEF, MIN, and MAX options for the *resolution* parameter are not used for frequency measurements. If you specify one of these options, the multimeter will ignore it and no errors are generated.

- Use the INPut:COUPLing command to specify whether the input signal is AC voltage or AC + DC voltage.
- **Related Commands:** FETCh?, INITiate, INPut:COUPLing, READ?

**:FRESistance**

CONFigure:FRESistance [ < *expected value* > [, < *resolution* > ] ] selects the 4-wire ohms function and allows you to specify the expected value and desired resolution.

*For a complete listing of range and resolution values available, see Table 5-2 at the beginning of this chapter.*

**Parameters**

Parameter Name	Parameter Type	Range of Values	Default Units
<i>expected value</i>	numeric	0Ω through 3 GΩ   AUTOMatic   DEFault   MINimum   MAXimum	ohms
<i>resolution</i>	numeric	<i>resolution</i> (see Table 5-2)   DEFault   MINimum   MAXimum	ohms

**Example**

**Making 4-Wire Ohms Measurements**

dimension array  
**CONF:FRES 1560,MAX**

TRIG:COUN 3

READ?

enter statement

*Dimension computer array*

*Function: 4-wire ohms;  
 range selected: 3 kΩ;  
 MAX resolution: 1Ω*

*Multimeter will accept 3 triggers  
 (one measurement is taken  
 per trigger)*

*Place multimeter in  
 wait-for-trigger state and make  
 measurements; send readings  
 to output buffer*

*Enter readings into computer*

**Comments**

- To select a standard measurement range, specify *expected value* as the input signal's maximum expected resistance. The multimeter then selects the correct range.
- The AUTO and DEF options for the *expected value* parameter have the same effect (enable autorange). The DEF option for the *resolution* parameter defaults the integration time to 1 PLC.

- The MIN and MAX parameters select the minimum or maximum values for *expected value* and *resolution*:

For *expected value*: MIN = 0Ω; MAX = 3 GΩ

For *resolution*: MIN selects the best resolution (the smallest value from Table 5-2) for the selected range. MAX selects the worst resolution (the largest value from Table 5-2) for the selected range.

- When autoranging, MIN or MAX are the only *resolution* settings which are allowed. Specify a numeric resolution only when making measurements on a fixed range. If you specify a numeric value for *resolution* while autoranging, the “Settings conflict” error is generated.
- To select autorange, specify AUTO (or DEF) for *expected value* or do not specify a value for the parameter.
- To specify a MIN or MAX resolution while autoranging, you must specify CONF:FRES AUTO or CONF:FRES DEF (you cannot omit the *expected value* parameter). This prevents the MIN or MAX resolution from being interpreted as a range setting.
- **Related Commands:** FETCh?, INITiate, READ?

**:PERiod**

CONFigure:PERiod [ < *expected value* > [, < *resolution* > ]] selects the period function.

**Parameters**

Parameter Name	Parameter Type	Range of Values	Default Units
<i>expected value</i>	numeric	0.67 μs through 0.1s   AUTOMatic   DEFault   MINimum   MAXimum	seconds
<i>resolution</i>	numeric	1 μs through 1 ppm   DEFault   MINimum   MAXimum	seconds

**Example**

**Making Period Measurements**

dimension array

CONF:PER

INP:COUP DC

TRIG:COUN 3

READ?

enter statement

*Dimension computer array*

*Function: period*

*Input source is AC + DC voltage (DC-coupled)*

*Multimeter will accept 3 triggers (one measurement is taken per trigger)*

*Place multimeter in wait-for-trigger state and make measurements; send readings to output buffer*

*Enter readings into computer*

**Comments**

- Specify *expected value* as the input signal's maximum expected period. The multimeter verifies that the input period is between 0.67  $\mu$ s and 0.1 seconds. The multimeter automatically voltage autoranges in the period function.
- The AUTO, DEF, MIN, and MAX options for the *expected value* parameter are not used for period measurements. If you specify one of these options, the multimeter will ignore it and no errors are generated.
- The multimeter provides a constant 1 ppm of resolution (the minimum resolution is 1  $\mu$ s). Specifying a resolution greater than 1 ppm generates an error.
- The DEF, MIN, and MAX options for the *resolution* parameter are not used for period measurements. If you specify one of these options, the multimeter will ignore it and no errors are generated.
- Use the INPut:COUPling command to specify whether the input signal is AC voltage or AC + DC voltage.
- **Related Commands:** FETCh?, INITiate, INPut:COUPling, READ?

**:RESistance**

CONFigure:RESistance [ <expected value > [, <resolution > ] ] selects the 2-wire ohms function and allows you to specify the expected value and desired resolution.

*For a complete listing of range and resolution values available, see Table 5-2 at the beginning of this chapter.*

**Parameters**

Parameter Name	Parameter Type	Range of Values	Default Units
<i>expected value</i>	numeric	0 $\Omega$ through 3G $\Omega$   AUTOMATIC   DEFault   MINimum   MAXimum	ohms
<i>resolution</i>	numeric	<i>resolution</i> (see Table 5-2)   DEFault   MINimum   MAXimum	ohms

**Example**

**Making 2-Wire Ohms Measurements**

dimension array  
**CONF:RES 1320,MAX**

TRIG:COUN 3  
 INIT

FETC?  
 enter statement

*Dimension computer array  
 Function: 2-wire ohms;  
 range selected: 3 k $\Omega$ ;  
 MAX resolution: 1 $\Omega$   
 Multimeter will accept 3 triggers  
 Place multimeter in wait-for-trigger state; store readings in multimeter memory; trigger source is IMMEDIATE by default  
 Place readings in output buffer  
 Enter readings into computer*

## Comments

- To select a standard measurement range, specify *expected value* as the input signal's maximum expected resistance. The multimeter then selects the correct range.
- The AUTO and DEF options for the *expected value* parameter have the same effect (enable autorange). The DEF option for the *resolution* parameter defaults the integration time to 1 PLC.
- The MIN and MAX parameters select the minimum or maximum values for *expected value* and *resolution*:  
  
For *expected value*: MIN = 0Ω; MAX = 3 GΩ  
  
For *resolution*: MIN selects the best resolution (the smallest value from Table 5-2) for the selected range. MAX selects the worst resolution (the largest value from Table 5-2) for the selected range.
- When autoranging, MIN or MAX are the only *resolution* settings which are allowed. Specify a numeric resolution only when making measurements on a fixed range. If you specify a numeric value for *resolution* while autoranging, the "Settings conflict" error is generated.
- To select autorange, specify AUTO (or DEF) for *expected value* or do not specify a value for the parameter.
- To specify a MIN or MAX resolution while autoranging, you must specify CONF:RES AUTO or CONF:RES DEF (you cannot omit the *expected value* parameter). This prevents the MIN or MAX resolution from being interpreted as a range setting.
- **Related Commands:** FETCh?, INITiate, READ?



**:TEMPerature**

CONFigure:TEMPerature <transducer> , <type> selects the temperature function. All measurements are returned in Degrees Celsius. The following transducers can be measurements using the multimeter:

- Thermistors (2-wire or 4-wire measurement)
- RTDs (2-wire or 4-wire measurement)

**Parameters**

Parameter Name	Parameter Type	Range of Values	Default Units
<i>transducer</i>	discrete	THERmistor   FTHermistor   RTD   FRTD	none
<i>type</i>	numeric	THER/FTH: 2252   5000   10000 RTD/FRTD: 85   92	ohms alpha

**Example**

**Making Thermistor Measurements**

**CONF:TEMP THER,5000**

*Measure 5000Ω thermistor (2-wire measurement); trigger source is IMMEDIATE by default*

**READ?**

*Place multimeter in wait-for-trigger state and make measurement; send reading to output buffer*

**enter statement**

*Enter reading into computer*

**Comments**

- You can measure RTD types 85 (alpha = 0.00385 Ω/Ω/°C) and 92 (alpha = 0.00392 Ω/Ω/°C).
- You can also use 385, 0.00385, 392, 0.00392 for the *type* parameter.
- The multimeter automatically makes temperature measurements using a 1 PLC integration time and autoranging.
- **Related Commands:** FETCh?, INITiate, READ?

**:VOLTage:AC**

CONFigure:VOLTage:AC [ <expected value> [, <resolution> ] ] selects the AC-coupled RMS voltage function and allows you to specify the expected value and desired resolution.

*For a complete listing of range and resolution values available, see Table 5-1 at the beginning of this chapter.*

**Parameters**

Parameter Name	Parameter Type	Range of Values	Default Units
<i>expected value</i>	numeric	0V through ± 300V   AUTOMATIC   DEFAULT   MINIMUM   MAXIMUM	volts
<i>resolution</i>	numeric	<i>resolution</i> (see Table 5-1)   DEFAULT   MINIMUM   MAXIMUM	volts

**Example**

**Making AC Voltage Measurements (AC-Coupled)**

dimension array

CONF:VOLT:AC 0.54,MAX

TRIG:COUN 3

READ?

enter statement

*Dimension computer array*

*Function: AC volts;  
range selected: 3V;  
MAX resolution: 1 mV*

*Multimeter will accept 3 triggers  
(one measurement is taken  
per trigger)*

*Place multimeter in  
wait-for-trigger state and make  
measurements; send readings  
to output buffer*

*Enter readings into computer*

**Comments**

- To select a standard measurement range, specify *expected value* as the input signal's maximum expected voltage. The multimeter then selects the correct range.
- The AUTO and DEF options for the *expected value* parameter have the same effect (enable autorange). The DEF option for the *resolution* parameter defaults the integration time to 1 PLC.
- The MIN and MAX parameters select the minimum or maximum values for *expected value* and *resolution*:

*For expected value: MIN = 0V; MAX = ± 300V*

*For resolution: MIN selects the best resolution (the smallest value from Table 5-1) for the selected range. MAX selects the worst resolution (the largest value from Table 5-1) for the selected range.*

- When autoranging, MIN or MAX are the only *resolution* settings which are allowed. Specify a numeric resolution only when making measurements on a fixed range. If you specify a numeric value for *resolution* while autoranging, the "Settings conflict" error is generated.

- To select autorange, specify AUTO (or DEF) for *expected value* or do not specify a value for the parameter.
- To specify a MIN or MAX resolution while autoranging, you must specify CONF:VOLT:AC AUTO or CONF:VOLT:AC DEF (you cannot omit the *expected value* parameter). This prevents the MIN or MAX resolution from being interpreted as a range setting.
- **Related Commands:** FETCh?, INITiate, READ?

**:VOLTage:ACDC**

CONFigure:VOLTage:ACDC [ < *expected value* > [, < *resolution* > ]] selects the DC-coupled RMS voltage function and allows you to specify the expected value and desired resolution.

*For a complete listing of range and resolution values available, see Table 5-1 at the beginning of this chapter.*

**Parameters**

Parameter Name	Parameter Type	Range of Values	Default Units
<i>expected value</i>	numeric	0V through ± 300V   AUTOmatic   DEFault   MINimum   MAXimum	volts
<i>resolution</i>	numeric	<i>resolution</i> (see Table 5-1)   DEFault   MINimum   MAXimum	volts

**Example**

**Making AC Voltage Measurements (DC-Coupled)**

dimension array

**CONF:VOLT:ACDC 0.54,MAX**

TRIG:COUN 3

READ?

enter statement

*Dimension computer array*

*Function: AC volts (DC coupled); range selected: 3V; MAX resolution: 1 mV*

*Multimeter will accept 3 triggers (one measurement is taken per trigger)*

*Place multimeter in wait-for-trigger state and make measurements; send readings to output buffer*

*Enter readings into computer*

**Comments**

- To select a standard measurement range, specify *expected value* as the input signal's maximum expected voltage. The multimeter then selects the correct range.
- The AUTO and DEF options for the *expected value* parameter have the same effect (enable autorange). The DEF option for the *resolution* parameter defaults the integration time to 1 PLC.

- The MIN and MAX parameters select the minimum or maximum values for *expected value* and *resolution*:

For *expected value*: MIN = 0V; MAX = ± 300V

For *resolution*: MIN selects the best resolution (the smallest value from Table 5-1) for the selected range. MAX selects the worst resolution (the largest value from Table 5-1) for the selected range.

- When autoranging, MIN or MAX are the only *resolution* settings which are allowed. Specify a numeric resolution only when making measurements on a fixed range. If you specify a numeric value for *resolution* while autoranging, the “Settings conflict” error is generated.
- To select autorange, specify AUTO (or DEF) for *expected value* or do not specify a value for the parameter.
- To specify a MIN or MAX resolution while autoranging, you must specify CONF:VOLT:ACDC AUTO or CONF:VOLT:ACDC DEF (you cannot omit the *expected value* parameter). This prevents the MIN or MAX resolution from being interpreted as a range setting.
- **Related Commands:** FETCh?, INITiate, READ?

**:VOLTage[:DC]**

CONFigure:VOLTage[:DC] [ < *expected value* > [, < *resolution* > ]] selects the DC voltage function and allows you to specify the *expected value* and desired *resolution*.

*For a complete listing of range and resolution values available, see Table 5-1 at the beginning of this chapter.*

**Parameters**

Parameter Name	Parameter Type	Range of Values	Default Units
<i>expected value</i>	numeric	0V through ± 300V   AUTOMATIC   DEFault   MINimum   MAXimum	volts
<i>resolution</i>	numeric	<i>resolution</i> (see Table 5-1)   DEFault   MINimum   MAXimum	volts

## Example

## Making DC Voltage Measurements

dimension array  
**CONF:VOLT 8.25,MAX**

TRIG:COUN 3

READ?

enter statement

*Dimension computer array*

*Function: DC voltage;  
 range selected: 30V;  
 MAX resolution: 10 mV*

*Multimeter will accept 3 triggers  
 (one measurement is taken  
 per trigger)*

*Place multimeter in  
 wait-for-trigger state and make  
 measurements; send readings  
 to output buffer*

*Enter readings into computer*

## Comments

- The :DC parameter is optional. Both of the following command statements select the DC voltage function:

CONF:VOLT:DC or CONF:VOLT

- To select a standard measurement range, specify *expected value* as the input signal's maximum expected voltage. The multimeter then selects the correct range.
- The AUTO and DEF options for the *expected value* parameter have the same effect (enable autorange). The DEF option for the *resolution* parameter defaults the integration time to 1 PLC.
- The MIN and MAX parameters select the minimum or maximum values for *expected value* and *resolution*:

For *expected value*: MIN = 0V; MAX = ± 300V

For *resolution*: MIN selects the best resolution (the smallest value from Table 5-1) for the selected range. MAX selects the worst resolution (the largest value from Table 5-1) for the selected range.

- When autoranging, MIN or MAX are the only *resolution* settings which are allowed. Specify a numeric resolution only when making measurements on a fixed range. If you specify a numeric value for *resolution* while autoranging, the "Settings conflict" error is generated.
- To select autorange, specify AUTO (or DEF) for *expected value* or do not specify a value for the parameter.
- To specify a MIN or MAX resolution while autoranging, you must specify CONF:VOLT:DC AUTO or CONF:VOLT:DC DEF (you cannot omit the *expected value* parameter). This prevents the MIN or MAX resolution from being interpreted as a range setting.
- **Related Commands:** FETCh?, INITiate, READ?

## CONFigure?

The CONFigure? command queries the multimeter to return the configuration set by the most recent CONFigure or MEASure command. It returns a quoted string to the output buffer in the following format:

*“<function> <parameter>, <parameter>”*

### Subsystem Syntax

CONFigure?

### Example

#### Querying the Multimeter Configuration

dimension string array  
CONF:FRES 1560,MAX

*Dimension computer array  
Function: 4-wire ohms;  
range selected: 3 kΩ;  
MAX resolution: 1Ω*

CONF?  
enter statement

*Query configuration  
Enter string into computer*

#### String Returned:

*“FRES 3.000000E + 003,1.000000E + 000”*

### Comments

- When the multimeter is configured for voltage, resistance, frequency, or period measurements, CONFigure? returns the function followed by the selected range and resolution. For example:

*“FREQ DEF,DEF”  
“FRES 3.000000E + 002,1.000000E-003”  
“PER DEF,DEF”  
“RES 3.000000E + 006,1.000000E-006”  
“VOLT:AC 3.000000E + 000,1.000000E-006”  
“VOLT:ACDC 3.000000E-003,1.000000E-006”  
“VOLT 3.000000E-001,1.000000E-005”*

- Since you cannot set the range or resolution for temperature measurements, CONFigure? returns “TEMP” followed by the specified transducer and type. For example:

*“TEMP FRTD,385”  
“TEMP THER,2252”*

- If you specify AUTO, DEF, MIN, or MAX for the *range* or *resolution* parameters in CONFigure or MEASure, the CONFigure? command returns the selected value.

- **Related Commands:** CONFigure, MEASure



## DIAGnostic

The DIAGnostic command subsystem provides multimeter servicing and diagnostic routines. This is a service-related command. Refer to the HP E1410A Service Manual for details.

---



## FETCh?

The FETCh? command retrieves measurements stored in multimeter memory by the most recent INITiate command and places them in the output buffer. This command is most commonly used with CONFigure.

### Subsystem Syntax

FETCh?

### Example

#### Transferring Stored Readings to Output Buffer

dimension array	<i>Dimension computer array</i>
CONF:VOLT:DC	<i>Function: DC voltage</i>
SAMP:COUN 100	<i>100 readings per trigger</i>
INIT	<i>Store readings in multimeter memory; trigger source is IMMEDIATE by default</i>
<b>FETC?</b>	<i>Place readings in output buffer</i>
enter statement	<i>Enter readings into computer</i>

### Comments

- Execute INITiate before sending the FETCh? command to place the multimeter in the wait-for-trigger state. If the multimeter is in the idle state (i.e., if INITiate has not been executed), FETCh? will generate the “Data corrupt or stale” error.
- Each reading sent to the output buffer consists of 17 bytes (characters) in Real ASCII format:

$\pm 1.23456789E \pm 123 LF$

If multiple readings are returned by a command, the readings are separated by commas. A Line Feed (*LF*) and the HP-IB End-or-Identify (EOI) signal follow the last reading returned.

- The multimeter’s output buffer capacity is 128 bytes. Therefore, seven readings (17 bytes each) can be transferred to the output buffer at a time. The multimeter remains “busy” until you begin removing readings from the output buffer using your computer’s enter statement. New data sent to the output buffer overwrites data sent from previous commands.
- **Related Commands:** CONFigure, INITiate, READ?
- **\*RST Condition:** Since \*RST places the multimeter in the idle state, executing FETCh? immediately after a \*RST generates the “Data corrupt or stale” error.



## INITiate

The INITiate command subsystem places the multimeter in the wait-for-trigger state. This command is most commonly used with CONFigure.

### Subsystem Syntax

INITiate  
[:IMMediate]

### [:IMMediate]

INITiate[:IMMediate] places the multimeter in the wait-for-trigger state and stores readings in multimeter memory when a trigger occurs. Readings stored in memory from previous commands are replaced by the new readings.

### Example

#### Placing Multimeter in Wait-For-Trigger State

CONF:VOLT:DC  
TRIG:SOUR EXT

INIT

FETC?

INIT

*Function: DC voltage*

*Trigger source is external BNC on multimeter front panel*

*Place multimeter in wait-for-trigger state; store readings in multimeter memory when trigger is received*

*Place readings in output buffer*

*You must re-initiate the wait-for-trigger state after each trigger cycle*

### Comments

- The :IMMediate parameter is optional. Both of the following command statements place the multimeter in the wait-for-trigger state:

INIT:IMM or INIT

- After the trigger system is initiated using INITiate, use the TRIGger command subsystem to control the behavior of the trigger system.
- If TRIGger:SOURce is IMMediate, the measurement starts and readings are stored in multimeter memory as soon as INITiate is executed. Readings stored in memory from previous commands are replaced by the new readings.
- To transfer readings from multimeter memory to the output buffer, use the FETCh? command.
- If the multimeter is in the wait-for-trigger state, the ABORt command places the multimeter in its idle state and terminates any measurement in progress.
- The multimeter has enough memory to store 4,096 readings. Each reading stored is eight bytes long. Since readings are stored in an eight-byte format, INITiate is faster than sending readings directly to the output buffer using the READ? command.
- The READ? command executes INITiate implicitly. The MEASure command executes READ? implicitly.
- **Related Commands:** ABORt, CONFigure, FETCh?, READ?
- **\*RST Condition:** \*RST places the multimeter in the idle state.

## INPut

The INPut command subsystem:

- Selects the input coupling source for AC voltage, frequency, and period measurements (INPut:COUPling).
- Enables or disables the automatic input impedance mode for DC voltage measurements (INPut:IMPedance:AUTO).
- Selects the input source for making measurements (INPut:STATe).

## Subsystem Syntax

```
INPut
:COUPling <source >
:COUPling?
:IMPedance:AUTO <mode >
:IMPedance:AUTO?
:STATe <mode >
:STATe?
```

## :COUPling

INPut:COUPling <source > configures the multimeter to accept either AC voltage or AC + DC voltage as the input coupling source for AC voltage, frequency, or period measurements.

## Parameters

Parameter Name	Parameter Type	Range of Values	Default Units
<i>source</i>	discrete	AC DC	none

## Example

## Selecting the Input Coupling Source

CONF:FREQ

*Function: frequency;  
trigger source is IMMEDIATE  
by default*

INP:COUP DC

*Input source is AC + DC  
voltage (DC-coupled)*

READ?

*Place multimeter in  
wait-for-trigger state and make  
measurement; send reading  
to output buffer*

enter statement

*Enter reading into computer*

## Comments

- AC configures the multimeter for AC voltage inputs (AC-coupled).  
DC configures the multimeter for AC + DC voltage inputs (DC-coupled).
- The INPut:COUPling command does not alter the present SENSE:BANDwidth:DETECTOR (AC fast or slow) configuration.
- \*RST Condition: INP:COUP AC

**:COUPling?**

**INPut:COUPling?** returns “AC” or “DC” to show the present input source. The string is sent to the output buffer.

**Example****Querying the Input Source**

INP:COUP DC

*Input source is AC + DC voltage*

INP:COUP?

*Query multimeter to return input source setting*

enter statement

*Enter string into computer***:IMPedance:AUTO**

**INPut:IMPedance:AUTO <mode>** enables or disables the automatic input impedance mode for DC voltage measurements. When disabled (AUTO OFF), the multimeter maintains its input impedance of 10 M $\Omega$  for all DC voltage ranges. This is useful to prevent a change in input impedance (caused by changing ranges) from affecting the measurements.

**Parameters**

Parameter Name	Parameter Type	Range of Values	Default Units
<i>mode</i>	boolean	OFF 0 ON 1	none

<i>mode</i> Parameter	Input Impedances	
	30 mV, 300 mV, 3V DCV ranges	30V, 300V DCV ranges
OFF or 0	10 M $\Omega$	10 M $\Omega$
ON or 1	10 G $\Omega$	10 M $\Omega$

**Example**

**Disabling Automatic Input Impedance** (use 10 M $\Omega$  impedance for all ranges)

INP:IMP:AUTO OFF

*Disable automatic input impedance***Comments**

- You can substitute decimal values for the OFF (“0”) and ON (“1”) parameters.
- The automatic input impedance mode remains disabled (AUTO OFF) after you change from DC voltage measurements to 2-wire resistance or 4-wire resistance measurements. This can affect the resistance measurements since the 10 M $\Omega$  resistance remains connected in parallel with the input terminals. Enable the automatic input impedance mode (AUTO ON) before selecting resistance measurements.
- The automatic input impedance mode is temporarily enabled (AUTO ON) when you change from DC voltage measurements to AC voltage, AC + DC voltage, frequency, or period measurements. When you return the measurement function to DC voltage, automatic input impedance is once again disabled (AUTO OFF).
- **\*RST Condition:** INP:IMP:AUTO ON

**:IMPedance:AUTO?**

INPut:IMPedance:AUTO? returns a number to show whether the automatic input impedance mode is enabled or disabled: “1” = ON, “0” = OFF. The number is sent to the output buffer.

**Example**

**Querying the Input Impedance Mode**

INP:IMP:AUTO OFF	<i>Disable automatic input impedance</i>
INP:IMP:AUTO?	<i>Query multimeter to return input impedance mode (“0”)</i>
enter statement	<i>Enter value into computer</i>

**:STATe**

INPut:STATe <mode> enables or disables the multimeter’s input terminals. The input terminals are either connected (INPut:STATe ON) or open (INPut:STATe OFF).

**Parameters**

Parameter Name	Parameter Type	Range of Values	Default Units
<i>mode</i>	boolean	OFF 0 ON 1	none

**Example**

**Disabling the Input Terminals**

INP:STAT OFF	<i>Open input terminals</i>
--------------	-----------------------------

**Comments**

- You can substitute decimal values for the OFF (“0”) and ON (“1”) parameters.
- This command enables/disables only the HI, LO, Ω SENSE HI, and Ω SENSE LO terminals. The Guard, External Trigger, and Voltmeter Complete terminals are not affected.
- \*RST Condition: INP:STAT ON

**:STATe?**

INPut:STATe? returns a number to show whether the input terminals are enabled or disabled: “1” = ON (enabled), “0” = OFF (disabled). The number is sent to the output buffer.

**Example**

**Querying the Input Terminal State**

INP:STAT OFF	<i>Open input terminals</i>
INP:STAT?	<i>Query multimeter to return input terminal state (“0”)</i>
enter statement	<i>Enter value into computer</i>

## MEASure

The MEASure command subsystem configures the multimeter to perform the specified measurement with the given range and resolution. MEASure makes the measurement and sends the readings to the output buffer.

Executing MEASure is equivalent to configuring the multimeter with the low-level commands shown in the following table.

Parameter	Command	Setting
Function	SENSe:FUNctIon:FREQUency, SENSe:FUNctIon:FRESistance, SENSe:FUNctIon:PERiod, SENSe:FUNctIon:RESistance, SENSe:FUNctIon:VOLTage:AC, or SENSe:FUNctIon:VOLTage:DC	As specified by CONFigure.
Range	SENSe:RESistance:RANGe or SENSe:VOLTage:RANGe	As specified, or autorange.
Autozero	CALibration:ZERO:AUTO	ON (performs autozero after each measurement).
Input Terminals	INPut:STATe	ON (connects input source).
Input Coupling	INPut:COUPling	AC Voltage.
Integration Time	SENSe:RESistance:NPLC or SENSe:VOLTage:NPLC	1 Power Line Cycle (PLC), or based on specified resolution.
Aperture Time	SENSe:RESistance:APERture or SENSe:VOLTage:APERture	16.7 ms (60 Hz) or 20 ms (50 Hz), or based on specified resolution.
Offset Compensation	SENSe:RESistance:OCOMpensated	OFF (useful for resistance measurements only).
Input Impedance	INPut:IMPedance:AUTO	ON (useful for DC voltage measurements only).
AC Bandwidth	SENSe:BANDwidth:DETEctor	Selects slow measurement mode (useful for AC voltage, frequency, and period measurements only).
Readings per Trigger	SAMPle:COUNt	1 reading.
Trigger Source	TRIGger:SOURce	IMMEDIATE (trigger signal is always true).
Trigger Count	TRIGger:COUNt	1 trigger.
Trigger Delay	TRIGger:DElay	Default (see Table 4-9).

Subsystem Syntax

MEASure

- :FREQUENCY? [ < expected value > [, < resolution > ]]
- :RESistance? [ < expected value > [, < resolution > ]]
- :PERiod? [ < expected value > [, < resolution > ]]
- :RESistance? [ < expected value > [, < resolution > ]]
- :TEMPerature? < transducer > , < type >
- :VOLTage:AC? [ < expected value > [, < resolution > ]]
- :VOLTage:ACDC? [ < expected value > [, < resolution > ]]
- :VOLTage[:DC]? [ < expected value > [, < resolution > ]]

MEASure Subsystem Data Format

- Each reading sent to the output buffer consists of 17 bytes (characters) in Real ASCII format:

± 1.23456789E ± 123 LF

If multiple readings are returned by a command, the readings are separated by commas. A Line Feed (LF) and the HP-IB End-or-Identify (EOI) signal follow the last reading returned.

- The multimeter's output buffer capacity is 128 bytes. Therefore, seven readings (17 bytes each) can be transferred to the output buffer at a time. The multimeter remains "busy" until you begin removing readings from the output buffer using your computer's enter statement. New data sent to the output buffer overwrites data sent from previous commands.

:FREQUENCY?

MEASure:FREQUENCY? [ < expected value > [, < resolution > ]] selects the frequency function.

Parameters

Parameter Name	Parameter Type	Range of Values	Default Units
<i>expected value</i>	numeric	10 Hz through 1.5 MHz AUTOMATIC   DEFault   MINimum   MAXimum	hertz
<i>resolution</i>	numeric	1 Hz through 1 ppm   DEFault   MINimum   MAXimum	hertz

Example

Making Frequency Measurements

MEAS:FREQ?

*Function: frequency;  
trigger source is IMMEDIATE  
by default*

enter statement

*Enter reading into computer*

**Comments**

- Specify *expected value* as the input signal's maximum expected frequency. The multimeter verifies that the input frequency is between 10 Hz and 1.5 MHz. The multimeter automatically voltage autoranges in the frequency function.
- The AUTO, DEF, MIN, and MAX options for the *expected value* parameter are not used for frequency measurements. If you specify one of these options, the multimeter will ignore it and no errors are generated.
- The multimeter provides a constant 1 ppm of resolution (the minimum resolution is 1 Hz). Specifying a resolution greater than 1 ppm generates an error.
- The DEF, MIN, and MAX options for the *resolution* parameter are not used for frequency measurements. If you specify one of these options, the multimeter will ignore it and no errors are generated.
- The MEASure command automatically sets the input coupling to AC voltage (INPut:COUPling AC).
- **Related Commands:** READ?

**:FRESistance?**

MEASure:FRESistance? [*<expected value>* [,*<resolution>* ]] selects the 4-wire ohms function and allows you to specify the expected value and desired resolution.

*For a complete listing of range and resolution values available, see Table 5-2 at the beginning of this chapter.*

**Parameters**

Parameter Name	Parameter Type	Range of Values	Default Units
<i>expected value</i>	numeric	0Ω through 3 GΩ   AUTOMatic   DEFault   MINimum   MAXimum	ohms
<i>resolution</i>	numeric	<i>resolution</i> (see Table 5-2)   DEFault   MINimum   MAXimum	ohms

**Example**

**Making 4-Wire Ohms Measurements**

**MEAS:FRES? 1560,MAX**

*Function: 4-wire ohms;  
range selected: 3 kΩ;  
MAX resolution: 1Ω;  
trigger source is IMMEDIATE  
by default*

enter statement

*Enter reading into computer*

**Comments**

- To select a standard measurement range, specify *expected value* as the input signal's maximum expected resistance. The multimeter then selects the correct range.
- The AUTO and DEF options for the *expected value* parameter have the same effect (enable autorange). The DEF option for the *resolution* parameter defaults the integration time to 1 PLC.
- The MIN and MAX parameters select the minimum or maximum values for *expected value* and *resolution*:  
  
 For *expected value*: MIN = 0Ω; MAX = 3 GΩ  
  
 For *resolution*: MIN selects the best resolution (the smallest value from Table 5-2) for the selected range. MAX selects the worst resolution (the largest value from Table 5-2) for the selected range.
- When autoranging, MIN or MAX are the only *resolution* settings which are allowed. Specify a numeric resolution only when making measurements on a fixed range. If you specify a numeric value for *resolution* while autoranging, the "Settings conflict" error is generated.
- To select autorange, specify AUTO (or DEF) for *expected value* or do not specify a value for the parameter.
- To specify a MIN or MAX resolution while autoranging, you must specify MEAS:FRES? AUTO or MEAS:FRES? DEF (you cannot omit the *expected value* parameter). This prevents the MIN or MAX resolution from being interpreted as a range setting.
- **Related Commands:** READ?

**:PERiod?**

MEASure:PERiod? [ <expected value > [, <resolution > ] ] selects the period function.

**Parameters**

Parameter Name	Parameter Type	Range of Values	Default Units
<i>expected value</i>	numeric	0.67 μs through 0.1s   AUTOMatic   DEFault   MINimum   MAXimum	seconds
<i>resolution</i>	numeric	1 μs through 1 ppm   DEFault   MINimum   MAXimum	seconds

**Example**

**Making Period Measurements**

**MEAS:PER?**

enter statement

*Function: period;  
trigger source is IMMEDIATE  
by default*

*Enter reading into computer*



**Comments**

- Specify *expected value* as the input signal's maximum expected period. The multimeter verifies that the input period is between 0.67  $\mu$ s and 0.1 seconds. The multimeter automatically voltage autoranges in the period function.
- The AUTO, DEF, MIN, and MAX options for the *expected value* parameter are not used for period measurements. If you specify one of these options, the multimeter will ignore it and no errors are generated.
- The multimeter provides a constant 1 ppm of resolution (the minimum resolution is 1  $\mu$ s). Specifying a resolution greater than 1 ppm generates an error.
- The DEF, MIN, and MAX options for the *resolution* parameter are not used for period measurements. If you specify one of these options, the multimeter will ignore it and no errors are generated.
- The MEASure command automatically sets the input coupling to AC voltage (INPut:COUPLing AC).
- **Related Commands:** READ?

**:RESistance?**

MEASure:RESistance? [ <expected value > [, <resolution > ]] selects the 2-wire ohms function and allows you to specify the expected value and desired resolution.

*For a complete listing of range and resolution values available, see Table 5-2 at the beginning of this chapter.*

**Parameters**

Parameter Name	Parameter Type	Range of Values	Default Units
<i>expected value</i>	numeric	0 $\Omega$ through 3 G $\Omega$   AUTOMatic   DEFault   MINimum   MAXimum	ohms
<i>resolution</i>	numeric	<i>resolution</i> (see Table 5-2)   DEFault   MINimum   MAXimum	ohms

**Example**

**Making 2-Wire Ohms Measurements**

MEAS:RES? 1320,MAX

*Function: 2-wire ohms;  
range selected: 3 k $\Omega$ ;  
MAX resolution: 1 $\Omega$ ;  
trigger source is IMMEDIATE  
by default*

enter statement

*Enter reading into computer*

**Comments**

- To select a standard measurement range, specify *expected value* as the input signal's maximum expected resistance. The multimeter then selects the correct range.
- The AUTO and DEF options for the *expected value* parameter have the same effect (enable autorange). The DEF option for the *resolution* parameter defaults the integration time to 1 PLC.
- The MIN and MAX parameters select the minimum or maximum values for *expected value* and *resolution*:  
  
For *expected value*: MIN = 0Ω; MAX = 3 GΩ  
  
For *resolution*: MIN selects the best resolution (the smallest value from Table 5-2) for the selected range. MAX selects the worst resolution (the largest value from Table 5-2) for the selected range.
- When autoranging, MIN or MAX are the only *resolution* settings which are allowed. Specify a numeric resolution only when making measurements on a fixed range. If you specify a numeric value for *resolution* while autoranging, the "Settings conflict" error is generated.
- To select autorange, specify AUTO (or DEF) for *expected value* or do not specify a value for the parameter.
- To specify a MIN or MAX resolution while autoranging, you must specify MEAS:RES? AUTO or MEAS:RES? DEF (you cannot omit the *expected value* parameter). This prevents the MIN or MAX resolution from being interpreted as a range setting.
- **Related Commands:** READ?

**:TEMPerature?**

MEASure:TEMPerature? <transducer>, <type> selects the temperature function. All measurements are returned in Degrees Celsius. The following transducers can be measured using the multimeter:

- Thermistors (2-wire or 4-wire measurement)
- RTDs (2-wire or 4-wire measurement)

**Parameters**

Parameter Name	Parameter Type	Range of Values	Default Units
<i>transducer</i>	discrete	THERmistor   FTHERmistor   RTD   FRTD	none
<i>type</i>	numeric	THER/FTH: 2252   5000   10000 RTD/FRTD: 85   92	ohms alpha

**Example**

**Making Thermistor Measurements**

**MEAS:TEMP? THER,5000**

enter statement

*Measure 5000Ω thermistor (2-wire measurement); trigger source is IMMEDIATE by default  
Enter reading into computer*

**Comments**

- You can measure RTD types 85 (alpha = 0.00385 Ω/Ω/°C) and 92 (alpha = 0.00392 Ω/Ω/°C).
- You can also use 385, 0.00385, 392, 0.00392 for the *type* parameter.
- The multimeter automatically makes temperature measurements using a 1 PLC integration time and autoranging.
- **Related Commands:** READ?

**:VOLTage:AC?**

MEASure:VOLTage:AC? [ <expected value> [, <resolution> ]] selects the AC-coupled RMS voltage function and allows you to specify the expected value and desired resolution.

For a complete listing of range and resolution values available, see Table 5-1 at the beginning of this chapter.

**Parameters**

Parameter Name	Parameter Type	Range of Values	Default Units
<i>expected value</i>	numeric	0V through ± 300V   AUTOMatic   DEFault   MINimum   MAXimum	volts
<i>resolution</i>	numeric	<i>resolution</i> (see Table 5-1)   DEFault   MINimum   MAXimum	volts

**Example**

**Making AC Voltage Measurements (AC-Coupled)**

**MEAS:VOLT:AC? 0.54,MAX**

*Function: AC volts;  
range selected: 3V;  
MAX resolution: 1 mV;  
trigger source is IMMEDIATE  
by default*

enter statement

*Enter reading into computer*

**Comments**

- To select a standard measurement range, specify *expected value* as the input signal's maximum expected voltage. The multimeter then selects the correct range.
- The AUTO and DEF options for the *expected value* parameter have the same effect (enable autorange). The DEF option for the *resolution* parameter defaults the integration time to 1 PLC.
- The MIN and MAX parameters select the minimum or maximum values for *expected value* and *resolution*:

For *expected value*: MIN = 0V; MAX = ± 300V

For *resolution*: MIN selects the best resolution (the smallest value from Table 5-1) for the selected range. MAX selects the worst resolution (the largest value from Table 5-1) for the selected range.

- When autoranging, MIN or MAX are the only *resolution* settings which are allowed. Specify a numeric resolution only when making measurements on a fixed range. If you specify a numeric value for *resolution* while autoranging, the “Settings conflict” error is generated.
- To select autorange, specify AUTO (or DEF) for *expected value* or do not specify a value for the parameter.
- To specify a MIN or MAX resolution while autoranging, you must specify MEAS:VOLT:AC? AUTO or MEAS:VOLT:AC? DEF (you cannot omit the *expected value* parameter). This prevents the MIN or MAX resolution from being interpreted as a range setting.
- **Related Commands:** READ?

**:VOLTage:ACDC?**

MEASure:VOLTage:ACDC? [*<expected value>* [,*<resolution>* ]] selects the DC-coupled RMS voltage function and allows you to specify the expected value and desired resolution.

*For a complete listing of range and resolution values available, see Table 5-1 at the beginning of this chapter.*

**Parameters**

Parameter Name	Parameter Type	Range of Values	Default Units
<i>expected value</i>	numeric	0V through ± 300V   AUTOMatic   DEFault   MINimum   MAXimum	volts
<i>resolution</i>	numeric	<i>resolution</i> (see Table 5-1)   DEFault   MINimum   MAXimum	volts

**Example**

**Making AC Voltage Measurements (DC-Coupled)**

**MEAS:VOLT:ACDC? 0.54,MAX**

*Function: AC volts  
(DC coupled);  
range selected: 3V;  
MAX resolution: 1 mV;  
trigger source is IMMEDIATE  
by default*

enter statement

*Enter reading into computer*

**Comments**

- To select a standard measurement range, specify *expected value* as the input signal's maximum expected voltage. The multimeter then selects the correct range.
- The AUTO and DEF options for the *expected value* parameter have the same effect (enable autorange). The DEF option for the *resolution* parameter defaults the integration time to 1 PLC.
- The MIN and MAX parameters select the minimum or maximum values for *expected value* and *resolution*:  
  
 For *expected value*: MIN = 0V; MAX = ± 300V  
  
 For *resolution*: MIN selects the best resolution (the smallest value from Table 5-1) for the selected range. MAX selects the worst resolution (the largest value from Table 5-1) for the selected range.
- When autoranging, MIN or MAX are the only *resolution* settings which are allowed. Specify a numeric resolution only when making measurements on a fixed range. If you specify a numeric value for *resolution* while autoranging, the "Settings conflict" error is generated.
- To select autorange, specify AUTO (or DEF) for *expected value* or do not specify a value for the parameter.
- To specify a MIN or MAX resolution while autoranging, you must specify MEAS:VOLT:ACDC? AUTO or MEAS:VOLT:ACDC? DEF (you cannot omit the *expected value* parameter). This prevents the MIN or MAX resolution from being interpreted as a range setting.
- **Related Commands:** READ?

**:VOLTage[:DC]?**

MEASure:VOLTage[:DC]? [ < *expected value* > [, < *resolution* > ] ] selects the DC voltage function and allows you to specify the expected value and desired resolution.

*For a complete listing of range and resolution values available, see Table 5-1 at the beginning of this chapter.*

**Parameters**

Parameter Name	Parameter Type	Range of Values	Default Units
<i>expected value</i>	numeric	0V through ± 300V   AUTOMatic   DEFault   MINimum   MAXimum	volts
<i>resolution</i>	numeric	<i>resolution</i> (see Table 5-1)   DEFault   MINimum   MAXimum	volts

<b>Example</b>	<p><b>Making DC Voltage Measurements</b></p> <p><b>MEAS:VOLT:DC? 8.25,MAX</b></p> <p>enter statement</p>	<p><i>Function: DC voltage; range selected: 30V; MAX resolution: 10 mV; trigger source is IMMEDIATE by default</i></p> <p><i>Enter reading into computer</i></p>
<b>Comments</b>	<ul style="list-style-type: none"> <li>● The :DC parameter is optional. Both of the following command statements select the DC voltage function: <p style="margin-left: 20px;">MEAS:VOLT:DC?    or    MEAS:VOLT?</p> </li> <li>● To select a standard measurement range, specify <i>expected value</i> as the input signal's maximum expected voltage. The multimeter then selects the correct range.</li> <li>● The AUTO and DEF options for the <i>expected value</i> parameter have the same effect (enable autorange). The DEF option for the <i>resolution</i> parameter defaults the integration time to 1 PLC.</li> <li>● The MIN and MAX parameters select the minimum or maximum values for <i>expected value</i> and <i>resolution</i>: <p style="margin-left: 20px;">For <i>expected value</i>: MIN = 0V; MAX = ± 300V</p> <p style="margin-left: 20px;">For <i>resolution</i>: MIN selects the best resolution (the smallest value from Table 5-1) for the selected range. MAX selects the worst resolution (the largest value from Table 5-1) for the selected range.</p> </li> <li>● When autoranging, MIN or MAX are the only <i>resolution</i> settings which are allowed. Specify a numeric resolution only when making measurements on a fixed range. If you specify a numeric value for <i>resolution</i> while autoranging, the "Settings conflict" error is generated.</li> <li>● To select autorange, specify AUTO (or DEF) for <i>expected value</i> or do not specify a value for the parameter.</li> <li>● To specify a MIN or MAX resolution while autoranging, you must specify MEAS:VOLT:DC? AUTO or MEAS:VOLT:DC? DEF (you cannot omit the <i>expected value</i> parameter). This prevents the MIN or MAX resolution from being interpreted as a range setting.</li> <li>● <b>Related Commands:</b> READ?</li> </ul>	

# MEMory

The MEMory command subsystem enables you to store multimeter readings on external VME memory cards.

## Subsystem Syntax

```
MEMory
:VME:ADDRess < address >
:VME:ADDRess? [MINimum|MAXimum]
:VME:SIZE < bytes >
:VME:SIZE? [MINimum|MAXimum]
:VME:STATe < mode >
:VME:STATe?
```

## MEMory Subsystem Data Format

The multimeter sends readings to external VME memory in IEEE-754 64-bit notation (this is the IEEE standard for binary floating-point representation).

## :VME:ADDRess

MEMory:VME:ADDRess < address > sets the address of the external memory board in A24 memory address space.

### Parameters

Parameter Name	Parameter Type	Range of Values	Default Units
<i>address</i>	numeric	2097152 – 14680056   #H200000 – #HDFFFF8	none

### Example

Setting the VME Memory Address

**MEM:VME:ADDR #H250000**

*Set memory address location*

### Comments

- You can specify the address location in decimal or hexadecimal (#H...).
- MIN sets the address to 2097152 (#H200000). MAX sets the address to 14680056 (#HDFFFF8).
- \*RST Condition: MEM:VME:ADDR #H200000

## :VME:ADDRess?

MEMory:VME:ADDRess? [MINimum|MAXimum] returns one of the following numbers to the output buffer:

- The present decimal address selected if MIN or MAX are not specified.
- The lowest decimal address available (2097152) if MIN is specified.
- The highest decimal address available (14680056) if MAX is specified.

### Example

Querying the VME Memory Address

dimension string array

*Dimension computer string array*

**MEM:VME:ADDR #H250000**

*Set memory address location*

**MEM:VME:ADDR?**

*Query multimeter to return memory address (in decimal)*

enter statement

*Enter string into computer*

**:VME:SIZE** MEMory:VME:SIZE <bytes> sets the size, in bytes, of the external VME memory card.

**Parameters**

Parameter Name	Parameter Type	Range of Values	Default Units
bytes	numeric	0 through 12582912   0 through #HC00000	bytes

**Example**

Setting the VME Memory Size

**MEM:VME:SIZE 64000**

*Set memory size to 64 kBytes*

**Comments**

- You can specify the memory size in decimal or hexadecimal (#H....).
- MIN sets the memory size to 0 bytes. MAX sets the memory size to 12582912 (#HC00000) bytes.
- The memory address (MEM:VME:ADDR) plus memory size (MEM:VME:SIZE) must not exceed 14680064 (#HE00000).
- Since each reading requires 8 bytes of memory, the sample count multiplied by the trigger count must be less than or equal to MEM:VME:SIZE/8.
- \*RST Condition: MEM:VME:SIZE 0

**:VME:SIZE?**

MEMory:VME:SIZE? [MINimum | MAXimum] returns one of the following numbers to the output buffer:

- The present memory size (in decimal) selected if MIN or MAX are not specified.
- The smallest memory size available (0) if MIN is specified.
- The largest memory size available (12582912) if MAX is specified.

**Example**

Querying the VME Memory Size

MEM:VME:SIZE 64000

*Set memory size to 64 kBytes*

MEM:VME:SIZE?

*Query multimeter to return memory size*

enter statement

*Enter string into computer*



**:VME:STATe**

MEMory:VME:STATe <mode> enables or disables use of an external VME memory card for reading storage.

**Parameters**

Parameter Name	Parameter Type	Range of Values	Default Units
<i>mode</i>	boolean	OFF 0 ON 1	none

**Example****Enabling VME Memory**

CONF:VOLT 8.25,MAX

*Function: DC voltage;  
range selected: 30V;  
MAX resolution: 10 mV*

TRIG:COUN 3

*Multimeter will accept 3 triggers  
(one measurement is taken  
with each trigger)*

MEM:VME:ADDR #H250000

*Set memory address location*

MEM:VME:SIZE 64000

*Set memory size to 64 kBytes*

MEM:VME:STAT ON

*Enable use of external memory  
card*

INIT

*Place multimeter in  
wait-for-trigger state; store  
readings on memory card;  
trigger source is IMMEDIATE by  
default*

**Comments**

- You can substitute decimal values for the OFF ("0") and ON ("1") parameters.
- \*RST Condition: MEM:VME:STAT OFF

**:VME:STATe?**

MEMory:VME:STATe? returns a number to show whether use of the external VME memory card is enabled or disabled: "1" = ON, "0" = OFF. The number is sent to the output buffer.

**Example****Querying the VME Memory State**

MEM:VME:STAT ON

*Enable use of external memory  
card*

MEM:VME:STAT?

*Query multimeter to return  
external memory state ("1")*

enter statement

*Enter value into computer*

OUTPut:TTLTrg <n> [:STATe]

OUTPut:TTLTrg <n> [:STATe]

## OUTPut

The OUTPut command subsystem enables you to route the multimeter's *voltmeter complete* signal to the VXIbus TTL trigger lines.

### Subsystem Syntax

OUTPut  
:TTLTrg <n> [:STATe] <mode>  
:TTLTrg <n> [:STATe]?

**NOTE:** The *STATe* parameter is not currently implemented on this multimeter. You can omit the parameter when executing the *OUTPut* command.

### :TTLTrg <n> [:STATe]

OUTPut:TTLTrg <n> [:STATe] <mode> enables or disables routing of the *voltmeter complete* signal to the specified VXIbus trigger line (TTLTRG0 through TTLTRG7) on the backplane P2 connector.

### Parameters

Parameter Name	Parameter Type	Range of Values	Default Units
<i>n</i>	discrete	0 1 2 3 4 5 6 7	none
<i>mode</i>	boolean	OFF 0 ON 1	none

### Example

#### Routing Voltmeter Complete to Trigger Line

OUTP:TTL7 ON

*Route signal to trigger line 7*

### Comments

- You can substitute decimal values for the OFF ("0") and ON ("1") parameters.
- The *voltmeter complete* signal is always routed to the multimeter's front panel "VM Complete" BNC connector. When enabled (ON), the OUTPut command also routes *voltmeter complete* to the specified trigger line on connector P2. When disabled (OFF), *voltmeter complete* is routed only to the multimeter's front panel connector.
- The multimeter generates the *voltmeter complete* signal after it has sampled the input for each reading. This low-going TTL signal has a pulse width of approximately 3  $\mu$ s.
- The VXIbus trigger lines are open-collector TTL lines that remain in a non-asserted (high) state until the *voltmeter complete* signal is sent.
- **\*RST Condition:** OUTP:TTL*n* OFF

**:TTLTrg <n>  
[:STATe]?**

**OUTPut:TTLTrg <n> [:STATe]?** returns a number to show whether VXIbus trigger line routing of the *voltmeter complete* signal is enabled or disabled: "1" = ON, "0" = OFF. The number is sent to the output buffer.

**NOTE:** *The STATe parameter is not currently implemented on this multimeter. You can omit the parameter when executing the OUTPut command.*

**Example**

**Querying Voltmeter Complete Destination**

OUTP:TTLT7 ON

*Route signal to trigger line 7*

OUTP:TTLT7?

*Query multimeter to return trigger line mode*

enter statement

*Enter value into computer*

**READ?**

The READ? command is most commonly used with CONFigure to:

- Place the multimeter in the wait-for-trigger state (executes the INITiate command).
- Transfer the readings directly to the output buffer when the trigger is received (same action as FETCh? but the readings are not stored in multimeter memory).

**Subsystem Syntax**

READ?

**Example**

**Transferring Readings Directly to Output Buffer**

dimension array  
 CONF:VOLT:DC  
 SAMP:COUN 100  
**READ?**

*Dimension computer array  
 Function: DC voltage  
 Specify 100 readings per trigger  
 Place multimeter in  
 wait-for-trigger state and make  
 measurements; send readings  
 to output buffer; trigger source  
 is IMMEDIATE by default  
 Enter readings into computer*

enter statement

**Comments**

- The READ? command is slower than the INITiate command since readings are formatted and sent to the output buffer as they are taken. However, the sample count and trigger count are not limited with READ? since multimeter memory is not used.

- Each reading sent to the output buffer consists of 17 bytes (characters) in Real ASCII format:

$\pm 1.23456789E \pm 123 LF$

If multiple readings are returned by a command, the readings are separated by commas. A Line Feed (*LF*) and the HP-IB End-or-Identify (EOI) signal follow the last reading returned.

- The multimeter's output buffer capacity is 128 bytes. Therefore, seven readings (17 bytes each) can be transferred to the output buffer at a time. The multimeter remains "busy" until you begin removing readings from the output buffer using your computer's enter statement. New data sent to the output buffer overwrites data sent from previous commands.

- **Related Commands:** CONFigure, FETCh?, INITiate

# SAMPLE

The SAMPlE command subsystem operates with the TRIGger command subsystem. The SAMPlE subsystem:

- Designates the number of readings made for each trigger signal received (SAMPlE:COUNT).
- Selects the pacing source for the sample rate (SAMPlE:SOURce).
- Sets the sample rate when the sample count is greater than one (SAMPlE:TIMer).

## Subsystem Syntax

SAMPLE  
 :COUNT <number>  
 :COUNT? [MINimum | MAXimum]  
 :SOURce <source>  
 :SOURce?  
 :TIMer <period>  
 :TIMer? [MINimum | MAXimum]

## :COUNT

SAMPLE:COUNT <number> designates the number of readings per trigger.

### Parameters

Parameter Name	Parameter Type	Range of Values	Default Units
<i>number</i>	numeric	1 through 16,777,215   MINimum   MAXimum	none

### Example

#### Setting the Sample Count

dimension array  
 CONF:VOLT:DC  
 TRIG:SOUR EXT  
  
**SAMP:COUNT 10**  
 READ?

*Dimension computer array  
 Function: DC voltage  
 Trigger source is external BNC on multimeter front panel  
 Specify 10 readings per trigger  
 Place multimeter in wait-for-trigger state; make measurements when external trigger is received; send readings to output buffer  
 Enter readings into computer*

enter statement

### Comments

- MIN sets 1 reading per trigger. MAX sets 16,777,215 readings per trigger.
- CONFigure and MEASure set the sample count to 1.
- \*RST Condition: SAMP:COUNT 1

**:COUNT?**

SAMPle:COUNT? [MINimum | MAXimum] returns one of the following numbers to the output buffer:

- The present sample count (1 through 16,777,215) if MIN or MAX is not specified.
- The minimum sample count available (1) if MIN is specified.
- The maximum sample count available (16,777,215) if MAX is specified.

**Example**

**Querying the Sample Count**

SAMP:COUN 10	<i>Specify 10 readings per trigger</i>
SAMP:COUNT?	<i>Query multimeter to return sample count</i>
enter statement	<i>Enter value into computer</i>

**:SOURCE**

SAMPle:SOURce <source> selects the pacing source for the sample rate when SAMPle:COUNT is greater than 1. The sources available are:

- IMMEDIATE: Initiate reading whenever multimeter is not busy.
- TIMER: Specify sample rate using the SAMPle:TIMER command.

**Parameters**

Parameter Name	Parameter Type	Range of Values	Default Units
source	discrete	IMMEDIATE   TIMER	none

**Example**

**Setting the Pacing Source**

dimension array	<i>Dimension computer array</i>
CONF:VOLT:DC 25	<i>Function: DC voltage; range selected: 30V (disable autorange for fastest rate)</i>
SAMP:COUN 10	<i>Specify 10 readings per trigger</i>
SAMP:SOUR TIM	<i>Sample source is SAMPle:TIMER command</i>
SAMP:TIM 0.065	<i>Set 65 ms sample rate</i>
READ?	<i>Place multimeter in wait-for-trigger state and make measurements; send readings to output buffer</i>
enter statement	<i>Enter readings into computer</i>

**Comments**

- CONFigure and MEASure set the sample source to IMM.
- Related Commands: SAMPle:COUNT, SAMPle:TIMER
- \*RST Condition: SAMP:SOUR IMM

**:SOURce?**

SAMPle:SOURce? returns “IMM” or “TIM” to show the present pacing source. The string is sent to the output buffer.

**Example**

**Querying the Pacing Source**

SAMP:SOUR TIM

*Sample source is  
SAMPle:TIMer command*

SAMP:SOUR?

*Query multimeter to return  
pacing source setting*

enter statement

*Enter string into computer*

**:TIMer**

SAMPle:TIMer <period> defines the period between readings in a burst of readings when SAMPle:COUNt is greater than 1 and SAMPle:SOURce is TIMer.

**Parameters**

Parameter Name	Parameter Type	Range of Values*	Default Units
<i>period</i>	numeric	680 $\mu$ s through 2100s   MINimum   MAXimum	seconds

\* Resolution: 1.0  $\mu$ s

**Example**

**Setting the Sample Rate**

dimension array

*Dimension computer array*

CONF:VOLT:DC 25

*Function: DC voltage;  
range selected: 30V (disable  
autorange for fastest rate)*

SAMP:COUN 10

*Specify 10 readings per trigger*

SAMP:SOUR TIM

*Sample source is  
SAMPle:TIMer command*

SAMP:TIM 0.065

*Set 65 ms sample rate*

READ?

*Place multimeter in  
wait-for-trigger state and make  
measurements; send readings  
to output buffer*

enter statement

*Enter readings into computer*

**Comments**

- MIN sets the time to 680  $\mu$ s. MAX sets the time to 2100 seconds.
- When using SAMP:TIM, the first measurement occurs without the specified period. However, you can insert a time interval before the first measurement using the TRIGger:DELAy command.
- To achieve specific sample rates, the aperture time must be set accordingly (see the SENSE subsystem). The following table shows the minimum sample rate for each available aperture time setting. The aperture times and sample rate shown assume a fixed range and autozero off. Reading rates are for the DC voltage function with readings stored in multimeter memory.

Aperture Time	Minimum Sample Rate (SAMPlE:TIMer)	Maximum Reading Rate (Readings/second)
2.0s	2.5s	0.4
1.67s	2.04s	0.49
200 ms	250 ms	4.0
167 ms	204 ms	4.9
20 ms	21.2 ms	47
16.7 ms	17.8 ms	56
2.0 ms	3.2 ms	312
1.67 ms	2.7 ms	360
100 $\mu$ s	800 $\mu$ s	1250
10 $\mu$ s	680 $\mu$ s	1450

- The sample rate must be longer than the specified aperture time.
- **Related Commands:** SAMPlE:COUNt, SAMPlE:SOURce, SENSE
- **\*RST Condition:** SAMP:TIM 1.0

**:TIMer?**

SAMP:TIMer? [MINimum|MAXimum] returns one of the following numbers to the output buffer:

- The present sample rate (680  $\mu$ s through 2100 seconds) if MIN or MAX is not specified.
- The minimum sample rate available (680  $\mu$ s) if MIN is specified.
- The maximum sample rate available (2100 seconds) if MAX is specified.

**Example**

**Querying the Sample Rate**

SAMP:SOUR TIM  
 SAMP:TIM MAX  
 SAMP:TIM?  
 enter statement

*Sample source is  
 SAMPlE:TIMer command  
 Set sample rate to maximum  
 Query multimeter to return  
 sample rate (2100 seconds)  
 Enter value into computer*



[SENSe:]

[SENSe:]

[SENSe:]

The SENSE command subsystem is most commonly used with CONFIGure to change specific “low-level” measurement parameters. SENSE enables you to change the following measurement parameters without completely re-configuring the multimeter:

- AC Bandwidth
- Function
- Range
- Resolution
- Aperture and Integration Times
- Offset Compensation

#### Subsystem Syntax

```
[SENSe:]  
  BANDwidth:DETEctor <frequency >  
  BANDwidth:DETEctor? [MINimum | MAXimum]  
  FUNCTION[: <function > ]  
  FUNCTION?  
  RESistance  
    :APERTure <time >  
    :APERTure? [MINimum | MAXimum]  
    :NPLC <number >  
    :NPLC? [MINimum | MAXimum]  
    :OCOMPensated <mode >  
    :OCOMPensated?  
    :RANGE:AUTO <mode >  
    :RANGE:AUTO?  
    :RANGE <expected value >  
    :RANGE? [MINimum | MAXimum]  
    :RESolution <resolution >  
    :RESolution? [MINimum | MAXimum]  
  VOLTage  
    :AC:RANGE <expected value >  
    :AC:RANGE? [MINimum | MAXimum]  
    :APERTure <time >  
    :APERTure? [MINimum | MAXimum]  
    [:DC]:RANGE <expected value >  
    [:DC]:RANGE? [MINimum | MAXimum]  
    :NPLC <number >  
    :NPLC? [MINimum | MAXimum]  
    :RANGE:AUTO <mode >  
    :RANGE:AUTO?  
    :RESolution <resolution >  
    :RESolution? [MINimum | MAXimum]
```

**NOTE:** The root command SENSE is an implied command and can be omitted.

**BANDwidth:DETEctor**

[SENSe:]BANDwidth:DETEctor <*frequency*> selects the slow or fast measurement mode for AC voltage, frequency, or period measurements.

**Parameters**

Parameter Name	Parameter Type	Range of Values	Default Units
<i>frequency</i>	numeric	< 400 Hz (select slow mode)   ≥ 400 Hz (select fast mode)   MINimum   MAXimum	hertz

**Example**

Selecting the AC Bandwidth

**BAND:DET 5000**

*Select fast mode*

**Comments**

- You specify *frequency* as the expected frequency of the input signal. The multimeter automatically selects the slow mode (20 Hz is used) or fast mode (400 Hz is used) based on the frequency you specify.
- MIN selects the slow mode (20 Hz). MAX selects the fast mode (400 Hz).
- The slow mode selects a long time constant for the AC voltage input filter and a long delay time for AC volts, frequency, and period. Use this mode for measurements where the frequency is below 400 Hz. The fast mode selects a short time constant and a short delay time. Use this mode for measurements where the frequency is equal to or greater than 400 Hz. Table 4-9 (Chapter 4) shows the slow and fast mode delays for all functions and ranges.
- Since the fast mode has a short delay, it allows you to make a series of measurements faster than in the slow mode.
- If you are unsure of the input frequency, or if the frequency may dip below 400 Hz, use the slow mode. This takes slightly more time per measurement, but ensures accurate measurements.
- \*RST Condition: BAND:DET 20

**BANDwidth:DETEctor?**

[SENSe:]BANDwidth:DETEctor? [MINimum|MAXimum] returns one of the following numbers to the output buffer:

- The present bandwidth (in hertz) selected by the multimeter (either 20 or 400) if MIN or MAX is not specified.
- The minimum bandwidth available (20) if MIN is specified.
- The maximum bandwidth available (400) if MAX is specified.

**Example**

Querying the AC Bandwidth

**BAND:DET 5000**

*Select fast mode*

**BAND:DET?**

*Query multimeter to return bandwidth value (returns "400")*

enter statement

*Enter value into computer*

**FUNCTION**

[SENSe:]FUNCTION[:<function >] selects the measurement function. You can select 2-wire or 4-wire resistance, DC voltage, AC RMS voltage, frequency, or period measurements. The default function is DC voltage.

**Parameters**

Parameter Name	Parameter Type	Range of Values	Default Units
<i>function</i>	discrete	FREquency   FRESistance   PERiod   RESistance   VOLTage:AC   VOLTage[:DC]	none

**Example****Changing Measurement Function**

CONF:VOLT:DC

*Function: DC voltage*

FUNC:FRES

*Change function to 4-wire resistance*

READ?

*Place multimeter in wait-for-trigger state and make measurement; send reading to output buffer*

enter statement

*Enter reading into computer*

**Comments**

- The :DC parameter is optional. Both of the following command statements select the DC voltage function:

FUNC:VOLT:DC *or* FUNC:VOLT

- To select the AC + DC voltage function, set the input coupling to DC (INPut:COUPling DC) before executing the FUNC:VOLT:AC command.

- \*RST Condition: FUNC:VOLT:DC

**FUNCTION?**

[SENSe:]FUNCTION? returns one of the following strings to the output buffer: "FREQ", "FRES", "PER", "RES", "VOLT:AC", or "VOLT".

**Example****Querying the Measurement Function**

FUNC:FRES

*Function: 4-wire ohms*

FUNC?

*Query multimeter to return selected function*

enter statement

*Enter quoted string into computer*

**RESistance:APERture**

[SENSe:]RESistance:APERture <time> sets the integration time in seconds for resistance measurements. Values are rounded up to the nearest aperture time shown in the following table.

**Parameters**

Parameter Name	Parameter Type	Range of Values	Default Units
<i>time</i>	numeric	1.67s   2s   167 ms   200 ms   16.7 ms   20 ms   1.67 ms   2 ms   100 $\mu$ s   10 $\mu$ s   MINimum   MAXimum	seconds

**Example**

Setting the Aperture Time in Seconds

**RES:APER 1.67E-01**

*Aperture time is 167 ms*

**Comments**

- MIN sets the aperture time to 10  $\mu$ s. MAX sets the aperture time to 2 seconds.
- Setting the aperture time also sets the integration time in power line cycles (PLCs) and the resolution. For example, an aperture time of 16.7 ms (60 Hz line frequency) sets an integration time of 1 PLC. The corresponding resolution depends on the function and range you select.
- The line frequency reference set by the CALibration:LFRrequency command can be overridden by the 50 or 60 Hz aperture time set by RES:APER. The last command executed has priority.
- The RES:APER command overrides the results of previously executed RESistance:NPLC and RESistance:RESolution commands. The last command executed has priority.
- The greater the aperture time, the greater the normal mode rejection (and the lower the reading rate).
- **Related Commands:** CALibration:LFRrequency
- **\*RST Condition:** RES:APER 1.67E-02 (60 Hz) or RES:APER 2E-02 (50 Hz)

**RESistance:APERture?**

[SENSe:]RESistance:APERture? [MINimum|MAXimum] returns one of the following numbers to the output buffer:

- The present aperture time in seconds if MIN or MAX is not specified.
- The minimum aperture time available (10  $\mu$ s) if MIN is specified.
- The maximum aperture time available (2 seconds) if MAX is specified.

**Example**

Querying the Aperture Time

**RES:APER 1.67E-01**

*Aperture time is 167 ms*

**RES:APER?**

*Query multimeter to return aperture time*

enter statement

*Enter value into computer*

**RESistance:NPLC**

[SENSe:]RESistance:NPLC <number> sets the integration time in power line cycles (PLCs) for resistance measurements. Values are rounded up to the nearest number of PLCs shown in the following table.

**Parameters**

Parameter Name	Parameter Type	Range of Values	Default Units
<i>number</i>	numeric	0.0005   0.005   0.1   1   10   100   MINimum   MAXimum	PLCs

**Example**

**Setting the Integration Time in PLCs**

**RES:NPLC 10**

*Integration time is 10 PLCs*

**Comments**

- MIN selects 0.0005 PLCs. MAX selects 100 PLCs.
- Setting the integration time in power line cycles (PLCs) also sets the aperture time and the resolution. For example, 10 PLCs (60 Hz line frequency) sets an aperture time of 167 ms. The corresponding resolution depends on the function and range you select.
- The RES:NPLC command overrides the results of previously executed RESistance:APERture and RESistance:RESolution commands. The last command executed has priority.
- The greater the number of PLCs, the greater the normal mode rejection (and the lower the reading rate).
- Use the CALibration:LFrequency command to select the line frequency reference for the multimeter's A/D converter.
- **Related Commands:** CALibration:LFrequency
- **\*RST Condition:** RES:NPLC 1

**RESistance:NPLC?**

[SENSe:]RESistance:NPLC? [MINimum | MAXimum] returns one of the following numbers to the output buffer:

- The present integration time in PLCs if MIN or MAX is not specified.
- The minimum integration time available (0.0005) if MIN is specified.
- The maximum integration time available (100) if MAX is specified.

**Example**

**Querying the Integration Time**

**RES:NPLC 10**

*Integration time is 10 PLCs*

**RES:NPLC?**

*Query multimeter to return integration time*

**enter statement**

*Enter value into computer*

**RESistance  
:OCOMpensated**

[SENSe:]RESistance:OCOMpensated <mode> enables or disables the offset compensated ohms function.

NOTE: *Offset compensation only works on the 30Ω, 300Ω, and 3 kΩ ranges.*

**Parameters**

Parameter Name	Parameter Type	Range of Values	Default Units
<i>mode</i>	boolean	OFF 0 ON 1	none

**Example**

Enabling Offset Compensation

**RES:OCOM ON**

*Enable offset compensation*

**Comments**

- You can substitute decimal values for the OFF ("0") and ON ("1") parameters.
- With offset compensation enabled, the multimeter measures the offset voltage before each resistance measurement and subtracts it from the following reading. This prevents the offset voltage from affecting the resistance but doubles the time required per reading.
- You can use offset compensation for 2-wire or 4-wire ohms measurements.
- **\*RST Condition: RES:OCOM OFF**

**RESistance  
:OCOMpensated?**

[SENSe:]RESistance:OCOMpensated? returns a number to show whether offset compensation is enabled or disabled: "1" = ON, "0" = OFF. The number is sent to the output buffer.

**Example**

Querying the Offset Compensation Mode

**RES:OCOM ON**

*Enable offset compensation*

**RES:OCOM?**

*Query multimeter to return offset compensation mode*

**enter statement**

*Enter value into computer*

**RESistance:RANGe  
:AUTO**

[SENSe:]RESistance:RANGe:AUTO <mode> enables or disables the autorange function for resistance measurements.

**Parameters**

Parameter Name	Parameter Type	Range of Values	Default Units
<i>mode</i>	boolean	OFF 0 ON 1	none

**Example**

**Disabling Autoranging**

**RES:RANG:AUTO OFF**

*Disable autorange*

**Comments**

- You can substitute decimal values for the OFF ("0") and ON ("1") parameters.
- When autoranging is ON, the multimeter samples the input before each measurement and selects the appropriate range.
- If you explicitly select a range using RESistance:RANGe, autoranging is turned OFF.
- **Related Commands:** CONFigure, RESistance:RANGe
- **\*RST Condition:** RES:RANG:AUTO ON

**RESistance:RANGe  
:AUTO?**

[SENSe:]RESistance:RANGe:AUTO? returns a number to show whether the autorange mode is enabled or disabled: "1" = ON, "0" = OFF. The number is sent to the output buffer.

**Example**

**Querying the Autorange Mode**

**RES:RANG:AUTO OFF**

*Disable autorange*

**RES:RANG:AUTO?**

*Query multimeter to return autorange mode*

**enter statement**

*Enter value into computer*

**RESistance:RANGe**

[SENSe:]RESistance:RANGe < *expected value* > selects the range for resistance measurements.

*For a complete listing of range and resolution values available, see Table 5-2 at the beginning of this chapter.*

**Parameters**

Parameter Name	Parameter Type	Range of Values	Default Units
<i>expected value</i>	numeric	0Ω through 3 GΩ   MINimum   MAXimum	ohms

**Example****Changing the Range**

CONF:RES 1320,MAX

*Function: 2-wire ohms;  
range selected: 3 kΩ;  
MAX resolution: 1Ω*

RES:RANG 220

*Range selected: 300Ω;  
MAX resolution: 100 mΩ*

READ?

*Place multimeter in  
wait-for-trigger state and make  
measurement; send reading to  
output buffer*

enter statement

*Enter reading into computer*

**Comments**

- To select a standard measurement range, specify *expected value* as the input signal's maximum expected resistance. The multimeter then selects the correct range.
- MIN selects the minimum range available (0Ω). MAX selects the maximum range available (3 GΩ).
- Specifying a fixed range disables the autorange mode set by the RES:RANG:AUTO command.
- The RES:RANG command overrides the range setting from a previous CONFigure command specifying the same function. With the new range, a new resolution is also selected. However, this resolution is based on the aperture time set by CONFigure.
- \*RST Condition: RES:RANG 3.0E + 04



**RESistance:RANGe?**

[SENSe:]RESistance:RANGe? [MINimum|MAXimum] returns one of the following numbers to the output buffer:

- The present resistance range selected if MIN or MAX is not specified.
- The minimum resistance range available (0Ω) if MIN is specified.
- The maximum resistance range available (3 GΩ) if MAX is specified.

**Example****Querying the Measurement Range**

RES:RANG 220

*Range selected: 300Ω*

RES:RANG?

*Query multimeter to return the present range*

enter statement

*Enter value into computer***RESistance :RESolution**

[SENSe:]RESistance:RESolution <resolution> selects the resolution for resistance measurements.

*For a complete listing of range and resolution values available, see Table 5-2 at the beginning of this chapter.*

**Parameters**

Parameter Name	Parameter Type	Range of Values	Default Units
<i>resolution</i>	numeric	<i>resolution (see Table 5-2)   MINimum   MAXimum</i>	ohms

**Example****Changing the Resolution**

CONF:FRES 1560,MAX

*Function: 4-wire ohms;  
range selected: 3 kΩ;  
MAX resolution: 1Ω*

RES:RES 1.0E-03

*Set resolution to 1 mΩ;  
selects 16.7 ms aperture time  
(60 Hz line frequency)*

READ?

*Place multimeter in  
wait-for-trigger state and make  
measurement; send reading to  
output buffer*

enter statement

*Enter reading into computer*

**Comments**

- MIN selects the best resolution (the smallest value from Table 5-2) for the selected range. MAX selects the worst resolution (the largest value from Table 5-2) for the selected range.
- You must select a fixed range *before* specifying resolution. Also, only specify a numeric resolution (i.e., not MIN or MAX) when making measurements on a fixed range. Otherwise, the resolution will change to correspond with the range selected during autoranging.
- If autoranging is required, set the resolution using the MIN or MAX parameters or select a specific aperture time using RESistance:APERTure.
- If necessary to achieve the specified resolution, the multimeter will increase the integration time as needed. This command overrides the results of previously executed RESistance:APERTure and RESistance:NPLC commands. The last command executed has priority.
- The RES:RES command overrides the resolution setting from a previous CONFigure command on the same function.
- **Related Commands:** CONFigure, RESistance:APERTure, RESistance:NPLC
- **\*RST Condition:** Based on the \*RST values for the RESistance:APERTure and RESistance:NPLC commands.

**RESistance  
:RESolution?**

[SENSe:]RESistance:RESolution? [MINimum | MAXimum] returns one of the following numbers to the output buffer:

- The present resolution selected for the specified function and range if MIN or MAX are not specified.
- The resolution with the smallest value (i.e., the best resolution) for the specified function and range if MIN is specified.
- The resolution with the largest value (i.e., the worst resolution) for the specified function and range if MAX is specified.

**Example****Querying the Resolution**

```
RES:RES 1.0E-03
```

*Set resolution to 1 mΩ*

```
RES:RES?
```

*Query multimeter to return the present resolution*

```
enter statement
```

*Enter value into computer*

**VOLTage:AC:RANGe**

[SENSe:]VOLTage:AC:RANGe < *expected value* > selects the range for AC voltage measurements.

**NOTE:** *The AC voltage and DC voltage ranges are the same on this multimeter. Therefore, all information pertaining to range selection for the AC function also applies to the DC voltage function. See the SENSe:VOLTage[:DC]:RANGe command for more information on selecting the voltage range.*

**VOLTage:AC:RANGe?**

[SENSe:]VOLTage:AC:RANGe? [MINimum | MAXimum] returns one of the following numbers to the output buffer:

- The present voltage range selected if MIN or MAX is not specified.
- The minimum voltage range available (0V) if MIN is specified.
- The maximum voltage range available ( $\pm 300V$ ) if MAX is specified.

**Example****Querying the Measurement Range**

VOLT:AC:RANG 0.2

*Range selected: 300 mV*

VOLT:AC:RANG?

*Query multimeter to return the present range*

enter statement

*Enter value into computer*

**VOLTage:APERture**

[SENSe:]VOLTage:APERture < *time* > sets the integration time in seconds for voltage measurements. Values are rounded up to the nearest aperture time shown in the following table.

**Parameters**

Parameter Name	Parameter Type	Range of Values	Default Units
<i>time</i>	numeric	1.67s   2s   167 ms   200 ms   16.7 ms   20 ms   1.67 ms   2 ms   100 $\mu$ s   10 $\mu$ s   MINimum   MAXimum	seconds

**Example****Setting the Aperture Time in Seconds**

VOLT:APER 1.67E-01

*Aperture time is 167 ms*

**Comments**

- MIN sets the aperture time to 10  $\mu$ s. MAX sets the aperture time to 2 seconds.
- Setting the aperture time also sets the integration time in power line cycles (PLCs) and the resolution. For example, an aperture time of 16.7 ms (60 Hz line frequency) sets an integration time of 1 PLC. The corresponding resolution depends on the function and range you select.
- The line frequency reference set by the CALibration:LFRrequency command can be overridden by the 50 or 60 Hz aperture time set by VOLT:APER. The last command executed has priority.

[SENSe:]VOLTage:APERture?

[SENSe:]VOLTage[:DC]:RANGe

- The VOLT:APER command overrides the results of previously executed VOLTage:NPLC and VOLTage:RESolution command. The last command executed has priority.
- The greater the aperture time, the greater the normal mode rejection (and the lower the reading rate).
- **Related Commands:** CALibration:LFRequency
- **\*RST Condition:** RES:APER 1.67E-02 (60 Hz) or RES:APER 2E-02 (50 Hz)

VOLTage:APERture?

[SENSe:]VOLTage:APERture? [MINimum | MAXimum] returns one of the following numbers to the output buffer:

- The present aperture time in seconds if MIN or MAX is not specified.
- The minimum aperture time available (10 μs) if MIN is specified.
- The maximum aperture time available (2 seconds) if MAX is specified.

Example

Querying the Aperture Time

VOLT:APER 1.67E-01

*Aperture time is 167 ms*

VOLT:APER?

*Query multimeter to return aperture time*

enter statement

*Enter value into computer*

VOLTage[:DC]:RANGe

[SENSe:]VOLTage[:DC]:RANGe < expected value > selects the range for DC voltage measurements.

**NOTE:** The DC voltage and AC voltage ranges are the same on this multimeter. Therefore, all information pertaining to range selection for the DC function (SENSe:VOLTage:DC:RANGe) also applies to the AC voltage function (SENSe:VOLTage:AC:RANGe).

For a complete listing of range and resolution values available, see Table 5-1 at the beginning of this chapter.

Parameters

Parameter Name	Parameter Type	Range of Values	Default Units
<i>expected value</i>	numeric	0V through ± 300V   MINimum   MAXimum	volts

**Example****Changing the Range**

CONF:VOLT:DC 0.54,MAX

*Function: DC volts;  
range selected: 3V;  
MAX resolution: 1 mV*

VOLT:DC:RANG 25

*Range selected: 30V;  
MAX resolution: 10 mV*

READ?

*Place multimeter in  
wait-for-trigger state and make  
measurement; send reading to  
the output buffer*

enter statement

*Enter reading into computer***Comments**

- To select a standard measurement range, specify *expected value* as the input signal's maximum expected voltage. The multimeter then selects the correct range.
- MIN selects the minimum range available (0V). MAX selects the maximum range available ( $\pm 300V$ ).
- Specifying a fixed range disables the autorange mode set by the VOLT:RANG:AUTO command.
- The VOLT:DC:RANG command overrides the range setting from a previous CONFIGure command specifying the same function. With the new range, a new resolution is also selected. However, this resolution is based on the aperture time set by CONFIGure.
- \*RST Condition: VOLT:DC:RANG 30

**VOLTage[:DC]  
:RANGe?**

[SENSe:]VOLTage[:DC]:RANGe? [MINimum | MAXimum] returns one of the following numbers to the output buffer:

- The present voltage range selected if MIN or MAX is not specified.
- The minimum voltage range available (0V) if MIN is specified.
- The maximum voltage range available ( $\pm 300V$ ) if MAX is specified.

**Example****Querying the Measurement Range**

VOLT:DC:RANG 0.2

*Range selected: 300 mV*

VOLT:RANG?

*Query multimeter to return  
the present range*

enter statement

*Enter value into computer*

**VOLTage:NPLC**

[SENSe:]VOLTage:NPLC <number> sets the integration time in power line cycles (PLCs) for voltage measurements. Values are rounded up to the nearest number of PLCs shown in the following table.

**Parameters**

Parameter Name	Parameter Type	Range of Values	Default Units
<i>number</i>	numeric	0.0005 0.005 0.1 1 10 100  MINimum MAXimum	PLCs

**Example**

**Setting the Integration Time in PLCs**

**VOLT:NPLC 10**

*Integration time is 10 PLCs*

**Comments**

- MIN selects 0.0005 PLCs. MAX selects 100 PLCs.
- Setting the integration time in power line cycles (PLCs) also sets the aperture time and the resolution. For example, 10 PLCs (60 Hz line frequency) sets an aperture time of 167 ms. The corresponding resolution depends on the function and range you select.
- The VOLT:NPLC command overrides the results of previously executed VOLTage:APERTure and VOLTage:RESolution commands. The last command executed has priority.
- The greater the number of PLCs, the greater the normal mode rejection (and the lower the reading rate).
- Use the CALibration:LFRrequency command to select the line frequency reference for the multimeter's A/D converter.
- **Related Commands:** CALibration:LFRrequency
- **\*RST Condition:** VOLT:NPLC 1

**VOLTage:NPLC?**

[SENSe:]VOLTage:NPLC? [MINimum|MAXimum] returns one of the following numbers to the output buffer:

- The present integration time in PLCs if MIN or MAX is not specified.
- The minimum integration time available (0.0005) if MIN is specified.
- The maximum integration time available (100) if MAX is specified.

**Example****Querying the Integration Time**

VOLT:NPLC 10

*Integration time is 10 PLCs*

VOLT:NPLC?

*Query multimeter to return integration time*

enter statement

*Enter value into computer***VOLTage:RANGe :AUTO**

[SENSe:]VOLTage:RANGe:AUTO <mode> enables or disables the autorange function for voltage measurements.

**Parameters**

Parameter Name	Parameter Type	Range of Values	Default Units
<i>mode</i>	boolean	OFF 0 ON 1	none

**Example****Disabling Autoranging**

VOLT:RANG:AUTO OFF

*Disable autorange***Comments**

- You can substitute decimal values for the OFF ("0") and ON ("1") parameters.
- When autoranging is ON, the multimeter samples the input before each measurement and selects the appropriate range.
- If you explicitly select a range using VOLTage:AC:RANGe or VOLTage:DC:RANGe, autoranging is turned OFF.
- **Related Commands:** CONFigure, VOLTage:AC:RANGe, VOLTage:DC:RANGe
- **\*RST Condition:** VOLT:RANG:AUTO ON

**VOLTage:RANGe  
:AUTO?**

[SENSe:]VOLTage:RANGe:AUTO? returns a number to show whether the autorange mode is enabled or disabled: "1" = ON, "0" = OFF. The number is sent to the output buffer.

**Example****Querying the Autorange Mode**

VOLT:RANG:AUTO OFF  
VOLT:RANG:AUTO?

*Disable autorange**Query multimeter to return  
autorange mode*

enter statement

*Enter value into computer***VOLTage:RESolution**

[SENSe:]VOLTage:RESolution <resolution> selects the resolution for voltage measurements.

*For a complete listing of range and resolution values available, see Table 5-1 at the beginning of this chapter.*

**Parameters**

Parameter Name	Parameter Type	Range of Values	Default Units
<i>resolution</i>	numeric	<i>resolution</i> (see Table 5-1)   MINimum   MAXimum	volts

**Example****Changing the Resolution**

CONF:VOLT:DC 8.25,MAX

*Function: DC volts;  
range selected: 30V;  
MAX resolution: 10 mV*

VOLT:RES 100E-06

*Set resolution to 100  $\mu$ V;  
selects 1.67 ms aperture time  
(60 Hz line frequency)*

READ?

*Place multimeter in  
wait-for-trigger state and make  
measurement; send reading  
to output buffer*

enter statement

*Enter reading into computer***Comments**

- MIN selects the best resolution (the smallest value from Table 5-1) for the selected range. MAX selects the worst resolution (the largest value from Table 5-1) for the selected range.
- You must select a fixed range *before* specifying resolution. Also, only specify a numeric resolution (i.e., not MIN or MAX) when making measurements on a fixed range. Otherwise, the resolution will change to correspond with the range selected during autoranging.
- If autoranging is required, set the resolution using the MIN or MAX parameters or select a specific aperture time using VOLTage:APERture.



- If necessary to achieve the specified resolution, the multimeter will increase the integration time as needed. This command overrides the results of previously executed VOLTage:APERture and VOLTage:NPLC commands. The last command executed has priority.
- The VOLT:RES command overrides the resolution setting from a previous CONFigure command on the same function.
- **Related Commands:** CONFigure, VOLTage:APERture, VOLTage:NPLC
- **\*RST Condition:** Based on the \*RST values for the VOLTage:APERture and VOLTage:NPLC commands.

**VOLTage:RESolution?**

[SENSe:]VOLTage:RESolution? [MINimum|MAXimum] returns one of the following numbers to the output buffer:

- The present resolution selected for the specified function and range if MIN or MAX are not specified.
- The resolution with the smallest value (i.e., the best resolution) for the specified function and range if MIN is specified.
- The resolution with the largest value (i.e., the worst resolution) for the specified function and range if MAX is specified.

**Example**

**Querying the Resolution**

VOLT:RES 100E-06

*Set resolution to 100 μV*

VOLT:RES?

*Query multimeter to return the present resolution*

enter statement

*Enter value into computer*

STATUS

The STATUS subsystem enables you to examine the status of the multimeter by monitoring the Operation Status Register and Questionable Data/Signal Register groups. Figure 5-1 shows the multimeter's status registers.

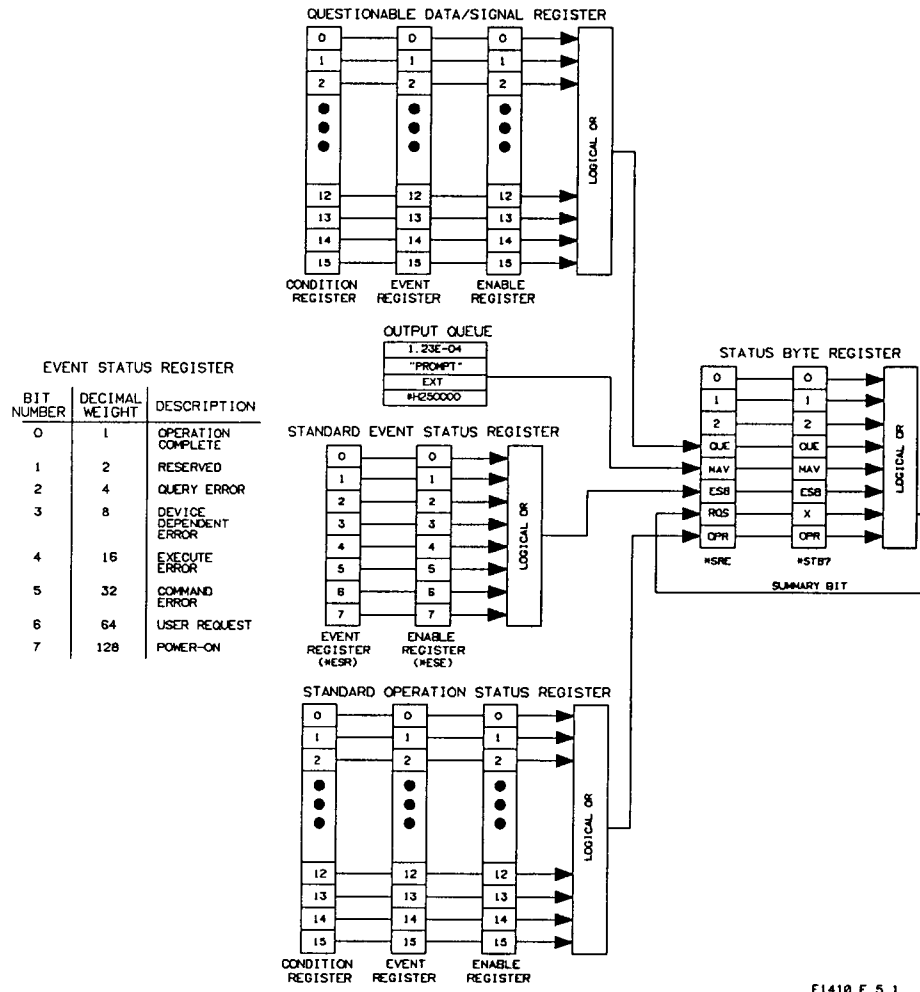

E1410 F. 5. 1

Figure 5-1. Multimeter Status Register

The various registers are set and queried using decimal weighted bit values. The decimal equivalent values for bits 15 through 0 are shown below.

Bit Number to Decimal Value Conversion

Bit Number	15	14	13	12	11	10	9	8	7	6	5	4	3	2	1	0
Decimal Value	32768	16384	8192	4096	2048	1024	512	256	128	64	32	16	8	4	2	1

**Subsystem Syntax**

STATus  
 :OPERation  
   :CONDition?  
   :ENABle <number>  
   :ENABle?  
   [:EVENT]?  
 :QUESTionable  
   :CONDition?  
   :ENABle <number>  
   :ENABle?  
   [:EVENT]?

**Using the Operation Status Register**

The 16-bit Operation Status Register monitors multimeter operations currently being performed. The multimeter implements bits 0, 2, and 5.

Bit Number	Decimal Weight	Description
0	1	Multimeter is Performing a Calibration.
1	—	Not used by multimeter.
2	4	Multimeter is Currently Changing Range.
3	—	Not used by multimeter.
4	—	Not used by multimeter.
5	32	Multimeter is in the Wait-for-Trigger State.
6-15	—	Not used by multimeter.

The Operation Status Register group consists of a condition register, an event register, and an enable register as shown in Figure 5-1. The commands in the STATus:OPERation subsystem control and monitor these registers.

**:OPERation: CONDition?**

STATus:OPERation:CONDition? returns a decimal-weighted number representing the bits set in the Operation Status Register's condition register. Reading the condition register does not destroy its contents.

**Example**

**Reading the Condition Register**

STAT:OPER:COND?  
 enter statement

*Read condition register*  
*Enter value into computer*

**Comments**

- This command returns "0" (no bits set) or "32" (bit 5 set). Bits 0 and 2 cannot be read real-time by the STAT:OPER:COND? command.
- The condition register does not implement latching or buffering. The register is updated in real-time whenever the multimeter takes a reading.

**:OPERation:ENABLE**

**STATus:OPERation:ENABLE** <number> enables bits in the Operation Status Register's enable register to be reported to the summary bit (setting Status Byte Register bit 7 true). The event register bits are not reported in the Status Bytes Register unless specifically enabled.

*NOTE: If any bits are enabled in the enable register, the corresponding bits set in the Operation Status Register's event register are reported to the Status Byte Register.*

**Example**

**Enabling Bits in the Enable Register**

**STAT:OPER:ENAB 33**

*Enable bit 0 and bit 5*

**:OPERation:ENABLE?**

**STATus:OPERation:ENABLE?** returns a decimal-weighted number representing the bits enabled in the Operation Status Register's enable register.

**Example**

**Reading the Enabled Bits in the Enable Register**

**STAT:OPER:ENAB 33**

*Enable bit 0 and bit 5*

**STAT:OPER:ENAB?**

*Read condition register;  
clear register contents*

enter statement

*Enter value into computer*

**:OPERation[:EVENT]?**

**STATus:OPERation[:EVENT]?** returns a decimal-weighted number representing the bits set in the Operation Status Register's event register. This command clears all bits in the event register.

**Example**

**Reading the Event Register**

**STAT:OPER:EVEN?**

*Read event register;  
clear register contents*

enter statement

*Enter value into computer*

**Comments**

- The :EVENT parameter is optional. Both of the following command statements read the event register:

**STAT:OPER:EVEN? or STAT:OPER?**

- The event register latches conditions from the condition register. Bits in the event register are latched, and once set they remain set until cleared by STAT:OPER:EVEN? or the \*CLS (clear status) command.
- The \*CLS command clears all status registers (Standard Event Status Register, Operation Status Register, Questionable Data/Signal Register).

**Using the Questionable Data/Signal Register**

The Questionable Data/Signal Register conveys information about the quality of the measurements taken by the multimeter. The multimeter implements bits 0, 2, 5, 8, 9, and 10.

Bit Number	Decimal Weight	Description
0	1	Voltage Overrange.
1	—	Not used by multimeter.
2	4	Period Overrange.
3	—	Not used by multimeter.
4	—	Not used by multimeter.
5	32	Frequency Overrange.
6	—	Not used by multimeter.
7	—	Not used by multimeter.
8	256	Invalid Calibration.
9	512	Resistance Overrange.
10	1024	Temperature Overrange.
11-15	—	Not used by multimeter.

The Questionable Data/Signal Register group consists of a condition register, an event register, and an enable register as shown in Figure 5-1. The commands in the STATus:QUESTionable subsystem control and monitor these registers.

**:QUESTionable:CONDition?**

STATus:QUESTionable:CONDition? returns zero.

*NOTE: This command is not currently implemented on this multimeter.*

**:QUESTionable:ENABle**

STATus:QUESTionable:ENABle <number> enables bits in the Questionable Data/Signal Register's enable register to be reported to the summary bit (setting Status Byte Register bit 3 true). The event register bits are not reported in the Status Bytes Register unless specifically enabled.

*NOTE: If any bits are enabled in the enable register, the corresponding bits set in the Questionable Data/Signal Register's event register are reported to the Status Byte Register.*

**Example**

**Enabling Bits in the Enable Register**

**STAT:QUES:ENAB 513**

*Enable bit 0 (voltage overrange) and bit 9 (resistance overrange)*

---

**:QUESTionable: ENABle?**      **STATus:QUESTionable:ENABle?** returns a decimal-weighted number representing the bits enabled in the Questionable Data/Signal Register's enable register.

**Example**      **Reading the Enabled Bits in the Enable Register**

<b>STAT:QUES:ENAB 513</b>	<i>Enable bit 0 (voltage overrange) and bit 9 (resistance overrange)</i>
<b>STAT:QUES:ENAB?</b>	<i>Read condition register; clear register contents</i>
enter statement	<i>Enter value into computer</i>

---

**:QUESTionable [:EVENT]?**      **STATus:QUESTionable[:EVENT]?** returns a decimal-weighted number representing the bits set in the Questionable Data/Signal Register's event register. This command clears all bits in the event register.

**Example**      **Reading the Event Register**

<b>STAT:QUES:EVEN?</b>	<i>Read event register; clear register contents</i>
enter statement	<i>Enter value into computer</i>

**Comments**      ● The :EVENT parameter is optional. Both of the following command statements read the event register:

**STAT:QUES:EVEN?    or    STAT:QUES?**

- The event register latches conditions from the condition register. Bits in the event register are latched, and once set they remain set until cleared by STAT:QUES:EVEN? or the \*CLS (clear status) command.
- The \*CLS command clears all status registers (Standard Event Status Register, Operation Status Register, Questionable Data/Signal Register).

## SYSTem

The SYSTem command subsystem returns error numbers and messages stored in the error queue.

### Subsystem Syntax

SYSTem  
:ERRor?

### :ERRor?

SYSTem:ERRor? returns the error numbers and error messages stored in the error queue. See Appendix B at the end of this manual for a listing of the error numbers and messages.

### Example

Reading the Error Queue

**SYST:ERR?**

*Query the error queue*

### Comments

- As multimeter errors are detected, they are placed in its error queue. The error queue is first-in, first-out. This means that if several error messages are waiting in the queue, each SYST:ERR? command returns the oldest error message, and that message is deleted from the queue.
- If the error queues fills to 30 entries, the last error is replaced with -350, "Too many errors". No additional errors are accepted until space becomes available using SYST:ERR?, or the queue is cleared using the \*CLS (clear status) command.
- When SYST:ERR? is sent while the error queue is empty, the multimeter responds with +0, "No error".
- \*RST Condition: \*RST does not clear the error queue.

**TEST**

The TEST command subsystem performs a series of internal self-tests on the multimeter. Refer to the HP E1410A Service Manual for additional details.

**Subsystem Syntax**

```
TEST
[:ALL]?
:INGuard
:CALibrate?
:FLATness?
:GAIN?
:INTegrator?
:LINK?
:OFFSet?
:PRECharge?
:ZERO?
```

**[:ALL]?**

TEST[:ALL]? performs a series of internal self-tests on the multimeter. If any test fails, the multimeter returns a decimal-weighted number representing the failed condition (see below). The number is sent to the output buffer.

Weighted Value	Description
0	All tests passed.
1	Inguard UART failure.
2	Inguard CPU failure.
4	Inguard link failure.
8	Integrator convergence error.
16	Front end zero measurement error.
32	Gain test error.
128	AC amplifier's DC offset test failure.
256	AC flatness check failure.
512	Ohms precharge failure.
4096	Calibration RAM checksum failure.
8192	Autocalibration RAM checksum failure.
16384	ROM checksum failure.

**Example****Performing a Self-Test**

```
TEST?
```

*Perform self-test routines and place result in output buffer*

```
enter statement
```

*Enter value into computer*

**Comments**

- The :ALL parameter is optional. Both of the following command statements perform the multimeter self-test:

```
TEST:ALL? or TEST?
```

- The TEST? command performs the same action as the \*TST? common command.
- Always disconnect all input signals before you run self-test. If you leave an input signal connected to the multimeter, it may cause a self-test failure.



**:INGuard:CALibrate?**

**TEST:INGuard:CALibrate?** performs a self-test on the calibration RAM. The command returns one of the following numbers to the output buffer:

- “0” if all tests pass.
- “4096” if the calibration RAM checksum fails.

**Example****Performing the Calibration RAM Self-Test****TEST:ING:CAL?**

*Perform calibration RAM self-test routine and place result in output buffer*

enter statement

*Enter value into computer*

**:INGuard:FLATness?**

**TEST:INGuard:FLATness?** performs the AC flatness self-test. The command returns one of the following numbers to the output buffer:

- “0” if all tests pass.
- “256” if the AC flatness check fails.

**Example****Performing the AC Flatness Self-Test****TEST:ING:FLAT?**

*Perform AC flatness self-test routine and place result in output buffer*

enter statement

*Enter value into computer*

**:INGuard:GAIN?**

**TEST:INGuard:GAIN?** performs the gain self-test. The command returns one of the following numbers to the output buffer:

- “0” if all tests pass.
- “32” if the gain test fails.

**Example****Performing the Gain Self-Test****TEST:ING:GAIN?**

*Perform gain self-test routine and place result in output buffer*

enter statement

*Enter value into computer*

**:INGuard:INTEGRATOR?**

TEST:INGuard:INTEGRATOR? performs the integrator convergence self-test. The command returns one of the following numbers to the output buffer:

- “0” if all tests pass.
- “32” if the integrator convergence test fails.

**Example****Performing the Integrator Convergence Self-Test****TEST:ING:INT?**

*Perform integrator convergence self-test routine and place result in output buffer*

enter statement

*Enter value into computer*

**:INGuard:LINK?**

TEST:INGuard:LINK? performs a self-test on the Inguard CPU and link. The command returns one of the following numbers to the output buffer:

- “0” if all tests pass.
- “1” if the Inguard UART test fails.
- “2” if the Inguard CPU test fails.
- “4” if the Inguard link test fails.

**Example****Performing the Inguard CPU and Link Self-Test****TEST:ING:LINK?**

*Perform CPU and link self-test routines and place result in output buffer*

enter statement

*Enter value into computer*

**:INGuard:OFFSET?**

TEST:INGuard:OFFSET? performs the AC amplifier’s DC offset self-test. The command returns one of the following numbers to the output buffer:

- “0” if all tests pass.
- “128” if the offset test fails.

**Example****Performing the Offset Self-Test****TEST:ING:OFFS?**

*Perform offset self-test routine and place result in output buffer*

enter statement

*Enter value into computer*

**:INGuard:PRECharge?**

**TEST:INGuard:PRECharge?** performs the ohms precharge self-test. The command returns one of the following numbers to the output buffer:

- “0” if all tests pass.
- “512” if the ohms precharge test fails.

**Example****Performing the Ohms Precharge Self-Test****TEST:ING:PREC?**

*Perform ohms precharge self-test routine and place result in output buffer*

enter statement

*Enter value into computer*

**:INGuard:ZERO?**

**TEST:INGuard:ZERO?** performs the front end zero measurement self-test. The command returns one of the following numbers to the output buffer:

- “0” if all tests pass.
- “16” if the zero measurement test fails.

**Example****Performing the Zero Measurement Self-Test****TEST:ING:ZERO?**

*Perform zero measurement self-test routine and place result in output buffer*

enter statement

*Enter value into computer*

# TRIGger

The TRIGger command subsystem controls the behavior of the trigger system. The subsystem can control:

- Trigger buffering (TRIGger:BUFFered).
- The number of triggers to occur before the multimeter returns to the idle state (TRIGger:COUNT).
- The delay between trigger and measurement (TRIGger:DELAy).
- An immediate internal trigger (TRIGger:IMMediate).
- The trigger slope of the multimeter’s front panel “EXT TRIG” connector (TRIGger:SLOPe).
- The source of the trigger (TRIGger:SOURce).

## Subsystem Syntax

```
TRIGger
:BUFFered <mode>
:BUFFered?
:COUNT <number>
:COUNT? [MINimum|MAXimum]
:DELAy:AUTO <mode>
:DELAy:AUTO?
:DELAy <period>
:DELAy? [MINimum|MAXimum]
[:IMMediate]
:SLOPe <edge>
:SLOPe?
:SOURce <source>
:SOURce?
```

## :BUFFered

TRIGger:BUFFered <mode> enables or disables the multimeter’s trigger buffer and corrects for a “Trigger too fast” error. The trigger source must be the multimeter’s front panel “EXT TRIG” connector.

### Parameters

Parameter Name	Parameter Type	Range of Values	Default Units
<i>mode</i>	boolean	OFF 0 ON 1	none

### Example

Enabling the Trigger Buffer

```
TRIG:SOUR EXT
TRIG:BUFF ON
```

*Trigger source is external BNC on multimeter front panel  
Enable trigger buffer*

**Comments**

- You can substitute decimal values for the OFF (“0”) and ON (“1”) parameters.
- With TRIG:BUFF OFF, any external trigger occurring during a reading generates a “Trigger too fast” error and the trigger(s) are ignored.
- With TRIG:BUFF ON, the first external trigger occurring during a reading is stored and no error is generated. After the reading is complete, the stored trigger satisfies the EXT event if the multimeter is so programmed. However, a second trigger occurring during a reading does generate the “Trigger too fast” error.
- \*RST Condition: TRIG:BUFF OFF

**:BUFFered?**

TRIGger:BUFFered? returns a number to show whether trigger buffering is enabled or disabled: “1” = ON, “0” = OFF. The number is sent to the output buffer.

**Example**

**Querying the Trigger Buffer Mode**

TRIG:BUFF ON	<i>Enable trigger buffer</i>
TRIG:BUFF?	<i>Query multimeter to return trigger buffer mode</i>
enter statement	<i>Enter value into computer</i>

**:COUNT**

TRIGger:COUNT <number> sets the number of triggers issued.

**Parameters**

Parameter Name	Parameter Type	Range of Values	Default Units
<i>number</i>	numeric	1 through 16,777,215   MINimum   MAXimum	none

**Example**

**Setting the Trigger Count**

dimension array	<i>Dimension computer array</i>
CONF:VOLT:DC	<i>Function: DC voltage</i>
TRIG:SOUR EXT	<i>Trigger source is external BNC on multimeter front panel</i>
TRIG:COUN 10	<i>Multimeter will accept 10 external triggers (one measurement is taken per trigger)</i>
READ?	<i>Place multimeter in wait-for-trigger state; make measurements when external trigger is received; send readings to output buffer</i>
enter statement	<i>Enter readings into computer</i>

- Comments**
- MIN selects 1 trigger. MAX selects 16,777,215 triggers.
  - The multimeter has enough memory to store 4,096 readings. The trigger count (TRIG:COUN) multiplied by the sample count (SAMP:COUN) must be less than or equal to 4,096.
  - CONFIgure and MEASure set the trigger count to 1.
  - \*RST Condition: TRIG:COUN 1

- :COUNT?**
- TRIGger:COUNT? [MINimum | MAXimum] returns one of the following numbers to the output buffer:
- The present trigger count (1 through 16,777,215) if MIN or MAX are not specified.
  - The minimum trigger count available (1) if MIN is specified.
  - The maximum trigger count available (16,777,215) if MAX is specified.

**Example**      **Querying the Trigger Count**

TRIG:COUN 10	<i>Multimeter will accept 10 triggers from current trigger source</i>
TRIG:COUN?	<i>Query multimeter to return trigger count</i>
enter statement	<i>Enter value into computer</i>

**:DELAy:AUTO**      TRIGger:DELAy:AUTO <mode> enables or disables a trigger delay based on the present function, range, and integration time. The trigger delay specifies the period between the trigger signal and the start of the measurement.

**Parameters**

Parameter Name	Parameter Type	Range of Values	Default Units
<i>mode</i>	boolean	OFF 0 ON 1	none

**Example**      **Disabling Automatic Trigger Delay**

TRIG:DEL:AUTO OFF	<i>Disable automatic trigger delay</i>
-------------------	--

## Comments

- You can substitute decimal values for the OFF (“0”) and ON (“1”) parameters.
- If you do not specify a trigger delay (TRIGger:DElay command), the multimeter automatically determines a delay time (default delay) based on the present measurement function, range, resolution, and AC bandwidth setting. The delay time is actually the settling time allowed before measurements which ensures accurate readings. The default delay time is automatically updated whenever you change the function or range. Once you specify a delay time value, however, the value does not change until you specify another value or reset the multimeter. Table 4-9 (Chapter 4) shows the default delay times for all functions.
- The values shown in Table 4-9 (for AC measurement functions) assume the range and function have been selected for at least one reading. Whenever the range changes on an AC measurement function, the first reading after the change has an additional delay added to the default delay. This is shown in Table 4-10. Whenever you select an AC measurement function, an additional delay is added to the default delay before the first reading. This delay is shown in Table 4-11.
- If you specify a trigger delay using the TRIGger:DElay command, TRIG:DEL:AUTO is automatically turned OFF.
- \*RST Condition: TRIG:DEL:AUTO ON

## :DElay:AUTO?

TRIGger:DElay:AUTO? returns a number to show whether the automatic trigger delay mode is enabled or disabled: “1” = ON, “0” = OFF. The number is sent to the output buffer.

## Example

## Querying the Trigger Delay Mode

```
TRIG:DEL:AUTO OFF
```

*Disable automatic trigger delay*

```
TRIG:DEL:AUTO?
```

*Query multimeter to return trigger delay mode*

```
enter statement
```

*Enter value into computer*

**:DELaY**

TRIGger:DELaY <period> sets the delay period between receipt of the trigger and the start of the measurement.

**Parameters**

Parameter Name	Parameter Type	Range of Values*	Default Units
<i>period</i>	numeric	1 $\mu$ s through 2100s   MINimum   MAXimum	seconds

\* Resolution: 1.0  $\mu$ s

**Example**

Setting the Trigger Delay

TRIG:DEL 2

*Wait 2 seconds between trigger and start of measurement*

**Comments**

- MIN selects the minimum delay of 1  $\mu$ s. MAX selects the maximum delay of 2100 seconds.
- The *period* values are accurate down to 150  $\mu$ s. If you specify a value below 150  $\mu$ s, the actual delay is approximately:
  - 67  $\mu$ s for the MINimum aperture time.
  - 82  $\mu$ s for all other aperture times.
- If you specify a trigger delay using TRIG:DEL, TRIGger:DELaY:AUTO is automatically turned OFF.
- You can set a delay between measurements in a burst using the SAMPLE:TiMEr command.
- **\*RST Condition:** The multimeter automatically determines a delay time (default delay) based on the present measurement function, range, resolution, and AC bandwidth setting (see TRIG:DEL:AUTO).

**:DELaY?**

TRIGger:DELaY? [MINimum | MAXimum] returns one of the following numbers to the output buffer:

- The present trigger delay (1  $\mu$ s through 2100 seconds) if MIN or MAX is not specified.
- The minimum trigger delay available (1  $\mu$ s) if MIN is specified.
- The maximum trigger delay available (2100 seconds) if MAX is specified.

**Querying the Trigger Delay**

TRIG:DEL 2

*Wait 2 seconds between trigger and start of measurement*

TRIG:DEL?

*Query multimeter to return trigger count*

enter statement

*Enter value into computer*

*0-149 05  
Returns  
to significant  
the value  
accurate - is not*

**Example**



## [:IMMediate]

TRIGger[:IMMediate] causes a trigger to occur immediately if the multimeter is in the wait-for-trigger state (see the INITiate subsystem). The trigger source must be TRIGger:SOURce BUS or TRIGger:SOURce HOLD.

## Example

## Sending an Immediate Trigger

```
CONF:VOLT:DC
TRIG:SOUR HOLD
INIT
```

*Function: DC voltage*

*Suspend triggering*

*Place multimeter in wait-for-trigger state; store reading in memory when trigger is received*

```
TRIG
FETC?
enter statement
```

*Trigger the multimeter*

*Place reading in output buffer*

*Enter reading into computer*

## Comments

- The :IMMediate parameter is optional. Both of the following command statements are valid:

```
TRIG:IMM or TRIG
```

- The TRIG:IMM command must be executed after the multimeter is placed in the wait-for-trigger state by the INITiate command. When the TRIG:IMM command is executed, the readings are stored in multimeter memory. Use FETCh? to place the readings in the output buffer.
- The TRIGger:SOURce BUS or TRIGger:SOURce HOLD commands remain in effect after TRIG:IMM is executed.
- Do not confuse the levels of triggering commands containing the IMMediate parameter. The TRIGger:SOURce IMMediate command (later in this chapter) bypasses the trigger system so that the multimeter is triggered immediately if it is in the wait-for-trigger state. The TRIG:IMM command initiates a single trigger cycle after the trigger system has been disabled.
- **Related Commands:** FETCh?, INITiate, TRIGger:SOURce

**:SLOPe**

TRIGger:SLOPe <edge> determines which edge (rising or falling) of a signal input to the front panel “EXT TRIG” connector will trigger the multimeter.

**Parameters**

Parameter Name	Parameter Type	Range of Values	Default Units
<i>edge</i>	discrete	POSitive   NEGative	none

**Example**

Selecting the Trigger Slope

TRIG:SLOP POS

*Select positive (rising) edge*

**Comments**

- The minimum pulse width recognized on the “EXT TRIG” connector is 10 ns.
- \*RST Condition: TRIG:SLOP NEG

**:SLOPe?**

TRIGger:SLOPe? returns “NEG” or “POS” to show the present trigger slope. The string is sent to the output buffer.

**Example**

Querying the Trigger Slope

TRIG:SLOP POS

*Select positive (rising) edge*

TRIG:SLOP?

*Query multimeter to return trigger slope*

enter statement

*Enter value into computer*

**:SOURce**

TRIGger:SOURce <source> configures the trigger system to respond to the specified source. The following sources are available:

- **BUS:** Group Execute Trigger (GET) bus command or \*TRG common command.
- **EXTernal:** The multimeter’s front panel “EXT TRIG” connector.
- **HOLD:** Suspend triggering. Only the TRIGger:IMMediate command will trigger the multimeter.
- **IMMediate:** The trigger system is always true (continuous triggering).
- **TTLTrg0 through TTLTrg7:** The VXIbus TTL trigger lines on the backplane P2 connector.

**Parameters**

Parameter Name	Parameter Type	Range of Values	Default Units
<i>source</i>	discrete	BUS   EXTernal   HOLD   IMMediate   TTLTrg0 through TTLTrg7	none

**Example****Setting the Trigger Source**

dimension array  
 CONF:VOLT:DC  
 TRIG:SOUR EXT

TRIG:COUN 10

READ?

enter statement

*Dimension computer array*

*Function: DC voltage*

*Trigger source is external BNC on multimeter front panel*

*Multimeter will accept 10 external triggers*

*Place multimeter in wait-for-trigger state; make measurements when external trigger is received; send readings to output buffer*

*Enter readings into computer*

**Comments**

- The TRIGger:SOURce command only selects the trigger source. You must use the INITiate command to place the multimeter in the wait-for-trigger state.
- You can change the trigger source only when the multimeter is in the idle state. Attempting to change the trigger source while the multimeter is in the wait-for-trigger state will generate the “Settings conflict” error.
- TRIGger:SOURce EXTERNAL uses the multimeter’s front panel “EXT TRIG” connector as the trigger source. The trigger slope for this BNC connector is controlled by the TRIGger:SLOPe command.
- TRIGger:SOURce IMMEDIATE causes a trigger to occur immediately if the multimeter is placed in the wait-for-trigger state using INITiate.
- When TRIGger:SOURce BUS is selected, ABORt returns the multimeter to the idle state. When a Group Execute Trigger (GET) bus command or \*TRG common command is executed, the “Trigger ignored” error is generated.
- When TRIGger:SOURce HOLD is selected, ABORt returns the multimeter to the idle state. All subsequent single triggers sent using TRIGger:IMMEDIATE are ignored and the “Trigger ignored” error is generated.
- TRIGger:SOURce TTLT uses the VXIbus TTL trigger lines as the trigger source. The multimeter triggers on the falling (negative-going) edge of a TTL input signal.
- The CONFigure and MEASure command subsystems automatically set the trigger source to TRIG:SOUR IMM.
- The READ? command cannot be used if the trigger source is TRIG:SOUR BUS or TRIG:SOUR HOLD.

- Do not confuse the levels of triggering commands containing the IMMEDIATE parameter. The TRIGger:SOURce IMMEDIATE command bypasses the trigger system so that the multimeter is triggered immediately if it is in the wait-for-trigger state. The TRIGger[:IMMEDIATE] command (earlier in this chapter) initiates a single trigger cycle after the trigger system has been disabled (the trigger source must be TRIGger:SOURce BUS or TRIGger:SOURce HOLD).
- Related Commands: ABORT, INITiate, TRIGger:IMMEDIATE
- \*RST Condition: TRIG:SOUR IMM

**:SOURce?**

TRIGger:SOURce? returns "BUS", "EXT", "HOLD", "IMM", or "TTLTn" to show the present trigger source. The string is sent to the output buffer.

**Example****Querying the Trigger Source**

TRIG:SOUR EXT

*Trigger source is external BNC on multimeter front panel*

TRIG:SOUR?

*Query multimeter to return trigger source setting*

enter statement

*Enter quoted string into computer*

## IEEE 488.2 Common Command Reference

The following table lists the IEEE 488.2 Common (\*) Commands that can be executed by the HP E1410A 6½-Digit Multimeter. See the HP 1405A Command Module User's Manual, or the ANSI/IEEE Standard 488.2-1987 for more information on these commands.

Command	Title	Description
*CAL?	Internal Calibration	Performs the multimeter's AC flatness, AC offset, extended ohms, and precharge autocalcs. Returns "0" unless calibration fails.
*IDN?	Identification Query	Returns the identification string of the multimeter.
*PUD <block>	Protected User Data	Stores up to 63 bytes of arbitrary data in non-volatile memory. The protection mechanism is the CALibration:SECure:STATe command.
*PUD?	Protected User Data Query	Returns the stored block of data.
*RST	Reset	Resets the multimeter to its power-on state (Table 1-2 shows the multimeter's power-on state).
*TST?	Self-Test	Performs the multimeter's internal self-test. Returns "0" unless self-test fails.
*CLS	Clear Status	Clears all status registers (Standard Event Status, Operation Status, Questionable Data/Signal) and the error queue.
*ESE <mask>	Event Status Enable	Enables one or more events in the Standard Event Status Register to be reported in bit 5 (summary bit) of the Status Byte Register.
*ESE?	Event Status Enable Query	Returns the weighted sum of all enabled bits in the Standard Event Status Register.
*ESR?	Event Status Register Query	Returns the weighted sum of all set bits in the Standard Event Status Register (all bits are cleared).
*PSC <value>	Power-On Status Clear	Enables the automatic power-on clearing of enabled Status Byte Register and Standard Event Status Register bits.
*PSC?	Power-On Status Clear Query	Returns "0" or "1" to show whether the Status Byte Register and Standard Event Status Register bits remain enabled or disabled at power-on.
*SRE <mask>	Service Request Enable	Enables status register bits to assert an HP-IB service request (SRQ).
*SRE?	Service Request Enable Query	Returns the weighted sum of all enabled events (those enabled to assert SRQ) in the Status Byte Register.
*STB?	Read Status Byte Query	Returns the weighted sum of all set bits in the Status Byte Register.
*TRG	Bus Trigger	Issues a trigger when the multimeter is in the wait-for-trigger state and the trigger source is TRIGger:SOURce BUS.
*LRN?	Learn Query	Returns a string of TMSL commands which define the multimeter's current state.
*OPC?	Operation Complete Query	Places "1" in output buffer when operation is complete.
*RCL <number>	Recall Instrument State	Recalls previously stored multimeter configuration.
*SAV <number>	Store Instrument State	Stores the present multimeter configuration.

# NOTES



## Command Quick Reference

The following tables summarize Standard Commands for Programmable Instruments (SCPI) commands and IEEE 488.2 Common (\*) commands for the HP E1410A 6½-Digit Multimeter.

### SCPI Commands Quick Reference

Command	Description	
ABORt		Place multimeter in idle state.
CALibration	:INTernal? AC RES ALL :LFRequency 50 60 400 MIN MAX :LFRequency? [MIN MAX] :NUMBer? :ZERO:AUTO OFF 0 ON 1 ONCE :ZERO:AUTO?	Perform one or both autocal. Change line frequency reference. Query line frequency reference. Read calibration number. Enable/disable autozero mode. Query autozero mode.
CONFigure	:FREQuency [ < expected value > [, < resolution > ] ] :FRESistance [ < expected value > [, < resolution > ] ] :PERiod [ < expected value > [, < resolution > ] ] :RESistance [ < expected value > [, < resolution > ] ] :TEMPerature < transducer > , < type > :VOLTage:AC [ < expected value > [, < resolution > ] ] :VOLTage:ACDC [ < expected value > [, < resolution > ] ] :VOLTage[:DC] [ < expected value > [, < resolution > ] ]	Configure multimeter for frequency. ]Configure multimeter for 4-wire ohms. Configure multimeter for period. Configure multimeter for 2-wire ohms. Configure multimeter for temperature. Configure multimeter for AC voltage. Configure multimeter for AC + DC voltage. Configure multimeter for DC voltage.
CONFigure?		Query multimeter configuration.
FETCh?		Place stored readings in output buffer.
INITiate	[:IMMediate]	Place multimeter in wait-for trigger state.
INPut	:COUPling AC DC :COUPling? :IMPedance:AUTO OFF 0 ON 1 :IMPedance:AUTO? :STATe OFF 0 ON 1 :STATe?	Select input coupling source. Query input coupling source. Enable/disable automatic input impedance. Query input impedance mode. Enable/disable input terminals. Query input terminal configuration.
MEASure	:FREQuency? [ < expected value > [, < resolution > ] ] :FRESistance? [ < expected value > [, < resolution > ] ] :PERiod? [ < expected value > [, < resolution > ] ] :RESistance? [ < expected value > [, < resolution > ] ] :TEMPerature? < transducer > , < type > :VOLTage:AC? [ < expected value > [, < resolution > ] ] :VOLTage:ACDC? [ < expected value > [, < resolution > ] ] :VOLTage[:DC]? [ < expected value > [, < resolution > ] ]	Make frequency measurement. Make 4-wire ohms measurement. Make period measurement. Make 2-wire ohms measurement. Make temperature measurement. Make AC voltage measurement. Make AC + DC voltage measurement. Make DC voltage measurement.
MEMory	:VME:ADDRes 2097152 - 14680056 :VME:ADDRes? [MIN MAX] :VME:SIZE 0-12582912 :VME:SIZE? [MIN MAX] :VME:STATe OFF 0 ON 1 :VME:STATe?	Set address of external VME memory card. Query VME memory address. Set size of external VME memory card. Query VME memory size. Enable/disable external VME memory card. Query VME memory mode.
OUTPut	:TTLTrg0 1 2 3 4 5 6 7 [:STATe] OFF 0 ON 1 :TTLTrg0 1 2 3 4 5 6 7 [:STATe]?	Send voltmeter complete to VXIbus trigger lines. Query voltmeter complete destination.
READ?		Place multimeter in wait-for-trigger state; place readings in output buffer.

SCPI Commands Quick Reference (continued)

Command	Description	
SAMPlE	:COUNt 1-16,777,215 MIN MAX :COUNt? [MIN MAX] :SOURce IMM TIM :SOURce? :TIMer 680 $\mu$ s-2100s MIN MAX :TIMer? [MIN MAX]	Set number of readings per trigger. Query number of readings per trigger. Set pacing source. Query pacing source. Define period between readings. Query period between readings.
[SENSE:]	BANDwidth:DETEctor 20 400 MIN MAX BANDwidth:DETEctor? [MIN MAX] FUNction[: < function > ] FUNction? RESistance:APERture < time >  MIN MAX RESistance:APERture? [MIN MAX] RESistance:NPLC < number >  MIN MAX RESistance:NPLC? [MIN MAX] RESistance:OCOMPensated OFF 0 ON 1 RESistance:OCOMPensated? RESistance:RANGE:AUTO OFF 0 ON 1 RESistance:RANGE:AUTO? RESistance:RANGE < expected value >  MIN MAX RESistance:RANGE? [MIN MAX] RESistance:RESolution < resolution >  MIN MAX RESistance:RESolution? [MIN MAX] VOLTage:AC:RANGE < expected value >  MIN MAX VOLTage:AC:RANGE? [MIN MAX] VOLTage:APERture < time >  MIN MAX VOLTage:APERture? [MIN MAX] VOLTage[:DC]:RANGE < expected value >  MIN MAX VOLTage[:DC]:RANGE? [MIN MAX] VOLTage:NPLC < number >  MIN MAX VOLTage:NPLC? [MIN MAX] VOLTage:RANGE:AUTO OFF 0 ON 1 VOLTage:RANGE:AUTO? VOLTage:RESolution < resolution >  MIN MAX VOLTage:RESolution? [MIN MAX]	Select slow or fast AC measurement mode. Query AC measurement mode. Select measurement function. Query measurement function. Set aperture time in seconds. Query aperture time. Set integration time in PLCs. Query integration time. Enable/disable offset compensation. Query offset compensation mode. Enable/disable autoranging. Query autorange mode. Select range. Query range. Specify resolution. Query resolution. Select range. Query range. Set aperture time in seconds. Query aperture time. Select range. Query range. Set integration time in PLCs. Query integration time. Enable/disable autoranging. Query autorange mode. Specify resolution. Query resolution.
STATus	:OPERation:CONDition? :OPERation:ENABle < number > :OPERation:ENABle? :OPERation[:EVENT]? :QUESTionable:ENABle < number >  :QUESTionable:ENABle?  :QUESTionable[:EVENT]?	Read Operation Status condition register. Set conditions in Operation Status enable register. Query set conditions in Operation Status Register. Read Operation Status event register. Set conditions in Questionable Data/Signal enable register. Query set conditions in Questionable Data/Signal Status Register. Read Questionable Data/Signal event register.
SYSTem	:ERRor?	Read error queue.



SCPI Commands Quick Reference (continued)

Command	Description	
TEST	[:ALL]? :INGuard:CALibrate? :INGuard:FLATness? :INGuard:GAIN? :INGuard:INTEgrator? :INGuard:LINK? :INGuard:OFFSet? :INGuard:PRECharge? :INGuard:ZERO?	Perform self-test. Perform calibration RAM self-test. Perform AC flatness self-test. Perform gain self-test. Perform integrator convergence self-test. Perform Inguard CPU and link self-test. Perform DC offset self-test. Perform ohms precharge self-test. Perform front end zero measurement self-test.
TRIGger	:BUFFered OFF 0 ON 1 :BUFFered? :COUNt 1-16,777,215 MIN MAX :COUNt? [MIN MAX] :DELay:AUTO OFF 0 ON 1 :DELay:AUTO? :DELay 1 $\mu$ s-2100s MIN MAX  :DELay? [MIN MAX] [:IMMediate] :SLOPe POS NEG :SLOPe? :SOURce BUS EXT HOLD IMM TTLT0-TTLT7 :SOURce?	Enable/disable trigger buffering. Query trigger buffering mode. Set number of triggers or scans. Query trigger count. Enable/disable automatic trigger delay. Query automatic trigger delay mode. Set delay between trigger and start of measurement. Query trigger delay. Trigger immediately. Set trigger slope. Query trigger slope. Specify trigger source. Query trigger source.

IEEE 488.2 Common Commands Quick Reference

Command	TitleDescription	
*CAL?	Internal Calibration	Perform multimeter autocalcs Returns "0" unless calibration fails.
*CLS	Clear Status Register	Clear all status registers and the error queue.
*ESE <mask >	Event Status Enable	Enable events in Standard Event Status Register to be reported.
*ESE?	Event Status Enable Query	Return sum of all enabled bits in the Standard Event Status Register.
*ESR?	Event Status Register Query	Return sum of all set bits in the Standard Event Status Register.
*IDN?	Identification Query	Return identification string.
*LRN?	Learn Query	Return string of SCPI commands which define current multimeter state.
*OPC?	Operation Complete Query	Send "1" to the output buffer when complete.
*PSC <value >	Power-On Status Clear	Enable power-on clearing of enabled status register bits.
*PSC?	Power-On Status Clear Query	Return power-on clearing status.
*PUD <block >	Protected User Data	Store up to 63 bytes of arbitrary data.
*PUD?	Protected User Data Query	Returns block of stored data.
*RCL 0-9	Recall Instrument State	Recall configuration previously stored by *SAV.
*RST	Reset	Reset multimeter to power-on state.
*SAV 0-9	Store Instrument State	Store present configuration.
*SRE <mask >	Service Request Enable	Enable status register bits to assert SRQ.
*SRE?	Service Request Enable Query	Return sum of enabled bits.
*STB?	Read Status Byte Query	Return sum of all bits set in Status Byte Register.
*TRG	Bus Trigger	Trigger multimeter.
*TST?	Self-Test	Returns "0" unless self-test fails.

# A

## Specifications

### DC Voltage

#### Maximum Non-Destructive Input (volts)

Terminals	DC	AC RMS	AC Peak
HI to LO	300	300	450
HI to Guard	300	300	450
HI to Chassis	300	300	450
LO to Guard	300	300	450
LO to Chassis	300	300	450
Guard to Chassis	300	300	450

#### Maximum Reading vs. Range (volts)

Range	Maximum Reading
30 mV	30.30000 mV
300 mV	303.0000 mV
3V	3.030000V
30V	30.30000V
300V	303.0000V

#### Input Resistance vs. Range (ohms)

Range	Input Resistance
30 mV	> 10 G $\Omega$
300 mV	> 10 G $\Omega$
3V	> 10 G $\Omega$
30V	10 M $\Omega$ $\pm$ 1%
300V	10 M $\Omega$ $\pm$ 1%

Conditions: With INPut:IMPedance:AUTO ON. If INPut:IMPedance:AUTO is OFF, the input resistance is 10 M $\Omega$  on all ranges.

## Noise Rejection (dB)

	Aperture									
	2s	1.67s	200 ms	167 ms	20 ms	16.7 ms	2 ms	1.67 ms	100 $\mu$ s	10 $\mu$ s
<b>A. DC Voltage and Resistance</b>										
DC Common Mode Rejection (DC CMR) - Guarded	140	140	140	140	140	140	140	140	140	140
DC Common Mode Rejection (DC CMR) - Non-Guarded	120	120	120	120	120	120	120	120	120	120
AC Common Mode Rejection (AC CMR)	see below									
AC Effective Common Mode Rejection (AC ECMR)	see below									
<b>50 Hz Power Line Cycles of Integration (NPLCs)</b>										
Normal Mode (50 Hz) Noise Rejection (NMR)	100	–	10	–	1	–	0.1	–	–	–
AC ECMR (Guarded) at 50 Hz	90	0	80	0	60	0	0	0	0	0
AC ECMR (Non-Guarded) at 50 Hz	160	82	160	82	142	82	82	82	82	82
AC CMR (Guarded) DC to 50 Hz	142	52	132	52	112	52	52	52	52	52
AC CMR (Non-Guarded) DC to 50 Hz	82	82	82	82	82	82	82	82	82	82
AC CMR (Non-Guarded) DC to 50 Hz	52	52	52	52	52	52	52	52	52	52
<b>60 Hz Power Line Cycles of Integration (NPLCs)</b>										
Normal Mode (60 Hz) Noise Rejection (NMR)	–	100	–	10	–	1	–	0.1	–	–
AC ECMR (Guarded) at 60 Hz	0	90	0	80	0	60	0	0	0	0
AC ECMR (Non-Guarded) at 60 Hz	80	160	80	160	80	140	80	80	80	80
AC CMR (Guarded) DC to 60 Hz	50	140	50	130	50	110	50	50	50	50
AC CMR (Non-Guarded) DC to 60 Hz	80	80	80	80	80	80	80	80	80	80
AC CMR (Non-Guarded) DC to 60 Hz	50	50	50	50	50	50	50	50	50	50
<b>400 Hz Power Line Cycles of Integration (NPLCs)</b>										
Normal Mode (400 Hz) Noise Rejection (NMR)	800	–	80	–	8	–	–	–	–	–
AC ECMR (Guarded) at 400 Hz	90	0	80	0	60	0	0	0	0	0
AC ECMR (Non-Guarded) at 400 Hz	154	64	144	64	124	64	64	64	64	64
AC CMR (Guarded) DC to 400 Hz	124	34	114	34	94	34	34	34	34	34
AC CMR (Non-Guarded) DC to 400 Hz	64	64	64	64	64	64	64	64	64	64
AC CMR (Non-Guarded) DC to 400 Hz	34	34	34	34	34	34	34	34	34	34

## B. AC and ACDC Voltage

### DC to 60 Hz

AC Common Mode Rejection (AC CMR) - Guarded	80	80	80	80	80	80	80	80	80	80
AC Common Mode Rejection (AC CMR) - Non-Guarded	50	50	50	50	50	50	50	50	50	50

### DC to 400 Hz

AC Common Mode Rejection (AC CMR) - Guarded	64	64	64	64	64	64	64	64	64	64
AC Common Mode Rejection (AC CMR) - Non-Guarded	34	34	34	34	34	34	34	34	34	34

Conditions: 50/60/400 Hz  $\pm$  0.08%,  $\leq$  1 k $\Omega$  in LO lead, resistance in HI lead is irrelevant. The noise current will flow through the LO lead; the HI lead has 1 M $\Omega$ , 10 M $\Omega$ , or  $>$  10<sup>10</sup>  $\Omega$  in series internally.

## Resolution (volts)

Range	Aperture			
	≥ 16.7 ms	2 ms/1.67 ms	100 μs	10 μs
30 mV	10 nV	100 nV	1 μV	10 μV
300 mV	100 nV	1 μV	10 μV	100 μV
3V	1 μV	10 μV	100 μV	1 mV
30V	10 μV	100 μV	1 mV	10 mV
300V	100 μV	1 mV	10 mV	100 mV

Conditions: Useful resolution. In some instances, the multimeter may give additional digits.

## DC Voltage Accuracy Conditions

Autozero on (CALibration:ZERO:AUTO ON). After one-hour warm-up. Tcal is the temperature of calibration from 18°C to 28°C.

### 24-Hour Accuracy ±(% of reading + volts)

Range	Aperture					
	2s/1.67s	200 ms/167 ms	20 ms/16.7 ms	2 ms/1.67 ms	100 μs	10 μs
30 mV	0.0017% + 2.2 μV	0.0017% + 2.4 μV	0.0017% + 3.5 μV	0.0017% + 5.5 μV	0.0017% + 17 μV	0.0017% + 60 μV
300 mV	0.0010% + 2.4 μV	0.0010% + 2.5 μV	0.0010% + 3.5 μV	0.0010% + 7.0 μV	0.0010% + 40 μV	0.0010% + 400 μV
3V	0.0008% + 5.0 μV	0.0008% + 6.0 μV	0.0008% + 6.0 μV	0.0008% + 40 μV	0.0008% + 400 μV	0.0008% + 4 mV
30V	0.0011% + 90 μV	0.0011% + 100 μV	0.0011% + 200 μV	0.0011% + 600 μV	0.0011% + 4.0 mV	0.0011% + 40 mV
300V	0.0030% + 500 μV	0.0030% + 600 μV	0.0030% + 600 μV	0.0030% + 4.0 mV	0.0030% + 40 mV	0.0030% + 400 mV

Conditions: Tcal ± 1°C. Accuracy is relative to calibration standard. The module should be calibrated as used.

### 90-Day Accuracy ±(% of reading + volts)

Range	Aperture					
	2s/1.67s	200 ms/167 ms	20 ms/16.7 ms	2 ms/1.67 ms	100 μs	10 μs
30 mV	0.0040% + 3.7 μV	0.0040% + 3.9 μV	0.0040% + 5.0 μV	0.0040% + 7.0 μV	0.0040% + 19 μV	0.0040% + 60 μV
300 mV	0.0025% + 3.9 μV	0.0025% + 4.0 μV	0.0025% + 5.0 μV	0.0025% + 9.0 μV	0.0025% + 40 μV	0.0025% + 400 μV
3V	0.0017% + 6.0 μV	0.0017% + 7.0 μV	0.0017% + 7.0 μV	0.0017% + 40 μV	0.0017% + 400 μV	0.0017% + 4.0 mV
30V	0.0035% + 190 μV	0.0035% + 200 μV	0.0035% + 300 μV	0.0035% + 700 μV	0.0035% + 4.0 mV	0.0035% + 40 mV
300V	0.0050% + 600 μV	0.0050% + 700 μV	0.0050% + 700 μV	0.0050% + 4.0 mV	0.0050% + 40 mV	0.0050% + 400 mV

Conditions: Tcal ± 5°C. Accuracy relative to calibration standard. See the Factory Calibration adders at the end of this Appendix. The Tcal specification is based on the ambient temperature when the calibration was performed.

Factory calibration was performed in an HP E1400B mainframe with various other low-power modules. Variations due to different mainframes, modules, or module locations may cause variations in the module temperature. For highest accuracy, the module should be calibrated as used.

## 1-Year Accuracy $\pm$ (% of reading + volts)

### Aperture

Range	2s/1.67s	200 ms/167 ms	20 ms/16.7 ms	2 ms/1.67 ms	100 $\mu$ s	10 $\mu$ s
30 mV	0.0045% + 3.7 $\mu$ V	0.0045% + 3.9 $\mu$ V	0.0045% + 5.0 $\mu$ V	0.0045% + 7.0 $\mu$ V	0.0045% + 19 $\mu$ V	0.0045% + 60 $\mu$ V
300 mV	0.0035% + 3.9 $\mu$ V	0.0035% + 4.0 $\mu$ V	0.0035% + 5.0 $\mu$ V	0.0035% + 9.0 $\mu$ V	0.0035% + 40 $\mu$ V	0.0035% + 400 $\mu$ V
3V	0.0025% + 6.0 $\mu$ V	0.0025% + 7.0 $\mu$ V	0.0025% + 7.0 $\mu$ V	0.0025% + 40 $\mu$ V	0.0025% + 400 $\mu$ V	0.0025% + 4.0 mV
30V	0.0040% + 190 $\mu$ V	0.0040% + 200 $\mu$ V	0.0040% + 300 $\mu$ V	0.0040% + 700 $\mu$ V	0.0040% + 4.0 mV	0.0040% + 40 mV
300V	0.0055% + 600 $\mu$ V	0.0055% + 700 $\mu$ V	0.0055% + 700 $\mu$ V	0.0055% + 4.0 mV	0.0055% + 40 mV	0.0055% + 400 mV

Conditions: Tcal  $\pm$  5°C. Accuracy relative to calibration standard. See the Factory Calibration adders at the end of this Appendix. The Tcal specification is based on the ambient temperature when the calibration was performed.

Factory calibration was performed in an HP E1400B mainframe with various other low-power modules. Variations due to different mainframes, modules, or module locations may cause variations in the module temperature. For highest accuracy, the module should be calibrated as used.

## Temperature Coefficient $\pm$ (% of reading + volts)/°C

To determine the additional error for operation outside the temperature ranges shown in the accuracy specifications, multiply the temperature coefficient by the difference between the operating temperature and Tcal.

Range	Temperature Coefficient
30 mV	0.0005% + 0.3 $\mu$ V
300 mV	0.0005% + 0.3 $\mu$ V
3V	0.0005% + 0.3 $\mu$ V
30V	0.0005% + 10 $\mu$ V
300V	0.0005% + 30 $\mu$ V

## Autozero OFF Offset Error (volts)

Range	Additional Offset Error
30 mV	<del>100 <math>\mu</math>V</del> 100 nV
300 mV	1 $\mu$ V
3V	10 $\mu$ V
30V	100 $\mu$ V
300V	1 mV

Conditions: Add additional offset error if autozero is off (CALibration:ZERO:AUTO OFF). Assumes stable environment,  $\pm$  1°C over 10 minutes.

## Range-to-Range Response Error

For default settling times, add 0.0005% of input voltage step to the first reading following a range change.

# Resistance (Two- and Four-Wire)

## Input Protection (ohms)

Terminals	DC	AC RMS	AC Peak
HI to LO	300	300	450
HI Sense to LO Sense	250	250	350
HI Sense/LO Sense to LO	250	250	350
HI/HI Sense to Guard	300	300	450
HI/HI Sense to Chassis	300	300	450
LO/LO Sense to Guard	300	300	450
LO/LO Sense to Chassis	300	300	450
Guard to Chassis	300	300	450

## Maximum Reading vs. Range (ohms)

Range	Maximum Reading
30Ω	30.30000Ω
300Ω	303.0000Ω
3 kΩ	3.030000 kΩ
30 kΩ	30.30000 kΩ
300 kΩ	303.0000 kΩ
3 MΩ	3.030000 MΩ
30 MΩ	30.30000 MΩ
300 MΩ	303.0000 MΩ
3 GΩ	3.030000 GΩ

## Measurement Characteristics vs. Range

Range	Source Current	Maximum Open Circuit Voltage	Maximum Allowable Current Source Lead Resistance	Maximum Allowable Offset Voltage for Offset Compensated Ohms	Default Measurement Settling Time
30Ω	1 mA	12V	1Ω	1 mV	560 μs
300Ω	1 mA	12V	10Ω	10 mV	350 μs
3 kΩ	1 mA	12V	100Ω	100 mV	350 μs
30 kΩ	100 μA	12V	1 kΩ	N/A	350 μs
300 kΩ	10 μA	12V	10 kΩ	N/A	2.4 ms
3 MΩ	1 μA	12V	100 kΩ	N/A	24 ms
30 MΩ	100 nA	8.5V	1 MΩ	N/A	240 ms
300 MΩ	100 nA	8.5V	N/A	N/A	2.4s
3 GΩ	100 nA	8.5V	N/A	N/A	2.5s

Conditions: The first reading meets accuracy specification with preprogrammed settling times and < 200 pF circuit capacitance. An additional delay of 0.1 seconds is necessary after a range or function change to meet rated accuracy. On the 300 MΩ and 3 GΩ ranges, the current source is in parallel with 10 MΩ.

## Noise Rejection

See the DC Voltage Noise Rejection specifications.

## Resolution (ohms)

Range	Aperture			
	$\geq 16.7$ ms	2 ms/1.67 ms	100 $\mu$ s	10 $\mu$ s
30 $\Omega$	10 $\mu\Omega$	100 $\mu\Omega$	1 m $\Omega$	10 m $\Omega$
300 $\Omega$	100 $\mu\Omega$	1 m $\Omega$	10 m $\Omega$	100 m $\Omega$
3 k $\Omega$	1 m $\Omega$	10 m $\Omega$	100 m $\Omega$	1 $\Omega$
30 k $\Omega$	10 m $\Omega$	100 m $\Omega$	1 $\Omega$	10 $\Omega$
300 k $\Omega$	100 m $\Omega$	1 $\Omega$	10 $\Omega$	100 $\Omega$
3 M $\Omega$	1 $\Omega$	10 $\Omega$	100 $\Omega$	1 k $\Omega$
30 M $\Omega$	10 $\Omega$	100 $\Omega$	1 k $\Omega$	10 k $\Omega$
300 M $\Omega$	100 $\Omega$	1 k $\Omega$	10 k $\Omega$	100 k $\Omega$
3 G $\Omega$	1 k $\Omega$	10 k $\Omega$	100 k $\Omega$	1 M $\Omega$

Conditions: Useful resolution. In some instances, the multimeter may give additional digits.

## Resistance Accuracy Conditions

Autozero on (CALibration:ZERO:AUTO ON). Offset compensation on or off (SENSe:RESistance:OCOMpensated). After one-hour warm-up. Tcal is the temperature of calibration from 18°C to 28°C.

## 24-Hour Four-Wire Accuracy $\pm$ (% of reading + ohms)

Range	Aperture					
	2s/1.67s	200 ms/167 ms	20 ms/16.7 ms	2 ms/1.67 ms	100 $\mu$ s	10 $\mu$ s
30 $\Omega$	0.0035% + 2.2 m $\Omega$	0.0035% + 2.4 m $\Omega$	0.0035% + 3.5 m $\Omega$	0.0035% + 5.5 m $\Omega$	0.0035% + 17 m $\Omega$	0.0035% + 60 m $\Omega$
300 $\Omega$	0.0020% + 2.4 m $\Omega$	0.0020% + 2.5 m $\Omega$	0.0020% + 3.5 m $\Omega$	0.0020% + 6 m $\Omega$	0.0020% + 40 m $\Omega$	0.0020% + 400 m $\Omega$
3 k $\Omega$	0.0015% + 5 m $\Omega$	0.0015% + 6 m $\Omega$	0.0015% + 6 m $\Omega$	0.0015% + 40 m $\Omega$	0.0015% + 400 m $\Omega$	0.0015% + 4 $\Omega$
30 k $\Omega$	0.0015% + 50 m $\Omega$	0.0015% + 60 m $\Omega$	0.0015% + 60 m $\Omega$	0.0015% + 400 m $\Omega$	0.0015% + 4 $\Omega$	0.0015% + 40 $\Omega$
300 k $\Omega$	0.0018% + 600 m $\Omega$	0.0018% + 700 m $\Omega$	0.0018% + 800 m $\Omega$	0.0018% + 4 $\Omega$	0.0018% + 40 $\Omega$	0.0018% + 400 $\Omega$
3 M $\Omega$	0.0040% + 12 $\Omega$	0.0040% + 14 $\Omega$	0.0040% + 16 $\Omega$	0.0040% + 70 $\Omega$	0.0040% + 500 $\Omega$	0.0040% + 5 k $\Omega$
30 M $\Omega$	0.0225% + 800 $\Omega$	0.0225% + 830 $\Omega$	0.0225% + 930 $\Omega$	0.0225% + 1.4 k $\Omega$	0.0225% + 6 k $\Omega$	0.0225% + 40 k $\Omega$
300 M $\Omega$	Only specified for two-wire ohms.					
3 G $\Omega$	Only specified for two-wire ohms.					

Conditions: Tcal  $\pm$  1°C. Accuracy relative to calibration standard. The module should be calibrated as used.

## 90-Day Four-Wire Accuracy $\pm$ (% of reading + ohms)

Aperture						
Range	2s/1.67s	200 ms/167 ms	20 ms/16.7 ms	2 ms/1.67 ms	100 $\mu$ s	10 $\mu$ s
30 $\Omega$	0.0065% + 3.2 m $\Omega$	0.0065% + 3.4 m $\Omega$	0.0065% + 4.5 m $\Omega$	0.0065% + 6.5 m $\Omega$	0.0065% + 18 m $\Omega$	0.0065% + 60 m $\Omega$
300 $\Omega$	0.0045% + 3.4 m $\Omega$	0.0045% + 3.5 m $\Omega$	0.0045% + 4.5 m $\Omega$	0.0045% + 8 m $\Omega$	0.0045% + 40 m $\Omega$	0.0045% + 400 m $\Omega$
3 k $\Omega$	0.0035% + 6 m $\Omega$	0.0035% + 7 m $\Omega$	0.0035% + 7 m $\Omega$	0.0035% + 40 m $\Omega$	0.0035% + 400 m $\Omega$	0.0035% + 4 $\Omega$
30 k $\Omega$	0.0035% + 60 m $\Omega$	0.0035% + 70 m $\Omega$	0.0035% + 70 m $\Omega$	0.0035% + 400 m $\Omega$	0.0035% + 4 $\Omega$	0.0035% + 40 $\Omega$
300 k $\Omega$	0.0040% + 700 m $\Omega$	0.0040% + 800 m $\Omega$	0.0040% + 900 m $\Omega$	0.0040% + 4 $\Omega$	0.0040% + 40 $\Omega$	0.0040% + 400 $\Omega$
3 M $\Omega$	0.0055% + 12 $\Omega$	0.0055% + 14 $\Omega$	0.0055% + 16 $\Omega$	0.0055% + 70 $\Omega$	0.0055% + 500 $\Omega$	0.0055% + 5 k $\Omega$
30 M $\Omega$	0.0250% + 800 $\Omega$	0.0250% + 830 $\Omega$	0.0250% + 930 $\Omega$	0.0250% + 1.4 k $\Omega$	0.0250% + 6 k $\Omega$	0.0250 + 50 k $\Omega$
300 M $\Omega$	Only specified for two-wire ohms.					
3 G $\Omega$	Only specified for two-wire ohms.					

Conditions: Tcal  $\pm$  5°C. Accuracy relative to calibration standard. See the Factory Calibration adders at the end of this Appendix. The Tcal specification is based on the ambient temperature when the calibration was performed.

Factory calibration was performed in an HP E1400B mainframe with various other low-power modules. Variations due to different mainframes, modules, or module locations may cause variations in the module temperature. For highest accuracy, the module should be calibrated as used.

## 1-Year Four-Wire Accuracy $\pm$ (% of reading + ohms)

Aperture						
Range	2s/1.67s	200 ms/167 ms	20 ms/16.7 ms	2 ms/1.67 ms	100 $\mu$ s	10 $\mu$ s
30 $\Omega$	0.0075% + 3.2 m $\Omega$	0.0075% + 3.4 m $\Omega$	0.0075% + 4.5 m $\Omega$	0.0075% + 6.5 m $\Omega$	0.0075% + 18 m $\Omega$	0.0075% + 60 m $\Omega$
300 $\Omega$	0.0055% + 3.4 m $\Omega$	0.0055% + 3.5 m $\Omega$	0.0055% + 4.5 m $\Omega$	0.0055% + 8 m $\Omega$	0.0055% + 40 m $\Omega$	0.0055% + 400 m $\Omega$
3 k $\Omega$	0.0050% + 6 m $\Omega$	0.0050% + 7 m $\Omega$	0.0050% + 7 m $\Omega$	0.0050% + 40 m $\Omega$	0.0050% + 400 m $\Omega$	0.0050% + 4 $\Omega$
30 k $\Omega$	0.0050% + 60 m $\Omega$	0.0050% + 70 m $\Omega$	0.0050% + 70 m $\Omega$	0.0050% + 400 m $\Omega$	0.0050% + 4 $\Omega$	0.0050% + 40 $\Omega$
300 k $\Omega$	0.0050% + 700 m $\Omega$	0.0050% + 800 m $\Omega$	0.0050% + 900 m $\Omega$	0.0050% + 4 $\Omega$	0.0050% + 40 $\Omega$	0.0050% + 400 $\Omega$
3 M $\Omega$	0.0065% + 12 $\Omega$	0.0065% + 14 $\Omega$	0.0065% + 16 $\Omega$	0.0065% + 70 $\Omega$	0.0065% + 500 $\Omega$	0.0065% + 5 k $\Omega$
30 M $\Omega$	0.0400% + 800 $\Omega$	0.0400% + 830 $\Omega$	0.0400% + 930 $\Omega$	0.0400% + 1.4 k $\Omega$	0.0400% + 6 k $\Omega$	0.0400% + 50 k $\Omega$
300 M $\Omega$	Only specified for two-wire ohms.					
3 G $\Omega$	Only specified for two-wire ohms.					

Conditions: Tcal  $\pm$  5°C. Accuracy relative to calibration standard. See the Factory Calibration adders at the end of this Appendix. The Tcal specification is based on the ambient temperature when the calibration was performed.

Factory calibration was performed in an HP E1400B mainframe with various other low-power modules. Variations due to different mainframes, modules, or module locations may cause variations in the module temperature. For highest accuracy, the module should be calibrated as used.

## 24-Hour Two-Wire Accuracy $\pm$ (% of reading + ohms)

Add  $\pm$  200 m $\Omega$  to all four-wire specifications except those on the 300 M $\Omega$  and 3 G $\Omega$  ranges (see below).

Aperture						
Range	2s/1.67s	200 ms/167 ms	20 ms/16.7 ms	2 ms/1.67 ms	100 $\mu$ s	10 $\mu$ s
300 M $\Omega$	0.96% + 100 k $\Omega$	0.96% + 100 k $\Omega$	0.96% + 100 k $\Omega$ (1)	(1)	(1)	(1)
3 G $\Omega$	9.60% + 1 M $\Omega$	9.60% + 1 M $\Omega$	9.60% + 1 M $\Omega$ (1)	(1)	(1)	(1)

Conditions: Inputs > 10% of full scale only, and within 24 hours of autocalibration (CALibration:INTernal?).

(1) Not specified for aperture times less than 16.7 ms.



## 90-Day Two-Wire Accuracy $\pm$ (% of reading + ohms)

Add  $\pm 200\text{ m}\Omega$  to all four-wire specifications except those on the  $300\text{ M}\Omega$  and  $3\text{ G}\Omega$  ranges (see below).

### Aperture

Range	2s/1.67s	200 ms/167 ms	20 ms/16.7 ms	2 ms/1.67 ms	100 $\mu\text{s}$	10 $\mu\text{s}$
300 M $\Omega$	1.6% + 100 k $\Omega$	1.6% + 100 k $\Omega$	1.6% + 100 k $\Omega$	(1)	(1)	(1)
3 G $\Omega$	16% + 1 M $\Omega$	16% + 1 M $\Omega$	16% + 1 M $\Omega$	(1)	(1)	(1)

Conditions: Inputs > 10% of full scale only. For stable conditions ( $\pm 1^\circ\text{C}$ ) and within 24 hours of autocalibration (CALibration:INTernal?), use the 24-hour specifications.

(1) Not specified for aperture times less than 16.7 ms.

## 1-Year Two-Wire Accuracy $\pm$ (% of reading + ohms)

Add  $\pm 200\text{ m}\Omega$  to all four-wire specifications except those on the  $300\text{ M}\Omega$  and  $3\text{ G}\Omega$  ranges (see below).

### Aperture

Range	2s/1.67s	200 ms/167 ms	20 ms/16.7 ms	2 ms/1.67 ms	100 $\mu\text{s}$	10 $\mu\text{s}$
300 M $\Omega$	1.6% + 100 k $\Omega$	1.6% + 100 k $\Omega$	1.6% + 100 k $\Omega$	(1)	(1)	(1)
3 G $\Omega$	16% + 1 M $\Omega$	16% + 1 M $\Omega$	16% + 1 M $\Omega$	(1)	(1)	(1)

Conditions: Inputs > 10% of full scale only. For stable conditions ( $\pm 1^\circ\text{C}$ ) and within 24 hours of autocalibration (CALibration:INTernal?), use the 24-hour specifications.

(1) Not specified for aperture times less than 16.7 ms.

## Temperature Coefficient $\pm$ (% of reading + ohms)/ $^\circ\text{C}$

To determine the additional error for operation outside the temperature ranges shown in the accuracy specifications above, multiply the temperature coefficient by the difference between the operating temperature and Tcal.

Range	Temperature Coefficient
30 $\Omega$	0.0005% + 500 $\mu\Omega$
300 $\Omega$	0.0005% + 500 $\mu\Omega$
3 k $\Omega$	0.0005% + 500 $\mu\Omega$
30 k $\Omega$	0.0005% + 5 m $\Omega$
300 k $\Omega$	0.0008% + 50 m $\Omega$
3 M $\Omega$	0.0010% + 500 m $\Omega$
30 M $\Omega$	0.0025% + 5 $\Omega$
300 M $\Omega$	0.3500% + 0 $\Omega$
3 G $\Omega$	3.5000% + 0 $\Omega$

## Autozero OFF Offset Error (ohms)

Range	Additional Offset Error
30 $\Omega$	100 $\mu\Omega$
300 $\Omega$	1 m $\Omega$
3 k $\Omega$	10 m $\Omega$
30 k $\Omega$	100 m $\Omega$
300 k $\Omega$	1 $\Omega$
3 M $\Omega$	10 $\Omega$
30 M $\Omega$	100 $\Omega$
300 M $\Omega$	1 k $\Omega$
3 G $\Omega$	10 k $\Omega$

Conditions: Add additional offset error if autozero is off (CALibration:ZERO:AUTO OFF). Assumes stable environment,  $\pm 1^\circ\text{C}$  over 10 minutes. With autozero off, changes in the four-wire ohms LO lead resistance are not corrected.

# True RMS AC Voltage (AC- and DC-Coupled)

## Maximum Non-Destructive Input (volts)

---

Terminals	DC	AC RMS	AC Peak
HI to LO	300	300	450
HI to Guard	300	300	450
HI to Chassis	300	300	450
LO to Guard	300	300	450
LO to Chassis	300	300	450
Guard to Chassis	300	300	450

## Maximum Reading vs. Range (volts)

---

Range	Maximum Reading
30 mV	32.50000 mV
300 mV	325.0000 mV
3V	3.250000V
30V	32.50000V
300V	325.00000V

## Input Impedance vs. Range (ohms $\pm$ %, shunt capacitance)

---

Range	Input Impedance
30 mV	1 M $\Omega$ $\pm$ 1%, <90 pF
300 mV	1 M $\Omega$ $\pm$ 1%, <90 pF
3V	1 M $\Omega$ $\pm$ 1%, <90 pF
30V	1M $\Omega$ $\pm$ 1%, <90 pF
300V	1 M $\Omega$ $\pm$ 1%, <90 pF

## Crest Factor

---

% Full Scale	Crest Factor
100%	3.5

## Noise Rejection (dB)

---

Noise Configuration	Rejection
DC to 60 Hz Common Mode Rejection (CMR) - Guarded	> 80 dB
DC to 60 Hz Common Mode Rejection (CMR) - Non-Guarded	> 50 dB

Conditions: 1 k $\Omega$  imbalance in LO lead.

## Resolution (volts)

### Aperture

Range	$\geq 16.7$ msec	2/1.67 msec	100 $\mu$ s	10 $\mu$ s
30 mV	10 nV	100 nV	1 $\mu$ V	10 $\mu$ V
300 mV	100 nV	1 $\mu$ V	10 $\mu$ V	100 $\mu$ V
3V	1 $\mu$ V	10 $\mu$ V	100 $\mu$ V	1 mV
30V	10 $\mu$ V	100 $\mu$ V	1 mV	10 mV
300V	100 $\mu$ V	1 mV	10 mV	100 mV

Conditions: Useful resolution. In some instances, the multimeter may give additional digits.

## AC-Coupled Accuracy Conditions

AC voltage accuracy specified for sinewave inputs > 10% of range. DC component < 10% of AC component. AC slow filter on (SENSE:BANDwidth:DETECTOR 20). After one-hour warm-up. Autozero on (CALIBRATION:ZERO:AUTO ON). With preprogrammed settling times, add an additional error of 0.1% of the input voltage step to the first reading. Tcal is the temperature of calibration from 18°C to 28°C.

## 24-Hour AC-Coupled Accuracy $\pm$ (% of reading + % of range)

### Aperture

Range	Frequency	$\geq 16.7$ ms	2 ms/1.67 ms	100 $\mu$ s	10 $\mu$ s
30 mV	20 Hz-45 Hz	0.51%+0.1067%	0.51%+0.108%	0.51%+0.124%	0.51%+0.314%
	45 Hz-100 Hz	0.16%+0.1067%	0.16%+0.108%	0.16%+0.124%	0.16%+0.314%
	100 Hz-20 kHz	0.08%+0.1067%	0.08%+0.108%	0.08%+0.124%	0.08%+0.314%
	400 Hz-20 kHz (1)	0.09%+0.1067%	0.09%+0.253%	0.09%+0.267%	0.09%+0.447%
	20 kHz-100 kHz	0.61%+0.1394%	0.61%+0.244%	0.61%+0.160%	0.61%+0.347%
	100 kHz-300 kHz	3.28%+0.3937%	3.28%+0.394%	3.28%+0.410%	3.28%+0.580%
300 mV to 30V	300 kHz-1 MHz	10.3%+2.2840%	10.3%+2.284%	10.3%+2.297%	10.3%+2.480%
	20 Hz-45 Hz	0.51%+0.0267%	0.51%+0.028%	0.51%+0.044%	0.51%+0.234%
	45 Hz-100 Hz	0.16%+0.0267%	0.16%+0.028%	0.16%+0.044%	0.16%+0.234%
	100 Hz-20 kHz	0.08%+0.0267%	0.08%+0.028%	0.08%+0.044%	0.08%+0.234%
	400 Hz-20 kHz (1)	0.09%+0.0267%	0.09%+0.173%	0.09%+0.187%	0.09%+0.367%
	20 kHz-100 kHz	0.61%+0.0594%	0.61%+0.064%	0.61%+0.080%	0.61%+0.267%
300V	100 kHz-300 kHz	3.28%+0.3137%	3.28%+0.314%	3.28%+0.330%	3.28%+0.500%
	300 kHz-1 MHz	10.3%+2.2040%	10.3%+2.204%	10.3%+2.217%	10.3%+2.400%
	20 Hz-45 Hz	0.57%+0.0267%	0.57%+0.028%	not specified	not specified
	45 Hz-100 Hz	0.22%+0.0267%	0.22%+0.028%	not specified	not specified
	100 Hz-20 kHz	0.14%+0.0267%	0.14%+0.028%	not specified	not specified
	400 Hz-20 kHz (1)	0.15%+0.0267%	0.15%+0.170%	not specified	not specified
	20 kHz-100 kHz	1.01%+0.1127%	1.01%+0.114%	not specified	not specified
	100 kHz-1 MHz	not specified	not specified	not specified	not specified

Conditions: Tcal  $\pm$  1°C. Accuracy relative to calibration standard. The module should be calibrated as used.

(1) Using AC fast filter (SENSE:BANDwidth:DETECTOR 400).

## 90-Day AC-Coupled Accuracy

Add 0.07% of reading + 0.0174% of range to the 24-hour specifications above.

Conditions: Tcal  $\pm$  5°C. Within one week of autocal (CALIBRATION:INTERNAL? AC) and within  $\pm$  5°C of Tcal (Tcal is the temperature of autocal).

The Tcal specification is based on the ambient temperature when the calibration was performed.

Factory calibration was performed in an HP E1400B mainframe with various other low-power modules. Variations due to different mainframes, modules, or module locations may cause variations in the module temperature. For highest accuracy, the module should be calibrated as used.

Accuracy relative to calibration standard. See the Factory Calibration adders at end of this Appendix. Stable conditions. If autocal is not used, add an additional 0.6% to the % of reading.

## 1-Year AC-Coupled Accuracy

Add 0.11% of reading + 0.024% of range to the 24-hour specifications above.

Conditions: Tcal ± 5°C. Within one week of autocal (CALibration:INTernal? AC) and within ± 5°C of Tcal (Tcal is the temperature of autocal). The Tcal specification is based on the ambient temperature when the calibration was performed.

Factory calibration was performed in an HP E1400B mainframe with various other low-power modules. Variations due to different mainframes, modules, or module locations may cause variations in the module temperature. For highest accuracy, the module should be calibrated as used.

Accuracy relative to calibration standard. See the Factory Calibration adders at end of this Appendix. Stable conditions. If autocal is not used, add an additional 0.6% to the % of reading.

## AC-Coupled Temperature Coefficient ±(% of reading + % of range)/°C

To determine the additional error for operation outside the temperature ranges shown in the accuracy specifications, multiply the temperature coefficient by the difference between the operating temperature and Tcal.

Range	Frequency	Temperature Coefficient
All Ranges	20 Hz-100 kHz	0.01% + 0.005%
All Ranges	100 kHz-1 MHz	0.08% + 0.01%

## DC-Coupled Accuracy Conditions

AC voltage accuracy specified for sinewave inputs > 10% of range. DC component < 10% of AC component. AC slow filter on (SENSe:BANDwidth:DETECTOR 20). After one-hour warm-up. Autozero on (CALibration:AUTO:ZERO ON). With preprogrammed settling times, add an additional error of 0.1% of the input voltage step to the first reading. Tcal is the temperature of calibration from 18°C to 28°C. Source impedance < 10 kΩ.

## 24-Hour DC-Coupled Accuracy ±(% of reading + % of range)

### Aperture

Range	Frequency	≥ 16.7 ms	2 ms/1.67 ms	100 μs	10 μs
30 mV	20 Hz-45 Hz	1.31% + 0.144%	1.31% + 0.146%	1.31% + 0.164%	1.31% + 0.314%
	45 Hz-100 Hz	0.12% + 0.144%	0.12% + 0.146%	0.12% + 0.164%	0.12% + 0.314%
	100 Hz-20 kHz	0.12% + 0.144%	0.12% + 0.146%	0.12% + 0.164%	0.12% + 0.314%
	400 Hz-20 kHz (1)	0.39% + 0.144%	0.39% + 0.961%	0.39% + 0.977%	0.39% + 1.147%
	20 kHz-100 kHz	0.61% + 0.178%	0.61% + 0.180%	0.61% + 0.197%	0.61% + 0.347%
	100 kHz-300 kHz	3.28% + 0.404%	3.28% + 0.406%	3.28% + 0.424%	3.28% + 0.580%
300 mV to 30V	300 kHz-1 MHz	10.3% + 2.350%	10.3% + 2.350%	10.3% + 2.370%	10.3% + 2.520%
	20 Hz-45 Hz	1.31% + 0.064%	1.31% + 0.066%	1.31% + 0.084%	1.31% + 0.234%
	45 Hz-100 Hz	0.12% + 0.064%	0.12% + 0.066%	0.12% + 0.084%	0.12% + 0.234%
	100 Hz-20 kHz	0.12% + 0.064%	0.12% + 0.066%	0.12% + 0.084%	0.12% + 0.234%
	400 Hz-20 kHz (1)	0.39% + 0.064%	0.39% + 0.881%	0.39% + 0.897%	0.39% + 1.067%
	20 kHz-100 kHz	0.61% + 0.098%	0.61% + 0.100%	0.61% + 0.117%	0.61% + 0.267%
300V	100 kHz-300 kHz	3.28% + 0.324%	3.28% + 0.326%	3.28% + 0.344%	3.28% + 0.500%
	300 kHz-1 MHz	10.3% + 2.270%	10.3% + 2.270%	10.3% + 2.290%	10.3% + 2.440%
	20 Hz-45 Hz	1.31% + 0.064%	1.31% + 0.066%	not specified	not specified
	45 Hz-100 Hz	0.18% + 0.064%	0.18% + 0.066%	not specified	not specified
	100 Hz-20 kHz	0.18% + 0.064%	0.18% + 0.066%	not specified	not specified
	400 Hz-20 kHz (1)	0.45% + 0.064%	0.45% + 0.881%	not specified	not specified
	20 kHz-100 kHz	1.11% + 0.158%	1.11% + 0.161%	not specified	not specified
	100 kHz-1 MHz	not specified	not specified	not specified	not specified

Conditions: Tcal ± 1°C. Accuracy relative to calibration standard. The module should be calibrated as used.

(1) Using AC fast filter (SENSe:BANDwidth:DETECTOR 400)

## 90-Day AC-Coupled Accuracy

---

ALL Ranges: Add  $\pm$  (0.07% of reading + 0.105% of range) to the 24-hour specifications.

Conditions: Tcal  $\pm$  5°C. Within one week of autocal (CALibration:INTernal? AC) and within  $\pm$  5°C of Tcal (Tcal is the temperature of autocal from 18°C to 28°C). The Tcal specification is based on the ambient temperature when the calibration was performed.

Factory calibration was performed in an HP E1400B mainframe with various other low-power modules. Variations due to different mainframes, modules, or module locations may cause variations in the module temperature. For highest accuracy, the module should be calibrated as used.

Accuracy relative to calibration standard. See the Factory Calibration adders at end of this Appendix. Stable conditions. If autocal is not used, add the following:  $\pm$  (0.6% of reading + 0.2% of range).

## 1-Year DC-Coupled Accuracy

---

ALL Ranges: Add  $\pm$  (0.11% of reading + 0.105% of range) to the 24-hour specifications.

Conditions: Tcal  $\pm$  5°C. Within one week of autocal (CALibration:INTernal? AC) and within  $\pm$  5°C of Tcal (Tcal is the temperature of autocal from 18°C to 28°C). The Tcal specification is based on the ambient temperature when the calibration was performed.

Factory calibration was performed in an HP E1400B mainframe with various other low-power modules. Variations due to different mainframes, modules, or module locations may cause variations in the module temperature. For highest accuracy, the module should be calibrated as used.

Accuracy relative to calibration standard. See the Factory Calibration adders at end of this Appendix. Stable conditions. If autocal is not used, add the following:  $\pm$  (0.6% of reading + 0.2% of range).

## DC-Coupled Temperature Coefficient $\pm$ (% of reading + % of range)/°C

---

To determine the additional error for operation outside the temperature ranges shown in the accuracy specifications, multiply the temperature coefficient by the difference between the operating temperature and Tcal.

Range	Frequency	Temperature Coefficient
30 mV, 3V	20 Hz-100 kHz	0.01% + 0.19%
30 mV, 3V	100 kHz-1 MHz	0.08% + 0.20%
300 mV, 30V, 300V	20 Hz-100 kHz	0.01% + 0.034%
300 mV, 30V, 300V	100 kHz-1 MHz	0.08% + 0.044%

## DC-Coupled DC Component Error (DC component > 10% of AC component)

---

ALL ranges: Add  $\pm$  (0.14% of reading + 0.766% of range)

## Frequency and Period

Frequency and period of the AC component of the AC- or DC-coupled voltage input is measured. The counter uses a reciprocal counting technique to give constant resolution independent of the input frequency.

<b>Input Impedance (resistance <math>\pm</math> %, capacitance):</b>	1 M $\Omega$ $\pm$ 1%, <90 pF
<b>Maximum Input (volts):</b>	Refer to AC Voltage specifications
<b>Frequency Range (Hz):</b>	10 Hz to 1.5 MHz
<b>Period Range (seconds):</b>	0.1 seconds to 667 ns
<b>Trigger Level (volts):</b>	Triggers and counts on zero crossings
<b>Sensitivity (<math>\pm</math> volts):</b>	10 mV RMS (sinewave)

### Accuracy $\pm$ (% of reading)

---

Frequency	Period	Accuracy
10 Hz-400 Hz	0.1 - 0.025 seconds	0.05%
400 Hz-1.5 MHz	0.025 seconds - 667 ns	0.01%

## Memory

**Reading Storage into Internal RAM:** 4096 readings (all aperture times)

**Reading Storage into external VME memory card:** 8 bytes/reading (all aperture times); 1,572,864 with 12 Megabyte RAM card

**Multimeter State Memory:** 10 states (\*SAV 0 to \*SAV 9)

## Timer/Pacer (SAMPLE:SOURCE TIMER;;SAMPLE:TIMER)

Allows the selection of the time between measurements cycles after the time set for TRIGger:DELay has past. Its primary purpose is to generate a precise internal timing pulse to pace the measurement cycles.

**Timer Range:** 680  $\mu$ s to 2100 seconds in 1  $\mu$ s increments

**Accuracy:** 0.02% of setting

**Jitter:** <2 ns RMS

**Conditions:** Autozero off (CALibration:ZERO:AUTO OFF) and autorange off in DCV or OHMs for aperture times of 10  $\mu$ s or 100  $\mu$ s.

## Programmable Delay (TRIGger:DELay)

Allows selection of the time between measurement cycles. It is provided to allow the selection of settling time and precise triggering of the measurement. The input range is from 0 to 2100 seconds in increments of 1  $\mu$ s.

# External Trigger/VXIbus TTL Trigger Lines

Voltmeter Complete is always routed to the "VM Compl" BNC on the multimeter's front panel and can be programmed to one or more TTLTRGs using the OUTPut:TTLTRGn command.

The TRIGger:SOURce can selected to the multimeter's "Ext Trig" front panel BNC or any one of TTLTRGs or other trigger sources.

The VXIbus TTLTRG SYNC and ASYNC TRIGGER PROTOCOLS can implemented using the OUTPut:TTLTRG and TRIGger:SOURce commands.

TTLTRGs meet VXIbus specifications.

The multimeter's front panel BNCs (VM Compl and Ext Trig) are at TTL levels.

## Trigger Condition (edge):

External Trigger BNC: Programmable - Negative (default) or positive (TRIGger:SLOPe command)

Voltmeter Complete BNC: Negative

VXIbus Trigger Lines (TTLTRGs): Negative

## Minimum Pulse Width (seconds):

Voltmeter Complete BNC: 1  $\mu$ s

VXIbus Trigger Lines (TTLTRGs): 10 ns

## Latency (minimum time from external trigger to start of measurement):

Average Latency: 67 ns (minimum 64 ns to maximum 71  $\mu$ s) with delay set to 0 seconds

Average Latency: 200 ns (minimum 197 ns to maximum 204 ns) with delay set to 200  $\mu$ s

Conditions: TRIGger:SOURce set to EXTERNAL or TTLTrg and Aperture times  $\leq$  20 ms

# General Specifications

## Reading Rates (readings/second)

---

Function	Aperture									
	2s	1.67s	200 ms	167 ms	20 ms	16.7 ms	2 ms	1.67 ms	100 $\mu$ s	10 $\mu$ s
DC Voltage, 2- and 4-Wire Ohms	0.4	0.49	4	4.9	47	56	312	360	1250	1450
AC Voltage (fast response)	0.2	0.25	1.7	2.0	6.9	7.2	9.2	9.2	9.5	9.5
AC Voltage (slow response)	0.17	0.2	0.65	0.7	1.0	1.0	1.0	1.0	1.0	1.0

Conditions: For DC voltage, 2- and 4-wire resistance: autozero, autorange, and offset compensation are OFF; fixed range (30 $\Omega$  to 3 k $\Omega$  range for resistance); delay set to 0 seconds; sample source timer and sample count > 1; readings to internal memory.

For AC voltage: autozero OFF in fixed range with preprogrammed settling times; readings to internal memory. No VXIbus backplane activity such as serial polls or query operations occurring.

## A/D Resolution (bits/digits)

---

Units	Aperture			
	$\geq$ 16.7 ms	2 ms/1.67 ms	100 $\mu$ s	10 $\mu$ s
Binary Bits	$\pm$ 21.5	$\pm$ 18.2	$\pm$ 14.9	$\pm$ 11.5
Decimal Digits	6.5	5.5	4.5	3.5

Conditions: Useful resolution. In some instances, the multimeter may return additional digits.

# Factory Calibration Adders

Function	Range	Adder Value
DCV	30 mV	33.3 PPM
	300 mV	7.1 PPM
	3V	5.5 PPM
	30V	9.7 PPM
	300V	10.5 PPM
ACV	30 mV	250 PPM
	300 mV	155 PPM
	3V	155 PPM
	30V	285 PPM
	300V	485 PPM
OHMS	30 $\Omega$	33.3 PPM
	300 $\Omega$	16.5 PPM
	3 k $\Omega$	16.5 PPM
	30 k $\Omega$	16.5 PPM
	300 k $\Omega$	21.0 PPM
	3 M $\Omega$	25.0 PPM
	30 M $\Omega$	120.0 PPM



## Error Messages

Code	Message	Cause
- 101	Invalid character	Unrecognized character in specified parameter.
- 102	Syntax error	Command is missing a space or comma between parameters.
- 103	Invalid separator	Command parameter is separated by a space rather than a comma.
- 104	Data type error	The wrong data type (i.e., number, character, string, expression) was used when specifying a parameter.
- 108	Parameter not allowed	Parameter specified in a command which has no parameters.
- 109	Missing parameter	No parameter specified in the command in which a parameter is required.
- 113	Undefined header	Command header was incorrectly specified.
- 124	Too many digits	More than 256 digits were specified for a parameter.
- 128	Numeric data not allowed	Number specified for a parameter when a letter is required.
- 131	Invalid suffix	Parameter suffix incorrectly specified (e.g., 5 K rather than 5 KOHM).
- 138	Suffix not allowed	Parameter suffix is specified when one is not allowed.
- 141	Invalid character data	The parameter type specified is not allowed (e.g., MEAS:TEMP? TC,O - "O" is not a choice).
- 178	Expression data not allowed	A parameter other than the channel list is enclosed in parentheses.
- 211	Trigger ignored	Trigger occurred while the multimeter is in the idle state, or a trigger occurred from a source other than the specified source.
- 213	INIT ignored	An INIT command is received when the multimeter is already in the wait-for-trigger state following TRIG:SOUR HOLD.
- 214	Trigger deadlock	The multimeter is triggered from another source (e.g., READ?) after the trigger source has been set to TRIG:SOUR BUS.

Code	Message	Cause
- 221	Settings conflict	Multimeter parameters are set such that a measurement cannot be made (e.g., specifying a fixed resolution while autoranging).
- 222	Data out of range	The parameter value specified is too large or too small.
- 224	Illegal parameter value	The numeric value specified is not allowed (e.g., MEAS:TEMP? RTD).
- 230	Data corrupt or stale	Data in mainframe memory is fetched after a command (e.g., MEASure, READ?) has returned data to the output buffer.
- 231	Data questionable	Resolution is too great for specified range. Measurement is still taken.
- 240	Hardware error	Hardware error detected during power-on cycle. Return multimeter to Hewlett-Packard for repair.
- 350	Too many errors	The error queue is full as more than 30 errors have occurred.
- 410	Query interrupted	Data is not read from the output buffer before another command is executed.
- 420	Query unterminated	Command which generates data not able to finish executing due to a multimeter configuration error.
- 430	Query deadlocked	Command execution cannot continue since the mainframe's command input.
1000	Out of memory	Not enough memory to store the number of measurements requested.
2602	Timer too fast	Aperture time is longer than the sample rate.

## B-2 Error Messages

- 2-wire ohms:
  - Measurement connections, 2-10
  - Measurements, 4-10
- 4-wire ohms:
  - Measurement connections, 2-11
  - Measurements, 4-10
- 9.9000000E + 37, 4-7, 4-16

## A

- Abbreviated commands, 5-2
- ABORt subsystem, 4-35, 5-5
- Abort, measurement, 4-35
- AC bandwidth:
  - Checking, 4-14
  - Setting, 4-13
- AC fast mode, 4-13
- AC line, noise rejection, 2-7, 4-18
- AC slow mode, 4-13
- AC voltage:
  - Measurement connections, 2-9
  - Measurements, 4-8
- AC + DC voltage:
  - Measurement connections, 2-9
  - Measurements, 4-8
- Access LED, 2-2
- A/D timeout error, 4-7
- Added delay:
  - Function change, 4-30
  - Range change, 4-29
- Address, logical:
  - Dynamic configuration, 2-4
  - Factory setting, 2-4
  - Setting switches, 2-4
  - Static configuration, 2-4
- Annunciators, front panel, 2-2
- Aperture time:
  - Checking, 4-20
  - Setting, 4-18
  - vs. resolution, ohms, 4-9, 5-4
  - vs. resolution, voltage, 4-8, 5-4
  - vs. sample rates, 4-32
- ASCII format, 4-7

- Autocalibration:
  - AC routine, 2-8
  - Failure codes, 5-7
  - Resistance routine, 2-8
  - Time required, 2-8
- Autorange:
  - Checking, 4-16
  - Enabling/disabling, 4-15
- Autozero:
  - Checking, 4-21
  - Enabling/disabling, 4-21

## B

- Backplane trigger lines, 3-10, 4-25, 4-36
- Boolean parameters, 5-3
- Buffer:
  - Output, 4-7
  - Trigger, checking, 4-35
  - Trigger, enabling/disabling, 4-35
- Bus request:
  - Factory setting, 2-5
  - Setting jumpers, 2-5

## C

- \*CAL?, 2-8, 5-85
- Calibration number, reading, 5-8
- CALibration subsystem, 5-6 – 5-9:
  - :INTernal?, 2-8, 5-6
  - :LFRequency, 2-7, 5-7
  - :LFRequency?, 2-7, 5-8
  - :NUMBer?, 5-8
  - :ZERO:AUTO, 4-21, 5-9
  - :ZERO:AUTO?, 4-21, 5-9
- CALibration? subsystem, 5-10
- Causes, error messages, B-1 – B-2
- Chassis connection, 2-2
- CLEAR, 1-3, 4-36
- Clear state, 1-3
- Clear the multimeter, 1-3
- Combined voltage, 4-21

**Command:**

- Quick reference, 5-87
- Common (IEEE 488.2) format, 5-1
- Separator, 5-2
- TMSL format, 5-1
- Types, 5-1

**Command Reference:**

- ABORt subsystem, 5-5
- CALibration subsystem, 5-6 – 5-9
- CALibration? subsystem, 5-10
- CONFigure subsystem, 5-11 – 5-21
- CONFigure? subsystem, 5-22
- DIAGnostic subsystem, 5-23
- FETCh? subsystem, 5-24
- INITiate subsystem, 5-25
- INPUt subsystem, 5-26 – 5-28
- MEASure subsystem, 5-29 – 5-38
- MEMory subsystem, 5-39 – 5-41
- OUTPUt subsystem, 5-42 – 5-43
- READ? subsystem, 5-44
- SAMPle subsystem, 5-45 – 5-48
- SENSe subsystem, 5-49 – 5-65
- STATus subsystem, 5-66 – 5-70
- SYSTem subsystem, 5-71
- TEST subsystem, 5-72 – 5-75
- TRIGger subsystem, 5-76 – 5-84

**Commands:**

- Abbreviated, 5-2
- Implied, 5-2
- Linking, 5-3

**Common Command Reference:**

- \*CAL?, 5-85
- \*CLS, 5-85
- \*ESE, 5-85
- \*ESE?, 5-85
- \*ESR?, 5-85
- \*IDN?, 5-85
- \*LRN?, 5-85
- \*OPC?, 5-85
- \*PSC, 5-85
- \*PSC?, 5-85
- \*PUD, 5-85
- \*PUD?, 5-85
- \*RCL, 5-85
- \*RST, 5-85
- \*SAV, 5-85
- \*SRE, 5-85
- \*SRE?, 5-85
- \*STB?, 5-85
- \*TRG, 5-85
- \*TST?, 5-85

Common mode rejection, 4-18

Compensation, offset, 4-21

CONFigure, 3-2, 4-4:

Default settings, 4-2

CONFigure subsystem, 5-11 – 5-21:

:FREQuency, 5-12

:FRESistance, 5-13

:PERiod, 5-14

:RESistance, 5-15 – 5-16

:TEMPerature, 5-17

:VOLTage:AC, 5-18

:VOLTage:ACDC, 5-19

:VOLTage:DC, 5-20 – 5-21

CONFigure? subsystem, 5-22

Connections:

AC voltage, 2-9

AC + DC voltage, 2-9

DC voltage, 2-9

Frequency, 2-12

Period, 2-12

Resistance, 2-wire, 2-10

Resistance, 4-wire, 2-11

Current, sourced (ohms), 4-10

**D**

**Data format:**

To external memory, 5-39

To internal memory, 4-7

Data retrieval, 4-6

DC voltage:

Measurement connections, 2-9

Measurements, 4-8

Default delay times, 4-28

Delay:

Added for function change, 4-30

Added for range change, 4-29

Checking, 4-30

Default, 4-28

DIAGnostic subsystem, 5-23

Discrete parameters, 5-3

Dynamic logical addressing, 2-4

## E

- Error:
  - Annunciator, front panel, 2-2
  - Example program, 3-14 – 3-15
  - Messages, B-1 – B-2
  - LED, front panel, 2-2
  - Number, negative, B-1 – B-2
  - Queue, clearing, 1-4
  - Queue, reading, 1-4
  - SYStem:ERRor?, 1-4, 5-71
- Enter/Output statements, 3-2
- EOI, 4-7
- Error Messages, causes, B-1 – B-2
- Event Status Register, 5-66 – 5-70
- Example:
  - Checking for errors, 3-14
  - Externally trigger measurements, 3-6
  - Maximizing accuracy, 3-7
  - Maximizing speed, 3-8
  - Multiple burst measurements, 3-5
  - Saving multimeter state, 4-38
  - Setting the bus request level, 2-6
  - Single burst measurement, 3-4
  - Single measurement, 3-3
  - Storing/retrieving readings, 4-6
  - Synchronizing, computer, 3-12
  - Synchronizing, switch module, 3-10
  - Using backplane trigger lines, 3-10
- Execution errors, B-1 – B-2
- External computer, synchronizing, 3-12
- External trigger BNC, 2-2, 4-25

## F

- Factory setting:
  - Bus request, 2-5
  - Logical address, 2-4
- Failed LED, 2-2
- Failure codes:
  - Autocalibration, 5-7
  - Self-test, 1-2
- FETCh? subsystem, 4-6, 5-24
- Fixed input impedance:
  - Checking, 4-23
  - Enabling/disabling, 4-22
- Format:
  - IEEE 488.2 commands, 5-1
  - TMSL commands, 5-1

- Four-wire ohms:
  - Measurement connections, 2-11
  - Measurements, 4-10
- Frequency:
  - Measurement connections, 2-12
  - Measurements, 4-11
- Frequency, line reference, 2-7
- Front panel:
  - Enabling/disabling, 2-2, 4-13
  - LEDs, 2-2
  - Maximum input voltages, 2-1
  - Terminals, 2-2

## G

- Ground connection, chassis, 2-2
- Group execute trigger (GET), 4-25

## H

- HP-IB trigger, 4-25

## I

- Idle trigger state, 4-23
- IEEE 488.2:
  - Command format, 5-1
  - Quick reference, 5-89
- Implied commands, 5-2
- Initial operation, 1-4
- INITiate:IMMediate subsystem, 4-5, 4-33, 5-25
- Input:
  - Coupling source, checking, 4-15
  - Coupling source, setting, 4-15
  - Fixed impedance, checking, 4-23
  - Fixed impedance, enabling/disabling, 4-22
- INPut subsystem, 5-26 – 5-28:
  - :COUPling, 4-15, 5-26
  - :COUPling?, 4-15, 5-27
  - :IMPedance:AUTO, 4-22, 5-27
  - :IMPedance:AUTO?, 4-23, 5-28
  - :STATe, 2-2, 4-13, 5-28
  - :STATe?, 2-2, 4-13, 5-28
- Input terminals, 2-2:
  - Checking, 4-13
  - Enabling/disabling, 2-2, 4-13
  - Maximum input voltages, 2-1
- Integration time:
  - Checking, 4-20
  - Setting, 4-18

## J

Jumpers, bus request, 2-5

## L

LEDs, front panel:

Access, 2-2

Error, 2-2

Failed, 2-2

Sample, 2-2

Line frequency reference:

Checking, 2-7

Factory setting, 2-7

Setting, 2-7

Linking commands, 5-3

Logical address:

Dynamic configuration, 2-4

Factory setting, 2-4

Setting switches, 2-4

Static configuration, 2-4

## M

Maximum input voltages, 2-1

MEASure, 3-2, 4-2:

Default settings, 4-2

MEASure subsystem, 5-29 – 5-38:

:FREQuency?, 5-30

:FREStance?, 5-31

:PERiod?, 5-32

:RESistance?, 5-33

:TEMPerature?, 5-34

:VOLTagE:AC?, 5-35

:VOLTagE:ACDC?, 5-36

:VOLTagE:DC?, 5-37 – 5-38

Measurement data format:

To external memory, 5-39

To internal memory, 4-7

Measurement terminals, 2-2

Measurements:

2-wire ohms, 4-10

4-wire ohms, 4-10

Abort, 4-35

AC voltage, 4-8

AC + DC voltage, 4-8

DC voltage, 4-8

Frequency, 4-11

Period, 4-11

RTD, 4-12

Thermistor, 4-12

Memory:

External VME card, 5-39

Internal capacity, 4-5

Reading retrieval from, 4-6

Reading storage to, 4-5

Saving multimeter state to, 4-37

MEMory subsystem, 5-39 – 5-41:

:VME:ADDReSS, 5-39

:VME:ADDReSS?, 5-39

:VME:SIZE, 5-40

:VME:SIZE?, 5-40

:VME:STATe, 5-41

:VME:STATe?, 5-41

Multiplexer card, synchronizing, 3-10

Multimeter specifications, A-1 – A-15

## N

Negative error numbers, B-1 – B-2

Noise rejection:

AC effective common mode, 4-18

AC normal mode, 2-7, 4-18

DC common mode, 4-18

Normal mode rejection, 2-7, 4-18

NPLC:

vs. resolution, ohms, 4-9, 5-4

vs. resolution, voltage, 4-8, 5-4

Numeric parameters, 5-3

## O

Offset compensation:

Checking, 4-22

Enabling/disabling, 4-21

Ohms:

Aperture vs. resolution, 4-9, 5-4

Measurement connections, 2-10 – 2-11

Measurements, 4-9

NPLC vs. resolution, 4-9, 5-4

Range vs. resolution, 4-9, 5-4

\*OPC?, 5-85

Operation Status Register, 5-67

Optional parameters, 5-3

Output:

Buffer, capacity, 4-7

Data format, VME memory, 5-39

Data format, internal memory, 4-7

Overload, 4-7, 4-16

Output/Enter statements, 3-2

OUTPut subsystem, 5-42 – 5-43:  
:TTLTrg:STATe, 4-36, 5-42  
:TTLTrg:STATe?, 4-36, 5-43  
Overload, 4-7, 4-16

## P

Parameters:  
  Boolean, 5-3  
  Discrete, 5-3  
  Numeric, 5-3  
  Optional, 5-3  
Period:  
  Measurement connections, 2-12  
  Measurements, 4-11  
Port:  
  Ext Trig, 2-2, 4-25  
  VM Compl, 2-2  
Power-on state, 1-3  
Programming examples  
  *See Example*  
Programming overview, 3-2

## Q

Questionable Data/Signal Register, 5-69  
Quick Reference:  
  IEEE 488.2 commands, 5-89  
  TMSL commands, 5-87

## R

\*RCL, 4-37, 5-85  
\*RST, 1-3, 5-85  
Range:  
  Checking, 4-16  
  Selecting, 4-16  
  vs. resolution, ohms, 4-9, 5-4  
  vs. resolution, voltage, 4-8, 5-4  
READ? subsystem, 4-34, 5-44  
Reading format:  
  To external memory, 5-39  
  To internal memory, 4-7  
Reading rate, 4-14, 4-18  
Readings:  
  Per second (AC), 4-14  
  Per trigger, 4-30  
Recall state, 4-37

Reference, commands:

  IEEE 488.2, 5-85  
  TMSL, 5-5 – 5-84

Reset state, 1-3

Resistance:

  Aperture vs. resolution, 4-9, 5-4  
  Measurement connections, 2-10 – 2-11  
  Measurements, 4-9  
  NPLC vs. resolution, 4-9, 5-4  
  Range vs. resolution, 4-9, 5-4

Resolution:

  Checking, 4-17  
  Selecting, 4-17  
  vs. aperture time, ohms, 4-9, 5-4  
  vs. aperture time, voltage, 4-8, 5-4  
  vs. NPLC, ohms, 4-9, 5-4  
  vs. NPLC, voltage, 4-8, 5-4  
  vs. range, ohms, 4-9, 5-4  
  vs. range, voltage, 4-8, 5-4

Retrieval:

  Internal readings, 4-46  
  Multimeter state, 4-37

RTD:

  Measurements, 4-12  
  Types supported, 4-12

## S

\*SAV, 4-37, 5-85  
Sample count:  
  Checking, 4-31  
  Setting, 4-30  
Sample LED, 2-2  
Sample rate:  
  Checking, 4-33  
  Selecting, 4-31  
  vs. aperture time, 4-32  
Sample source:  
  Checking, 4-33  
  Selecting, 4-31  
SAMPLE subsystem, 5-45 – 5-48:  
  :COUNT, 4-30, 5-45  
  :COUNT?, 4-31, 5-46  
  :SOURce, 4-31, 5-46  
  :SOURce?, 4-33, 5-47  
  :TIMER, 4-31, 5-47  
  :TIMER?, 4-33, 5-48  
Save multimeter state, 4-37  
SCPI:  
  Command format, 5-1  
  Quick reference, 5-87  
Secondary address, 2-4

## Self-Test:

- \*TST?, 1-2, 5-85
- Failure Codes, 1-2
- Performing, 1-2
- TEST?, 1-2, 5-72

## SENSe subsystem, 5-49 – 5-65:

- :BANDwidth:DETECTOR, 4-14, 5-50
- :BANDwidth:DETECTOR?, 4-14, 5-50
- :FUNction, 5-51
- :FUNction?, 5-51
- :RESistance:APERture, 4-19, 5-52
- :RESistance:APERture?, 4-20, 5-52
- :RESistance:NPLC, 4-19, 5-53
- :RESistance:NPLC?, 4-20, 5-53
- :RESistance:OCOMpensated, 4-22, 5-54
- :RESistance:OCOMpensated?, 4-22, 5-54
- :RESistance:RANGE:AUTO, 4-15, 5-55
- :RESistance:RANGE:AUTO?, 4-16, 5-55
- :RESistance:RANGE, 4-16, 5-56
- :RESistance:RANGE?, 4-16, 5-57
- :RESistance:RESolution, 4-17, 5-57
- :RESistance:RESolution?, 4-17, 5-58
- :VOLTage:AC:RANGE, 5-59
- :VOLTage:AC:RANGE?, 5-59
- :VOLTage:APERture, 4-19, 5-59
- :VOLTage:APERture?, 4-20, 5-60
- :VOLTage:DC:RANGE, 4-16, 5-60
- :VOLTage:DC:RANGE?, 4-16, 5-61
- :VOLTage:NPLC, 4-19, 5-62
- :VOLTage:NPLC?, 4-20, 5-63
- :VOLTage:RANGE:AUTO, 4-15, 5-63
- :VOLTage:RANGE:AUTO?, 4-16, 5-64
- :VOLTage:RESolution, 4-17, 5-64
- :VOLTage:RESolution?, 4-17, 5-65

## Separator, command, 5-2

- Serial poll (SPOLL), 3-12
- Set bus request level, 2-5
- Set logical address, 2-4
- Settings conflict error, 4-25
- Single trigger, 4-34
- Sourced current (ohms), 4-10
- Specifications, A-1 – A-15
- SPOLL (serial poll), 3-12
- Static logical addressing, 2-4
- Status byte, 5-66 – 5-70
- Status registers, 5-66 – 5-70

## STATus subsystem, 5-66 – 5-70:

- :OPERation:CONDition?, 5-67
- :OPERation:ENABLE, 5-68
- :OPERation:ENABLE?, 5-68
- :OPERation:EVENT?, 5-68
- :QUESTionable:CONDition?, 5-69
- :QUESTionable:ENABLE, 5-69
- :QUESTionable:ENABLE?, 5-70
- :QUESTionable:EVENT?, 5-70

## Storage:

- Multimeter state, 4-37
- Reading, external VME card, 5-39 – 5-41
- Readings, internal, 4-5

## Switch card, synchronizing, 3-10

- Switches, logical address, 2-4
- SYSTEM:ERROR? subsystem, 1-4, 5-71
- System specifications, A-1 – A-15

## T

### \*TRG, 4-25, 5-85

### \*TST?, 1-2, 5-85

## Temperature:

- Measurements, 4-12
- Transducers supported, 4-12

## Terminals:

- Enabling/disabling, 2-2, 4-13
- Ext Trig BNC, 2-2, 4-25
- Input, 2-2
- Maximum input voltages, 2-1
- VM Compl BNC, 2-2

## Test:

- Command, 1-2
- Failure codes, 1-2
- Performing, 1-2

## TEST subsystem, 5-72 – 5-75:

- :ALL?, 1-2, 5-72
- :INGuard:CALibrate?, 5-73
- :INGuard:FLATness?, 5-73
- :INGuard:GAIN?, 5-73
- :INGuard:INTegrator?, 5-74
- :INGuard:LINK?, 5-74
- :INGuard:OFFSet?, 5-74
- :INGuard:PRECharge?, 5-75
- :INGuard:ZERO?, 5-75

## Timer too fast error, 4-32

## Thermistor

- Measurements, 4-12
- Types supported, 4-12



## TMSL:

Command format, 5-1

Quick reference, 5-87

## Trigger:

Abort, 4-35

Buffering, checking, 4-35

Buffering, enabling/disabling, 4-35

Count, checking, 4-27

Count, setting, 4-26

Delay, inserting, 4-27

Hold, 4-25

Idle state, 4-23

Overview, 4-23

Sample count, checking, 4-31

Sample count, setting, 4-30

Single, 4-34

Slope, checking, 4-26

Slope, setting, 4-26

Source, checking, 4-26

Source, selecting, 4-25

Wait-for-trigger state, 4-23, 4-33

Trigger hold, 4-25

## Trigger lines:

Example program, 3-10

Routing VM complete, 4-36

Trigger lines, 3-10, 4-25

## TRIGger subsystem, 5-76 – 5-84:

:BUFFered, 4-35, 5-76

:BUFFered?, 4-35, 5-77

:COUNT, 4-26, 5-77

:COUNT?, 4-27, 5-78

:DELAy:AUTO, 5-78

:DELAy:AUTO?, 5-79

:DELAy, 4-27, 5-80

:DELAy?, 4-30, 5-80

:IMMEDIATE, 4-34, 5-81

:SLOPe, 4-26, 5-82

:SLOPe?, 4-26, 5-82

:SOURce, 4-25, 5-82 – 5-83

:SOURce?, 4-26, 5-84

## Two-wire ohms:

Measurement connections, 2-10

Measurements, 4-10

## V

Verify operation, 1-4

VME card, reading storage, 5-39 – 5-41

## Voltage:

Aperture time vs. resolution, 4-8, 5-4

Maximum input, 2-1

Measurement connections, 2-9

Measurements, 4-8

NPLC vs. resolution, 4-8, 5-4

Range vs. resolution, 4-8, 5-4

## Voltmeter complete:

BNC connector, 2-2

Checking destination, 4-36

To backplane trigger lines, 4-36

VXIbus trigger lines: 3-10, 4-25

Example program, 3-10

Routing VM complete, 4-36

## W

Wait-for-trigger state, 4-23, 4-33