

# Reference Guide

## Agilent Technologies 8753ES and 8753ET Network Analyzers



**Part Number 08753-90473**

**Printed in USA**

**June 2002**

Supersedes February 2001

© Copyright 1999–2002  
Agilent Technologies, Inc.

---

## Notice

The information contained in this document is subject to change without notice.

Agilent Technologies makes no warranty of any kind with regard to this material, including but not limited to, the implied warranties of merchantability and fitness for a particular purpose. Agilent Technologies shall not be liable for errors contained herein or for incidental or consequential damages in connection with the furnishing, performance, or use of this material.

---

## Certification

Agilent Technologies certifies that this product met its published specifications at the time of shipment from the factory. Agilent Technologies further certifies that its calibration measurements are traceable to the United States National Institute of Standards and Technology, to the extent allowed by the Institute's calibration facility, and to the calibration facilities of other International Standards Organization members.

## Regulatory and Warranty Information

The regulatory and warranty information is located in the user's guide.

---

## Assistance

Product maintenance agreements and other customer assistance agreements are available for Agilent Technologies products. For any assistance, contact your nearest Agilent Technologies sales or service office. See the user's guide for the nearest office.

---

## Safety Notes

The following safety notes are used throughout this manual. Familiarize yourself with each of the notes and its meaning before operating this instrument. All pertinent safety notes for using this product are located in the user's guide.

---

<b>WARNING</b>	<b>Warning denotes a hazard. It calls attention to a procedure which, if not correctly performed or adhered to, could result in injury or loss of life. Do not proceed beyond a warning note until the indicated conditions are fully understood and met.</b>
----------------	---

---

---

<b>CAUTION</b>	Caution denotes a hazard. It calls attention to a procedure that, if not correctly performed or adhered to, would result in damage to or destruction of the instrument. Do not proceed beyond a caution sign until the indicated conditions are fully understood and met.
----------------	---

---

---

## How to Use This Guide

This guide uses the following conventions:

<code>Front-Panel Key</code>	This represents a key physically located on the instrument.
<b>SOFTKEY</b>	This represents a “softkey,” a key whose label is determined by the instrument’s firmware.
Screen Text	This represents text displayed on the instrument’s screen.

---

## Documentation Map

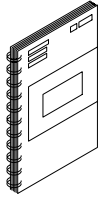

The *Installation and Quick Start Guide* provides procedures for installing, configuring, and verifying the operation of the analyzer. It also will help you familiarize yourself with the basic operation of the analyzer.

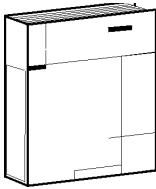

The *User's Guide* shows how to make measurements, explains commonly-used features, and tells you how to get the most performance from your analyzer.

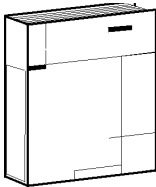

The *Reference Guide* provides reference information, such as specifications, menu maps, and key definitions.

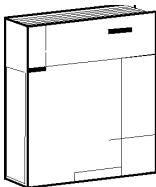

The *Programmer's Guide* provides general GPIB programming information, a command reference, and example programs. The *Programmer's Guide* contains a CD-ROM with example programs.

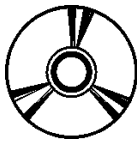

The **CD-ROM** provides the *Installation and Quick Start Guide*, the *User's Guide*, the *Reference Guide*, and the *Programmer's Guide* in PDF format for viewing or printing from a PC.

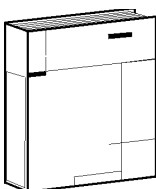

The *Service Guide* provides information on calibrating, troubleshooting, and servicing your analyzer. The *Service Guide* is not part of a standard shipment and is available only as Option 0BW, or by ordering part number 08753-90484. A CD-ROM with the *Service Guide* in PDF format is included for viewing or printing from a PC.

---

# Contents

<b>1. 8753ES Specifications and Characteristics</b>	
Definitions . . . . .	1-2
Corrected System Performance . . . . .	1-3
Instrument Specifications . . . . .	1-10
Uncorrected Port Performance . . . . .	1-10
Test Port Output . . . . .	1-12
Test Port Input . . . . .	1-16
General Information . . . . .	1-22
Speed Parameters . . . . .	1-28
Power Meter Calibration Accuracy . . . . .	1-31
<b>2. 8753ET Specifications and Characteristics</b>	
Definitions . . . . .	2-2
Corrected System Performance . . . . .	2-3
Instrument Specifications . . . . .	2-6
Uncorrected Port Performance . . . . .	2-6
Test Port Output . . . . .	2-7
Test Port Input . . . . .	2-11
General Information . . . . .	2-18
Speed Parameters . . . . .	2-24
<b>3. Front/Rear Panel</b>	
Front Panel Features . . . . .	3-2
Analyzer Display . . . . .	3-5
Rear Panel Features and Connectors . . . . .	3-10
<b>4. Menu Maps</b>	
Menu Maps . . . . .	4-2
<b>5. Hardkey/Softkey Reference</b>	
Key Reference . . . . .	5-2
Where to Look for More Information . . . . .	5-3
Guide Terms and Conventions . . . . .	5-3
Analyzer Functions . . . . .	5-4
<b>6. Error Messages</b>	
Error Messages . . . . .	6-2
Error Messages in Alphabetical Order . . . . .	6-3
Error Messages in Numerical Order . . . . .	6-26
<b>7. Options and Accessories</b>	
Using This Chapter . . . . .	7-2
Analyzer Options Available . . . . .	7-3
Option 1D5, High Stability Frequency Reference . . . . .	7-3
Option 002, Harmonic Mode . . . . .	7-3
Option 004, Source Attenuator (ET Only) . . . . .	7-3
Option 006, 6 GHz Operation . . . . .	7-3
Option 010, Time Domain . . . . .	7-3
Option 011, Delete Built-In Test Set (ES Only) . . . . .	7-3
Option 014, Configurable Test Set (ES Only) . . . . .	7-3
Option 075, 75 $\Omega$ Impedance (ES Only) . . . . .	7-4
Option 1CM, Rack Mount Flange Kit Without Handles . . . . .	7-4

---

# Contents

Option 1CP, Rack Mount Flange Kit With Handles	7-4
Service and Support Options	7-4
Accessories Available	7-5
Measurement Accessories	7-5
Test-Port Cables: 7-mm	7-5
Test-Port Cables: Type-N	7-5
Calibration Kits	7-5
RF electronic calibration (ECal) modules and PC software	7-7
Verification Kit	7-9
Minimum Loss Pads and Adapters	7-9
Test Configuration Accessories	7-10
RF Limiter	7-10
Probe	7-10
Amplifier	7-10
Power Meters	7-10
Power Sensors	7-11
Keyboard Template	7-12
<b>8. Preset State and Memory Allocation</b>	
Preset State	8-2
Memory Allocation	8-12
Types of Memory and Data Storage	8-12
Volatile Memory	8-12
Non-Volatile Memory	8-12
Determining Memory Requirements	8-14
Storing Data to Disk	8-16
Conserving Memory	8-18
Using Saved Calibration Sets	8-18
Clearing Memory	8-19
<b>9. Understanding the CITIfile Data Format</b>	
Using This Chapter	9-2
The CITIfile Data Format	9-3
Description and Overview	9-3
Data Formats	9-3
File and Operating System Formats	9-3
Definition of CITIfile Terms	9-3
A CITIfile Package	9-4
The CITIfile Header	9-4
An Array of Data	9-4
CITIfile Keyword	9-5
CITIfile Examples	9-5
Example 2, An 8510 Display Memory File	9-5
Example 3, 8510 Data file	9-5
Example 4, 8510 3-Term Frequency List Cal Set File	9-6
CITIfile Keywords	9-8
Useful Calculations	9-11
Computing Frequency Points	9-11
Expressing CITIfile Data in Other Data Formats	9-12
Example Data	9-13

<b>10. Determining System Measurement Uncertainties</b>	
Introduction	10-2
Sources of Measurement Errors	10-3
Sources of Systematic Errors	10-3
Sources of Random Errors	10-4
Determining Expected System Performance	10-5
Determining Cable Stability Terms ( $C_{R1}$ , $C_{R2}$ , $C_{TM1}$ , $C_{TM2}$ , $C_{TP1}$ , $C_{TP2}$ )	10-6
Measurement Uncertainty Equations	10-8
Forward Reflection Uncertainty	10-8
Forward Transmission Uncertainty	10-9
Reverse Reflection Uncertainty	10-10
Reverse Transmission Uncertainty	10-11





---

# **1 8753ES**

## **Specifications and Characteristics**

## Definitions

All specifications and characteristics apply over a  $25\text{ }^{\circ}\text{C} \pm 5\text{ }^{\circ}\text{C}$  range (unless otherwise stated) and 1/2 hour after the instrument has been turned on.

**Specification (spec.):** Warranted performance. Specifications include guardbands to account for the expected statistical performance distribution, measurement uncertainties, and changes in performance due to environmental conditions.

**Characteristic (char.):** A performance parameter that the product is expected to meet before it leaves the factory, but that is not verified in the field and is not covered by the product warranty. A characteristic includes the same guardbands as a specification.

**Typical (typ.):** Expected performance of an average unit which does not include guardbands. It is not covered by the product warranty.

**Nominal (nom.):** A general, descriptive term that does not imply a level of performance. It is not covered by the product warranty.

**Calibration:** The process of measuring known standards from a calibration kit to characterize a network analyzer's systematic (repeatable) errors.

**Corrected (residual) Performance:** Indicates performance after error correction (calibration). It is determined by the quality of calibration standards and how well "known" they are, plus system repeatability, stability, and noise.

**Uncorrected (raw) Performance:** Indicates instrument performance without error correction. The uncorrected performance affects the stability of a calibration.

**Standard:** When referring to the analyzer, this includes all options unless noted otherwise.

## Corrected System Performance

The specifications in this section apply for measurements made using 10 Hz IF bandwidth, no averaging, and at an environmental temperature of  $25 \pm 5$  °C, with less than 1 °C deviation from the calibration temperature. Assumes that an isolation calibration was performed with an averaging factor of 16.

**Table 1-1 System Dynamic Range, All Device Connector Types**

8753ES, All Options, All Cal Kits, All Cables, 10 Hz IF BW		
Description	Specification	Supplemental Information
<b>System Transmission Dynamic Range<sup>a</sup></b>		
Standard (50 Ω)		
30 kHz to 50 kHz		70 dB
50 kHz to 300 kHz		90 dB
300 kHz to 16 MHz	100 dB	
16 MHz to 1.3 GHz	110 dB	
1.3 GHz to 3 GHz	110 dB	
3 GHz to 6 GHz	105 dB	
Option 075 (75 Ω)		
30 kHz to 50 kHz		68 dB
50 kHz to 300 kHz		90 dB
300 kHz to 16 MHz	96 dB	
16 MHz to 1.3 GHz	106 dB	
1.3 GHz to 3 GHz	106 dB	
Option 014		
30 kHz to 50 kHz		68 dB
50 kHz to 300 kHz		90 dB
300 kHz to 16 MHz	98 dB	
16 MHz to 1.3 GHz	108 dB	
1.3 GHz to 3 GHz	108 dB	
3 GHz to 6 GHz	103 dB	

- a. The System Transmission Dynamic Range is calculated as the difference between the receiver noise floor and the lesser of either: the source maximum output or the receiver maximum input.

**Table 1-2 7-mm Device Connector Type**

Network Analyzer: 8753ES, Standard and Option 006 Calibration Kit: 85031B (7-mm, 50 Ω) Cables: 11857D Calibration: Full 2-Port				
IF BW = 10 Hz, Avg off, Temp = 25 ± 5 °C with < 1 °C deviation from cal temp, Isol cal with avg = 8				
Description	Typical	Specification		
	30 to 300 kHz	300 kHz to 1.3 GHz	1.3 to 3 GHz	3 to 6 GHz (Opt 006 only)
Directivity	55 dB	55 dB	51 dB	46 dB
Source Match	55 dB	51 dB	49 dB	43 dB
Load Match	55 dB	55 dB	51 dB	46 dB
Refl. Tracking				
Magnitude (db)	±(0.001 + .02/°C)	±(0.001 + .01/°C)	±(0.005 + .02/°C)	±(0.020 + .03/°C)
Phase (deg)	±(0.007 + .05/°C)	±(0.007 + .05/°C)	±(0.033 + .05/°C)	±(0.132 + 0.2/°C)
Trans. Tracking				
Magnitude (db)	±(0.009 + .02/°C)	±(0.006 + .01/°C)	±(0.009 + .02/°C)	±(0.021 + .03/°C)
Phase (deg)	±(0.060 + .05/°C)	±(0.040 + .05/°C)	±(0.059 + .05/°C)	±(0.139 + 0.2/°C)

**Transmission Uncertainty (Specification)**

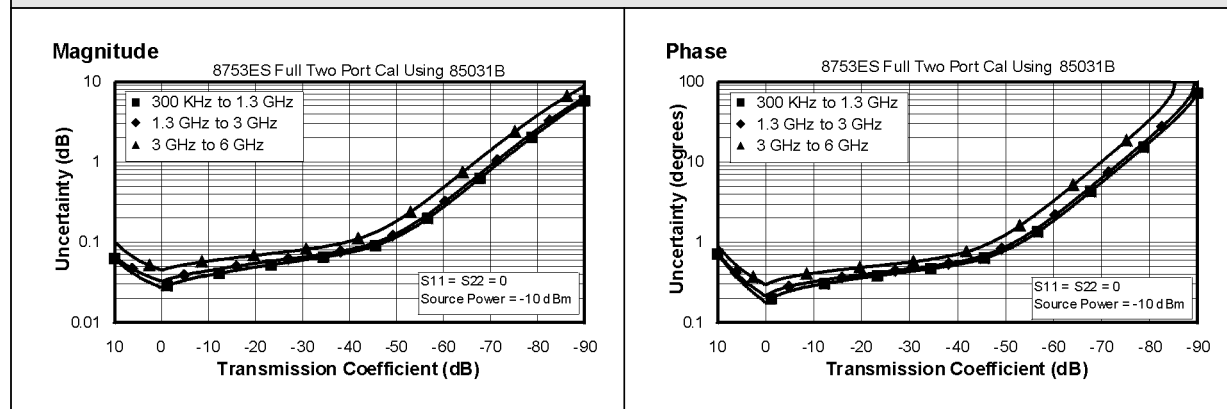

**Reflection Uncertainty (Specification)**

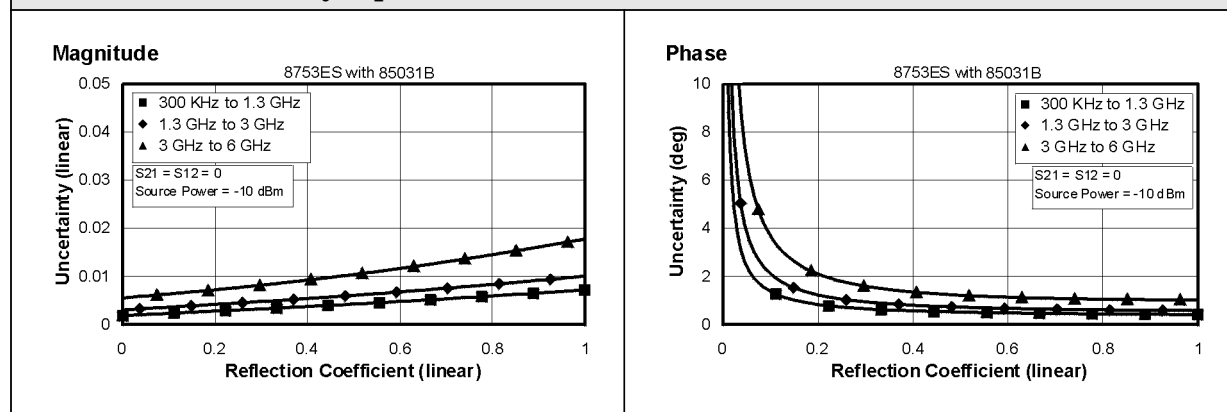

**Table 1-3 Type-N (50 Ω) Device Connector Type**

Network Analyzer: 8753ES, Standard and Option 006 Calibration Kit: 85032B/E (Type-N, 50 Ω) Cables: 11857D Calibration: Full 2-Port				
IF BW = 10 Hz, Avg off, Temp = 25 ± 5 °C with < 1 °C deviation from cal temp, Isol cal with avg = 8				
Description	Typical	Specification		
	30 to 300 kHz	300 kHz to 1.3 GHz	1.3 to 3 GHz	3 to 6 GHz (Opt 006 only)
Directivity	50 dB	50 dB	47 dB	40 dB
Source Match	49 dB	42 dB	36 dB	31 dB
Load Match	50 dB	50 dB	47 dB	40 dB
Refl. Tracking				
Magnitude (db)	±(0.005 + .02/°C)	±(0.009 + .01/°C)	±(0.019 + .02/°C)	±(0.070 + .03/°C)
Phase (deg)	±(0.033 + .05/°C)	±(0.059 + .05/°C)	±(0.125 + .05/°C)	±(0.462 + 0.2/°C)
Trans. Tracking				
Magnitude (db)	±(0.017 + .02/°C)	±(0.013 + .01/°C)	±(0.026 + .02/°C)	±(0.065 + .04/°C)
Phase (deg)	±(0.113 + .05/°C)	±(0.277 + .05/°C)	±(0.172 + .05/°C)	±(0.429 + 0.2/°C)

**Transmission Uncertainty (Specification)**

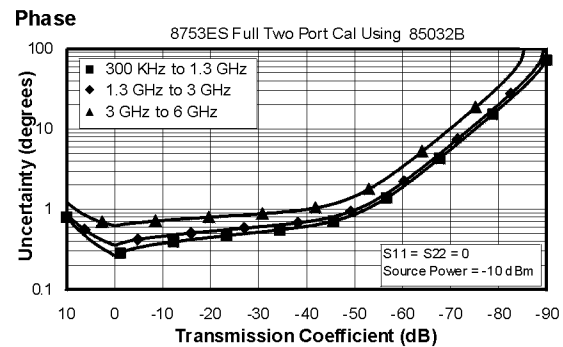
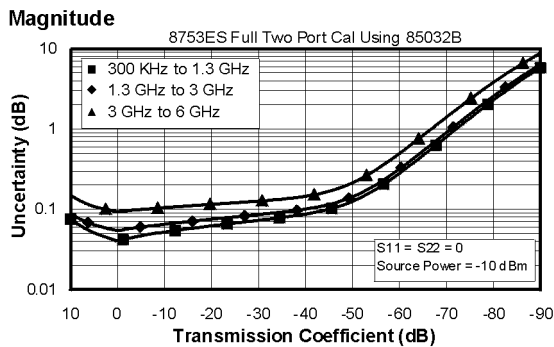

**Reflection Uncertainty (Specification)**

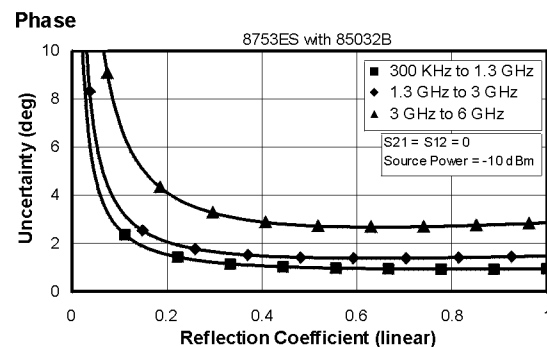
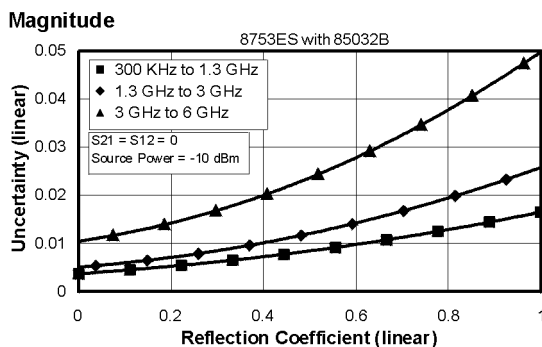

**Table 1-4 3.5-mm Device Connector Type**

Network Analyzer: 8753ES, Standard and Option 006 Calibration Kit: 85033D (3.5-mm, 50 Ω) Cables: 11857D Calibration: Full 2-Port				
IF BW = 10 Hz, Avg off, Temp = 25 ± 5°C with < 1°C deviation from cal temp, Isol cal with avg = 8				
Description	Typical	Specification		
	30 to 300 kHz	300 kHz to 1.3 GHz	1.3 to 3 GHz	3 to 6 GHz (Opt 006 only)
Directivity	49 dB	46 dB	44 dB	38 dB
Source Match	49 dB	44 dB	41 dB	37 dB
Load Match	49 dB	46 dB	44 dB	38 dB
Refl. Tracking				
Magnitude (db)	±(0.001 + .02/°C)	±(0.005 + .01/°C)	±(0.007 + .02/°C)	±(0.009 + .03/°C)
Phase (deg)	±(0.007 + .05/°C)	±(0.033 + .05/°C)	±(0.046 + .05/°C)	±(0.059 + 0.2/°C)
Trans. Tracking				
Magnitude (db)	±(0.019 + .02/°C)	±(0.014 + .01/°C)	±(0.022 + .02/°C)	±(0.048 + .03/°C)
Phase (deg)	±(0.124 + .05/°C)	±(0.092 + .05/°C)	±(0.145 + .05/°C)	±(0.317 + 0.2/°C)

**Transmission Uncertainty (Specification)**

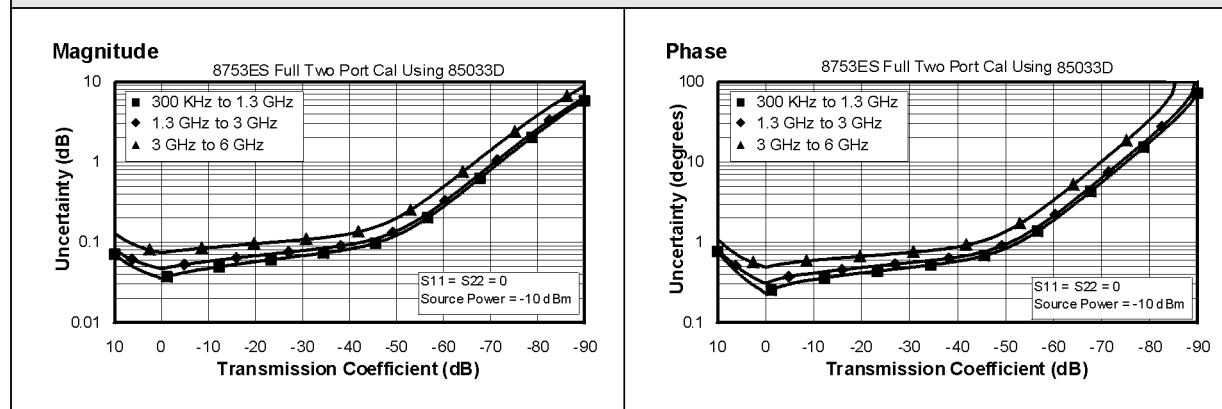

**Reflection Uncertainty (Specification)**

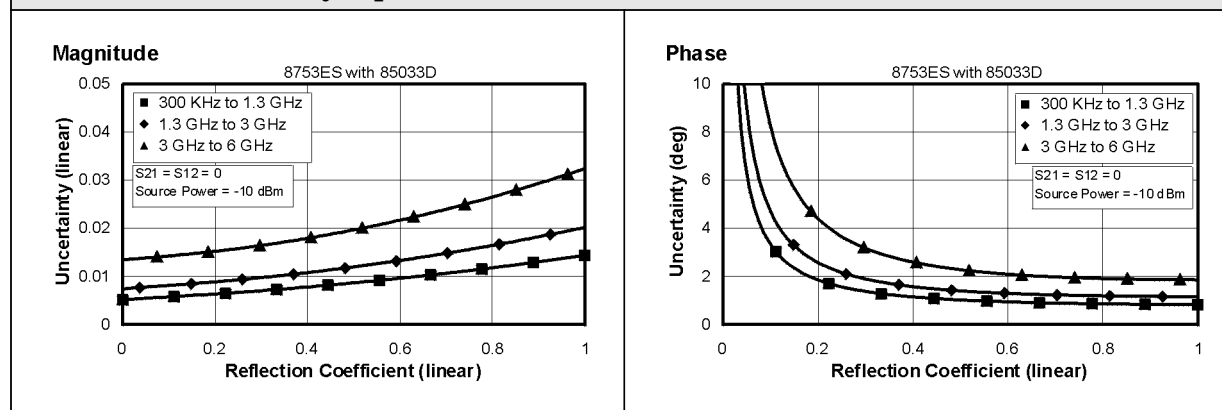

**Table 1-5 7/16-mm Device Connector Type**

Network Analyzer: 8753ES, Standard and Option 006 Calibration Kit: 85038A (7/16-mm, 50 Ω) Cables: 11857D Calibration: Full 2-Port				
IF BW = 10 Hz, Avg off, Temp = 25 ± 5°C with < 1°C deviation from cal temp, Isol cal with avg = 8				
Description	Typical	Specification		
	30 to 300 kHz	300 kHz to 1.3 GHz	1.3 to 3 GHz	3 to 6 GHz (Opt 006 only)
Directivity	40 dB	40 dB	40 dB	36 dB
Source Match	37 dB	37 dB	37 dB	34 dB
Load Match	40 dB	40 dB	40 dB	36 dB
Refl. Tracking				
Magnitude (db)	±(0.089 + .02/°C)	±(0.089 + .01/°C)	±(0.089 + .02/°C)	±(0.115 + .03/°C)
Phase (deg)	±(0.587 + .05/°C)	±(0.587 + .05/°C)	±(0.587 + .05/°C)	±(0.759 + 0.2/°C)
Trans. Tracking				
Magnitude (db)	±(0.066 + .02/°C)	±(0.029 + .01/°C)	±(0.033 + .02/°C)	±(0.062 + .03/°C)
Phase (deg)	±(0.436 + .05/°C)	±(0.192 + .05/°C)	±(0.219 + .05/°C)	±(0.436 + 0.2/°C)

**Transmission Uncertainty (Specification)**

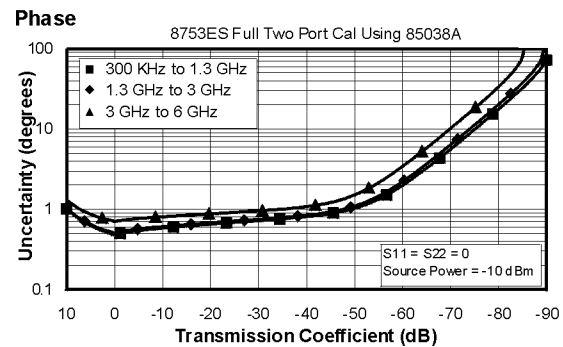
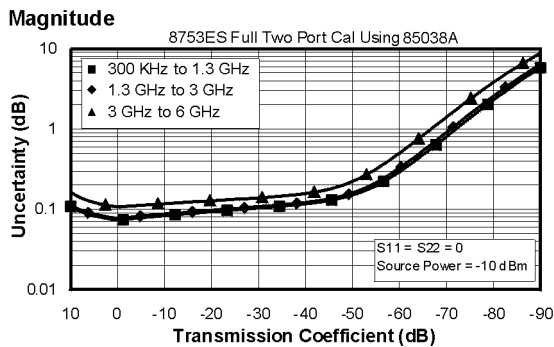

**Reflection Uncertainty (Specification)**

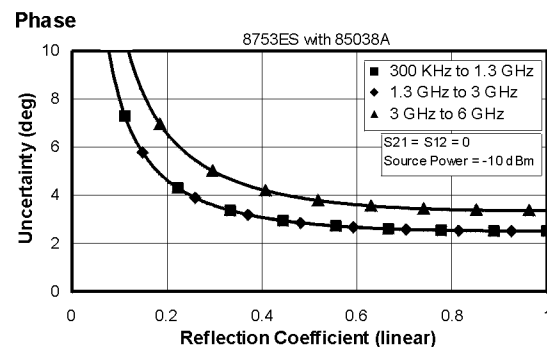
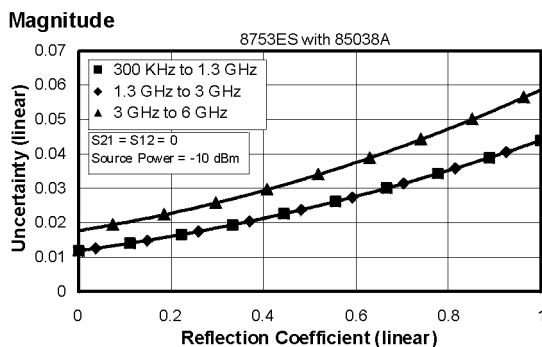

**Table 1-6 Type-N (75Ω) Device Connector Type**

Network Analyzer: 8753ES, Option 075 Calibration Kit: 85036B/E (Type-N, 75Ω) Cables: 11857B Calibration: Full 2-Port				
IF BW = 10 Hz, Avg off, Temp = 25 ± 5°C with < 1°C deviation from cal temp, Isol cal with avg = 8				
Description	Typical	Specification		
	30 to 300 kHz	300 kHz to 1.3 GHz	1.3 to 3 GHz	3 to 6 GHz (Opt 006 only)
Directivity	48 dB	48 dB	43 dB	N/A
Source Match	47 dB	41 dB	35 dB	N/A
Load Match	48 dB	48 dB	43 dB	N/A
Refl. Tracking				
Magnitude (db)	±(0.004 + .02/°C)	±(0.010 + .01/°C)	±(0.019 + .02/°C)	N/A
Phase (deg)	±(0.026 + .05/°C)	±(0.066 + .05/°C)	±(0.125 + .05/°C)	N/A
Trans. Tracking				
Magnitude (db)	±(0.022 + .02/°C)	±(0.016 + .01/°C)	±(0.033 + .02/°C)	N/A
Phase (deg)	±(0.143 + .05/°C)	±(0.106 + .05/°C)	±(0.218 + .05/°C)	N/A

**Transmission Uncertainty (Specification)**

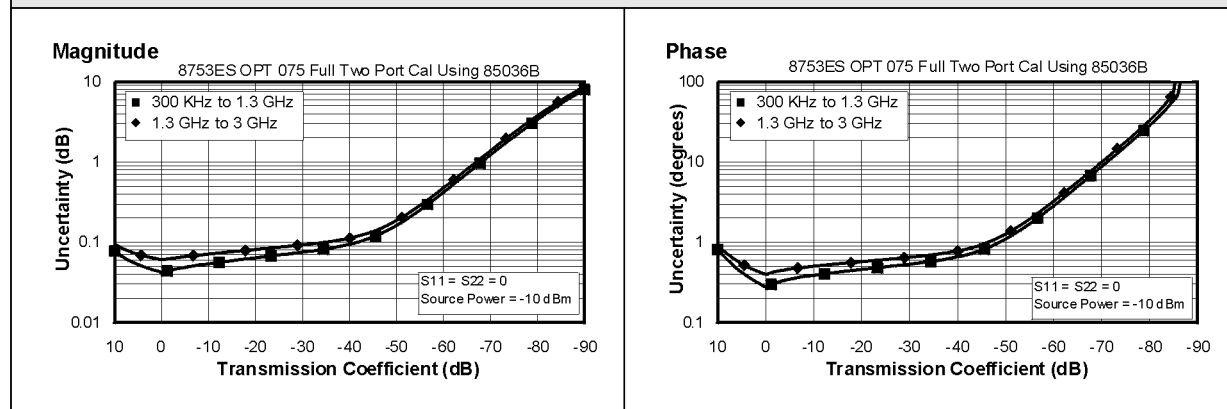

**Reflection Uncertainty (Specification)**

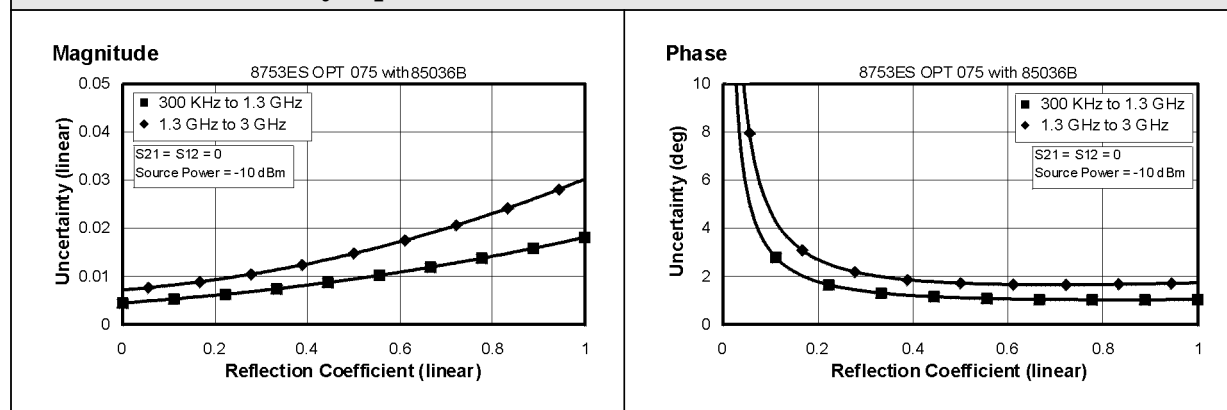
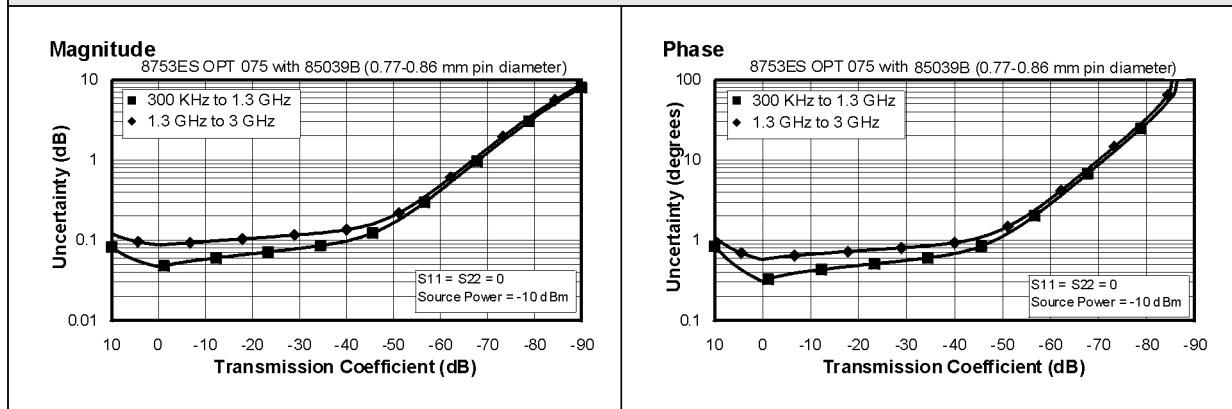



**Table 1-7 Type-F (75 Ω) Device Connector Type**

Network Analyzer: 8753ES, Option 075 Calibration Kit: 85039B (Type-F, 75 Ω) Cables: 11857B Calibration: Full 2-Port				
IF BW = 10 Hz, Avg off, Temp = 25 ± 5 °C with < 1 °C deviation from cal temp, Isol cal with avg = 8				
Description	Typical	Specification		
	30 to 300 kHz	300 kHz to 1.3 GHz	1.3 to 3 GHz	3 to 6 GHz (Opt 006 only)
Directivity	45 dB	45 dB	40 dB	N/A
Source Match	40 dB	40 dB	30 dB	N/A
Load Match	45 dB	45 dB	40 dB	N/A
Refl. Tracking				
Magnitude (db)	±(0.043 + .02/°C)	±(0.060 + .01/°C)	±(0.0240 + .02/°C)	N/A
Phase (deg)	±(0.396 + .05/°C)	±(0.396 + .05/°C)	±(0.158 + .05/°C)	N/A
Trans. Tracking				
Magnitude (db)	±(0.033 + .02/°C)	±(0.019 + .01/°C)	±(0.057 + .02/°C)	N/A
Phase (deg)	±(0.283 + .05/°C)	±(0.125 + .05/°C)	±(0.376 + .05/°C)	N/A

**Transmission Uncertainty (Specification)**



**Reflection Uncertainty (Specification)**

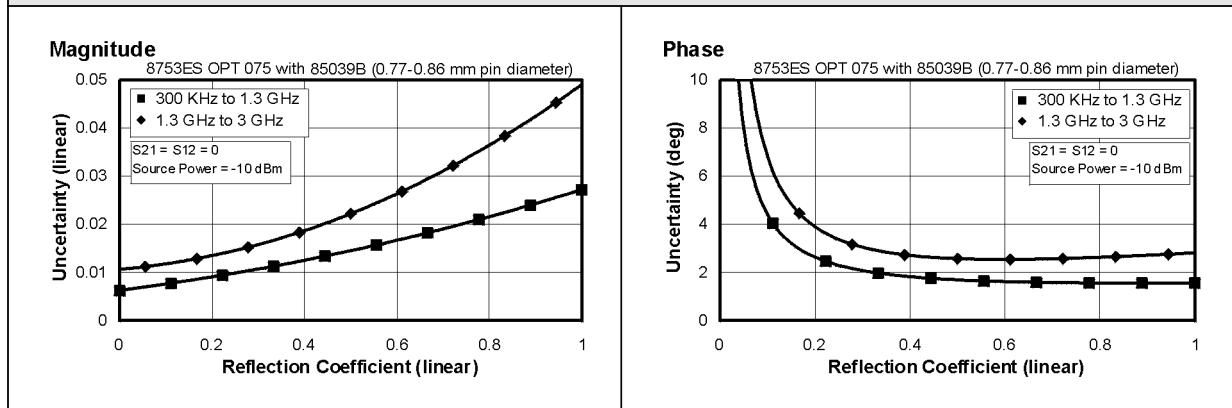

## Instrument Specifications

### Uncorrected Port Performance

Table 1-8 7-mm Device Connector Type

8753ES (7-mm, 50 Ω), Standard and Option 006					
Description	Specification				
	30 kHz to 50 kHz	50 kHz to 300 kHz	300 kHz to 1.3 GHz	1.3 GHz to 3 GHz	3 to 6 GHz (Opt 006 only)
Directivity <sup>a</sup> (dB)	15, typ.	20, typ.	35	30	25
Source Match <sup>a</sup> (dB)	10, typ.	18, typ.	16	16	14
Load Match <sup>a</sup> (dB)	10, typ.	18, typ.	18	16	14
Reflection Tracking <sup>a</sup> (dB)	±2.5, typ.	±2.5, typ.	±1.0	±1.0	±1.5
Transmission Tracking <sup>a</sup> (dB)	±2.5, typ.	±2.5, typ.	±1.0	±1.0	±1.5
Tracking Stability (Ratio Measurement)					
Magnitude (dB)	.002/°C, typ.	.002/°C, typ.	.002/°C, typ.	.002/°C, typ.	0.04/°C, typ.
Phase (deg)	.004/°C, typ.	.004/°C, typ.	.004/°C, typ.	.004/°C, typ.	0.20/°C, typ.
Crosstalk <sup>b</sup> (dB)	60, typ.	90, typ.	100	100	90

- a. Does not include the effect of the cable set on the test ports.  
b. **Measurement conditions:** Normalized to a thru, measured with two shorts, 10 Hz IF bandwidth, averaging factor of 8, alternate mode, source power set to the lesser of the maximum power out or the maximum receiver power.

**Table 1-9 Type-N (75 Ω) Device Connector Type**

<b>8753ES (Type-N, 75Ω), Option 075</b>					
<b>Description</b>	<b>Specification</b>				
	<b>30 kHz to 50 kHz</b>	<b>50 kHz to 300 kHz</b>	<b>300 kHz to 1.3 GHz</b>	<b>1.3 GHz to 3 GHz</b>	<b>3 to 6 GHz (Opt 006 only)</b>
Directivity <sup>a</sup> (dB)	15, typ.	20, typ.	35	30	N/A
Source Match <sup>a</sup> (dB)	10, typ.	18, typ.	16	16	N/A
Load Match <sup>a</sup> (dB)	10, typ.	18, typ.	18	16	N/A
Reflection Tracking <sup>a</sup> (dB)	±2.5, typ.	±2.5, typ.	±1.0	±1.0	N/A
Transmission Tracking <sup>a</sup> (dB)	±2.5, typ.	±2.5, typ.	±1.0	±1.0	N/A
Tracking Stability (Ratio Measurement)					
Magnitude (dB)	.002/°C, typ.	.002/°C, typ.	.002/°C, typ.	.002/°C, typ.	0.04/°C, typ.
Phase (deg)	.004/°C, typ.	.004/°C, typ.	.004/°C, typ.	.004/°C, typ.	0.20 °/°C, typ.
Crosstalk <sup>b</sup> (dB)	60, typ.	90, typ.	100	100	N/A

a. Does not include the effect of the cable set on the test ports.

b. **Measurement conditions:** Normalized to a thru, measured with two shorts, 10 Hz IF bandwidth, averaging factor of 8, alternate mode, source power set to the lesser of the maximum power out or the maximum receiver power.

## Test Port Output

Table 1-10 Test Port Output

8753ES Test Port Output		
Description	Specification	Supplemental Information
<b>Frequency</b>		
Range		
Standard	30 kHz to 3.0 GHz	10 kHz to 3 GHz, typ.
Option 006	30 kHz to 6.0 GHz	10 kHz to 6 GHz, typ.
Resolution	1 Hz	
Stability		
Standard		±7.5 ppm, 0° to 55°C, typ. ±3 ppm/year, typ.
Option 1D5		0.05 ppm, 0° to 55°C, typ. ±0.5 ppm/year, typ.
CW Accuracy	±10 ppm	at 25°C ±5 °C
<b>Output Power<sup>a</sup> (above 300 kHz)</b>		
Level Accuracy <sup>b</sup>		
Standard	±1.0 dB	at 0 dBm output level
Option 075	±1.0 dB	at 0 dBm output level
Maximum Levelled Power <sup>c</sup>		
Standard		+10 dBm, char.
Option 075		+8 dBm, char.
Option 014		+8 dBm, char.
Power Range <sup>d</sup>		
Standard	-85 to +10 dBm	
Option 075	-85 to +8 dBm	
Option 014	-85 to +8 dBm	
Power Sweep Range		
Standard	25 dB	33 dB, typ.
Option 075	23 dB	31 dB, typ.
Option 014	23 dB	31 dB, typ.

- a. Source output performance on port 1 only. Port 2 output performance is a characteristic.  
b. Absolute power accuracy at a given power level. Includes absolute accuracy and relative flatness across frequency.  
c. At any given frequency, the achievable power while remaining levelled. Applies to CW mode only.  
d. Power to which the source can be set and phase lock is assured.

**Table 1-11 Test Port Output**

8753ES Test Port Output		
Description	Specification	Supplemental Information
<b>Output Power<sup>a</sup> (above 300 kHz)</b>		
Power Resolution	0.01 dB	
Attenuator Switch Points:		
<p>TEST PORT POWER (dBm)</p> <p>RANGE NUMBER</p> <p>EXAMPLE: -32dBm WILL SET RANGE 3 &amp; ADJ. ALC FOR THIS LEVEL</p> <p>KEY: — UPPER RANGE LIMIT "OPTIMUM RANGE" — LOWER RANGE LIMIT</p>		

a. Source output performance on port 1 only. Port 2 output performance is a characteristic.

**Table 1-12 Test Port Output**

8753ES Test Port Output			
Description	Specification	Supplemental Information	
<b>Output Power<sup>a</sup> (above 300 kHz)</b>			
Linearity <sup>b</sup>			
Standard			
-15 to +5 dBm	±0.2 dB	relative to 0 dBm output level	
+5 to +10 dBm	±0.5 dB	relative to 0 dBm output level	
Option 014/Option 075			
-15 to +5 dBm	±0.2 dB	relative to 0 dBm output level	
+5 to +8 dBm	±0.5 dB	relative to 0 dBm output level	
<b>Impedance</b>			
Standard		50 Ω, nom.	
Option 075		75 Ω, nom.	
<b>Return Loss</b>			
Standard			
300 kHz to 3 GHz		> 16 dB, typ.	
3 GHz to 6 GHz		> 14 dB, typ.	
Option 075			
300 kHz to 3 GHz		> 16 dB, typ.	
<b>Attenuator Accuracy<sup>c</sup></b>			
0 dB		reference; at 50 MHz	
		300 kHz to 3 GHz	3 GHz to 6 GHz
10 dB		± 0.2 dB, char.	± 0.5 dB, char.
20 dB		± 0.4 dB, char.	± 0.7 dB, char.
30 dB		± 0.5 dB, char.	± 0.9 dB, char.
40 dB		± 0.7 dB, char.	± 1.2 dB, char.
50 dB		± 0.8 dB, char.	± 1.5 dB, char.
60 dB		± 1.0 dB, char.	± 1.8 dB, char.
70 dB		± 1.2 dB, char.	± 2.1 dB, char.

- a. Source output performance on port 1 only. Port 2 output performance is a characteristic.
- b. Change in source output power for a given change in source power setting at any given frequency.
- c. The accuracy, relative to the 0 dB setting, of each setting of an attenuator, at a given frequency.

**Table 1-13 Test Port Output**

<b>8753ES Test Port Output</b>		
<b>Description</b>	<b>Specification</b>	<b>Supplemental Information</b>
<b>Signal Purity<sup>a</sup></b>		
2nd Harmonic  at maximum output power  at 10 dB below maximum output power  at 20 dB below maximum output power	  < -25 dBc (Option 002 only)	16 MHz to 1.5 GHz (source freq.) 16 MHz to 3 GHz (Option 006, source freq.) < -25 dBc, char. (non-Option 002) < -40 dBc, typ. < -50 dBc, typ.
3rd Harmonic  at maximum output power  at 10 dB below maximum output power  at 20 dB below maximum output power	  < -25 dBc (Option 002 only)	16 MHz to 1 GHz (source freq.) 16 MHz to 2 GHz (Option 006, source freq.) < -25 dBc, char. (non-Option 002) < -40 dBc, typ. < -50 dBc, typ.
Non-harmonic Spurious Mixer Related  at maximum output power  at 20 dB below maximum output power		  < -30 dBc, typ. < -55 dBc, typ.

a. Source output performance on port 1 only. Port 2 output performance is a characteristic.

## Test Port Input

**Table 1-14 Test Port Input**

<b>8753ES Test Port Input</b>		
<b>Description</b>	<b>Specification</b>	<b>Supplemental Information</b>
<b>Frequency Range</b>		
Standard	30 kHz to 3.0 GHz	10 kHz to 3 GHz, typ.
Option 006	30 kHz to 6.0 GHz	10 kHz to 6 GHz, typ.
<b>Frequency Response, Non-Ratio Measurement (A or B)</b>		
300 kHz to 3 GHz	±1 dB	at preset power level
3 GHz to 6 GHz	±2 dB	at preset power level
<b>Impedance</b>		
Standard		50 Ω, nominal.
<b>Return Loss</b>		
Standard		See uncorrected load match chart
<b>Maximum Input Level</b>		
Standard	+10 dBm	
Compression		See dynamic accuracy chart
<b>Damage Level</b>		
Standard		> +26 dBm or > 35 Vdc, typ.
<b>Noise Floor<sup>a</sup></b>		
8753ES		
300 kHz to 3 GHz		
3 kHz IF Bandwidth	≤-82 dBm	
10 Hz IF Bandwidth	≤-102 dBm	≤-110 dBm, typ.
3 GHz to 6 GHz		
3 kHz IF Bandwidth	≤-77 dBm	
10 Hz IF Bandwidth	≤-97 dBm	≤-105 dBm, typ.
8753ES Option 075		
300 kHz to 3 GHz		
3 kHz IF Bandwidth	≤-80 dBm	
10 Hz IF Bandwidth	≤-100 dBm	≤-110 dBm, typ.

a. RMS value of a linear magnitude trace expressed in dBm, with the source power set to minimum to minimize the effects of crosstalk.



**Table 1-15 Test Port Input**

<b>8753ES Test Port Input</b>		
<b>Description</b>	<b>Specification</b>	<b>Supplemental Information</b>
<b>Internally Generated Harmonics (Option 002 Only)</b>		
2nd Harmonic at +8 dBm input level at +0 dBm input level at -15 dBm input level	< -15 dBc	16 MHz to 3 GHz  < -30 dBc, typ. < -45 dBc, typ.
3rd Harmonic at +8 dBm input level at +0 dBm input level at -15 dBm input level	< -30 dBc	16 MHz to 2 GHz  < -50 dBc, typ. < -50 dBc, typ.
<b>Harmonic Measurement Accuracy</b>		
16 MHz to 3 GHz	±1.5 dB	
3 GHz to 6 GHz	±3 dB	
<b>Harmonic Measurement Dynamic Range</b>		
Standard		-40 dBc, typ. output at -10 dBm and input at < -15 dBm
<b>Frequency Offset Operation<sup>a</sup></b>		
Frequency Range Standard Option 006	300 kHz to 3 GHz 300 kHz to 6 GHz	
R Channel Input Requirements 300 kHz to 3 GHz 3 GHz to 6 GHz	0 to -35 dBm 0 to -30 dBm	
LO Spectral Purity and Accuracy Maximum Spurious Input Residual FM Frequency Accuracy		< -25 dBc, typ. < 20 kHz, typ. -1 to +1 MHz of nominal frequency, typ.

a. The RF source characteristics in this mode are dependent on the stability of the external LO source. The RF source tracks the LO to maintain a stable IF signal at the R channel receiver input.

**Table 1-16 Test Port Input**

<b>8753ES Test Port Input</b>		
<b>Description</b>	<b>Specification</b>	<b>Supplemental Information</b>
<b>External Source Mode<sup>a</sup></b>		
Frequency Range Standard Option 006	300 kHz to 3 GHz 300 kHz to 6 GHz	at -25 dBm R channel power level
R Input Requirements Power Level		0 to -25 dBm, typ.
R Input Spectral Purity Requirement Maximum Spurious Input Residual FM		< -30 dBc, typ. < 20 kHz, typ.
Settling Time Auto Manual		500 ms, typ. 50 ms, typ.
Frequency Readout Accuracy		0.1%, auto, typ.
Input Frequency Accuracy Requirement Manual		-0.5 to 5 MHz, typ.

a. Measurement accuracy is dependent on the stability of the input signal.

**Table 1-17 Test Port Input**

8753ES Test Port Input		
Description	Specification	
	System Bandwidths	
	3000 Hz	10 Hz
<b>Trace Noise<sup>a</sup></b>		
Magnitude		
300 kHz to 3GHz	< 0.006 dB rms	< 0.001 dB rms
3 GHz to 6 GHz	< 0.010 dB rms	< 0.002 dB rms
Phase		
300 kHz to 3GHz	< 0.038° rms	< 0.006° rms
3 GHz to 6 GHz	< 0.070° rms	< 0.012° rms

a. Trace noise is defined for a transmission measurement in CW mode, using a “through” cable having 0 dB loss, with the source set to +5 dBm, and no averaging.

**Table 1-18 Test Port Input**

8753ES Test Port Input		
Description	Specification	Supplemental Information
<b>Reference Level</b>		
Magnitude		
Range	±500 dB	
Resolution	0.001 dB	
Phase		
Range	±500°	
Resolution	0.01°	

**Table 1-19 Test Port Input**

<b>8753ES Test Port Input</b>	
<b>Dynamic Accuracy (Specification)</b>	
<p>For input ports 1 and 2, accuracy of the test port input power reading relative to the reference input power level.</p> <ul style="list-style-type: none"> <li>Inputs: testport 1 and 2</li> <li>For test port powers &gt; -50 dBm and &lt; 0 dBm, magnitude dynamic accuracy is 0.02 dB + 0.001 dB/dB from the reference power, phase dynamic accuracy is 0.132 deg + 0.0066 deg/dB from the reference power.</li> <li>For Option 075 and 014, for test port powers up to the maximum source power.</li> </ul>	
<p><b>Magnitude</b></p> <p style="text-align: center;">8753ES</p>	<p><b>Phase</b></p> <p style="text-align: center;">8753ES</p>
<p><b>Magnitude</b></p> <p style="text-align: center;">8753ES</p>	<p><b>Phase</b></p> <p style="text-align: center;">8753ES</p>

**Table 1-20 Test Port Input**

<b>8753ES R-Channel Input</b>		
<b>Dynamic Accuracy (Typical)</b>		
Accuracy of the R-channel power reading relative to the R-channel reference power level. This table applies when the calibrated power level and the measurement power level are not the same. Inputs:		
<ul style="list-style-type: none"> <li>• R-channel</li> <li>• For Option 075 and 014, for test port powers up to the maximum source power.</li> </ul>		
	<b>300 KHz to 3 GHz</b>	<b>3 to 6 GHz</b>
<b>Magnitude Dynamic Accuracy for Test Port Powers</b>		
> -50 dBm and < 0 dBm	.02 dB + .001 dB/dB from the reference power	.02 dB + .001 dB/dB from the reference power
> 0 dBm and < 10 dBm	.02 dB + .02 dB/dB above 0 dBm	.02 dB + .03 dB/dB above 0 dBm
<b>Phase Dynamic Accuracy for Test Port Powers</b>		
> -50 dBm and < 0 dBm	.132 deg + .0066 deg/dB from the reference power	.132 deg + .0066 deg/dB from the reference power
> 0 dBm and < 10 dBm	.132 deg + .132 deg/dB above 0 dBm	.132 deg + .198 deg/dB above 0 dBm

## General Information

**Table 1-21 General Information**

<b>8753ES General Information</b>		
<b>Description</b>	<b>Specification</b>	<b>Supplemental Information</b>
<b>Display Range</b>		
Magnitude	±200 dB (at 20 dB/div), max	
Phase	±180°, max	
Polar	10 pico units, min 1000 units, max	
<b>Display Resolution</b>		
Magnitude	0.001 dB/div, min	
Phase	0.01°/div, min	
<b>Reference Value Range</b>		
Magnitude	±500 dB, max	
Phase	±360°, max	
<b>Reference Level Resolution</b>		
Magnitude	0.001 dB, min	
Phase	0.01°, min	
<b>Marker Resolution</b>		
Magnitude	0.001 dB, min	
Phase	0.01°, min	
Polar	0.01 mUnit, min; 0.01, min	

**Table 1-22 General Information**

8753ES General Information		
Description	Specification	Supplemental Information
<b>Group Delay<sup>a</sup></b>		
Aperture (selectable)	(frequency span)/(number of points -1)	
Maximum Aperture	20% of frequency span	with smoothing enabled
Range	$1/2 \times (1/\text{minimum aperture})$	
Maximum Delay		Limited to measuring no more than 180° of phase change within the minimum aperture.)
Accuracy		See graph. Char.

The following graph shows group delay accuracy with 7-mm full 2-port calibration and a 10 Hz IF bandwidth. Insertion loss is assumed to be < 2 dB and electrical length to be ten meters.

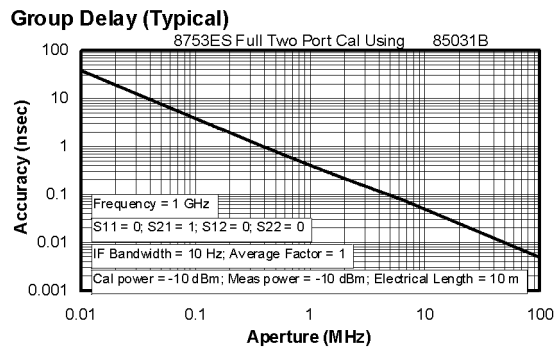

In general, the following formula can be used to determine the accuracy, in seconds, of specific group delay measurement:

$$\pm \text{Relative Phase Accuracy}^b \text{ (deg)} / [360 \times \text{Aperture (Hz)}]$$

Depending on the aperture and device length, the phase accuracy used is either phase dynamic accuracy specification or worst case transmission uncertainty phase specification.

- Group delay is computed by measuring the phase change within a specified frequency step (determined by the frequency span and the number of points per sweep).
- Relative phase accuracy is an unspecified parameter. For very narrow apertures with short devices under test RF systematic error terms can be assumed constant. As aperture or device electrical length or both increase, RF systematic errors become increasingly important. Eventually, relative phase accuracy is the same as absolute phase accuracy.

**Table 1-23 General Information**

<b>8753ES General Information</b>	
<b>Description</b>	<b>Supplemental Information</b>
<b>System Bandwidths</b>	
IF bandwidth settings	6000 Hz, nom. 3700 Hz, nom. 3000 Hz, nom. 1000 Hz nom. 300 Hz, nom. 100 Hz, nom. 30 Hz, nom. 10 Hz, nom.
<b>Rear Panel</b>	
External Auxiliary Input Connector Range	Female BNC $\pm 10$ V, typ.
External Trigger Damage Level	Triggers on a positive or negative TTL transition or contact closure to ground. < -0.2 V; > +5.2 V, typ.
Limit Test Output Damage Level	Female BNC. < -0.2 V; > +5.2 V, typ.
Test Sequence Output	Outputs a TTL signal which can be set to a TTL high pulse (default) or low pulse at end of sweep; or a fixed TTL high or low. If limit test is on, the end of sweep pulse occurs after the limit test is valid. This is useful when used in conjunction with test sequencing.
Test Set Interconnect	25-pin-D-sub (DB-25) female; use for external special test sets (K36, K39, etc.)
Measure Restart	Floating closure to restart measurement.
External AM Input	$\pm 1$ volt into a 5 k $\Omega$ resistor, 1 kHz maximum, resulting in approximately 8 dB/volt amplitude modulation.
High Stability Frequency Reference Output (10 MHz) (Option 1D5) Frequency Frequency Stability (0 °C to 55 °C) Daily aging rate (after 30 days) Yearly aging rate Output Output Impedance	10.0000 MHz, char. $\pm 0.05$ ppm, char. < $3 \times 10^{-9}$ /day, char. $\pm 0.5$ ppm/year, char. $\geq 0$ dBm, char. 50 $\Omega$ , nom.



**Table 1-24 General Information**

<b>8753ES General Information</b>		
<b>Description</b>	<b>Specification</b>	<b>Supplemental Information</b>
<b>Rear Panel</b>		
Test Port Bias Input		
Maximum voltage	±30 Vdc	
Maximum current (no degradation in RF specifications)	±200 mA	
Maximum current	±1 A	
External Reference In		
Input Frequency	1, 2, 5, and 10 MHz	±200 Hz at 10 MHz
Input Power		-10 dBm to +20 dBm, typ.
Input Impedance		50 Ω, nom.
VGA Video Output		15-pin mini D-Sub; female. Drives VGA compatible monitors.
GPIB		Type-57, 24-pin; Microribbon female
Parallel Port		25-pin D-Sub (DB-25); female; may be used as printer port or general purpose I.O. port
RS232		9-pin D-Sub (DB-9); male
Mini-DIN Keyboard/Barcode Reader		6-pin mini DIN (PS/2); female
Line Power		A third-wire ground is required.
Frequency	47 Hz to 66 Hz	
Voltage at 115 V setting	90 V to 132 V	115 V, nom.
Voltage at 220 V setting	198 V to 265 V	230 V, nom.
VA Maximum	350 VA max	
<b>Front Panel</b>		
RF Connectors		7-mm precision, 50 ohm Type-N, 75 ohm (Option 075)
Connector center pin protrusion (for 7-mm precision only)		0.000 to 0.003 in.
Probe Power		3-pin connector; male
Positive Supply	400 mA, max	+15 V ±2%, char. the maximum combined load for both probe connectors, char.
Negative Supply	300 mA, max	-12.6 V ±5%, char. the maximum combined load for both probe connectors, char.

**Table 1-25 General Information**

<b>8753ES General Information</b>	
<b>Description</b>	<b>Specification</b>
<b>Front Panel</b>	
Display Pixel Integrity	
Red, Green, or Blue Pixels	<p>Red, green, or blue “stuck on” pixels may appear against a black background. In a properly working display, the following will not occur:</p> <ul style="list-style-type: none"> <li>• complete rows or columns of stuck pixels</li> <li>• more than 5 stuck pixels (not to exceed a maximum of 2 red or blue, and 3 green)</li> <li>• 2 or more consecutive stuck pixels</li> <li>• stuck pixels less than 6.5 mm apart</li> </ul>
Dark Pixels	<p>Dark “stuck on” pixels may appear against a white background. In a properly working display, the following will not occur:</p> <ul style="list-style-type: none"> <li>• more than 12 stuck pixels (not to exceed a maximum of 7 red, green, or blue)</li> <li>• more than one occurrence of 2 consecutive stuck pixels</li> <li>• stuck pixels less than 6.5 mm apart</li> </ul>

**Table 1-26 General Information**

<b>8753ES General Information</b>		
<b>Description</b>	<b>Specification</b>	<b>Supplemental Information</b>
<b>General Environmental</b>		
RFI/EMI Susceptibility		Defined by CISPR Pub. 11 and FCC Class B standards.
ESD		Minimize using static-safe work procedures and an antistatic bench mat (part number 9300-0797).
Dust		Minimize for optimum reliability.
<b>Operating Environment</b>		
Temperature	0 °C to +55 °C	Instrument powers up, phase locks, and displays no error messages within this temperature range.
Error-corrected temperature range		see system specifications
Humidity	5% to 95% at +40 °C (non-condensing)	
Altitude	0 to 4.5 km (15,000 ft)	
<b>Storage Conditions</b>		
Temperature	-40 °C to +70 °C	
Humidity	0% to 95% RH at +65 °C (non-condensing)	
Altitude	0 to 15.24 km (50,000 ft)	
<b>Cabinet Dimensions</b>		
Height x Width x Depth		222 x 425 x 457 mm, nom. (8.75 x 16.75 x 18 in, nom.) Cabinet dimensions exclude front and rear protrusions.
<b>Weight</b>		
Shipping		32 kg (77 lb), nom.
Net		24 kg (53 lb), nom.
<b>Internal Memory - Data Retention Time with 3 V, 1.2 Ah Battery<sup>a</sup></b>		
70 °C		250 days (0.68 year), typ.
40 °C		1244 days (3.4 years), typ.
25 °C		10 years, typ.

a. Analyzer power is switched off.

## Speed Parameters

**Table 1-27 8753ES Measurement and Data Transfer Speed Performance**

Typical Time for Completion (ms)				
Description	Number of Points			
	51	201	401	1601
Typical Time for Completion (in ms), Center 1 GHz, Span 10 MHz, IFBW=6000				
Uncorrected	32	70	121	423
1-port and Enhanced Response cal <sup>a</sup>	35	71	1271	440
2-port cal <sup>b</sup>	62	139	240	848
Typical Time for Completion (in ms), Start 30 kHz, Stop 3 GHz, IFBW=6000				
Uncorrected	202	270	304	615
1-port and Enhanced Response cal <sup>a</sup>	202	270	304	615
2-port cal <sup>b</sup>	402	540	607	1237
Typical Time for Completion (in ms), Start 30 kHz, Stop 6 GHz, IFBW=6000				
Uncorrected	310	380	415	658
1-port and Enhanced Response cal <sup>a</sup>	310	380	415	658
2-port cal <sup>b</sup>	618	757	829	1315
Time Domain <sup>c</sup> (increase over uncorrected sweep time)				
Conversions	12	42	86	378
Gating (Frequency Domain)	14	40	80	349
GPIB Data Transfer <sup>d</sup> :				
Binary (Internal)	10	16	21	58
IEEE754 floating point format				
32 bit	11	19	28	83
64 bit	13	26	42	141
ASCII	35	112	214	831

- a. S11 1-port calibration, with a 6 kHz IF bandwidth. Includes system retrace time, but does not include bandswitch time. Time domain gating is assumed off.
- b. S21 measurement with full 2-port calibration, using a 6 kHz IF bandwidth. Includes system retrace time and RF switching time, but does not include bandswitch time. Time domain gating is assumed off.
- c. Option 010 only, gating off.
- d. Measured with HP Omnibook 7100 Pentium Pro computer.

**Table 1-28 8753ES Recall and Sweep Speed Performance**

Operations	Channel	Points	Raw Offset	Total Time, typical (secs)		Recall-Only Time, typical (secs)	
				Blank Off	Blank On	Blank Off	Blank On
<b>Error Correction ON</b>							
Recall and Sweep	Single Chan.	201	On	0.389	0.260	0.250	0.126
Recall and Sweep	Single Chan.	201	Off	0.340	0.210	0.201	0.077
Sweep only (no Recall)	Single Chan.	201	N/A	0.139	0.134	N/A	N/A
Recall and Sweep	Single Chan.	1601	On	1.480	1.347	0.632	0.506
Recall and Sweep	Single Chan.	1601	Off	1.102	0.969	0.254	0.128
Sweep only (no Recall)	Single Chan.	1601	N/A	0.848	0.841	N/A	N/A
Recall and Sweep	Dual Chan.	201	On	0.539	0.389	0.357	0.215
Recall and Sweep	Dual Chan.	201	Off	0.489	0.328	0.308	0.154
Sweep only (no Recall)	Dual Chan.	201	N/A	0.182	0.174	N/A	N/A
Recall and Sweep	Dual Chan.	1601	On	2.386	2.219	1.208	1.049
Recall and Sweep	Dual Chan.	1601	Off	2.007	1.839	0.829	0.669
Sweep only (no Recall)	Dual Chan.	1601	N/A	1.178	1.170	N/A	N/A
<b>Error Correction OFF</b>							
Recall and Sweep	Single Chan.	201	On	0.240	0.147	0.170	0.082
Recall and Sweep	Single Chan.	201	Off	0.227	0.134	0.157	0.069
Sweep only (no Recall)	Single Chan.	201	N/A	0.070	0.065	N/A	N/A
Recall and Sweep	Single Chan.	1601	On	0.675	0.587	0.252	0.168
Recall and Sweep	Single Chan.	1601	Off	0.581	0.491	0.157	0.073
Sweep only (no Recall)	Single Chan.	1601	N/A	0.423	0.419	N/A	N/A
Recall and Sweep	Dual Chan.	201	On	0.306	0.170	0.235	0.104
Recall and Sweep	Dual Chan.	201	Off	0.281	0.145	0.211	0.080
Sweep only (no Recall)	Dual Chan.	201	N/A	0.071	0.066	N/A	N/A
Recall and Sweep	Dual Chan.	1601	On	0.802	0.692	0.377	0.273
Recall and Sweep	Dual Chan.	1601	Off	0.613	0.503	0.188	0.084
Sweep only (no Recall)	Dual Chan.	1601	N/A	0.424	0.419	N/A	N/A
Instrument State: CF = 1 GHz, Span = 2 MHz, IF BW = 6 kHz. GPIB commands sent for timing are Recall;OPC?;SING; or, for sweep only, OPC?;SING;.							

**Table 1-29 Sweep Time vs. IF Bandwidth**

IF Bandwidth	Typical Sweep Time (seconds) <sup>a</sup>
6000	0.070
3700	0.095
3000	0.121
1000	0.248
300	0.704
100	2.022
30	6.987
10	21.365

a. Preset condition, CF = 1 GHz, Span = 100 MHz; includes retrace time, 201 points.

**Table 1-30 Sweep Time vs. Number of Points**

Number of Points	Typical Sweep Time (seconds) <sup>a</sup>
51	0.039
101	0.057
201	0.095
401	0.171
801	0.323
1601	0.625

a. Preset condition, CF = 1 GHz, Span = 100 MHz, Correction off; includes retrace time. Measurement speed can be improved by selecting the widest IF bandwidth setting of 6000 Hz.

**Power Meter Calibration Accuracy**

**Table 1-31 Power Meter Calibration Sweep Speed and Accuracy**

Power Desired at Test Port	Number of Readings	Sweep Time Setting (seconds) <sup>a</sup>	Characteristic Accuracy (dB) <sup>b</sup>
+5 dBm	1	33	±0.7
	2	64	±0.2
	3	95	±0.1
-15 dBm	1	48	±0.7
	2	92	±0.2
	3	123	±0.1
-30 dBm	1	194	±0.7
	2	360	±0.2
	3	447	±0.1

- a. Sweep speed applies to every sweep in continuous correction mode, and to the first sweep in sample-and-sweep mode. Subsequent sweeps in sample-and-sweep mode will be much faster.
- b. The accuracy values were derived by combining the accuracy of the power meter and linearity of the analyzer's internal source, as well as the mismatch uncertainty associated with the power sensor.





---

## **2 8753ET Specifications and Characteristics**

## Definitions

All specifications and characteristics apply over a  $25\text{ }^{\circ}\text{C} \pm 5\text{ }^{\circ}\text{C}$  range (unless otherwise stated) and 1/2 hour after the instrument has been turned on.

**Specification (spec.):** Warranted performance. Specifications include guardbands to account for the expected statistical performance distribution, measurement uncertainties, and changes in performance due to environmental conditions.

**Characteristic (char.):** A performance parameter that the product is expected to meet before it leaves the factory, but that is not verified in the field and is not covered by the product warranty. A characteristic includes the same guardbands as a specification.

**Typical (typ.):** Expected performance of an average unit which does not include guardbands. It is not covered by the product warranty.

**Nominal (nom.):** A general, descriptive term that does not imply a level of performance. It is not covered by the product warranty.

**Calibration:** The process of measuring known standards from a calibration kit to characterize a network analyzer's systematic (repeatable) errors.

**Corrected (residual) Performance:** Indicates performance after error correction (calibration). It is determined by the quality of calibration standards and how well "known" they are, plus system repeatability, stability, and noise.

**Uncorrected (raw) Performance:** Indicates instrument performance without error correction. The uncorrected performance affects the stability of a calibration.

**Standard:** When referring to the analyzer, this includes all options unless noted otherwise.

## Corrected System Performance

The specifications in this section apply for measurements made using 10 Hz IF bandwidth, no averaging, and at an environmental temperature of  $25 \pm 5$  °C, with less than 1 °C deviation from the calibration temperature. Assumes that an isolation calibration was performed with an averaging factor of 16.

**Table 2-1 System Dynamic Range, All Device Connector Types**

8753ET, All Options, All Cal Kits, All Cables, 10 Hz IF BW		
Description	Specification	Supplemental Information
<b>System Transmission Dynamic Range<sup>a</sup></b>		
300 kHz to 16 MHz	100 dB	
16 MHz to 1.3 GHz	110 dB	
1.3 GHz to 3 GHz	110 dB	
3 GHz to 6 GHz	105 dB	

- a. The System Transmission Dynamic Range is calculated as the difference between the receiver noise floor and the lesser of either: the source maximum output or the receiver maximum input.

**Table 2-2 Type-N (50 Ω) Device Connector Type**

<b>Network Analyzer: 8753ET Standard or Option 004 Attenuator                      Calibration Kit: 85032B/E (Type-N, 50 Ω)                      Cables: 8120-5639                      Calibration: See Below</b>			
<b>IF BW = 10 Hz, Avg = off, Temp = 25 ± 5 °C with &lt; 1 °C deviation from cal temp, Isol cal with avg = 8</b>			
<b>Description</b>	<b>Specification</b>		
	<b>300 kHz to 1.3 GHz</b>	<b>1.3 to 3 GHz</b>	<b>3 to 6 GHz (Opt 006 only)</b>
<b>Reflection Measurements<sup>a</sup></b>			
Directivity (dB)	50	47	40
Source Match (dB)	42	36	31
Load Match			
One-Port Cal	24	19	16
Tracking			
Magnitude (dB)	±(0.009 + .01/°C)	±(0.019 + .02/°C)	±(0.07 + .03/°C)
Phase (deg)	±(0.059 + .05/°C)	±(0.125 + .05/°C)	±(0.462 + .2/°C)
<b>Transmission Measurements<sup>b</sup></b>			
Source Match (dB)			
Enhanced Response Cal	42	36	31
Response Only Cal			
Standard	25	20	14
Option 004	23	18	14
Load Match	24	19	16
Tracking			
Enhanced Response Cal			
Magnitude (dB)	±(0.006 + .01/°C)	±(0.018 + .02/°C)	±(0.054 + .03/°C)
Phase (deg)	±(0.0396 + .05/°C)	±(0.119 + .05/°C)	±(0.389 + .20/°C)
Response Only Cal			
Standard			
Magnitude (dB)	±(0.031 + .01/°C)	±(0.1 + .02/°C)	±(0.27 + .03/°C)
Phase (deg)	±(0.203 + .05/°C)	±(0.66 + .05/°C)	±(1.78 + .20/°C)
Option 004			
Magnitude (dB)	±(0.039 + .01/°C)	±(0.122 + .02/°C)	±(0.27 + .03/°C)
Phase (deg)	±(0.255 + .05/°C)	±(0.804 + .05/°C)	±(1.78 + .20/°C)
<b>Uncertainty graphs are on the following page.</b>			

- a. One-port or enhanced response calibration.
- b. Enhanced response or response only calibration.

**Transmission<sup>a</sup> Uncertainty: Enhanced Response Calibration (Specification)**

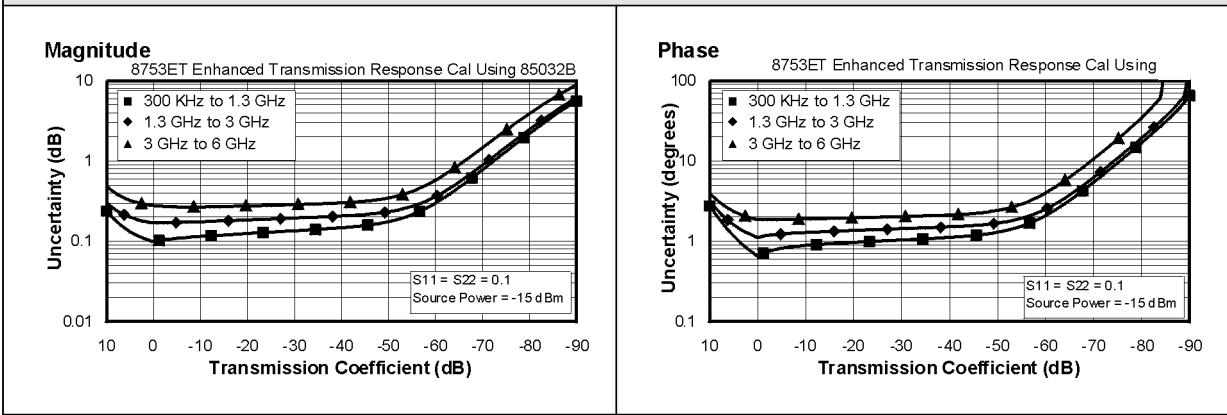

**Transmission Uncertainty: Response Calibration (Specification)**

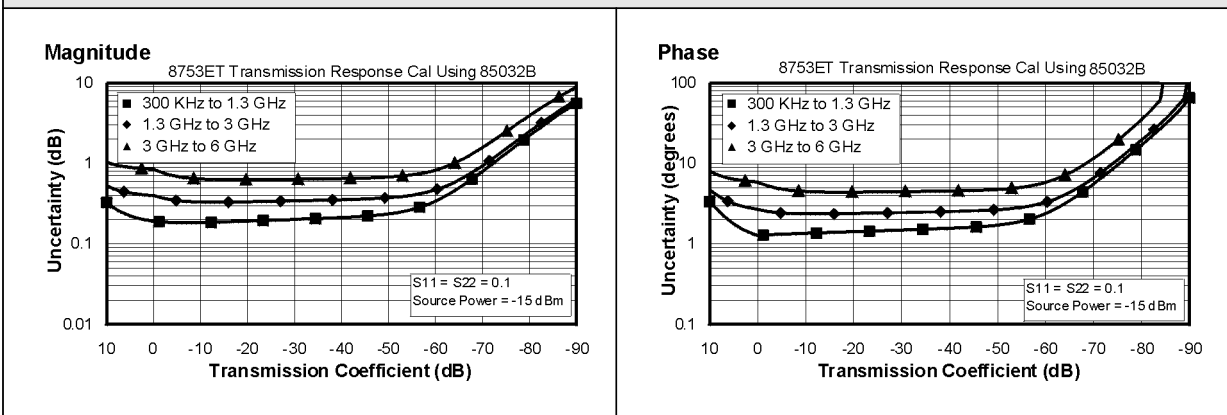

**Reflection Uncertainty: One-Port Calibration (Specification)**

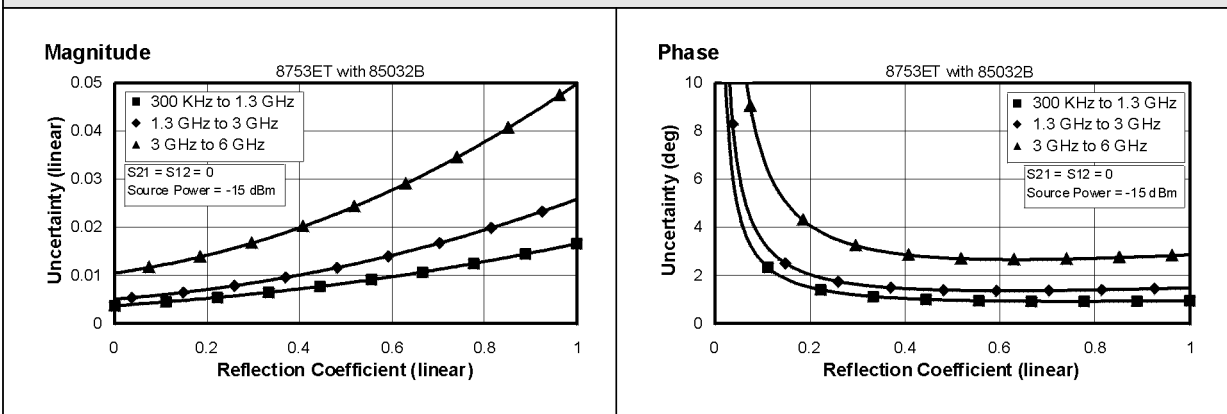

a. Option 004 may degrade transmission source match as much as 2 dB, resulting in up to 0.05 dB additional uncertainty in transmission uncertainty.

## Instrument Specifications

### Uncorrected Port Performance

**Table 2-3 Type-N (50 Ω) Device Connector Type**

8753ET (Type-N, 50 Ω)			
Description	Specification		
	300 kHz to 1.3 GHz	1.3 to 3 GHz	3 to 6 GHz (Opt 006 only)
Directivity <sup>a</sup> (dB)	30	24	19
Source Match <sup>a</sup>			
Standard (dB)	25	20	14
Option 004 (dB)	23	18	14
Load Match <sup>a</sup> (dB)	24	19	16
Reflection Tracking <sup>a</sup> (dB)	±1.0	±1.0	±2.0
Transmission Tracking <sup>a</sup> (dB)	±1.5	±1.5	±2.5
Tracking Stability (Ratio Measurement)			
Magnitude (db)	.002/°C, typ.	.002/°C, typ.	.004/°C, typ.
Phase (deg)	.004/°C, typ.	.004/°C, typ.	.020/°C, typ.
Crosstalk <sup>b</sup> (dB)	100	100	90

a. Does not include the effect of the cable set on the test ports.

b. **Measurement conditions:** Normalized to a thru, measured with two shorts, 10 Hz IF bandwidth, averaging factor of 8, alternate mode, source power set to the lesser of the maximum power out or the maximum receiver power.

## Test Port Output

Table 2-4 Test Port Output

8753ET Test Port Output		
Description	Specification	Supplemental Information
<b>Frequency</b>		
Range		
Standard	300 kHz to 3.0 GHz	10 kHz to 3 GHz, typ.
Option 006	300 kHz to 6.0 GHz	10 kHz to 6 GHz, typ.
Resolution	1 Hz	
Stability		
Standard		±7.5 ppm, 0° to 55 °C, typ. ±3 ppm/year, typ.
Option 1D5		±0.05 ppm, 0° to 55 °C, typ. ±0.5 ppm/year, typ.
CW Accuracy	±10 ppm	at 25 °C ±5 °C
<b>Output Power (above 300 kHz)</b>		
Level Accuracy <sup>a</sup>		
With Option 004 Attenuator	±1.0 dB	at -10 dBm output level
Without Attenuator	±1.0 dB	at -5 dBm output level
Maximum Leveled Power <sup>b</sup>		
With Option 004 Attenuator		+10 dBm, char.
Without Attenuator		+5 dBm, char.
Power Range <sup>c</sup>		
With Option 004 Attenuator	-85 to +10 dBm	
Without Attenuator	-20 to +5 dBm	
Power Sweep Range		
With Option 004 Attenuator	25 dB	33 dB, typ.
Without Attenuator	25 dB	33 dB, typ.

- a. Absolute power accuracy at a given power level. Includes absolute accuracy and relative flatness across frequency.
- b. At any given frequency, the achievable power while remaining leveled. Applies to CW mode only.
- c. Power to which the source can be set and phase lock is assured.

**Table 2-5 Test Port Output**

8753ET Test Port Output		
Description	Specification	Supplemental Information
<b>Output Power<sup>a</sup> (above 300 kHz)</b>		
Power Resolution	0.01 dB	
Attenuator Switch Points (Option 004 Only):		
<p>TEST PORT POWER (dBm)</p> <p>RANGE NUMBER</p> <p>EXAMPLE:          -32dBm          WILL SET RANGE 3          &amp; ADJ. ALC FOR THIS LEVEL</p> <p>KEY:          UPPER RANGE LIMIT          "OPTIMUM RANGE"          LOWER RANGE LIMIT</p>		

a. Source output performance on port 1 only. Port 2 output performance is a characteristic.



**Table 2-6 Test Port Output**

8753ET Test Port Output			
Description	Specification	Supplemental Information	
<b>Output Power (above 300 kHz)</b>			
Linearity <sup>a</sup>			
Standard			
-20 to -15 dBm	±0.5 dB	relative to -5 dBm output level	
-15 to 0 dBm	±0.2 dB	relative to -5 dBm output level	
0 to +15 dBm	±0.5 dB	relative to -5 dBm output level	
Option 004			
-15 to +5 dBm	±0.2 dB	relative to 0 dBm output level	
+5 to +10 dBm	±0.5 dB	relative to 0 dBm output level	
<b>Impedance</b>			
Standard		50 Ω, nom.	
<b>Return Loss</b>			
Standard			
300 kHz to 3 GHz		> 20 dB, typ.	
3 GHz to 6 GHz		> 14 dB, typ.	
Option 004			
300 kHz to 3 GHz		> 18 dB, typ.	
3 GHz to 6 GHz		> 14 dB, typ.	
<b>Attenuator Accuracy<sup>b</sup> (Option 004 only)</b>			
0 dB		reference; at 50 MHz	
		300 kHz to 3 GHz	3 GHz to 6 GHz
10 dB		± 0.2 dB, char.	± 0.5 dB, char.
20 dB		± 0.4 dB, char.	± 0.7 dB, char.
30 dB		± 0.5 dB, char.	± 0.9 dB, char.
40 dB		± 0.7 dB, char.	± 1.2 dB, char.
50 dB		± 0.8 dB, char.	± 1.5 dB, char.
60 dB		± 1.0 dB, char.	± 1.8 dB, char.

- a. Change in source output power for a given change in source power setting at any given frequency.
- b. The accuracy, relative to the 0 dB setting, of each setting of an attenuator, at a given frequency.

**Table 2-7 Test Port Output**

<b>8753ET Test Port Output</b>		
<b>Description</b>	<b>Specification</b>	<b>Supplemental Information</b>
<b>Signal Purity</b>		
2nd Harmonic  at the maximum output power at 10 dB below maximum output power at 20 dB below maximum output power		16 MHz to 1.5 GHz (source frequency) 16 MHz to 3 GHz (Option 006, source frequency) < -25 dBc, char. (Option 002)  < -40 dBc, typ.  < -50 dBc, typ.
3rd Harmonic  at the maximum output power at 10 dB below maximum output power at 20 dB below maximum output power		16 MHz to 1 GHz (source frequency) 16 MHz to 2 GHz (Option 006, source frequency) < -25 dBc, char. (Option 002)  < -40 dBc, typ.  < -50 dBc, typ.
Non-harmonic Spurious Mixer Related  at maximum output power at 20 dB below maximum output power		< -30 dBc, typ. < -55 dBc, typ.

## Test Port Input

Table 2-8 Test Port Input

8753ET Test Port Input		
Description	Specification	Supplemental Information
<b>Frequency Range</b>		
Standard	300 kHz to 3.0 GHz	10 kHz to 3 GHz, typ.
Option 006	300 kHz to 6.0 GHz	10 kHz to 6 GHz, typ.
<b>Frequency Response (Transmission)</b>		
300 kHz to 3 GHz	±1 dB	at preset power level
3 GHz to 6 GHz	±2 dB	at preset power level
<b>Impedance</b>		
Standard		50 Ω, nominal.
<b>Return Loss</b>		
Standard		See uncorrected load match chart.
<b>Maximum Input Level</b>		
Transmission Port	0 dBm	
Reflection Port	+10 dBm	
Compression		See dynamic accuracy chart
<b>Damage Level</b>		
Standard		> +20 dBm or > 35 Vdc, typ.
<b>Noise Floor<sup>a</sup></b>		
8753ET Transmission Port		
300 kHz to 3 GHz		
3 kHz IF Bandwidth	≤ -90 dBm	≤ -120 dBm, typ.
10 Hz IF Bandwidth	≤ -110 dBm	
3 GHz to 6 GHz		
3 kHz IF Bandwidth	≤ -85 dBm	≤ -114 dBm, typ.
10 Hz IF Bandwidth	≤ -105 dBm	

a. RMS value of a linear magnitude trace expressed in dBm.

**Table 2-9 Test Port Input**

<b>8753ET Test Port Input</b>		
<b>Description</b>	<b>Specification</b>	<b>Supplemental Information</b>
<b>Internally Generated Harmonics (Option 002 Only)</b>		
2nd Harmonic at 0 dBm input level at -10 dBm input level at -25 dBm input level		16 MHz to 3 GHz < -15 dBc, char. < -30 dBc, typ. < -45 dBc, typ.
3rd Harmonic at 0 dBm input level at -10 dBm input level at -25 dBm input level		16 MHz to 2 GHz < -30 dBc, char. < -50 dBc, typ. < -50 dBc, typ.
<b>Harmonic Measurement Accuracy</b>		
16 MHz to 3 GHz		±1.5 dB, char.
3 GHz to 6 GHz		±3 dB, char.
<b>Harmonic Measurement Dynamic Range</b>		
Standard		-40 dBc, typ. output at -10 dBm and input at < -15 dBm

**Table 2-10 Test Port Input**

<b>8753ET Test Port Input</b>		
<b>Description</b>	<b>Specification</b>	<b>Supplemental Information</b>
<b>Frequency Offset Operation<sup>a</sup></b>		
Frequency Range		
Standard	300 kHz to 3 GHz	
Option 006	300 kHz to 6 GHz	
R Channel Input Requirements		
300 kHz to 3 GHz	0 to -35 dBm	
3 GHz to 6 GHz	0 to -30 dBm	
LO Spectral Purity and Accuracy		
Maximum Spurious Input		< -25 dBc, typ.
Residual FM		< 20 kHz, typ.
Frequency Accuracy		-1 to +1 MHz of nominal frequency, typ.
<b>External Source Mode<sup>b</sup></b>		
Frequency Range		
Standard	300 kHz to 3 GHz	at -25 dBm R channel power level
Option 006	300 kHz to 6 GHz	
R Input Requirements		
Power Level		0 to -25 dBm, typ.
R Input Spectral Purity Requirement		
Maximum Spurious Input		< -30 dBc, typ.
Residual FM		< 20 kHz, typ.
Settling Time		
Auto		500 ms, typ.
Manual		50 ms, typ.
Frequency Readout Accuracy		0.1%, auto, typ.
Input Frequency Accuracy Requirement		
Manual		-0.5 to 5 MHz, typ.

a. The RF source characteristics in this mode are dependent on the stability of the external LO source. The RF source tracks the LO to maintain a stable IF signal at the R channel receiver input.

b. Measurement accuracy is dependent on the stability of the input signal.

**Table 2-11 Test Port Input**

8753ET Test Port Input		
Description	Specification	
	System Bandwidths	
	3000 Hz	10 Hz
<b>Trace Noise<sup>a</sup></b>		
Magnitude		
300 kHz to 3GHz	< 0.006 dB rms	< 0.001 dB rms
3 GHz to 6 GHz	< 0.010 dB rms	< 0.002 dB rms
Phase		
300 kHz to 3GHz	< 0.038° rms	< 0.006° rms
3 GHz to 6 GHz	< 0.070° rms	< 0.012° rms

a. Trace noise is defined for a ratio measurement. For the transmission measurement (B/R), the connection is a 0 dB loss thru with 0 dBm into the receiver. For a reflection measurement (A/R), an open is used on the Reflection port with +5 dBm reflected power.

**Table 2-12 Test Port Input**

8753ET Test Port Input		
Description	Specification	Supplemental Information
<b>Reference Level</b>		
Magnitude		
Range	± 500 dB	
Resolution	0.001 dB	
Phase		
Range	± 500°	
Resolution	0.01°	
<b>Stability (Ratio Measurement)</b>		
Magnitude		
300 kHz to 3 GHz		0.02 dB/°C, typ.
3 GHz to 6 GHz		0.04 dB/°C, typ.
Phase		
300 kHz to 3 GHz		0.05 deg/°C, typ.
3 GHz to 6 GHz		0.20 deg/°C, typ.

**Table 2-13 Test Port Input**

8753ET Test Port Input	
<b>Dynamic Accuracy (Characteristic)</b>	
For the transmission port, accuracy of the test port input power reading relative to the reference input power level.	
<ul style="list-style-type: none"> <li>• Input: transmission port</li> <li>• For test port powers &gt; -60 dBm and &lt; -10 dBm, magnitude dynamic accuracy is 0.02 dB + 0.001 dB/dB from the reference power, phase dynamic accuracy is 0.132 deg + 0.0066 deg/dB from the reference power.</li> </ul>	
<p><b>Magnitude</b></p>	<p><b>Phase</b></p>
<p><b>Magnitude</b></p>	<p><b>Phase</b></p>

**Table 2-14 Test Port Input**

8753ET Test Port Input	
<b>Dynamic Accuracy (Characteristic)</b>	
For the reflection port, accuracy of the test port input power reading relative to the reference input power level.	
<ul style="list-style-type: none"> <li>• Input: reflection port</li> <li>• For test port powers &gt; -50 dBm and &lt; 0 dBm, magnitude dynamic accuracy is 0.02 dB + 0.001 dB/dB from the reference power, phase dynamic accuracy is 0.132 deg + 0.0066 deg/dB from the reference power.</li> <li>• For frequencies &lt; 2 MHz, the accuracy is degraded 0.1 dB above 5 dBm test port power.</li> </ul>	
<p><b>Magnitude</b></p> <p>8753ET Port 1</p>	<p><b>Phase</b></p> <p>3753ET Port 1</p>
<p><b>Magnitude</b></p> <p>8753ET Port 1</p>	<p><b>Phase</b></p> <p>8753ET Port 1</p>



**Table 2-15 Test Port Input**

<b>8753ET R-Channel Input</b>		
<b>Dynamic Accuracy (Typical)</b>		
Accuracy of the R-channel power reading relative to the R-channel reference power level. This chart applies when the calibrated power level and the measurement power level are not the same.		
<ul style="list-style-type: none"> <li>Inputs: R-channel</li> </ul>		
	<b>300 KHz to 3 GHz</b>	<b>3 to 6 GHz</b>
<b>Magnitude Dynamic Accuracy for Test Port Powers</b>		
> -50 dBm and < 0 dBm	.02 dB + .001 dB/dB from the reference power	.02 dB + .001 dB/dB from the reference power
> 0 dBm and < 10 dBm	.02 dB + .02 dB/dB above 0 dBm	.02 dB + .03 dB/dB above 0 dBm
<b>Phase Dynamic Accuracy for Test Port Powers</b>		
> -50 dBm and < 0 dBm	.132 deg + .0066 deg/dB from the reference power	.132 deg + .0066 deg/dB from the reference power
> 0 dBm and < 10 dBm	.132 deg + .132 deg/dB above 0 dBm	.132 deg + .198 deg/dB above 0 dBm

## General Information

**Table 2-16 General Information**

<b>8753ET General Information</b>		
<b>Description</b>	<b>Specification</b>	<b>Supplemental Information</b>
<b>Display Range</b>		
Magnitude	± 200 dB (at 20 dB/div), max	
Phase	± 180°, max	
Polar	10 pico units, min 1000 units, max	
<b>Display Resolution</b>		
Magnitude	0.001 dB/div, min	
Phase	0.1°/div, min	
<b>Reference Level Range</b>		
Magnitude	± 500 dB, max	
Phase	± 360°, max	
<b>Reference Level Resolution</b>		
Magnitude	0.001 dB, min	
Phase	0.01°, min	
<b>Marker Resolution</b>		
Magnitude	0.001 dB, min	
Phase	0.01°, min	
Polar	0.01 mUnit, min; 0.01, min	

**Table 2-17 General Information**

8753ET General Information		
Description	Specification	Supplemental Information
<b>Group Delay<sup>a</sup></b>		
Aperture (selectable)	(frequency span)/(number of points - 1)	
Maximum Aperture	20% of frequency span	
Range	$1/2 \times (1/\text{minimum aperture})$	
Maximum Delay		Limited to measuring no more than 180° of phase change within the minimum aperture.
Accuracy		See graph. Char.

The following graph shows group delay accuracy with 7-mm full 2-port calibration and a 10 Hz IF bandwidth. Insertion loss is assumed to be < 2 dB and electrical length to be ten meters.

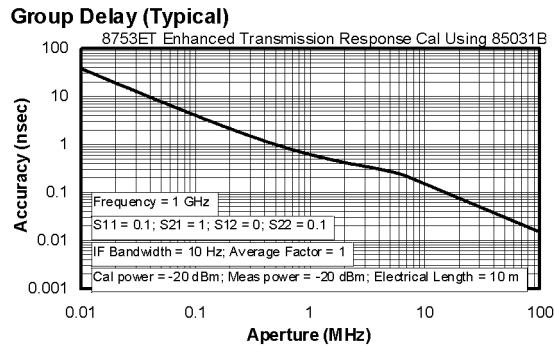

In general, the following formula can be used to determine the accuracy, in seconds, of specific group delay measurement:

$$\pm \text{Relative Phase Accuracy}^b \text{ (deg)} / [360 \times \text{Aperture (Hz)}]$$

Depending on the aperture and device length, the phase accuracy used is either phase dynamic accuracy specification or worst case transmission uncertainty phase specification.

- Group delay is computed by measuring the phase change within a specified frequency step (determined by the frequency span and the number of points per sweep).
- Relative phase accuracy is an unspecified parameter. For very narrow apertures with short devices under test RF systematic error terms can be assumed constant. As aperture and/or device electrical length increase RF systematic errors become increasingly important, eventually relative phase accuracy is the same as absolute phase accuracy.

**Table 2-18 General Information**

<b>8753ET General Information</b>	
<b>Description</b>	<b>Supplemental Information</b>
<b>System Bandwidths</b>	
IF bandwidth settings	6000 Hz, nom. 3700 Hz, nom. 3000 Hz, nom. 1000 Hz nom. 300 Hz, nom. 100 Hz, nom. 30 Hz, nom. 10 Hz, nom.
<b>Rear Panel</b>	
External Auxiliary Input Connector Range	Female BNC 10 V, typ.
External Trigger Damage Level	Triggers on a positive or negative TTL transition or contact closure to ground. < -0.2 V; > +5.2 V, typ.
Limit Test Output Damage Level	Female BNC. < -0.2 V; > +5.2 V, typ.
Test Sequence Output	Outputs a TTL signal which can be set to a TTL high pulse (default) or low pulse at end of sweep; or a fixed TTL high or low. If limit test is on, the end of sweep pulse occurs after the limit test is valid. This is useful when used in conjunction with test sequencing.
Test Set Interconnect	25-pin-D-sub (DB-25) female; use for external special test sets (K36, K39, etc.)
Measure Restart	Floating closure to restart measurement.
External AM Input	$\pm 1$ volt into a 5 k $\Omega$ resistor, 1 kHz maximum, resulting in approximately 8 dB/volt amplitude modulation.
High Stability Frequency Reference Output (10 MHz) (Option 1D5) Frequency Frequency Stability (0 °C to 55 °C) Daily aging rate (after 30 days) Yearly aging rate Output Output Impedance	10.0000 MHz, char. $\pm 0.05$ ppm, char. < $3 \times 10^{-9}$ /day, char. $\pm 0.5$ ppm/year, char. $\geq 0$ dBm, char. 50 $\Omega$ , nom.

**Table 2-19 General Information**

<b>8753ET General Information</b>		
<b>Description</b>	<b>Specification</b>	<b>Supplemental Information</b>
<b>Rear Panel</b>		
External Reference In Input Frequency Input Power Input Impedance	1, 2, 5, and 10 MHz	± 200 Hz at 10 MHz –10 dBm to +20 dBm, typ. 50 Ω, nom.
VGA Video Output		15-pin mini D-Sub; female. Drives VGA compatible monitors.
GPIB		Type-57, 24-pin; Microribbon female
Parallel Port		25-pin D-Sub (DB-25); female; may be used as printer port or general purpose I.O. port
RS232		9-pin D-Sub (DB-9); male
Mini-DIN Keyboard/Barcode Reader		6-pin mini DIN (PS/2); female
Line Power Frequency Voltage at 115 V setting Voltage at 220 V setting VA Maximum	47 Hz to 66 Hz 90 V to 132 V 198 V to 265 VAC 350 VA max	A third-wire ground is required.  115 V, nom. 230 V, nom.
<b>Front Panel</b>		
RF Connectors		Type-N, 50 ohm
Probe Power Positive Supply  Negative Supply	400 mA, max  300 mA, max	3-pin connector; male +15 V ± 2%, char. the maximum combined load for both probe connectors, char. – 12.6 V ± 5%, char. the maximum combined load for both probe connectors, char.

**Table 2-20 General Information**

<b>8753ET General Information</b>	
<b>Description</b>	<b>Specification</b>
<b>Front Panel</b>	
Display Pixel Integrity	
Red, Green, or Blue Pixels	<p>Red, green, or blue "stuck on" pixels may appear against a black background. In a properly working display, the following will not occur:</p> <ul style="list-style-type: none"> <li>• complete rows or columns of stuck pixels</li> <li>• more than 5 stuck pixels (not to exceed a maximum of 2 red or blue, and 3 green)</li> <li>• 2 or more consecutive stuck pixels</li> <li>• stuck pixels less than 6.5 mm apart</li> </ul>
Dark Pixels	<p>Dark "stuck on" pixels may appear against a white background. In a properly working display, the following will not occur:</p> <ul style="list-style-type: none"> <li>• more than 12 stuck pixels (not to exceed a maximum of 7 red, green, or blue)</li> <li>• more than one occurrence of 2 consecutive stuck pixels</li> <li>• stuck pixels less than 6.5 mm apart</li> </ul>

**Table 2-21 General Information**

<b>8753ET General Information</b>		
<b>Description</b>	<b>Specification</b>	<b>Supplemental Information</b>
<b>General Environmental</b>		
RFI/EMI Susceptibility		Defined by CISPR Pub. 11 and FCC Class B standards.
ETD		Minimize using static-safe work procedures and an antistatic bench mat (part number 9300-0797).
Dust		Minimize for optimum reliability.
<b>Operating Environment</b>		
Temperature	0 °C to +55 °C	Instrument powers up, phase locks, and displays no error messages within this temperature range.
Error-corrected temperature range		see system specifications
Humidity	5% to 95% at +40 °C (non-condensing)	
Altitude	0 to 4.5 km (15,000 ft)	
<b>Storage Conditions</b>		
Temperature	-40 °C to +70 °C	
Humidity	0% to 95% RH at +65 °C (non-condensing)	
Altitude	0 to 15.24 km (50,000 ft)	
<b>Cabinet Dimensions</b>		
Height x Width x Depth		222 x 425 x 457 mm, nom. (8.75 x 16.75 x 18 in, nom.) Cabinet dimensions exclude front and rear protrusions.
<b>Weight</b>		
Shipping		32 kg (77 lb), nom.
Net		24 kg (53 lb), nom.
<b>Internal Memory - Data Retention Time with 3 V, 1.2 Ah Battery<sup>a</sup></b>		
70 °C		250 days (0.68 year), char.
40 °C		1244 days (3.4 years), char.
25 °C		10 years, char.

a. Analyzer power is switched off.

## Speed Parameters

**Table 2-22 Measurement and Data Transfer Speed Performance**

Typical Time for Completion (ms)				
Description	Number of Points			
	51	201	401	1601
Typical Time for Completion (in ms), Center 1 GHz, Span 10 MHz, IFBW=6000				
Uncorrected	32	70	121	423
1-port and Enhanced Response cal <sup>a</sup>	35	71	127	440
2-port cal <sup>b</sup>	62	139	240	848
Typical Time for Completion (in ms), Start 30 kHz, Stop 3 GHz, IFBW=6000				
Uncorrected	202	270	304	615
1-port and Enhanced Response cal	202	270	304	615
2-port cal	402	540	607	1237
Typical Time for Completion (in ms), Start 30 kHz, Stop 6 GHz, IFBW=6000				
Uncorrected	310	380	415	658
1-port and Enhanced Response cal	310	380	415	658
2-port cal	618	757	829	1315
Time Domain <sup>c</sup> (increase over uncorrected sweep time)				
Conversions	12	42	86	378
Gating (Frequency Domain)	14	40	80	349
GPIB Data Transfer <sup>d</sup> :				
Binary (Internal)	10	16	21	58
IEEE754 floating point format				
32 bit	11	19	28	83
64 bit	13	26	42	141
ASCII	35	112	214	831

- a. S11 1-port calibration, with a 6 kHz IF bandwidth. Includes system retrace time, but does not include bandswitch time. Time domain gating is assumed off.
- b. S21 measurement with full 2-port calibration, using a 6 kHz IF bandwidth. Includes system retrace time and RF switching time, but does not include bandswitch time. Time domain gating is assumed off.
- c. Option 010 only, gating off.
- d. Measured with HP Omnibook 7100 Pentium computer.



**Table 2-23 Recall and Sweep Speed Performance**

Operations	Channel	Points	Raw Offset	Total Time, typical (secs)		Recall-Only Time, typical (secs)	
				Blank Off	Blank On	Blank Off	Blank On
<b>Error Correction ON</b>							
Recall and Sweep	Single Chan.	201	On	0.389	0.260	0.250	0.126
Recall and Sweep	Single Chan.	201	Off	0.340	0.210	0.201	0.077
Sweep only (no Recall)	Single Chan.	201	N/A	0.139	0.134	N/A	N/A
Recall and Sweep	Single Chan.	1601	On	1.480	1.347	0.632	0.506
Recall and Sweep	Single Chan.	1601	Off	1.102	0.969	0.254	0.128
Sweep only (no Recall)	Single Chan.	1601	N/A	0.848	0.841	N/A	N/A
Recall and Sweep	Dual Chan.	201	On	0.539	0.389	0.357	0.215
Recall and Sweep	Dual Chan.	201	Off	0.489	0.328	0.308	0.154
Sweep only (no Recall)	Dual Chan.	201	N/A	0.182	0.174	N/A	N/A
Recall and Sweep	Dual Chan.	1601	On	2.386	2.219	1.208	1.049
Recall and Sweep	Dual Chan.	1601	Off	2.007	1.839	0.829	0.669
Sweep only (no Recall)	Dual Chan.	1601	N/A	1.178	1.170	N/A	N/A
<b>Error Correction OFF</b>							
Recall and Sweep	Single Chan.	201	On	0.240	0.147	0.170	0.082
Recall and Sweep	Single Chan.	201	Off	0.227	0.134	0.157	0.069
Sweep only (no Recall)	Single Chan.	201	N/A	0.070	0.065	N/A	N/A
Recall and Sweep	Single Chan.	1601	On	0.675	0.587	0.252	0.168
Recall and Sweep	Single Chan.	1601	Off	0.581	0.491	0.157	0.073
Sweep only (no Recall)	Single Chan.	1601	N/A	0.423	0.419	N/A	N/A
Recall and Sweep	Dual Chan.	201	On	0.306	0.170	0.235	0.104
Recall and Sweep	Dual Chan.	201	Off	0.281	0.145	0.211	0.080
Sweep only (no Recall)	Dual Chan.	201	N/A	0.071	0.066	N/A	N/A
Recall and Sweep	Dual Chan.	1601	On	0.802	0.692	0.377	0.273
Recall and Sweep	Dual Chan.	1601	Off	0.613	0.503	0.188	0.084
Sweep only (no Recall)	Dual Chan.	1601	N/A	0.424	0.419	N/A	N/A
Instrument State: CF = 1 GHz, Span = 2 MHz, IF BW = 6 kHz. GPIB commands sent for timing are Recall;OPC?;SING; or, for sweep only, OPC?;SING;.							

**Table 2-24 Sweep Time vs. IF Bandwidth**

<b>IF Bandwidth</b>	<b>Typical Sweep Time (seconds) <sup>a</sup></b>
6000	0.070
3700	0.095
3000	0.121
1000	0.248
300	0.704
100	2.022
30	6.987
10	21.365

a. Preset condition, CF = 1 GHz, Span = 100 MHz; includes retrace time, 201 points.

**Table 2-25 Sweep Time vs. Number of Points**

<b>Number of Points</b>	<b>Typical Sweep Time (seconds)<sup>a</sup></b>
51	0.039
101	0.057
201	0.095
401	0.171
801	0.323
1601	0.625

a. Preset condition, CF = 1 GHz, Span = 100 MHz, Correction off; includes retrace time.  
Measurement speed can be improved by selecting the widest IF bandwidth setting of 6000 Hz.

**Power Meter Calibration Accuracy**

**Table 2-26 Power Meter Calibration Sweep Speed and Accuracy**

<b>Power Desired at Test Port</b>	<b>Number of Readings</b>	<b>Sweep Time Setting (seconds) <sup>a</sup></b>	<b>Characteristic Accuracy (dB) <sup>b</sup></b>
+5 dBm	1	33	±0.7
	2	64	±0.2
	3	95	±0.1
-15 dBm	1	48	±0.7
	2	92	±0.2
	3	123	±0.1
-30 dBm	1	194	±0.7
	2	360	±0.2
	3	447	±0.1

- a. Sweep speed applies to every sweep in continuous correction mode, and to the first sweep in sample-and-sweep mode. Subsequent sweeps in sample-and-sweep mode will be much faster.
- b. The accuracy values were derived by combining the accuracy of the power meter and linearity of the analyzer's internal source, as well as the mismatch uncertainty associated with the power sensor.



---

## **3 Front/Rear Panel**

## Front Panel Features

**CAUTION** Do not mistake the line switch for the disk eject button. See the following illustrations. If the line switch is mistakenly pushed, the instrument will be turned off, losing all settings and data that have not been saved.

**Figure 3-1 8753ES Front Panel**

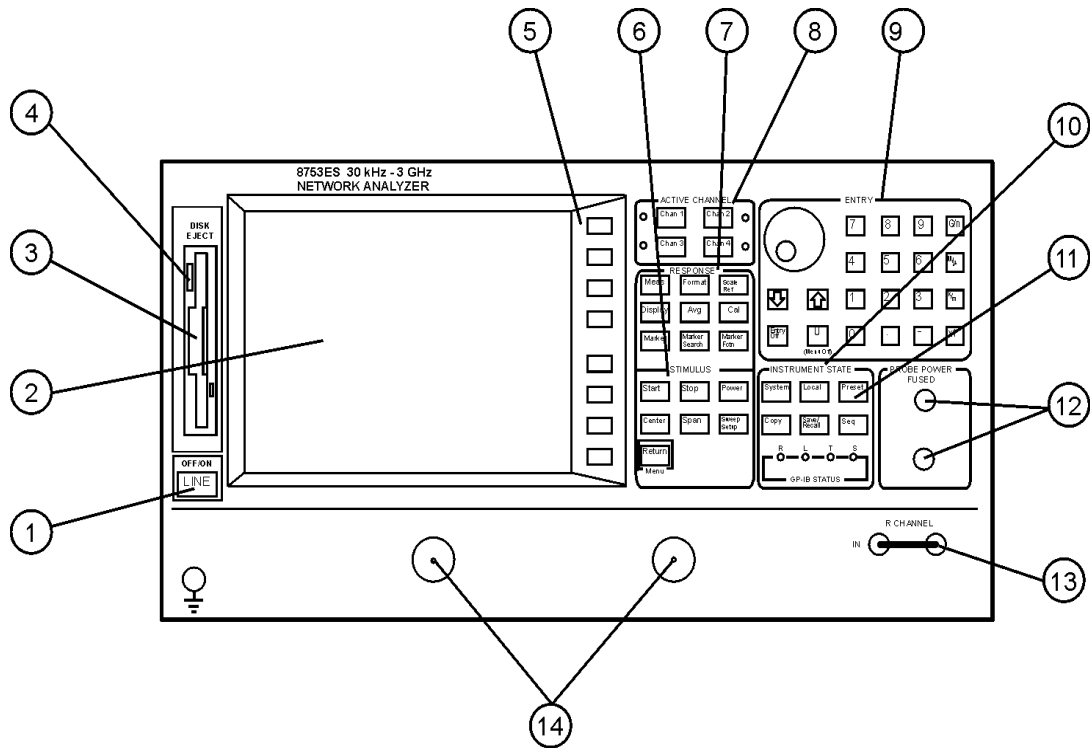

ka51e

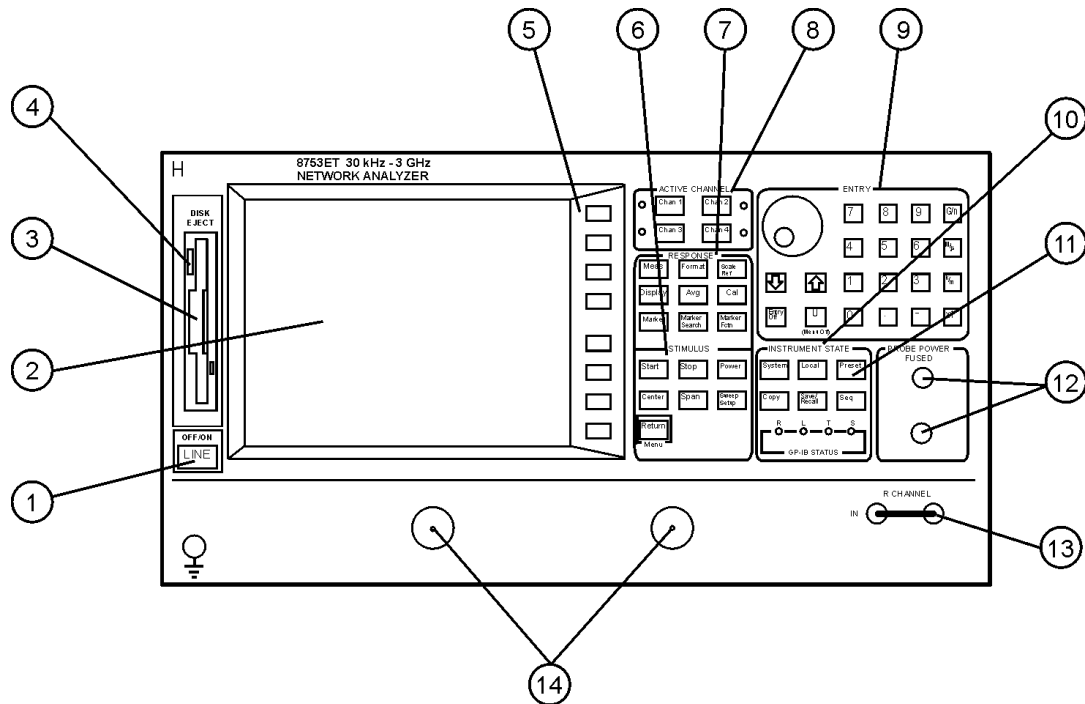

**Figure 3-2 8753ET Front Panel**



ka52e

The location of the following front panel features and key function blocks is shown in [Figure 3-1](#) and [Figure 3-2](#). These features are described in more detail later in this chapter, and in [Chapter 5](#), “[Hardkey/Softkey Reference](#),”.

1. **LINE switch.** This switch controls ac power to the analyzer. 1 is on, 0 is off.
2. **Display.** This shows the measurement data traces, measurement annotation, and softkey labels. The display is divided into specific information areas, illustrated in [Figure 3-3](#).
3. **Disk drive.** This 3.5 inch floppy-disk drive allows you to store and recall instrument states and measurement results for later analysis.
4. **Disk eject button.**
5. **Softkeys.** These keys provide access to menus that are shown on the display.
6. **STIMULUS function block.** The keys in this block allow you to control the analyzer source's frequency, power, and other stimulus functions.
7. **RESPONSE function block.** The keys in this block allow you to control the measurement and display functions of the active display channel.
8. **ACTIVE CHANNEL keys.** The analyzer has two independent primary channels and two auxiliary channels. These keys allow you to select the active channel. Any function you enter applies to the selected channel.

9. **The ENTRY block.** This block includes the knob, the step   keys, the number pad, and the backspace key. These allow you to enter numerical data and control the markers.
- You can use the numeric keypad to select digits, decimal points, and a minus sign for numerical entries. You must also select a units terminator to complete value inputs.
- The backspace key has two independent functions: it modifies entries, and it turns off the softkey menu so that marker information can be moved off of the grids and into the softkey menu area. For more details, refer to the “Making Measurements” chapter in the user’s guide.
10. **INSTRUMENT STATE function block.** These keys allow you to control channel-independent system functions such as the following:
- copying, save/recall, and GPIB controller mode
  - limit testing
  - external source mode
  - tuned receiver mode
  - frequency offset mode
  - test sequence function
  - harmonic measurements (Option 002)
  - time domain transform (Option 010)
- GPIB STATUS indicators are also included in this block.
11.  key. This key returns the instrument to either a known factory preset state, or a user preset state that can be defined. Refer to [Chapter 8](#), “Preset State and Memory Allocation,” for a complete listing of the instrument preset condition.
12. **PROBE POWER connectors.** These connector (fused inside the instrument) supply power to an active probe for in-circuit measurements of ac circuits.
13. **R CHANNEL connectors.** These connectors allow you to apply an input signal to the analyzer's R channel, for frequency offset mode.
14. (ES) **PORT 1 and PORT 2.** These ports output a signal from the source and receive input signals from a device under test. PORT 1 allows you to measure  $S_{12}$  and  $S_{11}$ . PORT 2 allows you to measure  $S_{21}$  and  $S_{22}$ .
14. (ET) **REFLECTION and TRANSMISSION ports.** The REFLECTION port outputs a signal from the source and allows you to make reflection measurements. The TRANSMISSION port receives input signals from a device under test and allows you to make transmission measurements.



## Analyzer Display

**Figure 3-3 Analyzer Display (Single Channel, Cartesian Format)**

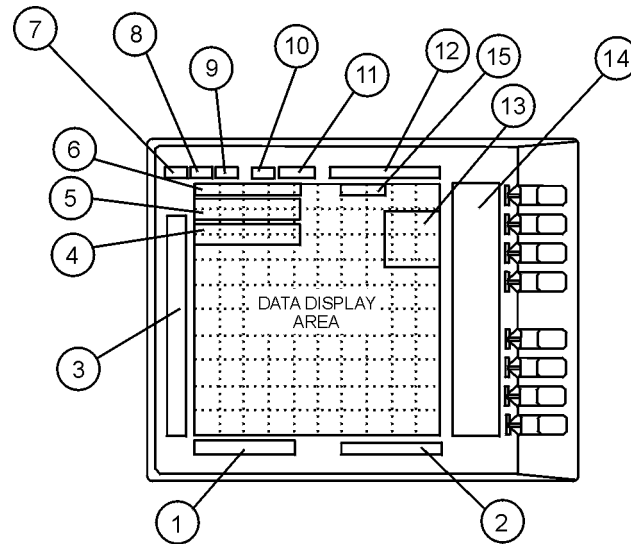

ka531e

The analyzer display shows various measurement information:

- The grid where the analyzer plots the measurement data.
- The currently selected measurement parameters.
- The measurement data traces.

Figure 3-3 illustrates the locations of the different information labels described below.

In addition to the full-screen display shown in the illustration above, multi-graticule and multi-channel displays are available, as described in the “Making Measurements” chapter of the user’s guide.

Several display formats are available for different measurements, as described under **Format** in Chapter 5, “Hardkey/Softkey Reference.”

1. **Stimulus Start Value.** This value could be any one of the following:
  - The start frequency of the source in frequency domain measurements.
  - The start time in CW mode (0 seconds) or time domain measurements.
  - The lower power value in power sweep.

When the stimulus is in center/span mode, the center stimulus value is shown in this space. The color of the stimulus display reflects the current active channel.

2. **Stimulus Stop Value.** This value could be any one of the following:
- The stop frequency of the source in frequency domain measurements.
  - The stop time in time domain measurements or CW sweeps.
  - The upper limit of a power sweep.

When the stimulus is in center/span mode, the span is shown in this space. The stimulus values can be blanked, as described under the **FREQUENCY BLANK** softkey in [Chapter5 ,“Hardkey/Softkey Reference.”](#)

(For CW time and power sweep measurements, the CW frequency is displayed centered between the start and stop times or power values.)

3. **Status Notations.** This area shows the current status of various functions for the active channel.

The following notations are used:

<b>Avg</b>	Sweep-to-sweep averaging is on. The averaging count is shown immediately below. (See the <b>Avg</b> key in <a href="#">Chapter5 ,“Hardkey/Softkey Reference.”</a> )
<b>Cor</b>	Error correction is on. (For error-correction procedures, refer to the “Calibrating for Increased Measurement Accuracy” chapter in the user’s guide. For error correction theory, refer to the “Operating Concepts” chapter of the user’s guide.
<b>CΔ</b>	Stimulus parameters have changed from the error-corrected state, or interpolated error correction is on. (For error-correction procedures, refer to the “Calibrating for Increased Measurement Accuracy” chapter in the user’s guide. For error correction theory, refer to the “Operating Concepts” chapter of the user’s guide.
<b>C2 (ES)</b>	Full two-port error-correction is on and the reverse sweep is not updated each sweep  Any one of the following causes the reverse sweep not to be updated each sweep: <ul style="list-style-type: none"><li>• the instrument uses a mechanical switch, for example Options 85 and 007.</li><li>• different channel power ranges (PORT POWER UNCOUPLED) which puts the test set switch in HOLD mode except Option 400 (dual step attenuators).</li><li>• the user manually puts the test set switch in HOLD mode (TESTSET SW 0 or &gt;1).</li></ul>
<b>Del</b>	Electrical delay has been added or subtracted, or port extensions are active. (See the “Operating Concepts” chapter of the user’s guide and the <b>Scale Ref</b> key in <a href="#">Chapter5 ,“Hardkey/Softkey Reference.”</a> )

<b>ext</b>	Waiting for an external trigger.
<b>Ofs</b>	Frequency offset mode is on. (See the “Making Mixer Measurements” chapter in the user’s guide.)
<b>Of?</b>	Frequency offset mode error, the IF frequency is not within 10 MHz of expected frequency. LO inaccuracy is the most likely cause. (See the “Making Mixer Measurements” chapter in the user’s guide.)
<b>Gat</b>	Gating is on (time domain Option 010 only). (For time domain measurement procedures and theory, refer to the “Making Time Domain Measurements” chapter of the user’s guide.)
<b>H=2</b>	Harmonic mode is on, and the second harmonic is being measured (harmonics Option 002 only). (See <a href="#">Chapter7 ,“Options and Accessories.”</a> )
<b>H=3</b>	Harmonic mode is on, and the third harmonic is being measured (harmonics Option 002 only). (See <a href="#">Chapter7 ,“Options and Accessories.”</a> )
<b>Hld</b>	Hold sweep. (See <b>HOLD</b> in <a href="#">Chapter5 ,“Hardkey/Softkey Reference.”</a> )
<b>man</b>	Waiting for manual trigger.
<b>PC</b>	Power meter calibration is on. (For power meter calibration procedures, refer to the “Calibrating for Increased Measurement Accuracy” chapter of the user’s guide.)
<b>PC?</b>	The analyzer's source could not be set to the desired level, following a power meter calibration. (For power meter calibration procedures, refer to the “Calibrating for Increased Measurement Accuracy” chapter in the user’s guide.)
<b>P?</b>	Source power is unlevelled at start or stop of sweep. (Refer to the service guide for troubleshooting.)
<b>P↓</b>	Source power has been automatically set to minimum, due to receiver overload. (See <b>POWER</b> in <a href="#">Chapter5 ,“Hardkey/Softkey Reference.”</a> )
<b>PRm</b>	(ES or ET Option 004) Power range is in manual mode.
<b>Smo</b>	Trace smoothing is on. (See <a href="#">Avg</a> in <a href="#">Chapter5 ,“Hardkey/Softkey Reference.”</a> )

- tsH** (ES or ET Option 004) Indicates that the test set hold mode is engaged. That is, a mode of operation is selected which would cause repeated switching of the step attenuator. This hold mode may be overridden. See **MEASURE RESTART** or **NUMBER OF GROUPS** in Chapter 5, “Hardkey/Softkey Reference.”
- ↑ Fast sweep indicator. This symbol is displayed in the status notation block when sweep time is  $\leq 1.0$  second. When sweep time is  $\geq 1.0$  second, this symbol moves along the displayed trace.
- \* Source parameters changed: measured data in doubt until a complete fresh sweep has been taken.

4. **Active Entry Area.** This displays the active function and its current value.
5. **Message Area.** This displays prompts or error messages.
6. **Title.** This is a descriptive alphanumeric string title that you define and enter through an attached keyboard or as described in the “Printing, Plotting, and Saving Measurement Results” chapter of the user’s guide.
7. **Active Channel.** This is the label for the number for the active channel, selected with the **Chan 1**, **Chan 2**, **Chan 3**, and **Chan 4** keys.  
  
If multiple channels are overlaid, the labels will appear in this area. The active channel is denoted by a rectangle around the channel number.  
  
For multiple-graticule displays, the channel information labels will be in the same relative position for each graticule.

---

**NOTE** The label of the active channel is enclosed in a rectangle to differentiate it from inactive channels.

---

8. **Measured Input(s).** This shows the parameter, input, or ratio of inputs currently measured, as selected using the **Meas** key. Also indicated in this area is the current display memory status.
9. **Format.** This is the display format that you selected using the **Format** key.
10. **Scale/Div.** This is the scale that you selected using the **Scale Ref** key, in units appropriate to the current measurement.
11. **Reference Level.** This value is the reference line in Cartesian formats or the outer circle in polar formats, whichever you selected using the **Scale Ref** key. The reference level is also indicated by a small triangle adjacent to the graticule, at the left for channel 1 and at the right for channel 2 in Cartesian formats.

12. **Marker Values.** These are the values of the active marker, in units appropriate to the current measurement. (Refer to “Using Analyzer Display Markers” in the “Making Measurement” chapter of the user’s guide.)
13. **Marker Stats, Bandwidth.** These are statistical marker values that the analyzer calculates when you access the menus with the **Marker Fctn** key. (Refer to “Using Analyzer Display Markers” in the “Making Measurements” chapter of the user’s guide.)  
  
This general area is also where information for additional markers is placed. Note that Stats and Bandwidth have priority.
14. **Softkey Labels.** These menu labels redefine the function of the softkeys that are located to the right of the analyzer display.
15. **Pass Fail.** During limit testing, the result will be announced as `PASS` if the limits are not exceeded, and `FAIL` if any points exceed the limits.

## Rear Panel Features and Connectors

Figure 3-4 8753ET/ES Rear Panel

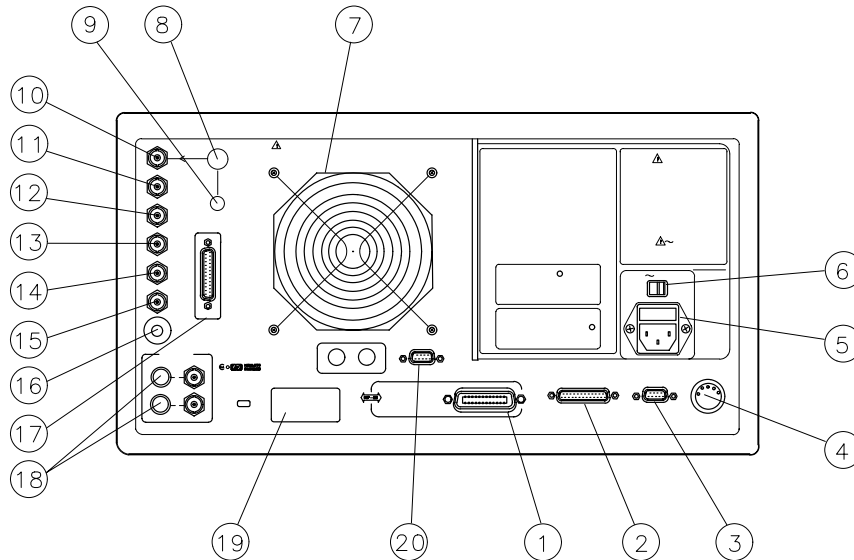

pg63e

Figure 3-4 illustrates the features and connectors of the rear panel, described below. Requirements for input signals to the rear panel connectors are provided in the specifications and characteristics chapter.

- 1. GPIB connector.** This allows you to connect the analyzer to an external controller, compatible peripherals, and other instruments for an automated system. Refer to [Chapter 7 , “Options and Accessories,”](#) for GPIB information, limitations, and configurations.
- 2. PARALLEL interface.** This connector allows the analyzer to output to a peripheral with a parallel input. Also included, is a general purpose input/output (GPIO) bus that can control eight output bits and read five input bits through test sequencing. Refer to [Chapter 7 , “Options and Accessories,”](#) for information on configuring a peripheral. Also refer to “The GPIO Mode” in the “Operating Concepts” chapter of the user’s guide.
- 3. RS-232 interface.** This connector allows the analyzer to output to a peripheral with an RS-232 (serial) input.
- 4. KEYBOARD input (mini-DIN).** This connector allows you to connect an external keyboard. This provides a more convenient means to enter a title for storage files, as well as substitute for the analyzer's front panel keyboard.
- 5. Power cord receptacle, with fuse.** For information on replacing the fuse, refer to the installation and quick start guide.
- 6. Line voltage selector switch.** For more information, refer to the installation and quick start guide.

7. **Fan.** This fan provides forced-air cooling for the analyzer.
8. **10 MHZ PRECISION REFERENCE OUTPUT. (Option 1D5)**
9. **10 MHZ REFERENCE ADJUST. (Option 1D5)**
10. **EXTERNAL REFERENCE INPUT connector.** This allows for a frequency reference signal input that can phase lock the analyzer to an external frequency standard for increased frequency accuracy.  

The analyzer automatically enables the external frequency reference feature when a signal is connected to this input. When the signal is removed, the analyzer automatically switches back to its internal frequency reference.
11. **AUXILIARY INPUT connector.** This allows for a dc or ac voltage input from an external signal source, such as a detector or function generator, which you can then measure, using the S-parameter menu. (You can also use this connector as an analog output in service routines, as described in the service guide.)
12. **EXTERNAL AM connector.** This allows for an external analog signal input that is applied to the ALC circuitry of the analyzer's source. This input analog signal amplitude modulates the RF output signal.
13. **EXTERNAL TRIGGER connector.** This allows connection of an external negative-going TTL-compatible signal that will trigger a measurement sweep. The trigger can be set to external through softkey functions.
14. **TEST SEQUENCE.** This outputs a TTL signal that can be programmed in a test sequence to be high or low, or pulse (10  $\mu$ seconds) high or low at the end of a sweep for robotic part handler interface.
15. **LIMIT TEST.** This outputs a TTL signal of the limit test results as follows:
  - Pass: TTL high
  - Fail: TTL low
16. **MEASURE RESTART.** This allows the connection of an optional foot switch. Using the foot switch will duplicate the key sequence **Meas** **MEASURE RESTART**
17. **TEST SET INTERCONNECT.** Not used in standard configuration.
18. **BIAS INPUTS AND FUSES.** These connectors bias devices connected to port 1 and port 2. The fuses (1 A, 125 V) protect the port 1 and port 2 bias lines.
19. **Serial number plate.** The serial number of the instrument is located on this plate.
20. **EXTERNAL MONITOR: VGA.** VGA output connector provides analog red, green, and blue video signals which can drive a VGA monitor.





---

## **4 Menu Maps**

## Menu Maps

This chapter contains menu maps for the hardkeys listed below. The figure number of these menu maps is listed next to the name of the hardkey. Fold Outs are located at the end of this chapter.

**Table 4-1 Menu Map Locations**

Menu Map	Figure Number	Menu Map	Figure Number
Avg	<a href="#">Figure 4-1</a>	Meas (ES Models)	<a href="#">Figure 4-8</a>
Cal (ET Models)	Fold Out	Power & Sweep Setup (ET Models)	<a href="#">Figure 4-9</a>
Cal (ES Models)	Fold Out	Power and Sweep Setup (ES Models)	<a href="#">Figure 4-10</a>
Copy	<a href="#">Figure 4-2</a>	Preset	<a href="#">Figure 4-11</a>
Display	<a href="#">Figure 4-3</a>	Save/Recall	<a href="#">Figure 4-12</a>
Format	<a href="#">Figure 4-4</a>	Scale Ref	<a href="#">Figure 4-13</a>
Local	<a href="#">Figure 4-5</a>	Seq	Fold Out
Marker, Marker Fctn, and Marker Search	<a href="#">Figure 4-6</a>	System (ET Models)	Fold Out
Meas (ET Models)	<a href="#">Figure 4-7</a>	System (ES Models)	Fold Out

**Figure 4-1 Menu Map for Avg**

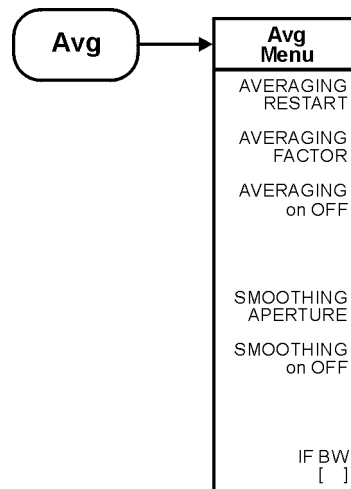

ka56e

**Figure 4-2 Menu Map for Copy**

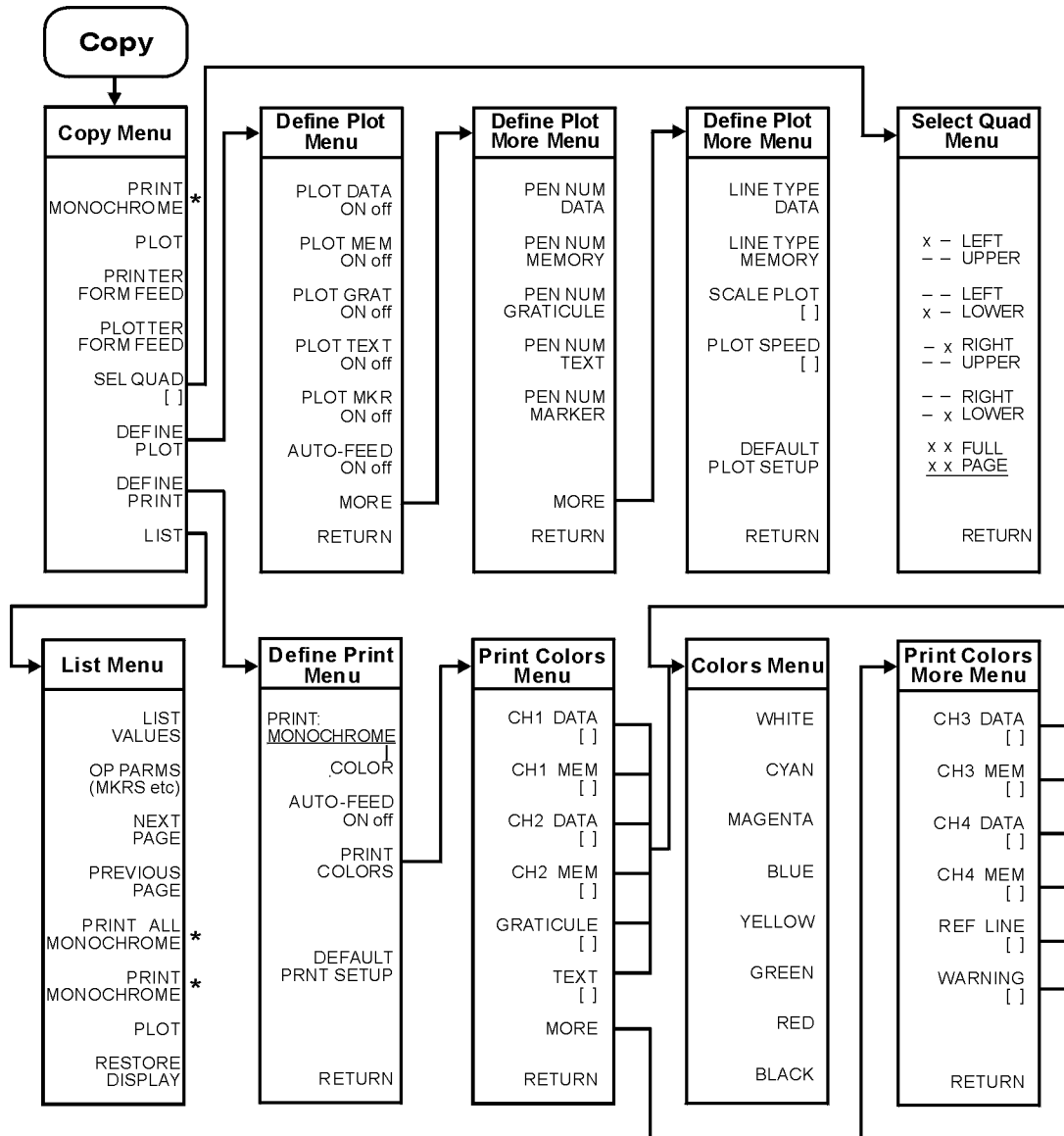

\* This key label changes between PRINT MONOCHROME and PRINT COLOR, depending on the setting of the PRINT: MONOCHROME/COLOR key selection in the Define Print Menu.

ka57e

**Figure 4-3 Menu Map for Display**

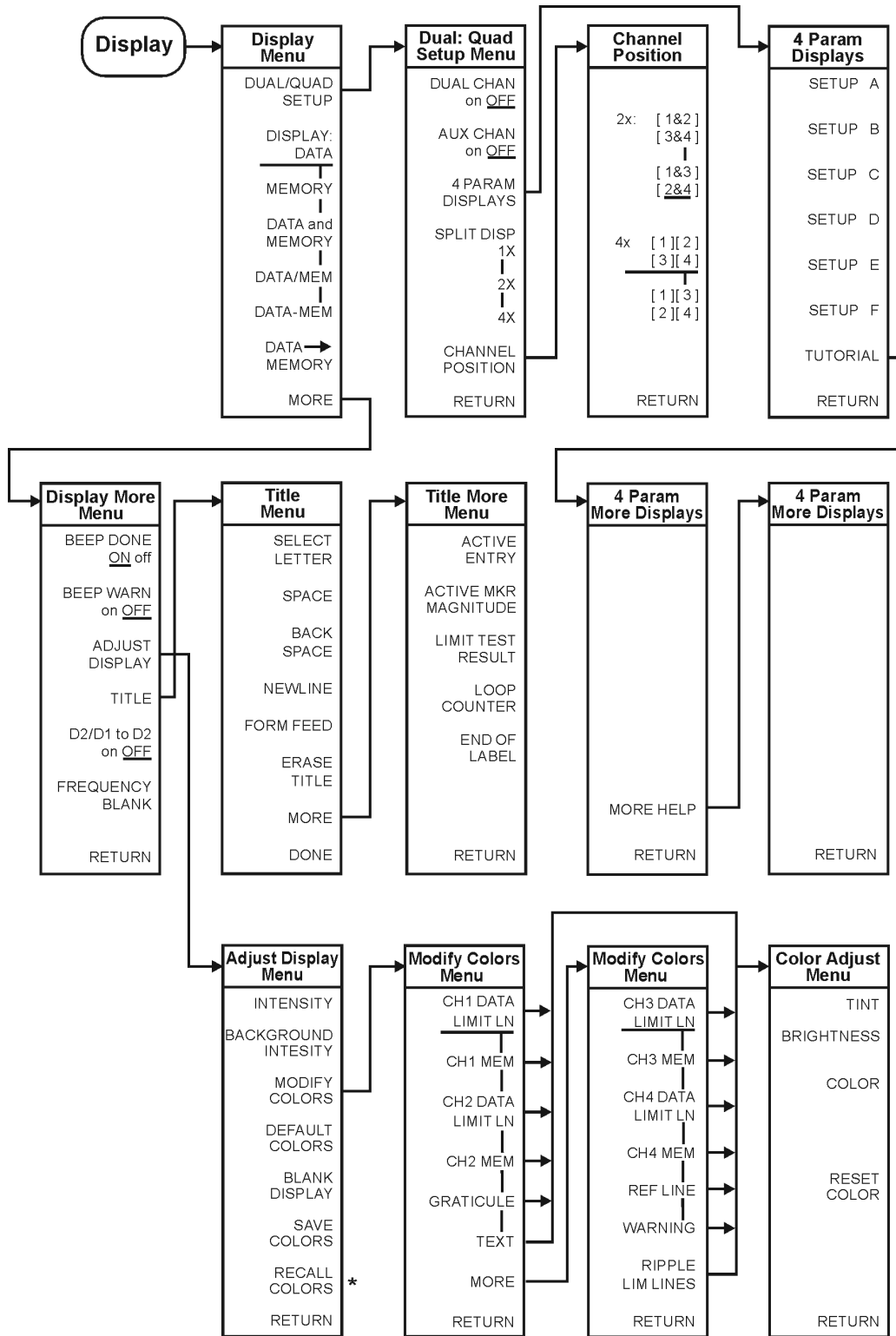

\* Appears only when colors have been saved

**Figure 4-4 Menu Map for Format**

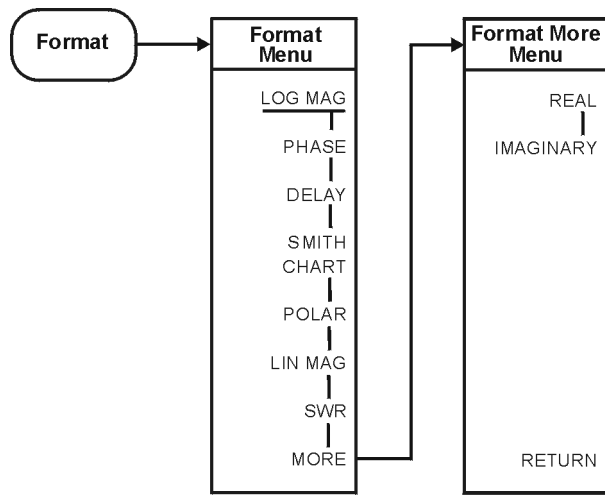

ka59e

Figure 4-5 Menu Map for Local

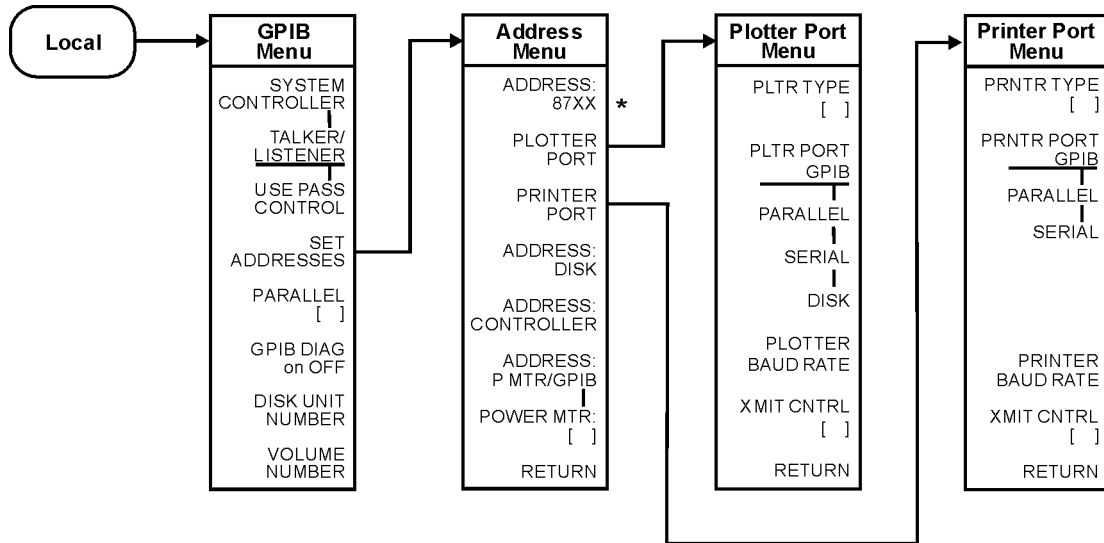

\* 87XX is the model number of the analyzer.

ka510e

**Figure 4-6 Menu Map for Marker, Marker Fctn, and Marker Search**

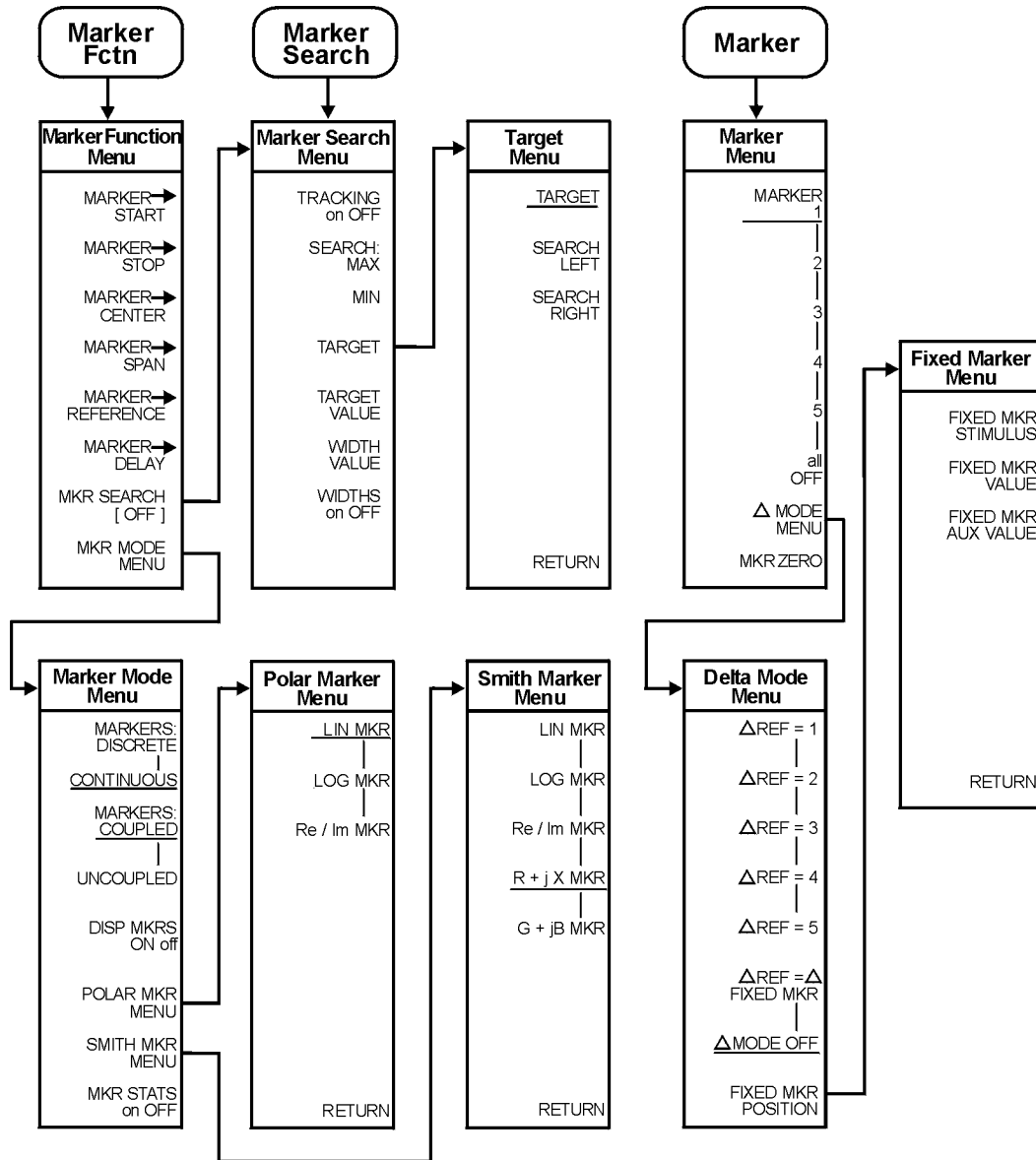

ka511e

**Figure 4-7 Menu Map for Meas (ET Models Only)**

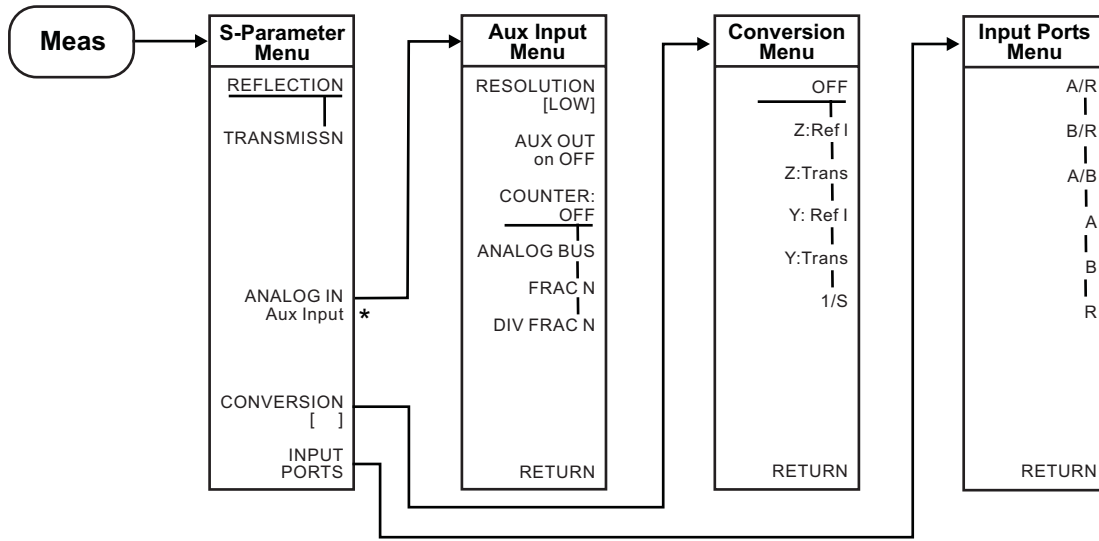

\* Aux input menu appears only when the analog bus on OFF (service menu key under the system hardkey) is turned to ON.

ka513e



**Figure 4-8 Menu Map for Meas (ES Models Only)**

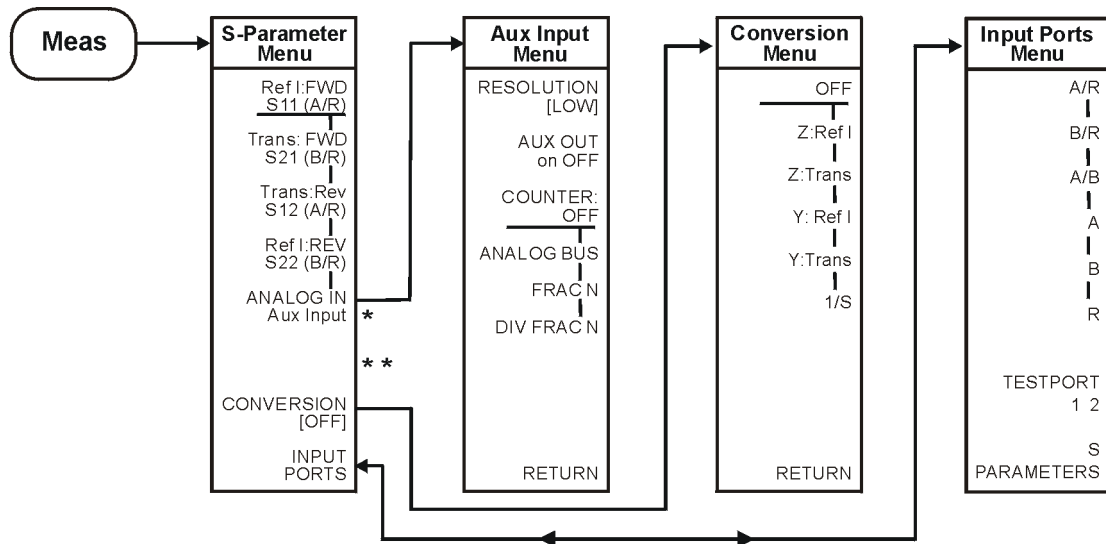

\* Aux input menu appears only when the analog bus on OFF (service menu key under the system hardkey) is turned to ON.

\*\* SELECT key will appear here if K36 or K39 modes are on.

ka512e

**Figure 4-9 Menu Map for Power and Sweep Setup (ET Only)**

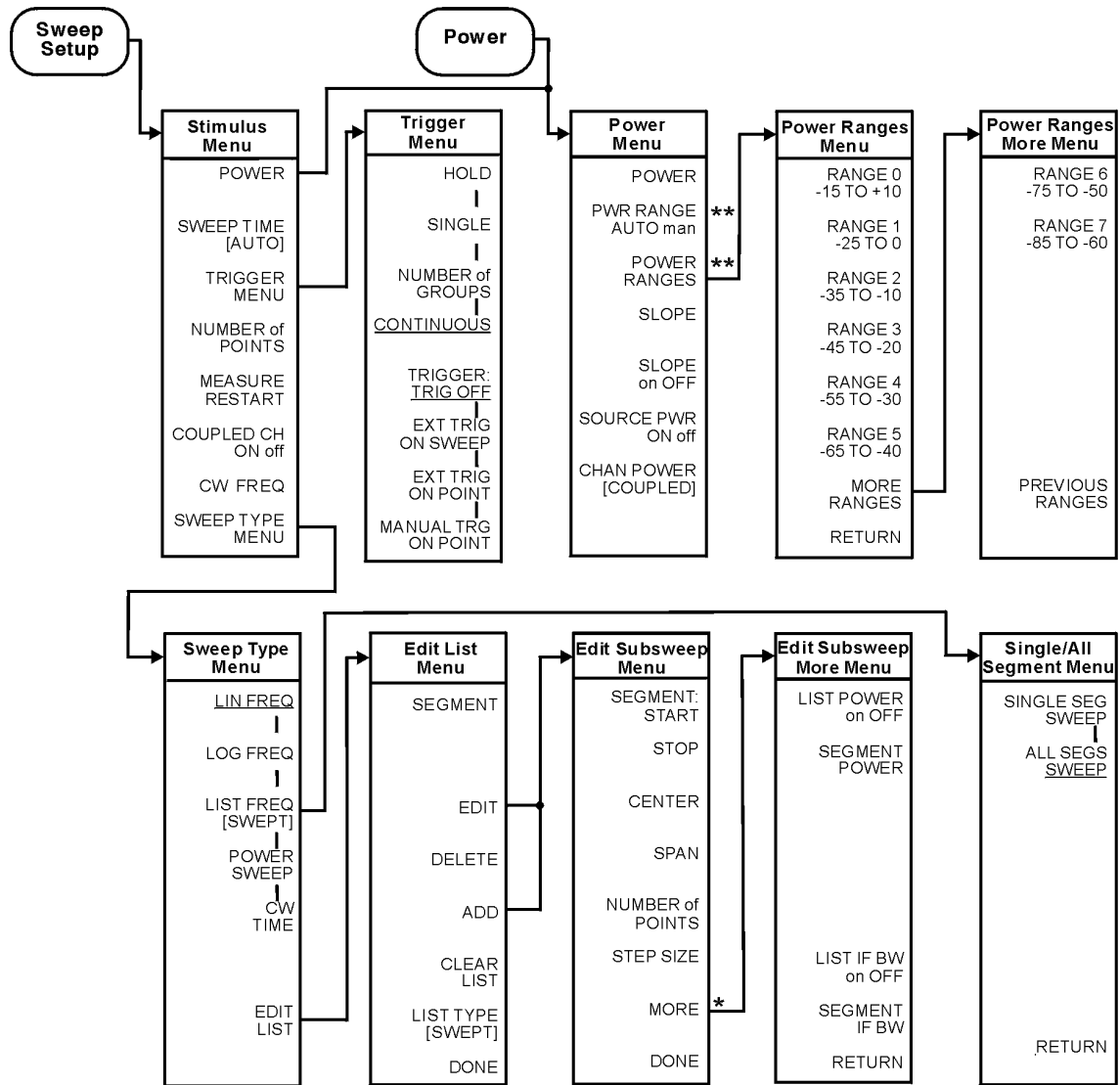

\* CW FREQ appears when LIST TYPE [STEPPED] is selected

\*\* Appears on instruments equipped with Option 004 only

ka515e

**Figure 4-10 Menu Map for Power and Sweep Setup (ES Only)**

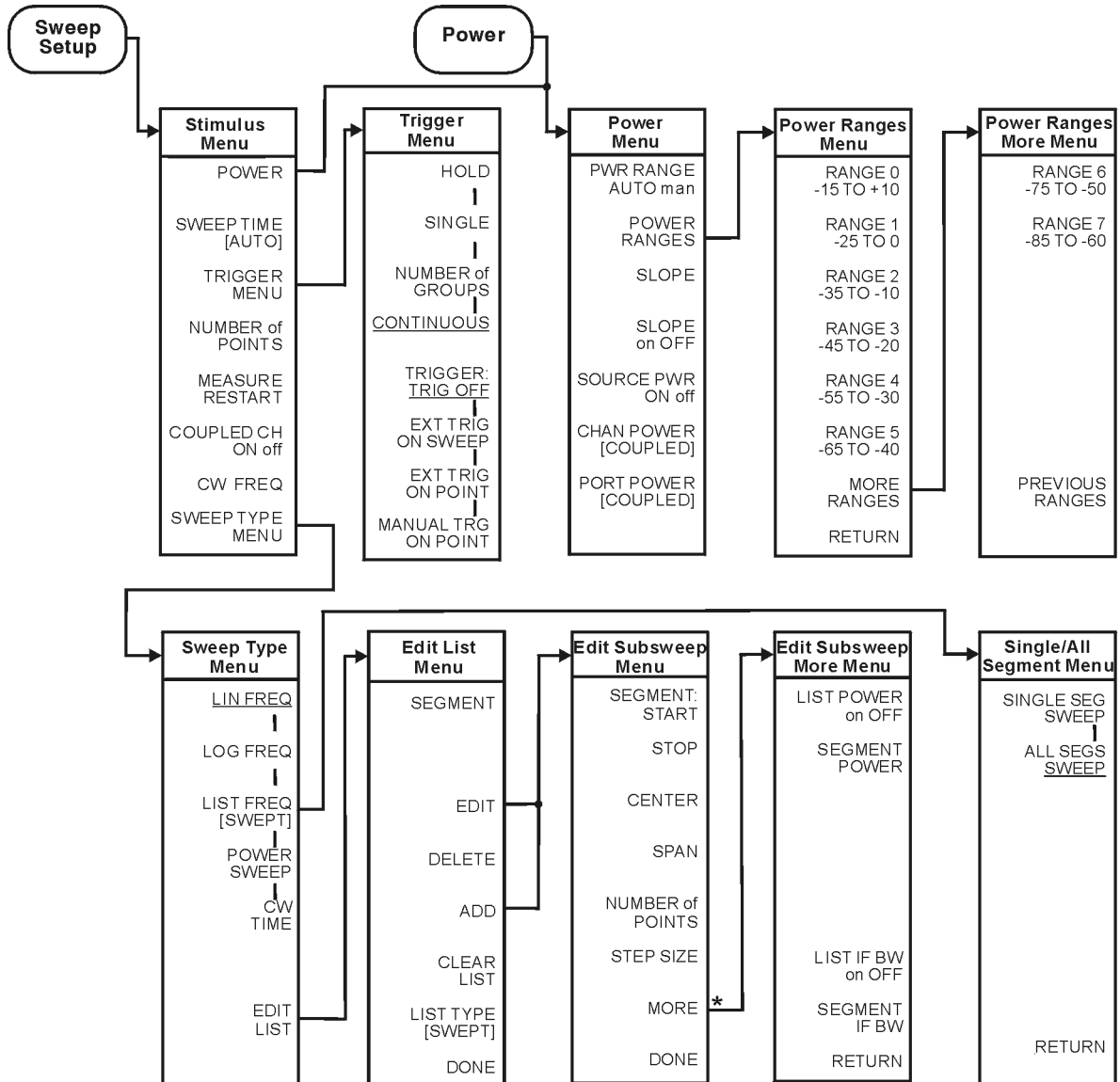

\*CW FREQ appears when LIST TYPE [STEPPED] is selected

ka51

**Figure 4-11 Menu Map for Preset**

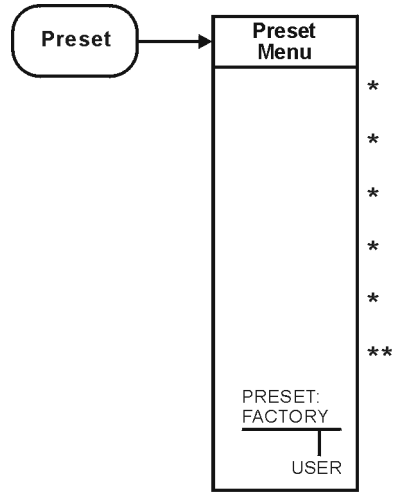

- \* User-defined sequences will appear in these locations.
- \*\* Sequence 6 is the only user-defined sequence that will survive power-off.

ka519e

Figure 4-12 Menu Map for Save/Recall

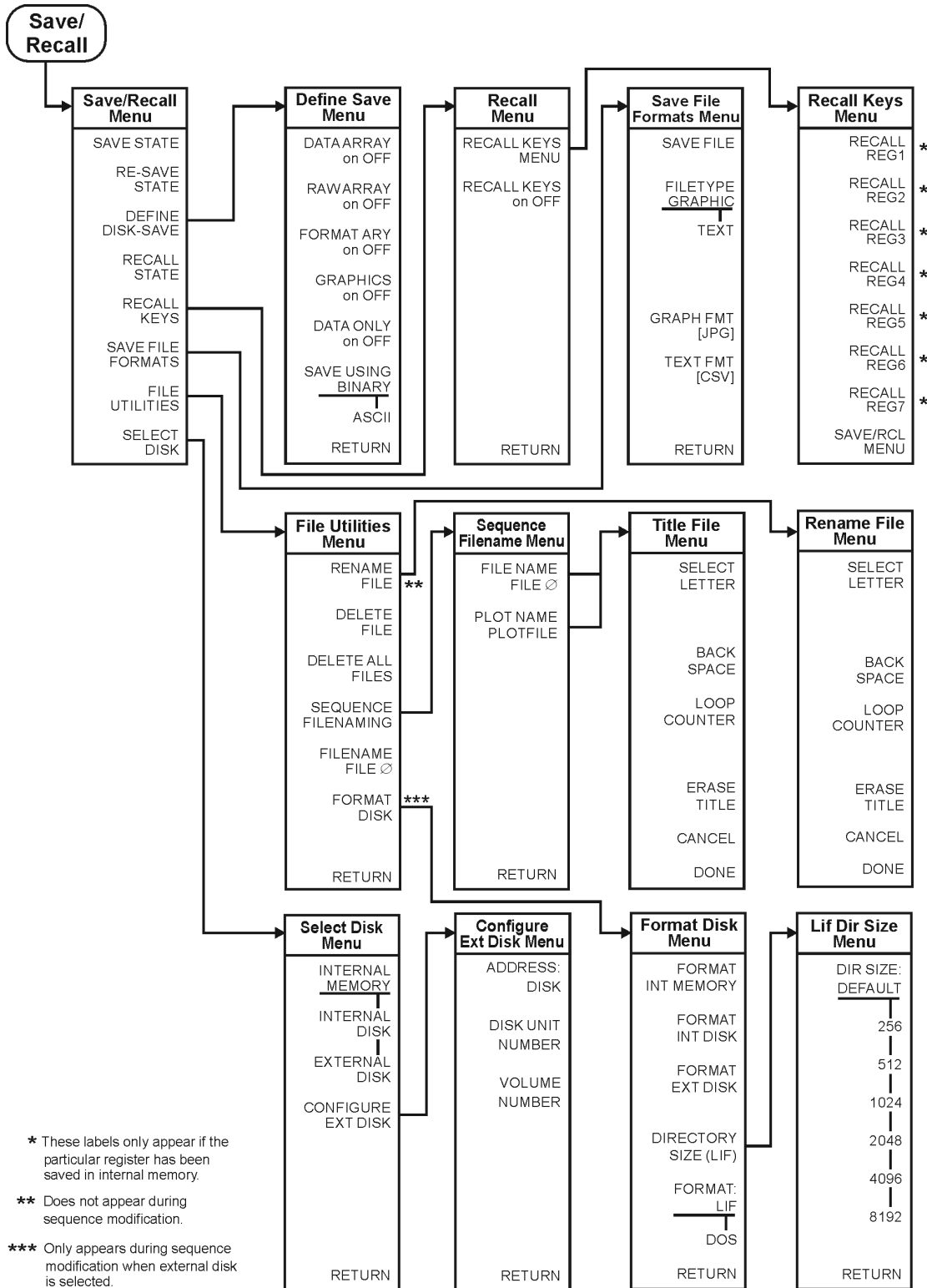

\* These labels only appear if the particular register has been saved in internal memory.

\*\* Does not appear during sequence modification.

\*\*\* Only appears during sequence modification when external disk is selected.

kl501ets

**Figure 4-13 Menu Map for Scale Ref**

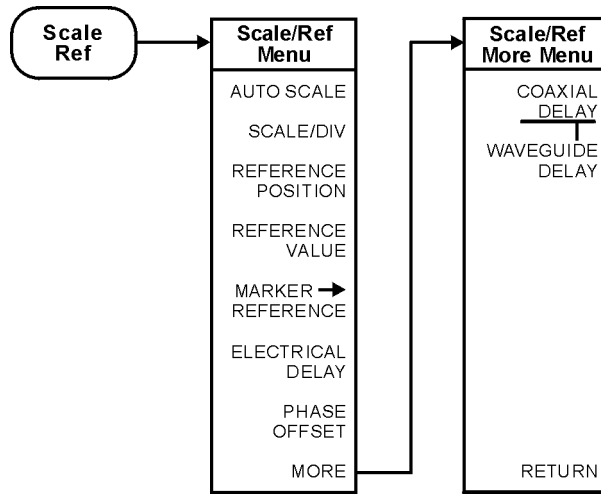

ka520e

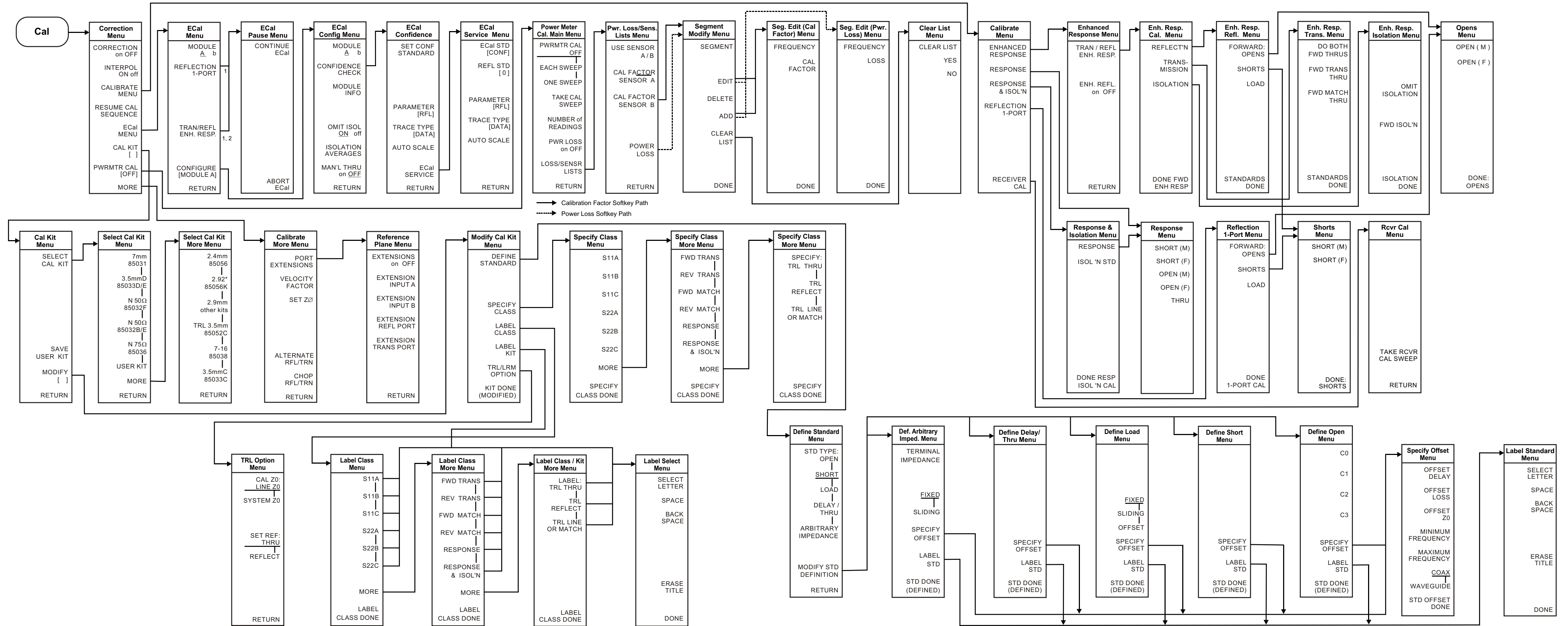

- When two ECal modules are used in a measurement, the routine will pause to allow you to insert the next module. A "CONTINUE ECal" and "ABORT ECal" menu will be displayed during the pause.
- When "MAN'L THRU" is turned "ON", the calibration will pause and allow you to insert your own thru. A "CONTINUE ECal" and "ABORT ECal" menu will be displayed during the pause.

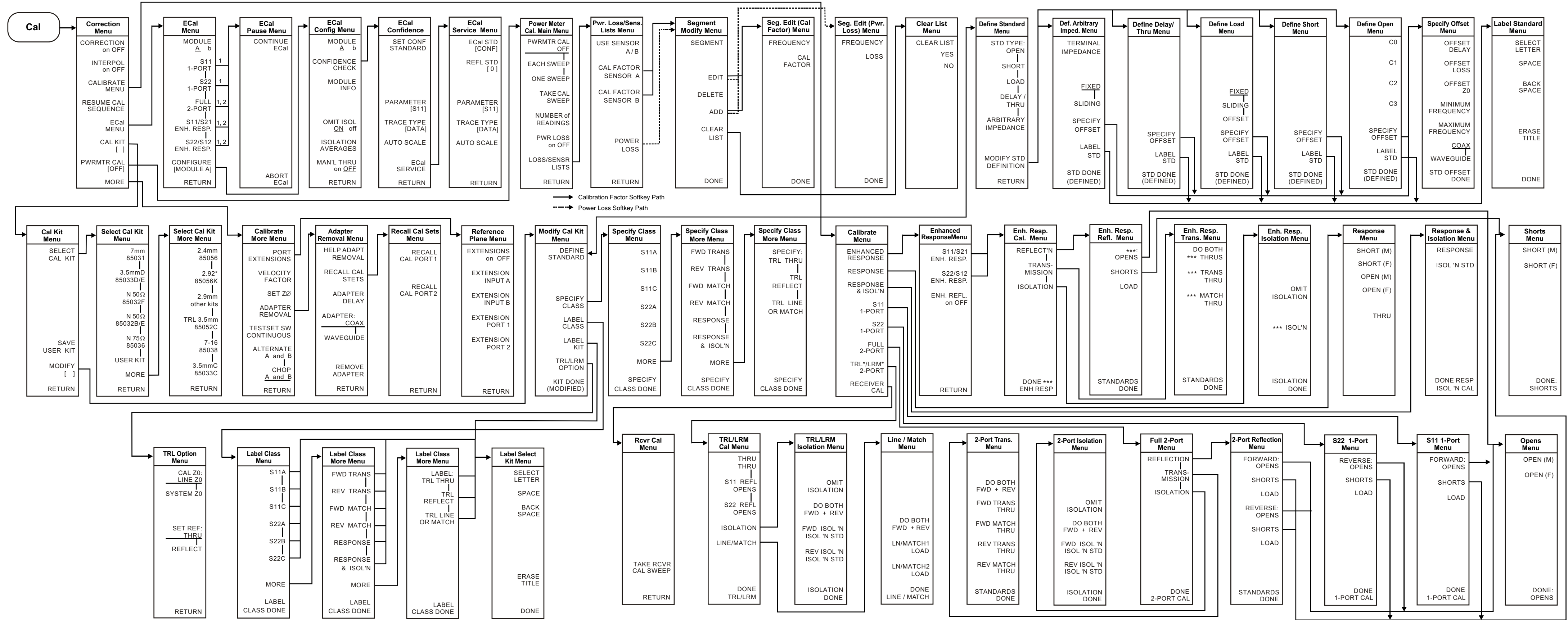

- When two ECal modules are used in a measurement, the routine will pause to allow you to insert the next module. A "CONTINUE ECal" and "ABORT ECal" menu will be displayed during the pause.
- When "MAN'L THRU" is turned "ON", the calibration routine will pause and allow you to insert your own thru. A "CONTINUE ECal" and "ABORT ECal" menu will be displayed during the pause.

\*\*\* Represents "FORWARD"/"FWD" when calibrating the forward path or "REVERSE"/"REV" when calibrating the reverse path.



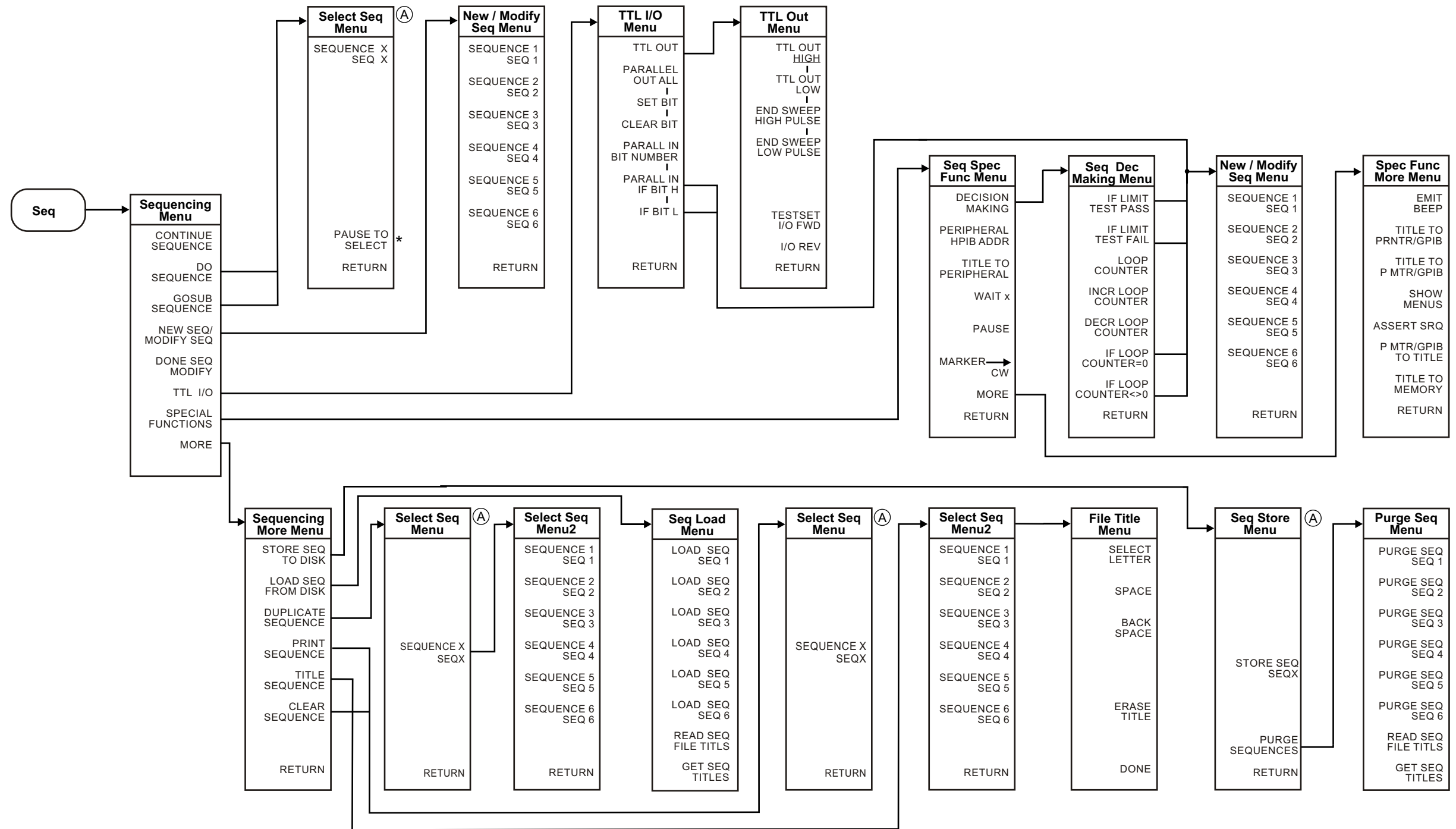

Ⓐ Displays only the user-defined sequence (X), where X is the sequence number, when not modifying a sequence. When modifying a sequence all sequence labels are shown.

Menu Map for Seq

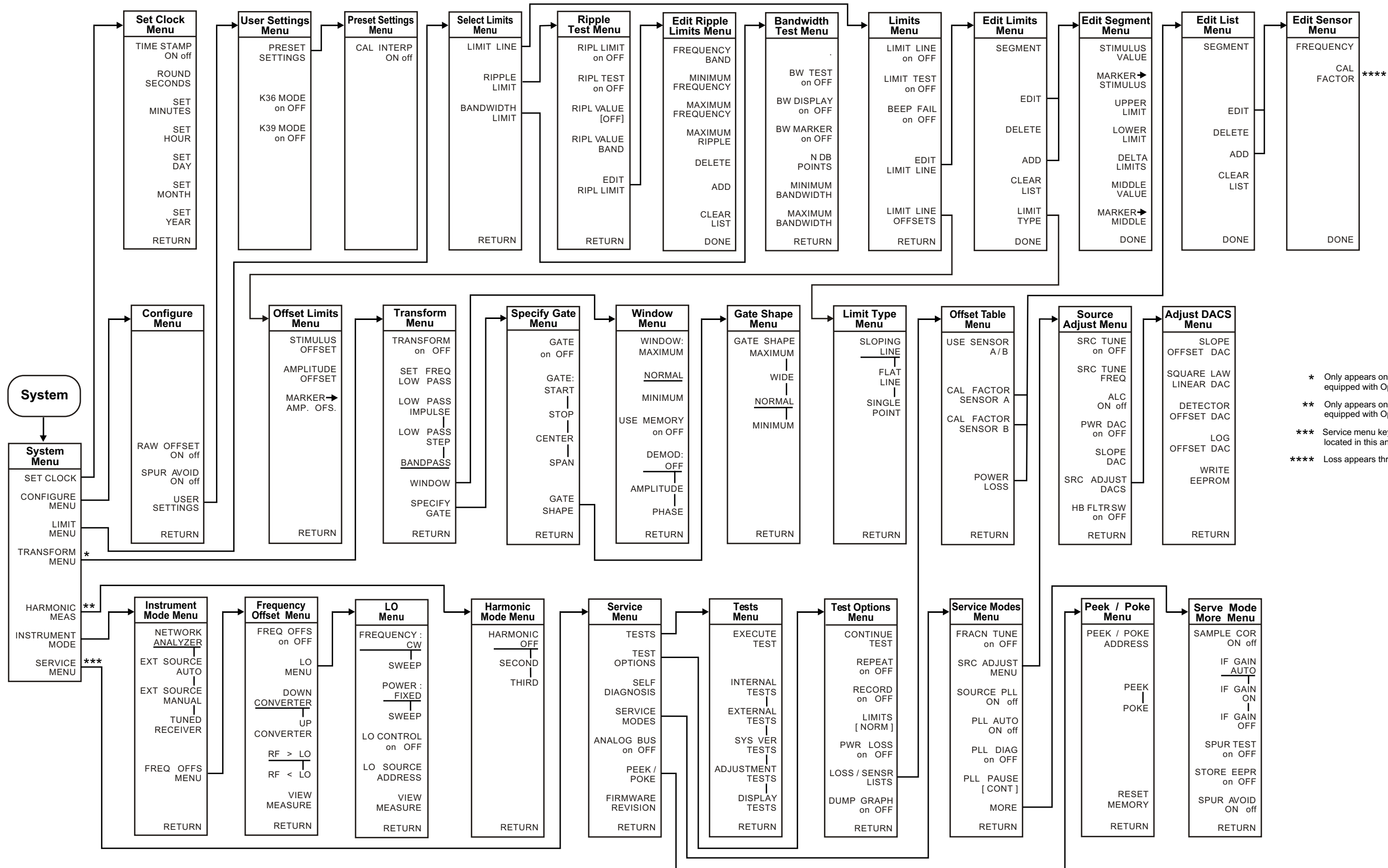

- \* Only appears on instruments equipped with Option 010.
- \*\* Only appears on instruments equipped with Option 002.
- \*\*\* Service menu key descriptions are located in this analyzer's service guide.
- \*\*\*\* Loss appears thru the power loss path.

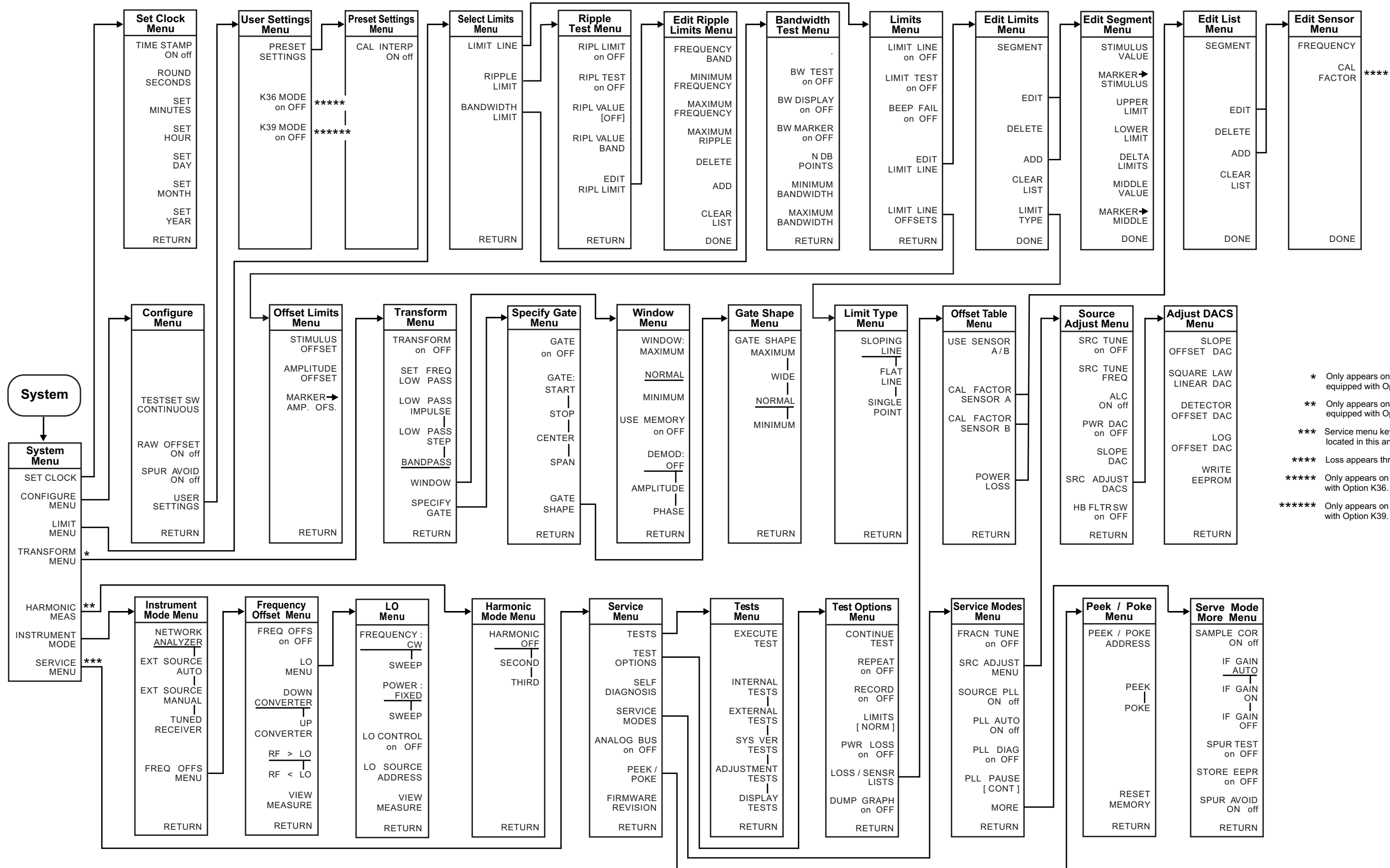

- \* Only appears on instruments equipped with Option 010.
- \*\* Only appears on instruments equipped with Option 002.
- \*\*\* Service menu key descriptions are located in this analyzer's service guide.
- \*\*\*\* Loss appears thru the power loss path.
- \*\*\*\*\* Only appears on instruments equipped with Option K36.
- \*\*\*\*\* Only appears on instruments equipped with Option K39.



---

## **5 Hardkey/Softkey Reference**

## Key Reference

This chapter contains information on the following topics:

- softkey and front-panel functions in alphabetical order (includes a brief description of each function)
- cross reference of programming commands to key functions
- cross reference of softkeys to front-panel access keys

---

**NOTE**      The **SERVICE MENU** keys are not included in this chapter. Information on the **SERVICE MENU** keys can be found in the service guide.

---

## Where to Look for More Information

Additional information about many of the topics discussed in this chapter is located in the following areas:

- "Making Measurements" in the user's guide contains step-by-step procedures for making measurements or using particular functions.
- "Printing, Plotting, and Saving Measurement Results" in the user's guide contains instructions for saving to disk or the analyzer internal memory, and printing and plotting displayed measurements.
- "Optimizing Measurement Results" in the user's guide describes techniques and functions for achieving the best measurement results.
- "Operating Concepts" chapter of the user's guide contains explanatory-style information about many applications and analyzer operation.
- The programmer's guide provides a complete description of all GPIB mnemonics.

---

## Guide Terms and Conventions

The eight keys along the right side of the analyzer display are called softkeys. Their labels are shown on the display. The softkeys appear in shaded boxes in this chapter (for example, **TRANSMISSION**). The labeled keys that are on the front panel of the analyzer are called front-panel keys or hardkeys. The front-panel keys appear in unshaded boxes in this chapter (for example, **Start**).

## Analyzer Functions

This section contains an alphabetical listing of softkey and front-panel functions, and a brief description of each function.



is used to add a decimal point to the number you are entering.



is used to add a minus sign to the number you are entering.



is used to step up the current value of the active function. The analyzer defines the step size for different functions. No units terminator is required. For editing a test sequence, this key can be used to scroll through and execute the displayed sequence one step at a time.



is used to step down the current value of the active function. The analyzer defines the step size for different functions. No units terminator is required. For editing a test sequence, this key can be used to scroll backwards through the displayed sequence without executing it.





has two independent functions:

- modifies entries and test sequences
- moves marker information off of the graticules

The backspace key will delete the last entry, or the last digit entered from the numeric keypad. The backspace key can also be used in two ways for modifying a test sequence:

- deleting a single-key command that you may have pressed by mistake, (for example **A/R** )
- deleting the last digit in a series of entered digits, as long as you haven't yet pressed a terminator, (for example if you pressed **(Start)** **1** **2** but did not press **(G/n)**, etc.)

The second function of this key is to move marker information off of the graticules so that the display traces are clearer. If there are two or more markers activated on a channel on the right side of the display, pressing  will turn off the softkey menu and move the marker information into the softkey display area. Pressing , or any hardkey which brings up a menu, or a softkey, will restore the softkey menu and move the marker information back onto the graticules.



**Δ MODE MENU**

goes to the delta marker menu, which is used to read the difference in values between the active marker and a reference marker.

**Δ MODE OFF**

turns off the delta marker mode, so that the values displayed for the active marker are absolute values.

**Δ REF = 1**

establishes marker 1 as a reference. The active marker stimulus and response values are then shown relative to this delta reference. Once marker 1 has been selected as the delta reference, the softkey label **Δ REF = 1** is underlined in this menu, and the marker menu is returned to the screen. In the marker menu, the first key is now labeled **MARKER Δ REF = 1**. The notation "ΔREF=1" appears at the top right corner of the graticule.

**Δ REF = 2**

makes marker 2 the delta reference. Active marker stimulus and response values are then shown relative to this reference.

**Δ REF = 3**

makes marker 3 the delta reference.

**Δ REF = 4**

makes marker 4 the delta reference.

**Δ REF = 5**

makes marker 5 the delta reference.

**Δ REF = Δ FIXED MKR**

sets a user-specified fixed reference marker. The stimulus and response values of the reference can be set arbitrarily, and can be anywhere in the display area. Unlike markers 1 to 5, the fixed marker need not be on the trace. The fixed marker is indicated by a small triangle Δ, and the active marker stimulus and response values are shown relative to this point. The notation "ΔREF=Δ" is displayed at the top right corner of the graticule.

Pressing this softkey turns on the fixed marker. Its stimulus and response values can then be changed using the fixed marker menu, which is accessed with the **FIXED MKR POSITION** softkey described below. Alternatively, the fixed marker can be set to the current active marker position, using the **MKR ZERO** softkey in the marker menu.

**1/S**

expresses the data in inverse S-parameter values, for use in amplifier and oscillator design.

**2X: [1&2]/[3&4]**

sets up a two-graticule display with channel 1 and 2 on the top graticule and channels 3 and 4 in the bottom graticule.

**2X: [1&3]/[2&4]**

sets up a two-graticule display with channel 1 and 3 in the top graticule and channels 2 and 4 in the bottom graticule.

**2.4mm 85056**

selects the 85056A or the 85056D cal kit.

<b>2.92* 85056K</b>	selects the 85056K cal kit.
<b>2.92mm other kits</b>	selects the 2.92 mm cal kit model.
<b>3.5mmC 85033C</b>	selects the 85033C cal kit.
<b>3.5mmD 85033D/E</b>	selects the 85033D or the 85033E cal kit.
<b>4X: [1] [2]/[3] [4]</b>	sets up a four-graticule display with channel 2 in the upper right quadrant and channel 3 in the lower left quadrant.
<b>4X: [1] [3]/[2] [4]</b>	sets up a four-graticule display with channel 3 in the upper right quadrant and channel 2 in the lower left quadrant.
<b>4 PARAM DISPLAYS</b>	provides single-keystroke options to quickly set up multiple-channel displays, and information on multiple-channel displays.
<b>7-16 85038</b>	selects the 85038A/F/M cal kit.
<b>7 mm 85031</b>	selects the 85031B cal kit.
<b>A</b>	measures the absolute power amplitude at input A.
<b>A/B</b>	calculates and displays the complex ratio of input A to input B.
<b>ABORT ECal</b>	is displayed during ECal dual module operation and during manual thru operation as a pause in the process of measurement. Press this softkey to stop the process and return to the main ECal menu.
<b>A/R</b>	calculates and displays the complex ratio of the signal at input A to the reference signal at input R.
<b>ACTIVE ENTRY</b>	puts the name of the active entry in the display title.
<b>ACTIVE MAGNITUDE</b>	puts the active marker magnitude in the display title.
<b>ADAPTER: COAX</b>	selects coaxial as the type of adapter used in adapter removal calibration.
<b>ADAPTER: WAVEGUIDE</b>	selects waveguide as the type of adapter used in adapter removal calibration.
<b>ADAPTER DELAY</b>	is used to enter the value of electrical delay of the adapter used in adapter removal calibration.
<b>ADAPTER REMOVAL</b>	provides access to the adapter removal menu.
<b>ADD</b>	1) displays the edit segment menu and adds a new segment to the end of the list. The new segment is initially a duplicate of the segment indicated by the pointer > and selected with the <b>SEGMENT</b> softkey.

2) adds a new frequency band to the Ripple Limit list which is indicated by the pointer >. The new frequency band is a duplicate of the most recently selected frequency band.

**ADDRESS: 8753**

sets the GPIB address of the analyzer, using the entry controls. There is no physical address switch to set in the analyzer. The default GPIB address is 16.

**ADDRESS: CONTROLLER**

sets the GPIB address the analyzer will use to communicate with the external controller.

**ADDRESS: DISK**

sets the GPIB address the analyzer will use to communicate with an external GPIB disk drive.

**ADDRESS: P MTR/GPIB**

sets the GPIB address the analyzer will use to communicate with the power meter used in service routines.

**ADJUST DISPLAY**

presents a menu for adjusting display intensity, colors, and accessing save and recall functions for modified LCD color sets.

**ADJUSTMENT TESTS**

leads to the beginning of the adjustment tests. These tests generate correction constants that are used by the analyzer.

**ALL SEGS SWEEP**

retrieves the full frequency list sweep.

**ALTERNATE A and B**

measures only one input, A or B, per frequency sweep, in order to reduce spurious signals. Thus, this mode optimizes the dynamic range for all four S-parameter measurements.

**AMPLITUDE OFFSET**

adds or subtracts an offset in amplitude value. This allows limits already defined to be used for testing at a different response level. For example, if attenuation is added to or removed from a test setup, the limits can be offset an equal amount. Use the entry block controls to specify the offset.

**ANALOG IN Aux Input**

displays a dc or low frequency ac auxiliary voltage on the vertical axis, using the real format. An external signal source such as a detector or function generator can be connected to the rear panel AUXILIARY INPUT connector.

**ARBITRARY IMPEDANCE**

defines the standard type to be a load, but with an arbitrary impedance (different from system Z0).

**ASSERT SRQ**

sets the sequence bit in the Event Status Register, which can be used to generate an SRQ (service request) to the system controller.

**AUTO FEED ON off**

turns the plotter auto feed function on or off when in the define plot menu. It turns the printer auto feed on or off when in the define print menu.

**AUTO SCALE**

brings the trace data in view on the display with one keystroke. Stimulus values are not affected, only scale and reference values. The analyzer determines the smallest possible scale factor that will put all displayed data onto 80% of the vertical graticule. The reference value is chosen to put the trace in center screen, then rounded to an integer multiple of the scale factor.

**AUX CHAN on OFF**

enables and disables auxiliary channels 3 and 4.

**AUX OUT on OFF**

allows you to monitor the analog bus nodes (except nodes 1, 2, 3, 4, 9, 10, and 12) with external equipment. To do this, connect the equipment to the AUX INPUT BNC connector on the rear panel.

**AVERAGING FACTOR**

makes averaging factor the active function. Any value up to 999 can be used. The algorithm used for averaging is:

$$A(n) = [S(n) + S(n - 1) + \dots + S(n - F + 1)] / F$$

where

A(n) = current average

S(n) = current measurement

F = average factor

**AVERAGING on OFF**

turns the averaging function on or off for the active channel. "Avg" is displayed in the status notations area at the left of the display, together with the sweep count for the averaging factor, when averaging is on. The sweep count for averaging is reset to 1 whenever an instrument state change affecting the measured data is made.

At the start of the averaging or following

**AVERAGING RESTART**, averaging starts at 1 and averages each new sweep into the trace until it reaches the specified averaging factor. The sweep count is displayed in the status notations area below "Avg" and updated every sweep as it increments. When the specified averaging factor is reached, the trace data continues to be updated, weighted by that averaging factor.

**AVERAGING RESTART**

averaging starts at 1 and averages each new sweep into the trace until it reaches the specified averaging factor. The sweep count is displayed in the status notations area below "Avg" and updated every sweep as it increments.

<b>Avg</b>	is used to access three different noise reduction techniques: sweep-to-sweep averaging, display smoothing, and variable IF bandwidth. Any or all of these can be used simultaneously. Averaging and smoothing can be set independently for each channel, and the IF bandwidth can be set independently if the stimulus is uncoupled.
<b>B</b>	measures the absolute power amplitude at input B.
<b>B/R</b>	calculates and displays the complex ratio of input B to input R.
<b>BACK SPACE</b>	deletes the last character entered.
<b>BACKGROUND INTENSITY</b>	sets the background intensity of the LCD as a percent of white. The factory-set default value is stored in non-volatile memory.
<b>BANDPASS</b>	(Option 010 only) sets the time-domain bandpass mode.
<b>BANDWIDTH LIMIT</b>	selects the bandwidth limit line choice. This selection leads to the menu used to define and test bandwidth limits of a bandpass filter. Refer to the “Using Bandwidth Limits to Test a Bandpass Filter” section in the “Making Measurements” chapter of the user’s guide.
<b>BEEP DONE ON off</b>	toggles an annunciator which sounds to indicate completion of certain operations such as calibration or instrument state save.
<b>BEEP FAIL on OFF</b>	turns the limit fail beeper on or off. When limit testing is on and the fail beeper is on, a beep is sounded each time a limit test is performed and a failure detected. The limit fail beeper is independent of the warning beeper and the operation complete beeper.
<b>BEEP WARN on OFF</b>	toggles the warning annunciator. When the annunciator is on it sounds a warning when a cautionary message is displayed.
<b>BLANK DISPLAY</b>	switches off the analyzer's display. This feature may be helpful in prolonging the life of the LCD in applications where the analyzer is left unattended (such as in an automated test system). Pressing any front panel key will restore the default display operation.
<b>BRIGHTNESS</b>	adjusts the brightness of the color being modified. Refer to the section on adjusting the display color in the “Using Measurement Functions” chapter of the user’s guide for an explanation of using this softkey for color modification of display attributes.
<b>BW DISPLAY on OFF</b>	displays the measured bandwidth value to the right of the pass/fail message.

**BW MARKER on OFF**

displays the cutoff frequencies of the bandwidth using markers on the data trace.

**BW TEST on OFF**

turns bandpass filter bandwidth testing on or off. When bandwidth testing is on, the analyzer locates the maximum point of the data trace and uses it as the reference from which to measure the filter's bandwidth. Then, the analyzer determines the two cutoff frequencies of the bandpass filter. The cutoff frequencies are the two points on the data trace at a user-specified amplitude below the reference point. The cutoff frequencies are also referred to as the *N dB Points* where "N" is defined as the number of decibels below the peak of the bandpass that the filter is specified. (The amplitude is specified using the **N DB POINTS** softkey.)

The bandwidth is the frequency difference between the two cutoff frequencies. The bandwidth is compared to the user-specified minimum and maximum bandwidth limits (entered using the **MINIMUM BANDWIDTH** and **MAXIMUM BANDWIDTH** softkeys.)

If the test passed, a message is displayed in green text in the upper left portion of the LCD. An example of this message is: **BW1: Pass**, where the "1" indicates the channel where the bandwidth test is performed. If the bandwidth test does not pass, a fail message indicating whether the bandpass was too wide or too narrow is displayed in red text. An example of this message is **BW1: Wide**.

**C0**

is used to enter the C0 term in the definition of an OPEN standard in a calibration kit, which is the constant term of the cubic polynomial and is scaled by  $10^{-15}$ .

**C1**

is used to enter the C1 term, expressed in F/Hz (Farads/Hz) and scaled by  $10^{-27}$ .

**C2**

is used to enter the C2 term, expressed in  $F/Hz^2$  and scaled by  $10^{-36}$ .

**C3**

is used to enter the C3 term, expressed in  $F/Hz^3$  and scaled by  $10^{-45}$ .

**Cal**

key leads to a series of menus to perform measurement calibrations for vector error correction (accuracy enhancement), and for specifying the calibration standards used. The **CAL** key also leads to softkeys which activate interpolated error correction and power meter calibration.

**CAL FACTOR**

accepts a power sensor calibration factor % for the segment.

**CAL FACTOR SENSOR A**

brings up the segment modify menu and segment edit (calibration factor menu) which allows you to enter a power sensor's calibration factors. The calibration factor data entered in this menu will be stored for power sensor A.

**CAL INTERP ON off**

sets the preset state of interpolated error-correction on or off.

**CAL FACTOR SENSOR B**

brings up the segment modify menu and segment edit (calibration factor menu) which allows you to enter a power sensor's calibration factors. The calibration factor data entered in this menu will be stored for power sensor B.

**CAL KIT [ ]**

indicates the currently selected cal kit and leads to the select cal kit menu, which is used to select one of the default calibration kits available for different connector types. This, in turn, leads to additional menus used to define calibration standards other than those in the default kits (refer to “Modifying Calibration Kits” in the “Operating Concepts” chapter of the user’s guide). When a calibration kit has been specified, its connector type is displayed in brackets in the softkey label. The cal kits available are listed below, refer to the softkey descriptions for these softkeys for more information.

— **2.4mm 85056**

— **2.92\* 85056K**

— **2.92mm other kits**

— **3.5mmC 85033C**

— **3.5mmD 85033D/E**

— **7-16 85038**

— **7mm 85031**

— **N 50Ω 85032B/E**

— **N 50Ω 85032F**

— **N 75Ω 85036**

— **TRL 3.5mm 85052C**

**CAL Z0: LINE Z0**

this default selection establishes the TRL/LRM LINE/MATCH standard as the characteristic impedance.



<b>CAL Z0: SYSTEM Z0</b>	allows you to modify the characteristic impedance of the system for TRL/LRM calibration.
<b>CALIBRATE MENU</b>	leads to the calibration menu, which provides several accuracy enhancement procedures ranging from a simple frequency response calibration to a full two-port calibration. At the completion of a calibration procedure, this menu is returned to the screen, correction is automatically turned on, and the notation <b>Cor</b> or <b>C2</b> is displayed at the left of the screen.
<b>Center</b>	is used, along with the <b>Span</b> key, to define the frequency range of the stimulus. When the <b>Center</b> key is pressed, its function becomes the active function. The value is displayed in the active entry area, and can be changed with the knob, step keys, or numeric keypad.
<b>CENTER</b>	sets the center frequency of a subsweep in a list frequency sweep.
<b>CH1 DATA [ ]</b>	brings up the printer color selection menu. The channel 1 data trace default color is magenta for color prints.
<b>CH1 DATA LIMIT LN</b>	selects channel 1 data trace and limit line for display color modification.
<b>CH1 MEM</b>	selects channel 1 memory trace for display color modification.
<b>CH1 MEM [ ]</b>	brings up the printer color selection menu. The channel 1 memory trace default color is green for color prints.
<b>CH2 DATA [ ]</b>	brings up the printer color selection menu. The channel 2 data trace default color is blue for color prints.
<b>CH2 DATA LIMIT LN</b>	selects channel 2 data trace and limit line for display color modification.
<b>CH2 MEM</b>	selects channel 2 memory trace for display color modification.
<b>CH2 MEM [ ]</b>	brings up the printer color selection menu. The channel 2 memory trace default color is red for color prints.
<b>CH3 DATA [ ]</b>	brings up the printer color selection menu. The channel 3 data trace default color is magenta for color prints.
<b>CH3 DATA LIMIT LN</b>	selects channel 3 data trace and limit line for display color modification.
<b>CH3 MEM</b>	selects channel 3 memory trace for display color.
<b>CH3 MEM [ ]</b>	brings up the printer color selection menu. The channel 2 data trace default color is green for color prints.



<b>CH4 DATA [ ]</b>	brings up the printer color selection menu. The channel 4 data trace default color is blue for color prints.
<b>CH4 DATA LIMIT LN</b>	selects channel 4 data trace and limit line for display color modification.
<b>CH4 MEM</b>	selects channel 4 memory trace for display color modification.
<b>CH4 MEM [ ]</b>	brings up the printer color selection menu. The channel 4 memory trace default color is red for color prints.
<b>Chan 1</b>	allows you to select channel 1 as the active channel. The active channel is indicated by an amber LED adjacent to the corresponding channel key. All of the channel-specific functions you select, such as format or scale, apply to the active channel. By default, <b>Chan 1</b> measures S11 in log mag format.
<b>Chan 2</b>	allows you to select channel 2 as the active channel. The active channel is indicated by an amber LED adjacent to the corresponding channel key. All of the channel-specific functions you select, such as format or scale, apply to the active channel. By default, <b>Chan 2</b> measures S21 in log mag format.
<b>Chan 3</b>	allows you to select channel 3 as the active channel. The active channel is indicated by an amber LED adjacent to the corresponding channel key. All of the channel-specific functions you select, such as format or scale, apply to the active channel. <b>Chan 3</b> is the auxiliary channel of <b>Chan 1</b> . By default, <b>Chan 3</b> measures S12 in log mag format.
<b>Chan 4</b>	allows you to select channel 4 as the active channel. The active channel is indicated by an amber LED adjacent to the corresponding channel key. All of the channel-specific functions you select, such as format or scale, apply to the active channel. <b>Chan 4</b> is the auxiliary channel of <b>Chan 2</b> . By default, <b>Chan 4</b> measures S22 in log mag format.
<b>CHAN POWER [COUPLED]</b>	is used to apply the same power levels to Chan 1/3 & 2/4.
<b>CHAN POWER [UNCOUPLED]</b>	is used to apply different power levels to Chan 1/3 & 2/4.
<b>CHANNEL POSITION</b>	configures multiple-channel displays so that the auxiliary channels are adjacent to or beneath the primary channels.
<b>CHOP A and B</b>	measures A and B inputs simultaneously for faster measurements.

**CLEAR BIT**

when the parallel port is configured for GPIO, 8 output bits can be controlled with this key. When this key is pressed, “TTL OUT BIT NUMBER” becomes the active function. This active function must be entered through the keypad number keys, followed by the **(x1)** key. The bit is cleared when the **(x1)** key is pressed. Entering numbers larger than 7 will result in bit 7 being cleared, and entering numbers lower than 0 will result in bit 0 being cleared.

**CLEAR LIST**

deletes all segments or bands in the list.

**CLEAR SEQUENCE**

clears a sequence from memory. The titles of cleared sequences will remain in load, store, and purge menus. This is done as a convenience for those who often reuse the same titles.

**COAX**

defines the standard (and the offset) as coaxial. This causes the analyzer to assume linear phase response in any offsets.

**COAXIAL DELAY**

applies a linear phase compensation to the trace for use with electrical delay. That is, the effect is the same as if a corresponding length of perfect vacuum dielectric coaxial transmission line was added to the reference signal path.

**COLOR**

adjusts the degree of whiteness of the color being modified. Refer to the section on adjusting the display color in the “Using Measurement Functions” chapter of the user’s guide for an explanation of using this softkey for color modification of display attributes.

**CONFIDENCE CHECK**

provides access to the ECal confidence menu. This menu contains choices to compare current measurements of the selected ECal module against factory measurements.

**CONFIGURE EXT DISK**

provides access to the configure ext disk menu. This menu contains softkeys used to the disk address, unit number, and volume number.

**CONFIGURE MENU**

provides access to the configure menu. This menu contains softkeys to control raw offsets, spur avoidance, the test set transfer switch, and user preset settings.

**CONFIGURE [MODULE A]**

provides access to the ECal module configure menu. This menu contains softkeys to check the operation of the module, to get information about the module, and to set isolation parameters.

**CONTINUE ECal**

is displayed during ECal dual module operation and during manual thru operation as a pause in the process of measurement. After you have inserted the next module or connected the thru, press this softkey to continue the process.

**CONTINUE SEQUENCE**

resumes a paused sequence.

**CONTINUOUS**

located under the **Sweep Setup** key, is the standard sweep mode of the analyzer, in which the sweep is triggered automatically and continuously and the trace is updated with each sweep.

**CONVERSION [ ]**

brings up the conversion menu which converts the measured data to impedance (Z) or admittance (Y). When a conversion parameter has been defined, it is shown in brackets under the softkey label. If no conversion has been defined, the softkey label reads **CONVERSION [OFF]**.

**Copy**

provides access to the menus used for controlling external plotters and printers and defining the plot parameters.

**CORRECTION on OFF**

turns error correction on or off. The analyzer uses the most recent calibration data for the displayed parameter. If the stimulus state has been changed since calibration, the original state is recalled, and the message "SOURCE PARAMETERS CHANGED" is displayed.

**COUNTER: ANALOG BUS**

switches the counter to count the analog bus.

**COUNTER: DIV FRAC N**

switches the counter to count the A14 fractional-N VCO frequency after it has been divided down to 100 kHz for phase-locking the VCO.

**COUNTER: FRAC N**

switches the counter to count the A14 fractional-N VCO frequency at the node shown on the overall block diagram.

**COUNTER: OFF**

switches the internal counter off and removes the counter display from the LCD.

**COUPLED CH ON off**

toggles the channel coupling of stimulus values. With **COUPLED CH ON** (the preset condition), both channels have the same stimulus values (the inactive channel takes on the stimulus values of the active channel).

**CW FREQ**

is used to set the frequency for power sweep and CW time sweep modes. If the instrument is not in either of these two modes, it is automatically switched into CW time mode.

**CW TIME**

turns on a sweep mode similar to an oscilloscope. The analyzer is set to a single frequency, and the data is displayed versus time. The frequency of the CW time sweep is set with **CW FREQ** in the stimulus menu.

**D2/D1 to D2 on OFF**

this math function ratios channels 1 and 2, and puts the results in the channel 2 data array. Both channels must be on and have the same number of points. Refer to the "Making Measurements" chapter in the user's guide for information on how to use this function to make gain compression measurements.

**DATA and MEMORY**

displays both the current data and memory traces.

**DATA ARRAY on OFF**

specifies whether or not to store the error-corrected data on disk with the instrument state.

**DATA/MEM**

divides the data by the memory, normalizing the data to the memory, and displays the result. This is useful for ratio comparison of two traces, for instance in measurements of gain or attenuation.

**DATA - MEM**

subtracts the memory from the data. The vector subtraction is performed on the complex data. This is appropriate for storing a measured vector error, for example directivity, and later subtracting it from the device measurement.

**DATA → MEMORY**

stores the current active measurement data in the memory of the active channel. It then becomes the memory trace, for use in subsequent math manipulations or display. If a parameter has just been changed and the \* status notation is displayed at the left of the display, the data is not stored in memory until a clean sweep has been executed. The gating and smoothing status of the trace are stored with the measurement data.

**DATA ONLY on OFF**

stores only the measurement data of the device under test to a disk file. The instrument state and calibration are not stored. This is faster than storing with the instrument state, and uses less disk space. It is intended for use in archiving data that will later be used with an external controller, and data cannot be read back by the analyzer.

**DECISION MAKING**

presents the sequencing decision making menu under the **Seq** menu.

**DECR LOOP COUNTER**

decrements the value of the loop counter by 1.

**DEFAULT COLORS**

returns all the display color settings back to the factory-set default values that are stored in non-volatile memory.

**DEFAULT PLOT SETUP**

resets the plotting parameters to their default values.

**DEFAULT PRNT SETUP**

resets the printing parameters to their default values.

**DEFINE DISK-SAVE**

leads to the define save menu. Use this menu to specify the data to be stored on disk in addition to the instrument state.

**DEFINE PLOT**

leads to a sequence of three menus. The first defines which elements are to be plotted and the auto feed state. The second defines which pen number is to be used with each of the elements (these are channel dependent.) The third defines the line types (these are channel dependent), plot scale, and plot speed.

<b>DEFINE PRINT</b>	leads to the define print menu. This menu defines the printer mode (monochrome or color) and the auto-feed state.
<b>DEFINE STANDARD</b>	makes the standard number the active function, and brings up the define standard menus. The standard number (1 to 8) is an arbitrary reference number used to reference standards while specifying a class.
<b>DELAY</b>	selects the group delay format, with marker values given in seconds.
<b>DELAY/THRU</b>	defines the standard type as a transmission line of specified length, for calibrating transmission measurements.
<b>DELETE</b>	deletes the segment or the frequency band indicated by the > pointer.
<b>DELETE ALL FILES</b>	deletes all files.
<b>DELETE FILE</b>	deletes a selected file.
<b>DELTA LIMITS</b>	<p>sets the limits an equal amount above and below a specified middle value, instead of setting upper and lower limits separately. This is used in conjunction with <b>MIDDLE VALUE</b> or <b>MARKER → MIDDLE</b>, to set limits for testing a device that is specified at a particular value plus or minus an equal tolerance.</p> <p>For example, a device may be specified at 0 dB ±3 dB. Enter the delta limits as 3 dB and the middle value as 0 dB.</p>
<b>DEMOD: AMPLITUDE</b>	(Option 010 only) amplitude demodulation for CW time transform measurements.
<b>DEMOD: OFF</b>	(Option 010 only) turns time domain demodulation off.
<b>DEMOD: PHASE</b>	(Option 010 only) phase demodulation for CW TIME transform measurements.
<b>DIRECTORY SIZE</b>	lets you specify the number of directory files to be initialized on a disk. This is particularly useful with a hard disk, where you may want a directory larger than the default 256 files, or with a floppy disk you may want to reduce the directory to allow extra space for data files. The number of directory files must be a multiple of 8. The minimum number is 8, and there is no practical maximum limit. Set the directory size before initializing a disk.

**DISK UNIT NUMBER**

specifies the number of the disk unit in the disk drive that is to be accessed in an external disk store or load routine. This is used in conjunction with the GPIB address of the disk drive, and the volume number, to gain access to a specific area on a disk. The access hierarchy is GPIB address, disk unit number, disk volume number.

**DISP MKRS ON off**

displays response and stimulus values for all markers that are turned on. Available only if no marker functions are on, for example **MKR STATS**.

**Display**

provides access to a series of menus for instrument and active channel display functions. The first menu defines the displayed active channel trace in terms of the mathematical relationship between data and trace memory. Other functions include auxiliary channel enabling, dual channel display (overlaid or split), display intensity, color selection, active channel display title, and frequency blanking.

**DISPLAY: DATA**

displays the current measurement data for the active channel.

**DISPLAY TESTS**

leads to a series of service tests for the display.

**DO BOTH FWD + REV**

activates both forward and reverse measurements of selected calibration standards.

**DO BOTH FWD THRU**

activates both forward measurements (reflection and transmission) of the thru standard from the selective enhanced response calibration menus.

**DO BOTH REV THRU**

activates both reverse measurements of the thru standard S22/S12 from the S11/S21 selective enhanced response calibration menus. (ES only).

**DO SEQUENCE**

has two functions:

- It shows the current sequences in memory. To run a sequence, press the softkey next to the desired sequence title.
- When entered into a sequence, this command performs a one-way jump to the sequence residing in the specified sequence position (SEQUENCE 1 through 6). **DO SEQUENCE** jumps to a softkey position, not to a specific sequence title. Whatever sequence is in the selected softkey position will run when the **DO SEQUENCE** command is executed. This command prompts the operator to select a destination sequence position.

<b>DONE 1-PORT CAL</b>	finishes one-port calibration (after all standards are measured) and turns error correction on.
<b>DONE 2-PORT CAL</b>	finishes two-port calibration (after all standards are measured) and turns error correction on (ES only).
<b>DONE FWD ENH RESP.</b>	finishes the transmission portion of the enhanced response calibration.
<b>DONE LOADS</b>	finishes all the load standards when the cal kit defines more than one load standard.
<b>DONE OPENS</b>	finishes all the open standards when the cal kit defines more than one open standard.
<b>DONE SHORTS</b>	finishes all the short standards when the cal kit defines more than one short standard.
<b>DONE RESP ISOL'N CAL</b>	finishes response and isolation calibration (after all standards are measured) and turns error correction on.
<b>DONE REV ENH RESP.</b>	finishes the transmission portion of the enhanced response calibration. (ES only)
<b>DONE SEQ MODIFY</b>	terminates the sequencing edit mode.
<b>DONE TRL/LRM</b>	finishes TRL/LRM two-port calibration (after all standards are measured) and turns error correction on.
<b>DOWN CONVERTER</b>	sets the analyzer's source higher than the analyzer's receiver for making measurements in frequency offset mode.
<b>DUAL CH on OFF</b>	toggles between the display of both measurement channels or the active channel only. This is used in conjunction with <b>SPLIT DISP 1X 2X 4X</b> in the display <b>DUAL QUAD SETUP</b> menu to display multiple channels. With <b>SPLIT DISP 1X</b> the two traces are overlaid on a single graticule.
<b>DUAL QUAD SETUP</b>	activates a sub-menu of <b>Display</b> , which allows you to enable the auxiliary channels and configure multiple-channel displays.
<b>DUPLICATE SEQUENCE</b>	duplicates a sequence currently in memory into a different softkey position. Duplicating a sequence is straightforward. Follow the prompts on the analyzer screen. This command does not affect the original sequence.



**EACH SWEEP**

Power meter calibration occurs on each sweep. Each measurement point is measured by the power meter, which provides the analyzer with the actual power reading. The analyzer corrects the power level at that point. The number of measurement/correction iterations performed on each point is determined by the

**NUMBER OF READINGS** softkey. This measurement mode sweeps slowly, especially when the measured power is low. Low power levels require more time for the power meter to settle. The power meter correction table in memory is updated after each sweep. This table can be read or changed via GPIB.

**ECal MENU**

provides access to the calibration menu for ECal correction routines and other menu choices that pertain to ECal operation.

**ECal SERVICE**

provides access to the service menu for ECal. In this menu you can check the operation of the ECal module.

**ECal STD [CONF]**

is located in the ECal service menu. This softkey allows you to check ECal module parameters. The choices are: CONF (confidence state), THRU, ISOL, S11 REFL, and S22 REFL.

**EDIT LIMIT LINE**

displays a table of limit segments on the LCD, superimposed on the trace. The edit limits menu is presented so that limits can be defined or changed. It is not necessary for limit lines or limit testing to be on while limits are defined.

**EDIT LIST**

presents the edit list menu. This is used in conjunction with the edit subsweep menu to define or modify the frequency sweep list. The list frequency sweep mode is selected with the **LIST FREQ** softkey described below.

**EDIT RIPL LIMIT**

selects the menu used to edit the ripple limits. The edit ripple limits menu allows you to add, change, or delete ripple limits for the ripple test.

**ELECTRICAL DELAY**

adjusts the electrical delay to balance the phase of the DUT. It simulates a variable length loss-less transmission line, which can be added to or removed from a receiver input to compensate for interconnecting cables, etc. This function is similar to the mechanical or analog "line stretchers" of other network analyzers. Delay is annotated in units of time with secondary labeling in distance for the current velocity factor.

**EMIT BEEP**

causes the instrument to beep once.

**END OF LABEL**

terminates the HP-GL "LB" command.



<b>END SWEEP HIGH PULSE</b>	sets the TTL output on TEST SEQ BNC or the test set interconnect to normally high with a 10 microseconds pulse high at the end of each sweep.
<b>END SWEEP LOW PULSE</b>	sets the TTL output on TEST SEQ BNC or the test set interconnect to normally low with a 10 $\mu$ s pulse low at the end of each sweep.
<b>ENHANCED RESPONSE</b>	provides access to the series of menus used to perform an enhanced response calibration.
<b>ENH. REFL. on OFF</b>	selects the enhanced reflection calibration. This calibration improves the response of an enhanced response calibration.

---

**NOTE** Use enhanced reflection only on a bilateral device. A bilateral device has similar forward and reverse transmission characteristics. Examples of bilateral devices are passive devices (filters, attenuators, and switches). Most active devices (amplifiers) and some passive devices (isolators and circulators) are not bilateral. If this calibration is used for a non-bilateral device, errors may occur in the resulting measurement.

---

<b>ENTRY Off</b>	turns the active entry off. This also removes error and warning messages.
<b>ERASE TITLE</b>	deletes the entire title.
<b>EXECUTE TEST</b>	runs the selected service test.
<b>EXT SOURCE AUTO</b>	selects the auto external source mode.
<b>EXT SOURCE MANUAL</b>	selects the manual external source mode.
<b>EXT TRIG ON POINT</b>	is similar to the trigger on sweep, but triggers each data point in a sweep.
<b>EXT TRIG ON SWEEP</b>	is used when the sweep is triggered on an externally generated signal connected to the rear panel EXT TRIGGER input. The sweep is started with a high to low transition of a TTL signal. If this key is pressed when no external trigger signal is connected, the notation "Ext" is displayed at the left side of the display to indicate that the analyzer is waiting for a trigger. When a trigger signal is connected, the "Ext" notation is replaced by the sweep speed indicator either in the status notation area or on the trace. External trigger mode is allowed in every sweep mode.
<b>EXTENSION INPUT A</b>	Use this feature to add electrical delay (in seconds) to extend the reference plane at input A to the end of the cable. This is used for any input measurements including S-parameters.

<b>EXTENSION INPUT B</b>	adds electrical delay to the input B reference plane for any B input measurements including S-parameters.
<b>EXTENSION PORT 1</b>	extends the reference plane for measurements of $S_{11}$ , $S_{21}$ , and $S_{12}$ .
<b>EXTENSION PORT 2</b>	extends the reference plane for measurements of $S_{22}$ , $S_{12}$ , and $S_{21}$ .
<b>EXTENSIONS on OFF</b>	toggles the reference plane extension mode. When this function is on, all extensions defined above are enabled; when off, none of the extensions are enabled.
<b>EXTERNAL DISK</b>	selects an (optional) external disk drive for SAVE/RECALL.
<b>EXTERNAL TESTS</b>	leads to a series of service tests.
<b>FILETITLE FILE0</b>	appears during sequence modification, when external disk is selected. FILE0 is the default name. A new name can be entered when you save the state to disk.
<b>FILETYPE: GRAPHIC</b>	saves the display to the disk drive as a graphic file when <b>SAVE FILE</b> pressed. The format of the graphic file is determined by the <b>GRAPH FMT [ ]</b> selection.
<b>FILETYPE: TEXT</b>	saves the display to the disk drive as a text file when <b>SAVE FILE</b> is pressed. The form of the text file is determined by the <b>TEXT FMT [ ]</b> selection.
<b>FILE NAME</b>	supplies a name for the saved state and or data file. Brings up the TITLE FILE MENU.
<b>FILE UTILITIES</b>	provides access to the file utilities menu.
<b>FIXED</b>	defines the load in a calibration kit as a fixed (not sliding) load.
<b>FIXED MKR AUX VALUE</b>	is used only with a polar or Smith format. It changes the auxiliary response value of the fixed marker. This is the second part of a complex data pair, and applies to a magnitude/phase marker, a real/imaginary marker, an R+jX marker, or a G+jB marker. Fixed marker auxiliary response values are always uncoupled in the two channels.  To read absolute active marker auxiliary values following a <b>MKR ZERO</b> operation, the auxiliary value can be reset to zero.
<b>FIXED MKR POSITION</b>	leads to the fixed marker menu, where the stimulus and response values for a fixed reference marker can be set arbitrarily.

**FIXED MKR STIMULUS**

changes the stimulus value of the fixed marker. Fixed marker stimulus values can be different for the two channels if the channel markers are uncoupled using the marker mode menu. To read absolute active marker stimulus values following a **MKR ZERO** operation, the stimulus value can be reset to zero.

**FIXED MKR VALUE**

changes the response value of the fixed marker. In a Cartesian format this is the y-axis value. In a polar or Smith chart format with a magnitude/phase marker, a real/imaginary marker, an  $R+jX$  marker, or a  $G+jB$  marker, this applies to the first part of the complex data pair. Fixed marker response values are always uncoupled in the two channels.

To read absolute active marker response values following a **MKR ZERO** operation, the response value can be reset to zero.

**FLAT LINE**

defines a flat limit line segment whose value is constant with frequency or other stimulus value. This line is continuous to the next stimulus value, but is not joined to a segment with a different limit value. If a flat line segment is the final segment it terminates at the stop stimulus. A flat line segment is indicated as FL on the table of limits.

**FORM FEED**

puts a form feed command into the display title.

**Format**

presents a menu used to select the display format for the data. Various rectangular and polar formats are available for display of magnitude, phase, impedance, group delay, real data, and SWR.

**FORMAT ARY on OFF**

specifies whether or not to store the formatted data on disk with the instrument state.

**FORMAT DISK**

brings up a menu for formatting a LIF or DOS disk.

**FORMAT: DOS**

causes subsequent disk initialization to use the DOS disk format.

**FORMAT: LIF**

causes subsequent disk initialization to use the LIF disk format. **FORMAT: LIF** is the default setting.

**FORMAT EXT DISK**

initializes media in external drive, and formats the disk using the selected (DOS or LIF) format.

**FORMAT INT DISK**

initializes media in internal drive, and formats the disk using the selected (DOS or LIF) format.

**FORMAT INT MEMORY**

clears all internal save registers and associated cal data and memory traces.

<b>FORWARD: OPEN</b>	a calibration standard type.
<b>FREQ OFFS MENU</b>	leads to the frequency offset menu (Option 089 only).
<b>FREQ OFFS on OFF</b>	switches the frequency offset mode on and off.
<b>FREQUENCY</b>	specifies the frequency of a calibration factor or loss value in the power meter cal loss/sensor lists.
<b>FREQUENCY BAND</b>	selects an existing frequency band to be reviewed, edited, or deleted. The maximum number of frequency bands is 12 (numbered 1 to 12).
<b>FREQUENCY BLANK</b>	blanks the displayed frequency notation for security purposes. Frequency labels cannot be restored except by instrument preset or turning the power off and then on.
<b>FREQUENCY: CW</b>	sets the LO frequency to CW mode for frequency offset.
<b>FREQUENCY: SWEEP</b>	sets the LO frequency to sweep mode for frequency offset.
<b>FULL 2-PORT</b>	provides access to the series of menus used to perform a complete calibration for measurement of all four S-parameters of a two-port device. This is the most accurate calibration for measurements of two-port devices. (ES only)
<b>FWD ISOL'N</b>	measures the forward isolation of the calibration standard.
<b>FWD MATCH</b> (Label Class)	lets you enter a label for the forward match class. The label appears during a calibration that uses this class.
<b>FWD MATCH</b> (Specify Class)	specifies which standards are in the forward match class in the calibration kit.
<b>FWD MATCH THRU</b>	measures the forward match using a thru standard.
<b>FWD TRANS</b> (Label Class)	lets you enter a label for the forward transmission class. The label appears during a calibration that uses this class.
<b>FWD TRANS</b> (Specify Class)	specifies which standards are in the forward transmission class in the calibration kit.
<b>FWD TRANS THRU</b>	measures the forward transmission frequency response in a two-port calibration.
<b>G+jB MKR</b>	displays the complex admittance values of the active marker in rectangular form. The active marker values are displayed in terms of conductance (in Siemens), susceptance, and equivalent capacitance or inductance. Siemens are the international units of admittance, and are equivalent to mhos (the inverse of $\Omega$ s). The Smith chart graticule is changed to admittance form.
<b>G/n</b>	giga/nano ( $10^9 / 10^{-9}$ ). Used to terminate numeric entries.

<b>GATE on OFF</b>	(Option 010 only) turns gating on or off in time domain mode.
<b>GATE: CENTER</b>	(Option 010 only) allows you to specify the time at the center of the gate.
<b>GATE: SPAN</b>	(Option 010 only) allows you to specify the gate periods.
<b>GATE: START</b>	(Option 010 only) allows you to specify the starting time of the gate.
<b>GATE: STOP</b>	(Option 010 only) allows you to specify the stopping time of the gate.
<b>GATE SHAPE</b>	(Option 010 only) leads to the gate shape menu.
<b>GATE SHAPE MAXIMUM</b>	(Option 010 only) selects the widest time domain gate with the smallest passband ripple.
<b>GATE SHAPE MINIMUM</b>	(Option 010 only) selects the narrowest time domain gate with the largest passband ripple.
<b>GATE SHAPE NORMAL</b>	(Option 010 only) selects an intermediate time domain gate.
<b>GATE SHAPE WIDE</b>	(Option 010 only) selects an intermediate time domain gate.
<b>GET SEQ TITLES</b>	copies the sequence titles currently in memory into the six softkey positions.
<b>GOSUB SEQUENCE</b>	calls sub-routines in sequencing.
<b>GPIB DIAG on off</b>	toggles the GPIB diagnostic feature (debug mode). This mode should only be used the first time a program is written: if a program has already been debugged, it is unnecessary.  When diagnostics are on, the analyzer scrolls a history of incoming GPIB commands across the display in the title line. Nonprintable characters are represented as pi. If a syntax error is received, the commands halt and a pointer wedge indicates the misunderstood character. For information on clearing a syntax error, refer to the programmer's guide.
<b>GRAPH FMT [ ]</b>	sets the format of the graphic file when <b>FILETYPE: GRAPHIC</b> is selected. The only graphic selection currently available is the JPEG format.
<b>GRAPHICS on OFF</b>	specifies whether or not to store display graphics on disk with the instrument state.
<b>GRATICULE [ ]</b>	brings up the graticule print color definition menu. The graticule default print color is cyan.

<b>GRATICULE</b>	selects the display graticule for color modification.
<b>HARMONIC MEAS</b>	(Option 002 only) leads to the harmonics menu. Measured harmonics cannot exceed the frequency range of the analyzer receiver.
<b>HARMONIC OFF</b>	(Option 002 only) turns off the harmonic measurement mode.
<b>HARMONIC SECOND</b>	(Option 002 only) selects measurement of the second harmonic.
<b>HARMONIC THIRD</b>	(Option 002 only) selects measurement of the third harmonic.
<b>HELP ADAPT REMOVAL</b>	provides an on-line quick reference guide to using the adapter removal technique.
<b>HOLD</b>	freezes the data trace on the display, and the analyzer stops sweeping and taking data. The notation "Hld" is displayed at the left of the graticule. If the * indicator is on at the left side of the display, trigger a new sweep with <b>SINGLE</b> .
<b>IF BW [ ]</b>	is used to select the bandwidth value for IF bandwidth reduction. Allowed values (in Hz) are 6000, 3700, 3000, 1000, 300, 100, 30, and 10. Any other value will default to the closest allowed value. A narrow bandwidth slows the sweep speed but provides better signal-to-noise ratio. The selected bandwidth value is shown in brackets in the softkey label.
<b>IF LIMIT TEST FAIL</b>	jumps to one of the six sequence positions (SEQUENCE 1 through 6) if the limit test fails. This command executes any sequence residing in the selected position. Sequences may jump to themselves as well as to any of the other sequences in memory. When this softkey is pressed, the analyzer presents a softkey menu showing the six sequence positions and the titles of the sequences located in them. Choose the destination sequence to be called if the limit test fails.
<b>IF LIMIT TEST PASS</b>	jumps to one of the six sequence positions (SEQUENCE 1 through 6) if the limit test passes. This command executes any sequence residing in the selected position. Sequences may jump to themselves as well as to any of the other sequences in memory. When this softkey is pressed, the analyzer presents a softkey menu showing the six sequence positions, and the titles of the sequences located in them. Choose the sequence to be called if the limit test passes (destination sequence).

<b>IF LOOP COUNTER = 0</b>	prompts the user to select a destination sequence position (SEQUENCE 1 through 6). When the value of the loop counter reaches zero, the sequence in the specified position will run.
<b>IF LOOP &lt; &gt; COUNTER 0</b>	prompts the user to select a destination sequence position (SEQUENCE 1 through 6). When the value of the loop counter is no longer zero, the sequence in the specified position will run.
<b>IMAGINARY</b>	displays only the imaginary (reactive) portion of the measured data on a Cartesian format. This format is similar to the real format except that reactance data is displayed on the trace instead of impedance data.
<b>INCR LOOP COUNTER</b>	increments the value of the loop counter by 1.
<b>INPUT PORTS</b>	accesses a menu that allows you to measure the R, A, and B channels and their ratios.
<b>INSTRUMENT MODE</b>	presents the instrument mode menu. This provides access to the primary modes of operation (analyzer modes).
<b>INTENSITY</b>	sets the LCD intensity as a percent of the brightest setting. The factory-set default value is stored in non-volatile memory.
<b>INTERNAL TESTS</b>	leads to a series of service tests.
<b>INTERNAL DISK</b>	selects the analyzer internal disk for the storage device.
<b>INTERNAL MEMORY</b>	selects internal non-volatile memory as the storage medium for subsequent save and recall activity.
<b>INTERPOL on OFF</b>	turns interpolated error correction on or off. The interpolated error correction feature allows the operator to calibrate the system, then select a subset of the frequency range or a different number of points. Interpolated error correction functions in linear frequency, power sweep and CW time modes. When using the analyzer in linear sweep, it is recommended that the original calibration be performed with at least 67 points per 1 GHz of frequency span.
<b>ISOLATION</b>	leads to the isolation menu.
<b>ISOLATION AVERAGES</b>	allows the number of isolation averages taken in the ECal correction to be set manually. Use the number keypad to set the number of averages. The number of averages can be set from 1 to 999. The default number of averages is 10.
<b>ISOLATION DONE</b>	returns to the two-port cal menu.
<b>ISOL'N STD</b>	measures the isolation of the device connected to the test port.



<b>(k/m)</b>	kilo/milli ( $10^3 / 10^{-3}$ )
<b>KIT DONE (MODIFIED)</b>	terminates the cal kit modification process, after all standards are defined and all classes are specified. Be sure to save the kit with the <b>SAVE USER KIT</b> softkey, if it is to be used later.
<b>LABEL CLASS</b>	leads to the label class menu, to give the class a meaningful label for future reference during calibration.
<b>LABEL CLASS DONE</b>	finishes the label class function and returns to the modify cal kit menu.
<b>LABEL KIT</b>	leads to a menu for constructing a label for the user-modified cal kit. If a label is supplied, it will appear as one of the five softkey choices in the select cal kit menu. The approach is similar to defining a display title, except that the kit label is limited to ten characters.
<b>LABEL STD</b>	The function is similar to defining a display title, except that the label is limited to ten characters.
<b>LEFT LOWER</b>	draws a quarter-page plot in the lower left quadrant of the page.
<b>LEFT UPPER</b>	draws a quarter-page plot in the upper left quadrant of the page.
<b>LIMIT LINE</b>	selects the standard limit line choice. This selection leads to a series of menus used to define limits or specifications with which to compare a test device. Refer to “Limit Line Operation” in the “Operating Concepts” chapter of the user’s guide and the limit line testing section of the “Making Measurements” chapter of the user’s guide.
<b>LIMIT LINE OFFSETS</b>	leads to the offset limits menu, which is used to offset the complete limit set in either stimulus or amplitude value.
<b>LIMIT LINE on OFF</b>	turns limit lines on or off. To define limits, use the <b>EDIT LIMIT LINE</b> softkey described below. If limits have been defined and limit lines are turned on, the limit lines are displayed on the LCD for visual comparison of the measured data in all Cartesian formats.  If limit lines are on, they are plotted with the data on a plot, and saved in memory with an instrument state. In a listing of values from the copy menu with limit lines on, the upper limit and lower limit are listed together with the pass or fail margin, as long as other listed data allows sufficient space.
<b>LIMIT MENU</b>	accesses the menu that allows you to set up the three limit line types: standard limit lines, ripple limit lines, and bandwidth limit lines.



**LIMIT TEST on OFF**

turns limit testing on or off. When limit testing is on, the data is compared with the defined limits at each measured point. Limit tests occur at the end of each sweep, whenever the data is updated, when formatted data is changed, and when limit testing is first turned on.

Limit testing is available for both magnitude and phase values in Cartesian formats. In polar and Smith chart formats, the value tested depends on the marker mode and is the magnitude or the first value in a complex pair. The message "NO LIMIT LINES DISPLAYED" is displayed in polar and Smith chart formats if limit lines are turned on.

Five indications of pass or fail status are provided when limit testing is on. A PASS or FAIL message is displayed at the right of the LCD. The trace vector leading to any measured point that is out of limits is set to red at the end of every limit test, both on a displayed plot and a hard copy plot. The limit fail beeper sounds if it is turned on. In a listing of values using the copy menu, an asterisk \* is shown next to any measured point that is out of limits. A bit is set in the GPIB status byte.

**LIMIT TEST RESULT**

puts the result of a limit test into the display title.

**LIMIT TYPE**

leads to the limit type menu, where one of three segment types can be selected: sloping line, flat line, or single point.

**LIN FREQ**

activates a linear frequency sweep displayed on a standard graticule with ten equal horizontal divisions. This is the default preset sweep type.

**LIN MAG**

displays the linear magnitude format. This is a Cartesian format used for unitless measurements such as reflection coefficient magnitude  $\rho$  or transmission coefficient magnitude  $\tau$ , and for linear measurement units. It is used for display of conversion parameters and time domain transform data.

**LIN MKR**

displays a readout of the linear magnitude and the phase of the active marker. Marker magnitude values are expressed in units and phase is expressed in degrees.

**LINE/MATCH**

provides access to the Line/Match Menu for TRL/LRM calibration.

**LINE TYPE DATA**

selects the line type for the data trace plot. The default line type is 7, which is a solid unbroken line.

**LINE TYPE MEMORY**

selects the line type for the memory trace plot. The default line type is 7.

**LIST**

provides a tabular listing of all the measured data points and their current values, together with limit information if it is turned on. At the same time, the screen menu is presented, to enable hard copy listings and access new pages of the table. 30 lines of data are listed on each page, and the number of pages is determined by the number of measurement points specified in the stimulus menu.

**LIST FREQ [SWEPT]**

or **[STEPPED]**

provides two user-definable arbitrary frequency list modes. This list is defined and modified using the edit list menu and the edit subsweep menu. Up to 30 frequency subsweeps (called “segments”) of several different types can be specified, for a maximum total of 1601 points. One list is common to both channels. Once a frequency list has been defined and a measurement calibration performed on the full frequency list, one or all of the frequency segments can be measured and displayed without loss of calibration.

For more information on the different list frequency sweep modes, refer to “Sweep Types” in the “Operating Concepts” chapter of the user’s guide.

**LIST IF BW on OFF**

enables or disables the ability to set independent IF bandwidths for each segment in a swept list measurement.

**LIST POWER on OFF**

enables or disables the ability to set independent power levels for each segment in a swept list measurement.

When on, sets power range mode to manual to set a range for the power values. (The range can be chosen using the **PWR RANGE** key.) The power values can be entered using the **SEGMENT POWER** key. If ports are uncoupled, the power can be set independently for each port.

When off, the **SEGMENT POWER** key will not function and the power column in the swept list table will display asterisks. In this case, the power is set by the normal test port power value.

**LIST TYPE [SWEPT]**

selects either stepped or swept list mode. For in-depth information on swept list mode, refer to “Swept List Frequency Sweep (Hz)” in the “Operating Concepts” chapter of the user’s guide.

**LN/MATCH 1**

measures the TRL/LRM line or match standard for PORT 1.

**LN/MATCH 2**

measures the TRL/LRM line or match standard for PORT 2.

**LO CONTROL on OFF**

turns the LO control mode on and off for frequency offset.

<b>LO MENU</b>	leads to the LO menu. Allows you to configure the external source for frequency offset.
<b>LO SOURCE ADDRESS</b>	shows the GPIB address of the LO source.
<b>LOAD</b>	defines the standard type as a load (termination). Loads are assigned a terminal impedance equal to the system characteristic impedance $Z_0$ , but delay and loss offsets may still be added. If the load impedance is not $Z_0$ , use the arbitrary impedance standard definition.
<b>LOAD NO OFFSET</b>	initiates measurement of a calibration standard load without offset.
<b>LOAD OFFSET</b>	initiates measurement of a calibration standard load with offset.
<b>LOAD SEQ FROM DISK</b>	presents the load sequence from disk menu. Select the desired sequence and the analyzer will load it from disk.
<b>Local</b>	This key is used to return the analyzer to local (front panel) operation from remote (computer controlled) operation. This key will also abort a test sequence or hardcopy print/plot. In this local mode, with a controller still connected on GPIB, the analyzer can be operated manually (locally) from the front panel. This is the only front panel key that is not disabled when the analyzer is remotely controlled over GPIB by a computer. The exception to this is when local lockout is in effect: this is a remote command that disables the <b>Local</b> key, making it difficult to interfere with the analyzer while it is under computer control.
<b>LOG FREQ</b>	activates a logarithmic frequency sweep mode. The source is stepped in logarithmic increments and the data is displayed on a logarithmic graticule. This is slower than a continuous sweep with the same number of points, and the entered sweep time may therefore be changed automatically. For frequency spans of less than two octaves, the sweep type automatically reverts to linear sweep.
<b>LOG MAG</b>	displays the log magnitude format. This is the standard Cartesian format used to display magnitude-only measurements of insertion loss, return loss, or absolute power in dB versus frequency.

**LOG MKR**

displays the logarithmic magnitude value and the phase of the active marker in Polar or Smith chart format. Magnitude values are expressed in dB and phase in degrees. This is useful as a fast method of obtaining a reading of the log magnitude value without changing to log magnitude format.

**LOOP COUNTER**

displays the current value of the loop counter and allows you to change the value of the loop counter. Enter any number from 0 to 32767 and terminate with the **(x1)** key. The default value of the counter is zero. This command should be placed in a sequence that is separate from the measurement sequence. For this reason: the measurement sequence containing a loop decision command must call itself in order to function. The **LOOP COUNTER** command must be in a separate sequence or the counter value would always be reset to the initial value.

**LOOP COUNTER**

(Sequence Filenaming)

inserts the string “[LOOP]” into the file name.

**LOSS**

accepts a power loss value for a segment in the power meter cal power loss list. This value, for example, could be the difference (in dB) between the coupled arm and through arm of a directional coupler.

**LOSS/SENSR LISTS**

presents the power loss/sensor lists menu. This menu performs two functions:

- Corrects coupled-arm power loss when a directional coupler is used to sample the RF output.
- Allows calibration factor data to be entered for one or two power sensors.

Each function provides up to 12 separate frequency points, called segments, at which the user may enter a different power loss or calibration factor. The instrument interpolates between the selected points. Two power sensor lists are provided because no single power sensor can cover the frequency range of the network analyzer.

**LOW PASS IMPULSE**

(Option 010 only) sets the transform to low pass impulse mode, which simulates the time domain response to an impulse input.

**LOW PASS STEP**

(Option 010 only) sets the transform to low pass step mode, which simulates the time domain response to a step input.

**LOWER LIMIT**

sets the lower limit value for the start of the segment in a limit line list. If an upper limit is specified, a lower limit must also be defined. If no lower limit is required for a particular measurement, force the lower limit value out of range (for example -500 dB).

**M/μ**

mega/micro ( $10^6 / 10^{-6}$ )

**MAN ' L THRU on OFF**

allows the insertion of a different thru during the ECal correction routine. When turned ON, the routine will pause for the insertion of the thru and display a menu that contains a continue and abort softkey.

**MANUAL TRG ON POINT**

waits for a manual trigger for each point. Subsequent pressing of this softkey triggers each measurement. The annotation "man" will appear at the left side of the display when the instrument is waiting for the trigger to occur. This feature is useful in a test sequence when an external device or instrument requires changes at each point.

**Marker**

displays an active marker on the screen and provides access to a series of menus to control from one to five display markers for each channel. Markers provide numerical readout of measured values at any point of the trace.

The menus accessed from the **Marker** key provide several basic marker operations. These include special marker modes for different display formats, and a marker delta mode that displays marker values relative to a specified value or another marker.

**MARKER → AMP. OFS.**

uses the active marker to set the amplitude offset for the limit lines. Move the marker to the desired middle value of the limits and press this softkey. The limits are then moved so that they are centered an equal amount above and below the marker at that stimulus value.

**MARKER → CENTER**

changes the stimulus center value to the stimulus value of the active marker, and centers the new span about that value.

**MARKER → CW**

sets the CW frequency of the analyzer to the frequency of the active marker. This feature is useful in automated compression measurements. Test sequences allow the instrument to automatically find a maximum or minimum point on a response trace. The **MARKER → CW** command sets the instrument to the CW frequency of the active marker. When power sweep is engaged, the CW frequency will already be selected.

**MARKER → DELAY**

adjusts the electrical delay to balance the phase of the DUT. This is performed automatically, regardless of the format and the measurement being made. Enough line length is added to or subtracted from the receiver input to compensate for the phase slope at the active marker position. This effectively flattens the phase trace around the active marker, and can be used to measure electrical length or deviation from linear phase. Additional electrical delay adjustments are required on DUTs without constant group delay over the measured frequency span. Since this feature adds phase to a variation in phase versus frequency, it is applicable only for ratioed inputs.

**MARKER → MIDDLE**

sets the midpoint for **DELTA LIMITS** using the active marker to set the middle amplitude value of a limit segment. Move the marker to the desired value or device specification, and press this key to make that value the midpoint of the delta limits. The limits are automatically set an equal amount above and below the marker.

**MARKER → REFERENCE**

makes the reference value equal to the active marker's response value, without changing the reference position. In a polar or Smith chart format, the full scale value at the outer circle is changed to the active marker response value. This softkey also appears in the scale reference menu.

**MARKER → SPAN**

changes the start and stop values of the stimulus span to the values of the active marker and the delta reference marker. If there is no reference marker, the message "NO MARKER DELTA – SPAN NOT SET" is displayed.

**MARKER → START**

changes the stimulus start value to the stimulus value of the active marker.

**MARKER → STIMULUS**

sets the starting stimulus value of a limit line segment using the active marker. Move the marker to the desired starting stimulus value before pressing this key, and the marker stimulus value is entered as the segment start value.

**MARKER → STOP**

changes the stimulus stop value to the stimulus value of the active marker.

**MARKER 1**

turns on marker 1 and makes it the active marker. The active marker appears on the display as ∇. The active marker stimulus value is displayed in the active entry area, together with the marker number. If there is a marker turned on, and no other function is active, the stimulus value of the active marker can be controlled with the knob, the step keys, or the numeric keypad. The marker response and stimulus values are displayed in the upper right-hand corner of the screen.

<b>MARKER 2</b>	turns on marker 2 and makes it the active marker. If another marker is present, that marker becomes inactive and is represented on the display as $\Delta$ .
<b>MARKER 3</b>	turns on marker 3 and makes it the active marker.
<b>MARKER 4</b>	turns on marker 4 and makes it the active marker.
<b>MARKER 5</b>	turns on marker 5 and makes it the active marker.
<b>MARKER all OFF</b>	turns off all the markers and the delta reference marker, as well as the tracking and bandwidth functions that are accessed with the <b>MKR FCTN</b> key.
<b>Marker Fctn</b>	key activates a marker if one is not already active, and provides access to additional marker functions. These can be used to quickly change the measurement parameters, to search the trace for specified information, and to analyze the trace statistically.
<b>MARKER MODE MENU</b>	provides access to the marker mode menu, where several marker modes can be selected including special markers for polar and Smith chart formats.
<b>Marker Search</b>	allows user to turn tracking on, off and search for the maximum, minimum, and target points on the trace.
<b>MARKERS: CONTINUOUS</b>	located under the <b>Marker</b> key, interpolates between measured points to allow the markers to be placed at any point on the trace. Displayed marker values are also interpolated. This is the default marker mode.
<b>MARKERS: COUPLED</b>	ouples the marker stimulus values for the two display channels. Even if the stimulus is uncoupled and two sets of stimulus values are shown, the markers track the same stimulus values on each channel as long as they are within the displayed stimulus range.
<b>MARKERS: DISCRETE</b>	places markers only on measured trace points determined by the stimulus settings.
<b>MARKERS: UNCOUPLED</b>	allows the marker stimulus values to be controlled independently on each channel.
<b>MAX</b>	moves the active marker to the maximum point on the trace.
<b>MAXIMUM BANDWIDTH</b>	sets the maximum bandwidth value of the bandwidth test limits.



**MAXIMUM FREQUENCY**

is used to:

1) define the highest frequency at which a calibration kit standard can be used during measurement calibration. In waveguide, this is normally the upper cutoff frequency of the standard.

or

2) set the maximum frequency of the selected frequency band when setting up ripple test parameters.

**MAXIMUM RIPPLE**

sets the maximum ripple allowed of the selected frequency band. The maximum allowable ripple is 100 dB.

**Meas**

key provides access to a series of softkey menus for selecting the parameters or inputs to be measured.

**MEASURE RESTART**

aborts the sweep in progress, then restarts the measurement. This can be used to update a measurement following an adjustment of the device under test. When a full two-port calibration is in use, the

**MEASURE RESTART** key will initiate another update of both forward and reverse S-parameter data. This softkey will also override the test set hold mode, which inhibits continuous switching of either the test port transfer switch or step attenuator. This softkey will override the test set hold mode for one measurement.

If the analyzer is taking a number of groups, the sweep counter is reset at 1. If averaging is on,

**MEASURE RESTART** resets the sweep-to-sweep averaging and is effectively the same as

**AVERAGING RESTART**. If the sweep trigger is in

**HOLD** mode, **MEASURE RESTART** executes a single sweep.

**MEMORY**

displays the trace memory for the active channel. This is the only memory display mode where the smoothing and gating of the memory trace can be changed. If no data has been stored in memory for this channel, a warning message is displayed.

**MIDDLE VALUE**

sets the midpoint for **DELTA LIMITS**. It uses the entry controls to set a specified amplitude value vertically centered between the limits.

**MIN**

moves the active marker to the minimum point on the trace.

**MINIMUM BANDWIDTH**

sets the minimum bandwidth value of the bandwidth test limits.



**MINIMUM FREQUENCY**

is used to:

1) define the lowest frequency at which a calibration kit standard can be used during measurement calibration. In waveguide, this must be the lower cutoff frequency of the standard, so that the analyzer can calculate dispersive effects correctly (see **OFFSET DELAY** ).

or

2) set the minimum frequency of the selected frequency band when setting up ripple test parameters.

**MKR SEARCH [ ]**

leads to the marker search menu, which is used to search the trace for a particular value or bandwidth.

**MKR STATS on OFF**

calculates and displays the mean, standard deviation, and peak-to-peak values of the section of the displayed trace between the active marker and the delta reference marker. If there is no delta reference, the statistics are calculated for the entire trace. A convenient use of this feature is to find the peak-to-peak value of passband ripple without searching separately for the maximum and minimum values.

The statistics are absolute values: the delta marker here serves to define the span. For polar and Smith chart formats, the statistics are calculated using the first value of the complex pair (magnitude, real part, resistance, or conductance).

**MKR ZERO**

puts a fixed reference marker at the present active marker position, and makes the fixed marker stimulus and response values at that position equal to zero. All subsequent stimulus and response values of the active marker are then read out relative to the fixed marker. The fixed marker is shown on the display as a small triangle  $\Delta$  (delta), smaller than the inactive marker triangles. The softkey label changes from **MKR ZERO** to **MKR ZERO  $\Delta$ REF =  $\Delta$**  and the notation " $\Delta$ REF =  $\Delta$ " is displayed at the top right corner of the graticule. Marker zero is canceled by turning delta mode off in the delta marker menu or turning all the markers off with the **ALL OFF** softkey.

**MODIFY [ ]**

leads to the modify cal kit menu, where a default cal kit can be user-modified.

**MODIFY COLORS**

present a menu for color modification of display elements. Refer to the section on adjusting the display color in the "Using Measurement Functions" chapter of the user's guide for information on modifying display elements.

<b>MODULE A b</b>	selects the module to be used in the ECal operation. Select the module according to frequency range and connector type of the DUT. In some cases the Module B selection will not be used.
<b>MODULE INFO</b>	presents a text window that contains information about the selected module.
<b>MORE RANGES</b>	provides access to more power ranges.
<b>N 50Ω 85032B/E</b>	selects the 85032B/E cal kit.
<b>N 50Ω 85032F</b>	selects the 85032F cal kit.
<b>N 75Ω 85036</b>	selects the 85036B/E cal kit.
<b>N DB POINTS</b>	sets the N dB point which is used to determine the bandwidth test cutoff frequencies. Enter the number of decibels below the peak of the bandpass that the filter is specified.
<b>NETWORK ANALYZER</b>	sets the analyzer to network analyzer mode.
<b>NEW SEQ/MODIFY SEQ</b>	activates the sequence edit mode and presents the new/modify sequence menu with a list of sequences that can be created or modified.
<b>NEWLINE</b>	puts a new line command into the display title.
<b>NEXT PAGE</b>	steps forward through a tabular list of data page-by-page.
<b>NUMBER OF GROUPS</b>	<p>triggers a user-specified number of sweeps, and returns to the hold mode. This function can be used to override the test set hold mode (indicated by the notation “tsH” at the left of the screen). In this mode, the electro-mechanical transfer switch (Option 007) and attenuator are not protected against unwanted continuous switching. This occurs in a full two-port calibration, in a measurement of two different parameters that require power out from both ports, or when the channels are uncoupled and a different power level is set for each channel.</p> <p>If averaging is on, the number of groups should be at least equal to the averaging factor selected to allow measurement of a fully averaged trace. Entering a number of groups resets the averaging counter to 1.</p>
<b>NUMBER of POINTS</b>	is used to select the number of data points per sweep to be measured and displayed. Using fewer points allows a faster sweep time but the displayed trace shows less horizontal detail. Using more points gives greater data density and improved trace resolution, but slows the sweep and requires more memory for error correction or saving instrument states.

The possible values that can be entered for number of points are 3, 11, 26, 51, 101, 201, 401, 801, and 1601. The number of points can be different for the two channels if the stimulus values are uncoupled.

In list frequency sweep, the number of points displayed is the total number of frequency points for the defined list (see “Sweep Types” in the “Operating Concepts” chapter of the user’s guide).

**NUMBER OF READINGS**

determines the number of measurement/correction iterations performed on each point in a power meter calibration. This feature helps eliminate residual power errors after the initial correction. The amount of residual error is directly proportional to the magnitude of the initial correction. The user should initially set the source power so that it is approximately correct at the device under test. If power uncertainty at the device under test is expected to be greater than a few dB, it is recommended that the number of readings be greater than 1.

**OFFSET**

selects the calibration standard load as being offset.

**OFFSET DELAY**

is used to specify the one-way electrical delay from the measurement (reference) plane to the standard, in seconds (s). (In a transmission standard, offset delay is the delay from plane to plane.) Delay can be calculated from the precise physical length of the offset, the permittivity constant of the medium, and the speed of light.

**OFFSET LOADS DONE**

completes the selection in the Offset Load Menu.

**OFFSET LOSS**

is used to specify energy loss, due to skin effect, along a one-way length of coax offset. The value of loss is entered as  $\Omega$ s/nanosecond (or Giga  $\Omega$ s/second) at 1 GHz. (Such losses are negligible in waveguide, so enter 0 as the loss offset.)

**OFFSET Z0**

is used to specify the characteristic impedance of the coax offset. (Note: This is not the impedance of the standard itself.) (For waveguide, the offset impedance should always be assigned a value equal to the system Z0.)

**OMIT ISOLATION**

is used to omit the isolation portion of the calibration.

**OMIT ISOL ON off**

is used to toggle the isolation portion of the calibration for the ECal correction routine.

**ONE-PATH 2-PORT**

leads to the series of menus used to perform a high-accuracy two-port calibration without an S-parameter test set. This calibration procedure effectively removes directivity, source match, load match, isolation, reflection tracking, and transmission tracking errors in one direction only. Isolation correction can be omitted for measurements of devices with limited dynamic range. (The device under test must be manually reversed between sweeps to accomplish measurement of both input and output responses.) The required standards are a short, an open, a thru, and an impedance-matched load.

**ONE SWEEP**

This mode does not measure each sweep, but corrects each point with the data currently in the power meter correction table.

**OP PARMS (MKRS etc)**

provides a tabular listing on the analyzer display of the key parameters for both channels. The screen menu is presented to allow hard copy listings and access new pages of the table. Four pages of information are supplied. These pages list operating parameters, marker parameters, and system parameters that relate to control of peripheral devices rather than selection of measurement parameters.

**OPEN**

defines the standard type as an open, used for calibrating reflection measurements. Opens are assigned a terminal impedance of infinite  $\Omega$ s, but delay and loss offsets may still be added.

**OPEN (F)**

for cal kits with different models for male and female test port standards, this selects the open model for a female test port. Note that the sex of a calibration standard always refers to the test port.

**OPEN (M)**

for cal kits with different models for male and female test port standards, this selects the open model for a male test port. Note that the sex of a calibration standard always refers to the test port.

**P MTR/GPIB TO TITLE**

gets data from an GPIB device set to the address at which the analyzer expects to find a power meter. The data is stored in a title string. The analyzer must be in system controller or pass control mode.

**PARAMETER [S11]**

is located in the ECal confidence and ECal service menus. In ES models you can display the S11, S22, S21, or S12 ECal module factory response and the actual measurement response. In ET models, you can display the TRN or RFL responses.

**PARALL IN BIT NUMBER**

while creating a sequence, this softkey will insert a command that selects the single bit (0 to 4) that a sequence will be looking for from the GPIO bus.

**PARALL IN IF BIT H**

while creating a sequence, this softkey inserts a command to jump to another sequence if the single input selected is in a high state.

**PARALL IN IF BIT L**

while creating a sequence, this softkey inserts a command to jump to another sequence if the single input selected is in a low state.

**PARALLEL**

sets the printer or plotter port to parallel.

**PARALLEL [COPY/GPIO]**

toggles the parallel output port between the copy and GPIO output modes.

**PARALLEL OUT ALL**

allows you to input a number (0 to 255) in base 10, and outputs it to the bus as binary, when the parallel port is in GPIO mode.

**PAUSE**

pauses the sequence so the operator can perform a needed task, such as changing the DUT, changing the calibration standard, or other similar task. Press **CONTINUE SEQUENCE** when ready.

**PAUSE TO SELECT**

when editing a sequence, **PAUSE TO SELECT** appears when you press **DO SEQUENCE**. When placed in a sequence, it presents the menu of up to 6 available sequences (softkeys containing non-empty sequences). If the operator selects one of the sequences, that sequence is executed. Any other key can be used to exit this mode. This function is not executed if used during modify mode and does nothing when operated manually. This softkey is not visible on the display, and the function is not available, unless programmed into analyzer memory.

**PEN NUM DATA**

selects the number of the pen to plot the data trace. The default pen for channel 1 is pen number 2, and for channel 2 is pen number 3.

**PEN NUM GRATICULE**

selects the number of the pen to plot the graticule. The default pen for channel 1 is pen number 1, and for channel 2 is pen number 1.

**PEN NUM MARKER**

selects the number of the pen to plot both the markers and the marker values. The default pen for channel 1 is pen number 7, and for channel 2 is pen number 7.

**PEN NUM MEMORY**

selects the number of the pen to plot the memory trace. The default pen for channel 1 is pen number 5, and for channel 2 is pen number 6.

**PEN NUM TEXT**

selects the number of the pen to plot the text. The default pen for channel 1 is pen number 7, and for channel 2 is pen number 7.

<b>PHASE OFFSET</b>	adds or subtracts a phase offset that is constant with frequency (rather than linear). This is independent of <b>MARKER → DELAY</b> and <b>ELECTRICAL DELAY</b> .
<b>PHASE</b>	(Option 010 only) displays a Cartesian format of the phase portion of the data, measured in degrees. This format displays the phase shift versus frequency.
<b>PLOT</b>	makes a hard copy plot of one page of the tabular listing on the display, using a compatible HP plotter connected to the analyzer through GPIB. This method is appropriate when speed of output is not a critical factor.
<b>PLOT DATA ON off</b>	specifies whether the data trace is to be drawn (on) or not drawn (off) on the plot.
<b>PLOT GRAT ON off</b>	specifies whether the graticule and the reference line are to be drawn (on) or not drawn (off) on the plot. Turning <b>PLOT GRAT ON</b> and all other elements off is a convenient way to make preplotted grid forms. However, when data is to be plotted on a preplotted form, <b>PLOT GRAT OFF</b> should be selected.
<b>PLOT MEM ON off</b>	specifies whether the memory trace is to be drawn (on) or not drawn (off) on the plot. Memory can only be plotted if it is displayed (refer to the “Making Measurements” chapter in the user’s guide).
<b>PLOT MKR ON off</b>	specifies whether the markers and marker values are to be drawn (on) or not drawn (off) on the plot.
<b>PLOT NAME PLOTFILE</b>	supplies a name for the plot file generated by a PLOT to disk. Brings up the TITLE FILE MENU.
<b>PLOT SPEED [ ]</b>	toggles between fast and slow speeds.
<b>PLOT TEXT ON off</b>	selects plotting of all displayed text except the marker values, softkey labels, and display listings such as the frequency list table or limit table. (Softkey labels can be plotted under the control of an external controller. Refer to the programmer’s guide.)
<b>PLOTTER BAUD RATE</b>	sets the serial port data transmission speed for plots.
<b>PLOTTER FORM FEED</b>	sends a page eject command to the plotter.
<b>PLOTTER PORT</b>	configures the port analyzer will use to communicate with the plotter.
<b>PLTR PORT: DISK</b>	directs plots to the selected disk (internal or external).
<b>PLTR PORT GPIB</b>	directs plots to the GPIB port and sets the GPIB address the analyzer will use to communicate with the plotter.

<b>PLTR PORT PARALLEL</b>	configures the analyzer for a plotter that has a parallel (centronics) interface.
<b>PLTR PORT SERIAL</b>	configures the analyzer for a plotter that has a serial (RS-232) interface.
<b>PLTR TYPE [PLOTTER]</b>	selects a pen plotter such as the HP 7440A, HP 7470A, HP 7475A, or HP 7550B as the plotter type.
<b>PLTR TYPE [HPGL PRT]</b>	selects a PCL5 compatible printer, which supports HP-GL/2, such as the LaserJet III or LaserJet 4 for a monochrome plotter type, or the DeskJet 1200C for a color plotter type.
<b>POLAR</b>	displays a polar format. Each point on the polar format corresponds to a particular value of both magnitude and phase. Quantities are read vectorally: the magnitude at any point is determined by its displacement from the center (which has zero value), and the phase by the angle counterclockwise from the positive x-axis. Magnitude is scaled in a linear fashion, with the value of the outer circle usually set to a ratio value of 1. Since there is no frequency axis, frequency information is read from the markers.
<b>POLAR MKR MENU</b>	leads to a menu of special markers for use with a polar format.
<b>PORT EXTENSIONS</b>	goes to the reference plane menu, which is used to extend the apparent location of the measurement reference plane or input.
<b>PORT POWER [COUPLED]</b>	is used to set the same power levels at each port.
<b>PORT POWER [UNCOUPLED]</b>	allows you to set different power levels at each port.
<b>Power</b>	makes power level the active function and sets the RF output power level of the analyzer's internal source. The analyzer will detect an input power overload at any of the three receiver inputs. This is indicated with the message "OVERLOAD ON INPUT (R, A, B)." If power meter cal is on, cal power is the active entry.
<b>POWER: FIXED</b>	sets the external LO fixed power.
<b>POWER RANGES</b>	leads to the power ranges menu which allows the user to select among 12 power ranges from -75 to -5 dBm.
<b>POWER: SWEEP</b>	sets the external LO power sweep.
<b>POWER LOSS</b>	brings up the segment modify menu and segment edit (power loss) menu explained in the following pages. This softkey is intended for use when the power output is being sampled by a directional coupler or power splitter. In the case of the directional coupler, enter the power loss caused by the coupled arm.



This feature may be used to compensate for attenuation non-linearities in either a directional coupler or a power splitter. Up to 12 segments may be entered, each with a different frequency and power loss value.

**POWER MTR**

toggles between **436A** or **438A/437**. These power meters are GPIB compatible with the analyzer. The model number in the softkey label must match the power meter to be used.

**POWER SWEEP**

turns on a power sweep mode that is used to characterize power-sensitive circuits. In this mode, power is swept at a single frequency, from a start power value to a stop power value, selected using the **(Start)** and **(Stop)** keys and the entry block. This feature is convenient for such measurements as gain compression or AGC (automatic gain control) slope. To set the frequency of the power sweep, use **CW FREQ** in the stimulus menu. Refer to the user's guide for an example of a gain compression measurement.

Note that power range switching is not allowed in power sweep mode.

In power sweep, the entered sweep time may be automatically changed if it is less than the minimum required for the current configuration (number of points, IF bandwidth, averaging, etc.).

**(Preset)**

presents a menu to select a factory or user defined preset state.

**PRESET: FACTORY**

is used to select the preset conditions defined by the factory.

**PRESET: USER**

is used to select a preset condition defined by the user. This is done by saving a state in a register under **(Save/Recall)** and naming the register **UPRESET**. When **PRESET: USER** is underlined, the **(Preset)** key will bring up the state of the **UPRESET** register.

**PRESET SETTINGS**

selects a menu to set the preset states of some items, such as calibration interpolation and step sweep mode.

**PREVIOUS PAGE**

steps backward through a tabular list of data page-by-page.

**PREVIOUS RANGES**

steps back to the previous range menus.

**PRINT ALL COLOR**

when displaying list values, prints the entire list in color. When displaying operating parameters, prints all but the last page in color. The data is sent to the printer as ASCII text rather than as raster graphics, which causes the printout to be faster.



<b>PRINT ALL MONOCHROME</b>	when displaying list values, prints the entire list in monochrome. When displaying operating parameters, prints all but the last page in monochrome. The data is sent to the printer as ASCII text rather than as raster graphics, which causes the printout to be faster.
<b>PRINT: COLOR</b>	sets the print command to default to a color printer. The printer output is always in the analyzer default color values. This command does not work with a black and white printer.
<b>PRINT COLOR</b>	prints the displayed measurement results in color.
<b>PRINT COLORS</b>	is used to select the print colors menu.
<b>PRINT: MONOCHROME</b>	sets the print command to default to a black and white printer.
<b>PRINT MONOCHROME</b>	prints the displayed measurement results in black and white.
<b>PRINT SEQUENCE</b>	prints any sequence currently in memory to a compatible printer.
<b>PRINTER BAUD RATE</b>	sets the serial port data transmission speed for prints.
<b>PRINTER FORM FEED</b>	sends a conditional form feed to the printer.
<b>PRINTER PORT</b>	configures the port the analyzer will use to communicate with the printer.
<b>PRNTR PORT GPIB</b>	directs prints to the GPIB port and sets the GPIB address the analyzer will use to communicate with the printer.
<b>PRNTR PORT PARALLEL</b>	configures the analyzer for a printer that has a parallel (centronics) interface.
<b>PRNTR PORT SERIAL</b>	configures the analyzer for a printer that has a serial (RS-232) interface.
<b>PRNTR TYPE [DESKJET]</b>	sets the printer type to the DeskJet series.
<b>PRNTR TYPE [EPSON-P2]</b>	sets the printer type to Epson compatible printers, which support the Epson ESC/P2 printer control language.
<b>PRNTR TYPE [LASERJET]</b>	sets the printer type to the LaserJet series.
<b>PRNTR TYPE [PAINTJET]</b>	sets the printer type to the PaintJet.
<b>PRNTR TYPE [THINKJET]</b>	sets the printer type to the ThinkJet or QuietJet.
<b>PWR LOSS on OFF</b>	turns on or off power loss correction. Power loss correction should be used when the power output is measured by a directional coupler. Enter the power loss caused by the coupled arm with the <b>LOSS/SENSR LISTS</b> softkey submenus described below.

<b>PWR RANGE AUTO man</b>	toggles the power range mode between auto and manual. Auto mode selects the power range based on the power selected. Manual mode limits power entry to within the $\pm 6$ to $-12$ dB selected range.
<b>PWRMTR CAL [ ]</b>	leads to the power meter calibration menu which provides two types of power meter calibration, continuous (each sweep) and single-sample (one sweep).
<b>PWRMTR CAL [OFF]</b>	turns off power meter calibration, terminate a power meter calibration sweep.
<b>R</b>	measures the absolute power amplitude at input R.
<b>R+jX MKR</b>	converts the active marker values into rectangular form. The complex impedance values of the active marker are displayed in terms of resistance, reactance, and equivalent capacitance or inductance. This is the default Smith chart marker.

---

**NOTE** Each of the range softkeys will have different ranges dependent on the analyzer model and options installed.

---

<b>RANGE 0 [ ]</b>	selects power range 0 when in manual power range.
<b>RANGE 1 [ ]</b>	selects power range 1 when in manual power range.
<b>RANGE 2 [ ]</b>	selects power range 2 when in manual power range.
<b>RANGE 3 [ ]</b>	selects power range 3 when in manual power range.
<b>RANGE 4 [ ]</b>	selects power range 4 when in manual power range.
<b>RANGE 5 [ ]</b>	selects power range 5 when in manual power range.
<b>RANGE 6 [ ]</b>	selects power range 6 when in manual power range.
<b>RANGE 7 [ ]</b>	selects power range 7 when in manual power range.
<b>RANGE 8 [ ]</b>	selects power range 8 when in manual power range.
<b>RANGE 9 [ ]</b>	selects power range 9 when in manual power range.
<b>RANGE 10 [ ]</b>	selects power range 10 when in manual power range.
<b>RANGE 11 [ ]</b>	selects power range 11 when in manual power range.
<b>RAW ARRAY on OFF</b>	specifies whether or not to store the raw data (ratioed and averaged) on disk with the instrument state.
<b>RAW OFFSET On Off</b>	selects whether sampler and attenuator offsets are ON or OFF. By selecting raw offsets OFF, a full two port error correction can be performed without including the effects of the offsets. It also saves substantial time at recalls and during frequency changes. Raw offsets follow the channel coupling. This softkey is used with "Take4" mode. Refer to the examples in the programmer's guide.

**Re/Im MKR**

when in the smith marker menu, **Re/Im MKR** displays the values of the active marker on a Smith chart as a real and imaginary pair. The complex data is separated into its real part and imaginary part. The first marker value given is the real part  $M \cos \theta$ , and the second value is the imaginary part  $M \sin \theta$ , where  $M$  = magnitude.

When in the polar marker menu, **Re/Im MKR** displays the values of the active marker as a real and imaginary pair. The complex data is separated into its real part and imaginary part. The first marker value given is the real part  $M \cos \theta$ , and the second value is the imaginary part  $M \sin \theta$ , where  $M$  = magnitude.

**READ FILE TITLES**

searches the directory of the disk for file names recognized as belonging to an instrument state, and displays them in the softkey labels. No more than five titles are displayed at one time. If there are more than five, repeatedly pressing this key causes the next five to be displayed. If there are fewer than five, the remaining softkey labels are blanked.

**READ SEQ FILE TITLS**

is a disk file directory command. Pressing this softkey will read the first six sequence titles and display them in the softkey labels. These sequences can then be loaded into internal memory.

If **READ SEQ FILE TITLS** is pressed again, the next six sequence titles on the disk will be displayed. To read the contents of the disk starting again with the first sequence: remove the disk, reinsert it into the drive, and press

**READ SEQ FILE TITLS** .

**REAL**

displays only the real (resistive) portion of the measured data on a Cartesian format. This is similar to the linear magnitude format, but can show both positive and negative values. It is primarily used for analyzing responses in the time domain, and also to display an auxiliary input voltage signal for service purposes.

**RECALL CAL PORT 1**

Press this key after selecting the file associated with port 1 error correction for adapter removal calibration.

**RECALL CAL PORT 2**

Press this key after selecting the file associated with port 2 error correction for adapter removal calibration.

**RECALL COLORS**

recalls the previously saved modified version of the color set. This key appears only when a color set has been saved.

**RECALL KEYS**

accesses two recall keys which allows you to set the recall keys menu as the initial menu displayed when

**(Save/Recall)** is pressed or select specific registers to recall.

<b>RECALL KEYS MENU</b>	provides access to the recall keys menu where specific registers can be recalled.
<b>RECALL KEYS on OFF</b>	presents the recall keys menu as the initial menu when <b>Save/Recall</b> has been pressed.
<b>RECALL REG1</b>	recalls the instrument state saved in register 1.
<b>RECALL REG2</b>	recalls the instrument state saved in register 2.
<b>RECALL REG3</b>	recalls the instrument state saved in register 3.
<b>RECALL REG4</b>	recalls the instrument state saved in register 4.
<b>RECALL REG5</b>	recalls the instrument state saved in register 5.
<b>RECALL REG6</b>	recalls the instrument state saved in register 6.
<b>RECALL REG7</b>	recalls the instrument state saved in register 7.
<b>RECALL STATE</b>	is used in conjunction with sequencing, to return the instrument to the known preset state without turning off the sequencing function. This is not the same as pressing the <b>Preset</b> key: no preset tests are run, and the GPIB and sequencing activities are not changed.
<b>RECEIVER CAL</b>	provides access to the Receiver Cal Menu.
<b>REF LINE</b>	selects the display reference line for color modification.
<b>REF LINE [ ]</b>	selects the reference line for printer color modification.
<b>REFERENCE POSITION</b>	sets the position of the reference line on the graticule of a Cartesian display, with 0 the bottom line of the graticule and 10 the top line. It has no effect on a polar or Smith display. The reference position is indicated with a small triangle just outside the graticule, on the left side for channel 1 and the right side for channel 2.
<b>REFERENCE VALUE</b>	changes the value of the reference line, moving the measurement trace correspondingly. In polar and Smith chart formats, the reference value is the same as the scale, and is the value of the outer circle.
<b>REFL: FWD S11 (A/R)</b>	defines the measurement as $S_{11}$ , the complex reflection coefficient (magnitude and phase) of the test device input.
<b>REFL: REV S22 (B/R)</b>	defines the measurement as $S_{22}$ , the complex reflection coefficient (magnitude and phase) of the test device output.
<b>REFLECT AND LINE</b>	measures the reflection and thru paths of the current calibration standard.
<b>REFLECTION</b>	leads to the reflection calibration menu.

**REFL STD [0]**

is located in the ECal service menu. This allows you to select different reflection standards in the ECal module. The number of reflection standards varies with ECal module type.

**REFLECTION 1-PORT**

leads to the reflection calibration menu (ET only). In the ECal menu, this softkey performs the reflection 1-port calibration.

**REMOVE ADAPTER**

completes the adapter removal procedure, removing the effects of the adapter being used.

**RENAME FILE**

allows you to change the name of a file that has already been saved.

**RESET COLOR**

resets the color being modified to the default color.

**RESPONSE**

- When in the specify class more menu, **RESPONSE** is used to enter the standard numbers for a response calibration. This calibration corrects for frequency response in either reflection or transmission measurements, depending on the parameter being measured when a calibration is performed. (For default kits, the standard is either the open or short for reflection measurements, or the thru for transmission measurements.)
- When in the response cal menu, **RESPONSE** leads to the frequency response calibration. This is the simplest and fastest accuracy enhancement procedure, but should be used when extreme accuracy is not required. It effectively removes the frequency response errors of the test setup for reflection or transmission measurements.

**RESPONSE ISOL'N**

- When in the specify class more menu, **RESPONSE ISOL'N** is used to enter the standard numbers for a response and isolation calibration. This calibration corrects for frequency response and directivity in reflection measurements, or frequency response and isolation in transmission measurements.
- When in the response and isolation menu, **RESPONSE ISOL'N** leads to the menus used to perform a response and isolation measurement calibration, for measurement of devices with wide dynamic range. This procedure effectively removes the same frequency response errors as the response calibration. In addition, it effectively removes the isolation (crosstalk) error in transmission measurements or the directivity error in reflection measurements. As well as the devices required for a

simple response calibration, an isolation standard is required. The standard normally used to correct for isolation is an impedance-matched load (usually 50 or 75  $\Omega$ s). Response and directivity calibration procedures for reflection and transmission measurements are provided in the following pages.

<b>RESTORE DISPLAY</b>	turns off the tabular listing and returns the measurement display to the screen.
<b>RESUME CAL SEQUENCE</b>	eliminates the need to restart a calibration sequence that was interrupted to access some other menu. This softkey goes back to the point where the calibration sequence was interrupted.
<b>REV ISOL'N</b>	measures the reverse isolation of the calibration standard during an enhanced response cal.
<b>REV ISOL'N ISOL'N STD</b>	measures the reverse isolation of the calibration standard during a full 2-port cal.
<b>REV MATCH</b> (Label Class)	lets you enter a label for the reverse match class. The label appears during a calibration that uses this class.
<b>REV MATCH</b> (Specify Class)	specifies which standards are in the reverse match class in the calibration kit.
<b>REV MATCH THRU</b>	is used to enter the standard numbers for the reverse match (thru) calibration. (For default kits, this is the thru.)
<b>REV TRANS</b> (Label Class)	lets you enter a label for the reverse transmission class. The label appears during a calibration that uses this class.
<b>REV TRANS</b> (Specify Class)	specifies which standards are in the reverse transmission class in the calibration kit.
<b>REV TRANS THRU</b>	is used to enter the standard numbers for the reverse transmission (thru) calibration. (For default kits, this is the thru.)
<b>RF &gt; LO</b>	adjusts the source frequency higher than the LO by the amount of the LO (within the limits of the analyzer).
<b>RF &lt; LO</b>	adjusts the source frequency lower than the LO by the amount of the LO (within the limits of the analyzer).
<b>RIGHT LOWER</b>	draws a quarter-page plot in the lower right quadrant of the page.
<b>RIGHT UPPER</b>	draws a quarter-page plot in the upper right quadrant of the page.
<b>RIPL LIMIT on OFF</b>	displays lines that represent the ripple limits when the ripple test is set to ON.

#### **RIPL TEST on OFF**

turns ripple testing on or off. When ripple testing is on, the analyzer sets the lower ripple limit line at the lowest amplitude point within the frequency band and sets the upper limit line at the user-specified amplitude above. If the trace data remains at or below the upper limit line, that portion of the ripple test passes. If the trace data rises above the upper limit line within the frequency band, the test fails. Data within each frequency band is compared with the defined ripple limit of the band. The ripple test checks each frequency band using this method. A maximum of 12 frequency bands can be tested on each channel. These bands may overlap in frequency. If all of the channel's frequency bands pass the ripple test, the analyzer displays a pass message.

If the test passed, a message is displayed in orange text in the upper right portion of the LCD. An example of this message is: **RIPL1 PASS**, where the "1" indicates the channel where the ripple test is performed. If the ripple test does not pass, a fail message is displayed in red text. An example of this message is **RIPL1 FAIL**.

#### **RIPL VALUE [ ]**

displays the ripple value of the selected frequency band. The ripple value can be displayed in two ways or turned off. Selecting OFF removes the displayed ripple value from the display. Selecting ABSOLUTE or MARGIN displays the ripple value. The ripple value is preceded on the display by an indicator of the selected band. For example, when the ripple value is preceded by "B2", this indicates that the ripple value shown is for Band 2. The frequency band indicator and ripple value are displayed in the same color as the pass/fail message for the overall ripple test.

When ABSOLUTE is selected, the display shows the absolute ripple of the data trace within the frequency band.

When MARGIN is selected, the display shows the difference between the maximum allowable ripple and the absolute ripple value within the frequency band. When the margin value is preceded by a plus sign (+), this indicates that the ripple within the selected frequency band is passing by the value shown. When the margin value is preceded by a negative sign (-), this indicates that the ripple within the selected band is failing by the value shown.

#### **RIPL VALUE BAND**

selects a frequency band to display the ripple value. When **RIPL VALUE [ ]** is set to the absolute or margin choices, this softkey selects the ripple measurement for the selected frequency band.



<b>RIPPLE LIM LINES</b>	selects ripple limit line trace on the display color modification.
<b>RIPPLE LIMIT</b>	selects the ripple limit line choice. This selection leads to menus used to define ripple limits or specifications with which to compare a test device. Refer to the “Using Ripple Limits to Test a Device” section in the “Making Measurements” chapter of the user’s guide.
<b>ROUND SECONDS</b>	resets the seconds counter to zero in real-time clock.
<b>SET CONF STANDARD</b>	is located in the ECal confidence check menu. This softkey activates and displays the ECal confidence state.
<b>S PARAMETERS</b>	presents the S-parameter menu, which is used to define the input ports and test set direction for S-parameter measurements.
<b>S11 1-PORT</b>	provides a measurement calibration for reflection-only. Measurements of one-port devices or properly terminated two-port devices, at port 1 of an S-parameter test set. (ES only)
<b>S11A</b>	is used to enter the standard numbers for the first class required for an $S_{11}$ 1-port calibration. (For default cal kits, this is the open.)
<b>S11B</b>	is used to enter the standard numbers for the second class required for an $S_{11}$ 1-port calibration. (For default cal kits, this is the short.)
<b>S11C</b>	is used to enter the standard numbers for the third class required for an $S_{11}$ 1-port calibration. (For default kits, this is the load.)
<b>S11 REFL SHORT</b>	measures the short circuit TRL/LRM calibration data for PORT 1.
<b>S11/S21 ENH. RESP.</b>	provides an S11 and S21 enhanced response calibration (forward direction). Enhanced response generates a 1-port cal for S11 and an improved calibration over the response cal for S21 (ES only).
<b>S22 1-PORT</b>	provides a measurement calibration for reflection-only. Measurements of one-port devices or properly terminated two-port devices, at port 2 of an S-parameter test set. (ES only)
<b>S22/S12 ENH. RESP.</b>	provides an S22 and S12 enhanced response calibration (reverse direction). Enhanced response generates a 1-port cal for S22 and an improved calibration over the response cal for S12 (ES only).



<b>S22A</b>	is used to enter the standard numbers for the first class required for an S <sub>22</sub> 1-port calibration. (For default cal kits, this is the open.)
<b>S22B</b>	is used to enter the standard numbers for the second class required for an S <sub>22</sub> 1-port calibration. (For default cal kits, this is the short.)
<b>S22C</b>	is used to enter the standard numbers for the third class required for an S <sub>22</sub> 1-port calibration. (For default kits, this is the load.)
<b>S22 REFL SHORT</b>	measures the short circuit TRL/LRM calibration data for PORT 2.
<b>SAMPLR COR on OFF</b>	selects whether sampler correction is on or off.
<b>SAVE COLORS</b>	saves the modified version of the color set.
<b>SAVE FILE</b>	saves the display information to the disk drive. The type of information saved is dependent on the FILETYPE selection. The FILETYPE selection can either be graphic or text.
<b>SAVE FILE FORMATS</b>	accesses the save file menu which allows you to save the display information to the disk drive as either graphic or textual information.
<b>SAVE USER KIT</b>	stores the user-modified or user-defined kit into memory, after it has been modified.
<b>SAVE USING ASCII</b>	selects ASCII format for data storage to disk.
<b>SAVE USING BINARY</b>	selects binary format for data storage.
<b>Save/Recall</b>	provides access to all the menus used for saving and recalling instrument states in internal memory and for storing to, or loading from the internal or external disk. This includes the menus used to define titles for internal registers and external disk files, to define the content of disk files, to initialize disks for storage, and to clear data from the registers or purge files from disk.
<b>SCALE/DIV</b>	changes the response value scale per division of the displayed trace. In polar and Smith chart formats, this refers to the full scale value at the outer circumference, and is identical to reference value.
<b>SCALE PLOT [ ]</b>	toggles between two selections for plot scale, FULL and GRAT.

**SCALE PLOT [FULL]**

is the normal scale selection for plotting on blank paper. It includes space for all display annotations such as marker values, stimulus values, etc. The entire display fits within the user-defined boundaries of P1 and P2 on the plotter, while maintaining the exact same aspect ratio as the display.

**SCALE PLOT [GRAT]**

expands or reduces the horizontal and vertical scale so that the lower left and upper right graticule corners exactly correspond to the user-defined P1 and P2 scaling points on the plotter. This is convenient for plotting on preprinted rectangular or polar forms (for example, on a Smith Chart).

**Scale Ref**

makes scale per division the active function. A menu is displayed that is used to modify the vertical axis scale and the reference line value and position. In addition this menu provides electrical delay offset capabilities for adding or subtracting linear phase to maintain phase linearity.

**SEARCH LEFT**

searches the trace for the next occurrence of the target value to the left.

**SEARCH RIGHT**

searches the trace for the next occurrence of the target value to the right.

**SEARCH: MAX**

moves the active marker to the maximum point on the trace.

**SEARCH: MIN**

moves the active marker to the minimum point on the trace.

**SEARCH: OFF**

turns off the marker search function.

**SEARCH: TARGET**

searches for the user-specified target point on the trace.

**SEGMENT**

specifies which limit segment in the table is to be modified. A maximum of three sets of segment values are displayed at one time, and the list can be scrolled up or down to show other segment entries. Use the entry block controls to move the pointer > to the required segment number. The indicated segment can then be edited or deleted. If the table of limits is designated "EMPTY," new segments can be added using the **ADD** or **EDIT** softkey.

**SEGMENT: CENTER**

sets the center frequency of a subsweep in a list frequency sweep.

**SEGMENT IF BW**

enters the IF bandwidth for the active segment in a swept list table. This key is disabled if **LIST IF BW on OFF** is set to OFF.

**SEGMENT POWER**

enters absolute power values in the swept list table. The power values are restricted to the current power range setting.

If port power is uncoupled, power applies to the currently selected port, otherwise it applies to both ports. (The list table only displays one port's power values at time due to limited display area.) To set the alternate port's power level, you must exit the edit list menus, select a measurement that activates the alternate port, and then re-enter the edit list menus.

This key is disabled if **LIST POWER** is set to **OFF**.

**SEGMENT: SPAN**

sets the frequency or power span of a subsweep about a specified center frequency.

**SEGMENT: START**

sets the start frequency of a subsweep.

**SEGMENT: STOP**

sets the stop frequency of a subsweep.

**SEL QUAD**

leads to the select quadrant menu, which provides the capability of drawing quarter-page plots.

**SELECT DISK**

provides access to the select disk menu.

**SELECT LETTER**

The active entry area displays the letters of the alphabet, digits 0 through 9, and mathematical symbols. To define a title, rotate the knob until the arrow ↑ points at the first letter, then press **SELECT LETTER**. Repeat this until the complete title is defined, for a maximum of 50 characters. As each character is selected, it is appended to the title at the top of the graticule.

**SELF DIAGNOSE**

prompts the analyzer to run a series of tests to determine a problem.

**Seq**

accesses a series of sequencing menus. These allow you to create, modify, and store up to 6 sequences which can be run automatically.

**SEQUENCE 1 SEQ1**

activates editing mode for the segment titled "SEQ1" (default title).

**SEQUENCE 2 SEQ2**

activates editing mode for the segment titled "SEQ2" (default title).

**SEQUENCE 3 SEQ3**

activates editing mode for the segment titled "SEQ3" (default title).

**SEQUENCE 4 SEQ4**

activates editing mode for the segment titled "SEQ4" (default title).

**SEQUENCE 5 SEQ5**

activates editing mode for the segment titled "SEQ5" (default title).

<b>SEQUENCE 6 SEQ6</b>	activates editing mode for the segment titled "SEQ6" (default title).
<b>SEQUENCE FILENAMING</b>	accesses a file naming menu which is used to automatically increment or decrement the name of a file that is generated by the network analyzer during a SEQUENCE.
<b>SERVICE MENU</b>	leads to a series of service and test menus described in detail in the service guide.
<b>SERVICE MODES</b>	a collection of common modes used for troubleshooting.
<b>SET ADDRESSES</b>	goes to the address menu, which is used to set the GPIB address of the analyzer, and to display and modify the addresses of peripheral devices in the system, such as the printer, plotter, disk drive, and power meter.
<b>SET CONF STANDARD</b>	sets the ECal module back the confidence state. Used after exiting the ECal service menu to reset the Ecal module back to the confidence state.
<b>SET CLOCK</b>	allows you to set the analyzer's internal clock.
<b>SET DAY</b>	allows you to set the day in the analyzer's internal clock.
<b>SET FREQ LOW PASS</b>	(Option 010 only) changes the frequency sweep to harmonic intervals to accommodate time domain low-pass operation. If this mode is used, the frequencies must be set before calibration.
<b>SET HOUR</b>	allows you to set the hour in the analyzer's internal clock.
<b>SET MINUTES</b>	allows you to set the minutes in the analyzer's internal clock.
<b>SET MONTH</b>	allows you to set the month in the analyzer's internal clock.
<b>SET REF: REFLECT</b>	sets the measurement reference plane to the TRL/LRM REFLECT standard.
<b>SET REF: THRU</b>	sets the measurement reference plane to the TRL/LRM THRU standard.
<b>SET YEAR</b>	allows you to set the year in the analyzer's internal clock.
<b>SET Z0</b>	sets the characteristic impedance used by the analyzer in calculating measured impedance with Smith chart markers and conversion parameters. Characteristic impedance must be set correctly before calibration procedures are performed.
<b>SETUP A</b>	sets up four-graticule, four-channel display as described in the <b>4 PARAM HELP KEYS</b> menu. All four graticules are in log format.

<b>SETUP B</b>	sets up two-graticule, four-channel display as described in the <b>4 PARAM HELP KEYS</b> menu.
<b>SETUP C</b>	sets up single-graticule, four-channel display as described in the <b>4 PARAM HELP KEYS</b> menu.
<b>SETUP D</b>	sets up four-graticule, four-channel display as described in the <b>4 PARAM HELP KEYS</b> menu. Two of the graticules are in Smith chart format with the other two in log format.
<b>SETUP E</b>	sets up two-graticule, four-channel display as described in the <b>4 PARAM HELP KEYS</b> menu.
<b>SETUP F</b>	sets up three-graticule, three-channel display as described in the <b>4 PARAM HELP KEYS</b> menu.
<b>SHORT</b>	defines the standard type as a short, for calibrating reflection measurements. Shorts are assigned a terminal impedance of $0 \Omega$ , but delay and loss offsets may still be added.
<b>SHORT (F)</b>	for cal kits with different models for male and female test port standards, this selects the short model for a female test port. Note that the sex of a calibration standard always refers to the test port.
<b>SHORT (M)</b>	for cal kits with different models for male and female test port standards, this selects the short model for a male test port. Note that the sex of a calibration standard always refers to the test port.
<b>SHOW MENU</b>	used to display a specific menu prior to a pause statement in a sequence.
<b>SINGLE</b>	takes one sweep of data and returns to the hold mode.
<b>SINGLE POINT</b>	sets the limits at a single stimulus point. If limit lines are on, the upper limit value of a single point limit is displayed as $\vee$ and the lower limit is displayed as $\wedge$ . A limit test at a single point not terminating a flat or sloped line tests the nearest actual measured data point. A single point limit can be used as a termination for a flat line or sloping line limit segment. When a single point terminates a sloping line or when it terminates a flat line and has the same limit values as the flat line, the single point is not displayed as $\vee$ and $\wedge$ . The indication for a single point segment in the displayed table of limits is SP.
<b>SINGLE SEG SWEEP</b>	enables a measurement of a single segment of the frequency list, without loss of calibration. The segment to be measured is selected using the entry block.

In single segment mode, selecting a measurement calibration will force the full list sweep before prompting for calibration standards. The calibration will then be valid for any single segment.

If an instrument state is saved in memory with a single-segment trace, a recall will re-display that segment while also recalling the entire list.

**SLIDING**

defines the load as a sliding load. When such a load is measured during calibration, the analyzer will prompt for several load positions, and calculate the ideal load value from it.

**SLOPE**

compensates for power loss versus the frequency sweep, by sloping the output power upwards proportionally to frequency. Use this softkey to enter the power slope in dB per GHz of sweep.

**SLOPE on OFF**

toggles the power slope function on or off. With slope on, the output power increases with frequency, starting at the selected power level.

**SLOPING LINE**

defines a sloping limit line segment that is linear with frequency or other stimulus value, and is continuous to the next stimulus value and limit. If a sloping line is the final segment, it becomes a flat line terminated at the stop stimulus. A sloping line segment is indicated as SL on the displayed table of limits.

**SMITH CHART**

displays a Smith chart format. This is used in reflection measurements to provide a readout of the data in terms of impedance. It provides information such as the reflection coefficient and input/output impedance of the DUT.

**SMITH MKR MENU**

leads to a menu of special markers for use with a Smith chart format.

**SMOOTHING APERTURE**

lets you change the value of the smoothing aperture as a percent of the span. When smoothing aperture is the active function, its value in stimulus units is displayed below its percent value in the active entry area.

Smoothing aperture is also used to set the aperture for group delay measurements. Note that the displayed smoothing aperture is not the group delay aperture unless smoothing is on.

**SMOOTHING on OFF**

turns the smoothing function on or off for the active channel. When smoothing is on, the annotation "Smo" is displayed in the status notations area.

**SOURCE PWR on OFF**

use this key to restore power after a power interruption. ON returns the source power to its original setting, while OFF sets the source to the minimum power level of the analyzer.

**SPACE**

inserts a space in the title.

**Span**

is used, along with the **Center** key, to define the frequency range of the stimulus. When the **Span** key is pressed, it becomes the active function. The value is displayed in the active entry area, and can be changed with the knob, step keys, or numeric keypad.

**SPAN**

sets the frequency or power span of a subsweep about a specified center frequency.

**SPECIAL FUNCTIONS**

presents the special function menu.

**SPECIFY CLASS**

leads to the specify class menu. After the standards are modified, use this key to specify a class to consist of certain standards.

**SPECIFY CLASS DONE**

finishes the specify class function and returns to the modify cal kit menu.

**SPECIFY GATE**

(Option 010 only) is used to specify the parameters of the gate.

**SPECIFY OFFSET**

allows additional specifications for a user-defined standard. Features specified in this menu are common to all five types of standards.

**SPLIT DISP 1X 2X 4X**

toggles between a full-screen single graticule display or two-, three-, or four-graticule, multiple-channel display. Works with **DUAL CHAN on OFF** to determine the number of channels displayed.

**SPUR AVOID On Off**

selects whether spur avoidance is ON or OFF. Selecting spur avoidance OFF, along with selecting raw offsets OFF, saves substantial time at recalls and during frequency changes. Spur avoidance is always coupled between channels.

**STANDARD DONE**

returns to the define standard menu.

**Start**

is used to define the start frequency of a frequency range. When the **Start** key is pressed it becomes the active function. The value is displayed in the active entry area, and can be changed with the knob, step keys, or numeric keypad.

**STD OFFSET DONE**

is used to end the specify offset sequence.

**STD TYPE:**

is used to specify the type of calibration device being measured.



**STD TYPE: ARBITRARY IMPEDANCE**

defines the standard type to be a load, but with an arbitrary impedance (different from system Z0).

**STD TYPE: DELAY/THRU**

defines the standard type as a transmission line of specified length, for calibrating transmission measurements.

**STD TYPE: LOAD**

defines the standard type as a load (termination). Loads are assigned a terminal impedance equal to the system characteristic impedance Z0, but delay and loss offsets may still be added. If the load impedance is not Z0, use the arbitrary impedance standard definition.

**STD TYPE: OPEN**

defines the standard type as an open used for calibrating reflection measurements. Opens are assigned a terminal impedance of infinite  $\Omega$ s, but delay and loss offsets may still be added. Pressing this key also brings up a menu for defining the open, including its capacitance.

**STD TYPE: SHORT**

defines the standard type as a short used for calibrating reflection measurements. Shorts are assigned a terminal impedance of 0  $\Omega$ s, but delay and loss offsets may still be added.

**STEP SIZE**

is used to specify the subsweep in frequency steps instead of number of points. Changing the start frequency, stop frequency, span, or number of points may change the step size. Changing the step size may change the number of points and stop frequency in start/stop/step mode or the frequency span in center/span/step mode. In each case, the frequency span becomes a multiple of the step size.

**STIMULUS VALUE**

sets the starting stimulus value of a segment, using entry block controls. The ending stimulus value of the segment is defined by the start of the next line segment. No more than one segment can be defined over the same stimulus range.

**STIMULUS OFFSET**

adds or subtracts an offset in stimulus value. This allows limits already defined to be used for testing in a different stimulus range. Use the entry block controls to specify the offset required.

**Stop**

is used to define the stop frequency of a frequency range. When the **Stop** key is pressed, it becomes the active function. The value is displayed in the active entry area, and can be changed with the knob, step keys, or numeric keypad.

**STOP**

sets the stop frequency of a subsweep.



**STORE SEQ TO DISK**

presents the store sequence to disk menu with a list of sequences that can be stored.

**SWEEP**

is used to set the frequency of the LO source to sweep.

**SWEEP SETUP**

provides access to a series of menus which are used to define and control all stimulus functions other than start, stop, center, and span. Operating parameters such as power, sweeptime, trigger condition, and number of points are accessible through this hardkey.

**SWEEP TIME [ ]**

toggles between automatic and manual sweep time.

**SWEEP TYPE MENU**

presents the sweep type menu, where one of the available types of stimulus sweep can be selected.

**SWR**

reformats a reflection measurement into its equivalent SWR (standing wave ratio) value. SWR is equivalent to  $(1+\rho)/(1-\rho)$ , where  $\rho$  is the magnitude of the reflection coefficient. Note that the results are valid only for reflection measurements. If the SWR format is used for measurements of  $S_{21}$  or  $S_{12}$ , the results are not valid.

**System**

presents the system menu. It allows to set the instrument mode and to access the configure, limit and service menus.

**SYSTEM CONTROLLER**

is the mode used when peripheral devices are to be used and there is no external controller. In this mode, the analyzer can directly control peripherals (plotter, printer, disk drive, or power meter). System controller mode must be set in order for the analyzer to access peripherals from the front panel to plot, print, store on disk, or perform power meter functions, if there is no other controller on the bus.

The system controller mode can be used without knowledge of GPIB programming. However, the GPIB address must be entered for each peripheral device.

This mode can only be selected manually from the analyzer's front panel, and can be used only if no active computer controller is connected to the system through GPIB. If you try to set system controller mode when another controller is present, the message `ANOTHER SYSTEM CONTROLLER ON GPIB` is displayed. Do not attempt to use this mode for programming.

**TAKE CAL SWEEP**

Each data point is measured during the initial sweep and the correction data is placed in the power meter correction table. This provides data usable in the **ONE SWEEP** mode.

**TAKE RCVR CAL SWEEP**

executes a receiver calibration.

**TALKER/LISTENER**

is the mode normally used for remote programming of the analyzer. In this mode, the analyzer and all peripheral devices are controlled from the external controller. The controller can command the analyzer to talk, and the plotter or other device to listen. The analyzer and peripheral devices cannot talk directly to each other unless the computer sets up a data path between them.

This mode allows the analyzer to be either a talker or a listener, as required by the controlling computer for the particular operation in progress.

A talker is a device capable of sending out data when it is addressed to talk. There can be only one talker at any given time. The analyzer is a talker when it sends information over the bus.

A listener is a device capable of receiving data when it is addressed to listen. There can be any number of listeners at any given time. The analyzer is a listener when it is controlled over the bus by a computer.

**TARGET**

makes target value the active function, and places the active marker at a specified target point on the trace. The default target value is  $-3$  dB. The target menu is presented, providing search right and search left options to resolve multiple solutions.

For relative measurements, a search reference must be defined with a delta marker or a fixed marker before the search is activated.

**TARGET VALUE**

sets the value for target searches, without activating a search.

**TERMINAL IMPEDANCE**

is used to specify the (arbitrary) impedance of the standard, in  $\Omega$ s.

**TEST OPTIONS**

is used to set configurations before running the service tests.

**TESTPORT 1 2**

is used to direct the RF power to port 1 or port 2. (For non-S parameter inputs only.)

**TESTSET I/O FWD**

is used to support specialized test sets, such as a test set that measures duplexers. It allows you to set three bits (D1, D2, and D3) to a value of 0 to 7, and outputs it as binary from the rear panel test set connector. It tracks the coupling flag, so if coupling is on, and FWD channel 1 is the active channel, FWD channel 2 will be set to the same value.

**TESTSET I/O REV**

is used to support specialized test sets, such as a test set that measures duplexers. It allows you to set three bits (D1, D2, and D3) to a value of 0 to 7, and outputs it as binary from the rear panel test set connector. It tracks the coupling flag, so if coupling is on, and REV channel 1 is the active channel, REV channel 2 will be set to the same value.

**TESTS**

presents the service test menu.

**TEXT**

selects all the non-data display text for color modification. For example: operating parameters.

**TEXT [ ]**

brings up the print color definition menu. The default color for text is black.

**TEXT FMT [ ]**

sets the format of the text file when **FILETYPE: TEXT** is selected. The only text selection currently available is the comma separated values (CSV) format.

**THRU**

a calibration standard type.

**THRU THRU**

measures all four S-parameters in a TRL/LRM calibration.

**TIME STAMP on OFF**

turns the time stamp function on or off.

**TINT**

adjusts the continuum of hues on the color wheel of the chosen attribute. Refer to the section on adjusting the display color in the “Making Measurements” chapter of the user’s guide for an explanation of using this softkey for color modification of display attributes.

**TITLE**

presents the title menu in the softkey labels area and the character set in the active entry area. These are used to label the active channel display. A title more menu allows up to four values to be included in the printed title active entry, active marker amplitude, limit test results, and loop counter value.

**TITLE SEQUENCE**

allows the operator to rename any sequence with an eight character title. All titles entered from the front panel must begin with a letter, and may only contain letters and numbers. A procedure for changing the title of a sequence is provided at the beginning of this chapter.

**TITLE TO MEMORY**

moves the title string data obtained with the **P MTR/GPIB TO TITLE** command into a data array. **TITLE TO MEMORY** strips off leading characters that are not numeric, reads the numeric value, and then discards everything else. The number is converted into analyzer internal format, and is placed into the real portion of the memory trace at:

Display point = total points – 1 – loop counter

If the value of the loop counter is zero, then the title number goes in the last point of memory. If the loop counter is greater than or equal to the current number of measurement points, the number is placed in the first point of memory. A data to memory command must be executed before using the title to memory command.

**TITLE TO P MTR/GPIB**

outputs a title string to any device with an GPIB address that matches the address set with the analyzer **(Local)** **SET ADDRESSES ADDRESS: P MTR/GPIB** commands. This softkey is generally used for two purposes:

- Sending a title to a printer when a CR-LF is not desired.
- Sending commands to an GPIB device.

**TITLE TO PERIPHERAL**

outputs a title string to any device with an GPIB address that matches the address set with the analyzer **(Seq)** **SPECIAL FUNCTIONS PERIPHERAL GPIB ADDR** commands. This softkey is generally used for two purposes:

- Sending a title to a printer when a CR-LF is not desired.
- Sending commands to an GPIB device.

**TITLE TO PRNTR/GPIB**

outputs a title string to any device with an GPIB address that matches the address set with the analyzer **(Local)** **SET ADDRESSES ADDRESS: PRINTER** commands. This softkey is generally used for two purposes:

- Sending a title to a printer for data logging or documentation purposes.
- Sending commands to a printer or other GPIB device.

**TRACE TYPE [DATA]**

is located in the ECal confidence menu and ECal service menu. This softkey allows you to display the ECal module factory response and measurement data in different forms. The choices include: DATA, DATA&MEM, DATA/MEM, DATA-MEM, and MEM.

**TRACKING on OFF**

is used in conjunction with other search features to track the search with each new sweep. Turning tracking on makes the analyzer search every new trace for the specified target value and put the active marker on that point. If bandwidth search is on, tracking searches every new trace for the specified bandwidth, and repositions the dedicated bandwidth markers.

When tracking is off, the target is found on the current sweep and remains at the same stimulus value regardless of changes in trace response value with subsequent sweeps.

A maximum and a minimum point can be tracked simultaneously using two channels and uncoupled markers.

<b>TRANS: FWD S21 (B/R)</b>	defines the measurement as $S_{21}$ , the complex forward transmission coefficient (magnitude and phase) of the test device.
<b>TRANS: REV S12 (A/R)</b>	defines the measurement as $S_{12}$ , the complex reverse transmission coefficient (magnitude and phase) of the test device.
<b>TRANSFORM MENU</b>	(Option 010 only) leads to a series of menus that transform the measured data from the frequency domain to the time domain.
<b>TRANSFORM on OFF</b>	(Option 010 only) switches between time domain transform on and off.
<b>TRANSMISSION</b>	leads to the transmission menu.
<b>TRIGGER MENU</b>	presents the trigger menu, which is used to select the type and number of the sweep trigger.
<b>TRIGGER: TRIG OFF</b>	turns off external trigger mode.
<b>TRL 3.5 mm 85052C</b>	selects the 85052C cal kit.
<b>TRL*/LRM* 2-PORT</b>	leads to the TRL*/LRM* 2-port calibration menu.
<b>TRL/LRM OPTION</b>	selects the TRL/LRM Option Menu, under the modify cal kit menu.
<b>TRL LINE OR MATCH</b>	is used to enter the standard numbers for the TRL LINE or MATCH class.
<b>TRL THRU</b>	is used to enter the standard numbers for the TRL THRU class.
<b>TRL REFLECT</b>	is used to enter the standard numbers for the TRL REFLECT class.
<b>TTL OUT HIGH</b>	sets the TTL output (TEST SEQ BNC) on the back of the analyzer high.
<b>TTL OUT LOW</b>	sets the TTL output (TEST SEQ BNC) on the back of the analyzer low.
<b>TUNED RECEIVER</b>	sets the analyzer to function as a tuned receiver only, disabling the source.

**UNCOUPLED**

allows the marker stimulus values to be controlled independently on each channel.

**UP CONVERTER**

sends the sum frequency of the RF and LO to the R channel.

**UPPER LIMIT**

sets the upper limit value for the start of the segment. If a lower limit is specified, an upper limit must also be defined. If no upper limit is required for a particular measurement, force the upper limit value out of range (for example +500 dB).

When **UPPER LIMIT** or **LOWER LIMIT** is pressed, all the segments in the table are displayed in terms of upper and lower limits, even if they were defined as delta limits and middle value.

If you attempt to set an upper limit that is lower than the lower limit, or vice versa, both limits will be automatically set to the same value.

**USE MEMORY ON off**

(Option 010 only) remembers a specified window pulse width (or step rise time) different from the standard window values. A window is activated only for viewing a time domain response, and does not affect a displayed frequency domain response.

**USE PASS CONTROL**

lets you control the analyzer with the computer over GPIB as with the talker/listener mode, and also allows the analyzer to become a controller in order to plot, print, or directly access an external disk. During this peripheral operation, the host computer is free to perform other internal tasks that do not require use of the bus (the bus is tied up by the network analyzer during this time).

The pass control mode requires that the external controller is programmed to respond to a request for control and to issue a take control command. When the peripheral operation is complete, the analyzer passes control back to the computer. Refer to the GPIB programming chapters in the programmer's guide for more information.

In general, use the talker/listener mode for programming the analyzer unless direct peripheral access is required.

**USE SENSOR A/B**

selects the A or B power sensor calibration factor list for use in power meter calibration measurements.

**USER**

is used to select the preset condition defined by the user.

**USER KIT**

is used to define kits other than those offered by Agilent Technologies.

**VELOCITY FACTOR**

enters the velocity factor used by the analyzer to calculate equivalent electrical length in distance-to-fault measurements using the time domain option. Values entered should be less than 1.

Velocity factor is the ratio of the velocity of wave propagation in a coaxial cable to the velocity of wave propagation in free space. Most cables have a relative velocity of about 0.66 the speed in free space. This velocity depends on the relative permittivity of the cable dielectric

( $\epsilon_r$ ) as:  $Velocity\ Factor = \frac{1}{\sqrt{\epsilon_r}}$

**USER SETTINGS**

selects a menu of user settings, including preset settings that can be changed by the user.

**VIEW MEASURE**

toggles to become view setup when the analyzer is in frequency offset mode.

**VOLUME NUMBER**

specifies the number of the disk volume to be accessed. In general, all 3.5 inch floppy disks are considered one volume (volume 0). For hard disk drives, such as the HP 9153A (Winchester), a switch in the disk drive must be set to define the number of volumes on the disk.

**WAIT x**

pauses the execution of subsequent sequence commands for x number of seconds. Terminate this command with .

Entering a 0 in wait x causes the instrument to wait for prior sequence command activities to finish before allowing the next command to begin. The wait 0 command only affects the command immediately following it, and does not affect commands later in the sequence.

**WARNING**

selects the display warning annotation for color modification.

**WARNING [ ]**

brings up the color definition menu. The warning annotation default color is black.

**WAVEGUIDE**

defines the standard (and the offset) as rectangular waveguide. This causes the analyzer to assume a dispersive delay. See **OFFSET DELAY**.

**WAVEGUIDE DELAY**

applies a non-linear phase shift for use with electrical delay which follows the standard dispersive phase equation for rectangular waveguide. When

**WAVEGUIDE DELAY** is pressed, the active function becomes the WAVEGUIDE CUTOFF frequency, which is used in the phase equation. Choosing a Start frequency less than the Cutoff frequency results in phase errors.



**WIDTH VALUE**

is used to set the amplitude parameter (for example 3 dB) that defines the start and stop points for a bandwidth search. The bandwidth search feature analyzes a bandpass or band reject trace and calculates the center point, bandwidth, and Q (quality factor) for the specified bandwidth. Bandwidth units are the units of the current format.

**WIDTHS on OFF**

turns on the bandwidth search feature and calculates the center stimulus value, bandwidth, and Q of a bandpass or band reject shape on the trace. The amplitude value that defines the pass band or reject band is set using the

**WIDTH VALUE** softkey.

Four markers are turned on, and each has a dedicated use.

Marker 1 is a starting point from which the search is begun. Marker 2 goes to the bandwidth center point. Marker 3 goes to the bandwidth cutoff point on the left, and Marker 4 to the cutoff point on the right.

If a delta marker or fixed marker is on, it is used as the reference point from which the bandwidth amplitude is measured. For example, if marker 1 is the delta marker and is set at the passband maximum, and the width value is set to -3 dB, the bandwidth search finds the bandwidth cutoff points 3 dB below the maximum and calculates the 3 dB bandwidth and Q.

If marker 2 (the dedicated bandwidth center point marker) is the delta reference marker, the search finds the points 3 dB down from the center.

If no delta reference marker is set, the bandwidth values are absolute values.

**WINDOW**

(Option 010 only) is used to specify the parameters of the window in the transform menu.

**WINDOW: MAXIMUM**

(Option 010 only) sets the pulse width to the widest value allowed. This minimizes the sidelobes and provides the greatest dynamic range.

**WINDOW: MINIMUM**

(Option 010 only) is used to set the window of a time domain measurement to the minimum value. Provides essentially no window.

**WINDOW: NORMAL**

(Option 010 only) is used to set the window of a time domain measurement to the normal value. Usually the most useful because it reduces the sidelobes of the measurement somewhat.

(x1)

is used to terminate basic units: dB, dBm, Hz, dB/GHz, degrees, or seconds. It may also be used to terminate unitless entries such as averaging factor.



**XMIT CNTRL [ ]**

toggles the PLOTTER/PRINTER serial port data transmit control mode between the Xon-Xoff protocol handshake and the DTR-DSR (data terminal ready-data set ready) hardware handshake.

**Y: REFL**

converts reflection data to its equivalent admittance values.

**Y: TRANS**

converts transmission data to its equivalent admittance values.

**Z: REFL**

converts reflection data to its equivalent impedance values.

**Z: TRANS**

converts transmission data to its equivalent impedance values.



---

## **6 Error Messages**

## Error Messages

This chapter contains the following information to help you interpret any error messages that may be displayed on the analyzer LCD or transmitted by the instrument over GPIB:

- An alphabetical listing of all error messages, including:
  - ❑ An explanation of the message
  - ❑ Suggestions to help solve the problem
- A numerical listing of all error messages

---

**NOTE**        Some messages described in this chapter are for information only and do not indicate an error condition. These messages are not numbered and so they will not appear in the numerical listing.

---

---

## Error Messages in Alphabetical Order

---

### ABORTING COPY OUTPUT

**Information Message** This message is displayed briefly if you have pressed **Local** to abort a copy operation. If the message is not subsequently replaced by error message number 25, PRINT ABORTED (or PLOT ABORTED) the copy device may be hung. Press **Local** once more to exit the abort process and verify the status of the copy device. At this point, the copy device will probably have an error condition which must be fixed. (For example: out of paper or paper jam.)

---

### ADDITIONAL STANDARDS NEEDED

**Error Number 68** Error correction for the selected calibration class cannot be computed until you have measured all the necessary standards.

---

### ADDRESSED TO TALK WITH NOTHING TO SAY

**Error Number 31** You have sent a read command to the analyzer (such as ENTER 716) without first requesting data with an appropriate output command (such as OUTPDATA). The analyzer has no data in the output queue to satisfy the request.

---

### ALL REGISTERS HAVE BEEN USED

**Error Number 200** You have used all of the available registers; you can store no more instrument states even though you may still have sufficient memory. There are 31 registers available, plus the preset instrument state.

---

### ANALOG BUS DISABLED IN 6 KHZ IF BW

**Error Number 212** When you press **Avg IF BW [6000]**, the analog bus is disabled and not available for use in troubleshooting. For a description of the analog bus, refer to the service guide.

---

### ANALOG INPUT OVERLOAD

**Error Number 60** The power level of the analog input is too high. Reduce the power level of the analog input source.

---

### ANOTHER SYSTEM CONTROLLER ON GPIB

**Error Number 37** You must remove the active controller from the bus or the controller must relinquish the bus before the analyzer can assume the system controller mode.

---

ARGUMENT OUT OF RANGE

**Error Number** 206      The argument for a programming command is out of the specified range. Refer to the programmer's guide for a list of programming commands and argument ranges.

---

ASCII: MISSING 'BEGIN' STATEMENT

**Error Number** 193      The CITIfile you just downloaded over the GPIB or via disk was not properly organized. The analyzer is unable to read the "BEGIN" statement.

---

ASCII: MISSING 'CITIFILE' STATEMENT

**Error Number** 194      The CITIfile you just downloaded over the GPIB or via disk was not properly organized. The analyzer is unable to read the "CITIFILE" statement.

---

ASCII: MISSING 'DATA' STATEMENT

**Error Number** 195      The CITIfile you just downloaded over the GPIB or via disk was not properly organized. The analyzer is unable to read the "DATA" statement.

---

ASCII: MISSING 'VAR' STATEMENT

**Error Number** 196      The CITIfile you just downloaded over the GPIB or via disk was not properly organized. The analyzer is unable to read the "VAR" statement.

---

AVERAGING INVALID ON NON-RATIO MEASURE

**Error Number** 13      You cannot use sweep-to-sweep averaging in single-input measurements. Sweep-to-sweep averaging is valid only for ratioed measurements (A/R, B/R, A/B, and S-parameters). You can use other noise reduction techniques, such as narrower IF bandwidth, for single input measurements.

---

BAD FREQ FOR HARMONIC OR FREQ OFFSET

**Error Number** 181      You turned on time domain or recalled a calibration that resulted in start and stop frequencies that are beyond the allowable limits.

---

BANDWIDTH LIMIT INVALID: MIN BW > MAX BW

**Information Message**      The bandwidth test has a minimum bandwidth greater than the maximum bandwidth. Change the minimum bandwidth to a frequency less than the frequency of the maximum bandwidth or change the maximum bandwidth to a frequency greater than the frequency of the minimum bandwidth

---

BATTERY FAILED. STATE MEMORY CLEARED

**Error Number** 183      The battery protection of the non-volatile CMOS memory has failed. The CMOS memory has been cleared. Refer to the service guide for battery replacement instructions. See [Chapter 8](#) , “Preset State and Memory Allocation” for more information about the CMOS memory.

---

BATTERY LOW! STORE SAVE REGS TO DISK

**Error Number** 184      The battery protection of the non-volatile CMOS memory is in danger of failing. If this occurs, all of the instrument state registers stored in CMOS memory will be lost. Save these states to a disk and refer to the service guide for battery replacement instructions. See [Chapter 8](#) , “Preset State and Memory Allocation” for more information about the CMOS memory.

---

BLOCK INPUT ERROR

**Error Number** 34      The analyzer did not receive a complete data transmission. This is usually caused by an interruption of the bus transaction. Clear by pressing the **Local** key or aborting the I/O process at the controller.

---

BLOCK INPUT LENGTH ERROR

**Error Number** 35      The length of the header received by the analyzer did not agree with the size of the internal array block. Refer to the programmer’s guide for instructions on using analyzer input commands.

---

CALIBRATION ABORTED

**Error Number** 74      You have changed the active channel during a calibration, so the calibration in progress was terminated. Make sure the appropriate channel is active and restart the calibration.

---

CALIBRATION REQUIRED

**Error Number** 63      A calibration set could not be found that matched the current stimulus state or measurement parameter. You will have to perform a new calibration.

---

CANNOT DETERMINE ORIENTATION

**Information Message**      There is a problem with the ECal module in the RF path. Check RF connections, power connections, and interface connections to module.

---

CANNOT FORMAT DOS DISKS ON THIS DRIVE

**Error Number** 185      You have attempted to initialize a floppy disk to DOS format on an external disk drive that does not support writing to all 80 tracks of the double density and high density disks. The older single-sided disks had only 66 tracks and some disk drives were limited to accessing that number of tracks. To format the disk, either choose another external disk drive or use the analyzer's internal disk drive.

---

CANNOT MODIFY FACTORY PRESET

**Error Number** 199      You have attempted to rename, delete, or otherwise alter the factory preset state. The factory preset state is permanently stored in ROM and cannot be altered. If your intent was to create a user preset state, you must create a new instrument state, save it, and then rename it to "UPRESET". Refer to [Chapter 8](#), "Preset State and Memory Allocation" for more detailed instructions.

---

CANNOT READ/WRITE HFS FILE SYSTEM

**Error Number** 203      The disk is being accessed by the analyzer and is found to contain an HFS (hierarchical file system) or files nested within subdirectories. The analyzer does not support HFS. Replace the disk medium with a LIF or DOS formatted disk that does not contain files nested within subdirectories.

---

CAN'T STORE/LOAD SEQUENCE, INSUFFICIENT MEMORY

**Error Number** 127      Your sequence transfer to or from a disk could not be completed due to insufficient memory.

---

CAUTION: CORRECTION OFF: AUX CHANNEL(S) DISABLED

**Error Number** 215      This message is displayed when correction is forced off due to a stimulus change that is not compatible with the current calibration while an auxiliary channel is enabled. The auxiliary channels are restored when correction is turned on by pressing **Cal** **CORRECTION on OFF**.

---

CAUTION: FLOPPY DISK IS FULL

**Error Number** 218      This message is displayed if you try to save files to the floppy disk that does not have enough memory to perform the save task. Correct by inserting a new floppy disk in the front panel disk drive or by erasing files from the current floppy disk.

---

CAUTION: TOO MANY SEGMENTS OR POINTS

**Information Message**      This message is displayed if you try to insert too many segments or points using your current function.



---

CH1 (CH2, CH3, CH4) TARGET VALUE NOT FOUND

**Error Number** 159      Your target value for the marker search function does not exist on the current data trace.

---

CONTINUOUS SWITCHING NOT ALLOWED

**Error Number** 10      Your current measurement requires different power ranges on channel 1 and channel 2. To protect the attenuator from undue mechanical wear, test set hold will be activated. The “tsH” (test set hold) indicator in the left margin of the display indicates that the inactive channel has been put in the sweep hold mode.

This message is also displayed if a mechanical switch test set is in use and channels are measuring parameters that require the test set to switch continuously, for example S11 on Channel 1 and S22 on Channel 2

---

COPY: device not responding; copy aborted

**Error Number** 170      The printer or plotter is not accepting data. Verify the cable connections, GPIB addresses, and otherwise ensure that the copy device is ready.

---

COPY OUTPUT COMPLETED

**Information Message**      The analyzer has completed outputting data to the printer or plotter. The analyzer can now accept another copy command.

---

CORRECTION AND DOMAIN RESET

**Error Number** 65      When you change the frequency range, sweep type, or number of points, error-correction is switched off and the time domain transform is recalculated, without error-correction. You can either correct the frequency range, sweep type, or number of points to match the calibration, or perform a new calibration. Then perform a new time domain transform.

---

CORRECTION CONSTANTS NOT STORED

**Error Number** 3      A store operation to the EEPROM was not successful. You must change the position of the write-protect jumper on the A9 CPU assembly. Refer to the “Adjustments and Correction Constants” chapter of the service guide for information on the A9 CC jumper position.

---

CORRECTION ON: AUX CHANNEL(S) RESTORED

**Error Number** 214      This message is displayed when a calibration is restored and that calibration previously had one or both auxiliary channels enabled.

---

CORRECTION TURNED OFF

**Error Number**    **66**            Critical parameters in your current instrument state do not match the parameters for the calibration set, therefore correction has been turned off. The critical instrument state parameters are sweep type, start frequency, frequency span, and number of points.

---

CURRENT PARAMETER NOT IN CAL SET

**Error Number**    **64**            Correction is not valid for your selected measurement parameter. Either change the measurement parameters or perform a new calibration.

---

D2/D1 INVALID WITH SINGLE CHANNEL

**Error Number**    **130**            You can only make a D2/D1 measurement if both channels are on.

---

D2/D1 INVALID: CH1 CH2 NUM PTS DIFFERENT

**Error Number**    **152**            You can only make a D2/D1 measurement if both channels have the same number of points.

---

DEADLOCK

**Error Number**    **111**            A fatal firmware error occurred before instrument preset completed. Call your local Agilent Technologies sales and service office.

---

DEMODULATION NOT VALID

**Error Number**    **17**            Demodulation was selected when the analyzer was not in CW time mode. Select demodulation only after putting the analyzer into CW time mode.

---

DEVICE: not on, not connect, wrong addr

**Error Number**    **119**            The device at the selected address cannot be accessed by the analyzer. Verify that the device is switched on, and check the GPIB connection between the analyzer and the device. Ensure that the device address recognized by the analyzer matches the GPIB address set on the device itself.

---

DIRECTORY FULL

**Error Number**    **188**            There is no room left in the directory to add files. Either delete files or get a new disk.

---

DISK HARDWARE PROBLEM

**Error Number**    **39**            The disk drive is not responding correctly. Refer to the service guide for troubleshooting information. If using an external disk drive, refer to the disk drive operating manual.

---

DISK IS WRITE PROTECTED

**Error Number**    The store operation cannot write to a write-protected disk. Slide the  
48                    write-protect tab over the write-protect opening in order to write data on the  
                         disk.

---

DISK MEDIUM NOT INITIALIZED

**Error Number**    You must initialize the disk before it can be used.  
40

---

DISK MESSAGE LENGTH ERROR

**Error Number**    The analyzer and the external disk drive aren't communicating properly. Check  
190                   the GPIB connection and then try substituting another disk drive to isolate the  
                         problem instrument.

---

DISK: not on, not connected, wrong addr

**Error Number**    The disk cannot be accessed by the analyzer. Verify power to the disk drive, and  
38                   check the GPIB connection between the analyzer and the disk drive. Ensure  
                         that the disk drive address recognized by the analyzer matches the GPIB  
                         address set on the disk drive itself.

---

DISK READ/WRITE ERROR

**Error Number**    There may be a problem with your disk. Try a new floppy disk. If a new floppy  
189                   disk does not eliminate the error, suspect hardware problems.

---

DISK WEAR - REPLACE DISK SOON

**Error Number**    Cumulative use of the disk is approaching the maximum. Copy files as  
49                   necessary using an external controller. If no controller is available, load  
                         instrument states from the old disk and store them to a newly initialized disk  
                         using the save/recall features of the analyzer. Discard the old disk.

---

DOMAIN RESET

**Error Number**    Time domain calculations were reset due to a change in the frequency range,  
67                   sweep type, or number of points. Perform a new time domain transform on the  
                         new state.

---

DUPLICATING TO THIS SEQUENCE NOT ALLOWED

**Error Number**    A sequence cannot be duplicated to itself.  
125

---

ECal: CHECKING ORIENTATION

**Information Message** This message is displayed while the network analyzer verifies that the ECal module is properly connected in the RF path.

---

ECal: CONFIDENCE STATE

**Information Message** This message is displayed when the confidence state is initiated. The confidence state response will be displayed.

---

ECal FAILED

**Error Number 224** This is a serious ECal failure. It may occur due to corrupt data in the ECal module or a problem with the network analyzer. If the error message continues, contact the service center. For a list of sales and service centers near you, refer to *Chapter 8, Safety and Regulatory Information* in the user's guide.

---

ECal: ISOLATION STATE

**Information Message** This message is displayed when ECal module is set to the isolation state.

---

ECal: MODULE NOT IN RF PATH

**Error Number 219** The ECal module is not in the RF path. Check all connections to the ECal module.

---

ECal: MODULE NOT RESPONDING

**Error Number 222** The ECal module is not responding to the network analyzer. Check all the ECal module connections and the power supply connection.

---

ECal: MODULE NOT SUPPORTED

**Information Message** The ECal module that is being used for calibration is not compatible with the network analyzer. Refer to the *Electronic Calibration Module Reference Guide* for information regarding compatibility.

---

ECal: REFLECTION STATE

**Information Message** This message is displayed when the ECal module is set to the reflection state.

---

ECal: SELECTING BEST REFLECTION REFLECTION STATE

**Information Message** The network analyzer is in the process of selecting the most accurate reflection response.

---

ECal: SELECT OTHER MODULE

**Error Number** 221      This error occurs when two ECal modules are connected. The selected ECal module may not be able to measure the selected frequency range. Check the frequency range of the other module and connect in the RF path.

---

ECal: THRU STATE

**Information Message**      This message is displayed when the ECal module is set to the thru state.

---

EXCEEDED 7 STANDARDS PER CLASS

**Error Number** 72      When modifying calibration kits, you can define a maximum of seven standards for any class.

---

EXTERNAL SOURCE MODE REQUIRES CW TIME

**Error Number** 148      An external source can only be phase locked and measured in the CW time sweep mode.

---

EXT SOURCE NOT READY FOR TRIGGER

**Error Number** 191      There is a hardware problem with the 8625A external source. Verify the connections between the analyzer and the external source. If the connections are correct, refer to the source operating manual.

---

EXT SRC: NOT ON/CONNECTED OR WRONG ADDR

**Error Number** 162      The analyzer is unable to communicate with the external source. Check the connections and the GPIB address on the source.

---

FILE NOT COMPATIBLE WITH INSTRUMENT

**Information Message**      You cannot recall user graphics that had been saved on an earlier model of analyzer with a monochrome display. These files cannot be used with the analyzer.

---

FILE NOT FOUND

**Error Number** 192      The requested file was not found on the current disk medium.

---

FILE NOT FOUND OR WRONG TYPE

**Error Number** 197      During a recall operation, either the file was not found or the type of file was not an instrument state file.

---

FIRST CHARACTER MUST BE A LETTER

**Error Number**    The first character of a disk file title or an internal save register title must be an alpha character.  
**42**

---

FORMAT NOT VALID FOR MEASUREMENT

**Error Number**    Conversion measurements (Z or Y reflection and transmission) are not valid with Smith chart and SWR formats.  
**75**

---

FORMATTING DATA

**Information**    The list information is being processed for a list data output to a copy device and stored in the copy spool buffer. During this time, the analyzer's resources are dedicated to this task (which takes less than a few seconds).  
**Message**

---

FREQS CANNOT BE CHANGED, TOO MANY POINTS

**Error Number**    The number of points selected for setting the low pass transform frequencies is too high. Reduce the number of points so that the low pass criteria is met.  
**204**

---

FUNCTION NOT AVAILABLE

**Error Number**    The function you requested over GPIB is not available on the current instrument.  
**202**

---

FUNCTION NOT VALID

**Error Number**    The function you requested is incompatible with the current instrument state.  
**14**

---

FUNCTION NOT VALID DURING MOD SEQUENCE

**Error Number**    You cannot perform sequencing operations while a sequence is being modified.  
**131**

---

FUNCTION NOT VALID FOR INTERNAL MEMORY

**Error Number**    The function you selected only works with disk files.  
**201**

---

FUNCTION ONLY VALID DURING MOD SEQUENCE

**Error Number**    You can only use the **GOSUB SEQUENCE** capability when you are building a sequence. Attempting to use this softkey at any other time returns an error message and no action is taken.  
**163**

---

8753 SOURCE PARAMETERS CHANGED

**Error Number** 61      Some of the stimulus parameters of the instrument state have been changed, because you have turned correction on. A calibration set for the current measurement parameter was found and activated. The instrument state was updated to match the stimulus parameters of the calibration state. This message also appears when you have turned on harmonic mode or frequency offset, and the present frequency range cannot be used with one of these modes.

---

GPIB COPY IN PROGRESS, ABORT WITH LOCAL

**Error Number** 169      An GPIB copy was already in progress when you requested the GPIB for another function. To abort the first copy, press **Local**, otherwise the GPIB is unavailable until the first copy is completed.

---

IF BW KEY DISABLED, EDIT LIST MODE TBL

**Information**      When list IF bandwidth has been enabled and swept list mode is on, you will not  
**Message**            be able to change the IF bandwidth using the **IF BW** key. To change the IF bandwidth, edit the swept list table.

---

ILLEGAL UNIT OR VOLUME NUMBER

**Error Number** 46      The disk unit or volume number set in the analyzer is not valid. Refer to the disk drive operating manual.

---

INIT DISK removes all data from disk

**Information**      Continuing with the initialize operation will *destroy* any data currently on the  
**Message**            disk.

---

INITIALIZATION FAILED

**Error Number** 47      The disk initialization failed, probably because the disk is damaged.

---

INSTRUMENT STATE MEMORY CLEARED

**Error Number** 56      All instrument state registers have been cleared from memory along with any saved calibration data, memory traces, and calibration kit definitions. Additionally, all user-settable selections (such as GPIB addresses) are set to their defaults.

---

INSUFFICIENT MEMORY

**Error Number** 51      Your last front panel or GPIB request could not be implemented due to insufficient memory space. In some cases, this is a fatal error from which you can escape only by presetting the instrument.

---

INSUFFICIENT MEMORY FOR PRINT/PLOT

**Error Number** 168      There is not enough memory available for the print or plot function. Increase the available memory by changing or eliminating a memory-intensive operation such as reducing the number of points in the sweep.

---

INSUFFICIENT MEMORY, PWR MTR CAL OFF

**Error Number** 154      There is not enough memory space for the power meter calibration array. Increase the available memory by clearing one or more save/recall registers, or by reducing the number of points.

---

INVALID KEY

**Error Number** 2      You pressed an undefined softkey.

---

ISOL AVERAGES < SWP AVERAGES

**Error Number** 223      The isolation averages are less than the instrument sweep averages. Increase the isolation averages to be equal to or greater than instrument sweep averages. This error can only occur when instrument averaging is turned on.

---

LIMIT TABLE EMPTY

**Error Number** 205      Limit lines cannot be turned on unless a limit table has been created. Refer to the “Making Measurements” chapter of the user’s guide for information on how to create a limit table.

---

LIST MODE OFF: INVALID WITH LO FREQ

**Error Number** 182      List mode has been turned off in the frequency offset mode because it is incompatible with your selected LO frequency.

---

LIST TABLE EMPTY

**Error Number** 9      The frequency list is empty. To implement list frequency mode, add segments to the list table.

---

LOG SWEEP REQUIRES 2 OCTAVE MINIMUM SPAN

**Error Number** 150      A logarithmic sweep is only valid if the stop frequency is greater than four times the start frequency. For frequency spans of less than two octaves, the sweep type automatically reverts to linear sweep.



---

LOW PASS: FREQ LIMITS CHANGED

**Information Message**      The frequency domain data points must be harmonically related from dc to the stop frequency. That is,  $\text{stop} = n \times \text{start}$ , where  $n$  = number of points. If this condition is not true when a low pass mode (step or impulse) is selected and transform is turned on, the analyzer resets the start and stop frequencies. The stop frequency is set close to the entered stop frequency, and the start frequency is set equal to  $\text{stop}/n$ .

---

MEMORY FOR CURRENT SEQUENCE IS FULL

**Error Number 132**      All the memory in the sequence you are modifying is filled with instrument commands.

---

MORE SLIDES NEEDED

**Error Number 71**      When you use a sliding load (in a user-defined calibration kit), you must set at least three slide positions to complete the calibration.

---

NO CALIBRATION CURRENTLY IN PROGRESS

**Error Number 69**      The **RESUME CAL SEQUENCE** softkey is not valid unless a calibration is already in progress. Start a new calibration.

---

NO DISK MEDIUM IN DRIVE

**Error Number 41**      You have no disk in the current disk unit. Insert a disk, or check the disk unit number stored in the analyzer.

---

NO FAIL FOUND

**Service Error Number 114**      The self-diagnose function of the instrument operates on an internal test failure. At this time, no failure has been detected.

---

NO FILE(S) FOUND ON DISK

**Error Number 45**      No files of the type created by an analyzer store operation were found on the disk or the disk drive is empty. If you requested a specific file title, that file was not found on the disk.

---

NO IF FOUND: CHECK R INPUT LEVEL

**Error Number 5**      The first IF signal was not detected during pretune. Check the front panel R channel jumper. If there is no visible problem with the jumper, refer to the service guide for troubleshooting.

---

NO LIMIT LINES DISPLAYED

**Error Number**    You can turn limit lines on but they cannot be displayed on polar or Smith chart display formats.  
**144**

---

NO MARKER DELTA - SPAN NOT SET

**Error Number**    You must turn the delta marker mode on, with at least two markers displayed, in order to use the **MARKER → SPAN** softkey function.  
**15**

---

NO MEMORY AVAILABLE FOR INTERPOLATION

**Error Number**    You cannot perform interpolated error correction due to insufficient memory.  
**123**

---

NO MEMORY AVAILABLE FOR SEQUENCING

**Error Number**    You cannot modify the sequence due to insufficient memory.  
**126**

---

NO MODULE DATA FOR THIS PARAMETER

**Information**        This message is displayed in Ecal service when there is no parameter data in the ECal module.  
**Message**

---

NO PHASE LOCK: CHECK R INPUT LEVEL

**Error Number**    The first IF signal was detected at pretune, but phase lock could not be acquired. Check the signal level to the R channel input to make sure it is -35 dBm or higher. Refer to the service guide for troubleshooting.  
**7**

---

NO SPACE FOR NEW CAL. CLEAR REGISTERS

**Error Number**    You cannot store a calibration set due to insufficient memory. You can free more memory by clearing a saved instrument state from an internal register (which may also delete an associated calibration set, if all the instrument states using the calibration set have been deleted). You can store the saved instrument state and calibration set to a disk before clearing them. After deleting the instrument states, press **(Preset)** to run the memory packer.  
**70**

---

NO MODULE DATA FOR ISOLATION STD

**Information**        This message is displayed in ECal service when there is no isolation data in the ECal module.  
**Message**

---

NOT ALLOWED DURING POWER METER CAL

**Error Number**    When the analyzer is performing a power meter calibration, the GPIB bus is unavailable for other functions such as printing or plotting.  
**198**

---

NOT ENOUGH SPACE ON DISK FOR STORE

**Error Number**    The store operation will overflow the available disk space. Insert a new disk or  
44                    purge files to create free disk space.

---

NO VALID MEMORY TRACE

**Error Number**    If you are going to display or otherwise use a memory trace, you must first store  
54                    a data trace to memory.

---

NO VALID STATE IN REGISTER

**Error Number**    You have requested the analyzer, over GPIB (or by sequencing), to load an  
55                    instrument state from an *empty* internal register.

---

OK TO ALTER CORRECTION CONSTANTS?

**Error Number**    This message is displayed as a prompt during operations when the correction  
186                   constants will be changed. Correction constants may be change in the  
                         adjustment tests in the service menu.

---

ONLY LETTERS AND NUMBERS ARE ALLOWED

**Error Number**    You can only use alpha-numeric characters (and underscores) in disk file titles  
43                    or internal save register titles. Other symbols are not allowed, except for the  
                         “underscore” symbol.

---

OPTIONAL FUNCTION; NOT INSTALLED

**Error Number**    The function you requested requires a capability provided by an option to the  
1                    standard analyzer. That option is not currently installed. (Refer to [“Analyzer  
Options Available” on page 7-3](#) for a description of the available options.)

---

OVERLAP! LIST TYPE CHANGED TO STEPPED

**Error Number**    The list type changed to stepped because one or more frequency segments in the  
211                   swept list table overlapped. Change the frequency ranges of the overlapping  
                         segments and switch back to swept list mode.

---

OVERLOAD ON INPUT A, POWER REDUCED (ES only)

**Error Number**    See OVERLOAD ON INPUT R, POWER REDUCED (error number 57).  
58

---

OVERLOAD ON INPUT B, POWER REDUCED (ES only)

**Error Number**    See OVERLOAD ON INPUT R, POWER REDUCED (error number 57).  
59

---

OVERLOAD ON REFL PORT, POWER REDUCED (ET only)

**Error Number** 58     See OVERLOAD ON INPUT R, POWER REDUCED (error number 57).

---

OVERLOAD ON TRANS PORT, POWER REDUCED (ET only)

**Error Number** 59     See OVERLOAD ON INPUT R, POWER REDUCED (error number 57).

---

OVERLOAD ON INPUT R, POWER REDUCED

**Error Number** 57     You have exceeded approximately +14 dBm at one of the test ports. The RF output power is automatically reduced to -85 dBm. The annotation P↓ appears in the left margin of the display to indicate that the power trip function has been activated. When this occurs, reset the power to a lower level, then toggle the softkey to switch on the power again.

---

PARALLEL PORT NOT AVAILABLE FOR GPIO

**Error Number** 165     You have defined the parallel port as COPY for printing in the GPIB menu. To access the parallel port for general purpose I/O (GPIO), set the selection to **PARALLEL [GPIO]**.

---

PARALLEL PORT NOT AVAILABLE FOR COPY

**Error Number** 167     You have defined the parallel port as general purpose I/O (GPIO) for sequencing. The definition was made under the **Local** key menus. To access the parallel port for copy, set the selection to **PARALLEL [COPY]**.

---

PHASE LOCK CAL FAILED

**Error Number** 4     An internal phase lock calibration routine is automatically executed at power-on, preset, and any time a loss of phase lock is detected. This message indicates that phase lock calibration was initiated and the first IF detected, but a problem prevented the calibration from completing successfully. Refer to the service guide and execute pretune correction test 48. This message may appear if you connect a mixer between the RF output and R input before turning on frequency offset mode. Ignore it: it will go away when you turn on frequency offset. This message may also appear if you turn on frequency offset mode before you define the offset.

---

PHASE LOCK LOST

**Error Number** 8     Phase lock was acquired but then lost. Refer to the service guide for troubleshooting information.

---

PLOT ABORTED

**Error Number** 27      When you press the **Local** key, the analyzer aborts the plot in progress.

---

PLOTTER: not on, not connect, wrong addr

**Error Number** 26      The plotter does not respond to control. Verify power to the plotter, and check the GPIB connection between the analyzer and the plotter. Ensure that the plotter address recognized by the analyzer matches the GPIB address set on the plotter itself.

---

PLOTTER NOT READY-PINCH WHEELS UP

**Error Number** 28      The plotter pinch wheels clamp the paper in place. If you raise the pinch wheels, the plotter indicates a “not ready” status on the bus.

---

POSSIBLE FALSE LOCK

**Error Number** 6      Phase lock has been achieved, but the source may be phase locked to the wrong harmonic of the synthesizer. Perform the source pretune correction routine documented in the “Adjustments and Correction Constants” chapter in the service guide.

---

POWER SUPPLY HOT!

**Error Number** 21      The temperature sensors on the A8 post-regulator assembly have detected an over-temperature condition. The power supplies regulated on the post-regulator have been shut down.

---

POWER SUPPLY SHUT DOWN!

**Error Number** 22      One or more supplies on the A8 post-regulator assembly have been shut down due to an over-current, over-voltage, or under-voltage condition.

---

POWER UNLEVELED

**Error Number** 179      There is either a hardware failure in the source or you have attempted to set the power level too high. The analyzer allows the output power to be set higher or lower than the specified available power range. However, these output powers may be unlevelled or unavailable. Check to see if the power level you set is within specifications. If it is, refer to the service guide for troubleshooting.

---

PRESS [MENU], SELECT CW (IF) FREQ, THEN SWEPT LO

**Error Number** 161      When you are sweeping the RF and LO, the IF must be fixed.

---

PRINT ABORTED

**Error Number** 25      When you press the **Local** key, the analyzer aborts output to the printer.

---

print color not supported with EPSON

**Error Number** 178      You have defined the printer type as EPSON-P2. Color print is not supported with this printer. The print will abort.

---

PRINTER: busy

**Error Number** 176      The parallel port printer is not accepting data.

---

PRINTER: error

**Error Number** 175      The parallel port printer is malfunctioning. The analyzer cannot complete the copy function.

---

PRINTER: not connected

**Error Number** 173      There is no printer connected to the parallel port.

---

PRINTER: not handshaking

**Error Number** 177      The printer at the parallel port is not responding.

---

PRINTER: not on line

**Error Number** 172      The printer at the parallel port is not set on line.

---

PRINTER: not on, not connected, wrong addr

**Error Number** 24      The printer does not respond to control. Verify power to the printer, and check the GPIB connection between the analyzer and the printer. Ensure that the printer address recognized by the analyzer matches the GPIB address set on the printer itself.

---

PRINTER: paper error

**Error Number** 171      There is a paper-related problem with the parallel port printer such as a paper jam or out-of-paper condition.

---

PRINTER: power off

**Error Number** 174     The power to the printer at the parallel port is off.

---

PRINTER: reset in progress

**Information Message**     If the printer takes longer than a half-second to reset, this message will be displayed until printer is finished with reset.

---

PRINT/PLOT IN PROGRESS, ABORT WITH LOCAL

**Error Number** 166     If a print or plot is in progress and you attempt a second print or plot, this message is displayed and the second attempt is ignored. To abort a print or plot in progress, press **Local**.

---

PROBE POWER SHUT DOWN!

**Error Number** 23     One or both of the probe power supplies have been shut down due to an over-current, over-voltage, or under-voltage condition.

---

PROCESSING DISPLAY LIST

**Information Message**     The display information is being processed for a screen print to a copy device and stored in the copy spool buffer. During this time, the analyzer's resources are dedicated to this task (which takes less than a few seconds).

---

PWR MTR NOT ON/CONNECTED OR WRONG ADDR

**Error Number** 117     The power meter cannot be accessed by the analyzer. Verify that the power meter address and model number set in the analyzer match the address and model number of the actual power meter.

---

RANGE CAUSED POWER LVL CHANGE IN LIST

**Error Number** 213     The selected power range changed the power level of one or more segments in the swept list table. Change the segment power or change the power range.

---

REQUESTED DATA NOT CURRENTLY AVAILABLE

**Error Number** 30     The analyzer does not currently contain the data you have requested. For example, this condition occurs when you request error term arrays and no calibration is active.

---

RIPPLE LIMIT TABLE EMPTY.

**Information Message**     The ripple limit table does not have any frequency bands defined. Add at least one frequency band to the ripple limit table for ripple testing.

---

SAVE FAILED. INSUFFICIENT MEMORY

**Error Number** 151      You cannot store an instrument state in an internal register due to insufficient memory. Increase the available memory by clearing one or more save/recall registers and pressing **Preset**, or by storing files to a disk.

---

SEGMENT #n POWER OUTSIDE RANGE LIMIT

**Information Message**      The selected power range does not support the power level of one or more segments in the swept list table. This message appears when swept list mode is not on and reports the first segment that is out of range. Change the segment power or change the power range.

---

SEGMENT #n START FREQ OVERLAPS PREVIOUS SEGMENT

**Information Message**      A segment entered in the swept list table caused one or more frequency segments to overlap. This message appears when swept list mode is not on and reports the first segment that is overlapping another. Change the frequency ranges of the overlapping segments.

---

SELECTED MODULE OUTSIDE START-STOP FREQ RANGE

**Error Number** 220      The start and stop frequency range is outside the limits of the ECal module. Manually set the frequency limits to within the module range.

---

SELECTED SEQUENCE IS EMPTY

**Error Number** 124      The sequence you attempted to run does not contain instrument commands.

---

SELF TEST #n FAILED

**Service Error Number** 112      Internal test #n has failed. Several internal test routines are executed at instrument preset. The analyzer reports the first failure detected. Refer to the service guide for troubleshooting information on internal tests and the self-diagnose feature.

---

SEQUENCE ABORTED

**Error Number** 157      The sequence running was stopped prematurely when you pressed the **Local** key.

---

SEQUENCE MAY HAVE CHANGED, CAN'T CONTINUE

**Error Number** 153      When you pause a sequence, you cannot continue it if you have modified it. You must start the sequence again.



---

SLIDES ABORTED (MEMORY REALLOCATION)

**Error Number** 73      You cannot perform sliding load measurements due to insufficient memory. Increase the available memory by clearing one or more save/recall registers and pressing **Preset**, or by storing files to a disk and then deleting them from internal memory.

---

SOURCE POWER DISABLED, EDIT LIST MODE TBL

**Information Message**      When list power has been enabled and swept list mode is on, you will not be able to change the power level using the **Power** key. To change the power level, edit the swept list table.

---

SOURCE POWER TURNED OFF, RESET UNDER POWER MENU

**Information Message**      You have exceeded the maximum power level at one of the inputs and power has been automatically reduced. The annotation P↓ indicates that power trip has been activated. When this occurs, reset the power and then press **Power** **SOURCE PWR on OFF**, to switch on the power.

---

STARTING COPY SPOOLER

**Information Message**      The analyzer is beginning to output data from the spool buffer to the copy device. The analyzer resumes normal operation; the data is being output to the copy device in the background.

---

STOP/CW FREQ + OFFSET MUST BE < 3 GHz

**Error Number** 141      The output frequency of the mixer cannot violate the minimum/maximum frequency of the analyzer.

---

SWEEP MODE CHANGED TO CW TIME SWEEP

**Error Number** 187      If you select external source auto or manual instrument mode and you do not also select CW mode, the analyzer is automatically switched to CW.

---

SWEEP TIME INCREASED

**Error Number** 11      You have made instrument changes that cause the analyzer sweep time to be automatically increased. Some parameter changes that cause an increase in sweep time are narrower IF bandwidth, an increase in the number of points, and a change in sweep type.

---

SWEEP TIME TOO FAST

**Error Number** 12      The fractional-N and digital IF circuits have lost synchronization. Refer to the service guide for troubleshooting information.

---

SWEEP TRIGGER SET TO HOLD

**Information Message** The instrument is in a hold state and is no longer sweeping. To take a new sweep, press **Sweep Setup** **TRIGGER MENU** **SINGLE** or **CONTINUOUS**.

---

SYNTAX ERROR

**Error Number 33** You have improperly formatted a GPIB command. Refer to the programmer's guide for proper command syntax.

---

SYST CTRL OR PASS CTRL IN LOCAL MENU

**Error Number 36** The analyzer is in talker/listener mode. In this mode, the analyzer cannot control a peripheral device on the bus. Use the local menu to change to system controller or pass control mode.

---

TEST ABORTED

**Error Number 113** You have prematurely stopped a service test.

---

THIS LIST FREQ INVALID IN HARM/3 GHZ RNG

**Error Number 133** You have set frequencies in the list that are outside of the allowable frequency range for harmonic measurements, or are greater than 3 GHz on instruments without Option 006. Reduce the frequency range of the list.

---

TOO MANY NESTED SEQUENCES. SEQ ABORTED

**Error Number 164** You can only nest sequences to a maximum level of six. The sequence will abort if you nest more than six.

---

TOO MANY SEGMENTS OR POINTS

**Error Number 50** You can have a maximum of 30 segments or 1601 points in frequency list mode. In power meter calibrations, you can have a maximum of 12 segments for power sensor cal factors and power loss functions.

---

TRANSFORM, GATE NOT ALLOWED

**Error Number 16** You can perform a time domain transformation only in linear and CW sweep types.

---

TROUBLE! CHECK SETUP AND START OVER

**Service Error Number 115** Your equipment setup for the adjustment procedure in progress is not correct. Check the setup diagram and instructions in the service guide. Start the procedure again.

---

VALID ONLY FOR BILATERAL DEVICES

**Information Message** This message is displayed when an enhanced reflection calibration is initiated. If the device tested is not a bilateral device, the enhanced reflection calibration will cause errors in the measurement results.

A bilateral device has similar forward and reverse transmission characteristics. Examples of bilateral devices are passive devices (filters, attenuators, and switches). Most active devices (amplifiers) and some passive devices (isolators and circulators) are not bilateral.

---

WAIT: ECal MODULE BEING READ

**Information Message** The data from ECal is being read by the network analyzer.

---

WAITING FOR CLEAN SWEEP

**Information Message** In single sweep mode, the instrument ensures that all changes to the instrument state, if any, have been implemented before taking the sweep. The command that you have initiated is being processed and will not be complete until the new sweep is completed. An asterisk \* is displayed in the left margin until a complete fresh sweep has been taken.

---

WAITING FOR DISK

**Information Message** This message is displayed between the start and finish of a read or write operation to a disk.

---

WAITING FOR GPIB CONTROL

**Information Message** You have instructed the analyzer to use pass control (USEPASC). When you send the analyzer an instruction that requires active controller mode, the analyzer requests control of the bus and simultaneously displays this message. If the message remains, the system controller is not relinquishing the bus.

---

WRITE ATTEMPTED WITHOUT SELECTING INPUT TYPE

**Error Number 32** You have sent the data header "#A" to the analyzer with no preceding input command (such as INPUDATA). The instrument recognized the header but did not know what type of data to receive. Refer to the programmer's guide for command syntax information.

---

WRONG DISK FORMAT, INITIALIZE DISK

**Error Number 77** You have attempted to store, load, or read file titles, but your disk format does not conform to the Logical Interchange Format (LIF) or DOS format. You must initialize the disk before reading or writing to it.

---

## Error Messages in Numerical Order

<b>Error Number</b>	<b>Error</b>
1	OPTIONAL FUNCTION; NOT INSTALLED
2	INVALID KEY
3	CORRECTION CONSTANTS NOT STORED
4	PHASE LOCK CAL FAILED
5	NO IF FOUND: CHECK R INPUT LEVEL
6	POSSIBLE FALSE LOCK
7	NO PHASE LOCK: CHECK R INPUT LEVEL
8	PHASE LOCK LOST
9	LIST TABLE EMPTY
10	CONTINUOUS SWITCHING NOT ALLOWED
11	SWEEP TIME INCREASED
12	SWEEP TIME TOO FAST
13	AVERAGING INVALID ON NON-RATIO MEASURE
14	FUNCTION NOT VALID
15	NO MARKER DELTA - SPAN NOT SET
16	TRANSFORM, GATE NOT ALLOWED
17	DEMODULATION NOT VALID
21	POWER SUPPLY HOT!
22	POWER SUPPLY SHUT DOWN!
23	PROBE POWER SHUT DOWN!
24	PRINTER: not on, not connect, wrong addr
25	PRINT ABORTED
26	PLOTTER: not on, not connect, wrong addr
27	PLOT ABORTED
28	PLOTTER NOT READY-PINCH WHEELS UP
30	REQUESTED DATA NOT CURRENTLY AVAILABLE
31	ADDRESSED TO TALK WITH NOTHING TO SAY

Error Number	Error
32	WRITE ATTEMPTED WITHOUT SELECTING INPUT TYPE
33	SYNTAX ERROR
34	BLOCK INPUT ERROR
35	BLOCK INPUT LENGTH ERROR
36	SYST CTRL OR PASS CTRL IN LOCAL MENU
37	ANOTHER SYSTEM CONTROLLER ON GPIB
38	DISK: not on, not connected, wrong addr
39	DISK HARDWARE PROBLEM
40	DISK MEDIUM NOT INITIALIZED
41	NO DISK MEDIUM IN DRIVE
42	FIRST CHARACTER MUST BE A LETTER
43	ONLY LETTERS AND NUMBERS ARE ALLOWED
44	NOT ENOUGH SPACE ON DISK FOR STORE
45	NO FILE(S) FOUND ON DISK
46	ILLEGAL UNIT OR VOLUME NUMBER
47	INITIALIZATION FAILED
48	DISK IS WRITE PROTECTED
49	DISK WEAR-REPLACE DISK SOON
50	TOO MANY SEGMENTS OR POINTS
51	INSUFFICIENT MEMORY
54	NO VALID MEMORY TRACE
55	NO VALID STATE IN REGISTER
56	INSTRUMENT STATE MEMORY CLEARED
57	OVERLOAD ON INPUT R, POWER REDUCED
58	OVERLOAD ON INPUT A, POWER REDUCED (ES only)
58	OVERLOAD ON REFL PORT, POWER REDUCED (ET only)
59	OVERLOAD ON INPUT B, POWER REDUCED (ES only)
59	OVERLOAD ON TRANS PORT, POWER REDUCED (ET only)
60	ANALOG INPUT OVERLOAD
61	8753 SOURCE PARAMETERS CHANGED

<b>Error Number</b>	<b>Error</b>
62	NOT VALID FOR PRESENT TEST SET
63	CALIBRATION REQUIRED
64	CURRENT PARAMETER NOT IN CAL SET
65	CORRECTION AND DOMAIN RESET
66	CORRECTION TURNED OFF
67	DOMAIN RESET
68	ADDITIONAL STANDARDS NEEDED
69	NO CALIBRATION CURRENTLY IN PROGRESS
70	NO SPACE FOR NEW CAL. CLEAR REGISTERS
71	MORE SLIDES NEEDED
72	EXCEEDED 7 STANDARDS PER CLASS
73	SLIDES ABORTED (MEMORY REALLOCATION)
74	CALIBRATION ABORTED
75	FORMAT NOT VALID FOR MEASUREMENT
77	WRONG DISK FORMAT, INITIALIZE DISK
111	DEADLOCK
112	SELF TEST #n FAILED
113	TEST ABORTED
114	NO FAIL FOUND
115	TROUBLE! CHECK SETUP AND START OVER
117	PWR MTR: NOT ON/CONNECTED OR WRONG ADDRS
119	DEVICE: not on, not connect, wrong addr
123	NO MEMORY AVAILABLE FOR INTERPOLATION
124	SELECTED SEQUENCE IS EMPTY
125	DUPLICATING TO THIS SEQUENCE NOT ALLOWED
126	NO MEMORY AVAILABLE FOR SEQUENCING
127	CAN'T STORE/LOAD SEQUENCE, INSUFFICIENT MEMORY
130	D2/D1 INVALID WITH SINGLE CHANNEL
131	FUNCTION NOT VALID DURING MOD SEQUENCE
132	MEMORY FOR CURRENT SEQUENCE IS FULL

Error Number	Error
133	THIS LIST FREQ INVALID IN HARM/3 GHZ RNG
141	STOP/CW FREQ + OFFSET MUST BE < 3 GHz
144	NO LIMIT LINES DISPLAYED
145	SWEEP TYPE CHANGED TO LINEAR SWEEP
148	EXTERNAL SOURCE MODE REQUIRES CW TIME
150	LOG SWEEP REQUIRES 2 OCTAVE MINIMUM SPAN
151	SAVE FAILED / INSUFFICIENT MEMORY
152	D2/D1 INVALID: CH1 CH2 NUM PTS DIFFERENT
153	SEQUENCE MAY HAVE CHANGED, CAN'T CONTINUE
154	INSUFFICIENT MEMORY, PWR MTR CAL OFF
157	SEQUENCE ABORTED
159	CH1 (CH2) TARGET VALUE NOT FOUND
161	PRESS [MENU], SELECT CW (IF) FREQ, THEN SWEPT LO
162	EXT SRC: NOT ON/CONNECTED OR WRONG ADDR
163	FUNCTION ONLY VALID DURING MOD SEQUENCE
164	TOO MANY NESTED SEQUENCES. SEQ ABORTED
165	PARALLEL PORT NOT AVAILABLE FOR GPIO
166	PRINT/PLOT IN PROGRESS, ABORT WITH LOCAL
167	PARALLEL PORT NOT AVAILABLE FOR COPY
168	INSUFFICIENT MEMORY FOR PRINT/PLOT
169	GPIB COPY IN PROGRESS, ABORT WITH LOCAL
170	COPY: device not responding; copy aborted
171	PRINTER: paper error
172	PRINTER: not on line
173	PRINTER: not connected
174	PRINTER: power off
175	PRINTER: error
176	PRINTER: busy
177	PRINTER: not handshaking
178	print color not supported with EPSON

<b>Error Number</b>	<b>Error</b>
179	POWER UNLEVELED
180	DOS NAME LIMITED TO 8 CHARS + 3 CHAR EXTENSION
181	BAD FREQ FOR HARMONIC OR FREQ OFFSET
182	LIST MODE OFF: INVALID WITH LO FREQ
183	BATTERY FAILED. STATE MEMORY CLEARED
184	BATTERY LOW! STORE SAVE REGS TO DISK
185	CANNOT FORMAT DOS DISKS ON THIS DRIVE
186	OK TO ALTER CORRECTION CONSTANTS?
187	SWEEP MODE CHANGED TO CW TIME SWEEP
188	DIRECTORY FULL
189	DISK READ/WRITE ERROR
190	DISK MESSAGE LENGTH ERROR
191	EXT SOURCE NOT READY FOR TRIGGER
192	FILE NOT FOUND
193	ASCII: MISSING 'BEGIN' statement
194	ASCII: MISSING 'CITIFILE' statement
195	ASCII: MISSING 'DATA' statement
196	ASCII: MISSING 'VAR' statement
197	FILE NOT FOUND OR WRONG TYPE
198	NOT ALLOWED DURING POWER METER CAL
199	CANNOT MODIFY FACTORY PRESET
200	ALL REGISTERS HAVE BEEN USED
201	FUNCTION NOT VALID FOR INTERNAL MEMORY
202	FUNCTION NOT AVAILABLE
203	CANNOT READ/WRITE HFS FILE SYSTEM
204	FREQS CANNOT BE CHANGED, TOO MANY POINTS
205	LIMIT TABLE EMPTY
206	ARGUMENT OUT OF RANGE
209	SWEEP MUST BE STEPPED FOR FREQUENCY OFFSET MODE?
211	OVERLAP!LIST TYPE CHANGED TO STEPPED



<b>Error Number</b>	<b>Error</b>
212	ANALOG BUS DISABLED IN 6 KHZ IF BW
213	RANGE CAUSED POWER LVL CHANGE IN LIST
214	CORRECTION ON: AUX CHANNEL(S) RESTORED
215	CAUTION: CORRECTION OFF: AUX CHANNEL(S) DISABLED
218	CAUTION: FLOPPY DISK IS FULL
219	ECal MODULE NOT IN RF PATH
220	SELECTED MODULE OUTSIDE START-STOP FREQ RANGE
221	ECal SELECT OTHER MODULE
222	ECal MODULE NOT RESPONDING
223	ISOL AVGS < SWP AVGS
224	ECal FAILED

Error Messages

**Error Messages in Numerical Order**

---

## **7 Options and Accessories**

## **Using This Chapter**

This chapter contains information on the following subjects:

- “Analyzer Options Available” on page 7-3
- “Accessories Available” on page 7-5

## **Analyzer Options Available**

### **Option 1D5, High Stability Frequency Reference**

Option 1D5 offers  $\pm 0.05$  ppm temperature stability from 0 to 55 °C (referenced to 25 °C), and aging rate of  $\pm 0.5$  ppm per year (typical).

### **Option 002, Harmonic Mode**

Provides measurement of second or third harmonics of the test device's fundamental output signal. Frequency and power sweep are supported in this mode. Harmonic frequencies can be measured up to the maximum frequency of the receiver. However, the fundamental frequency may not be lower than 16 MHz.

### **Option 004, Source Attenuator (ET Only)**

This option adds a 55 dB step attenuator that extends the output power range by allowing lower power levels.

### **Option 006, 6 GHz Operation**

Option 006 extends the maximum source and receiver frequency of the analyzer to 6 GHz.

### **Option 010, Time Domain**

This option displays the time domain response of a network by computing the inverse Fourier transform of the frequency domain response. It shows the response of a test device as a function of time or distance. Displaying the reflection coefficient of a network versus time determines the magnitude and location of each discontinuity. Displaying the transmission coefficient of a network versus time determines the characteristics of individual transmission paths. Time domain operation retains all accuracy inherent with the correction that is active in the frequency domain. The time domain capability is useful for the design and characterization of such devices as SAW filters, SAW delay lines, RF cables, and RF antennas.

### **Option 011, Delete Built-In Test Set (ES Only)**

Option 011 allows front panel access to the source output and the R, A, and B sampler inputs. The transfer switch, couplers, and bias tees have been removed. Therefore, external accessories are required to make most measurements.

### **Option 014, Configurable Test Set (ES Only)**

This option adds SMA connectors on the front panel for access to various source output and receiver input signal paths, including direct access to receivers. When jumpers are in place, the analyzer performs like a standard 8753ES network analyzer except that the maximum source output power is reduced by 2 dB. Not compatible with Option 011 or 075.

### **Option 075, 75 $\Omega$ Impedance (ES Only)**

Option 075 offers 75 ohm impedance bridges with type-N (f) test port connectors.

### **Option 1CM, Rack Mount Flange Kit Without Handles**

Option 1CM is a rack mount kit containing a pair of flanges and the necessary hardware to mount the instrument, with handles detached, in an equipment rack with 482.6-mm (19 inches) horizontal spacing.

### **Option 1CP, Rack Mount Flange Kit With Handles**

Option 1CP is a rack mount kit containing a pair of flanges and the necessary hardware to mount the instrument with handles attached in an equipment rack with 482.6 mm (19 inches) spacing.

### **Service and Support Options**

Agilent Technologies offers many repair and calibration options for your analyzer. Contact the nearest Agilent Technologies sales or service office for information on options available for your analyzer.

---

## Accessories Available

For accessories not listed in this section, refer to the configuration guide for your analyzer or refer to the following Internet site:

[www.agilent.com/find/8753](http://www.agilent.com/find/8753)

## Measurement Accessories

Accessories are available in these connector types: 3.5-mm, 7-mm, 50  $\Omega$  type-N, 7-16, 75  $\Omega$  type-N, and type-F. A standard 8753ES or one equipped with Option 014 or Option 075 includes a built-in test set. A calibration kit and test port cables should be added for a complete measurement system. For an 8753ES Option 011 network analyzer, you also need to add a test set or power splitter and bridge.

Test port cables are used to connect to the device under test. Calibration kits include standards, such as open/short circuits and loads, which are measured by the network analyzer for increased measurement accuracy. Electronic calibration (ECal) modules are used with the ECal PC interface kit to provide automated calibration (in place of a calibration kit). A verification kit is used to verify system performance.

### Test-Port Cables: 7-mm

- 11857D 50  $\Omega$  7-mm test-port return cables  
A pair of 610-mm (24-in) cables, for use with the standard 8753ES network analyzer or the 85406A and 85047A test sets.

### Test-Port Cables: Type-N

- 11857B 75  $\Omega$  type-N test-port cables  
A pair of 610-mm (24-in) cables, for use with the standard 8753ES Option 075 or the 85046B S-parameter test set.
- 11857F 75  $\Omega$  type-N test-port cables  
Includes one 75  $\Omega$  type-N (m) to type-F (m) cable, and one type-N (m) to type-F (f).

### Calibration Kits

Choose a kit for each connector type to be used.

- 85031B 7-mm calibration kit  
Contains fixed loads, open and short circuits.
- 85032B type-N calibration kit  
Contains fixed loads, open and short circuits and 7-mm to type-N adapters.
  - Option 001  
Deletes 7-mm to type-N adapters.  
These adapters are not needed when this kit is used exclusively with an 8753ET system.

**Accessories Available**

- 85032F 50  $\Omega$  type-N calibration kit (30 kHz to 9 GHz)  
Contains a female and male open and short, female and male load standard, and a torque wrench.
  - Option 500  
Adds four type-N to 7- mm adapter.
- 85033D 3.5-mm calibration kit  
Contains fixed loads, one-piece open and short circuits, and 7-mm to 3.5-mm adapters for both connector sexes for use with 7-mm test-port cables.
  - Option 001  
Deletes 7-mm to 3.5-mm adapters.  
These adapters are not needed when this kit is used exclusively with an 8753ET system.
  - Option 002  
Adds 50  $\Omega$  type-N to 3.5-mm adapters for the 8753ET only.
- 85033E 50  $\Omega$  3.5-mm calibration kit (30kHz to 9 GHz)  
Contains a female and male open and short, female and male load standard, and a torque wrench.
  - Option 400  
Adds four 3.5 mm to Type-N adapters.
  - Option 500  
Adds four 3.5 mm to 7- mm adapters.
- 85038A 50  $\Omega$  7-16 calibration kit (30 kHz to 7.5 GHz)  
Contains male and female open and short circuits, fixed loads and wrenches.
- 85038F 50  $\Omega$  7-16 calibration kit (30 kHz to 7.5 GHz)  
Contains a female fixed load, open and short circuits, and 7-16 (f) to 7-16 (f) adapter.
- 85038M 50  $\Omega$  7-16 calibration kit (30 kHz to 7.5 GHz)  
Contains a male fixed load, open and short circuits, and a 7-16 (m) to 7-16 (m) adapter.
- 85036B 75  $\Omega$  type-N calibration kit  
Contains fixed loads, open and short circuits, and 50  $\Omega$  type-N to 70  $\Omega$  type-N adapters (m) and (f).
- 85039B 75  $\Omega$  type-F calibration kit  
Contains 75  $\Omega$  male/female open, short and load standards and precision adapters type-N (f) to F (m), type-N (m) to F (f), type-F (m) to F (m) and type-F (f) to F (m) adapters.
  - Option 00M male standards kit  
Includes male open, short and load standards and precision F (m) to F (m) adapter.
  - Option 00F female standards kit  
Includes female open, short and load standards and precision F (f) to F (f) adapter



## RF electronic calibration (ECal) modules and PC software

This product family provides electronic calibration (ECal) capability. With ECal, the usual calibration kit standards are replaced by one solid-state calibration module. A full two-port calibration can be done with a single connection, with reduced errors and wear on connectors. ECal requires the 85097A/B PC interface kit, an 85090-series calibration module with the appropriate connector type, and a network analyzer with firmware version 7.68 and above.

---

**NOTE** For network analyzers with firmware versions between 7.60 and 7.68, a PC with Windows®<sup>1</sup> 95, 98, 2000 or NT 4.0 loaded with software from the 85097A/B PC interface kit is used to perform the ECal calibration.

---

- 85097A/B ECal PC interface kit and software
  - Contains PC interface module for connecting an ECal module to a PC or a network analyzer (with firmware version 7.68 and above) and PC ECal control software.
- 85091B RF ECal module (30 kHz to 9 GHz), 7-mm connectors
- 85092B RF ECal module (30 kHz to 9 GHz), 50  $\Omega$  type-N (m) to 50  $\Omega$  type-N (f) connectors
  - Option 00F substitutes type-N (f) to type-N (f) RF ECal module.
  - Option 00M substitutes type-N (m) to type-N (m) RF ECal module.
  - Option 00A adds:
    - type-N (f) to type-N (f) adapter
    - type-N (m) to type-N (m) adapter
- 85093B RF ECal module (30 kHz to 9 GHz), 3.5-mm (m) to 3.5-mm (f) connectors
  - Option 00F substitutes 3.5-mm (f) to 3.5-mm (f) RF ECal module.
  - Option 00M substitutes 3.5-mm (m) to 3.5-mm (m) RF ECal module.
  - Option 00A adds:
    - 3.5-mm (f) to 3.5-mm (f) adapter
    - 3.5-mm (m) to 3.5-mm (m) adapter
- 85098B RF ECal module (30 kHz to 7.5 GHz), 7-16 (m) to 7-16 (f) connectors
  - Option 00F substitutes 7-16 (f) to 7-16 (f) RF ECal module.
  - Option 00M substitutes 7-16 (m) to 7-16 (m) RF ECal module.
  - Option 00A adds:
    - 7-16 (f) to 7-16 (f) adapter
    - 7-16 (m) to 7-16 (m) adapter

---

1. Windows is a U.S. registered trademark of Microsoft Corporation.

## Accessories Available

- 85096B RF ECal module (30 kHz to 3 GHz), 75  $\Omega$  type-N (m) to 75  $\Omega$  type-N (f) connectors
  - Option 00F substitutes module with two type-N female connectors.
  - Option 00M substitutes module with two type-N male connectors.
  - Option 00A adds:
    - type-N (m) to type-N (m) adapter
    - type-N (f) to type-N (f) adapter
- 85099B RF ECal module (30 kHz to 3 GHz), 75  $\Omega$  type-F (m) to type-F (f) connectors
  - Option 00F substitutes module with two type-F female connectors.
  - Option 00M substitutes module with two type-F male connectors.
  - Option 00A adds:
    - type-F (m) to type-F (m) adapter
    - type-F (f) to type-F (f) adapter
- N4431A 4-Port RF ECal module (300 kHz to 9 GHz)
  - Option 010 provides for all four ports with 3.5-mm (f) connectors.
  - Option 020 provides for all four ports with Type-N 50 $\Omega$  (f) connectors.
  - Option UK6 adds commercial calibration certificate with measured data.
  - Mixed Connector Options.

**Table 7-1 N4431A Mixed Connector Options**

Connector Type	Port A Option	Port B Option	Port C Option	Port D Option
3.5 mm (f)	101	201	301	401
3.5 mm (m)	102	202	302	402
Type-N 50 $\Omega$ (f)	103	203	303	403
Type-N 50 $\Omega$ (m)	104	204	304	404
7-16 (f) <sup>a</sup>	105	205	305	405
7-16 (m) <sup>a</sup>	106	206	306	406

a. Limits ECal module high frequency to 7.5 GHz

## Verification Kit

### 85029B 7-mm verification kit

Includes attenuators and mismatch attenuator with data on a 3.5 inch disk for use in confirming accuracy enhanced system measurement performance, traceable to national standards. Test procedure is provided in the service guide. For use with a standard 8753ES, or with systems including an 8753ES Option 011 and an 85046A, or 85047A test set. This verification kit may also be used with an 8753ET with the addition of two type-N (m) to 7-mm adapters. The 85031B 7-mm calibration kit and 11857D test-port cables are also required.

## Minimum Loss Pads and Adapters

- 11525A 7-mm to 50  $\Omega$  type-N (m) adapter  
Adapts from 7-mm to 50  $\Omega$  type-N male.
- 11852B 50 to 75  $\Omega$  minimum loss pad (300 kHz to 3 GHz)  
Adapts from 50  $\Omega$  type-N female to 75  $\Omega$  type-N male. Nominal insertion loss is 5.7 dB.  
— Option 004 provides 50  $\Omega$  type-N male and 75  $\Omega$  type-N female connectors.
- 11853A 50  $\Omega$  type-N accessory kit  
Contains type-N (m) to type-N (m) adapters, type-N (f) to type-N (f) adapters, and type-N male and female shorts.
- 11854A 50  $\Omega$  BNC accessory kit  
Contains type-N to BNC adapters for both connector sexes and a BNC male short.
- 11855A 75  $\Omega$  type-N accessory kit  
Contains 75  $\Omega$  type-N male to type-N male adapters, type-N female to type-N female adapters, type-N male and female shorts, and type-N male termination.

**Accessories Available**

- 11856A 75  $\Omega$  BNC accessory kit  
Contains 75  $\Omega$  type-N to 75  $\Omega$  BNC adapters for both connector sexes, a BNC male short and BNC male termination.
- 11906A 7-16 to 7-16 adapter kit  
Contains one 7-16(m) to 7-16(m) adapter, one 7-16(f) to 7-16(f) adapter, and two 7-16(m) to 7-16(f) adapters.
- 11906B 7-16 to 50  $\Omega$  type-N adapter kit  
Contains adapters for type-N (m) to 7-16(m), type-N (m) to 7-16(f), type-N (f) to 7-16(m), and type-N (f) to 7-16(f).
- 11906C 7-16 to 7-mm adapter kit  
Contains two 7-mm to 7-16(m) adapters and two 7-mm to 7-16(f) adapters.
- 11906D 7-16 to 3.5-mm adapter kit  
Contains adapters for 3.5-mm(m) to 7-16(m), 3.5-mm(m) to 7-16(f), 3.5-mm(f) to 7-16(m), and 3.5-mm(f) to 7-16(f) adapters.

## Test Configuration Accessories

### RF Limiter

Externally attaches to one or both test ports of the analyzer. Provides protection against potential high-power transients from external devices.

- 11930A 7-mm RF limiter, DC to 6 GHz, max power +28 dBm typical
- 11930B 50  $\Omega$  type-N RF limiter, 5 MHz to 6 GHz, max power +28 dBm typical

### Probe

85024A high-frequency probe

Provides high-impedance in-circuit test capability, from 300 kHz to 3 GHz.

### Amplifier

8347A RF power amplifier

Used to set leveled output power or increase system dynamic range, from 100 kHz to 3 GHz.

8347A RF power amplifier

Used to set leveled output power or increase system dynamic range, from 100 kHz to 3 GHz.

### Power Meters

For more accurate control of leveled test-port power. Requires a 8480-series power sensor and an GPIB cable for connection to the 8753ET or 8753ES.

- E4418B single-channel power meter
- E4419B dual-channel power meter

## Power Sensors

For more accurate control of leveled test-port power. Requires a 436A, 437B, 438B, or E4419B power meter and an GPIB cable for connection to the network analyzer.

- 8481A 10 MHz to 18 GHz, type-N (m), 100 mwatt
- 8481B 10 MHz to 18 GHz, type-N (m), 25 watt
- 8482A 100 kHz to 4.2 GHz, type-N (m), 100 mwatt
- 8482B 100 kHz to 4.2 GHz, type-N (m), 25 watt
- 8483A 100 kHz to 2 GHz, 75  $\Omega$  type-N (m), 100 mwatt
- 8485A 50 MHz to 26.5 GHz, 3.5-mm (m), 100 mwatt

## Keyboard Template

The analyzer is designed to accept most PC-AT-compatible keyboards with a mini-DIN connector. The keyboard can be used for control or data input, such as titling files. The information found on the analyzer keyboard template (part number 08753-80220) is also listed in [Table 7-2](#).

**Table 7-2 Keyboard Template Definition**

Keyboard Key Name	Analyzer Function	Keyboard Key Name	Analyzer Function
F1	Softkey 1	Shift F8	CAL
F2	Softkey 2	Shift F9	MARKER
F3	Softkey 3	Shift F10	MARKER SEARCH
F4	Softkey 4	Shift F11	MARKER FUNCTION
F5	Softkey 5	Shift F12	SEQ
F6	Softkey 6	Ctrl F1	CHAN 3
F7	Softkey 7	Ctrl F2	CHAN 4
F8	Softkey 8	Ctrl F3	POWER
F9	x1	Ctrl F4	SWEEP SETUP
F10	k/m	Ctrl F5	START
F11	M/μ	Ctrl F6	STOP
F12	G/n	Ctrl F7	CENTER
Shift F1	CHAN 1	Ctrl F8	SPAN
Shift F2	CHAN 2	Ctrl F9	SYSTEM
Shift F3	MEAS	Ctrl F10	LOCAL
Shift F4	FORMAT	Ctrl F11	COPY
Shift F5	SCALE	Ctrl F12	SAVE/RECALL
Shift F6	DISPLAY	Alt F1	TITLE
Shift F7	AVG		

---

## **8 Preset State and Memory Allocation**

## Preset State

When the **Ⓟ** key is pressed, the analyzer reverts to a known state called the factory preset state. This state is defined in [Table 8-1](#). There are subtle differences between the preset state and the power-up state. These differences are documented in [Table 8-3](#). If power to non-volatile memory is lost, the analyzer will have certain parameters set to default settings. The affected parameters are shown in [Table 8-4](#).

When line power is cycled, the analyzer performs a self-test routine. Upon successful completion of that routine, the instrument state is set to the conditions shown in [Table 8-1](#). The same conditions are true following a “PRES;” or “RST;” command over GPIB, although the self-test routines are not executed.

You also can create an instrument state and define it as your user preset state:

1. Set the instrument state to your desired preset conditions.
2. Save the state (save/recall menu).
3. Rename that register to “UPRESET”.
4. Press **Ⓟ** PRESET:USER.

The **Ⓟ** key is now toggled to the **USER** selection and your defined instrument state will be recalled each time you press **Ⓟ** and when you turn power on. You can toggle back to the factory preset instrument state by pressing **Ⓟ** and selecting **FACTORY**.

---

**NOTE** When you send a preset over GPIB, you will always get the factory preset. You can, however, activate the user-defined preset over GPIB by recalling the register in which it is stored.

---



**Table 8-1 Preset Conditions**

Preset Conditions	Preset Value
<b>Analyzer Mode</b>	
Analyzer Mode	Network Analyzer Mode
Frequency Offset Operation	Off
Offset Value	0
Harmonic Operation	Off
<b>Stimulus Conditions</b>	
Sweep Type	Linear Frequency
Display Mode	Start/Stop
Trigger Type	Continuous
External Trigger	Off
Sweep Time	87.5 ms, Auto Mode
Start Frequency	ES: 30 kHz. ET: 300 kHz
Frequency Span	ES: 2999.97 MHz ET: 2999.7 MHz
Frequency Span (Opt. 006)	ES: 5999.97 MHz ET: 5999.7 MHz
Start Time	0
Time Span	75.375 ms
CW Frequency	1000 MHz
Source Power	ES: 0 dBm ET: -10 dBm
Power Slope (ES Only)	0 dB/GHz; Off
Start Power	-15.0 dBm
Power Span	25 dB
Coupled Channel Power	On
Source Power	On
Coupled Channels	On
Coupled Port Power (ES Only)	On
Power Range (ES Only)	Auto; Range 0
Number of Points	201
List Freq Sweep Mode	Swept

**Table 8-1 Preset Conditions (Continued)**

Preset Conditions	Preset Value
<b>Frequency List</b>	
Frequency List	Empty
Edit Mode	Start/Stop, Number of Points
<b>Response Conditions</b>	
Parameter (ES)	Channel 1: S11 Channel 2: S21 Channel 3: S12 Channel 4: S22
Parameter (ET)	Channel 1: Refl Channel 2: Trans Channel 3: Refl Channel 4: Trans
Conversion	Off
Format	Log Magnitude (all inputs)
Display	Data
Color Selections	Same as before <input type="button" value="Preset"/>
Dual Channel	Off
Active Channel	Channel 1
Auxiliary Channel	Disabled
Frequency Blank	Disabled
Test Set Switch (ES)	Continuous
Split Display	2X
Intensity	100%
Beeper: Done	On
Beeper: Warning	Off
D2/D1 to D2	Off
Title	Channel 1 = Empty Channel 2 = Empty
IF Bandwidth	3700 Hz
IF Averaging Factor	16; Off

**Table 8-1 Preset Conditions (Continued)**

Preset Conditions	Preset Value
Smoothing Aperture	1% SPAN; Off
Phase Offset	0 Degrees
Electrical Delay	0 ns
Scale/Division	10 dB/Division
<b>Calibration</b>	
Correction	Off
Calibration Type	None
Calibration Kit (ES)	7-mm, type-N 75-ohm (Option 075)
Calibration Kit (ET)	Type-N 50 Ohms
Enhanced Reflection Calibration	Off
System Z0	50 Ohms
Velocity Factor	1
Extensions	Off
Port 1	0 s
Port 2	0 s
Input A	0 s
Input B	0 s
Chop A and B (ES)	On
Chop RFL & TRN (ET)	On
Power Meter Calibration	Off
Number of Readings	1
Power Loss Correction	Off
Sensor A/B	A
Interpolated Error Correction	On
<b>Electronic Calibration (ECal)</b>	
Module	A (information may not be loaded)
Omit Isolation	On
Isolation Averages	10
Manual Thru	Off

**Table 8-1 Preset Conditions (Continued)**

Preset Conditions	Preset Value
<b>Markers (coupled)</b>	
Markers 1, 2, 3, 4, 5	1 GHz; All Markers Off
Last Active Marker	1
Reference Marker	None
Marker Mode	Continuous
Display Markers	On
Delta Marker Mode	Off
Coupling	On
Marker Search	Off
Marker Target Value	-3 dB
Marker Width Value	-3 dB; Off
Marker Tracking	Off
Marker Stimulus Offset	0 Hz
Marker Value Offset	0 dB
Marker Aux Offset (Phase)	0 Degrees
Marker Statistics	Off
Polar Marker	Lin Mkr
Smith Marker	R+jX Mkr
<b>Limit Menu</b>	
Limit Lines	
Limit Lines	Off
Limit Testing	Off
Limit List	Empty
Edit Mode	Upper/Lower Limits
Stimulus Offset	0 Hz
Amplitude Offset	0 dB
Limit Type	Sloping Line
Beep Fail	Off
Ripple Limit	
Ripple Limit	Off

**Table 8-1 Preset Conditions (Continued)**

Preset Conditions	Preset Value
Ripple Test	Off
Bandwidth Limit	
Bandwidth Test	Off
Bandwidth Display	Off
Bandwidth Marker	Off
<b>Time Domain</b>	
Transform	Off
Transform Type	Bandpass
Start Transform	-20 nanoseconds
Transform Span	40 nanoseconds
Gating	Off
Gate Shape	Normal
Gate Start	-10 nanoseconds
Gate Span	20 nanoseconds
Demodulation	Off
Window	Normal
Use Memory	Off
<b>System Parameters</b>	
GPIB Addresses	Last Active State
GPIB Mode	Last Active State
Clock Time Stamp	On
Preset: Factory/User	Last Selected State
<b>Copy Configuration</b>	
Parallel Port	Last Active State
Plotter Type	Last Active State
Plotter Port	Last Active State
Plotter Baud Rate	Last Active State
Plotter Handshake	Last Active State

**Table 8-1 Preset Conditions (Continued)**

Preset Conditions	Preset Value
GPIB Address	Last Active State
Printer Type	Last Active State
Printer Port	Last Active State
Printer Baud Rate	Last Active State
Printer Handshake	Last Active State
Printer GPIB Address	Last Active State
<b>Disk Save Configuration (Define Store)</b>	
Data Array	Off
Raw Data Array	Off
Formatted Data Array	Off
Graphics	Off
Data Only	Off
Directory Size	Default <sup>a</sup>
Save Using	Binary
Select Disk	Internal Memory
Disk Format	LIF
<b>Sequencing<sup>b</sup></b>	
Loop Counter	0
TTL OUT	High
<b>Service Modes</b>	
GPIB Diagnostic	Off
Source Phase Lock	Loop On
Sampler Correction	On
Spur Avoidance	On
Aux Input Resolution	Low
Analog Bus Node	11 (Aux Input)

**Table 8-1 Preset Conditions (Continued)**

Preset Conditions	Preset Value
<b>Plot</b>	
Plot Data	On
Plot Memory	On
Plot Graticule	On
Plot Text	On
Plot Marker	On
Autofeed	On
Plot Quadrant	Full Page
Scale Plot	Full
Plot Speed	Fast
Pen Number:	
Ch1/Ch3 Data	2
Ch2/Ch4 Data	3
Ch1/Ch3 Memory	5
Ch2/Ch4 Memory	6
Ch1/Ch3 Graticule	1
Ch2/Ch4 Graticule	1
Ch1/Ch3 Text	7
Ch2/Ch4 Text	7
Ch1/Ch3 Marker	7
Ch2/Ch4 Marker	7
Line Type:	
Ch1/Ch3 Data	7
Ch2/Ch4 Data	7
Ch1/Ch3 Memory	7
Ch2/Ch4 Memory	7
<b>Print</b>	
Printer Mode	Last Active State
Auto-Feed	On

**Table 8-1 Preset Conditions (Continued)**

Preset Conditions	Preset Value
Printer Colors	
Ch1/Ch3 Data	Magenta
Ch1/Ch3 Mem	Green
Ch2/Ch4 Data	Blue
Ch2/Ch4 Mem	Red
Graticule	Cyan
Warning	Black
Text	Black
Reference Line	Black

- a. The directory size is calculated as 0.013% of the floppy disk size (which is ≈256) or 0.005% of the hard disk size.
- b. Pressing preset turns off sequencing modify (edit) mode and stops any running sequence.

**Table 8-2 Preset Conditions**

Format Table	Scale	Reference	
		Position	Value
Log Magnitude (dB)	10.0	5.0	0.0
Phase (degree)	90.0	5.0	0.0
Group Delay (ns)	10.0	5.0	0.0
Smith Chart	1.00	–	1.0
Polar	1.00	–	1.0
Linear Magnitude	0.1	0.0	0.0
Real	0.2	5.0	0.0
Imaginary	0.2	5.0	0.0
SWR	1.00	0.0	1.0



**Table 8-3 Power-On Conditions (versus Preset)**

GPIB MODE	Talker/listener.
SAVE REGISTERS	Power meter calibration data and calibration data not associated with an instrument state are cleared.
COLOR DISPLAY	Default color values.
SEQUENCES	Sequence 1 through 5 are erased.
DISK DIRECTORY	Cleared.

**Table 8-4 Results of Power Loss to Non-Volatile Memory**

GPIB ADDRESSES are set to the following defaults:	
ANALYZER	16
USER DISPLAY	17
PLOTTER	5
PRINTER	1
POWER METER	13
DISK	0
DISK UNIT NUMBER	0
DISK VOLUME NUMBER	0
POWER METER TYPE is set to 438A/437	
INTERNAL REGISTER TITLES <sup>a</sup> are set to defaults: REG1 through REG32	
EXTERNAL REGISTER TITLES <sup>a</sup> (store files) are set to defaults: FILE1 through FILE 5	
PRINT TYPE is set to default: MONOCHROME	
PRINTING/PLOTTING SETUPS are set to the following defaults:	
PARALLEL PORT	COPY
PLOTTER TYPE	PLOTTER
PLOTTER PORT	GPIB
PLOTTER BAUD RATE	9600
PLOTTER HANDSHAKE	Xon-Xoff
PRINTER TYPE	DESKJET
PRINTER PORT	PARALLEL
PRINTER BAUD RATE	19200
PRINTER HANDSHAKE	Xon-Xoff

a. Only applies to GPIB operation.

## Memory Allocation

The analyzer is capable of saving complete instrument states for later retrieval. It can store these instrument states into the internal memory, to the internal disk, or to an external disk. This section contains information on the following subjects:

- [“Types of Memory and Data Storage” on page 8-12](#)
- [“Determining Memory Requirements” on page 8-14](#)
- [“Storing Data to Disk” on page 8-16](#)
- [“Conserving Memory” on page 8-18](#)
- [“Using Saved Calibration Sets” on page 8-18](#)

### Types of Memory and Data Storage

The analyzer utilizes two types of internal memory and can also utilize the internal disk drive or be connected to an external disk drive:

#### Volatile Memory

This is dynamic read/write memory, of approximately 4 Mbytes, that contains all of the parameters that make up the *current* instrument state. An instrument state consists of all the stimulus and response parameters that set up the analyzer to make a specific measurement.

Some data that you may think is part of the instrument state (such as calibration data and memory traces) are actually stored in non-volatile memory. See [“Non-Volatile Memory”](#) to read more about the differences.

Volatile memory is cleared upon a power cycle of the instrument and, except as noted, upon instrument preset.

#### Non-Volatile Memory

This is CMOS read/write memory that is protected by a battery to provide storage of data when line power to the instrument is turned off. With this battery protection, data can be retained in memory for  $\approx 250$  days at 70 °C and for  $\approx 10$  years at 25 °C (characteristically).

Non-volatile memory consists of a block of user-allocated memory and a block of fixed memory.

The user-allocated memory is available for you to save the following data:

- instrument states
- measurement calibration data
- power meter calibration data
- user calibration kit definitions
- memory traces
- user preset

---

**NOTE** Even though calibration data is stored in non-volatile memory, if the associated instrument state is not saved, you will not be able to retrieve the calibration data after a power cycle.

---

The fixed memory is used to store the following data (you cannot change where this data is stored and it does not affect your memory availability for storing user-allocated data):

- GPIB addresses
- copy configuration (printer and plotter type, port, baud rate, handshake)
- power meter type (436/437/438)
- display colors
- sequence titles
- sixth sequence
- power sensor calibration factors and loss tables
- user-defined calibration kits
- system Z0
- factory preset
- GPIB configuration
- display intensity default

The maximum number of instrument states, calibrations, and memory traces that can reside in non-volatile memory at any one time is limited to 31 instrument states, 128 calibrations (4 per instrument state, including the present instrument state), and 64 memory traces (4 per instrument state, including the present instrument state).

In addition, the number of instrument states and associated calibrations and memory traces are limited by the available memory. To display the amount of unused memory on the analyzer, press **Save/Recall**. (Be sure you have selected **INTERNAL MEMORY** as your disk type.) In the upper right-hand portion of the display, the value displayed as **Bytes free:** is the unused non-volatile memory. When you save to the internal memory, you will see the number of bytes free decrease. When you delete files, the number of bytes free increases. There is a maximum of 2 MBytes available.

If you have deleted registers since the last time the instrument was preset, the bytes available for you to use may be less than the actual “bytes free” that is displayed. Deleting registers to increase the available memory will work in cases where the registers being deleted and the registers needing to be added are of the same standard size (such as instrument states not having calibrations associated with them). In certain other cases, however, you may have to press **Preset** after deleting registers so that the “bytes free” value equals the available memory value. During a preset, the analyzer runs a memory packer that de-fragments the free memory into one contiguous block.

## Determining Memory Requirements

Table 8-5 shows the memory requirements of calibration arrays and memory trace arrays to help you approximate memory requirements. For example, add the following memory requirements:

- a full 2-port calibration with 801 points (58 k)
- the memory trace array (4.9 k)
- the instrument state (6 k)

The total memory requirement is 68.9 kbytes. There is sufficient memory to store 29 calibrations of this type. However, the same calibration performed with 1601 points and 2 channels uncoupled would require 255 k bytes:

- a full 2-port calibration with 1601 points, two channels, uncoupled (230 k)
- the memory trace array (19 k)
- the instrument state (6 k)

Only 2 of these calibrations could reside in memory before the available memory would be depleted.

**Table 8-5 Memory Requirements of Calibration and Memory Trace Arrays**

Variable	Data Length (Bytes) <sup>a</sup>	Approximate Totals (Bytes)			
		401 pts	801 pts	1601 pts	
		1 chan		1 chan	2 chans
<b>Calibration Arrays</b>					
Response	$N \times 6 + 52$	2.5 k	5 k	10 k	19 k
Response and isolation	$N \times 6 \times 2 + 52$	5 k	10 k	19 k	38 k
1-Port	$N \times 6 \times 3 + 52$	7 k	14 k	29 k	58 k
2-Port	$N \times 6 \times 12 + 52$	29 k	58 k	115 k	230 k
Interpolated cal	Same as above in addition to regular cal				
<b>Power Meter Cal<sup>b</sup></b>	$(N^c \times 2 \times \text{number channels}^d) + 208$	1 k	1.8 k	3.4 k	6.6 k
<b>Measurement Data</b>					
Memory trace array <sup>b</sup>	$N \times 6 + 52$	2.5 k	4.9 k	9.7 k	19 k
<b>Instrument State<sup>e</sup></b>		6 k	6 k	6 k	6 k

- a. N = number of points
- b. This variable is allocated once per active channel.
- c. The number of points that was set at the time the cal was turned on.
- d. If the channels are coupled, this number is always 1. If the channels are uncoupled, this number refers to the number of channels that have power meter cal on.
- e. This value may change with different firmware revisions.

The analyzer attempts to allocate memory at the start of a calibration. If insufficient memory is available, an error message is displayed. It is possible that the CMOS memory might be fragmented due to the sequence of saving and deleting states of various sizes. So another alternative would be to store the current state to disk and then press **(Preset)**. The analyzer runs a memory packer which might regain some previously inaccessible memory. If memory is still inadequate, delete an instrument state and restart the calibration.

## Storing Data to Disk

You can use the internal disk drive or connect an external disk drive for storage of instrument states, calibration data, measurement data, and plot files. (Refer to the “Printing, Plotting, and Saving Measurement Results” chapter in the user’s guide for more information on saving measurement data and plot files.)

The analyzer displays one file name per stored instrument state when you list the disk directory. In reality, several files are actually stored to the disk when you store the instrument state. Thus, when the disk directory is accessed from a remote system controller, the directory will show several files associated with a particular saved state. The maximum number of files that you can store on a disk depends on the directory size. You can define the directory size when you format a disk. For the default directory size for floppy disks and hard disks, refer to [Table 8-1](#).

The maximum number of instrument states and calibrations that can reside on a disk is limited by the available disk space. To see the available disk space displayed on the analyzer, press **(Save/Recall)**. (Be sure you have selected either **INTERNAL DISK** or **EXTERNAL DISK** depending on your disk type.) In the upper right-hand portion of the display, the value displayed as *Bytes free:* is the available disk space. If your disk is formatted in LIF, this value is the largest contiguous block of disk space. Since the analyzer is reporting the largest contiguous block of disk space, you may or may not see the bytes free number change when you delete files. If your disk is formatted in DOS, the number reported as bytes free is the total available disk space. That number is updated whenever you save to or delete files from the disk.

A disk file created by the analyzer appends a suffix to the file name. (This is on the analyzer's directory and is not visible.) The suffix consists of one or two characters: the first character is the file type and the second is a data index. (Each suffix character is defined in [Table 8-6](#).)

**Table 8-6 Suffix Character Definitions**

Char 1	Definition	Char 2	Definition
<b>I, P</b>	Instrument state <sup>a</sup>		
<b>W</b>	Four-channel instrument state		
<b>G</b>	Graphics	<b>1</b> <b>0</b>	Display graphics Graphics index
<b>D</b>	Error corrected data	<b>1</b> <b>2</b> <b>3</b> <b>4</b>	Channel 1 Channel 2 Channel 3 Channel 4
<b>R</b>	Raw data	<b>1 to 4</b> <b>5 to 8</b>	Channel 1/3, raw arrays 1 to 4 <sup>b</sup> Channel 2/4, raw arrays 5 to 8
<b>F</b>	Formatted data	<b>1</b> <b>2</b> <b>3</b> <b>4</b>	Channel 1 Channel 2 Channel 3 Channel 4
<b>C</b>	Cal	<b>K</b>	Cal kit
<b>1</b>	Cal data, channel 1	<b>0</b> <b>1 to 9</b> <b>A</b> <b>B</b> <b>C</b>	Stimulus state Coefficients 1 to 9 Coefficient 10 Coefficient 11 Coefficient 12
<b>2</b>	Cal data, channel 2	<b>0 to C</b>	same as channel 1
<b>M</b>	Memory trace data	<b>1</b> <b>2</b> <b>3</b> <b>4</b>	Channel 1 Channel 2 Channel 3 Channel 4
<b>S</b>	Error corrected data (S2P) <sup>c</sup>	<b>1</b> <b>2</b>	Channel 1 Channel 2

- a. These are two-channel instrument states readable by previous firmware versions.
- b. Files R1 through R8 will be saved if a full two-port calibration is active. Otherwise, only R1 is saved for Channel 1, R5 for Channel 3, R2 for Channel 2, and R6 for Channel 4.
- c. These files are written only when a 2-port error correction (full 2-port or TRL) has been applied.

If correction is on at the time of an external store, the calibration set is stored to disk. (Note that inactive calibrations are not stored to disk.) When an instrument state is loaded into the analyzer from disk, the stimulus and response parameters are restored first. If correction is on for the loaded state, the analyzer will load a calibration set from disk that carries the same title as the one stored for the instrument state.

## Conserving Memory

If you are concerned about conserving memory, either internal memory or external disk space, some of the most memory-intensive operations include:

- two-port error correction
- interpolated error correction
- 1601 measurement points
- using time domain
- saving data arrays and graphics with the instrument state

## Using Saved Calibration Sets

When you are saving to internal memory (CMOS, non-volatile memory), calibration sets are linked to the instrument state and measurement parameter for which the calibration was done. Therefore a saved calibration can be used for multiple instrument states as long as the measurement parameter, frequency range, and number of points are the same. A full 2-port calibration is valid for any S-parameter measurement with the same frequency range and number of points. When an instrument state is deleted from memory, the associated calibration set is also deleted if it is unused by any other state.

The following hints will help you avoid potential problems:

- If a measurement is saved with calibration and interpolated calibration on, it will be restored with interpolated calibration on.
- A calibration stored from one instrument and recalled by a different one will be invalid. To ensure maximum accuracy, always recalibrate in these circumstances.
- No record is kept in memory of the temperature when a calibration set was stored. Instrument characteristics change as a function of temperature, and a calibration stored at one temperature may be inaccurate if recalled and used at a different temperature. Refer to [Chapter 2](#), “8753ET Specifications and Characteristics,” for allowable temperature ranges for individual specifications.
- The analyzer can read disk files created by the 8753B/C/D and the 8753B/C/D can read files created by the 8753E. Note, however, that only those cal sets supported by the 8753B/C/D can be read by an 8753B/C/D from a disk created by an 8753E. A disk file translator is available to make 8753A disk files compatible with 8753B files. These files can then be read by the 8753E. Contact your local Agilent Technologies sales and service office for a copy of this disk file translator.



## Clearing Memory

For security reasons, you may have the need to clear the network analyzer's internal memory. As explained in [“Types of Memory and Data Storage” on page 8-12](#), the internal memory consists of the 2 Mbyte non-volatile CMOS memory and the 4 Mbyte volatile memory (RAM). Clearing the internal memory clears all instrument states and measured data from the network analyzer.

To clear the internal memory:

1. Press **SERVICE MENU** , **PEEK/POKE** , **RESET MEMORY** , and then press **Preset**.

This step clears the 2 Mbyte non-volatile CMOS memory.

2. Turn the network analyzer power off and then back on.

This step clears the 4 Mbyte volatile memory (RAM).



---

## **9 Understanding the CITIfile Data Format**

## Using This Chapter

The descriptions and examples shown in this chapter demonstrate how CITIfile may be used to store and transfer both measurement information and data. The use of a single, common format will allow data to be more easily moved between instruments and computers.

This chapter contains the following sections:

- [“The CITIfile Data Format” on page 9-3](#)
  - Description and Overview
  - Definition Of CITIfile Terms
  - CITIfile Examples
- [“CITIfile Keywords” on page 9-8](#)
- [“Useful Calculations” on page 9-11](#)

---

**NOTE** For many data processing applications, the S2P file (filename.S1 and filename.S2) may provide a more convenient format.

---

## The CITIfile Data Format

### Description and Overview

CITIfile is a standardized data format, used for exchanging data between different computers and instruments. CITIfile is an abbreviation for “Common Instrumentation Transfer and Interchange file”. This standard has been a group effort between instrument designers and designers of computer-aided design programs. As much as possible, CITIfile meets current needs for data transfer, and it was designed to be expandable so it can meet future needs.

CITIfile defines how the data inside an ASCII package is formatted. Since it is not tied to any particular disk or transfer format, it can be used with any operating system (BASIC, DOS, UNIX, etc.), with any disk format (LIF, DOS, HFS, etc.), or with any transfer mechanism (disk, LAN, GPIB, etc.). By careful implementation of the standard, instruments and software packages using CITIfile are able to load and work with data created on another instrument or computer. It is possible, for example, for a network analyzer to directly load and display data measured on a scalar analyzer, or for a software package running on a computer to read data measured on the network analyzer.

### Data Formats

There are two main types of data formats: binary and ASCII. CITIfile uses the ASCII text format. While this format does take up more bytes of space than a binary format, ASCII data is a transportable, standard type of format which is supported by all operating systems. In addition, the ASCII format is accepted by most text editors. This allows files to be created, examined, and edited easily, making CITIfile easier to test and debug.

### File and Operating System Formats

CITIfile was designed to be independent of the data storage mechanism, and therefore may be implemented for any file system. However transfer between file systems may sometimes be necessary. Any commercially available software that has the ability to transfer ASCII files between systems may be used to transfer CITIfile data.

### Definition of CITIfile Terms

This section will define the following terms:

- package
- header
- data array
- keyword

## A CITIfile Package

A typical package is divided into two parts: The first part, the header, is made up of keywords and setup information. The second part, the data, usually consists of one or more arrays of data. Example 1 shows the basic structure of a CITIfile package:

### Example 1, A CITIfile Package

```
The "header" part  CITIFILE A.01.00
                   NAME MEMORY
                   VAR FREQ MAG 3
                   DATA S RI
The "data" part    BEGIN
                   -3.54545E-2, -1.38601E-3
                   0.23491E-3, -1.39883QE-3
                   2.00382E-3, -1.40022E-3
                   END
```

When stored in a disk file there may be more than one CITIfile package. With the 8510 network analyzer, for example, storing a "memory all" will save all eight of the memories held in the instrument. This results in a single file which contains eight CITIfile packages.

## The CITIfile Header

The header section contains information about the data that will follow. It may also include information about the setup of the instrument that measured the data. For example, the header may include information such as:

- CITIfile version number
- Network analyzer model number
- Firmware revision currently installed in the analyzer
- Type of Data
- Data Format
- Measurement parameters
- Start and stop frequencies
- Number of sample points

The CITIfile header shown in Example 1 has just the bare minimum of information necessary; no instrument setup information was included.

## An Array of Data

An array is numeric data that is arranged with one data element per line. In the Smith chart and polar formats, the data is in real and imaginary pairs. In all other formats, the data is still in pairs, but the second term of the pair is 0E0. All information is true formatted data in the same format as on the analyzer display (dB, SWR, etc.).

A CITIfile package may contain more than one array of data. Arrays of data start after the BEGIN keyword, and the END keyword will follow the last data element in an array. A CITIfile package does not necessarily need to include data arrays; for instance, CITIfile could be used to store the current state of an instrument. In that case the keywords VAR, DATA, BEGIN, and END would not be required.

### **CITIfile Keyword**

Keywords are always the first word on a new line. They are always one continuous word without embedded spaces. A listing of all the keywords used in the latest A.01.01 version of CITIfile is shown in "CITIfile Keywords." When reading a CITIfile, unrecognized keywords should be ignored. This allows new keywords to be added, without affecting an older program or instrument that might not use the new keywords. The older instrument or program can still use the rest of the data in the CITIfile as it did before. Ignoring unknown keywords allows backwards compatibility to be maintained.

### **CITIfile Examples**

#### **Example 2, An 8510 Display Memory File**

Example 2 shows a simple file that contains no frequency information. Some instruments do not keep frequency information for display memory data, so this information is not included in the CITIfile package. Note that instrument-specific information (#NA= Network Analyzer information) is also stored in this file. This convention allows the designer to define keywords that are particular to his or her particular implementation.

Example:

```
CITIFILE A.01.00
#NA VERSION HP8510B.05.00
NAME MEMORY
#NA REGISTER 1
VAR FREQ MAG 5
DATA S RI
BEGIN
-1.31189E-3,-1.47980E-3
-3.67867E-3,-0.67782E-3
-3.43990E-3,0.58746E-3
-2.70664E-4,-9.76175E-4
0.65892E-4,-9.61571E-4
END
```

#### **Example 3, 8510 Data file**

Example 3 shows a CITIfile package created from the data register of an 8510 Network Analyzer. In this case 10 points of real and imaginary data was stored, and frequency information was recorded in a segment list table.

Example:

```
CITIFILE A.01.00
#NA VERSION HP8510B.05.00
```

```
NAME DATA
#NA REGISTER 1
VAR FREQ MAG 10
DATA S[1,1] RI
SEG_LIST_BEGIN
SEG 1000000000 4000000000 10
SEG_LIST_END
BEGIN
0.86303E-1,-8.98651E-1
8.97491E-1,3.06915E-1
-4.96887E-1,7.87323E-1
-5.65338E-1,-7.05291E-1
8.94287E-1,-4.25537E-1
1.77551E-1,8.96606E-1
-9.35028E-1,-1.10504E-1
3.69079E-1,-9.13787E-1
7.80120E-1,5.37841E-1
-7.78350E-1,5.72082E-1
END
```

#### Example 4, 8510 3-Term Frequency List Cal Set File

Example 4 shows how CITIfile may be used to store instrument setup information. In the case of an 8510 Cal Set, a limited instrument state is needed in order to return the instrument to the same state that it was in when the calibration was done. Three arrays of error correction data are defined by using three DATA statements. Some instruments require these arrays to be in the proper order, from E1 to E3. In general, CITIfile implementations should strive to handle data arrays that are arranged in any order.

Example:

```
CITIFILE A.01.00
#NA VERSION HP8510B.05.00
NAME CAL_SET
#NA REGISTER 1
VAR FREQ MAG 4
DATA E[1] RI
DATA E[2] RI
DATA E[3] RI
#NA SWEEP_TIME 9.999987E-2
#NA POWER1 1.0E1
#NA POWER2 1.0E1
#NA PARAMS 2
#NA CAL_TYPE 3
#NA POWER_SLOPE 0.0E0
#NA SLOPE_MODE 0
#NA TRIM_SWEEP 0
#NA SWEEP_MODE 4
#NA LOWPASS_FLAG -1
#NA FREQ_INFO 1
#NA SPAN 1000000000 3000000000 4
```



```
#NA DUPLICATES 0
#NA ARB_SEG 1000000000 1000000000 1
#NA ARB_SEG 2000000000 3000000000 3
VAR_LIST_BEGIN
1000000000
2000000000
2500000000
3000000000
VAR_LIST_END
BEGIN
1.12134E-3,1.73103E-3
4.23145E-3,-5.36775E-3
-0.56815E-3,5.32650E-3
-1.85942E-3,-4.07981E-3
END
BEGIN
2.03895E-2,-0.82674E-2
-4.21371E-2,-0.24871E-2
0.21038E-2,-3.06778E-2
1.20315E-2,5.99861E-2
END
BEGIN
4.45404E-1,4.31518E-1
8.34777E-1,-1.33056E-1
-7.09137E-1,5.58410E-1
4.84252E-1,-8.07098E-1
END
```

When an instrument's frequency list mode is used, as it was in Example 4, a list of frequencies is stored in the file after the VAR\_LIST\_BEGIN statement. The unsorted frequency list segments used by this instrument to create the VAR\_LIST\_BEGIN data are defined in the #NA ARB\_SEG statements.

## CITIfile Keywords

Keyword	Explanation and Examples
CITIFILE	CITIFILE A.01.01 identifies the file as a CITIfile, and indicates the revision level of the file. The CITIfile keyword and revision code must precede any other keywords. The CITIfile keyword at the beginning of the package assures the device reading the file that the data that follows is in the CITIfile format. The revision number allows for future extensions of the CITIfile standard. The revision code shown here following the CITIfile keyword indicates that the machine writing this file is using the A.01.01 version of CITIfile as defined here. Any future extensions of CITIfile will increment the revision code.
NAME	NAME CAL_SET allows the current CITIfile “package” to be named. The name of the package should be a single word with no embedded spaces. A list of standard package names follows:
Label	Definition.
RAW_DATA	Uncorrected data.
DATA	Data that has been error corrected. When only a single data array exists, it should be named DATA.
FORMATTED	Corrected and formatted data.
MEMORY	Data trace stored for comparison purposes.
CAL_SET	Coefficients used for error correction.
CAL_KIT	Description of the standards used.
DELAY_TABLE	Delay coefficients for calibration.
VAR	VAR FREQ MAG 201 defines the name of the independent variable (FREQ), the format of values in a VAR_LIST_BEGIN table (MAG, if used), and the number of data points (201). Typical names for the independent variable are FREQ (in Hz), TIME (in seconds), and POWER (in dBm). For the VAR_LIST_BEGIN table, only the “MAG” format is supported at this point. # #NA POWER1 1.0E1 allows variables specific to a particular type of device to be defined. The pound sign (#) tells the device reading the file that the following variable is for a particular device. The “NA” shown here indicates that the information is for a Network Analyzer. This convention allows new devices to be defined without fear of conflict with keywords for previously defined devices. The device identifier (i.e. NA) may be any number of characters.

SEG_LIST_BEGIN	SEG_LIST_BEGIN indicates that a list of segments for the independent variable follow. Format for the segments is: [segment type] [start] [stop] [number of points]. The current implementation only supports a single segment. If there is more than one segment, the VAR_LIST_BEGIN construct is used. CITIfile revision A.01.00 supports only the SEG (linear segment) segment type.
SEG_LIST_END	SEG_LIST_END defines the end of a list of independent variable segments.
VAR_LIST_BEGIN	VAR_LIST_BEGIN indicates that a list of the values for the independent variable (declared in the VAR statement) follow. Only the MAG format is supported in revision A.01.00.
VAR_LIST_END	VAR_LIST_END defines the end of a list of values for the independent variable.
DATA	DATA S[1,1] RI defines the name of an array of data that will be read later in the current CITIfile package, and the format that the data will be in. Multiple arrays of data are supported by using standard array indexing. Versions A.01.00 and A.01.01 of CITIfile only support the RI (real and imaginary) format, and a maximum of two array indexes. Commonly used array names include the following: “S” for “S parameter” Example: S[2,1] “E” for “Error term” Example: E[1] “USER” for “User parameter” Example: USER[1] “VOLTAGE” Example: VOLTAGE[1] “VOLTAGE_RATIO” for a ratio of Example: VOLTAGE_RATIO[1,0] two voltages (A/R).

## CONSTANT

CONSTANT [name] [value] allows for the recording of values which don't change when the independent variable changes.

CONSTANTS are part of the main CITIfile definition. Users must not define their own CONSTANTS. Use the #KEYWORD device specification to create your own KEYWORD instead. The #NA device specification is an example of this. No constants were defined for revision A.01.00 of CITIfile. CITIfile revision A.01.01 defined the following constant:

CONSTANTS are part of the main CITIfile definition. Users must not define their own CONSTANTS. Use the #KEYWORD device specification to create your own KEYWORD instead. The #NA device specification is an example of this. No constants were defined for revision A.01.00 of CITIfile. CITIfile revision A.01.01 defined the following constant:

CONSTANT TIME [year] [month] [day] [hour] [min] [secs]  
Example:

COMMENT	YEAR	MONTH	DAY	HOURL	MINUTE	SECONDS
CONSTANT TIME	1999	02	26	17	33	53.25

- The COMMENT statement is not absolutely required, but is highly recommended to aid readability.
- The year should always be the full four digits ("1999" is correct, but "99" is not). This is to avoid problems with the year 2000, when the shortened version of the year will be "00."
- The hour value should be in 24-hour "military" time.
- When writing a CITIfile and the fractional seconds value is zero, then the "seconds" value may be printed either with or without a decimal point: either "47.0" or "47" would be acceptable. When reading a CITIfile, the seconds value should always be read as if it were a floating point number.

---

## Useful Calculations

This section contains information on computing frequency points and expressing CITIfile data in other data formats.

### Computing Frequency Points

In CITIfile, the frequency data is not listed point by point, only the start and stop values are given. If you are using a spreadsheet program, you can create a new frequency column to the left of the data pairs. Use the following formula to obtain each frequency point:

$$F_n = F_{\text{start}} + \{(n-1) * [(F_{\text{stop}} - F_{\text{start}}) / (\# \text{ of points} - 1)]\}$$

where:

$F_{\text{start}}$  = Start Frequency

$F_{\text{stop}}$  = Stop Frequency

$F_n$  = Frequency point with  $n$  being an integer

# of points = number of sample points per sweep

Here is an example of how this formula may be entered:

$$F_1 = 30E3 + \{(1-1) * [(6E9 - 30E3) / (201 - 1)]\} = 30E3 = 30 \text{ kHz}$$

$$F_2 = 30E3 + \{(2-1) * [(6E9 - 30E3) / (201 - 1)]\} = 30E6 = 30 \text{ MHz}$$

$$F_{201} = 30E3 + \{(201 - 1) * [(6E9 - 30E3) / (201 - 1)]\} = 6E9 = 6 \text{ GHz}$$

Once these cells are entered, copy the formula to the remaining data points, and the frequency will be indicated for each row.

## Expressing CITIfile Data in Other Data Formats

CITIfile data is represented in real and imaginary pairs. Equations can be used to express this information in logarithmic magnitude, phase, polar, and Smith chart formats. Refer to the following table for these equations.

Desired Format	Mathematical Equation <sup>a</sup>	Microsoft Excel Command <sup>b</sup>
Log Magnitude	$20 \cdot \text{Log}_{10}((\text{Re}^2 + \text{Im}^2))^{1/2}$	=20*LOG10(SQRT((SUMSQ(ReCell 1,Im Cell 1)))) (dB)
Phase	$\tan^{-1}(\text{Im}/\text{Re})$ or $\arctan(\text{Im}/\text{Re})$	ATAN2(ReCell 1, ImCell 1)*180/PI() (Degree)
Polar	Magnitude = $((\text{Re}^2 + \text{Im}^2))^{1/2}$ Phase = $\tan^{-1}(\text{Im}/\text{Re})$ or $\arctan(\text{Im}/\text{Re})$	Magnitude = (SQRT((SUMSQ(ReCell 1,Im Cell 1))) Phase = ATAN2(ReCell 1, ImCell 1)*180/PI()
Smith Chart (Marker)	Resistance = $(1 - \text{Re}^2 - \text{Im}^2) /$ $((1 - \text{Re})^2 + \text{Im}^2) * Z_0$ Reactance = $(2 * \text{Im}) /$ $((1 - \text{Re})^2 + \text{Im}^2) * Z_0$	Resistance = $((1 - \text{POWER}(\text{ReCell 1}, 2) - \text{POWER}(\text{ImCell 1}, 2)) /$ $(\text{POWER}((1 - \text{ReCell 1}), 2) + \text{POWER}(\text{ImCell 1}, 2))) * Z \text{ Cell 1}$ Reactance = $(2 * \text{ImCell 1}) /$ $(\text{POWER}((1 - \text{ReCell 1}), 2) + \text{POWER}(\text{ImCell 1}, 2)) * Z \text{ Cell 1}$

a. Re = real. Im = imaginary.

b. The references to ReCell 1, ImCell 1, and Z Cell 1 refer to the real and imaginary data pair numeric values that have been entered into specific cells in the Microsoft Excel spread sheet.

### Example Data

This example shows how the following CITIfile data for a three-point trace can be expressed in other data formats.

```
CITIFILE A.01.00
#NA VERSION HP8753E.07.12
NAME DATA
VAR FREQ MAG 3.0000
DATA S[11] RI
SEG_LIST_BEGIN
SEG 1550000000 1570000000 3.0000
SEG_LIST_END
BEGIN
```

**Table 9-1 Data Values**

				Calculated Smith Chart Readings		Calculated Polar Readings	
Real Value	Imag Value	Calculated LogMag	Calculated Phase	Resistance	Reactance	Magnitude	Phase
4.43E-02	-4.52E-01	-6.8593	-84.4025	35.5204	-40.4294	0.4539	-84.4025
-6.32E-02	-4.47E-01	-6.9150	-98.0545	29.9477	-33.5840	0.4510	-98.0545
-1.66E-01	-4.38E-01	-6.5847	-110.7272	25.1562	-28.2510	0.4685	-110.727

**Table 9-2 Marker Reading Values**

Log Mag (Marker)	Phase (Marker)	S11 Smith Chart Resistance (Marker)	S11 Smith Chart Reactance (Marker)	Polar Magnitude (Marker)
-6.859	-84.403	35.520	-40.429	454.98mU
-6.915	-98.055	29.948	-33.584	451.07mU
-6.585	-110.737	25.156	-28.251	468.56mU





---

# **10 Determining System Measurement Uncertainties**

## Introduction

In any measurement, certain measurement errors associated with the system add uncertainty to the measured results. This uncertainty defines how accurately a device under test (DUT) can be measured. This chapter describes how the various network analyzer measurement error sources contribute to uncertainties in the magnitude and phase measurements of both transmission and reflection.

Network analysis measurement errors can be separated into two types: raw and residual. The raw error terms are the errors associated with the uncorrected system. Network analyzer errors can be classified as systematic (repeatable), random (non-repeatable), and drift. The residual error terms are the errors that remain after a measurement calibration.

The error correction procedure, also called measurement calibration, measures a set of calibration devices with known characteristics. It uses the measurement results to effectively remove systematic errors, using the vector math capabilities of the analyzer. Differences between calibration standard measured and modeled responses yield residual errors. The residual systematic errors remain after error correction, primarily due to the limitations of how accurately the electrical characteristics of the calibration devices can be defined and determined. Random errors cannot be corrected because their contribution is not constant between calibration and measurement. However, the effects of random errors can be reduced through averaging. Drift errors are caused by ambient temperature variation and component aging. The residual systematic errors along with the random and drift errors continue to affect measurements after error correction, adding an uncertainty to the measurement results. Therefore, measurement uncertainty is defined as the combination of the residual systematic (repeatable), random (non-repeatable), and drift errors in the measurement system after error correction.

The following measurement uncertainty equations show the relationship of the systematic, random, and drift errors. These are useful for predicting overall measurement performance.

## Sources of Measurement Errors

Measurement errors are made up of systematic errors, random errors, and drift errors. Each of these measurement error types is discussed in this section.

### Sources of Systematic Errors

The residual (after measurement calibration) systematic errors result from imperfections in the calibration standards. All measurements are affected by dynamic accuracy. For reflection measurements, the associated residual errors are residual directivity, residual source match, residual load match, and residual reflection tracking. For transmission measurements, the additional residual errors are residual crosstalk, residual source match, residual load match, and residual transmission tracking.

The listing below shows the abbreviations used for residual systematic errors that are in the uncertainty equations.

- $E_{DF}$  = forward residual directivity
- $E_{SF}$  = forward residual source match
- $E_{RF}$  = forward residual reflection tracking
- $E_{XF}$  = forward crosstalk
- $E_{LF}$  = forward load match
- $E_{TF}$  = forward transmission tracking
- $E_{DR}$  = reverse residual directivity
- $E_{SR}$  = reverse residual source match
- $E_{RR}$  = reverse residual reflection tracking
- $E_{XR}$  = reverse crosstalk
- $E_{LR}$  = reverse load match
- $E_{TR}$  = reverse transmission tracking
- $A_M$  = magnitude dynamic accuracy
- $A_P$  = phase dynamic accuracy

Dynamic accuracy includes errors during internal self-calibration routines, gain compression in the microwave frequency converter (sampler) at high signal levels, errors generated in the synchronous detectors, localized non-linearities in the IF filter system, and from LO leakage into the IF signal paths.

## Sources of Random Errors

The random error sources are noise, connector repeatability and interconnecting cable stability. There are two types of noise in any measurement system: low level noise (noise floor) and high level noise (trace noise).

Low level noise is the broadband noise floor of the receiver which can be reduced through averaging or by changing the IF bandwidth.

High level noise or trace noise is due to the noise floor, the phase noise of the LO source inside the test set, or by reducing the IF bandwidth.

Connector repeatability is the random variation encountered when connecting a pair of RF connectors. Variations in both reflection and transmission can be observed.

Cable stability is dependent on the cable used and the amount of cable movement between calibration and measurement.

The listing below shows the abbreviations used for random errors in the error models and uncertainty equations.

- $N_F$  = noise floor
- $N_T$  = trace noise
- $C_{R1}$  = port 1 cable reflection stability
- $C_{TM1}$  = port 1 cable magnitude transmission stability
- $C_{TP1}$  = port 1 cable phase transmission stability
- $C_{R2}$  = port 2 cable reflection stability
- $C_{TM2}$  = port 2 cable magnitude transmission stability
- $C_{TP2}$  = port 2 cable phase transmission stability
- $R_{R1}$  = port 1 connector reflection repeatability
- $R_{T1}$  = port 1 connector transmission repeatability
- $R_{R2}$  = port 2 connector reflection repeatability
- $R_{T2}$  = port 2 connector transmission repeatability

## Determining Expected System Performance

Improper connection techniques and contact surfaces can degrade measurement accuracy.

Proper connection techniques include using a torque wrench with proper torque limits, ensuring that the connector pin depths meet specifications, ensuring that the center conductor of sliding loads is properly set, and observing proper handling procedures for beadless airlines.

Contact surface errors are caused by improper cleaning procedures, scratches, worn plating, and rough seating.

If proper connection techniques and connector care is observed, [Table 10-1](#) provides an indication of connector repeatability.

**Table 10-1 Connector Repeatability ( $R_{R1}$ ,  $R_{R2}$ ,  $R_{T1}$ , and  $R_{T2}$ )**

Connector Type	
Frequency Range	Repeatability
<b>2.4-mm</b>	
0 to 2 GHz	0.0002
2 to 20 GHz	0.0004
20 to 36 GHz	0.0006
36 to 40 GHz	0.0008
<b>7-mm</b>	
0 to 2 GHz	0.0001
2 to 8 GHz	0.0003
8 to 18 GHz	0.0006
<b>Type-F</b>	
0 to 3 GHz	0.0006

Connector Type	
Frequency Range	Repeatability
<b>3.5-mm</b>	
0 to 2 GHz	0.0001
2 to 8 GHz	0.0003
8 to 20 GHz	0.0006
20 to 26.5 GHz	0.0010
<b>Type-N</b>	
0 to 2 GHz	0.0006
2 to 8 GHz	0.0006
8 to 18 GHz	0.0010
<b>Waveguide</b>	
0 to 40 GHz	0.0002

## Determining Cable Stability Terms ( $C_{R1}$ , $C_{R2}$ , $C_{TM1}$ , $C_{TM2}$ , $C_{TP1}$ , $C_{TP2}$ )

Cable stability is dependent on the cable used and the amount of cable movement between calibration and measurement. Values for cable reflection stability are determined by connecting a fixed load to the free end of the cable and measuring the change in reflection coefficient after flexing the cable through the normal range of cable movement for a particular setup. Cable transmission stability is determined by connecting a short to the free end of the cable and measuring the change in reflection coefficient due to changes in cable position.

Figure 10-1, Figure 10-2, and Figure 10-3 show an example that demonstrates the concepts useful in determining cable stability. In each case, a cable (part number 8120-4779) was connected to port 1, with a fixed load connected to the free end. A reference trace is obtained by measuring  $S_{11}$  with the free end held close to port 2 and storing the results in memory. Two additional  $S_{11}$  measurements are made; one with the cable flexed out to its straight position and the other with the cable positioned back to the same location as reference trace. The flexed position demonstrates the effect of moving the cable after calibration, the repeatability trace in Figure 10-1 demonstrates the stability of the cable when moved to its original position.

**Figure 10-1 Cable Stability with Fixed Load Connected**

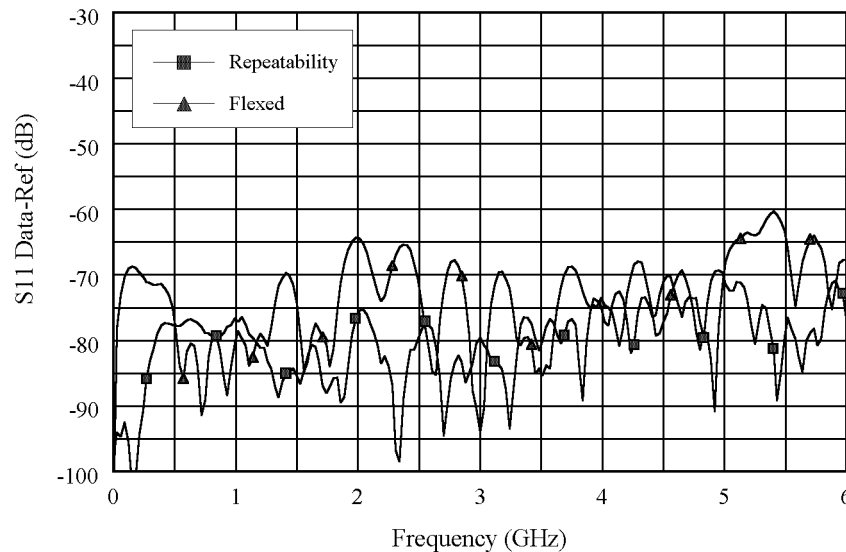

Figure 10-1 demonstrates the concepts useful in determining cable reflection stability. A fixed load is connected to the free end. The DATA-MEM feature provides an indication of the cable reflection stability. A 60-dB peak on the chart yields a reflection stability estimated as  $10^{(-60/20)}$  or 0.001.

**Figure 10-2 Cable Stability with a Short Connected**

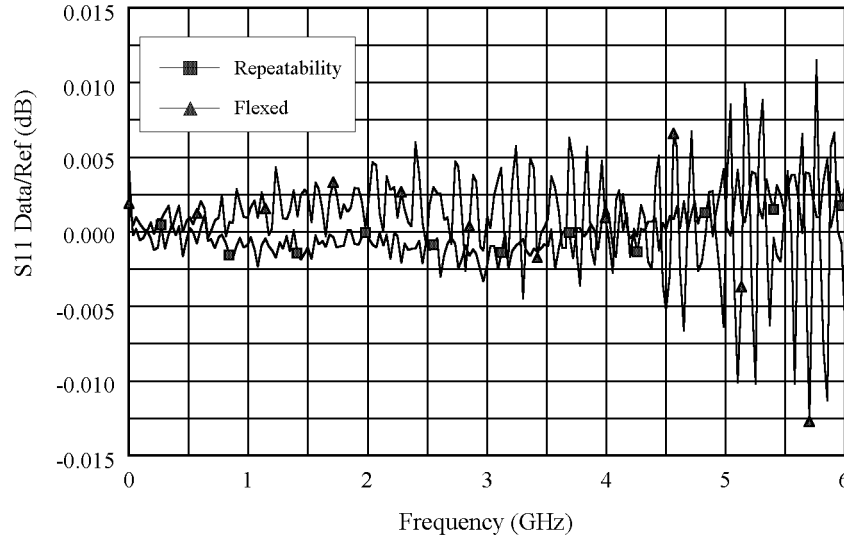
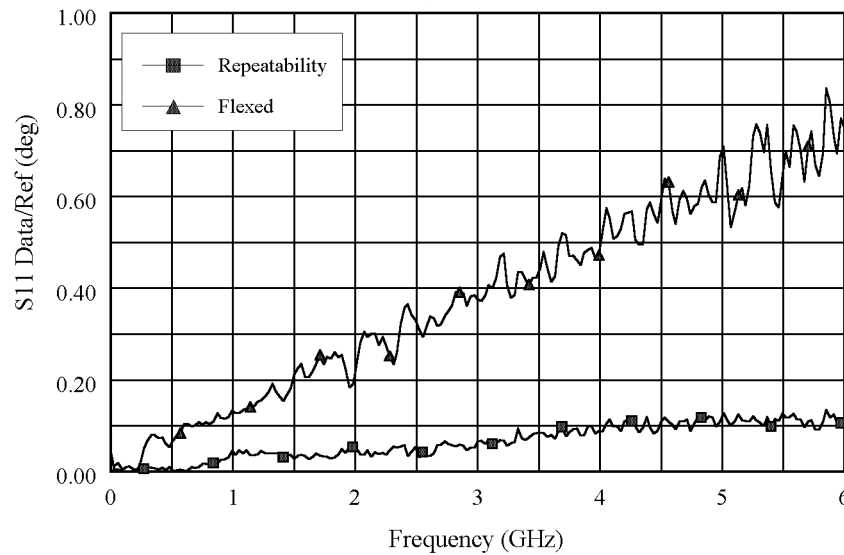

Figure 10-2 and Figure 10-3 demonstrate the concepts useful in determining cable transmission stability. A short is connected to the free end. The DATA/MEM feature provides an indication of the two-way cable transmission stability. The one-way transmission magnitude stability is determined by dividing the two-way magnitude measurement by two before it is converted to linear. A 0.013-dB peak on the chart yields transmission magnitude stability estimated as  $10^{(0.013/40)} - 1$  or 0.00075. The one-way transmission phase stability is determined by dividing the two-way phase measurement by two.

**Figure 10-3 Cable Stability with a Short Connected**



Cable movement often has a much larger effect on phase measurements than magnitude measurements.

## Measurement Uncertainty Equations

Any measurement result is the vector sum of the actual test device response plus all error terms. The precise effect of each error term depends on its magnitude and phase relationship to the actual test device response. When the phase of an error response is not known, phase is assumed to be worst case ( $-180^\circ$  to  $+180^\circ$ ).

### Forward Reflection Uncertainty

#### Equation 10-1. Forward Reflection Magnitude Uncertainty

$$\Delta S_{11(\text{mag})} = \sqrt{(\text{Systematic} + \text{Stability})^2 + \text{Noise}^2}$$

**Where:**

$$\text{Systematic} = E_{DF} + E_{RF}S_{11} + E_{SF}S_{11}^2 + E_{LF}S_{21}S_{12} + A_M S_{11}$$

$$\text{Stability} = \sqrt{C^2 + R^2}$$

$$C^2 = C_{RM1}^2(1 + S_{11}^4) + 4C_{TM1}^2S_{11}^2 + C_{RM2}^2S_{21}^2S_{12}^2$$

$$R^2 = (R_{R1}(1 + S_{11}^2) + 2R_{T1}S_{11})^2 + (R_{R2}S_{21}S_{12})^2$$

$$\text{Noise}^2 = (N_T S_{11})^2 + N_F^2$$

#### Equation 10-2. Forward Reflection Phase Uncertainty

$$\Delta S_{11(\text{phase})} = \sin^{-1}\left(\frac{\sqrt{(\text{Systematic} + \text{Stability})^2 + \text{Noise}^2}}{S_{11}}\right) + 2C_{TP1}$$

**Where:**

$$\text{Systematic} = E_{DF} + E_{RF}S_{11} + E_{SF}S_{11}^2 + E_{LF}S_{21}S_{12} + \sin(A_P)S_{11}$$

$$\text{Stability} = \sqrt{C^2 + R^2}$$

$$C^2 = C_{RM1}^2(1 + S_{11}^4) + 4C_{TM1}^2S_{11}^2 + C_{RM2}^2S_{21}^2S_{12}^2$$

$$R^2 = (R_{R1}(1 + S_{11}^2) + 2R_{T1}S_{11})^2 + (R_{R2}S_{21}S_{12})^2$$

$$\text{Noise}^2 = (N_T S_{11})^2 + N_F^2$$



## Forward Transmission Uncertainty

### Equation 10-3. Forward Transmission Magnitude Uncertainty

$$\Delta S_{21(mag)} = \sqrt{(Systematic + Stability)^2 + Noise^2}$$

**Where:**

$$Systematic = E_{XF} + S_{21}(E_{TF} + E_{SF}S_{11} + E_{LF}S_{22} + E_{SF}E_{LF}S_{21}S_{12} + A_M)$$

$$Stability = \sqrt{C^2 + R^2}$$

$$C^2 = S_{21}^2(C_{TM1}^2 + C_{TM2}^2 + (C_{R1}S_{11})^2 + (C_{R2}S_{22})^2)$$

$$R^2 = S_{21}^2((R_{T1} + R_{R1}S_{11})^2 + (R_{T2} + R_{R2}S_{22})^2)$$

$$Noise^2 = (N_T S_{21})^2 + N_F^2$$

### Equation 10-4. Forward Transmission Phase Uncertainty

$$\Delta S_{21(phase)} = \sin^{-1}\left(\frac{\sqrt{(Systematic + Stability)^2 + Noise^2}}{S_{21}}\right) + C_{TP1} + C_{TP2}$$

**Where:**

$$Systematic = E_{XF} + S_{21}(E_{TF} + E_{SF}S_{11} + E_{LF}S_{22} + E_{SF}E_{LF}S_{21}S_{12} + \sin(A_p))$$

$$Stability = \sqrt{C^2 + R^2}$$

$$C^2 = S_{21}^2(C_{TM1}^2 + C_{TM2}^2 + (C_{R1}S_{11})^2 + (C_{R2}S_{22})^2)$$

$$R^2 = S_{21}^2((R_{T1} + R_{R1}S_{11})^2 + (R_{T2} + R_{R2}S_{22})^2)$$

$$Noise^2 = (N_T S_{21})^2 + N_F^2$$

## Reverse Reflection Uncertainty

### Equation 10-5. Reverse Reflection Magnitude Uncertainty

$$\Delta S_{22(mag)} = \sqrt{(Systematic + Stability)^2 + Noise^2}$$

**Where:**

$$Systematic = E_{DR} + E_{RR}S_{22} + E_{SR}S_{22}^2 + E_{LR}S_{21}S_{12} + A_M S_{22}$$

$$Stability = \sqrt{C^2 + R^2}$$

$$C^2 = C_{RM2}^2(1 + S_{22}^4) + 4C_{TM2}^2S_{22}^2 + C_{RM1}^2S_{21}^2S_{12}^2$$

$$R^2 = (R_{R2}(1 + S_{22}^2) + 2R_{T2}S_{22})^2 + (R_{R1}S_{21}S_{12})^2$$

$$Noise^2 = (N_T S_{22})^2 + N_F^2$$

### Equation 10-6. Reverse Reflection Phase Uncertainty

$$\Delta S_{22(phase)} = \sin^{-1}\left(\frac{\sqrt{(Systematic + Stability)^2 + Noise^2}}{S_{22}}\right) + 2C_{TP2}$$

**Where:**

$$Systematic = E_{DR} + E_{RR}S_{22} + E_{SR}S_{22}^2 + E_{LR}S_{21}S_{12} + \sin(A_P)S_{22}$$

$$Stability = \sqrt{C^2 + R^2}$$

$$C^2 = C_{RM2}^2(1 + S_{22}^4) + 4C_{TM2}^2S_{22}^2 + C_{RM1}^2S_{21}^2S_{12}^2$$

$$R^2 = (R_{R2}(1 + S_{22}^2) + 2R_{T2}S_{22})^2 + (R_{R1}S_{21}S_{12})^2$$

$$Noise^2 = (N_T S_{22})^2 + N_F^2$$

## Reverse Transmission Uncertainty

### Equation 10-7. Reverse Transmission Magnitude Uncertainty

$$\Delta S_{12(mag)} = \sqrt{(Systematic + Stability)^2 + Noise^2}$$

**Where:**

$$Systematic = E_{XR} + S_{12}(E_{TR} + E_{SR}S_{22} + E_{LR}S_{11} + E_{SR}E_{LR}S_{21}S_{12} + A_M)$$

$$Stability = \sqrt{C^2 + R^2}$$

$$C^2 = S_{12}^2(C_{TM1}^2 + C_{TM2}^2 + (C_{R1}S_{11})^2 + (C_{R2}S_{22})^2)$$

$$R^2 = S_{12}^2((R_{T1} + R_{R1}S_{11})^2 + (R_{T2} + R_{R2}S_{22})^2)$$

$$Noise^2 = (N_T S_{12})^2 + N_F^2$$

### Equation 10-8. Reverse Transmission Phase Uncertainty

$$\Delta S_{12(phase)} = \sin^{-1}\left(\frac{\sqrt{(Systematic + Stability)^2 + Noise^2}}{S_{12}}\right) + C_{TP1} + C_{TP2}$$

**Where:**

$$Systematic = E_{XR} + S_{12}(E_{TR} + E_{SR}S_{22} + E_{LR}S_{11} + E_{SR}E_{LR}S_{21}S_{12} + \sin(A_P))$$

$$Stability = \sqrt{C^2 + R^2}$$

$$C^2 = S_{12}^2(C_{TM1}^2 + C_{TM2}^2 + (C_{R1}S_{11})^2 + (C_{R2}S_{22})^2)$$

$$R^2 = S_{12}^2((R_{T1} + R_{R1}S_{11})^2 + (R_{T2} + R_{R2}S_{22})^2)$$

$$Noise^2 = (N_T S_{12})^2 + N_F^2$$



## Numerics

- 6 GHz operation, Option 006, 7-3
- 75 Ohm impedance, Option 075, 7-4

## A

- accessories available, 7-5
  - keyboard template, 7-12
  - measurement accessories, 7-5
- adapters, 7-9
- allocation, memory, 8-12
- amplifier, 7-10
- Analyzer
  - panels
    - front, 3-2
- analyzer display, 3-5
- analyzer functions, 5-4
- analyzer options available, 7-3
  - 6 GHz operation, Option 006, 7-3
  - 75 Ohm impedance, Option 075, 7-4
- configurable test set, Option 014, 7-3
- harmonic mode, Option 002, 7-3
- high stability frequency reference, Option 1D5, 7-3
- rack mount flange kit with handles, Option 1CP, 7-4
- rack mount flange kit without handles, Option 1CM, 7-4
- receiver configuration, Option 011, 7-3
- service and support options, 7-4
- source attenuator, Option 004, 7-3
- time domain, Option 010, 7-3

## C

- cable stability, 10-6
- calculations, 9-11
  - computing frequency points, 9-11
  - expressing CITIfile data in other data formats, 9-12
- calibration, 10-2
- calibration kits, 7-5
- CITIfile data format, 9-3
  - examples, 9-5
- CITIfile data formats
  - file formats, 9-3
  - operating system formats, 9-3
- CITIfile data, expressing in other data formats, 9-12
- CITIfile keywords, 9-8
- CITIfile terms

- array of data, 9-4
  - header, 9-4
  - keyword, 9-5
  - package, 9-4
- computing frequency points, 9-11
- configurable test set, Option 014, 7-3
- connector repeatability, 10-5
- connectors and features, rear panel, 3-10
- conserving memory, 8-18

## D

- data format, CITIfile, 9-3
- data storage, 8-12
- data, storing to disk, 8-16
- definitions, specifications, 1-2, 2-2
- determining memory requirements, 8-14
- display, analyzer, 3-5
- drift errors, 10-2

## E

- equations
  - forward reflection uncertainty, 10-8
  - forward transmission uncertainty, 10-9
  - reverse reflection uncertainty, 10-10
  - reverse transmission uncertainty, 10-11
- uncertainty, 10-8
- error correction, 10-2
- error messages, 6-2
- error messages in alphabetical order, 6-3
- error messages in numerical order, 6-26
- expressing CITIfile data in other data formats, 9-12

## F

- features, front panel, 3-2
- file formats, 9-3
- forward
  - reflection uncertainty, 10-8
  - transmission uncertainty, 10-9
- forward reflection uncertainty, 10-8
- frequency points, computing, 9-11
- front panel features, 3-2
- functions, analyzer, 5-4

## G

- general information, specifications, 1-22, 2-18

## H

- hardkey definitions, 5-4
- harmonic mode, Option 002, 7-3
- high stability frequency reference, Option 1D5, 7-3

## K

- key definitions, 5-4
- keyboard template, 7-12
- kits
  - verification, 7-9
- kits, calibration, 7-5

## M

- measurement
  - calibration, 10-2
  - uncertainty, 10-1
- uncertainty equations, 10-8
- measurement accessories, 7-5
  - calibration kits, 7-5
  - minimum loss pads and adapters, 7-9
  - RF ECal modules and PC software, 7-7
  - verification kit, 7-9
- memory, 8-12
  - non-volatile, 8-12
  - volatile, 8-12
- memory allocation, 8-12
  - conserving memory, 8-18
  - determining memory requirements, 8-14
  - storing data to disk, 8-16
  - types of memory and data storage, 8-12
  - using saved calibration sets, 8-18

- menu maps, 4-2
- minimum loss pads, 7-9

## N

- non-volatile memory, 8-12

## O

- operating system formats, 9-3
- options available, analyzer, 7-3
- options, service and support, 7-4

## P

- pads, minimum loss, 7-9
- PC software, 7-7

performance, determining, [10-5](#)  
power meters, [7-10](#), [7-11](#)  
preset state, [8-2](#)  
probe, [7-10](#)

## R

rack mount flange kit with  
handles, Option 1CP, [7-4](#)  
rack mount flange kit without  
handles, Option 1CM, [7-4](#)  
random errors, [10-2](#), [10-4](#)  
raw error terms, [10-2](#)  
rear panel features and  
connectors, [3-10](#)  
receiver configuration, Option  
011, [7-3](#)  
repeatability, connector, [10-5](#)  
repeatable errors, [10-2](#)  
residual errors, [10-2](#), [10-3](#)  
reverse  
reflection uncertainty, [10-10](#)  
transmission uncertainty, [10-11](#)  
RF ECal modules, [7-7](#)  
RF limiter, [7-10](#)

## S

saved calibration sets, [8-18](#)  
service and support options, [7-4](#)  
settings and data, [3-2](#)  
softkey definitions, [5-4](#)  
source attenuator, Option 004, [7-3](#)  
specifications, [1-22](#), [2-18](#)  
definitions, [1-2](#), [2-2](#)  
general information, [1-22](#), [2-18](#)  
stability, cable, [10-6](#)  
storing data to disk, [8-16](#)  
system measurement  
uncertainty, [10-1](#)  
system performance, [10-5](#)  
systematic errors, [10-2](#), [10-3](#)

## T

test configuration accessories,  
[7-10](#)  
amplifier, [7-10](#)  
power meters, [7-10](#), [7-11](#)  
probe, [7-10](#)  
RF limiter, [7-10](#)  
time domain, Option 010, [7-3](#)

## U

uncertainties  
cable stability, [10-6](#)  
connector repeatability, [10-5](#)  
uncertainty  
equations, [10-8](#)

forward reflection, [10-8](#)  
forward transmission, [10-9](#)  
reverse reflection, [10-10](#)  
reverse transmission, [10-11](#)  
uncertainty, measurement, [10-1](#)

## V

verification kit, [7-9](#)  
volatile memory, [8-12](#)