

Errata

Title & Document Type: 8673B Synthesized Signal Generator Operating Manual

Manual Part Number: 08673-90114

Revision Date: February 1988

HP References in this Manual

This manual may contain references to HP or Hewlett-Packard. Please note that Hewlett-Packard's former test and measurement, semiconductor products and chemical analysis businesses are now part of Agilent Technologies. We have made no changes to this manual copy. The HP XXXX referred to in this document is now the Agilent XXXX. For example, model number HP8648A is now model number Agilent 8648A.

About this Manual

We've added this manual to the Agilent website in an effort to help you support your product. This manual provides the best information we could find. It may be incomplete or contain dated information, and the scan quality may not be ideal. If we find a better copy in the future, we will add it to the Agilent website.

Support for Your Product

Agilent no longer sells or supports this product. You will find any other available product information on the Agilent Test & Measurement website:

www.tm.agilent.com

Search for the model number of this product, and the resulting product page will guide you to any available information. Our service centers may be able to perform calibration if no repair parts are needed, but no other support from Agilent is available.



HP 8673B

SYNTHESIZED SIGNAL GENERATOR

2.0 — 26.0 GHz

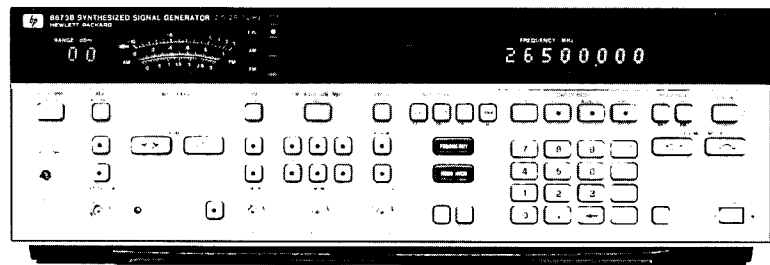

HP Part No. 08673-90114
Edition 2 E0389
HP Binder Part No. 9282-1078



HP 8673B
SYNTHESIZED SIGNAL GENERATOR
2.0 — 26.0 GHz
Including Options 001, 002, 003, 004, 005,
006, 008, 907, 908, 909, 915, and 916

SERIAL NUMBERS

Attached to the rear panel of the instrument is a serial number plate. The serial number is in the form: 0000A00000. The first four digits and the letter are the serial number prefix. The last five digits are the suffix. the prefix is the same for identical instruments; it changes only when a configuration change is made to the instrument. The suffix, however, is assigned sequentially and is different for each instrument.

This manual applies directly to instruments with serial numbers prefixed 2332A and above.



**HEWLETT
PACKARD**

© Copyright HEWLETT-PACKARD COMPANY 1984, 1988, 1989
1501 PAGE MILL ROAD, PALO ALTO, CALIFORNIA, U.S.A.

OPERATING MANUAL PART NO. 08673-90114

Edition 2 E0389

HP Binder Part No. 9282-1078

Operating Manual Microfiche Part No. 08673-90115

Service Manual Part No. 08673-90116

Service Manual Microfiche Part No. 08673-90117

CONTENTS

	Page		Page
Section 1			
GENERAL INFORMATION			
Introduction	1-3	PULSE Modulation	3-7
Specifications	1-3	SWEEP Mode in MASTER/SLAVE	
Safety Considerations	1-3	Configuration	3-7
Manual Updates	1-3	SWEEP Mode (Option 008 Only)	3-7
Description	1-3	Operator's Checks	3-17
Options	1-4	Basic Functional Checks	3-17
Electrical Options	1-4	HP-IB Functional Checks	3-25
Mechanical Options	1-4	Remote and Local Messages and the	
Miscellaneous Options	1-4	LOCAL Key	3-25
Accessories Supplied	1-5	Receiving the Data Message	3-26
Equipment Required but not Supplied	1-5	Sending the Data Message	3-26
Electrical Equipment Available	1-5	Local Lockout and Clear Lockout/	
Recommended Test Equipment	1-5	Set Local Messages	3-27
		Clear Message	3-28
		Abort Message	3-28
		Status Byte Message	3-28
		Require Service Message	3-29
		Status Bit Message	3-29
		Trigger Message	3-30
		Remote Operation, Auxiliary Control	3-32
		AUX Input Lines	3-32
		AUX Output Lines	3-32
		Remote Operation HP-IB	3-33
		HP-IB Compatibility	3-33
		Remote Mode	3-33
		Local Mode	3-33
		Addressing	3-35
		Turn-on Default Conditions	3-36
		Displays	3-36
		Output Level	3-36
		Data Messages	3-36
		Receiving Data Messages	3-36
		Sending the Data Message	3-37
		Receiving the Clear Message	3-40
		Receiving the Trigger Message	3-40
		Receiving the Remote Message	3-40
		Receiving the Local Message	3-40
		Receiving the Local Lockout Message	3-40
		Receiving the Clear Lockout/Set Local	
		Message	3-40
		Receiving the Pass Control Message	3-41
		Sending the Require Service Message	3-41
		Sending the Status Byte Message	3-41
		Clearing the Status Byte	3-41
		Sending the Status Bit Message	3-42
		Receiving the Abort Message	3-42
		Detailed Operating Instructions	3-45
		Amplitude Modulation	3-46
		Auto Peak	3-49
		Auto Sweep Mode	3-52
		Center Frequency (Sweep)	3-56
		Delta Frequency (Sweep)	3-60
Section 2			
INSTALLATION			
Introduction	2-1		
Initial Inspection	2-1		
Preparation for Use	2-1		
Power Requirements	2-1		
Line Voltage and Fuse Selection	2-1		
Power Cables	2-1		
HP-IB Address Selection	2-2		
Interconnections	2-4		
Mating Connectors	2-4		
Frequency Reference Sensitivity Selection	2-4		
Operating Environment	2-4		
Bench Operation	2-4		
Rack Mounting	2-4		
Storage and Shipment	2-4		
Environment	2-4		
Packaging	2-4		
Section 3			
OPERATION			
Introduction	3-1		
System Compatibility	3-1		
Operating Characteristics	3-1		
Local Operation	3-1		
Remote Operation	3-1		
Operator's Checks	3-1		
Operator's Maintenance	3-1		
Battery Replacement	3-1		
General Instructions	3-5		
Turn-On	3-5		
Frequency Standard Selection	3-5		
Additional Operating Information	3-6		
Auto Peak	3-6		
ALC (Automatic Level Control)	3-6		

CONTENTS (cont'd)

	Page
Diode Automatic Level Control	3-64
Dwell Time (Sweep)	3-68
Frequency (CW)	3-70
Frequency Increment and Tuning	3-76
Frequency Modulation	3-83
Internal Automatic Level Control	3-86
Manual Sweep Mode	3-89
Marker Frequency (Sweep)	3-93
Master/Slave Sweep	3-97
Messages	3-100
Multiplier Mode	3-102
Offset Frequency	3-105
Power Meter Automatic Level Control	3-108
Pulse Modulation	3-113
Range Output Level	3-116
Recall and Store Registers	3-119
RF Output On/Off	3-122
Single Sweep Mode	3-124
Start Frequency (Sweep)	3-128
Status Byte and Polling	3-134
Steps (Sweep)	3-141
Step Size (Sweep)	3-144
Stop Frequency (Sweep)	3-147
System Automatic Level Control	3-153
Vernier (Output Level)	3-156

**Section 4
PERFORMANCE TESTS**

Introduction	4-1
Abbreviated Performance Test	4-1
Calibration Cycle	4-1

	Page
Performance Test Record	4-1
Equipment Required	4-1
Test Procedures	4-1
Abbreviated Performance Tests	4-2
Turn-On Checks	4-2
Frequency Range and Resolution Test	4-3
Output Level and Flatness Tests	4-5
Level Accuracy Tests	4-8
Pulse Modulation Test	4-11
AM Accuracy Tests	4-16
External FM Accuracy and Meter Accuracy	4-17
Frequency Range and Resolution Test	4-22
Internal Time Base Aging Rate	4-25
Frequency Switching Time Test	4-27
Single-Sideband Phase Noise Test	4-34
Harmonics, Subharmonics, & Multiples Tests	4-39
Non-Harmonically Related Spurious Signals Tests	4-41
Power Line Related Spurious Signals Tests	4-43
Output Level and Flatness Tests	4-46
Absolute Level Accuracy Tests	4-50
Output Level Switching Time Test	4-56
Pulse On/Off Ratio Test	4-61
Pulse Rise/Fall Time and Overshoot Test	4-63
Pulse Peak Level Accuracy Test	4-70
AM Bandwidth	4-73
AM Accuracy Tests	4-75
Incidental FM	4-78
FM Frequency Response	4-80
External FM Accuracy and Meter Accuracy	4-82
Incidental AM	4-85

ILLUSTRATIONS

Figure	Page
1-1. HP 8673B Accessories Supplied and Options 907, 908, and 909	1-2
1-2. Special Interconnect Cable	1-20
2-1. Line Voltage and Fuse Selection	2-2
2-2. Power Cable and Mains Plug Part Numbers	2-2
2-3. HP-IB Address Switch Factory Settings	2-3
2-4. Hewlett-Packard Interface Bus Connection	2-6
2-5. AUX Interface Connector	2-7
3-1. Front Panel Features	3-2
3-2. Displays and Status Annunciators	3-9
3-3. Output Level Features	3-10
3-4. Frequency Control Features and LINE Switch	3-11

Figure	Page
3-5. Sweep Features and LOCAL Key	3-13
3-6. Modulation Features	3-15
3-7. Rear Panel Features	3-16
3-8. AM Functional Check Setup	3-21
3-9. FM Functional Check Setup	3-22
3-10. Pulse Modulation Functional Check Setup	3-23
3-11. Status Byte Information	3-42
4-1. Frequency Range and Resolution Test Setup	4-3
4-2. Output Level and Flatness Test Setup	4-5
4-3. Level Accuracy Test Setup	4-8
4-4. On/Off Ratio Test Setup	4-11
4-5. Rise Time, Overshoot and Ringing Test Setup	4-12

ILLUSTRATIONS (cont'd)

Figure	Page	Figure	Page
4-6. Risetime, Overshoot and Ringing Measurement	4-13	4-21. Output Level and Flatness Test Setup	4-47
4-7. Pulse Peak Accuracy Measurement	4-14	4-22. Absolute Level Accuracy Test Setup	4-51
4-8. AM Accuracy Test Setup	4-15	4-23. Output Level Switching Time Test Setup	4-57
4-9. External FM Accuracy and Meter Accuracy Test Setup	4-17	4-24. Output Level Switching Waveform	4-59
4-10. Frequency Range and Resolution Test Setup	4-22	4-25. Level Switching Time Measurement Waveform	4-60
4-11. Internal Time Base Aging Rate Test Setup	4-25	4-26. Pulse ON/OFF Ratio Test Setup	4-61
4-12. Frequency Switching Time Test Setup	4-28	4-27. Pulse Rise/Fall Time and Overshoot Test Setup	4-64
4-13. Frequency Switching Waveform	4-29	4-28. Pulse Rise/Fall Time and Overshoot Waveform	4-65
4-14. Frequency Switching Time Measurement Waveform	4-30	4-29. Pulse Definitions	4-66
4-15. Amplitude Recovery Switching Waveform	4-32	4-30. Pulse Peak Level Accuracy Test Setup	4-70
4-16. Amplitude Recovery Measurement Waveform	4-33	4-31. Pulse Peak Level Accuracy Measurement	4-71
4-17. Single-Sideband Phase Noise Test Setup ..	4-35	4-32. AM Bandwidth Test Setup	4-74
4-18. Harmonics, Subharmonics, and Multiples Test Setup	4-39	4-33. AM Accuracy Test Setup	4-75
4-19. Non-harmonically Related Spurious Test Setup	4-41	4-34. Incidental FM Test Setup	4-79
4-20. Power Line Related Spurious Signals Test Setup	4-44	4-35. FM Frequency Response Test Setup	4-80
		4-36. External FM Accuracy and Meter Accuracy Test Setup	4-83
		4-37. Incidental AM Test Setup	4-85

TABLES

Table	Page	Table	Page
1-1. Specifications	1-6	3-4. Talk Functions	3-39
1-2. Supplemental Characteristics	1-14	3-5. Response to a Clear Message	3-40
1-3. Recommended Test Equipment	1-17	3-6. HP-IB Program Codes	3-43
1-4. Abbreviated Performance Test Recommended Test Equipment	1-21	3-7. Index of Detailed Operating Instructions ..	3-45
2-1. Allowable HP-IB Address Codes	2-3	3-8. Error Messages	3-101
3-1. Operating Characteristics	3-1	4-1. Abbreviated Performance Test Record	4-19
3-2. AUX Connector Functions	3-32	4-2. High Level Accuracy Test Record	4-53
3-3. Message Reference Table	3-34	4-3. Low Level Accuracy Test Record	4-55
		4-4. Performance Test Record	4-87

CERTIFICATION

Hewlett-Packard Company certifies that this product met its published specifications at the time of shipment from the factory. Hewlett-Packard further certifies that its calibration measurements are traceable to the United States National Bureau of Standards, to the extent allowed by the Bureau's calibration facility, and to the calibration facilities of other International Standards Organization members.

WARRANTY

This Hewlett-Packard instrument product is warranted against defects in material and workmanship for a period of one year from date of shipment. During the warranty period, Hewlett-Packard Company will, at its option, either repair or replace products which prove to be defective.

For warranty service or repair, this product must be returned to a service facility designated by HP. Buyer shall prepay shipping charges to HP and HP shall pay shipping charges to return the product to Buyer. However, Buyer shall pay all shipping charges, duties, and taxes for products returned to HP from another country.

HP warrants that its software and firmware designated by HP for use with an instrument will execute its programming instructions when properly installed on that instrument. HP does not warrant that the operation of the instrument, or software, or firmware will be uninterrupted or error free.

LIMITATION OF WARRANTY

The foregoing warranty shall not apply to defects resulting from improper or inadequate maintenance by Buyer, Buyer-supplied software or interfacing, unauthorized modification or misuse, operation outside of the environmental specifications for the product, or improper site preparation or maintenance.

NO OTHER WARRANTY IS EXPRESSED OR IMPLIED. HP SPECIFICALLY DISCLAIMS THE IMPLIED WARRANTIES OF MERCHANTABILITY AND FITNESS FOR A PARTICULAR PURPOSE.

EXCLUSIVE REMEDIES

THE REMEDIES PROVIDED HEREIN ARE BUYER'S SOLE AND EXCLUSIVE REMEDIES. HP SHALL NOT BE LIABLE FOR ANY DIRECT, INDIRECT, SPECIAL, INCIDENTAL, OR CONSEQUENTIAL DAMAGES, WHETHER BASED ON CONTRACT, TORT, OR ANY OTHER LEGAL THEORY.

ASSISTANCE

Product maintenance agreements and other customer assistance agreements are available for Hewlett-Packard products.

For any assistance, contact your nearest Hewlett-Packard Sales and Service Office. Addresses are provided at the back of this manual.

HP 8673B

Herstellerbescheinigung

Hiermit wird bescheinigt, dass dieses Gerät/System in Übereinstimmung mit den Bestimmungen von Postverfügung 1046/84 funkenstört ist.

Der Deutschen Bundespost wurde das Inverkehrbringen dieses Gerätes/Systems angezeigt und die Berechtigung zur Überprüfung der Serie auf Einhaltung der Bestimmungen eingeräumt.

Zusatzinformation für Mess- und Testgeräte:

Werden Mess- und Testgeräte mit ungeschirmten Kabeln und/oder in offenen Messaufbauten verwendet, so ist vom Betreiber sicherzustellen, dass die Funk-Entstörbestimmungen unter Betriebsbedingungen an seiner Grundstücksgrenze eingehalten werden.

Manufacturer's Declaration

This is to certify that this product meets the radio frequency interference requirements of Directive FTZ 1046/1984. The German Bundespost has been notified that this equipment was put into circulation and has been granted the right to check the product type for compliance with these requirements.

Note: If test and measurement equipment is operated with unshielded cables and/or used for measurements on open set-ups, the user must ensure that under these operating conditions, the radio frequency interference limits are met at the border of his premises.

SAFETY CONSIDERATIONS

GENERAL

This product and related documentation must be reviewed for familiarization with safety markings and instructions before operation.

This product is a Safety Class I instrument (provided with a protective earth terminal).

BEFORE APPLYING POWER

Verify that the product is set to match the available line voltage and the correct fuse is installed.

SAFETY EARTH GROUND

An uninterruptible safety earth ground must be provided from the main power source to the product input wiring terminals, power cord, or supplied power cord set.

WARNINGS

Any interruption of the protective (grounding) conductor (inside or outside the instrument) or disconnecting the protective earth terminal will cause a potential shock hazard that could result in personal injury. (Grounding one conductor of a two conductor outlet is not sufficient protection.) In addition, verify that a common ground exists between the unit under test and this instrument prior to energizing either unit.

Whenever it is likely that the protection has been impaired, the instrument must be made inoperative and be secured against any unintended operation.

If this instrument is to be energized via an auto-transformer (for voltage reduction) make sure the common terminal is connected to neutral (that is, the grounded side of the mains supply).

Servicing instructions are for use by service-trained personnel only. To avoid dangerous electric shock, do not perform any servicing unless qualified to do so. Adjustments described in the manual are performed with power supplied to the instrument while protective covers

are removed. Energy available at many points may, if contacted, result in personal injury.

Capacitors inside the instrument may still be charged even if the instrument has been disconnected from its source of supply.

For continued protection against fire hazard, replace the line fuse(s) only with 250V fuse(s) of the same current rating and type (for example, normal blow, time delay, etc.) Do not use repaired fuses or short-circuited fuseholders.

SAFETY SYMBOLS



Instruction manual symbol: the product will be marked with this symbol when it is necessary for the user to refer to the instruction manual (see Table of Contents for page references).



Indicates hazardous voltages.



Indicates earth (ground) terminal.

WARNING

The WARNING sign denotes a hazard. It calls attention to a procedure, practice, or the like, which, if not correctly performed or adhered to, could result in personal injury. Do not proceed beyond a WARNING sign until the indicated conditions are fully understood and met.

CAUTION

The CAUTION sign denotes a hazard. It calls attention to an operating procedure, practice, or the like, which, if not correctly performed or adhered to, could result in damage to or destruction of part or all of the product. Do not proceed beyond a CAUTION sign until the indicated conditions are fully understood and met.

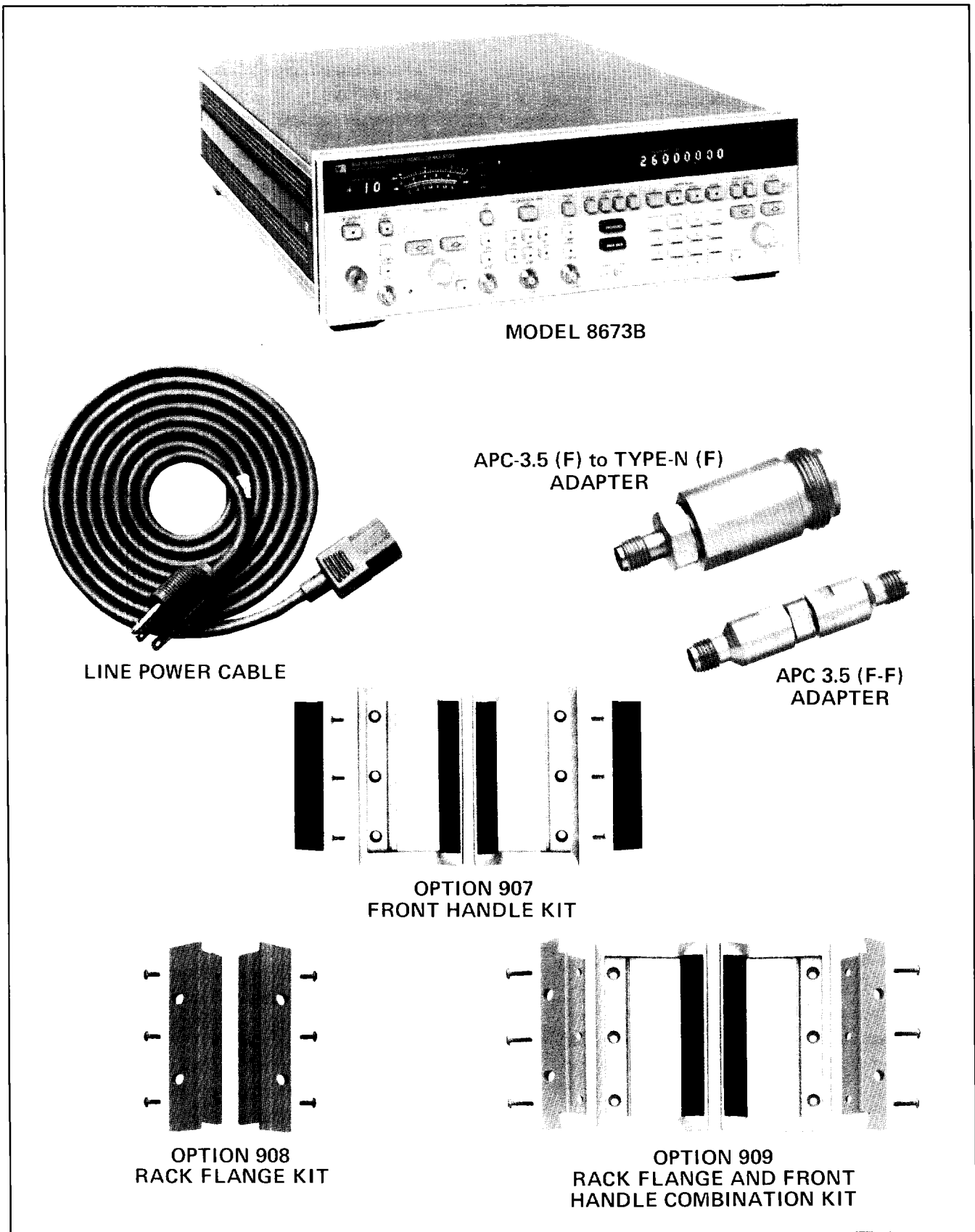

Figure 1-1. HP 8673B Accessories Supplied, and Options 907, 908, and 909

SECTION 1 GENERAL INFORMATION

1-1. INTRODUCTION

The HP 8673B Operating Manual contains all the information required to install, operate, and test the Hewlett-Packard Model 8673B Synthesized Signal Generator. Figure 1-1 shows an HP 8673B Signal Generator with all of its externally supplied accessories.

The HP 8673B Operating Manual has four sections:

- Section 1, General Information
- Section 2, Installation
- Section 3, Operation
- Section 4, Performance Tests

The HP 8673B Service Manual, which is shipped with the instrument as Option 915 or ordered separately, has four sections:

- Section 5, Adjustments
- Section 6, Replaceable Parts
- Section 7, Manual Changes
- Section 8, Service

Additional copies of the Operating Manual or the Service Manual can be ordered separately through your nearest Hewlett-Packard office.

1-2. SPECIFICATIONS

Instrument specifications are listed in Table 1-1. These specifications are the performance standards or limits against which the instrument may be tested. Supplemental characteristics are listed in Table 1-2. Supplemental characteristics are not warranted specifications, but are typical characteristics included as additional information for the user.

1-3. SAFETY CONSIDERATIONS

This product is a Safety Class I instrument, that is, one provided with a protective earth terminal. The Signal Generator and all related documentation should be reviewed for familiarization with safety markings and instructions before operation. Refer to the Safety Considerations page found at the beginning of this manual for a summary of the safety information. Safety information for installation, operation, performance testing, adjustment, or service is found in appropriate places throughout this manual.

1-4. MANUAL UPDATES

Manual Updates provide information necessary to update the manual. The Manual Update is identified by the manual print date and part number, both of which appear on the manual title page.

1-5. DESCRIPTION

The HP 8673B Synthesized Signal Generator has a frequency range of 2.0 to 26.0 GHz (1.95 to 26.5 GHz overrange). The output is leveled and calibrated from +8 dBm to -100 dBm, depending on the frequency and options. For additional information, see Table 1-1. AM, FM, and pulse modulation modes can be selected. Frequency, output level, modulation modes, and all other functions except line switch can be remotely programmed via HP-IB.

Long-term frequency stability is dependent on the time base, either an internal or external reference oscillator. The internal crystal reference oscillator operates at 10 MHz while an external oscillator may operate at 5 or 10 MHz. The output of the Signal Generator is exceptionally flat due to the action of the internal automatic leveling control (ALC) loop.

External drive signals are required for all modulation modes. AM depth and FM deviation vary linearly with the applied external voltage. Full scale modulation is attained with a 1.0 volt peak signal. Pulse modulation is compatible with TTL levels.

Two ranges of AM depth can be selected: 30% and 100%. The front panel meter can be used to set AM depth. Specified AM rates are from 20 Hz to 100 kHz.

Six ranges of FM deviation are selectable: 0.03, 0.1, 0.3, 1, 3, and 10 MHz. FM peak deviation can be set using the front panel meter. At output frequencies below 6.6 GHz, peak deviation is limited to 10 MHz or five times the modulation frequency, whichever is lower. From 6.6 to 12.3 GHz, peak deviation is limited to the lesser of 10 MHz or ten times the modulation frequency; from 12.3 to 18.6 GHz the lesser of 10 MHz or fifteen times the modulation frequency; from 18.6 to 26.0 GHz the lesser of

DESCRIPTION (cont'd)

10 MHz or twenty times the modulation frequency. Usable modulation rates fall between 100 Hz and 10 MHz.

Pulse modulation has two operating modes: NORM (normal mode) and COMPL (complement mode). In normal mode the RF output is On when the drive signal is the TTL high state. In the complement mode the RF output is On when the drive signal is in the TTL low state.

The Signal Generator is compatible with HP-IB to the extent indicated by the following code: SH1, AH1, T5, TE0, L3, LE0, SR1, RL1, PP1, DC1, DT1, and C0. The Signal Generator interfaces with the bus via three-state TTL circuitry. An explanation of the compatibility code can be found in IEEE Standard 488 (1978), "IEEE Standard Digital Interface for Programmable Instrumentation" or the identical ANSI Standard MC1.1. For more detailed information relating to programmable control of the Signal Generator, refer to Remote Operation, Hewlett-Packard Interface Bus in Section 3 of this manual.

1-6. OPTIONS**1-7. Electrical Options**

Option 001. The internal 10 dB/step attenuator has been deleted. The specified output level is listed in Table 1-1.

Option 002. The internal 10 MHz crystal reference is removed. An external 5 or 10 MHz reference must be used.

Option 003. A special fan allows operation from 400 Hz power mains, as well as 50–60 Hz.

Option 004. The Signal Generator's RF OUTPUT connector is located on the rear panel. Maximum output power is listed in Table 1-1.

Option 005. The Signal Generator's RF OUTPUT connector is located on the rear panel and the attenuator is removed. This combines Options 001 and 004. The specified output level is listed in Table 1-1.

Option 008. Option 008 provides +8 dBm leveled output power from 2.0 to 18.0 GHz and +7 dBm leveled output power from 18.0 to 26.0 GHz.

1-8. Mechanical Options

The following options may have been ordered and received with the Signal Generator. If they were

not ordered with the original shipment and are now desired, they can be ordered from the nearest Hewlett-Packard office using the part numbers included in each of the following paragraphs.

CAUTION

In the options below both English and metric screws are provided. If your instrument's frame is stamped with the word "Metric" or "M", use metric screws; otherwise use English screws. The use of incompatible screws will result in damage to the frame.

Option 006 (Chassis Slide Mount Kit). This kit is extremely useful when the Signal Generator is rack mounted. Access to the internal circuits and components, or the rear panel is possible without removing the Signal Generator from the rack. The chassis Slide Mount Kit part number is 1494-0059. An adapter is needed if the instrument rack mounting slides are to be mounted in a non-HP rack. The slides without the adapter can be directly mounted in the HP system enclosures. The adapter part number is 1494-0061.

Option 907. (Front Handle Kit). Ease of handling is increased with the front panel handles. The Front Handle Kit part number is 5061-9689.

Option 908 (Rack Flange Kit). The Signal Generator can be solidly mounted to the instrument rack without handles, using the flange kit. The Rack Flange Kit part number is 5061-9677.

Option 909 (Rack Flange and Front Handle Combination Kit). This is a unique part which combines both functions. It is not simply a front handle kit and a rack flange kit packaged together. The Rack Flange and Front Panel Combination Kit part number is 5061-9683.

1-9. Miscellaneous Options

Option 915. Provides a service manual.

Option 916. Provides an extra operating manual.

Option W30. Provides two additional years of return-to-HP service. The first year of normal warranty is combined with this extended service to provide three full continuous years of HP service. All repairs of failures due to defects in materials or workmanship, are covered under this

OPTIONS (cont'd)

extended service. Repair services do not include routine preventative maintenance or periodic calibrations of the instrument.

1-10. ACCESSORIES SUPPLIED

The accessories supplied with the Signal Generator are shown in Figure 1-1.

a. The line power cable is supplied in several configurations, depending on the destination of the original shipment. Refer to Power Cables in Section 2 of this manual.

b. An additional fuse is shipped only with instruments that are factory configured for 100/120 Vac operation. This fuse has a 2A rating for reconfiguring the instrument for 220/240 Vac operation.

c. Two adapters are provided: APC-3.5(F) to TYP-N(F); HP Part No. 1250-1745. APC-3.5(F-F); HP Part No. 1250-1749.

1-11. EQUIPMENT REQUIRED BUT NOT SUPPLIED

For Option 002 instruments, which lack an internal frequency standard, an external reference must be used. The performance of the external reference should at least match the specifications of the internal reference oscillator. In particular, the frequency should be within ± 50 Hz of 10 MHz. When using an external oscillator, microphonically generated or line related spurious signals may increase. SSB phase noise may also be degraded at some offsets from the carrier.

An external signal source is required if amplitude, frequency, or pulse modulation is desired. For AM, the source should have a variable output of 0 to 1 V peak into 600 Ω , frequency rates up to 100 kHz. For FM, the source should have a variable output of 0 to 1 V peak into 50 Ω , frequency rates up to 10 MHz, and distortion of less than 1%. For pulse modulation, the source should have TTL output levels (>2.4 V for a TTL high state and <0.4 V for a TTL low state) and 50 ohms nominal impedance. Pulse repetition frequency rates should be 50 Hz to 1 MHz with transition times <10 ns.

1-12. ELECTRICAL EQUIPMENT AVAILABLE

The Signal Generator has an HP-IB interface and can be used with any HP-IB compatible computing controller or computer for automatic systems applications.

The HP-IB Controller and various ROM's are needed to do the automated SRD Bias, YTM Tune, Flatness and ALC adjustment procedures. Specific equipment needed for automated adjustments are:

Test Cassette HP Part No. 11726-10002
 HP 85F Controller
 82903A 16K Memory Module
 00085-15005 Advanced Programming ROM
 00085-15002 Plotter/Printer ROM
 00085-15004 Matrix ROM
 HP 3455A Digital Voltmeter
 HP 436A/HP 8485A Power Meter and Sensor

Although the test cassette is part of the HP 11726A Support Kit, it can be ordered separately through the nearest Hewlett-Packard office. The HP 11726A Support Kit is available for maintaining and servicing the Signal Generator. It consists of cables, adapters, termination, and prerecorded programs, extender boards and test extender boards.

The HP 8116A Pulse/Function Generator is adequate for modulating the Signal Generator and meeting stated standards. This remotely programmable signal source is convenient for full remote control of modulation levels and rates.

The Synthesizer Interface Cable, part number 5061-5391, provides an interface to the HP 8349B Microwave Amplifier. This provides calibrated output level under control of the system-compatible Signal Generator. This cable (as well as the HP 8349B Microwave Amplifier), is required for use with the HP 83550 family of frequency multipliers. For more information, see paragraph 3-2, System Compatibility.

1-13. RECOMMENDED TEST EQUIPMENT

Table 1-3 lists the test equipment recommended for testing, adjusting and servicing the Signal Generator. Table 1-4 lists the test equipment recommended for Abbreviated Performance Tests. Essential requirements for each piece of test equipment are described in the Critical Specifications column. Other equipment can be substituted if it meets or exceeds the critical specifications.

Table 1-1. Specifications (1 of 8)

Electrical Characteristics	Performance Limits	Conditions
<p>Note: Specifications apply after 1-hour warm-up, over temperature range 0 to 55°C (except specifications for harmonically related spurious signals, RF output, pulse peak level accuracy, and amplitude modulation, which apply +15 to +35°C), and after an AUTO PEAK operation has been performed. Specifications for output flatness, absolute level accuracy, and modulation apply only when internal leveling is used.</p>		
<p>FREQUENCY Range</p> <p>Resolution</p> <p>Accuracy and Stability</p> <p>Reference Oscillator: Frequency Aging Rate</p> <p>Switching Time (for frequency to be within specified resolution and output power to be within 3 dB of set level)</p> <p>For Option 008: Switching time (for frequency table within specified resolution and output power to be within 3 dB of set level)</p>	<p>2.0—26.0 GHz (1.95—26.5 GHz overrange)</p> <p>1 kHz 2 kHz 3 kHz 4 kHz</p> <p>Same as reference oscillator</p> <p>10 MHz <5 x 10⁻¹⁰/day</p> <p><25 ms (2703A and above and all Option 008 instruments) <20 ms (2640A and below but not for Option 008)</p> <p><25 ms for frequency changes across 16 GHz</p>	<p>2.0 to 6.6 GHz >6.6 to 12.3 GHz >12.3 to 18.6 GHz >18.6 to 26.0 GHz</p> <p>After a 10 day warmup (typically 24 hours in a normal operating environment)</p> <p>CW and AM modes; AUTO PEAK disabled</p> <p>CW and AM modes; AUTO PEAK disabled</p>
<p>SPECTRAL PURITY Single-sideband Phase Noise 2.0—6.6 GHz</p> <p>>6.6—12.3 GHz</p> <p>>12.3—18.6 GHz</p>	<p>-58 dBc -70 dBc -78 dBc -86 dBc -110 dBc</p> <p>-52 dBc -64 dBc -72 dBc -80 dBc -104 dBc</p> <p>-48 dBc -60 dBc -68 dBc -76 dBc -100 dBc</p>	<p>1 Hz bandwidth; CW mode 10 Hz offset from carrier 100 Hz offset from carrier 1 kHz offset from carrier 10 kHz offset from carrier 100 kHz offset from carrier</p> <p>10 Hz offset from carrier 100 Hz offset from carrier 1 kHz offset from carrier 10 kHz offset from carrier 100 kHz offset from carrier</p> <p>10 Hz offset from carrier 100 Hz offset from carrier 1 kHz offset from carrier 10 kHz offset from carrier 100 kHz offset from carrier</p>

Table 1-1. Specifications (2 of 8)

Electrical Characteristics	Performance Limits	Conditions
SPECTRAL PURITY (cont'd)		
>18.6—26.0 GHz	-46 dBc -58 dBc -66 dBc -74 dBc -98 dBc	10 Hz offset from carrier 100 Hz offset from carrier 1 kHz offset from carrier 10 kHz offset from carrier 100 kHz offset from carrier
Harmonics	<-40 dBc	Up to 26 GHz; output level meter readings ≤ 0 dB on 0 dBm range and below
Subharmonics and Multiples thereof	<-25 dBc <-20 dBc	2.0 to 18.6 GHz 18.6 to 26.0 GHz
For Option 008: Subharmonics and Multiples thereof	<-25 dBc <-15 dBc	2.0 to 26 GHz 18.6 to 26 GHz (1/2 and 3/4 subharmonics only)
Spurious Signals Nonharmonically Related	<-70 dBc <-64 dBc <-60 dBc <-58 dBc	CW and AM modes 2.0 to 6.6 GHz >6.6 to 12.3 GHz >12.3 to 18.6 GHz >18.6 to 26.0 GHz
Power line related and fan rotation related within 5 Hz below line frequencies and multiples thereof (Option 003 is not specified. See Table 1-2 for supplemental characteristics for Option 003.)		
2.0—6.6 GHz	-50 dBc -60 dBc -65 dBc	<300 Hz offset from carrier 300 Hz to 1 kHz offset from carrier >1 kHz offset from carrier
>6.6—12.3 GHz	-44 dBc -54 dBc -59 dBc	<300 Hz offset from carrier 300 Hz to 1 kHz offset from carrier >1 kHz offset from carrier
>12.3—18.6 GHz	-40 dBc -50 dBc -55 dBc	<300 Hz offset from carrier 300 Hz to 1 kHz offset from carrier >1 kHz offset from carrier
>18.6—26.0 GHz	-38 dBc -48 dBc -53 dBc	<300 Hz offset from carrier 300 Hz to 1 kHz offset from carrier >1 kHz offset from carrier
RF OUTPUT		
Output Level: Standard Leveled Output	+8 dBm to -100 dBm +4 dBm to -100 dBm 0 dBm to -100 dBm	+15 to +35°C 2.0 to 18.0 GHz 18.0 to 22.0 GHz 22.0 to 26.0 GHz

Table 1-1. Specifications (3 of 8)

Electrical Characteristics	Performance Limits	Conditions
RF OUTPUT (cont'd)		
Option 001 Leveled Output	+10 dBm to -100 dBm +6 dBm to -100 dBm +3 dBm to -100 dBm	2.0 to 18.0 GHz 18.0 to 22.0 GHz 22.0 to 26.0 GHz
Option 004 Leveled Output	+7 dBm to -100 dBm +2 dBm to -100 dBm -2 dBm to -100 dBm	2.0 to 18.0 GHz 18.0 to 22.0 GHz 22.0 to 26.0 GHz
Option 005 Leveled Output	+9 dBm to -100 dBm +4 dBm to -100 dBm +1 dBm to -100 dBm	2.0 to 18.0 GHz 18.0 to 22.0 GHz 22.0 to 26.0 GHz
Option 008 Leveled Output	+8 dBm to -100 dBm +7 dBm to -100 dBm	2.0 to 18.0 GHz 18.0 to 26.0 GHz
Remote Programming Absolute Level Accuracy		+15 to +35°C
2.0 — 6.6 GHz	±1.25 dB ±1.00 dB ±1.50 dB ±1.70 dB ±2.00 dB ±2.00 dB plus ±0.1 dB per 10 dB step below -30 dBm	+10 dBm output level range 0 dBm output level range -10 dBm output level range -20 dBm output level range -30 dBm output level range <-30 dBm output range
>6.6 — 12.3 GHz	±1.50 dB ±1.25 dB ±1.75 dB ±1.95 dB ±2.25 dB ±2.25 dB plus ±0.1 dB per 10 dB step below -30 dBm	+10 dBm output level range 0 dBm output level range -10 dBm output level range -20 dBm output level range -30 dBm output level range <-30 dBm output range
>12.3—18.6 GHz	±1.75 dB ±1.50 dB ±2.10 dB ±2.30 dB ±2.70 dB ±2.70 dB plus ±0.2 dB per 10 dB step below -30 dBm	+10 dBm output level range 0 dBm output level range -10 dBm output level range -20 dBm output level range -30 dBm output level range <-30 dBm output range
>18.6—26.0 GHz	±2.25 dB ±2.00 dB ±2.55 dB ±2.85 dB ±3.30 dB ±3.30 dB plus ±0.2 dB per 10 dB step below -30 dBm	+10 dBm range (Option 008) 0 dBm output level range -10 dBm output level range -20 dBm output level range -30 dBm output level range <-30 dBm output range

Table 1-1. Specifications (4 of 8)

Electrical Characteristics	Performance Limits	Conditions
RF OUTPUT (cont'd) Manual Absolute Level Accuracy	Add ± 0.75 dB to remote programming absolute level accuracy	Absolute level accuracy specifications include allowances for detector linearity, temperature, flatness, attenuator accuracy, meter accuracy, and measurement uncertainty
Remote Programming Output Level Resolution	0.1 dB	
For Option 008	0.1 dB	+7 to -100 dBm, plus 6 dB of overrange
Flatness	± 0.75 dB ± 1.00 dB ± 1.25 dB ± 1.75 dB	0 dBm range; +15 to +35°C 2.0 to 6.6 GHz 2.0 to 12.3 GHz 2.0 to 18.6 GHz 2.0 to 26.0 GHz (Min. to max. variation in power level across specified frequency limits is less than 2 times flatness spec.)
Output Level Switching Time (to be within ± 1 dB of final level)	<25 ms	
PULSE MODULATION ON/OFF Ratio	>80 dB	
Rise and Fall Times	<35 ns	AUTO PEAK enabled
For Option 008	<40 ns	2.0 to 26.0 GHz AUTO PEAK enabled
Minimum Leveled RF Pulse Width	<100 ns	
Pulse Repetition Frequency	dc to 1 MHz	
Minimum Duty Cycle	<0.0001	When internally leveled; no restriction when unleveled
Minimum Pulse Off-Time	<300 ns	
Maximum Peak Power	Same as in CW mode	
Peak Level Accuracy	+1.5 dB, -1.0 dB	Relative to CW; +15 to +35°C
Overshoot, Ringing	<20% <25%	2.0 to 6.6 and 6.7 to 26.0 GHz 6.6 to 6.7 GHz
For Option 008	<25%	2.0 to 26.0 GHz

Table 1-1. Specifications (5 of 8)

Electrical Characteristics	Performance Limits	Conditions
AMPLITUDE MODULATION		
<p>Depth</p> <p>For Option 008</p> <p>Rates</p> <p>Sensitivity (% AM per Vpk)</p> <p>Indicated Meter Accuracy</p> <p>Accuracy Relative to External AM Input Level</p> <p>Incidental Phase Modulation (100 Hz to 10 kHz rates; 30% depth)</p> <p>Incidental FM</p>	<p>0 to 75%</p> <p>0 to 75%</p> <p>0 to 50%</p> <p>0 to 75%</p> <p>20 Hz to 100 kHz</p> <p>$\leq(\text{pulse width}) \times (\text{PRF}) \times (4 \text{ kHz})$</p> <p>30%/V and 100%/V (depending on range)</p> <p>$\pm 7\%$ of reading $\pm 3\%$ of range</p> <p>$\pm 4\%$ of reading $\pm 2\%$ of range</p> <p><0.4 radians <0.8 radians <1.2 radians <1.6 radians <2.5 radians</p> <p>Incidental phase modulation $\times f_{\text{mod}}$</p>	<p>+15 to +35°C</p> <p>2.0 to 18.0 GHz; 0 dBm maximum carrier level</p> <p>>18.0 to 24.0 GHz; -3 dBm maximum carrier level</p> <p>>24.0 to 26.0 GHz; -5 dBm maximum carrier level</p> <p>At range and vernier settings of 0 dBm and below</p> <p>3 dB bandwidth, 30% depth, Pulse Modulation off</p> <p>With Pulse Modulation on</p> <p>Maximum input 1 Vpk into 600Ω nominal; AM depth is linearly controlled by varying input level between 0 and 1V peak</p> <p>100 Hz to 10 kHz rates</p> <p>100 Hz to 10 kHz rates</p> <p>2.0 to 6.6 GHz >6.6 to 12.3 GHz >12.3 to 18.6 GHz >18.6 to 24.0 GHz >24.0 to 26.0 GHz</p>
FREQUENCY MODULATION		
<p>Frequency Response (Relative to 100 kHz rate)</p> <p>100 Hz to 3 MHz</p> <p>3 kHz to 3 MHz</p>	<p>$\pm 2 \text{ dB}$</p> <p>$\pm 2 \text{ dB}$</p>	<p>30 and 100 kHz/V ranges</p> <p>300 kHz/V and 1, 3, and 10 MHz/V ranges</p>

Table 1-1. Specifications (6 of 8)

Electrical Characteristics	Performance Limits	Conditions
<p>FREQUENCY MODULATION</p> <p>Maximum Peak Deviation</p> <p>Sensitivity (peak deviation per Vpk)</p> <p>Indicated Meter Accuracy</p> <p>Accuracy Relative to External FM Input Level</p> <p>Incidental AM</p>	<p>The smaller of 10 MHz or $f_{mod} \times 5$</p> <p>The smaller of 10 MHz or $f_{mod} \times 10$</p> <p>The smaller of 10 MHz or $f_{mod} \times 15$</p> <p>The smaller of 10 MHz or $f_{mod} \times 20$</p> <p>Maximum input 1 Vpk into 50 ohms nominal</p> <p>$\pm 12\%$ of reading $\pm 3\%$ of range</p> <p>$\pm 7\%$ of reading $\pm 3\%$ of range</p> <p>$< 5\%$</p>	<p>2.0 to 6.6 GHz</p> <p>> 6.6 to 12.3 GHz</p> <p>> 12.3 to 18.6 GHz</p> <p>> 18.6 to 26.0 GHz</p> <p>All ranges; peak deviation is linearly controlled by varying input level between 0 and 1 Vpk</p> <p>100 kHz rate</p> <p>100 kHz rate</p> <p>Rates < 100 kHz; peak deviations ≤ 1 MHz</p>
<p>DIGITAL SWEEP</p> <p>Sweep Function</p> <p>Sweep Modes</p> <p>Step Size</p> <p>Dwell Time</p> <p>Maximum Sweep Width:</p> <p>Markers</p>	<p>Start/Stop or Center Frequency/ΔF (Span) Sweep</p> <p>Manual, Auto, Single</p> <p>Maximum equals the maximum sweepspan; minimum is equal to the greater of the frequency resolution or span divided by 9999.</p> <p>Set from 1 to 255 ms per step</p> <p>Manual, Single, and Auto sweep modes: 2.0 to 26.5 GHz Option 008: Auto sweep 2.0 to < 16.0 GHz 16.0 to 26.5 GHz</p> <p>5 independent, fixed frequency markers set from front panel</p>	<p>Maximum of 9999 frequency points per sweep.</p> <p>Resolution and accuracy are identical to RF output frequency specifications.</p>

Table 1-1. Specifications (7 of 8)

Electrical Characteristics	Performance Limits	Conditions
<p>REAR PANEL AUXILIARY CONTROL CONNECTOR 14-Pin Connector</p> <p>Input Required</p> <p>Outputs</p>	<p>Inputs: Stop Sweep (HP 8410B/C Compatible) Trigger Output Service Function Frequency Increment Frequency Decrement Blank Frequency Display Recall Register 1 Sequential Register Recall</p> <p>Outputs: Trigger (HP 8410B/C Compatible) End Sweep Negative Z-axis Blanking Ground</p> <p>Contact closure to ground or 5 μs, negative true TTL pulse</p> <p>5 μs negative true TTL pulse</p>	<p>(Internal debounce circuit available to debounce external inputs.)</p>
<p>REMOTE PROGRAMMING</p> <p>Output Data:</p> <p>Interface Function Codes:</p>	<p>All functions HP-IB programmable, except LINE switch, HP-IB address, and (for 2626A, 2608A, 2540A and below) the Backspace function.</p> <p>Frequencies and output level settings, error/malfunction messages, operational status and learn mode strings.</p> <p>SH1, AH1, T5, TE0, L3, LE0, SR1, RL1, PP1, DC1, DT1, C0, E1</p>	
<p>REAR PANEL CONNECTORS</p> <p>Frequency Reference Output</p> <p>Sweep Output</p> <p>Tone Marker Output</p> <p>Z-Axis Blanking Marker</p> <p>Penlift</p> <p>10 MHz Output</p> <p>100 MHz Output</p>	<p>0.5V or 1V/GHz +18V maximum (2552A, 2634A and above). 1 V/GHz +18V maximum (2608A through 2629A, 2536A and below). 0 to +10V ramp, start to stop</p> <p>5 kHz sine wave output Z-Axis control for CRT Compatible with devices that have penlift control</p> <p>0 dBm (nominal) into 50 ohms 0 dBm (nominal) into 50 ohms</p>	<p>Factory set to 0.5 V/GHz. Internal switch provides 1 V/GHz capability.</p> <p>Maximum level adjustable between +4V and +12V.</p>

Table 1-1. Specifications (8 of 8)

Electrical Characteristics	Performance Limits	Conditions
<p>GENERAL</p> <p>Operating Temperature Range</p> <p>Power Requirements: Line Voltage (100, 120, 220, or 240V)</p> <p>Power Dissipation</p> <p>Conducted and Radiated Electromagnetic Interference</p> <p>Net Weight</p> <p>Dimensions: Height Width Depth</p>	<p>0 to +55°C (except specifications for harmonically related spurious signals, RF output, pulse peak level accuracy, and amplitude modulation, which are limited to +15 to +35°C).</p> <p>+5, -10%</p> <p>400 V · A maximum</p> <p>MIL-STD 461A-1968</p> <p>29 kg (64 lb)</p> <p>146 mm (5.7 in.) 425 mm (16.8 in.) 620 mm (24.4 in.)</p>	<p>48—66 Hz</p> <p>Conducted and radiated interference is within the requirements of methods CE03 and RE02 of MIL-STD 461A, VDE 0871, and CISPR publication 11.</p> <p>For ordering cabinet accessories, module sizes are 5¼H, 1MW, 23D.</p>

Table 1-2. Supplemental Characteristics (1 of 3)

Supplemental characteristics are intended to provide information useful in applying the instrument by giving typical, but non-warranted, performance parameters.

FREQUENCY

Internal Reference: The internal reference oscillator accuracy is a function of time base calibration \pm aging rate, \pm temperature effects, and \pm line voltage effects. Typical temperature and line voltage effects are $<1 \times 10^{-10}/^{\circ}\text{C}$ and $<5 \times 10^{-10} / +5\%$ to -10% line voltage change. Reference oscillator is kept at operating temperature in STANDBY mode with the instrument connected to mains power. For instruments disconnected from mains power less than 24 hours, the aging rate is $<5 \times 10^{-10}/\text{day}$ after a 24-hour warmup.

External Reference Input: 5 or 10 MHz at a level of 0.1 to 1 Vrms into 50 ohms. Stability and spectral purity of the microwave output will be partially determined by characteristics of the external reference frequency.

Reference Outputs: 10 MHz and 100 MHz at a level of 0.2 Vrms nominal into 50 ohms.

SPECTRAL PURITY

Single-sideband Phase Noise (1 Hz BW, CW mode, 2.0 to 6.6 GHz*):

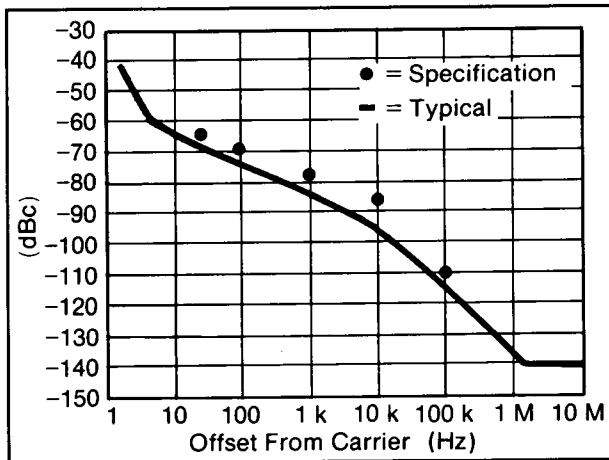

*Add 6 dB for 6.6 to 12.3 GHz, 10 dB for 12.3 to 18.6 GHz, and 12 dB for 18.6 to 26.0 GHz.

Residual FM in CW and FM Modes, 2.0 to 6.6 GHz* (noise and power line related):

Mode/FM Range	Post-Detection Bandwidth	
	300 Hz - 3 kHz	50 Hz - 15 kHz
CW, 30, and 100 kHz/V	12 Hz rms	60 Hz rms
300 kHz/V, and 1, 3, and 10 MHz/V	15 Hz rms	75 Hz rms

*Residual FM doubles for 6.6 to 12.3 GHz, triples for 12.3 to 18.6 GHz, and quadruples for 18.6 to 26.0 GHz.

Spurious Signals (CW and AM modes), Option 003 instruments (400 Hz line operation): Power line related and fan rotation related within 5 Hz below line frequency and multiples thereof:

Frequency Range (GHz)	Offset from Carrier		
	<2 kHz	2 to 8 kHz	>8 kHz
2.0-6.6	-40 dBc	-50 dBc	-65 dBc
>6.6-12.3	-34 dBc	-44 dBc	-59 dBc
>12.3-18.6	-30 dBc	-40 dBc	-55 dBc
>18.6-26.0	-28 dBc	-38 dBc	-53 dBc

RF OUTPUT

Output Level Switching Time (to be within ± 1 dB of final level with no range change):

Operating Mode	Output Level Switching Time
CW AM, Pulse, Sweep	<15 ms <5 ms

Table 1-2. Supplemental Characteristics (2 of 3)

RF OUTPUT (cont'd)

For power settings >0 dBm, changes in frequency of several GHz in one step may require additional AUTO PEAK enabling to stabilize power at the desired level. Spurious output oscillations may occur for settings above +8 dBm.

External leveling device characteristics will determine output flatness, absolute level accuracy, and switching time in external leveling modes.

Impedance: 50 ohms

Source SWR: <2.0

Output Level Accuracy:

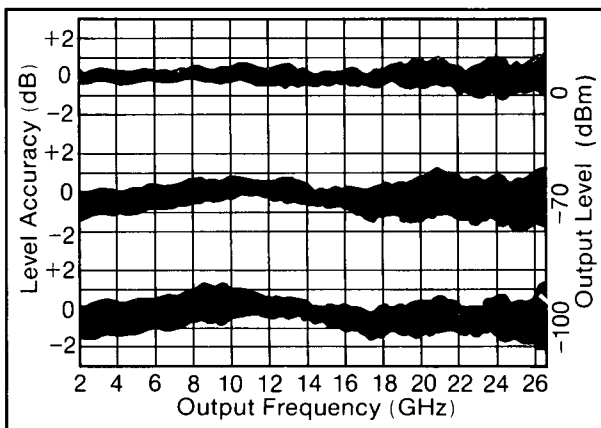

Typical HP 8673B output level accuracy at 0, -70, and -100 dBm level settings.

PULSE MODULATION

Pulse Width: Pulse widths less than 100 ns are possible with degraded peak power level accuracy relative to CW.

Pulse Input:

Normal Mode: >3V on, <0.5V off

Complement Mode: <0.5V on, >3V off

Impedance: 50 ohms nominal

Damage Level: More positive than +6 Vpk from <50 ohm source or more negative than -0.5 Vpk from ≤50 ohm source.

Pulse Width Compression: <35 ns

Maximum Delay Time: 150 ns

Video Feedthrough: <-50 dBc

AMPLITUDE MODULATION

Frequency Response Relative to a 1 kHz Rate: ±0.25 dB, 100 Hz—10 kHz.

Distortion:

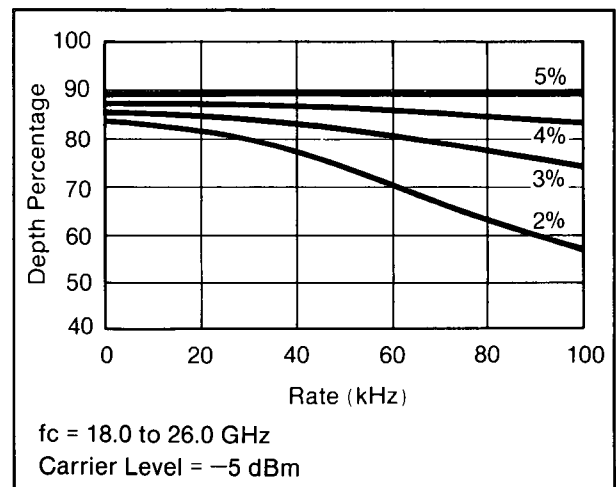
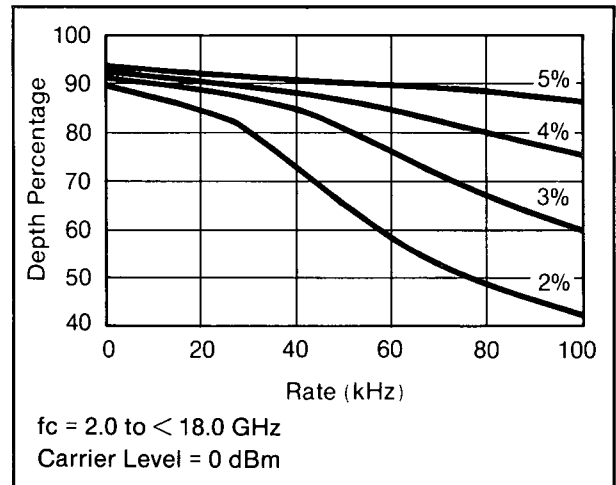

Typical HP 8673B AM distortion versus modulation rate and depth.

Table 1-2. Supplemental Characteristics (3 of 3)

FREQUENCY MODULATION

Rates (3 dB bandwidth): 100 Hz to 10 MHz, 30 and 100 kHz/V ranges; 1 kHz to 10 MHz, 300 kHz/V, and 1, 3, and 10 MHz/V ranges.

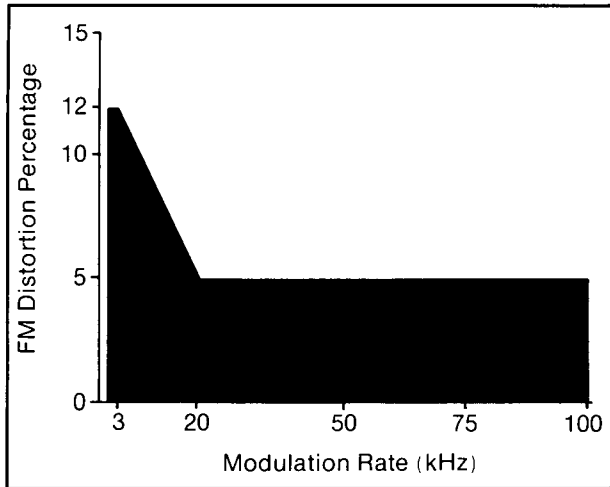

Typical HP 8673B FM Distortion versus modulation rate.

Table 1-3. Recommended Test Equipment (1 of 4)

Instrument	Critical Specifications	Recommended Model	Use*
AC Voltmeter	Range: 1 mV to 10V, Accuracy: $\pm 1.5\%$ of full scale $\pm 1.5\%$ of reading Frequency Response: 3 kHz to 3 MHz	HP 400E	P, A
Attenuator, Fixed 3 dB	Range: dc to 1 GHz Accuracy: ± 0.5 dB SWR: < 1.3	HP 8491A Option 003	P, A
Attenuator, Fixed 6 dB	Range: dc to 26 GHz Accuracy: ± 0.6 dB SWR: < 1.6	HP 8493C Option 006	P
Attenuator, Fixed 10 dB	Range: dc to 12.4 GHz Accuracy: ± 0.6 dB SWR: < 1.3	HP 8491A Option 010	P
Attenuator, Fixed 20 dB	Range: dc to 26 GHz Accuracy: ± 1.0 dB SWR: < 1.6	HP 8493C Option 020	P, A
Attenuator, 10 dB Step	Range: dc to 26 GHz Accuracy: $\pm 7\%$ SWR: < 2.2	HP 8495D Option 004	P
Audio Analyzer ¹	Frequency Range: 20 Hz to 100 kHz Accuracy: $\pm 4\%$ of full scale	HP 8903B	P
Audio Source ¹	Frequency Range: 20 Hz to 100 kHz Output Level: 1 mV to 6V open circuit Flatness: $\pm 2.5\%$	HP 8903B	P
Cable, Special Interconnect	Special (see Figure 1-2)	Locally Fabricated	A
Controller, HP-IB	HP-IB compatibility as defined by IEEE Standard 488-1978 and the identical ANSI Standard MC1.1: SH1, AH1, T2, TE0, L2, LE0, SR0, RL0, PP0, DC0, DT0, and C1, 2, 3, 4, 5. Automated adjustment programs require specific test equipment. Therefore no substi- tute is recommended	HP 85A/82937A/ 00085-15001/ 00085-15002/ 00085-15003/ 00085-15004/ 00085-15005 or HP 85B/82937A/ 00085-15002, 00085-15003, 00085-15005	C, A
Crystal Detector	Frequency Range: 2 to 26 GHz Frequency Response: ± 1.5 dB	HP 8473C	P
Current Probe	Frequency Range: 2 to 35 MHz	HP 1110B	A

Table 1-3. Recommended Test Equipment (2 of 4)

Instrument	Critical Specifications	Recommended Model	Use*
Digital Voltmeter	Automated adjustment programs require specific test equipment. No substitute is recommended.	HP 3456A	P, A, T
Foam Pads (2 required)	43 × 58 cm (17 × 23 in.), 5 cm (2 in.) thick		P
Frequency Counter	Range: 10 MHz to 26.5 GHz Resolution: 100 Hz 10 MHz Frequency Standard Output: ≥0.1 Vrms	HP 5343A	P, A
Frequency Standard	Long Term Stability: Better than 10^{-10} /day	HP 5065A	P, A
Local Oscillator	Range: 10 MHz to 26 GHz Level: 10 MHz to 18.6 GHz — +7 dBm 18.6 to 26 GHz — +5 dBm Single Sideband Phase Noise and Spurious Signals: Same as HP 8340B.	HP 8340B	P, A
Logic Pulser	TTL compatible	HP 546A	T
Mixer	Response: 1 to 26 GHz VSWR, LO: < 2.5:1 VSWR, RF: < 4.0:1	RHG DMS1-26 ²	P
Modulation Analyzer	Frequency Range: 150 to 990 MHz Input Level: -20 to +13 dBm Amplitude Modulation: Rates — 25 Hz to 25 kHz Depth — to 99% Accuracy — ±2% at 1 kHz Flatness — ±0.5% Demodulated Output Distortion — <0.3% for 50% depth; <0.6% for 90% depth Incidental Phase Modulation — <0.05 radians for 50% depth at 1 kHz rate (50 Hz to 3 kHz bandwidth) Frequency Modulation: Rates — 25 Hz to 25 kHz Deviation — to 99 kHz Accuracy — ±2% at 1 kHz	HP 8902A/11722A	P, A
Oscilloscope	Bandwidth: 100 MHz Vertical Sensitivity: 5 mV/div Vertical Input: ac, dc or 50Ω dc coupled External Trigger Capability Delayed Sweep Capability One-Shot Digitizer	HP 1980B/19860A	C, P, A, T

Table 1-3. Recommended Test Equipment (3 of 4)

Instrument	Critical Specifications	Recommended Model	Use*
Power Meter	Automated adjustment programs require specific test equipment. Therefore, no substitute is recommended.	HP 436A	P, A
Power Sensor	Frequency Range: 2 to 26 GHz Input Impedance: 50Ω SWR: < 1.25 Must be compatible with power meter	HP 8485A	P, A
Power Source, Variable Frequency AC	Range: 60 Vac to 240 Vac Frequency: 48 to 400 Hz Accuracy ± 2 Hz	California Instruments 501TC/800T ³	P P
Preamp - Power Amp	Preamp Frequency: 100 kHz to 1.3 GHz Gain: 26 ± 2 dB Output Power: > 7 dBm Noise Figure: < 8.5 dB Impedance: 50Ω Power Amp Frequency: 100 kHz to 1.3 GHz Gain: 22 ± 5 dB Output Power: > 6 dBm Noise Figure: < 5 dBm Impedance: 50Ω	HP 8447D HP8447E Note: HP 8447F is a dual amplifier and will satisfy both requirements.	P P
Probe, 10:1	Must be compatible with the oscilloscope.	HP 10081A	C, P, A
Pulse Generator	Rate: 10 Hz to 4 MHz Rise and Fall Times: < 5 ns Output Impedance: 50Ω Output Level: 0 to 3.5V Pulse Width: 80 ns to 2 μs	HP 8116A or HP 8013B	C, P, A
Signal Generator	Output Level: -5 to -20 dBm at 240 MHz	HP 8340B or HP 8640B	A
Signature Analyzer	Because signatures depend upon the model selected, only the models listed are approved for usage.	HP 5005A/B, HP 5006A	T
Spectrum Analyzer	Frequency Range: 20 Hz to 300 kHz Resolution Bandwidth: 3 Hz minimum Frequency Span/Division: 20 Hz minimum Noise Sidebands: > 90 dB below CW signal, 3 kHz offset, 100 Hz IF bandwidth Input Level Range: 0 to -70 dBm Log Reference: 70 dB dynamic range in 10 dB steps Accuracy: ± 0.2 dB Tracking Generator: 0 dBm to -11 dBm	HP 3585B	P

Table 1-3. Recommended Test Equipment (4 of 4)

Instrument	Critical Specifications	Recommended Model	Use*
Spectrum Analyzer System	Frequency Range: 10 MHz to 22 GHz Frequency Span/Division: 1 kHz minimum Amplitude Range: 0 to -70 dB Noise Sideband: > 75 dB down 30 kHz from signal at 1 kHz resolution bandwidth	HP 8566B	P, A
Support Kit	Required for servicing and troubleshooting.	HP 11726A	A, T
Sweep Oscillator	Center Frequency: 150 to 200 MHz Center Frequency Resolution: 0.1 MHz Sweep Range: 10 and 200 MHz	HP 8340B or HP 86222B/8620C	A
Termination 50Ω	50Ω BNC	HP 11593A	P, A
Test Oscillator	Level: 0 to 3V into 50Ω or 300Ω Range: 10 kHz to 10 MHz	HP 3335A	C, P

* C = Operator's Check, P = Performance Tests, A = Adjustments, T = Troubleshooting

¹ The HP 8903B is recommended for the combined use as an analyzer and audio source. A separate audio analyzer and an audio source can be used if critical specifications are met.

² RHG Electronics Laboratory, Inc., 161 East Industry Court, Deer Park, NY 11729, Tel. (516) 242-1100, TWX 510-227-6083.

³ California Instruments, 5150 Convoy Street, San Diego, CA 92111, Tel. (714) 279-8620.

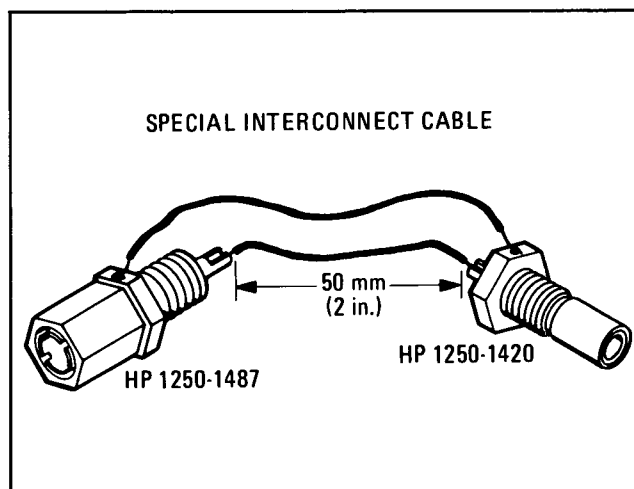

Figure 1-2. Special Interconnect Cable

Table 1-4. Abbreviated Performance Test Recommended Test Equipment (1 of 2)

Instrument	Critical Specifications	Recommended Model
Attenuator, Fixed 6 dB	Range: dc to 26 GHz Accuracy: ± 0.6 dB SWR: < 1.6	HP 8493C Option 006
Attenuator, Fixed 10 dB (two needed)	Range: dc to 12.4 GHz Accuracy: ± 0.6 dB SWR: < 1.3	HP 8491A, Option 010
Attenuator, Fixed 10 dB	Range: dc to 26 GHz Accuracy: ± 1.0 dB SWR: < 1.6	HP 8493C Option 010
Attenuator, Fixed 20 dB	Range: dc to 26 GHz Accuracy: ± 1.0 dB SWR: < 1.6	HP 8493C Option 020
Audio Analyzer	Frequency Range: 20 Hz to 100 kHz Accuracy: $\pm 4\%$ of full scale	HP 8903B
Audio Source	Frequency Range: 20 Hz to 100 kHz Output Level: 1 mV to 6V open circuit Flatness: $\pm 2.5\%$	HP 8903B
Cable, Semi-Rigid	8" length SMA (m, m)	Locally Fabricated
Digital Voltmeter	Resolution: ± 1 mV Range: .212 to .707 Vrms Frequency Response: 100 Hz to 100 kHz	HP 3456A
Frequency Counter	Range: 10 MHz to 26.5 GHz Resolution: 100 Hz 10 MHz Frequency Standard Output ≥ 1 Vrms	HP 5340A or HP 5343A
Local Oscillator	Range: 2 GHz to 19 GHz Level: $> +5$ dBm	HP 8340B
Mixer	Response: 1 to 26 GHz VSWR, LO: $\leq 2.5:1$ VSWR, RF: $\leq 4.0:1$	RHG DMS1-26 ¹
Measuring Receiver	Frequency Range: 150 to 990 MHz Input Level: -20 to $+13$ dBm Amplitude Modulation: Rates — 25 Hz to 25 kHz Depth — to 99% Accuracy — $\pm 2\%$ at 1 kHz Flatness — $\pm 0.5\%$ Demodulated Output Distortion — $< 0.3\%$ for 50% depth; $< 0.6\%$ for 90% depth Incidental Phase Modulation — < 0.05 radians for 50% depth at 1 kHz rate (50 Hz to 3 kHz bandwidth)	HP 8902A/11722A

Table 1-4. Abbreviated Performance Test Recommended Test Equipment (2 of 2)

Instrument	Critical Specifications	Recommended Model
Measuring Receiver (cont'd)	Frequency Modulation: Rates — 25 Hz to 25 kHz Deviation — to 99 kHz Accuracy — $\pm 2\%$ at 1 kHz	
Oscilloscope	Bandwidth: 100 MHz Vertical Sensitivity: 10 mV/div Vertical Input: ac, dc or 50 Ω dc coupled External Trigger Capability Delayed Sweep Capability One-Shot Digitizer	HP 1980B/19860A
Power Meter and Sensor	Frequency Range: 50 MHz to 26 GHz Input Impedance: 50 Ω SWR: < 1.25 Max Input Level: 15 dBm	HP 436A/HP 8485A
20 dB Preamp	Preamp Frequency: 100 kHz to 400 kHz Gain: 26 ± 6 dB Output Power: > 7 dBm Noise Figure: < 8.5 dB Impedance: 50 Ω	HP 8447D
20 dB Power Amp	Power Amp Frequency: 100 kHz to 400 kHz Gain: 22 ± 5 dB Output Power: > 6 dBm Noise Figure: < 5 dBm Impedance: 50 Ω	HP 8447E Note: HP 8447F is a dual amplifier and will satisfy both requirements.
Pulse Generator	Rate: 10 Hz to 4 MHz Rise and Fall Times: < 5 ns Output Impedance: 50 Ω Output Level: 0 to 3.5V Pulse Width: 80 ns to 2 μ s	HP 8116A or HP 8013B
Spectrum Analyzer	Frequency Range: 50 MHz to 7 GHz Frequency Span/Division: 1 kHz minimum Amplitude Range: 0 to -70 dB	HP 8566B
Test Oscillator	Level: 0 to 3V into 50 Ω or 300 Ω Range: 10 kHz to 10 MHz	HP 3335A or HP 8116A

¹ RHG Electronics Laboratory, Inc., 161 East Industry Court, Deer Park, NY 11729, Tel. (516) 242-1100, TWX 510-227-6083.

SECTION 2 INSTALLATION

2-1. INTRODUCTION

This section provides the information needed to install the Signal Generator. Included is information pertinent to initial inspection, power requirements, line voltage selection, power cables, interconnection, environment, instrument mounting, storage and shipment.

2-2. INITIAL INSPECTION

WARNING

To avoid hazardous electrical shock, do not perform electrical tests when there are signs of shipping damage to any portion of the outer enclosure (covers, panels, meters).

Inspect the shipping container for damage. If the shipping container or cushioning material is damaged, it should be kept until the contents of the shipment have been checked for completeness and the instrument has been checked mechanically and electrically. The contents of the shipment should be as shown in Figure 1-1. Procedures for checking electrical performance are given in Section 4. If the contents are incomplete, if there is mechanical damage or defect, or if the instrument does not pass the electrical performance test, notify the nearest Hewlett-Packard office. If the shipping container is damaged or the cushioning material shows signs of stress, notify the carrier as well as the Hewlett-Packard office. Keep the shipping materials for the carrier's inspection.

2-3. PREPARATION FOR USE

2-4. Power Requirements

The Signal Generator requires a power source of 100, 120, 220 or 240 Vac, +5% to -10%, 48 to 66 Hz single phase (for Option 003 instruments, 400 Hz single phase and 120 Vac, +5%, -10% only). Power consumption is 400 VA maximum.

WARNINGS

This is a Safety Class I product (that is, provided with a protective earth terminal). An uninterruptible safety earth ground must be

provided from the main power source to the product input wiring terminal, power cable or supplied power cable set. Whenever it is likely that the protection has been impaired, the product must be made inoperative and be secured against any unintended operation.

If this instrument is to be energized via an external autotransformer, make sure the auto transformer's common terminal is connected to the neutral (that is, the grounded side of the mains supply).

2-5. Line Voltage and Fuse Selection

CAUTION

BEFORE PLUGGING THIS INSTRUMENT into the mains (line) voltage, be sure the correct voltage and fuse have been selected.

Verify that the line voltage selection card and the fuse are matched to the power source. Refer to Figure 2-1, Line Voltage and Fuse Selection.

Fuses may be ordered under HP part numbers listed in the following table:

Fuse	100—120V		220—240V	
	Rating	HP P/N	Rating	HP P/N
A3F1	4A	2110-0055	2A	2110-0002

2-6. Power Cables

WARNING

BEFORE CONNECTING THIS INSTRUMENT, the protective earth terminal of this instrument must be connected to the protective conductor of the (mains) power cable. The mains plug shall only be inserted in socket outlets provided with a protective earth contact. The protective action must not be negated by the use of an extension cord (power cable) without a protective conductor (grounding).

Power Cables (cont'd)

This instrument is equipped with a three-wire power cable. When connected to an appropriate ac power receptacle, this cable grounds the instrument cabinet. The power cable plugs shipped with each instrument depend on the country of destination. Refer to Figure 2-2 for the part numbers of power cables available.

2-7. HP-IB Address Selection

In the Signal Generator, the HP-IB talk and listen addresses can be selected by an internal switch or by a front panel setting. Refer to Table 2-1 for a listing of talk and listen addresses. The address is factory set for a Talk address of "S" and a Listen address of "3". (In binary this is 10011; in decimal this is 19.)

Internal Switch Setting. To change the internal HP-IB address switch, proceed as follows:

WARNINGS

Internal switch settings should be changed only by service trained persons who are aware of the potential shock hazard of working on an instrument with protective covers removed.

Operating voltage is shown in module window.

SELECTION OF OPERATING VOLTAGE

1. Open cover door, pull the FUSE PULL lever and rotate to left. Remove the fuse.
2. Remove the Line Voltage Selection Card. Position the card so the line voltage appears at top-left corner. Push the card firmly into the slot.
3. Rotate the FUSE PULL lever to its normal position. Insert a fuse of the correct value in the holder. Close the cover door.

WARNING

To avoid the possibility of hazardous electrical shock, do not operate this instrument at line voltages greater than 126.5 Vac with line frequencies greater than 66 Hz (leakage currents at these line settings may exceed 3.5 mA).

Figure 2-1. Line Voltage and Fuse Selection

<p>220/240V OPERATION</p>  <p>PLUG*: SEV 1011.1959-24507 TYPE 12 CABLE*: HP 8120-2104</p>	<p>220/240V OPERATION</p>  <p>PLUG*: NZSS 198/AS C112 CABLE*: HP 8120-1369</p>	<p>100/120V OPERATION</p>  <p>PLUG*: NEMA 5-15P CABLE*: 8120-1378</p>	<p>220/240V OPERATION</p>  <p>PLUG*: NEMA 6-15P CABLE*: HP 8120-0698</p>
<p>220/240V OPERATION</p>  <p>PLUG*: CEE7-VII CABLE*: HP 8120-1689</p>	<p>220/240V OPERATION</p>  <p>PLUG*: DHCK 107 CABLE*: HP 8120-2956</p>	<p>220/240V OPERATION</p>  <p>PLUG*: BS 1363A CABLE: HP 8120-1351</p>	
<p>*The number shown for the plug is the industry identifier for the plug only. The number shown for the cable is an HP part number for a complete cable including the plug.</p>			

Figure 2-2. Power Cable and Mains Plug Part Numbers

Address Selection Cont'd

To avoid hazardous electrical shock, the line (mains) power cable should be disconnected before attempting to change the internal HP-IB address switch settings.

NOTE

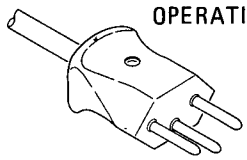
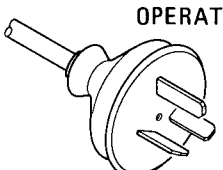
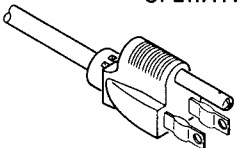
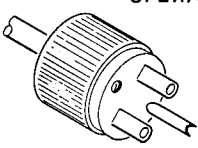
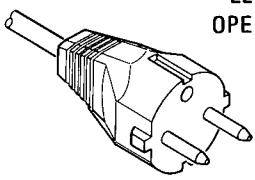
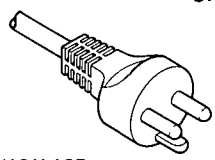
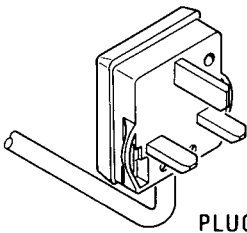
The HP-IB address switches can be set without removing any circuit boards from the Signal Generator. If any circuit boards are removed, observe all electrostatic discharge precautions to avoid damaging the Signal Generator.

- a. Set the LINE switch to STBY. Disconnect the line power cable.
- b. Remove the Signal Generator's top cover by removing the two plastic standoffs from the rear of the top cover and loosening the screw at the middle of the rear edge of the top cover.

Table 2-1. Allowable HP-IB Address Codes

Address Switches					Talk Address Char-acter	Listen Address Char-acter	Decimal Equiv-alent
MSB				LSB			
0	0	0	0	0	@	SP	0
0	0	0	0	1	A	!	1
0	0	0	1	0	B	"	2
0	0	0	1	1	C	#	3
0	0	1	0	0	D	\$	4
0	0	1	0	1	E	%	5
0	0	1	1	0	F	&	6
0	0	1	1	1	G	'	7
0	1	0	0	0	H	(8
0	1	0	0	1	I)	9
0	1	0	1	0	J	*	10
0	1	0	1	1	K	+	11
0	1	1	0	0	L	,	12
0	1	1	0	1	M	-	13
0	1	1	1	0	N	.	14
0	1	1	1	1	O	/	15
1	0	0	0	0	P	0	16
1	0	0	0	1	Q	1	17
1	0	0	1	0	R	2	18
1	0	0	1	1	S	3	19
1	0	1	0	0	T	4	20
1	0	1	0	1	U	5	21
1	0	1	1	0	V	6	22
1	0	1	1	1	W	7	23
1	1	0	0	0	X	8	24
1	1	0	0	1	Y	9	25
1	1	0	1	0	Z	:	26
1	1	0	1	1	[;	27
1	1	1	0	0	}	<	28
1	1	1	0	1]	=	29
1	1	1	1	0	^	>	30

c. Remove the A2 Assembly's protective cover. The A2 Assembly is located just forward and to the left of the fan (as viewed from the rear).

d. Locate the A2A9 Frequency Output/HP-IB Assembly. This assembly can be recognized as having one black and one white printed circuit board extractor.

e. Set the switches to the desired HP-IB address (in binary) or the Talk Only or Listen Only setting. The switch is illustrated in Figure 2-3. If both the Talk Only and the Listen Only switches are set to "1", the Talk Only setting overrides the Listen Only setting. Setting the address switch to Talk Only or Listen Only selects a unique HP-IB address; Talk Only = 50, Listen Only = 40. Talk Only and Listen Only are used when the Signal Generator is in a master/slave configuration. See the Detailed Operating Instructions in Section 3 for more information.

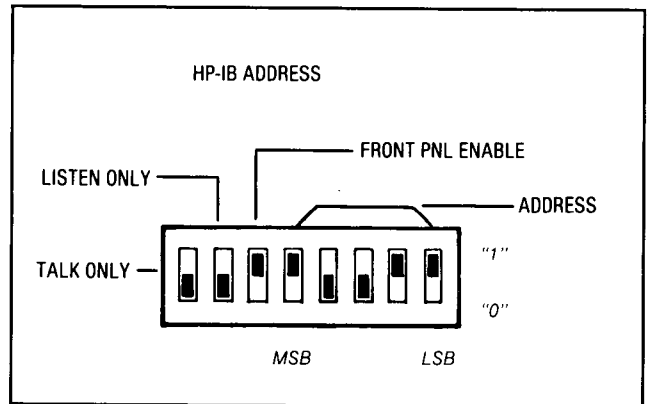

Figure 2-3. HP-IB Address Switch Shown as Set by the Factory

f. To confirm the address setting, turn on the Signal Generator and press and hold the LOCAL/DISPLAY ADDRESS key on the front panel. The current HP-IB address will be displayed in decimal in the FREQUENCY MHz display.

g. Replace the A2 Assembly's internal cover and the Signal Generator's top cover. Replace the two plastic standoffs.

h. Connect the line (mains) power cable to the Line Power Module and set the LINE switch to ON.

Front Panel HP-IB Address Setting. To set the Signal Generator's HP-IB address from the front panel, the FRONT PNL ENABLE switch on the

HP-IB Address Selection (cont'd)

HP-IB address switch must be set to "1". To change the address from the front panel, key in the desired address, press the STO key, then press the LOCAL key. Refer to Remote Operation, HP-IB, in Section 3 for additional information.

2-8. Interconnections

Interconnection data for the Hewlett-Packard Interface Bus is provided in Figure 2-4.

2-9. Mating Connectors

HP-IB Interface Connector. The HP-IB mating connector is shown in Figure 2-4.

AUX Interface Connector. The rear panel AUX control connector requires a male 14-pin Micro-Ribbon (57 Series) connector. The HP part number is 1251-0142. This connector is also available from Amphenol (Oak Brook, Illinois 60521). Interconnection data for the rear panel AUX control connector is provided in Figure 2-5.

Coaxial Connectors. Coaxial mating connectors used with the RF Output of the Signal Generator should be APC 3.5 female connectors.

CAUTION

Using an SMA connector may damage the RF output connector unless care is used to avoid excessive torque.

2-10. Frequency Reference Sensitivity Selection

The Signal Generator generates a dc voltage that is proportional to the CW RF frequency. This voltage is available at the rear panel FREQ REF connector. Signal Generators with serial number prefixes of 2626A, 2608A, and 2540A and below have a frequency reference voltage sensitivity of 1 V/GHz. Signal Generators with serial number prefixes of 2552A or 2634A and above have a selectable frequency reference voltage sensitivity of 0.5 V/GHz or 1 V/GHz. The sensitivity is selected using C1 of switch S2 on A2A7, the I/O assembly.

2-11. Operating environment

The operating environment should be within the following limitations:

- Temperature 0 to +55°C
- Humidity <95% relative
- Altitude <4570 metres (15 000 feet)

Specifications for harmonically related spurious signals, RF output, pulse, and amplitude modulation apply only over the temperature range of +15 to +35°C.

2-12. Bench Operation

The instrument cabinet has plastic feet and fold-away tilt stands for convenience in bench operation. (The plastic feet are shaped to ensure self-aligning of the instruments when stacked.) The tilt stands raise the front of the instrument for easier viewing of the front panel.

2-13. Rack Mounting

WARNING

The Signal Generator weighs 29 kg (64 lbs), therefore extreme care must be exercised when lifting to avoid personal injury.

To avoid personal injury and equipment damage, use equipment slides when rack mounting the instrument.

Rack mounting information is provided with the rack mounting kits. If the kits were not ordered with the instrument as options, they may be ordered through the nearest Hewlett-Packard office. Refer to the paragraph entitled Mechanical Options in Section 1.

2-14. STORAGE AND SHIPMENT

2-15. Environment

The instrument should be stored in a clean, dry environment. The following environmental limitations apply to both storage and shipment:

- Temperature -55 to +75°C
- Humidity <95% relative
- Altitude 15 300 metres (50 000 feet)

2-16. Packaging

Preparation for Packaging. Remove handles and/or rack mount flanges before packaging instrument for shipping.

Tagging for Service. If the instrument is being returned to Hewlett-Packard for service, please complete one of the blue repair tags located at the back of this manual and attach it to the instrument.

STORAGE AND SHIPMENT (Cont'd)

Original Packaging. Containers and materials identical to those used in factory packaging are available through Hewlett-Packard offices. Mark the container "FRAGILE" to assure careful handling. In any correspondence refer to the instrument by model number and full serial number.

Other Packaging. The following general instructions should be used for re-packaging with commercially available materials:

a. Wrap the instrument in heavy paper or plastic. (If shipping to a Hewlett-Packard office or service center, complete one of the blue tags mentioned above and attach it to the instrument.)

b. Use a strong shipping container. A double-wall carton made of 2.4 MPa (350 psi) test material is adequate.

c. Use enough shock-absorbing material (75 to 100 mm layer; 3 to 4 inches) around all sides of the instrument to provide firm cushion and prevent movement in the container. Protect the front panel with cardboard.

d. Seal the shipping container securely.

e. Mark the shipping container "FRAGILE" to assure careful handling.

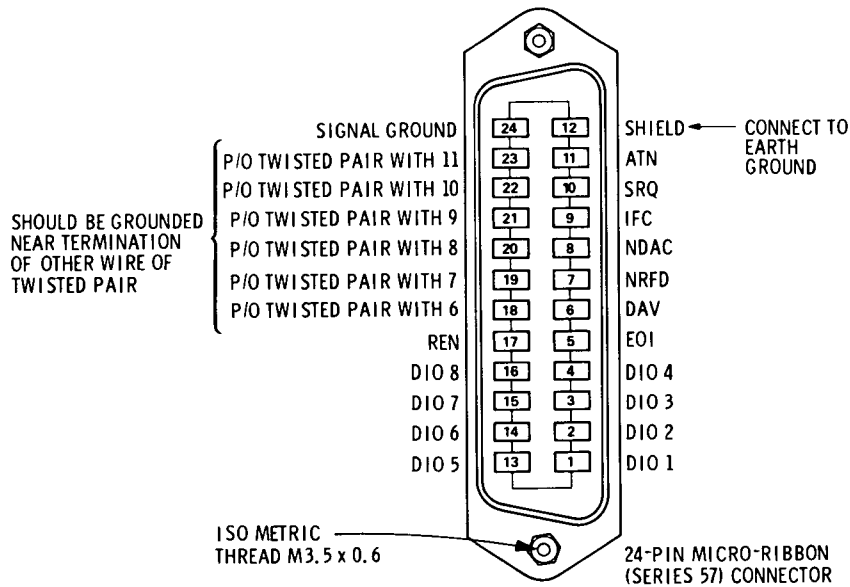

Logic Levels

The Hewlett-Packard Interface Bus Logic Levels are TTL compatible, i.e., the true (1) state is 0.0 Vdc to +0.4 Vdc and the false (0) state is +2.5 Vdc to +5.0 Vdc.

Programming and Output Data Format

Refer to Section 3, Operation.

Mating Connector

HP 1251-0293; Amphenol 57-30240.

Mating Cables Available

HP 10833A, 1 metre (3.3 ft), HP 10833B, 2 metres (6.6 ft)
 HP 10833C 4 metres (13.2 ft), HP 10833D, 0.5 metres (1.6 ft)

Cabling Restrictions

1. A Hewlett-Packard Interface Bus system may contain no more than 2 metres (6 ft) of connecting cable per instrument.
2. The maximum cumulative length of connecting cable for any Hewlett-Packard Interface Bus system is 20.0 metres (65.6 ft).

A3W18 HP-IB Adapter

HP part number 5060-9462.

Figure 2-4. Hewlett-Packard Interface Bus Connection

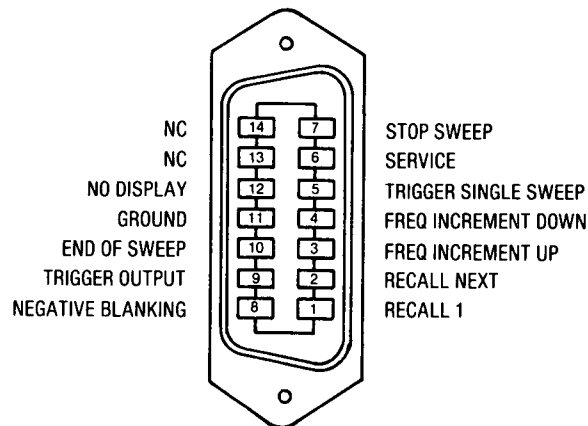

14-Pin Micro-Ribbon (57 Series) Connector

Logic Levels

The rear panel AUX connector logic levels are TTL compatible (5 microseconds negative-true TTL pulse or a contact closure to ground).

Internal Jumper Selection

If the signals to the rear panel AUX connector require contact debouncing (e.g., for mechanical switches), an internal jumper must be changed. The jumper is installed at the factory for electronically clean input signals (i.e., those signals that do not require the use of the debounce circuit). The jumper is located on the A2A2 Key-Code board. To change the jumper position, the top cover of the Signal Generator must be removed.

WARNINGS

This task should be performed by service trained persons who are aware of the potential shock hazard of working on an instrument with protective covers removed.

To avoid hazardous electrical shock, the line (mains) power cable should be disconnected before removing the Signal Generator's cover.

The following procedure describes how to locate and change the jumper position.

- a. Set the LINE switch to STBY and disconnect the line power cable.
- b. Remove the Signal Generator's top cover by removing the two plastic feet from the rear of the top cover and loosening the screw at the middle of the rear edge of the top cover.
- c. Remove the A2A2 Key-Code board by gently lifting the board's extractors (the extractors are color-keyed red and black).
- d. The jumper is located on the center of the board.
- e. To enable the debounce circuit remove the jumper from W2 and reinstall the jumper at W1.
- f. Reinstall the A2A2 Key-Code board and the Signal Generator's top cover.

Figure 2-5. AUX Interface Connector

SECTION 3 OPERATION

3-1. INTRODUCTION

This section provides complete operating information for the HP 8673B Signal Generator. Included are both general and detailed operating instructions, detailed descriptions of the front and rear panel, local and remote operator's checks, and operator's maintenance procedures.

3-2. System Compatibility

System compatibility is defined as the ability of the Signal Generator to operate in system mode. System mode enables the Signal Generator to control a compatible external amplifier, frequency multiplier, etc.

Two methods can be used to determine system compatibility:

1. Serial Number Prefix Examination.
2. Front Panel Examination.

Serial Number Prefix Examination. Check the prefix of the Signal Generator's serial number. If the prefix is 2552A or 2634A and above, the Signal Generator is system compatible.

Front Panel Examination. Examine the front panel of the Signal Generator. In the lower middle of the front panel, underneath the **FREQ INCR** key, are two small keys. If the left-hand key is blue, the Signal Generator is system compatible. See Figure 3-1 for key location.

3-3. Operating Characteristics

Table 3-1 briefly summarizes the major operating characteristics of the Signal Generator. This table is not intended to be a complete listing of all operations and ranges but gives a general description of the instrument's capabilities. For more information on the Signal Generator's capabilities, refer to Table 1-1, Specifications, and Table 1-2, Supplemental Characteristics. For information on HP-IB capabilities, refer to the summary contained in Table 3-3, Message Reference Table.

3-4. Local Operation

Information covering front panel operation of the Signal Generator is given in the sections described

below. To quickly learn the operation of the instrument, begin with Simplified Operation, Operator's Checks and the instrument's pull-out card. Once familiar with the general operation of the instrument, use the Detailed Operating Instructions for more complete information about operating the Signal Generator.

Turn-On Information. Instructions relating to the Signal Generator's turn-on procedure are presented in paragraphs 3-9 through 3-11 to acquaint the user with the general operation of the instrument. The user should perform these procedures prior to using the Simplified Operating Instructions, or the Detailed Operating instructions.

Simplified Operation. The instructions located on the inside of this fold provide a quick introduction to front panel operation of the Signal Generator. These instructions are designed to quickly acquaint the new user with basic operating procedures and therefore are not an exhaustive listing of all Signal Generator functions. Additional operating information is given in paragraphs 3-12 through 3-16.

Detailed Operating Instructions. The Detailed Operating Instructions provide the complete operating reference for the Signal Generator user. The instructions are organized alphabetically by subject and are placed at the end of this section for easy reference. They are also indexed by subject in Table 3-7.

Panel Features. Front and rear panel features are described in detail in Figures 3-1 through 3-7.

Operating Information Pull-Out Card. The Operating Information pull-out card is a flexible plastic reference sheet located in a tray below the front panel. It presents general operating instructions. With examples of most of the Signal Generator's features, it is a good learning aid as well as a quick reference.

3-5. Remote Operation

HP-IB. The Signal Generator is capable of remote operation via the Hewlett-Packard Interface Bus (HP-IB). In remote operation, the Signal Generator operates in one of three modes: normal talker/lis-

Table 3-1. Operating Characteristics

Frequency	Range: 2.0 to 26.0 GHz 1.95 to 26.5 GHz overrange Resolution 1 kHz 2.0 to 6.6 GHz 2 kHz 6.6 to 12.3 GHz 3 kHz 12.3 to 18.6 GHz 4 kHz 18.6 to 26.0 GHz
Output Level	Range: -90 to +10 dB in 10 dB steps (except Options 001 and 005) 0 and +10 dB (Options 001 and 005 only) Vermier: -10 to +3 dBm continuously variable
Modulation	AM Sensitivity: 30%/V and 100%/V ranges Maximum Input: 1 Vpk into 600 ohms nominal Rates (3 dB bandwidth): 20 Hz to 100 kHz FM Ranges: 30 kHz/V, 100 kHz/V, 300 kHz/V, 1 MHz/V, 3 MHz/V, and 10 MHz/V Maximum Input: 1 Vpk into 50 ohms nominal Maximum Peak Deviation: the smaller of 10 MHz or $f_{mod} \times 5$ 2.0 to 6.6 GHz $f_{mod} \times 10$ >6.6 to 12.3 GHz $f_{mod} \times 15$ >12.3 to 18.6 GHz $f_{mod} \times 20$ >18.6 to 26.0 GHz Rates (3 dB bandwidth): 100 Hz to 3 MHz for 30 kHz/V and 100 kHz/V ranges; 3 kHz to 3 MHz for 300 kHz/V, 1 MHz/V, 3 MHz/V, and 10 MHz/V ranges Pulse Pulse Input: Normal Mode: >3V on, <0.5V off Complement Mode: <0.5V on, >3V off Impedance: 50 ohms nominal RF Output: ON/OFF Ratio: >80 dB Rise and Fall Times: <35 ns <40 ns (Option 008) Minimum Leveled Pulse Width: <100 ns Pulse Repetition Frequency: dc to 1 MHz
Sweep	Configuration: Start-Stop Frequencies or Center Frequency- Δ F (Span) Modes: Automatic, Single, and Manual Step Size: as large as sweep span to as small as 1 kHz 2.0 to 6.6 GHz 2 kHz 6.6 to 12.3 GHz 3 kHz 12.3 to 18.6 GHz 4 kHz 18.6 to 26.0 GHz Number of Steps: 1 to 9999 Dwell Time: 1 to 255 ms per step Markers: 5 Markers Rear Panel BNC Sweep Connections: Sweep Out; Sweep Reference; Z-Axis Blanking/Markers; Tone Marker Output; Penlift

Output level controlled from +10 to -90 dB with continuous level vernier leveling of output power external diode, external meter, or (2552A, 2634) system references.

Output level settable from dBm. Resolution is 0.1 dB control.

 The RF Output against reverse power a 1W. However, for best internal circuitry, do not reverse power.

Remote Operation (cont'd)

tener, talk only or listen only. The HP-IB operating instructions are found in paragraphs 3-23 through 3-45. These instructions relate to remote operation, including capabilities, addressing, input and output formats, the status byte, and service requests. At the end of the discussion is a complete summary of all codes.

In addition to the section described above, information concerning remote operation appears in several other locations. General information about HP-IB codes and formats appear on the Operating Information pull-out card. Numerous examples of program strings appear throughout the Detailed Operating Instructions described under Local Operation above.

Auxiliary. The following keyboard functions can be controlled by TTL signals at the rear panel AUX connector:

RECALL 1
FREQ INCREMENT (up and down)
SINGLE Sweep

In addition, several remote-only functions are available. These controls are described in detail in paragraphs 3-19 through 3-22.

3-6. Operator's Checks

Operator's Checks are procedures designed to verify the proper operation of the Signal Generator's main functions. Two procedures are provided as described below.

Basic Functional Checks. This procedure, found in paragraph 3-18, requires a function generator, a microwave frequency counter, a power meter, a power sensor, a crystal detector, and interconnecting cables. It assures that most front panel controlled functions are being properly executed by the Signal Generator.

HP-IB HP-IB Functional Checks. These procedures, found in paragraph 3-19, require an HP-IB compatible computing controller, an HP-IB interface, and connecting cable. The procedures check all of the applicable bus messages summarized in Table 3-3. The HP-IB Checks assume that front panel operation has been verified by performing the Basic Functional Checks.

3-7. Operator's Maintenance

WARNING

For continued protection against fire hazard, replace the line fuses with 250V fuses of the same rating only. Do not use repaired fuses or short-circuited fuseholders.

Operator's maintenance consists of replacing defective fuses and adjusting the mechanical zero of the front panel meter.

The primary power fuse is located within the Line Power Module Assembly. Refer to Figure 2-1 for instructions on how to change the fuse.

To mechanically zero the front panel meter, set the LINE switch to the STBY position and place the Signal Generator in its normal operating position. Turn the mechanical zeroing adjustment clockwise to move the

Operator's Maintenance (cont'd)

needle up scale or counter-clockwise to move the needle down scale. The zero point is located at the left end of the 0—1 or the 0—3 scales. DO NOT zero on the left end of the top dB scale at —10 because this is not the proper zeroing point.

If the instrument does not operate properly and is being returned to Hewlett-Packard for service, please complete one of the blue tags located at the end of this manual and attach it to the instrument. Refer to Section 2 for packaging instructions.

3-8. Battery Replacement

Yearly replacement of the internal battery is recommended to ensure proper operation of the memory circuitry. See Service Sheet 26 of the HP 8673B Service Manual for the location of the battery.

WARNING

To replace the battery, the Signal Generator's protective covers must be removed. This should only be done by service-trained personnel who are aware of the hazards involved (for example, fire and electrical shock).

FRONT PANEL FEATURES

Message key illuminates or flashes to indicate input errors or hardware failures respectively. Depressing the key displays error/malfunction code in frequency display.

Amplitude, frequency, and pulse modulation of microwave carrier via external modulating signals.

Calibrated metering of output level vernier, AM depth, and FM deviation.

Output level controlled in 10 dB steps from +10 to -90 dB with -10 to +3 dBm continuous level vernier.

Leveling of output power by internal, external diode, external power meter, or (2552A, 2634A and above) system references.

Output level settable from +13 to -100 dBm. Resolution is 0.1 dB under HP-IB control.

! The RF Output is protected against reverse power applications up to 1W. However, for best protection of internal circuitry, do not apply any reverse power.

AUTO, MANUAL, and SINGLE digital sweep modes.

11-digit LED display for all frequency related parameters and error/malfunction messages.

Annunciators monitor instrument modes for confidence in operational status.

HP-IB address displayed and set by front panel keystroke sequence.

Rotary pulse generator tuning knob and up/down increment keys change frequency in user-selected steps.

Frequency entered by function, data, and unit keys. XFREQ key is used as a units key for entry of frequency multiplication factors.

(2552A, 2634A and above): Store and recall up to 9 front panel settings for measurement efficiency. Blue SHIFT key required for store function.

(2608A-2626A, 2530A and below): Recall up to 9 front panel settings for measurement efficiency.

(2552A, 2634A and above): Blue SHIFT key allows access to secondary functions of certain keys. Keys containing shift functions are labeled with that function in blue.

(2608A-2626A, 2530A and below): STORE key permits storing up to 9 front panel settings for measurement efficiency.

Pull-out card for convenient operating reference and error code interpretation.

AUTO PEAK function maximizes available output power at RF connector and optimizes pulse modulation characteristics.

Refer to Figure 3-2 through 3-6 for detailed description of these features.

Figure 3-1. Front Panel Features

SIMPLIFIED OPERATION PRESETTING THE FRONT PANEL

Press **REC** **0** to set the front panel to the following conditions:

- RF OUTPUT to ON
- ALC Mode to INTERNAL
- RANGE to -70 dB (except Options 001 and 005)
- RANGE to 0 dB (for Options 001 and 005 only)
- AUTO PEAK to ON
- Meter Scale to LVL
- AM, FM, and PULSE Modulation to OFF
- FREQUENCY to 3000.000 MHz
- FREQ INCR to 1.000 MHz
- START to 2000.000 MHz
- STOP to 4000.000 MHz
- ΔF to 2000.000 MHz
- MKRS to OFF (initialized to 3, 6, 9, 12, and 15 GHz)
- SWEEP MODE to OFF
- STEP to 100 steps (20.000 MHz step size)
- DWELL to 20 ms
- TUNE Knob to ON

PRESETTING THE FRONT PANEL FOR SYSTEM MODE (2552A, 2634A and above)

Press **REC** **←** to invoke an alternate set of preset conditions more suitable for system mode. (System mode enables the Signal Generator to control a compatible external amplifier, multiplier, etc.) These preset conditions are shown below.

- RF OUTPUT to ON
- OFFSET = 0
- MULTIPLIER unchanged
- RANGE to -70 dB (except Options 001 and 005)
- RANGE to 0 dB (for Options 001 and 005)
- AUTO PEAK to ON
- Meter Scale to LVL
- FREQUENCY to 14 000.000 MHz x multiplier
- FREQ INCR to 1.000 MHz x multiplier
- START to 13 000.000 MHz x multiplier
- STOP to 15 000.000 MHz x multiplier
- ΔF to 2 000.000 MHz x multiplier
- MKRS to OFF (initialized to 3, 6, 9, 12, and 18 GHz x multiplier)
- SWEEP MODE to OFF
- STEP to 100 steps (20.000 MHz x multiplier)
- DWELL to 20 ms
- TUNE knob to ON
- ALC mode unchanged

SETTING FREQUENCY

Frequency and frequency increment values are set in a Function-Data-Units format.

For example, to set frequency to 4.5 GHz and frequency increment to 500 MHz:

FUNCTION	DATA	UNITS
FREQ	4 . 5	GHz
FREQ INCR	5 0 0	MHz

Frequencies may be entered in GHz, MHz, or kHz, but are always displayed in MHz.

To change the current frequency by the selected increment value, use:

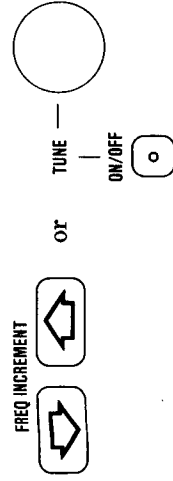

SETTING FREQUENCY IN SYSTEM MODE (OFFSET & MULTIPLIER) (2552A, 2634A and above)

The SYSTEM FREQ (shifted SWEEP FREQ) keys are used to enter and display offset or multiplied frequencies. (For use with external devices such as multipliers, mixers, etc.)

OFFSET

To set an offset of + (or -) 10 MHz (for example, for use with an external mixer) press:

SHIFT **+OFFSET** **0** **0** (or **0** **0**) **1** **0** **MHz**

The entered and displayed frequency is 10 MHz *above* (or *below*) the Signal Generator's actual output frequency.

To end the use of the offset function press:

SHIFT **+OFFSET** **0** **0** (or **0** **0**) **0** **MHz**

MULTIPLIER

To accommodate an external x2 multiplier press:

SHIFT **MULT** **XFREQ** **2**

The displayed frequency will be twice the signal Generator's actual output frequency.

Note: When in multiplier mode, enter frequencies according to desired output. For example, to obtain 30 GHz, enter 30 GHz into the keyboard. The Signal Generator will output 15 GHz into the x2 frequency multiplier.

To end the use of the multiplier function press:

SHIFT **MULT** **XFREQ** **1**

SETTING THE OUTPUT LEVEL

The output level is set with the RANGE and VERNIER controls.

First, press ^{ALC}_{INTERNAL} To maintain output power at a constant level.

Then, press ^{RANGE} to step the output level down or up by increments of 10 dB. The selected range is shown in the RANGE dB display.

Then, press ^{MTR} LVL to select OUTPUT LEVEL VERNIER to be displayed on the meter.

Adjust ^{VERNIER} between -10 and +3 dBm, as read on the meter.

The output level is determined by adding the meter dBm display to the RANGE dB display.

Enable ^{AUTO}_{PEAK} to ON to maximize power at the output frequency, minimize power of spurious signals and optimize pulse shape for pulse modulation.

STORE/RECALL

Up to nine front panel settings can be stored for later use. All Signal Generator front panel functions can be stored, although OUTPUT LEVEL VERNIER is stored in remote mode only.

(2552A, 2634A and above):

stores a front panel setting in register 3.

recalls a front panel setting stored in register 4 and changes the output of the Signal Generator to the recalled parameters.

(2608A-2626A, 2530A and below):

stores a front panel setting in register 3.

recalls a front panel setting stored in register 4 and changes the output of the Signal Generator to the recalled parameters.

MODULATION

Three types of modulation are available: amplitude (AM), frequency (FM), and pulse. Each type requires an external drive signal. Front panel keys select the maximum of AM depth, FM deviation in MHz, and normal (NORM) or complement (COMPL) pulse mode. For AM and FM, a 1 V_{pk} signal develops full scale modulation. Modulation varies linearly with the input signal. For pulse modulation, a TTL level positive-true pulse turns RF on in normal mode. A TTL level negative-true pulse turns RF on in complement mode.

MESSAGES

Entry errors, hardware malfunctions, and other significant conditions are indicated by the lighted MESSAGE key.

Press ^{MESSAGE} to read the two-digit code in the FREQUENCY MHz display. The codes are explained in Table 3-8 and on the operating information pull-out card.

SWEEP

Values for SWEEP FREQ (START, STOP, ΔF , and MKR) and SWEEP RATE (STEP and DWELL) are entered in a Function-Data-Units format.

SWEEP FREQ

The SWEEP FREQ keys set the span of the sweep (that is, the range that the sweep covers). The sweep span can be set with either the START and STOP keys or with the FREQUENCY and ΔF keys.

For example, to set a sweep span of 2 GHz with a start frequency of 7 GHz and a stop frequency of 9 GHz press:

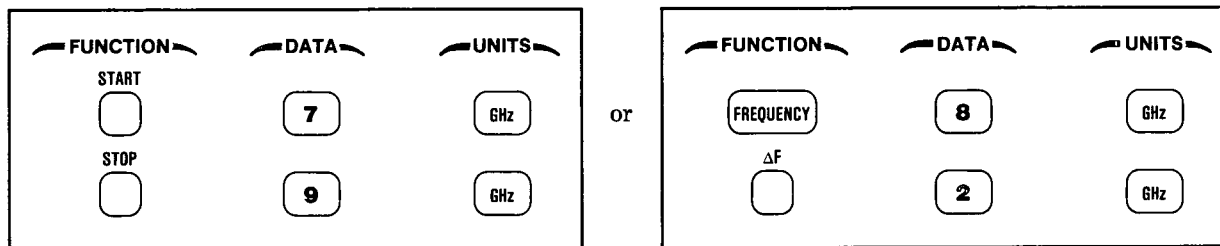

SWEEP RATE

During a sweep, the Signal Generator changes frequency in discrete steps. Sweep rate is determined by the number of steps and the dwell time. The number of steps can be set in either of two ways.

To set the number of steps to be used in a sweep press ^{STEP}, use the numeric keys to enter the number of steps, then press _{ms}.

The sweep span is divided by the number of steps to determine the step size.

To set the step size, press ^{STEP}, use the numeric keys to enter the step size, then press GHz or MHz or kHz.

The sweep span is divided by the step size to determine the number of steps.

The dwell time determines how much time elapses before the next frequency step is taken.

To set the dwell time, press ^{DWELL}, use the numeric keys to enter time in milliseconds, then press _{ms}.

SWEEP MODE

To start a sweep press:

^{AUTO} for a repetitive sweep. If the k band amplifier (Option 008 only) crossing is required, only a single sweep will be executed and message 16 will be issued. The Auto key indicator will remain lit to indicate sweep has stopped.

^{MANUAL} for a sweep that is controlled by the TUNE knob or the FREQ INCREMENT Up or Down keys.

^{SINGLE} for one sweep only. Press this key once to tune the Signal Generator to the start frequency. Then, press this key again to actually initiate the sweep.

To stop a sweep, in any mode, press ^{OFF}.

3-9. GENERAL INSTRUCTIONS

WARNINGS

Before the instrument is switched on, all protective earth terminals, extension cords, autotransformers and devices connected to it should be connected to a protective earth grounded socket. Any interruption of the protective earth grounding will cause a potential shock hazard that could result in personal injury.

Only 250V normal blow fuses with the required rated current should be used. Do not use repaired fuses or short circuit fuseholders. To do so could cause a shock or fire hazard.

CAUTION

Before the instrument is switched on, it must be set to the voltage of the power source or damage to the instrument may result.

The Signal Generator's RF OUTPUT is protected against reverse power applications up to 1W. However, for greatest protection of expensive internal components, be careful not to apply any reverse power to the RF OUTPUT.

3-10. Turn-On

Turn-On Procedure. The Signal Generator has a standby state and an on state. Whenever the power cable is plugged in, an oven is energized to keep the reference oscillator at a stable operating temperature. If the Signal Generator is already plugged in, set the LINE switch to ON.

If the power cable is not plugged in, follow these instructions.

On the rear panel:

1. Check the selection card (see Figure 2-1) for correct voltage selection.
2. Check that the fuse rating is appropriate for the line voltage used. Fuse ratings are printed on the rear panel.
3. Plug in the power cable.

On the front panel, set the LINE switch to ON.

NOTE

The OVEN COLD status annunciator should light to indicate that the Signal Generator requires warming up. The annunciator should turn off within fifteen minutes and the Signal Generator should be ready for general use.

Turn-On Configuration. The Signal Generator turns on to the same control settings it had before it was switched to STBY or even completely off (that is, if line power was removed). The exception to this rule is that it always turns on in local mode.

Turn-On Memory Check. The Signal Generator performs a quick memory check at turn-on. It checks for a failure in ROM (permanent memory) or in RAM (temporary memory), and for the presence of correct data stored in RAM.

NOTE

An internal battery is used to retain data in RAM during standby and off periods. The data restores the last control setup and the nine storage registers.

If a ROM or serious RAM failure occurs, the Signal Generator will attempt to turn on to its last control setup. The Signal Generator might be useable but does require service.

If any, but not all, of the stored data is found to be incorrect, the Signal Generator will turn on to the configuration stored in the first valid register. This control setup will then be stored in registers 1 through 9. Incorrect stored data could be caused by even a single bit of data being lost due to line transients, noise or other unpredictable conditions. The Signal Generator should be useable and does not require service unless this situation occurs repeatedly.

If all of the register data has been altered (for example, if the battery failed) the Signal Generator will reinitialize to the front panel preset values stored in register 0 (refer to Simplified Operation for a list of preset values). The initialized control setup will then be stored in all of the registers. The Signal Generator might be useable but does require service.

3-11. Frequency Standard Selection

A FREQ STANDARD INT/EXT switch and two connectors are located on the rear panel. A jumper

Frequency Standard Selection (cont'd)

normally connects the **FREQ STANDARD INT** connector (A3J9) to the **FREQ STANDARD EXT** connector (A3J10). The **FREQ STANDARD EXT** connector can accept a reference signal to be used instead of the Signal Generator's internal frequency standard.

The internal frequency standard is a 10 MHz signal at +7 dBm (nominal) with an aging rate of $<5 \times 10^{-10}$ /day after warmup (typically 24 hours). When the **FREQ STANDARD INT/EXT** switch is in the **INT** position and the jumper is connected between A3J9 and A3J10, the internal reference is enabled.

When the **FREQ STANDARD INT/EXT** switch is in the **EXT** position and the jumper is disconnected from the **FREQ STANDARD EXT** connector, a frequency standard of 5 or 10 MHz at -7 to +13 dBm (0 to 1 Vrms into 50Ω) can be connected.

NOTE

*The **EXT REF** status annunciator on the front panel will light when an external reference is being used. Also, the ϕ **UNLOCKED** status annunciator may light if the external reference is not of sufficient accuracy in frequency or has an insufficient power level. The external reference must be within ± 200 Hz of 10 MHz or ± 100 Hz of 5 MHz for reliable locking to occur. If the external reference level is not within the specified limits (0.1 to 1 Vrms into 50 ohms), its level may be sufficient to turn off the ϕ **UNLOCKED** status annunciator, giving a false indication of normal operation. In fact, the phase noise of the Signal Generator may be degraded.*

3-12. ADDITIONAL OPERATING INFORMATION

Signal Generator performance can be optimized by considering the effect of the following controls on the RF output:

- a. **AUTO PEAK**
- b. **ALC**
- c. **PULSE Modulation**
- d. **SWEEP** mode in a Master/Slave configuration
- e. **SWEEP Mode** (Option 008 only)

3-13. AUTO PEAK

Major power and pulse modulation specifications are not warranted unless an **AUTO PEAK** operation has been performed. An **AUTO PEAK** operation is automatically performed when the frequency changes by more than 50 MHz while **AUTO PEAK** is enabled. **AUTO PEAK** is automatically enabled when the instrument is turned on, or when **PULSE** mode is selected. The front panel **AUTO PEAK** button toggles the state of the instrument between **AUTO PEAK** enabled and disabled mode. A user-initiated **AUTO PEAK** operation may be performed manually at any time by pressing the **AUTO PEAK** button twice to disable and re-enable **AUTO PEAK**. The actual peaking operation occurs when the **AUTO PEAK** is switched from the disabled to enabled mode. For more information about Auto Peak, see the detailed operating instructions.

3-14. ALC (Automatic Level Control)

Output power leveling for the instrument's frequency range occurs from sources selected by the operator. These sources are:

- a. **INTERNAL**
- b. **DIODE**
- c. **PWR MTR** (Power Meter)
- d. **SYS** (System) (2552A, 2634A and above)

INTERNAL. RF power output from the signal generator is automatically leveled.

DIODE. RF output power is leveled externally using a diode detector connected to the instrument's **EXT ALC IN** connector.

PWR MTR (Power Meter). RF output power is leveled externally using a power meter connected to the instrument **EXT ALC IN** connector.

SYS (System) (2552A, 2634A and above). RF output power is leveled externally using a feedback voltage proportional to the system output power in volts per dB. (A system is the Signal Generator with an external amplifier, multiplier, etc.). The reference voltage must be 0 Vdc at 0 dBm system output and change 30 mV per dB. This voltage is connected to the Signal Generator's **EXT ALC IN** connector.

CAL Adjustments. Power leveled at the load is adjusted to agree with the **OUTPUT LEVEL** meter reading when external leveling is used in **DIODE**

ALC (Automatic Level Control) (cont'd)

or PWR MTR. External leveling techniques are discussed in Hewlett-Packard Application Note 281-5 Microwave Synthesizer Series, May 1981, HP Part Number 5952-8251. Application Note 218-5 specifically applies to the HP 8672A; however, the main principles of applications also apply to the HP 8673B. Additionally, the input voltage fed back to the HP 8673B EXT ALC IN connector should be within a -1V to $+1\text{V}$ range. Polarity is of no consequence because an internal circuit in the HP 8673B performs an absolute value function on the input voltage. For more information on each of the Automatic Level Control functions, see the detailed operating instructions.

3-15. PULSE Modulation

The automatic execution of the AUTO PEAK function by the instrument's internal microprocessor ensures that key power and pulse specifications are met for nearly all circumstances (see Section 3-12). Three conditions that may necessitate a user-activated AUTO PEAK are: load changes, extreme frequency changes, and, in rare circumstances, frequency changes less than 50 MHz.

a. Changes of load impedance can shift the center frequency of internal filters and necessitate another AUTO PEAK operation. This could occur if highly reactive loads are switched in and out in automatic test systems.

b. Large frequency changes cause extreme changes in the self-heating of internal YIG filters. Although most of the resulting drift occurs in 15–20 seconds, complete settling may take up to 15 minutes. Some experimentation may be needed to determine when AUTO PEAK is necessary for this type of measurement.

c. Finally, on rare occasions, pulse overshoot parameters may drift out of specified range for frequency changes less than 50 MHz.

To be confident of obtaining warranted instrument performance, perform an AUTO PEAK operation just before each measurement is taken.

Another automatic instrument function determines the optimum injected pulse amplitude to the YTM. This occurs during an AUTO PEAK operation, and for vernier power level changes ≥ 0.4 dB. During this operation, the instrument switches briefly to CW for about 200 μs . Pulse mode is then re-enabled and the injected pulse amplitude is the

correct value to produce fast risetime pulses. Frequency switching speed is slowed to about 100 ms by this process.

If these bursts of CW power are objectionable, they can be eliminated by exploiting the following feature. At any one frequency, when the vernier is used to change the output power level by more than 0.4 dB, a "scratch pad" memory stores the correct injected pulse amplitude for that power level. Subsequent operation at that power level uses the "scratch pad" data instead of switching to CW to update the pulse control parameters. For more information on this feature, and on Pulse Modulation in general, see the detailed operating instructions.

3-16. SWEEP Mode in MASTER/SLAVE Configuration

In a Master/Slave configuration, two signal generators are interconnected to obtain two swept microwave signals, at a fixed offset from each other. The two instruments are interconnected through the Hewlett-Packard Interface Bus (HP-IB). The MASTER is set to HP-IB address 50 and the SLAVE unit is set to HP-IB address 40. The desired sweep start and stop frequencies are set to identical frequencies on both the master and slave instruments. Desired offsets are then entered on THE SLAVE UNIT USING THE FREQ INCREMENT control. Swept signals from the instruments will be offset by the FREQ INCREMENT value.

In each sweep mode of operation, the designated Slave Unit will have the MANUAL and SINGLE pushbutton lamps lit. The designated Master Unit will have only the selected mode pushbutton lamp lit. A step-by-step example follows:

a. Interconnect two instruments for HP-IB. Designate one instrument as the Master Unit and set its HP-IB Address to 50. Designate the other instrument as the Slave Unit and set its HP-IB Address to 40.

b. On both units, set SWEEP START to 2000 MHz and SWEEP STOP to 12000 MHz. On both units, set either the number of steps or step size to the desired value. (As one example: set both master and slave units for 500 steps.)

c. On the Slave Unit select a 50 MHz offset using the FREQ INCR and the FREQ INCREMENT (\blacktriangleleft) or (\blacktriangleright) to increase the Slave Unit frequency by 50 MHz.

SWEEP Mode in MASTER/SLAVE Configuration (cont'd)

d. Press and hold SWEEP START on the Slave Unit and check for a 50 MHz offset (Display should read 12050 MHz).

e. For AUTO Mode: Press AUTO on Master Unit; Slave Unit will have MANUAL and SINGLE key indicators lit.

f. For MANUAL Mode: Press MANUAL on Master Unit; Slave Unit will have MANUAL and SINGLE key indicators lit. On Master Unit enable TUNE ON/OFF. Use the TUNE Knob of the Master Unit to tune both Master and Slave Units according to STEP SIZE set on respective units.

g. For SINGLE Mode: On Master Unit, press SINGLE once to enable the sweep. Press it a second time to start one sweep. If SINGLE is pressed during a sweep, the in-progress sweep stops and re-enables.

Disabling Master/Slave Mode. Press SWEEP OFF on both Master and Slave Units. Set instrument HP-IB addresses to their previous settings. All

sweep indicators will be off. The Master Unit TUNE Knob will now cause changes only on the Master Unit Display.

For more information on Master/Slave Sweep, see the detailed operating instructions.

SWEEP Mode (Option 008 Only)

Option 008 adds a power amplifier which operates from 16 GHz to 26 GHz for increased output power. This power amp is switched out below 16 GHz and switched in $\geq 16\ 000.002$ MHz.

If an AUTO Sweep is initiated which has 16 GHz between the start and stop frequencies, only one, single sweep, will be executed. The sweep will then be halted at the stop frequency. This frequency will be displayed in the frequency display and the AUTO Sweep key LED will flash continuously. The message key will also light indicating error 16.

This feature prevents excessive wear during sweep modes on the microwave relays which switch in the power amplifier.

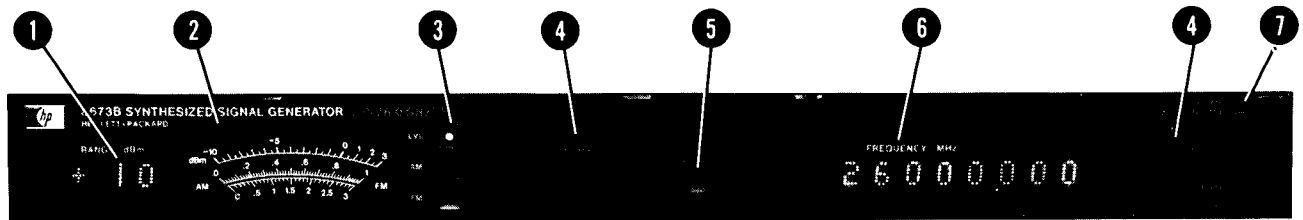

- 1 **RANGE dBm Display.** Indicates the selected range of the RF output in 10 dB steps from -90 to $+10$ dB. Range is set by the RANGE (\blacktriangledown and \blacktriangle) keys.
- 2 **Meter.** Monitors power level, AM depth, or FM deviation. Meter function is selected by the MTR keys.
 - 3 **MTR Keys.** Select the meter function.
 - LVL:** selects OUTPUT LEVEL VERNIER for -10 to $+3$ dBm scale indication. Read relative to the RANGE dB display.
 - AM:** selects 30% (read on the 0 to 3 scale) or 100% (read on the 0 to 1 scale) AM depth, full scale. A 1 volt peak signal applied to the AM IN connector develops full scale modulation.
 - FM:** selects FM deviation. Full scale indication read on the 0 to 3 scale is 30 kHz, 300 kHz, or 3 MHz. Full scale indication read on the 0 to 1 scale is 100 kHz, 1 MHz, or 10 MHz. A 1 volt peak signal applied to the FM IN connector develops full scale modulation.
- 4 **Status Annunciators.** Display the internal conditions of the Signal Generator.
 - OFFSET (2552A, 2634A and above):** lights when a frequency offset other than zero is entered. The displayed frequency is higher (+OFFSET) or lower (−OFFSET) than the actual output frequency.
 - MULTIPLIER (2552A, 2634A and above):** lights when a frequency multiplier greater than one is entered. The displayed frequency is the output frequency times the multiplier.
 - UNLEVELED (or ALC UNLEVELED on some instruments):** lights when RF OUTPUT is turned off, more power is requested than is available, no signal is applied to EXT ALC IN when PWR MTR, DIODE, or SYS (2552A, 2634A and above) is selected, no signal is applied to PULSE IN when NORM pulse mode is selected, overmodulation occurs in AM mode, or pulse width is less than 100 ns.
 - FM OVERMOD:** lights when the signal applied to the FM IN connector exceeds 1 volt peak or when the modulation index exceeds 5 (2.0 to 6.6 GHz), 10 (6.6 to 12.3 GHz), 15 (12.3 to 18.6 GHz), or 20 (18.6 to 26.0 GHz). The modulation index is equal to the maximum peak deviation divided by f_{mod} . Refer to Table 1-1, Specifications, for additional information.

to 12.3 GHz), 15 (12.3 to 18.6 GHz), or 20 (18.6 to 26.0 GHz). The modulation index is equal to the maximum peak deviation divided by f_{mod} . Refer to Table 1-1, Specifications, for additional information.

STANDBY: lights when power is applied but the LINE switch is in the STBY position.

OVEN COLD: lights when the reference oscillator oven is not up to nominal operating temperature.

φUNLOCKED (or NOT φLOCKED on some instruments): lights when one or more of the internal phase lock loops is unlocked, the RF OUTPUT is OFF, or the INT-EXT switch is in the EXT position with no external reference connected.

EXT REF (or EXTERNAL REF on some instruments): lights when the rear panel INT-EXT switch is in the EXT position.

- 5 **MESSAGE Key.** Lights to indicate entry errors and flashes to indicate hardware malfunctions. A two-digit code appears in the FREQUENCY MHz display when this key is pressed. Refer to the pull-out card or the Messages Detailed Operating Instruction for an explanation of the codes.
- 6 **FREQUENCY MHz Display.** Normally indicates output frequency. Message codes and previously set values for FREQ INCR, SWEEP FREQ, and SWEEP RATE functions are displayed for as long as their respective keys are pressed.
- 7 **HP-IB STATUS Annunciators.** Indicate the status of the Signal Generator when it is operating via the HP-IB.
 - RMT:** lights when the Signal Generator is in remote mode.
 - LSN:** lights when the Signal Generator is addressed to listen.
 - TLK:** lights when the Signal Generator is addressed to talk.
 - SRQ:** lights when the Signal Generator is issuing the Require Service message.

Figure 3-2. Displays and Status Annunciators

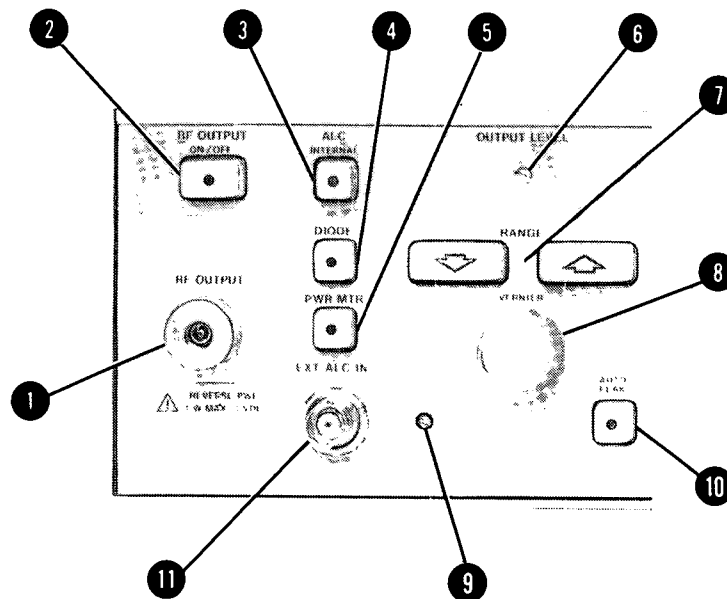

- 1 **RF OUTPUT Connector.** 50 ohm APC3.5 male connector supplies RF output over the entire frequency range of 2 to 26 GHz.
- 2 **RF OUTPUT ON/OFF Key.** Completely turns off the RF output when set to OFF. Setting the RF output to OFF causes the ϕ UNLOCKED (NOT ϕ LOCKED) and UNLEVELED (ALC UNLEVELED) status annunciators to light. When the RF OUTPUT is set to ON, the Signal Generator returns to normal operation.
- 3 **INTERNAL Key.** Selects internal circuitry for leveling the output power at the front panel RF OUTPUT connector.
- 4 **DIODE/SYS Key.** Normal operation (Diode). Selects external mode for leveling power using an external diode detector. The output of the diode is connected to the Signal Generator's EXT ALC IN connector.
Shifted function (SYS) (2552A, 2634A and above) . Selects the system leveling mode. RF output power is leveled externally using a feedback voltage proportional to the system output power in volts per dB. (A system is the Signal Generator with an external amplifier, multiplier, etc.). The reference voltage must be 0 VDC at 0 dBm system output and change 30 mV per dB. This voltage is connected to the EXT ALC IN connector. When SYS is selected, both the INTERNAL and DIODE keys will light.
- 5 **PWR MTR Key.** Selects external leveling mode for leveling power using an external power meter. The recorder output of the power meter is connected to the EXT ALC IN connector.
- 6 **Mechanical Meter Zero.** Sets meter suspension so that the meter indicates zero when power is removed from the Signal Generator and the Signal Generator is in its normal operating position.
- 7 **OUTPUT LEVEL RANGE Keys** (\blacktriangledown and \blacktriangle). Selects the RF output level range in 10 dB steps from -90 to $+10$ dB. The selected range is displayed in the RANGE dBm display.
- 8 **OUTPUT LEVEL VERNIER.** Adjusts the RF output level over the range of -10 to $+3$ dBm, relative to the LVL scale as read on the meter.
- 9 **CAL Control.** Adjusts the power level at the load when using a diode detector or power meter for external leveling from 2—26.5 GHz.
- 10 **AUTO PEAK Key.** Maximizes power at the output frequency and optimizes pulse shape for pulse modulation.
- 11 **EXT ALC IN Connector.** BNC female connector that accepts positive or negative leveling signals from a diode detector, power meter, or system reference.

Figure 3-3. Output Level Features

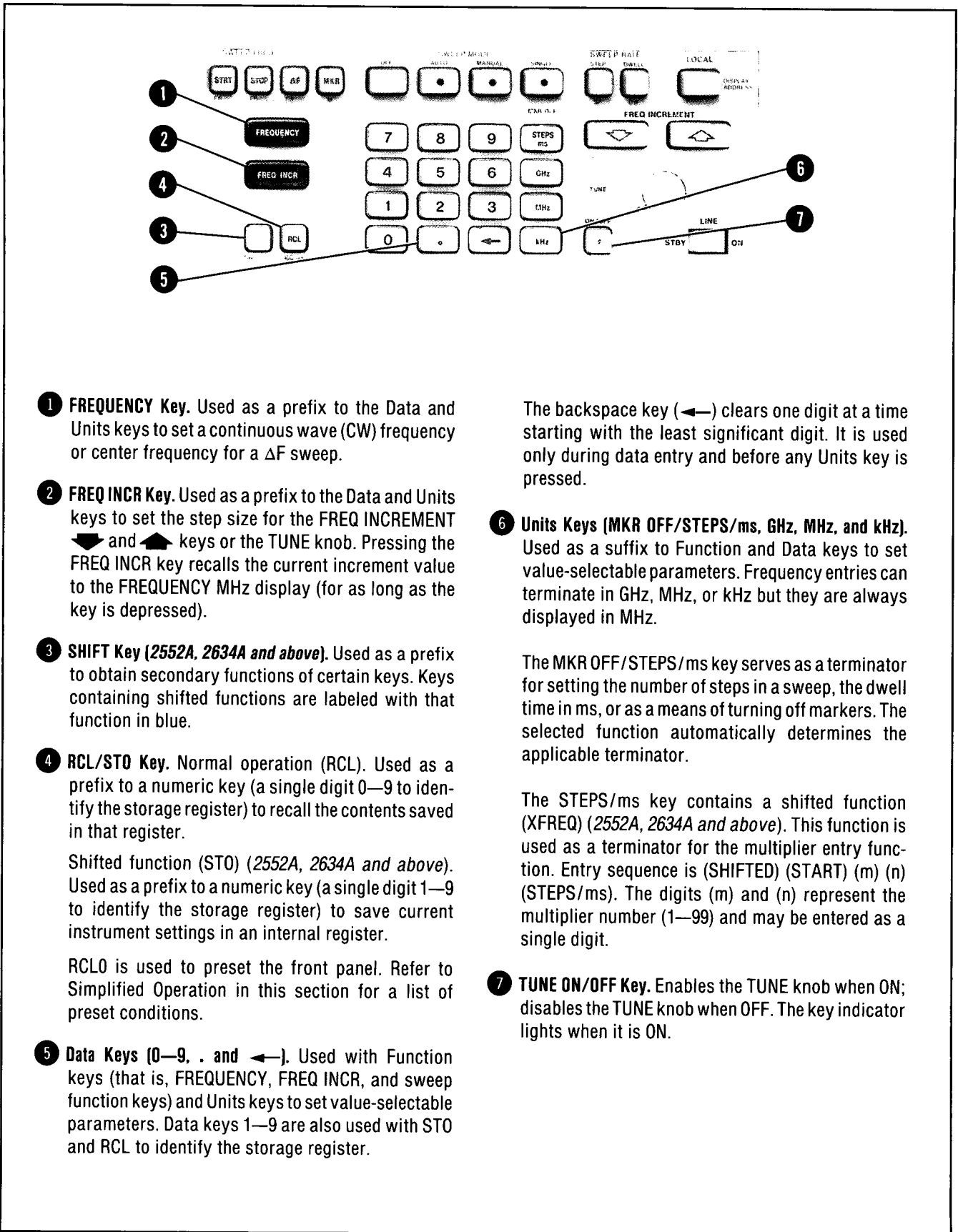

1 FREQUENCY Key. Used as a prefix to the Data and Units keys to set a continuous wave (CW) frequency or center frequency for a ΔF sweep.

2 FREQ INCR Key. Used as a prefix to the Data and Units keys to set the step size for the FREQ INCREMENT \blacktriangledown and \blacktriangle keys or the TUNE knob. Pressing the FREQ INCR key recalls the current increment value to the FREQUENCY MHz display (for as long as the key is depressed).

3 SHIFT Key (2552A, 2634A and above). Used as a prefix to obtain secondary functions of certain keys. Keys containing shifted functions are labeled with that function in blue.

4 RCL/STO Key. Normal operation (RCL). Used as a prefix to a numeric key (a single digit 0–9 to identify the storage register) to recall the contents saved in that register.

Shifted function (STO) (2552A, 2634A and above). Used as a prefix to a numeric key (a single digit 1–9 to identify the storage register) to save current instrument settings in an internal register.

RCL0 is used to preset the front panel. Refer to Simplified Operation in this section for a list of preset conditions.

5 Data Keys (0–9, . and ←). Used with Function keys (that is, FREQUENCY, FREQ INCR, and sweep function keys) and Units keys to set value-selectable parameters. Data keys 1–9 are also used with STO and RCL to identify the storage register.

The backspace key (\leftarrow) clears one digit at a time starting with the least significant digit. It is used only during data entry and before any Units key is pressed.

6 Units Keys (MKR OFF/STEPS/ms, GHz, MHz, and kHz). Used as a suffix to Function and Data keys to set value-selectable parameters. Frequency entries can terminate in GHz, MHz, or kHz but they are always displayed in MHz.

The MKR OFF/STEPS/ms key serves as a terminator for setting the number of steps in a sweep, the dwell time in ms, or as a means of turning off markers. The selected function automatically determines the applicable terminator.

The STEPS/ms key contains a shifted function (XFREQ) (2552A, 2634A and above). This function is used as a terminator for the multiplier entry function. Entry sequence is (SHIFTED) (START) (m) (n) (STEPS/ms). The digits (m) and (n) represent the multiplier number (1–99) and may be entered as a single digit.

7 TUNE ON/OFF Key. Enables the TUNE knob when ON; disables the TUNE knob when OFF. The key indicator lights when it is ON.

Figure 3-4. Frequency Control Features and LINE Switch (1 of 2)

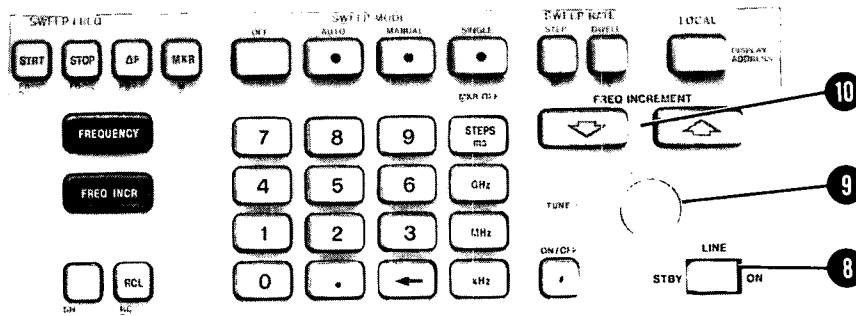

- 8 **LINE Switch.** Applies power to the Signal Generator when set to the ON position. Power is supplied to the reference oscillator oven and the battery charger circuit in the STBY and ON positions.
- 9 **TUNE Knob.** Changes the CW frequency by the value set with FREQ INCR. The knob is enabled by the ON/OFF key. The knob also serves as a manual sweep mode control.



- 10 **FREQ INCREMENT**  and  **Keys.** Decreases or increases the CW frequency in steps; the increment size is set with the FREQ INCR key. Holding either key down causes the frequency to continuously change. These keys also serve as a manual sweep mode control. In manual sweep, the increment size is equal to the sweep step size.

Figure 3-4. Frequency Control Features and LINE Switch (2 of 2)



SWEEP FREQ

- 1** **STRT Key.** Normal operation (STRT). Used as a prefix to the Data and Units keys to set the beginning frequency of a sweep. Pressing this key displays the present START value in the FREQUENCY MHz display (for as long as the key is depressed).

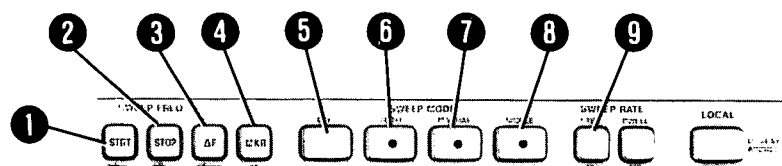
Shifted function (MULT) (2552A, 2634A and above). Used as a prefix to the Data and Units keys. Invokes the multiplier mode of operation and allows entry of the frequency multiplication factor. The entered multiplication factor affects all frequencies; that is, markers, increments, FM deviation, CW, sweep, and center frequencies. The multiplication effect on FM deviation is not indicated on the FM meter.

- 2** **STOP Key.** Normal operation (STOP). Used as a prefix to the Data and Units keys to set the ending frequency of a sweep. Pressing this key displays the present STOP value in the FREQUENCY MHz display (for as long as the key is depressed).

Shifted function (+OFFSET) (2552A, 2634A and above). Used as a prefix to the Data and Units keys. Invokes the offset mode of frequency entry and display. Frequency entries will be displayed as entered but the actual instrument output frequency will be the offset amount BELOW the entered and displayed frequency.

- 3** **ΔF Key.** Normal operation (ΔF). Used as a prefix to the Data and Units keys to set sweep span. Pressing this key displays the present span value in the FREQUENCY MHz display (for as long as the key is depressed). Center frequency of the span is set with the FREQUENCY key.

Shifted function (-OFFSET) (2552A, 2634A and above). Used as a prefix to the Data and Units keys. Invokes the offset mode of frequency entry and display. Frequency entries will be displayed as entered but the actual instrument output frequency will be the offset amount ABOVE the entered and displayed frequency.

- 4** **MKR Key.** Enables previously selected marker frequencies when used as a prefix to Data keys 1 through 5. For example, pressing MKR and 1 enables Marker 1. When used as prefix to the Data and Units keys, it sets marker frequencies. For example, pressing MKR, 3, 15, and GHz sets the frequency of Marker 3 to 15 GHz. (The first digit pressed after the MKR key is always the marker number.) Pressing the MKR key displays all currently enabled marker numbers within the set sweep range in the FREQUENCY MHz display. Pressing the MKR key and a Data key displays the present frequency of the requested marker.

SWEEP MODE

- 5** **OFF Key.** Disables all sweep modes.
- 6** **AUTO Key.** Starts a repetitive sweep (restarting at the end of each sweep). On Option 008 executes single sweep only if sweep range includes 16 GHz (see Additional Operating Information, paragraph 3-12).
- 7** **MANUAL Key.** Enables the sweep circuitry. It does not start a sweep. The TUNE knob (if enabled) or the FREQ INCREMENT (▼ and ▲ keys) control the sweep.
- 8** **SINGLE Key.** Arms the single sweep and tunes the Signal Generator to the start frequency. The sweep does not begin until the key is pressed again to trigger the sweep. When pressed during a sweep, the in-progress sweep aborts and rearms the single sweep.

SWEEP RATE

- 9** **STEP Key.** Used as a prefix to the Data and Units keys to set the number of steps or the size of each step of a sweep. When the entry is terminated by STEPS, the number of steps is set. When the entry is terminated

Figure 3-5. Sweep Features and LOCAL Key (1 of 2)

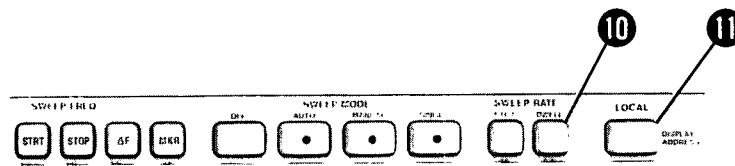

by GHz, MHz, or kHz, the step size is set. When this key is pressed, the number of steps is displayed on the left side of the FREQUENCY MHz display and the corresponding step size is displayed on the right side. The maximum number of steps allowed is 9999.

10 DWELL Key. Used as a prefix to the Data and ms keys to set the time interval between sweep steps. Pressing this key displays the present dwell time value in the FREQUENCY MHz display (for as long as the key

is depressed). The allowable values for dwell time range from 1 to 255 ms.

11 LOCAL/DISPLAY ADDRESS Key. Returns the Signal Generator to local keyboard control from HP-IB (remote) control provided the instrument is not in local lockout. Also displays the current HP-IB address in the FREQUENCY MHz display for as long as the key is depressed. This key is also used to set the HP-IB address. Refer to the HP-IB Address Selection in Section 2 for more information.

Figure 3-5. Sweep Features and LOCAL Key (2 of 2)

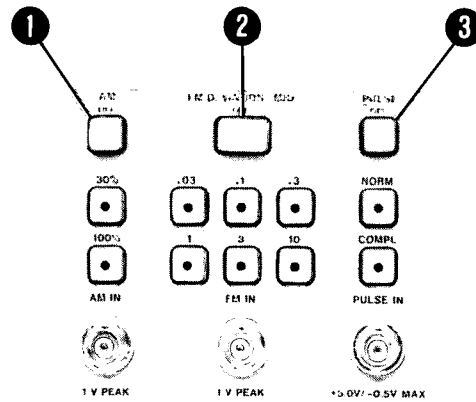

1 AM

AM OFF Key. Disables AM.

AM 30% Key. Enables AM and selects 30% full scale modulation for 1 volt peak applied to the AM IN connector.

AM 100% Key. Enables AM and selects 100% full scale modulation for 1 volt peak applied to the AM IN connector.

AM IN Connector. BNC female connector with an input impedance of 600 ohms. 1 volt peak sets full scale modulation as selected by the AM 30% or 100% key. AM depth varies linearly with the input signal level.

2 FM DEVIATION

FM DEVIATION MHz OFF Key. Disables FM.

FM DEVIATION Keys (.03, .1, .3, 1, 3, and 10). Enables FM and selects the peak deviation sensitivity in MHz obtained when a signal is applied to the FM IN connector. The peak deviation is read on the meter. This

deviation is not corrected when an external frequency multiplier is used. For example, if a frequency doubler is being used, the actual frequency deviation will be twice that shown on the meter.

FM IN Connector. BNC female connector with an input impedance of 50 ohms. 1 volt peak gives full scale modulation. Deviation varies linearly with the input signal level. Deviation ranges are controlled by the FM DEVIATION keys.

3 PULSE

PULSE OFF Key. Disables pulse modulation.

NORM (Normal Mode) Key. Turns RF output on when the signal to the PULSE IN connector is greater than 2.4 volts.

COMP (Complement Mode) Key. Turns RF output on when the signal to the PULSE IN connector is less than 0.4 volts.

PULSE IN Connector. BNC female connector with an input impedance of 50 ohms. Accepts TTL levels.

Figure 3-6. Modulation Features

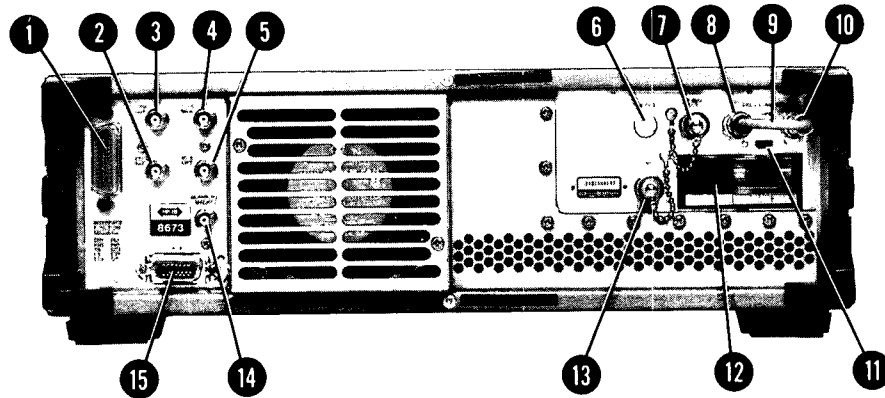

- 1 **HP-IB Connector.** Connects the Signal Generator to the Hewlett-Packard Interface Bus for remote operation.
- 2 **FREQ REF.** BNC female connector. Output impedance is 100 Ω nominal. Provides 1 V/GHz (2608A–2626A, 2530A and below) or a 0.5 V/GHz (2552A, 2634A and above) voltage that is always on, even when sweep is off.
- 3 **SWP OUT.** BNC female connector. Output impedance is 100 Ω nominal. Provides a 0 to +10V ramp from start to stop. An internal adjustment can set the slope of the ramp from 0 to between +4 and +12V.
- 4 **TONE MKR.** BNC female connector. Output impedance is 600 Ω nominal, 5 kHz sine wave. Can be connected to front panel AM IN to provide AM markers.
- 5 **PEN LIFT.** BNC female connector. TTL-high lifts pen; TTL-low lowers pen. 100 ms delay to lift or lower pen in single sweep mode.
- 6 **RF OUT (A3J6).** For Options 004 and 005 only. 50 Ω APC 3.5 male output connector.
- 7 **10 MHz OUT (A3J8).** 0 dBm (nominal) into 50 Ω , can be used as an external timebase.
- 8 **FREQ STANDARD Output (A3J9).** 10 MHz into 50 Ω at +7 dBm (nominal) from the internal frequency standard except when INT/EXT switch is in the EXT position.
- 9 **Jumper (A3W3).** Normally connects the Internal Frequency Standard Output (A3J9) to the External Frequency Standard Input (A3J10).
- 10 **FREQ STANDARD Input (A3J10).** Normally connected by A3W3 to A3J9. Also used to connect an external frequency standard of 5 or 10 MHz at 0 dBm to the Signal Generator.
- 11 **FREQ STANDARD INT/EXT Switch.** Normally left in the INT position. Removes power from internal frequency standard when in the EXT position.
- 12 **Line Power Modules.** Permit operation from 100, 120, 220, or 240 Vac. The number visible in the window displays the nominal line (mains) voltage for which the module is set (see Figure 2-1). The protective grounding conductor connects to the Signal Generator through this module. The line power fuse is part of this module and is the only part to be changed by the operator.
- 13 **100 MHz OUT (A3J7).** 0 dBm (nominal) into 50 Ω . Can be used as an external time base.
- 14 **BLANKING/MARKER.** BNC female connector. Output impedance is 100 Ω nominal. Provides +5V at the beginning of each frequency change for blanking a swept display (to eliminate display of switching transients). Goes to –5V during remainder of frequency step for Z-Axis intensity marker or to 0V for non-marker frequencies.
- 15 **AUX Connector.** Allows remote control of frequency increment, display blanking, register recall, and start and stop sweep. Refer to Table 3-3, AUX Connector Functions, for additional information.

Figure 3-7. Rear Panel Features

OPERATOR'S CHECKS

3-17. OPERATOR'S CHECKS

3-18. Basic Functional Checks

Description The purpose of these checks is to give reasonable assurance that the instrument is operating properly.

Each check has been designed to be performed with a minimum of test equipment, and in as short a time as possible. Therefore, although these checks are extremely valuable in identifying malfunctions, they are not a substitute for the Performance Tests in Section 4, which verify that the instrument is performing within its published specifications.

Each check is independent from the others and can be performed separately. Simply press RCL 0 to preset the Signal Generator to a known state before beginning an individual check.

If a malfunction is suspected, the entire procedure should be performed in the order given. Make a note of all the checks that failed. Refer to the Service Manual for the appropriate troubleshooting procedures to follow if the Signal Generator is to be repaired at the user's facility.

If the instrument is to be returned to Hewlett-Packard for repair, fill out a blue repair tag (found at the end of this manual). Include on the back of the tag a list of all checks that failed and attach the tag to the instrument. This will give the repair technician a good description of the malfunction and help assure the best possible service and the shortest repair time.

Equipment Test Oscillator/Pulse Generator HP 8013B or HP 8116A
 Oscilloscope HP 1980B
 Attenuator, 10 dB HP 8493C, Option 006

- Procedure** **Turn-On Check**
1. Set the LINE switch to STBY. Remove all external cables from the front and rear panels of the Signal Generator, including the power cable connecting the instrument to mains power.
 2. Set the rear panel FREQ STANDARD INT/EXT switch to INT.
 3. Connect the short jumper (A3W3) between A3J9 and A3J10.
 4. After the power cable has been disconnected from the Signal Generator for at least 1 minute, reconnect it to the Signal Generator. Check the front panel of the instrument to verify that the STANDBY and OVEN COLD status annunciators are on.
 5. Leave the LINE switch set to STBY until the OVEN COLD status annunciator turns off. This should occur in 15 minutes or less, depending upon how long the Signal Generator was disconnected from mains power. (The OVEN COLD annunciator may flicker off and on temporarily just as the oven stabilization temperature is reached. This is normal operation.) Once the OVEN COLD status annunciator is off set the LINE switch to ON.

OPERATOR'S CHECKS

Basic Functional Checks (cont'd)**Procedure
(cont'd)****NOTES**

If the MESSAGE key indicator is on or flashing, the instrument self-diagnostics detected a malfunction during turn-on. Press and hold the MESSAGE key to display the message code in the FREQUENCY MHz display. Any code other than 00 represents an error. Refer to Table 3-8 or the operating information pull-out card for a complete listing of message codes and the malfunctions they represent. Occasionally, due to line transients or other external conditions, the instrument self-diagnostics may indicate a false error. Pressing the MESSAGE key and repeating the turn-on procedure will usually differentiate between real and false errors. Errors that repeat are real.

6. Set the **FREQ STANDARD INT/EXT** switch to **EXT**. Verify that the **EXT REF** and ϕ **UNLOCKED** status annunciators turn on. Set the switch back to **INT**. The status annunciators should then turn off.
7. Press **RCL 0**. Verify that the instrument is now preset to the following conditions:
 - RF OUTPUT** to **ON**
 - ALC mode** to **INTERNAL**
 - OUTPUT LEVEL RANGE** to **-70 dBm** (0 dB for Option 004 and 005)
 - AUTO PEAK** to **ON**
 - Meter scale** to **LVL**
 - AM, FM, and Pulse Modulation** to **OFF**
 - FREQUENCY** to **3000.000 MHz**
 - FREQ INCR** to **1.000 MHz**
 - START** to **2000.000 MHz**
 - STOP** to **4000.000 MHz**
 - ΔF** to **2000.000 MHz**
 - SWEEP** to **OFF**
 - STEP** to **100 Steps (20.000 MHz)**
 - DWELL** to **20 ms**
 - TUNE Knob** to **ON**
 - All Status Annunciators** off
 - MESSAGE key light** off

Frequency Check:

The **FREQUENCY MHz** display and ϕ **UNLOCKED** status annunciator are used to check that the internal phase-lock loops remain phase locked across their tuning range. The actual frequency at the **RF OUTPUT** connector is not checked. However, this connector can be monitored with a microwave frequency counter or spectrum analyzer for greater assurance that the Signal Generator is operating properly.

8. Press **RCL 0**.
9. Set the Signal Generator frequency to **2.000000 GHz** and **FREQ INCREMENT** to **1.111111 GHz**.

OPERATOR'S CHECKS

Basic Functional Checks (cont'd)**Procedure
(cont'd)**

10. Step the Signal Generator from 2.000000 GHz to 12.000000 GHz in 1.111111 GHz steps. Verify that the ϕ UNLOCKED annunciator remains off at each step.

NOTE

Fast stepping or tuning of frequency may cause the ϕ UNLOCKED annunciator to flash on momentarily. This is normal and does not indicate a malfunction. Also note that some steps will not exactly equal 1.111111 GHz depending upon the resolution of each frequency band.

11. Set FREQUENCY to 2 GHz and then to 26.0 GHz. Verify that the ϕ UNLOCKED annunciator remains off at both frequencies.

Output Level Check:

The Signal Generator's internal Automatic Leveling Control (ALC) is checked to ensure that it remains leveled at all specified power levels. The ALC monitors most of the RF output circuitry.

12. Press RCL 0 to set the Signal Generator to a known state.
13. Connect a 50-ohm load or 6 dB attenuator to the Signal Generator's RF OUTPUT connector. This reduces unwanted power reflections back into the RF OUTPUT connector, thereby preventing a false UNLEVELED annunciator indication.
14. Set FREQUENCY to 6.6 GHz and Output Level VERNIER to -2 dBm.
15. Press the RF OUTPUT key to OFF. Verify that the UNLEVELED and ϕ UNLOCKED status annunciators turn on and that the meter indicates <-10 dBm.
16. Press the RF OUTPUT ON/OFF key to ON. Verify that the status annunciators turn off and that the meter indicates -2 dBm.
17. Step the output level down in 10 dB steps from 0 to -90 dB using the RANGE key. Then, step the output level up in 10 dB steps from -90 to $+10$ dB. Verify that the UNLEVELED annunciator remains off at each step.
18. Set Output Level RANGE to 0 dB and sweep the Output Level VERNIER from -10 dBm to $+3$ dBm. Verify that the UNLEVELED annunciator remains off at all VERNIER settings.
19. Press RCL 0 to set the Signal Generator to a known state.
20. Set frequency to 16.1 GHz.
21. Repeat step 18.
22. Set FREQ INCR to 10 MHz. Then, set the output level to the values shown in the following table. Tune from the corresponding start frequency to the stop frequency for each output level. Verify that the indicated power level on the meter remains

OPERATOR'S CHECKS

Basic Functional Checks (cont'd)

Procedure (cont'd)

constant and stable and that the UNLEVELED annunciator remains off. (This ensures that the instrument can generate specified output power and remain leveled.)

STANDARD

Range	Vernier	Start	Stop
+10 dB	-2 dBm	2.00 GHz	17.99 GHz
+10 dB	-6 dBm	18.00 GHz	21.99 GHz
0 dB	0 dBm	22.00 GHz	26.00 GHz

OPTION 001

Range	Vernier	Start	Stop
+10 dB	0 dBm	2.00 GHz	17.99 GHz
+10 dB	-4 dBm	18.00 GHz	21.99 GHz
0 dB	+3 dBm	22.00 GHz	26.00 GHz

OPTION 004

Range	Vernier	Start	Stop
+10 dB	-3 dBm	2.00 GHz	17.99 GHz
0 dB	+2 dBm	18.00 GHz	21.99 GHz
0 dB	-2 dBm	22.00 GHz	26.00 GHz

OPTION 005

Range	Vernier	Start	Stop
+10 dB	-1 dBm	2.00 GHz	17.99 GHz
+10 dB	-6 dBm	18.00 GHz	21.99 GHz
0 dB	+1 dBm	22.00 GHz	26.00 GHz

OPTION 008

Range	Vernier	Start	Stop
+10 dB	-2 dBm	2.00 GHz	17.99 GHz
+10 dB	-3 dBm	18.00 GHz	26.00 GHz

Sweep Check:

The FREQUENCY MHz display is used to check the ability of the Signal Generator to SWEEP.

OPERATOR'S CHECKS

Basic Functional Checks (cont'd)

Procedure (cont'd)

23. Press RCL 0 to set the instrument to a known state. Then, press the AUTO sweep key. Verify that the FREQUENCY MHz display now shows a start frequency of 2000.000 MHz and a stop frequency of 4000.000 MHz. The AUTO key indicator should flash once each time a new sweep begins.
24. Press SWEEP OFF. Verify that the FREQUENCY MHz display returns to 3000.000 MHz.
25. Press the MANUAL sweep key. The FREQUENCY MHz display should show 2000.000 MHz. Tune the frequency up by turning the TUNE knob clockwise. Verify that the FREQUENCY MHz display changes in 20 MHz increments and stops at 4000.000 MHz.
26. Tune the frequency down to 2000.000 MHz by turning the TUNE knob counterclockwise. Verify that the FREQUENCY MHz display changes in 20 MHz steps and stops at 2000.000 MHz.
27. Press the SWEEP OFF key and verify that the FREQUENCY MHz returns to 3000.000 MHz.
28. Press the SINGLE sweep key. Verify that the key indicator turns on and the FREQUENCY display shows 2000.000 MHz.
29. Press the SINGLE sweep key again. A single sweep should now be executed. Verify that the FREQUENCY MHz display changes in 20 MHz steps very rapidly until 4000.000 MHz is reached. The display then returns to the START frequency of 2000.000 MHz.
30. Press the SWEEP OFF key. Verify that the FREQUENCY MHz display returns to 3000.000 MHz.

AM Check:

The front panel meter and UNLEVELED status annunciator are used as an indication of AM. The meter monitors input signal level only, rather than actual AM. A modulation analyzer can be used to monitor the signal at the RF output connector for greater assurance of AM performance.

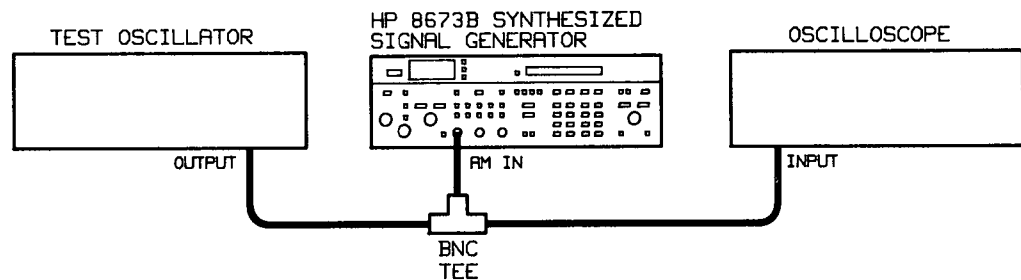

Figure 3-8. AM Functional Check Setup

OPERATOR'S CHECKS

Basic Functional Checks (cont'd)

Procedure (cont'd)

31. Press RCL 0 to preset the Signal Generator to a known state.
32. Set the test oscillator to 10 kHz at a minimum output level or 0V. Then, connect the test oscillator and oscilloscope to the Signal Generator as shown in Figure 3-8.
33. Set the Signal Generator to each setting shown in the table below. For each setting, slowly increase the test oscillator's output level (starting from 0V) while observing the Signal Generator's meter in AM mode. The meter should indicate a smooth and continuous increase in AM depth. When the meter displays the %AM indicated in the table, verify that the oscilloscope shows the corresponding voltage. The UNLEVELED status annunciator should remain off at all times.

Signal Generator					Oscilloscope Display
FREQUENCY	RANGE	VERNIER	AM Key	% AM	
2 GHz	0 dB	0 dBm	100%	75	0.75V peak
18 GHz	0 dB	0 dBm	100%	75	0.75V peak
24 GHz	0 dB	-3 dBm	100%	75	0.75V peak
26 GHz	0 dB	-5 dBm	100%	50	0.5V peak
26 GHz	0 dB	-5 dBm	30%	30	1.0V peak

34. Press AM OFF. Disconnect the test oscillator and oscilloscope from the Signal Generator.

FM Check:

The front panel meter is used to monitor input signal level, which is proportional to FM deviation. A spectrum analyzer can be used to monitor the signal at the RF OUTPUT connector for greater assurance of FM performance. The FM OVERMOD status annunciator detects a FM overmodulation condition.

35. Press RCL 0 to preset the Signal Generator to a known state. Set Output Level RANGE to 0 dB, Output Level VERNIER to 0 dBm, and FM DEVIATION range to 0.03 MHz. Then, set the meter scale to FM.

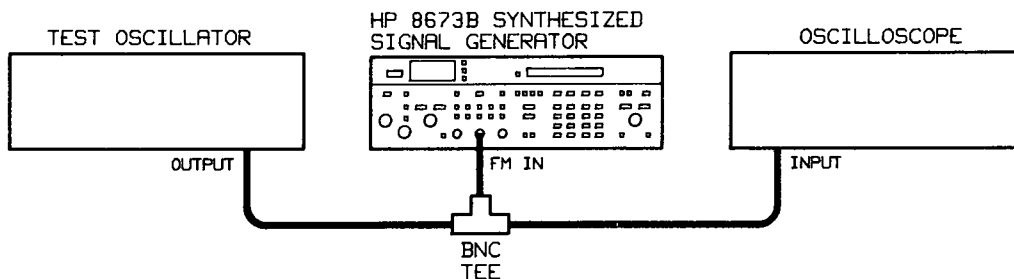

Figure 3-9. FM Functional Check Setup

OPERATOR'S CHECKS

Basic Functional Checks (cont'd)

Procedure (cont'd)

36. Set the test oscillator to 3 MHz at minimum output level or 0V. Then, connect test oscillator and oscilloscope to the Signal Generator as shown in Figure 3-9.
37. Slowly increase the output level of the test oscillator (starting from 0V) until the Signal Generator's meter reads full scale. Verify that the meter increases slowly and continuously and that the FM OVERMOD status annunciator remains off. The oscilloscope display should be approximately 1V peak.
38. Repeat step 37 for each of the following FM deviation ranges: 0.1, 0.3, 1, 3, and 10 MHz.
39. Set the Signal Generator's FM DEVIATION range to 10 MHz. Increase the test oscillator output level until a full scale reading is obtained. Decrease the test oscillator frequency slowly until the Signal Generator's FM OVERMOD status annunciator turns on. This should occur at a modulation frequency of 1 to 2 MHz, (modulation index approximately 6.5).
40. Press FM DEVIATION MHz OFF and disconnect the test oscillator and oscilloscope from the Signal Generator.

Pulse Modulation Check:

Pulse modulation is checked using various front panel status annunciators. Although pulse modulation is not monitored at the RF OUTPUT connector, the status annunciators give a high degree of confidence that pulse modulation is functionally working.

41. Press RCL 0. Set Output Level RANGE to 0 dB and Output Level VERNIER to 0 dBm.
42. Press the PULSE COMPL key. The UNLEVELED status annunciator should remain off.
43. Press the PULSE NORM key. Verify that the UNLEVELED status annunciator turns on. Press PULSE OFF and verify that UNLEVELED status annunciator now turns off.
44. Connect the pulse generator and oscilloscope to the Signal Generator as shown in Figure 3-10.

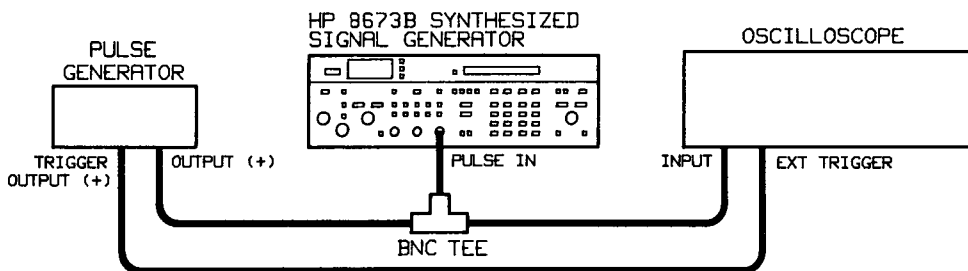

Figure 3-10. Pulse Modulation Functional Check Setup

OPERATOR'S CHECKS

Basic Functional Checks (cont'd)**Procedure
(cont'd)**

45. Set the oscilloscope to 50 ohm input impedance and external horizontal trigger.
46. Set the pulse generator for a 150 ns pulse width at one pulse per microsecond (1 MHz).
47. On the pulse generator, adjust the pulse amplitude for a pulse height of approximately 3V peak.
48. With PULSE OFF selected (CW mode), note the indicated power level on the Signal Generator's meter (should be 0 dBm). Press PULSE NORM and PULSE COMPL keys while observing any change in indicated output power level. Indicated level should not vary more than ± 1 dB from the level referenced with pulse off (CW mode).
49. While in PULSE NORM mode, slowly reduce the pulse width from 150 ns to 50 ns. The UNLEVELED annunciator should come on as 100 ns pulse width is approached. It should remain on down to at least 50 ns. The output level indicated on Signal Generator meter may also vary >1 dB as the UNLEVELED annunciator comes on. This is normal instrument operation, indicating a "pulse unlevelled" condition.
50. Press PULSE OFF and disconnect the oscilloscope and test oscillator from the Signal Generator.

Memory Check:

51. Set FREQUENCY to 15 GHz and Output Level RANGE to -20 dB.
52. Turn the Signal Generator's LINE switch to STBY, wait 30 seconds, then turn the LINE switch to ON. Verify that the FREQUENCY MHz display shows 15000.000 MHz and the RANGE dB display shows -20 dB.

Message Check:

53. Press RCL 0 to preset the Signal Generator to a known state. Enter a FREQUENCY of 30 GHz (out of range) and verify that the FREQUENCY DISPLAY remains at 3000 MHz and the MESSAGE key indicator turns on.
54. Press and hold the MESSAGE key. The FREQUENCY MHz display should show message code 01 (frequency out of range).
55. Release the MESSAGE key. Verify that the key indicator turns off.

OPERATOR'S CHECKS

3-19. HP-IB Functional Checks **HP-IB**

Description These procedures check the Signal Generator's ability to process or send the HP-IB messages described in Table 3-3. Only the Signal Generator, a controller, and an HP-IB interface are needed to perform these checks.

These procedures do not check if all Signal Generator program codes are being properly interpreted and executed by the instrument. However, if the power-up sequence (including the memory checks) and the front panel operation is good, the program codes, in all likelihood, will be correctly implemented.

The validity of these checks is based on the following assumptions:

- a. The Signal Generator performs properly when operated via the front panel keys (that is, in local mode). This can be verified by the Basic Functional Checks.
- b. The bus controller properly executes HP-IB operations.
- c. The bus controller's HP-IB interface properly executes the HP-IB operations.

If the Signal Generator appears to fail any of these HP-IB checks, the validity of the above assumptions should be confirmed before attempting to service the instrument.

The select code of the controller's HP-IB interface is assumed to be "7". The address of the Signal Generator is assumed to be "19" (its address as set at the factory). This particular select code address combination (that is, 719) is not necessary for these checks to be valid. However, the program lines presented here have to be modified for any other combination.

These checks can be performed together or separately. Any special requirements for a check are described at the beginning of the check.

Initial Setup The test setup is the same for all of the checks. Connect the Signal Generator to the bus controller via the HP-IB interface.

Equipment

HP-IB Controller	HP 85B/82903A (16K Memory Module)/00085-15005 (Advanced Programming ROM)
HP-IB Interface	HP 82937A

NOTE

Any HP 9000 series 200 or series 300 controller with an HP-IB interface and BASIC operating system can be used for this check.

Remote and Local Messages and the LOCAL Key

Note This check determines if the Signal Generator properly switches from local to remote control, from remote to local control, and if the LOCAL key returns the instrument to local control. If the Signal Generator is in remote mode (that is, the front panel RMT annunciator is on), switch the instrument to STBY, then to ON.

OPERATOR'S CHECKS

HP-IB Functional Checks (cont'd)

Description	Series 200/300	HP 85B (BASIC)
Send the Remote message (by setting Remote Enable, REN, true and addressing the Signal Generator to listen).	REMOTE 719	REMOTE 719

Operator's Response

Check that the Signal Generator's RMT and LSN annunciators are on.

Send the Local message to the Signal Generator	LOCAL 719	LOCAL 719
--	-----------	-----------

Operator's Response

Check that the Signal Generator's RMT annunciator is off but its LSN annunciator is on.

Send the Remote message to the Signal Generator	REMOTE 719	REMOTE 719
---	------------	------------

Operator's Response

Check that both the Signal Generator's RMT and LSN annunciators are on. Press the LOCAL key on the Signal Generator. Check that the Signal Generator's RMT annunciator is now off, but that its LSN annunciator remains on.

Receiving the Data Message**Note**

This check determines if the Signal Generator properly receives Data messages.

Description	Series 200/300	HP 85B (BASIC)
Send the first part of the Remote message (enabling the Signal Generator to remote).	REMOTE 7	
Address the Signal Generator to listen (completing the Remote message), then send a Data message.	OUTPUT 719; "FR15GZ"	OUTPUT 719; "FR15GZ"

Operator's Response

The Signal Generator should be set to 15 GHz.

Sending the Data Message**Note**

This check determines if the Signal Generator properly issues Data messages when addressed to talk. Before beginning this check, turn the Signal Generator's LINE switch to STBY, then to ON. Then key in RCL 0 to preset the instrument. (If a series 200/300 controller is used, a short program is required to perform the check.)

OPERATOR'S CHECKS

HP-IB Functional Checks (cont'd)

Description	Series 200/300	HP 85B (BASIC)
Send the Remote message	10 REMOTE 719	REMOTE 719
Send a Data message causing Generator to output its lock frequency.	20 OUTPUT 719; "OK"	OUTPUT 719; "OK"
Address the Generator to talk and store its output in variable V.	30 ENTER 719;V	ENTER 719;V
Display the value of V.	40 DISP V 50 END	DISP V

Operator's Response

Check that the Signal Generator's TLK annunciator is on. The controller's display should read 3.E + 9 (series 200/300) or 3000000000 (HP 85B). This corresponds to the data output shown in the FREQUENCY MHz display.

Local Lockout and Clear Lockout/Set Local Messages

Note

This check determines if the Signal Generator properly receives the Local Lockout message, disabling the LOCAL key. The check also determines if the Clear Lockout/Set Local message is properly received and executed by the Signal Generator. This check assumes that the Signal Generator is in the remote mode.

Description	Series 200/300	HP 85B (BASIC)
Send the Local Lockout message.	LOCAL LOCKOUT 7	LOCAL LOCKOUT 7

Operator's Response

Check that the Signal Generator's RMT annunciator is on. Press the Signal Generator's LOCAL key. The RMT annunciator should remain on.

Send the Clear Lockout/Set Local message.	LOCAL 7	LOCAL 7
---	---------	---------

Operator's Response

Check that the Signal Generator's RMT annunciator is off but the TLK annunciator is still on.

Return the Signal Generator to remote mode if the remaining checks in this section are to be performed.	REMOTE 719	REMOTE 719
---	------------	------------

Operator's Response

Check that the Signal Generator's RMT and LSN annunciators are on.

OPERATOR'S CHECKS

HP-IB Functional Checks (cont'd)**Clear Message****Note**

This check determines if the Signal Generator properly responds to the Clear message. This check assumes that the Signal Generator is in the remote mode.

Description	Series 200/300	HP 85F (BASIC)
Send a Data message that turns AUTO PEAK off.	OUTPUT 719; "K0"	OUTPUT 719; "K0"

Operator's Response

Check that the Signal Generator's AUTO PEAK key indicator is off.

Send the Clear message (turning the Signal Generator's AUTO PEAK function on).	CLEAR 719	CLEAR 719
--	-----------	-----------

Operator's Response

Check that the Signal Generator's AUTO PEAK key indicator is on.

Abort Message**Note**

This check determines if the Signal Generator becomes unaddressed when it receives the Abort message. This check assumes that the Signal Generator is in the remote mode.

Description	Series 200/300	HP 85F (BASIC)
Address the Signal Generator to listen.	OUTPUT 719	OUTPUT 719

Operator's Response

Check that the Signal Generator's LSN and RMT annunciators are on.

Send the Abort message, unaddressing the Signal Generator from listening.	ABORT 7	ABORTIO 7
---	---------	-----------

Operator's Response

Check that the Signal Generator's LSN annunciator is off, but the RMT annunciator is on.

Status Byte Message**Note**

This check determines if the Signal Generator sends the Status Byte message. Before beginning this check, turn the Signal Generator's LINE switch to STBY, then to ON.

Description	Series 200/300	HP 85F (BASIC)
Place the Signal Generator in serial-poll mode (causing it to send the Status Byte message).	SPOLL (719)	SPOLL (719)

OPERATOR'S CHECKS

HP-IB Functional Checks (cont'd)

Status Byte Message (cont'd)

Operator's Response The controller's display should read 12 .

Require Service Message

Note This check determines if the Signal Generator can issue the Require Service message (set the SRQ bus control line true). This check can be performed in either local or remote mode.

Description	Series 200/300	HP 85B (BASIC)
Send a Data message to set the RQS Mask to 32.	OUTPUT 719 USING "2A, B"; "@1", 32	OUTPUT 719 USING "2A, B"; "@1", 32
Send a Data message containing an invalid frequency. This causes a Require Service message to be sent.	OUTPUT 719; "FR35GZ"	OUTPUT 719; "FR35GZ"

Operator's Response Check that the SRQ annunciator is on.

Note In the next step, a short program is required if series 200/300 is the controller.

Read the binary status of the controller's HP-IB interface and store the data in variable V (in this step, 7 is the interface's select code).	10 V=0 20 STATUS 7, 7; V	STATUS 7, 2;V
Display the value of the SRQ bit (in this step 10 is the SRQ bit for the series 200/300 and 5 is the SRQ bit for the HP 85B, numbered from 0).	30 DISP "SRQ="; BIT (V, 10) 40 END	DISP"SRQ=";BIT(V, 6)

Operator's Response Check that the SRQ value is 1, indicating the Signal Generator issued the Require Service message.

Status Bit Message

Note This check determines whether or not the Signal Generator sends the Status Bit message. This check can be performed in either local or remote mode. If the Signal Generator's SRQ annunciator is off, perform the first part of the Require Service Message check before beginning this check. If a series 200/300 controller is used, two short programs are required to perform this check.

OPERATOR'S CHECKS

HP-IB Functional Checks (cont'd)

Status Bit Message (cont'd)

Description	Series 200/300	HP 85B (BASIC)
Configure the Signal Generator to respond to a parallel poll on HP-IB data line DI03.	10 PPOLL CONFIGURE (719); 10	SEND 7; LISTEN 19 CMD 5 SCG 10
Place the Signal Generator in parallel poll mode (causing it to send the Status Bit message) and store the result in variable V.	20 V = PPOLL(7)	V = PPOLL(7)
Display the value of V.	30 DISP V 40 END	DISP V

Operator's Response

Check that the SRQ annunciator is on and that the response to the parallel poll is 4, indicating that the Signal Generator issued the Status Bit message.

Description	Series 200/300	HP 85B (BASIC)
Unconfigure the Signal Generator from responding to a parallel poll.	10 PPOLL UNCONFIGURE (719)	SEND 7; LISTEN 19 CMD 5 SCG 18
Place the Signal Generator in parallel poll mode.	20 V = PPOLL(7)	V = PPOLL (7)
Display the value of V.	30 DISP V 40 END	DISP V

Operator's Response

Check that the SRQ annunciator is on and that the response to the parallel poll is 0, indicating that Signal Generator is no longer configured to respond to a parallel poll. Then, turn the LINE switch to STBY, then to ON, to turn the SRQ annunciator off.

Trigger Message

Note

This check determines if the Signal Generator responds to the Trigger message.

Description	Series 200/300	HP 85B (BASIC)
Send the Remote message.	REMOTE 719	REMOTE 719
Send a Data message to set the Signal Generator's frequency to 9999 MHz.	OUTPUT 719; "FR 9999 MZ"	OUTPUT 719; "FR 9999 MZ"
Set the Signal Generator's frequency increment to 1111 MHz.	OUTPUT 719; "FI 1111 MZ"	OUTPUT 719; "FI 1111 MZ"

OPERATOR'S CHECKS

HP-IB Functional Checks (cont'd)

Trigger Message (cont'd)

Operator's Response

Check that the Signal Generator's frequency is set to 9999 MHz. Then press the Signal Generator's FREQ INCR key to check for an increment of 1111 MHz. This keyboard function is possible in the remote state (even if local lockout is enabled).

Configure the Signal Generator's trigger response to be an INCREMENT (down) function (that is, DN).	OUTPUT 719; "CT DN"	OUTPUT 719; "CT DN"
Send a Trigger message.	TRIGGER 719	TRIGGER 719

Operator's Response

Check that the Signal Generator's frequency changes to 8888 MHz.



3-20. REMOTE OPERATION, AUXILIARY CONTROL

3-21. AUX Input Lines

A limited number of instrument functions can be controlled through the rear panel AUX connector. These functions are listed in Table 3-2 below.

The input lines are TTL compatible and negative-edge sensitive. They require a minimum of 5 μ s between negative edges. Input signals can be generated by clean TTL drivers or by mechanical switches that require debouncing. The Signal Generator has a built-in debouncing circuit that should be enabled or bypassed depending upon which type of driver is used.

The Signal Generator is shipped from the factory configured for electrically-clean control signals (i.e., the internal debouncing circuit is bypassed). Refer to Figure 2-5 in Section 2, Installation, for

the procedure for enabling or bypassing the debouncing circuit.

NOTE

Section 2, Installation, also shows the pinout configuration of the AUX connector as well as information for a recommended mating connector.

3-22. AUX Output Lines

The AUX connector also has a ground line and three TTL-compatible output lines. The output lines are normally held at the high TTL level. The End of Sweep line produces one 5 μ s low-going pulse at the end of each sweep. The Trigger line produces one 5 μ s low-going pulse when the Signal Generator has made a large frequency change that may cause loss of phase lock in an instrument tracking the Signal Generator. The Negative Blanking line produces -5V for Z-axis blanking of CRT displays that require a negative blanking voltage.

Table 3-2. AUX Connector Functions

	Pin	Function	Description
INPUTS	1	Recall 1	Recalls the contents of internal storage register 1.
	2	Recall Next	Sequential recall of internal storage registers 2 through 9
	3	FREQ INCREMENT Up	Same as FREQ INCREMENT Up key
	4	FREQ INCREMENT Down	Same as FREQ INCREMENT Down key
	5	Trigger Single Sweep	Same as SINGLE key
	6	Service	Same as internal service switch (on A2A2 Key Code Assembly). Refer to Section 8, Service.
	7	Stop Sweep	Stops sweep. Sweep resumes when this line goes high.
	12	No Display	Blanks FREQUENCY MHz display when this pin is grounded and the existing display changes.
OUTPUTS	8	Negative Blanking	-5V for blanking
	9	Trigger	One pulse when the Signal Generator has made a frequency change that may cause loss of phase lock to an instrument tracking the Signal Generator.
	10	End of Sweep	One pulse at end of each sweep
	11	Ground	

3-23. REMOTE OPERATION 

The Signal Generator can be operated through the Hewlett-Packard Interface Bus (HP-IB). Bus compatibility, programming, and data formats are described in the following paragraphs.

Most front panel functions and remote-only functions are bus programmable. Front panel functions that are not programmable are the line switch, the HP-IB address, and for 2626A, 2608A, 2540A and below, the Backspace key.

A quick test of the Signal Generator's HP-IB interface is described earlier in this section under Remote Operator's Checks. These checks verify that the Signal Generator can respond to or send each of the applicable bus messages described in Table 3-3.

3-24. HP-IB Compatibility

The Signal Generator has a three-state, TTL, HP-IB interface which can be used with any HP-IB computing controller or computer for automatic system applications. The Signal Generator is programmable via the HP Interface Bus. Its programming capability is described by the twelve HP-IB messages listed in Table 3-3. The Signal Generator's compatibility with HP-IB is further defined by the following list of interface functions: SH1, AH1, T5, TE0, L3, LE0, SR1, RL1, PP1, DC1, DT1, and C0. A more detailed explanation of these compatibility codes can be found in IEEE Standard 488-1978 (and the identical ANSI Standard MC1.1). For more information about HP-IB, refer to the Hewlett-Packard Electronic Instruments and Systems catalog and the booklet titled "Improving Measurements in Engineering and Manufacturing" (HP part number 5952-0058).

3-25. Remote Mode

Remote Capability. The Signal Generator communicates on the bus in both remote and local modes. In remote, most of the Signal Generator's front panel controls are disabled. Exceptions are the LINE switch, the LOCAL key, the MTR keys, the MESSAGE key, and the FREQUENCY, FREQUENCY INCR, SWEEP FREQUENCY and SWEEP RATE keys for displaying "hidden" parameters. However, front panel displays remain active and valid. In remote, the Signal Generator can be addressed to talk or listen. When addressed to listen, the Signal Generator automatically stops talking and responds to the following messages: Data, Trigger (if configured), Clear (SDC), Remote, Local, Local Lockout, and Abort. When addressed to talk, the Signal

Generator automatically stops listening and sends one of the following messages: Data, Require Service, or Status Byte. Whether addressed or not, the Signal Generator responds to the Clear (DCL), Local Lockout, Clear Lockout/Set Local, and Abort messages. In addition, the Signal Generator can issue the Require Service message and the Status Bit message.

Local-to-Remote Mode Changes. The Signal Generator switches to remote operation upon receipt of the Remote message. The Remote message has two parts. They are:

- a. Remote enable bus control line (REN) set true.
- b. Device listen address received once (while REN is true).

When the Signal Generator switches to remote, the RMT annunciator on the front panel turns on. With the exception of VERNIER, which may change by less than 0.1 dB, the Signal Generator's control settings remain unchanged with the Local-to-Remote transition.

3-26. Local Mode

Local Capability. In local, the Signal Generator's front panel controls are fully operational and the instrument responds to the Remote message. The Signal Generator can send a Require Service message, a Status Byte message, and a Status Bit message.

Remote-to-Local Mode Changes. The Signal Generator switches to local from remote whenever it receives the Local message (GTL) when addressed to listen or the Clear Lockout/Set Local message. (The Clear Lockout/Set Local message sets the Remote Enable control line [REN] false.) The Signal Generator can also be switched to local by pressing the front panel LOCAL key (assuming Local Lockout is not in effect). With the exception of VERNIER, which returns to the front panel setting, the Signal Generator's control settings remain unchanged with the Remote-to-Local transition.

Local Lockout. When a data transmission is interrupted, which can happen by pressing the LOCAL key to return the Signal Generator to local mode, the data could be lost. This would leave the Signal Generator in an unknown state. To prevent this, a local lockout is recommended for purely automatic

Table 3-3. Message Reference Table (1 of 2)

HP-IB Message	Applicable	Response	Related Commands and Controls	Interface Functions*
Data	Yes	Most front panel functions and remote-only functions are bus programmable. Front panel functions that are not programmable are the line switch, the HP-IB address, and for 2626A, 2608A, 2540A and below, the Backspace key.		AH1 SH1 T5 TE0 L3 LEO
Trigger	Yes	If in remote and addressed to listen, the Signal Generator executes a previously selected program code. It responds equally to the Group Execute Trigger (GET) bus command and program code TR (a Data message).	GET	DT1
Clear	Yes	Sets output to 3000.000 MHz at -70 dBm with sweep and modulation off. Resets many additional parameters as shown in Table 3-5. Responds equally to Device Clear (DCL) and Selected Device Clear (SDC) bus commands.	DCL SDC	DC1
Remote	Yes	Remote mode is enabled when the REN bus control line is true. However, remote mode is not entered until the first time the Signal Generator is addressed to listen. The front panel RMT annunciator lights when the instrument is actually in the remote mode.	REN	RL1
Local	Yes	The Signal Generator returns to local mode (front panel control). It responds equally to the Go To Local (GTL) bus command and the front panel LOCAL key.	GTL	RL1
Local Lockout	Yes	The LOCAL key is disabled. Only the controller can return the Signal Generator to local (front panel control).	LLO	RL1
Clear Lockout/ Set Local	Yes	The Signal Generator returns to local (front panel control) and local lockout is cleared when the REN bus control line goes false.	REN	RL1
Pass Control/ Take Control	No	The Signal Generator has no controller capability.		C0
Require Service	Yes	The Signal Generator sets the SRQ bus control line true if one of the following conditions exists and it has been enabled by the Request Mask to send the message for that condition: Front Panel Key Pressed, Front Panel Entry Complete, Change in Extended Status, Source Settled, End of Sweep, Entry Error, and Change in Sweep Parameters.	SRQ	SR1
Status Byte	Yes	The Signal Generator responds to a Serial Poll Enable (SPE) bus command by sending an 8-bit byte when addressed to talk. If the instrument is holding the SRQ control line true (issuing the Require Service message), bit 7 (RQS bit) in the Status Byte and the bit representing the condition causing the Require Service message to be issued will both be true. The bits in the Status Byte are latched but can be cleared upon receiving the Clear Status (CS) program code, executing the Output Status function, or executing a serial poll while the SRQ control line is held true.	SPE SPD	T5

Table 3-3. Message Reference Table (2 of 2)

HP-IB Message	Applicable	Response	Related Commands and Controls	Interface Functions*
Status Bit	Yes	The Signal Generator responds to a Parallel Poll Enable (PPE) bus command by sending a bit on a controller selected HP-IB data line.	PPE PPD PPC PPU	PP1
Abort	Yes	The Signal Generator stops talking and listening.	IFC	T5, TE0 LE, LEO

*Commands, Control lines, and Interface Functions are defined in IEEE Std 488-1978. Knowledge of these may not be necessary if your controller's manual describes programming in terms of the twelve HP-IB Messages shown in the left column.

Complete HP-IB capability as defined in IEEE Std 488 and ANSI Std MC1.1 is: SH1, AH1, T5, TE0, L3, LE0, SR1, RL1, PP1, DC1, DT1, and C0.

Local Mode (cont'd)

applications. Local lockout disables the LOCAL key and allows return-to-local only under program control.

NOTE

Return-to-local can also be accomplished by turning the Signal Generator's LINE switch to STBY, then back to ON. However, this technique has some disadvantages:

- a. It defeats the purpose and advantage of local lockout (that is, the system controller loses control of a system element).*
- b. There are several HP-IB conditions that reset to default states at turn-on.*

3-27. Addressing

The Signal Generator interprets the byte on the eight HP-IB data lines as an address or a bus command if the bus is in the command mode. The command mode is defined as attention control line (ATN) true and interface clear control line (IFC) false. Whenever the Signal Generator is addressed (if in local or remote), either the TLK or LSN annunciator on the front panel turns on.

The Signal Generator's Talk and Listen addresses can be set from switches located inside the instrument or from the front panel. The address selection procedure is described in Section 2.

The decimal equivalent of the addresses can be displayed in the FREQUENCY MHz display by pressing and holding the LOCAL key. This is the decimal equivalent of the last five bits of both the Talk and Listen ASCII address codes. Refer to Table 2-1 for a comprehensive listing of all valid HP-IB address codes.

Listen Only Mode. If the internal Listen Only switch is set to "1", the Signal Generator is placed in the Listen Only mode. The instrument then responds to all Data messages, and the Trigger, Clear, and Local Lockout messages. It can also respond to a parallel poll with the Status Bit message. However, the Signal Generator cannot send Data messages and cannot respond to a serial poll with the Status Byte message.

The Signal Generator's Listen Only address can also be set from the front panel by keying in 4 0, then pressing the STO key and the LOCAL key. Note that the FRONT PNL ENABLE switch on the internal HP-IB address switch must be set to "1" to allow front panel entries.

Talk Only Mode. If the internal address switches are set to a valid Talk address and the Talk Only switch is set to "1", the Signal Generator is placed in the Talk Only mode. In this mode the instrument is configured to send Data messages whenever the bus is in the data mode. It can also send the Status Byte message in response to a serial poll.



Addressing (cont'd)

The Signal Generator's Talk Only address can also be set from the front panel by keying in 5 0, then pressing the STO key and the LOCAL key. Note that the FRONT PNL ENABLE switch on the internal HP-IB address switch must be set to "1" to allow front panel entries.

3-28. Turn-on Default Conditions

Several HP-IB parameters are reset at turn-on. The parameters and their default conditions are listed below.

- HP-IB Local Mode
- Immediate Execution Mode
- Unaddressed
- Trigger Configuration cleared
- Request Mask cleared
- SRQ cleared

3-29. Displays

The RMT annunciator is on when the Signal Generator is in the remote mode and after it has received its first Data message. The TLK annunciator is on when the Signal Generator is currently addressed to talk; the LSN annunciator is on when the Signal Generator is currently addressed to listen. The SRQ annunciator is on when the Signal Generator is sending the Require Service message.

The MESSAGE key lights for the same conditions in remote as in local. The message can be read in either remote or local when the Signal Generator is under program control. Once the message has been read the key light turns off, whether or not the causing condition has been corrected.

The FREQUENCY MHz and RANGE dBm displays operate in remote mode just as they do in local. Hidden parameters can still be displayed in the FREQUENCY MHz display by pressing and holding their front panel keys. (This capability is not available to the controller since it cannot hold a program code in the same manner that an operator can hold down a key. However, the Output Active Parameter talk function allows the controller to read the current value of hidden parameters.)

3-30. Output Level

Setting output level is the only front panel feature that is not operated in an identical manner in local and remote modes. In local, RANGE is set in steps

of 10 dB and displayed in the RANGE dBm display. The VERNIER knob sets the intermediate values of output power and is read on the meter. In remote, VERNIER is set in 0.1 dBm steps. A selection of programming codes allows either combined or independent setting of the RANGE and VERNIER power. The entry format is [Program Code] [Numeric Value] [Units Terminator]. The code LE sets both range and vernier. The code RA sets just the range. The code VE sets just the vernier.

In going from local to remote the output level might change by a fraction of a dB. In going from remote to local the front panel knob takes control. There is no assurance of whether the power will go up, go down, or stay the same.

3-31. Data Messages

The Signal Generator communicates on the interface bus primarily with Data messages. Data messages consist of one or more bytes sent over the bus' data lines when the bus is in the data mode (attention control line [ATN] false). Unless it is set to Talk Only, the Signal Generator receives Data messages when addressed to listen. Unless it is set to Listen Only, the Signal Generator sends Data messages or the Status Byte message when addressed to talk. Virtually all instrument operations available in local mode can be performed in remote mode via Data messages. The major exceptions are changing the LINE switch settings and changing the HP-IB address of the Signal Generator.

3-32. Receiving Data Messages

The Signal Generator responds to Data messages when it is enabled to remote (REN control line true) and it is addressed to listen. The instrument remains addressed to listen until it receives an Abort message or until its talk address or a universal unlisten command is sent by the controller.

Data Message Input Format. The Data message string, or program string, consists of a series of ASCII codes. Each code is typically equivalent to a front panel keystroke in local mode and follows one of three formats:

- [Program Code] [Numeric Value] [Units Terminator] [EOS]
- [Program Code] [Numeric Value] [EOS]
- [Program Code] [EOS]

Receiving Data Messages (cont'd)

Program codes are typically 2 character mnemonics. All codes normally used by the operator to control the Signal Generator are given in Table 3-6, HP-IB Program Codes.

Numeric values are either a single decimal digit, a set of 11 characters or less representing a number, or a string of binary bytes. A string of 11 characters maximum can be expressed in decimal form only. Digits beyond the front panel display capability of a particular parameter are truncated. Therefore, it is best to format the data so that it is rounded to the correct number of digits.

Units terminators are 2 character codes that terminate and scale the associated numeric value. Frequency can be entered in GHz, MHz, kHz, or Hz. Sweep time values are entered in milliseconds. Power values are entered in dB.

End-of-String messages (EOS) can be the ASCII characters Line Feed (LF), semicolon (;), or the bus END message (that is, bus lines EOI true and ATN false). The at sign (@) acts as an EOS when the Signal Generator is in the Deferred Execution mode.

Valid Characters. The ASCII characters used for program strings are: A—Z a—z 0—9 . - + LF , ; @. The alpha program codes can be either upper or lower case since the Signal Generator will accept either type (they can be interchanged). Spaces, unnecessary signs (+, -), leading zeros, and carriage returns (CR) are ignored. However, if a space or other such character were inserted between 2 characters of a program code, the program code would be invalid and any remaining characters in a string might be misinterpreted by the Signal Generator. After receiving an invalid program code, the Signal Generator requires a valid program code before it will respond to numeric entries.

Immediate Execution Mode. ASCII characters can be accepted in the Deferred or Immediate execution modes. Immediate Execution is the default mode at turn-on. It can be set, if necessary, by sending the program code @3. In this mode the Signal Generator produces an End-of-String (EOS) message at the end of each character and does not require one from the controller. The Signal Generator processes each character before accepting the next one. Therefore, the Immediate Execution mode does slow down overall data transfer. However, the Signal Generator can switch faster after

the final EOS message than it can in the other mode. This is useful when the system controller is slow enough (data rate < 1000 bytes/second) that it cannot take advantage of the Deferred mode's transfer speed or when switching time, independent of message length, is more important than program execution speed.

Deferred Execution Mode. This ASCII mode must be selected by sending the program code @2. In this mode, the Signal Generator accepts strings up to 96 characters at a time, executing the string upon receiving an EOS message. The Signal Generator produces its own EOS message upon receipt of the 96th character in a string. If a block of strings containing more than 96 characters is sent, the first 96 characters are accepted and the Signal Generator holds the bus busy until it executes them. Then the next 96 characters are accepted and so on until the entire block is accepted. If only one string of less than 96 characters is sent, the Signal Generator accepts the strings and frees the bus allowing program execution to continue.

Binary Mode. The Signal Generator's Request Mask is programmed in binary format. Also, learn mode data is sent and received in binary. Binary data is always processed in the Immediate Execution mode.

3-33. Sending the Data Message

The Signal Generator can send Data messages when addressed to talk. It remains configured to talk until it is unaddressed to talk by the controller. To unaddress the Signal Generator, the controller must send the Signal Generator's listen address, an Abort message, a new talk address, or a universal untalk command.

Talk Functions. The types of information that the Signal Generator can send in a Data message are:

- Front Panel Learn Mode
- Special Function Learn Mode
- Messages
- Output Active Parameter
- Output Couple
- Output Lock Frequency
- Test Interface
- Output Status
- Output Request Mask Value (explained later under Sending the Request Mask Value).

Each function is enabled by first addressing the Signal Generator to listen. Then, the Signal Gen-

Sending the Data Message (cont'd)

erator must receive a Data message with the appropriate program code. When the Signal Generator is addressed to talk, it will output data for the selected talk function. If the controller does not repeat the program code or send a new one, the Signal Generator sends data for the last selected talk function when it is addressed to talk. However, it is recommended that a talk function program code be sent each time, prior to addressing the Signal Generator to talk. This will ensure that the Signal Generator sends the appropriate data. Refer to Table 3-4 for a summary of talk functions.

Front Panel Learn Mode. The front panel learn mode uses the controller's memory to learn and store a data string that describes the Signal Generator's current front panel setting. Once an instrument state has been learned, the Signal Generator can be restored to that configuration at a later time. The learn mode requires a controller that can transfer information in binary form.

After receiving an L1 program code (Front Panel Learn Mode) and when addressed to talk, the Signal Generator sends 2 ASCII characters, @ and A, followed by a string of 94 8-bit binary bytes containing information on the front panel configuration. This binary data can then be stored in the controller's memory for future use. In addition, as each configuration goes out onto the bus, it is also stored in the Signal Generator's register 9. The most straight-forward way to program the system controller is to use a loop to read 96 binary characters and store them in an array.

When the Signal Generator is addressed to listen, the binary data can be returned to it in 96-byte strings. When the Signal Generator detects the @A, it will expect the next 94 characters to be in the learn mode string. A checksum is embedded in the string so that possible errors in the storage or transmission of the data will be detected, and the input will be ignored.

Whenever data is being transferred between controller and Signal Generator, it must do so in uninterrupted strings. If a data string is broken or interrupted, the data could be lost or offset, and misinterpreted by the Signal Generator. An offset of data bytes can persist through later data strings until the Signal Generator is eventually switched to standby, then on again.

Special Function Learn Mode. This mode is intended for servicing the Signal Generator. It is similar in operation to the front panel learn mode. After receiving an L2 program code (Special Function Learn Mode) and when addressed to talk, the Signal Generator sends 2 ASCII characters, @ and 9, followed by a string of 26 8-bit binary bytes. This binary data can then be stored in the controller's memory.

The binary characters are directly related to the digital outputs of the Signal Generator's internal controller. There is no checksum or other error detecting scheme, allowing diagnostic and other special functions that are not normally possible with the Signal Generator. Refer to Section 8, Service, for additional information.

Messages. This function enables the MESSAGE key to be read under program control. After receiving an MG program code (Message) and when addressed to talk, the Signal Generator sends a two-digit number coded in ASCII followed by a Line Feed (LF) and EOI. The codes represent entry errors and instrument malfunctions. The two-digit codes are explained on the operating information pull-out card and in the Message Detailed Operating Instruction. The Message can always be read by pressing the MESSAGE key, even when the Signal Generator is in remote mode. However, reading the Message once, either in remote or local, clears it to 00 (No Error) whether or not the causing condition has been corrected.

Output Active Parameter. This function allows the user to determine the present value of a specific parameter. After receiving the program code for a value-selectable parameter followed by the program code OA (Output Active) and when addressed to talk, the Signal Generator will output a string over the bus consisting of the following: [Selected Program Code][Current Numeric Value][Units Terminator][LF and EOI]. Any parameter that has a numeric value associated with it can be interrogated. An exception to this output format is Steps. When the controller sends "SPOA", the Signal Generator returns with the string: SP[Step Size] HZ, SP [Number of Steps] SS, [LF and EOI]. The Signal Generator may output a program code that differs from the code sent to it by the controller. For example, the Signal Generator responds with the program code CF (center frequency) when sent FR (frequency) and MK (marker) when sent M1, M2, M3, M4, or M5 (Markers 1 through 5).

Table 3-4. Talk Functions

Function	Program Code	Signal Generator Output Response to Program Code	Comments
Front Panel Learn Mode	L1	96 Binary Bytes [EOI]	
Special Function Learn Mode	L2	26 Binary Bytes [EOI]	See Section 8, Service
Message	MG	2 Digits [LF and EOI]	
Output Active Parameter	[Program Code] OA	[Program Code] [Numeric Value] [Units Terminator] [LF and EOI]	Valid Functions: CF, FI, FA, FB, FS, M1-5, DW, LE, VE, RA
Output Sweep Steps/ Step Size	SPOA	SP [Step Size] HZ, SP [# of Steps] SS [LF and EOI]	
Output Couple	OC	[START Value], [Center-Frequency Value], [Dwell Value] [LF and EOI]	Frequency is in Hz; dwell is in milliseconds.
Output Lock Frequency	OK	FR [Numeric Value] Hz [LF and EOI]	
Test Interface	TI [1 Byte]	1 Byte [EOI]	
Output Status	OS	2 Bytes [EOI]	
Output Request Mask	OR	1 Byte [EOI]	

Sending the Data Message (cont'd)

Output Couple. After receiving the program code OC (Output Couple) and when addressed to talk, the Signal Generator sends a data string that gives the current numeric values for the following parameters in the order listed: [START], [Center Frequency], [DWEELL] [LF and EOI]. No program codes prefix the numeric values. Hz is the implied terminator for start and center frequency; milliseconds is the implied terminator for dwell time.

Output Lock Frequency. This function causes the Signal Generator to output the value of its tuned frequency. After receiving the program code OK and when addressed to talk, the Signal Generator sends the value of the frequency at which it is currently phase locked. The data output from the Signal Generator is in the following format: FR [Numeric Value] HZ [LF and EOI].

Test Interface Function. This function allows testing of the HP-IB interface. After receiving the program code TI, followed by an 8-bit byte representing one or more data lines (see table below) and

when addressed to talk, the Signal Generator sends the binary byte that it just received. Refer to Section 8, Service, for additional information.

HP-IB Data Line	D108	D107	D106	D105	D104	D103	D102	D101
Weight	128	64	32	16	8	4	2	1

Output Status. After receiving the program code OS (Output Status) and when addressed to talk, the Signal Generator sends two binary bytes, each 8 bits wide. The first byte is identical to the Status Byte of the Serial Poll. The second byte is the Extended Status Byte which provides additional information. See Figure 3-11 for a description of each Status Byte. Bits in the main Status Byte are cleared upon execution of the Output Status function or the Clear Status (CS) program code. Bits on the Extended Status Byte are cleared by removing the causing condition and performing the Output Status function.

3-34. Receiving the Clear Message

The Signal Generator responds to the Clear message by assuming the settings detailed in Table 3-5. The Signal Generator responds equally to the Selected Device Clear (SDC) bus command when addressed to listen, and the Device Clear (DCL) bus command whether addressed or not. The Clear message clears any pending Require Service message.

Table 3-5. Response to a Clear Message

Parameter	Condition
Execution Mode	Immediate
Request Mask	Cleared
Require Service (SRQ)	Cleared
Trigger Configuration	Cleared
MESSAGE	Cleared (set to 00)
RF OUTPUT	ON
ALC	INTERNAL
RANGE	-70 dB
VERNIER	0.0 dBm
AUTO PEAK	ON
MTR Scale	LVL
AM, FM, and Pulse Modulation	OFF
FREQUENCY	3000.000 MHz
FREQ INCR	1.000 MHz
START	2000.000 MHz
STOP	4000.000 MHz
ΔF	2000.000 MHz
MKR	OFF
SWEEP MODE	OFF
STEP	100 steps (20.000 MHz)
DWELL	20 ms
TUNE Knob	ON

3-35. Receiving the Trigger Message

The Signal Generator responds to a Trigger message only if a response has been pre-programmed (see Configure Trigger). Otherwise, it ignores a Trigger message. It responds equally to a Trigger message (with bus command GET) and a Data message with program code TR (Trigger).

Configure Trigger. The Signal Generator's response to a Trigger message is set when it receives a Data message containing the program code CT followed by one valid program code. For example, CTW6 causes a single sweep (W6) when the Trigger message is received.

3-36. Receiving the Remote Message

The Remote message has two parts. First, the remote enable bus control line (REN) is held true; second, the device listen address is sent by the controller. These two actions combine to place the Signal Generator in remote mode. Thus, the Signal Generator is enabled to go into remote when the controller begins the Remote message, but it does not actually switch to remote until addressed to listen the first time. When actually in remote, the Signal Generator's front panel RMT annunciator lights.

3-37. Receiving the Local Message

The Local message is the means by which the controller sends the Go To Local (GTL) bus command. If addressed to listen, the Signal Generator returns to front panel control when it receives the Local message.

When the Signal Generator goes to local mode, the front panel RMT annunciator turns off. However, even when in local, if the Signal Generator is being addressed, its front panel LSN or TLK annunciator turns on.

3-38. Receiving the Local Lockout Message

The Local Lockout message is the means by which the controller sends the Local Lockout (LLO) bus command. If in remote, the Signal Generator responds to the Local Lockout Message by disabling the front panel LOCAL key. The local lockout mode prevents loss of data or system control due to someone accidentally pressing front panel keys. If, while in local, the Signal Generator is enabled to remote (that is, REN is set true) and it receives the Local Lockout message, it will switch to remote mode with local lockout the first time it is addressed to listen. When in local lockout, the Signal Generator can be returned to local only by the controller (using the Local or Clear Lockout/Set Local messages), by setting the LINE switch to STBY and back to ON, or by removing the bus cable.

3-39. Receiving the Clear Lockout/Set Local Message

The Clear Lockout/Set Local message is the means by which the controller sets the Remote Enable (REN) bus control line false. The Signal Generator returns to local mode (full front panel control) when it receives the Clear Lockout/Set Local message. When the Signal Generator goes to local mode, the front panel RMT annunciator turns off.

3-40. Receiving the Pass Control Message

The Signal Generator does not respond to the Pass Control message because it does not have this controller capability.

3-41. Sending the Require Service Message

The Signal Generator sends a Require Service message if one or more of the following conditions exist and if it has been pre-programmed to send the message by the Request Mask.

- **Front Panel Key Pressed:** when the Signal Generator is in local mode and one of the front panel keys is pressed.
- **Front Panel Entry Complete:** when the Signal Generator is in local mode and is finished processing a front panel entry.
- **Change in Extended Status:** when one of the bits on the Extended Status Byte changes.
- **Source Settled:** when the Signal Generator is settled. Switching transients occur when RF and AUTO PEAK are turned on, and when FM ranges and frequency are changed. If the controller responds to the Signal Generator as soon as the source is settled, instead of waiting a specified time, program speed is increased.
- **Entry Error:** When an invalid keystroke or program command occurs.
- **New Sweep Parameters:** when the value of START, STOP, ΔF , DWELL, STEP, or any Marker changes.

The Signal Generator can send a Require Service message in either the local or remote mode.

The Signal Generator sends a Require Service message by setting the Service Request (SRQ) bus line true. The SRQ annunciator on the front panel turns on when the Require Service message is being sent. The Require Service message is cleared after the Output Status function or the Clear Status (CS) program code has been executed by the controller.

Request Mask. The Request Mask functions within the Status Byte. It determines which bits can set the RQS bit true (see Figure 3-11) and consequently set the SRQ bus line true.

The Request Mask is set by the program code @1 followed by an 8-bit byte (a Data Message). The value of the byte is determined by summing the weight of each bit to be checked. Each bit, if true, enables a corresponding condition to set the RQS bit true. This message is executed immediately and does not require an End-of-String message to be sent. At turn-on, the Request Mask is cleared (that is, set to 0).

Sending the Request Mask Value (a Data Message).

After receiving an OR program code (Output Request Mask) and when addressed to talk, the Signal Generator will send a single binary word (8 bits) that describes the present state of the mask. The bit pattern can be interpreted with the information in Figure 3-11.

NOTE

This byte is sent with the bus EOI line true, thus terminating the message.

3-42. Sending the Status Byte Message

After receiving a Serial Poll Enable bus command (SPE) and when addressed to talk, the Signal Generator sends a Status Byte message. The message consists of one 8-bit byte of which 7 bits correspond to the pattern and descriptions for the Request Mask. The remaining bit, bit 7, is the RQS Request Service bit (see Figure 3-11).

The RQS bit is set when one of the other seven conditions exists and that condition has been enabled by the Request Mask. Bits 1–6 and 8 might be true regardless of conditioning by the Request Mask. However, if a condition has not been selected by the mask, it cannot cause the RQS bit to be set true.

Extended Status Byte. A second status byte is available but can only be accessed via the Output Status function (see explanation under Sending the Data Message). Bit 3 of the Status Byte indicates whether a change has occurred in the Extended Status Byte. If Bit 3 is true, the second status byte should be accessed via the Output Status function to determine the cause of the status change. The bit pattern can be interpreted with the information in Figure 3-11.

3-43. Clearing the Status Byte

Once the Signal Generator sets the SRQ bus line true, it is no longer allowed to alter the Status Byte. If a bit has been enabled and the condition occurs after the SRQ bus line has been set true, the

STATUS BYTE (#1)								
BIT	8	7	6	5	4	3	2	1
WEIGHT	128	64	32	16	8	4	2	1
Condition	Change in Sweep Parameters	RQS Bit Request Service	Entry Error	End of Sweep	Source Settled	Change in Extended Status	Front Panel Entry Complete	Front Panel Key Pressed

EXTENDED STATUS BYTE (#2)								
BIT	8	7	6	5	4	3	2	1
WEIGHT	128	64	32	16	8	4	2	1
Condition	0 (always)	ALC Unleveled	Power Failure/On	Not Phase Locked	External Ref	0 (always)	FM Overmodulated	Self-Test Failed

Figure 3-11. Status Byte Information

bit is stored in a buffer and is read the next time the Signal Generator receives the Serial Poll Enable (SPE) bus command. When addressed to talk (following SPE), the Signal Generator sends the Status Byte message.

After the Status Byte message has been sent it will be cleared if the Serial Poll Disable (SPD) bus command is received, if the Abort message is received, or if the Signal Generator is unaddressed to talk. However, bits stored in the buffer waiting to be read are not cleared. Regardless of whether or not the Status Byte message has been sent, the Status Byte and any Require Service message pending will be cleared if a Clear Status (CS) program code is received or the Output Status function is executed.

NOTE

The Signal Generator must receive a universal untalk command after sending the Status Byte message. Most system controllers send this automatically. However, if a universal untalk command is not sent, the SRQ bus line may not be re-initialized and pending Service Requests may get lost.

3-44. Sending the Status Bit Message

The Signal Generator sends the Status Bit message (if configured) as part of the interface's response byte to the Parallel Poll Enable (PPE) bus command. In order for the Signal Generator to respond to a Parallel Poll Enable bus command it must be assigned a single HP-IB data line by the controller. The controller also assigns the logic level of the bit. Both tasks can be accomplished by the Parallel Poll Configure (PPC) bus command. If the Signal Generator is sending the Require Service message, it will set its assigned status bit true. The Signal Generator can send the Status Bit message without being addressed to talk.

The data line that the Signal Generator is assigned to respond on can be cleared by turning the instrument to STBY or by sending the Parallel Poll Unconfigure (PPU) bus command.

3-45. Receiving the Abort Message

The Abort message is the means by which the controller sets the Interface Clear (IFC) bus control line true. When the Abort message is received, the Signal Generator becomes unaddressed and stops talking or listening.

Table 3-6. HP-IB Program Codes (1 of 2)

Program Code	Parameter	Program Code	Parameter
AP	Level (RANGE and VERNIER)	L1	Front Panel Learn Mode
A0, AO	AM OFF	L2	Special Function Learn Mode
A1	AM OFF	MG	MESSAGE
A2	AM 30%	MS	milliseconds
A3	AM 100%	MU	MULT (or SHFA) (2552A, 2634A and above)
BS	Backspace (2552A, 2634A and above)	MY	MULT (2552A, 2634A and above)
CF	Center Frequency	MZ	MHz
CS	Clear Status	M0,MO	Marker(s) OFF
CT	Configure Trigger	M1	Marker 1
CW	CW Frequency	M2	Marker 2
C1	ALC INTERNAL	M3	Marker 3
C2	ALC DIODE	M4	Marker 4
C3	ALC PWR MTR	M5	Marker 5
C4	ALC SYS Mode (or SHC2) (2552A, 2634A and above)	N0,NO	TUNE Knob OFF
DB	dB	N1	TUNE Knob ON
DF	ΔF	OA	Output Active Parameter
DM	dB	OC	Output Couple
DN	FREQ INCREMENT (Down)	OK	Output Lock Frequency
DW	DWELL	OL	Front Panel Learn Mode
D0,DO	FM DEVIATION OFF	OR	Output Request Mask
D1	FM DEVIATION OFF	OS	Output Status
D2	FM DEVIATION .03 MHz	PL	Power Level (RANGE and VERNIER)
D3	FM DEVIATION .1 MHz	P0,PO	PULSE OFF
D4	FM DEVIATION .3 MHz	P1	PULSE OFF
D5	FM DEVIATION 1 MHz	P2	PULSE NORM
D6	FM DEVIATION 3 MHz	P3	PULSE COMP
D7	FM DEVIATION 10 MHz	RA	RANGE
FA	START Sweep Frequency	RC	Recall (RCL)
FB	STOP Sweep Frequency	RCBS	Alternate Instrument Preset (2552A, 2634A and above)
FI	FREQ INCR	RD	RANGE Down 10 dB
FN	FREQ INCR	RF0	RF OFF
FO	+OFFSET (or SHFB) (2552A, 2634A and above)	RF1	RF ON
FO-	-OFFSET (or SHDF) (2552A, 2634A and above)	RL	Recall (RCL)
FR	FREQUENCY	RM	RQS Mask
FS	ΔF	RS	Reset Sweep
FT	+ OFFSET (2552A, 2634A and above)	RU	RANGE Up 10 dB
FT-	- OFFSET (2552A, 2634A and above)	R0,RO	RF OFF
F1	FREQ INCR	R1	RF ON
GZ	GHz	SD	Slave Down
HZ	Hz	SF	STEP
IF	Increment Frequency (Sweep)	SM	MANUAL Sweep
IP	Instrument Preset	SP	STEP
KZ	kHz	SH	Shift (2552A, 2634A and above)
K0	AUTO PEAK OFF	SS	Steps (suffix)
K1	AUTO PEAK ON	ST	Store (STO)
K2	AUTO PEAK without extra settling time	SU	Slave Up
LE	Level (RANGE and VERNIER)	SV	Service Function
		TI	Test Interface



Table 3-6. HP-IB Program Codes (2 of 2)

Program Code	Parameter	Program Code	Parameter
TR	Execute Trigger	XF	XFREQ (2552A, 2634A and above)
T1	Meter LVL	X0	Marker(s) OFF
T2	Meter AM	X1	Marker 1
T3	Meter FM	X2	Marker 2
UP	FREQ INCREMENT (Up)	X3	Marker 3
VE	VERNIER	X4	Marker 4
W0,W0	SWEEP MODE OFF	X5	Marker 5
W1	SWEEP MODE OFF	Y0	FREQ display off
W2	AUTO Sweep	Y1	FREQ display on
W3	MANUAL Sweep	@A	Start of Front Panel Learn Mode
W4	SINGLE Sweep	@1	Prefix for Request Mask
W5	SINGLE Sweep: Arm Only	@2	Deferred Execution Mode
W6	SINGLE Sweep: Arm and Begin	@3	Immediate Execution Mode
W7	Master Sweep	@9	Start of Special Function Learn Mode
W8	Slave Sweep		

Table 3-7. Index of Detailed Operating Instructions

<p>Note: The Detailed Operating Instructions are referenced to the front panel controls and are arranged in alphabetical order.</p>	
Function	Subjects
AUTOMATIC LEVEL CONTROL	Diode Automatic Level Control Internal Automatic Level Control Power Meter Automatic Level Control System Automatic Level Control
FREQUENCY	Frequency (CW) Frequency Increment and Tuning
MISCELLANEOUS CAPABILITIES	Auto Peak Master/Slave Sweep Messages Multiplier Mode Offset Frequency Recall and Store Registers Status Byte and Polling
MODULATION	Amplitude Modulation Frequency Modulation Pulse Modulation
RF OUTPUT LEVEL	Range (Output Level) RF Output On/Off Vernier (Output Level)
SWEEP	Auto Sweep Mode Center Frequency (Sweep) Δ Frequency (Sweep) Dwell Time (Sweep) Manual Sweep Mode Marker Frequency (Sweep) Single Sweep Mode Start Frequency (Sweep) Steps (Sweep) Step Size (Sweep) Stop Frequency (Sweep)

Amplitude Modulation

Description The Signal Generator provides linear amplitude modulation when internally leveled or when externally leveled with a power meter. External leveling with a diode detector requires that the diode is operating in the square law region to provide linear amplitude modulation.

The Signal Generator has a selectable sensitivity of 30% AM per volt or 100% AM per volt. AM depth is linearly controlled by varying the AM input drive level between 0 and 1 volt peak into 600 ohms. For example, 0.5 volts peak will develop 15% AM depth on the 30% range and 50% AM depth on the 100% range.

AM depth is monitored using the Signal Generator's front panel meter in the AM meter mode. The meter monitors the signal at the AM input connector and displays the corresponding AM depth in percent. An overmodulation condition is indicated by the UNLEVELED annunciator when the modulation depth exceeds the Signal Generator capability.

Local Procedure

To set the Signal Generator to a desired AM depth:

1. Press the 30% or 100% AM range key. If the desired depth is less than or equal to 30%, use the 30% range for better display resolution. Otherwise, select the 100% range. The key indicator should light when the key is pressed to indicate which range is selected.
2. Connect an external oscillator to the AM input and set the frequency of the external oscillator to the desired modulation rate at an amplitude of 0 volts.
3. Press the Signal Generator's AM meter mode key which is located near the front panel meter. This will allow the amplitude of the external oscillator to be monitored as the desired AM depth.
4. Adjust the external oscillator amplitude until the meter indicates the desired AM depth. If the UNLEVELED annunciator is lighted, reduce the AM depth or the Signal Generator's output level until the annunciator extinguishes.

Remote Procedure

The AM range can be programmed to the 100% range, 30% range, or AM off using the program codes A3, A2, or A1 respectively. The actual AM depth is controlled by the amplitude of the external modulation source. The meter mode can be set to AM with the program code T2.

An overmodulation condition can be detected by the controller by checking the status byte. The ALC UNLEVELED bit of the extended status byte is used to indicate AM overmodulation.

The AM range and the AM depth cannot be read by the controller. The AM depth is determined by the amplitude setting of the external oscillator used to provide the modulating signal. If the output impedance of the external oscillator is 600 ohms, the AM depth can be determined by the controller by reading the external oscillator amplitude and multiplying by the programmed Signal Generator AM range.

Example

To modulate the Signal Generator at 75% AM depth:

Local

1. Press the AM 100% key to set the Signal Generator to AM mode. Press the AM key near the Signal Generator's front panel meter to set the meter to AM mode.

Amplitude Modulation (cont'd)

Example (cont'd)

2. Set the external oscillator to the desired modulating rate and adjust the amplitude to zero volts.
3. Connect the external oscillator to the Signal Generator's AM input connector. Adjust the external oscillator amplitude until the middle scale (0 to 1) indicates 75% AM depth. The required external oscillator amplitude will be approximately 0.75 volts peak or 0.53 volts rms.

Remote

The programming string for setting the 100% AM depth range is A3. The amplitude and frequency of the modulating signal must be set by programming the external modulating signal source. The alpha character (A) can be sent as upper or lower case.

Program Codes

HP-IB

Program Code	Description
A0	AM Off
A1	AM Off
A2	AM 30% Range
A3	AM 100% Range

Comments

AM bandwidth is determined by the frequency response of the automatic level control (ALC) circuitry. Using internal leveling will provide the specified AM bandwidth up to the maximum specified AM depth. External leveling will typically preserve the AM bandwidth but is dependent on the detector used. System leveling on system compatible Signal Generators will typically reduce the usable AM bandwidth to 80 kHz. Useable AM bandwidth can be more than doubled by activating any sweep mode.

Pulse modulation uses a sample and hold system to maintain pulse level accuracy. A capacitor is used to hold the automatic level control (ALC) circuit setting between pulses. When pulse and amplitude modulation are used together, the sampling capacitor has the effect of reducing the effective AM bandwidth. The effective AM bandwidth when pulse mode and AM are enabled and sweep is disabled is calculated as follows:

$$\text{Bandwidth} = (4 \text{ kHz}) * (P_w) * (\text{PRF})$$

Where: P_w is the pulse width in seconds
PRF is the pulse repetition frequency in Hz

For example, a pulse width of 10 microseconds at a pulse repetition rate of 10 kHz will yield an effective AM bandwidth of 400 Hz. The effective AM bandwidth is directly proportional to the duty cycle ($P_w * \text{PRF}$).

Programming Example

The following program is written in BASIC for HP 9000 Series 200 or 300 controllers. The program will set the AM range to an appropriate setting and return the peak voltage required (into 600 ohms) for the AM depth specified by *Depth*.

Amplitude Modulation (cont'd)

**Programming
Example
(cont'd)**

```
10 SUB Am_depth(Err,Depth,V_required)           ! Depth is in %
20 !
30 SELECT Depth
40 CASE ≤30
50 Depth$+"A2"                                   ! Code for 30% depth
60 V_required+Depth/30                          ! In peak volts into 600 ohms
70 CASE ≤100
80 Depth$+"A3"                                   ! Code for 100% depth
90 V_required+Depth/100                         ! In peak volts into 600 ohms
100 CASE ELSE
110 Err=-1
120 DISP "Desired AM depth is greater than 100%"
130 END SELECT
140 !
150 OUTPUT 719 USING "2A";Depth$
160 !
170 SUBEND
```

**Error
Messages**

There are no messages associated with the setting of amplitude modulation.

Auto Peak

Description

The Signal Generator uses an internal tracking filter for increased spectral purity and for rejecting unwanted multiplication products when generating frequencies above 6.6 GHz. If the passband of the tracking filter is off by as little as 10 MHz, maximum available power is reduced, pulse modulation is distorted and the frequency modulation sidebands are filtered asymmetrically.

The tuning accuracy of the internal tracking filter must be better than 0.1% to avoid these problems. Because of nonlinearities, hysteresis and temperature sensitivities of the tuning, the filter must be fine tuned with an Auto Peak operation to center the passband of the tracking filter.

The Auto Peak operation occurs whenever the frequency has changed by more than 50 MHz from the last frequency where an Auto Peak operation was performed. An Auto Peak also occurs whenever Auto Peak is switched from disabled to enabled, when pulse mode is enabled, when an FM deviation range is changed, when the RF output is turned on, and when the output level VERNIER causes a change greater than 0.4 dB.

Pulse modulation requires Auto Peak to be enabled to guarantee the published specifications. See the pulse modulation detailed operating instructions for more information regarding pulse modulation and Auto Peak.

Local Procedure

To perform an Auto Peak operation:

1. Press the AUTO PEAK key to disable Auto Peak operations. If the key indicator is off, this step is not required.
2. Press the AUTO PEAK key again to enable Auto Peak operations. The key indicator should now be lighted. The Auto Peak operation is performed immediately after the Auto Peak key is pressed (if the key indicator was off).

Auto Peak should be enabled at all times to provide optimum RF output signals. However, for faster frequency switching times or digital sweeps, Auto Peak may be disabled at the expense of slightly degrading the RF output signal.

Remote Procedure

There are three programming codes associated with the Auto Peak operation. K0 disables all Auto Peak operations. Selecting pulse modulation will automatically re-enable Auto Peak. The disable programming code must follow the selection of pulse modulation mode if Auto Peak is to remain disabled.

K1 is used to enable Auto Peak operations if Auto Peak is disabled when the program code is received. If Auto Peak is enabled when the program code is received, an Auto Peak operation is performed and Auto Peak is left enabled. In either case, this program code will perform an Auto Peak operation.

Part of the Auto Peak operation algorithm involves a delay for frequency changes of more than 1 GHz or band crossings. This delay is required to eliminate the effects of filter drift after a large frequency change. The filter is immediately tuned to the correct frequency when the frequency change occurs and then the algorithm waits for the filter to settle. In applications that require a very fast measurement cycle, the Auto Peak may be performed immediately after the frequency change by sending the program code K2 after the frequency change. This will immediately perform an Auto Peak operation but will not correct for the filter drift as the filter settles. Some experimentation may be required to determine whether a measurement system can benefit from the faster Auto Peak operation.

Auto Peak (cont'd)

Remote Procedure (cont'd)

The SOURCE SETTLED bit of the extended status byte will be set to indicate that the Auto Peak operation has been completed. Since the settling times of other operations are also indicated by the setting of this bit, the status byte should be cleared before performing the Auto Peak operation. The Auto Peak can then be performed and will be finished when the bit is set.

Program Codes

HP-IB

Program Code	Description
K0	Disables Auto Peak Operations
*K1	Enables and Performs Auto Peak Operation
K2	Performs Auto Peak Operation Without Settling

* Preferred program code

Comments

Auto Peak operations will produce small perturbations in the output level during peaking as the filter passband is adjusted. If the tuning is too far off to be centered by the Auto Peak operation, message 90 will be issued to indicate that the filter tracking requires adjustment.

When Auto Peak operations are disabled, the filter fine tuning is not changed. This feature can be used to achieve faster frequency switching time by performing a peak at the destination frequency and then disabling peaking. The frequency switching time will then be minimized since an Auto Peak operation will not have to be performed. Wide band sweeps can also use this feature to maintain power level at the higher frequencies by peaking at the higher frequency band and then disabling Auto Peak operations. Output power typically decreases with increasing frequency.

The Auto Peak operation is slowed when any FM range is selected. FM is not completely turned off when an Auto Peak occurs due to the relatively long turn off time required by the FM circuitry. Instead, the FM range is set to the lowest deviation range and the peak is performed after a brief settling time.

Auto Peak will slow the effective sweep time for low dwell settings. The Auto Peak operation will occur every 50 MHz during sweep modes. With FM selected, the effective sweep time will be increased further. Auto Peak may be disabled during sweep modes at the expense of maximum available power and modulation performance. Pulse modulation requires a longer auto peak operation to maintain pulse performance. Therefore, pulse modulation while sweeping will dramatically lengthen sweep time.

Programming Example

The following program is written in BASIC for HP 9000 Series 200 or 300 controllers. The program will execute an Auto Peak operation and then return after the Auto Peak operation is complete.

Auto Peak (cont'd)**Programming
Example
(cont'd)**

```

10 SUB Peak(Err)
20 OUTPUT 719 USING "4A";"CSK1"           ! Force an Auto Peak and enable peaking
30 !
40 V+SPOLL(719)
50 IF NOT BIT(V,3) THEN GOTO 40           ! Wait for completed Auto Peak
60 !
70 OUTPUT 719 USING "2A";"MG"           ! Check for error
80 ENTER 719 USING "2A";Message$
90 IF Message$="90" THEN
100 Err=90
110 ELSE
120 Err=0
130 SUBEND

```

**Error
Messages**

If an Auto Peak operation cannot be performed due to low power output or a mistuned filter, error message 90 will be issued to indicate that service is required.

Auto Sweep Mode

Description

The Signal Generator performs a digital sweep by stepping the RF output frequency in discrete steps from the start frequency to the stop frequency. The number of steps that the Signal Generator produces between the start and stop frequency is controlled by the number of steps or the sweep step size parameters. The time that the Signal Generator remains at each step after switching frequencies is controlled by the dwell time parameter.

The Signal Generator has three sweep modes to accommodate a variety of applications. Auto sweep mode is used when a repetitive sweep is required. Auto sweep mode will step the RF output frequency from the start frequency to the stop frequency and then repeat the sweep until the sweep is turned off or a band crossing is encountered.

Single sweep mode will step the RF output frequency from the start frequency to the stop frequency once and then stop. This mode is useful when a single sweep is taken during a measurement where the measuring device can store the results.

Manual sweep provides a convenient method to limit the tuning range of the frequency tuning controls. In applications requiring a single band of frequencies, the tuning limits can be set to cover the band of interest which allows the user to tune the frequency without having to watch the Signal Generator display to determine when the frequency is outside of the selected band.

There are four rear panel connectors that are used for sweep coordinating signals. SWP OUT provides a signal that is 0 volts at the beginning of a sweep and 10 volts at the end of the sweep regardless of the sweep width. The output impedance is nominally 100 ohms.

The TONE MKR connector provides a 5 kHz signal when an active marker frequency is generated. This signal can be connected to the AM IN connector on the front panel to provide AM markers on the external display. Nominal impedance of the TONE MKR is 600 ohms.

The BLANKING/MARKER output provides a +5 volt signal at the beginning of each frequency change for blanking an external display. The blanking function is used to eliminate the display of switching transients. Once the frequency has settled, the signal returns to 0 volts unless the new frequency is an active marker frequency. If the frequency is an active marker frequency, the signal is set to -5 volts to provide a Z-axis input for intensifying the display at the marker sweep point.

The PEN LIFT connector provides control for an external X-Y recorder. A TTL logic high is used to raise the pen and a TTL logic low is used to lower the pen. The pen is only lowered in single sweep and there is a 100 millisecond sweep delay for the pen to rise or lower.

Local Procedure

To set the Signal Generator for automatic sweeping:

1. Set the desired sweep parameters.
2. Press the AUTO SWEEP MODE key to activate automatic sweep mode. The key indicator will light and the display will indicate that a sweep is in progress with a start/stop frequency display or a running indication of the RF output frequency.

If a new center frequency is entered when automatic sweep mode is active, the sweep will begin at the center of the sweep (the new center frequency) and continue sweeping. Tuning the frequency will also move the sweep center frequency when automatic sweep mode is active.

Auto Sweep Mode (cont'd)

Local Procedure (cont'd)

If another sweep mode was enabled when auto sweep is selected, the first sweep will begin at the current RF output frequency. Subsequent sweeps will begin at the sweep start frequency.

If the k band amplifier (Option 008 only) band crossing is encountered during an automatic sweep, only one sweep will be executed. The message key will light and a message number will be issued to indicate that a band crossing has occurred. This feature is included to prevent excessive wear on internal mechanical switches. For more information on this feature, see "Additional Operating Information", paragraph 3-12.

Remote Procedure

Automatic sweep mode is activated with the program code W1. The sweep can be reset with the program code RS. Resetting the sweep will restart the automatic sweep at the start frequency.

The controller can monitor the END OF SWEEP bit of the extended status byte to determine when each sweep is finished. The bit will be set when the stop frequency is reached and will not be reset until it is read or the status byte is cleared.

Example

To sweep from 2 to 4 GHz in automatic sweep mode:

Local

1. Set the start frequency to 2 GHz and the stop frequency to 4 GHz.
2. Press the AUTO SWEEP MODE key to activate automatic sweeping. The key indicator will blink briefly at the beginning of each new sweep.

Remote

The programming string to set automatic sweep is "W2".

The alpha character (W) can be sent as upper or lower case.

Program Codes

HP-IB

Program Code	Function
W2	Auto Sweep Mode

Comments

The Signal Generator digital sweep is composed of discrete frequencies that are produced sequentially. The minimum step size is limited to the frequency resolution which is defined as the minimum change in frequency that the Signal Generator can produce. The number of steps is dependent on the frequency resolution and the frequency span. For information regarding sweep time, see the DWELL TIME detailed operating instruction.

The actual change in output frequency during a sweep will not be uniform for some frequency bands and may vary up to 2 kHz. This is required to accommodate sweep step sizes that are not exact multiples of the frequency resolution. The sweep steps averaged over several sweep points will be equal to the selected sweep step size. An example of the averaging is defining a sweep step size of 10 kHz at a start frequency of 15 GHz. The minimum tuning increment at 15 GHz is 3 kHz which means that the sweep step size can be 9 kHz or 12 kHz for exact step sizes. To obtain a sweep step size of 10 kHz, the Signal Generator will step by 9 kHz, 9 kHz, 12 kHz and then will repeat the sequence.

Auto Sweep Mode (cont'd)

Comments (cont'd)

The average step size is 10 kHz even though the sweep does not execute exactly 10 kHz steps. If the step size is reduced to 1 kHz, the Signal Generator will step by 0 kHz, 0 kHz and then 3 kHz for a 1 kHz average step size in the 3 kHz resolution frequency band.

Sweeps from a higher frequency to a lower frequency can be accomplished by setting the start frequency higher than the stop frequency. This combination results in a negative frequency span as indicated when the frequency span is displayed. Negative frequency spans can only be entered by setting the start frequency higher than the stop frequency.

An Auto Peak operation is performed whenever the RF output frequency is more than 50 MHz from the frequency at which the last Auto Peak operation was performed. The Auto Peak operation optimizes the Signal Generator performance at the current frequency. The Auto Peak operation produces small changes in the RF output level as the peaking is performed. For applications requiring fastest sweeps, Auto Peak may be disabled. However, with Auto Peak disabled, modulation performance and maximum output power may be degraded. The time required for the Auto Peak operation is not included in the dwell time setting.

The automatic level control (ALC) bandwidth is increased when sweep mode is activated. This provides fast response to switching transients when sweeping. In addition, AM bandwidth is typically increased by 2.5 times.

The front panel annunciators are filtered in sweep mode to prevent false indications. While sweeping, the frequency changes cause a loss of phase lock and unlevelled automatic level control during the frequency change. To prevent constant flashing of the front panel annunciators, the response is damped to indicate only major problems during a sweep. The bits of the extended status byte are also buffered and should not be used to check individual sweep points for phase lock and leveled RF output.

The Signal Generator Option 008 has a frequency where mechanical switches are actuated to change the internal microwave signal path. The automatic sweep is only permitted one sweep across these mechanical switches. The message key will light and an error code will be issued to indicate that a crossing occurred in automatic sweep mode. The switch point is given below.

Frequency Switch Point	Description
16.0 GHz	An amplifier is switched in to increase output power above 16 GHz (Option 008 only)

Auto Sweep Mode (cont'd)

Programming Example

The following program is written in BASIC for HP 9000 Series 200 or 300 controllers. The following program is used to set the Signal Generator to the sweep mode specified by the variable *Mode\$*.

```

10 SUB Sweep_set(Err,Mode$)
20 OUTPUT 719 USING "2A";"MG"      ! Read message from 8673
30 ENTER 719 USING "2A";Message$  ! to clear any old messages
40 SELECT Mode$
50 CASE "AUTO","AUTOMATIC"
60 Code$="W2"                      ! Auto sweep mode
70 CASE "MANUAL"
80 Code$="W3"
90 CASE "SINGLE","ONCE"
100 Code$="W6"                     ! Arm and begin single
110 CASE ELSE
120 DISP "WARNING: Invalid sweep mode specified"
130 Err=-1
140 SUBEXIT
150 END SELECT
160 !
170 OUTPUT 719 USING "2A";Code$
180 !
190 SUBEND                          ! End of subroutine

```

Error Messages

The following message numbers may be displayed when activating automatic sweep mode. Each message is explained as it pertains to activating automatic sweep mode. For a more complete description of the messages, see the MESSAGES detailed operating instructions.

- 10 The start and stop frequency are set to the same value. No sweep will be generated.
- 11 The current sweep span is set such that the start frequency would be below the frequency range of the instrument. The sweep will begin at the lowest sweep point that is within the range of the Signal Generator. All sweep points will be allotted, but the frequency will not change until the sweep is within the frequency range of the Signal Generator.
- 12 The current sweep span is set such that the stop frequency would be above the frequency range of the instrument. The sweep will end at the highest sweep point that is within the frequency range of the Signal Generator. All sweep points will be allotted, but the last sweep points will all be at the highest valid frequency.
- 16 The k-band amplifier (Option 008 only) crossing occurred during automatic sweep mode. Only one sweep will occur and then the sweep will stop.
- 90 Auto Peak malfunction. This indicates that the instrument may require service.

Center Frequency (Sweep)

Description

The sweep center frequency is used in conjunction with the sweep delta frequency to set the frequency sweep limits. The sweep frequency limits can also be set using the sweep start and stop frequencies. Setting the sweep start and stop frequency will begin the sweep at the start frequency and end the sweep at the stop frequency. Setting the center frequency and delta frequency will start the sweep at one-half the sweep delta frequency below the center frequency and end the sweep at one-half the sweep delta frequency above the center frequency. Setting the CW frequency when sweep modes are off will also reset the sweep center frequency to the same value.

Setting the sweep center frequency will automatically reset the sweep start and stop frequencies to the required values. The sweep step size will also be recalculated by dividing the sweep delta frequency by the current number of steps. Resetting the start or stop frequency will reset the sweep delta frequency and will reset the sweep center frequency if a sweep mode is enabled, or the CW frequency if sweep is off. Changing the sweep center frequency has the effect of changing the start and stop frequencies by the same value.

The sweep center frequency can be set to any valid frequency within the Signal Generator's frequency range.

Local Procedure

To set the Signal Generator to a specific sweep center frequency:

1. Press the FREQUENCY key to indicate that the next entry will be for sweep center frequency. This procedure is identical to the setting of CW frequency. The Signal Generator always sets the CW frequency equal to the entered sweep center frequency when sweep mode is turned off. When sweep modes are on, CW frequency entries also reset the sweep center frequency to the same value.
2. Enter the desired frequency using the numeric keypad. If a mistake is made while entering the frequency, press the backspace key until the incorrect digit disappears. Continue entering the correct digits until the frequency displayed in the FREQUENCY MHz display is correct.
3. Press the appropriate units key. You may enter the frequency in GHz, MHz or kHz. Once the units key is pressed, the displayed frequency will be adjusted to display MHz and the output frequency will be set.

If a sweep mode is active when sweep center frequency is entered, the actual frequency displayed after pressing the units key will usually not be the entered frequency. The FREQUENCY MHz display is used to display sweep information during sweep mode so the new sweep center frequency will not be displayed. Setting the sweep center frequency during a sweep changes the center frequency to the value entered. If auto sweep is enabled, the sweep will continue about the new center frequency. If manual sweep is enabled, the sweep frequency will be reset to the new start frequency. For single sweep, the frequency will reset to the new start frequency and the sweep will remain armed. The center frequency can be tuned in the same manner as CW frequency except when manual sweep mode is active.

To check the current sweep center frequency during sweep, press and hold the FREQUENCY key. The FREQUENCY MHz display will display the sweep center frequency as long as the key is held.

Center Frequency (Sweep) (cont'd)

Remote Procedure

The Signal Generator accepts any frequency within its specified frequency range. Above 6.6 GHz, the programmed frequency may be rounded by the Signal Generator to be compatible with the 2, 3 or 4 kHz resolution at the programmed frequency (see comments).

The format of the remote programming follows the front panel key sequence. To program the sweep center frequency, the program code CF is sent followed by the desired frequency and the units (GZ, MZ, KZ, or HZ).

The sweep center frequency can be read by the controller using the output active program code suffix. To read the center frequency, the program codes CFOA are sent and then the frequency is read. The Signal Generator will send the frequency in fundamental (Hz) units. If the frequency is read as a string, the format will be the program code, CF, followed by the center frequency in Hz and then the units terminator (Hz).

Example

To set the sweep center frequency to 16 232.334 MHz:

Local

1. Press the FREQUENCY key.
2. Key in 16232.334 using the numeric keypad. The FREQUENCY MHz display should show 16232.334 when you have finished keying in the value. Note that the entry is left justified at this point.
3. Press the MHz units key to finish the sequence. The FREQUENCY MHz display should now show the entered frequency until the units key is released. The frequency display should now be right justified.

The frequency could also have been entered as 16.232334 GHz or 16232334 kHz. The only difference is the placement of the decimal point and the units key pressed after the frequency has been entered using the numeric keypad.

Remote

The programming string for setting the sweep center frequency is composed of a program code, numeric data and the units terminator. The frequency may be programmed in units of GHz, MHz, kHz or Hz. To program the Signal Generator to 16232.334 MHz, the possible program strings are:

"CF16.232334GZ" or "CF16232.334MZ" or "CF16232334KZ" or "CF16232334000HZ"

The alpha characters can be sent as upper or lower case (or even mixed upper and lower case).

Program Codes

HP-IB

Program Code	Function	Applicable Units
*CF FR	Center Frequency	GZ *MZ KZ HZ

* Preferred Program Code

Center Frequency (Sweep) (cont'd)

Comments

Due to the use of frequency multiplication to generate frequencies above 6.6 GHz, the frequency sometimes cannot be set precisely to a desired value. Frequencies below 6.6 GHz can be set to the nearest 1 kHz. All frequencies between 6.6 and 12.3 GHz can be set within 2 kHz of the desired value. Frequencies between 12.3 and 18.6 GHz can be set within 3 kHz of the desired value and frequencies between 18.6 and 26.5 GHz can be set within 4 kHz of the desired frequency. However, with careful selection of frequency, the roundoff error can be reduced to 1 kHz below 18.6 GHz and 2 kHz for frequencies between 18.6 and 26.5 GHz.

When the Signal Generator is programmed to a frequency that cannot be set exactly due to frequency resolution, a random roundoff occurs. To prevent this, the remote program should perform a calculation to determine whether the frequency can be set exactly and adjust the desired frequency accordingly.

To determine whether a frequency can be set to a given value, divide the desired frequency (in kHz) by two if it is between 6.6 and 12.3 GHz, by three if it is between 12.3 and 18.6 GHz or by four if it is above 18.6 GHz. If the result is a whole number (no remainder), the frequency can be set to the desired value. For example, 16 GHz divided by three (it is between 12.3 and 18.6 GHz) is 5 333333.33 kHz. Since the dividend is not a whole number, this frequency cannot be set exactly. The nearest frequencies that can be set are 15.999999 GHz (5.333333X3) and 16.000002 GHz (5.333334X3). Note that the roundoff error is only 1 kHz if 15.999999 GHz is programmed instead of 16 GHz.

Reading the sweep center frequency will not indicate frequency rounding. The programmed frequency is saved for use in calculating the appropriate sweep start and stop frequencies. To avoid errors during this calculation due to roundoff, the sweep center frequency is saved and the calculated start and stop frequencies are rounded off.

Programming Example

The following program is written in BASIC for HP 9000 Series 200 or 300 controllers. The following program is used to set the Signal Generator sweep center frequency to the frequency specified by the variable *Expected*. The desired value must be in MHz and should be within the frequency range of the Signal Generator.

```
10 SUB Center_freq_set(Err,Expected)           ! Expected frequency in MHz
20 OUTPUT 719 USING "2A";"MG"                 ! Read message from 8673
30 ENTER 719 USING "2A";Message$              ! to clear any old messages
40 Frequency=INT(Expected*1000)/1000          ! Round off to nearest kHz
50 OUTPUT 719 USING "4A,5D.DDD,2A";"CF";Frequency;"MZ" !
60 OUTPUT 719 USING "2A";"MG"                 ! Check for message from 8673
70 ENTER 719 USING "2A";Message$
80 SELECT VAL(Message$)
90 CASE 1                                     ! Frequency was out of range
100 Err=1
110 DISP "WARNING: Attempt to set frequency out of range"
120 CASE ELSE
130 Err=0                                     ! Other errors not applicable
140 END SELECT
150 !
160 OUTPUT 719 USING "4A";"CFOA"              ! Requests center frequency
170 ENTER 719 USING "K";Set_freq              ! Frequency in Hz
180 Set_freq=INT(Set_freq/1000)/1000          ! Convert to MHz
190 !
200 IF ABS(Set_freq-Frequency)>.001 AND Err=0 THEN
210 DISP "WARNING: Programmed frequency is incorrect"
220 END IF
230 SUBEND                                     ! End of subroutine
```

Center Frequency (Sweep) (cont'd)

Error Messages

The following message numbers may be displayed when setting the sweep center frequency. Each message is explained as it pertains to setting sweep center frequency. For a more complete description of the messages, see the MESSAGES detailed operating instruction.

- 01 Entered frequency is not within the range of the Signal Generator.
- 03 Invalid multiplier entry for system compatible instruments. See paragraph 3-2, System Compatibility, for more information about system compatibility.

Delta Frequency (Sweep)

Description The sweep delta frequency determines the sweep span about the center frequency.

The sweep frequency limits are determined by setting either the start and stop frequency or the center frequency and frequency span. Setting start and stop frequency will begin the sweep at the start frequency and end at the stop frequency. Setting the center frequency and sweep delta frequency will start the sweep at one-half the sweep delta frequency below the center frequency and end the sweep at one-half the sweep delta frequency above the center frequency. Setting the CW frequency when sweep is off will also reset the sweep center frequency to the same value.

Setting the center frequency or sweep delta frequency will automatically recalculate the appropriate sweep start and stop frequencies and will recalculate the sweep step size. Resetting the sweep start or stop frequency will reset the sweep center frequency if in sweep mode, or the CW frequency if sweep is off. The sweep delta frequency will be recalculated whenever the sweep start or stop frequency is changed.

The sweep delta frequency can be set as low as 1 kHz to as high as the maximum frequency of the Signal Generator. If the sweep start frequency is set above the sweep stop frequency, a negative sweep delta frequency will be stored. Entering the start frequency above the stop frequency is the only way to enter a negative frequency span.

Local Procedure

To set the Signal Generator to a specific sweep delta frequency:

1. Press the SWEEP FREQ ΔF key to indicate that the next entry will be for sweep delta frequency.
2. Enter the desired frequency using the numeric keypad. If a mistake is made while entering the frequency, press the backspace key until the incorrect digit disappears. Continue entering the correct digits until the frequency displayed in the FREQUENCY MHz display is correct.
3. Press the appropriate units key. The frequency can be entered in GHz, MHz or kHz. Once the units key is pressed, the displayed frequency will be adjusted to display in MHz units and the sweep delta frequency will be set. The sweep delta frequency will continue to be displayed until the units key is released.

The frequency displayed after releasing the units key may not be the same frequency displayed before the entry. If sweep mode is off, the displayed frequency will be the CW frequency (no change). If auto sweep is on, the sweep will be reset and then continue using the new delta frequency. If single sweep is on, the sweep will be reset and the sweep will remain armed at the new start frequency. If manual sweep is on, the sweep frequency will be reset to the new start frequency.

To check the current sweep delta frequency, press and hold the SWEEP FREQ ΔF key. The FREQUENCY MHz display will display the sweep delta frequency as long as the key is held. When any sweep mode is turned off, the CW frequency will be set to halfway between the start and stop frequencies (equal to the sweep center frequency).

Remote Procedure

The Signal Generator accepts any sweep delta frequency between 1 kHz and the maximum Signal Generator frequency. Once the sweep delta frequency is entered, the Signal Generator will recalculate the sweep start and stop frequencies. If the recalculated start and/or stop is above 6.6 GHz, the calculated frequency may be rounded by the Signal Generator to be compatible with the 2, 3, or 4 kHz resolution at the calculated frequency (see comments).

Delta Frequency (Sweep) (cont'd)

Remote Procedure (cont'd)

The format of the remote programming follows the front panel key sequence. To program the sweep delta frequency, the program code DF is sent followed by the desired frequency and the units (GZ, MZ, KZ, or HZ).

The current sweep delta frequency can be read by the controller using the output active program code suffix. To read the stop frequency, send the program codes "DFOA" and then read the delta frequency. The Signal Generator will send the frequency in fundamental (Hz) units. If the frequency is read as a string, the format will be the program code, DF, followed by the sweep stop frequency in Hz and then the units terminator (Hz).

Example

To set the sweep delta frequency to 4500 MHz:

Local

1. Press the SWEEP FREQ ΔF key.
2. Key in 4500 using the numeric keypad. The FREQUENCY MHz display should show 4500 when you have finished keying in the value. Note that the entry is left justified at this point.
3. Press the MHz units key to finish the sequence. The FREQUENCY MHz display should show the entered frequency until the units key is released. The FREQUENCY MHz display should now be right justified.

The frequency could also have been entered as 4.5 GHz or 4500000 kHz. The only differences are the placement of the decimal point and the selection of the appropriate units key, pressed after the frequency has been entered using the numeric keypad.

Remote

The programming string for setting the sweep delta frequency is composed of a program code, numeric data and the units terminator. The frequency may be programmed in units of GHz, MHz, kHz or Hz. To program the Signal Generator delta frequency to 4500 MHz, the possible program strings are:

"FB4.5GZ" or "FB4500MZ" or "FB4500000KZ" or "FB4500000000HZ"

The alpha characters can be sent as upper or lower case (or even mixed upper and lower case). Setting the sweep delta frequency will not change the CW frequency when sweep is off.

Program Codes



Program Code	Function	Applicable Units
DF	ΔFrequency	GZ *MZ KZ HZ

* Preferred Program Code

Comments

Due to the use of frequency multiplication to generate frequencies above 6.6 GHz, the sweep start and stop frequencies recalculated when the sweep delta frequency is entered may not be set precisely to one-half of the sweep delta frequency below (or above) the center frequency. Frequencies below 6.6 GHz can be set to the nearest 1 kHz. All

Delta Frequency (Sweep) (cont'd)

Comments (cont'd)

frequencies between 6.6 and 12.3 GHz can be set within 2 kHz of the desired value. Frequencies between 12.3 and 18.6 GHz can be set within 3 kHz of the desired value and frequencies between 18.6 and 26.5 GHz can be set within 4 kHz of the desired frequency. However, with careful selection of frequency, the roundoff error can be reduced to 1 kHz below 18.6 GHz and 2 kHz for frequencies between 18.6 and 26.5 GHz.

When the sweep start and/or stop frequency cannot be set exactly due to frequency resolution, a random roundoff occurs. To prevent this, the remote program can perform a calculation to determine whether the frequency can be set exactly and adjust the desired frequency accordingly. If the actual start and stop frequencies are critical, setting the start and stop frequency instead of center frequency and delta frequency can be used for greater assurance that the start and stop frequencies are correct.

To determine whether a frequency can be set to a given value, divide the desired frequency (in kHz) by two if it is between 6.6 and 12.3 GHz, by three if it is between 12.3 and 18.6 GHz or by four if it is above 18.6 GHz. If the result is a whole number (no remainder), the frequency can be set to the desired value. For example, 16 GHz divided by three (it is between 12.3 and 18.6 GHz) is 5 333333.33 kHz. Since the dividend is not a whole number, this frequency cannot be set exactly. The nearest frequencies that can be set are 15.999999 GHz (5.333333X3) and 16.000002 GHz (5.333334X3). Note that the roundoff error is only 1 kHz if 15.999999 GHz is programmed instead of 16 GHz.

Programming Example

The following program is written in BASIC for HP 9000 Series 200 or 300 controllers. The following program is used to set the Signal Generator to the sweep delta frequency specified by the variable *Expected*. The desired value must be in MHz and should be between 1 kHz and the maximum frequency of the Signal Generator.

```

10 SUB Sweep_delta_set(Err,Expected)           ! Expected frequency in MHz
20 OUTPUT 719 USING "2A";"MG"                 ! Read message from 8673
30 ENTER 719 USING "2A";Message$              ! to clear any old messages
40 OUTPUT 719 USING "4A,5D.DDD,2A";"CSDF";Expected;"MZ" ! Update status
50 OUTPUT 719 USING "2A";"MG"                 ! Check for message from 8673
60 ENTER 719 USING "2A";Message$
70 SELECT VAL(Message$)
80 CASE 1                                     ! Frequency was out of range
90 Err=1
100 DISP "WARNING: Attempt to set sweep delta frequency out of range"
110 CASE 11
120 Err=11
130 DISP "WARNING: Sweep start frequency adjusted to be in range"
140 CASE 12                                   ! Auto Peak Error
150 Err=12
160 DISP "WARNING: Sweep stop frequency adjusted to be in range"
170 CASE ELSE
180 Err=0                                     ! Other errors not applicable
190 END SELECT
200 !
210 OUTPUT 719 USING "4A";"DFOA"              ! Requests current delta freq
220 ENTER 719 USING "K";Set_freq              ! Frequency in Hz
230 !
240 IF Set_freq<>Expected THEN
250 DISP "WARNING: Error in programmed delta frequency"
260 END IF
270 SUBEND                                     ! End of subroutine

```

Delta Frequency (Sweep) (cont'd)

Error Messages

The following message numbers may be displayed when setting the sweep delta frequency. Each message is explained as it pertains to setting sweep delta frequency. For a more complete description of the messages, see the MESSAGES detailed operating instructions.

- 01 Entered delta frequency is not within the capability of the Signal Generator.
- 11 Indicates that the desired sweep start frequency is below the frequency range of the instrument. The start frequency is set to the lowest valid frequency.
- 12 Indicates that the desired sweep stop frequency is above the frequency range of the instrument. The stop frequency is set to the highest valid frequency.
- 13 Number of steps were adjusted to give even step size. This ensures that the full sweep span is covered by adjusting the number of steps. For example, if the number of steps is set to 100 and the delta frequency is set to 10 kHz, the number of steps will be reset to 10 to accommodate the minimum frequency resolution of 1 kHz.

Diode Automatic Level Control

Description

Automatic Leveling Control (ALC) is used to maintain a constant power control at a given point. External ALC enables the Signal Generator to level the signal at a point other than the output of the Signal Generator. The signal level must be detected using an external detector that provides a DC signal that is proportional to the power at the remote point. The Signal Generator will adjust the signal level at the RF output connector to maintain a constant level at the point where the signal is detected. External ALC also enables external devices such as amplifiers, mixers and other specialized devices to be inserted into the RF signal path with control of the final output level by the Signal Generator.

In applications where the external signal path has frequency dependent losses (and/or gains), the RF signal at the end of the signal path will no longer have a constant amplitude over the Signal Generator's frequency range. For example, if a cable is used that has a constant .5 dB/GHz loss, a level error of 5 dB would occur after a 10 GHz frequency change. The signal at the RF output connector of the Signal Generator has not changed, but an extra 5 dB of attenuation is introduced in the signal path when the output frequency is changed.

The detection of the external signal level can be done using one of several methods. The simplest method uses a crystal detector or Schottky diode which has an output voltage that is proportional to the detected power (square law). A positive or negative crystal detector may be used with equal results since the Signal Generator does an absolute value conversion on the feedback signal.

External ALC using a diode (crystal detector or Schottky diode) has the advantage of fast settling time. In addition, diode leveling is simpler and less expensive than other methods. The detector, however, must be operating in the square law region for calibrated output level control.

Local Procedure

To set the Signal Generator for external diode leveling:

1. Connect the diode to the remote point using a directional coupler. For calibrated output levels, the diode must be operating in the square law region. If the diode is above the square law region (typically > -20 dBm), a change in the VERNIER setting of 1 dB will produce less than 1 dB change in actual RF output level. If the diode is in the linear region, a 1 dB change in the VERNIER setting will produce a 0.5 dB change in the leveled power. The ALC circuitry will still produce leveled power output for any diode operating region, but meter calibration and HP-IB control will be uncalibrated.
2. Set the Signal Generator range to at least 10 dB above the range required for the desired RF output level. The range may have to be adjusted to compensate for losses and gains in the RF signal path. If the RF signal path will have a relatively high loss, a higher Signal Generator range will be required.
3. Connect the diode output to the external ALC input of the Signal Generator. The detector output typically varies from 0.05 to 5 millivolts for the square law region.
4. Press the ALC DIODE key to set the Signal Generator to external diode ALC mode.
5. Connect a power meter to the output of the directional coupler (the output port, not the coupled port). The power meter will be used to calibrate the output level to the Signal Generator level meter.

Diode Automatic Level Control (cont'd)

Local Procedure (cont'd)

- Adjust the ALC CAL control on the Signal Generator front panel until the UNLEVELED annunciator is extinguished. Set the Signal Generator VERNIER for a 0 dBm indication on the Signal Generator's level meter. Continue adjusting the CAL control until the power meter indicates the desired level. For example, for a desired level in the range of -17 to -10 dBm using a 20 dB directional coupler, adjust the CAL control for a power meter reading of -10 dBm.

Once the calibration is complete, the level at the output of the directional coupler can be varied over a $+3$ to -10 dB range. If turning the CAL control fully clockwise does not have sufficient range to calibrate the output level, set the range higher until the calibration can be completed.

If the output level cannot be set low enough, step the RANGE down until the calibration can be performed as per this step. Using the highest range will provide the best compensation for increasing losses (higher power levels at the Signal Generator output). Using a lower range will provide the best compensation for decreasing losses. See the comments section for more information on selecting the optimum range.

Remote Procedure

The equipment setup for remote control of diode leveling is the same as the local procedure. However, the calibration must be performed manually. The program code for diode ALC is C2. Once the calibration is complete, the level can be remotely controlled by programming the VERNIER to the appropriate level. Changing the range while using external diode leveling will have no effect on the level but can force the Signal Generator to lose control of the level due to insufficient attenuation (lack of ALC dynamic range) or too much attenuation (attempted operation beyond maximum power specification).

The VERNIER setting can be read by the controller using the output active program code suffix. To read the VERNIER setting, send the program string VEOA and then read the VERNIER setting. The Signal Generator will send the VERNIER setting in units of dBm. If the setting is read as a string, the format will be the program code VE followed by the VERNIER setting in dBm and then the units code DM.

Example

To set the Signal Generator to diode leveling over the range of -10 to 0 dBm using a 20 dB directional coupler.

Local

- Connect the coupler to the point where the RF power is to be leveled. Connect the diode to the coupled port of the 20 dB directional coupler.
- Connect a power meter to the output of the directional coupler to monitor the actual power at the leveling point.
- Press the ALC DIODE key on the Signal Generator and set the Signal Generator range to $+10$ dB. The UNLEVELED annunciator may come on when the diode leveling mode is activated. The calibration in the next step will eliminate this indication.
- Adjust the front panel CAL control until the UNLEVELED annunciator is extinguished. Set the VERNIER for a 0 dBm indication on the level meter and then adjust the CAL control until the power meter reads -10 dBm.
- The output level can now be set by adjusting the VERNIER for the desired output level as read on the level meter. Setting the range to 0 dB will reduce the output level

Diode Automatic Level Control (cont'd)

Example (cont'd)

by 10 dB. However, setting the range lower than 0 dB will not change the output level until the ALC goes unlevelled due to insufficient output power to overcome the additional loss in the RF signal path.

Remote

1. Perform the above steps 1 to 4 to calibrate the external ALC circuitry.
2. Set the output level remotely by programming vernier settings between -10 and 0 dBm. Changing the range will have the same affects as described in step 5 above.

Program Codes



Program Code	Description
C2	External Diode Leveling Mode

Comments

Using external diode leveling mode has the advantages of fast response time with a relatively simple leveling setup. The disadvantages of diode leveling are the limited dynamic range of the square law region and the absence of temperature compensation. 23 dB of dynamic range is typically available using the Signal Generator's 0 and +10 dB ranges. In addition, amplitude modulation up to 75% depth at rates as high as 100 kHz is typically available using external diode leveling mode.

The response time for a level change using diode leveling mode will typically be about 1 millisecond in CW mode and about 0.1 millisecond in AM mode. The square law region for a point-contact diode is typically -45 to -20 dBm. The square law region for a Schottky (hot-carrier) diode is -50 to -20 dBm.

External diode leveling is not temperature compensated. Power drift over temperature is dependent on the detector used. Frequency recalibration may be required in environments that are not temperature stabilized.

The Signal Generator range selected will have a direct affect on ALC. The range selected depends primarily on the losses and gains in the RF signal path. In most applications, the ALC dynamic range is limited by the maximum RF power available at a given frequency. For example, with 15 dB of loss in the signal path, the Signal Generator must compensate with at least 15 dB of additional RF output power. With no internal attenuation (0 or +10 dB ranges), the Signal Generator would have to supply 15 dBm for a leveled signal at 0 dBm. Since the maximum RF output power is specified at less than +13 dBm, the Signal Generator may not be able to supply the required power.

Output level ranges of -10 to -90 dB add attenuation to the RF signal path. These ranges are useful mainly when attempting to level low amplitude signals. For example, to level a signal with an amplitude of -50 dBm after a signal path with losses of 30 dB, the attenuation can be set to 10 dB (range -10 dB) to place the Signal Generator at an RF output level of only -20 dBm.

The internal circuitry generates RF levels of -10 dBm and higher before introducing attenuation to increase the dynamic range of the Signal Generator. When selecting the proper range for external leveling, the lowest and highest gain/loss should be calculated. The range is then set 10 dB higher than the level required to keep the internally generated RF level near -10 dBm.

Diode Automatic Level Control (cont'd)

Comments (cont'd)

Using a range lower than 0 dB has the advantage of improving the source match and reducing the noise floor of the Signal Generator at the expense of reducing maximum available power.

The external ALC circuitry is used to adjust the Signal Generator's output level until the detected voltage at the external ALC input is correct. If high harmonics or spurious signals are present in the signal that is being detected, they will affect level flatness. This is especially important when using external amplifiers and mixers within the signal path. For example, if the RF signal level is +10 dBm and the second harmonic is at 0 dBm, the actual detected power will be 11 milliwatts (10.4 dBm) instead of 10 milliwatts (10 dBm). The RF output signal would be reduced for a detected level of 10 milliwatts which would reduce the amplitude of the fundamental and introduce an error in the leveled RF output.

Application Example

Example 1. External ALC over the range of 0 to +10 dBm is required. The RF signal path exhibits an insertion loss of 4 dB that varies ± 2 dB over the frequency range. To control the output level over a 0 to +10 dBm range, an amplifier capable of +16 dBm (10 dBm + 4 dB + 2 dB) is required.

The range selected for this application depends mainly on the gain of the amplifier. If we assume a gain of +10 dB, the optimum Signal Generator range is 0 dB. The overall signal path gain varies from +12 to +16 dBm. To reduce the Signal Generator output level to -10 dBm would require 10 dB of attenuation. The range is set 10 dB above this requirement or 0 dB.

Example 2. The IF output of a mixer is to be leveled at -20 dBm. The conversion loss of the mixer is 10 dB and varies ± 3 dB over the frequency range. Using the Signal Generator as the RF source for the mixer, the diode detector is connected to the IF port of the mixer using a 10 dB directional coupler. This will place the power at the diode at -30 dBm which is within the square law region of the detector.

The attenuation of the signal path is 10 dB and varies ± 3 dB. For an IF level of -20 dBm, the RF port must be at a level of approximately -10 dBm. The range selected for the Signal Generator would then be +10 since 0 dB attenuation would be required and the +10 dB range is one step above zero attenuation.

Error Messages

The following message may be displayed when programming the RF output level.

24 The programmed RF output level (VERNIER, RANGE or both) is outside the Signal Generator's range.

Dwell Time (Sweep)

Description The Signal Generator performs a sweep by stepping the RF output frequency in discrete steps between the start and stop frequency of the sweep. The number of steps that the Signal Generator makes between the start and stop frequency is set by the number of steps or the sweep step size. The time that the Signal Generator spends on each step of the sweep is controlled by the dwell time.

For longer dwell times (>50 milliseconds), the sweep time is approximately equal to the number of steps multiplied by the dwell time. The time required for changing frequency is not included in the dwell time. Therefore, for shorter dwell times the sweep will take longer than the number of steps multiplied by the dwell time.

Local Procedure To set the sweep dwell time:

1. Press the DWELL key to indicate that the next entry will be for the sweep dwell time.
2. Enter the desired dwell time in milliseconds using the numeric keypad. If a mistake is made while entering the dwell time, press the backspace key until the incorrect digit disappears. Continue entering the correct digits until the dwell time in the FREQUENCY MHz display is correct.
3. Press the ms key to finish the sweep dwell time entry. The dwell time will be displayed until the ms key is released.

Remote Procedure The Signal Generator accepts any dwell setting between 1 and 255 milliseconds. The format of the remote programming follows the front panel key sequence. The program code DW is sent followed by the desired dwell time and the units MS.

The dwell times can be read by the controller using the output active program code suffix. To read the current dwell time, the program string DWOA is sent and then the dwell time is read. If read as a string, the format is the program code DW followed by the dwell time in milliseconds and the units terminator (MS).

Example To set the sweep dwell time to 20 milliseconds:

Local

1. Press the DWELL key.
2. Key in 20 using the numeric keypad. The FREQUENCY MHz display should show 20 when you have finished keying in the value. Note that the entry is left justified at this point.
3. Press the ms units key to finish the sequence. The FREQUENCY MHz display should show the entered dwell time until the ms key is released.

Remote

The programming string for setting the dwell time is composed of a program code, numeric data and the units terminator. To program the dwell time to 20 milliseconds, the program string is:

"DW20MS"

The alpha characters can be sent as upper or lower case (or even mixed upper and lower case).

Dwell Time (Sweep) (cont'd)**Program
Codes****HP-IB**

Program Code	Description	Units
DW	Sweep Dwell Time	MS

Comments

The Signal Generator digital sweep is composed of discrete frequencies that are produced sequentially. The time spent at each of the sweep steps is controlled by the dwell time. The actual time between frequencies is dependent on step size, band crossings, modulation used and whether Auto Peak is enabled.

With Auto Peak enabled, an Auto Peak operation will be performed for every 50 MHz change in frequency from the last frequency where an Auto Peak operation was performed. For sweep step sizes greater than 50 MHz, an Auto Peak operation will be performed for each sweep step. Depending on the adjustment of the instrument, the Auto Peak operation can add 30 to 100 milliseconds per step.

Generally, small step sizes over a narrow span will provide the shortest time between steps. Dwell times less than 5 milliseconds will not produce a true phase locked signal for all sweeps. An algorithm is used to provide the shortest phase lock without waiting for complete settling.

**Programming
Example**

The following program is written in BASIC for HP 9000 Series 200 or 300 controllers. The program is used to set the sweep dwell time to the number specified by the variable *Expected*. The desired value must be between 1 and 255 milliseconds.

```

10 SUB Sweep_dwell(Err,Expected)           ! Dwell in milliseconds
20 OUTPUT 719 USING "2A";"MG"             !Clear message from 8673
30 ENTER 719 USING "2A";Message$         ! to clear any old messages
40 OUTPUT 719 USING "2A,DDD,2A";"SP";Expected;"SS" ! Set size
50 OUTPUT 719 USING "2A";"MG"           ! Get any error message
60 ENTER 719 USING "2A";Message$
70 SELECT VAL(Message$)
80 CASE 8
90 Err=1
100 DISP "WARNING: The specified dwell time is out of range"
110 CASE ELSE
120 Err=0
130 END SELECT
140 !
150 SUBEND

```

**Error
Messages**

The following message numbers may be displayed when setting the sweep dwell time. Each message is explained as it pertains to setting the dwell time. For a more complete description of the messages, see the MESSAGES detailed operating instructions.

08 The entered dwell time is not within the range of 1 millisecond to 255 milliseconds.

Frequency (CW)

Description

When sweep modes are off, the Signal Generator can be set to any frequency within its range. The frequency can also be tuned in any step size that will result in a new frequency within its specified range. All valid frequencies can be remotely programmed or entered manually via the numeric keypad or tuning controls.

For applications requiring setting a single specific frequency, direct entry using the numeric keypad is the most efficient method. However, for tuning over a specific range or observing several frequencies, the tuning controls allow convenient control for setting frequency.

Tuning with the TUNING knob is useful for observing a range of frequencies and still being able to speed up or slow down the tuning as desired. In addition, the frequency increment may be decreased if finer resolution is desired around a specific frequency.

The frequency increment step keys are very useful for tuning between channels with a fixed channel spacing. Setting the frequency increment to the channel spacing allows easy stepping with a single key press. In addition, holding down the frequency increment step key will allow stepping at a rate of about ten steps per second. This "power tune" feature does not offer as much control as the TUNING knob because the stepping rate is fixed for the frequency increment step keys.

Signal Generator frequency settings can be stored in memory for later use. The nine store/recall registers of the Signal Generator allow up to nine different front panel settings to be stored and recalled. This feature is useful when several unrelated frequencies are required.

Local Procedure

To set the Signal Generator to a specific frequency:

1. Press the FREQUENCY key to indicate that the next entry will be for CW frequency.
2. Enter the desired frequency using the numeric keypad. If a mistake is made while entering the frequency, press the backspace key until the incorrect digit disappears. Continue entering the correct digits until the frequency displayed in the FREQUENCY MHz display is correct.
3. Press the appropriate units key. You may enter the frequency in GHz, MHz or kHz. Once the units key is pressed, the displayed frequency will be adjusted to display MHz and the output frequency will be set.

If a sweep mode is active when CW frequency is entered, the actual frequency displayed after pressing the units key will usually not be the entered frequency. The FREQUENCY MHz display is used to display sweep information during sweep mode so the new CW frequency will not be displayed. Setting the CW frequency during a sweep changes the sweep center frequency to the value entered. The sweep will continue about the new CW (center) frequency. Tuning the frequency will also move the sweep center frequency when in sweep mode.

To check the current CW (center) frequency during sweep, press and hold the FREQUENCY key. The FREQUENCY MHz display will display the CW frequency as long as the key is held. The Signal Generator will return to the CW frequency when the sweep mode is turned off.

Frequency (CW) (cont'd)

Remote Procedure

The Signal Generator accepts any frequency within its specified frequency range. Above 6.6 GHz, the programmed frequency may be rounded by the Signal Generator to be compatible with the 2, 3 or 4 kHz resolution at the programmed frequency (see Comments).

The format of the remote programming follows the front panel key sequence. To program the CW frequency, the program code FR or CW is sent followed by the desired frequency and the units (GZ, MZ, KZ, or HZ). The CW programming code also turns off sweep if any sweep mode is active when the program code is received by the Signal Generator.

Once a frequency is programmed, the SOURCE SETTLED bit of the status byte can be monitored to determine when the frequency has settled. Once this bit is set, the NOT PHASE LOCKED bit in the extended status byte may be checked to ensure that the instrument is working correctly. The NOT PHASE LOCKED bit is not valid until after the SOURCE SETTLED bit has been set.

Both the set CW frequency and the current RF output frequency can be read by the controller using the output active program code suffix or a special program code. To read the CW frequency (not the output frequency if the frequency was rounded), send the program codes FROA and then read the frequency. The Signal Generator will send the CW frequency in fundamental (Hz) units. If the CW frequency is read as a string, the format will be the program code CF followed by the CW frequency in Hz and then the units terminator (Hz).

To read the current output frequency, the program code OK is sent and then the current RF output frequency can be read. The format is the same as the FROA method described above. This method should not be used while sweeping as the frequency read will not be correct during sweep. Note that the latter method indicates the rounded frequency while the former does not.

Example

To set the frequency to 16 232.334 MHz:

Local

1. Press the FREQUENCY key.
2. Key in 16 232.334 using the numeric keypad. The FREQUENCY MHz display should show 16 232.334 when you have finished keying in the value. Note that the entry is left justified at this point.
3. Press the MHz units key to finish the sequence. The FREQUENCY MHz display should now show the entered frequency. The FREQUENCY MHz display should now be right justified.

The frequency could also have been entered as 16.232334 GHz or 16232334 kHz. The only difference is the placement of the decimal point and the units key pressed after the frequency has been entered using the numeric keypad.

Remote

The programming string for setting the CW frequency is composed of a program code, numeric data and the units terminator. The frequency may be programmed in units of GHz, MHz, kHz or Hz. To program the Signal Generator to 16 232.334 MHz, the possible program strings are:

Frequency (CW) (cont'd)

Example (cont'd)

"FR16.232334GZ"
or
"FR16232.334MZ"
or
"FR16232334KZ"
or
"FR16232334000HZ"

In addition, the program code could be CF or CW instead of FR. The alpha characters can be sent as upper or lower case (or even mixed upper and lower case). The Signal Generator output frequency is valid once the SOURCE SETTLED bit of the status byte is set (see comments).

Program Codes

HP-IB

Program Code	Function	Applicable Units
CF CW *FR	CW Frequency	GZ *MZ KZ HZ

* Preferred Program Code

Comments

Due to the use of frequency multiplication to generate frequencies above 6.6 GHz, the frequency sometimes cannot be set precisely to a desired value. Frequencies below 6.6 GHz can be set to the nearest 1 kHz. All frequencies between 6.6 and 12.3 GHz can be set within 2 kHz of the desired value. Frequencies between 12.3 and 18.6 GHz can be set within 3 kHz of the desired value and frequencies between 18.6 and 26.5 GHz can be set within 4 kHz of the desired frequency. However, with careful selection of frequency, the roundoff error can be reduced to 1 kHz below 18.6 GHz and 2 kHz for frequencies between 18.6 and 26.5 GHz.

When the Signal Generator is programmed to a frequency that cannot be set exactly due to frequency resolution, a random roundoff occurs. To prevent this, the remote program should perform a calculation to determine whether the frequency can be set exactly and adjust the desired frequency accordingly.

To determine whether a frequency can be set to a given value, divide the desired frequency (in kHz) by two if it is between 6.6 and 12.3 GHz, by three if it is between 12.3 and 18.6 GHz or by four if it is above 18.6 GHz. If the result is a whole number (no remainder), the frequency can be set to the desired value. For example, 16 GHz divided by three (it is between 12.3 and 18.6 GHz) is 5 333333.33 kHz. Since the dividend is not a whole number, this frequency cannot be set exactly. The nearest frequencies that can be set are 15.999999 GHz (5.333333X3) and 16.000002 GHz (5.333334X3). Note that the roundoff error is only 1 kHz if 15.999999 GHz is programmed instead of 16 GHz.

Frequencies above 6.6 GHz are produced by multiplying the baseband frequency (2.0—6.6 GHz). The time it takes to switch from one frequency to another depends on the largest baseband (<6.6 GHz) frequency digit being changed. Generally, the smaller the digit being changed, the shorter the switching time. For example, a change of 3 kHz (the 1 kHz digit) would be faster than a change of 3 GHz (the 1 GHz digit). Typical switching times by largest digit being changed for frequencies less than 6.6 GHz can be summarized as follows:

Frequency (CW) (cont'd)**Comments
(cont'd)**

Largest Digit Changed	Time to be Within 1 kHz
100 MHz	10 ms
10 MHz	10 ms
1 MHz	10 ms
100 kHz	5 ms
10 kHz	3 ms
1 kHz	1.5 ms

For frequency changes involving frequencies above 6.6 GHz, the actual frequency digits being changed must be determined by dividing the frequency change by two (6.6 to 12.3 GHz), three (12.3 to 18.6 GHz) or four (18.6 to 26.5 GHz). The result will indicate which digits of the fundamental (unmultiplied) frequency will actually change. The frequency switching time will depend only on which digits of the baseband frequency are changing.

For applications that require fastest execution, the SOURCE SETTLED bit of the status byte can be used. Once the bit is set, the output is valid and the program may continue. If the frequency is programmed and the status byte is not checked, the program should wait at least the frequency switching speed time before assuming the output valid. For controllers using buffered output, an additional wait is required so that the RF output is not used until at least the specified frequency switching time elapses after the Signal Generator has received the program string. If the status byte is to be used to monitor settling, the program string that sets the frequency should be prefaced with the program code CS. This will clear any previous setting of the SOURCE SETTLED bit to avoid an incorrect indication.

For frequency changes greater than 50 MHz, an Auto Peak operation is performed by the Signal Generator. The Auto Peak operation optimizes the Signal Generator performance at the set frequency. The Auto Peak operation produces small changes in the RF output level as the peaking is performed. In some cases, the Auto Peak may require longer than the frequency switching time specification. For applications requiring fastest switching speed, Auto Peak may be disabled. However, with Auto Peak disabled, modulation performance and maximum output power may be degraded. The SOURCE SETTLED bit of the status byte is set when the Auto Peak operation is completed. However, when sending several program codes in the same data string, the SOURCE SETTLED bit may be set by one of the other codes. For maximum assurance that the Auto Peak is finished, an Auto Peak should be performed just before the RF output is to be used in a measurement. Once the SOURCE SETTLED bit is set after sending the program code K1 (Auto Peak On), the RF output is settled and the Auto Peak operation is finished.

The Signal Generator Option 008 has a frequency where mechanical switches are actuated to change the internal microwave signal path. When a frequency change crosses these switches, the RF output is blanked (disabled) to eliminate transients of the switching process. The actual frequency change will still occur as described above but the RF output will be blanked for approximately 20 milliseconds during the frequency change. For this reason, frequency changes across these switches will require a longer settling time before the output amplitude is settled. The switch point is given in the following page.

Frequency (CW) (cont'd)

Comments (cont'd)

Frequency Switch Point	Description
16.0 GHz	An amplifier is switched in to increase output power above 16 GHz (Option 008 only)

Programming Example

The following programs are written in BASIC for HP 9000 Series 200 or 300 controllers. The following program is used to set the Signal Generator to the frequency specified by the variable called *Expected*. The desired value must be in MHz and should be within the frequency range of the Signal Generator.

```

10 SUB Freq_set(Err,Expected)           ! Expected frequency in MHz
20 OUTPUT 719 USING "2A";"MG"         ! Read message from 8673
30 ENTER 719 USING "2A";Message$      ! to clear any old messages
40 Frequency=INT(Expected*1000)/1000  ! Round off to nearest kHz
50 OUTPUT 719 USING "4A,5D.DDD,2A";"CSFR";Frequency;"MZ" ! Update status
60 CALL Settled                       ! Wait for source to settle
70 OUTPUT 719 USING "2A";"MG"         ! Check for message from 8673
80 ENTER 719 USING "2A";Message$
90 SELECT VAL(Message$)
100 CASE 1                             ! Frequency was out of range
110 Err=1
120 DISP "WARNING: Attempt to set frequency out of range"
130 CASE 90                             ! Auto Peak Error
140 Err=90
150 DISP "WARNING: Auto Peak error. Service may be required"
160 CASE ELSE
170 Err=0                               ! Other errors not applicable
180 END SELECT
190 !
200 OUTPUT 719 USING "2A";"OK"         ! Requests current frequency
210 ENTER 719 USING "K";Set_freq       ! Frequency in Hz
220 Set_freq=INT(Set_freq/1000)/1000  ! Convert to MHz
230 !
240 IF ABS(Set_freq-Frequency)>.001 AND Err=0 THEN
250 DISP "WARNING: Requested frequency rounded to ";Set_freq
260 END IF
270 SUBEND                             ! End of subroutine

```

Frequency (CW) (cont'd)

Programming Example (cont'd)

To prevent roundoff errors from occurring, the following subprogram may be used to adjust a frequency so that it is always within 1 or 2 kHz of the desired frequency. Frequencies below 18.6 GHz will be within 1 kHz of the desired frequency and frequencies between 18.6 and 26 GHz will be within 2 kHz of the desired frequency.

```

300 SUB Round_off(Err,Expected)                ! Expected frequency in MHz
310 Err=0                                       ! Initialize Err
320 Band=5
330 IF Expected<26500.001 THEN Band=4
340 IF Expected<18600.001 THEN Band=3
350 IF Expected<12300.001 THEN Band=2
360 IF Expected<6600.001 THEN Band=1
370 !
380 Baseband=INT((Expected*1000)/Band)/1000    ! Rounded fundamental
390 Round_down=Baseband*Band
400 IF Round_down<>Expected THEN              ! Requires rounding
410 Round_up=(Baseband+.001)*Band
420 IF ABS(Round_down-Expected)<ABS(Round_up-Expected) THEN
430 Expected=Round_down                       ! Minimum error is round down
440 ELSE
450 Expected=Round_up                         ! Minimum error is round up
460 END IF
470 END IF
480 SUBEND

```

The following program can be called to wait for a source settled indication from the Signal Generator. The program will wait a maximum of 1 second before assuming the SOURCE SETTLED bit is not going to be set. The status byte must be cleared with the CS program code before the frequency is set. If the status byte is not cleared, the SOURCE SETTLED bit may have been set by a previous command (the bit is latched until the status byte is read or cleared).

```

500 SUB Settled
510 T_counter=TIMEDATE                          ! In case no source settled
520 Stat=SPOLL(719)                             ! Serial poll
530 IF TIMEDATE-T_counter>1 THEN Done          ! Default of 1 second
540 IF NOT BIT(Stat,3) THEN GOTO 520           ! Wait for set bit
550 Done: !
560 SUBEND                                     ! Source is settled or 1 second has passed

```

Error Messages

The following message numbers may be displayed when setting the CW frequency. Each message is explained as it pertains to setting CW frequency. For a more complete description of the messages, see the MESSAGES detailed operating instructions.

- 01 Entered frequency is not within the range of the Signal Generator.
- 03 Invalid multiplier entry for system compatible instruments.
- 90 Auto Peak malfunction. This indicates that the instrument may require service.

Frequency Increment and Tuning

Description

The Signal Generator frequency can be tuned in any tuning increment that will result in a new frequency within its specified range. The tuning increment is set with the **FREQ INCR** key and the numeric keypad. All valid frequency increments may be remotely programmed or entered manually via a numeric keypad.

Tuning the Signal Generator frequency is accomplished using the **FREQ INCREMENT** up and down keys or the **TUNE** knob. The tuning increment size for both methods is equal to the frequency increment value except during manual sweep mode. The sweep step size controls the tuning increment in manual sweep mode.

Tuning with the **TUNE** knob is useful for observing a range of frequencies and still being able to speed up or slow down the tuning as desired. In addition, the frequency increment may be decreased if finer resolution is desired around a specific frequency. The **TUNE** knob can be disabled to avoid accidental changes in the set frequency.

The frequency increment step keys are very useful for tuning between channels with a fixed channel spacing. Setting the frequency increment to the channel spacing allows easy stepping with a single key press. In addition, holding down the frequency increment step key will allow tuning at a rate of about ten steps per second. This “power tune” feature does not offer as much control as the **TUNE** knob because the stepping rate is fixed for the frequency increment step keys.

The nine store/recall registers of the Signal Generator allow up to nine different front panel settings to be stored and recalled. This feature is useful when several unrelated frequencies are required. Each register can be stored with the same frequency increment or different frequency increments depending on the application. A simple two stroke key sequence will recall each register as needed.

Local Procedure

To set the Signal Generator frequency increment:

1. Press the **FREQ INCR** key to indicate that the next entry will be for frequency increment.
2. Enter the desired frequency increment using the numeric keypad. If a mistake is made while entering the frequency increment, press the backspace key until the incorrect digit disappears.

Continue entering the correct digits until the frequency increment displayed in the **FREQUENCY MHz** display is correct.

3. Press the appropriate units key. You may enter the frequency increment in GHz, MHz or kHz. The entered frequency increment will be displayed as long as the units key is held down.

The frequency may now be incremented or decremented using the **TUNE** knob or the **FREQ INCREMENT** up and down keys. The tuning step will be equal to the frequency increment or the tuning resolution (whichever is greater). For frequency increments that are not a multiple of the frequency resolution, the tuning occurs in a way to make the average tuning increment equal to the frequency increment. See the comments section for more information about frequency increments that are not a multiple of the frequency resolution.

Frequency Increment and Tuning (cont'd)

Local Procedure (cont'd)

If a sweep mode is active when the frequency increment is entered, the frequency displayed after releasing the units key will be either the current RF output frequency or the start and stop frequency of the sweep. Tuning the frequency during single or auto sweep mode changes the sweep center frequency in steps equal to the frequency increment. In auto sweep mode, the sweep will continue about the new center frequency. In single sweep mode, the sweep will reset to the new start frequency and remain armed. In manual sweep mode, tuning the frequency has the effect of changing the RF output frequency by the sweep step size. The frequency increment is not used during manual sweep mode.

To check the current frequency increment, press and hold the **FREQ INCR** key. The **FREQUENCY MHz** display will display the frequency increment as long as the key is held.

Remote Procedure

The Signal Generator accepts frequency increments between 1 kHz and the maximum Signal Generator frequency (18.6 or 26.5 GHz). The minimum tuning increment is dependent on the RF output frequency. For output frequencies less than 6.6 GHz, the minimum tuning increment is 1 kHz. Above 6.6 GHz, the minimum tuning increment is 2 kHz (6.6 to 12.3 GHz), 3 kHz (12.3 to 18.6 GHz) or 4 kHz (18.6 to 26.5 GHz). Although the frequency increment can be set to 1 kHz, the actual tuning increment used will be determined by the RF output frequency (see comments).

The format of the remote programming follows the front panel key sequence. To program the frequency increment, the program code **FI** or **FN** is sent followed by the desired frequency increment and the units (**GZ**, **MZ**, **KZ**, or **HZ**).

The CW frequency is incremented or decremented in the same manner as the **FREQ INCREMENT** up and down keys. The "UP" program code is equivalent to a single press of the **FREQ INCREMENT** up key. "DN" is equivalent to a single press of the **FREQ INCREMENT** down key. If a frequency increment (UP) will produce a frequency that is above the range of the instrument, the frequency will not change and an error (02) will be issued to indicate that the frequency increment is out of range. If a frequency decrement (DN) will produce a frequency that is below the range of the instrument, the frequency will not change and an error (01) will be issued to indicate that the desired frequency is out of range.

Example

To tune the CW frequency in 1.5 MHz steps:

Local

1. Press the **FREQ INCR** key.
2. Key in 1.5 using the numeric keypad. The **FREQUENCY MHz** display should show 1.5 when you have finished keying in the value. Note that the entry is left justified at this point.
3. Press the **MHz** units key to finish the sequence. The **FREQUENCY MHz** display will show the entered frequency increment until the units key is released. The entry should now be right justified.
4. Turn the **TUNE** knob clockwise or press the **FREQ INCREMENT** up key to increment the frequency in 1.5 MHz steps. Turn the **TUNE** knob counter-clockwise or press the **FREQ INCREMENT** down key to decrement the frequency in 1.5 MHz

Frequency Increment and Tuning (cont'd)

Example (cont'd)

steps. Note that an error is not indicated if an attempt is made to tune the frequency above or below the frequency range of the Signal Generator.

The frequency increment could also have been entered as .0015 GHz or 1500 kHz. The only difference is the placement of the decimal point and the units key pressed after the frequency increment has been entered using the numeric keypad.

Remote

The programming string for setting the frequency increment is composed of a program code, numeric data and the units terminator. The frequency increment may be programmed in units of GHz, MHz, kHz or Hz. To program the Signal Generator for a 1.5 MHz frequency increment, the possible program strings are:

"F1.015GZ" or "F11.5MZ" or "F11500KZ" or "F1150000HZ"

In addition, the program code could be FN or F1 instead of F1. The alpha characters can be sent as upper or lower case (or even mixed upper and lower case).

To increment the frequency in 1.5 MHz steps, send the program code "UP." To decrement the frequency in 1.5 MHz steps, send the program code "DN." A single step will be made for each program code received. To increment or decrement more than one step, send a program string with multiple program codes. For example, "DNDNDNDN" will decrement the frequency four times.

Program Codes HP-IB

Frequency Increment Codes

Program Code	Function	Applicable Units
*F1 FN F1	Frequency Increment	GZ MZ KZ HZ

Frequency Tuning Codes

Program Code	Function
UP	Increment CW (center) frequency by frequency increment (by step size in MANUAL sweep mode)
DN	Decrement CW (center) frequency by frequency increment (by step size in MANUAL sweep mode)
IF	MANUAL sweep mode only (see MANUAL SWEEP)
N0	Disable TUNE knob (not active in remote or local mode)
N1	Enable TUNE knob (active in local mode only)

* Preferred Program Code

Frequency Increment and Tuning (cont'd)

Comments

Due to the use of frequency multiplication to generate frequencies above 6.6 GHz, the minimum tuning increment is increased. Frequencies below 6.6 GHz can be tuned with a minimum step size of 1 kHz. For frequencies between 6.6 and 12.3 GHz, the minimum tuning resolution is 2 kHz. Frequencies between 12.3 and 18.6 GHz can be tuned with a minimum resolution of 3 kHz and frequencies between 18.6 and 26.5 GHz can be tuned with a minimum resolution of 4 kHz.

When setting a frequency increment, the entered value can be as low as 1 kHz even though a 1 kHz tuning resolution is not possible for all output frequencies. If a frequency increment is entered that is not a multiple of the specified frequency resolution for the RF output frequency, the two nearest tuning resolutions will be used in combination so that the overall affect will be the desired tuning resolution.

For example, if a frequency increment of 7 kHz is selected and the output frequency is set to 20 GHz, tuning down one step will change the output frequency by 4 kHz for one step and then 8 kHz for the next three steps. The overall affect is to change 28 kHz in four steps which is the same as four 7 kHz steps. If the output frequency is reset to 5 GHz, the tuning increment will be 7 kHz (a multiple of the specified 1 kHz).

When tuning the frequency, the time it takes to switch from one frequency to the next depends on the largest baseband (<6.6 GHz) frequency digit being changed. Generally, the smaller the digit being changed, the shorter the switching time. For example, a change of 3 kHz (the 1 kHz digit) would be faster than a change of 3 GHz (the 1 GHz digit). Typical switching times by largest digit being changed for frequencies less than 6.6 GHz can be summarized as follows:

Largest Digit Changed	Time to be Within 1 kHz
100 MHz	10 ms
10 MHz	10 ms
1 MHz	10 ms
100 kHz	5 ms
10 kHz	3 ms
1 kHz	1.5 ms

Frequencies above 6.6 GHz are produced by multiplying the baseband (2.0—6.6 GHz) frequency. For frequency changes involving frequencies above 6.6 GHz, the actual frequency digits being changed must be determined by dividing the frequency change by two (6.6 to 12.3 GHz), three (12.3 to 18.6 GHz) or four (18.6 to 26.5 GHz). The result will indicate which digits of the fundamental (unmultiplied) frequency will actually change. The frequency switching time will depend only on which digits of the baseband frequency are changing.

For applications that require fastest execution, the SOURCE SETTLED bit of the status byte can be used. Once the bit is set after a frequency has been incremented or decremented, the output is valid and the program may continue. If the frequency is changed and the status byte is not checked, the program should wait at least the frequency switching speed time specification before assuming the output valid. For controllers with buffered output capability, an additional wait is required to ensure that the frequency switching time plus the time required for the Signal Generator to receive the program string has elapsed before assuming the RF output is valid.

Frequency Increment and Tuning (cont'd)

Comments (cont'd)

If the status byte is to be used to monitor settling, the program string that changes the frequency should start with the program code CS. This will clear any previous setting of the SOURCE SETTLED bit to avoid an incorrect indication.

For frequency changes greater than 50 MHz, an Auto Peak operation is performed by the Signal Generator. The Auto Peak operation optimizes the Signal Generator performance at the set frequency. The Auto Peak operation produces small changes in the RF output level as the peaking is performed. In some cases, the Auto Peak operation may require longer than the frequency switching time specification. For applications requiring fastest switching speed, Auto Peak may be disabled. However, with Auto Peak disabled, modulation performance and maximum output power may be degraded. The SOURCE SETTLED bit of the status byte is set when the Auto Peak operation is completed. However, when sending several program codes in the same data string, the SOURCE SETTLED bit may be set by one of the other program codes. For maximum assurance that the Auto Peak is finished, an Auto Peak should be performed just before the RF output is used for a measurement. Once the SOURCE SETTLED bit is set after sending the program code "K1" (Auto Peak On), the RF output is settled and the Auto Peak operation is finished.

The multiplied bands are defined as 6.6—12.3 GHz for band 2, 12.3—18.6 GHz for band 3, and 18.6—26 GHz for band 4. When using a frequency increment that is less than the specified frequency resolution, there will be hysteresis about the band crossing points. For example, if the frequency increment is set to 1 kHz and the frequency is incremented from below 6.6 GHz to at least two increments above 6.6 GHz, tuning back to 6.6 GHz will leave the 6.6 GHz output in band 3 instead of band 2. Incrementing less than one increment past a band point will leave the band point in the lower band. When tuning upward from the 6.6 GHz band point with 1 kHz resolution, the first increment will change the frequency to 6.6000002 GHz. The second increment will not change the frequency, but tuning back to 6.6 GHz will leave the 6.6 GHz frequency in band 2. This hysteresis will affect subharmonics (the 2—6.6 GHz fundamental feedthrough) and multiples of the subharmonics.

The Signal Generator Option 008 has a frequency where mechanical switches are actuated to change the internal microwave signal path. When a frequency change crosses these switches, the RF output is blanked (disabled) to eliminate transients of the switching process. The actual frequency change will still occur as described above but the RF output will be blanked for approximately 20 milliseconds during the frequency change. For this reason, frequency changes across these switches will require a longer settling time before the output amplitude is settled. The switch point is given in the following table.

Frequency Switch Point	Description
16.0 GHz	An amplifier is switched in to increase output power above 16 GHz (Option 008 only)

Frequency Increment and Tuning (cont'd)

Programming Example

The following programs are written in BASIC for HP 9000 Series 200 or 300 controllers. The following program is used to step the Signal Generator from *Start* to *Stop* in *Step* increments. A subroutine called *Read_power* is called after each frequency increment.

```

10 SUB Freq_step(Err,Start,Stop,Step)
20 CALL Freq_set(Err,Start)
30 OUTPUT 719 USING "2A,5D.DDD,2A","FI,"Step,"MZ"
40 IF STOP-START<0 THEN
50 P_code$="DN"
60 ELSE
70 P_code$="UP"
80 END IF
90 !
100 Start:
110 CALL Read_power
120 OUTPUT 719 USING "2A";P_code$
130 CALL Settled
140 OUTPUT 719 USING "2A";"OK"
150 ENTER 719 USING "K";Frequency
160 IF Frequency<Stop AND P_code$="UP" THEN GOTO Start
170 IF Frequency>Stop AND P_code$="DN" THEN GOTO Start
180 !
190 SUBEND

```

! Frequencies in MHz
! Sub under CW Frequency
! Decrement from Start to Stop
! Begin the process
! Do for this frequency
! Increment or decrement
! Wait for source to settle
! Get new frequency
! This is current frequency
! Next step
! End of subroutine

Note that the above program does not take into account the different resolution ranges and their effect on the actual step size. This is usually not significant (especially with large frequency increments).

The following program can be called to wait for a source settled indication from the Signal Generator. The program will wait a maximum of 1 second before assuming the SOURCE SETTLED bit is not going to be set. The status byte must be cleared with the CS program code before the frequency is changed. If the status byte is not cleared, the SOURCE SETTLED bit may have been set by a previous command (the bit is latched until the status byte is read or cleared).

```

500 SUB Settled
510 T_counter=TIMEDATE
520 Stat=SPOLL(719)
530 IF TIMEDATE-T_counter>1 THEN Done
540 IF NOT BIT(Stat,3) THEN GOTO 520
550 Done: !
560 SUBEND

```

! In case no source settled
! Serial poll
! Default of 1 second
! Wait for set bit
! Source is settled or 1 second has passed

Frequency Increment and Tuning (cont'd)

Error Messages

The following message numbers may be displayed when setting the frequency increment or changing the frequency. Each error message is explained as it pertains to setting the frequency increment or changing the frequency. For a more complete description of the messages, see the MESSAGES detailed operating instructions.

- 01 Desired frequency is out of range. Occurs in remote mode when a frequency decrement would place the new frequency below the Signal Generator's frequency range.
- 02 Entered frequency increment is not within the capability of the Signal Generator. Also occurs in remote mode when a frequency increment would place the frequency above the Signal Generator's frequency range.
- 90 Auto Peak malfunction. This indicates that the instrument may require service.

Frequency Modulation

Description

The Signal Generator provides frequency modulation at modulation indexes up to 5 for frequencies below 6.6 GHz, 10 for frequencies between 6.6 and 12.3 GHz, 15 for frequencies between 12.3 and 18.6 GHz and 20 for frequencies above 18.6 GHz. The FM modulation index is the peak deviation divided by the modulating rate.

FM peak deviation is linearly controlled by the signal at the FM IN connector with 1 volt peak developing the maximum deviation for the selected range. There are six FM peak deviation ranges available with maximum deviations of 0.03, 0.1, 0.3, 1, 3, and 10 MHz respectively.

FM peak deviation is monitored using the Signal Generator's front panel meter in the FM meter mode. The meter monitors the signal at the FM IN connector and displays the corresponding FM peak deviation in MHz. An overmodulation condition is indicated by the FM OVERMOD annunciator when the modulation index exceeds 5 or the input signal exceeds 1 volt peak.

Local Procedure

To set the Signal Generator to a desired FM peak deviation:

1. Select an FM deviation range that is greater than the desired FM peak deviation.
2. Connect an external oscillator to the FM input and set the frequency of the external oscillator to the desired modulation rate at an amplitude of 0 volts.
3. Press the Signal Generator's FM meter mode key which is located near the front panel meter. This will allow the amplitude of the external oscillator to be monitored as the desired FM peak deviation.
4. Adjust the external oscillator amplitude until the meter indicates the desired FM peak deviation. If the FM OVERMOD annunciator is lighted, reduce the peak deviation or increase the modulating rate until the annunciator extinguishes. The peak deviation divided by the modulating rate must be less than or equal to the maximum modulation index for the carrier frequency.

Remote Procedure

The FM range can be programmed to any of the six ranges or off. The actual FM peak deviation is controlled by the external oscillator and is not directly programmable via the Signal Generator. The meter mode can be set to FM mode with the program code T3.

An overmodulation condition can be detected by the controller by checking the status byte. The FM Overmodulated bit of the extended status byte is used to indicate FM overmodulation in remote mode.

The FM range and the FM peak deviation cannot be read by the controller. The FM peak deviation is determined by the amplitude setting of the external oscillator used to provide the modulating signal and the selected FM deviation range. If the output impedance of the external oscillator is 50 ohms, the FM peak deviation can be determined by the controller by reading the external oscillator amplitude and multiplying by the programmed Signal Generator FM range.

Example

To FM modulate the Signal Generator at 100 kHz peak deviation at a rate of 10 kHz:

Local

1. Press the FM 0.1 key to set the Signal Generator for 100 kHz maximum deviation. Press the FM key near the Signal Generator's front panel meter to set the meter to FM mode.

Frequency Modulation (cont'd)

Example (cont'd)

2. Set the external oscillator to 10 kHz and adjust the amplitude to zero volts.
3. Connect the external oscillator to the Signal Generator's FM IN connector. Adjust the external oscillator amplitude until the middle scale (0 to 1) indicates 100 kHz deviation. The required external oscillator amplitude will be approximately 1 volt peak or 0.707 volts rms.

Remote

The programming string for setting the 100 kHz FM range is D3. The amplitude and frequency of the modulating signal must be set by programming the external modulating signal source. The alpha character (D) can be sent as upper or lower case.

Program Codes HP-IB

Program Code	Description
D0	FM Off
D1	FM Off
D2	FM 0.03 MHz Range
D3	FM 0.1 MHz Range
D4	FM 0.3 MHz Range
D5	FM 1 MHz Range
D6	FM 3 MHz Range
D7	FM 10 MHz Range

Comments

An Auto Peak operation occurs any time Auto Peak is enabled and an FM range is changed to maintain optimum operation. With FM selected, an Auto Peak operation does not turn off Auto Peak but instead sets the FM range to 0.03 MHz during the Auto Peak operation.

FM meter accuracy is specified for 100 kHz rates only. To determine the meter accuracy at other modulation rates, the FM frequency response specification is added to the meter accuracy. The FM frequency response specification is a specification that indicates how much the power level at the FM IN connector may have to be adjusted to provide the desired (and indicated) FM peak deviation. This correction is required due to the frequency response characteristics of the FM circuitry for rates other than 100 kHz.

Programming Example

The following program is written in BASIC for HP 9000 Series 200 or 300 controllers. The program will set the FM range to an appropriate setting and return the peak voltage required (into 50 ohms) for the FM peak deviation specified by the variable called *Deviation*.

```
10 SUB Fm_deviation(Err,Deviation,V_required) ! Deviation is in MHz
20 !
30 IF Deviation<=10 THEN
40 Dev$="D7" ! Code for 10 MHz peak deviation
50 V_required=Deviation/10 ! In peak volts into 50 ohms
60 END IF
70 IF Deviation<=3 THEN
80 Dev$="D6" ! Code for 3 MHz deviation
90 V_required=Deviation/3 ! In peak volts into 50 ohms
```

Frequency Modulation (cont'd)**Programming
Example
(cont'd)**

```

100 END IF
110 IF Deviation≤1 THEN
120 Dev$="D5"                                ! Code for 1 MHz deviation
130 V_required=Deviation/1                    ! In peak volts into 50 ohms
140 END IF
150 IF Deviation≤.3 THEN
160 Dev$="D4"                                ! Code for 300 kHz peak deviation
170 V_required=Deviation/.3                  ! In peak volts into 50 ohms
180 END IF
190 IF Deviation≤.1 THEN
200 Dev$="D3"                                ! Code for 100 kHz deviation
210 V_required=Deviation/.1                  ! In peak volts into 50 ohms
220 END IF
230 IF Deviation≤.03 THEN
240 Dev$="D2"                                ! Code for 30 kHz deviation
250 V_required=Deviation/.03                 ! In peak volts into 50 ohms
260 END IF
270 IF Deviation=0 THEN
280 Dev$="D1"                                ! Turns FM off
290 V_required=0
300 END IF
310 !
320 OUTPUT 719 USING "2A";Dev$               ! Program range
330 SUBEND !

```

**Error
Messages**

There are no messages associated with the setting of frequency modulation.

Internal Automatic Level Control

Description Automatic Leveling Control (ALC) is used to maintain a constant power level at a given point. Internal ALC provides a leveled output signal at the RF output connector that is held constant over the entire frequency range of the instrument.

Internal ALC is the simplest mode to operate and requires no additional equipment to use. The RF output level is controlled over the entire frequency range of the instrument with a dynamic range of -100 dBm up to a maximum of $+13$ dBm. The actual maximum leveled power is dependent on RF output frequency and is specified within frequency bands. To level the RF output over the entire frequency range of the Signal Generator, the output level must be set no higher than the maximum leveled power of the lowest-power frequency (typically the highest frequency).

Local Procedure To set the Signal Generator for internal leveling:

1. Press the Signal Generator ALC INT key to set the ALC circuitry to detect the RF output power internally.
2. Set the OUTPUT LEVEL RANGE and the OUTPUT LEVEL VERNIER so the sum of the RANGE display and the LEVEL meter equal the desired output power. Stepping the range up or down allows the output level to be changed in 10 dB steps. Adjusting the vernier enables the output level to be changed continuously for levels between -10 and $+3$ dB of the RANGE.

Remote Procedure The program code used to set the ALC mode to internal is C1. Once the Signal Generator is set to internal ALC mode, the output level can be set and read directly by the controller. Internal ALC is set when the instrument is preset.

The VERNIER and RANGE settings and the RF output level (the sum of RANGE and VERNIER) can be read using the output active program code suffix. To read the VERNIER setting (-10.0 to $+3.0$ dBm), send the program string VEOA and then read the VERNIER setting using the ENTER command. The Signal Generator will send the setting in units of dBm. If the setting is read as a string, the format will be the program code VE followed by the VERNIER setting in dBm and then the units code DM.

The RANGE setting is read by sending the program string RAOA and then reading the RANGE setting using the ENTER command. The Signal Generator will send the range in units of dBm (-90 to $+10$). If the RANGE setting is read as a string, the format will be the program code RA followed by the range setting in dBm and then the units code DM.

The RF output level is read by sending the program string LEOA and then reading the output level. The Signal Generator will send the level in units of dBm (-102 to $+13.0$). If the RF level is read as a string, the format will be the program code LE followed by the RF output level in dBm and then the units code DM. The program code AP or PL can be used instead of LE, but the program code returned from the Signal Generator will always be LE.

Example To set the Signal Generator to an output level of -16 dBm.

Local

1. Press the ALC INT key on the Signal Generator to set the leveling to internal.
2. Set the Signal Generator RANGE to -10 dB. The VERNIER can be adjusted for levels between -20 and -7 dBm in the -10 dB range.

Internal Automatic Level Control (cont'd)

Example (cont'd)

- Adjust the VERNIER for a -6 dBm reading on the LEVEL meter. This sets the output level to -16 dBm.

Remote

The program string to set the ALC mode and the output level is "C1LE-16DM." Additional information on setting the output level can be found under RANGE and VERNIER detailed operating instructions.

Program Codes

HP-IB

Program Code	Description
C1	Internal Automatic Leveling Control

Comments

Internal ALC is used to control the internal RF signal over a range of -10 to $+13$ dBm. Additional dynamic range is provided by a 90 dB step attenuator to give an effective dynamic range of -100 dBm to $+13$ dBm. The actual maximum leveled power available is dependent on the frequency and varies for the different frequency bands.

An ALC UNLEVELED condition occurs when the internal ALC circuitry cannot maintain leveling. This can occur due to an instrument fault or because the instrument is set to level for an RF output level that is beyond its capability. Calibrated output level is only guaranteed with the UNLEVELED annunciator extinguished.

When the UNLEVELED annunciator is lighted, the Signal Generator's LVL meter will indicate approximate available power. For example, if the Signal Generator is capable of $+9$ dBm leveled power at a given frequency, and the RF output level is set for $+13$ dBm, the level meter will give an indication of -1 dBm to indicate that the maximum available power is $+9$ dBm.

The choice of RANGE and VERNIER settings can have a significant effect on some applications. If a continuous 13 dB range about a specific output level is required, the VERNIER alone can be used. If 10 dB steps are required, the RANGE up and down keys may be used to step the RF output level in 10 dB steps.

High VERNIER settings give the worst case performance for harmonics while the low VERNIER settings give the worst case performance for subharmonics. For applications requiring lowest harmonics, use a higher range setting to allow setting the VERNIER at a lower setting. For example, if an output level of -10 dBm is required with a minimum harmonic, use the 0 dB range and the -10 dBm setting of the VERNIER.

Subharmonics are due to the frequency multiplication process within the Signal Generator. Frequencies above 6.6 GHz are generated by multiplying the fundamental (2 to 6.6 GHz) microwave signal by two, three or four to provide output frequencies up to 26 GHz. In the multiplied bands, there is feedthrough from the fundamental and its harmonics. These spurious signals are termed subharmonics and are typically at a fixed amplitude with respect to the multiplied frequency. For this reason, the higher VERNIER settings provide a better signal to spurious ratio.

Programming Example

The following program is written in BASIC for HP 9000 Series 200 or 300 controllers. The following program is used to set the ALC mode of the Signal Generator. Valid *Mode\$* strings are "INTERNAL," "DIODE," "POWER METER" and "SYSTEM."

Internal Automatic Level Control (cont'd)

**Programming
Example
(cont'd)**

```
10 SUB Set_alc(Err,Mode$)
20 IF Mode$="INTERNAL" THEN P_code$="C1"
30 IF Mode$="DIODE" THEN P_code$="C2"
40 IF Mode$="POWER METER" THEN P_code$="C3"
50 IF Mode$="SYSTEM" THEN P_code$="C4"
60 OUTPUT 719 USING "2A";P_code$
70 END
```

**Error
Messages**

The following message may be displayed when programming the RF output level.

24 The programmed RF output level is outside of the Signal Generator's range.

Manual Sweep Mode

Description

The Signal Generator performs a digital sweep by stepping the RF output frequency in discrete steps from the start frequency to the stop frequency. The number of steps that the Signal Generator produces between the start and stop frequency is controlled by the number of steps or the sweep step size parameters.

The Signal Generator has three sweep modes to accommodate a variety of applications. Auto sweep mode is used when a repetitive sweep is required. Auto sweep mode will step the RF output frequency from the start frequency to the stop frequency and then repeat the sweep until the sweep is turned off or a band crossing is encountered.

Single sweep mode will step the RF output frequency from the start frequency to the stop frequency once and then stop. This mode is useful when a single sweep is required for a measuring device to store the results. Additional control signals are provided for control of X-Y recorders and external displays.

Manual sweep provides a convenient method to limit the tuning range of the frequency tuning controls. In applications requiring a single band of frequencies, the tuning limits can be set to cover the band of interest which allows the user to tune the frequency without having to watch the Signal Generator display to determine when the frequency is outside of the selected band.

There are four rear panel connectors that are used for sweep coordinating signals. SWP OUT provides a signal that is 0 volts at the beginning of a sweep and 10 volts at the end of the sweep regardless of the sweep width. The output impedance is nominally 100 ohms.

The TONE MKR connector provides a 5 kHz signal when an active marker frequency is generated. This signal can be connected to the AM IN connector on the front panel to provide AM markers on the external display. Nominal impedance of the TONE MKR is 600 ohms.

The BLANKING/MARKER output provides a +5 volt signal at the beginning of each frequency change for blanking an external display. The blanking function is used to eliminate the display of switching transients. Once the frequency has settled, the signal returns to 0 volts unless the new frequency is an active marker frequency. If the frequency is an active marker frequency, the signal is set to -5 volts to provide a Z-axis input for intensifying the display at the marker sweep point.

The PENLIFT connector provides control for an external X-Y recorder and is only active during single sweep mode. A TTL logic high is used to raise the pen and a TTL logic low is used to lower the pen. The pen is only lowered in single sweep and there is a 100 millisecond sweep delay for the pen to raise or lower.

Local Procedure

To set the Signal Generator for manual sweep mode:

1. Set the desired sweep parameters. The tuning controls will change the current sweep frequency by the sweep step size and not by the current frequency increment.
2. Press the MANUAL SWEEP MODE key to activate manual sweep mode. The key indicator will light and the frequency will be set to the start frequency. Using the FREQ INCREMENT up or down key or the TUNE knob will change the RF frequency by the sweep step size.

Manual Sweep Mode (cont'd)

Local Procedure (cont'd)

Direct entry of a frequency using the numeric keypad will change the center frequency of the sweep. This will reset the start and stop frequency and set the current frequency equal to the new start frequency. The **FREQ INCREMENT** keys and the **TUNE** knob will tune the frequency between the start and stop frequency.

The **FREQ INCREMENT** keys and the **TUNE** knob will always operate just as in CW mode. Setting the start frequency above the stop frequency will place the frequency at the higher (start) frequency when manual sweep is activated, however, counter-clockwise rotation of the **TUNE** knob and the **FREQ INCREMENT** down key will always decrement the frequency whether the start frequency is set above or below the stop frequency.

Remote Procedure

Manual sweep mode is activated with the program code **W3**. The sweep can be reset with the program code **RS**. Resetting the sweep will reset the sweep frequency to the start frequency.

The **IF** program code will produce a step toward the stop frequency even if the start frequency has been set above the stop frequency. The **UP** program code will always produce an increase in the absolute frequency and **DN** will always produce a decrease in the absolute frequency.

The output couple, **OC**, program code can be used to read the start frequency, center frequency and dwell time in that order. The values are not prefixed by program codes and the frequencies are sent in Hz while the dwell time is sent in seconds.

Example

To sweep from 2 to 4 GHz in manual sweep mode:

Local

1. Set the start frequency to 2 GHz and the stop frequency to 4 GHz.
2. Press the **MANUAL SWEEP MODE** key to activate manual sweep. The key indicator will light to indicate manual sweep sweep is active.

Remote

The programming string to set manual sweep is: "W3"

The alpha character (**W**) can be sent as upper or lower case.

Program Codes

HP-IB

Program Code	Function
W3	Manual Sweep Mode
IF	Increment Frequency (Sweep)

Comments

The Signal Generator digital sweep is composed of discrete frequencies that are produced sequentially. The minimum step size is limited to the minimum change in frequency that the Signal Generator can produce which is defined as the frequency resolution. The number of steps is dependent on the frequency resolution and the frequency span.

The actual change in output frequency during a sweep will not be uniform for some frequency bands and may vary up to 2 kHz. This is required to accommodate sweep step sizes that are not exact multiples of the frequency resolution. The sweep steps averaged

Manual Sweep Mode (cont'd)

Comments

over several sweep points will be equal to the selected sweep step size. An example of the averaging is defining a sweep step size of 10 kHz at a start frequency of 15 GHz. The minimum tuning increment at 15 GHz is 3 kHz. This means that the sweep step size can be 9 kHz or 12 kHz for exact step sizes. To obtain a sweep step size of 10 kHz, the Signal Generator will step by 9 kHz, 9kHz, 12 kHz and then repeat the sequence. The average step size is 10 kHz even though the sweep does not execute exactly 10 kHz steps. If the step size is reduced to 1 kHz, the Signal Generator will step by 0 kHz, 0 kHz and then 3 kHz for a 1 kHz average step size in the 3 kHz resolution frequency band.

Sweeps from a higher frequency to a lower frequency can be accomplished by setting the start frequency higher than the stop frequency. This combination results in a negative frequency span as indicated when the frequency span is displayed. Negative frequency spans can only be entered by setting the start frequency higher than the stop frequency. The tuning controls will work as with a positive span, but the remote program code IF will always produce a sweep step toward the stop frequency.

An Auto Peak operation is performed whenever the RF output frequency is more than 50 MHz from the frequency at which the last Auto Peak operation was performed. The Auto Peak operation optimizes the Signal Generator performance at the current frequency. The Auto Peak operation produces small changes in the RF output level as the peaking is performed. For applications requiring fastest sweeps, Auto Peak may be disabled. However, with Auto Peak disabled, modulation performance and maximum output power may be degraded. The time required for the Auto Peak operation is not included in the dwell time setting.

The automatic level control (ALC) bandwidth is increased when sweep mode is activated. This provides fast response to switching transients when sweeping. In addition, activating sweep mode while amplitude modulating increases the useable AM bandwidth by more than 250 times. See the amplitude modulation detailed operating instructions for more information about AM bandwidth while in sweep mode.

The front panel annunciators are filtered in sweep mode to prevent false indications. While sweeping, the frequency changes cause a loss of phase lock and unlevelled automatic level control during the frequency change. To prevent constant flashing of the front panel annunciators, the response is damped to indicate only major problems during a sweep. The bits of the extended status byte are also buffered and should not be used to check individual sweep points for phase lock and leveled RF output.

Programming Example

The following program is written in BASIC for HP 9000 Series 200 or 300 controllers. The program is used to set the Signal Generator to the sweep mode specified by the variable *Mode\$*.

```

10 SUB Sweep_set(Err,Mode$)
20 OUTPUT 719 USING "2A";"MG"                ! Read message from 8673
30 ENTER 719 USING "2A";Message$           ! to clear any old messages
40 SELECT Mode$
50 CASE "AUTO","AUTOMATIC"
60 Code$="W2"                                ! Auto sweep mode
70 CASE "MANUAL"
80 Code$="W3"
90 CASE "SINGLE","ONCE"
100 Code$="W6"                                ! Arm and begin single
110 CASE ELSE

```

Manual Sweep Mode (cont'd)

Programming Example (cont'd)

```
120 DISP "WARNING: Invalid sweep mode specified"  
130 Err+_1  
140 SUBEXIT  
150 END SELECT  
160 !  
170 OUTPUT 719 USING "2A";Code$  
180 !  
190 SUBEND                               ! End of subroutine
```

Error Messages

The following message numbers may be displayed when activating manual sweep mode. Each message is explained as it pertains to activating manual sweep mode. For a more complete description of the messages, see the MESSAGES detailed operating instructions.

- 10 The start and stop frequency are set to the same value. No sweep will be generated.
- 11 The current sweep span is set such that the start frequency would be below the frequency range of the instrument. The sweep will begin at the lowest sweep point that is within the range of the Signal Generator. All sweep points will be allotted, but the frequency will not change until the sweep is within the frequency range of the Signal Generator.
- 12 The current sweep span is set such that the stop frequency would be above the frequency range of the instrument. The sweep will end at the highest sweep point that is within the frequency range of the Signal Generator. All sweep points will be allotted, but the last sweep points will all be at the highest valid frequency.
- 16 The k-band amplifier (Option 008 only) crossing occurred during automatic sweep mode. Only one sweep will occur and then the sweep will stop.
- 90 Auto Peak malfunction. This indicates that the instrument may require service.

Marker Frequency (Sweep)

Description

The Signal Generator has five markers that can be used during a sweep to activate rear panel control signals when selected frequencies are generated. These control signals can be used to generate distinctive calibrated frequency markers on an external display. Using the Signal Generator's markers provides up to five easily identified display markers at known frequencies.

When a marker is activated, an extra frequency point at the sweep marker frequency will be generated during a sweep and the BLANKING/MARKER and TONE MKR signals will be activated. The rear panel BLANKING/MARKER signal is used to produce a -5 volt dc level to intensify a portion of the trace on a CRT display (Z axis input). The signal level will be zero volts dc for non-marker frequencies.

The TONE MKR is a 5 kHz signal that can be used to amplitude modulate the RF output signal of the Signal Generator or can be summed into an external display to generate a distinctive marker on the displayed trace.

Each of the five markers can be set to trigger on any valid Signal Generator frequency and can be individually enabled or disabled. Each active marker will add a distinct frequency to the sweep even if two markers are set to the same sweep marker frequency. For example, if two markers are set for 3 GHz and 3 GHz is also a valid point in the frequency sweep, three sweep points will be generated at 3 GHz. See the comments section for more details on marker priority and marker frequency points.

Local Procedure

To set and activate a sweep frequency marker:

1. Press the MKR key to indicate that a marker will be set, activated or turned off.
2. Enter the marker number that is to be set using the numeric keypad. Valid marker numbers are one through five.
3. Enter the desired marker frequency using the numeric keypad. If a mistake is made while entering the frequency, press the backspace key until the incorrect digit disappears. Continue entering the correct digits until the frequency displayed in the FREQUENCY MHz display is correct.
4. Press the appropriate units key. The frequency may be entered in GHz, MHz or kHz. Once the units key is pressed, the displayed frequency will be adjusted to display MHz and the sweep marker frequency will be displayed until the units key is released.

Setting the sweep marker frequency will activate the sweep marker. If the sweep marker frequency is between the sweep start and stop frequency, pressing the MKR key will display the marker number to indicate that it is active. If the sweep marker frequency is not between the sweep start and stop frequency, it will not be displayed as active until the start or stop frequencies are reset to place the sweep marker frequency within the sweep.

A sweep marker is deactivated by pressing the MKR key, entering the marker number using the numeric keypad and then pressing the MKR OFF units key. All five markers can be deactivated by pressing the MKR key and then pressing the MKR OFF units key.

The sweep marker frequency for a given marker can be displayed by pressing the MKR key and then entering the marker number using the numeric keypad. The sweep marker frequency for that marker will be displayed as long as the marker number key is pressed. This sequence is also used to activate a marker so reading a sweep marker frequency will activate the marker.

Marker Frequency (Sweep) (cont'd)

Local Procedure (cont'd)

The active markers can be displayed by pressing and holding the MKR key. The active markers will be displayed in the FREQUENCY MHz display in the order in which they will occur. For example, if marker 3 is set to 15 GHz and marker 5 is set to 10 GHz, the marker display will display 5 and then 3 as long as both sweep marker frequencies are within the current sweep.

Remote Procedure

Each of the five markers can be programmed to any frequency within the Signal Generator's frequency range. Above 6.6 GHz, the programmed frequency may be rounded by the Signal Generator to be compatible with the 2, 3 or 4 kHz frequency resolution at the programmed frequency.

Specifying a marker in remote mode is done using the letter M followed by the marker number. For example, M1 specifies marker 1. Deactivating all markers is done by specifying marker zero (M0). Deactivating a single marker is done by specifying a marker and then sending the program code MO (Marker Off).

Activating a marker is done by specifying a marker. For example, the program string M5 will activate marker 5. To set the marker to a specific frequency, the marker is specified and then the frequency is specified with the appropriate units terminator (GZ, MZ, KZ, or HZ).

The sweep marker frequency can be read for any given marker by specifying the marker followed by the output active program suffix. The Signal Generator will send the frequency in fundamental (Hz) units. If the marker frequency is read as a string, the format will be the program code MK followed by the marker frequency in Hz and then the units terminator (Hz).

Example

To set marker 3 to 12.34 GHz:

Local

1. Press the MKR key.
2. Key in 3 using the numeric keypad. This indicates that marker 3 is to be acted upon by the next entry and activates marker number three. Note that the FREQUENCY MHz display shows the current sweep marker frequency when the 3 is pressed.
3. Key in 12.34 using the numeric keypad. The FREQUENCY MHz display should show 12.34 and should be left justified.
4. Press the GHz units key to finish the sequence. The FREQUENCY MHz display should display the entered frequency in MHz and should also be right justified when the units key is pressed.

The frequency could also have been entered as 12340 MHz or 12340000 kHz. The only difference is the placement of the decimal point and the units terminator. Pressing the MKR key and then MKR OFF will deactivate all of the markers.

Remote

The programming string for setting a marker is composed of a marker identifier, the frequency and a units terminator. The sweep marker frequency can be programmed in units of GHz, MHz, kHz or Hz. To program marker 3 to 12.34 GHz, the possible program strings are:

Marker Frequency (Sweep) (cont'd)

Example (cont'd)

"M312.34GZ" or "M312340MZ" or "M312340000KZ" or "M312340000000HZ"

The alpha (non-numeric) characters can be sent as upper or lower case (or even mixed upper and lower case).

Program Codes



Marker Activation Codes

Program Code	Description
M0,MO	All markers off
M1	Activate marker 1
M2	Activate marker 2
M3	Activate marker 3
M4	Activate marker 4
M5	Activate marker 5
X0	All markers off
X1	Activate marker 1
X2	Activate marker 2
X3	Activate marker 3
X4	Activate marker 4
X5	Activate marker 5

Setting Sweep Marker Deactivation

Program Code	Description	Units
M1	Sweep Marker Frequency	GZ MZ KZ HZ
M2		
M3		
M4		
M5		
X1		
X2		
X3		
X4		
X5		

Selected Marker Deactivation

Program Code	Description	Program Suffix
M1	Sweep Marker Off	MO
M2		
M3		
M4		
M5		
X1		
X2		
X3		
X4		
X5		

Comments

Each marker that is activated adds a frequency point to the sweep. If the marker frequency already exists in the sweep, an additional frequency will be added to the sweep and will occur before the existing frequency. When the marker frequency is generated, the BLANKING/MARKER and TONE MKR signals are activated to provide markers on the external display. The next frequency in the sweep will be the same RF frequency except that the two rear panel marker signals are turned off. This feature allows the marker to be used to mark the display while still being able to observe the response (at the marker frequency) without the marker signals present.

Marker Frequency (Sweep) (cont'd)

Comments (cont'd)

During a sweep where the marker is set to an existing sweep point, the marker frequency is always generated first unless the marker frequency is set to the start frequency. For a marker that is set equal to the start frequency, the first generated frequency will be the existing sweep point and then the marker frequency will be generated.

Connecting the TONE MKR rear panel output to the Signal Generator's AM IN connector provides amplitude markers for a spectrum analyzer display. The RF output is modulated at a 5 kHz rate with approximately 25% or 75% AM for the 30% and 100% ranges respectively. The spectrum analyzer will display a modulated signal at each of the active marker frequencies to provide calibrated frequency markers on the display.

Programming Example

The following program is written in BASIC for HP 9000 Series 200 or 300 controllers. The program is used to set the marker specified by Marker to the frequency specified by the variable *Expected*. The marker must be between 1 and 5 and the marker frequency can be any valid Signal Generator frequency.

```
10 SUB Marker_set(Err,Marker,Expected)
20 IF Marker<1 or Marker>5 then
30 Err=-1
40 DISP "ERROR: Marker number not between 1 and 5"
50 SUBEXIT
60 END IF
70 !
80 OUTPUT 719 USING "2A";"MG"           ! Clear any old messages
90 ENTER 719 USING "2A";Message$
100 !
110 OUTPUT 719 USING "2A,5D.DDD,2A";"M"&VAL$(Marker),Expected,"MZ"
120 !
130 OUTPUT 719 USING "2A";"MG"         ! Check for errors
140 ENTER 719 USING "2A";Message$
150 SELECT VAL(Message$)
160 CASE 1
170 Err=1
180 DISP "ERROR: Marker frequency is out of range"
190 CASE ELSE
200 Err=0
210 END SELECT
220 !
230 SUBEND
```

Error Messages

The following messages may be displayed when setting the sweep markers. Each message is explained as it pertains to setting sweep markers. For a more complete description of the messages, see the MESSAGES detailed operating instructions.

01 The entered frequency is not within the range of the Signal Generator.

09 The entered marker number is not between 1 and 5.

Master/Slave Sweep

Description

Master/Slave Sweep enables two Signal Generators to track each other while sweeping. The output frequencies of the Signal Generators can be identical or offset by a fixed amount. The Master Signal Generator controls stepping the the sweep of the Slave.

In Master/Slave mode, two Signal Generators are interconnected through the Hewlett-Packard Interface Bus (HP-IB). The Master unit is set to HP-IB address 50 and the Slave is set to HP-IB address 40. The sweep start and stop frequencies are set to identical frequencies on both the master and slave instruments. Desired offset is then entered on the Slave unit by adjusting the sweep center frequency. The Master unit is swept using any of the three sweep modes. The Slave unit will track the Master unit, offset in frequency by the difference in sweep center frequencies.

Local Procedure

To set two Signal Generators to Master/Slave sweep mode:

1. Interconnect the two Signal Generators using an HP-IB cable.
2. Press RCL 0 on both units.
3. Designate one Signal Generator as the Master unit by setting the HP-IB address to 50. The HP-IB address can be set from the front panel by keying in 50, pressing the STO key, then pressing the LOCAL key. When the HP-IB address is set to 50, the TLK annunciator on the front panel will light to indicate that the Signal Generator has entered the talk only mode.
4. Designate the second Signal Generator as the Slave unit by setting the HP-IB address to 40. When the HP-IB address is set to 40, the LSN annunciator on the front panel will light.
5. On both instruments, set SWEEP START and SWEEP STOP frequencies to the desired Master sweep values.
6. On both instruments, set the number of sweep steps to the desired value. For constant offsets, both instruments must be set for the same number of steps.
7. On the Slave unit, select a frequency offset by resetting the Slave center frequency to the desired offset from the Master center frequency.
8. Press and hold the SWEEP START frequency key on the Slave unit. The frequency should be different from the Master unit start frequency by the desired offset. The SWEEP STOP frequency should also be offset by the same amount.
9. To operate Master/Slave sweep in AUTO sweep mode: press AUTO on the Master unit. The Master unit will begin to sweep and the Slave unit will track it. The Slave unit will enter Slave mode when sweep is selected on the Master unit. When the Signal Generator is in Slave mode, the MANUAL and SINGLE indicators will be illuminated.
10. To operate Master/Slave in MANUAL sweep mode: Press MANUAL on the Master unit. Use the TUNE knob on the Master unit to tune both Master and Slave units. The Slave unit will enter Slave mode when sweep is selected on the Master unit. When the Signal Generator is in Slave mode, the MANUAL and SINGLE indicators will be illuminated.

Master/Slave Sweep (cont'd)

Local Procedure (cont'd)

11. To operate Master/Slave in SINGLE mode: Press SINGLE on the Master unit once to arm the sweep. Press it a second time to execute a single sweep. If SINGLE is pressed during the sweep, the in-progress sweep stops and is re-armed. The Slave unit will enter Slave mode when sweep is selected on the Master unit. When the Signal Generator is in Slave mode, the MANUAL and SINGLE indicators will be illuminated.

Remote Procedure

Master/Slave sweep mode cannot be remotely programmed because the Master unit is acting as a limited HP-IB controller.

Example

To operate Master/Slave sweep with an offset of 50 MHz:

1. Interconnect the two Signal Generators using an HP-IB cable.
2. Press RCL 0 on both Signal Generators.
3. Designate one Signal Generator as the master unit by setting the HP-IB address to 50. When the HP-IB address is set to 50, the TLK annunciator on the front panel will light.
4. Designate the second Signal Generator as the Slave unit by setting the HP-IB address to 40. When the HP-IB address is set to 40, the LSN annunciator on the front panel will light.
5. On both instruments, set SWEEP START to 6000 MHz, and SWEEP STOP to 12000 MHz.
6. On both instruments, set the number of sweep steps to 100. This corresponds to a sweep step size of 60 MHz.
7. On the Slave unit, select a 50 MHz offset as follows: press the **FREQ INCR** key and then key in 50 MHz. Press **FREQ INCREMENT**  key. This changes the center frequency of the slave unit from 9.000 GHz to 9.050 GHz.
8. Press and hold the SWEEP START key on the Slave unit. Check the display for a 50 MHz offset. The display should read 6050 MHz.
9. Initiate the desired sweep mode (AUTO, MANUAL, or SINGLE) by selecting the desired sweep mode on the Master unit.

Comments

Any number of slave units up to the limit of the HP-IB can be controlled with a single Master unit. To add another Slave unit, connect the additional Signal Generator to the Master unit with an HP-IB cable, set the Slave unit's HP-IB address to 40, and enter the desired sweep parameters.

When entering sweep step size or number of steps, use identical values for the Master and Slave units. If identical values are not entered, the sweeps will not track identically, resulting in increasing or decreasing offsets as the sweep progresses.

Adjusting the TUNE knob on the Slave unit will tune the sweep center frequency to a different value, resulting in loss of the desired frequency offset between the Master and Slave units.

Master/Slave Sweep (cont'd)

Comments (cont'd)

When in MANUAL mode, the Master unit can be used to reset both units to the sweep start frequency. To do so, press the SINGLE key, then press the MANUAL key on the Master unit. The Master and Slave units will be reset to their respective start frequencies.

The sweep modes of the Master unit (AUTO, MANUAL, and SINGLE) are controlled by the Master's front panel. The Slave unit's MANUAL and SINGLE keys will always be lit, no matter which mode the Master unit is operating in.

When using Master/Slave sweep, the 10 MHz frequency reference should be supplied by only one instrument. This will improve the accuracy of the sweep and maintain phase coherent signals during the sweep.

Error Messages

The following messages may be displayed when using Master/Slave sweep:

- 01 Entered frequency is not within the range of the Signal Generator.
- 03 Invalid multiplier entry for system compatible instruments. See paragraph 3-2, System Compatibility, for more information about system compatibility.
- 10 The sweep start frequency has been set equal to the stop frequency. No sweep will occur when a sweep mode is selected.
- 11 Indicates that the current sweep start frequency is below the range of the Signal Generator. This error may be displayed when the SWEEP FREQ START key is pressed if tuning the instrument placed the sweep start frequency below the frequency range of the Signal Generator.
- 12 Indicates that the current sweep stop frequency is above the frequency range of the Signal Generator. This error may be displayed when the SWEEP FREQ START key is pressed if tuning the instrument placed the sweep stop frequency above the frequency range of the Signal Generator.
- 13 Number of steps were adjusted to give an even step size. This ensures that the full sweep span is covered by adjusting the number of steps. For example, if the number of steps is set to 100 and the stop frequency is 2000.010 MHz, setting the start frequency to 2 GHz will automatically adjust the number of steps to 10 to accommodate the minimum frequency resolution of 1 kHz.
- 90 Auto Peak malfunction. This indicates that the instrument may require service.

Messages

Description

MESSAGE is a two-digit code that indicates errors. The error code indicates either a data entry error or a hardware malfunction. When the error is an entry error, the MESSAGE indicator on the front panel lights. When the error is a hardware malfunction, the MESSAGE indicator flashes.

To read the error code, press the MESSAGE key on the front panel. The two-digit code will appear in the FREQUENCY MHz display when this key is pressed. After reading the code, consult Table 3-8, Error Messages, or the pull-out card for an explanation of the error codes.

The error code will remain in the FREQUENCY MHz display as long as the MESSAGE key is pressed. Once the message is read, however, the error code is cleared to 00 (no error) whether or not the causing condition has been corrected.

Types of error codes:

Messages 01 through 09 are front panel entry errors. The entry is ignored and the previous parameter value is retained.

Messages 10 through 16 are errors that result from unusual combinations of sweep entries. A message is displayed and all entered values are stored in anticipation that further entries will resolve the conflict.

Messages 30 through 90 are service-related errors. This type of error message should be referred to service-trained personnel. See Section 8 in the Service Manual for more information.

Local Procedure

To read the error code:

1. Press and hold the front panel MESSAGE key to read the two-digit error code.
2. Refer to Table 3-8, Error Messages, or the pull-out card for an explanation of the error codes.

Remote Procedure

Error messages can be read using the HP-IB. To do so, send the program code "MG" to the Signal Generator, then read back the two-digit error code (00 to 99). Refer to Table 3-8, Error Messages, or the pull-out card for an explanation of the message codes.

Error messages are not cleared in remote mode by sending new program strings. To ensure correct error messages, clear MESSAGE by reading the error code (via front panel or HP-IB) before programming the Signal Generator with a new program string. This will clear any previous messages that have not been read so the message indicated after sending the programming string will be the response to that programming string.

Program Codes

HP-IB

Program Code	Description
MG	Enable Message output

Messages (cont'd)

Comments The Entry Error bit of the status byte is analogous to the MESSAGE key. When the service request mask is used to generate an SRQ on an entry error, the MESSAGE must be read (via the front panel or HP-IB) before the SRQ is cleared. Clearing the status byte will not clear SRQ until the message has been read.

Error Messages

Following are notes about certain error codes:

- 03 Invalid multiplier entry for system compatible instruments. See paragraph 3-2, System Compatibility, for more information.
- 90 Auto Peak malfunction. If error 90 occurs during pulse mode, pulse performance may not be correct. Clear the message and attempt an Auto Peak function. If error 90 occurs again, service is required.

Table 3-8. Error Messages

Code	Definition	Code	Definition
00	NO ERROR	13	NUMBER OF STEPS ADJUSTED TO GIVE STEP SIZE IN EVEN kHz. Press STEP to see result.
Messages 01-09 are operator errors. The entry is ignored and the previous values are retained.		14	STEP SIZE TOO SMALL FOR SPAN. Press STEP to see result (maximum number of steps is 9999).
01	FREQUENCY OUT OF RANGE	15	STEP SIZE > SPAN. Step size is set to span.
02	FREQ INCR OUT OF RANGE	16	BAND CROSSING IN AUTO SWEEP
03	MULTIPLIER ENTRY OUT OF RANGE	Messages 20-24 are HP-IB errors. The entry is ignored.	
04	CANNOT STORE REGISTER 0	20	INVALID HP-IB CODE
05	STEP SIZE OUT OF RANGE	21	HP-IB DATA WITHOUT VALID PREFIX
06	BYPASS AND SYSTEM LEVELING NOT FUNCTIONAL BELOW 2.0 GHz	22	INVALID HP-IB ADDRESS ENTRY
07	NUMBER OF STEPS OUT OF RANGE	23	TALK FUNCTION NOT PROPERLY SPECIFIED
08	DWELL OUT OF RANGE	24	OUTPUT LEVEL OUT OF RANGE
09	MARKER NUMBER NOT 1-5	Messages 28-99 are service-related errors. Refer to Section 8 in the manual.	
Messages 10-16 are "soft errors" that result from unusual combinations of sweep entries. A message is displayed and all entered values are stored in anticipation that further entries will resolve the conflict.		28	SERVICE CODE OUT OF RANGE
10	START FREQ=STOP FREQ. No sweep.	90	AUTO PEAK FUNCTION
11	SWEEP SPAN RESULTS IN START FREQUENCY OUT OF RANGE. Truncated sweep will result.	92	RECALL CHECKSUM ERROR
12	SWEEP SPAN RESULTS IN STOP FREQUENCY OUT OF RANGE. Truncated sweep will result.	95	LOSS OF DATA ON POWER UP
		96	MEMORY TEST FAILURE
		97	ROM TEST FAILURE, A2A10
		98	RAM TEST FAILURE, A2A10
		99	RAM NOT FUNCTIONAL AT POWER UP

Multiplier Mode (2552A, 2634A and above)

Description

Display multiplier mode is available on system compatible Signal Generators only. See paragraph 3-2, System Compatibility, for more information. Display multiplier mode provides direct output frequency display of a system of instruments. The system may be composed of the Signal Generator and a frequency multiplier, or a combination of equipment that produces an integer multiple of the Signal Generator's RF output frequency. By entering the multiplying factor, the Signal Generator can be used to directly display and control the output of the system as long as a linear relationship exists between the Signal Generator RF output frequency and the output frequency of the system.

Once the multiplier is entered, a front panel annunciator lights to indicate that the displayed frequency is not equal to the actual RF output frequency. All frequencies (except frequency offset) will be displayed after being multiplied by the entered multiplier. For example, with a multiplier of 2 entered, an actual RF output frequency of 3 GHz will be displayed as 6 GHz. Entering 6 GHz will produce an actual frequency of 3 GHz.

Local Procedure

To enter a frequency display multiplier:

1. Press the blue shift key to access the shifted key functions.
2. Press the MULT (shifted STRT) key to indicate that the next entry will be for display multiplier.
3. Enter the desired display multiplier using the numeric keypad. The FREQUENCY MHz display should display the entry.
4. Press the X FREQ units key to finish the entry. The display multiplier will be displayed until the X FREQ key is released. Once the key is released, the FREQUENCY MHz display will indicate the multiplier value times the previous display. For example, if the Signal Generator RF output frequency was 3 GHz before the multiplier was entered and the multiplier is three, the display will indicate 9 GHz. The multiplier annunciator will be lighted to indicate that the displayed frequency is an integer multiple of the actual output frequency.

Entering a multiplier of 1 will disable the frequency multiplier mode. Valid entries are 1 to 99. For some sweep displays, the least significant digits may be truncated due to insufficient space to display large frequencies (corresponding to large frequency display multipliers).

Entering a frequency with a display multiplier active will display the entered frequency. The actual frequency at the RF output will be the displayed frequency divided by the multiplier.

Remote Procedure

The program code for display multiplier is MY. The programming format follows the front panel entry format. To program a frequency display multiplier, the program code MY is sent followed by the multiplier and the units XF.

The multiplier can be read by the controller using the output active program code suffix. To read the multiplier, send the program codes MYOA and then read the multiplier. If the multiplier is read as a string, the format will be the program code MY followed by the multiplier and then the units program code HZ.

Multiplier Mode (cont'd)

Example

To set a frequency display multiplier of 2:

Local

1. Press the blue shift key to access the shifted functions. The shifted functions are printed in blue above certain keys.
2. Press the MULT key to indicate that a display multiplier is to be entered.
3. Enter a 2 using the number keypad. The entered value should be displayed in the FREQUENCY MHz display.
4. Press the X FREQ units key to complete the sequence. The FREQUENCY MHz display should show the entered multiplier (2) until the X FREQ key is released.

The entered display multiplier can be read by pressing the shift key and then pressing and holding the MULT key. The entered multiplier will be displayed until the key is released.

Once a multiplier is entered, all frequencies will be displayed after being multiplied by the entered multiplier. The offset frequency (if entered) will not be multiplied by the display multiplier.

Remote

The programming string for setting the display multiplier to 2 is "MY2XF." The alpha (non-numeric) characters can be sent as upper case or lower case (or even upper and lower case).

Once a display multiplier is entered, all frequencies (except offset) will be multiplied by the entered multiplier. This allows the controller to read the system frequency over the bus and also the multiplier in case the Signal Generator's actual RF output frequency is to be determined.

Program Codes

HP-IB

Program Code	Description	Units
MU MY	Display Multiplier	XF

Comments

Frequency multiplication reduces the frequency resolution of the multiplied frequency. For example, an RF output frequency of 16 GHz corresponds to a frequency resolution of 3 kHz. If an external frequency doubler (multiplier=2) is used, the 32 GHz multiplied frequency would have a frequency resolution of 6 kHz.

When a frequency offset and a display multiplier are entered, the displayed frequency is multiplied before being offset. For an application such as a harmonic mixer, the desired harmonic can be entered as the multiplier and the desired IF frequency as an offset. Once these two values are entered, the frequency that is to be downconverted can be entered directly on the Signal Generator. The actual Signal Generator frequency will be the entered frequency offset by the IF frequency and then divided by the harmonic (multiplier). The calculations are internal to the Signal Generator and frees the user from the tedious calculations required to set the actual frequency present at the local oscillator port of the harmonic mixer.

Multiplier Mode (cont'd)

Comments (cont'd)

The system output frequency must be linearly related to the actual output of the Signal Generator. An example of a linear relationship is that the ratio of the system output frequency to the Signal Generator output frequency is a constant. Care must be taken with a complicated system to maintain a linear relationship to preserve display accuracy.

Programming Example

The following program is written in BASIC for HP 9000 Series 200 or 300 controllers. The program is used to set a frequency display multiplier. Entering a 1 will disable frequency display multiplier mode.

```
10 SUB Display_mult(Err,Multiplier)
20 IF Multiplier>99 OR Multiplier<1 THEN
30 DISP "WARNING: Display multiplier is out of range"
40 Err=-1
50 SUBEXIT
60 END IF
70 Mult=INT(Multiplier)           ! Make sure it is an integer
80 !
90 OUTPUT 719 USING "2A,DD,2A";"MY",Mult,"XF"
100 !
110 SUBEND
```

Error Messages

- 01 Entered frequency is not within the range of the Signal Generator.
- 03 Invalid multiplier entry for system compatible instruments. See paragraph 3-2, System Compatibility, for more information.

Offset Frequency

(2552A, 2634A and above)

Description

For applications that require a constant frequency offset to be used when setting the Signal Generator frequency, a frequency offset can be entered. For example, using the Signal Generator as a local oscillator with a frequency offset equal to the IF frequency allows both the RF source and the local oscillator to be set to the same frequency. Because of the offset frequency on the local oscillator, the actual frequency will be lower or higher than the programmed frequency, which will maintain the correct IF frequency. Offset frequency is only available on system compatible instruments. To determine if a specific Signal Generator is system compatible, see paragraph 3-2, System Compatibility.

Once the desired positive or negative offset is entered, the frequency displayed by the Signal Generator will be different from the actual RF frequency by the frequency offset. Entering or programming frequencies with frequency offset enabled will automatically calculate the required output frequency according to the frequency offset.

Local Procedure

To set a frequency display offset:

1. Press the blue shift key to access the shifted functions. The shifted functions are printed in blue above the associated key.
2. Press the +OFFSET key if the displayed frequency is to be above the actual output frequency. Otherwise, press the -OFFSET key if the displayed frequency is to be below the actual offset frequency.
3. Enter the desired offset frequency using the numeric keypad. If a mistake is made while entering the frequency, press the backspace key until the incorrect digit disappears. Continue entering the correct digits until the frequency displayed in the FREQUENCY MHz display is correct.
4. Press the appropriate units key. The frequency may be entered in GHz, MHz or kHz. Once the units key is pressed, the displayed frequency will be adjusted to display MHz and the offset frequency will be displayed until the units key is released. Once the units key is released, the FREQUENCY MHz display will be adjusted to display the RF output frequency offset by the entered offset frequency.

When the offset mode is activated, the OFFSET front panel annunciator will be lighted to indicate that the actual frequency is not the displayed frequency. Entering an offset of zero will deactivate the offset frequency mode. An instrument preset will also clear the offset frequency and deactivate offset frequency mode.

Once the offset frequency is entered, all subsequent frequency entries will be adjusted before setting the actual output frequency. For a positive offset, the actual frequency will be lower than the entered frequency and for a negative offset, the actual frequency will be higher than the entered frequency.

Remote Procedure

The offset frequency can be programmed to any frequency between 1 kHz and the Signal Generator's maximum frequency. Once the offset is programmed, frequencies read by the controller will be offset by the current offset frequency. Note that all frequencies except sweep step size and sweep frequency span are offset.

The format of the remote programming uses a program code to specify frequency offset followed by the desired offset frequency and the appropriate units terminator (GZ, MZ, KZ, or HZ). Entering a negative frequency specifies a negative offset and entering a positive frequency specifies a positive frequency offset.

Offset Frequency (cont'd)

Remote Procedure (cont'd)

Once the offset frequency is programmed, the controller can read the entered value using the output active program code suffix. To read the offset frequency, send the program string FTOA and then read the actual frequency offset. If the offset frequency is read as a string, the format will be the program code FT followed by the frequency offset (positive or negative) in Hz and then the units terminator (Hz).

Example

To set a frequency offset of 63.238 MHz:

Local

1. Press the blue shift key to indicate that a shifted function is to be accessed. The shifted functions are printed in blue above certain keys.
2. Press the +OFFSET key if the displayed frequency is to be above the actual RF output frequency. Press the -OFFSET key if the displayed frequency is to be below the actual RF output frequency.
3. Key in 63.238 using the numeric keypad. The FREQUENCY MHz display should show 63.238 and should be left justified.
4. Press the MHz units key to finish the sequence. The FREQUENCY MHz display should show the entered frequency until the units key is released. The FREQUENCY MHz display should be right justified when the units key is pressed.

The frequency could also have been entered as .063238 GHz or 63238 kHz. The only difference is the placement of the decimal point and the units terminator. Entering a frequency offset of zero will deactivate the frequency offset mode.

Remote

The programming string for setting a marker is composed of the frequency offset program code, the positive or negative frequency offset and the units terminator. The offset frequency can be programmed in units of GHz, MHz, kHz or Hz. To program a positive frequency offset of 63.238 MHz, the possible program strings are:

"FT.063238GZ" or "FT63.238MZ" or "FT63238KZ" or "FT63238000HZ"

The alpha (non-numeric) characters can be sent as upper or lower case (or even mixed upper and lower case). A positive frequency offset does not require the plus sign before the offset frequency.

Program Codes

HP-IB

Program Code	Function	Units
*FT	Offset Frequency	GZ
SHFB	Positive Offset	MZ
SHDF	Negative Offset	KZ
SHFS	Negative Offset	HZ
FO	Offset Frequency	

*Preferred Program Code

Offset Frequency (cont'd)

Comments

When using the Signal Generator as the local oscillator in a downconverter process, the frequency offset can be set to the intermediate frequency (IF). Once the offset is set, setting both the RF and the local oscillator to the same frequency will produce an IF frequency that is equal to the entered offset.

Using the frequency offset in conjunction with the multiplier mode is useful for harmonic mixing applications. In harmonic mixing, a harmonic of the local oscillator is used to downconvert a signal near the harmonic frequency. Setting the multiplier equal to the harmonic and then entering a frequency offset equal to the desired offset enables the local oscillator to be set to the frequency of the signal to be downconverted.

Programming Example

The following program is written in BASIC for HP 9000 Series 200 or 300 controllers. The following program is used to set the frequency offset to the offset specified by the variable called *Expected*. The offset can be positive or negative and must be in units of MHz.

```

10 SUB Offset_freq(Err,Expected)
20 !
30 OUTPUT 719 USING "2A";"MG"           ! Clear any old messages
40 ENTER 719 USING "2A";Message$
50 !
60 OUTPUT 719 USING "2A,5D.DDD,2A";"FT,"Expected,"MZ"
70 !
80 OUTPUT 719 USING "2A";"MG"           ! Check for errors
90 ENTER 719 USING "2A";Message$
100 SELECT VAL(Message$)
110 CASE 1
120 Err=1
130 DISP "ERROR: Offset frequency is out of range"
140 CASE ELSE
150 Err=0
160 END SELECT
170 !
180 OUTPUT 719 USING "4A";"FTOA"        ! Read offset back
190 ENTER 719 USING "K";Offset
200 !
210 IF ABS((Offset/1.E+6)-Expected)>.001 THEN ! More than 1 kHz error
220 Err=-1
230 DISP "WARNING: Programmed offset is more than 1 kHz in error"
240 END IF
250 !
260 SUBEND

```

Error Messages

The following message may be displayed when setting the offset frequency. The message is explained as it pertains to setting offset frequency. For a more complete description of the messages, see the MESSAGES detailed operating instructions.

01 The entered frequency is not within the range of the Signal Generator.

Power Meter Automatic Level Control

Description

External ALC enables the Signal Generator to level the signal at a point other than the output of the Signal Generator. The signal level must be detected using a signal splitter or directional coupler with an RF detector or power meter to provide a DC signal that is proportional to power at the remote point. The Signal Generator will adjust the signal level at the RF output connector to maintain a constant level at the point where the signal is detected. External ALC also enables external devices such as amplifiers, mixers and other specialized devices to be inserted into the RF signal path with control of the final output level by the Signal Generator.

In applications where the external signal path has frequency dependent losses (and/or gains), the RF signal at the end of the signal path will no longer be a constant amplitude over the Signal Generator's frequency range. For example, if a cable is used that has a constant 0.5 dB/GHz loss, a level error of 5 dB would occur after a 10 GHz frequency change. The signal at the RF output connector of the Signal Generator has not changed, but an extra 5 dB of attenuation is introduced in the signal path when the output frequency is changed.

The detection of the signal level can be done using a power meter with an appropriate sensor. The power meter must have an output signal that is proportional to the signal level in watts. The recorder output of most power meters provides the feedback signal for power meter leveling.

External ALC using a power meter has the advantages of temperature compensation and wide dynamic range. Using a sensitive power sensor allows ALC at levels as low as the power meter and sensor can measure. The disadvantage of power meter leveling is the longer settling time and the added complexity of a separate instrument.

Local Procedure

To set the Signal Generator for power meter leveling:

1. Connect the power meter to the remote point using a directional coupler or a power splitter. The power meter sensor must have enough dynamic range to measure the level at the coupled port of the directional coupler. For example, to level a signal of -7 to 0 dBm using a 10 dB coupler, the power sensor must be capable of measuring -17 to -10 dBm in a single range.
2. Press the Signal Generator ALC INT key to set automatic leveling control to internal. Adjust the Signal Generator output level to place the power meter in the appropriate range to monitor the coupled port over the required range. Press the range hold key to prevent a range change. A power meter range change will rescale the feedback voltage and cause oscillations in the leveling circuitry.
3. Reset the Signal Generator range to at least 10 dB above the range required for the desired RF output level. The range may have to be adjusted to compensate for losses and gains in the RF signal path. If the RF signal path will have a relatively high loss, a higher Signal Generator range will be required.
4. Connect the recorder output of the power meter to the external ALC input of the Signal Generator. The recorder output signal typically varies from 0 to 2 Vdc for each power meter range corresponding to a 23 dB dynamic range.
5. Press the ALC PWR MTR key to set the Signal Generator to external power meter ALC mode.

Power Meter Automatic Level Control (cont'd)

Local Procedure (cont'd)

- Adjust the ALC CAL control on the Signal Generator front panel until the UNLEVELED annunciator is extinguished. Set the Signal Generator VERNIER for a 0 dBm indication on the Signal Generator level meter. Continue adjusting the CAL control until the power meter indicates a level that is in the desired leveling range and lower than the VERNIER setting by the coupling factor. For example, for a desired level in the range of -17 to -10 dBm using a 10 dB directional coupler, adjust the CAL control for a power meter reading of -20 dBm.

A more accurate calibration can be made using another power meter at the output of the directional coupler. This will eliminate a possible error due to the coupling factor and will give greater assurance that the output of the coupler is accurate.

Once the calibration is complete, the level at the output of the directional coupler can be varied over a $+3$ to -10 dB range. If turning the CAL control fully clockwise does not have sufficient range to calibrate the output level, set the range higher until the calibration can be completed.

If the output level cannot be set low enough, step the RANGE down until the calibration can be performed as described in this step. Using the highest range will provide the best compensation for increasing losses (higher power levels at the Signal Generator output). Using a lower range will provide the best compensation for decreasing losses. See the comments section for more information on selecting the optimum range.

Remote Procedure

The equipment setup for remote control of power meter leveling is the same as the local procedure. However, the calibration must be performed manually. The program code for power meter ALC is C3. Once the calibration is complete, the level can be remotely controlled by programming the VERNIER to the appropriate level. Changing the range while using external power meter leveling will have no effect on the level but can force the Signal Generator to lose control of the level due to insufficient attenuation (lack of ALC dynamic range) or too much attenuation (attempted operation beyond maximum power specification).

The VERNIER setting can be read by the controller using the output active program code suffix. To read the VERNIER setting, send the program string VEOA and then read the VERNIER setting using the ENTER command. The Signal Generator will send the VERNIER setting in units of dBm. If the setting is read as a string, the format will be the program code VE followed by the VERNIER setting in dBm and then the units code DM.

Example

To set the Signal Generator to power meter leveling over the range of -10 to 0 dBm using a 10 dB coupler.

Local

- Connect the directional coupler to the point where the RF power is to be leveled. Connect the power meter sensor to the coupled port of the 10 dB directional coupler.
- Press the ALC INT key to place the Signal Generator into internal ALC mode.
- Set the RF output level for a -15 dBm power meter reading on the power meter. Allow the power meter to auto-range to the coupled power (-15 dBm). Once the power meter has stabilized, press the RANGE HOLD key (or set the range manually) to prevent auto-ranging. The power meter should now be set to read power levels of -20 to -10 dBm on the set range.

Power Meter Automatic Level Control (cont'd)

Example (cont'd)

4. Press the ALC PWR MTR key on the Signal Generator and set the Signal Generator range to +10 dB. The UNLEVELED annunciator may come on when the power meter leveling mode is activated. The calibration in the next step will eliminate this indication.
5. Adjust the front panel CAL control until the UNLEVELED annunciator is extinguished. Reset the VERNIER for a 0 dBm indication on the Signal Generator's front panel LVL meter and then adjust the CAL control until the power meter indicates exactly -10 dBm.
6. The output level can now be set by adjusting the VERNIER for the desired output level as read on the level meter. Setting the range to 0 dB will reduce the output level by 10 dB. However, setting the range lower than 0 dB will not change the output level until the ALC goes unlevelled due to insufficient output power to overcome the additional loss in the RF path.

Remote

1. Perform the above steps 1 to 5 to calibrate the external ALC circuitry.
2. Set the output level remotely by programming vernier settings between -10 and +3 dBm. Changing the range will have the same affects as described in step 6 above.

Program Codes

HP-IB

Program Code	Description
C3	External Power Meter Leveling Mode

Comments

Using external power meter leveling mode has the advantages of high stability, temperature compensation and high sensitivity. The disadvantage of power meter leveling is the longer settling time (0.2 to 6 seconds). 23 dB of dynamic range is typically available using the Signal Generator's 0 and +10 dB ranges. In addition, amplitude modulation up to 90% depth at rates as high as 100 kHz is typically available using external power meter leveling mode since the Signal Generator's internal detector is used to provide the AM detection.

The response time for a level change using power meter leveling mode will vary depending on the type of power meter, the power meter range setting and filter setting (if used) of the power meter. Settling time increases as the sensitivity of the range used increases. In addition, the response to a level change can be underdamped, critically damped or overdamped depending on the type of meter and filter selection.

Typical 99% settling times for the HP 436A, HP 437B, and HP 438A power meters are shown in the following table. The 99% settling time is the time the power meter requires to make a measurement in a given range.

Power Meter Automatic Level Control (cont'd)

**Comments
(cont'd)**

Power Meter Range Settling Times

Power Meter Range	Typ. 99% Settling	
	HP 437B HP 438A	HP 436A
1	600 ms	10s
2	600 ms	1s
3	66 ms	38 ms
4	66 ms	38 ms
5	66 ms	38 ms

The leveling system will have a longer settling time due to the settling time of the Signal Generator ALC circuitry and the response time of the signal path. Typical settling times for leveling using the HP 432A/B, HP 435B, HP 436A, HP 437B, and HP 438A power meters are given in the following table.

ALC Typical Settling Times

Power Meter	Power Meter Range (dBm)	Power Sensor	10 dB Step to Within ± 1 dB	Step Response
HP 432A/B HP 435B " " "	-20 to +10	HP 478A	400 ms	Overdamped
	-10 to +20	HP 8485A	550 ms	Critically Damped
	-15	"	3s	Underdamped
	-20	"	5s	Underdamped
	-25	"	Unstable	—
HP 436A	0 to +20	HP 8485A	150 ms	Critically Damped
	-10	"	4s	Underdamped
	-20	"	4s	Unstable
	-40 to -20	HP 8484A	200 ms	Critically Damped
	-50	"	2.5s	Underdamped
-70 to -60	"	—	Unstable	
HP 437B HP 438A (All Ranges)	Filter No.			
	0 to 2	HP 8485A	200 ms	Critically Damped
	3 to 9	"	4s	Underdamped
	0 to 2	HP 8484A	200 ms	Critically Damped
3 to 9	"	4s	Underdamped	

The HP 437B and HP 438A auto filter mode will select filters automatically depending on range. Using the manual filter mode can provide faster ALC settling time.

The Signal Generator range selected will have a direct affect on ALC. The range selected depends primarily on the losses and gains in the RF signal path. In most applications, the ALC dynamic range is limited by the maximum RF power available at a given frequency. For example, with 15 dB of loss in the signal path, the Signal Generator must compensate with at least 15 dB of additional RF output power. With no internal attenuation (0 or +10 dB ranges), the Signal Generator would have to

Power Meter Automatic Level Control (cont'd)

Comments (cont'd)

supply +15 dBm for a leveled signal at 0 dBm. Since the maximum RF output power is specified at less than +13 dBm, the Signal Generator may not be able to supply the required power.

Using Signal Generator ranges of -10 to -90 dB add attenuation to the RF signal path. These ranges are useful mainly when attempting to level low amplitude signals. For example, to level a signal with an amplitude of -50 dBm after a signal path with losses of 30 dB, the attenuation can be set to 10 dB (range -10 dB) to place the Signal Generator at an RF output level of -10 dBm.

The internal circuitry generates RF levels of -10 dBm and higher before introducing attenuation to increase the dynamic range of the Signal Generator. When selecting the proper range for external leveling, the lowest and highest gain/loss should be calculated. The range is then set 10 dB higher than the level required to keep the internally generated RF level near -10 dBm.

The external ALC circuitry is used to adjust the Signal Generator's output level until the detected voltage at the external ALC input is correct. If high harmonics or spurious signals are present in the signal that is being detected, they will affect level flatness. This is especially important when using external amplifiers and mixers within the signal path. For example, if the RF signal level is +10 dBm and the second harmonic is at 0 dBm, the actual detected power will be 11 milliwatts instead of 10 milliwatts (10 dBm). For a detected voltage of 1 volt for +10 dBm, the detected signal will be at 1.1 volts for the 11 milliwatt signal. This will cause a leveling error of about 0.83 dB.

Application Examples

Example 1. External ALC over the range of 0 to +10 dBm is required. The RF signal path exhibits an insertion loss of 6 dB that varies ± 12 dB over the frequency range. To control the output level over a 0 to +10 dBm range, an amplifier capable of +16 dBm (10 dBm +4 dB +2 dB) is required.

The range selected for this application depends mainly on the gain of the amplifier. If we assume a gain of +10 dB, the optimum Signal Generator range is 0 dB. The overall signal path gain varies from +12 to +16 dBm. To reduce the level to -10 dBm would require 10 dB of attenuation. The range is set 10 dB above this requirement or 0 dB.

Example 2. The IF output of a mixer is to be leveled at -20 dBm. The conversion loss of the mixer is 10 dB and varies ± 3 dB over the frequency range. Using the Signal Generator as the RF source for the mixer, the power meter is connected to the IF port of the mixer using a 10 dB directional coupler.

The attenuation of the signal path is 10 dB and varies ± 3 dB. For an IF level of -20 dBm, the RF port must be at a level of approximately -10 dBm. The range selected for the Signal Generator would then be +10 since 0 dB attenuation would be required and the +10 dB range is one step above zero attenuation.

Error Messages

The following message may be displayed when programming the RF output level.

- 24 The programmed RF output (VERNIER, RANGE or both) is outside the Signal Generator's range.

Pulse Modulation

Description

The Signal Generator provides normal and complemented pulse modulation. In normal pulse modulation, a TTL high level (>3 volts) will turn on the carrier while a TTL low level (<0.5 volts) turns the carrier off. Complement pulse modulation uses a TTL low level to turn on the carrier and a TTL high level to turn off the carrier. Having two modes available allows easiest interfacing to positive or negative logic conventions.

Pulse widths more narrow than the specified minimum pulse width will light the UNLEVELED annunciator to indicate that the pulse peak level accuracy is degraded. Pulse overmodulation is indicated by the UNLEVELED annunciator. Pulse overmodulation occurs at narrow pulse widths as mentioned above and at very low duty cycles when the time between pulses exceeds the instrument's ability to retain a leveled pulse.

Local Procedure

To set the Signal Generator for pulse modulation:

1. Connect an external pulse source to the PULSE IN connector and set the frequency of the external pulse source to the desired pulse repetition rate. Set the amplitude of the external pulse source to a TTL compatible pulse (0 to 5 volts).
2. Press the Signal Generator's PULSE NORM key if the TTL high level is to be used to turn on the carrier.

If the TTL high level is to turn off the carrier, select pulse complement mode by pressing the PULSE COMPL key.

Remote Procedure

Pulse modulation can be programmed to the normal or complement mode using the program codes P2 or P3 respectively. The program codes P0 and P1 turn off pulse modulation.

The pulse mode (NORM or COMPL) cannot be read by the controller. The pulse width and pulse repetition rate are set by the external pulse source. The controller can interrogate the external source to determine pulse width and repetition rate.

Example

To pulse modulate the Signal Generator at 1 MHz with a 100 nanosecond pulse width:

Local

1. Set the external pulse source for a TTL compatible pulse of 100 nanosecond width at a pulse repetition frequency of 1 MHz.
2. Connect the external pulse source to the PULSE IN connector.
3. Press the pulse NORM key to activate pulse modulation.

Remote

The programming string for setting pulse normal mode on the Signal Generator is P2. The modulating signal is set by programming the external modulating signal source. The alpha character (P) can be sent as upper or lower case.

Pulse Modulation (cont'd)

Program Codes

HP-IB

Program Code	Description
P0	Pulse Off
P1	Pulse Off
P2	Pulse Normal Mode
P3	Pulse Complement Mode

Comments

Overmodulation in pulse mode due to peak level accuracy degradation (narrow pulse widths) or an extremely low duty cycle (too long between pulses) are indicated by the UNLEVELED annunciator. The overmodulation condition can be read by the controller using the ALC UNLEVELED bit of the extended status byte.

Major pulse modulation specifications are not warranted unless an Auto Peak operation has been performed. An Auto Peak operation is performed automatically whenever the frequency is changed by more than 50 MHz while Auto Peak is enabled or the output level is changed by more than 0.4 dB while pulse modulation is enabled.

Changes in load impedance can shift the center frequency of internal filters and require an Auto Peak operation to maintain optimum pulse performance. This could occur if highly reactive loads are switched in and out in automatic test systems.

Large frequency changes cause changes in the self-heating of internal Yttrium Iron Garnet (YIG) filters. Most of the filter passband drift occurs in 15 to 20 seconds but complete settling can require up to 15 minutes. Some experimentation may be required to determine when the Auto Peak operation should be performed during measurements that have large frequency changes and extremely long measurement cycles.

To ensure that pulse performance is optimized before making a measurement, execute an Auto Peak operation before each measurement. The status byte may be monitored to determine when the Auto Peak operation is complete. The SOURCE SETTLED bit is set when the Auto Peak operation is finished.

The Signal Generator uses frequency multiplication to generate frequencies above 6.6 GHz. To produce fast rise times when the frequency is multiplied, a pulse injection circuit is used to pre-bias the multiplication circuits. The pulse injection circuit is critical for fastest rise times and minimum overshoot. The Auto Peak operation measures critical parameters for the pulse injection circuit when pulse mode is enabled.

With pulse mode enabled, a frequency change of 50 MHz or a VERNIER change 0.4 dB or more will trigger an Auto Peak operation. During the Auto Peak, the Signal Generator will switch to CW mode for approximately 200 microseconds while the Auto Peak operation is performed. Pulse mode is then re-enabled and the pulse injection circuitry uses the measured parameters to optimize the pulse risetime.

The bursts of CW power due to changes in the VERNIER setting can be eliminated by using an internal "scratch pad" memory. When an Auto Peak is performed, the parameters required for the pulse injection circuitry are stored in the scratch pad memory. Subsequent operation at this VERNIER setting will use the scratch pad data instead of performing another Auto Peak operation. By sweeping the VERNIER over the entire ALC range (-10 to +3 dBm on the 0 and +10 dB ranges), the scratch pad memory will be filled with the required parameters for the pulse injection circuitry. Once the scratch pad memory contains the data for the current frequency, an Auto Peak operation will not occur for any change in RF output level. A frequency change will erase the scratch pad memory so this process must be repeated at the new frequency.

Pulse Modulation (cont'd)

Comments (cont'd)

Pulse modulation uses a sample and hold system to maintain pulse level accuracy. A capacitor is used to hold the automatic level control (ALC) circuit setting between pulses to reduce the time required for output level settling at the next pulse. When pulse and amplitude modulation are used together, the capacitor has the effect of reducing the effective AM bandwidth. The reduction in AM bandwidth is explained under AM detailed operating instructions.

When pulse modulation is selected with no input pulse, the level meter will drift. This is a normal occurrence due to the limitations of the sample and hold circuitry.

Due to the Auto Peak operations performed during pulse modulation, frequency switching time is slowed to approximately 100 milliseconds. Disabling Auto Peak will speed frequency switching time at the expense of degradation of risetime and overshoot. Pulse specifications only apply when Auto Peak is enabled.

Programming Example

The following program is written in BASIC for HP 9000 Series 200 or 300 controllers. The program will set the pulse mode to the mode specified by the variable *Mode\$*.

```

10 SUB Pulse_mode(Err,Mode$)
20 !
30 SELECT UPC$(TRIM$(Mode$))
40 CASE "NORM","NORMAL"
50 Code$="P2" ! Code for NORMAL mode
60 CASE "COMP","COMPLEMENT"
70 Code$="P3" ! Code for COMPLEMENT mode
80 CASE "OFF",""
90 Code$="P0"
100 CASE ELSE
110 Err=-1
120 DISP "Invalid pulse mode specified"
130 END SELECT
140 !
150 OUTPUT 719 USING "2A";Code$
160 !
170 SUBEND

```

Error Messages

The following message number may be displayed when pulse modulating. For a more complete description of the message, see the MESSAGES detailed operating instructions.

- 90 An error occurred in the Auto Peak operation. Service may be required to correct the problem.

Range (Output Level)

Description

The RF output level of the Signal Generator is set using the RANGE and VERNIER controls. The RANGE controls change the RF output level in 10 dB steps and the VERNIER changes the RF output level continuously over a 13 dB range. The sum of the output level RANGE and VERNIER is the actual RF output level.

The RANGE is set using the RANGE up or down key. The selected RANGE (+10 to -90) is displayed in the RANGE dB display. The display indicates the RANGE whether in remote or local mode. The local to remote and remote to local transitions do not change the output level RANGE. An instrument preset will set the RANGE to -70 dB.

Local Procedure

To set the RF output level using internal ALC:

1. Press the RANGE up or down key until the desired RANGE appears in the RANGE dB display. Holding the key down will continue stepping the RANGE until the key is released. The RANGE setting represents the maximum level available using that range. The VERNIER control will allow setting output levels from -10 dB below to +3 dB above the RANGE.

There is a slight overlap of output level settings due to the 13 dB range of the VERNIER control. For best results, the VERNIER setting should be within the range of -10 to 0 dBm. VERNIER settings from 0 to +3 dBm are available for observing a continuous range up to +3 dB above the RANGE setting without changing the RANGE setting.

2. Adjust the VERNIER control until the sum of the RANGE and the level meter reading equal the desired RF output level. The VERNIER can be used to vary the output level continuously about the set level or the RANGE up or down key can be used to step the output level in 10 dB steps.

If the UNLEVELED annunciator lights for high output level settings, the level meter will indicate maximum available output power. This should only occur when output levels above the specified maximum leveled power are set. For example, if the RF output level is set to +13 dBm and the level meter reads -4 dBm with the UNLEVELED annunciator lighted, only +6 dBm of output power is available at that frequency.

Remote Procedure

The Signal Generator accepts any RF output level between -101.9 and +13 dBm. RF output levels above the specified maximum leveled power may not be available at all frequencies. Programming the RF output level can be done in one of two ways.

The RF output level can be programmed directly using the program code LE, AP, or PL. The units terminator for the output level is dBm which corresponds to the program code DM. The Signal Generator will also accept the program code DB as the terminator. When programming the RF output level, the VERNIER is set between 0 and -9.9 dBm and the RANGE is set accordingly.

The RF output level can also be programmed by programming the VERNIER and the RANGE separately. The program code to set the RANGE is RA and the program code to set the VERNIER is VE. The units terminator for both codes can be either DB or DM.

The output active program code suffix can be used to read the current values of the RANGE, VERNIER or the RF output level directly. To read the RANGE setting, send the program codes RAOA and then read the RANGE setting. The Signal Generator will send the RANGE in fundamental (dBm) units. If the RANGE is read as a string, the format will be the program code RA followed by the RANGE in dBm and then the units terminator DM (dBm).

Range (Output Level) (cont'd)

Remote Procedure (cont'd)

In local mode, the Signal Generator keeps track of the VERNIER setting to within .1 dB. When switching to remote mode, the local RF level setting is preserved. This feature also allows the controller to read the local VERNIER setting by briefly switching to remote to read the VERNIER setting and then returning the Signal Generator to local mode. The VERNIER setting is read by sending the program codes VEOA and then reading the setting. The Signal Generator will send the VERNIER setting in fundamental (dBm) units. If the VERNIER setting is read as a string, the format will be the program code VE followed by the VERNIER setting in dBm and then the units terminator DM (dBm).

The RF output level is read directly by sending the program codes LEOA and then reading the RF output level. The Signal Generator will send the RF output level in fundamental (dBm) units. If the RF output level is read as a string, the format will be the program code LE followed by the RF output level in dBm and then the units terminator DM (dBm). The program codes AP or PL can also be used in place of LE but the Signal Generator will always send the program code LE when the RF output level is read as a string.

Example

To set the RF output level to -56 dBm:

Local

1. Press the ALC INT key to place the Signal Generator into internal ALC mode. The process for setting the RF output level for external ALC modes is covered under the appropriate ALC mode.
2. Set the RANGE to the lowest range that is less than 10 dB above the power or -50 dBm in this case.
3. Adjust the VERNIER until the level meter indicates -6 dBm. For the -50 dBm RANGE, the VERNIER can adjust the output level from -60 to -47 dBm.

Remote

The programming string for setting the RF output level is composed of a program code, numeric data and the units terminator. The RF output level may be programmed directly or the RANGE and VERNIER may be programmed separately. To program the Signal Generator to a level of -56 dBm, the possible program strings are:

"LE-56DM" or "RA-50DBVE-6DM"

In addition, the program code could be AP or PL instead of LE. The alpha characters can be sent as upper or lower case (or even mixed upper and lower case). The Signal Generator RF output level is valid once the SOURCE SETTLED bit of the status byte is set (see comments). The units terminator could be DB or DM. The Signal Generator accepts either terminator for all power related settings.

Program Codes

HP-IB

Program Code	Description	Units
RA	Output Level Range	
*LE	RF Output Level	DB
AP	RF Output level	*DM
PL	RF Output level	

*Preferred Program Code

Range (Output Level) (cont'd)

Comments The 0 to -90 dB ranges directly control a 90 dB step attenuator. The 0 and +10 dB ranges correspond to an internal attenuator setting of 0 dB. The -90 dB range corresponds to an attenuation setting of 90 dB. The +10 dB range is used by the automatic level control (ALC) circuitry to enable the VERNIER to directly control the RF output level between 0 dBm up to a maximum possible level of +13 dBm.

Programming Example The following program is written in BASIC for HP 9000 Series 200 or 300 controllers. The program will set the output level between -100 and +13 dBm. If a level above 0 dBm is set and is not leveled, an error will be reported.

```
10 SUB Rf_Level(Err,Expected)                ! Expected is in dBm
20 !
30 IF Expected<-100 OR Expected>+13 THEN
40 Err=-1
50 DISP "ERROR: Requested output level is out of range"
60 SUBEXIT
70 END IF
80 !
90 OUTPUT 719 USING "2A";"MG"                ! Clear old messages
100 ENTER 719 USING "2A";Message$
110 !
120 OUTPUT 719 USING "4A,4D.D,2A";"CSLE,"Expected,"DM" ! Set the level
130 !
140 OUTPUT 719 USING "4A";"LE0A"
150 ENTER 719 USING "K";Level
160 !
170 IF ABS(Level-Expected)>.1 THEN           ! More than .1 dB in error
180 Err=-1
190 DISP "WARNING: Programmed level is more than .1 dB in error"
200 END IF
210 !
220 V=SPOLL(719)                             ! Get the status byte
230 IF NOT BIT(V,3) THEN GOTO 220            ! Wait for source to settle
240 !
250 IF Expected>0 THEN                         ! Check for unleveled
260 OUTPUT 719 USING "2A";"OS"              ! Get extended status byte
270 ENTER 719 USING "%,B,B";V,Extended
280 IF BIT(Extended,6) THEN
290 Err=-1
300 DISP "WARNING: The Signal Generator RF output is not leveled"
310 END IF
320 END IF
330 !
340 SUBEND
```

Error Messages The following message may be displayed when setting the RF output level. For a more complete description of the messages, see the MESSAGES detailed operating instructions.

24 The programmed RF output level is not within the range of the Signal Generator.

Recall and Store Registers

Description

The Signal Generator has nine instrument state storage registers. These registers allow the complete instrument state to be saved in non-volatile memory. A subsequent recall of the stored register will set the Signal Generator to the state that was saved. All front panel settings, including sweep and modulation, are stored when one of the nine registers is used for instrument state storage.

Powering down the instrument will not destroy the setting of the nine state registers. The registers may be cleared to the preset state with a special key sequence (see comments). Register 0 is the instrument preset register. Recalling this register will set the instrument to a known state. An alternate preset state is set by another special key sequence.

Local Procedure

To store the current instrument state in one of the nine storage registers:

1. Press the STO key to indicate that the current settings are about to be saved in one of the storage registers. For system compatible instruments, (*2552A, 2634A and above*) the STO key is a shifted RCL key.
2. Press a number corresponding to one of the nine storage registers. Any number between 1 and 9 may be used as a storage register. Once the key is pressed, the instrument state is saved in that register.

To recall the instrument state from one of the storage registers:

1. Press the RCL key to indicate that one of the ten registers is to be recalled. The zero register is the preset conditions for the instrument.
2. Press one of the numeric keys corresponding to the register that is to be recalled. Valid register numbers are 0 through 9.

Register 0, the preset register, cannot be used to save an instrument state. An attempt to store an instrument state in this register will generate an error message. If a different set of preset conditions are required, one of the nine storage registers may be used to store the alternate preset conditions. For system compatible instruments (*2552A, 2634A and above*) pressing RCL and then the backspace key will provide another set of preset conditions (see comments).

Remote Procedure

The nine storage registers can be used in remote applications. If a register is stored in remote mode, recalling the register will recall the remote VERNIER setting. Local VERNIER control will be locked out until the instrument is preset or the Signal Generator is set to remote mode and then local mode.

The format of the program string follows the front panel sequence. The program code for storing an instrument state is ST. Recalling a register is done using the RC program code. The program string is composed of the appropriate program code followed by a number corresponding to the appropriate register.

Example

To store the current instrument settings in register 1:

Local

1. Press the STO key to indicate that the instrument state is about to be saved. For system compatible instruments (*2552A, 2634A and above*), the STO key is accessed by pressing the blue shift key followed by the RCL key.

Recall and Store Registers (cont'd)

Example (cont'd)

2. Press the number 1 on the numeric keypad. The register is now filled with the current instrument state. Subsequent operations (except re-storing the register) will not affect the settings in register 1.

To recall the instrument state stored in register 1:

1. Press the RCL key to indicate that the instrument state will be recalled from one of the ten registers.
2. Press the number 1 on the numeric keypad. The instrument will be set to the state that was stored in register 1. This recall is non-destructive so recalling register 1 later will produce the same results as this step.

If a register is recalled that was originally stored during remote mode, the VERNIER will not affect the output level. This restriction is required to allow the storage and recall of instrument states in remote mode that include the VERNIER setting. A register that is stored in local mode will preserve the local VERNIER setting. Recall of the register in remote mode will use the same local level VERNIER setting.

Remote

The programming string to store the current instrument state in register 1 is "ST1." To recall the register at a later time, the program string "RC1" would be used. Sending the program string "RC0" or "IP" will preset the instrument.

Program Codes



Storage Register Codes

Program Code	Description
ST	Store Instrument State
RC	Recall Instrument State
RL	Recall Instrument State

Instrument Preset Codes

Program Code	Description
RC0	Instrument Preset
IP	Instrument Preset
RCBS	Alternate Preset (2552A, 2634A and above)

Comments

The nine storage registers can be cleared using a special front panel key sequence. This feature is useful in high security applications to destroy any instrument settings that might compromise the security. To clear the storage registers, press the LVL key near the front panel meter and the FM 3 MHz deviation range keys at the same time. A successful initialization of all of the storage registers can be confirmed by an instrument preset when the two keys are pressed. All of the registers will be initialized to the preset state.

Storing a register in remote mode will store the remote VERNIER setting. If this register is recalled in local mode, the remote VERNIER setting will be selected and local VERNIER control will be disabled. The local VERNIER setting is stored when a register is stored in local mode. Recalling this register in remote mode will use the stored local mode setting as the remote VERNIER setting.

There are two preset states that can be selected in remote mode or from the front panel. The first preset state is selected by recalling register zero in local or remote mode or sending the program code IP in remote mode. The register 0 preset conditions are given below.

Recall and Store Registers (cont'd)**Comments
(cont'd)**

RF OUTPUT to ON
 ALC mode to INT
 RANGE to -70 dB (0 dB for Options 001 and 005)
 AUTO PEAK to ON
 MTR scale to LVL
 AM, FM and PULSE modulation to OFF
 FREQUENCY to 3000.000 MHz
 FREQ INCR to 1.000 MHz
 START to 2000.000 MHz
 STOP to 4000.000 MHz
 ΔF to 2000.000 MHz
 MKRs disabled (initialized to 3, 6, 9, 12, and 15 GHz)
 SWEEP MODE to OFF
 STEP to 100 steps (20.000 MHz)
 DWELL to 20 ms
 TUNE knob to ON

For system compatible instruments (*2552A, 2634A and above*), alternate preset provides a different set of conditions more suitable for some applications. The alternate preset conditions (selected with RCL and Backspace) are given below.

RF OUTPUT to ON
 OFFSET frequency to 0
 MULTIPLIER and ALC mode unchanged
 RANGE to -70 dB (0 dB for Options 001 and 005)
 AUTO PEAK to ON
 MTR scale to LVL
 AM, FM and PULSE modulation to OFF
 FREQUENCY to 14 000.000 MHz X Multiplier
 FREQ INCR to 1.000 MHz X Multiplier
 START to 13 000.000 MHz X Multiplier
 STOP to 15 000.000 MHz X Multiplier
 ΔF to 2000.000 MHz X Multiplier
 MKRs disabled (initialized to 3, 6, 9, 12, and 15 GHz X Multiplier)
 SWEEP MODE to OFF
 STEP to 100 steps (20.000 MHz X Multiplier)
 DWELL to 20 ms
 TUNE knob to ON

**Error
Messages**

The following errors apply to storing or recalling instrument state registers.

- 04 Cannot store a state in register 0. This register is reserved for instrument preset conditions.
- 92 The data stored in the register being recalled has been corrupted. The instrument will be reset.

RF Output On/Off

Description The RF output of the Signal Generator can be disabled with the RF ON/OFF key on the front panel. The RF output can be disabled when the minimum power level setting is not low enough to prevent interference as when zeroing a power meter using a high sensitivity power sensor.

With the RF output disabled, the UNLEVELED and ϕ UNLOCKED annunciators will turn on to indicate that the microwave signal source is disabled. In addition, if frequency modulation is enabled, the FM OVERMOD annunciator will also light.

Local Procedure To turn off the RF output:

1. Press the RF ON/OFF key. The indicator on the key will be lighted whenever the RF output is enabled and extinguished when the RF output is disabled. Pressing the key repeatedly will toggle the RF output between the on and off state.

Remote Procedure The Signal Generator RF output is turned on or off using a single program code. The program code to turn the RF output on is RF1 or R1. The program code to turn the RF output off is RF0 or R0.

Example To turn off the RF output:

Local

If the indicator in the RF ON/OFF key is not lighted, the RF output is already off. If the indicator is lighted, press the RF ON/OFF key once.

Remote

The programming string for setting the RF output level to off is RF0 or R0. The alpha characters can be sent as upper or lower case (or even mixed upper and lower case).

Program Codes
HP-IB

Program Code	Description
RF0	RF Output Off
R0	RF Output Off
RF1	RF Output On
R1	RF Output On

Comments Turning on the RF output will start an Auto Peak operation. To determine when the RF output is settled, the source settled bit of the status byte can be monitored. Once the bit is set, the RF output is settled and the application may continue.

Programming Example The following program is written in BASIC for HP 9000 Series 200 or 300 controllers. The program will enable the RF output if the parameter is set to "ON" or disable the output if the parameter is set to "OFF."

```
10 SUB Rf_output(Err,State$)
20 !
30 SELECT UPC$(TRIM$(State$))           ! Check for action
40 CASE "OFF"
50 OUTPUT 719 USING "3A";"RF0"         ! Turns RF output off
60 CASE "ON"
```

RF Output On/Off (cont'd)

Programming Example (cont'd)

```
70 OUTPUT 719 USING "5A";"CSRF1"           ! Turns RF on and Auto Peaks
80 Wait_settle:                             ! Wait for Auto Peak to finish
90 V=SPOLL(719)                               ! Get the status byte
100 IF NOT BIT(V,3) THEN GOTO Wait_settle
110 CASE ELSE
120 DISP "ERROR: Invalid parameter "&State$&" was passed"
130 Err=-1
140 END SELECT
150 !
160 SUBEND
```

Error Messages

The following message may be displayed when enabling the RF output. The message is displayed as it pertains to enabling the RF output. For a more complete description of the message, see the MESSAGES detailed operating instructions.

- 90 An Auto Peak error has occurred during the Auto Peak operation. This message indicates that service may be required.

Single Sweep Mode

Description

The Signal Generator performs a digital sweep by stepping the RF output frequency in discrete steps from the start frequency to the stop frequency. The number of steps that the Signal Generator produces between the start and stop frequency is controlled by the number of steps or the sweep step size parameters. The time that the Signal Generator remains at each step after switching frequencies is controlled by the dwell time parameter.

The Signal Generator has three sweep modes to accommodate a variety of applications. Auto sweep mode is used when a repetitive sweep is required. Auto sweep mode will step the RF output frequency from the start frequency to the stop frequency and then repeat the sweep until the sweep is turned off or a band crossing is encountered.

Single sweep mode will step the RF output frequency from the start frequency to the stop frequency once and then stop. This mode is useful when a single sweep is required for a measuring device to store results. Control signals are provided at the rear panel of the Signal Generator for control of X-Y recorders and external displays.

Manual sweep provides a convenient method to limit the tuning range of the frequency tuning controls. In applications requiring a single band of frequencies, the tuning limits can be set to cover the band of interest which allows the user to tune the frequency without having to watch the Signal Generator display to determine when the frequency is outside of the selected band.

There are four rear panel connectors that are used for sweep coordinating signals. SWP OUT provides a signal that is 0 volts at the beginning of a sweep and 10 volts at the end of the sweep regardless of the sweep width. The output impedance is nominally 100 ohms.

The TONE MKR connector provides a 5 kHz signal when an active marker frequency is generated. This signal can be connected to the AM IN connector on the front panel to provide AM markers on the external display. Nominal impedance of the TONE MKR is 600 ohms.

The BLANKING/MARKER output provides a +5 volt signal at the beginning of each frequency change for blanking an external display. The blanking function is used to eliminate the display of switching transients. Once the frequency has settled, the signal returns to 0 volts unless the new frequency is an active marker frequency. If the frequency is an active marker frequency, the signal is set to -5 volts to provide a Z-axis input for intensifying the display at the marker sweep point.

The PENLIFT connector provides control for an external X-Y recorder and is only active during the single sweep mode. A TTL logic high is used to raise the pen and a TTL logic low is used to lower the pen. The pen is only lowered in single sweep and there is a 100 millisecond sweep delay for the pen to raise or lower.

Local Procedure

To set the Signal Generator for a single sweep:

1. Set the desired sweep parameters.
2. Press the SINGLE SWEEP MODE key to arm the single sweep. The key indicator will light and the RF frequency will be set to the start frequency.
3. Press the SINGLE SWEEP MODE key again to begin the single sweep. The sweep will continue to the stop frequency and then reset to the armed state.

Single Sweep Mode (cont'd)

Local Procedure (cont'd)

If a new center frequency is entered when single sweep mode is active, the start and stop frequencies will be reset and the single sweep will be set to the armed state in preparation for a sweep. Tuning the frequency will also move the sweep center frequency and reset the single sweep. Pressing the SINGLE SWEEP MODE key during a sweep will reset the sweep to the armed state.

A 100 millisecond wait is executed both at the beginning of a single sweep and at the end of the sweep. This wait is required for the pen of an external recorder to lower at the beginning of a sweep and raise at the end of the sweep.

Remote Procedure

Single sweep is armed with the program code W4 or W5. Once the sweep is armed, it can be executed with the program code W4. A single sweep can be armed and executed with the program code W6.

The controller can monitor the SWEEP DONE bit of the extended status byte to determine when the sweep is finished. The bit will be set when the stop frequency is reached and will not be reset until it is read or the status byte is cleared.

The output couple program code (OC), can be used to read the start frequency, center frequency and dwell time in that order. The three values are not prefixed by program codes and the frequencies are sent in Hz while the dwell time is sent in units of seconds.

Example

To perform a single sweep from 2 to 4 GHz:

Local

1. Set the start frequency to 2 GHz and the stop frequency to 4 GHz.
2. Press the SINGLE SWEEP MODE key to arm the single sweep. The key indicator will light to indicate that single sweep mode has been selected.
3. Press the SINGLE SWEEP MODE key again to execute the sweep. Once the sweep is finished, the single sweep will be rearmed in preparation for another sweep.

Remote

The programming string to perform a single sweep is: "W6"

The alpha character (W) can be sent as upper or lower case. The sweep can be armed and then executed later using the W4 or W5 program codes followed by a W4 program code when the sweep is to be executed. Using the W5 program code always ensures that a single sweep is armed and does not execute immediately. If the single sweep mode is armed when a W4 program code is received, the sweep will execute.

Program Codes



Program Code	Function
W4	Single Sweep Arm or Execute
W5	Single Sweep Arm Only
W6	Single Sweep Arm and Execute

Single Sweep Mode (cont'd)

Comments

The Signal Generator digital sweep is composed of discrete frequencies that are produced sequentially. The minimum step size is limited to the minimum change in frequency that the Signal Generator can produce which is defined as the frequency resolution. The number of steps is dependent on the frequency resolution and the frequency span. For information regarding sweep time, see the DWELL TIME detailed operating instruction.

The actual change in output frequency during a sweep will not be uniform for some frequency bands and may vary up to 2 kHz. This is required to accommodate sweep step sizes that are not exact multiples of the frequency resolution. The sweep steps averaged over several sweep points will be equal to the selected sweep step size. An example of the averaging is defining a sweep step size of 10 kHz at a start frequency of 15 GHz. The minimum tuning increment at 15 GHz is 3 kHz which means that the sweep step size can be 9 kHz or 12 kHz for exact step sizes. To obtain a sweep step size of 10 kHz, the Signal Generator will step by 9 kHz, 9 kHz, 12 kHz and then will repeat the sequence. The average step size is 10 kHz even though the sweep does not execute exactly 10 kHz steps. If the step size is reduced to 1 kHz, the Signal Generator will step by 0 kHz, 0 kHz and then 3 kHz for a 1 kHz average step size in the 3 kHz resolution frequency band.

Sweeps from a higher frequency to a lower frequency can be accomplished by setting the start frequency higher than the stop frequency. This combination results in a negative frequency span as indicated when the frequency span is displayed. Negative frequency spans can only be entered by setting the start frequency higher than the stop frequency.

An Auto Peak operation is performed whenever the RF output frequency is more than 50 MHz from the frequency at which the last Auto Peak operation was performed. The Auto Peak operation optimizes the Signal Generator performance at the current frequency. The Auto Peak operation produces small changes in the RF output level as the peaking is performed. For applications requiring fastest sweeps, Auto Peak may be disabled. However, with Auto Peak disabled, modulation performance and maximum output power may be degraded. The time required for the Auto Peak operation is not included in the dwell time setting.

The automatic level control (ALC) bandwidth is increased when sweep mode is activated. This provides fast response to switching transients when sweeping. In addition, activating sweep mode while amplitude modulating increases the usable AM bandwidth by about 250 times. See the amplitude modulation detailed operating instructions for more information about AM bandwidth while in sweep mode.

The front panel annunciators are filtered in sweep mode to prevent false indications. While sweeping, the frequency changes cause a loss of phase lock and unlevelled automatic level control during the frequency change. To prevent constant flashing of the front panel annunciators, the response is damped to indicate only major problems during a sweep. The bits of the extended status byte are also buffered and should not be used to check individual sweep points for phase lock and leveled RF output.

Single Sweep Mode (cont'd)

Programming Example

The following program is written in BASIC for HP 9000 Series 200 or 300 controllers. The program is used to set the Signal Generator to the sweep mode specified by the variable *Mode\$*.

```

10 SUB Sweep_set(Err,Mode$)
20 OUTPUT 719 USING "2A";"MG"           ! Read message from 8673
30 ENTER 719 USING "2A";Message$       ! to clear any old messages
40 SELECT Mode$
50 CASE "AUTO","AUTOMATIC"
60 Code$="W2"                           ! Auto sweep mode
70 CASE "MANUAL"
80 Code$="W3"
90 CASE "SINGLE","ONCE"
100 Code$="W6"                           ! Arm and begin single
110 CASE ELSE
120 DISP "WARNING: Invalid sweep mode specified"
130 Err=-1
140 SUBEXIT
150 END SELECT
160 !
170 OUTPUT 719 USING "2A";Code$
180 !
190 SUBEND                               ! End of subroutine

```

Error Messages

The following message numbers may be displayed when activating single sweep mode. Each message is explained as it pertains to activating single sweep mode. For a more complete description of the messages, see the MESSAGES detailed operating instructions.

- 10 The start and stop frequency are set to the same value. No sweep will be generated.
- 11 The current sweep span is set such that the start frequency would be below the frequency range of the instrument. The sweep will begin at the lowest sweep point that is within the range of the Signal Generator. All sweep points will be allotted, but the frequency will not change until the sweep is within the frequency range of the Signal Generator.
- 12 The current sweep span is set such that the stop frequency would be above the frequency range of the instrument. The sweep will end at the highest sweep point that is within the frequency range of the Signal Generator. All sweep points will be allotted, but the last sweep points will all be at the highest valid frequency.
- 16 The k-band amplifier (Option 008 only) crossing occurred during automatic sweep mode. Only one sweep will occur and then the sweep will stop.
- 90 Auto Peak malfunction. This indicates that the instrument may require service.

Start Frequency (Sweep)

Description

The sweep start frequency determines where the Signal Generator will begin a sweep in each of the three sweep modes. The sweep frequency limits are determined by setting either the start and stop frequency or the center frequency and frequency span. Setting start and stop frequency will begin the sweep at the start frequency and end at the stop frequency. Setting the center frequency and frequency span will start the sweep at one-half the frequency span below the center frequency and end the sweep at one-half the frequency span above the center frequency. Setting the CW frequency when sweep is off will also reset the sweep center frequency to the same value.

Setting the center frequency or frequency span will automatically recalculate the appropriate sweep start and stop frequencies. Resetting the sweep start or stop frequency will reset the sweep center frequency if in sweep mode, or the CW frequency if sweep is off. The frequency span will be recalculated whether sweep is on or off. The sweep center frequency or CW frequency will be reset to be halfway between the start and stop frequencies.

The sweep start frequency can be set to any valid Signal Generator frequency. In addition, if the start frequency is set above the stop frequency, single and auto sweep modes will still sweep from the start to the stop frequency. Manual sweep will start at the lower absolute frequency and move toward the higher absolute frequency.

Local Procedure

To set the Signal Generator to a specific sweep start frequency:

1. Press the SWEEP FREQ START key to indicate that the next entry will be for sweep start frequency.
2. Enter the desired frequency using the numeric keypad. If a mistake is made while entering the frequency, press the backspace key until the incorrect digit disappears. Continue entering the correct digits until the frequency displayed in the FREQUENCY MHz display is correct.
3. Press the appropriate units key. The frequency can be entered in GHz, MHz or kHz. Once the units key is pressed, the displayed frequency will be adjusted to display MHz and the sweep start frequency will be set. The sweep start frequency will continue to be displayed until the units key is released.

The actual frequency displayed after releasing the units key will usually not be the entered frequency. If sweep mode is off, the displayed frequency will indicate the frequency halfway between the new start frequency and the stop frequency. If auto sweep is on, the sweep will be reset and then continue using the new start frequency. If single sweep is on, the sweep will be reset and the sweep will remain armed at the new start frequency. If manual sweep is on, the sweep frequency will be reset to the start frequency.

To check the current sweep start frequency, press and hold the SWEEP FREQ START key. The FREQUENCY MHz display will display the sweep start frequency as long as the key is held. When any sweep mode is turned off, the CW frequency will be set to halfway between the start and stop frequencies (equal to the sweep center frequency).

Remote Procedure

The Signal Generator accepts any sweep start frequency within its specified frequency range. Above 6.6 GHz, the programmed frequency may be rounded by the Signal Generator to be compatible with the 2, 3, or 4 kHz resolution at the programmed frequency (see Comments).

Start Frequency (Sweep) (cont'd)

Remote Procedure (cont'd)

The format of the remote programming follows the front panel key sequence. To program the sweep start frequency, the program code FA is sent followed by the desired frequency and the units (GZ, MZ, KZ, or HZ).

If setting the new start frequency causes a change of the CW frequency (normally the case), the SOURCE SETTLED bit of the status byte can be monitored to determine when the new frequency has settled. Once this bit is set, the NOT ϕ LOCKED bit in the extended status byte may be checked to ensure that the instrument is working correctly. The NOT ϕ LOCKED bit is not valid until after the SOURCE SETTLED bit has been set.

The current sweep start frequency can be read by the controller using the output active program code suffix. To read the start frequency, send the program codes "FAOA" and then read the start frequency. The Signal Generator will send the frequency in fundamental (Hz) units. If the frequency is read as a string, the format will be the program code, FA, followed by the sweep start frequency in Hz and then the units terminator (Hz).

Example

To set the sweep start frequency to 16 232.334 MHz:

Local

1. Press the SWEEP FREQ START key.
2. Key in 16232.334 using the numeric keypad. The FREQUENCY MHz display should show 16232.334 when you have finished keying in the value. Note that the entry is left justified at this point.
3. Press the MHz units key to finish the sequence. The FREQUENCY MHz display should show the entered frequency until the units key is released. The FREQUENCY MHz display should now be right justified.

The frequency could also have been entered as 16.232334 GHz or 16232334 kHz. The only difference is the placement of the decimal point and the units key pressed after the frequency has been entered using the numeric keypad.

Remote

The programming string for setting the sweep start frequency is composed of a program code, numeric data and the units terminator. The frequency may be programmed in units of GHz, MHz, kHz or Hz. To program the Signal Generator start frequency to 16232.334 MHz, the possible program strings are:

"FA16.232334GZ" or "FA16232.334MZ" or "FA16232334KZ" or "FA16232334000HZ"

The alpha characters can be sent as upper or lower case (or even mixed upper and lower case). If the CW frequency changes, the output frequency is valid once the SOURCE SETTLED bit of the status byte is set (see Comments).

Start Frequency (Sweep) (cont'd)

Program Codes

HP-IB

Program Code	Function	Applicable Units
FA	Start Frequency	GZ *MZ KZ HZ

* Preferred Program Code

Comments

Due to the use of frequency multiplication to generate frequencies above 6.6 GHz, the frequency sometimes cannot be set precisely to a desired value. Frequencies below 6.6 GHz can be set to the nearest 1 kHz. All frequencies between 6.6 and 12.3 GHz can be set within 2 kHz of the desired value. Frequencies between 12.3 and 18.6 GHz can be set within 3 kHz of the desired value and frequencies between 18.6 and 26.5 GHz can be set within 4 kHz of the desired frequency. However, with careful selection of frequency, the roundoff error can be reduced to 1 kHz below 18.6 GHz and 2 kHz for frequencies between 18.6 and 26.5 GHz.

When the Signal Generator is programmed to a frequency that cannot be set exactly due to frequency resolution, a random roundoff occurs. To prevent this, the remote program should perform a calculation to determine whether the frequency can be set exactly and adjust the desired frequency accordingly.

To determine whether a frequency can be set to a given value, divide the desired frequency (in kHz) by two if it is between 6.6 and 12.3 GHz, by three if it is between 12.3 and 18.6 GHz or by four if it is above 18.6 GHz. If the result is a whole number (no remainder), the frequency can be set to the desired value. For example, 16 GHz divided by three (it is between 12.3 and 18.6 GHz) is 5 333333.33 kHz. Since the dividend is not a whole number, this frequency cannot be set exactly. The nearest frequencies that can be set are 15.999999 GHz (5.333333X3) and 16.000002 GHz (5.333334X3). Note that the roundoff error is only 1 kHz if 15.999999 GHz is programmed instead of 16 GHz.

For applications that require fastest execution, the SOURCE SETTLED bit of the status byte can be used. Once the bit is set after a frequency has been programmed, the output is valid and the program may continue. If the frequency is programmed and the status byte is not checked, the program should wait at least the frequency switching speed time before assuming the output valid. If the status byte is to be used to monitor settling, the program string that sets the frequency should start with the program code CS. This will clear any previous setting of the SOURCE SETTLED bit to avoid an incorrect indication.

The Signal Generator Option 008 has one frequency where mechanical switches are actuated to change the internal microwave signal path. To avoid excessive mechanical wear on these switches due to repetitive sweeps, only a single sweep is allowed that crosses them in Auto Sweep mode. Single sweep is not affected by this restriction since single sweep will only cross the mechanical switches once. Manual Sweep mode is also not restricted since the operator can hear the switch and react to the number of crossings. The switch point is shown on the following page. See AUTO SWEEP MODE for more information about sweep limitations and ways to expand sweep ranges.

Start Frequency (Sweep) (cont'd)

Comments (cont'd)

Frequency Switch Point	Description
16.0 GHz	The k-band amplifier is switched in to increase output power above 16 GHz (Option 008 only)

Programming Example

The following programs are written in BASIC for HP 9000 Series 200 or 300 controllers. The program below is used to set the Signal Generator to the sweep start frequency specified by the variable called *Expected*. The desired value must be in MHz and should be within the frequency range of the Signal Generator.

```

10 SUB Sweep_start_set(Err,Expected)           ! Expected frequency in MHz
20 OUTPUT 719 USING "2A";"MG"                 ! Read message from 8673
30 ENTER 719 USING "2A";Message$              ! to clear any old messages
40 Frequency=INT(Expected*1000)/1000          ! Round off to nearest kHz
50 OUTPUT 719 USING "4A,5D.DDD,2A";"CSFA";Frequency;"MZ" ! Update status
60 CALL Settled                               ! Wait for source to settle
70 OUTPUT 719 USING "2A";"MG"                 ! Check for message from 8673
80 ENTER 719 USING "2A";Message$
90 SELECT VAL(Message$)
100 CASE 1                                     ! Frequency was out of range
110 Err=1
120 DISP "WARNING: Attempt to set sweep start frequency out of range"
130 CASE 10
140 Err=10
150 DISP "WARNING: Sweep start and stop frequency are equal"
160 CASE 90                                     ! Auto Peak Error
170 Err=90
180 DISP "WARNING: Auto Peak error. Service may be required"
190 CASE ELSE
200 Err=0                                     ! Other errors not applicable
210 END SELECT
220 !
230 OUTPUT 719 USING "4A";"FAOA"               ! Requests current start freq
240 ENTER 719 USING "K";Set_freq              ! Frequency in Hz
250 Set_freq=INT(Set_freq/1000)/1000          ! Convert to MHz
260 !
270 IF ABS(Set_freq-Frequency)>.001 AND Err=0 THEN
280 DISP "WARNING: Requested frequency rounded to ";Set_freq
290 END IF
295 SUBEND                                     ! End of subroutine
    
```

To prevent roundoff errors from occurring, the following subprogram may be used to adjust a frequency so that it is always within 1 or 2 kHz of the desired frequency. Frequencies below 18.6 GHz will be within 1 kHz of the desired frequency and frequencies between 18.6 and 26 GHz will be within 2 kHz of the desired frequency.

Start Frequency (Sweep) (cont'd)

Programming Example (cont'd)	300 SUB Round_off(Err,Expected)	! Expected frequency in MHz
	310 Err=0	! Initialize Err
	320 Band=5	
	330 IF Expected<26500.001 THEN Band=4	
	340 IF Expected<18600.001 THEN Band=3	
	350 IF Expected<12300.001 THEN Band=2	
	360 IF Expected<6600.001 THEN Band=1	
	370 !	
	380 Baseband=INT((Expected*1000)/Band)/1000	! Rounded fundamental
	390 Round_down=Baseband*Band	
	400 IF Round_down<>Expected THEN	! Requires rounding
	410 Round_up=(Baseband+.001)*Band	
	420 IF ABS(Round_down-Expected)<ABS(Round_up-Expected) THEN	
	430 Expected=Round_down	! Minimum error is round down
	440 ELSE	
	450 Expected=Round_up	! Minimum error is round up
	460 END IF	
	470 END IF	
480 SUBEND		

The following program can be called to wait for a source settled indication from the Signal Generator. The program will wait a maximum of 1 second before assuming the SOURCE SETTLED bit is not going to be set. The status byte must be cleared with the CS program code before the frequency is set. If the status byte is not cleared, the SOURCE SETTLED bit may have been set by a previous command (the bit is latched until the status byte is read or cleared).

500 SUB Settled	
510 T_counter=TIMEDATE	! In case no source settled
520 Stat=SPOLL(719)	! Serial poll
530 IF TIMEDATE-T_counter>1 THEN Done	! Default of 1 second
540 IF NOT BIT(Stat,3) THEN GOTO 520	! Wait for set bit
550 Done: !	
560 SUBEND	! Source is settled or 1 second has passed

Error Messages

The following message numbers may be displayed when setting the sweep start frequency. Each message is explained as it pertains to setting sweep start frequency. For a more complete description of the messages, see the MESSAGES detailed operating instructions.

- 01 Entered frequency is not within the range of the Signal Generator.
- 10 The sweep start frequency has been set equal to the stop frequency. No sweep will occur when a sweep mode is selected.
- 11 Indicates that the current sweep start frequency is below the range of the Signal Generator. This error may be displayed when the SWEEP FREQ START key is pressed if tuning the instrument placed the sweep start frequency below the frequency range of the Signal Generator.

Start Frequency (Sweep) (cont'd)

Error Messages (cont'd)

- 12 Indicates that the current sweep stop frequency is above the frequency range of the Signal Generator. This error may be displayed when the SWEEP FREQ STOP key is pressed if tuning the instrument placed the sweep stop frequency above the frequency range of the Signal Generator.
- 13 Number of steps were adjusted to give even step size. This ensures that the full sweep span is covered by adjusting the number of steps. For example, if the number of steps is set to 100 and the stop frequency is 2000.010 MHz, setting the start frequency to 2 GHz will automatically adjust the number of steps to 10 to accommodate the minimum frequency resolution of 1 kHz.
- 90 Auto Peak malfunction. This indicates that the instrument may require service.

Status Byte and Polling

Description The status byte enables a remote controller to determine the instrument's status. There is also an extended status byte which can be read by the controller to determine the state of most of the front panel annunciators.

Status Byte. The status byte contains eight bits which correspond to certain conditions of the instrument. Each bit is defined as follows:

BIT 1 FRONT PANEL KEY PRESSED: This bit is used to indicate that one of the front panel keys has been pressed since the last time the status byte was cleared. The bit is not set if the Signal Generator is in remote mode when a key is pressed. The bit can be used in applications requiring the controller to know when a user changes one of the instrument parameters. For example, the bit can be used to indicate when a user has changed frequency so that measuring equipment (under remote control) can be retuned for another measurement.

Changes of the VERNIER are not indicated by this bit. The RANGE up and down keys and the FREQ INCREMENT up and down keys will have this bit set once for each key press. However, holding the key down will increment or decrement more than one time even though the bit is set only once.

BIT 2 FRONT PANEL ENTRY COMPLETE: This bit is used to detect the completion of a front panel data entry using the numeric keypad, the TUNE knob or the FREQ INCREMENT up or down key. The bit is set once the entry is completed. For example, the bit is set after the units key is pressed when setting the frequency. Since front panel entry is disabled when in remote mode, this bit is not set for entries during remote mode.

When used in conjunction with the FRONT PANEL KEY PRESSED bit, the controller can determine when a user begins entering a front panel value and when the entry is complete. The FRONT ENTRY COMPLETE bit can also be used to detect when the FREQ INCREMENT up or down key is released. The bit will continue to be set until the key is released. The FRONT PANEL KEY PRESSED bit will only be set once for this condition.

BIT 3 CHANGE IN EXTENDED STATUS: The status byte can be read using a serial poll, but the extended status byte requires a program code to be sent to the Signal Generator and then the controller must read both the status byte and the extended status byte from the Signal Generator. The CHANGE IN EXTENDED STATUS bit is used to indicate that the extended status byte has changed from its value the last time was read. This enables the status byte to be monitored using a serial poll until there is a status change in the extended status byte. Once a change has occurred, the controller can read the extended status byte to check the instrument status. For more information regarding the use of this status bit, see the Comments section.

BIT 4 SOURCE SETTLED: The Signal Generator requires a certain length of time to process a command. For example, when setting frequency, the Signal Generator can require anywhere from several milliseconds to 50 milliseconds to change frequency and settle the RF output level. The actual time required depends on the frequency change (see CW Frequency). If the application waits 50 milliseconds (the specified worst case frequency switching time) after

Status Byte and Polling (cont'd)

Description (cont'd)

each frequency change, the RF output will be settled. Note that the wait must start after the Signal Generator has received the frequency programming string. For controllers with buffered output capability, an additional wait is required to allow the buffered output to be received by the Signal Generator. However, for applications requiring faster execution, the source settled bit can be monitored to determine when the RF output has settled. Since most frequency changes will be much faster than the worst case frequency switching time, the application will execute faster if the SOURCE SETTLED bit is monitored.

The SOURCE SETTLED bit is intended to indicate settling after the RF output or AUTO PEAK is turned on and when FM ranges, frequency, output level or pulse modes are changed. The bit will be set after any parameter change except AM, storing a register and changing sweep parameters that do not immediately change the output frequency. However, the bit is not always valid as an indication that the RF output is settled and should only be used to check for settling of the intended parameter changes.

- BIT 5 END OF SWEEP:** During sweep mode, the END OF SWEEP bit is used to indicate that the current sweep has finished. In AUTO sweep mode the bit will be set once each time the stop frequency is reached. In MANUAL sweep mode, the bit will be set anytime the start or stop frequency is reached. The bit is set when the stop frequency is reached for SINGLE sweep mode. The bit can be used to detect when a single sweep is finished so the controller can spend time computing while the Signal Generator is sweeping.
- BIT 6 ENTRY ERROR:** The ENTRY ERROR bit is set when an invalid front panel key sequence, HP-IB program code, or parameter value is entered. This bit corresponds to the front panel MESSAGE key. Reading the message after detecting this bit will enable the controller to identify and possibly correct the error.
- BIT 7 RQS SERVICE REQUEST BIT:** The Signal Generator can generate a service request when one (or more) of the bits in the status byte are set. A request mask must be set to allow one or more of the bits to generate a service request. At power on, the request mask is set to disable any of the bits from generating a service request. A bit is enabled by setting the corresponding bit in the request mask to a logical one (true). The front panel SRQ indicator will be lighted whenever this bit is set in local or remote mode. The HP-IB service request will also be generated in remote or local mode.
- BIT 8 CHANGE IN SWEEP PARAMETERS:** Changing the CW frequency will reset the start and stop frequencies of the sweep. Any changes to start or stop frequencies, delta frequency, number of steps or step size, dwell time, or center frequency will set this bit.

Extended Status Byte. The extended status byte is read by sending the "0S" program code to the Signal Generator and then reading the status byte and extended status byte. The bits in the extended status byte are set whenever a valid condition exists. The only way to clear a bit that has been set is to clear the status bytes with a CS program code or to read the extended status byte. Once the extended status byte is read, it will be cleared and updated. Note that the bits are not cleared until after the extended status is read. To read the current instrument extended status, the program string "CSOS" should be sent to clear both status bytes and to update the extended status byte. The extended status byte is composed of eight bits with each bit defined as follows:

Status Byte and Polling (cont'd)

Description (cont'd)

- BIT 1 SELF TEST FAILED:** When the Signal Generator is first turned on, a self-test is performed to check the instrument's Digital Control Unit. If a failure is detected, the SELF TEST FAILED bit is set.
- BIT 2 FM OVERMOD:** If the FM circuitry is overmodulated by applying more than one volt peak at the input or by exceeding the instrument capability, the FM OVERMOD front panel annunciator and status bit will be set.
- BIT 3** This bit is always set to zero.
- BIT 4 EXTERNAL REF:** When the Signal Generator's rear panel panel **FREQ STANDARD INT/EXT** switch is set to **EXT**, the front panel **EXT REF** annunciator and the **EXTERNAL REF** status bit will be set.
- BIT 5 NOT PHASE LOCKED:** If the Signal Generator is not phase locked due to instrument malfunction, is severely FM overmodulated, has the **FREQ STANDARD INT/EXT** switch in the **EXT** position with no external frequency reference or has the RF output off, the **NOT PHASE LOCKED** status bit will be set. This bit is not valid after a frequency change until the **SOURCE SETTLED** bit is set. The ϕ **UNLOCKED** annunciator on the front panel corresponds to this bit.
- BIT 6 POWER FAILURE/ON:** If the mains power to the Signal Generator is interrupted and then returned, this bit will be set. The bit can be used to verify that the line main has not been interrupted since the last time the status byte was checked.
- BIT 7 ALC UNLEVELED:** If the Signal Generator output level is not calibrated (as indicated by the front panel **UNLEVELED** annunciator) or the amplitude modulation circuitry is being overmodulated or the RF output is off, the **ALC UNLEVELED** bit in the extended status byte will be set.
- BIT 8** This bit is always set to zero.

Local Procedure

The status byte and the extended status byte can only be read using a controller. All but one of the extended status bits can be read also on the front panel. The **POWER FAILURE/ON** bit can only be read using a controller. The **SELF TEST FAILED** will be indicated by a message just after the instrument is turned on. All of the other bits have a status annunciator that is turned on whenever the appropriate conditions exist.

A controller can be used to poll the Signal Generator while in remote mode to determine when a key is pressed or when the extended status byte changes. This is useful in applications requiring retuning of test instruments under remote control while allowing an operator to manually tune the Signal Generator.

Remote Procedure

Serial Poll. When a condition occurs that sets one of the bits of the status byte or the extended status byte, the bit is set and remains set until it is cleared by the controller. When the status byte is cleared, all bits are first cleared and then updated to reflect the current status of the Signal Generator.

A serial poll is used to read the status byte without clearing any of the bits of the status byte. To read the status byte, the command **SPOLL** is used. The status byte is then read into the controller. The status byte is read as the sum of the weighted values of the bits. See the status byte in the Comments section to determine bit weight value. To clear the status byte, the program code **CS** must be sent or the status byte and extended status

Status Byte and Polling (cont'd)

Remote Procedure (cont'd)

byte must be read. The clear status command (CS) will clear both the status byte and the extended status byte. If clearing the status changes the extended status byte, the CHANGE IN EXTENDED STATUS bit will be set in the status byte. This enables the controller to monitor the status byte using a serial poll until the extended status byte changes. Reading both status bytes after the output status command (OS) will clear both bytes after they are read.

To read the extended status byte, the program code OS is sent and then the status byte and extended status byte are read into the controller. Since the extended status bits are latched, the extended status byte may indicate that a problem exists that has already been corrected. For example, if the RF output is turned off, the NOT ϕ LOCKED bit and the ALC UNLEVELED bit will be set. If the RF output is then turned on and the extended status byte read, the NOT ϕ LOCKED and ALC UNLEVELED bit will still be set. To read the current instrument status, the status should be cleared (CS) and then the extended status byte will reflect current conditions.

Service Request (SRQ). The Signal Generator can generate a service request whenever one of the bits of the status byte is set. However, the bits must be enabled before a service request will be generated. To enable a bit, the corresponding bit of the Request Mask must be set to a one. For example, to generate a service request when the END OF SWEEP bit is set, bit five of the Request Mask must be set to a logical one (true). The program string required to set bit 5 is "RM16" since bit 5 has a weight of 16 (see the status byte in Comments).

When the Signal Generator is first turned on, the Request Mask is cleared so that a service request will not be generated. The Request Mask value can be read by the controller so bits can be added or cleared from the present values. The Request Mask is cleared by an HP-IB clear but not by an instrument preset.

When a service request is generated (whenever the RQS bit is set true), the status byte is latched so the first cause of the service request can be identified. Reading the stored status byte can only be done using a serial poll. Reading the status byte using the output status program code (OS) will read the current status only. Once the stored status byte is read, the status byte is updated so a subsequent service request is not lost. If more than one bit is enabled to generate a service request and more than one bit is set before the serial poll, the first serial poll will read the status byte associated with the first service request. Once the poll is completed, another service request will be generated due to the one or more other bits that were set after the status byte was stored.

The service request (SRQ) HP-IB bus line is set true whenever the RQS bit of the status byte is set. The front panel SRQ annunciator is also lighted when the RQS bit is set. The service request is cleared when a clear status (CS) is executed or the extended status byte is read (OS). When the controller detects a service request by testing the HP-IB SRQ line, a serial poll must be performed for each instrument on the bus to determine which instrument generated the request. For large systems, the parallel poll can be used to reduce the number of polls required to identify the instrument requiring service.

Parallel Poll. The parallel poll (PPOLL) is used to allow several instruments to respond with the service request status on a single bus line. Since there are eight bus lines, up to eight groups of instruments can be polled at the same time. By testing the data lines after a parallel poll, the group generating a service request can be quickly identified and then the instruments in that group can be serially polled until the instrument(s) requiring service is located. In a system with eight instruments, this reduces the number of polls from eight serial polls to one parallel poll and then a single serial poll.

Status Byte and Polling (cont'd)

Remote Procedure (cont'd)

The controller assigns a data line and the parallel poll sense using a parallel poll configure command. The assigned data line is the line that the Signal Generator will output the SRQ if it is set. The sense determines whether the active (true) value will be a logical zero or a logical one. For example, assigning the Signal Generator parallel poll response to data line five and the sense to false will cause the Signal Generator to output a false signal on data bus line five when the parallel poll occurs (if the SRQ bit is set).

Program Codes

HP-IB

Program Code	Function
CS	Clear status and extended status bytes
OR	Output Request Mask (in binary)
OS	Output status and extended status bytes (in binary)
RM	Prefix to set Request Mask (in binary)
@1	Prefix to set Request Mask (in binary)

Comments

STATUS BYTE								
BIT	8	7	6	5	4	3	2	1
WEIGHT	128	64	32	16	8	4	2	1
Condition	Change in Sweep Parameters	RQS Bit Request Service	Entry Error	End of Sweep	Source Settled	Change in Extended Status	Front Panel Entry Complete	Front Panel Key Pressed

EXTENDED STATUS BYTE								
BIT	8	7	6	5	4	3	2	1
WEIGHT	128	64	32	16	8	4	2	1
Condition	0 (always)	ALC Un-leveled	Power Failure/On	Not Phase Locked	External Ref	0 (always)	FM Over-modulated	Self-Test Failed

When using the status byte to monitor the results of program strings, care must be taken to avoid incorrect results. When the instrument is preset and the frequency and/or level do not change, the SOURCE SETTLED bit will be set before the extended status byte is set. In addition, some conditions may cause bits in the extended status byte to not be set. For maximum assurance that the instrument is settled and the extended status byte is valid after a preset, the following procedure should be used.

1. Set the Signal Generator to 2 GHz and then preset the instrument with the program string "FR2GZRC0."
2. Monitor the status byte using a serial poll until the SOURCE SETTLED bit is set.
3. Clear the status and prepare the extended status byte with the program string "CSOS."

Status Byte and Polling (cont'd)

Comments (cont'd)

If the above procedure is followed, the extended status byte will be valid and the preset will be complete by the time the extended status is read. If a selected device clear (i.e. CLEAR 719) or a device clear (i.e. CLEAR 7) are used, a settling time of about 2 seconds is required before the extended status byte is valid and the source is settled. Setting the Signal Generator to 2 GHz before the clear will allow the preceding procedure to be followed starting with step 2 after the preset.

The SOURCE SETTLED bit is set once the affected parameter has settled. If a clear status is executed before this bit is set from a previous command, the bit will be set after the status byte has been cleared and before the parameter being programmed has changed. For example, if the instrument is preset and the status cleared as part of a frequency change before the Signal Generator has settled, the SOURCE SETTLED bit will be set by the instrument preset before the frequency change is complete. If the bit is being checked before proceeding, the program will continue before the frequency change has settled.

Status bits are set asynchronously whenever the corresponding condition occurs. If a condition occurs between the time the output extended status program code is received and the time both status bytes are read, the status byte will reflect the changed condition by setting the appropriate bit. Note that once a bit is set, only a clear status or reading the extended status can clear it.

When the ENTRY ERROR bit is enabled to cause a service request, the message must be cleared after the service request. Failure to clear the message will result in additional service requests generated with each program string. To clear the message, output the program code "MG" and then read the message. Once the message is read or the MESSAGE key on the front panel is pressed, the message will be cleared.

The status byte and the extended status byte are both binary values. When entering the status byte and extended status byte into the controller, use a formatted statement to input the values as binary. If a formatted statement is not used, the controller may recognize a value of twelve as a carriage return and terminate the entry. This can occur when the SOURCE SETTLED BIT and the CHANGE IN EXTENDED STATUS bits are the only bits set in the status byte. In addition, the controller should be instructed not to accept the linefeed character (decimal 12) as an early termination of the data transfer. The correct format for the HP 9000 Series 200 and 300 or the HP 85 controllers is:

```
ENTER 719 USING "%,B,B";S1,S2
```

Programming Example

The following programs are written in BASIC for HP 9000 Series 200 or 300 controllers. The program below is used to test for the SOURCE SETTLED bit after a frequency or level change. Since the SOURCE SETTLED bit is not set for some program codes, a timeout is provided to terminate the subroutine.

```
10 SUB Source_settled
20 Time_in=TIMEDATE                ! Reference for timeout
30 Check_it: !
40 V=SPOLL(719)                    ! Take a serial poll to check the bit
50                                  ! Check for set bit or more than 3 seconds
60 IF NOT BIT(V,3) AND TIMEDATE-Time_in<3 THEN GOTO Check_it
70 SUBEND                            ! >3 seconds or bit is set
```

Status Byte and Polling (cont'd)

Programming Example (cont'd)

The parallel poll is set up using the Request Mask and the parallel poll commands of the controller. The following program sets up a parallel poll to check for entry errors or changes in the extended status. The parallel poll response will be positive and set for line 1 of the HP-IB bus.

The second subroutine is used to test the HP-IB with a parallel poll and call a user subroutine, Err_8673. The poll indicates an SRQ by the HP 8673.

```
100 SUB Set_8673_poll
110 Mask=4+32                               ! Bits for Entry error (32) and status change (4)
120 PPOLL CONFIGURE 719;1+8                 ! Line one with positive sense
130 OUTPUT 719 USING "2A,B";"RM",Mask       ! Enable bits
140 SUBEND

150 SUB Poll_bus
160 Bus=PPOLL(7)
170 IF BIT(Bus,1) THEN CALL Err_8673        ! Routine will serial poll
180 SUBEND

190 SUB Err_8673
200 V=SPOLL(719)
210 IF BIT(V,5) THEN                        ! Entry error occurred
220 DISP "Entry error occurred for HP 8673 (Press MESSAGE key)."
230 PAUSE
240 OUTPUT 719;"MG"                         !Clear message to prevent more requests
250 ENTER 719;Dummy
260 DISP                                     ! Clear display line
270 END IF
280 IF BIT(V,2) THEN                         ! Change in extended status is indicated
290 OUTPUT 719;"OS"
300 ENTER 719 USING "%,B,B";Stat1,Stat2
310 IF BIT(Stat2,0) THEN PRINT "HP 8673 Self Test Failed"
320 IF BIT(Stat2,1) THEN PRINT "HP 8673 FM is overmodulated"
330 IF BIT(Stat2,3) THEN PRINT "HP 8673 is using External Ref"
340 IF BIT(Stat2,4) THEN PRINT "HP 8673 is not phase locked"
350 IF BIT(Stat2,5) THEN PRINT "HP 8673 has had a power failure"
360 IF BIT(Stat2,6) THEN PRINT "HP 8673 is not leveled"
370 END IF
380 SUBEND
```

Error Messages

All messages except NO ERROR will set the ENTRY ERROR bit of the status byte. Errors 95 through 99 are related to the self test performed at power up. If one of these errors is reported and the instrument is still functional, the SELF TEST FAILED bit in the extended status byte will be set.

Steps (Sweep)

Description

The Signal Generator performs a sweep by stepping the RF output frequency in discrete steps between the start and stop frequency of the sweep. The number of steps that the Signal Generator makes between the start and stop frequency is set by the number of steps or the sweep step size.

Setting the number of steps in a sweep will change the sweep step size and setting the sweep step size will change the number of steps. Sweep step size is calculated by dividing the frequency span (VF) by the number of steps when the number of steps is set. The number of steps is set by dividing the frequency span (VF) by the sweep step size when the sweep step size is entered.

The Signal Generator is capable of 1 to 9999 steps within a sweep span as long as the calculated step size is greater than 1 kHz. For a sweep with one step, the Signal Generator will produce the start frequency and the stop frequency.

Sweep step size can be set between 1 kHz and the currently defined sweep span as long as the calculated number of steps is between 1 and 9999 steps. Entering a sweep step size larger than the sweep span will set the step size equal to the span and will cause the Signal Generator to issue a message.

Local Procedure

To set the number of sweep steps:

1. Press the STEP key to indicate that the next entry will be for the sweep step size or the number of steps. The only difference in entering the two parameters is the units terminator.
2. Enter the desired number of steps using the numeric keypad. If a mistake is made while entering the number of steps, press the backspace key until the incorrect digit disappears. Continue entering the correct digits until the number of steps in the FREQUENCY MHz display is correct.
3. Press the STEPS key to indicate that the number of steps rather than the sweep step size has been entered. The sweep step size will be calculated and the sweep step size and the number of steps will be displayed until the STEPS key is released

If the entered value does not produce a sweep step size equal to or greater than the frequency resolution, the number of steps will be reduced until a valid sweep step size is obtained. The number of steps must be between 1 and 9999 steps. If the sweep step size is adjusted, the entered value of number of steps is retained for use when other sweep parameters are changed. This feature enables the sweep parameters to be entered in any order without restrictions due to previous sweep parameters that do not affect the final values. For example, if the number of steps is entered as 200 with the current sweep span defined as 100 kHz, the number of steps will be adjusted to be 100 (1 kHz resolution) and a message will be issued. However, changing the sweep span to 200 kHz will restore the number of steps to 200 without having to re-enter the value.

Remote Procedure

The Signal Generator accepts any number of sweep steps between 1 and 9999 steps. The programmed value may be adjusted as required to be consistent with the remaining sweep parameters and the frequency resolution.

The format of the remote programming follows the front panel key sequence. The program code SS or SP is sent followed by the desired number of steps and the units SS.

Steps (Sweep) (cont'd)

Remote Procedure (cont'd)

The programmed number of steps can be read by the controller using the output active program code suffix. To read the current number of steps, the program string SPOA or SSOA is sent and then the step size and the number of steps must be read. Since step size and the number of steps are directly related, both are sent when the output active program code suffix is used. If read as a string the format is: the program code SP followed by the sweep step size in fundamental units (Hz), the units terminator (Hz), a comma, the program code SP followed by the current number of steps, and the units terminator SS.

Example

To set the number of sweep steps to 350 steps:

Local

1. Press the STEP key.
2. Key in 350 using the numeric keypad. The FREQUENCY MHz display should show 350 when you have finished keying in the value. Note that the entry is left justified at this point.
3. Press the STEP units key to finish the sequence. The FREQUENCY MHz display should show the entered (or adjusted) number of steps on the left half of the display and the calculated sweep step size on the right half of the display. The message key will light if the number of steps are adjusted to indicate the change from the desired value.

Remote

The programming string for setting the number of sweep steps is composed of a program code, numeric data and the units terminator. To program the number of steps to 350 steps, the program string is: "SP350SS"

The program codes SS and SP can be used interchangeably in the above program string. The alpha characters can be sent as upper or lower case (or even mixed upper and lower case).

Program Codes

HP-IB

Program Code	Description	Units
*SP SS	Number of Sweep Steps	*SS SP

* Preferred Program Code

Comments

The Signal Generator digital sweep is composed of discrete frequencies that are produced sequentially. The minimum step size is limited to the frequency resolution which is the minimum change in frequency that the Signal Generator can produce. The number of steps is dependent on the frequency resolution and the sweep span.

The actual change in output frequency will not be uniform for some frequencies and may vary up to 2 kHz. This is required to accommodate sweep step sizes that are not exact multiples of the frequency resolution. The sweep steps averaged over several sweep points will be equal to the selected sweep step size. An example of the averaging is defining a sweep step size of 10 kHz at a start frequency of 15 GHz. The minimum tuning increment at 15 GHz is 3 kHz which means that the sweep step size can be 9 or 12

Steps (Sweep) (cont'd)

Comments (cont'd)

kHz for exact step sizes. To obtain a sweep step size of 10 kHz, the Signal Generator will step by 9 kHz, 9 kHz, 12 kHz, and then repeat the sequence. The average step size is 10 kHz even though the sweep does not execute exactly 10 kHz steps. If the step size is reduced to 1 kHz, the Signal Generator will step by 0 kHz, 0 kHz and then 3 kHz for a 1 kHz average step size.

When the sweep frequency span is changed, the sweep step size is recalculated by dividing the entered span by the current number of steps. Entering the number of sweep steps will recalculate the sweep step size by dividing the sweep frequency span by the entered number of steps. The number of steps will be adjusted until the sweep step size is equal to or larger than the frequency resolution. If the number of steps times the sweep step size does not exactly equal the frequency span, the last sweep point (the stop frequency) will not be included.

The number of steps may be increased automatically by the Signal Generator to offset the effect of frequency resolution on the step size. For example, if the sweep span is set to 1 MHz and 400 steps are selected, the number of steps will be increased to 500 steps. This adjustment is made since 2 kHz steps would yield a span of 800 kHz while 3 kHz steps would provide a span of 1.2 MHz. Since both of the resulting spans are incorrect, the number of steps is increased to 500 to produce a 1 MHz span with 2 kHz steps. The original entry will be retained for recalculation when other sweep parameters are changed.

Programming Example

The following program is written in BASIC for HP 9000 Series 200 or 300 controllers. The program is used to set the number of sweep steps to the number specified by the variable called *Expected*. The desired value must be between 1 and 9999 steps.

```

10 SUB Sweep_steps(Err,Expected)
20 OUTPUT 719 USING "2A";"MG"           ! Clear message from 8673
30 ENTER 719 USING "2A";Message$       ! to clear any old messages
40 OUTPUT 719 USING "2A,DDDD,2A";"SP";Expected;"SS" ! Set size
50 OUTPUT 719 USING "2A";"MG"         ! Get any error message
60 ENTER 719 USING "2A";Message$
70 SELECT VAL(Message$)
80 CASE 7
90 Err=1
100 DISP "WARNING: The number of steps is out of range"
110 CASE ELSE
120 Err=0
130 END SELECT
140 !
150 SUBEND

```

Error Messages

The following message numbers may be displayed when setting the number of steps. Each message is explained as it pertains to setting the number of steps. For a more complete description of the messages, see the MESSAGES detailed operating instructions.

- 07 The entered number of steps is less than 1 or greater than 9999.
- 13 The number of steps was adjusted to achieve a step size that is equal to or greater than the specified resolution. This adjustment also occurs when the selected number of steps would produce a sweep step size that is not a multiple of the 1 kHz minimum frequency resolution. For example, a frequency span of 350 kHz with 140 steps would require a 2.5 kHz step size. The Signal Generator would use 175 steps of 2 kHz to produce a step size that is a multiple of 1 kHz.

Step Size (Sweep)

Description

The Signal Generator performs a sweep by stepping the RF output frequency in discrete steps between the start and stop frequency of the sweep. The number of steps that the Signal Generator makes between the start and stop frequency is set by the number of steps or the sweep step size.

Setting the number of steps in a sweep will change the sweep step size and setting the sweep step size will change the number of steps. Sweep step size is calculated by dividing the frequency span (ΔF) by the number of steps when the number of steps is set. The number of steps is set by dividing the frequency span (ΔF) by the sweep step size when the sweep step size is entered.

The Signal Generator is capable of 1 to 9999 steps within a sweep span as long as the calculated step size is greater than 1 kHz. For a sweep with one step, the Signal Generator will produce the start frequency and the stop frequency.

Sweep step size can be set between 1 kHz and the currently defined sweep span as long as the calculated number of steps is between 1 and 9999 steps. Entering a sweep step size larger than the sweep span will set the step size equal to the span and will cause the Signal Generator to issue a message.

Local Procedure

To set the sweep step size:

1. Press the STEP key to indicate that the next entry will be for the sweep step size or the number of steps. The only difference in entering the two is the units terminator.
2. Enter the desired sweep step size using the numeric keypad. If a mistake is made while entering the frequency, press the backspace key until the incorrect digit disappears. Continue entering the correct digits until the sweep step size in the FREQUENCY MHz display is correct.
3. Press the appropriate units key. You may enter the sweep step size in GHz, MHz or kHz. Once the units key is pressed, the sweep step size will be adjusted to read in MHz and the sweep step size will continue to be displayed until the units key is released.

If the entered value does not result in at least one step and less than 9999 steps, the step size will be adjusted until the Signal Generator is capable of performing the sweep. The entered value is retained for use when other sweep parameters are changed. This feature enables the sweep parameters to be entered in any order with restrictions due to previous sweep parameters not affecting the final values. For example, if the sweep step size is entered as 1 GHz with the current sweep span defined as 100 kHz, the sweep step size will be adjusted to be 100 kHz and a message will be issued. However, changing the sweep span to 10 GHz will restore the sweep step size to 1 GHz without having to re-enter the value.

Remote Procedure

The Signal Generator accepts any sweep step size within the range of 1 kHz and the maximum frequency of the Signal Generator. Any digits below 1 kHz will be truncated and the entered value may be adjusted to be consistent with the remaining sweep parameters.

The format of the remote programming follows the front panel key sequence. The program code SS or SP is sent followed by the desired sweep step size and the units (GHz, MHz, kHz, or Hz).

Step Size (Sweep) (cont'd)

Remote Procedure (cont'd)

The actual step size can be read by the controller using the output active program code suffix. To read the current step size, the program string SPOA or SSOA is sent and then the step size and the number of steps must be read. Since step size and the number of steps are directly related, both are sent when the output active program code suffix is used. If read as a string, the format is the program code SP followed by the sweep step size in fundamental units (Hz) and the units terminator (Hz), a comma, and the program code SP followed by the current number of steps and the units terminator SS.

Example

To set the sweep step size to 455 kHz:

Local

1. Press the STEP key.
2. Key in 455 using the numeric keypad. The FREQUENCY MHz display should show 455 when you have finished keying in the value. Note that the entry is left justified at this point.
3. Press the kHz units key to finish the sequence. The FREQUENCY MHz display should show the calculated number of steps on the left half of the display and the entered (or adjusted) sweep step size on the right half of the display. The message key will light if the sweep step size is adjusted to indicate the change from the desired value.

The sweep step size could also have been entered as .455 MHz or .000455 GHz. The only difference is the placement of the decimal point and the units key pressed after the sweep step size has been entered using the numeric keypad.

Remote

The programming string for setting the sweep start frequency is composed of a program code, numeric data and the units terminator. The frequency may be programmed in units of GHz, MHz, kHz or Hz. To program the sweep step size to 455 kHz, the possible program strings are:

"SP.000455GZ" or "SP.455MZ" or "SP455KZ" or "SP455000HZ"

In addition, the program code SS can be used in place of SP in the above program strings. The alpha characters can be sent as upper or lower case (or even mixed upper and lower case).

Program Codes HP-IB

Program Code	Function	Units
*SP SS	Sweep step size	GZ *MZ KZ HZ

* Preferred Program Code

Comments

The Signal Generator digital sweep is composed of discrete frequencies that are produced sequentially. The minimum step size is limited to the minimum change in frequency that the Signal Generator can produce which is defined as the frequency resolution. The sweep step size can change depending on the current frequency and the next frequency in the sweep.

Step Size (Sweep) (cont'd)

Comments (cont'd)

The actual change in output frequency will not be uniform for some frequencies and may vary up to 2 kHz. This is required to accommodate sweep step sizes that are not exact multiples of the frequency resolution. The sweep steps averaged over several sweep points will be equal to the selected sweep step size. An example of the averaging is defining a sweep step size of 10 kHz at a start frequency of 15 GHz. The minimum tuning increment at 15 GHz is 3 kHz which means that the sweep step size can be 9 or 12 kHz for exact step sizes. To obtain a sweep step size of 10 kHz, the Signal Generator will step by 9 kHz, 9 kHz, 12 kHz, and then will repeat the sequence. The average step size is 10 kHz even though the sweep does not execute exactly 10 kHz steps. If the step size is reduced to 1 kHz, the Signal Generator will step by 0 kHz, 0 kHz and then 3 kHz for a 1 kHz average step size.

When the sweep frequency span is changed, the sweep step size is recalculated by dividing the entered span by the current number of steps. Entering a sweep step size will recalculate the number of steps by dividing the sweep frequency span by the entered sweep step size. The sweep step size will be adjusted until the number of steps is an integer number between 1 and 9999 steps.

Programming Example

The following program is written in BASIC for HP 9000 Series 200 or 300 controllers. The program is used to set the Signal Generator sweep step size to the frequency specified by the variable *Expected*. The desired value must be in MHz and should be between 1 kHz and the maximum frequency of the Signal Generator.

```
10 SUB Step_size(Err,Expected)
20 OUTPUT 719 USING "2A";"MG"
30 ENTER 719 USING "2A";Message$
40 OUTPUT 719 USING "2A,5D.DDD,2A";"SP";Expected;"MZ"
50 OUTPUT 719 USING "2A";"MG"
60 ENTER 719 USING "2A";Message$
70 SELECT VAL(Message$)
80 CASE 1
90 Err=1
100 DISP "WARNING: Sweep step size is out of range"
110 CASE ELSE
120 Err=0
130 END SELECT
140 !
150 SUBEND
```

! Clear message from 8673
! to clear any old messages
! Set size
! Get any error message

Error Messages

The following message numbers may be displayed when setting the sweep step size. Each message is explained as it pertains to setting sweep step size. For a more complete description of the messages, see the MESSAGES detailed operating instructions.

- 05 The entered sweep step size is not within the capability of the Signal Generator.
- 14 The step size is too small for the current frequency span. The entry is saved in anticipation that a new frequency span is going to be entered. The frequency span divided by the entered frequency step size must be less than 9999. If the span is not changed, the step size will be adjusted to produce an integer number of steps between 1 and 9999.
- 15 The entered step size is larger than the currently defined frequency span. The entry is saved in anticipation that the frequency span will be changed. If the span is not changed, the step size is set to equal to the span (1 step).

Stop Frequency (Sweep)

Description

The sweep stop frequency determines where the Signal Generator will end a sweep in each of the three sweep modes. The sweep frequency limits are determined by setting either the start and stop frequency or the center frequency and frequency span. Setting start and stop frequency will begin the sweep at the start frequency and end at the stop frequency. Setting the center frequency and frequency span will start the sweep at one-half the frequency span below the center frequency and end the sweep at one-half the frequency span above the center frequency. Setting the CW frequency when sweep is off will also reset the sweep center frequency to the same value.

Setting the center frequency or frequency span will automatically recalculate the appropriate sweep start and stop frequencies. Resetting the sweep start or stop frequency will reset the sweep center frequency if in sweep mode, or the CW frequency if sweep is off. The frequency span will be recalculated whether sweep is on or off. The sweep center frequency or CW frequency will be reset to be halfway between the start and stop frequencies.

The sweep stop frequency can be set to any valid Signal Generator frequency. In addition, if the start frequency is set above the stop frequency, single and auto sweep modes will still sweep from the start to the stop frequency. Manual sweep will start at the lower absolute frequency and move toward the higher absolute frequency.

Local Procedure

To set the Signal Generator to a specific sweep stop frequency:

1. Press the SWEEP FREQ STOP key to indicate that the next entry will be for sweep stop frequency.
2. Enter the desired frequency using the numeric keypad. If a mistake is made while entering the frequency, press the backspace key until the incorrect digit disappears. Continue entering the correct digits until the frequency displayed in the FREQUENCY MHz display is correct.
3. Press the appropriate units key. The frequency can be entered in GHz, MHz or kHz. Once the units key is pressed, the displayed frequency will be adjusted to display MHz and the sweep stop frequency will be set. The sweep stop frequency will continue to be displayed until the units key is released.

The actual frequency displayed after releasing the units key will usually not be the entered frequency. If sweep mode is off, the displayed frequency will indicate the frequency halfway between the start frequency and the new stop frequency. If auto sweep is on, the sweep will be reset and then continue using the new stop frequency. If single sweep is on, the sweep will be reset and the sweep will remain armed at the start frequency. If manual sweep is on, the sweep frequency will be reset to the start frequency.

To check the current sweep stop frequency, press and hold the SWEEP FREQ STOP key. The FREQUENCY MHz display will display the sweep stop frequency as long as the key is held. When any sweep mode is turned off, the CW frequency will be set to halfway between the start and stop frequencies (equal to the sweep center frequency).

Remote Procedure

The Signal Generator accepts any sweep stop frequency within its specified frequency range. Above 6.6 GHz, the programmed frequency may be rounded by the Signal Generator to be compatible with the 2, 3, or 4 kHz resolution at the programmed frequency (see comments).

Stop Frequency (Sweep) (cont'd)

Remote Procedure (cont'd)

The format of the remote programming follows the front panel key sequence. To program the sweep stop frequency, the program code FB is sent followed by the desired frequency and the units (GZ, MZ, KZ, or HZ).

If setting the new start frequency causes a change of the CW frequency (normally the case), the SOURCE SETTLED bit of the status byte can be monitored to determine when the new frequency has settled. Once this bit is set, the NOT PHASE LOCKED bit in the extended status byte may be checked to ensure that the instrument is working correctly. The NOT PHASE LOCKED bit is not valid until after the SOURCE SETTLED bit has been set.

The current sweep stop frequency can be read by the controller using the output active program code suffix. To read the stop frequency, send the program codes "FBOA" and then read the stop frequency. The Signal Generator will send the frequency in fundamental (Hz) units. If the frequency is read as a string, the format will be the program code, FB, followed by the sweep stop frequency in Hz and then the units terminator (Hz).

Example

To set the sweep stop frequency to 16 232.334 MHz:

Local

1. Press the SWEEP FREQ STOP key.
2. Key in 16232.334 using the numeric keypad. The FREQUENCY MHz display should show 16232.334 when you have finished keying in the value. Note that the entry is left justified at this point.
3. Press the MHz units key to finish the sequence. The FREQUENCY MHz display should show the entered frequency until the units key is released. The FREQUENCY MHz display should now be right justified.

The frequency could also have been entered as 16.232334 GHz or 16232334 kHz. The only difference is the placement of the decimal point and the units key pressed after the frequency has been entered using the numeric keypad.

Remote

The programming string for setting the sweep stop frequency is composed of a program code, numeric data and the units terminator. The frequency may be programmed in units of GHz, MHz, kHz or Hz. To program the Signal Generator start frequency to 16232.334 MHz, the possible program strings are:

"FB16.232334GZ" or "FB16232.334MZ" or "FB16232334KZ" or "FB16232334000HZ"

The alpha characters can be sent as upper or lower case (or even mixed upper and lower case). If the CW frequency changes, the output frequency is valid once the SOURCE SETTLED bit of the status byte is set (see Comments).

Stop Frequency (Sweep) (cont'd)

Program
Codes
HP-IB

Program Code	Function	Applicable Units
FB	Start Frequency	GZ *MZ KZ HZ

* Preferred Program Code

Comments

Due to the use of frequency multiplication to generate frequencies above 6.6 GHz, the frequency sometimes cannot be set precisely to a desired value. Frequencies below 6.6 GHz can be set to the nearest 1 kHz. All frequencies between 6.6 and 12.3 GHz can be set within 2 kHz of the desired value. Frequencies between 12.3 and 18.6 GHz can be set within 3 kHz of the desired value and frequencies between 18.6 and 26.5 GHz can be set within 4 kHz of the desired frequency. However, with careful selection of frequency, the roundoff error can be reduced to 1 kHz below 18.6 GHz and 2 kHz for frequencies between 18.6 and 26.5 GHz.

When the Signal Generator is programmed to a frequency that cannot be set exactly due to frequency resolution, a random roundoff occurs. To prevent this, the remote program should perform a calculation to determine whether the frequency can be set exactly and adjust the desired frequency accordingly.

To determine whether a frequency can be set to a given value, divide the desired frequency (in kHz) by two if it is between 6.6 and 12.3 GHz, by three if it is between 12.3 and 18.6 GHz or by four if it is above 18.6 GHz. If the result is a whole number (no remainder), the frequency can be set to the desired value. For example, 16 GHz divided by three (it is between 12.3 and 18.6 GHz) is 5 333333.33 kHz. Since the dividend is not a whole number, this frequency cannot be set exactly. The nearest frequencies that can be set are 15.999999 GHz (5.333333X3) and 16.000002 GHz (5.333334X3). Note that the roundoff error is only 1 kHz if 15.999999 GHz is programmed instead of 16 GHz.

For applications that require fastest execution, the SOURCE SETTLED bit of the status byte can be used. Once the bit is set after a frequency has been programmed, the output is valid and the program may continue. If the frequency is programmed and the status byte is not checked, the program should wait at least the frequency switching speed time before assuming the output valid. If the status byte is to be used to monitor settling, the program string that sets the frequency should start with the program code CS. This will clear any previous setting of the SOURCE SETTLED bit to avoid an incorrect indication.

The Signal Generator Option 008 has a frequency where mechanical switches are actuated to change the internal microwave signal path. To avoid excessive mechanical wear on these switches due to repetitive sweeps, only a single sweep is allowed that crosses them in auto sweep mode. Single sweep is not affected by this restriction since single sweep will only cross the mechanical switches once. Manual sweep mode is also not restricted since the operator can hear the switch and react to the number of crossings. The switch point is shown in the following table. See AUTO SWEEP MODE for more information about sweep limitations and ways to expand sweep ranges.

Stop Frequency (Sweep) (cont'd)

Comments (cont'd)

Frequency Switch Point	Description
16.0 GHz	The k-band amplifier is switched in to increase output power above 16 GHz (Option 008 only)

Programming Example

The following programs are written in BASIC for HP 9000 Series 200 or 300 controllers. The following program is used to set the Signal Generator to the sweep start frequency specified by the variable called *Expected*. The desired value must be in MHz and should be within the frequency range of the Signal Generator.

```

10 SUB Sweep_start_set(Err,Expected)           ! Expected frequency in MHz
20 OUTPUT 719 USING "2A";"MG"                 ! Read message from 8673
30 ENTER 719 USING "2A";Message$             ! To clear any old messages
40 Frequency=INT(Expected*1000)/1000         ! Round off to nearest kHz
50 OUTPUT 719 USING "4A,5D.DDD,2A";"CSFB";Frequency;"MZ" ! Update status
60 CALL Settled                               ! Wait for source to settle
70 OUTPUT 719 USING "2A";"MG"                 ! Check for message from 8673
80 ENTER 719 USING "2A";Message$
90 SELECT VAL(Message$)
100 CASE 1                                     ! Frequency was out of range
110 Err=1
120 DISP "WARNING: Attempt to set sweep stop frequency out of range"
130 CASE 10
140 Err=10
150 DISP "WARNING: Sweep start and stop frequency are equal"
160 CASE 90                                     ! Auto Peak Error
170 Err=90
180 DISP "WARNING: Auto Peak error. Service may be required"
190 CASE ELSE
200 Err=0                                     ! Other errors not applicable
210 END SELECT
220 !
230 OUTPUT 719 USING "4A";"FBOA"              ! Requests current stop freq
240 ENTER 719 USING "K";Set_freq              ! Frequency in Hz
250 Set_freq=INT(Set_freq/1000)/1000         ! Convert to MHz
260 !
270 IF ABS(Set_freq-Frequency)>.001 AND Err=0 THEN
280 DISP "WARNING: Requested frequency rounded to";Set_freq
290 END IF
295 SUBEND                                     ! End of subroutine

```

To prevent roundoff errors from occurring, the following subprogram may be used to adjust a frequency so that it is always within 1 or 2 kHz of the desired frequency. Frequencies below 18.6 GHz will be within 1 kHz of the desired frequency and frequencies between 18.6 and 26 GHz will be within 2 kHz of the desired frequency.

Stop Frequency (Sweep) (cont'd)

Programming Example (cont'd)

```

300 SUB Round_off(Err,Expected)
310 Err=0
320 Band=5
330 IF Expected<26500.001 THEN Band=4
340 IF Expected<18600.001 THEN Band=3
350 IF Expected<12300.001 THEN Band=2
360 IF Expected<6600.001 THEN Band=1
370 !
380 Baseband=INT((Expected*1000)/Band)/1000
390 Round_down=Baseband*Band
400 IF Round_down<>Expected THEN
410 Round_up=(Baseband+.001)*Band
420 IF ABS(Round_down-Expected)<ABS(Round_up-Expected) THEN
430 Expected=Round_down
440 ELSE
450 Expected=Round_up
460 END IF
470 END IF
480 SUBEND

```

! Expected frequency in MHz
! Initialize Err
! Rounded fundamental
! Requires rounding
! Minimum error is round down
! Minimum error is round up

The following program can be called to wait for a source settled indication from the Signal Generator. The program will wait a maximum of 1 second before assuming the SOURCE SETTLED bit is not going to be set. The status byte must be cleared with the CS program code before the frequency is set. If the status byte is not cleared, the SOURCE SETTLED bit may have been set by a previous command (the bit is latched until the status byte is read or cleared).

```

500 SUB Settled
510 T_counter=TIMEDATE
520 Stat=SPOLL(719)
530 IF TIMEDATE-T_counter>1 THEN Done
540 IF NOT BIT(Stat,3) THEN GOTO 520
550 Done: !
560 SUBEND

```

! In case no source settled
! Serial poll
! Default of 1 second
! Wait for set bit
! Source is settled or 1 second has passed

Error Messages

The following message numbers may be displayed when setting the sweep start frequency. Each message is explained as it pertains to setting sweep start frequency. For a more complete description of the messages, see the MESSAGES detailed operating instructions.

- 01 Entered frequency is not within the range of the Signal Generator.
- 03 Invalid multiplier entry for system compatible instruments. See paragraph 3-2, System Compatibility, for more information about system compatibility.

Stop Frequency (Sweep) (cont'd)

Error Messages (cont'd)

- 10 The sweep stop frequency has been set equal to the start frequency. No sweep will occur when a sweep mode is selected.
- 11 Indicates that the desired sweep start frequency is below the frequency range of the instrument. This error may be displayed when the SWEEP FREQ STOP key is pressed if tuning the instrument placed start frequency below the frequency range of the Signal Generator.
- 12 Indicates that the desired sweep stop frequency is above the frequency range of the instrument. This error may be displayed when the SWEEP FREQ STOP key is pressed if tuning the instrument placed the stop frequency above the frequency range of the Signal Generator.
- 13 Number of steps were adjusted to give even step size. This ensures that the full sweep span is covered by adjusting the number of steps. For example, if the number of steps is set to 100 and the stop frequency is 2000.010 MHz, setting the start frequency to 2 GHz will automatically adjust the number of steps to 10 to accommodate the minimum frequency resolution of 1 kHz.
- 90 Auto Peak malfunction. This indicates that the instrument may require service.

System Automatic Level Control

(2552A, 2634A and above)

Description

External ALC enables the Signal Generator to level the signal at a point other than the output of the Signal Generator. The signal level must be detected using a signal splitter or a directional coupler and a detector to provide a DC signal that is proportional to power at the remote point. The Signal Generator will adjust the signal level at the RF output connector to maintain a constant level at the point where the signal is detected. External ALC also enables external devices such as amplifiers, mixers and other specialized devices to be inserted into the RF signal path with control of the final output level by the Signal Generator.

In applications where the external signal path has frequency dependent losses (and/or gains), the RF signal at the end of the signal path will no longer be a constant amplitude over the Signal Generator's frequency range. For example, if a cable is used that has a constant 0.5 dB/GHz loss, a level error of 5 dB would occur after a 10 GHz frequency change. The signal at the RF output connector of the Signal Generator has not changed, but an extra 5 dB of attenuation is introduced in the signal path when the output frequency is changed.

System leveling mode is available on system compatible Signal Generators only. To determine if a specific Signal Generator is system compatible. (See paragraph 3-2, System Compatibility.) System leveling is used with other system compatible equipment to provide the Signal Generator with the means to control the output level of the system. External mixers, amplifiers and other equipment may be connected in the signal path with feedback from the last component in the signal path generating a system feedback voltage that is 0 volts at 0 dBm and has a sensitivity of 30 millivolts/dB into a 50 ohm load.

The advantages of system leveling are automatic calibration to the Signal Generator's level meter, temperature compensation built into the Signal Generator, and the addition of a +20 dBm range to be used with external amplifiers. When used with a 2 to 20 GHz amplifier, the maximum leveled power of the Signal Generator can be as high as +23 dBm.

Local Procedure

To set the Signal Generator for external system leveling:

1. Connect the external equipment to the Signal Generator with the component generating the system feedback voltage at the end of the signal path.
2. Press the Signal Generator's shift key and then press the SYSTEM key (shifted DIODE key). This sets the Signal Generator to system leveling mode which is indicated by the ALC INT key and the SYSTEM key being lighted. (See paragraph 3-2, System Compatibility.)
3. Reset the Signal Generator range to at least 10 dB above the range required for the desired RF output level. The range may have to be adjusted to compensate for losses and gains in the RF signal path. If the RF signal path will have a relatively high loss, a higher Signal Generator range will be required.
4. Connect the system feedback voltage to the external ALC input of the Signal Generator. No calibration is required on the Signal Generator.
5. If the UNLEVELED annunciator is on, step the range up or down until the UNLEVELED annunciator is extinguished. The UNLEVELED annunciator indicates that the Signal Generator is unable to supply enough power because the signal path has too much attenuation or that the ALC circuitry cannot attenuate the Signal Generator's RF level enough to achieve leveling.

System Automatic Level Control (cont'd)

Local Procedure (cont'd)

6. When the Signal Generator is in the 0, +10 and +20 dB ranges, the system RF output level is equal to the sum of the RANGE and VERNIER settings. Range settings below 0 dB add attenuation to the signal path and do not affect the system level until the ALC goes unlevelled.

Remote Procedure

The equipment setup for remote control of system leveling is the same as the local procedure. The program code for system ALC is C4. The system level can be remotely controlled directly for power levels between 0 and +23 dBm. For levels between 0 and -10 dBm, the RANGE should be set to 0 dB and the VERNIER programmed for the appropriate level. Using a range less than 0 dB while using external system leveling will have no effect on the level but can force the Signal Generator to lose control of the level due to insufficient attenuation (lack of ALC dynamic range) or too much attenuation (attempted operation beyond maximum power specification).

The VERNIER and RANGE settings and the RF output level (the sum of the VERNIER and RANGE settings) can be read by the controller using the output active program code suffix. To read the VERNIER setting (-12.0 to +3 dBm), send the program string VEOA and then read the VERNIER setting. The Signal Generator will send the setting in units of dBm. If the setting is read as a string, the format will be the program code VE followed by the setting in dBm and then the units code DM.

The RANGE setting is read by sending the program string RAOA and then reading the RANGE setting. The Signal Generator will send the range in units of dB (-90 to +20 dB). If the RANGE setting is read as a string, the format will be the program code RA followed by the RANGE setting in dB and then the units code DM.

The RF output level is read by sending the program string LEOA and then reading the output level. The Signal Generator will send the range in units of dBm (-102 to +23 dBm). If the RF level is read as a string, the format will be the program code LE followed by the system RF level and then the units code DM. The program code AP or PL can be used instead of LE, but the program code sent by the Signal Generator will always be LE.

Comments

To set the Signal Generator to system leveling using an external system compatible amplifier.

Local

1. Connect the amplifier to the output of the Signal Generator.
2. Connect the system feedback signal from the amplifier to the external ALC input connector on the Signal Generator front panel.
3. Press the shift key and then the SYSTEM key (shifted DIODE). With the Signal Generator range set to 0 dB and above, the output level of the amplifier can be directly controlled using the RANGE and VERNIER.

Remote

1. Perform the above steps 1 to 3 to connect the system.
2. The controller can now directly set and read the output level of the RF amplifier by setting the Signal Generator output level to the desired level.

System Automatic Level Control (cont'd)

Program Codes

HP-IB

Program Code	Function
C4 SHC2	External System Leveling Mode

Comments

Using external system leveling mode has the advantages of no calibration required, built-in temperature compensation, direct control of the leveled RF signal, and an extra range for high power applications. The dynamic range available is dependent only on the signal path gain and losses. Amplitude modulation up to 90% depth at rates as high as 80 kHz is typically available using system leveling mode.

The external ALC circuitry is used to adjust the Signal Generator's output level until the detected voltage at the external ALC input is correct. If high harmonics or spurious signals are present in the signal that is being detected, they will affect level flatness. This is especially important when using external amplifiers and mixers within the signal path. The actual magnitude of the error introduced is dependent on the method used to generate the system feedback signal.

Application Example

Example 1. An RF signal is required to deliver a +20 to +13 dBm signal in the range of 2 to 20 GHz. A system compatible amplifier is available that has a frequency range of 2 to 20 GHz and a maximum output level of +25 dBm.

The amplifier is connected to the Signal Generator and the system feedback signal from the amplifier is connected to the external ALC input connector on the Signal Generator front panel. Pressing the shift key and then the SYSTEM key (shifted DIODE) sets the Signal Generator to system leveling mode. The required output levels can be set directly using the RANGE and VERNIER controls

Example 2. An amplifier and a frequency multiplier are to be connected together to form a frequency multiplier system. The multiplier is system compatible and requires +17 dBm at the input. The RF amplifier is capable of +20 dBm over the 2 to 20 GHz frequency range.

The system is connected by connecting the amplifier to the Signal Generator and the multiplier to the amplifier. The system feedback signal is connected to the external ALC input connector on the Signal Generator front panel. System leveling is set by pressing the shift key and then the SYSTEM key (shifted DIODE). The multiplied frequency can now be set using the RANGE and VERNIER controls.

Error Messages

The following message may be displayed when programming the RF output level.

24 The programmed RF output (VERNIER, RANGE or both) is outside the Signal Generator's range.

Vernier (Output Level)

Description The RF output level of the Signal Generator is set using the RANGE and VERNIER controls. The RANGE controls change the RF output level in 10 dB steps and the VERNIER changes the RF output level continuously over a 13 dB range. The sum of the output level RANGE and VERNIER is the actual RF output level.

In local mode, the output level meter displays the VERNIER setting. In remote mode, the output level meter displays the remote setting. When going from local to remote mode, the RF output level should not change by more than 0.1 dB. When changing from remote to local mode, the RF output level will return to the front panel setting of the VERNIER which may change the RF output level by as much as 13 dB. The RANGE setting will not change for either transition.

When setting RF output levels above the specified maximum power, an UNLEVELED condition may occur due to insufficient available power. When this occurs, the output level meter will indicate the maximum available power. Increasing the VERNIER setting will not change the displayed level on the output level meter.

Local Procedure

To set the RF output level using internal ALC:

1. Press the RANGE up or down key until the desired RANGE appears in the RANGE dB display. Holding the key down will continue stepping the RANGE until the key is released. The RANGE setting represents the maximum level available using that range. The VERNIER control will allow setting output levels from -10 dB below to $+3$ dB above the RANGE.

There is a slight overlap of output level settings due to the 13 dB range of the VERNIER control. For best results, the VERNIER setting should be within the range of -10 to 0 dBm. VERNIER settings from 0 to $+3$ dBm are available for observing a continuous range up to $+3$ dB above the RANGE setting without changing the RANGE setting.

2. Adjust the VERNIER control until the sum of the RANGE and the level meter reading equal the desired RF output level. The VERNIER can be used to vary the output level continuously about the set level or the RANGE up or down key can be used to step the output level in 10 dB steps.

If the UNLEVELED annunciator lights for high output level settings, the level meter will indicate maximum available output power. This should only occur when output levels above the specified maximum leveled power are set. For example, if the RF output level is set to $+13$ dBm and the level meter reads -4 dBm with the UNLEVELED annunciator lighted, only $+19$ dBm of output power is available at that frequency.

Remote Procedure

The Signal Generator accepts any RF output level between -101.9 and $+13$ dBm. RF output levels above the specified maximum leveled power may not be available at all frequencies. Programming the RF output level can be done in one of two ways.

The RF output level can be programmed directly using the program code LE, AP, or PL. The units terminator for the output level is dBm which corresponds to the program code DM. The Signal Generator will also accept the program code DB as the terminator. When programming the RF output level, the VERNIER is set between 0 and -9.9 dBm and the RANGE is set accordingly.

Vernier (Output Level) (cont'd)

Remote Procedure (cont'd)

The RF output level can also be programmed by programming the VERNIER and the RANGE separately. The program code to set the RANGE is RA and the program code to set the VERNIER is VE. The units terminator for both codes can be either DB or DM.

The output active program code suffix can be used to read the current values of the RANGE, VERNIER or the RF output level directly. To read the RANGE setting, send the program codes RAOA and then read the RANGE setting. The Signal Generator will send the RANGE in fundamental (dBm) units. If the RANGE is read as a string, the format will be the program code RA followed by the RANGE in dBm and then the units terminator DM (dBm).

In local mode, the Signal Generator keeps track of the VERNIER setting to within 0.1 dB. When switching to remote mode, the local RF level setting is preserved. This feature also allows the controller to read the local VERNIER setting by briefly switching to remote to read the VERNIER setting and then returning the Signal Generator to local mode. The VERNIER setting is read by sending the program codes VEOA and then reading the setting. The Signal Generator will send the VERNIER setting in fundamental (dBm) units. If the VERNIER setting is read as a string, the format will be the program code VE followed by the VERNIER setting in dBm and then the units terminator DM (dBm).

The RF output level is read directly by sending the program codes LEOA and then reading the RF output level. The Signal Generator will send the RF output level in fundamental (dBm) units. If the RF output level is read as a string, the format will be the program code LE followed by the RF output level in dBm and then the units terminator DM (dBm). The program codes AP or PL can also be used in place of LE but the Signal Generator will always send the program code LE when the RF output level is read as a string.

Example

To set the RF output level to -56 dBm:

Local

1. Press the ALC INT key to place the Signal Generator into internal ALC mode. The process for setting the RF output level for external ALC modes is covered under the appropriate section of the Detailed Operating Instructions.
2. Set the RANGE to the lowest range that is less than 10 dB above the power or -50 dBm in this case.
3. Adjust the VERNIER until the level meter indicates -6 dBm. For the -50 dBm RANGE, the VERNIER can adjust the output level from -60 to -47 dBm.

Remote

The programming string for the setting the RF output level is composed of a program code, numeric data and the units terminator. The RF output level may be programmed directly or the RANGE and VERNIER may be programmed separately. To program the Signal Generator to a level of -56 dBm, the possible program strings are:

"LE-56DM" or "RA-50DBVE-6DM"

In addition, the program code could be AP or PL instead of LE. The alpha characters can be sent as upper or lower case (or even mixed upper and lower case). The Signal Generator RF output level is valid once the SOURCE SETTLED bit of the status byte is set (see Comments). The units terminator could be DB or DM. The Signal Generator accepts either terminator for all power related settings.

Vernier (Output Level) (cont'd)

Program Codes
HP-IB

Program Code	Description	Units
VE	Vernier Setting	
*LE	RF Output Level	DB
AP	RF Output Level	*DM
PL	RF Output Level	

*Preferred Program Code

Comments

The VERNIER controls the automatic level control (ALC) circuit directly. The ALC is capable of controlling the RF output level over a -10 to +13 dBm range. Additional dynamic range is provided by a 90 dB step attenuator that is controlled by the RANGE setting.

In remote mode, a Digital to Analog Converter (DAC) is substituted for the front panel VERNIER control. The resolution of the front panel VERNIER is as fine as can be measured while the resolution of the remote mode DAC is 0.1 dB.

Optimum AM performance is achieved for VERNIER settings of 0 dBm and below. Highest harmonic levels occur at high VERNIER settings while subharmonics and spurious signals are highest at low VERNIER settings. Changing ranges below 0 dB will result in approximately the same performance as the 0 dB range at the lower RF output level.

Programming Example

The following program is written in BASIC for HP 9000 Series 200 or 300 controllers. The program will set the output level between -100 and +13 dBm. If a level above 0 dBm is set and the Signal Generator is not leveled, an error will be reported.

```

10 SUB Rf_Level(Err,Expected)                ! Expected is in dBm
20 !
30 IF Expected<-100 OR Expected>=13 THEN
40 Err=-1
50 DISP "ERROR: Requested output level is out of range"
60 SUBEXIT
70 END IF
80 !
90 OUTPUT 719 USING "2A";"MG"                ! Clear old messages
100 ENTER 719 USING "2A";Message$
110 !
120 OUTPUT 719 USING "4A,4D.D,2A";"CSLE,"Expected,"DM" ! Set the level
130 !
140 OUTPUT 719 USING "4A";"LE0A"
150 ENTER 719 USING "K";Level
160 !
170 IF ABS(Level-Expected)>.1 THEN           ! More than .1 dB in error
180 Err=-1
190 DISP "WARNING: Programmed level is more than .1 dB in error"
200 END IF
210 !
220 V=SPOLL(719)                             ! Get the status byte
230 IF NOT BIT(V,3) THEN GOTO 220           ! Wait for source to settle
240 !

```

Vernier (Output Level) (cont'd)**Programming
Example
(cont'd)**

```

250 IF Expected>0 THEN
260 OUTPUT 719 USING "2A";"0S"
270 ENTER 719 USING "%,B,B";V,Extended
280 IF BIT(Extended,6) THEN
290 Err=-1
300 DISP "WARNING: The Signal Generator RF output is not leveled"
310 END IF
320 END IF
330 !
340 SUBEND

```

! Check for unlevelled
! Get extended status byte

**Error
Messages**

The following message may be displayed when setting the RF output level. Each message is displayed as it pertains to setting the RF output level. For a more complete description of the messages, see the MESSAGES detailed operating instructions.

24 The programmed RF output level is not within the range of the Signal Generator.

SECTION 4 PERFORMANCE TESTS

4-1. INTRODUCTION

The procedures in this section test the instrument's electrical performance using the specifications of Table 1-1 as the performance standards. These tests are suitable for incoming inspection, troubleshooting, and preventive maintenance. All tests can be performed without accessing the interior of the instrument. A simpler operational test is included in Section 3 under Operator's Checks.

NOTE

To consider the performance tests valid, the following conditions must be met:

- a. The Signal Generator must have a 1-hour warmup for all specifications.*
- b. The line voltage must be 100, 120, 220, or 240 Vac +5%, -10%.*
- c. The ambient temperature must be +15 to +35°C for Harmonically Related Spurious signals, RF Output Level, Pulse Peak Level Accuracy, and Amplitude Modulation tests; 0 to 55°C for all other tests.*

4-2. ABBREVIATED PERFORMANCE TEST

In most cases, it is not necessary to perform all of the tests in this section. Paragraph 4-7 contains the abbreviated performance tests. These tests can be used for operation verification. Results of these tests may be recorded in Table 4-1, Abbreviated Performance Test Record.

These tests can also be used for incoming inspections and preventive maintenance. They are not intended to be a complete check of specifications, but will provide 90% confidence that the Signal Generator is meeting its major performance specifications. These tests can be performed with less time and equipment than the full Performance Tests.

4-3. CALIBRATION CYCLE

This instrument requires periodic verification of performance to ensure that it is operating within

specified tolerances. The performance tests described in this section should be performed at least once each year; under conditions of heavy usage or severe operating environments, the tests should be more frequent. Adjustments that may be required are described in Section 5, Adjustments. Annual and biannual cleaning procedures are detailed in Section 8, Service.

4-4. PERFORMANCE TEST RECORD

Results of the performance tests may be tabulated in Table 4-4, Performance Test Record. The Performance Test Record lists all of the performance test specifications and the acceptable limits for each specification. If performance test results are recorded during an incoming inspection of the instrument, they can be used for comparison during periodic maintenance or troubleshooting. The test results may also prove useful in verifying proper adjustments after repairs are made.

4-5. EQUIPMENT REQUIRED

Equipment required for the performance tests is listed in Table 1-3, Recommended Test Equipment. Any equipment that satisfies the critical specifications given in the table may be substituted.

4-6. TEST PROCEDURES

It is assumed that the person performing the following tests understands how to operate the specified test equipment. Equipment settings, other than those for the Signal Generator, are stated in general terms. For example, a test might require that a spectrum analyzer's resolution bandwidth be set to 100 Hz; however, the sweep time would not be specified and the operator would be expected to set that control and other controls as required to obtain an optimum display. It is also assumed that the technician will select the cables, adapters, and probes required to complete the test setups illustrated in this section.

ABBREVIATED PERFORMANCE TESTS

4-7. ABBREVIATED PERFORMANCE TESTS**TURN-ON CHECKS****Procedure**

1. Set the LINE switch to ON.
2. Ensure that the message key indicator is not flashing. If the message key indicator is flashing, refer to the pull-out card for a list of message codes.
3. Press RCL 0. Verify that the instrument is now preset to the following conditions:

RF OUTPUT to ON
ALC to INTERNAL
OUTPUT LEVEL RANGE to -70 dB (0 dB for Option 001 or 005)
AUTO PEAK to ON
MTR scale to LVL
AM, FM, and PULSE Modulation to OFF
FREQUENCY to 3000.000 MHz
FREQ INCR to 1.000 MHz
START to 2000.000 MHz
STOP to 4000.000 MHz
 ΔF to 2000.000 MHz
SWEEP mode to OFF
STEP to 100 Steps (20.000 MHz)
DWELL to 20 ms
TUNE Knob to ON
All Status Annunciators off
MESSAGE key indicator off

ABBREVIATED PERFORMANCE TESTS

FREQUENCY RANGE AND RESOLUTION TEST

Description This test checks the tuning resolution and phase lock capabilities of the baseband (2.0 to 6.6 GHz) frequency generation circuitry using a frequency counter.

Equipment Frequency CounterHP 5343A

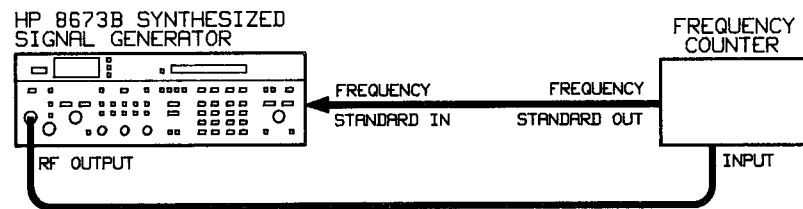

Figure 4-1. Frequency Range and Resolution Test Setup

Procedure

1. Connect the equipment as shown in Figure 4-1. Set the Signal Generator rear panel FREQ STANDARD INT/EXT switch to EXT. Remove the FREQ STANDARD jumper and connect A3J10 to the 10 MHz frequency standard output of the frequency counter. With the Signal Generator and the frequency counter sharing a common timebase, the frequency counter should agree with the Signal Generator FREQUENCY MHz display ± 1 count with any selected frequency counter resolution.
2. Select 1 kHz display resolution on the frequency counter.
3. Press RCL 0 on the Signal Generator. Tune the Signal Generator to 2000 MHz at an output level of 0 dBm.
4. Verify that the frequency counter reads 2000.000 MHz ± 1 count (due to the accuracy of the frequency counter).

1999.999 MHz _____ 2000.001 MHz

5. Tune the Signal Generator to each of the frequencies listed in the following table. Verify that the ϕ UNLOCKED annunciator remains off at each frequency and that the frequency counter agrees with the Signal Generator FREQUENCY MHz display ± 1 count. Record the readings.

NOTE

Fast tuning of the frequency may cause the ϕ UNLOCKED annunciator to flash on momentarily. This is normal and does not indicate a malfunction.

ABBREVIATED PERFORMANCE TESTS

FREQUENCY RANGE AND RESOLUTION TEST (cont'd)

**Procedure
(cont'd)**

Frequency (MHz)	Minimum Frequency (MHz)	Actual Frequency (MHz)	Maximum Frequency (MHz)
2 090.000	2 089.999	_____	2 090.001
2 280.001	2 280.000	_____	2 280.002
2 471.112	2 471.111	_____	2 471.113
2 662.223	2 662.222	_____	2 662.224
2 853.334	2 853.333	_____	2 853.335
3 044.445	3 044.444	_____	3 044.446
3 235.556	3 235.555	_____	3 235.557
3 426.667	3 426.666	_____	3 426.668
3 617.778	3 617.777	_____	3 617.779
3 808.889	3 808.888	_____	3 808.890
3 999.999	3 999.998	_____	4 000.000
4 180.000	4 179.999	_____	4 180.001
4 370.000	4 369.999	_____	4 370.001
4 560.000	4 559.999	_____	4 560.001
4 750.000	4 749.999	_____	4 750.001
4 940.000	4 939.999	_____	4 940.001
5 130.000	5 129.999	_____	5 130.001
5 320.000	5 319.999	_____	5 320.001
5 510.000	5 509.999	_____	5 510.001
5 700.000	5 699.999	_____	5 700.001
5 900.000	5 899.999	_____	5 900.001
6 100.000	6 099.999	_____	6 100.001
6 600.000	5 999.999	_____	6 600.001

ABBREVIATED PERFORMANCE TESTS

OUTPUT LEVEL AND FLATNESS TESTS

Description This test checks output level (maximum leveled power) and output level flatness. The output level test uses a power meter to verify that the specified maximum leveled output power can be generated over the full frequency range. Level flatness measures the variation in output power level as the frequency is changed.

Equipment Power Meter HP 436A
 Power Sensor HP 8485A

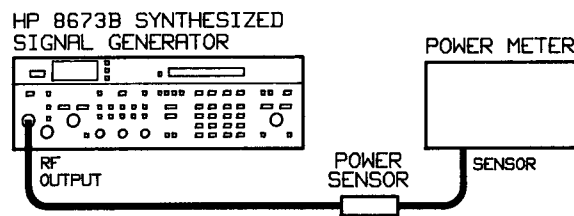

Figure 4-2. Output Level and Flatness Test Setup

Procedure

Output Level Test

1. Connect the equipment as shown in Figure 4-2.
2. Zero and calibrate the power meter.
3. Tune the Signal Generator frequency to 2000.00 MHz.
4. Set the OUTPUT LEVEL RANGE to +10 dB.
5. For a standard Signal Generator, adjust the VERNIER for a power meter reading of +8 dBm or, for a Signal Generator with an option, for one of the following power levels:

Option 001	+10 dBm
Option 004	+7 dBm
Option 005	+9 dBm
Option 008	+8 dBm
6. Activate the AUTO PEAK key. (The AUTO PEAK key indicator should be lighted.)
7. Tune the Signal Generator in 100 MHz steps from 2.0 GHz to 18.0 GHz while observing the power meter reading. Record the frequency at which minimum power occurs.

Frequency _____
8. Tune the Signal Generator to the recorded frequency. Re-adjust the VERNIER for the same power meter reading used in Step 5.

ABBREVIATED PERFORMANCE TESTS

OUTPUT LEVEL AND FLATNESS TESTS (cont'd)**Procedure
(cont'd)**

9. Re-tune the Signal Generator from 2.0 GHz to 18.0 GHz in 100 MHz steps while observing the power meter readings. Ensure that the specified maximum leveled output power level is met.
 10. For a standard Signal Generator, adjust the VERNIER for a power meter reading of +4 dBm or, for a Signal Generator with an option, for one of the following power levels:

Option 001	+6 dBm
Option 004	+2 dBm
Option 005	+4 dBm
Option 008	+7 dBm
 11. Verify that the AUTO PEAK key indicator is lighted.
 12. Tune the Signal Generator in 100 MHz steps from 18.0 GHz to 22.0 GHz while observing the power meter reading. Record the frequency at which minimum power occurs.

Frequency _____
 13. Tune the Signal Generator to the recorded frequency. Re-adjust the VERNIER for the same power meter reading used in step 10.
 14. Re-tune the Signal Generator from 18.0 GHz to 22.0 GHz in 100 MHz steps while observing the power meter readings. Ensure that the specified maximum leveled output power level is met.
 15. For a standard Signal Generator, adjust the VERNIER for a power meter reading of 0 dBm or, for a Signal Generator with an option, for one of the following power levels:

Option 001	+3 dBm
Option 004	-2 dBm
Option 005	+1 dBm
Option 008	+7 dBm
 16. Verify that the AUTO PEAK key indicator is lighted.
 17. Tune the Signal Generator in 100 MHz steps from 22.0 GHz to 26.0 GHz while observing the power meter reading. Record the frequency at which minimum power occurs.

Frequency _____
 18. Tune the Signal Generator to the recorded frequency. Re-adjust the VERNIER for the same power meter reading used in step 15.
 19. Re-tune the Signal Generator from 22.0 GHz to 26.0 GHz in 100 MHz steps while observing the power meter readings. Ensure that the specified maximum leveled output power level is met.
-

ABBREVIATED PERFORMANCE TESTS

OUTPUT LEVEL AND FLATNESS TESTS (cont'd)

**Procedure
(cont'd)**

Level Flatness Test

NOTE

The flatness specification for power output is not referenced to a particular frequency. The specification represents the total power variation over the entire frequency range.

20. Tune the Signal Generator to 2.0 GHz. Set the OUTPUT LEVEL RANGE to 0 dB. Set the VERNIER for a power meter reading of -5 dBm.
21. Set the power meter mode to dB Relative.
22. Tune the Signal Generator from 2.0 GHz to 6.6 GHz in 100 MHz steps while observing the power meter readings. Record the minimum and maximum output power levels in the following table. Maximum power variation must be within 1.5 dB (highest point to lowest point).
23. Continue tuning the Signal Generator to 12.3 GHz in 100 MHz steps while observing the power meter readings. Maximum power variation must be within 2.0 dB. Record the minimum and maximum output power levels in the following table.
24. Continue tuning the Signal Generator to 18.6 GHz in 100 MHz steps while observing the power meter readings. Maximum power variation must be within 2.5 dB. Record the minimum and maximum output power levels in the following table.
25. Continue tuning the Signal Generator to 26.0 GHz in 100 MHz steps while observing the power meter readings. Maximum power variation must be within 3.5 dB. Record the minimum and maximum output power levels in the following table.

Frequency Range	Power Variation
2.0 — 6.6 GHz	Maximum _____ Minimum _____ Total Variation _____ 1.50 dB
2.0 — 12.3 GHz	Maximum _____ Minimum _____ Total Variation _____ 2.00 dB
2.0 — 18.6 GHz	Maximum _____ Minimum _____ Total Variation _____ 2.5 dB
2.0 — 26.0 GHz	Maximum _____ Minimum _____ Total Variation _____ 3.5 dB

ABBREVIATED PERFORMANCE TESTS

LEVEL ACCURACY TESTS

Description This test checks level accuracy of the RF output signal. The first test uses a power meter to verify that power levels between 0 dBm and -20 dBm are within specification. Power levels of -30 dBm and below are checked using a spectrum analyzer. The output level of the Signal Generator is adjusted to -20 dBm using the power meter. The Signal Generator output is then mixed with a local oscillator to produce an IF frequency. The IF frequency is displayed on the spectrum analyzer. A reference level corresponding to the -20 dBm output is set on the spectrum analyzer and each 10 dB decrease in range is checked for a 10 dB decrease on the spectrum analyzer display.

Equipment	Power Meter	HP 436A
	Power Sensor	HP 8485A
	Local Oscillator	HP 8340A
	Mixer	RHG DMS1-26
	Spectrum Analyzer	HP 8566B
	40 dB Amplifier	HP 8447F
	20 dB Attenuator	HP 8493C Option 020

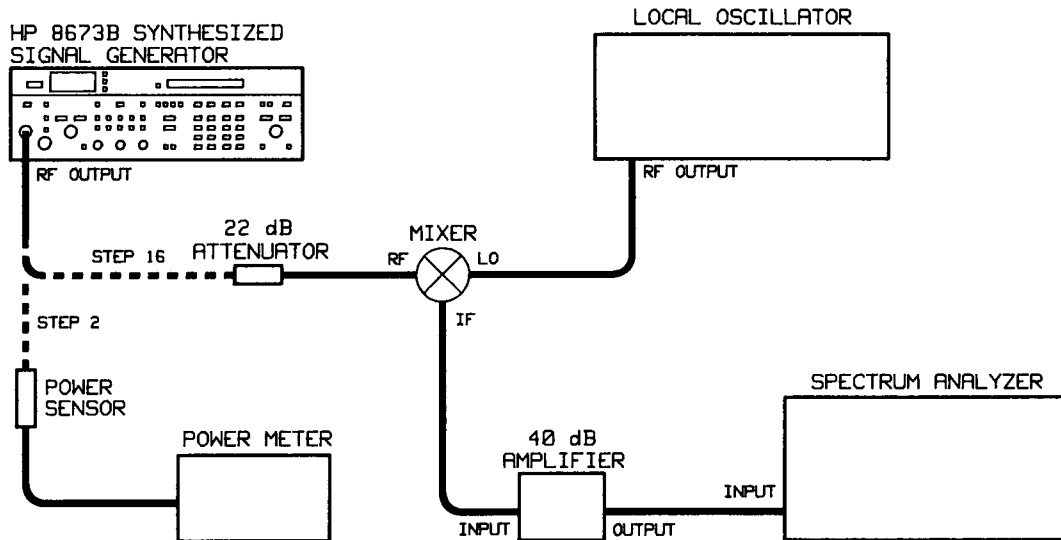

Figure 4-3. Level Accuracy Test Setup

Procedure High Level Accuracy Test

1. Zero and calibrate the power meter. Set the power meter to dBm mode.
2. Connect the Signal Generator to the power meter as shown in Figure 4-3.
3. Tune the Signal Generator to 2.0 GHz.
4. Set the OUTPUT LEVEL RANGE to 0 dB. Adjust the VERNIER for a front panel meter reading of 0 dBm.
5. Peak the Signal Generator output with the AUTO PEAK key.

ABBREVIATED PERFORMANCE TESTS

LEVEL ACCURACY TESTS (cont'd)**Procedure
(cont'd)****High Level Accuracy Test (cont'd)**

6. Observe the power meter reading. The reading should be within the limits specified. Record the reading.

(2.0 GHz, 0 dBm) -1.75 dBm _____ $+1.75$ dBm

7. Adjust the Signal Generator's VERNIER for a front panel meter reading of -10 dBm (leave RANGE set to 0 dB).

8. Observe the power meter reading. The reading should be within the limits specified. Record the reading.

(2.0 GHz, -10 dBm) -11.75 dBm _____ -8.25 dBm

9. Tune the Signal Generator to 18.6 GHz.

10. Adjust the VERNIER for a front panel meter reading of 0 dBm.

11. Observe the power meter reading. The reading should be within the specified limits. Record the reading.

(18.6 GHz, 0 dBm) -2.25 dBm _____ $+2.25$ dBm

12. Adjust the Signal Generator's RANGE to -10 dB.

13. Observe the power meter reading. The reading should be within the limits specified. Record the reading.

(18.6 GHz, -10 dBm) -12.85 dBm _____ -7.15 dBm

14. Adjust the RANGE to -20 dB.

15. Observe the power meter reading. The reading should be within the limits specified. Record the reading.

(18.6 GHz, -20 dBm) -23.05 dBm _____ -16.95 dBm

Low Level Accuracy Test

16. Disconnect the power meter and connect the Signal Generator to the attenuator and mixer as shown in Figure 4-3.

NOTE

Connect the mixer directly to the local oscillator to avoid any power loss.

17. Tune the local oscillator to 18.7 GHz. Set the output power to $+7$ dBm.

18. Set the resolution bandwidth on the spectrum analyzer to 300 Hz or less. Adjust the vertical sensitivity to place the peak of the 100 kHz IF signal on the center horizontal graticule line. This calibrates the center graticule line for an absolute reference power level of -20 dBm.
-

ABBREVIATED PERFORMANCE TESTS

LEVEL ACCURACY TESTS (cont'd)

Procedure (cont'd)

Low Level Accuracy Test (cont'd)

19. Set the RANGE of the Signal Generator 10 dB lower and adjust the VERNIER for a front panel meter reading of 0 dBm.
20. Set the spectrum analyzer reference level 10 dB lower to bring the signal level near the reference graticule line.
21. Read the difference between the new signal level and the center reference graticule line. Calculate the actual power as follows:

NOTE

The difference is positive if the signal is above the reference graticule; negative if below.

$$\begin{aligned}
 & \text{_____ Output level set in step 18.} \\
 + & \text{_____ Difference measured in step 21.} \\
 & \text{_____ Actual level.}
 \end{aligned}$$

Record the actual level calculated in the following table. The level reading should be within the limits specified.

22. Repeat steps 19 through 21 with Signal Generator RANGE settings of -40 dB and -50 dB in step 19. Record the output level readings in the following table.
23. Note the Signal Generator's signal level (at -50 dBm) on the spectrum analyzer display. Remove the 20 dB attenuator, set the spectrum analyzer's IF sensitivity 20 dB higher, and reset the vertical sensitivity to the level noted before removing the 20 dB attenuator.
24. Repeat steps 19 through 21 with Signal Generator RANGE settings of -60 dB through -90 dB. Record the output level readings in the following table.

Test	Results		
	Min	Actual	Max
18.6 GHz			
-30 dBm	-33.45 dBm	_____	-26.55 dBm
-40 dBm	-43.65 dBm	_____	-36.35 dBm
-50 dBm	-53.85 dBm	_____	-46.15 dBm
-60 dBm	-64.05 dBm	_____	-55.95 dBm
-70 dBm	-74.25 dBm	_____	-65.75 dBm
-80 dBm	-84.45 dBm	_____	-75.55 dBm
-90 dBm	-94.65 dBm	_____	-85.35 dBm

ABBREVIATED PERFORMANCE TESTS

PULSE MODULATION TEST

Description On-off ratio is measured at 6.7 GHz with a spectrum analyzer. A local oscillator and mixer is used with an oscilloscope to measure peak level accuracy at 6.7 GHz, and to measure rise time, overshoot and ringing at 6.7, 12, 18 and 19.0 GHz. The IF frequency used is 50 MHz.

Equipment	Spectrum Analyzer	HP 8566B
	Pulse Generator	HP 8116A
	Oscilloscope	HP 1980B
	Local Oscillator	HP 8340A
	Preamplifier, 20 dB	HP 8447D
	Power Amplifier, 20 dB	HP 8447E
	Mixer	RHG DMS1-26
	Attenuator, 10 dB (2)	HP 8491A Option 010
	Attenuator, 10 dB	HP 8493C Option 010

- Procedure** **On/Off Ratio at 6.7 GHz**
1. Connect equipment as shown in Figure 4-4.
 2. Press RCL 0 on the Signal Generator.
 3. Set the Signal Generator frequency to 6.7 GHz, RANGE and VERNIER to 0 dBm, PULSE to OFF.
 4. Adjust the spectrum analyzer to display the 6.7 GHz CW signal so that the peak of the signal is at the top of the display. The resolution bandwidth should be set for 300 Hz or less, and the span to 20 kHz or less, to reduce broadband noise.

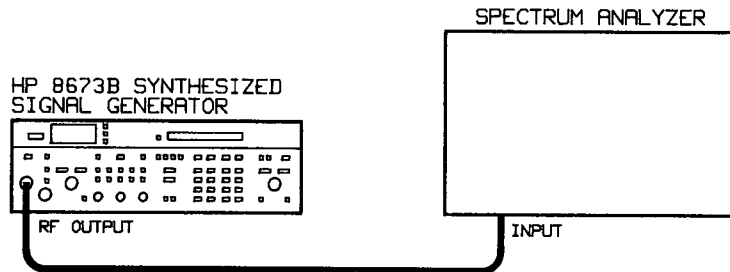

Figure 4-4. On/Off Ratio Test Setup

ABBREVIATED PERFORMANCE TESTS

PULSE MODULATION TEST (cont'd)

Procedure (cont'd)

5. Press the PULSE NORM switch. The signal level should be at least 80 dB below the reference established in PULSE OFF mode.

On/Off Ratio -6.7 GHz _____ >80 dBc

Rise Time, Overshoot and Ringing at 6.7, 12, 18, and 19 GHz

6. Connect equipment as shown in Figure 4-5.
7. Set Channels 1 and 2 of the oscilloscope to 50 ohm input impedance.
8. Set the pulse generator to 1 MHz PRF, 200 ns width, and 2V peak output level.
9. Set the local oscillator to 6.75 GHz and output level to +7 dBm.
10. Set the Signal Generator to 6.7 GHz. Set RANGE to 0 dBm and the VERNIER to -10 dBm. This will result in a 50 MHz IF pulse modulated signal displayed on the oscilloscope.

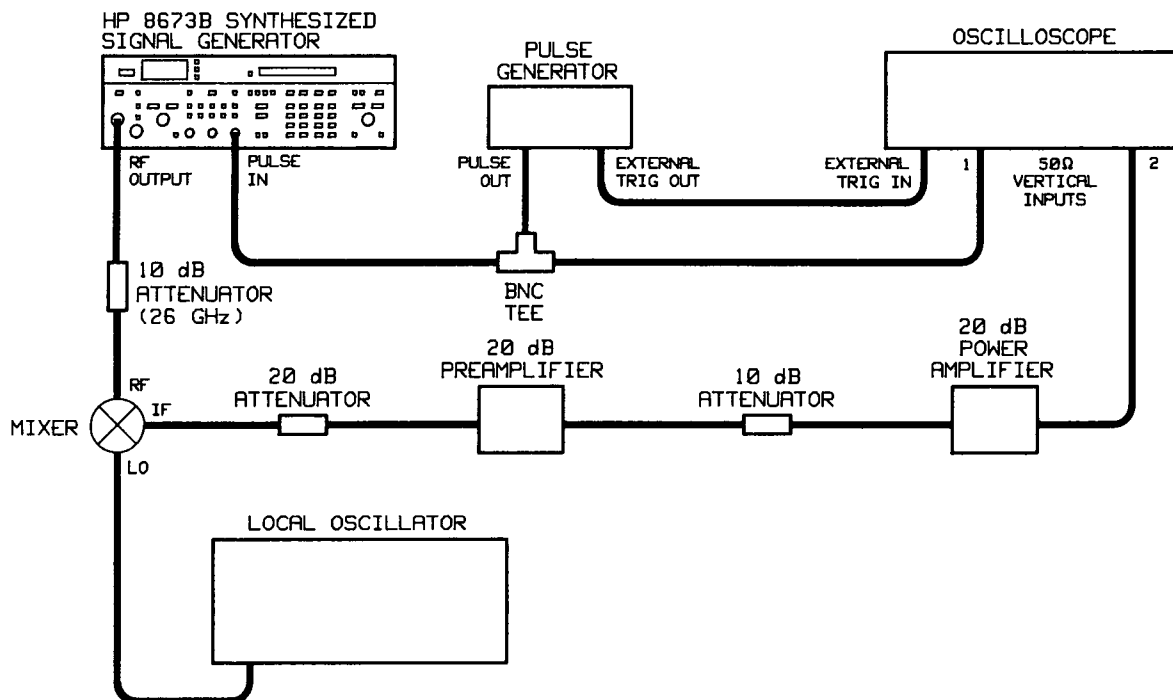

Figure 4-5. Rise Time, Overshoot and Ringing Test Setup

ABBREVIATED PERFORMANCE TESTS

PULSE MODULATION TEST (cont'd)

Procedure (cont'd)

11. Center the 50 MHz waveform on the oscilloscope display. Adjust the oscilloscope vertical position and sensitivity controls so that the pulse base line is one division from the bottom graticule line, and the waveform is 5 divisions in peak amplitude. See Figure 4-6.
12. Measure the pulse rise time, overshoot and ringing. Record the results in the following table.

Signal Generator Frequency	Local Oscillator Frequency	Rise Time	Overshoot and Ringing	Peak Level Accuracy
6.7 GHz	6.75 GHz	___ 35 ns ___ 40 ns (Opt. 008)	___ 30%	-10.8 _____ +18.8%
12 GHz	12.05 GHz	___ 35 ns ___ 40 ns (Opt. 008)	___ 25%	
18 GHz	18.05 GHz	___ 35 ns ___ 40 ns (Opt. 008)	___ 25%	
19 GHz	19.05 GHz	___ 35 ns ___ 40 ns (Opt. 008)	___ 25%	

13. Repeat measurements for rise time and overshoot at 12, 18, and 19 GHz, keeping the local oscillator frequency 50 MHz above the Signal Generator frequency.

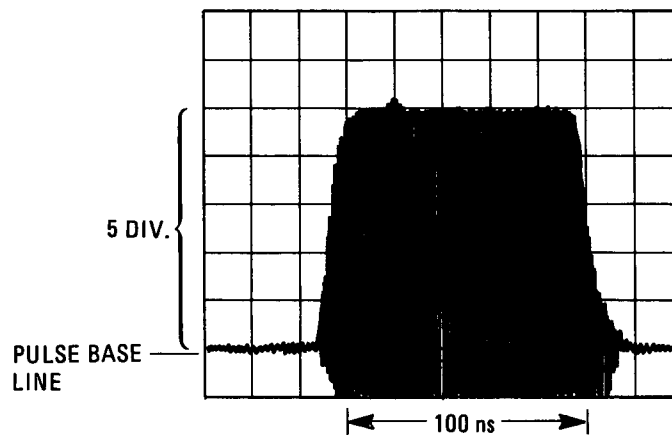

Figure 4-6. Risetime, Overshoot and Ringing Measurement

ABBREVIATED PERFORMANCE TESTS

PULSE MODULATION TEST (cont'd)

Procedure (cont'd)

Peak Level Accuracy at 6.7 GHz

14. Tune the Signal Generator to 6.7 GHz and the local oscillator to 6.75 GHz.
15. Adjust the pulse width on the pulse generator for a 100 ns RF pulse as displayed on the oscilloscope.
16. Switch the Signal Generator to PULSE OFF mode.
17. Adjust the oscilloscope vertical sensitivity for a display 5 divisions above the pulse base line. The peak of the CW signal is now the CW peak reference level.

NOTE

Do not adjust the vertical position controls after the CW peak reference level and pulse base line have been set.

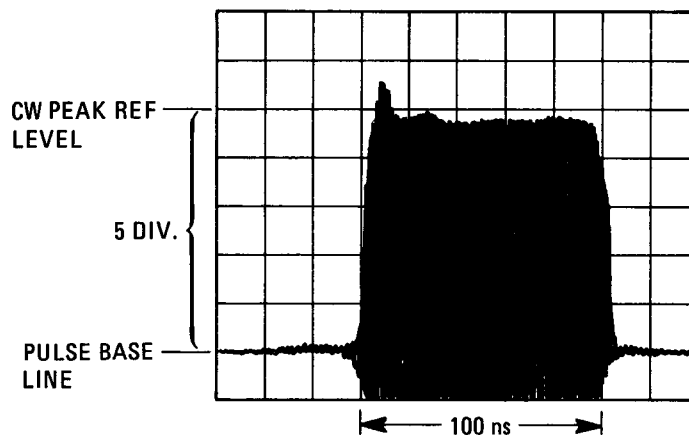

Figure 4-7. Pulse Peak Level Accuracy Measurement

18. Switch back to PULSE NORM. The display should be as shown in Figure 4-7. Measure the difference between the CW peak reference level and the average peak pulse level excluding any over/undershoot. Record the peak level accuracy below.

NOTE

The error can be read in percent. Using 5 divisions for the CW peak reference, each division represents 20% error. Measured error must be within the limits of -10.8% (-0.5 division) and +18.8% (+0.9 division) on the oscilloscope display. This is equal to +1.5/-1.0 dB peak level accuracy.

Peak Level Accuracy -6.7 GHz -10.8% _____ +18.8%

ABBREVIATED PERFORMANCE TESTS

AM ACCURACY TESTS

Description The Signal Generator is amplitude modulated by an audio source. The modulated signal is mixed with a local oscillator to produce a modulated 100 MHz IF signal. The AM depth, meter accuracy, and accuracy relative to the external AM input are measured using a measuring receiver.

Equipment

Local Oscillator	HP 8340A
Measuring Receiver	HP 8902A
Audio Analyzer/Source	HP 8903B
Digital Voltmeter	HP 3456A
6 dB Attenuator	HP 8493C Option 006
Mixer	RHG DMS1-26

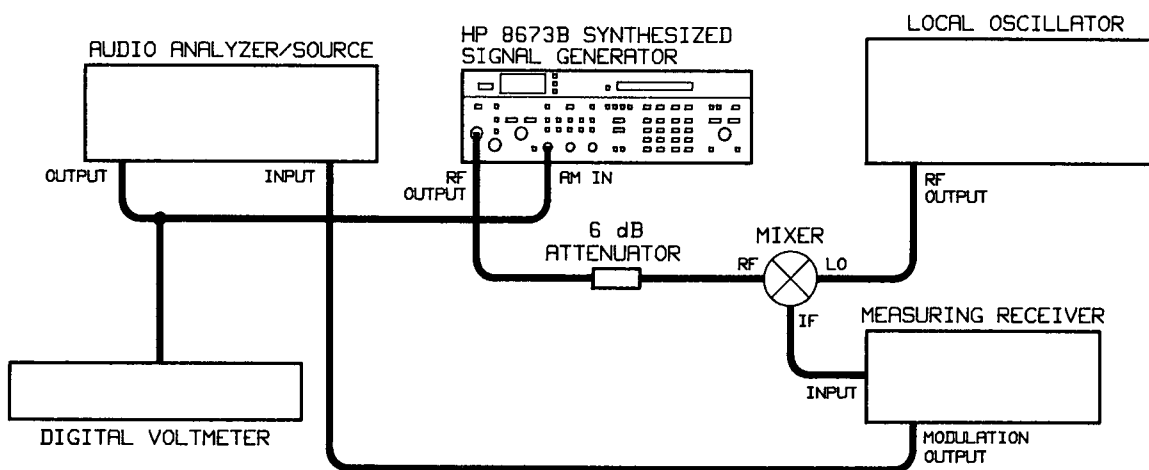

Figure 4-8. AM Accuracy Test Setup

Procedure

Meter Accuracy

1. Connect equipment as shown in Figure 4-8.
2. Set the Signal Generator as follows:

FREQUENCY	2.0 GHz
OUTPUT LEVEL RANGE	0 dB
OUTPUT LEVEL VERNIER	0 dBm
ALC	INT
AM	100% range
FM	Off
PULSE	Off
3. Tune the local oscillator to 2.05 GHz with an output amplitude of +7 dBm and all modulation off.
4. Select AM mode on the measuring receiver. Set the measurement frequency of the measuring receiver to 50 MHz.

ABBREVIATED PERFORMANCE TESTS

AM ACCURACY TESTS (cont'd)

Procedure (cont'd)

5. Set the modulation source to 1 kHz. Adjust the output level to obtain 50% AM as read on the measuring receiver.
6. The AM meter on the Signal Generator should indicate 50% AM $\pm 6.5\%$. Record the reading.

43.5% _____ 56.5%

Accuracy Relative to External AM Input

7. Set the audio source frequency to 10 kHz with an output amplitude of 0.530 Vrms as read on the digital voltmeter. This corresponds to 75% AM depth.
8. Read the actual AM depth on the measuring receiver. The reading should be within $\pm 5.0\%$ of 75% AM. Record the reading in the table below.
9. Repeat steps 7 and 8 with the frequencies and modulation rates listed in the table below.

Signal Generator Frequency	Local Oscillator Frequency	Modulation Rate	Low Limit	Actual Depth	High Limit
6.6 GHz	6.5 GHz	10 kHz	70.0%	_____	80.0%
6.6 GHz	6.5 GHz	1 kHz	70.0%	_____	80.0%
6.6 GHz	6.5 GHz	.1 kHz	70.0%	_____	80.0%
10 GHz	9.9 GHz	10 kHz	70.0%	_____	80.0%
14 GHz	13.9 GHz	10 kHz	70.0%	_____	80.0%
18.6 GHz	18.5 GHz	10 kHz	70.0%	_____	80.0%
22 GHz	21.9 GHz	10 kHz	70.0%	_____	80.0%

ABBREVIATED PERFORMANCE TESTS

EXTERNAL FM ACCURACY AND METER ACCURACY

Description The Signal Generator is frequency modulated by an external source. The output of the Signal Generator is then mixed with a local oscillator to produce a modulated 500 MHz IF signal. A measuring receiver measures the FM characteristics of the IF signal.

Equipment

Local Oscillator	HP 8340A
Measuring Receiver	HP 8902A
Test Oscillator	HP 8116A
Digital Voltmeter	HP 3456A
Frequency Counter	HP 5343A
Mixer	RHG DMS1-26

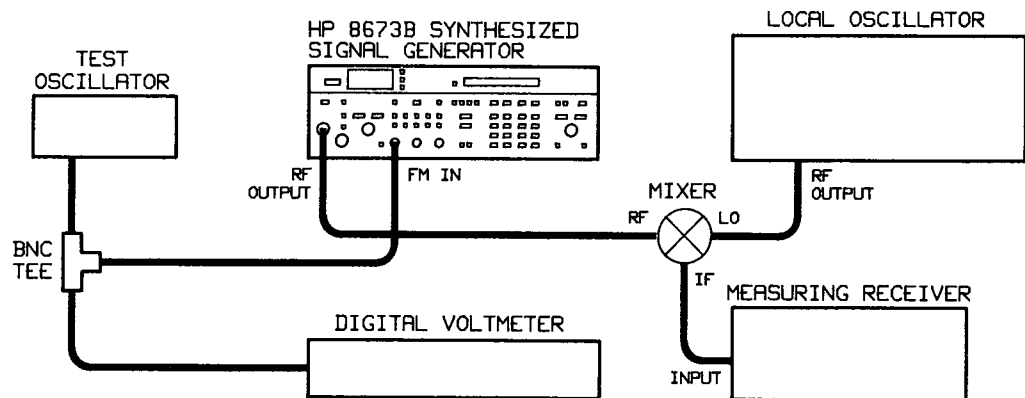

Figure 4-9. External FM Accuracy and Meter Accuracy Test Setup

Procedure Sensitivity and Meter Accuracy

1. Connect equipment as shown in Figure 4-9.

NOTE

Connect the mixer directly to the local oscillator to avoid any power loss.

2. Set the Signal Generator as follows:

FREQUENCY	2 GHz
OUTPUT LEVEL RANGE	0 dB
OUTPUT LEVEL VERNIER	-5 dBm
FM DEVIATION range	0.3 MHz
Meter Scale	FM
3. Tune the local oscillator to 2.5 GHz with an output amplitude of +8 dBm.
4. Set the measuring receiver to measure FM.
5. Set the test oscillator to a 100 kHz rate. Adjust the test oscillator output level to obtain a full scale reading on the Signal Generator's front panel meter.
6. The measuring receiver should read 300 kHz ± 45 kHz deviation. Record the reading.

255 kHz _____ 345 kHz

ABBREVIATED PERFORMANCE TESTS

EXTERNAL FM ACCURACY AND METER ACCURACY (cont'd)

Procedure (cont'd)

7. Adjust the test oscillator level to obtain 50 kHz deviation as read on the Signal Generator's front panel meter.
8. The measuring receiver should read 50 kHz \pm 15 kHz deviation. Record the reading.

35 kHz _____ 65 kHz

Accuracy Relative to External FM Input

9. Tune the test oscillator to 100 kHz with an output amplitude of 0.707 Vrms as read on the digital voltmeter.
10. Set the Signal Generator FM DEVIATION range to 0.03 MHz. The measuring receiver should indicate FM deviation within the limits listed in the table below. Record the reading in the table.
11. Repeat step 10 using the FM deviation ranges and test oscillator levels listed in the table below. Record the readings in the table.

FM Deviation Range	Test Oscillator Level	Low Limit	Actual Deviation	High Limit
0.03 MHz	0.707 Vrms	27 kHz	_____	33 kHz
0.1 MHz	0.707 Vrms	90 kHz	_____	110 kHz
0.3 MHz	0.707 Vrms	270 kHz	_____	330 kHz
1 MHz	0.212 Vrms	249 kHz	_____	351 kHz

12. Tune the Signal Generator to 6.7 GHz. Set the FM DEVIATION range to 0.3 MHz.
13. Tune the local oscillator to 7.2 GHz.
14. Set the test oscillator's output level to .707 Vrms as read on the digital voltmeter.
15. Read the FM deviation on the measuring receiver. Verify that the measured deviation is within the limits shown in the table below. Record the readings.
16. Repeat steps 12 through 15 using the Signal Generator frequencies listed in the table below. Record the readings.

Signal Generator Frequency	Local Oscillator Frequency	Low Limit	Actual Deviation	High Limit
6.7 GHz	7.2 GHz	270 kHz	_____	330 kHz
12.3 GHz	12.9 GHz	270 kHz	_____	330 kHz
18.6 GHz	19.1 GHz	270 kHz	_____	330 kHz

Table 4-1. Abbreviated Performance Test Record (1 of 3)

Test	Results		
	Min.	Actual	Max.
FREQUENCY RANGE AND RESOLUTION			
Baseband Test			
2 000.000 MHz	1 999.999	_____	2 000.001
2 090.000 MHz	2 089.999	_____	2 090.001
2 280.001 MHz	2 280.000	_____	2 280.002
2 471.112 MHz	2 471.111	_____	2 471.113
2 662.223 MHz	2 662.222	_____	2 662.224
2 853.334 MHz	2 853.333	_____	2 853.335
3 044.445 MHz	2 044.444	_____	3 044.446
3 235.556 MHz	3 235.555	_____	3 235.557
3 426.667 MHz	3 426.666	_____	3 426.668
3 617.778 MHz	3 617.777	_____	3 617.776
3 808.889 MHz	3 808.888	_____	3 808.890
3 999.999 MHz	3 999.998	_____	4 000.000
4 180.000 MHz	4 179.999	_____	4 180.001
4 370.000 MHz	4 369.999	_____	4 370.001
4 560.000 MHz	4 559.999	_____	4 560.001
4 750.000 MHz	4 749.999	_____	4 750.001
4 940.000 MHz	4 939.999	_____	4 940.001
5 130.000 MHz	5 129.999	_____	5 130.001
5 320.000 MHz	5 319.999	_____	5 320.001
5 510.000 MHz	5 509.999	_____	5 510.001
5 700.000 MHz	5 699.999	_____	5 700.001
5 900.000 MHz	5 899.999	_____	5 900.001
6 100.000 MHz	6 099.999	_____	6 100.001
6 600.000 MHz	5 999.999	_____	6 600.001
OUTPUT LEVEL AND FLATNESS			
Output Level			
Frequency and Power at Minimum Power Point			
2.0—18.0 GHz			
Frequency _____			
Minimum Power:	Standard	+8 dBm	_____ (✓)
	Option 001	+10 dBm	_____ (✓)
	Option 004	+7 dBm	_____ (✓)
	Option 005	+9 dBm	_____ (✓)
	Option 008	+8 dBm	_____ (✓)
18.0—22.0 GHz			
Frequency _____			
Minimum Power:	Standard	+4 dBm	_____ (✓)
	Option 001	+6 dBm	_____ (✓)
	Option 004	+2 dBm	_____ (✓)
	Option 005	+4 dBm	_____ (✓)
	Option 008	+7 dBm	_____ (✓)

Table 4-1. Abbreviated Performance Test Record (3 of 3)

Test	Results		
	Min.	Actual	Max.
PULSE MODULATION (cont'd) Rise Time, Overshoot and Ringing (cont'd) 18 GHz Rise Time Overshoot and Ringing 19 GHz Rise Time Overshoot and Ringing Peak Level Accuracy 6.7 GHz			35 ns 40 ns (Opt. 008) 25% 35 ns 40 ns (Opt. 008) 25% -10.8% +18.8%
AM ACCURACY Meter Accuracy 1 kHz rate, 50% AM Accuracy Relative to External AM Input Frequency Rate 6.6 GHz 10 kHz 6.6 GHz 1 kHz 6.6 GHz 0.1 kHz 10 GHz 10 kHz 14 GHz 10 kHz 18.6 GHz 10 kHz 22.0 GHz 10 kHz	43.5% 70% 70% 70% 70% 70% 70% 70%		56.5% 80% 80% 80% 80% 80% 80% 80%
EXTERNAL FM ACCURACY AND METER ACCURACY Meter Accuracy Full Scale 50 kHz Accuracy Relative to External FM Input 0.03 MHz Range 0.1 MHz Range 0.3 MHz Range 1.0 MHz Range 0.3 MHz Range Accuracy 6.7 GHz 12.3 GHz 18.6 GHz	255 kHz 35 kHz 27 kHz 90 kHz 270 kHz 249 kHz 270 kHz 270 kHz 270 kHz		345 kHz 65 kHz 33 kHz 110 kHz 330 kHz 351 kHz 330 kHz 330 kHz 330 kHz

PERFORMANCE TESTS

4-8. FREQUENCY RANGE AND RESOLUTION TEST

Specification

Electrical Characteristics	Performance Limits	Conditions
FREQUENCY Range	2.0 to 6.6 GHz (1.95—26.5 GHz Overrange)	
Resolution	1 kHz 2 kHz 3 kHz 4 kHz	2.0 to 6.6 GHz 6.6 to 12.3 GHz 12.3 to 18.6 GHz 18.6 to 26.0 GHz

Description

This test checks the tuning resolution in each of four internal frequency bands using a frequency counter. The performance test is divided into a baseband check (2.0 to 6.6 GHz) and a check for bands 2, 3, and 4 (6.6 to 12.3 GHz, 12.3 to 18.6 GHz and 18.6 to 26.0 GHz respectively).

Equipment

Frequency Counter HP 5343A

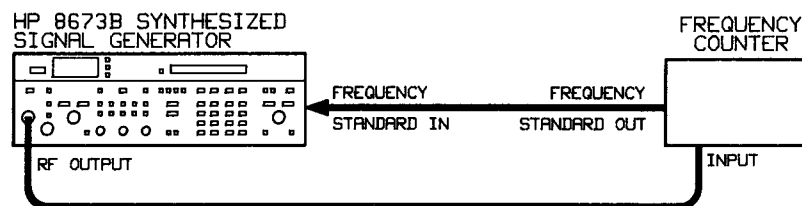

Figure 4-10. Frequency Range and Resolution Test Setup

Procedure

Baseband Test

1. Connect the equipment as shown in Figure 4-10. Set the Signal Generator rear panel **FREQ STANDARD INT/EXT** switch to **EXT**. Remove the **FREQ STANDARD** jumper and connect A3J10 to the 10 MHz frequency standard output of the frequency counter. With the Signal Generator and the frequency counter sharing a common timebase, the frequency counter should agree with the Signal Generator **FREQUENCY MHz** display ± 1 count with any selected frequency counter resolution.
2. Select 1 kHz display resolution on the frequency counter.
3. Press **RCL 0** on the Signal Generator. Set the Signal Generator to 2000.000 MHz at an output level of 0 dBm.
4. Verify that the frequency counter reads 2 000.000 MHz ± 1 count (due to the accuracy of the frequency counter).

1 999.999 MHz _____ 2 000.001 MHz

PERFORMANCE TESTS

FREQUENCY RANGE AND RESOLUTION TEST (cont'd)

Procedure (cont'd)

- Set the Signal Generator frequency increment to 1 kHz. Using the TUNE knob, tune the Signal Generator to each of the frequencies listed below. Verify that the ϕ UNLOCKED annunciator remains off at each frequency and that the frequency counter agrees with the Signal Generator FREQUENCY MHz display ± 1 count.

Frequency (MHz)	Minimum Frequency (MHz)	Actual Frequency (MHz)	Maximum Frequency (MHz)
2 000.001	2 000.000	_____	2 000.002
2 001.112	2 001.111	_____	2 001.113
2 002.223	2 002.222	_____	2 002.224
2 003.334	2 003.333	_____	2 003.335
2 004.445	2 004.444	_____	2 004.446
2 005.556	2 005.555	_____	2 005.557
2 006.667	2 006.666	_____	2 006.668
2 007.778	2 007.777	_____	2 007.779
2 008.889	2 008.888	_____	2 008.890
2 009.999	2 009.998	_____	2 010.000

- Set the Signal Generator frequency increment to 10.000 MHz. Using the TUNE knob, tune the Signal Generator to each of the frequencies listed below. Verify that the ϕ UNLOCKED annunciator remains off at each frequency and that the frequency counter agrees with the Signal Generator FREQUENCY MHz display ± 1 count.

Frequency (MHz)	Minimum Frequency (MHz)	Actual Frequency (MHz)	Maximum Frequency (MHz)
2 090.000	2 089.999	_____	2 090.001
2 280.000	2 279.999	_____	2 280.001
2 470.000	2 469.999	_____	2 470.001
2 660.000	2 659.999	_____	2 660.001
2 850.000	2 849.999	_____	2 850.001
3 040.000	3 039.999	_____	3 040.001
3 230.000	3 229.999	_____	3 230.001
3 420.000	3 419.999	_____	3 420.001
3 610.000	3 609.999	_____	3 610.001
3 800.000	3 799.999	_____	3 800.001
3 990.000	3 989.999	_____	3 990.001
4 180.000	4 179.999	_____	4 180.001
4 370.000	4 369.999	_____	4 370.001
4 560.000	4 559.999	_____	4 560.001
4 750.000	4 749.999	_____	4 750.001
4 940.000	4 939.999	_____	4 940.001
5 130.000	5 129.999	_____	5 130.001
5 320.000	5 319.999	_____	5 320.001
5 510.000	5 509.999	_____	5 510.001
5 700.000	5 699.999	_____	5 700.001
5 900.000	5 899.999	_____	5 900.001
6 100.000	6 099.999	_____	6 100.001
6 600.000	5 999.999	_____	6 600.001

PERFORMANCE TESTS

FREQUENCY RANGE AND RESOLUTION TEST (cont'd)**Procedure
(cont'd)****NOTE**

Fast tuning of frequency may cause the ϕ UNLOCKED annunciator to flash on momentarily. This is normal and does not indicate a malfunction.

Bands 2 and 3 Test

7. Tune the Signal Generator to 10 000.000 MHz and set the frequency increment (FREQ INCR) to 1 kHz.
8. Tune the frequency down one increment and verify that the Signal Generator frequency display changes to 9 999.998 MHz and the frequency counter reading agrees within ± 1 count.
9. Tune the frequency up two increments and verify that the Signal Generator frequency display changes to 10 000.002 MHz. Verify also that the frequency counter reading agrees within ± 1 count.

10 GHz frequency resolution, 2 kHz _____(✓)

10. Tune the Signal Generator to 18 599.997 MHz and set the frequency increment (FREQ INCR) to 1 kHz.
11. Tune the frequency down one increment and verify that the Signal Generator frequency display indicates 18 599.994 MHz and the frequency counter reading agrees within ± 1 count.
12. Tune the frequency up two increments and verify that the Signal Generator frequency display changes to 18 600.000 MHz. Verify also that the frequency counter reading agrees within ± 1 count.

18.599 995 GHz frequency resolution, 3 kHz _____(✓)

Band 4 Test

13. Tune the Signal Generator to 25 999.996 MHz and set the frequency increment (FREQ INCR) to 1 kHz.
14. Tune the frequency down one increment and verify that the Signal Generator frequency display indicates 25 999.992 MHz and the frequency counter reading agrees within ± 1 count.
15. Tune the frequency up two increments and verify that the Signal Generator frequency display changes to 26 000.000 MHz. Verify also that the frequency counter reading agrees within ± 1 count.

25.999 996 GHz frequency resolution, 4 kHz _____(✓)

16. Disconnect the frequency counter and replace the FREQ STANDARD jumper between A3J9 and A3J10. Set the FREQ STANDARD INT/EXT switch to INT.
-

PERFORMANCE TESTS

4-9. INTERNAL TIME BASE AGING RATE

Specification

Electrical Characteristics	Performance Limits	Conditions
FREQUENCY Reference Oscillator Frequency Aging Rate Accuracy and Stability	10 MHz $< 5 \times 10^{-10}$ /day Same as reference oscillator	After warmup (typically 24 hours in a normal operating environment)

Description

A reference signal from the Signal Generator (10 MHz OUT) is connected to the oscilloscope's vertical input. A frequency standard (with long term stability greater than 1×10^{-10} /day) is connected to the trigger input. The time required for a specific phase change is measured immediately and after a period of time. The aging rate is inversely proportional to the absolute value of the difference in the measured times.

Equipment

Oscilloscope HP 1980B
 Frequency Standard HP 5065A

NOTE

The internal 10 MHz reference oscillator will typically take 24 to 48 hours to reach its specified rate after instrument storage or shipment. In some cases, if extreme environmental conditions were encountered during storage, the reference oscillator could take as long as one week to achieve its specified aging rate.

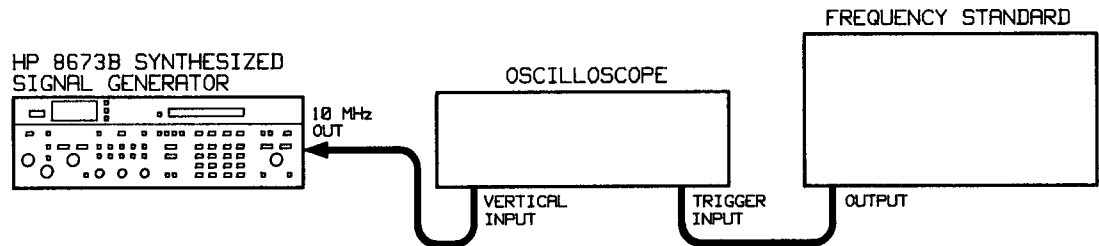

Figure 4-11. Internal Time Base Aging Rate Test Setup

Procedure

1. Connect the equipment as shown in Figure 4-11.

NOTE

This test requires a waiting period of 3 to 24 hours between initial and final measurements.

PERFORMANCE TESTS

INTERNAL TIME BASE AGING RATE (cont'd)

Procedure (cont'd)

2. Set the rear panel FREQ REFERENCE INT/EXT switch to the INT position.
3. Adjust the oscilloscope controls for a stable display of the 10 MHz Signal Generator reference output.
4. Measure the time required for a phase change of 360° (one cycle). Record the time (T_1) in seconds.

$$T_1 = \text{_____ s}$$

5. Wait for a period of time (from 3 to 24 hours) and re-measure the phase change time. Record the period of time between measurements (T_2) in hours and the new phase change time (T_3) in seconds.

$$T_2 = \text{_____ h}$$

$$T_3 = \text{_____ s}$$

6. Calculate the aging rate from the following equation:

$$\text{Aging Rate} = \left| \left(\frac{1 \text{ cycle}}{f} \right) \left(\frac{1}{T_1} - \frac{1}{T_3} \right) \left(\frac{T}{T_2} \right) \right|$$

where: 1 cycle = the phase change reference for the time measurement (in this case, 360°)

f = Signal Generator's reference output frequency (10 MHz)

T = specified time for aging rate (24h)

T_1 = initial time measurement for a 360° (1 cycle) change

T_2 = time between measurements

T_3 = final time measurement for a 360° (1 cycle) change

for example:

$$\text{if } T_1 = 351\text{s}$$

$$T_2 = 3\text{h}$$

$$T_3 = 349\text{s}$$

then:

$$\begin{aligned} \text{Aging Rate} &= \left| \left(\frac{1 \text{ cycle}}{10 \text{ MHz}} \right) \left(\frac{1}{351\text{s}} - \frac{1}{349\text{s}} \right) \left(\frac{24\text{h}}{3\text{h}} \right) \right| \\ &= 1.306 \times 10^{-11}/\text{day} \end{aligned}$$

7. Verify that the aging rate is less than $5 \times 10^{-10}/\text{day}$.

NOTE

If the absolute frequencies of the frequency standard and the Signal Generator's reference oscillator are extremely close, the measurement time in steps 4 and 5 (T_1 and T_3) can be reduced by measuring the time required for a phase change of something less than 360°. Change 1 cycle in the formula (e.g.: 180° = ½-cycle, 90° = ¼-cycle).

PERFORMANCE TESTS

4-10. FREQUENCY SWITCHING TIME TEST

Specification

Electrical Characteristics	Performance Limits	Conditions
SWITCHING TIME Frequency to be within the specified resolution and amplitude to be within 3 dB of final level.	< 25 ms (2703A and above) < 20 ms (2640A and below)	CW and AM only; AUTO PEAK disabled.

Description

This test measures the frequency switching speed of the Signal Generator. The Signal Generator output is mixed with a local oscillator whose output frequency is set to the frequency resolution specification above (or below) the destination frequency. The difference frequency (IF) is displayed on the oscilloscope.

Frequency switching speed is measured using a digitizing oscilloscope. The oscilloscope is set to trigger the digitizing process at the beginning of the frequency change. Delayed sweep is used to improve the measurement resolution. As the unit under test is switched from the starting frequency to the destination frequency, the IF signal will pass through zero (when the unit under test frequency is equal to the local oscillator frequency). This will generate a phase reversal. The last phase reversal of the IF frequency is the time that the unit under test is within the specified frequency resolution.

The amplitude recovery time is tested using the same measurement setup. The ± 3 dB amplitude points of the IF signal are calibrated on the oscilloscope display and the amplitude recovery time is tested to ensure that the IF level is within ± 3 dB of the final level.

NOTE

A storage oscilloscope simplifies these tests because it only needs two sweeps to display the switching time. This is especially important for Option 008 where many sweeps cause undue wear on internal relays. If you perform these tests with a non-storage scope, keep the number of sweeps to a minimum.

Equipment

Local Oscillator HP 8340A
 Mixer RHG DMS1-26
 Digitizing Oscilloscope HP 1980B/19860A

Procedure

1. Set up the equipment as shown in Figure 4-12. The external trigger input of the oscilloscope is connected to the Signal Generator's rear panel Blanking/Marker output. This signal will trigger the oscilloscope at the start of a frequency change when any sweep mode is selected.

PERFORMANCE TESTS

FREQUENCY SWITCHING TIME TEST (cont'd)

Procedure (cont'd)

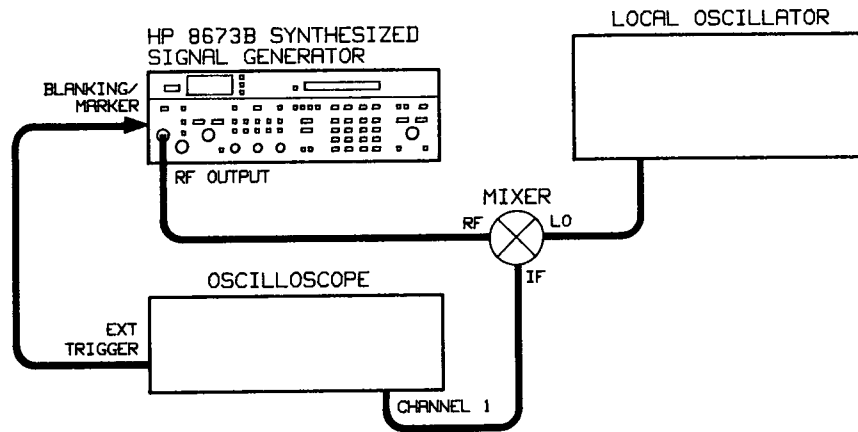

Figure 4-12. Frequency Switching Time Test Setup

2. Set the oscilloscope as follows:
 - Channel 1:
 - Vertical Sensitivity to 50 mV/Division
 - Coupling to AC
 - Set sweep to delayed
 - Main Sweep Parameters:
 - External trigger with DC coupling
 - Positive slope trigger
 - Auto sweep mode
 - Set trigger level to E1.00
 - Delayed Sweep Parameters:
 - Internal trigger with AC coupling
 - Positive slope trigger
 - Auto sweep mode

NOTE

Triggered main sweep must be used to trigger the digitizer at the start of frequency change. If auto trigger mode is selected while digitizing, the oscilloscope will trigger the sweep even without an external trigger signal and the waveform digitized will not be valid for this measurement.

3. Set the oscilloscope's main sweep to 5 ms/per division and delayed sweep to 1 ms/per division. The delayed sweep will be used once the approximate delay required is determined from the main sweep.
4. Set the Signal Generator to the following conditions:

Output Level 0 dBm	Stop Frequency 2 000.000 MHz
ALC Internal	Step 1 Step
Modulation Off	Dwell 20 ms
Sweep Mode Manual	Auto Peak Off
Start Frequency 3 000.000 MHz	

PERFORMANCE TESTS

FREQUENCY SWITCHING TIME TEST (cont'd)

Procedure (cont'd)

5. Set the local oscillator to 2000.001 MHz CW with an output level of +8 dBm.
6. Using the **FREQ INCREMENT** keys, set the Signal Generator to the stop frequency (2 000.000 MHz).
7. Set the oscilloscope to main sweep mode and **AUTO**. Adjust the oscilloscope's channel 1 vertical sensitivity for a 2 division peak-to-peak display of the IF frequency.
8. Set the oscilloscope's main sweep mode to triggered (or **NORM**). This sweep mode will not trigger the digitizer until the external trigger signal is received.
9. Using the **FREQ INCREMENT** keys, reset the Signal Generator's frequency to the start frequency (3 000.000 MHz). Press the digitizer (**STORE M1**) key on the oscilloscope and then use the appropriate **FREQ INCREMENT** key to step the Signal Generator to the stop frequency (2 000.000 MHz). The oscilloscope should digitize the switching waveform as the frequency changes. The waveform should be similar to the waveform shown in Figure 4-13.

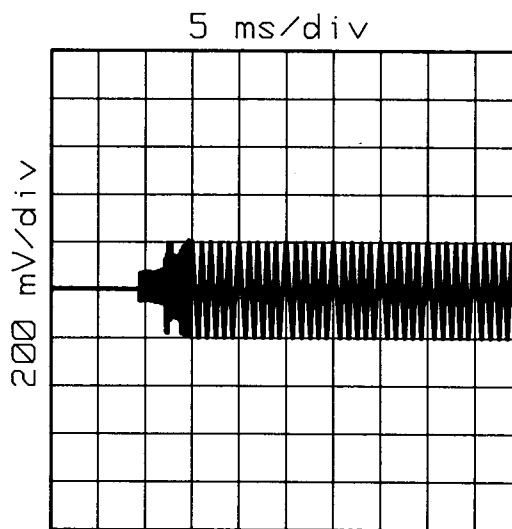

Figure 4-13. Frequency Switching Waveform

10. Set the oscilloscope to delayed sweep mode.
11. Using the digitized signal displayed on the oscilloscope, measure the time to the point at which the IF frequency amplitude suddenly increases and remains more than 1 division peak-to-peak. Set the oscilloscope's delay time to the measured time.
12. Using the **FREQ INCREMENT** keys, reset the Signal Generator's frequency to the start frequency.

PERFORMANCE TESTS

FREQUENCY SWITCHING TIME TEST (cont'd)

Procedure (cont'd)

13. Press the digitizer (STORE M1) key on the oscilloscope and step the Signal Generator to the stop frequency with the appropriate FREQ INCREMENT key. The oscilloscope should digitize the switching waveform as the frequency changes. The waveform should now look like that shown in Figure 4-14.

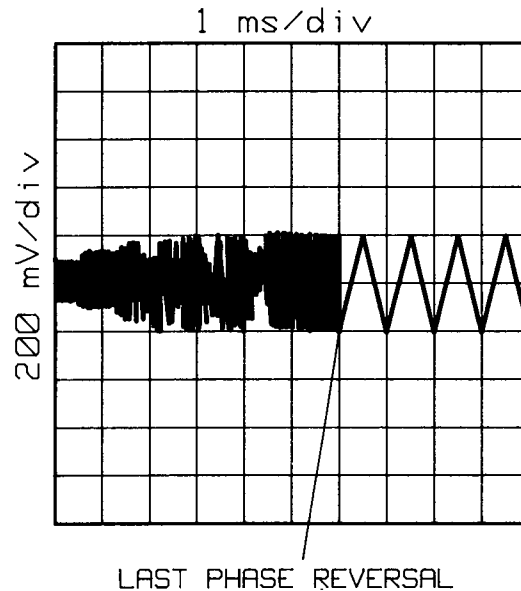

Figure 4-14. Frequency Switching Time Measurement Waveform

14. Measure the frequency switching time by observing the digitized signal on the oscilloscope display. The external trigger is the reference for determining switching speed. The switching time is measured from the display's left graticule to the last phase reversal (as the Signal Generator frequency passes the local oscillator frequency) before the IF signal settles into a steady frequency. Refer to Figure 4-14. Record the frequency switching time.

NOTE

With the oscilloscope in delayed sweep mode, the left graticule of the display corresponds to the delay time. This delay must be added to the time from the left graticule to the last phase reversal to obtain the frequency switching time.

_____ < 25 ms (2703A and above)

_____ < 20 ms (2640A and below)

15. Repeat steps 5 through 12 for each of the start and stop frequencies listed in the following table. Record the switching time for each indicated frequency change.

Amplitude Recovery Time

16. Set the local oscillator to 6 599.999 MHz.

PERFORMANCE TESTS

FREQUENCY SWITCHING TIME TEST (cont'd)**Procedure
(cont'd)**

Start Frequency (MHz)	Stop Frequency (MHz)	LO Frequency (MHz)	Measured Switching Time
4 000.000	2 000.000	2 000.001	_____ <25 ms*
18 000.000	2 000.000	2 000.001	_____ <25 ms*
6 200.000	2 090.000	2 090.001	_____ <25 ms*
6 000.000	2 100.000	2 100.001	_____ <25 ms*
6 500.000	2 100.000	2 100.001	_____ <25 ms*
6 490.000	2 200.000	2 200.001	_____ <25 ms*
2 000.000	3 000.000	2 999.999	_____ <25 ms*
2 200.000	6 490.000	6 489.999	_____ <25 ms*
2 100.000	6 500.000	6 499.999	_____ <25 ms*
6 610.000	6 590.000	6 590.001	_____ <25 ms*
6 590.000	6 610.000	6 609.998	_____ <25 ms*
3 999.000	12 400.000	12 399.998	_____ <25 ms
19 500.000	2 100.000	2 100.001	_____ <25 ms*
26 000.000	2 100.000	2 100.001	_____ <25 ms*
2 100.000	19 500.000	19 499.999	_____ <25 ms*
2 000.000	26 000.000	25 999.996	_____ <25 ms*
2 100.000	26 000.000	25 999.996	_____ <25 ms*

*For 2640A and below, maximum switching time is 20 ms.

17. Set the Signal Generator start frequency to 2 000.000 MHz and stop frequency to 6 600.000 MHz.
 18. Set the oscilloscope to main sweep with auto sweep mode. This allows viewing the IF signal without using the external trigger signal.
 19. Using the **FREQ INCREMENT** keys, set the Signal Generator to 6.6 GHz and set the output level to +3 dBm.
 20. Adjust the vertical sensitivity and position of the oscilloscope display (main sweep) until a change in output level from +3 dBm to -3 dBm indicates an IF signal amplitude change of exactly 4 divisions peak-to-peak. This calibrates the oscilloscope display to ± 3 dB about 0 dBm. The smaller signal represents -3 dBm and the larger signal represents +3 dBm.
 21. Set the top of the displayed signal to a convenient reference near the center of the display. Note the +3 dBm and -3 dBm levels for reference. The measurement will be determined by the time required before the amplitude of the IF signal stays between these two levels. Return the Signal Generator output level to 0 dBm.
 22. Set the oscilloscope's sweep mode to triggered (or **NORM**). This sweep mode will not trigger the digitizer until the external trigger signal is received.
 23. Using the **FREQ INCREMENT** keys, set the Signal Generator to the start frequency (2 000.000 MHz).
-

PERFORMANCE TESTS

FREQUENCY SWITCHING TIME TEST (cont'd)

Procedure (cont'd)

24. Press the digitizer (STORE M1) key on the oscilloscope and then step the Signal Generator to the stop frequency (6 600.000 MHz). The oscilloscope should digitize the switching waveform as the frequency changes. The waveform should be as shown in Figure 4-15.

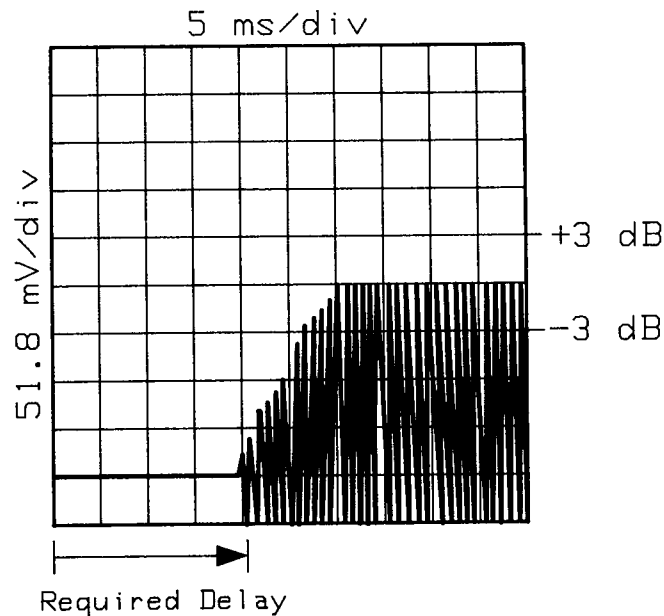

Figure 4-15. Amplitude Recovery Switching Waveform

25. Set the oscilloscope to delayed sweep. Set the oscilloscope's delay time to the time the IF frequency amplitude suddenly increases.
26. Using the **FREQ INCREMENT** keys, reset the Signal Generator's frequency to the start frequency.
27. Press the digitizer (STORE M1) key on the oscilloscope and step the Signal Generator to the stop frequency with the **FREQ INCREMENT** key. The oscilloscope should digitize the switching waveform as the frequency changes. The waveform should now look like that shown in Figure 4-16.
28. Measure the amplitude recovery time. The measurement is the time from the left graticule of the display to the last time the IF signal amplitude is outside the reference points established in steps 16 through 21.

NOTE

With the oscilloscope in delayed sweep mode, the left graticule of the display corresponds to the delay time. This delay must be added to the time from the left graticule to the last point the IF amplitude is outside of the references to obtain the amplitude recovery time.

_____ <25 ms

PERFORMANCE TESTS

FREQUENCY SWITCHING TIME TEST (cont'd)

Procedure (cont'd)

- 29. Repeat steps 22 through 28 for each of the start and stop frequencies listed in the following table. Record the amplitude recovery time for each indicated frequency change.

Start Frequency (MHz)	Stop Frequency (MHz)	LO Frequency (MHz)	Measured Recovery Time
6 601.000	12 300.000	12 299.998	_____ <25 ms*
3 000.000	4 000.000	3 999.999	_____ <25 ms*
4 000.000	10 000.000	9 999.998	_____ <25 ms*
12 301.000	18 600.000	18 599.997	_____ <25 ms*
18 601.000	26 000.000	25 999.996	_____ <25 ms*
2 000.000	26 000.000	25 999.996	_____ <25 ms*
6 601.000	26 000.000	25 999.996	_____ <25 ms*
2 000.000	18 600.000	18 599.997	_____ <25 ms*

*For 2640A and below, maximum switching time is 20 ms.

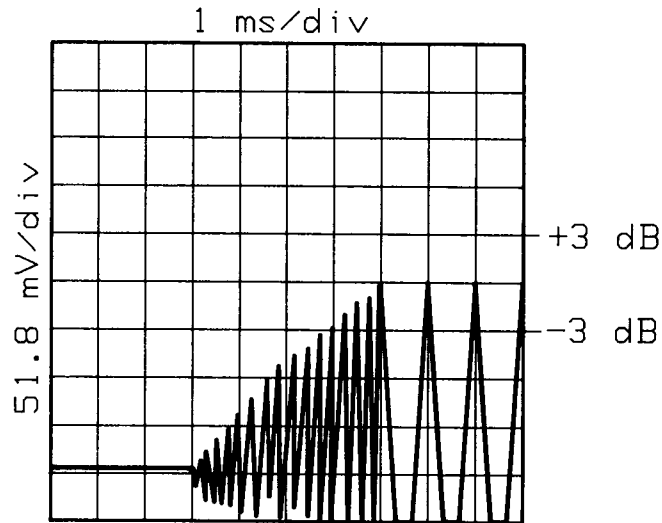

Figure 4-16. Amplitude Recovery Measurement Waveform

PERFORMANCE TESTS

4-11. SINGLE-SIDEBAND PHASE NOISE TEST

Specification

Electrical Characteristics	Performance Limits	Conditions
SPECTRAL PURITY		
Single-sideband Phase Noise		1 Hz bandwidth; CW mode
2.0 — 6.6 GHz	-58 dBc	10 Hz offset from carrier
	-70 dBc	100 Hz offset from carrier
	-78 dBc	1 kHz offset from carrier
	-86 dBc	10 kHz offset from carrier
	-110 dBc	100 kHz offset from carrier
6.6 — 12.3 GHz	-52 dBc	10 Hz offset from carrier
	-64 dBc	100 Hz offset from carrier
	-72 dBc	1 kHz offset from carrier
	-80 dBc	10 kHz offset from carrier
	-104 dBc	100 kHz offset from carrier
12.3 — 18.6 GHz	-48 dBc	10 Hz offset from carrier
	-60 dBc	100 Hz offset from carrier
	-68 dBc	1 kHz offset from carrier
	-76 dBc	10 kHz offset from carrier
	-100 dBc	100 kHz offset from carrier
18.6 — 26.0 GHz	-46 dBc	10 Hz offset from carrier
	-58 dBc	100 Hz offset from carrier
	-66 dBc	1 kHz offset from carrier
	-74 dBc	10 kHz offset from carrier
	-98 dBc	100 kHz offset from carrier

Description

The RF output of the Signal Generator is mixed with a local oscillator to obtain a 40 kHz or 200 kHz IF signal. The noise sidebands are observed on a spectrum analyzer. Correction factors are applied to the readings to compensate for using the spectrum analyzer in the log mode, local oscillator noise contributions, and bandwidths wider than 1 Hz.

NOTE

Normally, phase quadrature needs to be maintained between the Signal Generator and the local oscillator for true phase noise measurement. However, the additional amplitude noise components are so small that they are not significant in these tests.

Equipment

Local Oscillator HP 8340A
 Spectrum Analyzer HP 3585A
 Mixer RHG DMS1-26

PERFORMANCE TESTS

SINGLE-SIDEBAND PHASE NOISE TEST (cont'd)

NOTE

The signal-to-phase noise ratio as measured must be corrected to compensate for 3 errors contributed by the measurement system. These are

- a. Using the spectrum analyzer in the log mode requires a +2.5 dB correction.*
- b. Equal noise contributed by the local oscillator requires a -3 dB correction.*
- c. The spectrum analyzer noise measurement must be normalized to a 1 Hz noise equivalent bandwidth. The noise equivalent bandwidth for HP spectrum analyzers is 1.2 times the 3 dB bandwidth.*

For a 3 Hz bandwidth, the correction factor for the normalized measurement bandwidth would be:

$$\text{Normalizing Factor dB} = 10 \log (1.2 \times 3 \text{ Hz}/1\text{Hz}) = 5.56 \text{ dB.}$$

The total correction for 3 Hz bandwidth would be:

$$\text{True measurement (dBc)} = \text{Reading (dBc)} - 5.56 + 2.5 - 3 = \text{Reading (dBc)} - 6.06 \text{ dB.}$$

Procedure

1. Connect the equipment as shown in Figure 4-17.

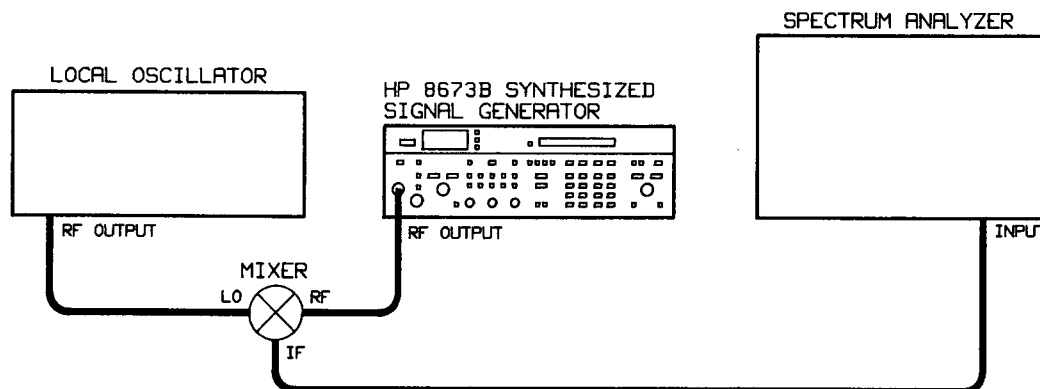

Figure 4-17. Single-Sideband Phase Noise Test Setup

NOTE

Connect the mixer directly to the local oscillator to avoid any power loss.

2. Set the spectrum analyzer's start frequency to 40 kHz, resolution bandwidth to 3 Hz, and stop frequency of 40.05 kHz.
3. Tune the Signal Generator to 6 600 MHz. Set the RANGE to -20 dB. Set the VERNIER to 0 dBm as read on the front panel meter.
4. Tune the local oscillator to 6 599.960 MHz with an output amplitude of +8 dBm.
5. Set the spectrum analyzer controls so that the peak of the 40 kHz signal is at the top graticule line.

PERFORMANCE TESTS

SINGLE-SIDEBAND PHASE NOISE TEST (cont'd)**Procedure
(cont'd)**

6. Observe the noise level 10 Hz from the carrier. The displayed level should be greater than 51.94 dB below the carrier (< -51.94 dBc). Record the measured and actual level after correction.

Measured _____ dBc
 Correction -6.06 dB
 Actual Level _____ dBc

7. Tune the Signal Generator to 12 300 MHz.

8. Tune the local oscillator to 12 299.960 MHz.

9. Observe the noise level 10 Hz from the carrier. The displayed level should be greater than 45.94 dB below the carrier (< -45.94 dBc). Record the measured and actual level.

Measured _____ dBc
 Correction -6.06 dB
 Actual Level _____ dBc

10. Tune the Signal Generator to 18 600 MHz.

11. Tune the local oscillator to 18 599.960 MHz.

12. Observe the noise level 10 Hz from the carrier. The displayed level should be greater than 41.94 dB below the carrier (< -41.94 dBc). Record the measured and actual level.

Measured _____ dBc
 Correction -6.06 dB
 Actual Level _____ dBc

13. Tune the Signal Generator to 26 000 MHz.

14. Tune the local oscillator to 25 999.960 MHz.

15. Observe the noise level 10 Hz from the carrier. The displayed level should be greater than 39.94 dB below the carrier (< -39.94 dBc). Record the measured and actual level.

Measured _____ dBc
 Correction -6.06 dB
 Actual Level _____ dBc

16. Set the spectrum analyzer controls for a resolution bandwidth of 3 Hz and a frequency span per division of 20 Hz. Using a 3 Hz resolution bandwidth requires a 6.06 dB correction factor.

17. Repeat steps 3 through 15 while observing the noise 100 Hz from the carrier. Record the results in the following table.
-

PERFORMANCE TESTS

SINGLE-SIDEBAND PHASE NOISE TEST (cont'd)**Procedure
(cont'd)**

Frequency	Measured	Correction	Actual	Limit
6600 MHz	_____	-6.06 dB =	_____	<-70 dBc
12 300 MHz	_____	-6.06 dB =	_____	<-64 dBc
18 600 MHz	_____	-6.06 dB =	_____	<-60 dBc
26 000 MHz	_____	-6.06 dB =	_____	<-58 dBc

18. Set the spectrum analyzer resolution bandwidth to 30 Hz and frequency span per division to 200 Hz. The 30 Hz bandwidth requires 16.06 dB correction.

19. Tune the Signal Generator to 6 599.800 MHz.

20. Tune the local oscillator to 6 600.000 MHz

21. Adjust the spectrum analyzer to place the 200 kHz IF signal at the left edge of the display. Set the spectrum analyzer controls to place the peak of the signal at the top graticule line. Increase the log reference level control to move the peak of the IF signal 20 dB above the top graticule line. (The top graticule line is now -20 dBc.)

22. Observe the noise level 1 kHz from the carrier. The displayed level should be greater than 61.94 dB below the carrier (<-61.94 dBc). Record the measured and actual level.

Measured _____ dBc
Correction -16.06 dB
Actual level _____ dBc

23. Tune the Signal Generator to 12 300 MHz.

24. Tune the local oscillator to 12 299.800 MHz.

25. Observe the noise level 1 kHz from the carrier. The displayed level should be greater than 55.94 dB below the carrier (<-55.94 dBc). Record the measured and actual level.

Measured _____ dBc
Correction -16.06 dB
Actual level _____ dBc

26. Tune the Signal Generator to 18 600 MHz.

27. Tune the local oscillator to 18 599.800 MHz.

28. Observe the noise level 1 kHz from the carrier. The displayed level should be greater than 51.94 dB below the carrier (<-51.94 dBc). Record the measured and actual level.

Measured _____ dBc
Correction -16.06 dB
Actual level _____ dBc

PERFORMANCE TESTS

SINGLE-SIDEBAND PHASE NOISE TEST (cont'd)

Procedure (cont'd)

- 29. Tune the Signal Generator to 26 000 MHz.
- 30. Tune the local oscillator to 25 999.800 MHz.
- 31. Observe the noise level 1 kHz from the carrier. The displayed level should be greater than 49.94 dB below the carrier (< -49.94 dBc). Record the measured and actual level.

Measured _____ dBc
 Correction -16.06 dB
 Actual level _____ dBc

- 32. Set the spectrum analyzer controls for a resolution bandwidth of 300 Hz and a frequency span per division of 2 kHz. Using a 300 Hz bandwidth requires a 26.06 dB correction factor.
- 33. Repeat steps 19 through 31 while observing the noise 10 kHz from the carrier. Record the results in the table below.

Frequency	Measured	Correction	Actual	Limit
6600 MHz	_____	-26.06 dB =	_____	< -86 dBc
12 300 MHz	_____	-26.06 dB =	_____	< -80 dBc
18 600 MHz	_____	-26.06 dB =	_____	< -76 dBc
26 000 MHz	_____	-26.06 dB =	_____	< -74 dBc

- 34. Set the spectrum analyzer controls for a resolution bandwidth of 3 kHz and a frequency span per division of 20 kHz. Using a 3 kHz bandwidth requires a 36.06 dB correction factor.
- 35. Repeat steps 19 through 31 while observing the noise 100 kHz from the carrier. Record the results in the table below.

Frequency	Measured	Correction	Actual	Limit
6600 MHz	_____	-36.06 dB =	_____	< -110 dBc
12 300 MHz	_____	-36.06 dB =	_____	< -104 dBc
18 600 MHz	_____	-36.06 dB =	_____	< -100 dBc
26 000 MHz	_____	-36.06 dB =	_____	< -98 dBc

PERFORMANCE TESTS

4-12. HARMONICS, SUBHARMONICS, & MULTIPLES TEST

Specification

Electrical Characteristics	Performance Limits	Conditions
SPECTRAL PURITY Harmonics	<-40 dBc	Up to 26 GHz; output level at or below 0 dBm.
Subharmonics and Multiples Thereof	<-25 dBc <-20 dBc	2.0 to 18.6 GHz 18.6 to 26.0 GHz
For Option 008 Subharmonics and Multiples Thereof	<-25 dBc <-15 dBc	2.0 to 26.0 GHz 18.6 to 26.0 GHz (1/2 and 3/4 subharmonics only)

Description

This test checks the amplitude of various harmonics of the Signal Generator's output signal. In the multiplied frequency bands (>6.6 GHz), subharmonics and multiples (harmonics of the internal fundamental signal) are also checked for specific levels. Reasonable care must be taken to ensure that the harmonics are not being generated by the spectrum analyzer.

Harmonics are tested at high VERNIER settings (+3 dBm). Subharmonics and multiples are tested at low VERNIER settings (-10 dBm) where the feedthrough of the fundamental signal is largest in relation to the multiplied signal.

Equipment

Spectrum Analyzer HP 8566B

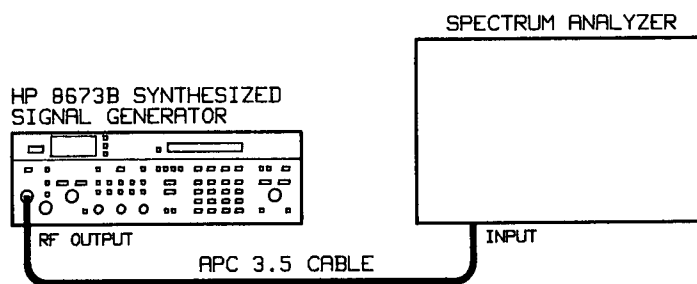

Figure 4-18. Harmonics, Subharmonics, and Multiples Test Setup

Procedure

1. Connect the equipment as shown in Figure 4-18.
2. Tune the Signal Generator to 4 000.000 MHz and set the output level to 0.0 dBm.
3. Set the spectrum analyzer's controls to display the fundamental signal. Set the resolution bandwidth to 10 kHz, the input attenuation to 40 dB, and the sweep span to 100 MHz. Adjust the controls to set the displayed signal to the top graticule line of the display.

PERFORMANCE TESTS

HARMONICS, SUBHARMONICS, & MULTIPLES TEST (cont'd)

Procedure (cont'd)

- Tune the Signal Generator to 2000.000 MHz. The second harmonic, now displayed on the spectrum analyzer at 4000.000 MHz, should be greater than 40 dB below the reference (top graticule line).

_____ <-40 dBc

- Repeat steps 2 through 4 for each of the frequencies listed below. Use an output level of 0.0 dBm (0 dBm RANGE) to check harmonics and a VERNIER setting of -10 dBm to check subharmonics and multiples. Record the measurements in Table 4-4.

NOTE

This procedure may be repeated for any fundamental frequency of interest within the Signal Generator frequency range. The worst case performance for harmonics is at high VERNIER settings while the worst case performance for subharmonics and multiples is at low VERNIER settings. Use the appropriate VERNIER setting for each test.

Output Frequency (MHz)	Harmonic Frequency (MHz)	Subharmonic			Multiple	
		1/4	1/3	1/2	2/3	3/4
2000.000	4000.000					
4000.000	8000.000					
6000.000	12000.000					
8000.000	16000.000			4000.000		
10000.000	20000.000			5000.000		
11000.000	22000.000			5500.000		
14000.000			4666.667		9333.333	
16000.000			5333.333		10666.667	
18000.000			6000.000		12000.000	
20000.000		5000.000		10000.000		15000.000
22000.000		5500.000		11000.000		16500.000
24000.000		6000.000		12000.000		18000.000
26000.000		6500.000		13000.000		19500.000

PERFORMANCE TESTS

4-13. NON-HARMONICALLY RELATED SPURIOUS SIGNALS TESTS

Specification

Electrical Characteristics	Performance Limits	Conditions
Spurious Non-harmonically Related	<-70 dBc <-64 dBc <-60 dBc <-58 dBc	CW and AM Modes 2.0 to 6.6 GHz >6.6 to 12.3 GHz >12.3 to 18.6 GHz >18.6 to 26.0 GHz

Description

A spectrum analyzer is calibrated for -50 dBc and then tuned to any frequency from 12.3 to 18.6 GHz in search of spurious signals.

NOTE

The non-harmonically related spurious signals will always increase in amplitude above 6.6 GHz. This is due to multiplication in the internal YIG-tuned multiplier. The increase is determined by a strict mathematical relationship. Therefore, satisfactory performance in the 2.0 to 6.6 GHz range will always ensure meeting the specification in the other bands.

Equipment

Spectrum Analyzer HP 8566B

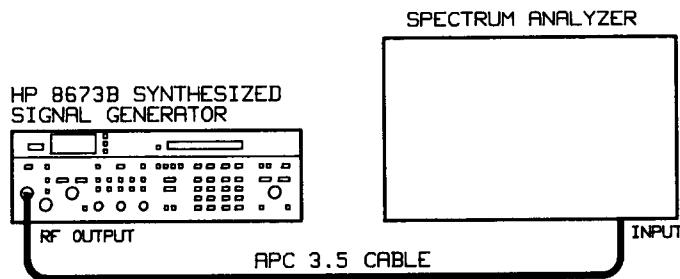

Figure 4-19. Non-harmonically Related Spurious Test Setup

Procedure

1. Connect the equipment as shown in Figure 4-19.
2. Tune the Signal Generator to 3000.000 MHz.
3. Set the OUTPUT LEVEL RANGE to -60 dB. Adjust the VERNIER to 0 dBm.
4. Set the spectrum analyzer controls to display the fundamental signal. Set the resolution bandwidth to 1 kHz and the frequency span per division to 10 kHz.
5. Set the spectrum analyzer controls so that the displayed signal is at the top graticule line.

PERFORMANCE TESTS

NON-HARMONICALLY RELATED SPURIOUS SIGNALS TESTS (cont'd)

Procedure (cont'd)

6. Set the Signal Generator's RANGE to 0 dB. Adjust the VERNIER to -10 dBm. Do not adjust the spectrum analyzer amplitude calibration. The top graticule line now represents -50 dBc.
7. Tune the spectrum analyzer to any desired frequency in search of non-harmonically related spurious signals. Verify that any signals found are non-harmonically related and are not generated by the spectrum analyzer. Verify that the spurious signals are below the specified limits. Record the results.

Carrier Frequency	Spurious Signal Frequency	Spurious Signal Amplitude
3 000.000 MHz	_____	_____
3 000.000 MHz	_____	_____

8. Repeat steps 2 through 7 for any desired carrier frequency from 2.0 to 6.6 GHz. Record the results. (Checking non-harmonically related spurious signals from 2.0 to 6.6 GHz provides a high level of confidence that the instrument meets its published specifications from 2.0 to 26 GHz.)

Carrier Frequency	Spurious Signal Frequency	Spurious Signal Amplitude
_____	_____	_____
_____	_____	_____

PERFORMANCE TESTS

4-14. POWER LINE RELATED SPURIOUS SIGNALS TESTS

Specification

Electrical Characteristics	Performance Limits	Conditions
SPECTRAL PURITY Power line related and fan rotation related within 5 Hz below line frequencies and multiples thereof.	-50 dBc -60 dBc -65 dBc -44 dBc -54 dBc -59 dBc -40 dBc -50 dBc -55 dBc -38 dBc -48 dBc -53 dBc	CW and AM Modes 2.0 — 6.6 GHz <300 Hz offset from carrier. 300 Hz to 1 kHz offset from carrier. >1 kHz offset from carrier. 6.6 — 12.3 GHz <300 Hz offset from carrier. 300 Hz to 1 kHz offset from carrier. >1 kHz offset from carrier. 12.3 — 18.6 GHz <300 Hz offset from carrier. 300 Hz to 1 kHz offset from carrier. >1 kHz offset from carrier. 18.6 — 26.0 GHz <300 Hz offset from carrier. 300 Hz to 1 kHz offset from carrier. >1 kHz offset from carrier.

Description

The RF output of the Signal Generator is mixed with a local oscillator to obtain a 20 kHz IF signal. The line related sidebands are observed on a spectrum analyzer.

NOTE

The Signal Generator and local oscillator are isolated from vibration on a two-inch thick foam pad. The Signal Generator must be operated from a separate power line source (52 to 58 Hz) in order to differentiate its spurious signals from other line related spurious signals.

Equipment

Local Oscillator HP 8340A
 Spectrum Analyzer HP 3585A
 Mixer RHG DMS1-26
 Variable Frequency AC Power Supply 501TC/800T, California Instruments

Procedure

1. Connect the equipment as shown in Figure 4-20.

NOTE

Connect the mixer directly to the local oscillator to avoid any power loss.

2. Place the Signal Generator and the local oscillator on separate two-inch thick foam pads.
3. Tune the Signal Generator to 3 000.000 MHz.
4. Set the OUTPUT LEVEL RANGE to -20 dB. Adjust the VERNIER to 0 dBm.

PERFORMANCE TESTS

POWER LINE RELATED SPURIOUS SIGNALS TESTS (cont'd)

Procedure (cont'd)

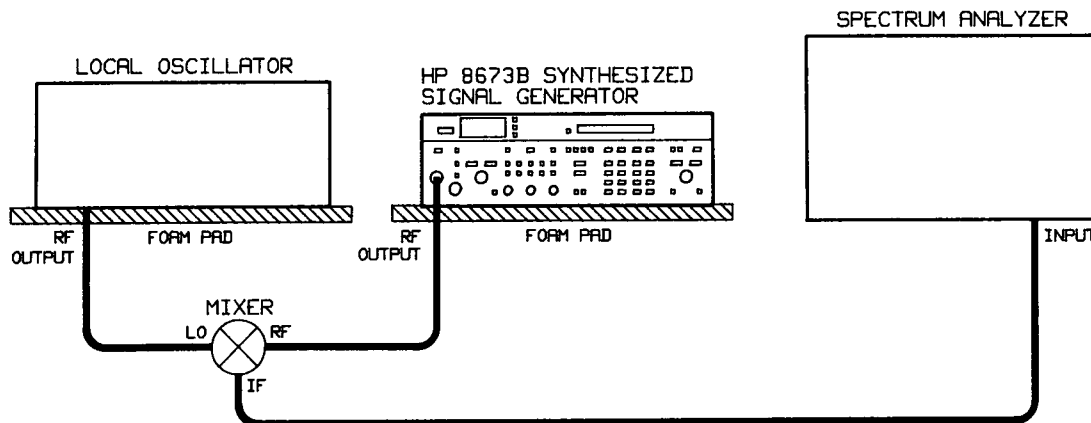

Figure 4-20. Power Line Related Spurious Signals Test Setup

5. Tune the local oscillator to 3 000.020 MHz with an output amplitude of +7 dBm.
6. Set the spectrum analyzer start frequency to 20 kHz, frequency span to 500 Hz, and resolution bandwidth to 3 Hz.
7. Adjust the spectrum analyzer controls to place the peak of the 20 kHz IF signal on the top graticule line. Verify that the line related harmonics of the Signal Generator do not exceed the values shown below. Record the highest spurious signal level in each offset band.

2.0—6.6 GHz <300 Hz offset _____ <-50 dBc

8. Set the spectrum analyzer frequency span to 1 kHz. Ensure that the start frequency is 20 kHz. Measure and record the highest spurious signal level.

300 Hz — 1 kHz offset _____ <-60 dBc

9. Set the spectrum analyzer frequency span to 5 kHz. Ensure that the start frequency is 20 kHz. Measure and record the highest spurious signal level.

>1 kHz offset _____ <-65 dBc

10. Tune the Signal Generator to 7000 MHz.
11. Tune the local oscillator to 7000.020 MHz.
12. Set the spectrum analyzer frequency span per division to 500 Hz. Adjust the spectrum analyzer controls to place the peak of the 20 kHz IF signal on the top graticule line. Verify that the line related harmonics of the Signal Generator do not exceed the values shown below. Record the highest spurious signal level in each offset band.

6.6 — 12.3 GHz <300 Hz offset _____ <-44 dBc

PERFORMANCE TESTS

POWER LINE RELATED SPURIOUS SIGNALS TESTS (cont'd)**Procedure
(cont'd)**

13. Set the spectrum analyzer frequency span to 1 kHz. Ensure that the start frequency is 20 kHz. Measure and record the highest spurious signal level.

300 Hz — 1 kHz offset _____ < -54 dBc

14. Set the spectrum analyzer frequency span to 5 kHz. Ensure that the start frequency is 20 kHz. Measure and record the highest spurious signal level.

>1 kHz offset _____ < -59 dBc

15. Tune the Signal Generator to 16 000.000 MHz.

16. Tune the local oscillator to 16 000.020 MHz.

17. Set the spectrum analyzer frequency span to 500 Hz. Adjust the spectrum analyzer controls to place the peak of the 20 kHz IF signal on the top graticule line. Verify that the line related harmonics of the Signal Generator do not exceed the values shown below. Record the highest spurious signal level in each offset band.

12.3 — 18.6 GHz <300 Hz offset _____ < -40 dBc

18. Set the spectrum analyzer frequency span to 1 kHz. Ensure that the start frequency is 20 kHz. Measure and record the highest spurious signal level.

300 Hz — 1 kHz offset _____ < -50 dBc

19. Set the spectrum analyzer frequency span to 5 kHz. Ensure that the start frequency is 20 kHz. Measure and record the highest spurious signal level.

>1 kHz offset _____ < -55 dBc

20. Tune the Signal Generator to 20 000.000 MHz.

21. Tune the local oscillator to 20 000.020 MHz.

22. Set the spectrum analyzer frequency span to 500 Hz. Adjust the spectrum analyzer controls to place the peak of the 20 kHz IF signal on the top graticule line. Verify that the line related harmonics of the Signal Generator do not exceed the values shown below. Record the highest spurious signal level in each offset band.

18.6 — 26.0 GHz <300 Hz offset _____ < -38 dBc

23. Set the spectrum analyzer frequency span to 1 kHz. Ensure that the start frequency is 20 kHz. Measure and record the highest spurious signal level.

300 Hz — 1 kHz offset _____ < -48 dBc

24. Set the spectrum analyzer frequency span to 5 kHz. Ensure that the start frequency is 20 kHz. Measure and record the highest spurious signal level.

>1 kHz offset _____ < -53 dBc

PERFORMANCE TESTS

4-15. OUTPUT LEVEL AND FLATNESS TESTS

Specification

Electrical Characteristics	Performance Limits	Conditions
RF OUTPUT		
Output Level:		+15 to +35°C
Standard Leveled Output	+8 dBm to -100 dBm	2.0 to 18.0 GHz
	+4 dBm to -100 dBm	18.0 to 22.0 GHz
	0 dBm to -100 dBm	22.0 to 26.0 GHz
Option 001 Leveled Output	+10 dBm to -100 dBm	2.0 to 18.0 GHz
	+6 dBm to -100 dBm	18.0 to 22.0 GHz
	+3 dBm to -100 dBm	22.0 to 26.0 GHz
Option 004 Leveled Output	+7 dBm to -100 dBm	2.0 to 18.0 GHz
	+2 dBm to -100 dBm	18.0 to 22.0 GHz
	-2 dBm to -100 dBm	22.0 to 26.0 GHz
Option 005 Leveled Output	+9 dBm to -100 dBm	2.0 to 18.0 GHz
	+4 dBm to -100 dBm	18.0 to 22.0 GHz
	+1 dBm to -100 dBm	22.0 to 26.0 GHz
Option 008 Level Output	+8 dBm to -100 dBm	2.0 to 18.0 GHz
	+7 dBm to -100 dBm	18.0 to 26.0 GHz
Flatness		0 dBm range; +15 to +35°C
	±0.75 dB	2.0 to 6.6 GHz
	±1.00 dB	2.0 to 12.3 GHz
	±1.25 dB	2.0 to 18.6 GHz
	±1.75 dB	2.0 to 26.0 GHz
		(Min. to max. variation in power level across specified frequency limits is less than 2 times flatness spec.)

Description

This test checks output level (maximum leveled power) and output level flatness. The output level test uses a power meter to verify that the specified maximum leveled output power can be generated over the full frequency range. Level flatness measures the variation in output power level as the frequency is changed.

Equipment

Power Meter HP 436A
 Power Sensor HP 8485A

Procedure

Output Level Test

1. Connect the equipment as shown in Figure 4-21.
2. Zero and calibrate the power meter.
3. Tune the Signal Generator frequency to 2 000.0 MHz.
4. Set the OUTPUT LEVEL RANGE to +10 dB.

PERFORMANCE TESTS

OUTPUT LEVEL AND FLATNESS TESTS (cont'd)

Procedure (cont'd)

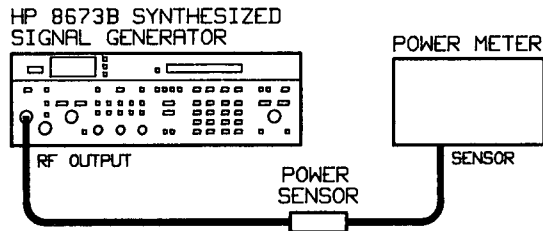

Figure 4-21. Output Level and Flatness Test Setup

5. For a standard Signal Generator, adjust the VERNIER for a power meter reading of +8 dBm or, for a Signal Generator with an option, for one of the following power levels:
 - Option 001 +10 dBm
 - Option 004 +7 dBm
 - Option 005 +9 dBm
 - Option 008 +8 dBm
6. Activate the AUTO PEAK key. (The AUTO PEAK key indicator should be lighted.)
7. Tune the Signal Generator in 100 MHz steps from 2000.0 MHz to 18 000.0 MHz while observing the power meter reading. Record the frequency at which minimum power occurs.

Frequency _____
8. Tune the Signal Generator to the recorded frequency. Re-adjust the VERNIER for the same power meter reading used in Step 5.
9. Re-tune the Signal Generator from 2 000.0 MHz to 18 000.0 MHz in 100 MHz steps while observing the power meter readings. Ensure that the specified maximum leveled output power level is met.
10. For a standard Signal Generator, adjust the VERNIER for a power meter reading of +4 dBm or, for a Signal Generator with an option, for one of the following power levels:
 - Option 001 +6 dBm
 - Option 004 +2 dBm
 - Option 005 +4 dBm
 - Option 008 +7 dBm
11. Verify that the AUTO PEAK key indicator is lighted.
12. Tune the Signal Generator in 100 MHz steps from 18 000.0 MHz to 22 000.0 MHz while observing the power meter reading. Record the frequency at which minimum power occurs.

Frequency _____

PERFORMANCE TESTS

OUTPUT LEVEL AND FLATNESS TESTS (cont'd)**Procedure
(cont'd)**

13. Tune the Signal Generator to the recorded frequency. Re-adjust the VERNIER for the same power meter reading used in Step 10.
14. Re-tune the Signal Generator from 18 000.0 MHz to 22 000.0 MHz 100 MHz steps while observing the power meter readings. Ensure that the specified maximum leveled output power level is met.
15. For a standard Signal Generator, adjust the VERNIER for a power meter reading of 0 dBm or, for a Signal Generator with an option, for one of the following power levels:

Option 001	+3 dBm
Option 004	-2 dBm
Option 005	+1 dBm
Option 008	+7 dBm
16. Verify that the AUTO PEAK key indicator is lighted.
17. Tune the Signal Generator in 100 MHz steps from 22 000.0 MHz to 26 000.0 MHz while observing the power meter reading. Record the frequency at which minimum power occurs.

Frequency _____
18. Tune the Signal Generator to the recorded frequency. Re-adjust the VERNIER for the same power meter reading used in Step 15.
19. Re-tune the Signal Generator from 22 000.0 MHz to 26 000.0 MHz in 100 MHz steps while observing the power meter readings. Ensure that the specified maximum leveled output power level is met.

Level Flatness Test**NOTE**

The flatness specification for power output is not referenced to a particular frequency. The specification represents the total power variation over the entire frequency range.

20. Tune the Signal Generator to 2000.0 MHz. Set the OUTPUT LEVEL RANGE to 0 dB. Adjust the VERNIER for a power meter reading of -5 dBm.
 21. Set the power meter mode to dB Relative.
 22. Tune the Signal Generator from 2000.0 MHz to 6600.0 MHz in 100 MHz steps while observing the power meter readings. Record the minimum and maximum output power levels in the following table. Maximum power variation must be within 1.5 dB (highest point to lowest point).
 23. Continue tuning the Signal Generator to 12 300.0 GHz in 100 MHz steps while observing the power meter readings. Maximum power variation must be within 2.0 dB. Record the minimum and maximum output power levels in the following table.
-

PERFORMANCE TESTS

OUTPUT LEVEL AND FLATNESS TESTS (cont'd)

**Procedure
(cont'd)**

- 24. Continue tuning the Signal Generator to 18 600.0 GHz in 100 MHz steps while observing the power meter readings. Maximum power variation must be within 2.5 dB. Record the minimum and maximum output power levels in the table below.

- 25. Continue tuning the Signal Generator to 26 000.0 GHz in 100 MHz steps while observing the power meter readings. Maximum power variation must be within 3.5 dB. Record the minimum and maximum output power levels in the table below.

Frequency Range	Power Variation
2.0 — 6.6 GHz	Maximum _____ Minimum _____ Total Variation _____ 1.50 dB
2.0 — 12.3 GHz	Maximum _____ Minimum _____ Total Variation _____ 2.00 dB
2.0 — 18.6 GHz	Maximum _____ Minimum _____ Total Variation _____ 2.50 dB
2.0 — 26.0 GHz	Maximum _____ Minimum _____ Total Variation _____ 3.50 dB

PERFORMANCE TESTS

4-16. ABSOLUTE LEVEL ACCURACY TESTS

Specification

Electrical Characteristics	Performance Limits	Conditions
RF OUTPUT		
Remote Programming Absolute Level Accuracy (+15 to +35°C)	± 1.25 dB ± 1.00 dB ± 1.50 dB ± 1.70 dB ± 2.00 dB ± 2.00 dB & 0.1 dB / 10 dB step	2.0 to 6.6 GHz +10 dB RANGE 0 dB RANGE -10 dB RANGE -20 dB RANGE -30 dB RANGE <-30 dB RANGE
	± 1.50 dB ± 1.25 dB ± 1.75 dB ± 1.95 dB ± 2.25 dB ± 2.25 dB & 0.1 dB / 10 dB step	6.6 to 12.3 GHz +10 dB RANGE 0 dB RANGE -10 dB RANGE -20 dB RANGE -30 dB RANGE <-30 dB RANGE
	± 1.75 dB ± 1.50 dB ± 2.10 dB ± 2.30 dB ± 2.70 dB ± 2.70 dB & 0.2 dB / 10 dB step	12.3 to 18.6 GHz +10 dB RANGE 0 dB RANGE -10 dB RANGE -20 dB RANGE -30 dB RANGE <-30 dB RANGE
	± 2.25 dB ± 2.00 dB ± 2.55 dB ± 2.85 dB ± 3.30 dB ± 3.30 dB & 0.2 dB / 10 dB step	18.6 to 26.0 GHz +10 dB RANGE 0 dB RANGE -10 dB RANGE -20 dB RANGE -30 dB RANGE <-30 dB RANGE
Manual Absolute Level Accuracy	Add ± 0.75 dB to remote programming absolute level accuracy	Absolute level accuracy specifications include allowances for detector linearity, temperature, flatness, attenuator accuracy, and measurement uncertainty.

Description

This test checks absolute level accuracy of the RF output signal using manual settings. The first test uses a power meter to verify that power levels between the maximum leveled power and -20 dBm are within specification. Power levels of -30 dBm and below are checked using a spectrum analyzer. The output level of the Signal Generator is adjusted to -20 dBm using the power meter. The Signal Generator output is mixed

PERFORMANCE TESTS

ABSOLUTE LEVEL ACCURACY TESTS (cont'd)

Description (cont'd) with a local oscillator to produce an IF frequency. The IF frequency is displayed on the spectrum analyzer. A reference level corresponding to the -20 dBm output is set on the spectrum analyzer and each 10 dB decrease in range is checked for a 10 dB decrease on the spectrum analyzer display.

Equipment	Power Meter	HP 436A
	Power Sensor	HP 8485A
	Local Oscillator	HP 8340A
	Mixer	RHG DMS1-26
	Spectrum Analyzer	HP 8566B
	40 dB Amplifier	HP 8447F
	20 dB Attenuator	HP 8493C Option 020

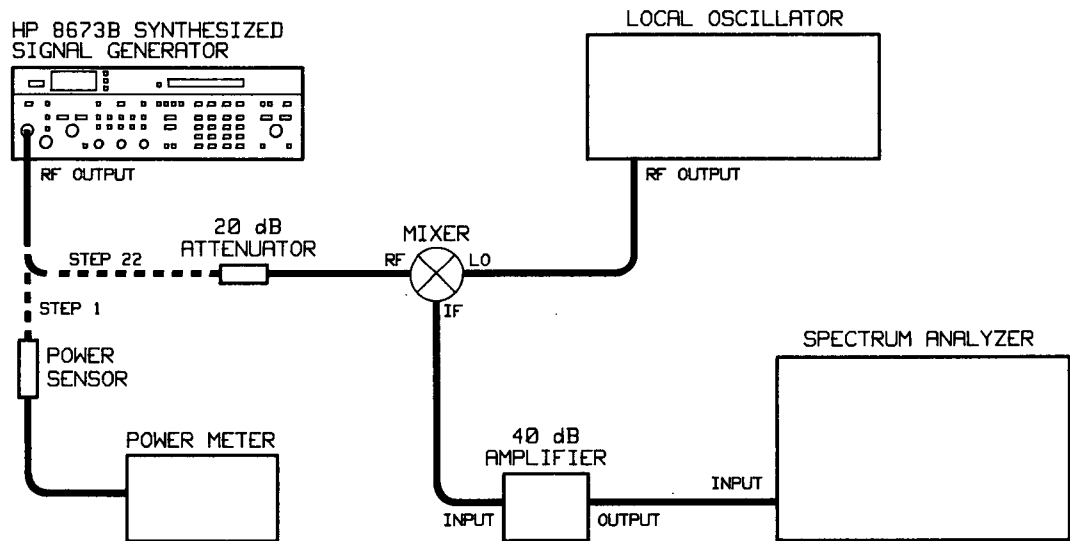

Figure 4-22. Absolute Level Accuracy Test Setup

Procedure High Level Accuracy Test

1. Connect the equipment as shown in Figure 4-22.
2. Zero and calibrate the power meter. Set the power meter to dBm mode.
3. Tune the Signal Generator to 2.0 GHz.
4. Set the OUTPUT LEVEL RANGE to +10 dB. For a standard Signal Generator, adjust the VERNIER for a power meter reading of +8 dBm or, for a Signal Generator with an option, for one of the following power levels:

Option 001	+10 dBm
Option 004	+7 dBm
Option 005	+9 dBm
Option 008	+8 dBm

PERFORMANCE TESTS

ABSOLUTE LEVEL ACCURACY TESTS (cont'd)**Procedure
(cont'd)**

5. Peak the Signal Generator output with the AUTO PEAK key.
6. Set the power meter to dB Relative.
7. For a standard Signal Generator, adjust the VERNIER for a front panel indication of +8 dBm or, for a Signal Generator with an option, for one of the following power levels:
 - Option 001 +10 dBm
 - Option 004 +7 dBm
 - Option 005 +9 dBm
 - Option 008 +8 dBm
8. Tune the Signal Generator from 2.0 to 6.6 GHz in 100 MHz steps while noting the power meter readings at each frequency step. Do not readjust the VERNIER. The power meter readings should be within the limits specified.

(2.0 — 6.6 GHz) -2.00 dB _____ +2.00 dB

9. Tune the Signal Generator to 2.0 GHz.
10. Set the power meter to dBm mode.
11. Adjust the VERNIER for a power meter reading of +5.0 dBm.
12. Set the power meter mode to dB Relative.
13. Adjust the Signal Generator's VERNIER for an output amplitude of +5 dBm (-5 dBm front panel meter indication).
14. Tune the Signal Generator from 2.0 to 6.6 GHz in 100 MHz steps while noting the power meter readings at each frequency step. Do not readjust the VERNIER. The power meter readings should be within the limits specified.

(2.0 — 6.6 GHz) -2.00 dB _____ +2.00 dB

15. Tune the Signal Generator from 6.6 to 12.3 GHz in 100 MHz steps while noting the power meter readings at each frequency step. The power meter readings should be within the limits specified.

(6.6 — 12.3 GHz) -2.25 dB _____ +2.25 dB

16. Tune the Signal Generator from 12.3 to 18.0 GHz in 100 MHz steps while noting the power meter readings at each frequency step. The power meter readings should be within the limits specified.

(12.3 — 18.0 GHz) -2.50 dB _____ +2.50 dB

17. Repeat steps 9 through 16 using the power levels and frequency ranges listed in Table 4-2.
-

PERFORMANCE TESTS

ABSOLUTE LEVEL ACCURACY TESTS (cont'd)

Procedure
(cont'd)

Table 4-2. High Level Accuracy Test Record

Output Power	Frequency Range	Min.	Actual	Max.
0.0 dBm (+10 dB RANGE)	2.0—6.6 GHz	-2.00 dB	_____	+2.00 dB
	6.6—12.3 GHz	-2.25 dB	_____	+2.25 dB
	12.3—18.6 GHz	-2.50 dB	_____	+2.50 dB
	(Not for Option 004)			
	18.6—26.0 GHz	-3.00 dB	_____	+3.00 dB
-5.0 dBm (0 dB RANGE)	2.0—6.6 GHz	-1.75 dB	_____	+1.75 dB
	6.6—12.3 GHz	-2.00 dB	_____	+2.00 dB
	12.3—18.6 GHz	-2.25 dB	_____	+2.25 dB
	18.6—26.0 GHz	-2.75 dB	_____	+2.75 dB
-10 dBm (0 dB RANGE)	2.0—6.6 GHz	-1.75 dB	_____	+1.75 dB
	6.6—12.3 GHz	-2.00 dB	_____	+2.00 dB
	12.3—18.6 GHz	-2.25 dB	_____	+2.25 dB
	18.6—26.0 GHz	-2.75 dB	_____	+2.75 dB
-10 dBm (-10 dB RANGE)	2.0—6.6 GHz	-2.25 dB	_____	+2.25 dB
	6.6—12.3 GHz	-2.50 dB	_____	+2.50 dB
	12.3—18.6 GHz	-2.85 dB	_____	+2.85 dB
	18.6—26.0 GHz	-3.30 dB	_____	+3.30 dB
-20 dBm (-20 dB RANGE)	2.0—6.6 GHz	-2.45 dB	_____	+2.45 dB
	6.6—12.3 GHz	-2.70 dB	_____	+2.70 dB
	12.3—18.6 GHz	-3.05 dB	_____	+3.05 dB
	18.6—26.0 GHz	-3.60 dB	_____	+3.60 dB

Low Level Accuracy Test

18. Tune the Signal Generator to 4.0 GHz.
19. Set the OUTPUT LEVEL RANGE to -20 dB. Adjust the VERNIER for a front panel meter indication of 0 dBm.
20. Peak the Signal Generator with the AUTO PEAK key.
21. Adjust the VERNIER for a power meter reading of -20.0 dBm \pm 0.1 dB.
22. Disconnect the power meter and connect the Signal Generator to the attenuator and mixer as shown in Figure 4-22.

NOTE

Connect the mixer directly to the local oscillator to avoid any power loss.

PERFORMANCE TESTS

ABSOLUTE LEVEL ACCURACY TESTS (cont'd)**Procedure
(cont'd)**

23. Tune the local oscillator to a frequency 100 kHz \pm 1 kHz higher than the Signal Generator setting in step 18.
24. Set the local oscillator output power to +7 dBm.
25. Set the resolution bandwidth on the spectrum analyzer to 300 Hz or less. Adjust the vertical sensitivity to place the peak of the 100 kHz IF signal on the center horizontal graticule line. This calibrates the center graticule line for an absolute reference power level of -20 dBm.
26. Set the RANGE of the Signal Generator 10 dB lower and adjust the VERNIER for a front panel meter reading of 0 dBm.
27. Set the spectrum analyzer reference level 10 dB lower to bring the signal level near the reference graticule line.
28. Read the difference between the new signal level and the center reference graticule line. Calculate the actual power as follows:

NOTE

The difference is positive if the signal is above the reference graticule; negative if below. Use the spectrum analyzer marker, if available, for best accuracy.

$$\begin{array}{r}
 \text{_____ Output level set in step 25.} \\
 + \text{ _____ Difference measured in step 28.} \\
 \text{_____ Actual level.}
 \end{array}$$

Record the actual level calculated in Table 4-3. The level reading should be within the limits specified.

29. Repeat steps 26 through 28 with Signal Generator settings of -40 dBm and -50 dBm in step 26. Record the output level readings in Table 4-3.
 30. Note the Signal Generator's signal level (at -50 dBm) on the spectrum analyzer display. Remove the 20 dB attenuator, set the spectrum analyzer's reference level 20 dB lower, and reset the vertical sensitivity to the level noted before removing the 20 dB attenuator.
 31. Repeat steps 26 through 28 with Signal Generator RANGE settings of -60 dBm through -90 dBm. Record the output level readings in Table 4-3.
 32. Repeat steps 18 through 32 with Signal Generator frequencies of 10 GHz, 14 GHz, and 20 GHz.
-

PERFORMANCE TESTS

ABSOLUTE LEVEL ACCURACY TESTS (cont'd)
**Procedure
(cont'd)**
Table 4-3. Low Level Accuracy Test Record

Test	Results		
	Min	Actual	Max
4.0 GHz			
-30 dBm	-32.75 dBm	_____	-27.25 dBm
-40 dBm	-42.85 dBm	_____	-37.15 dBm
-50 dBm	-52.95 dBm	_____	-47.05 dBm
-60 dBm	-63.05 dBm	_____	-56.95 dBm
-70 dBm	-73.15 dBm	_____	-66.85 dBm
-80 dBm	-83.25 dBm	_____	-76.75 dBm
-90 dBm	-93.35 dBm	_____	-86.65 dBm
10 GHz			
-30 dBm	-33.00 dBm	_____	-27.00 dBm
-40 dBm	-43.10 dBm	_____	-36.90 dBm
-50 dBm	-53.20 dBm	_____	-46.80 dBm
-60 dBm	-63.30 dBm	_____	-56.70 dBm
-70 dBm	-73.40 dBm	_____	-66.60 dBm
-80 dBm	-83.50 dBm	_____	-76.50 dBm
-90 dBm	-93.60 dBm	_____	-86.40 dBm
14 GHz			
-30 dBm	-33.45 dBm	_____	-26.55 dBm
-40 dBm	-43.65 dBm	_____	-36.35 dBm
-50 dBm	-53.85 dBm	_____	-46.15 dBm
-60 dBm	-64.05 dBm	_____	-55.95 dBm
-70 dBm	-74.25 dBm	_____	-65.75 dBm
-80 dBm	-84.45 dBm	_____	-75.55 dBm
-90 dBm	-94.65 dBm	_____	-85.35 dBm
20 GHz			
-30 dBm	-34.05 dBm	_____	-25.95 dBm
-40 dBm	-44.25 dBm	_____	-35.75 dBm
-50 dBm	-54.45 dBm	_____	-45.55 dBm
-60 dBm	-64.65 dBm	_____	-55.35 dBm
-70 dBm	-74.85 dBm	_____	-65.15 dBm
-80 dBm	-85.05 dBm	_____	-74.95 dBm
-90 dBm	-95.25 dBm	_____	-84.75 dBm

PERFORMANCE TESTS

4-17. OUTPUT LEVEL SWITCHING TIME TEST

Specification

Electrical Characteristics	Performance Limits	Conditions
SWITCHING TIME Output level to be within ± 1 dB of final output level.	< 25 ms	

Description

This test measures the output level switching speed of the Signal Generator. The Signal Generator output is detected using a crystal detector. The detected amplitude is displayed on the oscilloscope.

Level switching speed is measured using a digitizing oscilloscope. The oscilloscope is set to trigger the digitizing process at the beginning of a small frequency change which produces a trigger signal at the Signal Generator's Blanking/Marker rear panel output. As the unit under test is switched, the RF output signal will be blanked and then rise and settle at a fixed amplitude (the final level). The oscilloscope is calibrated to display the ± 1 dB points about the final level. The switching time is the time required before the IF signal amplitude remains within the reference levels.

NOTE

A storage oscilloscope simplifies these tests because it only needs two sweeps to display the switching time. This is especially important for Option 008 where many sweeps cause undue wear on internal relays. If you perform these tests with a non-storage scope, keep the number of sweeps to a minimum.

Equipment

- Crystal Detector HP 8473C
- Digitizing Oscilloscope HP 1980B/19860A
- Controller HP 85B or HP 9836A

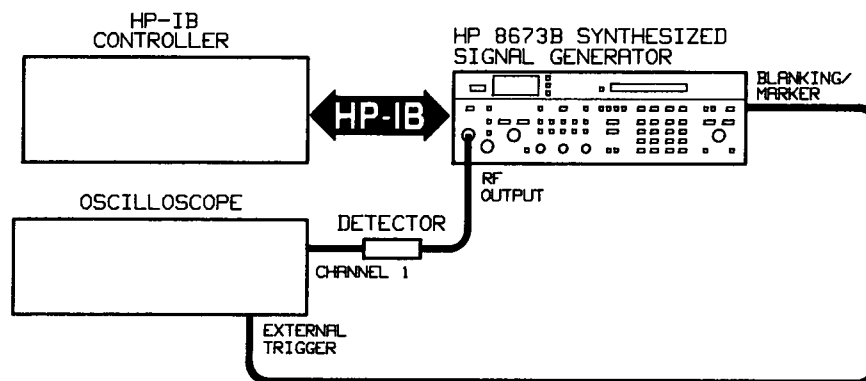

Figure 4-23. Output Level Switching Time Test Setup

PERFORMANCE TESTS

OUTPUT LEVEL SWITCHING TIME TEST (cont'd)**Procedure (cont'd)**

1. Set up the equipment as shown in Figure 4-23. The external trigger input of the oscilloscope is connected to the Signal Generator's rear panel Blanking/Marker output. This signal will trigger the oscilloscope at the start of a frequency change when any sweep mode is selected. By making a simultaneous frequency and level change, the oscilloscope can be triggered to view the level switching process.
2. Set the oscilloscope as follows:
 - Channel 1:
 - Vertical Sensitivity to 5 mV/Division
 - Coupling to DC
 - Set sweep to delayed
 - Main Sweep Parameters:
 - External trigger with DC coupling
 - Positive slope trigger
 - Auto sweep mode
 - Set Trigger Level to E 1.00
 - Delayed Sweep Parameters:
 - Internal trigger with AC coupling
 - Positive slope trigger
 - Auto sweep mode

NOTE

Triggered sweep mode must be used to trigger the digitizer at the start of the simultaneous level and frequency change. If auto sweep mode is selected on the oscilloscope while digitizing, the oscilloscope will trigger the sweep even without an external trigger signal and the waveform digitized will not be valid for this measurement.

3. Set the oscilloscope's main sweep to 5 ms per division and delayed sweep to 1 ms per division. The delayed sweep will be used once the approximate delay required is determined from the main sweep.
4. Set the Signal Generator to the following conditions:
 - Output Level0 dBm
 - ALCInternal
 - ModulationOff
 - Sweep ModeManual
 - Start Frequency3 000.000 MHz
 - Stop Frequency3 000.010 MHz
 - Step10 Steps
 - Dwell20 ms
5. Set the oscilloscope to main sweep with auto sweep mode to view the signal without using the external trigger signal.
6. Enter and run the following HP-IB controller program.

PERFORMANCE TESTS

OUTPUT LEVEL SWITCHING TIME TEST (cont'd)

```

Procedure          10 L2+0
(cont'd)           20 FOR I+1 TO 20
                    30 OUTPUT 719;"LE";L2+1;"DB"
                    40 NEXT I
                    50 FOR I+1 TO 20
                    60 OUTPUT 719;"LE";L2-1;"DB"
                    70 NEXT I
                    80 GOTO 20
                    90 ! NEXT PROGRAM
                    100 L1+-99
                    110 L2+0
                    120 OUTPUT 719;"LE";L1;"DB;UP"
                    130 PRINT "PLEASE PRESS THE DIGITIZER KEY."
                    140 PRINT "PRESS THE CONTINUE KEY ON THE"
                    150 PRINT "CONTROLLER WHEN DONE."
                    160 PAUSE
                    170 OUTPUT 719;"DN;LE";L2;"DB"
                    180 END

```

7. While the program is executing, adjust channel 1 vertical controls for an amplitude change of exactly two divisions centered about the middle horizontal graticule. This calibrates the display for a ± 1 dB reference about 0 dBm.
8. Set the oscilloscope's main sweep mode to triggered (or NORM). This sweep mode will not trigger the digitizer until the external trigger signal is received.
9. Press the pause key on the controller to stop the first part of the program. Run the second part of the program by executing the statement "RUN 100." Press the digitizer key on the oscilloscope when instructed to by the program.

The program will set the output level to the starting value (L1) and step the frequency up. The program will then pause to allow the digitizer key on the oscilloscope to be pressed. After the key is pressed, the program triggers the oscilloscope as the level is switched from the start level (L1) to the stop level (L2). The oscilloscope should digitize the switching waveform as the frequency and level changes. The waveform should be similar to the waveform shown in Figure 4-24.

NOTE

If a negative detector is used, channel 1 should be inverted. If channel 1 is not inverted, the actual waveforms will be the inverse of those shown.

10. Set the oscilloscope to delayed sweep mode. Set the oscilloscope's delay time to the time corresponding to about $\frac{1}{2}$ a division before the digitized signal's amplitude settles into the final value. The measurement will be the time required before the signal stays within ± 1 division of the middle horizontal graticule (the final amplitude). Setting the delay time to begin the sweep at this point will allow more detail to be digitized since the oscilloscope will digitize a smaller portion of the switching waveform.

PERFORMANCE TESTS

OUTPUT LEVEL SWITCHING TIME TEST (cont'd)

Procedure
(cont'd)

Figure 4-24. Output Level Switching Waveform

11. Rerun the program entered in step 9 by executing the command "RUN 100." Press the digitizer key on the oscilloscope when instructed to by the program. The oscilloscope should digitize the switching waveform with greater detail. The waveform should now look like that shown in Figure 4-25.
12. Measure the level switching time by observing the digitized signal on the oscilloscope display. The external trigger is the reference for determining switching speed. The switching time is measured from the display's left graticule to the last point that the signal is more than ± 1 division from the middle horizontal graticule. Refer to Figure 4-25. Record the level switching time.

NOTE

With the oscilloscope in delayed sweep mode, the left graticule of the display corresponds to the delay time. This delay must be added to the time from the left graticule to the last time the signal is more than ± 1 division from the middle graticule to obtain the level switching time.

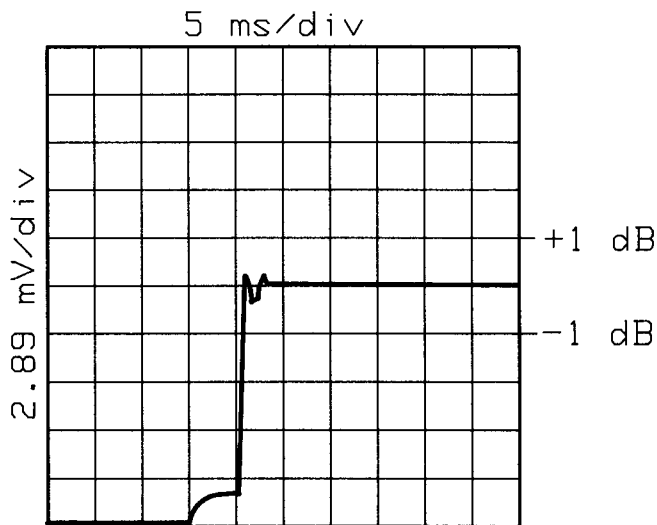
_____ <25 ms

13. Repeat steps 5 through 12 for each of the start and stop levels listed below. Instead of re-entering the program, modify lines 10, 100 and 110 and then run the program as directed. Modify line 10 and 110 of the program by setting L2 to the stop level (i.e. L2=0). Modify line 100 of the program by setting L1 to the start level (i.e. L1=-88). Record the switch time for each indicated level change.

PERFORMANCE TESTS

OUTPUT LEVEL SWITCHING TIME TEST (cont'd)

**Procedure
(cont'd)**

Start Level (dBm)	Stop Level (dBm)	Measured Switching Time
-88.0	0.0	_____ <25 ms
-77.0	0.0	_____ <25 ms
-66.0	0.0	_____ <25 ms
-50.0	-2.0	_____ <25 ms
-40.0	0.0	_____ <25 ms
-30.0	0.0	_____ <25 ms
-20.0	4.0	_____ <25 ms
-10.0	2.0	_____ <25 ms
- 9.9	7.0	_____ <25 ms
- 8.0	6.0	_____ <25 ms
- 9.9	0.0	_____ <25 ms
- 7.0	3.0	_____ <25 ms

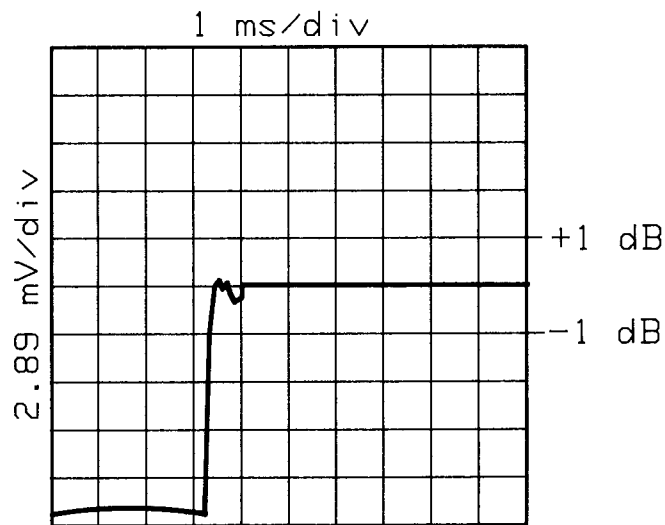

Figure 4-25. Level Switching Time Measurement Waveform

PERFORMANCE TESTS

4-18. PULSE ON/OFF RATIO TEST

Specification

Electrical Characteristics	Performance Limits	Conditions
ON/OFF Ratio	>80 dB	

Description

A spectrum analyzer is used to measure the change in output power when the pulse modulator is switched from complement mode to normal mode.

Equipment

Spectrum Analyzer HP 8566B

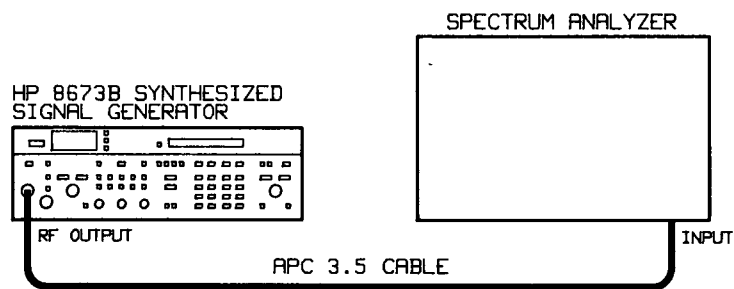

Figure 4-26. Pulse ON/OFF Ratio Test Setup

Procedure

1. Connect the equipment as shown in Figure 4-26.
2. Set the Signal Generator as follows:
 - FREQUENCY 2 000.0 MHz
 - OUTPUT LEVEL RANGE 0 dBm
 - OUTPUT LEVEL VERNIER -10 dBm
 - PULSE COMPL
 - AM OFF
 - FM DEVIATION OFF
 - SWEEP MODE OFF
3. Set the spectrum analyzer controls as follows:
 - Center Frequency 2 000.0 MHz
 - Frequency Span 100 kHz
 - Resolution Bandwidth 1 kHz
 - Video Bandwidth 100 Hz
 - Sweep Time 3 sec
4. Adjust the spectrum analyzer controls to establish a reference at the top graticule line.

PERFORMANCE TESTS

PULSE ON/OFF RATIO TEST (cont'd)

**Procedure
(cont'd)**

NOTE

The spectrum analyzer must not be in the gain compression region for this measurement. If a 3 dB increase in the Signal Generator output level does not produce a 3 dB increase in the level of the displayed signal, the spectrum analyzer is in gain compression. If this happens, increase the spectrum analyzer's input attenuation until a 3 dB increase in the Signal Generator's output level produces a 3 dB change in the displayed signal level.

5. Set PULSE MODE on the Signal Generator to NORM.
6. Reduce the spectrum analyzer reference level as needed to observe the residual signal. It should be >80 dB below the reference established in step 4. Record the reading.

2 000.0 MHz _____ >80 dB

7. Repeat steps 4 through 6 for the Signal Generator frequencies listed below. Record the results in the table below.

Frequency (MHz)	Level (dB below reference)
3 000.0	> 80 _____
4 000.0	> 80 _____
5 000.0	> 80 _____
6 000.0	> 80 _____
6 600.0	> 80 _____

PERFORMANCE TESTS

4-19. PULSE RISE/FALL TIME AND OVERSHOOT TEST

Specification

Electrical Characteristics	Performance Limits	Conditions
PULSE MODULATION		
Rise and Fall Times	<35 ns	AUTO PEAK enabled
For Option 008	<40 ns	2.0 to 26.0 GHz
		AUTO PEAK enabled
Overshoot, Ringing	<20%	2.0 to 6.6 GHz,
		6.7 to 26.0 GHz
	<25%	6.6 to 6.7 GHz,
For Option 008	<25%	2.0 to 26.0 GHz

Description

The pulse test uses a mixer to generate an IF signal of 70 MHz. The resulting IF signal is amplified and viewed on an oscilloscope to determine pulse performance.

Equipment

- HP-IB Controller HP 9836A or HP85B/82903
- Local Oscillator HP 8340A
- Pulse Generator HP 8013B
- Oscilloscope HP 1980B
- Pre Amp-Power Amp HP 8447F
- Mixer RHG DMS1-26
- 20 dB Attenuator HP 8493C Option 020
- 3 dB Attenuator HP 8491A Option 003
- 10 dB Attenuator HP 8491A Option 010

Procedure

1. Connect the equipment as shown in Figure 4-27.

NOTE

Make sure there are no sharp bends in the cables, and that all connections are tight. Connect the LO port of the mixer directly to the output connector of the local oscillator. Connect the 3 dB attenuator directly to the IF port of the mixer. This will minimize distortion of the pulse shape, and thus give more accurate measurements.

2. Set the Signal Generator as follows:

- FREQUENCY 2 000.0 MHz
- PULSE NORM
- OUTPUT LEVEL RANGE 10 dB
- OUTPUT LEVEL VERNIER Maximum specified power

NOTE

Maximum specified power at 2 000.0 MHz and up to 18 000.0 MHz is as follows:

- Standard: +8 dBm
- Option 001: +10 dBm
- Option 004: +7 dBm
- Option 005: +9 dBm
- Option 008: +8 dBm

PERFORMANCE TESTS

PULSE RISE/FALL TIME AND OVERSHOOT TEST (cont'd)

Procedure
(cont'd)

Figure 4-27. Pulse Rise/Fall Time and Overshoot Test Setup

- Set the pulse generator and oscilloscope controls as follows:

Pulse Generator:

Pulse Rate	1 MHz
Pulse Width	120 ns
Pulse Amplitude	5V peak

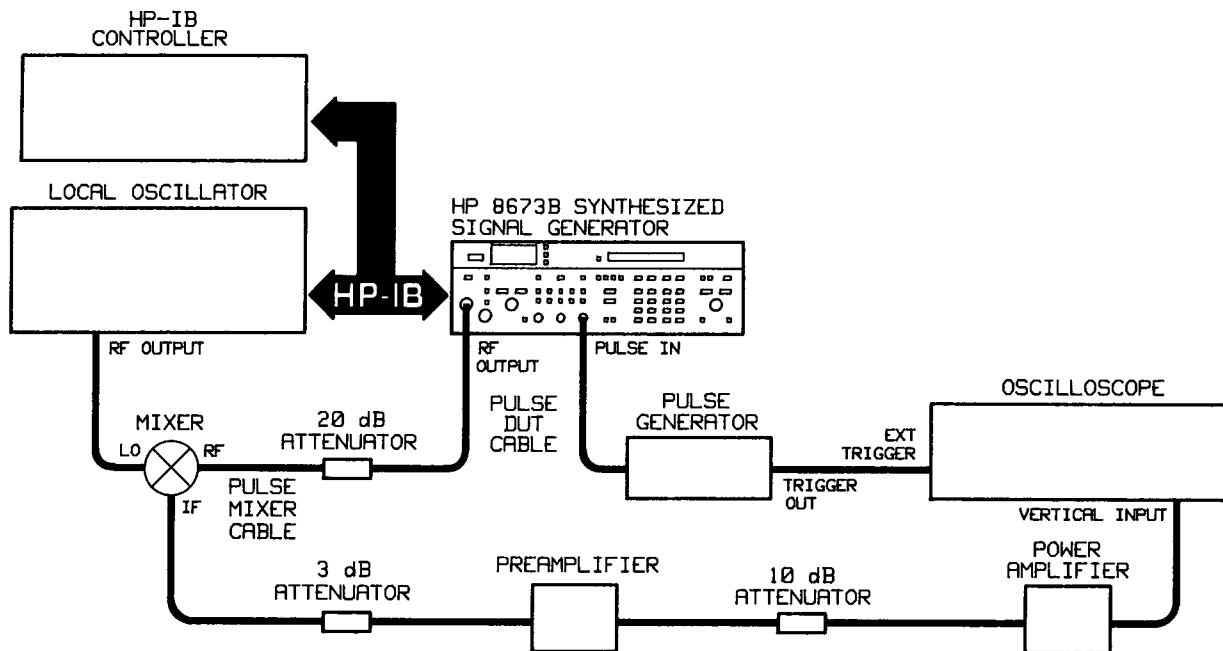
Oscilloscope:

Vertical Display	Channel 1, DC 50 Ω Coupling
Time/Div Main	20 ns
Time/Div Delayed	20 ns
Vertical Sensitivity	20 mV/div.
Trigger	External DC Coupled
Sweep	Triggered

- Set the local oscillator address to 718. Enter and run the following program.

NOTE

The following program will cause the local oscillator to track the frequency of the Signal Generator with a positive offset of 70 MHz. A change in the Signal Generator's frequency will be detected by the controller and the frequency output of the local oscillator will be automatically changed to maintain the positive offset.

PERFORMANCE TESTS

PULSE RISE/FALL TIME AND OVERSHOOT TEST (cont'd)

**Procedure
(cont'd)**

```

10 F1+0
20 F0+0
30 OUTPUT 719;"FROA"
                                     Read current UUT frequency
40 ENTER 719;F2
45 OUTPUT 719;"CS"
50 LOCAL 719
                                     Convert reading to MHz
55 F2+F2/1000000
60 IF F2 <> F1 THEN F1+F2
                                     Calculate 70 MHz offset frequency
70 F3+F1+70
90 IF F0 <> F3 THEN GOSUB 500
100 V+SPOLL(719)
110 IF NOT BIT(V,1) THEN GOTO 100
120 V+SPOLL(719)
130 IF NOT BIT(V,1) THEN GOTO 120
140 GOTO 30
500 F0+F3
                                     Local oscillator address
505 OUTPUT 718;"CW";F0;"MZAP7DB"
                                     Tune local oscillator to offset frequency
510 RETURN
520 END

```

5. Adjust the oscilloscope to center the pulse waveform. Adjust the vertical controls for a 5 division peak pulse display. See Figure 4-28.

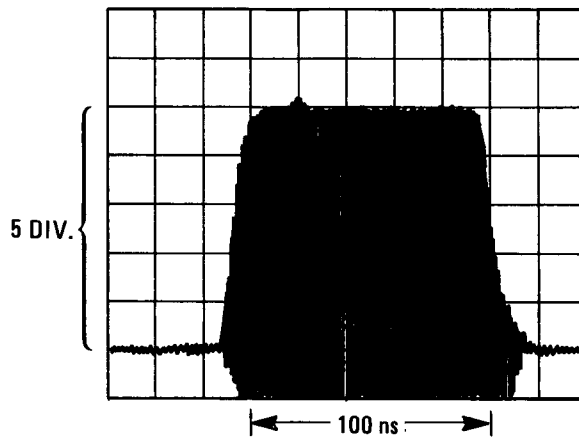

Figure 4-28. Pulse Rise/Fall Time and Overshoot Waveform

PERFORMANCE TESTS

PULSE RISE/FALL TIME AND OVERSHOOT TEST (cont'd)

Procedure (cont'd)

6. Measure the pulse rise time, fall time, overshoot and ringing. Record the results.

Rise Time _____	<35 ns	For Option 008:	Rise Time _____	<40 ns
Fall Time _____	<35 ns		Fall Time _____	<40 ns
Overshoot and Ringing _____	<20%		Overshoot and Ringing _____	<25%

NOTE

For the measurements in this procedure, refer to Figure 4-29, Pulse Definitions, for explanations of the pulse parameters.

- Pulse Rise Time = The time required for a pulse to increase from 10% to 90% of peak amplitude (T_R).
- Pulse Fall Time = The time required for a pulse to decrease from 90% to 10% of peak amplitude (T_F).
- Overshoot and Ringing = The ratio of pulse overshoot (V_{or}) to peak amplitude (V_p). (V_{or}/V_p)

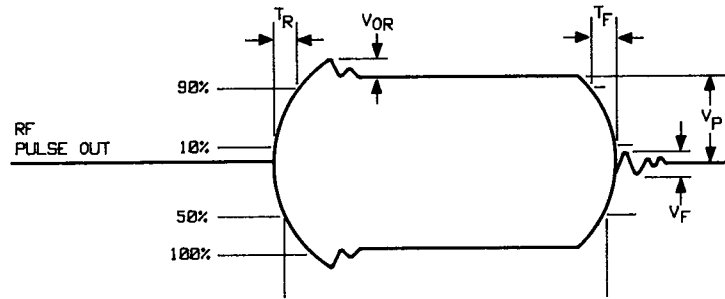

Figure 4-29. Pulse Definitions

7. Tune the Signal Generator to 6600 MHz. Measure the pulse rise time, fall time, overshoot and ringing. Record the results.

Rise Time _____	<35 ns	For Option 008:	Rise Time _____	<40 ns
Fall Time _____	<35 ns		Fall Time _____	<40 ns
Overshoot and Ringing _____	<20%		Overshoot and Ringing _____	<25%

8. Set the Signal Generator to the levels shown in the table below. Tune the Signal Generator's output frequency as shown for each level. The local oscillator should track the Signal Generator with a 70 MHz offset. Measure rise time, fall time, overshoot, and ringing at each frequency. Rise and fall times should be less than 35 ns (40 ns. for Option 008). Overshoot and ringing should be less than 25% from 6600 to

PERFORMANCE TESTS

PULSE RISE/FALL TIME AND OVERSHOOT TEST (cont'd)

Procedure (cont'd)

6700 MHz, less than 20% from 6700 to 26 000 MHz, and less than 25% for Option 008 at all frequencies. Record the results in the following table.

OUTPUT LEVEL		FREQUENCY (MHz)	RISE (ns)	FALL (ns)	Overshoot and Ringing (%)
RANGE	VERNIER				
+10 dB	Max.*	6600.002	_____	_____	_____
+10 dB	Max.*	6700.002	_____	_____	_____
+10 dB	Max.*	12 290.002	_____	_____	_____
0 dB	0 dBm	6600.002	_____	_____	_____
0 dB	0 dBm	6700.002	_____	_____	_____
0 dB	0 dBm	12 290.002	_____	_____	_____
0 dB	-10 dBm	6600.002	_____	_____	_____
0 dB	-10 dBm	6700.002	_____	_____	_____
0 dB	-10 dBm	12 290.002	_____	_____	_____

* Adjust VERNIER for maximum output power as defined in step 2.

9. Tune the Signal Generator from 6.6 to 12.3 GHz. Ensure that rise time, fall time, overshoot, and ringing are within the limits specified at output levels of maximum specified power, 0 dBm, and -10 dBm for all frequencies within this range. Record the worst case results.

FREQUENCY (MHz)	OUTPUT LEVEL		RISE (ns)	FALL (ns)	Overshoot and Ringing (%)
	RANGE	VERNIER			
_____	+10 dB	Max.*	_____	_____	_____
_____	0 dB	0 dBm	_____	_____	_____
_____	0 dB	-10 dBm	_____	_____	_____

* Adjust VERNIER for maximum output power as defined in step 2.

10. Set the Signal Generator to the levels shown in the following table. Tune the Signal Generator's output frequency as shown for each level. Measure rise time, fall time, overshoot, and ringing at each setting. Rise and fall times should be less than 35 ns (40 ns for Option 008). Overshoot and ringing should be less than 20% (25% for Option 008). Record the measurements in the following table.

OUTPUT LEVEL		FREQUENCY (MHz)	RISE (ns)	FALL (ns)	Overshoot and Ringing (%)
RANGE	VERNIER				
+10 dB	Max.*	12 300.003	_____	_____	_____
+10 dB	Max.*	17 990.003	_____	_____	_____
0 dB	0 dBm	12 300.003	_____	_____	_____
0 dB	0 dBm	17 990.003	_____	_____	_____
0 dB	-10 dBm	12 300.003	_____	_____	_____
0 dB	-10 dBm	17 990.003	_____	_____	_____

* Adjust VERNIER for maximum output power as defined in step 2.

PERFORMANCE TESTS

PULSE RISE/FALL TIME AND OVERSHOOT TEST (cont'd)

Procedure (cont'd)

11. Tune the Signal Generator from 12.3 to 18.0 GHz at output levels of -10 dBm, 0 dBm, and maximum power. Verify that the rise and fall times are less than 35 ns (40 ns for Option 008) and overshoot and ringing are less than 20% (25% for Option 008). Record the worst case readings in the following table.

FREQUENCY (MHz)	OUTPUT LEVEL		RISE (ns)	FALL (ns)	Overshoot and Ringing (%)
	RANGE	VERNIER			
_____	-10 dB	Max.*	_____	_____	_____
_____	0 dB	0 dBm	_____	_____	_____
_____	0 dB	-10 dBm	_____	_____	_____

* Adjust VERNIER for maximum output power as defined in step 2.

12. Set the Signal Generator to the levels shown in the following table. Tune the Signal Generator's output frequency as shown for each level. Measure rise time, fall time, overshoot, and ringing at each setting. Rise and fall times should be less than 35 ns (40 ns for Option 008). Overshoot and ringing should be less than 20% (25% for Option 008).

NOTE

Maximum specified power at 18 000 MHz and up to 22 000 MHz is as follows:

- Standard: +4 dBm
- Option 001: +6 dBm
- Option 004: +2 dBm
- Option 005: +4 dBm
- Option 008: +7 dBm

OUTPUT LEVEL		FREQUENCY (MHz)	RISE (ns)	FALL (ns)	Overshoot and Ringing (%)
RANGE	VERNIER				
+10 dB	Max.*	18 600.004	_____	_____	_____
+10 dB	Max.*	21 990.004	_____	_____	_____
0 dB	0 dBm	18 600.004	_____	_____	_____
0 dB	0 dBm	21 990.004	_____	_____	_____
0 dB	-10 dBm	18 600.004	_____	_____	_____
0 dB	-10 dBm	21 990.004	_____	_____	_____

* Adjust VERNIER for maximum output power as defined in step 12.

13. Tune the Signal Generator from 18.0 to 22.0 GHz at output levels of -10 dBm, 0 dBm, and maximum. Verify that rise and fall times are less than 35 ns (40 ns for Option 008) and that overshoot and ringing are less than 20% (25% for Option 008). Record the worst case results in the following table.

PERFORMANCE TESTS

PULSE RISE/FALL TIME AND OVERSHOOT TEST (cont'd)

**Procedure
(cont'd)**

FREQUENCY (MHz)	OUTPUT LEVEL		RISE (ns)	FALL (ns)	Overshoot and Ringing (%)
	RANGE	VERNIER			
_____	+10 dB	Max.*	_____	_____	_____
_____	0 dB	0 dBm	_____	_____	_____
_____	0 dB	-10 dBm	_____	_____	_____

* Adjust VERNIER for maximum output power as defined in step 12.

- Set the Signal Generator to 25 990.004 MHz and its output to the levels shown in the following table. Measure rise time, fall time, overshoot, and ringing at each setting. Rise and fall times should be less than 35 ns (40 ns for Option 008). Overshoot and ringing should be less than 20% (25% for Option 008).

NOTE

Maximum specified power at 22 000 MHz and up to 26 000 MHz is as follows:

- Standard: 0 dBm
- Option 001: +3 dBm
- Option 004: -2 dBm
- Option 005: +1 dBm
- Option 008: +7 dBm

OUTPUT LEVEL		FREQUENCY (MHz)	RISE (ns)	FALL (ns)	Overshoot and Ringing (%)
RANGE	VERNIER				
+10 dB (Not for Opt. 004)	Max.*	25 990.004	_____	_____	_____
0 dB (Not for Opt. 004)	0 dBm	25 990.004	_____	_____	_____
0 dB (For Opt. 004)	-2 dBm	25 990.004	_____	_____	_____
0 dB	-10 dBm	25 990.004	_____	_____	_____

* Adjust VERNIER for maximum output power as defined in step 14.

- Tune the Signal Generator from 22.0 to 26.0 GHz at output levels of -10 dBm, 0 dBm, and +6 dBm. Verify that rise and fall times are less than 35 ns (40 ns for Option 008) and that overshoot and ringing are less than 20% (25% for Option 008). Record the worst case results in the table below.

FREQUENCY (MHz)	OUTPUT LEVEL		RISE (ns)	FALL (ns)	Overshoot and Ringing (%)
	RANGE	VERNIER			
_____	+10 dB (Not for Opt. 004)	Max.*	_____	_____	_____
_____	0 dB (Not for Opt. 004)	0 dBm	_____	_____	_____
_____	0 dB (For Opt. 004)	-2 dBm	_____	_____	_____
_____	0 dB	-10 dBm	_____	_____	_____

* Adjust VERNIER for maximum output power as defined in step 14.

PERFORMANCE TESTS

4-20. PULSE PEAK LEVEL ACCURACY TEST

Specification

Electrical Characteristics	Performance Limits	Conditions
PULSE MODULATION Maximum Peak Power	Same as in CW mode	
Peak Level Accuracy	+1.5/-1.0 dB	Relative to CW; +15 to +35°C

Description

The output of the Signal Generator is switched between CW and pulse modulation mode using the CW level as a reference. The difference in level between the two modes represents the peak level accuracy error.

Equipment

- Local Oscillator HP 8340A
- Pulse Generator HP 8013B
- Oscilloscope HP 1980B
- Pre Amp-Power Amp HP 8447F
- Mixer RHG DMS1-26
- 20 dB Attenuator HP 8493C Option 020
- 3 dB Attenuator HP 8491A Option 003
- 10 dB Attenuator HP 8491A Option 010

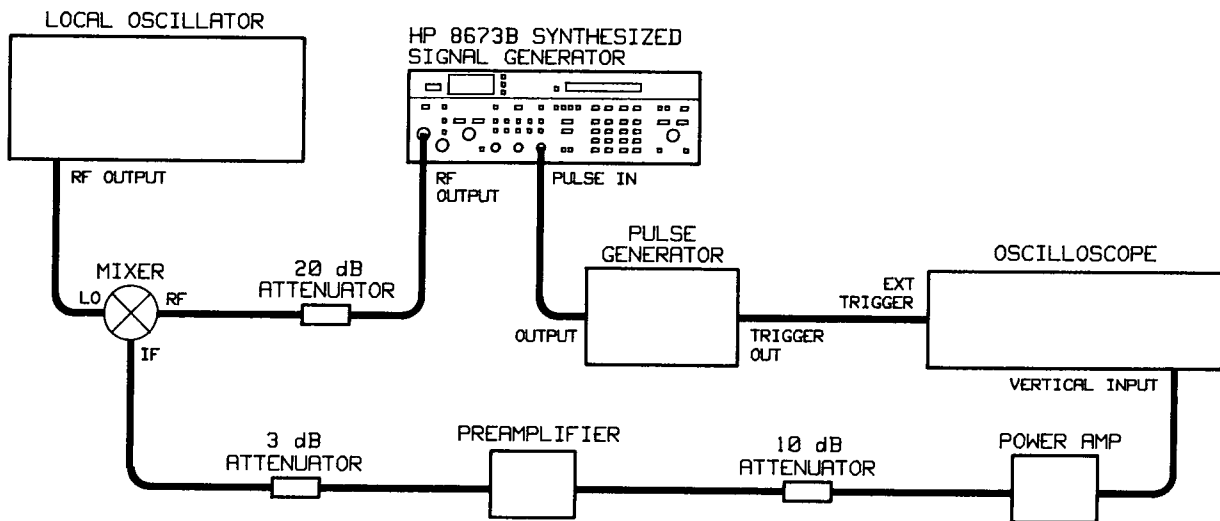

Figure 4-30. Pulse Peak Level Accuracy Test Setup

Procedure

1. Connect the equipment as shown in Figure 4-30.
2. Set the Signal Generator to 6.6 GHz with an output amplitude of +7 dBm.
3. Set the local oscillator to 6.67 GHz with an output amplitude of +8 dBm.
4. Set the pulse generator for a 100 ns pulse width at a 1 MHz pulse rate.

PERFORMANCE TESTS

PULSE PEAK LEVEL ACCURACY TEST (cont'd)

Procedure (cont'd)

5. Set the Signal Generator to PULSE NORM. Adjust the oscilloscope vertical position and sensitivity controls so that the pulse base line is one division from the bottom graticule line and approximately 5 divisions high in peak amplitude.
6. Adjust the RF pulse width with the pulse generator to obtain a 100 ns RF pulse width as displayed on the oscilloscope.
7. Switch the Signal Generator to CW mode.
8. Adjust the oscilloscope's vertical sensitivity controls to place the peak of the CW signal on the fifth graticule above the pulse base line (refer to Figure 4-31). The peak of the CW signal is now the CW peak reference level.

NOTE

Do not touch the oscilloscope's vertical position controls after the reference pulse base line has been set.

9. Switch the Signal Generator to PULSE NORM. Without adjusting the oscilloscope's vertical sensitivity controls, measure the difference between the CW peak reference level and the average peak pulse level excluding any overshoot. See Figure 4-31.

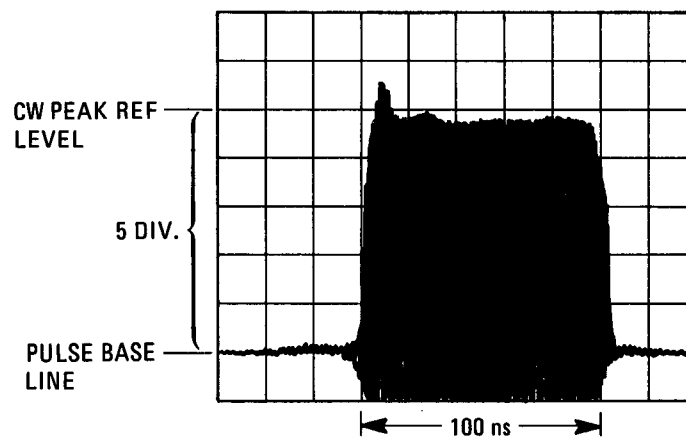

Figure 4-31. Pulse Peak Level Accuracy Measurement

10. Measure the peak level difference in percent. Using a 5 division peak reference, each division represents a 20% difference. Measured difference must be within the limits of -10.8% to $+18.8\%$. (-10.8% corresponds to -0.5 divisions on the oscilloscope; $+18.8\%$ corresponds to $+0.9$ divisions.) This is equal to $+1.5$ dB, -1 dB. Record the measurement in the following table.
11. Repeat steps 1 through 10 for the frequencies and levels listed in the following table. Record the results.

PERFORMANCE TESTS

PULSE PEAK LEVEL ACCURACY TEST (cont'd)

**Procedure
(cont'd)**

Signal Generator		Local Oscillator		% Difference
FREQ	LEVEL	FREQ	LEVEL	
6.6 GHz	+7 dBm	6.67 GHz	+8 dBm	_____
6.61 GHz	+7 dBm	6.68 GHz	+8 dBm	_____
	0 dBm			_____
	-10 dBm			_____
12.3 GHz	+7 dBm	12.37 GHz	+8 dBm	_____
	0 dBm			_____
	-10 dBm			_____
18.61 GHz	+2 dBm	18.68 GHz	+8 dBm	_____
	0 dBm			_____
	-10 dBm			_____
22.1 GHz	-2 dBm	22.17 GHz	+8 dBm	_____
	-10 dBm			_____

PERFORMANCE TESTS

4-21. AM BANDWIDTH

Specification

Electrical Characteristics	Performance Limits	Conditions
AM Bandwidth	20 Hz to 100 kHz ≤ (Pulsewidth x (PRF) x (4 kHz))	3 dB bandwidth, 30% depth, Pulse Modulation off Pulse Modulation On

Description

The Signal Generator is amplitude modulated by an audio source and mixed down with a local oscillator to produce a modulated 100 MHz IF signal. The AM depth is measured with a measuring receiver. The detected audio output from the measuring receiver is input to an audio analyzer. A 0 dB reference level is established on the audio analyzer at a 1 kHz modulation rate. The modulation rate is then stepped from 20 Hz to 100 kHz to verify that the detected audio output remains within ±3 dB (the 3 dB bandwidth).

Equipment

- Local Oscillator HP 8340A
- Measuring Receiver HP 8902A
- Audio Analyzer/Source HP 8903B
- Mixer RHG DMS1-26
- 6 dB Attenuator HP 8493C Option 006

Procedure

1. Connect the equipment as shown in Figure 4-32.
2. Set the Signal Generator as follows:
 - FREQUENCY 4.0 GHz
 - OUTPUT LEVEL RANGE 0 dB
 - OUTPUT LEVEL VERNIER -2 dBm
 - ALC INT
 - AM 100% range
 - FM OFF
3. Tune the local oscillator to 3.9 GHz with an output amplitude of +8 dBm and all modulation off.
4. Select AM mode on the measuring receiver.
5. Set the audio source to a 1 kHz rate. Adjust the audio source output level for 30% AM depth, as read on the measuring receiver.
6. Set the audio analyzer to read the amplitude of the input signal in dB.
7. Set the audio analyzer to the dB Relative mode using the input signal from the measuring receiver as a 0 dB reference.
8. Tune the audio source from 20 Hz to 100 kHz. The signal level reading on the audio analyzer should not change more than ±3 dB from the reference.

NOTE

The modulation source level may need slight adjustments to hold it at the reference level in step 5.

PERFORMANCE TESTS

AM BANDWIDTH (cont'd)

Procedure (cont'd)

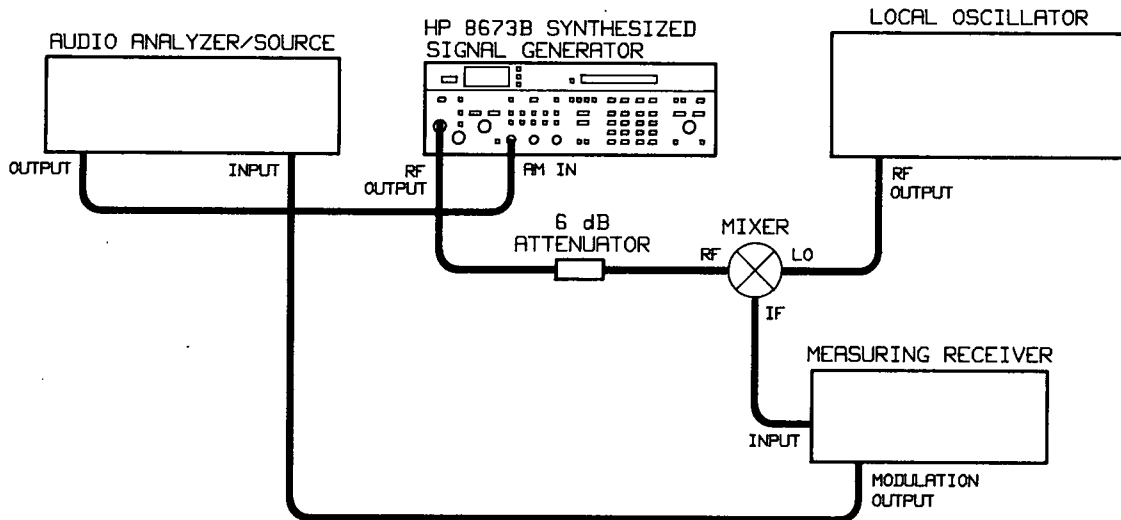

Figure 4-32. AM Bandwidth Test Setup

- Repeat steps 5 through 8 for the frequencies listed below.

Signal Generator Frequency	Local Oscillator Frequency	AM Depth	Modulation	
			Frequency	Change
4.0 GHz	3.9 GHz	30%	_____	_____
6.7 GHz	6.6 GHz	30%	_____	_____
15.0 GHz	14.9 GHz	30%	_____	_____
24.0 GHz	23.9 GHz	30%	_____	_____
26.0 GHz	25.9 GHz	30%	_____	_____

PERFORMANCE TESTS

4-22. AM ACCURACY TESTS

Specification

Electrical Characteristics	Performance Limits	Conditions
AMPLITUDE MODULATION Indicated Meter Accuracy	$\pm 7\%$ of reading, $\pm 3\%$ of range.	100 Hz to 10 kHz rates
Accuracy Relative to External AM Input Level	$\pm 4\%$ of reading, $\pm 2\%$ of range.	100 Hz to 10 kHz rates

Description

The Signal Generator is amplitude modulated by an audio source. The modulated signal is mixed with a local oscillator to produce a modulated 100 MHz IF signal. The AM depth, meter accuracy, and accuracy relative to the external AM input are measured on a measuring receiver.

Equipment

- Local Oscillator HP 8340A
- Measuring Receiver HP 8902A
- Audio Analyzer/Source HP 8903B
- Digital Voltmeter HP 3455A
- 6 dB Attenuator HP 8493C Option 006
- Mixer RHG DMS1-26

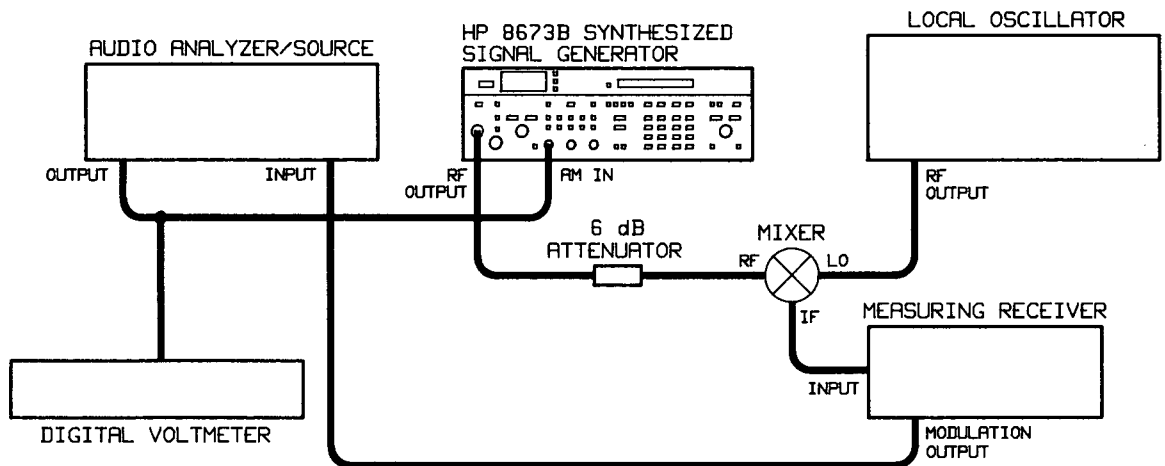

Figure 4-33. AM Accuracy Test Setup

Procedure

Meter Accuracy

1. Connect the equipment as shown in Figure 4-33.

PERFORMANCE TESTS

AM ACCURACY TESTS (cont'd)

Procedure (cont'd)

2. Set the Signal Generator as follows:

- FREQUENCY 2.0 GHz
- OUTPUT LEVEL RANGE 0 dB
- OUTPUT LEVEL VERNIER 0 dBm
- ALC INT
- AM 100% range
- FM OFF

- 3. Tune the local oscillator to 2.05 GHz at an output amplitude of +8 dBm.
- 4. Select AM mode on the measuring receiver.
- 5. Set the modulation source to 1 kHz. Adjust the output level to obtain 50% AM as read on the measuring receiver.
- 6. The AM meter on the Signal Generator should indicate 50% AM \pm 6.5%. Record the reading.

AM Meter reading 43.5% _____ 56.5%

Accuracy Relative to External AM Input

- 7. Set the audio source frequency to 10 kHz with an output amplitude of 0.530 Vrms as read on the digital voltmeter. This corresponds to 75% AM depth.
- 8. Read the actual AM depth on the measuring receiver. The reading should be within \pm 5.0% of 75% AM. Record the reading in the table below.
- 9. Repeat steps 7 and 8 with the frequencies and modulation rates listed in the table below.

Signal Generator Frequency	Local Oscillator Frequency	Modulation Rate	Low Limit	Actual Depth	High Limit
6.6 GHz	6.5 GHz	10 kHz	70.0%	_____	80.0%
6.6 GHz	6.5 GHz	1 kHz	70.0%	_____	80.0%
6.6 GHz	6.5 GHz	0.1 kHz	70.0%	_____	80.0%
10 GHz	9.9 GHz	10 kHz	70.0%	_____	80.0%
14 GHz	13.9 GHz	10 kHz	70.0%	_____	80.0%

- 10. Set the Signal Generator OUTPUT LEVEL VERNIER to -3 dBm.
- 11. Repeat steps 7 and 8 for the frequency listed below.

Signal Generator Frequency	Local Oscillator Frequency	Modulation Rate	Low Limit	Actual Depth	High Limit
18.6 GHz	18.5 GHz	10 kHz	70.0%	_____	80.0%

PERFORMANCE TESTS

AM ACCURACY TESTS (cont'd)

Procedure (cont'd)

12. Set the Signal Generator OUTPUT LEVEL VERNIER to -5 dBm.
13. Set the audio source amplitude to 0.354 Vrms as read on the digital voltmeter. This corresponds to 50% AM depth.
14. Read the actual AM depth on the measuring receiver. The reading should be within $\pm 5.0\%$ of 50% AM. Record the reading in the table below.

Signal Generator Frequency	Local Oscillator Frequency	Modulation Rate	Low Limit	Actual Depth	High Limit
22 GHz	21.9 GHz	10 kHz	45.0%	_____	55.0%

PERFORMANCE TESTS

4-23. INCIDENTAL FM

Specification

Electrical Characteristics	Performance Limits	Conditions
Incidental Phase Modulation (100 Hz to 10 kHz rates; 30% depth)	<0.4 radians <0.8 radians <1.2 radians <1.6 radians <2.5 radians	2.0 to 6.6 GHz >6.6 to 12.3 GHz >12.3 to 18.6 GHz >18.6 to 24.0 GHz >24.0 to 26.0 GHz
Incidental FM	Incidental phase modulation $\times f_{\text{mod}}$	

Description

Incidental FM is measured using a measuring receiver. The output of the Signal Generator is amplitude modulated. An AM reference level is set on the measuring receiver. The modulation analyzer is then set to measure FM. The amount of incidental FM present on the signal is measured and recorded.

NOTE

The specification for incidental FM is derived from incidental phase modulation and the modulation rate (f_{mod}). Thus, worst cases of incidental FM at a 10 kHz maximum modulation rate are as follow:

4 kHz	2.0 to 6.6 GHz
8 kHz	>6.6 to 12.3 GHz
12 kHz	>12.3 to 18.6 GHz
16 kHz	>18.6 to 24.0 GHz
25 kHz	>24.0 to 26.0 GHz

Equipment

Local Oscillator HP 8340A
 Measuring Receiver HP 8902A
 Audio Analyzer/Source HP 8903B
 Mixer RHG DMS1-26
 6 dB Attenuator HP 8493C Option 006

Procedure

1. Connect the equipment as shown in Figure 4-34.
2. Set the Signal Generator as follows:

FREQUENCY	6.2 GHz
OUTPUT LEVEL RANGE	0 dB
OUTPUT LEVEL VERNIER	0 dBm
ALC	INT
AM	100% range
FM	OFF
3. Tune the local oscillator to 6.1 GHz with an output amplitude of +7 dBm.
4. Select AM mode on the measuring receiver.

PERFORMANCE TESTS

INCIDENTAL FM (cont'd)

Procedure (cont'd)

5. Set the modulation source to 10 kHz. Adjust the output level to obtain 30% AM as read on the measuring receiver.
6. Select FM mode on the measuring receiver. The incidental FM indicated on the measuring receiver should be less than 4 kHz. Record the reading in the following table.
7. Repeat steps 2 through 6 for the frequencies listed in the table below.

Signal Generator		Local Oscillator		Incidental FM	
Frequency	Level	Frequency	Level	Actual	Limit
6.2 GHz	0 dBm	6.1 GHz	+7 dBm	_____	<4 kHz
12.3 GHz	0 dBm	12.2 GHz	+7 dBm	_____	<8 kHz
18.0 GHz	0 dBm	17.9 GHz	+7 dBm	_____	<12 kHz
24.0 GHz	-3 dBm	23.9 GHz	+7 dBm	_____	<16 kHz
26.0 GHz	-5 dBm	25.9 GHz	+7 dBm	_____	<25 kHz

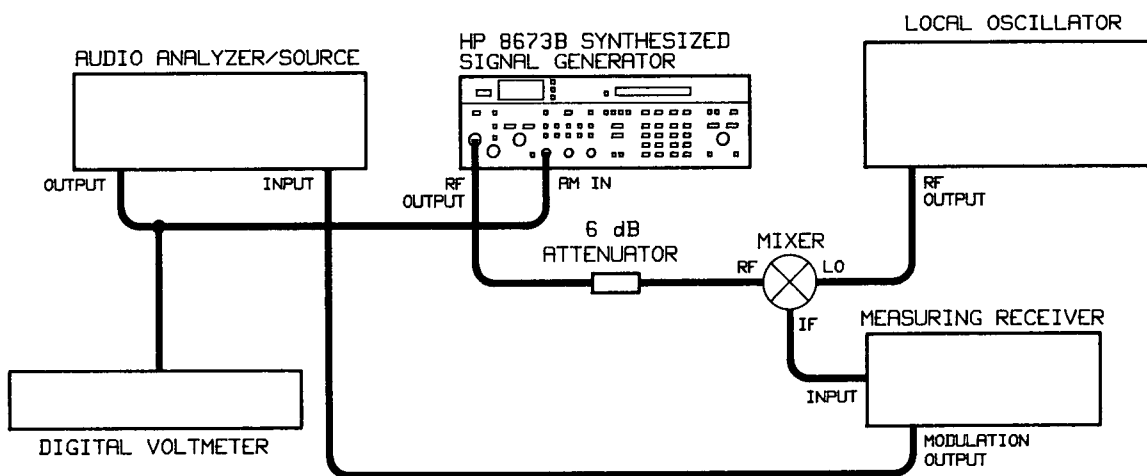

Figure 4-34. Incidental FM Test Setup

PERFORMANCE TESTS

4-24. FM FREQUENCY RESPONSE

Specification

Electrical Characteristics	Performance Limits	Conditions
FM Frequency Response (Relative to 100 kHz rate): 100 Hz to 3 MHz 3 kHz to 3 MHz	± 2.0 dB ± 2.0 dB	30 and 100 kHz/V ranges. 300 kHz and 1, 3, and 10 MHz/V ranges.

Description

The test oscillator is tuned to 100 kHz and the output level is adjusted to obtain the first carrier (Bessel) null. This output level and the 100 kHz rate are the references for later calculations. At other modulation rates, the output level is set and measured for the first carrier null. The measured voltage and the rate are then compared to the established reference to determine frequency response.

Equipment

- AC Voltmeter HP 400E
- Frequency Counter HP 5343A
- Spectrum Analyzer HP 8566B
- Test Oscillator HP 8116A

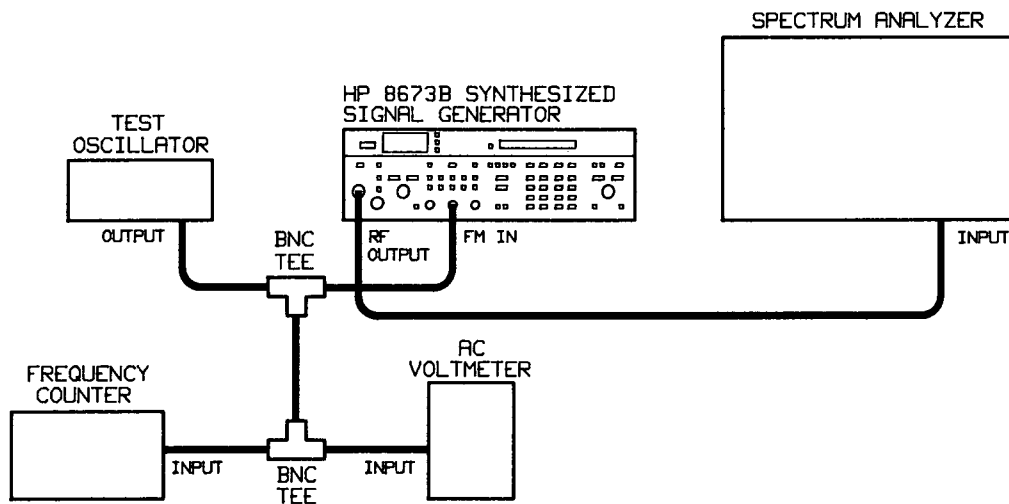

Figure 4-35. FM Frequency Response Test Setup

Procedure

1. Connect the equipment as shown in Figure 4-35.
2. Set the Signal Generator as follows:
 FREQUENCY 4000 MHz
 OUTPUT LEVEL RANGE 0 dB
 OUTPUT LEVEL VERNIER 0 dBm
 FM DEVIATION range 10 MHz

PERFORMANCE TESTS

FM FREQUENCY RESPONSE (cont'd)

Procedure (cont'd)

3. Adjust the spectrum analyzer to display the 4 GHz RF signal. Set the spectrum analyzer sweep span to 1 MHz initially. (It will be necessary to change the sweep span for later measurements.) Set the other controls as needed for a calibrated display.
4. Tune the test oscillator to 100 kHz.
5. Adjust the test oscillator's output level to obtain the first carrier (Bessel) null. Record the voltage indicated on the AC voltmeter in the table below. (The voltage should be approximately 0.017 Vrms).
6. Reduce the test oscillator's output level to 0 Vrms.
7. Tune the test oscillator to 3 kHz (f_x). Adjust the test oscillator's output voltage to obtain the first carrier null. Record the measured frequency and voltage in the table below.
8. Repeat steps 6 and 7 for each of the remaining frequencies listed in the table below.

Modulation Frequency (kHz)	Measured Frequency (kHz)	Measured Voltage (Vrms)	Calculated Response (dB)
3	_____	_____	_____
30	_____	_____	_____
100	100.0	_____	0
300	_____	_____	_____
1000	_____	_____	_____
3000	_____	_____	_____

9. Use the following equation to calculate the FM frequency response.

$$dB = 20 \log \frac{V_x}{V_{100 \text{ kHz}}} - 20 \log \frac{f_x}{100 \text{ kHz}}$$

where dB = the calculated frequency response

V_x = the voltage measured at f_x

$V_{100 \text{ kHz}}$ = the reference voltage measured at 100 kHz

f_x = the measured frequency.

PERFORMANCE TESTS

4-25. EXTERNAL FM ACCURACY AND METER ACCURACY

Specification

Electrical Characteristics	Performance Limits	Conditions
FREQUENCY MODULATION		
Maximum Peak Deviation	The smaller of 10 MHz or $f(\text{mod}) \times 5$. The smaller of 10 MHz or $f(\text{mod}) \times 10$. The smaller of 10 MHz or $f(\text{mod}) \times 15$. The smaller of 10 MHz or $f(\text{mod}) \times 20$.	2.0 to 6.6 GHz >6.6 to 12.3 GHz >12.3 to 18.6 GHz >18.6 to 26.0 GHz
Sensitivity (peak deviation per Vpk)	Maximum input 1 Vpk into 50Ω nominal.	All ranges; peak deviation is linearly controlled by varying input level between 0 and 1 Vpk.
Indicated Meter Accuracy	±12% of reading, ±3% of range.	100 kHz rate.
Accuracy Relative to External FM Input Level	±7% of reading, ±3% of range.	100 kHz rate.

Description

The Signal Generator is frequency modulated by an external source. The output of the Signal Generator is mixed with a local oscillator to produce a modulated 500 MHz IF signal. A measuring receiver measures the FM characteristics of the IF signal.

Equipment

- Local Oscillator HP 8340A
- Measuring Receiver HP 8902A
- Test Oscillator HP 8116A
- Digital Voltmeter HP 3456A
- Mixer RHG DMS1-26

Procedure

Sensitivity and Meter Accuracy

1. Connect the equipment as shown in Figure 4-36.

NOTE

Connect the mixer directly to the local oscillator to avoid any power loss.

2. Set the Signal Generator as follows:

- FREQUENCY 2 GHz
- OUTPUT LEVEL RANGE 0 dB
- OUTPUT LEVEL VERNIER -5 dBm
- FM DEVIATION range 0.3 MHz
- Meter Scale FM

PERFORMANCE TESTS

EXTERNAL FM ACCURACY AND METER ACCURACY (cont'd)

Procedure (cont'd)

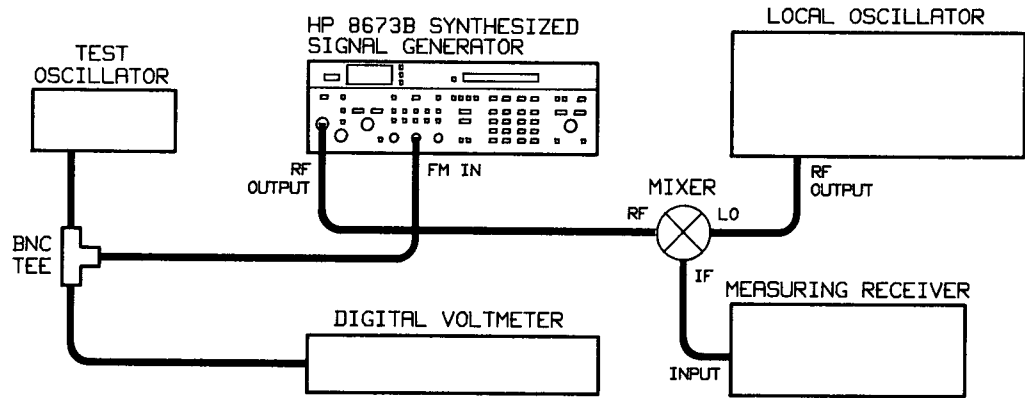

Figure 4-36. External FM Accuracy and Meter Accuracy Test Setup

3. Tune the local oscillator to 2.5 GHz with an output amplitude of +8 dBm.
4. Set the measuring receiver to measure FM.
5. Set the test oscillator to a 100 kHz rate. Adjust the output level to obtain a full scale reading on the Signal Generator's front panel meter.
6. The measuring receiver should read 300 kHz \pm 45 kHz deviation. Record the reading.

FM reading 255 kHz _____ 345 kHz

7. Adjust the test oscillator level to obtain 50 kHz deviation as read on the Signal Generator's front panel meter.
8. The measuring receiver should read 50 kHz \pm 15 kHz deviation. Record the reading.

FM reading 35 kHz _____ 65 kHz

Accuracy Relative to External FM Input

9. Tune the test oscillator to 100 kHz with an output amplitude of 0.707 Vrms.
10. Set the Signal Generator FM DEVIATION range to 0.3 MHz. The measuring receiver should indicate FM deviation within the limits listed in the following table. Record the reading in the table.
11. Repeat step 10 using the FM deviations and levels listed in the following table. Record the readings in the table.

PERFORMANCE TESTS

EXTERNAL FM ACCURACY AND METER ACCURACY (cont'd)**Procedure
(cont'd)**

FM Deviation	Test Oscillator Level (Vrms)	Low Limit	Actual Deviation	High Limit
0.03 MHz	0.707	27 kHz	_____	33 kHz
0.1 MHz	0.707	90 kHz	_____	110 kHz
0.3 MHz	0.707	270 kHz	_____	330 kHz
1 MHz	0.212	249 kHz	_____	351 kHz

12. Tune the Signal Generator to 6.7 GHz. Set the FM DEVIATION range to 0.3 MHz.
13. Tune the local oscillator to 7.2 GHz.
14. Set the test oscillator's output level to 0.707 Vrms.
15. Read the FM deviation on the measuring analyzer. Verify that the measured deviation is within the limits shown in the following table. Record the readings.
16. Repeat steps 12 through 15 using the frequencies listed in the following table. Record the readings.

Signal Generator Frequency	Local Oscillator Frequency	Low Limit	Actual Deviation	High Limit
6.7 GHz	7.2 GHz	270 kHz	_____	330 kHz
12.3 GHz	12.9 GHz	270 kHz	_____	330 kHz
18.6 GHz	19.1 GHz	270 kHz	_____	330 kHz

PERFORMANCE TESTS

4-26. INCIDENTAL AM

Specification

Electrical Characteristics	Performance Limits	Conditions
FREQUENCY MODULATION Incidental AM	<5%	Rates <100 kHz; peak deviations ≤1 MHz.

Description

The Signal Generator is modulated at 5% AM (the maximum allowable incidental AM). The output signal is detected and measured with a voltmeter. The detected signal is recorded as a reference level. The Signal Generator is then frequency modulated and the detected AM level is compared to the reference level.

Equipment

- Test Oscillator HP 8116A
- Digital Voltmeter HP 3456A
- Crystal Detector HP 8473C
- 50 Ohm Termination HP 11593A

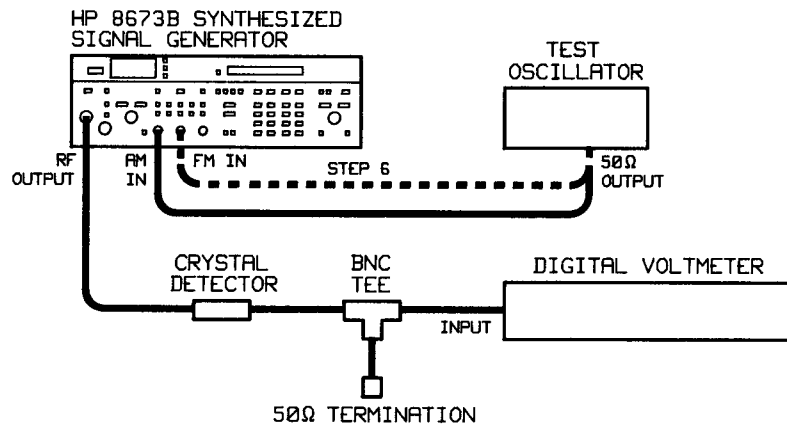

Figure 4-37. Incidental AM Test Setup

Procedure

1. Connect the equipment as shown in Figure 4-37.
2. Set the Signal Generator as follows:
 - FREQUENCY 2 000.0 MHz
 - OUTPUT LEVEL RANGE 0 dB
 - OUTPUT LEVEL VERNIER 0 dBm
 - AM switch 30% range
3. Set the test oscillator to 10 kHz. Adjust the output level for a 5% AM reading on the Signal Generator.
4. Record the detected AM level indicated on the digital voltmeter.

Reference Level _____ Vrms

PERFORMANCE TESTS

INCIDENTAL AM (cont'd)**Procedure
(cont'd)**

5. Set the Signal Generator's AM switch to OFF. Set the FM DEVIATION range to 1 MHz.
6. Connect the test oscillator to the Signal Generator's FM IN connector.
7. Set the test oscillator frequency to 100 kHz.
8. Vary the test oscillator amplitude between 0 and 0.35 Vrms. Verify that the voltmeter reading is less than the level recorded in step 4. Record the maximum level.

2.0 GHz _____ Vrms

9. Repeat step 8 for Signal Generator frequencies of 6.7 GHz, and 12.4 GHz.

NOTE

For frequencies of 6.7 GHz and 12.4 GHz, vary the test oscillator amplitude between 0 and 0.707 Vrms. Verify that the voltmeter reading does not exceed the level recorded in step 4. Record the maximum level.

6.7 GHz _____ Vrms

12.4 GHz _____ Vrms

10. Tune the Signal Generator to 18.7 GHz. Vary the test oscillator amplitude between 0 and 0.707 Vrms. Verify that the voltmeter reading does not exceed the level recorded in step 4. Record the maximum level.

18.7 GHz _____ Vrms

Table 4-4. Performance Test Record (1 of 18)

Hewlett-Packard Company Model HP 8673B Signal Generator Serial Number _____		Tested by _____ Date _____		
Para. No.	Test	Results		
		Min.	Actual	Max.
4-8.	FREQUENCY RANGE AND RESOLUTION			
	Baseband Test			
	2 000.000 MHz	1 999.999	_____	2 000.001
	2 000.001 MHz	2 000.000	_____	2 000.002
	2 001.112 MHz	2 001.111	_____	2 001.113
	2 002.223 MHz	2 002.222	_____	2 002.224
	2 003.334 MHz	2 003.333	_____	2 003.335
	2 004.445 MHz	2 004.444	_____	2 004.446
	2 005.556 MHz	2 005.555	_____	2 005.557
	2 006.667 MHz	2 006.666	_____	2 006.668
	2 007.778 MHz	2 007.777	_____	2 007.779
	2 008.889 MHz	2 008.888	_____	2 008.890
	2 009.999 MHz	2 009.998	_____	2 010.000
	2 090.000 MHz	2 089.999	_____	2 090.001
	2 280.000 MHz	2 279.999	_____	2 280.001
	2 470.000 MHz	2 469.999	_____	2 470.001
	2 660.000 MHz	2 659.999	_____	2 660.001
	2 850.000 MHz	2 849.999	_____	2 850.001
	3 040.000 MHz	3 039.999	_____	3 040.001
	3 230.000 MHz	3 229.999	_____	3 230.001
	3 420.000 MHz	3 419.999	_____	3 420.001
	3 610.000 MHz	3 609.999	_____	3 610.001
	3 800.000 MHz	3 799.999	_____	3 800.001
	3 990.000 MHz	3 989.999	_____	3 990.001
	4 180.000 MHz	4 179.999	_____	4 180.001
	4 370.000 MHz	4 369.999	_____	4 370.001
	4 560.000 MHz	4 559.999	_____	4 560.001
	4 750.000 MHz	4 749.999	_____	4 750.001
	4 940.000 MHz	4 939.999	_____	4 940.001
	5 130.000 MHz	5 129.999	_____	5 130.001
	5 320.000 MHz	5 319.999	_____	5 320.001
	5 510.000 MHz	5 509.999	_____	5 510.001
	5 700.000 MHz	5 699.999	_____	5 700.001
	5 900.000 MHz	5 899.999	_____	5 900.001
	6 100.000 MHz	6 099.999	_____	6 100.001
6 600.000 MHz	5 999.999	_____	6 600.001	
	Bands 2 and 3 Test			
	10 GHz, 2 kHz Resolution		_____ (✓)	
	18.6 GHz, 3 kHz Resolution		_____ (✓)	
	26 GHz, 4 kHz Resolution		_____ (✓)	

Table 4-4. Performance Test Record (2 of 18)

Para. No.	Test	Results		
		Min.	Actual	Max.
4-9.	INTERNAL TIME BASE AGING RATE		_____	5×10^{-10} /day
4-10.	FREQUENCY SWITCHING TIME			
	Frequency Switching			
	3.0 to 2.0 GHz		_____	25 ms*
	4.0 to 2.0 GHz		_____	25 ms*
	18.0 to 2.0 GHz		_____	25 ms*
	6.2 to 2.09 GHz		_____	25 ms*
	6.0 to 2.1 GHz		_____	25 ms*
	6.5 to 2.1 GHz		_____	25 ms*
	6.49 to 2.2 GHz		_____	25 ms*
	2.0 to 3.0 GHz		_____	25 ms*
	2.2 to 6.49 GHz		_____	25 ms*
	2.1 to 6.5 GHz		_____	25 ms*
	6.61 to 6.59 GHz		_____	25 ms*
	6.59 to 6.61 GHz		_____	25 ms*
	3.999 to 12.4 GHz		_____	25 ms*
	19.5 to 2.1 GHz		_____	25 ms*
	26.0 to 2.1 GHz		_____	25 ms*
	2.1 to 19.5 GHz		_____	25 ms*
	2.0 to 26.0 GHz		_____	25 ms*
	2.1 to 26.0 GHz		_____	25 ms*
	Amplitude Recovery			
	2.0 to 6.6 GHz		_____	25 ms*
	6.601 to 12.3 GHz		_____	25 ms*
3.0 to 4.0 GHz		_____	25 ms*	
4.0 to 10.0 GHz		_____	25 ms*	
12.301 to 18.6 GHz		_____	25 ms*	
18.601 to 26.0 GHz		_____	25 ms*	
2.0 to 26.0 GHz		_____	25 ms*	
6.601 to 26.0 GHz		_____	25 ms*	
2.0 to 18.6 GHz		_____	25 ms*	
4-11.	SINGLE-SIDEBAND PHASE NOISE			
	10 Hz offset from carrier			
	6600 GHz		_____	-58 dBc
	12 300 GHz		_____	-52 dBc
	18 600 GHz		_____	-48 dBc
	26 000 GHz		_____	-46 dBc
	100 Hz offset from carrier			
	6600 GHz		_____	-70 dBc
	12 300 GHz		_____	-64 dBc
	18 600 GHz		_____	-60 dBc
26 000 GHz		_____	-58 dBc	

*For 2640A and below, maximum time is 20 ms.

Table 4-4. Performance Test Record (3 of 18)

Para. No.	Test	Results		
		Min.	Actual	Max.
4-11.	SINGLE-SIDEBAND PHASE NOISE (cont'd)			
	1 kHz offset from carrier			
	6600 GHz		_____	-78 dBc
	12 300 GHz		_____	-72 dBc
	18 600 GHz		_____	-68 dBc
	26 000 GHz		_____	-66 dBc
	10 kHz offset from carrier			
	6600 GHz		_____	-86 dBc
	12 300 GHz		_____	-80 dBc
	18 600 GHz		_____	-76 dBc
	26 000 GHz		_____	-74 dBc
	100 kHz offset from carrier			
	6600 GHz		_____	-110 dBc
	12 300 GHz		_____	-104 dBc
	18 600 GHz		_____	-100 dBc
26 000 GHz		_____	-98 dBc	
4-12.	HARMONICS, SUBHARMONICS, AND MULTIPLES			
	Fundamental (MHz)	Harmonic or Subharmonic Number		
	2000.000	2	_____	-40 dBc
	4000.000	2	_____	-40 dBc
	6000.000	2	_____	-40 dBc
	8000.000	2	_____	-40 dBc
	8000.000	1/2	_____	-25 dBc
	10000.000	2	_____	-40 dBc
	10000.000	1/2	_____	-25 dBc
	11000.000	2	_____	-40 dBc
	11000.000	1/2	_____	-25 dBc
	14000.000	1/3	_____	-40 dBc
	14000.000	2/3	_____	-25 dBc
	16000.000	1/3	_____	-25 dBc
	16000.000	2/3	_____	-25 dBc
	18000.000	1/3	_____	-25 dBc
	18000.000	2/3	_____	-25 dBc
	20000.000	1/4	_____	-20 dBc
	20000.000	1/2	_____	-20 dBc*
	20000.000	3/4	_____	-20 dBc*
	22000.000	1/4	_____	-20 dBc
22000.000	1/2	_____	-20 dBc*	
22000.000	3/4	_____	-20 dBc*	

* For Option 008, maximum subharmonic or multiples level is -15 dBc.

Table 4-4. Performance Test Record (4 of 18)

Para. No.	Test	Results		
		Min.	Actual	Max.
4-12.	HARMONICS, SUBHARMONICS, AND MULTIPLES (cont'd)			
	Fundamental (MHz)	Harmonic or Subharmonic Number		
	24000.000	1/4	_____	-20 dBc
	24000.000	1/2	_____	-20 dBc*
	24000.000	3/4	_____	-20 dBc*
	26000.000	1/4	_____	-20 dBc
	26000.000	1/2	_____	-20 dBc*
26000.000	3/4	_____	-20 dBc*	
4-13.	NON-HARMONICALLY RELATED SPURIOUS SIGNALS			
	Carrier Frequency	Spurious Signal Frequency		
	3 000.000 MHz	_____	_____	-70 dBc
	3 000.000 MHz	_____	_____	-70 dBc
	(2.0 - 6.6 GHz)	_____	_____	-70 dBc
(2.0 - 6.6 GHz)	_____	_____	-70 dBc	
4-14.	POWER LINE RELATED SPURIOUS SIGNALS			
	2.0-6.6 GHz	< 300 Hz offset	_____	-50 dBc
		300 Hz - 1 kHz offset	_____	-60 dBc
		> 1 kHz offset	_____	-65 dBc
	6.6-12.3 GHz	< 300 Hz offset	_____	-44 dBc
		300 Hz - 1 kHz offset	_____	-54 dBc
		> 1 kHz offset	_____	-59 dBc
	12.3-18.6 GHz	< 300 Hz offset	_____	-40 dBc
		300 Hz - 1 kHz offset	_____	-50 dBc
		> 1 kHz offset	_____	-55 dBc
	18.6-26.0 GHz	< 300 Hz offset	_____	-38 dBc
		300 Hz - 1 kHz offset	_____	-48 dBc
		> 1 kHz offset	_____	-53 dBc
4-15.	OUTPUT LEVEL AND FLATNESS			
	Output Level			
	Frequency and power at minimum power point			
	2000.0 - 18 000 MHz			
	Frequency _____			
Minimum power	(Standard)	+8 dBm	_____ (✓)	
	(Option 001)	+10 dBm	_____ (✓)	
	(Option 004)	+7 dBm	_____ (✓)	
	(Option 005)	+9 dBm	_____ (✓)	
	(Option 008)	+8 dBm	_____ (✓)	

* For Option 008, maximum subharmonic or multiples level is -15 dBc.

Table 4-4. Performance Test Record (5 of 18)

Para. No.	Test	Results		
		Min.	Actual	Max.
4-15.	OUTPUT LEVEL AND FLATNESS (cont'd)			
	Output Level (cont'd)			
	18 000—22 000 MHz			
	Frequency _____			
	Minimum power (Standard)	+4 dBm	_____ (✓)	
	(Option 001)	+6 dBm	_____ (✓)	
	(Option 004)	+2 dBm	_____ (✓)	
	(Option 005)	+4 dBm	_____ (✓)	
	(Option 008)	+7 dBm	_____ (✓)	
	22 000—26 000 MHz			
	Frequency _____			
	Minimum power (Standard)	+0 dBm	_____ (✓)	
	(Option 001)	+3 dBm	_____ (✓)	
	(Option 004)	-2 dBm	_____ (✓)	
(Option 005)	+1 dBm	_____ (✓)		
(Option 008)	+7 dBm	_____ (✓)		
Level Flatness (total variation)				
2.0—6.6 GHz, ±0.75 dB		_____	1.50 dB	
6.6—12.3 GHz, ±1.00 dB		_____	2.00 dB	
12.3—18.6 GHz, ±1.25 dB		_____	2.50 dB	
18.6—26.0 GHz, ±1.75 dB		_____	3.50 dB	
4-16.	ABSOLUTE LEVEL ACCURACY			
	High Level Accuracy			
	+8 dBm (Option 001 +10 dBm)			
	(Option 004 +7 dBm)			
	(Option 005 +9 dBm)			
	(Option 008 +8 dBm)			
	2.0—6.6 GHz	-2.00 dB	_____	2.00 dB
	+5 dBm			
	2.0—6.6 GHz	-2.00 dB	_____	2.00 dB
	6.6—12.3 GHz	-2.25 dB	_____	2.25 dB
	12.3—18.0 GHz	-2.50 dB	_____	2.50 dB
	0 dBm (+10 dB range)			
	2.0—6.6 GHz	-2.00 dB	_____	2.00 dB
	6.6—12.3 GHz	-2.25 dB	_____	2.25 dB
12.3—18.6 GHz	-2.50 dB	_____	2.50 dB	
18.6—26.0 GHz (Not for Opt. 004)	-3.00 dB	_____	3.00 dB	
-5.0 dBm (0 dB range)				
2.0—6.6 GHz	-1.75 dB	_____	1.75 dB	
6.6—12.3 GHz	-2.00 dB	_____	2.00 dB	
12.3—18.6 GHz	-2.25 dB	_____	2.25 dB	
18.6—26.0 GHz	-2.75 dB	_____	2.75 dB	

Table 4-4. Performance Test Record (6 of 18)

Para. No.	Test	Results		
		Min.	Actual	Max.
4-16.	ABSOLUTE LEVEL ACCURACY (cont'd)			
	High Level Accuracy (cont'd)			
	-10 dBm (0 dB range)			
	2.0—6.6 GHz	-1.75 dB	_____	1.75 dB
	6.6—12.3 GHz	-2.00 dB	_____	2.00 dB
	12.3—18.6 GHz	-2.25 dB	_____	2.25 dB
	18.6—26.0 GHz	-2.75 dB	_____	2.75 dB
	-10 dBm (-10 dB range)			
	2.0—6.6 GHz	-2.25 dB	_____	2.25 dB
	6.6—12.3 GHz	-2.50 dB	_____	2.50 dB
	12.3—18.6 GHz	-2.85 dB	_____	2.85 dB
	18.6—26.0 GHz	-3.30 dB	_____	3.30 dB
	-20 dBm (-20 dB range)			
	2.0—6.6 GHz	-2.45 dB	_____	2.45 dB
	6.6—12.3 GHz	-2.70 dB	_____	2.70 dB
	12.3—18.6 GHz	-3.05 dB	_____	3.05 dB
	18.6—26.0 GHz	-3.60 dB	_____	3.60 dB
	Low Level Accuracy			
	2.0 GHz			
	-30 dBm	-32.75 dBm	_____	-27.25 dBm
	-40 dBm	-42.85 dBm	_____	-37.15 dBm
	-50 dBm	-52.95 dBm	_____	-47.05 dBm
	-60 dBm	-63.05 dBm	_____	-56.95 dBm
	-70 dBm	-73.15 dBm	_____	-66.85 dBm
	-80 dBm	-83.25 dBm	_____	-76.75 dBm
	-90 dBm	-93.35 dBm	_____	-86.65 dBm
	4.0 GHz			
	-30 dBm	-32.75 dBm	_____	-27.25 dBm
	-40 dBm	-42.85 dBm	_____	-37.15 dBm
	-50 dBm	-52.95 dBm	_____	-47.05 dBm
	-60 dBm	-63.05 dBm	_____	-56.95 dBm
	-70 dBm	-73.15 dBm	_____	-66.85 dBm
	-80 dBm	-83.25 dBm	_____	-76.75 dBm
-90 dBm	-93.35 dBm	_____	-86.65 dBm	
10 GHz				
-30 dBm	-33.00 dBm	_____	-27.00 dBm	
-40 dBm	-43.10 dBm	_____	-36.90 dBm	
-50 dBm	-53.20 dBm	_____	-46.80 dBm	
-60 dBm	-63.30 dBm	_____	-56.70 dBm	
-70 dBm	-73.40 dBm	_____	-66.60 dBm	
-80 dBm	-83.50 dBm	_____	-76.50 dBm	
-90 dBm	-93.60 dBm	_____	-86.40 dBm	

Table 4-4. Performance Test Record (7 of 18)

Para. No.	Test	Results		
		Min.	Actual	Max.
4-16.	ABSOLUTE LEVEL ACCURACY (cont'd)			
	Low Level Accuracy (cont'd)			
	14 GHz			
	-30 dBm	-33.45 dBm	_____	-26.55 dBm
	-40 dBm	-43.65 dBm	_____	-36.35 dBm
	-50 dBm	-53.85 dBm	_____	-46.15 dBm
	-60 dBm	-64.05 dBm	_____	-55.95 dBm
	-70 dBm	-74.25 dBm	_____	-65.75 dBm
	-80 dBm	-84.45 dBm	_____	-75.55 dBm
	-90 dBm	-94.65 dBm	_____	-83.35 dBm
	20 GHz			
	-30 dBm	-34.05 dBm	_____	-25.95 dBm
	-40 dBm	-44.25 dBm	_____	-35.75 dBm
	-50 dBm	-54.45 dBm	_____	-45.55 dBm
	-60 dBm	-64.65 dBm	_____	-56.70 dBm
	-70 dBm	-74.85 dBm	_____	-65.15 dBm
	-80 dBm	-85.05 dBm	_____	-74.95 dBm
	-90 dBm	-95.25 dBm	_____	-84.75 dBm
4-17.	OUTPUT LEVEL SWITCHING TIME			
	Start Level (dBm)	Stop Level (dBm)		
	-99.0	0.0	_____	< 25 ms
	-88.0	0.0	_____	< 25 ms
	-77.0	0.0	_____	< 25 ms
	-66.0	0.0	_____	< 25 ms
	-50.0	-2.0	_____	< 25 ms
	-40.0	0.0	_____	< 25 ms
	-30.0	0.0	_____	< 25 ms
	-20.0	4.0	_____	< 25 ms
	-10.0	2.0	_____	< 25 ms
	-9.9	7.0	_____	< 25 ms
	-8.0	6.0	_____	< 25 ms
	-9.9	0.0	_____	< 25 ms
-7.0	3.0	_____	< 25 ms	
4-18.	PULSE ON/OFF RATIO			
	2.0 GHz	>80 dB	_____	
	3.0 GHz	>80 dB	_____	
	4.0 GHz	>80 dB	_____	
	5.0 GHz	>80 dB	_____	
	6.0 GHz	>80 dB	_____	
	6.6 GHz	>80 dB	_____	

Table 4-4. Performance Test Record (8 of 18)

Para. No.	Test	Results		
		Min.	Actual	Max.
4-19.	PULSE RISE/FALL TIMES AND OVERSHOOT			
	2000.000 MHz at:	Standard +8 dBm		
		Option 001 +10 dBm		
		Option 004 +7 dBm		
		Option 005 +9 dBm		
		Option 008 +8 dBm		
		Rise	_____	<35 ns
		Fall	_____	<35 ns
		Overshoot and Ringing	_____	<20%
		For Option 008:		
		Rise	_____	<40 ns
		Fall	_____	<40 ns
		Overshoot and Ringing	_____	<25%
	6600.000 MHz at:	Standard +8 dBm		
		Option 001 +10 dBm		
		Option 004 +7 dBm		
		Option 005 +9 dBm		
		Option 008 +8 dBm		
		Rise	_____	<35 ns
		Fall	_____	<35 ns
		Overshoot and Ringing	_____	<20%
		For Option 008:		
		Rise	_____	<40 ns
		Fall	_____	<40%
	Overshoot and Ringing	_____	<25%	
6600.002 MHz at:	Standard +8 dBm			
	Option 001 +10 dBm			
	Option 004 +7 dBm			
	Option 005 +9 dBm			
	Option 008 +8 dBm			
	Rise	_____	<35 ns	
	Fall	_____	<35 ns	
	Overshoot and Ringing	_____	<25%	
	For Option 008:			
	Rise	_____	<40 ns	
	Fall	_____	<40%	
	Overshoot and Ringing	_____	<25%	
6600.002 MHz at:	0 dBm			
	Rise	_____	<35 ns	
	Fall	_____	<35 ns	
	Overshoot and Ringing	_____	<25%	

Table 4-4. Performance Test Record (9 of 18)

Para. No.	Test	Results		
		Min.	Actual	Max.
4-19.	PULSE RISE/FALL TIMES AND OVERSHOOT (cont'd)			
	6600.002 MHz at: 0 dBm (cont'd)			
	For Option 008:			
	Rise			_____ <40 ns
	Fall			_____ <40 ns
	Overshoot and Ringing			_____ <25%
	6600.002 MHz at: -10 dBm			
	Rise			_____ <35 ns
	Fall			_____ <35 ns
	Overshoot and Ringing			_____ <25%
	For Option 008:			
	Rise			_____ <40 ns
	Fall			_____ <40 ns
	Overshoot and Ringing			_____ <25%
	6700.002 MHz at: Standard +8 dBm			
	Option 001 +10 dBm			
	Option 004 +7 dBm			
	Option 005 +9 dBm			
	Option 008 +8 dBm			
	Rise			_____ <35 ns
	Fall			_____ <35 ns
	Overshoot and Ringing			_____ <20%
	For Option 008:			
	Rise			_____ <40 ns
Fall			_____ <40 ns	
Overshoot and Ringing			_____ <25%	
6700.002 MHz at: 0 dBm				
Rise			_____ <35 ns	
Fall			_____ <35 ns	
Overshoot and Ringing			_____ <20%	
For Option 008:				
Rise			_____ <40 ns	
Fall			_____ <40 ns	
Overshoot and Ringing			_____ <25%	
6700.002 MHz at: -10 dBm				
Rise			_____ <35 ns	
Fall			_____ <35 ns	
Overshoot and Ringing			_____ <20%	
For Option 008:				
Rise			_____ <40 ns	
Fall			_____ <40 ns	
Overshoot and Ringing			_____ <25%	

Table 4-4. Performance Test Record (10 of 18)

Para. No.	Test	Results		
		Min.	Actual	Max.
4-19.	PULSE RISE/FALL TIMES AND OVERSHOOT (cont'd)			
	12290.002 MHz at:	Standard +8 dBm		
		Option 001 +10 dBm		
		Option 004 +7 dBm		
		Option 005 +9 dBm		
		Option 008 +8 dBm		
		Rise	_____	<35 ns
		Fall	_____	<35 ns
		Overshoot and Ringing	_____	<20%
		For Option 008:		
		Rise	_____	<40 ns
		Fall	_____	<40 ns
		Overshoot and Ringing	_____	<25%
	12290.002 MHz at:	0 dBm		
		Rise	_____	<35 ns
		Fall	_____	<35 ns
		Overshoot and Ringing	_____	<20%
		For Option 008:		
		Rise	_____	<40 ns
		Fall	_____	<40 ns
		Overshoot and Ringing	_____	<25%
	12290.002 MHz at:	-10 dBm		
		Rise	_____	<35 ns
		Fall	_____	<35 ns
	Overshoot and Ringing	_____	<20%	
	For Option 008:			
	Rise	_____	<40 ns	
	Fall	_____	<40 ns	
	Overshoot and Ringing	_____	<25%	
_____ at:	Standard +8 dBm			
(6.6 to 6.7 GHz)	Option 001 +10 dBm			
	Option 004 +7 dBm			
	Option 005 +9 dBm			
	Rise	_____	<35 ns	
	Fall	_____	<35 ns	
	Overshoot and Ringing	_____	<25%	
_____ at:	Standard +8 dBm			
(6.7 to 12.3 GHz)	Option 001 +10 dBm			
	Option 004 +7 dBm			
	Option 005 +9 dBm			
	Rise	_____	<35 ns	
	Fall	_____	<35 ns	
	Overshoot and Ringing	_____	<20%	

Table 4-4. Performance Test Record (11 of 18)

Para. No.	Test	Results		
		Min.	Actual	Max.
4-19.	PULSE RISE/FALL TIMES AND OVERSHOOT (cont'd)			
	For Option 008:			
	_____ at: +8 dBm			
	(6.6 to 12.3 GHz)			
		Rise	_____	<40 ns
		Fall	_____	<40 ns
		Overshoot and Ringing	_____	<25%
	Except Option 008:			
	_____ at: 0 dBm			
	(6.6 to 6.7 GHz)			
		Rise	_____	<35 ns
		Fall	_____	<35 ns
		Overshoot and Ringing	_____	<25%
	_____ at: 0 dBm			
	(6.7 to 12.3 GHz)			
		Rise	_____	<35 ns
		Fall	_____	<35 ns
		Overshoot and Ringing	_____	<20%
	For Option 008:			
	_____ at: 0 dBm			
	(6.6 to 12.3 GHz)			
		Rise	_____	<40 ns
		Fall	_____	<40 ns
		Overshoot and Ringing	_____	<25%
Except Option 008:				
_____ at: -10 dBm				
(6.6 to 6.7 GHz)				
	Rise	_____	<35 ns	
	Fall	_____	<35 ns	
	Overshoot and Ringing	_____	<25%	
_____ at: -10 dBm				
(6.7 to 12.3 GHz)				
	Rise	_____	<35 ns	
	Fall	_____	<35 ns	
	Overshoot and Ringing	_____	<20%	
For Option 008:				
_____ at: -10 dBm				
(6.6 to 12.3 GHz)				
	Rise	_____	<40 ns	
	Fall	_____	<40 ns	
	Overshoot and Ringing	_____	<25%	

Table 4-4. Performance Test Record (12 of 18)

Para. No.	Test	Results		
		Min.	Actual	Max.
4-19.	PULSE RISE/FALL TIMES AND OVERSHOOT (cont'd)			
	12300.003 MHz at:	Standard +8 dBm		
		Option 001 +10 dBm		
		Option 004 +7 dBm		
		Option 005 +9 dBm		
		Option 008 +8 dBm		
		Rise	_____	<35 ns
		Fall	_____	<35 ns
		Overshoot and Ringing	_____	<20%
		For Option 008:		
		Rise	_____	<40 ns
		Fall	_____	<40 ns
		Overshoot and Ringing	_____	<25%
		12300.003 MHz at:	0 dBm	
		Rise	_____	<35 ns
		Fall	_____	<35 ns
		Overshoot and Ringing	_____	<20%
		For Option 008:		
		Rise	_____	<40 ns
		Fall	_____	<40 ns
		Overshoot and Ringing	_____	<25%
		12300.003 MHz at:	-10 dBm	
		Rise	_____	<35 ns
		Fall	_____	<35 ns
	Overshoot and Ringing	_____	<20%	
	For Option 008:			
	Rise	_____	<40 ns	
	Fall	_____	<40 ns	
	Overshoot and Ringing	_____	<25%	
	17990.003 MHz at:	Standard +8 dBm		
	Option 001 +10 dBm			
	Option 004 +7 dBm			
	Option 005 +9 dBm			
	Option 008 +8 dBm			
	Rise	_____	<35 ns	
	Fall	_____	<35 ns	
	Overshoot and Ringing	_____	<20%	
	For Option 008:			
	Rise	_____	<40 ns	
	Fall	_____	<40 ns	
	Overshoot and Ringing	_____	<25%	

Table 4-4. Performance Test Record (13 of 18)

Para. No.	Test	Results			
		Min.	Actual	Max.	
4-19.	PULSE RISE/FALL TIMES AND OVERSHOOT (cont'd)				
	17990.003 MHz at:	0 dBm	Rise	_____	<35 ns
			Fall	_____	<35 ns
		Overshoot and Ringing		_____	<20%
		For Option 008:			
			Rise	_____	<40 ns
			Fall	_____	<40 ns
		Overshoot and Ringing		_____	<25%
	17990.003 MHz at:	-10 dBm	Rise	_____	<35 ns
			Fall	_____	<35 ns
		Overshoot and Ringing		_____	<20%
		For Option 008:			
			Rise	_____	<40 ns
			Fall	_____	<40 ns
		Overshoot and Ringing		_____	<25%
	_____ at:	Standard +8 dBm			
	(12.3 to 18.0 GHz)	Option 001 +10 dBm			
		Option 004 +7 dBm			
		Option 005 +9 dBm			
		Option 008 +8 dBm			
			Rise	_____	<35 ns
			Fall	_____	<35 ns
		Overshoot and Ringing		_____	<20%
		For Option 008:			
		Rise	_____	<40 ns	
		Fall	_____	<40 ns	
	Overshoot and Ringing		_____	<25%	
_____ at:	0 dBm	Rise	_____	<35 ns	
(12.3 to 18.0 GHz)		Fall	_____	<35 ns	
	Overshoot and Ringing		_____	<20%	
	For Option 008:				
		Rise	_____	<40 ns	
		Fall	_____	<40 ns	
	Overshoot and Ringing		_____	<25%	
_____ at:	-10 dBm	Rise	_____	<35 ns	
(12.3 to 18.0 GHz)		Fall	_____	<35 ns	
	Overshoot and Ringing		_____	<20%	
	For Option 008:				
		Rise	_____	<40 ns	
		Fall	_____	<40 ns	
	Overshoot and Ringing		_____	<25%	

Table 4-4. Performance Test Record (14 of 18)

Para. No.	Test	Results		
		Min.	Actual	Max.
4-19.	PULSE RISE/FALL TIMES AND OVERSHOOT (cont'd)			
	18600.004 MHz at:	Standard +4 dBm		
		Option 001 +6 dBm		
		Option 004 +2 dBm		
		Option 005 +4 dBm		
		Option 008 +7 dBm		
		Rise	_____	<35 ns
		Fall	_____	<35 ns
		Overshoot and Ringing	_____	<20%
		For Option 008:		
		Rise	_____	<40 ns
		Fall	_____	<40 ns
		Overshoot and Ringing	_____	<25%
		18600.004 MHz at:	0 dBm	
		Rise	_____	<35 ns
		Fall	_____	<35 ns
		Overshoot and Ringing	_____	<20%
		For Option 008:		
		Rise	_____	<40 ns
		Fall	_____	<40 ns
		Overshoot and Ringing	_____	<25%
		18600.004 MHz at:	-10 dBm	
		Rise	_____	<35 ns
		Fall	_____	<35 ns
	Overshoot and Ringing	_____	<20%	
	For Option 008:			
	Rise	_____	<40 ns	
	Fall	_____	<40 ns	
	Overshoot and Ringing	_____	<25%	
	21990.004 MHz at:	Standard +4 dBm		
	Option 001 +6 dBm			
	Option 004 +2 dBm			
	Option 005 +4 dBm			
	Option 008 +7 dBm			
	Rise	_____	<35 ns	
	Fall	_____	<35 ns	
	Overshoot and Ringing	_____	<20%	
	For Option 008:			
	Rise	_____	<40 ns	
	Fall	_____	<40 ns	
	Overshoot and Ringing	_____	<25%	

Table 4-4. Performance Test Record (15 of 18)

Para. No.	Test	Results		
		Min.	Actual	Max.
4-19.	PULSE RISE/FALL TIMES AND OVERSHOOT (cont'd)			
	21990.004 MHz at: 0 dBm	Rise	_____	<35 ns
		Fall	_____	<35 ns
		Overshoot and Ringing	_____	<20%
		For Option 008:		
		Rise	_____	<40 ns
		Fall	_____	<40 ns
		Overshoot and Ringing	_____	<25%
	21990.004 MHz at: -10 dBm	Rise	_____	<35 ns
		Fall	_____	<35 ns
		Overshoot and Ringing	_____	<20%
		For Option 008:		
		Rise	_____	<40 ns
		Fall	_____	<40 ns
		Overshoot and Ringing	_____	<25%
	_____ at: Standard +4 dBm	Rise	_____	<35 ns
	(18.0 to 22.0 GHz) Option 001 +6 dBm	Fall	_____	<35 ns
	Option 004 +2 dBm	Overshoot and Ringing	_____	<20%
	Option 005 +4 dBm	For Option 008:		
	Option 008 +7 dBm	Rise	_____	<40 ns
		Fall	_____	<40 ns
		Overshoot and Ringing	_____	<25%
	_____ at: 0 dBm	Rise	_____	<35 ns
	(18.0 to 22.0 GHz)	Fall	_____	<35 ns
	Overshoot and Ringing	_____	<20%	
	For Option 008:			
	Rise	_____	<40 ns	
	Fall	_____	<40 ns	
	Overshoot and Ringing	_____	<25%	
_____ at: -10 dBm	Rise	_____	<35 ns	
(18.0 to 22.0 GHz)	Fall	_____	<35 ns	
	Overshoot and Ringing	_____	<20%	
	For Option 008:			
	Rise	_____	<40 ns	
	Fall	_____	<40 ns	
	Overshoot and Ringing	_____	<25%	

Table 4-4. Performance Test Record (16 of 18)

Para. No.	Test	Results			
		Min.	Actual	Max.	
4-19.	PULSE RISE/FALL TIMES AND OVERSHOOT (cont'd)				
	25990.004 MHz at:	Standard 0 dBm			
		Option 001 +3 dBm			
		Option 005 +1 dBm			
		Option 008 +7 dBm			
		Rise	_____	<35 ns	
		Fall	_____	<35 ns	
		Overshoot and Ringing	_____	<20%	
		For Option 008:			
		Rise	_____	<40 ns	
		Fall	_____	<40 ns	
		Overshoot and Ringing	_____	<25%	
		25990.004 MHz at 0 dBm (Except Opt. 004):	Rise	_____	<35 ns
			Fall	_____	<35 ns
			Overshoot and Ringing	_____	<20%
		For Option 008:			
		Rise	_____	<40 ns	
		Fall	_____	<40 ns	
		Overshoot and Ringing	_____	<25%	
		25990.004 MHz at -2 dBm (Opt. 004 only):	Rise	_____	<35 ns
			Fall	_____	<35 ns
			Overshoot and Ringing	_____	<20%
		25990.004 MHz at: -10 dBm	Rise	_____	<35 ns
			Fall	_____	<35 ns
		Overshoot and Ringing	_____	<20%	
	For Option 008:				
	Rise	_____	<40 ns		
	Fall	_____	<40 ns		
	Overshoot and Ringing	_____	<25%		
	_____ at: Standard 0 dBm				
	(22.0 to 26.0 GHz) Option 001 +3 dBm				
	Option 005 +1 dBm				
	Option 008 +7 dBm				
	Rise	_____	<35 ns		
	Fall	_____	<35 ns		
	Overshoot and Ringing	_____	<20%		
	For Option 008:				
	Rise	_____	<40 ns		
	Fall	_____	<40 ns		
	Overshoot and Ringing	_____	<25%		

Table 4-4. Performance Test Record (17 of 18)

Para. No.	Test	Results		
		Min.	Actual	Max.
4-19.	PULSE RISE/FALL TIMES AND OVERSHOOT (cont'd) _____ at 0 dBm (Opt. 004 at -2 dBm): Rise (22.0 to 26.0 GHz) Fall Overshoot and Ringing For Option 008: Rise Fall Overshoot and Ringing _____ at: -10 dBm Rise (22.0 to 26.0 GHz) Fall Overshoot and Ringing For Option 008: Rise Fall Overshoot and Ringing		_____	<35 ns
			_____	<35 ns
			_____	<20%
			_____	<40 ns
			_____	<40 ns
			_____	<25%
			_____	<35 ns
			_____	<35 ns
			_____	<20%
			_____	<40 ns
			_____	<40 ns
			_____	<25%
4-20.	PULSE PEAK LEVEL ACCURACY Frequency Level 6.6 GHz +7 dBm 6.61 GHz +7 dBm 0 dBm -10 dBm 12.3 GHz +7 dBm 0 dBm -10 dBm 18.61 GHz +2 dBm 0 dBm -10 dBm 22.1 GHz -2 dBm -10 dBm	-10.8%	_____	+18.8%
		-10.8%	_____	+18.8%
		-10.8%	_____	+18.8%
		-10.8%	_____	+18.8%
		-10.8%	_____	+18.8%
		-10.8%	_____	+18.8%
		-10.8%	_____	+18.8%
		-10.8%	_____	+18.8%
		-10.8%	_____	+18.8%
		-10.8%	_____	+18.8%
		-10.8%	_____	+18.8%
		-10.8%	_____	+18.8%
4-21.	AM BANDWIDTH (Modulation Frequency) 4.0 GHz _____ 6.7 GHz _____ 15.0 GHz _____ 24.0 GHz _____ 26.0 GHz _____	-3 dB	_____	+3 dB
		-3 dB	_____	+3 dB
		-3 dB	_____	+3 dB
		-3 dB	_____	+3 dB
		-3 dB	_____	+3 dB
		-3 dB	_____	+3 dB

Table 4-4. Performance Test Record (18 of 18)

Para. No.	Test	Results		
		Min.	Actual	Max.
4-22.	AM ACCURACY			
	Meter Accuracy			
	1 kHz Rate, 50% AM	43.5%	_____	56.5%
	Accuracy Relative to External AM Input			
	6.6 GHz 10 kHz	70.0%	_____	80.0%
	6.6 GHz 1 kHz	70.0%	_____	80.0%
	6.6 GHz 0.1 kHz	70.0%	_____	80.0%
	10 GHz 10 kHz	70.0%	_____	80.0%
14 GHz 10 kHz	70.0%	_____	80.0%	
18.6 GHz 10 kHz	70.0%	_____	80.0%	
22 GHz 10 kHz	45.0%	_____	55.0%	
4-23.	INCIDENTAL FM			
	6.2 GHz		_____	< 4 kHz
	12.3 GHz		_____	< 8 kHz
	18.0 GHz		_____	< 12 kHz
	24.0 GHz		_____	< 16 kHz
26.0 GHz		_____	< 25 kHz	
4-24.	FM FREQUENCY RESPONSE			
	3 kHz	-2 dB	_____	+2 dB
	30 kHz	-2 dB	_____	+2 dB
	100 kHz		0 dB	
	300 kHz	-2 dB	_____	+2 dB
	1000 kHz	-2 dB	_____	+2 dB
3000 kHz	-2 dB	_____	+2 dB	
4-25.	EXTERNAL FM ACCURACY AND METER ACCURACY			
	Meter Accuracy			
	Full Scale	255 kHz	_____	345 kHz
	50 kHz	35 kHz	_____	65 kHz
	Accuracy Relative to External FM Input			
	0.03 MHz range	27 kHz	_____	33 kHz
	0.1 MHz range	90 kHz	_____	110 kHz
	0.3 MHz range	270 kHz	_____	330 kHz
	1.0 MHz range	249 kHz	_____	351 kHz
	0.3 MHz Range Accuracy			
6.7 GHz	270 kHz	_____	330 kHz	
12.3 GHz	270 kHz	_____	330 kHz	
18.6 GHz	270 kHz	_____	330 kHz	
4-26.	INCIDENTAL AM			
	2.0 GHz		_____	< 5%
	6.7 GHz		_____	< 5%
	12.4 GHz		_____	< 5%
18.7 GHz		_____	< 5%	