

Errata

Title & Document Type: 8656B Signal Generator Operation and Calibration Manual

Manual Part Number: 08656-99001

Revision Date: October 1, 1984

HP References in this Manual

This manual may contain references to HP or Hewlett-Packard. Please note that Hewlett-Packard's former test and measurement, semiconductor products and chemical analysis businesses are now part of Agilent Technologies. We have made no changes to this manual copy. The HP XXXX referred to in this document is now the Agilent XXXX. For example, model number HP8648A is now model number Agilent 8648A.

About this Manual

We've added this manual to the Agilent website in an effort to help you support your product. This manual provides the best information we could find. It may be incomplete or contain dated information, and the scan quality may not be ideal. If we find a better copy in the future, we will add it to the Agilent website.

Support for Your Product

Agilent no longer sells or supports this product. You will find any other available product information on the Agilent Test & Measurement website:

www.tm.agilent.com

Search for the model number of this product, and the resulting product page will guide you to any available information. Our service centers may be able to perform calibration if no repair parts are needed, but no other support from Agilent is available.



OPERATION AND CALIBRATION MANUAL

HP 8656B SYNTHESIZED SIGNAL GENERATOR

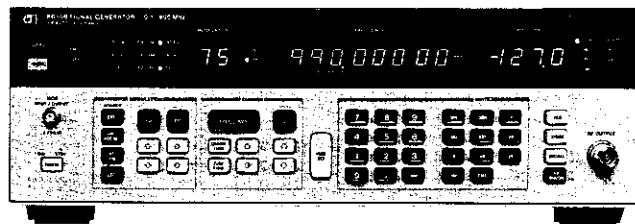

HERSTELLERBESCHEINIGUNG

Hiermit wird bescheinigt, daß das Gerät/System

8656B

in Übereinstimmung mit den Bestimmungen von Postverfügung 1046/84 funkenstört ist.

Der Deutschen Bundespost wurde das Inverkehrbringen dieses Gerätes/Systems angezeigt und die Berechtigung zur Überprüfung der Serie auf Einhaltung der Bestimmungen eingeräumt.

Zusatzinformation für Meß- und Testgeräte

Werden Meß- und Testgeräte mit ungeschirmten Kabeln und/oder in offenen Meßaufbauten verwendet, so ist vom Betreiber sicherzustellen, daß die Funk-Entstörbestimmungen unter Betriebsbedingungen an seiner Grundstücksgrenze eingehalten werden.

MANUFACTURER'S DECLARATION

This is to certify that this product 8656B meets the radio frequency interference requirements of directive 1046/84. The German Bundespost has been notified that this equipment was put into circulation and was granted the right to check the product type for compliance with these requirements.

Note: If test and measurement equipment is operated with unshielded cables and/or used for measurement on open set-ups, the user must ensure that under these operating conditions, the radio frequency interference limits are met at the border of his premises.

CERTIFICATION

Hewlett-Packard Company certifies that this product met its published specifications at the time of shipment from the factory. Hewlett-Packard further certifies that its calibration measurements are traceable to the United States National Bureau of Standards, to the extent allowed by the Bureau's calibration facility, and to the calibration facilities of other International Standards Organization members.

WARRANTY

This Hewlett-Packard instrument product is warranted against defects in material and workmanship for a period of one year from date of shipment. During the warranty period, Hewlett-Packard Company will at its option, either repair or replace products which prove to be defective.

For warranty service or repair, this product must be returned to a service facility designated by HP. Buyer shall prepay shipping charges to HP and HP shall pay shipping charges to return the product to Buyer. However, Buyer shall pay all shipping charges, duties, and taxes for products returned to HP from another country.

HP warrants that its software and firmware designated by HP for use with an instrument will execute its programming instructions when properly installed on that instrument. HP does not warrant that the operation of the instrument, or software, or firmware will be uninterrupted or error free.

LIMITATION OF WARRANTY

The foregoing warranty shall not apply to defects resulting from improper or inadequate maintenance by Buyer, Buyer-supplied software or interfacing, unauthorized modification or misuse, operation outside of the environmental specifications for the product, or improper site preparation or maintenance.

NO OTHER WARRANTY IS EXPRESSED OR IMPLIED. HP SPECIFICALLY DISCLAIMS THE IMPLIED WARRANTIES OF MERCHANTABILITY AND FITNESS FOR A PARTICULAR PURPOSE.

EXCLUSIVE REMEDIES

THE REMEDIES PROVIDED HEREIN ARE BUYER'S SOLE AND EXCLUSIVE REMEDIES. HP SHALL NOT BE LIABLE FOR ANY DIRECT, INDIRECT, SPECIAL, INCIDENTAL, OR CONSEQUENTIAL DAMAGES, WHETHER BASED ON CONTRACT, TORT, OR ANY OTHER LEGAL THEORY.

ASSISTANCE

Product maintenance agreements and other customer assistance agreements are available for Hewlett-Packard products.

For any assistance, contact your nearest Hewlett-Packard Sales and Service Office. Addresses are provided at the back of this manual.

SAFETY CONSIDERATIONS

GENERAL

This product and related documentation must be reviewed for familiarization with safety markings and instructions before operation.

This product is a Safety Class I instrument (provided with a protective earth terminal).

BEFORE APPLYING POWER

Verify that the product is set to match the available line voltage and the correct fuse is installed.

SAFETY EARTH GROUND

An uninterruptible safety earth ground must be provided from the main power source to the product input wiring terminals, power cord, or supplied power cord set.

SAFETY SYMBOLS



Instruction manual symbol: the product will be marked with this symbol when it is necessary for the user to refer to the instruction manual (refer to Table of Contents).



Indicates hazardous voltages



Indicates earth (ground) terminal

WARNING

The WARNING sign denotes a hazard. It calls attention to a procedure, practice, or the like, which, if not correctly performed or adhered to, could result in personal injury. Do not proceed beyond a WARNING sign until the indicated conditions are fully understood and met.

CAUTION

The CAUTION sign denotes a hazard. It calls attention to an operating procedure, practice, or the like, which, if not correctly per-

formed or adhered to, could result in damage to or destruction of part or all of the product. Do not proceed beyond a CAUTION sign until the indicated conditions are fully understood and met.

WARNING

Any interruption of the protective (grounding) conductor (inside or outside the instrument) or disconnecting the protective earth terminal will cause a potential shock hazard that could result in personal injury. (Grounding one conductor of a two conductor outlet is not sufficient protection).

Whenever it is likely that the protection has been impaired, the instrument must be made inoperative and be secured against any unintended operation.

If this instrument is to be energized via an auto-transformer (for voltage reduction) make sure the common terminal is connected to the earth terminal of the power source.

Servicing instructions are for use by service-trained personnel only. To avoid dangerous electric shock, do not perform any servicing unless qualified to do so.

Adjustments described in the manual are performed with power supplied to the instrument while protective covers are removed. Energy available at many points may, if contacted, result in personal injury.

Capacitors inside the instrument may still be charged even if the instrument has been disconnected from its source of supply.

For continued protection against fire hazard, replace the line fuse(s) only with 250V fuse(s) of the same current rating and type (for example, normal blow, time delay, etc.). Do not use repaired fuses or short circuited fuseholders.

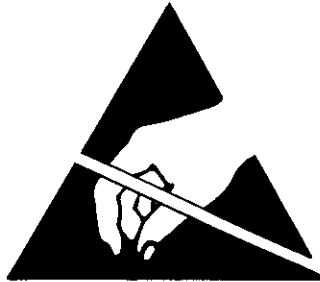

**ATTENTION
Static Sensitive
Devices**

This instrument was constructed in an ESD (electro-static discharge) protected environment. This is because most of the semiconductor devices used in this instrument are susceptible to damage by static discharge.

Depending on the magnitude of the charge, device substrates can be punctured or destroyed by contact or mere proximity of a static charge. The results can cause degradation of device performance, early failure, or immediate destruction.

These charges are generated in numerous ways such as simple contact, separation of materials, and normal motions of persons working with static sensitive devices.

When handling or servicing equipment containing static sensitive devices, adequate precautions must be taken to prevent device damage or destruction.

Only those who are thoroughly familiar with industry accepted techniques for handling static sensitive devices should attempt to service circuitry with these devices.

In all instances, measures must be taken to prevent static charge build-up on work surfaces and persons handling the devices.

For further information on ESD precautions, refer to "SPECIAL HANDLING CONSIDERATIONS FOR STATIC SENSITIVE DEVICES" in Section VIII Service Section.

Volume I Contents

| | <u>Page</u> | | <u>Page</u> |
|--|-------------|---|-------------|
| Section I | | | |
| GENERAL INFORMATION | | | |
| Introduction | 1-1 | Operator's Checks | 3-1 |
| Specifications | 1-1 | Basic Functional Checks | 3-1 |
| Safety Considerations | 1-1 | HP-IB Functional Checks | 3-1 |
| Instruments Covered By This Manual | 1-2 | Remote Operation | 3-2 |
| Description | 1-2 | Operator's Maintenance | 3-2 |
| Carrier Frequency | 1-2 | General Operating Instructions | 3-2 |
| Output Amplitude | 1-2 | Power-On Procedure | 3-2 |
| Modulation Capabilities | 1-2 | Power-On Sequence | 3-3 |
| Options | 1-3 | Power STBY Sequence | 3-3 |
| Electrical Options | 1-3 | Front-Panel Features | 3-4 |
| Mechanical Options | 1-3 | Keystroke Sequence | 3-9 |
| Rear-Panel Inputs and Outputs Option 002 | 1-3 | Carrier Keystroke Sequence | 3-9 |
| Front Handle Kit Option 907 | 1-3 | Modulation Keystroke Sequence | 3-10 |
| Rack Flange Kit Option 908 | 1-3 | Store-Recall Display Keystroke Sequence | 3-10 |
| Rack Flange and Front Handle | | Time Base Selection | 3-10 |
| Combination Kit Option 909 | 1-3 | Rear-Panel Features | 3-10 |
| Hewlett-Packard Interface Bus | 1-3 | Operator's Maintenance | 3-10 |
| Compatibility | 1-3 | Operator's Checks | 3-11 |
| Selecting the HP-IB Address | 1-3 | Basic Functional Checks | 3-11 |
| Accessories Supplied | 1-4 | Frequency Check | 3-12 |
| Recommended Test Equipment | 1-4 | Output Level Checks | 3-13 |
| | | FM Check | 3-14 |
| | | DC FM Check | 3-14 |
| | | AM Check | 3-14 |
| | | HP-IB Functional Checks | 3-15 |
| | | Address Recognition | 3-16 |
| | | Remote and Local Messages and the | |
| | | LOCAL Key | 3-16 |
| | | Data Message | 3-17 |
| | | Local Lockout and Clear Lockout/ | |
| | | Set Local Messages | 3-17 |
| | | Clear Message | 3-18 |
| | | Abort Message | 3-18 |
| | | Remote Operation, Hewlett-Packard | |
| | | Interface Bus | 3-20 |
| | | HP-IB Compatibility | 3-20 |
| | | Remote Operation | 3-20 |
| | | Remote Capability | 3-20 |
| | | Local-to-Remote Change | 3-20 |
| | | Local Operation | 3-20 |
| | | Local Capability | 3-20 |
| | | Remote-to-Local Change | 3-20 |
| | | Local Lockout | 3-20 |
| | | Addressing | 3-22 |
| | | Data Messages | 3-22 |
| | | Receiving the Data Message | 3-23 |
| | | Data Message Input Format | 3-23 |
| | | Keyboard-to-Program Code Correlation | 3-23 |
| | | Value-Selectable Parameters | 3-23 |
| | | Data | 3-23 |
| | | Sending the Data Message | 3-23 |
| | | Receiving the Trigger Message | 3-23 |
| | | Receiving the Clear Message | 3-24 |
| | | Receiving the Remote Message | 3-25 |
| | | Receiving the Local Message | 3-25 |
| | | Receiving the Local Lockout Message | 3-25 |
| Section II | | | |
| INSTALLATION | | | |
| Introduction | 2-1 | | |
| Initial Inspection | 2-1 | | |
| Preparation for Use | 2-1 | | |
| Power Requirements | 2-1 | | |
| Line Voltage and Fuse Selection | 2-2 | | |
| Power Cables | 2-3 | | |
| Time Base Selection | 2-3 | | |
| HP-IB Address Selection | 2-5 | | |
| Interconnection | 2-6 | | |
| Mating Connectors | 2-6 | | |
| Coaxial Connectors | 2-6 | | |
| Interface Connector | 2-6 | | |
| Operating Environment | 2-6 | | |
| Bench Operation | 2-6 | | |
| Rack Mounting | 2-6 | | |
| Storage and Shipment | 2-9 | | |
| Environment | 2-9 | | |
| Packaging | 2-9 | | |
| Original Packaging | 2-9 | | |
| Other Packaging | 2-9 | | |
| Section III | | | |
| OPERATION | | | |
| Introduction | 3-1 | | |
| Operating Characteristics | 3-1 | | |
| Local Operation | 3-1 | | |
| General Operating Instructions | 3-1 | | |
| Simplified Front-Panel Features | | | |
| and Operation | 3-1 | | |
| Detailed Operating Instructions | 3-1 | | |

Volume I Contents (cont'd)

| | <u>Page</u> | | <u>Page</u> |
|---|-------------|--|-------------|
| Receiving the Clear Lockout/ Set Local Message | 3-26 | Calibration Cycle | 4-2 |
| Receiving the Pass Control Message | 3-27 | Abbreviated Performance Testing | 4-2 |
| Sending the Require Service Message | 3-27 | Test Procedures | 4-2 |
| Sending the Status Byte Message | 3-27 | Spectral Purity Tests | 4-4 |
| Sending the Status Bit Message | 3-27 | Output Level Accuracy and Flatness Tests | 4-14 |
| Receiving the Abort Message | 3-27 | Modulation Tests | 4-17 |
| Switching Characteristics | 3-28 | Output Leakage Tests | 4-29 |
| Frequency Switching | 3-28 | SWR Test | 4-31 |
| Amplitude Switching | 3-28 | | |
| Modulation Switching | 3-28 | | |
| Introduction to the | | Section V | |
| Detailed Operating Instructions | 3-30 | ADJUSTMENTS | |
| Amplitude | 3-31 | Introduction | 5-1 |
| Amplitude Conversion | 3-33 | Safety Considerations | 5-1 |
| Amplitude Offset | 3-35 | Equipment Required | 5-1 |
| Amplitude Up/Down | 3-36 | Factory-Selected Components | 5-1 |
| Display Amplitude Offset | 3-37 | Post Repair Adjustments | 5-2 |
| Display | 3-38 | Related Adjustments | 5-3 |
| Display Sequence | 3-39 | Power Supply Voltage Adjustment | 5-4 |
| Frequency | 3-40 | Reference Voltage Adjustment | 5-5 |
| Frequency, Coarse and Fine Tune | 3-42 | Audio Oscillator Level Adjustment | 5-6 |
| Frequency, Phase Up/Down | 3-43 | AM Offset Adjustment | 5-7 |
| Frequency, Up/Down | 3-44 | 715 MHz Sideband Adjustment | 5-9 |
| HP-IB Address Display | 3-46 | Notch Filter Adjustments | 5-11 |
| Increment Value Change | 3-48 | High Frequency Loop Offset Adjustment | 5-14 |
| Increment Value Display | 3-50 | 50 MHz Reference Oscillator Frequency Adjustment | 5-16 |
| Instrument Preset | 3-52 | 50 MHz Reference Oscillator Level Adjustment | 5-17 |
| Modulation, AM | 3-53 | 60 to 110 MHz Oscillator Flatness Adjustment | 5-19 |
| Modulation, AM Up/Down | 3-55 | 690 to 740 MHz IF Compensation Adjustment | 5-21 |
| Modulation, DC FM | 3-57 | 400 MHz Bandpass Filter Adjustment | 5-23 |
| Modulation, DC FM Up/Down | 3-59 | Level and ALC Loop Detector Adjustments | 5-24 |
| Modulation, External Source | 3-60 | Heterodyne Band 800 MHz Bandpass Filter Adjustment | 5-26 |
| Modulation, FM | 3-61 | Heterodyne Band Accuracy and Flatness Adjustments | 5-26.2 |
| Modulation, FM Up/Down | 3-63 | AM% and ALC Loop AM Adjustments | 5-28 |
| Modulation, Mixed | 3-65 | FM Deviation Adjustment | 5-30 |
| Modulation, Off | 3-69 | FM Calibration Pretune Adjustment | 5-32 |
| RF Off/On | 3-71 | API 1, 2, 3, and 4 Adjustments | 5-34 |
| Recall | 3-72 | Pedestal Adjustment | 5-36 |
| Sequence | 3-73 | DC FM Adjustment | 5-38 |
| Store | 3-73 | FM In-Band Gain Adjustment | 5-40 |
| | | Voltage Offset Adjustment | 5-42 |
| Section IV | | DC FM Offset Adjustment | 5-43 |
| PERFORMANCE TESTS | | Option 001 10 MHz Reference Oscillator Frequency Adjustment | 5-44 |
| Introduction | 4-1 | | |
| Equipment Required | 4-1 | | |
| Performance Test Record | 4-1 | | |

SECTION I GENERAL INFORMATION

1-1. INTRODUCTION

This manual contains information required to install, operate, test, adjust, and service the Hewlett-Packard Model 8656B Signal Generator. The Model 8656B will generally be referred to as the Signal Generator throughout this manual. This manual also documents Signal Generators supplied with the high stability time base, Option 001, and rear-panel connectors, Option 002.

This section of the manual describes the instruments documented by this manual, it covers instrument description, options, accessories, specifications, and other basic information. The other sections contain the following information:

Section II, Installation: provides information about initial inspection, preparation for use (including time base selection, and HP-IB address selection for remote operation), and storage and shipment.

Section III, Operation: provides information about panel features and includes operator's checks, operating instructions for both local and remote operation, and operator's maintenance information.

Section IV, Performance Tests: provides the information required to check performance of the instrument against the critical specifications listed in Table 1-1.

Section V, Adjustments: provides the information required to properly adjust the instrument.

Section VI, Replaceable Parts: provides ordering information for all replaceable parts and assemblies.

Section VII, Instrument Changes: provides instrument modification recommendations and procedures.

Section VIII, Service: provides the information required to repair the instrument.

One copy of the operating information is supplied with the Signal Generator. Operating information is found in Section III of the Operating and Service Manual. A copy of the Operating Manual may be ordered separately through your nearest Hewlett-Packard office. Its part number is listed on the title page of this manual.

Also listed on the title page of this manual, below the manual part number, is a "Microfiche" part number. This number may be used to order 100 × 150 millimetre (4- × 6-inch) microfilm transparencies of this manual. Each microfiche contains up to 96 photo-duplicates of the manual's pages. The microfiche package also includes the latest MANUAL CHANGES supplement, as well as all pertinent Service Notes.

1-2. SPECIFICATIONS

Instrument specifications are listed in Table 1-1. These specifications are the performance standards or limits against which the instrument may be tested. Supplemental characteristics are listed in Table 1-2. Supplemental characteristics are not warranted specifications, but are typical characteristics included as additional information for the user.

1-3. SAFETY CONSIDERATIONS

This product is a Safety Class I instrument, that is, one provided with a protective earth terminal. The Signal Generator and all related documentation must be reviewed for familiarization with safety markings and instructions before operation. Refer to the Safety Considerations pages found at the

beginning of this manual for a summary of the safety information. Safety information pertinent to the task at hand, that is, installation, operation, performance testing, adjustment, or service is found throughout this manual.

1-4. INSTRUMENTS COVERED BY THIS MANUAL

This instrument has a two-part serial number in the form 0000A00000 which is stamped on the serial number plate attached to the rear of the instrument. The first four digits and the letter constitute the serial number prefix, and the last five digits form the suffix. The prefix is the same for all identical instruments. It changes only when a change is made to the instrument. The suffix, however, is assigned sequentially and is different for each instrument. The contents of this manual apply directly to instruments having the same serial number prefix(es) as listed under SERIAL NUMBERS on the title page.

Manual Updates. An instrument manufactured after the printing of this manual may have a serial prefix that is not listed on the title page. An unlisted serial prefix number indicates that the instrument differs in some way from those documented in this manual.

A "MANUAL UPDATES" packet is shipped with the manual when necessary to provide you with the most current information available at the time of shipment. These packets consist of replacement and addition pages which should be incorporated into the manual to bring it up to date.

Hewlett-Packard offers a **Documentation Update Service** that will provide you with further updates as they become available.

If you operate or service instruments of different serial prefixes, we strongly recommend that you join this service immediately to ensure that your manual is kept current. For more information refer to the **Documentation Update Service** reply card included with this manual or contact the Technical Writing Department through the address listed on the title page of this manual.

1-5. DESCRIPTION

The Hewlett-Packard Model 8656B is a synthesized signal generator with a carrier frequency range of 100 kHz to 990 MHz. Its output amplitude is leveled and calibrated from +13 to -127 dBm. AM and/or FM functions can be individually selected. The carrier frequency, output amplitude, and modulation functions can be remotely programmed via the Hewlett-Packard Interface Bus. The unique modular design and incorporated service features permit rapid and easy calibration and service.

1-6. Carrier Frequency

The Signal Generator covers a carrier frequency range of 100 kHz to 990 MHz (10 kHz to 990 MHz with underrange) which can be extended to 1.8 GHz with an external doubler. Frequency resolution is 10 Hz. An 8-digit LED display of the carrier frequency in MHz is provided. Pushbutton keys permit coarse tuning, fine tuning, and incrementing of the carrier frequency.

Frequency accuracy and stability are dependent on the reference source being used, either the internal 50 MHz reference oscillator or an external source that operates at 1, 5, or 10 MHz. An optional 10 MHz crystal reference is available for increased accuracy and stability.

1-7. Output Amplitude

The Signal Generator has precise power levels from +13 to -127 dBm (+1.00 V to +0.100 V) with overrange at decreased accuracy. The output amplitude from +13 to -127 dBm is accurate to less than or equal to ± 1.0 dB from 100 kHz to 990 MHz. Level flatness is less than or equal to ± 1.0 dB with an output amplitude setting of 0.0 dBm. Output amplitude resolution is 0.1 dB. A 3½-digit LED display of output amplitude is provided with 7 LED annunciators used to display unit information. Easy conversion of units between dBm, +V, EMF, and so forth is possible.

1-8. Modulation Capabilities

The Signal Generator features a versatile internal and external modulation capability for AM and FM. This includes internal 400 Hz or 1 kHz tones; mixed modulation, such as AM/FM, AM/AM, or

FM/FM; and the capability to accept low frequency digital unsquelching signals. A 2-digit display of AM depth or FM peak deviation is provided with 11 LED annunciators used to display internal or external modulation source information. Simple keyboard entries of AM depth up to 99% with a resolution of 1%, and FM peak deviation up to 99 kHz with resolutions of 100 Hz (for deviations less than 10 kHz) or 1 kHz (for deviations greater than or equal to 10 kHz) are possible.

1-9. OPTIONS

The following options are available and may have been ordered and received with the Signal Generator. If they were not received with the original shipment and are now desired, except for option 002, they may be ordered from your nearest Hewlett-Packard office using the part number included in each of the following paragraphs.

1-10. Electrical Options

Option 001 provides a 10 MHz crystal reference for increased frequency accuracy and stability. Order HP part number 08656-60079.

1-11. Mechanical Options

Rear-Panel Inputs and Outputs Option 002. RF Output and Modulation Input/Output Connectors are located on the rear-panel. The SEQ (sequencing) input is eliminated.

Front Handle Kit Option 907. Ease of handling is increased with the front-panel handles. Order HP part number 5061-0089.

Rack Flange Kit Option 908. This kit contains all necessary hardware and installation instructions for mounting the Signal Generator in a rack with 482.5 millimeter (standard 19-inch) spacing. Order HP part number 5061-0077.

Rack Flange and Front Handle Combination Kit Option 909. This kit is not simply a front handle kit and rack flange kit packaged together. The combination is made up of unique parts which include both functions. Order HP part number 5061-0083.

1-12. HEWLETT-PACKARD INTERFACE BUS *

1-13. Compatibility

The Signal Generator has an HP-IB interface and can be used with any HP-IB computing controller or computer for automatic system applications. The Signal Generator is fully programmable via the HP Interface Bus. The Signal Generator's complete compatibility with HP-IB is defined by the following list of interface functions: SH0, E1, AH1, T0, L2, SR0, RL1, PP0, DC1, DT0, and C0. The Signal Generator interfaces with the bus via open collector TTL circuitry. An explanation of the compatibility codes can be found in the IEEE Standard 488 and the identical ANSI Standard MC1.1.

For more detailed information relating to programmable control of the Signal Generator, refer to Remote Operation, Hewlett-Packard Interface Bus in Section III of this manual.

1-14. Selecting the HP-IB Address

Five miniature HP-IB address switches are located inside the Signal Generator. These switches represent a five-bit binary number (00 through 31 in decimal). HP-IB addresses greater than 30 (decimal) are invalid. When the instrument is shipped from the factory, the HP-IB address is preset to 07 (decimal). To determine the Signal Generator's HP-IB address, refer to HP-IB Address Display in Section III of this manual. To change the HP-IB address, refer to paragraph 2-8, HP-IB Address Selection.

 *: Not just IEEE-488, but the hardware, documentation and support that delivers the shortest path to a measurement system.

1-15. ACCESSORIES SUPPLIED

The power cable and fuse supplied for the Signal Generator are selected at the factory according to the Mains voltage available in the country of destination. For the part numbers of the power cables and Mains plugs available, refer to paragraph 2-6, Power Cables. For the part numbers and ratings of the fuses available, refer to paragraph 2-5, Line Voltage and Fuse Selection. If the Signal Generator is equipped with Option 001, a coaxial time base cable is supplied. This cable must be connected between the rear-panel TIME BASE HIGH STABILITY OPTION connector and the TIME BASE INPUT connector.

1-16. RECOMMENDED TEST EQUIPMENT

Table 1-3 lists the test equipment required for testing, adjusting, and servicing the Signal Generator. The Critical Specifications column describes the essential requirements for each piece of test equipment. Other equipment can be substituted if it meets or exceeds these critical specifications.

The Recommended Model column may suggest more than one model. The first model listed is usually the least expensive, single-purpose model. Alternate models are suggested for additional features that would make them a better choice in some applications. For example, reasons for recommending an alternate model might be:

- HP-IB programmability
- or -
- Multi-function capability (that is, one model can replace two or more single purpose models).

Table 1-4 presents the advantages of the alternate suggestions.

Table 1-1. Specifications (1 of 3)

| Electrical Characteristics | Performance Limits | Conditions |
|---|--|---|
| Frequency Range Resolution Switching | 100 kHz to 990 MHz 10 Hz 150 ms | |
| Spectral Purity Spurious Signals: Harmonics Non-harmonics Sub-harmonics Residual AM (in CW mode) (0.05 to 15 kHz Post Detection Noise Bandwidth) Residual FM (in CW mode) (0.3 to 3 kHz Post Detection Noise Bandwidth) Residual FM (in CW mode) (0.05 to 15 kHz Post Detection Noise Bandwidth) SSB ϕ Noise (in CW mode): 20 kHz offset from carrier | <-25 dBc <-60 dBc None <-75 dBc <7 Hz rms <2 Hz rms <4 Hz rms <7 Hz rms <15 Hz rms <4 Hz rms <8 Hz rms <15 Hz rms <-114 dBc/Hz <-126 dBc/Hz <-120 dBc/Hz <-114 dBc/Hz | $\leq +7$ dBm output levels >5 kHz from carrier in CW mode 0.1 to 990 MHz 0.1 to 123.5 MHz 123.5 to 247 MHz 247 to 494 MHz 494 to 990 MHz 0.1 to 123.5 MHz 123.5 to 247 MHz 247 to 494 MHz 494 to 990 MHz 0.1 to 123.5 MHz 123.5 to 247 MHz 247 to 494 MHz 494 to 990 MHz |
| Output Level Range Resolution Absolute Level Accuracy ¹ Level Flatness SWR Reverse Power Protection | +13 dBm to -127 dBm 0.1 dB $\leq \pm 1.0$ dB $\leq \pm 1.5$ dB $\leq \pm 1.0$ dB <2.0 <1.5 50W (max) 25V (max) | Into 50 ohms 123.5 to 990 MHz, +7 to -124 dBm 0.1 to 123.5 MHz, and <-124 dBm or >+7 dBm at 0.1 to 990 MHz Output level setting of 0.0 dBm; frequencies from 0.1 to 990 MHz >-5 dBm ≤ -5 dBm RF power to 990 MHz into RF OUTPUT connector dc voltage |

¹ Absolute level accuracy includes allowances for detector linearity, temperature, flatness, attenuator accuracy, and measurement error.

Table 1-1. Specifications (2 of 3)

| Electrical Characteristics | Performance Limits | Conditions |
|--|---|--|
| Amplitude Modulation Depth ² Resolution Incidental Phase Modulation Indicator Accuracy ² AM Rates: Internal External AM Distortion (internal rates) | 0 to 99% 0 to 30% 1% <0.3 radian peak ±2% (±4% of reading) 400 Hz and 1 kHz, ±3% 20 Hz to 40 kHz <1.5% <3% <4% | Output levels of <+7 dBm; frequencies from 0.1 to 990 MHz Output levels to +10 dBm; frequencies from 0.1 to 990 MHz 30% AM depth and internal rates Depths <90% and internal rates, and levels <+7 dBm 1 dB bandwidth, ac coupled 0 to 30% AM 31 to 70% AM 71 to 90% AM |
| FM Modulation Maximum Peak Deviation (Δf_{pk}): ³ Rates ≥ 50 Hz (ac mode) Rates <50 Hz (ac mode) Rates (dc mode) Center Frequency Accuracy (dc mode) Stability (dc mode) Resolution Incidental AM Indicator Accuracy ³ FM Distortion (Total Harmonic Distortion) ⁴ FM Rates: Internal External | 99 kHz 50 kHz 99 kHz 99 kHz 4000 × Rate (Hz) 1000 × Rate (Hz) 2000 × Rate (Hz) 4000 × Rate (Hz) 99 kHz 50 kHz 99 kHz 99 kHz ±500 Hz ±125 Hz ±250 Hz ±500 Hz <10 Hz/hour 0.1 kHz 1 kHz <0.1% <1% <5% ±5% of reading <0.5% 400 Hz and 1 kHz, ±3% dc to 50 kHz dc to 100 kHz | 0.1 to 123.5 MHz (fc) 123.5 to 247 MHz (fc) 247 to 494 MHz (fc) 494 to 990 MHz (fc) 0.1 to 123.5 MHz (fc) 123.5 to 247 MHz (fc) 247 to 494 MHz (fc) 494 to 990 MHz (fc) 0.1 to 123.5 MHz (fc) 123.5 to 247 MHz (fc) 247 to 494 MHz (fc) 494 to 990 MHz (fc) (FM not specified for $f_c - \Delta f_{pk} < 100$ kHz) 0.1 to 123.5 MHz (fc) 123.5 to 247 MHz (fc) 247 to 494 MHz (fc) 494 to 990 MHz (fc) Deviations <10 kHz Deviations ≥ 10 kHz <20 kHz peak deviation and internal rates: >500 kHz (fc) 200 to 500 kHz (fc) <200 kHz (fc) At internal rates >1 kHz peak deviations and at internal rates ac coupled, ±1 dB 20 Hz to 50 kHz ±3 dB |
| ² AM depth is further limited by the Indicator Accuracy specification. ³ FM deviation is further limited by the Indicator Accuracy specification. | | |

Table 1-1. Specifications (3 of 3)

| Electrical Characteristics | Performance Limits | Conditions |
|---|--|---|
| <p>General</p> <p>Operating Temperature Range</p> <p>Storage Temperature Range</p> <p>Power Requirements</p> <p>Line Voltage</p> <p>Line Frequency</p> <p>Power Dissipation</p> <p>Conducted and Radiated Electromagnetic Interference</p> <p>Net Weight</p> <p>Dimensions</p> <p>Full Envelope:</p> <p>Height</p> <p>Width</p> <p>Depth</p> | <p>0 to 55°C</p> <p>-55 to +70°C</p> <p>100, 120, 220, or 240 Vac, +5%, -10%</p> <p>48 to 440 Hz</p> <p>125VA maximum</p> <p>MIL STD 461B, FTZ 1115</p> <p><1.0 μV</p> <p>18.2 kg (40 lb)</p> <p>133 mm (5.25 in.) nominal</p> <p>425 mm (16.75 in.) nominal</p> <p>520 mm (20.5 in.) nominal</p> | <p>Conducted and radiated interference is within the requirements of methods CE03 and RE02 of MIL STD 461B, and FTZ 1115</p> <p>Induced in a two-turn 2.5 cm (1 inch) diameter loop held 2.5 cm (1 inch) away from the front surface.</p> <p>NOTE: For ordering cabinet accessories, the module sizes are 5¼H, 1MW,17D.</p> |
| Electrical Characteristics | Features | |
| <p>HP-IB (IEEE 488) Capability:</p> <p>Interface</p> <p>Functions Controlled</p> | <p>Hewlett-Packard Interface Bus (HP-IB). HP-IB is Hewlett-Packard's implementation of IEEE Standard 488 (and the identical ANSI Standard MC1.1). The Signal Generator's compatibility with HP-IB is defined by the following list of interface functions: SH0, E1, AH1, T0, L2, SR0, RL1, PP0, DC1, DT0, and C0.</p> <p>All functions controlled from the front-panel with the exception of DISPLAY, DISPLAY in conjunction with SEQ, display Amplitude Offset, Backspace, COARSE TUNE, FINE TUNE, and display HP-IB ADRS are programmable with the same accuracy and resolution as in local operation.</p> | |
| <p>⁴FM distortion only applies at deviations up to 25 kHz for 123.5 < fc <247 MHz, and 50 kHz for 247 < fc <494 MHz. Typical total FM distortion (harmonic and non-harmonic) is less than 1.5% for all specified deviations and external rates of dc to 100 kHz.</p> | | |

Table 1-2. Supplemental Characteristics

Supplemental characteristics are intended to provide information useful in applying the instrument by giving typical, but non-warranted performance parameters.

FREQUENCY

Accuracy and Stability: same as internal time base.

Time Base Characteristics:

| Characteristic | Standard Time Base | Option 001 Time Base |
|---|---|-----------------------------------|
| Aging Rate | ±2 ppm/year | 1 × 10 ⁻⁹ /day |
| Temperature | ±10 ppm (0-55°C) | 7 × 10 ⁻⁹ (0-55°C) |
| Line Voltage | — | 2 × 10 ⁻⁹ (+5 to -10%) |
| Frequency | 50 MHz | 10 MHz |
| Time Base Reference Signal (Rear-Panel) | Available at a level of >0.15 Vrms into 50 ohms (output of 10, 5 or 1 MHz is selectable via internal jumper). If the Option 001 or another external reference is used, only that reference frequency is available as an output. | |
| External Reference Input (Rear-Panel) | Accepts any 10, 5 or 1 MHz (±0.002%) frequency standard at a level of >0.15 Vrms into 50 ohms. | |

Phase Offset: Output phase is adjustable via HP-IB, or from the front-panel in nominal 1 degree increments.

Frequency Underrange: 10 kHz with uncalibrated output.

MODULATION

(Amplitude and Frequency Modulation)

External Sensitivity: 1V peak for indicated accuracy for ac signals or 1 Vdc when in dc FM mode.

External Modulation Input: front-panel BNC; 600 ohms, dc-coupled; front-panel annunciators indicate application of 1V peak signal ±5%.

Modulating Signal Output: internal modulating signal is provided at the front-panel BNC connector nominally 1 Vpk into a 600 ohm resistive load.

Simultaneous Modulation: Internal/external: AM/FM, FM/AM, AM/AM, and FM/FM. Internal/internal: AM/FM.

OUTPUT

Impedance: 50 ohms nominal.

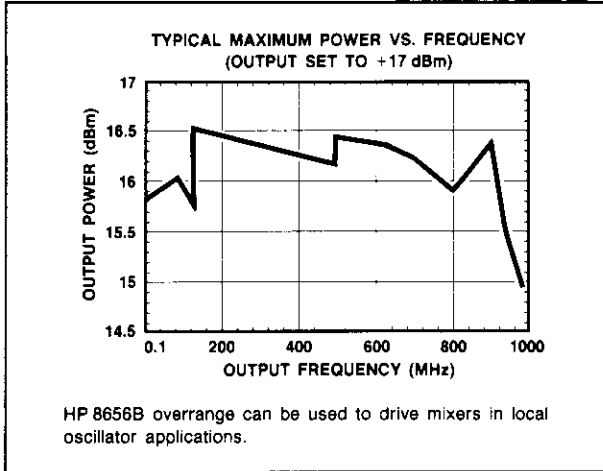

Typical maximum power output versus frequency (output set to +17 dBm)

SPECTRAL PURITY

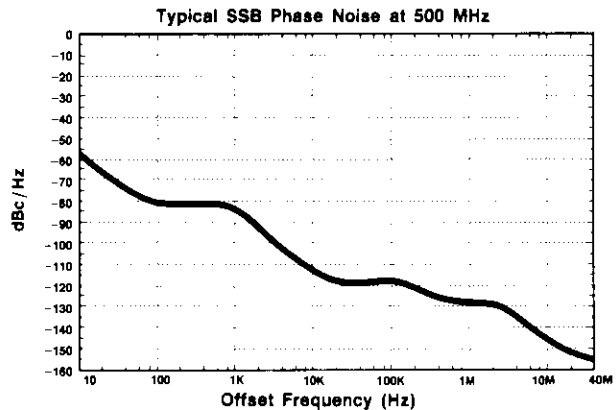

Typical SSB ϕ Noise, $f_c = 450$ MHz

Table 1-3. Recommended Test Equipment (1 of 3)

| Instrument | Critical Specifications | Recommended Model | Use ¹ |
|--|---|--|------------------|
| AM/FM Test Source (required for modulation analyzer verification) | Range: 10 MHz to 400 MHz Residual AM ² FM Flatness: $\pm 1\%$ (dc to 250 kHz) Peak Deviation: to 100 kHz | HP 11715A | P |
| Attenuator, Fixed | Attenuation: 6 dB Frequency Range: 10 MHz to 990 MHz SWR: <1.2 | HP 8491A Option 006 | P |
| Attenuator, Fixed | Attenuation: 20 dB Frequency Range: 10 MHz to 990 MHz SWR: <1.2 | HP 8491A Option 020 | A |
| Controller, HP-IB | HP-IB compatibility as defined as IEEE Standard 488 and the identical ANSI Standard MC1.1: SH0, E1, AH1, T4, TE0, L0, LE0, SR0, RL0, PP0, DC0, DT0, and C1, 2, 3, 28. | Use any HP controller and HP-IB interface to implement HP-IB functional checks | T |
| DC Power Supply | Output: 0-25 V Current: 500 mA | HP 6215A | P, A |
| Digital Multimeter | Accuracy: $4\frac{1}{2}$ digit, $\pm 0.05\%$ of reading ± 3 Ranges: 20 mV to 30 Vdc and 2 Vac Sensitivity: 100 μ V | HP 3466A or HP 3455A (see Table 1-4) | P, A, T |
| Distortion Analyzer | Distortion Range: <0.1% Range: 25 Hz to 25 kHz | HP 339A or HP 8903A (see Table 1-4) | P, T |
| Frequency Counter | Range: 10 MHz Resolution: 1 Hz | HP 5328A Option 031 or HP 5328A Options 001 and 031 (see Table 1-4) | A |
| Frequency Counter | Range: 990 MHz Resolution: 10 Hz | HP 5328A Option 031 | T |
| Loop Antenna 2.5 cm (1 in.) | To ensure measurement accuracy, no substitution is possible. Fabrication depends upon machining and assembling to close tolerances. | HP 08640-60501 | P |
| Low-Noise Amplifier | Input/Output Impedance: 50 ohms Frequency Bandwidth: 1 kHz to 1 MHz Noise Figure: <3 dB Gain: 40 ± 1 dB | HP 08640-60506 Requires 19-25 Vdc Power Supply | P |
| Measuring Receiver and Sensor Module | Frequency Range: 150 kHz to 990 MHz Input Level: -127 to +13 dBm RF Power: 0.2 dB Tuned RF Level: 0.36 dB RSS Referenced to -10 dBm input | HP 8902A and 11722A | P, A, T |

¹A = Adjustments; P = Performance Tests; T = Troubleshooting.

²The residual AM specification of both the HP 8901A Modulation Analyzer and HP 11715A AM/FM Test Source are stated in a 50 Hz to 3 kHz bandwidth. In order to assure the validity of the residual AM measurement in the bandwidths stated for the HP 8656B Signal Generator (namely, 50 Hz to 15 kHz) the combined performance of both the HP 8901A and HP 11715A must be verified to be better than 0.022% rms for the 50 Hz to 15 kHz bandwidth. See paragraph 4-7, step 4, for the verification procedure.

Table 1-3. Recommended Test Equipment (2 of 3)

| Instrument | Critical Specifications | Recommended Model | Use ¹ |
|---|---|--|------------------|
| Measuring Receiver and Sensor Module (Cont'd) | <p>Amplitude Modulation:</p> <p>Rates²: 25 Hz to 25 kHz</p> <p>Depth: to 99%</p> <p>Accuracy: $\pm 2\%$ at 1 kHz</p> <p>Flatness: $\pm 0.5\%$</p> <p>Demodulated Output Distortion: 0.3% for 50% depth; <0.6% for 90% depth</p> <p>Incidental ΦM: <0.05 radians for 50% depth at 1 kHz rate (50 Hz to 3 kHz bandwidth)</p> <p>Residual AM²</p> <p>Frequency Modulation:</p> <p>Rates: 25 Hz to 25 kHz</p> <p>Deviation: to 99 kHz</p> <p>Accuracy: $\pm 2\%$ at 1 kHz</p> <p>Demodulated Output Distortion: <0.3%</p> <p>Incidental AM³:</p> <p>Residual FM: <8 Hz rms at 1300 decreasing linearly with frequency to <1 Hz rms for 100 MHz and below (50 Hz to 3 kHz bandwidth)</p> | HP 8902A and 11722A | P, A, T |
| Mixer | <p>Frequency: 0.2 MHz to 500 MHz</p> <p>Type: Double Balanced</p> | HP 10514A | P |
| Oscilloscope | <p>Vertical Sensitivity: 0.01 mV/div</p> <p>Bandwidth: 50 MHz</p> <p>Time/Div: .05 μsec</p> <p>Input: Dual Channel</p> | HP 1740A | A, T |
| Signal Source | <p>Frequency: 50 to 300 MHz</p> <p>Level: -20 dBm</p> | HP 8640B | A, T |
| Signature Analyzer | Provides preferred method for troubleshooting digital circuitry | HP 5005A | T |
| Spectrum Analyzer, RF | <p>Frequency Range: 0.1 to 990 MHz</p> <p>Resolution Bandwidth: <1 kHz to 3 kHz</p> | HP 8568A or HP 8558B/P/181T or (see Table 1-4) | P, A, T |
| SWR Bridge | <p>Frequency Range: 5 MHz to 990 MHz</p> <p>Impedance: 50 ohms</p> <p>Directivity: >40 dB</p> <p>Test Connector: Type N male</p> | Wiltron 60N50 | P |
| Test Oscillator | <p>Level: 0.0 to 1 Vpk into 50 and 600 ohms</p> <p>Frequency: 25 Hz to 25 MHz</p> | HP 651B | P, A, T |
| Wideband Amplifier | <p>Gain: 20 or greater</p> <p>Frequency Range: 10 MHz to 990 MHz</p> <p>Impedance: 50 ohms</p> <p>Connector: Type N</p> | HP 8447D Option 010 | P |

¹A = Adjustments; P = Performance Tests; T = Troubleshooting.

²The residual AM specification of both the HP 8901A Modulation Analyzer and HP 11715A AM/FM Test Source are stated in a 50 Hz to 3 kHz bandwidth. In order to assure the validity of the residual AM measurement in the bandwidths stated for the HP 8656B Signal Generator (namely, 50 Hz to 15 kHz) the combined performance of both the HP 8901A and HP 11715A must be verified to be better than 0.022% rms for the 50 Hz to 15 kHz bandwidth. See paragraph 4-7, step 4, for the verification procedure.

³The incidental AM specification for the Signal Generator is not equivalent to the published specification of the Model 8901A Modulation Analyzer. In order to assure the validity of the incidental AM measurement, the incidental AM of the modulation analyzer must be verified to be less than 0.02% for the 300 Hz to 3 kHz bandwidth and 20 kHz peak deviation at internal rates. Refer to paragraph 4-9, step 18, for the verification procedures.

Table 1-3. Recommended Test Equipment (3 of 3)

| Adapter | Quantity | Type | Recommended Model | Use ¹ |
|---------|----------|----------------------------------|-------------------|------------------|
| Coaxial | 1 | BNC(f) to BNC(f) | HP 1250-0080 | A, T |
| Coaxial | 1 | N(f) to BNC(m) | HP 1250-0077 | A |
| Coaxial | 3 | N(m) to BNC(f) | HP 1250-0780 | P, A, T |
| Probe | 2 | SMC(f) to RF Test Point | HP 1250-1598 | A, T |
| RF | 2 | BNC(f) to SMC(f) | HP 08662-60075 | P |
| RF | 1 | Connector: UG-21D/U Type N(m) | HP 11500A | P, A, T |
| RF | 2 | Connector: UG-21D/U Type N(m) | HP 11500B | P, A, T |

¹A = Adjustments; P = Performance Tests; T = Troubleshooting.

Table 1-4. Alternate Test Equipment

| Instrument | Recommended Model | Suggested Alternative | Advantages of Alternative |
|-------------------------|---------------------|--|--|
| Digital Voltmeter (DVM) | HP 3466A | HP 3455A | HP-IB* Compatible |
| Distortion Analyzer | HP 339A | HP 8903A | HP-IB* Compatible |
| Frequency Counter | HP 5328A Option 031 | HP 5328A Options 001 and 031 | HP-IB* Compatible |
| Spectrum Analyzer, RF | HP 8568A | HP 8558B/P/181T or HP 8554B/8552B/141T | Satisfies the requirements for testing the Signal Generator. |

*HP-IB is Hewlett-Packard's implementation of IEEE Standard 488 and the identical ANSI Standard MC1.1.

SECTION II INSTALLATION

2-1. INTRODUCTION

This section provides the information needed to install the Signal Generator. Included is information pertinent to initial inspection, power requirements, line voltage and fuse selection, power cables, time base selection, HP-IB address selection, interconnection, mating connectors, operating environment, instrument mounting, storage, and shipment.

2-2. INITIAL INSPECTION

WARNING

To avoid hazardous electrical shock, do not perform electrical tests when there are any signs of shipping damage to any portion of the outer enclosure (covers and panels).

Inspect the shipping container for damage. If the shipping container or cushioning material is damaged, it should be kept until the contents of the shipment have been checked for completeness and the instrument has been checked mechanically and electrically. The contents of the shipment should be as shown in Figure 1-1. Procedures for checking electrical performance are given in Section IV. If the contents are incomplete, if there is mechanical damage or defect, or if the instrument does not pass the electrical performance test, notify the nearest Hewlett-Packard office. If the shipping container is damaged, or the cushioning material shows signs of stress, notify the carrier as well as the Hewlett-Packard office. Keep the shipping materials for the carrier's inspection.

2-3. PREPARATION FOR USE

The Signal Generator requires a power source of 110, 120, 220, or 240 Vac from 48 to 440 Hz. Power consumption is 125 VA maximum.

WARNING

This is a Safety Class I product (i.e., provided with a protective earth terminal). An uninterruptible safety earth ground must be provided from the Mains power source to the product input wiring terminals, power cord, or supplied power cord set. Whenever it is likely that the protection has been impaired, the instrument must be made inoperative and be secured against any unintended operation.

If this instrument is to be energized via an external autotransformer for voltage reduction, make sure that the common terminal is connected to the earthed pole of the power source.

2-5. Line Voltage Selection and Fuse Replacement (2425A to 2509A)

CAUTION

BEFORE PLUGGING THIS INSTRUMENT into the Mains (line) voltage, be sure the correct voltage has been selected.

A rear-panel, line power module permits operation from 100, 120, 220, or 240 Vac. The number visible in the window (located on the module) indicates the nominal line voltage to which the instrument must be connected. Verify that the line voltage selection card is matched to the power source. See Figure 2-1, Line Voltage Selection and Fuse Replacement. Table 2-1 lists the ratings and the HP part number for the replaceable fuse.

Two fuses are supplied with each instrument. One fuse has the proper rating for 110/120 Vac line operation; the other fuse is rated for 220/240 Vac operation.

One fuse is installed in the instrument at the time of shipment. Refer to Table 2-1 for fuse ratings and part numbers. The rating of the line voltage selection card and installed fuse is selected according to the line voltage specified by the customer. If the voltage is not specified, the rating of the installed card and fuse is selected according to the country of destination.

WARNING

For protection against fire hazard, the line fuse should only be a 250V fuse with the correct current rating.

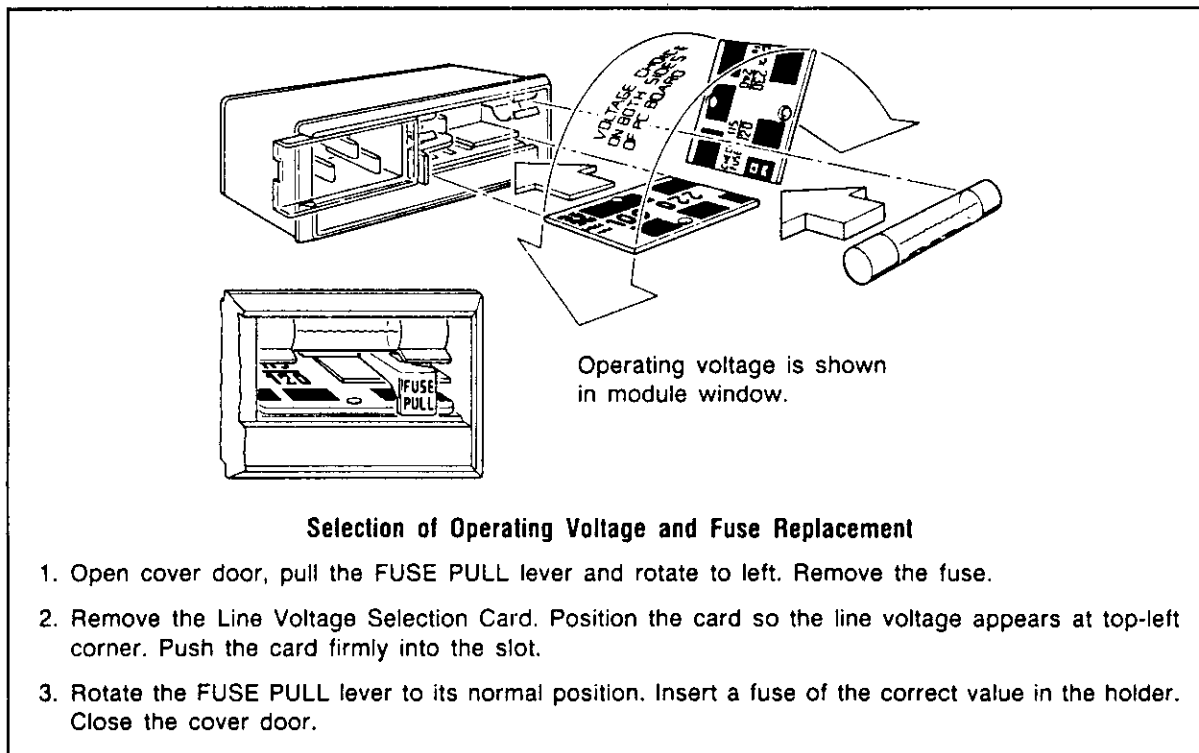

Figure 2-1 (2425A to 2509A). Line Voltage Selection and Fuse Replacement

2-5. Line Voltage Selection and Fuse Replacement (2511A and above, 2608U and above)

CAUTION

BEFORE PLUGGING THIS INSTRUMENT into the Mains (line) voltage, be sure the correct voltage has been selected.

A rear-panel line power module permits operation from 100, 120, 220, or 240 Vac. The number visible in the window (located on the module) indicates the nominal line voltage to which the instrument must be connected. Verify that the line voltage selection cam and fuse are matched to the power source. See Figure 2-1, Line Voltage Selection and Fuse Replacement. Table 2-1 lists the recommended HP part number for the replaceable fuse.

Two fuses are supplied with each instrument. One fuse has the proper rating for 110/120 Vac line operation; the other fuse is rated for 220/240 Vac operation.

One fuse is installed in the instrument at the time of shipment. Refer to Table 2-1 for fuse ratings and part numbers. The rating of the line voltage selection cam and installed fuse is selected according to the line voltage specified by the customer. If the voltage is not specified, the rating of the installed cam and fuse is selected according to the country of destination.

WARNING

For protection against fire hazard, the line fuse should only be a 250V fuse with the correct current rating.

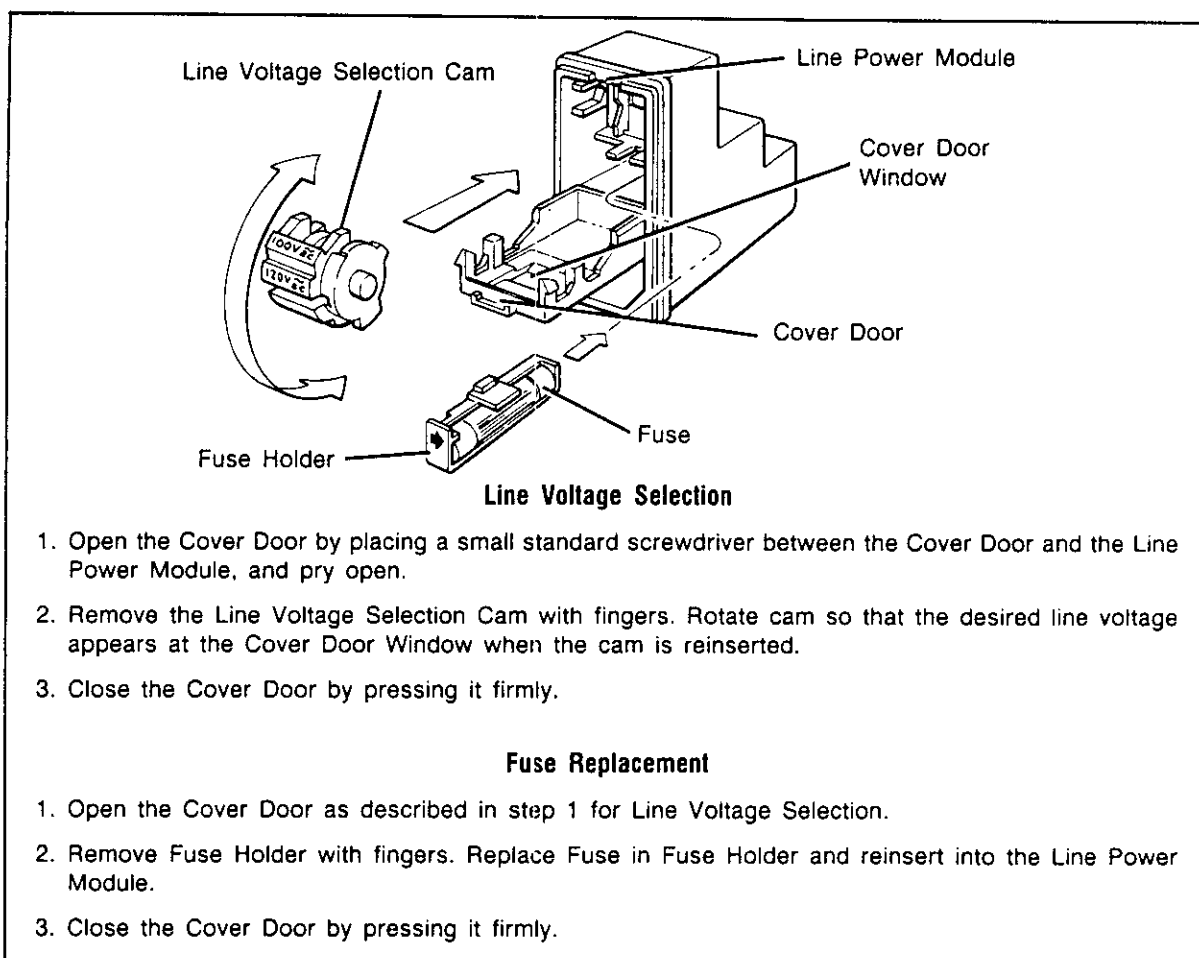

Figure 2-1 (2511A and above, 2608U and above). Line Voltage Selection and Fuse Replacement

2-7. Time Base Selection (2511A and above, 2608U and above)

One of three time base output signals (1, 5, or 10 MHz at a level greater than 0.15 Vrms into 50 ohms) is accessible at the rear-panel TIME BASE OUTPUT connector. This output signal is derived from the internal reference oscillator frequency and is jumper selectable through a resistor located inside the Signal Generator on the Low Frequency Loop Assembly—A3. When the instrument is shipped from the factory, the resistive jumper is hard-wired to provide a 10 MHz time base output signal. If the Option 001 or another external 10 MHz reference is applied to the rear-panel TIME BASE INPUT connector, only that reference frequency will be available as an output signal. Also, if either a 1 or 5 MHz output signal is desired, the internal resistive jumper will have to be repositioned. Similarly, if an external 1 or 5 MHz reference input is to be applied to the rear-panel TIME BASE INPUT connector, the resistive jumper will have to be repositioned to the position that corresponds to the frequency of the external reference input. The top cover of the Signal Generator, and the top cover of the Low Frequency Loop 50 MHz Reference Oscillator and Phase Locked Loop will have to be removed to gain access to the time base jumper. The following procedure describes how to change the location of the resistive jumper.

- a. Remove the top cover from the Signal Generator by first removing the two screws used to secure the strap handle to each side of the instrument. Next, remove the front and rear handle caps, and then lift the top cover away from the frame.
- b. Remove the top cover of the Low Frequency Loop 50 MHz Reference Oscillator and Phase Locked Loop by first loosening eight screws on the top cover's four sides. The top cover is located on the Low Frequency Loop Assembly—A3 to the rear of the Signal Generator. The top cover lifts off exposing the time base jumper (see Figure 2-2).
- c. Unsolder one end of the resistive jumper and resolder it in the position that corresponds to the desired time base output or to the external reference input.
- d. Reinstall the instrument by reversing the procedure given in step b and then in step a.
- e. If the Signal Generator is equipped with Option 001, ensure that the coaxial time base cable (A16W2) is connected between the rear-panel TIME BASE HIGH STABILITY OPTION connector and the TIME BASE INPUT connector.

Table 2-1. Line Fuse Rating and HP Part Number

| Line Voltage | Rating | Part Number |
|--------------|------------|-------------|
| 100, 120 Vac | 1.5A, 250V | 2110-0043 |
| 220, 240 Vac | 1.0A, 250V | 2110-0001 |

2-6. Power Cables

WARNING

BEFORE CONNECTING THIS INSTRUMENT, the protective earth terminal of the instrument must be connected to the protective conductor of the (Mains) power cord. The Mains plug shall only be inserted in a socket outlet provided with a protective earth contact. The protective action must not be negated by the use of an extension cord (power cable) without a protective conductor (grounding). Grounding one conductor of a two-conductor outlet is not sufficient protection.





This instrument is equipped with a three-wire power cable. When connected to an appropriate ac power receptacle, this cable grounds the instrument cabinet. The type of power cable plug shipped with each instrument depends on the country of destination. Refer to Table 2-2 for the part numbers of the power cables and Mains plugs available.

2-7. Time Base Selection (2425A to 2509A)

One of three time base output signals (1, 5, or 10 MHz at a level greater than 0.15 Vrms into 50 ohms) is accessible at the rear-panel TIME BASE OUTPUT connector. This output signal is derived from the internal reference oscillator frequency and is jumper selectable through a resistor located inside the Signal Generator on the Low Frequency Loop Assembly—A3. When the instrument is shipped from the factory, the resistive jumper is hard-wired to provide a 10 MHz time base output signal. If the Option 001 or another external 10 MHz reference is applied to the rear-panel TIME BASE INPUT connector, only that reference frequency will be available as an output signal. Also, if either a 1 or 5 MHz output signal is desired, the internal resistive jumper will have to be repositioned. Similarly, if an external 1 or 5 MHz reference input is to be applied to the rear-panel TIME BASE INPUT connector, the resistive jumper will have to be repositioned to the position that corresponds to the frequency of the external reference input. The top cover of the Signal Generator, and the top cover of the Low Frequency Loop 50 MHz Reference Oscillator and Phase Locked Loop will have to be removed to gain access to the time base jumper. The following procedure describes how to change the location of the resistive jumper.

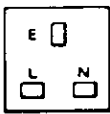
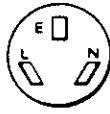
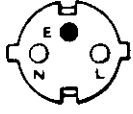
- a. Remove the top cover from the Signal Generator by first removing the two screws used to secure the strap handle to each side of the instrument. Next, remove the front and rear handle caps, slide the side cover in the direction of the arrow, then lift the side cover away from the frame. Finally, lift the top cover away from the frame.
- b. Remove the top cover of the Low Frequency Loop 50 MHz Reference Oscillator and Phase Locked Loop by first removing eight screws on the top cover's four sides. The top cover is located on the Low Frequency Loop Assembly—A3 to the rear of the Signal Generator. The top cover lifts off exposing the time base jumper (see Figure 2-2).
- c. Unsolder one end of the resistive jumper and resolder it in the position that corresponds to the desired time base output or to the external reference input.
- d. Reinstall the instrument by reversing the procedure given in step b and then in step a.
- e. If the Signal Generator is equipped with Option 001, ensure that the coaxial time base cable (A16W2) is connected between the rear-panel TIME BASE HIGH STABILITY OPTION connector and the TIME BASE INPUT connector.

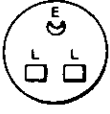
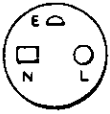
Table 2-2. AC Power Cables Available

| Plug Type | Cable HP Part Number | C D | Plug Description | Cable Length (inches) | Cable Color | For Use In Country |
|--|--|----------------------------|--|----------------------------------|--|--|
| 250V  | 8120-1351 8120-1703 | 0 4 | Straight*BS1363A 90° | 90 90 | Mint Gray Mint Gray | United Kingdom, Cyprus, Nigeria, Rhodesia, Singapore |
| 250V  | 8120-1369 8120-0696 | 0 4 | Straight*NZSS198/ASC112 90° | 79 87 | Gray Gray | Australia, New Zealand |
| 250V  | 8120-1689 8120-1692 | 7 2 | Straight*CEE7-Y11 90° | 79 79 | Mint Gray Mint Gray | East and West Europe, Saudi Arabia, Egypt, (unpolarized in many nations) |
| 125V  | 8120-1378 8120-1398 8120-1754 8120-1378 8120-1521 8120-1676 | 5 5 7 1 6 2 | Straight*NEMA5-15P 90° Straight*NEMA5-15P Straight*NEMA5-15P 90° Straight*NEMA5-15P | 80 80 36 80 80 36 | Black Black Black Jade Gray Jade Gray Jade Gray | United States, Canada, Mexico, Japan (100V or 200V), Philippines, Taiwan |
| 250 V  | 8120-2104 | 3 | Straight*SEV1011 1959-24507 Type 12 | 79 | Gray | Switzerland |
| 250V  | 8120-0698 | 6 | Straight*NEMA6-15P | | | United States, Canada |
| 220V  | 8120-1957 8120-2956 | 2 3 | Straight*DHCK107 90° | 79 79 | Gray Gray | Denmark |
| 250V  | 8120-4211 | 7 | Straight*IEC83-B1 | 79 | Black | South Africa, India |
| 250V  | 8120-1860 | 6 | Straight*CEE22-VI (Systems Cabinet Use) | | | |

*Part number shown for plug is industry identifier for plug only. Number shown for cable is HP Part Number for complete cable including plug.

E = Earth Ground; L = Line; N = Neutral

2-8. HP-IB Address Selection 

The Signal Generator is strictly a listener, never a talker, and therefore only its HP-IB (listen) address can be selected. This HP-IB address is switch-selectable through five miniature rocker-switches located inside the Signal Generator on the Microprocessor/Memory/HP-IB Assembly—A11. These switches provide the means to select one of 31 valid HP-IB addresses (00 through 30). HP-IB addresses greater than 30 (decimal) are invalid. Refer to Table 2-3 for the allowable HP-IB address codes. Listed are the valid address switch settings and the equivalent ASCII character and decimal value. When the instrument is shipped from the factory, the HP-IB address is preset to 07 (decimal). (In binary, this is 00111; the ASCII equivalent character is an apostrophe.) This preset address is shown shaded in Table 2-3. The bottom cover of the Signal Generator will have to be removed to gain access to the HP-IB switches. The following procedure describes how to change the settings of the HP-IB address switches.

NOTE

The HP-IB address stored in memory only changes when the instrument is powered up. Therefore, the instrument must be unplugged once the settings of the HP-IB address switches have been changed, otherwise, the stored HP-IB address remains unchanged.

 Table 2-3. Allowable HP-IB Address Codes

| Address Switch | | | | | Equivalent ASCII Character (LISTEN) | Equivalent Decimal Value (LISTEN) |
|----------------|----|----|----|----|-------------------------------------|-----------------------------------|
| A5 | A4 | A3 | A2 | A1 | | |
| 0 | 0 | 0 | 0 | 0 | SP | 00 |
| 0 | 0 | 0 | 0 | 1 | ! | 01 |
| 0 | 0 | 0 | 1 | 0 | " | 02 |
| 0 | 0 | 0 | 1 | 1 | # | 03 |
| 0 | 0 | 1 | 0 | 0 | \$ | 04 |
| 0 | 0 | 1 | 0 | 1 | % | 05 |
| 0 | 0 | 1 | 1 | 0 | & | 06 |
| 0 | 0 | 1 | 1 | 1 | ' | 07 |
| 0 | 1 | 0 | 0 | 0 | (| 08 |
| 0 | 1 | 0 | 0 | 1 |) | 09 |
| 0 | 1 | 0 | 1 | 0 | * | 10 |
| 0 | 1 | 0 | 1 | 1 | + | 11 |
| 0 | 1 | 1 | 0 | 0 | , | 12 |
| 0 | 1 | 1 | 0 | 1 | - | 13 |
| 0 | 1 | 1 | 1 | 0 | . | 14 |
| 0 | 1 | 1 | 1 | 1 | / | 15 |
| 1 | 0 | 0 | 0 | 0 | 0 | 16 |
| 1 | 0 | 0 | 0 | 1 | 1 | 17 |
| 1 | 0 | 0 | 1 | 0 | 2 | 18 |
| 1 | 0 | 0 | 1 | 1 | 3 | 19 |
| 1 | 0 | 1 | 0 | 0 | 4 | 20 |
| 1 | 0 | 1 | 0 | 1 | 5 | 21 |
| 1 | 0 | 1 | 1 | 0 | 6 | 22 |
| 1 | 0 | 1 | 1 | 1 | 7 | 23 |
| 1 | 1 | 0 | 0 | 0 | 8 | 24 |
| 1 | 1 | 0 | 0 | 1 | 9 | 25 |
| 1 | 1 | 0 | 1 | 0 | : | 26 |
| 1 | 1 | 0 | 1 | 1 | ; | 27 |
| 1 | 1 | 1 | 0 | 0 | < | 28 |
| 1 | 1 | 1 | 0 | 1 | = | 29 |
| 1 | 1 | 1 | 1 | 0 | > | 30 |

Indicates factory-set address.

- a. Unplug the Signal Generator.
- b. Remove the bottom cover from the Signal Generator by first removing the two screws used to secure the strap handle to each side of the instrument. Next, remove the front and rear handle caps, slide the cover in the direction of the arrow, then lift the side cover away from the frame. Finally, lift the bottom cover away from the frame.
- c. Locate the HP-IB address switches S2 and S3 on the Microprocessor/Memory/HP-IB Assembly—A11 (see Figure 2-3).
- d. Use a pencil to set the switches to the desired HP-IB address in binary (see Figure 2-3). The five switches are labeled A1 through A5, where A1 is the least significant address bit and A5 is the most significant address bit. Pressing the right-hand side of the switch (as viewed from the front of the instrument) “sets” the corresponding address bit (bit = 1), while pressing the left-hand side “clears” the bit (bit = 0). Setting all of the address bits to “1” will result in an invalid HP-IB address (31 decimal). In this case, an HP-IB address of 30 (decimal) is stored in memory once the instrument is powered up.
- e. Reinstall the bottom cover by reversing the procedure given in step b.
- f. Plug in the Signal Generator.
- g. To confirm the HP-IB address, simply press the SHIFT key, and hold the ADRS key. The internally-set, decimal HP-IB address is displayed in the MODULATION Display as long as the ADRS key remains pressed.

2-9. Interconnection

Interconnection data for the Hewlett-Packard Interface Bus is provided in Figure 2-4.

2-10. Mating Connectors

Coaxial Connectors. Coaxial mating connectors used with the Signal Generator should be either 50-ohm BNC male connectors or 50-ohm Type N male connectors that are compatible with those specified in US MIL-C-39012.

Interface Connector. HP-IB mating connector is shown in Figure 2-4. Note that the two securing screws are metric.

2-11. Operating Environment

The operating environment should be within the following limitations:

| | |
|-------------------|----------------------------|
| Temperature | 0°C to +55°C |
| Humidity | <95% relative at 40°C |
| Altitude | <4570 meters (15,000 feet) |

2-12. Bench Operation

The instrument cabinet has plastic feet and foldaway tilt stands for convenience in bench operation. (The plastic feet are shaped to ensure self-alignment of instruments when they are stacked.) The tilt stands raise the front of the Signal Generator for easier viewing of the front-panel.

2-13. Rack Mounting



The Signal Generator weighs 18.2 kg (40 lb); therefore, care must be exercised when lifting to avoid personal injury. Use equipment slides when rack mounting.

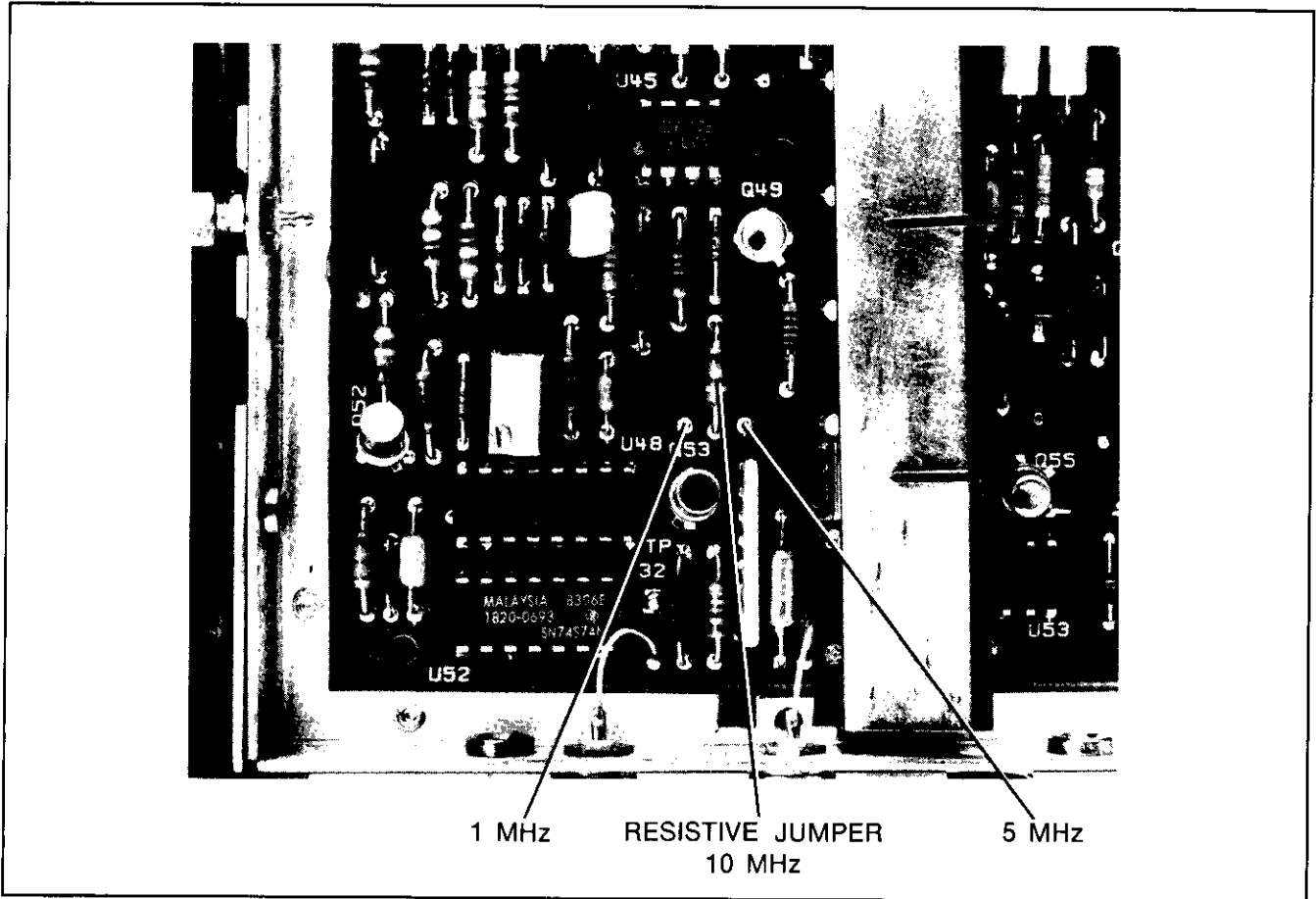
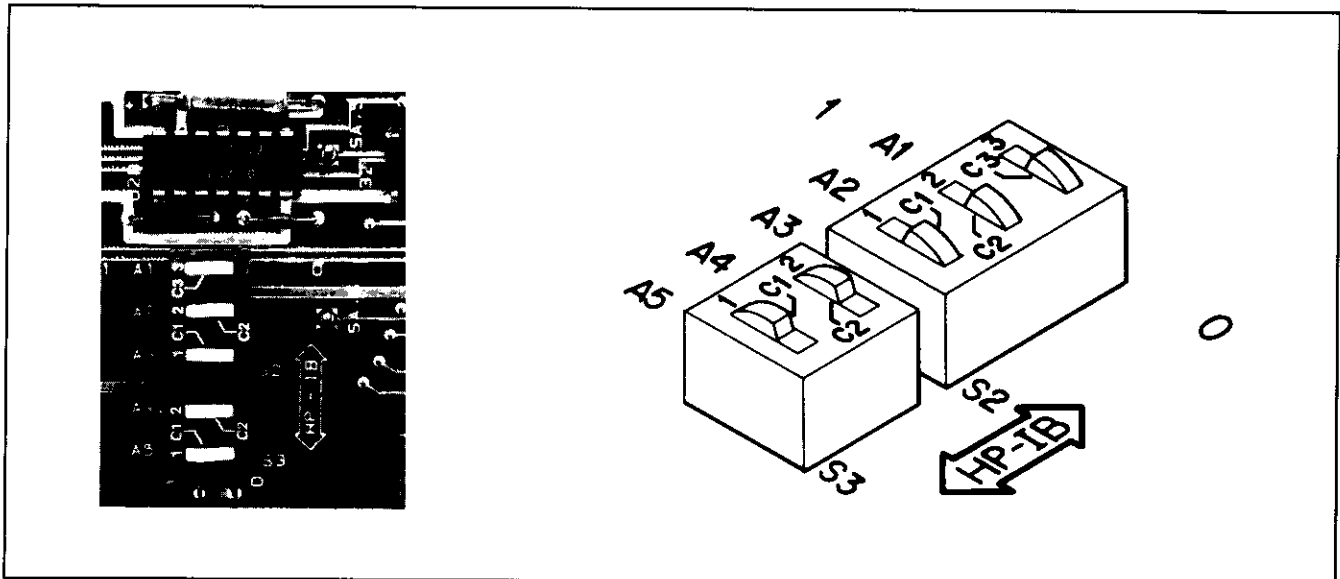
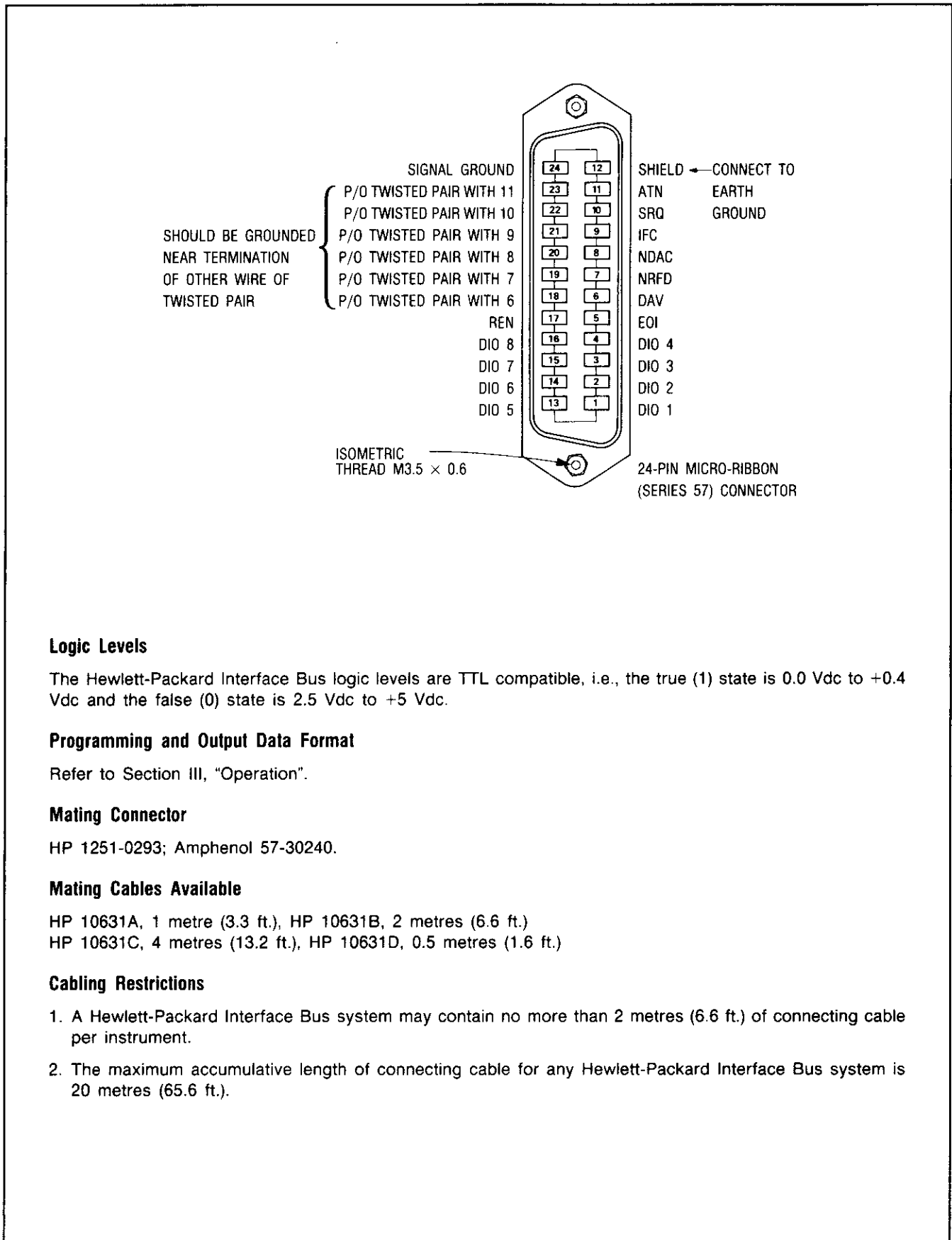

Figure 2-2. Time Base Jumper Location



HP-IB Figure 2-3. HP-IB Address Switch Location and Settings



Logic Levels

The Hewlett-Packard Interface Bus logic levels are TTL compatible, i.e., the true (1) state is 0.0 Vdc to +0.4 Vdc and the false (0) state is 2.5 Vdc to +5 Vdc.

Programming and Output Data Format

Refer to Section III, "Operation".

Mating Connector

HP 1251-0293; Amphenol 57-30240.

Mating Cables Available

HP 10631A, 1 metre (3.3 ft.), HP 10631B, 2 metres (6.6 ft.)
 HP 10631C, 4 metres (13.2 ft.), HP 10631D, 0.5 metres (1.6 ft.)

Cabling Restrictions

1. A Hewlett-Packard Interface Bus system may contain no more than 2 metres (6.6 ft.) of connecting cable per instrument.
2. The maximum accumulative length of connecting cable for any Hewlett-Packard Interface Bus system is 20 metres (65.6 ft.).

Figure 2-4. Hewlett-Packard Interface Bus Connections

2-13. Rack Mounting (Cont'd)

Rack mounting information is provided with the rack mounting kits. If a kit was not ordered with the Signal Generator as an option, it may be ordered through the nearest Hewlett-Packard office. Slide rack mount kits are discussed in the following paragraphs; refer to paragraph 1-11, Mechanical Options, in Section I for information and part numbers pertaining to other rack mount kits.

Slide rack mount kits allow the convenience of rack mounting with the flexibility of easy access. The slide kits for the Signal Generator are listed below.

- Standard Slide Kit for HP rack enclosures HP 1494-0018
- Special Tilt Slide Kit for HP rack enclosures HP 08656-82001
- Slide Adapter Bracket Kit for Standard Slides
(for non HP rack enclosures) HP 1494-0023

2-14. STORAGE AND SHIPMENT

2-15. Environment

The instrument should be stored in a clean, dry environment. The following environmental limitations apply to both storage and shipment.

- Temperature -40°C to +75°C
- Humidity <95% relative
- Altitude 15 300 meters (50,000 feet)

2-16. Packaging

Original Packaging. Containers and materials identical to those used in factory packaging are available through Hewlett-Packard offices. If the instrument is being returned to Hewlett-Packard for servicing, attach a tag indicating the type of service required, return address, model number, and full serial number. Also, mark the container FRAGILE to assure careful handling. In any correspondence, refer to the instrument by model number and full serial number.

Other Packaging. The following general instructions should be used for repackaging with commercially available materials.

- a. Wrap the instrument in heavy paper or plastic. (If shipping to a Hewlett-Packard office or service center, attach a tag indicating the type of service required, return address, model number, and full serial number.)
- b. Use a strong shipping container. A double-wall carton made of 2.4 MPa (350 psi) test material is adequate.
- c. Use enough shock-absorbing material (75 to 100 millimeter layer; 3 to 4 inches) around all sides of the instrument to provide a firm cushion and to prevent movement in the container. Protect the front-panel with cardboard.
- d. Seal the shipping container securely.
- e. Mark the shipping container FRAGILE to assure careful handling.

**HP 8656B
SYNTHESIZED
SIGNAL GENERATOR
0.1–990 MHz
OPERATION AND CALIBRATION
(Including Options 001 and 002)**

SERIAL NUMBERS

This manual applies directly to instruments with serial numbers prefixed:

2608U to 2703U

Information for MAJOR changes is also provided for instruments with serial-number prefixes not listed in the above range.

NOTE

Use this manual only with instruments that have a “U” in their serial-number prefix.

First Edition

© HEWLETT-PACKARD LTD 1987
SOUTH QUEENSFERRY, WEST LOTHIAN, EH30 9TG, SCOTLAND

Operation and Calibration Manual Part Number 08656-90227

Other Documents Available:

Service Manual Part Number 08656-90197

Printed in U.K.
Print Date: APRIL 1987



SECTION III OPERATION

3-1. INTRODUCTION

This section provides complete operating information for the Signal Generator. Included are both general and detailed operating instructions; detailed descriptions of each front and rear panel key, connector, switch and display; information on remote operation; operator's checks; and operator's maintenance procedures.

3-2. Operating Characteristics

Table 3-3 briefly summarizes the major operating characteristics of the Signal Generator. This table is not intended to be an in-depth listing of all characteristics. For more detailed information on the Signal Generator's characteristics, refer to Table 1-1, Specifications and Table 1-2, Supplemental Characteristics. For information on the instrument's HP-IB capabilities, refer to the summary contained in Table 3-5, HP-IB Message Reference Table.

3-3. Local Operation

Information covering front-panel operation of the Signal generator is presented in three areas of this section, namely General Operating Instructions, Simplified Front-Panel Features and Operation, and Detailed Operating Instructions.

General Operating Instructions. Instructions relating to the Signal Generator's power-on procedure, power-on sequence, various keystroke sequences, and time-base selection are presented to acquaint the user with general operation of the instrument.

Simplified Front-Panel Features and Operation. Figure 3-1 illustrates the front-panel of the Signal Generator and provides simplified descriptions of each key, connector, switch, and display. The instructions on operation also provide a quick introduction to front-panel operation of the Signal Generator. These instructions are designed to rapidly acquaint the novice user with the basic operation of the instrument. Included are instructions for setting carrier functions, setting modulation functions, and changing parameter values. This is a good starting point for the first-time user. Table 3-4 provides an index (in functional order) to the detailed operating instructions. This index is intended to direct the user to the more complete operating instructions which are arranged alphabetically at the end of this section.

Detailed Operating Instructions. The detailed operating instructions present the most comprehensive information about all of the Signal Generator's functions. These instructions are arranged alphabetically by subject and are included at the end of this section for easy reference. They are indexed in functional order in Table 3-4.

3-4. Operator's Checks

Operator's checks are simple procedures designed to verify that the main functions of the Signal Generator operate properly. Two procedures are provided, one for basic (front-panel) functional checks and the other for HP-IB functional checks.

Basic Functional Checks. This procedure requires a frequency counter, a spectrum analyzer and the interconnecting cables and adapters. It provides assurance that most of the front-panel controlled functions are being properly executed by the Signal Generator.

HP-IB Functional Checks. This series of procedures requires an HP-IB compatible computing controller, and an HP-IB interface with its interconnecting cable. These procedures assume that front-panel operation has been previously verified, that is, that the basic functional checks have been previously performed. The procedures check all of the applicable bus messages summarized in Table 3-5.

3-5. Remote Operation

The Signal Generator is capable of remote operation via the Hewlett-Packard Interface Bus. Knowledge of local operation is essential for HP-IB programming since most of the data messages contain the same keystroke-like sequences. HP-IB information is presented in the following areas of this section:

- a. General HP-IB information begins with paragraph 3-19.
- b. A summary of HP-IB capabilities is provided in Table 3-5.
- c. A summary of program codes is provided in Tables 3-9 and 3-10.
- d. Detailed information relating to the Signal Generator's HP-IB programmable features together with tables and examples of associated program codes are presented in the detailed operating instructions which are arranged alphabetically at the end of this section.

3-6. Operator's Maintenance

The only maintenance the operator should normally perform is replacement of the primary power fuse. All other maintenance should be referred to qualified service personnel.

3-7. GENERAL OPERATING INSTRUCTIONS

WARNING

Before the Signal Generator is switched on, all protective earth terminals, extension cords, autotransformers, and devices connected to it should be connected to a protective earth grounded socket. Any interruption of the protective earth grounding will cause a potential shock hazard that could result in personal injury.

For continued protection against fire hazard, replace the line fuse with only a 250V fuse of the same rating. Do not use repaired fuses or short circuited fuseholders.

CAUTION

Before the Signal Generator is switched on, it must be set to the same line voltage as the power source or damage to the instrument may result.

The Signal Generator is protected against reverse power applications up to 50 watts; however, for greatest protection of expensive internal components be careful not to apply any reverse power to the RF OUTPUT connector.

3-8. Power-On Procedure

The Signal Generator has a standby state and an on state. Whenever the power cable is plugged in, the internal +5V power supply is activated. All other power supply voltage levels are energized by the POWER switch put to ON. If the instrument is equipped with the high stability reference (Option 001), when the power cable is plugged in, the oven will be energized to keep the reference oscillator stable. If the Signal Generator is already plugged in, set the POWER switch to ON. If the power cable is not plugged in, follow these instructions:

1. Check that the line voltage setting matches the power source. Refer to paragraph 2-5.
2. Check that the fuse rating is appropriate for the line voltage being used. Refer to paragraph 2-5.
3. Plug in the power cable.
4. Set the POWER switch to ON.

3-9. Power-On Sequence

When the POWER switch is set to ON after the instrument is first connected to Mains power, an internal memory check is initiated. This check tests for a failure in ROM (read-only memory) and in RAM (read-write memory). During this check, all front-panel indicators will light for approximately 1.5 seconds to provide a quick visual inspection of each front-panel annunciator and display segment. If a memory failure is detected, a RAM or ROM error code will be displayed in the frequency display window. A 2-digit numeral is displayed and all other displays and LEDs will be off. Table 3-1 lists the codes and respective faults for the power-on check-tests. The error code remains displayed until any front-panel key is pressed. If the memory check was successful, the front-panel indicators display a carrier frequency of 100.00000 MHz, an output amplitude of -127.0 dBm, and no modulation. All annunciators (except dBm) remain off, and the sequence counter is set to zero. Table 3-2 lists the conditions of the Signal Generator as a result of a successful initialization sequence.

Table 3-1. Power-On Error Codes

| Error Code | Fault | Address |
|------------|--------------------------|-----------|
| 10 | Microprocessor RAM Error | 0000-007F |
| 11 | RAM 1 Error | 0080-00FF |
| 12 | RAM 2 Error | 0100-017F |
| 20 | ROM Error 1st 4K | 4000-4FFF |
| 21 | ROM Error 2nd 4K | 5000-5FFF |
| 22 | ROM Error 3rd 4K | 6000-6FFF |
| 23 | ROM Error 4th 4K | 7000-7FFF |
| 30 | RAM and ROM Error | |

Table 3-2. Initialized Conditions

| Parameter | Initialized Condition |
|------------------------------|--|
| Carrier Frequency | 100.00000 MHz |
| Output Amplitude | -127.0 dBm |
| AM Depth | 0% |
| FM Peak Deviation | 0.0 kHz |
| Carrier Frequency Increment | 10.00000 MHz |
| Output Amplitude Increment | 10.0 dB |
| AM Depth Increment | 1% |
| FM Peak Deviation Increment | 1.0 kHz |
| Coarse and Fine Tune Pointer | 10.00000 MHz |
| Sequence Counter | 0 |
| All 10 Storage Registers | 100.00000 MHz and -127.0 dBm with no modulation |

3-10. Power STBY Sequence

When the instrument is turned to STBY after being ON, Modulation, Frequency, and Amplitude at its last setting is stored and then displayed when the instrument is turned back ON. The instrument displays the last front-panel settings regardless of whether or not it was stored in one of the 10 storage registers. Front-panel information must be stored or else sequencing through the storage registers will clear the instrument of all previous settings. Turning the instrument to STBY and then back to ON will always set the sequence counter to zero.

Table 3-3. Operating Characteristics

| Frequency | Range: 100 kHz to 990 MHz Resolution: 10 Hz | | | | | | | | | | | | | | | | | | | | | | | | | |
|-------------------------|---|-------------------------|------------------------|--|--|---------|--|---------|--------------------|-----------------|--------------|--------|-----------------------|--------|--------------|--------|-----------------------|--------|------------|--------|-----------------------|--------|------------|--------|-----------------------|--------|
| Amplitude | Range: +13 dBm to -127 dBm (+1.00V to +0.100 μ V) Resolution: 0.1 dB Absolute Level Accuracy: $\leq \pm 1.5$ dB; 0.1 to 123.5 MHz; < -124 dBm or $> +7$ dBm $\leq \pm 1.0$ dB; 123.5 to 990 MHz, +7 to -124 dBm Level Flatness: $\leq \pm 1.0$ dB (100 kHz to 990 MHz with output level setting of 0.0 dBm) | | | | | | | | | | | | | | | | | | | | | | | | | |
| Modulation | AM Depth: 0% to 99% to +7 dBm 0% to 30% to +10 dBm Resolution: 1% FM Peak Deviation: <table border="1" data-bbox="474 772 1256 1041"> <thead> <tr> <th rowspan="3">Carrier Frequency (MHz)</th> <th colspan="3">Maximum Peak Deviation</th> </tr> <tr> <th colspan="2">AC Mode</th> <th rowspan="2">DC Mode</th> </tr> <tr> <th>Rates \geq 50 Hz</th> <th>Rates $<$ 50 Hz</th> </tr> </thead> <tbody> <tr> <td>0.1 to 123.5</td> <td>99 kHz</td> <td>4000 \times rate Hz</td> <td>99 kHz</td> </tr> <tr> <td>123.5 to 247</td> <td>50 kHz</td> <td>1000 \times rate Hz</td> <td>50 kHz</td> </tr> <tr> <td>247 to 494</td> <td>99 kHz</td> <td>2000 \times rate Hz</td> <td>99 kHz</td> </tr> <tr> <td>494 to 990</td> <td>99 kHz</td> <td>4000 \times rate Hz</td> <td>99 kHz</td> </tr> </tbody> </table> Resolution: 0.1 kHz (deviations $<$ 10 kHz) 1 kHz (deviations \geq 10 kHz) Rates: 400 Hz or 1 kHz $\pm 3\%$, internal dc to 50 kHz; external (ac coupled, ± 1 dB 20 Hz to 50 kHz) dc to 100 kHz; external (± 3 dB) External Modulation Source: 600 ohms nominal, ac coupled Mixed Modulation: Internal/Internal: AM/FM Internal/External: AM/FM, FM/AM, AM/AM and FM/FM | Carrier Frequency (MHz) | Maximum Peak Deviation | | | AC Mode | | DC Mode | Rates \geq 50 Hz | Rates $<$ 50 Hz | 0.1 to 123.5 | 99 kHz | 4000 \times rate Hz | 99 kHz | 123.5 to 247 | 50 kHz | 1000 \times rate Hz | 50 kHz | 247 to 494 | 99 kHz | 2000 \times rate Hz | 99 kHz | 494 to 990 | 99 kHz | 4000 \times rate Hz | 99 kHz |
| Carrier Frequency (MHz) | Maximum Peak Deviation | | | | | | | | | | | | | | | | | | | | | | | | | |
| | AC Mode | | DC Mode | | | | | | | | | | | | | | | | | | | | | | | |
| | Rates \geq 50 Hz | Rates $<$ 50 Hz | | | | | | | | | | | | | | | | | | | | | | | | |
| 0.1 to 123.5 | 99 kHz | 4000 \times rate Hz | 99 kHz | | | | | | | | | | | | | | | | | | | | | | | |
| 123.5 to 247 | 50 kHz | 1000 \times rate Hz | 50 kHz | | | | | | | | | | | | | | | | | | | | | | | |
| 247 to 494 | 99 kHz | 2000 \times rate Hz | 99 kHz | | | | | | | | | | | | | | | | | | | | | | | |
| 494 to 990 | 99 kHz | 4000 \times rate Hz | 99 kHz | | | | | | | | | | | | | | | | | | | | | | | |

3-11. FRONT-PANEL FEATURES

The Signal Generator is designed to be simple and easy to operate. The front-panel primarily consists of 48 pushbutton keys, 3 digital displays, and 20 LED annunciators. Each key has a single purpose and only one key should ever be pressed at any given time. In most cases, keys are pressed, then released, with the action occurring as the key is pressed. In some cases, a key must be pressed and held for the action to occur. The four main functions of the Signal Generator are selected by four dark gray colored keys labeled FREQUENCY, AMPTD, AM and FM. The only other dark gray colored key (located in the upper left-hand corner of the front-panel) selects local operation when in the remote mode. The 28 medium gray colored keys control the modulation source, enter numeric data, select the unit(s) which terminates data entry, and turn RF off and on. The 14 light gray colored keys set an increment value for each of the four main functions, change main function parameters by the set increment values, and store up to 10 complete front-panel settings (exclusive of increment values) for either selectable or sequential recall at a later time. The light blue colored key, SHIFT (located in the upper left-hand corner of the front-panel) changes the capabilities of some keys to their blue labeled function. The SHIFT key allows the user to access DC FM, phase-up, phase-down, instrument-preset, and to display the contents of the sequence counter and display the internally set decimal HP-IB address.

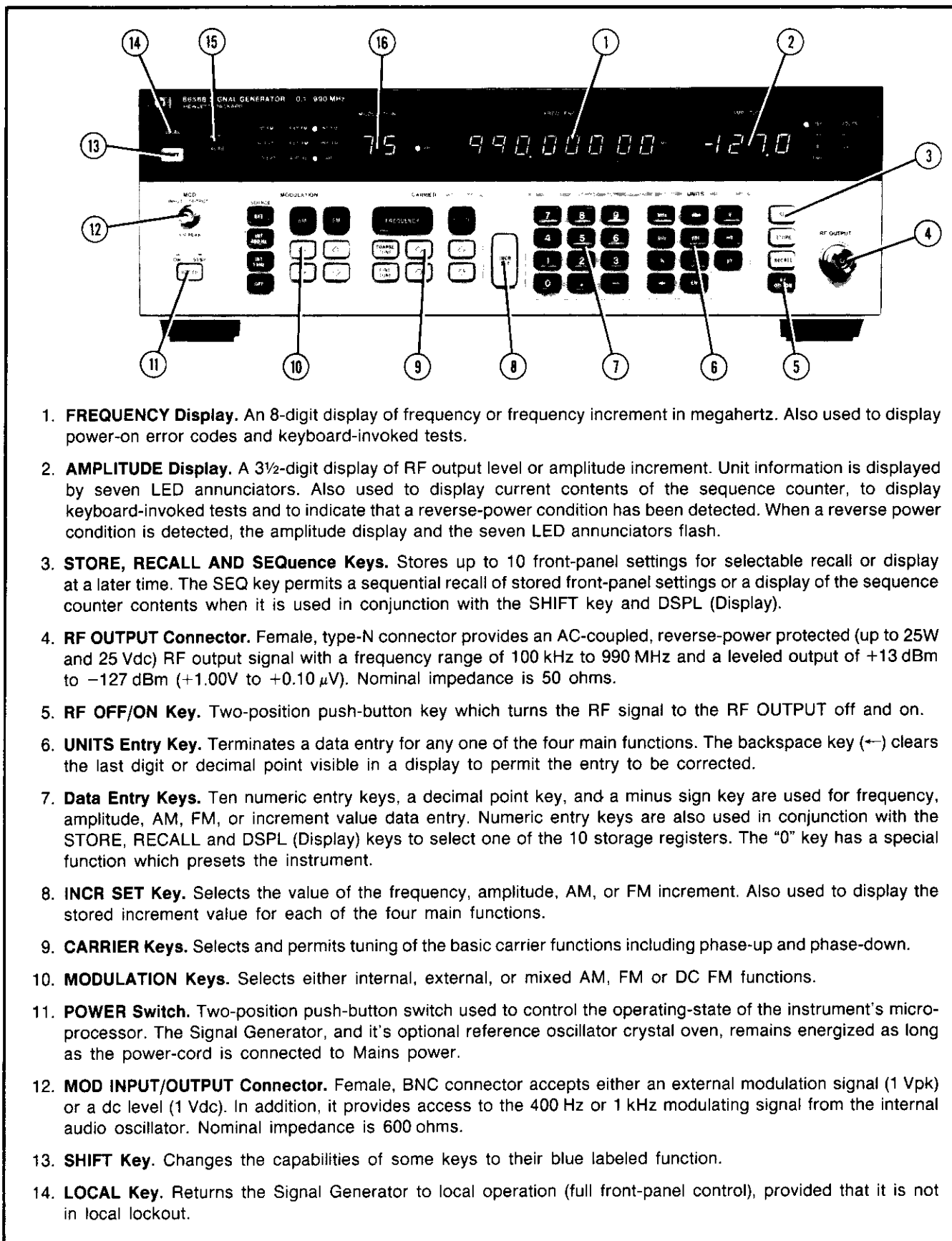

1. **FREQUENCY Display.** An 8-digit display of frequency or frequency increment in megahertz. Also used to display power-on error codes and keyboard-invoked tests.
2. **AMPLITUDE Display.** A 3½-digit display of RF output level or amplitude increment. Unit information is displayed by seven LED annunciators. Also used to display current contents of the sequence counter, to display keyboard-invoked tests and to indicate that a reverse-power condition has been detected. When a reverse power condition is detected, the amplitude display and the seven LED annunciators flash.
3. **STORE, RECALL AND Sequence Keys.** Stores up to 10 front-panel settings for selectable recall or display at a later time. The SEQ key permits a sequential recall of stored front-panel settings or a display of the sequence counter contents when it is used in conjunction with the SHIFT key and DSPL (Display).
4. **RF OUTPUT Connector.** Female, type-N connector provides an AC-coupled, reverse-power protected (up to 25W and 25 Vdc) RF output signal with a frequency range of 100 kHz to 990 MHz and a leveled output of +13 dBm to -127 dBm (+1.00V to +0.10 μ V). Nominal impedance is 50 ohms.
5. **RF OFF/ON Key.** Two-position push-button key which turns the RF signal to the RF OUTPUT off and on.
6. **UNITS Entry Key.** Terminates a data entry for any one of the four main functions. The backspace key (\leftarrow) clears the last digit or decimal point visible in a display to permit the entry to be corrected.
7. **Data Entry Keys.** Ten numeric entry keys, a decimal point key, and a minus sign key are used for frequency, amplitude, AM, FM, or increment value data entry. Numeric entry keys are also used in conjunction with the STORE, RECALL and DSPL (Display) keys to select one of the 10 storage registers. The "0" key has a special function which presets the instrument.
8. **INCR SET Key.** Selects the value of the frequency, amplitude, AM, or FM increment. Also used to display the stored increment value for each of the four main functions.
9. **CARRIER Keys.** Selects and permits tuning of the basic carrier functions including phase-up and phase-down.
10. **MODULATION Keys.** Selects either internal, external, or mixed AM, FM or DC FM functions.
11. **POWER Switch.** Two-position push-button switch used to control the operating-state of the instrument's micro-processor. The Signal Generator, and its optional reference oscillator crystal oven, remains energized as long as the power-cord is connected to Mains power.
12. **MOD INPUT/OUTPUT Connector.** Female, BNC connector accepts either an external modulation signal (1 Vpk) or a dc level (1 Vdc). In addition, it provides access to the 400 Hz or 1 kHz modulating signal from the internal audio oscillator. Nominal impedance is 600 ohms.
13. **SHIFT Key.** Changes the capabilities of some keys to their blue labeled function.
14. **LOCAL Key.** Returns the Signal Generator to local operation (full front-panel control), provided that it is not in local lockout.

Figure 3-1. Simplified Front-Panel Features and Operation (1 of 3)

- 15. **Remote Annunciators.** Remote operation status is indicated by two LED annunciators. The RMT annunciator lights when the instrument is in remote operation. The ADRS annunciator lights when the instrument has been addressed to listen via the bus (regardless of whether or not the instrument is in remote operation).
- 16. **MODULATION Display.** A 2-digit display of AM depth, FM peak deviation, or modulation increment. Internal and external modulation source information is displayed by 11 LED annunciators. It is also used to display the internally set, decimal HP-IB address and used to display the keyboard-invoked tests.

SETTING CARRIER FUNCTIONS

SETTING MODULATION FUNCTIONS

CHANGING PARAMETER VALUES

STORE/RECALL/DISPLAY/SEQUence

SETTING CARRIER FUNCTIONS

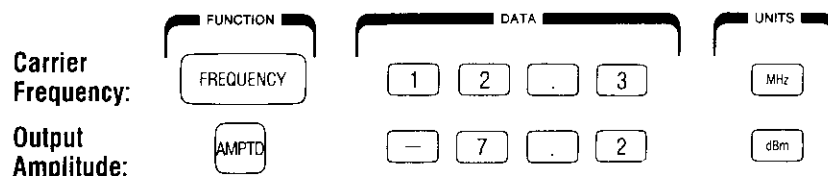

Both of the Signal Generator's carrier functions have value-selectable parameters. These parameters are selected in the Function-Data-Units format as shown in the examples above.

SETTING MODULATION FUNCTIONS

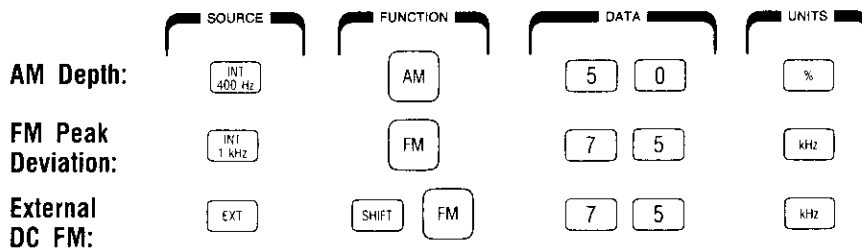

Internal, external, or mixed AM or FM functions can be selected. Modulation parameters are selected in the Source-Function-Data-Units format as shown in the examples above. One of the two internal modulation sources (400 Hz or 1 kHz) and/or a signal or dc level from an external modulation source coupled through the front-panel connector may be used to modulate the carrier.

CHANGING PARAMETERS VALUES

Value-selectable parameters can be changed by making new Function-Data-Units entries, or by using the step up or down keys associated with each of the four main functions. These keys are used in conjunction with the INCR SET key.

Step Up and Down Keys



The step up and down keys are always enabled to change the value of the associated main function. The initialized value of each increment is listed as follows:

| | |
|-------------------|--------|
| Carrier Frequency | 10 MHz |
| Output Amplitude | 10 dB |
| AM Depth | 1% |
| FM Peak Deviation | 1 kHz |

The value of each increment can be displayed or modified by using the INCR SET key. The stored increment value is displayed as long as the INCR SET key remains pressed.

Figure 3-1. Simplified Front-Panel Features and Operation (2 of 3)

The increment value for the four main functions can be modified as follows:

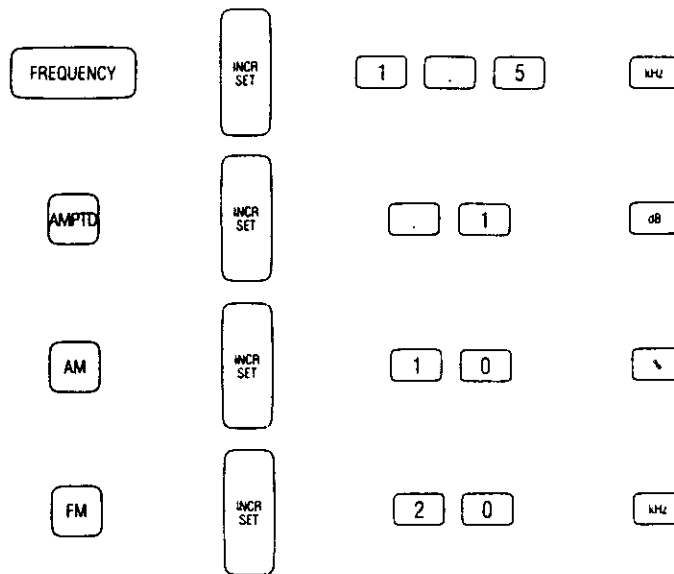

The maximum allowable increment value for each of the four main functions is as follows:

| | |
|-----------------------------|-------------|
| Carrier Frequency | ≤989.99 MHz |
| Output Amplitude | ≤144 dB |
| AM Depth | ≤99% |
| FM Peak Deviation Frequency | ≤99 kHz |

NOTE

The carrier frequency increment is rejected if it is not a multiple of 10 Hz.



In addition, value-selectable carrier frequency parameters can be changed using the COARSE TUNE or FINE TUNE keys in conjunction with the step up or down keys associated with the carrier frequency function. The COARSE TUNE key causes the carrier frequency value to be increased by a factor of 10 each time it is pressed, while the FINE TUNE key causes the carrier frequency tuning value to be decreased by a factor of 10. Pressing the INCR SET key disables the effect of these keys and enables the original carrier frequency increment value.

STORE-RECALL-DISPLAY-SEQUENCE

Up to ten complete front-panel settings (exclusive of increment values) can be stored for either selectable or sequential recall at a later time. The output of the Signal Generator is changed so that it agrees with the recalled parameter values. Stored front-panel settings can also be displayed without actually changing the output signal.

Figure 3-1. Simplified Front-Panel Features and Operation (3 of 3)

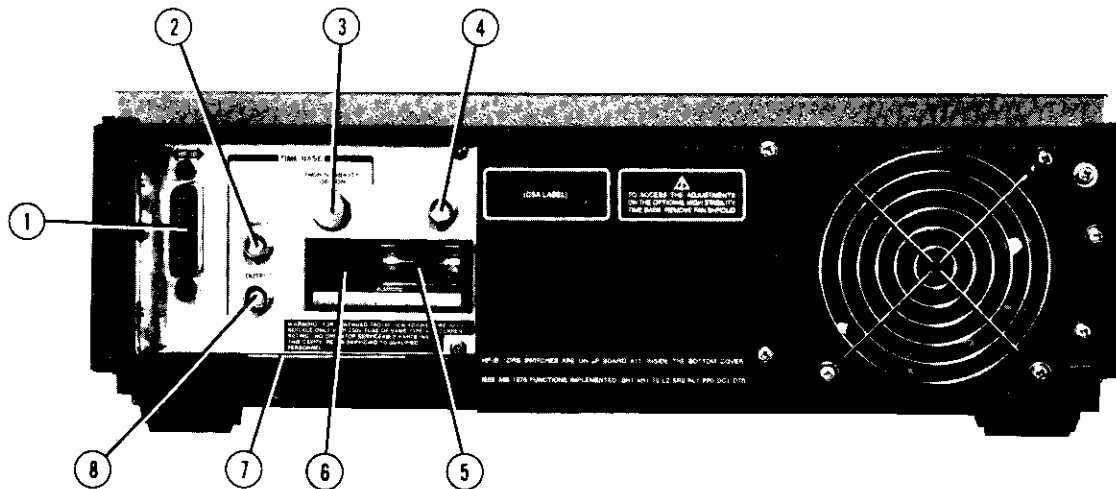

NOTE

For Option 002 instruments, the RF OUTPUT and MOD INPUT/OUTPUT connectors are located on the rear-panel. The RF OUTPUT connector is located above (2) Time Base Input while the MOD INPUT/OUTPUT connector replaces (4) SEQ.

1. **HP-IB Connector.** A 24-pin female connector is used to connect the Signal Generator to the Hewlett-Packard Interface Bus for remote operation. Connection information is presented in Section II, Installation.
2. **TIME BASE INPUT.** Female BNC connector (J3) accepts an external 1, 5, or 10 MHz ($\pm 0.005\%$) time base reference input at a level of 0.2 to 0.4 Vrms into 50 ohms. An internal jumper must be installed in the position that corresponds to the external time base reference input used (refer to paragraph 2-7).
3. **TIME BASE HIGH STABILITY OPTION.** Female BNC connector (A16J1) provides access to the optional 10 MHz time base reference output. With Option 001 installed and its output connected to the TIME BASE INPUT connector through the supplied cable (not shown), the frequency accuracy and stability of the Signal Generator is increased. The optional reference oscillator is kept at operating temperature in the STBY (Standby) mode as long as the Signal Generator remains connected to Mains power.
4. **SEQ.** Female BNC connector (J5) accepts external contact closure (from foot pedal, pushbutton switch, etc.) which causes the Signal Generator to sequentially recall the stored contents (exclusive of increment settings) from each of its 10 storage registers.
5. **Fuse.** Fuse selection and ordering information is presented in Section II, Installation (Refer to paragraph 2-5).
6. **Line Power Module.** Permits operation from 100, 120, 220, or 240 Vac. The number visible in the window indicates nominal line voltage to which the instrument must be connected (see Figure 2-1). Center conductor is safety earth ground.
7. **Serial Number Plate.** First four digits and letter constitute the prefix which defines the instrument configuration. The last five digits form a sequential suffix that is unique to each instrument.
The plate also indicates any options supplied with the instrument.
8. **TIME BASE OUTPUT.** Female BNC connector (J4) provides access to an internal 10 MHz time base reference output at a level greater than 0.2 Vrms into 50 ohms which is derived from the internal reference oscillator. An internal jumper may be repositioned to select either a 1 or 5 MHz reference output (refer to paragraph 2-7).

Figure 3-2 (2425A to 2509A). Rear Panel Features

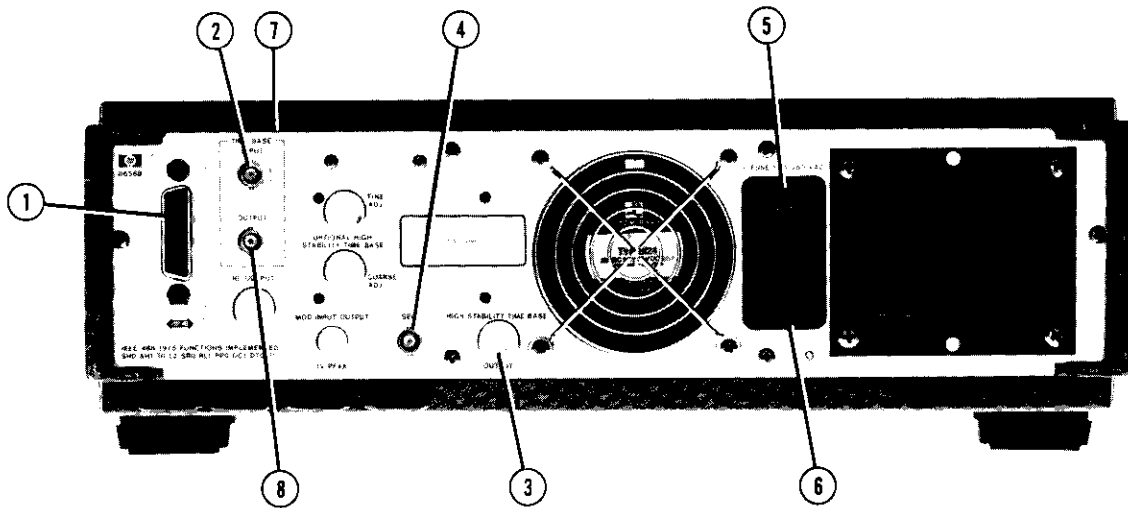

NOTE

For Option 002 instruments, the RF OUTPUT and MOD INPUT/OUTPUT connectors are located on the rear-panel.

1. **HP-IB Connector.** A 24-pin female connector is used to connect the Signal Generator to the Hewlett-Packard Interface Bus for remote operation. Connection information is presented in Section II, Installation.
2. **TIME BASE INPUT.** Female BNC connector (J3) accepts an external 1, 5, or 10 MHz ($\pm 0.005\%$) time base reference input at a level of 0.2 to 0.4 Vrms into 50 ohms. An internal jumper must be installed in the position that corresponds to the external time base reference input used (refer to paragraph 2-7).
3. **HIGH STABILITY TIME BASE OPTION.** Female BNC connector (A16J1) provides access to the optional 10 MHz time base reference output. With Option 001 installed and its output connected to the TIME BASE INPUT connector through the supplied cable (not shown), the frequency accuracy and stability of the Signal Generator is increased. The optional reference oscillator is kept at operating temperature in the STBY (Standby) mode as long as the Signal Generator remains connected to Mains power.
4. **SEQ.** Female BNC connector (J5) accepts external contact closure (from foot pedal, pushbutton switch, etc.) which causes the Signal Generator to sequentially recall the stored contents (exclusive of increment settings) from each of its 10 storage registers.
5. **Fuse.** Fuse selection and ordering information is presented in Section II, Installation (Refer to paragraph 2-5).
6. **Line Power Module.** Permits operation from 100, 120, 220, or 240 Vac. The number visible in the window indicates nominal line voltage to which the instrument must be connected (see Figure 2-1). Center conductor is safety earth ground.
7. **Serial Number Plate.** First four digits and letter constitute the prefix which defines the instrument configuration. The last five digits form a sequential suffix that is unique to each instrument.
The plate also indicates any options supplied with the instrument.
8. **TIME BASE OUTPUT.** Female BNC connector (J4) provides access to an internal 10 MHz time base reference output at a level greater than 0.2 Vrms into 50 ohms which is derived from the internal reference oscillator. An internal jumper may be repositioned to select either a 1 or 5 MHz reference output (refer to paragraph 2-7).

Figure 3-2 (2511A and above, 2608U and above). Rear Panel Features

Table 3-4. Index of Detailed Operating Instructions

| Instruction | Page | Instruction | Page |
|---------------------------------------|------|--------------------------------|------|
| Frequency | 3-40 | Modulation, Mixed | 3-65 |
| Frequency, Coarse and Fine Tune | 3-42 | Modulation, Off | 3-69 |
| Frequency, Phase Up/Down | 3-43 | Increment Value Change | 3-48 |
| Frequency, Up/Down | 3-44 | Increment Value Display | 3-50 |
| Amplitude | 3-31 | Display | 3-38 |
| Amplitude Conversion | 3-33 | Display Amplitude Offset | 3-37 |
| Amplitude Offset | 3-35 | Display Sequence | 3-39 |
| Amplitude, Up/Down | 3-36 | Instrument Preset | 3-52 |
| Modulation, AM | 3-53 | Recall | 3-72 |
| Modulation, AM Up/Down | 3-55 | RF OFF/ON | 3-71 |
| Modulation, DC FM | 3-57 | Sequence | 3-73 |
| Modulation, DC FM Up/Down | 3-59 | Store | 3-74 |
| Modulation, FM | 3-61 | HP-IB Address Display | 3-46 |
| Modulation, FM Up/Down | 3-63 | | |

The actual detailed operating instructions are arranged in alphabetical order at the end of this section.

3-11. FRONT-PANEL FEATURES (Cont'd)

The 3 digital displays show frequency of the carrier in megahertz, output amplitude of the carrier in one of 14 possible units, and percentage of AM depth or frequency of FM peak deviation used to modulate the carrier. In addition, the FREQUENCY Display can show the value of the carrier frequency increment, and is used to display an error code if a memory failure occurs; the AMPLITUDE Display can show the value of the output amplitude increment or current contents of the sequence counter; and the MODULATION Display can show the value of the modulation increment or internally set, decimal HP-IB address. All 3 digital displays are used when the keyboard-invoked tests are run.

The 20 LED annunciators are used to indicate remote operation status, internal or external modulation source and unit information, and amplitude unit information.

3-12. Keystroke Sequences

The Signal Generator's functions can be selected in any order; however, each function selection requires a prescribed sequence of keystrokes. A keystroke sequence might contain only a single keystroke, such as SEQUENCE, RF OFF, or return to local operation. More often though the sequence contains several keystrokes which must be entered in a specific order. This is true whenever one of the four main functions (Frequency, Amplitude, AM, or FM) is selected. Once one of these functions is selected, the instrument remains in that function until one of the following events occurs:

- a. One of the three remaining functions is selected.
- b. One of the STORE, RECALL, SEQUENCE keys or Display (SHIFT, DSPL) is pressed.
- c. The instrument is preset, unplugged or switched to standby.

As long as a function remains in effect, it is not necessary to re-select that function before entering new data. The following paragraphs discuss multiple-entry keystroke sequences.

Carrier Keystroke Sequence. The parameter used to set the carrier's frequency and amplitude are entered in a Function-Data-Units format. Data entered following a function selection is interpreted for that function. Data previously entered remains unaffected until the new data entry is terminated by pressing a valid unit key. If any other function key is pressed before the data entry is terminated, that entry is rejected, the last valid display is restored so that it agrees with the actual output of the Signal Generator, and the last function selected is in effect.

Modulation Keystroke Sequence. Internal, external, or mixed AM or FM functions can be selected. Modulation parameters are selected in a Source-Function-Data-Units format. The modulation source, either one of the two internal modulation signals (400 Hz or 1 kHz) and/or a signal or dc level from an external modulation source (coupled through the front-panel connector), may be selected before or after the AM depth or FM peak deviation parameters are selected. The internal 400 Hz or 1 kHz modulation source will be common to both AM and FM functions whenever they are simultaneously selected.

Store-Recall-Display Keystroke Sequence. Up to 10 complete front-panel settings (exclusive of increment values) can be stored for either selectable or sequential recall at a later time. Stored front-panel settings can also be displayed without actually changing the output signal. A 2-keystroke sequence is necessary to store or recall front-panel settings. First, the desired function is entered and then a numeric entry (0–9). A 3-keystroke sequence is necessary to display front-panel settings. First, the SHIFT key is pressed followed by DSPL (the blue labeled function of SEQUENCE key) and then a numeric entry (0–9). The numeric entry represents the location of the storage register.

3-13. Time Base Selection

The Signal Generator is shipped from the factory with a resistive jumper hard-wired to provide a 10 MHz time base output signal at the rear-panel TIME BASE OUTPUT connector. If either a 1 or 5 MHz output signal is desired, this internal resistive jumper will have to be repositioned. Also, if an external 1 or 5 MHz reference input is to be applied at the rear-panel TIME BASE INPUT connector, this internal resistive jumper will have to be repositioned. In either case, this internal resistive jumper has to be installed in the position that corresponds to the frequency of the time base input or output signal being used. Refer to paragraph 2-7 for the time base selection procedure.

3-14. Rear Panel Features

See Figure 3-2, Rear Panel Features for a description of the HP-IB connector, Time Base Input, Time Base High Stability Option, Sequencer, Fuse Line Power Module, Serial Number Plate and Time Base Output.

3-15. OPERATOR'S MAINTENANCE

NOTE

For continued protection against fire hazard, replace line fuse with only a 250V fuse of the same rating. Do not use repaired or short circuited fuseholders.

The only maintenance that the operator should normally perform is the replacement of the primary power fuse located within the Line Power Module –A15. For instructions on how to change the fuse, see Figure 2-1, steps 1 and 3. Fuses may be ordered under HP Part Numbers 2110-0043 (1.5A, 250V) for 100/120 Vac operation and 2110-0001 (1.0A, 250V) for 220/240 Vac operation.



OPERATOR'S CHECKS

3-16. OPERATOR'S CHECKS

Operator's checks are simple procedures designed to verify that the main functions to the Signal Generator operate properly. Two procedures are provided, one for basic (front-panel) functional checks and the other for HP-IB functional checks.

3-17. Basic Functional Checks

Description This procedure requires a frequency counter, a spectrum analyzer, a power supply, and the interconnecting cables and adapters. It provides assurance that most of the front-panel controlled functions are being executed by the Signal Generator.

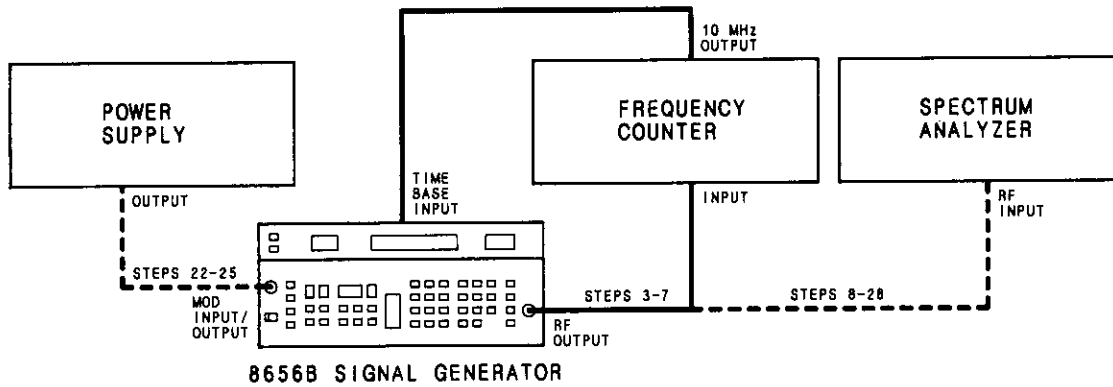

Figure 3-3. Test Setup for Basic Functional Checks

| | | |
|------------------|-----------------------------|---------------------|
| Equipment | Frequency Counter | HP 5328A Option 031 |
| | Spectrum Analyzer | HP 8668B/182T |
| | Power Supply | HP 6235A |

- Procedure**
1. Ensure that the power cable is plugged into a suitable source of Mains power (refer to paragraph 2-4).
 2. Press the POWER switch to ON.

An internal memory check is initiated to test for a failure in ROM (read-only-memory). All front-panel indicators light for approximately 1.5 seconds to provide a quick visual inspection of each front-panel annunciator and display segment.

If a memory failure is detected, a RAM or ROM error code is displayed in the FREQUENCY Display window (refer to Table 3-1 Power-On Error Codes). The error code remains displayed until any front-panel key is pressed. If the memory check was successful, the front-panel indicators display a carrier frequency of 100.00000 MHz, an output amplitude of -127.0 dBm, and no modulation. Only the dBm annunciator is lit, all of the others will be off.

3. Connect the RF OUTPUT of the Signal Generator to the input of the frequency counter, and the 10 MHz reference output from the frequency counter to the TIME BASE INPUT located at the rear of the Signal Generator as shown in Figure 3-3.

Connecting the 10 MHz reference output of the frequency counter to the TIME BASE INPUT of the Signal Generator phase locks the two instruments to the same time base reference.

OPERATOR'S CHECKS

3-17. Basic Functional Checks (Cont'd)**NOTE**

If the Signal Generator is equipped with the high stability time base (Option 001), disconnect its cable from the TIME BASE INPUT before performing this step.

Frequency Check

- Set the output amplitude of the Signal Generator to -10.0 dBm and the carrier frequency to the values listed in the following table:

| Carrier Frequency (MHz) |
|-------------------------|
| 100.00000 |
| 140.00000 |
| 200.00000 |
| 300.00000 |
| 400.00000 |
| 600.00000 |
| 800.00000 |
| 990.00000 |

Verify that the FREQUENCY Display on the Signal Generator agrees with the frequency displayed on the frequency counter (except for the resolution of the frequency counter being used).

- Set the carrier frequency of the Signal Generator to 111.11111 MHz and the frequency increment value to 111.11111 MHz. Leave the output amplitude set at -10.0 dBm.

Verify that the FREQUENCY display on the Signal Generator agrees with the frequency displayed on the frequency counter.

- Quickly press and release the frequency step-up key to increase the carrier frequency.

Verify that the FREQUENCY Display on the Signal Generator agrees with the frequency displayed on the frequency counter.

Continue to increase the carrier frequency to the maximum value listed in the following table:

| Carrier Frequency (MHz) |
|-------------------------|
| 111.11111 |
| 222.22222 |
| 333.33333 |
| 444.44444 |
| 555.55555 |
| 666.66666 |
| 777.77777 |
| 888.88888 |

Verify that the FREQUENCY Display on the Signal Generator agrees with the frequency displayed on the frequency counter each time the carrier frequency is increased.

- Quickly press and release the frequency step-down key to decrease the carrier frequency.
-



OPERATOR'S CHECKS

3-17. Basic Functional Checks (Cont'd)

Verify that the FREQUENCY Display on the Signal Generator agrees with the frequency displayed on the frequency counter.

Continue to decrease the carrier frequency to the minimum value listed in the previous table.

Verify that the FREQUENCY Display on the Signal Generator agrees with the frequency displayed on the frequency counter each time the carrier frequency is decreased.

Output Level Checks

8. Connect the RF OUTPUT of the Signal Generator to the input of the spectrum analyzer as shown in Figure 3-3.
9. Set the output amplitude of the Signal Generator to 0.0 dBm, carrier frequency to 0.1 MHz, and frequency increment value to 10 MHz.
10. Set the amplitude scale of the spectrum analyzer to display 1 dB/division, and make the necessary adjustments to properly display the output signal from the Signal Generator.

NOTE

This check only verifies level flatness, it does not verify absolute level accuracy.

11. Slowly increase the carrier frequency through its entire frequency range (0.1 to 990.00000 MHz) and observe the level displayed on the spectrum analyzer. The level should not vary more than a total of 3 dBm (± 1.5 dB from 0.0 dBm).
12. Set the carrier frequency of the Signal Generator to 600 MHz, output amplitude to +13 dBm, and output amplitude increment value to 1.0 dB.
13. Adjust the spectrum analyzer as necessary to display the output signal from the Signal Generator. The displayed carrier should be positioned in the center of the graticule with its maximum level positioned near the top of the graticule.
14. Slowly decrease the output amplitude down to -4.0 dBm and observe the level displayed on the spectrum analyzer. The level should decrease in relatively uniform 1 dB steps.
15. Set the output amplitude of the Signal Generator to -10.0 dBm and the output amplitude increment value to 5 dB. Leave the carrier frequency set to 600 MHz.
16. Set the amplitude scale of the spectrum analyzer to display 10 dB/division and make the necessary adjustments to properly display the output signal from the Signal Generator. The displayed carrier should be positioned in the center of the graticule with its maximum level positioned near the top of the graticule.
17. Slowly decrease the output amplitude down to -80 dBm and observe the level displayed on the spectrum analyzer. The level should decrease in relatively uniform 5 dB steps.



OPERATOR'S CHECKS

3-17. Basic Functional Checks (Cont'd)

FM Check

18. Set the output amplitude of the Signal Generator to 0.0 dBm. Leave the carrier frequency set to 600 MHz. Select FM with a peak deviation of 99 kHz using the internal 1 kHz source. Set the FM peak deviation increment value to 1 kHz.
19. Set the spectrum analyzer for a 50 kHz frequency span/division, a resolution bandwidth of 3 kHz, and a reference level of 0 dBm. The waveform displayed should be similar to that shown in Figure 3-4.
20. Slowly decrease the FM peak deviation to zero. The deviation displayed on the spectrum analyzer should decrease in relatively uniform steps.
21. Press FM, then OFF to turn off the FM function.

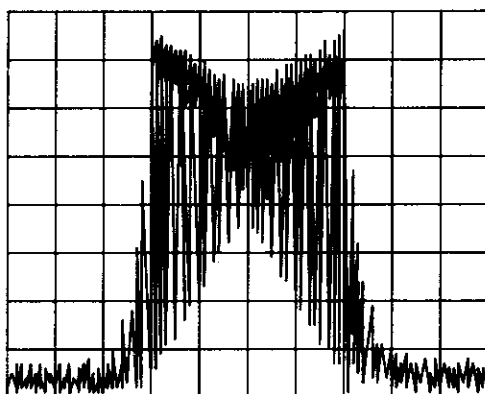

Figure 3-4. FM Functional Check Waveform

DC FM Check

22. Leave the output amplitude of the Signal Generator set to 0.0 dBm, and the carrier frequency set to 600 MHz. Select external DC FM with a peak deviation of 60 kHz.
23. Set the spectrum analyzer for a 200 kHz frequency span/division and a reference level of 0 dBm. Adjust the spectrum analyzer as necessary to display the output signal from the Signal Generator in the center of the display.
24. Connect a power supply to the MODULATION INPUT/OUTPUT Connector of the Signal Generator as shown in Figure 3-3. Set the power supply for a +1 Vdc output and switch the voltage line on. Notice the LO EXT annunciator will remain on. The carrier frequency displayed on the Spectrum Analyzer should move three divisions to the right. The carrier frequency is off-set by 60 kHz.
25. Press FM, then OFF to turn off the DC FM function.

AM Check

26. Leave the carrier frequency set to 600 MHz, and the output amplitude set to 0.0 dBm. Select AM with a depth of 50% using the internal 400 Hz source.



OPERATOR'S CHECKS

3-17. Basic Functional Checks (Cont'd)

27. Set the spectrum analyzer to the linear amplitude mode. Set a frequency span/division of zero. Increase the resolution bandwidth, then fine tune for the maximum level of the demodulated signal. The displayed demodulated signal should be a sine wave with a period of 2.5 ms (400 Hz).
28. Press the INT 1 kHz key to change the frequency of the internal modulation source from 400 Hz to 1 kHz. The displayed demodulated signal should be a sine wave with a period of 1 ms (1 kHz).

3-18. HP-IB Functional Checks

Description

The following procedures check the Signal Generator's ability to recognize its own HP-IB (listen) address, properly make remote/local transitions, and process all the applicable HP-IB messages described in Table 3-5. During the process, all of the Signal Generator's HP-IB data input/output bus, control, and handshake lines are checked, except for DIO8 (the most significant data input/output bus line which is not used by the Signal Generator). Only the Signal Generator, a bus controller, and an HP-IB interface with appropriate cabling are required to perform these procedures. The checks are intended to be as independent of one another as possible, since each begins with the instrument being reset to its initialized condition. Nevertheless, it is suggested that the first four checks be performed in order before any other check. Any special initialization steps or requirements for a given check are provided in the beginning of the check.

The validity of these checks is based on the following assumptions:

- The Signal Generator performs properly when operated via the front-panel keys (that is, in local operation). This can be verified by performing the basic functional checks as outlined in paragraph 3-17.
- The bus controller properly executes HP-IB operations.
- The bus controller's HP-IB interface properly transfers the controller's instructions.
- The select code of the bus controller's interface is set to 7.
- The HP-IB address of the Signal Generator is set to 07 (the factory-set address).
- The select code address combination (that is, 707) is not necessary for these checks to be valid, however, the program lines presented in the following procedures would have to be modified for any other combination.

If the Signal Generator appears to fail any of the remote functional checks, the validity of the preceding assumptions should be confirmed before attempting to service the instrument.

If all of these checks are performed successfully, the Signal Generator's HP-IB capability can be considered to be operating properly. These procedures do not check whether or not all of the Signal Generator's program codes are being properly interpreted and executed by the instrument, however, if the front-panel operation is confirmed to be working properly and its HP-IB capability operates correctly, then there is a high probability that the Signal Generator will respond properly to all of its program codes.

Initial Setup

The test setup is the same for all of the checks. That is, the Signal Generator is connected to the bus controller through the bus controller's HP-IB interface via the appropriate cable.

Equipment

Use any HP Controller and HP-IB Interface to implement HP-IB functional checks.

OPERATOR'S CHECKS

Address Recognition

Note This check determines whether or not the Signal Generator recognizes when it is being addressed and when it is not. It is assumed that the Signal Generator is in local operation and that it can properly handshake on the bus. Before beginning this check, verify that the instrument is in local operation and unaddressed by the controller.

| Description | HPL | BASIC |
|---|---------|------------|
| Set the Remote Enable (REN) bus control line false. | lcl 7 | LOCAL 7 |
| Send the listen address to the Signal Generator. | wrt 707 | OUTPUT 707 |

Operator's Response

Verify that the Signal Generator's RMT annunciator remains off, and that its ADRS annunciator lights.

| Description | HPL | BASIC |
|--|---------|------------|
| Unaddress the Signal Generator by sending a different address. | wrt 715 | OUTPUT 715 |

Operator's Response

Verify that the Signal Generator's RMT and ADRS annunciators are both off.

Remote and Local Messages and the LOCAL Key

Note This check determines whether the Signal Generator properly switches from local to remote operation, switches from remote to local operation, and whether the LOCAL key can return the instrument to local operation. It is assumed that the Signal Generator is able to both handshake and recognize its own address. Before beginning this check verify that the instrument is in local operation and unaddressed by the controller.

| Description | HPL | BASIC |
|--|---------|------------|
| Send the Remote message which sets the Remote Enable (REN) bus control line true and addresses the Signal Generator to listen. | rem 707 | REMOTE 707 |

Operator's Response

Verify that the Signal Generator's RMT and ADRS annunciators both light.

| Description | HPL | BASIC |
|---|---------|-----------|
| Send the Local message to the Signal Generator. | lcl 707 | LOCAL 707 |

Operator's Response

Verify that the Signal Generator's RMT annunciator turns off, and that its ADRS annunciator remains on.

| Description | HPL | BASIC |
|---|---------|------------|
| Send the Local message to the Signal Generator. | rem 707 | REMOTE 707 |



OPERATOR'S CHECKS

3-18. HP-IB Functional Checks

Operator's Response

Verify that the Signal Generator's RMT and ADRS annunciators are both on. Press the LOCAL key on the front-panel of the Signal Generator and verify that the RMT annunciator turns off, and that the ADRS annunciator remains on.

Data Message

Note

This check determines whether or not the Signal Generator properly receives Data messages. Because the Signal Generator is only a listener, it can only receive Data messages, but never send them. It is assumed that the Signal Generator is able to handshake, recognize its own address, and properly make remote/local transitions. The Data message that is sent will cause the 7 least significant HP-IB data lines to be placed in both their true and false states. Before beginning this check, verify that the instrument is in local operation and unaddressed by the controller.

| Description | HPL | BASIC |
|--|--------------------|-----------------------|
| Send the first part of the Remote message (which enables the Signal Generator to remote). | rem 707 | REMOTE 707 |
| Address the Signal Generator to listen (which completes the Remote message) and send the Data message (which tunes the Signal Generator to 990 MHz). | wrt 707, "fr990mz" | OUTPUT 707; "FR990MZ" |

Operator's Response

Verify that the Signal Generator's RMT and ADRS annunciators both light, and that the FREQUENCY Display shows a carrier frequency of 990.00000 MHz.

Local Lockout and Clear Lockout/Set Local Messages

Note

This check determines whether or not the Signal Generator properly receives the Local Lockout message which disables all of the front-panel keys. In addition, this check determines whether or not the Clear Lockout/Set Local message is properly received and executed by the Signal Generator. It is assumed that the Signal Generator is able to handshake, recognize its own address, and properly make remote/local transitions. Before beginning this check, verify that the instrument is in local operation and unaddressed by the controller.

| Description | HPL | BASIC |
|---|---------|-----------------|
| Send the first part of the Remote message (which enables the Signal Generator to remote). | rem 707 | REMOTE 707 |
| Send the Local Lockout message. | llo 7 | LOCAL LOCKOUT 7 |
| Address the Signal Generator to listen (which completes the Remote message). | wrt 707 | OUTPUT 707 |

Operator's Response

Verify that the Signal Generator's RMT and ADRS annunciators both light. Press the LOCAL key on the front-panel of the Signal Generator, and verify that its RMT and ADRS annunciators both remain on.

| Description | HPL | BASIC |
|---|-------|---------|
| Send the Clear Lockout/Set Local message. | icl 7 | LOCAL 7 |



OPERATOR'S CHECKS

3-18. HP-IB Functional Checks

Operator's Response Verify that the Signal Generator's RMT annunciator is turned off, and that its ADRS annunciator remains on.

Clear Message

Note

This check determines whether or not the Signal Generator properly responds to the Clear message. It is assumed that the Signal Generator is able to handshake, recognize its own address, properly make remote/local transitions, and receive Data messages. Before beginning this check, verify that the instrument is in local operation, and unaddressed by the controller.

| Description | HPL | BASIC |
|---|-----------------------|--------------------------|
| Send the first part of the Remote message (which enables the Signal Generator to remote). | rem 7 | REMOTE 7 |
| Address the Signal Generator to listen (which completes the Remote message) and send the Data message (which sets the output amplitude of the Signal Generator to 3.0 dB mV). | wrt 707, "ap3dbmv" | OUTPUT 707; "AP3DBMV" |

Operator's Response Verify that the Signal Generator's RMT, ADRS, dB, and mV annunciators all light, and that the AMPLITUDE Display shows an output amplitude of 3.0 dB mV.

| Description | HPL | BASIC |
|-------------------------|---------|-----------|
| Send the Clear message. | clr 707 | CLEAR 707 |

Operator's Response Verify that the Signal Generator's RMT and ADRS annunciators remain on, and that the AMPLITUDE Display now shows the initialized output amplitude of -127.0 dBm. The dB and mV annunciators will now be off and the dBm annunciator will be on.

Abort Message

Note

This check determines whether or not the Signal Generator becomes unaddressed when it receives the Abort message. It is assumed that the Signal Generator is able to handshake, recognize its own address, and properly make remote/local transitions. Before beginning this check, verify that the instrument is in local operation and unaddressed by the controller.

| Description | HPL | BASIC |
|-----------------------------------|---------|------------|
| Send the complete Remote message. | rem 707 | REMOTE 707 |

Operator's Response Verify that the Signal Generator's RMT and ADRS annunciators both light.

| Description | HPL | BASIC |
|--|-------|-----------|
| Send the Abort message (which unaddresses the Signal Generator to listen). | cli 7 | ABORTIO 7 |



OPERATOR'S CHECKS

3-18. HP-IB Functional Checks **Operator's
Response**

Verify that the ADRS annunciator turns off. Note that the HP 9835A and HP 9845A ABORTIO statement sends both the Abort message and the Local message. Therefore, if the HP 9825A is being used, the Signal Generator's RMT annunciator will remain on. If the HP 9835A or HP 9845A is being used, the Signal Generator's RMT annunciator will turn off.



3-19. REMOTE OPERATION, HEWLETT-PACKARD INTERFACE BUS

The Signal Generator can be operated through the Hewlett-Packard Interface Bus (HP-IB). Bus compatibility, programming, and data formats are described in the following paragraphs.

All front-panel functions (except for DSPL, DSPL in conjunction with SEQ, display Amplitude Offset, Backspace, COARSE TUNE, FINE TUNE, and display HP-IB ADRS) are programmable through HP-IB.

A quick check of the Signal Generator's HP-IB input/output capability is described in paragraph 3-18, HP-IB Functional Checks. These checks are used to verify that the Signal Generator can respond to each of the applicable HP-IB messages described in Table 3-5.

3-20. HP-IB Compatibility

The Signal Generator has an open-collector, TTL, HP-IB interface which can be used with any HP-IB computing controller or computer for automatic system applications. The Signal Generator is fully programmable via the HP Interface Bus. Its programming capability is described by the 13 HP-IB messages listed in Table 3-5. Foremost among these messages is the Data message. Data messages contain the program codes that control the Signal Generator's output signal. The Signal Generator's complete compatibility with HP-IB is further defined by the following list of interface functions: SH0, E1, AH1, T0, L2, SR0, RL1, PP0, DC1, DT0, and C0. A more detailed explanation of these compatibility codes can be found in the IEEE Standard 488 (and the identical ANSI Standard MC1.1). For more information about HP-IB, refer to the Hewlett-Packard Electronic Instruments and Systems catalog and the booklet titled "Improving Measurements in Engineering and Manufacturing" (HP part number 5952-0058).

3-21. Remote Operation

Remote Capability. In remote operation, the front-panel keys are disabled (except for the POWER switch and the LOCAL key). The Signal Generator can only be addressed to listen. When addressed to listen, the Signal Generator responds to the following messages: Data, Clear, Remote, Local, Local Lockout, Clear Lockout/Set Local, and Abort. Each is discussed in detail further on in this section.

Local-to-Remote Change. The Signal Generator switches to remote operation upon receipt of the Remote message. The Remote message is comprised of two parts. They are:

- Remote Enable bus control line (REN) set true.
- Device listen address received once (while REN is true).

The Signal Generator's RMT and ADRS annunciators will both light, and its output signal and all preselected functions remain unchanged when the local-to-remote transition occurs.

3-22. Local Operation

Local Capability. In local operation, the Signal Generator's front-panel is fully operational, and the instrument will respond to the Remote message. Whether addressed or not, the Signal Generator also responds to the Clear, Local Lockout, Clear Lockout/Set Local, and Abort messages. It will not, however, respond to the Data message unless it has been previously addressed.

Remote-to-Local Change. The Signal Generator returns to local operation upon receipt of the Local message (GTL) or Clear Lockout/Set Local message. The Clear Lockout/Set Local message sets the Remote Enable bus control line (REN) false. The instrument can always be set to local operation by pressing the front-panel LOCAL key, provided that local lockout is not in effect. The output signal remains unchanged, and all preselected functions remain unchanged when the remote-to-local transition occurs.

Local Lockout. When a data transmission is interrupted, which can happen by returning the Signal Generator to local operation with the LOCAL key, the data could be lost. This would leave the Signal Generator in an unknown state. To prevent this, a local lockout is recommended. Local lockout disables the LOCAL key and allows return-to-local only under program control.



Table 3-5. HP-IB Message Reference Table

| HP-IB Message | Applicable | Response | Related Commands Controls* | Interface Functions* |
|-------------------------------|------------|---|----------------------------|----------------------|
| Data | Yes | All front panel functions, except for DSPL, DSPL in conjunction with SEQ, display Amplitude Offset, Backspace, COARSE TUNE, FINE TUNE, and display HP-IB ADRS are programmable. The front-panel ADRS annunciator lights when the Signal Generator is addressed to listen. | | T0, L2 AH1, SH0 |
| Trigger | No | The Signal Generator does not have a Device Trigger (DT0) capability. | GET | DT0 |
| Clear | Yes | Resets the Signal Generator to a carrier frequency of 100 MHz, an output amplitude of -127 dBm, and no modulation. Responds equally to Device Clear (DCL) and Selected Device Clear (SDC) bus commands. | DCL, SDC | DC1 |
| Remote | Yes | Remote operation is entered when the Remote Enable (REN) bus control line is true and the Signal Generator is first addressed to listen. The front-panel RMT and ADRS annunciators both light when remote operation is entered, all front-panel keys are disabled (except for the LOCAL key and the POWER switch), and the output signal remains unchanged. | REN | RL1 |
| Local | Yes | The Signal Generator returns to local operation (full front-panel control) when either the Go to Local (GTL) bus command is received or the front-panel LOCAL key is pressed. The output signal remains unchanged. | GTL | RL1 |
| Local Lockout | Yes | Disables the front-panel LOCAL key so that only the controller can return the Signal Generator to local operation. | LLO | RL1 |
| Clear Lockout/ Set Local | Yes | The Signal Generator returns to local operation and local lockout is cleared when the REN bus control line goes false. | REN | RL1 |
| Pass Control/ Take Control | No | The Signal Generator has no control capability. | | C0 |
| Require Service | No | The Signal Generator does not have the capability to request service. | | SR0 |
| Status Byte | No | The Signal Generator does not have the capability to respond to a serial poll. | | T0 |
| Status Bit | No | The Signal Generator does not have the capability to respond to a parallel poll. | | PP0 |
| Abort | Yes | The Signal Generator stops listening. | IFC | T0, L2 |
| Driver Electronics | Yes | The Signal Generator does have an open-collector, TTL, interface. | | E1 |

*Commands, control lines, and interface functions are defined in IEEE Standard 488 (and the identical ANSI Standard MC1.1). Knowledge of these might not be necessary if your controller's manual describes programming in terms of the twelve HP-IB Messages shown in the left-hand column above.

Complete HP-IB compatibility as defined in IEEE Standard 488 (and the identical ANSI Standard MC1.1) is: SH0, E1, AH1, T0, L2, SR0, RL1, PP0, DC1, DT0, and C0.



NOTE

Return-to-local can also be accomplished by setting the POWER switch to STBY, and then back to ON. This technique, however, has some potential disadvantages.

It defeats the purpose and advantage of local lockout, that is, the system controller will lose control of the Signal Generator.

Some HP-IB conditions are reset to their default state during turn on.

3-23. Addressing

The Signal Generator interprets the byte of information on its eight data input/output bus lines as either an address or a bus command. Whenever the bus is in the command entry mode, the Attention bus control line (ATN) is true and the Interface Clear bus control line (IFC) is false. Whenever the Signal Generator is being addressed (whether in local or remote operation), the front-panel ADRS annunciator will light.

The Signal Generator's listen address is established by five miniature rocker switches located inside the instrument. The address selection procedure is described in Section II, Installation. The decimal equivalent of the listen address can be displayed in the MODULATION Display by pressing the SHIFT key first and then the Local key. Refer to Table 3-6 for a list of the valid decimal (listen address) values and their equivalent ASCII characters.

3-24. Data Messages

The Signal Generator communicates on the interface bus with Data messages. Each Data message consists of one or more bytes of information sent over the Signal Generator's eight data input/output bus lines DIO1 through DIO8 during the data entry mode. The data entry mode is established when the Attention bus control line (ATN) is false. Data messages include the program codes listed in Tables 3-9 and 3-10. These program codes contain the necessary information to program virtually all of the instrument functions available in local operation. The only exceptions are DSPL, DSPL in conjunction with SEQ, display Amplitude Offset, Backspace, COARSE TUNE, FINE TUNE, and display HP-IB ADRS.

Table 3-6. Valid Decimal Values vs. Equivalent ASCII Characters

| Equivalent Decimal Value (Listen) | Equivalent ASCII Character (Listen) | Equivalent Decimal Value (Listen) | Equivalent ASCII Character (Listen) |
|-----------------------------------|-------------------------------------|-----------------------------------|-------------------------------------|
| 00 | SP | 16 | 0 |
| 01 | ! | 17 | 1 |
| 02 | " | 18 | 2 |
| 03 | # | 19 | 3 |
| 04 | \$ | 20 | 4 |
| 05 | % | 21 | 5 |
| 06 | & | 22 | 6 |
| 07 | ' | 23 | 7 |
| 08 | (| 24 | 8 |
| 09 |) | 25 | 9 |
| 10 | * | 26 | : |
| 11 | + | 27 | ; |
| 12 | , | 28 | < |
| 13 | — | 29 | = |
| 14 | . | 30 | > |
| 15 | / | | |

Indicates factory-set address.



3-25. Receiving the Data Message

The Signal Generator must be in remote operation and addressed to listen before it can respond to Data messages. The instrument remains addressed to listen until it receives an Abort message or a universal unlisten command from the controller.

The paragraph entitled Switching Characteristics, 3-38, shows how the Signal Generator responds to Data Messages. Timing considerations and other characteristics pertinent to operation are included.

Data Message Input Format. Data messages contain the controller's talk address, the Signal Generator's listen address, a string of program codes, and an End of String message (EOS). The string of program codes follows the same protocol as a front-panel keystroke sequence in local operation. The EOS message can be a Line Feed (LF), a bus END message (EOI and ATN bus control lines both set true), or an internally produced EOS.

The following paragraphs explain other key elements of the program code strings. Figure 3-5 provides some examples of Data messages.

NOTE

After any function terminator (UNITS entry) is sent to the Signal Generator, the instrument is unable to respond to the interface bus until the micro-processor has completed execution of the particular task. Any attempt to send data to the Signal Generator delays bus operation until the execution is complete. The normal terminators carriage-return, and line-feed are considered further data. Data cannot be sent on the bus until the Signal Generator has processed the carriage-return, and line-feed. The bus is free, however, for communication between controller and other equipment. It is recommended that the carriage-return, and line-feed be omitted from data messages sent to the Signal Generator by using a semicolon after the function terminator.

Keyboard-to-Program Code Correlation. There is a program code that corresponds to nearly every front-panel key. The exceptions are DSPL, DSPL in conjunction with SEQ, display Amplitude Offset, Backspace, COARSE TUNE, FINE TUNE, and display HP-IB ADRS. In addition, the program code HZ is available for carrier frequency entries, RP is available to reset the reverse power protection circuitry after the source of reverse power has been removed, and R0 and R1 are available to programmatically place the instrument in the STBY and ON states, respectively.

Value-Selectable Parameters. Carrier parameters are set using a Function-Data-Units sequence of program codes, while modulation parameters are set using a Source-Function-Data-Units sequence of program codes. Single-value parameters; such as, INT 400 Hz, INT 1 kHz, and so forth, are set with a single program code sequence.

Data. The term "Data" in each program sequence refers to the numeric value and not to the entire Data message. Data can be any number of arbitrary length in fixed point notation. Digits that exceed the maximum data length for the particular function will be truncated. This maximum limit includes any embedded decimal points. In the case of the Amplitude function, this maximum limit also includes the minus sign. The minus sign is only applicable during Amplitude Data entries. Table 3-7 summarizes these input data restrictions. A complete list of ASCII characters with conversions to binary, octal, decimal, and hexadecimal is provided in Table 3-11.

3-26. Sending the Data Message

The Signal Generator does not have the capability to talk; therefore, it cannot send Data messages.

3-27. Receiving the Trigger Message

The Signal Generator does not have the capability to respond to the trigger message.

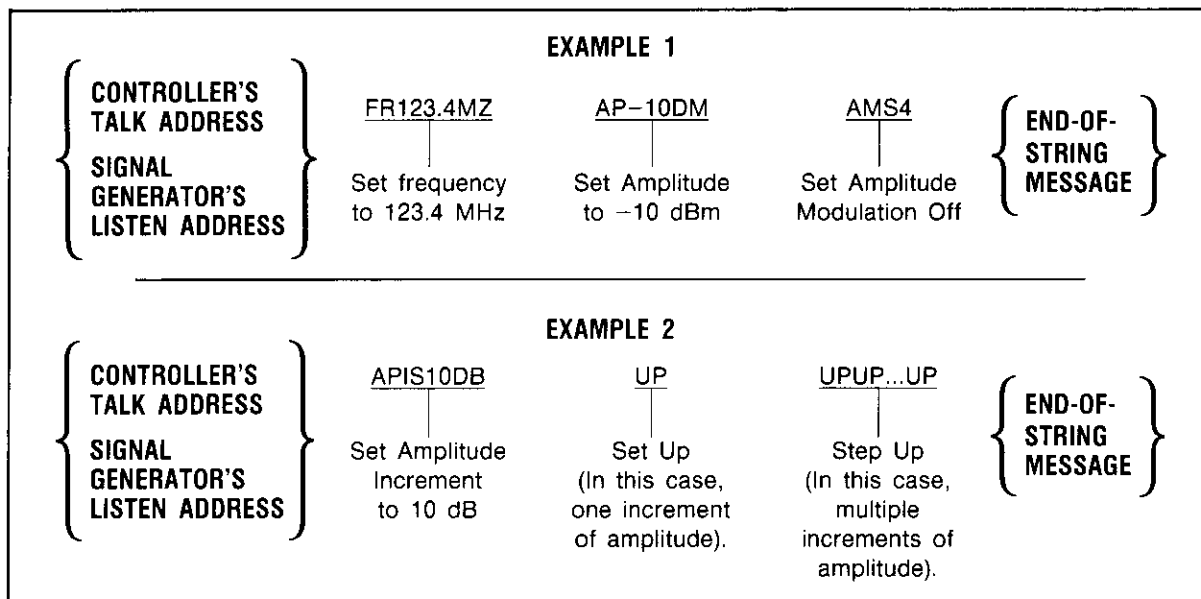

Figure 3-5. Data Message Examples

Table 3-7. Input Data Restrictions

| Function | Maximum Data Length | Decimal Point Allowed | Minus Sign Allowed |
|--|-------------------------------|-----------------------|--------------------|
| Frequency | 9 Digits | Yes | No |
| Amplitude | 9 Digits (1) | Yes | Yes |
| AM | 2 Digits | Yes | No |
| FM | 2 Digits | Yes | No |
| Increment Set | Same as for selected function | Yes | No |
| <p>NOTES:</p> <ol style="list-style-type: none"> 1. In the Amplitude function, leading zeros are not counted. 2. Unused or unidentifiable characters are ignored. 3. Either upper or lower case letters can be used in Data messages. 4. Only the following ASCII characters are recognized by the Signal Generator: <div style="text-align: center; margin: 5px 0;"> A-Z a-z 0-9 LF — . % </div> <p>All other characters, including spaces, are ignored.</p> | | | |

3-28. Receiving the Clear Message

The Signal Generator responds to a Clear message by setting each function parameter to the value listed in Table 3-8. The Signal Generator responds equally to the Selected Device Clear (SDC) bus command when addressed to listen, and to the Device Clear (DCL) bus command whether addressed or not.



Table 3-8. Response to Clear Message

| Parameter | Value |
|------------------------------|------------------|
| Carrier Frequency | 100.00000 MHz |
| Output Amplitude | -127.0 dBm |
| AM Depth | 0% |
| FM Peak Deviation | 0.0 kHz |
| Carrier Frequency Increment | 10.00000 MHz |
| Output Amplitude Increment | 10.0 dB |
| AM Depth Increment | 1% |
| FM Peak Deviation Increment | 1.0 kHz |
| Coarse and Fine Tune Pointer | 10.00000 MHz |
| Sequence Counter | 0 |
| All 10 Storage Registers | Remain unchanged |

3-29. Receiving the Remote Message

The Remote message is comprised of two parts. First, the Remote Enable bus control line (REN) is held true, then the device listen address is sent by the controller. These two actions combine to place the Signal Generator into remote operation. Therefore, the instrument is enabled to go into remote operation when the controller begins the Remote message, but it does not actually make the transition until it is addressed to listen for the first time. All instrument settings remain unchanged when the transition from local-to-remote operation occurs. The front-panel RMT and ADRS annunciators will both light once the Signal Generator has received the Remote message and is addressed to listen.

3-30. Receiving the Local Message

The Local message is the means by which the controller sends the Go to Local (GTL) bus command. If addressed to listen, the Signal Generator returns to local operation (full front-panel control) when it receives the Local message. If the instrument is in local lockout when the Local message is received, full front-panel control is returned, but local lockout remains in effect. Unless the Signal Generator receives the Clear Lockout/Set Local message, it returns to local lockout the next time it receives a Remote message. All instrument settings remain unchanged when the transition from remote-to-local operation occurs.

The front-panel RMT annunciator turns off when the Signal Generator switches to local operation. However, the front-panel ADRS annunciator remains lit if the Signal Generator is still being addressed to listen (whether in remote or local operation).

The front-panel LOCAL key can also be used to return the Signal Generator to local operation. However, pressing the LOCAL key (when the instrument is not in local lockout) might interrupt a Data message being sent to the Signal Generator. This would leave the Signal Generator in a state unknown to the controller. This situation is undesirable and can be avoided by sending the Local Lockout message to disable the LOCAL key.

3-31. Receiving the Local Lockout Message

The Local Lockout message is the means by which the controller sends the Local Lockout (LLO) bus command. If the Signal Generator is in remote operation, it responds to the Local Lockout message by disabling the front-panel LOCAL key. Local lockout prevents the loss of data or system control due to someone accidentally pressing any of the front-panel keys. If the Signal Generator is in local operation when it is enabled to remote operation (that is, REN is set true) and it receives the Local Lockout message, it switches to remote with local lockout operation the first time it is addressed to listen. Once in local lockout, the Signal Generator can only be returned to local operation by the controller or by unplugging or switching the instrument to STBY and then back to ON.



3-32. Receiving the Clear Lockout/Set Local Message

The Clear Lockout/Set Local message is the means by which the controller sets the Remote Enable bus control line (REN) false. The Signal Generator returns to local operation (full front-panel control) when it receives the Clear Lockout/Set Local message. All instrument settings remain unchanged when the transition from remote with lockout to local operation occurs.

The front-panel RMT annunciator is turned off when the Signal Generator switches to local operation.

Table 3-9. HP-IB Program Codes (Alphabetical Order)

| Program Code ¹ | Parameter | Comments |
|---------------------------|---|--------------------|
| AM | Amplitude Modulation | Function Entry |
| AO | Amplitude Offset | Function Entry |
| AP | Amplitude (carrier) | Function Entry |
| DB | dB | Units Entry |
| DF | dBf | Units Entry |
| DM | dBm | Units Entry |
| DN | Step Down (↓) | Function Feature |
| EM | EMF | Units Entry |
| FM | Frequency Modulation | Function Entry |
| FR | Frequency (carrier) | Function Entry |
| HZ | Hz | Units Entry |
| IS | Increment Set | Function Qualifier |
| KZ | kHz | Units Entry |
| MV | mV | Units Entry |
| MZ | MHz | Units Entry |
| PC | Percent ² | Units Entry |
| PD | Phase Decrement | Function Feature |
| PI | Phase Increment | Function Feature |
| RC | Recall | Feature |
| RP | Reverse Power Protection Reset ³ | Feature |
| R0 | Standby ⁴ | Feature |
| R1 | On ⁴ | Feature |
| R2 | RF OFF | Function Feature |
| R3 | RF ON | Function Feature |
| SQ | Sequence | Feature |
| ST | Store | Feature |
| S1 | External Modulation Source | Source Qualifier |
| S2 | Internal 400 Hz Modulation Source | Source Qualifier |
| S3 | Internal 1 kHz Modulation Source | Source Qualifier |
| S4 | Modulation Source Off | Source Qualifier |
| S5 | DC FM | Function Entry |
| UP | Step Up (^) | Function Feature |
| UV | μV | Units Entry |
| VL | Volts | Units Entry |
| 0-9 | Numerals 0-9 | Data Entries |
| - | Minus Sign | Data Entry |
| . | Decimal Point | Data Entry |
| % | Percent ² | Units Entry |

¹ Program codes can be either upper or lower case.
² Either PC or % can be used.
³ The source of reverse power must be removed.
⁴ The POWER switch must be set to the ON position.

3-33. Receiving the Pass Control Message

The Signal Generator does not respond to the Pass Control message because it cannot act as a controller.

3-34. Sending the Require Service Message

The Signal Generator does not have the capability to require service by setting the Service Request bus control line (SRQ) true.

3-35. Sending the Status Byte Message

The Signal Generator does not have the capability to respond to a Serial Poll Enable (SPE) bus command; therefore, it cannot send the Status Byte message.

3-36. Sending the Status Bit Message

The Signal Generator does not have the capability to respond to a Parallel Poll Enable (PPE) bus command; therefore, it cannot send the Status Bit message.

3-37. Receiving the Abort Message

The Abort message is the means by which the controller sets the Interface Clear bus control line (IFC) true. When the Abort message is received, the Signal Generator becomes unaddressed and stops listening.

Table 3-10. HP-IB Program Codes (Functional Order)

| Parameter | Program Code ¹ | Parameter | Program Code ¹ |
|-----------------------------------|---------------------------|---|---------------------------|
| Frequency | | Units (Cont'd) | |
| Frequency (carrier) | FR | EMF | EM |
| Amplitude | | Volts | VL |
| Amplitude (carrier) | AP | mV | MV |
| Amplitude Offset | AO | μV | UV |
| Modulation | | Hz | HZ |
| Amplitude Modulation | AM | kHz | KZ |
| Frequency Modulation | FM | MHz | MZ |
| External Modulation Source | S1 | Percent ² | PC |
| Internal 400 Hz Modulation Source | S2 | Percent ² | % |
| Internal 1 kHz Modulation Source | S3 | Other | |
| Modulation Source Off | S4 | Step Up (↑) | UP |
| DC FM | S5 | Step Down (↓) | DN |
| Data | | Increment Set | IS |
| Numerals 0-9 | 0-9 | Standby ³ | R0 |
| Minus Sign | - | On ³ | R1 |
| Decimal Point | . | RF OFF | R2 |
| Units | | RF ON | R3 |
| dB | DB | Store | ST |
| dBf | DF | Recall | RC |
| dBm | DM | Sequence | SQ |
| | | Reverse Power Protection Reset ⁴ | RP |
| | | Phase Increment | PI |
| | | Phase Decrement | PD |

¹ Program codes can be either upper or lower case.

² Either PC or % can be used.

³ The POWER switch must be in the ON position.

⁴ The source of reverse power must be removed.



3-38. Switching Characteristics

The Signal Generator's switching characteristics are an important consideration in applications involving a computer controller. If the timing requirements are not taken into account in the controller's program, it will be impossible in many situations to make meaningful measurements on a device driven by the Signal Generator.

Switching times for frequency, modulation, and amplitude have several characteristics in common. In each case a finite amount of time passes from the command (manual or computer generated) until the required output occurs. Software execution time is required for the microprocessor and related digital circuits to process the data. This begins with a valid final terminator (keystroke or data entry) and ends with the execution in the hardware. The software time may vary considerably depending on the function. Examples are internal instructions to more than one hardware location, (may be serial, parallel or both) and differing amounts of control data and calculations.

Hardware execution time will also vary considerably. This depends on the number of circuits affected, the length of time each takes to change, and whether the changes occur one at a time or concurrently.

Frequency Switching. The Signal Generator will typically be within 100 Hz of the final frequency within 140 ms after receiving the valid units data (terminator). Figure 3-6 shows the sequence of events and the typical error frequency relative to time. Area I shows the software execution time. Areas II through IV make up the hardware execution time.

At times certain events in the frequency switching cycle may be bypassed. For example, small frequency changes will often eliminate event II, the loop settling time or event III, the FM calibration mode. However, the frequency change that allows these events to be bypassed depends on an involved algorithm that is a function of frequency. Therefore, it is best to assume that the entire sequence of events shown in Figure 3-6 occurs every time a frequency change is made.

To minimize the effects of frequency hysteresis (especially near the frequency band edges), switch to the desired frequency from the same direction each time, that is, from either above or below the desired frequency. Ideally, the frequency change should be made from the same preset frequency. The main band frequency hysteresis is 100 kHz at the main band edges, that is, 123.5, 247 and 494 MHz.

During an FM calibration cycle as a result of a frequency change, all modulation is disabled if the FM mode has been enabled. This applies to FM only or mixed modulation such as FM from two sources or simultaneous AM and FM. After the frequency change and FM calibration is completed, the modulation is turned on.

Amplitude Switching. During an RF amplitude change, the final level is always approached from a lower level. This means that a critical amplitude level is never exceeded in the course of normal Signal Generator operation.

Software correction of amplitude with respect to frequency may cause the amplitude to be uncalibrated while a frequency change occurs.

The basic unit for amplitude in the Signal Generator is dBm. An input in other units requires calculations. This tends to increase the software execution time considerably. For example, an input in dBm generally will take about 40 ms from the terminator to the end of software execution. Examples of a change with calculations involved are: a preset level in mV with a change in dB, 80 ms; a level and change in mV, 220 ms; a level in dBm and a change in mV, 340 ms.

A 10 dB change without modulation (narrowband Automatic Level Control—ALC) may take up to 110 ms in the vernier hardware circuits. With modulation (wideband ALC) the switching time is typically 1 to 25 ms. The step attenuator switching time is on the order of 12 ms.

Total time requirements for simple amplitude inputs or changes, that is, minimal software and hardware execution time is 150 ms. A more complex change may take up to 400 ms.

Modulation Switching. There are applications where it is necessary to turn modulation on or off or to change to another modulation level. It takes about 400 ms for the modulation accuracy (AM or



Table 3-11. Commonly Used Code Conversions

| ASCII | Binary | Octal | Decimal | Hexadecimal | ASCII | Binary | Octal | Decimal | Hexadecimal |
|-------|------------|-------|---------|-------------|-------|------------|-------|---------|-------------|
| NUL | 00 000 000 | 000 | 0 | 00 | @ | 01 000 000 | 100 | 64 | 40 |
| SOH | 00 000 001 | 001 | 1 | 01 | A | 01 000 001 | 101 | 65 | 41 |
| STX | 00 000 010 | 002 | 2 | 02 | B | 01 000 010 | 102 | 66 | 42 |
| ETX | 00 000 011 | 003 | 3 | 03 | C | 01 000 011 | 103 | 67 | 43 |
| EOT | 00 000 100 | 004 | 4 | 04 | D | 01 000 100 | 104 | 68 | 44 |
| ENQ | 00 000 101 | 005 | 5 | 05 | E | 01 000 101 | 105 | 69 | 45 |
| ACK | 00 000 110 | 006 | 6 | 06 | F | 01 000 110 | 106 | 70 | 46 |
| BEL | 00 000 111 | 007 | 7 | 07 | G | 01 000 111 | 107 | 71 | 47 |
| BS | 00 001 000 | 010 | 8 | 08 | H | 01 001 000 | 110 | 72 | 48 |
| HT | 00 001 001 | 011 | 9 | 09 | I | 01 001 001 | 111 | 73 | 49 |
| LF | 00 001 010 | 012 | 10 | 0A | J | 01 001 010 | 112 | 74 | 4A |
| VT | 00 001 011 | 013 | 11 | 0B | K | 01 001 011 | 113 | 75 | 4B |
| FF | 00 001 100 | 014 | 12 | 0C | L | 01 001 100 | 114 | 76 | 4C |
| CR | 00 001 101 | 015 | 13 | 0D | M | 01 001 101 | 115 | 77 | 4D |
| SO | 00 001 110 | 016 | 14 | 0E | N | 01 001 110 | 116 | 78 | 4E |
| SI | 00 001 111 | 017 | 15 | 0F | O | 01 001 111 | 117 | 79 | 4F |
| DLE | 00 010 000 | 020 | 16 | 10 | P | 01 010 000 | 120 | 80 | 50 |
| DC1 | 00 010 001 | 021 | 17 | 11 | Q | 01 010 001 | 121 | 81 | 51 |
| DC2 | 00 010 010 | 022 | 18 | 12 | R | 01 010 010 | 122 | 82 | 52 |
| DC3 | 00 010 011 | 023 | 19 | 13 | S | 01 010 011 | 123 | 83 | 53 |
| DC4 | 00 010 100 | 024 | 20 | 14 | T | 01 010 100 | 124 | 84 | 54 |
| NAK | 00 010 101 | 025 | 21 | 15 | U | 01 010 101 | 125 | 85 | 55 |
| SYN | 00 010 110 | 026 | 22 | 16 | V | 01 010 110 | 126 | 86 | 56 |
| ETB | 00 010 111 | 027 | 23 | 17 | W | 01 010 111 | 127 | 87 | 57 |
| CAN | 00 011 000 | 030 | 24 | 18 | X | 01 011 000 | 130 | 88 | 58 |
| EM | 00 011 001 | 031 | 25 | 19 | Y | 01 011 001 | 131 | 89 | 59 |
| SUB | 00 011 010 | 032 | 26 | 1A | Z | 01 011 010 | 132 | 90 | 5A |
| ESC | 00 011 011 | 033 | 27 | 1B | [| 01 011 011 | 133 | 91 | 5B |
| FS | 00 011 100 | 034 | 28 | 1C | \ | 01 011 100 | 134 | 92 | 5C |
| GS | 00 011 101 | 035 | 29 | 1D |] | 01 011 101 | 135 | 93 | 5D |
| RS | 00 011 110 | 036 | 30 | 1E | ^ | 01 011 110 | 136 | 94 | 5E |
| US | 00 011 111 | 037 | 31 | 1F | _ | 01 011 111 | 137 | 95 | 5F |
| SP | 00 100 000 | 040 | 32 | 20 | ` | 01 100 000 | 140 | 96 | 60 |
| ! | 00 100 001 | 041 | 33 | 21 | a | 01 100 001 | 141 | 97 | 61 |
| " | 00 100 010 | 042 | 34 | 22 | b | 01 100 010 | 142 | 98 | 62 |
| # | 00 100 011 | 043 | 35 | 23 | c | 01 100 011 | 143 | 99 | 63 |
| \$ | 00 100 100 | 044 | 36 | 24 | d | 01 100 100 | 144 | 100 | 64 |
| % | 00 100 101 | 045 | 37 | 25 | e | 01 100 101 | 145 | 101 | 65 |
| & | 00 100 110 | 046 | 38 | 26 | f | 01 100 110 | 146 | 102 | 66 |
| ' | 00 100 111 | 047 | 39 | 27 | g | 01 100 111 | 147 | 103 | 67 |
| (| 00 101 000 | 050 | 40 | 28 | h | 01 101 000 | 150 | 104 | 68 |
|) | 00 101 001 | 051 | 41 | 29 | i | 01 101 001 | 151 | 105 | 69 |
| * | 00 101 010 | 052 | 42 | 2A | j | 01 101 010 | 152 | 106 | 6A |
| + | 00 101 011 | 053 | 43 | 2B | k | 01 101 011 | 153 | 107 | 6B |
| , | 00 101 100 | 054 | 44 | 2C | l | 01 101 100 | 154 | 108 | 6C |
| - | 00 101 101 | 055 | 45 | 2D | m | 01 101 101 | 155 | 109 | 6D |
| . | 00 101 110 | 056 | 46 | 2E | n | 01 101 110 | 156 | 110 | 6E |
| / | 00 101 111 | 057 | 47 | 2F | o | 01 101 111 | 157 | 111 | 6F |
| 0 | 00 110 000 | 060 | 48 | 30 | p | 01 110 000 | 160 | 112 | 70 |
| 1 | 00 110 001 | 061 | 49 | 31 | q | 01 110 001 | 161 | 113 | 71 |
| 2 | 00 110 010 | 062 | 50 | 32 | r | 01 110 010 | 162 | 114 | 72 |
| 3 | 00 110 011 | 063 | 51 | 33 | s | 01 110 011 | 163 | 115 | 73 |
| 4 | 00 110 100 | 064 | 52 | 34 | t | 01 110 100 | 164 | 116 | 74 |
| 5 | 00 110 101 | 065 | 53 | 35 | u | 01 110 101 | 165 | 117 | 75 |
| 6 | 00 110 110 | 066 | 54 | 36 | v | 01 110 110 | 166 | 118 | 76 |
| 7 | 00 110 111 | 067 | 55 | 37 | w | 01 110 111 | 167 | 119 | 77 |
| 8 | 00 111 000 | 070 | 56 | 38 | x | 01 111 000 | 170 | 120 | 78 |
| 9 | 00 111 001 | 071 | 57 | 39 | y | 01 111 001 | 171 | 121 | 79 |
| : | 00 111 010 | 072 | 58 | 3A | z | 01 111 010 | 172 | 122 | 7A |
| ; | 00 111 011 | 073 | 59 | 3B | { | 01 111 011 | 173 | 123 | 7B |
| < | 00 111 100 | 074 | 60 | 3C | | 01 111 100 | 174 | 124 | 7C |
| = | 00 111 101 | 075 | 61 | 3D | ~ | 01 111 101 | 175 | 125 | 7D |
| > | 00 111 110 | 076 | 62 | 3E | DEL | 01 111 110 | 176 | 126 | 7E |
| ? | 00 111 111 | 077 | 63 | 3F | | | 177 | 127 | 7F |

FM) to be within tolerance from the time the modulation (audio oscillator) is initially turned on. An FM deviation change typically occurs 60 ms after the final terminator (Units key) triggers the change. Turning the FM off takes about 20 ms. Amplitude modulation normally takes about 120 ms to turn off or to change to a new depth. Software execution time in the modulation mode is insignificant.

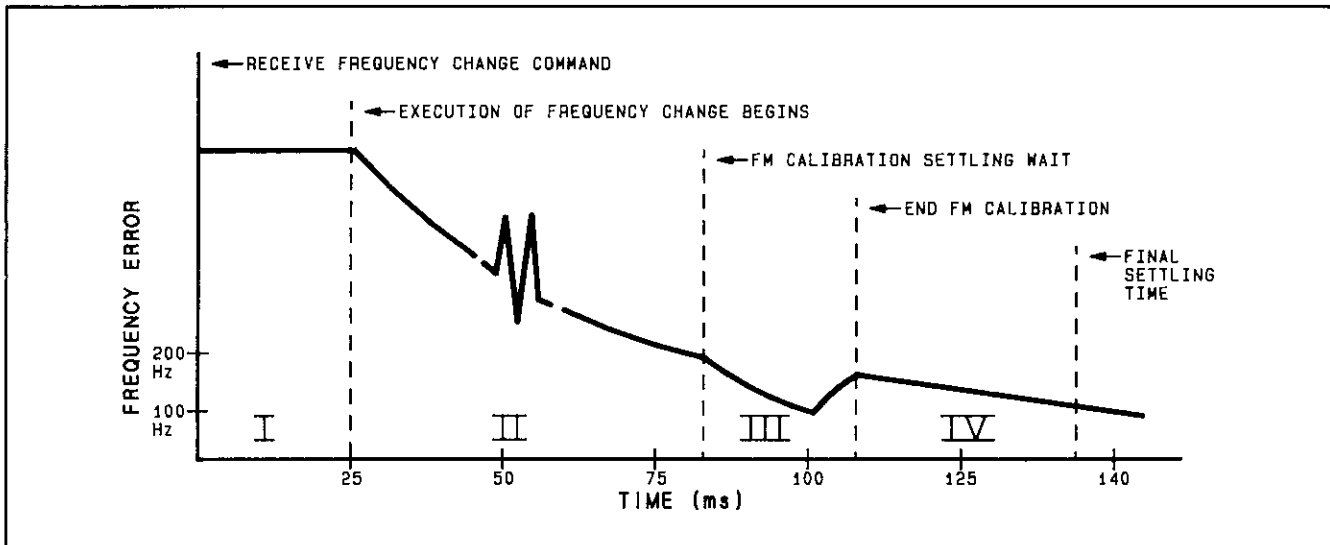

Figure 3-6. Frequency Switching Characteristics

3-39. Introduction to the Detailed Operating Instructions.

The Detailed Operating Instructions describe most of the features and functions that can be accessed by the user.

Title: Lists the main feature or function to be discussed.

Description: Describes the feature or function.

Keystroke Sequence: Enables the user to perform the feature or function that is explained in the "Description."

Example: Describes the necessary steps required to accomplish one or more of the features or functions discussed in the "Keystroke Sequence."

Keys and Program Codes: Lists a table with the associated keys and HP-IB program codes for controller execution of that feature or function.

Indications: Describes the expected response of the instrument when the keystroke sequence is performed; which annunciators will light, and which displays are used.

Comments: Describes any miscellaneous information, any discrepancies in the instrument's performance or statements to clarify the feature or function capabilities.

Related Instructions: Lists other features or functions which are similar in operation.

DETAILED OPERATING INSTRUCTIONS

AMPLITUDE

Description This instruction details how to set the output amplitude.

Operating Characteristics:

Range: +13 dBm to -127 dBm (+1.00V to +0.100 μ V)
Resolution: 0.1 dB

Keystroke Sequence Press the AMPTD Function key, the desired Data keys, and a valid Units key or combination of valid Units keys.

Examples Set the output amplitude to -12.3 dBm.

| LOCAL (keys) | FUNCTION | DATA | UNITS |
|-----------------------|-------------|-----------|-------|
| | AMPTD | - 1 2 . 3 | dBm |
| HP-IB (program codes) | AP -12.3 DM | | |

Set the output amplitude to -2.0 dB EMF μ V.

| LOCAL (keys) | FUNCTION | DATA | UNITS |
|-----------------------|------------------|---------|----------------|
| | AMPTD | - 2 . 0 | dB EMF μ V |
| HP-IB (program codes) | AP -2.0 DB EM UV | | |

Keys and Program Codes



| Keys | Codes |
|---------|-------|
| AMPTD | AP |
| dBm | DM |
| dBf | DF |
| dB | DB |
| EMF | EM |
| V | VL |
| mV | MV |
| μ V | UV |

Indications The selected output amplitude (with sign and units) will be displayed in the AMPLITUDE Display.

DETAILED OPERATING INSTRUCTIONS

AMPLITUDE (Cont'd)
Comments

Digits selected beyond the specified resolution of the AMPLITUDE Display are truncated.

Leading zeros are blanked.

Calibrated level is from -127 dBm to $+13$ dBm with overrange to the maximum power of the instrument.

Minus sign may be entered at any time before the final terminator.

Amplitude Data entries that would cause the peak envelope power of the instrument to exceed $+17$ dBm are rejected.

Amplitude function remains selected until:

- a. One of the three remaining functions is selected (AM, FM, or FREQUENCY).
- b. One of the STORE, RECALL, SEQUENCE keys or Display (SHIFT, DSPL) is pressed.
- c. The instrument is preset, unplugged, or switched to standby.

Fourteen valid units entries are possible which will cause one or more AMPLITUDE annunciators to light. They are as follows:

| | | | |
|-------|----------------|-------|-------------|
| dBm | dB μ V | V EMF | mV |
| dBf | dB EMF V | mV | EMF μ V |
| dB V | dB EMF mV | uV | |
| dB mV | dB EMF μ V | EMF V | |

Whenever a reverse power condition is detected, all segments and all seven LED annunciators associated with the AMPLITUDE Display flash until the source of reverse power is removed and the AMPTD key is pressed.

Related Instructions

Amplitude Conversion
Amplitude, Up/Down

DETAILED OPERATING INSTRUCTIONS

AMPLITUDE CONVERSION

Description This instruction details how to change the AMPLITUDE Display from power units in dBm to any one of 13 other valid unit configurations. This feature does not affect the actual output amplitude of the Signal Generator.

Keystroke Sequence Press any valid Units key or combination of valid Units keys with the amplitude function selected.

Example The AMPLITUDE display shows 10.0 dBm. Change the display to units of dB μ V. (The resulting display will be 117.0 dB μ V.)

| | | |
|----------------------------------|--------------------------|-------------------------|
| | PREFIX TERMINATOR | FINAL TERMINATOR |
| LOCAL (keys) | dB | μ V |
| HP-IB (program codes) | DB UV | |

Keys and Program Codes

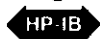

| Keys | Codes |
|----------------------|-------------------|
| dBm ¹ | DM ¹ |
| dBf ¹ | DF ¹ |
| dB ^{2,3} | DB ^{2,3} |
| EMF ² | EM ² |
| V ¹ | VL ¹ |
| mV ¹ | MV ¹ |
| μ V ¹ | UV ¹ |

¹ Final Terminator.
² Prefix Terminator.
³ Final Terminator for Increment Set Mode.

Indications The AMPLITUDE Display changes to reflect the newly selected units, and the corresponding annunciator(s) will light.

Comments The Amplitude function must be selected before the conversion entry or entries are made. Logarithmic Data entries (dBm or dBf) will be displayed in the AMPLITUDE Display with 0.1 dB resolution. The dBm or dBf Units terminator overrides a dB or EMF terminator. If a dB or EMF Units terminator is selected, the AMPLITUDE Display is blanked, the corresponding annunciator lights, and the Signal Generator waits for a final terminator to be entered.

DETAILED OPERATING INSTRUCTIONS

AMPLITUDE CONVERSION (Cont'd)

Linear Data entries (V, mV, or μ V) are displayed in the three most significant digits of the AMPLITUDE Display, and the linear terminator is autoranged (or adjusted) to comply with this condition.

Conversion formulas used are as follows:

$$\begin{aligned} \text{dBm} &= \text{dBm} \\ \text{dBf} &= \text{dBm} + 120.0 \\ \text{dB V} &= \text{dBm} - 13.0 \\ \text{dB mV} &= \text{dBm} + 47.0 \\ \text{dB } \mu\text{V} &= \text{dBm} + 107.0 \\ \text{dB EMF V} &= \text{dBm} - 7.0 \\ \text{dB EMF mV} &= \text{dBm} + 53.0 \\ \text{dB EMF } \mu\text{V} &= \text{dBm} + 113.0 \\ \text{V} &= 10^{(\text{dBm} - 13.0)/20} \\ \text{mV} &= 10^{(\text{dBm} + 47.0)/20} \\ \text{uV} &= 10^{(\text{dBm} + 107.0)/20} \\ \text{EMF V} &= 10^{(\text{dBm} - 7.0)/20} \\ \text{EMF mV} &= 10^{(\text{dBm} + 53.0)/20} \\ \text{EMF } \mu\text{V} &= 10^{(\text{dBm} + 113.0)/20} \end{aligned}$$

**Related
Instructions**

Amplitude
Amplitude, Up/Down

DETAILED OPERATING INSTRUCTIONS

AMPLITUDE OFFSET

Description This instruction details how to change the RF output amplitude by the value stored in the Amplitude Offset storage register.

Keystroke Sequence Press the SHIFT key, the AMPTD key, then enter the Amplitude Offset in dB.

Example Add Amplitude Offset of +2 dB to the RF OUTPUT.

| LOCAL (keys) | SPECIAL FEATURE | DATA | UNITS |
|-----------------------|-----------------|------|-------|
| | SHIFT AMPTD | 2 | dB |
| HP-IB (program codes) | AO 2 D3 | | |

Keys and Program Codes



| Keys | Codes |
|---|-----------|
| SHIFT AMPTD dB | AO* DB |
| *NOTE: Not to be confused with AO (zero). | |

Indications The actual RF OUTPUT amplitude is increased by 2 dB over the displayed value.

Comments The Amplitude Offset value is shown in the AMPLITUDE display until a valid UNITS terminator is pressed.

A change in RF OUTPUT amplitude that would make the sum of the amplitude and offset to be above or below the legal limits of the instrument, will cause the instrument to output only a maximum or minimum output limit.

The Amplitude Offset storage register initializes to a value of 0 dB whenever an instrument preset is done, and whenever the instrument is switched from STBY to ON.

Performing this feature:

- Clears any previously selected function.

- Does not affect the original AMPLITUDE display setting.

Related Instructions Display Amplitude Offset

DETAILED OPERATING INSTRUCTIONS

AMPLITUDE, UP/DOWN

Description This instruction details how to change the output amplitude by the value stored in the output amplitude increment register.

Keystroke Sequence Press the step-up or step-down keys associated with the output amplitude function.

Keys and Program Codes



| Keys | Codes |
|-----------------|----------------|
| AMPTD ▲ ▼ | AP UP DN |

NOTE

During remote operation, repeated UP or DN codes can be sent over the bus once the amplitude function is selected.

Indications The output amplitude shown in the AMPLITUDE Display, and the output of the Signal Generator changes by the value stored in the output amplitude increment register.

Comments Step-up and step-down keys, associated with the output amplitude function, are used to change the output amplitude by the value stored in the output amplitude increment register.

If the output amplitude increment is set to a value that would cause the instrument to exceed a range of +17 dBm to -127 dBm, the step-up and step-down keys become inoperative. A correct decrease in the increment setting re-enables the step-up and step-down keys.

Performing this feature:

Places the instrument in the Amplitude Data entry mode, and clears any previously selected function.

Continues to change the output amplitude by the value stored in the output amplitude increment register if either key remains pressed.

Increment entries are checked against maximum and minimum allowable increment limits. If a limit is exceeded, the increment entry is either truncated or rejected.

Initialized value and limits of the output amplitude increment are as follows:

| Initialized Value | Minimum Value | Maximum Value |
|-------------------|--|--|
| 10.0 dB | 0.1 dB 0.001 μ V 0.001 EMF μ V | \leq 144.0 dB \leq 1.57V \leq 3.15 EMF V |

Related Instructions Amplitude
Amplitude Conversion
Increment Value Change
Increment Value Display

DETAILED OPERATING INSTRUCTIONS

DISPLAY AMPLITUDE OFFSET

Description This instruction details how to display the stored contents of the Amplitude Offset register.

Keystroke Sequence Press the SHIFT key, then press and hold the AMPTD key.

Example Display contents of the Amplitude Offset register.

| | | |
|----------------------------------|---|-------|
| LOCAL (keys) | SHIFT | AMPTD |
| HP-IB (program codes) | This feature is not accessible via HP-IB. | |

Indications The Amplitude Offset value is shown in the AMPLITUDE display as long as the AMPTD key remains pressed.

Comments The Amplitude Offset storage register initializes to a value of 0 dB whenever an instrument preset is done, and whenever the instrument is switched from STBY to ON.
If the RF OFF/ON control is switched to OFF, the AMPLITUDE display can still be used to display the Amplitude Offset value.

- Performing this feature:
- Clears any previously selected function.
 - Does not affect the original AMPLITUDE display setting.
 - Keeps the instrument in the Amplitude Offset mode until another mode key is pressed.

Related Instructions Amplitude Offset Display
Display Sequence
HP-IB Address Display
Increment Value Display

DETAILED OPERATING INSTRUCTIONS

DISPLAY

- Description** This instruction details how to selectively display the stored contents of a storage register.
- Keystroke Sequence** Press the SHIFT key, press DSPL, then press and hold the Data key (a single digit register number 0—9).
- Example** Display the stored contents from register 2.

| | | | |
|----------------------------------|---|-------------|---|
| LOCAL (keys) | SHIFT | DSPL SEQ | 2 |
| HP-IB (program codes) | This feature is not accessible via HP-IB. | | |

- Indications** The stored contents from the selected register are displayed as long as the Data key remains pressed.
- Comments** Ten storage registers are available (0—9). Each is capable of storing complete front-panel setups (exclusive of increment settings).
 Performing this feature:
 Does not affect the actual output of the Signal Generator.
 Does not change the contents of the sequence counter.
 Does not affect the current increment settings.
 Clears any previously selected function.
 All displays are restored to reflect the actual Signal Generator output when the Data key is released.

- Related Instructions**
- Display Amplitude Offset
 - Display Sequence
 - Recall
 - Sequence
 - Store

DETAILED OPERATING INSTRUCTIONS

DISPLAY SEQUENCE

Description This instruction details how to display the contents of the sequence counter.

Keystroke Sequence Press the SHIFT key, press DSPL, and then press and hold the SEQ key.

Example Display the contents of the sequence counter.

| | | | |
|----------------------------------|---|-------------|-----|
| LOCAL (keys) | SHIFT | DSPL SEQ | SEQ |
| HP-IB (program codes) | This feature is not accessible via HP-IB. | | |

Indications The stored contents from the sequence counter are displayed in the least significant digit of the AMPLITUDE Display as long as the SEQ key remains pressed.

Comments Ten storage register numbers can be displayed (0—9), a different register number each time the sequence feature is performed.

Performing this feature:

- Clears any previously selected function.
- Does not affect the current increment settings.
- Does not change the contents of the sequence counter.
- Does not affect the actual output of the Signal Generator.

The AMPLITUDE Display is restored to reflect the actual Signal Generator output when the SEQ key is released.

Related Instructions Display
Display Amplitude Offset
Sequence

DETAILED OPERATING INSTRUCTIONS

FREQUENCY

Description This instruction details how to set the carrier frequency.

Operating Characteristics:

Range: 100 kHz to 990 MHz (990.00000 MHz)

Resolution: 10 Hz

Keystroke Sequence Press the FREQUENCY Function key, the desired Data keys, and a valid Units key.

Example Set the carrier frequency to 123.45 MHz.

| | | | |
|----------------------------------|-----------------|-------------|--------------|
| LOCAL (keys) | FUNCTION | DATA | UNITS |
| | FREQUENCY | 1 2 3 . 4 5 | MHz |
| HP-IB (program codes) | FR 123.45 MZ | | |

Keys and Program Codes



| Keys | Codes |
|-----------|-------|
| FREQUENCY | FR |
| MHz | MZ |
| kHz | KZ |
| No key | HZ |

Indications The selected carrier frequency is displayed in megahertz in the FREQUENCY Display.

Comments Digits selected beyond the specified resolution of the FREQUENCY Display are truncated. Leading zeros are blanked.

Carrier frequencies below 100 kHz will result in an uncalibrated output amplitude.

The MODULATION Display flashes if a change in carrier frequency causes the FM peak deviation allowed for that frequency band to be exceeded. Entering a carrier frequency that sets the instrument in the correct band for the selected deviation frequency clears the error condition, or pressing one of the following keys automatically adjusts the FM peak deviation to the maximum frequency possible for that frequency band.

| Band | Carrier Frequency (MHz) |
|------|-------------------------|
| 1 | 0.1-123.5 |
| 2 | 123.5-247 |
| 3 | 247-494 |
| 4 | 494-990 |



DETAILED OPERATING INSTRUCTIONS

FREQUENCY (Cont'd)

Frequency function remains selected until:

- a. One of the three remaining functions is selected (AM, FM, or AMPTD).
- b. One of the STORE, RECALL, SEQUENCE keys or Display (SHIFT, DSPL) is pressed.
- c. The instrument is preset, unplugged, or switched to standby.

**Related
Instructions**

Frequency, Coarse and Fine Tune
Frequency, Up/Down

DETAILED OPERATING INSTRUCTIONS

FREQUENCY, COARSE AND FINE TUNE





Description This instruction details how to quickly tune the carrier frequency in decade steps using the step-up and step-down keys associated with the carrier frequency function.

Keystroke Sequence This feature is enabled by pressing either the COARSE TUNE or FINE TUNE key. Pressing either key will increase (COARSE TUNE) or decrease (FINE TUNE) the carrier frequency timing value by a factor of 10.

Pressing the step-up key increases the carrier frequency by the newly selected carrier frequency timing value, while pressing the step-down key decreases the carrier frequency.

This feature is disabled and the original carrier frequency increment value is enabled by pressing the INCR SET key (with the frequency function selected).

Example Enable a carrier frequency tuning value of 10 kHz (assuming a starting value of 10 MHz).

| | | | |
|---|---|--|---|
| LOCAL (keys) |  |  |  |
|  (program codes) | This feature is not accessible via HP-IB. | | |

Indications Whenever the COARSE TUNE or FINE TUNE key is pressed and held, the frequency digit that corresponds to the carrier frequency tuning value will flash.

When the COARSE TUNE key is pressed again, the next digit to the left will flash to indicate the new tuning value.

When the FINE TUNE key is pressed again, the next digit to the right will flash to indicate the new tuning value.

Comments This feature only applies to the carrier frequency function.

COARSE TUNE and FINE TUNE keys are always available to change the carrier frequency timing value by a factor of 10.

Performing this feature:

Places the instrument into the frequency Data entry mode, and clears any previously selected function, once either the step-up or step-down key is pressed.

Enables the last valid carrier frequency increment value when the INCR SET key is pressed.

Related Instructions Frequency
Frequency, Up/Down
Increment Value Change

DETAILED OPERATING INSTRUCTIONS

FREQUENCY, PHASE UP/DOWN

Description This instruction details how to change the carrier frequency phase in one-degree increments or decrements.

Keystroke Sequence Press the SHIFT key, then press the step-up or step-down keys associated with the carrier frequency function.

Example Change the carrier frequency phase to lead one degree.

| | | |
|----------------------------------|-------|------------|
| LOCAL (keys) | SHIFT | ▲ Φ ↑ |
| HP-IB (program codes) | PI | |

Keys and Program Codes



| Keys | Codes |
|----------|-------|
| Φ ▲ | PI |
| Φ ▼ | PD |

NOTE

During remote operation, repeated PI or PD codes can be sent over the bus.

Indications The carrier frequency phase at the RF OUTPUT of the Signal Generator changes in one-degree steps each time the keystroke sequence is followed.

Comments Step-up and step-down keys, associated with the carrier frequency function, are used to change the carrier frequency phase by one-degree increments or decrements.

Performing this feature:

Continues to change the carrier frequency phase in one-degree increments or decrements if either step-up or step-down key remains pressed.

Does not affect any previously selected function.

Related Instructions None

DETAILED OPERATING INSTRUCTIONS

FREQUENCY, UP/DOWN

Description

This instruction details how to change the carrier frequency by the value stored in the carrier frequency increment register.

Keystroke Sequence

Press the step-up or step-down keys associated with the carrier frequency function.

Keys and Program Codes



| Keys | Codes |
|---------------------|----------------|
| FREQUENCY ↑ ↓ | FR UP DN |

NOTE

During remote operation, repeated UP or DN codes can be sent over the bus once the frequency function is selected.

Indications

The carrier frequency shown in the FREQUENCY Display, and the output of the Signal Generator changes by the value stored in the carrier frequency increment register.

Comments

Step-up and step-down keys associated with the carrier frequency function are used to change the carrier frequency by the value stored in the carrier frequency increment register.

Performing this feature:

Places the instrument in the Frequency Data entry mode, and clears any previously selected function.

Continues to change the carrier frequency by the value stored in the carrier frequency increment register if either key remains pressed.

Increment entries are checked against maximum and minimum allowable increment limits. If a limit is exceeded, the increment entry is either truncated or rejected.

If the carrier frequency increment is set to a value that would cause the instrument to exceed its frequency range, the step-up and step-down keys become inoperative. A correct decrease in the increment setting re-enables the step-up and step-down keys.

The MODULATION Display flashes if a change in carrier frequency causes the FM peak deviation allowed for that frequency band to be exceeded. Entering a carrier frequency that sets the instrument in the correct band for the selected deviation frequency clears the error condition, or pressing one of the following keys automatically adjusts the FM peak deviation to the maximum frequency possible for that frequency band.

| Band | Carrier Frequency (MHz) |
|------|-------------------------|
| 1 | 0.1-123.5 |
| 2 | 123.5-247 |
| 3 | 247-494 |
| 4 | 494-990 |



DETAILED OPERATING INSTRUCTIONS

FREQUENCY, UP/DOWN (Cont'd)

Initialized value and limits of the carrier frequency increment are as follows:

| Initialized Value | Minimum Value | Maximum Value |
|-------------------|---------------|---------------|
| 10.00000 MHz | 0.01 kHz | ≤989.99 MHz |

**Related
Instructions**

Frequency
Frequency, Coarse and Fine Tune
Increment Value Change
Increment Value Display

DETAILED OPERATING INSTRUCTIONS

HP-IB ADDRESS DISPLAY

Description This instruction details how to display the internally set, decimal HP-IB address.

Keystroke Sequence Press the SHIFT key, then press and hold ADRS.

Example Display the internally-set, decimal HP-IB address.

| | | |
|---|--|---|
| <p>LOCAL (keys)</p> | <p style="text-align: center;">SHIFT</p> | <p style="text-align: center;">ADRS LOCAL</p> |
| <p>HP-IB (program codes)</p> | <p style="text-align: center;">This feature is not accessible via HP-IB.</p> | |

Indications The internally set, decimal HP-IB address is displayed in the MODULATION Display as long as ADRS remains pressed.

Comments HP-IB addresses greater than 30 (decimal) are interpreted as 30.
 HP-IB address is factory-set to 07 decimal. (In binary, this is 00111, the equivalent ASCII character is an apostrophe).
 The HP-IB address is updated only when the instrument is powered up.
 To change the HP-IB address, refer to paragraph 2-8, HP-IB Address Selection.
 The MODULATION Display is restored to reflect the actual Signal Generator output when ADRS is released.

DETAILED OPERATING INSTRUCTIONS

HP-IB ADDRESS DISPLAY (Cont'd)

Allowable HP-IB Address Codes

| Address Switch | | | | | Equivalent ASCII Character (Listen) | Equivalent Decimal Value (Listen) |
|----------------|----|----|----|----|---|---|
| A5 | A4 | A3 | A2 | A1 | | |
| 0 | 0 | 0 | 0 | 0 | SP | 00 |
| 0 | 0 | 0 | 0 | 1 | ! | 01 |
| 0 | 0 | 0 | 1 | 0 | " | 02 |
| 0 | 0 | 0 | 1 | 1 | # | 03 |
| 0 | 0 | 1 | 0 | 0 | \$ | 04 |
| 0 | 0 | 1 | 0 | 1 | % | 05 |
| 0 | 0 | 1 | 1 | 0 | & | 06 |
| 0 | 0 | 1 | 1 | 1 | ' | 07 |
| 0 | 1 | 0 | 0 | 0 | (| 08 |
| 0 | 1 | 0 | 0 | 1 |) | 09 |
| 0 | 1 | 0 | 1 | 0 | * | 10 |
| 0 | 1 | 0 | 1 | 1 | + | 11 |
| 0 | 1 | 1 | 0 | 0 | , | 12 |
| 0 | 1 | 1 | 0 | 1 | - | 13 |
| 0 | 1 | 1 | 1 | 0 | . | 14 |
| 0 | 1 | 1 | 1 | 1 | / | 15 |
| 1 | 0 | 0 | 0 | 0 | 0 | 16 |
| 1 | 0 | 0 | 0 | 1 | 1 | 17 |
| 1 | 0 | 0 | 1 | 0 | 2 | 18 |
| 1 | 0 | 0 | 1 | 1 | 3 | 19 |
| 1 | 0 | 1 | 0 | 0 | 4 | 20 |
| 1 | 0 | 1 | 0 | 1 | 5 | 21 |
| 1 | 0 | 1 | 1 | 0 | 6 | 22 |
| 1 | 0 | 1 | 1 | 1 | 7 | 23 |
| 1 | 1 | 0 | 0 | 0 | 8 | 24 |
| 1 | 1 | 0 | 0 | 1 | 9 | 25 |
| 1 | 1 | 0 | 1 | 0 | : | 26 |
| 1 | 1 | 0 | 1 | 1 | ; | 27 |
| 1 | 1 | 1 | 0 | 0 | < | 28 |
| 1 | 1 | 1 | 0 | 1 | = | 29 |
| 1 | 1 | 1 | 1 | 0 | > | 30 |

Indicates factory-set address.

**Related
Instructions**

Display Amplitude Offset

DETAILED OPERATING INSTRUCTIONS

INCREMENT VALUE CHANGE

Description

This instruction details how to change the value of the stored increments which are controlled by the step-up and step-down keys associated with each of the four main functions. Increment values for the carrier frequency, output amplitude, AM depth, and FM peak deviation can be stored. The initialized value of each stored increment is listed as follows:

| Function | Initialized Value |
|-------------------|-------------------|
| Carrier Frequency | 100.00000 MHz |
| Output Amplitude | 10.0 dB |
| AM Depth | 1% |
| FM Peak Deviation | 1.0 kHz |

Keystroke Sequence

Press a Function key, the INCR SET key, the desired Data keys, and a valid Units Key.

Example

Set a carrier frequency increment of 1 MHz.

| | FUNCTION | INCREMENT SET | DATA | UNITS |
|------------------------------|------------|---------------|------|-------|
| LOCAL (keys) | FREQUENCY | INCR SET | 1 | MHz |
| HP-IB (program codes) | FR IS 1 MZ | | | |

Keys and Program Codes



| Keys | Codes |
|-----------|-------|
| INCR SET | IS |
| FREQUENCY | FR |
| AMPTD | AP |
| AM | AM |
| FM | FM |
| MHz | MZ |
| kHz | KZ |
| No Key | HZ |

| Keys | Codes |
|------|---------|
| % | PC or % |
| dBm | DM |
| dBf | DF |
| dB | DB |
| EMF | EM |
| V | VL |
| mV | MV |
| μV | UV |

Indications

The value of the increment appears in the display associated with the selected function as the data is entered.

Comments

FM peak deviation increments are selected in units of kHz only. AM depth is selected without fractional digits. All fractional digits are truncated.

DETAILED OPERATING INSTRUCTIONS

INCREMENT VALUE CHANGE (Cont'd)

If the increment value change is set to a value that would cause the instrument to exceed a minimum or maximum range, the step-up and step-down key associated with that function become inoperative. A correct decrease in the increment setting re-enables the step-up and step-down keys.

Increment entries are checked against maximum and minimum allowable increment limits. If a limit is exceeded the increment entry is either truncated or rejected.

Minimum and maximum allowable increment values for each of the four main functions are listed as follows:

| Function | Minimum Value | Maximum Value |
|-------------------|---------------|---------------|
| Carrier Frequency | 0.01 kHz | ≤989.99 MHz |
| Output Amplitude | 0.1 dB | ≤144.0 dB |
| | 0.001 μV | ≤1.57 V |
| | 0.001 EMF μV | ≤3.15 EMF V |
| AM Depth | 1% | ≤99% |
| FM Peak Deviation | 0.1 kHz | ≤99 kHz |

All displays are restored to reflect the actual Signal Generator output as soon as a valid increment terminator is selected.

Related Instructions

- Amplitude, Up/Down
- Frequency, Coarse and Fine Tune
- Frequency, Up/Down
- Modulation, AM Up/Down
- Modulation, DC FM
- Modulation, FM Up/Down
- Increment Value Display

DETAILED OPERATING INSTRUCTIONS

INCREMENT VALUE DISPLAY

Description This instruction details how to display the stored value of the increments which are controlled by the step-up and step-down keys associated with each of the four main functions. Increment values for the carrier frequency, output amplitude, AM depth, and FM peak deviation can be displayed.

Keystroke Sequence Press a function key, then press and hold the INCR SET key.

Example Display the stored carrier frequency increment.

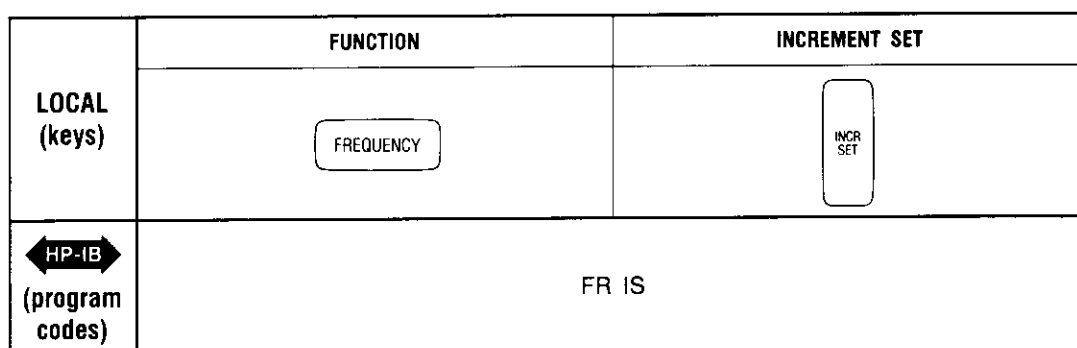

Keys and Program Codes

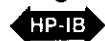

| Keys | Codes |
|-----------|-------|
| INCR SET | IS |
| FREQUENCY | FR |
| AMPTD | AP |
| AM | AM |
| FM | FM |

Indications The stored value of the increment is displayed in the display associated with the selected function as long as the INCR SET key remains pressed.

Comments The initialized value of each stored increment is listed as follows:

| Function | Initialized Value |
|-------------------|-------------------|
| Carrier Frequency | 100.00000 MHz |
| Output Amplitude | 10.0 dB |
| AM Depth | 1% |
| FM Peak Deviation | 1.0 kHz |

The display is restored to reflect the actual Signal Generator output when the INCR SET key is released.

DETAILED OPERATING INSTRUCTIONS

INCREMENT VALUE DISPLAY (Cont'd)

**Related
Instructions**

Amplitude Up/Down
Display Amplitude Offset
Frequency, Up/Down
Increment Value Change
Modulation, AM Up/Down
Modulation, DC FM
Modulation, FM Up/Down



DETAILED OPERATING INSTRUCTIONS

INSTRUMENT PRESET

Description This instruction details how to perform an instrument preset.

Keystroke Sequence Press the SHIFT key, and then the 0 units key.

Example Preset the instrument.

| | | |
|---|---|---|
| LOCAL (keys) |  |  |
|  (program codes) | This feature is not accessible via HP-IB. | |

NOTE

Sending the Clear message via HP-IB is equivalent to performing an instrument preset.

Indications An instrument preset clears any previously selected function. The front-panel indicators will display a carrier frequency of 100.00000 MHz, an output amplitude of -127.0 dBm, and no modulation.

Comments Performing this feature:
 Does not affect storage register memory.
 Clears sequence counter to zero, and current increment setting of each function to their initialized values.

Related Instructions None

DETAILED OPERATING INSTRUCTIONS

MODULATION, AM

Description This instruction details how to select amplitude modulation using the internal modulation source.

Operating Characteristics:

- Depth:** 0—99% +7 dBm
0—30% +10 dBm
- Resolution:** 1%
- Rate (internal):** 400 Hz and 1 kHz, ±3%

Keystroke Sequence Press an Internal Source key, the AM function key, the desired Data keys, and a valid Units key.

Example Select AM with a depth of 75% using the internal 400 Hz source.

| | | | | |
|----------------------------------|------------------|-----------------|-------------|--------------|
| LOCAL (keys) | SOURCE | FUNCTION | DATA | UNITS |
| | INT 400 Hz | AM | 7 5 | % |
| HP-IB (program codes) | S2 AM 75 PC or % | | | |

Keys and Program Codes



| Keys | Codes |
|------------|---------|
| INT 400 Hz | S2 |
| INT 1 kHz | S3 |
| AM | AM |
| % | PC or % |

Indications Selected AM depth is displayed in the MODULATION Display, and the source annunciators (INT AM, 400 Hz, and %) will light.

Comments Digits selected beyond the specified resolution for AM depth are truncated.
 Leading zeros are blanked.
 AM depth Data entries that would cause the peak envelope power of the instrument to exceed +17 dBm are rejected.
 The External Source key may be selected in place of the Internal Source key.
 AM function remains selected until:

- a. One of the three remaining functions is selected (AMPTD, FM, or FREQUENCY).

DETAILED OPERATING INSTRUCTIONS

MODULATION, AM (Cont'd)

- b. One of the STORE, RECALL, SEquence keys or Display (SHIFT, DSPL) is pressed.
- c. The instrument is preset, unplugged, or switched to standby.

A one key sequence acts as a select between the two internal modulation sources.

Only one internal modulation source can be selected at any time either 400 Hz or 1 kHz.

**Related
Instructions**

Modulation, AM Up/Down
Modulation, External Source
Modulation, Mixed
Modulation, Off

DETAILED OPERATING INSTRUCTIONS

MODULATION, AM UP/DOWN

Description This instruction details how to change the percentage of AM depth by the value stored in the AM depth increment register.

Keystroke Sequence Press the step-up or step-down keys associated with the amplitude modulation function.

Keys and Program Codes



| Keys | Codes |
|--------------|----------------|
| AM ↑ ↓ | AM UP DN |

NOTE

In remote operation, repeated UP or DN codes can be sent over the bus once the AM function is selected.

Indications The percentage of AM depth shown in the MODULATION Display, and the output of the Signal Generator changes by the value stored in the AM depth increment register.

Comments Step-up and step-down keys associated with the amplitude modulation function are used to change the percentage of AM depth by the value stored in the AM depth increment register.

Performing this feature:

Places the instrument in the AM Data entry mode, and clears any previously selected function.

Selects default modulation source (internal 1 kHz) if no other source is selected.

Will automatically stop incrementing when the maximum percentage of AM depth permitted for a selected output amplitude is reached.

Continues to change the percentage of AM depth by the value stored in the AM depth increment register if either key remains pressed.

If the AM depth increment is set to a value that would cause the instrument to exceed a modulation depth of 1 to 99% the step-up and step-down keys become inoperative. A correct decrease in the increment setting re-enables the step-up and step-down keys.

Increment entries are checked against maximum and minimum allowable increment limits. If an AM depth increment limit is exceeded the entry is truncated.

Initialized value and limits of the AM depth increment are as follows:

| Initialized Value | Minimum Value | Maximum Value |
|-------------------|---------------|---------------|
| 1% | 1% | ≤99% |

DETAILED OPERATING INSTRUCTIONS

MODULATION, AM UP/DOWN (Cont'd)**Related
Instructions**

Increment Value Change
Increment Value Display
Modulation, AM
Modulation, Off
Modulation, DC FM Up/Down
Modulation, FM Up/Down

DETAILED OPERATING INSTRUCTIONS

MODULATION, DC FM

Description This instructions details how to select dc coupled frequency modulation using an external power source.

Operating Characteristics:

| Carrier Frequency (MHz) | Maximum Peak Deviation |
|-------------------------|------------------------|
| | DC Mode (kHz) |
| 0.1-123.5 | 99 |
| 123.5-247 | 50 |
| 247-494 | 99 |
| 494-990 | 99 |

Resolution: 0.1 kHz for peak deviations <10 kHz
1 kHz for peak deviations ≥10 kHz

DC calibrated input level: ±1 Vdc

CAUTION

Maximum allowable input level is ±15 Vdc. Exceeding this limit may cause damage to the instrument.

Keystroke Sequence

Press the SHIFT key, the FM function key, the desired Data Keys and a valid Units key.

Example

Select DC FM with a peak deviation of 50 kHz.

| LOCAL (keys) | FUNCTION | DATA | UNITS |
|-----------------------|----------|------|-------|
| | SHIFT FM | 5 0 | KHz |
| HP-IB (program codes) | S5 50 KZ | | |

Keys and Program Codes



| Keys | Codes |
|--------------|----------|
| DC FM kHz | S5 KZ |

Indications

Selected DC FM peak deviation are displayed in the MODULATION Display, and the Modulation annunciators (DC FM, EXT FM, and LO EXT) will light.

Comments

Selecting DC FM automatically enables the front-panel MOD INPUT/OUTPUT connector for an external modulation source.

DETAILED OPERATING INSTRUCTIONS

MODULATION, DC FM (Cont'd)

The LO EXT Modulation annunciator remains on regardless of the dc input level applied to the MOD INPUT/OUTPUT connector.

The LO EXT Modulation annunciator turns off if external AM or FM is selected along with DC FM, and the external source has been adjusted to 1 Vpk (0.707 Vrms ±5%).

Digits selected beyond the specified resolution for DC FM peak deviation are truncated.

Leading zeros are blanked.

The instrument is placed in the DC FM Data entry mode, any previously selected function is cleared.

DC FM peak deviation Data entries that would be out-of-range for the selected carrier frequency are rejected.

The MODULATION Display flashes if a change in carrier frequency causes the FM peak deviation allowed for that frequency band to be exceeded. Entering a carrier frequency that sets the instrument in the correct band for the selected deviation frequency clears the error condition, or pressing one of the following keys automatically adjusts the FM peak deviation to the maximum deviation possible for that frequency band.

| Band | Carrier Frequency (MHz) |
|------|-------------------------|
| 1 | 0.1-123.5 |
| 2 | 123.5-247 |
| 3 | 247-494 |
| 4 | 494-990 |



DC FM function remains selected until:

- a. One of the three remaining functions is selected (AM, AMPTD, or FREQUENCY).
- b. One of the STORE, RECALL, SEQUENCE keys or Display (SHIFT, DSPL) is pressed.
- c. The instrument is preset, unplugged, or switched to standby.

Related Instructions

- Modulation, DC FM Up/Down
- Modulation, External Source
- Modulation, Mixed
- Modulation, Off

DETAILED OPERATING INSTRUCTIONS

MODULATION, DC FM UP/DOWN

Description This instruction details how to change the DC FM peak deviation by the value stored in the FM peak deviation increment register.

Keystroke Sequence Press the step-up or step-down keys associated with the frequency modulation function.

Keys and Program Codes



| Keys | Codes |
|-----------------|----------------|
| DC FM ↑ ↓ | S5 UP DN |

NOTE

During remote operation, repeated UP or DN codes can be sent over the bus once the DC FM function is selected.

Indications The DC FM peak deviation shown in the MODULATION Display, and the output of the Signal Generator changes by the value stored in the FM peak deviation increment register.

Comments Step-up and step-down keys associated with the DC FM function are used to change the DC FM peak deviation by the value stored in the FM peak deviation increment register.

Performing this feature:

Continues to change the DC FM peak deviation by the value stored in the FM peak deviation increment register if either key remains pressed.

Will automatically stop incrementing when the maximum FM peak deviation permitted for a selected carrier frequency is reached.

If an out-of-range condition exists (MODULATION Display flashing) pressing either the step-up or the step-down (or FM) key automatically selects the maximum FM peak deviation permitted for the currently selected carrier frequency.

Initialized value and limits of the FM peak deviation increment are as follows:

| Initialized Value | Minimum Value | Maximum Value |
|-------------------|---------------|---------------|
| 1 kHz | 0.1 kHz | ≤99 kHz |

Related Instructions

- Increment Value Change
- Increment Value Display
- Modulation, AM Up/Down
- Modulation, DC FM
- Modulation, FM Up/Down
- Modulation, Off

DETAILED OPERATING INSTRUCTIONS

MODULATION, EXTERNAL SOURCE

Description

This instruction details how to apply an external modulation signal via the front-panel MOD INPUT/OUTPUT connector.

Operating Characteristics:

- Rate:** (AM) 20 Hz to 40 kHz; 1 dB bandwidth, ac coupled
(FM) dc to 50 kHz; ±1 dB 20 Hz to 50 kHz, ac coupled
dc to 100 kHz; ±3 dB
- Input Impedance:** 600 ohms (resistive)
- Input Level:** 1 Vpk (0.707 Vrms)

Keystroke Sequence

Press the EXT key to enable the front-panel MOD INPUT/OUTPUT connector, then set the signal level of the external modulation source to 1 Vpk (0.707 Vrms) for calibrated internal control of the AM depth or FM peak deviation.

Keys and Program Codes



| Keys | Codes |
|------|---------|
| EXT | S1 |
| AM | AM |
| % | PC or % |
| FM | FM |
| kHz | KZ |

Indications

The HI EXT annunciator lights if the external modulation signal is greater than 1.02 Vpk (0.721 Vrms), and the LO EXT annunciator lights if the signal is less than 0.98 Vpk (0.693 Vrms). Both annunciators are off when the input level is 1.00 ±0.02 Vpk (0.707 Vrms), except when exclusively in the DC FM Mode in which case the LO EXT annunciator remains on.

NOTE

If greater accuracy is required, use a calibrated voltmeter to measure the external modulation signal.

Comments

In addition to being able to accept an external modulation signal, the MOD INPUT/OUTPUT connector provides access to the internally generated 400 Hz or 1 kHz signal whenever either is selected, and the external modulation source is not selected. Its signal level is 1 Vpk (0.707 Vrms), and it can not be adjusted by the operator.

For AM or FM the front-panel MOD INPUT/OUTPUT connector is ac coupled. For DC FM the front-panel MOD INPUT/OUTPUT connector is dc coupled.

Related Instructions

- Modulation, AM
- Modulation, DC FM
- Modulation, FM
- Modulation, Mixed
- Modulation, Off

DETAILED OPERATING INSTRUCTIONS

MODULATION, FM

Description This instruction details how to select frequency modulation using the internal modulation source.

Operating Characteristics:

| Carrier Frequency (MHz) | Maximum Peak Deviation | |
|-------------------------|------------------------|---------------|
| | Rates ≥ 50 Hz | Rates < 50 Hz |
| 0.1-123.5 | 99 kHz | 4000 × Rate |
| 123.5-247 | 50 kHz | 2000 × Rate |
| 247-494 | 99 kHz | 4000 × Rate |
| 494-990 | 99 kHz | 4000 × Rate |

Resolution: 0.1 kHz for peak deviations <10 kHz
 1 kHz for peak deviations ≥10 kHz

Rate (internal): 400 Hz or 1 kHz, ±3%

Keystroke Sequence Press an internal Source key, the FM Function key, the desired Data keys, and a valid Units key.

Example Select FM with a peak deviation of 25 kHz using the internal 400 Hz source.

| LOCAL (keys) | SOURCE | FUNCTION | DATA | UNITS |
|-----------------------|-------------|----------|------|-------|
| | INT 400 Hz | FM | 2 5 | kHz |
| HP-IB (program codes) | S2 FM 25 KZ | | | |

Keys and Program Codes



| Keys | Codes |
|------------|-------|
| INT 400 Hz | S2 |
| INT 1 kHz | S3 |
| FM | FM |
| kHz | KZ |

Indications Selected FM peak deviation are displayed in the MODULATION Display, and the source annunciators (INT FM, 400 Hz, and 1 kHz) will light.

Comments Digits selected beyond the specified resolution for FM peak deviation are truncated. Leading zeros are blanked.

A one-key sequence acts as a select between the two internal modulation sources.

DETAILED OPERATING INSTRUCTIONS

MODULATION, FM (Cont'd)

The External Source key may be selected in place of the Internal Source key.

Only one internal modulation source can be selected at any time, either 400 Hz or 1 kHz.

FM peak deviation Data entries are rejected if they would cause the selected carrier frequency to be out-of-range.

The MODULATION Display flashes if a change in carrier frequency causes the FM peak deviation allowed for that frequency band to be exceeded. Entering a carrier frequency that sets the instrument in the correct band for the selected deviation frequency clears the error condition, or pressing one of the following keys automatically adjusts the FM peak deviation to the maximum frequency possible for that frequency band.

| Band | Carrier Frequency (MHz) |
|------|-------------------------|
| 1 | 0.1-123.5 |
| 2 | 123.5-247 |
| 3 | 247-494 |
| 4 | 494-990 |



FM function remains selected until:

- a. One of the three remaining functions is selected (AM, AMPTD, or FREQUENCY).
- b. One of the STORE, RECALL, SEQUENCE keys or Display (SHIFT, DSPL) is pressed.
- c. The instrument is preset, unplugged, or switched to standby.

Related Instructions

- Modulation, FM Up/Down
- Modulation, External Source
- Modulation, Mixed
- Modulation, Off

DETAILED OPERATING INSTRUCTIONS

MODULATION, FM UP/DOWN

Description This instruction details how to change the FM peak deviation by the value stored in the FM peak deviation increment register.

Keystroke Sequence Press the step-up or step-down keys associated with the frequency modulation function.

Keys and Program Codes



| Keys | Codes |
|--------------|----------------|
| FM ↑ ↓ | FM UP DN |

NOTE

In remote operation, repeated UP or DN codes can be sent over the bus once the FM function is selected.

Indications The FM peak deviation shown in the MODULATION Display, and the output of the Signal Generator changes by the value stored in the FM peak deviation increment register.

Comments Step-up and step-down keys associated with the frequency modulation function are used to change the FM peak deviation by the value stored in the FM peak deviation increment register.

If the FM peak deviation increment is set to a value that would cause the instrument to exceed its peak deviation range, the step-up and step-down keys become inoperative. A correct decrease in the increment setting re-enables the step-up and step-down keys.

Performing this feature:

Places the instrument in the FM Data entry mode, and clears any previously selected function.

Selects default modulation source (internal 1 kHz) if no other source is selected.

Continues to change the FM peak deviation by the value stored in the FM peak deviation increment register if either key remains pressed.

Will automatically stop incrementing when the maximum FM peak deviation permitted for a selected carrier frequency is reached.

If an out-of-range condition exists (MODULATION Display flashing), pressing either the step-up or step-down (or FM) key automatically selects the maximum FM peak deviation permitted for the currently selected carrier frequency.

Increment entries are checked against maximum and minimum allowable increment limits. If a limit is exceeded, the increment entry is either truncated or rejected.

Initialized value and limits of the FM peak deviation increment are as follows:

| Initialized Value | Minimum Value | Maximum Value |
|-------------------|---------------|---------------|
| 1.0 kHz | 0.1 kHz | ≤99 kHz |

DETAILED OPERATING INSTRUCTIONS

MODULATION, FM UP/DOWN (Cont'd)

**Related
Instructions**

Increment Value Change
Increment Value Display
Modulation, AM Up/Down
Modulation, FM
Modulation, DC FM Up/Down
Modulation, Off

DETAILED OPERATING INSTRUCTIONS

MODULATION, MIXED

Description

These instructions detail the selection of mixed modulation. Modulation is selected in one of five ways.











1. Simultaneous AM and FM is selected using common or separate modulation sources (rate).
2. Simultaneous AM or FM at two rates is selected by using internal and external modulation sources. Only one AM depth or one FM deviation can be selected.
3. Three simultaneous modulation signals, AM and FM using a common source (rate) and either AM or FM from a separate source, may be selected.
4. Four simultaneous modulation signals, two AM and two FM, may be selected. Each AM/FM pair must have a common modulation source (rate). Only one AM depth and one FM deviation can be selected.
5. DC FM may be selected and entered along with any of the four ways mentioned in statements 1-4.

Keystroke Sequence 1

To select simultaneous AM and FM, press the Source key to provide the desired AM rate, the AM Function key, the desired Data keys, and the % Units key. Then press the Source key to provide the desired FM rate, the FM Function key, the desired Data keys, and the kHz Units key. (The Source key need not be pressed for FM if the AM and FM rate is the same. Only one internal rate can be used at a time.)

Example 1

Simultaneously select AM with a depth of 70% and FM with a peak deviation of 3 kHz using the internal 400 Hz source, and an external 1 kHz source respectively.

| | SOURCE | FUNCTION | DATA | UNITS |
|---|---|---|---|---|
| LOCAL (keys) |  |  |   |  |
| |  |  |  |  |
|  (program codes) | S2 AM 70 PC or % S1 FM 3 KZ | | | |

Keystroke Sequence 2

To select simultaneous AM or FM, press the desired Source key, the desired Function key, the desired Data keys, and a valid Units key. Then press the other Source key, and the same Function key that was selected previously.

DETAILED OPERATING INSTRUCTIONS

MODULATION, MIXED (Cont'd)

Example 2

Select FM with a peak deviation of 5 kHz using both an internal 1 kHz modulation source and an external 150 Hz modulation source.

| | SOURCE | FUNCTION | DATA | UNITS |
|----------------------------------|---------------------|----------|------|-------|
| LOCAL (keys) | INT 1 kHz | FM | 5 | kHz |
| | EXT | FM | | |
| HP-IB (program codes) | S3 FM 5 KZ S1 FM | | | |

Keystroke Sequence 3

To select three simultaneous modulation signals, AM and FM using a common source (rate) and AM or FM from a separate source, press the Source key to provide the common AM and FM rate. Then press a Function key, the desired Data keys, and the valid Units key. Press the other Function key, the desired Data keys, and the valid Units key. Press the other Source key, the appropriate Function key, the desired Data keys, and the valid Units key.

Example 3

Simultaneously select AM with a depth of 90% and FM with a peak deviation of 25 kHz using the internal 400 Hz source, and AM with a depth of 90% using an external 6 kHz modulation source.

| | SOURCE | FUNCTION | DATA | UNITS |
|----------------------------------|---------------------------------------|----------|------|-------|
| LOCAL (keys) | INT 400 Hz | AM | 9 0 | % |
| | | FM | 2 5 | kHz |
| | EXT | AM | | |
| HP-IB (program codes) | S2 AM 90 PC or % FM 25 KZ S1 AM | | | |

Keystroke Sequence 4

To select four simultaneous modulation signals, press the appropriate Source key, a Function key, the desired Data keys, and the valid Units key. Press the other Function key, the desired Data keys and valid Units key. Press the other Source key, and then both Function keys.

Example 4

Simultaneously select AM with a depth of 10% and FM with a peak deviation of 50 kHz using the internal 1 kHz modulation source. AM and FM with the same depth and deviation as selected previously are also selected using an external 5 kHz source.

DETAILED OPERATING INSTRUCTIONS

MODULATION, MIXED (Cont'd)

| | SOURCE | FUNCTION | DATA | UNITS |
|----------------------------------|--|----------|------|-------|
| LOCAL (keys) | INT 1 kHz | AM | 1 0 | % |
| | | FM | 5 0 | kHz |
| | EXT | AM | | |
| | EXT | FM | | |
| HP-IB (program codes) | S3 AM 10 PC or % FM 50 KZ S1 AM S1 FM | | | |

Keys and Program Codes



| Keys | Codes |
|------------|-------|
| AM | AM |
| FM | FM |
| DC FM | S5 |
| EXT | S1 |
| INT 400 Hz | S2 |
| INT 1 kHz | S3 |

Indications

The last selected AM depth or FM peak deviation is displayed in the MODULATION Display, and the source annunciators will light. In the case where an external modulation source is used, the HI EXT and LO EXT annunciators will also light until the signal level of the external source is adjusted to 1 Vpk (0.707 Vrms) ±5%.

Comments

Digits selected beyond the specified resolution for AM depth or FM peak deviation are truncated.

Leading zeros are blanked.

AM depth Data entries that would cause the peak envelope power of the instrument to exceed +17 dBm are rejected.

FM peak deviation Data entries that are out-of-range for the selected carrier frequency are rejected.

The MODULATION Display flashes if a change in carrier frequency causes the FM peak deviation allowed for that frequency band to be exceeded. Entering a carrier frequency that sets the instrument in the correct band for the selected deviation clears the error condition, or pressing one of the following keys automatically adjusts the the FM peak deviation to the maximum frequency possible for that frequency band.

DETAILED OPERATING INSTRUCTIONS

MODULATION, MIXED (Cont'd)

| Band | Carrier Frequency (MHz) |
|------|-------------------------|
| 1 | 0.1-123.5 |
| 2 | 123.5-247 |
| 3 | 247-494 |
| 4 | 494-990 |



AM or FM function remains selected until:

- a. One of the three remaining functions is selected.
- b. One of the STORE, RECALL, SEquence keys or Display (SHIFT, DSPL) is pressed.
- c. The instrument is preset, unplugged, or switched to standby.

Setting the level of the external modulation source is described under Modulation, External Source.

Related Instructions

- Modulation, AM
- Modulation, DC FM
- Modulation, External Source
- Modulation, FM
- Modulation, OFF

DETAILED OPERATING INSTRUCTIONS



MODULATION, OFF

Description This instruction details how to selectively turn off DC FM, and the AM or FM function. In addition, it details how to selectively turn off a modulation source.



Keystroke Sequences To turn off a modulation function (AM or FM), press the Function key, then the OFF key.

To turn off a modulation source (internal 400 Hz, internal 1 kHz, or external), press the associated Function key, Source key, then the OFF key.



Examples Selectively turn off DC FM.

| | FUNCTION | SOURCE |
|------------------------------|---|---|
| LOCAL (keys) |  |   |
| HP-IB (program codes) | FM S1 S4 | |

Selectively turn off AM modulation function with only one modulation source in use.

| | FUNCTION | SOURCE |
|------------------------------|---|---|
| LOCAL (keys) |  |  |
| HP-IB (program codes) | AM S4 | |

Selectively turn off internal 400 Hz source.

| | FUNCTION | SOURCE |
|------------------------------|---|---|
| LOCAL (keys) |  |   |
| HP-IB (program codes) | AM S2 S4 | |

DETAILED OPERATING INSTRUCTIONS

MODULATION, OFF (Cont'd)
**Keys and
Program Codes**

| Keys | Codes |
|------------|-------|
| AM | AM |
| FM | FM |
| EXT | S1 |
| INT 400 Hz | S2 |
| INT 1 kHz | S3 |
| OFF | S4 |
| DC FM | S5 |

Indications

The current MODULATION Display is blanked or the modulation source (including its annunciator) is turned off when the OFF key is pressed.

Comments

The currently selected modulation function (AM or FM) is turned off when the OFF key is pressed, provided only one source (internal 400 Hz or 1 kHz, or external) is selected for use.

If more than one source is selected, then a Source key (INT 400 Hz, INT 1 kHz, or EXT) has to be pressed before the OFF key is pressed. In this case, the currently selected modulation function remains selected, and only the chosen source (including its annunciator) is turned off.

If both modulation functions are simultaneously selected and share the same source, then; only the currently selected modulation function is turned off when the OFF key is pressed, and the MODULATION Display is restored to show the modulation parameters of the remaining function.

**Related
Instructions**

Modulation, AM
 Modulation, AM Up/Down
 Modulation, DC FM
 Modulation, DC FM Up/Down
 Modulation, FM
 Modulation, FM Up/Down
 Modulation, External Source
 Modulation, Mixed



DETAILED OPERATING INSTRUCTIONS

SEQUENCE

Description This instruction details how to sequentially recall the stored contents from each of the storage registers.

Keystroke Sequence Press the SEQ key.

Example Sequentially recall the stored contents from each of the storage registers.

| | |
|---|--|
| LOCAL (keys) |  |
|  (program codes) | SQ |

Keys and Program Codes



| Keys | Codes |
|------|-------|
| SEQ | SQ |

Indications Each time the SEQ key is pressed, the stored contents from each storage register is recalled, and the output of the Signal Generator is changed so that it agrees with the recalled parameter values.

Comments Ten storage registers are available (0—9). Each is capable of storing complete front-panel setups (exclusive of increment settings).

Performing this feature:

Clears any previously selected function.

Updates contents of the sequence counter, so that it agrees with the numerical location of the recalled register.

Clears any previously selected Modulation, Frequency, and Amplitude setting which has not been stored in one of the storage registers.

Does not affect current increment settings.

Remote sequence operation is permitted through an external switch closure connected at the rear-panel SEQ connector J5.

Related Instructions
 Display
 Display Sequence
 Recall
 Store

DETAILED OPERATING INSTRUCTIONS

STORE

Description This instruction details how to store complete front-panel setups (exclusive of increment settings) for either selectable or sequential recall or display at a later time.

Keystroke Sequence Press the STORE key, then a Data key (a single digit register number 0—9).

Example Store the current front-panel settings in register 2.

| | | |
|----------------------------------|-------|---|
| LOCAL (keys) | STORE | 2 |
| HP-IB (program codes) | ST 2 | |

Keys and Program Codes



| Keys | Codes |
|-------|-------|
| STORE | ST |

Indications No visible front-panel change.

Comments Ten storage registers are available (0—9). Each is capable of storing complete front-panel setups (exclusive of increment settings).

Performing this feature:

Clears any previously selected function.

Initialized conditions of the Signal Generator are stored in each of the 10 storage registers when the instrument is powered up or reset.

Related Instructions Display
Recall
Sequence

DETAILED OPERATING INSTRUCTIONS

RF OFF/ON

Description This instruction details how to turn OFF and ON the carrier frequency at the RF OUTPUT of the Signal Generator.

Keystroke Sequence Press the RF OFF/ON key.

Keys and Program Codes



| Keys | Codes |
|--------|-------|
| RF OFF | R2 |
| RF ON | R3 |

Indications The AMPLITUDE Display, and Amplitude annunciators are blanked when RF OFF/ON is off. Pressing RF OFF/ON again turns on the RF and restores the AMPLITUDE Display and annunciators.

Comments The RF OFF/ON key turns off the carrier frequency to the output without affecting the attenuators.

Performing this feature:

Does not affect the currently selected function.

Does not change the contents of the sequence counter.

Related Instructions None

DETAILED OPERATING INSTRUCTIONS

RECALL

Description This instruction details how to selectively recall the stored contents from a storage register.

Keystroke Sequence Press the RECALL key, and then a Data key (a single digit register number 0—9).

Example Recall the stored contents from register 2.

| | | |
|----------------------------------|--------|---|
| LOCAL (keys) | RECALL | 2 |
| HP-IB (program codes) | RC 2 | |

Keys and Program Codes



| Keys | Codes |
|--------|-------|
| RECALL | RC |

Indications The stored contents from the selected register is recalled, and the output of the Signal Generator is changed so that it agrees with the recalled parameter values.

Comments Ten storage registers are available (0—9). Each is capable of storing complete front-panel setups (exclusive of increment settings).

Performing this feature:

Clears any previously selected function.

Updates contents of the sequence counter, so that it agrees with the numerical location of the recalled register.

Does not affect current increment settings.

Related Instructions Display
Store
Sequence

SECTION IV

PERFORMANCE TESTS

4-1. INTRODUCTION

The procedures in this section test the instrument's electrical performance using the specifications of Table 1-1 as the performance standards. All tests can be performed without access to the interior of the instrument. A simpler operational test is included in Section III under Operator's Checks.

NOTES

If the performance tests are to be considered valid, the following conditions must be met:

- a. The Signal Generator must have a 30-minute warmup.*
- b. The line voltage must be 100, 120, 220, or 240 Vac (+5%, -10%) from 48 to 440 Hz. The voltage selector card must be in the proper position. Refer to Figure 2-1.*
- c. The ambient temperature must be 0 to 55°C for the Level Accuracy and Flatness Test.*

4-2. EQUIPMENT REQUIRED

Equipment required for the performance tests is listed in Table 1-3, Recommended Test Equipment. Any equipment that satisfies the critical specifications given in the table may be substituted for the recommended model(s).

4-3. PERFORMANCE TEST RECORD

Results of the performance tests may be tabulated on Table 4-2 which is the Performance Test Record. The Performance Test Record located at the end of this section lists all of the tested specifications and their acceptable limits. The results recorded at incoming inspection can be used for comparison in periodic maintenance and troubleshooting and after repairs or adjustments.

4-4. CALIBRATION CYCLE

This instrument requires periodic verification of performance. Depending on the use and environmental conditions, the instrument should be checked using the following performance tests at least once each year.

4-5. ABBREVIATED PERFORMANCE TESTING

In most cases, it is not necessary to perform all of the tests in this section. Table 4-1 shows which tests are recommended for various situations. The Operator's Checks in Section III should be the first step in all testing situations.

4-6. TEST PROCEDURES

It is assumed that the person performing the following tests understands how to operate the specified test equipment. Equipment settings, other than those for the Signal Generator, are stated in general terms. For example, a test might require that a spectrum analyzer's resolution bandwidth be set to 100 Hz; however, the time per division setting would not be specified and the operator would set that control so that the analyzer operates correctly.

It is also assumed that the person performing the tests will supply whatever cables, connectors, and adapters are necessary.

Table 4-1. Abbreviated Performance Tests

| Testing Situations | | Basic Functional Checks Section III | HP-IB Functional Checks Section III | Spectral Purity Para. 4-7 | Output Level Accuracy & Flatness Para. 4-8 | Modulation Para. 4-9 | Output Leakage Para. 4-10 | SWR Para. 4-11 |
|---|-----------------------------|-------------------------------------|-------------------------------------|---------------------------|--|----------------------|---------------------------|----------------|
| Incoming Inspection or Overall Performance Verification | | X | X | X | X | X | X | X |
| After Complete Adjustment | | X | | X | X | X | X | X |
| After Repairs to an Individual Assembly | | | | | | | | |
| Assembly | Reference Service Sheet No. | | | | | | | |
| A1 | 21 | X | | | | | | |
| A2 | 21 to 24 | X | | | | | | |
| A3A1 | 9 | X | | X | | FM | | |
| A3 | 9 | X | | | | | | |
| A3 | 10 | X | | X | | FM | | |
| A3 | 11 | X | | X | | | | |
| A3 | 12 | X | | X | | | | |
| A3 | 13 | X | | X | | FM | | |
| A3 | 14 | X | | X | | FM | | |
| A3 | 15 | X | | X | | FM | | |
| A3 | 16 | X | | X | | | | |
| A4 | 1 | X | | X | | | | |
| A4 | 2 | X | | X | | | | |
| A5 | 1 | X | | | | | | |
| A6 | 4 | X | | X | X | AM | | |
| A6 | 5 | X | | X | X | | | |
| A6 | 8 | X | | | | | | |
| A7* | 4, 5, and 17 | X | | | | | | |
| A8 | 3 | X | | X | | | | |
| A9 | 8 | X | | X | X | | X | X |
| A10 | 6 | X | | | | | | |
| A10 | 7 | X | | | X | X | | |
| A10 | 8 | X | | | | | | |
| A10 | 25 | X | | | | X | | |
| A11 | 17 thru 20 | X | X | | X | X | | |
| A13* | 20 | | X | | | | | |
| A14* | 17 and 25 | X | | | | | | |
| A15 | 25 | X | | | | | | |
| A16 | 25 | X | | | | | | |
| FL1* | 3 | X | | X | | | | |

*To be performed with instruments that have a serial prefix range from 2425A to 2509A only.

PERFORMANCE TESTS

4-7. SPECTRAL PURITY TESTS

SPECIFICATIONS:

| Electrical Characteristics | Performance Limits | Conditions |
|--|--------------------|--|
| Spurious Signals: | | |
| Harmonics (<i>2425A only</i>) | <-25 dBc | ≤+7 dBm output levels |
| Harmonics (<i>2447A and above</i>) | <-30 dBc | ≤+7 dBm output levels |
| Non-harmonics | <-60 dBc | >5 kHz from carrier in CW mode |
| Sub-harmonics | None | |
| Residual Modulation CW Mode: | | |
| AM (0.5 to 15 kHz Post Detection Noise Bandwidth) | <-75 dBc | 0.1 to 990 MHz |
| FM (0.3 to 3 kHz Post Detection Noise Bandwidth) | <7 Hz rms | 0.1 to 123.5 MHz |
| | <2 Hz rms | 123.5 to 247 MHz |
| | <4 Hz rms | 247 to 494 MHz |
| | <7 Hz rms | 494 to 990 MHz |
| FM (0.05 to 15 kHz Post Detec- tion Noise Bandwidth) | <15 Hz rms | 0.1 to 123.5 MHz |
| | < 4 Hz rms | 123.5 to 247 MHz |
| | < 8 Hz rms | 247 to 494 MHz |
| | <15 Hz rms | 494 to 990 MHz |
| SSB Phase Noise | | |
| | <-114 dBc/Hz | 20 kHz offset from carrier 0.1 to 123.5 MHz |
| | <-126 dBc/Hz | 123.5 to 247 MHz |
| | <-120 dBc/Hz | 247 to 494 MHz |
| | <-114 dBc/Hz | 494 to 990 MHz |

DESCRIPTION: Spurious signals are checked using a spectrum analyzer. Residual AM and FM Modulation are checked using a measuring receiver. SSB phase noise is measured by mixing the RF output of the Generator and a reference signal in a double balanced mixer to eliminate the carrier and translate the noise spectrum to a low frequency where it can be viewed on a spectrum analyzer. The output of the mixer is viewed on a spectrum analyzer.

PERFORMANCE TESTS

4-7. SPECTRAL PURITY TESTS (cont'd)

NOTES

Adjust the Center Frequency, Frequency Span, and Resolution Bandwidth controls as required.

Change the frequency increment from 100 kHz to 10 MHz at 10 MHz, if desired.

| Spurious Signals | Results | |
|---------------------------------------|---------|----------|
| | Actual | Max. |
| Harmonics <i>(2425A only)</i> | _____ | <-25 dBc |
| Harmonics <i>(2447A and above)</i> | _____ | <-30 dBc |
| Non-Harmonics (5 kHz from carrier) | _____ | <-60 dBc |
| Sub-Harmonics | _____ | None |

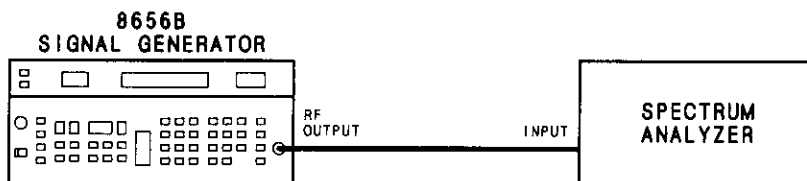

Figure 4-1. Spurious Signals Test Setup

PERFORMANCE TESTS

4-7. SPECTRAL PURITY TESTS (cont'd)

Residual AM

NOTE

The residual AM specification of the Signal Generator is not equivalent to the published specification of the HP 8902A Measuring Receiver. To make a valid residual AM measurement, the residual AM of the measuring receiver should be at least 3 dB better than the specification being tested. In order to verify that the residual AM of the measuring receiver is adequate to measure the Signal Generator's residual AM specification, the residual AM of the measuring receiver must be verified to ensure the validity of the measurement. If the Signal Generator's residual AM is measured frequently, it is not necessary to verify the residual AM of the measuring receiver each time; however, it is recommended that it be verified monthly to ensure an accurate measurement.

4. Verify the residual AM of the measuring receiver as follows:
 - a. Connect the modulation output of the measuring receiver to the input of the digital multimeter and the AM output of the AM/FM test source to the input of the measuring receiver as shown in Figure 4-2. Nothing should be connected to the audio input of the AM/FM test source.

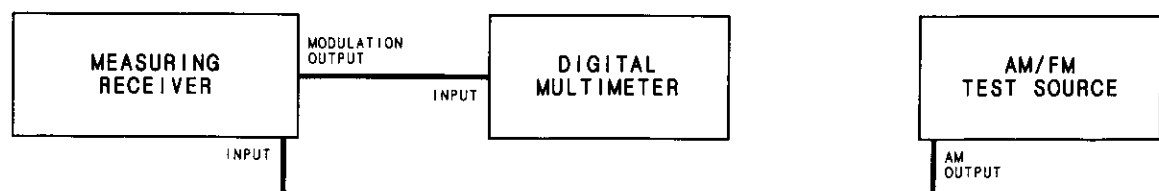

Figure 4-2. Measuring Receiver Residual AM Verification Test Setup

PERFORMANCE TESTS

4-7. SPECTRAL PURITY TESTS (cont'd)

- b. Set the measuring receiver as follows:
- Measurement Frequency
- c. Set the AM/FM test source as follows:
- Test Mode FM
- d. Tune the carrier frequency on the AM/FM test source for a measuring receiver reading of 12.5 ± 0.1 MHz.
- e. Set the digital multimeter as follows:
- Function Vac
- Range 200 mV
- f. Set the measuring receiver as follows:
- Measurement AM
- HP Filter 50 Hz
- LP Filter 15 kHz
- g. The digital multimeter should indicate 1.26 mV or less.

NOTE

To make a valid residual AM measurement, the residual AM of the measuring receiver should be at least 3 dB better than the specification being tested or < -78 dBc (0.0126%). With an output sensitivity of 10%/V, the corresponding output level is 1.26 mV.

5. Set the measuring receiver as follows:
- Measurement AM
- Detector Peak+
- HP Filter 50 Hz
- LP Filter 15 kHz
- FM De-Emphasis Off
6. Set the Signal Generator as follows:
- Frequency ≥ 150 kHz
- Amplitude 0.0 dBm
- Modulation Off
-

PERFORMANCE TESTS

4-7. SPECTRAL PURITY TESTS (cont'd)

7. Set the digital multimeter as follows:

Function Vac
 Range 200 mV

8. Connect the RF OUTPUT of the Signal Generator to the input of the measuring receiver and the output of the measuring receiver to the input of the digital multimeter as shown in Figure 4-3.

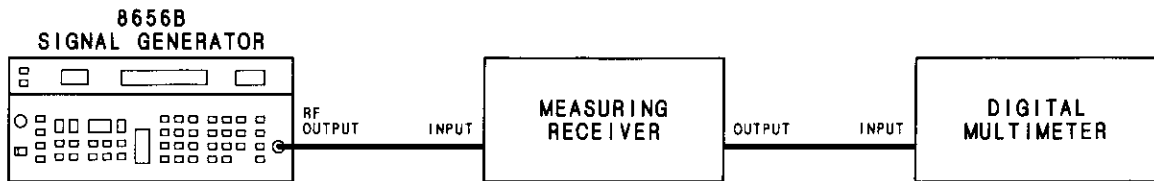

Figure 4-3. Residual AM Test Setup

9. The digital multimeter should indicate <1.78 mVrms.

| Actual | Maximum |
|--------|-------------|
| _____ | <1.78 mVrms |

Residual FM

NOTE

A standard HP 8902A can be used to verify the residual FM specifications to 640 MHz. The heterodyne band and frequencies in the divide by 1, divide by 2 and divide by 4 band can be checked. Tests performed at these frequencies will verify that the instrument meets its specifications. The residual FM of the HP 8656B can be checked at all frequencies with an HP 8902A option 003 and an external Local Oscillator (LO). The residual FM of the external LO must be less than the instrument under test and less than the internal LO of the HP 8902A to improve the residual FM measurement.

PERFORMANCE TESTS

4-7. SPECTRAL PURITY TESTS (cont'd)

10. Set the measuring receiver as follows:

Measurement FM
 Detector AVG
 FM De-Emphasis Off
 Automatic Operation Selected

11. Set the Signal Generator under test as follows:

Frequency Any From Chart
 Amplitude 0.0 dBm
 Modulation Off

12. Connect the RF OUTPUT of the Signal Generator under test to the input of the measuring receiver and the RF output of the signal generator to the LO input of the measuring receiver as shown in Figure 4-4.



Figure 4-4. Residual FM Test Setup

13. Set the Signal Generator frequency and select the measuring receiver high-pass and low-pass filters as indicated in the following table. Verify that the measured results do not exceed the limits specified.

| Signal Generator Frequency MHz | Modulation Analyzer Filter | | Results (Hz rms) | |
|-----------------------------------|----------------------------|----------------|------------------|------|
| | High Pass (Hz) | Low Pass (kHz) | Actual | Max. |
| 0.15 to 123.5 | 300 | 3 | _____ | <7 |
| 123.5 to 150 | 300 | 3 | _____ | <2 |
| 247 to 350 | 300 | 3 | _____ | <4 |
| 494 to 750 | 300 | 3 | _____ | <7 |
| 0.15 to 123.5 | 50 | 15 | _____ | <15 |
| 123.5 to 150 | 50 | 15 | _____ | <4 |
| 247 to 350 | 50 | 15 | _____ | <8 |
| 494 to 750 | 50 | 15 | _____ | <15 |

PERFORMANCE TESTS

4-7. SPECTRAL PURITY TESTS (cont'd)

SSB Phase Noise (1 Hz Bandwidth)

DESCRIPTION: SSB phase noise is measured at Signal Generator RF Output frequencies from 200 KHz to 500 MHz (frequency range of the mixer) by mixing RF output and a reference in a double balanced mixer. The RF OUTPUT reference is set in quadrature (90° apart) so the mixer output is a dc component, and a high frequency component. The high frequency component is filtered out leaving the dc, which is proportional to the phase noise. The Signal Generator frequency is offset from the reference frequency by 20 KHz to set a reference on the spectrum analyzer. The Signal Generator frequency is then set to the reference frequency and amplitude to 0 dBm. The SSB phase noise is measured at the 20 KHz offset.

NOTE

This test measures the total SSB Phase Noise of both Generators. Therefore, the reference generator must have SSB Phase Noise less than or equal to the specifications for the Generator under test.

14. Connect the equipment as shown in Figure 4-5.

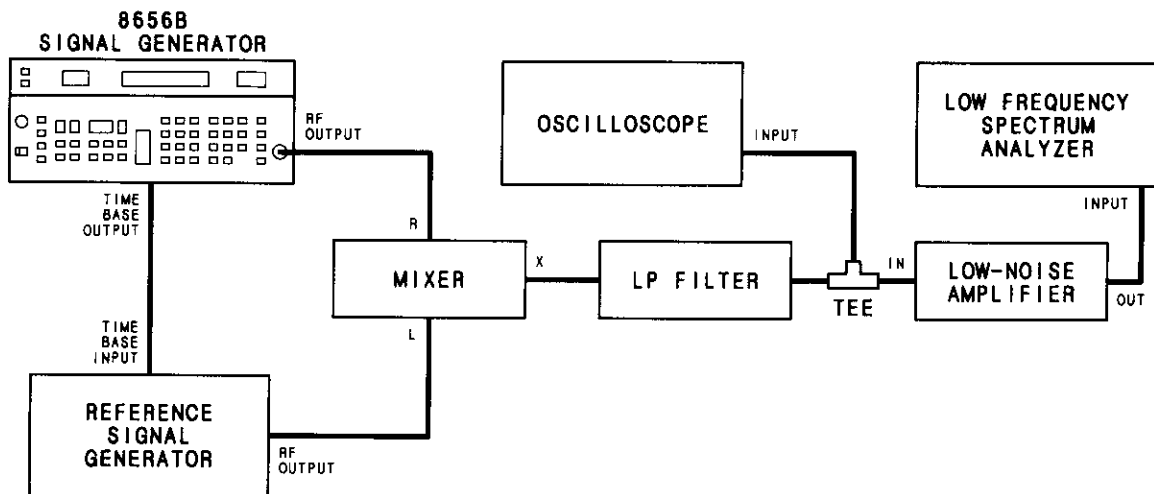

Figure 4-5. SSB Phase Noise Test Setup

PERFORMANCE TESTS

4-7. SPECTRAL PURITY TESTS (cont'd)

NOTE

The following symbols are used in the procedure:

f_{RF} = the RF output frequency where SSB phase noise will be checked.

f_{off} = the frequency offset from f_{RF} where SSB phase noise will be checked.

15. Set the reference generator frequency to f_{RF} and output level to +13 dBm. Set the Signal Generator under test to $f_{RF} + f_{off}$ and output level to -50 dBm.
16. 8568A spectrum analyzer, set the REFERENCE LEVEL to -20 dBm, FREQUENCY SPAN to 1 kHz and view the signal at f_{off} .
17. Set the 8568A spectrum analyzer's reference level so the signal is 9 dB below the spectrum analyzer reference (-6 dB converts measured reading to SSB phase noise and -3 dB corrects for equal SSB phase noise RF sources).
18. Set the Signal Generator under test to f_{RF} and 0 dBm output Amplitude.
19. Set the frequency increment of the Signal Generator under test to 10 Hz.
20. Set the oscilloscope as follows:

| | |
|-----------------|---------|
| INPUT | CHAN A |
| VOLTS/DIV | 0.1, dc |
| DISPLAY | CHAN A |
| TRIGGER | CHAN A |
| TIME/DIV | 10 mSEC |
21. Press the Signal Generator frequency Increment UP key and view the signal on the oscilloscope. The signal is a low frequency signal moving around ground level. Stop the signal at ground level (within 50 mV of ground) by pressing the frequency Increment DOWN key. The key sequence to increment the frequency UP and DOWN may have to be executed several times to stop the signal within 50 mV of ground. This sets the two input signals to the mixer in phase quadrature.

PERFORMANCE TESTS

4-7. SPECTRAL PURITY TESTS (cont'd)

22. Set the spectrum analyzer to measure SSB Phase Noise in a 1 Hz bandwidth, select SHIFT (M) NORMAL keys, and to Video Averaging, select SHIFT (G) VIDEO BW, 1, 2, Hz keys.
23. The SSB Phase Noise is read directly from the spectrum analyzer display, -XXX dB in 1 Hz bandwidth plus the following correction:
 - a. Take the difference between -50 dB and the spectrum analyzer reference.
 - b. Add this difference to the spectrum analyzer -XXX dB in 1 Hz bandwidth to correct for the change in the attenuator setting of the Signal Generator under test.
24. Measured SSB Phase Noise should be at or below the specified value.

| Offset From Carrier | SSB Phase Noise | | Carrier Frequency MHz |
|---------------------|-----------------|--------|-----------------------|
| | Min. | Actual | |
| 20 kHz | -114 dBc/Hz | _____ | 0.1 to 123.5 |
| | -126 dBc/Hz | _____ | 123.5 to 247 |
| | -120 dBc/Hz | _____ | 247 to 494 |
| | -114 dBc/Hz | _____ | 494 to 990 |

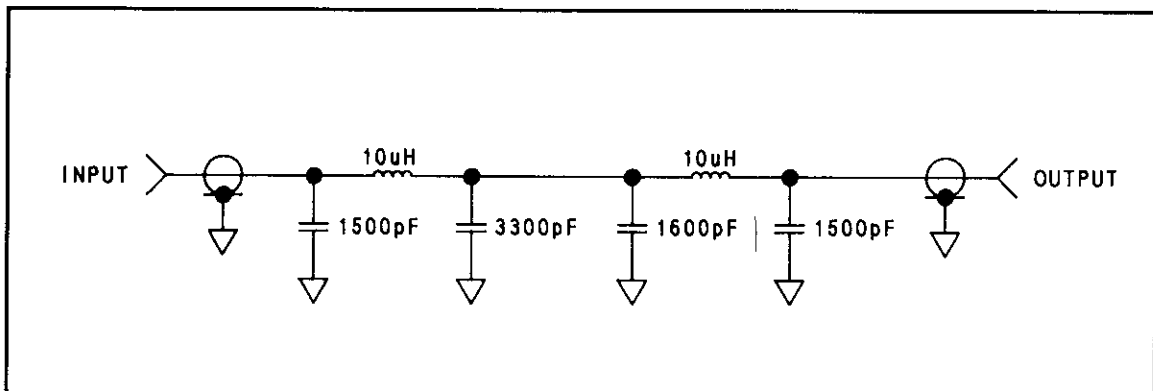

Figure 4-6. 1MHz Low-Pass filter

PERFORMANCE TESTS

4-8. OUTPUT LEVEL ACCURACY AND FLATNESS TESTS

SPECIFICATION:

| Electrical Characteristics | Performance Limits | Conditions |
|--------------------------------------|---------------------|---|
| OUTPUT: | | |
| Level Range | +13 dBm to -127 dBm | Into 50 ohms |
| Resolution | 0.1 dB | |
| Absolute Level Accuracy ¹ | $\leq \pm 1.0$ dB | Output levels of +7 dBm to -124 dBm; frequencies from 123.5 to 990 MHz |
| | $\leq \pm 1.5$ dB | 100 kHz to 123.5 MHz and output levels >+7 dBm or <-124 dBm; frequencies 100 kHz to 990 MHz |
| Level Flatness | $\leq \pm 1.0$ dB | Output level setting of 0.0 dBm; frequencies from 100 kHz to 990 MHz |

¹Absolute level accuracy includes allowances for detector linearity, temperature, flatness, attenuator accuracy, and measurement errors.

DESCRIPTION: Output level accuracy and flatness are verified using a measuring receiver and a sensor module.

EQUIPMENT: Measuring Receiver HP 8902A
 Sensor Module HP 11722A

PROCEDURE: *Level Flatness*

1. Connect the sensor module to the measuring receiver. Zero and calibrate the sensor module and measuring receiver.
2. Connect the sensor module to the Signal Generator as shown in Figure 4-7.

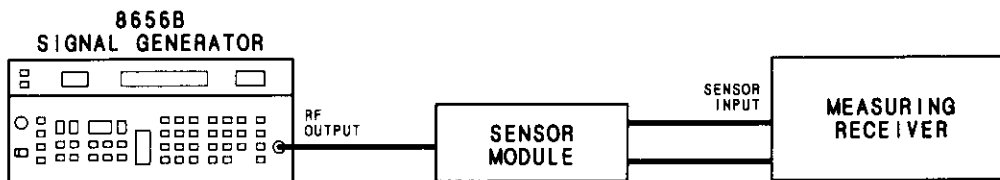

Figure 4-7. Output Level Accuracy and Flatness Test Setup

PERFORMANCE TESTS

4-8. OUTPUT LEVEL ACCURACY AND FLATNESS TESTS (cont'd)

3. Set the measuring receiver as follows:

Measurement RF POWER
 Display LOG

4. Set the Signal Generator as follows:

Frequency 150 KHz Frequency
 Increment 100 KHz
 Amplitude 0.0 dBm
 Modulation Off

5. Wait for the power measurement to settle and then select **DISPLAY RATIO** to set a 0.0 dB reference.

6. Step the Signal Generator through the frequency range of 150 KHz to 990 MHz (use 10 MHz steps above 10 MHz) and record the highest and lowest readings.

_____ Highest Reading _____ Frequency

_____ Lowest Reading _____ Frequency

The amplitude variation should not exceed 2.0 dB. Record the maximum variation (highest reading - lowest reading).

_____ $\leq \pm 1.0$ dB

Absolute Level Accuracy

7. Set the Signal Generator as follows:

Frequency 3 MHz
 Amplitude +13 dBm
 Amplitude Increment 5 dBm
 Modulation Off

Set the measuring receiver as follows:

Measurement RF POWER

PERFORMANCE TESTS

4-8. OUTPUT LEVEL ACCURACY AND FLATNESS TESTS (cont'd)

8. At each step, the measuring receiver reading must be within the tolerances shown in the Tables for RF Output Frequencies. Step the amplitude down to -2 dBm. Change the measuring receiver's measurement to TUNED RF LEVEL. If RECAL or UNCAL is displayed press and release the CALIBRATE key. Continue to step the amplitude down to -127 dBm; and each time RECAL is displayed press and release the CALIBRATE key.

*RF Output Frequencies
3 to 123.5 MHz*

| Minimum (dBm) | Actual (dBm) | Maximum (dBm) |
|---------------|--------------|---------------|
| +11.5 | _____ | +14.5 |
| +6.5 | _____ | +9.5 |
| +1.5 | _____ | +4.5 |
| -3.5 | _____ | -0.5 |
| -8.5 | _____ | -5.5 |
| -13.5 | _____ | -10.5 |
| -18.5 | _____ | -15.5 |
| -23.5 | _____ | -20.5 |
| -28.5 | _____ | -25.5 |
| -33.5 | _____ | -30.5 |
| -38.5 | _____ | -35.5 |
| -43.5 | _____ | -40.5 |
| -48.5 | _____ | -45.5 |
| -53.5 | _____ | -50.5 |
| -58.5 | _____ | -55.5 |
| -63.5 | _____ | -60.5 |
| -68.5 | _____ | -65.5 |
| -73.5 | _____ | -70.5 |
| -78.5 | _____ | -75.5 |
| -83.5 | _____ | -80.5 |
| -88.5 | _____ | -85.5 |
| -93.5 | _____ | -90.5 |
| -98.5 | _____ | -95.5 |
| -103.5 | _____ | -100.5 |
| -108.5 | _____ | -105.5 |
| -113.5 | _____ | -110.5 |
| -118.5 | _____ | -115.5 |
| -123.5 | _____ | -120.5 |
| -128.5 | _____ | -125.5 |

*RF Output Frequencies
123.5 to 990 MHz*

| Minimum (dBm) | Actual (dBm) | Maximum (dBm) |
|---------------|--------------|---------------|
| +11.5 | _____ | +14.5 |
| +6.5 | _____ | +9.5 |
| +1.0 | _____ | +4.0 |
| -3.0 | _____ | -1.0 |
| -8.0 | _____ | -6.0 |
| -13.0 | _____ | -11.0 |
| -18.0 | _____ | -16.0 |
| -23.0 | _____ | -21.0 |
| -28.0 | _____ | -26.0 |
| -33.0 | _____ | -31.0 |
| -38.0 | _____ | -36.0 |
| -43.0 | _____ | -41.0 |
| -48.0 | _____ | -46.0 |
| -53.0 | _____ | -51.0 |
| -58.0 | _____ | -56.0 |
| -63.0 | _____ | -61.0 |
| -68.0 | _____ | -66.0 |
| -73.0 | _____ | -71.0 |
| -78.0 | _____ | -76.0 |
| -83.0 | _____ | -81.0 |
| -88.0 | _____ | -86.0 |
| -93.0 | _____ | -91.0 |
| -98.0 | _____ | -96.0 |
| -103.0 | _____ | -101.0 |
| -108.0 | _____ | -106.0 |
| -113.0 | _____ | -111.0 |
| -118.0 | _____ | -116.0 |
| -123.0 | _____ | -121.0 |
| -128.5 | _____ | -125.5 |

9. Repeat steps 7 and 8 for frequencies greater than 3 MHz.

PERFORMANCE TESTS

4-9. MODULATION TESTS

SPECIFICATIONS:

| Electrical Characteristics | Performance Limits | Conditions |
|--|----------------------|---|
| Amplitude Modulation | | |
| Depth ¹ | 0 to 99% | Output levels of <+7 dBm; frequencies from 100 kHz to 990 MHz |
| | 0 to 30% | Output levels to +10 dBm; frequencies from 100 kHz to 990 MHz |
| Resolution | 1% | |
| Incidental Phase Modulation | <0.3 radian peak | 30% AM depth and internal rates |
| Indicator Accuracy ² | ±2% (±4% of reading) | Depths <90% and internal rates and levels <+7 dBm |
| AM Rates: | | |
| Internal | 400 and 1 kHz, ±3% | |
| External | 20 Hz to 40 kHz | 1 dB bandwidth, ac coupled |
| AM Distortion (internal rates) | <1.5% | 0 to 30% AM |
| | <3% | 31 to 70% AM |
| | <4% | 71 to 90% AM |
| FM Modulation | | |
| Maximum Peak Deviation (Δf _{pk}): ² | | |
| Rates ≥25 Hz (ac mode) | 99 kHz | 0.1 to 123.5 MHz (fc) |
| Rates ≥50 Hz (ac mode) | 50 kHz | 123.5 to 247 MHz (fc) |
| Rates ≥50 Hz (ac mode) | 99 kHz | 247 to 494 MHz (fc) |
| Rates ≥25 Hz (ac mode) | 99 kHz | 494 to 990 MHz (fc) |
| Rates <25 Hz (ac mode) | 4000 × Rate Hz | 0.1 to 123.5 MHz (fc) |
| Rates <50 Hz (ac mode) | 1000 × Rate Hz | 123.5 to 247 MHz (fc) |
| Rates <50 Hz (ac mode) | 2000 × Rate Hz | 247 to 494 MHz (fc) |
| Rates <25 Hz (ac mode) | 4000 × Rate Hz | 494 to 990 MHz (fc) |
| Rates (dc mode) | 99 kHz | 0.1 to 123.5 MHz (fc) |
| | 50 kHz | 123.5 to 247 MHz (fc) |
| | 99 kHz | 247 to 494 MHz (fc) |
| | 99 kHz | 494 to 990 MHz (fc) |
| | | (FM not specified for fc—Δf _{pk} <100 kHz) |
| Center Frequency Accuracy (dc mode) | ±500 Hz | 0.1 to 123.5 MHz (fc) |
| | ±125 Hz | 123.5 to 247 MHz (fc) |
| | ±250 Hz | 247 to 494 MHz (fc) |
| | ±500 Hz | 494 to 990 MHz (fc) |
| Stability (dc mode) | <10 Hz/hour | |
| Resolution | 0.1 kHz | Deviations <10 kHz |
| | 1 kHz | Deviations ≥10 kHz |
| ¹ AM depth is further limited by the Indicator Accuracy specification. ² FM deviation is further limited by the Indicator Accuracy specification. | | |

PERFORMANCE TESTS

4-9. MODULATION TESTS (cont'd)

DESCRIPTION: AC modulation specifications are verified by measuring the specified parameters with a measuring receiver. Distortion is verified by measuring the demodulated output from the measuring receiver with a distortion analyzer.

EQUIPMENT:

| | |
|---|----------------|
| Measuring Receiver | HP 8902A |
| Sensor Module | HP 11722A |
| Distortion Analyzer | HP 339A |
| Audio Analyzer | HP 8903A |
| AM/FM Test Source (required for measuring receiver verification of incidental AM) | HP 11715A |
| Test Oscillator | HP 651B |
| Cable (UG-21D/U type N connectors) | HP 11500B |
| Cable (UG-88C/U BNC and dual banana plug connectors) | HP 11001-60001 |

PROCEDURE: *AM Indicator Accuracy*

1. Connect the RF OUTPUT of the Signal Generator to the input of the measuring receiver as shown in Figure 4-8.
2. Connect the modulation output of the measuring receiver to the input of the distortion analyzer as shown in figure 4-8.

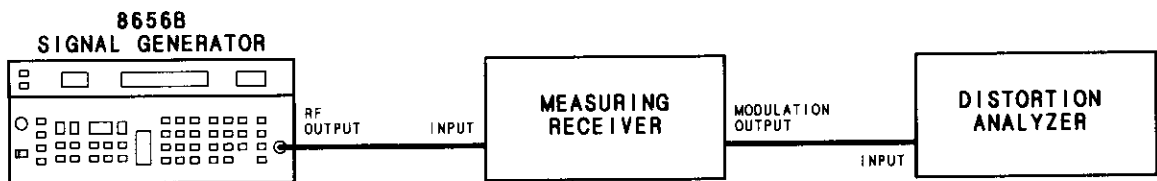

Figure 4-8. Modulation Test Setup

3. Set the measuring receiver as follows:

| | |
|---------------------------|----------|
| Measurement | AM |
| Detector | Peak+ |
| HP Filter | 300 Hz |
| LP Filter | 15 kHz |
| FM De-Emphasis | Off |
| Automatic Operation | Selected |

PERFORMANCE TESTS

4-9. MODULATION TESTS (cont'd)

4. Set the Signal Generator as follows:

Frequency 100 MHz
 Amplitude +7 dBm
 Modulation 1 kHz (Int.) AM 10%

5. Set the AM depth to the values listed in the following table and verify that the measured results are within the limits specified.

| AM Depth for 100 MHz | Results | | |
|-------------------------|---------|--------|-------|
| | Min. | Actual | Max. |
| 10% | 7.6% | _____ | 12.4% |
| 30% | 26.8% | _____ | 33.2% |
| 70% | 65.2% | _____ | 74.8% |
| 90% | 84.4% | _____ | 95.6% |

6. Repeat step 5 with the Signal Generator set to frequencies of 240 MHz, 400 MHz and 990 MHz.

| AM Depth for 240 MHz | Results | | |
|-------------------------|---------|--------|-------|
| | Min. | Actual | Max. |
| 10% | 7.6% | _____ | 12.4% |
| 30% | 26.8% | _____ | 33.2% |
| 70% | 65.2% | _____ | 74.8% |
| 90% | 84.4% | _____ | 95.6% |

| AM Depth for 400 MHz | Results | | |
|-------------------------|---------|--------|-------|
| | Min. | Actual | Max. |
| 10% | 7.6% | _____ | 12.4% |
| 30% | 26.8% | _____ | 33.2% |
| 70% | 65.2% | _____ | 74.8% |
| 90% | 84.4% | _____ | 95.6% |

| AM Depth for 990 MHz | Results | | |
|-------------------------|---------|--------|-------|
| | Min. | Actual | Max. |
| 10% | 7.6% | _____ | 12.4% |
| 30% | 26.8% | _____ | 33.2% |
| 70% | 65.2% | _____ | 74.8% |
| 90% | 84.4% | _____ | 95.6% |

PERFORMANCE TESTS

4-9. MODULATION TESTS (cont'd)

7. Select the measuring receiver's 50 Hz high-pass filter. Verify the AM accuracy with the Signal Generator frequency at 100 MHz and internal 400 Hz AM modulation.

| AM Depth for 100 MHz | Results | | |
|-------------------------|---------|--------|-------|
| | Min. | Actual | Max. |
| 10% | 7.6% | _____ | 12.4% |
| 30% | 26.8% | _____ | 33.2% |
| 70% | 65.2% | _____ | 74.8% |
| 90% | 84.4% | _____ | 95.6% |

Incidental Phase Modulation

8. Set the measuring receiver as follows:

Measurement Phase Modulation
 HP Filter 300 Hz
 LP Filter 15 kHz
 Detector Peak+

9. Set the Signal Generator as follows:

Frequency 150 kHz
 Frequency Increment 100 kHz
 Amplitude +7 dBm
 Modulation 1 kHz (Int.) AM 30%

10. Step the Signal Generator through the frequency range of 150 kHz to 990 MHz use 10 MHz steps above 10 MHz) and record the highest reading. The highest reading should not exceed the limit specified.

| Signal Generator Frequency | | Result | |
|----------------------------|---------|--------|------------------|
| Min. | Max. | Actual | Max. |
| 150 kHz | 990 MHz | _____ | <0.3 radian peak |

PERFORMANCE TESTS

4-9. MODULATION TESTS (cont'd)

AM Distortion

11. Set the measuring receiver as follows:

Measurement AM
HP Filter 300 Hz
LP Filter 15 kHz
Detector Peak+

12. Set the distortion analyzer as follows:

Function Distortion
Analyzer Input Select Distortion
Frequency 1 kHz

13. Set the Signal Generator as follows:

Frequency 10 MHz
Amplitude +7 dBm
Modulation 1 kHz (Int.) AM 30%

14. Set the AM depth to the values listed in the following table and verify that the measured results do not exceed the limits specified.

| AM Depth for 100 MHz | Results | |
|-------------------------|---------|-------|
| | Actual | Max. |
| 30% | _____ | <1.5% |
| 70% | _____ | <3.0% |
| 90% | _____ | <4.0% |

15. Repeat step 13 with the Signal Generator set to frequencies of 240 MHz, 400 MHz, and 990 MHz.

| AM Depth for 240 MHz | Results | |
|-------------------------|---------|-------|
| | Actual | Max. |
| 30% | _____ | <1.5% |
| 70% | _____ | <3.0% |
| 90% | _____ | <4.0% |

PERFORMANCE TESTS

4-9. MODULATION TESTS (cont'd)

| AM Depth for 400 MHz | Results | |
|-------------------------|---------|-------|
| | Actual | Max. |
| 30% | _____ | <1.5% |
| 70% | _____ | <3.0% |
| 90% | _____ | <4.0% |

| AM Depth for 990 MHz | Results | |
|-------------------------|---------|-------|
| | Actual | Max. |
| 30% | _____ | <1.5% |
| 70% | _____ | <3.0% |
| 90% | _____ | <4.0% |

FM Indicator Accuracy

16. Set the measuring receiver as follows:

Measurement FM
 Detector Peak+
 HP Filter 300 Hz
 LP Filter 3 kHz

17. Set the Signal Generator as follows:

Frequency 100 MHz
 Amplitude +7 dBm
 Modulation 1 kHz (Int) FM 5 kHz

18. Set FM deviation to the values listed in the following table and verify that the measured results are within the limits specified.

| FM Deviation for 100 MHz | Results | | |
|-----------------------------|-----------|--------|------------|
| | Min. | Actual | Max. |
| 5.0 kHz | 4.75 kHz | _____ | 5.25 kHz |
| 30.0 kHz | 28.50 kHz | _____ | 31.50 kHz |
| 70.0 kHz | 66.50 kHz | _____ | 73.50 kHz |
| 99.0 kHz | 94.05 kHz | _____ | 103.95 kHz |

PERFORMANCE TESTS

4-9. MODULATION TESTS (cont'd)

Incidental AM

NOTE

The incidental AM specification of the Signal Generator is not equivalent to the published specification of the HP 8902A Measuring Receiver. To make a valid incidental AM measurement, the incidental AM of the measuring receiver must be four times better than the specification being tested. In order to verify that the incidental AM of the measuring receiver is adequate to measure the Signal Generator's incidental AM specification, the incidental AM of the measuring receiver must be verified to ensure the validity of the measurement. If the Signal Generator's incidental AM is measured frequently, it is not necessary to verify the incidental AM of the measuring receiver each time; however, it is recommended that it be verified monthly to ensure an accurate measurement.

19. Verify the incidental AM of the measuring receiver as follows:
 - a. Connect the FM divide-by-4 output of the AM/FM test source to the input of the measuring receiver and the 50 ohm output of the test oscillator to the audio input of the AM/FM test source, as shown in Figure 4-9.
 - b. Set the measuring receiver as follows:

Measurement Frequency

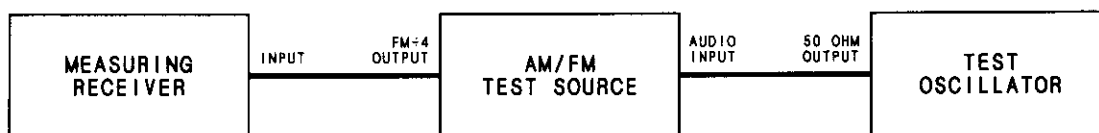

Figure 4-9. Measuring Receiver Incidental AM Verification Test Setup

PERFORMANCE TESTS

4-9. MODULATION TESTS (cont'd)

- c. Set the AM/FM test source as follows:

Test Mode FM

- d. Tune the carrier frequency on the AM/FM test source for a measuring receiver reading of 100 MHz \pm 0.1 MHz.

- e. Set the test oscillator as follows:

Frequency 1 kHz
Output Attenuator -10 dBm
Amplitude Course Fully ccw

- f. Set the measuring receiver as follows:

Measurement FM
Detector Peak+
HP Filter 300 Hz
LP Filter 3 kHz

- g. Increase the output of the test oscillator by rotating the Amplitude Coarse control clockwise until the measuring receiver indicates 20.0 kHz \pm 0.1 kHz peak deviation.

- h. Set the measuring receiver as follows:

Measurement AM

- i. The modulation must be <0.02% AM to test the incidental AM of the Signal Generator.

20. Set the measuring receiver as follows:

Measurement AM
Detector Peak+
HP Filter 300 Hz
LP Filter 3 kHz

21. Set the Signal Generator as follows:

Amplitude +7 dBm
Modulation 1 kHz (Int) FM 20 kHz

22. Connect the equipment as shown in Figure 4-8, Modulation Test Setup.

PERFORMANCE TESTS

4-9. MODULATION TESTS (cont'd)

23. Set the Signal Generator frequency to a value within the range specified in the following table and verify that the measured result does not exceed the limit specified.

| Signal Generator | | Result | |
|------------------|---------|--------|-------|
| Min. | Max. | Actual | Max. |
| 10 MHz | 990 MHz | _____ | <0.1% |

NOTE

Below 10 MHz, the incidental AM of the Signal Generator is less than that of the measuring receiver.

FM Distortion

24. Set the measuring receiver as follows:

Measurement FM
 Detector Peak+
 HP Filter 50 Hz
 LP Filter 3 kHz

25. Set the distortion analyzer as follows:

Function Distortion
 Analyzer Input Select Distortion
 Frequency 1 kHz

26. Set the Signal Generator as follows:

Frequency 100.0 MHz
 Amplitude +7 dBm
 Modulation 1 kHz (Int) FM

27. Connect the equipment as shown in Figure 4-8, Modulation Test Setup.
28. Verify that the measured Total Harmonic Distortion does not exceed 0.5%.

PERFORMANCE TESTS

4-9. MODULATION TESTS (cont'd)

29. Set the Signal Generator FM deviation to a value within the range specified in the following table and verify that the measured result does not exceed the limit specified.

| FM Deviation | | Result | |
|--------------|--------|--------|-------|
| Min. | Max. | Actual | Max. |
| 3 kHz | 99 kHz | _____ | <0.5% |

NOTE

At peak deviations less than 3 kHz, residual FM and other type of FM distortion become a greater portion of the distortion reading. If the distortion falls within tolerance at or above 3 kHz, the Signal Generator typically meets the <0.5% specification for deviations down to 1 kHz.

DESCRIPTION: DC FM specifications are verified by measuring the RF OUTPUT frequency offset with a frequency counter.

EQUIPMENT: Frequency Counter HP 5328A OPT 31

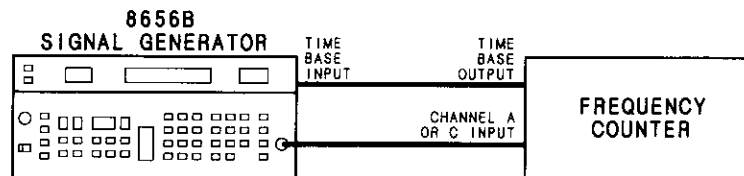

Figure 4-10. DC FM Test Setup

PERFORMANCE TESTS

4-9. MODULATION TESTS (cont'd)

PROCEDURE: *DC FM Center Frequency Accuracy*

30. Connect the RF OUTPUT from the Signal Generator to the INPUT of the frequency counter, and connect the Signal Generator TIME BASE INPUT to the frequency counter TIME BASE OUTPUT as shown in Figure 4-10.

31. Set the frequency counter as follows:

INPUT CHANNEL A
 TRIGGER CHANNEL A

32. Set the Signal Generator as follows:

Frequency 100 MHz
 Amplitude 0 dBm
 Modulation DC FM

33. Set the Signal Generator FM deviation to a value for the frequency range specified in the following table. Verify that the measured frequency does not exceed the limits specified.

| Frequency MHz | DC FM Deviation kHz | Frequency Offset kHz |
|---------------|---------------------|----------------------|
| 0.1 to 123.5 | 1 to 99 | _____ ± 500 Hz |
| 123.5 to 247 | 1 to 50 | _____ ± 125 Hz |
| 247 to 494 | 1 to 99 | _____ ± 250 Hz |
| 494 to 990 | 1 to 99 | _____ ± 500 Hz |

DC FM Center Frequency Stability

34. Set the Signal Generator FM deviation and frequency as shown in the following table and verify that the frequency drift does not exceed the limits specified.

| Frequency MHz | DC FM Deviation kHz | Frequency Drift Hz/Hr |
|---------------|---------------------|-----------------------|
| 0.1 to 123.5 | 1 to 99 | _____ ± 10 |
| 123.5 to 247 | 1 to 50 | _____ ± 10 |
| 247 to 494 | 1 to 99 | _____ ± 10 |
| 494 to 990 | 1 to 99 | _____ ± 10 |

PERFORMANCE TESTS

4-10. OUTPUT LEAKAGE TESTS

SPECIFICATION: Leakage: Leakage limits are within those specified in MIL STD 461B, and FTZ 1115. Furthermore, less than 1.0 uV is induced in a two-turn, 2.5 cm (1 inch) diameter loop held 2.5 cm (1 inch) away from the front surface and measured into a 50 ohm receiver.

DESCRIPTION: Output leakage is verified by holding a loop antenna 2.5 cm (1 inch) from the front surface of the Signal Generator and measuring the resulting signal with a spectrum analyzer.

The loop antenna is suspended in a molding so that when the molding is in contact with a surface, the loop antenna is one inch from the surface.

NOTE

The use of a screen room may be necessary to reduce external radiated interference.

EQUIPMENT:

| | |
|-----------------------------|----------------|
| One-Inch Loop Antenna | HP 08640-60501 |
| 26 dB Amplifier | HP 8447D |
| Spectrum Analyzer | HP 8558A |
| 50 ohm Termination | HP 908A |

PROCEDURE: 1. Connect equipment as shown in Figure 4-11.

NOTE

To avoid disturbing the antenna's field and causing measurement error, grasp the antenna at the end that has the BNC connector.

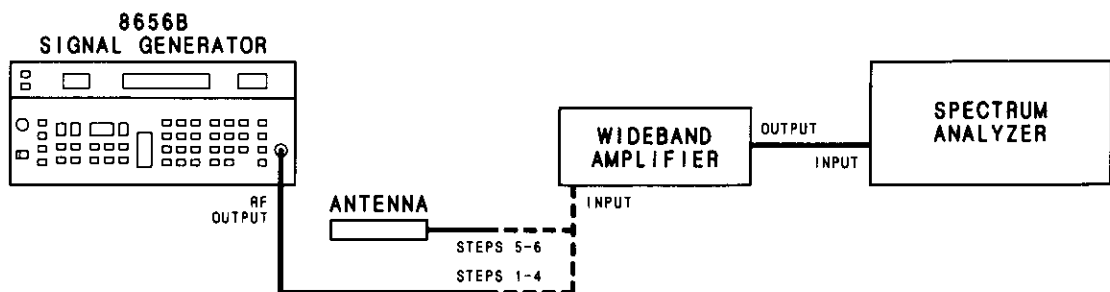

Figure 4-11. Output Leakage Test Setup

PERFORMANCE TESTS

4-10. OUTPUT LEAKAGE TESTS (cont'd)

2. Set the Signal Generator as follows:

Frequency 100 MHz
Amplitude -107 dBm
Modulation Off

3. Set the spectrum analyzer as follows:

Center Frequency 100 MHz
Input Attenuation -40 dB
Reference Level -20 dBm
Frequency Span 20 MHz
Resolution Bandwidth 10 kHz

4. View the signal on the spectrum analyzer and adjust the reference level controls of the spectrum analyzer to set the -107 dBm signal from the Signal Generator to reference graticule line on the spectrum analyzer display. Set the video filter to further separate the signal from the noise. Disconnect the Signal Generator from the spectrum analyzer, and connect a 50 ohm termination to the Signal Generator's RF OUTPUT connector.

5. Connect the one-inch loop antenna to the analyzer through the 26 dB amplifier as shown in Figure 4-11. Hold the end of the loop antenna cylinder in contact with the front surfaces of the Signal Generator. All signals and noise should be below the reference graticule line (i.e., below -107 dBm).

_____ < -107 dBm (<1.0 μ V) at 100 MHz

6. Repeat step 5 for frequencies of 300, 500, 700, 900, and 990 MHz.

_____ < -107 dBm (<1.0 μ V) at 300 MHz

_____ < -107 dBm (<1.0 μ V) at 500 MHz

_____ < -107 dBm (<1.0 μ V) at 700 MHz

_____ < -107 dBm (<1.0 μ V) at 900 MHz

_____ < -107 dBm (<1.0 μ V) at 990 MHz

PERFORMANCE TESTS

4-11. SWR TEST <-5 dBm (10 dB Attenuator Pad Selected)

SPECIFICATION:

| Electrical Characteristics | Performance Limits | Conditions |
|----------------------------|------------------------------|--|
| SWR: RF OUTPUT | <2.0, -9.6 dB Return Loss | >-5 dBm |
| | <1.5, -14 dB Return Loss | ≤-5 dBm |
| Impedance | 50 ohms nominal | |
| Reverse Power | 25 watts | RF power to 990 MHz into RF OUTPUT, dc voltage cannot exceed 25 V |

DESCRIPTION: SWR is verified by comparing the reflected power (frequencies 0.5 to 990 MHz from an RF signal source) to a reference that represents 100% return loss. The reference level is determined by disconnecting the SWR bridge from the Signal Generator under test, and connecting a short to the SWR bridge (100% reflected power) to the spectrum analyzer. The reference is established on the spectrum analyzer display. The SWR bridge is then connected to the Signal Generator under test, and return loss for the frequency is displayed on the spectrum analyzer. The output frequency of Signal Generator under test must be set 100 MHz from the frequency of the RF signal source.

EQUIPMENT: RF Signal Source HP 8656B
 Spectrum Analyzer HP 8558A/181T
 SWR Bridge Wiltron 60N50
 Cables (UG-21D/U type N connectors) HP 11500B (2 Required)

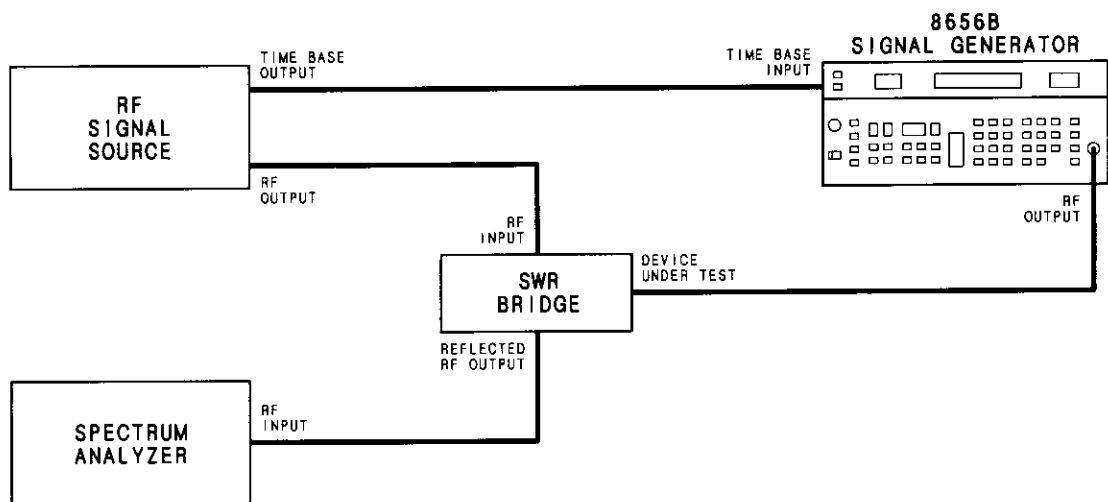

Figure 4-12. SWR Performance Test Setup (Out of Band)

PERFORMANCE TESTS

4-11. SWR TEST <-5 dBm (10 dB Attenuator Pad Selected) (cont'd)

PROCEDURE: 1. Set the equipment as follows:

Signal Generator 8656B

Frequency 0.1 MHz
Modulation Off
Amplitude -10 dBm

Spectrum Analyzer

Frequency Span 100 MHz
Resolution Bandwidth 300 kHz
Reference Level 0 dBm
Center Frequency 100 MHz

RF Signal Source

Output Level +10 dBm
Frequency 100 MHz

2. Connect the equipment as shown in Figure 4-12.
3. With the SWR bridge disconnected from the Signal Generator under test, and a short connected to the SWR bridge, set the reference level on the spectrum analyzer for a 100% reflected signal.
4. Connect the SWR bridge to the Signal Generator's RF OUTPUT connector. The difference, in dB, of the level on the display and the reference is the return loss of the Signal Generator's RF OUTPUT connector. The return loss must be >14 dB.

_____ 14dB

5. Repeat steps 3 through 4 with the RF signal source set to any frequency between 5 MHz and 990 MHz and 100 MHz from the Signal Generator's frequency.

_____ 14dB

PERFORMANCE TESTS

4-11. SWR TEST (cont'd)

SWR Test > -2 dBm (Attenuator Pads Not Selected)

DESCRIPTION: SWR, without any attenuation, is verified by the following procedure. Set the amplitude of the Signal Generator under test and turn off the RF signal source. Then the amplitude of the reflected signal from the RF source is set to an equal level with the Device Under Test port shorted. The maximum and minimum voltages in dB are read from the spectrum analyzer to compute the SWR using the equation listed below.

6. Set the equipment as follows:

Signal Generator 8656B

Frequency 100 MHz
Modulation Off
Amplitude -2 dBm

Spectrum Analyzer

Frequency Span 0 Hz
Resolution Bandwidth 3 MHz
Reference Level 0 dBm
Center Frequency 100 MHz
Scale LOG 2dB/Div

RF Signal Source

Amplitude -127 dBm
Modulation Off
Frequency 100 MHz
RF Off

- 7. Connect the equipment as shown in Figure 4-12.
- 8. With the SWR bridge connected to the Signal Generator under test, and the amplitude of the RF signal source turned off, set a reference on the spectrum analyzer. Tune the frequency of the spectrum analyzer for maximum level on the display.

PERFORMANCE TESTS

4-11. SWR TEST (cont'd)

9. Disconnect the SWR bridge from the Signal Generator under test and connect a short to the Device Under Test port.
10. Set the amplitude of the RF signal source to +13 dBm.
11. Set the amplitude of the RF signal source to the same level on the spectrum analyzer as set in step 8.
12. Remove the short from the SWR bridge, and connect the SWR bridge to the Signal Generator under test.
13. Press and release the Blue SHIFT key. Press and hold the Phase Decrement DOWN key (frequency decrement DOWN key). The level on the spectrum analyzer changes as the phase changes.

NOTE

Each time the Phase Decrement key is released, the Blue SHIFT must be pressed to reselect the Phase Decrement function.

14. Read the maximum and minimum levels from the spectrum analyzer and substitute their value in the following equation and solve for the SWR of the Signal Generator.
$$\frac{\text{Maximum Level} - \text{Minimum Level}}{\text{Maximum Level} + \text{Minimum Level}} < 2.0$$
15. Repeat steps 3 through 8 for each frequency between 5 and 990 MHz SWR is to be checked.

PERFORMANCE TESTS

$$\text{SWR} = \frac{1 + \rho}{1 - \rho} = \frac{E_{\max}}{E_{\min}}$$

$$E_{\max} = A + \rho A \quad E_{\min} = A - \rho A$$

$$\text{SWR} = \frac{E_{\max}/A}{E_{\min}/A} = \frac{E_{\max}}{E_{\min}}$$

$$20 \log E_{\max} = E_{\max} \text{ dB} \quad 20 \log E_{\min} = E_{\min} \text{ dB}$$

$$20 \log \text{SWR} = 20 \log \frac{(E_{\max})}{(E_{\min})}$$

$$20 \log \text{SWR} = 20 \log E_{\max} - 20 \log E_{\min}$$

$$20 \log \text{SWR} = E_{\max} \text{ dB} - E_{\min} \text{ dB}$$

$$\text{SWR} = 10^{\frac{(E_{\max} \text{ dB} - E_{\min} \text{ dB})}{20}}$$

Table 4-2. Performance Test Record (1 of 4)

| Hewlett-Packard Company | | Tested by _____ | | |
|-------------------------|---|-----------------|-------------|-------------------------|
| Model 8656B | | | | |
| Signal Generator | | | | |
| Serial Number _____ | | Date _____ | | |
| Para. No. | Test | Results | | |
| | | Min. | Actual | Max. |
| 4-7 | SPURIOUS SIGNALS | | | |
| | Harmonics (2425A only) | | _____ | -25 dBc |
| | Harmonics (2447A and above) | | _____ | -30 dBc |
| | Non-Harmonics (>5 kHz from carrier) | | _____ | -60 dBc |
| | Sub-Harmonics | | _____ | None |
| | RESIDUAL MODULATION CW MODE | | | |
| | AM (0.05 to 15 kHz Post Detection Noise Bandwidth) 0.1 to 990 MHz | | _____ | 1.78 mVrms (-75 dBc) |
| | FM (0.3 to 3 kHz Post Detection Noise Bandwidth) 0.1 to 123.5 MHz | | _____ | 7 Hz rms |
| | 123.5 to 247 MHz | | _____ | 2 Hz rms |
| | 247 to 494 MHz | | _____ | 4 Hz rms |
| | 494 to 990 MHz | | _____ | 7 Hz rms |
| | FM (0.05 to 15 kHz Post Detection Noise Bandwidth) 0.1 to 123.5 MHz | | _____ | 15 Hz rms |
| | 123.5 to 247 MHz | | _____ | 4 Hz rms |
| | 247 to 494 MHz | | _____ | 8 Hz rms |
| | 494 to 990 MHz | | _____ | 15 Hz rms |
| | SSB ϕ Noise (20 kHz offset from carrier) 0.1 to 123.5 MHz | | _____ | -114 dBc/Hz |
| | 123.5 to 247 MHz | | _____ | -126 dBc/Hz |
| 247 to 494 MHz | | _____ | -120 dBc/Hz | |
| 494 to 990 MHz | | _____ | -114 dBc/Hz | |
| 4-8 | OUTPUT LEVEL ACCURACY AND FLATNESS | | | |
| | Absolute Level Accuracy ($\leq \pm 1.0$ dB; 123.5 to 990 MHz; +7 to -124 dBm) ($\leq \pm 1.5$ dB; 0.1 to 123.5 MHz, and < -124 dBm or $> +7$ dBm at 0.1 to 990 MHz) | +11.5 dBm | _____ | +14.5 dBm |
| | | +6.5 dBm | _____ | +9.5 dBm |
| | | +1.5 dBm | _____ | +4.5 dBm |
| | | -3.5 dBm | _____ | -0.5 dBm |
| | | -8.5 dBm | _____ | -5.5 dBm |
| | | -13.5 dBm | _____ | -10.5 dBm |
| | | -18.5 dBm | _____ | -15.5 dBm |
| | | -23.5 dBm | _____ | -20.5 dBm |
| | | -28.5 dBm | _____ | -25.5 dBm |
| | | -33.5 dBm | _____ | -30.5 dBm |
| | -38.5 dBm | _____ | -35.5 dBm | |

Table 4-2. Performance Test Record (2 of 4)

| Para. No. | Test | Results | | |
|-------------------------|--|------------|---------|------------|
| | | Min. | Actual | Max. |
| 4-8 (Cont'd) | OUTPUT LEVEL ACCURACY AND FLATNESS Absolute Level Accuracy ($\leq \pm 1.0$ dB; 123.5 to 990 MHz; +7 to -124 dBm) ($\leq \pm 1.5$ dB; 0.1 to 123.5 MHz, and < -124 dBm or $> +7$ dBm at 0.1 to 990 MHz) RF Output Frequencies 123.5 to 990 MHz | -43.5 dBm | _____ | -40.5 dBm |
| | | -48.5 dBm | _____ | -45.5 dBm |
| | | -53.5 dBm | _____ | -50.5 dBm |
| | | -58.5 dBm | _____ | -55.5 dBm |
| | | -63.5 dBm | _____ | -60.5 dBm |
| | | -68.5 dBm | _____ | -65.5 dBm |
| | | -73.5 dBm | _____ | -70.5 dBm |
| | | -78.5 dBm | _____ | -75.5 dBm |
| | | -83.5 dBm | _____ | -80.5 dBm |
| | | -88.5 dBm | _____ | -85.5 dBm |
| | | -93.5 dBm | _____ | -90.5 dBm |
| | | -98.5 dBm | _____ | -95.5 dBm |
| | | -103.5 dBm | _____ | -100.5 dBm |
| | | -108.5 dBm | _____ | -105.5 dBm |
| | | -113.5 dBm | _____ | -110.5 dBm |
| | | -118.5 dBm | _____ | -115.5 dBm |
| | | -123.5 dBm | _____ | -120.5 dBm |
| | | -128.5 dBm | _____ | -125.5 dBm |
| | | +11.5 dBm | _____ | +14.5 dBm |
| | | +6.5 dBm | _____ | +9.5 dBm |
| | | +1.0 dBm | _____ | +4.0 dBm |
| | | -3.0 dBm | _____ | -1.0 dBm |
| | | -8.0 dBm | _____ | -6.0 dBm |
| | | -13.0 dBm | _____ | -11.0 dBm |
| | | -18.0 dBm | _____ | -16.0 dBm |
| | | -23.0 dBm | _____ | -21.0 dBm |
| | | -28.0 dBm | _____ | -26.0 dBm |
| | | -33.0 dBm | _____ | -31.0 dBm |
| | | -38.0 dBm | _____ | -36.0 dBm |
| | | -43.0 dBm | _____ | -41.0 dBm |
| | | -48.0 dBm | _____ | -46.0 dBm |
| | | -53.0 dBm | _____ | -51.0 dBm |
| | | -58.0 dBm | _____ | -56.0 dBm |
| | | -63.0 dBm | _____ | -61.0 dBm |
| | | -68.0 dBm | _____ | -66.0 dBm |
| | | -73.0 dBm | _____ | -71.0 dBm |
| | | -78.0 dBm | _____ | -76.0 dBm |
| | | -83.0 dBm | _____ | -81.0 dBm |
| | | -88.0 dBm | _____ | -86.0 dBm |
| | | -93.0 dBm | _____ | -91.0 dBm |
| | | -98.0 dBm | _____ | -96.0 dBm |
| -103.0 dBm | _____ | -101.0 dBm | | |
| -108.0 dBm | _____ | -106.0 dBm | | |
| -113.0 dBm | _____ | -111.0 dBm | | |
| -118.0 dBm | _____ | -116.0 dBm | | |
| -123.0 dBm | _____ | -121.0 dBm | | |
| -128.5 dBm | _____ | -125.5 dBm | | |
| Level Flatness (0.0 dB) | -1.0 dB | _____ | +1.0 dB | |

Table 4-2. Performance Test Record (3 of 4)

| Para. No. | Test | Results | | |
|-----------------|--|---------|------------|-----------------|
| | | Min. | Actual | Max. |
| 4-9 | MODULATION | | | |
| | Indicator Accuracy (Internal 1 kHz source) | | | |
| | 100 MHz 10% | 7.6% | _____ | 12.4% |
| | 30% | 26.8% | _____ | 33.2% |
| | 70% | 65.2% | _____ | 74.8% |
| | 90% | 84.4% | _____ | 95.6% |
| | 240 MHz 10% | 7.6% | _____ | 12.4% |
| | 30% | 26.8% | _____ | 33.2% |
| | 70% | 65.2% | _____ | 74.8% |
| | 90% | 84.4% | _____ | 95.6% |
| | 400 MHz 10% | 7.6% | _____ | 12.4% |
| | 30% | 26.8% | _____ | 33.2% |
| | 70% | 65.2% | _____ | 74.8% |
| | 90% | 84.4% | _____ | 95.6% |
| | 990 MHz 10% | 7.6% | _____ | 12.4% |
| | 30% | 26.8% | _____ | 33.2% |
| | 70% | 65.2% | _____ | 74.8% |
| | 90% | 84.4% | _____ | 95.6% |
| | (Internal 400 Hz source) | | | |
| | 100 MHz 10% | 7.6% | _____ | 12.4% |
| | 30% | 26.8% | _____ | 33.2% |
| | 70% | 65.2% | _____ | 74.8% |
| | 90% | 84.4% | _____ | 94.6% |
| | Incidental Phase Modulation (30% AM Internal Rates) 0.1 to 990 MHz | | | 0.3 radian peak |
| | AMPLITUDE MODULATION | | | |
| | AM Distortion (Internal 1 kHz Source) | | | |
| | 100 MHz 30% | | _____ | 1.5% |
| | 70% | | _____ | 3.0% |
| | 90% | | _____ | 4.0% |
| | 240 MHz 30% | | _____ | 1.5% |
| | 70% | | _____ | 3.0% |
| | 90% | | _____ | 4.0% |
| | 400 MHz 30% | | _____ | 1.5% |
| | 70% | | _____ | 3.0% |
| | 90% | | _____ | 4.0% |
| | 990 MHz 30% | | _____ | 1.5% |
| | 70% | | _____ | 3.0% |
| | 90% | | _____ | 4.0% |
| | FREQUENCY MODULATION | | | |
| | Indicator, Accuracy (Internal 1 kHz Source) | | | |
| 100 MHz 5.0 kHz | 4.75 kHz | _____ | 5.25 kHz | |
| 30.0 kHz | 28.50 kHz | _____ | 31.50 kHz | |
| 70.0 kHz | 66.50 kHz | _____ | 73.50 kHz | |
| 99.0 kHz | 94.05 kHz | _____ | 103.95 kHz | |

Table 4-2. Performance Test Record (4 of 4)

| Para. No. | Test | Results | | |
|--|--|-----------|---|---|
| | | Min. | Actual | Max. |
| 4-9 (Cont'd) | FREQUENCY MODULATION | | | |
| | Incidental AM (<20 kHz Peak Deviation, and at Internal Rates) | | | |
| | >500 kHz (fc) | | _____ | 0.1% |
| | 200 to 500 kHz (fc) | | _____ | 1% |
| | <200 kHz (fc) | | _____ | 5% |
| | FM Distortion (≥ 3 kHz Peak Deviation, and at Internal Rates) | | _____ | 0.5% |
| | DC FREQUENCY MODULATION | | | |
| | DC FM Center Frequency Accuracy | | | |
| | 0.1 to 123.5 MHz (1 to 99 kHz Deviation) | -500 Hz | _____ | +500 Hz |
| | 123.5 to 247 MHz (1 to 50 kHz Deviation) | -125 Hz | _____ | +125 Hz |
| | 247 to 494 MHz (1 to 99 kHz Deviation) | -250 Hz | _____ | +250 Hz |
| | 494 to 990 MHz (1 to 99 kHz Deviation) | +500 Hz | _____ | +500 Hz |
| | DC FM Center Frequency Stability | | | |
| | 0.1 to 123.5 MHz (1 to 99 kHz Deviation) | -10 Hz/hr | _____ | +10 Hz/hr |
| 123.5 to 247 MHz (1 to 50 kHz Deviation) | -10 Hz/hr | _____ | +10 Hz/hr | |
| 247 to 494 MHz (1 to 99 kHz Deviation) | -10 Hz/hr | _____ | +10 Hz/hr | |
| 494 to 990 MHz (1 to 99 kHz Deviation) | -10 Hz/hr | _____ | +10 Hz/hr | |
| 4-10 | OUTPUT LEAKAGE | | | |
| | Leakage (Two-turn 2.5 cm diameter loop held 2.5 cm away from front surface) | | | |
| | | | _____ | -107 dBm (1.0 μ V) at 100 MHz |
| | | | _____ | -107 dBm (1.0 μ V) at 300 MHz |
| | | | _____ | -107 dBm (1.0 μ V) at 500 MHz |
| | | | _____ | -107 dBm (1.0 μ V) at 700 MHz |
| | | | _____ | -107 dBm (1.0 μ V) at 900 MHz |
| | | | -107 dBm (1.0 μ V) at 990 MHz | |
| 4-11 | SWR | | | |
| | Return Loss (Signal Generator at 0.1 MHz) | 14 dB | _____ | |
| | Return Loss (Signal Generator at 5 to 990 MHz) | 14 dB | _____ | |
| | SWR | | _____ | 2 |

SECTION V

ADJUSTMENTS

5-1. INTRODUCTION

This section contains adjustments and checks that assure peak performance of the Signal Generator. The instrument should be readjusted after repair or failure to pass a performance test. Allow a 30-minute warm-up prior to performing the adjustments. Removal of the instrument top and bottom covers is required for most adjustments. Included in this section are test setups and illustrations that show the location of each assembly. Removal and disassembly procedures are given in Section VIII. To determine which performance tests and adjustments to perform after a repair, refer to paragraph 5-5, Post-Repair Adjustments.

5-2. SAFETY CONSIDERATIONS

Refer to the Safety Considerations page found at the beginning of this manual for a summary of the safety information.

5-3. EQUIPMENT REQUIRED

All adjustment procedures contain a list of required test equipment. The test equipment is also identified by callouts in the test setup diagrams, where included. If substitutions must be made for the specified test equipment, refer to Table 1-3, Recommended Test Equipment, in Section I of this manual for the critical specifications. It is important that the test equipment meet the critical specifications listed in the table if the Signal Generator is to meet its performance requirements.

5-4. FACTORY-SELECTED COMPONENTS

Factory-selected components are identified on the schematics and parts lists by asterisk (*) which follows the reference designator. The nominal value or range of the components is shown. Manual Update addition and replacement pages provide updated information pertaining to selected components. Table 5-1 lists the reference designator, the basis used for selecting a particular value, the nominal value range, and the service sheet where the component part is shown.

Table 5-1. Factory Selected Components

| Reference Designator | Service Sheet | Range of Values | Basis of Selection | | | | | | | | | | | | | | | | | | | | | | | | | | | | | | | | | | | | | | | | | | | | | |
|----------------------|----------------------|--------------------------------------|---|---------------------------|----------------------|---------------------------|-----------------|---------------------------|---|-----|---------------|------|---------------|---|-----|---------------|------|---------------|---|-----|---------------|------|---------------|---|-----|---------------|------|---------------|---|-----|---------------|------|---------------|---|-----|---------------|------|---------------|---|-----|---------------|------|---------------|----|-----|---------------|------|---------------|
| A3C23 | 16 | 33 pF to 47 pF | Select capacitor so that the output level of the 50 MHz Reference Oscillator can be adjusted to greater than +17 dBm | | | | | | | | | | | | | | | | | | | | | | | | | | | | | | | | | | | | | | | | | | | | | |
| A4R6,7,10 | 1 | See table under "Basis of Selection" | Attenuator pad selected for -8 dBm input to mixer A4U1. Measure power level at RF Test Point A4TP3 with A4R6 and A4R7 disconnected. Select pad values for -8 dBm to mixer. Level must be checked whenever the A3, A4, A8, or FL1 assemblies are replaced. <table border="1" data-bbox="659 621 1414 947"> <thead> <tr> <th>Attenuation (dB)</th> <th>R6, R10 (Ω)</th> <th>HP Part No. (Check Digit)</th> <th>R7 (Ω)</th> <th>HP Part No. (Check Digit)</th> </tr> </thead> <tbody> <tr> <td>3</td> <td>287</td> <td>0698-7223 (2)</td> <td>17.8</td> <td>0698-7194 (6)</td> </tr> <tr> <td>4</td> <td>215</td> <td>0698-7220 (9)</td> <td>23.7</td> <td>0698-7197 (9)</td> </tr> <tr> <td>5</td> <td>178</td> <td>0698-7218 (5)</td> <td>31.6</td> <td>0698-7200 (5)</td> </tr> <tr> <td>6</td> <td>147</td> <td>0698-7216 (3)</td> <td>38.3</td> <td>0698-7202 (7)</td> </tr> <tr> <td>7</td> <td>133</td> <td>0698-7215 (2)</td> <td>46.4</td> <td>0698-7204 (9)</td> </tr> <tr> <td>8</td> <td>121</td> <td>0698-7214 (1)</td> <td>51.1</td> <td>0698-7205 (0)</td> </tr> <tr> <td>9</td> <td>110</td> <td>0698-7213 (0)</td> <td>61.9</td> <td>0698-7207 (2)</td> </tr> <tr> <td>10</td> <td>100</td> <td>0698-7212 (9)</td> <td>75.0</td> <td>0698-7209 (4)</td> </tr> </tbody> </table> | Attenuation (dB) | R6, R10 (Ω) | HP Part No. (Check Digit) | R7 (Ω) | HP Part No. (Check Digit) | 3 | 287 | 0698-7223 (2) | 17.8 | 0698-7194 (6) | 4 | 215 | 0698-7220 (9) | 23.7 | 0698-7197 (9) | 5 | 178 | 0698-7218 (5) | 31.6 | 0698-7200 (5) | 6 | 147 | 0698-7216 (3) | 38.3 | 0698-7202 (7) | 7 | 133 | 0698-7215 (2) | 46.4 | 0698-7204 (9) | 8 | 121 | 0698-7214 (1) | 51.1 | 0698-7205 (0) | 9 | 110 | 0698-7213 (0) | 61.9 | 0698-7207 (2) | 10 | 100 | 0698-7212 (9) | 75.0 | 0698-7209 (4) |
| Attenuation (dB) | R6, R10 (Ω) | HP Part No. (Check Digit) | R7 (Ω) | HP Part No. (Check Digit) | | | | | | | | | | | | | | | | | | | | | | | | | | | | | | | | | | | | | | | | | | | | |
| 3 | 287 | 0698-7223 (2) | 17.8 | 0698-7194 (6) | | | | | | | | | | | | | | | | | | | | | | | | | | | | | | | | | | | | | | | | | | | | |
| 4 | 215 | 0698-7220 (9) | 23.7 | 0698-7197 (9) | | | | | | | | | | | | | | | | | | | | | | | | | | | | | | | | | | | | | | | | | | | | |
| 5 | 178 | 0698-7218 (5) | 31.6 | 0698-7200 (5) | | | | | | | | | | | | | | | | | | | | | | | | | | | | | | | | | | | | | | | | | | | | |
| 6 | 147 | 0698-7216 (3) | 38.3 | 0698-7202 (7) | | | | | | | | | | | | | | | | | | | | | | | | | | | | | | | | | | | | | | | | | | | | |
| 7 | 133 | 0698-7215 (2) | 46.4 | 0698-7204 (9) | | | | | | | | | | | | | | | | | | | | | | | | | | | | | | | | | | | | | | | | | | | | |
| 8 | 121 | 0698-7214 (1) | 51.1 | 0698-7205 (0) | | | | | | | | | | | | | | | | | | | | | | | | | | | | | | | | | | | | | | | | | | | | |
| 9 | 110 | 0698-7213 (0) | 61.9 | 0698-7207 (2) | | | | | | | | | | | | | | | | | | | | | | | | | | | | | | | | | | | | | | | | | | | | |
| 10 | 100 | 0698-7212 (9) | 75.0 | 0698-7209 (4) | | | | | | | | | | | | | | | | | | | | | | | | | | | | | | | | | | | | | | | | | | | | |
| A5C15 | 1 | 10 pF to 33 pF | Decrease the value of C15 if the 494-990 MHz oscillator fails to oscillate at 494 MHz only. Increase C15's value if spurs are present at half the fundamental frequency from 494 to 990 MHz. | | | | | | | | | | | | | | | | | | | | | | | | | | | | | | | | | | | | | | | | | | | | | |
| A5C22 | 1 | 0 or 1 pF | Selected to eliminate spurious signals at 690 to 740 MHz. | | | | | | | | | | | | | | | | | | | | | | | | | | | | | | | | | | | | | | | | | | | | | |
| A6R57 | 5 | 237 Ω to 562 Ω | Resistor A6R57 is selected to center the adjustment range of variable capacitor A6C56, so the RF OUTPUT can be adjusted ± 0.5 dB from 0.0 dBm. | | | | | | | | | | | | | | | | | | | | | | | | | | | | | | | | | | | | | | | | | | | | | |
| A8C5 | 3 | 47 pF to 82 pF | Select A8C5 to maximize DC voltage measured at J2 pin 4. | | | | | | | | | | | | | | | | | | | | | | | | | | | | | | | | | | | | | | | | | | | | | |
| A8C19 | 3 | 20 pF to 39 pF | Select A8C19 to maximize DC voltage measured at J2 pin 6. | | | | | | | | | | | | | | | | | | | | | | | | | | | | | | | | | | | | | | | | | | | | | |
| A8C40 | 3 | 0 or 1000 pF | Selected to eliminate a spurious signal at 700 MHz. | | | | | | | | | | | | | | | | | | | | | | | | | | | | | | | | | | | | | | | | | | | | | |

5-5. POST-REPAIR ADJUSTMENTS

Table 5-2 lists the adjustments related to repairs or replacement of any of the assemblies.

5-6. RELATED ADJUSTMENTS

The procedures in this section can be done in any order; however, it is suggested that the power supply voltage, reference voltage, and audio oscillator adjustments be performed first. Changes in these adjustments can affect other adjustments, especially level and modulation accuracies.

WARNING

Maintenance described herein is performed with power supplied to the instrument, and protective covers removed. Such maintenance should be performed only by service-trained personnel who are aware of the hazards involved (for example, fire and electrical shock). Where maintenance can be performed without power applied, the power should be removed.

Table 5-2. Post-Repair Adjustments

| Assembly Repaired or Replaced | Reference Service Sheet No. | Related Adjustments (Paragraph) |
|-------------------------------|-----------------------------|---|
| A1 | 21 | None |
| A2 | 21 through 24 | None |
| A3 | 10 | 5-7 |
| A3 | 11 | None |
| A3 | 12 | 5-24 |
| A3 | 13 | 5-25 |
| A3 | 14 | 5-23 |
| A3 | 15 | 5-26 and 5-27 |
| A3 | 16 | 5-14 and 5-15 |
| A3A1 | 9 | 5-16 |
| A4 | 1 | 5-12 |
| A4 | 2 | 5-11 and 5-13 |
| A5 | 1 | None |
| A6 | 4 | 5-19 and 5-21 |
| A6 | 5 | 5-20 and 5-20A |
| A7 | 3 | None |
| A8 | 1 | 5-17 |
| A8 | 3 | 5-17 and 5-18 |
| A9 | 8 | None |
| A10 | 6 | 5-8 |
| A10 | 7 | 5-9, 5-10, 5-19, 5-21, 5-22, 5-28 and 5-29 |
| A10 | 25 | 5-7 |
| A11 | 17 through 20 | None |
| A12 | 25 | None |
| A13 | 20 | None |
| A14 | 17 and 25 | None |
| A15 | 25 | None |
| A16 | 25 | 5-30 |
| A17 | 7, 21, and 25 | None |
| A18 | 21 | None |
| A19 | 5, 6, 17 and 25 | None |

ADJUSTMENTS

5-7. POWER SUPPLY VOLTAGE ADJUSTMENT

REFERENCE: Service Sheets 10 and 25.

DESCRIPTION: The +5.4 Vdc power supply is adjusted for +5.25 Vdc \pm 0.02 Vdc at A3J1 pin 3 using a digital multimeter.

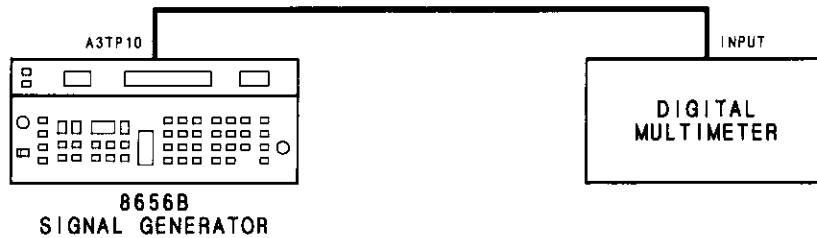

Figure 5-1. +5.4 Vdc Power Supply Adjustment Setup

EQUIPMENT: Digital Multimeter HP 3466A

PROCEDURE: 1. Set the digital multimeter as follows:

Function Vdc
Range 20V

2. Set the Signal Generator as follows:

Frequency 140 MHz
Amplitude -10 dBm
Modulation AM 50%

3. Connect the digital multimeter to A3J1 pin 3 (+5V). Adjust A10R102 (+5.4V ADJ) for a reading of +5.25 Vdc \pm 0.02 Vdc on the digital multimeter.

Top Internal View, Level 1

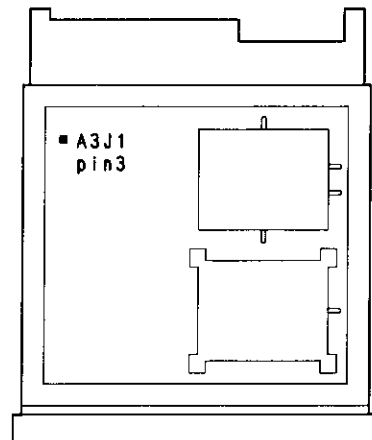

Bottom Internal View, Level 4

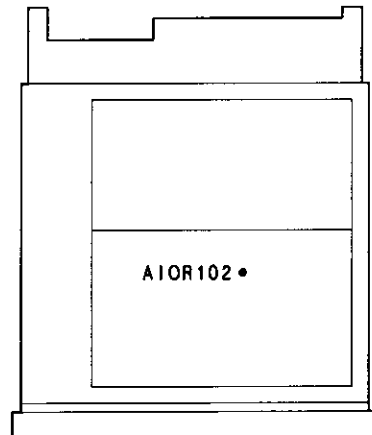

ADJUSTMENTS

5-8. REFERENCE VOLTAGE ADJUSTMENT

REFERENCE: Service Sheet 6.

DESCRIPTION: The +2 Vdc reference is adjusted for +2.000 Vdc \pm 0.004 Vdc at Test Point A10J6 pin 4 using a digital multimeter.

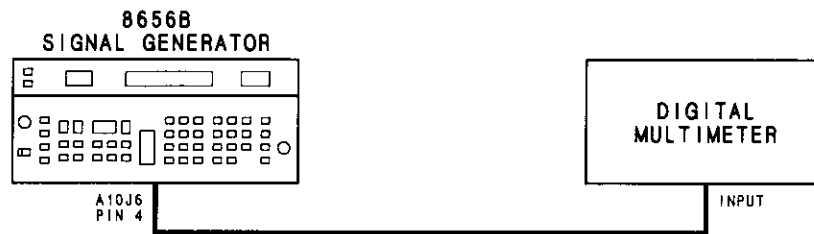

Figure 5-2. +2 Vdc Reference Adjustment Setup

EQUIPMENT: Digital Multimeter HP 3466A

PROCEDURE: 1. Set the digital multimeter as follows:

Function Vdc
Range 20V

2. Set the Signal Generator as follows:

Frequency 140 MHz
Amplitude -10 dBm
Modulation AM 50%

3. Connect the digital multimeter to Test Point A10J6 pin 4 (+2V (R)) and adjust A10R2 (+2V REF ADJ) for a reading of 2.000 Vdc \pm 0.004 Vdc on the digital multimeter.

Bottom Internal View, Level 4

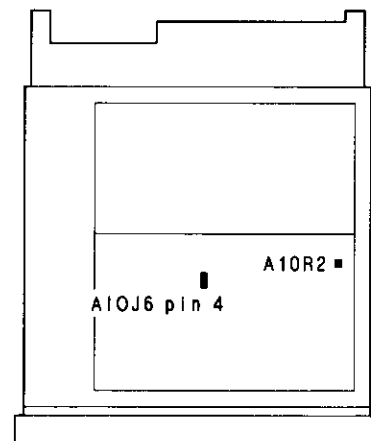

ADJUSTMENTS

5-9. AUDIO OSCILLATOR LEVEL ADJUSTMENT

REFERENCE: Service Sheet 7.

DESCRIPTION: The internal 1 kHz modulation source is adjusted to $0.707 \text{ Vrms} \pm 0.007 \text{ Vrms}$ at Test Point OSC A10J6 pin 6. Then, the internal 400 Hz modulation source is checked to ensure that it is within the same limits.

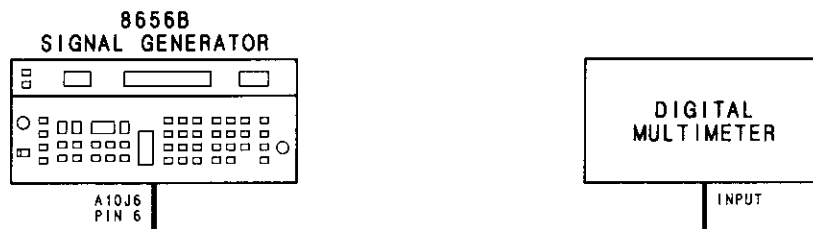

Figure 5-3. Audio Oscillator Level Adjustment Setup

EQUIPMENT: Digital Multimeter HP 3466A

PROCEDURE: 1. Set the digital multimeter as follows:

Function Vac
Range 2V

2. Set the Signal Generator as follows:

Frequency Any
Amplitude Any
Modulation AM
Source 1 kHz

3. Connect the digital multimeter to Test Point OSC A10J6 pin 6.

4. Adjust A10R28 (OSC ADJ) for a $0.707 \text{ Vrms} \pm 0.007 \text{ Vrms}$ reading on the digital multimeter.

5. Select the internal 400 Hz modulation source. Check that the 400 Hz oscillator level is within $0.707 \text{ Vrms} \pm 0.007 \text{ Vrms}$. If it is not, repeat step 4 until both readings are within the specified limits.

Bottom Internal View, Level 4

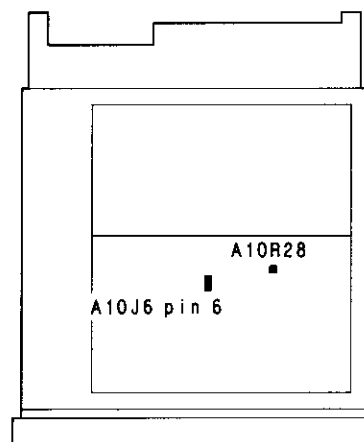

ADJUSTMENTS

5-10. AM OFFSET ADJUSTMENT

REFERENCE: Service Sheet 7.

DESCRIPTION: The dc offset of the AM Offset Buffer is adjusted for 0.000 Vdc \pm 0.001 Vdc at Test Point A10J6 pin 12 (AM) with the reference inputs to the Level DAC and AM% DAC grounded, and the digital input to each programmatically set to zero.

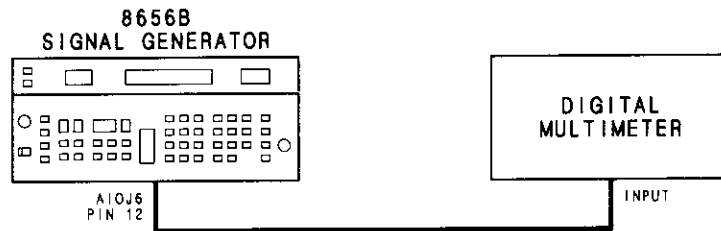

Figure 5-4. AM Offset Adjustment Setup

EQUIPMENT: Digital Multimeter HP 3466A

PROCEDURE: 1. Set the digital multimeter as follows:

Function Vdc
Range 200 mV

2. Set the Signal Generator modulation off.
3. Short INPUT 1 and INPUT 2 Test Points to ground.
4. Select Keyboard Invoked Tests number 2 by pressing the SHIFT key, and then the INCR SET key. Next, press the AMPT up-arrow key once to show the number "2" in the MODULATION Display. Press the INCR SET key once to zero the AM and FM modulation DACs. In the AMPLITUDE DISPLAY "00" should be seen to indicate that test number 2 is complete.

Bottom Internal View, Level 4

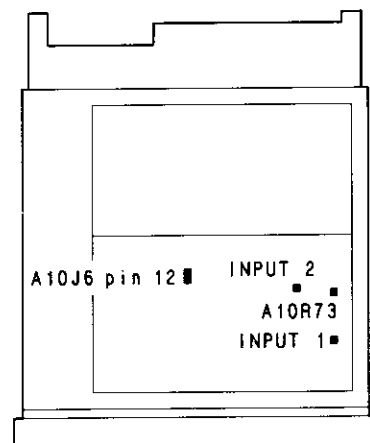

ADJUSTMENTS

5-10. AM OFFSET ADJUSTMENT (cont'd)

5. Connect the digital multimeter to A10J6 pin 12 AM.
6. Adjust A10R73 (AM OFFSET ADJ) for 0.000 Vdc \pm 0.001 Vdc.
7. Remove the two shorts installed in step 3.
8. Press the AMPT up arrow key five times until "7" is shown in the MODULATION Display. Press the INCR SET key once to exit from the Keyboard Invoked Tests.

ADJUSTMENTS

5-11. 715 MHz SIDEBAND ADJUSTMENT

REFERENCE: Service Sheet 2.

DESCRIPTION: The 715 MHz Sideband adjustment is made so that both inputs to the Sideband Comparator are equal with the Signal Generator frequency set to 715 MHz. The dc voltage between Test Points A4TP10 and A4TP11 (which are the inputs to the Sideband Comparator) is adjusted to 0 Vdc \pm 0.007 Vdc as the frequency is returned to 715 MHz from 765 MHz in a 50 MHz step.

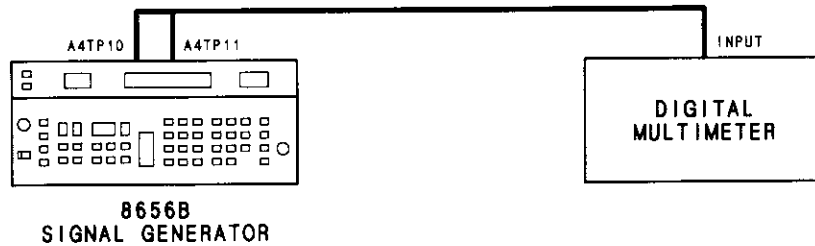
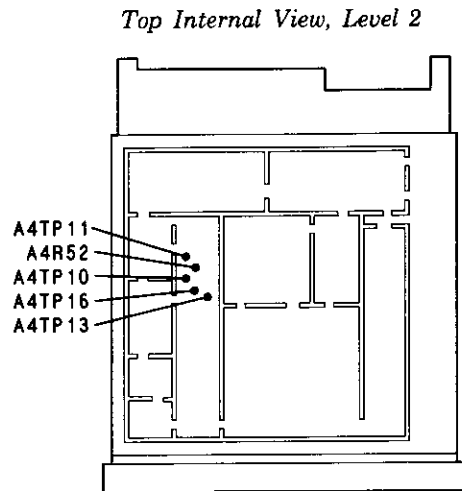

Figure 5-5. 715 MHz Sideband Adjustment Setup

EQUIPMENT: Digital Multimeter HP 3466A

- PROCEDURE:
1. Set the digital multimeter as follows:
 - Function Vdc
 - Range 200 mV
 2. Set the Signal Generator as follows:
 - Frequency 715 MHz
 - Frequency Increment ... 50 MHz
 - Amplitude Any
 - Modulation Off



CAUTION

DO NOT CONNECT TP13 to TP16 when the test points are not grounded.

ADJUSTMENTS

5-11. 715 MHz SIDEBAND ADJUSTMENT (cont'd)

3. Connect the digital multimeter input between Test Points A4TP10 and A4TP11. Short Test Points A4TP13 and A4TP16 to ground.
4. Increment the frequency up to 765 MHz and back to 715 MHz.
5. Adjust A4R52 (715 MHz ADJ) for 0 Vdc \pm 0.007 Vdc.
6. Remove the two shorts installed in step 3.

ADJUSTMENTS

5-12. NOTCH FILTER ADJUSTMENTS

REFERENCE: Service Sheet 1.

DESCRIPTION: Each one of the Notch Filters is adjusted using a signal source set to 50, 100, 150, 200, 250, and 300 MHz. The 50 to 250 MHz Notch Filters are de-selected one at a time to pass that frequency. With each filter de-selected and its output centered on a spectrum analyzer display, the Notch Filter is then re-selected and adjusted for a minimum signal output on the spectrum analyzer.

The two 300 MHz Notch Filters are in the circuit all of the time. A 300 MHz signal source is applied to the input of each filter and its output is connected to a spectrum analyzer. Each filter is then adjusted for a minimum signal output.

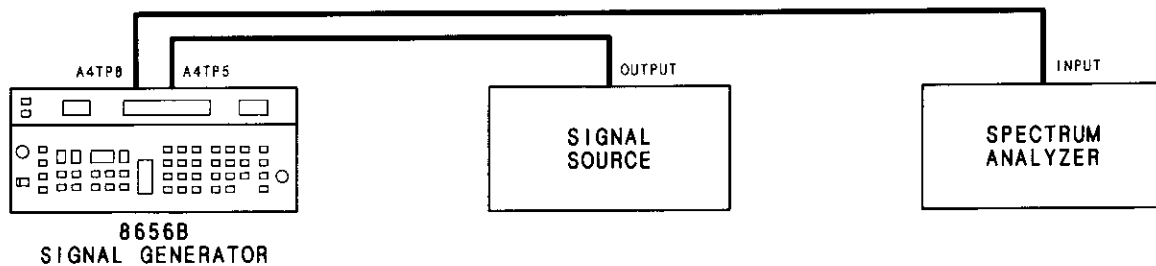

Figure 5-6. Notch Filters Adjustment Setup

EQUIPMENT:

| | |
|----------------------------------|-------------------|
| Signal Source | HP 8640B |
| Spectrum Analyzer | HP 8568A or 8558B |
| Adapter Probes (2) | HP 1250-1598 |
| Adapters (2) N(m) to BNC(f) | HP 1250-0780 |
| Cables (2) BNC(m) to SMC(f) | HP 08662-60075 |

PROCEDURE:

1. Set the signal source as follows:
 - Frequency 250.000 MHz
 - Counter Mode Expand X10
 - Level -20 dBm
 - Modulation Off

2. Set the spectrum analyzer as follows:
 - Optimum Input -10 dBm
 - Reference Level 0 dBm
 - Frequency Span/Div 500 kHz
 - Resolution Bandwidth ... 30 kHz

ADJUSTMENTS

5-12. NOTCH FILTER ADJUSTMENTS (cont'd)

3. Set the Signal Generator as follows:

Frequency 950 MHz
 Frequency Increment ... 50 MHz
 Amplitude Any
 Modulation Off

4. Connect the signal source to the Signal Generator at RF Test Point A4TP5 using an adapter (HP part number 1250-1598).
5. Connect the spectrum analyzer to the Signal Generator at RF Test Point A4TP8 using an adapter (HP part number 1250-1598).
6. Adjust the spectrum analyzer to center the 250 MHz signal on the spectrum analyzer display.
7. Step the frequency down 50 MHz to 900 MHz.
8. Adjust A4C53 (250 MHz IF ADJ) for a minimum signal output on the spectrum analyzer display.
9. Tune the signal source to 200.000 MHz and center the 200 MHz signal on the spectrum analyzer display.
10. Step the frequency down 50 MHz to 850 MHz.
11. Adjust A4L36 (200 MHz IF ADJ) for a minimum signal output on the spectrum analyzer display.
12. Tune the signal source to 150.000 MHz and center the 150 MHz signal on the spectrum analyzer display.
13. Step the frequency down 50 MHz to 800 MHz.
14. Adjust A4L37 (150 MHz IF ADJ) for a minimum signal output on the spectrum analyzer display.

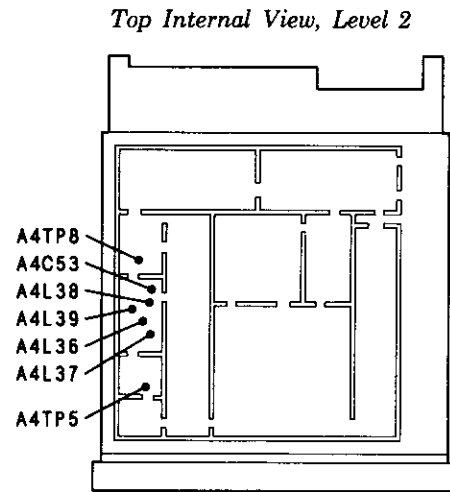

*50 to 250 MHz IF Adjustments
(Steps 4-20)*

ADJUSTMENTS

5-12. NOTCH FILTER ADJUSTMENTS (cont'd)

15. Remove X10 COUNTER MODE Expand. Tune the signal source to 100.000 MHz and center the 100 MHz signal on the spectrum analyzer display.
16. Step the frequency down 50 MHz to 750 MHz.
17. Adjust A4L38 (100 MHz IF ADJ) for a minimum signal output on the spectrum analyzer display.
18. Tune the signal source to 50.000 MHz and center the 50 MHz signal on the spectrum analyzer display.
19. Step the frequency up 50 MHz to 800 MHz.
20. Adjust A4L39 (50 MHz IF ADJ) for a minimum signal output on the spectrum analyzer display.
21. Connect the spectrum analyzer to the Signal Generator at RF Test Point A4TP6 using an adapter (HP part number 1250-1598).
22. Set the signal source COUNTER MODE Expand to X10. Tune the signal source to 300.000 MHz and center the 300 MHz signal on the spectrum analyzer display.
23. Adjust A4L28 (300 MHz IN IF ADJ) for a minimum signal output on the spectrum analyzer display.
24. Connect the spectrum analyzer to the Signal Generator at RF Test Point A4TP8 using an adapter (HP part number 1250-1598).
25. Connect the signal source to the Signal Generator at RF Test Point A4TP6 using an adapter (HP part number 1250-1598) and bypass A4L28 (300 MHz IN IF ADJ) by placing a jumper across it.
26. Adjust A4C85 (300 MHz IF ADJ) for a minimum signal output on the spectrum analyzer display. Remove the jumper across A4L28.

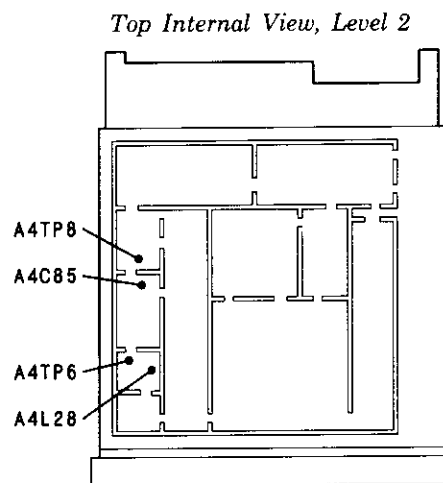

*300 MHz IF Adjustment
(Steps 21-26)*

ADJUSTMENTS

5-13. HIGH FREQUENCY LOOP OFFSET ADJUSTMENT

REFERENCE: Service Sheet 2.

DESCRIPTION: The tune voltage ramp from the Loop Amplifier is disconnected from the High Frequency Oscillator Assembly (A5) and then it is adjusted for a symmetrical ramp using an oscilloscope.

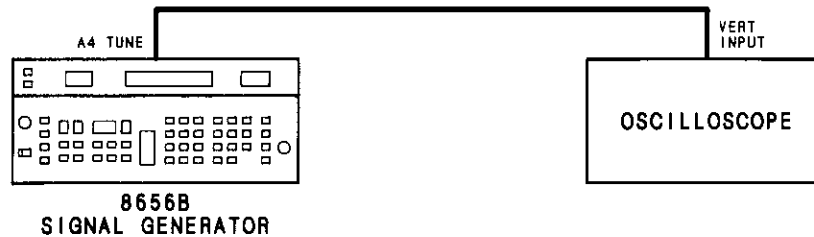
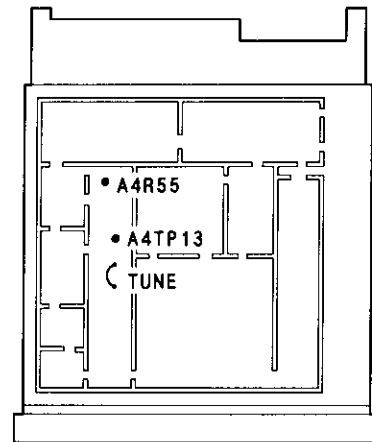

Figure 5-7. High Frequency Loop Offset Adjustment Setup

EQUIPMENT: Oscilloscope HP 1740A
 Probe HP 10040A

- PROCEDURE:
1. Set the oscilloscope as follows:
 - Vertical Gain 0.5V/div
 - Sweep Speed 0.5 ms/div
 2. Set the Signal Generator as follows:
 - Frequency 140 MHz
 - Amplitude -10 dBm
 - Modulation AM 50%
 - Source kHz (Int.)
 3. Disconnect the TUNE voltage wire (white-black-orange) from the High Frequency Oscillator Assembly (A5).
 4. Connect oscilloscope to TUNE voltage wire (white-black-orange).
 5. Short Test Point A4TP13 to ground.
 6. Adjust A4R55 (OFFSET ADJ) for the most symmetrical ramp as analyzed on the oscilloscope (equal rise and fall times) as shown in Figure 5-8.

Top Internal View, Level 2



ADJUSTMENTS

5-13. HIGH FREQUENCY LOOP OFFSET ADJUSTMENT (cont'd)

7. Remove the oscilloscope and reconnect the TUNE voltage wire to the High Frequency Oscillator Assembly (A5).
8. Remove the short installed in step 5.

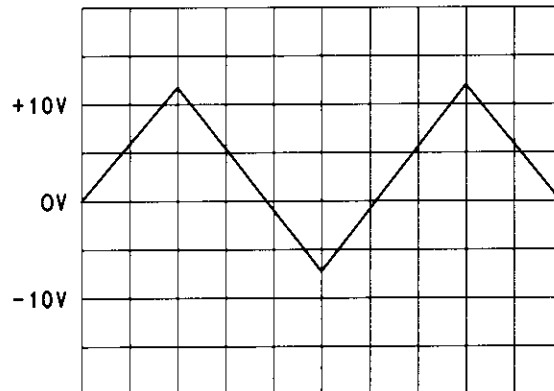

Figure 5-8. Tune Voltage Waveform

ADJUSTMENTS

5-14. 50 MHz REFERENCE OSCILLATOR FREQUENCY ADJUSTMENT

REFERENCE: Service Sheet 16.

DESCRIPTION: The internal 50 MHz Reference Oscillator frequency is adjusted to 50.0000 MHz \pm 100 Hz by adjusting the TIME BASE OUTPUT for 10.000 000 MHz \pm 20 Hz (50 MHz reference divided-by-10) using a frequency counter.

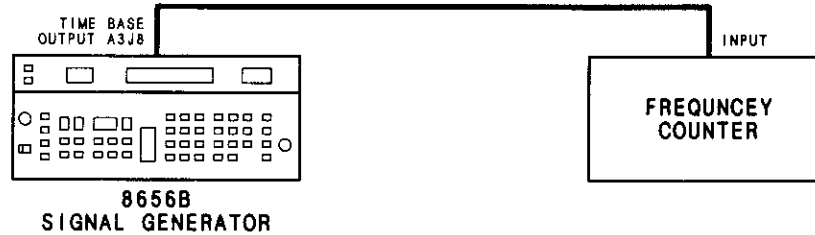

Figure 5-9. 50 MHz Reference Oscillator Frequency Adjustment Setup

EQUIPMENT: Frequency Counter HP 5328A
Cable BNC(m) HP 10503A

NOTE

If the Signal Generator has Option 001 installed disconnect coaxial cable A16W2 from the rear-panel TIME BASE INPUT connector J3.

- PROCEDURE:
1. Connect the frequency counter to A3J4 using the BNC cable.
 2. Adjust A3R22 (TIME BASE ADJ) for a frequency counter reading of 10.000 000 MHz \pm 20 Hz.

Top Internal View, Level 1

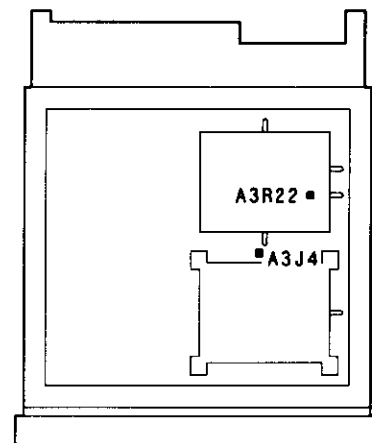

ADJUSTMENTS

5-15. 50 MHz REFERENCE OSCILLATOR LEVEL ADJUSTMENT

REFERENCE: Service Sheet 16.

DESCRIPTION: The output power level of the 50 MHz Reference Oscillator is adjusted for a maximum level between +16 and +19 dBm at A3J8 using a measuring receiver.

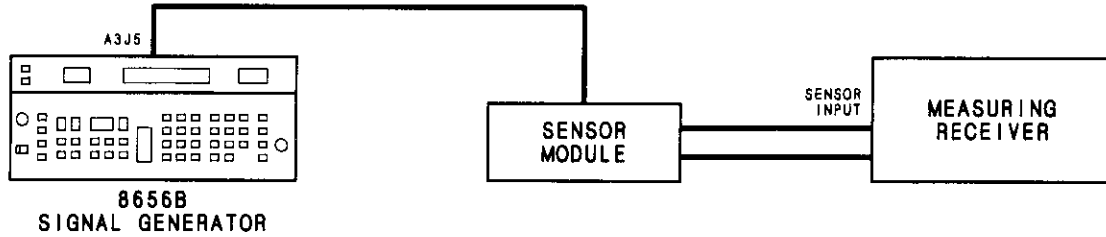

Figure 5-10. 50 MHz Reference Oscillator Level Adjustment Setup

EQUIPMENT:

- Measuring Receiver HP 8902A
- Sensor Module HP 11722A
- Cable BNC(m) to SMC(f) HP 08662-60075
- Adapter N(f) to BNC(m) HP 1250-0077
- Adapter BNC(f) to BNC(f) HP 1250-0080

PROCEDURE:

1. Set the measuring receiver with the sensor module precalibrated and connected as follows:
 - Measurement RF POWER
 - Display LOG
2. Disconnect coaxial cable W5 from A3J8 (50 MHz Reference Oscillator output). Connect the sensor module to A3J8 using the appropriate cable and adapters.
3. Press the **FREQ** key on the measuring receiver for calibration, then press the **RF POWER** key.

Top Internal View, Level 1

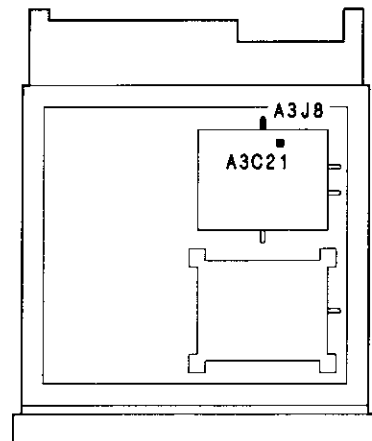

ADJUSTMENTS

5-15. 50 MHz REFERENCE OSCILLATOR LEVEL ADJUSTMENT (cont'd)

4. Adjust A3C21 (50 MHz LEVEL ADJ) for a maximum RF Power reading from +16 dBm to +19 dBm. Do not adjust for a reading greater than +19 dBm.

NOTE

Do not remove the 50 MHz Section covers for this adjustment.

5. Disconnect the measuring receiver and reconnect W5 to A3J8.

ADJUSTMENTS

5-16. 60 TO 110 MHz OSCILLATOR FLATNESS ADJUSTMENT

REFERENCE: Service Sheet 9.

DESCRIPTION: The 60 to 110 MHz Low Frequency Oscillator is adjusted so that its output varies $\leq \pm 1.3$ dB across its frequency range at A3A1J1 using a measuring receiver.

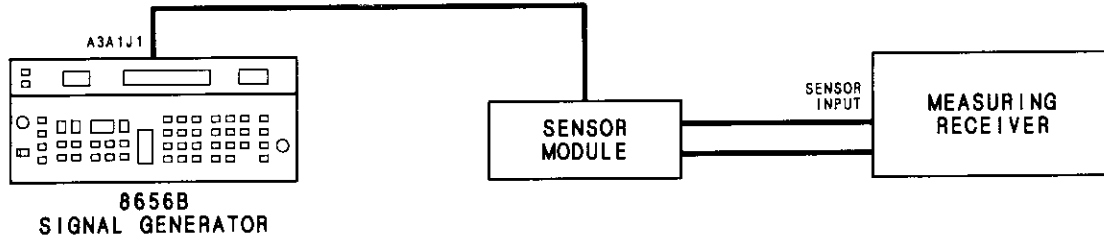
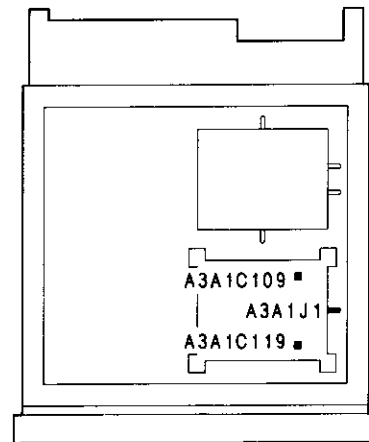

Figure 5-11. 60 to 110 MHz Oscillator Flatness Adjustment Setup

EQUIPMENT: Measuring Receiver HP 8902A
 Sensor Module HP 11722A
 Adapter N (f) to BNC (m) HP 1250-0077
 Adapter BNC (f) to BNC (f) HP 1250-0080
 Cable BNC (m) to SMC (f) HP 08662-60075

- PROCEDURE:
1. Set the measuring receiver with the sensor module precalibrated and connected as follows:
 - Measurement RF POWER
 - Display LOG
 2. Set the Signal Generator as follows:
 - Frequency 50 MHz
 - Frequency Increment ... 10 MHz
 - Amplitude Any
 - Modulation Off
 3. Disconnect coaxial cable W3 from A3A1J1 (60 to 110 MHz Oscillator output). Connect the sensor module to A3A1J1 using the appropriate cable and adapters.

Top Internal View, Level 1



ADJUSTMENTS

5-16. 60 TO 110 MHz OSCILLATOR FLATNESS ADJUSTMENT (cont'd)

4. Press the **FREQ** key to tune the measuring receiver, then press the **RF POWER** key.
5. Step the Signal Generator to 40 MHz.
6. Adjust A3A1C109 (**LOW PASS ADJ**) for maximum power.
7. Allow the reading on the measuring receiver to stabilize, then press the **RATIO** key to set a 0 dB reference.
8. Adjust A3A1C119 (**60-110 MHz FLATNESS ADJ**) for a difference of $\leq \pm 1.3$ dB from the reference as the frequency is stepped between 40 and 90 MHz in 10 MHz steps. The 60 to 110 MHz oscillator frequency will vary from 60 to 110 MHz.
9. Disconnect the measuring receiver and reconnect W3 to A3A1J1.

ADJUSTMENTS

5-17. 690 TO 740 MHz IF COMPENSATION ADJUSTMENT

REFERENCE: Service Sheets 1 and 3

DESCRIPTION: The power levels of the IF frequencies 690 to 740 MHz are measured at RF Test Point A4TP3 and adjusted for flatness within ± 1.5 dB using a measuring receiver.

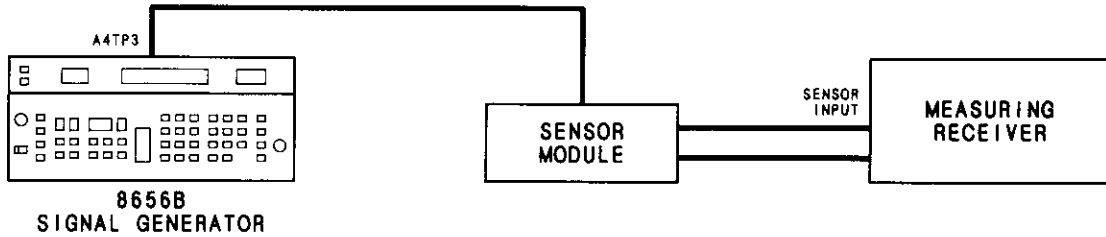

Figure 5-12. 690 to 740 MHz IF Compensation Adjustment Setup

EQUIPMENT: Measuring Receiver HP 8902A
 Sensor Module HP 11722A
 Adapter Probe HP 1250-1598
 Adapter N(f) to BNC(m) HP 1250-0077
 Adapter BNC(f) to BNC(f) HP 1250-0080
 Cable BNC(m) to SMC(f) HP 08662-60075

- PROCEDURE:
1. Set the measuring receiver with the sensor module precalibrated and connected as follows:

Measurement RF POWER
 Display LOG
 2. Set the Signal Generator as follows:

Frequency 40 MHz
 Frequency Increment 10 MHz
 Amplitude Any
 Modulation Off
 3. Zero the measuring receiver and wait for zero LED to go out.
 4. Connect the sensor module to the Signal Generator at RF Test Point A4TP3 using an adapter (HP part number 1250-1598).

Top Internal View, Level 2

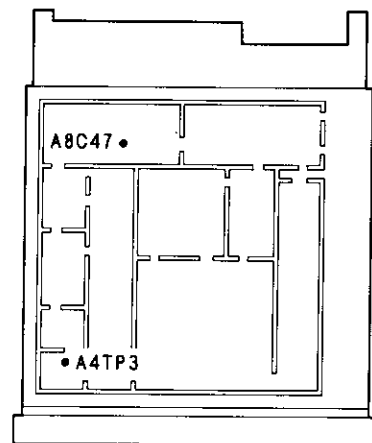

ADJUSTMENTS

5-17. 690 TO 740 MHz IF COMPENSATION ADJUSTMENT (cont'd)

5. Step the Signal Generator frequency up in 10 MHz steps to 90 MHz recording the RF Power reading at each frequency. Manually tune the measuring receiver for each change in frequency by entering in the IF frequency with the DATA keys. The measuring receiver must be in the FREQ measurement mode to manually tune the instrument.
6. Step the Signal Generator to the frequency with the lowest reading. Using that power level as a reference, press the RATIO key after the measuring receiver is tuned for that frequency.
7. Step the frequency up and down between 40 and 90 MHz and adjust A8C47 (COMP ADJ) until the maximum and minimum RF Power readings are within 3 dB. The 690 to 740 MHz IF will then be flat to within ± 1.5 dB.

| | |
|--|------------------|
| | 40 MHz (690 MHz) |
| | 50 MHz (700 MHz) |
| | 60 MHz (710 MHz) |
| | 70 MHz (720 MHz) |
| | 80 MHz (730 MHz) |
| | 90 MHz (740 MHz) |

ADJUSTMENTS

5-18. 400 MHz BANDPASS FILTER ADJUSTMENT

REFERENCE: Service Sheet 3.

DESCRIPTION: The 400 MHz Bandpass Filter is adjusted for maximum power at RF Test Point A8TP3 using a measuring receiver.

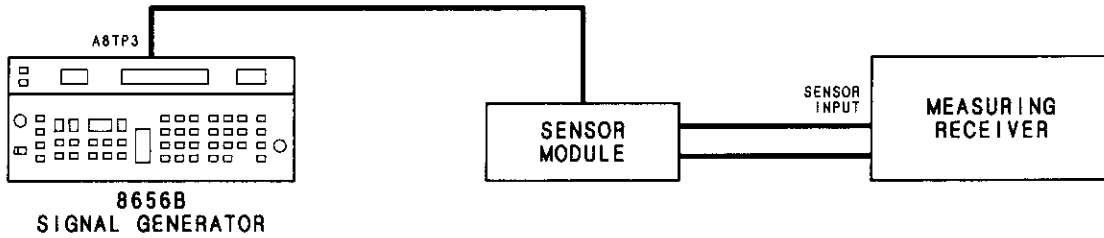

Figure 5-13. 400 MHz Bandpass Filter Adjustment Setup

EQUIPMENT: Measuring Receiver HP 8902A
 Sensor Module HP 11722A
 Adapter Probe HP 1250-1598
 Adapter N(f) to BNC(m) HP 1250-0077
 Adapter BNC(f) to BNC(f) HP 1250-0080
 Cable BNC(m) to SMC(f) HP 08662-60075

PROCEDURE: 1. Set the measuring receiver with the sensor module precalibrated and connected as follows:

Measurement RF POWER
 Display LOG

2. Set the Signal Generator as follows:

Frequency Any
 Amplitude -10 dBm
 Modulation Off

3. Zero the measuring receiver and wait for the zero LED to go out.

4. Connect the sensor module to the Signal Generator at RF Test Point A8TP3 using an adapter (HP part number 1250-1598).

5. Tune the measuring receiver to the frequency of the Signal Generator and adjust A8C31 (PEAK ADJ) for a maximum RF Power reading.

Top Internal View, Level 2

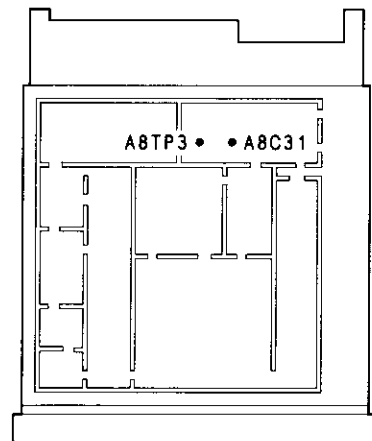

ADJUSTMENTS

5-19. LEVEL AND ALC LOOP DETECTOR ADJUSTMENTS

REFERENCE: Service Sheets 4 and 7.

DESCRIPTION: First, the reference level to the Level Digital to Analog Converter (DAC) is adjusted to +7.00 dBm ±0.02 dB. Then the detector bias reference level to the ALC Amplifier is adjusted to -4.00 dBm ±0.02 dB.

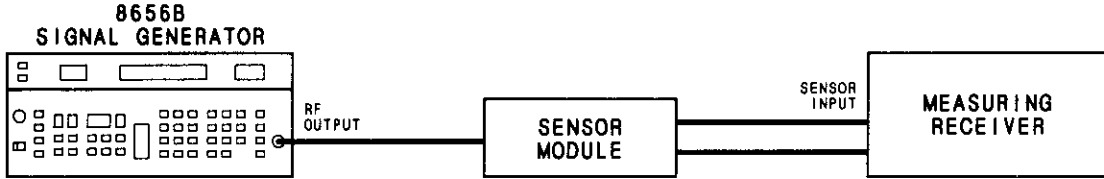
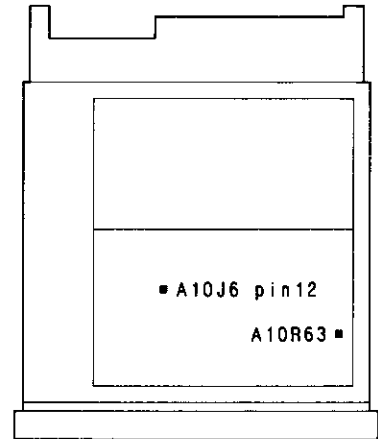

Figure 5-14. Level and ALC Loop Detector Adjustment Setup

EQUIPMENT: Measuring Receiver HP 8902A
 Sensor Module HP 11722A

Bottom Internal View, Level 4

- PROCEDURE:
1. Set the measuring receiver with the sensor module precalibrated and connected as follows:
 Measurement RF POWER
 Display LOG
 2. Set the Signal Generator as follows:
 Frequency 820 MHz
 Amplitude +7 dBm
 Modulation Off
 Amplitude Increment ... 10 dB



ADJUSTMENTS

5-19. LEVEL AND ALC LOOP DETECTOR ADJUSTMENTS (cont'd)

NOTE

Before making the adjustment, the instrument must be warmed up for a minimum of 1/2 hour.

3. Zero the sensor module and connect it to the RF OUTPUT connector on the Signal Generator.
4. Tune the measuring receiver to the Signal Generator frequency by pressing the **FREQ** key. Press the **RF POWER** key and adjust A10R63 (LEVEL ADJ) for a reading of $+7 \text{ dBm} \pm 0.2 \text{ dB}$.
5. Press the **RATIO** key on the measuring receiver to set a reference level of 0 dB.
6. Step the signal Generator amplitude down to -3 dBm .
7. Adjust A6R35 (DET ADJ) for an RF Power level of $-10.00 \text{ dB} \pm 0.1 \text{ dB}$ on the measuring receiver.
8. Repeat steps 4, 5, 6, and 7 until both readings are within the required tolerance.

Top Internal View, Level 2

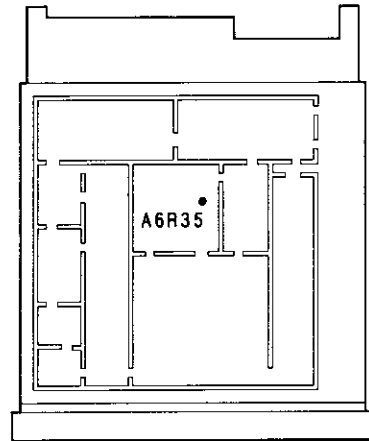

ADJUSTMENTS

5-20. HETERODYNE BAND 800 MHz BANDPASS FILTER ADJUSTMENT

NOTE

This adjustment must be done before the "HETERODYNE BAND ACCURACY AND FLATNESS ADJUSTMENTS" in paragraph 5-20A.

REFERENCE: Service Sheet 5.

DESCRIPTION: The 800 MHz Bandpass Filter (input to the Heterodyne Mixer) is adjusted for maximum Signal Generator output amplitude and minimum spurs. Output amplitude, and 800 MHz are adjusted for a maximum with the frequency set to 100 MHz. The frequency is then set to 99 MHz and 101 MHz and readjusted as required for minimum spurs 1 MHz and 2 MHz offset from 99 MHz and 101 MHz. The amplitude of the output must stay within 1 dB of the peak, and the amplitude of the 800 MHz must stay within 2 dB of the peak.

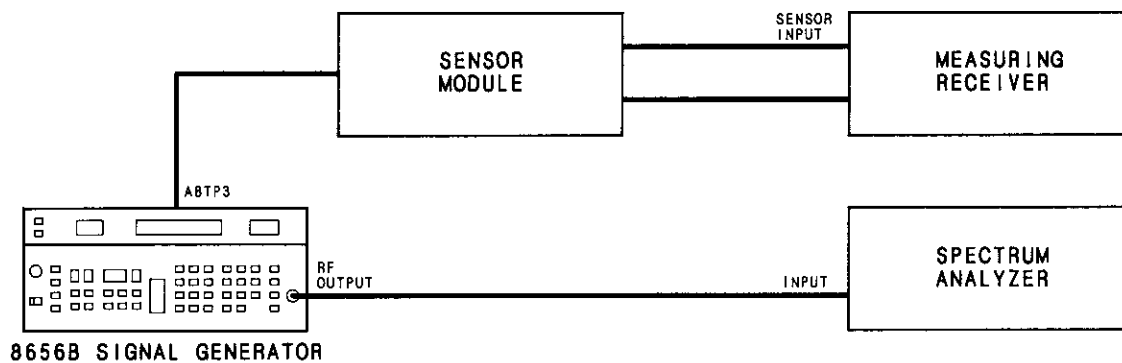

Figure 5-15. Heterodyne Band 800 MHz Bandpass Filter Adjustment Setup

EQUIPMENT: Spectrum Analyzer HP 8568A or 8558B
 Measuring Receiver HP 8902A
 Cable BNC(m) to SMC(f) HP 08662-60075
 Adapter N(f) to BNC(m) HP 1250-0077
 Adapter 3NC(f) to BNC(f) HP 1250-0080
 Adapter Probe HP 1250-1598

PROCEDURE: 1. Set the spectrum analyzer as follows:

Center Frequency 100 MHz
 Frequency Span 10 MHz
 Reference Level 0 dB
 Scale 1 dB/Div
 Resolution Bandwidth 30 kHz

ADJUSTMENTS

5-20. HETERODYNE BAND 800 MHz BANDPASS FILTER ADJUSTMENT (cont'd)

2. Set the Signal Generator as follows:

Frequency 100 MHz
 Frequency Increment 1 MHz
 Amplitude -3 dBm
 Modulation Off

3. Set the measuring receiver with the sensor module precalibrated and connected as follows:

Measurement RF POWER
 Display LOG

Top Internal View, Level 2

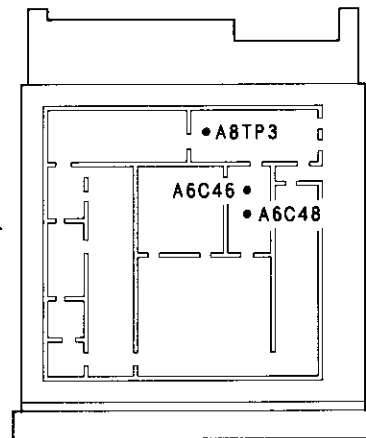

4. Zero the measuring receiver and wait for the zero LED to go out. Connect the measuring receiver to A8TP3.
5. Adjust A6C46 and A6C48 for maximum signal level on the spectrum analyzer's display, and on the measuring receiver.
6. Set the spectrum analyzer to 10 dB/Div.
7. Increment the Signal Generator's frequency down to 99 MHz. Adjust A6C46 and A6C48 as required so spurs 1 MHz and 2 MHz offset from 99 MHz are -65 dBc. The amplitude of the Signal Generator's output amplitude must be within 1 dB of the peak in step 5.
8. Increment the Signal Generator's frequency up to 101 MHz. Adjust A6C46 and A6C48 as required so spurs 1 MHz and 2 MHz offset from 101 MHz are -65 dBc.
9. Increment the Signal Generator's frequency down to 100 MHz. The amplitude of the Signal Generator's output amplitude must be within 1 dB of the peak in step 5, and the 800 MHz at A8TP3 must be within 2 dB of the peak in step 5.
10. If the 800 MHz at A8TP3 has changed more than 2 dB adjust A6C46 to reset the power level, and recheck for spurs.
11. If the amplitude of the Signal Generator's output has changed more than 1 dB perform the Heterodyne Band Accuracy and Flatness Adjustment 5-20A.

ADJUSTMENTS

5-20A. HETERODYNE BAND ACCURACY AND FLATNESS ADJUSTMENTS

REFERENCE: Service Sheet 5.

DESCRIPTION: The accuracy and flatness of the heterodyne band are adjusted for an equal power difference from 0 dBm at 10 MHz and 123 MHz and power variation not greater than ± 0.5 dB for frequencies between 3 MHz and 123 MHz.

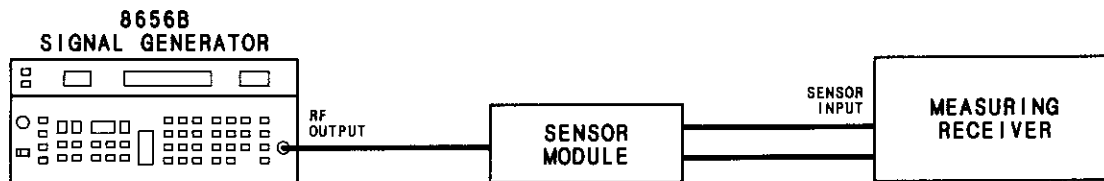

Figure 5-15A. Heterodyne Band Accuracy and Flatness Adjustment Setup

EQUIPMENT: Measuring Receiver HP 8902A
 Sensor Module HP 11722A

PROCEDURE: 1. Set the measuring receiver with the sensor module precalibrated and connected as follows:

Measurement RF POWER
 Display LOG

2. Set the Signal Generator as follows:

Frequency 10 MHz
 Frequency Increment 5 MHz
 Amplitude 0 dBm
 Modulation Off

3. Zero the sensor module and connect it to the RF OUTPUT connector on the Signal Generator.

4. Tune the measuring receiver to the Signal Generator frequency by pressing the **FREQ** key. Press the **RF POWER** key and adjust **A6C56** (**ACC ADJ**) for a 0 dBm ± 0.5 dB reading on the measuring receiver.

Top Internal View, Level 2

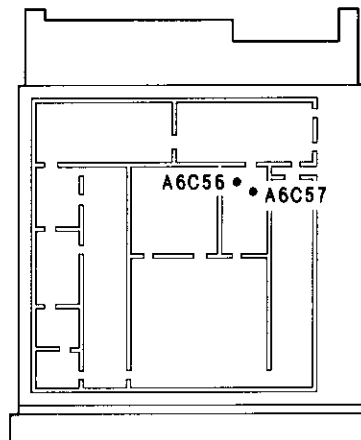

ADJUSTMENTS

5-20A. HETERODYNE BAND ACCURACY AND FLATNESS ADJUSTMENTS (cont'd)

5. Change the frequency to 123 MHz and tune the measuring receiver to the Signal Generator frequency as shown in step 4.
6. Adjust A6C57 (FLAT ADJ) for a 0 dBm ± 0.5 dB reading on the measuring receiver.

NOTE

1. If A6C57 does not have the range to adjust the amplitude at 123 MHz to 0.0 dBm ± 0.5 dB, repeat step 4, adjusting A6C56 to increase or decrease the amplitude until both adjustments are within the specified limits. A6C56 is used to shift the amplitude level of the heterodyne band.

7. Step the frequency in 5 MHz increments between 3 MHz and 123 MHz, recalibrating the measuring receiver as mentioned in step 4 for each change in frequency. The amplitude variation from maximum to minimum should not exceed 1 dB. If amplitude variation is greater than 1 dB repeat steps 4, 5, and 6 to compensate the flatness so that the amplitude remains within 0.0 dBm ± 0.5 dB.

ADJUSTMENTS

5-21. AM% AND ALC LOOP AM ADJUSTMENTS

REFERENCE: Service Sheets 4 and 7.

DESCRIPTION: The reference level to the AM% Digital to Analog Converter (DAC) is adjusted for an average amplitude modulation of 21.21%. The AM reference to the ALC Amplifier is adjusted for minimum distortion of the modulation.

NOTE

The AM Offset, Level, Heterodyne Bandpass, and Heterodyne Flatness adjustments must be performed before performing these adjustments. Refer to paragraphs 5-10, 5-19, 5-20, and 5-20A.

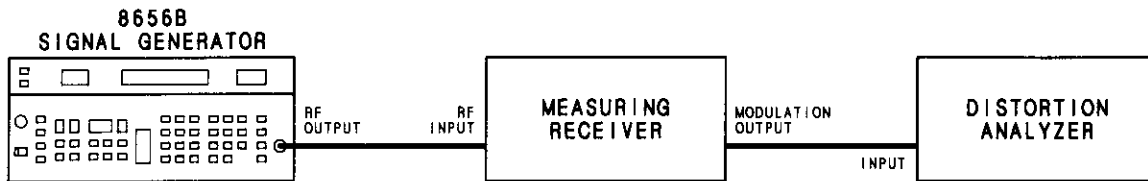

Figure 5-16. AM% and ALC Loop AM Adjustments Setup

EQUIPMENT: Measuring Receiver HP 8902A
 Distortion Analyzer HP 339A

- PROCEDURE:
1. Set the measuring receiver as follows:
 - Measurement AM
 - Detector AVG
 - HP Filter 50 Hz
 - LP Filter 15 kHz
 2. Set the Signal Generator as follows:
 - Frequency 200 MHz
 - Amplitude +4 dBm
 - Modulation AM 30%
 - Source 1 kHz (Int.)

ADJUSTMENTS

5-21. AM% AND ALC LOOP AM ADJUSTMENTS (cont'd)

3. Connect the measuring receiver to the RF OUTPUT connector on the Signal Generator and connect the distortion analyzer as shown in Figure 5-16.
4. Adjust A10R66 (AM% ADJ) for a reading of 21.21% on the measuring receiver.

NOTE

Do not remove any of the internal RF covers for this adjustment.

5. Set the Signal Generator as follows:

Frequency 200 MHz
Amplitude -3 dBm
Modulation AM 90%

6. Set the measuring receiver as follows:

Detector PEAK -

7. Adjust A6R30 (AM ADJ) for a reading on the measuring receiver as close to 90% as possible, while keeping the reading on the distortion analyzer less than 4%.

Bottom Internal View, Level 4

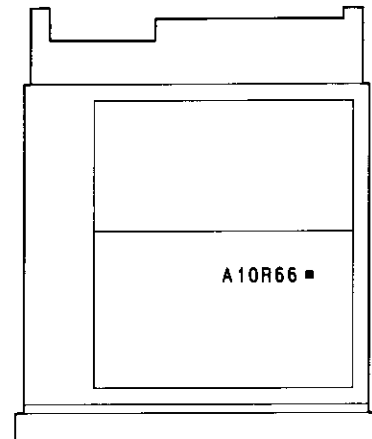

Top Internal View, Level 2

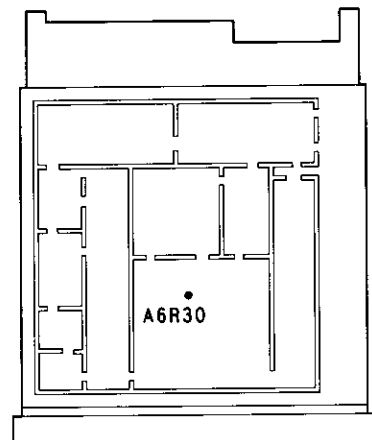

ADJUSTMENTS

5-22. FM DEVIATION ADJUSTMENT

REFERENCE: Service Sheet 7.

DESCRIPTION: The FM deviation is adjusted with a maximum FM peak deviation of 99 kHz entered into the Signal Generator. The carrier frequency is changed in 10 MHz steps from 990 to 940 MHz and A10R39 is adjusted for an equal error around 99 kHz deviation.

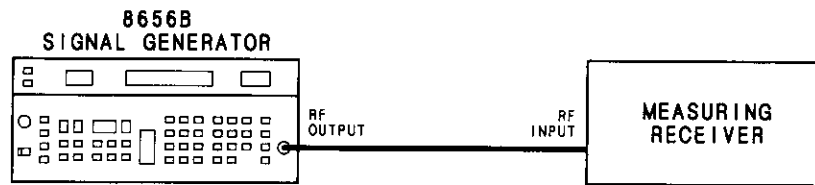

Figure 5-17. FM Deviation Adjustment Setup

EQUIPMENT: Measuring Receiver HP 8902A
 Cable (50 ohm coax,
 UG-21D/U type N (m) connectors) ... HP 11500A

PROCEDURE: 1. Set the measuring receiver as follows:

Measurement FM
 Detector +Peak
 HP Filter 300 Hz
 LP Filter 3 kHz

2. Set the Signal Generator as follows:

Frequency 970 MHz
 Frequency Increment ... 10 MHz
 Amplitude +4 dBm
 Modulation FM 99 kHz
 Source 1 kHz (Int.)

3. Connect the measuring receiver input to the RF OUTPUT on the Signal Generator.

4. Adjust A10R39 (FM GAIN ADJ) for a 99.0 kHz deviation reading on the measuring receiver.

Bottom Internal View, Level 4

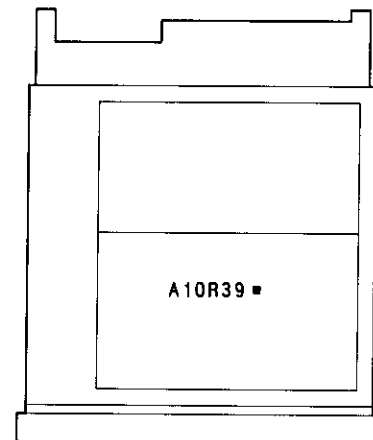

ADJUSTMENTS

5-22. FM DEVIATION ADJUSTMENT (cont'd)

5. Step the frequency from 990 to 940 MHz and record the deviation at each of the 10 MHz steps.
6. If necessary re-adjust A10R39 for equal error $<\pm 2$ kHz from 99 kHz at the frequencies of maximum and minimum peak kHz deviation.

| | |
|--|---------|
| | 990 MHz |
| | 980 MHz |
| | 970 MHz |
| | 960 MHz |
| | 950 MHz |
| | 940 MHz |

ADJUSTMENTS

5-23. FM CALIBRATION PRETUNE ADJUSTMENT

REFERENCE: Service Sheet 14

DESCRIPTION: The data bits of the FM CAL DAC are fixed by removing jumper A3W2. This prevents the DAC data bits from being changed when the Signal Generator RF Frequency is changed. The change in VCO tune voltage is adjusted to $+3.0\text{ V} \pm 0.2\text{ V}$ using an oscilloscope.

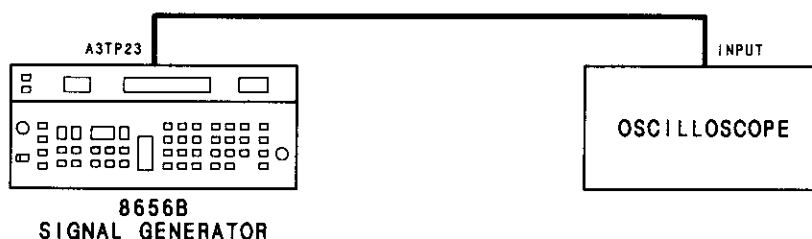
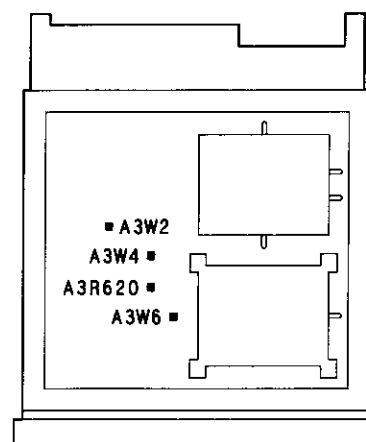

Figure 5-18. FM Calibration Pretune Adjustment Setup

EQUIPMENT: Oscilloscope HP 1740A
Oscilloscope Probe HP 10040A

- PROCEDURE:
1. Set the oscilloscope as follows:
 - INPUT CHANNEL A
 - INPUT DC
 - TRIGGER CHANNEL A
 - TIME/DIV 10 μ SEC
 - VOLTS/DIV 0.1
 2. Set the Signal Generator as follows:
 - Frequency 97 MHz
 - Amplitude Any
 - Modulation Off
 - Frequency Increment 1 MHz
 3. Connect the oscilloscope probe to A3W6.
 4. Remove jumpers A3W2 and A3W4 and change jumper A3W3 to the W3B (alternate) position.

Top Internal View, Level 1



ADJUSTMENTS

5-23. FM CALIBRATION PRETUNE ADJUSTMENT

5. Center the trace on the scope as a reference and replace jumper A3W4.
6. Adjust A3R620 (PRETUNE) for a dc voltage change of $+3.0 \text{ Vdc} \pm 0.2 \text{ Vdc}$ from the reference.
7. Replace all jumpers in their original positions.

ADJUSTMENTS

5-24. API 1, 2, 3 and 4 ADJUSTMENTS

REFERENCE: Service Sheet 12

DESCRIPTION: The API, Analog Phase Interpolation, spurious signals are adjusted for -60 dBc using a spectrum analyzer.

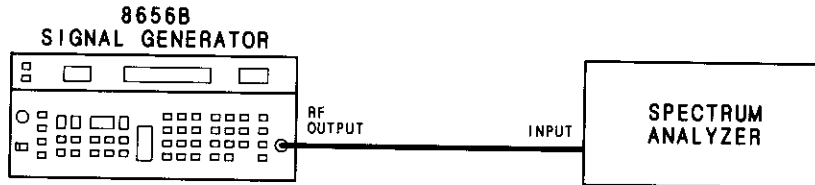

Figure 5-19. API 1, 2, 3 and 4 Adjustment Setup

EQUIPMENT: Spectrum Analyzer HP 8568A
 Cable (50 ohm coax,
 UG-21D/U type N (m) connectors) ... HP 11500A

NOTE

The A3 Assembly must be fastened to deck MP12 before making API adjustments.

PROCEDURE: 1. Set the spectrum analyzer as follows:

Center Frequency 65 MHz
 Frequency Span 10 kHz
 Reference Level 0 dBm

2. Set the Signal Generator as follows:

Frequency 65 MHz
 Amplitude 0 dBm
 Modulation Off

3. Connect the RF OUTPUT of the Signal Generator to the spectrum analyzer SIGNAL INPUT 2 as show in Figure 5-19.

Top Internal View, Level 1

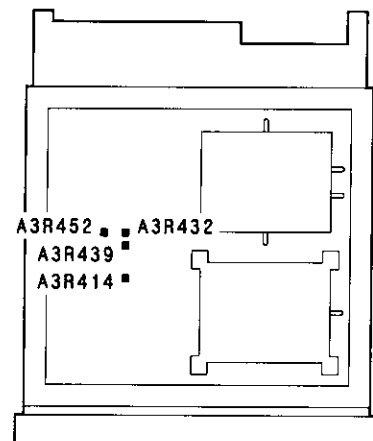

ADJUSTMENTS

5-24. API 1, 2, 3 and 4 ADJUSTMENTS (cont'd)

4. Offset the Signal Generator frequency by 2 kHz to 65.002 MHz.
5. Adjust A3R439 (API 1) so the spurious signals 1 and 2 kHz from the carrier are -60 dBc.
6. Offset the Signal Generator frequency by 200 Hz to 65.0002 MHz.
7. Adjust A3R432 (API 2) so the spurious signals 1 and 2 kHz from the carrier are -60 dBc.
8. Offset the Signal Generator frequency by 20 Hz to 65.00002 MHz.
9. Adjust A3R452 (API 3) so the spurious signals 1 and 2 kHz from the carrier are -60 dBc.
10. Offset the Signal Generator frequency by 10 Hz to 65.00001 MHz.
11. Set the spectrum analyzer frequency span to 25 kHz.
12. Adjust A3R414 (API 4) so spurious signals 5 and 10 kHz from the carrier are -60 dBc.

ADJUSTMENTS

5-25. PEDESTAL ADJUSTMENT

REFERENCE: Service Sheet 13

DESCRIPTION: The Sample and Hold circuit current is adjusted for continuous voltage using an oscilloscope.

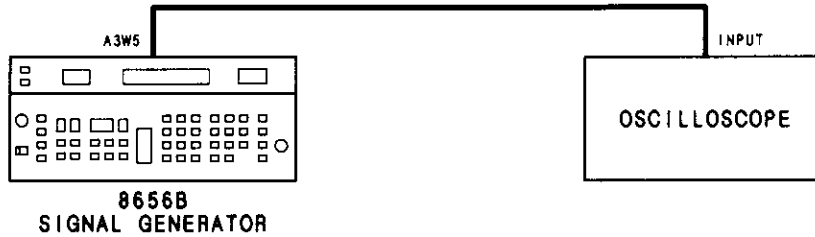
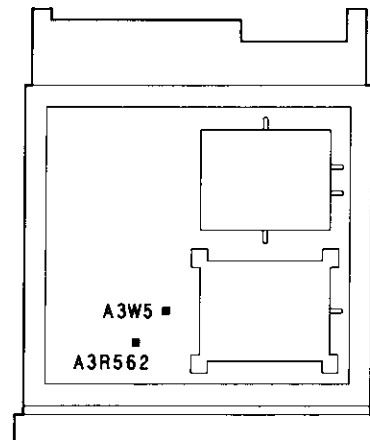

Figure 5-20. Pedestal Adjustment Setup

EQUIPMENT: Oscilloscope HP 1740A
Oscilloscope Probe HP 10021A

- PROCEDURE:**
1. Set the oscilloscope as follows:
 - INPUT CHANNEL A, AC
 - TRIGGER CHANNEL A
 - VOLTS/DIV .. 0.005
 - TIME/DIV ... 2 uSEC
 2. Set the Signal Generator as follows:
 - Frequency 65 MHz
 - Amplitude Any
 - Modulation Off
 3. Connect the oscilloscope probe to A3W5.
 4. Adjust A3R562 (PED) for a straight line display on the oscilloscope.

Top Internal View, Level 1



ADJUSTMENTS

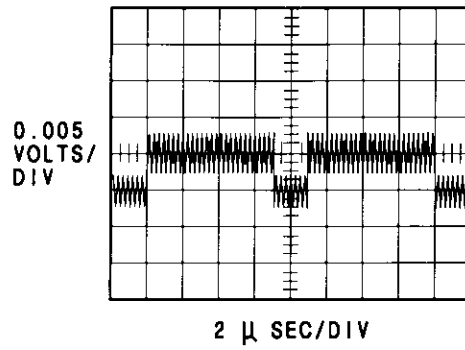

Figure 5-21. Oscilloscope Display with Pedestal Needing Adjustment

ADJUSTMENTS

5-26. DC FM ADJUSTMENT

REFERENCE: Service Sheet 15

DESCRIPTION: The DC FM spurious signals are adjusted using a spectrum analyzer and a dc power supply.

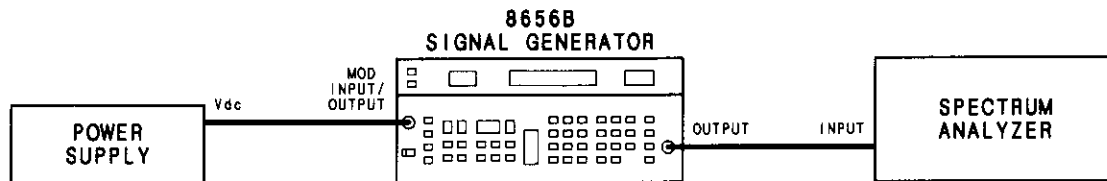

Figure 5-22. DC FM Adjustment Setup

EQUIPMENT: Spectrum Analyzer HP 8568A or 8558B
 Power Supply HP 6235A
 Cable (50 ohm coax,
 UG-21D/U type N(m) connectors) HP 11500A
 Cable (112 cm 50 ohm coax,
 UG-88C/U BNC to dual banana plug) ... HP 11001-60001

PROCEDURE: 1. Set the spectrum analyzer as follows:

Center Frequency 66 MHz
 Frequency Span 10 kHz
 Reference Level 0 dBm

2. Set the power supply as follows:

Meter V, +6
 Voltage 1 Vdc

3. Set the Signal Generator as follows:

Frequency 66 MHz
 Amplitude 0 dBm
 Modulation DC FM, 3 kHz

4. Connect the Signal Generator RF OUTPUT to the spectrum analyzer SIGNAL INPUT 2 and the MOD INPUT/OUTPUT to the power supply +1 Vdc as shown in Figure 5-22.

Top Internal View, Level 1

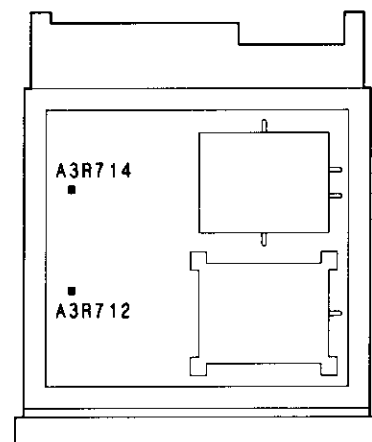

ADJUSTMENTS

5-26. DC FM ADJUSTMENT (cont'd)

NOTE

The LO EXT Modulation annunciator remains on regardless of the dc input level applied to the MOD INPUT/OUTPUT connector.

5. Adjust A3R712 (+DC FM) so spurious signals are -50 dBc.
6. Connect -1 Vdc to the MOD INPUT/OUTPUT.
7. Adjust A3R714 (-DC FM) so spurious signals are -50 dBc.

ADJUSTMENTS

5-27. FM IN-BAND GAIN ADJUSTMENT

REFERENCE: Service Sheet 15

DESCRIPTION: An external modulation signal whose frequency is outside the Low Frequency Loop bandwidth is used to frequency modulate the Signal Generator. The frequency modulation is measured with the EXT FM of the Signal Generator set to 50 kHz for a reference. The external modulation signal is changed to 100 Hz and the FM IN-BAND GAIN is adjusted for the same FM peak deviation.

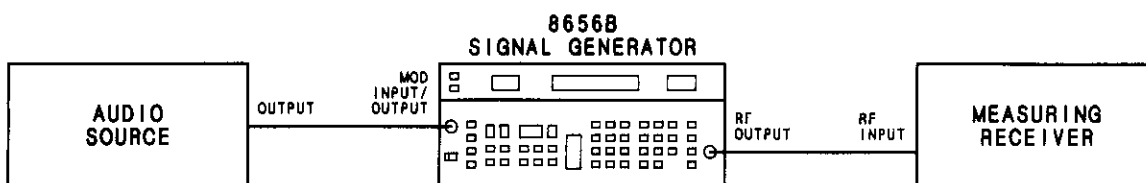

Figure 5-23. FM In-band Gain Adjustment Setup

EQUIPMENT:

- Measuring Receiver HP 8902A
- Audio Source HP 651A
- Cable (50 ohm coax,
UG-21D/U type N(m) connectors) ... HP 11500A
- Cable, BNC Connectors HP 10503A

PROCEDURE:

1. Set the measuring receiver as follows:
 - Measurement FM, PEAK +
2. Set the audio source as follows:
 - Frequency 20 kHz
 - Amplitude 1.414 Vac
3. Set the Signal Generator as follows:
 - Frequency 65 MHz
 - Amplitude 0 dBm
 - Modulation EXT FM, 50 kHz

Top Internal View, Level 1

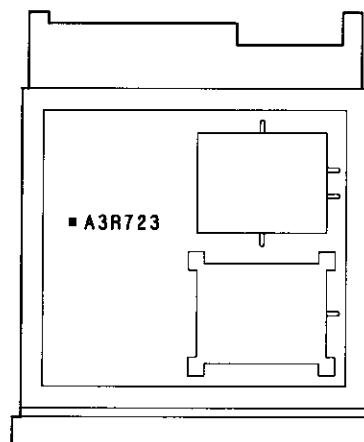

ADJUSTMENTS

5-27. FM IN-BAND GAIN ADJUSTMENT (cont'd)

4. Connect the Signal Generator RF OUTPUT to the measuring receiver INPUT, and the Signal Generator MOD INPUT/OUTPUT to the audio source OUTPUT as shown in Figure 5-23. The Signal Generator LO EXT and HI EXT LED's should be out.
5. Set the measuring receiver to RATIO and the audio source frequency to 100 Hz.
6. Adjust A3R723 (FM IN-BAND GAIN ADJ) for a reading of 100 % on the measuring receiver.
7. Repeat steps 5 through 7 and readjust A3R723 if required.

ADJUSTMENTS

5-28. VOLTAGE OFFSET ADJUSTMENT

REFERENCE: Service Sheet 7

DESCRIPTION: The DC offset of the FM Deviation Summing Amplifier is adjusted for 0.000 Vdc \pm 0.001 Vdc at pin 6 of A10TP7.

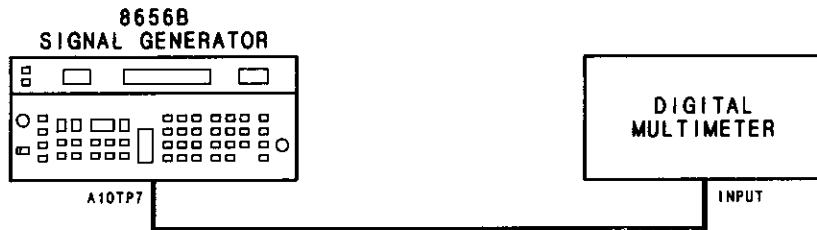

Figure 5-24. DC FM Offset Adjustment Setup

EQUIPMENT: Digital Multimeter HP 3466A

NOTE

The A10 Assembly must be fastened to deck MP22 before making the Voltage Offset Adjustment

PROCEDURE: 1. Set the digital multimeter as follows:

Function Vdc
Range 200 mV

2. Set the Signal Generator as follows:

Frequency 65 MHz
Amplitude Any
Modulation DC FM, 99 kHz

3. Remove any signal connected to the Signal Generator MOD INPUT/OUTPUT connector.

4. Connect the digital multimeter to A10TP7 pin 8 as shown in Figure 5-24.

5. Adjust A10R38 (OFFSET VOLTAGE) for 0.000 Vdc \pm 0.001 Vdc.

Bottom Internal View, Level 4

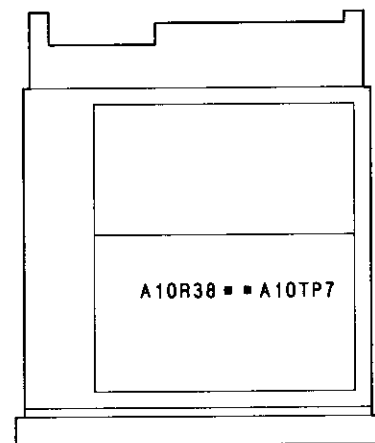

ADJUSTMENTS

5-29. DC FM OFFSET ADJUSTMENT

REFERENCE: Service Sheet 7

DESCRIPTION: The DC Offset of the FM Deviation Amplifier is adjusted for an output frequency error of +10 Hz with DC FM selected.

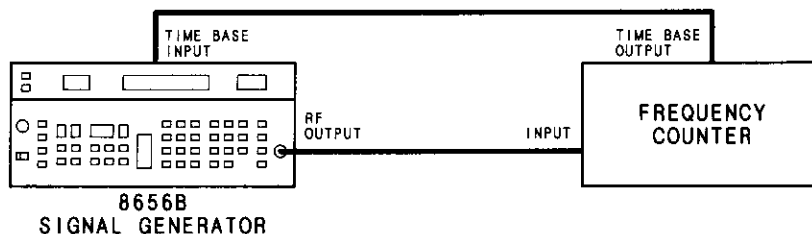

Figure 5-25. DC FM Frequency Offset Adjustment Setup

EQUIPMENT: Frequency Counter HP 5328A
 Adapter, N(m) to BNC (f) HP 1250-0780
 Cable, BNC (2 EA) HP 10503A

NOTE

Both the A3 and A10 Assemblies must be fastened to decks before making the DC FM Adjustment.

PROCEDURE: 1. Set the frequency counter as follows:

Frequency Input A

2. Set the Signal Generator as follows:

Frequency 65 MHz
 Amplitude 0 dBm
 Modulation DC FM, 99 kHz

3. Connect the Signal Generator RF OUTPUT to the frequency counter CHANNEL A INPUT and the counter time base OUT to the Signal Generator Time Base INPUT as shown in Figure 5-25.

4. Adjust A10R52 (DC FM OFFSET ADJ) for a frequency counter reading of 65.000000 MHz ±10 Hz.

Bottom Internal View, Level 4

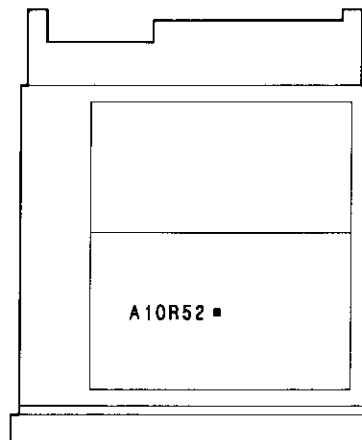

ADJUSTMENTS



5-30. OPTION 001 10 MHz REFERENCE OSCILLATOR FREQUENCY ADJUSTMENT

REFERENCE: Service Sheet 25

DESCRIPTION: The Option 001 10 MHz Reference Oscillator frequency is adjusted to 10.000 MHz \pm 10.0 Hz using a frequency counter.

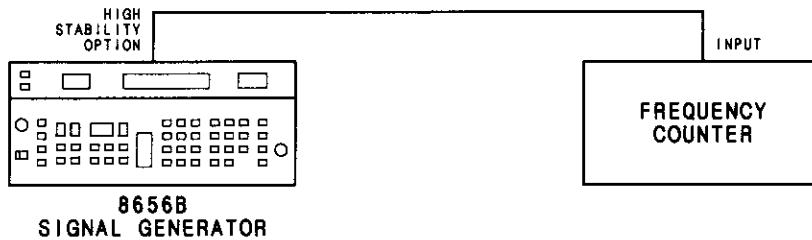

Figure 5-26. 10 MHz Reference Oscillator Frequency Adjustment Setup

EQUIPMENT: Frequency Counter HP 5328A

NOTE

Before making the adjustment, the instrument must be warmed up for a minimum of 24 hours.

- PROCEDURE:
1. Remove the fan shroud from the rear of the instrument. (Refer to Disassembly Procedures in Section VIII.)
 2. Remove the COARSE and FINE screws on the adjustment cover.
 3. Connect the frequency counter to the TIME BASE HIGH STABILITY OPTION connector (J6) on the rear-panel of the Signal Generator.
 4. Adjust the COARSE and FINE adjustments for a reading of 10.000 MHz \pm 10 Hz on the frequency counter.
 5. Replace the COARSE and FINE screws and fan shroud.