

Notice

Hewlett-Packard to Agilent Technologies Transition

This documentation supports a product that previously shipped under the Hewlett-Packard company brand name. The brand name has now been changed to Agilent Technologies. The two products are functionally identical, only our name has changed. The document still includes references to Hewlett-Packard products, some of which have been transitioned to Agilent Technologies.



Agilent Technologies

Printed in USA March 2000

By internet, phone, or fax, get assistance with all your test and measurement needs.

Table 1-1 Contacting Agilent

Online assistance: www.agilent.com/find/assist

United States
(tel) 1 800 452 4844

Latin America
(tel) (305) 269 7500
(fax) (305) 269 7599

Canada
(tel) 1 877 894 4414
(fax) (905) 282-6495

Europe
(tel) (+31) 20 547 2323
(fax) (+31) 20 547 2390

New Zealand
(tel) 0 800 738 378
(fax) (+64) 4 495 8950

Japan
(tel) (+81) 426 56 7832
(fax) (+81) 426 56 7840

Australia
(tel) 1 800 629 485
(fax) (+61) 3 9210 5947

Asia Call Center Numbers

Country	Phone Number	Fax Number
Singapore	1-800-375-8100	(65) 836-0252
Malaysia	1-800-828-848	1-800-801664
Philippines	(632) 8426802 1-800-16510170 (PLDT Subscriber Only)	(632) 8426809 1-800-16510288 (PLDT Subscriber Only)
Thailand	(088) 226-008 (outside Bangkok) (662) 661-3999 (within Bangkok)	(66) 1-661-3714
Hong Kong	800-930-871	(852) 2506 9233
Taiwan	0800-047-866	(886) 2 25456723
People's Republic of China	800-810-0189 (preferred) 10800-650-0021	10800-650-0121
India	1-600-11-2929	000-800-650-1101

HP 8645A

AGILE SIGNAL GENERATOR

(Including Options 001, 002, and 003)

Operation and Calibration Manual

SERIAL NUMBERS

This manual applies directly to instruments with serial numbers prefixed:

3203A and all MAJOR changes that apply to your instrument.

For additional important information about serial numbers, refer to "INSTRUMENTS COVERED BY THIS MANUAL" in Section 1.

Sixth Edition

This material may be reproduced by or for the U.S. Government pursuant to the Copyright License under the clause at DFARS 52.227-7013 (APR 1988).

Copyright © HEWLETT-PACKARD COMPANY 1988

Operation and Calibration Manual HP Part 08645-90023

Other Documents Available:

Service Diagnostics Manual HP Part 08645-90104

Microfiche Operation and Calibration Manual HP Part 08645-90026

Microfiche Service Diagnostics Manual HP Part 08645-90028

Printed in U.S.A. : March 1996



**HEWLETT
PACKARD**

CERTIFICATION

Hewlett-Packard Company certifies that this product met its published specifications at the time of shipment from the factory. Hewlett-Packard further certifies that its calibration measurements are traceable to the United States National Bureau of Standards, to the extent allowed by the Bureau's calibration facility, and to the calibration facilities of other International Standards Organization members.

WARRANTY

This Hewlett-Packard instrument product is warranted against defects in material and workmanship for a period of one year from date of shipment. During the warranty period, Hewlett-Packard Company will at its option, either repair or replace products which prove to be defective.

For warranty service or repair, this product must be returned to a service facility designated by HP. Buyer shall prepay shipping charges to HP and HP shall pay shipping charges to return the product to the Buyer. However, Buyer shall pay all shipping charges, duties, and taxes for products returned to HP from another country.

HP warrants that its software and firmware designated by HP for use with an instrument will execute its programming instructions when properly installed on that instrument. HP does not warrant that the operation of the instrument, or software, or firmware will be uninterrupted or error free.

LIMITATION OF WARRANTY

The foregoing warranty shall not apply to defects resulting from improper or inadequate maintenance by Buyer, Buyer-supplied software or interfacing, unauthorized modification or misuse, operation outside of the environmental specifications for the product, or improper site preparation or maintenance.

NO OTHER WARRANTY IS EXPRESSED OR IMPLIED. HP SPECIFICALLY DISCLAIMS THE IMPLIED WARRANTIES OF MERCHANTABILITY AND FITNESS FOR A PARTICULAR PURPOSE.

EXCLUSIVE REMEDIES

THE REMEDIES PROVIDED HEREIN ARE BUYER'S SOLE AND EXCLUSIVE REMEDIES. HP SHALL NOT BE LIABLE FOR ANY DIRECT, INDIRECT, SPECIAL, INCIDENTAL, OR CONSEQUENTIAL DAMAGES, WHETHER BASED ON CONTRACT, TORT, OR ANY OTHER LEGAL THEORY.

ASSISTANCE

Product maintenance agreements and other customer assistance agreements are available for Hewlett-Packard products.

For any assistance, contact your nearest Hewlett-Packard Sales and Service Office.

SAFETY CONSIDERATIONS

GENERAL

This product and related documentation must be reviewed for familiarization with safety markings and instructions before operation.

This product is a Safety Class I instrument (provided with a protective earth terminal).

BEFORE APPLYING POWER

Verify that the product is set to match the available line voltage and the correct fuse is installed.

SAFETY EARTH GROUND

An uninterruptible safety earth ground must be provided from the main power source to the product input wiring terminals, power cord, or supplied power cord set.

SAFETY SYMBOLS



Instruction manual symbol: the product will be marked with this symbol when it is necessary for the user to refer to the instruction manual (refer to Table of Contents.)



Indicates hazardous voltages.



Indicates earth (ground) terminal.

WARNING

The WARNING sign denotes a hazard. It calls attention to a procedure, practice, or the like, which, if not correctly performed or adhered to, could result in personal injury. Do not proceed beyond a WARNING sign until the indicated conditions are fully understood and met.

CAUTION

The CAUTION sign denotes a hazard. It calls attention to an operating procedure, practice, or the like, which, if not correctly performed or adhered to, could result in damage to or destruction of part or all of the product. Do not proceed beyond a CAUTION sign until the indicated conditions are fully understood and met.

WARNING

Any interruption of the protective (grounding) conductor (inside or outside the instrument) or disconnecting the protective earth terminal will cause a potential shock hazard that could result in personal injury. (Grounding one conductor of a two conductor outlet is not sufficient protection).

Whenever it is likely that the protection has been impaired, the instrument must be made inoperative and be secured against any unintended operation.

If this instrument is to be energized via an autotransformer (for voltage reduction) make sure the common terminal is connected to the earth terminal of the power source.

Servicing instructions are for use by service trained personnel only. To avoid dangerous electric shock, do not perform any servicing unless qualified to do so.

Adjustments described in the manual are performed with power supplied to the instrument while protective covers are removed. Energy available at many points may, if contacted, result in personal injury.

Capacitors inside the instrument may still be charged even if the instrument has been disconnected from its source of supply.

For continued protection against fire hazard, replace the line fuse(s) only with 250V fuse(s) of the same current rating and type (for example, normal blow, time delay, etc.) Do not use repaired fuses or short circuited fuseholders.

TABLE OF CONTENTS

Chapter 1 Learning to Operate the HP 8645A

- Getting Started the Easy Way 1-1
 - What's in this Guide? 1-1
 - Equipment You Will Need 1-1
- Meet the HP 8645A 1-2
- Frequency Hop the HP 8645A 1-2
 - Set Up Your Equipment 1-2
 - Procedure to Frequency Hop the HP8645A 1-3
- In Conclusion 1-8

Chapter 2 What About Modulating?

- In this Chapter 2-1
- The Directory 2-1
- Frequency Modulation - An Overview 2-2
- Frequency Modulation - An Introduction 2-2
 - Carrier Frequency Accuracy 2-3
 - Audio Frequency Rates 2-3
 - Group Delay 2-4
 - Synthesis Modes 2-5
- Frequency Modulation - An Exercise 2-6
 - Equipment Needed 2-6
 - Procedure #1 - FM Using the Internal Audio Source 2-6
 - Procedure #2 - FM Using an External Audio Source 2-10
- Frequency Modulation - Things to Remember 2-13
- Amplitude Modulation - An Overview 2-14
- Amplitude Modulation - An Introduction 2-14
- Amplitude Modulation - An Exercise 2-15
 - Equipment Needed 2-15
 - Procedure #1 - AM Using the Internal Audio Source 2-15
 - Procedure #2 - AM Using an External Audio Source 2-19
- Amplitude Modulation - Things to Remember 2-22
- Pulse Modulation - An Overview 2-23
- Pulse Modulation - An Introduction 2-23
- Pulse Modulation - An Exercise 2-24
 - Equipment Needed 2-24
 - Procedure - Pulse Modulation Using an External Audio Source 2-24

Pulse Modulation – Things to Remember	2-27
Simultaneous Modulation – An Overview	2-28
Simultaneous Modulation – An Introduction	2-28
Simultaneous Modulation – An Exercise	2-29
Equipment Needed	2-29
Procedure – Simultaneous FM and AM	2-29
Simultaneous Modulation – Things to Remember	2-33

Chapter 3 What About Frequency Hopping?

In this Chapter	3-1
The Directory	3-2
Channels and Sequences – An Overview	3-3
Channels and Sequences – An Introduction	3-3
The Channel Table	3-4
The Sequence Table	3-5
Rate and Dwell – An Overview	3-7
Rate and Dwell – An Introduction	3-7
Hop Rate	3-8
Dwell Time	3-8
Hop Rate and Dwell Time Resolution	3-10
Frequency Hop Modes – An Overview	3-12
Frequency Hop Modes – An Introduction	3-12
How to Access the Frequency Hop Modes	3-13
A Brief Description of Frequency Hop Modes	3-13
Timing Control and Synchronization – An Overview	3-16
Timing Control and Synchronization – An Introduction	3-16
The Idle State	3-17
The Learn State	3-18
The Hop State	3-19
The Fast Hop Bus	3-20
Ground and No Connection	3-21
Address Output Enable	3-21
RF Dwell	3-21
Trigger	3-21
Data Valid	3-21
Hop	3-22
Memory Address	3-22
Internal Triggering	3-23
External Triggering	3-26
Amplitude Control – An Overview	3-36
Amplitude Control – An Introduction	3-36
Closed Loop ALC	3-36
Open Loop ALC	3-38
Frequency Hop Exercise – An Overview	3-39
Frequency Hop Exercise – An Introduction	3-39
Frequency Hop Exercise – The Procedure	3-40
Equipment Needed	3-40
Procedure #1 – Internal Single Mode	3-40
Procedure #2 – External Stepped Internal Dwell Mode	3-44
Frequency Hop Exercise – Things to Remember	3-45

Chapter 4 What About Sweeping?

In this Chapter	4-1
The Directory	4-1
Frequency Sweep - General Information	4-2
Start, Stop, Center, and Span	4-3
Sweep Markers	4-6
X-Axis	4-6
Z-Axis	4-7
Sweep Types	4-7
Digitally-Stepped Sweep	4-7
Fast-Hop Sweep	4-8
Phase-Continuous Sweep	4-8
Sweep Spacing and Sweep Time	4-10
Linear or Log Sweep Spacing	4-10
Permissible Sweep Times	4-10
Sweep Triggering	4-11
Auto Sweep	4-11
Single Sweep	4-11
Manual Sweep	4-12
Stopping the Sweep	4-12
Sweep Exercise	4-13
Equipment Needed	4-13
Procedure	4-13

Chapter 5 What About Programming?

In this Chapter	5-1
The Directory	5-1
Introduction to HP-SL	5-2
Getting Started with HP-SL	5-3
How is HP-SL Organized?	5-3
The HP-SL Colon	5-4
Programming with HP-SL	5-5
HP-SL Command Statements	5-5
More about the Colon	5-6
The HP-SL Semicolon	5-6
More about HP-SL Command Statements	5-6
Combining the HP-SL Semicolon and Colon	5-7
What Else do I Need to Know?	5-8
Introduction to the Programming Reference Information	5-9
HP-IB Address	5-10
How to Display or Change the HP-IB Address	5-10
HP-IB Capabilities	5-11
HP-IB Control Language Dictionary	5-13
Table of Contents	5-13
HP-SL Notes	5-14
HP-IB Device Status Dictionary	5-56
Table of Contents	5-56

IEEE 488.2 Definitions	5-58
Condition Register	5-58
Event Register	5-58
Transition Filter	5-58
Event Enable Register	5-59
Queue	5-59
Summary Bit	5-59
Status Register Model	5-59
IEEE 488.2 HP-IB Status Byte Register	5-61
Device Dependent Summary Bits	5-61
MAV Summary Bit	5-61
RQS and MSS Summary Bits	5-61
IEEE 488.2 Service Request Enable Register	5-62
IEEE 488.2 Standard Event Status Register	5-62
Power On Bit	5-62
User Request Bit	5-62
Command Error Bit	5-63
Execution Error Bit	5-63
Device Dependent Error Bit	5-63
Query Error Bit	5-63
Request Control Bit	5-63
Operation Complete Bit	5-63
Standard Event Status Enable Register	5-63
HP-SL Device Dependent Condition/Event Status Registers	5-64
Device Dependent Bit Definitions.	5-64
Temperature Drift Bit	5-65
Fast Hop Active Bit	5-65
Ready for Fast Hop Bit	5-65
Fast Learn Active Bit	5-65
Signal Integrity Bit	5-65
Autorange Bit	5-65
Calibration Bit	5-65
Signal Settled Bit	5-65
Sweep in Progress Bit	5-66
Data Questionable Bit	5-66
HP 8645A Signal Integrity Condition/Event Status Registers	5-67
Hardware Integrity Summary Bit	5-67
Modulation Integrity Summary Bit	5-68
Reference Integrity Summary Bit	5-68
Frequency Integrity Summary Bit	5-69
Amplitude Integrity Summary Bit	5-69
Calibration Integrity Condition Bit	5-69
IEEE 488.2 and HP-SL Status Register Syntax	5-70
Example HP-SL Programs	5-72
Table of Contents	5-72
A Tool for Developing HP-SL Programs	5-72

**Appendix A
Installation**

Unpack Your HP 8645A A-1
 Connect Power A-1
 Turn On Instrument A-1

**Appendix B
Options and Accessories**

Available for the HP 8645A B-1

**Appendix C
Special Functions**

How to Access the Special Functions C-1

**Appendix D
Error Messages**

What Happens When You Get an Error Message D-1

**Appendix E
Question and Answers**

Answers to Commonly Asked Questions E-1

**Appendix F
HP-SL Quick Reference Guide**

Introduction to HP-SL Syntax Drawings F-1
 Command Statements F-1
 Command Message F-1
 Subsystem Syntax F-2
 HP-SL Notes F-2
 Table of Contents F-3

Appendix G Miscellaneous Operating Features

Everything Else You Need to Know	G-1
Table of Contents	G-1
Amplitude Offset	G-2
Auto Sequence	G-2
Clear All	G-3
Display	G-3
Display Special	G-3
Display Recall	G-3
Display Sequence	G-4
EMF	G-4
Frequency Offset	G-4
Knob Hold	G-5
Knob Increment	G-5
Phase Decrement	G-6
Phase Increment	G-6
Sequence	G-6
Set Sequence	G-6

Appendix-H Synthesized Audio Oscillator

In this Appendix	H-1
The Directory	H-2
A Quick Demonstration	H-3
Procedure to Sum Channel 1 with Channel 2.	H-3
An Explanation of the Synthesized Audio Oscillator	H-7
Block Diagrams - An Introduction	H-8
Subcarrier Sources - Maximum that may be Active	H-10
Subcarrier Sources - Maximum Voltage Levels	H-10
Audio Source: Channel 1	H-11
Audio Source: Channel 2	H-12
Subcarrier Modulation Sources in Channel 1	H-14
Modulating the RF Carrier	H-19
Increment/Decrement the Internal Audio Source	H-21
Save and Recall Settings	H-21
Typical Applications	H-22

Appendix I Glossary

Glossary	I-1
--------------------	-----

1

Learning to Operate the HP 8645A

Getting Started the Easy Way

This *Operation Guide* provides you with a quick and easy way to learn about the HP 8645A Agile Signal Generator. If this is your first introduction to frequency hopping the HP 8645A, we recommend that you take 15 minutes to read this chapter and do the frequency hop procedure before going on to other chapters.

Note

If you are unpacking a new HP 8645A, you will want to refer to the installation suggestions provided in appendix A.

What's in this Guide?

This Guide will help you learn how to operate the Agile Signal Generator from both the front panel and via HP-IB. Specifically:

- Chapter 1 shows you how easy it is to frequency hop the Agile Signal Generator.
- Chapters 2–5 describe in detail how to modulate, frequency hop, sweep, and program the HP 8645A. These chapters will give you the skill to operate the Agile Signal Generator for most of your needs. (Refer to appendix G to find miscellaneous operating information for all your other needs.)

Equipment You Will Need

The following table lists the equipment we recommend that you use throughout this Guide. You can substitute equipment; however, be aware that you may get different results than the ones shown in this Guide.

Table 1–1. List of Recommended Equipment.

Equipment	Recommended Model Numbers	Used in Chapter(s)
Spectrum Analyzer	HP 8562A/B, or HP 8566B, or HP 8568B	1–5
Oscilloscope	HP 1741A, HP 54100A, or HP 54200A	2
Function Generator	HP 3312A, HP 3314A, HP 8111A, HP 8116A, or HP 8904A	2,3

Meet the HP 8645A

The HP 8645A is a 1 (or 2) GHz RF signal generator specifically designed to perform the most demanding tests on frequency agile radios and on state of the art communication systems; with its modulation, amplitude control, and sweep functions, the HP 8645A also performs in and out-of-channel tests on high-performance radios.

Specifically, your frequency agile and communication testing needs are met in the following ways:

- A frequency range of 251.5 kHz to 2060 MHz (1030–2060 MHz is covered by ordering Option 002).
- Modulation formats of AM, FM, Φ M, and Pulse.
- Frequency hopping is controlled from the front panel, or by the rear panel HP-IB, Sequence, Hop, and Fast Bus connectors.
- Digitally-stepped, fast-hop, or phase-continuous frequency sweeping.
- Remote ATE programming through HP-IB (Hewlett-Packard's implementation of IEEE Standard 488.2).
- Complex signal generation with the synthesized audio oscillator.

Frequency Hop the HP 8645A

The following procedure demonstrates the HP 8645A's flexibility and precision needed for Frequency Agile testing.

All you'll need is the HP 8645A and a Spectrum Analyzer, so let's get started.

Set Up Your Equipment

Connect the HP 8645A to the Spectrum Analyzer as shown in figure 1-1. Turn on the Spectrum Analyzer and adjust it as follows:

Center Frequency 100 MHz
Frequency Span 10 MHz
Reference Level +10 dBm

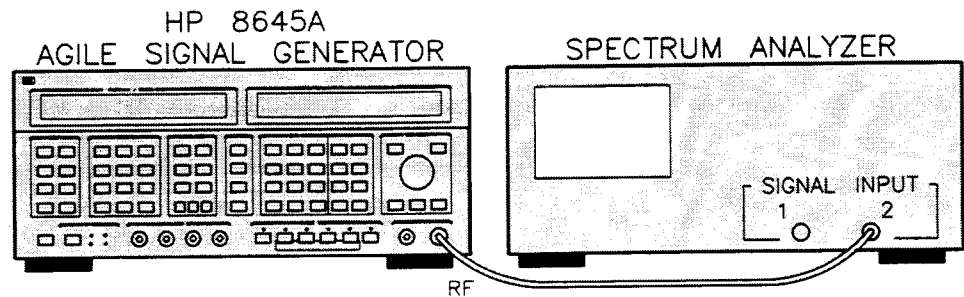

Figure 1-1. Equipment Setup for Frequency Hop Procedure.

Procedure to Frequency Hop the HP 8645A

This procedure guides you through a simplified procedure to frequency hop the HP 8645A. In the procedure, you will set up three channels. (Each channel is a frequency and amplitude setting stored in the instrument's RAM memory. The instrument cycles through the channels when frequency hopping.) You will also set the hop rate and dwell time to repetitively frequency hop the instrument through each channel. (For simplicity, no modulation information is put on the RF output.)

1. Press the HP 8645A's **POWER** switch **ON**. Notice that as the HP 8645A powers up, it performs a self-test that includes turning on front-panel display segments and annunciator lights.

After the self-test, the front panel should display a frequency of 100 MHz, with the Modulation Level, Audio Frequency, and Amplitude off. You will see the following on the HP 8645A front panel:

In the FREQUENCY/STATUS display:



100,000,000.00 Hz

In the MODULATION/AMPLITUDE display:

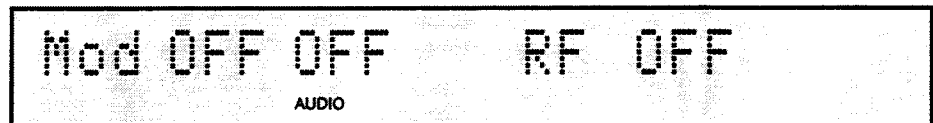

Mod OFF OFF RF OFF
AUDIO

Note

If you've already used the HP 8645A, something other than the display shown above may appear on the front panel. That's okay, simply press the green INSTR PRESET key to re-initialize the instrument, and then proceed to step 2.

Enter the Frequency Hop Channels

Set Up Channel 0.

2. Press the **MODE 5, FAST HOP** key. The yellow annunciator above this key lights up. Frequency Hopping the instrument must be done with this key selected.

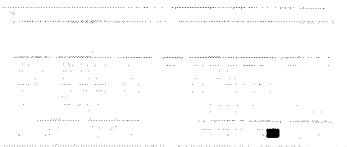

STEP 2

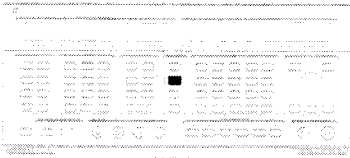

STEP 3

- Press the **AMPTD** key, and enter an output amplitude of 0 dBm. The following display should now appear on the Spectrum Analyzer:

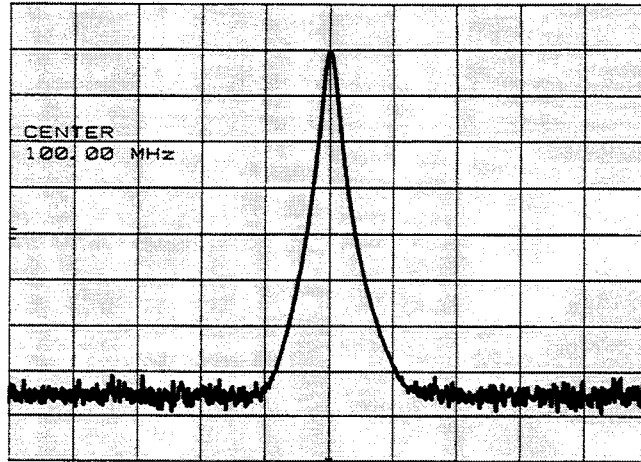

Note

If the Spectrum Analyzer does not display a 100 MHz 0 dBm signal, verify that you have set it up for a 100 MHz Center Frequency, 10 MHz Frequency Span, and +10 dBm Reference Level.

Store Channel 0 Settings.



STEP 4 & 5

- Press the blue **SHIFT** key, and the **STO CHAN** key on the HP 8645A. You now have access to the area where channels are stored. On the HP 8645A's **FREQUENCY/STATUS** display you will see the following:



- Press the **ENTER** key. Pressing the **ENTER (ON)** key causes the HP 8645A to assign its current frequency and amplitude settings to the channel shown on the display; in this case, Channel 0.

Set Up Channel 1.



STEP 6

- Press the **FREQ** key, and enter a frequency of 98 MHz.



STEP 7

- Press the **AMPTD** key, and enter an output amplitude of **-10 dBm**. The following display should now appear on the Spectrum Analyzer:

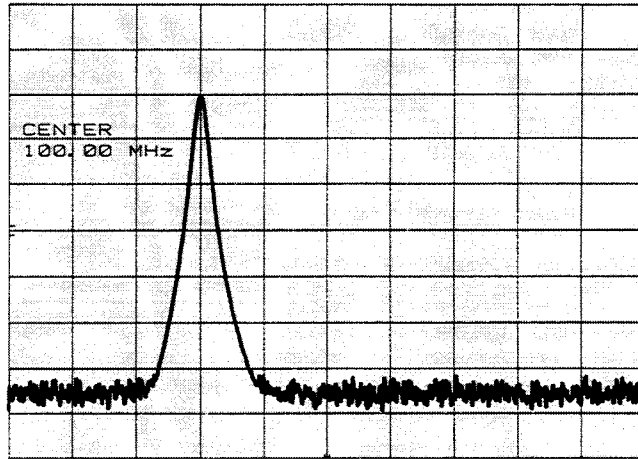

Store Channel 1 Settings.

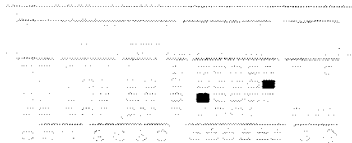

STEP 8 & 9

- Press the **blue SHIFT** key, and the **STO CHAN** key. Notice how the numeral shown in the display has been incremented by 1. You should now see the following:



- Press the **ENTER** key. Frequency and amplitude settings are now stored in Channel 1.

Set Up Channel 2.



STEP 10

- Press the **FREQ** key, and enter a frequency of **102 MHz**.



STEP 11

- Press the **AMPTD** key, and enter an output amplitude of 10 dBm. The following display should now appear on the Spectrum Analyzer:

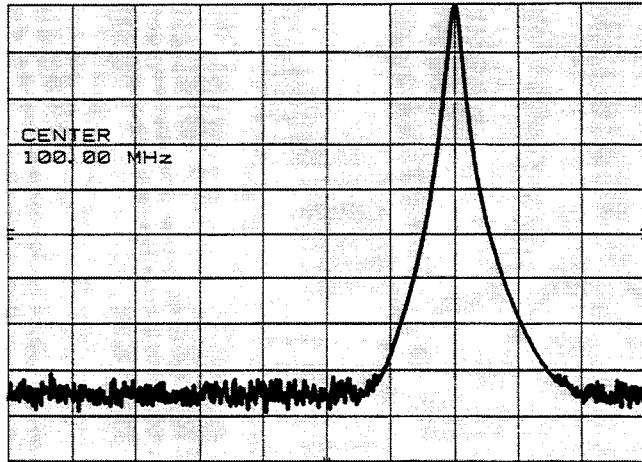

Store Channel 2 Settings.



STEP 12 & 13

- Press the blue **SHIFT** key, and the **STO CHAN** key. Once again the numeral shown in the display has been incremented by 1. You should now see the following:



- Press the **ENTER** key. Frequency and Amplitude settings are now stored in Channel 2.

Now that settings for all three channels are stored, you will need to specify the hop rate and dwell time. The hop rate sets the number of hops per second, and the dwell time sets duration for each hop.

Enter the Hop Rate and Dwell Time

Set the HP 8645A's Hop Rate.



STEP 14

- Press the blue **SHIFT** key, and then the **RATE** key. On the HP 8645A's **FREQUENCY/STATUS** display you will see the following:

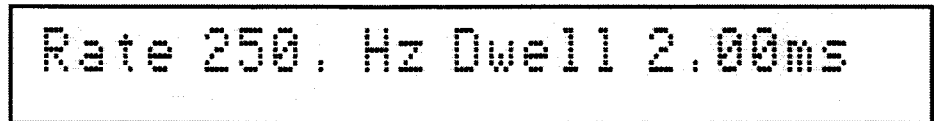

- Enter a hop rate of 8 Hz.

Set the HP 8645A's Dwell Time.

16. Press the blue SHIFT key, and then the DWELL key.
17. Enter a dwell time of 99 ms. With hop rate and dwell time both set, you should now see the following:



STEP 16

Rate 8.00 Hz Dwell 99.0ms

The HP 8645A is now ready to repetitively frequency hop from Channel 0, to Channel 1, and then to Channel 2 at an 8 Hz rate (that is, 8 channel hops per/second). The HP 8645A will dwell at each channel setting for a period of 99 milliseconds.

Remember

Hop rate and dwell time limits are described in chapter 3; also, directions are given for setting up a hop sequence of your choice.

Enable the Fast Hop Mode**Frequency Hop the HP 8645A.**

18. Press the blue SHIFT key, and the HOP key. For approximately ten seconds, you will see the following on the HP 8645A's MODULATION/AMPLITUDE display:



STEP 18

Mod OFF OFF Learning
AUDIO

The HP 8645A must go through a "Learning" cycle in order to store internal instrument settings for each channel. The settings are retrieved while the instrument frequency hops. Refer to chapter 3 for more information about "Learning".

After a learn cycle, MODULATION/AMPLITUDE display on the HP 8645A shows the following:

Mod OFF OFF Fast Hop
AUDIO

Congratulations. The Spectrum Analyzer should now display the RF output hopping between each channel as shown below:

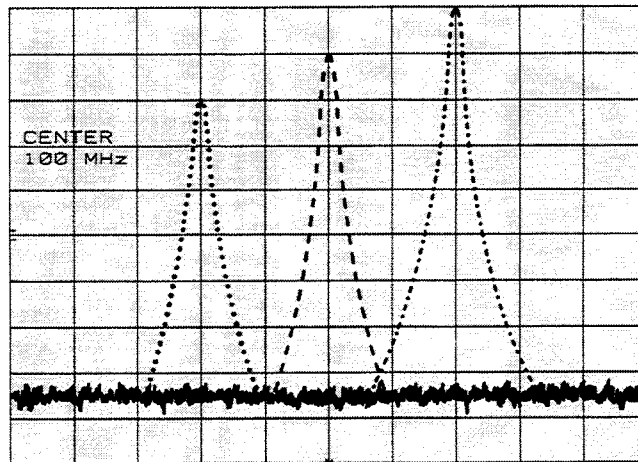

In Conclusion

This chapter has given you a brief exposure to the frequency hopping capabilities of the HP 8645A. There's much more to know about frequency hopping; turn to chapter 3 if you have further questions.

You may also have questions about modulating, sweeping, and programming. At this point, refer to another chapter as shown below:

Note

Appendix E contains answers to commonly asked questions about operating the HP 8645A.

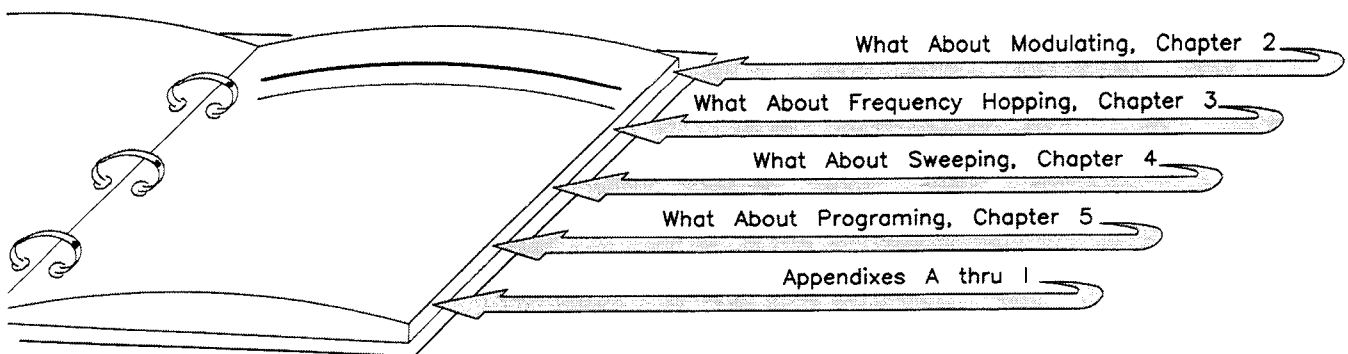

2

What About Modulating?

In this Chapter

This chapter describes how to modulate the HP 8645A Agile Signal Generator. Three kinds of modulation are discussed: FM, AM, and Pulse. Instructions to modulate the HP 8645A with both an internal and an external audio source are given; also, one example of simultaneous modulation is given.

Additional information contained in this chapter is about:

- **Special Functions.** How to select special functions relating to modulation.
- **Save and Recall registers.** How to save and recall front-panel settings.
- **Digitized and Linear FM Synthesis.** How carrier frequency accuracy, audio frequency rates, and group delay affect frequency modulation.
- **Synthesis Modes.** How to control the RF output quality (when FM deviation, switching time, and phase noise are considerations).

Note

Appendix H provides instructions to create complex audio signals for modulating the RF Output.

The Directory

Use the illustration shown below and find the subject you want. Turn to that subject, and notice a look-up table which provides you with an overview of the specific topics covered in that section of the chapter.

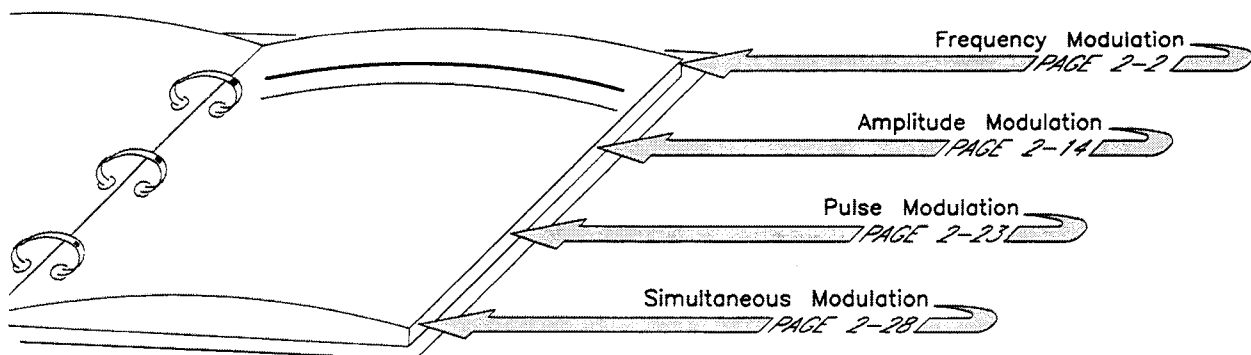

Frequency Modulation – An Overview

If You Need to Know:	Refer to:
<u>Frequency Modulation</u>	
<ul style="list-style-type: none"> • <i>About Digitized vs Linear FM synthesis in relation to carrier frequency accuracy, audio frequency rates, group delay, and modes of operation</i> 	<p>Frequency Modulation—An Introduction (2-2 to 2-5)</p>
<ul style="list-style-type: none"> • <i>How to FM the HP 8645A using the internal audio source</i> 	<p>Frequency Modulation—An Exercise. Procedure #1 (2-6 to 2-9)</p>
<ul style="list-style-type: none"> • <i>How to FM the HP 8645A with an external audio source</i> 	<p>Frequency Modulation—An Exercise. Procedure #2 (2-10 to 2-12)</p>
<ul style="list-style-type: none"> • <i>The key things to remember about frequency modulating the HP 8645A</i> 	<p>Frequency Modulation—Things to Remember (2-13)</p>

Frequency Modulation – An Introduction

The HP 8645A accurately simulates many different types of FM signals used in RF communication systems. Also, a wide variety of unsymmetrical modulation signals, such as digital FSK squelching sequences, and FM telemetry can be coupled to the front-panel FM connector.

You can FM the RF output over a wide bandwidth, with deviations up to 10 MHz (20 MHz with Option 002) using either internally or externally generated modulation signals. External modulation signals can be ac or dc coupled. You can simultaneously modulate AM, FM, and pulse. The ext FM input has an impedance of either 50 Ω (at FM input connector) or 600 Ω (at Φmod connector with Special Function 123 enabled).

The HP 8645A has an internal audio source that generates waveforms at rates up to 400 kHz. Five different internal audio waveforms are available when you access Special Function 130: sine, square, triangle, sawtooth, or white Gaussian noise as demonstrated in Procedure #1.

The HP 8645A generates FM in two ways. Digitized FM synthesis is the default method, and Linear FM synthesis is the method you access from Special Function 120; you have control over selection of either method.

Both Digitized FM and Linear FM synthesis have their advantages and disadvantages. Your signal generation and testing needs will determine which method to use. Let's examine the different factors to be considered:

Carrier Frequency Accuracy

Carrier frequency accuracy is a measure of the frequency shift in the RF output relative to its desired frequency.

Digitized FM synthesis offers you the best carrier frequency accuracy. This accuracy is a function of the programmed FM deviation (**FM Indicator Accuracy**, as shown in the specification table, chapter 1 of the *Calibration Manual*).

Linear FM synthesis produces slight carrier frequency inaccuracies that are more apparent as FM deviation increases.

Audio Frequency Rates

The HP 8645A causes either an external audio source, or its internal audio source to frequency modulate the RF output. The external or internal audio waveform can be sine, or can be complex (for example, square, sawtooth, and so forth). Also, you may create complex audio signals for modulating the RF carrier as described in appendix H.

In general, the HP 8645A specifies audio frequency rates for FM to be no higher than the maximum peak deviation specified for the RF output frequency. Refer to chapter 1 in the HP 8645A *Calibration Manual* for the maximum peak deviation limits.

Digitized FM synthesis is primarily used for single-tone audio modulation with a sinewave; however, complex waveforms can be used as long as their rates are less than 10 kHz. The maximum internal audio frequency rate can be 400 kHz; higher external audio frequency rates can be input.

Linear FM synthesis is primarily used for complex audio modulation. The maximum internal audio frequency rate is also 400 kHz; higher external audio frequency rates can be input.

Group Delay

Group delay is a measure of the time delay between the information input at the FM Modulation Input connector, and the signal effects at the RF Output connector. Effects from group delay are apparent only when the complex audio modulation signal has significant harmonic content between 10 kHz and 100 kHz. The modulation rate and the method of FM synthesis both contribute to the amount of group delay that is present.

Digitized FM synthesis causes a greater amount of group delay than Linear FM synthesis, as shown in figure 2-1:

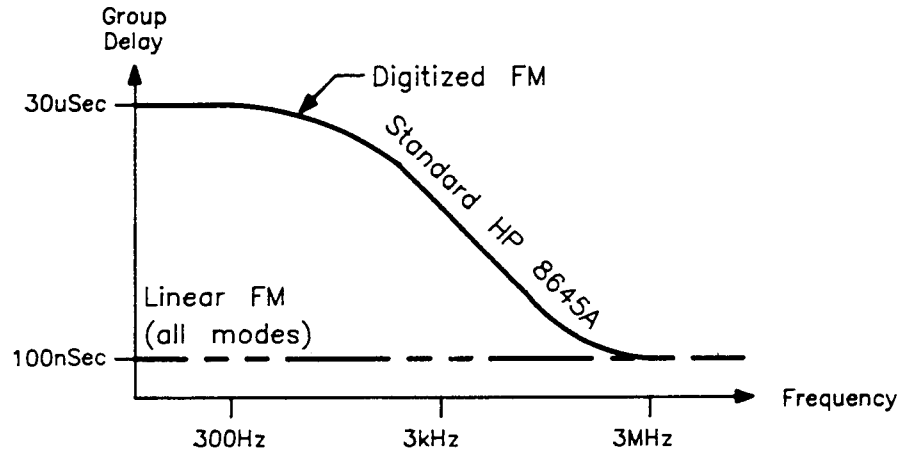

Figure 2-1. Group Delay for Digitized and Linear FM Synthesis.

Synthesis Modes

On the lower-right side of the HP 8645A's front panel, you will notice a group of keys under the label **SYNTHESIS MODE**. With these keys, the HP 8645A allows you control the character of the RF output.

In most applications, the HP 8645A can be kept in the Auto Select mode. As you tune the HP 8645A over its frequency range with FM turned on, you will notice that different LED annunciators associated with the Mode keys will light up. This is a visual indication that the HP 8645A is automatically selecting the "best" mode of operation for the selected frequency and modulation settings. In the Auto Select mode, the "best" mode of operation is an RF output with the lowest phase noise.

In other applications, you may want the RF output to switch faster and have more FM deviation. In this case, press the Mode key of your choice to take the HP 8645A out of the Auto Select mode. There are three basic factors to consider when you choose a "mode of operation"—they are (1) switching speed, (2) FM deviation, and (3) phase noise. A typical comparison of these three factors for an RF output of 1 GHz is shown in figure 2-2:

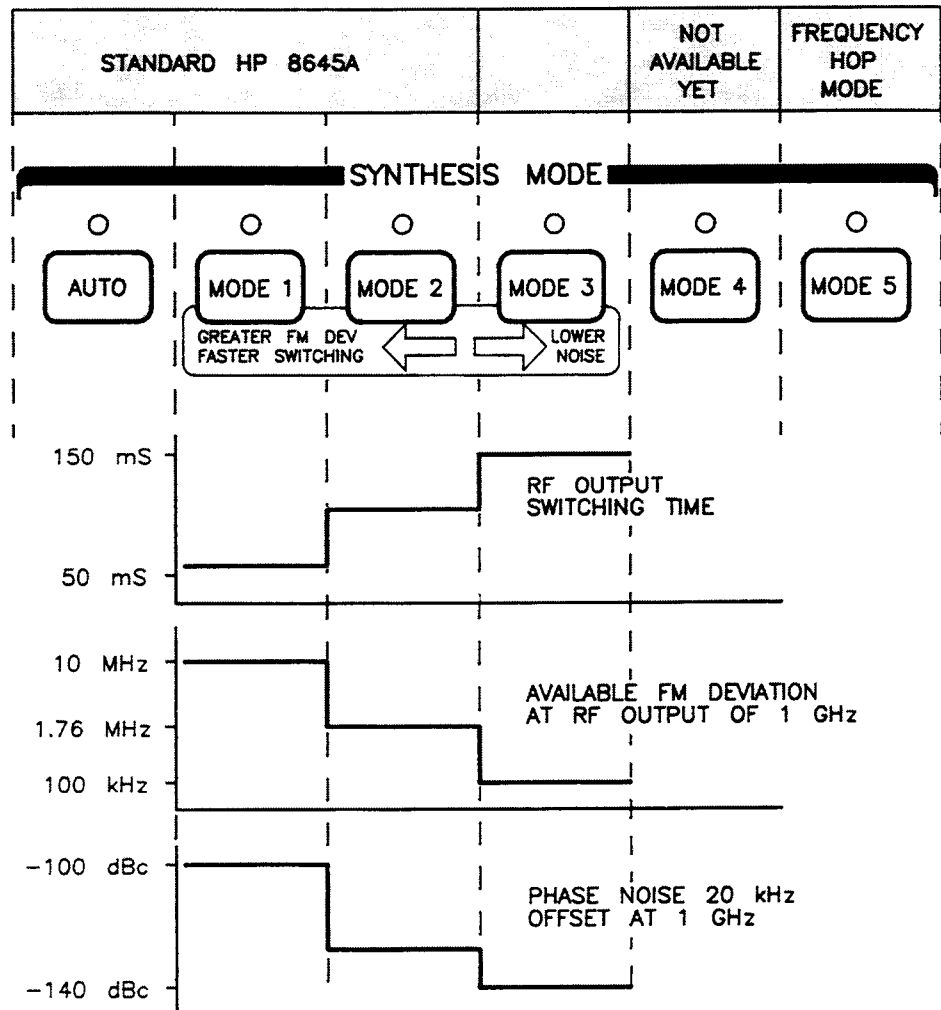

Figure 2-2. Modes of Operation for RF Output of 1 GHz.

rev.02JUN89

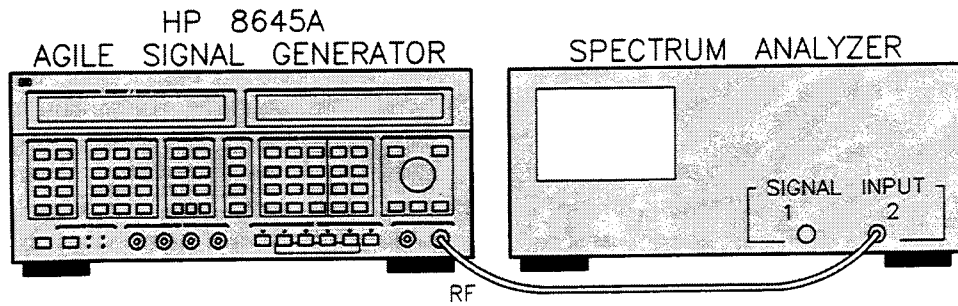

Figure 2-3. Equipment Setup for FM Procedure #1.

Frequency Modulation – An Exercise

The following exercise is made up of two procedures. Each procedure takes about 10 minutes to complete. The first procedure frequency modulates the HP 8645A using the internal audio source. The second procedure frequency modulates the HP 8645A using an external audio source.

Equipment Needed

Both procedures require use of the following equipment:

Equipment	Recommended Model Numbers
Spectrum Analyzer	HP 8562A/B, or HP 8566B, or HP 8568B
Function Generator	HP 3312A, or HP 3314A, or HP 8111A, HP 8116A, or HP 8904A

Procedure #1 – FM Using the Internal Audio Source

Procedure #1 starts with step 1 shown on the next page. A review of the four major steps in the procedure is as follows:

- Set up and adjust the Spectrum Analyzer, and connect it to the HP 8645A.
- Adjust the RF output to 600 MHz, and the output amplitude to 0 dBm on the HP 8645A.
- Adjust the FM deviation to 10 MHz, and the audio frequency rate to 400 kHz on the HP 8645A.
- Observe and modify the results.

Set Up and Adjust the Spectrum Analyzer

1. Connect the HP 8645A to the Spectrum Analyzer as shown in figure 2-3. Turn on the equipment, and make the following adjustments to the Spectrum Analyzer:

Center Frequency 600 MHz
 Frequency Span 50 MHz
 Reference Level 0 dBm

Adjust RF Output and Output Amplitude on the HP 8645A

2. Press the green INSTR PRESET key. Doing so presets the HP 8645A to a known state for the following steps.
3. Press the FREQ key, and enter a frequency of 600 MHz.

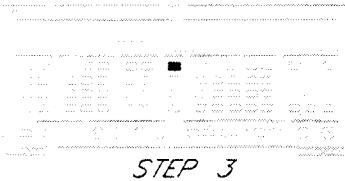

Remember

On the HP 8645A, a “∇ cursor” appears in either the FREQUENCY/STATUS or the MODULATION/AMPLITUDE display, and points to the currently active function. This means, for example, that presently you could change the frequency of the HP 8645A without having to first press the FREQ key.

4. Press the AMPTD key, and enter an output amplitude of 0 dBm. You will notice that the “∇ cursor” is now in the MODULATION/AMPLITUDE display. The following display should appear on the Spectrum Analyzer:

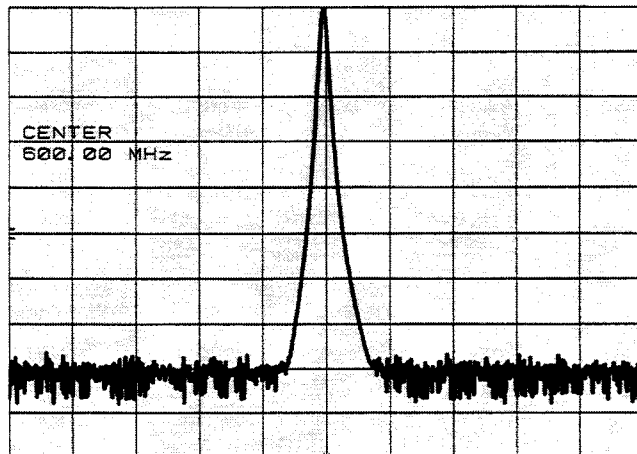
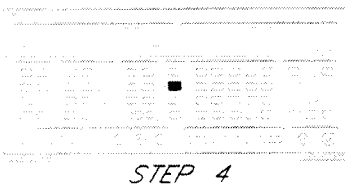

Adjust FM Deviation and Audio Frequency Rate on the HP 8645A

5. Press the FM key, and enter an FM deviation of 10 MHz. When FM deviation is first turned on, the audio frequency rate defaults to 1 kHz.

Notice that the yellow annunciators above the FM and INT keys light up; this indicates that FM, using its internal audio source, is active.

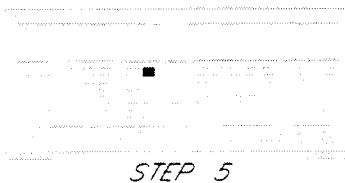

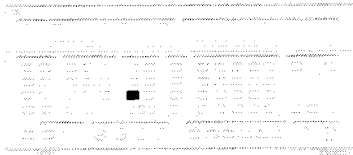

STEP 6

- Press the **AUDIO FREQ** key, and enter an audio frequency rate of **400 kHz**. The HP 8645A should now show the following in the **MODULATION/AMPLITUDE** display:



Observe and Modify the Results

- The following display should appear on the **Spectrum Analyzer**:

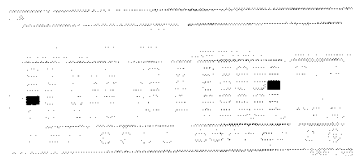
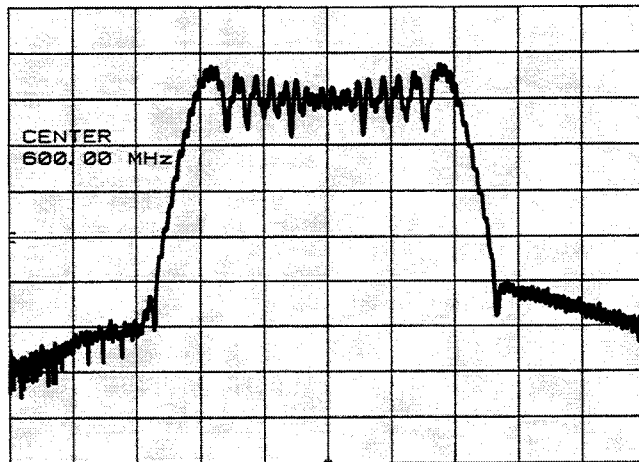

STEP 8 & 9

- Press the **SAVE** key. The HP 8645A should show the following in the **FREQUENCY/STATUS** display:

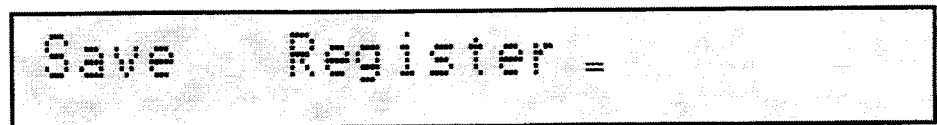

- Press the **0** key, and the **ENTER** key. This step enters the frequency, modulation and amplitude settings in **Register 0** for use in Procedure #2; the **FREQUENCY/STATUS** display should now show the last RF output setting (600 MHz).

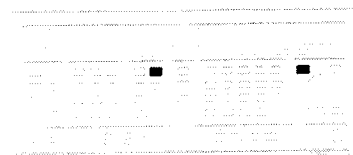

STEP 10

- Press the **FM** key, the **INCR/DECR**  key, and turn the knob counterclockwise to decrease the FM deviation. You will notice the Spectrum Analyzer display changing as FM deviation is adjusted.

Return FM deviation to 10 MHz, and proceed to the next step where you will change the audio frequency waveform by using Special Function 130.



STEP 11 & 12

11. Press the **SPECIAL** key. The HP 8645A should now show the following in the FREQUENCY/STATUS display:



Enter Special Number

12. Enter number "130" and press the **ENTER** key. The HP 8645A should now show the following in the FREQUENCY/STATUS display:



130:Audio Wave Sine

13. Turn the knob to change the audio frequency waveform. Notice how the Spectrum Analyzer responds to the square, triangle, sawtooth, and white Gaussian noise waveforms.

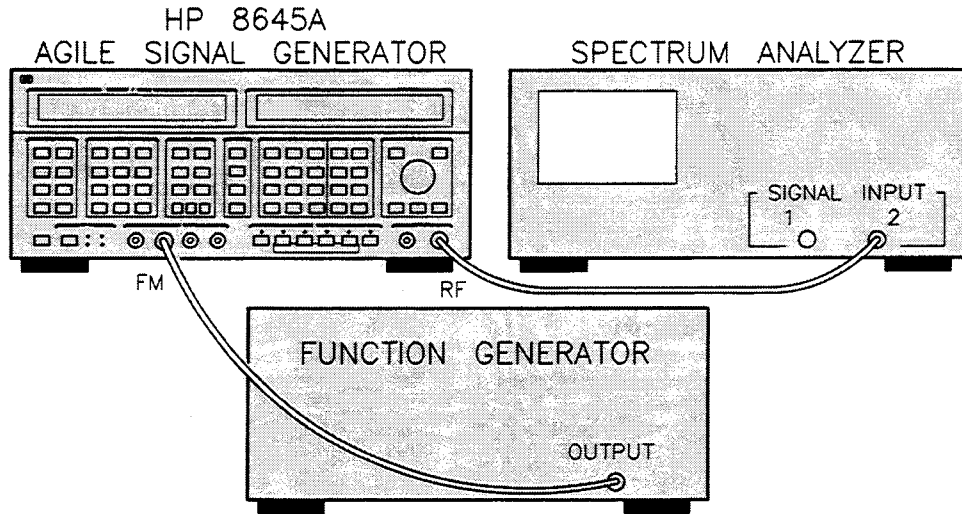

Figure 2-4. Equipment Setup for FM Procedure #2.

**Procedure #2 – FM
Using an External
Audio Source**

Procedure #2 starts with step 1 shown below. A review of the four major steps in the procedure is as follows:

- Set up and adjust the Spectrum Analyzer and Function Generator, and connect them to the HP 8645A.
- Adjust the RF output to 600 MHz, and the output amplitude to 0 dBm on the HP 8645A.
- Adjust the FM deviation to 10 MHz on the HP 8645A.
- Observe and modify the results.

Set Up and Adjust the Spectrum Analyzer and Function Generator

1. **Connect the HP 8645A to the Spectrum Analyzer and Function Generator as shown in figure 2-4.** Turn on the equipment and make the following adjustments:

On the Spectrum Analyzer

Center Frequency 600 MHz
 Frequency Span 100 MHz
 Reference Level 0 dBm

On the Function Generator

Frequency 5 MHz
 Amplitude 1 Vpk
 Waveform Sine

Adjust RF Output and Output Amplitude on the HP 8645A

2. Press the green INSTR PRESET key. Doing so presets the HP 8645A to a known state for the following steps.
3. Press the FREQ key, and enter a frequency of 600 MHz.
4. Press the AMPTD key, and enter an output amplitude of 0 dBm. The following display should appear on the Spectrum Analyzer:

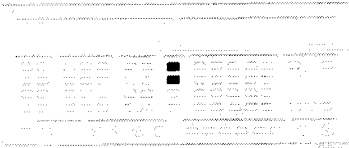

STEP 3 & 4

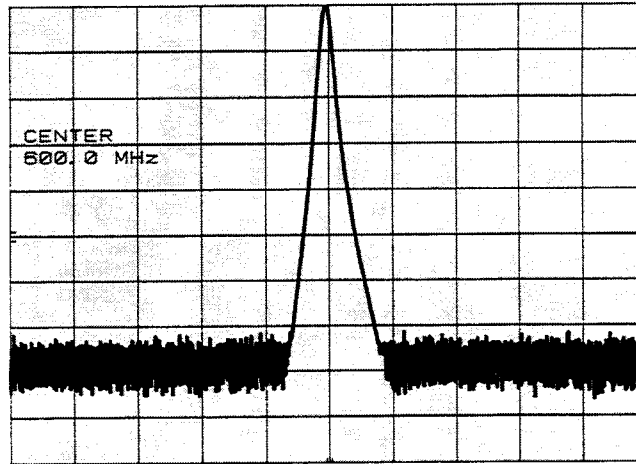

Adjust FM Deviation on the HP 8645A

5. Press the FM key, the EXT AC key, the INT key, and then enter an FM deviation of 10 MHz. The INT key is pressed in this step to turn off the internal audio source.

Notice that the yellow annunciators above the FM and EXT AC keys light up; this indicates that FM using an external audio source is active.

The HP 8645A should now show the following in the MODULATION/AMPLITUDE display:



Remember

The EXT HI and EXT LOW annunciators in the MODULATION/AMPLITUDE display indicate if the amplitude of the external audio source is too high or too low. When the amplitude is at 1 Vpk ±1%, both annunciators are off. However, both annunciators only work at external audio rates from 20 Hz to 100 kHz.

Observe and Modify the Results

6. The following display should appear on the Spectrum Analyzer:

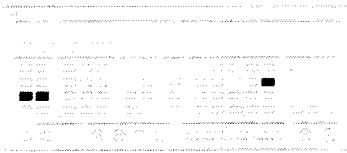
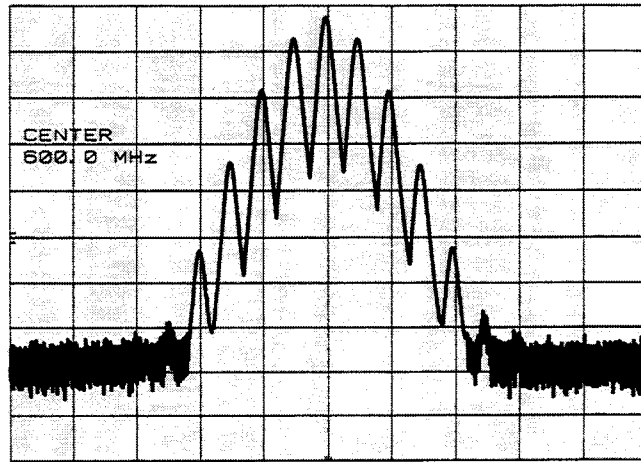

STEP 7, 8, & 9

7. Press the **SAVE** key, and put the current front-panel settings in Register 1.
8. Press the **RECALL** key. The HP 8645A should show the following in the **FREQUENCY/STATUS** display:



9. Press the **0** and the **ENTER** key to recall the settings from Procedure #1. Notice that the display on the Spectrum Analyzer reflects the recalled settings from Procedure #1.
10. **Recall Register 1 to return to the Procedure #2 settings.** Notice once again that the display on the Spectrum Analyzer reflects the recalled settings for Procedure #2.

Remember

The HP 8645A has 50 available storage registers. The first 10, Registers 0-9, accepts all front panel settings (except for some Special Functions). The next 40, Registers 10-49, accepts only frequency and amplitude settings.

Performing an Instrument Preset, or unplugging the HP 8645A does not alter contents of the 50 storage registers.

Frequency Modulation – Things to Remember

The following list is a summary of the most important points previously discussed in the FM modulation section:

- Digitized FM synthesis, and Linear FM synthesis are two methods of generating FM in the HP 8645A. Special Function 120 allows you to choose between either method.
- Carrier frequency accuracy, audio frequency rates, and group delay are three factors to consider when you decide on a method of FM synthesis.
- FM deviation, switching time, and phase noise are three factors to consider if you decide to use a mode of operation other than the Auto mode.
- The internal audio source generates sine, square, triangle, sawtooth, or white Gaussian noise waveforms. Access Special Function 130 to change the internal audio source waveform.
- Refer to appendix H for information about creating complex audio signals that modulate the RF carrier.

After completing the procedures for FM modulation, you may go to the AM, Pulse, or Simultaneous FM and AM modulation exercises in this chapter; an alternative is to proceed to another chapter in this Guide.

Amplitude Modulation – An Overview

If You Need to Know:	Refer to:
<u>Amplitude Modulation</u>	
<ul style="list-style-type: none"> • <i>Some general information about amplitude modulation</i> 	<p>Amplitude Modulation–An Introduction (2-14)</p>
<ul style="list-style-type: none"> • <i>How to AM the HP 8645A using the internal audio source</i> 	<p>Amplitude Modulation–An Exercise. Procedure #1 (2-15 to 2-18)</p>
<ul style="list-style-type: none"> • <i>How to AM the HP 8645A with an external audio source</i> 	<p>Amplitude Modulation–An Exercise. Procedure #2 (2-19 to 2-21)</p>
<ul style="list-style-type: none"> • <i>The key things to remember about amplitude modulating the HP 8645A</i> 	<p>Amplitude Modulation–Things to Remember (2-22)</p>

Amplitude Modulation – An Introduction

The HP 8645A amplitude modulates the RF output either with a variable internal audio source, or with an ac or dc-coupled external audio source applied to the front-panel **AM** connector. You cannot use both the internal audio source and an external audio source at the same time. The **AM** connector has an input impedance of 600 Ω.

The HP 8645A has an internal audio source that generates waveforms at rates up to 400 kHz; however, for precise AM depth, the audio frequency rates should not exceed the specified limits shown in chapter 1 of the HP 8645A *Calibration Manual* for the RF output.

You can simultaneously modulate AM with FM or pulse modulation. Refer to appendix H if you need to create complex audio signals for the RF carrier.

Note

AM accuracy and distortion specifications are not valid when you simultaneously modulate AM and Pulse together.

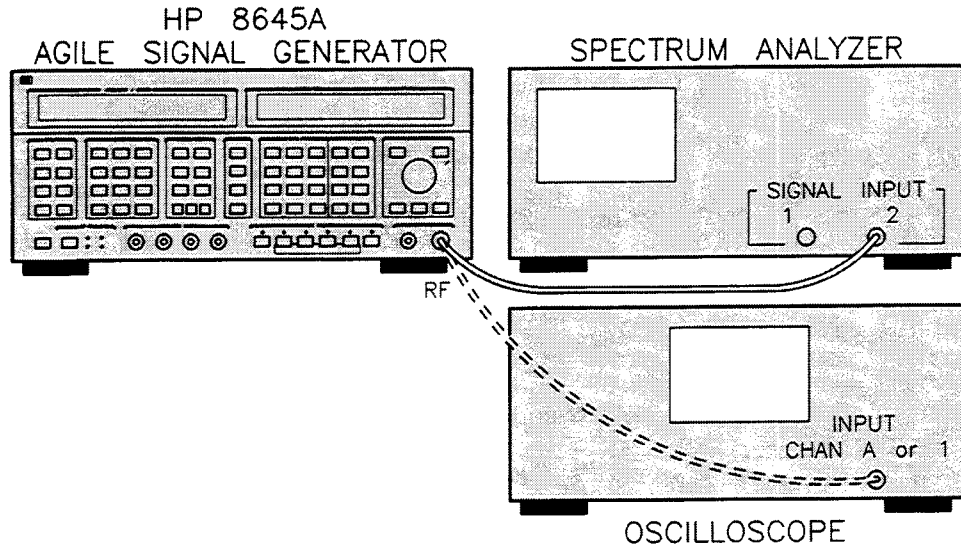

Figure 2-5. Equipment Setup for AM Procedure #1.

Amplitude Modulation – An Exercise

The following exercise is made up of two procedures. Each procedure takes about 10 minutes to complete. The first procedure amplitude modulates the HP 8645A using the internal audio source. The second procedure amplitude modulates the HP 8645A using an external audio source. In both procedures, you have the choice of viewing results either on a Spectrum Analyzer or on an Oscilloscope.

Equipment Needed

Both procedures require use of the following equipment:

Equipment	Recommended Model Numbers
Spectrum Analyzer	HP 8562A/B, or HP 8566B, or HP 8568B
Function Generator	HP 3312A, or HP 3314A, or HP 8111A, HP 8116A, or HP 8904A
Oscilloscope	HP 1741A, or HP 54100A, or HP 54200A

Procedure #1 – AM Using the Internal Audio Source

Procedure #1 starts with step 1 shown on the next page. A review of the four major steps in the procedure is as follows:

- Set up and adjust the Spectrum Analyzer (or Oscilloscope), and connect it to the HP 8645A.
- Adjust the RF output to 20 MHz, and the output amplitude to 0 dBm on the HP 8645A.
- Adjust the AM depth to 50%, and the audio frequency rate to 50 kHz on the HP 8645A.
- Observe and modify the results.

Set Up and Adjust the Spectrum Analyzer (or Oscilloscope)

1. Connect the HP 8645A to the Spectrum Analyzer (or Oscilloscope) as shown in figure 2-5. Turn on the equipment, and make the following adjustments:

On the Spectrum Analyzer

Center Frequency 20 MHz
 Frequency Span 250 kHz
 Reference Level 0 dBm

On the Oscilloscope

Volts/Div 0.5
 Time/Div 5 μ sec

Adjust RF Output and Output Amplitude on the HP 8645A

2. Press the green INSTR PRESET key. Doing so presets the HP 8645A to a known state for the following steps.
3. Press the FREQ key, and enter a frequency of 20 MHz.

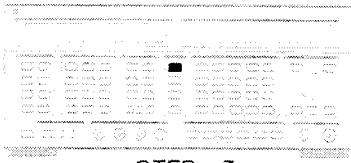

STEP 3

Remember

On the HP 8645A, a “ ∇ cursor” appears in either the FREQUENCY/STATUS or the MODULATION/AMPLITUDE display, and points to the currently active function. This means, for example, that presently you could change the frequency of the HP 8645A without having to first press the FREQ key.

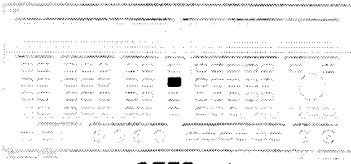

STEP 4

4. Press the AMPTD key, and enter an output amplitude of 0 dBm. You will notice that the “ ∇ cursor” is now in the MODULATION/AMPLITUDE display.

Adjust AM Depth and Audio Frequency Rate on the HP 8645A

5. Press the AM key, and enter an AM depth of 50%. When AM depth is first turned on, the audio frequency rate defaults to 1 kHz.

Notice that the yellow annunciators above the AM and INT keys light up; this indicates that AM, using its internal audio source, is active.



STEP 5



STEP 6

- Press the **AUDIO FREQ** key, and enter an audio frequency rate of **50 kHz**. The HP 8645A should now show the following in the **MODULATION/AMPLITUDE** display:

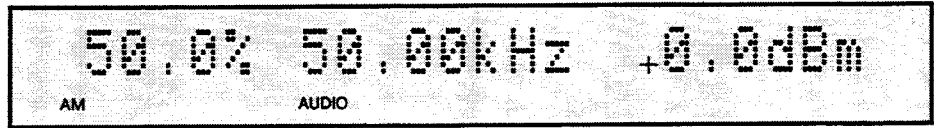

Observe and Modify the Results.

- The following display should appear on the **Spectrum Analyzer** (or **Oscilloscope**):

Spectrum Analyzer

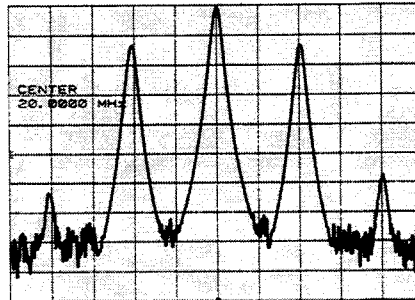

Oscilloscope

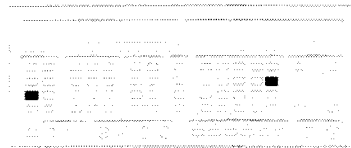
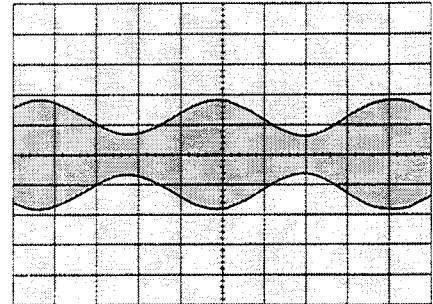

STEP 8 & 9

- Press the **SAVE** key. The HP 8645A should show the following in the **FREQUENCY/STATUS** display:



- Press the **0** key, and the **ENTER** key. This step enters the frequency, modulation and amplitude settings in Register 0 for use in Procedure #2; the **FREQUENCY/STATUS** display should now show the last RF output setting (20 MHz).
- Press the **AM** key, and turn the knob counterclockwise to **decrease the AM depth**. You will notice the Spectrum Analyzer (or Oscilloscope) display changing as AM depth is adjusted.

Return AM depth to 50%, and proceed to the next step where you will change the audio frequency waveform using Special Function 130.



STEP 11 & 12

11. Press the **SPECIAL** key. The HP 8645A should now show the following in the FREQUENCY/STATUS display:



12. Enter number "130" and press the **ENTER** key. The HP 8645A should now show the following in the FREQUENCY/STATUS display:



13. Turn the knob to change the audio frequency waveform. Notice how the Spectrum Analyzer (or Oscilloscope) responds to the square, triangle, sawtooth, and white Gaussian noise waveforms.

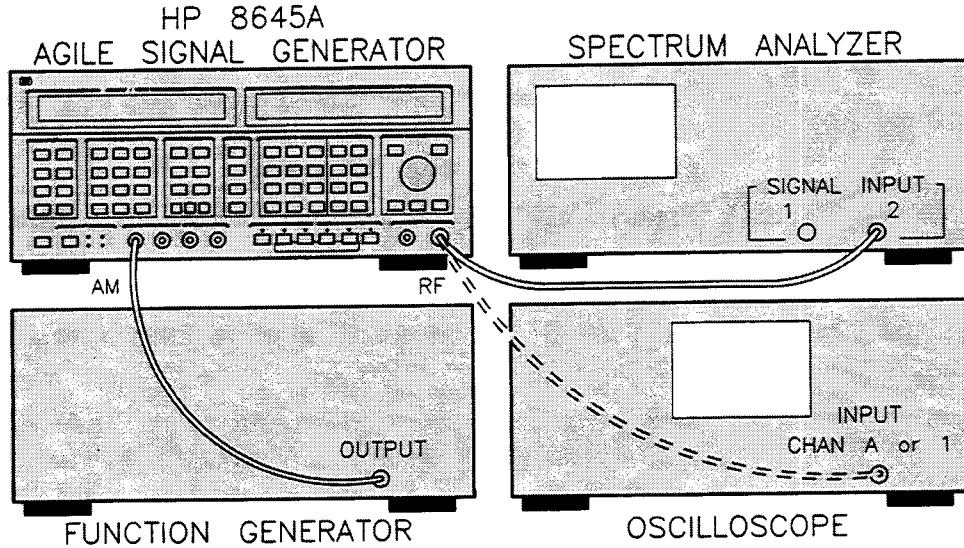

Figure 2-6. Equipment Setup for AM Procedure #2.

**Procedure #2 – AM
Using an External
Audio Source**

Procedure #2 starts with step 1 shown below. A review of the five major steps in the procedure is as follows:

- Set up and adjust the Spectrum Analyzer (or Oscilloscope) and Function Generator, and connect them to the HP 8645A.
- Adjust the RF output to 100 MHz, and the output amplitude to 0 dBm on the HP 8645A.
- Adjust the AM depth to 90% on the HP 8645A.
- Adjust output amplitude on the Function Generator.
- Observe and modify the results.

**Set Up and Adjust the Spectrum Analyzer (or Oscilloscope),
and Function Generator**

1. Connect the HP 8645A to the Spectrum Analyzer (or Oscilloscope) and Function Generator as shown in figure 2-6. Turn on the equipment and make the following adjustments:

On the Spectrum Analyzer

Center Frequency 100 MHz
 Frequency Span 250 kHz
 Reference Level 0 dBm

On the Oscilloscope

Volts/Div 0.2
 Time/Div 5 μ sec

On the Function Generator

Frequency 50 kHz
 Amplitude 1 Vpk
 Waveform Sine

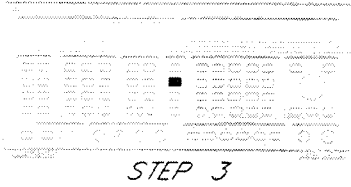

Adjust RF Output and Output Amplitude on the HP 8645A

2. Press the green INSTR PRESET key. Doing so presets the HP 8645A to a known state for the following steps. Notice the RF output frequency is now set to 100 MHz.
3. Press the AMPTD key, and enter an output amplitude of 0 dBm.

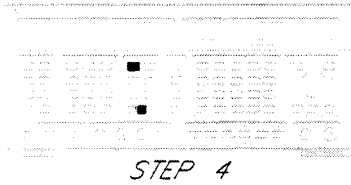

Adjust AM Depth on the HP 8645A

4. Press the AM key, the EXT AC key, and then enter an AM depth of 90%.

Notice that the yellow annunciators above the AM and EXT AC keys light up; this indicates that AM using an external audio source is active.

The HP 8645A should now show the following in the MODULATION/AMPLITUDE display:



Remember

The EXT HI and EXT LOW annunciators in the MODULATION/AMPLITUDE display indicate if the amplitude of the external audio source is too high or too low. When the amplitude is at 1 Vpk ±1%, both annunciators are off. However, both annunciators only work at external audio rates from 20 Hz to 100 kHz.

Adjust Output Amplitude on the Function Generator

Note

Proceed to step 6 if both the EXT HI and EXT LOW annunciators are off.

5. Slowly adjust the output amplitude on the function generator until both the EXT HI and EXT LOW annunciators are off. The HP 8645A requires the input signal to the AM connector to be 1 Vpk ±1%.

Observe and Modify the Results

- The following display should appear on the Spectrum Analyzer (or Oscilloscope):

Spectrum Analyzer

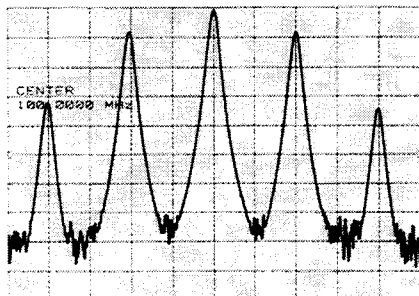

Oscilloscope

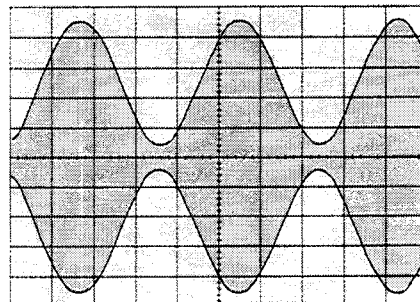

STEP 7, 8, & 9

- Press the **SAVE** key, and put the current front-panel settings in Register 1.
- Press the **RECALL** key. The HP 8645A should show the following in the **FREQUENCY/STATUS** display:

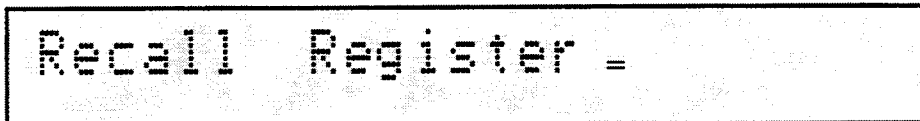

- Press the **0** and the **ENTER** key to recall the settings from Procedure #1. You will have to re-adjust the Spectrum Analyzer for a center frequency of 20 MHz. Then, notice that the display on the Spectrum Analyzer reflects the recalled settings from Procedure #1.
- Recall Register 1 to return to the Procedure #2 settings.** Re-adjust the Spectrum Analyzer's center frequency to 100 MHz. Notice once again that the display on the Spectrum Analyzer reflects the recalled settings for Procedure #2.

Remember

The HP 8645A has 50 available storage registers. The first 10, Registers 0-9, accepts all front panel settings (except for some Special Functions). The next 40, Registers 10-49, accepts only frequency and amplitude settings.

Performing an Instrument Preset, or unplugging the HP 8645A does not alter contents of the 50 storage registers.

**Amplitude
Modulation
– Things to
Remember**

The following list is a summary of the most important points previously discussed in the AM modulation section:

- For accurate AM depth, audio frequency rates should not exceed the specified limits shown in chapter 1 of the *HP 8645A Calibration Manual* for the RF output.
- An internal or external audio source can be used to amplitude modulate the RF output.
- The internal audio source generates sine, square, triangle, sawtooth, or white Gaussian noise waveforms. Access Special Function 130 to change the internal audio source waveform.
- Refer to appendix H for information about creating complex audio signal that modulate the RF carrier.

After completing the procedures for AM modulation, you may go to the FM, Pulse, or Simultaneous FM and AM modulation exercises in this chapter; an alternative is to proceed to another chapter in this Guide.

Pulse Modulation – An Overview

If You Need to Know:	Refer to:
<u>Pulse Modulation</u>	
• <i>Some general information about pulse modulation</i>	Pulse Modulation–An Introduction (2-23)
• <i>How to Pulse Modulate the HP 8645A with an external audio source</i>	Pulse Modulation–An Exercise (2-24 to 2-26)
• <i>The key things to remember about pulse modulating the HP 8645A</i>	Pulse Modulation–Things to Remember (2-27)

Pulse Modulation – An Introduction

The HP 8645A pulse modulates the RF output with a dc-coupled external audio source applied to the front-panel **PULSE** connector. Pulse modulation using the internal audio source or an external ac-coupled audio source is not allowed. You can simultaneously modulate AM or FM with pulse modulation. The **PULSE** connector has an input impedance of 600 Ω.

Note

AM accuracy and distortion specifications are not valid when you simultaneously modulate AM and Pulse together.

To generate pulse modulation, use an external audio source with a pulse waveform. When the pulse waveform from the external audio source goes high, the pulse output from the HP 8645A turns on. Vary the external pulse rate, amplitude, and width to simulate the pulse modulated signal you need.

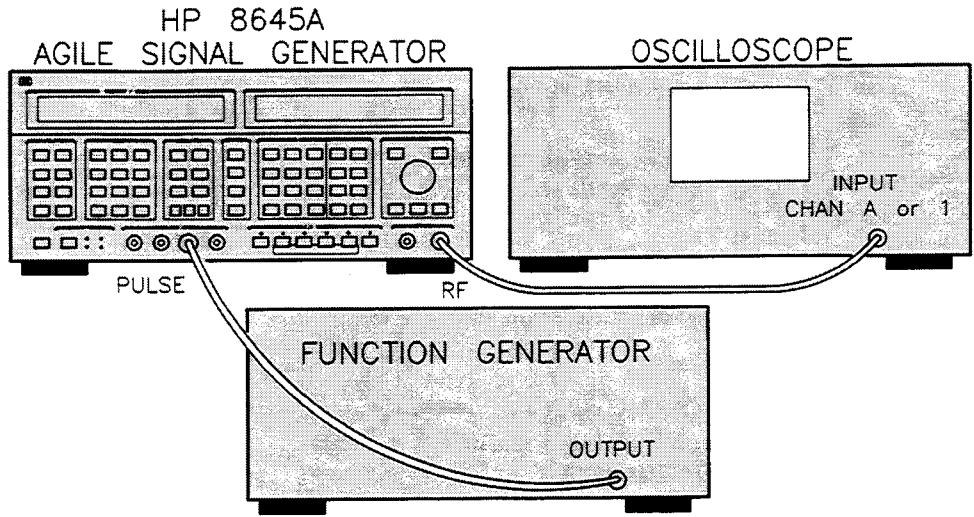

Figure 2-7. Equipment Setup for Pulse Modulation Procedure.

Pulse Modulation – An Exercise

In this exercise you will pulse modulate the HP 8645A with an external audio source. This procedure takes about 10 minutes. The results from the pulse modulation exercise are displayed on an oscilloscope.

Equipment Needed

This procedure requires use of the following equipment:

Equipment	Recommended Model Numbers
Function Generator	HP 3312A, or HP 3314A, or HP 8111A, HP 8116A, or HP 8904A
Oscilloscope	HP 1741A, or HP 54100A, or HP 54200A

Procedure – Pulse Modulation Using an External Audio Source

The procedure starts with step 1 shown on the next page. A review of the five major steps in the procedure is as follows:

- Set up and adjust the Oscilloscope and Function Generator, and connect them to the HP 8645A.
- Adjust the RF output to 50 MHz, and the output amplitude to 0 dBm on the HP 8645A.
- Set up pulse modulation on the HP 8645A.
- Adjust output amplitude on the Function Generator.
- Observe and modify the results.

Set Up and Adjust the Oscilloscope, and Function Generator

1. Connect the HP 8645A to the Oscilloscope and Function Generator as shown in figure 2-7. Turn on the equipment and make the following adjustments:

On the Oscilloscope

Volts/Div 0.2
 Time/Div 0.5 msec

On the Function Generator

Frequency 1 kHz
 Amplitude 3 Vpk
 Waveform Pulse
 Width 100 μ sec

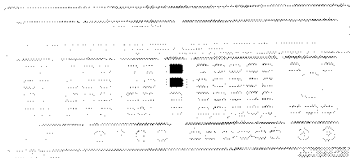

STEP 3 & 4

Remember

Adjust RF Output and Output Amplitude on the HP 8645A

2. Press the green INSTR PRESET key. Doing so presets the HP 8645A to a known state for the following steps.
3. Press the FREQ key, and enter a frequency of 50 MHz.

On the HP 8645A, a "▽ cursor" appears in either the FREQUENCY/STATUS or the MODULATION/AMPLITUDE display, and points to the currently active function. This means, for example, that presently you could change the frequency of the HP 8645A without having to first press the FREQ key.

4. Press the AMPTD key, and enter an output amplitude of 0 dBm. You will notice that the "▽ cursor" is now in the MODULATION/AMPLITUDE display.

Set Up Pulse Modulation on the HP 8645A

5. Press the PULSE key, and then press the ENTER key.

Notice that the yellow annunciators above the PULSE and EXT DC keys light up; this indicates that pulse modulation using an external audio source is active.

The HP 8645A should now show the following in the MODULATION/AMPLITUDE display:



STEP 5

Adjust Output Amplitude on the Function Generator

6. Slowly increase the output amplitude on the function generator until the Oscilloscope displays the pulse modulated signal. The output amplitude from the Function Generator must be at some value greater than 3 Vpk to pulse modulate the HP 8645A.

Note

The EXT HI and EXT LOW annunciators are not active with pulse modulation.

Observe and Modify the Results

7. The following display should appear on the Oscilloscope:

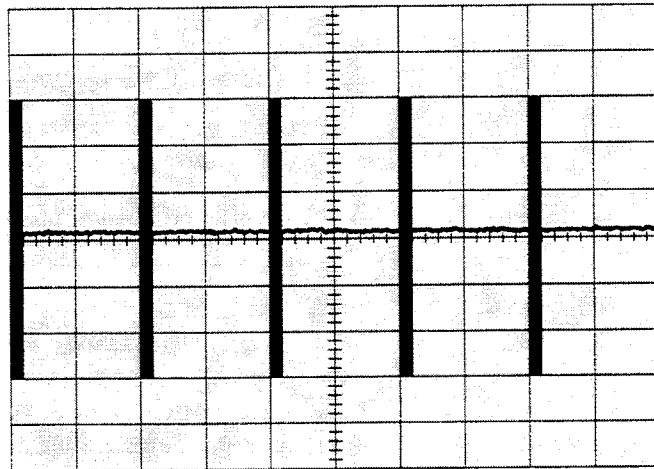

8. Vary the width and rate of the external audio source, and notice the corresponding changes on the Oscilloscope. Periodically adjust the Oscilloscope to compensate for changes you make to the external audio source.

Caution

Do not apply more than ± 10 Vpk to the PULSE connector or you may damage the Agile Signal Generator's circuitry.

Pulse Modulation – Things to Remember

The following list is a summary of the most important points discussed in the pulse modulation section:

- Use an external audio source to generate pulse modulation with the HP 8645A.
- A positive going pulse greater than 3 Vpk (but less than ± 10 Vpk) from the Function Generator turns on pulse modulation from the HP 8645A.
- Damage to circuitry in the HP 8645A could result if the external audio source outputs a pulse greater than ± 10 Vpk.
- RF output is turned on for the duration of the pulse from the Function Generator.
- The external audio source controls the rate and width of the pulse modulated signal from the HP 8645A.

After completing the procedures for Pulse modulation, you may go to the FM, AM, or Simultaneous FM and AM modulation exercises in this chapter; an alternative is to proceed to another chapter in this Guide.

Simultaneous Modulation – An Overview

If You Need to Know:	Refer to:
<u>Simultaneous Modulation</u>	
• <i>Some general information about simultaneous modulation</i>	Simultaneous Modulation–An Introduction (2–28)
• <i>How to simultaneously modulate FM with AM</i>	Simultaneous Modulation–An Exercise (2–29 to 2–32)
• <i>The key things to remember about simultaneous modulating the HP 8645A</i>	Simultaneous Modulation–Things to Remember (2–33)

Simultaneous Modulation – An Introduction

The HP 8645A generates simultaneous modulation in one of five ways:

1. Simultaneous FM and AM is selected using a common or separate audio source.
2. Simultaneous FM at two rates using both the internal and an external audio source.
3. Simultaneous FM and AM using a common audio source (either internal or external), and FM from a separate audio source.
4. Pulse modulation may be selected and entered along with any of the three ways mentioned in statements 1–3.
5. Phase modulation may be selected with AM and/or Pulse modulation. If phase modulation is selected, FM is turned off.

Refer to appendix H to learn about the multifunction synthesis capabilities of the HP 8645A. Special Functions allow you to generate a subcarrier from complex audio signals that is applied, in turn, as a modulating wave to the RF carrier signal.

Note

AM accuracy and distortion specifications are not valid when you simultaneously modulate AM and Pulse together.

The AM, Pulse, and Φ M Input connectors have an external input impedance of 600 Ω ; the FM Input connector has an input impedance of 50 Ω . By activating Special Function 123, you can use the Φ M Input connector as an FM input to provide an external input impedance of 600 Ω . The FM Input connector is then disabled.

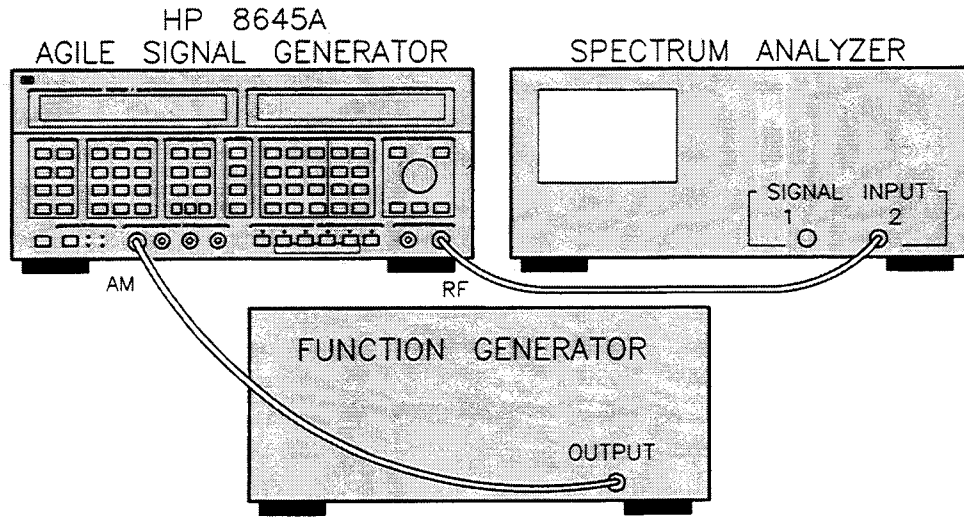

Figure 2-8. Equipment Setup for Simultaneous FM and AM Procedure.

Simultaneous Modulation – An Exercise

There are many possible combinations and applications for simultaneous modulation. In this exercise, the HP 8645A simultaneously modulates FM with AM. The application for this exercise represents an FM radio signal fading 30 dB as a result of interference. This procedure takes about 15 minutes.

Equipment Needed

This procedure requires use of the following equipment:

Equipment	Recommended Model Numbers
Spectrum Analyzer	HP 8562A/B, or HP 8566B, or HP 8568B
Function Generator	HP 3312A, or HP 3314A, or HP 8111A, HP 8116A, or HP 8904A

Procedure – Simultaneous FM and AM

In the procedure, you will set up the HP 8645A with a wanted FM signal modulated by the internal audio source, and then introduce an AM signal used for fading, which is modulated with an external audio source.

The procedure starts with step 1 shown on the next page. A review of the five major steps in the procedure is as follows:

- Set up and adjust the Spectrum Analyzer and Function Generator, and connect them to the HP 8645A.
- Adjust the RF output to 100 MHz, and the output amplitude to 0 dBm on the HP 8645A.
- Adjust the AM depth to 90% on the HP 8645A.
- Adjust the FM deviation to 75 kHz, and the audio frequency rate to 1 kHz on the HP 8645A.
- Observe and modify the results.

Set Up and Adjust the Spectrum Analyzer, and Function Generator

1. Connect the HP 8645A to the Spectrum Analyzer and Function Generator as shown in figure 2-8. Turn on the equipment and make the following adjustments:

On the Spectrum Analyzer

Center Frequency 100 MHz
 Frequency Span 500 kHz
 Reference Level +10 dBm

On the Function Generator

Frequency 0.5 Hz
 Amplitude 3.5 Vpk
 Waveform Sine

Adjust RF Output and Output Amplitude on the HP 8645A

2. Press the green INSTR PRESET key. Doing so presets the HP 8645A to a known state for the following steps. Notice the RF output frequency is now set to 100 MHz.

Remember

On the HP 8645A a "∇ cursor" appears in either the FREQUENCY/STATUS or the MODULATION/AMPLITUDE display, and points to the currently active function. This means, for example, that presently you could change the frequency of the HP 8645A without having to first press the FREQ key.



STEP 3



STEP 4

3. Press the AMPTD key, and enter an output amplitude of 0 dBm. You will notice that the "∇ cursor" is now in the MODULATION/AMPLITUDE display.

Adjust AM Depth on the HP 8645A

4. Press the AM key, the EXT DC key, and then enter an AM depth of 90%.

Notice that the yellow annunciators above the AM and EXT DC keys light up; this indicates that AM using an external audio source is active.

The HP 8645A should now show the following in the MODULATION/AMPLITUDE display:



Remember

The EXT HI and EXT LOW annunciators in the MODULATION/AMPLITUDE display indicate if the amplitude of the external audio source is too high or too low. When the amplitude is at 1 Vpk ±1%, both annunciators are off. However, both annunciators only work at external audio rates from 20 Hz to 100 kHz.

Since the external audio rate is at 0.5 Hz, you can ignore the EXT HI and EXT LOW annunciator displays.

5. The following display should appear on the Spectrum Analyzer: The RF output should be slowly changing for a full amplitude swing of about 30 dB.

Note

Increase the Function Generator's output amplitude if a full 30 dB swing is not present. Decrease the Function Generator's output amplitude if more than a 30 dB swing is present.

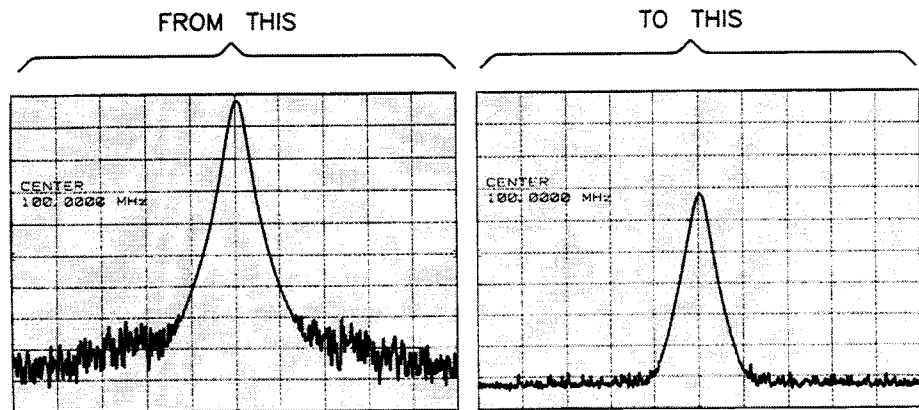

Adjust FM Deviation

6. Press the FM key, and enter an FM deviation of 75 kHz. When FM deviation is first turned on, the audio frequency rate defaults to 1 kHz.

Notice that the yellow annunciators above the FM and INT keys light up; this indicates that FM, using its internal audio source, is active.

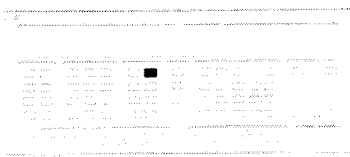

STEP 6

The HP 8645A should now show the following in the MODULATION/AMPLITUDE display:

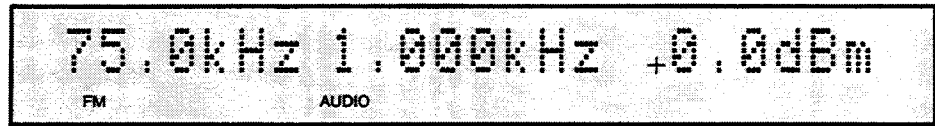

Observe and Modify the Results

7. **The following display should appear on the Spectrum Analyzer:** The FM signal should be slowly changing for a full amplitude swing of about 30 dB.

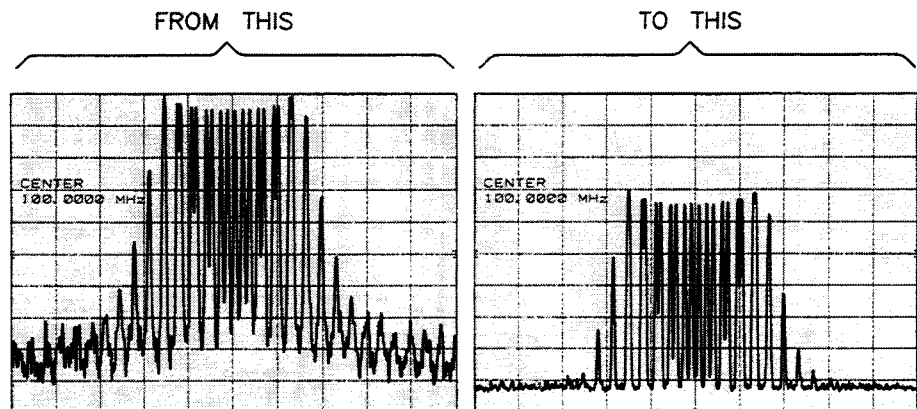

8. **Vary the Function Generator's output amplitude in 0.1 Vpk steps, and notice the corresponding changes on the Spectrum Analyzer.** The FM signal will have a greater swing as output amplitude is increased, and a smaller swing as output amplitude is decreased.

When you are done, put the Function Generator's output amplitude back to the 3.5 Vpk setting for the 30 dB swing.

9. **Vary the Function Generator's audio frequency rate in small steps.** The amplitude swings of the FM signal take longer to change as the audio frequency rate is decreased, and will change faster as the audio frequency rate is increased.

When you are done, put the Function Generator's audio frequency rate back to 0.5 Hz.

10. **Vary AM depth on the HP 8645A.** The amplitude swings of the FM signal are smaller as the AM depth is decreased.

Simultaneous Modulation – Things to Remember

The following list is a summary of the most important points discussed in the simultaneous modulation section:



- There are five ways simultaneous modulation can be generated, refer to page 2-28.
- The Modulation Input connectors all have an external input impedance of 600 Ω except for the FM connector which has an input impedance of 50 Ω . By activating Special Function 123, you can use the Φ M Input connector as an FM input to provide an external input impedance of 600 Ω . The FM Input connector is then disabled.
- All features and limitations previously described for FM, AM, and Pulse apply when simultaneously modulating the HP 8645A.
- During simultaneous internal and external FM, the typical input voltage allowed is +0.4 Vpk to +1 Vpk. Under these conditions, the amount of available external deviation is reduced.

After completing the procedures for Simultaneous FM and AM modulation, you may go to the FM, AM, or Pulse modulation exercises in this chapter; an alternative is to proceed to another chapter in this Guide.

Note

You may want to reduce the output level of the internal audio source during simultaneous internal and external modulation. Doing so would allow you to increase the amount of external modulation. The sum of the internal and external voltages should not exceed 1.4 Vpk or clipping may occur.

The output level of the internal audio source can be adjusted from 0 V dc to 1 V dc in 100 mV steps. Adjusting the output level affects the amount of internal modulation such that a decrease in output level proportionately decreases the amount of internal modulation.

Vary the output level of the internal audio source by first pressing the blue SHIFT key, and then the AUDIO LEVEL key. Turn the knob or press one of the   keys to change the output level.

3

What About Frequency Hopping?

In this Chapter

This chapter has two main objectives. First, it provides you with detailed information to help you understand the concepts which are fundamental to frequency hopping the HP 8645A. Second, it exercises your understanding of frequency hopping by having you perform the procedures found in the last part of this chapter.

As shown in figure 3-1, frequency hopping is controlled locally from the front panel, remotely from HP-IB, and externally from the rear panel. Your specific needs determine the best way to control the HP 8645A.

The subject of this chapter is to discuss front panel, and external control. In chapter 5, you will find information about HP-SL programming control over HP-IB.

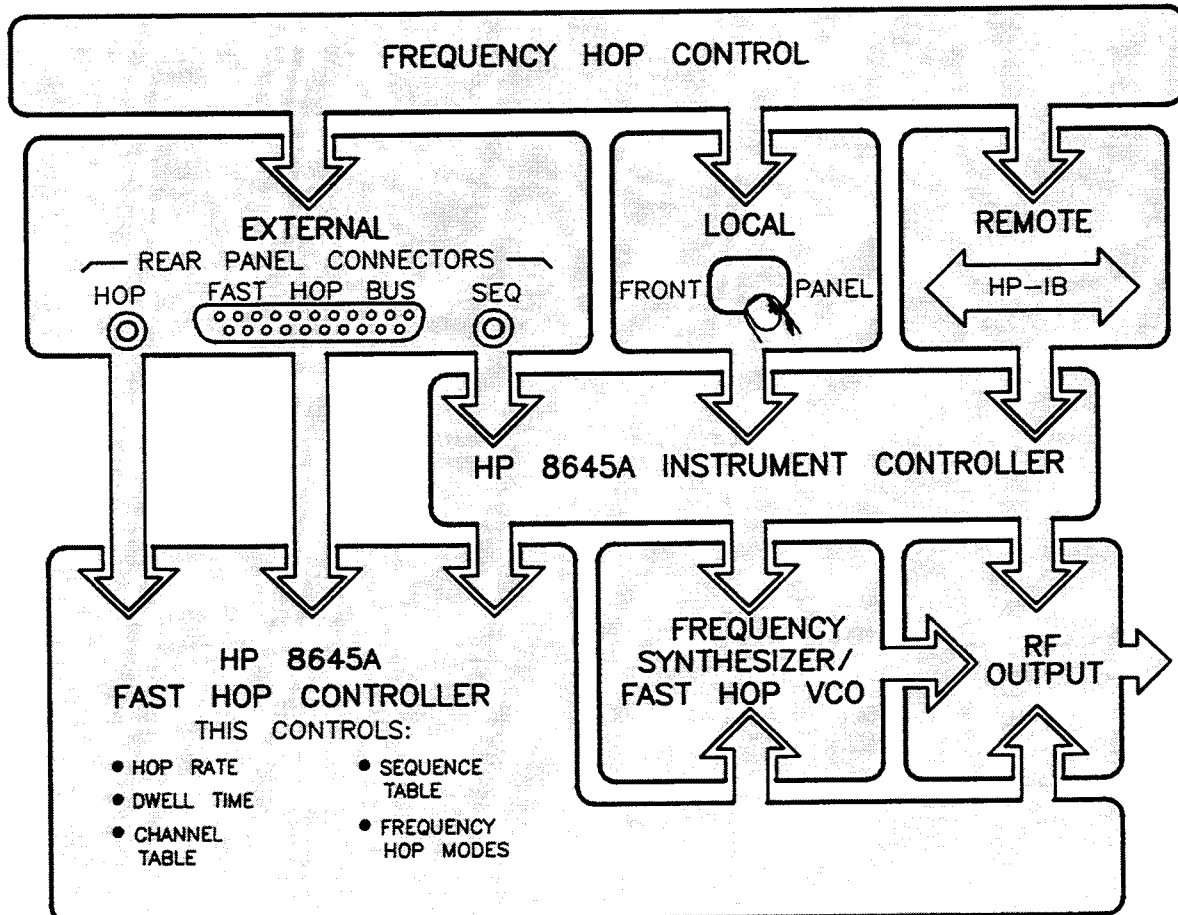

Figure 3-1. How to Control Frequency Hopping.

Whatever your method of controlling the HP 8645A, there are six basic steps to follow when you frequency hop the HP 8645A:

1. Put the HP 8645A into the Fast Hop, Mode 5.
2. Enter frequency and amplitude settings into a channel table, and then arrange the sequence table in a specific order.
3. Enter values for the hop rate and dwell time.
4. Select any one of the nine frequency hop modes.
5. Set up modulation on the RF output.
6. Activate the HP 8645A to frequency hop.

The Directory

Use the illustration shown below to find the subject you want. Turn to that subject, and notice a look-up table which provides you with an overview of the specific topics covered in that section of the chapter.

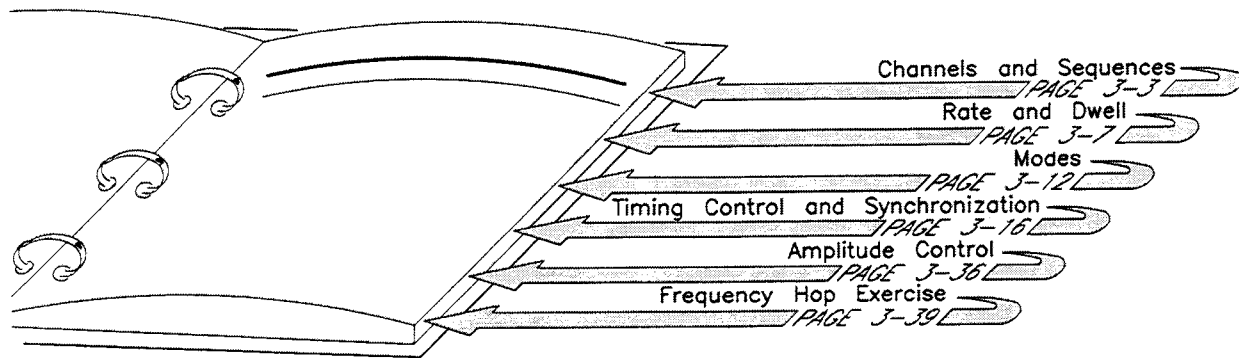

Channels and Sequences – An Overview

If You Need to Know:	Refer to:
<u>Channels and Sequences</u>	
<ul style="list-style-type: none"> • <i>Some general information about using frequency hop channels and sequences</i> 	<p>Channels and Sequences—An Introduction (3-3)</p>
<ul style="list-style-type: none"> • <i>Specific information about using frequency hop channels</i> 	<p>The Channel Table (3-4)</p>
<ul style="list-style-type: none"> • <i>A description of the three keys used to set up a channel table</i> 	<p>Local Entry Keys for the Channel Table (3-4)</p>
<ul style="list-style-type: none"> • <i>Specific information about frequency hop sequences</i> 	<p>The Sequence Table (3-5)</p>
<ul style="list-style-type: none"> • <i>A description of the three keys used to set up a sequence table</i> 	<p>Local Entry Keys for the Sequence Table (3-6)</p>

Channels and Sequences – An Introduction

The HP 8645A frequency hops between sets of frequency and amplitude parameters. Each set is stored in a unique memory location called a "channel". As you store each set into different channels you create what is called a "channel table".

Entries in the channel table do not contain information about the order in which each channel is output from the Agile Signal Generator. The order is specified in what is called a "sequence table". You determine the organization of the sequence table.

The Channel Table

The channel table consists of 2400 (or 8000 for instruments with serial prefix 3019A and above) internal memory locations stored in non-volatile memory. Each channel in the table is used to specify a frequency and amplitude to which the HP 8645A will hop. Channel storage registers start at numeral 0 and go to numeral 2399 (or 7999 for instruments with serial prefix 3019A and above). An example channel table is as follows:

Table 3-1. Example Channel Table.

Channel Number	Channel Frequency	Channel Amplitude
0	100 MHz	10 dBm
1	550 MHz	8 dBm
2	1020 MHz	12 dBm
⋮	⋮	⋮
2399	250 MHz	6 dBm
* 7999	400 MHz	9 dBm
* 3019A and above		

Local Entry Keys for the Channel Table

Three front-panel keys are used to set up a channel table. The keys are accessed by first pressing the blue **SHIFT** key. A description of each key follows the illustration shown below:

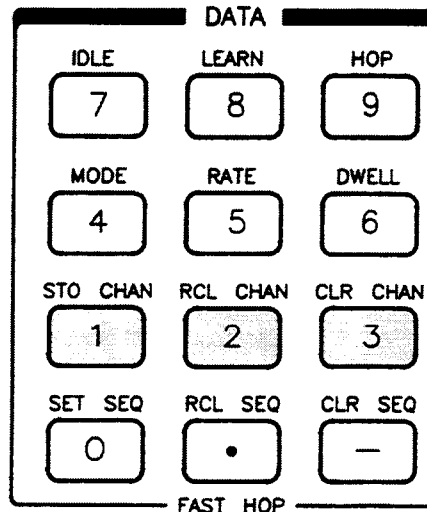

Figure 3-2. Local Entry Keys for the Channel Table.

The **STO CHAN** key is used to store frequency and amplitude settings in a channel, and to overwrite any current channel settings. You must sequentially store each channel starting with storage register 0. If you do not, an error message appears to indicate a Bad fast chan address. The maximum allowed variation for amplitude settings may vary from 20 to 30 dB. The error message *Amptd range too large* appears if you exceed the attenuator's vernier range.

The **RCL CHAN** key is used to recall frequency and amplitude settings for any existing channel from the channel table. You must recall an existing channel number, or else an error message appears to indicate a Bad fast chan address.

The **CLR CHAN** key is used to clear all entries from the channel table. When you re-enter data into the channels after clearing all entries, start again with storage register 0.

Remember

*All front-panel keys associated with frequency hopping cannot be accessed unless the **MODE 5, FAST HOP** key is active. If this mode is not active, an error message appears to indicate that the instrument is Not in Fast Hop Mode. A yellow annunciator above the **MODE 5** key lights up to let you know that it is active.*

The Sequence Table

You may have noticed that the frequency hop example in chapter 1 did not require you to set up a sequence table. The HP 8645A has a time saving feature which uses a hop sequence that is based on the order of the channel table. That is, if you do not set up the sequence table, the HP 8645A frequency hops in ascending numerical order starting from channel number 0 and on up to the last channel in which you have stored a set of frequency and amplitude parameters. Refer to table 3-1 for an example of this default condition.

However, you may set up the sequence table in a specific order for the frequency hop. The sequence table consists of up to 4000 (or 8000 for instruments with serial prefix 3019A and above) channel table entries stored in non-volatile memory. The sequence table starts at numeral 0 and can go to numeral 3999 (or 7999 for instruments with serial prefix 3019A and above). A Channel may be repetitively used in the sequence table. An example of a sequence table is as follows:

Table 3-2. Example Sequence Table.

Sequence Step #	Channel
0	3
1	0
2	100
3	0
⋮	⋮
3999	1
* 7999	20
* 3019A and above	

Local Entry Keys for the Sequence Table

Three front-panel keys are used to set up a sequence table. The keys are accessed by first pressing the blue **SHIFT** key. A description of each key follows the illustration shown below:

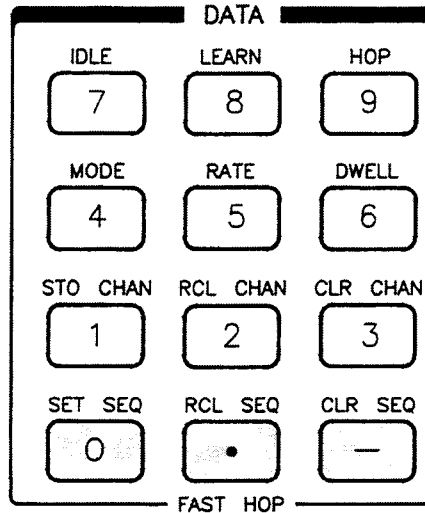

Figure 3-3. Local Entry Keys for the Sequence Table.

The **SET SEQ** key is used to set up channels in the sequence table. The HP 8645A automatically increments to the next available sequence location as you enter each channel. The sequence table starts at numeral 0. Channels are entered in any order, and can be entered more than once in the sequence table.

The sequence table cannot be corrected one entry at a time. If modifications to the sequence table are required, the sequence table must first be cleared, and new sequences entered.

The **RCL SEQ** key is used to recall frequency and amplitude settings for any existing channel from the sequence table. You must recall an existing sequence number, or else an error message appears to indicate a `Bad fast sequence address`.

The **CLR SEQ** key is used to clear all channels from the sequence table. When you re-enter data into the sequence table after clearing all channels, you will start over with sequence number 0.

Remember

If your sequence table has channel number entries that do not exist in the channel table, and you attempt to frequency hop the instrument, an error message appears to indicate a `Bad fast sequence entry`. Fix either the channel table or the sequence table.

Rate and Dwell - An Overview

If You Need to Know:	Refer to:
<u>Rate and Dwell</u>	
• <i>Some general information about rate and dwell</i>	Rate and Dwell- An Introduction (3-7)
• <i>Specific information about frequency hop rates.....</i>	Hop Rate (3-8)
• <i>Specific information about frequency dwell time</i>	Dwell Time (3-8)
• <i>Specific information about hop rate and dwell time resolution</i>	Hop Rate and Dwell Time Resolution (3-10)

Rate and Dwell - An Introduction

The HP 8645A allows you to set the number of hops per second (called the "hop rate"), and the duration of the RF output for each hop (called the "dwell time"). Hop rate and dwell time values are interactive. If the hop rate and dwell time values clash when the HP 8645A is asked to frequency hop, an error message appears to indicate a Rate and dwell conflict.

The hop rate and dwell time may be set prior to activating the frequency hop, or varied during the frequency hop (as described on page 3-11) without having to relearn the frequency/amplitude channel settings. Using an external triggering source also allows you to vary the hop rate and/or dwell time while frequency hopping.

Note

For information about using an external triggering source to vary the hop rate and/or dwell time, refer in this chapter to the section titled "External Triggering". Specifically, Ext Stepped Ext Dwell and Fast Hop Bus Ext Dwell.

Hop Rate Hop rate is the number of frequency changes per second expressed in Hertz. The internal hop rate is specified as a fixed frequency over the frequency range of 8 Hz to 50 kHz. However, the maximum allowable hop rate is limited by the frequency range over which the HP 8645A frequency hops.

For example, the table on the next page indicates that if you were to frequency hop two channels, one at 150 MHz and the other at 100 MHz, the maximum hop rate you can use is 10.9 kHz.

Dwell Time Dwell time is the duration of the RF output power for any channel at the RF Output connector. The duration covers a time period between two points where RF output power is turned 90% on, and is turned 10% off, as shown below:

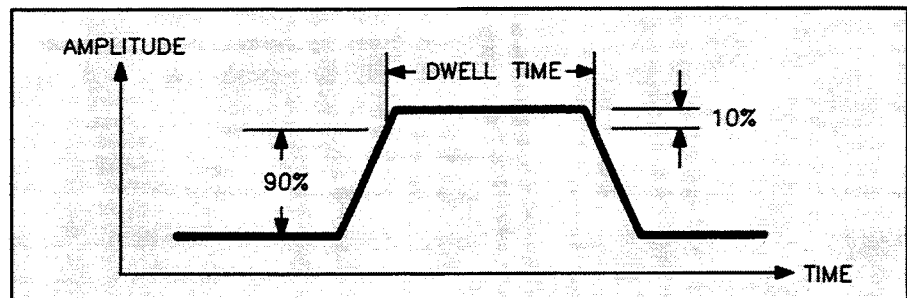

Figure 3-4. Dwell Time Duration.

The internal dwell time is specified as a fixed duration over the range of 6.4 μ sec to 99 msec (an external trigger input allows longer and variable dwell times). A fundamental characteristic of dwell time is that it cannot be longer than the period of the hop rate, which is:

$$\text{Hop Period} = \frac{1}{\text{Hop Rate}}$$

In fact, the dwell time must be less than or equal to the Hop Period minus the Switching Time, as follows:

$$\text{Dwell Time} \leq \text{Hop Period} - \text{Switching Time (see table 3 - 3)}$$

Switching time is a function of the frequency range over which the Agile Signal Generator frequency hops. As the switching time increases, the maximum hop rate decreases.

Switching times for each frequency range, along with the maximum hop rates for each frequency range are shown below:

Table 3-3. Switching Times and Maximum Hop Rates.

Frequency Range (MHz)	Closed Loop ALC Switching Time* (μsec)	Maximum Hop Rate (kHz)
128 - 2060	<15	50**
8 - 2060	<85	10.9
0.252 - 2060	<500	1.98
* Add 5 μsec for Option 002. ** With hop rates above 46.7 kHz, dwell time must be less than 6.4 μsec to allow for frequency switching.		

For example, let's see if it is possible to use a 100 μsec dwell time to frequency hop channels over an 8 MHz to 1 GHz frequency range at a 5 kHz hop rate. Note the following calculations:

$$\text{Dwell Time} = 100 \mu\text{sec}$$

$$\text{Hop Period} = 200 \mu\text{sec}$$

$$\text{Switching Time} = 85 \mu\text{sec (worst case)}$$

$$115 \mu\text{sec} = 200 \mu\text{sec} - 85 \mu\text{sec}$$

$$100 \mu\text{sec} \leq 115 \mu\text{sec}$$

Calculations show that the 100 μsec dwell time will work. Switching time, shown in the above calculation, is a "worst case" value derived from the table shown on the previous page.

Local Entry Keys for the Hop Rate and Dwell Time

Two front-panel keys are used to set hop rate and dwell time. The keys are accessed by first pressing the blue **SHIFT** key. A description of each key follows the illustration shown below:

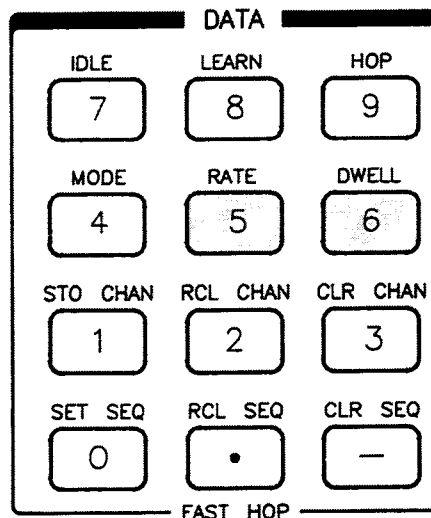

Figure 3-5. Local Entry Keys for the Hop Rate and Dwell Time.

The **RATE** key is used to set the hop rate. Whenever an instrument preset is done, the hop rate defaults to 250 Hz.

The **DWELL** key is used to set the dwell time. Whenever an instrument preset is done, the dwell time defaults to 2.00 msec.

Remember

If you get a Rate and dwell conflict error message, modify the values for either hop rate or dwell time so that $Dwell\ Time \leq Hop\ Period - Switching\ Time$.

Hop Rate and Dwell Time Resolution

Dwell time for the RF output can be entered from a minimum of 5 μ sec, and up to a maximum of 125 msec; however, 6.4 μ sec is the lower limit, and 99 msec is the upper limit specified for internal triggering. Hop rate can be entered from a minimum of 8 Hz, and up to a maximum of 200 kHz; however, 50 kHz is the upper limit specified for internal triggering.

Dwell time resolution is determined as follows:

- Dwell time resolution is limited by 3 significant digits shown on the front-panel display, and can be entered in 200 nsec intervals if the hop rate is greater than or equal to 77 Hz. (For frequency hop modes 1, 2, 4, and 5, refer to table 3-4.)
- Dwell time resolution is limited by 3 significant digits shown on the front-panel display, and can be entered in 2 μ sec intervals if the hop rate is less than 77 Hz. (For frequency hop modes 1, 2, 4, and 5, refer to table 3-4.)
- Dwell time resolution is 200 nsec if the dwell time is less than 13 msec, or 2 μ sec if dwell time is greater than or equal to 13 msec. (For frequency hop modes 3, and 6-9, refer to table 3-4.)

Hop rate resolution is determined as follows:

- When the hop rate is less than 77 Hz, resolution is limited by 3 significant digits shown on the front-panel display, or by 200 nsec increments in the hop rate period.
- When hop rate is greater than or equal to 77 Hz, resolution is limited by 3 significant digits shown on the front-panel display, or by 2 μ sec increments in the hop rate period.

Hop rate or dwell time values may be changed while the HP 8645A is learning or frequency hopping. Select either hop rate or dwell time, and do the following:

- Key in the new hop rate or dwell time value. If the hop rate or dwell time conflict, you will get an error message while learning or hopping (the last valid values will still be active).
- Turn the knob. You may use the INCR/DECR \leftarrow or \rightarrow keys to change the resolution of the knob. Turning the knob in either direction will set hop rate or dwell time without causing an error during the learning or hopping.
- Press one of the INCR/DECR \uparrow \downarrow keys to change the hop rate in 10 Hz increments, and the dwell time in 100 μ sec increments. These keys can set hop rate or dwell time without causing an error during the learning or hopping.

Increments for the \uparrow \downarrow keys may be changed in the following way:

1. Press the blue **SHIFT** key, and either the **RATE** or **DWELL** key.
2. Press the **INCR SET** key. The **FREQUENCY/STATUS** display should show either **Rate Incr** or **Dwell Incr** and the currently active increment value.
3. Enter the new increment value.

Frequency Hop Modes – An Overview

If You Need to Know:	Refer to:
Frequency Hop Modes	
<ul style="list-style-type: none"> • <i>Some general information about frequency hop modes</i> 	<p>Frequency Hop Modes – An Introduction (3-12)</p>
<ul style="list-style-type: none"> • <i>Directions for accessing the frequency hop modes</i> 	<p>How to Access the Frequency Hop Modes (3-13)</p>
<ul style="list-style-type: none"> • <i>What each mode does</i> 	<p>A Brief Description of Frequency Hop Modes (3-13)</p>

Frequency Hop Modes – An Introduction

The HP 8645A has nine frequency hop modes (not to be confused with the front-panel **SYNTHESIS MODE** keys). Each frequency hop mode determines how the RF output is controlled during the frequency hop. Your testing or operating needs determine which frequency hop mode to use.

Only one frequency hop mode can be active at a time, and as you will see, each frequency hop mode has either an internal or an external triggering mechanism.

Internal triggering allows you to start or control the frequency hop from either the front-panel, or via HP-IB. External triggering allows you to start or control the frequency hop with TTL signals either to the rear-panel **HOP** connector, or to the rear-panel **FAST HOP BUS** connector.

For detailed information about internal and external triggering, refer in this chapter to the section titled "External Triggering".

How to Access the Frequency Hop Modes

You can view each of the nine frequency hop modes in the FREQUENCY/STATUS display by doing the following:

1. Press the Synthesis Mode **MODE 5, FAST HOP** key. Otherwise, you will get an error message that indicates Not in Fast Hop Mode.
2. Press the blue **SHIFT** key, and the **MODE** key. You'll notice the currently active frequency hop mode is shown.
3. Turn the knob, or press one of the **↑** **↓** keys. One at a time the other frequency hop modes are shown. A frequency hop mode becomes active when it is shown in the FREQUENCY/STATUS display.
4. To exit, press any front-panel key. Remember, whichever mode is displayed when you exit is the active mode for subsequent operation.

A Brief Description of Frequency Hop Modes

A brief description of each frequency hop mode is as follows:

Table 3-4. Frequency Hop Modes.

Internal Triggering		
Mode	Frequency Hop Mode	Description
1	Int Repetitive	Continuously cycles through the sequence table.
2	Int Single	Cycles once completely through the sequence table.
3	Int Stepped	Cycles one channel at a time through the sequence table.
External Triggering		
Mode	Frequency Hop Mode	Description
4	Ext Repetitive	Same as 1, except that frequency hopping is enabled by a TTL signal.
5	Ext Single	Same as 2, except that frequency hopping is initiated by a TTL signal.
6	Ext Stepped Int Dwell	Same as 3, except that frequency hopping is controlled by a TTL signal.
7	Ext Stepped Ext Dwell	Same as 3, except that frequency hopping and dwell time are controlled by a TTL signal.
8	Fast Hop Bus Int Dwell	Frequency hop in any order to any channel in the sequence table. Dwell time is fixed.
9	Fast Hop Bus Ext Dwell	Same as 8, except that dwell time is controlled by a TTL signal.

When the HP 8645A is frequency hopping, a message in the FREQUENCY/STATUS display alerts the user to the status of the frequency hop mode. As shown in table 3-5, the message is dependent upon which frequency hop mode is active:

Table 3-5. Status Messages for the Frequency Hop Modes.

Mode(s)	FREQUENCY/STATUS Message
1	Fast Hop (Free Running)
2,3	Fast Hop (Man/HP\IB Trig)
4-9	Fast Hop (External Trig)

For Frequency Hop Mode 1

When Fast Hop (Free Running) is displayed, the HP 8645A continuously cycles through each channel in the sequence table.

For Frequency Hop Modes 2 and 3

When Fast Hop (Man/HP\IB Trig) is displayed, the HP 8645A waits for the user to trigger the frequency hop either manually (from the front panel) or remotely (through HP-IB).

For Frequency Hop Modes 4 through 9

When Fast Hop (External Trig) is displayed, the HP 8645 waits for the user to externally trigger the frequency hop with a TTL signal on either the rear-panel HOP connector, or on the Fast Hop Bus HOP line.

Local Entry Key for the Frequency Hop Modes

The **MODE** key is used to change the frequency hop mode. This key is accessed by first pressing the blue **SHIFT** key. A description of the **MODE** key follows the illustration shown below:

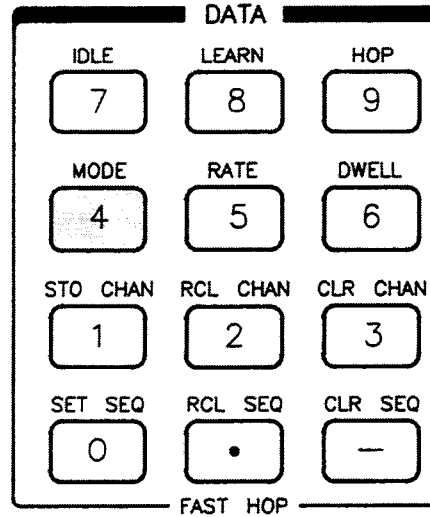

Figure 3-6. Local Entry Key for the Frequency Hop Modes.

The **MODE** key gives you access to the frequency hop modes. Whenever an instrument preset is done, the frequency hop mode defaults to Int Repetitive.

Remember

A Not in Fast Hop Mode error message indicates that you do not have the instrument in the FAST HOP mode; correct this problem by pressing the SYNTHESIS MODE, MODE 5 key.

Timing Control and Synchronization – An Overview

If You Need to Know:	Refer to:
Timing Control and Synchronization	
• <i>General information about timing control and synchronization</i>	Timing Control and Synchronization – An Introduction (3-16)
• <i>How to put the HP 8645A into a state where it accepts frequency hop entries or modifications</i>	The Idle State (3-17)
• <i>How to put the HP 8645A into a state where it learns how to change channels for the frequency hop</i>	The Learn State (3-18)
• <i>How to put the HP 8645A into a state where it frequency hops</i>	The Hop State (3-19)
• <i>The description of each line on the Fast Hop Bus</i>	The Fast Hop Bus (3-20)
• <i>About the three internal triggering modes</i>	Internal Triggering (3-23)
• <i>About the six external triggering modes</i>	External Triggering (3-26)

Timing Control and Synchronization – An Introduction

This section contains essential information about timing control and synchronization for the frequency hop.

Timing control refers to implementation of the nine frequency hop modes discussed in the previous four pages. There are two types of triggering mechanisms for timing control, internal and external. Both *Internal Triggering* and *External Triggering* are described in detail later on in this section.

Synchronization refers to the arrangement in time of events that must take place for the frequency hop to occur. A timing diagram for each frequency hop mode explains the synchronization for both *Internal Triggering* and *External Triggering*.

To fully understand the timing diagrams shown with the *Internal Triggering* and *External Triggering* descriptions, you should read about the *Fast Hop Bus*.

Before investigating the details of timing control and synchronization, understand that you can put the HP 8645A into one of three conditions after pressing the Synthesis Mode **MODE 5, FAST HOP** key:

1. the Idle State,
2. the Learn State, and
3. the Hop State.

Continue reading for a description of these three conditions.

The Idle State

When the HP 8645A is in the Idle State, it accepts entries or modifications to the channel table, sequence table, hop rate, dwell time, and frequency hop modes.

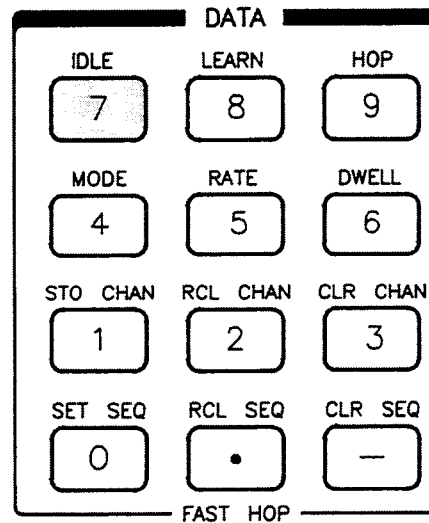

Figure 3-7. Local Entry Key for the Idle State.

The **IDLE** key, shown above, is accessed by first pressing the blue **SHIFT** key. There are two ways the Idle State can occur:

1. Whenever you change to the **MODE 5, FAST HOP** position from **AUTO** or any of the other Synthesis Mode positions.
2. Whenever you press the **IDLE** key.
3. Whenever you change certain parameters while the HP 8645A is frequency hopping (for example, turning on FM or changing output amplitude, etc.).

The HP 8645A goes from the Idle State to the Learn State upon request.

The Learn State

In the Learn State, the HP 8645A calibrates its internal circuitry to quickly switch from one channel to another with specified accuracy. It takes at least 10 seconds to complete the learn operation; additional time depends upon the number of channels set up in the sequence table.

Since the frequency accuracy of the RF output is temperature dependent, the Learn State should be kept active when not frequency hopping, or re-initiated if the ambient temperature has changed significantly since the last completed learn operation. This ensures the most accurate RF output while frequency hopping.

Note

If the ALC loop is closed (refer to the section in this chapter titled "Amplitude Control"), the RF output is shut off during the Learn State. This prevents the output of undesired signals prior to frequency hopping. However, if the ALC loop is open, the RF output will be on during portions of the Learn State.

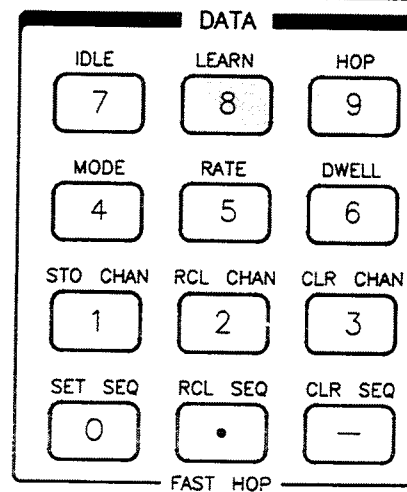

Figure 3-8. Local Entry Key for the Learn State.

The **LEARN** key, shown above, is accessed by first pressing the blue **SHIFT** key. There are three ways the Learn State can occur:

1. Whenever you press the **LEARN** key.
2. Whenever you press the **HOP** key, from the Idle State, to start the frequency hop. A Learn State occurs prior to the frequency hop even if the sequence table or channel table have not been changed.
3. When using external triggering, the TTL level at the rear-panel **SEQ** (sequence) connector determines if the HP 8645A is in the Learn State. A TTL high keeps the HP 8645A in the Hop State; a TTL low puts the HP 8645A into the Learn State.

The HP 8645A can go from the Learn State to either the Idle State, or the Hop State.

The Hop State

Frequency hopping occurs in the Hop State.

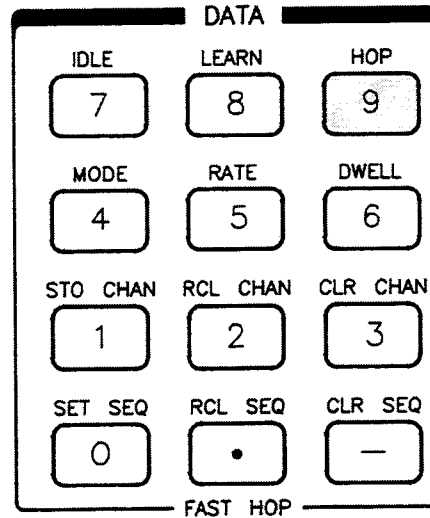

Figure 3-9. Local Entry Key for the Hop State.

The **HOP** key, shown above, is accessed by first pressing the blue **SHIFT** key. Going from the Learn State to the Hop State happens in one of two ways:

1. If the HP 8645A is internally triggered, the transition to the Hop State occurs immediately after pressing the **HOP** key (assuming that the sequence table has been learned at least once).
2. If the HP 8645A is externally triggered, the transition to the Hop State occurs when specific timing control and synchronization conditions are met.

Note

Whenever you go from the Idle State to the Hop State, the HP 8645A will first enter the Learn State.

The Fast Hop Bus

The Fast Hop Bus is a DB-25 pin connector located on the rear-panel of the HP 8645A. Its purpose is to provide a means of external control and synchronization for the frequency hop sequence. Specific control and synchronization information on the Fast Hop Bus is found in the timing diagrams for *Internal Triggering* and *External Triggering*.

- When the HP 8645A is configured to operate with one of the three **internal** frequency hop modes, the Fast Hop Bus is used to trigger external control circuitry.
- When the HP 8645A is configured to operate with one of the six **external** frequency hop modes, the Fast Hop Bus is used to control the frequency hop.

The Fast Hop Bus connector is illustrated in figure 3-10; a description of each line on the Fast Hop Bus starts on the next page:

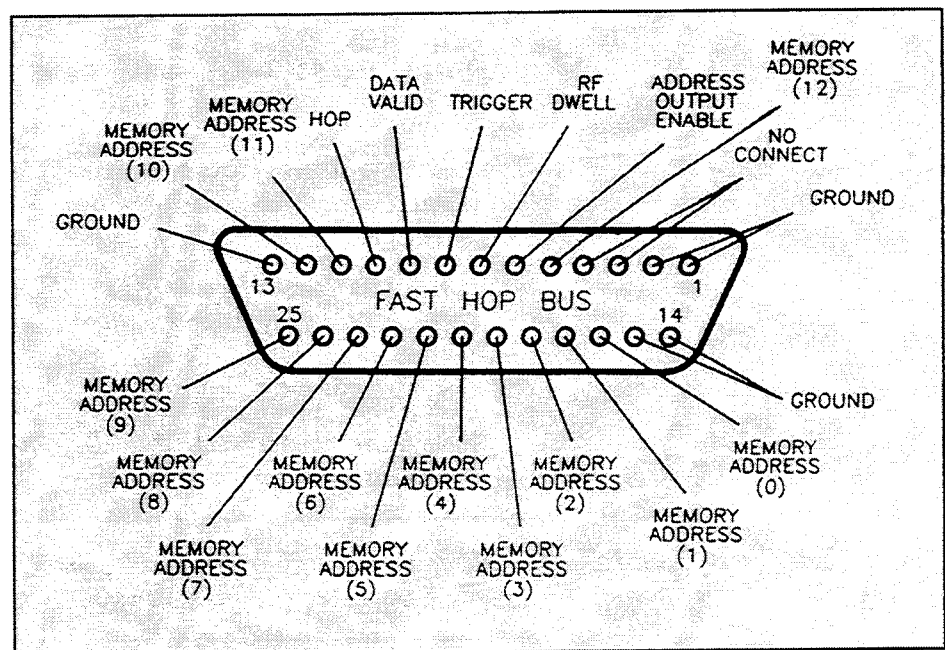

Figure 3-10. Rear-Panel, Fast Hop Bus Connector.

Note

The HP 8645A has either 4000 or 8000 channel table capabilities beginning with serial prefix 3019A.

Memory address 12 (J1 pin 5) must be tied to a TTL low for 4000 channel operation, or for emulation of HP 8645s built prior to serial prefix 3019A.

**Ground and
No Connection**

The *Ground* connections for the Fast Hop Bus are found on J1 pins 1, 2, 13, 14, and 15.

There are no connections on the Fast Hop Bus for J1 pins 3 and 4.

**Address
Output Enable**

The *Address Output Enable* line on J1 pin 6 determines whether the *Memory Address* lines are to be used as inputs or outputs.

If the *Address Output Enable* line is at a TTL high or is floated, then the *Memory Address* lines are available as inputs. A binary address can then be synchronized on the *Memory Address* lines to indicate the desired position in the sequence table.

If the *Address Output Enable* line is grounded, then the *Memory Address* lines output the current sequence position during the frequency hop.

RF Dwell

The *RF Dwell* line on J1 pin 7 outputs a TTL signal to indicate the on/off state of the RF output. A TTL high on the *RF Dwell* line indicates that the RF output is on; a TTL low on the *RF Dwell* line indicates that the RF output is off.

The *RF Dwell* line is filtered to reduce RF emissions. As a result of the filtering, there is up to a 1 μ sec delay from the time the RF output starts changing states from a low to a high, to when this transition appears at the rear-panel Fast Hop Bus connector.

Trigger

The *Trigger* line on J1 pin 8 outputs a TTL signal that goes from low to high to indicate when the HP 8645A has hopped to the next frequency in the sequence table. The transition back to a TTL low occurs when the RF output is turned off. No synchronization information is included with the *Trigger* line to indicate when the RF output is turned on.

The low to high transition of the *Trigger* line tracks the low to high transition of the **HOP** line (J1 pin 10) but is delayed by up to 200 nsec.

The *Trigger* line is not filtered, so there are only a few nanoseconds of delay for transitions to appear at the rear-panel Fast Hop Bus connector.

Data Valid

The *Data Valid* line on J1 pin 9 allows you to input a TTL signal to indicate that the *Memory Address* lines have set up a valid address on the Fast Hop Bus. A TTL high indicates that the valid address is present; a TTL low indicates that a valid address is not present.

In the *External Triggering* timing diagrams for Fast Hop Bus Internal Dwell and for Fast Hop Bus External Dwell, you will see how to synchronize the *Data Valid* line with the other Fast Hop Bus lines. The *Data Valid* line is used for synchronization with only these two frequency hop modes.

Hop The *Hop* line on J1 pin 10 receives a TTL input signal to control the hop rate. Certain frequency hop modes also allow the *Hop* line to even control the dwell time. To control the *Hop* line, refer to the detailed descriptions for each frequency hop mode controlled by *External Triggering*.

The *Hop* line on the Fast Hop Bus, and the rear-panel **HOP** connector are internally connected, and consequently have the same synchronization.

Memory Address The *Memory Address* lines on J1 pins 5, 11, 12, and 16 through 25 receives TTL input signals to set up a desired address in the sequence table. The *Address Output Enable* line must first be set to a TTL high before an address can be input. The *Data Valid* line indicates if the input address is valid.

Internal Triggering

There are three internal triggering modes. Timing control and synchronization for each one is described in detail as follows:

Int Repetitive

The *Internal Repetitive* mode causes the HP 8645A to repetitively frequency hop through the sequence table when the Hop State is activated from the front panel or through HP-IB.

Frequency hopping continues until the Learn State or Idle State is invoked. Hop rate and dwell time are fixed at the internally set values when this mode is active.

The following diagram in figure 3-11 depicts the synchronization that occurs when the HP 8645A frequency hops in the Internal Repetitive mode:

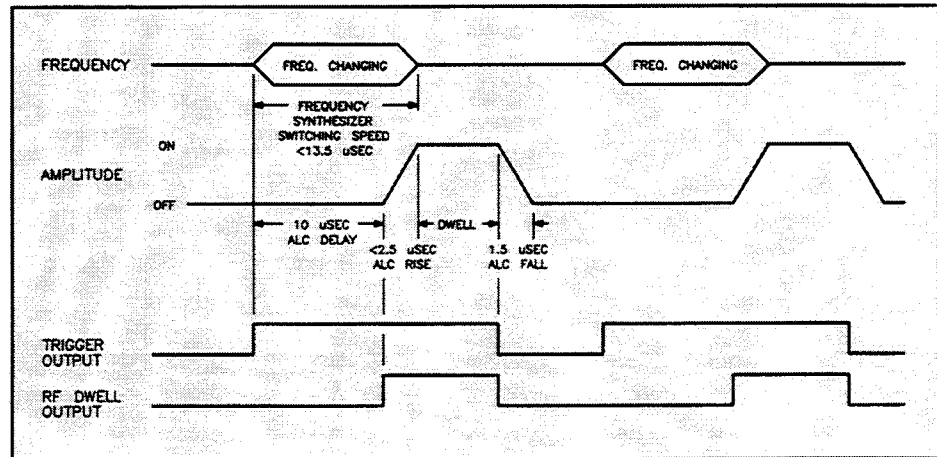

Figure 3-11. Internal Repetitive Synchronization.

Int Single

The *Internal Single* mode allows the HP 8645A to frequency hop once through the sequence table when the Hop State is activated from the front panel or through HP-IB. At the completion of the Internal Single sequence, the HP 8645A remains in the Hop State with the RF output turned off and waits for another Hop command.

Hop rate and dwell time are fixed at the internally set values when this mode is active. To cycle through the sequence table again, re-activate the Hop State.

The following diagram in figure 3-12 depicts the synchronization that occurs when the HP 8645A frequency hops in the Internal Single mode:

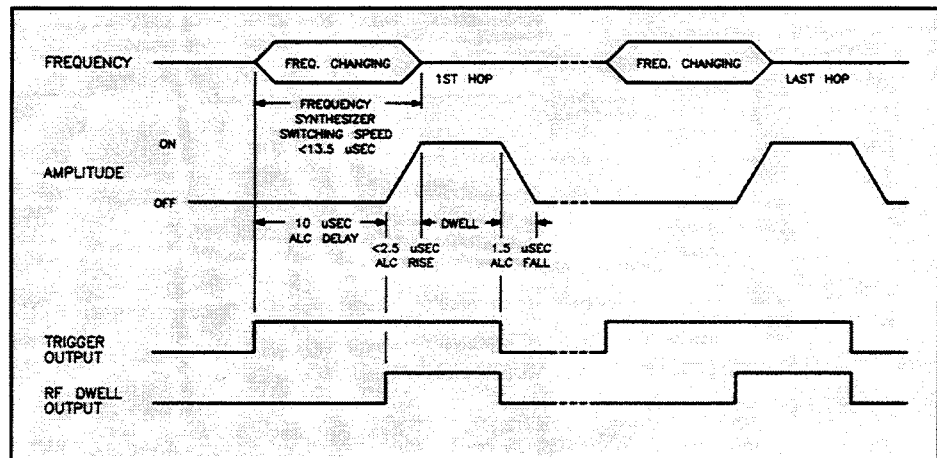

Figure 3-12. Internal Single Synchronization.

Int Stepped

The *Internal Stepped* mode allows the HP 8645A to cycle through the sequence table one channel at a time. In this mode, the user controls the hop rate either from the front panel, or from the rear-panel HP-IB connector. Dwell time is fixed at the internally set value.

When this mode is active, a frequency hop occurs only when the \uparrow key is pressed, the knob is rotated, or the frequency hop is invoked through HP-IB.

In the *Internal Stepped* mode, you can even cycle backwards through the sequence table one channel at a time. To do this, press the \downarrow key, or turn the knob counterclockwise.

The following diagram in figure 3-13 depicts the synchronization that occurs when the HP 8645A frequency hops in the Internal Stepped mode:

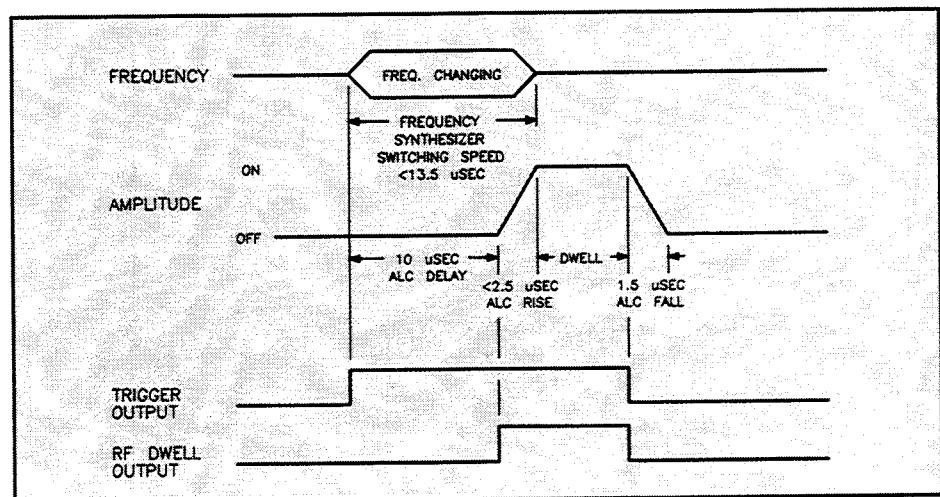

Figure 3-13. Internal Stepped Synchronization.

External Triggering

There are six external triggering modes. Timing control and synchronization for each one is described in detail as follows:

Ext Repetitive

The *External Repetitive* mode causes the HP 8645A to repetitively frequency hop through the sequence table when the Hop State is enabled. In this mode, the Hop State is enabled by keeping a TTL high signal either on the rear-panel **HOP** connector, or on the Fast Hop Bus *HOP* line. When the TTL signal is dropped to a low state, frequency hopping is suspended.

The following diagram in figure 3-14 depicts the synchronization that occurs when the HP 8645A frequency hops in the External Repetitive mode:

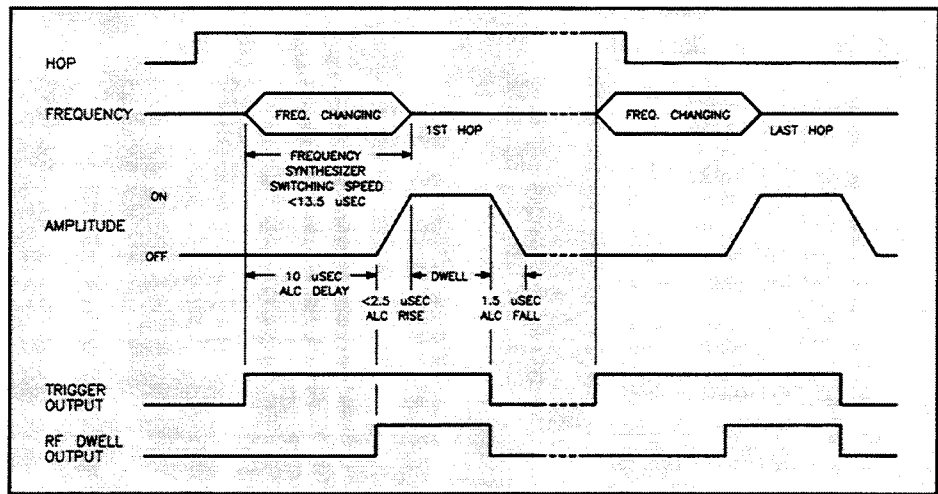

Figure 3-14. External Repetitive Synchronization.

Ext Single

The *External Single* mode allows the HP 8645A to frequency hop once through the sequence table when the Hop State is enabled. In this mode, the Hop State is enabled by an external TTL signal. At the completion of the External Single sequence, the HP 8645A remains in the Hop State with the RF output turned off and waits for another Hop command.

The rising edge from a TTL signal, input to the rear-panel **HOP** connector, or on the Fast Hop Bus *HOP* line, causes the HP 8645A to cycle once through the sequence table after completing a learn operation. Hop rate and dwell time are fixed at the internally set values.

To cycle through the sequence table again, the HP 8645A must re-enter the Learn State by a low TTL signal input pulse to the rear-panel **SEQ** connector. Then, the rising edge of the next TTL signal input to the rear-panel **HOP** connector will activate the Hop State for another External Single sequence.

The following diagram in figure 3-15 depicts the synchronization that occurs when the HP 8645A frequency hops in the External Single mode:

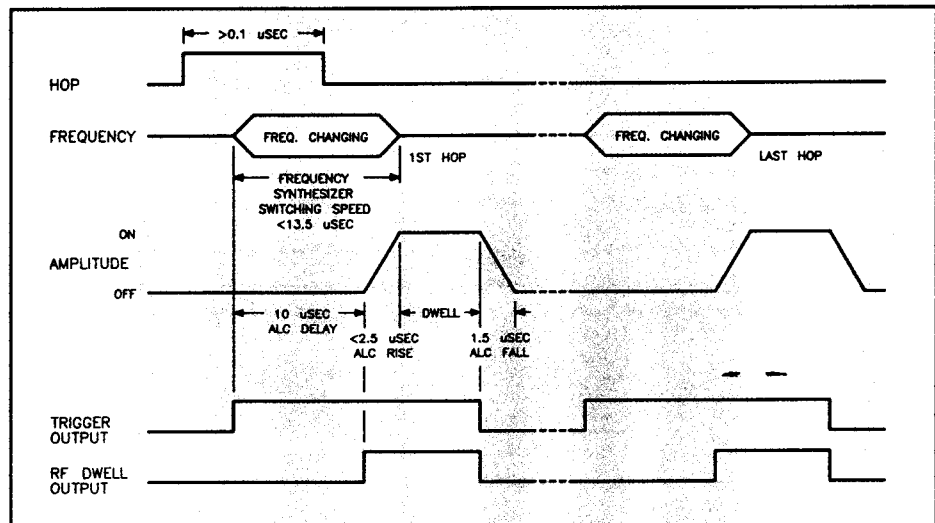

Figure 3-15. External Single Synchronization.

Ext Stepped Int Dwell

The *External Stepped Internal Dwell* mode allows the HP 8645A to cycle through the sequence table one channel at a time. In this mode, the user externally controls the hop rate; dwell time is fixed at the internally set value.

When this mode is active, the rising edge from a TTL signal, input to the rear-panel **HOP** connector, or on the Fast Hop Bus *HOP* line, causes the HP 8645A to change to the next channel in the sequence table. The RF output remains on for the duration of the dwell time.

The following diagram in figure 3-16 depicts the synchronization that occurs when the HP 8645A frequency hops in the External Stepped Internal Dwell mode:

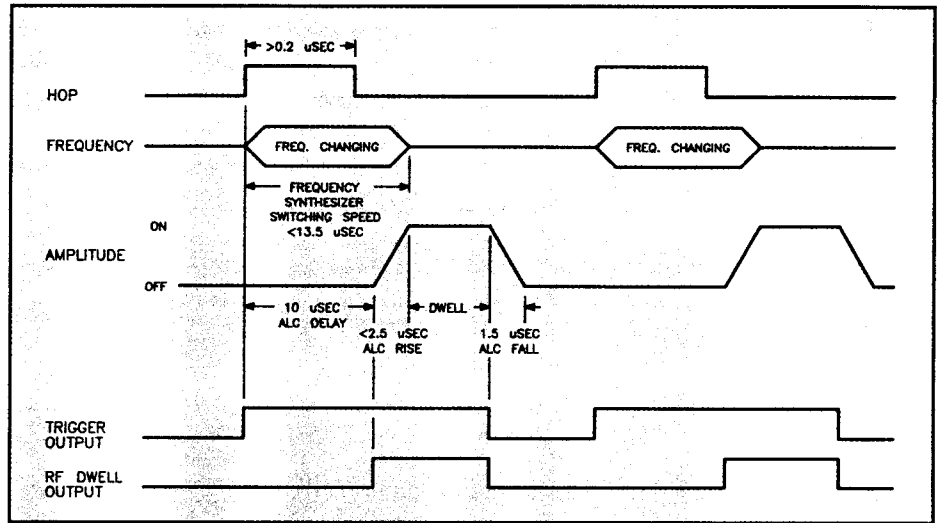

Figure 3-16. External Stepped Internal Dwell Synchronization.

Ext Stepped Ext Dwell

The *External Stepped External Dwell* mode allows the HP 8645A to cycle through the sequence table one channel at a time. In this mode, the user externally controls the hop rate and dwell time. The dwell time and hop rate can be varied for each channel in the sequence table while the HP 8645A is frequency hopping.

When this mode is active, a TTL signal input to the rear-panel **HOP** connector, or on the Fast Hop Bus *HOP* line, controls the hop rate and dwell time. The HP 8645A changes to the next channel in the sequence table on each rising edge of the TTL signal.

Keeping the TTL signal in a "high state" causes the RF output to remain on. Returning the TTL signal to a "low state" causes the RF output to shut off. The TTL signal must be in a low state for at least the ALC fall time between frequency hops.

The following diagram in figure 3-17 depicts the synchronization that occurs when the HP 8645A frequency hops in the External Stepped External Dwell mode:

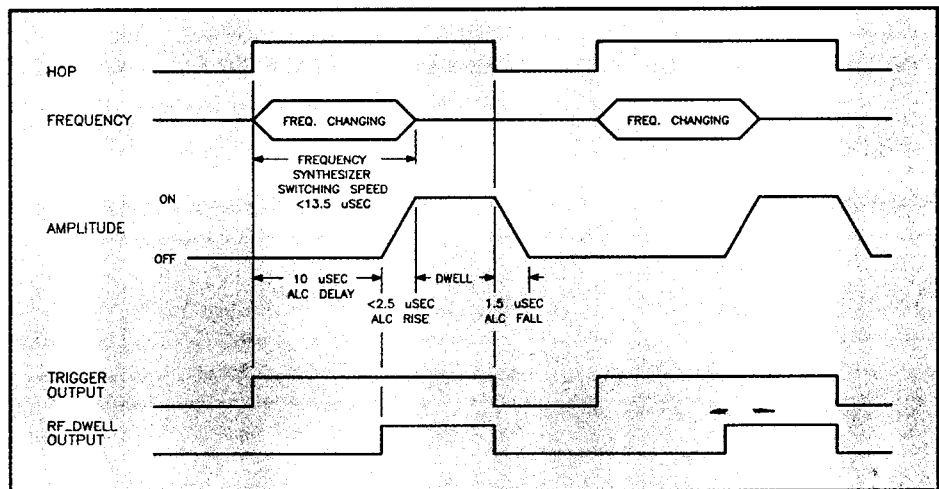

Figure 3-17. External Stepped External Dwell Synchronization.

Fast Hop Bus Int Dwell

The *Fast Hop Bus Internal Dwell* mode allows the HP 8645A to frequency hop in any order to any channel in the sequence table. In this mode, the dwell time is fixed to the internally set value.

This mode and the *Fast Hop Bus External Dwell* mode have the most complicated synchronization, and require more external hardware for control than any of the other seven frequency hop modes.

To frequency hop in this mode, you are required to interface TTL signals to the rear-panel **FAST HOP BUS** connector, **SEQ** (sequence) connector, and **HOP** connector (only if it is used instead of the Hop line on the Fast Hop Bus).

Place a high/low TTL bit pattern on the 13 Memory Address lines to address the sequence table. The address data on the Fast Hop Bus will correspond directly to one of the 4000 positions (or 8000 for instruments with serial prefix 3019A and above) in the sequence table.

For example, the Memory Address lines shown in table 3-6 can be set up to correspond to "step #54" in the sequence table by sending specific address data over the Fast Hop Bus (add up the decimal equivalent for each Memory Address Line that is high to arrive at the address position in the sequence table):

$$32 + 16 + 4 + 2 = 54$$

Table 3-6. Memory Address Lines for the Fast Hop Bus.

Memory Address Lines (J1 Pin #)	Decimal Equivalent	High/Low TTL Bit Pattern
* 5	4096	0(MSB)
11	2048	0
12	1024	0
25	512	0
24	256	0
23	128	0
22	64	0
21	32	1
20	16	1
19	8	0
18	4	1
17	2	1
16	1	0(LSB)
* 3019A and above		

rev. 24APR91

Note

The sequence table contains up to 4000 channel table entries from address position 0 to 3999 (or 8000 channel table entries from address position 0 to 7999 for serial prefix 3019A and above). However, if you add up the decimal equivalent for each Memory Address Line shown in table 3-6, the result would indicate that positions greater than 3999 could be addressed. All address positions greater than 3999 (or 7999 for serial prefix 3019A and above) are invalid.

Synchronize the *Data Valid* line to toggle to a TTL high when the address data is valid.

To frequency hop to a new channel in the sequence table, input the rising edge of a TTL signal to the Hop line on the Fast Hop Bus (or to the HOP connector).

Remember

The TTL level at the SEQ (sequence) connector determines if the HP 8645A is in the Learn State. A TTL high keeps the HP 8645A in the Hop State; a TTL low puts the HP 8645A into the Learn State.

In normal operation, the HP 8645A allows for a faster switching speed by buffering the position addressed in the sequence table. This results in a synchronization delay of one frequency hop over the Fast Hop Bus.

If you do not want a one frequency hop delay, and are willing to accept a 7 μ sec slower frequency switching time, you can turn off the buffered Fast Hop Bus with Special Function 201. This special function only works with the Fast Hop Bus Internal Dwell mode. Also, if you turn the buffering off, the Hop line must be held at a TTL high for 3 μ sec or less.

The diagrams in figures 3-18 and 3-19 depict the synchronization that occurs when the HP 8645A frequency hops in the Fast Hop Bus Internal Dwell mode with and without the buffering.

Note

If you use the Fast Hop Bus Internal Dwell with the Buffering off, you will notice in figure 3-19 that there is an overlap between when the frequency is changing and when the output amplitude comes on.

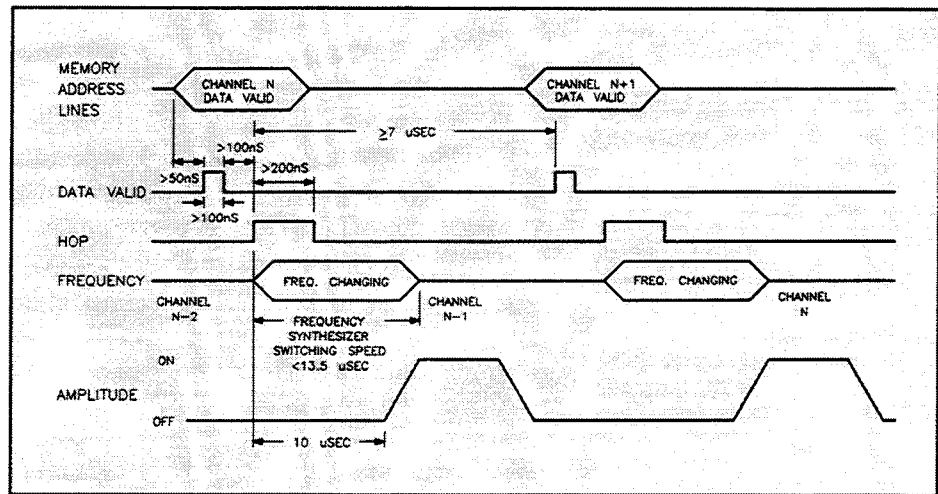

Figure 3-18. Fast Hop Bus Internal Dwell Synchronization, Buffering On.

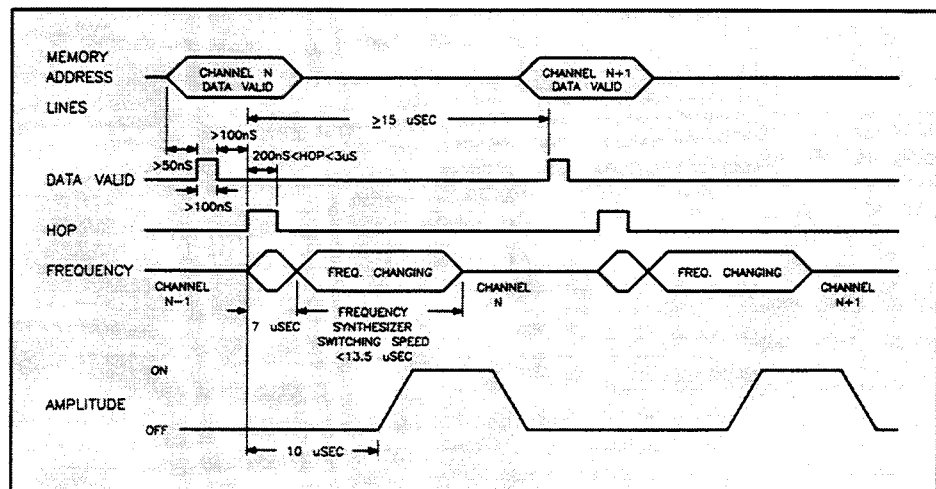

Figure 3-19. Fast Hop Bus Internal Dwell Synchronization, Buffering Off.

Fast Hop Bus Ext Dwell

The *Fast Hop Bus External Dwell* mode allows the HP 8645A to frequency hop in any order to any channel in the sequence table. In this mode, dwell time is controlled by the duration of the TTL signal on the Hop line.

This mode and the *Fast Hop Bus Internal Dwell* mode have the most complicated synchronization, and require more external hardware for control than any of the other seven frequency hop modes.

To frequency hop in this mode, you are required to interface TTL signals to the rear-panel **FAST HOP BUS** connector, **SEQ** (sequence) connector, and **HOP** connector (only if it is used instead of the Hop line on the Fast Hop Bus).

The variable dwell time in this mode allows you to have the RF output on for different amounts of time for each channel in the sequence table. As long as the TTL signal on the Hop line is high, the RF output is turned on; whenever the TTL signal on the Hop line is low, the RF output is turned off.

Place a high/low TTL bit pattern on the 13 Memory Address lines to address the sequence table. Address data on the Fast Hop Bus corresponds directly to one of the 4000 (or 8000 for serial prefix 3019A and above) sequence table positions.

For example, the Memory Address lines shown in table 3-7 can be set up to correspond to "Step #342" in the sequence table by sending specific address data over the Fast Hop Bus (add up the decimal equivalent for each Memory Address Line that is high to arrive at the address position in the sequence table):

$$256 + 64 + 16 + 4 + 2 = 342$$

Table 3-7. Memory Address Lines for the Fast Hop Bus.

Memory Address Lines (J1 Pin #)	Decimal Equivalent	High/Low TTL Bit Pattern
* 5	4096	0(MSB)
11	2048	0
12	1024	0
25	512	0
24	256	1
23	128	0
22	64	1
21	32	0
20	16	1
19	8	0
18	4	1
17	2	1
16	1	0(LSB)
* 3019A and above		

Note

The sequence table contains up to 4000 channel table entries from address position 0 to 3999 (or 8000 channel table entries from address position 0 to 7999 for serial prefix 3019A and above). However, if you add up the decimal equivalent for each Memory Address Line shown in table 3-7, the result would indicate that positions greater than 3999 could be addressed. All address positions greater than 3999 (or 7999 for serial prefix 3019A and above) are invalid.

Synchronize the *Data Valid* line to toggle to a TTL high when the address data is valid.

To frequency hop to a new channel in the sequence table, input the rising edge of a TTL signal to the Hop line on the Fast Hop Bus (or to the HOP connector).

Remember

The TTL level at the SEQ (sequence) connector determines if the HP 8645A is in the Learn State. A TTL high keeps the HP 8645A in the Hop State; a TTL low puts the HP 8645A into the Learn State.

In normal operation, the HP 8645A allows for a faster switching speed by buffering the position addressed in the sequence table. This results in a synchronization delay of one frequency hop over the Fast Hop Bus.

If you do not want a one frequency hop delay, and are willing to accept a 7 μ sec slower frequency switching time, you can un-buffer the Fast Hop Bus by means of an external hop generating circuit. An example circuit shown in figure 3-20 indicates that the External Control Line pulse must originate from a timing source that you provide.

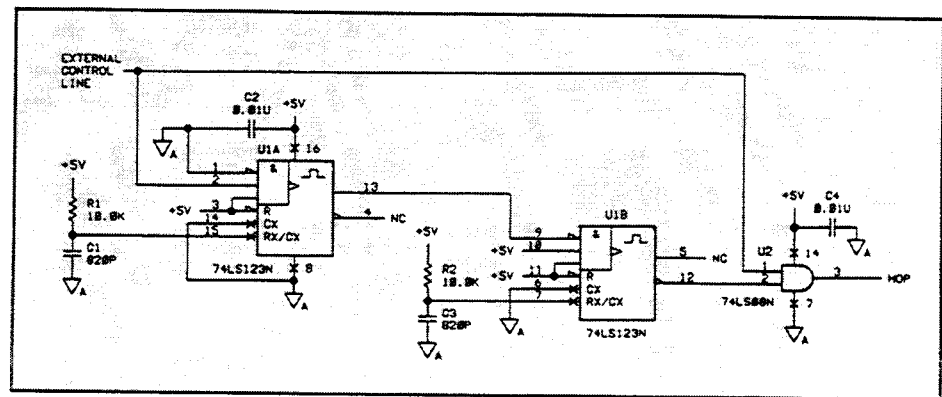

Figure 3-20. Sample Circuit to Control the Frequency Hop.

The following diagrams in figures 3-21 and 3-22 depict the synchronization that occurs when the HP 8645A frequency hops in the Fast Hop Bus External Dwell mode with and without the buffering:

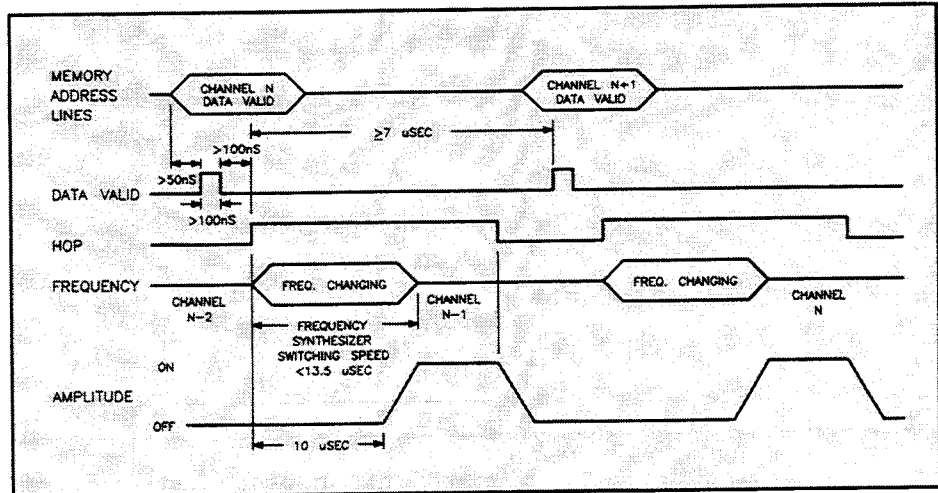

Figure 3-21. Fast Hop Bus External Dwell Synchronization, Buffering On.

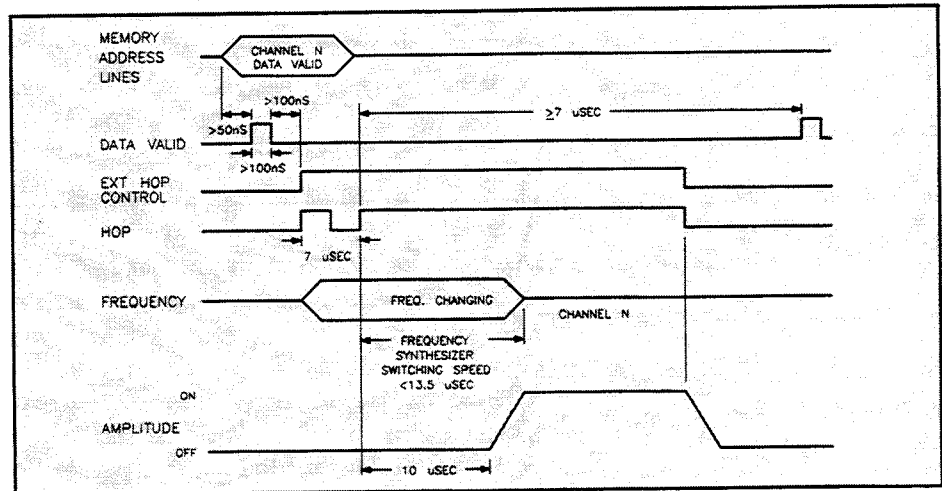

Figure 3-22. Fast Hop Bus External Dwell Synchronization, Buffering Off.

Amplitude Control – An Overview

If You Need to Know:	Refer to:
<u>Amplitude Control</u>	
• <i>Some general information about Amplitude control</i>	Amplitude Control – An Introduction (3-36)
• <i>Specific information about Closed Loop ALC control</i>	Closed Loop ALC (3-36)
• <i>Specific information about Open Loop ALC control</i>	Open Loop ALC (3-38)

Amplitude Control – An Introduction

A maximum amplitude level variation of 20 dB is allowed between any two channels entered into the channel table. You can extend the amplitude level variation of the RF output by -15 dB during the Hop State without causing the HP 8645A to enter the Learn State by using special function 203.

Note

When Special Function 203 is evoked, the Fast Hop Operation, Amplitude accuracy specification, and the Amplitude Modulation, AM indicator accuracy specification will be degraded.

Amplitude level is controlled in one of two ways: Open, or Closed Loop ALC (Automatic Level Control). Each method has its advantages and disadvantages. You must decide which method best meets your needs.

Closed Loop ALC is the default method. Open loop ALC is selected by Special Function 202. If Pulse modulation is selected, Open Loop ALC is automatically turned on during the Learn State. Continue reading for a detailed discussion of both Open, and Closed Loop ALC.

Closed Loop ALC

Closed Loop ALC operation quickly turns on the RF output by 40 dB, and then exponentially ramps up to the desired level. In the same manner, the RF output exponentially ramps down to turn off. After this initial power drop, the RF output is quickly shut off by an additional 40 dB. Refer to figure 3-23.

The main disadvantage of operating with Closed Loop ALC is:

1. A longer switching time between frequency hops.

There are six main advantages of operating with Closed Loop ALC as follows:

1. Less spectral splatter.
2. Better linear AM control of the RF output level.
3. Better isolation between frequency hops.
4. Better level accuracy.
5. Power is off during the Learn State.
6. Shorter Learn State time.

During the Learn State with Closed Loop ALC operation, the RF output is turned off by about 70 dB while the HP 8645A learns all of the electronic settings for each channel in the sequence table. This prevents the output of undesired signals prior to the frequency hop.

The following diagram in figure 3-23 depict Closed Loop ALC operation during the frequency hop:

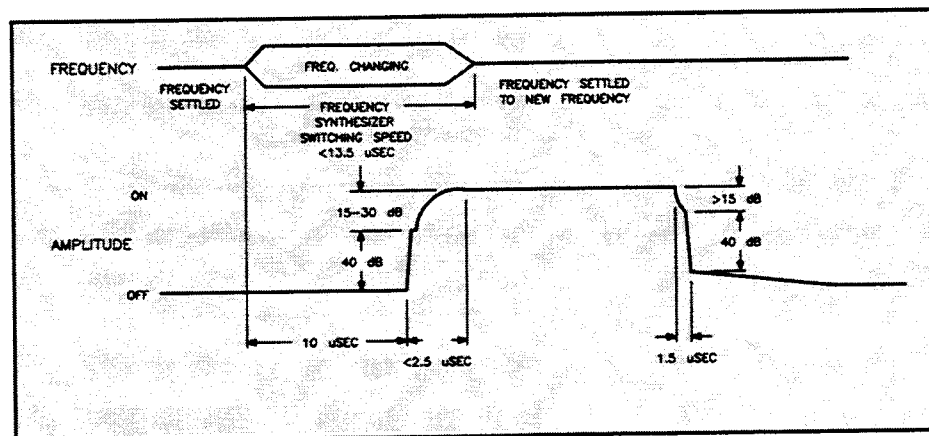

Figure 3-23. Closed Loop ALC Amplitude Control.

Open Loop ALC

Open Loop ALC operation turns on the RF output by quickly ramping up the amplitude level to 40 dB in less than 100 nsec. In the same manner, the RF output quickly turns off as it ramps down 40 dB in less than 100 nsec. Refer to figure 3-24.

The main advantage of operating with Open Loop ALC is:

1. A quicker switching time between frequency hops.

There are six main disadvantages of operating with Open Loop ALC as follows:

1. More spectral splatter.
2. Less linear AM control of the RF output level.
3. Less isolation between frequency hops.
4. Less level accuracy.
5. Power is on during the Learn State.
6. Longer Learn State time.

During the Learn State with Open Loop ALC operation, the RF output is turned on and off while the HP 8645A learns all of the electronic settings for each channel in the sequence table. This increases the Learn State time by about 3 msec for each channel.

The following diagram in figure 3-24 depict Open Loop ALC operation during the frequency hop:

Note *There is an overlap between when the frequency is changing and when the output amplitude comes on.*

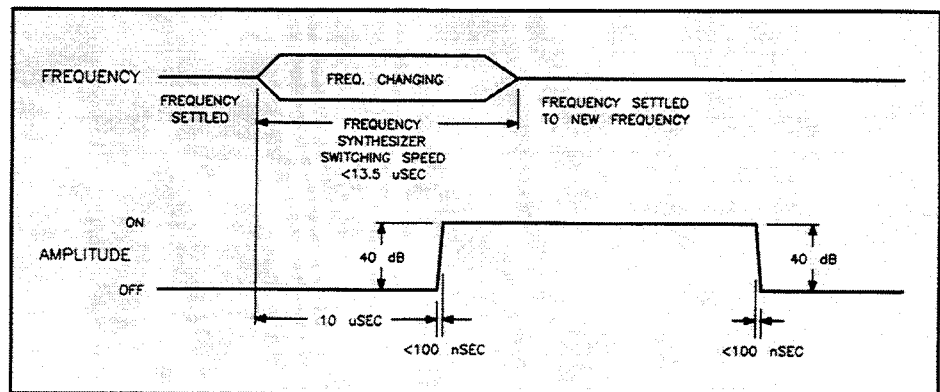

Figure 3-24. Open Loop ALC Amplitude Control.

Frequency Hop Exercise – An Overview

If You Need to Know:	Refer to:
<u>Frequency Hop Exercise</u>	
<ul style="list-style-type: none"> • <i>How to frequency hop the HP 8645A in the Internal Single mode</i> 	<p>Procedure #1 – Internal Single Mode (3-40)</p>
<ul style="list-style-type: none"> • <i>How to frequency hop the HP 8645A in the External Stepped Internal Dwell mode</i> 	<p>Procedure #2 –External Stepped Internal Dwell Mode (3-44)</p>
<ul style="list-style-type: none"> • <i>The key things to remember about the Frequency Hop Exercise</i> 	<p>Frequency Hop Exercise – Things to Remember (3-45)</p>

Frequency Hop Exercise – An Introduction

Previous pages in this chapter have provided you with detailed information for most of your frequency hop applications. Here you will have an opportunity to use some of this newly acquired knowledge.

It is assumed in the following exercise that you have completed the frequency hop procedure in chapter 1 and have turned to this chapter for more information.

To avoid redundancy, you will be asked to set up frequency hop channels, and to change the hop rate and dwell time without being given specific directions. If you are unfamiliar with doing these tasks, refer to the frequency hop procedure in chapter 1 for details.

In order to simplify the procedure and the results, the exercise uses an unmodulated RF output. You may repeat the exercise using a modulated RF output.

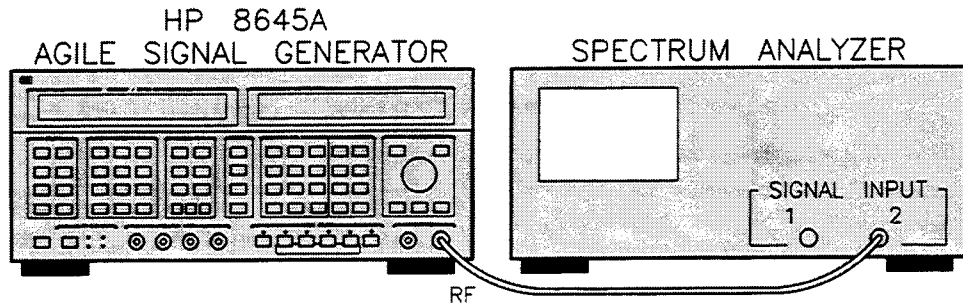

Figure 3-25. Equipment Setup for Internal Single Procedure #1.

Frequency Hop Exercise – The Procedure

By now, you have probably recognized that the frequency hop exercise in chapter 1 had used the `Int Repetitive` triggering mode. The following exercise shows you how to use two other triggering modes. You will also learn how to set up a frequency hop sequence of your choice.

The following exercise is made up of two procedures. The first procedure demonstrates how to frequency hop the HP 8645A in the `Int Single` mode. The second procedure demonstrates how to frequency hop the HP 8645A in the `Ext Stepped Int Dwell` mode. Each procedure takes about 10 minutes to complete.

Equipment Needed

Both procedures require use of the following equipment:

Equipment	Recommended Model Numbers
Spectrum Analyzer	HP 8562A/B, or HP 8566B, or HP 8568B
Function Generator	HP 3312A, or HP 3314A, or HP 8111A, HP 8116A, or HP 8904A

Procedure #1 – Internal Single Mode

Procedure #1 starts with step 1 shown on the next page. A review of the six major steps in the procedure are as follows:

- Set up and adjust the Spectrum Analyzer.
- Set up six frequency hop channels.
- Enter the hop rate and dwell time.
- Set up the sequence table.
- Activate the Internal Single mode.
- Enable the Fast Hop State.

Set Up and Adjust the Spectrum Analyzer

1. Connect the HP 8645A to the Spectrum Analyzer as shown in figure 3-25. Turn on the equipment and make the following adjustments to the Spectrum Analyzer:

Center Frequency 100 MHz
 Frequency Span 100 MHz
 Reference Level 10 dBm

Set Up Five Frequency Hop Channels

2. Press the green INSTR PRESET key. Doing so presets the HP 8645A to a known state for the following steps.
3. Press the MODE 5, FAST HOP key. The yellow annunciator above this key lights up. The HP 8645A is now in the Idle State and is ready to accept modifications to the channel table, sequence table, hop rate and dwell time, and frequency hop modes.
4. Set up six frequency hop channels as shown in table 3-8. Refer to the frequency hop procedure in chapter 1 if you have any difficulty with doing this step.

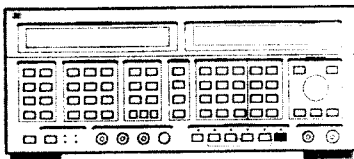

STEP 3

Table 3-8. Channel Table for the Internal Single Mode Procedure.

Channel Number	Channel Frequency	Channel Amplitude
0	70 MHz	0 dBm
1	80 MHz	0 dBm
2	90 MHz	0 dBm
3	100 MHz	0 dBm
4	110 MHz	0 dBm
5	120 MHz	0 dBm

Enter the Hop Rate and Dwell Time

5. Enter a hop rate of 8 Hz, and a dwell time of 99 msec. Once again, the hop rate is slow and the dwell time long; this allows you to clearly see the results on the spectrum analyzer. Refer to the frequency hop procedure in chapter 1 if you have any difficulty with doing this step.

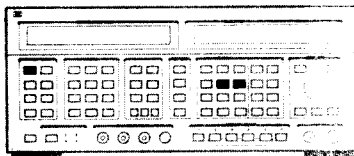

STEP 5

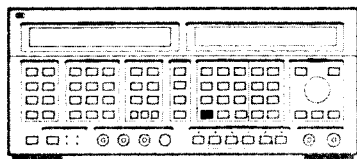

STEP 6

Set Up the Sequence Table

6. Press the blue **SHIFT** key, and the **SET SEQ** key. The HP 8645A is now ready for sequence table entries. You will see the following in the **FREQUENCY/STATUS** display:

Step # 0 => Chan

Note

*If a Step # other than "0" appears in the **FREQUENCY/STATUS** display, a sequence table has already been set up. If this is the case, clear the sequence table with the **CLR SEQ** key.*

7. Press the numeral **5** key. This step sets up channel 5 for the first position (Step #0) in the sequence table. You will see the following in the **FREQUENCY/STATUS** display:

Step # 0 => Chan 5

8. Press the **ENTER** key to put channel number 5 into sequence position **Step #0**. Notice how the Step # increments up to the next sequence position, namely Step #1.

9. Continue to set up the sequence table with the pattern shown in table 3-9. When you reach Step #6, press the blue **SHIFT** key and the **EXIT** key to terminate entries into the sequence table. When you are done with this step, a channel pattern of 5, 0, 4, 1, 3, 2 is ready for the frequency hop.



Table 3-9. Example Sequence Table.

Sequence Step #	Channel
0	5
1	0
2	4
3	1
4	3
5	2

Activate the Internal Single Mode

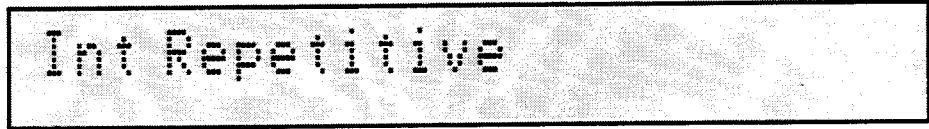
10. Press the blue SHIFT key, and the MODE key. You will see the following in the FREQUENCY/STATUS display:



11. Turn the knob, or press one of the   keys until "Int Single" is shown in the FREQUENCY/STATUS display. The Internal Single mode is now activated.
12. Press the blue SHIFT key, and the EXIT key to get out of the frequency hop mode selection area.

Enable the Fast Hop State

13. Activate the Maximum Hold function on the Spectrum Analyzer. The Maximum Hold function allows the Spectrum Analyzer to display all the channels as the HP 8645A frequency hops to them. If your Spectrum Analyzer does not have a Maximum Hold function, that's okay, just proceed to the next step.
14. Press the blue SHIFT key, and the HOP key. The AMPLITUDE displays shows Learning for about 10 seconds, and then the HP 8645A frequency hops once through the sequence table one Step # at a time. The following display should appear on the Spectrum Analyzer:

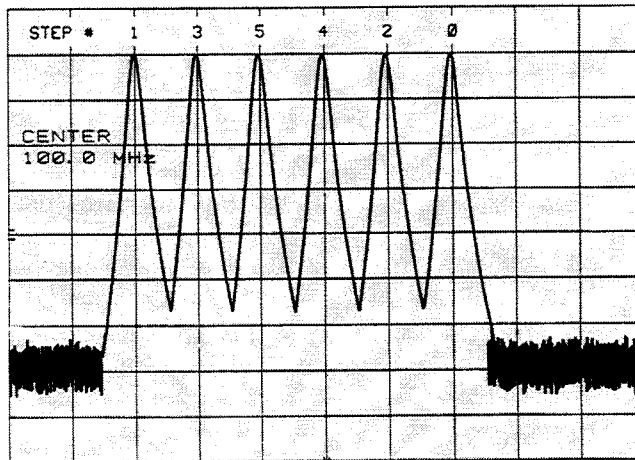

15. Remove the Maximum Hold function from the Spectrum Analyzer. Press the blue SHIFT key, and the HOP key again. You'll notice on the Spectrum Analyzer that the HP 8645A cycles through the sequence table once again. Every time the Hop State is activated in the Internal Single mode, the HP 8645A cycles once through the sequence table.

STEP 10

STEP 12

STEP 14

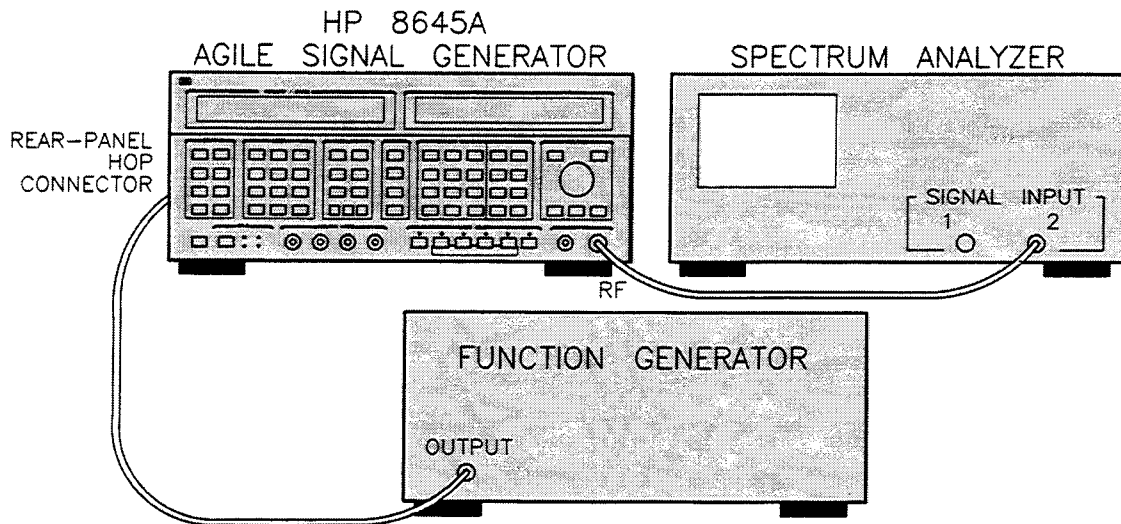

Figure 3-26. Equipment Setup for External Stepped Internal Dwell Procedure #2.

Procedure #2 – External Stepped Internal Dwell Mode

Procedure #2 starts with step 16 shown below; Procedure #2 is a continuation of Procedure #1. A review of the four major steps in the procedure is as follows:

- Set up and adjust the and Function Generator.
- Activate the External Stepped mode.
- Enable the Fast Hop State.
- Modify the Results.

Set Up and Adjust the Function Generator

16. Connect the HP 8645A to the Spectrum Analyzer and Function Generator as shown in figure 3-26. Keep the Spectrum Analyzer set to the adjustments made in Procedure #1. Turn on the Function Generator and make the following adjustments:

On the Function Generator

Frequency 1 Hz
 Amplitude 1.5 Vpk
 Waveform..... Square

Activate the External Stepped mode

17. Press the blue SHIFT key, and the IDLE key. The HP 8645A must be in an Idle State before changing the frequency hop mode.

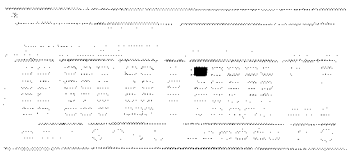

STEP 17

18. Change the frequency hop mode from Int Single to Ext Stepped Int Dwell, and then exit. The following should be shown in the FREQUENCY/STATUS display before you exit:

```
Ext Stepped Int Dwell
```

Enable the Fast Hop State

19. With the Function Generator's output active, press the blue SHIFT key, and the HOP key. Once again, the Learn State is invoked for about 10 seconds. Notice on the Spectrum Analyzer that the HP 8645A frequency hops from one channel in the sequence table to the next at a 1 Hz rate.

Modify the Results

20. Slowly increase the rate of the Function Generator's output. Notice on the Spectrum Analyzer that the HP 8645A frequency hops at a faster rate which is proportional to the increased rate of the Function Generator.



STEP 19

Frequency Hop Exercise – Things to Remember

The following list is a summary of the most important points previously discussed in the Frequency Hop Exercise:

- Channel and sequence table entries are made with the HP 8645A in the Idle State.
- Any channel may be used more than once in the sequence table.
- Activate any of the nine frequency hop modes by showing your selection in the FREQUENCY/STATUS display.
- The Learn State is invoked before the Hop State to ensure the most accurate RF output while frequency hopping.

After completing this chapter, you may want to go to chapter 5 to understand how to frequency hop the HP 8645A through HP-IB; an alternative is to proceed to another chapter in this Guide.

4

What About Sweeping?

In this Chapter

This chapter describes how to frequency sweep the HP 8645A Agile Signal Generator. Information is provided regarding front-panel control of frequency sweeping. Refer to chapter 5 if you need information about HP-SL programming control over HP-IB.

Three types of sweep are available to help you characterize RF devices quickly and accurately. This chapter focuses on each frequency sweep feature; advantages and limitations are mentioned where appropriate. At the end of this chapter is an exercise that may be helpful to you.

The Directory

Use the illustration shown below to find the subject you want. Turn to that subject for specific information.

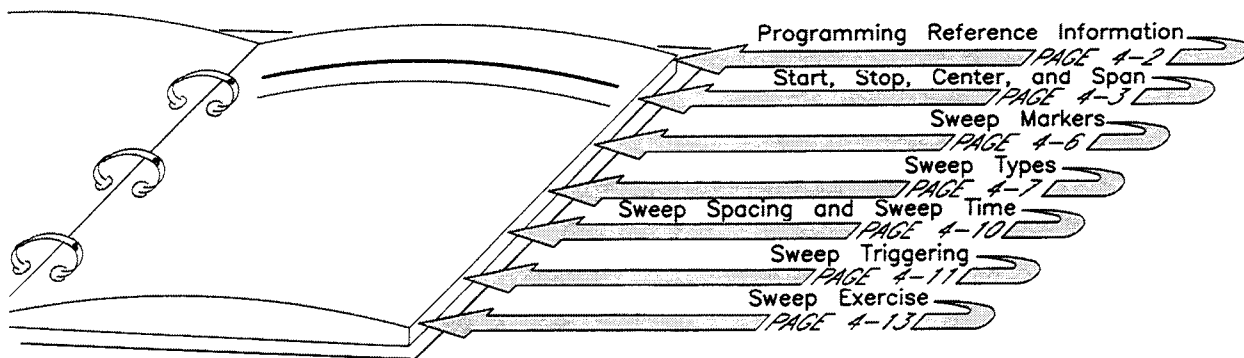

Frequency Sweep – General Information

The procedure to frequency sweep the HP 8645A can be summarized in five basic steps. The following steps reflect the order in which sweeping is described in this chapter; you are not constrained to use this sequence of steps once you become familiar with frequency sweeping the HP 8645A:

1. Set up a start, stop, center, or span frequency.
2. Activate sweep markers (optional step).
3. Select one of the three types of frequency sweeping (digitally-stepped, fast-hop, or phase-continuous).
4. Select the sweep spacing (linear is the default spacing, log is selectable from the front panel), and set the sweep time.
5. Trigger the HP 8645A to frequency sweep (using Auto, Single, or Manual).

The HP 8645A has attributes of two different types of instruments. First, it acts as a non-swept CW signal source, and second, it acts as a frequency-swept signal source (that is, a sweeper). By pressing any of the front-panel keys shaded in figure 4-1, the HP 8645A becomes a sweeper.

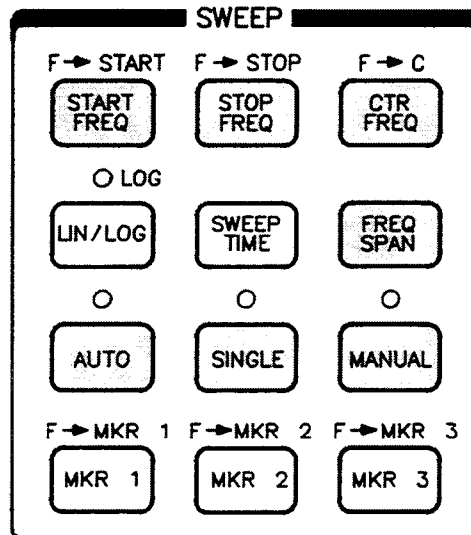
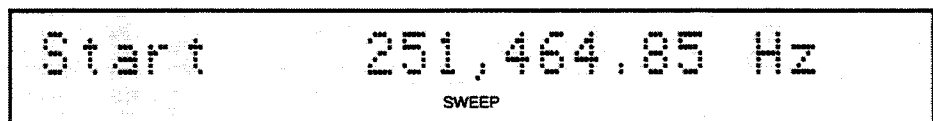

Figure 4-1. Keys that Turn the HP 8645A into a Sweeper.

When the HP 8645A has become a sweeper, whether the signal source is paused or running, you will notice a **SWEEP** annunciator in the FREQUENCY/STATUS display. For example, after an instrument preset, if you were to press the **START FREQ** key, you would see the following display:



Start, Stop, Center, and Span

To set up a frequency-swept measurement, the HP 8645A must know the start, stop, center, and span frequency values that you want. Simply press any one of the front-panel keys shaded in figure 4-2:

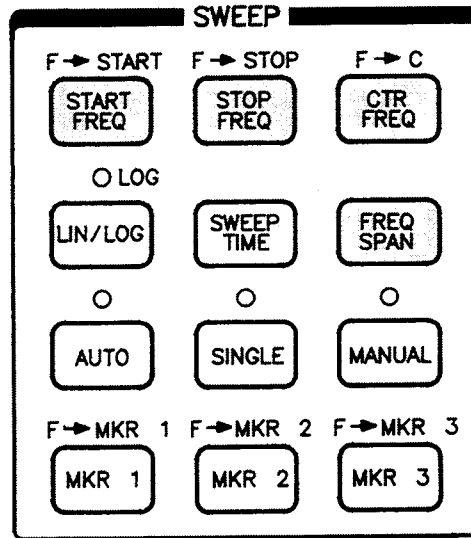

Figure 4-2. Start, Stop, Center, and Span Frequency Keys.

You may then specify a sweep frequency in one of four ways, as follows:

- Use the front-panel **DATA** keys shaded in figure 4-3:

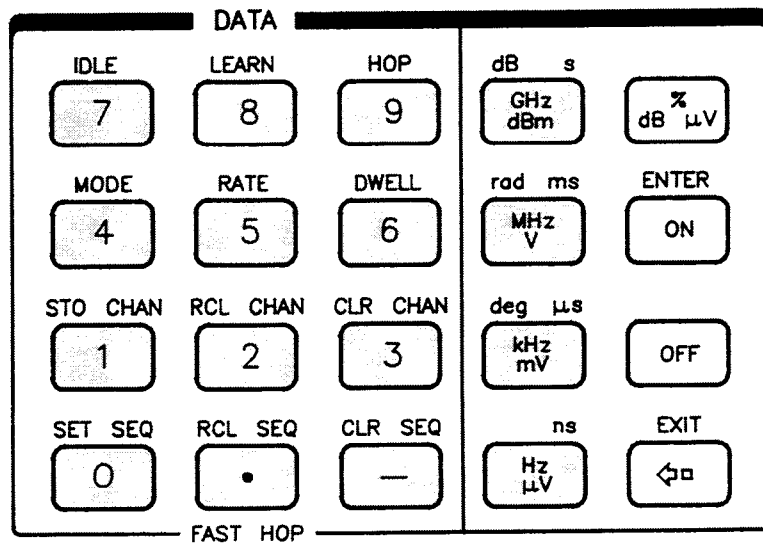

Figure 4-3. Data Keys for Start, Stop, Center, and Span.

- Press one of the increment or decrement front-panel keys shaded in figure 4-4:

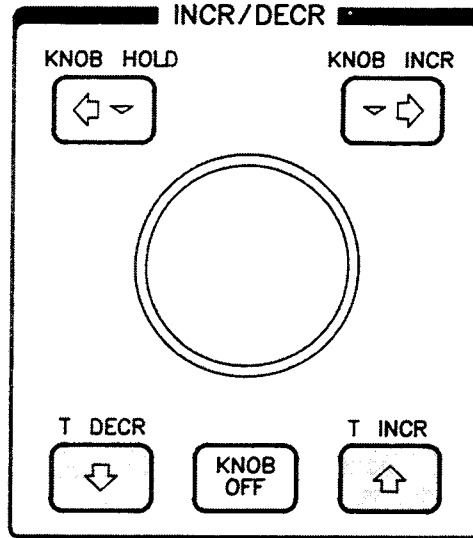

Figure 4-4. Increment/Decrement Keys for Start, Stop, Center, and Span.

- Turn the knob (shaded in figure 4-5) clockwise to increase frequency, or turn the knob counterclockwise to decrease the displayed frequency:

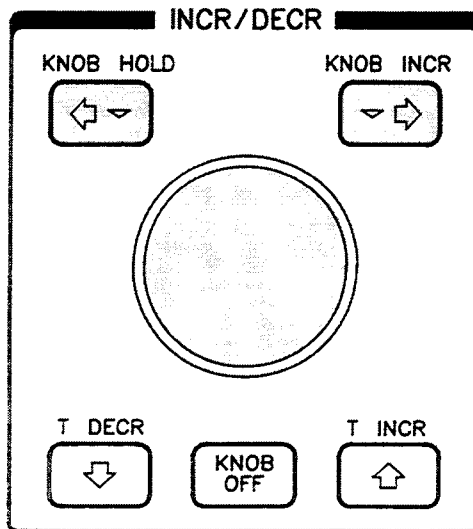

Figure 4-5. Knob for Start, Stop, Center, and Span.

- Press the blue **SHIFT** key, and then one of the start, stop, center, or span keys shaded in figure 4-6. This enters the value of the RF output frequency last displayed when the HP 8645A was acting as a non-swept CW signal source:

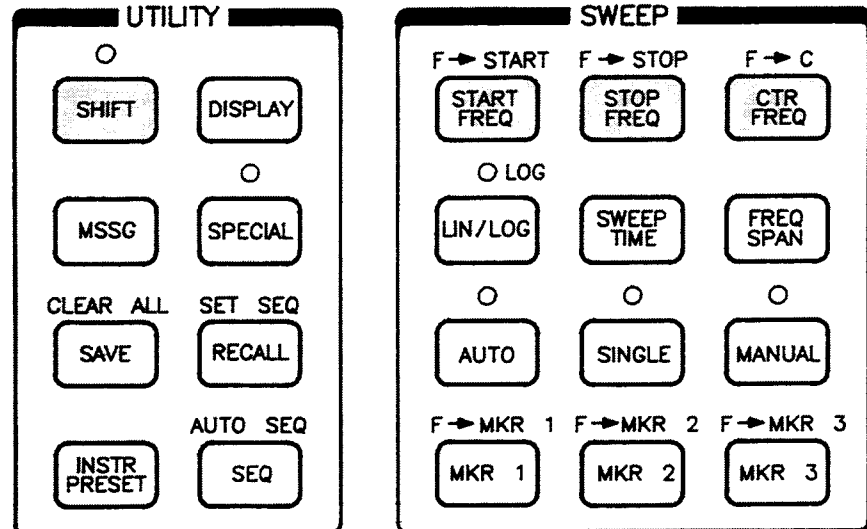

Figure 4-6. Shift Key for Start, Stop, Center, and Span.

When you specify a sweep frequency, the start, stop, center, and span frequency values are interactive; they affect each other in the following ways:

If START FREQ is changed:

STOP FREQ is unchanged
 CTR FREQ is set to $(\text{START FREQ} + \text{STOP FREQ})/2$
 FREQ SPAN is set to $(\text{STOP FREQ} - \text{START FREQ})$

If STOP FREQ is changed:

START FREQ is unchanged
 CTR FREQ is set to $(\text{START FREQ} + \text{STOP FREQ})/2$
 FREQ SPAN is set to $(\text{STOP FREQ} - \text{START FREQ})$

If CTR FREQ is changed:

FREQ SPAN is unchanged
 START FREQ is set to $(\text{CTR FREQ} - (\text{FREQ SPAN}/2))$
 STOP FREQ is set to $(\text{CTR FREQ} + (\text{FREQ SPAN}/2))$

If FREQ SPAN is changed:

CTR FREQ is unchanged
 START FREQ is set to $(\text{CTR FREQ} - (\text{FREQ SPAN}/2))$
 STOP FREQ is set to $(\text{CTR FREQ} + (\text{FREQ SPAN}/2))$

Sweep Markers

Up to three sweep markers can be set to locate positions of interest during the frequency sweep. When you set a sweep marker, the HP 8645A does not become a sweeper; this allows you to set sweep markers at any time. Simply press one of the front-panel keys shaded in figure 4-7:

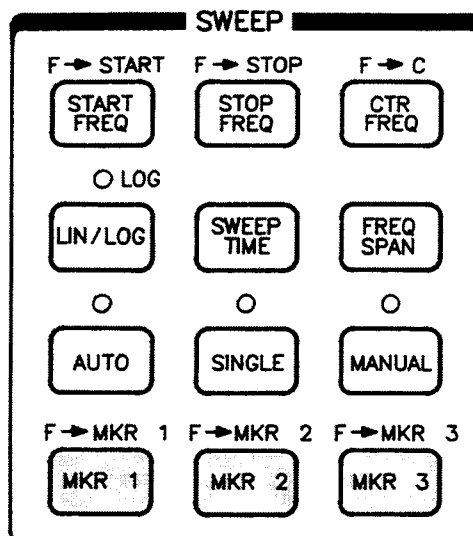
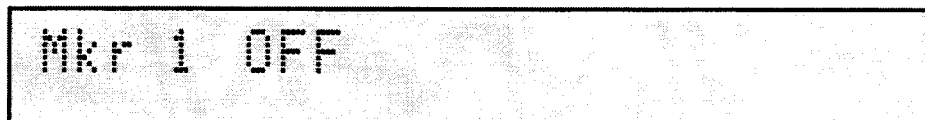

Figure 4-7. Marker Keys.

For example, if you were to press the **MKR 1** key after an instrument preset, you would see the following:



Select a frequency for the marker position in any one of the four ways previously mentioned for selecting start, stop, center, and span frequencies. Press the marker key, and then the **OFF** key to disable a sweep marker.

Sweep markers are active only when the HP 8645A is a sweeper. Voltage levels from the X-axis and Z-axis outputs are compatible with most typical analog oscilloscopes as follows:

X-Axis

The rear-panel **X AXIS** output connector provides a voltage ramp with a nominal +0 to +10 V dc signal when sweep is triggered in one of three ways (Auto, Single, or Manual). As shown in figure 4-8, voltage points at the extremities of the X-axis ramp coincide with start and stop frequency values. That is, +0 V dc is the start frequency value, and +10 V dc is the stop frequency value. In the time domain, as the sweep time decreases, the slope of the X-axis ramp increases.

Z-Axis The rear-panel **Z AXIS** output connector provides a +1 V dc output signal that changes to a +5 V dc pulse during retrace to blank the oscilloscope CRT, and also changes to a 0 V dc level whenever a sweep marker is present as shown in figure 4-8.

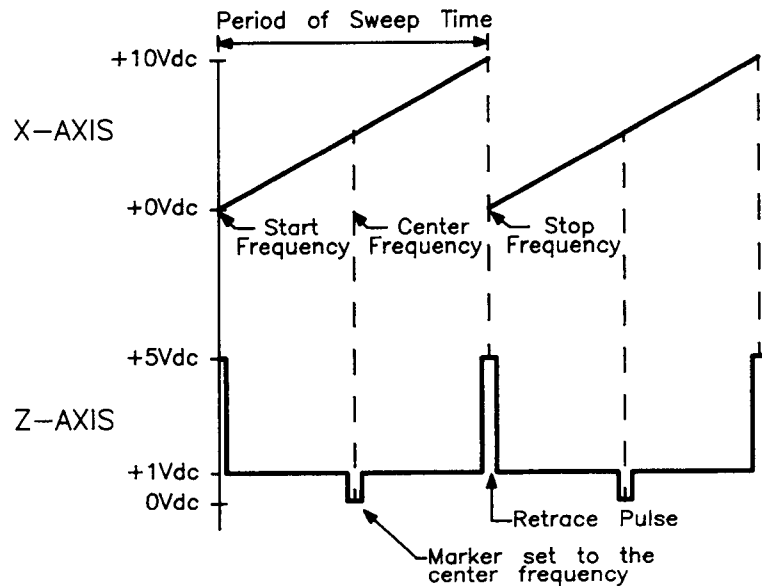

Figure 4-8. X-Axis and Z-Axis.

Sweep Types

Three types of frequency sweep are available:

- Digitally-stepped sweep.
- Fast-hop sweep.
- Phase-continuous sweep.

Continue reading for a description of each sweep type.

Digitally-Stepped Sweep

The digitally-stepped sweep can be used to characterize broad band devices such as wideband filters, RF power amplifiers, and mixers by sweeping between two selected endpoints. The frequency sweep is synthesized across any span in either a linear or log frequency spacing. The number of discrete steps is determined by both the frequency span, the active Synthesis Mode, and the sweep time selected by the user.

The main advantage of digitally-stepped sweeping is that it provides an RF synthesized sweep across a broad frequency range. This sweep type is useful for quick verification of broadband RF devices when used with a stored graphic display such as the Maximum Hold feature on certain spectrum analyzers.

Sweep time for the digitally-stepped sweep can range from 0.5 to 1000 seconds with each discrete step requiring 90 msec (typically) to complete.

To reduce the amount of transient switching spurs when each frequency change occurs, the output amplitude is reduced approximately 60 dB between each frequency step. This amplitude reduction may cause dropouts on the displayed frequency response of the RF device being swept; if this kind of characterization is not satisfactory, use one of the other sweep types.

Fast-Hop Sweep

When the HP 8645A is functioning as a sweeper, you may produce a fast-hop sweep after the **MODE 5, FAST HOP** key on the front panel has been pressed. You may then utilize the frequency agile capabilities to sweep across large frequency spans. For example, it is possible to have 1000 discrete frequency steps in as little as 100 msec per sweep.

The number of discrete steps is determined by both the sweep time, and the duration of each step which is based upon the frequency range being swept. Typical time per step (switching + dwell) is 30 μ sec when sweeping over the frequency range of 128 to 1030 MHz, 170 μ sec for 8 to 1030 MHz, and 650 μ sec for 0.25 to 1030 MHz (the frequency range mentioned in the previous three statements is extended from 1030 MHz to 2060 MHz with an Option 002 equipped instrument).

Sweep time for the fast-hop sweep can range from 10 msec to 100 seconds. Although the output amplitude is blanked between each step as in the digitally-stepped sweep, the duration of the blanking is so short that typically the dropout shown with fast-hop sweep is much less than with digitally-stepped sweep.

When you initiate a fast-hop sweep (using the Auto, Single, or Manual sweep triggering), the HP 8645A must first learn the frequency and amplitude settings in a manner similar to frequency hopping. The learn time takes from 10 to 45 seconds depending upon the frequency span and whether or not FM is on. Any time you change a frequency or amplitude parameter, the learn cycle must be repeated. The learn cycle is sometimes repeated when you change the sweep time.

Phase-Continuous Sweep

With phase-continuous sweep, precise measurements can be made when characterizing narrowband devices such as passband filters, SAWs, cavity tuned resonators, receiver crystals or ceramic IF filters. The frequency sweep occurs between two selected endpoints in a linear, phase-continuous manner.

Narrowband devices generally have large time constants. This means that they respond slowly to stepping transients, and it also implies that they cannot be swept too quickly. Since phase-continuous sweeping has no discrete steps, you can sweep high-Q devices more rapidly than with the digitally-stepped or fast-hop sweep, and be assured of not missing critical response peaks or dips.

Another advantage of phase-continuous sweep is that it has synthesized frequency accuracy. This is vital when sweeping a narrow frequency range because there is less room for frequency error.

Sweep time for the phase-continuous sweep can range from 10 msec to 10 seconds and is not dependent upon the span frequency selected. However, the maximum and minimum span is limited by frequency range of the start and stop frequencies, as shown in table 4-1:

Table 4-1. Maximum and Minimum Span in Phase-Continuous Sweep.

Frequency Range (MHz)	Maximum Span* (MHz)	Minimum Span* (Hz)
1030 to 2060	40	400
515 to 1030	20	200
257 to 515	10	100
128 to 257	5	50
64 to 128	2.5	25
32 to 64	1.25	12.50
16 to 32	0.625	6.25
8 to 16	0.312	3.13
4 to 8	0.156	2
2 to 4	0.078	2
1 to 2	0.039	2
0.5 to 1	0.019	2
0.25 to 0.5	0.009	2

* Maximum and minimum span shown is valid for Mode 1 frequency synthesis.

Phase-continuous sweep is enabled by activating Special Function 112. The HP 8645A cannot have modulation on, cannot have the internal audio frequency on, and cannot be in **MODE 5, FAST HOP** when you enable the phase-continuous sweep; also, log sweep is not allowed with phase-continuous sweep.

Sweep Spacing and Sweep Time

The HP 8645A allows you to choose two types of sweep spacing, linear and log. Setting the sweep spacing and sweep time will not make the HP 8645A a sweeper. Also, various sweep times are available, depending upon the sweep type that is running. Sweep spacing and sweep time keys are shaded in figure 4-9:

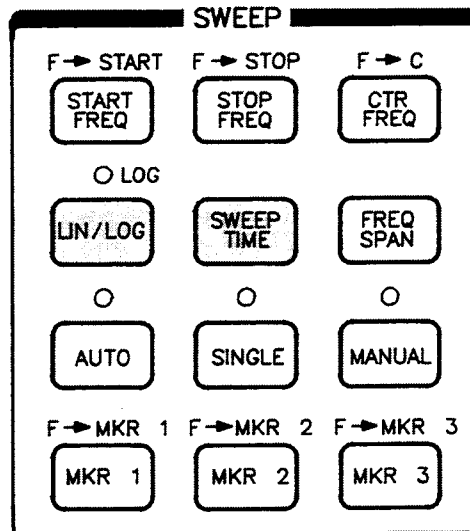

Figure 4-9. Sweep Spacing and Sweep Time Keys.

Linear or Log Sweep Spacing

Selecting either linear or log sweep spacing is done with the front-panel LIN/LOG key. When log sweep spacing is active, the yellow LED annunciator above the LIN/LOG key will light up.

Permissible Sweep Times

The graph in figure 4-10 lists the permissible sweep times for each sweep type.

TIME	SWEEP		
	DIGITALLY-STEPPED	FAST HOP	PHASE-CONTINUOUS
10 Milliseconds			
20 Milliseconds			
50 Milliseconds			
100 Milliseconds			
200 Milliseconds			
500 Milliseconds			
1 Second			
2 Seconds			
5 Seconds			
10 Seconds			
20 Seconds			
50 Seconds			
100 Seconds			
200 Seconds			
500 Seconds			
1000 Seconds			

Note: In the original figure, the cells for DIGITALLY-STEPPED (10-500 ms), FAST HOP (10-100 s), and PHASE-CONTINUOUS (10-50 s) are shaded with a cross-hatch pattern.

Figure 4-10. Sweep Times for Each Sweep Type.

You may set the sweep time in one of three ways:

- Turn the knob.
- Press either the or the key.
- Enter a sweep time, chosen from figure 4-10, by using the Data keys. (If you choose an incorrect sweep time, the HP 8645A will display an error if the sweep time is out of range, or it will choose the closest allowable sweep time within the range shown in figure 4-10.)

Sweep Triggering

Auto and Single sweep triggering may be done in conjunction with any of the three sweep types (digitally-stepped, fast-hop, and phase-continuous sweep). Manual sweep triggering is available only with two sweep types (digitally-stepped, and fast-hop sweep). Sweep triggering keys are shaded in figure 4-11:

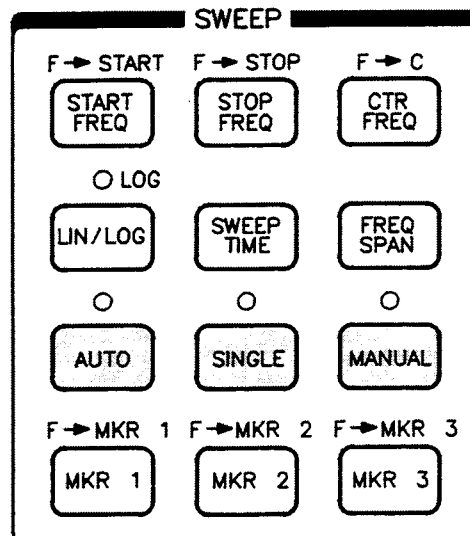

Figure 4-11. Sweep Trigger Keys.

Auto Sweep

The Auto sweep continually repeats the sweep sequence from the start frequency to the stop frequency. Press the **AUTO** key to start the Auto sweep. When Auto sweep is running, the yellow LED annunciator above the **AUTO** key will light up. Press the **AUTO** key again to turn off the sweep.

Single Sweep

The Single sweep starts or restarts a single sweep sequence. Single sweep initiates one sweep only when you press the **SINGLE** key; at the end of the sweep, the RF output returns to the Start Frequency value. When Single sweep is running, the yellow LED annunciator above the **SINGLE** key will light up for the duration of the sweep.

Manual Sweep

Selecting Manual sweep by pressing the **MANUAL** key does not start a sweep, but enables the knob, or the \uparrow and \downarrow keys to control a sweep. When Manual sweep is running, the yellow LED annunciator above the **MANUAL** key lights up, and the FREQUENCY/STATUS display will show the current frequency of the RF output. For example, if you press the **MANUAL** key after doing an instrument preset, you will see the following:



When you turn the knob or press one of the \uparrow or \downarrow keys to activate a sweep, the RF output changes in discrete steps determined by three different factors:

- Sweep time. The number of sweep steps may be different depending upon the sweep time you select.
- Synthesis Mode. The number of sweep steps may be different between one frequency synthesis Mode and another.
- Linear or log sweep. The frequency of the RF output is different depending upon whether linear or log sweep is active.

Stopping the Sweep

There are two ways to stop the sweep and make the HP 8645A a non-swept CW signal source:

- Press the **FREQ** key.
- Press the blue **SHIFT** key and then the **EXIT** key.

Sweep Triggering Characteristics

A synchronization period occurs whenever the HP 8645A performs an Auto, or Single **phase-continuous** sweep. The synchronization period may pose a problem, depending upon the kind of measurement you are making.

- The synchronization period happens everytime the **SINGLE** key is pressed.
- The synchronization period happens once when the **AUTO** key is pressed, and then a shorter synchronization period happens successively after each sweep when the RF output moves from the stop frequency to the start frequency. (The shorter synchronization periods between each sweep vary in duration depending upon the sweep time set at the front panel.)

Three triggering characteristics always happen during the synchronization period and prior to the actual start of the sweep, as follows:

1. The RF output turns off and/or shifts in frequency (several times) in a seemingly random manner immediately after a sweep is triggered.
2. The RF output is then set to the start frequency, and remains there for approximately 10 msec before the sweep begins.
3. The Z-axis blanking signal is active during the entire synchronization period, and becomes un-blanked only during the actual sweep.

After the synchronization period, the sweep begins at the start frequency and ends at the stop frequency.

Calculating Steps in a Digitally-Stepped Sweep

The number of steps in a digitally-stepped sweep can be calculated from the sweep-time and step-time values, as follows:

- **Sweep Time.** Is set from the front panel **SWEEP TIME** key, and may range from 0.5 to 1000 seconds.
- **Step Time.** Is set by the HP 8645A and is dependent upon the frequency synthesis mode, as follows:

Mode	(Minimum) Step Time (ms)
1	125
2	225
3	300

The formula to calculate the number of steps in a sweep is:

$$\frac{\text{Number of steps} = \text{Sweep Time} - (\text{Step Time} \times 0.3)}{\text{Step Time}}$$

The HP 8645A allows for a maximum number of steps equal to 1023 (even if your calculations exceeds this value). The HP 8645A also rounds down any calculation to the last step (for example, a calculated value of 9.7 steps is rounded down to 9 steps for each sweep).

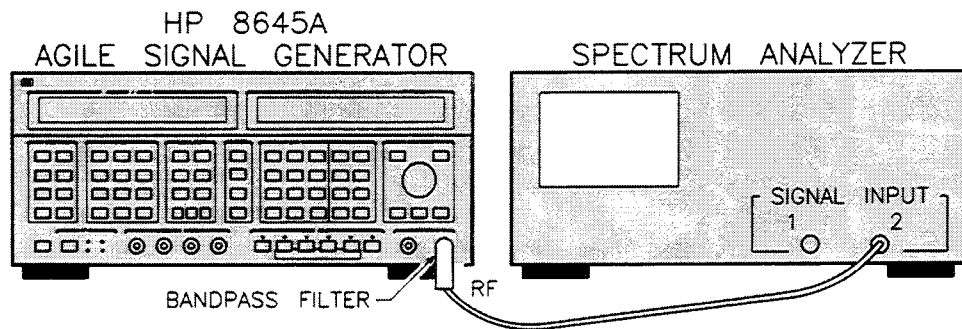

Figure 4-12. Equipment Setup for the Sweep Exercise.

Sweep Exercise

The following exercise takes about 15 minutes to complete. In the procedure, you will characterize a bandpass filter using the three sweep types: digitally-stepped sweep, fast-hop sweep, and phase-continuous sweep.

Equipment Needed

This procedure uses the following equipment:

Equipment	Recommended Model Numbers
Spectrum Analyzer	HP 8562A/B, or HP 8566B, or HP 8568B
Bandpass Filter	HP 11697A

Procedure

The procedure starts on the next page with step 1. A review of the five major steps in the procedure is as follows:

- Set up and adjust the Spectrum Analyzer, and connect it to the HP 11697A bandpass filter and HP 8645A.
- Set the start and stop frequencies for the sweep.
- Set the sweep time.
- Trigger the sweep.
- Observe and modify the results.

Set Up and Adjust the Spectrum Analyzer

1. Connect the HP 8645A to the Bandpass Filter and the Spectrum Analyzer as shown in figure 4-12. Turn on the equipment and make the following adjustments to the Spectrum Analyzer:

Center Frequency 500 MHz
 Frequency Span 1000 MHz
 Reference Level 10 dBm

Set the Start, and Stop Frequencies

2. Press the green INST PRESET key. Doing so presets the HP 8645A to a known state for the following steps.
3. Press the AMPTD key and enter an output amplitude of 0 dBm.
4. Press the START FREQ key, and enter a start frequency of 300 kHz. You should then see the following in the FREQUENCY/STATUS display:

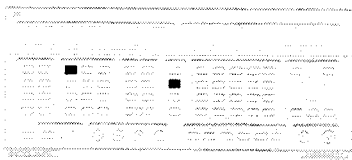

STEP 3 & 4

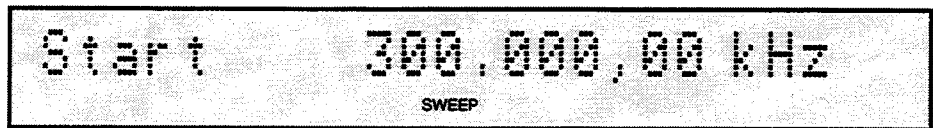

5. Press the STOP FREQ key, and enter a stop frequency of 1 GHz. You should then see the following in the FREQUENCY/STATUS display:



STEP 5



6. Press the CTR FREQ key. You will see that the HP-8645A has automatically calculated the center frequency to be 500,150,000.00 Hz.
7. Press the FREQ SPAN key. You will see that the HP 8645A has automatically calculated the span frequency to be 999,700,000.00 Hz.

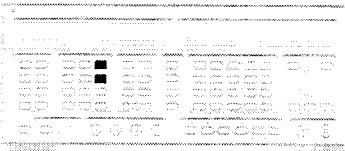

STEP 6 & 7

Set the Sweep Time

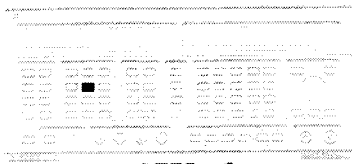

STEP 8

8. Press the **SWEEP TIME** key, and enter a sweep time of 10 seconds. There are four ways to set the sweep time as previously mentioned in this chapter. You should then see the following in the **FREQUENCY/STATUS** display:



Trigger the Sweep



STEP 9

9. Press the **AUTO** sweep key. Notice that the yellow LED annunciator above the **AUTO** sweep key lights to indicate that the sweep is continually repeated from the start frequency to the stop frequency.

Observe and Modify the Results

10. The following display should appear on the Spectrum Analyzer. Use the **Maximum Hold** function on the Spectrum Analyzer to capture the bandpass filter response using digitally-stepped sweep:

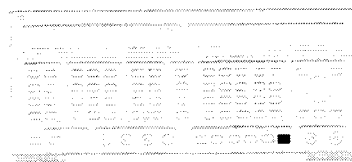
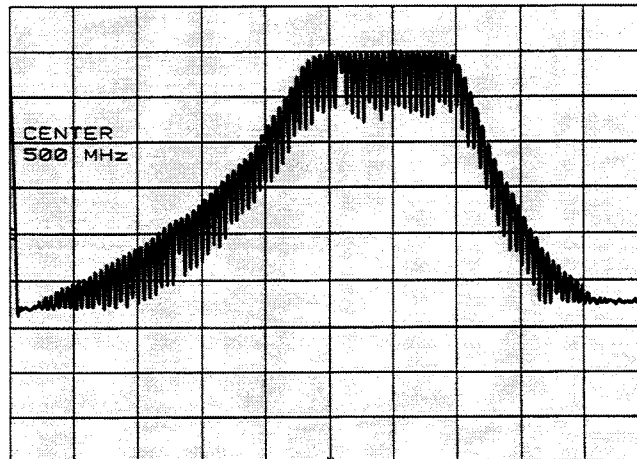

STEP 11

11. Press the **Synthesis Mode, MODE 5** key. This step activates the fast-hop sweep. For about 20 seconds, you should see the following in the **FREQUENCY/STATUS** display:



- The following display should appear on the Spectrum Analyzer. The display shows the typical response of a bandpass filter using fast-hop sweep. Notice that there are many more steps for the same sweep time (10 seconds). With time, the Spectrum Analyzer display would smooth out even more:

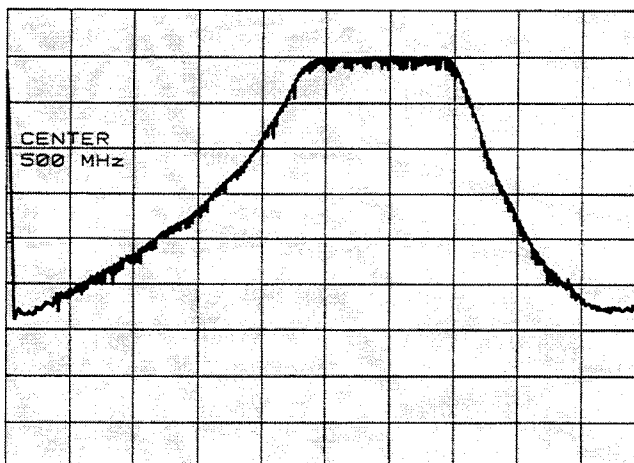

- Press the **AUTO** sweep key, to turn off the sweep. The yellow LED annunciator light above the **AUTO** sweep key should turn off.
- Press the Utility **SPECIAL** key, enter number "112" and press the **ENTER** key. You should then see the following in the **FREQUENCY/STATUS** display:



STEP 14 & 15



- Press the **ON** key to activate Special Function 112. This step allow you to activate phase-continuous sweep. The yellow LED annunciator above the **SPECIAL** key should light up to indicate that a special function is active.

With phase-continuous sweep, you may characterize any segment of the bandpass filter response that is of interest to you.

- Press the **Synthesis Mode, MODE 1** key. This step exits from the fast-hop sweep. Phase-continuous sweep is not allowed when the **Synthesis Mode MODE 5** key is active.
- Make the following adjustments to the Spectrum Analyzer to look at the bandpass filter response where the 3 dB roll-off occurs.

Center Frequency 460 MHz
 Frequency Span 20 MHz
 Reference Level 10 dBm



STEP 16

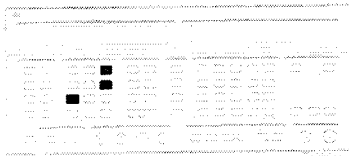

STEP 18, 19, & 20

18. Press the **SPAN FREQ** key, and enter a span frequency of 10 MHz.
19. Press the **CTR FREQ** key, and enter a center frequency of 460 MHz. The HP 8645A will automatically calculate the start frequency to be 455 MHz, and the stop frequency to be 465 MHz.
20. Press the **AUTO** sweep key to activate the **phase-continuous sweep**. The following display should appear on the Spectrum Analyzer:

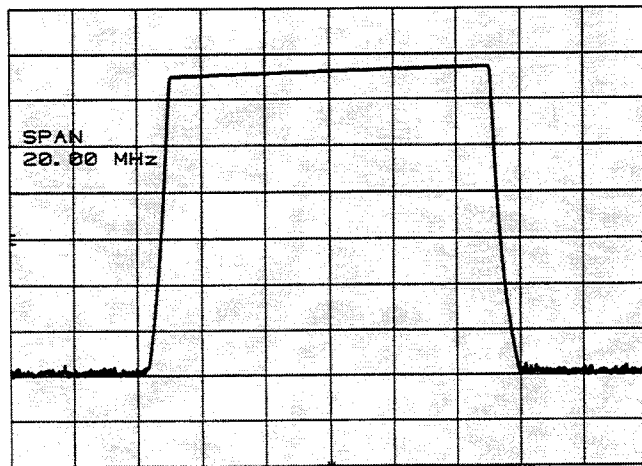

21. Try duplicating any of the previous steps using another sweep mode, either **Single** or **Manual**.
22. Try duplicating any of the previous steps using a different sweep time.
23. Try duplicating any of the previous steps using a **logarithmic sweep** instead of a linear sweep. Remember, log sweep spacing is not allowed with phase-continuous sweep.

5

What About Programming?

In this Chapter

This chapter has three main objectives. First, it provides you with an introduction to the Hewlett-Packard System Language (HP-SL) which is the new programming language for remote control of the HP 8645A over HP-IB. Second, it provides tutorial information helpful to the HP-SL programmer. Third, it provides reference information for programming the HP 8645A with HP-SL.

Novice programmers of HP-SL should read this chapter thoroughly up to the *Programming Reference Information* section. Once you understand the concept of programming with HP-SL, use the reference information as needed.

Note

Refer to appendix F for "HP-SL Quick Reference Information" once you become familiar with the information in this chapter.

The Directory

Use the illustration shown below as your guide for each subject in this chapter. If you are unfamiliar with HP-SL, please use the flow-chart in the direction indicated; the first three sections have been written especially for you.

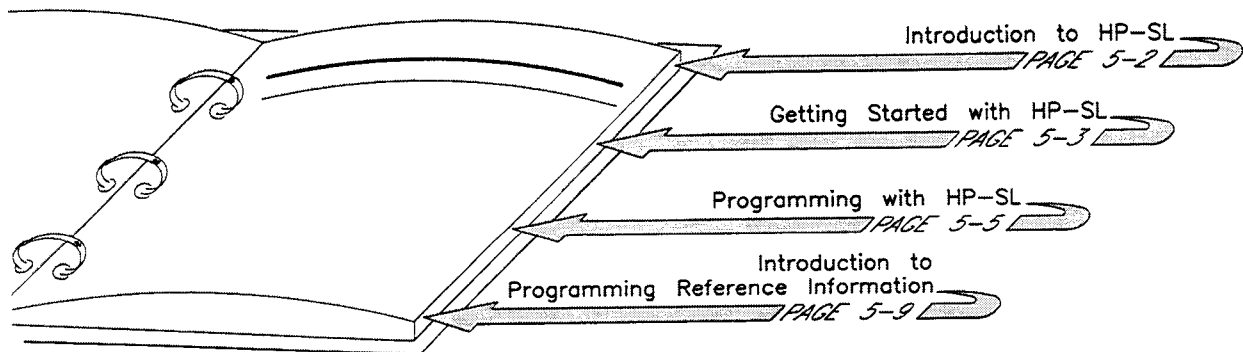

Introduction to HP-SL

Hewlett-Packard Systems Language (HP-SL) is the new programming language adopted by Hewlett-Packard for controlling instrument functions. This language uses standard HP-IB hardware (connectors and cables) and will be used in many future Hewlett-Packard products.

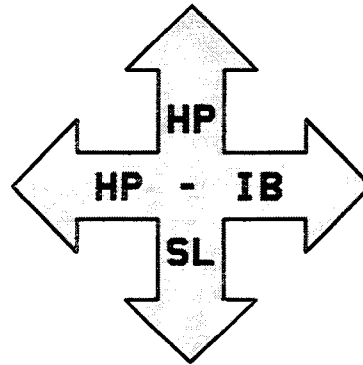

HP-SL isn't just another set of HP-IB commands. The general use of HP-SL provides you with programming commands that are common from one Hewlett-Packard product to another thereby eliminating "device specific" commands.

HP-SL uses easy to learn, self explanatory commands, and is flexible for both novice and expert programmers. Once you become familiar with the organization and structure of HP-SL, you will see that it reduces your effort to write programs for controlling instrumentation regardless of the programming language you use.

HP-SL was developed to conform to the new IEEE 488.2 standard (which replaces IEEE 728-1982). The advantage of the IEEE 488.2 standard is that it provides codes, formats, protocols, and common commands that were not available in the previous IEEE 488.1 standards. For more information, refer to the IEEE 488.2 standard itself.

Another advantage of HP-SL is that commands can be grouped in a single output statement without regard to the order in which the commands are combined. This eliminates the problem of "sequence dependency", where the lines in a program must be written in a specific order to prevent illegal instrument states from occurring.

Getting Started with HP-SL

How is HP-SL Organized?

This section explains how HP-SL is organized, and introduces you to its basic structure. Once you understand the fundamental parts of HP-SL, proceed to the next section titled *Programming With HP-SL* where command messages are described.

HP-SL commands are organized in a "tree" structure. In its simplest form, figure 5-1 helps you visualize HP-SL syntax. Starting from the base of the tree, you move along a path from the root, up the tree to the different branches as shown in trees "A-D". Each branch represents an optional path that the programmer can use in writing a command statement. Keywords on the trunk and branches are used to build command statements and command messages.

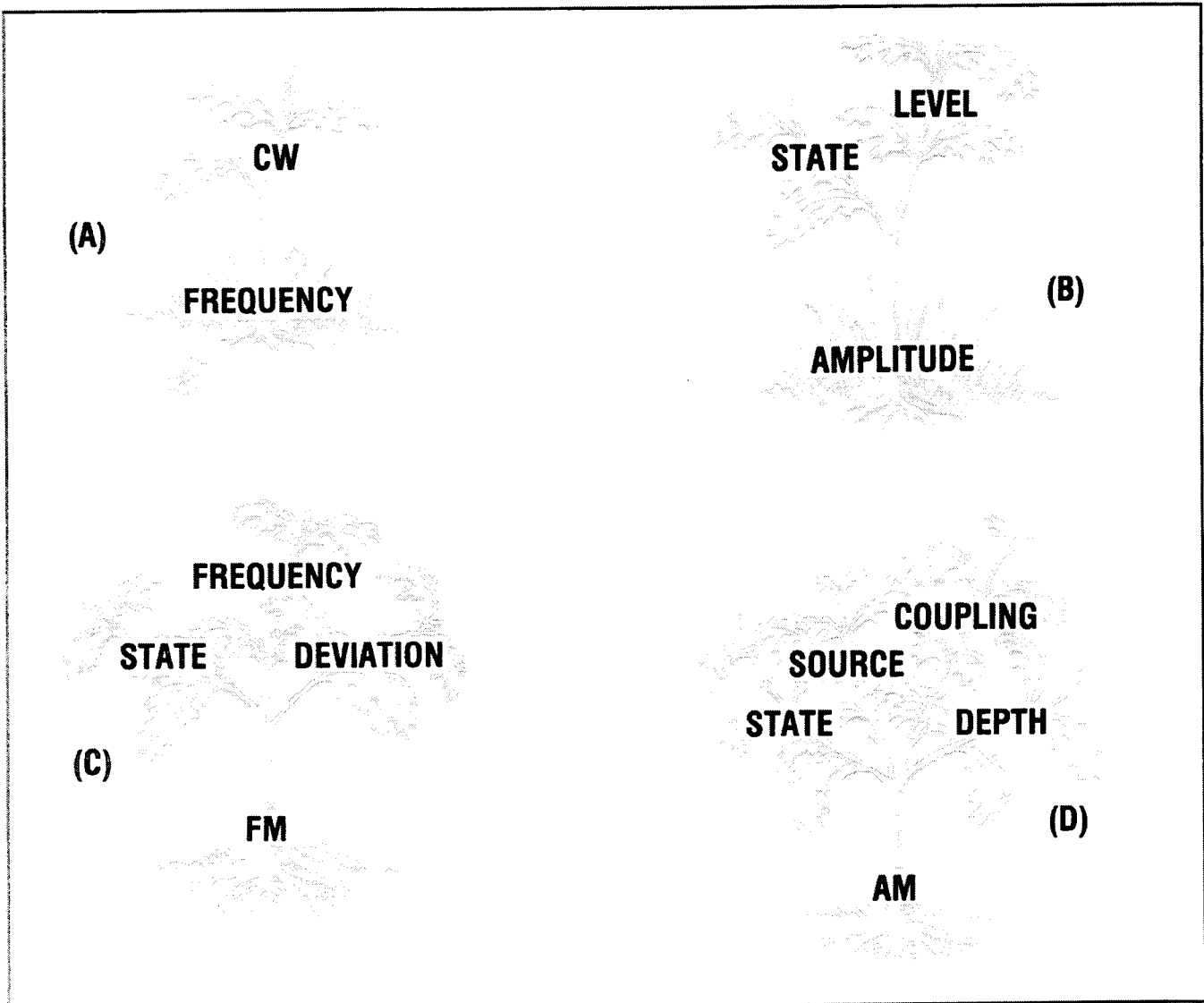

Figure 5-1. Simple HP-SL Tree Structures.

The HP-SL Colon

HP-SL uses the colon " : " to separate the keyword in the root from a branch. For example, the command statement for setting a CW frequency of 1 GHz, as shown in tree "A", would be as follows:

```
FREQUENCY: CW 1GHZ
```

Notice that the command parameter 1 GHz was added to the command statement.

Example command statements for trees "B-D" depict a sampling of the different command parameters available for your use; command parameters must always be preceded by a space:

Tree B

```
AMPLITUDE: LEVEL 10DBM  
AMPLITUDE: STATE ON
```

Tree C

```
FM: DEVIATION 10KHZ  
FM: FREQUENCY 1KHZ  
FM: STATE ON
```

Tree D

```
AM: DEPTH 50%  
AM: SOURCE EXTERNAL  
AM: COUPLING AC  
AM: STATE ON
```

Programming with HP-SL

This section explains how to generate command messages in HP-SL. A command message is two or more command statements put on the same line.

Once you understand the concepts contained in this section, you will be able to start programming the HP 8645A. You may then proceed to the *Programming Reference Information* section for further details on HP-SL programming.

HP-SL Command Statements

Let's expand the analogy of the HP-SL "tree". In reality, the tree structure as previously described is really more complex. You will find that an HP-SL command statement has a hierarchy that may contain many branches. Tree "A" from figure 5-1 is shown in greater (but not complete) detail in figure 5-2 to depict the branching that occurs. Any command that ends with a question mark "?" is a query for information from the HP 8645A.

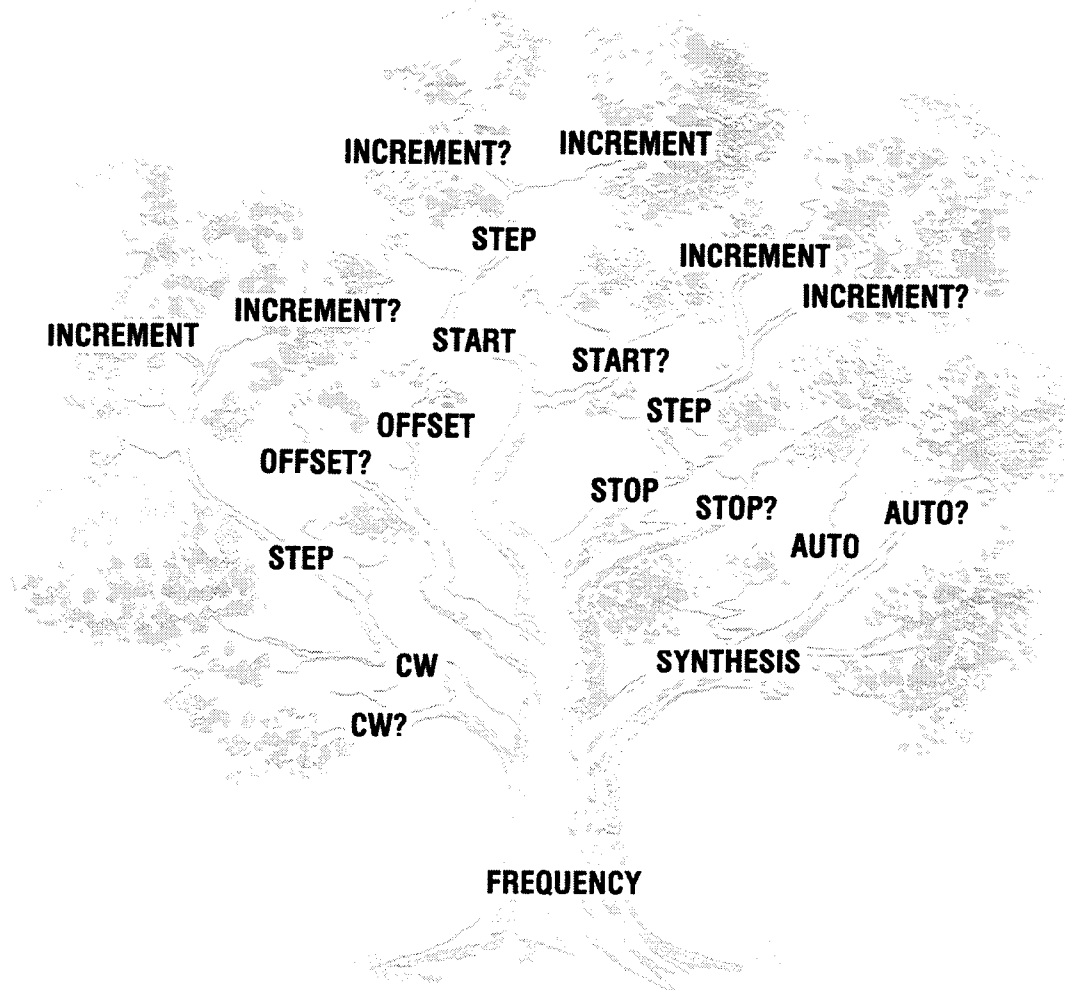

Figure 5-2. Expanding the Detail of Tree "A".

More about the Colon

The colon has another function in the command statement. It is used to connect segments of the same branch. For example, to set the HP 8645A at a frequency increment of 5 MHz, you could write the following command statement:

```
FREQUENCY:STEP:INCREMENT 5MHZ
```

Notice how the colon is used to connect one segment of the branch to the next. Also, the keyword "CW" was left out. You will find that HP-SL has optional keywords in its branches that may be kept in or left out depending upon your programming needs.

An important concept to understand with HP-SL is that only one input or output command may be put in a command statement. You could not have tried to change the RF output and set the frequency increment in the same command statement. To have more than one input or output command on the same line you must create a command message.

The HP-SL Semicolon

The semicolon ";" is used to create a command message, and has two functions. It separates one command statement from another on the same line of code, and it backs the following command down the HP-SL hierarchy to the previous keyword.

You can see how the semicolon works by using two branches from the tree in figure 5-2. For example, to set an RF output of 175 MHz with the HP 8645A in Mode 2 frequency synthesis, you would write the following in HP-SL:

```
FREQUENCY 175MHZ;FREQUENCY:SYNTHESIS 2
```

In this case, the semicolon is simply used to separate one command statement from the other.

**More about HP-SL
Command Statements**

There is no "one way" to program with HP-SL. You may write programs in HP-SL that reflect your style of programming. The previous example may have been written in a number of ways. For example:

```
FREQUENCY:CW 175MHZ;SYNTHESIS 2
```

In this case, notice how the semicolon is used not only to separate one command statement from the other, but also to back the command "SYNTHESIS" down to the previous colon in the HP-SL hierarchy.

The command statements shown so far have been lengthy. In the *Reference Information Section*, you will see that all statements can be written in a short form. For example, the previous command statement may be rewritten as follows:

```
FREQ:CW 175MHZ;SYNT 2
```

Remember

Command statements are not sequence dependent. A line of code may be written with the command statements placed in any order as long as you never have conflicting conditions in a command message.

A conflicting condition occurs when ambiguous command statements are found in the same command message. Turning FM on and then off, or setting the RF output frequency to one value and then to another value are examples of ambiguous command statements in the same command message.

The path for each command statement starts at the root and proceeds up the tree to the different branches. The previous command statement could be rewritten as:

```
FREQ:SYNT 2;CW 175MHZ.
```

Optional keywords may be ignored; use the colon and semicolon in the appropriate places, and have a space before command parameters.

Combining the HP-SL Semicolon and Colon

A special case exists when the semicolon and colon " ;:" are placed next to each other between command statements. This situation lets you start with another keyword at the root of any tree. By using the semicolon & colon sequence in the command statement, you may even string together operations from other trees.

For example, if you were to string an operation from another tree (say setting output amplitude to 10 dBm) to the previous command statement, you could do it as follows (in the short form):

```
FREQ: CW 175MHZ;SYNT 2;:AMPL 10DBM
```

Note

Never leave a space after a colon or you will get the following message:

```
Error\Space after colon
```

***What Else do I
Need to Know?***

Always use the common command *RST (equivalent to instrument preset) on a separate line of code. If *RST is put on a line of code with other command statements, the other command statements would be ignored by the instrument preset.

You will need to initially rely upon the reference information contained in the remaining part of this chapter in order to complete your introduction to HP-SL programming. In time, you will find that the syntax and mnemonics used in HP-SL are predictable. Your reliance on the reference section will then be reduced.

It may be necessary for you to run some example programs to gain experience with HP-SL before attempting to write programs of your own. If this is true, turn to the flow-chart found on the next page, and you will see where the example programs are located. All example programs are written in BASIC, however, you may use any programming language with HP-SL.

Note

Appendix D contains a list of any error messages you may receive while programming with HP-SL.

Introduction to the Programming Reference Information

The remaining part of this chapter provides you with detailed reference information for programming the HP 8645A with HP-SL. HP-IB addressing, HP-IB capabilities, and data input/output information is available for all of your remote operating needs.

All data input/output operations are described in the *HP-IB Control Language Dictionary* and the *HP-IB Device Status Dictionary* sections. Helpful example programs are provided for your use at the end of these sections.

Use the flow-chart directory shown below as your guide for each subject in this section. Turn to the subject you want; where it is appropriate, you will find a table of contents to give you an overview of the specific topics covered for that subject.

Note

Refer to appendix F for "HP-SL Quick Reference Information" once you become familiar with the information in the "HP-IB Control Language Dictionary".

Also, you may want to refer to the document "Tutorial Description of the Hewlett-Packard Interface Bus" HP Part Number 5952-0156 for detailed information about the HP-IB bus.

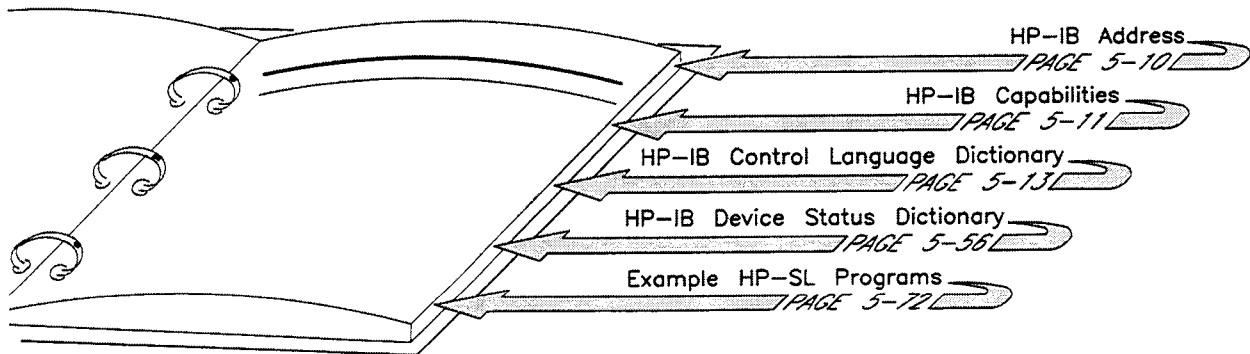

HP-IB Address

The HP-IB address for the HP 8645A is set at the factory to 19. You can display or change the HP-IB address at any time from the front panel. Any HP-IB address from 00 to 30 can be assigned.

The HP-IB address is stored in non-volatile memory, and remains valid through switching the Power from Standby to On and unplugging the ac power cord; performing a RAM wipe (Special Function 172) does not change the HP-IB address.

How to Display or Change the HP-IB Address

Display the HP-IB address:

1. If the yellow **REM** (remote) annunciator is turned on, press the **LOCAL** key to put the HP 8645A into Local operation. All front panel keys (except for the Power switch and the **LOCAL** key) are inoperative when the HP 8645A is in Remote operation.
2. Press the blue **SHIFT** key, and then the **ADRS** key. You will see the following in the FREQUENCY/STATUS display:



HP-IB Address = 19

Change the HP-IB address:

3. Select a new HP-IB address from 00 to 30, and press the **ENTER** key. The new HP-IB address should then be displayed.
4. Press the **FREQ** key to clear the HP-IB address off of the front-panel display. Then, re-display the HP-IB address to verify the new HP-IB address.

HP-IB Capabilities

The HP 8645A Agile Signal Generator is designed to be compatible with a controller that interfaces in terms of the 14 bus messages summarized in table 5-1. This table describes each of the interface functions available as defined by the IEEE Standard 488 and the identical ANSI Standard MC1.1.

When the HP 8645A is in the remote mode (the front-panel **REM** annunciator lights up), all front-panel controls are disabled except the **POWER** switch, and the **LOCAL** key (the **LOCAL** key can be disabled by configuring the HP 8645A in Local Lockout over HP-IB).

Table 5-1. HP-IB Capability Reference Table. (1 of 2)

HP-IB Capability	Applicable	Response	Related Commands and Controls*	Interface Functions*
Talker/ Listener	Yes	All Signal Generator functions with the exception of Knob control are programmable over HP-IB. The Signal Generator can send query responses and status information. The front-panel annunciators (TALK, REM, LSTN, SRQ) show the Signal Generator's current HP-IB state.	MLA MTA EOI	AH1 SH1 T6 L4
Trigger	No	The Signal Generator does not have a device trigger capability.	GET	DT0
Clear	Yes	The Signal Generator responds equally to DCL and SDC bus commands. The Clear capability does not reset instrument parameters.	DCL SDC	DC1
Remote	Yes	The Signal Generator's remote mode is enabled when the REN bus line is true. However, it remains in local (that is, the keyboard is active) until it is first addressed to listen. The output signal is unchanged when the Signal Generator enters remote mode. The front-panel RMT annunciator turns on when in remote mode.	REN MLA	RL1
Local	Yes	The Signal Generator returns to front-panel control when it enters local mode. The output signal is unchanged. Responds either to the GTL bus command or the front-panel Local key. The LOCAL key will not work if the instrument is in the LOCAL LOCKOUT state.	GTL	RL1

* Commands, Control Lines, and Interface Functions are defined in IEEE Std 488 (and the identical ANSI Standard MC1.1). Knowledge of these might not be necessary if your controller's manual describes programming in terms of the fourteen HP-IB messages shown in the left column.

Table 5-1. HP-IB Capability Reference Table. (2 of 2)

HP-IB Capability	Applicable	Response	Related Commands and Controls*	Interface Functions*
Local Lockout	Yes	The LOCAL key is disabled during Local Lockout so that only the controller or the POWER switch can return the Signal Generator to Local.	LLO	RL1
Clear Lockout/ Set Local	Yes	The Signal Generator returns to Local and Local Lockout is no longer true when the REN bus line goes false.	$\overline{\text{REN}}$	RL1
Pass Control/ Take Control	No	The Signal Generator cannot take control of HP-IB.	ATN IFC	C0
Request Service	Yes	The Signal Generator sets the SRQ bus line true if there is an unmasked bit in the status byte.	SRQ	SR1
Abort	Yes	The Signal Generator stops talking or listening.	IFC	T6 L4
Status Byte	Yes	The Signal Generator responds to a Serial Poll Enable (SPE) bus command by sending an 8-bit byte when addressed to talk. Bit 6 (RQS bit) is true if the Signal Generator has sent the Service Request Message. Each bit requires different conditions for clearing.	SPE SPD MTA	T6
Status Bit	No	The Signal Generator does not respond to a parallel poll.	ATN EOI	PP0
Extended Talker/ Listener	No	The Signal Generator does not have secondary addressing capabilities for talking or listening.	MSA	TE0 LE0
Driver Electronics	Yes	The Signal Generator uses tri-state electrical drivers.	None	E2
* Commands, Control Lines, and Interface Functions are defined in IEEE Std 488 (and the identical ANSI Standard MC1.1). Knowledge of these might not be necessary if your controller's manual describes programming in terms of the fourteen HP-IB messages shown in the left column.				

HP-IB Control Language Dictionary

All IEEE 488.2 common commands, and HP-SL commands are contained in the control language dictionary. All devices that comply with the IEEE 488.2 standard must have a set of common commands. The requirement of having common commands guarantees that all devices will have a minimum set of capabilities to permit programmers to write code that will work with all devices.

Before you proceed to use the dictionary, please read the HP-SL notes starting on the next page. The notes provide you with essential information and directions for using the dictionary.

The dictionary is alphabetically arranged by subsystems. A table of contents for all subsystems is as follows:

Table of Contents	AM Subsystem	5-18
	Amplitude Subsystem	5-19
	Calibration Subsystem	5-21
	Diagnostic Subsystem	5-21
	Display Subsystem	5-22
	FM Subsystem	5-23
	Frequency Subsystem	5-24
	Frequency Hop Subsystem	5-28
	HP-SL System Commands	5-32
	IEEE 488.2 Common Commands	5-33
	Initialize Subsystem	5-35
	LF Source Subsystem	5-36
	Marker Subsystem	5-45
	Modulation Subsystem	5-45
	Phase Modulation Subsystem	5-46
	Phase Subsystem	5-47
	Power Meter Subsystem	5-47
	Pulse Subsystem	5-48
	Reference Oscillator Subsystem	5-48
	Sequence Subsystem	5-49
	Status Subsystem	5-50
	Sweep Subsystem	5-54
	Take Sweep Subsystem	5-55
	Voltmeter Subsystem	5-55

HP-SL Notes

The entire dictionary is for use with the IEEE 488.2 standard.

All HP-SL entries in the dictionary can be written in uppercase or lowercase letters. Also, all entries are shown in either **bold** or *italics* typeface.

Any HP-SL entries in the dictionary that are written in *italics* are commands which allow you to set or query parameters which have only one accepted value, or are commands that cause an event which has no useful effect on the HP 8645A, or are commands that are aliases to another. In any case, the commands are accepted for purposes of HP-SL compatibility.

All HP-SL entries in the dictionary show the "short form" of the command in uppercase letters. The "long form" of the command includes both the uppercase and lowercase letters. For example, the keyword "frequency" is listed as "FREQuency". This indicates that "FREQ" is all that is required to execute this command. You could even have "FrEq" as the command since case is ignored.

Command messages sent to the HP 8645A must be terminated by a linefeed character (ASCII character 10) or EOI on the last character (unless the EOI would be embedded within a BCList or BSList string).

Commands statements must be separated by a semicolon. The keywords within the command message are separated by colons. Refer to the first part of this chapter for details about the HP-SL colon and semicolon.

All HP-SL entries in the dictionary that are enclosed in square brackets " [] " are considered optional keywords. The optional keywords are assumed by default and may be omitted.

Command parameters that you may choose between are separated by a vertical bar " | ". Parameters available with the commands in the dictionary include frequency ranges, amplitude ranges, On state, Off state, ac coupling, dc coupling, and so forth.

HP-SL Notes (Continued)

When the command parameter is acting like a switch, "ON", "OFF", "1", or "0" may be sent (ON=1 and OFF=0). But when responding to a query, either a "1" or a "0" will be sent.

Where MINimum and MAXimum are listed as command parameters, they will set that function to its specified minimum or maximum value. For example, the command statement "FREQ MAX" will set the standard HP 8645A to 1030 MHz. MINimum and MAXimum may also be coupled to a subsystem state. For example, if FM is off, FM? MAX is not limited by the RF frequency and would be 10 MHz. But if FM is on, FM? MAX is reduced by the synthesis mode and may be less than 10 MHz.

All HP-SL entries in the dictionary are arranged in a manner that explicitly defines its hierarchy in the tree structure. The keyword at the root is located at the extreme left, branching from the root is indicated by indentation. For example, a portion of the FM subsystem command tree is as follows:

```

FM
  [:DEVIation]
    :STEP
      [:INCRement]
        :STATe
        :COUPling

```

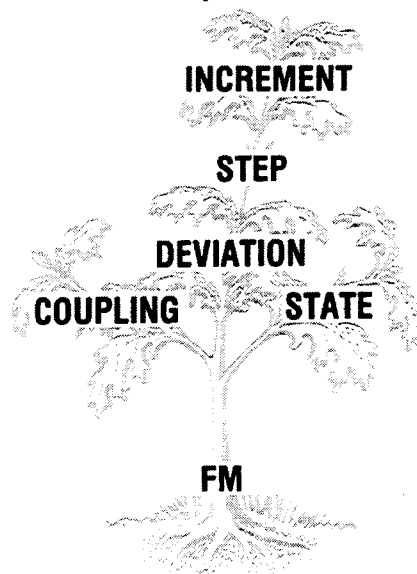

The following command statements and messages can be derived from this portion of the FM subsystem command tree. You will notice that several of the command statements are aliases for each other due to implicit couplings of optional keywords.

```

FM
FM:DEVIation
FM:DEVIation:STEP
FM:DEVIation:STEP:INCRement
FM:STEP
FM:STEP:INCRement
FM:STATe
FM:COUPling

```

HP-SL Notes (Continued)

Any command message whose first character is an asterisk (such as *CLS) is treated as though the leading asterisk were a colon. For example, "FM:SOURce EXTernal;*CLS" is interpreted as "FM:SOURce EXTernal" and "*CLS".

When you query a command which has mnemonic settings, like GROund or INTernal, the shortform version will be returned. For example, after setting "AM:COUPling" to "GRO", "GROUND", or "GND" the response from a query would always be "GRO".

To read instrument settings over HP-IB, send the query form of the command statement with the correct syntax as specified with a "?" in the dictionary, and address the HP 8645A to talk.

Phase Modulation "ΦM" will be referred to as PM in the dictionary.

<AM term>	When found in the dictionary, indicates that a "%" or "PCT" termination is required in the command statement. If no termination is specified, then a "% " value is assumed.
<ampl step term>	When found in the dictionary, indicates that a "dB", "V", "mV", "uV" termination is required in the command statement. If no termination is specified, then a "dB" value is assumed.
<ampl step unit>	When found in the dictionary, indicates that a "dB", or "V" termination must be specified in the command statement.
<ampl term>	When found in the dictionary, indicates that "dBm", "dBmW" ("dBmW" is alias for "dBm"), "dBuV", "V", "mV", "uV", or no termination is required in the command statement. If the command statement is not terminated, then "AMPLitude:UNIT" is assumed, except on "STEP" in which case "AMPLitude:STEP:UNIT" is assumed.
<ampl unit term>	When found in the dictionary, indicates that a "dBm", "dBmW", "V", or "dBuV" termination must be specified in the command statement.
<angle term>	When found in the dictionary, indicates that a "DEG", "RAD", or no termination must be specified in the command statement. If no termination is specified, then a "RAD" (radian) value is assumed.
<coupling type>	When found in the dictionary, indicates that sources "AC", "DC", "GROund", or "GND" are available.

**HP-SL Notes
(Continued)**

<freq term>	When found in the dictionary, indicates that "HZ", "KHZ", "MHZ", "MAHZ", "GHZ", or no termination is required in the command statement. If the command statement is not terminated, then "HZ" is assumed.
<lin ampl term>	When found in the dictionary, indicates that "V", "mV", "uV", or no termination is required in the command statement. If the command statement is not terminated, then "V" is assumed.
<mod_type>	When found in the dictionary, indicates that "AM", "FM", "PM", or "PULSe" is required in the command statement.
<non-decimal numeric program data>	When found in the dictionary, indicates that the pound symbol "#" should be followed by either a "B" and a binary representation of a number, or "Q" and a octal representation of a number, or "H" and a hexadecimal representation of a number. For example, the number 943 could be represented as "B1110101111", or "Q1657", or "H3AF".
<nrf>	When found in the dictionary, indicates that an ASCII representation of a number is required in the command statement. The number may be integer or floating-point, and may include a decimal exponent. (nrf stands for - flexible numeric representation - for further information, refer to the IEEE 488.2 standard.)
<ohms term>	When found in the dictionary, indicates that an "OHM", "KOHM", "MOHM" or no termination is required in the command statement. If the command statement is not terminated, "OHM" is assumed.
<source list>	When found in the dictionary, indicates that "INTernal", or "EXTernal", or more than one source separated by commas is required in the command statement. For example: "INTernal,EXTernal" or "EXTernal,INTernal".
<time term>	When found in the dictionary, indicates that "S", "mS", "uS", "nS" or no termination is required in the command statement. If the command statement does not have a termination "S" (seconds) is assumed.

AM Subsystem

AM

:DEPTH? [*MINimum* | *MAXimum*]

:DEPTH <nrf> [*<AM term>*] | *UP* | *DOWN* | *MINimum* | *MAXimum*
Sets AM depth in percent. *RST value is 0%.

:STEP

:INCRement? [*MINimum* | *MAXimum*]

:INCRement <nrf> [*<AM term>*] | *MINimum* | *MAXimum*

Sets AM depth step size in percent. *MINimum*/*MAXimum* refers to the smallest/largest programmable step size, not the smallest/largest allowed change. *RST value is 1% .

:STATe?

:STATe *ON* | *OFF* | *1* | *0*

Turns AM modulation ON or OFF. AM is not turned ON by just setting *AM:DEPth*. *RST value is OFF.

:SOURce?

:SOURce <source list>

Selects AM source: "EXTernal" or "INTernal". "INTernal,EXTernal" is accepted but will cause an execution error since the HP 8645A does not use both the internal audio source and an external audio source at the same time. *RST value is INTernal.

:COUPling?

:COUPling <coupling type>

Set source coupling for AM. GROund coupling is equivalent to having NONE displayed on the front panel; it does not turn AM OFF, but all sources are disconnected. *RST value is DC.

:FREQuency? [*MINimum* | *MAXimum*]

:FREQuency <nrf> [*<freq term>*] | *UP* | *DOWN* | *MINimum* | *MAXimum*
Alias to LFSOURCE:FREQuency.

:STEP

:INCRement? [*MINimum* | *MAXimum*]

:INCRement <nrf> [*<freq term>*] | *MINimum* | *MAXimum*

Alias to LFSOURCE:FREQuency:STEP.

Amplitude Subsystem

POWER may be used in place of AMPLitude as an alias. AMPLitude:OUT may be used in place of AMPLitude to specify front-panel output. AMPLitude:SOURce may be used in place of AMPLitude to refer to driving source voltage (EMF).

AMPLitude or POWER

[:OUT] or :SOURce

[:LEVel]? [MINimum | MAXimum]

[:LEVel] <nrf> [<ampl term>] | UP | DOWN | MINimum | MAXimum

Sets CW AMPLitude. LEVel is assumed if omitted in the command statement. *RST value is -137.0 dBm.

:STEP

[:INCRement]? [MINimum | MAXimum]

[:INCRement] <nrf> [<ampl step term>] | MINimum | MAXimum

Sets/queries the AMPLitude step size. MINimum/MAXimum refers to the smallest/largest programmable step size, not the allowed change. *RST value is 10 dB.

:UNIT?

:UNIT <ampl step unit>

Sets/queries the UNIT for amplitude steps. Allowable values of UNIT are V and dB.

If STEP:UNIT is specified as volts, an AMPLitude increment causes the amplitude to be stepped in volts regardless of AMPLitude:UNIT.

If STEP:UNIT is specified as dB, an AMPLitude increment causes the amplitude to be stepped in dB regardless of AMPLitude:UNIT. This allows operations such as setting level in volts and changing it in dB steps.

Setting AMPLitude:STEP with a UNITs suffix causes AMPLitude:STEP:UNIT to be set to dB or V based on the units sent. *RST value is dB.

:STATe?

:STATe ON | OFF | 1 | 0

Turns RF output ON or OFF. OFF disables the output. Setting LEVel does not turn this ON implicitly. *RST value is OFF.

:UNIT?

:UNIT <ampl unit term>

Specifies the units of AMPLitude for the HP 8645A. This command sets the implied UNIT for all parameters which have units of power or amplitude (except when the AMPLitude:STEP:UNIT command is sent). It is also used in a query response for these parameters.

If AMPLitude is set with a units suffix different than AMPLitude:UNIT, that UNIT is used in the command, but AMPLitude:UNIT is not changed. *RST is dBm.

:ULIMit? [MINimum | MAXimum]

:ULIMit <nrf> [<ampl term>] | MINimum | MAXimum

Sets MAXimum upper limit for AMPLitude. This command is equivalent to activating Special Function 103 from the front panel.

ULIMit is affected by POWER:GAIN in the same way as AMPLitude. If AMPLitude:ULIMit is set to less than AMPLitude, then AMPLitude is set to AMPLitude:ULIMit and an error is issued.

The MINimum value that can be set is 1 dB more than the minimum allowable amplitude setting. *RST value is 19.9 dBm.

:ATTenuation? [MINimum | MAXimum]

:ATTenuation <nrf> [dB] | UP | DOWN | MINimum | MAXimum

Sets or reads the value of the attenuator. This command is equivalent to activating Special Function 101 from the front panel.

Units are in dB of attenuation. Setting attenuation in dB sets POW:ATT:AUTO to OFF. Changing attenuation in dB changes the output level. *RST value is dependent on the option configuration, and is coupled to POWER:LEVel.

:STEP

[:INCRement]?

Reads the attenuator step size.

:AUTO?

:AUTO ON | OFF | 1 | 0

When set ON, the firmware will control the attenuators.

Turning it OFF, causes the attenuator range to hold to its present setting. This command is equivalent to activating Special Function 100 from the front panel. *RST value is ON.

:GAIN? [MINimum | MAXimum]

:GAIN <nrf> [dB] | MINimum | MAXimum

Adjusts displayed/entered power level. Changing the GAIN does not change the actual output level, but it does change the displayed values shown on the front panel. *RST value is 0 dB.

:ALC

:BANDwidth

:AUTO?

:AUTO ON | OFF | 1 | 0

Enables or disables automatic selection of ALC bandwidth based on frequency and modulation. When OFF the widest ALC BANDwidth is forced. This command is equivalent to activating Special Function 104 from the front panel (in which case, off = narrowband and on = wideband). *RST value is ON.

:MUTing?

:MUTing ON | OFF | 1 | 0

The muting command is equivalent to activating Special Function 105 from the front panel.

Calibration Subsystem

CALibration

[:ALL]?

Performs an instrument self-calibration, and then returns an error code (an error code of "0" indicates no failures). Alias to *CAL?

:AMPLitude

:STATe?

:STATe ON | OFF | 1 | 0

Enables or disables the use of AMPLitude correction data. This command is equivalent to activating Special Function 102 from the front panel. *RST value is ON.

Diagnostic Subsystem

These command descriptions are detailed in the Service Diagnostics Manual (part number 08645-90024).

Display Subsystem

Front Panel display and annunciators may be blanked completely or in selective function groups.

DISPlay

:STATe?

:STATe ON | OFF | 1 | 0

:ANNotation

[:ALL]?

[:ALL] ON | OFF | 1 | 0

Enables/disables the front-panel display. This command is equivalent to activating Special Function 191 from the front panel. *RST value is ON.

:FREQuency?

:FREQuency ON | OFF | 1 | 0

Enables/disables front-panel display of RF output frequency. This command is equivalent to activating Special Function 192 from the front panel. *RST value is ON.

:MODulation?

:MODulation ON | OFF | 1 | 0

Enables/disables front-panel display of modulation. This command is equivalent to activating Special Function 193 from the front panel. *RST value is ON.

:AMPLitude?

:AMPLitude ON | OFF | 1 | 0

Enables/disables front-panel display of amplitude. This command is equivalent to activating Special Function 195 from the front panel. *RST value is ON.

:LFSource?

:LFSource ON | OFF | 1 | 0

Enables/disables front-panel display of audio source. This command is equivalent to activating Special Function 194 from the front panel. *RST value is ON.

:RADix?

:RADix US | EUROpean

When US (United States) is active, numbers shown on the front panel use a decimal to indicate the "ones" digit position. Commas are used to indicate thousands, millions, and so forth, positions.

When EUROpean is active, the commas and decimals shown on the front panel are reversed. For example 123456789 Hz would be shown as 123,456,789.00 Hz in US mode and 123.456.789,00 Hz in EUROpean.

This command affects the front-panel display only, all numbers sent over HP-IB must be sent in the US radix.

This command is equivalent to activating Special Function 196 from the front panel. *RST value is US.

FM Subsystem

The HP 8645A cannot do simultaneous FM and PM. If PM is on, and someone requests FM, the following will happen: FM is turned on, PM is turned off, and an error is displayed on the front panel.

FM

[:DEViation]? [MINimum | MAXimum]

[:DEViation] <nrf> [<freq term>] | UP | DOWN | MINimum | MAXimum

Set/query FM deviation. *RST value is 1 kHz.

:STEP

[:INCRement]? [MINimum | MAXimum]

[:INCRement] <nrf> [<freq term>] | MINimum | MAXimum

Set/query the step size for FM. MINimum/MAXimum refers to the smallest/largest programmable step size, not the smallest/largest allowed change. *RST value is 1 kHz.

:STATe?

:STATe ON | OFF | 1 | 0

Queries/turns FM ON or OFF. *RST value is OFF.

:SOURce?

:SOURce <source list>

Selects FM source: "INternal", "EXternal", or "INternal,EXternal". *RST value is INternal.

:COUPling?

:COUPling <coupling type>

Sets/queries coupling for FM. GROund coupling is equivalent to having NONE displayed on the front panel; it does not turn FM OFF but disconnects all sources. *RST value is DC.

:MODE?

:MODE **LINEar** | **DIGitized**

Sets/queries true (LINEar) or synthesized (DIGitized) FM. This command is equivalent to activating Special Function 120 from the front panel. *RST value is DIGitized.

:FREQuency? [**MINimum** | **MAXimum**]

:FREQuency <nrf> [<freq term>] | **UP** | **DOWN** | **MINimum** | **MAXimum**
Alias to LFSOURCE:FREQuency.

:STEP

[**:INCRement**]? [**MINimum** | **MAXimum**]

[**:INCRement**] <nrf> [<freq term>] | **MINimum** | **MAXimum**

Alias to LFSOURCE:FREQuency:STEP.

:IMPedance? **MINimum** | **MAXimum**

:IMPedance <nrf> [<ohms term>] | **MINimum** | **MAXimum**

Sets the Φ M Modulation Input connector as an FM input to provide a port with an external input impedance of 600 Ω . The front-panel FM Modulation Input connector (which has an external input impedance of 50 Ω) is then disabled. This command is equivalent to activating Special Function 123 from the front panel.

A query will respond with either 50 or 600 ohms.

Frequency Subsystem

FREQuency

[**:CW**]? [**MINimum** | **MAXimum**]

[**:CW**] <nrf> [<freq term>] | **UP** | **DOWN** | **MINimum** | **MAXimum**
Set/query non-swept frequency. Does not disable SWEep. *RST value is 100 MHz.

:STEP

[**:INCRement**]? [**MINimum** | **MAXimum**]

[**:INCRement**] <nrf> [<freq term>] | **MINimum** | **MAXimum**

Sets STEP size for RF output frequency related commands (FREQuency, FREQuency:STARt, FREQuency:STOP, CENTer, SPAN, MARKer, MARKer2, MARKer3).

MINimum/MAXimum refers to the smallest/ largest programmable step size, not the smallest/largest allowed change. *RST value is 10 MHz.

:START? [MINimum | MAXimum]

:START <nrf> [<freq term>] | UP | DOWN | MINimum | MAXimum

Sets START frequency for a sweep. Does not enable SWEEP. May change other SWEEP parameters as listed in the following "Rules for Couplings Between:". *RST value is 251,464.85 Hz.

:STEP

[:INCREMENT]? [MINimum | MAXimum]

[:INCREMENT] <nrf> [<freq term>] | MINimum | MAXimum

Alias to FREQUENCY:STEP.

:STOP? [MINimum | MAXimum]

:STOP <nrf> [<freq term>] | UP | DOWN | MINimum | MAXimum

Sets STOP frequency for a sweep. Does not enable SWEEP. May change other SWEEP parameters as listed in the following "Rules for Couplings Between:". *RST value is 1030 MHz.

:STEP

[:INCREMENT]? [MINimum | MAXimum]

[:INCREMENT] <nrf> [<freq term>] | MINIMUM | MAXIMUM

Alias to FREQUENCY:STEP.

:CENTER? [MINimum | MAXimum]

:CENTER <nrf> [<freq term>] | UP | DOWN | MINimum | MAXimum

Sets CENTER frequency for a sweep. Does not enable SWEEP. May change other SWEEP parameters as listed in the following "Rules for Couplings Between:". *RST value is (START+STOP)/2.

:STEP

[:INCREMENT]? [MINimum | MAXimum]

[:INCREMENT] <nrf> [<freq term>] | MINimum | MAXimum

Alias to FREQUENCY:STEP.

:SPAN? [MINimum | MAXimum]

:SPAN <nrf> [<freq term>] | UP | DOWN | MINimum | MAXimum

Sets frequency SPAN for a sweep. Does not enable SWEEP. May change other SWEEP parameters as listed in the following "Rules for Couplings Between:". *RST value is STOP-START.

:STEP

[:INCRement]? [MINimum | MAXimum]

[:INCRement] <nrf> [<freq term>] | MINimum | MAXimum

Alias to FREQUENCY:STEP.

Rules for

Couplings Between: FREQUENCY:START, FREQUENCY:STOP,
FREQUENCY:CENTER, and FREQUENCY:SPAN

If only START is sent in the command message:

STOP is unchanged
CENTER is set to $(START + STOP)/2$
SPAN is set to $(STOP - START)$

If only STOP is sent in the command message:

START is unchanged
CENTER is set to $(START + STOP)/2$
SPAN is set to $(STOP - START)$

If only CENTER is set in the command message:

SPAN is unchanged
START is set to $(CENTER - (SPAN/2))$
STOP is set to $(CENTER + (SPAN/2))$

If only SPAN is set in the command message:

CENTER is unchanged
START is set to $(CENTER - (SPAN/2))$
STOP is set to $(CENTER + (SPAN/2))$

If START and STOP are set in the same command message:

CENTER is set to $(START + STOP)/2$
SPAN is set to $(STOP - START)$

If START and CENTER are set in the same command message:

STOP is set to $(START + 2(CENTER-START))$
SPAN is set to $2(CENTER-START)$

If START and SPAN are set in the same command message:

STOP is set to $(START + SPAN)$
CENTER is set to $(START + (SPAN/2))$

If STOP and CENTER are set in the same command message:

START is set to $(STOP - 2(STOP-CENTER))$
SPAN is set to $2(STOP-CENTER)$

If STOP and SPAN are set in the same command message:

START is set to (STOP - SPAN)
CENTer is set to (STOP - (SPAN/2))

If CENTER and SPAN are set in the same command message:

START is set to (CENTer - (SPAN/2))
STOP is set to (CENTer + (SPAN/2))

If more than two of START, STOP, CENTER SPAN commands are sent in one statement, the last two sweep parameters modified will be used, as described in the "Rules for Couplings Between". All changes to the other parameters will be ignored.

:MANual? [MINimum | MAXimum]

:MANual <nrf> [<freq term>] | UP | DOWN | MINimum | MAXimum

Controls frequency during a manual sweep. Limits are FREQUENCY:START to FREQUENCY:STOP. *RST value is the same as FREQUENCY:START.

:OFFSet? [MINimum | MAXimum]

:OFFSet <nrf> [<freq term>] | MINimum | MAXimum

Sets a reference frequency for other absolute frequency settings in the HP 8645A (CW, START, STOP, but not FM or SPAN).

Changes entered/displayed values but does not change RF output frequency. *RST value is 0 Hz. The coupling equation is as follows:

$$\text{Entered/Displayed Frequency} = (\text{Hardware Freq} \times \text{Multiplier}) + \text{Offset}$$

:MULTIplier? [MINimum | MAXimum]

:MULTIplier <nrf> | MINimum | MAXimum

Sets a reference multiplier for other frequency settings in the HP 8645A (CW, START, STOP, as well as FM and SPAN). This command is equivalent to activating Special Function 111 from the front panel.

This command changes the entered/displayed values, but does not actually change the RF output frequency.

Resolution for this command is integer values, or one over integer values (1/2, 1/3, 1/4 ...). *RST value is 1.

The coupling equation is as follows:

$$\text{Entered/Displayed Frequency} = (\text{Hardware Freq} \times \text{Multiplier}) + \text{Offset}$$

OR

$$\text{Entered/Displayed Frequency} = (\text{Hardware Freq} \times \text{Multiplier}) \text{ in cases where offset is not to be used.}$$

:SYNThesis?**:SYNThesis** <nrf>

Sets synthesis mode for the HP 8645A. This command is equivalent to pressing one of the Synthesis Mode keys on front panel.

Setting this value sets FREQUency:SYNThesis:AUTO to OFF. *RST value is dependent on hardware configuration.

:AUTO?**:AUTO** ON | OFF | 1 | 0

Turning AUTO to ON, allows the firmware to select the synthesis mode. This command is equivalent to pressing the Synthesis Mode key AUTO on the front panel.

Turning AUTO to OFF, leaves the HP 8645A in its current synthesis mode. *RST value is ON.

:MODE?**:MODE** CW | SWEEp

Determines which commands control the frequency subsystem. If SWEEp is selected, then the commands FREQUency:START, STOP, CENTer, SPAN, and MANual control the frequency subsystem. *RST value is CW.

:INSTantaneous?

Returns the instantaneous RF output frequency during DIGitized FM. This command is equivalent to activating Special Function 121 from the front panel.

Frequency Hop Subsystem

These commands will work only when the HP 8645A is put into the Mode 5, Fast Hop position (FREQUency:SYNThesis 5). At other times, these commands may be queried, but attempting to set them when not in the Mode 5, Fast Hop, causes an error.

FHOP**[:IMMEDIATE]**

Triggers a hop when the FHOP:MODE is set to STEPPed, and the source is set to INTernal.

:ALC**:STATE?****:STATE** ON | OFF | 1 | 0

Selects whether ALC is in closed loop (ON) or open loop (OFF) operation in Mode 5, Fast Hop. This command is equivalent to activating Special Function 202 from the front panel (in which case, off = closed and on = open). *RST value is ON.

:BUFFering?**:BUFFering** ON | OFF | 1 | 0

Selects whether frequency hop channel sequences from the Fast Hop Bus are buffered (ON) or sent unbuffered (OFF) to the Fast Hop Controller. This command is equivalent to activating Special Function 201 from the front panel (in which case, on = buffered and off = unbuffered). *RST value is ON.

:MODE?**:MODE** SINGle | STEPped | CONTInuous | FBUS

Used in selecting one of the nine frequency hop modes as shown below. *RST value is CONTInuous.

Nine frequency hop modes:

Ext Repetitive	FHOP:MODE CONT;SOUR EXT
Int Repetitive	FHOP:MODE CONT;SOUR INT
Ext Stepped Int Dwell	FHOP:MODE STEP;SOUR EXT;DWEL:SOUR INT
Ext Stepped Ext Dwell	FHOP:MODE STEP;SOUR EXT;DWEL:SOUR EXT
Int Stepped	FHOP:MODE STEP;SOUR INT
Ext Single	FHOP:MODE SING;SOUR EXT
Int Single	FHOP:MODE SING;SOUR INT
Fast Hop Bus Int Dwell	FHOP:MODE FBUS;DWEL:SOUR INT
Fast Hop Bus Ext Dwell	FHOP:MODE FBUS;DWEL:SOUR EXT

:SOURce?**:SOURce** INTernal | EXTernal

Selects source for fast hop control with one of the nine frequency hop modes. *RST value is INTernal.

:DWELI? [MINimum | MAXimum]**:DWELI** <nrf> [<time term>] | MINimum | MAXimum | UP | DOWN

Sets dwell time for the frequency hop. *RST value is 2 mS.

:SOURce?**:SOURce** INTernal | EXTernal

Determines whether DWELI is controlled by the INTernal timer or by EXTernal control for the selected frequency hop mode. *RST value is INTernal.

:STEP

[:INCRement]? [MINimum | MAXimum]

[:INCRement] <nrf> [<freq term>] | MINimum | MAXimum

Sets the increment value for the dwell time. MINimum/MAXimum refers to the smallest/largest programmable increment, not the smallest/largest allowed change. *RST value is 100 μ sec.

:RATE? [MINimum | MAXimum]

:RATE <nrf> [<freq term>] | MINimum | MAXimum | UP | DOWN
Sets hop rate for the frequency hop. *RST value is 250 Hz.

:STEP

[:INCRement]? [MINimum | MAXimum]

[:INCRement] <nrf> [<freq term>] | MINimum | MAXimum

Sets the increment value for the hop rate. MINimum/MAXimum refers to the smallest/largest programmable increment, not the smallest/largest allowed change. *RST value is 10 Hz.

:STATe?

:STATe IDLE | LEARn | HOP

Controls the state that the HP 8645A is put into. Three conditions are available when the HP 8645A is set to Mode 5, Fast Hop: the IDLE state, the LEARn state, and the HOP state.

Changing any FHOP or RF output parameters will force STATe to be IDLE.

Final error checking to ensure correct programming is done when the transition is made from the IDLE state, to the LEARn state. The HP 8645A cannot go directly from the IDLE state, to the HOP state without first going through the Learn State. *RST value is IDLE.

:SCHannel <nrf>

Store current frequency and amplitude settings in a channel register. There are 2400 (or 8000 channel registers for instruments with serial prefix 3019A and above) channel registers available from 0 to 2399. *RST does not affect the channel register.

:RCHannel <nrf>

Recall the frequency and amplitude settings from any channel register in the channel table. The channel table consists of 2400 channel registers available from 0 to 2399 (or 8000 channel registers for instruments with serial prefix 3019A and above).

:CLISt?

:CLISt <chan_list>

The CLISt command is used to clear all entries in the channel table when a null list is sent. Also, the CLISt command sets up the channel table when <chan_list> is specified as shown below. The channel table consists of 2400 channel registers available from 0 to 2399 (or 8000 channel registers available from 0 to 7999 for serial prefix 3019A and above).

The syntax used to generate a <chan_list> is:

chan_list figure goes here

<chan> = — <freq> [<freq term>] , <ampl> [<ampl term>] —>

The CLISt? command is a query that lists the contents of the channel table (NOTE: When queried, frequency units are always returned in HZ, and amplitude units are returned in the units set by AMPLitude:UNIT). *RST does not change CLISt.

:BCList?

:BCList <binary_chan_list>

The BCList/BCList? commands are the same as the CLIST/CLIST? commands, except that data is sent/returned faster in a binary format. To get data in a binary form, load a list of channels into the HP 8645A using the CLIST command, then read the data out using the BCList? command. Save the data on a disc for use later on. *RST does not change BCList.

:SLIST?

:SLIST <seq_list>

The SLIST command is used to clear all entries in the sequence table when a null list is sent. Also, the SLIST command sets up the sequence table when <seq_list> is specified as shown below. The sequence table consists of 4000 registers available from 0 to 3999 (or 8000 registers available from 0 to 7999 for instruments with serial prefix 3019A and above).

The syntax used to generate a <seq_list> is:

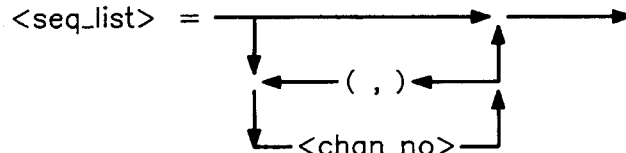

<chan_no> = number of next channel in the sequence.

The SLIST? command is a query that lists the contents of the sequence table (NOTE: If the sequence list is clear, a default sequence of 0,1,2...N-1 is used where N is the number of channels programmed). *RST does not change SLIST.

:BSList?

:BSList <binary_seq_list>

The BSList/BSList? commands are the same as the SLIST/SLIST? commands, except that data is sent/returned faster in a binary format. To get data in a binary form, load a list of sequences into the HP 8645A using the SLIST command, then read the data out using the BSList? command. Save the data on a disc for use later on. *RST does not change BSList.

:RSEquence <nrf>

Recalls the frequency and amplitude settings of the any channel in the sequence table. The sequence table has 4000 registers available from 0 to 3999 (or 8000 registers available from 0 to 7999 for instruments with serial prefix 3019A and above).

:AOFFset?

:AOFFset <nrf> [<ampl term>] | MINimum | MAXimum | UP | DOWN

Allows you to extend the amplitude level variation of the RF output by -15 dB during the Hop State without causing the HP 8645A to enter the Learn State. This command is equivalent to activating special function 203 from the front panel.

HP-SL System Commands

SYSTEM

:ERRor? [NUMeric | STRing]

Reads an error from the system error queue. Returns a zero if the queue is empty. If SYSTEM:ERRor? or SYSTEM:ERRor? NUMeric is used, the HP 8645A returns only a number as described in the table shown below. If SYSTEM:ERRor? STRing is used, the HP 8645A returns a number followed by a comma, and a quoted string containing a standard generic error message, a colon, and a specific error message.

Numeric	Error Message	Numeric	Error Message
100	Command Error	211	Legal Command but Settings Conflict
101	Invalid Character Received	212	Argument out of Range
110	Command Header Error	222	Insufficient Capability or Configuration
111	Header Delimiter Error	232	Output Buffer Full or Overflow
120	Numeric Argument Error	300	Device Failure
121	Wrong Data Type (Numeric Expected)	310	RAM Error
123	Numeric Overflow	311	RAM Failure
129	Missing Numeric Argument	312	RAM Data Loss
130	Non Numeric Argument Error	313	Calibration Data Loss
131	Wrong Data Type (Char Expected)	320	ROM Error
132	Wrong Data Type (String Expected)	321	ROM Checksum
133	Wrong Data Type (Block Type #D Required)	322	Hardware and Firmware Incompatible
139	Missing Non Numeric Argument	330	Power on Test Failed
142	Too Many Arguments	340	Self Test Failed
143	Argument Delimiter Error	400	Query Error
144	Invalid Message Unit Delimiter	410	Query Interrupted
200	No Can Do	420	Query Unterminated
201	Not Executable in Local Mode	422	Addressed to Talk with Nothing to Say
202	Settings Lost Due to RTL* or PON*	430	Query Deadlocked

* Return to Local (RTL) or Power On (PON).

For example, if an attempt is made to set the frequency to a value higher than is possible, SYSTEM:ERRor? would return: -212 which is an argument out of range error. Under the same conditions a SYSTEM:ERRor? STRing query would return: -212,"ARGUMENT OUT OF RANGE:FREQUENCY TOO HIGH" Refer to appendix D for a descriptive list of all error messages.

:STATe

:CALL

This event causes all save/recall registers to be cleared.

:SECurity?**:SECurity** **ON | OFF | 1 | 0**

Controls the security mode of the HP 8645A. This command is equivalent to activating Special Function 173 from the front panel. When in the secure mode, any display annunciators which have been disabled cannot be re-enabled. This value is not affected by *RST or *RCL. This value is not effected by power cycles unless memory is lost during power down. When this value is switched from ON to OFF, all memory in the HP 8645A is erased when the equivalent of Special Function 172 (RAM Wipe) is performed.

IEEE 488.2 Common commands

***CAL? Self calibration query**

Causes the HP 8645A to perform an internal self-calibration and returns an integer error code. An error code of zero indicates no failures, other numbers indicate some error. A list of specific error codes are defined in the Service Diagnostics Manual (part number 08645-90024). This command is equivalent to activating Special Function 171 from the front panel.

***CLS Clear status command**

Clears the status register and associated status data structures summarized in the Status Byte, such as the Event Status Register. Clears output and error queues. Clears all event registers.

***ESE <nrf> <non-decimal numeric program data> Event status enable command**

Sets the Standard Event Status Enable Register. A more detailed description of the status reporting is included in the "HP-IB Device Status Dictionary".

***ESE? Event status enable query**

Queries the Standard Event Status Enable Register. A more detailed description of the status reporting is included in the "HP-IB Device Status Dictionary".

***ESR? Event status register query**

Queries the Standard Event Status Register. A more detailed description of the status reporting is included in the "HP-IB Device Status Dictionary".

***IDN? Identification query**

Returns an identification string which is 4 fields separated by commas.

Field 1 : Is always HEWLETT-PACKARD.

Field 2 : Is model number like 8645A.

Field 3 : Is a serial number in HP format e.g. 2419A00873 or a 0 if the serial number is unknown (Equivalent to activating Special Function 190).

Field 4 : Is the firmware version number.

For example: HEWLETT-PACKARD,8645A,2813A09875,REV 1.0.0

***OPC Operation complete command**

Will cause the OPC bit to be set in the standard event status register when a sweep or learn operation is complete. Since the bus is released before a sweep or learn is completed, you may re-synchronize after these operations are complete.

***OPC? Operation complete query**

Will cause an ASCII 1 to be returned when a sweep or learn operation is complete. Since the bus is released before a sweep or learn is completed, you may re-synchronize after these operations are complete.

***OPT? Option query**

Identifies reportable options in current instrument configuration. Each option is indicated by a mnemonic and multiple reportable options are separated by commas. If the HP 8645A has no reportable options in place, the option query returns a zero.

***RST Reset command**

Causes the HP 8645A to do an instrument preset. Sets all operating parameters to the known states listed in this Dictionary. It does not effect the status reporting information, nor does it clear the error or message queue, and does not affect the contents of the 50 storage registers, or the channel table and sequence table registers.

The *RST command must be put on a separate line of code.

***SAV <nrf> Save instrument state**

Saves the instrument state in the specified register number. The HP 8645A has 50 available storage registers. The first ten registers (0-9) accepts all front panel settings (except for some Special Functions). The next forty registers (10-49) accepts only frequency and amplitude settings.

***SRE <nrf> <non-decimal numeric program data> Service request enable command**

Sets the Service Request Enable Register. A more detailed description of the status reporting is included in the *"HP-IB Device Status Dictionary"*.

***SRE? Service request enable query**

Queries the Service Request Enable Register. A more detailed description of the status reporting is included in the *"HP-IB Device Status Dictionary"*.

***STB? Read status byte query**

Sets or queries the HP-IB Status Byte. A more detailed description of the status reporting is included in the *"HP-IB Device Status Dictionary"*.

***RCL <nrf> Recall instrument state**

Recalls the instrument state which was stored in the specified register number. The HP 8645A has 50 available storage registers. The first ten registers (0-9) accepts all front panel settings (except for some Special Functions). The next forty registers (10-49) accepts only frequency and amplitude settings.

***RCL <nrf> Recall instrument state**

Recalls the instrument state which was stored in the specified register number. The HP 8645A has 50 available storage registers. The first ten registers (0-9) accepts all front panel settings (except for some Special Functions). The next forty registers (10-49) accepts only frequency and amplitude settings.

***TST? Self-test query**

Causes the HP 8645A to perform internal instrument level diagnostics and returns an integer error code. An error code of zero indicates no failures, other numbers indicate some error. A list of specific error codes are defined in the Service Diagnostics Manual (part number 08645-90024). This command is equivalent to activating Special Function 170 from the front panel.

***WAI Wait-to-continue command**

Causes the HP 8645A to not accept any further input or output between the end of the message containing *WAI, and the completion of all command processing for that message.

Initialize Subsystem

INITialize

:STATe?

:STATe PAUSE | RUN

Returns PAUSE or RUN to determine if the HP 8645A is actually sweeping or idle. This parameter only has meaning when FREQUENCY:MODE is SWEep, and when SWEep:MODE is AUTO. *RST value is PAUSE.

:MODE?

:MODE CONTInuous | SINGLE

Determines if the HP 8645A is performing single sweep or continuous sweep. After a single SWEep is done, INITialize:STATe becomes PAUSE, and an INITialize command is required to restart the SWEep. *RST value is CONTInuous.

:ABORt

Aborts any current sweep. Sets INITialize:STATe to PAUSE.

[:IMMediate]

Sets INITialize:STATe to RUN, and starts a single SWEep or a continuous SWEep. If a SWEep is already in progress, it is aborted and restarted.

LF Source Subsystem

LFSource

[:FREQUency]? [MINimum | MAXimum]

[:FREQUency] <nrf> [<freq term>] | UP | DOWN | MINimum | MAXimum

Sets frequency of the audio source. This command is equivalent to the command <mod_type>:FREQ. *RST value is 1 kHz.

:STEP

[:INCRement]? [MINimum | MAXimum]

[:INCRement] <nrf> [<freq term>] | MINimum | MAXimum

Sets the step for the audio source. MINimum/MAXimum refers to the smallest/largest programmable step size, not the smallest/largest allowed change. *RST value is 100 Hz.

:STATe?

:STATe ON | OFF | 1 | 0

Turns the LF source ON or OFF. Setting the frequency or level for the LF does not by itself turn the source ON.

Any attempt to turn LFSource:STATe OFF while any <mod_type>'s STATe is ON, and its SOURce includes INTernal will result in an error. In other words, the HP 8645A will not turn off the LFSource while it is being used for modulation. *RST value is OFF.

:WAVEform?

:WAVEform SINE | SQUARE | SAWTOOTH | WGNnoise

Selects a waveform for the LF Source: SINE, SQUARE, SAWTOOTH or White Gaussian Noise (WGNnoise) is available. This command is equivalent to activating Special Function 130 from the front panel. *RST value is SIN.

:LEVel? [MINimum | MAXimum]

:LEVel <nrf> [<lin ampl term>] | UP | DOWN | MINimum | MAXimum

Sets level of the audio source in volts. *RST value is 1 V.

:STEP

[:INCRement]? [MINimum | MAXimum]

[:INCRement] <nrf> [<lin ampl term>] | MINimum | MAXimum

Sets the LFSOURCE:LEVEL step. MINimum/MAXimum refers to the smallest/largest programmable step size, not the smallest/largest allowed change. *RST value is 0.1 V.

:TRIGger

[:IMMediate]

Causes a one-shot trigger of the LFSOURCE if SOURCE is set to EXT. This command is equivalent to activating Special Function 132 with 131 turned ON, from the front panel.

:SOURCE?

:SOURCE EXTernal | CONTInuous

Defines whether the LFSOURCE is continuous or triggered by an external transition. This command is equivalent to activating Special Function 131 from the front panel. In which case, $\square H$ would be EXTernal and $\square FF$ would be CONTInuous. *RST value is CONTInuous.

:FREQUency2? [MINimum | MAXimum]

:FREQUency2 <nrf> [<freq term>] | UP | DOWN | MINimum | MAXimum

Sets the frequency of the audio source in Channel 2. This command is equivalent to setting frequency for the second audio source with Special Function 133 turned ON. *RST value is 400 Hz.

:STEP

[:INCRement]? [MINimum | MAXimum]

[:INCRement] <nrf> [<freq term>] | MINimum | MAXimum

Sets the LFSOURCE:FREQUency2 step size for the audio source in Channel 2. MINimum/MAXimum refers to the smallest/largest programmable step size, not the smallest/largest allowed change. *RST value is 100 Hz.

:WAVEform2?

:WAVEform2 SIN | SQUARE | TRIangle | SAWTooth | WGNoise

Selects a waveform for the audio source in Channel 2: SINE, SQUARE, TRIangle, SAWTooth or White Gaussian Noise (WGNoise). This command is equivalent to activating Special Function 135 from the front panel. *RST value is SINE.

:STATe2?

:STATe2 **ON | OFF | 1 | 0**

Turns the audio source in Channel 2 either ON or OFF. Setting the frequency or level does not by itself turn the audio source in Channel 2 ON. This command is equivalent to activating Special Function 133 from the front panel. *RST value is OFF.

:LEVel2? **[MINimum | MAXimum]**

:LEVel2 **<nrf> [<lin ampl term>] | UP | DOWN | MINimum | MAXimum**

Sets the level of the audio source in Channel 2. This command is equivalent to activating Special Function 134 from the front panel. *RST value is 100 mV.

:STEP

[:INCRement]? [MINimum | MAXimum]

[:INCRement] <nrf> [<lin ampl term>] | MINimum | MAXimum

Sets the LFSource:LEVel2 step size for the audio source in Channel 2. MINimum/MAXimum refers to the smallest/largest programmable step size, not the smallest/largest allowed change. *RST value is 100 mV.

:PHASe2

[:ADJust]? [MINimum | MAXimum]

[:ADJust] <nrf> [<angle term>] | UP | DOWN | MINimum | MAXimum

Adjusts the phase of the audio source in Channel 2 in terms of degrees or radians. This command is equivalent to activating Special Function 136 from the front panel. *RST value is 0°.

:STEP

[:INCRement]? [MINimum | MAXimum]

[:INCRement] <nrf> [<angle term>] | MINimum | MAXimum

Sets the LFSource:PHASe2 step size for the audio source in Channel 2. MINimum/MAXimum refers to the smallest/largest programmable step size, not the smallest/largest allowed change. *RST value is 1°(0.017 radians).

:AM

[:DEPTH]? [MINimum | MAXimum]

[:DEPTH] <nrf> [<am term>] | UP | DOWN | MINimum | MAXimum

Sets the percentage of AM depth applied to the audio source in Channel 1. This command is equivalent to setting AM depth on the sub-carrier with Special Function 137 turned ON. *RST value is 0%.

:STEP

[:INCREMENT]? [MINimum | MAXimum]

[:INCREMENT] <nrf> [<am term>] | MINimum | MAXimum

Sets the LFSOURCE:AM:DEPTH step size for the AM source in Channel 1. MINimum/MAXimum refers to the smallest/largest programmable step size, not the smallest/largest allowed change. *RST value is 1%.

:STATE?

:STATE ON | OFF | 1 | 0

Turns the AM source in Channel 1 either ON or OFF. Setting AM frequency or depth does not by itself turn the AM source in Channel 1 ON. This command is equivalent to activating Special Function 137 from the front panel. *RST value is OFF.

:FREQUENCY? [MINimum | MAXimum]

:FREQUENCY <nrf> [<freq term>] | UP | DOWN | MINimum | MAXimum

Sets the frequency rate for the AM source in Channel 1. This command is equivalent to activating Special Function 138 from the front panel. *RST value is 100 Hz.

:STEP

[:INCREMENT]? [MINimum | MAXimum]

[:INCREMENT] <nrf> [<freq term>] | MINimum | MAXimum

Sets the LFSOURCE:AM:FREQUENCY step size for the AM source in Channel 1. MINimum/MAXimum refers to the smallest/largest programmable step size, not the smallest/largest allowed change. *RST value is 100 Hz.

:WAVEFORM?

:WAVEFORM SIN | SQUARE | TRIANGLE | SAWTOOTH | WGNNOISE

Selects a waveform for the AM source in Channel 1: SINE, SQUARE, TRIANGLE, SAWTOOTH or White Gaussian Noise (WGNNOISE). This command is equivalent to activating Special Function 139 from the front panel. *RST value is SINE.

:PHASe**[:ADJust]? [MINimum | MAXimum]****[:ADJust] <nrf> [<angle term>] | UP | DOWN | MINimum | MAXimum**

Adjusts the phase of the AM source in Channel 1 in terms of degrees or radians. This command is equivalent to activating Special Function 140 from the front panel. *RST value is 0°.

:STEP**[:INCRement]? [MINimum | MAXimum]****[:INCRement] <nrf> [<angle term>] | MINimum | MAXimum**

Sets the LFSOURCE:AM:PHASe step size for the AM source in Channel 1. MINimum/MAXimum refers to the smallest/largest programmable step size, not the smallest/largest allowed change. *RST value is 1°(0.017 radians).

:FM**[:DEViation]? [MINimum | MAXimum]****[:DEViation] <nrf> [<freq term>] | UP | DOWN | MINimum | MAXimum**

Sets the percentage of FM deviation applied to the audio source in Channel 1. This command is equivalent to setting FM deviation on the sub-carrier with Special Function 141 turned ON. *RST value is 0 Hz.

:STEP**[:INCRement]? [MINimum | MAXimum]****[:INCRement] <nrf> [<freq term>] | MINimum | MAXimum**

Sets the LFSOURCE:FM:DEViation step size for the FM source in Channel 1. MINimum/MAXimum refers to the smallest/largest programmable step size, not the smallest/largest allowed change. *RST value is 10 Hz.

:STATe?**:STATe ON | OFF | 1 | 0**

Turns the FM source in Channel 1 either ON or OFF. Setting FM frequency or deviation does not by itself turn the FM source in Channel 1 ON. This command is equivalent to activating Special Function 141 from the front panel. *RST value is OFF.

:FREQUency? [MINimum | MAXimum]

:FREQUency <nrf> [<freq term>] | UP | DOWN | MINimum | MAXimum

Sets the frequency rate for the FM source in Channel 1. This command is equivalent to activating Special Function 142 from the front panel. *RST value is 100 Hz.

:STEP

[:INCRement]? [MINimum | MAXimum]

[:INCRement] <nrf> [<freq term>] | MINimum | MAXimum

Sets the LFSOURCE:FM:FREQUency step size for the FM source in Channel 1. MINimum/MAXimum refers to the smallest/largest programmable step size, not the smallest/largest allowed change. *RST value is 100 Hz.

:WAVEform?

:WAVEform SIN | SQUARE | TRIangle | SAWTooth | WGNoise

Selects a waveform for the FM source in Channel 1: SINE, SQUARE, TRIangle, SAWTooth or White Gaussian Noise (WGNoise). This command is equivalent to activating Special Function 143 from the front panel. *RST value is SINE.

:PHASe

[:ADJust]? [MINimum | MAXimum]

[:ADJust] <nrf> [<angle term>] | UP | DOWN | MINimum | MAXimum

Adjusts the phase of the FM source in Channel 1 in terms of degrees or radians. This command is equivalent to activating Special Function 144 from the front panel. *RST value is 0°.

:STEP

[:INCRement]? [MINimum | MAXimum]

[:INCRement] <nrf> [<angle term>] | MINimum | MAXimum

Sets the LFSOURCE:FM:PHASe step size for the FM source in Channel 1. MINimum/MAXimum refers to the smallest/largest programmable step size, not the smallest/largest allowed change. *RST value is 1°(0.017 radians).

:PM

[:DEVIation]? [MINimum | MAXimum]

[:DEVIation] <nrf> [<angle term>] | UP | DOWN | MINimum | MAXimum

Sets the percentage of Φ M deviation applied to the audio source in Channel 1. This command is equivalent to setting Φ M deviation on the sub-carrier with Special Function 145 turned ON. *RST value is 0°.

:STEP

[:INCRement]? [MINimum | MAXimum]

[:INCRement] <nrf> [<angle term>] | MINimum | MAXimum

Sets the LFSOURCE:PM:DEVIATION step size for the Φ M source in Channel 1. MINimum/MAXimum refers to the smallest/largest programmable step size, not the smallest/largest allowed change. *RST value is 1° (0.017 radians).

:STATE?

:STATE ON | OFF | 1 | 0

Turns the Φ M source in Channel 1 either ON or OFF. Setting Φ M frequency or deviation does not by itself turn the Φ M source in Channel 1 ON. This command is equivalent to activating Special Function 145 from the front panel. *RST value is OFF.

:FREQUency? [MINimum | MAXimum]

:FREQUency <nrf> [<freq term>] | UP | DOWN | MINimum | MAXimum

Sets the frequency rate for the Φ M source in Channel 1. This command is equivalent to activating Special Function 146 from the front panel. *RST value is 100 Hz.

:STEP

[:INCRement]? [MINimum | MAXimum]

[:INCRement] <nrf> [<freq term>] | MINimum | MAXimum

Sets the LFSOURCE:PM:FREQUENCY step size for the Φ M source in Channel 1. MINimum/MAXimum refers to the smallest/largest programmable step size, not the smallest/largest allowed change. *RST value is 100 Hz.

:WAVEform?

:WAVEform SIN | SQUARE | TRIangle | SAWTooth | WGNoise

Selects a waveform for the Φ M source in Channel 1: SINE, SQUARE, TRIangle, SAWTooth or White Gaussian Noise (WGNoise). This command is equivalent to activating Special Function 147 from the front panel. *RST value is SINE.

:PHASe

[:ADJust]? [MINimum | MAXimum]

[:ADJust] <nrf> [<angle term>] | UP | DOWN | MINimum | MAXimum

Adjusts the phase of the Φ M source in Channel 1 in terms of degrees or radians. This command is equivalent to activating Special Function 148 from the front panel. *RST value is 0°.

:STEP

[:INCRement]? [MINimum | MAXimum]

[:INCRement] <nrf> [<angle term>] | MINimum | MAXimum

Sets the LFSOURCE:PM:PHASe step size for the Φ M source in Channel 1. MINimum/MAXimum refers to the smallest/largest programmable step size, not the smallest/largest allowed change. *RST value is 1°(0.017 radians).

:PULSe**:STATe?**

:STATe ON | OFF | 1 | 0

Turns the Pulse source in Channel 1 either ON or OFF. Setting Pulse frequency does not by itself turn the Pulse source in Channel 1 ON. This command is equivalent to activating Special Function 149 from the front panel. *RST value is OFF.

:FREQuency? [MINimum | MAXimum]

:FREQuency <nrf> [<freq term>] | UP | DOWN | MINimum | MAXimum

Sets the frequency rate for the Pulse source in Channel 1. This command is equivalent to activating Special Function 150 from the front panel. *RST value is 100 Hz.

:STEP

[:INCRement]? [MINimum | MAXimum]

[:INCRement] <nrf> [<freq term>] | MINimum | MAXimum

Sets the LFSOURCE:PULSe:FREQuency step size for the Pulse source in Channel 1. MINimum/MAXimum refers to the smallest/largest programmable step size, not the smallest/largest allowed change. *RST value is 100 Hz.

:PHASe**[:ADJust]? [MINimum | MAXimum]****[:ADJust] <nrf> [<angle term>] | UP | DOWN | MINimum | MAXimum**

Adjusts the phase of the Pulse source in Channel 1 in terms of degrees or radians. This command is equivalent to activating Special Function 151 from the front panel. *RST value is 0°.

:STEP**[:INCRement]? [MINimum | MAXimum]****[:INCRement] <nrf> [<angle term>] | MINimum | MAXimum**

Sets the LFSOURCE:PULSE:PHASe step size for the Pulse source in Channel 1. MINimum/MAXimum refers to the smallest/largest programmable step size, not the smallest/largest allowed change. *RST value is 1°(0.017 radians).

:AVIonics

:SETup

:VOR

Configures the instrument for VOR receiver testing. This command is equivalent to activating Special Function 220 from the front panel.

:LOCalizer

Configures the instrument for Localizer receiver testing. This command is equivalent to activating Special Function 221 from the front panel.

:GSLope

Configures the instrument for Glideslope receiver testing. This command is equivalent to activating Special Function 222 from the front panel.

:OMBeacon

Configures the instrument for Outer Marker (OM) beacon testing. This command is equivalent to activating Special Function 223 from the front panel.

:MMBeacon

Configures the instrument for Middle (MM) beacon testing. This command is equivalent to activating Special Function 224 from the front panel.

:IMBeacon

Configures the instrument for Inner Marker (IM) beacon testing. This command is equivalent to activating Special Function 225 from the front panel.

Marker Subsystem

The HP 8645A firmware contains three markers. The behavior of all of the markers is identical, however, MARKer 1 has two references (that is, MARKer1, MARKer2, and MARKer3).

MARKer or MARKer1 or MARKer2 or MARKer3

[:FREQuency]? [MINimum | MAXimum]

[:FREQuency] <nrf> [<freq term>] | UP | DOWN | MINimum | MAXimum

Sets frequency of selected marker. The marker may be set outside of the START and STOP frequency range, if so, the marker is not shown but is still considered active.

The markers will have the same offset and multiplier values as determined by **FREQ:OFFSet** and **FREQ:MULT**. *RST value is 251,464.85 Hz.

:STEP

Step size for the markers will always be in increments equal to **FREQ:CW:STEP**.

[:INCRement]? [MINimum | MAXimum]

[:INCRement] <nrf> [<freq term>] | MINimum | MAXimum

*Alias to **FREQuency:STEP**.*

:STATe?

:STATe ON | OFF | 1 | 0

Turns the specified marker ON or OFF. Marker state is not turned ON when the marker frequency is set. *RST condition is OFF.

:AOFF

Turns off all markers (this is *RST condition). This command will be accepted for any specific marker (**MARK2:AOFF**) but will still turns off all the markers. This command cannot be queried.

Modulation Subsystem

MODulation

:STATe?

:STATe ON | OFF | 1 | 0

The **MODulation:STATe ON** and **MODulation:STATe OFF** commands toggle on and off the modulation type (<mod_type>) that was previously selected. If the modulation is already on when the **MODulation:STATe ON** command is received, the command has no effect.

The command **MODulation:STATe OFF** turns off all modulation types, and turns **LF-Source:STATe OFF**.

The command **MOD:STATe?** will give the response "1" if any modulation state is on, and will give the response "0" if all modulation states are off. *RST causes the list of "previously active modulation types" to be FM.

Phase Modulation Subsystem

The HP 8645A cannot do simultaneous FM and PM. If FM is on, and someone requests PM, the following will happen: PM is turned on, FM is turned off, and an error displayed on the front panel.

PM

:STATe?

:STATe **ON | OFF | 1 | 0**

Turns PM ON or OFF. *RST value is OFF.

:SOURce?

:SOURce **<source list>**

Selects PM source: "INTernal", "EXTernal", or "INTernal,EXTernal". *RST value is INTernal.

:COUPling?

:COUPling **<coupling type>**

Set source coupling for FM. GROund coupling is equivalent to having NONE displayed on the front panel, it does not turn FM off, but disconnects all sources. *RST value is DC.

:FREQuency? **[MINimum | MAXimum]**

:FREQuency **<nrf> [<freq term>] | UP | DOWN | MINimum | MAXimum**

Alias to LFSOURCE:FREQUENCY.

:STEP

[:INCRement]? **[MINimum | MAXimum]**

[:INCRement] **<nrf> [<freq term>] | MINimum | MAXimum**

Alias to LFSOURCE:FREQUENCY:STEP.

Phase Subsystem

This subsystem allows you to increment or decrement the phase of the RF output signal in steps relative to the present frequency reference.

PHASe

[:ADJust]? [MINimum | MAXimum]

[:ADJust] <nrf> [<angle term>] | UP | DOWN | MINimum | MAXimum

Controls the phase offset value relative to the reference. This command is equivalent to activating Special Function 110 from the front panel. *RST value is 0.

:STEP

[INCRement]? [MINimum | MAXimum]

[INCRement] <nrf> [<angle term>] | MINimum | MAXimum

Controls the step size in degrees. MINimum/MAXimum refers to the smallest/largest programmable step size, not the smallest/largest allowed change. *RST value is one degree. (NOTE - base unit for angle measurements is radians. All queries will be returned in radians).

:REFerence

This event resets the PHASe value to 0 without changing the actual PHASe of the HP 8645A. This means that any further references to PHASe will be considered to be relative to the PHASe at the time this command was last issued.

Power Meter Subsystem

PMETer

[:POWer]?

Queries the internal power meter. This command is equivalent to activating Special Function 182 from the front panel.

Pulse Subsystem

PULSe

[:STATe]?

[:STATe] ON | OFF | 1 | 0

Turns PULSe ON or OFF. *RST value is OFF.

:SOURce?

:SOURce <source list>

Selects the PULSe source. The only allowable value for the HP 8645A is EXTernal. INTernal,EXTernal or INTernal will cause execution errors. *RST value is EXTernal.

Reference Oscillator Subsystem

ROSCillator

:CALibration? [MINimum | MAXimum]

:CALibration <nrf> | UP | DOWN | MINimum | MAXimum

Adjusts frequency of internal reference oscillator. Values used to adjust the reference frequency are in the range of 0 to 255. A change in the value of "1" corresponds to about a 4 Hz change in the reference frequency. The value required to set the reference to exactly 10 MHz will vary from instrument to instrument. Value is returned to calibrated value at *RST. This command is equivalent to activating Special Function 160 from the front panel.

:STEP

[:INCRement]?

The reference oscillator calibration increment is always one. This command is included to meet an HP-SL requirement of allowing the step size to be queried on any value which can be stepped.

:SOURce?

A SOURCe? query returns the status of the current reference source (INT or EXT). The query command is equivalent to activating Special Function 161 from the front panel.

Sequence Subsystem

SEquence

:REGister?

:REGister <register list>

Sets up a list of save/recall registers to step through. All registers are cleared from memory when you send the null list SEquence:REGister. The REGister command sets up registers 0-9 only. The maximum sequence length is 10 registers. Sending any command statement or message over HP-IB aborts the Auto Sequence state.

The syntax used to generate a <register list> is:

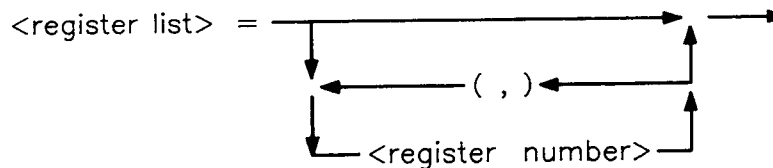

<register number> = number of save/recall register

[:IMMediate]

Causes a step to the next register in the sequence list.

:STATe?

:STATe ON | OFF | 1 | 0

When ON, the HP 8645A will automatically step through the registers in the sequence list. The step time for each register is 1 second, except if a fast hop sequence occurs (in which case the step time lasts for the duration of one cycle through the sequence table), or if a sweep sequence occurs (in which case the step time lasts for the duration of the sweep).

Status Subsystem

STATus

[:DEVIce]

[:EVENT]?

Queries the Device Dependent Event Status Register.

:CONDition?

Queries the Device Dependent Condition Status Register.

:ENABle <nrf> | <non-decimal numeric program data>

:ENABle?

Sets/queries the Device Dependent Event Enable Register.

:PTRansition?

Queries the Device Dependent Positive Transition Filter. Always returns 65535.

:NTRansition?

Queries the Device Dependent Negative Transition Filter.

Always returns 0.

:DQuestionable

[:EVENT]?

Queries the HP-SL Signal Integrity Event Status Register.

:CONDition?

Queries the HP-SL Signal Integrity Condition Status Register.

:ENABle <nrf> | <non-decimal numeric program data>

:ENABle?

Sets/queries the HP-SL Signal Integrity Event Enable Register.

:PTRansition?

Queries the HP-SL Signal Integrity Positive Transition Filter. Always returns 65535.

:NTRansition?

Queries the HP-SL Signal Integrity Negative Transition Filter. Always returns 0.

:SINTEGRITY**[:EVENT]?**

Queries the HP 8645A Signal Integrity Event Status Register.

:CONDITION?

Queries the HP 8645A Signal Integrity Condition Status Register.

:ENABLE <nrf> | <non-decimal numeric program data>

:ENABLE?

Sets/queries the HP 8645A Signal Integrity Event Enable Register.

:PTRANSITION?

Queries the HP 8645A Signal Integrity Positive Transition Filter. Always returns 65535.

:NTRANSITION?

Queries the HP 8645A Signal Integrity Negative Transition Filter. Always returns 0.

:HARDWARE**[:EVENT]?**

Queries the HP 8645A HARDWARE Integrity Event Status Register.

:CONDITION?

Queries the HP 8645A HARDWARE Integrity Condition Status Register.

:ENABLE <nrf> | <non-decimal numeric program data>

:ENABLE?

Sets or queries the HP 8645A HARDWARE Integrity Event Enable Register.

:PTRANSITION?

Queries the HP 8645A HARDWARE Integrity Positive Transition Filter. Always returns 65535.

:NTRANSITION?

Queries the HP 8645A HARDWARE Integrity Negative Transition Filter. Always returns 0.

:AMPLitude**[[:EVENT]]?**

Queries the AMPLitude Integrity Event Status Register.

:CONDition?

Queries the AMPLitude Integrity Condition Status Register.

:ENABLE <nrf> | <non-decimal numeric program data>

:ENABLE?

Sets or queries the AMPLitude Integrity Event Enable Register.

:PTRansition?

Queries the AMPLitude Integrity Positive Transition Filter. Always returns 65535.

:NTRansition?

Queries the AMPLitude Integrity Negative Transition Filter. Always returns 0.

:FREQuency**[[:EVENT]]?**

Queries the FREQuency Integrity Event Status Register.

:CONDition?

Queries the FREQuency Integrity Condition Status Register.

:ENABLE <nrf> | <non-decimal numeric program data>

:ENABLE?

Sets or queries the FREQuency Integrity Event Enable Register.

:PTRansition?

Queries the FREQuency Integrity Positive Transition Filter. Always returns 65535.

:NTRansition?

Queries the FREQuency Integrity Negative Transition Filter. Always returns 0.

:REference**[:EVENTt]?**

Queries the REference Integrity Event Status Register.

:CONDition?

Queries the REference Integrity Condition Status Register.

:ENABle <nrf> | <non-decimal numeric program data>

:ENABle?

Sets or queries the REference Integrity Event Enable Register.

:PTRansition?

Queries the REference Integrity Positive Transition Filter. Always returns 65535.

:NTRansition?

Queries the REference Integrity Negative Transition Filter. Always returns 0.

:MODulation**[:EVENTt]?**

Queries the MODulation Integrity Event Status Register.

:CONDition?

Queries the MODulation Integrity Condition Status Register.

:ENABle <nrf> | <non-decimal numeric program data>

:ENABle?

Sets or queries the MODulation Integrity Event Enable Register.

:PTRansition?

Queries the MODulation Integrity Positive Transition Filter. Always returns 65535.

:NTRansition?

Queries the MODulation Integrity Negative Transition Filter. Always returns 0.

Sweep Subsystem

Other commands used with the sweep function are found in the Initialize Subsystem.

SWEep

[:FREQuency]

:TIME? [MINimum | MAXimum]

:TIME <nrf> [<time term>] | UP | DOWN | MINimum | MAXimum

Sets the sweep time. The commands UP and DOWN will step to the next/previous valid setting since the HP 8645A has 1, 2, 5, 10, 20, 50 ... steps on sweep time.

This command does not turn the SWEep ON. The command statements **FREQ:MODE SWEep** or **INITialize:STATe RUN** activate the SWEep. *RST value is 1 second.

:STEP

[:INCRement]?

Always returns 3. This indicates that the step on the sweep time is 3 steps per decade.

:MODE?

Always returns LOG. This indicates that the sweep time is stepped logarithmically.

:MODE?

:MODE AUTO | MANual

Selects sweep type. AUTO allows single or continuous sweeps, MANual allows control of frequency with **FREQuency:MANual**. *RST value is AUTO.

:SPACing?

:SPACing LINear | LOGarithmic

Selects LINear or LOGarithmic sweep. *RST value is LINear.

:GENeration?

:GENeration STEPped | ANALog

Selects STEPped, or phase continuous (ANALog) SWEep. This command is equivalent to activating Special Function 112 from the front panel. *RST value is STEPped.

Take Sweep Subsystem

TSweep

Has the same effect as:

```
INIT:ABORt  
SWE:MODE AUTO  
FREQ:MODE SWEEP  
INIT:MODE SINGle  
INIT:IMMEDIATE
```

This causes any sweep action to stop and a single sweep to take place.

Voltmeter Subsystem

VMETer

[[:VOLTage]]?

Uses the internal voltmeter to measure voltage at the rear panel voltmeter port.

:MODE?

:MODE AC | DC

Selects DC or AC (rms) measurement for voltmeter. This command is equivalent to activating Special Functions 180 or 181 from the front panel. *RST is DC.

HP-IB Device Status Dictionary

The HP 8645A has a great amount of status information available for your needs via the HP-IB bus. Unfortunately, the single 8 bit status byte register defined in the IEEE 488 standard is not large enough or flexible enough to contain the necessary information for an instrument with the complexity of the Agile Signal Generator. Consequently, the HP 8645A contains different levels of registers to overcome this limitation.

The new IEEE 488.2 standard, does however, expand the status byte definition to provide an extremely flexible mechanism for organizing status information. In addition, Hewlett Packard Systems Language (HP-SL) defines a portion of the 488.2 device status model in order to promote as much commonality as possible within various HP instruments. The *HP-IB Device Status Dictionary* describes in detail the HP 8645A implementation of the IEEE 488.2 standard, and HP-SL device status models.

To use the *HP-IB Device Status Dictionary*, refer to the table of contents shown below. All entries in the table of contents are arranged in an order of progressive dependency.

Figure 5-3 helps you understand how each set of registers are progressively dependent upon each other. For example, a bit in the HP-IB Status Byte Register "DEV" is dependent upon the status of bits in the Device Dependent Condition/Event Status Register, and so forth.

Table of Contents

IEEE 488.2 Definitions	5-58
IEEE 488.2 HP-IB Status Byte Register	5-61
IEEE 488.2 HP-IB Standard Event Status Register	5-62
HP-SL Device Dependent Condition/Event Status Registers	5-64
HP 8645A Signal Integrity Condition/Event Status Registers	5-67
IEEE 488.2 and HP-SL Status Register Syntax	5-70

Event Enable Register

Event enable registers select which event bits in the corresponding event register will cause a TRUE summary message when set. Each event bit will have a corresponding enable bit in the event enable register. Each event enable register will be the same length as the corresponding event status register.

All unused bits are read as a value of zero and cannot be written to by the associated event enable command. Any time a bit in the event status register or the event enable register changes, a logical AND is performed on all bits of the event status register and the event enable register. If the result is not zero then the associated summary message is set TRUE.

Queue

A queue is a data structure containing a sequential list of data. Data may be placed in the queue in any order and a single item of data is removed every time the queue is read. A queue has a summary message that is TRUE whenever there is data in the queue and FALSE when the queue is empty.

The data in a queue may be in any format, but all data items must be in that same format. A queue may be cleared using the *CLS command (except for the IEEE 488.2 output queue).

Summary Bit

A summary bit is a condition bit that reflects the current status of the associated summary message. The summary message may be generated by the current values of an event status register and an event enable register or the contents of a queue.

Status Register Model

The diagram in figure 5-4 shows the relationship between the various components of a status register.

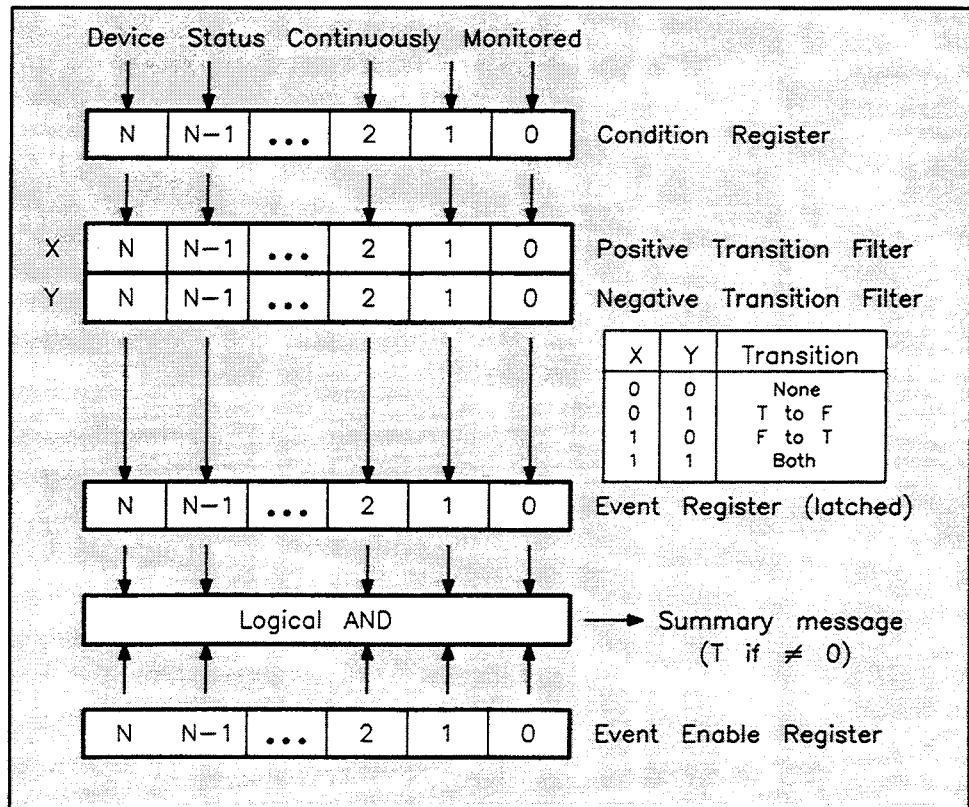

Figure 5-4. Status Register Map.

IEEE 488.2 HP-IB Status Byte Register

The IEEE 488.2 standard and HP-SL defines the 8 bit HP-IB status byte register as follows :

Table 5-2. Status Byte Register.

Bit #	Mnemonic	Definition
7	DEV	HP-SL device dependent event status register summary bit.
6	RQS or MSS	IEEE 488.2 master status summary bit.
5	ESB	IEEE 488.2 standard event status register summary bit.
4	MAV	IEEE 488.2 output queue summary bit.
0-3	-	Device dependent summary bits.

Device Dependent Summary Bits

Bits 0 through 3 are not defined in IEEE 488.2 or HP-SL and may be used as the device designer sees fit, as long as their use does not violate the IEEE 488.2 rules for summary bits. Bits 0 through 3 are not used in the HP 8645A implementation and will always be read as zero.

The status byte register is accessed using the *STB common command and *STB? common query or by performing a HP-IB serial poll operation.

MAV Summary Bit

Bit 4, the MAV (message available) summary bit indicates that there are characters in the instrument output queue. The output queue is read by addressing the instrument to talk and reading data bytes until a line feed character is sent with the EOI control line asserted.

A complete description of the behavior of the output queue is beyond the scope of the *HP-IB Device Status Dictionary*. Interested readers should refer to IEEE 488.2 for the complete definition and behavior of the output queue.

RQS and MSS Summary Bits

Bit 6 of the HP-IB status register has two definitions, depending on the method used to access the status register.

If the register is accessed via the HP-IB serial poll mechanism, then the bit is called the RQS (request service) bit and indicates to the active controller that the instrument is asserting the service request control line (SRQ). The RQS bit is cleared after the active controller performs a serial poll operation.

When the register is accessed via the IEEE 488.2 *STB? common query, then the bit is called the MSS (master status summary) bit and indicates that the device has at least one reason for requesting service. Unlike the RQS bit, the MSS bit is not cleared as a result of a serial poll and will always reflect the current status of all of the instrument status registers.

**IEEE 488.2
Service Request
Enable Register**

The service request enable register is an 8 bit register that enables corresponding summary bits in the status byte register. When a status bit is enabled and makes a FALSE to TRUE transition, the instrument will generate a service request.

A service request will also be generated when a status bit is enabled and the bit is already set. The service request enable register is accessed using the *SRE common command and the *SRE? common query. Bit 6 of the service request enable register is unused and will always be read as a zero. The service request enable register may be cleared when the instrument is turned on.

**IEEE 488.2
Standard Event
Status Register**

The standard event status register is a 16 bit event register with the following bit definitions :

Table 5-3. Standard Event Status Register.

Bit #	Mnemonic	Definition
8-15	-	Reserved for future use by IEEE.
7	PON	Power on.
6	URQ	User request.
5	CME	Command error.
4	EXE	Execution error.
3	DDE	Device dependent error.
2	QYE	Query error.
1	RQC	Request control.
0	OPC	Operation complete.

The standard event status register is accessed using the *ESR common command and the *ESR? common query. Because this is an event register, the register is cleared after it is read.

Power On Bit

The power on event bit 7 is set TRUE whenever there has been an OFF to ON transition of the instrument power supply.

User Request Bit

The user request bit 6 is set whenever one of a set of device dependent local instrument controls is activated. At present this feature is not implemented in the HP 8645A firmware and the bit will always be read as a zero.

Command Error Bit	The command error bit 5 is set whenever the parser detects an error in the format or contents of a program message. The HP 8645A implementation will place an HP-SL defined error code in the HP-SL error queue that may specify the exact error (bad header, missing argument, wrong data type, etc.).
Execution Error Bit	The execution error bit 4 is set whenever the current command cannot be processed due to an out of range parameter, conflicting settings, etc. The HP 8645A implementation will place an HP-SL defined error code in the HP-SL error queue.
Device Dependent Error Bit	The device dependent error bit 3 is used to indicate an error that is neither a command error or an execution error. The HP 8645A implementation uses this bit to indicate a hardware failure. An HP-SL defined error code will be placed in the HP-SL error queue that may specify the exact error (self test failure, ROM CRC error, etc.).
Query Error Bit	The query error bit 2 indicates that there is a problem with the output queue. Either there has been an attempt to read the queue when it was empty or the output data has been lost. For a complete description of query errors consult the IEEE 488.2 standard.
Request Control Bit	The request control bit 1 is used to initiate the IEEE 488.2 pass control protocol. The feature is not implemented in the HP 8645A firmware and the bit will always be read as a zero.
Operation Complete Bit	The operation complete bit 0 is set in response to the *OPC common command and indicates that all overlapped commands have completed execution. The HP 8645A firmware supports two overlapped operations; the frequency sweep, and the fast hop learn cycle. For a complete description of the 'operation complete flag', consult the IEEE 488.2 standard.
Standard Event Status Enable Register	The standard event status enable register is a 16 bit register that allows one or more event bits in the standard event status register to be reflected in the ESB summary message in the HP-IB status byte. This register follows all the rules of an event enable register. The standard event status enable register is accessed using the *ESE common command and the *ESE? common query. The standard event status enable register may be cleared when the instrument is turned on.

HP-SL Device Dependent Condition/Event Status Registers

HP-SL defines a group of status registers used to contain device dependent status information. These registers include a condition register, an event register, two transition filters, and an enable register. Each register has the following bit definitions :

Table 5-4. Device Dependent Condition/Event Status Registers.

Bit #	Mnemonic	Definition
11-15	-	Device dependent.
9-10	-	Reserved for use by HP-SL language subset.
8	RNG	Autorange operation in progress.
7	CAL	Calibration in progress.
6	STLD	Signal is settled.
2-5	-	Reserved for future use by HP-SL.
1	SWP	A sweep cycle is in progress.
0	DQU	HP-SL signal integrity summary bit.

The commands used to access these registers are too complex to explain in the *HP-IB Device Status Dictionary*. Refer to *IEEE 488.2 and HP-SL Status Register Syntax* found later on in this chapter for a complete description of the status register syntax.

Device Dependent Bit Definitions.

The HP 8645A firmware defines the device dependent bits 11-15 in the *Device Dependent Condition/Event Status Register* as follows :

Table 5-5. Device Dependent Bit 11-15 Definitions.

Bit #	Mnemonic	Definition
15	TEMP	Temperature drift.
14	HOP	Fast hop active.
13	RHOP	Ready to start hopping.
12	LRN	Fast learn active.
11	SINT	HP 8645A signal integrity summary bit.

Note *The programmer should be aware that in order to write fully transportable device status routines, only HP-SL mnemonics that do not use any device dependent status bits should be used.*

Temperature Drift Bit The temperature drift bit 15 is set when the internal instrument temperature has changed by more than 10 degrees C since the last time the instrument was calibrated.

Fast Hop Active Bit The fast hop active bit 14 is set when the instrument exits the learn state and enters the fast hop active state. The bit is cleared when the instrument exits the fast hop active state.

Ready for Fast Hop Bit The ready for fast hop bit 13 is set when the instrument has completed at least one learn cycle and is able to enter the fast hop active state. The bit is cleared when the instrument exits the fast hop learn state.

Fast Learn Active Bit The fast hop learn active bit 12 is set when the instrument is actively performing a learn cycle. The bit is cleared when the instrument exits the fast hop learn state or prepares to start a new learn cycle.

Signal Integrity Bit The signal integrity summary bit 11 is described in detail later on in this chapter in the section titled *HP 8645A Signal Integrity Condition/Event Status Registers*.

Autorange Bit The autorange bit 8 is set whenever the instrument halts the current measurement in order to automatically select the proper range. The HP 8645A firmware does not support any autorange operations and this bit will always be read as a zero.

Calibration Bit The calibration bit 7 is set whenever the instrument is performing a calibration operation. Because the HP 8645A calibration is not an overlapped command, the condition register bit will always be read as a zero but the event register bit may be used to see if the instrument has been calibrated since the last time the event register was read.

Signal Settled Bit The signal settled bit 6 is set when the output signal has settled to its final value. The HP 8645A firmware does not currently support this feature and this bit will always be read as a one.

Sweep in Progress Bit The sweep in progress bit 1 is set whenever the instrument is in the sweep active state.

Data Questionable Bit The data questionable bit 0 refers to the HP-SL signal integrity status registers in the following ways.

The HP-SL signal integrity status registers have the same bit definitions as the device dependent signal integrity registers with the following critical difference.

The HP-SL signal integrity condition status register bits are current device conditions, not summary bits. These device conditions are derived from the condition and enable registers associated with the corresponding summary bits in the device dependent signal integrity condition status register.

The HP 8645A firmware provides these two redundant registers so that novice programmers can follow the exact HP-SL model while expert programmers can expand the signal integrity condition bits to the full resolution of the instrument.

HP 8645A Signal Integrity Condition/Event Status Registers

The HP 8645A firmware defines a group of status registers used to contain information about the integrity of the output signal. These registers include a condition register, an event register, two transition filters, and an enable register. Each register has the following bit definitions :

Table 5-6. HP 8645A Signal Integrity Condition/Event Status Registers.

Bit #	Mnemonic	Definition
15	HDW	Misc. hardware integrity summary bit.
8-14	-	Device dependent summary bits.
5-7	-	Reserved for future use by HP-SL.
4	MOD	Modulation integrity summary bit.
3	REF	Reference integrity summary bit.
2	FREQ	Frequency integrity summary bit.
1	AMPL	Amplitude integrity summary bit.
0	CALI	Calibration integrity condition bit.

Note

Each of the summary bits in these registers refer to other groups of condition/event registers whose format is device dependent.

Hardware Integrity Summary Bit

The hardware integrity summary bit 15 indicates that there is some reason to suspect that the miscellaneous support hardware is not performing correctly. The HP 8645A firmware defines the hardware integrity condition/event register bits as follows :

Table 5-7. Hardware Integrity Summary Bit.

Bit #	Mnemonic	Definition
4-15	-	Reserved for future use.
3	FPE	Front panel hardware error.
2	IOE	I/O board hardware error.
1	PSE	Power supply error.
0	CPE	CPU hardware error.

Modulation Integrity Summary Bit

The modulation integrity summary bit 4 indicates that there is some reason to suspect that the modulation performance of the instrument is not correct. The HP 8645A firmware defines the modulation integrity condition/event register bits as follows:

Table 5-8. Modulation Integrity Summary Bit.

Bit #	Mnemonic	Definition
5-15	-	Reserved for future use.
4	ASCE	Audio source calibration error.
3	ASOL	Audio source PLL out of lock.
2	MCE	Mod distribution calibration error.
1	MLO	External modulation too low.
0	MHI	External modulation too high.

Reference Integrity Summary Bit

The reference integrity summary bit 3 indicates that there is some reason to suspect that the instrument reference frequency is not correct. The HP 8645A firmware defines the reference integrity condition/event register bits as follows:

Table 5-9. Reference Integrity Summary Bit.

Bit #	Mnemonic	Definition
3-15	-	Reserved for future use.
2	RCE	Reference calibration error.
1	ROL	Reference out of lock.
0	OVEN	10811 crystal reference oven cold.

Frequency Integrity Summary Bit

The frequency integrity summary bit 2 indicates that there is some reason to suspect that the output frequency performance of the instrument is not correct. The HP 8645A firmware defines the frequency integrity condition/event register bits as follows :

Table 5-10. Frequency Integrity Summary Bit.

Bit #	Mnemonic	Definition
7-15	-	Reserved for future use.
6	CDCE	140 nS coax FLL calibration error.
5	CDFL	140 nS coax FLL out of lock.
4	VCE	VCO calibration error.
3	VFL	VCO 70 nS FLL out of lock.
2	-	Reserved.
1	NCE	NF calibration error.
0	NPL	NF PLL out of lock.

Amplitude Integrity Summary Bit

The amplitude integrity summary bit 1 indicates that there is some reason to suspect that the output amplitude of the instrument is not correct. The HP 8645A firmware defines the amplitude integrity condition/event register bits as follows :

Table 5-11. Amplitude Integrity Summary Bit.

Bit #	Mnemonic	Definition
13-15	-	Reserved for future use.
12	DCE	Freq doubler calibration error.
11	DOL	Freq doubler ALC out of lock.
10	ATCE	Attenuator calibration error.
4-9	-	Reserved.
3	ACE	ALC calibration error.
2	AOL	ALC out of lock.
1	LCE	Level calibration error.
0	REV	Reverse power detected.

Calibration Integrity Condition Bit

The calibration integrity condition bit 0 indicates that an error has occurred during a calibration or diagnostic operation. This bit will remain set until the entire instrument has been re-calibrated with no errors using the *CAL? query.

IEEE 488.2 and HP-SL Status Register Syntax

All of the status registers defined in the previous sections may be accessed using the following commands :

Table 5-12. IEEE 488.2 and HP-SL Status Register Syntax. (1 of 2)

Command syntax	Definition
*CLS	Clears all event registers and queues.
*STB?	HP-IB status byte register.
*SRE <nrf> ?	HP-IB service request enable register.
*ESR?	IEEE 488.2 standard event status register.
*ESE <nrf> ?	IEEE 488.2 standard event status enable register.
STATUS	
[:DEVICE]	
[:EVENT]?	HP-SL device dependent event status register.
:CONDition?	HP-SL device dependent condition status register.
:PTRansition ⁽¹⁾ ?	HP-SL device dependent positive transition filter.
:NTRansition ⁽¹⁾ ?	HP-SL device dependent negative transition filter.
:ENABle <nrf> ?	HP-SL device dependent event enable register.
:DQUestionable	
[:EVENT]?	HP-SL signal integrity event status register.
:CONDition?	HP-SL signal integrity condition status register.
:PTRansition ⁽¹⁾ ?	HP-SL signal integrity positive transition filter.
:NTRansition ⁽¹⁾ ?	HP-SL signal integrity negative transition filter.
:ENABle ⁽²⁾ <nrf> ?	HP-SL signal integrity event enable register.
:SINTegrity	
[:EVENT]?	HP 8645A signal integrity event status register.
:CONDition?	HP 8645A signal integrity condition status register.
:PTRansition ⁽¹⁾ ?	HP 8645A signal integrity positive transition filter.
:NTRansition ⁽¹⁾ ?	HP 8645A signal integrity negative transition filter.
:ENABle ⁽²⁾ <nrf> ?	HP 8645A signal integrity event enable register.
:HARDware	
[:EVENT]?	HP 8645A hardware integrity event status register.
:CONDition?	HP 8645A hardware integrity condition status register.
:PTRansition ⁽¹⁾ ?	HP 8645A hardware integrity positive transition filter.
:NTRansition ⁽¹⁾ ?	HP 8645A hardware integrity negative transition filter.
:ENABle ⁽²⁾ <nrf> ?	HP 8645A hardware integrity event enable register.
<p>(1) The HP 8645A firmware does not implement programmable transition filters. All positive transition filters will be fixed at all ones and all negative transition filters will be fixed at all zeros.</p> <p>(2) The HP 8645A firmware will set the default value of these event enable registers to all ones.</p>	

Table 5-12. IEEE 488.2 and HP-SL Status Register Syntax. (2 of 2)

Command syntax	Definition
<p>:SINTEGRity (cont'd)</p> <p>:MODulation</p> <p> [:EVENT]?</p> <p> :CONDition?</p> <p> :PTRansition⁽³⁾ ?</p> <p> :NTRansition⁽³⁾ ?</p> <p> :ENABLE⁽⁴⁾ <nrf> ?</p> <p>:REFerence</p> <p> [:EVENT]?</p> <p> :CONDition?</p> <p> :PTRansition⁽³⁾ ?</p> <p> :NTRansition⁽³⁾ ?</p> <p> :ENABLE⁽⁴⁾ <nrf> ?</p> <p>:FREQuency</p> <p> [:EVENT]?</p> <p> :CONDition?</p> <p> :PTRansition⁽³⁾ ?</p> <p> :NTRansition⁽³⁾ ?</p> <p> :ENABLE⁽⁴⁾ <nrf> ?</p> <p>:AMPLitude</p> <p> [:EVENT]?</p> <p> :CONDition?</p> <p> :PTRansition⁽³⁾ ?</p> <p> :NTRansition⁽³⁾ ?</p> <p> :ENABLE⁽⁴⁾ <nrf> ?</p>	<p>HP 8645A modulation integrity event status register.</p> <p>HP 8645A modulation integrity condition status register.</p> <p>HP 8645A modulation integrity positive transition filter.</p> <p>HP 8645A modulation integrity negative transition filter.</p> <p>HP 8645A modulation integrity event enable register.</p> <p>HP 8645A reference integrity event status register.</p> <p>HP 8645A reference integrity condition status register.</p> <p>HP 8645A reference integrity positive transition filter.</p> <p>HP 8645A reference integrity negative transition filter.</p> <p>HP 8645A reference integrity event enable register.</p> <p>HP 8645A frequency integrity event status register.</p> <p>HP 8645A frequency integrity condition status register.</p> <p>HP 8645A frequency integrity positive transition filter.</p> <p>HP 8645A frequency integrity negative transition filter.</p> <p>HP 8645A frequency integrity event enable register.</p> <p>HP 8645A amplitude integrity event status register.</p> <p>HP 8645A amplitude integrity condition status register.</p> <p>HP 8645A amplitude integrity positive transition filter.</p> <p>HP 8645A amplitude integrity negative transition filter.</p> <p>HP 8645A amplitude integrity event enable register.</p>
<p>(3) The HP 8645A firmware does not implement programmable transition filters. All positive transition filters will be fixed at all ones and all negative transition filters will be fixed at all zeros.</p> <p>(4) The HP 8645A firmware will set the default value of these event enable registers to all ones.</p>	

Example HP-SL Programs

In this section, you will find example programs to assist you in becoming familiar with HP-SL. Also, a program to help you develop HP-SL code is provided for your use.

All of the following examples have been written in BASIC Programming Language, however, you may convert the examples into PASCAL or into any other language.

The example HP-SL programs are alphabetically arranged. A table of contents for all examples is as follows:

Table of Contents

A Tool for Developing HP-SL Programs	5-73
AM Examples	5-73
Amplitude Examples	5-74
FM Example	5-74
Frequency Examples.....	5-75
Frequency Hop Example	5-76
EMF Mode Example	5-76
HP-IB Device Status Examples	5-77
Initialize Example	5-78
Modulation Example	5-78
Phase Examples	5-79

A Tool for Developing HP-SL Programs

Programs written in HP-SL are not instrument dependent; that is, HP-SL has removed the one-to-one correspondence between front-panel keystrokes and HP-IB codes. In previous instruments, development of controller programs could be done by trying out functions on the front panel, and then converting the keystrokes into HP-IB codes to send to the instrument.

The following program, written in BASIC, allows you to send command statements and messages to test their effect on the HP 8645A. In addition, the program traps error conditions and reads the error messages back to the controller in an underlined format.

The program is written for HP 8645A instruments with an HP-IB address of 19. You may modify the program to have any HP-IB address.

When you run the program, simply type in the command statement or message and press the **ENTER** key. For example, the command statement:

```
FREQ 1.234 MHz
```

Will set an RF output frequency of 1.234 MHz. If the command statement or message contains a query "?", the program will generate a response in an inverse video window.

A Tool for Developing HP-SL Programs

```

100 DIM A$[255],L$[255],E$[255]
200 PRINT "ENTER MESSAGE STRING TO SEND TO 8645. REPLIES ARE SHOWN IN INVERSE"
300 PRINT "AND ERROR MESSAGES ARE UNDERLINED."
400 PRINT "#####"
500 ON KBD GOSUB 1100
600 CLEAR 719
700 OUTPUT 719;"*ESE 60;*SRE 48"
800 GOSUB 1600
900 ON INTR 7 GOSUB 1600
1000 GOTO 1000
1100 OUTPUT 2;KBD$;
1200 INPUT "ENTER MESSAGE STRING TO SEND TO 8645:",A$
1300 PRINT A$
1400 OUTPUT 719;A$
1500 RETURN
1600 Z=SPOLL(719)
1700 IF BIT(Z,4)=0 THEN GOTO 2000
1800 ENTER 719;L$
1900 PRINT CHR$(129);L$;CHR$(128)
2000 OUTPUT 719;"*ESR?"
2100 ENTER 719;Z
2200 OUTPUT 719;"SYST:ERR? STR"
2300 ENTER 719;E$
2400 IF E$[1;1]="0" THEN GOTO 2700
2500 PRINT CHR$(132);E$;CHR$(128)
2600 GOTO 2200
2700 ENABLE INTR 7;2
2800 RETURN
2900 END

```

AM Examples

Set the AM depth to a value of 57% and select External AC, AM.

```

100 ! Set the Source to external and the coupling to AC.
200 OUTPUT 719;"AM:SOUR EXT;COUP AC"
300 ! Set the AM depth to a value of 57% and turn AM on.
400 OUTPUT 719;"AM:DEPT 57%;STATE ON"

```

Set the AM depth to 73% with internal AM at 2.5 kHz modulation frequency.

```

100 ! Set the Source to internal and no coupling.
200 OUTPUT 719;"AM:SOUR INT"
300 ! Set the AM depth to a value of 73%.
400 OUTPUT 719;"AM 73 %"
500 ! Set the LFSource Frequency to 2.5 kHz.
600 OUTPUT 719;"LFS:FREQ 2.5 KHZ"

```

rev.16APR90

Amplitude Examples

Set amplitude to 100 mV, increment in 0.1 dB steps until some other measurement returns proper reading. Query amplitude in volts.

```
100 ! Set output level to 100 mV and enable RF output
200 OUTPUT 719;"AMPL 100mV;AMPL:STATE ON"
300 ! Set default instrument amplitude units to return volts
400 ! and default instrument amplitude step to dB this allows
500 ! logarithmic stepping of the amplitude in volts.
600 OUTPUT 719;"AMPL:UNIT V;STEP:UNIT DB"
700 ! Set increment to 0.1 dB.
800 OUTPUT 719;"AMPL:STEP:INCR 0.1"
900 ! Loop testing value and incrementing output level by 0.1 dB
1000 ! Make what ever tests are required here, if proper level
1100 ! has been reached, goto line 1700
1200 ! Increase source amplitude by 0.1 dB.
1300 OUTPUT 719;"AMPL UP"
1400 ! Jump back to test.
1500 GOTO 1000
1600 ! Read current amplitude back from source.
1700 OUTPUT 719;"AMPL?"
1800 ENTER 719;Level
1900 PRINT "Level required was ";Level;" Volts."
```

FM Example

Set the FM deviation to a value read in from controller keyboard. Also set the FM Source to external.

```
100 ! Set the Source to external and the coupling to DC.
200 OUTPUT 719;"FM:SOUR EXT;COUP DC"
300 ! Input the FM deviation from the console.
400 INPUT "Enter the FM Deviation in kHz: ",Fm_deviation
500 ! Set the FM deviation to the value given as input.
600 OUTPUT 719;"FM ";Fm_deviation;"KHZ"
700 ! Now turn FM on.
800 OUTPUT 719;"FM:STATE ON"
```

Frequency Examples

Reset the instrument, then set frequency to 137 MHz, and turn amplitude on at 4.5 dBm:

```

100 ! Set instrument to known state.
200 OUTPUT 719;"*RST"
300 ! Set frequency to 137 MHz
400 OUTPUT 719;"FREQ 137MHZ"
500 ! Set output level to 4.5 dBm and enable RF output
600 OUTPUT 719;"AMPL 4.5DBM;AMPL:STATE ON"

```

Reset the instrument, turn amplitude on and set frequency and amplitude to values read in from controller keyboard:

```

100 ! Set instrument to known state.
200 OUTPUT 719;"*RST"
300 ! Input the Frequency and the Amplitude from the console.
400 INPUT "Enter frequency in MHz: ",Freq
500 INPUT "Enter amplitude in dBm: ",Ampl
600 ! Set the Frequency and Amplitude to the input values.
700 OUTPUT 719;"FREQ ";Freq;"MHZ;AMPL ";Ampl;"DBM;AMPL:STATE ON"

```

Reset the instrument, turn amplitude on at 0 dBm and step frequency from 200 to 300 MHz in 1 MHz steps, making some measurement at each frequency:

```

100 ! Set instrument to known state.
200 OUTPUT 719;"*RST"
300 ! Set frequency to 200 MHz and set frequency increment to 1MHz.
400 OUTPUT 719;"FREQ 200MHZ;FREQ:STEP 1MHZ"
500 ! Turn RF on at 0 dBm
600 OUTPUT 719;"AMPL 0;AMPL:STATE ON"
700 FOR X = 0 TO 100
800     ! Add code to make whatever
900     ! measurement is needed here.
1000    ! Increase frequency by 1MHz
1100    OUTPUT 719;"FREQ UP"
1200 NEXT X

```

The instrument is to be used as a local oscillator where it's output frequency will be doubled, and that signal will be mixed with the "frequency of interest" and put through a 10.7 MHz I.F. bandpass filter.

This means (Frequency of interest) = (L.O. Frequency) X 2 - 10.7 MHz. Set up frequency offsets and multipliers to allow the signal generator to be programmed to the frequency of interest, rather than the L.O. frequency.

```

100 ! Set freq multiplier to two and frequency offset to -10.7MHz
200 OUTPUT 719;"FREQ:MULT 2;OFFSET -10.7MHZ"
300 ! Set signal generator so that frequency of interest will be
400 ! 107.7 (actual signal generator output frequency is 59.2 MHz).
500 OUTPUT 719;"FREQ 107.7MHZ"

```

Frequency Hop Example

The following example will reset the signal generator, put the generator in Mode 5, Fast Hop condition, set the dwell time to 5 milliseconds, set the hop rate to 100 hops/second, define channels 0-2, define the sequence to frequency hop through the 3 channels, and set the HP8645A to hop continuously.

```
100 Output 719; "*RST"  
200 Output 719; "FREQ:Synt 5"  
300 Output 719; "FHOP:Dwell 5 mS"  
400 Output 719; "FHOP:Rate 100 Hz"  
500 Output 719; "FHOP:CLIST 50 MHz,0 dBm,100 MHz,0 dBm,150 MHz,0 dBm"  
600 Output 719; "FHOP:SLIST 0,1,1,2"  
700 Output 719; "FHOP:Mode Cont"
```

EMF Mode Examples

```
10 ! SAMPLE PROGRAM TO TURN EMF MODE ON AND OFF IN PSG.  
20 !  
30 Address=719  
40 OUTPUT Address; "AMPLITUDE:SOURCE:UNIT V" ! SETS EMF MODE  
50 !  
60 OUTPUT Address; "AMPLITUDE:OUT:UNIT V" ! SETS NON EMF MODE  
70 !  
80 END
```

HP-IB Device Status Examples

The following section presents several examples of the use of HP 8645A device status mnemonics.

Example 1:

Configure the instrument to generate a service request whenever an error is placed in the error queue.

```
*ESE 60;*SRE 32
```

Enable the CME, EXE, QYE, and DDE bits in the standard event status register and the ESB summary message in the HP-IB status byte.

Example 2:

Configure the instrument to generate a service request whenever the fractional-N phase locked loop goes out of lock.

```
STAT:ENAB 2048;SINT:ENAB 4;FREQ:ENAB 1;*SRE 128
```

Enable the signal integrity summary message, the frequency integrity summary message, the NPL event bit, and the DEV summary message in the HP-IB status byte.

Example 3:

Respond to a service request and decode the instrument status.

```
*STB?           Read the HP-IB status byte.
data = 128      The DEV summary message is set.
STAT?          Read the device dependent event status
                register.
data = 2048     The HP-SL signal integrity summary bit is set.
STAT:DQU?      Read the HP 8645A signal integrity event
                status register.
data = 4        The frequency integrity summary bit is
                set.
STAT:SINT:FREQ? Read the HP 8645A frequency integrity event
                status register.
data = 1        The NF PLL has been out of lock.
STAT:SINT:FREQ:COND? Read the frequency integrity condition
                status register.
data = 0        The NF PLL is not currently out of lock.
```

It is clear from this dialog that there has been a transient out of lock in the NF PLL.

Initialize Example

Set up a ten second logarithmic sweep. Prompt user for the start frequency and sweep over a 200 MHz span. Put markers at start freq +50 MHz, +100 MHz, and +150 MHz. Make a single sweep.

```

100 ! Get start frequency from user.
200 INPUT "Enter Start Frequency in Hz: ";Startfreq
300 ! Set start frequency and span for sweep.
400 OUTPUT 719;"FREQ:START ";Startfreq;"SPAN 200MHZ"
500 ! Set sweep time to 10 Sec. and select log sweep
600 OUTPUT 719;"SWEEP:TIME 10;SPACING LOG"
700 ! Set markers
800 OUTPUT 719;"MARKER ";Startfreq+50000000;"MARKER:STATE ON"
900 OUTPUT 719;"MARK2 ";Startfreq+100000000;"MARK2:STATE ON"
1000 OUTPUT 719;"MARK3 ";Startfreq+150000000;"MARK3:STATE ON"
1100 ! Become sweeper, enable auto sweeping and select single.
1200 OUTPUT 719;"FREQ:MODE SWEEP;:SWEEP:MODE AUTO"
1300 OUTPUT 719;"INITialize:MODE SINGLE"
1400 ! The next line will cause the sweep to begin.
1500 OUTPUT 719;"INITialize:IMMediate"

```

Modulation Example

If in the middle of some procedure, it may be necessary to make some measurement which require that the HP 8645A be at the current RF output frequency and output amplitude level, but all modulation must be turned off.

The following example will disable all modulation, make necessary measurements, and then turn back on whatever modulation was on before this section of code started. (Note: this section of programming code will work regardless of what modulation(s) were on when it was executed.)

```

. . .
. . .
. . .
7100 ! Shut off all modulation.
7200 OUTPUT 719;"MOD:STATE OFF"
7300 ! Make any necessary tests/measurements ...
7400 !
7500 ! Return modulation to the state it was in before line 7200
7600 OUTPUT 719;"MOD:STATE ON"
. . .
. . .
. . .

```

Phase Examples

Adjust the phase to set the quadrature between two sources.

```
100 ! Set the phase step to 1 degree
200 OUTPUT 719;"PHAS:STEP 1DEG"
300 ! Continue adjusting the Phase by 1 degree until the voltage is
400 ! equal.
450 DONE = 0
500 REPEAT
600 ! Measure mixer voltage using appropriate equipment and store
700 ! the value as "Measurement".
800 ! If measurement is greater than 0.1 V increment phase.
900 IF (Measurement) $>$ 0.1V THEN
1000 OUTPUT 719;"PHAS UP"
1100 ELSE
1200 ! If measurement is less than -0.1 V decrement phase.
1300 IF (Measurement) $<$ -0.1V THEN OUTPUT 719;"PHAS DOWN"
1400 ! If measurement is okay then set done to quit looping.
1500 ELSE
1600 Done = 1
1700 UNTIL (Done = 1)
```

Shift Carrier Phase by 30 degrees and make a measurement. Then set the Phase back to 0.

```
100 ! Set Phase value to 0.
200 OUTPUT 719;"PHAS:REF"
300 ! Shift Phase by 30 degrees.
400 OUTPUT 719;"PHAS 30DEG"
500 ! Make some appropriate measurement.
600 ! Set Phase back to zero.
700 OUTPUT 719;"PHAS 0DEG"
```

A

Installation

Unpack Your HP 8645A

Inspect the shipping container for damage. If the shipping container is damaged or the cushioning material inside is stressed, keep them until you have checked the shipment for completeness and the instrument for proper operation.

If items are missing from your shipment, or if there is mechanical damage or defect, notify the nearest Hewlett-Packard office. If the shipping container or cushioning material shows signs of stress, notify the carrier as well as the Hewlett-Packard office. Keep the shipping materials for inspection by the carrier.

Connect Power

The HP 8645A Agile Signal Generator requires a power source of 100 to 120 V ac ($\pm 10\%$) at 48 to 440 Hz, or 220 to 240 V ac ($\pm 10\%$) at 48 to 440 Hz. Power consumption is 500 VA maximum. If you need further information about the power requirements for your instrument, refer to the HP 8645A Operation and Calibration Manual.

Warning

This is a Safety Class I product (i.e., provided with a protective earth terminal). An uninterruptible safety earth ground must be provided from the Main power source to the product input wiring terminals, power cord, or supplied power cord set. Whenever it is likely that the protection has been impaired, the instrument must be made inoperative and be secured against any unintended operation.

Turn On Instrument

If you are operating this instrument in extreme environmental conditions, refer to the HP 8645A Operation and Calibration Manual for specific operating limitations.

Press the **POWER** key to the ON position. The front panel annunciators momentarily light up for a quick visual inspection.

If the **MSSG** annunciator is displayed in the lower right corner of the FREQUENCY/STATUS display, an instrument error has occurred. Press the UTILITY **MSSG** key as many times as needed to scroll through the error messages. Refer to appendix D for error message descriptions.

B

Options and Accessories

Available for the HP 8645A

The following table lists the options and accessories that are presently available for the HP 8645A. Refer to your nearest Hewlett-Packard office for ordering information, and for an update on options that have been made available since the printing of this Operation Guide.

Option:

- 001:** High Stability Time Base.
- 002:** 2 GHz Output
- 003:** Rear Panel Inputs/Outputs (deletes front panel inputs/outputs)
- 907:** Front Handle Kit (5061-9690)
- 908:** Rack Flange Kit (5061-9678)
- 909:** Combined Front Handle/Rack Flange Kit (5061-9684)
- 910:** Extra Manual Set (includes Service Manual)
- 915:** Add Service Manual
- W03:** 90 day On-site Warranty (replaces 1-year standard warranty)

Accessories Available:

- HP 11845A 2 GHz Retrofit Kit
- Service Kit (08645-61116)
- Transit Case (9211-2662)
- Transit Case Wheels (1490-0913)
- Non-tilting Rack Slide Kit (1494-0059)
- Tilting Rack Slide Kit (1494-0063)

C

Special Functions

How to Access the Special Functions

There are two ways to access special functions for the HP 8645A.

1. Press the **SPECIAL** key and then turn either the knob or press one of the knob $\downarrow\uparrow$ keys to show the available special functions in the FREQUENCY/STATUS display. Access the special function of your choice by pressing the **ENTER** key.

-OR-

2. Press the **SPECIAL** key and enter the special function number of your choice. Access the special function by pressing the **ENTER** key.

The yellow annunciator above the **SPECIAL** key lights up to indicate that a special function is invoked. At any time, you may display all of the special functions that are invoked by pressing the **DISPLAY** key, and then the **SPECIAL** key.

Listed numerically, the special functions are as follows:

100:Auto Attenuation

This special function allows you to lock or unlock the attenuators at their present setting. When ON (unlocked), the instrument's output amplitude can be set at any level within the range of the instrument. When OFF (locked), the instrument's output amplitude can only be set within the vernier range of the locked attenuators.

101:Attenuation

This special function gives you the choice of manually selecting which attenuators to switch in for operating the instrument. Activating this special function essentially turns off Auto Attenuation described in Special Function 100.

102:Amptd Correction

This special function allows you to either have a calibrated or an uncalibrated output amplitude level. When ON, internal calibration data is used. When OFF, the internal calibration data is not used.

103:Amptd Limit

This special function allows you to specify the upper limit for the instrument's output amplitude.

104:Wideband ALC

This special function allows you to determine the ALC bandwidth. When OFF, the ALC is configured for the most narrow bandwidth. When ON, the ALC is configured for the widest bandwidth possible for the RF output selected.

105:Amplitude Muting

This special function, when OFF, allows you to minimize the affect of changes that occur when the HP 8645A is in transition from one output amplitude level to another or from one center frequency value to another as seen at the RF Output. Typically, the carrier frequency can swing several MHz while in transition, and the output amplitude may change ± 6 dBm while in transition. In the default condition, Amplitude Muting ON, output amplitude and center frequency changes occur with 20 to 40 dB of attenuation.

110:Rel ϕ Adjust

This special function allows you to increment or decrement the phase of the RF output signal in one-degree steps relative to the present frequency reference.

111:Freq Multiplier

This special function allows you to use an external divider or multiplier on the RF output and still have the instrument display the final RF output signal. A positive integer, for example +2 would cause the frequency display to be multiplied by 2. A negative integer, for example -2 would cause the frequency display to be divided by 2. The front-panel **OFFSET** annunciator turns on when the frequency multiplier is a value other than +1.

112:Phase Cont Sweep

This special function allows you to put the instrument's sweep in a phase-continuous mode. During phase-continuous frequency sweep, the instrument sweeps between two selected endpoints in a linear, phase-continuous manner. This sweep function resembles a true sweeper in that it has no frequency transients; yet it is fully synthesized, yielding a very linear, precise sweep.

120:FM Synthesis

This special function allows you to have the instrument synthesize the FM signal in a digitized or linear manner. Digitized FM is best for single-tone modulation and provides a very accurate center frequency at low deviation rates. Linear FM is best for multi-tone modulation and provides a more constant group delay than the Digitized FM.

121:F(t)

This special function displays the phase-locked loop frequency during digitized FM. The display is continually updated.

123:600 Ohm FM

This special function allows you to use the Φ M Modulation Input connector as an FM input to provide a port with an input impedance of 600 Ω . The front-panel FM Modulation Input connector (which has an input impedance of 50 Ω) is then disabled.

130:Audio Wave

This special function allows you to select the waveform for the audio source. You have five choices: Sine, Square, Triangle, Sawtooth, or White Gaussian Noise.

131:Audio Triggered

This special function (when ON) enables Special Function 132.

132:Trig Audio

This special function, when enabled by Special Function 131, allows you to trigger the audio source to output a single 360° cycle. When the audio is triggered for a single cycle of White Gaussian Noise, the result is a burst of noise for the duration of "1/audio frequency". You can output any one of the five audio waveforms. Triggering is done from either the front-panel ON key or from the rear-panel HOP connector.

133:Aud2 Freq

This special function allows you to turn on and off the audio source for Channel 2, and it allows you to set the audio source frequency for Channel 2. The audio source frequency for Channel 2 may be set to a minimum of 0.1 Hz, a maximum of 400 kHz, or any value in between.

134:Aud2 Level

This special function allows you to adjust the level of the audio source for Channel 2. The level for the audio source in Channel 2 may be set to a minimum of 0 V, a maximum of 1 V, or any value in between.

135:Aud2 Wave

This special function allows you to select the waveform for the audio source in Channel 2. You have five choices: Sine, Square, Triangle, Sawtooth, or White Gaussian Noise.

136:Aud2 Φ

This special function allows you to adjust the phase of the audio source in Channel 2. Phase may be expressed in terms of radians or degrees. The front panel display immediately changes units of degrees and radians when you switch between the **deg** and **rad** keys. Entries may be scaled; for example, entering 560° would yield -160°.

137:Aud AM Depth

This special function allows you to turn on and off the AM source in Channel 1, and it allows you to set the percentage of depth for the AM source. Depth may be set to a minimum of 0%, a maximum of 100%, or any value in between.

138:Aud AM Freq

This special function allows you to set the frequency for the AM source in Channel 1. The frequency may be set to a minimum of 0.1 Hz, a maximum of 400 kHz, or any value in between.

139:Aud AM Wave

This special function allows you to select the waveform for the AM source in Channel 1. You have five choices: Sine, Square, Triangle, Sawtooth, or White Gaussian Noise.

140:Aud AM Φ

This special function allows you to adjust the phase of the AM source in Channel 1. Phase may be expressed in terms of radians or degrees. The front panel display immediately changes units of degrees and radians when you switch between the **deg** and **rad** keys. Entries may be scaled; for example, entering 560° would yield -160°.

141:Aud FM Dev

This special function allows you to turn on and off the FM source in Channel 1, and it allows you to set the amount of deviation for the FM source. Deviation may be set to a minimum of 0 Hz, a maximum of 400 kHz, or any value in between.

142:Aud FM Freq

This special function allows you to set the frequency for the FM source in Channel 1. The frequency may be set to a minimum of 0.1 Hz, a maximum of 400 kHz, or any value in between.

143:Aud FM Wave

This special function allows you to select the waveform for the FM source in Channel 1. You have five choices: Sine, Square, Triangle, Sawtooth, or White Gaussian Noise.

144:Aud FM Φ

This special function allows you to adjust the phase of the FM source in Channel 1. Phase may be expressed in terms of radians or degrees. The front panel display immediately changes units of degrees and radians when you switch between the **deg** and **rad** keys. Entries may be scaled; for example, entering 560° would yield -160°.

145:Aud Φ M Dev

This special function allows you to turn on and off the Φ M source in Channel 1, and it allows you to set the amount of deviation for the Φ M source. Deviation may be set to a minimum of 0° , a maximum of 179.9° , or any value in between. Φ M deviation may be expressed in terms of radians or degrees. The front panel display immediately changes units of degrees and radians when you switch between the **deg** and **rad** keys.

146:Aud Φ M Freq

This special function allows you to set the frequency for the Φ M source in Channel 1. The frequency may be set to a minimum of 0.1 Hz, a maximum of 400 kHz, or any value in between.

147:Aud Φ M Wave

This special function allows you to select the waveform for the Φ M source in Channel 1. You have five choices: Sine, Square, Triangle, Sawtooth, or White Gaussian Noise.

148:Aud Φ M Φ

This special function allows you to adjust the phase of the Φ M source in Channel 1. Phase may be expressed in terms of radians or degrees. The front panel display immediately changes units of degrees and radians when you switch between the **deg** and **rad** keys. Entries may be scaled; for example, entering 560° would yield -160°.

149:Aud Pulse

This special function allows you to turn on and off the Pulse source in Channel 1.

150:Aud Pulse Freq

This special function allows you to set the frequency for the Pulse source in Channel 1. The frequency may be set to a minimum of 0.1 Hz, a maximum of 50 kHz, or any value in between.

151:Aud Pulse Φ

This special function allows you to adjust the phase of the Pulse source in Channel 1. Phase may be expressed in terms of radians or degrees. The front panel display immediately changes units of degrees and radians when you switch between the **deg** and **rad** keys. Entries may be scaled; for example, entering 560° would yield -160°.

160:Ref Calibration

This special function allows you to adjust the frequency of the internal reference oscillator. Values used to adjust the reference frequency are in the range of 0 to 255. A change in the value of "1" corresponds to about a 4 Hz change in the reference frequency. The value required to set the reference to approximately 10 MHz will vary from instrument to instrument. When an instrument preset or power on/off is done, the reference frequency value is returned to its calibrated value. (Activate service Special Function 331 to save the reference calibration value.)

161:Ref Source

This special function monitors whether the instrument is using its internal reference oscillator source or if an external timebase source is connected. (The High Stability timebase Option 001 is seen by the HP 8645A as an external timebase source to the rear panel REF IN connector.) The display is continuously updated.

170:Test

This special function tests the instrument and module hardware for failures. Turn the knob to select the test you want, and then press the **ENTER** key. The message **Result Code = 0** indicates that the instrument is operating normally. A result code other than the numeral "0" appearing on the front-panel display indicates a failure. All error codes are defined in the Service Diagnostics Manual.

171:Recal

This special function allows you to recalibrate the whole instrument. A recalibration takes about three minutes. The message **Result Code = 0** appears if the recalibration passes. All error codes are defined in the Service Diagnostics Manual.

172:RAM Wipe

This special function allows you to do a 'hard' reset of the instrument to wipe out the memory contents of RAM (including the calibration data). This eliminates any instrument settings entered by the user through the front panel or through HP-IB. An instrument recalibration is then automatically done.

173:Security

This special function allows you to secure Special Functions 191 to 195. When ON, Special Functions 191 to 195 cannot be turned off without first forcing an automatic RAM wipe as described in Special Function 172. When this special function is active (turned ON), it executes a RAM wipe when turned OFF. Also, if the instrument's power switch is turned to STBY and then back to ON, a RAM wipe will be executed.

180:DC Voltmeter

This special function allows you to use the instrument as a DC voltmeter. DC voltages are monitored from the rear-panel **VOLTMETER IN** connector. The front-panel displays a continuously updated DC voltage reading. The following typical operating characteristics apply:

Range: ± 50 V dc
Sensitivity: 0.5 V dc
Maximum Input Voltage: ± 180 V dc
Input Impedance: 130 k Ω

181:AC Voltmeter

This special function allows you to use the instrument as an AC voltmeter. AC voltages are monitored from the rear-panel **VOLTMETER IN** connector. The front-panel displays a continuously updated AC voltage reading in V rms. The following typical operating characteristics apply:

Range: ± 50 Vpk
Bandwidth: 10 kHz
Sensitivity: 0.5 Vpk
Maximum Input Voltage: ± 180 Vpk
Input Impedance: 130 k Ω

182:Power Meter

This special function allows you to use the instrument as a power meter. Power is monitored from a connector located under the instrument's top cover. The front-panel displays a continuously updated power reading in dBm. The following typical operating characteristics apply:

Power Range: -10 to +20 dBm
Frequency Range: 250 kHz to 2 GHz
Accuracy: ± 5 dBm at -10 to 0 dBm
 ± 3 dBm at 0 to +10 dBm
 ± 1 dBm at +10 to +20 dBm
Maximum Input Power: 25 dBm
Input Impedance: 50 Ω AC coupled

190:Serial #

This special function displays the instrument's serial number.

191:Blank Display

This special function allows you to blank out all instrument settings displayed on the front panel (including the LED annunciator lights). User interaction with the instrument is not displayed on the front panel.

192:Blank Frequency

This special function allows you to blank out just the frequency setting from being displayed on the front panel. When ON, each segment in the Frequency/Status display will show a dash, Mode Select LED annunciators turn off, and any special functions relating to frequency are blanked.

193:Blank Modulation

This special function allows you to blank out just the modulation level setting from being displayed on the front panel. When ON, each segment in the Modulation Level display will show a dash, Modulation LED annunciators turn off, and any special functions relating to modulation are blanked.

194:Blank Audio

This special function allows you to blank out just the audio frequency setting from being displayed on the front panel. When ON, each segment in the Modulation Frequency display will show a dash, and any special functions relating to audio frequency are blanked.

195:Blank Amptd

This special function allows you to blank out just the RF amplitude setting from being displayed on the front panel. When ON, each segment in the Amplitude display will show a dash, and any special functions relating to RF amplitude are blanked.

196:European Radix

This special function allows you to determine which 'radix mark' and which 'separator mark' to use in a number. A radix mark is the divider between the integer portion of a number and the fractional portion of a number. The separator mark is the separator between groups of digits in a large number.

When OFF, the radix mark displayed on the front panel is a period and the separator mark is a comma. When ON, the radix mark displayed on the front panel is a comma, and the separator mark is a period. For example, 123456789 Hz would be shown as 123,456,789.00 Hz in normal operation, however, it would be shown as 123.456.789,00 with the European Radix ON.

200:Fast Hop Demo

This special function sets up the HP 8645A for a frequency hop demonstration. When you activate (turn ON) this special function, the sequence table is cleared and sample frequency and amplitude parameters are entered into the channel table. Then, the HP 8645A is set up to receive an external DCFM signal programmed to 5 kHz deviation. Finally, after about 10 seconds in the Learn State, the HP 8645A goes into the Hop State. When the Fast Hop Demo is activated, the current front-panel settings for the instrument are lost.

201:Buffered Hop Bus

This special function allows you to choose whether or not to buffer the **FAST HOP BUS** connector on the rear panel (the instrument must be in the Fast Hop Bus Int Dwell mode to use this special function). When ON, the Fast Hop Bus is buffered, and the sequence position addressed by the instrument will be delayed by one hop. When OFF, the Fast Hop Bus is not buffered, resulting in a 5 μ sec slower frequency switching time without the one-hop delay.

202:Open Loop Hop

This special function allows you to open the ALC loop when frequency hopping the instrument. When OFF, the ALC loop is closed; closed loop operation has less spectral splatter, more linear AM control of output level, better isolation when power is off between frequency hops, better level accuracy, power off during learning, and a shorter learn time. When ON, the ALC loop is open; open loop operation provides a shorter switching time between frequency hops.

203:Fast Lvl Shift

This special function allows you to vary the amplitude level of the RF output by -15 dB during the Hop State without causing the HP 8645A to enter the Learn State. However, using this special function degrades the *Fast Hop Operation*, *Amplitude accuracy* specification, and the *Amplitude Modulation*, *AM indicator accuracy* specification (refer to the Specification table in Section 1 of the *Calibration Manual* for details).

Vary the amplitude level of the RF output by:

- turning the knob counter-clockwise to reduce the amplitude level and then clockwise to reverse the amplitude level variation,
- or by entering the amplitude level variation with the front-panel **DATA** keys.

220:VOR Setup

This special function allows you to generate a composite VOR test signal. The instrument is set for a bearing of 0° to the station on a carrier of 108.0 MHz.

221:Localizer Setup

This special function allows you to generate a composite Localizer test signal. The instrument is set for 0 DDM on a carrier of 108.1 MHz.

222:Glideslope Setup

This special function allows you to generate a composite Glideslope test signal. The instrument is set for 0 DDM on a carrier of 334.7 MHz.

223:OM Beacon Setup

This special function allows you to generate an OM Beacon test signal. The instrument is set for a 2 Hz pulsed tone beacon.

224:MM Beacon Setup

This special function allows you to generate an MM Beacon test signal. The instrument is set for a 2 Hz pulsed tone beacon.

225:IM Beacon Setup

This special function allows you to generate an IM Beacon test signal. The instrument is set for a 2 Hz pulsed tone beacon.

300:Service Mode

This special function allows you to run the instrument's service diagnostic routines. The service-diagnostic switch (referred to in the Service Diagnostics Manual) must be in the correct position in order to access and run any of the diagnostic tests.

D

Error Messages

What Happens When You Get an Error Message

The Signal Generator interacts with the user to communicate error messages about its operating condition. The error messages suggest or imply that a problem exists either with the instrument or the way in which the user is operating the instrument. Error messages are presented to the user in two ways.

First, if the user attempts to operate the instrument beyond its capabilities, intentionally or not, an error message is immediately shown in the FREQUENCY/STATUS display. Refer to table D-1 for a description of the error messages that occur under these circumstances.

Second, if the instrument detects a malfunction at power up, or as a result of performing service diagnostics or calibration, an error message is put into the message queue. You will know that this has occurred because the **MSSG** annunciator lights up in the FREQUENCY/STATUS display. Refer to table 7-2 for a description of the error messages that occur under these circumstances.

The error messages in the message queue can then be viewed at the users request by simply pressing the Utility **MSSG** key on the front panel; repetitively pressing the **MSSG** key allows you to view all of the error messages.

To view the error messages again, simply press the blue **SHIFT** key, and then the **MSSG** key. If you have corrected the malfunction shown in the error message list, the message for that error will not reappear.

Note

A hardware failure message does not always indicate that a hardware problem exists. Certain operating conditions may also cause a hardware problem.

Also, if you program the Signal Generator to operate outside of its specified operating ranges a hardware failure may occur. For example, if the current output amplitude and AM depth results in an output signal greater than approximately +16 dBm you may get a hardware failure message.

Table D-1. Error Messages Immediately Shown to the User. (1 of 9)

Error Message	Description
Φ cont and hop conflict	An attempt was made to initiate a Fast Hop sweep with phase-continuous sweep active (Special Function 112), or an attempt was made to start phase-continuous sweep with the Fast Hop Mode 5 active.
AM depth too large	The entered amount of AM depth is greater than the maximum permitted (100%). Also, AM depth is limited by the current amplitude setting, by Special Function 103 (Amptd Limit). For example, if the current amplitude setting is +19.9 dBm, the maximum AM depth is 0%.
AM depth too small	The AM depth value entered is less than the minimum permitted (0%).
AM incr too large	The AM increment value entered is greater than the maximum permitted (100%).
AM incr too small	The AM increment value entered is less than the minimum permitted (0.1%).
Amptd incr too large	The amplitude increment value entered is greater than the maximum permitted (100 dB or 1V).
Amptd incr too small	The amplitude increment value entered is less than the minimum permitted (0.1 dB or 0.001 μV).
Amptd limit too high	The Amplitude Limit value entered is greater than the maximum permitted (+19.9 dBm specified by Special Function 103).
Amptd limit too low	The Amplitude Limit value entered is less than the minimum permitted (-137 dBm specified by Special Function 103).
Amptd offset too large	The amplitude offset value entered is greater than the maximum permitted (50 dB).
Amptd offset too small	The amplitude offset value entered is less than the minimum permitted (-50 dB).
Amptd range too large	The range of amplitudes requested for the frequency hop are too large. The HP 8645A does not switch attenuator pads during frequency hopping, this would result in very slow switching times. The maximum allowed variation of all amplitudes entered in the channel table may vary from 20 to 30 dB.
Amptd setting too low	The carrier amplitude value entered is less than the minimum permitted (-137 dBm).
Amptd setting too high	The carrier amplitude value entered is greater than the maximum permitted (+19.9 dBm).
Argument out of range	An attempt was made over HP-IB to send an invalid numeral in the command parameter. For example, sending "FM:STATE 2"(there is no STATE 2), or "FREQ:SYNT 6" (there is no Mode 6 synthesis) would give you this error.

Table D-1. Error Messages Immediately Shown to the User. (2 of 9)

Error Message	Description
Attenuation too large	The attenuation value entered is greater than the maximum permitted (145 dB).
Attenuation too small	The attenuation value entered is less than the minimum permitted (0 dB).
Audio2 freq too high	The frequency of the audio source in Channel 2, entered from Special Function 133, is greater than the maximum permitted (400 kHz).
Audio2 freq too low	The frequency of the audio source in Channel 2, entered from Special Function 133, is less than the minimum permitted (0.1 Hz).
Audio2 level too high	The level of the audio source in Channel 2, entered from Special Function 134, is greater than the maximum permitted (1 V).
Audio2 level too low	The level of the audio source in Channel 2, entered from Special Function 134, is less than the minimum permitted (0 V).
Audio Φ incr too large	The increment value for phase in the audio source is greater than the maximum permitted (359.9°).
Audio Φ incr too small	The increment value for phase in the audio source is less than the minimum permitted (0.1°).
Audio Φ M dev too large	The Φ M deviation for the audio source in Channel 1, entered from Special Function 145, is greater than the maximum permitted (179.9°).
Audio Φ M dev too small	The Φ M deviation for the audio source in Channel 1, entered from Special Function 145, is less than the minimum permitted (0°).
Audio Φ M freq too high	The Φ M frequency for the audio source in Channel 1, entered from Special Function 146, is greater than the maximum permitted (400 kHz).
Audio Φ M freq too low	The Φ M frequency for the audio source in Channel 1, entered from Special Function 146, is less than the minimum permitted (0.1 Hz).
Audio Φ M incr too large	The increment value of Φ M deviation for the audio source in Channel 1, entered from Special Function 145, is greater than the maximum permitted (179.9°).
Audio Φ M incr too small	The increment value of Φ M deviation for the audio source in Channel 1, entered from Special Function 145, is less than the minimum permitted (0.1°).
Audio AM depth too large	The AM depth for the audio source in Channel 1, entered from Special Function 137, is greater than the maximum permitted (100%).
Audio AM depth too small	The AM depth for the audio source in Channel 1, entered from Special Function 137, is less than the minimum permitted (0%).

Table D-1. Error Messages Immediately Shown to the User. (3 of 9)

Error Message	Description
Audio AM freq too high	The AM frequency for the audio source in Channel 1, entered from Special Function 138, is greater than the maximum permitted (400 kHz).
Audio AM freq too low	The AM frequency for the audio source in Channel 1, entered from Special Function 138, is less than the minimum permitted (0.1 Hz).
Audio AM incr too large	The increment value of AM depth for the audio source in Channel 1, entered from Special Function 137, is greater than the maximum permitted (100%).
Audio AM incr too small	The increment value of AM depth for the audio source in Channel 1, entered from Special Function 137, is less than the minimum permitted (0.1%).
Audio FM dev too large	The FM deviation for the audio source in Channel 1, entered from Special Function 141, is greater than the maximum permitted (400 kHz).
Audio FM dev too small	The FM deviation for the audio source in Channel 1, entered from Special Function 141, is less than the minimum permitted (0 kHz).
Audio FM freq too high	The FM frequency for the audio source in Channel 1, entered from Special Function 142, is greater than the maximum permitted (400 kHz).
Audio FM freq too low	The FM frequency for the audio source in Channel 1, entered from Special Function 142, is less than the minimum permitted (0.1 Hz).
Audio FM incr too large	The increment value of FM deviation for the audio source in Channel 1, entered from Special Function 141, is greater than the maximum permitted (400 kHz).
Audio FM incr too small	The increment value of FM deviation for the audio source in Channel 1, entered from Special Function 141, is less than the minimum permitted (0.1 Hz).
Audio freq incr too low	The audio frequency increment value entered is less than the minimum permitted (0.1 Hz).
Audio freq incr too high	The audio frequency increment value entered is greater than the maximum permitted (400 kHz).
Audio freq too low	The audio frequency value entered is less than the minimum permitted (0.1 Hz).
Audio freq too high	The audio frequency value entered is greater than the maximum permitted (400 kHz).

Table D-1. Error Messages Immediately Shown to the User. (4 of 9)

Error Message	Description
Audio level/AM conflict	The sum of the audio levels in Channels 1 and 2 cannot exceed 1 V (pk) with the AM source in Channel 1 ON.
Audio level conflict	The sum of the audio levels in Channels 1 and 2 cannot exceed 1 V (pk).
Audio level incr high	The audio level increment value entered is greater than the maximum permitted (1 V).
Audio level incr low	The audio level increment value entered is less than the minimum permitted (1.0 mV).
Aud lev/source conflict	The sum of the audio levels in Channels 1 and 2 cannot exceed 1 V (pk), and too many audio sources are turned ON.
Aud pulse freq too high	The frequency of the audio pulse entered from Special Function 150 is greater than the maximum permitted (50 kHz).
Aud pulse freq too low	The frequency of the audio pulse entered from Special Function 150 is less than the minimum permitted (0.1 Hz).
Bad char during numeric	While the instrument was reading in a numeric argument, a character other than "0" through "9" occurred at a place where it is not valid to end the number.
Bad fast chan address	An attempt was made to access an invalid channel table address.
Bad fast seq address	An attempt was made to access an invalid sequence table address.
Bad fast sequence entry	An attempt was made to enter invalid channels into the sequence table. Refer to chapter 3 for information about the sequence table.
Bad/missing exponent	After getting a valid mantissa and an "E" (for exponential), a character was found that was not a digit "0" through "9" or a \pm sign, or the character was not a digit "0" through "9" after an "E+" or an "E-".
Bad register number	The recalled Save Register does not contain a SAVE setting, or the recalled Save Register is less than 0 or greater than 49.
Bad sequence entry	An attempt was made to enter a register value less than 0 or greater than 9 into the Save/Recall Sequence list.
Cannot continue	An attempt has been made to restart diagnostic testing after altering an internal cable or module without being in the repair mode, or you have come to the point where no additional tests are available or the test sequence has ended.
Center freq too high	The center frequency value entered for the sweep is greater than the maximum permitted.
Center freq too low	The center frequency value entered for the sweep is less than the minimum permitted.
Channel table empty	An attempt was made to frequency hop with an empty channel table.

Table D-1. Error Messages Immediately Shown to the User. (5 of 9)

Error Message	Description
Dwell incr too large	The dwell time increment value entered is greater than the maximum permitted (100 msec).
Dwell incr too small	The dwell time increment value entered is less than the minimum permitted (1 μ sec).
Empty sequence list	An attempt was made to sequence through an empty Save/Recall sequence list.
EOC during numeric	While the instrument was reading in a numeric argument, an end-of-command (EOC) condition occurred at a place where it is not valid to end the number (for example, after a \pm sign, after a decimal with no leading digits, or after an "E" for exponential).
EOM during numeric	While the instrument was reading in a numeric argument, an end-of-message (EOM) condition occurred at a place where it is not valid to end the number (for example, after a \pm sign, after a decimal with no leading digits, or after an "E" for exponential).
EOM in #B/Q/H W/O data	An end-of-message (EOM) was encountered without getting any data in, or without getting the "B" (for binary), "Q" (for octal), or "H" (for hexadecimal) while the instrument was reading in a non-decimal numeric argument.
EOM in arbitrary block	An end-of-message (EOM) was encountered before the end of data while the instrument was reading in an "arbitrary block program data".
Error\EOC after colon	An end-of-command (EOC) was encountered after a colon in the command header. A colon in the command header must always be followed by a keyword mnemonic.
Error\EOC after comma	An end-of-command (EOC) was found after a comma. A comma in the data string must be followed with an additional data item(s).
Error\EOM after colon	An end-of-message (EOM) condition was encountered after a colon in the command header. A colon in the command header must always be followed by a keyword mnemonic.
Error\EOM after comma	An end-of-message (EOM) was found after a comma. A comma in the data string must be followed with an additional data item(s).
Error\Space after colon	A space character was encountered after a colon in the command header. A colon in the command header must always be followed by a keyword mnemonic.
Exponent too big	The numeric exponent was either less than -127 or greater than 127.
Fast hop dwell too large	The dwell time value entered is greater than the maximum permitted. Refer to chapter 3 for information about correct dwell times.
Fast hop dwell too small	The dwell time value entered is less than the minimum permitted. Refer to chapter 3 for information about correct dwell times.
Fast hop rate too large	The hop rate value entered is greater than the maximum permitted. Refer to chapter 3 for information about correct hop rates.
Fast hop rate too small	The hop rate value entered is less than the minimum permitted. Refer to chapter 3 for information about correct hop rates.

Table D-1. Error Messages Immediately Shown to the User. (6 of 9)

Error Message	Description
Fast level shift too high	The amplitude level entered, with Special Function 203 active, was too high.
Fast level shift too low	The amplitude level entered, with Special Function 203 active, was too low.
FM deviation too large	The FM deviation value entered is greater than the maximum permitted. Refer to the specifications in the technical data sheet or to section 1 in the <i>Calibration Manual</i> for FM deviation limits.
FM deviation too small	The FM deviation value entered is less than the minimum permitted. Refer to the specifications in the technical data sheet or to section 1 in the <i>Calibration Manual</i> for FM deviation limits.
FM incr too large	The FM increment value entered is greater than the maximum permitted (100 MHz).
FM incr too small	The FM increment value entered is less than the minimum permitted (0.01 Hz).
FM out of range for mode	An attempt was made to change from a Synthesis Mode setting with a higher deviation range, to a Synthesis Mode setting with less deviation range for the set RF output. Push the Synthesis Mode AUTO key to let the HP 8645A determine the best mode for the deviation and RF output you have selected.
Freq divider too large	The frequency divider value entered is greater than the maximum permitted (-10 from the front panel, 0.1 over HP-IB).
Freq incr too large	The frequency increment value entered is greater than the maximum permitted (10 GHz).
Freq incr too small	The frequency increment value entered is less than the minimum permitted (0.01 Hz).
Freq mult too large	The frequency multiplier value entered is greater than the maximum permitted (10).
Freq offset too large	The frequency offset value entered is greater than the maximum permitted (50 GHz).
Freq offset too small	The frequency offset value entered is less than the minimum permitted (-50 GHz).
Freq range high for FM	An attempt was made to frequency hop over a frequency range of more than 3 specified HP 8645A octaves with FM turned on.
Freq range too large	The range of frequencies requested for the frequency hop are too large (refer to the specifications for limits).
Freq setting too high	The frequency value entered is greater than the maximum permitted.
Freq setting too low	The frequency value entered is less than the minimum permitted.
Frequency span too large	The frequency span value entered for the sweep is greater than the maximum permitted.
Frequency span too small	The frequency span value entered for the sweep is less than the minimum permitted.

Table D-1. Error Messages Immediately Shown to the User. (7 of 9)

Error Message	Description
Hardware not installed	An attempt was made to activate a Synthesis Mode setting presently not installed in the instrument.
Hop and sweep conflict	An attempt was made, while the HP 8645A is a Fast Hop sweeper, to set a Fast Hop parameter (Idle, Hop, Sto Chan, etc.). Or, an attempt was made, while the HP 8645A is frequency hopping, to set a sweep parameter (Start, Stop, Center, Span, etc.) when in the Learn State.
HP\IB Command error	This is a generic HP-IB command error. Something is wrong with the command, but the firmware does not recognize the specific problem.
HP\IB No response data	The instrument was given the HP-IB interface command to talk, but has not been told to say anything.
HP\IB Query interrupted	The instrument was given a command to return some data, then given another command before the entire response was read back from the instrument.
HP\IB Query unterminated	The instrument was given the HP-IB interface command to talk, and has received part of a message including a command to return some data, but the message was not terminated (not completely sent, or no end-of-message sent).
Insufficient capability	An attempt has been made to activate a function or feature presently not configured or accessible.
Int modulation enabled	An attempt has been made over HP-IB to turn off the audio source with the internal modulation source turned on.
Invalid char after '.'	While the instrument was reading in a numeric argument, a character other than "0" through "9", or an "E" (for exponential) with no digits before the decimal occurred.
Invalid char after sign	While the instrument was reading in a numeric argument, a character other than "0" through "9", or a decimal point occurred after the \pm sign.
Invalid data mnemonic	A mnemonic was not recognized as the instrument was reading in a non-numeric parameter.
Invalid header mnemonic	A keyword mnemonic in the command header is not recognized as a keyword. Incorrect protocol or a spelling mistake might be the cause.
Invalid suffix	While the instrument was reading in a numeric argument, an invalid suffix occurred after a comma, semicolon, or end-of-command.
Log sweep not allowed	An attempt has been made to do phase continuous log sweep.
Marker freq too high	The marker frequency value entered is greater than the maximum permitted.
Marker freq too low	The marker frequency value entered is less than the minimum permitted (251,464.85 Hz).
Missing space after '?'	A non-blank character other than a semicolon followed a question mark. The question mark must either be followed by an end-of-message, an end or command, or a space before a parameter.

Table D-1. Error Messages Immediately Shown to the User. (8 of 9)

Error Message	Description
Mod and sweep conflict	An attempt was made to phase continuous sweep with internal modulation on, or with internal or external FM, Φ M, or the audio source turned on.
Needs space after header	The characters following the command header must have a space or an end-of-command message.
No manual Φ cont. sweep	An attempt was made to do Manual phase continuous sweep.
No such special	An invalid Special Function number was entered. Refer to appendix C for a list of available Special Functions.
Not allowed\Security on	An attempt has been made to turn on a "Blanked" display area when the security Special Function 173 is active.
Notice >> FM turned off	An attempt was made to turn on Φ M with FM on, or an attempt was made to go from CW to sweep or from sweep to CW with FM set to a value out of range for the frequency that was entered.
Notice >> Φ M turned off	An attempt was made to turn on FM with Φ M already on.
Notice Aud state changed	A conflict has occurred which causes a subcarrier modulation source to be turned off in order to allow modulation on the RF carrier.
Not in Fast Hop Mode	An attempt was made to enter or modify a frequency hop parameter without having first activated the MODE 5, FAST HOP key.
Not in service mode	An attempt has been made over HP-IB to access a service Special Function that is not accessible because the service mode switch has been turned off.
Numeric overflow	The number was out of range for the parameter being set.
Rate and dwell conflict	Hop rate and dwell time values conflict. (Modify the values according to the instructions found in chapter 3 for <i>Rate and Dwell</i> .)
Rate incr too large	The hop rate increment value entered is greater than the maximum permitted (100 kHz).
Rate incr too small	The hop rate increment value entered is less than the minimum permitted (1 Hz).
Reference cal too high	The reference calibration value entered is greater than the maximum permitted (255).
Reference cal too low	The reference calibration value entered is less than the minimum permitted (0).
Reverse power detected	A reverse power condition was detected at either the RF Output. (Disconnect the affected output from any external equipment and re-enter the key sequence that originally resulted in the error. If an error is still detected by the instrument, a reverse power problem still exists.)
RF must be turned ON	An attempt was made to activate the Fast Hop Learn State without having the RF output turned on.
Sequence overflow	An attempt was made to enter more than 10 entries into the Save/Recall Sequence list.

Table D-1. Error Messages Immediately Shown to the User. (9 of 9)

Error Message	Description
Settings conflict	Certain operating conditions are in conflict. For example, an attempt was made over HP-IB to set the Amplitude Limit to a value less than the current amplitude setting.
Start frequency too high	The start frequency value entered for the sweep is greater than the maximum permitted.
Start frequency too low	The start frequency value entered for the sweep is less than the minimum permitted.
Stop frequency too high	The stop frequency value entered for the sweep is greater than the maximum permitted.
Stop frequency too low	The stop frequency value entered for the sweep is less than the minimum permitted.
Sweep settings conflict	An attempt was made over HP-IB to send a command message with conflicting sweep statements.
Sweep time too large	The sweep time value entered is greater than the maximum permitted (refer to the specifications for limits).
Sweep time too small	The sweep time value entered is less than the minimum permitted (refer to the specifications for limits).
Too many audio sources	There cannot be more than three other audio sources turned ON with the audio source in Channel 1 turned ON.
Too many commands	Too many commands were sent in a single message. The message must be broken up into several messages with less commands in each one.
Unexpected '?'	A question mark was found in the data string. A question mark should only occur immediately after the command header.
Unexpected colon	A colon was found in the command header in an invalid location (for example, after another colon, after a question mark, or found with a command parameter).
Unexpected comma	A comma was found in the command header, before the first argument, or after another comma. Commas are only allowed between certain arguments in the command header or message.
Unexpected EOC	An unexpected end-of-command (EOC) condition was found by the instrument before a valid command was complete. This includes not having a required parameter in a command.
Unexpected EDM	An unexpected end-of-message (EOM) condition was found by the instrument before a valid command was complete. This includes not having a required parameter in a command.
Unrecognized '#' format	In a non-decimal numeric argument you must use a binary, octal, hexadecimal, or "arbitrary block program data" format.
Wrong char after suffix	An unexpected character was encountered by the instrument after reading in a numeric suffix. This may indicate a missing comma, semicolon, or an end-of-message.
Wrong position for '?'	A question mark was found at the start of the message, after a colon or a space, or after an argument or a suffix. Question marks must follow directly after command header mnemonics.

Table D-2. Error Messages Put In the Message Queue for the User. (1 of 4)

Error Message	Description
Hardware Failure 1	A communications discriminator failure has been detected at power up, or detected as a result of a self-calibration or self-test. Refer to figure D-1 for corrective action.
Hardware Failure 2	A VCO failure has been detected at power up, or detected as a result of a self-calibration or self-test. Refer to figure D-1 for corrective action.
Hardware Failure 3	A Fractional-N failure has been detected at power up, or detected as a result of a self-calibration or self-test. Refer to figure D-1 for corrective action.
Hardware Failure 4	A modulation distribution failure has been detected at power up, or detected as a result of a self-calibration or self-test. Refer to figure D-1 for corrective action.
Hardware Failure 5	An ALC failure has been detected at power up, or detected as a result of a self-calibration or self-test. Refer to figure D-1 for corrective action.
Hardware Failure 6	An attenuator failure has been detected at power up, or detected as a result of a self-calibration or self-test. Refer to figure D-1 for corrective action.
Hardware Failure 7	An audio source failure has been detected at power up, or detected as a result of a self-calibration or self-test. Refer to figure D-1 for corrective action.
Hardware Failure 8	A reference failure has been detected at power up, or detected as a result of a self-calibration or self-test. Refer to figure D-1 for corrective action.
Hardware Failure 9	A doubler failure has been detected at power up, or detected as a result of a self-calibration or self-test. Refer to figure D-1 for corrective action.
Hardware Failure 13	A front panel failure has been detected at power up, or detected as a result of a self-calibration or self-test. Refer to figure D-1 for corrective action.
Hardware Failure 14	A power supply failure has been detected at power up, or detected as a result of a self-calibration or self-test. Refer to figure D-1 for corrective action.
Hardware Failure 15	An I/O board failure has been detected at power up, or detected as a result of a self-calibration or self-test. Refer to figure D-1 for corrective action.

Table D-2. Error Messages Put In the Message Queue for the User. (2 of 4)

Error Message	Description
Hardware Failure 16	A controller failure has been detected at power up, or detected as a result of a self-calibration or self-test. Refer to figure D-1 for corrective action.
Hardware Failure 18	A frequency counter failure has been detected at power up. Refer to figure D-1 for corrective action.
Hardware Failure 21	A communications discriminator out-of-lock (OOL) condition exists. Refer to figure D-1 for corrective action.
Hardware Failure 23	A Fractional-N (NF) phase-locked-loop (PLL) out-of-lock (OOL) condition exists. Refer to figure D-1 for corrective action.
Hardware Failure 24	A VCO frequency-locked-loop (FLL) out-of-lock (OOL) condition exists. Refer to figure D-1 for corrective action.
Hardware Failure 25	A VCO phase-locked-loop (PLL) out-of-lock (OOL) condition exists. Refer to figure D-1 for corrective action.
Hardware Failure 26	A fast controller failure has been detected at power up, or detected as a result of a self-calibration or self-test. Refer to figure D-1 for corrective action.
Hardware Failure 27	An audio source out-of-lock (OOL) condition exists. Refer to figure D-1 for corrective action.
Hardware Failure 28	A reference out-of-lock (OOL) condition exists. Refer to figure D-1 for corrective action.
Hardware Failure 31	A ROM failure has been detected at power up, or detected as a result of a self-calibration or self-test. Refer to figure D-1 for corrective action.
Hardware Failure 32	A ROM failure has been detected at power up, or detected as a result of a self-calibration or self-test. Refer to figure D-1 for corrective action.
Hardware Failure 33	A ROM failure has been detected at power up, or detected as a result of a self-calibration or self-test. Refer to figure D-1 for corrective action.

Table D-2. Error Messages Put In the Message Queue for the User. (3 of 4)

Error Message	Description
Hardware Failure 34	A ROM failure has been detected at power up, or detected as a result of a self-calibration or self-test. Refer to figure D-1 for corrective action.
Hardware Failure 35	A voltmeter failure has been detected at power up, or detected as a result of a self-calibration or self-test. Refer to figure D-1 for corrective action.
Hardware Failure 36	A RAM failure has been detected at power up, or detected as a result of a self-calibration or self-test. Refer to figure D-1 for corrective action.
Calibration Error 1	A condition occurred where invalid level calibration data resides in either the Output or the Attenuator modules. Follow the external calibration procedures outlined in figure D-1 .
Calibration Error 2	At some time during the calibration or self-test, a condition occurred where some hardware was unable to be calibrated. Fix the hardware and re-calibrate. Refer to figure D-1 for corrective action. This error message will always be accompanied by other error messages.
Calibration Error 3	A sensor indicates that inside temperature has varied $\pm 10^{\circ}$ Centigrade ($\pm 18^{\circ}$ Fahrenheit) from where the temperature was when the instrument was last calibrated. A re-calibration by activating Special Function 171 may be necessary for the instrument to maintain its specifications.
Amplitude Error 1	An Automatic-Level-Control (ALC) out-of-lock (OOL) condition exists. An operating condition may have caused the OOL error, or a hardware problem may exist; check out both possibilities.
Amplitude Error 2	A doubler amplitude out-of-lock (OOL) condition exists. An operating condition may have caused the OOL error, or a hardware problem may exist; check out both possibilities.
User Memory Cleared	A memory failure has been detected, all battery backup memory is lost. Refer to figure D-1 for corrective action.
Reverse power detected	A reverse power condition was detected at the RF Output. (Disconnect the affected output from any external equipment and re-enter the key sequence that originally resulted in the error. If an error is still detected by the instrument, a reverse power problem still exists.)

Note

The "Transient Errors" listed in the following table (4 of 4) will only appear if Special Function 328 is activated. Refer to the Service Documentation for corrective action if you see one of these messages.

Table D-2. Error Messages Put In the Message Queue for the User. (4 of 4)

Error Message	Description
Transient Error 1	A transient communications discriminator out-of-lock (OOL) condition occurred. Refer to the service documentation for corrective action.
Transient Error 3	A transient Fractional-N (NF) phase-locked-loop (PLL) out-of-lock (OOL) condition occurred. Refer to the service documentation for corrective action.
Transient Error 5	A transient Automatic-Level-Control (ALC) out-of-lock (OOL) condition occurred. Refer to the service documentation for corrective action.
Transient Error 7	A transient audio source out-of-lock (OOL) condition occurred. Refer to the service documentation for corrective action.
Transient Error 8	A transient reference out-of-lock (OOL) condition occurred. Refer to figure D-1 for corrective action.
Transient Error 9	A transient doubler out-of-lock (OOL) condition occurred. Refer to figure D-1 for corrective action.
Transient Error 24	A transient VCO frequency-locked-loop (FLL) out-of-lock (OOL) condition occurred. Refer to the service documentation for corrective action.
Transient Error 25	A transient VCO phase-locked-loop (PLL) out-of-lock (OOL) condition occurred. Refer to the service documentation for corrective action.

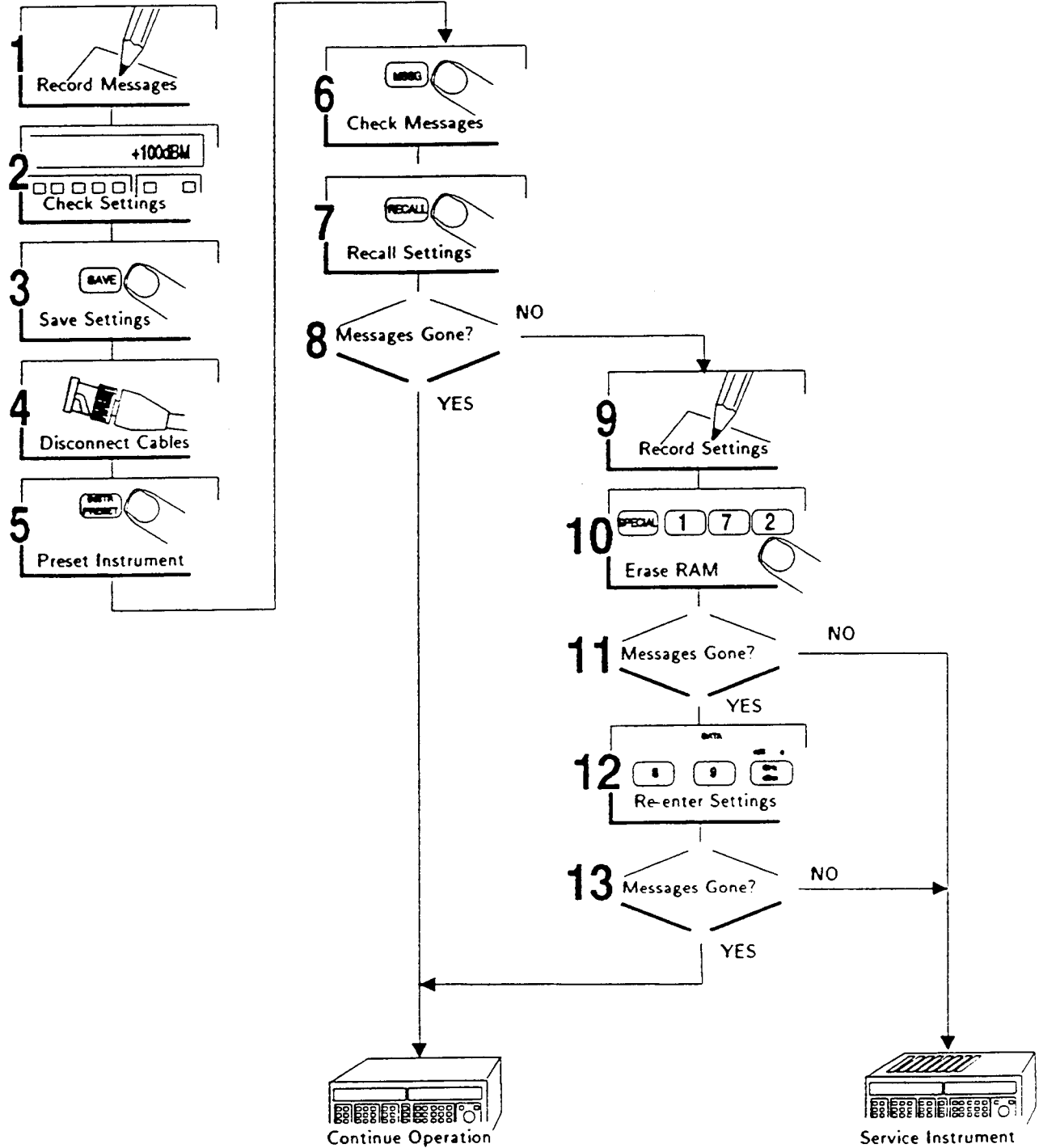

Figure D-1. Corrective Action for Error Messages

E

Questions and Answers

Answers to Commonly Asked Questions

This appendix is intended to provide answers to some of the most commonly asked questions about the HP 8645A *Agile Signal Generator*. While this is not an exhaustive list of questions, it is a forum for dealing with issues pertaining to operation of the HP 8645A.

The following list in the left column shows the topic for each subject discussed. The list in the right column shows you where to find a corresponding question and answer to the subject.

Demo mode	Q/A #1
Simultaneous modulation	Q/A #2
Pulse shaping	Q/A #3
FM bandwidth	Q/A #4
Learn State	Q/A #5
Spectral Purity	Q/A #6
Fast Hop Bus	Q/A #7
Recalibration	Q/A #8
Frequency Accuracy	Q/A #9
Frequency Switching	Q/A #10
Pseudo random hopping	Q/A #11
Amplitude control	Q/A #12

Question #1 Does the HP 8645A have a "demo mode" to display its frequency hopping capabilities with a modulated signal?

Answer #1 Yes, the HP 8645A does have a "demo mode". If you activate Special Function 200, sample frequency and amplitude parameters are entered into the channel table. Then, the HP 8645A is set up to receive an external DCFM signal programmed to 5 kHz deviation. rate. Then, after about 10 seconds in the Learn State, the HP 8645A goes into the Hop State.

Question #2 Will the HP 8645A perform simultaneous AM, FM, and Pulse modulation while frequency hopping?

Answer #2 Yes, the HP 8645A performs simultaneous AM, FM, and Pulse modulation while frequency hopping. However, the HP 8645A is only specified for internal or external AM & FM, or simultaneous AM and FM.

Question #3 Can we shape pulses between hop frequencies? If we can, how is it done?

Answer #3 Yes, by putting a DCAM signal into the AM Modulation Input connector while frequency hopping you can emulate a transmitter that uses a rigorous shaping technique; this also allows you to even decrease spectral splatter since energy is spread over adjacent channels as a result of pulsing the RF output on and off during frequency hopping.

Pulse shaping is done by the use of timers built into the HP 8645A that first, as power is being shut off at a specific frequency, send a negative step into the ALC loop so the amplitude drops at a rate consistent with the ALC bandwidth. After several microseconds, the pulse modulator is actuated to get an additional 35 dB or more off ratio. The timing is reversed for the power coming up at the new frequency, and the pulse modulator is activated first and then the ALC loop is allowed to return to its normal level delayed by several microseconds.

Pulse shaping cannot take place when the ALC loop is open (as a result of activating Special Function 202 or by using the HP-SL command statement FHOP:ALC:STATE OFF).

Question #4 What is the FM bandwidth when the HP 8645A is frequency hopping?

Answer #4 The FM bandwidth when the HP 8645A is frequency hopping is the same when in normal operation. FM bandwidth is a function of the maximum rate at which the RF output is modulated. The following table will help to illustrate the FM bandwidth (note: the lower 3 dB bandwidth limit is typically 20 Hz for ac coupling).

Carrier Frequency (MHz)	Maximum Rate (3 dB BW) (kHz)
1030 to 2060	10000
515 to 1030	10000
257 to 515	5000
128 to 257	2500
64 to 128	1250
32 to 64	625
16 to 32	313
8 to 16	156
4 to 8	78
2 to 4	39
1 to 2	19.5
0.5 to 1	9.7
0.25 to 0.5	4.8

Question #5 How long does the HP 8645A take to learn frequency and amplitude settings before it can frequency hop, and how often does it need to be done?

Answer #5 It takes at least 10 seconds and as much as 2.5 minutes to learn all of the frequency and amplitude settings before frequency hopping can occur. The time it takes depends upon the number of unique channels set up in the sequence table.

Since the frequency accuracy of the RF output is temperature dependant, the Learn State should be kept active when not frequency hopping, or re-initiated if the ambient temperature has changed significantly since the last completed learn operation. This ensures the most accurate RF output while frequency hopping. Refer to chapter 3 in this *Operation Guide* for more information about the Learn State.

Question #6 What is the spectral purity while frequency hopping?

Answer #6 The spectral purity depends upon the carrier frequency during the frequency hop operation. The following table summarizes the SSB phase noise specifications (which are typically 6 dB better) at the different carrier frequency bands for CW, AM, or FM operation. Refer to chapter 1 in the HP 8645A *Calibration Manual* for specific information about spurious signals:

Carrier Frequency (MHz)	Fast Hop Operation (20 kHz Offset dBc/Hz)
1030 to 2060	-117
515 to 1030	-124
257 to 515	-130
128 to 257	-133
64 to 128	-137
32 to 64	-139
16 to 32	-141
8 to 16	-142
4 to 8	-143
2 to 4	-144
1 to 2	-144
0.5 to 1	-144
0.25 to 0.5	-144

Question #7 What is the Fast Hop Bus, and how do I use it?

Answer #7 The Fast Hop Bus is a DB-25 pin connector located on the rear-panel of the HP 8645A. Its purpose is to provide a means of external control and synchronization for the frequency hop sequence. Specific control and synchronization information on the Fast Hop Bus is found in chapter 3 of this *Operation Guide*.

Question #8 How temperature sensitive is the HP 8645A, and how often do I need to perform a recalibration?

Answer #8 The HP 8645A has a general operating temperature range of 0 to +55°C. Whenever the instrument senses a temperature variation of $\pm 10^\circ\text{C}$, a recalibration should be done to ensure that all specifications are being met. The error message `Temp Drift, Recalibrate` is put into the message queue if the temperature variation occurs. Activate Special Function 171 to recalibrate the instrument.

If an instrument failure occurs, the **MSSG** annunciator will appear in the FREQUENCY/STATUS display. Activate Special Function 171 to recalibrate the instrument.

Depending upon use and environmental conditions, the instrument should be checked using the Performance Tests in the *Calibration Manual* every three years.

Question #9 What kind of frequency accuracy does the HP 8645A have with FM on, and will I get the same kind of accuracy when frequency hopping?

Answer #9 Carrier frequency accuracy for FM is specified in the HP 8645A technical data sheet. You get the best carrier frequency accuracy when Digitized FM synthesis is active. Linear FM synthesis (activated by Special Function 121) produces slight carrier frequency inaccuracies that are more apparent as FM deviation increases.

During frequency hopping, carrier frequency accuracy is ± 2 ppm and typically is ± 1 ppm.

One important fact to remember is that all HP 8645A specifications are warranted to apply 24 hours after the unit has been connected to a power line and 10 minutes after turning on the **POWER** switch (except frequency hopping in Mode 5 which has a 2 hour warm up after turn on).

Question #10 How fast does the HP 8645A switch from one frequency to another when frequency hopping?

Answer #10 To answer this question, you need to understand the concept of dwell time in relation to switching time. Dwell time is the duration of the RF output power for any channel at the RF Output connector. The duration covers a time period between two points where the RF output power is turned 90% on and 10% off. So with this in mind, the user has a limited amount of control over the speed in which the HP 8645A switches by controlling the dwell time.

The amount of control the user has over the dwell time is dependent upon the internal switching time of the hardware in the HP 8645A, and upon the hop rate you choose. If you refer to chapter 3 in this *Operation Guide* for more information, you will see that switching time is a function of the frequency range over which the HP 8645A is commanded to frequency hop.

Question #11 Can you frequency hop to channels in a pseudo random manner?

Answer #11 Yes, the HP 8645A will frequency hop in a pseudo random manner when the user provides the external triggering, timing control, and synchronization. Pseudo random frequency hopping may also be done with internal triggering if a pseudo-random sequence is loaded into the sequence table from the front panel or through HP-IB. The HP 8645A by itself does not generate pseudo random frequency hops.

Question #12 Can I control the output amplitude while frequency hopping for receiver sensitivity measurements?

Answer #12 The HP 8645A has a 20 dB output amplitude dynamic range over which frequency hopping can occur. You can extend the output amplitude level variation of the RF output by -15 dB during the Hop State without causing the HP 8645A to enter the Learn State by activating special function 203.

Connecting an external attenuator to the RF output will allow you to further reduce the output amplitude.

F

HP-SL Quick Reference Guide

Introduction to HP-SL Syntax Drawings

This appendix provides syntax drawings with Hewlett-Packard System Language (HP-SL) information for remote operation of the HP 8645A over the Hewlett-Packard Interface Bus (HP-IB). Use this appendix once you are familiar with the basic structure of HP-SL. Refer to chapter 5 *What About Programming?* for an introduction to HP-SL, and for programming reference information.

Command Statements

Command statements are used to either modify or query the HP 8645A. A general representation of a command statement is shown in figure F-1. Keywords are recognized in the command statement as those listed in either the *HP-IB Control Language Dictionary* or the *HP-SL Device Status Dictionary*.

Keywords may be followed by a question mark for a query, or by a space and then a command parameter (as described in the *HP-SL Notes* in chapter 5).

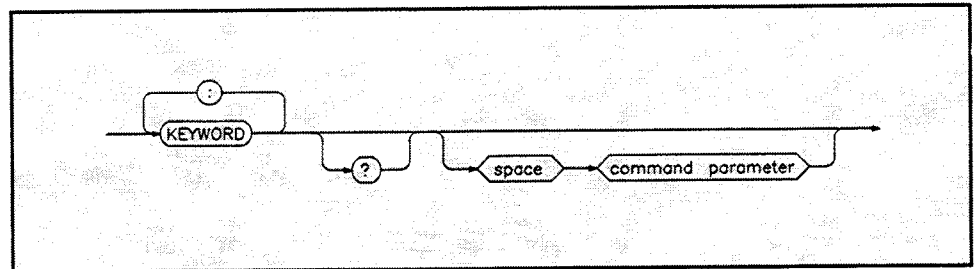

Figure F-1. Command Statement Syntax Drawing.

Command Message

One or more command statements on a line of programming code make up a command message. A general representation of a command message is shown in figure F-2. All command messages are terminated by either a new line (ASCII character 10), or an HP-IB end-or-identify (EOI). (The EOI is not a separate character but is a bus message sent along with a data character "new line" or the last character of the command statement.)

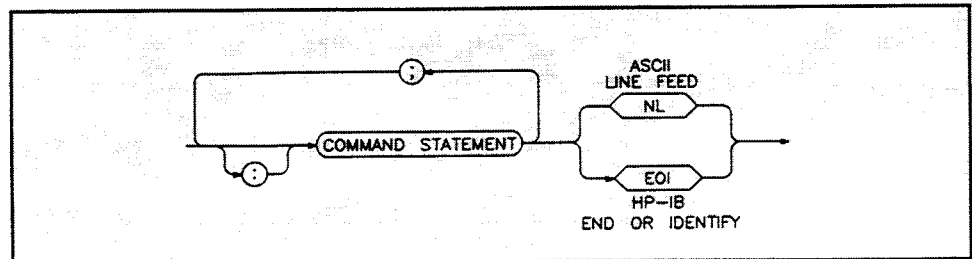
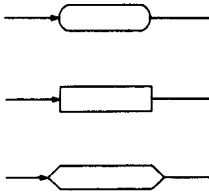

Figure F-2. Command Message Syntax Drawing.

Subsystem Syntax



MINimum

HP-SL Notes

All subsystem syntax drawings are represented pictorially. The following rules apply to all syntax drawings:

- A rounded envelope indicates that the HP-SL command must be included in the command statement.
- A rectangular box indicates an optional HP-SL command which may or may not be included in the command statement.
- A diamond shaped envelope usually indicates a command parameter preceded by a space, and in some cases the diamond shaped envelope is used to indicate that a "term" (terminator) is required to finish the command statement. Refer to the *HP-SL Notes* shown below for a description of each command parameter.
- Any HP-SL command written in *italics* is an alias to another HP-SL command.

AM term indicates that a "%" or "PCT" termination is required. "%" is assumed as the default value .

ampl step term indicates that a "dB", "V", "mV", "uV" termination is required. "dB" is assumed as the default value.

ampl step unit indicates that a "dB", or "V" termination must be specified.

ampl term indicates that "dBm", "dBmW" ("dBmW" is alias for "dBm"), "dBuV", "V", "mV", "uV", or no termination is required.

ampl unit term indicates that a "dBm", "dBmW", "V", or "dBuV" termination must be specified.

angle term indicates that a "DEG", "RAD", or no termination must be specified. "RAD" (radian) is assumed as the default value.

coupling type indicates that sources "AC", "DC", "GROund", or "GND" are available.

freq term indicates that "HZ", "KHZ", "MHZ", "MAHZ", "GHZ", or no termination is required. "HZ" is assumed as the default value.

lin ampl term indicates that "V", "mV", "uV", or no termination is required. "V" is assumed as the default value.

mod_type indicates that "AM", "FM", "PM", or "PULSe" is required.

non-decimal numeric program data indicates that the pound symbol "#" should be followed by either a "B" and a binary representation of a number, or "Q" and a octal representation of a number, or "H" and a hexadecimal representation of a number.

(nrf) indicates that an ASCII representation of a number is required.

(ohms term) indicates that an "OHM", "KOHM", "MOHM" or no termination is required. "OHM" is assumed as the default value.

(source list) indicates that "INTernal", or "EXTernal", or more than one source separated by commas is required.

(space) indicates an ASCII character in the range of 0 through 9 or 11 through 32 decimal.

(time term) indicates that "S", "mS", "uS", "nS" or no termination is required. "S" (seconds) is assumed as the default value.

Table of Contents

AM Subsystem F-5

Amplitude Subsystem F-6

Calibration Subsystem F-8

Display Subsystem F-8

FM Subsystem F-9

Frequency Subsystem F-10

Frequency Hop Subsystem F-12

HP-SL System Commands F-14

IEEE 488.2 Common Commands F-14

Initialize Subsystem F-14

LF Source Subsystem F-15

Marker Subsystem F-21

Modulation Subsystem F-21

Phase Modulation Subsystem F-22

Phase Subsystem F-22

Power Meter Subsystem F-23

Pulse Subsystem F-23

Reference Oscillator Subsystem F-23

Sequence Subsystem F-24

Status Subsystem F-24

Sweep Subsystem F-25

Take Sweep Subsystem F-25

Voltmeter Subsystem F-25

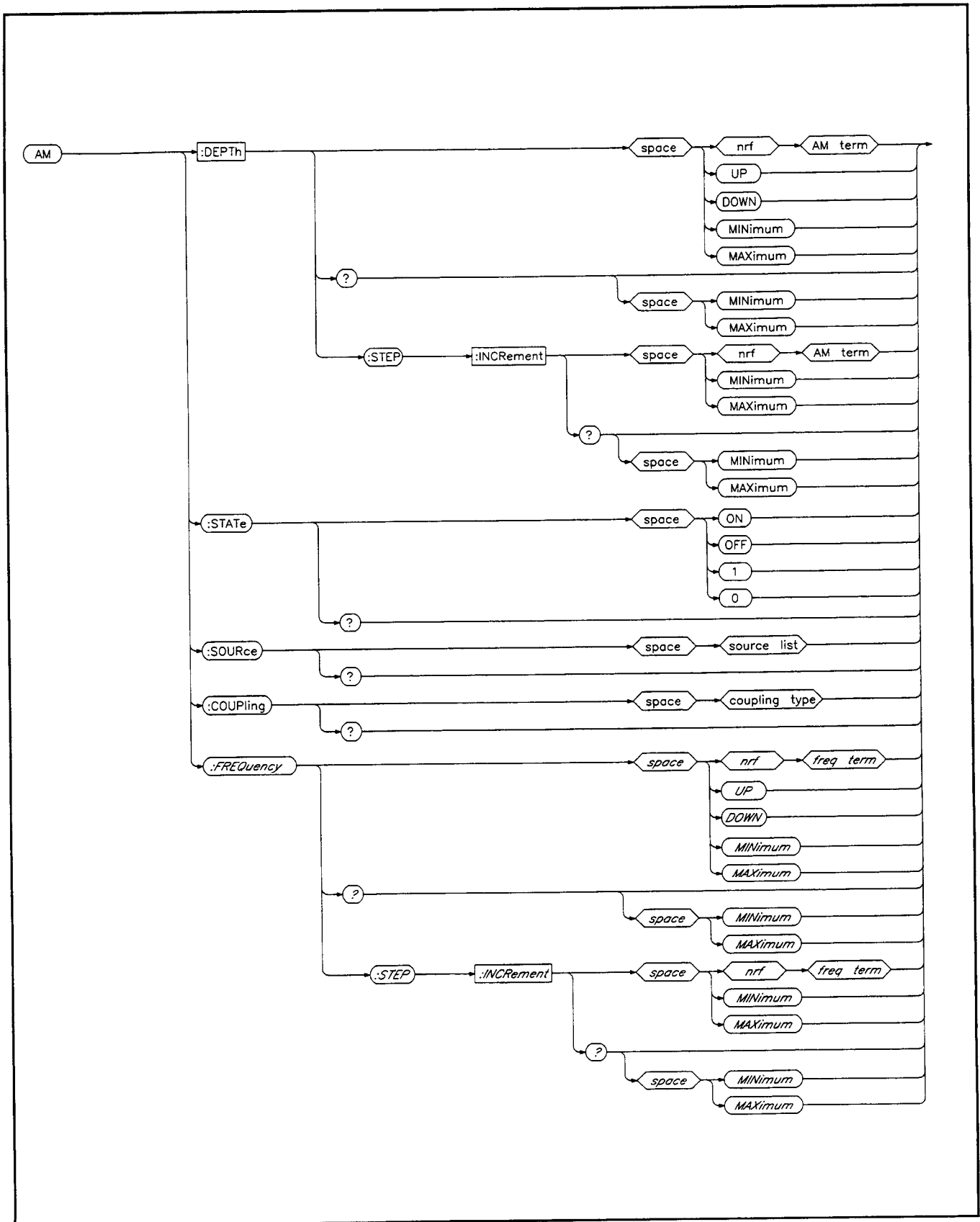

Figure F-3. AM Subsystem.

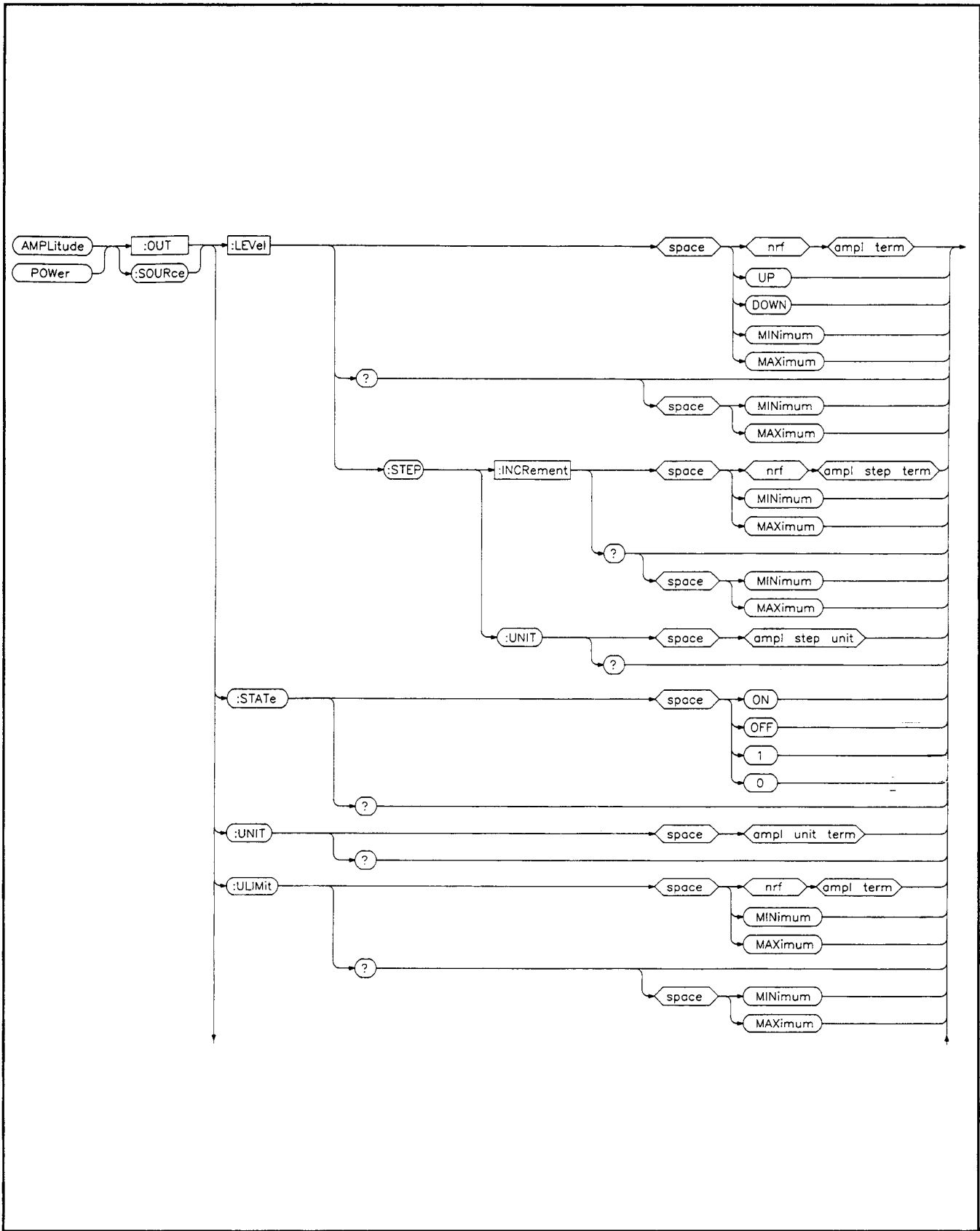

Figure F-4. Amplitude Subsystem. (1 of 2)

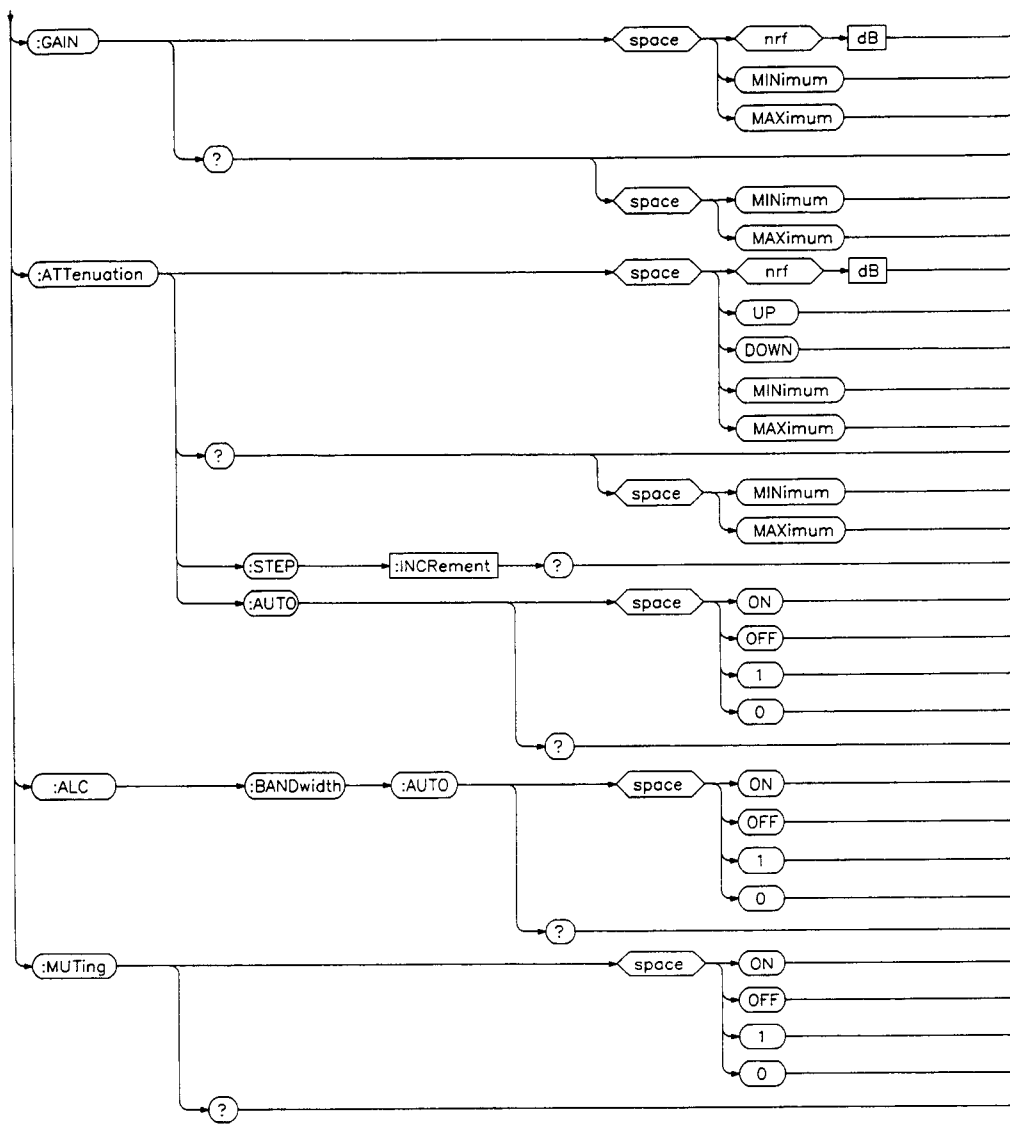

Figure F-4. Amplitude Subsystem. (2 of 2)

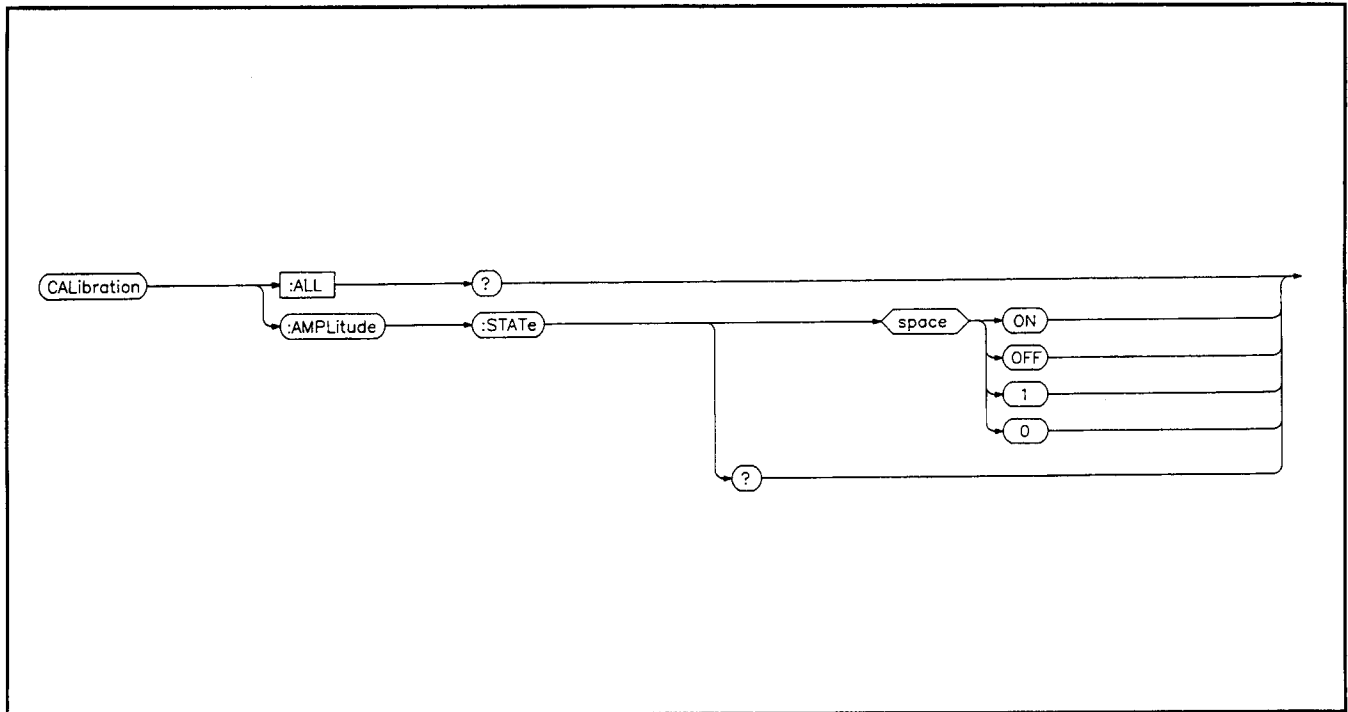

Figure F-5. Calibration Subsystem.

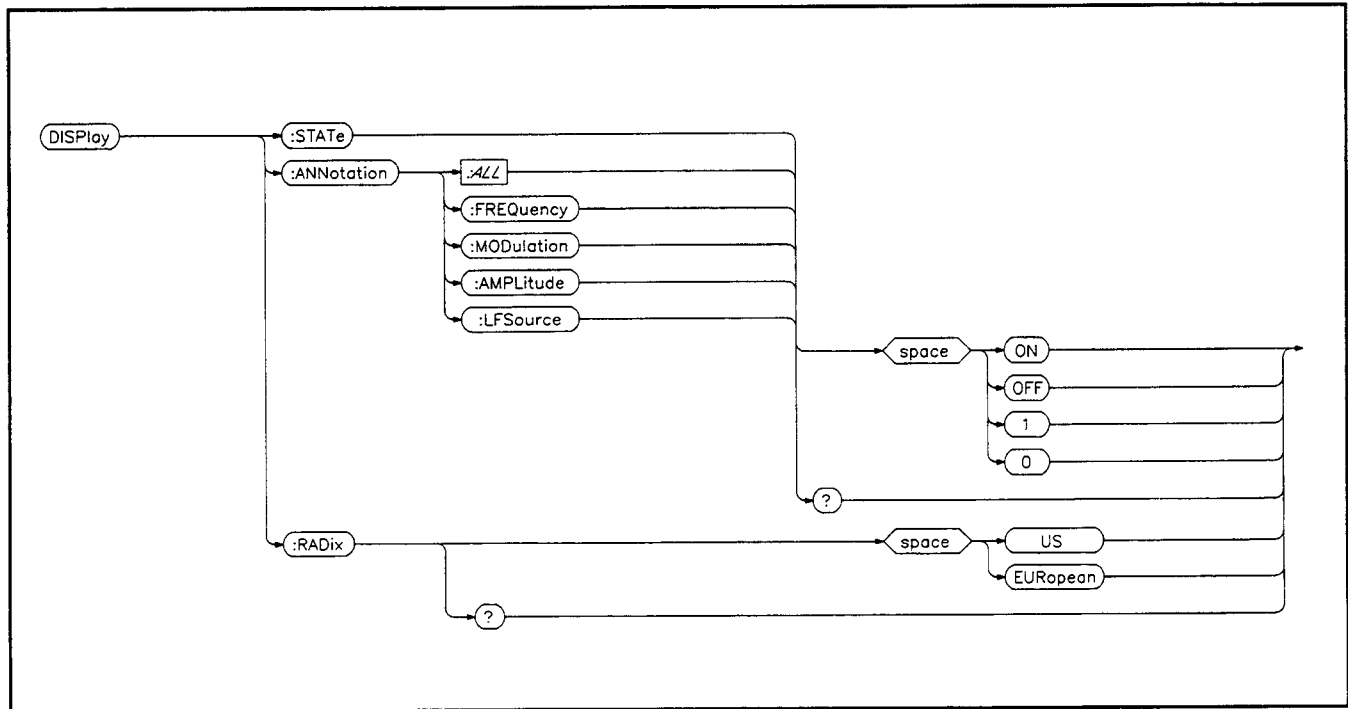

Figure F-6. Display Subsystem.

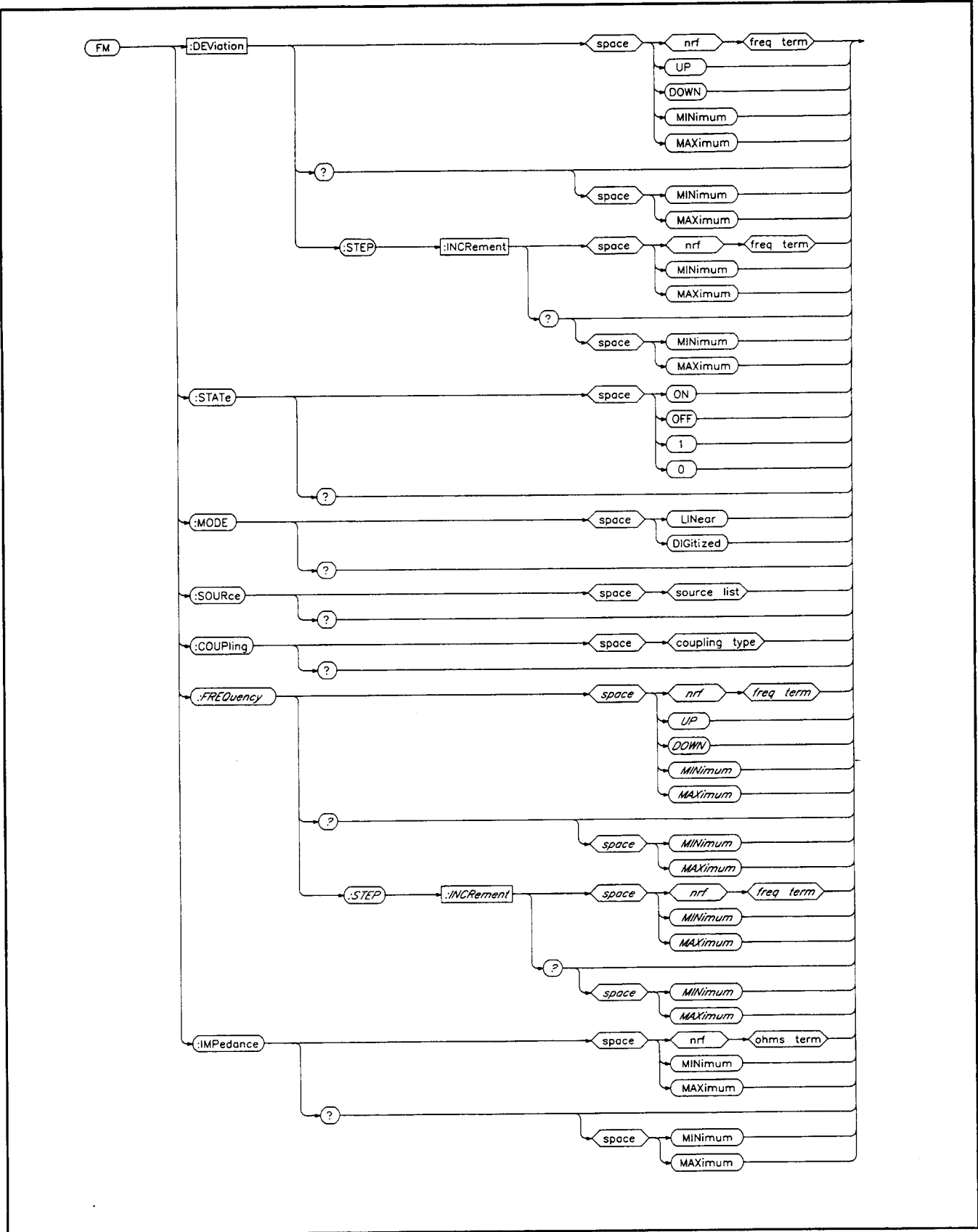

Figure F-7. FM Subsystem.

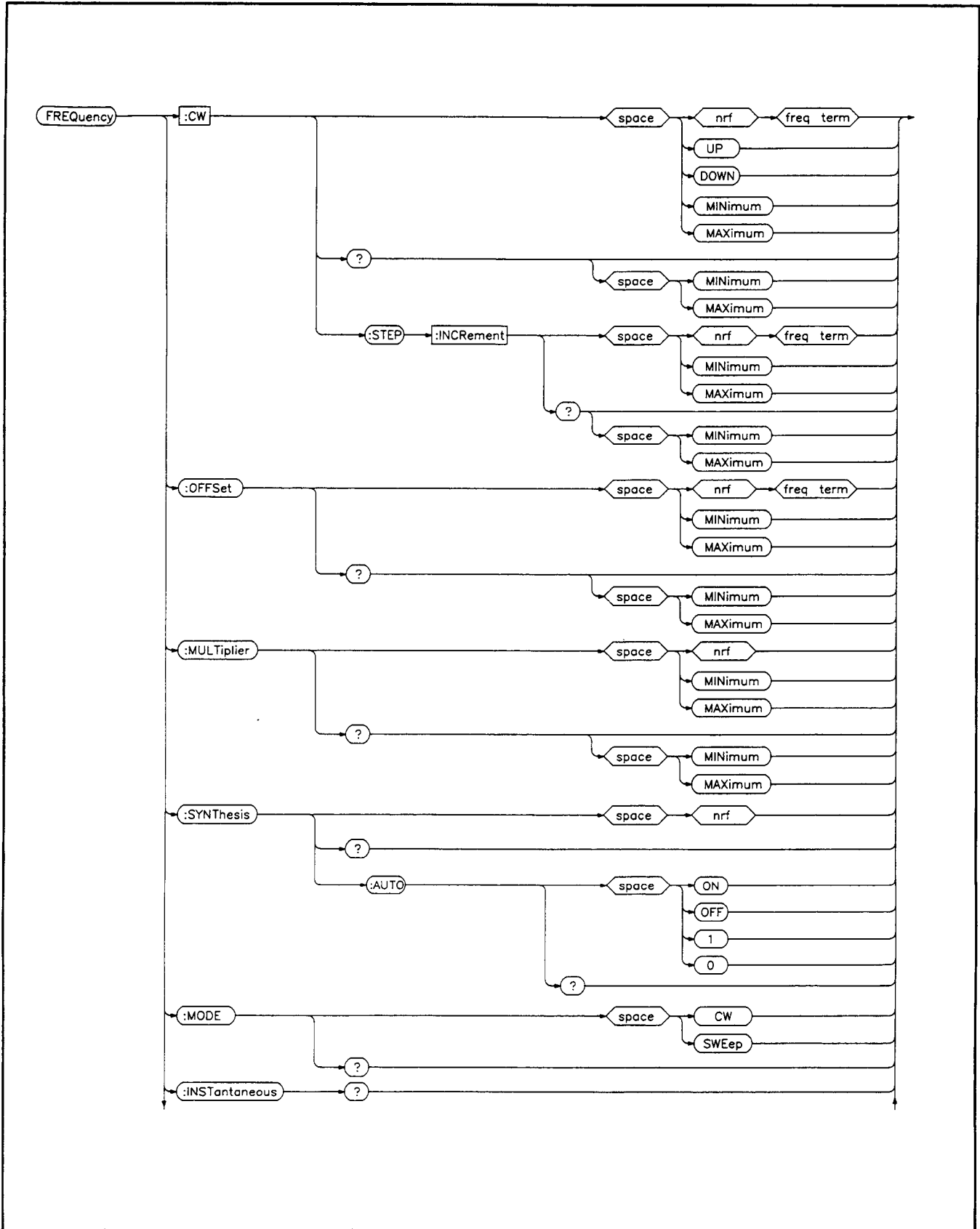

Figure F-8. Frequency Subsystem. (1 of 2)

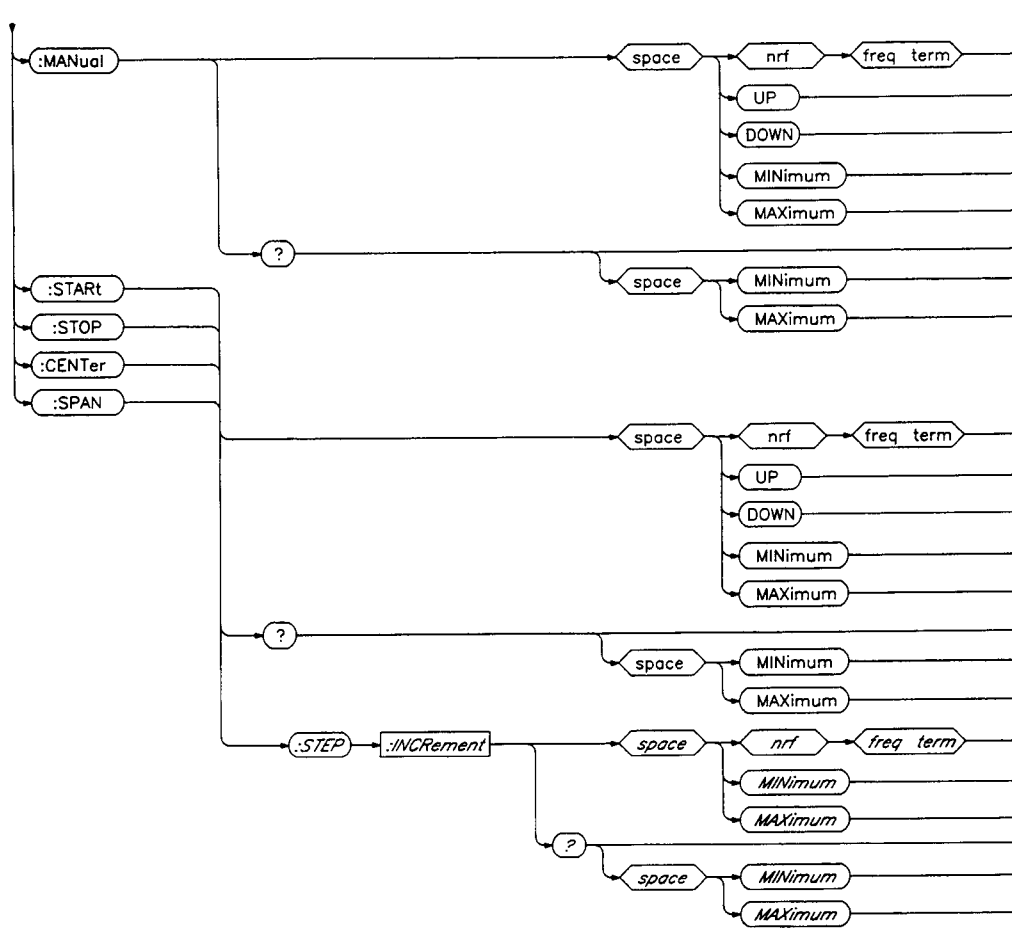

Figure F-8. Frequency Subsystem. (2 of 2)

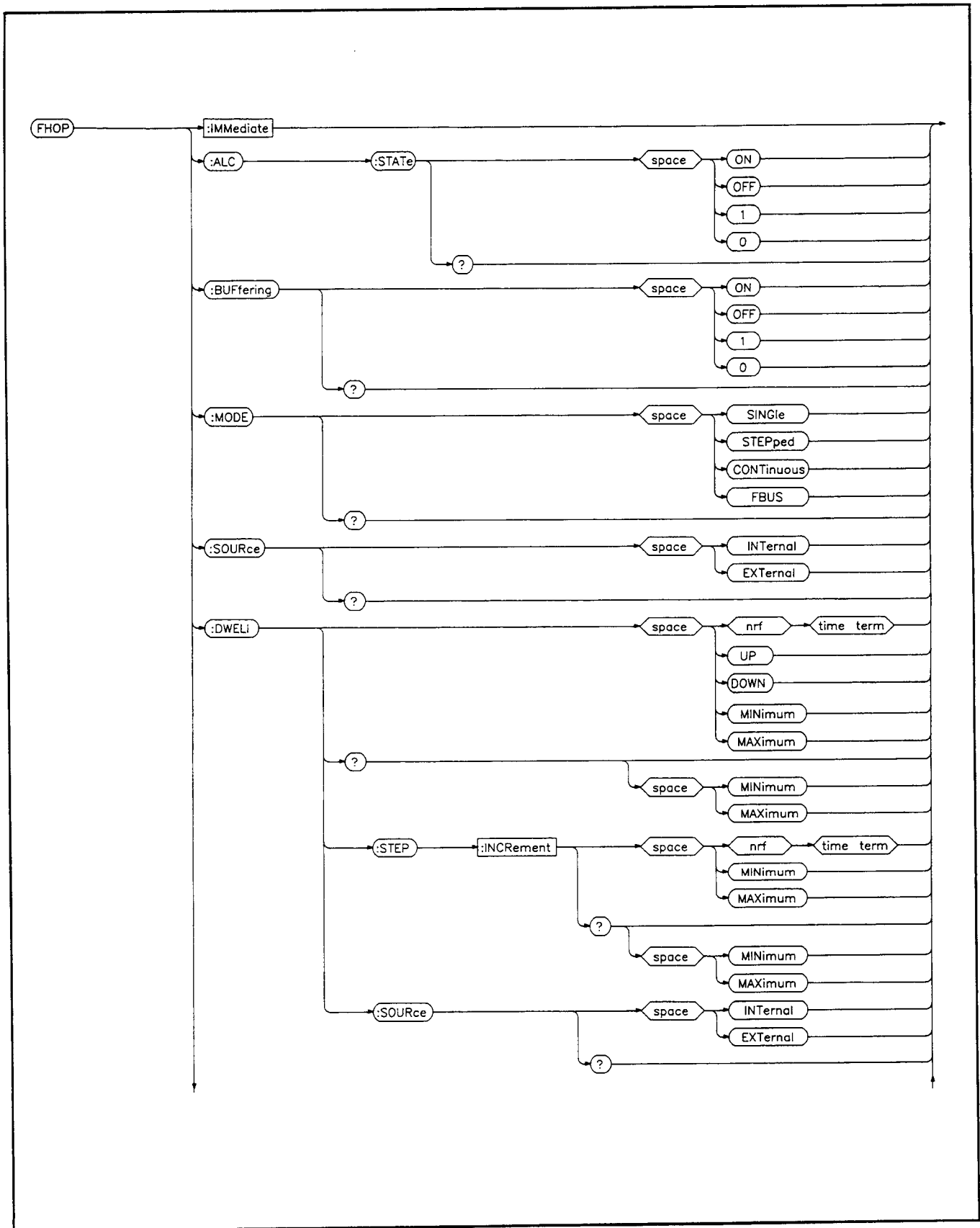

Figure F-9. Frequency Hop Subsystem. (1 of 2)

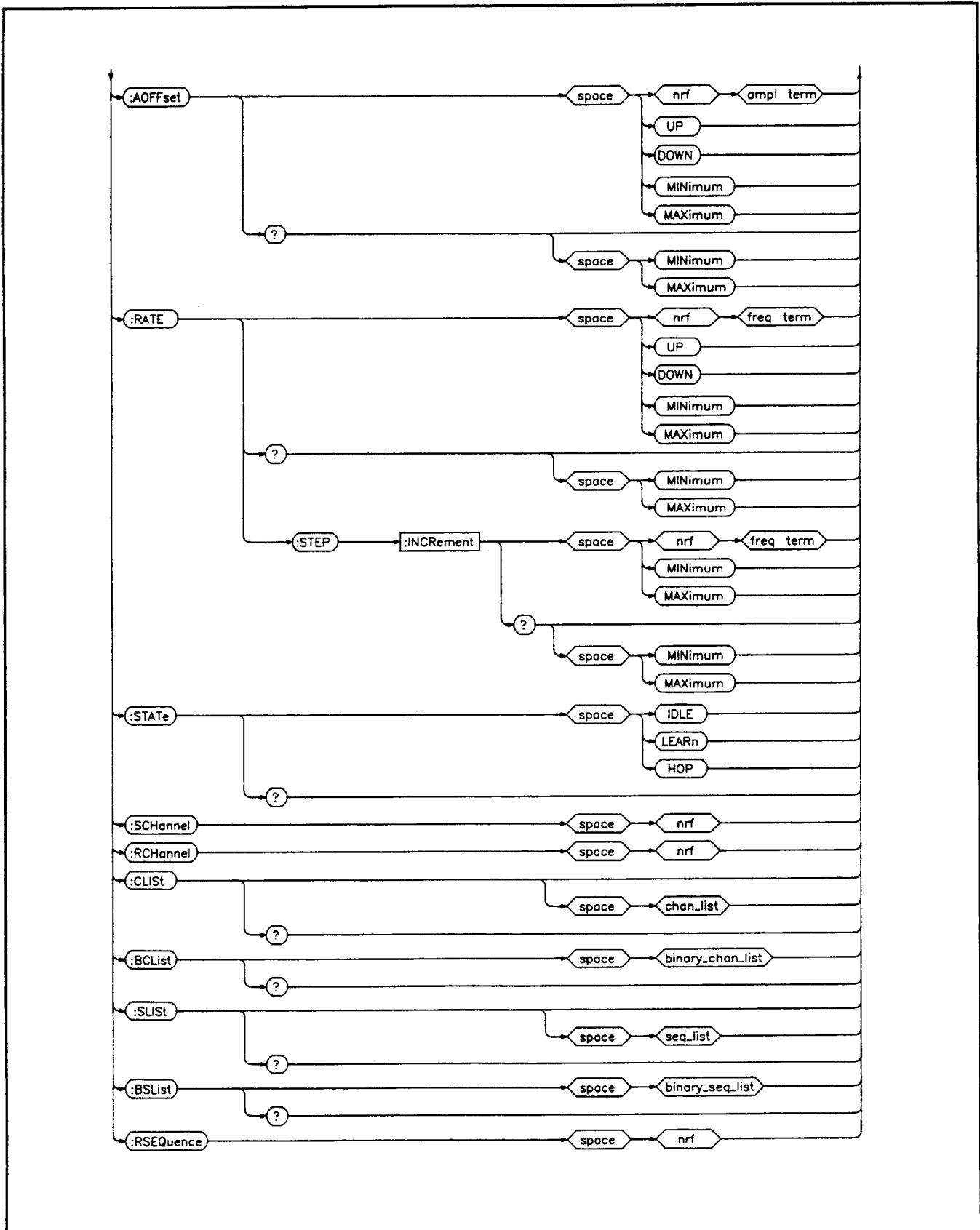

Figure F-9. Frequency Hop Subsystem. (2 of 2)

rev.02/JUN89

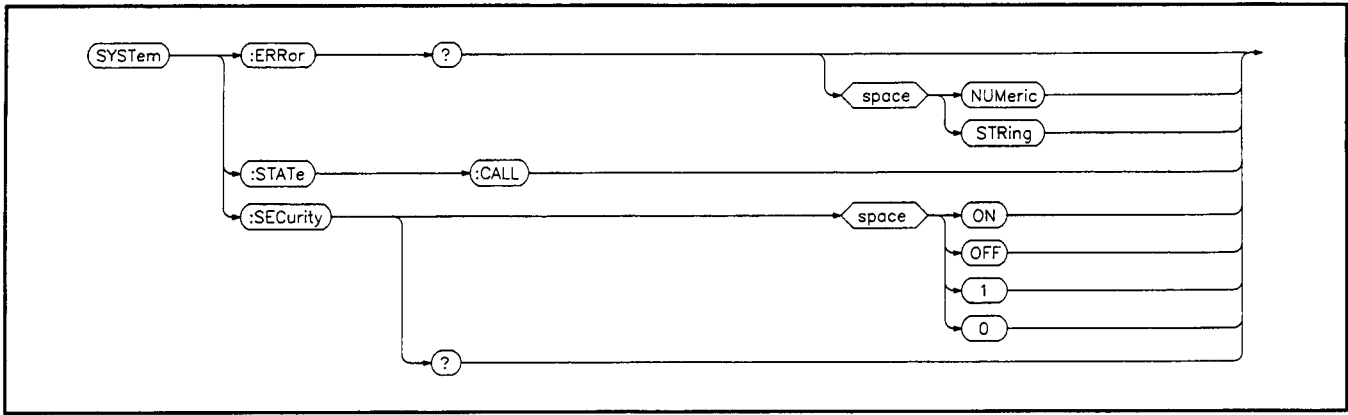

Figure F-10. HP-SL System Commands.

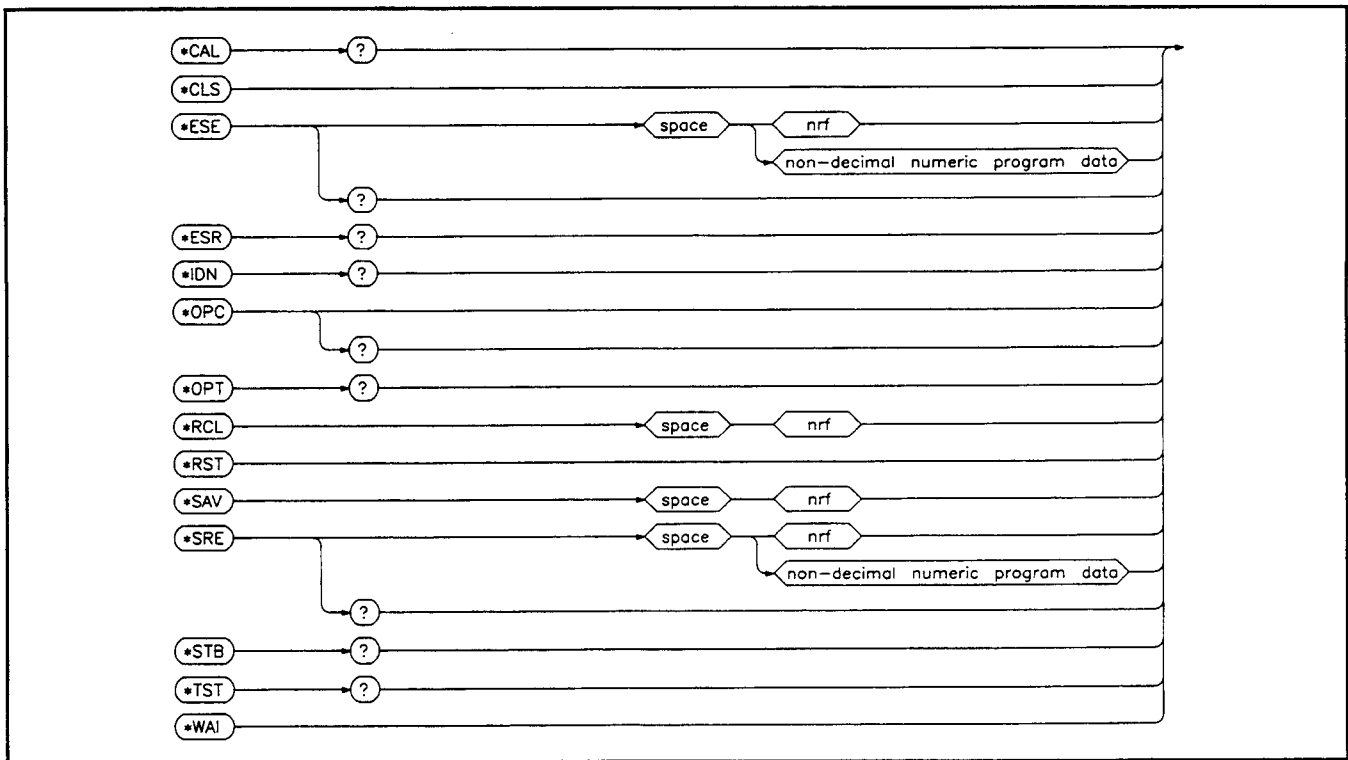

Figure F-11. IEEE 488.2 Common Commands.

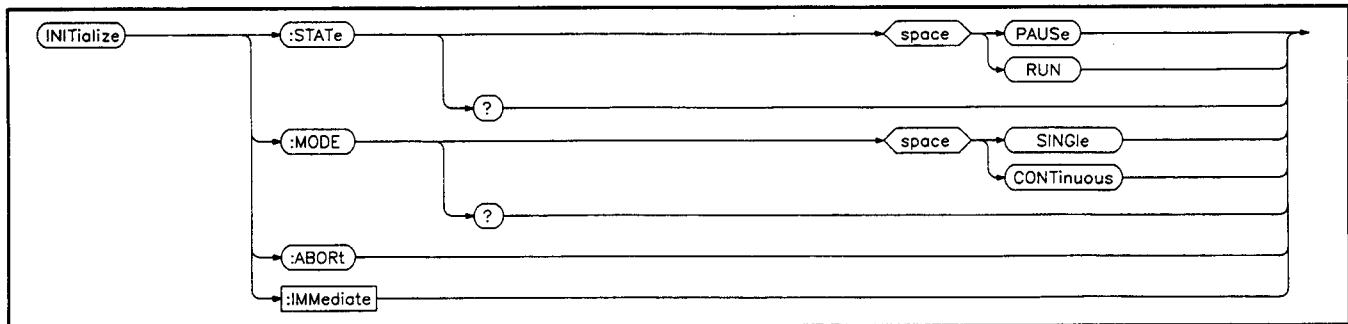

Figure F-12. Initialize Subsystem.

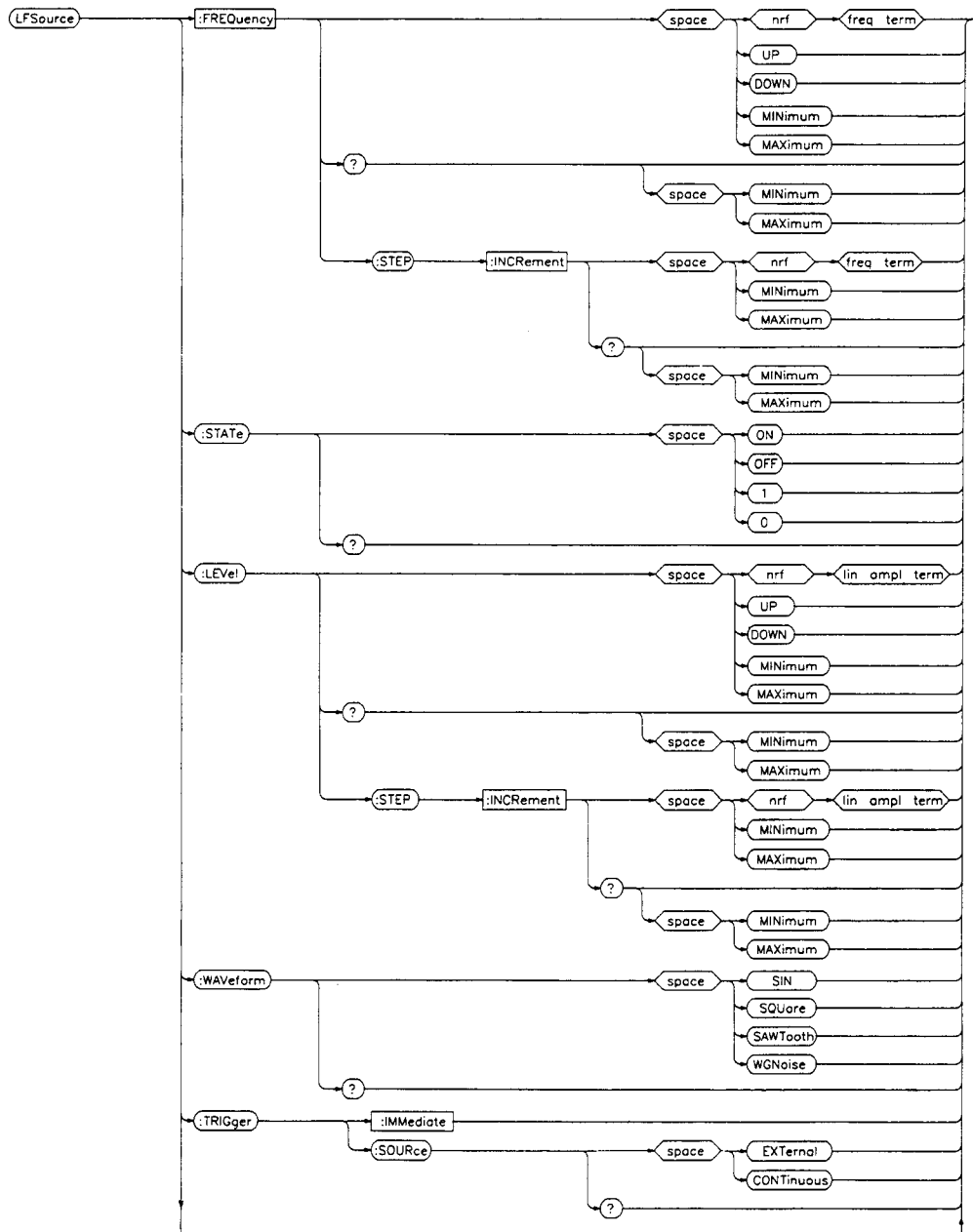

Figure F-13. LF Source Subsystem. (1 of 6)

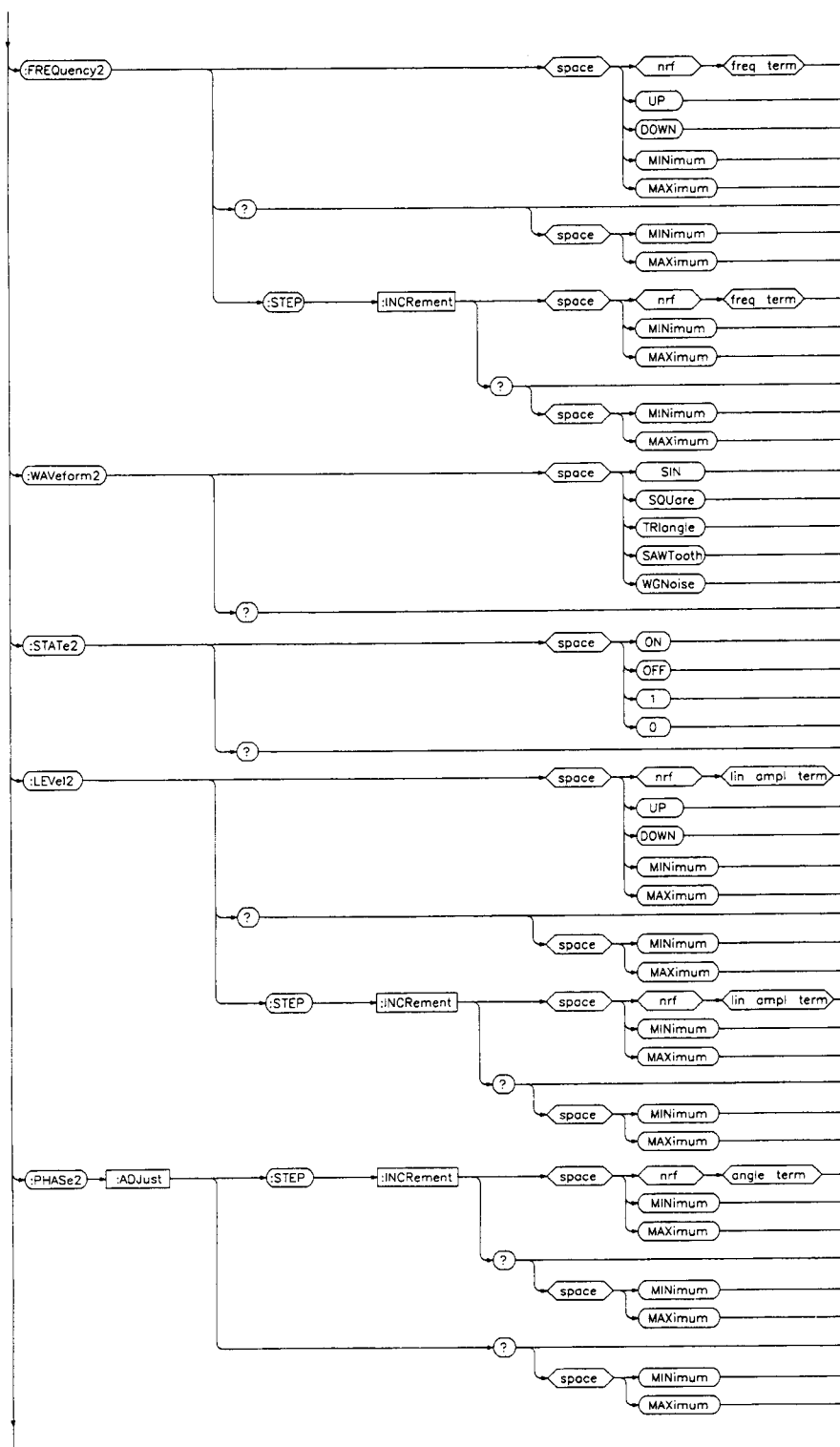

Figure F-13. LF Source Subsystem. (2 of 6)

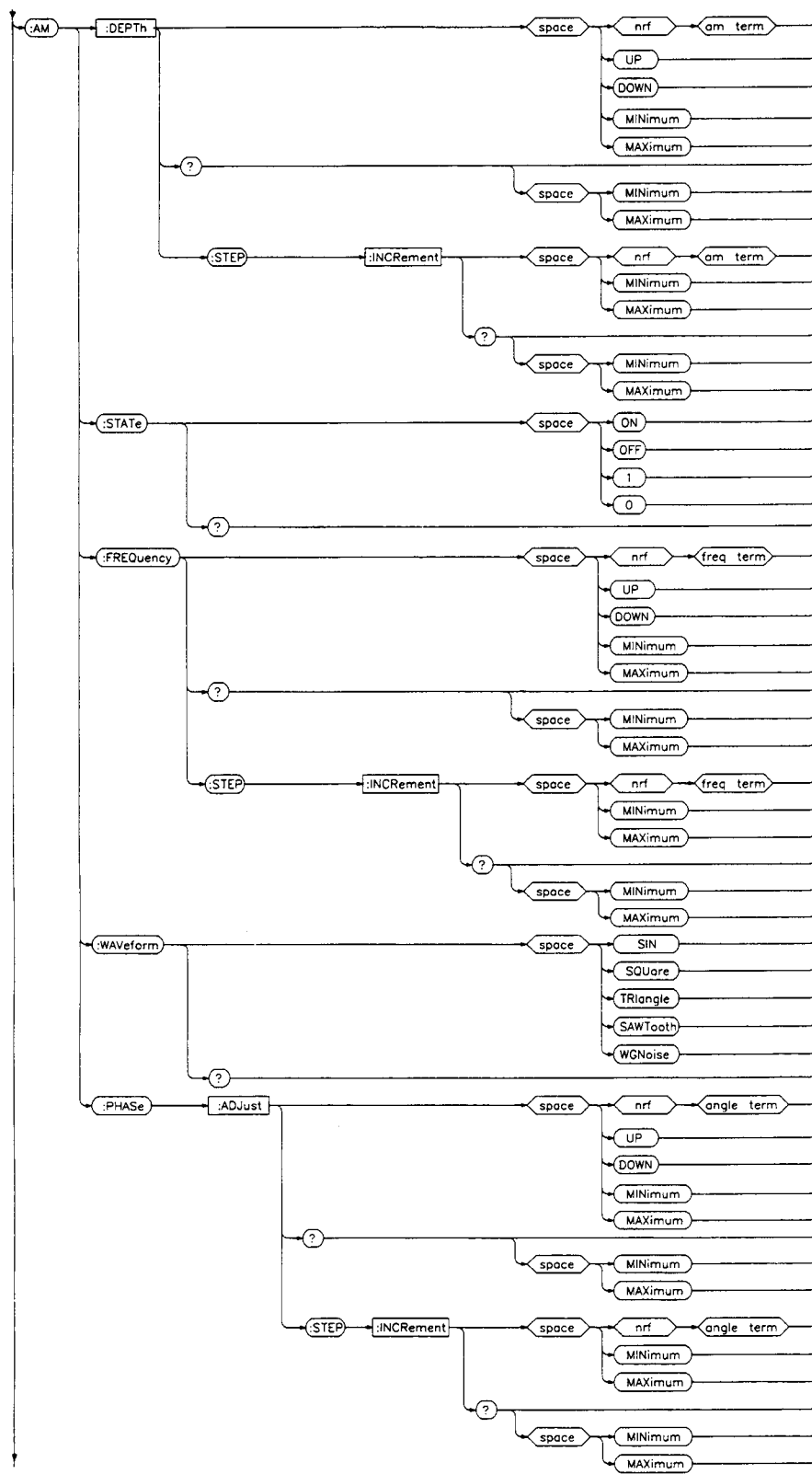

Figure F-13. LF Source Subsystem. (3 of 6)

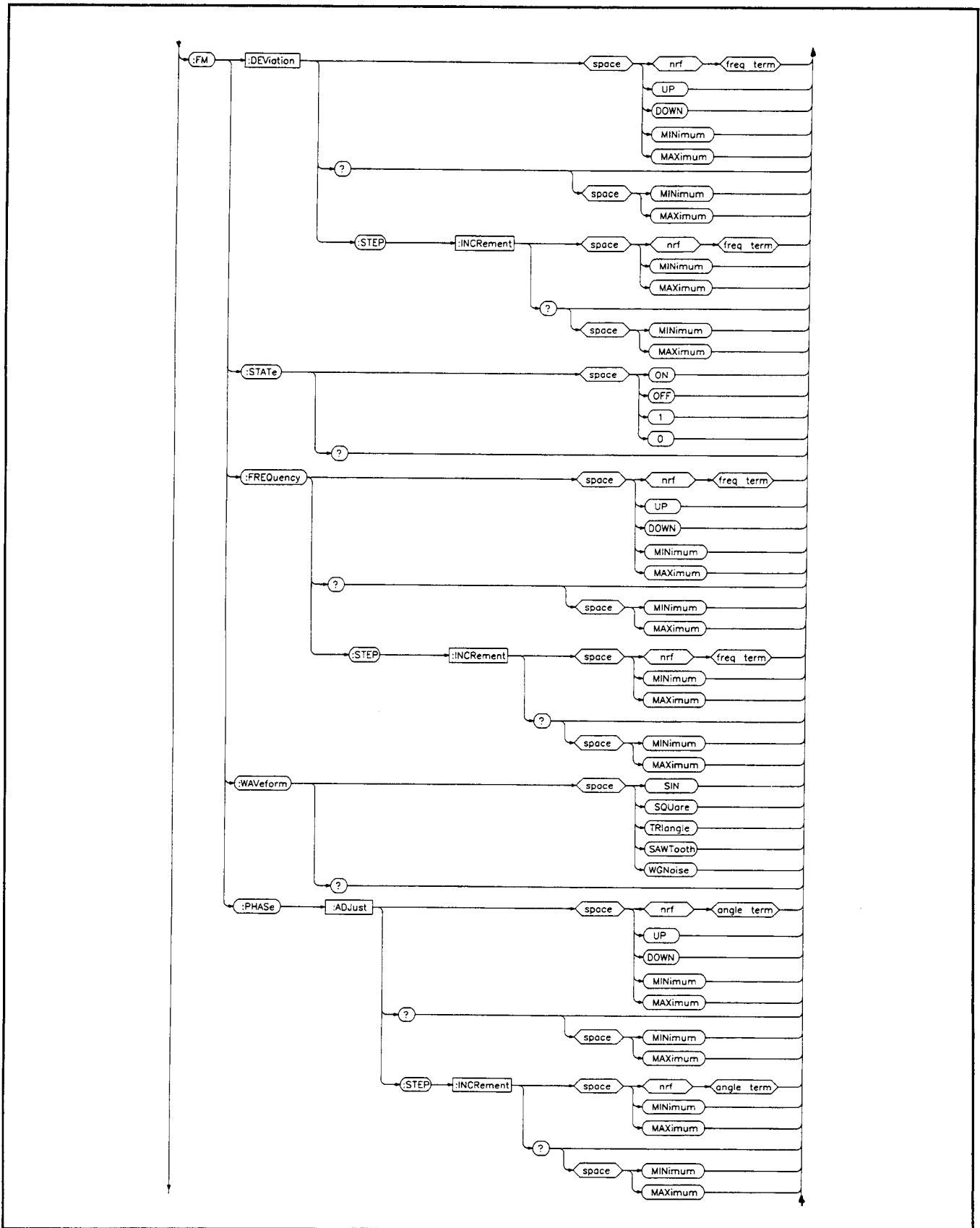

Figure F-13. LF Source Subsystem. (4 of 6)

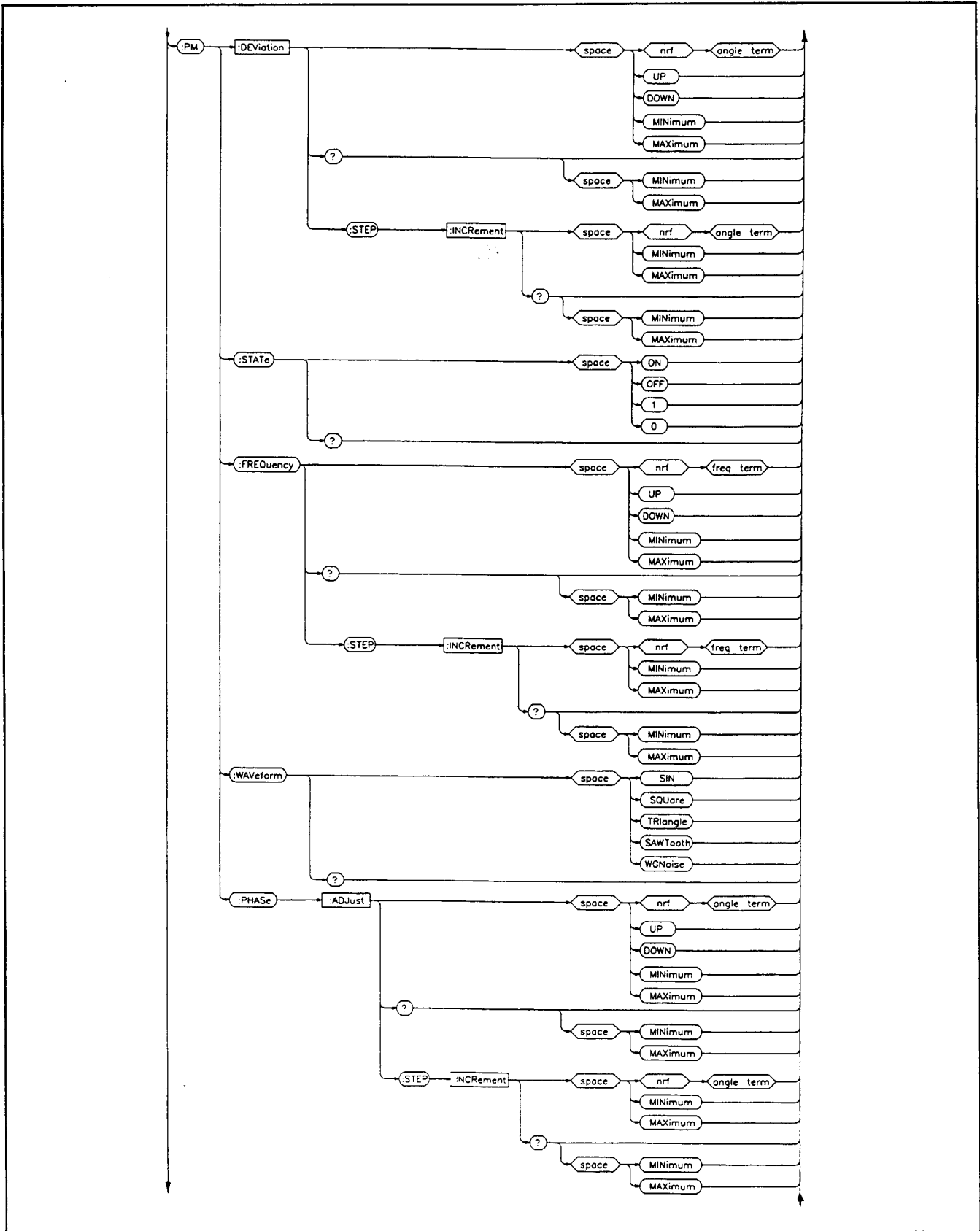

Figure F-13. LF Source Subsystem. (5 of 6)

rev.01MAR90

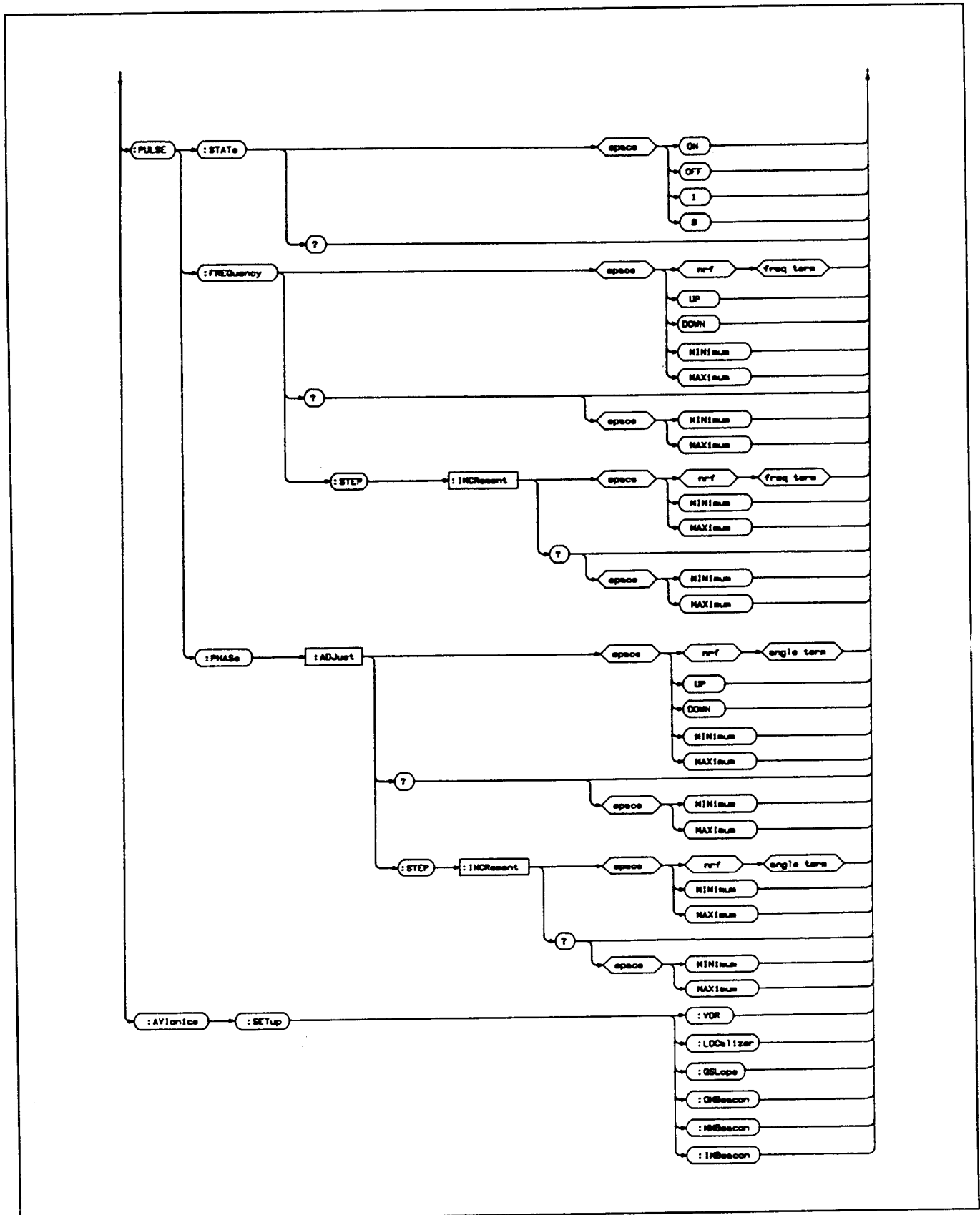

Figure F-13. LF Source Subsystem. (6 of 6)

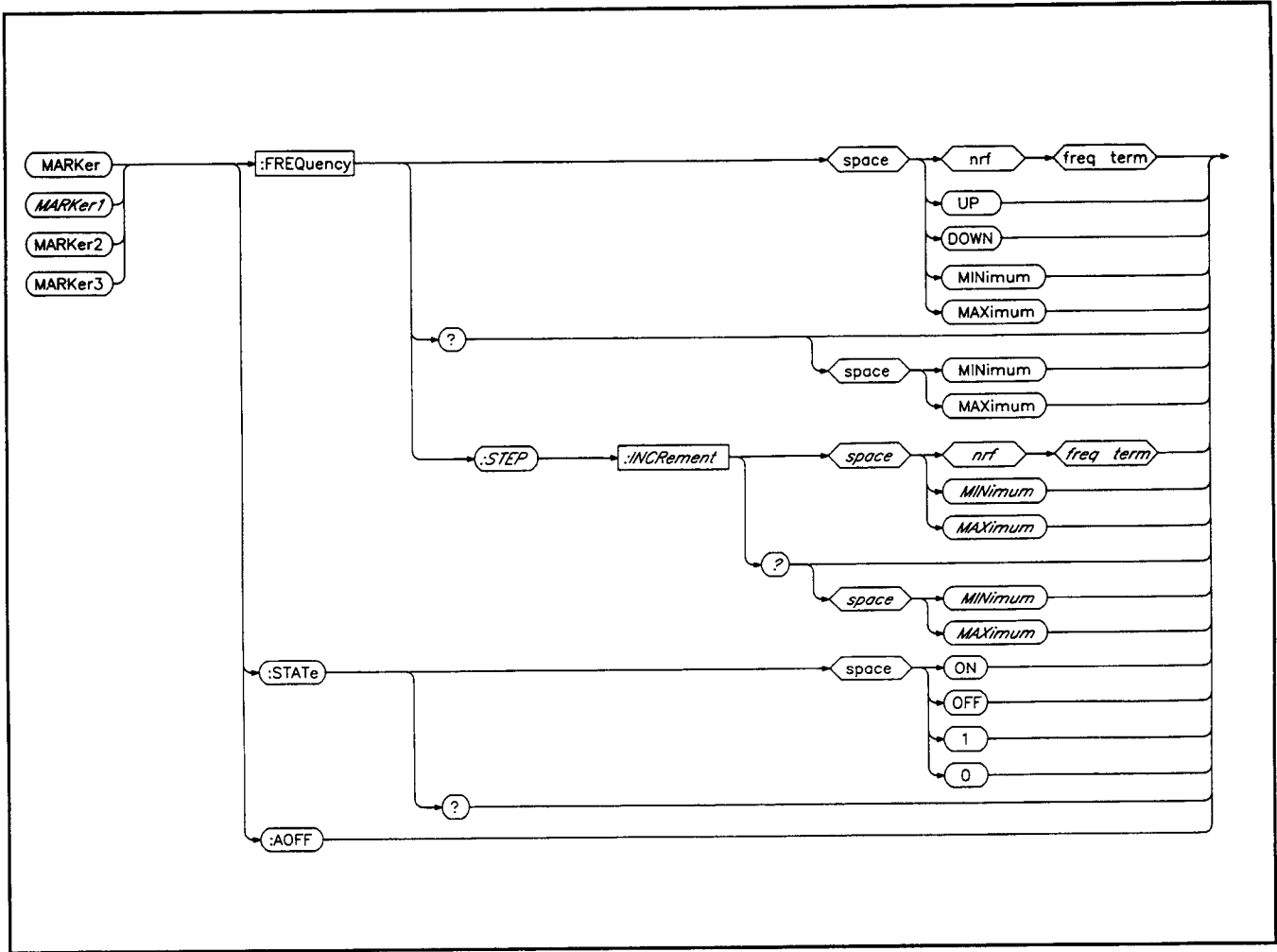

Figure F-14. Marker Subsystem.

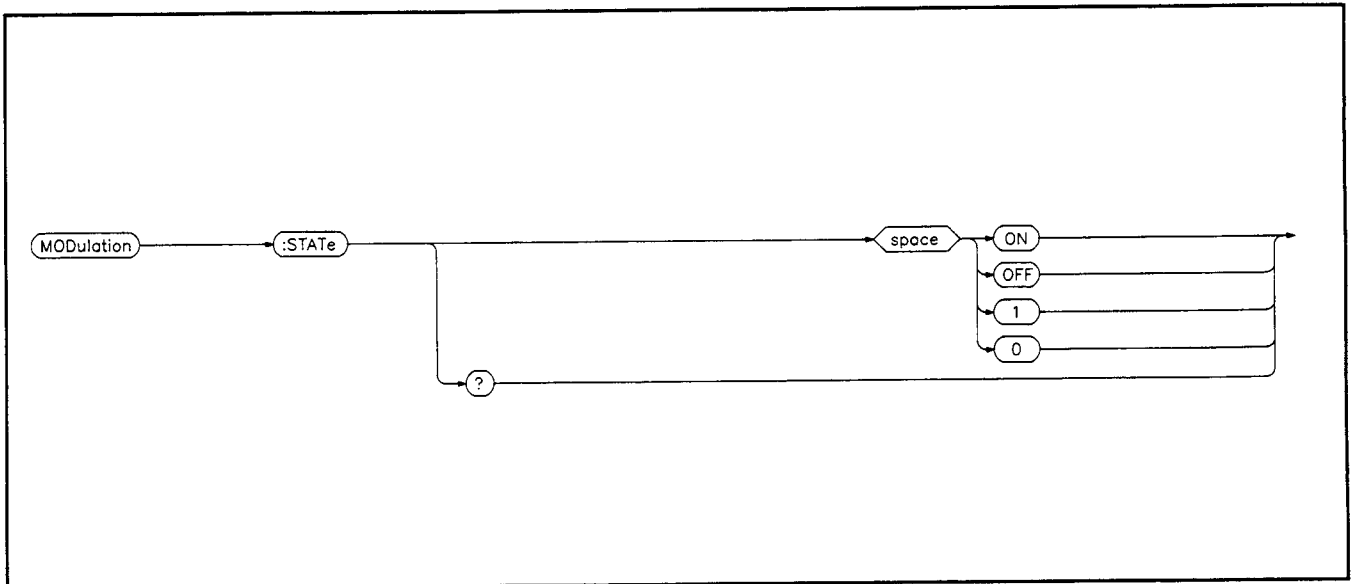

Figure F-15. Modulation Subsystem.

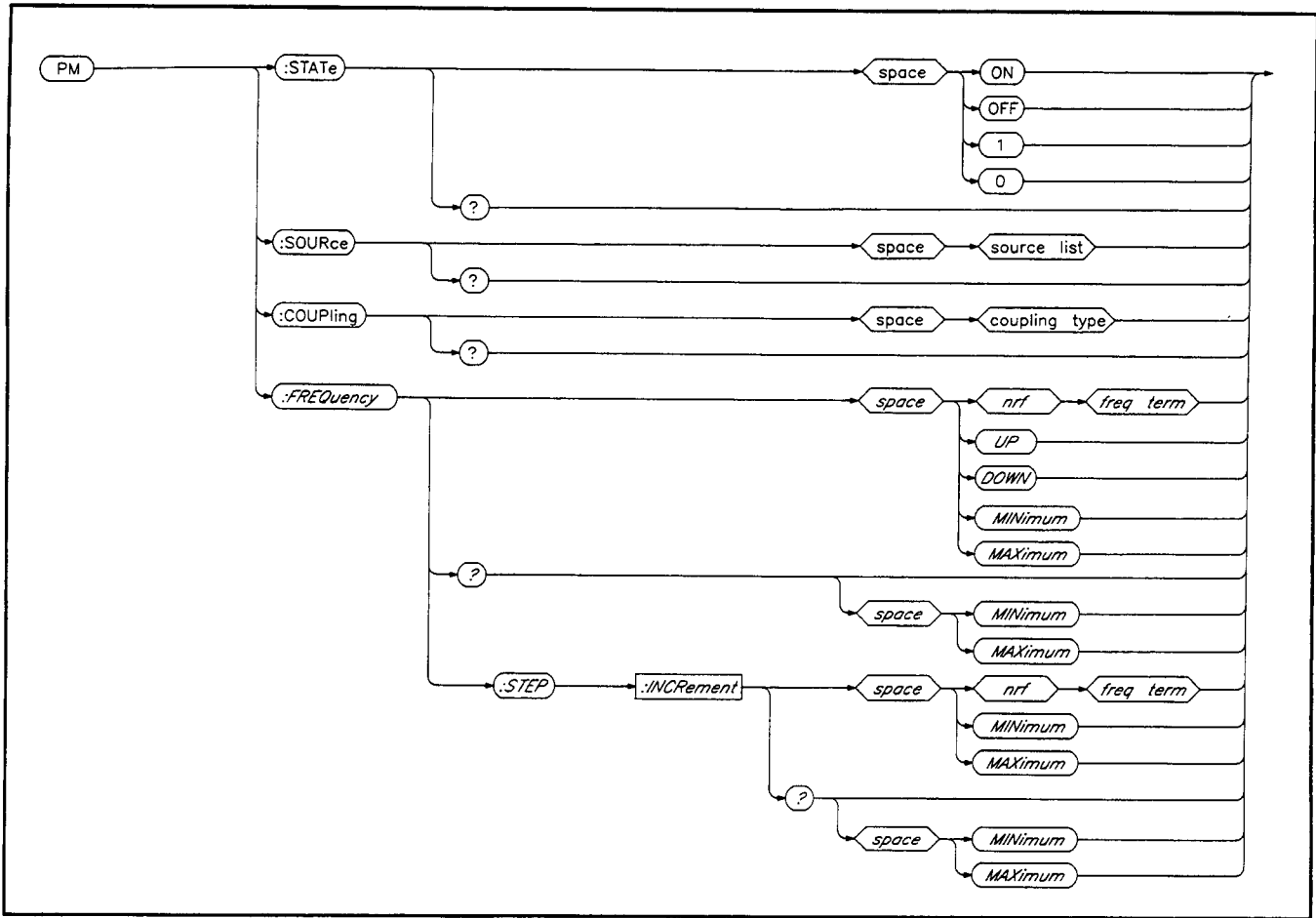

Figure F-16. Phase Modulation Subsystem.

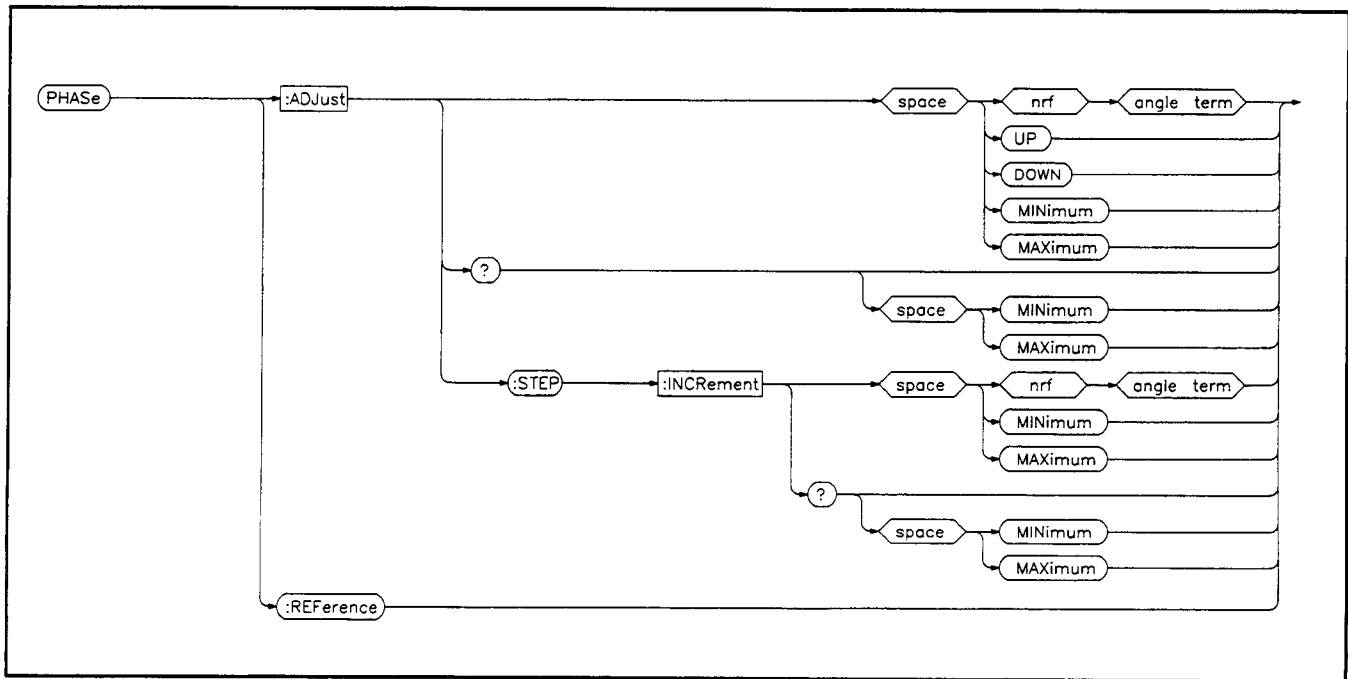

Figure F-17. Phase Subsystem.

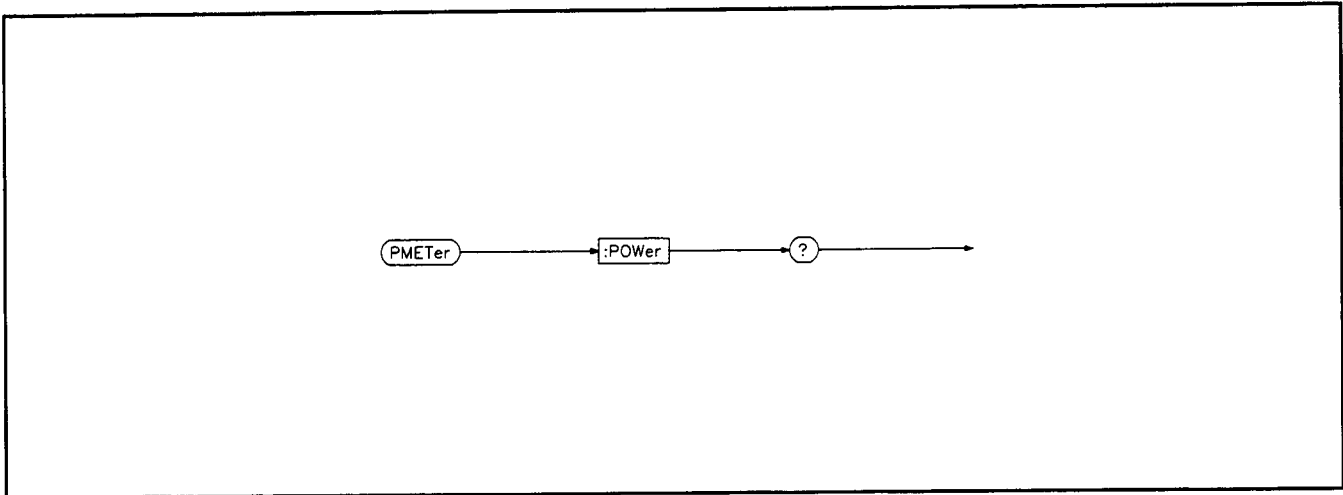

Figure F-18. Power Meter Subsystem.

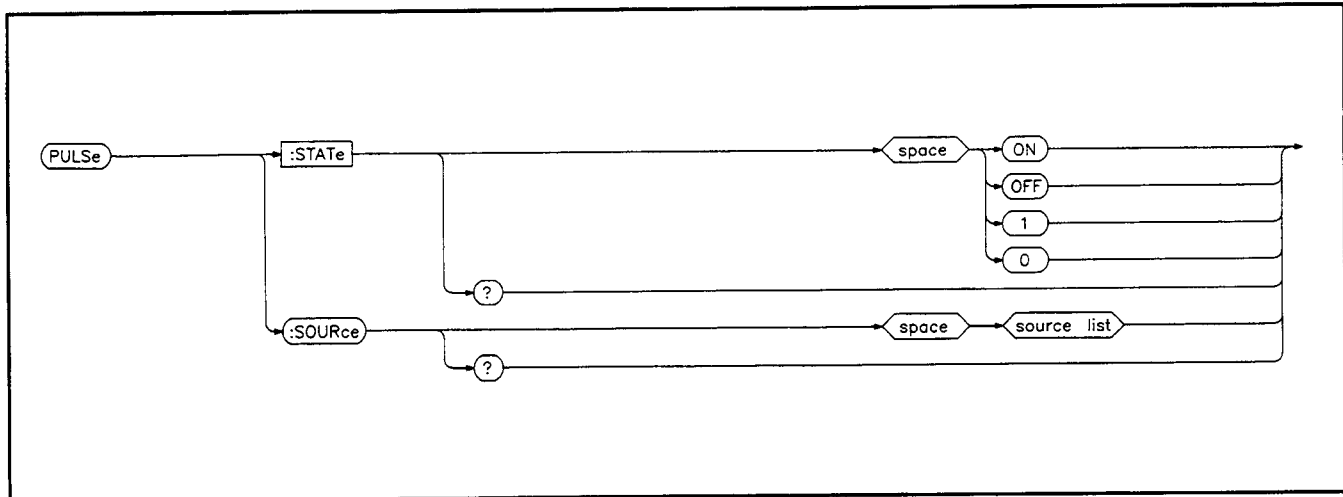

Figure F-19. Pulse Subsystem.

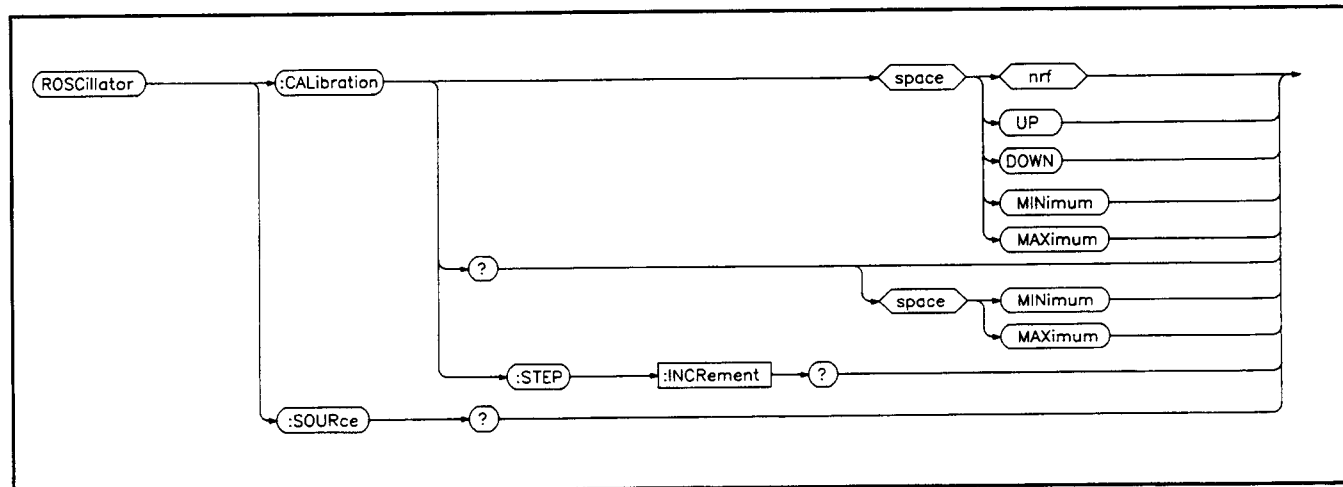

Figure F-20. Reference Oscillator Subsystem.

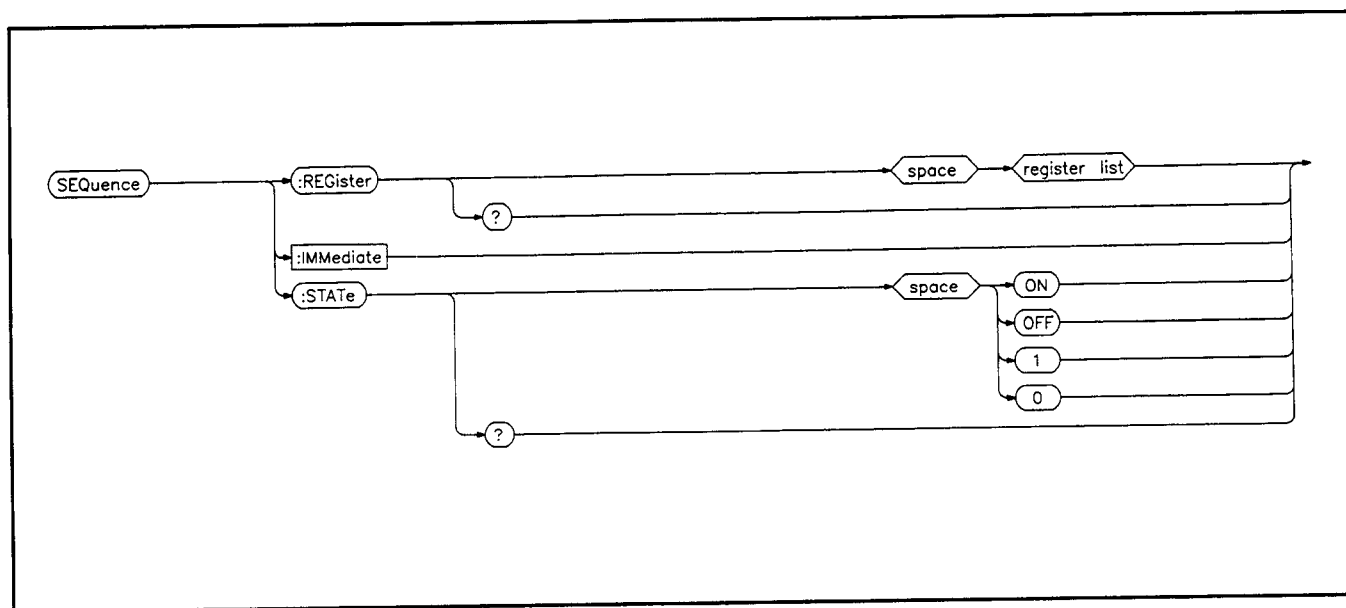

Figure F-21. Sequence Subsystem.

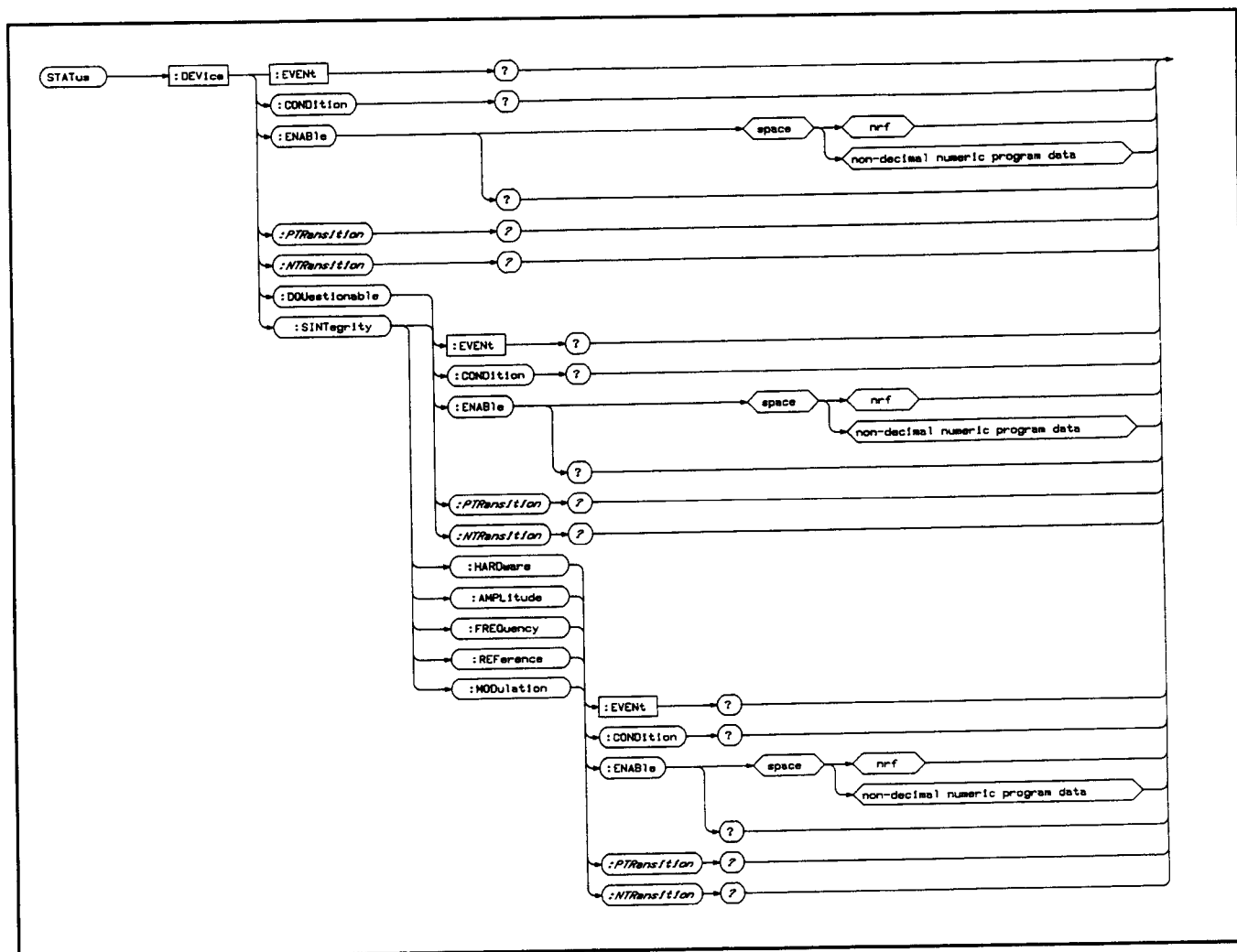

Figure F-22. Status Subsystem.

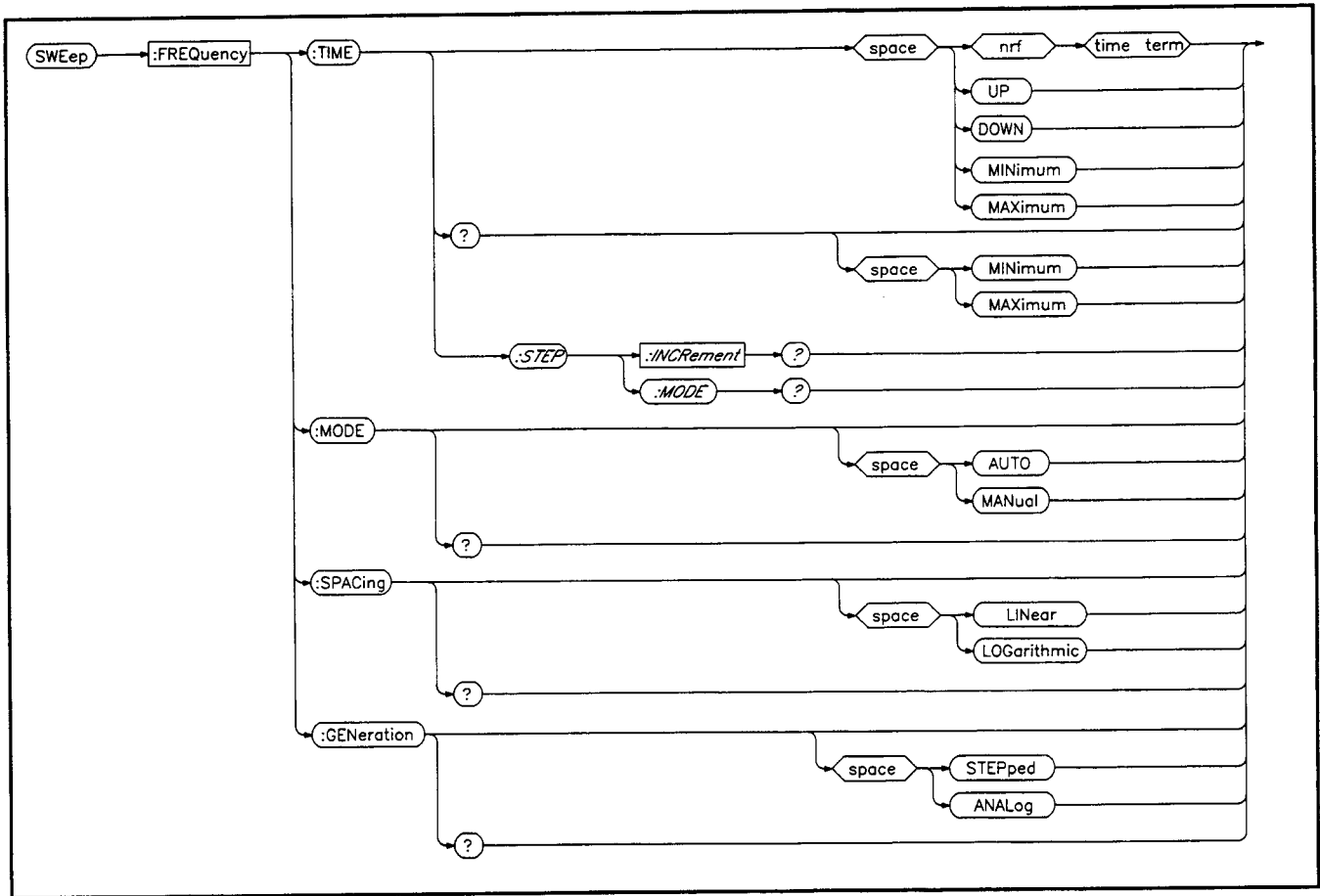

Figure F-23. Sweep Subsystem.

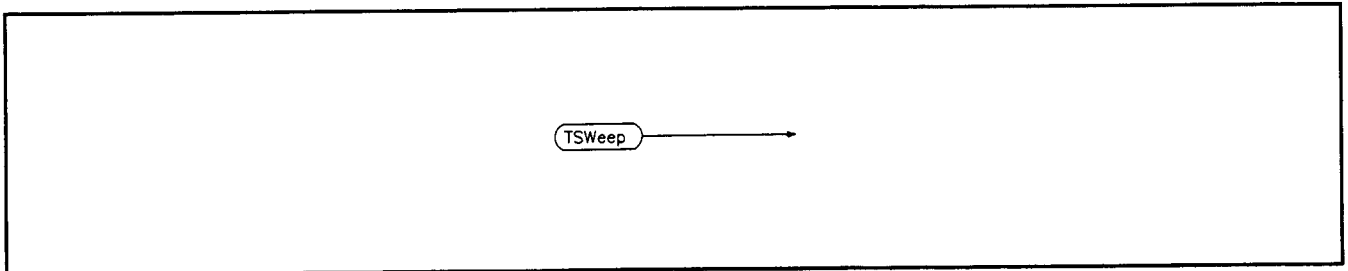

Figure F-24. Take Sweep Subsystem.

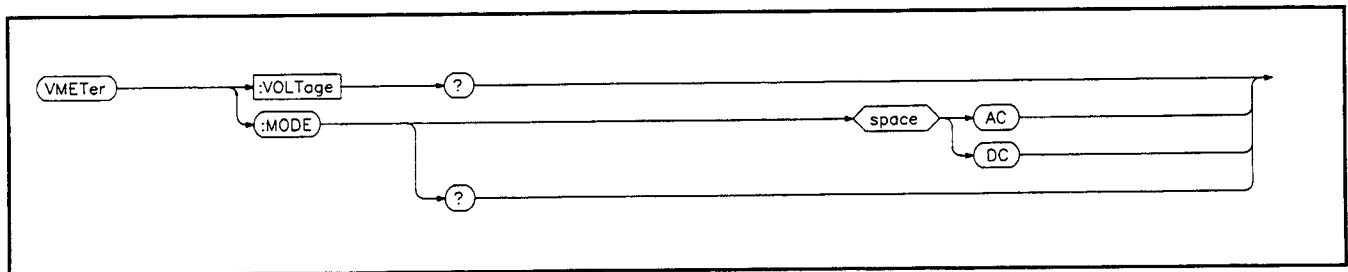

Figure F-25. Voltmeter Subsystem.

G

Miscellaneous Operating Features

Everything Else You Need to Know

The chapters and appendixes in this *Operation Guide* have provided you with operating information for most of your needs. This appendix describes the operating features that include everything else you need to know to operate the HP 8645A.

The miscellaneous operating features are alphabetically arranged. A table of contents for each feature is as follows:

Table of Contents

Amplitude Offset	G-2
Auto Sequence	G-2
Clear All	G-3
Display	G-3
EMF	G-4
Frequency Offset	G-4
Knob Hold	G-5
Knob Increment	G-5
Phase Decrement	G-6
Phase Increment	G-6
Sequence	G-6
Set Sequence	G-6

Amplitude Offset

The **CARRIER AMPTD OFS** key allows you to change the output amplitude displayed on the front panel by a value ranging from +50 dB to -50 dB without changing the actual output amplitude value. Press the blue **SHIFT** key, and then the **AMPTD OFS** key; you will see the following in the **FREQUENCY/STATUS** display:

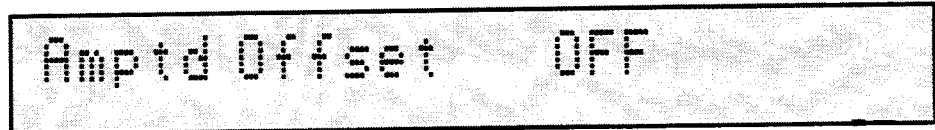

Simply enter the amplitude offset that you want. The default amplitude offset value is 0 dB.

Auto Sequence

The **UTILITY AUTO SEQ** key allows you to continually sequence through the first 10 storage registers (0-9) in the order you determine by using the **SET SEQ** key; any storage register 0-9 may be recalled more than once in the Auto Sequence.

Press the blue **SHIFT** key, and then the **AUTO SEQ** key to start the Auto Sequence routine. The Auto Sequence routine will perform frequency sweep and frequency hopping under the following conditions:

- If a frequency sweep occurs when the Auto Sequence is active, the HP 8645A outputs a single sweep and then proceeds to output the settings recalled from the next sequence. (Frequency sweep parameters must be saved while the HP 8645A is sweeping.)
- If frequency hopping occurs when the Auto Sequence is active, the HP 8645A cycles through channels in the sequence table once and then proceeds to output the settings recalled from the next sequence. (Frequency hop parameters must be saved while the HP 8645A is frequency hopping. The Learn State occurs each time the Auto Sequence comes to a storage register that contains frequency hop parameters.)

A frequency hop and frequency sweep cannot occur in the same sequence. The HP 8645A uses the same memory locations for the channel table and for calculating sweep steps. Stop the Auto Sequence by pressing the blue **SHIFT** key, and then the **EXIT** key.

Clear All

The UTILITY **CLEAR ALL** key allows you to clear all storage registers from memory. When you press the **CLEAR ALL** key, you will see the following in the FREQUENCY/STATUS display:



Clr Registers (Press ON)

Simply press the **ON** key to execute the clear all function.

Display

The UTILITY **DISPLAY** key allows you to see the settings for three things:

- The currently active special functions.
- The settings for any storage register.
- The storage register numbers used with the sequence function.

Press the **DISPLAY** key, and you will see the following:



Press SPECIAL, RECALL, or SEQ

Display Special

Press the **SPECIAL** key to see the numeral of any special function that has been activated. For example, if Special Functions 112, and 130 are active, you would see the following in the FREQUENCY/STATUS display:



112, 130

Display Recall

Press the **RECALL** key to see the following in the FREQUENCY/STATUS display:



Display Register # =

Simply enter the number of the storage register you want to recall, and press the **ENTER** key. Then for approximately 5 seconds, the contents of the storage register are displayed. The RF output does not change to the settings in the displayed storage register.

Display Sequence

Press the **SEQ** key to see the storage register sequence that was set up by using the **SET SEQ** key. For example, if a sequence was set up using storage registers 0, 5, 2, and 6, you would see the following in the FREQUENCY/STATUS display:



Seq=0, 5, 2, 6

Only 10 storage registers are allowed in a sequence. The storage registers may be any from 0 through 9; storage registers 10 through 49 are not allowed in the sequence.

EMF

The CARRIER **emf** key allows you to display the output amplitude in emf units. When emf units are active, the output amplitude is referenced in volts to an open circuit output impedance. Press the blue **SHIFT** key, and then the **emf** key; you will see the following in the FREQUENCY/STATUS display:



Amptd Units EMF OFF

Simply press the **ON** key to activate the emf function. You will notice that the **emf** annunciator appears in the AMPLITUDE display. The emf function has no effect on output amplitude values in dBm. However, if the displayed output amplitude is 1 V, for example, it would be 2 Vemf.

Frequency Offset

The CARRIER **FREQ OFS** key allows you to change the RF output displayed on the front panel by a value from +50 GHz to -50 GHz without changing the actual RF output value. Press the blue **SHIFT** key, and then the **FREQ OFS** key; you will see the following in the FREQUENCY/STATUS display:





Offset OFF

Simply enter the frequency offset that you want. The default value of frequency offset is 0 Hz.

Knob Hold

The INCR/DECR **KNOB HOLD** key allows you to hold knob control to one of the following functions:



- Frequency
- Amplitude
- Audio Frequency
- AM Depth
- FM Deviation
- Start Frequency
- Stop Frequency
- Center Frequency
- Span Frequency
- Marker Frequency

When the Knob Hold is active, you may change any other function by entering the parameter value with the Data keys, or the INCR/DECR  and  keys.

To activate the Knob Hold, select a function (so the “▽” cursor is located in that area), press the blue **SHIFT** key, and then the **KNOB HOLD** key.



When you select another function, a duplicate “▽” cursor appears to indicate that the function is active.

Knob Increment

The INCR/DECR **KNOB INCR** key allows you to set knob increment values for any front-panel function that can be modified by turning the knob, or pressing the  or  keys. Use the following directions:

1. Select the function you want.
2. Press the blue **SHIFT** key, and the **KNOB INCR** key.
3. Press the **INCR SET** key, and then enter the new Knob Increment value.

There are two ways to turn off the Knob Increment, as follows:

- Press the **KNOB OFF** key.
- Press either the INCR/DECR  or  keys.

Phase Decrement

The INCR/DECR Φ **DECR** key allows you to decrease the phase of the RF output in one-degree decrements each time the key is pressed. If the Φ **DECR** key remains pressed, the phase of the RF output continues to decrease in one-degree decrements.

Phase Increment

The INCR/DECR Φ **INCR** key allows you to increase the phase of the RF output in one-degree increments each time the key is pressed. If the Φ **INCR** key remains pressed, the phase of the RF output continues to increase in one-degree increments.

Sequence

The UTILITY **SEQ** key allows you to sequence through the first 10 storage registers (0-9), one register at a time, in the order you determine by using the **SET SEQ** key; any storage register may be recalled more than once in the sequence.

Repetitively press the **SEQ** key to cycle through each storage register in the sequence. The HP 8645A will output the settings for each storage register that was saved in the sequence.

A frequency hop and frequency sweep cannot occur in the same sequence. The HP 8645A uses the same memory locations for the channel table and for calculating sweep steps.

Set Sequence

The UTILITY **SET SEQ** key allows you to recall storage registers 0-9 in any order. You may only set up 10 sequences; however, storage registers 0-9 may be recalled more than once. Storage registers 10 through 49 are not allowed in the sequence. The **AUTO SEQ** key or the **SEQ** key are used to recall the set sequences.

Press the blue **SHIFT** key, and then the **SET SEQ** key; you will then see the following in the FREQUENCY/STATUS display:



```
Seq #0 => Register
```

Simply enter the storage register you want in the #0 sequence position, and then press the **ENTER** key. The sequence position number increments up one number at a time to #9 and then automatically exits the set sequence mode. If you want less than 10 storage registers in the sequence, exit the sequence mode by pressing the blue **SHIFT** key, and then the **EXIT** key.

You may display the sequence positions set for each storage register. Refer to the "Display" directions in this appendix.

H

Synthesized Audio Oscillator

In this Appendix

This appendix describes how to use the Synthesized Audio Oscillator in the HP 8645A. The Synthesized Audio Oscillator provides multifunction synthesis capabilities that allows you to generate a subcarrier from complex audio signals from 0.1 Hz to 400 kHz. The subcarrier is applied, in turn, as a modulating wave to the RF carrier signal. You will also see that the **AUDIO** connector provides access to the complex audio signals for external applications.

The Synthesized Audio Oscillator consists of two audio source channels; each may be summed together. In addition, the audio signal in one channel may be modulated with a combination of AM, FM, Φ M, or Pulse. Five fundamental waveforms are at your disposal: sine, square, triangle, sawtooth, and white Gaussian noise. Read this appendix to:

- Learn how to use the audio source as a subcarrier to modulate the RF carrier.
- Understand the multifunction synthesis capabilities by reviewing block diagrams.
- Create complex audio signals by activating Special Functions.
- Apply the multifunction synthesis feature set to your specific testing or experimental needs.

The Synthesized Audio Oscillator uses Special Functions 130 through 151 and 220 through 225. As you will see, these special functions control the multifunction synthesis for the Internal Audio Source. (A brief description of each special function is found in appendix C.)

The Directory

Use the illustration shown below as your guide for each subject in this appendix. Two choices are recommended for first time users:

1. Get some "hands on" experience by doing the *Quick Demonstration* starting on the next page.
2. Otherwise, turn to the section titled *An Explanation of the Synthesized Audio Oscillator* for specific information about the multifunction synthesis capabilities of the HP 8645A.

Refer to the section titled *Typical Applications* once you are familiar with generating complex audio signals.

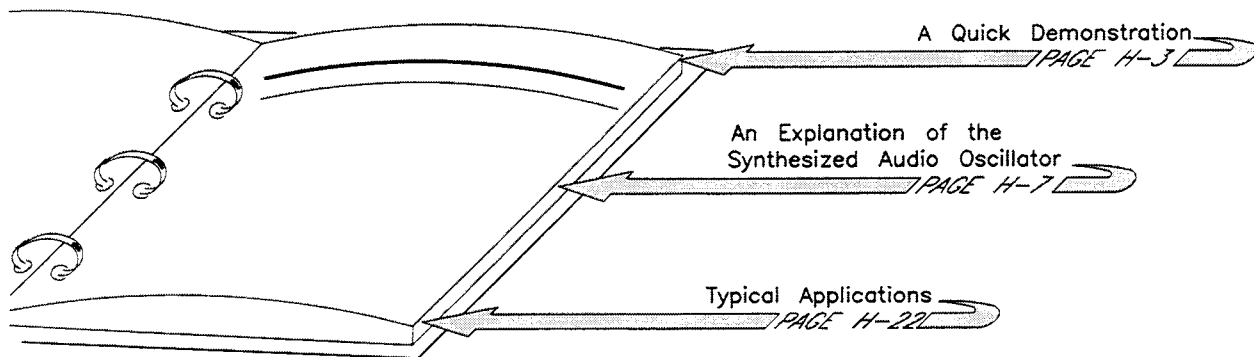

A Quick Demonstration

Procedure to Sum Channel 1 with Channel 2.

In the following procedure (which takes about 15 minutes), you will learn how to make the HP 8645A sum the audio source in Channel 1 with the audio source in Channel 2 to simulate dual-tone modulation on a subcarrier. The next section of this appendix *An Explanation of the Synthesized Audio Oscillator* fully describes both Channels 1 and 2.

Use an oscilloscope to observe the results of the following procedure:

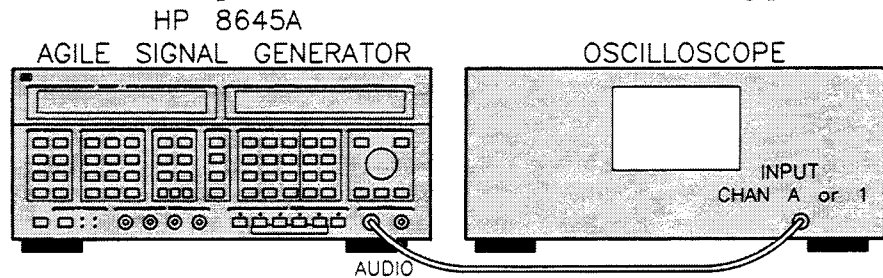

Figure H-1. Equipment Setup for the Quick Demonstration.

Set Up and Adjust the Oscilloscope

1. Connect the HP 8645A to the oscilloscope as shown in figure H-1. Turn on the equipment and make the following adjustments:

On the Oscilloscope:

Volts/Div 500 mV
 Time/Div 300 μ sec

Adjust the Audio Source in Channel 1

2. Press the green INSTR PRESET key. Doing so presets the HP 8645A to a known state for the following steps.
3. Press the AUDIO FREQ key, and then the ON key. An audio frequency of 1 kHz should be displayed on the front panel.
4. Press the blue SHIFT key, and then the AUDIO LEVEL key. The HP 8645A should now show the following in the MODULATION/AMPLITUDE display:



5. Turn the knob counterclockwise to reduce the audio level to 500 mV. In a following step, the audio source in Channel 2 will also be set to 500 mV; this is because the HP 8645A cannot sum together more than 1 V_{pk} from both channels.

A 1 kHz sine wave 500 mV is then applied to the oscilloscope from the 600 Ω AUDIO output connector.



STEP 3 & 4



STEP 6

Adjust the Audio Source in Channel 2

6. Press the SPECIAL key, number "134", and press the ON key.
7. Adjust the audio source level in Channel 2 to be 500 mV (pk). The HP 8645A should now show the following in the FREQUENCY/STATUS display:

```
134: Aud2 Level 500. mV
```

8. Press the SPECIAL key, number "133", and press the ON key. The HP 8645A should now show the following in the FREQUENCY/STATUS display:

```
133: Aud2 Freq OFF
```

9. Press the ON key, and then adjust the audio source of Channel 2 to a frequency of 1 kHz. A 1 kHz sine wave 1 Vpk should appear on the oscilloscope display. The 1 Vpk signal is the result of Channel 1 and Channel 2 being summed together.

Observe and Modify the Results

10. Press the **SPECIAL** key, number "135", and press the **ON** key. The HP 8645A should now show the following in the FREQUENCY/STATUS display:

135: Aud2 Wave Sine

11. Turn the knob. For each waveform, a different composite signal appears on the oscilloscope display:

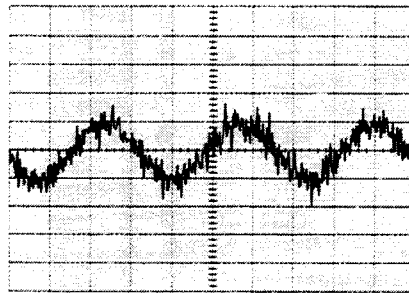
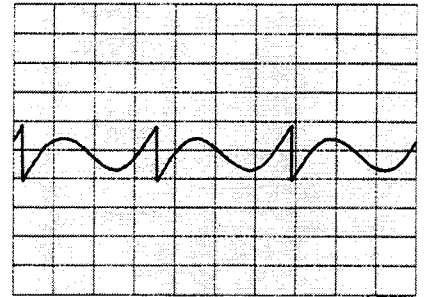
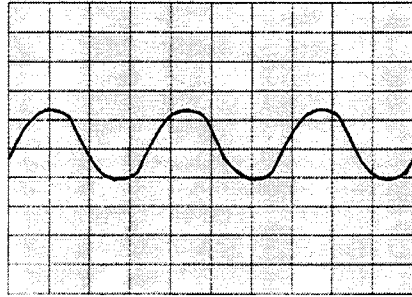
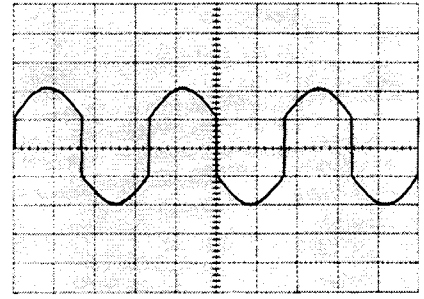
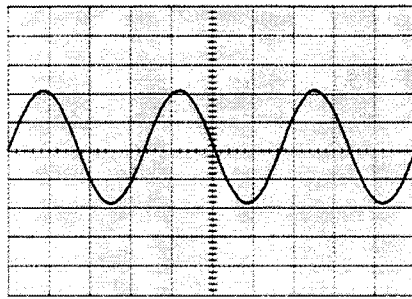
**Remember**

*The signal from the Internal Audio Source can be used to modulate the RF carrier. The same signal taken from the **AUDIO** connector may also be used for external applications (for example, on an external speaker).*

12. Turn the knob to display the sine wave on the oscilloscope.

13. Press the **SPECIAL** key, number "136", and press the **ON** key.
14. Turn the knob to adjust the audio source in Channel 2 to be $+180^\circ$ out of phase with the audio source in Channel 1. Notice the sine wave shown in the oscilloscope display decreases in amplitude until 0 V dc is left.
15. Press the **SPECIAL** key, number "135", and press the **ON** key. Turn the knob. For each waveform, a different composite signal appears on the oscilloscope display (the Volts/Division setting on your oscilloscope may need to be changed to get the same displays shown below):

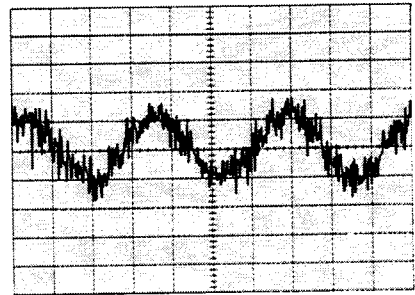
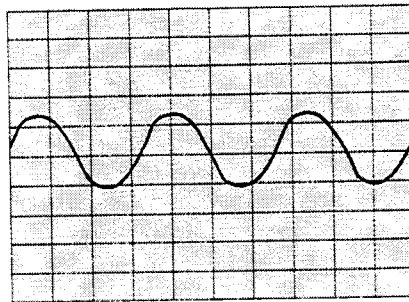
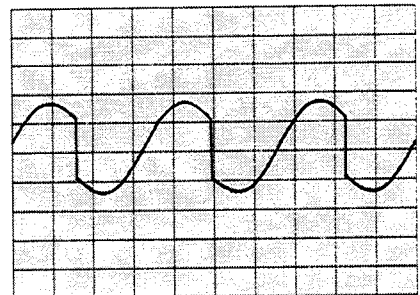
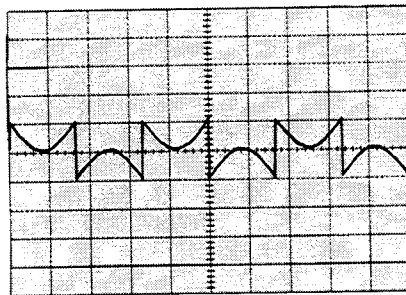

Note

The subcarrier waveforms shown above do not refer to a specific application. They are simply shown to provide you with an example of the multifunction synthesis that takes place. Refer to "Typical Applications" for specific application examples.

An Explanation of the Synthesized Audio Oscillator

If You Need to Know:	Refer to:
<ul style="list-style-type: none"> • <i>how the Internal Audio Source generates Complex audio signals</i> 	<p>Block Diagrams – An Introduction (H-8)</p>
<ul style="list-style-type: none"> • <i>how many subcarrier sources can be active at any time</i> 	<p>Subcarrier Sources – Maximum that may be Active (H-10)</p>
<ul style="list-style-type: none"> • <i>what is the maximum output voltage from the Internal Audio Source</i> 	<p>Subcarrier Sources – Maximum Voltage Levels (H-10)</p>
<ul style="list-style-type: none"> • <i>about the main audio source</i> 	<p>Audio Source: Channel 1 (H-11)</p>
<ul style="list-style-type: none"> • <i>about the second audio source</i> 	<p>Audio Source: Channel 2 (H-12)</p>
<ul style="list-style-type: none"> • <i>how to modulate the main audio source</i> 	<p>Subcarrier Modulation Sources in Channel 1 (H-14)</p>
<ul style="list-style-type: none"> • <i>how to modulate the RF carrier</i> 	<p>Modulating the RF Carrier (H-19)</p>
<ul style="list-style-type: none"> • <i>how to set increment and decrement values</i> 	<p>Increment/Decrement the Internal Audio Source (H-21)</p>
<ul style="list-style-type: none"> • <i>how to save and recall storage registers</i> 	<p>Save and Recall Settings (H-21)</p>

Block Diagrams
- An Introduction

The HP 8645A Signal Generator is depicted by the simplified block diagram shown in figure H-2. The Internal Audio Source shown in figure H-2 produces audio frequency signals from 0.1 Hz to 400 kHz. By activating Special Function 130, the audio frequency waveform may be changed; five waveforms, sine, square, triangle, sawtooth, and white Gaussian noise are available.

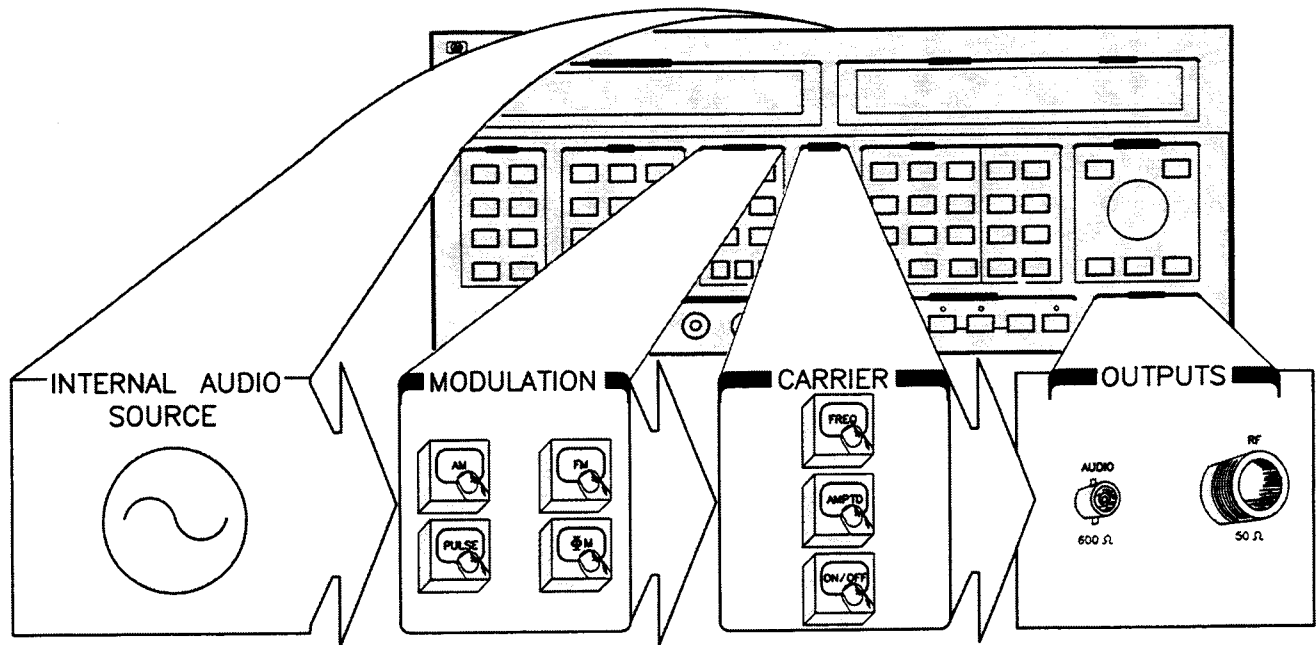

Figure H-2. Simplified Overall Block Diagram.

When you use Special Functions 133–135, the Internal Audio Source becomes a two channel multifunction synthesizer as shown in figure H-3. The audio source in Channel 1 may be modulated; AM, FM, Φ M, and Pulse subcarrier modulation are available.

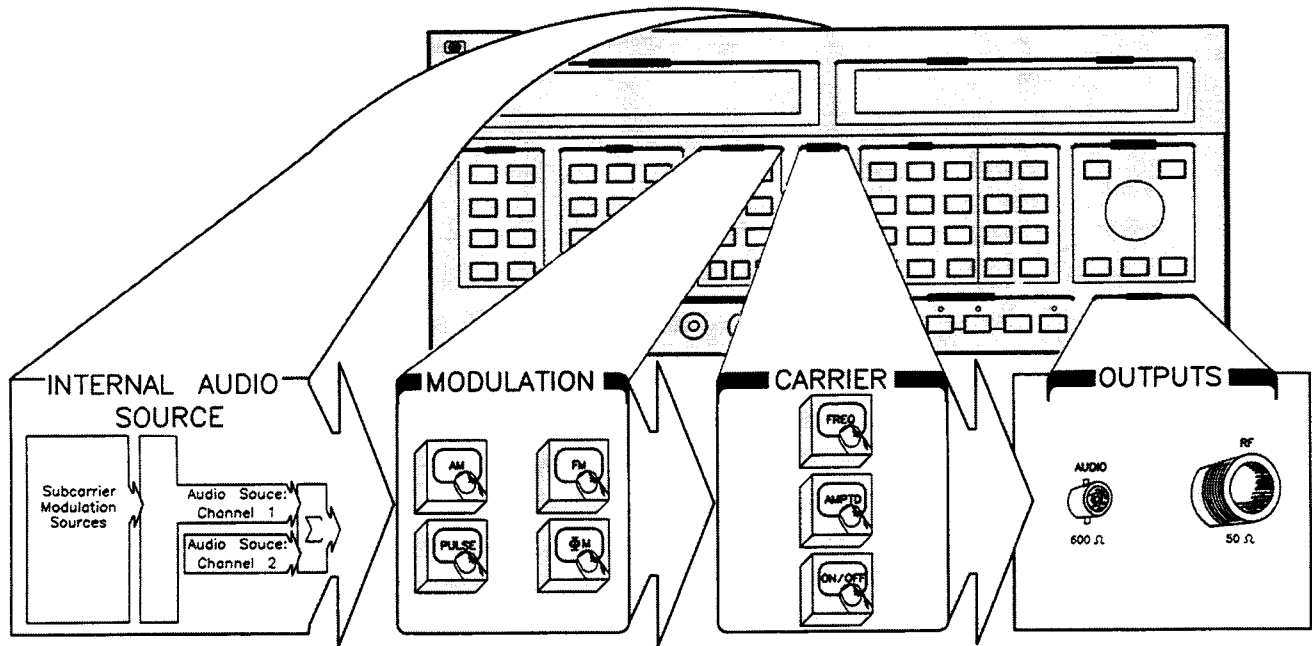
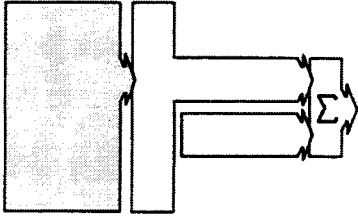

Figure H-3. The Internal Audio Source Using Special Functions 133–135.

**Subcarrier Sources
- Maximum that
may be Active**



It is not permissible to turn **ON** all the subcarrier sources at once. The following rule applies to the maximum allowed **ON** at any time:

Rule: The audio source in Channel 1 may be turned **ON** in combination with any **three** other sources.

Besides the audio source in Channel 1, there are five other sources, as follows:

- Audio Source: Channel 2
- Subcarrier AM Source
- Subcarrier FM Source
- Subcarrier Φ M Source
- Subcarrier Pulse Source

Note

The error message "Too many audio sources" appears if you exceed the maximum limit described above.

**Subcarrier Sources
- Maximum
Voltage Levels**

The Internal Audio Source may have a maximum of 1 Vpk summed (Σ) together from the audio sources in Channels 1 and 2. The preset condition of the HP 8645A sets the **AUDIO LEVEL** of the audio source in Channel 1 to 1 Vpk into 600 Ω . You must reduce this level before turning **ON** any one of the other five sources.

Note

The error message "Audio level conflict" appears if you attempt to exceed the maximum summed limit of 1 Vpk for Channels 1 and 2.

*Also, the error message "Audio level/AM conflict" appears if you attempt to exceed the maximum summed limit of 1 Vpk for Channels 1 and 2 with the subcarrier AM source in Channel 1 turned **ON**.*

**Audio Source:
Channel 1**

The *Quick Demonstration* showed that frequency, level, and on/off state are controlled by keys on the front panel; whereas, waveform is controlled only after Special Function 130 is activated. As shown in figure H-4, the audio source in Channel 1 has four parts:

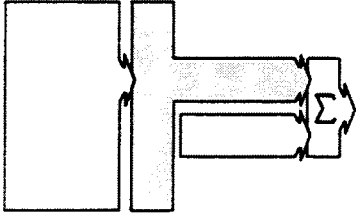

- Audio Frequency
- Audio Level
- Waveform
- On/Off State

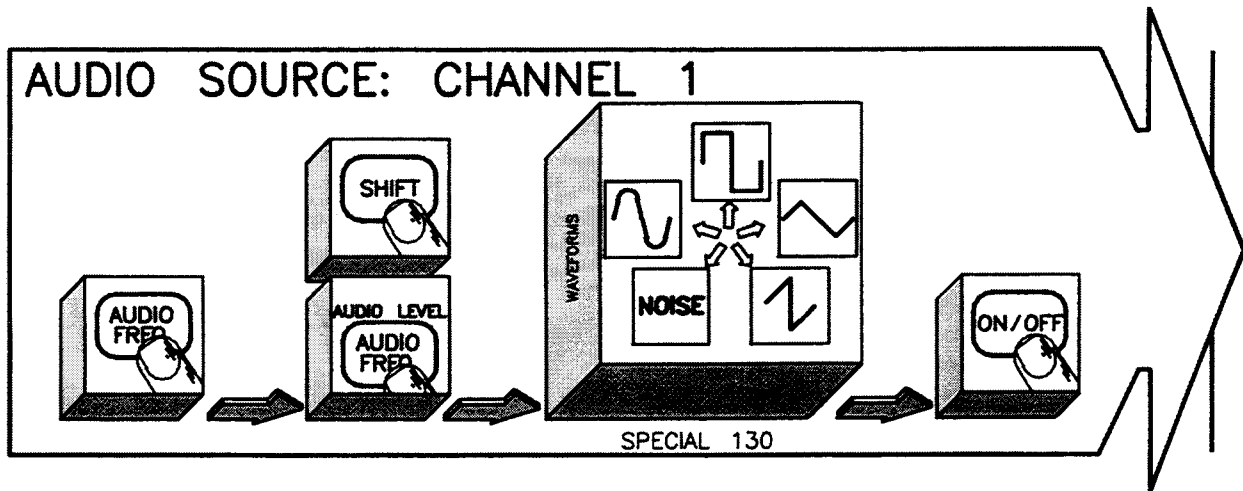

Figure H-4. Block Diagram of the Audio Source in Channel 1.

Note

The audio source in Channel 1 is the reference to which the phase of the other sources is relative to.

The audio source in Channel 1 operates within the limits shown in table H-1. You'll receive an appropriate error message if the limits are exceeded. (appendix D provides error message descriptions.)

Table H-1. Limits for the Audio Source in Channel 1.

Limits	Frequency	Level
Minimum	0.1 Hz	0 Vpk
Maximum	400 kHz*	1 Vpk
Resolution	4 digits	0.001 Vpk

* The AUDIO output has a typical bandwidth of 400 kHz for all waveforms. This affects complex waveforms with frequency components greater than 400 kHz.

**Audio Source:
Channel 2**

The *Quick Demonstration* showed that special functions are used to control the audio source in Channel 2. As shown in figure H-5, the audio source in Channel 2 has five parts:

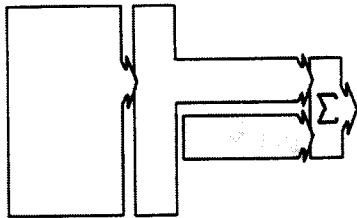

- On/Off State
- Frequency
- Level
- Waveform
- Phase

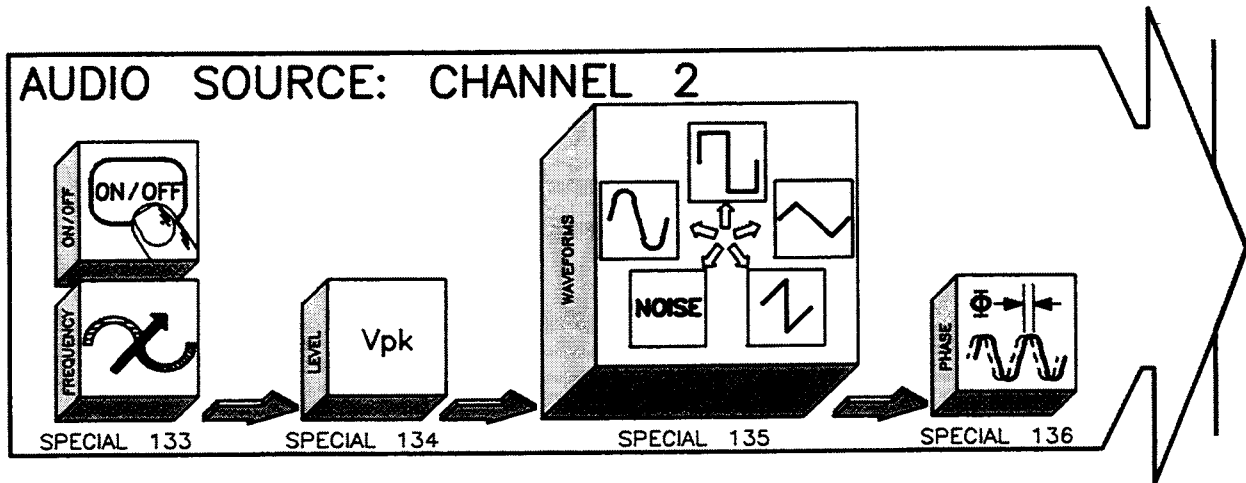

Figure H-5. Block Diagram of the Audio Source in Channel 2.

Remember

The phase of the audio source in Channel 2 is relative to the phase of the audio source in Channel 1.

The audio source in Channel 2 operates within the limits shown in table H-2. You'll receive an appropriate error message if the limits are exceeded. (Appendix D provides error message descriptions.)

Table H-2. Limits for the Audio Source in Channel 2.

Limits	Frequency	Level	Phase**
Minimum	0.1 Hz	0 Vpk	-179.9°
Maximum	400 kHz*	1 Vpk	+180°
Resolution	4 digits	0.001 Vpk	0.1°

* The **AUDIO** output has a typical bandwidth of 400 kHz for all waveforms. This affects complex waveforms with frequency components greater than 400 kHz.

** Phase may also be expressed in terms of radians by pressing the front panel **rad** key. Any entry beyond the maximum and minimum limits will be scaled. For example, entering 560° would yield -160°.

Subcarrier Modulation Sources in Channel 1

Four subcarrier sources (AM, FM, Φ M, and Pulse) are available to modulate the audio source in Channel 1. Each subcarrier modulation source may be modified to control frequency, phase, level, depth, or deviation; also, each may be turned ON and OFF.

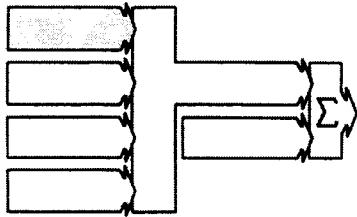

AM Modulating the Audio Source in Channel 1.

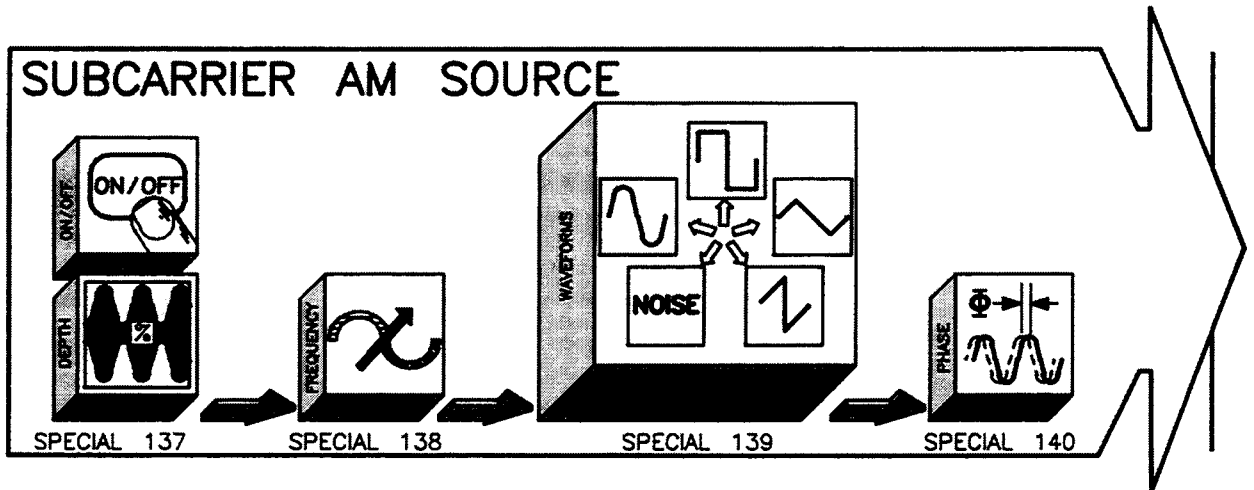

Figure H-6. Block Diagram of the Subcarrier AM Source.

Remember

The phase of each subcarrier modulation source is relative to the phase of the audio source in Channel 1.

The on/off state, depth, frequency, waveform, and phase of the subcarrier AM source in Channel 1 is controlled by special functions as shown in figure H-6. The subcarrier AM source operates within the limits shown in table H-3. You'll receive an appropriate error message if the limits are exceeded. (Appendix D provides error message descriptions.)

Note

A common operator's mistake occurs when the subcarrier AM source is turned ON with the AUDIO LEVEL of the audio source in Channel 1 set to 1 Vpk (the preset condition), or to a value greater than the amount allowed for the desired AM depth. The error message Audio level/AM conflict will then appear. Simply reduce the AUDIO LEVEL to an appropriate value for the amount of subcarrier AM depth selected.

Table H-3. Limits for the Subcarrier AM Source.

Limits	Depth	Frequency	Phase**
Minimum	0 %	0.1 Hz	-179.9°
Maximum	100 %	400 kHz*	+180°
Resolution	0.1 %	4 digits	0.1°

* The AUDIO output has a typical bandwidth of 400 kHz for all waveforms. This affects complex waveforms with frequency components greater than 400 kHz.

** Phase may also be expressed in terms of radians by pressing the front panel **rad** key. Any entry beyond the maximum and minimum limits will be scaled. For example, entering 560° would yield -160°.

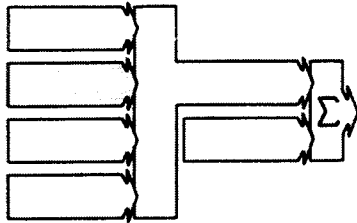

FM Modulating the Audio Source in Channel 1

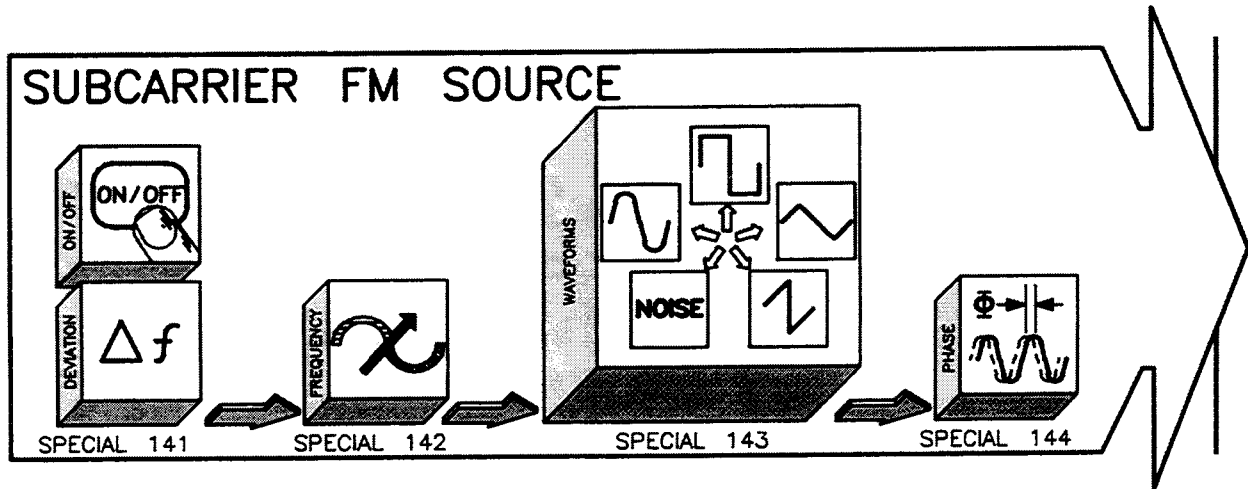

Figure H-7. Block Diagram of the Subcarrier FM Source.

The on/off state, deviation, frequency, waveform, and phase of the subcarrier FM source in Channel 1 is controlled by Special Functions as shown in figure H-7. The subcarrier FM source operates within the limits shown in table H-4. You'll receive an error message if the limits are exceeded. (Appendix D provides error message descriptions.)

Table H-4. Limits for the Subcarrier FM Source.

Limits	Deviation	Frequency	Phase**
Minimum	0 Hz	0.1 Hz	-179.9°
Maximum	400 kHz	400 kHz*	+180°
Resolution	0.001 Hz	4 digits	0.1°

* The AUDIO output has a typical bandwidth of 400 kHz for all waveforms. This affects complex waveforms with frequency components greater than 400 kHz.

** Phase may also be expressed in terms of radians by pressing the front panel **rad** key. Any entry beyond the maximum and minimum limits will be scaled. For example, entering 560° would yield -160°.

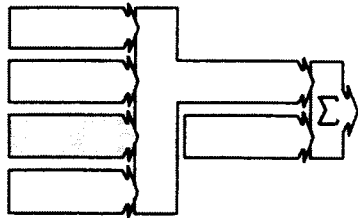
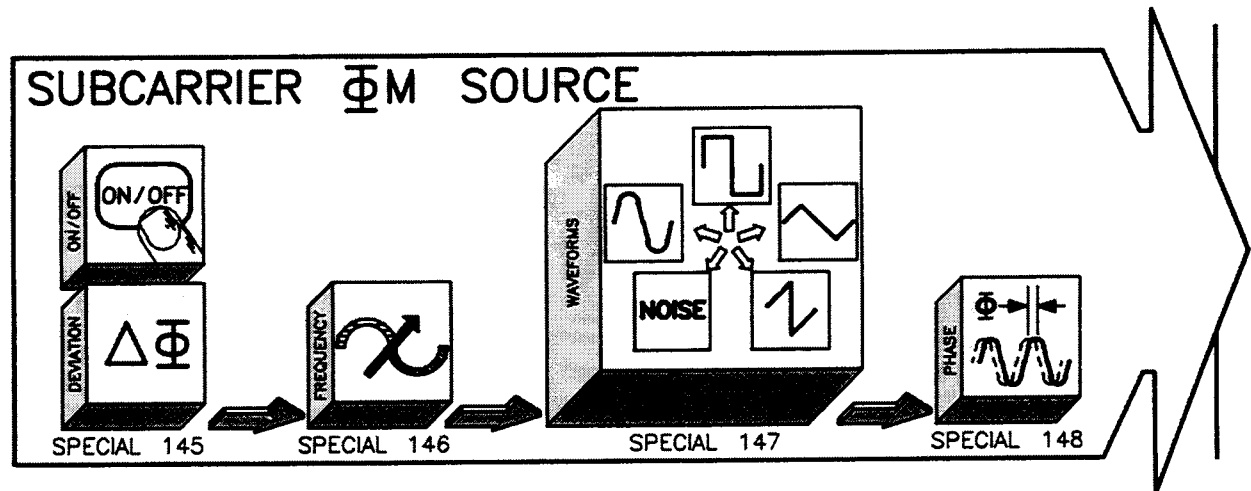
 Φ M Modulating the Audio Source in Channel 1Figure H-8. Block Diagram of the Subcarrier Φ M Source.

The on/off state, deviation, frequency, waveform, and phase of the subcarrier Φ M source in Channel 1 is controlled by Special Functions as shown in figure H-8. The subcarrier Φ M source operates within the limits shown in table H-5. You'll receive an error message if the limits are exceeded. (Appendix D provides error message descriptions.)

Table H-5. Limits for the Subcarrier Φ M Source.

Limits	Deviation	Frequency	Phase**
Minimum	0°	0.1 Hz	-179.9°
Maximum	+179.9°	400 kHz*	+180°
Resolution	0.1°	4 digits	0.1°

* The **AUDIO** output has a typical bandwidth of 400 kHz for all waveforms. This affects complex waveforms with frequency components greater than 400 kHz.

** Phase may also be expressed in terms of radians by pressing the front panel **rad** key. Any entry beyond the maximum and minimum limits will be scaled. For example, entering 560° would yield -160°.

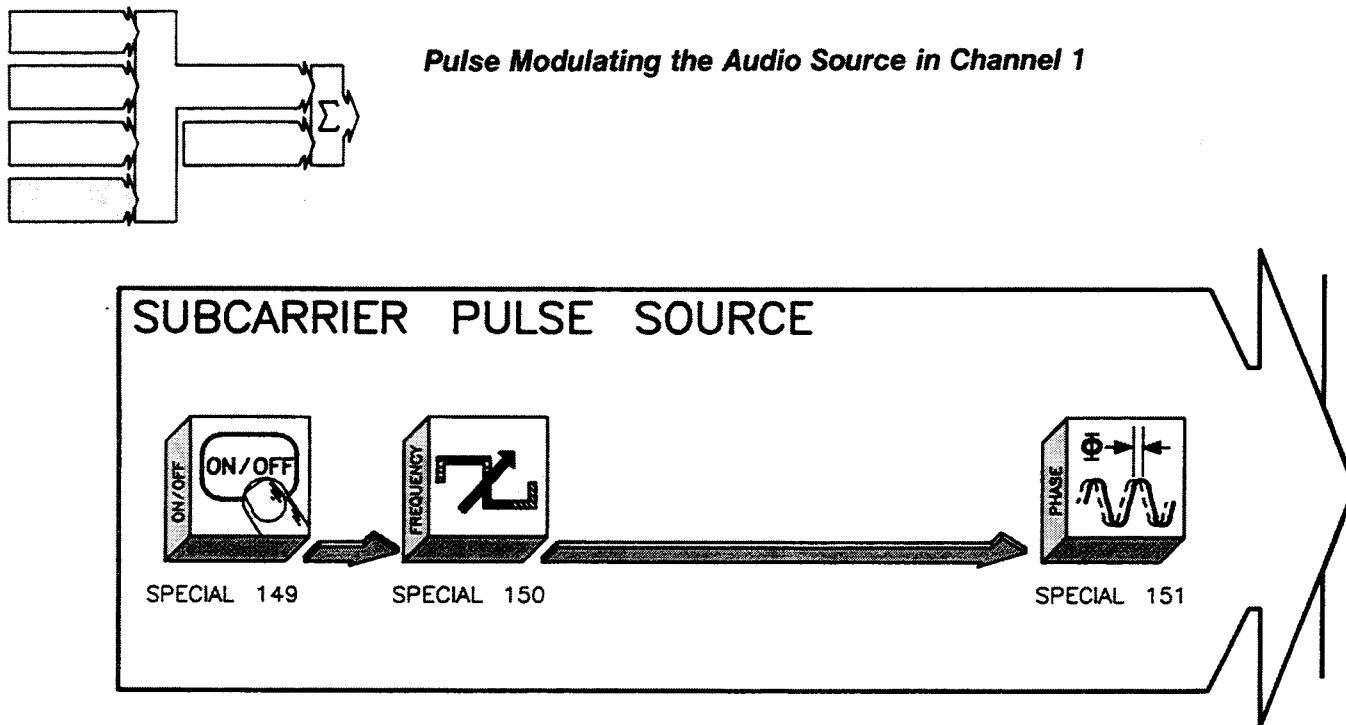

Figure H-9. Block Diagram of the Subcarrier Pulse Source.

The on/off state, frequency, and phase of the subcarrier Pulse source in Channel 1 is controlled by Special Functions as shown in figure H-9. The subcarrier Pulse source operates within the limits shown in table H-6. You'll receive an error message if the limits are exceeded. (Appendix D provides error message descriptions.)

Table H-6. Limits for the Subcarrier Pulse Source.

Limits	Frequency	Phase*
Minimum	0.1 Hz	-179.9°
Maximum	50 kHz	+180°
Resolution	4 digits	0.1°

* Phase may also be expressed in terms of radians by pressing the front panel **rad** key. Any entry beyond the maximum and minimum limits will be scaled. For example, entering 560° would yield -160°.

Modulating the RF Carrier

In standard operation (no special functions active), the Audio Source on the HP 8645A provides a sinusoidal waveform with an **AUDIO LEVEL** that may be reduced from a value of 1 V (pk) to 0 V (pk). Reducing the **AUDIO LEVEL** allows you to turn **ON** the audio source in Channel 2, and to set depth for the subcarrier AM source.

As shown in figure H-10, the HP 8645A requires a 1 Vpk signal from an external audio source, and/or a 1 Vpk signal from the Internal Audio Source to provide calibrated operation when the RF carrier is being modulated. Voltage levels less than these reduce the amount of modulation on the RF carrier.

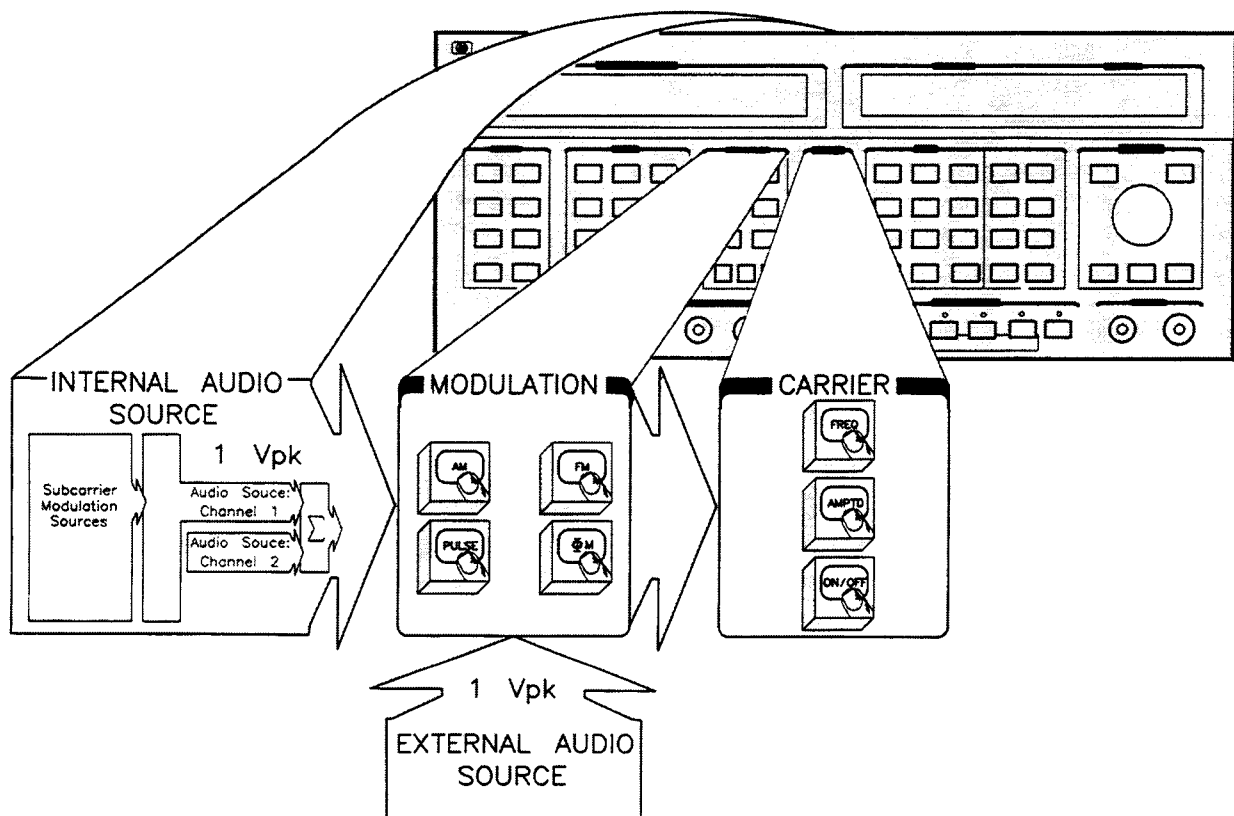

Figure H-10. Voltage Levels to Produce a Calibrated RF Output.

Internal Audio Source voltage originates from:

- Channel 1 only, or
- summing Channel 1 with any of the other subcarrier modulation sources, or
- summing Channels 1 and 2, or
- summing Channels 1 and 2 with any of the other subcarrier modulation sources.

If you use the Internal Audio Source, you can calculate the amount of modulation on the RF carrier by using the following formulas:

$$\begin{aligned}\% \text{ Depth} &= (\text{Vpk from Int. Aud. Source} \bullet \text{displayed AM depth}) \\ \text{FM Deviation} &= (\text{Vpk from Int. Aud. Source} \bullet \text{displayed FM deviation}) \\ \Phi M \text{ Deviation} &= (\text{Vpk from Int. Aud. Source} \bullet \text{displayed } \Phi M \text{ deviation})\end{aligned}$$

For example, if you FM the RF carrier with the Internal Audio Source at an audio level of 0.5 Vpk (Channel 1 only), you will get half the specified amount of deviation shown in the **MODULATION** display. However, if you also turn on the audio source in Channel 2 and set its level to 0.5 Vpk (summing Channels 1 and 2 to get 1 Vpk), the HP 8645A will output the full amount of deviation.

Audio frequency rates up to 400 kHz are allowed, which is also the typical bandwidth of the audio output circuitry. This bandwidth affects complex waveforms with frequency components greater than 400 kHz, causing waveform degradation.

When the Internal Audio Source is used, the maximum bandwidth is specified as the maximum rate (AM bandwidth is a function of the carrier frequency). Refer to the specification table in the *Calibration Manual* for maximum rates.

Increment/Decrement the Internal Audio Source

The **INCR SET** key allows you to change increment and decrement values for frequency, level, phase, depth, and deviation of the Internal Audio Source. Use the following procedure:

1. **Select the special function.** For example, after an instrument preset, if Special Function 138 is active, you would then see the following in the FREQUENCY/STATUS display:

```
138: Aud AM Freq 100 Hz
```

2. **Press the INCR SET key.** With Special Function 138 active, you would see the following:

```
Audio Freq Incr 100 Hz
```

3. **Change the increment value.** If you want the Audio Frequency Increment to be 10 Hz instead of 100 Hz, simply press the 1, 0, and Hz keys. You can then verify that the new increment value is 10 Hz by pressing the **INCR SET** key once again.

Increment values can have a global affect. In the previous example, the new increment value of 10 Hz for Special Function 138 would be effective whenever frequency is incremented or decremented for any audio source. Increment values for phase exhibit the same global affect in the Internal Audio Source.

Save and Recall Settings

The HP 8645A has 50 available storage registers. The first 10, Registers 0–9, accept all front panel settings for Special Functions 133–151. The remaining 40, Registers 10–49, accepts only RF frequency and output amplitude settings.

Performing an Instrument Preset, or unplugging the HP 8645A does not alter the contents of the 50 storage registers.

Typical Applications

The multifunction synthesis capabilities of the HP 8645A creates complex signals for:

1. VHF omnidirectional range (VOR),
 2. ILS two-tone signaling,
 3. dual-tone modulation,
 4. audio-tone sweep,
 5. AM radio testing,
 6. amplitude sweep,
 7. modem testing,
 8. AM noise generation,
- and more...

The following collection of waveforms present a sample of the many different waveforms possible using the HP 8645A. The collection is intended to give you an indication of the capabilities of the instrument and to stimulate ideas for creating other waveforms. In most cases, the waveforms may be altered to match your specific application by changing frequency, phase, waveforms, or their amplitudes.

Each waveform in the collection is numerically organized by the list shown above. Use the foldout in figure H-11, and the list of special functions in table H-7 to assist you in generating waveforms with your HP 8645A.

Note

Waveforms in the collection are output at the AUDIO connector (600 Ω), and viewed on an oscilloscope. If the waveform is designated as being applied to an RF carrier, the display is output from the RF OUTPUT connector, and viewed on a spectrum analyzer.

Table H-7. Special Functions 130 to 151.

SPECIAL FUNCTIONS						
Number	Name (Abbreviated)	Limits		Number	Name (Abbreviated)	Limits
130	Audio Wave	5 Waveforms		141	Aud FM Dev	0 Hz to 400 kHz
131	Audio Triggered	ON/OFF		142	Aud FM Freq	0.1 Hz to 400 kHz
132	Trig Audio	Press ON		143	Aud FM Wave	5 Waveforms
133	Aud2 Freq	0.1 Hz to 400 kHz		144	Aud FM Φ	* -179.9° to $+180^\circ$
134	Aud2 Level	0 V to 1 V		145	Aud Φ M Dev	0° to $+179.9^\circ$
135	Aud2 Wave	5 Waveforms		146	Aud Φ M Freq	0.1 Hz to 400 kHz
136	Aud2 Φ	* -179.9° to $+180^\circ$		147	Aud Φ M Wave	5 Waveforms
137	Aud AM Depth	0 to 100%		148	Aud Φ M Φ	* -179.9° to $+180^\circ$
138	Aud AM Freq	0.1 Hz to 400 kHz		149	Aud Pulse	ON/OFF
139	Aud AM Wave	5 Waveforms		150	Aud Pulse Freq	0.1 Hz to 50 kHz
140	Aud AM Φ	* -179.9° to $+180^\circ$		151	Aud Pulse Φ	* -179.9° to $+180^\circ$

* Phase may also be expressed in terms of radians by pressing the front panel **rad** key. Any entry beyond these limits will be scaled. For example, entering 560° would yield -160° .

No. 1. HP 8645A Synthesized Audio Oscillator Waveform

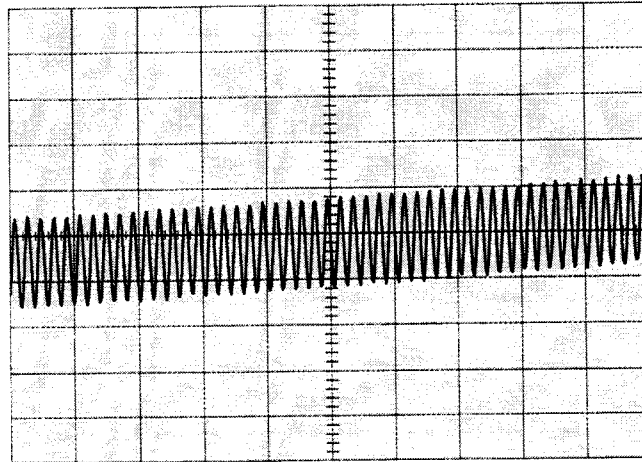

Waveform Name/Description: VHF omnidirectional range (VOR) composite signal.

Waveform Application: Avionics receiver test and metrology for VOR test equipment.

Instrument Settings

Source	Frequency	Phase	Waveform	Amplitude	Deviation
Audio-Channel 1	9960 Hz	0°	Sine	0.5 V	-
Audio-Channel 2	30 Hz	0°	Sine	0.5 V	-
Subcarrier FM	30 Hz	0° ⁽¹⁾	Sine	-	480 Hz

⁽¹⁾ The phase of the FM Source sets the bearing direction.

Waveform Applied to an RF Carrier: The RF carrier has AM at a 90% depth.

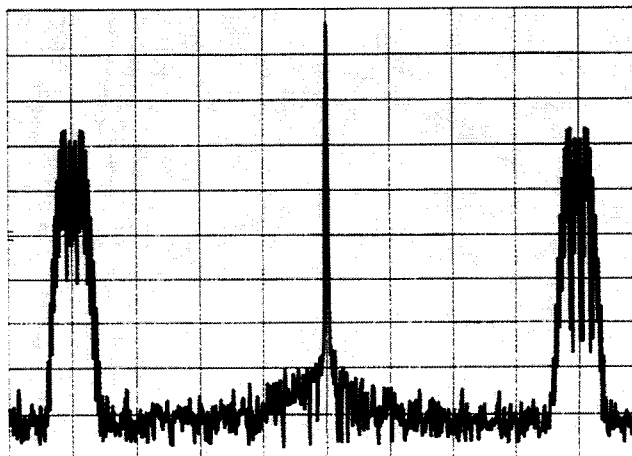

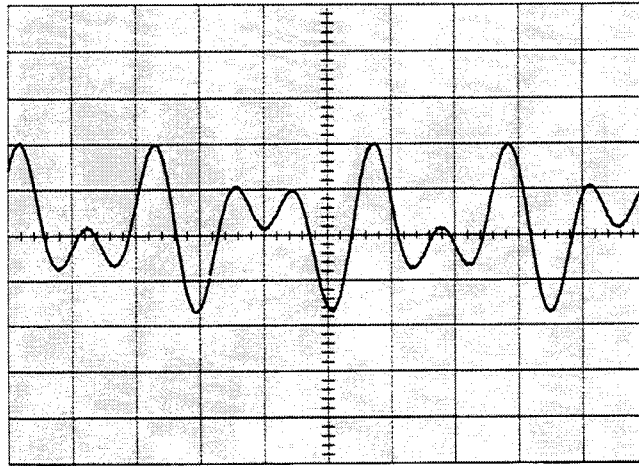
No. 2. HP 8645A Synthesized Audio Oscillator Waveform

Waveform Name/Description: ILS two-tone composite signal.

Waveform Application: ILS receiver testing.

Instrument Settings

Source	Frequency	Phase	Waveform	Amplitude
Audio-Channel 1	90 Hz	0°	Sine	0.5 V
Audio-Channel 2	150 Hz	0°	Sine	0.5 V

Comments: Difference in depth of modulation is set by the relative amplitudes of Channels 1 & 2.

Waveform Applied to an RF Carrier: The RF carrier has AM at a 50% depth.

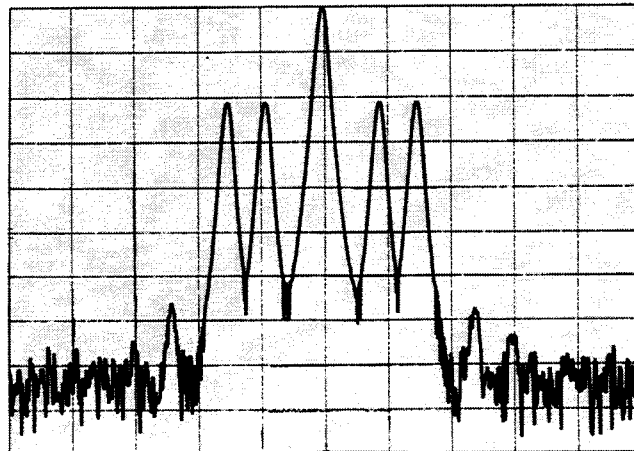

No. 3. HP 8645A Synthesized Audio Oscillator Waveform

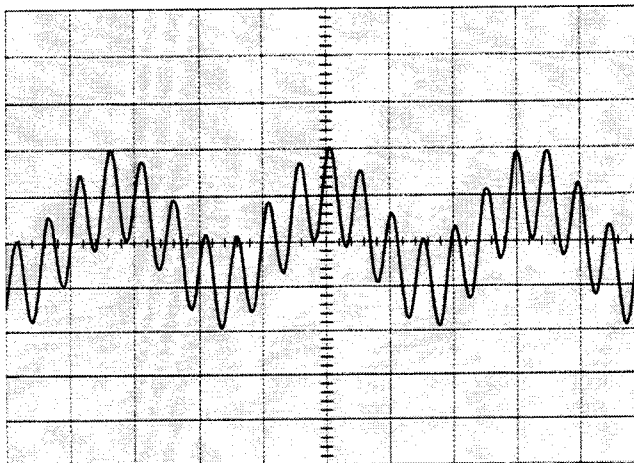

Waveform Name/Description: Dual-tone modulation.

Waveform Application: Sub-audible squelch testing, pocket pagers.

Instrument Settings

Source	Frequency	Phase	Waveform	Amplitude
Audio-Channel 1	1 kHz	0°	Sine	0.5 V
Audio-Channel 2	150 Hz	0°	Sine	0.5 V

Waveform Applied to an RF Carrier: The RF carrier has AM at a 50% depth.

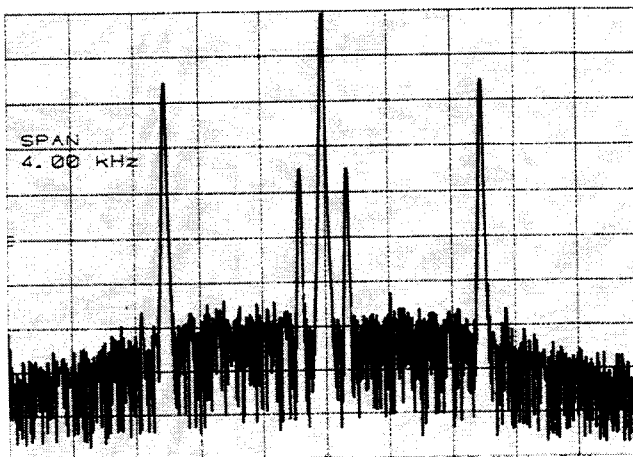

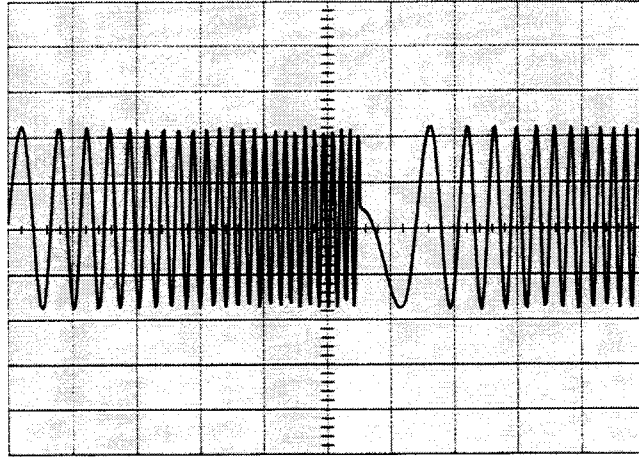
No. 4. HP 8645A Synthesized Audio Oscillator Waveform

Waveform Name/Description: Audio-tone sweep.

Waveform Application: Audio response of FM receiver.

Instrument Settings

Source	Frequency	Phase	Waveform	Amplitude	Deviation
Audio-Channel 1	2.5 kHz	0°	Sine	1 V	-
Subcarrier FM	150 Hz ⁽¹⁾	0°	Sawtooth	-	2.5 kHz

⁽¹⁾ Change the FM Source frequency to vary rate for the audio-tone sweep.

No. 5. HP 8645A Synthesized Audio Oscillator Waveform

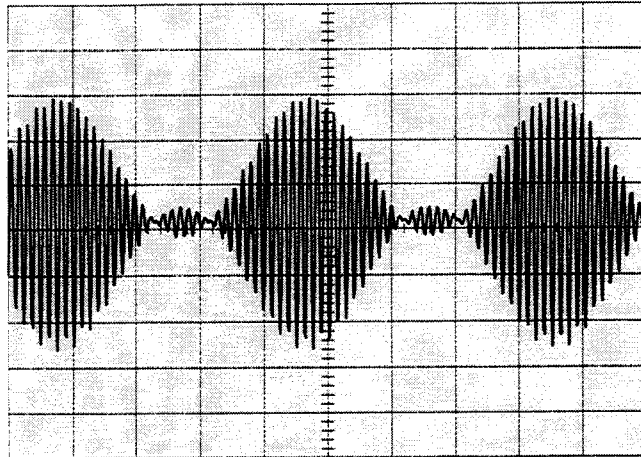

Waveform Name/Description: AM signal with over 100% negative peak modulation.

Waveform Application: AM radio testing.

Instrument Settings

Source	Frequency	Phase	Waveform	Amplitude	Depth
Audio-Channel 1	50 kHz	0°	Sine	450 mV	-
Audio-Channel 2	50 kHz	180°	Sine	100 mV	-
Subcarrier AM	1 kHz	0°	Sine	-	100%

Comments: A 180° phase inversion of the carrier occurs at the trough of the modulating waveform.

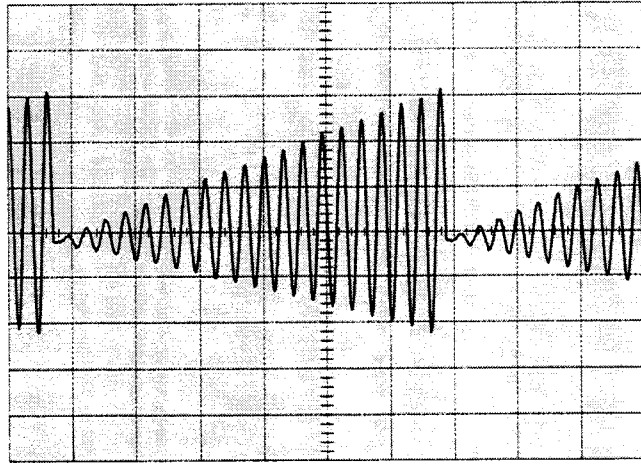
No. 6. HP 8645A Synthesized Audio Oscillator Waveform

Waveform Name/Description: Amplitude sweeps.

Waveform Application: Receiver testing.

Instrument Settings

Source	Frequency	Phase	Waveform	Amplitude	Depth
Audio-Channel 1	1 kHz	0°	Sine	500 mV	-
Subcarrier AM	50 Hz	0°	Sawtooth	-	100%

No. 7. HP 8645A Synthesized Audio Oscillator Waveform

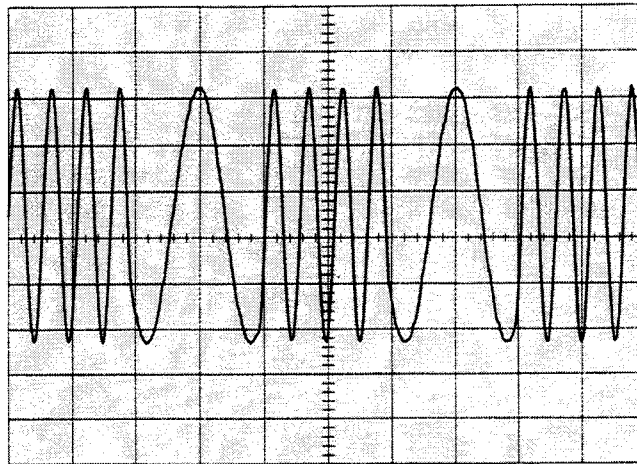

Waveform Name/Description: Two-tone FSK with 50% duty cycle.

Waveform Application: Modem testing.

Instrument Settings

Source	Frequency	Phase	Waveform	Amplitude	Deviation
Audio-Channel 1	10 kHz	0°	Sine	1 V	-
Subcarrier FM	2 kHz	0°	Square	-	5 kHz

Comments: The frequencies of the two tones are the frequency of Audio-Channel 1 plus or minus the amplitude of the FM Source. The data rate is set by the frequency of the FM Source.

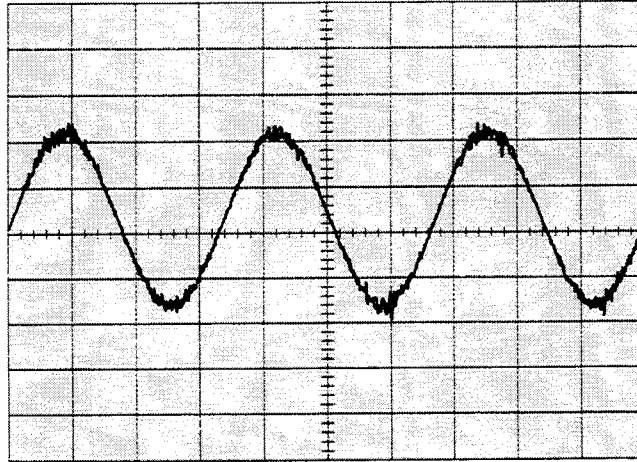
No. 8. HP 8645A Synthesized Audio Oscillator Waveform

Waveform Name/Description: Sine wave with AM noise.

Waveform Application: Receiver rejection of AM noise.

Instrument Settings

Source	Frequency	Phase	Waveform	Amplitude
Audio-Channel 1	1 kHz	0°	Sine	800 mV
Subcarrier AM	100 Hz	0°	Noise	20%

Glossary

Alias.

A keyword or command statement in a program that is an alternate (synonymous) term for commands of the same type. For example, the command statement FM:FREQUENCY:STEP is an alias for the command statement LFSOURCE:FREQUENCY:STEP.

Argument.

An argument is an independent variable (command parameter) whose value or state determines the value or state of a function. For example, the argument in the command statement FREQ:CW 150MHZ is "150MHZ".

Auto Select.

When the front-panel **AUTO** key is active, the HP 8645A will choose a signal path with the best possible spectral purity for the present control setting.

Channel.

A channel, with reference to frequency hopping, is an internal memory location comprised of a frequency and amplitude setting.

Channel Address.

A channel address is a numeral used to designate one of the 2400 (or 8000 for instruments with serial prefix 3019A and above) channel locations for storing frequency and amplitude settings for frequency hopping.

Channel Table.

The channel table is a set of up to 2400 (or 8000 for instruments with serial prefix 3019A and above) storage registers located in non-volatile memory. The channel table is set up by the user to contain pairs of frequency and amplitude settings for frequency hopping. Refer to chapter 3 *Channels and Sequences* for more information.

Command Header.

The command header is the first part of the command statement which is used to direct the control of the command. For example, in the command statement FM:STATE ON, the command header is simply "FM:STATE".

Command Message.

A command message is a line of information in a program containing one or more command statements. For example, the command statements to set FM deviation to 10 kHz, and to turn FM deviation on would make a command message as follows: FM 10KHZ;FM:STATE ON.

Command Parameter.

A command parameter is an independent variable (argument) whose value or state determines the value or state of a function. For example, the command parameter in the command statement `FREQ:CW 150MHZ` is "150MHZ".

Command Statement.

A command statement is a string of mnemonics used to accomplish one task, that is, either to set or query a function. For example, the string of mnemonics used to set the Auto selection of frequency synthesis would be as follows: `FREQ:SYNT:AUTO ON`.

Dwell Time.

Dwell time is the duration of the output power for any channel at the RF Output connector. The duration covers a time period between two points where RF output power is turned 90% on and 10% off. Refer to chapter 3 *Rate and Dwell* for the formula to calculate dwell time.

External Triggering.

External triggering, with reference to frequency hopping, refers to the user providing synchronized TTL voltage levels and signals to activate frequency hopping. Six frequency hop modes use external triggering to generate frequency hops.

Fast Hop.

Fast Hop specifically refers to Mode 5, the synthesis mode that must be active to initiate frequency hopping. The term "Fast Hop" is synonymous with the term "frequency hop".

Fast Hop Bus.

The Fast Hop Bus is a DB-25 pin connector located on the rear-panel of the HP 8645A. Its purpose is to provide a means of external triggering control and synchronization for frequency hop sequences.

Frequency Hop Modes.

The HP 8645A has nine frequency hop modes (not to be confused with the front-panel **SYNTHESIS MODE** keys). Each frequency hop mode determines how the RF output is controlled during a frequency hop. There are three frequency hop modes that are controlled by internal triggering, and six frequency hop modes that are controlled by external triggering. Refer to chapter 3 *Frequency Hop Modes* for more information.

Glideslope.

The Glideslope signal is part of the Instrument Landing System. It provides up and down orientation for the ideal angle of descent to the runway.

Header.

Same as "Command Header". This is the first part of the command statement which is used to direct the control of the command. For example, in the command statement FM:STATE ON, the header is simply "FM:STATE".

HP-SL.

HP-SL is the acronym for "Hewlett-Packard System Language". Refer to chapter 5 for a thorough discussion of HP-SL.

Hop Rate.

Hop rate is the number of frequency changes per second expressed in Hertz. Hop rate is internally or externally controlled.

Hop State.

The Hop State refers to a condition the HP 8645A is in when frequency hopping, or when it is waiting for a trigger to initiate frequency hopping.

Idle State.

The Idle State refers to a condition the HP 8645A is in when it accepts entries or modifications to the channel table, sequence table, hop rate, dwell time, and frequency hop modes or other instrument parameters.

ILS.

ILS is the acronym for "Instrument Landing System". ILS is a group of navigation signals used for aircraft landings.

Internal Audio Source.

The internal audio source refers to the circuitry that generates the modulation source for the RF carrier. Modulation rates are from 0.1 Hz to 400 kHz, which exceeds the typical audio frequency range of 20 kHz.

Learn State.

The Learn State refers to a condition that calibrates HP 8645A internal circuitry to quickly switch from one channel to another when frequency hopping. The HP 8645A must "learn" the internal settings to prepare for frequency hopping.

Localizer.

Localizer is one of the Instrument Landing System signals. It provides left and right orientation to the center of the runway.

Marker Beacon.

The Marker Beacon signals are part of the Instrument Landing System. The three markers indicate distance from the end of the runway.

Multifunction Synthesis.

This term refers to the operating capabilities that allow the HP 8645A to generate complex waveforms for modulating the RF carrier.

Sequence Table.

The sequence table is a set of up to 4000 (or 8000 for instruments with serial prefix 3019A and above) storage registers located in non-volatile memory. The sequence table is set up by the user to contain channel numbers for frequency hopping. Refer to chapter 3 *Channels and Sequences* for more information.

Short Form.

HP-SL commands may be written in a long or short form. The short form of any command will be three or four characters in length. For example the short form of the command AMPLitude is AMPL. The *HP-IB Control Language Dictionary* in chapter 5 lists all short form commands in upper case lettering.

Subcarrier Sources.

The subcarrier sources are used to generate a modulated wave which is applied, in turn, as a modulating wave to the RF carrier. As described in appendix F, there are four subcarrier sources (AM, FM, Φ M, and Pulse) that may be applied to the audio source in Channel 1.

Synchronization.

Synchronization refers to the arrangement in time, of events that must take place for the frequency hop to occur. Refer to chapter 3 *Timing Control and Synchronization* for timing diagrams.

Syntax.

Syntax refers to the make-up or structure of command statements and messages in HP-SL for use over the HP-IB bus.

Synthesis Mode.

A row of **SYNTHESIS MODE** keys on the front panel represent the internal signal paths that are used to minimize phase noise and spurs on the RF output, as a function of the selected FM deviation. The **AUTO** key is used to choose the signal path that provides the best possible spectral purity for any control setting. The **MODE 5** key is primarily used for frequency hopping, or for the fast hop sweep.

Synthesized Audio Oscillator.

This internal modulation source uses digital synthesis to generate waveforms of sine, sawtooth, triangle, squarewave, and white Gaussian noise, all with variable frequency, amplitude, and relative phase. Refer to appendix F for more information.

Timing Control.

Timing control refers to implementation of the nine frequency hop modes. There are two types of triggering mechanisms for timing control, internal and external.

Tree Structure.

HP-SL commands are organized in a tree structure. Commands start at a "root level" and proceed to branch out from the root. Multiple branching occurs with tree structure organization.

VOR.

VOR is the acronym for VHF Omni-Range. The VOR signal provides directional information to in-flight aircraft.

600 ohm FM, C-3

A

abort, 5-12
AC coupling, for AM 2-14
AC coupling, for FM 2-2
AC coupling, for Pulse, 2-23
AC coupling, HP-SL parameter, 5-14
AC voltmeter, C-8
accuracy, carrier frequency, 2-3
address output enable, Fast Hop Bus, 3-21
address selection, HP-IB, 5-10
adjust phase, C-4
ADRS, key, 5-10
ALC bandwidth, C-2
ALC loop, E-2
ALC loop, is closed or open, 3-18
ALC, open and closed loop, 3-36
alias, I-1
AM accuracy specification, 2-14, 2-28
AM bandwidth, H-20
AM example, HP-SL, 5-73
AM noise generation, H-22
AM noise, example, H-31
AM radio testing, H-22, H-28
AM signal, example, H-28
AM source, C-4
AM source, audio level, H-15
AM source, audio subcarrier, H-14
AM subsystem, HP-SL, 5-18
AM term, F-2
AM term, description, 5-16
AM using external audio source, 2-19
AM using internal audio source, 2-15
AM, ac coupling, 2-14
AM, an exercise, 2-15
AM, an introduction, 2-14
AM, an overview, 2-14
AM, coupling, 2-14
AM, dc coupling, 2-14
AM, equipment, 2-15
AM, things to remember, 2-22
ampl step term, F-2
ampl step term, description, 5-16
ampl step unit, F-2
ampl step unit, description, 5-16
ampl term, F-2
ampl term, description, 5-16
ampl unit term, F-2
ampl unit term, description, 5-16
amplitude control, E-1
amplitude control, introduction, 3-36
amplitude example, HP-SL, 5-74
amplitude integ. summary bit, 5-69
amplitude level, control, 3-36
amplitude muting, C-2
amplitude offset, G-2
amplitude subsystem, HP-SL, 5-19
amplitude sweep, example, H-29
amptd correction, C-1
amptd limit, C-1
AMPTD OFS, key, G-2
amptd range too large, error, 3-4
angle term, F-2
angle term, description, 5-16
annunciator, EXT HI, 2-11, 2-20, 2-31
annunciator, EXT LOW, 2-11, 2-20, 2-31
ANSI standard, mc1.1, 5-11
appendix D, error messages, 5-8
argument, I-1
ASCII, linefeed character, 5-14
ASCII, new line, F-1
asterisks, in a command message, 5-16
ATE programming, 1-2
attenuation, C-1
Aud ϕ M ϕ , C-6
Aud ϕ M Dev, C-5
Aud ϕ M Freq, C-5
Aud ϕ M Wave, C-5
Aud AM ϕ , C-4
Aud AM Depth, C-4
Aud AM Freq, C-4
Aud AM Wave, C-4
Aud FM ϕ , C-5
Aud FM Dev, C-4
Aud FM Freq, C-5
Aud FM Wave, C-5
Aud Pulse, C-6
Aud Pulse ϕ , C-6
Aud Pulse Freq, C-6
Aud2 ϕ , C-4
Aud2 Freq, C-3
Aud2 Level, C-3
Aud2 Wave, C-3
audio connector impedance, H-22
audio freq. rates, max., 2-3
audio freq. waveform, change, 2-8, 2-17

audio frequency rates, 2-3, 2-14, 2-22, H-20
 audio level, for AM source, H-15
 audio level, maximum voltages, H-10
 audio level, on RF carrier, H-19
 audio level, voltages, H-19
 audio mod. signal, complex, 2-4
 audio mod., complex, 2-3
 audio mod., single-tone, 2-3
 audio oscillator, 1-2, H-1
 audio output, bandwidth, H-13
 audio response, FM receiver, H-27
 audio signals, H-1
 audio source ϕ M deviation, H-20
 audio source bandwidth, H-20
 audio source channels, H-1
 audio source decrement, H-21
 audio source degradation, H-20
 audio source frequency, C-3
 audio source increment, H-21
 audio source phase reference, H-11
 audio source, Channel 2, C-4
 audio source, Channel 1, H-11
 audio source, Channel 2, H-12
 audio source, Channel 1 limits, H-12
 audio source, Channel 2 limits, H-13
 audio source, depth, H-20
 audio source, external, 2-3
 audio source, FM deviation, H-20
 audio source, internal, 2-3
 audio source, internal output level, 2-33
 audio source, modulated, H-14
 audio triggered, C-3
 audio wave, C-3
 audio, connector, H-1
 audio-tone sweep, H-22
 audio-tone sweep, example, H-27
 auto attenuation, C-1
 AUTO select, I-1
 AUTO select mode, 2-5
 AUTO SEQ, key, G-2
 auto sequence, G-2
 auto sweep, 4-11
 autorange bit, 5-65
 avionics, 5-44.1

B

Bad fast chan address, error, 3-4
 Bad fast sequence entry, error, 3-6
 bandwidth, affecting audio source, H-20
 bandwidth, ALC, C-2
 bandwidth, FM, 2-2
 bandwidth, for AM, H-20
 bandwidth, for FM, H-20
 bandwidth, of audio output, H-13
 beacon, marker, I-4
 beacon, IM, 5-44.1, C-11
 beacon, MM, 5-44.1, C-11
 beacon, OM, 5-44.1, C-11
 blank amptd, C-9
 blank audio, C-9
 blank display, C-8
 blank frequency, C-8
 blank modulation, C-9
 buffered hop bus, C-10
 buffering off, one hop delay, 3-31, 3-34
 buffering on, for faster switching speed, 3-31,
 3-34

C

- calculation example, for dwell time, 3-9
- calibration bit, 5-65
- calibration data, C-1
- calibration integ. summary bit, 5-69
- calibration subsystem, HP-SL, 5-21
- carrier frequency accuracy, 2-3, 2-13
- center frequency, 4-3
- channel, I-1
 - Channel 1, audio source, H-11
 - channel address, I-1
 - channel table, I-1
 - channel table, description, 3-4
 - channel table, example, 3-4
 - channel table, introduction, 3-3
 - channel table, local keys, 3-4
 - channel table, storage registers, 3-4
 - channels in sequence table, 3-6
- clear all, G-3
- CLEAR ALL, key, G-3
- clear lockout/set local, 5-12
- clear, HP-IB, 5-11
- closed loop ALC, 3-36
- closed loop ALC operation, 3-9, 3-37
- closed loop ALC, advantages, 3-36
- closed loop ALC, disadvantage, 3-36
- CLR CHAN key, 3-4
- CLR SEQ key, 3-6, 3-42
- colon, in command statements, 5-14
- command error bit, 5-63
- command header, I-1
- command message, I-2
- command message, definition, F-1
- command message, introduction, 5-6
- command message, syntax, F-1
- command message, with an asterisk, 5-16
- command parameter, I-2
- command parameter, introduction, 5-4
- command parameter, maximum, 5-15
- command parameter, minimum, 5-15
- command parameter, syntax, F-1
- command parameters, vertical bar, 5-14
- command statement, I-2
- command statement, definition, F-1
- command statement, introduction, 5-4
- command statement, syntax, F-1
- command statements, aliases, 5-15
- command statements, ambiguous, 5-7
- command statements, colon, 5-14

- common command, *RST, 5-8
- common commands, for IEEE 488.2, 5-33
- common commands, IEEE 488.2, 5-13
- communication systems, 1-2
- complex audio mod., 2-3
- complex audio signals, H-1
- complex signal generation, 1-2
- condition register, 5-58, 5-64
- conflicting conditions, HP-SL, 5-7
- connector impedances, 2-28
- connector, FAST HOP BUS, 1-2
- connector, HOP, 1-2
- connector, HP-IB, 1-2
- connector, SEQUENCE, 1-2
- control language dictionary, 5-13
- coupling type, F-2
- coupling type, description, 5-16
- coupling, AM signals, 2-14
- coupling, FM signals, 2-2
- coupling, Pulse modulation, 2-23
- cushioning material, A-1

D

- data input/output operations, 5-9
- data questionable bit, 5-66
- data valid line, 3-31, 3-34
- data valid, Fast Hop Bus, 3-21
- dc coupling, for AM, 2-14
- dc coupling, for FM, 2-2
- dc coupling, for Pulse, 2-23
- dc coupling, HP-SL parameter, 5-14
- dc voltmeter, C-7
- dcAM, E-2
- decrement, the audio source, H-21
- deg, key, C-4, C-5, C-6
- demo mode, E-1
- depth, for audio source, H-20
- deviation, FM, 2-1, C-4
- device dependent bits, 5-64
- device dependent error bit, 5-63
- device specific commands, 5-2
- device status dictionary, 5-56
- device status reporting, 5-58
- device status routines, 5-65
- diagnostic subsystem, HP-SL, 5-21
- digital FSK, 2-2
- digitally stepped, sweeping, 1-2
- digitally-stepped sweep, 4-7
- digitized FM, C-2
- digitized FM synthesis, 2-1, 2-3, 2-4, 2-13
- DISPLAY, G-3
- DISPLAY recall, G-3
- DISPLAY sequence, G-4
- DISPLAY special, G-3
- display subsystem, HP-SL, 5-22
- DISPLAY, key, C-1, G-3
- divider, external, C-2
- driver electronics, 5-12
- dual-tone modulation, example, H-26
- DWELL key, 3-10
- dwelt time, I-2
- dwelt time resolution, 3-10
- dwelt time, calculation example, 3-9
- dwelt time, definition, 1-6, 3-8
- dwelt time, first example of, 1-3
- dwelt time, formula, 3-8
- dwelt time, introduction, 3-7
- dwelt time, limits, 1-7
- dwelt time, variable, 3-33
- dynamic range, E-5

E

- emf, G-4
- emf, key, G-4
- enable register, 5-64
- EOI, 5-14
- equipment recommended, list of, 1-1
- error messages, A-1, D-1
- error messages, appendix D, 5-8
- error, Amptd range too large, 3-4
- error, Bad fast chan address, 3-4
- error, Bad fast sequence entry, 3-6
- error, Not in fast hop mode, 3-15
- error, Rate and dwell conflict, 3-10
- error-space after colon, 5-7
- european radix, C-9
- event enable register, 5-59
- event register, 5-58, 5-64
- example HP-SL programs, 5-72
- example programs, HP-SL, 5-8
- execution error bit, 5-63
- EXIT, key, G-6
- EXT HI annunciator, 2-11, 2-20, 2-31
- EXT LOW annunciator, 2-11, 2-20, 2-31
- ext repetitive, description, 3-26
- ext repetitive, mode, 3-13
- ext single, description, 3-27
- ext single, mode, 3-13
- ext stepped ext dwell, description, 3-29
- ext stepped ext dwell, mode, 3-13
- ext stepped int dwell, activate, 3-44
- ext stepped int dwell, description, 3-28
- ext stepped int dwell, mode, 3-13
- ext stepped int dwell, triggering, 3-39
- extended talker/listener, 5-12
- external audio source, 2-3
- external control and synchronization, 3-20
- external control, frequency hop, 3-1
- external divider, C-2
- external frequency hop modes, 6, 3-20
- external multiplier, C-2
- external single sequence, 3-27
- external trig, status message, 3-14
- external triggering, 3-12, 3-16, 3-19, 3-21, I-2
- external triggering, modes, 3-26

F

- f(t), C-3
- FAST HOP BUS, connector, 1-2
- FAST HOP, I-2
- Fast Hop Bus, E-1, E-4, I-2
- FAST HOP BUS connector, 3-12, 3-30, 3-33
- fast hop bus ext dwell, description, 3-33
- fast hop bus ext dwell, mode, 3-13
- fast hop bus external dwell, mode, 3-21
- fast hop bus int dwell, description, 3-30
- fast hop bus int dwell, mode, 3-13
- fast hop bus internal dwell, mode, 3-21
- FAST HOP BUS, connector drawing, 3-20
- fast hop bus, description, 3-20
- fast hop bus, pin descriptions, 3-21, 3-22
- fast hop demo, C-9
- FAST HOP key, MODE 5, 3-4, 3-13
- fast hop sweep, 4-8
- FAST HOP, annunciator, 1-3
- fast hop, frequency switching, E-5
- faster switching speed, 3-31, 3-34
- FM bandwidth, 2-2, E-1, E-2, H-20
- FM deviation, 2-1, 2-2, 2-13, C-4
- FM deviation, greater, 2-5
- FM deviation, on audio source, H-20
- FM example, HP-SL, 5-74
- FM indicator accuracy, 2-3
- FM input impedance, HP-SL, 5-24
- FM receiver, audio response, H-27
- FM source, subcarrier, H-16
- FM subsystem, HP-SL, 5-23
- FM switching time, 2-1
- FM synthesis, 2-3, 2-4, 2-13, C-2
- FM synthesis, digitized, 2-1
- FM synthesis, linear, 2-1
- FM telemetry, 2-2
- FM using external audio source, 2-10
- FM using internal audio source, 2-5
- FM, ac coupling, 2-2
- FM, an exercise, 2-5
- FM, an introduction, 2-2
- FM, an overview, 2-2
- FM, coupling, 2-2
- FM, dc coupling, 2-2
- FM, digitized or linear, C-2
- FM, equipment, 2-5
- FM, external mod. signals, 2-2
- FM, generation, 2-3
- FM, internal mod. signals, 2-2
- FM, things to remember, 2-13
- free running, status message, 3-14
- freq multiplier, C-2
- FREQ OFS, key, G-4
- freq term, F-2
- freq term, description, 5-17
- frequency accuracy, E-1, E-4
- frequency accuracy, sweeping, 4-9
- frequency accuracy, temperature, 3-18
- frequency agile, radios, 1-2
- frequency agile, testing, 1-2
- frequency divider, C-2
- frequency examples, HP-SL, 5-75
- frequency hop example, HP-SL, 5-76
- frequency hop modes, 3-12, I-3
- frequency hop mode, status, 3-14
- frequency hop modes, 9 in all, 3-13
- frequency hop modes, access to, 3-13
- frequency hop modes, HP-SL, 5-29
- frequency hop modes, int. & ext., 3-20
- frequency hop subsystem, HP-SL, 5-28
- frequency hop, exercise, 3-39
- frequency hop, external control, 3-1
- frequency hop, HP-IB control, 3-1
- frequency hop, procedure, 1-2, 1-3
- frequency hop, remote control, 3-1
- frequency hop, sequence table, 3-31
- frequency hop, six basic steps, 3-2
- frequency hopping, control, 1-2
- frequency integ. summary bit, 5-69
- frequency multiplier, C-2
- frequency offset, G-4
- frequency range, of HP 8645A, 1-2
- frequency shift, 2-3
- frequency subsystem, HP-SL, 5-24
- frequency sweep, phase-cont., C-2
- frequency sweeping, 1-2
- frequency sweeping, basic steps, 4-2
- frequency switching, 3-9, E-1
- frequency switching, fast hop, E-5
- front panel, synthesis mode keys, 3-12
- FSK, example, H-30
- function generator, recommended, 1-1

G

- glideslope, I-3
- glideslope, setup, 5-44.1, C-11
- group delay, C-2
- group delay, effects of, 2-4
- group delay, graph, 2-4
- GSlope, 5-44.1

H

- hardware integ. summary bit, 5-67
- harmonic content, on group delay, 2-4
- header, I-3
- High-Q devices, 4-9
- HOP Connector, 1-2, 3-12, 3-26, 3-27, 3-28, 3-29, 3-31, 3-34, C-3
- HOP connector, ext. trigger, 3-14
- HOP key, 3-19
- HOP line, 3-26, 3-27, 3-28, 3-29, 3-31, 3-33, 3-34
- HOP line, fast hop bus, 3-22
- HOP line, on fast hop bus, 3-14
- HOP line, on the fast hop bus, 3-21
- hop rate, I-3
- hop rate resolution, 3-10
- hop rate, definition, 1-6, 3-8
- hop rate, first example of, 1-3
- hop rate, introduction, 3-7
- hop rate, limits, 1-7
- hop rate, maximum, 3-8
- hop sequence, 3-4
- hop state, 3-17, I-3
- hop state, description, 3-19
- HP-IB bus, 5-56
- HP-IB control language, 5-13
- HP-IB control, frequency hop, 3-1
- HP-IB dev. status examples, HP-SL, 5-77
- HP-IB device status dictionary, 5-56
- HP-IB tutorial, 5-9
- HP-IB, address selection, 5-10
- HP-IB, capabilities, 5-11
- HP-IB, connector, 1-2
- HP-IB, read settings, 5-16
- HP-SL, I-3
- HP-SL ?, 5-5
- HP-SL commands, 5-13
- HP-SL commands, in italics, 5-14
- HP-SL commands, short form, 5-14
- HP-SL hierarchy, 5-5, 5-15

- HP-SL programming, 5-5
- HP-SL programming control, 3-1
- HP-SL query, 5-5
- HP-SL quick reference, F-1
- HP-SL reference information, 5-9
- HP-SL short form, commands, 5-14
- HP-SL subsystem syntax, F-2
- HP-SL system commands, 5-32
- HP-SL table of contents, F-3
- HP-SL tree structure, example, 5-15
- HP-SL, *RST, 5-8
- HP-SL, a development tool, 5-72
- HP-SL, colon, 5-4
- HP-SL, command message, 5-6
- HP-SL, command parameter, 5-4
- HP-SL, command statement, 5-4
- HP-SL, conflicting conditions, 5-7
- HP-SL, example programs, 5-8
- HP-SL, getting started, 5-3
- HP-SL, introduction, 5-2
- HP-SL, keywords, 5-6
- HP-SL, more about colon, 5-6
- HP-SL, not sequence dependent, 5-7
- HP-SL, optional keywords, 5-14
- HP-SL, semicolon, 5-6
- HP-SL, short form, 5-6
- HP-SL, square brackets, 5-14
- HP-SL, tree structure, 5-3
- HPIB messages, 5-11, 5-12

I

idle state, 3-17, I-3
IEEE 488.2 common commands, 5-33
IEEE 488.2 definitions, 5-58
IEEE 488.2 standard, 5-2, 5-56, 5-61
IEEE 488.2, common commands, 5-13
ILS, I-4
ILS, example, H-25
ILS, signaling, H-22
IM beacon, setup, 5-44.1, C-11
impedance, ϕ M connector, 2-28
impedance, AM connector, 2-28
impedance, FM connector, 2-28
impedance, PULSE connector, 2-28
implicit couplings, 5-15
INCR SET, key, H-21
increment, the audio source, H-21
initialize example, HP-SL, 5-78
initialize subsystem, HP-SL, 5-35
installation, A-1
INSTR PRESET, 1-3
instrument preset, *RST, 5-8
int repetitive, description, 3-23
int repetitive, mode, 3-13
int repetitive, triggering, 3-39
int single, activate, 3-43
int single, description, 3-24
int single, mode, 3-13
int single, triggering, 3-39
int stepped, description, 3-25
int stepped, mode, 3-13
internal audio source, 2-2, 2-3, 2-14, 2-23,
H-1, H-8, I-4
internal audio source, output level, 2-33
internal audio source, voltage, H-19, H-20
internal audio waveform, 2-3
internal audio waveforms, 2-14
internal frequency hop modes, 3, 3-20
internal modulation, 2-33
internal triggering, 3-12, 3-16, 3-19, I-3
internal triggering, modes, 3-23
italics, HP-SL commands, 5-14

K

knob hold, G-5
KNOB HOLD, key, G-5
KNOB INCR, key, G-5
knob increment, G-5

L

LEARN key, 3-18
learn operation, time for, 3-18
learn state, 3-17, E-1, E-3, I-4
learn state time, shorter, 3-36
learn state, description, 3-18
learning cycle, 1-7
level accuracy, 3-36
LF source subsystem, HP-SL, 5-36
lin ampl term, F-2
lin ampl term, description, 5-17
linear am control, 3-36
linear FM, C-2
linear FM synthesis, 2-1, 2-3, 2-4, 2-13
linear sweep, 4-12
linear sweep spacing, 4-10
linefeed character, in ascii, 5-14
local lockout, 5-11
local lockout, HP-IB, 5-11, 5-12
local, HP-IB, 5-11
LOCAL, key, 5-10, 5-11
localizer, I-4
localizer, setup 5-44.1, C-11
log sweep, 4-12
log sweep spacing, 4-10
lowercase HP-SL commands, 5-14

M

man/HP-IB trig, status message, 3-14
manual sweep, 4-11, 4-12
marker beacon, I-4
marker subsystem, HP-SL, 5-45
maximum audio freq. rates, 2-3
maximum hop rates, 3-9
maximum, command parameter, 5-15
mechanical damage, A-1
mechanical defects, A-1
memory address line, 3-31, 3-34
memory address lines, 3-30
memory address, Fast Hop Bus, 3-22
memory locations, for channel table, 3-4
memory, RAM, 1-3
messages, error, A-1, D-1
minimum, command parameter, 5-15
MM Beacon, setup 5-44.1, C-11
mod type, F-2
mod type, description, 5-17
MODE 5, FAST HOP key, 3-4, 3-13, 3-17
MODE key, 3-15
mode selection, 2-1
MODE 5, Synthesis Mode key, 3-15
modem testing, H-22, H-30
modes, for the frequency hop, 3-12
modulation example, HP-SL, 5-78
modulation formats, 1-2
modulation integ. summary bit, 5-68
modulation subsystem, HP-SL, 5-45
MSSG, key, A-1, D-1
multifunction synthesis, H-1, I-4
multiplier, external, C-2

N

narrowband devices, 4-9
new line, ASCII char.10, F-1
noise generation, H-22
non-decimal numeric prog. data, F-2
non-decimal numeric program data, 5-17
not in fast hop mode, error, 3-15
nrf, F-3
nrf, description, 5-17

O

off state, HP-SL parameter, 5-14
offset, amplitude, G-2
offset, annunciator, C-2
offset, frequency, G-4
ohms term, F-3
ohms term, description, 5-17
OM Beacon, setup 5-44.1, C-11
on state, HP-SL parameter, 5-14
open loop ALC, 3-36
open loop ALC operation, 3-9, 3-38
open loop ALC, advantage, 3-38
open loop ALC, disadvantages, 3-38
open loop hop, C-10
operating features, misc., G-1
operation complete bit, 5-63
options, B-1
Option 001, timebase, C-6
optional keywords, HP-SL, 5-14
oscillator, audio, 1-2
oscilloscope, recommended, 1-1
out-of-lock, D-1
output amplitude, C-1
output amplitude control, E-5
output level, of internal audio source, 2-33

P

packaging material, A-1
pass/take control, 5-12
phase adjust, C-2, C-4
phase cont sweep, C-2
phase continuous, freq. sweep, C-2
phase continuous, sweeping, 1-2
phase decrement, G-6
phase example, HP-SL, 5-79
phase increment, G-6
phase modulation subsystem, HP-SL, 5-46
phase noise, 2-1, 2-13
phase noise, lowest, 2-5
phase reference, for audio source, H-11
phase subsystem, HP-SL, 5-47
phase-continuous sweep, 4-8, 4-9
 ϕ DECR, key, G-6
 ϕ INCR, key, G-6
 ϕ M deviation, for audio source, H-20
 ϕ M source, subcarrier, H-17
PM, as phase modulation, 5-16
pocket pagers, H-26
power meter, C-8
power meter subsystem, HP-SL, 5-47
power on bit, 5-62
power source, A-1
POWER, key, 5-11, A-1
preset, 1-3
programming language, 5-8
programming quick reference, F-1
programming reference information, 5-9
programming, ATE, 1-2
programming, HP-SL, 5-5
pseudo random hopping, E-1, E-5
pulse input damage, 2-27
pulse modulation, ac coupling, 2-23
pulse modulation, an exercise, 2-24
pulse modulation, an introduction, 2-23
pulse modulation, an overview, 2-23
pulse modulation, coupling, 2-23
pulse modulation, dc coupling, 2-23
pulse modulation, equipment, 2-24
pulse modulation, exercise review, 2-24
pulse modulation, input level, 2-27
pulse modulation, things to remember, 2-27
pulse rate, 2-27
pulse shaping, E-1, E-2
pulse source, subcarrier, H-18
pulse subsystem, HP-SL, 5-48

pulse width, 2-27

Q

query, F-1

query a command, 5-16

query error bit, 5-63

queue, 5-59

quick reference, HP-SL, F-1

R

rad, key, C-4, C-5, C-6
radios, frequency agile, 1-2
RAM memory, 1-3
RAM wipe, C-7
RAM wipe, special function 172, 5-10
Rate and dwell conflict, error, 3-10
RATE key, 3-10
rates, audio frequency, 2-3
RCL CHAN key, 3-4
RCL SEQ key, 3-6
re-initialize, preset, 1-3
rear panel connectors, 3-12
recal, C-7
recalibration, E-1, E-4
RECALL, key, G-3
receiver rejection, example, H-31
receiver testing, H-29
recommended equipment, list of, 1-1
ref calibration, C-3, C-6
REF IN, connector, C-6
ref source, C-3, C-6
reference information, 5-9
reference integ. summary bit, 5-68
reference osc. subsystem, HP-SL, 5-48
register, status byte, 5-61
registers, status, 5-56
rel phase adjust, C-2
REM, annunciator, 5-10, 5-11
remote control, frequency hop, 3-1
remote mode, 5-11
remote, HP-IB, 5-11
request control bit, 5-63
request service, 5-12
resolution, dwell time, 3-10
resolution, hop rate, 3-10
RF carrier signal, H-1
RF dwell, Fast Hop Bus, 3-21
RF output connector impedance, H-22
RF output, calibrated, H-19
RF output, pulse duration, 2-27
RF output, temperature dependent, 3-18
RF output, transition, C-2
*RST, common command, 5-8
RST, common command, 5-8

S

- safty class 1, A-1
- save and recall, audio source, H-21
- save & recall registers, 2-1
- sawtooth, int. waveform, 2-2, 2-13
- sawtooth, waveform, 2-22
- security, C-7
- self-test, results of, 1-3
- SEQ connector, 3-27, 3-30, 3-31, 3-33, 3-34
- SEQ connector, on rear panel, 3-18
- SEQ, key, G-4, G-6
- sequence, G-6
- sequence dependency, 5-2
- sequence subsystem, HP-SL, 5-49
- sequence table, I-4
- sequence table entries, 3-31, 3-34
- sequence table, description, 3-4
- sequence table, how to set up, 3-42
- sequence table, introduction, 3-3
- sequence table, set up channels, 3-6
- SEQuence, connector, 1-2
- serial number, C-8
- service diagnostics, 5-21
- service mode, C-11
- service request, 5-62
- SET SEQ key, 3-6 G-6
- set sequence, G-6
- shipping container, A-1
- short form, I-4
- short form, HP-SL, 5-6
- signal integrity bit, 5-65
- signal integrity status registers, 5-67
- signal settled bit, 5-65
- simultaneous mod., an exercise, 2-29
- simultaneous mod., equipment, 2-29
- simultaneous mod., exercise review, 2-29
- simultaneous mod., things to remember, 2-33
- simultaneous modulation, 2-28, E-1
- sine, int. waveform, 2-2, 2-13
- sine, waveform, 2-22
- single sweep, 4-11
- single-tone audio mod., 2-3
- source list, F-3
- source list, description, 5-17
- space, F-3
- span frequency, 4-3
- special functions, 2-1, C-1
- special function 100, 5-20
- special function 101, 5-20
- special function 102, 5-21
- special function 103, 5-20
- special function 104, 5-21
- special function 105, 5-21
- special function 110, 5-47
- special function 111, 5-27
- special function 112, 4-9, 5-54
- special function 120, 2-3, 2-13, 5-24
- special function 121, 5-28
- special function 123, 5-24
- special function 130, 2-2, 2-8, 2-13, 2-17, 2-22, 5-36
- special function 131, 5-37
- special function 132, 5-37
- special function 133, 5-37, 5-38
- special function 134, 5-38
- special function 135, 5-37
- special function 136, 5-38
- special function 137, 5-39
- special function 138, 5-39
- special function 139, 5-39
- special function 140, 5-40
- special function 141, 5-40
- special function 142, 5-41
- special function 143, 5-41
- special function 144, 5-41
- special function 145, 5-42
- special function 146, 5-42
- special function 147, 5-42
- special function 148, 5-43
- special function 149, 5-43
- special function 150, 5-43
- special function 151, 5-44
- special function 160, 5-48
- special function 161, 5-48
- special function 170, 5-35
- special function 171, 5-33
- special function 172, 5-10, 5-33
- special function 173, 5-33
- special function 180, 5-55
- special function 181, 5-55
- special function 182, 5-47
- special function 190, 5-33
- special function 191, 5-22
- special function 192, 5-22
- special function 193, 5-22
- special function 194, 5-22
- special function 195, 5-22
- special function 196, 5-23

special function 201, 3-31, 5-29
 special function 202, 3-36, 5-28
 special function 220, C-10, H-1
 special function 221, C-11, H-1
 special function 222, C-11, H-1
 special function 223, C-11, H-1
 special function 224, C-11, H-1
 special function 225, C-11, H-1
 special function 300, C-11
 special functions, recalled, H-21
 special functions, saved, H-21
 SPECIAL, key, C-1, G-3
 spectral purity, E-1, E-3
 spectral splatter, 3-36
 spectrum analyzer, recommended, 1-1
 square brackets, in HP-SL, 5-14
 square, int. waveform, 2-2, 2-13
 square, waveform, 2-22
 squelch testing, H-26
 start frequency, 4-3
 status bit, 5-12
 status byte, 5-12, 5-56
 status byte register, 5-61
 status byte, register syntax, 5-70
 status messages, for frequency hop, 3-14
 status registers, 5-56
 status register model, 5-59
 status register syntax, 5-70
 status register, std. event, 5-62
 status registers, signal integrity, 5-67
 status subsystem, HP-SL, 5-50
 status summary bits, 5-61
 STB, common query, 5-61
 std. event status enable register, 5-63
 STO CHAN key, 3-4
 stop frequency, 4-3
 storage registers, 2-12, 2-21
 storage registers, audio source, H-21
 sub-audible squelch testing, H-26
 subcarrier sources, I-5
 subcarrier generation, H-1
 subcarrier sources, active, H-10
 subcarrier sources, modulation, H-14
 subcarrier sources, voltage, H-10
 subcarrier, ϕ M source, H-17
 subcarrier, AM source, H-14
 subcarrier, FM source, H-16
 subcarrier, Pulse source, H-18
 summary bit, 5-59
 summary bits, 5-61
 summary bits, enabled, 5-62
 sweep exercise, 4-13
 sweep in progress bit, 5-66
 sweep markers, 4-6
 sweep spacing, 4-10
 sweep span, maximum, 4-9
 sweep span, minimum, 4-9
 sweep steps, 4-9
 sweep steps, synthesis mode, 4-12
 sweep subsystem, HP-SL, 5-54
 sweep time, 4-10, 4-12
 sweep triggering, 4-11
 sweep types, 4-7
 sweep, audio-tone, H-22
 sweeping, digitally stepped, 1-2
 sweeping, frequency, 1-2
 sweeping, phase continuous, 1-2
 switching speed, faster, 3-31, 3-34
 switching time, 2-13
 switching time, FM, 2-1
 switching time, quicker, 3-38
 switching times, vs max. hop rates, 3-9
 switching, speed, 2-5
 synchronization, I-5
 synchronization, for 9 freq. hop modes, 3-16
 syntax, I-5
 syntax, for HP-SL, F-1
 syntax, HP-SL subsystems, F-2
 synthesis mode, I-5
 synthesis modes, 2-5
 synthesis mode keys, on front panel, 3-12
 synthesis mode, sweep steps, 4-12
 synthesized audio oscillator, 1-2, I-5
 system commands, for HP-SL, 5-32

T

take sweep subsystem, HP-SL, 5-55
talker/listener, HP-IB, 5-11
temperature dependent, RF output, 3-18
temperature drift bit, 5-65
temperature sensitivity, E-4
temperature, frequency accuracy, 3-18
test, C-7
testing, frequency agile, 1-2
time term, F-3
time term, description, 5-17
timebase, high-stability, C-6
timing control, I-5
timing control, for 9 freq. hop modes, 3-16
transition filter, 5-58
transition filters, 5-64
tree structure, I-6
tree structure, HP-SL, 5-3
triangle, int. waveform, 2-2, 2-13
triangle, waveform, 2-22
trig audio, C-3
trigger, Fast Hop Bus, 3-21
trigger, HP-IB, 5-11
triggering, internal & external, 3-12, 3-16, 3-19
tutorial, for HP-IB, 5-9
two-tone FSK, example, H-30
two-tone signal, example, H-25
typical applications, H-22

U

unpacking, 1-1
uppercase HP-SL commands, 5-14
user request bit, 5-62

V

variable dwell time, 3-33
vernier range, attenuators, C-1
vertical bar, in command parameters, 5-14
VHF, example, H-24
VHF, range, H-22
voltage levels, for RF output, H-19
voltage levels, for subcarrier, H-10
voltage, for int. audio source, H-20
voltage, power source, A-1
voltmeter in, connector, C-8
voltmeter subsystem, HP-SL, 5-55
VOR, I-6
VOR, example, H-24
VOR, range, H-22
VOR, setup, 5-44.1, C-10

W

w.g. noise, int. waveform, 2-2, 2-13
w.g. noise, waveform, 2-22
waveform degradation, H-20
waveform selection, C-3
waveform, sawtooth, 2-2, 2-13, 2-22
waveform, sine, 2-2, 2-13, 2-22
waveform, square, 2-2, 2-13, 2-22
waveform, triangle, 2-2, 2-13, 2-22
waveform, w.g. noise, 2-2, 2-13, 2-22
wideband alc, C-2

X

x-axis output, 4-6

Z

z-axis output, 4-6, 4-7

TABLE OF CONTENTS

Section 1 General Information

Introduction to HP 8645A Documentation	1-1
Operation Guide	1-1
Calibration Manual	1-1
Service Diagnostics Manual	1-1
Specifications	1-2
Safety Considerations	1-2
Description	1-2
Output Amplitude	1-2
Modulation	1-3
Frequency Hopping	1-3
Sweep	1-3
Hewlett-Packard Interface Bus (HP-IB)	1-3
Compatibility	1-3
Selecting the HP-IB Address	1-3
Instruments Covered By This Manual	1-4
Serial Numbers	1-4
Documentation Updating	1-4
Signing Up for the Documentation Update Service	1-4
A Description of the Manual Update Packet	1-4
Additional Equipment Information	1-5
Electrical Options	1-5
Mechanical Options	1-5
Documentation Options	1-5
Available Electrical and Mechanical Equipment	1-6
Accessories Supplied	1-6
Recommended Test Equipment	1-6

Section 2 Installation

Introduction	2-1
Initial Inspection	2-1
Preparation For Use	2-1
Power Requirements	2-1
Line Voltage and Fuse Selection	2-3
Power Cables	2-3
Time Base Selection	2-5
HP-IB Address Selection	2-5

Interconnections 2-5
 Mating Connectors 2-5
 Operating Environment 2-5
 Bench Operation 2-5
 Rack Mounting 2-6
 Storage and Shipment 2-6
 Environment 2-6
 Packaging 2-6

Section 3
Performance Tests

Introduction 3-1
 Equipment Required 3-1
 Performance Test Record 3-1
 Calibration Cycle 3-1
 Internal Voltmeter Verification 3-1
 Basic Functional Checks 3-2
 Preliminary Test 3-2.1
 Performance Test 1 - Carrier Amplitude 3-3
 Performance Test 2 - AM 3-7
 Performance Test 3 - FM (Low Deviations and Rates) 3-11
 Performance Test 4 - FM (High Deviations and Rates) 3-19
 Performance Test 5 - Spectral Purity (SSB Phase Noise) 3-25
 Performance Test 6 - Spectral Purity (Harmonics) 3-36
 Performance Test 7 - Pulse Modulation 3-39
 Performance Test 8 - Fast Hop Switching 3-43

Section 1

GENERAL INFORMATION

1-1. INTRODUCTION TO HP 8645A DOCUMENTATION

Documentation for the HP 8645A includes an *Operation and Calibration Manual*, and a *Service Diagnostics Manual*. The *Operation and Calibration Manual* is made up of a *Operation Guide* and a *Calibration Manual* both in the same 3-ringed binder. These manuals contain all the information required to install, operate, test, and service the Hewlett-Packard Model 8645A Agile Signal Generator. The Model 8645A will generally be referred to as the Signal Generator throughout this manual.

The information to operate, calibrate, and service this instrument is as follows:

- The *Operation Guide* is provided with each instrument.
- The *Calibration Manual* is provided with each instrument.
- The *Service Diagnostics Manual* for assembly level repair is not included with the instrument but is obtained separately by ordering through your nearest Hewlett-Packard office.

Operation Guide

The *Operation Guide* documents front-panel operation, including special functions, error messages, and HP-SL programming. All operating information for the Signal Generator is found in the *Operation Guide*.

Calibration Manual

Section 1, General Information describes the Signal Generator, options, accessories, specifications, and other basic information.

Section 2, Installation provides information about initial inspection, preparation for use (including address selection for remote operation), instrument storage, and shipment.

Section 3, Performance Tests documents the tests that verify performance of the instrument against the critical specifications in table 1-1.

Service Diagnostics Manual

The *Service Diagnostics Manual* documents repairing the Signal Generator to the module level. This manual does not include component level repair.

Additional copies of any operation, calibration, or service manual can be ordered separately through your nearest Hewlett-Packard office. The part numbers are listed on the title page of this manual, and in the paragraph 1-8, *Additional Equipment Information* under *Documentation Options*.

1-2. SPECIFICATIONS

Instrument specifications are listed in table 1-1, *Specifications*. These are the performance standards, or limits, against which the instrument may be tested after a 24 hour warm-up (connection to ac power line), and after 10 minutes turn-on. The Signal Generator has a general operating temperature range of 0 to +55°C. Whenever the instrument senses an ambient temperature variation of $\pm 10^\circ\text{C}$, a recalibration should be done to ensure that all specifications are being met. The error message **Temp Drift. Recalibrate** is put into the message queue if the temperature variation occurs. Activate Special Function 171 to recalibrate the instrument.

Information printed in *Italics* are *Supplemental Characteristics*, and are not warranted specifications but are typical characteristics included as additional information for the user.

1-3. SAFETY CONSIDERATIONS

This product is a Safety Class I instrument (that is, one provided with a protective earth terminal). Review the Signal Generator and all related documentation to become familiar with safety markings and instructions before operation. Refer to the *Warnings* and *Cautions* found in section 2 for safety information.

Safety information pertinent to the task at hand (installation, operation, performance testing, adjustment, or service) are found throughout these manuals.

1-4. DESCRIPTION

The Hewlett-Packard Model 8645A Agile Signal Generator has an RF output range of 251 kHz to 1030 MHz. Its output amplitude is leveled and calibrated from +16 to -137 dBm. AM, FM, Pulse, or Phase Modulation functions can be selected. The RF output frequency, output amplitude, modulation, and Fast Hop functions may be remotely programmed via the Hewlett-Packard Interface Bus using the new Hewlett-Packard Standard Language (HP-SL). The unique modular design, internal calibration, and service diagnostic features permit accurate calibration and service.

RF Output

The Signal Generator covers an RF output range of 251 kHz to 1030 MHz which can be extended to 2060 MHz with the optional Doubler Module (Option 002). Frequency resolution is 0.01 Hz. A 12-digit display of the RF output in Hz, kHz, MHz, and GHz gives easy viewing of the desired frequency. Pushbutton keys and rotation of the Knob permit accurate tuning, and incrementing of the RF output.

Frequency accuracy and stability are dependent upon the reference source being used, which will be either the internal reference oscillator or an external source operating at 10 MHz. An optional 10 MHz reference with a temperature stabilized crystal is available for increased stability (Option 001).

Output Amplitude

The Signal Generator has precise power levels from +16 to -137 dBm over the entire frequency range. For instruments equipped with Option 002 (Doubler Module), the maximum output levels are +14 dBm for frequencies from 251 kHz to 1030 MHz, and +13 dBm at frequencies from 1030 to 2060 MHz. Output amplitude display resolution is 0.1 dBm. An 8 digit display provides easy viewing of the desired output. Easy conversion of units between dBm, +V, EMF, and so forth is possible.

Reverse Power protection is 50 Watts from a 50 Ω source, 25 V dc.

Modulation

The Signal Generator features AM, FM, Φ M, and Pulse modulation which can be simultaneously mixed, for example, AM/FM, AM/ Φ M, AM/Pulse, FM/Pulse, Φ M/Pulse, AM/FM/Pulse, or AM/ Φ M/Pulse. The Signal Generator also features versatile simultaneous internal and external modulation capability for AM, FM, Pulse, and Φ M.

The Internal Audio Source produces sine, square, triangle, sawtooth, and white Gaussian noise waveforms from 0.1 Hz to 400 kHz. However, the **AUDIO** output has a typical bandwidth of 400 kHz which affects complex waveforms with frequency components greater than 400 kHz. A 16 digit display and LED annunciators shows information for the internal or external modulation source. Direct keyboard entry for modulation selection is provided.

Frequency Hopping

The Signal Generator features frequency hop operation which can produce a modulated output signal that “fast hops” over a pre-selected set of frequencies. In the Fast Hop mode, RF output and output amplitude settings are entered into a channel table. A sequence table is used to determine the order for the frequency hop. Internal or external AM, FM, or simultaneous AM/FM Modulation is allowed while in frequency hopping.

Sweep

The Signal Generator has three types of sweep: phase-continuous, Fast Hop, and digitally-stepped. Linear or log frequency spacing may be selected with Fast Hop or digitally-stepped sweeping; only linear frequency spacing is available when phase-continuous sweeping.

1-5. HEWLETT-PACKARD INTERFACE BUS (HP-IB)

Compatibility

The Signal Generator is fully programmable via the HP Interface Bus. The The Signal Generator's capabilities are defined by the following interface functions: SH1, AH1, T6, TE0, L4, LE0, SR1, RL1, PP0, DC1, DT0, C0, E2. The Signal Generator interfaces with the bus via open-collector TTL circuitry. An explanation of the compatibility code may be found in IEEE Standard 488.2, in *IEEE Standard and Digital Interface for Programmable Instrumentation* or the identical ANSI Standard MC1.1.

For detailed information relating to programmable control of the Signal Generator over HP-IB using HP-SL, refer to chapter 5 in the *Operation Guide*.

Selecting the HP-IB Address

The instrument's HP-IB address is preset to 19 (decimal) when shipped from the factory.

The HP-IB address is front-panel programmable. To change your instrument's HP-IB address, press the blue SHIFT key, and then the ADRS key. You will see the current address in the FREQUENCY/STATUS display. Key in the desired decimal number between 00 and 30 if you want to change the HP-IB address, and then press the ENTER key.

1-6. INSTRUMENTS COVERED BY THIS MANUAL

This manual documents Signal Generators supplied with electrical options 001, 002, and 003. These, and various mechanical options are described in this manual under paragraph 1-8, *Additional Equipment Information*.

Serial Numbers

This instrument has a two-part serial number in the form 1234A00123 which is stamped on the serial number plate attached to the rear of the instrument (above and slightly to the right of the fan louvre). The first four digits and the letter are the serial number prefix, and the last five digits form the sequential suffix that is unique to each instrument. The prefix is the same for all identical instruments; it changes only when a change is made to the instrument.

The contents of these manuals apply directly to instruments having the same serial number prefix(es) as listed under SERIAL NUMBERS on the respective manual title pages.

1-7. MANUAL UPDATING

This manual may be revised as needed to make corrections and to document hardware and firmware changes. The latest revision of the manual can be purchased from the Hewlett-Packard locations shown below:

Inside the U.S.A.

Call HP Parts Direct Ordering at 800-227-8164. They can also help determine if a new revision is available.

Outside the U.S.A.

Contact the local Hewlett-Packard Sales and Service office for ordering information.

1-8. ADDITIONAL EQUIPMENT INFORMATION

Options are variations to the standard instrument which can be ordered during, or after the original purchase. If options were not ordered with the shipment but are now desired, they may be ordered from your nearest Hewlett-Packard office using the part number included in the following paragraphs. The following list defines all currently available options.

Electrical Options

High Stability Timebase (Option 001). A 10 MHz crystal High Stability Time Base for increased frequency accuracy and stability (less than 5×10^{-10} /day) is installed. A BNC 10 MHz time base output connector is provided on the rear panel as a time base reference.

2 GHz Doubler Output (Option 002). The Signal Generator RF output range is extended from 1030 MHz to 2060 MHz. Use the HP 11845A 2 GHz Retrofit Kit for instruments that do not have the Option 002 installed.

Rear Panel Inputs/Outputs (Option 003). This option provides rear-panel (instead of front-panel) connections for AM/FM/PULSE/PHASE MODULATION INPUTS, AUDIO and RF OUTPUTS.

Mechanical Options

Front Handle Kit (Option 907). Ease of handling is increased with the front-panel handles. Order HP part number 5062-3990.

Rack Flange Kit (Option 908). This kit contains all necessary hardware and installation instructions for mounting the Signal Generator in a rack with 482.5 millimeter (standard 19-inch) spacing. Order HP part number 5062-3978.

Rack Flange and Front Handle Combination Kit (Option 909). This kit is simply a front handle kit and a rack flange kit packaged together. The combination is made up of unique parts which include both functions. Order HP part number 5062-3984.

Chassis Slide-Mount Kit. This kit is extremely useful when the Signal Generator is rack mounted. Access to internal circuits and components or the rear panel is possible without removing the instrument from the rack. Order HP part number 1494-0059 for 432 mm (17 in.) fixed slides. (To order adapters for non-HP rack enclosures, use HP part number 1494-0023.)

Chassis-Tilt, Slide-Mount Kit. This kit is the same as the Chassis Slide Mount Kit above except it also allows the tilting of the instrument up or down 90°. Order HP part number 1494-0063 for 432 mm (17 in.) tilting slides. To order adapters for non-HP rack enclosures, use HP part number 1494-0023.

Documentation Options

Extra Manual Set (Option 910). Provides an additional copy of the Operation and Calibration Manual (HP part number 08645-90023), and two copies of the Service Diagnostics Manual (HP part number 08645-90024).

Add Service Manual (Option 915). Provides a copy of the Service Diagnostics Manual (HP part number 08645-90024) enabling a qualified service person to troubleshoot and repair the Signal Generator to the module and cable level.

1-9. AVAILABLE ELECTRICAL AND MECHANICAL EQUIPMENT

Service Accessory Kit. A Service accessory Kit (HP 08645-61116) is available which contains accessories (special test fixtures, cables, etc.) useful in servicing the Signal Generator.

Transit Case. Protection when transporting is increased with the Transit Case. Order HP part number 9211-2662. For ease of use when handling, Transit Case Wheels can be ordered using HP part number 1490-0913 (includes 4 wheels).

1-10. ACCESSORIES SUPPLIED

The Accessories Supplied are pieces of equipment which are shipped with every Signal Generator.

Line Power Cable. The line power cable may be supplied in several different plug configurations according to the Mains voltage available, and the country of destination of the original shipment. For the part numbers of the power cables and Mains plugs available, refer to *Power Cables* in section 2 of this *Operating Information* manual.

Fuses. Fuses with a 5A rating for 115 V ac (HP 2110-0010) and a 2.5A rating for 230 V ac (HP 2110-0083) are supplied. One fuse is factory installed according to the voltage available in the country of original destination. This same information (part numbers and ratings of the fuses available) is in the paragraph *Line Voltage and Fuse Selection* in section 2 of this *Operating Information* manual.

Coaxial Timebase Cable. A coaxial time base cable is supplied if the Signal Generator is equipped with Option 001. This cable must be connected between the rear-panel OVEN REF output connector from the High Stability Time Base, and the REF IN input connector.

1-11. RECOMMENDED TEST EQUIPMENT

Table 1-2, *Recommended Test Equipment* lists the test equipment required for testing, adjusting, and servicing the Signal Generator. The Critical Specifications column describes the essential requirements for each piece of test equipment. Other equipment can be substituted if it meets or exceeds these critical specifications.

Table 1-1. Specifications (1 of 5)

HP8645A specifications

Specifications describe the instrument's warranted performance and apply 24 hours after the unit has been connected to the ac power line and 10 minutes after turn-on (except Fast Hop: 2 hours warm-up). The specifications assume the instrument is operating in the Auto mode (except Fast Hop operation) which automatically optimizes the internal hardware configuration for maximum performance.

Supplemental Characteristics are intended to provide information useful in applying the instrument by giving typical, but not warranted performance. These characteristics are shown in italics or labeled as "typical", "approximate", or "nominal".

Frequency

Range: 251.46485 kHz to 1030 MHz. 251.46485 kHz to 2060 MHz with Option 002 or with HP11845A 2 GHz Retrofit Kit installed.

Frequency bands: Exact endpoints and their approximations for each frequency band of the instrument are shown below.

Approximate Frequency Band Endpoints (MHz)	Specified Frequency Band Endpoints (MHz)
1030 to 2060	1030 to 2060
515 to 1030	515 to 1029.9999999
257 to 515	257.5 to 514.99999999
128 to 257	128.75 to 257.49999999
64 to 128	64.375 to 128.74999999
32 to 64	32.1875 to 64.37499999
16 to 32	16.09375 to 32.18749999
8 to 16	8.046875 to 16.09374999
4 to 8	4.0234375 to 8.04687499
2 to 4	2.01171875 to 4.02343749
1 to 2	1.00585938 to 2.01171874
0.5 to 1	0.50292969 to 1.00585937
0.25 to 0.5	0.25146485 to 0.50292968

Resolution: 0.01 Hz.

Stability: Same as reference oscillator. See Fast Hop for exception.

Frequency switching time: <110 msec. to within 100 Hz of final frequency if FM is not active. <150 msec. to within 100 Hz of final frequency if FM is active. See Fast Hop Operation for exceptions.

Phase offset: Adjustable in 1° increments.

Internal Reference Oscillator *

Stability, Option 001: <5×10⁻¹⁰/day aging after 10 day warm-up.

	Standard	Option 001
Aging:	±2 ppm/year after 1 year	±3×10 ⁻¹⁰ /day after 10 days
Temperature:	±4 ppm, 0 to +55°C	±6×10 ⁻⁹ , 0 to +55°C
Line Voltage:	±0.1 ppm, ±10%	±1×10 ⁻¹⁰ , ±10%

Electronic frequency control, Option 001: ±0.01 ppm for ±1V at rear panel connector. Voltage range is ±10V. Input impedance is 10 kΩ.

Output: 10 MHz, >1V_{rms} level into 50Ω, output impedance of 50Ω.

External reference oscillator input: Accepts 10 MHz ± 1 kHz and a level range of 0.5 to 2V_{rms}. Input impedance is 50Ω.

* These Internal Reference Oscillator specifications apply only to instruments with a Serial Prefix 3026A and Below. See Table 1-1. Specifications (5 of 5).

Fast Hop Operation

Frequency switching time:

128 to 2060 MHz: <15 μsec.

8 to 2060 MHz: <85 μsec.

0.25 to 2060 MHz: <500 μsec.

Add 5 μsec for Option 002. in closed loop ALC operation.

Frequency hop range: 0.25 to 2060 MHz. With FM on, limited to any three consecutive carrier frequency bands.

Frequency accuracy: ±2 ppm of carrier frequency. Typically ±1 ppm.

Amplitude accuracy: ±1 dB, >-127 dBm output.

(±1.5 dB, > -127 dBm output when amplitude level is varied up to -5 dB from the constant learned value during Fast Hop.)

Channel and sequence tables: In Fast Hop each specific frequency and amplitude to be output is entered into a channel table. The order for the channels to be output is entered in a sequence table.

Maximum number of channels: 2400.

(3019A and above, Maximum number of channels: 8000)

Maximum number of channels in sequence table: 8000)

Maximum number of channels in sequence table: 4000.

Hop rate range: Fixed rates from 8 Hz to 50 kHz using the internal timer. An external trigger input allows extended range and variable rates.

Dwell time range: Fixed times of 6.4 μsec to 99 msec using the internal timer. An external trigger input allows longer and variable dwell times.

Learn cycle time: Typically 10 sec to 3.5 minutes depending on sequence table length.

Fast Hop bus: Allows real-time selection of any channel for output while fast hopping. Typically, frequency switching time increases by 5 μsec.

Modulation allowed: Internal or external AM, FM, or simultaneous AM and FM.

Output level: Maximum allowed variation of all amplitudes entered in channel table is 20 dB. Frequency switching time and absolute accuracy degrade with increasing amplitude variation. Output level is reduced by >60 dB while switching between channels. External dc AM can be used to shape the output level while fast hopping.

Spectral Purity

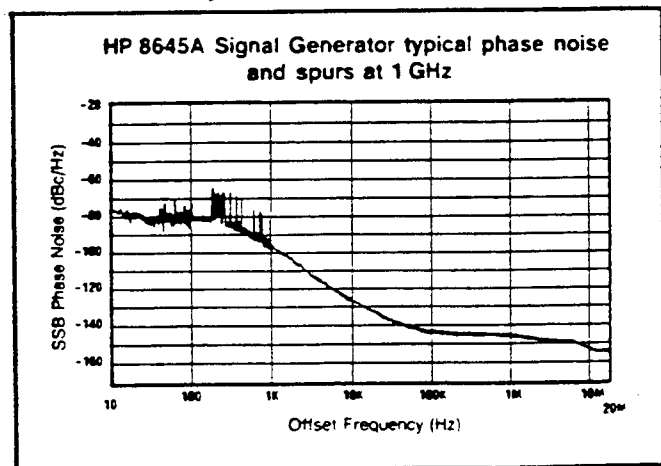

¹ Typically ±2 ppm of carrier frequency multiplied by the temperature change in °C must be added if ambient temperature changes occur between the Learn operation and the conclusion of frequency hopping. FM off or at minimum deviation.

Table 1-1. Specifications (2 of 5)

SSB phase noise (CW, AM, or FM² operation):

Carrier Frequency (MHz)	Standard Operation Offset Frequency		Fast Hop Operation
	20 kHz (dBc/Hz)	100 kHz (dBc/Hz)	20 kHz Offset (dBc/Hz)
1030 to 2060	-120	-127	-116
515 to 1030	-127	-134	-123
257 to 515	-132	-137	-128
128 to 257	-136	-140	-133
64 to 128	-139	-141	-137
32 to 64	-141	-141	-139
16 to 32	-142	-142	-141
8 to 16	-143	-143	-142
4 to 8	-144	-144	-143
2 to 4	-144	-144	-144
1 to 2	-144	-144	-144
0.5 to 1	-144	-144	-144
0.25 to 0.5	-144	-144	-144

Typical SSB phase noise and spurs at 1 GHz:

Residual FM⁴ (CW, AM, FM⁵ operation):

Carrier Frequency (MHz)	Post Detection Bandwidth	
	0.3 to 3 kHz (Hz rms)	0.05 to 15 kHz (Hz rms)
0.25 to 257	<1	<1.2
257 to 515	<1.2	<2
515 to 1030	<2	<4
1030 to 2060	<4	<8

Residual AM: <0.01% AM rms, 0.3 to 3 kHz post detection bandwidth.

SSB AM noise floor, offsets >100 kHz:

- <-157 dBc/Hz at +16 dBm output, 0.25 to 1030 MHz
- <-150 dBc/Hz at +13 dBm output, 1030 to 2060 MHz.

Spurious Signals

Harmonics: <-30 dBc, output \leq +10 dBm.

Harmonics, Option 002:

- <-30 dBc, 0.25 to 1030 MHz, output \leq -5 dBm.
- <-25 dBc, 1030 to 2060 MHz, output \leq -5 dBm

Subharmonics: None, 0.25 to 515 MHz

- <-55 dBc, 515 to 1030 MHz.
- <-40 dBc, 1030 to 2060 MHz.

Nonharmonics³:

- <-100 dBc, >20 kHz offset, 0.25 to 1030 MHz
- <-94 dBc, >20 kHz offset, 1030 to 2060 MHz

Output

Maximum level: +16 dBm, 0.25 to 1030 MHz.

Option 002: +14 dBm, 0.25 to 1030 MHz.
+13 dBm, 1030 to 2060 MHz.

Minimum level: -137 dBm.

Display resolution: 0.1 dB.

Absolute accuracy: \pm 1 dB, output \geq -127 dBm

Typically \pm 3 dB, output <-127 dBm.

Reverse power protection: 50 watts from a 50 Ω source, 25 Vdc.

Third order intermodulation: <-50 dBc, up to 1300 MHz.

with two signals at +8 dBm and 25 kHz apart passing through a resistive combiner (exception: Fast Hop operation). Decreases 10 dB for every 5 dB of combined level decrease.

Output level overrange: Typically 2 dB more than Maximum Level.

Output level switching time: <50 msec. See exception in Fast Hop.

SWR and output impedance: <1.7 : 1, output <-2 dBm

<2 : 1, output \geq -2 dBm; 50 Ω output impedance.

(or <2.4A), output \geq -2 dBm; 50 Ω output impedance. for Opt. 002.)

Modulation

External modulation input: Coupling is ac or dc for AM, FM and phase modulation. Pulse modulation input is dc coupled. Displayed deviation or depth corresponds to \pm 1V external input.

Simultaneous modulation: AM/FM, AM/Phase, AM/Pulse, FM/Pulse, Phase/Pulse, AM/FM/Pulse, AM/Phase/Pulse.

Simultaneous internal/external modulation: FM and Phase.

Amplitude Modulation

AM depth: 0 to 99.9%, for output \leq +7 dBm.

AM resolution: 0.1%.

AM indicator accuracy: \pm (6% of setting + 2% AM), up to 90% depth and 1 kHz rate for carrier frequencies >1 MHz

When amplitude level is varied up to -5 dB from the constant learned value during Fast Hop: \pm (7% of setting + 1% AM) up to 80% depth, 1 kHz rate)

AM distortion, at 400 Hz and 1 kHz rates:

Depth (%)	Carrier Frequency	
	1 to 1030 MHz	With Option 002
0 to 30	< 2%	< 5%
30 to 70	< 3%	< 5%
70 to 90	< 5%	< 8%

AM 3 dB bandwidth⁶: >5 kHz, 0.25 to 8 MHz

>50 kHz, 8 to 128 MHz

>100 kHz, 128 to 2060 MHz

Incidental phase modulation: <0.2 radians peak, at 30% depth and 1 kHz rate.

External AM input impedance: 600 Ω .

² FM at minimum deviation. FM <17% of maximum deviation

³ Typically nonharmonic spurs at all offsets are <30 dB above the instrument's phase noise level as measured in a 1 Hz bandwidth

⁴ Specified for 48 to 63 Hz power line. Typical for 400 Hz power line and for Fast Hop operation

⁵ Deviation \leq 0.1% of maximum available

⁶ Lower 3 dB bandwidth limit is typically 20 Hz for ac coupling. Upper 3 dB bandwidth limit is valid at 25 \pm 5 $^{\circ}$ C

Table 1-1. Specifications (3 of 5)

Frequency Modulation

FM deviation and rate:

Carrier Frequency (MHz)	Maximum Peak Deviation		Maximum Rate
	Standard (kHz)	Fast Hop ⁷ (kHz)	(3 dB BW) ⁸ (kHz)
1030 to 2060	20000	3520	10000
515 to 1030	10000	1760	10000
257 to 515	5000	880	5000
128 to 257	2500	440	2500
64 to 128	1250	220	1250
32 to 64	625	110	625
16 to 32	313	55	313
8 to 16	156	27.5	156
4 to 8	78	13.7	78
2 to 4	39	6.8	39
1 to 2	19.5	3.4	19.5
0.5 to 1	9.7	1.7	9.7
0.25 to 0.5	4.8	0.8	4.8

FM resolution: 2.5% of setting.

FM indicator accuracy:

Standard Operation		Fast Hop Operation	
Deviation (% of maximum)	Maximum Rate	Deviation (% of maximum)	Maximum Rate
Specified Accuracy $\pm 10\%$			
0 to 10	50 kHz ⁶	0 to 50	50 kHz ⁶
Specified Accuracy $\pm 18\%$			
0 to 17	3.75 MHz ⁶	0 to 100	3.75 MHz ⁶

FM distortion⁹, rates 20 Hz to 100 kHz:

Deviation (% of maximum)	Standard Operation	Fast Hop Operation
0 to 3	<2.7%	<2.7%
3 to 15	<6%	<2.7%
15 to 100	<6%	<6%

Carrier frequency accuracy in FM: $\pm 0.4\%$ of deviation setting, ac or dc coupled. Typically add 1% of deviation to frequency accuracy in Fast Hop operation.

Incidental AM: <0.5%, deviation $\leq 6\%$ of maximum or 20 kHz, whichever is less.

External FM group delay: 30 μsec for rates 20 Hz to 20 kHz, decreases to <1 μsec at rates above 200 kHz. Fast Hop: <1 μsec .

External FM input impedance: 50 Ω or 600 Ω .

Phase Modulation

Maximum phase deviation: 400 radians, 1030 to 2060 MHz, decreases by half for each frequency band below this band.

Phase modulation indicator accuracy: $\pm 10\%$.

Phase modulation distortion: <1%.

Phase modulation 3 dB bandwidth⁴: >150 Hz.

External input impedance: 600 Ω .

Pulse Modulation

On/off ratio: >35 dB.

Rise/fall time: <100 nsec, 10% to 90% response points.

Maximum pulse repetition frequency: 1 MHz.

Minimum pulse width: 0.5 μsec .

Video feedthrough and overshoot: <10%, 10 to 2060 MHz.

Output level accuracy: ± 2 dB.

External input levels: On: >3.0V peak. Off: <0.8V peak.

Damage Level: $\geq \pm 10$ V peak.

External input impedance: 600 Ω .

Internal Modulation Source

Waveforms: Sine, square, sawtooth and white Gaussian noise.

Frequency range:

Sine, white Gaussian noise: 0.1 Hz to 400 kHz.

Square, sawtooth: 0.1 Hz to 50 kHz.

Frequency switching time: Typically <30 msec.

Frequency resolution: 0.1 Hz.

Frequency accuracy: Same as internal reference oscillator.

Maximum output level: Nominal 1V peak into 600 Ω .

Typical accuracy: ± 20 mV, output ≤ 100 kHz.

Output level resolution: 2 mV. Typical output impedance: 600 Ω .

Distortion: <0.1%, output at 1V peak and ≤ 15 kHz.

Frequency Sweep

Phase continuous sweep:

Sweep type: Linear, phase continuous.

Sweep time: 10 msec to 10 sec, not dependent on sweep span selected.

Maximum sweep span:

Frequency Range (MHz)	Maximum span (MHz)
1030 to 2060	40
515 to 1030	20
257 to 515	10
128 to 257	5
64 to 128	2.5
32 to 64	1.25
16 to 32	0.625
8 to 16	0.312
4 to 8	0.156
2 to 4	0.078
1 to 2	0.039
0.5 to 1	0.019
0.25 to 0.5	0.009

Fast Hop sweep:

Sweep Type: Linear or log, frequency stepped.

Sweep Time Range: 10 msec to 100 sec, number of frequency steps varies with sweep time selected. Typical time per step is 30 μsec for outputs within 128 to 2060 MHz, 170 μsec for 8 to 2060 MHz, and 650 μsec for 0.25 to 2060 MHz.

⁷ Deviation is limited to the maximum available at the lowest carrier frequency output in the Fast Hop sequence

⁸ Limited by the maximum FM rate available in each carrier band

⁹ FM distortion in Mode 1 is <3% for deviations <50% of maximum available

Table 1-1. Specifications (4 of 5)

Digitally stepped sweep:

Sweep type: Linear or log, frequency stepped.
Sweep Time Range: 500 msec to 1000 sec, number of frequency steps varies with sweep time selected. Typical time per step is 90 msec.

X-axis output: Nominal 0 to +10 V.

Z-axis output: Nominal +5V during retrace.

Markers available: 3.

Remote Programming

Interface: HP-IB (Hewlett-Packard's implementation of IEEE-488.2).

HP-IB select code range: 00 to 30. Interface function is listener and talker.

Control language: Hewlett-Packard Systems Language (HP-SL).

Functions controlled: All front panel functions except power switch and knob.

IEEE-488 functions: SH1, AH1, T6, TE0, L4, LE0, SR1, RL1, PP0, DC1, DT0, C0, E2.

Fast Hop bus interface: DB-25 connector accepting TTL levels.

General

Power requirements: ±10% of 100V, 120V, 220V, or 240V; 48 to 440 Hz; 500 VA maximum.

Operating temperature range: 0 to +55°C.

Storage temperature range: -55 to +75°C.

Leakage: Leakage measured into a resonant dipole 1 inch from the instrument's surface with output level <0 dBm. (All inputs/outputs must be properly terminated. $f_c < 16$ Hz)

	Into a resonant dipole	Typical two-turn loop equivalent
Standard unit (at front panel)	16 μ V (typical)	1 μ V

Acoustic noise: Typically <5.5 bels.

Internal calibration: The operator can initiate an internal calibration and diagnostic function that will ensure all specifications are being met with a confidence level exceeding the accepted standard of 95%.

Internal diagnostics: The instrument monitors its operation and will alert the user to most internal malfunctions. Built-in test capability locates circuit malfunctions to allow repair through module or cable replacement.

Calibration interval: 3 years (MTBC).

Retrofit kit, HP 11845A: Installation of a single module and several cables extends the frequency range of the standard instrument to 2060 MHz.

Storage registers: 10 full function and 40 frequency/amplitude registers.

Memory erasure: All memory contents except generic calibration data can be erased according to Mil Std 380-380.

Weight: Approximately 29 to 31 kg (63 to 69 lbs) net and 40 to 42 kg (88 to 94 lbs) shipping depending on the options ordered.

Dimensions: Approximately 177H × 426W × 624D mm (7 × 16.8 × 24.6 in.).

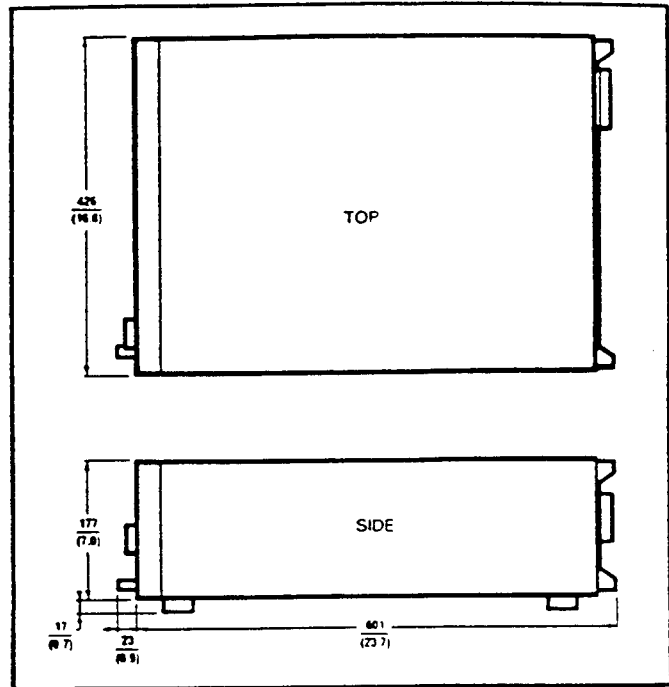

Table 1-1. Specifications (5 of 5)

<i>Serial Prefix 3203A and Above</i>		
Internal reference oscillator	<u>Standard high stability</u>	<u>Option 001 high stability with EFC</u>
Aging:	$\pm 1.5 \times 10^{-8}$ /day after ten days	$\pm 3 \times 10^{-10}$ /day after ten days
Temperature:	$\pm 7 \times 10^{-10}$, 0 to 55°C	$\pm 6 \times 10^{-10}$, 0 to 55°C
Line voltage:	$\pm 2 \times 10^{-10}$, (+5%, -10%)	$\pm 1 \times 10^{-10}$, $\pm 10\%$
Output:	10 MHz, >0.15 V _{rms} level into 50Ω	10 MHz, >1 V _{rms} level into 50Ω
External reference input:	Accepts 10 MHz \pm ppm and a level range of 0.5V to 2 V _{rms} into 50Ω.	
Electronic frequency control (EFC):	Option 001 only, ± 0.01 ppm for \pm dc at rear panel connector, voltage range ± 10 dc, input impedance 10kΩ.	

Table 1-2. Recommended Test Equipment (1 of 2)

Instrument Type	Critical Specifications	Recommended Model
Audio Source	Level: 1 Vpk into 50 ohms Frequency: 1 kHz to 3.75 MHz	HP 3325A
Distortion Analyzer	Distortion Range: < 0.1% Range: 20 Hz to 100 kHz	HP 339A, HP 8903B, or HP 8903E
Frequency and Time Interval Analyzer	The Performance Tests for Fast Hop Switching are complex and the procedure has been written specifically using the HP 5371A, no substitutions are recommended.	HP 5371A (with two HP 54002A pods)
Measuring Receiver and Sensor Module	<p>Frequency Range: 250 kHz to 1300 MHz Input Level: -127 to +17 dBm RF Power: 0.2 dB Tuned RF Level: 0.36 dB RSS Referenced to -10 dBm input</p> <p>Amplitude Modulation: Rates: 20 Hz to 100 kHz Depth: to 90% Accuracy: $\pm 2\%$ at 1 kHz Demodulated Output Distortion: 0.5% for 50% depth; < 1.0% for 90% depth Incidental ΦM: < 0.05 radians for 30% depth at 1 kHz rate (50 Hz to 3 kHz bandwidth) Residual AM: < 0.01% rms (0.3 to 3 kHz BW)</p> <p>Frequency Modulation: Rates: 20 Hz to 200 kHz Deviation: to 400 kHz Accuracy: $\pm 3\%$ at 1 kHz Demodulated Output Distortion: < 0.3% Incidental AM: 0.2% depth at 20 kHz FM deviation Residual FM: See specifications for External Local Oscillator for Measuring Receiver</p>	HP 8902A and HP 11722A
Oscilloscope	Vertical Sensitivity: 0.01 mV/div Bandwidth: 100 MHz Time/Div: 0.05 μs Input: Dual Channel	HP 1740A, or Tektronix 2245
Phase Noise Measurement System	The Performance Tests for SSB Phase Noise are complex and the procedure has been written specifically using the HP 3048A, no substitutions are recommended.	HP 3048A Opt. 101

Table 1-2. Recommended Test Equipment (2 of 2)

Instrument Type	Critical Specifications	Recommended Model
Pulse Generator (2 required)	Rates: to 1 MHz Pulse Width: 500 ns minimum Output Level: 4 Vpk into 50 ohms (One Pulse Generator must be a slave to the other at half the frequency as used in Performance Test 8.)	HP 8116A
Reference Signal Generator	Residual FM: Less than or equal to the specification for the HP 8645A. SSB Phase Noise: Less than or equal to the specification for the HP 8642B	HP 8645A HP 8642B
Spectrum Analyzer, RF	Frequency Range: 0.1 to 7 GHz Resolution Bandwidth: <1 kHz to 3 kHz	HP 8559A/853A or HP 8562B

DECLARATION OF CONFORMITY

according to ISO/IEC Guide 22 and EN 45014

Manufacturer's Name: Hewlett-Packard Co.

Manufacturer's Address: Spokane Division
24001 E. Mission Avenue
Liberty Lake, Washington 99019-9599
USA

declares that the product

Product Name: Name: Agile Signal Generator

Model Number: HP 8645A

Product Options: This declaration covers all options of the above product.

conforms to the following Product specifications:

Safety: HD 401/IEC 348

EMC: CISPR 11:1990/EN 55011:1991 Group 1, Class A
IEC 801-2:1984/EN 50082-1:1992 4 kV CD, 8 kV AD
IEC 801-3:1984/EN 50082-1:1992 3 V/m
IEC 801-4:1988/EN 50082-1:1992 0.5 kV Sig. Lines, 1 kV Power Lines

Supplementary Information:

The product herewith complies with the requirements of the Low Voltage Directive 73/23/EEC and the EMC Directive 89/336/EEC.

Safety qualification of this product was performed 9-1-89 (Report no. SA -PSG-89).

Spokane, Washington, USA November 6, 1995
Date

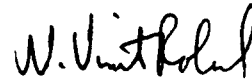

Vince Roland/Quality Manager

European Contact: Your local Hewlett-Packard Sales and Service Office or Hewlett-Packard GmbH, Department ZQ/Standards Europe, Herrenberger Strasse 130, D-71034 Böblingen, Germany (FAX +49-7031-14-3143)

Section 2 INSTALLATION

2-1. INTRODUCTION

This section provides the information needed to install the Signal Generator. Included is information pertinent to initial inspection, power requirements, line voltage, fuse selection, power cables, time base selection, HP-IB address selection, interconnection, mating connectors, operating environment, instrument mounting, storage, and shipment.

2-2. INITIAL INSPECTION

WARNING

To avoid hazardous electrical shock, do not perform electrical tests when there are any signs of shipping damage to any portion of the outer enclosure (covers and panels).

Inspect the shipping container for damage. If the shipping container or cushioning material is damaged, it should be kept until the contents of the shipment have been checked for completeness and the instrument has been checked mechanically and electrically. Procedures for checking electrical performance are given in section 3, *Performance Tests*. If the contents are incomplete, if there is mechanical damage or defect, or if the instrument does not pass the electrical performance tests, notify the nearest Hewlett-Packard office. If the shipping container is damaged, or the cushioning material shows signs of stress, notify the carrier as well as the Hewlett-Packard office. Keep the shipping materials for the carrier's inspection.

2-3. PREPARATION FOR USE

Power Requirements

The Signal Generator requires a power source of ($\pm 10\%$) 100, 120, 220, or 240 V ac from 48 to 440 Hz. Power consumption is 500 VA maximum.

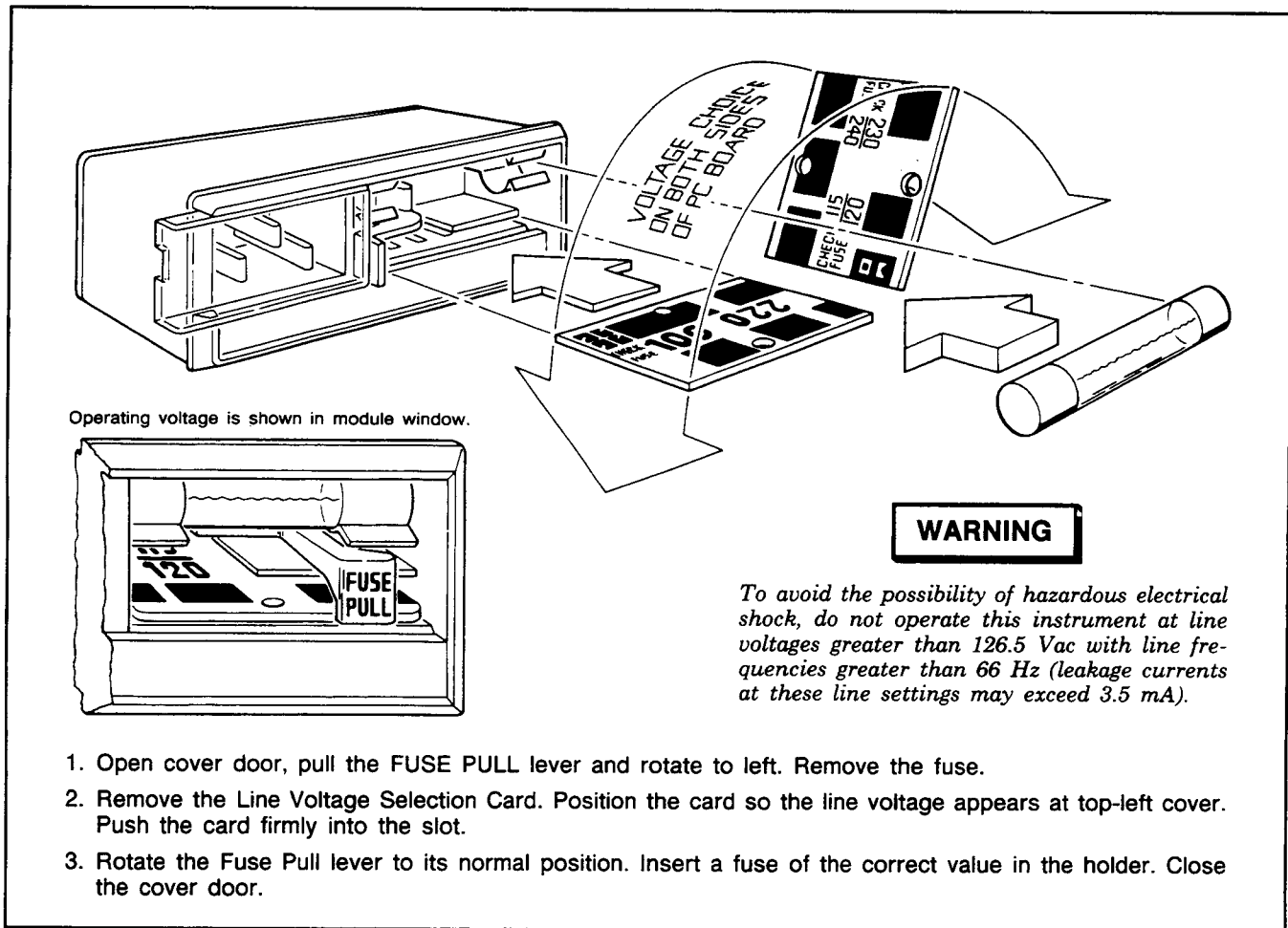

Figure 2-1. Line Voltage and Fuse Selection

WARNING

This is a Safety Class I product (i.e., provided with a protective earth terminal). An uninterruptible safety earth ground must be provided from the Mains power source to the product input wiring terminals, power cord, or supplied power cord set. Whenever it is likely that the protection has been impaired, the instrument must be made inoperative and be secured against any unintended operation.

If this instrument is to be energized via an external autotransformer for voltage reduction, make sure that the common terminal is connected to the earthed pole of the power source.

Line Voltage and Fuse Selection

CAUTION

BEFORE PLUGGING THIS INSTRUMENT into the Mains (line) voltage, be sure the correct voltage and fuse has been selected.

Verify that the Line Voltage Selection Card and fuse are matched to the power source. See figure 2-1, *Line Voltage and Fuse Selection*.

Fuses may be ordered under the HP part numbers listed in table 2-1, *Line Fuse Rating and HP Part Number*.

WARNING

For protection against fire hazard, the line fuse should only be a 250 V fuse with the correct current rating.

Table 2-1. Line Fuse Rating and HP Part Number

Line Voltage	Rating	Part Number
100, 120 V ac	5A, 250 V	2110-0010
220, 240 V ac	2.5A, 250 V	2110-0083









Power Cables

WARNING

BEFORE CONNECTING THIS INSTRUMENT, the protective earth terminal of the instrument must be connected to the protective conductor of the (Mains) power cord. The Mains plug shall only be inserted in a socket outlet provided with a protective earth contact. The protective action must not be negated by the use of an extension cord (power cable) without a protective conductor (grounding). Grounding one conductor of a two-conductor outlet is not sufficient protection.

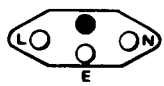
This instrument is equipped with a three-wire power cable. When connected to an appropriate ac power receptacle, this cable grounds the instrument cabinet. The type of Mains plug shipped with each instrument depends on the country of destination. Refer to table 2-2, *Power Cable and Mains Plug Part Numbers* for the part numbers of the power cables and Mains plugs available.

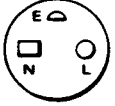
Table 2-2. Power Cable and Mains Plug Part Numbers

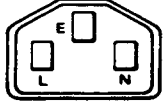
Plug Type	Cable HP Part Number	C D	Plug Description	Cable Length (inches)	Cable Color	For Use In Country
250V 	8120-1351 8120-1703	0 4	90°/STR BS1363A* 90°/90°	90 90	Mint Gray Mint Gray	United Kingdom, Cyprus, Nigeria, Rhodesia, Singapore
250V 	8120-1369 8120-0696	0 4	STR/STR NZSS198/ASC112* STR/90°	79 80	Gray Gray	Australia, New Zealand
250V 	8120-1689 8120-1692	7 2	STR/STR* STR/90°	79 79	Mint Gray Mint Gray	East and West Europe, Saudi Arabia, Egypt, (unpolarized in many nations)
125V 	8120-1378 8120-1521 8120-1751	1 6 1	STR/STR NEMA5-15P* STR/90° STR/STR	80 80 90	Jade Gray Jade Gray Jade Gray	United States, Canada, Mexico, Phillipines, Taiwan U.S./Canada
100V (Same plug as above)	8120-4753 8120-4754	2 3	STR/STR STR/90°	90 90	Dark Gray Dark Gray	Japan only Japan only
250V 	8120-2104 8120-2296 8120-3997	3 4 4	STR/STR SEV1011 1959-24507 Type 12 STR/90° STR/90°	79 79 177	Gray Gray Gray	Switzerland
250V 	8120-0698	6	STR/STR NEMA6-15P	90	Black	United States, Canada
250V 	8120-2956 8120-2957 8120-3997	3 4 4	90°/STR 90°/90° STR/STR	79	Gray	Denmark
250V 	8120-4211 8120-4600	7 8	STR/STR*IEC83-B1 STR/90°	79 79	Black Gray	South Africa, India
250V 	8120-1860 8120-1575 8120-2191 8120-4379	6 0 8 8	STR/STR*CEE22-V1 (Systems Cabinet Use) STR/STR STR/90° 90°/90°	59 31 59 80	Jade Gray Jade Gray Jade Gray Jade Gray	

* Part number shown for plug is industry identifier for plug only. Number shown for cable is HP Part Number for complete cable including plug. E = Earth Ground; L = Line; N = Neutral; STR = Straight

2-4. TIME BASE SELECTION

If your instrument has option 001 installed, the High Stability Time Base is automatically selected when the supplied coax cable is connected between the REF IN and OVEN REF OUT connectors on the rear panel.

To select the standard, internal reference oscillator remove the coax cable from between the REF IN and OVEN REF OUT connectors on the rear panel.

To confirm the time base selection, key in SPECIAL 161 ENTER. The FREQUENCY/STATUS display will show "161: Ref Source Int" if the standard internal reference oscillator is sensed, or "161: Ref Source Ext" if the High Stability Time Base oscillator is sensed.

The Signal Generator indicates any reference source connected (sensed) through the external rear panel BNC connectors as "Ext".

2-5. HP-IB ADDRESS SELECTION

The instrument's HP-IB address is preset to 19 (decimal) when shipped from the factory.

The HP-IB address is front-panel programmable. To change your instrument's HP-IB address, press the blue SHIFT key, and then the ADRS key to show the current address in the FREQUENCY/STATUS display. Key in the desired decimal number between 00 and 30, then press the ENTER key.

2-6. INTERCONNECTIONS

Interconnection data for the Hewlett-Packard Interface Bus is provided in figure 2-2, *Hewlett-Packard Interface Bus Connections*.

Mating Connectors

Coaxial Connectors. Coaxial mating connectors used with the Signal Generator should be either 50Ω BNC male connectors or 50Ω Type N male connectors that are compatible with those specified in US MIL-C-39012.

Interface Connector. The HP-IB mating connector is shown in figure 2-2, *Hewlett-Packard Interface Bus Connections*. Note that the two securing screws are metric.

2-7. OPERATING ENVIRONMENT

The operating environment should be within the following limitations:

- Temperature 0° C to + 55° C
- Humidity < 95% relative at 40° C
- Altitude < 4570 meters (15,000 feet)

2-8. BENCH OPERATION

The instrument cabinet has plastic feet that are shaped to ensure self-alignment of instruments when they are stacked.

2-9. RACK MOUNTING

NOTE

The Signal Generator weighs approximately 29 to 31 kg (63 to 69 lbs) net, and 40 to 42 kg (88 to 94 lbs) shipping depending upon the options ordered. Care must be exercised when lifting to avoid personal injury. Use equipment slides when rack mounting.

Specific rack mounting information is provided with the rack mounting kits. If a kit was not ordered with the Signal Generator as an option, it may be ordered through the nearest Hewlett-Packard office. Paragraph 1-8, under *Mechanical Options* in section 1 includes information and part numbers for other types of rack mount kits.

Slide rack mount kits allow the convenience of rack mounting with the flexibility of easy access. Slide kits for the Signal Generator are listed below.

Standard Slide Kit for HP rack enclosures	HP 1494-0059
Special Tilt Slide Kit for HP rack enclosures.....	HP 1494-0063
Slide Adapter Bracket Kit for Standard Slides (for non HP rack enclosures)	HP 1494-0023

2-10. STORAGE AND SHIPMENT

Environment

The instrument should be stored in a clean, dry environment. The following environmental limitations apply to both storage and shipment.

Temperature	-55° C to + 75° C
Humidity	< 95% relative
Altitude	15 300 meters (50,000 feet)

Packaging

Original Packaging. Containers and materials identical to those used in factory packaging are available through Hewlett-Packard offices. If the instrument is being returned to Hewlett-Packard for servicing, attach a tag indicating the type of service required, return address, model number, and full serial number. Also, mark the container **FRAGILE** to assure careful handling. In any correspondence, refer to the instrument by model number and full serial number.

Other Packaging. The following general instructions should be used for repackaging with commercially available materials.

- a. Wrap the instrument in heavy paper or plastic. (If shipping to a Hewlett-Packard office or service center, attach a tag indicating the type of service required, return address, model number, and full serial number.)
- b. Use a strong shipping container. A double-wall carton made of 2.4 MPa (350 psi) test material is adequate.
- c. Use enough shock-absorbing material (75 to 100 millimeter layer; 3 to 4 inches) around all sides of the instrument to provide a firm cushion and to prevent movement in the container. Protect the front-panel with cardboard.
- d. Seal the shipping container securely.
- e. Mark the shipping container **FRAGILE** to assure careful handling.

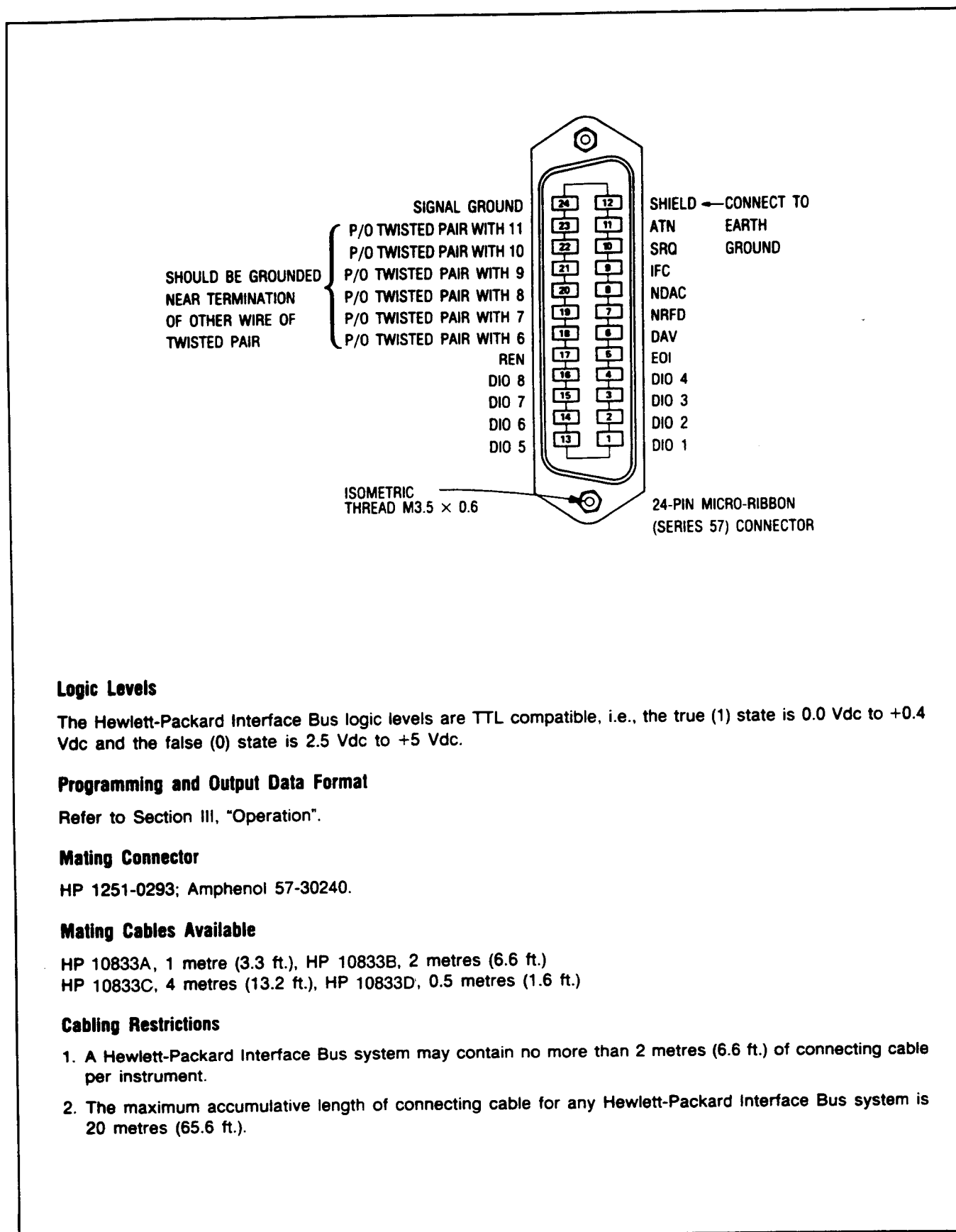

Logic Levels

The Hewlett-Packard Interface Bus logic levels are TTL compatible, i.e., the true (1) state is 0.0 Vdc to +0.4 Vdc and the false (0) state is 2.5 Vdc to +5 Vdc.

Programming and Output Data Format

Refer to Section III, "Operation".

Mating Connector

HP 1251-0293; Amphenol 57-30240.

Mating Cables Available

HP 10833A, 1 metre (3.3 ft.), HP 10833B, 2 metres (6.6 ft.)
HP 10833C, 4 metres (13.2 ft.), HP 10833D, 0.5 metres (1.6 ft.)

Cabling Restrictions

1. A Hewlett-Packard Interface Bus system may contain no more than 2 metres (6.6 ft.) of connecting cable per instrument.
2. The maximum accumulative length of connecting cable for any Hewlett-Packard Interface Bus system is 20 metres (65.6 ft.).

Figure 2-2. Hewlett-Packard Interface Bus Connections **HP-IB**

Section 3

PERFORMANCE TESTS

3-1. INTRODUCTION

The procedures in this section test the instrument's electrical performance using the specifications of table 1-1 as performance standards. All tests are performed without accessing the interior of the instrument.

NOTE

Before beginning the performance tests, the Signal Generator should be allowed a 24 hour warm-up period after being connected to the ac power line, a 10 minute warm-up period after turn-on, and a 2 hour warm up for Fast Hop. Line voltage must be within $\pm 10\%$ of nominal if the results of the performance tests are to be considered valid.

The specifications assume the Signal Generator is operating in the Auto mode (except for Fast Hop operation) which automatically optimizes the internal hardware configuration for best performance.

3-2. EQUIPMENT REQUIRED

Equipment required for the performance tests is listed in table 1-2, *Recommended Test Equipment*. Any equipment that satisfies the critical specifications provided in the table may be substituted for the recommended model(s).

3-3. PERFORMANCE TEST RECORD

Results of the performance tests may be tabulated on the *Performance Test Record* at the end of the procedures. The *Performance Test Record* lists all of the tested specifications and their acceptable limits. The results, recorded at incoming inspection, can be used for comparison in periodic maintenance and troubleshooting and after repairs or adjustments.

3-4. CALIBRATION CYCLE

This instrument requires periodic verification of performance. Depending on the use and environmental conditions, the instrument should be checked using the following performance tests at least every three years.

3-5. INTERNAL VOLTMETER VERIFICATION

Internal to the Signal Generator is a precision dc voltmeter. This voltmeter is used to collect calibration correction data when the Recal function is invoked. During normal instrument operation, Recal is automatically run whenever a significant temperature change is noted by the instrument. Recal should also be run prior to running the Performance Tests. The accuracy of the voltmeter is not explicitly specified but must be within $\pm 1\%$ of reading $\pm 0.25V$ for the Recal operation to give valid results.

3-6. BASIC FUNCTIONAL CHECKS

The basic functions of the HP 8645A can be verified by performing the instrument operating examples in the HP 8645A *Operation Guide* and comparing the output signals with the waveforms shown in the guide. Table 3-1 lists the functions that can be verified using the *Operation Guide*.

If you suspect an instrument failure when performing the Basic Functional Checks, test the Signal Generator by activating Special Function 170. Special Function 170 verifies most of the Signal Generator's circuitry. At the conclusion of the test, a result code equal to "0" indicates that the instrument is operating normally. Refer to the *Service Diagnostics Manual* whenever a result code other than "0" appears.

Table 3-1. Basic Functional Checks

Refer to <i>Operation Guide</i>	Functions and Operations Verified
Chapter 1 <i>Learning to Operate the HP 8645A</i>	Power Up and Self Check Frequency Hop
Chapter 2 <i>What About Modulating?</i>	Special Functions, Save and Recall Digitized FM Synthesis Linear FM Synthesis Output Amplitude, Synthesis Mode Modulation Frequency, Amplitude Pulse, Simultaneous
Chapter 3 <i>What About Frequency Hopping?</i>	Channel Table, Sequence Table, Hop Rate, Dwell Time, Frequency Hop Modes, Timing Control, Synchronization, Internal and External Triggering, Amplitude Control
Chapter 4 <i>What About Sweeping?</i>	Start, Stop, Center, and Span Frequencies Sweep Markers Frequency Range Digitally-Stepped Sweep Fast Hop Sweep Phase-Continuous Sweep Sweep Spacing Sweep Triggering
Chapter 5 <i>What About Programming?</i>	HP-SL Programming Frequencies HP-IB Address
Appendix G <i>Miscellaneous Operating Features</i>	Amplitude Offset, Auto Sequence, Clear All, Display, EMF, Frequency Offset, Knob Hold/Increment, Phase Increment/Decrement, Sequence, Set Sequence
Appendix H <i>Synthesized Audio Oscillator</i>	Audio Level Audio Frequency

Preliminary Test

INTERNAL VOLTMETER VERIFICATION

Specification

The accuracy of the internal voltmeter is not explicitly specified but it should be $\pm 1\%$ of reading $\pm 0.25V$ for the Recal routine to be valid.

Description

A dc voltage is applied to the voltmeter input of the Signal Generator. The voltage is measured by both the Signal Generator's internal voltmeter and an external voltmeter and the two readings are compared.

NOTE

This test should be run before beginning the Performance Tests.

Equipment

Digital Voltmeter HP 3478A
 Power Supply HP 6218C or HP 6236B

Procedure

1. Remove any connection to the Signal Generator's rear-panel VM IN connector.
2. On the Signal Generator, press INSTR PRESET then key in SPECIAL 180 ENTER to set the internal voltmeter to read the voltage at the Signal Generator's rear-panel VM IN connector. The reading should be between -0.25 and $+0.25$ Vdc.

Voltmeter Offset: -0.25 _____ $+0.25$ Vdc

3. Connect the dc power supply and digital voltmeter to the Signal Generator's rear-panel VM IN connector using a BNC tee. (If a dual power supply is used, stack the + and - outputs to obtain the 40V if needed.)
4. Set the power supply to $+40V$ and set the voltmeter to read $+40$ Vdc. The Signal Generator should display approximately $+40$, but more importantly it should agree with the reading of the external voltmeter within ± 0.65 Vdc (that is, $\pm 1\%$ of $40V \pm 0.25V$).

Voltmeter Accuracy at $+40V$: -0.65 _____ $+0.65$ Vdc

5. Reverse the power supply leads to produce $-40V$ at the Signal Generator's VM IN connector. The Signal Generator should display approximately -40 and should agree with the reading of the external voltmeter within ± 0.65 Vdc (that is, $\pm 1\%$ of $40V \pm 0.25V$).

Voltmeter Accuracy at $-40V$: -0.65 _____ $+0.65$ Vdc

Performance Test 1

CARRIER AMPLITUDE TEST

Specification

Characteristic	Performance Limits	Conditions
Output		
Maximum Level	+16 dBm +14 dBm +13 dBm	0.25 to 1030 MHz; standard 0.25 to 1030 MHz; Option 002 1030 to 2060 MHz; Option 002
Absolute Accuracy	±1 dB	output > -127 dBm

Description

The carrier amplitude specifications are verified with an HP 8902A Measuring Receiver. The higher amplitudes are measured directly with the measuring receiver's built-in power meter. Lower amplitudes are measured using the very sensitive tuned RF level feature of the measuring receiver. Carrier amplitude is set in the instrument both by switching attenuator pads and also by voltage-variable gain control. Both types of amplitude control are checked.

Equipment

Measuring Receiver HP 8902A
 Sensor Module HP 11722A

Procedure

Initial Setup

1. On the Signal Generator, press INSTR PRESET.
2. Preset the measuring receiver, then select the RF power measurement with units of dBm.

NOTE

Verify that the measuring receiver's calibration factors match the sensor module. Zero the power sensor and calibrate the power measurement using the measuring receiver's built-in power reference.

3. Connect the input of the measuring receiver's sensor module directly to the Signal Generator's OUTPUTS RF connector.

Maximum Level

4. Set the Signal Generator's carrier frequency and amplitude as indicated in the following table. Also, key the frequency into the measuring receiver to invoke the appropriate calibration factor. The carrier amplitude should be within the limits given in the table.

Signal Generator Carrier		Amplitude Limits (dBm)	
Frequency (MHz)	Amplitude (dBm)	Minimum	Actual
Standard			
0.26	+17	+16	_____
1	+17	+16	_____
10	+17	+16	_____
100	+17	+16	_____
1030	+17	+16	_____
Option 002			
0.26	+15	+14	_____
1	+15	+14	_____
10	+15	+14	_____
100	+15	+14	_____
1030	+15	+14	_____
2060	+14	+13	_____

High-Amplitude Accuracy

- Set the Signal Generator's carrier frequency and amplitude as indicated in the following table. Also, key the frequency into the measuring receiver to invoke the appropriate calibration factor. The output power should be within the limits given in the table.

Signal Generator Carrier		Amplitude Limits (dBm)		
Frequency (MHz)	Amplitude (dBm)	Minimum	Actual	Maximum
1030	+6	+5	_____	+7
1030	+7	+6	_____	+8
1030	+8	+7	_____	+9
1030	+9	+8	_____	+10
1030	+10	+9	_____	+11
1030	+11	+10	_____	+12
1030	+12	+11	_____	+13
1030	+13	+12	_____	+14
1030	+14	+13	_____	+15
2060 ⁽¹⁾	+13	+12	_____	+14
100	+14	+13	_____	+15
10	+14	+13	_____	+15
1	+14	+13	_____	+15
0.26	+14	+13	_____	+15

⁽¹⁾ Option 002 only.

Table continued on next page

Table continued from previous page

Signal Generator Carrier		Amplitude Limits (dBm)		
Frequency (MHz)	Amplitude (dBm)	Minimum	Actual	Maximum
0.26	+10	+9	_____	+11
1	+10	+9	_____	+11
10	+10	+9	_____	+11
100	+10	+9	_____	+11
2060 ⁽²⁾	+10	+9	_____	+11
2060 ⁽²⁾	+5	+4	_____	+6
1030	+5	+4	_____	+6
100	+5	+4	_____	+6
10	+5	+4	_____	+6
1	+5	+4	_____	+6
0.26	+5	+4	_____	+6
0.26	+0	-1	_____	+1
1	+0	-1	_____	+1
10	+0	-1	_____	+1
100	+0	-1	_____	+1
1030	+0	-1	_____	+1
2060 ⁽²⁾	+0	-1	_____	+1

⁽²⁾ Option 002 only.

Low-Amplitude Accuracy

6. On the Signal Generator key in FREQ 1030 MHz and AMPTD 0 dBm.
7. Set the measuring receiver to the tuned RF level measurement mode and key in automatic operation to tune the measuring receiver to the Signal Generator's output.
8. Set the Signal Generator's carrier amplitude as indicated in the following table and note the measured amplitude. The carrier amplitude should be within the limits given in the table.

NOTE

When the recalibration annunciator appears on the measuring receiver's display, press the CALIBRATE key, wait for completion of the calibration, then proceed.

Other frequencies can be tested if they are in the range of the measuring receiver. For high frequencies, a down-converter may be required.

Signal Generator Carrier Amplitude (dBm)	Amplitude Limits (dBm)		
	Minimum	Actual	Maximum
-5	-6	_____	-4
-10	-11	_____	-9
-15	-16	_____	-14
-20	-21	_____	-19
-25	-26	_____	-24
-30	-31	_____	-29
-35	-36	_____	-34
-40	-41	_____	-39
-45	-46	_____	-44
-50	-51	_____	-49
-55	-56	_____	-54
-60	-61	_____	-59
-65	-66	_____	-64
-70	-71	_____	-69
-75	-76	_____	-74
-80	-81	_____	-79
-85	-86	_____	-84
-90	-91	_____	-89
-95	-96	_____	-94
-100	-101	_____	-99
-105	-106	_____	-104
-110	-111	_____	-109
-115	-116	_____	-114
-120	-121	_____	-119
-127	-128	_____	-126

Performance Test 2

AM TEST

Specification

Characteristic	Performance Limits	Conditions
Spectral Purity Residual AM	<0.01% rms	0.3 to 3 kHz post-detection bandwidth
Amplitude Modulation Indicator Accuracy Distortion 3 dB Bandwidth Incidental Phase Modulation	±(6% of setting + 1%) <2% <5% <3% <5% <5% <8%	to 90% depth; 1 kHz rate 400 and 1000 Hz rates 0 to 30% depth; 0.25 to 1030 MHz 0 to 30% depth; 1030 to 2060 MHz; Option 002 30 to 70% depth; 0.25 to 1030 MHz 30 to 70% depth; 1030 to 2060 MHz; Option 002 70 to 90% depth; 0.25 to 1030 MHz 70 to 90% depth; 1030 to 2060 MHz; Option 002 0.25 to 8 MHz 8 to 128 MHz 128 to 1030 MHz 1030 to 2060 MHz; Option 002 at 30% depth; 1 kHz rate

Description

The AM specifications are verified directly with an HP 8902A Measuring Receiver.

Equipment

Measuring Receiver..... HP 8902A

Procedure

Initial Setup

1. On the Signal Generator, press INSTR PRESET.

2. Preset the measuring receiver, then set it as follows.
 - a. Select the AM measurement.

NOTE

Verify that the measuring receiver's AM is calibrated using its built-in AM calibrator.

- b. Set the high-pass filter to 300 Hz.
 - c. Set the low-pass filter to 3 kHz.
 - d. Set the detector to RMS.
3. Connect the Signal Generator's OUTPUTS RF directly to the RF input of the measuring receiver or, if a sensor module is being used, connect it to the input of the sensor module.

Residual AM

4. Set the Signal Generator's carrier frequency and amplitude as indicated in the following table. Allow the measuring receiver to retune. The residual AM should be within the limits given in the table.

Signal Generator Carrier Settings		Residual AM Limits (%)	
Frequency (MHz)	Amplitude (dBm)	Actual	Maximum
1000	+15	_____	0.01
1000	+6	_____	0.01
1300 ⁽¹⁾	+6	_____	0.01
1300 ⁽¹⁾	+13	_____	0.01

⁽¹⁾ Option 002 only.

Indicator Accuracy

5. Set the measuring receiver as follows.
 - a. Set the detector to peak \pm /2 (that is, to average peak+ and peak-). (To do this press the PEAK + and PEAK - keys simultaneously.)
 - b. Set the high-pass filter off.
 - c. Set the low-pass filter off.
6. Set the Signal Generator as follows.
 - a. Key in FREQ 1 GHz.
 - b. Key in AMPTD 0 dBm.
 - c. Key in AM ON. (Note that the modulation source is set to internal with a modulation rate of 1 kHz.)
7. Set the Signal Generator's AM depth as indicated in the following table. The AM depth, as read on the measuring receiver, should be within the limits shown in the table.

Signal Generator AM Depth (%)	AM Depth Limits (%)		
	Minimum	Actual	Maximum
10	8.4	_____	11.6
20	17.8	_____	22.2
30	27.2	_____	32.8
40	36.6	_____	43.4
50	46.0	_____	54.0
60	55.4	_____	64.6
70	64.8	_____	75.2
80	74.2	_____	85.8
90	83.6	_____	96.4

Distortion

- Set the measuring receiver to measure the audio distortion on the demodulated 1 kHz AM.
- Set the Signal Generator's AM depth as indicated in the following table. The AM distortion, as read on the measuring receiver, should be within the limits shown in the table.

Signal Generator AM Depth (%)	AM Distortion Limits (%)	
	Actual	Maximum
30	_____	2
70	_____	3
90	_____	5

- If the Signal Generator has Option 002, set its carrier frequency to 1.3 GHz. Repeat step 9 using the following table.

Signal Generator AM Depth (%)	AM Distortion Limits (%)	
	Actual	Maximum
90	_____	8
70	_____	5
30	_____	5

Incidental Phase Modulation

- On the Signal Generator key in FREQ 1 GHz and AM 30 %.
- Set the measuring receiver to read phase modulation (ϕ M) and set its detector to peak+. The phase deviation of the phase modulation should read 0.2 rad peak or less.

Incidental ϕ M Limit: _____ 0.2 rad peak

3 dB Bandwidth

13. Set the measuring receiver to measure AM depth.
14. On the Signal Generator key in AM 90 %.
15. Set the Signal Generator's carrier frequency and its audio frequency as indicated in the following table. For each setting perform the following steps.
 - a. After setting the Signal Generator's carrier frequency, allow the measuring receiver to retune.
 - b. On the Signal Generator key in AUDIO FREQ 1 kHz.
 - c. Set the measuring receiver ratio display off (if it is on). Then set the ratio back on to establish a new ratio reference. (Also, set the ratio to read in dB, that is, log.)
 - d. Set the Signal Generator's audio frequency as shown in the table.
 - e. Note the dB change in AM depth on the measuring receiver. The depth should be between -3 and +3 dB (relative).

Signal Generator Settings		Relative AM Depth Limits (dB)		
Carrier Frequency (MHz)	Audio Frequency (kHz)	Minimum	Actual	Maximum
0.26	5	-3	_____	+3
11	50	-3	_____	+3
129	100	-3	_____	+3
1030	100	-3	_____	+3
1300 ⁽¹⁾	100	-3	_____	+3

⁽¹⁾ Option 002 only.

Performance Test 3

FM TEST (LOW DEVIATIONS AND RATES)

Specification

Characteristic	Performance Limits	Conditions
Spectral Purity Residual FM	<1 Hz rms <1.2 Hz rms <2 Hz rms <4 Hz rms <1.2 Hz rms <2 Hz rms <4 Hz rms <8 Hz rms	0.3 to 3 kHz post-detection bandwidth 0.25 to 257 MHz carrier 257 to 515 MHz carrier 515 to 1030 MHz carrier 1030 to 2060 MHz carrier; Option 002 0.05 to 15 kHz post-detection bandwidth 0.25 to 257 MHz carrier 257 to 515 MHz carrier 515 to 1030 MHz carrier 1030 to 2060 MHz carrier; Option 002
Frequency Modulation Maximum Peak Deviation	20 MHz 10 MHz 5 MHz 2.5 MHz 1.25 MHz 625 kHz 313 kHz 156 kHz 78 kHz 39 kHz 19.5 kHz 9.7 kHz 4.8 kHz 3.52 MHz 1.76 MHz 880 kHz 440 kHz 220 kHz 110 kHz 55 kHz	Auto Mode 1030 to 2060 MHz carrier; Option 002 515 to 1030 MHz carrier 257 to 515 MHz carrier 128 to 257 MHz carrier 64 to 128 MHz carrier 32 to 64 MHz carrier 16 to 32 MHz carrier 8 to 16 MHz carrier 4 to 8 MHz carrier 2 to 4 MHz carrier 1 to 2 MHz carrier 0.5 to 1 MHz carrier 0.25 to 0.5 MHz carrier Fast Hop Mode 1030 to 2060 MHz carrier; Option 002 515 to 1030 MHz carrier 257 to 515 MHz carrier 128 to 257 MHz carrier 64 to 128 MHz carrier 32 to 64 MHz carrier 16 to 32 MHz carrier

Description

The FM specifications which can be verified directly with an HP 8902A Measuring Receiver are checked in these tests. The restrictions are that (1) the peak deviation must be less than 400 kHz, (2) the modulation rate must be less than 200 kHz, and (3) the local oscillator's residual FM must be less than the HP 8645A. This latter restriction can be overcome by choosing an external local oscillator with better or equal performance (such as a second HP 8645A).

This test is followed by Performance Test 4, *FM Test (High Deviations and Rates)*, which uses an HP 3048A Phase Noise Measurement System. This system can measure some FM specifications outside the range of the HP 8902A. Performance Tests 3 and 4 have some overlap.

The distortion of the internal modulation source is checked directly using a distortion analyzer.

Equipment

- Distortion Analyzer..... HP 8903B or HP 8903E
- Measuring Receiver..... HP 8902A Option 003
- Reference Signal Generator..... HP 8645A

NOTE

If the Signal Generator being tested has Option 002, the reference signal generator must have Option 002 also.

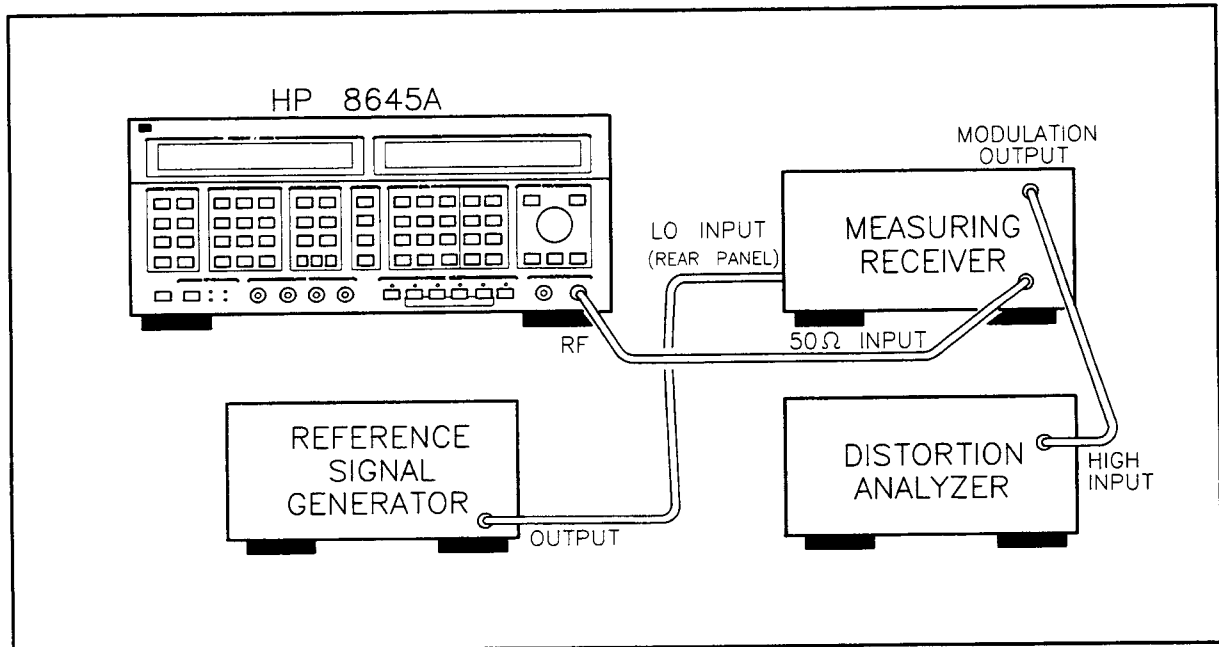

Figure 3-1. FM (Low Deviations and Rates) Test Setup

Procedure

Initial Setup

1. Connect the equipment as shown in figure 3-1. (If the measuring receiver does not have series 030 options (high selectivity), remove the rear-panel coaxial jumper from the local oscillator's input and output. Connect the reference signal generator's output to the measuring receiver's rear-panel local oscillator input.)
2. Set the reference signal generator's carrier to 251.5 MHz at 0 dBm.
3. On the Signal Generator under test, press INSTR PRESET.
4. Preset the measuring receiver, then set it to read FM with the RMS detector. (If the measuring receiver has series 030 options (high selectivity), invoke special function 23.1 to switch the local oscillator to external.)
5. Connect the Signal Generator-under-test's OUTPUTS RF directly to the RF input of the measuring receiver or, if a sensor module is being used, connect it to the input of the sensor module.

Residual FM

6. On the Signal Generator under test, key in AMPTD 0 dBm.
7. Set the Signal Generator-under-test's carrier frequency, the reference signal generator's carrier frequency, and the measuring receiver's high-pass and low-pass filters as indicated in the following table. For each setting, allow the measuring receiver to retune. The residual FM should be within the limits given in the table.

Signal Generator Carrier Frequency (MHz)		Measuring Receiver Filter		Residual FM Limits (Hz rms)	
Under Test	Reference	High-Pass	Low-Pass	Actual	Maximum
250	251.5	300 Hz	3 kHz	_____	1
500	501.5	300 Hz	3 kHz	_____	1.2
1000	1001.5	300 Hz	3 kHz	_____	2
1300 ⁽¹⁾	1301.5	300 Hz	3 kHz	_____	4
1300 ⁽¹⁾	1301.5	50 Hz	15 kHz	_____	8
1000	1001.5	50 Hz	15 kHz	_____	4
500	501.5	50 Hz	15 kHz	_____	2
250	251.5	50 Hz	15 kHz	_____	1.2

⁽¹⁾ Option 002

Indicator Accuracy

8. If the measuring receiver does not have series 030 options, disconnect the reference generator from the rear panel and re-connect the coaxial jumper. If the measuring receiver has series 030 options, invoke special function 23.0 to switch the local oscillator to internal.

NOTE

Verify that the measuring receiver's FM is calibrated using its built-in FM calibrator.

9. Set the measuring receiver as follows.
 - a. Set the detector to $\text{peak} \pm /2$ (that is, to average peak+ and peak-). (To do this press the PEAK + and PEAK - keys simultaneously.)
 - b. Set the high-pass filter off.
 - c. Set the low-pass filter off.
10. On the Signal Generator under test, press the FM key, then key in AUDIO FREQ 50 kHz. Set the Signal Generator's carrier frequency and FM peak deviation as indicated in the following table. For each step the FM peak deviation, as read on the measuring receiver, should be within the limits shown in the table (that is, within $\pm 10\%$).

Signal Generator Settings		FM Deviation Limits (kHz peak)		
Carrier Frequency (MHz)	FM Deviation (kHz peak)	Minimum	Actual	Maximum
500	360	324	_____	396
260	360	324	_____	396
250	250	225	_____	275
130	250	225	_____	275

Record the FM Deviation for the 500 MHz carrier for use in Performance Test 4.

FM Deviation for 500 MHz carrier: _____ kHz

11. On the Signal Generator under test, press FAST HOP (in the SYNTHESIS MODE key group). Repeat step 10 using the following table.

Signal Generator Settings		FM Deviation Limits (kHz peak)		
Carrier Frequency (MHz)	FM Deviation (kHz peak)	Minimum	Actual	Maximum
130	200	180	_____	220
250	200	180	_____	220
260	360	324	_____	396
500	360	324	_____	396

Distortion

12. Connect the distortion analyzer to the modulation output of the measuring receiver. (Refer to figure 3-1.)
13. Set the distortion analyzer to measure the distortion on the demodulated FM which will have an audio rate of 100 kHz. (Switch any low-pass filter off.)
14. Set the Signal Generator under test as follows.
 - a. Key in FREQ 130 MHz.
 - b. Key in AUDIO FREQ 100 kHz.

15. On the Signal Generator under test, set the FM peak deviation as indicated in the following table. For each step read the distortion on the distortion analyzer. The distortion should be within the limits shown in the table.

Signal Generator FM Deviation (kHz peak)	FM Distortion Limits (%)	
	Actual	Maximum
66	_____	1.3
400	_____	6

16. On the Signal Generator under test, press AUTO (in the SYNTHESIS MODE key group). Repeat step 15 using the following table.

Signal Generator FM Deviation (kHz peak)	FM Distortion Limits (%)	
	Actual	Maximum
400	_____	6
75	_____	1.3

Incidental AM

17. On the Signal Generator under test, key in **FREQ 17 MHz** and **FM 18 kHz**.
 18. Set the measuring receiver to read **AM**. The **AM depth** should read **0.5%** or less.

Incidental AM Limit: _____ 0.5%

Maximum Rate (3 dB Bandwidth)

19. Set the measuring receiver to measure **FM peak deviation**.
 20. On the Signal Generator under test, set the carrier frequency, FM deviation, and audio frequency as indicated in the following table. For each setting perform the following steps.
- After setting the Signal Generator-under-test's carrier frequency, allow the measuring receiver to retune.
 - On the Signal Generator key in **AUDIO FREQ 1 kHz**.
 - Set the measuring receiver ratio display off (if it is on). Then set the ratio back on to establish a new ratio reference. (Also, set the ratio to read in **dB**, that is, log.)
 - Set the Signal Generator's audio frequency as shown in the table.
 - Note the **dB change in FM deviation** on the measuring receiver. The deviation should be between **-3 and +3 dB** (relative).

NOTE

In some cases it will be necessary to set the FM deviation of the Signal Generator before entering its carrier frequency because the interim combination of the two may be incompatible.

Signal Generator Settings			Relative FM Deviation Limits (dB)		
Carrier Frequency (MHz)	FM Deviation (kHz peak)	Audio Frequency (kHz)	Minimum	Actual	Maximum
32	300	200	-3	_____	+3
17	300	200	-3	_____	+3
11	150	150	-3	_____	+3
0.8	9.6	9.6	-3	_____	+3
0.4	4.7	4.7	-3	_____	+3

21. On the Signal Generator under test, press FAST HOP. Repeat step 20 using the following table.

Signal Generator Settings			Relative FM Deviation Limits (dB)		
Carrier Frequency (MHz)	FM Deviation (kHz peak)	Audio Frequency (kHz)	Minimum	Actual	Maximum
0.4	0.7	4.7	-3	_____	+3
0.8	1.6	9.6	-3	_____	+3
11	27.4	150	-3	_____	+3
17	54	200	-3	_____	+3
32	54	200	-3	_____	+3

Carrier Frequency Accuracy in FM

- 22. Set the measuring receiver to measure carrier frequency.
- 23. On the Signal Generator under test, press AUTO (to exit the Fast Hop mode) and press INT (to turn off the internal modulation oscillator).
- 24. On the Signal Generator under test, set the carrier frequency and the FM peak deviation as indicated in the following table. For each step press FM OFF then press FM ON and note the shift in carrier frequency as read on the measuring receiver. (The frequency error measurement mode in the measuring receiver can also be used to measure carrier shift.) The carrier shift should be within the limits shown in the table.

NOTE

The FM system in the Signal Generator is turned on but no actual FM is generated because the audio source is turned off.

Signal Generator Settings		Carrier Shift Limits (kHz)	
Carrier Frequency (MHz)	FM Deviation (MHz peak)	Actual	Maximum
10	0.15	_____	0.6
20	0.3	_____	1.2
50	0.625	_____	2.5
100	1.25	_____	5
200	2.5	_____	10
500	5	_____	20
1000	10	_____	40

Internal Modulation Source Distortion

25. Connect the input of the distortion analyzer directly to the Signal Generator's OUTPUTS AUDIO connector.
26. On the Signal Generator key in SHIFT AUDIO LEVEL 1 V. Key in the audio frequency as listed in the following table. For each setting measure the audio distortion. The distortion should be within the limits indicated.

Audio Frequency (Hz)	Distortion Limits (%)	
	Actual	Maximum
15 000	_____	0.1
2 000	_____	0.1
200	_____	0.1
20	_____	0.1

Performance Test 4

FM TEST (HIGH DEVIATIONS AND RATES)

Specification

Characteristic	Performance Limits	Conditions
Frequency Modulation		
Maximum Peak Deviation	20 MHz 10 MHz 5 MHz 2.5 MHz 1.25 MHz 625 kHz 313 kHz 156 kHz 78 kHz 39 kHz 19.5 kHz 9.7 kHz 4.8 kHz	Auto Mode 1030 to 2060 MHz carrier; Option 002 515 to 1030 MHz carrier 257 to 515 MHz carrier 128 to 257 MHz carrier 64 to 128 MHz carrier 32 to 64 MHz carrier 16 to 32 MHz carrier 8 to 16 MHz carrier 4 to 8 MHz carrier 2 to 4 MHz carrier 1 to 2 MHz carrier 0.5 to 1 MHz carrier 0.25 to 0.5 MHz carrier Fast Hop Mode 1030 to 2060 MHz carrier; Option 002 515 to 1030 MHz carrier 257 to 515 MHz carrier 128 to 257 MHz carrier 64 to 128 MHz carrier 32 to 64 MHz carrier 16 to 32 MHz carrier 8 to 16 MHz carrier 4 to 8 MHz carrier 2 to 4 MHz carrier 1 to 2 MHz carrier 0.5 to 1 MHz carrier 0.25 to 0.5 MHz carrier
Maximum Rate (3 dB Bandwidth)	3.52 MHz 1.76 MHz 880 kHz 440 kHz 220 kHz 110 kHz 55 kHz 27.5 kHz 13.7 kHz 6.8 kHz 3.4 kHz 1.7 kHz 0.8 kHz 10 MHz 10 MHz 5 MHz 2.5 MHz 1.25 MHz 625 kHz 313 kHz 156 kHz 78 kHz	20 to 30 C 1030 to 2060 MHz carrier; Option 002 515 to 1030 MHz carrier 257 to 515 MHz carrier 128 to 257 MHz carrier 64 to 128 MHz carrier 32 to 64 MHz carrier 16 to 32 MHz carrier 8 to 16 MHz carrier 4 to 8 MHz carrier

Characteristic	Performance Limits	Conditions
Maximum Rate (3 dB Bandwidth) (cont'd)	39 kHz	2 to 4 MHz carrier
	19.5 kHz	1 to 2 MHz carrier
	9.7 kHz	0.5 to 1 MHz carrier
	4.8 kHz	0.25 to 0.5 MHz carrier
Indicator Accuracy		limited by the maximum FM rate available in each carrier band
	±10%	Auto Mode; 50 kHz rate; 10% of maximum peak deviation
	±18%	Auto Mode; 3.75 MHz rate; 17% of maximum peak deviation
	±10%	Fast Hop Mode; 50 kHz rate; 50% of maximum peak deviation
Distortion		Fast Hop Mode; 3.75 MHz rate; 100% of maximum peak deviation
	<1.3%	20 Hz to 100 kHz rates
	<6%	Auto Mode; 3% of maximum peak deviation
	<1.3%	Auto Mode; 100% of maximum peak deviation
	<6%	Fast Hop Mode; 15% of maximum peak deviation
	<6%	Fast Hop Mode; 100% of maximum peak deviation

Description

Measurements are made on signals with FM peak deviations up to 880 kHz and rates up to 3.75 MHz. These signals cannot be made directly by the HP 8902A Measuring Receiver which was used in Performance Test 3. (However, Performance Tests 3 and 4 have some overlap.)

FM is demodulated by an HP 3048A Phase Noise Measurement System. A power splitter and delay line (both supplied with the system) and an RF phase detector (built into the system's interface) are used as a delay-line FM discriminator. The demodulated FM is analyzed by an RF spectrum analyzer (optionally supplied with the system) and an oscilloscope. The test is not run by a system program; rather, the system's interface is manually controlled from the controller's keyboard.

Equipment

Audio Source HP 3325A
 Oscilloscope HP 1740A or Tektronix 2245
 Phase Noise Measurement System HP 3048A Option 101

NOTE

Since this test is written specifically for the HP 3048A, no substitute of equipment is recommended.

For this test, the HP 3048A is assumed to have the HP 11848-60132 Noise Floor Test Fixture (supplied with system) and an HP 3585A spectrum analyzer (which must have a 1 MΩ input). The HP 3561A Dynamic Signal Analyzer is required for the system but is not used in this test.

Procedure

Initial Setup and Establishing Quadrature

1. Run Performance Test 3, *FM Test (Low Deviations and Rates)*. Record the values measured in step 10 for use later in this test.
2. Connect the equipment as shown in figure 3-2. Check that the SPECTRUM ANALYZER output connector on the front panel of the HP 11848A Phase Noise Interface is terminated in 50 Ω . Also, check that the delay line connectors are tight.
3. On the Signal Generator press INSTR PRESET then key in **FREQ 400 MHz** and **AMPTD 17 dBm** (or the highest amplitude allowed for Signal Generators with Option 002 or 005).

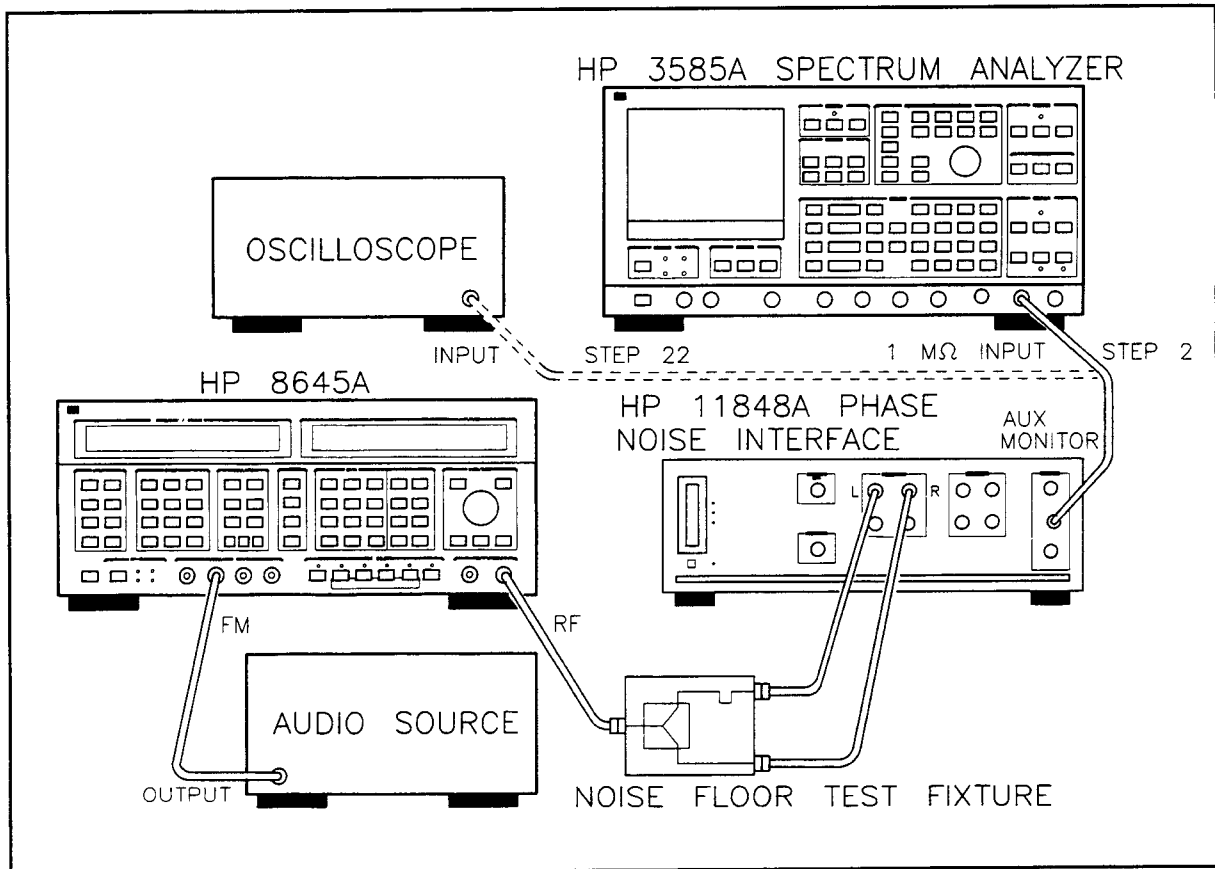

Figure 3-2. *FM (High Deviations and Rates) Test Setup*

4. Boot up the phase noise measurement system to the Main Software Menu level then set the system as follows.
 - a. Press the **[Spcl. Funct'n]** softkey available at the Main Software Level menu.
 - b. Press the **[11848A Control]** softkey to initiate manual control of the system's interface.
 - c. Press the **[Preset]** softkey to preset the interface.
 - d. Use the cursor control keys to move the cursor to the "SELECTED 'K' SWITCHES:" line then key in 10 and 12. (Refer to Figure 3-3.)
 - e. Use the cursor control keys to move the cursor to the "SELECTED 'S' SWITCHES:" line then key in 3 while not changing the "8" already present on the line.

- f. Press the **Send Command** softkey to initiate the commands. The display should appear as in figure 3-3 except for the cursor position, the values following “GAIN1:” and “GAIN2:” (which will be entered later), and the bottom line.
5. Tune the Signal Generator’s carrier frequency until the front-panel meter of the system’s interface reads approximately 0.
6. Set the phase noise measurement system as follows.
 - a. Use the system’s cursor control keys to move the cursor to the “GAIN1:” line then key in 28.
 - b. Use the system’s cursor control keys to move the cursor to the “GAIN2:” line then key in 20.
 - c. Press the **Send Command** softkey to initiate the commands.
7. Fine tune the Signal Generator’s carrier frequency until the front-panel meter of the system’s interface reads approximately 0. This establishes quadrature in the interface’s phase detector to make it function as a linear phase detector. (The display should now appear as in Figure 3-3.)
8. Set the RF spectrum analyzer to span 0 to 100 kHz. Set the input impedance to 1 M Ω .

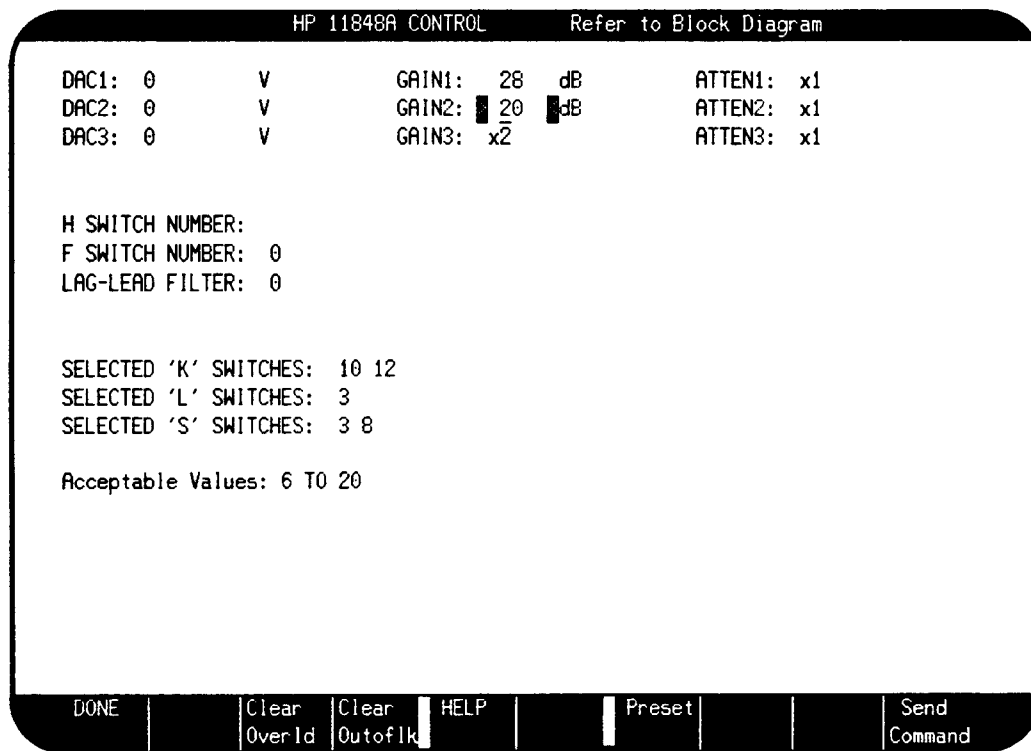

Figure 3-3. HP 11848A Control Display for FM Test

Indicator Accuracy

9. Let D equal the value in kHz of FM deviation measured in Performance Test 3, step 10, for a carrier frequency of 500 MHz. Calculate $720 - D$. (For example, if the value for D is 350 kHz, $720 - 350 = 370$.)

720 Minus the Value of D : _____ kHz

10. On the Signal Generator key in AUDIO FREQ 50 kHz. Also press FM then key in the value ($720 - D$) calculated in step 9 above (for example 370) then press kHz.
11. Adjust the RF spectrum analyzer's reference level so that the 50 kHz signal is at a convenient graticule line. (This line represents 360 kHz peak deviation.)
12. On the Signal Generator key in FM 500 kHz. The 50 kHz signal should move up between 1.9 and 3.7 dB (that is, to a peak deviation between 450 and 550 kHz).

FM Indicator Accuracy,
Auto Select, 500 kHz Peak Deviation, 50 kHz Rate: 1.9 _____ 3.7 dB

13. On the Signal Generator key in FM 440 kHz and press FAST HOP. The 50 kHz signal should move up from the reference graticule line of step 11 between 0.8 and 2.6 dB (that is, to a peak deviation between 396 and 484 kHz).

FM Indicator Accuracy,
Fast Hop, 440 kHz Peak Deviation, 50 kHz Rate: 0.8 _____ 2.6 dB

14. Set the audio source to +10 dBm at 50 kHz and connect it to the Signal Generator's MODULATION INPUTS FM connector. (Refer to Figure 3-2.)

15. Set the Signal Generator as follows.

- Press INT to turn the internal modulation oscillator off.
- Press EXT AC to select the external audio input.
- Key in FM 880 kHz.

16. Adjust the audio source level until neither the EXT LOW nor the EXT HI FM indicator in the Signal Generator's display is on. Now, set the audio source frequency to 3.75 MHz.

17. Set the RF spectrum analyzer to span 0 to 7.5 MHz. The 3.75 MHz signal should move up from the reference graticule line of step 11 between 6.3 and 9.2 dB (that is, to a peak deviation between 746 and 1038 kHz).

FM Indicator Accuracy,
Fast Hop, 880 kHz Peak Deviation, 3.75 MHz Rate: 6.3 _____ 9.2 dB

18. On the Signal Generator press AUTO SELECT and key in FM 850 kHz. The signal should move up from the reference graticule line of step 11 between 6.1 and 8.8 dB (that is, to a peak deviation between 726.5 and 994.5 kHz).

FM Indicator Accuracy,
Auto Select, 850 kHz Peak Deviation, 3.75 MHz Rate: 6.1 _____ 8.8 dB

Distortion

19. Set the Signal Generator as follows.
 - a. Key in AUDIO FREQ 100 kHz.
 - b. Press EXT AC to turn off the external audio input.
 - c. Press INT to turn on the internal modulation oscillator.
20. Set the RF spectrum analyzer to span 0 to 500 kHz.
21. On the Signal Generator, set the synthesis mode and FM deviation as indicated in the following table. For each setting, note the level of the harmonics of the 100 kHz signal relative to the fundamental. The harmonics should be below the limits shown in the table.

Signal Generator Settings		Harmonics Limits (dB)	
Synthesis Mode	FM Deviation (kHz peak)	Actual	Maximum
AUTO SELECT	150	_____	-37.7
AUTO SELECT	5000	_____	-24.4
FAST HOP	132	_____	-37.7
FAST HOP	880	_____	-24.4

Maximum Rate (3 dB Bandwidth)

22. Connect the auxiliary monitor output of the interface to the high impedance, ac coupled input of the oscilloscope. (Refer to figure 3-2.)
23. On the Signal Generator press INT to turn off the internal modulation oscillator and press EXT AC to turn on the external audio input.
24. Set the audio source’s frequency to 1 kHz.
25. On the system’s interface, use the cursor control keys to move the cursor to the “SELECTED ‘K’ SWITCHES:” line then key in 11 without overwriting the “10” and “12” already on the line, then press the **Send Command** softkey. (Note that a “14” also appears in the display. Switches 11 and 14 are coupled together.)
26. Adjust the oscilloscope’s vertical gain until the 1 kHz signal spans 5 divisions.
27. Increase the audio source’s frequency to 5 MHz. The 5 MHz signal should span 3.5 to 7.1 divisions.

FM Maximum Rate,

Fast Hop, 880 kHz Peak Deviation, 5 MHz Rate: 3.5 _____ 7.1 divisions

28. On the system’s interface, blank out the “11” and “14” on the “SELECTED ‘K’ SWITCHES:” line without blanking out the “10” and “12” on the line. Press the **Send Command** softkey.
29. On the Signal Generator press AUTO SELECT and key in FM 5 MHz.
30. Set the audio source’s frequency to 1 kHz.
31. Adjust the oscilloscope’s vertical gain until the 1 kHz signal spans 5 divisions.
32. Increase the audio source’s frequency to 5 MHz. The 5 MHz signal should span 3.5 to 7.1 divisions.

FM Maximum Rate,

Auto Select, 5 MHz Peak Deviation, 5 MHz Rate: 3.5 _____ 7.1 divisions

Performance Test 5

SPECTRAL PURITY TEST (SSB PHASE NOISE)

Specification

Characteristic	Performance Limits	Conditions
Spectral Purity		
SSB Phase Noise		CW, AM, or FM <1% of maximum deviation
		Auto Mode; 20 kHz frequency offset
	-120 dBc/Hz	1030 to 2060 MHz carrier; Option 002
	-127 dBc/Hz	515 to 1030 MHz carrier
	-132 dBc/Hz	257 to 515 MHz carrier
	-136 dBc/Hz	128 to 257 MHz carrier
	-139 dBc/Hz	64 to 128 MHz carrier
	-141 dBc/Hz	32 to 64 MHz carrier
	-142 dBc/Hz	16 to 32 MHz carrier
	-143 dBc/Hz	8 to 16 MHz carrier
	-144 dBc/Hz	0.25 to 8 MHz carrier
		Auto Mode; 100 kHz frequency offset
	-127 dBc/Hz	1030 to 2060 MHz carrier; Option 002
	-134 dBc/Hz	515 to 1030 MHz carrier
	-137 dBc/Hz	257 to 515 MHz carrier
	-140 dBc/Hz	128 to 257 MHz carrier
	-141 dBc/Hz	32 to 128 MHz carrier
	-142 dBc/Hz	16 to 32 MHz carrier
	-143 dBc/Hz	8 to 16 MHz carrier
	-144 dBc/Hz	0.25 to 8 MHz carrier
		Fast Hop Mode; 20 kHz frequency offset
	-116 dBc/Hz	1030 to 2060 MHz carrier; Option 002
	-123 dBc/Hz	515 to 1030 MHz carrier
	-128 dBc/Hz	257 to 515 MHz carrier
	-133 dBc/Hz	128 to 257 MHz carrier
	-137 dBc/Hz	64 to 128 MHz carrier
	-139 dBc/Hz	32 to 64 MHz carrier
	-141 dBc/Hz	16 to 32 MHz carrier
	-142 dBc/Hz	8 to 16 MHz carrier
	-143 dBc/Hz	4 to 8 MHz carrier
	-144 dBc/Hz	0.25 to 4 MHz carrier
Nonharmonic Spurious Signals		>20 kHz offset frequency
	<-100 dBc	0.25 to 1030 MHz carrier
	<-94 dBc	1030 to 2060 MHz carrier; Option 002

Description

The single-sideband (SSB) phase noise and non-harmonic spurious signals are measured by a system that is specifically designed to measure these parameters—the HP 3048A Phase Noise Measurement System. Measurements are made using a phase detector in a phase lock loop.

This method requires a reference signal generator that must have lower phase noise than the source being tested. A second HP 8645A can be used as this source (and thus both sources are measured as a pair) but the following considerations apply: (1) If the measured results are within specification, both generators meet the specification individually. (2) If the measured results are out of specification, at least one generator is out of specification and a third source must be measured against the first two to determine which one is faulty.

Equipment

Phase Noise Measurement System	HP 3048A
Reference Signal Generator	HP 8642B

NOTE

Neither the reference source nor the HP 8645A will be under remote control.
If a suitable reference source is unavailable, the 10 MHz A oscillator in the HP 11848A Phase Noise Interface to the HP 3048A system can be used as reference for a 10 MHz carrier.

Procedure

Initial Setup

1. Connect the equipment as shown in figure 3-4. (Note the connection to the ΦM input of the HP 8645A.)

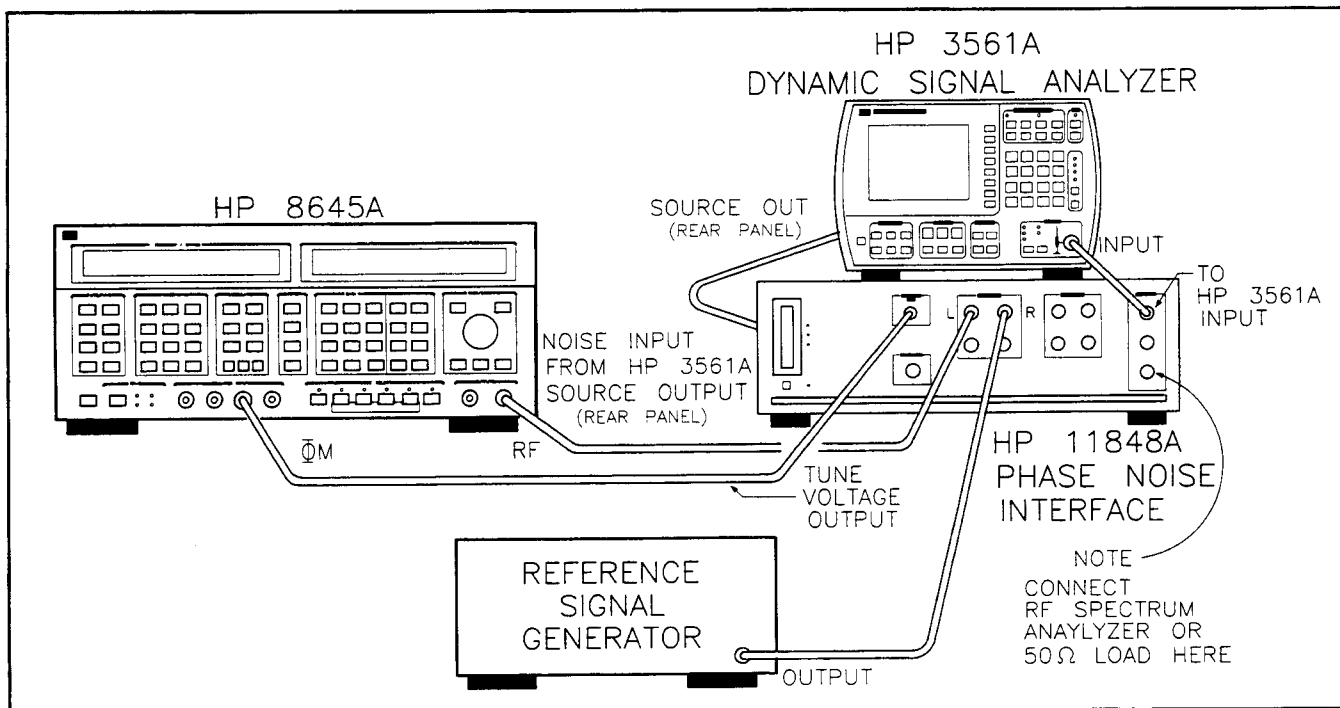

Figure 3-4. SSB Phase Noise Test Setup

2. Set the reference signal generator's carrier to 550 MHz at 6 dBm.
3. Set the Signal Generator under test as follows.
 - a. Press INSTR PRESET.
 - b. Key in AMPTD 17 dBm (or the highest amplitude allowed for Signal Generators with Option 002 or 005).
 - c. Key in FREQ 550 MHz.
 - d. Key in FM 2 kHz.
 - e. Press INT in the MODULATION key group to turn the internal modulation source off.
 - f. Press EXT DC in the MODULATION key group to enable DC FM.
 - g. Key in SPECIAL 123 ENTER ON. This sets the FM input resistance to 600 Ω with the Φ M connector serving as the actual input to the FM system.
4. Set the HP 3048A to the Main Software Level menu. Refer to figure 3-5.

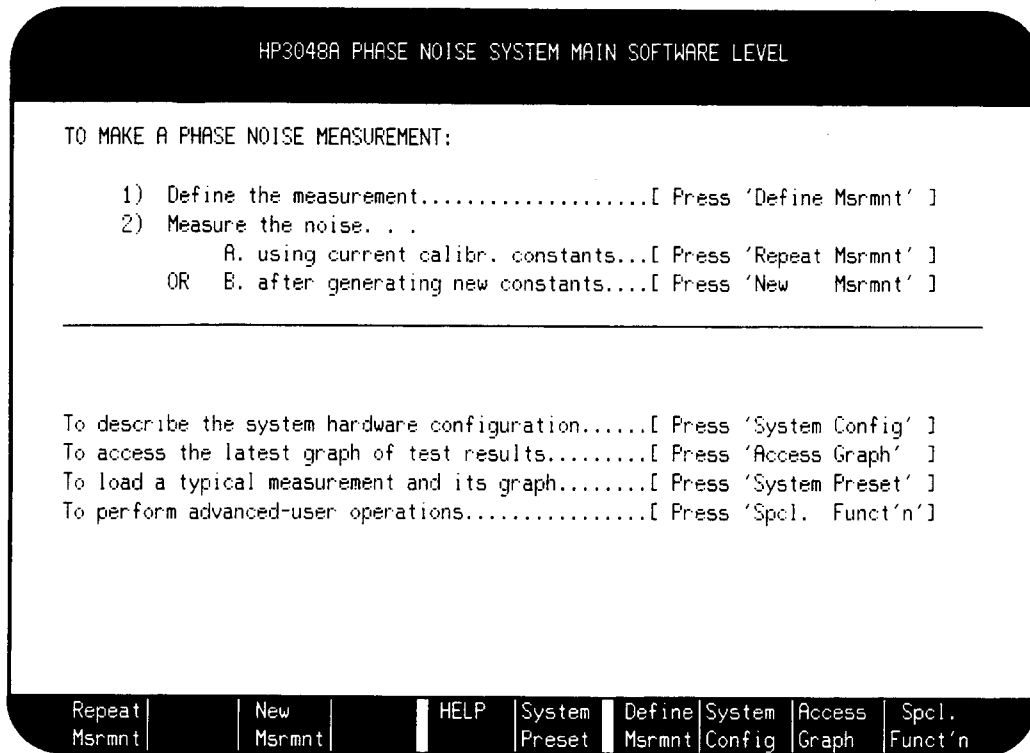

Figure 3-5. Main Software Level Menu

Example Measurement

NOTE

The following steps are the procedure for making a single-sideband phase noise measurement on a 550 MHz carrier and standard (not fast hop) operating mode. For other carrier frequencies and for fast hop, the procedure is similar. If these measurements are to be repeated in the future for this or other HP 8645A generators, it will be advantageous to record the test file entries for each carrier frequency; these test files can be recalled as needed later on instead of having to re-enter them each time.

5. On the HP 3048A press the **Define Msrmnt** softkey to obtain the Measurement Definition menu. Refer to figure 3-6.

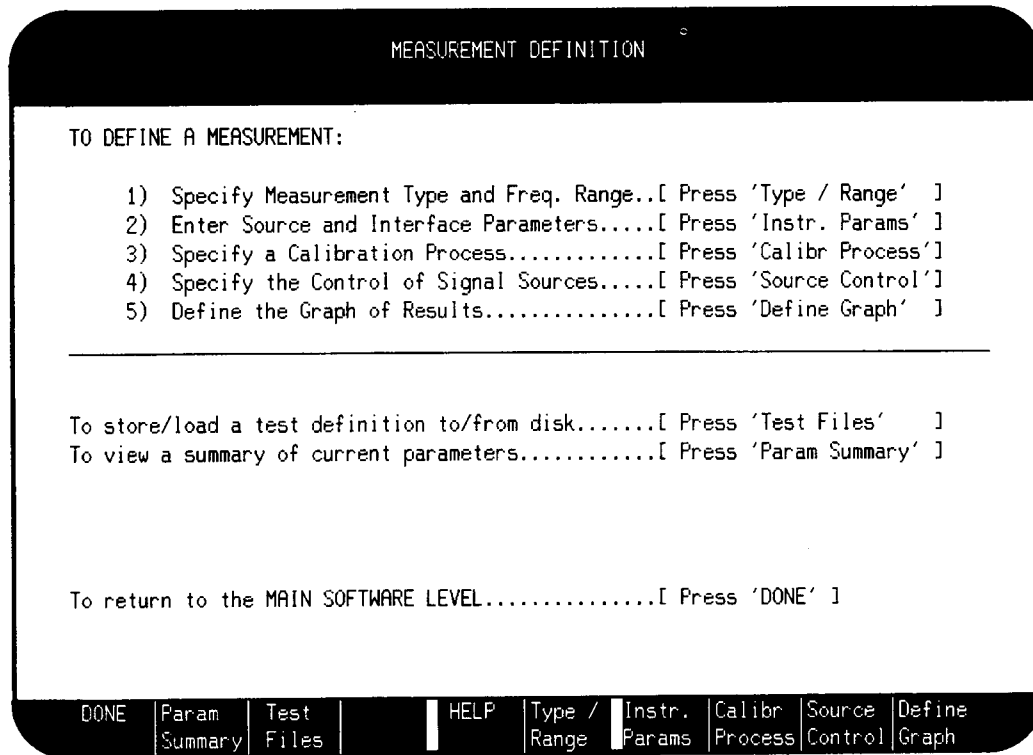

Figure 3-6. Measurement Definition Menu

- On the HP 3048A press the **Type / Range** softkey to obtain the Measurement Type and Frequency Range Specification menu. Set the measurement type and offset frequency range as shown in figure 3-7. When done, press the **DONE** softkey.

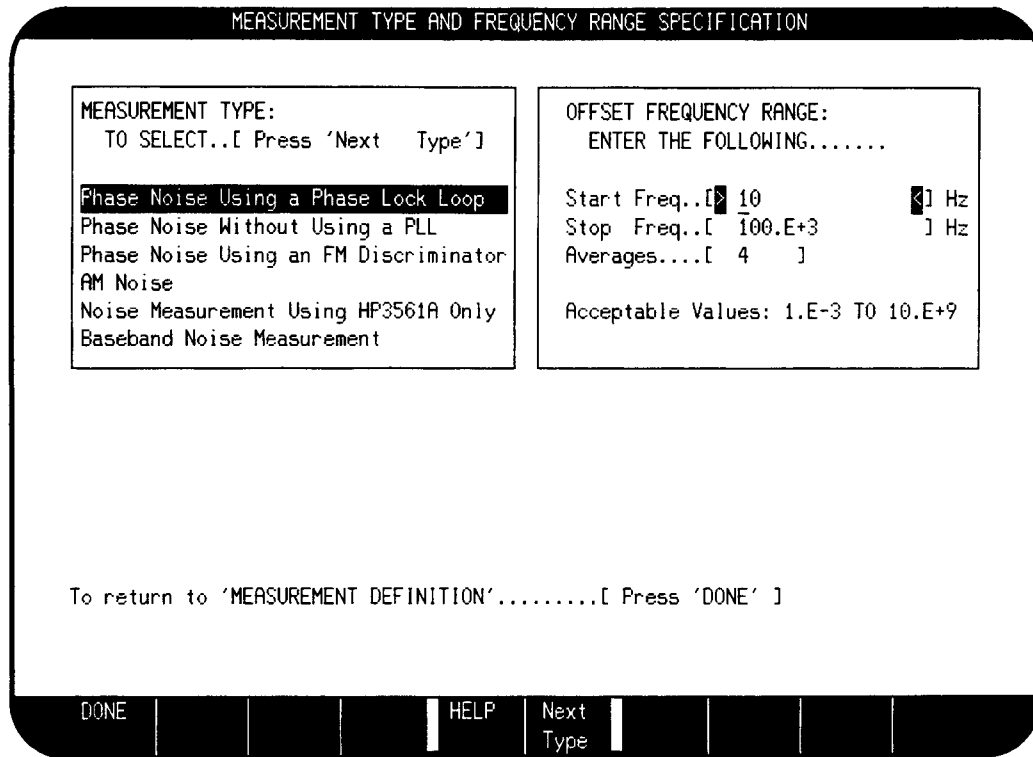

Figure 3-7. Measurement Type and Frequency Range Specification Menu

- On the HP 3048A press the **Instr. Params** softkey to obtain the Source and Interface Parameter Entry menu. Set the parameters and phase detector as shown in figure 3-8. When done, press the **DONE** softkey.

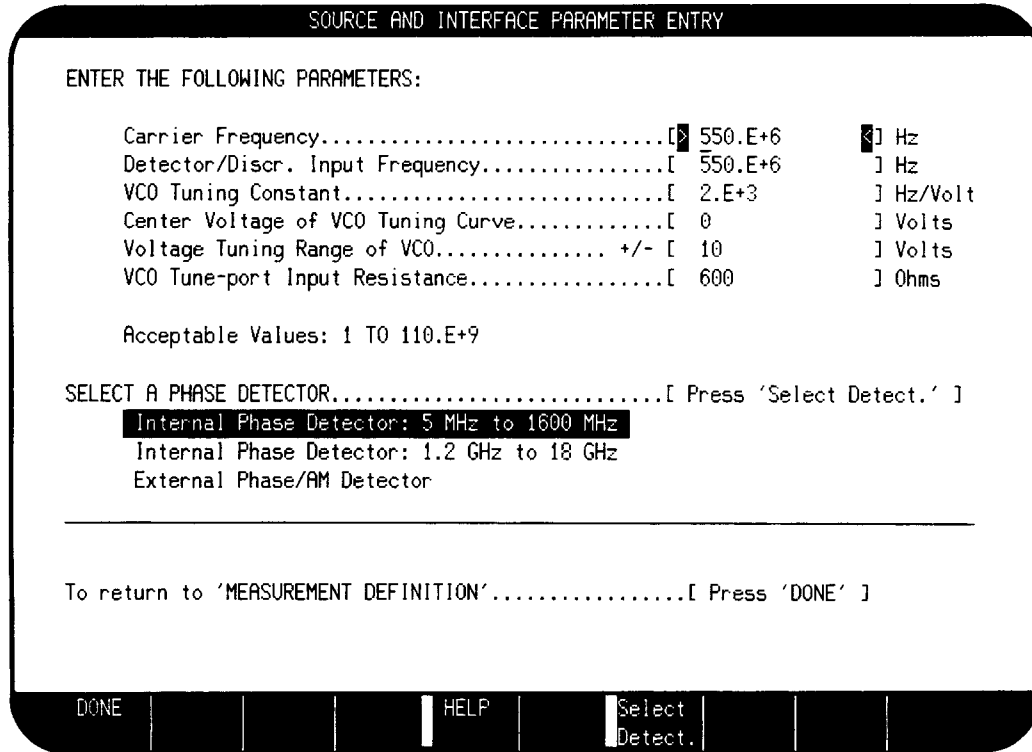

Figure 3-8. Source and Interface Parameter Entry Menu

- On the HP 3048A press the **Calibr Process** softkey to obtain the Determination of Phase Detector Constant and VCO Tuning Constant menu. Set the method of determining the phase detector and VCO tuning constants and the verification of the phase lock loop suppression as shown in figure 3-9. (The displayed Computed Constant may be quite different from the one in figure 3-9. It will be updated later.) When done, press the **DONE** softkey.

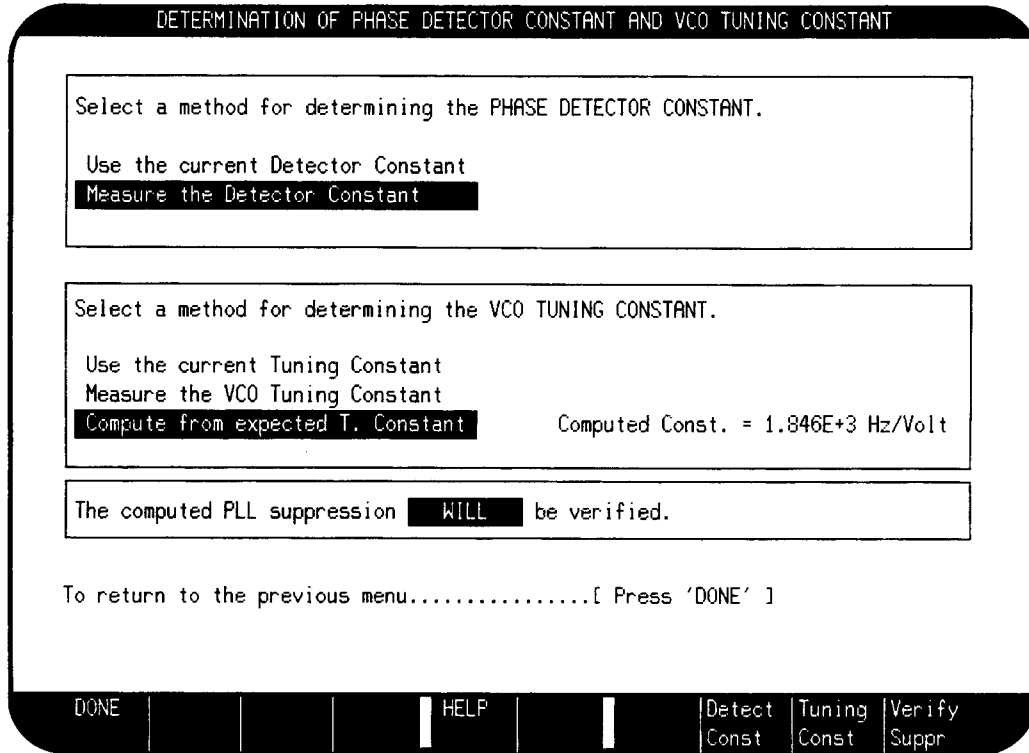

Figure 3-9. Determination of Phase Detector and VCO Tuning Constant Menu

- On the HP 3048A press the **Source Control** softkey to obtain the Source Control for Measurement Using a Phase Lock Loop menu. Set the various devices in the system as shown in figure 3-10. When done, press the **DONE** softkey.

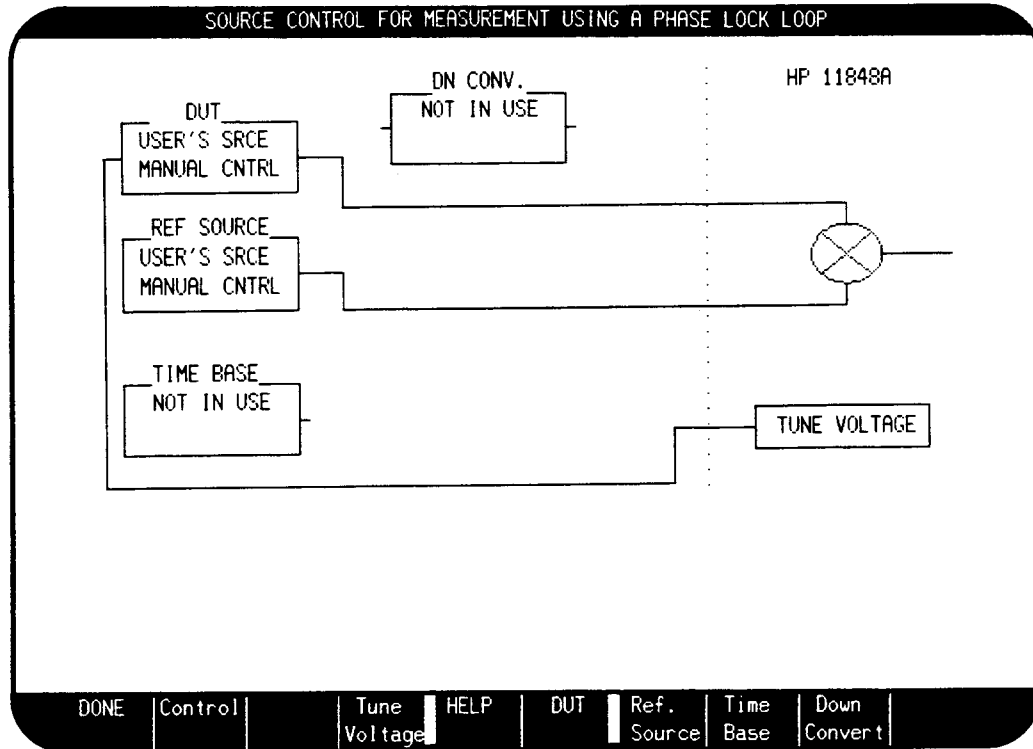

Figure 3-10. Source Control for Measurement Using a Phase Lock Loop Menu

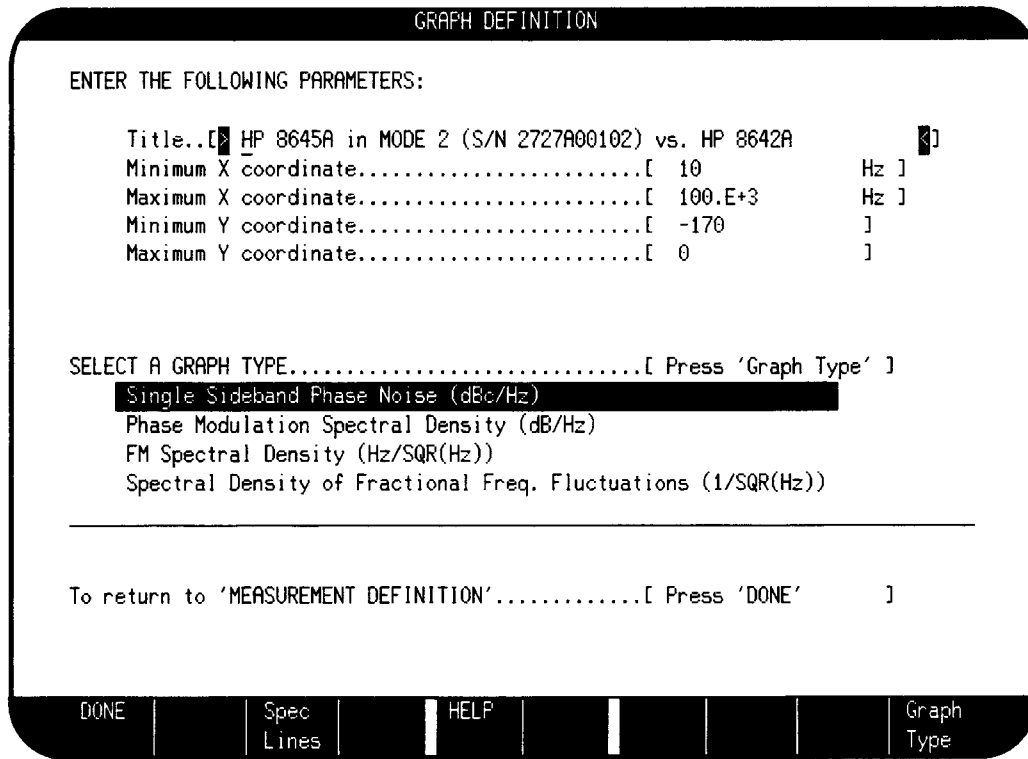

Figure 3-11. Graph Definition Menu

10. On the HP 3048A press the **Define Graph** softkey to obtain the Graph Definition menu. Set the graph parameters and graph type as shown in figure 3-11. Change the title as appropriate for your particular setup. (You may wish to include the serial number of the device under test for example. Note that date, time, and carrier frequency information will automatically appear on the measurement result graph.) When done, press the **DONE** softkey.
11. On the HP 3048A press the **DONE** softkey again to obtain the Main Software Level menu.
12. On the HP 3048A press the **New Msrmnt** softkey then press the **Yes, Proceed** softkey.
13. When the connect diagram appears on the display, verify that the instrument connections are properly made then press the **Proceed** softkey. (Note that even though the user's DUT shows a connection to FM IN, in the case of the HP 8645A the connection should be to the Φ M input.) The phase noise measurement should proceed without error and the phase noise plot should appear as in figure 3-12. Ignoring spurious signals, the phase noise ($\mathcal{L}(f)$) should be less than -127 dBc at a 20 kHz offset frequency and less than -134 dBc at 100 kHz. Spurious signals for offset frequencies greater than 20 kHz should be down more than 100 dBc.

SSB phase noise, 20 kHz offset: _____ -127 dBc
 SSB phase noise, 100 kHz offset: _____ -134 dBc

Non-harmonic spurious signals, 0.25 to 1030 MHz: _____ -100 dBc

NOTE

Figure 3-12 also shows a listing of measurement parameters. This listing with the graph itself can be printed by pressing the keyboard's **SHIFT** key while pressing the **Hard Copy** softkey.

If you intend to make measurements of this same type frequently, the setup information (carrier frequency, tuning constant, source control, etc.) can be easily stored as test files, then loaded as needed. Refer to the HP 3048A Reference Manual on storing and loading test files.

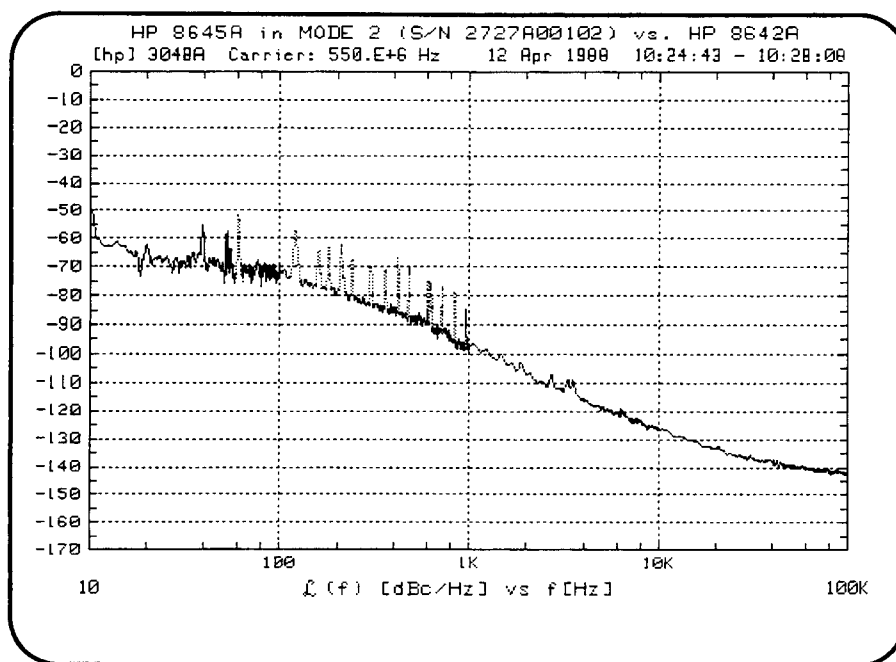

PERTINENT MEASUREMENT PARAMETERS

Measurement Type: PHASE LOCKED	K_VCO Method : COMPUTED
Start Offset Freq: 10 Hz	Tuneport Resist. : 600 Ohms
Stop Offset Freq: 100.E+3 Hz	VCO Tune Constant: 1.846E+3 Hz/Volt
Minimum Averages: 4	
	Loop Suppression : VERIFIED
Carrier Frequency: 550.E+6 Hz	Closed Pll Bandw.: 1.327E+3 Hz
Detect. Input Frq: 550.E+6 Hz	Peak Tuning Range: 16.33E+3 Hz
	Assumed Pole : 4.149E+3 Hz
Entered K_VCO : 2.E+3 Hz/Volt	
Center Voltage : 0 Volts	Dev. Under Test : USER'S SRCE, MAN
Tune-voltage Rnge: +/- 10 Volts	Reference Source : USER'S SRCE, MAN, VCO
Phase Detector : 5 TO 1600 MHz	Ext. Timebase : NOT IN USE
	Down Converter : NOT IN USE
K_Detector Method: MEASURED	
Detector Constant: 227.2E-3 V/Rad	HP 11848A LNA : IN

Figure 3-12. Phase Noise Plot and Pertinent Measurement Parameters

Further Measurements

14. To measure single-sideband phase noise for other carrier frequencies and modes of operation, set the signal generators and phase noise measurement system as outlined in the following table. The phase noise should be within the limits indicated in the table. Spurious signals for offset frequencies greater than 20 kHz should be down more than 100 dBc for carrier frequencies to 1030 MHz and more than 94 dBc for carrier frequencies between 1030 and 2060 MHz.

Non-harmonic spurious signals, 0.25 to 1030 MHz: _____ -100 dBc
 Non-harmonic spurious signals, 1030 to 2060 MHz (Option 002): _____ -94 dBc

Carrier Frequency (MHz) ⁽¹⁾	HP 8645A Settings		HP 3048A VCO Tuning (Hz/V)	Phase Noise Limits (dBc)			
	Synthesis Mode	FM Peak Deviation (Hz)		20 kHz Offset		100 kHz Offset	
				Actual	Maximum	Actual	Maximum
1100 ⁽²⁾	AUTO	4000	4000	_____	-120	_____	-127
1100 ⁽²⁾	FAST HOP	4000	4000	_____	-116	_____	
550	FAST HOP	2000	2000	_____	-123	_____	
550	AUTO	2000	2000	_____	-127	_____	-134
300	AUTO	1000	1000	_____	-132	_____	-137
300	FAST HOP	1000	1000	_____	-128	_____	
150	FAST HOP	500	500	_____	-133	_____	
150	AUTO	500	500	_____	-136	_____	-140
80	AUTO	250	250	_____	-139	_____	-141
80	FAST HOP	250	250	_____	-137	_____	
40	FAST HOP	100	100	_____	-139	_____	
40	AUTO	100	100	_____	-141	_____	-141
20	AUTO	50	50	_____	-142	_____	-142
20	FAST HOP	50	50	_____	-141	_____	
10	FAST HOP	25	25	_____	-142	_____	
10	AUTO	25	25	_____	-143	_____	-143

⁽¹⁾ Make the carrier frequency change to the HP 8645A, the reference source, the HP 3048A Source and Interface Parameter Entry menu (for Carrier Frequency and Detector/Disc. Input Frequency), and the Graph Definition menu (in the Title).

⁽²⁾ Option 002

Performance Test 6

SPECTRAL PURITY TEST (HARMONICS)

Specification

Characteristic	Performance Limits	Conditions
Spectral Purity		
Spurious Signals		
Harmonics	<-30 dBc <-30 dBc <-25 dBc	output <10 dBm; except Option 002 output <8 dBm; 0.25 to 1030 MHz carrier; Option 002 output <8 dBm; 1030 to 2060 MHz carrier; Option 002
Subharmonics	none <-55 dBc <-40 dBc	0.25 to 515 MHz carrier 515 to 1030 MHz carrier 1030 to 2060 MHz carrier; Option 002

Description

Harmonics and subharmonics are observed directly on an RF spectrum analyzer while the Signal Generator is swept slowly over its frequency range.

Equipment

RF Spectrum Analyzer.....HP 8562B or HP 853A/8559A

Procedure

Initial Setup

1. Set the Signal Generator as follows.
 - a. Press INSTR PRESET.
 - b. Key in AMPTD 10 dBm or if the Signal Generator has Option 002, key in AMPTD 8 dBm.
 - c. Key in SWEEP TIME 10 s.
 - d. Press AUTO (in the SWEEP key group). This initiates a continuous, 10s sweep from 0.25 to 1030 MHz (or 2060 MHz for Option 002).

2. Set the spectrum analyzer as follows.
 - a. Set the frequency span 0 to 3 GHz (or for Option 002, 0 to 6 GHz) with compatible resolution bandwidth and display smoothing. (If this span width is not available, use the widest span possible and, as the measurement progresses, retune the center frequency as needed to span the complete range in segments.)
 - b. Set the vertical scale to 10 dB per division log.
 - c. Set the vertical sensitivity and attenuation to view a 10 dBm signal with at least 40 dB of uncompressed range.
3. Connect the Signal Generator's OUTPUTS RF to the spectrum analyzer's input.

Harmonics

4. Set the spectrum analyzer sensitivity so that the peak of the sweeping fundamental is at a convenient horizontal graticule.
5. Observe the second and third harmonics of the signal as the fundamental sweeps over its range. If necessary, change the spectrum analyzer's center frequency to observe the harmonics at higher frequencies. The harmonics should be down more than 30 dBc over the 0.25 to 1030 MHz range, and, if the instrument has Option 002, more than 25 dBc from 1030 to 2060 MHz.

Harmonics (0.25 to 1030 MHz span): _____ -30 dBc
 Harmonics (1030 to 2060 MHz span, Option 002): _____ -25 dBc

Subharmonics

6. Set the spectrum analyzer to span 0 to 1 GHz (or 0 to 2 GHz for Option 002). Increase the vertical gain, sweep time, resolution bandwidth, and display smoothing as necessary to generate a dynamic range of 60 dB. (A slight compression of the signal is acceptable.)
7. Observe the subharmonics of the signal as the fundamental sweeps over its range. The subharmonics should be unobservable over the fundamental range to 0.25 to 515 MHz, more than 55 dBc from 515 to 1030 MHz range, and, if the instrument has Option 002, more than 40 dBc from 1030 to 2060 MHz.

Subharmonics (0.25 to 515 MHz span): _____ unobservable
 Subharmonics (515 to 1030 MHz span): _____ -55 dBc
 Subharmonics (1030 to 2060 MHz span, Option 002): _____ -40 dBc

Performance Test 7

PULSE MODULATION TEST

Specification

Characteristic	Performance Limits	Conditions
Pulse Modulation		>10 MHz carrier
On/Off Ratio	<-35 dB	
Rise/Fall Time	<100 ns	10% to 90% points
Maximum Pulse Repetition Rate	1 MHz	
Minimum Pulse Width	500 ns	

Description

For low carrier frequencies, the characteristics of the RF pulses are observed directly on an oscilloscope. For high frequencies, a crystal detector is used to peak-detect the pulse envelope which is then viewed on the oscilloscope. The pulse on/off ratio is measured statically on a spectrum analyzer by setting a CW reference then noting how far the amplitude drops when the Signal Generator is switched to the pulse modulation mode with no pulse input.

Equipment

Crystal Detector HP 423B
 600 Ω Feed Thru Termination HP 11095A
 Oscilloscope HP 1740A or Tektronix 2245
 Pulse Generator HP 8116A
 Spectrum Analyzer HP 8562A or HP 853A/8559A

Procedure

Initial Setup

1. Connect the equipment as shown in figure 3-13.
2. Set the oscilloscope as follows.
 - a. Set the input coupling to dc with 50 Ω input impedance.
 - b. Set the vertical scale to view a 2 V peak-to-peak signal.
 - c. Set the time sweep to 200 ns per division.
 - d. Set the triggering to trigger on the rising transition of the pulse generator's trigger output.

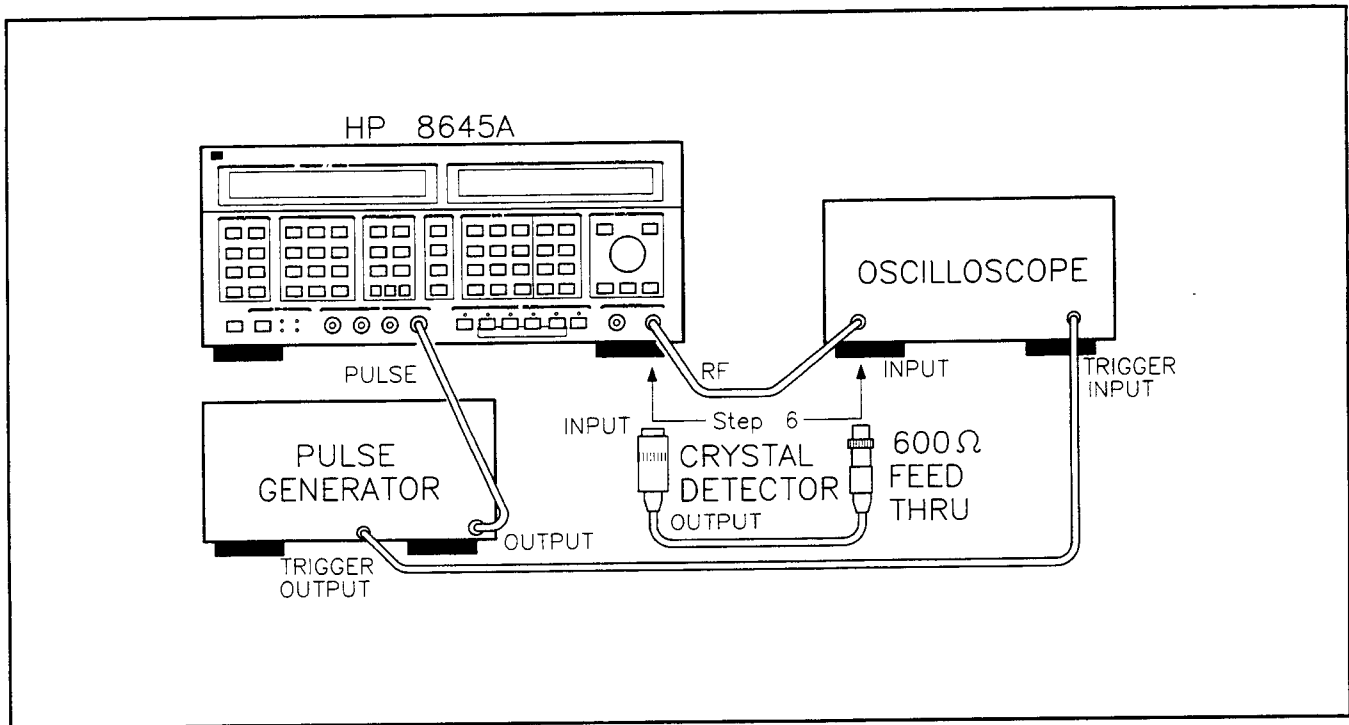

Figure 3-13. Pulse Modulation Test Setup

3. Set the pulse generator as follows.
 - a. Set the frequency (rate) to 100 kHz.
 - b. Set the pulse width to 1 μ s.
 - c. Set the amplitude to switch from 0V to 4V.
4. Set the Signal Generator as follows.
 - a. Press INSTR PRESET.
 - b. Key in AMPTD 10 dBm.
 - c. Key in FREQ 10 MHz.
 - d. Key in PULSE ON.

Risetime and Falltime (Using an Oscilloscope)

5. Set the equipment as indicated in the following table. For each step, observe the 10% to 90% risetime and falltime of the RF burst relative to its steady-state value. (Refer to figure 3-14 for details.) The risetime and falltime should be within the limits shown in the table.

NOTE

Figure 3-14 shows the RF burst envelope as displayed on a digitizing oscilloscope. The X and O markers are at the approximate 10 and 90% points on the envelope. The reading for ΔT is the approximate risetime.

If the oscilloscope does not have adequate bandwidth at the higher frequencies shown in the table, proceed with the following steps which use a crystal detector.

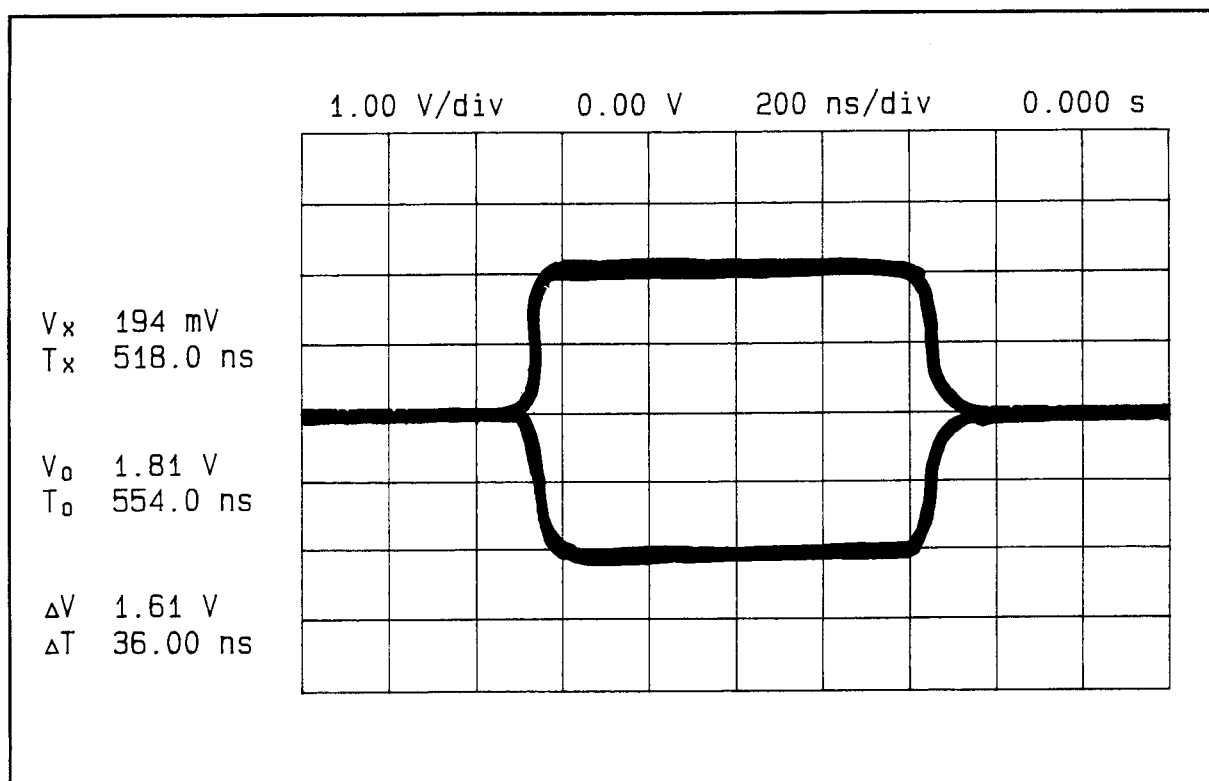

Figure 3-14. Pulse Modulation Envelope Waveform

Carrier Frequency (MHz)	Risettime Limits (ns)		Falltime Limits (ns)	
	Actual	Maximum	Actual	Maximum
10	_____	100	_____	100
20	_____	100	_____	100
50	_____	100	_____	100

Risettime (Using a Crystal Detector)

6. Connect the the crystal detector input to the Signal Generator's OUTPUT connector. Connect the feed-thru termination to the output of the detector then connect the output of the feed-thru to the oscilloscope's input.
7. Set the oscilloscope to high impedance, dc coupled.
8. Set the Signal Generator's carrier frequency as indicated in the following table. For each setting, observe the 10% to 90% risetime and falltime of the RF burst relative to its steady-state value as in step 5. Notice, however, that the waveform on the oscilloscope is now the peak-detected envelope (which may be negative). The risetime and falltime should be within the limits shown in the table.

NOTE

If there is RF feedthrough from the detector, measure the envelope of it.

Carrier Frequency (MHz)	Risetime Limits (ns)		Falltime Limits (ns)	
	Actual	Maximum	Actual	Maximum
100	_____	100	_____	100
200	_____	100	_____	100
500	_____	100	_____	100
1000	_____	100	_____	100
2000 ⁽¹⁾	_____	100	_____	100

⁽¹⁾ Option 002

Pulse On/Off Ratio

9. Set the Signal Generator as follows.
 - a. Key in AMPTD 0 dBm.
 - b. Key in FREQ 100 MHz.
10. Remove the crystal detector from the Signal Generator's OUTPUTS RF and connect the OUTPUTS RF to the spectrum analyzer's input. (The spectrum analyzer is not shown in figure 3-13.)
11. Set the pulse generator to produce a 0.5 Hz squarewave.
12. Set the spectrum analyzer as follows.
 - a. Set the center frequency to 100 MHz.
 - b. Set the vertical gain and the input attenuation to view the 0 dBm signal without compression.
 - c. Set a span suitable for viewing the RF signal which is switching on and off at a 0.5 Hz rate.
13. Set the Signal Generator's carrier frequency and the spectrum analyzer's center frequency as indicated in the following table. For each carrier frequency, observe the change in amplitude as the Signal Generator is pulsed on and off. The amplitude should drop at least 35 dB between pulse on and pulse off.

Carrier Frequency (MHz)	On/Off Ratio (dB)	
	Minimum	Actual
100	35	_____
200	35	_____
500	35	_____
1000	35	_____
2000 ⁽¹⁾	80	_____

⁽¹⁾ Option 002

Performance Test 8

FAST HOP SWITCHING TEST

Specification

Characteristic	Performance Limits	Conditions
Fast Hop Mode ⁽¹⁾		
Frequency Switching Time	<15 μ s <85 μ s <500 μ s add 5 μ s	128 to 2060 MHz carrier hop range ⁽²⁾ 8 to 2060 MHz carrier hop range ⁽²⁾ 0.25 to 2060 MHz carrier hop range ⁽²⁾ Option 002
Frequency Accuracy	± 2 ppm of the programmed carrier frequency	
Amplitude Accuracy	± 1 dB	> -127 dBm output
<p>⁽¹⁾ Typically, ± 2 ppm of carrier frequency multiplied by the temperature change in C must be added if ambient temperature changes occur between the "learn" operation and the conclusion of frequency hopping.</p> <p>⁽²⁾ Option 002. Without Option 002 the carrier range is to 1030 MHz.</p>		

Description

The output from the Signal Generator is mixed with a fixed reference to produce a beatnote (that is, a frequency equal to the difference between the two RF frequencies) that is examined on a frequency and time-interval analyzer and an oscilloscope. The Signal Generator is set to hop between two frequencies: one frequency (1 GHz) that produces a beatnote within range of the measuring instruments and one frequency that does not. (The frequencies are chosen to tune the Signal Generator's VCO over its total range.) The fast hop characteristics of the Signal Generator are measured in several stages. (Refer to figure 3-15 for waveform details.) The data for measurements made on the frequency and time-interval analyzer is presented in statistical form.

1. The CW amplitude of the beatnote is measured by the oscilloscope. The measured result is used as an amplitude reference.
2. The CW frequency of the beatnote is measured by the analyzer with the Signal Generator in its normal synthesized operating mode. The measured result is used as a frequency reference.
3. The Signal Generator is set to the Fast Hop mode. RF bursts from the Signal Generator are triggered by an external pulse generator which also triggers the analyzer and oscilloscope.
4. The pulse burst's envelope is measured with the oscilloscope and compared with the CW amplitude.
5. The time delay between the hop trigger and the occurrence of the first measurable cycle of the beatnote is measured with the analyzer.

6. The frequency of several beatnote cycles is measured with the analyzer beginning at a time after the hop trigger when measurable cycles of the beatnote are guaranteed to be present, but within the specified settling time. (The presence of beatnote cycles was confirmed by the previous measurement.)

The tests are made with the carrier hopping to 1 GHz from a frequency in one of the specified carrier bands as follows:

- 515 MHz in the 128 to 1030 MHz band
- 65 MHz in the 8 to 1030 MHz band
- 5 MHz in the 0.25 to 1030 MHz band

Two pulse generators are required. One is used to frequency hop the Signal Generator. The other is synchronized to the first and divides its output by two; it is used to trigger the oscilloscope and analyzer on the pulse burst that produces the in-range beatnote.

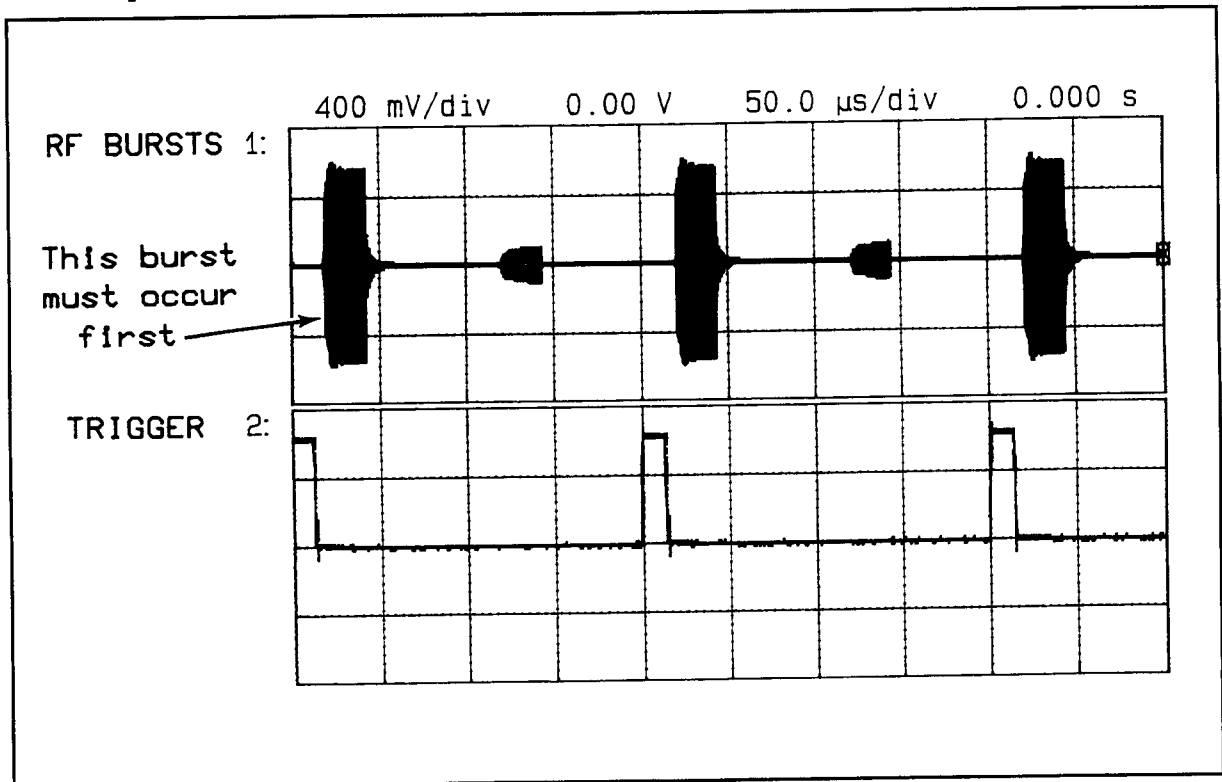

Figure 3-15. Fast Hop Switching Waveforms

Equipment

Frequency and Time Interval Analyzer	HP 5371A
Pods (2 required) for HP 5371A	HP 54002A
Oscilloscope	HP 1740A or Tektronix 2245
Phase Noise Measurement System	HP 3048A
Pulse Generator (2 required)	HP 8116A
Signal Generator	HP 8642B or HP 8645A or HP 8662A

NOTE

Since this test is written specifically for the HP 5371A and the HP 3048A, no substitute of this equipment is recommended.

Procedure

NOTE

Before beginning this performance test, the Signal Generator should be allowed a 24 hour warm-up period after being connected to the ac power line and an additional 2 hour warm up after being switched on.

In the following procedure, after entering the Fast Hop mode all measurements pertaining to that mode should be completed with an ambient temperature drift of no more than ± 0.5 C. In other words, do the test as quickly as possible.

Initial Setup

1. Connect the equipment as shown in figure 3-16.

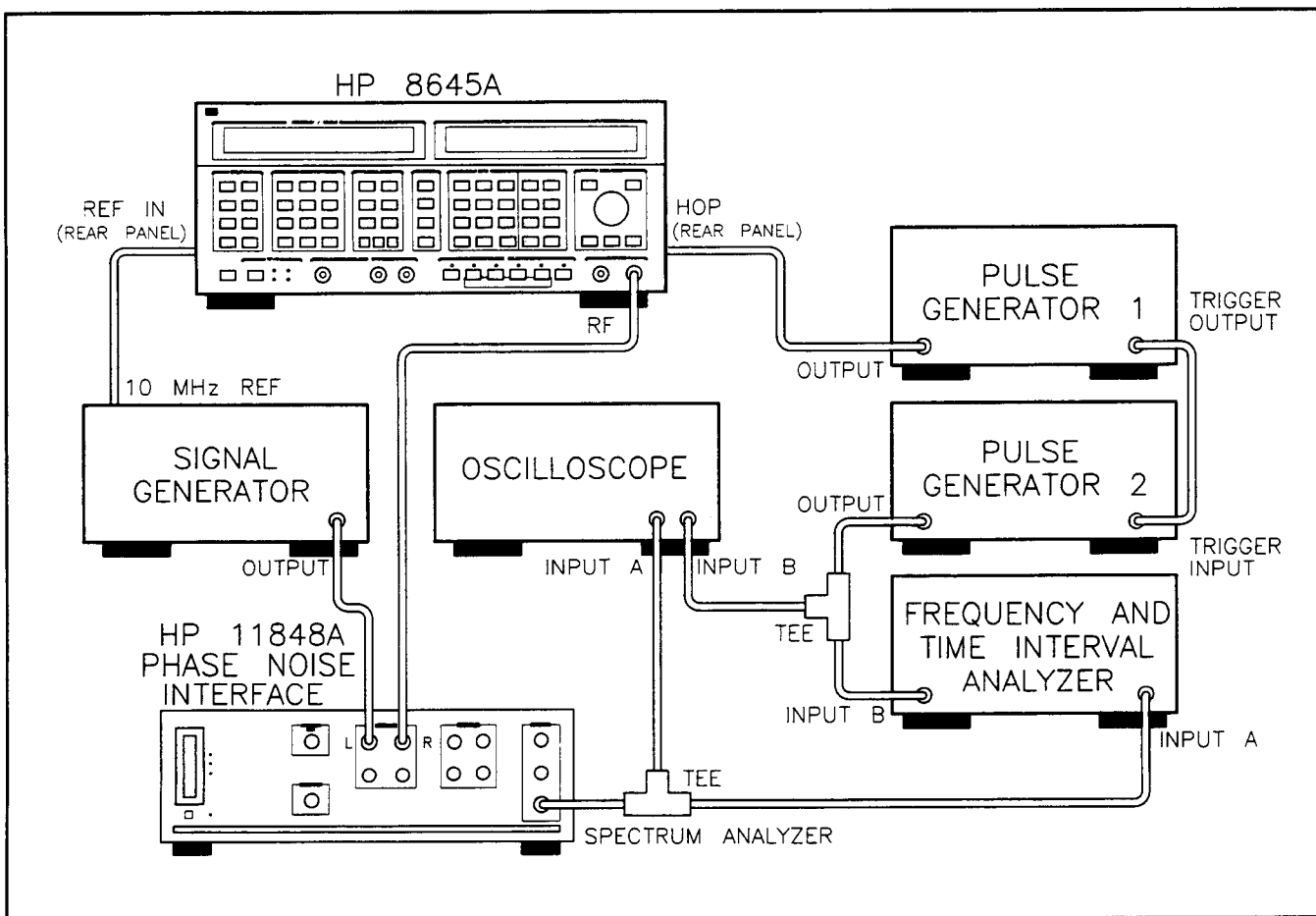

Figure 3-16. Fast Hop Switching Test Setup

2. Set the reference signal generator (not the Signal Generator under test) frequency to 1001 MHz CW and the level to 16 dBm.
3. On the Signal Generator under test press INSTR PRESET then key in FREQ 1 GHz and AMPTD 17 dBm (or the highest amplitude allowed for Signal Generators with Option 002 or 005).
4. Boot up the phase noise measurement system to the Main Software Menu level then set the system as follows.

- a. Press the **Spcl. Funct'n** softkey available at the Main Software Level menu.
- b. Press the **11848A Control** softkey to initiate manual control of the system's interface.
- c. Press the **Preset** softkey to preset the interface.
- d. Use the cursor control keys to move the cursor to the "SELECTED 'K' SWITCHES:" line then key in 12. (Refer to figure 3-17.)
- e. Press the **Send Command** softkey to initiate the commands. The display should appear as in figure 3-17.

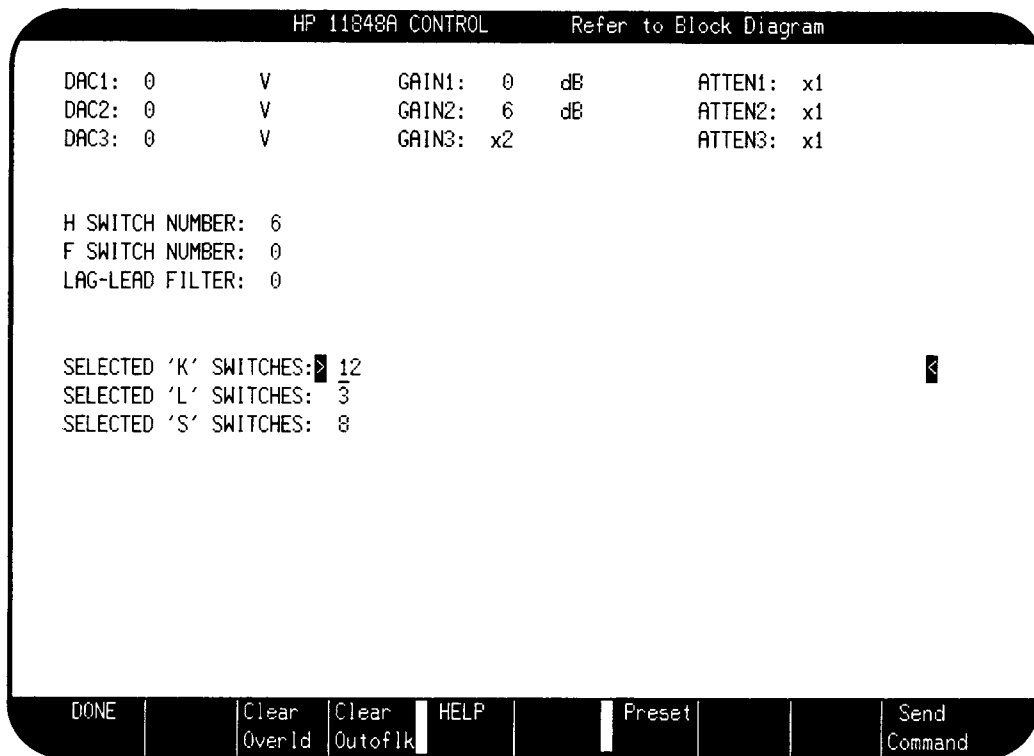

Figure 3-17. HP 11848A Control Display for Fast Hop Test

5. Set the first pulse generator as follows.
 - a. Set the pulse repetition rate (frequency) to 10 kHz.
 - b. Set the pulse width to 10 μ s.
 - c. Set the amplitude to be compatible with TTL devices (for example, 0V low and 4V high). (Do not allow the pulse to go below 0V.)
6. Set the second pulse generator as follows.
 - a. Set the pulse repetition rate (frequency) to 5 kHz.
 - b. Set the pulse width to 10 μ s.
 - c. Set the amplitude to be compatible with TTL devices.
 - d. Set its external gate mode to trigger from the trigger output of the first pulse generator. The output from the second pulse generator is correct when it outputs 5 kHz in synchronization with the 10 kHz of the first pulse generator. (The method of synchronizing the two pulse generators may vary from model to model. Use the oscilloscope to verify synchronization if necessary.)

7. Set the oscilloscope as follows.
 - a. Set the input coupling of channels A and B to dc with high input impedance.
 - b. Set the vertical scale of channel A to view a 1200 mV peak-to-peak signal.
 - c. Set the vertical scale of channel B to view a signal switching between 0 and 4 V dc.
 - d. Set the sweep time to 50 μ s per division.
 - e. Set the triggering to automatically trigger on the rising transition of the second pulse generator's output.

CW Amplitude

8. The oscilloscope should now display a 1 MHz (1 μ s) CW beatnote with an amplitude of approximately 1200 mVpp. Record this level for future reference. (Note that the Signal Generator is not yet in the Fast Hop mode.)

CW Amplitude: _____ mVpp

CW Frequency

NOTE

The configuration of the HP 5371A Frequency and Time Interval Analyzer is modified by changing parameters within menu screens obtained by the MENU SELECTION keys. When a new menu is to be modified, it is best to start at the first highlighted function and to work down the display modifying each highlighted function as needed.

9. Set the frequency and time-interval analyzer as follows.
 - a. Press the PRESET key.
 - b. Press the FUNCTION key and set the analyzer's functions as shown below.

```

Frequency A:                               1.000 0 MHz
FUNCTION _____
[FREQUENCY] Measurement Channel [A]
Acquire [1] block of [100] meas
Total Measurements = 100
[TIME/TIME] Arming Mode _____
Start Arm:
After [POS] edge of [CHN B], [Delay Ref]
Delay [13.000  $\mu$ s]
Then arm each measurement

Stop Arm:

Following the Delay Ref edge,
Delay [15.000  $\mu$ s]
Then arm the end of each measurement
    
```

c. Press the INPUT key and set the analyzer's inputs as shown below.

Frequency A:	1.000 0 MHz	SEPARATE	
INPUT	_____		
<input checked="" type="checkbox"/> SEPARATE	Input Channels	COMMON	
Trigger Event:	_____		
	Slope	Mode	Level
Chan A:	<input checked="" type="checkbox"/> POS	<input checked="" type="checkbox"/> MANUAL	<input checked="" type="checkbox"/> 0 V
Chan B:	<input checked="" type="checkbox"/> POS	<input checked="" type="checkbox"/> MANUAL	<input checked="" type="checkbox"/> 1.400 V
Ext Arm Level	<input checked="" type="checkbox"/> 0 V		
	Channel A	Channel B	
Input Pod	HP 54002A	HP 54002A	
Impedance	50 ohm	50 ohm	
Bias Level	<input checked="" type="checkbox"/> GND	<input type="checkbox"/> GND	
Attenuation	<input checked="" type="checkbox"/> 1:1	<input checked="" type="checkbox"/> 2.5:1	
Maximum Input	2 V peak	5 V peak	

d. Press the MATH key and set the analyzer's math channel processing as shown below.

Frequency A:	1.000 0 MHz	OFF	
MATH	_____		
	Channel A	Channel B	ON
Reference	0E+00	0E+00	Set Ch A Reference
Statistics	<input checked="" type="checkbox"/> ON	<input checked="" type="checkbox"/> OFF	_____
Math:	<input checked="" type="checkbox"/> OFF	<input checked="" type="checkbox"/> OFF	Clear Ch A Reference
Limits:	<input checked="" type="checkbox"/> OFF	<input checked="" type="checkbox"/> OFF	_____

- e. Press the NUMERIC key. (Repeating blocks of 100 measurements should be displayed.)
- f. Press the **Statistics** softkey. The display should be similar to the one shown below. The mean frequency should be approximately 1 MHz. Record this frequency for future reference.

CW Frequency: _____ MHz

Block Size = 1		Result
STATISTICS DISPLAY	_____	
Frequency A	14 Apr 1988 10:00:15	_____
Block # 1	100 Measurements	Statistics
Mean	1.000 05 MHz	_____
Std Dev	90 Hz	Result /
Maximum	1.000 3 MHz	Statistics
Minimum	999.8 kHz	=====
RMS	1.000 05 MHz	Limit
Rt Al Var	60 Hz	Status
Allan Var	3.5 kHz^2	_____
Variance	8.4 kHz^2	Bold

		Return to
		Main Menu

- g. Key in SAVE 1 to save the instrument setup in register 1. (If an error message indicates that the register is write-protected, press the INSTR STATE key and either select a register that is not protected or turn the write protection for register 1 off.)

Pulse Amplitude (Hopping from 515 MHz)

10. Set the Signal Generator as follows.

- a. Press FAST HOP (in the SYNTHESIS MODE key group).
- b. Key in SHIFT CLR CHAN ENTER to clear out previously stored hop channels. (The CLR CHAN key and many other keys used in this test are located in the DATA key group.)
- c. Key in SHIFT CLR SEQ ENTER to clear out previously stored hop sequences.
- d. Key in SHIFT STO CHAN ENTER to store 1 GHz in channel 0.
- e. Key in SHIFT SET SEQ ENTER to store 1 GHz as the frequency in sequence 0.
- f. Key in FREQ 515 MHz.
- g. Key in SHIFT STO CHAN ENTER to store 515 MHz in channel 1.
- h. Key in SHIFT SET SEQ ENTER to store 515 MHz as the frequency in sequence 1.
- i. Key in SHIFT DWELL then key in 20 μs to set the internal dwell time to 20 μs.
- j. Key in SHIFT MODE then rotate the knob until the display reads Ext Stepped Int Dwell.
- k. Key in SHIFT HOP to initiate the Fast Hop mode.

11. After a 10s “learn” period, the waveform on the oscilloscope should appear as shown in figure 3-15 (at the beginning of this procedure).

NOTE

Note that the waveform has two, alternating pulse bursts. The larger burst occurs when the Signal Generator is at 1 GHz, the smaller at 515 MHz. The larger burst should be triggered by the 5 kHz pulse generator. If it is not, momentarily remove then reconnect the Signal Generator’s HOP input and reconfirm the triggering. (More than one try may be required because the synchronization is completely random.)

12. Note the peak-to-peak amplitude of the pulse envelope and compute the amplitude error as follows:

$$\text{Amplitude Error} = \frac{\text{Reading of Step 12}}{\text{Reading of Step 8}}$$

The amplitude error should be between 0.88 and 1.12 (that is, ±1 dB).

Amplitude Error (Hopping from 515 MHz): 0.89 _____ 1.12

Pulse Burst Time Delay (Hopping from 515 MHz)

13. Set the frequency and time-interval analyzer as follows.
 - a. Press the PRESET key.
 - b. Press the FUNCTION key and set the analyzer’s functions as shown below.

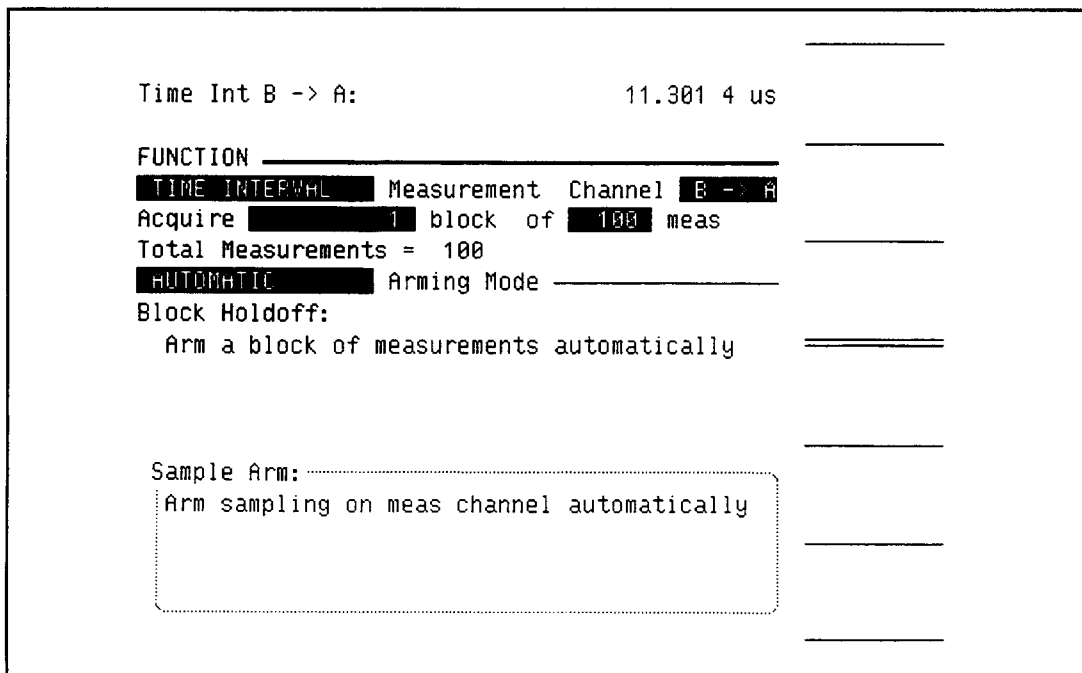

- c. Press the INPUT key and set the analyzer's inputs as shown below. (Note that the difference between this menu and the menu shown in step 9c is the trigger event level for channel A.)

Time Int B -> A:	11.205 0 us	1:1
INPUT	_____	
SEPARATE Input Channels		2.5:1
Trigger Event:	_____	
	Slope	Mode
Chan A:	POS	MANUAL
Chan B:	POS	MANUAL
	Level	
	200 mV	
	1.400 V	
Ext Arm Level	0 V	
	Channel A	Channel B
Input Pod	HP 54002A	HP 54002A
Impedance	50 ohm	50 ohm
Bias Level	GND	GND
Attenuation	1:1	2.5:1
Maximum Input	2 V peak	5 V peak

- d. Press the MATH key and set the analyzer's math channel processing as in step 9d.
- e. Press the NUMERIC key. (Repeating blocks of 100 measurements should be displayed.)

- f. Press the **Statistics** softkey. The display should be similar to the one shown below. The maximum time interval should be less than 12.5 μ s. (Ignore the "Events have been missed." error message.)

		Result
Measurement Size = 100		
STATISTICS DISPLAY		
Time Interval B -> A	14 Apr 1988 10:18:16	
Block # 1	100 Measurements	Statistics
Mean	11.425 33 us	
Std Dev	248.35 ns	Result /
Maximum	11.938 6 us	Statistics
Minimum	11.055 2 us	
RMS	11.428 00 us	Limit
Rt Al Var	175.27 ns	Status
Allan Var	30.720 148 4E-15s^2	
Variance	61.678 071 3E-15s^2	
		Bold
		Return to
		Main Menu

- g. Key in SAVE 2 to save the setup in register 2.

Pulse Frequency (Hopping from 515 MHz)

14. On the frequency and time-interval analyzer, key in RECALL 1, then press the NUMERIC key. The display should be similar to the one shown below.

STATISTICS DISPLAY		Measurement Size = 100	Result
Frequency A		14 Apr 1988 10:25:21	
Block # 1		100 Measurements	Statistics
Mean		999.43 kHz	
Std Dev		470 Hz	Result /
Maximum		1.000 1 MHz	Statistics
Minimum		998.5 kHz	
RMS		999.43 kHz	Limit
Rt Al Var		340 Hz	Status
Allan Var		118.5 kHz ²	
Variance		219.6 kHz ²	
			Bold
			Return to
			Main Menu

15. Note the mean frequency and compute the frequency error as follows:

$$\text{Frequency Error} = \text{Reading of Step 15} - \text{Reading of Step 9f.}$$

The frequency error should be between -2 and 2 kHz (that is, ± 2 ppm of 1 GHz).

Frequency Error (Hopping from 515 MHz): -2 _____ 2 kHz

Measurements Hopping from 65 MHz

16. Set the repetition rate (frequency) of the first pulse generator to 2 kHz, and if necessary, adjust the second pulse generator to produce a 1 kHz pulse rate synchronized to the first pulse generator.
17. Set the oscilloscope as necessary to observe the slower pulse rate.
18. Set the Signal Generator as follows.
 - a. Key in SHIFT IDLE.
 - b. Key in FREQ 65 MHz.
 - c. Key in SHIFT STO CHAN 1 ENTER.
 - d. Key in SHIFT DWELL 50 μ s.
 - e. Key in SHIFT HOP.
19. After the “learn” period verify on the oscilloscope that the pulse burst begins within 70 μ s after the positive edge of the hop trigger pulse. If it does not, momentarily remove then reconnect the Signal Generator’s HOP input. (The view on the oscilloscope will be similar to figure 3-15 but the delay is longer and the second, smaller burst might not be as visible.)
20. Note the peak-to-peak amplitude of the pulse envelope and compute the amplitude error as follows:

$$\text{Amplitude Error} = \frac{\text{Reading of Step 20}}{\text{Reading of Step 8}}$$

The amplitude error should be between 0.88 and 1.12.

Amplitude Error (Hopping from 65 MHz): 0.89 _____ 1.12

21. On the frequency and time-interval analyzer, key in RECALL 2 to recall the time interval function setup. The numeric statistics display should show. The maximum time interval should be less than 70 μ s.
22. Set the frequency and time-interval analyzer as follows.
 - a. Key in RECALL 1 to recal the frequency function setup.
 - b. Press the FUNCTION key.
 - c. Change the start arm delay entry from 13 μ s to 75 μ s.
 - d. Change the stop arm delay entry from 15 μ s to 85 μ s.
 - e. Press the NUMERIC key.
23. Note the mean frequency and compute the frequency error as follows:

$$\text{Frequency Error} = \text{Reading of Step 23} - \text{Reading of Step 9f.}$$

The frequency error should be between -2 and 2 kHz.

Frequency Error (Hopping from 65 MHz): -2 _____ 2 kHz

Measurements Hopping from 5 MHz

24. Set the repetition rate (frequency) of the first pulse generator to 500 Hz, and if necessary, adjust the second pulse generator to produce a 250 Hz pulse rate synchronized to the first pulse generator.
25. Set the oscilloscope as necessary to observe the slower pulse rate.
26. Set the Signal Generator as follows.
 - a. Key in SHIFT IDLE.
 - b. Key in FREQ 5 MHz.
 - c. Key in SHIFT STO CHAN 1 ENTER.
 - d. Key in SHIFT DWELL 500 μ s.
 - e. Key in SHIFT HOP.
27. After the “learn” period verify on the oscilloscope that the pulse burst begins within 200 μ s after the hop trigger pulse. If it does not, momentarily remove then reconnect the Signal Generator’s HOP input.
28. Note the peak-to-peak amplitude of the pulse envelope and compute the amplitude error as follows:

$$\text{Amplitude Error} = \frac{\text{Reading of Step 28}}{\text{Reading of Step 8}}$$

The amplitude error should be between 0.88 and 1.12.

Amplitude Error (Hopping from 5 MHz): 0.89 _____ 1.12

29. On the frequency and time-interval analyzer, key in RECALL 2 to recall the time interval function setup. The numeric statistics display should show. The maximum time interval should be less than 200 μ s.
30. Set the frequency and time-interval analyzer as follows.
 - a. Key in RECALL 1 to recal the frequency function setup.
 - b. Press the FUNCTION key.
 - c. Change the start arm delay entry from 13 μ s to 300 μ s.
 - d. Change the stop arm delay entry from 15 μ s to 500 μ s.
 - e. Press the NUMERIC key.
31. Note the mean frequency and compute the frequency error as follows:

$$\text{Frequency Error} = \text{Reading of Step 31} - \text{Reading of Step 9f.}$$

The frequency error should be between -2 and 2 kHz.

Frequency Error (Hopping from 5 MHz): -2 _____ 2 kHz

Table 3-2. Performance Test Record (1 of 8)

Hewlett-Packard Company HP 8645A Agile Signal Generator Tested By _____ Serial Number _____ Date _____				
Test No.	Test Description	Results		
		Minimum	Actual	Maximum
1	CARRIER AMPLITUDE PERFORMANCE TEST			
	Maximum Level-Standard			
	<i>Frequency and Amplitude Settings</i>			
	0.26 MHz; +17 dBm	+16 dBm	_____	
	1 MHz; +17 dBm	+16 dBm	_____	
	10 MHz; +17 dBm	+16 dBm	_____	
	100 MHz; +17 dBm	+16 dBm	_____	
	1030 MHz; +17 dBm	+16 dBm	_____	
	Maximum Level-Option 002			
	<i>Frequency and Amplitude Settings</i>			
	0.26 MHz; +15 dBm	+14 dBm	_____	
	1 MHz; +15 dBm	+14 dBm	_____	
	10 MHz; +15 dBm	+14 dBm	_____	
	100 MHz; +15 dBm	+14 dBm	_____	
	1030 MHz; +15 dBm	+14 dBm	_____	
	2060 MHz; +14 dBm	+13 dBm	_____	
	High-Amplitude Accuracy			
	<i>Frequency and Amplitude Settings</i>			
	1030 MHz; +6 dBm	+5 dBm	_____	+7 dBm
	1030 MHz; +7 dBm	+6 dBm	_____	+8 dBm
	1030 MHz; +8 dBm	+7 dBm	_____	+9 dBm
	1030 MHz; +9 dBm	+8 dBm	_____	+10 dBm
	1030 MHz; +10 dBm	+9 dBm	_____	+11 dBm
	1030 MHz; +11 dBm	+10 dBm	_____	+12 dBm
	1030 MHz; +12 dBm	+11 dBm	_____	+13 dBm
	1030 MHz; +13 dBm	+12 dBm	_____	+14 dBm
	1030 MHz; +14 dBm	+13 dBm	_____	+15 dBm
2060 MHz; +13 dBm (Option 002)	+12 dBm	_____	+14 dBm	
100 MHz; +14 dBm	+13 dBm	_____	+15 dBm	
10 MHz; +14 dBm	+13 dBm	_____	+15 dBm	
1 MHz; +14 dBm	+13 dBm	_____	+15 dBm	
0.26 MHz; +14 dBm	+13 dBm	_____	+15 dBm	

Table 3-2. Performance Test Record (2 of 8)

Test No.	Test Description	Results		
		Minimum	Actual	Maximum
1	CARRIER AMPLITUDE PERFORMANCE TEST (Continued)			
	High-Amplitude Accuracy (continued)			
	<i>Frequency and Amplitude Settings</i>			
	0.26 MHz; +10 dBm	+9 dBm	_____	+11 dBm
	1 MHz; +10 dBm	+9 dBm	_____	+11 dBm
	10 MHz; +10 dBm	+9 dBm	_____	+11 dBm
	100 MHz; +10 dBm	+9 dBm	_____	+11 dBm
	2060 MHz; +10 dBm (Option 002)	+9 dBm	_____	+11 dBm
	2060 MHz; +5 dBm (Option 002)	+4 dBm	_____	+6 dBm
	1030 MHz; +5 dBm	+4 dBm	_____	+6 dBm
	100 MHz; +5 dBm	+4 dBm	_____	+6 dBm
	10 MHz; +5 dBm	+4 dBm	_____	+6 dBm
	1 MHz; +5 dBm	+4 dBm	_____	+6 dBm
	0.26 MHz; +5 dBm	+4 dBm	_____	+6 dBm
	0.26 MHz; +0 dBm	-1 dBm	_____	+1 dBm
	1 MHz; +0 dBm	-1 dBm	_____	+1 dBm
	10 MHz; +0 dBm	-1 dBm	_____	+1 dBm
	100 MHz; +0 dBm	-1 dBm	_____	+1 dBm
	1030 MHz; +0 dBm	-1 dBm	_____	+1 dBm
	2060 MHz; +0 dBm (Option 002)	-1 dBm	_____	+1 dBm
	Low-Amplitude Accuracy			
	<i>Amplitude Setting</i>			
	-5 dBm	-6 dBm	_____	-4 dBm
	-10 dBm	-11 dBm	_____	-9 dBm
	-15 dBm	-16 dBm	_____	-14 dBm
	-20 dBm	-21 dBm	_____	-19 dBm
	-25 dBm	-26 dBm	_____	-24 dBm
	-30 dBm	-31 dBm	_____	-29 dBm
	-35 dBm	-36 dBm	_____	-34 dBm
	-40 dBm	-41 dBm	_____	-39 dBm
	-45 dBm	-46 dBm	_____	-44 dBm
	-50 dBm	-51 dBm	_____	-49 dBm
	-55 dBm	-56 dBm	_____	-54 dBm
	-60 dBm	-61 dBm	_____	-59 dBm
	-65 dBm	-66 dBm	_____	-64 dBm
-70 dBm	-71 dBm	_____	-69 dBm	
-75 dBm	-76 dBm	_____	-74 dBm	
-80 dBm	-81 dBm	_____	-79 dBm	
-85 dBm	-86 dBm	_____	-84 dBm	
-90 dBm	-91 dBm	_____	-89 dBm	
-95 dBm	-96 dBm	_____	-94 dBm	

Table 3-2. Performance Test Record (3 of 8)

Test No.	Test Description	Results		
		Minimum	Actual	Maximum
1	CARRIER AMPLITUDE PERFORMANCE TEST (Continued)			
	Low-Amplitude Accuracy (continued)			
	<i>Amplitude Setting</i>			
	-100 dBm	-101 dBm	_____	-99 dBm
	-105 dBm	-106 dBm	_____	-104 dBm
	-110 dBm	-111 dBm	_____	-109 dBm
	-115 dBm	-116 dBm	_____	-114 dBm
	-120 dBm	-121 dBm	_____	-119 dBm
	-127 dBm	-128 dBm	_____	-126 dBm
2	AM TEST			
	Residual AM			
	<i>Frequency and Amplitude Settings</i>			
	1000 MHz; +15 dBm		_____	0.01%
	1000 MHz; +6 dBm		_____	0.01%
	1300 MHz; +6 dBm (Option 002)		_____	0.01%
	1300 MHz; +15 dBm (Option 002)		_____	0.01%
	Indicator Accuracy			
	<i>AM Depth Setting</i>			
	10%	8.4%	_____	11.6%
	20%	17.8%	_____	22.2%
	30%	27.2%	_____	32.8%
	40%	36.6%	_____	43.4%
	50%	46.0%	_____	54.0%
	60%	55.4%	_____	64.6%
	70%	64.8%	_____	75.2%
	80%	74.2%	_____	85.8%
	90%	83.6%	_____	96.4%
	Distortion			
	<i>AM Depth Setting and Option</i>			
	30%; Standard		_____	2%
	70%; Standard		_____	3%
90%; Standard		_____	5%	
90%; Option 002		_____	8%	
70%; Option 002		_____	5%	
30%; Option 002		_____	5%	

Table 3-2. Performance Test Record (4 of 8)

Test No.	Test Description	Results		
		Minimum	Actual	Maximum
2	AM TEST (Continued)			
	Incidental Phase Modulation		_____	0.2 rad peak
	3 dB Bandwidth			
	<i>Carrier Frequency and AM Rate Settings</i>			
	0.26 MHz; 5 kHz	-3 dB	_____	+3 dB
	11 MHz; 50 kHz	-3 dB	_____	+3 dB
	129 MHz; 100 kHz	-3 dB	_____	+3 dB
1030 MHz; 100 kHz	-3 dB	_____	+3 dB	
1300 MHz; 100 kHz (Option 002)	-3 dB	_____	+3 dB	
3	FM TEST (LOW DEVIATIONS AND RATES)			
	Residual FM			
	<i>Frequency Setting (300 Hz to 3 kHz bandwidth)</i>			
	250 MHz		_____	1 Hz rms
	500 MHz		_____	1.2 Hz rms
	1000 MHz		_____	2 Hz rms
	1300 MHz (Option 002)		_____	4 Hz rms
	<i>Frequency Setting (50 Hz to 15 kHz bandwidth)</i>			
	1300 MHz (Option 002)		_____	8 Hz rms
	1000 MHz		_____	4 Hz rms
	500 MHz		_____	2 Hz rms
	250 MHz		_____	1.2 Hz rms
	Indicator Accuracy (Auto Mode)			
	<i>Frequency and FM Deviation Settings</i>			
	500 MHz; 360 kHz peak	324 kHz	_____	396 kHz
	260 MHz; 360 kHz peak	324 kHz	_____	396 kHz
	250 MHz; 250 kHz peak	225 kHz	_____	275 kHz
130 MHz; 250 kHz peak	225 kHz	_____	275 kHz	
Indicator Accuracy (Fast Hop)				
<i>Frequency and FM Deviation Settings</i>				
130 MHz; 200 kHz peak	180 kHz	_____	220 kHz	
250 MHz; 200 kHz peak	180 kHz	_____	220 kHz	
260 MHz; 360 kHz peak	324 kHz	_____	396 kHz	
500 MHz; 360 kHz peak	324 kHz	_____	396 kHz	

Table 3-2. Performance Test Record (5 of 8)

Test No.	Test Description	Results		
		Minimum	Actual	Maximum
3	FM TEST (LOW DEVIATIONS AND RATES) (Continued)			
	Distortion			
	<i>FM Deviation Setting (Fast Hop)</i>			
	66 kHz peak		_____	1.3%
	400 kHz peak		_____	6%
	<i>FM Deviation Setting (Auto Mode)</i>			
	400 kHz peak		_____	6%
	75 kHz peak		_____	1.3%
	Incidental AM		_____	0.5%
	Maximum Rate (3 dB Bandwidth)			
	<i>Frequency, FM Deviation, and Rate Settings (Auto Mode)</i>			
	32 MHz; 300 kHz peak; 200 kHz	-3 dB	_____	+3 dB
	17 MHz; 300 kHz peak; 200 kHz	-3 dB	_____	+3 dB
	11 MHz; 150 kHz peak; 150	-3 dB	_____	+3 dB
	0.8 MHz; 9.6 kHz peak; 9.6 kHz	-3 dB	_____	+3 dB
	0.4 MHz; 4.7 kHz peak; 4.7 kHz	-3 dB	_____	+3 dB
	<i>Frequency, FM Deviation, and Rate Settings (Fast Hop)</i>			
	0.4 MHz; 0.7 kHz peak; 4.7 kHz	-3 dB	_____	+3 dB
	0.8 MHz; 1.6 kHz peak; 9.6 kHz	-3 dB	_____	+3 dB
	11 MHz; 27.4 kHz peak; 150	-3 dB	_____	+3 dB
	17 MHz; 54 kHz peak; 200 kHz	-3 dB	_____	+3 dB
	32 MHz; 54 kHz peak; 200 kHz	-3 dB	_____	+3 dB
	Carrier Frequency Accuracy in FM			
	<i>Frequency and FM Deviation Settings</i>			
	10 MHz; 0.15 MHz peak		_____	0.6 kHz
	20 MHz; 0.3 MHz peak		_____	1.2 kHz
	50 MHz; 0.625 MHz peak		_____	2.5 kHz
100 MHz; 1.25 MHz peak		_____	5 kHz	
200 MHz; 2.5 MHz peak		_____	10 kHz	
500 MHz; 5 MHz peak		_____	20 kHz	
1000 MHz; 10 MHz peak		_____	40 kHz	

Table 3-2. Performance Test Record (6 of 8)

Test No.	Test Description	Results		
		Minimum	Actual	Maximum
3	FM TEST (LOW DEVIATIONS AND RATES) (Continued)			
	Internal Modulation Source Distortion			
	<i>Audio Rate Setting</i>			
	15 000 Hz		_____	0.1%
	2 000 Hz		_____	0.1%
	200 Hz		_____	0.1%
	20 Hz		_____	0.1%
4	FM TEST (HIGH DEVIATIONS AND RATES)			
	Indicator Accuracy			
	<i>Mode, FM Deviation, and Rate Settings</i>			
	Auto; 500 kHz peak; 50 kHz	1.9 dB	_____	3.7 dB
	Fast Hop; 440 kHz peak; 50 kHz	0.8 dB	_____	2.6 dB
	Fast Hop; 880 kHz peak; 3.75 kHz	6.3 dB	_____	9.2 dB
	Auto; 850 kHz peak; 3.75 kHz	6.1 dB	_____	8.8 dB
	Distortion			
	<i>Mode and FM Deviation Settings</i>			
	Auto; 150 kHz peak		_____	-37.7 dB
	Auto; 5000 kHz peak		_____	-24.4 dB
	Fast Hop; 132 kHz peak		_____	-37.7 dB
	Fast Hop; 880 kHz peak		_____	-24.4 dB
Maximum Rate (3 dB Bandwidth)				
<i>Mode, FM Deviation, and Rate Settings</i>				
Fast Hop; 880 kHz peak; 5 MHz	3.5 div	_____	7.1 div	
Auto; 5 MHz peak; 5 MHz	3.5 div	_____	7.1 div	
5	SPECTRAL PURITY TEST (SSB PHASE NOISE)			
	SSB Phase Noise			
	<i>Frequency, Mode, and Offset Settings</i>			
	1100 MHz; Auto, 20 kHz (Option 002)		_____	-120 dBc
	1100 MHz; Auto, 100 kHz (Option 002)		_____	-127 dBc
	1100 MHz; Fast Hop, 20 kHz (Option 002)		_____	-116 dBc
550 MHz; Fast Hop, 20 kHz		_____	-123 dBc	
550 MHz; Auto, 20 kHz		_____	-127 dBc	

Table 3-2. Performance Test Record (7 of 8)

Test No.	Test Description	Results		
		Minimum	Actual	Maximum
5	SPECTRAL PURITY TEST (SSB PHASE NOISE) (Continued)			
	SSB Phase Noise (Continued)			
	<i>Frequency, Mode, and Offset Settings</i>			
	550 MHz; Auto, 100 kHz		_____	-134 dBc
	300 MHz; Auto, 20 kHz		_____	-132 dBc
	300 MHz; Auto, 100 kHz		_____	-137 dBc
	300 MHz; Fast Hop, 20 kHz		_____	-128 dBc
	150 MHz; Fast Hop, 20 kHz		_____	-133 dBc
	150 MHz; Auto, 20 kHz		_____	-136 dBc
	150 MHz; Auto, 100 kHz		_____	-140 dBc
	80 MHz; Auto, 20 kHz		_____	-139 dBc
	80 MHz; Auto, 100 kHz		_____	-141 dBc
	80 MHz; Fast Hop, 20 kHz		_____	-137 dBc
	40 MHz; Fast Hop, 20 kHz		_____	-139 dBc
	40 MHz; Auto, 20 kHz		_____	-141 dBc
	40 MHz; Auto, 100 kHz		_____	-141 dBc
	20 MHz; Auto, 20 kHz		_____	-142 dBc
	20 MHz; Auto, 100 kHz		_____	-142 dBc
	20 MHz; Fast Hop, 20 kHz		_____	-141 dBc
	10 MHz; Fast Hop, 20 kHz		_____	-142 dBc
	10 MHz; Auto, 20 kHz		_____	-143 dBc
10 MHz; Auto, 100 kHz		_____	-143 dBc	
	Non-Harmonic Spurious			
	Worst Case, 0.25 to 1030 MHz		_____	-100 dBc
	Worst Case, 1030 to 2060 MHz (Option 002)		_____	-94 dBc
6	SPECTRAL PURITY TEST (HARMONICS)			
	Harmonics			
	0.25 to 1030 MHz		_____	-30 dBc
	1030 to 2060 MHz (Option 002)		_____	-30 dBc
	Subharmonics			
	515 MHz Span		_____	none
515 to 1030 MHz Span		_____	-55 dBc	
1030 to 2060 MHz Span (Option 002)		_____	-40 dBc	

Table 3-2. Performance Test Record (8 of 8)

Test No.	Test Description	Results		
		Minimum	Actual	Maximum
7	PULSE MODULATION TEST			
	Rise and Fall Time			
	<i>Frequency Setting and Measurement</i>			
	10 MHz, Risetime		_____	100 ns
	10 MHz, Falltime		_____	100 ns
	20 MHz, Risetime		_____	100 ns
	20 MHz, Falltime		_____	100 ns
	50 MHz, Risetime		_____	100 ns
	50 MHz, Falltime		_____	100 ns
	100 MHz, Risetime		_____	100 ns
	100 MHz, Falltime		_____	100 ns
	200 MHz, Risetime		_____	100 ns
	200 MHz, Falltime		_____	100 ns
	500 MHz, Risetime		_____	100 ns
	500 MHz, Falltime		_____	100 ns
	1000 MHz, Risetime		_____	100 ns
	1000 MHz, Falltime		_____	100 ns
	2000 MHz, Risetime (Option 002)		_____	100 ns
	2000 MHz, Falltime (Option 002)		_____	100 ns
	7	On/Off Ratio		
<i>Frequency Setting</i>				
100 MHz		35 dB	_____	
200 MHz		35 dB	_____	
500 MHz		35 dB	_____	
1000 MHz		35 dB	_____	
2000 MHz (Option 002)		35 dB	_____	
8	FAST HOP SWITCHING TEST			
	Amplitude and Frequency Error			
	Amplitude Error, Hopping from 515 MHz	0.89	_____	1.12
	Frequency Error, Hopping from 515 MHz	-2 kHz	_____	+2 kHz
	Amplitude Error, Hopping from 65 MHz	0.89	_____	1.12
	Frequency Error, Hopping from 65 MHz	-2 kHz	_____	+2 kHz
	Amplitude Error, Hopping from 5 MHz	0.89	_____	1.12
Frequency Error, Hopping from 5 MHz	-2 kHz	_____	+2 kHz	