

# Operating and Service Manual

## Agilent Technologies 86205A Directional Bridge

### Serial Numbers

This manual applies to Agilent 86205A bridges with serial number 3140A00101 and above. For additional information about serial numbers, refer to INSTRUMENTS COVERED BY MANUAL in the General Information Section.



**Agilent Technologies**

**Manufacturing Part Number: 86205-90001**

**Printed in USA**

**Print Date: January 1992**

© Copyright 1992 Agilent Technologies, Inc. All rights reserved.

---

## **Hewlett-Packard to Agilent Technologies Transition**

This manual may contain references to HP or Hewlett-Packard. Please note that Hewlett-Packard's former test and measurement, semiconductor products and chemical analysis businesses are now part of Agilent Technologies. To reduce potential confusion, the only change to product numbers and names has been in the company name prefix: where a product number/name was HP XXXX the current name/number is now Agilent XXXX. For example, model number HP8648 is now model number Agilent 8648.

---

## **Documentation Warranty**

THE MATERIAL CONTAINED IN THIS DOCUMENT IS PROVIDED "AS IS," AND IS SUBJECT TO BEING CHANGED, WITHOUT NOTICE, IN FUTURE EDITIONS. FURTHER, TO THE MAXIMUM EXTENT PERMITTED BY APPLICABLE LAW, AGILENT DISCLAIMS ALL WARRANTIES, EITHER EXPRESS OR IMPLIED WITH REGARD TO THIS MANUAL AND ANY INFORMATION CONTAINED HEREIN, INCLUDING BUT NOT LIMITED TO THE IMPLIED WARRANTIES OF MERCHANTABILITY AND FITNESS FOR A PARTICULAR PURPOSE. AGILENT SHALL NOT BE LIABLE FOR ERRORS OR FOR INCIDENTAL OR CONSEQUENTIAL DAMAGES IN CONNECTION WITH THE FURNISHING, USE, OR PERFORMANCE OF THIS DOCUMENT OR ANY INFORMATION CONTAINED HEREIN. SHOULD AGILENT AND THE USER HAVE A SEPARATE WRITTEN AGREEMENT WITH WARRANTY TERMS COVERING THE MATERIAL IN THIS DOCUMENT THAT CONFLICT WITH THESE TERMS, THE WARRANTY TERMS IN THE SEPARATE AGREEMENT WILL CONTROL.

---

## **DFARS/Restricted Rights Notice**

If software is for use in the performance of a U.S. Government prime contract or subcontract, Software is delivered and licensed as "Commercial computer software" as defined in DFAR 252.227-7014 (June 1995), or as a "commercial item" as defined in FAR 2.101(a) or as "Restricted computer software" as defined in FAR 52.227-19 (June 1987) or any equivalent agency regulation or contract clause. Use, duplication or disclosure of Software is subject to Agilent Technologies' standard commercial license terms, and non-DOD Departments and Agencies of the U.S. Government will receive no greater than Restricted Rights as defined in FAR 52.227-19(c)(1-2) (June 1987). U.S. Government users will receive no greater than Limited Rights as defined in FAR 52.227-14 (June 1987) or DFAR 252.227-7015 (b)(2) (November 1995), as applicable in any technical data.

---

## Printing Copies of Documentation from the Web

To print copies of documentation from the Web, download the PDF file from the Agilent web site:

- Go to <http://www.agilent.com>.
- Enter the document's part number (located on the title page) in the **Quick Search** box.
- Click GO.
- Click on the hyperlink for the document.
- Click the printer icon located in the tool bar.

# Contacting Agilent

This information supersedes all prior HP contact information.

**Online assistance:** [www.agilent.com/find/assist](http://www.agilent.com/find/assist)

Americas			
<b>Brazil</b> <i>(tel)</i> (+55) 11 3351 7012 <i>(fax)</i> (+55) 11 3351 7024	<b>Canada</b> <i>(tel)</i> 888 447 7378 <i>(fax)</i> 905 282 6495	<b>Mexico</b> <i>(tel)</i> 1 800 254 2440 <i>(fax)</i> 1 800 254 4222	<b>United States</b> <i>(tel)</i> 800 829 4444 <i>(alt)</i> (+1) 303 662 3998 <i>(fax)</i> 800 829 4433
Asia Pacific and Japan			
<b>Australia</b> <i>(tel)</i> 1 800 225 574 <i>(fax)</i> 1 800 681 776 <i>(fax)</i> 1 800 225 539	<b>China</b> <i>(tel)</i> 800 810 0508 <i>(alt)</i> 800 810 0510 <i>(fax)</i> 800 810 0507 <i>(fax)</i> 800 810 0362	<b>Hong Kong</b> <i>(tel)</i> 800 933 229 <i>(fax)</i> 800 900 701	<b>India</b> <i>(tel)</i> 1600 112 626 <i>(fax)</i> 1600 112 727 <i>(fax)</i> 1600 113 040
<b>Japan (Bench)</b> <i>(tel)</i> 0120 32 0119 <i>(alt)</i> (+81) 426 56 7799 <i>(fax)</i> 0120 01 2144	<b>Japan (On-Site)</b> <i>(tel)</i> 0120 802 363 <i>(alt)</i> (+81) 426 56 7498 <i>(fax)</i> (+81) 426 60 8953	<b>Singapore</b> <i>(tel)</i> 1 800 275 0880 <i>(fax)</i> (+65) 6755 1235 <i>(fax)</i> (+65) 6755 1214	<b>South Korea</b> <i>(tel)</i> 080 778 0011 <i>(fax)</i> 080 778 0013
<b>Taiwan</b> <i>(tel)</i> 0800 047 669 <i>(fax)</i> 0800 047 667 <i>(fax)</i> 886 3492 0779	<b>Thailand</b> <i>(tel)</i> 1 800 2758 5822 <i>(alt)</i> (+66) 2267 5913 <i>(fax)</i> 1 800 656 336	<b>Malaysia</b> <i>(tel)</i> 1800 880 399 <i>(fax)</i> 1800 801 054	
Europe			
<b>Austria</b> <i>(tel)</i> 0820 87 44 11* <i>(fax)</i> 0820 87 44 22	<b>Belgium</b> <i>(tel)</i> (+32) (0)2 404 9340 <i>(alt)</i> (+32) (0)2 404 9000 <i>(fax)</i> (+32) (0)2 404 9395	<b>Denmark</b> <i>(tel)</i> (+45) 7013 1515 <i>(alt)</i> (+45) 7013 7313 <i>(fax)</i> (+45) 7013 1555	<b>Finland</b> <i>(tel)</i> (+358) 10 855 2100 <i>(fax)</i> (+358) (0) 10 855 2923
<b>France</b> <i>(tel)</i> 0825 010 700* <i>(alt)</i> (+33) (0)1 6453 5623 <i>(fax)</i> 0825 010 701*	<b>Germany</b> <i>(tel)</i> 01805 24 6333* <i>(alt)</i> 01805 24 6330* <i>(fax)</i> 01805 24 6336*	<b>Ireland</b> <i>(tel)</i> (+353) (0)1 890 924 204 <i>(alt)</i> (+353) (0)1 890 924 206 <i>(fax)</i> (+353) (0)1 890 924 024	<b>Israel</b> <i>(tel)</i> (+972) 3 9288 500 <i>(fax)</i> (+972) 3 9288 501
<b>Italy</b> <i>(tel)</i> (+39) (0)2 9260 8484 <i>(fax)</i> (+39) (0)2 9544 1175	<b>Luxemburg</b> <i>(tel)</i> (+32) (0)2 404 9340 <i>(alt)</i> (+32) (0)2 404 9000 <i>(fax)</i> (+32) (0)2 404 9395	<b>Netherlands</b> <i>(tel)</i> (+31) (0)20 547 2111 <i>(alt)</i> (+31) (0)20 547 2000 <i>(fax)</i> (+31) (0)20 547 2190	<b>Russia</b> <i>(tel)</i> (+7) 095 797 3963 <i>(alt)</i> (+7) 095 797 3900 <i>(fax)</i> (+7) 095 797 3901
<b>Spain</b> <i>(tel)</i> (+34) 91 631 3300 <i>(alt)</i> (+34) 91 631 3000 <i>(fax)</i> (+34) 91 631 3301	<b>Sweden</b> <i>(tel)</i> 0200 88 22 55* <i>(alt)</i> (+46) (0)8 5064 8686 <i>(fax)</i> 020 120 2266*	<b>Switzerland (French)</b> <i>(tel)</i> 0800 80 5353 opt. 2* <i>(alt)</i> (+33) (0)1 6453 5623 <i>(fax)</i> (+41) (0)22 567 5313	<b>Switzerland (German)</b> <i>(tel)</i> 0800 80 5353 opt. 1* <i>(alt)</i> (+49) (0)7031 464 6333 <i>(fax)</i> (+41) (0)1 272 7373
<b>Switzerland (Italian)</b> <i>(tel)</i> 0800 80 5353 opt. 3* <i>(alt)</i> (+39) (0)2 9260 8484 <i>(fax)</i> (+41) (0)22 567 5314	<b>United Kingdom</b> <i>(tel)</i> (+44) (0)7004 666666 <i>(alt)</i> (+44) (0)7004 123123 <i>(fax)</i> (+44) (0)7004 444555		
<i>(tel)</i> = primary telephone number; <i>(alt)</i> = alternate telephone number; <i>(fax)</i> = FAX number; * = in country number			

8/03/04

---

Operating and Service Manual

# HP 86205A Directional Bridge

## SERIAL NUMBERS

This manual applies to HP 86205A bridges with serial number 3140A00101 and above. For additional information concerning serial numbers, see "Instruments Covered by this Manual" in "General Information."



HP Part No. 86205-90001  
Printed in USA January 1992

Edition 1

# Contents

---

<b>1. General Information</b>	
Manual Overview . . . . .	1-1
Product Description . . . . .	1-1
Instruments Covered By This Manual . . . . .	1-1
Accessories . . . . .	1-1
Specifications & Supplemental Characteristics . . . . .	1-1
Initial Inspection . . . . .	1-4
<b>2. Operation</b>	
Overview . . . . .	2-1
Bridge Operation . . . . .	2-1
Bridge Features . . . . .	2-2
Operating Precautions . . . . .	2-4
Measurement Configurations . . . . .	2-5
Remote Reflection Measurement Configuration . . . . .	2-5
To Set Up the Measurement . . . . .	2-5
Vector Impedance Measurement Configuration . . . . .	2-6
To Set Up the Measurement . . . . .	2-6
External Power Leveling Configuration . . . . .	2-8
To Set Up the Measurement . . . . .	2-8
Reflection Measurement Configuration . . . . .	2-10
To Set Up the Measurement . . . . .	2-10
<b>3. Performance Tests</b>	
Introduction . . . . .	3-1
Performance Test Record . . . . .	3-1
Functional Test . . . . .	3-1
Recommended Equipment . . . . .	3-1
In Case of Failure . . . . .	3-4
Return Loss Test . . . . .	3-5
Recommended Equipment . . . . .	3-5
Procedure . . . . .	3-5
In Case of Failure . . . . .	3-9
Directivity Test . . . . .	3-10
Recommended Equipment . . . . .	3-10
Procedure . . . . .	3-10
In Case of Failure . . . . .	3-12

<b>4. Maintenance</b>	
Mating Connectors . . . . .	4-1
Operating Environment . . . . .	4-1
Storage and Shipment . . . . .	4-1
Environment . . . . .	4-1
<b>5. Replaceable Parts and Connector Replacement</b>	
Introduction . . . . .	5-1
Ordering Parts . . . . .	5-1
Repair . . . . .	5-1
Returning a bridge for Service . . . . .	5-3
Packaging . . . . .	5-3
Connector Replacement Procedure . . . . .	5-5
Replacing the Outer Conductor . . . . .	5-5
Required Items . . . . .	5-5
Replacing the Pin and Bead Assembly . . . . .	5-6
Required Items . . . . .	5-6
Replacing the Connector Flange . . . . .	5-7
Required Items . . . . .	5-7
<b>A. Caring for Connectors</b>	
Visual Inspection . . . . .	A-2
Cleaning . . . . .	A-2
Mechanical Inspection . . . . .	A-2

**Index**

## Figures

---

1-1. Example Plot of HP 86205A Directivity . . . . .	1-3
1-2. Example Plot of HP 86205A Insertion Loss . . . . .	1-3
1-3. Example Plot of HP 86205A Coupling Factor . . . . .	1-3
2-1. HP 86205A Bridge Ports and Measurement Paths . . . . .	2-2
2-2. Location of Threaded Mounting Holes . . . . .	2-3
2-3. Remote Directivity Measurement Setup . . . . .	2-5
2-4. Vector Impedance Measurement Setup . . . . .	2-6
2-5. External Power Leveling Configuration . . . . .	2-8
2-6. Reflection Measurement Setup . . . . .	2-10
3-1. Equipment Setup for a Thru Measurement Calibration . . . . .	3-2
3-2. Equipment Setup for Insertion Loss Measurement . . . . .	3-3
3-3. Equipment Setup for Coupling Loss Measurement . . . . .	3-4
3-4. Equipment Setup for a S22 1-Port Measurement Calibration . . . . .	3-6
3-5. Equipment Setup for Return Loss Measurement on Port 1 . . . . .	3-7
3-6. Equipment Setup for Return Loss Measurement on Port 3 . . . . .	3-8
3-7. Equipment Setup for Return Loss Measurement on Port 2 . . . . .	3-9
3-8. Equipment Setup for S22 1-Port Measurement Calibration . . . . .	3-11
5-1. Module Exchange Program . . . . .	5-2
5-2. Shim Placement in the Connector Assembly . . . . .	5-5
5-3. Connector Pin Recession and Protrusion . . . . .	5-6
5-4. Center Pin and Bead Placement in the Connector Assembly . . . . .	5-7

## Tables

---

1-1. HP 86205A Specifications . . . . .	1-2
1-2. HP 86205A Supplemental Characteristics . . . . .	1-2
2-1. Port Orientation with Corresponding Application . . . . .	2-1
3-1. HP 86205A Test Record (1 of 3) . . . . .	3-13
5-1. Replaceable Parts & Accessories . . . . .	5-4



## General Information

---

### Manual Overview

This manual contains information for operating, testing, and servicing the HP 86205A bridge.

### Product Description

The HP 86205A is a high performance 50 $\Omega$  directional bridge designed for high quality reflection measurements and external source leveling applications over an RF frequency range of 300 kHz to 6 GHz. The bridge achieves a low through loss of 1.5 dB and a high coupling factor of 16 dB. These characteristics make it useful in applications requiring directional couplers, such as power monitoring and closed-loop leveling applications.

### Instruments Covered By This Manual

Each bridge has a unique serial number. The contents of this manual apply directly to bridges with serial numbers listed on the title page.

---

### Accessories

Table 5-1 lists accessories available for use with these bridges.

---

### Specifications & Supplemental Characteristics

Table 1-1 lists bridge specifications, which are the performance standards or limits against which you can test the device.

Table 1-2 lists supplemental (typical, non-warranted) bridge characteristics.

**Table 1-1. HP 86205A Specifications**

<b>Connector:</b>	50Ω Precision Type-N female	<b>Port Match:</b>	
<b>Frequency Range:</b>	300 kHz to 6 GHz	>23 dB	300 kHz to 2 GHz
<b>Directivity:</b>	25 ±5°C	>20 dB	2 to 3 GHz
>30 dB	300 kHz to 5 MHz	>18 dB typical	3 to 5 GHz
>40 dB	5 MHz to 2 GHz	>16 dB typical	5 to 6 GHz
>30 dB	2 GHz to 3 GHz		
>20 dB typical	3 to 5 GHz		
>16 dB typical	5 to 6 GHz		

**Table 1-2. HP 86205A Supplemental Characteristics**

<b>Nominal Through Loss:</b>		<b>Max Input Power:</b>	+25 dBm
1.5 dB +0.1 dB/GHz		<b>Max Input Voltage:</b>	
<b>Through Loss Deviation:</b>		30 VDC	port 1 or port 2
±0.2 dB from nominal		0 VDC	port 3
<b>Nominal Coupling Factor:</b>		<b>Max Input Current:</b>	1 amp DC
16 dB +0.15 dB/GHz	1 MHz to 3 GHz	<b>Connector Recession:</b> <sup>1</sup>	0.204 in to 0.207 in <sup>2</sup>
16.5 dB -0.2 dB/GHz	3 GHz to 6 GHz	<b>Weight:</b>	
<b>Coupling Factor Deviation:</b>		0.57 kg (1.3 lbs)	net
±0.2 dB from nominal	1 MHz to 3 GHz	1.80 kg (4.0 lbx)	shipping
±0.4 dB from nominal	3 GHz to 6 GHz	<b>Dimensions:</b>	
			160W x 93H x 23D (mm)
			6.3W x 3.7H x 1D (in)

<sup>1</sup> Recession refers to a female type-N connector center conductor dimension relative to 0.207 nominal offset.

<sup>2</sup> Before you performance test an HP 86205A bridge, gage all the connectors and enter the results in the test record at the end of "Performance Tests." For descriptive illustrations defining connector tolerances, see the *Microwave Connector Care Manual* (HP part number 08510-90064).

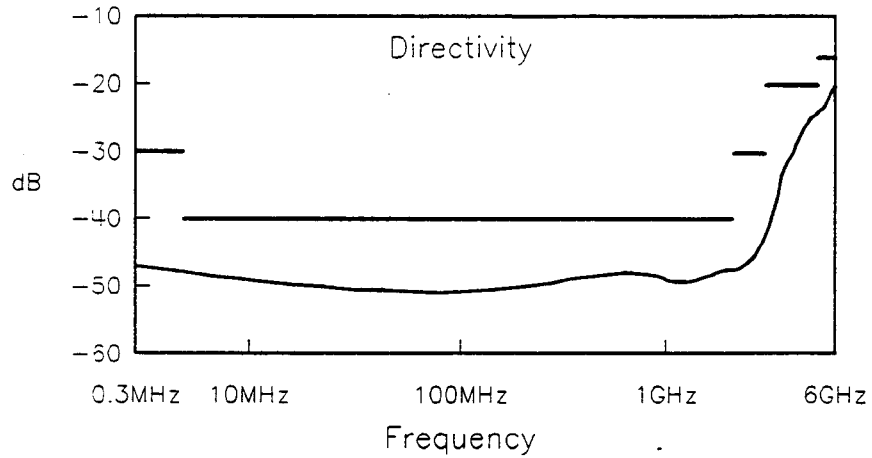

**Figure 1-1. Example Plot of HP 86205A Directivity**

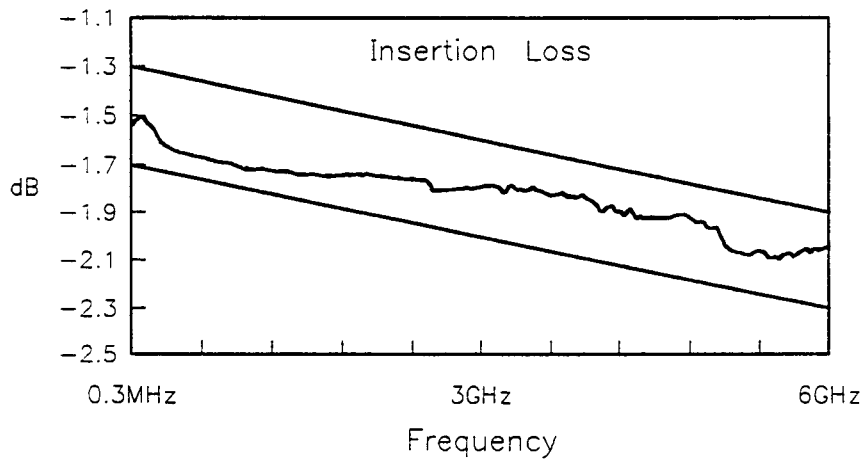

**Figure 1-2. Example Plot of HP 86205A Insertion Loss**

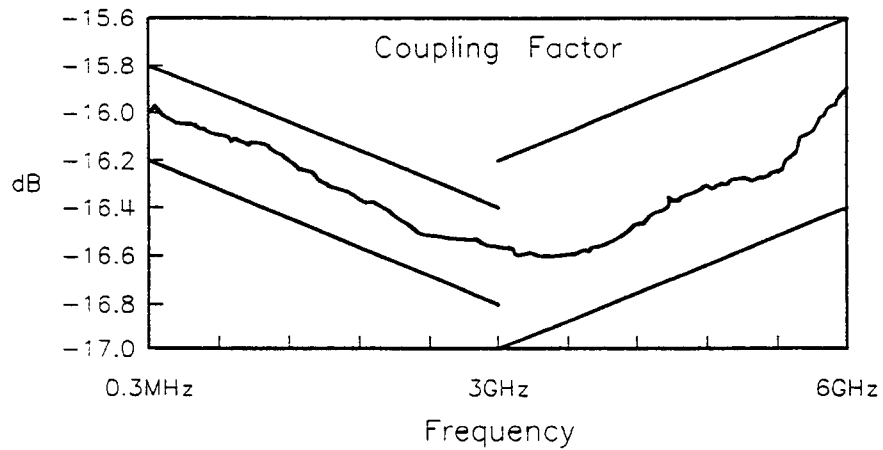

**Figure 1-3. Example Plot of HP 86205A Coupling Factor**

---

## Initial Inspection

1. Check the shipping container and packaging material for damage.
2. Check the shipment for completeness.
3. Check the connectors and bridge body for mechanical damage.
4. Check the bridge electrically.

Refer to the “Performance Tests” chapter for procedures that check the bridge electrically.

If any of the following conditions exist, notify your nearest Hewlett-Packard office:

- incomplete shipment
- mechanical damage or defect
- failed electrical test

If you find damage or signs of stress to the shipping container or the cushioning material, keep them for the carrier’s inspection. Hewlett-Packard does not wait for a claim settlement before arranging for repair or replacement.

## Operation

---

### Overview

This chapter includes the following information on the HP 86205A directional bridge:

- bridge operation
- bridge features
- operating precautions
- measurement configurations

---

### Bridge Operation

Table 2-1 and Figure 2-1 illustrate the bridge operation. The table shows the port orientation in a reflection measurement and in a power monitoring or leveling configuration. The figure identifies the paths and ports of the bridge and shows the electrical characteristics of each path.

**Table 2-1.**  
**Port Orientation**  
**with Corresponding Application**

Port Number	Application	
	Reflection Measurement	Power Monitoring/Leveling
1	Test Port	Input
2	Input Port	Output
3	Coupled	Coupled Level

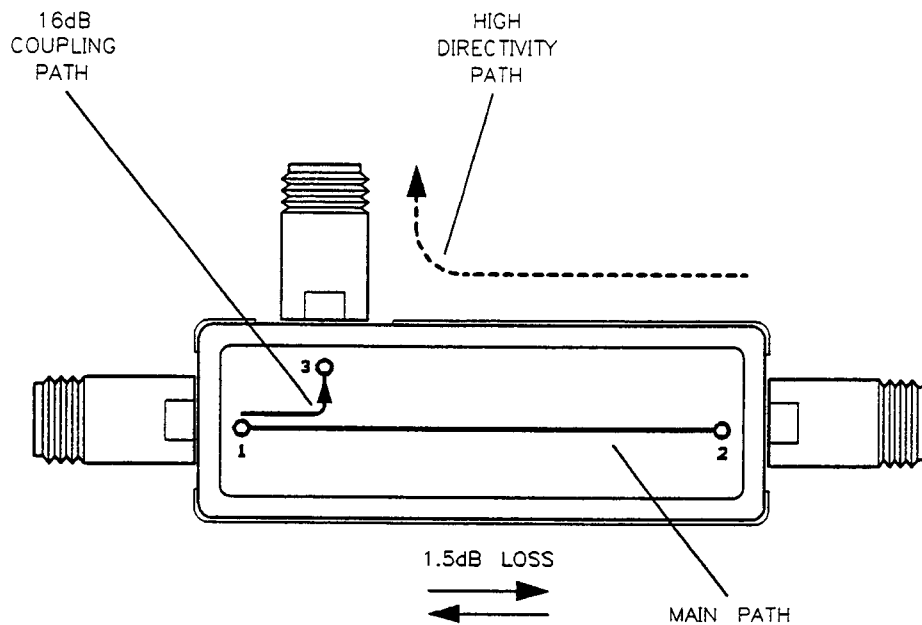

Figure 2-1. HP 86205A Bridge Ports and Measurement Paths

## Bridge Features

- frequency range from 300 kHz to 6 GHz
- high directivity
- insertion loss of 1.5 dB (nominal)
- coupled arm flatness of  $\pm 0.2$  dB from nominal

The HP 86205A operates over an RF frequency range of 300 kHz to 6 GHz and has excellent directivity for high quality reflection measurements. Additionally, the bridge has a very low insertion loss of 1.5 dB which means more power to the device under test; this is especially important in the measurement of high power solid state amplifiers and TWTs. The bridge also features a  $\pm 0.2$  dB flatness from the nominal 16 dB coupled arm. This capability is valuable in external leveling applications where a power meter or diode detector is used to level the power remotely from the source. Power variations are then minimized, which is important when measuring input-sensitive devices.

DC bias may be applied to a DUT through the main arm of the bridge. (**DO NOT** apply bias to the coupled port of the bridge.)

Threaded mounting holes (3.5 mm x 0.5 mm) are located under prepunched holes in the model number label, as shown in

Figure 2-2. Since the bridge package is brass, appropriate caution must be taken to avoid damaging the threaded holes.

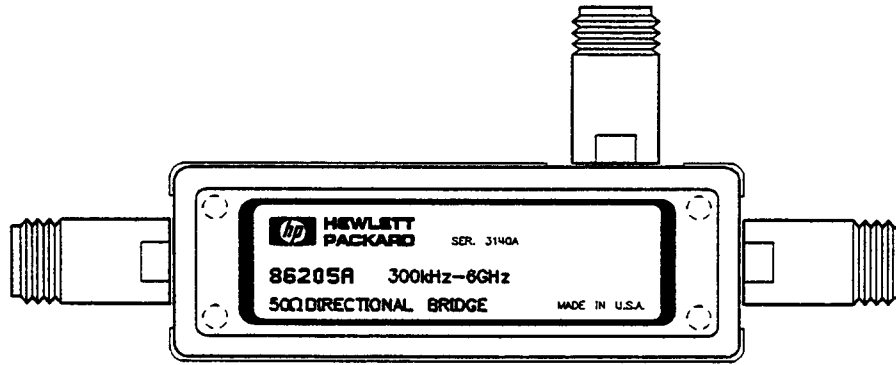

Figure 2-2. Location of Threaded Mounting Holes

---

## Operating Precautions

- Read and observe all cautions.
- Tighten the bridge connectors with fingers only.
- If you must use a wrench, use a torque wrench set at 9.2 cm-kg (12 lb-in).

### Cautions



---

Electrostatic discharge (ESD) can damage the highly sensitive microcircuits in this device; an ESD as low as 1000V can destroy your bridge.

ESD damage occurs most often as you connect or disconnect a device. Use the bridge at a static-safe workstation and wear a grounding strap. *Never* touch the input connector center contacts, or the contact pins of a connecting cable.

Do *not* apply more than +25 dBm RF CW power, or more than 1 amp DC or 0 VDC to port 3 or 30 VDC to port 1 or 2 of the bridge. Higher current/power/voltage can electrically damage the bridge.

Before you connect a cable to the bridge, always discharge the cable's center conductor static electricity to instrument-ground.

Do not drop the bridge or subject it to mechanical shock.

---



## Measurement Configurations

This section shows the HP 86205A directional bridge in the following configurations:

- remote reflection measurement using the HP 8711 network analyzer
- vector impedance measurement using two bridges and the HP 8753 network analyzer
- external power leveling with or without a controller
- reflection measurement using a spectrum analyzer and tracking generator

### Remote Reflection Measurement Configuration

You can use remote sensing in applications where your DUT is not easily accessible. For example: when measuring the reflection coefficient of an antenna that is located on a tower.

#### To Set Up the Measurement

1. Connect the equipment as shown in Figure 2-3.

#### Note



The cable length from the analyzer source to the bridge does not affect directivity, but may affect source match. However, you may put an attenuator between the cable and bridge to improve source match.

Connect the DUT either directly to the bridge or as close as possible.

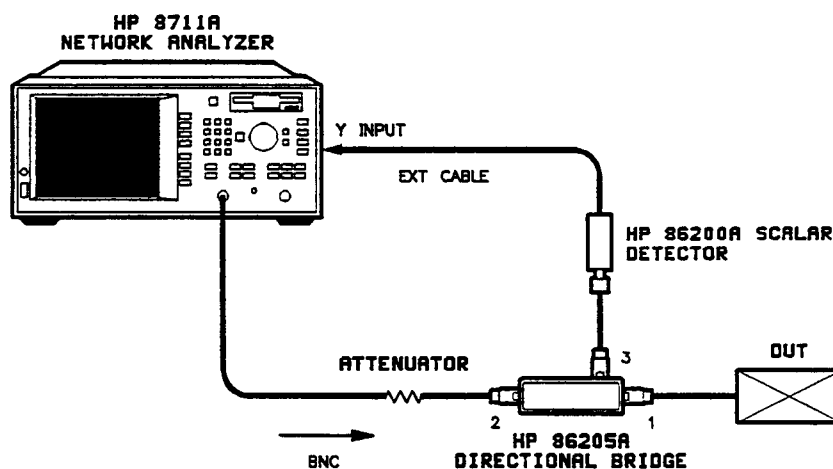

Figure 2-3. Remote Directivity Measurement Setup

- Set the parameters on the analyzer to measure with an external detector by pressing:

**CHAN 1** Det Options Broadband External Y/R\*

- With nothing connected to the bridge, make a normalization of the measurement setup by pressing:

**CAL** Normalize

- Connect the DUT to the bridge and adjust the scale/division under the **DISPLAY** key.

### Vector Impedance Measurement Configuration

This configuration provides a low-cost custom test system when full 2-port measurements are not needed.

#### To Set Up the Measurement

- Connect the equipment as shown in Figure 2-4

#### Note



You may connect the analyzer input signal to either the A or B input port. Use an A/R or B/R ratio measurement to improve the source match.

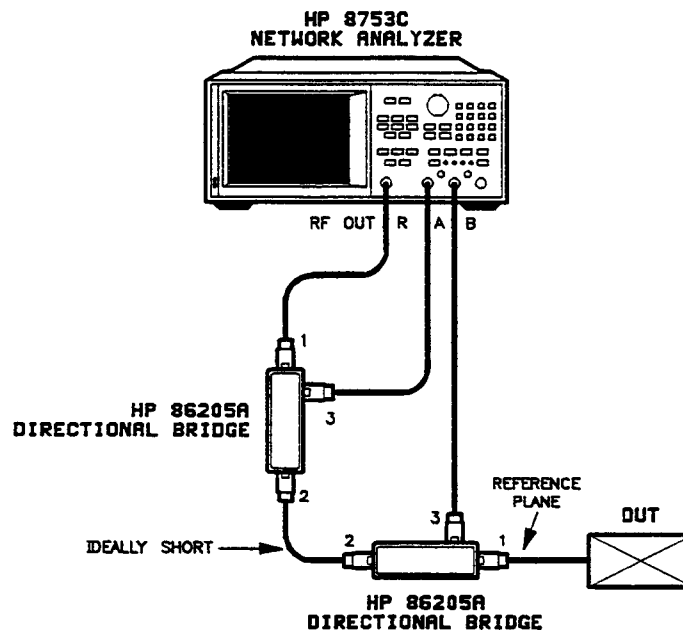

Figure 2-4. Vector Impedance Measurement Setup

2. Choose the following parameters on the analyzer:

**PRESET**

**MEAS** **A/R** (or **B/R** if you connected the analyzer input signal to the B input port)

**MENU** **POWER** then enter the power value and press **x1**

**NUMBER OF POINTS** then enter the desired number

**START** then enter the start frequency and press **x1**

**STOP** then enter the stop frequency and press **x1**

3. Make a measurement calibration by pressing one of the following key sequences:

**CAL**

**Cal Kit N 50Ω**

**Return** **Calibrate menu**

**RESPONSE** connect *either* an open *or* short calibration device to the reference plane and press the corresponding **OPEN (F)** or **SHORT (F)** key.

or

**CAL** **Calibrate Menu**

(for A/R) **S11 1-PORT**

(for B/R) **S22 1-PORT**

Connect an open, short, and load calibration device to the reference plane while pressing the corresponding key for measurement.

4. Connect the DUT to the reference plane and adjust the scale/division under the **SCALE REF** key.

## External Power Leveling Configuration

The measurement configuration shown in Figure 2-5 provides precision power levels to a remote DUT. With a power meter and bridge, the source power can be monitored and automatically adjusted.

The HP 8753 and HP 8625 sources can alternatively be used in this automated measurement configuration.

By substituting a frequency counter for the power meter, this configuration can be used for signal monitoring.

### To Set Up the Measurement

1. Connect the equipment as shown in Figure 2-5.

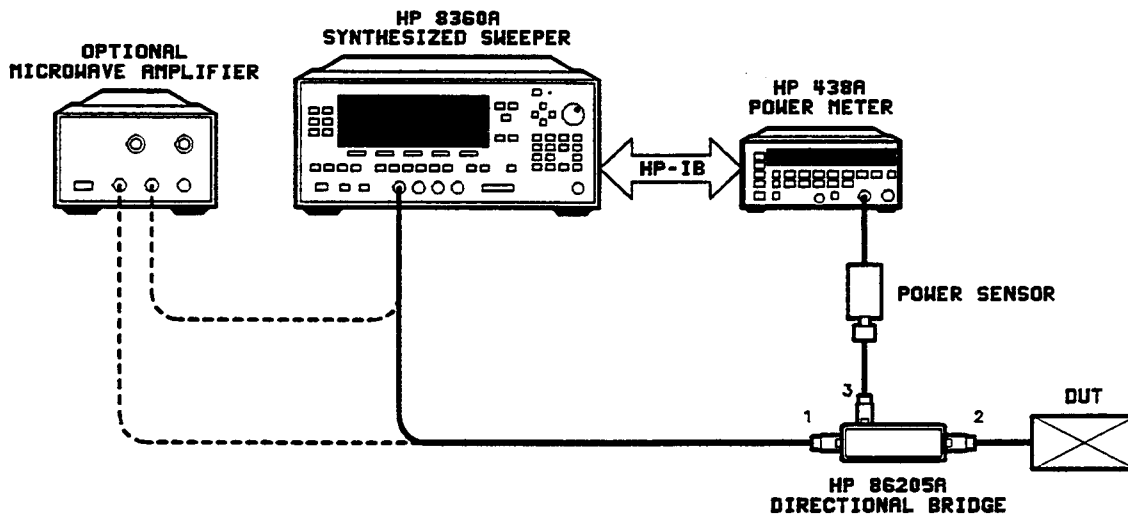

Figure 2-5. External Power Leveling Configuration

2. Zero and calibrate the power meter/sensor.
3. Enter the appropriate power sensor calibration factors into the power meter. (Can only be done with an HP 438A or 437B.)
4. Enable the power meter/sensor cal factor array. For operating information on the power meter refer to its operating manual.
5. Connect the power sensor to the bridge as shown in Figure 2-5.
6. Set up the synthesizer parameters by pressing:

**PRESET**

**START** then enter the desired start frequency

**STOP** then enter the desired stop frequency

7. Set up the user flatness correction by pressing:

**MENU** **Flatness Menu**

**Delete Menu** **Delete All**

**PRIOR**

**Auto Fill Start** and enter the desired start frequency

**Auto Fill Stop** and enter the desired stop frequency

**Auto Fill Incr** and enter the desired increment frequency value

8. Set the power meter under synthesizer control to perform the sequence of steps necessary to generate the correction information at each frequency point by pressing:

**Mtr Meas Menu** **Measure Corr All**

9. When a message is displayed, indicating the operation is complete, apply the flatness correction array to your measurement setup by pressing:

**FLTNESS ON/OFF** (the amber LED should be on)

The power produced at the point where the power meter/sensor was disconnected is now calibrated at the frequencies and power level specified above.

10. On the HP 8360, press:

**ALC** **Leveling Point ExtDet**

11. Set the coupling factor by pressing:

**Coupling Factor** **-14.5** **dB(m)**

**Note**



---

The 16 dB coupling factor is partially compensated by the through loss (1.5 dB) to give a 14.5 dB effective coupling factor (relative to the bridge output port).

The bridge coupling flatness has as good as 0.1 dB/GHz power level roll-off with  $\pm 0.2$  dB error.

---

## Reflection Measurement Configuration

This configuration is for portable reflection measurement applications.

### To Set Up the Measurement

1. Connect the equipment as shown in Figure 2-6.

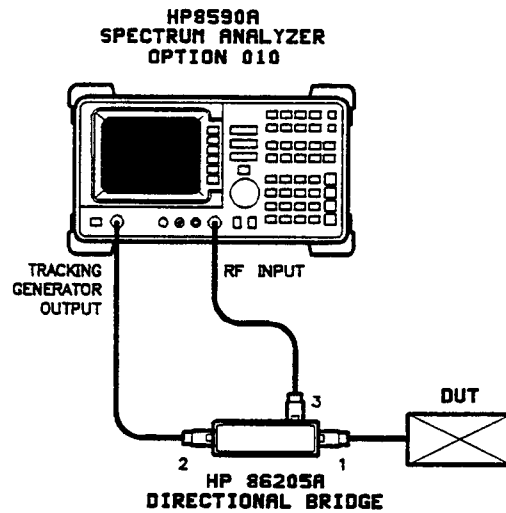

Figure 2-6. Reflection Measurement Setup

2. On the tracking generator, press:

**AUX CTRL**  
**TRACK GEN SRC PWR ON**

3. Set the desired center frequency and span to view the DUT.
4. Replace the DUT with a short circuit.
5. Normalize the trace by pressing:

**TRACE**  
**TRACE B CLEAR WRITE B**  
**BLANK B MORE 1 OF 3 NORMALIZE ON**

The normalized trace or flat line represents 0 dB return loss.

6. Measure the DUT by connecting it to port 1 of the bridge.  
Terminate the second port of a two-port DUT.
7. Press **MKR** and position the marker with the front panel knob to measure the return loss at the frequency of interest.

## Performance Tests

---

### Introduction

Use the procedures in this chapter to test the bridge's electrical performance. None of the tests require you to access the interior of the bridge. The procedures, and an explanation of what they check, are listed below.

- The functional test checks the bridge's typical operation.
- The return loss test verifies that the bridge operates within the return loss specification.
- The directivity test verifies that the bridge operates within the directivity specification.

### Performance Test Record

Record the results of the performance tests on the test record that is located at the end of this chapter.

Tables are also provided for recording the results of the functional test and connector pin depth measurements.

---

### Functional Test

The functional test confirms your bridge is operating correctly. The procedure checks the nominal insertion loss and coupling of the bridge.

### Recommended Equipment

Equipment	Recommended Model
Network analyzer	HP 8753C (or HP 8753A with 85046A)
S-parameter test set	HP 85046A or 85047A
50Ω type-N (m) load	HP 909F option 012
Type-N cable	HP p/n 8120-4781
Adapters 7 mm to type-N (f)	HP 11524A

1. Connect the equipment as shown in Figure 3-1.

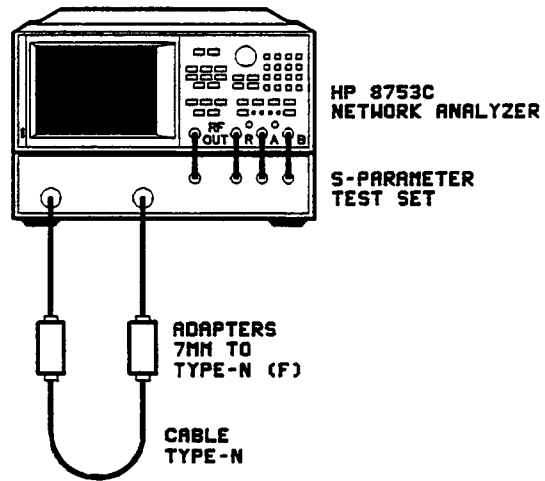

**Figure 3-1. Equipment Setup for a Thru Measurement Calibration**

2. To perform a thru measurement calibration, press the following keys on the HP 8753.

**PRESET**

**MEAS S21**

**CAL CALIBRATE MENU**

**RESPONSE THRU DONE:RESPONSE**



3. Connect the equipment as shown in Figure 3-2.

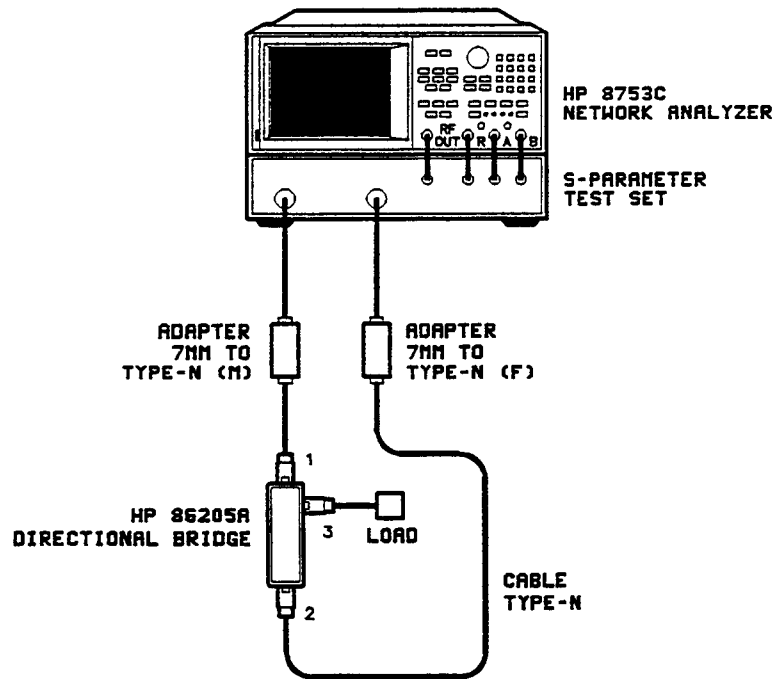

Figure 3-2. Equipment Setup for Insertion Loss Measurement

4. To measure the insertion loss, press the following keys.

SCALE 1 x1  
MKR FCTN MARKER SEARCH MAX

The insertion loss shown on the display should be between 0 and 3 dB. Write the maximum insertion loss on the test record located at the end of this chapter.

5. Press MIN to find the minimum value and record it also.

6. Connect the equipment as shown in Figure 3-3.

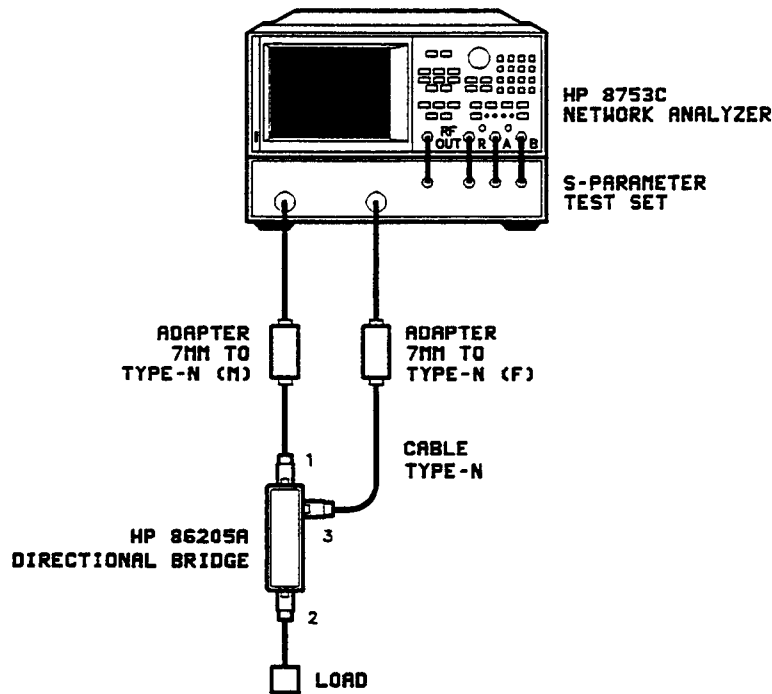

Figure 3-3. Equipment Setup for Coupling Loss Measurement

7. To measure the coupling loss, press the following keys.

**SCALE** **5** **x1**  
**MKR FCTN** **MARKER SEARCH** **MAX**

The value should be between -14 dB and -18 dB. Write the maximum coupling loss on the test record located at the end of this chapter.

8. Press **MIN** to find the minimum value and record it also.

### In Case of Failure

Check connectors for damage. Clean and gage connectors. If the pin depth is out of tolerance or the connector is damaged, refer to the "Connector Replacement Procedure" in this manual.

Verify that the calibration kit devices are within their tolerances. Check adapters and cables to make sure that they are not broken.

If the bridge appears to be bad, it must be replaced. It can only be repaired at the factory. See the "Replaceable Parts" chapter in this manual for information on ordering a replacement.

---

## Return Loss Test

### Recommended Equipment

Equipment	Recommended Model
Network analyzer	HP 8753C (or HP 8753A with 85046A)
S-parameter test set	HP 85046A or 85047A
50 $\Omega$ type-N calibration kit	HP 85032B
50 $\Omega$ type-N (m) load	HP 909F option 012
Type-N cable	HP p/n 8120-4781
Adapter 7mm to type-N (m)	HP 11525A (p/o HP 85032B)

### Procedure

1. Set the IF bandwidth to 100 Hz and select S22 as the measurement parameter, by pressing the following keys on the HP 8753:

PRESET  
MEAS S22  
AVG IF BW 100 x1

2. Set the stop frequency to 2 GHz and select a log frequency sweep, by pressing:

STOP 2 G/n  
MENU TRIGGER MENU SINGLE  
MENU SWEEP TYPE MENU LOG FREQ

3. Set the power to 20 dBm, by pressing:

MENU  
POWER 20 x1

4. Perform a one-port calibration on port 2, by pressing:

CAL  
CAL KIT N 50 ohm  
RETURN CALIBRATE MENU S22 1-PORT

5. When prompted, connect the standards as shown in Figure 3-4.

### Note



---

When measuring the open and short devices, select OPEN (m) and SHORT (m) on the analyzer. The selection must correspond to the test port, *not* the device being measured.

---

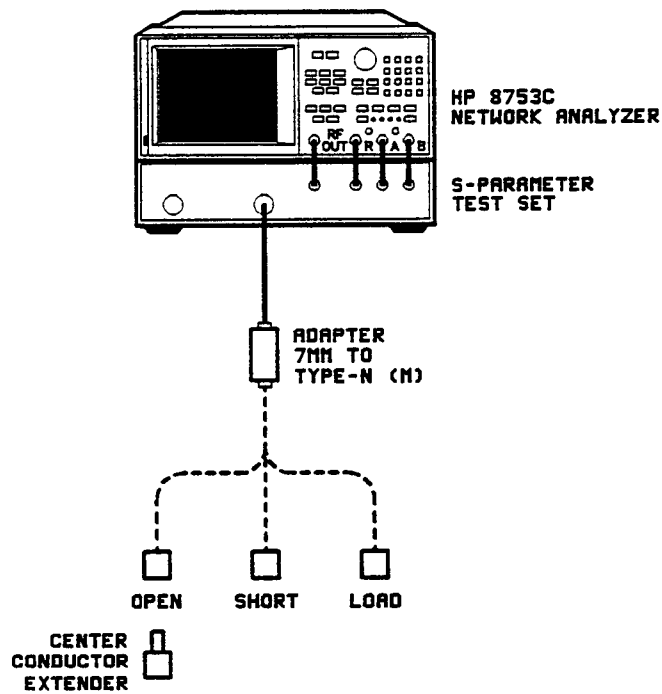

Figure 3-4. Equipment Setup for a S22 1-Port Measurement Calibration

- Save the calibration in a register by pressing:

**SAVE** **REG 1**

- Set a linear frequency sweep from 2 to 3 GHz, by pressing:

**CH2**  
**MEAS** **S22**  
**MENU** **COUPLED CH OFF**  
**SWEEP TYPE MENU** **LIN FREQ**  
**START** **2** **G/n**  
**STOP** **3** **G/n**

- Repeat steps 4 and 5 to perform a one-port calibration on port 2.
- Save the calibration in a register by pressing:

**SAVE** **REG 2**

- Connect the equipment as shown in Figure 3-5 to measure the return loss.

**Note**



Do not use a female load with a type-N adapter, since an adapter has poor return loss and may affect the measurement.

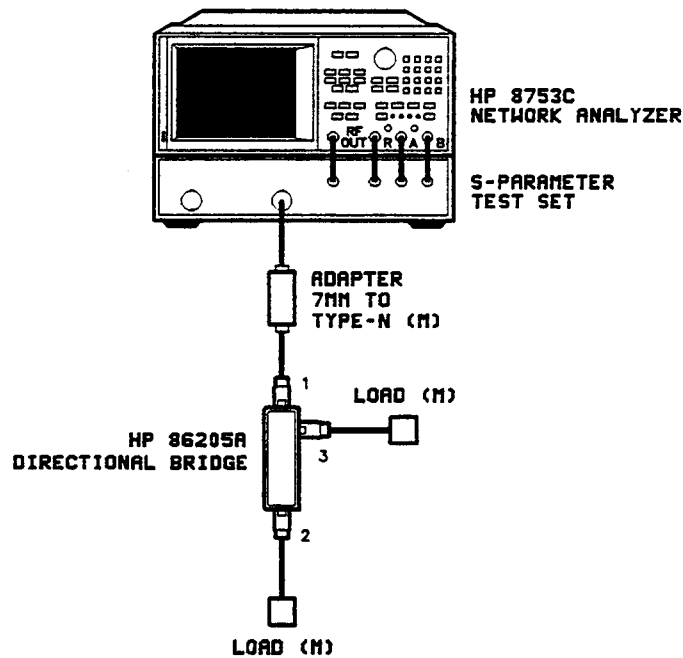

**Figure 3-5. Equipment Setup for Return Loss Measurement on Port 1**

11. Trigger a new sweep, by pressing:

**CH1**

**MENU MEASURE RESTART**

12. Find the worst-case return loss from 300 kHz to 2 GHz, by pressing:

**MKR FCTN**

**MARKER SEARCH MAX**

Write the value on the test record located at the end of this chapter.

13. Trigger a new sweep, by pressing:

**CH2**

**MENU MEASURE RESTART**

14. Find the worst-case return loss from 2 to 3 GHz, by pressing:

**MKR FCTN**

**MARKER SEARCH MAX**

Write the value on the test record located at the end of this chapter.

15. Connect the equipment as shown in Figure 3-6 and repeat steps 11 through 14 to find the return loss on port 3.

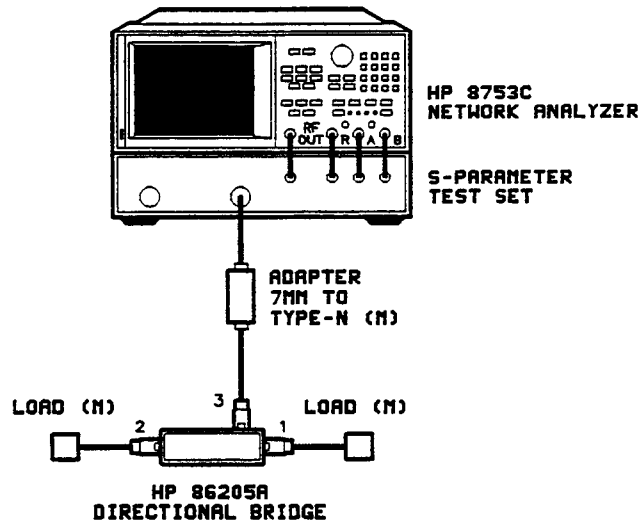

Figure 3-6. Equipment Setup for Return Loss Measurement on Port 3

16. Connect the equipment as shown in Figure 3-7 and repeat steps 11 through 14 to find the return loss on port 2.

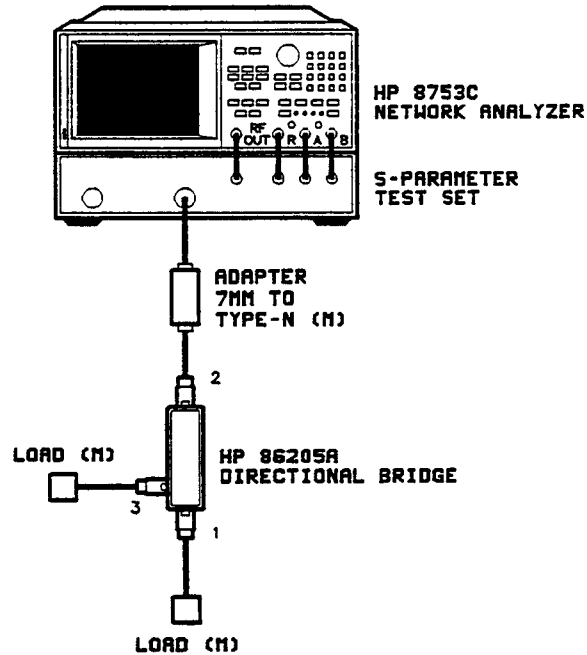

Figure 3-7. Equipment Setup for Return Loss Measurement on Port 2

### In Case of Failure

Check connectors for damage. Clean and gage connectors. If the pin depth is out of tolerance or the connector is damaged, refer to the "Connector Replacement Procedure" in this manual.

Verify that the calibration kit devices are within their tolerances. Check adapters and cables to make sure that they are not broken.

If the bridge appears to be bad, it must be replaced. It can only be repaired at the factory. See the "Replaceable Parts" chapter in this manual for information on ordering a replacement.

## Directivity Test

### Recommended Equipment

Equipment	Recommended Model
Network analyzer	HP 8753C (or HP 8753A with 85046A)
S-parameter test set	HP 85046A or 85047A
50Ω type-N calibration kit	HP 85032B
50Ω type-N (m) load	HP 909F option 012
Type-N cable	HP p/n 8120-4781

### Procedure

1. Switch the RF output to port 2 on the test set to prevent the test set from switching the test port power during the calibration, by pressing:

PRESET  
 MEAS S12  
 INPUT PORTS A/R

2. Set the IF bandwidth to 30 Hz and the analyzer power to 20 dBm, by pressing:

AVG  
 IF BW 30 x1  
 MENU  
 POWER 20 x1

3. Put the analyzer into hold mode and move the reference line up so that the data trace can be seen, by pressing:

RETURN TRIGGER MENU HOLD  
 SCALE/REF  
 REFERENCE POSITION 8 x1

4. Set up a log frequency sweep from 300 kHz to 5 MHz, by pressing:

STOP 5 M/μ  
 MENU  
 SWEEP TYPE MENU LOG FREQ

5. Make a S22 one-port calibration (to calibrate A/R, even though test port appears to be port 2), by pressing:

CAL  
 CAL KIT N 50 ohm  
 RETURN CALIBRATE MENU S22 1-port



- When prompted, connect the calibration devices to port 1 of the bridge as shown in Figure 3-8 (measure the load last).

**Note**



When measuring the open and short devices, select OPEN (f) and SHORT (f) on the analyzer. The selection made must correspond to the test port *not* the device being measured.

Measure the open and short circuit devices; then measure the load.

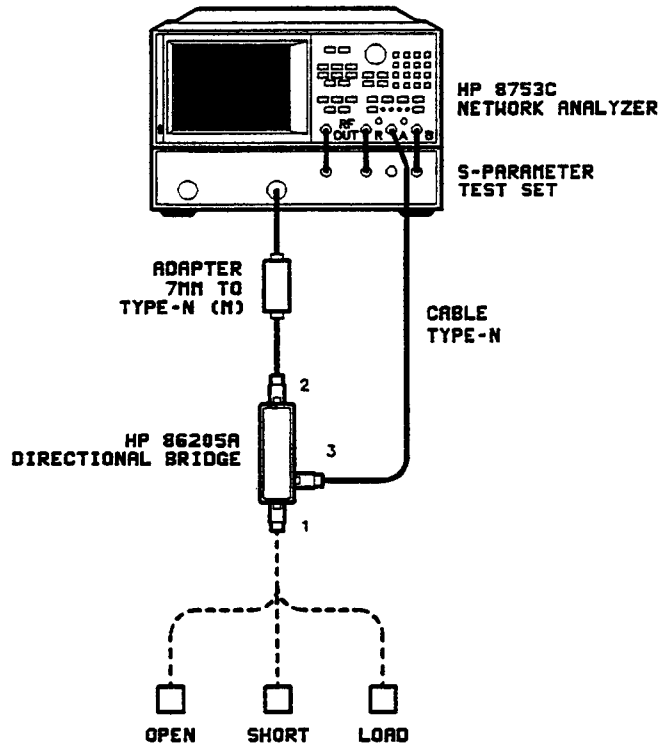

Figure 3-8. Equipment Setup for S22 1-Port Measurement Calibration

- Load the frequency response error term into memory when the calibration is done, by pressing:

```

SYSTEM
SERVICE MENU TESTS
34 x1 EXECUTE TEST
DISPLAY DATA/MEM
CAL CORRECTION OFF
  
```

The resulting display is the uncorrected load data (the last measurement taken during the calibration), normalized to the frequency response of the system.

8. Find the worst-case directivity value, by pressing:

**MKR FCTN**  
**MARKER SEARCH MAX**

Record this value in the test record located at the end of this chapter.

9. Set up a linear frequency sweep from 5 MHz to 3 GHz, by pressing:

**START** **5** **M/μ**  
**STOP** **3** **G/n**  
**MENU** **SWEEP TYPE MENU LIN FREQ**

10. Repeat steps 5 through 8. You will need to use the marker manually to find the worst case value in one of the two remaining frequency spans.

### **In Case of Failure**

Check connectors for damage. Clean and gage connectors. If the pin depth is out of tolerance or the connector is damaged, refer to the “Connector Replacement Procedure” in this manual.

Verify that the calibration kit devices are within their specifications. Check adapters and cables to make sure that they are not broken.

If the bridge appears to be bad, it must be replaced. It can only be repaired at the factory. See the “Replaceable Parts” chapter in this manual for information on ordering a replacement.

**Table 3-1. HP 86205A Test Record (1 of 3)**

Test Facility _____	Report Number _____
_____	Date _____
_____	Customer _____
_____	Tested by _____
Model _____	Ambient temperature _____ °C
Serial Number _____	Relative humidity _____ %
Options _____	Line frequency _____ Hz (nominal)
Calibration Constants Revision _____	
Functional Test Performed _____	
Special Notes	
_____	
_____	

Test Equipment Used	Model Number	Trace Number	Cal Due Date
1. _____	_____	_____	_____
2. _____	_____	_____	_____
3. _____	_____	_____	_____
4. _____	_____	_____	_____
5. _____	_____	_____	_____
6. _____	_____	_____	_____
7. _____	_____	_____	_____
8. _____	_____	_____	_____

**HP 86205A Test Record (2 of 3)  
Specifications**

Serial Number:	Report Number:		Date:
Test Description	Minimum Value	Measured Results	Measurement Uncertainty <sup>1</sup>
<b>Return Loss</b>			
300 kHz to 2 GHz			
Port 1	23 dB		±1.06 dB
Port 2	23 dB		±1.06 dB
Port 3	23 dB		±1.06 dB
2 GHz to 3 GHz			
Port 1	20 dB		±0.79 dB
Port 2	20 dB		±0.79 dB
Port 3	20 dB		±0.79 dB
<b>Directivity</b>			
300 kHz to 5 MHz	30 dB		±1.13 dB
5 MHz to 2 GHz	40 dB		±3.94 dB
2 GHz to 3 GHz	30 dB		±1.60 dB

<sup>1</sup> The measurement uncertainty is quoted for these performance tests using only the recommended models specified at the beginning of each test. The measurement uncertainty quoted represents limits of ±3 times the equivalent standard deviation (3σ) and is intended to represent a 99% confidence level.

**HP 86205A Test Record (3 of 3)**

Serial Number _____	Report Number _____
_____	Date _____

**Functional Test (Typical Operation)  
Data Record**

Characteristic	Nominal Values		Measured Values	
	Minimum	Maximum	Minimum	Maximum
Insertion Loss	0 dB	3 dB	_____	_____
Coupling Loss	-14 dB	-18 dB	_____	_____

**Typical Connector Pin Depths  
Data Record**

Connector Pin Depth	Minimum Value	Measured Results	Maximum Value
Port 1	0.204 in	_____	0.207 in
Port 2	0.204 in	_____	0.207 in
Port 3	0.204 in	_____	0.207 in



## Maintenance

---

### Mating Connectors

Figure 1-2 lists connector mechanical tolerances. The *Microwave Connector Care Manual* (HP part number 08510-90064) provides information on the proper maintenance, inspection, and gaging of connectors. When possible, use the appropriate torque wrench (see Table 5-1).

#### Caution



When tightening a connector, do not apply more than 9.2 cm·kg (12 lb·in) of torque. Greater torque can deform the mating surfaces.

---

### Operating Environment

**Temperature:** 0° to +55°C.  
**Humidity:** Up to 95%. Protect the bridge from temperature extremes, which can cause condensation.  
**Altitude:** Up to 7,620m (25,000 ft).

---

### Storage and Shipment

#### Environment

Store or ship the bridges in environments within the following limits:

**Temperature:** -25° to +75°C.  
**Humidity:** Up to 95%. Protect the bridge from temperature extremes, which can cause condensation.  
**Altitude:** Up to 7,620m (25,000 ft).

#### Note



Refer to the “Replaceable Parts and Connector Replacement” chapter for information on available shipment packaging materials.

---





## Replaceable Parts and Connector Replacement

---

### Introduction

The HP 86205A replaceable parts, and accessories are listed in this chapter. A connector replacement procedure is also provided in this chapter.

---

### Ordering Parts

To order a part listed in the replaceable parts list, quote the Hewlett-Packard part number, indicate the quantity required, and address the order to the nearest Hewlett-Packard office.

To order a part that is not listed in the replaceable parts list, include the instrument model number, complete instrument serial number, the description and function of the part, and the number of parts required. Address the order to the nearest Hewlett-Packard office.

---

### Repair

The HP 86205A bridge has repairable connectors. See the “Connector Replacement Procedure” in this chapter for instructions on connector repair.

If the bridge fails electrically, order the rebuilt/exchange bridge (see Table 5-1) and refer to the module exchange program instructions in Figure 5-1.

#### Remember



---

To receive exchange credit, you *must* return the failed assembly to Hewlett-Packard in the exchange assembly box.

---

Use this fast, efficient, economical method to keep your Hewlett-Packard instrument in service.

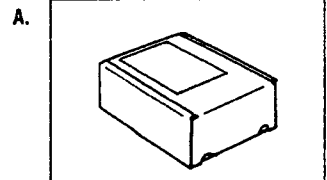
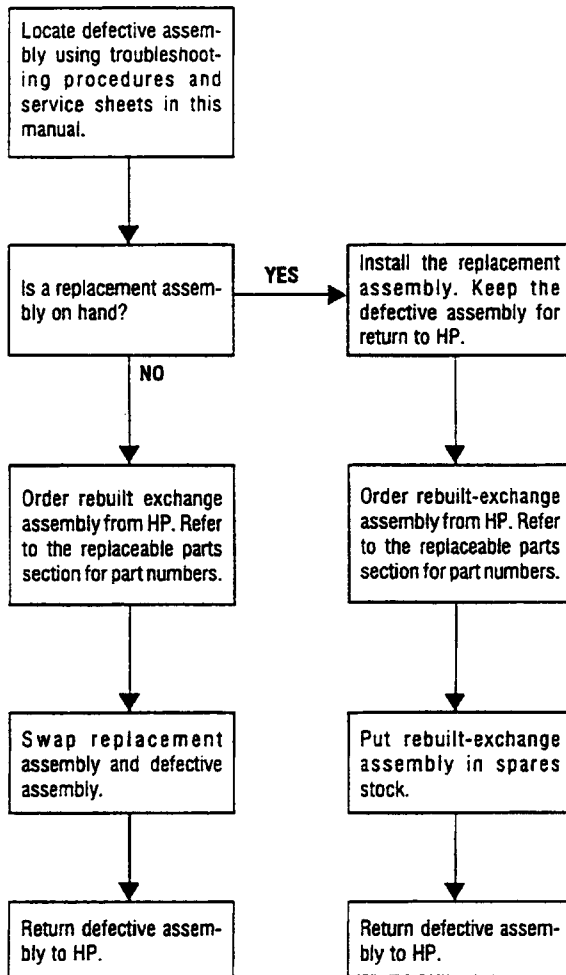

Rebuilt-exchange assemblies are shipped individually in boxes like this. In addition to the circuit assembly, the box contains:  
Exchange assembly failure report  
Return address label

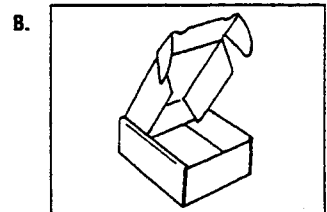

Open box carefully - it will be used to return defective assembly to HP. Complete failure report. Place it and defective assembly in box. Be sure to remove enclosed return address label.

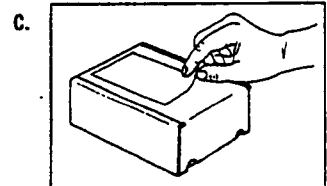

Seal box with tape. Inside U.S.A.\*: stick preprinted return address label over label already on box, and return box to HP. Outside U.S.A., do not use address label; instead address box to the nearest HP office.

\*HP pays postage on boxes mailed in U.S.A.

Figure 5-1. Module Exchange Program

---

## Returning a bridge for Service

If you ship the bridge to a Hewlett-Packard office or service center, please fill out a blue service tag (provided at the back of this manual), and include the following information:

1. Company name and address.

*Do not* give a P.O. Box. Products cannot be returned to a P.O. Box.

2. A technical contact person, with a complete phone number.
3. The complete model and serial number of the bridge.
4. The type of service required (calibration, repair).
5. Any other information that could expedite service.

When you make an inquiry, either by mail or by telephone, please refer to the bridge by both model number and full serial number.

## Packaging

If you wish, you can get containers and materials identical to those used in factory-packaging (contact your local Hewlett-Packard office). If you choose to package the bridge using commercially available material, follow these instructions:

1. Wrap the bridge in heavy paper.
2. Use a strong shipping container.

A double-wall carton of at least 350-pound test material.

3. Provide a firm cushion that prevents movement inside the container.

Use a 5 to 7 cm (3 to 4 inch) layer of shock-absorbing material around all sides of the bridge.

4. Mark the shipping container *Fragile*.

**Table 5-1. Replaceable Parts & Accessories**

Item	Description	HP Model or Part Number
<b>Connector Repair Kits</b>		
Type-N connector Kit For HP 86205A	Pin and bead assembly <sup>1</sup>	86205-60002
	Outer shim	08742-0006
	Outer conductor <sup>2</sup>	1250-0914
	Flange <sup>3</sup>	5022-0631
	Flange screw (4 required)	0515-1946
<b>New and Rebuilt/Exchange Assemblies</b>		
HP 86205A	New assembly	86205-60001
HP 86205A	Rebuilt/exchange assembly	86205-69001
<b>Miscellaneous Parts</b>		
1	Label: signal flow	86205-80001
2	Paint: bridge body	83557-60001
<b>Accessories</b>		
Calibration Kit	Type-N 50Ω	85032B
Pin depth gage	For Type-N female connectors	85054-60050
Calibration block	For 85054-60050	85054-60053
Pin depth gage	For Type-N male connectors	85054-60051
Calibration block	For 85054-60051	85054-60052
Adapters	50Ω Type-N(f) to BNC(m)	1250-1477
	50Ω Type-N(m) to Type-N(m)	1250-1475
	3.5 mm(f) to 3.5 mm(f)	1250-1749
Adapter kits	50Ω Type-N (m) to 3.5 mm	HP 11878A
	50Ω Type-N (m) to BNC	HP 11854A
	50Ω Type-N (m) to TNC	HP 86212A
Torx driver	T-10	8710-1623
Wrench	9/16 inch open ended	8710-1770
Extension Cables	50Ω RF cable kit	HP 11851B
	50Ω RF (24 in)	8120-4780
	50 Ω RF (34 in)	8120-4781
	Scalar detector	8120-5514
Scalar detector	Scalar detector	8120-5515
		HP 86200A
Connector Care Manual		08510-90064
Isopropyl alcohol	99.5% (30 ml)	8500-5344

1 Replacement of the pin and bead assembly requires the outer shim.

2 Replacement of the outer conductor requires the outer shim.

3 Replacement of the flange requires four new flange screws.

## Connector Replacement Procedure

Kits are available for replacing the following parts of the bridge connectors (see Table 5-1):

- outer conductor
- center pin and bead assembly
- connector flange

### Caution



This product is susceptible to damage from electrostatic discharge (ESD). When you perform any of the following procedures, wear a grounded static-strap and work at a static-safe work station.

### Replacing the Outer Conductor

#### Required Items

Outer conductor	Outer shim
Connector gage	9/16 inch wrench

1. Loosen the outer conductor, using the wrench. Unscrew and remove the outer conductor.
2. Look for a shim that is in the outer conductor or resting on the bead. (Not all connector assemblies require a shim.) If there is a shim, set it aside. Refer to Figure 5-2.

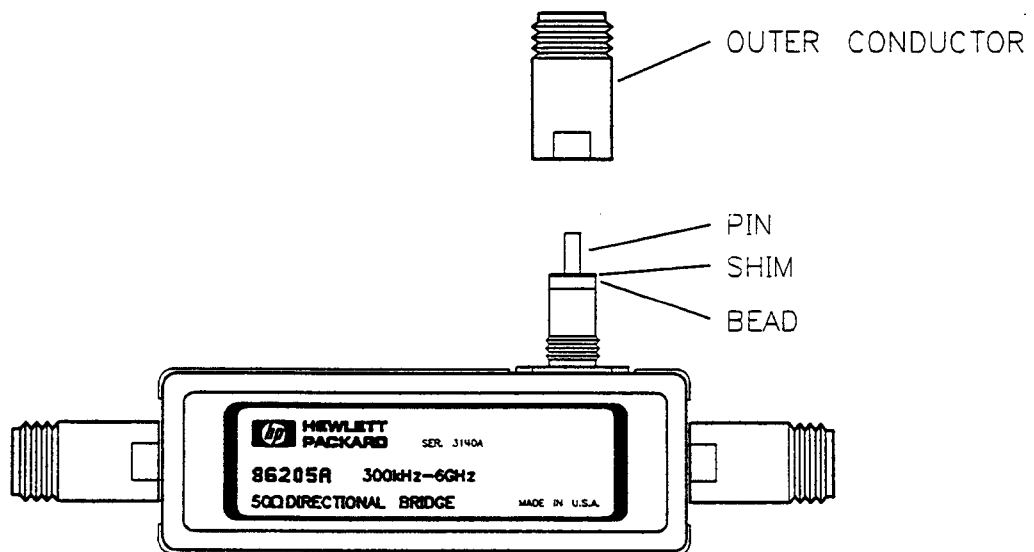
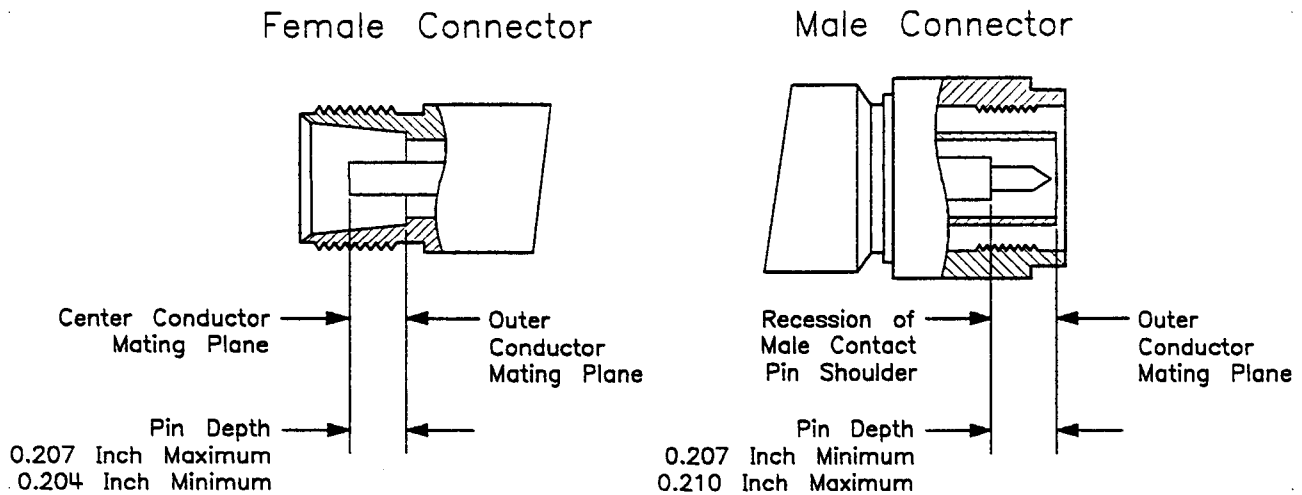

Figure 5-2. Shim Placement in the Connector Assembly

3. Put the new outer conductor on the flange and tighten to 25 lb-in.
4. Gage the connector to see if the pin depth is within tolerance. Refer to Figure 5-3.

If the pin depth is out of tolerance ( $>0.207$  in), insert a shim in the connector assembly by removing the outer conductor and placing a shim as shown in Figure 5-2.

5. Repeat steps 3 and 4.



**Figure 5-3. Connector Pin Recession and Protrusion**

### Replacing the Pin and Bead Assembly

#### Required Items

Pin and bead assembly	Outer shim
Connector gage	9/16 inch wrench

1. Loosen the outer conductor, using the wrench. Unscrew and remove the outer conductor.
2. Look for a shim that is in the outer conductor or resting on the bead. (Not all connector assemblies require a shim.) If there is a shim, set it aside.
3. Twist the center pin as you pull the pin and bead assembly free from the connector.
4. Insert the new pin and bead assembly by positioning the center pin over the connector flange and twisting the pin as you slowly, and carefully, push it down into the flange. The pin and bead assembly should be flush with the flange as shown in Figure 5-4.

#### Note



If the pin is correctly seated, you would have felt some resistance when you inserted the pin. It is not unusual to miss seating the center pin on the first try. Looking in the flange, you will see the glass seal where the pin and bead assembly is to be inserted.

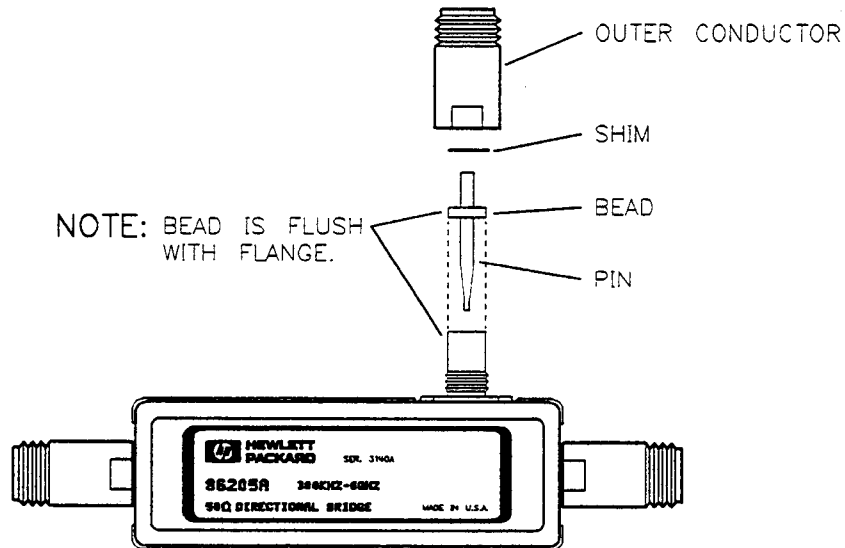

**Figure 5-4. Center Pin and Bead Placement in the Connector Assembly**

5. Put the outer conductor on the flange and tighten to 25 lb-in.
6. Gage the connector to see if the pin depth is within tolerance (0.204 to 0.207 in). Refer to Figure 5-3.

If the pin depth is out of tolerance ( $>0.207$  in), insert a shim in the connector assembly by removing the outer conductor and placing a shim as shown in Figure 5-4.

### Replacing the Connector Flange

#### Required Items

Connector flange	Flange screws
Connector gage	9/16 inch wrench
Torque wrench	T-10 Torx driver

1. Loosen the outer conductor, using the wrench. Unscrew and remove the outer conductor.
2. Look for a shim in the outer conductor and resting on the bead. (Not all connector assemblies include a shim.) If there is a shim, set it aside.
3. Twist the center pin as you pull the pin and bead assembly free from the connector.
4. Use the Torx driver to remove the four screws that attach the flange to the bridge.
5. Attach the new connector flange to the bridge with the new screws. Torque each screw approximately 5 lb-in.
6. Replace the center pin and bead as described in the previous procedure.

7. Put the outer conductor on the flange and tighten to 25 lb-in.
8. Gage the connector to see if the pin depth is within tolerance (0.204 to 0.207 in).

If the pin depth is out of tolerance, insert a shim in the connector assembly by removing the outer conductor and placing a shim as shown in Figure 5-2.



## Caring for Connectors

---

This appendix provides a brief introduction to the fundamentals of proper connector care, as important to good measurements as proper instrument calibration and adjustment. This appendix is intended to provide basic information and tell you where to find more: Hewlett-Packard's *Microwave Connector Care Manual* (see Table 5-1 for ordering information).

### Remember



---

A damaged connector can destroy any connector attached to it.

---

Basic connector care comprises three parts:

1. Visual inspection.
2. Cleaning.
3. Mechanical inspection.

## Visual Inspection

Visually inspect all system connectors often. Examine connectors for problems such as contamination or corrosion, especially on the contacting surfaces. Look for deformed threads, burrs, scratches, rounded shoulders, and similar signs of wear or damage. Any visible problem can degrade performance; clean, reinspect, and, if necessary, replace the connector.

## Cleaning

### ■ Try Compressed Air First

Use compressed air to loosen particles on the connector mating plane surfaces. Clean air cannot damage a connector, or leave particles or residues behind.

### ■ If a Solvent is Necessary, Use *Only High Purity (>98%) Isopropyl Alcohol*

If there is dirt or stubborn contaminants on a connector that you cannot removed with compressed air, try a foam swab or lint-free cleaning cloth moistened with isopropyl alcohol.

### ■ Use the Least Amount of Alcohol Possible

### ■ Avoid Wetting any Plastic Parts in the Connectors with the Alcohol

### ■ Never Spray Alcohol Directly into a Connector

### ■ Check the Alcohol Periodically for Contamination

Pour a few drops onto a clean glass plate or microscope slide and let it evaporate. Examine the glass in reflected light. It should be perfectly clean and free of residue. If not, do not use the alcohol from that container.

To keep your main supply of alcohol free from contamination, pour a small amount into a clean container and use that as your cleaning supply. When you are through cleaning connectors, safely discard any remaining alcohol in the small container and clean the container.

## Mechanical Inspection

Because coaxial connector mechanical tolerances can be very precise, even a perfectly clean, unused connector can cause trouble if it is mechanically out of specification. Use a connector gage to mechanically inspect coaxial connectors. Gage a connector at the following times:

- Before you use it for the first time.
- If either visual inspection or electrical performance suggests that the connector interface may be out of specification (due to wear or damage, for example).
- Either someone else uses the device, or you use the device on another system or piece of equipment.
- As a matter of routine: initially after every 100 connections, and after that as often as experience suggests.



# Index

---

- A**
  - Antenna measurement configuration, 2-5
  - Assembly exchange, 5-1
  - Automatic power monitoring, 2-8
  
- B**
  - Bead and pin replacement, 5-6
  - bridge
    - repairable parts, 5-5
    - repairing, 5-5
  - Bridge coupling flatness, 2-9
  - Bridge damage, 1-4
  - Bridge description, 1-1
  - bridge features, 2-2
  - Bridge frequency range, 1-1
  - Bridge maintenance, 4-1
  
- C**
  - Cable length , 2-5
  - Calibration device selection, 3-11
  - Calibration (measurement), 2-7
  - Care of connectors (introduction), A-1
  - Cautions for bridge operation, 2-4
  - Center pin and bead replacement, 5-6
  - Cleaning connectors, A-2
  - Compressed air (for connector cleaning), A-2
  - Conductor replacement, 5-5
  - Configurations for measurements, 2-5
  - connector
    - replacing, 5-5
  - Connector care introduction, A-1
  - Connector care manual, 4-1
  - Connector cleaning, A-2
  - Connector flange replacement, 5-7
  - Connector inspection, A-2
  - Connector mating, 4-1
  - Connector pin depth specification, 1-2
  - Connector pin depth test record, 3-15
  - Connector Replacement Procedure, 5-5
  - Coupled port specification, 1-2
  - Coupling factor graph, 1-3
  - Coupling flatness, 2-9
  - Coupling loss measurement, 3-4

- D** Damage to bridge, 1-4
  - Defective bridge, 5-1
  - Description
    - bridge, 1-1
    - manual, 1-1
  - Device selection (calibration), 3-11
  - Directivity graph, 1-3
  - Directivity specification, 1-2
  - Directivity Test, 3-10
  - Discharge static electricity, 2-4
  - Dropping the bridge, 2-4
  
- E** Electrical failure, 5-1
  - Electrostatic discharge (ESD) caution, 2-4
  - Environmental requirements, 4-1
  - Exchange assembly, 5-1
  - External detector use, 2-5
  - External power leveling configuration, 2-8
  
- F** Failure in test, 3-4
  - Failure of bridge, 5-1
  - Female load note, 3-6
  - Flange replacement, 5-7
  - Flatness for bridge coupling, 2-9
  - Frequency range of bridge, 1-1
  - Functional test, 3-1
  - Functional test record, 3-15
  
- G** Gage tolerances for connectors, 1-2
  - Graph of directivity, 1-3
  
- H** Hewlett-Packard notification, 1-4
  
- I** In case of failure, 3-4
  - Information that applies, 1-1
  - Initial inspection, 1-4
  - Input port specifications, 1-2
  - Insertion loss graph, 1-3
  - Insertion loss measurement, 3-3
  - Inspection of bridge, 1-4
  - Inspection of connectors (mechanical), A-2
  - Inspection of connectors (visual), A-2

- K** Kit part numbers, 5-4
  
- L** Limitations of bridge, 1-2  
Load (female) note, 3-6
  
- M** Manual content description, 1-1  
Mating connectors, 4-1  
Measurement
  - coupling loss, 3-4
  - insertion loss, 3-3
  - return loss, 3-6
 Measurement calibration, 2-7, 3-5  
 1-port, 3-5, 3-10  
 Measurement configuration
  - external power leveling, 2-8
  - reflection, 2-10
  - reflection measurement, 2-5
  - vector impedance measurement, 2-6
 Measurement configurations, 2-5  
 Mechanical inspection of connectors, A-2  
 Mechanical shock to bridge, 2-4  
 Mechanical tolerances of connectors, 1-2  
 Microwave connector care introduction, A-1  
 Miscellaneous parts , 5-4
  
- O** Open, short, load measurement calibration, 3-5  
Operating precautions, 2-4  
Operating temperature, 4-1  
Ordering parts, 5-1  
Outer conductor replacement, 5-5
  
- P** Packaging, 5-3  
Part numbers, 5-4  
Part ordering, 5-1  
Performance test
  - directivity, 3-10
  - return loss, 3-5
 Performance test record, 3-1, 3-13  
 Performance tests, 3-1  
 Pin and bead replacement, 5-6  
 Pin depth test record, 3-15  
 Portable reflection measurement, 2-10  
 Port specifications, 1-2  
 Precautions for operation, 2-4  
 Procedure for connector replacement, 5-5  
 Product description, 1-1

- R**
  - Rebuilt exchange assembly, 5-1
  - Recession of connector pin, 1-2
  - Reflection measurement configuration, 2-10
  - Remote reflection measurement configuration, 2-5
  - Repair, 5-1
  - Replaceable parts
    - chapter, 5-1
    - table, 5-4
  - Replacement procedure for connector, 5-5
  - replacing
    - connector, 5-5
  - Replacing the center pin and bead, 5-6
  - Replacing the connector flange, 5-7
  - Replacing the outer conductor, 5-5
  - Response measurement calibration, 2-7
  - Returning a bridge for service, 5-3
  - Return loss measurement, 3-6
  - Return loss specification, 1-2
  - Return loss test, 3-5
  
- S**
  - Saving measurement calibration, 3-6
  - Serial numbers, 1-1
  - Service for a bridge, 5-3
  - Setups for measurement, 2-5
  - Shipment and storage, 4-1
  - Shipment packaging, 5-3
  - Solvent for connector cleaning, A-2
  - Specifications, 1-2
  - Specifications test record, 3-13
  - Static electricity discharge caution, 2-4
  - Storage and shipment, 4-1
  - Supplemental specifications, 1-2
  
- T**
  - Temperature for bridge operation, 4-1
  - Test
    - return loss, 3-5
  - Test failure, 3-4
  - Test (functional), 3-1
  - Test record, 3-13
  - Test record (explanation), 3-1
  - Test record for pin depth, 3-15
  - Test set switch, 3-10
  - Tests that verify bridge's performance, 3-1
  - Through arm specification, 1-2
  - Through loss specification, 1-2
  - Thru measurement calibration, 3-2
  - Torque of connection, 4-1
  - Type-N connector specifications, 1-2
  
- V**
  - Vector impedance measurement configuration, 2-6
  - Visual inspection of connectors, A-2
  - Voltage input (maximum), 2-4

