

## Errata

**Title & Document Type:** 8592A Portable Microwave Spectrum Analyzer Operating Manual

**Manual Part Number:** 08592-90005

**Revision Date:** October 1987

---

### HP References in this Manual

This manual may contain references to HP or Hewlett-Packard. Please note that Hewlett-Packard's former test and measurement, semiconductor products and chemical analysis businesses are now part of Agilent Technologies. We have made no changes to this manual copy. The HP XXXX referred to in this document is now the Agilent XXXX. For example, model number HP8648A is now model number Agilent 8648A.

### About this Manual

We've added this manual to the Agilent website in an effort to help you support your product. This manual provides the best information we could find. It may be incomplete or contain dated information, and the scan quality may not be ideal. If we find a better copy in the future, we will add it to the Agilent website.

### Support for Your Product

Agilent no longer sells or supports this product. You will find any other available product information on the Agilent Test & Measurement website:

[www.tm.agilent.com](http://www.tm.agilent.com)

Search for the model number of this product, and the resulting product page will guide you to any available information. Our service centers may be able to perform calibration if no repair parts are needed, but no other support from Agilent is available.



**HP 8592A Portable Microwave Spectrum Analyzer**

# **Operating Manual**



Manual Part Number: 08592-90005  
Microfiche Part Number: 08592-90006  
Printed in U.S.A. October 1987

Copyright © 1987 by Hewlett-Packard Company  
1212 Valley House Drive, Rohnert Park, CA 94928-4999

- 
- \* Additional copies of the Operating Manual and the Installation Manual are not available separately; together, they constitute the HP 8592A Documentation Package and must be ordered by its HP Part Number — 08592-90001.
  - \*\* Option 915, Service Documentation (08592-90007), consists of one copy each of the Support Manual, the Installation Manual, and the Operating Manual.

---

## How to Use This Manual

### Where to Start

If you are familiar with spectrum analyzers:

Skim Chapter 1, "Making Your First Measurement," for a brief introduction to the HP 8592A Spectrum Analyzer.

To find a description of a particular analyzer function, consult the index at the end of this manual. Page numbers that are bold reference control descriptions in Chapter 3, "Analyzer Functions." Non-bold page numbers refer you to reference material used during applications in Chapter 2, "Analyzer Measurements and Applications."

### CAUTION

To prevent damage to your spectrum analyzer:

1. Do not exceed the maximum input power; the maximum input power is +30 dBm (1 Watt) continuous; 0 Volt dc.
2. Do not use the service functions unless you have access to the correct calibration data.



REVISION 2  
INSTRUMENT

If you are not familiar with spectrum analyzers (and your spectrum analyzer has already been unpacked and installed):

Read Chapter 1, "Making Your First Measurement," which introduces you to the HP 8592A, leads you through a simple spectrum analyzer measurement, and shows how to make more accurate measurements.

After you've successfully made your first measurement, continue with Chapter 2, "Analyzer Measurements and Applications," to gain experience with spectrum analyzer measurements.

## Manual Terms and Conventions

Words in this manual that appear CAPITALIZED in [BRACKETS] refer to softkeys that appear on the analyzer screen. Keys that appear on the front panel of the instrument appear in **BOLD ITALICS**.

## Printing History

Each new edition of this manual incorporates all material updated since the previous edition. Manual change sheets may be issued between editions, allowing you to correct or insert information in the current edition.

The manual part number changes only when a new edition is published. Corrections or additions may be made as the manual is reprinted between editions.

Part Number 08592-90005  
Printing October 1987

# INSTRUMENT SERVICES

---

## Table of Contents

Documentation Description	2
How to Use This Manual	4
Where to Start	4
Manual Terms and Conventions	5
Printing History	5
<b>1 Making Your First Measurement</b>	
<b>1st Measurement</b>	
What You'll Learn in This Chapter	1-1
Making a Measurement	1-1
1. Relax!	1-2
2. Frequency	1-2
3. Span	1-2
4. Amplitude	1-2
5. Marker	1-4
Measurement Summary	1-5
Getting Acquainted With the Analyzer	1-7
Front-Panel Feature Overview	1-7
Rear-Panel Feature Overview	1-10
Menu and Softkey Overview	1-12
Screen Annotation	1-13
Improving Accuracy With Calibration Routines	1-15
Warmup Time	1-15
Calibration Procedure	1-16

## **2 Analyzer Measurements and Applications**

What You'll Learn in This Chapter	2-1
Resolving Signals of Equal Amplitude With Resolution Bandwidth	2-2
Resolving Small Signals and Large Signals With Resolution Bandwidth	2-6
Automatic Zooming With Auto Zoom	2-8
Peaking Signal Amplitude With Preselector Peak	2-10
Tracking Unstable Signals With Signal Track and Maximum Hold	2-11
Comparing Signals With Delta Markers	2-16
Measuring Low-Level Signals With Attenuation, Bandwidth, and Video Averaging	2-22
Identifying Distortion Products Using the RF Attenuator and Traces	2-29
Distortion From the Analyzer	2-29
Third-Order Intermodulation Distortion	2-33
Using the Comb Generator To Perform More Accurate Frequency Measurements	2-37
Using the Analyzer as a Receiver in Zero Span	2-42
Measuring Amplitude Modulation With the Fast Fourier Transform Function	2-45
Measuring Signals Near Band Boundaries With Harmonic Lock	2-51

### 3 Analyzer Functions

What You'll Learn in This Chapter	3-1
Data Controls	3-2
Knob	3-2
Step Keys	3-3
Number/Units Keyboard	3-3
Hold Key	3-4
Frequency and Span	3-5
Amplitude	3-8
Instrument State	3-11
Configuration	3-13
Calibration	3-14
Copy	3-19
Marker	3-21
Marker	3-21
Marker To . . .	3-23
Peak Search	3-24
Signal Track	3-25
Control Functions	3-26
Sweep/Bandwidth	3-26
Service Functions	3-29
Auto Couple	3-30
Trace A	3-31
Trace B	3-33
Trigger	3-34
Display	3-35
Other Controls and Connectors	3-37
Intensity	3-37
Line Power	3-37
Front-Panel Connectors	3-37
Rear-Panel Connectors	3-38

---

Special Functions on Menu 1 and Menu 2	3-40
<b>Appendix A</b> <b>AM, FM, and Pulsed RF Reference Charts</b>	A-1
<b>Appendix B</b> <b>Analyzer Messages</b>	B-1
<b>Index</b>	Index-1
<b>Softkey Menus</b>	<b>Rear Inside Cover</b>

---

## What You'll Learn in This Chapter

This chapter introduces the basic functions of the spectrum analyzer. In this chapter you will:

- Measure a signal (the Calibration signal)
- Get acquainted with the front-panel, rear panel and display
- Overview the menus and softkeys
- Reference screen annotation
- Improve measurement accuracy using calibration routines

**Note:** Before using your analyzer, please read the Installation Manual, which describes how to install your analyzer and how to verify that it is installed correctly. The Installation Manual relates safety concerns.

## Making a Measurement

Let's begin using the Spectrum Analyzer by measuring an input signal. Since the 299.9 MHz calibration signal (CAL OUTPUT) is readily available, we will use it as our input signal.

First, turn the instrument on (or, if it is already on, press the green **PRESET** key). Connect the CAL OUTPUT to the analyzer INPUT on the front panel using the appropriate BNC cable and type N adapter, then proceed with the following steps.

---

## 1. Relax!

You cannot hurt the analyzer by using the calibration signal and pressing any of the keys described in this section. Don't be afraid to play with the knob, step keys, or number/units keyboard. (If you have experimented with other keys and wish to return to a known state, press the green **PRESET** key).

## 2. Frequency

Press the **FREQUENCY** key. "CENTER" appears on the left side of the screen, indicating that the center frequency function is active. (The space on the screen where "CENTER 12500 MHz" appears is called the **active function block**. Functions appearing in this block are active: their values can be changed with the knob, step keys, or number/units keyboard.) Set the center frequency to 299.9 MHz with the DATA keys by pressing **2 9 9 . 9 MHz**. The knob and step keys can also be used to set the center frequency.

## 3. Span

Press the **SPAN** key. "SPAN" is now displayed in the active function block. (Span refers to the frequency range on the screen.) Reduce the span to 200 MHz by using the down step key or pressing **2 0 0 MHz**.

## 4. Amplitude

When the peak of a signal does not appear on the screen, it may be necessary to adjust the amplitude level on the screen. Press the **AMPLITUDE** key: "REF LEVEL .0 dBm" appears in the active function block. The reference level is the top graticule line on the display and is set to 0.0 dBm. Changing the value of the reference level changes the amplitude level of the top graticule line.

---

If desired, use the reference level function to place the signal peak on the screen using the knob, step keys, or number/units keyboard. You do **not** need to place the signal peak at the top graticule line to improve accuracy. (Markers, described in step 5, display frequency and amplitude values.)

Figure 1-1 demonstrates the relationship between center frequency and reference level. The box in the figure represents the spectrum analyzer screen. Changing the center frequency changes the effective horizontal placement of the screen. Changing the reference level changes the effective vertical placement of the screen. Increasing the span increases the frequency range that appears horizontally on the screen.

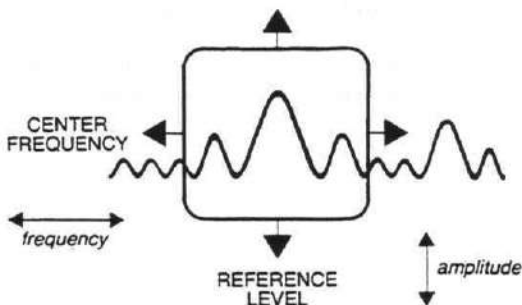

Figure 1-1



---

## 5. Marker

You can place a diamond-shaped marker on the signal peak to find the signal's frequency and amplitude.

To activate a marker, press the **MKR** key located in the **MARKER** section of the front panel. Turn the knob to place the marker at the signal peak.

You can also use the **PEAK SEARCH** key, which automatically places a marker at the highest peak on the trace.

Readouts of marker amplitude and frequency appear in the active function block and in the upper-right corner of the display. Look at the marker readout to determine the amplitude of the signal.

If another function is activated, the frequency and amplitude can still be found from the marker readout in the upper-right corner of the screen.

---

## Measurement Summary

1. Connect the CAL OUTPUT to the analyzer INPUT and press the green **PRESET** key.
2. Set the center frequency: **FREQUENCY 2 9 9 . 9 MHz**.
3. Set the span: **SPAN 2 0 0 MHz**.
4. If desired, adjust the reference level: press **AMPLITUDE** to activate the reference level and use the knob or step keys to change the reference level. The calibration signal is 20 dB (2 graticule divisions) below the top of the screen normally in these settings.
5. Determine the amplitude and frequency of the signal. Press **PEAK SEARCH**. Or, press **MKR** and move the marker to the signal peak. Read the amplitude and frequency.

The display screen should look like the one in Figure 1-2. Frequency is displayed horizontally and amplitude (power) is displayed vertically.



---

## Getting Acquainted With the Analyzer

### Front-Panel Feature Overview

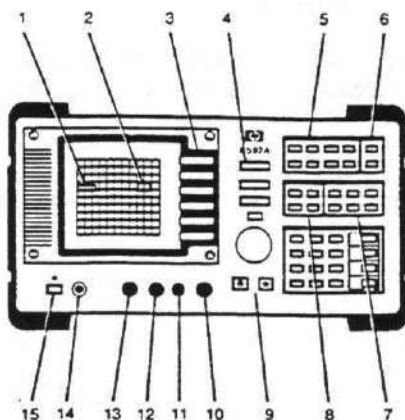

Figure 1-3. Front-Panel Overview

The following section provides a brief description of features. See Chapter 3 for more details.

1. **ACTIVE FUNCTION BLOCK** is the space on the screen that indicates the active function. The values of functions appearing in this block can be changed with the knob, step keys, or number/units keyboard.

- 
2. **MESSAGE BLOCK** is the space on the screen where messages appear. If one or more functions are manually set and the amplitude or frequency becomes uncalibrated, "MEAS UNCAL" appears on the right side of the graticule. Use **AUTO COUPLE** to recouple functions and get back to a calibrated mode.
  3. **SOFTKEYS** are unlabeled keys next to the screen that are annotated on the screen. The labeled keys on the analyzer's front panel access menus of related softkeys.
  4. **FREQUENCY**, **SPAN**, and **AMPLITUDE** are the three dark keys that activate the primary analyzer functions and access menus of related functions.
  5. **INSTRUMENT STATE** functions affect the states of the entire spectrum analyzer. Calibration routines and special-function menus are accessed with these keys. The green **PRESET** key resets the entire analyzer state and can be used as a "panic" button when you wish to return to a known state. **SAVE** and **RECALL** use non-volatile memory to save and recall traces and states.
  6. **COPY** functions allow you to print or plot screen data with or without an external controller. (This requires Option 021, 022, or 023.)
  7. **CONTROL** functions access menus that allow you to adjust the resolution bandwidth, manipulate trace data, and control the instrument display.
  8. **MARKER** functions read out frequencies and amplitudes along the spectrum-analyzer trace, automatically locate the signals of highest amplitude, and keep a marker signal in the center of the screen.

- 
9. DATA keys, STEP keys and the KNOB allow you to change the numeric value of an active function. The **HOLD** key deactivates an active function.
  10. INPUT 50  $\Omega$  is the signal input for the spectrum analyzer.
  11. CAL OUTPUT provides a calibration signal of 299.9 MHz at -20 dBm on the front panel.
  12. 100 MHz COMB OUT supplies a 100 MHz signal with harmonics up to 22 GHz for use as a frequency reference signal.
  13. 1ST LO OUTPUT provides the local oscillator signal with a 3.0 to 6.6 GHz range.

**CAUTION**

Excessive signal input damages the analyzer INPUT attenuator and the input mixer. The maximum power that the spectrum analyzer can tolerate appears on the front panel.

14. INTENSITY allows you to change the brightness of the screen display.
15. LINE turns on the instrument and starts an instrument check. For best measurement results, after applying power, allow the temperature of the instrument to stabilize. (See "Warmup Time" later in this chapter.)

---

## Rear-Panel Feature Overview

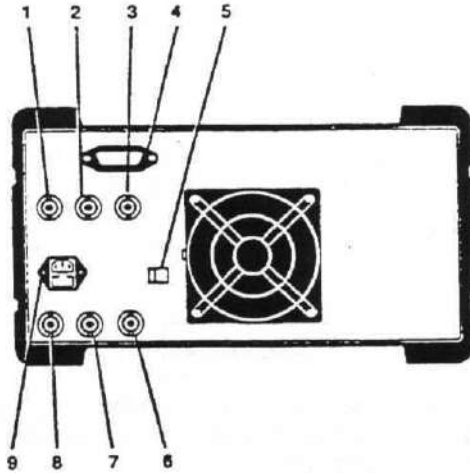

*Figure 1-4. Rear-Panel Overview*

1. SWEEP OUTPUT provides a voltage ramp proportional to the sweep and the analyzer span (nominal 0-10V).

- 
2. AUX VIDEO OUTPUT provides detected video output (before A/D conversion) proportional to vertical deflection of the CRT trace. Output increases 125 mV per division from 0 to 1V.
  3. AUX IF OUTPUT is a 50-ohm, 21.4-MHz IF output that is related to the INPUT 50  $\Omega$  of the analyzer.
  4. INTERFACE CONNECTORS are optional interfaces for HP-IB, RS-232, or HP-IL that allow remote instrument operation and direct plotting or printing of screen data.
  5. VOLTAGE SELECTOR adapts the unit to the power source: 115V or 230V.
  6. EXT TRIG INPUT allows the analyzer's internal sweep source to be triggered by an external voltage.
  7. MONITOR OUTPUT allows the use of external CRT monitors such as the HP 82913A with a 19.2 kHz horizontal synchronizing rate.
  8. HI SWEEP IN/OUT indicates sweep or can be grounded to stop sweep.
  9. POWER INPUT is the input for the main power cable. Insert the main power cable plug only into a socket outlet that has a protective ground contact.



---

## Menu and Softkey Overview

While performing the measurement in the first part of this chapter, you may have noticed the **menus** along the right side of the display. These menus list functions other than those accessed directly by the keys that are labeled on the front panel of the instrument. (**In this manual, front-panel keys appear in *BOLD ITALICS*.**)

When the instrument is first turned on, the frequency menu appears on the screen. To activate a function on the menu, press the unlabeled key immediately to the right of the annotation on the screen. The unlabeled keys next to the annotation on the display screen are called softkeys. (**In this manual, softkeys are enclosed in [BRACKETS].**)

Most front-panel keys access softkey menus which, in turn, list related functions. For example, press the ***FREQUENCY*** key. This calls up a menu containing frequency softkeys and activates the center frequency function. Press the [START FREQ] softkey. "START" appears in the active function block, indicating that start frequency is the active function. To activate a different frequency function, press another softkey. To select another menu, press another labeled front-panel key, or choose a softkey such as [MORE].

Some softkeys activate another menu. For example, the [BAND LOCK] softkey activates the Band Lock menu.

A summary of all softkeys can be found at the end of this manual.

## Screen Annotation

Figure 1-5 shows annotation as it appears on the screen of the analyzer when it is set to clear/write A, store blank B, free run trigger, and single sweep. Calibration correction data is ON. Table 1-1 lists the features of the front panel alphabetically and references the numbers in Figure 1-5.

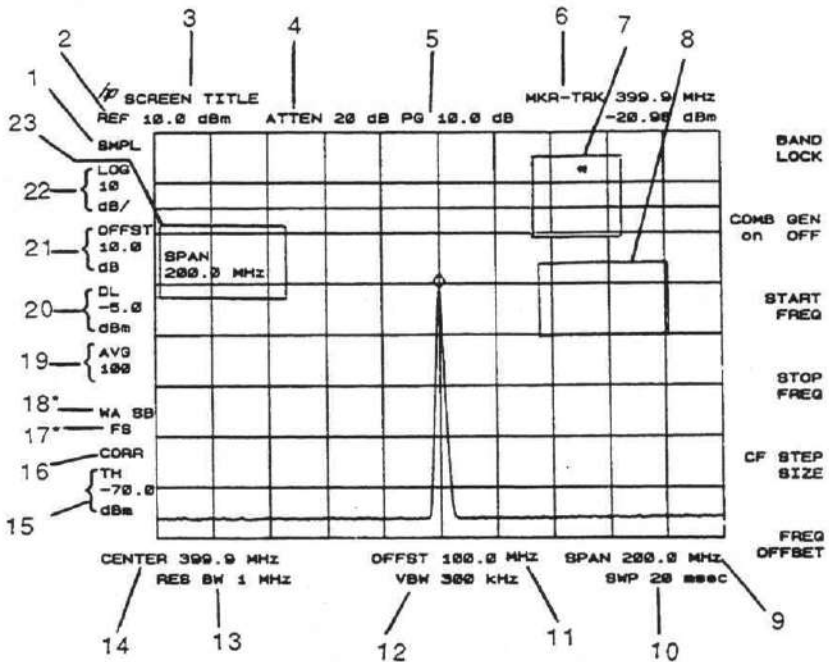

Figure 1-5

\*Trace, sweep, and trigger modes appear on the display, indicating the active functions listed in Table 1-1: (Clear/Write A, Store/Blank B, Free Trigger, Single Sweep)

<i>Trace</i>	<i>Trigger</i>	<i>Sweep</i>
W = clear write A/B	F = free	C = continuous
M = maximum hold A/B	L = line	S = single sweep
V = view A/B	V = video	
S = store blank A/B	E = external	

Table 1-1 Screen Annotation

Feature	Index	Feature	Index
active function block	23	scale	22
amplitude scale	22	screen title	3
amplitude offset	21	service request	8
attenuation	4	signal track	6
corrected	16	span	9
center frequency	14	trigger	17
detector mode	1	sweep time	10
display line	20	start frequency	14
frequency offset	11	(or center frequency)	
frequency span	9		
marker readout	6	stop frequency (or span)	9
trace requires update	7	threshold	15
preamplifier gain	5	trace mode	18
reference level	2	sweep mode	17
resolution bandwidth	13	video average	19
RF attenuation	4	video bandwidth	12

---

## Improving Accuracy With Calibration Routines

Calibration routines improve the analyzer's frequency and amplitude accuracy. Press the **CAL** key to view the calibration menus. The last function on this menu, labeled **MORE**, provides access to additional calibration functions. (For a summary of all calibration softkeys, see Chapter 3, "Analyzer Functions." For a complete description of the procedure, see "Turning on the Analyzer for the First Time" in the Installation Manual.)

The calibration routines should be used before calibrated measurements are made to ensure that the analyzer meets frequency and amplitude accuracy specifications. Allow the temperature of the instrument to stabilize before starting the calibration procedure. The calibration routines should be run whenever the instrument is first turned on.

Once the instrument has been frequency and amplitude calibrated, "CORR" (corrected) appears on the left side of the screen. (See "Calibration Procedure" which follows.)

### Warmup Time

To meet spectrum analyzer specifications, allow two hours warmup time after storage at a constant temperature within the operating temperature range, and 30 minutes after the analyzer has been turned on before attempting to make any calibrated measurements. (Because this is a calibrated measurement, be sure to calibrate the instrument after allowing the analyzer to stabilize.)

---

## Calibration Procedure

1. Turn the instrument on and press **PRESET**. Connect the CAL OUTPUT to the analyzer INPUT using the appropriate BNC cable and type N adapter. (If the CAL signal is not connected, the CAL routines will not run correctly.)
2. Press the **CAL** key to reach the calibration softkey menu.
3. Press the [CAL FREQ] softkey to run the frequency calibration routine. This routine adjusts the sweep time and span accuracy in approximately two minutes. When the frequency calibration routine has finished, "CAL: DONE" appears in the active function block.
4. Press the [CAL AMPTD] softkey to run the amplitude calibration routine. This routine takes approximately seven minutes to adjust the bandwidths, log/linear switching, IF gains, RF attenuation, and log amplifier. When the amplitude calibration routine has finished, "CAL: DONE" appears in the active function block.
5. Although the analyzer now uses this frequency and amplitude calibration data, the data will be lost if the analyzer is turned off.

To store the calibration data in the analyzer's nonvolatile memory, press the [CAL STORE] softkey. Once the calibration data has been stored, turning the instrument off and on automatically retrieves the stored calibration data. DO NOT store calibration data if an error occurs during step 2 or 3. (See the Installation Manual.)

- 
6. "CORR" (corrected) now appears on the left side of the screen, indicating that the analyzer is using its frequency and amplitude correction factors. Correction factors can be turned off by pressing [CORRECT ON OFF]. When ON is capitalized, the correction factors are used and CORR appears on the display.

When OFF is capitalized, correction factors are not used. The hardware still functions, but the accuracy of the measurement will be poor, especially in the higher frequency bands.

### CAUTION

Do not press [CAL STORE] if any of the calibration routines are not successfully completed per the above procedure. Press *CAL* and [CAL FETCH] to retrieve the previous calibration data if any of the calibration routines are interrupted such as by pressing *PRESET*. Press *PRESET*, *CAL* and [CAL FETCH] to retrieve the previous calibration data if [CAL FREQ] or [CAL AMPTD] is accidentally pressed when the CAL OUTPUT is not connected to the analyzer INPUT.

---

## What You'll Learn in This Chapter

This chapter demonstrates analyzer measurement techniques with examples of typical applications; each application focuses on different features. The measurement procedures covered in this chapter are listed below.

- Resolving signals of equal amplitude with resolution bandwidth
- Resolving small signals with large signals using the resolution bandwidth function
- Automatic zooming with auto zoom
- Peaking signal amplitude with preselector peak
- Tracking unstable signals with signal track and maximum hold
- Comparing signals with delta markers
- Measuring low-level signals with attenuation, video bandwidth, and video averaging
- Identifying distortion using the RF attenuator and traces
- Using the Comb Generator to perform more accurate frequency measurements
- Using the analyzer as a receiver in zero frequency span
- Measuring amplitude modulation with the Fast Fourier Transform function
- Measuring signals near band boundaries with harmonic lock

To find descriptions of specific analyzer functions, turn to Chapter 3, "Analyzer Functions," or look in the index.

---

## Resolving Signals of Equal Amplitude With Resolution Bandwidth

In responding to a continuous-wave signal, a swept-tuned spectrum analyzer traces out the shape of the spectrum analyzer's filter. As we change the filter bandwidth, we change the width of the displayed response. If a wide filter is used and two equal-amplitude input signals are close enough in frequency, then the two signals appear as one. Thus, signal resolution is determined by the IF filters inside the analyzer.

The **resolution bandwidth** function (RES BW) selects an IF filter setting for a measurement. Resolution bandwidth is defined as the 3-dB bandwidth of a filter. The 3-dB bandwidth tells us how close together equal amplitude signals can be and still be distinguished from each other.

Generally, to resolve two signals of equal amplitude, the resolution bandwidth must be less than or equal to the frequency separation of the two signals. Then a dip of at least 3 dB is seen between the peaks of the two signals, and it is clear that more than one signal is present.

**Hint:** In order to keep the analyzer calibrated, sweep time is automatically set to a value that is inversely proportional to the square of the resolution bandwidth. So, if the resolution bandwidth is reduced by a factor of 10, the sweep time is increased by a factor of 100. ( $ST = 1/[BW]^2$ ) For fastest measurement times, use the widest resolution bandwidth that still permits discrimination of all desired signals. The analyzer allows you to select from 1-kHz to 3-MHz resolution bandwidth in a 1,3,10 sequence for maximum measurement flexibility.



---

**Example:** Resolve two signals of equal amplitude with a frequency separation of 100 kHz.

1. To obtain two signals with a 100-kHz separation, connect the calibration signal and a signal source to the analyzer INPUT as shown in Figure 2-1. (If available, two sources can be used.)

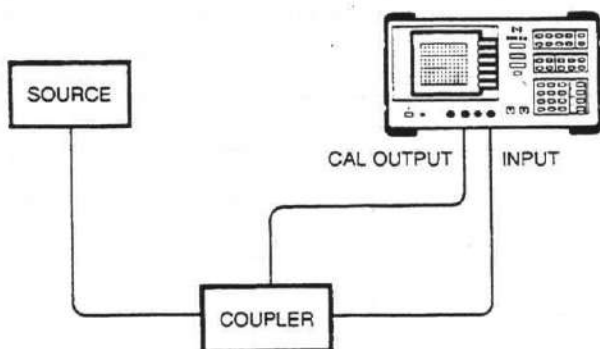

*Figure 2-1*

2. If you are using the 299.9-MHz calibration signal, set the frequency of the source 100 kHz greater than the calibration signal (that is, 300.0 MHz). The amplitude of both signals should be approximately -20 dBm.



---

As the resolution bandwidth is decreased, resolution of the individual signal is improved and the sweep time is increased. For fastest measurement times, use the widest possible resolution bandwidth. Under preset conditions, the resolution bandwidth is "coupled" (or linked) to span.

Since the resolution bandwidth has been changed, a "#" mark appears next to RES BW in the lower corner of the screen, indicating it is uncoupled. (Also see *AUTO COUPLE* in Chapter 3.)

**Note:** To resolve two signals of equal amplitude with a frequency separation of 200 kHz, the resolution bandwidth must be less than the signal separation, and resolution of 100 kHz must be used. The next larger filter, 300 kHz, would exceed the 200-kHz separation and would not resolve the signals.

---

## Resolving Small Signals and Large Signals With Resolution Bandwidth

When dealing with resolution of signals that are not equal in amplitude, you must consider the shape of the IF filter as well as its 3-dB bandwidth. The shape of the filter is defined by the **shape factor**, which is the ratio of the 60-dB bandwidth to the 3-dB bandwidth. (Generally, the IF filters in this spectrum analyzer have shape factors of 15:1 or less.)

If a small signal is too close to a larger signal, it can be hidden by the skirt of the larger signal. To view the smaller signal, you must select a resolution bandwidth such that  $k < a$ . See Figure 2-3.

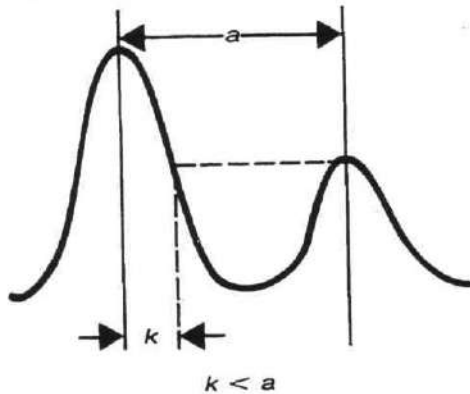

Figure 2-3

---

The separation between the two signals must be greater than half the filter width of the larger signal at the amplitude level of the smaller signal.

**Example:** Resolve two input signals with a frequency separation of 200 kHz and an amplitude separation of 50 dB.

1. To obtain two signals with a 200-kHz separation, connect the equipment as shown in the previous section, "Resolving Signals of Equal Amplitude."
2. Set the span to 2 MHz.
3. Set the source so that the signal is 200 kHz higher than the calibration signal. Set the amplitude of the signal to -70 dBm (50 dB below the calibration signal).
4. If a 10-kHz filter with a typical shape factor of 15:1 is used, the filter will have a bandwidth of 150 kHz at 60 dB. The half-bandwidth (75 kHz) is narrower than the frequency separation, so the input signals will be resolved.

If a 30-kHz filter is used, the 60-dB bandwidth will be 450 kHz. Since the half-bandwidth (225 kHz) is wider than the frequency separation, the signals most likely will not be resolved. (To determine resolution capability for intermediate values of amplitude level differences, consider the filter skirts between the 3-dB and 60-dB points to be straight. In this case, we simply used the 60-dB value.)

---

## Automatic Zooming With Auto Zoom

Using the spectrum analyzer's automatic zoom function, you can quickly zoom in to see the sidebands of a signal.

**Example:** Examine a carrier signal in a 200-kHz span to see the sidebands.

1. Press **PRESET** and tune to a carrier signal and place a marker at the peak. (If you are using the CAL OUTPUT signal, place the marker on the 299.9 MHz calibration signal. Press **FREQUENCY, 299.9 MHz, SPAN, 200 MHz**, and **PEAK SEARCH**.)
2. Press **SIGNAL TRACK** and the signal will move to the center of the screen, if it is not already positioned there. Because the signal track function automatically maintains the signal on the center of the screen, you can zoom in automatically from a wide span to a narrow span for a closer look. If the signal drifts off of the screen as you decrease the span, use a wider frequency span.
3. Press **SPAN, 200 kHz**. The span decreases in steps as automatic zoom is completed. You can also use the knob or step keys to decrease the span. See Figure 2-4.

Press **SIGNAL TRACK** again to turn off the tracking function.

**Note:** When you are finished with the example, turn off signal track. (Signal track must be off for zero span.)

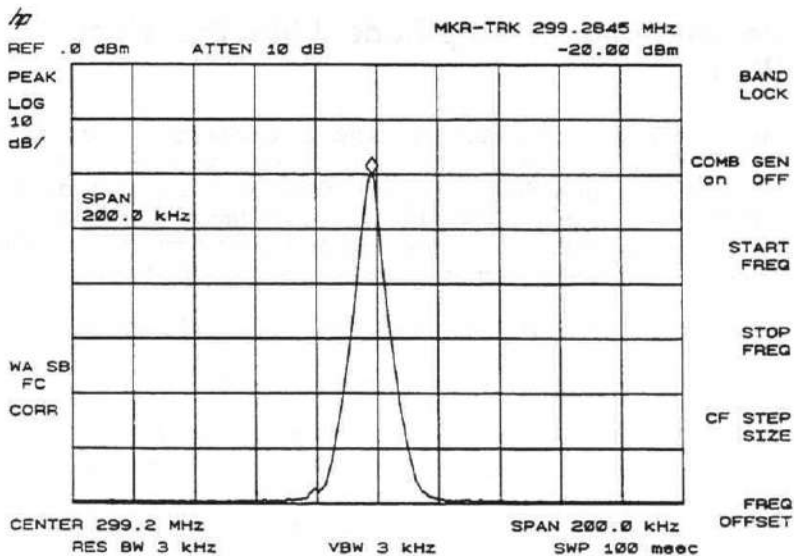

Figure 2-4

---

## Peaking Signal Amplitude With Preselector Peak

Preselector peak automatically adjusts the preselector tracking to peak the signal at the active marker. To search for the peak response of the preselector and adjust the tracking, tune the marker to a signal and press **AMPLITUDE**, then [PRESEL PEAK], which directs an internal routine to conduct the search. Using preselector peak prior to measuring a signal yields the most accurate amplitude reading at the specified frequency.

**Note:** Pressing **PRESET** clears all previous [PRESEL PEAK].

**Note:** This function only works in harmonic bands.

**Example:** Using the knob, step keys, or **PEAK SEARCH**, place the marker on your signal, and press [PRESEL PEAK]. The message "CAL: PEAKING" appears in the active function block while the routine is working. When this message disappears, the amplitude is maximized.



---

## Tracking Unstable Signals With Signal Track and Maximum Hold

Two techniques can be used to follow and measure drifting and changing signals; unstable signals which drift with time and may be difficult to track with the analyzer, and modulated signals which may appear unstable, but which have an envelope that contains the information bearing portion of the signal.

**PEAK SEARCH** and **SIGNAL TRACK** may be used to track these unstable signals. **PEAK SEARCH** places the marker on the highest signal on the display. **SIGNAL TRACK** brings that signal to the center frequency of the graticule and adjusts the center frequency every sweep to bring the highest point back to the center.

Using the above functions, a modulated signal may be brought to the center frequency. **SIGNAL TRACK** should then be turned off and **MAXIMUM HOLD** should be turned on for a period of time to fill in the envelope.

This example requires a modulated signal which can be easily found in air by connecting an antenna to the analyzer INPUT and tuning to the FM broadcast band (88 to 108 MHz), nominally 100 MHz with a span of 20 MHz, an attenuator setting of 0 dB, and reference level of approximately -50 dBm. Your circumstances may be slightly different, depending on building shielding and proximity to transmitters.

---

**Example:** The analyzer automatically maintains drifting signals at the center of the screen with the signal track function. As the signal drifts, the center frequency automatically changes to bring the signal and marker to the center of the screen. Use signal track to keep a drifting signal at the center of the display and monitor its change in "real-time."

1. Connect an antenna to the analyzer INPUT. (If you have no antenna, use a clip lead cable to a wire, or solder a wire to an appropriate connector to fasten to the INPUT). Enter the following sequence of softkeys and measurements.

Press **PRESET, FREQUENCY, 1 0 0 MHz**. Press **SPAN, 2 0 MHz**. Press **AMPLITUDE, 5 0 -dBm**. Press **[ATTEN], 0 dB**. Press **PEAK SEARCH, SIGNAL TRACK, SPAN, 5 0 0 kHz**.

Notice that the signal has been held in the center of the display.

2. If the signal you selected drifts too quickly for the analyzer to keep up with, use a wider span.
3. The "real-time" signal frequency drift can be read from the screen if both the signal track and marker delta functions are active. Press **MARKER, MARKER DELTA** and **SIGNAL TRACK**; the Marker readout indicates the amount of frequency and amplitude change as the signal drifts. (See Figure 2-5.)

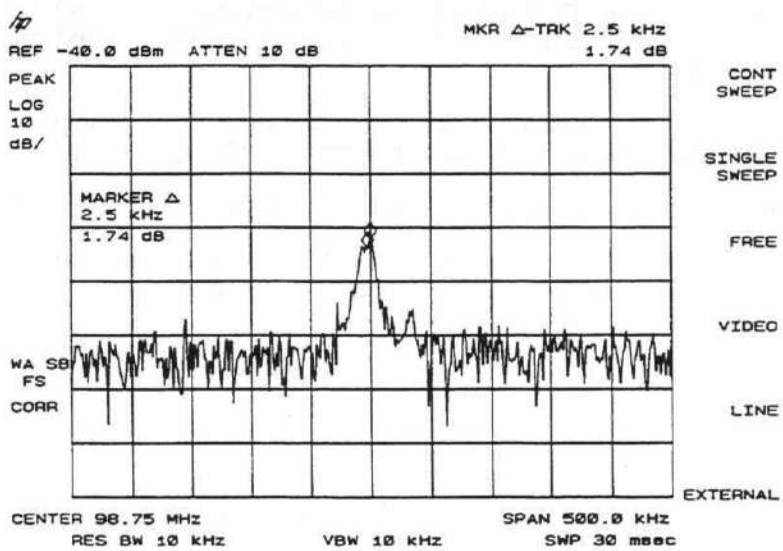

Figure 2-5

---

**Example:** A spectrum analyzer can measure the short- and long-term stability of a source. The maximum amplitude level and the frequency drift range of an input signal trace can be displayed and held with the **maximum hold** function.

You can use the maximum hold function if, for example, you want to determine how much of the frequency spectrum an FM signal occupies.

Using the maximum hold function, monitor the frequency drift of a signal.

1. Connect an antenna to the analyzer INPUT. (If you have no antenna, use a clip lead cable to a wire, or solder a wire to an appropriate connector to fasten to the INPUT).

Press **PRESET, FREQUENCY, 1 0 0 MHz**. Press **SPAN, 2 0 MHz**. Press **AMPLITUDE, 4 0 -dBm**. Press [ATTEN], **0 dB**. Press **PEAK SEARCH, SIGNAL TRACK, SPAN, 5 0 0 kHz**.

Notice that the signal has been held in the center of the display.

2. To measure the excursion of the signal, press **TRACE A** and [MAX HOLD A]. As the signal drifts, maximum hold maintains the maximum responses of the input signal.

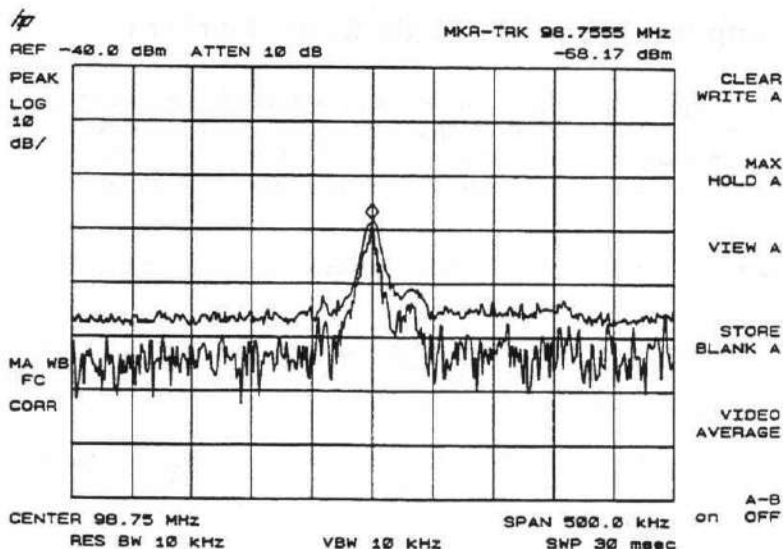

Figure 2-6

- Annotation on the left side of the screen indicates the trace mode. For example, "MA SB" indicates trace A is in maximum-hold mode and trace B is in store-blank mode. (See "Screen Annotation" in "Getting Acquainted.")

Press **TRACE B** and [CLEAR WRITE B] to place trace B in clear-write mode. The live signal is viewed in trace B as it moves. Trace A remains in maximum-hold mode, showing the frequency shift of the signal. (See Figure 2-6.)

---

## Comparing Signals With Delta Markers

With the spectrum analyzer you can easily compare frequency and amplitude differences between signals, such as radio or television signal spectra. The spectrum analyzer's delta marker function lets you compare two signals when both appear on the screen at one time or when only one appears on the screen.

**Example:** Measure the differences between two signals on the same display screen.

1. Connect the CAL OUTPUT to the analyzer INPUT on the front panel. Press **PRESET**, [BAND LOCK] [BAND 0]. The calibration signal and its harmonics appear on the display.
2. Press **PEAK SEARCH** to place a marker at the highest peak on the display. The [NEXT PK RIGHT] and [NEXT PK LEFT] softkeys move the marker from peak to peak. Press [NEXT PK RIGHT] to move the marker to the 299.9-MHz calibration signal. See Figure 2-7.

The signal that appears at the left edge of the screen is the spectrum analyzer's local oscillator and represents 0 Hz.



- 
3. Press [MARKER DELTA] to activate a second marker at the position of the first marker. Move the second marker to another signal peak with the [NEXT PK RIGHT] or [NEXT PK LEFT] softkeys. You may also use the knob or step keys to move the second marker.
  4. The amplitude and frequency difference between the markers is displayed in the active function block and in the upper-right corner of the screen. See Figure 2-8.

Press **MKR** and [MARKERS OFF] to turn the markers off, or press **AUTO COUPLE**.

Press [BAND LOCK], [HRM LOCK OFF] to unlock the frequency band. (See Harmonic Lock.)

5. The [DELTA MEAS] softkey also finds and displays the frequency and amplitude difference between the two highest amplitude signals. To use this automatic function, first remove the local oscillator (LO) signal by pressing **FREQUENCY**, [START FREQ], and turning the knob until the LO signal at 0 Hz is off the screen. Press **MENU 1** and [DELTA MEAS].



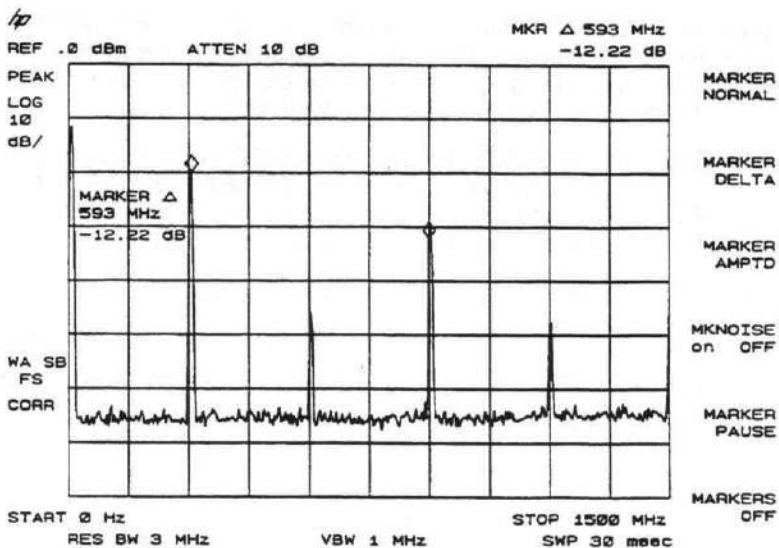

Figure 2-8

The frequency and amplitude differences between the signals appear in the active function block. In addition, the softkeys accessed by **PEAK SEARCH** appear on the screen.

---

**Example:** Measure the frequency and amplitude difference between two signals that do not appear on the screen at one time. (This technique is useful for harmonic distortion tests when narrow span and narrow bandwidth are necessary to measure the low-level harmonics.)

1. Connect the CAL OUTPUT to the analyzer INPUT on the front panel (if you have not already done so). Press **PRESET**, **FREQUENCY 299.9 MHz**, **SPAN**, and the down step key to narrow the frequency span until only one signal appears on the screen.
2. Press **PEAK SEARCH** to place a marker on the peak.
3. Press [MARKER DELTA] to identify the position of the first marker.
4. Press **FREQUENCY** to activate center frequency. Turn the knob clockwise to adjust the center frequency until a second signal peak is placed at the position of the second marker. The first marker remains on the screen at the amplitude of the first signal peak.

The annotation in the upper-right corner of the screen indicates the amplitude and frequency difference between the two signals. See Figure 2-9.

To turn the markers off, press **MKR** and [MARKERS OFF].

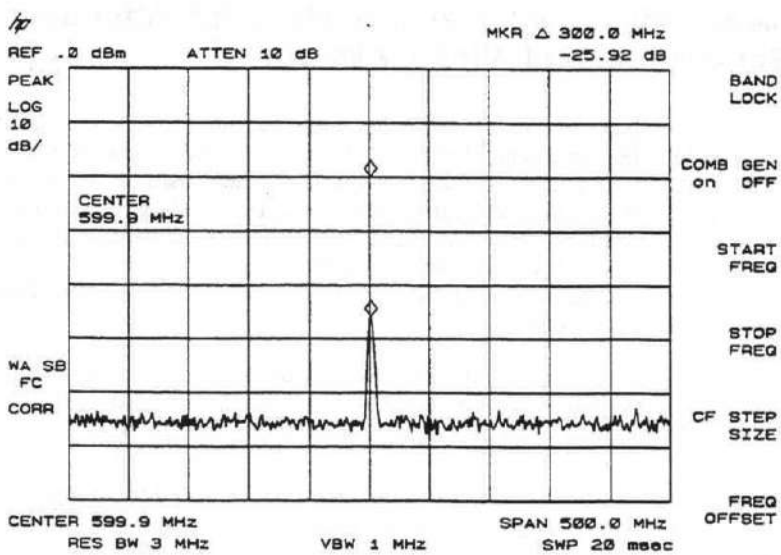

Figure 2-9

---

## Measuring Low-Level Signals With Attenuation, Bandwidth, and Video Averaging

Spectrum analyzer sensitivity is the ability to measure low-level signals and is limited by the noise generated inside the analyzer itself. The analyzer INPUT attenuator and bandwidth settings affect the sensitivity by changing the signal-to-noise ratio. The attenuator affects the level of a continuous wave signal passing through the instrument, whereas the bandwidth affects the level of internal noise without affecting the signal. In the first two examples in this section, the attenuator and bandwidth settings are adjusted to view low-level signals.

If, after adjusting the attenuation and resolution bandwidth, a signal is still near the noise, visibility can be improved with the video bandwidth and video averaging functions, as demonstrated in the third and fourth examples.

**Example:** If a signal is very close to the noise floor, reducing input attenuation brings the signal out of the noise. Reducing the attenuation to 0 dB maximizes signal power in the analyzer.

**Note:** The level of all input signals must not exceed the maximum power level for the analyzer.

1. Connect the CAL OUTPUT signal to the analyzer INPUT. (The calibration signal does not exceed the maximum power level.) Press **PRESET**, [BAND LOCK], [BAND 0], then **PEAK SEARCH**. Press [NEXT PK RIGHT] until the marker is placed on the low signal peak at the right side of the screen.
2. Press **SIGNAL TRACK** and the signal is moves to the center frequency. Press **SPAN**, **1 0 0 MHz** and **SIGNAL TRACK** to turn off the tracking function. (See Figure 2-10.)

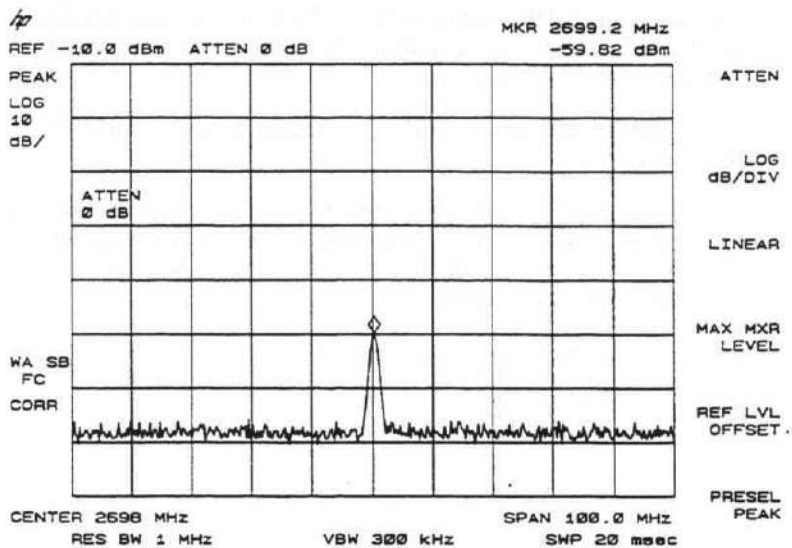

Figure 2-10

- 
3. Press **AMPLITUDE** and [ATTEN]. Press the up step key once to select 20-dB attenuation. Increasing the attenuation moves the noise floor closer to the signal.

A “#” mark appears next to ATTEN, indicating the attenuation is no longer coupled.

4. To see the signal more clearly, press **0 dB**. Zero attenuation makes the signal more visible. (As a precaution to protect the spectrum analyzer’s input mixer, 0-dB RF attenuation can be selected only with the number/units keyboard.)

Before connecting other signals to the analyzer INPUT, increase the RF attenuation to protect the analyzer’s input mixer by pressing **AUTO COUPLE**.

---

**Example:** The resolution bandwidth can be decreased to view low-level signals.

1. As in the previous example, connect the CAL OUTPUT signal to the analyzer INPUT connector. Press **PRESET**, [BAND LOCK], [BAND 0], then **PEAK SEARCH**. Press [NEXT PK RIGHT] until the marker is placed on the low signal peak at the right side of the screen.
2. Press **SIGNAL TRACK** and the signal moves to the center frequency. Press **SPAN** and select **400 MHz**.
3. Press **SWP/BW**, [RES BW], and the down step key. The low-level signal appears more clearly because the noise level is reduced.

A “#” mark appears next to RES BW on the left corner of the screen, indicating that the resolution bandwidth is uncoupled.

As the resolution bandwidth is reduced, the sweep time is increased to maintain calibrated data.

**Example:** The video filter control is useful for noise measurements and observation of low-level signals close to the noise floor. The video filter is a post-detection low-pass filter that smooths the displayed trace by averaging random noise. (The normal detection mode is PEAK, so the displayed level of the noise drops from the peak value to the average value in the smoothing process.)

---

Thus, when signal responses near the noise level of the analyzer will be visually masked by the noise, the video filter can be narrowed to smooth this noise and improve the visibility of the signal. (Since video filtering requires slower sweep times to keep the analyzer calibrated, it is not used all the time.)

Using the video bandwidth function, measure the amplitude of a low-level signal.

1. Position a low-level signal on the analyzer screen, as in steps 1 and 2 of the previous example. Narrow the video bandwidth using the down step key. This clarifies the signal by smoothing the noise, which allows better measurement of the signal amplitude.

A “#” mark appears next to VBW on the screen, indicating that the video bandwidth is not coupled to the resolution bandwidth.

Instrument preset conditions couple the video bandwidth to the resolution bandwidth so that the video bandwidth is equal to or narrower than the resolution bandwidth. If the bandwidths are uncoupled when video bandwidth is the active function, pressing **AUTO COUPLE** recouples the bandwidths.

**Note:** The video bandwidth must be set wider than the resolution bandwidth when measuring impulse noise levels.

2. Press **PEAK SEARCH**. See Figure 2-11. Move the marker and read the amplitude and frequency of the signal.



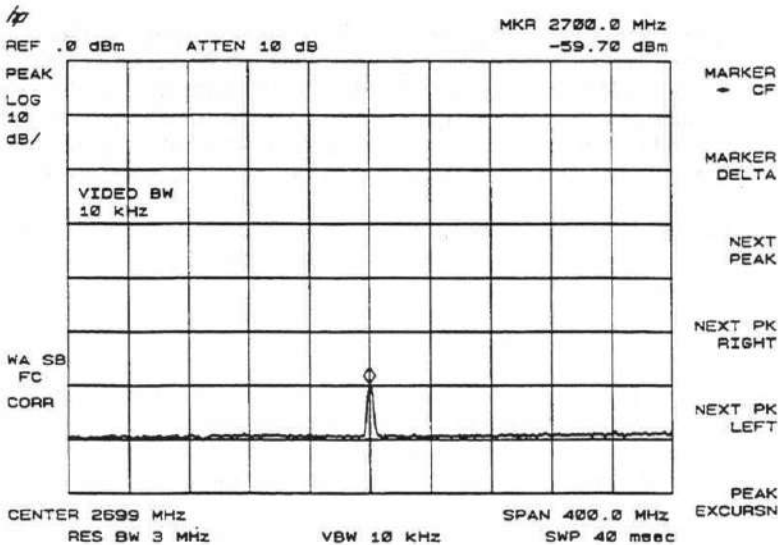

*Figure 2-11*

**Example:** If a signal level is very close to the noise floor, **video averaging** is another way to make the signal more visible. (Use this technique if your signals are subject to change. For example, you can use this technique to watch mobile radio transmissions since it shows you the "real time" responses.)

---

Video averaging is a digital process in which each trace point is averaged with the previous trace-point average. Selecting video averaging changes the detection mode from PEAK to SAMPLE. The sample mode displays the instantaneous value of the signal at the end of the time/frequency interval represented by each display point, rather than the value of the peak during the interval. The result is a sudden drop in the displayed noise level.

Video averaging clarifies low-level signals in wide bandwidths by averaging the signal and the noise. As the analyzer takes sweeps, you can observe video averaging smooth the trace.

1. Position a low-level signal on the analyzer screen.
2. Press **TRACE A** and [VIDEO AVERAGE]. As the averaging routine smooths the trace, low-level signals become more visible. "VID AVG 100" appears in the active function block. The number represents the number of samples (or sweeps) taken to complete the averaging routine.

During averaging, the current sampling appears at the left side of the graticule. Changes to active functions, such as the center frequency or reference level, will restart the sampling: Or, press [VIDEO AVERAGE] to restart sampling.

To set the number of samples, use the number/units keyboard. For example, press **2 5 Hz**, [VIDEO AVERAGE]. The number of samples equals the number of sweeps in the averaging routine. Once the set number of sweeps has been completed, the analyzer continues to provide a running average based on this set number.

## Identifying Distortion Products Using the RF Attenuator and Traces

### Distortion From the Analyzer

High-level input signals may cause spectrum analyzer distortion products which could mask the real distortion on the input signal. Using trace B and the RF attenuator, you can determine which signals, if any, are internally generated distortion products.

**Example:** The signal shown in Figure 2-12 produces harmonic distortion products in the analyzer's input mixer.

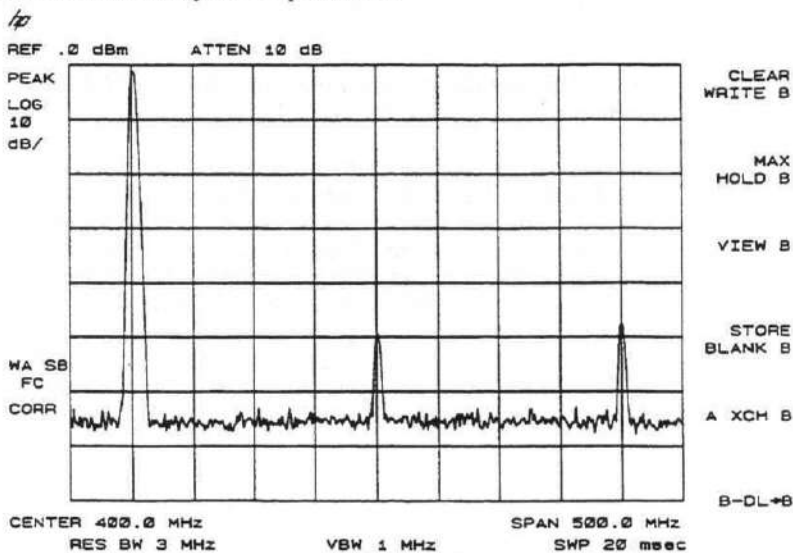

Figure 2-12

- 
1. Connect a signal generator to the analyzer INPUT connector on the spectrum analyzer. Set the frequency of the signal to 200 MHz and set the amplitude to 0 dBm.

Set the center frequency of the spectrum analyzer to 400 MHz and set the span to 200 MHz. Change the attenuation to 0 dB, press **AMPLITUDE**, [ATTEN], **0 dB**.

2. To determine whether the harmonic distortion products are generated by the analyzer, first save the screen data in trace B. Press **TRACE B**, [CLEAR WRITE B]. Allow the trace to update (two sweeps) and press [VIEW B], **PEAK SEARCH**, [MARKER DELTA]. The analyzer shows the stored data in trace B and the measured data in trace A on the display.
3. To increase the RF attenuation by 10 dB, press **AMPLITUDE**, [ATTEN], and the up step key once. (See Figure 2-13.)
4. Compare the response in trace A to the response in trace B. If the distortion product decreases as the attenuation increases, distortion products are caused by the analyzer's input mixer. This is shown by the marker delta value of less than the 10 dB attenuator change. The high-level signals causing the overload conditions must be attenuated to eliminate the interference caused by the internal distortion.

If the responses in trace A and trace B differ, as in Figure 2-13, attenuation is required. If the distortion was not caused internally, there would be no change in the signal level. (See Figure 2-14.)

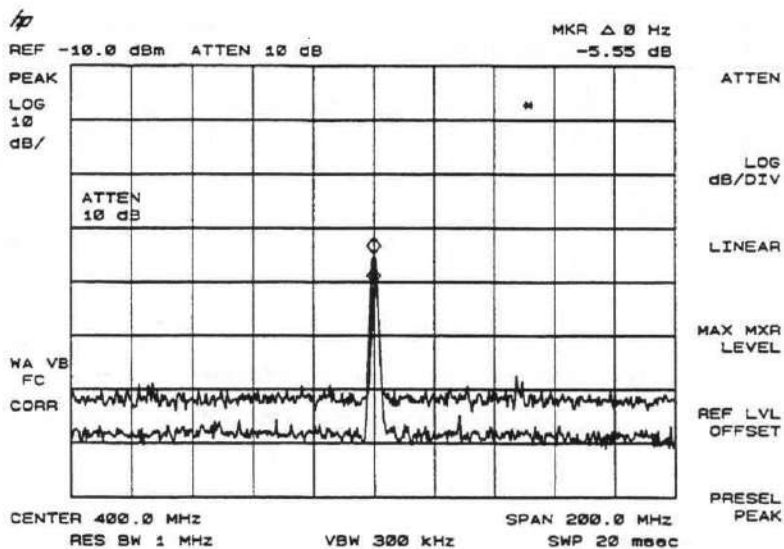

Figure 2-13

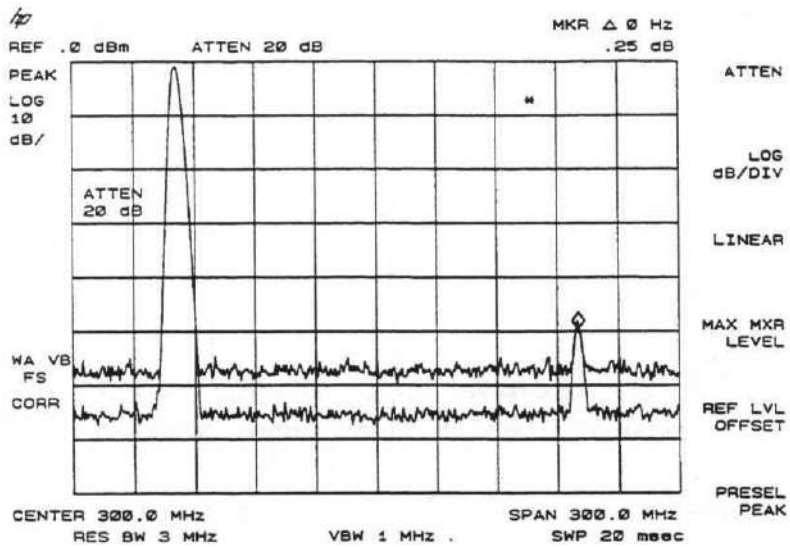

Figure 2-14

---

## Third-Order Intermodulation Distortion

Two-tone, third-order intermodulation is a common problem in communication systems. When two signals are present in a system, they can mix with the second harmonics generated and create third-order intermodulation distortion products, which are located close to the original signals. These distortion products are generated by system components such as amplifiers and mixers.

**Example:** Test a device for third-order intermodulation. This example uses two sources set to 300 and 301 MHz. (Other source frequencies may be substituted, but try to maintain a frequency separation of approximately 1 MHz.)

1. Connect the equipment as shown in Figure 2-15.
2. Set one source to 300 MHz and the other source to 301 MHz for a frequency separation of 1 MHz. Set the sources equal in amplitude (in this example, the sources are set to -5 dBm).
3. Tune both signals onto the screen by setting the center frequency to 300 and 301 MHz. Then, using the knob, center the two signals on the display. Reduce the frequency span to 5 MHz for a span wide enough to include the distortion products on the screen. To be sure the distortion products are resolved, reduce the resolution bandwidth until the distortion products are visible. Press *SWP/BW*, [RES BW], and then use the step down key to reduce the resolution bandwidth until the distortion products are visible.

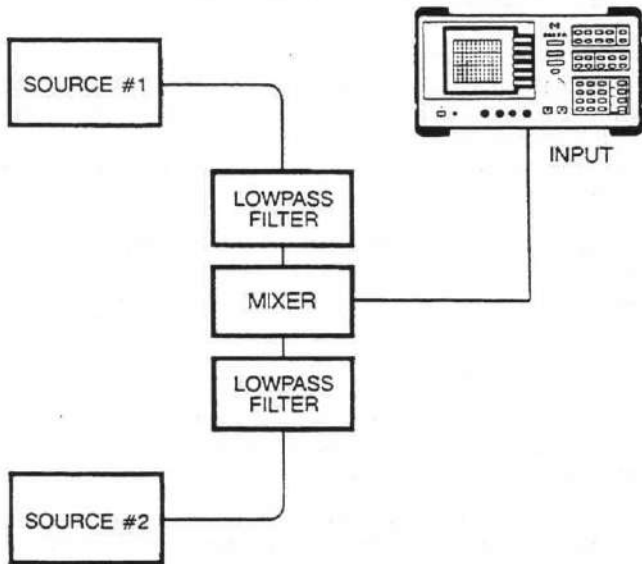

Figure 2-15



- 
4. For best dynamic range, set the mixer input level to -40 dBm: press **AMPLITUDE** and [MAX MXR LEVEL], and enter -40 dBm. The analyzer automatically sets the attenuation so that the maximum signal level seen at the input mixer is -40 dBm.
  5. To measure a distortion product, press **PEAK SEARCH** to place a marker on a source signal. To activate the second marker, press [MARKER DELTA]. Using the knob, adjust the second marker to the peak of the distortion product that is beside the test tone. The difference between the markers is displayed in the active function block.

To measure the other distortion product, press **PEAK SEARCH**, then [NEXT PEAK]. This places a marker on the next highest peak, which, in this case, is the other source signal. To measure the difference between this test tone and the second distortion product, press [MARKER DELTA] and, using the knob, adjust the second marker to the peak of the second distortion product. (See Figure 2-16.)

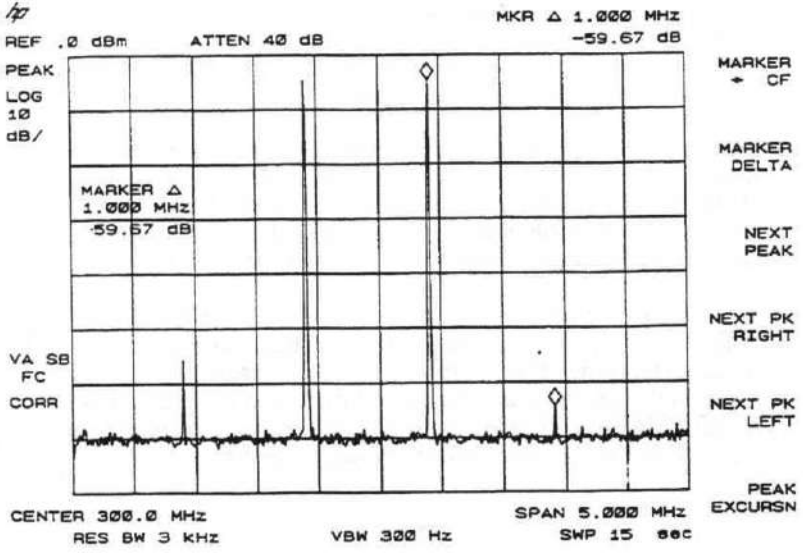

Figure 2-16

---

## Using the Comb Generator to Perform More Accurate Frequency Measurements

The spectrum analyzer has a built-in comb generator that can be connected temporarily to verify frequency accuracy. To identify a signal with the best frequency accuracy provided by the analyzer, use [CORRECT TO COMB].

### Example:

1. Set the analyzer to a state where your signal is displayed in a span  $> 17$  MHz and  $\leq 400$  MHz. The span should be such that a comb tooth can be identified; the narrowest span assures the best accuracy.

In Figure 2-17, the known signal is 4050.0 MHz, and is measured as being 4050.5 MHz.

2. Disconnect the input signal, and connect the 100 MHz COMB OUT to the analyzer INPUT.
3. Press **FREQUENCY** and [COMB GEN ON], and press **MENU 2** and [CORRECT TO COMB]. The marker activates and a comb correction menu is placed in the softkey display. The message "SET MARKER ON COMB TOOTH THEN PRESS 'CONTINUE' SOFTKEY TO CORRECT FREQ OFFST." is displayed. (See Figure 2-18.)
4. Use the softkeys [PEAK SEARCH], [NEXT PK RIGHT] or [NEXT PK LEFT], or use the knob to place the marker on the comb tooth that is nearest to the location of the input signal.
5. Press the [CONTINUE] softkey or you may end the routine at this point by pressing [ABORT].

- 
6. If you pressed [CONTINUE], the analyzer automatically calculates and puts in a frequency offset. The frequency offset in the analyzer is automatically set for the best accuracy available in the current span and center frequency.
  7. Reconnect the input signal and use the marker to read the corrected frequency.

The frequency offset is displayed at the bottom center of the screen. The "known" signal is measured as being 4050.0 MHz. See Figure 2-19.

**Note:** If you change the center frequency or span, you must recorrect the frequency. Note that the analyzer's frequency offset has been used to help calibrate the display, and remember to reset the offset before making other measurements. To clear the offset, use [CLEAR OFFST], or, if you are not in this menu, use the sequence *MENU 2*, [CORRECT TO COMB], [CLEAR OFFST], or press the **PRESET** key.

**Note:** For center frequencies less than 50 MHz, the local oscillator can be used as a referenced signal rather than a comb tooth to obtain better accuracy.

**Note:** The Correct to Comb function is recommended for spans 17 to 400 MHz, and is not useable in multibands. Refer to Table 1-1 in the Installation Manual for more information.

**Note:** When using the [CORRECT TO COMB] function in baseband, 20 dB of attenuation or greater should be used; otherwise the comb generator's power level overloads the first converter.

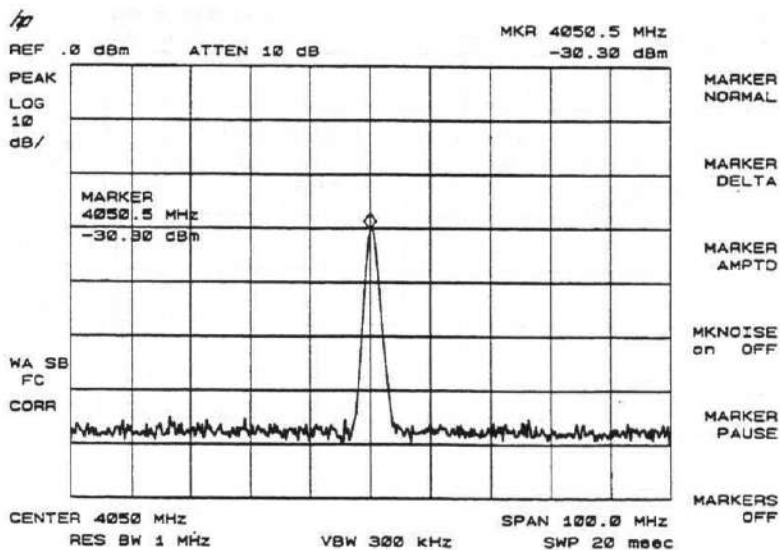

Figure 2-17

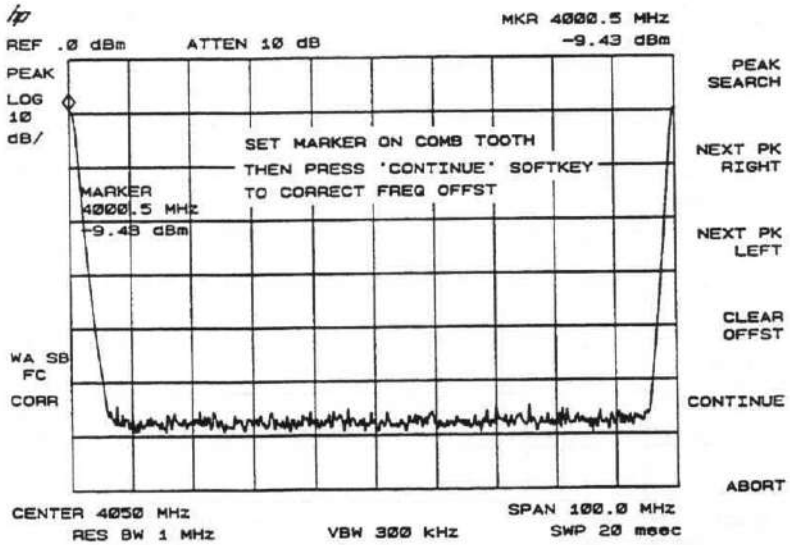

Figure 2-18

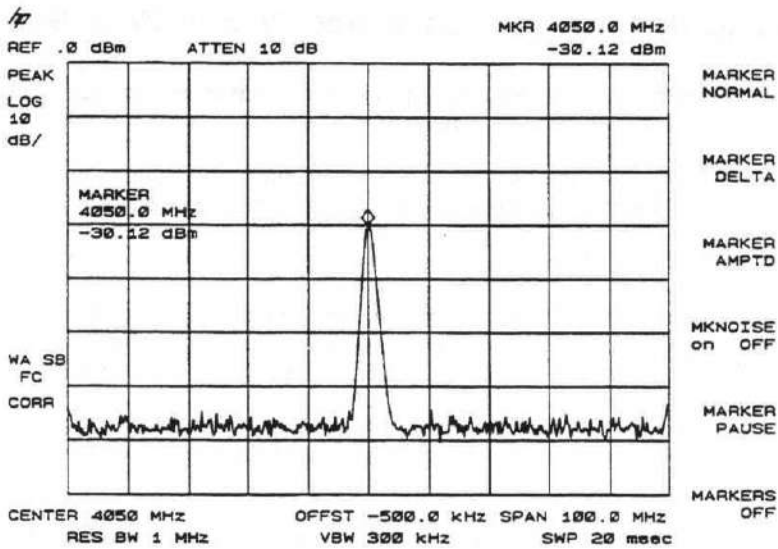

Figure 2-19

---

## Using the Analyzer as a Receiver in Zero Span

The spectrum analyzer operates as a fix-tuned receiver in zero span. The zero span mode can be used to recover modulation on a carrier signal.

Center frequency in the swept-tuned mode becomes the tuned frequency in zero span. The horizontal axis of the screen becomes calibrated in time.

The following functions establish a clear display of the video waveform:

TRIGGER stabilizes the waveform trace on the display by triggering on the modulation envelope. If the signal's modulation is stable, VIDEO TRIGGER synchronizes the sweep with the demodulated waveform.

LINEAR mode is used in amplitude modulation (AM) measurements to remove distortion caused by the logarithmic amplifier when demodulating signals.

SWEEP TIME adjusts the full sweep time down to 20 milliseconds (ms) in zero span, with the sweep time domain range being 20 ms to 100 seconds. The sweep time readout refers to the full 10-division graticule. Divide this value by 10 to determine sweep time per division.

RESOLUTION and VIDEO BANDWIDTH are selected according to the signal bandwidth.

Each of the coupled function values remains at its current value when zero span is activated.



**Example:** View the modulation waveform of an AM signal in the time domain.

1. To obtain an AM signal, you can connect an antenna to the analyzer INPUT and tune to a commercial AM broadcast station, or you can connect a source to the analyzer INPUT and set the percent modulation of the source. (A headset can be used with the VIDEO OUT connector, and the spectrum analyzer will operate as a radio.)
2. First, center and zoom in on the signal in the frequency domain. (See "Automatic Zooming.") (Signal Track must be off for zero span.) See Figure 2-20.

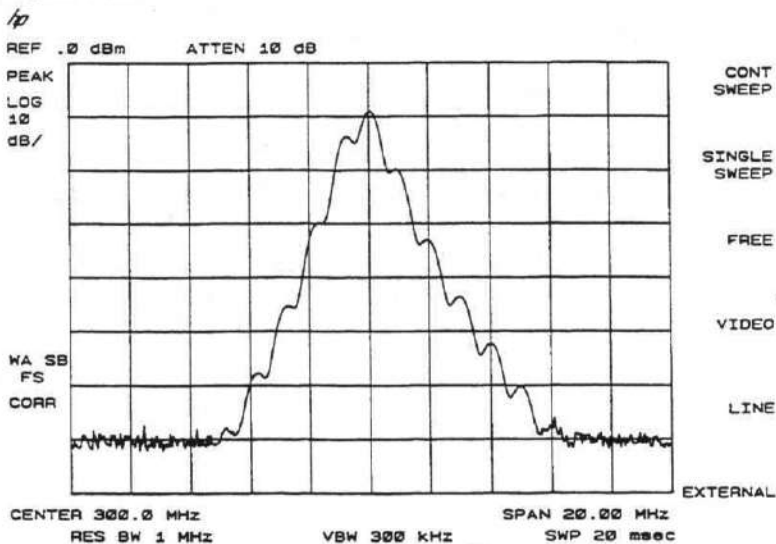

Figure 2-20

3. To demodulate the AM, press **SWP/BW** and [RES BW]. Increase the resolution bandwidth to include both sidebands of the signal within the passband of the spectrum analyzer. Be sure to set the resolution bandwidth wide enough to account for spectrum analyzer drift.
4. Position the signal at the reference level and select a linear voltage display. Press **AMPLITUDE** and change the reference level, then press [LINEAR].
5. To select zero span, press **SPAN, 0 Hz**. See Figure 2-21. If the modulation is a steady tone (for example, from a signal generator), use video trigger to trigger on waveform and stabilize the display. Adjust the sweep-time to change the horizontal scale. Use markers and delta to measure time parameters of the waveform.

*f*

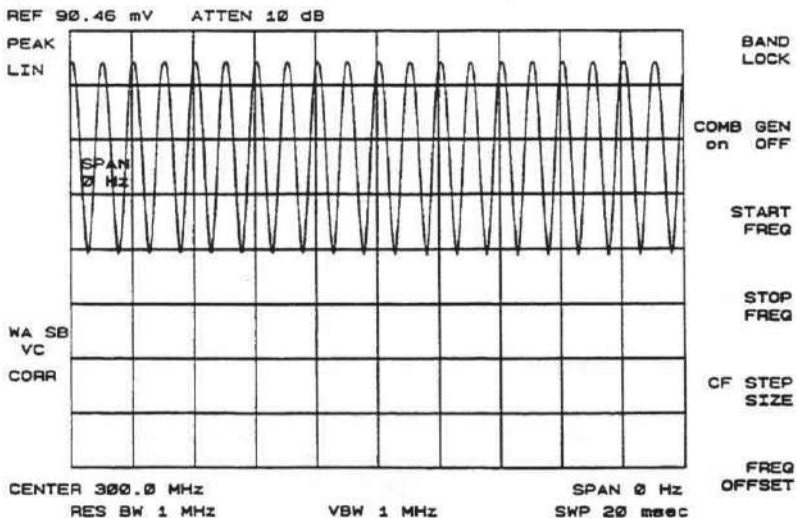

Figure 2-21

---

## Measuring Amplitude Modulation With the Fast Fourier Transform Function

The Fast Fourier Transform (FFT) function of the spectrum analyzer allows measurements of amplitude modulation (AM). FFT transforms demodulated AM data from the time domain (zero span) to the frequency domain. The FFT function calculates the magnitude of each frequency component from a block of time-domain samples of the input signal. It is commonly used to measure AM at rates that cannot be measured in the normal frequency domain.

The FFT function requires a specific analyzer configuration. First, an AM signal is demodulated in the time domain. In order to do this, the resolution bandwidth is widened to include the signal sidebands within the passband of the spectrum analyzer. Then zero span is selected so that the spectrum analyzer operates as a fixed-tuned receiver. Tuning is centered about the AM carrier.

When *MENU 2*, [FFT MEAS] is pressed, the function sets sample-detection mode and takes a sweep to obtain a sample of the input signal. Then the spectrum analyzer executes a series of computations on the time data to produce the frequency-domain results.

**Note:** After using the FFT function, the markers are still in FFT mode for use in evaluating data. The markers must be turned off before attempting to use markers in the normal fashion.

---

**Example:** Measure the sidebands on a signal using the Fast Fourier Transform function.

1. Connect a signal generator to the analyzer INPUT on the front panel of the spectrum analyzer. Adjust the signal generator to produce an AM signal. (For example, set the modulation rate to 60 Hz, which cannot normally be measured in the frequency domain.)
2. Center the signal on the analyzer screen using the automatic zoom function described earlier in this chapter. Turn signal track off before proceeding.
3. Press *SWP/BW* and [RES BW], and set the resolution bandwidth to 3 MHz. (The resolution bandwidth and video bandwidth must be at least 10 times greater than the modulation frequency.)
4. Change the reference level to place the signal peak within the first two graticules of the screen by pressing *AMPLITUDE* and turning the knob. The signal must be below the reference level. For best results, select linear display mode with [LINEAR].

Press *SPAN* and select 0 Hz. The spectrum analyzer now operates as a fixed-tuned receiver.

- Example continued on next page -

5. See Figure 2-22, which shows maximum modulation frequency ( $f_m$ ) in Hz versus sweep time ( $T_s$ ) in seconds. Set the sweep time less than  $T_s(\text{max})$  for that maximum modulation frequency ( $f_m$ ) including the harmonics of the signal. The upper curve relates the sweep time to the maximum modulation frequency that can be observed (that is, the modulation frequency represented by the right edge of the graticule). The lower curve represents the modulation frequency one division from the left side of the graticule.

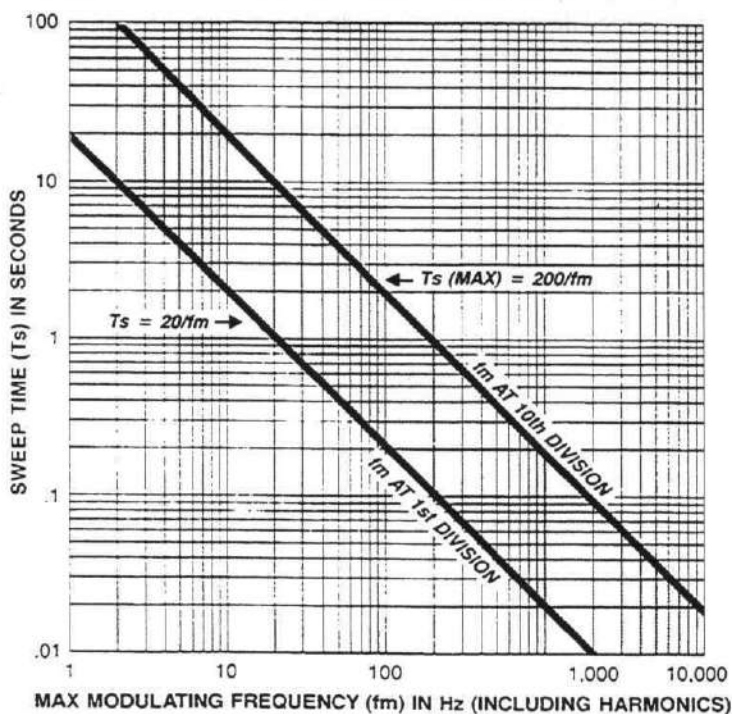

Figure 2-22

---

Set the sweep time to fall in the shaded area between the two lines and closer to the lower line. (Frequencies greater than the maximum modulation frequency for a specific sweep time will not be displayed accurately.) Press **SWP/BW** and [SWEEP TIME] to set the sweep time according to the figure. (For a right edge graticule limit of 250 Hz, use 800 ms.)

6. Press **SAVE, 2** (in the number/units keyboard) to save the current analyzer settings in instrument state 2. If the measurement is repeated later, retrieve the analyzer settings with **RECALL, 2**.
7. Press **MENU 2** and [FFT MEAS]. The spectrum analyzer performs a Fast Fourier Transform. The frequency-domain data appears on the screen.
8. A marker is automatically placed on the carrier at the 0-Hz reference (at the left edge of the graticule). Press [MARKER DELTA] and turn the knob to the modulation to determine the frequency and amplitude difference from the carrier. See Figure 2-23.

- Example continued on next page -

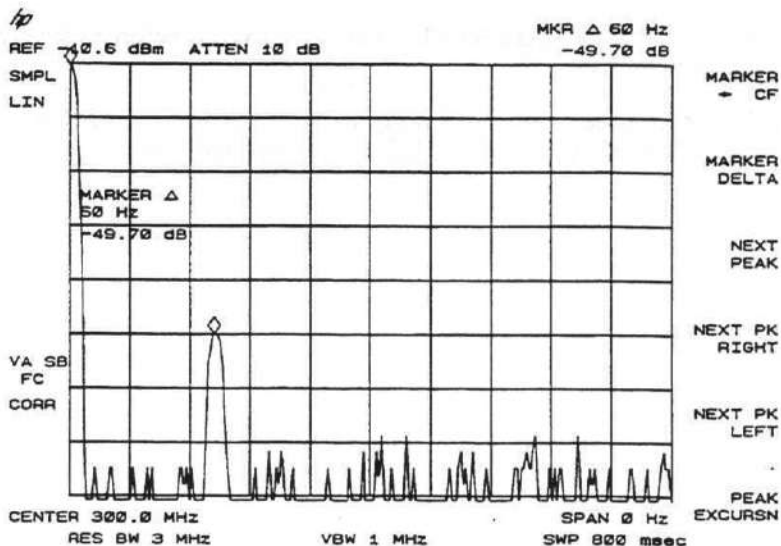

Figure 2-23

The results of the FFT function are displayed on the analyzer screen. The carrier appears at the left edge of the graticule with the modulation sidebands, and any distortion appearing along the horizontal graticule. The frequency calibration of the graticule is 20 Hz divided by the sweep time per division, and the left edge of the graticule represents 0 Hz relative to the carrier. The amplitude relationships among the carrier, sidebands, and distortion components are the same as they would be if the components were displayed with swept-tuned operation.

- 
9. Press **MKR**, [MARKERS OFF] to turn off markers before proceeding with other tests.
  10. To repeat the test, you must first clear the screen data by pressing **TRACE A** and [CLEAR WRITE A]. Then repeat step 7.



---

## Measuring Signals Near Band Boundaries with Harmonic Lock

When measuring across bands or when a single signal is at the edge of two bands, harmonic lock allows better frequency accuracy. When measuring at or across band edges, you must use the higher band. Harmonic Lock also allows for better specification performance, as well as increased frequency response.

To lock onto a specific harmonic, press **FREQUENCY**, [**BAND LOCK**], [**HRM LOCK ON**] or select a band (see Table 1-1 in the Installation Manual for band specifications). After setting the harmonic lock, only center frequencies and spans within the frequency band of the harmonic may be entered. The span automatically reduces to accommodate a center frequency specified near the end of the band range.

### Example:

1. Connect 100 MHz COMB OUT to the analyzer INPUT.
2. Press the following keys in the specified sequence:

Press **PRESET**, [**COMB GEN ON**], **FREQUENCY 6.2 GHz**, **SPAN 350 MHz**, [**BAND LOCK**], [**HRM LOCK ON**].

Place a marker on the left most peak by using the **PEAK SEARCH** and [**NEXT PEAK LEFT**] keys.

Press [**MARKER DELTA**], [**NEXT PEAK RIGHT**], and [**NEXT PEAK RIGHT**] to show the frequency and amplitude difference between the two comb teeth.

You will see three comb teeth on your display. The analyzer is locked in band 2 and will not allow multiband sweeps. See Figure 2-24.

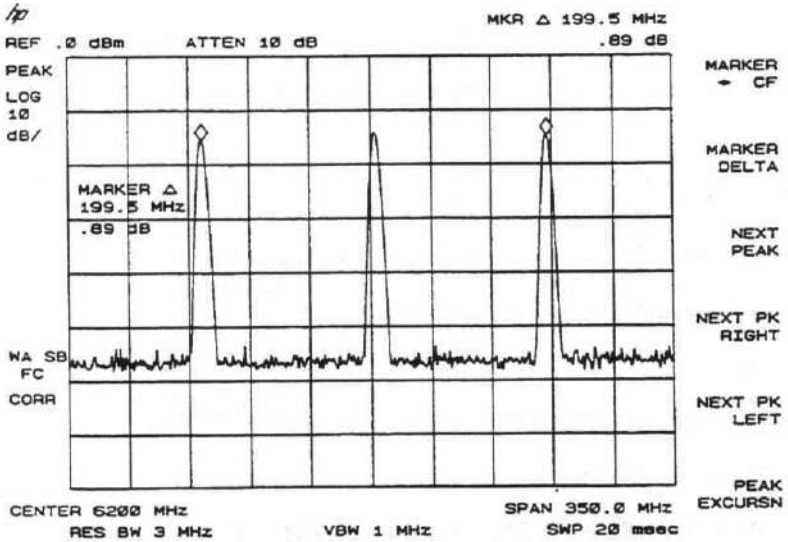

Figure 2-24

To see a multiband sweep, which does not offer better relative frequency measurements than being locked in a band, press the following keys:

**MKR**, [MARKERS OFF], **FREQUENCY**, [BAND LOCK], and [HRM LOCK OFF]. Place a marker on the left most peak by using the **PEAK SEARCH** and [NEXT PEAK LEFT] keys.

Press [MARKER DELTA], [NEXT PEAK RIGHT], and [NEXT PEAK RIGHT] to show the frequency and amplitude difference between the two comb teeth. See Figure 2-25.

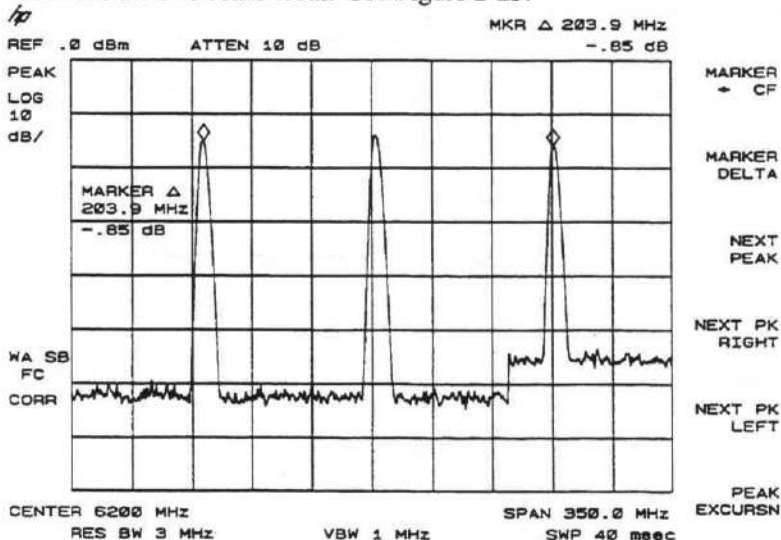

Figure 2-25

Note: The comb is at 100 MHz spacing.

Being an unlocked spectrum analyzer, your instrument can miss or show an extra signal(s) at the band crossing (see Figure 2-26). Figure 2-27 shows the same center frequency and span, but is locked in band 3 which disables multiband sweeping.

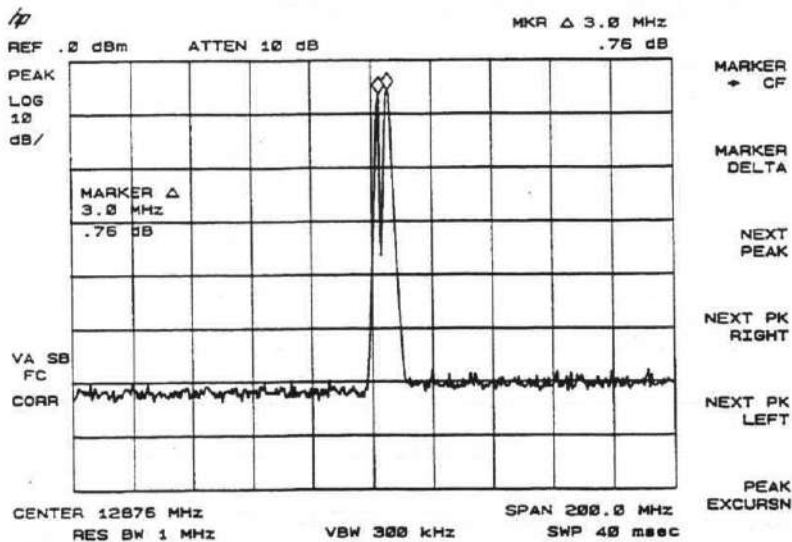

Figure 2-26





*(The following text is extremely faint and illegible due to low contrast and blurring. It appears to be a list of items or a detailed document.)*

---

## What You'll Learn in This Chapter

This chapter describes functions of the Spectrum Analyzer. The functions are divided into 10 sections, as follows:

- Data controls
- Frequency and span
- Amplitude
- Instrument state
- Copy
- Marker
- Control functions
- Service functions
- Other controls and connectors
- Special functions

**Note:** All analyzer functions are listed in the index at the end of this manual. The functions are followed by page numbers: the numbers in bold type refer to pages in this chapter. In addition, all softkeys are shown in the menu diagram inside the rear cover of this manual.

---

## Data Controls

Data controls are used to change values for functions such as center frequency, start frequency, resolution bandwidth, and marker position.

The data controls will change the active function in a manner prescribed by that function. For example, you can change center frequency in fine steps with the knob, in discreet steps with the step keys, or to an exact value with the number/units keyboard. Resolution bandwidth, which can be set to discrete values only, is changed to predetermined values with any of the data controls.

### Knob

The knob allows continuous change of functions such as center frequency, reference level, and marker position. It also changes the values of functions that change in increments only.

Clockwise rotation of the knob increases values. For continuous changes, the extent of alteration is determined by the number of degrees of the measurement range; the speed at which the knob is turned does not affect the values.



---

## Step Keys

The step keys allow discreet increases or decreases of the active function value. The step size depends upon the analyzer's measurement range or on a preset amount. Each press results in a single step change. For those parameters with fixed values, the next value in a sequence is selected each time a step key is pressed. Changes are predictable and can be set for large deltas. Out of range values will not occur using these keys, for example, 31 GHz stop frequency.

## Number/Units Keyboard

The number/units keyboard allows entry of exact values for center frequency, reference level, log scale, marker positions, display line, threshold, and the coupled functions. You may include a decimal point "." in the number portion. If not, the decimal point is placed at the end of the number.

Numeric entries must be terminated with a unit key. The unit keys change the active function in a manner prescribed by that function. For example, the units keys for frequency span are GHz, MHz, kHz, and Hz, whereas the units for reference level are +dBm and -dBm.

If an entry from the number/units keyboard does not coincide with an allowed function value (for example, that of a 1.5 MHz bandwidth), the analyzer defaults to the nearest allowed value.

---

## Hold Key

Deactivate functions with the **HOLD** key. The active function readout is blanked, indicating that no entry will be made inadvertently by using the knob, step keys, or keyboard. (Pressing a function key reenables the data controls.)

---

## Frequency and Span

The softkeys accessed by *FREQUENCY*, *SPAN*, and *PRESET* let you set the position and width of the horizontal frequency window that the spectrum analyzer displays. Pressing *FREQUENCY* activates the center frequency function and accesses the frequency menu. Pressing *SPAN* activates the span function and accesses the frequency menu.

The *FREQUENCY* key activates the center frequency function to allow selection of frequency at the center of the screen. The center frequency value appears below the graticule line on the screen.

The *SPAN* key activates the span function to allow you to change the frequency range symmetrically about the center frequency. The frequency span readout describes the total displayed frequency range; to determine frequency span per horizontal graticule division, divide the frequency span by 10.

When changing both the center frequency and span, change the frequency first since the span is affected by the frequency. (See [HRM LOCK on OFF] below).

[BAND LOCK] accesses the harmonic band menu.

---

[**BAND X**] locks onto the specified harmonic band and automatically selects the settings shown below:

*Table 3-1*

<b>SOFTKEY</b>	<b>FREQUENCY SETTINGS</b>		
BAND 0:	center frequency	1.45 GHz	span 2.9 GHz
BAND 1:	center frequency	4.47 GHz	span 3.4 GHz
BAND 2:	center frequency	9.4 GHz	span 6.8 GHz
BAND 3:	center frequency	15.9 GHz	span 7 GHz
BAND 4:	center frequency	20.55 GHz	span 7 GHz

**Note:** Before changing the frequency range to another harmonic, unlock the band by selecting [**HRM LOCK OFF**].

[**HRM LOCK ON**] locks the analyzer on the frequency band currently at center screen (local oscillator harmonic number). In normal operation, pressing the **FREQUENCY** key enables the analyzer to be tuned with one of the tuning controls from 0 to 22 GHz (-1 to 24 GHz over-range). Executing a harmonic lock limits the analyzer's tuning range to the selected harmonic number.

[**COMB GEN ON**] turns on the comb generator. It is needed for the [**CORRECT TO COMB**] and the [**CAL YTF**] functions. (See "Using the Comb Generator" in Chapter 2.)

[**START FREQ**] lets you set the frequency at the left side of the graticule. The left and right sides of the graticule sides correspond to the start and stop

---

frequencies. When these frequencies are activated, their values are displayed below the graticule in place of center frequency and span.

**[STOP FREQ]** lets you set the frequency at the right side of the graticule.

**[CF STEP SIZE]** lets you change the step size for the center frequency function. Once a step size has been selected and the center frequency function is activated, the step keys change center frequency by the step-size value. The step size function is useful for finding harmonics and sidebands beyond the analyzer's current frequency span.

**[FREQ OFFSET]** lets you add an offset value to the frequency readout to account for pre-analyzer frequency conversions. Offset entries are added to all frequency readouts including marker, start frequency, and stop frequency. Entering an offset does not affect the trace. Offsets are not added to the span.

When a frequency offset is entered, its value is displayed on the bottom of the screen. (Amplitude offsets, obtained through **AMPLITUDE**, are displayed on the left side of the screen.) To eliminate an offset, press **[FREQ OFFSET]** and enter zero. **PRESET** also sets the offset to zero.

---

## Amplitude

The softkeys accessed by **AMPLITUDE** change the input attenuation, vertical scale, mixer level, and amplitude offset. Pressing **AMPLITUDE** activates the reference level function and accesses the amplitude menu.

**REF LEVEL** is activated only when **AMPLITUDE** is pressed. The reference level is the amplitude power or voltage represented by the top graticule line on the screen. Changing the value of the reference level changes the absolute amplitude level (in dBm) of the top graticule line.

[**ATTEN**] lets you set the input attenuation from 0 to 70 dB, in 10-dB increments. The analyzer **INPUT** attenuator, which is normally coupled (linked) to the reference level control, reduces the power level of the analyzer **INPUT** signal at the input mixer.

The attenuator is recoupled with the **AUTO COUPLE** key.

### CAUTION

To prevent damage to the input mixer, the power level at the input mixer must not exceed +30 dBm. To prevent signal compression, power at the input to the input mixer must be kept below -10 dBm.

---

**Note:** As a precaution for the input mixer's health, 0-dB RF attenuation (no input power reduction to the mixer) can be selected only from the number/units keyboard.

**[LOG dB/DIV]** lets you scale the vertical graticule divisions in logarithmic units. Values may range from 1 to 20 dB per division.

**[LINEAR]** sets the vertical scale to linear mode. The reference level value is set to the top of the screen and the bottom graticule becomes zero volts. (Each division of the graticule is 1/10 the reference level in volts.)

**Note:** Pressing **[LOG dB/DIV]** or **[LINEAR]** always returns the units specified for that mode. **PRESET** and **POWER ON** set the configured values of dBm and volts so these units will always be used unless you set different values.

**[MAX MXR LEVEL]** lets you change the maximum input mixer level in 10-dB steps from -10 dBm to -100 dBm. The mixer level is equal to the input signal level minus the attenuator setting. As the reference level changes, the input attenuator setting is changed to keep the power levels of displayed signals less than the selected level at the input mixer. **PRESET** resets the input mixer level to -10 dBm.

---

[**REF LVL OFFSET**] lets you add an offset value to the displayed reference level. Offsets are entered with the number/units key board. Entering an offset does not affect the trace. Reference level offsets are used when gain or loss occurs between a device under test and the spectrum analyzer input. For example, using an offset of -20 dB references the spectrum analyzer to the input of a 20-dB preamplifier. Thus, the signal level measured by the analyzer is the level at the input of an external amplitude conversion device. When an amplitude offset is entered, its value is displayed on the **left** side of the screen. Frequency offsets, obtained through **FREQUENCY** are displayed at the bottom of the screen. To eliminate an offset, press [**REF LVL OFFSET**] and enter zero. **PRESET** also sets the offset to zero.

[**PRESEL PEAK**] allows you to adjust the offset of the ramp that drives the preselector. The maximum response found for the frequency at the marker determines the future adjustment values provided to the preselector for the harmonic band in use. **PRESET** resets this value to 0.

Preselector peak maximizes the amplitude at the position of the marker. If no marker is present, the analyzer puts a marker at the peak and then maximizes the amplitude at that frequency. The offset derived from the preselector peak algorithm is used for all subsequent measurements. (**PRESET** brings the offset back to zero.)

**Note:** This function only operates in the harmonic band settings since band 0 bypasses the preselector.



---

## Instrument State

**PRESET** provides a convenient starting point for making most measurements. Pressing **PRESET** places the **FREQUENCY** menu on the screen, setting the start frequency to 3 GHz and stop frequency to 22 GHz. The following conditions are established by pressing **PRESET**:

Start: 3 GHz  
Stop Frequency: 22 GHz  
Reference Level: 0 dBm  
Coupled Functions: All set to AUTO  
Resolution Bandwidth: 3 MHz  
Video Bandwidth: 1 MHz  
Sweep Time: 380 msec, full span  
Attenuator: 10 dB  
CF Step Size : 100 MHz  
Trace A : Clear write  
Trace B: Store blank  
A — B ON OFF: OFF  
Markers: OFF  
Display Line: OFF  
Threshold: OFF  
Sweep: Continuous  
Trigger: Free run  
State Registers: Unaffected  
Trace Registers: Unaffected

---

Turning the power on fetches CAL data and completes a processor test. Turning the power on clears Trace B and clears both the input and output buffers. The status byte is set to 0. The Power on message is displayed.

The **PRESET** key completes a processor test, but does not affect CAL data. **PRESET** clears both the input and output buffers, but does not clear Trace B. The status byte is set to 0.

**LOCAL** enables front-panel control after the analyzer has been placed in the remote mode by a controller. During remote operation, "RT" appears in the upper-right corner of the screen, indicating remote - talk, or "RL" appears indicating remote - listen. Pressing the **LOCAL** key turns off the "R" annotation in the upper-right hand corner.

---

## Configuration

*CONFIG* accesses the following softkeys:

[**ANALYZER ADDRESS**] allows you to change the HP-IB or HP-IL address of the analyzer. The analyzer is commonly set to 18 for HP-IB.

[**PLOTTER ADDRESS**] allows you to set the address for a plotter. It is used by analyzers that have an Optional HP-IB or HP-IL connector. (Also see "Copy.") (Factory default is 5.)

[**PRINTER ADDRESS**] allows you to set the address for a printer. It is used by analyzers that have an optional HP-IB or HP-IL connector. (Also see "Copy.") (Factory default is 1.)

[**BAUD RATE**] allows you to set the data transmission speed. It is used by analyzers that have an RS-232 interface. (Also see "Copy.")

[**PREAMP GAIN**], similar to the amplitude offset function, allows you to add a positive or negative preamplifier gain value, which is subtracted from the displayed signal. Preamplifier gain offsets are used for measurements that require an external preamplifier or long cables. Offsets are subtracted from the amplitude readouts so that the displayed signal level represents the signal level at the **input** of the preamplifier. Preamplifier gain offsets are displayed at the top of the screen and are removed by entering zero.

[**DISPOSE ALL**] allows you to clear the spectrum analyzer's Random Access Memory (RAM). The state registers, trace registers, and Read Only Memory (ROM) are not affected.

---

## Calibration

**CAL** calls up the following softkeys:

[**CAL FREQ**] initiates a frequency calibration routine. Connect CAL OUTPUT to the analyzer INPUT. (For more information, see “Improving Accuracy With Calibration Routines” in Chapter 1.)

[**CAL AMPTD**] initiates an amplitude calibration routine. Connect CAL OUTPUT to the analyzer INPUT. (For more information, see “Improving Accuracy With Calibration Routines” in Chapter 1.)

[**CORRECT ON off**] controls use of the correction factors. When ON is capitalized, correction factors are used and “CORR” appears on the display. When OFF is capitalized, correction factors are not used. Turning the correction factors off degrades amplitude accuracy.

[**CAL STORE**] allows you to save calibration data in nonvolatile analyzer memory. Calibration data is stored in volatile memory until [**CAL STORE**] is pressed. If calibration data is stored and the instrument has been turned off and then on again, the stored calibration data is automatically retrieved. (Also see “Improving Accuracy With Calibration Routines” in Chapter 1.)

[**CAL FETCH**] allows you to retrieve stored calibration data. If you have run a second calibration routine but have not stored it, you can retrieve previously stored calibration data by pressing [**CAL FETCH**]. To see the effects of [**CAL FETCH**], press **PRESET** to recall the calibration factors.

[**MORE**] access the following softkeys:

---

[**DISPLAY CAL DATA**] places the stored calibration data on the screen. Press **PRESET** to retrieve a normal display. For more information, refer to the Support Manual.

[**CAL YTO DELAY**] initiates a routine that calibrates the analyzer's timing delays. Connect CAL OUTPUT to analyzer INPUT.

[**CAL YTF**] generates the best slope and offset adjustment for the YIG-tuned preselector filter for each harmonic band. The comb generator output must be used for this calibration. COMB OUT should be connected to the analyzer INPUT. The instrument must be calibrated for frequency before running the YTF calibration.

[**VERT POSITION**] allows you to change the vertical position of the analyzer's display. (The position is saved in nonvolatile memory when [**CAL STORE**] is pressed.)

[**HORIZ POSITION**] allows you to change the horizontal position of the analyzer's display. (The position is saved in nonvolatile memory when [**CAL STORE**] is pressed.)

**CAUTION**

The following keys are designed for service usage only and may disrupt analyzer calibration data.

[**CAL FLATNESS**] accesses the following service functions.

[**EXECUTE TITLE**] tells the analyzer to execute the commands that appear in the screen title. (Also see [**SCREEN TITLE**].)

---

[**SET 20dB ERR**] and [**ENTER FLT ERR**], when pressed, let you modify the flatness and gain calibration data stored in the analyzer's nonvolatile memory.

**CAUTION**

Unless you have access to the correct calibration data, do not use the following keys. If you have made a numeric entry but have not pressed a units key, press **PRESET** to deactivate these functions. For more information, refer to the Support Manual (not supplied with the instrument).

[**STP GAIN ZERO**] is primarily a service function that turns off the spectrum analyzer's step gains. Press **PRESET** to reactivate the step gains. Recalling a previously stored state with **RECALL** also reactivates the step gains.

[**EEPROM INIT**], a service function used for EEPROM replacement, [**EEPROM INIT**] resets the EEPROMs to their default state, removing frequency and amplitude calibration data stored in the analyzer's nonvolatile memory.

---

**Note:** If [EEPROM INIT] has been pressed, the frequency, YTF, YTO delay, and amplitude calibration routines must be run again. (See "Improving Accuracy With Calibration Routines" in Chapter 1.)

[DACS] is a service function. For more information, refer to the Support Manual (not supplied with the instrument).

---

**SAVE** and **RECALL** allow you to store and retrieve nine spectrum analyzer states from the state registers. The analyzer's control settings can be saved in a state register and retrieved later at your convenience. States are saved even if the instrument is turned off or **PRESET** is pressed. To save a state, press **SAVE** and enter a register number. To recall a saved state, press **RECALL** and enter the register number. Trace data is not stored in these registers. These keys bring up menus for saving traces.

[SAVE 0 TRACE A] saves the current TRACE A data along with the analyzer state in trace register number 1. [SAVE 1 TRACE A], [SAVE 2 TRACE A], [SAVE 3 TRACE A] and [SAVE 4 TRACE A] are also available.

[RECALL 0 TRACE B] restores the analyzer's state from trace register 1 and places the saved trace into trace B in VIEW mode for the purpose of using it as a reference (as in the A-B function). [RECALL 1 TRACE B], [RECALL 2 TRACE B], [RECALL 3 TRACE B] and [RECALL 4 TRACE B] react in the same manner as [RECALL 0 TRACE B].

The [SAVE LOCK on OFF] softkey locks (or unlocks) all current state and trace registers against further data storage, they are useable only for recall.



---

## Copy

**Note:** Printing and plotting require one of the optional interfaces (HP-IB, HP-IL, or RS-232). Generally, spectrum analyzers with HP-IB set the plotter address to 5 and the printer address to 1. Unless there are additional instruments on the bus, analyzers with HP-IL set plotter and printer addresses to 1. Analyzers with RS-232 must have the baud rate set according to the printer or plotter being used.

The Programming Manual that comes with the optional interfaces detail peculiarities of the different interfaces. Refer to your Programming Manual for more information.

**PRNT** initiates a print dump of the screen data, without an external controller, to the graphics printer specified under **CONFIG** and [PRINTER ADDRESS]. After you have obtained the spectrum analyzer screen you want to print, press **PRNT** and the process will begin. It can be halted by pressing **PRESET**. The screen remains frozen (no further sweeps taken) until the data transfer to the printer is complete. The analyzer works with the HP Thinkjet, PaintJet, QuietJet, and QuietJet Plus Printers.

**PLOT** initiates a plot dump over the interface, without an external controller. (See **CONFIG**.) The plotting process is similar to the printing process. Printing is usually faster than plotting, but plotting provides higher resolution output. The analyzer works with plotters such as the HP 7440A (HP-IB, RS-232). Figure 3-1 shows the rear view of a typical plotter/spectrum analyzer configuration.

**Note:** The print and plot keys are different in that only **PRNT** provides the softkey menu and user text on the hardcopy output.

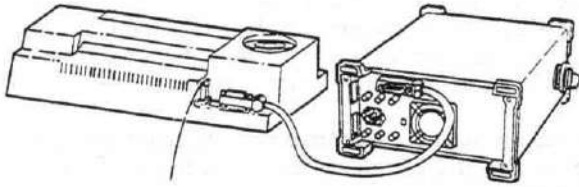

*Figure 3-1*

---

## Marker

Markers are diamond-shaped characters lying directly on the trace that identify points of traces and allow the traces to be manipulated and controlled on the screen. During manual operation, two markers may appear on the display simultaneously; only one can be controlled at a time. The marker that is controlled is called the "active" marker.

## Marker

The *MKR* accesses the following softkeys:

[**MARKER NORMAL**] activates a frequency marker at the center of the screen on the active trace. Use the data controls to position the marker. Annotation in the active function block and in the upper-right corner indicate the frequency and amplitude of the marker. The marker stays on the trace at the horizontal screen position where it was left unless signal track or [MARKER AMPTD] is engaged.

[**MARKER DELTA**] activates a second marker at the position of the first marker. (If no marker is present, two markers appear at the center of the display.) The position of the first marker is fixed, and the second marker is under your control. Annotation in the active function block and in the upper-right corner of the screen indicates the frequency and amplitude differences between the two markers.

**Note:** If there are already two markers when [MARKER DELTA] is pressed, the non-active marker disappears, the active marker becomes a reference marker, and the delta marker becomes the active marker.

---

**Note:** If [MARKER AMPTD] has been pressed, the delta marker will be positioned on the other side of the peak.

[MARKER AMPTD] keeps the active marker at a desired amplitude on the screen once the marker has been positioned. Once activated, the marker remains at the same vertical position on the screen even as the signal frequency is changed. If the input signal is removed, the marker searches for the signal closest to the last amplitude value. For example, place a marker on a signal peak, press [MARKER AMPTD] and then **FREQUENCY**. Turn the knob and the marker will remain at the same amplitude on the screen.

[MKNOISE ON off] reads out the average noise level referenced to a 1-Hz noise power bandwidth at the marker position. If no marker is present, a marker appears at the center of the screen. The root-mean-square noise level, normalized to a 1-Hz noise power bandwidth, is read out. The sample detector is activated.

[MARKER PAUSE] stops the analyzer sweep at the marker position. You can set the pause time for a period of 0 to 100 seconds.

[MARKERS OFF] turns off all markers, including signal track. Marker annotation is removed.

---

## Marker To . . .

**MKR** → (read "marker to") calls up the following softkeys for the transfer of marker information directly into other functions:

[**MARKER** → **CF**] changes the analyzer settings so that the frequency at the marker becomes the center frequency.

[**MARKER** → **RL**] changes the analyzer settings so that the amplitude at the active marker becomes the reference level.

[**MARKER** → **STEP**] assigns the value of the active marker to the center frequency step size. Press **FREQUENCY** and [**CF STEP SIZE**] to view the step size. If marker delta is active, the step size will be set to the frequency difference between the markers.

[**MKR**  $\Delta$  → **SPAN**] sets the start and stop frequencies to the values of the delta markers. The start and stop frequencies will not be set if the delta marker is off.

[**MORE**] accesses the softkeys under **PEAK SEARCH**. Pressing [**MORE**] instead of **PEAK SEARCH** lets you use those softkeys without initiating a new peak search.

---

## Peak Search

**PEAK SEARCH** automatically places a marker on the highest amplitude of a trace, displays the marker's amplitude and frequency, and calls up the following softkeys:

**Note:** These functions are for use with frequency type markers only.

[**MARKER** → **CF**] is described above.

[**MARKER DELTA**] activates a second marker at the position of the marker already on the trace. (If no marker is present, two markers appear at the center of the display.) The position of the first marker is fixed. The second marker is under your control. Annotation in the active function block and in the upper-right corner of the screen indicates the frequency and amplitude differences between the two markers.

**Note:** The peaks found below must be the peak excursion value above the threshold.

[**NEXT PEAK**] places the marker on the next highest peak. (Also see [**PEAK EXCURSN**] and [**THRESHOLD**].)

[**NEXT PK RIGHT**] moves the marker to the next peak to the right of the current marker. If there is no peak to the right, the marker will not move. (Also see [**PEAK EXCURSN**] and [**THRESHOLD**].)

[**NEXT PK LEFT**] moves the marker to the next peak to the left of the current marker. If there is no peak to the left, the marker will not move. (Also see [**PEAK EXCURSN**].)

---

[**PEAK EXCURSN**] allows you to set the minimum amplitude variation of signals that the marker can identify. If a value of 10 dB is selected, the marker moves only to peaks which rise and fall more than 10 dB from the threshold (or the noise floor of the display). Pushing **PRESET** or turning on power resets the excursion to 6 dB.

**Note:** When a peak has a lump on its skirt that is peak excursion above the threshold, it is considered a peak in its own right only if it has a peak excursion drop on both sides. Two peaks that are so close that only a valley divides them are not differentiated only if the valley is not peak excursion deep.

Signals whose amplitude variation is less than the peak excursion rate will not be recognized by the marker-peaking functions. To correct this when measuring signals near the noise floor, reduce the excursion value. To prevent the marker from identifying noise as signals, reduce the noise floor variance to a value less than the peak excursion by reducing the video bandwidth or using video averaging.

## Signal Track

**SIGNAL TRACK** moves the signal with an active marker to the center of the screen and fixes the signal there. "MKR-TRK" appears in the upper-right corner of the display. Press **SIGNAL TRACK** again, **PRESET**, [MARKER NORMAL], or [MARKER OFF] to turn this function off.

When signal track is on and the span is reduced, an automatic zoom is performed: the span is reduced in steps so that the signal remains at the center of the screen. If the span is zero, signal track cannot be activated.

---

## Control Functions

Six keys, located in the CONTROL section of the front panel, control the sweep, trigger, traces, and display.

### Sweep/Bandwidth

*SWP/BW* calls up softkeys that control the sweep time, bandwidth, detectors, and service functions:

[RES BW] allows you to manually change the analyzer's IF bandwidth to 1 kHz, 3 kHz, 10 kHz, 30 kHz, 100 kHz, 300 kHz, 1 MHz, or 3 MHz. As the RES BW is decreased, the sweep time is increased to maintain amplitude calibration. To indicate that it is not coupled, a "#" mark appears next to RES BW on the screen. To recouple the RES BW, press [RES BW] and *AUTO COUPLE*.

[VID BW] allows you to manually change the analyzer's post-detection filter from 30 Hz to 3 MHz in a 1, 3, 10 sequence. As the VIDEO BW is decreased, the sweep time is increased to maintain amplitude calibration. To indicate that it is not coupled, a "#" mark appears next to VBW on the screen. [VID BW] must terminate with MHz. To couple the VID BW, press [VID BW] and *AUTO COUPLE*.



---

**[VBW/RBW RATIO]** allows you to select the ratio between the video and resolution bandwidths. If signal responses near the noise level are visually masked by the noise, the ratio can be set to less than 1 to smooth this noise. The knob and step keys change the ratio in a 1, 3, 10 sequence. **PRESET** sets the ratio to 0.3 X.

**[SWEEP TIME]** lets you manually select the length of time in which the analyzer sweeps the displayed frequency span. In all frequency spans, the sweep time varies from 20 milliseconds (ms) to 100 seconds (sec). Reducing the sweep time increases the rate of sweeps.

From 20 ms to 1000 ms, the sweep time changes in 1-ms steps. From 1.0 sec to 10 sec, the sweep time changes in 0.1-sec steps. From 10 sec to 100 sec, the sweep time changes in 1-sec steps. The minimum sweep time is 20 msec per 1 GHz span.

**[DETECTOR]** accesses the following softkeys that control the signal detection and service functions. The type of detection affects only the displayed noise and impulse signals.

---

**[SAMPLE DETECTOR]** selects sample detection and "SMPL" appears in the upper-left corner of the screen. (During a sweep, only a specified amount of time is available to write data for each of the available display points into each of the trace memory addresses. In sample mode, the instantaneous signal value of the final analog-to-digital conversion for the time period is placed in memory.) Sample detection is automatically activated for noise level markers and during video averaging.

**[POS PK DETECTOR]** selects peak detection and "PEAK" appears in the upper-left corner of the screen. (During a sweep, only a specified amount of time is available to write data for each of the available display points into each of the trace memory addresses. In each of these time periods, the positive peak detector obtains the maximum video signal and stores this value in the trace memory address.) Peak detection is selected by *PRESET* and power on.

---

## Service Functions

The softkeys listed below are designed for troubleshooting and for diagnostic tests of the analyzer. They are described in the Support Manual which is not supplied with the instrument. The Support Manual is briefly described in the Documentation Description section at the front of this manual. Contact your HP Service Representative for more information.

These softkeys are accessed by *SWP/BW* [DETECTOR]:

[2v REF DETECTOR]	[MORE]
[GND REF DETECTOR]	[+10V REF DETECTOR]
[ANALYZER TEST]	[-10V REF DETECTOR]
[MAIN COIL DR]	[AUXA]
[FM COIL DRIVE]	[CONF TEST]
[FM SPAN]	[DROOP]
[MAIN SPAN]	[MORE]
[YTF SPAN]	[YTF TUNE COARSE]
[MORE]	[YTF TUNE FINE]
[SWEEP RAMP]	[YTF DRIVER]
[SWEEP TIME DAC]	[MIXER BIAS DAC]
[COARSE TUNE DAC]	[MORE]
[FINE TUNE DAC]	
[X FINE TUNE DAC]	

---

## Auto Couple

**AUTO COUPLE** is used to couple the operation of some spectrum analyzer functions after they have been uncoupled or to deactivate functions. (Coupled functions are functions that are linked: if one function is changed, the other function is changed.)

The functions are listed below:

Resolution Bandwidth	Display Line Off
Video Bandwidth	Threshold Off
Sweep Time	Markers Off
RF Attenuation	Video Averaged Off
Step Size	MkPause Off
Video Bandwidth Ratio	

During normal operation, the sweep time, resolution bandwidth, and video bandwidth are coupled to yield optimum amplitude accuracy. If any of these functions becomes uncoupled (that is, is manually set), a “#” will appear next to it on the screen. Recouple a single function by activating the function and pressing **AUTO COUPLE**.

**Note:** If no function is active, **AUTO COUPLE** couples all functions that can be coupled and turns other functions off.

Press **HOLD** followed by **AUTO COUPLE** to recouple all functions.

**Note:** If one or more function(s) is manually set so that the amplitude or frequency becomes uncalibrated, “MEAS UNCAL” appears on the right side of the graticule.

---

## Trace A

**TRACE A** accesses the following trace softkeys that allow you to store and manipulate trace information. Each trace is comprised of a series of data points that form a register where amplitude information is stored. The analyzer updates the information for the active trace with each sweep. (Also see "Screen Annotation" in Chapter 1.)

[**CLEAR WRITE A**] erases any data previously stored in trace A and continuously displays any signals detected in the frequency range of the analyzer. This function is activated by **PRESET** and power on.

[**MAX HOLD A**] updates each trace point with the maximum level detected at each point during successive sweeps.

[**VIEW A**] holds the amplitude data in the trace A register. It disconnects the trace register from the signal-detection circuitry so that the trace A register will not be updated as the analyzer sweeps. If trace A is deactivated with [**STORE BLANK A**], the stored data can be retrieved with [**VIEW A**]. [**CLEAR WRITE A**] overwrites the stored data.

---

[**STORE BLANK A**] stores the amplitude data for trace A and removes it from the screen. It also disconnects the trace A register from the signal detection circuitry so that the register will not be updated as the analyzer sweeps.

[**VIDEO AVERAGE**] initiates a digital averaging routine that averages displayed signals and noise. It does not affect the sweep time, bandwidth, or other analog characteristics of the analyzer. Annotation on the left side of the screen indicates the current number of sweeps averaged. The default number of sweeps is 100. Increasing the number of sweeps smooths the trace. Pressing [**VIDEO AVERAGE**] or the terminator keys restarts the averaging process. Deactivate video average with **AUTO COUPLE**.

[**A — B on OFF**], when ON, subtracts the data in trace B from the measured data. The resulting trace (trace A) is displayed, the input minus stored data. To deactivate this function, press the softkey so that OFF is capitalized. If trace B is in clear-write mode, it will be placed in view mode when A — B is turned on.

---

## Trace B

**TRACE B** accesses softkeys that manipulate trace B data. (Also see "Screen Annotation" in Chapter 1.)

[**CLEAR WRITE B**] operates the same as [CLEAR WRITE A]. However, **PRESET** and power on do not activate trace B.

[**MAX HOLD B**] operates the same as [MAX HOLD A].

[**VIEW B**] operates the same as [VIEW A].

[**STORE BLANK B**] operates the same as [STORE BLANK A].

[**A XCH B**] exchanges the contents of the trace A register with the trace B register and puts trace A in view mode.

[**B — DL → B**] subtracts the value of the display line from all the points in trace B and stores the results in trace B. Trace B is placed in view mode. (Also see [DISPLAY LINE] under the **DISPLAY** menu.)

---

## Trigger

**TRIG** accesses softkeys that let you select the sweep mode and trigger mode. (Also see “Screen Annotation” in Chapter 1.)

[**CONT SWEEP**] enables continuous-sweep mode. If trigger conditions are met, one sweep follows another as soon as triggered. **PRESET** and power on select continuous sweep.

[**SINGLE SWEEP**] enables single-sweep mode. Each time [**SINGLE SWEEP**] is pressed and the trigger conditions are met, a sweep is initiated. A sweep in progress is terminated and restarted each time [**SINGLE SWEEP**] is pressed.

[**FREE**] activates the trigger condition that allows the next sweep to start as soon as possible after the last sweep.

[**VIDEO**] activates the trigger condition that allows the next sweep to start if the detected RF envelope voltage rises to a level set by the display line. When [**VIDEO**] is pressed, the display line appears on the screen. With the CAL OUTPUT signal, lower the display line to the noise floor for an example of video triggering.

[**LINE**] activates the trigger condition that allows the next sweep to start when the line voltage passes through zero, becoming positive.

[**EXTERNAL**] activates the trigger condition that allows the next sweep to start when an external voltage (connected to the EXT TRIG INPUT on the rear panel) passes through approximately 1.5 volts, becoming positive. The external trigger signal must be a 0 V to +5 V TTL signal.



---

## Display

**DISPLAY** accesses softkeys that activate the display line and threshold, allow title entry, control the graticule and screen annotation, and set display units.

**[DISPLAY LINE]** activates an adjustable horizontal line that is used as a visual reference line. The line, which is used for trace arithmetic, has amplitude values that correspond to its vertical position when compared to the reference level. The value of the display line appears in the active function block and on the left side of the screen. To deactivate the display line, press **[DISPLAY LINE] AUTO COUPLE**. (Also see **[VIDEO]** trigger.)

**[THRESHOLD]** sets a lower boundary to the active trace. The threshold line "clips" signals that appear below the line. The boundary is defined in amplitude units that correspond to its vertical position when compared to the reference level.

The value of the threshold appears in the active function block and on the lower-left side of the screen. The threshold level does not influence the trace memory. The peaks found by the markers must be the peak excursion value above the threshold level.

If a threshold is active, press **[THRESHOLD]** and **AUTO COUPLE** to turn the threshold off.

---

[**SCREEN TITLE**] allows you to write a 58-character message across the top of the screen. The marker readout may interfere with the last 31 characters. When [**SCREEN TITLE**] is pressed, a character table appears on the screen. To select a character, turn the knob to position the cursor under the desired character and press the Hz key. Numbers may be selected with the numeric key pad. The step keys move the cursor between rows. When all characters have been entered, press **HOLD**. A title will remain on the screen until the title function is activated again, or **PRESET** is pressed.

[**GRAT ON off**] lets you turn the screen graticule on and off. This is helpful when alternative graphics are drawn on the screen through a remote controller and during plotting, when a graticule is not required.

[**ANOTATN on OFF**] lets you turn the screen annotation on and off. However, softkey annotation will remain on the screen. The annotation may not be required for prints or plots, or during remote operation.

[**DISPLAY UNITS**] accesses softkeys that let you choose the amplitude units. The choices are dBm, dBmV, dBuV, Volts, and Watts. The default amplitude units are dBm for log mode, and volts for linear mode.

[**INPUT IMPED**] lets you set the input impedance for power-to-voltage conversions. The impedance you select is for computational purposes only, since the actual impedance is set by internal hardware (50 ohms). The preset value is 50 ohms. Select either 50 and 75 ohms with the number/units keyboard. Press [**DISPLAY UNITS**] to access the input impedance softkey.

---

## Intensity

The intensity knob allows you to change the brightness of the writing on the screen.

## Line Power

The **LINE** key turns on the instrument and starts an instrument check. After applying power, allow the temperature of the instrument to stabilize for best measurement results.

## Front-Panel Connector

**1ST LO OUTPUT** provides the local oscillator signal with a 3.0 to 6.6 GHz range.

**100 MHz COMB OUT** supplies a 100 MHz signal with harmonics up to 22 GHz for use as a reference signal. This is connected to the analyzer INPUT for the YTF calibration routine. (See "Using the Comb Generator" in Chapter 2.)

**CAL OUTPUT** provides the calibration signal of 299.9 MHz at -20 dBm. CAL OUTPUT has a 50-ohm impedance. It is connected to the analyzer INPUT during calibration. (See "Improving Accuracy with Cal Routines.")

---

**INPUT 50  $\Omega$**  is the signal input for the spectrum analyzer. It has either a 50-ohm impedance. For calibration routines, the signal source is the CAL OUTPUT, or 100 MHz COMB OUT, depending upon the routine.

**CAUTION**

Excessive signal INPUT power will damage the analyzer INPUT attenuator and the input mixer. Use extreme caution when using the spectrum analyzer around high-power RF sources and transmitters. The spectrum analyzer's maximum total input power rating (+30 dBm RF level and 0 Vdc) appears on the front panel of the analyzer near the analyzer INPUT connector.

### Rear-Panel Connectors

The rear panel of your instrument may contain the following connectors, depending on the options ordered with the instrument. See the Installation Manual for more information on options.

**SWEEP OUTPUT** provides a voltage ramp proportional to the sweep and the spectrum analyzer span.

**AUX VIDEO OUTPUT** (standard) provides detected video output (before A/D conversion) proportional to vertical deflection of the CRT trace. Output increases 125 mV per division from 0 to 1V.

---

**AUX IF OUTPUT** is a 50-ohm, 21.4-MHz IF output that is related to the analyzer INPUT. Output bandwidth is controlled by the spectrum analyzer resolution bandwidth setting. Output amplitude is controlled by input attenuation and reference level (-10 through -60 dBm with 0-dB input attenuation). Output level is approximately -10 dBm into 50 ohms with a signal displayed at the reference level.

**VOLTAGE SELECTOR** adapts the unit to the power source: 115V or 230V.

**HI SWEEP IN/OUT (TTL)** provides an indication of sweep.

Input: provide input signal from open collector gate circuit. Use low input to stop sweep; otherwise leave open.

Output: high TTL indicates sweep; low TTL indicates retrace.

**MONITOR OUTPUT** allows the use of external CRT monitors, such as the HP 82913A, with NTSC format, 19.2 kHz horizontal synch.

**EXT TRIG INPUT (TTL)** allows the analyzer's internal sweep source to be triggered by an external voltage, positive edge trigger.

**INTERFACE CONNECTORS** are optional interfaces for HP-IB, RS-232, and HP-IL that allow remote instrument operation and direct plotting or printing of CRT screen data. (See the Installation Manual for more information.)

---

## Special Functions on Menu 1 and Menu 2

*MENU 1* and *MENU 2* access specialized softkeys. These keys appear in the upper-right corner of the front panel (as opposed to the *1* and *2* keys in the number/units keyboard).

**Note:** The softkeys appearing under *MENU 1* and *MENU 2* vary depending upon the options selected.

[**DELTA MEAS**] finds and displays the frequency and amplitude differences between the two highest amplitude signals.

[**DELTA MEAS**] performs the following key sequence:

**PEAK SEARCH**, [MARKER DELTA], [NEXT PEAK].

[**PK-PK MEAS**] finds and displays the frequency and amplitude differences between the highest and lowest signals. [**PK-PK MEAS**]

performs the following routine: **PEAK SEARCH**,

[MARKER DELTA], and then moves the second marker to the lowest detected signal.

[**3rd ORD MEAS**] finds the third-order product and measures the frequency and amplitude differences relative to the fundamental signal.

[**3rd ORD MEAS**] performs the following routine: **PEAK SEARCH**, [MARKER DELTA], [NEXT PEAK], [NEXT PEAK].

[**3 dB POINTS**] automatically places two markers at points 3 dB from the highest point on a signal and determines the frequency differences between the two markers. Thus, the 3-dB bandwidth of a signal is determined. The markers are placed on the highest signal on the screen. (This function is used with the HP 8444 Option 059 Tracking Generator.)

---

**[6 dB POINTS]** automatically places two markers at points 6 dB from the highest point on a signal and determines the frequency differences between the two markers. Thus, the 6-dB bandwidth of a signal is determined. The markers are placed on the highest signal on the screen.

**[99% PWR BW]** computes the power of all signal responses and returns the bandwidth under which 99% of total power is found.

**[FFT MEAS]** transforms zero span data into the frequency domain using a Fast Fourier Transform. The display is always in log mode. After using the FFT function, the markers are still in FFT mode for use in evaluating the data. The markers must be turned off before attempting to use them in the usual manner.

**[MODULATN MEAS]** determines the percent of amplitude modulation. The function finds the amplitude difference between the two highest peaks on the screen and computes the percent modulation for the calculated dB difference. (See Appendix for AM percent charts.)

**[CORRECT TO COMB]** allows correcting for better frequency accuracy using the comb teeth. **[CORRECT TO COMB]** accesses the following softkeys:

**[PEAK SEARCH]** places a marker on the highest peak.

**[NEXT PK RIGHT]** allows you to move the marker to the right.

**[NEXT PK LEFT]** allows you to move the marker to the left.

---

## **Appendix A**

This appendix contains charts and graphs that are helpful for amplitude modulation, frequency modulation, and pulsed RF measurements.



---

## Amplitude Modulation

Modulation information can easily be determined from the carrier signal and a sideband.

The difference in amplitude between the two signals can be used to determine the percent of modulation. Markers read the frequency difference between two signals, which is equal to the modulating frequency. The following tables and charts help you determine amplitude modulation information. Also see the [MODULTN MEAS] softkey description.

% Modulation	Sideband level below carrier (dB)
1	46
2	40
10	26
20	20
30	16.5
40	14
12	60
70	9.1
80	7.9
90	6.9
100	6.0

Sideband level below carrier (dB)	% Modulation
10	63
20	20
30	6.3
40	2.0
50	0.63
60	0.2
70	0.063
80	0.02

*Percent Modulation*

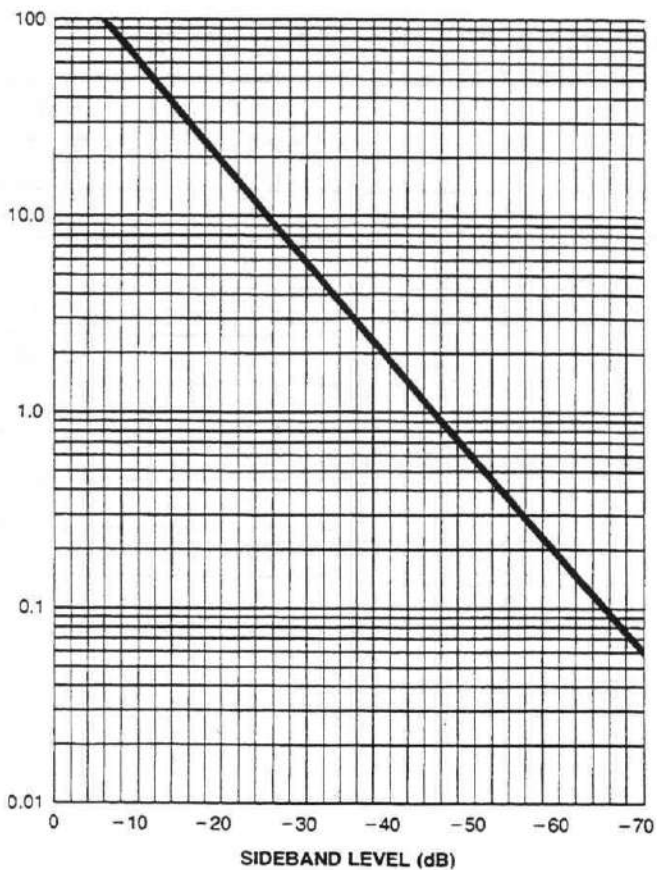

---

## Frequency Modulation

*Carrier and First Sideband Charts for Calibrating Deviation*

Carrier Bessel NULL Order	$t = \frac{\Delta F}{f}$
1st	2.4048
2nd	5.5201
3rd	8.6531
4th	11.7915
5th	14.9309
6th	18.0711
7th	21.2116
8th	24.3525
9th	27.4935
10th	30.6346

First Sideband	$t = \frac{\Delta F}{f}$
1st	3.83
2nd	7.02
3rd	10.17
4th	13.32
5th	16.47
6th	19.62
7th	22.76
8th	25.90
9th	29.05

### Bessel Null Graph

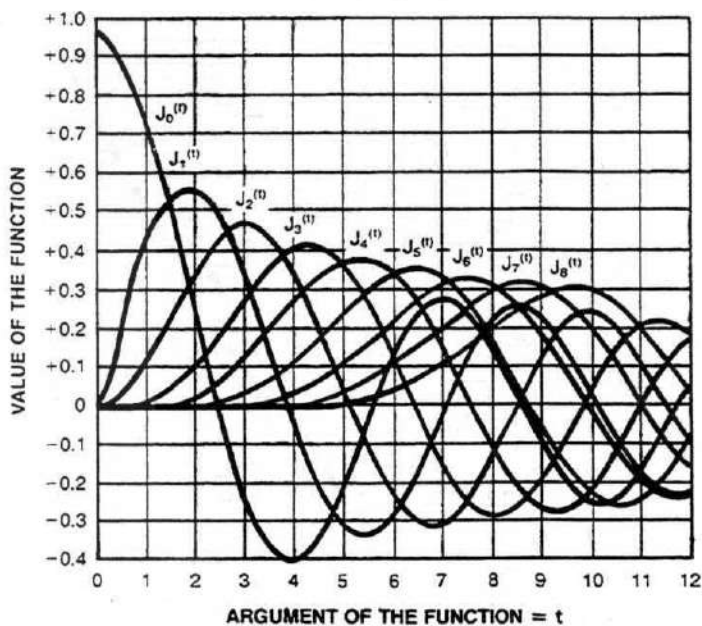

Bessel functions for the first eight orders

*Loss in Sensitivity  
(Pulsed RF versus CW)*

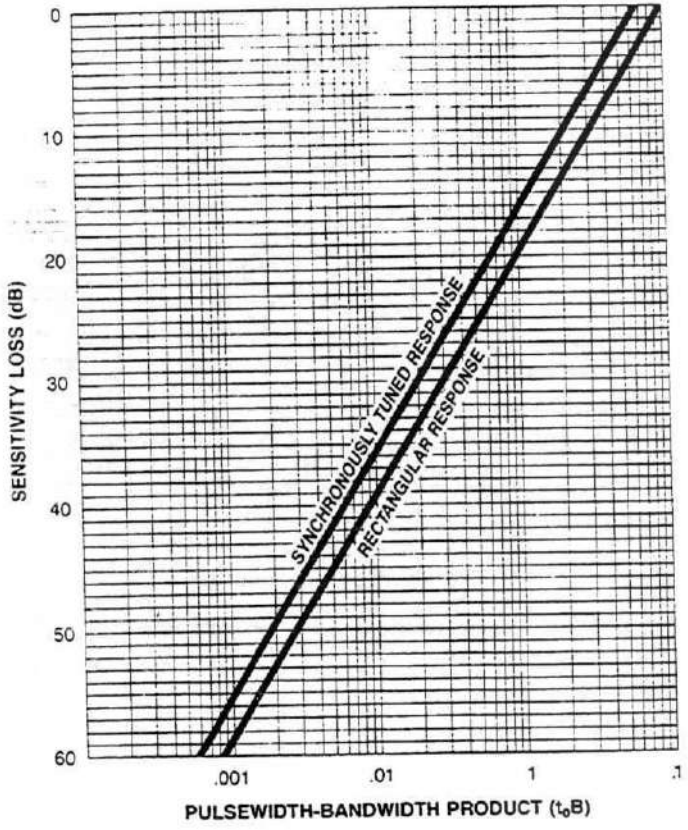

*Resolution Bandwidth Setting for Pulsed RF  
Computed from  $t_0B=0.1$*

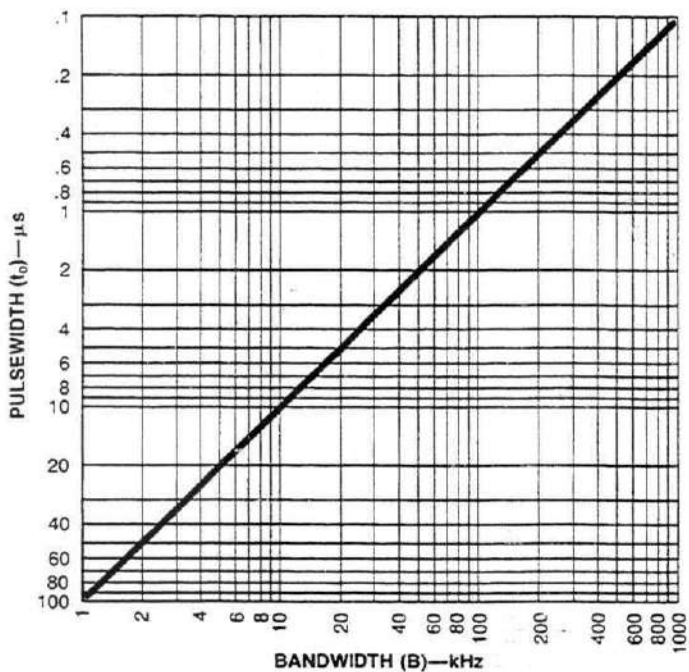

---

## APPENDIX B

### Screen Messages

The HP 8592A can generate various messages that appear on its screen during operation to provide an indication of progress through a procedure or to indicate a problem.

There are three types of messages: hardware error messages (H), user-created error messages (U), and informational messages (M).

- Hardware error messages indicate the HP 8592A hardware is probably broken.
- User-created error messages appear when the analyzer is used incorrectly. They are usually generated during remote operation.
- Informational messages indicate analyzer progress within a specific procedure.

The messages are listed in alphabetical order on the following pages; each message is defined, and its type is indicated by an (H), (U), or (M). In several instances, you are referred to the command description (for example, "See AUNITS.") These command descriptions are contained in the HP-IB, HP-IL, and RS-232 Programming Manuals.

#### ADC-GND FAIL

Indicates a failure in the processor — A/D  $\pm 15V$  supplies can cause ADC - GND and ADC - 2V. (H)

---

ADC-TIME FAIL

Indicates a failure in the processor — A/D a +5V supply can cause this..  
(H)

ADC-2V FAIL

Indicates a failure in the processor — A/D  $\pm 15V$  supplies can cause ADC -  
GND and ADC - 2V (H)

CAL: FM SPAN SENS FAIL

The analyzer could not set up span sensitivity of the FM coil. (H)

CAL: LINEAR DET FAIL

The linear calibration routine failed. (H)

CAL: RES BW AMPL FAIL

The relative insertion loss of the resolution bandwidth is incorrect. (H)

CAL: SPAN SENS FAIL

The calibration span sensitivity routine failed. (H)

CAL:

During the calibration routine, messages may appear on the display indicating the routine is progressing: MC DELAY, FM DELAY, DONE, SWEEP, SWP DELAY, FREQ, SPAN, AMPTD, 3dB BW, ATTN, LOG AMP.  
(M)

COMMAND ERROR:

The specified command is not recognized by the analyzer. The analyzer recognizes commands described in Chapter 4 of the Programming Manual.  
(U)



---

CONFLICT TABLE OVERFLOW

A command has been used that is not compatible with the analyzer. (U)

FAIL:

An error was discovered during the power-up check. The 4-digit by 8-digit code indicates the type of error. Error codes are described in the Support Manual. (H)

INVALID AUNITS:

The amplitude units are not valid. See the AUNITS command. (U)

INVALID DETECTOR:

The specified detector is not valid. See the DET command. (U)

INVALID ENTER FORMAT

The enter format is not valid. See the appropriate command description to determine the correct format. (U)

INVALID HP-IB ADDRESS OR OPERATION

An HP-IB operation was aborted due to an incorrect address or invalid operation. (U)

INVALID HP-IB OPERATION REN TRUE

The HP-IB operation is not allowed. (Usually caused by print/plot when a calculator is on the interface bus.) (U)

INVALID HP-IL ADDRESS OR OPERATION

An HP-IL operation was aborted due to an incorrect address or invalid operation. (U)

---

INVALID HP-IL OPERATION REN TRUE

The HP-IL operation is not allowed. (Usually caused by print/plot when a calculator is on the interface bus.) (U)

INVALID OUTPUT FORMAT

The output format is not valid. See the appropriate command description to determine the correct format. (U)

INVALID RS-232 ADDRESS OR OPERATION

An RS-232 operation was aborted due to an incorrect address or invalid operation. (U)

INVALID TRACE:

The specified trace is invalid. Use TRA or TRB.

See trace commands (VIEW, MXMH, CLRW, or BLANK). (U)

INVALID TRIGGER MODE:

The specified trigger mode is invalid. See the TM command. (U)

INVALID WINDOW TYPE:

The specified window is invalid. See the TWINDOW command. (U)

MEAS UNCAL

The measurement is uncalibrated. Check the sweep time, span, and bandwidth settings. (U)

PARAMETER ERROR:

The specified parameter is not recognized by the analyzer. See the appropriate command description to determine the correct parameters. (U)

---

SRO

The specified service request is active. Service requests are a form of informational message and are explained in Appendix B of the Installation Manual. (M)

---

## Index

Note: Page numbers in bold type indicate the primary function description.

1ST LO OUTPUT	3-37
100 MHz COMB OUT	3-37
[+10V REF]	3-29
[-10V REF]	3-29
[2v REF DETECTOR]	3-29
[3 dB POINTS]	3-40
[3rd ORD MEAS]	3-40
[6 dB POINTS]	3-41
[99% PWR BW]	3-41
[A— B on OFF]	3-32
[A XCH B]	3-33
[ABORT]	2-36, 3-42
Accuracy	1-15, 3-14
Active Function Block	1-7
Address	3-13
HP-IB	3-13
HP-IL	3-13
plotter	3-13
printer	3-13
trace memory	3-13
Amplitude	1-2
frequency	1-2
<b>AMPLITUDE</b>	2-10, 3-8
Amplitude Functions	3-8
Amplitude Modulation	A-2
[ANALYZER ADDRESS]	3-13

---

[ANALYZER TEST] .....	3-29
Annotation .....	1-13
marker .....	1-13
screen .....	1-13
softkey .....	1-13
[ANOTATN ON off] .....	3-36
[ATTEN] .....	3-8
Attenuation .....	2-23
Automatic Zooming With Auto Zoom .....	2-28
<i>AUTO COUPLE</i> .....	2-25, 3-30
[AUX A] .....	3-29
[AUX B] .....	3-31
AUX IF OUTPUT .....	3-29
AUX VIDEO OUTPUT .....	3-38
[B — DL → B] .....	3-33
[BAND LOCK] .....	2-16, 2-23, 2-48, 3-5
Bandwidth .....	2-25
[BAND X] .....	2-16, 3-6
[BAUD RATE] .....	3-13
Bessel Functions .....	A-5
<i>CAL</i> .....	3-14
[CAL AMPTD] .....	3-14
[CAL FETCH] .....	3-14
[CAL FLATNESS] .....	3-15
[CAL FREQ] .....	3-14

Calibration .....	1-2
amplitude .....	1-2
frequency .....	1-2
data .....	1-2
functions .....	1-2
routines .....	1-2
signal .....	1-2
softkeys .....	1-3
Calibration Procedure .....	1-16
CAL OUTPUT .....	1-1, 3-37
[CAL STORE] .....	3-14
[CAL YTF] .....	3-15
[CAL YTO DELAY] .....	3-15
Caution .....	3-8, 3-16, 3-38
input power .....	3-8, 3-38
key usage .....	3, 3-16
[CF STEP SIZE] .....	3-7
[CLEAR OFFST] .....	2-37, 3-42
[CLEAR WRITE A] .....	3-31
[CLEAR WRITE B] .....	2-15, 3-33
[COARSE TUNE DAC] .....	3-29
[COMB GEN ON] .....	2-36, 3-14
Comparing Signals With Delta Markers .....	2-16
Bandwidth .....	2-16
<b>CONFIG</b> .....	3-13
Configuration .....	3-13
[CONF TEST] .....	3-29
[CONT SWEEP] .....	3-34
[CONTINUE] .....	3-42
Control functions .....	1-8, 3-26

---

Controls and Connectors . . . . .	3-37
100 MHz COMB OUT . . . . .	3-37
1ST LO OUTPUT . . . . .	3-37
AUX IF OUTPUT . . . . .	3-39
CAL OUTPUT . . . . .	3-37
EXT TRIG INPUT (TTL) . . . . .	3-39
front-panel . . . . .	3-37
HI SWEEP IN/OUT (TTL) . . . . .	3-39
HP-IB . . . . .	3-39
HP-IL . . . . .	3-39
INPUT 50 $\Omega$ . . . . .	3-38
input/output . . . . .	3-39
INTERFACE CONNECTORS . . . . .	3-39
MONITOR OUTPUT . . . . .	3-39
rear-panel . . . . .	3-38
RS-232 . . . . .	3-39
SWEEP OUTPUT . . . . .	3-38
VOLTAGE SELECTOR . . . . .	3-39
Copy functions . . . . .	1-8, 3-19
[CORRECT on OFF] . . . . .	3-14
[CORRECT TO COMB] . . . . .	2-36, 3-41
[DACS] . . . . .	3-17
Data Controls . . . . .	3-3
[DELTA MEAS] . . . . .	3-40
[DETECTOR] . . . . .	3-27
<i>DISPLAY</i> . . . . .	3-35
[DISPLAY CAL DATA] . . . . .	3-15
[DISPLAY LINE] . . . . .	3-35
[DISPLAY UNITS] . . . . .	3-36
[DISPOSE ALL] . . . . .	3-13

---

Distortion From the Analyzer .....	2-29
Documentation Description .....	2
Down step key .....	2-20, 2-25, 2-26
[DROOP] .....	3-29
[EEPROM INIT] .....	3-16
[ENTER FLT ERR] .....	3-16
[EXECUTE TITLE] .....	3-15
[EXTERNAL] .....	3-34
EXT TRIG INPUT (TTL) .....	3-39
Fast Fourier Transform Function .....	2-46
[FFT MEAS] .....	2-43, 3-41
[FINE TUNE DAC] .....	3-29
[FM COIL DRIVE] .....	3-29
[FM SPAN] .....	3-29
[FREE] .....	3-34
[FREQ OFFSET] .....	3-7
Frequency .....	1-2
<i>FREQUENCY</i> .....	1-8, 3-5
Frequency and Span Functions .....	3-5
Frequency Modulation .....	A-4
Front-Panel Connectors .....	3-37
Front-Panel Overview .....	1-7



---

Gain	1-14, 1-16, 3-15
calibration data	3-15
IF	1-16
preamplifier step	1-14
Getting Acquainted With the Front-Panel and Display	1-7
Getting Acquainted With the Rear-Panel	1-10
[GND REF DETECTOR]	3-29
[GRAT ON off]	3-36
Harmonic Lock	2-48
HI SWEEP IN/OUT (TTL)	3-39
<i>HOLD</i>	3-4
[HORIZ POSITION]	3-15
How to Use This Manual	5
[HRM LOCK ON off]	2-48, 3-6
Identifying Distortion Products Using the RF Attenuator and Traces	2-29
Impedance	3-14
CAL OUTPUT	3-14
input	3-14
Improving Accuracy With Calibration Routines	1-15
INPUT 50 ohms	3-38
[INPUT IMPED]	3-36
Installation Manual	1-1, 1-15, 1-16, 2-38, 2-51, 3-38, 3-39
Instrument State Functions	1-8, 3-11
Intensity	3-37
Interface connectors	3-39
HP-IB	3-39
HP-IL	3-39
RS-232	3-39
Intermodulation Distortion	3-33

---

Knob .....	3-3
Linear .....	2-42
[LINEAR] .....	3-9
<i>LINE</i> (Power) .....	3-37
[LINE] (Trigger) .....	3-34
<i>LOCAL</i> .....	3-12
[LOG dB/DIV] .....	3-9
Loss in Sensitivity .....	A-6
[MAIN COIL DR] .....	3-29
[MAIN SPAN] .....	3-29
Making a Measurement .....	1-1
Manual Terms and Conventions .....	5
[MARKER AMPTD] .....	3-22
[MARKER DELTA] .....	3-21, 3-24
Marker Functions .....	1-8, 3-21
[MARKER NORMAL] .....	3-21
[MARKER PAUSE] .....	3-22
[MARKER → CF] .....	3-23, 3-24
[MARKER → RL] .....	3-23
[MARKER → STEP] .....	3-23
[MARKERS OFF] .....	2-18, 3-22
Max Modulating Frequency .....	2-47
[MAX HOLD A] .....	2-15, 3-31
[MAX HOLD B] .....	3-33
Maximum Hold Function .....	2-14
[MAX MXR LEVEL] .....	2-35, 3-9
Meas Uncal Indicator .....	3-30
Measurement Summary .....	1-5
Measuring Amplitude Modulation With the Fast Fourier Transform ..	2-43

---

Measuring Low-Level Signals With Attenuation, Bandwidth, and	
Video Average .....	2-22
[MENU 1] .....	3-40
[MENU 2] .....	2-43, 3-40
Menu and Softkey Overview .....	1-12
Message Block .....	1-8
<i>MKR</i> → .....	3-23
<i>MKR</i> .....	2-18, 3-21
[MKNOISE on OFF] .....	3-22
[MKR Δ → SPAN] .....	3-23
Modulation .....	2-42, 2-45, 2-46, 3-41, A-2, A-3, A-4
amplitude .....	2-45, 3-41, A-4
frequency .....	2-46, A-4
percent .....	3-41, A-3
[MODULATION MEAS] .....	3-41
Modulation Waveform .....	2-40
MONITOR OUTPUT .....	3-39
[MORE] .....	3-14, 3-23, 3-29
[NEXT PEAK] .....	3-24
[NEXT PK LEFT] .....	3-24, 41
[NEXT PK RIGHT] .....	3-24, 41
Number/Units Keyboard .....	3-3
Options .....	3-37
documentation .....	2
HP-IB .....	3-39
HP-IL .....	3-39
RS-232 .....	3-39
Other Controls and Connectors .....	3-37

---

[PEAK EXCURSN] .....	3-25
<i>PEAK SEARCH</i> .....	2-11, 3-24
Peaking Signal Amplitude With Preselector Peak .....	2-10
Percent Modulation .....	A-3
[PEAK SEARCH] .....	3-41
[PK-PK MEAS] .....	3-40
[PLOTTER ADDRESS] .....	3-13
<i>PLOT</i> .....	3-19
[POS PK DETECTOR] .....	3-28
Power .....	3-8, 3-40
amplitude .....	3-8
bandwidth .....	3-40
input .....	3-9
level .....	3-9
line .....	3-37
noise power bandwidth .....	3-22
Power-to-voltage conversions .....	3-36
<i>PRESET</i> .....	3-11
[PREAMP GAIN] .....	3-13
[PRESEL PEAK] .....	3-10
[PRINTER ADDRESS] .....	3-13
Printing History .....	5
<i>PRNT</i> .....	3-19
Pulsed RF Versus CW .....	A-6

Rear-Panel Connectors .....	3-38
<i>RECALL</i> .....	3-18
[RECALL 0 TRACE B] .....	3-18
[RECALL 1 TRACE B] .....	3-18
[RECALL 2 TRACE B] .....	3-18
[RECALL 3 TRACE B] .....	3-18
[RECALL 4 TRACE B] .....	3-18
REF LEVEL .....	3-8
[REF LVL OFFSET] .....	3-10
Remote Operation .....	(See Programming Manual)
[RES BW] .....	3-26
Resolution .....	2-42
Resolution Bandwidth .....	2-2, 2-25, 3-30
Resolution Bandwidth Setting for Pulsed RF .....	A-7
Resolving Signals of Equal Amplitude With Resolution Bandwidth ...	2-2
Resolving Small Signals with Large Signals Using the Resolution Bandwidth Function .....	2-6
RF attenuation .....	3-30
[SAMPLE DETECTOR] .....	3-28
<i>SAVE</i> .....	3-18
[SAVE 0 TRACE A] .....	3-18
[SAVE 1 TRACE A] .....	3-18
[SAVE 2 TRACE A] .....	3-18
[SAVE 3 TRACE A] .....	3-18
[SAVE 4 TRACE A] .....	3-18
[SAVE LOCK on OFF] .....	3-18
Screen Annotation .....	1-13
[SCREEN TITLE] .....	3-36
Service Functions .....	3-29
Service Requests .....	1-13, B-1

---

[SET 20 dB ERR] .....	3-16
<i>SIGNAL TRACK</i> .....	2-11, 3-25
Signal Track Function .....	2-12
[SINGLE SWEEP] .....	3-34
Softkeys .....	1-8
<i>SPAN</i> .....	3-5
Span .....	1-2
[START FREQ] .....	3-7
State .....	1-8, 3-11
instrument .....	1-15
preset .....	1-1
registers .....	3-11, 3-13, 3-18
Step Keys .....	3-3
Step Size .....	3-30
[STOP FREQ] .....	3-7
[STORE BLANK A] .....	3-32, 3-7
[STORE BLANK B] .....	3-33
[STP GAIN ZERO] .....	3-16
Sweep/Bandwidth .....	3-26
SWEEP OUTPUT .....	3-38
[SWEEP RAMP] .....	3-29
Sweep Time .....	2-42, 3-30
[SWEEP TIME] .....	3-27
[SWEEP TIME DAC] .....	3-29
<i>SWP/BW</i> .....	3-26, 3-29

Temperature (Power On) . . . . .	3-9
Third-Order Intermodulation Distortion . . . . .	2-32
[THRESHOLD] . . . . .	3-35
<i>TRACE A</i> . . . . .	2-15, 3-31
<i>TRACE B</i> . . . . .	2-15, 3-33
Tracking Renegade Signals With Signal Track and Maximum Hold . .	2-11
<i>TRIG</i> . . . . .	3-34
Trigger . . . . .	2-42, 3-34
Uncalibrated Indicator . . . . .	3-30
Units . . . . .	3-36
amplitude . . . . .	1-2
display . . . . .	3-35, 3-36
keyboard . . . . .	1-2, 2-24, 2-28, 2-48, 3-2, 3-36, 3-40, 3-48
linear . . . . .	3-9
logarithmic . . . . .	3-9
Units keys . . . . .	3-36
Up step key . . . . .	2-24, 2-30
Using the Analyzer as a Receiver in Zero Span . . . . .	2-42
Using the Comb Generator to Perform Accurate Frequency Measurements . . . . .	2-37
[VBW/RBW RATIO] . . . . .	3-27
[VERT POSITION] . . . . .	3-15
[VID BW] . . . . .	3-26
[VIDEO] . . . . .	3-34
[VIDEO AVERAGE] . . . . .	3-32
Video Averaging . . . . .	2-27
Video Bandwidth . . . . .	2-42, 3-30
Video Bandwidth Ratio . . . . .	3-30
Video Filter . . . . .	2-25

---

[VIEW A] .....	3-31
[VIEW B] .....	3-33
Warmup Time .....	1-15
[X FINE TUNE DAC] .....	3-29
[YTF SPAN] .....	3-29
[YTF SPAN TUNE COARSE] .....	3-29
[YTF SPAN TUNE FINE] .....	3-29
[YTF SPAN TUNE DRIVER] .....	3-29
Zero Span .....	2-42
Zoom (Auto Zoom) .....	2-8



## HP 8592A Softkey Menus

### FREQUENCY

BAND LOCK  
 0-2.9 GHz BAND 0  
 2.75-6.2 BAND 1  
 6.0-12.8 BAND 2  
 12.4-19.4 BAND 3\*  
 19.1-22 BAND 4  
 HRM LOCK on/OFF  
 COMB GEN on/OFF  
 START FREQ  
 STOP FREQ  
 CF STEP SIZE  
 FREQ OFFSET

### SPAN

### AMPLITUDE

ATTEN  
 LOG dB/DIV  
 LINEAR  
 MAX MXR LEVEL  
 REF LVL OFFSET  
 PRESEL PEAK

### Marker

#### MKR

MARKER NORMAL  
 MARKER DELTA  
 MARKER AMPTD  
 MKNOISE on/OFF  
 MARKER PAUSE  
 MARKERS OFF

#### MKR →

MARKER → CF  
 MARKER → RL  
 MARKER → STEP  
 MKR Δ → SPAN  
 MORE →

#### PEAK SEARCH

MARKER → CF  
 MARKER DELTA  
 NEXT PEAK  
 NEXT PK RIGHT  
 NEXT PK LEFT  
 PEAK EXCURSN

### Instrument State

#### CAL

CAL FREQ  
 CAL AMPTD  
 CORRECT ON off  
 CAL STORE  
 CAL FETCH  
 MORE  
 DISPLAY CAL DATA  
 CAL YTO DELAY  
 CAL YTF  
 VERT POSITION  
 HORIZ POSITION  
 CAL FLATNESS →

#### CONFIG

ANALYZER ADDRESS  
 PLOTTER ADDRESS  
 PRINTER ADDRESS  
 BAUD RATE  
 PREAMP GAN  
 DISPOSE ALL

#### MENU 1

DELTA MEAS  
 PK-PK MEAS  
 3rd ORD MEAS  
 3dB POINTS  
 6dB POINTS

#### MENU 2

99% PWR BW  
 FFT MEAS  
 MODULATN MEAS  
 CORRECT TO COMB  
 PEAK SEARCH  
 NEXT PK RIGHT  
 NEXT PK LEFT  
 CLEAR OFFST  
 CONTINUE  
 ABORT

#### SAVE

SAVE 0 TRACE A  
 SAVE 1 TRACE A  
 SAVE 2 TRACE A  
 SAVE 3 TRACE A  
 SAVE 4 TRACE A  
 SAV LOCK on/OFF

#### RECALL

RECALL 0 TRACE B  
 RECALL 1 TRACE B  
 RECALL 2 TRACE B  
 RECALL 3 TRACE B  
 RECALL 4 TRACE A

## Control

### TRACE A

CLEAR WRITE A  
MAX HOLD A  
VIEW A  
STORE BLANK A  
VIDEO AVERAGE  
A—B on OFF

### TRACE B

CLEAR WRITE B  
MAX HOLD B  
VIEW B  
STORE BLANK B  
A XCH B  
B—DL→B

### TRIG

CONT SWEEP  
SINGLE SWEEP  
FREE  
VIDEO  
LINE  
EXTERNAL

### SWP/BW

RES BW  
VID BW  
VBW/RBW RATIO  
SWEEP TIME  
DETECTOR

SAMPLE DETECTOR  
POS PK DETECTOR  
2v REF DETECTOR  
GND REF DETECTOR  
ANALYZER TESTS \*\*

MAIN COIL DR  
FM COIL DRIVE  
FM SPAN  
MAIN SPAN  
YTF SPAN  
MORE

SWEEP RAMP  
SWEEP TIME DAC  
COARSE TUNE DAC  
FINE TUNE DAC  
X FINE TUNE DAC  
MORE  
+10V REF DETECTOR  
-10V REF DETECTOR  
AUX A  
CONF TEST  
DROOP  
MORE

YTF TUNE COARSE  
YTF TUNE FINE  
YTF DRIVER  
MIXER BIAS DAC  
MORE

### DISPLAY

DISPLAY LINE  
THRESHOLD  
SCREEN TITLE  
GRAT ON off  
ANOTATN on OFF

DISPLAY UNITS  
dBm  
dBmV  
dBuV  
Volts  
Watts  
INPUT IMPED

\* Note: BAND 3 ranges from 12.4-19.4, however, the "4" in 19.4 does not appear on your screen.

### CAUTION

\*\* Denotes service functions that are described in the Support Manual.