

Errata

Title & Document Type: 8569B Spectrum Analyzer Operation Manual

Manual Part Number: 08569-90034

Revision Date: December 1982

HP References in this Manual

This manual may contain references to HP or Hewlett-Packard. Please note that Hewlett-Packard's former test and measurement, semiconductor products and chemical analysis businesses are now part of Agilent Technologies. We have made no changes to this manual copy. The HP XXXX referred to in this document is now the Agilent XXXX. For example, model number HP8648A is now model number Agilent 8648A.

About this Manual

We've added this manual to the Agilent website in an effort to help you support your product. This manual provides the best information we could find. It may be incomplete or contain dated information, and the scan quality may not be ideal. If we find a better copy in the future, we will add it to the Agilent website.

Support for Your Product

Agilent no longer sells or supports this product. You will find any other available product information on the Agilent Test & Measurement website:

www.tm.agilent.com

Search for the model number of this product, and the resulting product page will guide you to any available information. Our service centers may be able to perform calibration if no repair parts are needed, but no other support from Agilent is available.





8569B SPECTRUM ANALYZER OPERATION

Copyright © 1982, HEWLETT-PACKARD COMPANY
1424 FOUNTAIN GROVE PARKWAY, SANTA ROSA, CALIFORNIA, 95404, U.S.A.

HP Part No. 08569-90034

Printed: December 1982

CONTENTS

Chapter	Page	Chapter	Page
INTRODUCTION	1	Electromagnetic Interference (EMI)	31
Signal Analysis	1	Swept-Frequency Response	33
BASIC DESCRIPTION	2	5 HP-IB REMOTE OPERATION	35
1 OPERATING THE HP 8569B	3	APPENDIX A	38
Line Power On	3	OPERATING PRECAUTIONS	38
Front Panel Adjustment Procedure	3	Low Impedance AC	38
Getting Started	4	DC Precautions	38
2 FRONT PANEL OPERATION	8	APPENDIX B	39
Tuning	8	THEORY OF OPERATION	39
Frequency Span Mode	8	System Description	39
Resolution Bandwidth	10	RF Section	39
Reference Level	10	Automatic Stabilization Section	39
Digital Storage Display	13	IF Section	40
Traces	13	Digital Storage Display	40
Trace Memory	14	Tuning Control Section	40
Direct Plotter Output	17	APPENDIX C	43
3 SPECIAL TOPICS	18	AMPLITUDE CONVERSIONS	43
Maximum Dynamic Range	18	Conversion Equations	43
Improving Amplitude Measurement		APPENDIX D	44
Accuracy	22	OPTION STATUS INTERFACE	44
CRT Photography and X-Y Recording	22	APPENDIX E	45
External Mixer Operation	23	SYNTAX REFERENCE GUIDE	45
4 TYPICAL MEASUREMENTS	26	APPENDIX F	50
Distortion	26	CONTROL GLOSSARY	50
Modulation	27		
Noise	31		

INTRODUCTION

SIGNAL ANALYSIS

The spectrum analyzer is a receiver that displays signals in the frequency domain. The CRT on the analyzer displays signal amplitude (A) on the vertical axis and frequency (f) on the horizontal axis. A method of visualizing how a spectrum analyzer views the frequency domain is to picture a tunable bandpass filter that scans the frequency axis (see Figure 1). At any instant in time, the analyzer views only the signal it is tuned to receive, rejecting all others. In this way, all the individual components

of a signal are viewed separately. In comparison, an oscilloscope displays the signals in the time domain, and the amplitude displayed represents the vector sum of all signal components.

The purpose of this section is to acquaint the reader with the operation of the HP Model 8569B Spectrum Analyzer. Rather than discussing specific topics in detail, the reader is referred to existing application notes, which may be obtained by contacting your local Hewlett-Packard Sales Office.

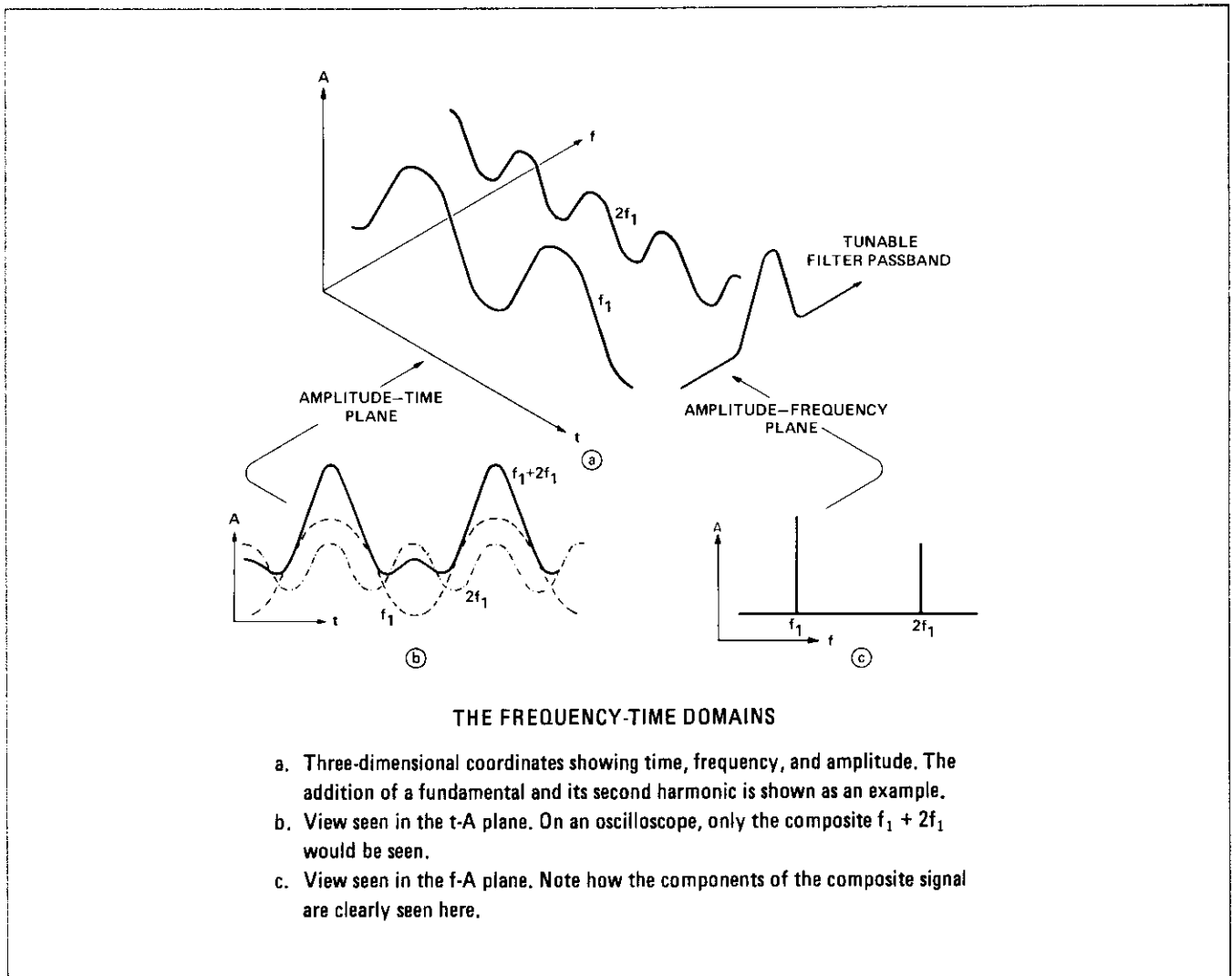

Figure 1. Frequency and Time Domain

BASIC DESCRIPTION

The HP 8569B (Figure 2) is a high-performance spectrum analyzer designed for ease of use. Most measurements can be made with just three controls once the normal (green) settings are preset. The HP 8569B has absolute amplitude and frequency calibration from 0.01 to 22 GHz. The frequency span, bandwidth, and video filter are all coupled with automatic sweep to maintain a calibrated display and simplify use of the analyzer. Internal preselection eliminates most spurious responses to simplify signal identification. The preselector also extends the dynamic range of the analyzer and provides some protection for the input mixer.

The HP 8569B has a digital storage display system. All the information necessary to analyze a signal is displayed on the top portion of the CRT. The trace information for

both Trace A and Trace B resides in a digital storage buffer which is updated at the sweep rate of the analyzer. The information in this buffer is then displayed on the CRT and automatically refreshed at a flicker-free rate. Certain arithmetic and logical functions, such as digital averaging and normalization, can be performed on the trace values. The graticule, character, and trace information can be output directly to a digital plotter set for the listen only mode without the need for a controller. A controller connected via HP-IB may control the output or input of display information (e.g., trace values, text, control information).

The frequency range of the HP 8569B is 10 MHz to 22 GHz in direct coaxial input and 14.5 to 115 GHz when used with external mixers.

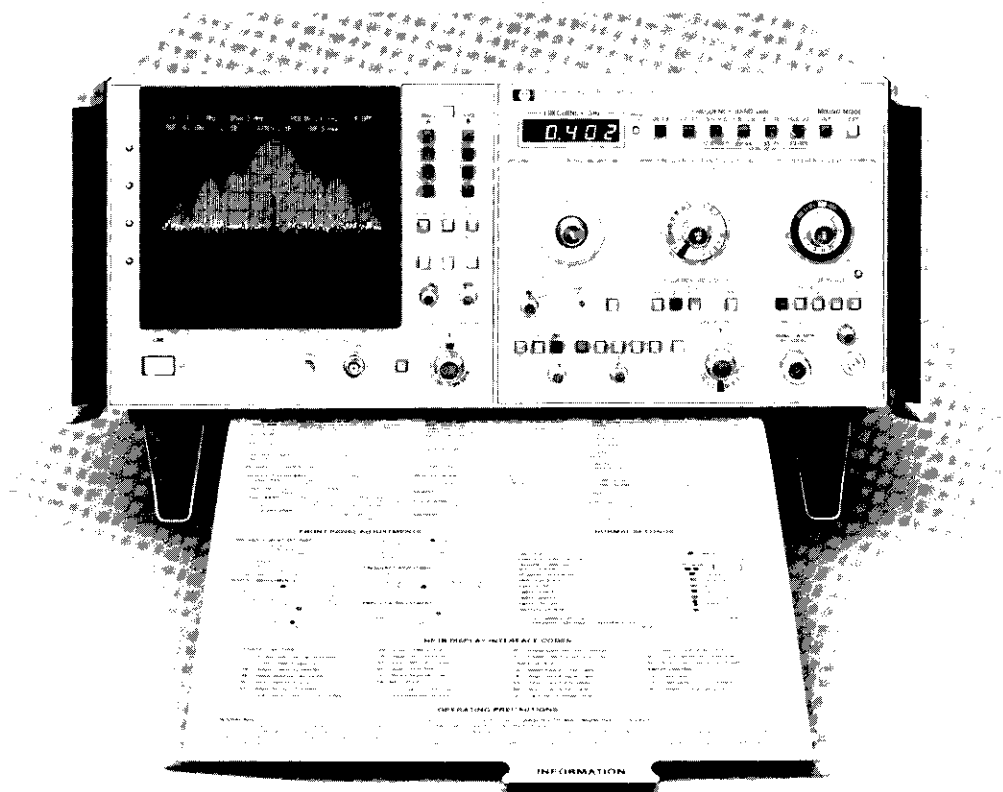

Figure 2. HP 8569B Spectrum Analyzer

CHAPTER 1

OPERATING THE HP 8569B

LINE POWER ON

CAUTION

Before connecting the line power cord, make sure the proper line voltage and line fuse have been selected for the instrument. For complete information on power cords, voltage and fuse selection, refer to the HP 8569B Operation and Service Manual, Section II.

When LINE is switched ON, the instrument performs an automatic internal instrument check. This routine checks the operation of the system memory (RAM), system program memory (ROM), and the stroke memory (RAM), located in the analyzer's display section. If the test routine fails partially or if the routine will not run at all, refer to the HP 8569B Operation and Service Manual, Sections V and VIII.

Contained in the HP 8569B program memory (firmware) is a series of test patterns which aid in troubleshooting and in the adjustment of the analyzer. (Refer to HP 8569B Operation and Service Manual, Sections V and VIII.)

FRONT PANEL ADJUSTMENT PROCEDURE

The front panel adjustment optimizes the performance of the HP 8569B Spectrum Analyzer to obtain its specified accuracy. The following step-by-step procedure is recommended for adjusting the HP 8569B. A condensed procedure is also located on a pull-out INFORMATION CARD attached to the analyzer.

Pre-adjustment Settings

1. Set normal (green) settings on analyzer (Table 1).
2. Set FREQUENCY BAND GHz to 0.01 – 1.8.
3. Set FREQUENCY SPAN/DIV to 1 MHz.
4. Set INPUT ATTEN to 10 dB.
5. Set REF LEVEL dBm to – 10 and REFERENCE LEVEL FINE to 0 dB.

Display Adjustments

1. Adjust FOCUS \odot for clearest control readout characters.
2. Press and hold in the GRAT while pressing the CLEAR/RESET to activate the Display Adjust line at top of screen as shown in Figure 3.

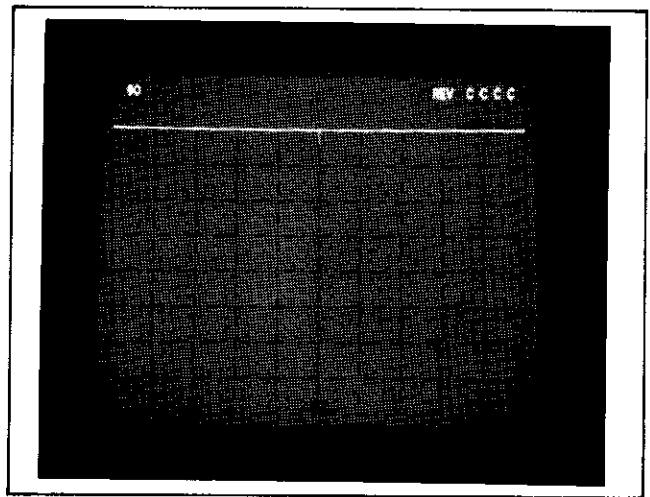

Figure 3. Display Line Adjustment

3. Adjust TRACE ALIGN \odot so that the displayed line is parallel to top graticule line.
4. Adjust VERT POSN \odot to place display line on top graticule line (REFERENCE LEVEL).
5. Adjust HORIZ POSN \odot to place center cross tick of displayed line at center of top graticule line.
6. Press CLEAR/RESET to return normal display.

Frequency Adjustment

1. Connect 100 MHz CAL OUTPUT signal to INPUT.
2. Center signal on CRT with TUNING control.
3. Uncouple the RESOLUTION BW and set it to 10 kHz.
4. Adjust FREQ CAL \odot to indicate 0.100 GHz on FREQUENCY GHz readout.

Amplitude Adjustment

1. Center signal on CRT with TUNING control.
2. While keeping signal centered on the CRT, reduce FREQUENCY SPAN/DIV to 50 kHz.
3. Set AMPLITUDE SCALE to 1 dB .
4. Adjust REF LEVEL CAL to position the peak of the signal on the REFERENCE LEVEL (top graticule line) of the CRT. Once the Front Panel Adjustment Procedure is completed, the CRT display should be similar to that shown in Figure 4.
5. Reset the AMPLITUDE SCALE to 10 dB .

The HP 8569B is now calibrated for absolute frequency and amplitude measurement.

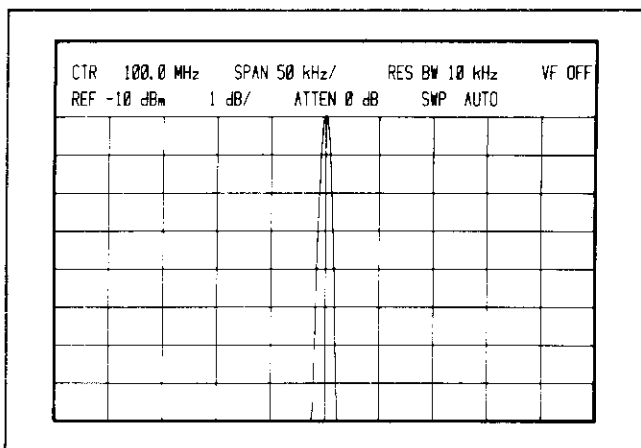

Figure 4. CAL OUTPUT Signal

GETTING STARTED

The HP 8569B Spectrum Analyzer is a sensitive measuring instrument. To avoid damage to the instrument, do not exceed the following:

Absolute Maximum Inputs:¹

Total RF Power: + 30 dBm (1 watt)
 dc or ac (<<50 Ω source impedance):
 0V with 0 dB RF input attenuation (<1 amp)
 ±7V with ≥10 dB RF input attenuation (<0.14 amp).

Peak Pulse Power:
 + 50 dBm (<10 μsec pulse width, 0.01% duty cycle) with ≥20 dB INPUT ATTEN.

¹For more detailed information regarding Operating Precautions refer to Appendix A.

WARNING

This instrument and any device connected to it must be connected to power line ground. Failure to ensure proper grounding could cause a shock hazard to personnel or damage to the instrument.

Normal Settings

The normal settings listed in Table 1 are used for the majority of measurements. For instance, 10 dB/division, INT sweep, and AUTO sweep time positions are most often used and so are classified as normal settings. All normal settings on the HP 8569B are colored green so the user can easily identify and set them initially.

Table 1. Normal Settings

Function	Setting
TRACE A, B	<input checked="" type="checkbox"/> WRITE
SAMPLE, DGTL AVG, INP-B→A	<input type="checkbox"/> OUT
FREQUENCY SPAN/DIV RESOLUTION BW	OPTIMUM (Push in to couple)
FREQUENCY SPAN MODE	<input checked="" type="checkbox"/> PER DIV
MIXING MODE	<input checked="" type="checkbox"/> INT
AMPLITUDE SCALE	<input checked="" type="checkbox"/> 10 dB
VIDEO FILTER	<input type="checkbox"/> OFF
SWEEP SOURCE	<input checked="" type="checkbox"/> INT
SWEEP TRIGGER	<input checked="" type="checkbox"/> FREE RUN
SWEEP TIME/DIV	<input type="checkbox"/> AUTO
PRESELECTOR PEAK	<input type="checkbox"/> Center in green area

With normal settings, most measurements can be made using only the TUNING, FREQUENCY SPAN/DIV and REFERENCE LEVEL controls. The analyzer is calibrated for any combination of control settings as long as the UNCAL indicator is not displayed (refer to Chapter 2).

Three-Knob Operation

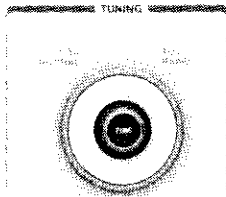

TUNING adjusts the center frequency of the analyzer. It also positions the marker in the full band and 1.7 to 22 GHz span modes.

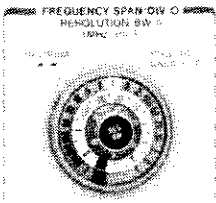

FREQUENCY SPAN/DIV sets the horizontal frequency calibration on the CRT. An optimum resolution bandwidth is automatically selected for a given frequency span when two arrows are aligned.

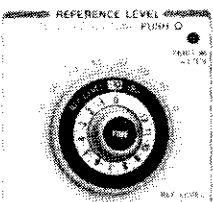

The REFERENCE LEVEL control sets the vertical amplitude calibration on the CRT. The REFERENCE LEVEL (top graticule line) on the CRT represents an absolute power level (in dBm or dBμV). Changes in RF INPUT ATTEN

will also change the indicated REFERENCE LEVEL.

Simplified Signal Analysis



The internal CAL OUTPUT signal is a convenient source to demonstrate how fast and easily the HP 8569B can measure frequency and amplitude.

Start by presetting the green normal settings listed in Table 1. This sets the analyzer in its normal, three-knob operation mode. Now connect the CAL OUTPUT signal to the INPUT connector of the analyzer and begin the measurement procedure:

1. Select the FREQUENCY BAND that includes the 100 MHz CAL OUTPUT signal (.01 – 1.8).

2. Use the TUNING control to tune the 100 MHz signal to the center of the display. The FREQUENCY SPAN/DIV control may be increased to facilitate tuning.
3. Adjust the FREQUENCY SPAN/DIV control to achieve the desired resolution. Since there is no modulation on the CAL OUTPUT signal, a 1 MHz/Div span is sufficient. Retune the signal to the center of the display if necessary.
4. Position the peak of the signal on the REFERENCE LEVEL (top graticule line) of the CRT using the REFERENCE LEVEL control.

Since the CAL OUTPUT signal is the calibration reference for the analyzer, FREQUENCY GHz should read 0.100 GHz and the REFERENCE LEVEL should read -10 dBm (Figure 5). If not, adjust the FREQ CAL and the REF LEVEL CAL to obtain the correct reading.²

For this next example, let us suppose that the microwave source in the test setup (Figure 6) operates in C-band (4 to

²A complete front panel adjustment procedure is included in this chapter.

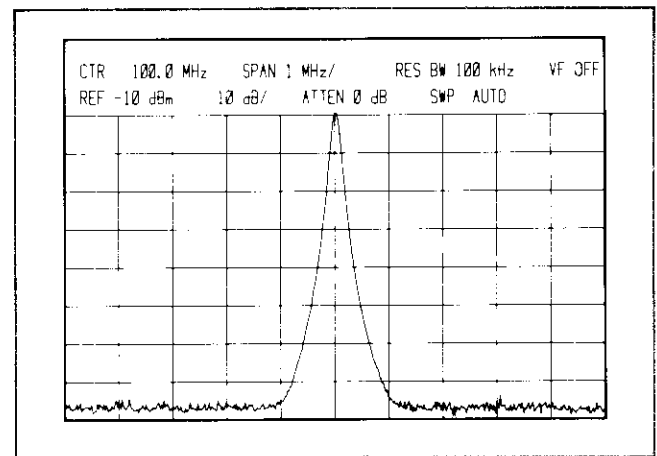

Figure 5. CAL OUTPUT Signal

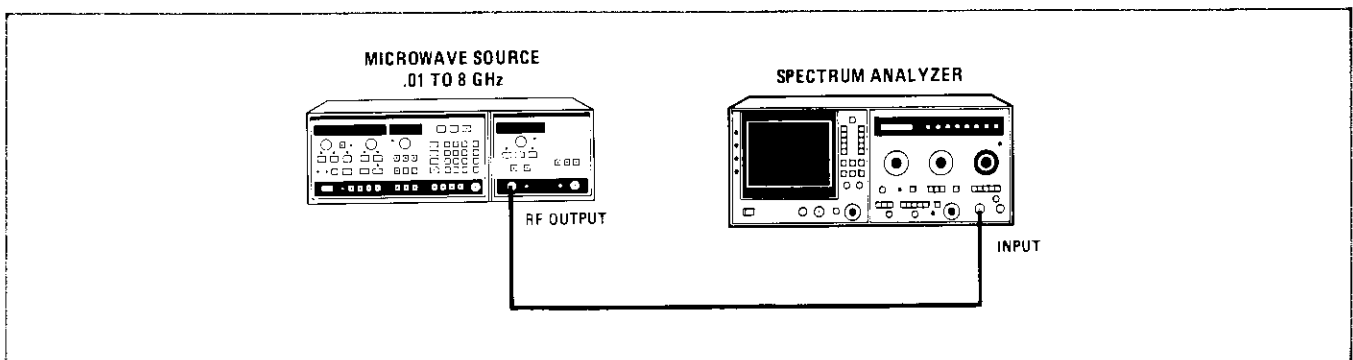

Figure 6. Microwave Source Test Setup

8 GHz). However, we do not know its exact output frequency. What, then, is the best way to locate a signal?

By using the full band feature of the HP 8569B, we can sweep an entire frequency band to search for a signal.

To view the microwave source in Figure 6 that operates in C-band, select the 3.8 to 8.5 GHz Frequency Band. Posi-

tion the tuning marker (which appears in the full band modes) under the signal to identify its frequency (Figure 7). Then by pushing the green PER DIV button, the signal at the marker will become the center frequency of the analyzer (Figure 8). In PER DIV mode, the desired frequency span can be adjusted with the FREQUENCY SPAN/DIV control. Figure 9 illustrates the procedure for locating a signal.

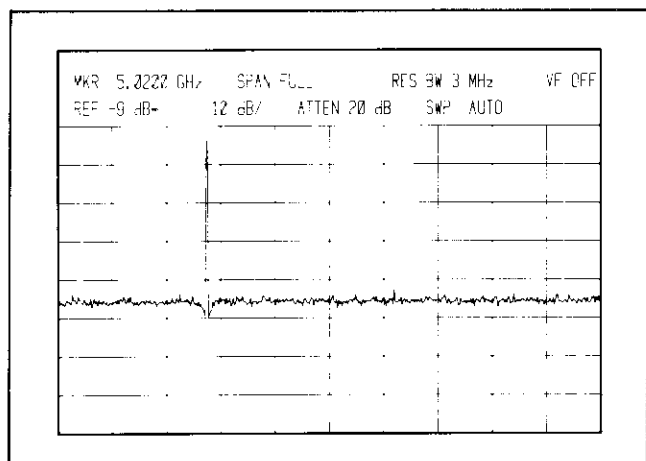

Figure 7. Tuning Marker in FULL BAND

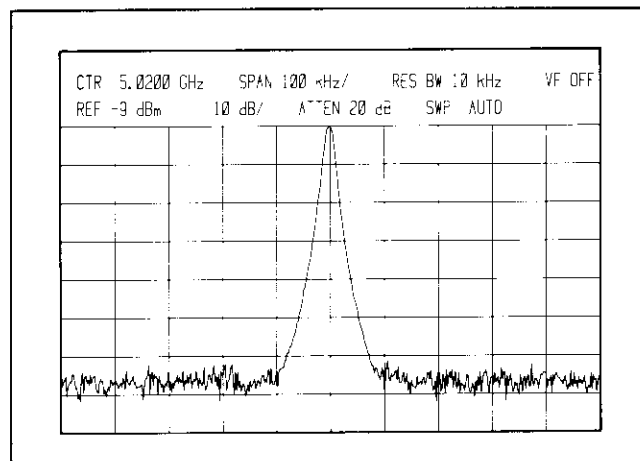
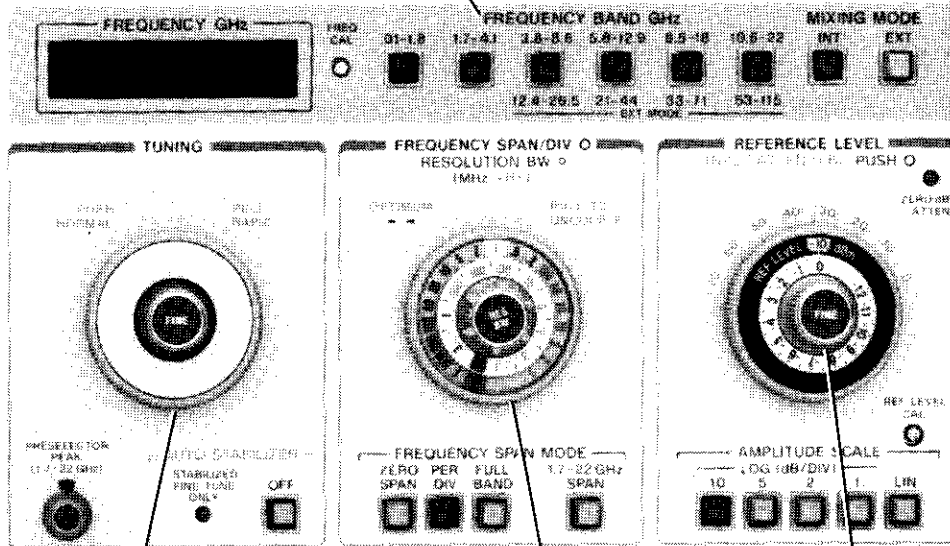

Figure 8. PER DIV Mode

Set desired FREQUENCY BAND while in FULL BAND Frequency Span Mode



2 TUNING Control sets marker which will be center frequency in PER DIV MODE

3 Reset to PER DIV and adjust FREQUENCY SPAN/DIV

4 Position signal on top REFERENCE LEVEL line

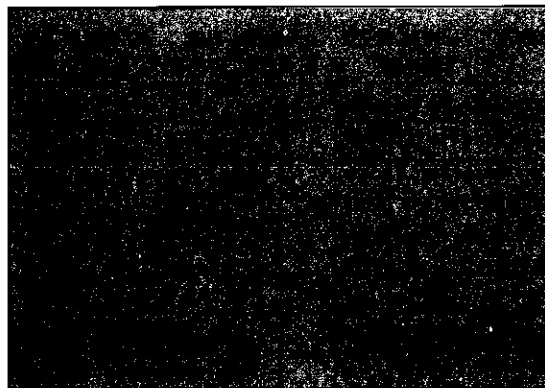
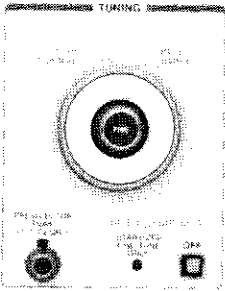

Figure 9. Locating a Signal

CHAPTER 2 FRONT PANEL OPERATION

This chapter provides detailed descriptions of all front-panel controls. Following each description, the relevant HP-IB code is given. For additional HP-IB information, refer to Chapter 5 and Appendix E.

TUNING



The TUNING control adjusts the center frequency of the analyzer. In the full-band modes, the TUNING control is used to locate an inverted marker on a particular signal. The FREQUENCY GHZ readout on the front panel and the CTR readout on the display indicate the center frequency of the analyzer or the frequency at the tuning marker.

By pulling out the outer control, rapid tuning is enabled. Rapid tuning is especially useful when moving the tuning marker in full band modes. Normal tuning resumes when the knob is pushed in. When the analyzer is stabilized (frequency spans ≤ 100 kHz/Div), only FINE TUNING should be used to tune the analyzer. If coarse tuning is desired, the AUTO STABILIZER can be disabled with the push button switch.

HP-IB Code:

CF (output center frequency)

FREQUENCY SPAN MODE

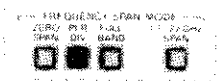

Four push button span modes are available on the HP 8569B: ZERO SPAN, PER DIV, FULL BAND, and 1.7–22 GHz SPAN.

An additional F (full-band) setting is available on the FREQUENCY SPAN/DIV control knob. The full-band modes (FULL BAND, F, and 1.7–22 GHz) enable the analyzer to monitor the various frequency bands or to provide multiband coverage from 1.7 to 22 GHz. PER DIV mode is generally used for detailed signal analysis, and ZERO SPAN is used for time domain analysis. The following text explains the various FREQUENCY SPAN MODE settings in more detail.

HP-IB Code:

SP (output FREQUENCY SPAN/DIV)

Zero Span

ZERO SPAN is used to recover the modulation on a carrier. In this mode, no sweep voltage is applied to the LO in the analyzer, so it operates as a manually tuned narrowband receiver. Carrier modulation is displayed in the time domain, and the calibrated SWEEP TIME/DIV control can be set manually to read the time variation of the signal. Selection of VIDEO trigger allows the sweep to be synchronized on the demodulated waveform. Figure 10 illustrates a demodulated AM carrier that was obtained with the analyzer in ZERO SPAN.

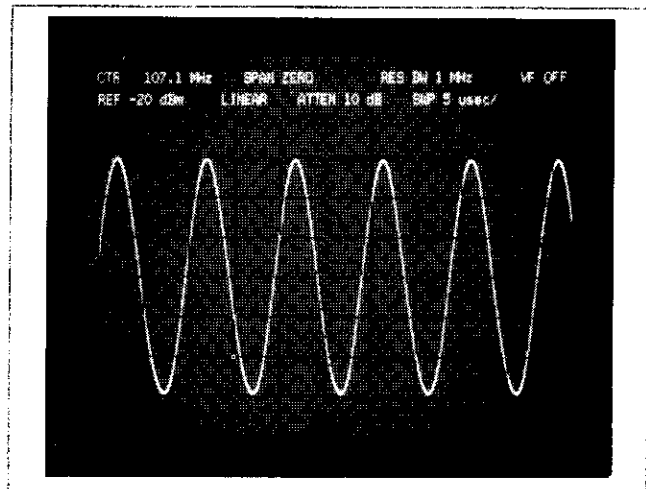

Figure 10. AM Carrier Demodulated in ZERO SPAN

Since the analyzer remains calibrated in ZERO SPAN, it is also possible to measure the amplitude and frequency of a CW signal. In this case, the CW signal appears as a horizontal line on the CRT. (See Figure 11.) Use a wide RESOLUTION BW setting and disable the AUTO STABILIZER for ease of tuning the signal.

The PER DIV mode enables the FREQUENCY SPAN/DIV control to set the horizontal frequency calibration of the CRT. The calibrated FREQUENCY SPAN/DIV control is adjustable from 1 kHz/Div to 500 MHz/Div in a 1, 2, 5 sequence of steps. An F (full-band) position allows the entire frequency band selected to be scanned. Normally, the RESOLUTION BW is coupled to the FREQUENCY SPAN/DIV so that the optimum RESOLUTION BW setting is automatically selected as the FREQUENCY SPAN/DIV is adjusted.

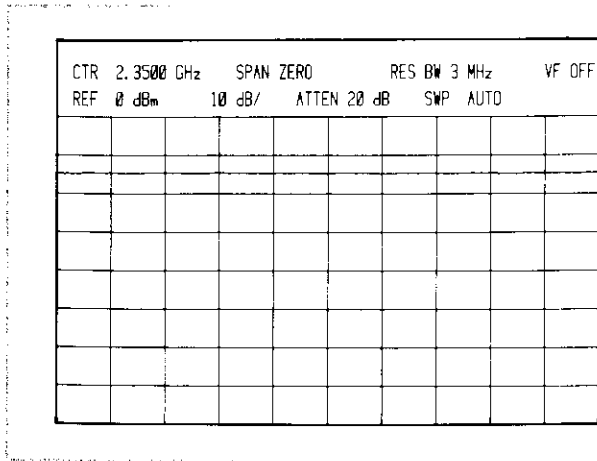

Figure 11. CW Measurement in ZERO SPAN

Full Band

The FULL BAND mode scans in one sweep the entire selected frequency band. A tuning marker, 3 MHz RESOLUTION BW and 0.003 VIDEO FILTER are automatically set in FULL BAND mode. Different frequency bands can be selected to look for unknown signals. Once a signal is located in a particular frequency band, the tuning marker can be positioned under the signal to identify its frequency (Figure 12). Then, by pushing PER DIV, the signal that was at the marker will be displayed at the center frequency on the CRT (Figure 13). The F position on the FREQUENCY SPAN/DIV control differs from the FULL BAND push button in that it allows independent adjustment of the RESOLUTION BW and VIDEO FILTER controls.

1.7 – 22 GHz Span

A multiband sweep, available when the 1.7–22 GHz SPAN push button is depressed, is useful for observing signal activity within a broad frequency range. A tuning marker can be used with rapid tuning to quickly identify the frequency of any signal in the 1.7–22 GHz range. Figure 14 illustrates a typical display with the 1.7–22 GHz SPAN selected.

The stair-step baseline display in Figure 14 is the result of gain compensation applied to the higher frequency bands to maintain a calibrated amplitude display. Gain compensation is required because the higher frequency bands utilize higher LO harmonics of lower amplitude, yielding reduced sensitivity. To obtain the highest sensitivity from the analyzer, use the lowest FREQUENCY BAND GHz setting available when there is a frequency overlap. For instance, a 7 GHz signal can be measured in the 3.8 to 8.5 GHz band or the 5.8 to 12.9 GHz band. The sensitivity, however, is better in the 3.8 to 8.5 GHz band.

The five frequency span modes available on the HP 8569B provide the user with maximum flexibility in making measurements. Table 2 summarizes the characteristics of each FREQUENCY SPAN MODE setting.

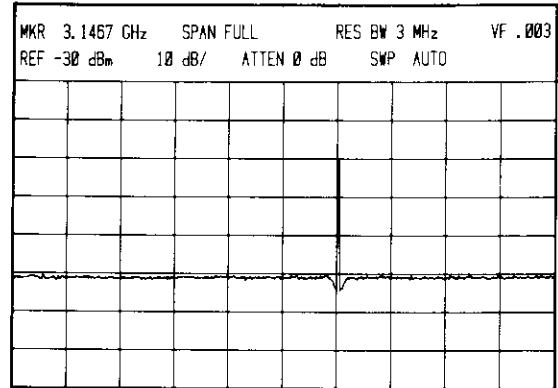

Figure 12. Identifying a Signal in FULL BAND

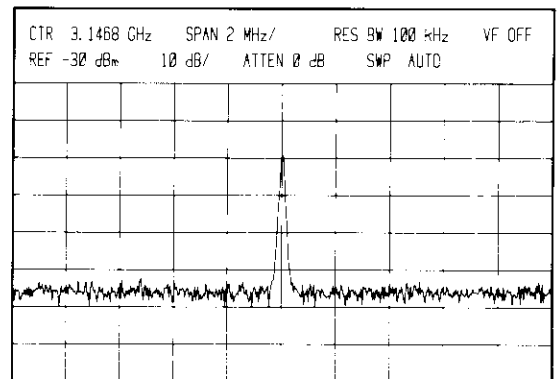

Figure 13. Analysis in PER DIV

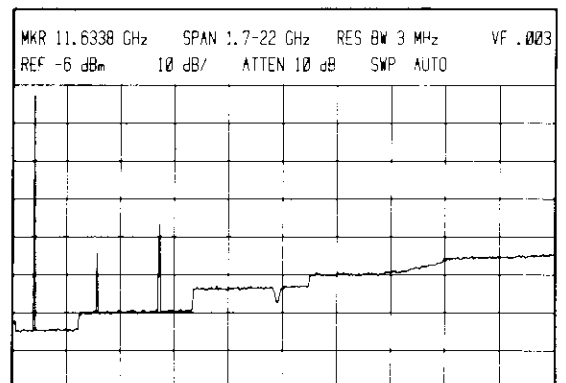
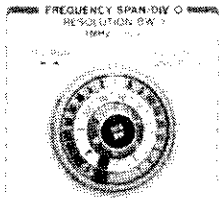



Figure 14. 1.7–22 GHz SPAN Mode

RESOLUTION BANDWIDTH



In OPTIMUM setting, the RESOLUTION BW is coupled to the FREQUENCY SPAN/DIV by aligning the green markers  and pushing the controls in. Once the controls are coupled at OPTIMUM, the best RESOLUTION

BW setting will be automatically chosen for any frequency span selected. The RESOLUTION BW control can also be coupled at a position other than OPTIMUM without loss of calibration of the spectrum analyzer. Calibration is always ensured when the UNCAL indication on the CRT annotation is not present.

For certain applications, independent control of the RESOLUTION BW control may be desirable. When either control knob is pulled out, the RESOLUTION BW control is decoupled, allowing different RESOLUTION BW settings to be selected. Figure 15 illustrates how an AM signal with 200 kHz sidebands is displayed at various RESOLUTION BW control settings. Note that the narrower resolution BW will yield increased sensitivity, since random noise decreases 10 dB for every reduction of Resolution BW by a factor of 10.

The SWEEP TIME/DIV control, when in AUTO position, will automatically select the proper sweep speed, whether the RESOLUTION BW control is coupled or uncoupled.

HP-IB Code:

RB (output RESOLUTION BW)

REFERENCE LEVEL

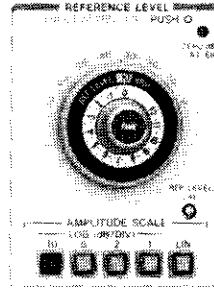

The main purpose of the REFERENCE LEVEL control is to set the absolute power at the REFERENCE LEVEL (top graticule line) on the CRT. When the peak of a signal is at the REFERENCE LEVEL, its absolute level (in dBm or dB μ V) is indicated on the CRT annotation as well as on the REFERENCE LEVEL control knob.

This characteristic of the analyzer is used to improve the amplitude measurement accuracy using IF substitution (refer to Chapter 3).

The REFERENCE LEVEL control, combined with the INPUT ATTEN control, has a range of 172 dB; from -112 dBm to +60 dBm, as shown in Figure 16a. Although the REFERENCE LEVEL control is calibrated from +30 dBm to +60 dBm, signal levels should never exceed +30 dBm since that is the maximum power the analyzer can withstand without damage. In Figure 16b, the REFERENCE LEVEL control was adjusted to position the peak of f_1 on the REFERENCE LEVEL line of the CRT. The absolute power of f_1 , then, is +30 dBm. The level at f_2 can be read from the calibrated CRT display as -20 dBm; that is, 50 dB below +30 dBm, assuming a 10 dB/Div Amplitude Scale factor. The Amplitude Scale factor can be set for 10 dB, 5 dB, 2 dB or 1 dB per division with respect to the REFERENCE LEVEL (top graticule line). The LIN scale factor sets the vertical calibration to volts with the bottom graticule line representing 0V. If desired, a low-level signal can be positioned at

Table 2. Frequency Span Modes

	Full Band Modes				
	ZERO SPAN <input type="checkbox"/> (Time Domain)	PER DIV <input checked="" type="checkbox"/> (Close Analysis)	<input checked="" type="checkbox"/> On Freq Span/Div Control	FULL BAND <input type="checkbox"/>	1.7-22 GHz SPAN <input type="checkbox"/>
TUNING MARKER	NO	NO	YES	YES	YES
FREQUENCY SPAN	ZERO (Manual Tune)	Selectable from 1 kHz/DIV to 500 MHz/DIV	Depends on FREQUENCY BAND selected	Depends on FREQUENCY BAND selected	1.7 to 22 GHz
RESOLUTION BANDWIDTH	Selectable	OPTIMUM  or Selectable	Selectable	Fixed at 3 MHz	Fixed at 3 MHz
VIDEO FILTER	Selectable	Selectable	Selectable	Fixed at 0.003 x 3 MHz = 9 kHz	Fixed at 0.003 x 3 MHz = 9 kHz

the REFERENCE LEVEL line to read its power level directly on the CRT annotation. The signal f_3 in Figure 16c is positioned on the REFERENCE LEVEL line to read -80 dBm directly.

The REFERENCE LEVEL line on the CRT is determined by a combination of IF gain (REFERENCE LEVEL control) and RF attenuation (INPUT ATTEN). The outer control knob adjusts the IF gain in 10 dB steps. A fine vernier knob provides continuous control from 0 to -12 dB.

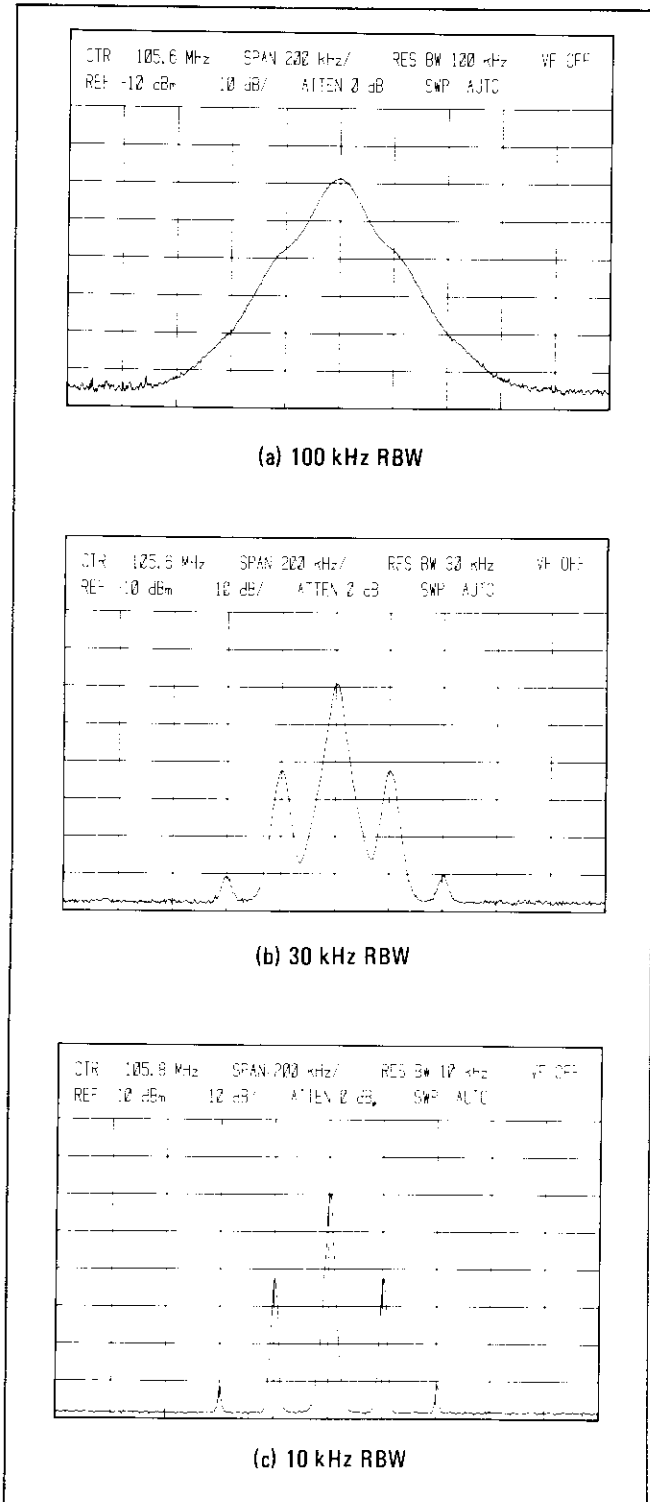
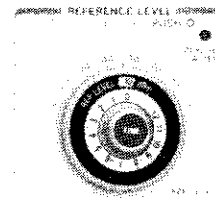

Figure 15. Resolving Modulation Sidebands



Pushing in the outer knob allows selection of RF input attenuation (blue numbers) from 0 to 70 dB. A reminder light is lit whenever 0 dB INPUT ATTEN is selected. Except for noise measurements or when maximum sensitivity is required, a minimum INPUT ATTEN setting of 10 dB should always be used to ensure a good SWR and to minimize uncertainties due to mismatches.

HP-IB Code:

- RL (output REFERENCE LEVEL)
- LG (output AMPLITUDE SCALE)
- AT (output RF INPUT ATTENUation)

Video Filter



The VIDEO FILTER control is useful for observation of a low-level signal that is close to the noise level. Figure 17 illustrates how use of the VIDEO FILTER control allows measurement of low-level signals, that are close to the noise level.

A NOISE AVG position on the VIDEO FILTER control allows the analyzer to perform noise level measurements or to measure its own sensitivity (for a given RESOLUTION BW setting). The NOISE AVG position engages a 1 Hz low-pass filter to average the noise displayed on the CRT. The sweep time of the analyzer increases to facilitate noise level measurements.³ Another method of making noise and low-level signal measurements easily and accurately is to use DGTL AVG (Digital Averaging) mode.

HP-IB Code:

- VF (output VIDEO FILTER)

³Because of detector and log amplifier characteristics, 2.5 dB should be added to obtain the correct noise power reading. Refer to Hewlett-Packard Application Notes 150-4 and 150-9 for details.

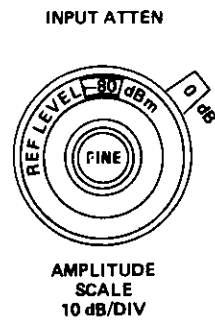
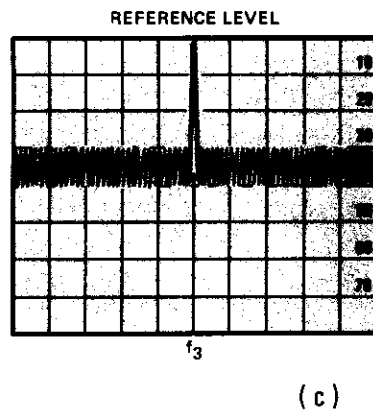
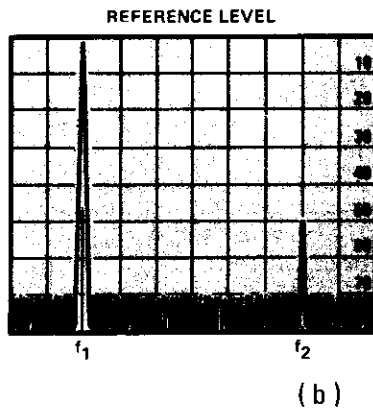
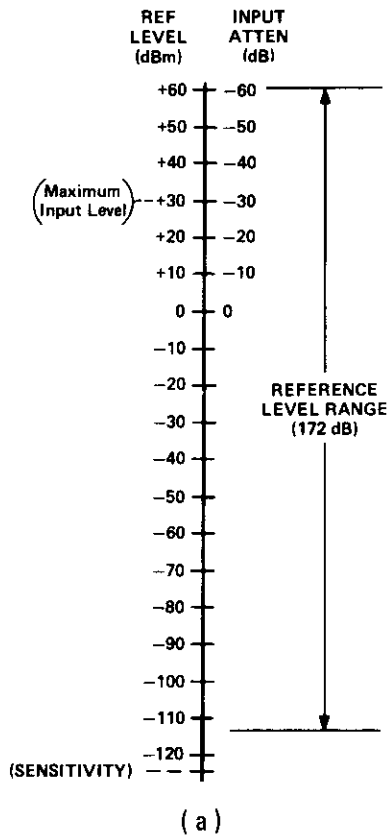
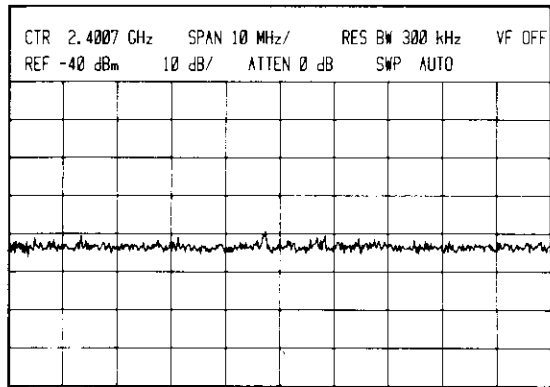
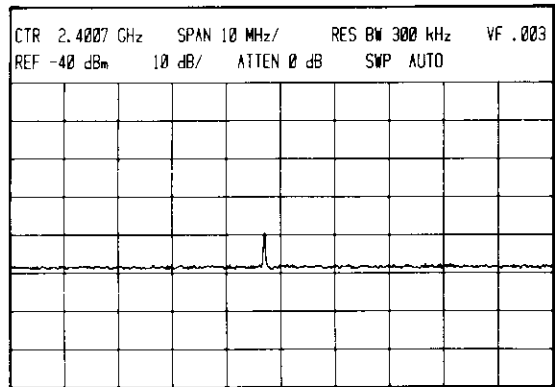

Figure 16. Reference Level



(a) Video Filter OFF



(b) Video Filter BW = .003 x 300 kHz = 900 Hz

Figure 17. Video Filtering

Sweep Time

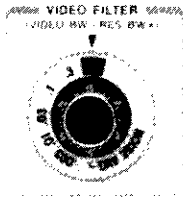

When SWEEP TIME/DIV is set to AUTO, the sweep time is automatically adjusted for all FREQUENCY SPAN/DIV, RESOLUTION BW, and VIDEO FILTER settings to maintain a calibrated amplitude display. The effect of the AUTO SWEEP TIME/DIV setting may be observed by decreasing the VIDEO FILTER bandwidth setting. The sweep rate slows automatically to allow the narrow video filter bandwidths more time to respond. Calibrated sweep times from 2 $\mu\text{sec}/\text{Div}$ to 10 sec/Div are available when the SWEEP TIME/DIV control is not in AUTO. The faster sweep times (2 $\mu\text{sec}/\text{Div}$ to 1 msec/Div) are used only to display fast signal variations in the time domain (ZERO SPAN selected). At sweep speeds of 2 msec/Div and faster, a mixed mode is enabled in which the display characters and the illumination for the graticule remain digitally controlled while the displayed trace information is analog. At a sweep speed of 5 msec/Div , a mixed mode is enabled if the ^{DGTL}_{AVG}, ^{INP-B}_{→A}, or ^{MAX}_{HOLD} push button is pressed. When the mixed mode is enabled, the trace information cannot be transferred digitally.

When the SWEEP TIME/DIV control is operated manually (not in AUTO) or in any full-band mode, care must be taken to ensure that amplitude calibration is maintained. An uncalibrated display can easily be verified by the presence of the UNCAL readout in the CRT annotation. The SWEEP TIME/DIV control (AUTO or manual operation) will operate with any SWEEP TRIGGER setting as long as INT SWEEP SOURCE is selected.

HP-IB Code:

ST (output SWEEP TIME/DIV or AUTO flag)
TS (take sweep)
SF (start sweep and set sweep flag)
MS (output value of sweep flag)

DIGITAL STORAGE DISPLAY

The spectrum analyzer CRT displays the signal response trace and all pertinent measurement data. The display information, provided at a flicker-free rate, can be stored for later reference. Certain arithmetic and signal processing functions such as MAX HOLD and digital averaging can be performed on the trace values.

The analyzer can output character information (Figure 18), or messages can be sent to the display via HP-IB.

HP-IB Code:

LU,LL (input lower, upper line messages)
AU,AL (display lower, upper line control settings)
CS (output annotation)

TRACES

Two independent traces (A and B) may be stored and then displayed either separately or simultaneously.

Error Detection

UNCAL: Uncalibrated display. Gives indication of incompatible FREQUENCY SPAN, RESOLUTION BW, VIDEO FILTER or SWEEP TIME/DIV settings when SWEEP TIME/DIV is not set to AUTO.

*: Invalid trace asterisk indicates that the displayed trace data has not been updated to reflect changes in control settings.

Display Error Messages: Provide feedback of incorrect control settings for the current measurement. (Display Error Messages are discussed later in this chapter.)

Clear/Reset

CLEAR/RESET clears trace data from the CRT and resets sweep when the instrument is in a write mode. In ^{MAX}_{HOLD} and ^{DGTL}_{AVG} modes, the processed trace is cleared and the sequence restarted. If a plot is in progress, it is aborted. During HP-IB operation, CLEAR/RESET halts HP-IB communication and returns the display to front-panel control.

Trace Modes

Four mutually exclusive modes for Trace A and Trace B determine the manner in which the traces of the input signal are displayed.

Write Modes. There are two write modes, in which the trace is updated, for Trace A and Trace B:

- WRITE displays the input signal response.
- MAX HOLD displays and holds the maximum responses of the input signal.

Store Modes. There are two store modes, in which the trace remains unchanged, for Trace A and Trace B:

- STORE VIEW stores the current trace and displays it on the CRT.
- STORE BLANK stores the current trace and blanks it from the CRT display.

When both Trace A and Trace B are in STORE BLANK, a single analog trace is displayed.

HP-IB Code:

TA,TB (output Trace A, Trace B integer values)
BA,BB (output Trace A, Trace B byte values)
AP,BP (output Trace A, Trace B peak signal coordinates)
IA,IB (input Trace A, Trace B integer values)

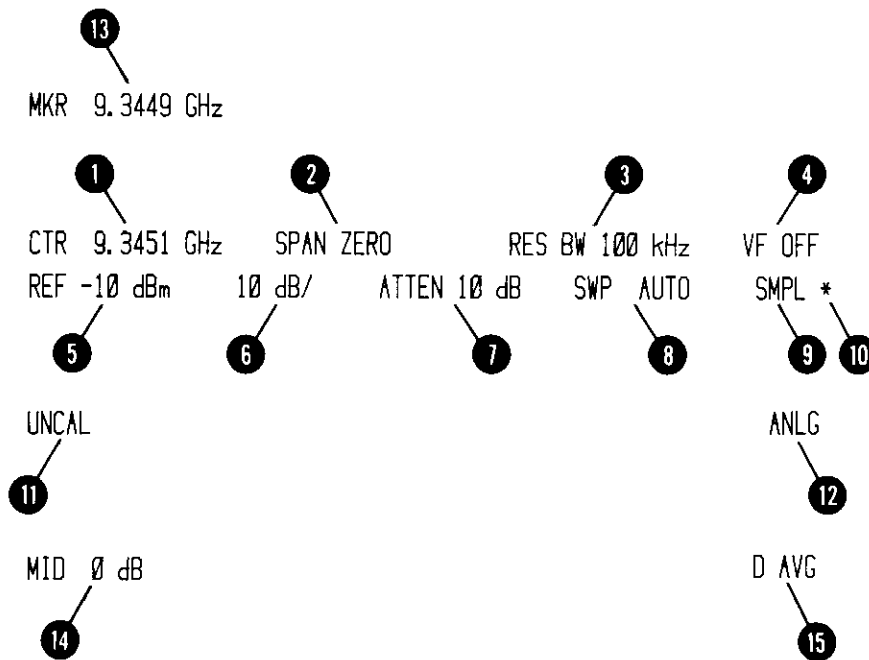

NOTE: ITEMS 11 THROUGH 15 ARE ALTERNATE ANNOTATIONS

Item	Description	Item	Description
1	Center Frequency	9	Sample mode indication
2	FREQUENCY SPAN/DIV setting	10	Trace invalid indication
3	RESOLUTION Bandwidth setting	11	Uncalibrated display indication
4	Video Filter setting	12	ANALOG DISPLAY mode indication
5	Reference Level setting	13	Marker Frequency in Full and 1.7-22 GHz Span modes
6	Amplitude Scale factor setting	14	Reference Level (dB) at center graticule line
7	Input Attenuator setting	15	Digital Averaging indication
8	Sweep Source - Sweep Time/DIV setting		

Figure 18. CRT Annotation

TRACE MEMORY

An understanding of the trace modes requires a description of trace memory and trace data transfer within the analyzer.

Display traces are not written directly to the CRT using the IF section video output (Figure 19). Instead, the video response is converted to digital information and stored in a trace memory which can then be transferred to the CRT display. The way in which the information is displayed depends upon the trace mode selected.

NOTE

It is important to understand the difference between "sweep" and "refresh."

In "sweep," the spectrum analyzer sweeps across a frequency span and stores measured amplitude data in a trace memory.

In "refresh," display memory data is transferred to the CRT.

The video response is transferred into the trace memory at the sweep rate of the analyzer (selected sweep time). The trace memory is written to the CRT display at a refresh rate of about 55 Hz. This is rapid enough to prevent flickering of the trace on the CRT. Thus, trace intensities remain constant as analyzer sweep times are changed.

For write modes, the analyzer signal response is written into trace memory during the sweep, and the memory

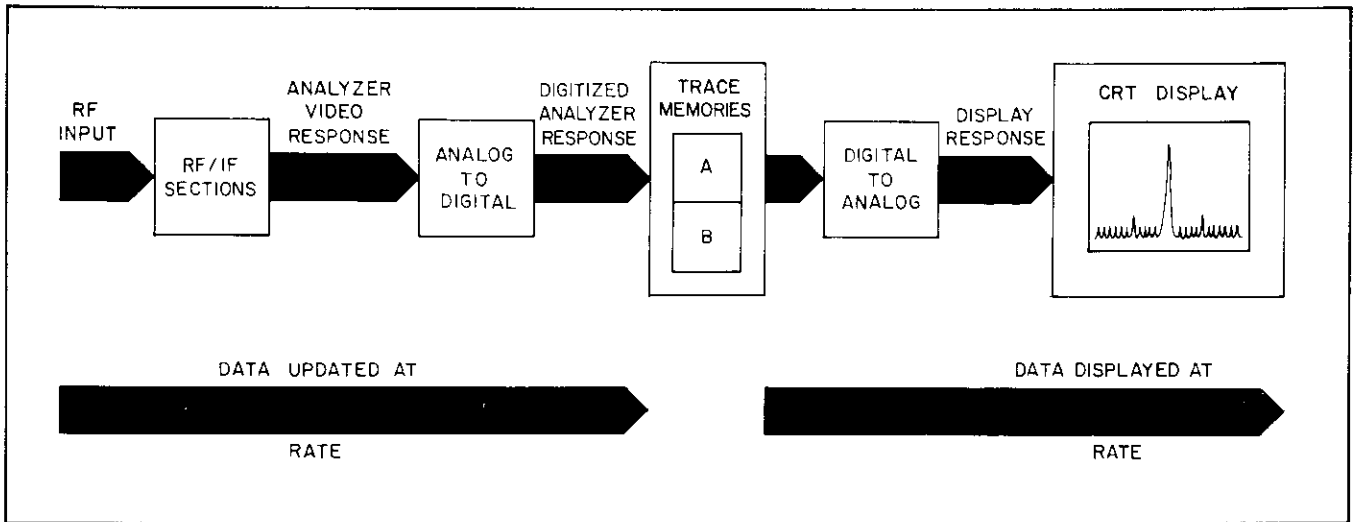

Figure 19. Data Acquisition and Transfer

contents are displayed on the CRT. In store modes, the trace memory is not updated. The current memory data is saved and is either displayed STORE VIEW or blanked STORE BLANK.

Signal Processing

One of two detection techniques can be selected for displaying trace information: Normal or Sample (Table 3).

Table 3. Detection Techniques

Mode	Access	Use
Normal	Default Mode Always selected if not in sample mode or in analog display	Most measurements when peak amplitude of response is desired
Sample	<input type="checkbox"/> SAMPLE pushed in	Random Noise Level measurements Digital Averaging (automatically selected) Zero Frequency Spans for sweep times ≥ 2 msec/DIV for most time domain analysis

During a sweep, only a specified amount of time is available for writing data into each of the 481 trace memory addresses. In each one of these time periods, the positive peak detector obtains the maximum video signal excursions and stores this value into the trace memory address. In the sample mode (SAMPLE), the instantaneous signal

value of the final analog-to-digital conversion for the time period is placed in memory (Figure 20).

In Figures 21 and 22, the same signal response is displayed with each trace detection mode.

HP-IB Code:

DM (output SAMPLE state)

Digital Averaging

DGT L AVG is a trace display routine that averages trace responses from sweep to sweep, thus averaging random noise without requiring a narrow video bandwidth. Maximum averaging is achieved after 64 sweeps. Both digital averaging and reduced video bandwidth are primarily used to improve the ability of the analyzer to measure low level signals by smoothing the noise response.

The advantage of digital averaging over narrowing the video filter is the ability for the user to view changes made to the amplitude or frequency scaling of the display while smoothing the noise response. For example, to display very low level signal responses, very narrow resolution and video bandwidths are required. The accompanying increase in sweep time can make measurements cumbersome. Digital averaging allows the display of low level signals without long sweep times. (Any change to control settings will cause the digital averaging process to be restarted.)

Display Error Message MAX HOLD If either Trace A or Trace B is in the mode, an error message is displayed on the upper portion of the CRT.

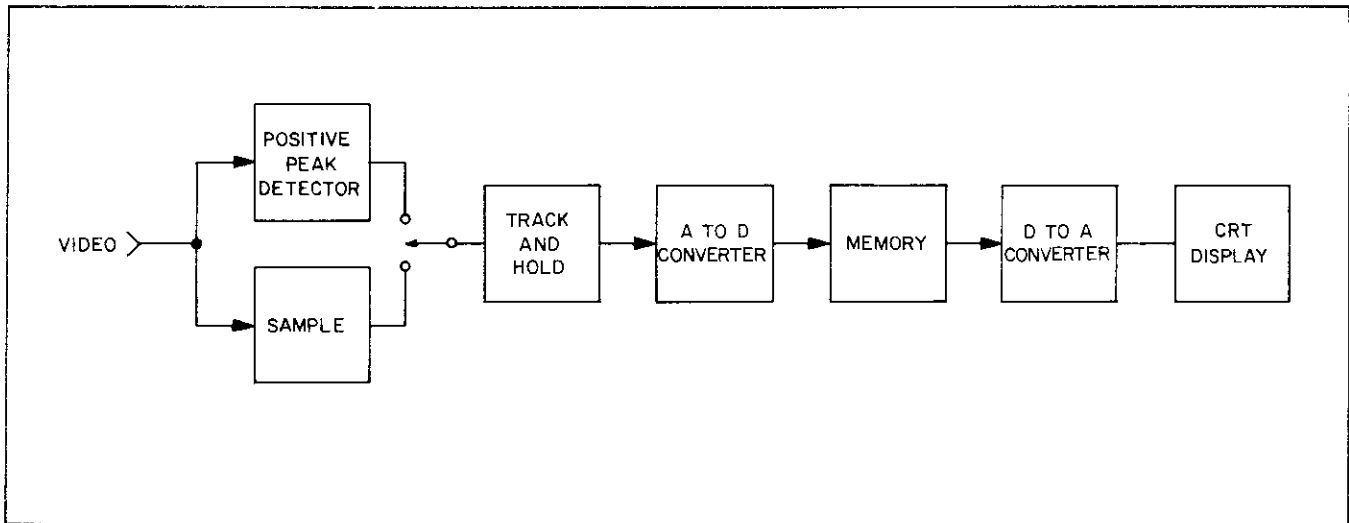

Figure 20. Detection Signal Flow

Digital Averaging Algorithm

The average of each amplitude point depends on the number of samples already taken and the last amplitude average. The exponentially weighted algorithm is expressed

$$Y_N = Y_{N-1} + \frac{S_N - Y_{N-1}}{F}$$

- where
- Y_N = the latest measurement average
 - Y_{N-1} = the previous measurement average
 - S_N = the current measurement
 - N = sweep number
 - $F = 2^{\text{INT}(1 + \text{LOG}_2(N))}$

In other words, the difference between the previous average and the current measurement is divided by F. The result is then added to the previous average to obtain the new average.

For each sweep when $n > 64$, F (now 64) remains constant, and all new data is weighted by 1/64 and added to the average amplitude after the most recent measurement. Therefore, the average follows only a slowly changing signal response.

HP-IB Code:

DG (output DGTL AVG state)

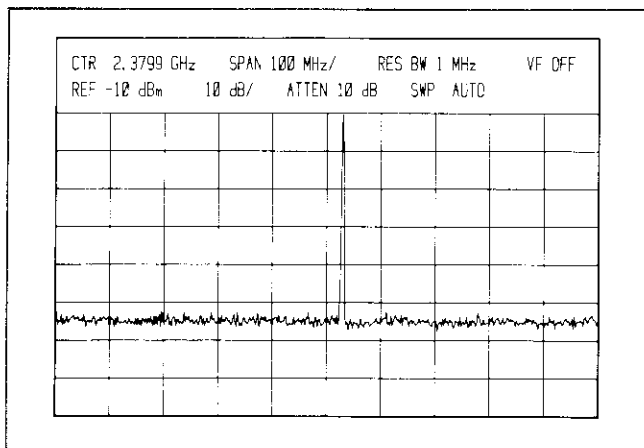

Figure 21. Normal Detection Mode

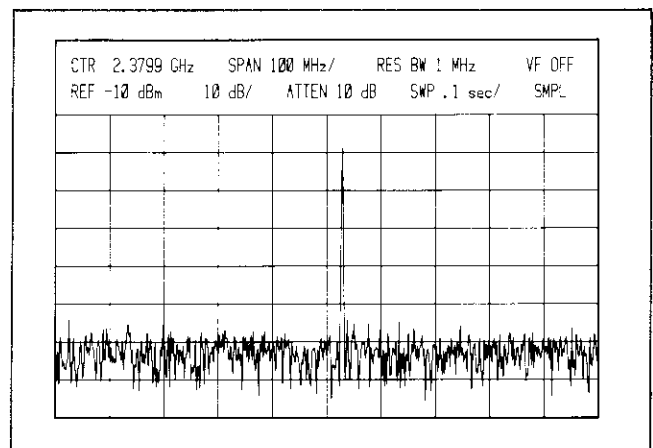

Figure 22. Sample Detection Mode

Trace Arithmetic

Trace arithmetic can be used either for comparison of two traces or for normalization in swept frequency measurements.

INP-B
→ A

Trace B amplitude (measured in divisions from the bottom graticule) is subtracted from the input trace (Trace A), and the result is written into Trace A from sweep to sweep. Trace B must be in one of the STORE modes.

Display Error Message

If Trace B is not in STORE VIEW or STORE BLANK, an error message is displayed in the upper portion of the CRT.

Trace arithmetic can be used to correct for the frequency response characteristics (flatness) of a swept measurement system. (Refer to Chapter 3 for more detail.)

HP-IB Code:

NS (output INP – B → A state)

DIRECT PLOTTER OUTPUT

Graticule GRAT, character CHAR, and trace TRACE information can be output directly to a digital plotter through an HP-IB cable, without the need for a controller.

NOTE

If an HP-IB controller is connected to the HP-IB output of the HP 8569B, place controller in reset state (terminate any running program) before the direct plot routine is executed.

Digital plotters can provide full-size copies – up to 11 by 16 inches (approximately 279 by 406 mm) with the HP 9872B – that are ideal for lab reports and that can be reproduced more easily than photographs.

The HP 7225A and HP 9872B are among the plotters that are directly compatible with the HP 8569B. (Most of the CRT illustrations in this manual were directly plotted with the HP 7225A.)

To generate a plot:

1. Attach HP-IB cable from the HP-IB connector on the rear panel of the HP 8569B to the plotter rear panel HP-IB connector as shown in Figure 25.
2. Establish the lower-left and upper-right limits on the plotter.
3. Press and release GRAT to plot graticule, CHAR to plot characters, and TRACE to plot trace data. (The plots may be run individually, or all three push buttons may be pressed immediately to run a complete plot of the total CRT display.)

To stop the direct plot routine, depress CLEAR/RESET.

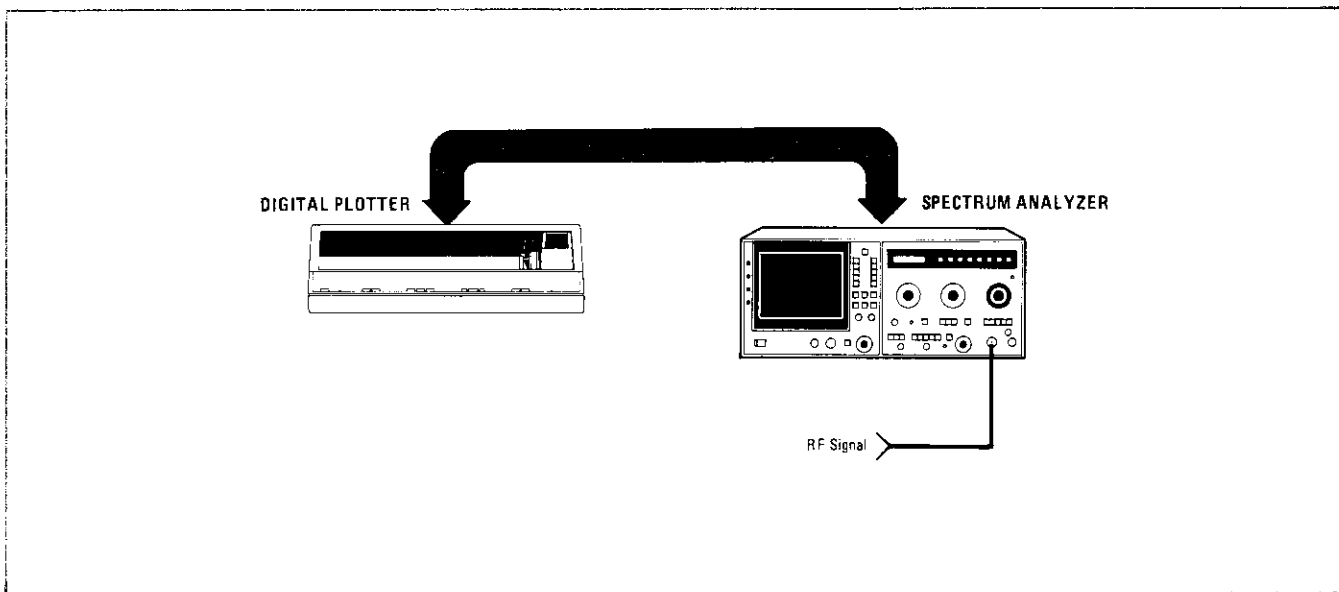

Figure 23. Digital Plotter Setup

CHAPTER 3 SPECIAL TOPICS

MAXIMUM DYNAMIC RANGE

Dynamic range is defined as the ratio of the largest to the smallest signal that can be measured without any interference from analyzer distortion products or internal noise. The maximum dynamic range occurs when the internally generated distortion of the analyzer is equal to its noise level (thus, the dynamic range is limited equally by both).

Mixer distortion, caused by a large signal at the mixer, changes non-linearly as the fundamental signal amplitude is changed. That is, for example, a 10 dB change in amplitude causes a 20 dB change in second-order distortion level and a 30 dB change in third-order distortion. Therefore, the objective of the following discussion is to show that maximum dynamic range can be achieved by the judicious use of RF attenuation.

The maximum dynamic range of the HP 8569B can be determined by referring to Figure 26. Three types of curves are presented on the chart: sensitivity (solid line), second-order distortion (large dashed line), and third-order distortion (small dashed line). The sensitivity curves for the six internal frequency bands (0.01 – 22 GHz) are given for a 100 Hz bandwidth. To use the sensitivity curves for other resolution bandwidths, simply subtract 10 dB from the signal to noise reading for an increase in resolution bandwidth by a factor of 10. For example, a signal to noise ratio of 70 dB for a 100 Hz bandwidth would be 60 dB for a 1 kHz bandwidth. The second- and third-order distortion curves are dependent on whether the 0.01 to 1.8 GHz band or one of the preselected internal mixing bands is used. When more than one signal is at the RF input to the mixer, the distortion curves are also dependent on signal separation. Two vertical axes are used in Figure 26: Signal to Noise Ratio (right side) and Spurious-Free Dynamic Range (left side). The maximum dynamic range occurs at the intersection of the particular sensitivity curve and distortion curve under consideration. This point is obtained on the spectrum analyzer by adjusting the RF input attenuation to achieve the appropriate signal amplitude at the mixer.

Two major factors determine the maximum achievable dynamic range of the HP 8569B. They are:

1. Signal level at the Input Mixer.

2. Sensitivity of the analyzer (dependent on frequency band and resolution bandwidth).

These two factors are examined separately in the following paragraphs.

Mixer Level

The Mixer Level is simply the signal at the input minus the analyzer INPUT ATTEN setting. In equation form:

$$\text{Mixer Level} = \text{Input Signal} - \text{INPUT ATTEN}$$

The horizontal axis on the dynamic range chart represents the Mixer Level.

Dynamic range varies as a function of Mixer Level. In the 0.01 to 1.8 GHz range, the Mixer Level (for maximum dynamic range) should be approximately –47 dBm when second-order distortion products are measured. Beyond this level, second-order distortion will increase 20 dB for every 10 dB increase in Input Signal. For third-order distortion measurements, the Mixer Level should be approximately –37 dBm. In the preselected 1.7 to 22 GHz frequency range, dynamic range variation as a function of Mixer Level is not as critical. The maximum dynamic range in the preselected bands is achieved at a Mixer Level of approximately –7 dBm, which is the 1 dB gain compression level of the spectrum analyzer. This applies for both second- and third-order distortion products.

Example (see Figure 26).

Measure the third-order intermodulation distortion products of a device. The spectrum analyzer input signals are 1146 MHz and 1156 MHz and have an amplitude of –10 dBm. Find the Mixer Level to obtain the maximum dynamic range, insuring that the distortion of the spectrum analyzer does not interfere with measuring the distortion products of the device.

Solution:

The Mixer Level to achieve the maximum dynamic range is approximately –37 dBm (about –40 dBm for each signal). Since this is a third-order measurement, use the small dashed third-order distortion curve applicable to the frequency range. Intersect this curve with the sensitiv-

ity curve that cover 0.01 to 1.8 GHz. The maximum dynamic range and optimum Mixer Level for a 100 Hz resolution bandwidth occurs at the intersection of the curves. The INPUT ATTEN control must therefore be set at 30dB (for a total power level at the mixer of -37 dBm) to achieve this dynamic range (see Figure 26a).

Sensitivity

Spectrum analyzer sensitivity has been traditionally defined as the average noise level displayed on the analyzer. The average noise level of the HP 8569B is dependent on the resolution bandwidth and on the frequency band selected. Since the noise displayed on the analyzer is random, it is dependent on bandwidth; therefore, for every decade increase (decrease) in resolution bandwidth the average noise level increases (decreases) by 10 dB.

The HP 8569B uses harmonic mixing to achieve 22 GHz (internal mixing) and 115 GHz (external mixing) frequency ranges. Thus, higher harmonic mixing modes (corresponding to higher frequency bands) have higher average noise levels, causing spectrum analyzer sensitivity to decrease). Therefore, the best sensitivities are achieved on the lower frequency bands. Figure 26c shows how the Signal to Noise Ratio is degraded with the higher frequency bands.

Preselection

Another factor to consider in determining maximum dynamic range, besides mixer level and sensitivity, is preselection. In comparing the distortion curves for the 1.7

to 22 GHz frequency range to the 0.01 to 1.8 GHz frequency range in Figure 26c, it can be seen that the dynamic range for the preselected band (1.7 to 22 GHz) is generally much greater when the signal separation is ≥ 100 MHz. This benefit is due to the tracking preselector, a tunable bandpass filter that tracks the tuning of the analyzer. The preselector extends the dynamic range of the analyzer to measure a low level signal in the presence of a potentially interfering high level signal. Since the preselector tracks the tuning of the analyzer, it allows a signal to pass to the mixer when both preselector and analyzer are tuned to receive it. When the analyzer is tuned to the low-level harmonic, the preselector rejects the high-level fundamental, thus preventing internal distortion products from affecting the measurement. This condition is illustrated in Figure 24.

In the preselected frequency bands (1.7 to 22 GHz) the tracking bandpass filter has a nominal 50 MHz bandwidth and a worst case rejection of >60 dB (60 dB – 18 to 22 GHz, 70 dB – 1.7 to 18 GHz). For signal separation ≥ 100 MHz, the tracking filter will allow only one signal to pass to the mixer while simultaneously rejecting the other signal. This is illustrated in Figure 25. Since only one signal is seen at the mixer at any instant of time, the third-order distortion products of the analyzer are significantly reduced. Also, for larger signal separation, the preselector has more rejection and hence the dynamic range is greater.

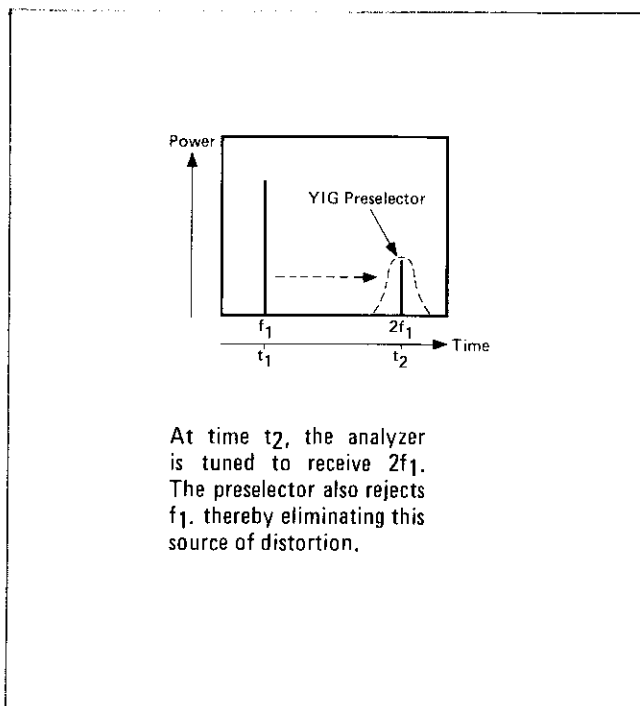

Figure 24. YIG Preselector Tuning

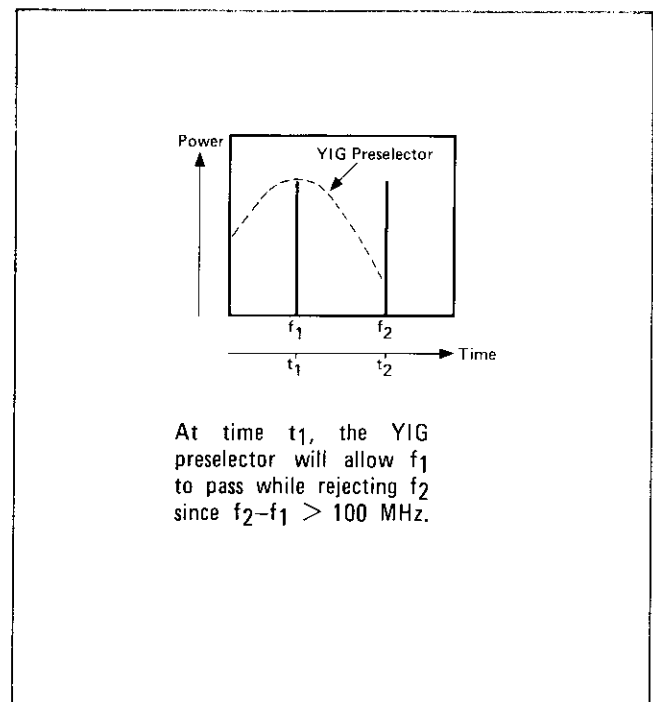
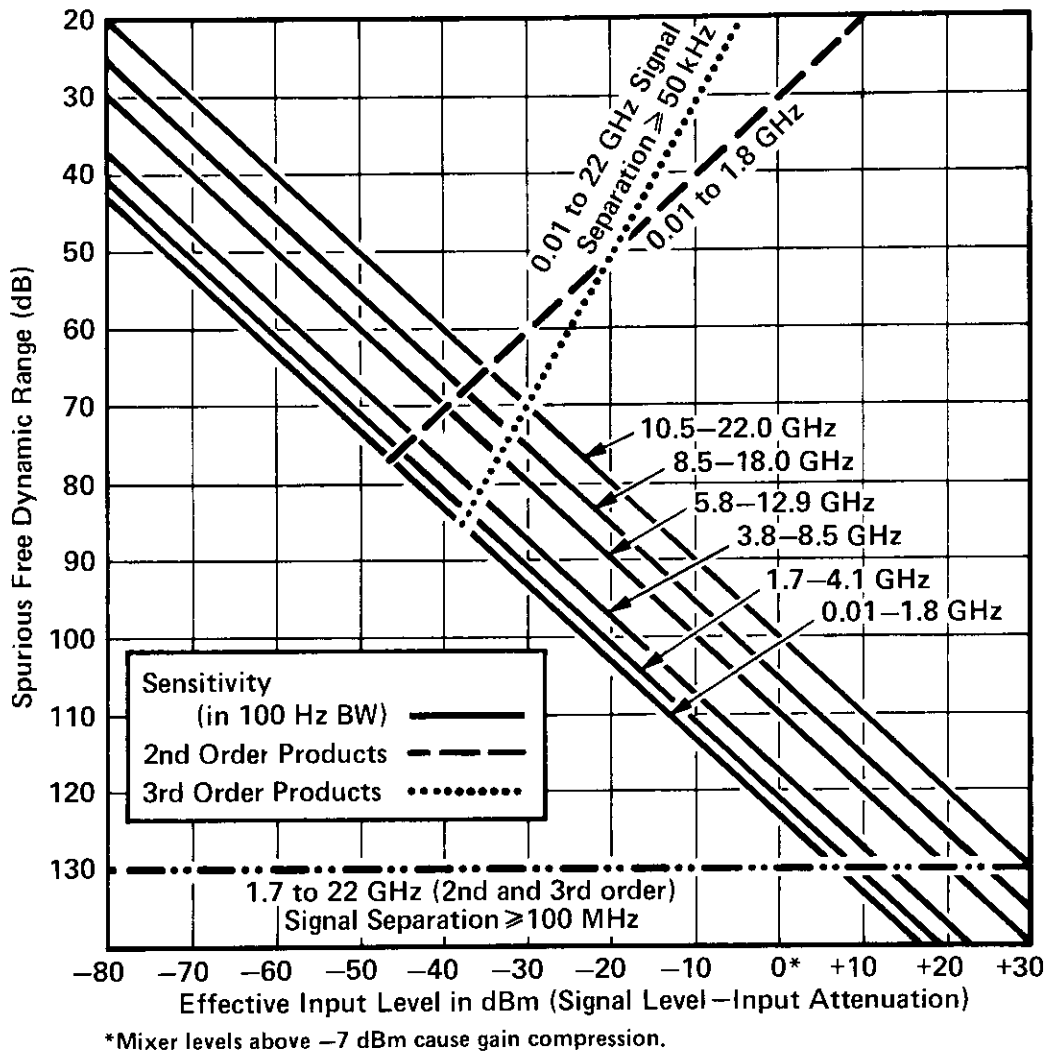
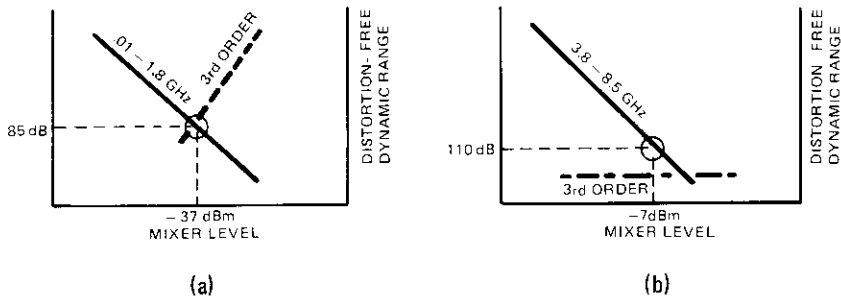

Figure 25. YIG Preselector Passband



(c)

Figure 26. Dynamic Range

The distortion curves for the 1.7–22 GHz frequency range are represented by a horizontal line. The line represents both the second- and third-order distortion curves, which theoretically have the same slope as the distortion curves in the non-preselected modes. However, the curves are represented as a horizontal line because the absolute levels of the internally generated distortion are generally well below the internally generated noise of the analyzer.

Example:

Measure the third-order intermodulation products of a microwave amplifier. The two output signals are –10 dBm at 5.9 and 6.1 GHz. What is the maximum dynamic range of the analyzer?

Solution:

The maximum dynamic range is approximately 110 dB. Note that the signal separation is 200 MHz; therefore, the second- and third-order distortion of the analyzer is represented by the distortion curve for the preselected band (1.7 to 22 GHz with signal separation ≥ 100 MHz). For a mixer input level of –7 dBm (–10 dBm for each signal) the distortion curve is below the sensitivity curve of the analyzer; therefore, the dynamic range is determined by the intersection of the 3.8–8.5 GHz sensitivity curve with the –7 dBm mixer level. The dynamic range of the analyzer is approximately 110 dB (see Figure 26b).

Other constraints: When measuring distortion products associated with low-level input signals, the noise floor of the analyzer is the limitation. In this case, find the input signal level on the Mixer Level (horizontal) axis (assuming INPUT ATTEN is set to 0 dB) and go vertically to the appropriate sensitivity curve. The maximum obtainable dynamic range is read from the Signal to Noise ratio (vertical) axis.

Dynamic Range Equations

The dynamic range chart shown in Figure 26 is based on the following equations for third- and second-order maximum dynamic range.

$$\text{For third-order} = \left| \frac{2}{3} (\text{average noise level} - \text{TOI}) \right| \text{ in dB}$$

$$\text{For second-order} = \left| \frac{1}{2} (\text{average noise level} - \text{SOI}) \right| \text{ in dB}$$

The third-order intercept (TOI) is theoretically defined as the mixer level at which third-order distortion equals the fundamental signal level (a condition which never occurs because compression in the mixer occurs first). The second-order intercept (SOI) is theoretically defined as the mixer level at which second-order distortion equals the fundamental signal level. The intercept is calculated from the following equation:

$$\text{Intercept} = \text{mixer level} - (\text{distortion (dBc)})/N - 1$$

where N = order of distortion

These equations are used to compute the best dynamic range for either third- or second-order distortion products and noise. The noise level is the displayed noise level for the resolution bandwidth and center frequency to be used, assuming 0 dB input attenuation.

Example: In measuring a 10.50 GHz signal and a 10.55 GHz signal in a 1 kHz resolution bandwidth, the typical sensitivity of the analyzer is –100 dBm, assuming 0 dB input attenuation. The HP 8569B has a TOI of +5 dBm and SOI of +30 dBm for signal separations of <100 MHz. What is the maximum dynamic range?

Solution:

70 dB for third-order and 65 dB for second-order.

$$\begin{aligned} \text{Third-order} &= \left| \frac{2}{3} (-100 \text{ dBm} - +5 \text{ dBm}) \right| \\ &= 70 \text{ dB} \end{aligned}$$

$$\begin{aligned} \text{Second-order} &= \left| \frac{1}{2} (-100 \text{ dBm} - +30 \text{ dBm}) \right| \\ &= 65 \text{ dB} \end{aligned}$$

It is also possible to determine the value of total RF attenuation (internal or external) needed to obtain the maximum dynamic range for a given input power level from the following equations.

For third-order:

$$\text{Atten} = \text{Input} - \frac{2}{3} \text{TOI} - \frac{1}{3} \text{Noise Level}$$

For second-order:

$$\text{Atten} = \text{Input} - \frac{1}{2} \text{SOI} - \frac{1}{2} \text{Noise Level}$$

For the same conditions as in the previous example, with total Input Signal Level of –20 dBm, the RF attenuation should be set to:

Third-order:

$$\begin{aligned} \text{Atten} &= -20 \text{ dBm} - \frac{2}{3}(+5 \text{ dBm}) - \frac{1}{3}(-100 \text{ dBm}) \\ &= 10 \text{ dB} \end{aligned}$$

Second-order:

$$\begin{aligned}\text{Atten} &= -20 \text{ dBm} - 1/2(+30 \text{ dBm}) - 1/2(-100 \text{ dBm}) \\ &= 15 \text{ dB}\end{aligned}$$

Therefore, RF attenuation must be set to 10 dB to maximize third-order and 15 dB to maximize second-order dynamic range.

IMPROVING AMPLITUDE MEASUREMENT ACCURACY

The technique known as IF substitution can be used to improve measurement accuracy on the HP 8569B. The IF substitution method uses only the accurate IF gain of the analyzer to position the signal on the calibrated REFERENCE LEVEL line. In this way, errors caused by CRT non-linearity, log amplifier, input attenuator, and bandwidth filter will be eliminated. The IF gain of the analyzer is controlled with the calibrated REFERENCE LEVEL dBm control.

Amplitude Measurement with IF Substitution

The steps for achieving accurate amplitude measurements with IF substitution are as follows:

1. Set the INPUT ATTEN control to 10 dB or greater. This ensures a good input SWR to minimize mismatch errors.
2. Set the FREQUENCY SPAN/DIV and RESOLUTION BW controls to the desired settings.
3. Connect the CAL OUTPUT signal to the analyzer to verify calibration.
4. Disconnect the CAL OUTPUT signal and connect the signal to be measured.
5. Press the desired FREQUENCY BAND push button and use only the TUNING control to center the signal on the CRT.
6. In the 1.7 to 22 GHz frequency range, adjust the PRESELECTOR PEAK control to maximize the signal level.⁴

⁴The best broadband tracking performance of the preselector is normally obtained with the PRESELECTOR PEAK control centered in the green area. However, for accurate power measurement, the PRESELECTOR PEAK control should be adjusted to maximize signal level every time an amplitude measurement is made.

7. Now, using only the REFERENCE LEVEL dBm control and vernier, position the peak of the signal on the REFERENCE LEVEL line of the CRT. The signal amplitude is indicated by the REF on the CRT annotation.

When the IF substitution technique is used for amplitude measurements, the only remaining measurement uncertainties are due to the CAL OUTPUT signal, flatness, and REFERENCE LEVEL control accuracy of the analyzer. Uncertainties caused by log amplifier fidelity, CRT non-linearities, and RESOLUTION BW and INPUT ATTEN switching errors have been eliminated because they were left unchanged throughout the measurement.

Further improvement in accuracy can be achieved by calibrating the analyzer at the same frequency to which the measurement will be made. This would eliminate any flatness uncertainties, and the measurement accuracy would be dependent only upon the accuracy of the calibration signal and the REFERENCE LEVEL control.

CRT PHOTOGRAPHY AND X-Y RECORDING

CRT Photography

The CRT annotation on the HP 8569B display provides an excellent means of information retention with the use of any compatible scope camera. Since the display has readouts for all major spectrum analyzer settings, the need for additional writing on the photograph is largely eliminated. Also, interference between trace and characters is not a problem because the character annotation is located on the upper portion of the display, outside the graticule (refer to Figure 27).

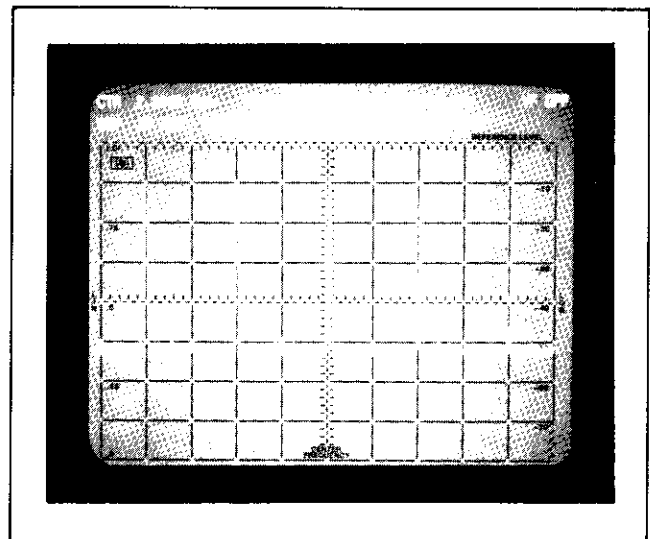



Figure 27. CRT Display with Character Annotation

The photo in Figure 27 was taken with a camera that has variable shutter speed and f-stop. A step-by-step procedure for photography is given below. These steps are applicable with the HP 197B Option 006 or other compatible scope cameras.

Photography Procedure

1. Set the HP 8569B SCALE INTEN and INTEN to the calibrated blue markings.
2. Set the camera shutter to 2 seconds and the f-stop to 8.
3. Push the  STORE VIEW button on the analyzer to store the trace. This ensures the trace and the CRT frequency readout on the display will not change while the camera shutter is opened. Press shutter on camera to take picture.

In the mixed display mode (refer to Appendix B), a double exposure is needed to provide the best contrast between signal trace, graticule lines, and CRT annotation.

Double Exposure Photography

1. Set INTEN fully counter-clockwise.
2. Set SCALE INTEN to calibrated blue markings.
3. Set SWEEP TIME/DIV to AUTO.
4. Set shutter speed to ≥ 2 sec and f-stop to 8.
5. Press shutter on camera to take first exposure.
6. Return SWEEP TIME/DIV to original setting.
7. Set INTEN to the calibrated blue markings.
8. Press  STORE VIEW.
9. Press shutter on camera to take second exposure.

To set up the initial focusing of the camera the user is referred to the Operation Section of the 197B Operation and Service Manual (HP Part Number 00197-90915).

Analog X-Y Recording

The HP 8569B is directly compatible with the HP line of X-Y recorders as well as strip-chart and magnetic tape recorders. The VERTICAL OUTPUT, BLANK OUTPUT, and HORIZONTAL SWEEP OUTPUT are available from the rear panel of the analyzer. As with digital

plotters, X-Y recorders can provide full-size, high-resolution copies – up to 11 by 14 inches (approximately 279 to 356 mm) – that are more convenient than photographs for laboratory report folders. Figure 28 illustrates a typical setup used for X-Y recording.

The bandwidth of most X-Y recorders is very narrow, typically 1 to 2 Hz. This narrow bandwidth requires a sweep rate that is slow enough for the recorder to fully respond to a signal. In general, a sweep rate of 2 sec div is sufficient for most X-Y recorders. The SINGLE or the MANUAL sweep mode on the HP 8569B can be used to control the sweep.

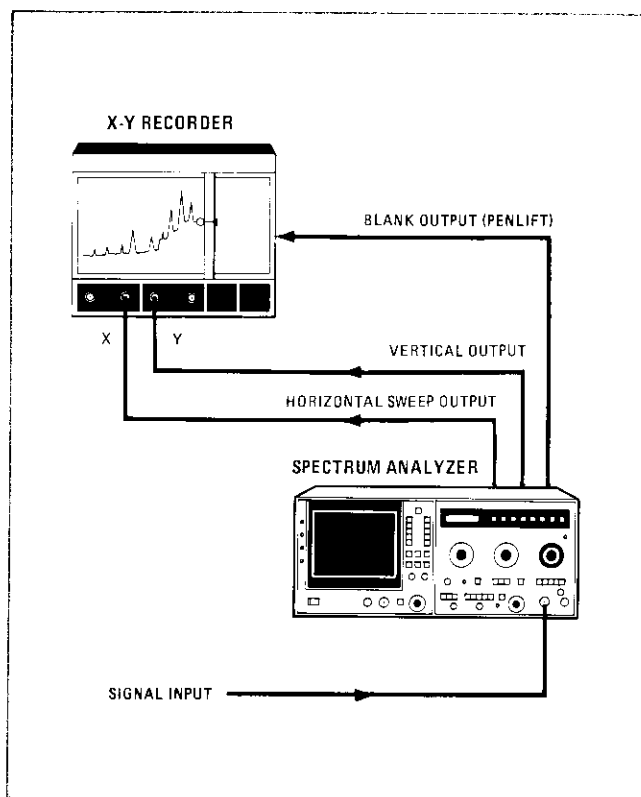

Figure 28. X-Y Recorder

EXTERNAL MIXER OPERATION

Calibrated frequency coverage from 12.4 to 40 GHz can be achieved by using the HP 11517A Option E03 External Mixer. Coverage above 40 GHz can be accomplished with a variety of commercially available mixers. The HP 11517A must be used with the appropriate waveguide adapter listed in Table 4. The external mixer connects to the IF INPUT port on the front panel of the HP 8569B by means of a coaxial cable that has male SMA connectors. Selection of the EXT MIXING MODE and the corresponding FREQUENCY BAND allows frequency coverage in four ranges: 12.4 to 26.5 GHz, 21 to 44 GHz, 33 to 71 GHz, and 53 to 115 GHz.

Table 4. External Mixer Components

HP Model Number	Description	HP Band Designation
11517A	12.4–40 GHz Mixer	
11518A	12.4–18 GHz Adapter	P
11519A	18–26.5 GHz Adapter	K
11520A	26.5–40 GHz Adapter	R

External mixers are used whenever the signal of interest is higher in frequency than the design limits of the coaxial input and internal mixer of the spectrum analyzer. Consider these four signals when using external mixers: the RF input, the spectrum analyzer first LO, the bias current for the mixer diode, and the IF output of the mixer. Some mixers have separate ports for each signal. One port is for the RF input. The other port is shared by the LO power and DC bias current inputs, and IF output. The HP 11517A is a two-port device. A diplexer (HP Part Number 5086-7721) must be used to separate the DC current from the LO power. A test setup of the HP 8569B with the HP 11517A External Mixer and adapter, and the diplexer, is illustrated in Figure 29.

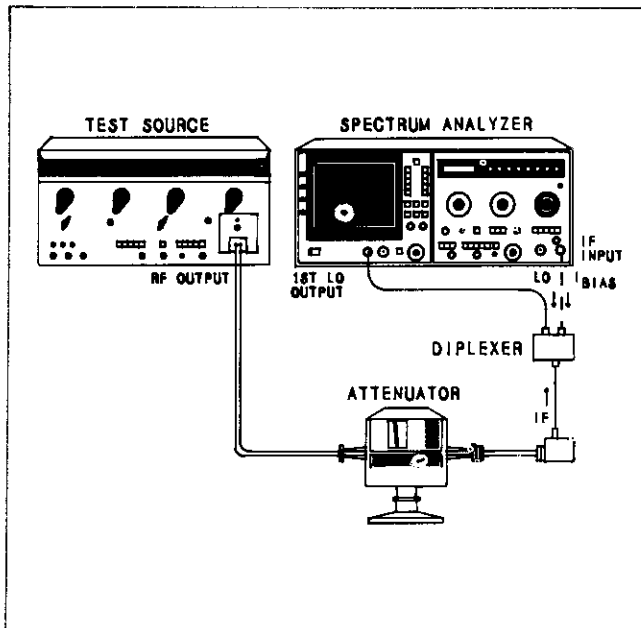

Figure 29. External Mixer Test Setup

A DC bias is necessary to optimize single diode mixers for minimum conversion loss at the frequency of the RF input signal. The HP 8569B can supply negative or positive DC bias. For positive polarity mixers such as the HP 11517A, the bias can vary from 0 to +5 mA. For negative polarity mixers, the bias can vary from -5 to 0 mA.

In operation, the HP 11517A External Mixer bypasses the input attenuator, preselector, and the internal mixer of the analyzer. Three things must be remembered when using the external mixer:

1. The INPUT ATTEN has no effect on the input signals.
2. Harmonic mixing responses must be properly identified, since there is no preselection in the EXT MIXER bands. With a FREQUENCY SPAN/DIV of 100 MHz, the HP 8569B displays mixing product pairs. The correct pair is 642.8 MHz apart. The lower frequency product of the pair is the correct one. To check this, center this signal on the display. Select FREQUENCY SPAN/DIV of 1 MHz and press the SIG IDENT button. The display should show two signals with 2 MHz separation.
3. Amplitude measurements are uncalibrated unless steps are taken to calibrate the analyzer. Refer to Section V, paragraph 5-31, in the HP 8569B Operation and Service Manual.

Signal Identification

To properly identify a signal on the CRT, the SIG IDENT push button on the HP 8569B is used. To use the SIG IDENT, center the unknown response on the CRT. Then press the SIG IDENT push button and note whether the response resembles that shown in Figure 30. If the

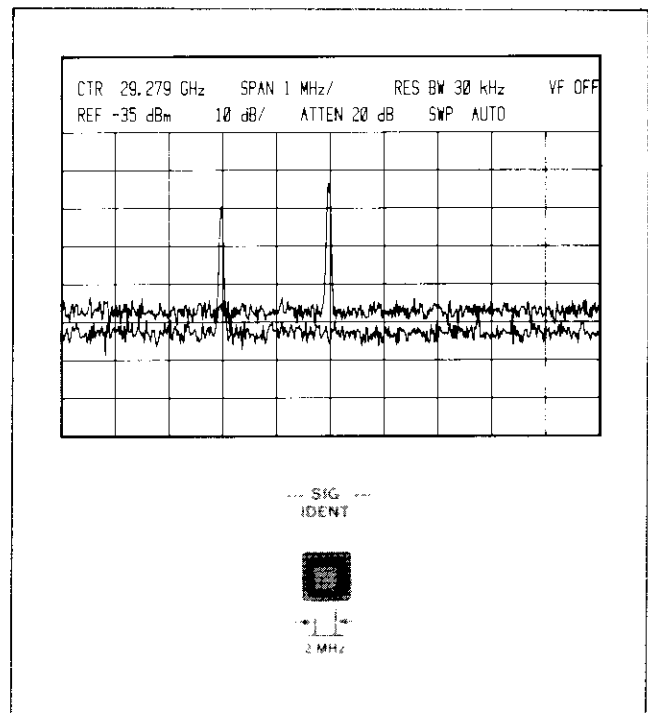

Figure 30. Signal Identifier

response moves to the left 2 MHz and drops in amplitude, it is the correct signal and its frequency is indicated on the display. When a signal cannot be identified in any of the EXT MIXER frequency bands, one of two conditions applies:

1. The signal is not in the 12.4 to 115 GHz frequency range.
2. The displayed response is a product generated by a harmonic of the Local Oscillator not utilized by the analyzer in displaying amplitude calibrated signals. However, there is a displayed response on one or more of the frequency bands which will identify the signal correctly.

In either case the signal frequency can be approximated from the following equation:

$$F_s = NF_{LO} \pm F_{IF} \quad (1)$$

where F_s = input signal

N = mixing mode

F_{LO} = first local oscillator frequency

F_{IF} = first intermediate frequency

The first step in calculating the input frequency is to calculate the actual mixing mode (N_A) using the following equation.

$$N_A = \frac{2 \text{ MHz}}{\text{Signal Shift (MHz)}} \times N \text{ of frequency band selected} \quad (2)$$

where N = harmonic mixing mode

N_A = actual mixing mode

Signal Shift = signal shift on CRT in MHz with ON

The next step in the determination of F_s , the actual input signal, is to calculate the local oscillator fundamental frequency. Referring to equation (1), the LO fundamental frequency can be calculated from the value of F_s (obtained from CRT or LED center FREQUENCY GHz display), N (determined from the FREQUENCY BAND selected), and F_{IF} (first Intermediate frequency of the HP 8569B which equals 321.4 MHz). The “+” or “-” sign is determined by the polarity of the mixing mode of the frequency band selected.

For example,

$$\begin{aligned} \text{If } F_s &= 34.5 \text{ GHz} \\ N &= 10+ \\ F_{IF} &= 321.4 \text{ MHz} \end{aligned}$$

From equation (1)

$$\begin{aligned} F_s &= NF_{LO} \pm F_{IF} \\ 34.5 \text{ GHz} &= (10) \times F_{LO} + 321.4 \text{ MHz} \\ F_{LO} &= 3.42 \text{ GHz} \end{aligned}$$

The final step is to calculate F_s (the actual input signal) using equation (1), and the value of F_{LO} , N_A , and F_{IF} . The “+” or “-” sign in this final calculation is determined by the direction of the signal shift. A shift to the left requires the “+” sign, while a shift to the right requires the “-” sign.

Example:

A signal displayed on the HP 8569B has a center FREQUENCY GHz readout of 38.00 GHz. When the SIG IDENT button is pressed, a second signal appears offset to the left by 4 MHz. What is the actual frequency of the signal?

Solution:

1. Calculate N_A using equation (2) while noting that 38.00 GHz is within the 21 – 44 GHz band, which has $N = 10+$.

$$N_A = (2 \text{ MHz}/4 \text{ MHz}) \times 10$$

$$N_A = 5$$

2. Calculate F_{LO} using equation (1) using

$$F_s = 38.00 \text{ GHz (center FREQUENCY GHz readout)}$$

$$N = 10 \text{ (corresponding to 21 – 44 GHz band)}$$

$$F_{IF} = 321.4 \text{ MHz (EXT MIXER 1st Intermediate frequency)}$$

Therefore,

$$38.00 \text{ GHz} = 10 \times f_{LO} + 321.4 \text{ MHz}$$

$$F_{LO} = 3.77 \text{ GHz}$$

NOTE

F_{LO} can also be obtained from Tuning Curves on Figure B-2.

CHAPTER 4 TYPICAL MEASUREMENTS

DISTORTION

Distortion measurement is an area in which the spectrum analyzer makes a significant contribution. Two basic types of distortion are usually specified by the manufacturer: harmonic distortion and two-tone, third-order intermodulation distortion. The third-order intermodulation products are represented by: $2f_1 - f_2$ and $2f_2 - f_1$ where f_1 and f_2 are the two-tone input signals.

The HP 8569B is capable of making a wide variety of distortion measurements with speed and precision. The instrument can measure harmonic distortion products greater than 100 dB down in the 1.7 to 22 GHz frequency range. Third-order intermodulation products can also be measured greater than 100 dB down, depending on signal separation and frequency range.

Amplifiers

All amplifiers generate some distortion at the output, and these distortion products can be significant if the amplifier is overdriven with a high-level input signal. The test setup in Figure 31 was used to measure the third-order intermodulation products of a microwave field-effect transistor (FET) amplifier. Directional couplers and attenuators were used to provide isolation between sources.

Figure 32 is a CRT plot of a two-tone, third-order intermodulation measurement. The third-order products ($2f_1 - f_2$ and $2f_2 - f_1$) are below the two-tone signals (f_1 and f_2).

Mixers

Mixers use the non-linear characteristics of an active or passive device to achieve a desired frequency conversion. As a result some distortion at the output is due to the inherent non-linearity of the device. Figure 33 illustrates the test setup and CRT plot of a typical mixer measurement. Once the RF input and LO input signals were measured on the spectrum analyzer, from a single display, the following information was determined:

Conversion loss (SSB):

$$RF_{in} - IF = (-25) - (-34) = 9 \text{ dB}$$

LO to IF isolation:

$$LO_{in} - LO_{out(IF)} = (+5) - (-38) = 43 \text{ dB}$$

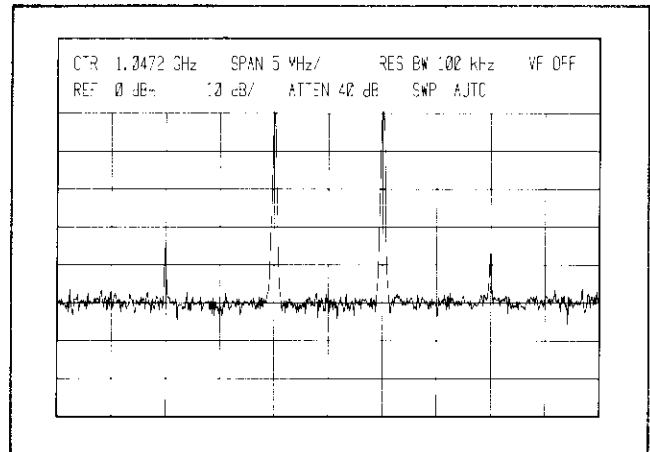

Figure 32. Two-Tone, Third Order Intermodulation Products

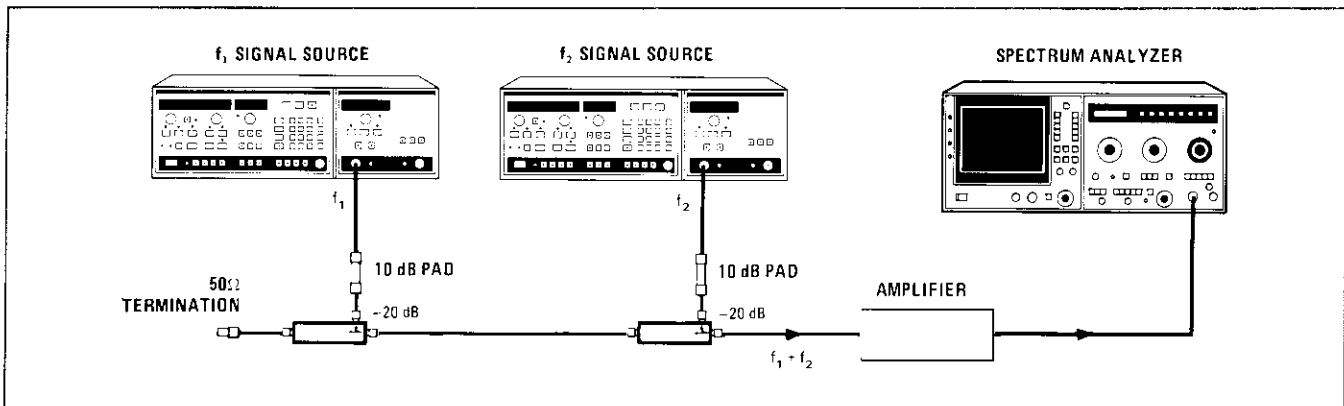

Figure 31. Two-Tone Test Setup

RF to IF isolation:

$$RF_{in} - RF_{out(IF)} = (-25) - (-54) = 29 \text{ dB}$$

Third-order distortion product (2 LO - RF):

-74 dBm at 360 MHz.

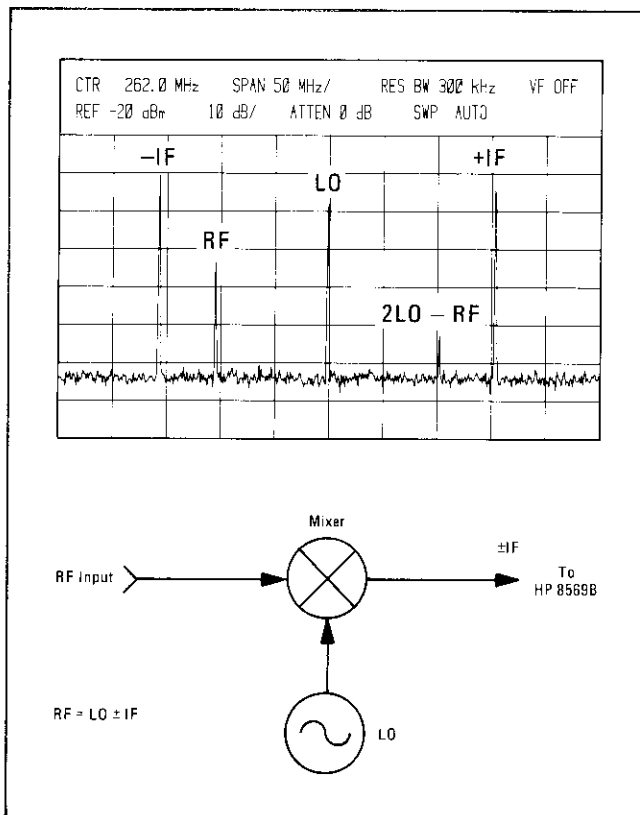

Figure 33. Mixer Measurement

Oscillators

Distortion in oscillators may be harmonically or non-harmonically related to the fundamental frequency. Non-harmonic oscillator outputs are usually termed spurious. Both harmonic and spurious outputs of an oscillator can be minimized with proper biasing and filtering techniques. The HP 8569B can monitor changes in distortion levels while modifications to the oscillator are made. In the full-band modes, a tuning marker can be located under any signal response to determine its frequency and, hence, its relationship to the fundamental frequency of the oscillator. Figure 34 is a CRT plot of the fundamental and second harmonic of an S-band (2 to 4 GHz) YIG oscillator. The internal preselector of the HP 8569B enables the analyzer to measure a low-level harmonic in the presence of a high-level fundamental. The plot was obtained using the MAX HOLD capability of the analyzer to allow storage of the maximum deviations of the signals.

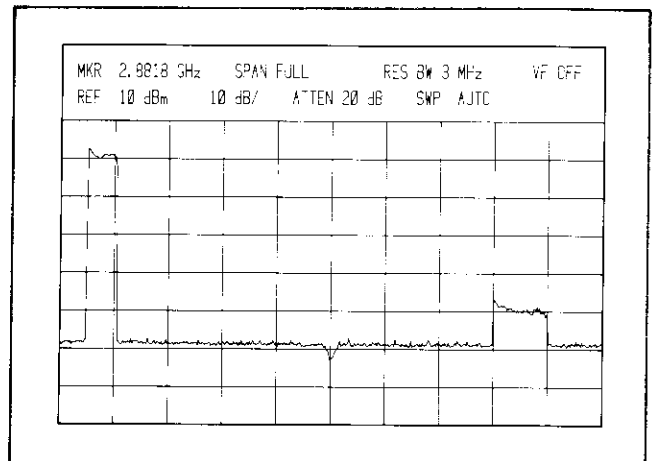

Figure 34. Oscillator Fundamental and Second Harmonic

NOTE

Consult AN 150-11 for more information on distortion measurements.

MODULATION

Amplitude Modulation

The wide dynamic range of the spectrum analyzer allows accurate measurement of modulation levels. A 0.06 percent modulation is a logarithmic ratio of 70 dB, which is easily measured with the HP 8569B. Figure 35 shows a signal with 2 percent AM displayed, a log ratio of 40 dB.

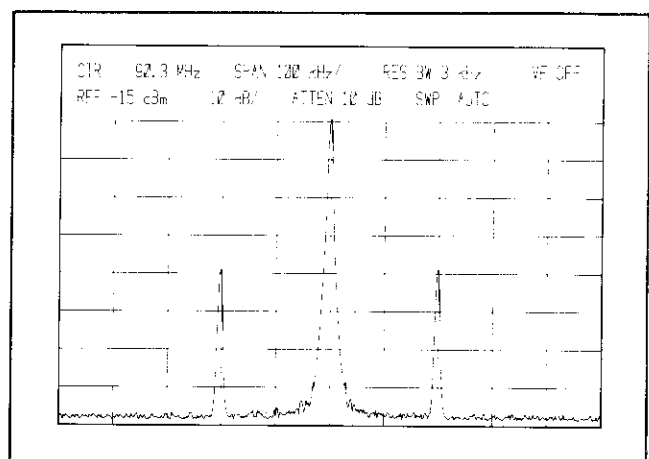

Figure 35. 2% AM

When the analyzer is used as a manually tuned receiver (Zero Span), the AM signal is demodulated and viewed in the time domain. To demodulate an AM signal, uncouple the RESOLUTION BW and set it to a value at least twice the modulation frequency. Then set the AMPLITUDE SCALE to LIN and center the signal,

horizontally and vertically, on the CRT. (Refer to Figure 38.) By pressing ZERO SPAN and VIDEO triggering, and adjusting the TRIGGER LEVEL for a stable trace, the modulation will be displayed in the time domain. (Refer to Figure 37.) The time variation of the modulation signal can then be measured with the calibrated SWEEP TIME/DIV control.

The example shown in Figure 37 demonstrates sinusoidal amplitude modulation, which can be used for narrow-band sine wave testing of components and systems. When the modulation is not a pure sine wave use the HP 8569B to obtain signatures (reference responses) of random modulation for comparison or listen to the VERTICAL OUTPUT with headphones (see Control Glossary). The display can be output to a controller for statistical analysis of random amplitude modulation.

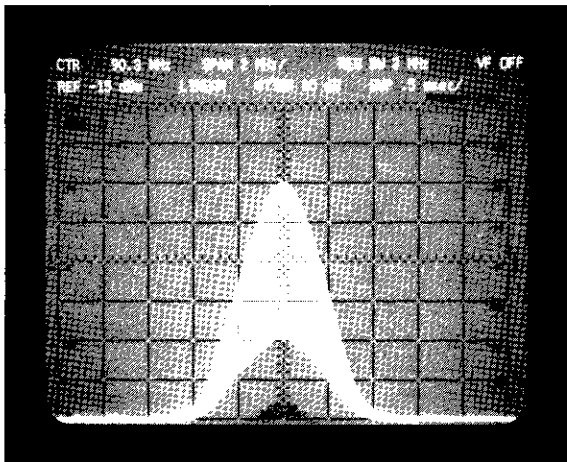

Figure 36. Linear Amplitude Display

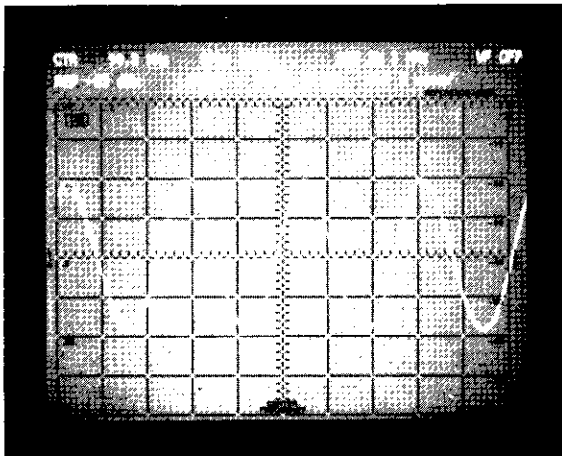

Figure 37. Demodulated AM Signal in ZERO SPAN

Frequency Modulation

For frequency modulated signals, parameters such as modulation frequency (f_m), modulation index (m), peak frequency deviation of carrier (Δf_{peak}) are all easily measured with the HP 8569B. The FM signal in Figure 38 was adjusted for the carrier null which corresponds to $m = 2.4$ on the *Bessel* function. The modulation frequency f_m , is 100 kHz, the frequency separation of the sidebands. The peak frequency deviation of the carrier (Δf_{peak}) can be calculated using the following equation:

$$m = \frac{\Delta f_{\text{peak}}}{f_m}$$

$$\text{or } \Delta f_{\text{peak}} = 2.4 \times 100 \text{ kHz} = 240 \text{ kHz}$$

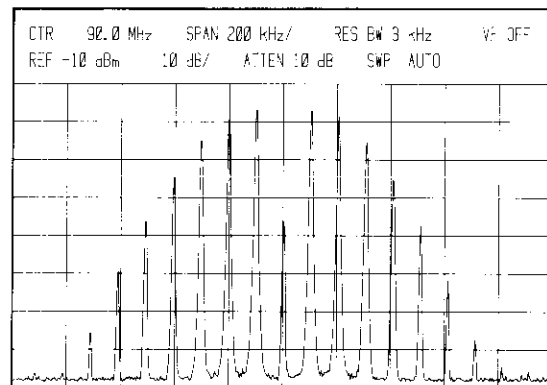

Figure 38. FM Signal

If the FM signal displayed does not correspond to a specific carrier or sideband null, then determination of the modulation index m , and final calculation of the peak frequency deviation Δf_{peak} , becomes much more complex and tedious. As with amplitude modulation, the display output can pass to a controller, then, by storing in the controller memory the values of certain analyzer characteristics (such as slope non-linearities of bandwidth filters) and by prompting the user to set certain controls, Δf_{peak} can be measured directly, or calculated.

Although the HP 8569B does not have a built-in discriminator, FM signals can be demodulated by slope detection. Rather than tuning the signal to the center of the CRT as in AM, the slope of the IF filter is tuned to the center of the CRT. At the slope of the IF filter, the frequency variation is converted to amplitude variation. In FM, the resolution bandwidth must be increased to yield a display similar to that shown in Figure 39 before switching to ZERO SPAN. When ZERO SPAN is selected, the amplitude variation is detected by the analyzer and displayed in the time domain as shown in Figure 40.

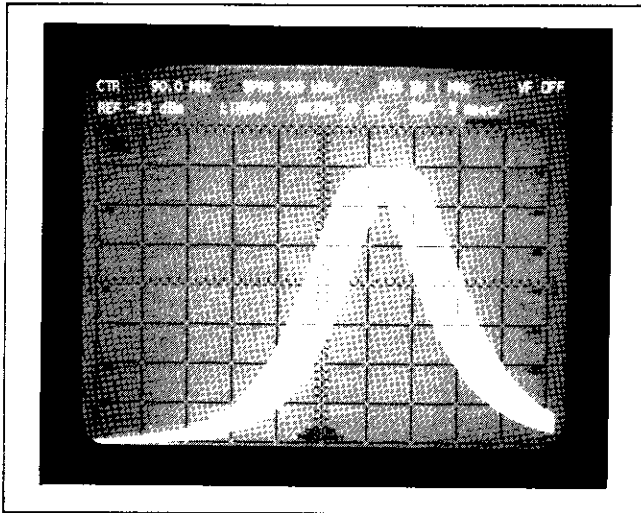

Figure 39. Slope Detection of FM Signal

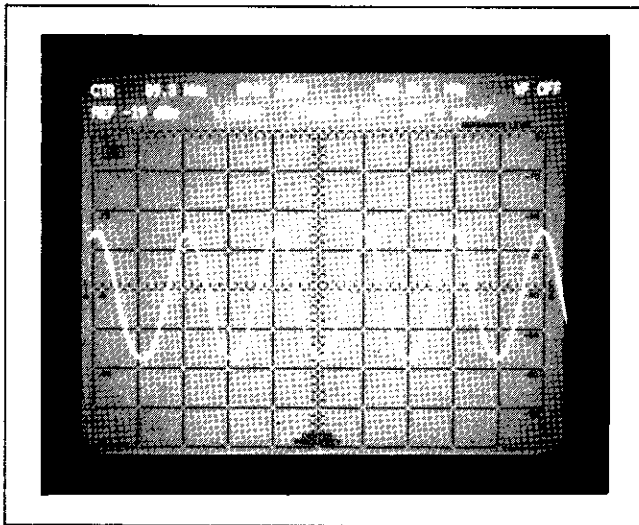

Figure 40. Demodulated FM Signal in ZERO SPAN

Pulsed RF

A pulsed RF signal is basically an RF signal which is turned on periodically for brief intervals of time. Some parameters to be determined in measuring pulsed RF signals are pulse repetition frequency (PRF), pulse width, duty cycle, on-off ratio of the modulator, and pulse power. Pulse power can refer to either the average power or to the peak power of the pulse.

The spectrum analyzer can display a pulsed RF signal in either of two modes, the line mode or the pulse mode. The factor that determines the display mode is the number of spectral components or lines that are in the passband of the spectrum analyzer at any one time. In the line mode, there is only one spectral component or line in the passband; i.e., the resolution bandwidth is

less than the PRF. In the pulse mode, there is more than one spectral line in the passband; i.e., the resolution bandwidth of the analyzer is greater than about twice the PRF.

Since a spectrum analyzer does not display the actual peak pulse power of the signal (a pulsed signal has its power distributed over a number of spectral components and each component represents a fraction of the peak pulse power), a correction or a desensitization factor must be added to the displayed main lobe power of the pulsed RF signal to obtain the peak pulse power. The calculation of the desensitization factor depends on whether the analyzer is displaying the signal in the line or pulse mode.

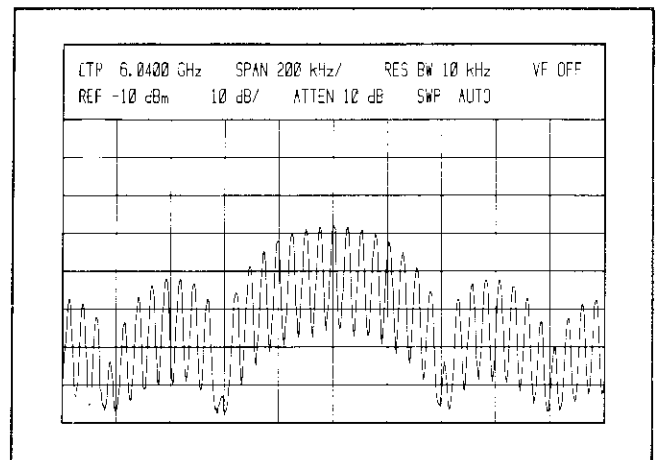

Figure 41. Line Spectrum

Line Mode

To obtain a *line* spectrum on the analyzer, the resolution bandwidth must be less than the PRF. This ensures that individual spectral lines will be resolved. From the line spectrum shown in Figure 41, it is possible to measure the following parameters:

$$\text{PRF} = 50 \text{ kHz (spacing between spectral lines)}$$

$$\text{Main lobe width} = 800 \text{ kHz}$$

$$\text{Main lobe power} = -38 \text{ dBm}$$

Then, from the above measurement, the following data can be calculated:

$$\begin{aligned} \text{Pulse width} &= \frac{2}{\text{Main Lobe width}} \\ &= \frac{2}{800 \text{ kHz}} = 2.5 \mu\text{sec} \end{aligned}$$

$$\begin{aligned} \text{Duty cycle} &= \frac{2 \text{ PRF}}{\text{Main Lobe width}} \\ &= \frac{2(50 \text{ kHz})}{800 \text{ kHz}} = 0.125 \end{aligned}$$

To determine the peak pulse power in a line spectrum, a pulse desensitization factor (α_L) must be added to the measured main lobe power. The desensitization factor is a function of the duty cycle and is represented by the following equation:

$$\alpha_L = 20 \log x \text{ (duty cycle)}$$

For duty cycle of 0.125, $\alpha_L = -18$ dB. Hence the peak pulse power in Figure 43 is -20 dBm.

Pulse Mode

To obtain a pulse spectrum on the analyzer, the resolution bandwidth of the analyzer must be set to greater than about twice the PRF, to ensure that more than one spectral line is within the passband of the analyzer. To find the peak pulse power in the pulse mode, add the pulse desensitization α_p , which is a function of pulse width and spectrum analyzer impulse bandwidth, to the main lobe power.

Figure 44 illustrates a signal in the pulse spectrum mode. As with the line spectrum, the pulse width can be determined from the main lobe width, while the impulse bandwidth is a characteristic of the analyzer.

$$\alpha_p = 20 \log (\text{pulse width} \times \text{Impulse BW})$$

For a pulse width of $2.5 \mu\text{sec}$ and an impulse bandwidth of 150 kHz , $\alpha_p = -8$ dB. The peak pulse power of the signal shown in Figure 44 then, is -20 dBm.

A wider resolution bandwidth results when in pulse spectrum mode. The wider resolution bandwidth provides two advantages. First, the signal to noise ratio is increased because the pulse amplitude increases linearly with the resolution bandwidth (BW). The random noise increases proportionally to the square root of the bandwidth ($\sqrt{\text{BW}}$). The only limitation is that the bandwidth should be no greater than about 5 percent of the main lobe width. Secondly, faster sweep times can be used because of the wider resolution bandwidths. The HP 8569B has a 3 MHz resolution BW which enables it to effectively display pulsed RF signals in the pulse mode. The 3 MHz bandwidth, along with fast sweep times, also enables narrow pulse widths to be measured in the time domain. The demodulated pulse signal of Figure 42 is shown in Figure 43.

Few operating pulsed RF systems have ideal spectra. Measurements can still be made regardless of the asymmetry of the spectrum. Examples of non-ideal spectra are found in digital communications and radar.

Since most radar systems do not have ideal spectra, the spectrum of a properly operating system is often stored

away for future reference. This reference or spectral signature can then be used to determine changes that would indicate potential problems. The HP 8569B has the capability of storing display information onto magnetic tape via HP-IB, or by directly plotting the information (hard copy) for use later (refer to Chapter 2).

In digital communications, one major concern is the limits placed on transmissions by regulatory agencies. When the HP 8569B is used with a controller, specification limits can be written directly on the CRT, making conformance testing less tedious.

An additional factor to consider when measuring pulsed RF signals is the VIDEO FILTER control and the digital averaging capability of the spectrum analyzer. In general, the VIDEO FILTER and DGTL AVG should

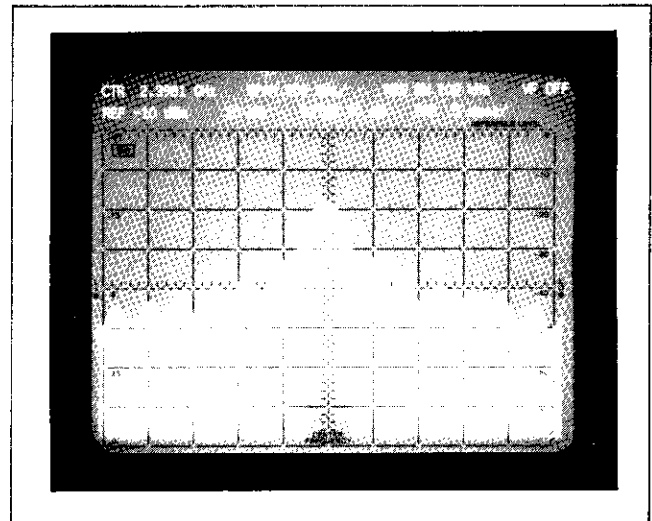

Figure 42. Pulse Spectrum

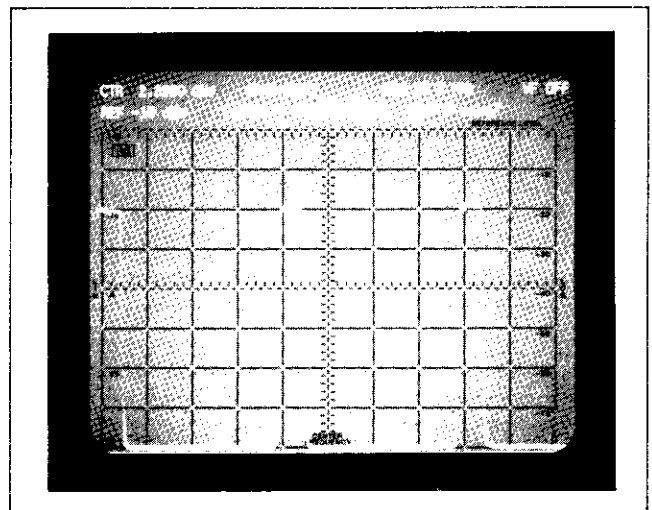

Figure 43. Demodulated Pulsed RF Signal in ZERO SPAN

be OFF when measuring pulsed RF signals. Adding video filtering or digital averaging will desensitize a pulsed signal and limit its displayed amplitude. Therefore, when monitoring pulsed signals in a full-band mode, it is important to use the F mode rather than the FULL BAND pushbutton mode. The FULL BAND pushbutton mode automatically engages a 9 kHz video (0.003 x 3 MHz) filter which will limit the displayed amplitude of the pulse bandwidth.

NOTE

Consult AN 150-2 for more information on pulsed RF measurements.

NOISE

Applications involving noise measurements include oscillator noise (spectral purity), signal to noise ratio, and noise figure. The NOISE AVG position of the VIDEO FILTER control and the digital averaging capability of the spectrum analyzer can be used to measure the analyzer sensitivity or noise power from 0.01 to 22 GHz.

The test setup in Figure 44 is used to make a swept noise figure measurement of an amplifier. First, the total gain of the amplifier under test and the pre-amp is determined. Then, the input of the amplifier is terminated and

its noise power is measured. The noise figure of the amplifier is the theoretical noise power (KTB) minus the total gain plus the amplifier noise power. Figure 45 is a plot of an amplifier's noise power output.

Another technique, called the Y-Factor Technique (refer to Figure 46), overcomes the problems associated with the analyzer's absolute accuracy by using a calibrated noise power standard such as the HP 346B excess noise source. By measuring the ratio of P_o with the noise source on, to P_o with noise source off (the test amplifier input terminated in Z_o impedance), we can determine Noise Figure to a much greater accuracy. Spectrum analyzer instrument errors in the measurement of P_o On/ P_o Off are typically less than a few tenths of a dB, leading to measurement accuracies approaching those of a noise figure meter. Figure 47 shows the results of a Y-Factor measurement.

NOTE

Consult AN 150-4, AN 150-7 and AN 150-9 for more information on noise measurements.

ELECTROMAGNETIC INTERFERENCE (EMI)

The objective of EMI measurements is to ensure compatibility between devices operating in the same vicinity.

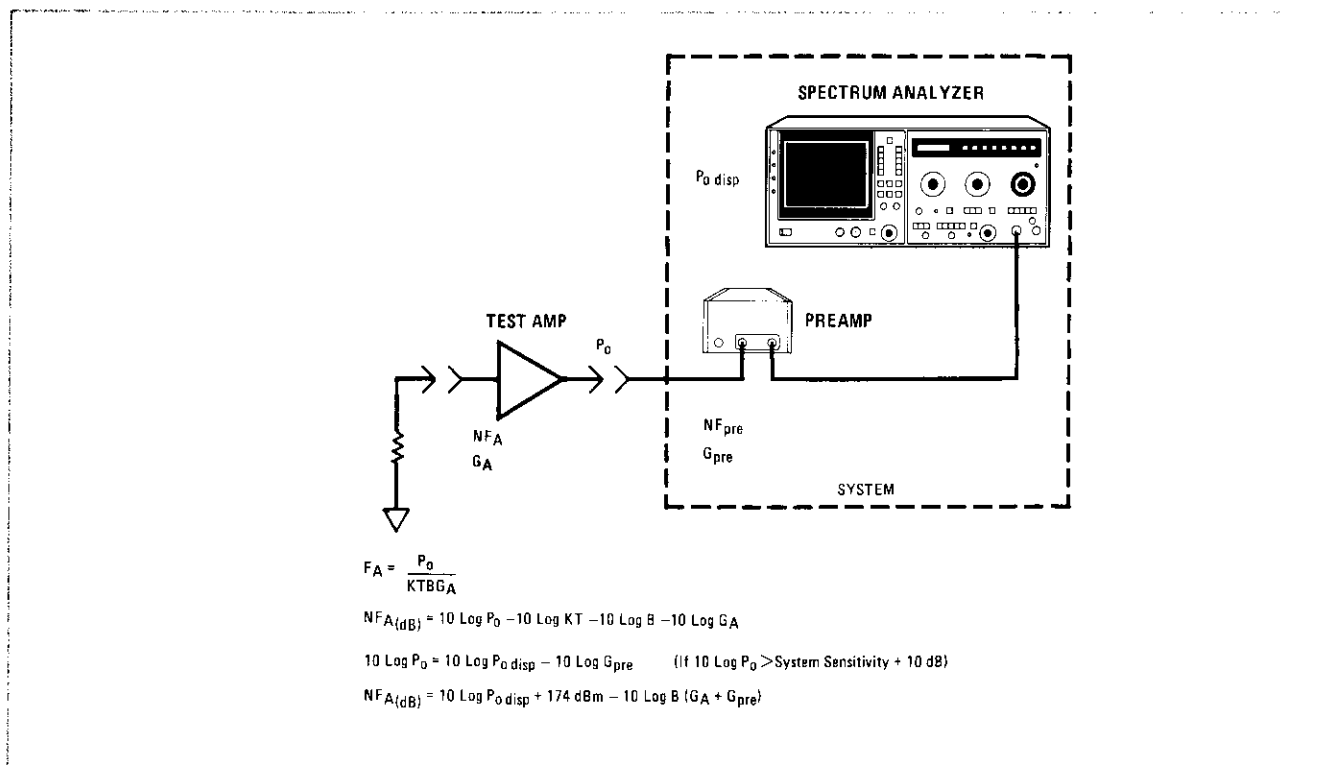

Figure 44. Measuring Noise Figure—Absolute Power Technique

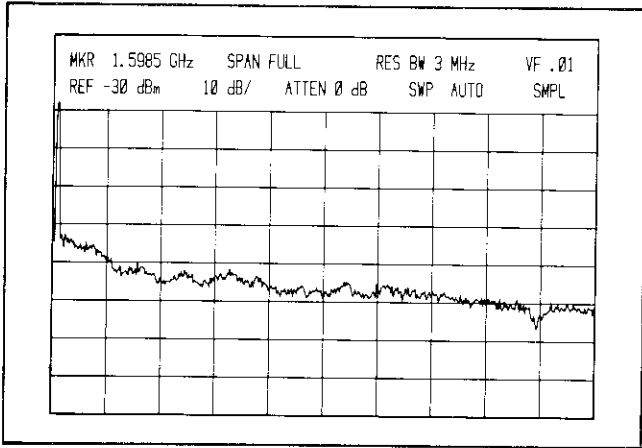

Figure 45. Noise Power Measurement

The HP 8569B, along with an appropriate transducer, is capable of measuring either conducted or radiated EMI and can also be used as a calibration tool for EMI susceptibility testing. Figure 48 illustrates an equipment setup used for measuring radiated field strength.

The antenna in Figure 48 is used to convert the radiated field to a voltage for the analyzer to measure. The field strength is the analyzer reading plus the antenna correction factor. Figure 49 illustrates radiated interference as displayed on the HP 8569B.

Compatibility is also important for high-frequency circuits which are in close proximity to each other. In a multi-stage circuit, parasitic oscillation from one stage can couple to a nearby stage and cause unpredictable

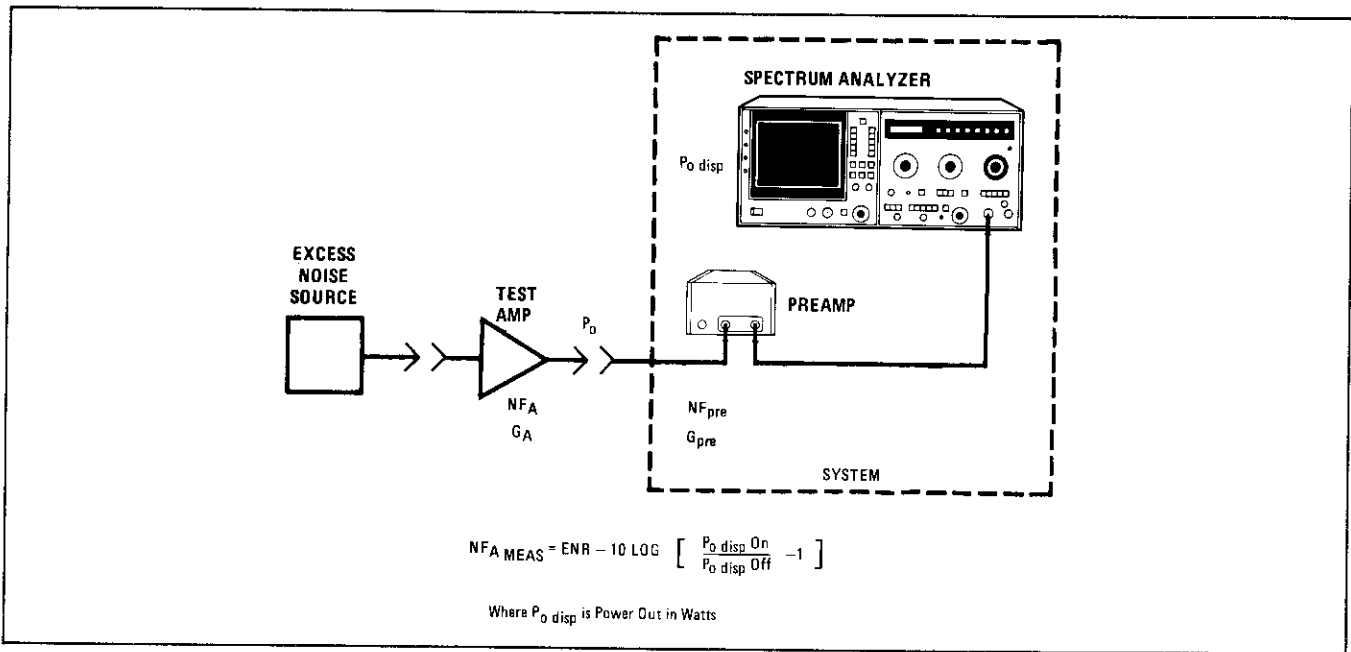

Figure 46. Measuring Noise Figure - Y Factor Technique

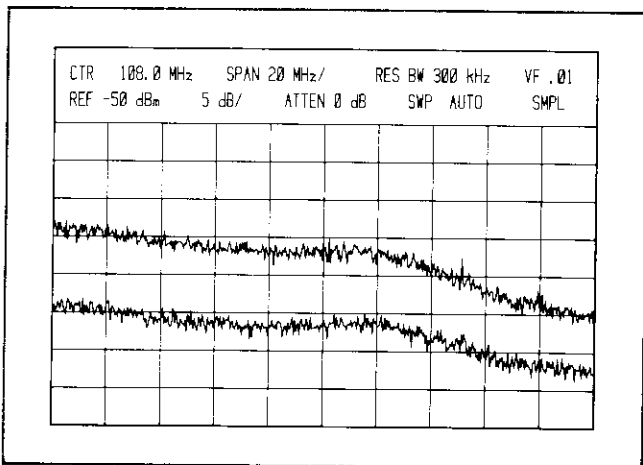

Figure 47. Y-Factor Measurement

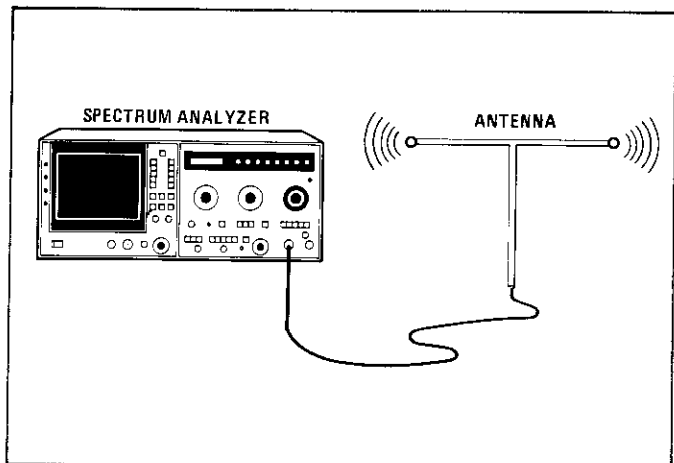

Figure 48. Field Strength Test Setup

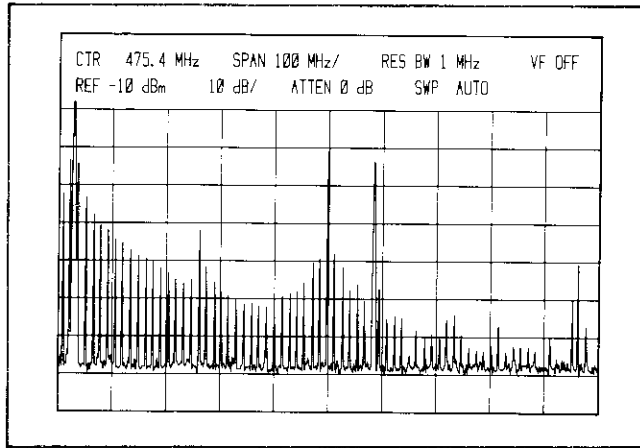

Figure 49. Radiated Interference

behavior. A popular technique used to search for spurious radiation utilizes an inductive loop probe. The loop probe is a few turns of wire that attaches to the spectrum analyzer with a flexible coaxial cable. (Refer to Figure 50.)

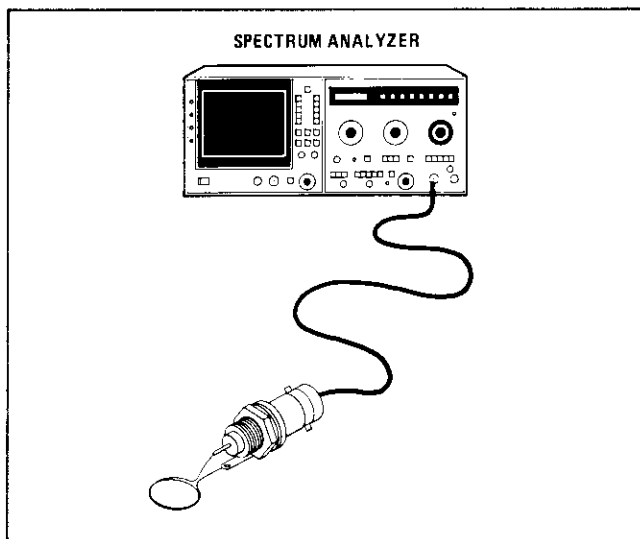

Figure 50. Loop Probe

Various parts of the circuit can be 'probed' to identify the location as well as the frequencies and relative amplitudes of spurious signals. Once the spurious signal has been identified, design techniques can be implemented to reduce or eliminate the cause of interference.

When testing to detailed specifications (i.e. MIL-STD), it is the worst case limits or the peaks of the signals that are of concern. MAX HOLD can be used to store the maximum amplitudes of these signals for later comparison to specified limits.

With interface to a desktop computer, the HP 8569B spectrum analyzer automatically reformats the display to reflect such test limits as impulse bandwidth normalizations, antenna factor, or current probe corrections.

NOTE

Consult AN 150-10 and AN 142 for more information on EMI measurements.

SWEPT-FREQUENCY RESPONSE

Frequency response measurements are a common requirement for many system components such as filters, amplifiers, and mixers. The addition of an appropriate source to the spectrum analyzer makes a powerful system for stimulus response (swept-frequency) measurements.

The HP 8444A Option 059 is a tracking generator whose RF output frequency follows (tracks) the tuning of the HP 8569B Spectrum Analyzer over the frequency range of .010 to 1.5 GHz. Since the first local oscillator from the spectrum analyzer is used as a reference by the tracking generator, the low residual FM of the spectrum analyzer is transferred to the tracking generator. The frequency spans of the two instruments are matched and synchronous, providing precise tracking between the two instruments. The equipment setup for this measurement is shown in Figure 51.

A significant advantage of the spectrum analyzer/tracking generator combination for swept measurements is the large dynamic range. The noise is bandwidth limited in the spectrum analyzer, and harmonics and spurious products are not limiting factors since the spectrum analyzer is always tuned to the fundamental of the tracking generator. The dynamic range for the tracking generator and spectrum analyzer extends from the output available on the tracking generator to the noise floor on the analyzer. For the HP 8569B/8444A Option 059 system, the dynamic range is generally greater than 100 dB. Figure 52 illustrates the large dynamic range that is possible using the HP 8444A Option 059 and the HP 8569B.

The system frequency response can be eliminated from the measurement results by using the INP-B mode. First, calibrate the system with a known standard (i.e., a through-line for transmission measurements). Then, store the displayed response in Trace B by using either STORE VIEW or STORE BLANK (see Figure 53a). Next, insert device under test, press INP-B → A (see Figure 53b). The displayed frequency response is that of device, not of system plus device (refer to Appendix D concerning position of reference line).

NOTE

Errors due to mismatch uncertainty are not removed from measurement by normalization.

The 8444A Option 059 can be used with a counter to make accurate, highly sensitive and very selective frequency measurements of unknown signals. Providing a signal can be resolved on the spectrum analyzer, it can

be counted. The system can count signals down to the sensitivity of the analyzer with the frequency accuracy several orders of magnitude better than the spectrum analyzer accuracy.

NOTE

Consult AN 150-3 and AN 150-13 for more information on Swept-Frequency Response measurements.

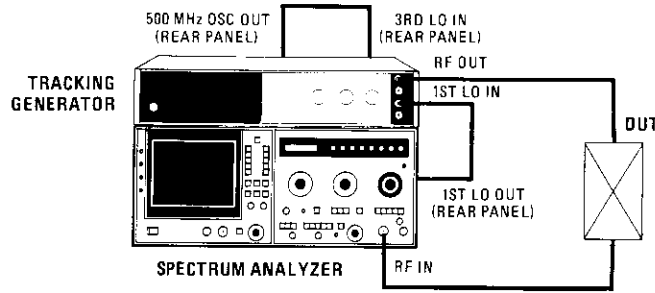
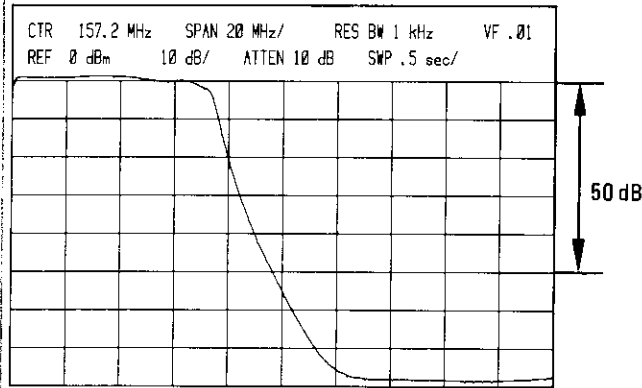
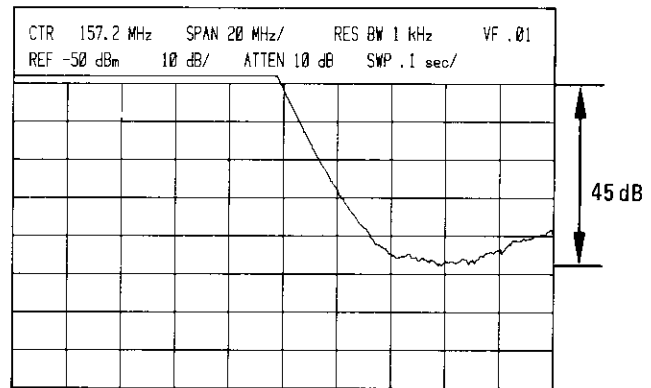

Figure 51. Swept Frequency Response Setup



(a)



(b)

Figure 52. Low Pass Filter Measurement with 95 dB of Rejection

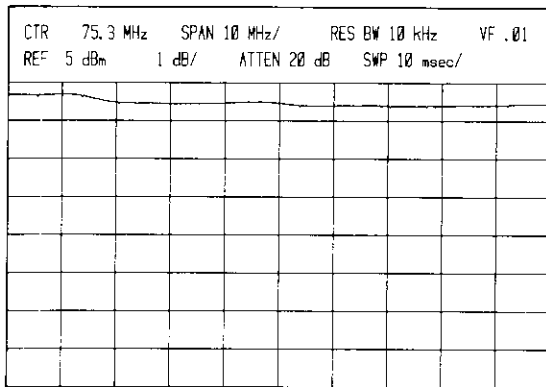

(a) Calibration-System Response

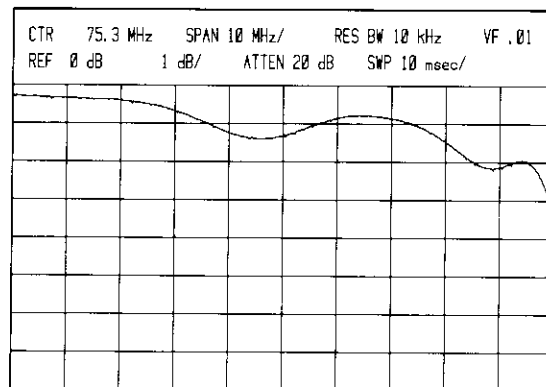

(b) Measurement-Normalized Response

Figure 53. Normalization of Frequency Response

CHAPTER 5 HP-IB REMOTE OPERATION

This chapter discusses the requirements for remote operation of the spectrum analyzer using an HP-IB⁵ controller.

General Description

The HP 8569B digital storage display and sweep control can be accessed through HP-IB. The HP-IB connector is located on the rear panel (see Figure 54). An HP-IB interconnection cable (often supplied with the HP-IB Interface) is required to connect the analyzer to the controller HP-IB interface.

Programming codes are summarized on the pull-out information card and in Table 5 of this section. A more detailed syntax summary can be found in Appendix E. Programming information dealing with specific HP-IB controllers can be found in the *Introductory Operating Guide* addressing that specific controller.

HP-IB Compatibility

The complete bus capability of the spectrum analyzer as defined in IEEE STD 488 (or the identical ANSI Standard MC 1.1), is presented following Table 6. The pro-

⁵Hewlett-Packard Interface Bus, the Hewlett-Packard implementation of IEEE STD 488-1975 and ANSI STD, MC 1.1, "Digital Interface for Programmable Instrumentation."

gramming capability of the instrument is further described by the three HP-IB messages in Table 6. Foremost among these messages is the data message, which is the primary method of communication between the analyzer and the controller. The responses of the analyzer to other messages are shown as well.

Addressing the Spectrum Analyzer

Communication between instruments on the HP-IB requires that a unique address be assigned to each instrument. The address switch (Figure 55) on the rear panel of the analyzer is used to set the analyzer address.

The instrument address is the binary number represented by the on (1) or off (0) states of the five switch segments (A1 through A5). For example, the address 18 is set when A2 and A5 are on (1) and the other switch segments are off (0).

Digital CRT Display Coordinates

References to the CRT display coordinates (specifically, commands AP/BP, BA/BB, IA/IB, and TA/TB as listed in Table 5) will follow the layout in Figure 56.

Within the range of the graticule, there are a total of 481 X-axis values (0 to 480, with 48 points per division) and 801 Y-axis values (0 to 800, with 100 points per division).

Table 5. HP-IB Programming Codes

HP-IB Commands (Alphabetical Listing)	
AL	Display lower line control settings
AP	Output trace A peak signal coordinates
AT	Output RF Input Attenuation
AU	Display upper line control settings
BA	Output trace A byte values
BB	Output trace B byte values
BP	Output trace B peak signal coordinates
CF	Output Center Frequency
CS	Output annotation
DG	Output display mode
DM	Output detection mode
IA	Input trace A integer values
IB	Input trace B integer values
LG	Output Amplitude Scale
LL	Input lower line message
LU	Input upper line message
MS	Output value of sweep flag
NS	Output INP-B→A state
RB	Output Resolution Bandwidth
RL	Output Reference Level
SF	Start sweep and set sweep flag
SP	Output Frequency Span/Div
ST	Output Sweep Time
TA	Output trace A integer values
TB	Output trace B integer values
TS	Take sweep
VF	Output Video Filter

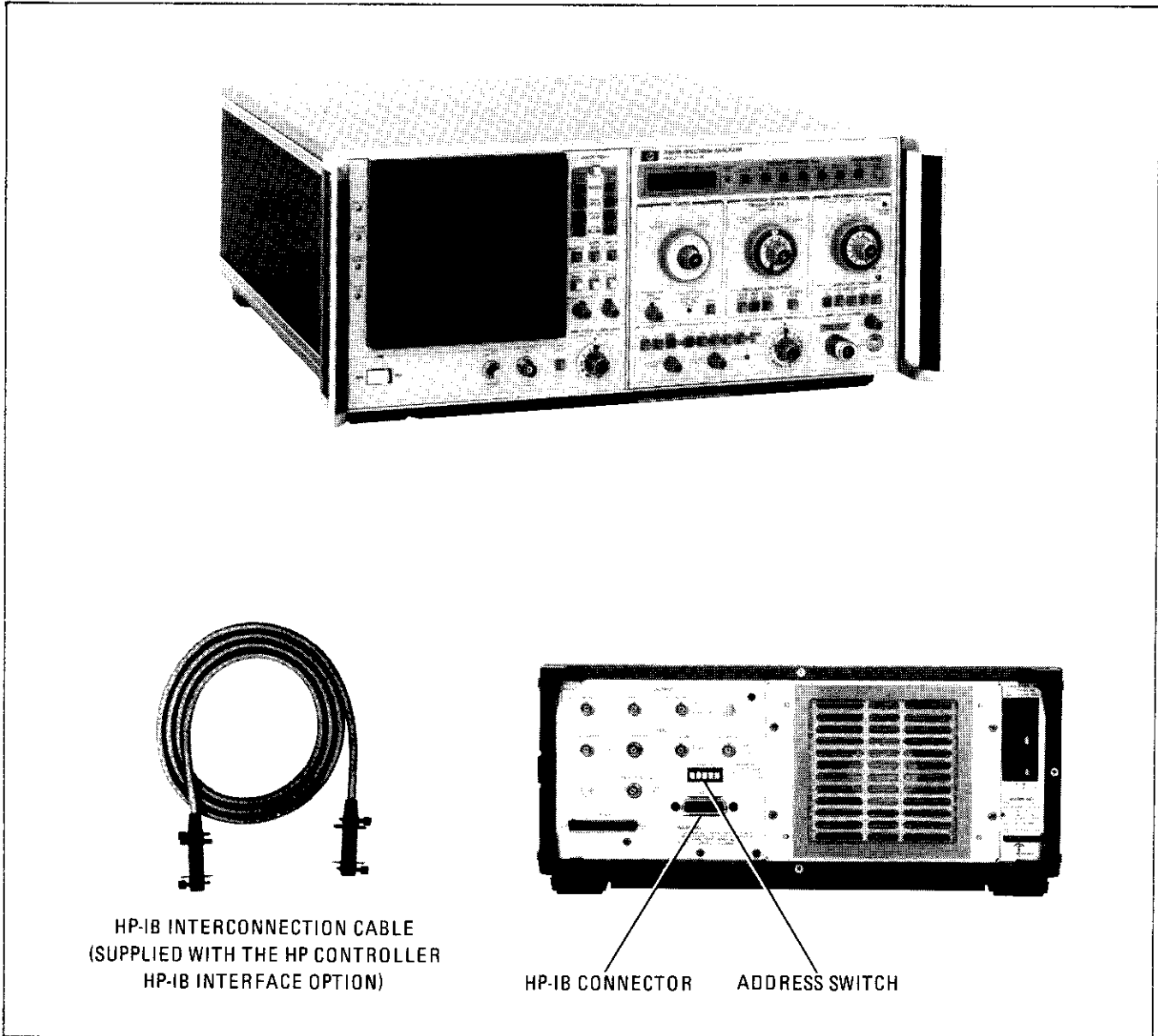

Figure 54. HP 8569B with HP-IB Interconnect Cable

The Y-axis overrange values displayed above the top of the graticule are 801 to 820 for the trace output commands AP/BP, BA/BB, and TA/TB and 801 to 975 for the trace input commands IA/IB. (Values above 950 may be deflected off the top of the screen.)

Two lines of annotation near the top of the CRT display are controlled by the labeling commands CS, LL/LU, and AL/AU.

Table 5 is a summary of the HP 8569B HP-IB Programming Codes. For more detailed information concerning the front-panel controls of the analyzer, refer to Chapter 2. For information on syntax requirements, refer to Appendix E.

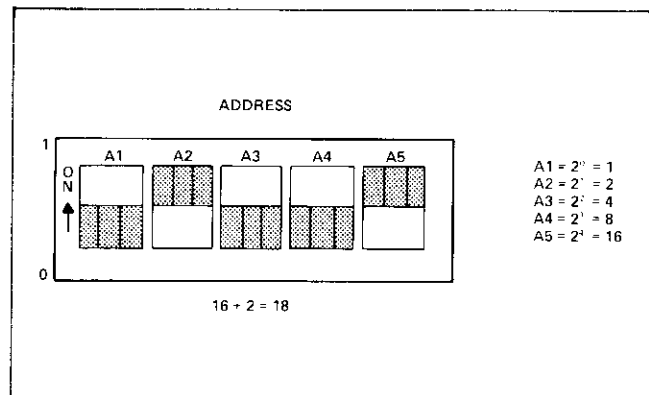

Figure 55. HP-IB Address Switch

Table 6. HP-IB Message Reference Table

HP-IB Message	Response	Related Commands and Controls*	Interface Functions*
Data	Information pertaining to the digital storage display is available to the bus. Trace data and display messages can be sent to the analyzer via HP-IB. Program instructions can initiate sweeps.		T7, L4 AH1, SH1
Clear	Device clear; clear active traces and reset sweep.	DCL SDC	DC1
Abort	Interface clear; unaddress instrument.	IFC	T7, L4

*Commands, Control lines and Interface Functions are defined in IEEE STD 488 (and the identical ANSI Standard MC1.1). Complete HP-IB capability is: SH1, AH1, T7, TE0, L4, LE0, SR0, RL0, PP0, DC1, DT0, C0, E2.

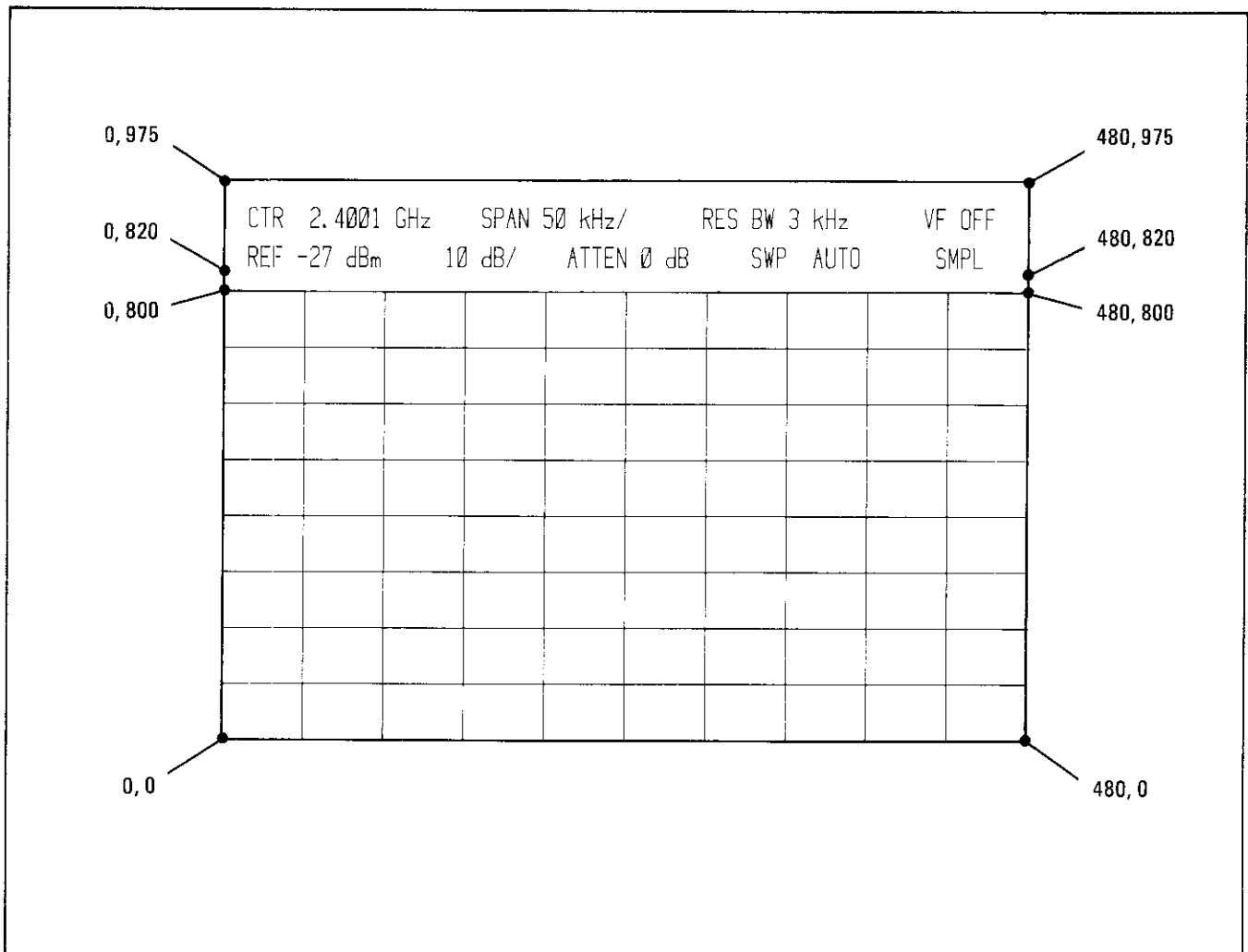

Figure 56. Display Coordinates

APPENDIX A OPERATING PRECAUTIONS

WARNING

This instrument and any device connected to it must be connected to power line ground. Failure to ensure proper grounding may cause a shock hazard to personnel or damage to the instrument.

The spectrum analyzer is a sensitive measuring instrument. To avoid damage to the instrument, do not exceed the following **absolute maximum input levels**:

- Total RF power: +30 dBm (1 watt)
- dc or ac ($\ll 50\Omega$ source impedance):
 - 0V with 0 dB input attenuation (<1 amp); $\pm 7V$ with ≥ 10 dB input attenuation (<0.14 amp).
- Peak pulse power: +50 dBm (<10 μ sec pulse width, 0.01% duty cycle) with ≥ 20 dB attenuation.

NOTE

Overdriving the input with too much power, either peak or dc voltages, might damage the input circuit and require expensive repairs.

If large dc components are present with ac signals, a blocking capacitor should be used at the INPUT of the analyzer to eliminate the dc components.

LOW IMPEDANCE AC

A source with much less than 50Ω nominal output impedance can produce excessive current which might damage the input circuit of the analyzer.

DC PRECAUTIONS

The HP 8569B *cannot* accept dc voltages in 0 dB INPUT ATTEN. With 10 dB or greater INPUT ATTEN, small dc voltages ($< \pm 7V$) can be accepted without damage if the total power (ac and dc) does not exceed 1 watt.

The input is direct-coupled and its dc input resistance varies from 0 to 87Ω , depending on the settings of INPUT ATTEN and FREQUENCY BAND GHz controls. (See Figure A-1.)

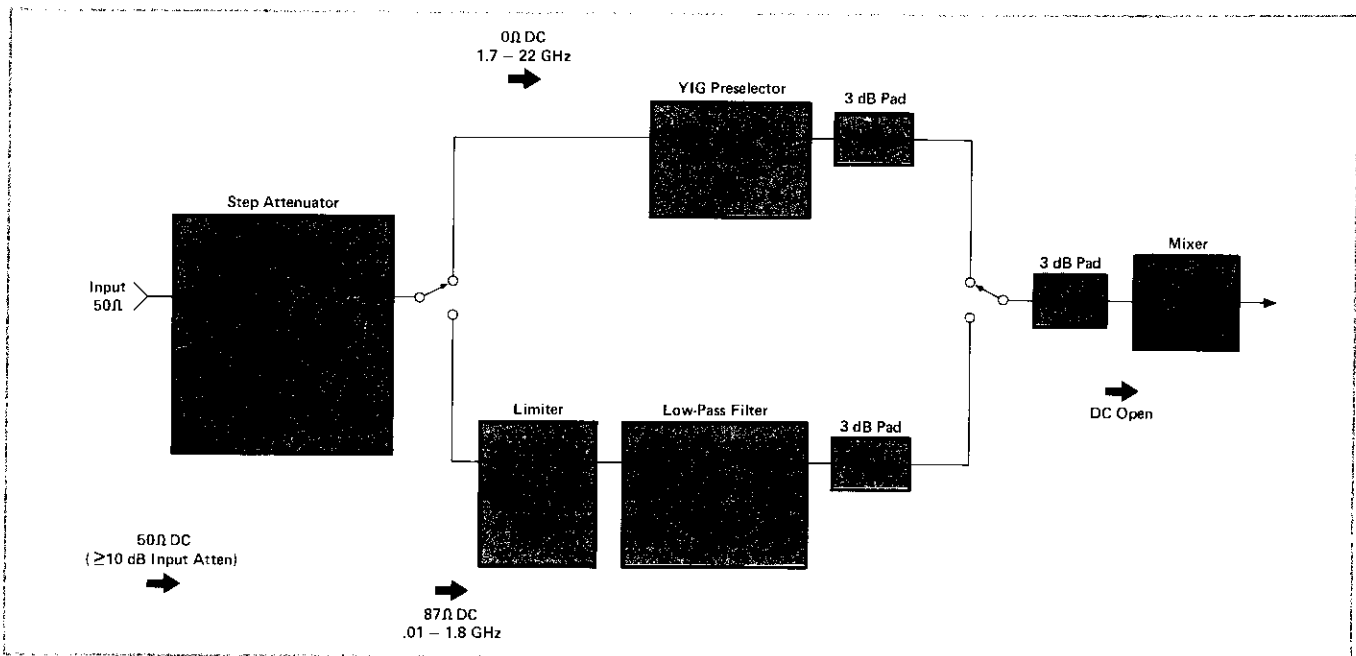

Figure A-1. DC Block Diagram

SYSTEM OF OPERATION

The HP Model 8569B Spectrum Analyzer is basically an electronically swept superheterodyne receiver. It has high sensitivity and selectivity, a wide, distortion-free dynamic range, and excellent flatness from 10 MHz to 22 GHz. With external mixing, frequency coverage can be extended up to 115 GHz. The HP 8569B consists of an RF and an IF section, an automatic stabilization and control section, and a digital storage display section. These sections will be discussed separately in this appendix. Figure B-1 is a simplified block diagram of the instrument.

RF SECTION

The RF section is composed of a 0–70 dB step attenuator, an automatic preselector, a tunable local oscillator (LO), and a broadband mixer. The step attenuator at the input to the spectrum analyzer is used to control the signal level to the mixer for optimum dynamic range and signal-to-noise ratio. The automatic preselector consists of a low-pass filter from 0.01 to 1.8 GHz and a yttrium-iron-garnet (YIG) tuned filter (YTF) from 1.7 to 22 GHz. Coaxial RF switches are used to switch to the proper filter, depending on the selected frequency band. The automatic preselector greatly reduces most image, multiple, and spurious responses of the analyzer and thus enhances its dynamic range. A transistorized YIG-tuned oscillator (YTO) with a fundamental tuning range of 2.05 to 4.46 GHz is used as the LO in this superheterodyne system.

The basic frequency conversion equation for a heterodyne system is given in equation 1:

$$F_s = F_{LO} \pm F_{IF} \quad (1)$$

where:

F_s = signal frequency

F_{LO} = local oscillator frequency

F_{IF} = intermediate frequency

The main IF in the HP 8569B is set at 321.4 MHz, and the first LO sweeps from 2.0 to 4.46 GHz. Therefore, from equation 1, F_s would cover approximately 1.68 to 4.14 GHz in fundamental operation. With harmonic mixing, the frequency range is extended to 115 GHz, as shown in equation 2:

$$F_s = NF_{LO} \pm F_{IF} \quad (2)$$

where:

$$N(\text{harmonic number}) = 1-, 2-, 3-, 4+, 5+, 6+, \\ 10+, 16+, 26+$$

Each harmonic number creates a tuning curve, illustrated in Figure B-2. Signal frequencies from 0.01 to 1.8 and 1.7 to 22 GHz are converted by the broadband internal mixer to a 2050 MHz IF and a 321.4 MHz IF, respectively. In the 1.7 to 22 GHz frequency range, the YIG-tuned filter tracks a particular tuning curve and thus eliminates spurious responses resulting from harmonic mixing. From 14.5 to 115 GHz, an external waveguide mixer is used to convert the input signals to a 321.4 MHz IF, which is then further processed by the analyzer.

Many factors can limit the resolution of the spectrum analyzer. Among these are the stability and spectral purity of the local oscillator and the bandwidth and shape factor of the IF filter. Of these limitations, the most significant for microwave analyzers is usually the stability (residual FM or drift) of an oscillator. For this reason, the HP 8569B utilizes an automatic stabilization circuit that locks the YTO to a 1 MHz crystal reference oscillator. The lock is automatically engaged when frequency spans of 100 kHz/Div or less are selected. The AUTO STABILIZER can be disabled by a push button switch located on the front panel. An added feature of the automatic stabilization circuit is the use of offset compensation to keep the signal of interest fixed on the CRT during stabilization. The circuit is designed so that the YTO is not moved when it is locked to the reference oscillator. Since there is no frequency shift in the YTO, there is no shift in the displayed signal. This eliminates the need for the user to retune the signal on the CRT once the instrument has been stabilized.

IF SECTION

The IF section consists of components in the signal path after the first mixer. The output from the first mixer is either 2050 MHz (for the .01 to 1.8 GHz band), or 321.4 MHz (for all other bands). Signals at 321.4 MHz bypass the second converter, whereas a 2050 MHz signal would mix with the second LO at 1.7286 GHz to also produce a 321.4 MHz IF. At the third converter, the 321.4 MHz IF is amplified, filtered, and mixed with the third LO at 300 MHz to produce a final IF of 21.4 MHz. The output of the third converter goes to a variable gain amplifier, selectable bandpass filters, variable gain logarithmic amplifiers, and linear amplifiers. It is then detected. The detected video signal goes through a selectable video filter before it is sent to the display for digital processing. The IF bandpass filter, log and linear amplifiers, and video filter are all controllable from the front panel of the spectrum analyzer.

DIGITAL STORAGE DISPLAY

The Digital Storage Display section performs two major functions. The first, which is controlled by the CPU (Central Processing Unit), is to acquire, process, and store display data in memory (referred to as Stroke Memory). The second, which is controlled by the counter, is to retrieve data from stroke memory and to display it on the CRT.

Since the CPU can process only digital information, an Analog to Digital Converter is provided to convert analog signals to digital information. The rate at which data is acquired varies with the instrument sweep speed, which is set by the Sweep Generator. During normal operation, the CPU alternately takes samples of the horizontal and vertical signals; the horizontal (X) value determines the memory address at which the vertical (Y) value is stored.

The counter accesses Stroke Memory and transfers the acquired data into the Y Data Buffer. Control logic determines the time at which the Y Data Buffer will transfer its data to the Digital Y Generator, which converts the retrieved data to an analog voltage that is applied through the Y Amplifier to the vertical deflection plates of the CRT. The horizontal (X) signal is generated by the Digital X Generator. The Digital X Generator receives control signals, derived from the counter, and generates an appropriate ramp voltage that is amplified and applied to the horizontal deflection plates of the CRT.

The Z-Axis signal controls both the brightness and the blanking of the trace. The Digital Y Generator outputs stroke length information, which is then converted to a brightness signal. The signal is used so that long strokes will not be dimmer than short ones. All remaining blanking inputs and control logic inputs are combined to produce one blanking signal that controls the blanking of the CRT. Generation of the display characters, seen on the top portion of the CRT, is accomplished by the Character Generator (addressed by the Counter and Data Bus) and by the blanking circuitry.

The Digital Storage Display section also performs secondary functions that are integral to the operation of the instrument but are not necessarily involved with acquisition and display of X and Y signals.

Secondary functions performed by the CPU (with the Input/Output Interface) include response to display control push buttons, interpretation of instrument control switches, and operation of the HP-IB Interface. The CPU also plays a major role in the performance of an automatic internal instrument check routine, as well as other test routines that are used to adjust, verify correct operation, and troubleshoot the digital storage circuitry. (Refer to the HP 8569B Operation and Service Manual, Section VIII.)

TUNING CONTROL SECTION

The Tuning Control Section contains the Frequency Control, YIG Driver, Frequency Display Unit, Sweep Attenuator, and Sweep Generator.

The Sweep Generator provides a sweep voltage that is simultaneously applied to the horizontal (X) deflection amplifier, data converter, and sweep attenuator. The sweep attenuator, controlled by the FREQUENCY SPAN/DIV control, reduces the sweep voltage to the Frequency Control Unit to maintain a calibrated horizontal scale on the CRT. In addition, the tuning control voltage, which sets the center frequency of the analyzer, is also applied to the Frequency Control Unit, where it is summed with the attenuated sweep. The resultant signal is then applied to the YIG oscillator drivers. Both the YTF and the YTO have separate YIG oscillator drivers which are basically voltage-to-current converters. A pre-selector peak adjustment is used to control the offset of the YTF YIG driver circuit. It is adjusted to eliminate any amplitude uncertainty due to nonlinear tracking between the YTF and the YTO. The Frequency Display Unit displays the frequency represented by the center of the CRT display.

APPENDIX C AMPLITUDE CONVERSIONS

The HP Model 8569B Spectrum Analyzer reads signal levels in dBm. The following equations allow conversion from dBm to dBmV or dBV in a 50Ω system.

CONVERSION EQUATIONS

$$\text{dBm} + 107 \text{ dB} = \text{dB}\mu\text{V}$$

$$\text{dBm} + 47 \text{ dB} = \text{dBmV}$$

$$\text{dBmV} + 60 \text{ dB} = \text{dBV}$$

If it is desired to convert from logarithmic units to linear units, then the equations given below will be useful. Keep in mind that the logarithmic levels are all referenced to linear units.

That is:

- 0 dBm referenced to 1 mW
- 0 dBmV referenced to 1 mV
- 0 dBμV referenced to 1 μV

To calculate a linear level, simply take the antilog of the logarithmic level.

dBm to P (mW)

$$\text{dBm} = 10 \log \frac{P}{1 \text{ mW}}, P = \log^{-1} \frac{\text{dBm}}{10}$$

dBmV to V (mV)

$$\text{dBmV} = 20 \log \frac{V}{1 \text{ mV}}, V = \log^{-1} \frac{\text{dBmV}}{20}$$

dBμV to V (μV)

$$\text{dB}\mu\text{V} = 20 \log \frac{V}{1 \mu\text{V}}, V = \log^{-1} \frac{\text{dB}\mu\text{V}}{20}$$

Figure C-1 can be used to convert from dBm to voltage in a 50Ω system.

Conversion from dBm to volts can be made whether the AMPLITUDE SCALE is in LOG or LINEar. To read voltage on the HP 8569B, position the signal on the REFERENCE LEVEL line of the CRT. Read the REF LEVEL in dBm and find its equivalent voltage from the conversion chart (Figure C-1). The REF LEVEL calibration can be changed from dBm to dBμV by means of an internal jumper (Appendix D).

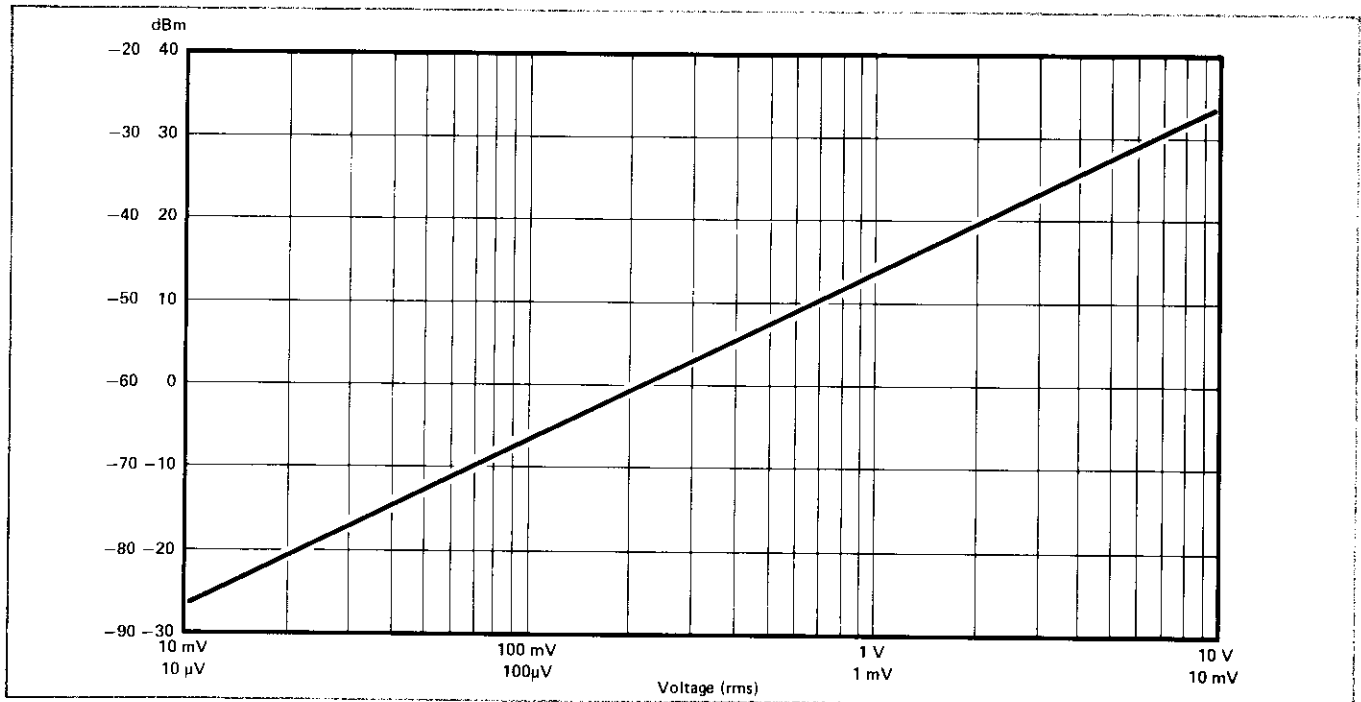

Figure C-1. Conversion Chart - Converts from dBm to Voltage in 50Ω

APPENDIX D OPTION STATUS INTERFACE

Certain options on the HP 8569B can be enabled by means of a single jumper per option.

The jumper socket (J2) is part of the Option Status Interface, located on the A7 Input/Output Assembly. A diagram showing the location of J2 is shown in Figure D-1.

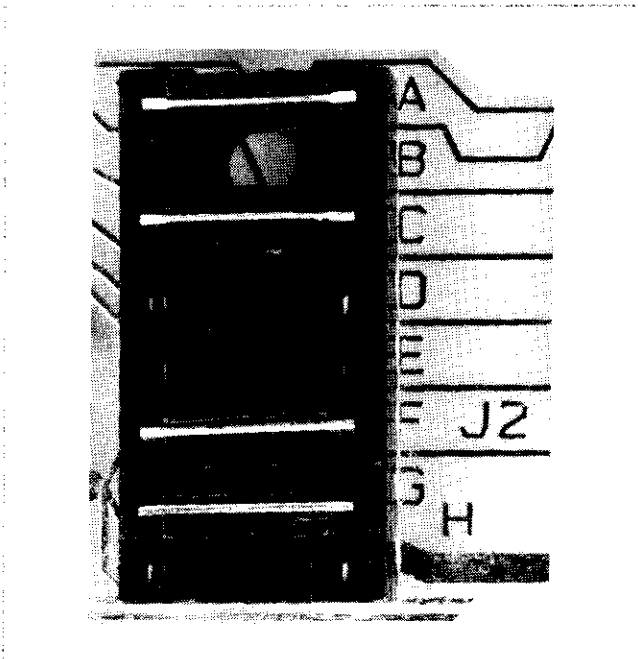

Figure D-1. Option Status Jumpers

WARNING

Positioning of the option jumpers requires working on the instrument with protective covers removed and should be done only by a qualified service techni-

cian who is aware of the potential shock hazard. To avoid electrical shock, the line (mains) power cable should be disconnected before removing the protective covers from the spectrum analyzer.

Four (4) options are available on the OPTION STATUS INTERFACE.

1. Minimum Resolution Bandwidth
Pin A to Pin 1 (100 Hz Bandwidth)*
Pin B to Pin 2 (1 kHz Bandwidth)

NOTE

The Minimum Resolution Bandwidth option is not usable with Option 002 instruments.

2. Display Units – Reference Level
Pin C to Pin 3 (dBm)*
Pin D to Pin 4 (dB μ V)
3. Display Resolution – Center Frequency
Pin E to Pin 5 (100 kHz)*
Pin F to Pin 6 (1 MHz)
4. Reference Position for Normalized Response (INP – B \rightarrow A)
Pin G to Pin 7*
(Center Horizontal Graticule Line)
Pin H to Pin 8
(Top Horizontal Graticule Line)

*No connection needed, default condition.

APPENDIX E SYNTAX REFERENCE GUIDE

This Syntax Reference Guide is intended to provide, in detail, the required forms of command to be used when addressing the analyzer from an external HP-IB controller, and to describe precisely the resulting HP-IB output from the analyzer. It is important to keep in mind that this guide is written from a controller point of view, as user-generated programs will always be executed in the controller, not in the spectrum analyzer.

A pictorial flow representation is used to delineate the sequence of bytes or blocks of traffic across the bus. Literal ASCII characters are bold and shown in rounded envelopes. These are transmitted exactly as shown. Items enclosed by rectangular boxes are blocks of bus traffic which require further explanation. Those used repeatedly are described immediately below; others are dealt with on a command by command basis.

Output UNL TA21 LA18: UNListen, Talk Address 21, Listen Address 18 (analyzer factory-set select code=18) (ASCII code: ?U2)

Enter UNL LA21 TA18: UNListen, Listen Address 21, Talk Address 18 (ASCII code: ?5R)

Additional Commands Additional analyzer commands (two letter mnemonics) may follow within the same "Output" statement

Note that data bytes passed across the bus originate from the controller (controller is talker) until an "Enter" block is transmitted at which time the analyzer generates any succeeding data (analyzer is talker).

In several cases, two commands are used in an identical fashion and are listed together. Each pair performs the same function either on lower or upper lines of text (e.g., AL and AU) or on Trace A or Trace B (e.g., AP and BP). Only the usage of the first command listed is described; the second command may simply be substituted in its place.

A reference in a command description to a "digit" should be understood to be the ASCII code for the character 1, 2, 3, 4, 5, 6, 7, 8, 9, or 0.

The analyzer is able to ignore extra delimiters such as **CR** (carriage return) and **LF** (linefeed) at several points in a command sequence to the analyzer. On the other hand,

every byte indicated as output from the analyzer, i.e., data which immediately follows an "Enter" block, must be read by the controller or the analyzer will not be able to resume normal operation.

All commands which return values to the controller, except for the binary transfer commands, BA, BB, and MS, are terminated by transmitting an LF with the interface bus line EOI (End or Identify) pulled true. The commands BA, BB, and MS send no terminating LF, but the EOI line is pulled true during transmission of the final byte of the returned data sequence. (The final byte is the 962nd byte for BA and BB and is the only byte for MS.)

Pressing RESET on HP-IB controllers generates an interface clear (IFC) command on the bus, which unaddresses the analyzer.

In case an illegal two-character mnemonic is entered (i.e., one which is not part of the analyzer's command set), a message appears on the upper annotation line:

SYNTAX ERROR

To remove the message, send a command AU, or press CLEAR/RESET and hold it in until the annotation returns to the control setting mode.

AU AU: Display lower line, display upper line control settings

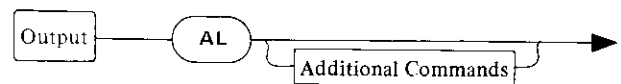

Returns labeling above graticule on CRT to the control setting mode after an LL or LU command. (AU = upper line, AL = lower line)

AP, BP Output coordinates of trace A, trace B peak

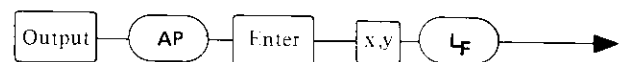

x,y: x,y coordinates (0-480, 0-820) of peak response on trace (AP = trace A, BP = trace B). Format is two 3-digit numbers separated by a comma:

$$\underbrace{d\ d\ d}_{x}, \underbrace{d\ d\ d}_{y}$$

If the peak value occurs at two or more horizontal positions, the leftmost point is returned.

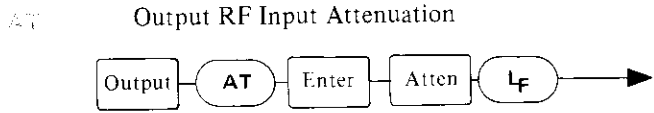

Atten: 0 to 70 for Attenuation in dB

AD See AL

BA, BB Output trace A, output trace B byte values

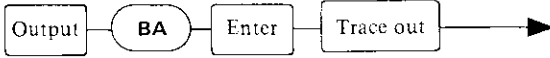

Trace out: 481 trace values (962 bytes) in double-byte format (BA = trace A, BB = trace B):

	ab	ab	ab	ab	ab
value number	1	2	3	480	481

where a and b are 8-bit bytes. Ten bits are required to specify trace values from 0 to 820 display units. 800 represents full-scale deflection. 801-820 are overrange values. The first byte in each number (a) represents the most significant two bits. The second byte (b) represents the least significant eight bits of this 10-bit value. For example, to represent 820, the pair of 8-bit bytes would be:

a = 00000011
b = 00110100

Therefore, when a BA or BB command initiates a byte transfer over the interface, the resulting pairs of bytes must be recombined in the controller to yield meaningful data. Normally, the first byte is either shifted or rotated 8 bits to the left (or multiplied by 2^8) and added to the second byte to effect the recombination.

BB See BA

BP See AP

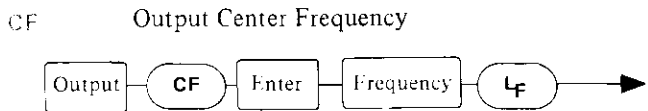

Frequency: -50000000 to 22600000000 for Center Frequency in Hz

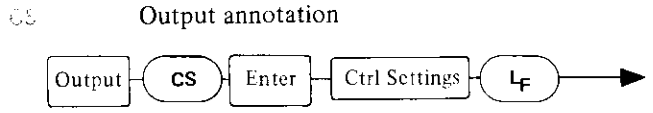

Ctrl settings: A 126-character string, represents two 63-character lines of control setting labels (or LL or LU generated labels) as they are displayed above the graticule on the analyzer CRT. Refer to LL, LU for a table of the character set.

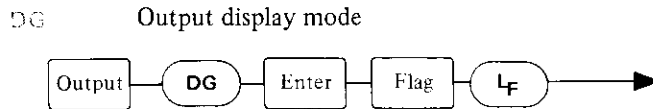

Flag: = 0 for normal mode
= 1 for Digital Average mode

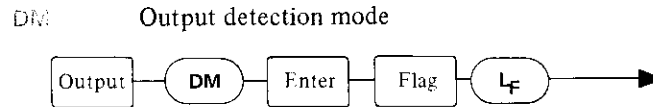

Flag: = 0 for Peak Detection mode
= 1 for Sample mode

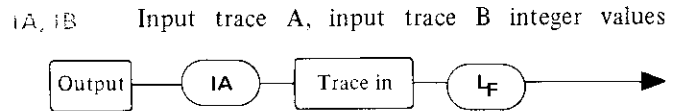

Trace in: Up to 481 values in the range 0-975. Only the integer portion of the number is used. Values will be displayed at the appropriate levels on the CRT except negative values, which will be blanked. The trace values are to be separated by commas, the last value followed by a semi-colon except when a full 481 values are sent, in which case the final semi-colon is optional. For example, an input of 300 values would look like this:

	v,	v,	v,	v,	v;
value number	1	2	3	299	300

where v = 1 to 3 digits

A carriage return before the terminating linefeed is optional and is ignored. If the trace values and commas are sent as a string, do not attempt to send additional commands following in the same 'Output' statement.

IB See IA

LG Output Amplitude Scale

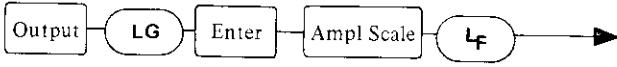

Ampl Scale: = 10, 5, 2, or 1 for LOG scale (dB/division)
= 0 for LINEAR scale

LL, LU Input lower line, input upper line message

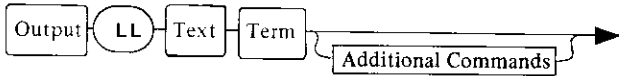

Text: Up to 63 ASCII characters to appear on upper line (LU) or lower line (LL) of labeling above graticule on CRT.

Term: An ASCII terminating character ETX, LF, CR or any byte in the range 0 to 31 decimal.

8569B Display Character Set

32* 63	!"#\$%&'()*+,-./0123456789:;<=>?
64 95	@ABCDEFGHIJKLMNPQRSTUVWXYZ[\]^_`
96 127	~`abcdefghijklmnopqrstuvwxyz{ }~*~

*Character 32 is a blank

LU See LL

MS Output value of sweep flag

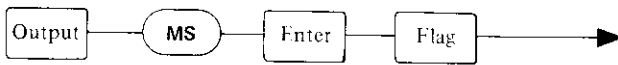

Flag: = 0 for sweep completed
= 1 for sweep in progress

The MS (mid-sweep) flag should be used only following an SF command and refers only to the single sweep triggered by that command. If the MS flag is tested when there has been no SF command, the flag has no meaning and a zero value is returned.

NS Output INP B→A state

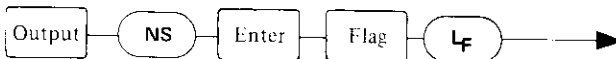

Flag: = 0 for INP-B→A OFF
= 1 for INP-B→A ON

RB Output Resolution Bandwidth

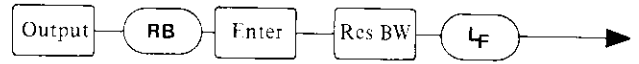

Res BW: = 100 to 3000000 for Resolution Bandwidth in Hz

RL Output Reference Level

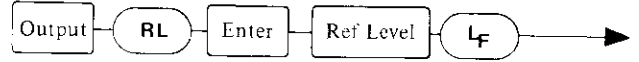

Ref Level: = 60 to -112 for Reference Level in dBm
= 167 to -5 for Reference Level in dBμV*
= 172 to -172 for relative level of center graticule in dB with INP-B→A ON

SF Start sweep and set sweep flag

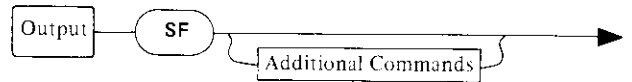

Triggers sweep, sets MS flag = 1. At completion of sweep, MS flag = 0. (SF may not be used when analyzer is in analog or mixed sweep mode.) During the sweep triggered by SF, the MS command may be used to test whether the sweep is in progress or complete. All other analyzer commands sent by the controller during the sweep for which the MS flag = 1 will be accepted and ignored by the analyzer. The MS command is the only command that has meaning during an SF-triggered sweep. See the example at the end of this appendix.

SP Output Frequency Span/Div



Span: = 1000 to 500000000 for Span in Hz/division
= 0 for Zero Span
= -1 for Full Span
= -2 for 1.7-22 GHz Span

*See Appendix D for conversion from dBm readout to dBμV.

Output Sweep Time/Div

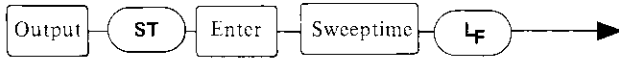

Sweeptime: = 2 to 10000000 for Sweeptime in μ s/division
 = -1 for AUTO sweep
 = -2 for MANual sweep
 = -3 for EXTernal sweep

Output trace A, output trace B integer values

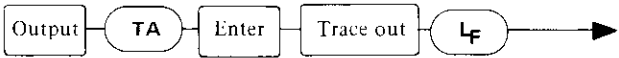

Trace out: 481 values in the range 000 to 820 (3 digits each including leading zeros), each value followed by a comma except the last value (1923 total bytes or ASCII characters).
 (TA = trace A, TB = trace B.)

value number v, v, v, v, v;
 1 2 3 480 481

where v = 3 digits

See TA

Take Sweep

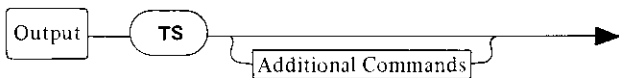

Triggers the analyzer to sweep and inhibits subsequent commands to the analyzer until that sweep is complete. Upon completion of the sweep, the analyzer resumes accepting commands normally. (TS may not be used when analyzer is in analog or mixed sweep mode.)

Output Video Filter

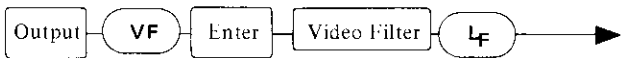

Video Filter: = .3 to .003 for ratio of VF to Res BW
 = -1 for VF 1 Hz (noise average)
 = -2 for VF OFF

EXAMPLE 1

Two of these are SF and MS, which provide the user with additional flexibility in sweep control over that provided by the simpler TS command*. When the analyzer receives the ASCII mnemonic TS, a sweep is triggered and no further commands are accepted until the sweep is finished. This allows a programmer to instruct the analyzer to obtain trace data for the current control settings and input signal conditions without interference from any subsequent commands.

To permit parallel usage of the controller and other HP-IB equipment while the analyzer is sweeping, followed by end-of-sweep program branching, use SF and MS.

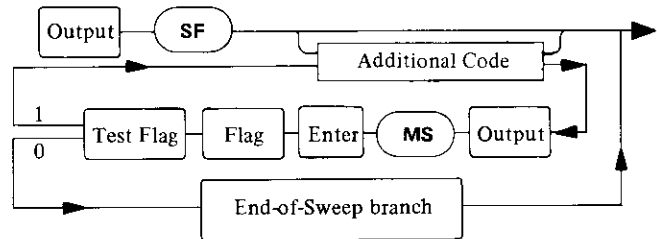

In the flow diagram, the SF instruction triggers a sweep and sets the MS flag = 1. The block Additional Code might represent digital processing of trace data from a previous sweep, or the execution of a separate measurement involving the controller and other instruments on the interface bus. If branching is desired at the end of the sweep (such as outputting the new trace data to the controller and triggering another sweep), the analyzer may be interrogated repeatedly to test the MS flag (the flag remains one for the duration of the sweep and then reverts to zero). Recognition of the zero condition leads to the 'End-of-Sweep branch' command.

It should be understood clearly that for the duration of an SF-triggered sweep (i.e., so long as the MS flag=1) only the specific instruction MS should be sent to the analyzer; any other command sent to the analyzer will be read and discarded. Therefore, resume sending other commands only after the MS flag has returned a zero.

An understanding of the interaction among six of the commands will facilitate their proper utilization in a user's program.

*For this discussion the analyzer is assumed to be in single-sweep trigger mode while executing controller generated sweep instructions TS and SF.

EXAMPLE 2

The four remaining instructions requiring further explanation are two pairs; LL,LU and AL,AU. As LL with AL and LU with AU perform identical functions for their respective lines (lower and upper), only LL and AL is discussed.

Two lines of annotation are displayed above the etched CRT graticule. These may be the turn-on state in which the instrument control settings are displayed, or in a user-enabled state where the labeling lines have been input through the use of LL and LU. To reset the labels to the

control setting mode, AL and AU are provided. Thus, to place the label "8569A Spectrum Analyzer" on the lower line use:

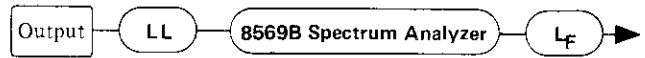

To subsequently reset the lower line to the control setting mode:



APPENDIX F CONTROL GLOSSARY

Front Panel

1. **LINE:** AC line switch. Turns instrument primary power ON-OFF.
2. **FOCUS:** Adjusts sharpness of CRT trace.
3. **TRACE ALIGN:** Rotates trace about center of CRT.
4. **HORIZ POSN:** Adjusts horizontal position of CRT trace.
5. **VERT POSN:** Adjusts vertical position of CRT trace.
6. **CLEAR/RESET:** Momentarily pressing CLEAR/RESET clears trace data in WRITE and MAX HOLD operation and resets sweep. Resets digital averaging routine to begin averaging of subsequent sweeps. Also resets INP – B→A. Aborts plot during plot mode. Clears display from HP-IB control. Holding CLEAR/RESET push button for 2 seconds returns control settings annotation to CRT.
7. **TRACE A, B:** Provides two independent digital traces in the following modes.
 - a. **WRITE:** Displays current input signal with each sweep.
 - b. **MAX HOLD:** Displays only the highest value of trace data over successive sweeps. Process restarted by pressing CLEAR/RESET.
 - c. **STORE VIEW:** Stores current trace and displays it on CRT.
 - d. **STORE BLANK:** Stores current trace without displaying it on CRT. When both STORE BLANK buttons are pressed, analog display appears.
8. **SAMPLE:** Selects sample detection mode for random noise measurements (see Chapter 2).
9. **DGTL AVG:** Digitally averages trace data over successive sweeps. Maximum averaging achieved after 64 sweeps. Sample detection mode automatically selected.
10. **INP – B→A:** Subtracts trace data stored in TRACE B from input signal data and displays resulting data in Trace A. Normalized trace is at the center horizontal graticule line when input signal is equal to stored Trace B (see Chapter 2). Center line reference level (MID) changes to dB for relative measurements.
11. **PLOT:** Provides control of HP-IB plotter set for Listen Only mode. Display information is frozen on screen during plot. Use CLEAR/RESET to abort plot and return to local control.
 - a. **GRAT** plots graticule.
 - b. **CHAR** plots CRT control readouts or HP-IB entered message.
 - c. **TRACE** plots displayed trace(s).
12. **SCALE INTEN:** Adjusts background illumination for photography. Set to blue area for CRT photographs. Does not operate in ANALOG DSPL mode.
13. **INTEN:** Adjusts brightness of CRT trace and characters. Set to the blue region for CRT photographs.
14. **1ST LO OUTPUT:** A 2.0 to 4.46 GHz, +7 dBm nominal output coupled from first local oscillator. Terminate with 50Ω load when not in use. (Refer to Appendix B for information on LO for each Frequency Band.)
15. **CAL OUTPUT:** An internal 100 MHz, –10 dBm (+97 dBμV) calibration signal.
16. **SIG IDENT:** Used to verify frequency of unknown signals. Especially useful in External Mixing bands.
17. **VIDEO FILTER:** Selects post-detection, low-pass filters which smooth the trace by averaging random noise. The Video Filter bandwidth is equal to the Resolution BW times the factor indicated on the control knob. The NOISE AVG position is a fixed 1 Hz low-pass filter used for noise measurements only.
18. **FREQUENCY GHz:** Displays the tuned center frequency of analyzer in PER DIV and ZERO SPAN. In Full Band modes, displays frequency of the tuning marker.