

Errata

Title & Document Type: 83731B/83732B Synthesized Signal Generators User's Guide

Manual Part Number: 83731-90128

Revision Date: July 1997

HP References in this Manual

This manual may contain references to HP or Hewlett-Packard. Please note that Hewlett-Packard's former test and measurement, semiconductor products and chemical analysis businesses are now part of Agilent Technologies. We have made no changes to this manual copy. The HP XXXX referred to in this document is now the Agilent XXXX. For example, model number HP8648A is now model number Agilent 8648A.

About this Manual

We've added this manual to the Agilent website in an effort to help you support your product. This manual provides the best information we could find. It may be incomplete or contain dated information, and the scan quality may not be ideal. If we find a better copy in the future, we will add it to the Agilent website.

Support for Your Product

Agilent no longer sells or supports this product. You will find any other available product information on the Agilent Test & Measurement website:

www.tm.agilent.com

Search for the model number of this product, and the resulting product page will guide you to any available information. Our service centers may be able to perform calibration if no repair parts are needed, but no other support from Agilent is available.



User's Guide



HP 83731B/32B Synthesized Signal Generators

The 83731B/32B Synthesized Signal Generators

The HP 83731B/32B synthesized signal generators (referred to as “synthesizers” throughout this manual) provide FM, Log/Lin AM, ϕ M, and pulse modulation capability. The HP 83731B has a carrier frequency range of 1 GHz to 20 GHz and the HP 83732B has a carrier frequency range of 10 MHz to 20 GHz. Specification information can be found in Chapter 4, “Specifications and Options.”

The *HP 83731B/32B Synthesized Signal Generators User's Guide* is written to accommodate the novice and the expert user. If you are unfamiliar with the synthesizer, Chapter 2, “Performing Fundamental Synthesizer Operations,” is useful. If you are familiar with the synthesizer, Chapter 3, “Generating Signals with the Synthesizer” section is helpful. If you are looking for specific, detailed information about the synthesizer, refer to the chapters as needed.

The Synthesizer at a Glance

The following figure and accompanying text explains some features of the HP 83731B and HP 83732B with Option 1E2 installed.

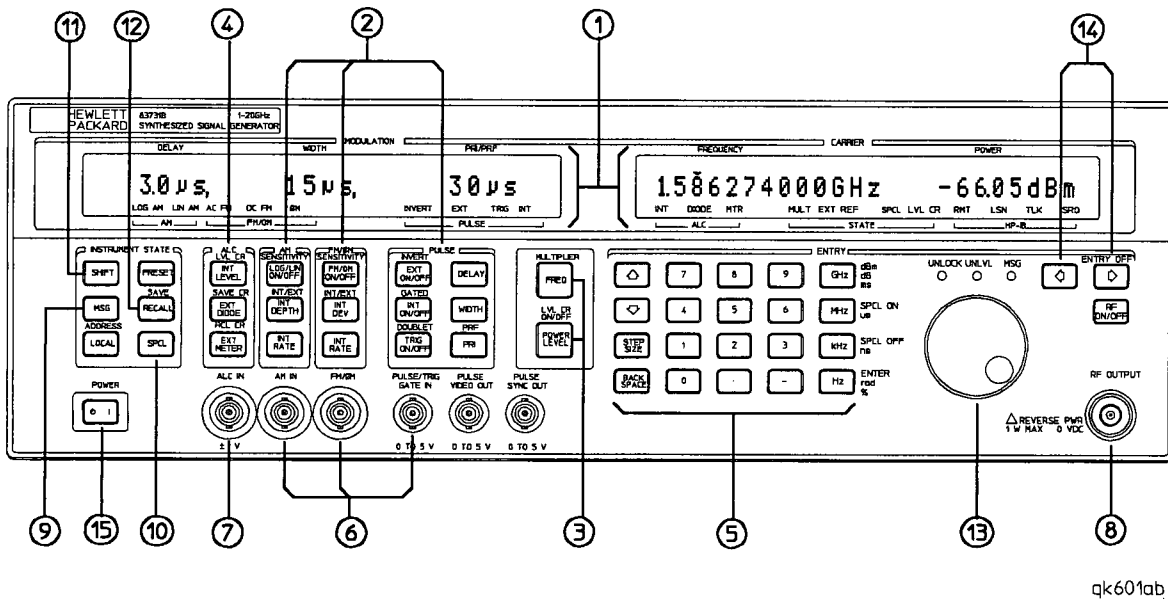

HP 83731B/32B Synthesized Signal Generator

1. The displays show the current values of synthesizer parameters as well as the status of many of the synthesizer functions. The right-most display shows the current carrier frequency and output power level. The left-most display shows current modulation parameters when they are selected. The left-most display also displays parameters as they are being entered or modified. The annunciators that appear below the parameters are only visible when their associated function is active. For example, the **LOG AM** annunciator will only be visible when logarithmic AM is active.

2. The modulation keys are used to select the various modulation types that are available and enter or modify their associated parameters.

3. These keys set the carrier frequency and RF output power level of the synthesizer.

4. The Automatic Level Control keys select the method used to regulate the synthesizer output power level. Either internal leveling, external power meter leveling, or external diode detector leveling can be selected. Additional external equipment is required when either external power meter leveling or external diode detector leveling is used.

5. The data entry keys are used to enter and modify various synthesizer parameters. The **BACKSPACE** key cancels all or part of an erroneous parameter entry before it has been terminated. The terminator keys (the right-most column of keys) are used to choose the units for the entered parameter as well as to terminate the parameter entry. The **↑**, **↓**, and **STEP SIZE** keys are used to increase or decrease a parameter in predetermined steps.

6. The modulation inputs provide the connections for external modulating signals. The RF output can be modulated with any combination of log/in AM, FM/φM, or pulse modulation. The **PULSE/TRIG, GATE IN** connector is also used as a trigger/gate input for certain internal pulse modulation modes. These connectors mate with male BNC type connectors.

7. The Automatic Level Control voltage input (ALC IN) connector is used as the feedback path to the synthesizer when its RF output power level is being leveled externally.

8. The **RF OUTPUT** connector mates with a female APC-3.5 mm precision connector on instruments with option 1E9 installed. The connector mates with a type-N male connector on non-option 1E9 instruments.

9. The **MSG** key allows you to display any error messages on the front panel display. Error messages are generated when you perform a keystroke sequence that is not valid, try to operate the synthesizer in a mode that is not allowed, an unlevelled condition exists, etc.

10. The **SPCL** key is used to initiate the activation of several special functions available in the synthesizer. Special functions are additional functions that are not activated by pressing a front panel key or shifted key.

11. The **SHIFT** key changes the function of some of the keys. When you press the **SHIFT** key and then press another key, the synthesizer performs the function printed in blue above the key.

12. The save/recall keys are used to save most of the synthesizer operating parameters in one of nine nonvolatile register locations so that they can be recalled and used at a later time.

13. The knob is used to increase or decrease the digit under the cursor (▼) in the display in steps of one.

14. The **←** and **→** keys move the cursor that is over one of the digits in the display either to the right or left when pressed. The digit that is under the cursor will be modified when the knob is rotated. If no cursor appears in the display, parameter entry or modification has been inhibited.

15. The **POWER** switch turns the synthesizer either on or off.

Synthesizer rear panel features are depicted and described in detail in Chapter 5, "Front/Rear Panel," in this book.

In This Book

This book is divided into the following chapters:

- **Chapter 1, “Installing and Verifying the Synthesizer,”** contains procedures for installing the synthesizer and verifying its operation.
- **Chapter 2, “Performing Fundamental Synthesizer Operations,”** familiarizes you with the fundamental operation of the synthesizer.
- **Chapter 3, “Generating Signals with the Synthesizer,”** explains how to generate signals using various combinations of AM, FM, ϕ M, pulse modulation, and signal leveling.
- **Chapter 4, “Specifications and Options,”** contains a list of the synthesizer performance specifications as well as the various mechanical, electrical, warranty, and documentation options that are available.
- **Chapter 5, “Front/Rear Panel,”** contains entries that explain different aspects of the synthesizer front and rear panel. (For example, you turn to this chapter for information on the RF connectors.)
- **Chapter 6, “Keys/Shifted Functions,”** contains entries on the function of each key on the synthesizer front panel as well as the shifted or alternate function of certain keys.
- **Chapter 7, “Special Functions,”** contains entries on the special functions available in the synthesizer. Special functions are hidden during normal instrument operation and can only be invoked by typing a specific key sequence on the synthesizer front panel.
- **Chapter 8, “Error Messages,”** contains a table that lists all of the error messages that might be generated during use of the instrument. Each table entry contains a sequence that can be followed to recover from the error condition.
- **Chapter 9, “Legal and Regulatory Information,”** contains information related to safety and SCPI conformance information. The product warranty is also contained in this chapter.

Contents

1. Installing and Verifying the Synthesizer	
Installing the Synthesizer	1-3
To Unpack the Synthesizer	1-3
To Install the Synthesizer	1-5
Verifying Synthesizer Functionality	1-7
If You Encounter a Problem	1-8
Mechanical or Electrical Damage	1-8
Power-up Problems	1-8
Self Test Failures	1-10
2. Performing Fundamental Synthesizer Operations	
To Enter Data with the Numeric Keypad	2-3
To Modify Data with the Knob	2-4
To Modify Data with the Arrow Keys	2-6
To Save and Recall Synthesizer States	2-8
Programming Example	2-9
To Read the Contents of the Error Queue	2-10
Programming Example	2-11
To Set the HP-IB Address	2-12
Programming Example	2-12
If You Encounter a Problem	2-13
Data Entry Problems	2-13
Programming Problems	2-14
3. Generating Signals with the Synthesizer	
To Generate a CW Signal	3-3
To Generate an Internal FM Signal (Option 1E2 Required)	3-4
To Generate an Externally Modulated AC FM Signal	3-6
To Generate a Power Sweep Using the Internal Function Generator (Option 1E2 Required)	3-9
To Generate a Power Sweep Using an External Function Generator	3-11
To Generate Repetitive, Internal Pulse Modulation	3-14
Related Tasks	3-16
To Generate Externally Triggered Pulse Modulation	3-17
Related Tasks	3-20

To Generate Repetitive, External Pulse Modulation . . .	3-21
Related Tasks	3-23
To Generate a Doublet Pulse	3-24
Related Tasks	3-27
To Generate Gated Pulse Modulation	3-28
Related Tasks	3-31
To Generate Simultaneous Log AM and Pulse Modulation	3-32
Related Tasks	3-35
To Generate an Internal Linear AM Signal (Option 1E2 Required)	3-36
To Generate an External Linear AM Signal	3-37
To Generate an Internal Phase Modulated Signal (Option 1E2 and 800 Required)	3-39
To Generate an External Phase Modulation Signal	3-40
To Generate Millimeter Signals	3-43
To Use External Diode Detector Leveling	3-46
Related Tasks	3-48
To Use External Power Meter Leveling	3-49
Related Tasks	3-51
To Use the Level Correct Routine	3-52
Related Tasks	3-57
To Use Previously Stored Level Correct Data	3-58
Related Tasks	3-59
If You Encounter a Problem	3-60
Annunciators Turned On	3-61
RF Output Problems	3-62
4. Specifications and Options	
Specifications	4-3
Frequency	4-3
RF Output	4-4
Spectral Purity	4-7
Modulation	4-10
Option 1E2	4-17
General	4-20
Front Panel Connectors	4-22
Rear Panel Connectors	4-23
Options	4-24
Electrical Options	4-25
Option 1E1 - Add Output Step Attenuator	4-25
Option 1E2 - Add Internal Modulation Generator . .	4-25

Option 1E5 - Add High Stability Timebase	4-25
Option 1E8 - 1 Hz Frequency Resolution	4-25
Option 1E9 - 3.5 mm RF Output Connector	4-26
Option 800 - Phase Modulation	4-26
Mechanical Options	4-27
Option 1CM - Rack Mount Kit	4-27
Option 1CP - Rack Mount and Handle Kit	4-27
Option 1CR - Rack Slide Kit	4-27
Warranty Options	4-28
Option W30 - Two Additional Years Return-to-HP Service	4-28
Option W32 - Three Year Return to HP Calibration Service	4-28
Documentation Options	4-29
Option OB0 - Delete Operating Documentation	4-29
Option OB1 - Extra Operating Documentation	4-29
Option OBV - Component-Level Information Packet (CLIP)	4-29
Option OBW - Service Documentation	4-29
Option OBX - Component-Level Information Packet (CLIP)/Service Documentation	4-29

5. Front/Rear Panel

Annunciators	5-3
See Also	5-5
Connectors	5-6
Coaxial Connectors	5-7
HP-IB Connector	5-10
Display	5-13
See Also	5-15
Knob	5-16
Equivalent SCPI Command	5-16
See Also	5-17
POWER Switch	5-18
See Also	5-18
Power Cables	5-19

6. Keys/Shifted Functions	
⇒	6-3
Equivalent SCPI Command	6-4
See Also	6-4
⇐	6-5
Equivalent SCPI Command	6-6
See Also	6-6
↑	6-7
Equivalent SCPI Commands	6-7
See Also	6-8
↓	6-9
Equivalent SCPI Commands	6-9
See Also	6-10
ADDRESS	6-11
Equivalent SCPI Command	6-11
See Also	6-11
BACK SPACE	6-12
Equivalent SCPI Command	6-12
See Also	6-12
DELAY	6-13
Positive/Negative Delay	6-14
Equivalent SCPI Command	6-14
See Also	6-14
DOUBLET	6-15
Doublet Pulse Mode	6-15
Equivalent SCPI Commands	6-16
See Also	6-16
Hz (ENTER)	6-17
Equivalent SCPI Command	6-17
See Also	6-18
ENTRY OFF	6-19
Equivalent SCPI Command	6-19
See Also	6-19
EXT DIODE	6-20
External Diode Detector Leveling	6-20
Applications	6-21
Advantages of Diode Detector Leveling	6-22
Disadvantages of Diode Detector Leveling	6-22
Equivalent SCPI Command	6-23
See Also	6-23
EXT METER	6-24

External Power Meter Leveling	6-25
Applications	6-26
External Equipment Limitations	6-26
Power Meter	6-26
Power Sensor	6-26
Advantages of Power Meter Leveling	6-26
Disadvantages of Power Meter Leveling	6-27
Equivalent SCPI Commands	6-28
See Also	6-28
EXT ON/OFF	6-29
Equivalent SCPI Commands	6-29
See Also	6-29
FM/ ϕ M ON/OFF (Option 800 Required for ϕ M)	6-30
Equivalent SCPI Command	6-30
See Also	6-31
FREQ	6-32
Equivalent SCPI Command	6-33
See Also	6-33
GATED	6-34
Internal Gated Pulse Mode	6-35
Equivalent SCPI Commands	6-36
See Also	6-36
INT DEPTH [AM] (Only Available with Option 1E2)	6-37
Equivalent SCPI Command	6-38
See Also	6-38
INT DEV (Only Available with Option 1E2)	6-39
FM Internal Deviation	6-39
Equivalent SCPI Command	6-40
See Also	6-41
ϕ M Internal Deviation (Options 1E2 and 800 Required)	6-41
Equivalent SCPI Command	6-43
See Also	6-43
INT/EXT (Only Available with Option 1E2)	6-44
AM Internal/External Function	6-44
Equivalent SCPI Commands	6-45
See Also	6-45
FM/ ϕ M Internal/External Function	6-45
Equivalent SCPI Commands	6-46
See Also	6-46
INT LEVEL	6-47
Advantages of Internal Leveling	6-48

Disadvantages of Internal Leveling	6-48
Equivalent SCPI Commands	6-48
See Also	6-49
INT ON/OFF	6-50
Equivalent SCPI Commands	6-50
See Also	6-50
INT RATE (Only Available with Option 1E2)	6-51
AM Internal Rate (Option 1E2 Required)	6-51
Equivalent SCPI Command	6-51
See Also	6-52
FM Internal Rate (Option 1E2 Required)	6-52
Equivalent SCPI Command	6-52
See Also	6-53
ϕM Internal Rate (Option 1E2 and Option 800 Required)	6-53
Equivalent SCPI Command	6-54
See Also	6-54
INVERT	6-55
Equivalent SCPI Commands	6-55
See Also	6-56
LOCAL	6-57
Equivalent SCPI Command	6-57
See Also	6-57
LOG/LIN ON/OFF	6-58
Equivalent SCPI Commands	6-59
See Also	6-59
LVL CR	6-60
Equivalent SCPI Command	6-63
See Also	6-63
LVL CR ON/OFF	6-64
Equivalent SCPI Commands	6-65
See Also	6-65
MSG	6-66
Equivalent SCPI Command	6-66
See Also	6-66
MULTIPLIER	6-67
Equivalent SCPI Command	6-68
See Also	6-68
Numeric Keypad	6-69
See Also	6-69
POWER LEVEL	6-70

Equivalent SCPI Command	6-71
See Also	6-71
PRESET	6-72
Equivalent SCPI Commands	6-74
See Also	6-74
PRF	6-75
Equivalent SCPI Command	6-76
See Also	6-77
PRI	6-78
Equivalent SCPI Command	6-79
See Also	6-79
RCL CR	6-80
Equivalent SCPI Command	6-81
See Also	6-81
RECALL	6-82
Equivalent SCPI Command	6-82
See Also	6-82
RF ON/OFF	6-83
Equivalent SCPI Command	6-83
See Also	6-83
SAVE	6-84
Equivalent SCPI Command	6-84
See Also	6-84
SAVE CR	6-85
Equivalent SCPI Command	6-86
See Also	6-86
SENSITIVITY	6-87
AM Sensitivity	6-87
Equivalent SCPI Command	6-88
See Also	6-88
FM Sensitivity	6-88
Equivalent SCPI Command	6-90
See Also	6-91
ϕ M Sensitivity	6-92
Equivalent SCPI Command	6-94
See Also	6-94
SHIFT	6-95
Equivalent SCPI Command	6-95
See Also	6-95
SPCL	6-96
Equivalent SCPI Command	6-96

See Also	6-97
SPCL OFF (kHz)	6-98
Equivalent SCPI Command	6-98
See Also	6-99
SPCL ON (MHz)	6-100
Equivalent SCPI Command	6-100
See Also	6-101
STEP SIZE	6-102
Equivalent SCPI Commands	6-102
See Also	6-103
TRIG ON/OFF	6-104
Equivalent SCPI Commands	6-105
See Also	6-105
WIDTH	6-106
Equivalent SCPI Command	6-106
See Also	6-107

7. Special Functions

AC PM COUPLING (Only Available with Option 800)	7-3
Advantages	7-3
Disadvantages	7-4
Equivalent SCPI Command	7-4
See Also	7-4
AM WAVEFORM (Only Available with Option 1E2)	7-5
Applications	7-6
Equivalent SCPI Command	7-8
See Also	7-8
ATTEN HOLD ON/OFF	7-9
Application	7-10
Advantages	7-10
Disadvantages	7-10
Equivalent SCPI Command	7-11
See Also	7-11
AVG PWR INHIBIT ON/OFF	7-12
Application	7-13
Pulsed Power Pre-Calibration Program	7-14
Equivalent SCPI Command	7-18
See Also	7-18
CLEAR DISPLAY	7-19
Equivalent SCPI Command	7-20
See Also	7-20

DC FM COUPLING	7-21
Advantage	7-21
Disadvantage	7-22
Equivalent SCPI Command	7-22
See Also	7-22
ERASE MEMORY	7-23
Application	7-23
Equivalent SCPI Command	7-23
See Also	7-24
FM WAVEFORM (Only Available with Option 1E2)	7-25
Applications	7-25
Equivalent SCPI Command	7-27
See Also	7-27
INT MOD OVERRANGE (Only Available with Option 1E2)	7-28
Advantages	7-29
Disadvantages	7-29
Equivalent SCPI Command	7-30
See Also	7-30
PM RANGE (Only Available with Options 1E2 and 800)	7-31
Additional Information	7-31
Advantages	7-33
Disadvantages	7-33
Equivalent SCPI Command	7-33
See Also	7-33
PM WAVEFORM (Only Available with Options 1E2 and 800)	7-34
Applications	7-35
Equivalent SCPI Command	7-36
See Also	7-36
PWR MTR ADDRS	7-37
Equivalent SCPI Command	7-38
See Also	7-38
PWR MTR SELECT	7-39
Equivalent SCPI Command	7-39
See Also	7-40
REMOTE LANGUAGE	7-41
Equivalent SCPI Command	7-41
See Also	7-41
SELECT RISETIME	7-42
Applications	7-43

Equivalent SCPI Command	7-44
See Also	7-44
SELF TEST	7-45
Equivalent SCPI Command	7-46
See Also	7-46
Service-Related Special Functions	7-47
See Also	7-47
SHOW INFO	7-48
Equivalent SCPI Command	7-48
See Also	7-48

8. Error Messages

Error Messages List	8-3
Messages	8-5

9. Legal and Regulatory Information

Safety Symbols	9-3
Miscellaneous Symbols	9-4
Safety Considerations	9-5
Before Applying Power	9-5
Safety Earth Ground	9-5
Cleaning the Product	9-6
Certification	9-7
Warranty	9-8
Limitation of Warranty	9-8
Exclusive Remedies	9-9
Assistance	9-10

Index

Figures

1-1. Line Fuse Removal and Replacement	1-9
3-1. AC FM Equipment Setup	3-6
3-2. 25 dB Power Sweep	3-10
3-3. Log AM Equipment Setup	3-11
3-4. Example Sawtooth Waveform	3-13
3-5. Externally Triggered Pulse Modulation Equipment Setup	3-17
3-6. Triggered Pulse Mode Timing Example	3-19
3-7. External Pulse Modulation Equipment Setup	3-21
3-8. Doublet Pulse Equipment Setup	3-24
3-9. Doublet Pulse Mode Timing Example	3-26
3-10. Gated Pulse Modulation Equipment Setup	3-28
3-11. Gated Pulse Mode Timing Example	3-30
3-12. Antenna Scan Equipment Setup	3-33
3-13. Example Antenna Scan Input	3-34
3-14. Example Modulated Antenna Scan Pattern	3-34
3-15. External Linear AM Equipment Setup	3-37
3-16. External Phase Modulation Equipment Setup	3-41
3-17. Millimeter-Wave Equipment Setup	3-43
3-18. External Diode Detector Leveling Setup	3-47
3-19. External Power Meter Leveling Setup	3-49
3-20. Level Correct Routine Equipment Setup	3-53
4-1. Typical Maximum Available Output Power from 1 to 20 GHz, at 25 °C with Output Step Attenuator (Option 1E1) Installed	4-4
4-2. Typical Maximum Available Output Power from 0.01 to 1 GHz at 25 °C	4-5
4-3. Typical Output Level Accuracy and Flatness at +10 and –85 dBm	4-6
4-4. Typical Single-sideband Phase Noise at 50 MHz, 1 GHz, 10 GHz, and 20 GHz, 25 °C, CW Mode. Offsets Less than 100 Hz Require the High Stability Timebase, Option 1E5.	4-7
4-5. Typical 2nd Harmonic Levels Measured at Output Power of +6 dBm	4-8
4-6. Typical Residual FM Measured in 50 Hz – 15 kHz Bandwidth, CW Mode, with High Stability Timebase (Option 1E5)	4-9
4-7. Typical Pulse Modulation On/Off Ratio at +8 dBm	4-11

Contents

4-8. Typical Pulse Modulation Envelope Illustrates the Fast Rise and Fall Times, Excellent Flatness and Pulse Fidelity . . .	4-12
4-9. Typical Log AM Error (deviation from desired depth) at 25 °C for Carrier Frequencies between 1.0 and 20 GHz	4-15
4-10. Dimensions	4-21
5-1. Synthesizer Display Annunciators	5-3
5-2. Synthesizer Connectors - Front Panel	5-6
5-3. Synthesizer Connectors - Rear Panel	5-6
5-4. HP-IB Connector and Cable	5-10
5-5. Synthesizer Display	5-13
5-6. Power Cable and Line (Mains) Plug Part Numbers	5-20
6-1. Doublet Pulse Mode Timing	6-15
6-2. External Diode Detector Leveling Setup	6-21
6-3. External Power Meter Leveling Setup	6-25
6-4. Internal Gated Pulse Mode Timing	6-35
6-5. Internal Triggered Pulse Mode Timing	6-104
7-1. Phase Deviation vs Phase Modulation Rate from 2–20 Ghz . .	7-32

Tables

4-1. Maximum Deviation (with sinewave modulation only)	4-13
4-2. Modulation Index	4-14
4-3. Hardware Resolution	4-18
4-4. ϕ M Hardware Resolution (Low Range)	4-19
4-5. ϕ M Hardware Resolution (High Range)	4-19
5-1. HP-IB Interface Cables Available	5-10
6-1. Allowable Delay Range	6-13
6-2. FM Deviation Resolution	6-40
6-3. ϕ M Deviation Resolution (Low Range)	6-42
6-4. ϕ M Deviation Resolution (High Range)	6-42
6-5. PRESET Conditions	6-73
6-6. Maximum Specified PRF	6-75
6-7. Minimum Specified PRI	6-78
6-8. FM Sensitivity Ranges	6-89
6-9. ϕ M Sensitivity Ranges	6-92
7-1. Service-Related Special Functions	7-47
9-1. Hewlett-Packard Sales and Service Offices	9-11

Contents







Installing and Verifying the
Synthesizer

Installing and Verifying the Synthesizer

This chapter contains procedures for properly installing your HP 83731B/32B synthesizer and procedures for functional verification of the instrument.



Installing the Synthesizer

This procedure explains how to inspect, install, and power-up the synthesizer.

To Unpack the Synthesizer

1. **Inspect the shipping container for damage.**

Look for signs of damage such as a dented or torn shipping container or cushioning material that shows signs of unusual stress or compacting.

2. **Carefully remove the contents from the shipping container and inspect each item for damage.**

If the instrument or any accessories appear to be damaged, refer to “Mechanical or Electrical Damage” at the end of this chapter. The following items should have been received in the shipment.

Installing and Verifying the Synthesizer

Installing the Synthesizer

Item	Model/Part Number
Instrument	HP 83731B/32B
Power Cable	Depends on shipment destination. Refer to "Power Cables" in Chapter 5 of this manual.
User's Guide	83731-90128
Quick Start Guide	83731-90130
Programming Guide	83731-90129
Calibration Kit	5063-1635
Calibration Guide	83731-90125
Calibration Software	5010-7723
<i>One of the following options is also included:</i>	
Handle Kit	5062-3989 (Standard)
Rack Mount Kit	5062-3977 (Option 1CM)
Rack Mount Kit with Handles	5062-3983 (Option 1CP)
Rack Slide Kit	1494-0059 (Option 1CR)

3. Keep the shipping materials for future use.

If undamaged, shipping materials are useful for shipment or storage of the instrument. If damaged, shipping materials should be kept for the carrier's inspection.

To Install the Synthesizer

The following provides a general procedure for installation and initial power up of the HP 83731B/32B synthesizer.

1. Check to make sure that the power cable is undamaged.

Do not use the power cable if the plug contacts are bent or broken or if the wire insulation is damaged or if wire is exposed. Never use a power cable if the grounding contact has been removed.

CAUTION

Always use the three-prong AC power cord supplied with this product. Failure to ensure adequate earth grounding by not using this cord may cause product damage.

2. Set the POWER switch on the synthesizer to standby (⏻).
3. Set the line voltage selector switch to match the mains voltage.

The line voltage selector switch is located on the rear panel of the synthesizer to the right of the power module. Use a small, flat blade screwdriver to set the switch up for mains voltages in the range of 90 V to 132 V; 50, 60, or 400 Hz or down for mains voltages in the range of 198 V to 264 V; 50 or 60 Hz.

WARNING

This is a Safety Class I product provided with a protective earthing ground incorporated in the power cord. The mains plug shall only be inserted in a socket outlet provided with a protective earth contact. Any interruption of the protective conductor inside or outside of the product is likely to make the product dangerous. Intentional interruption is prohibited.

4. Push the module end of the power cable into the power module on the rear panel of the synthesizer until it is firmly seated.
5. Connect the plug end of the power cable to a suitable mains power receptacle.

Installing the Synthesizer

6. Set the POWER switch to on (I).

When you turn the synthesizer on, the displays and annunciators light momentarily and the ventilation fan starts. In addition, it is normal for the LED annunciators (including the MSG LED) to turn on and then off during a power-up test. (The MSG LED should be off when the power-up test is complete.)

NOTE

Error message 940 TIMEBASE OVEN COLD will remain on after the power-up test if the instrument has the Option 1E5 installed, and has been disconnected from the mains power. This error should go away after a short warm-up period.

Once the power-up test is complete, the frequency and power level will be displayed in the right-most display and pulse parameters will be displayed in the left-most display if pulse modulation is enabled.

Verifying Synthesizer Functionality

The verification procedure is suitable for incoming inspection; however, you can refer to the *HP 83731A/32A and HP 83731B/32B Synthesized Signal Generators Service Guide* or the *HP 83711A/12A, HP 83711B/12B, HP 83731A/32A, and HP 83731B/32B Synthesized Signal Generators Calibration Guide* for procedures that test all warranted specifications.

1. Activate the self test special function.

To activate the self test special function, perform the following procedure.

- a. Press the **SPCL** key.
- b. Press **5** on the synthesizer numeric keypad.
- c. Terminate the special function entry by pressing the **Hz** (ENTER) key.

The left-most display will read: SELF TEST?, PRESS ENTER

2. Press the **Hz** (ENTER) key again to initiate the synthesizer self test routine.

When the self test routine is running, the left-most display will read: SELF TESTING. If the self-test fails, the left-most display momentarily reads: Test XX=XXXX. If self-test passes, then the left-most display reads: Self Test Pass.

3. If the self test indicates an error condition, refer to the section entitled "If You Encounter a Problem" at the end of this chapter.

An error condition exists when XX in the statement Test Result=XX is a non-zero value.

If You Encounter a Problem

If you have a problem while installing or verifying the synthesizer, check the following list of commonly encountered problems and troubleshooting procedures. If the problem that you encounter is not in the following list, contact the nearest Hewlett-Packard office for assistance.

Mechanical or Electrical Damage

If the instrument is mechanically or electrically damaged:

- Contact the nearest Hewlett-Packard office.

If the shipping materials are damaged and the instrument is mechanically or electrically damaged:

- Contact the carrier as well as the nearest Hewlett-Packard office.
- Keep the shipping materials for the carrier's inspection.

Power-up Problems

If the synthesizer has no power:

- Check that the power cord is fully seated in both the mains power receptacle and the synthesizer power module.
- Check that the synthesizer line fuse is not open.

WARNING

For continued protection against fire hazard, replace line fuse only with same type and ratings. The use of other fuses or materials is prohibited.

Refer to Figure 1-1 to remove the fuse from the power module. You can use a continuity light or an ohmmeter to check the fuse. An ohmmeter should read very close to zero ohms if the fuse is good. The 6.3A, 250 V fuse is HP part number 2110-0703.

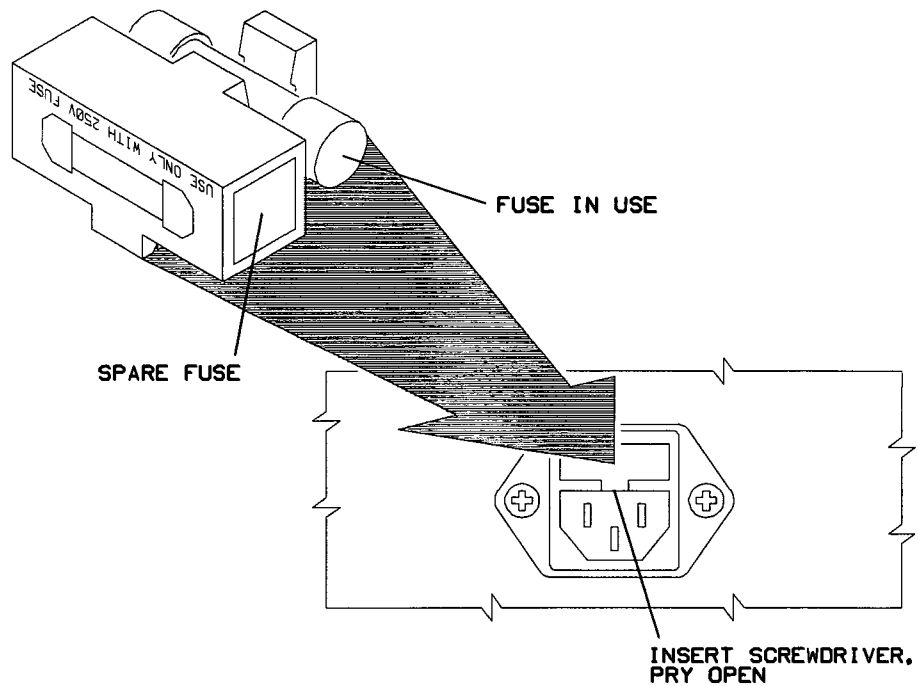

Figure 1-1. Line Fuse Removal and Replacement

- Contact the nearest Hewlett-Packard office for service, if necessary.
- If the displays light, but the ventilation fan does not start:**
- Check that the fan is not stuck. To check the fan, follow these steps:
 1. Set the POWER switch to standby (⏻).
 2. Check that the fan blades are not jammed.
 - Contact the nearest Hewlett-Packard office for service, if necessary.

Installing and Verifying the Synthesizer

If the synthesizer MSG LED annunciator remains on after the power-up test is complete:

If the synthesizer MSG LED annunciator is on, there is a problem with the synthesizer. To determine the error and turn off the MSG LED annunciator, refer to “To Read the Contents of the Error Queue” in Chapter 2 and the listing of error messages in Chapter 8.

NOTE

Error message 940 TIMEBASE OVEN COLD will remain on after the power-up test if the instrument has the Option 1E5 installed, and has been disconnected from the mains power. This error should go away after a short warm-up period.

Self Test Failures

If the Self Test Fails:

- Check the contents of the error queue for error messages.

To determine errors and clear them, refer to “To Read the Contents of the Error Queue” in Chapter 2 and the listing of error messages in Chapter 8.

2. Performing
Fundamental
Synthesizer Operations





Performing Fundamental Synthesizer Operations



Performing Fundamental Synthesizer Operations

This chapter describes fundamental synthesizer operations. The purpose of this chapter is to familiarize you with the fundamental operation of the synthesizer. Procedures cover how to enter or modify data, how to set the HP-IB address, how to save and recall instrument states, etc.

NOTE

This product has been designed and tested in accordance with IEC Publication 1010, Safety Requirements for Electronic Measuring Apparatus, and has been supplied in a safe condition. The instruction documentation contains information and warnings which must be followed by the user to ensure safe operation and to maintain the product in a safe condition.

WARNING

If this product is not used as specified, the protection provided by the equipment could be impaired. This product must be used in a normal condition (in which all means for protection are intact) only.

To Enter Data with the Numeric Keypad

The synthesizer numeric keypad and units terminator keys provide one way to enter function parameters.

1. Select the desired function key or shifted function key.

The function must have a numeric value (parameter) associated with it in order to enter a new value with the numeric keypad. **FREQ** and **SHIFT**, **PRI** (PRF) are examples of functions with parameters.

For example, to select power level so that its parameter is active, press the **POWER LEVEL** key.

Notice that a cursor (▼) appears over one of the digits in the power level display. The cursor will always appear over one of the digits of the active parameter.

NOTE

Two cursors will appear (▼▼) when the cursor is positioned off the display.

2. Enter the desired value of the parameter by pressing the numeric keys and, if necessary, the negative and decimal keys.

Notice that, as you press the keys, the display shows the numbers that are entered.

3. Press the appropriate units terminator key to enter the value.

The units terminator keys appear to the right side of the numeric keypad.

The following steps show how to enter a value of -0.5 dBm for power level:

- a. Press the **POWER LEVEL** key.
- b. Press **-0.5** on the numeric keypad.
- c. Press the **GHz** (dBm) key to terminate the entry.

Once you terminate the entry, the synthesizer updates the power level value to -0.5 dBm.

To Modify Data with the Knob

The knob on the synthesizer front panel is used to modify data. You turn the knob in order to increase or decrease the parameter value of the currently active function. Additionally, you can modify the position of the cursor (▼) that is over the active parameter in order to increase or decrease the rate at which the function parameter changes.

1. Select the function key of the parameter to be modified.

When the function key is selected, the cursor appears over one of the digits of the selected parameter.

For example, to select the frequency function, press the **FREQ** key. The frequency parameter is selected when the cursor appears over one of the digits of the frequency display.

2. Turn the knob clockwise to increase the parameter or counterclockwise to decrease the parameter.

When you turn the knob, the digit under the cursor increases or decreases in steps of one.

For example, when frequency is in its preset state and is the active parameter, the frequency display shows the following:

3.000000000 GHz

where the cursor appears over the third 0 to the right of the decimal. When you turn the knob in this case, the output frequency changes in 1 MHz steps.

3. If you wish to move the position of the cursor one position to the right, press the **⇒** key.

Pressing **⇒** once moves the position of the cursor to the right one digit in order to decrease the knob resolution by a factor of ten.

4. If you wish to move the position of the cursor one position to the left, press the **⇐** key.

⇐ moves the position of the cursor to the left one digit in order to increase the knob resolution by a factor of ten.

5. Continue to press the \Rightarrow or \Leftarrow key until the cursor is positioned over the desired digit.

For example, suppose that frequency is the current active parameter, and you wish to change the cursor position from 1 MHz to 1 GHz. The steps that follow illustrate how to accomplish this:

- a. Press the **PRESET** key.

When the instrument has been set to the preset state, the frequency display indicates the following:

3.000000000 GHz

where the cursor appears over the third 0 to the right of the decimal.

- b. Press the \Leftarrow key three times. This moves the cursor from the position corresponding to MHz to the position corresponding to GHz (the cursor is now over the 3).
- c. Rotate the knob slowly so that you can see the frequency change in 1 GHz steps.

NOTE

The knob and \uparrow , \downarrow keys operate independently of each other. The \uparrow , \downarrow keys increase or decrease parameters in defined steps.

To Modify Data with the Arrow Keys

The synthesizer \uparrow and \downarrow (arrow) keys increase or decrease the value of the currently active parameter by an amount set with the **STEP SIZE** key. The amount set with the **STEP SIZE** key is referred to as the increment value.

1. Select the function key of the parameter to be modified.

When the function key is selected, a cursor (\blacktriangledown) appears over one of the digits of the selected parameter.

For example, to select the frequency function, press the **FREQ** key. The frequency parameter is selected when the cursor appears over one of the digits of the frequency display.

2. Press the \uparrow key to increase the parameter by the current increment value or press the \downarrow key to decrease the parameter by the current increment value.

For example, when frequency is in its preset state, the frequency display shows the following:

3.000000000 GHz

Where the cursor appears over the third 0 to the right of the decimal. The preset frequency increment value is 100 MHz. When you press the \uparrow key, the value of frequency increases to 3.100000000 GHz.

3. If you wish to change the increment value, you can do so using the **STEP SIZE** key.

The **STEP SIZE** key allows you to change the increment value of the currently active function. For example, suppose that frequency is the current active parameter, and you wish to change the increment value from its preset value of 100 MHz to 250 MHz. The steps that follow illustrate how to accomplish this:

- a. Press the **STEP SIZE** key.
- b. Press **250** on the synthesizer numeric keypad.
- c. Terminate the frequency increment value entry by pressing the **MHz** key.

When either the **↑** or **↓** key is pressed, the frequency will be either increased or decreased by 250 MHz instead of 100 MHz.

NOTE

The knob and **↑**, **↓** keys operate independently of each other. The knob increases or decreases the digit in the display that is under the cursor.

To Save and Recall Synthesizer States

When you use the synthesizer for a specific application, you can save and then recall the instrument state for future use. You can save up to ten different instrument states.

1. Press the **(SHIFT)** key and then the **(RECALL)** (SAVE) key.

When **(SHIFT)**, **(RECALL)** is pressed, the text SAVE STATE IN REG XXX is shown on the synthesizer display where XXX is the last register number entered.

2. Use the numeric keypad to enter the desired register number.

Valid register numbers are 0 through 9.

3. Press the **(Hz)** (ENTER) key to terminate the entry.

4. To recall the instrument state from memory, press the **(RECALL)** key.

When **(RECALL)** is pressed, the text RECALL STATE FROM REG XX is shown on the synthesizer display where "XX" is the last register number recalled.

5. Use the numeric keypad to enter the desired register number.

6. Press the **(Hz)** (ENTER) key to terminate the entry.

Notes

1. When an instrument state is saved to an instrument state register, it will write over any instrument state previously stored to that register.
2. If an instrument state has not been previously stored to an instrument state register, the synthesizer will be set to the preset state if you attempt to recall the instrument state from that register.

Programming Example

Use the following commands to store the instrument state to register 9 and then recall it from register 9:

OUTPUT 719; "*SAV 9" *Saves the current instrument state to register #9.*

OUTPUT 719; "*RCL 9" *Recalls the previously stored instrument state from register #9.*

To Read the Contents of the Error Queue

When one or more error messages are stored in the synthesizer error queue, the front panel MSG LED annunciator will light. Once all error messages have been read and all error conditions have been corrected, the MSG annunciator will turn off.

1. Press the **MSG** key.

When the **MSG** key is pressed, the most recent uncleared manual error number and the front panel error message will appear on the left-most display.

2. Look up the manual error number in Chapter 8.

Chapter 8 is organized in ascending manual error number order.

3. Perform the instructions following the error message in the list to correct or clear the error condition.

After you have completed the procedure in the list, return to this procedure to continue.

4. If the MSG LED annunciator is still lit, perform steps 1 through 3 again until the MSG LED annunciator turns off. If the MSG annunciator is turned off, continue with the next step.

5. Press the **MSG** key one more time.

Pressing the **MSG** key again returns the left-most display to normal operation.

NOTE

In the case of unlevelled power or unlocked frequency, the MSG LED annunciator may remain lit continuously until the problem is corrected.

Programming Example

To read the entire contents of the error queue, run the following program:

10 DIM B\$[160]	<i>Dimensions array B\$ to accept 160 characters.</i>
20 OUTPUT 719; "SYST:ERR?"	<i>Queries the oldest uncleared error number and message in the HP-IB error queue.</i>
30 ENTER 719; A,B\$	<i>Enters the error number into variable A and the HP-IB error message into variable B\$.</i>
40 PRINT A,B\$	<i>Prints the error number and HP-IB error message to the controller screen.</i>
50 IF A<>0 THEN 20	<i>Returns to line 20 if there are more errors in the queue.</i>
60 END	

To Set the HP-IB Address

The synthesizer default HP-IB address is preset to 19. You can, however, change the HP-IB address of the synthesizer from the front panel.

1. Press the **(SHIFT)** key on the synthesizer front panel.
2. Press the **(LOCAL)** (ADDRESS) key.

The left-most display indicates HP-IB ADDRESS **XX** when the **(LOCAL)** key is pressed where **XX** is the current HP-IB address..

3. Enter the desired HP-IB address using the numeric keypad.

For example, if you want to set the synthesizer HP-IB address to 12, type **(12)** on the numeric keypad.

The display indicates HP-IB ADDRESS 12

4. Terminate the HP-IB address entry by pressing the **(Hz)** (ENTER) key.

Note that when **(Hz)** (ENTER) is pressed, the cursor appears over the address parameter in the display. The synthesizer HP-IB address is now set to the new value (12 in the example), but you can still change it with the numeric keypad, knob, or arrow keys at this point. Pressing **(Hz)** (ENTER) again returns the display to normal operation.

Programming Example

To set the synthesizer HP-IB address to 12, send the following command:

```
OUTPUT 719; "SYST:COMM:GPIB:ADDR 12" Sets the synthesizer HP-IB address to 12.
```





If You Encounter a Problem

If you have a problem operating the synthesizer, check the following list of commonly encountered problems and troubleshooting procedures. If the problem that you encounter is not in the following list, contact the nearest Hewlett-Packard office for assistance.

NOTE

When transporting the product, use original packaging or comparable only.

Data Entry Problems

If the data entry controls (keypad, knob, , , ,  keys) do not respond:

- Check that the **ENTRY OFF** function is not enabled.

The **ENTRY OFF** function is not enabled when the cursor () appears over any of the parameters in the display. To return to normal entry mode, press the desired function key which has a numeric parameter associated with it (for example, press **FREQ** if you want to enter frequency).

- Check that the function key which is selected accepts data.

For instance, **FREQ** accepts data, but, **LOCAL** does not.

- Check that the synthesizer is in the local (not remote) operating mode.

If the synthesizer is in the remote operating mode, the **RMT** annunciator will be lit. Press the **LOCAL** key on the front panel to return the synthesizer to local operating mode.

Performing Fundamental Synthesizer Operations

If no cursor (▼) appears over a parameter in the display:

- Check that the **ENTRY OFF** function is not enabled.

The **ENTRY OFF** function is not enabled when the cursor (▼) appears over any of the parameters in the display. To return to normal entry mode, press the desired function key which has a numeric parameter associated with it (for example, press **FREQ** if you want to enter frequency).

If the parameter you are trying to enter is not accepted by the synthesizer:

- Ensure that you are not trying to set the parameter greater than or less than its limit. Refer to the specification table in this manual for the parameter limits.
- Check that the **MSG LED** annunciator is off.

If the synthesizer **MSG** annunciator is on, there is a problem with the synthesizer. To determine the error and turn off the **MSG** annunciator, refer to "To Read the Contents of the Error Queue" in this chapter and the listing of error messages in Chapter 8.

If the synthesizer does not display/output the carrier frequency entered.

- Check that the frequency multiplier value entered is the expected value.

When a multiplier value other than one is entered, the frequency resolution of the signal before multiplication must be obeyed. For example, for a desired frequency of 40 GHz using a multiplier value of three, the synthesizer would have to output a frequency of 13.33333333 GHz. Since frequency resolution at that frequency is 1 kHz, the closest the synthesizer can set the frequency is 13.333333000 GHz. This yields 39.999999000 GHz after multiplication, not 40 GHz.

Programming Problems

If the synthesizer does not respond to programming commands:

- Refer to the procedure, "To Set the HP-IB Address," in this chapter to check and, if necessary, change the HP-IB address.





Generating Signals with the Synthesizer

Generating Signals with the Synthesizer

This section provides procedures for generating signals with the HP 83731B/32B synthesizers. The steps in the procedures assume that you are familiar with the fundamental synthesizer operations. Refer to Chapter 2, "Performing Fundamental Synthesizer Operations," if you are not familiar with these.

Procedures in this chapter include how to generate signals with various modulations, how to use external automatic level control, how to generate antenna scan patterns, etc.

The procedures in this chapter are, in general, listed in order of increasing complexity.



To Generate a CW Signal

You can generate a CW (continuous wave) signal with no modulation characteristics.

1. Press **PRESET** to set the synthesizer to the default state.
2. Set the desired frequency.

For example, perform the following procedure to set the frequency to 2.000203 GHz.

- a. Press the **FREQ** key.
 - b. Press **2.000203** on the synthesizer's numeric keypad.
 - c. Terminate frequency entry by pressing the **GHz** key.
3. Set the desired RF output power level.

For example, perform the following procedure to set the output power level to 2.5 dBm.

- a. Press the **POWER LEVEL** key.
- b. Press **2.5** on the synthesizer's numeric keypad.
- c. Terminate the power level entry by pressing the **GHz** (dBm) key.

To Generate an Internal FM Signal (Option 1E2 Required)

You can generate an internal FM signal at a rate of 1 kHz to 1 MHz.

When internal FM is used, you can set the deviation and rate of the modulated signal output using the synthesizer's front panel keys.

1. Press **PRESET** to set the synthesizer to the default state.
2. Generate a CW signal as described previously in the "To Generate a CW Signal" procedure.
3. Press the **FM/φM ON/OFF** key twice.
(The AC FM annunciator will be lit.)
4. Press **SHIFT** then the **INT DEV** key in the FM/φM key group.
5. Press **SHIFT** then **INT DEV** again, or press the **↑** key.
(INTERNAL FM MOD ON appears in the left-most display.)
6. Press **INT DEV** then set the desired FM deviation.

For example, perform the following procedure to set the FM deviation to 300 kHz.

- a. Press **300** on the synthesizer's numeric keypad.
- b. Terminate the FM deviation entry by pressing the **kHz** key.

Generating Signals with the Synthesizer
To Generate an Internal FM Signal (Option 1E2 Required)

7. Press **INT RATE** in the FM/φM key group (INT FM RATE 100 kHz will appear in the left-most part of the display) then set the desired rate.

For example, perform the following procedure to set the rate to 200 kHz.

- a. Press **200** on the synthesizer's numeric keypad.
- b. Terminate the rate entry by pressing the **kHz** key.

An FM signal is now generated with the following modulation index:

$$(\Delta F = 300 \text{ kHz} / f_m = 200 \text{ kHz}) = 1.5$$

NOTE

If you enter a combination of deviation and rate that produces an overmodulation condition, an error message will be generated and will remain until the overmodulation condition is removed.

NOTE

When **PRESET** is pressed, the waveform is set to sinusoid. To select a different waveform, refer to "Special Functions" in Chapter 7.

NOTE

The modulating signal is available at the AM OUT connector on the rear panel.

To Generate an Externally Modulated AC FM Signal

You can generate an AC-coupled frequency modulated (AC FM) signal at any carrier frequency within the synthesizer output frequency range. When the modulating signal has a minimum rate greater than 1 kHz, use AC FM. When using AC FM, the frequency accuracy and stability are not degraded. For rates less than 1 kHz, DC FM mode is used. In this mode, the frequency accuracy and stability are degraded. Refer to “DC FM Coupling” in Chapter 7.

Generating an AC FM signal requires the following external equipment.

Equipment	Requirements
Modulating Signal Source	Modulating signal level must be in the range of +2 V to -2 V for specified FM performance. The input impedance of the FM IN connector is 600Ω.

CAUTION

The modulating signal must never exceed ± 5 V or damage to the input can occur.

1. Connect the equipment as shown in Figure 3-1:

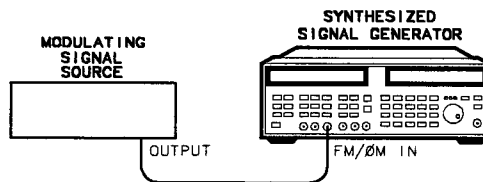

pk61ab

Figure 3-1. AC FM Equipment Setup

2. Press **PRESET** to set the synthesizer to the default state.
3. Press the **FM/φM ON/OFF** key twice to turn frequency modulation on.
(When frequency modulation is turned on, the AC FM annunciator will be lit.)
4. Set the desired carrier frequency.
For example, perform the following procedure to set the carrier frequency to 12.5 GHz.
 - a. Press the **FREQ** key.
 - b. Press **12.5** on the synthesizer's numeric keypad.
 - c. Terminate the carrier frequency entry by pressing the **GHz** key.
5. Set the desired RF output power level.
For example, perform the following procedure to set the output power level to -3 dBm.
 - a. Press the **POWER LEVEL** key.
 - b. Press **-3** on the synthesizer's numeric keypad.
 - c. Terminate the power level entry by pressing the **GHz** (dBm) key.
6. Press **SHIFT** then **FM/φM ON/OFF** to display the current sensitivity, then press the **↑** or **↓** key to select the desired range. FM sensitivity defaults to 5 MHz/V. External FM sensitivity is selectable between 10 MHz/V and 30 kHz/V, for carrier frequencies above 1 GHz. For carrier frequencies below 1 GHz, FM sensitivities are lower. Refer to Chapter 4 for table showing selectable sensitivities.
7. Set the frequency and amplitude of the modulating signal source to generate the desired frequency modulated signal. (Refer to the note below.) The modulating source should be less than 2 V_{peak} (4 V_{p-p}).

Generating Signals with the Synthesizer

To Generate an Externally Modulated AC FM Signal

NOTE

Do not exceed the maximum modulation index for a given CW frequency. Refer to the following formula:

$$\text{modulation index} = \Delta F / FM$$

where ΔF is the peak frequency deviation and FM is the modulation frequency.

Refer also to the FM specifications.



To Generate a Power Sweep Using the Internal Function Generator (Option 1E2 Required)

You can generate a power sweep by setting the internal AM function generator to RAMP and log AM mode. This will have the effect of linearly sweeping the power level of the RF output from a lower power level value to a higher power level value at a regular interval.

1. Press **PRESET** to set the synthesizer to the default state.
2. Press the **LOG/LIN ON/OFF** key twice to turn logarithmic amplitude modulation on.

When logarithmic amplitude modulation is turned on, the LOG AM annunciator will be lit.
3. Press **SHIFT**, **INT DEPTH** (INT/EXT).

(EXTERNAL LOG AM ON will be displayed in the left-most part of the display.)
4. Press **SHIFT**, **INT DEPTH** again, or press the **↑** or **↓** key to toggle between external and internal log AM. Stop when INTERNAL LOG AM ON is displayed.
5. Press **SPCL**, **50**, **Hz** (ENTER), to activate the AM waveform.

(AM WAVEFORM=SINUSOID will be displayed in the left-most part of the display.)
6. Press the **↑** or **↓** key until AM WAVEFORM=RAMP is displayed.
7. Set the desired carrier frequency.

For example, if you are performing an amplifier 1 dB gain compression test at 2.3 GHz, perform the following procedure to set the carrier frequency.

- a. Press the **FREQ** key.
- b. Press **2.3** on the synthesizer's numeric keypad.
- c. Terminate the carrier frequency entry by pressing the **GHz** key.

Generating Signals with the Synthesizer

To Generate a Power Sweep Using the Internal Function Generator (Option 1E2 Required)

8. Set the RF output power level to the highest value needed in the power sweep.

For example, if the power is to sweep from -25 dBm to 0 dBm, perform the following procedure to set the output power level to 0 dBm.

- a. Press the **POWER LEVEL** key.
 - b. Press **0** on the synthesizer's numeric keypad.
 - c. Terminate the power level entry by pressing the **GHz** (dBm) key.
9. Set the depth and rate of the desired power sweep.
 - a. Press the **AM DEPTH**, **25**, and **GHz** (dBm) keys to set the minimum power in the power sweep to 25 dB below vernier power.
 - b. Press the **INT RATE** key in the AM key group, then press **10** and **Hz** to set the internal rate to 10 Hz. The power will now sweep from -25 dBm to 0 dBm every 100 ms.

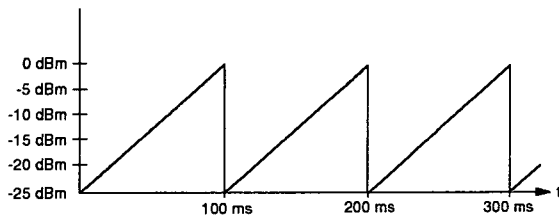

Figure 3-2. 25 dB Power Sweep

NOTE

The modulating signal is available at the AM OUT connector on the rear panel.

To Generate a Power Sweep Using an External Function Generator

You can generate a power sweep by connecting the output of a function generator to the AM IN connector and modulating the RF output with a sawtooth wave. This will have the effect of linearly sweeping the power level of the RF output from a lower power level value to a higher power level value (or vice versa) at a regular interval.

Generating a power sweep requires the following external equipment.

Equipment	Requirements
Function Generator	Must be capable of producing a sawtooth signal from a minimum of 0 V to a maximum up to +6 V, depending on the amount of attenuation required in the power sweep. The input impedance of the AM IN connector is 5 k Ω .

CAUTION

The sawtooth signal must never exceed the range of +15.5 V to -15.5 V or damage to the AM IN input can occur.

1. Connect the equipment as shown in Figure 3-3:

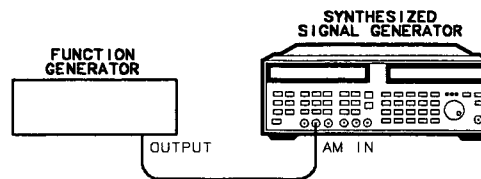

pk52ab

Figure 3-3. Log AM Equipment Setup

Generating Signals with the Synthesizer

To Generate a Power Sweep Using an External Function Generator

2. Press **PRESET** to set the synthesizer to the default state.
3. Press the **LOG/LIN ON/OFF** key twice to turn logarithmic amplitude modulation on.

When logarithmic amplitude modulation is turned on, the LOG AM annunciator will be lit.

4. Set the desired carrier frequency.

For example, if you are performing an amplifier 1 dB gain compression test at 2.3 GHz, perform the following procedure to set the carrier frequency.

- a. Press the **FREQ** key.
 - b. Press **2.3** on the synthesizer's numeric keypad.
 - c. Terminate the carrier frequency entry by pressing the **GHz** key.
5. Set the RF output power level to the highest value needed in the power sweep.

For example, if the power is to sweep from -30 dBm to -5 dBm, perform the following procedure to set the output power level to -5 dBm.

- a. Press the **POWER LEVEL** key.
- b. Press **-5** on the synthesizer's numeric keypad.
- c. Terminate the power level entry by pressing the **GHz (dBm)** key.

Generating Signals with the Synthesizer
**To Generate a Power Sweep Using an
External Function Generator**

- Set the controls of the function generator for a sawtooth waveform that will produce the desired power sweep.

For every +1 V at the AM IN connector, The RF output will be attenuated by 10 dB. For example, the waveform in Figure 3-4 applied to the AM IN connector will cause the RF output to sweep linearly from -5 dBm to -30 dBm every 100 ms.

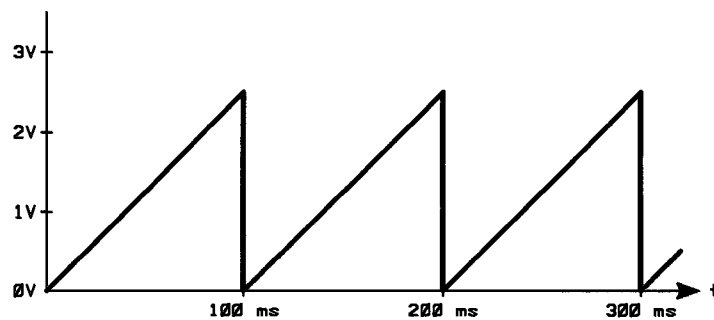

Figure 3-4. Example Sawtooth Waveform

The power sweep can vary from a lower to a higher power value or vice versa, depending on the slope of the sawtooth waveform. Note that maximum frequency of the sawtooth waveform that will produce a linear power sweep depends on the voltage excursion of the waveform. Refer to “Slew Time” in the specification table in Chapter 4 for the actual limitation.

To Generate Repetitive, Internal Pulse Modulation

You can generate a repetitive, pulse modulated signal at any carrier frequency within the synthesizer output frequency range. When internal pulse modulation is used, the pulsed RF output signal will have pulse width, delay, and pulse repetition frequency parameters set via the synthesizer front panel.

1. Press **PRESET** to set the synthesizer to the default state.
2. Press the **INT ON/OFF** key to turn internal pulse modulation on.

When internal pulse modulation is turned on, the INT (PULSE) annunciator will be lit.

3. Set the desired carrier frequency.

For example, perform the following procedure to set the carrier frequency to 3.085 GHz.

- a. Press the **FREQ** key.
- b. Press **3.085** on the synthesizer's numeric keypad.
- c. Terminate the carrier frequency entry by pressing the **GHz** key.

4. Set the desired RF output power level.

For example, perform the following procedure to set the output power level to -26 dBm.

- a. Press the **POWER LEVEL** key.
- b. Press **-26** on the synthesizer's numeric keypad.
- c. Terminate the power level entry by pressing the **GHz** (dBm) key.

5. Set the desired pulse repetition interval (PRI).

For example, perform the following procedure to set the pulse repetition interval to 100 ms.

- a. Press the **PRI** key.
- b. Press **100** on the synthesizer's numeric keypad.

Generating Signals with the Synthesizer
To Generate Repetitive, Internal Pulse Modulation

- c. Terminate the pulse repetition frequency entry by pressing the **GHz** (μ s) key.
6. Set the desired pulse width.
For example, perform the following procedure to set the pulse width to 25 ms.
 - a. Press the **WIDTH** key.
 - b. Press **25** on the synthesizer's numeric keypad.
 - c. Terminate the pulse width entry by pressing the **GHz** (μ s) key.
7. Set the desired pulse delay.
For example, perform the following procedure to set the pulse delay to 200 μ s.
 - a. Press the **DELAY** key.
 - b. Press **200** on the synthesizer's numeric keypad.
 - c. Terminate the pulse delay entry by pressing the **MHz** (μ s) key.
8. If the RF output is currently turned off, press the **RF ON/OFF** key to turn it on.
(If the RF output is off, the word OFF appears in the power level portion of the right-most display.)

The synthesizer will produce a pulsed RF output signal with pulse width, delay, and pulse repetition frequency parameters set via the front panel.

NOTE

If the synthesizer pulsed RF output is to be connected to average power sensitive circuitry, refer to section "AVG PWR INHIBIT ON/OFF" in Chapter 7 of this manual.

Generating Signals with the Synthesizer

To Generate Repetitive, Internal Pulse Modulation

Related Tasks

- AVG PWR INHIBIT ON/OFF
- To Generate Externally Triggered Pulse Modulation
- To Generate Repetitive, External Pulse Modulation
- To Generate a Doublet Pulse
- To Generate Gated Pulse Modulation
- To Generate Simultaneous Log AM and Pulse Modulation

To Generate Externally Triggered Pulse Modulation

You can generate an externally triggered, pulse modulated signal at any carrier frequency within the synthesizer output frequency range. When externally triggered pulse modulation is used, a valid TTL level trigger signal at the PULSE/TRIG, GATE IN connector will cause pulsed RF to appear at the RF OUTPUT connector with pulse width and delay set with the **WIDTH** and **DELAY** keys.

Generating externally triggered, pulse modulated signals requires the following external equipment.

Equipment	Requirements
Trigger Signal Source	Must be capable of sourcing a TTL level signal into a 50Ω load.

CAUTION

The trigger signal must never exceed the range of +5.5 V to -0.5 V or damage to the PULSE/TRIG, GATE IN input can occur.

1. Connect the equipment as shown in Figure 3-5.

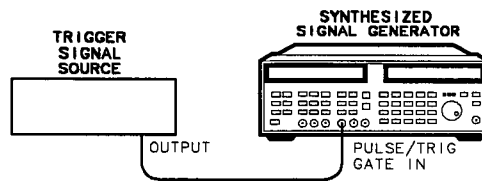

pk63ab

Figure 3-5. Externally Triggered Pulse Modulation Equipment Setup

To Generate Externally Triggered Pulse Modulation

2. Press **PRESET** to set the synthesizer to the default state.
3. Press the **TRIG ON/OFF** key to turn externally triggered internal pulse modulation on.

When externally triggered internal pulse modulation is turned on, the TRIG INT annunciator will be lit.

4. Set the desired carrier frequency.

For example, perform the following procedure to set the carrier frequency to 5 GHz.

- a. Press the **FREQ** key.
- b. Press **5** on the synthesizer's numeric keypad.
- c. Terminate the carrier frequency entry by pressing the **GHz** key.

5. Set the desired RF output power level.

For example, perform the following procedure to set the output power level to -5 dBm.

- a. Press the **POWER LEVEL** key.
- b. Press **-5** on the synthesizer's numeric keypad.
- c. Terminate the power level entry by pressing the **GHz (dBm)** key.

6. Set the desired pulse width.

For example, perform the following procedure to set the pulse width to 23 ms.

- a. Press the **WIDTH** key.
- b. Press **23** on the synthesizer's numeric keypad.
- c. Terminate the pulse width entry by pressing the **GHz (μ s)** key.

7. Set the desired pulse delay.

For example, perform the following procedure to set the pulse delay to 100 μ s.

- a. Press the **DELAY** key.
- b. Press **100** on the synthesizer's numeric keypad.
- c. Terminate the pulse delay entry by pressing the **MHz (μ s)** key.

Generating Signals with the Synthesizer
To Generate Externally Triggered Pulse Modulation

8. Set the controls of the trigger signal source to generate the desired external pulse trigger signal.
9. If the RF output is currently turned off, press the **RF ON/OFF** key to turn it on.
If the RF output is off, the word OFF appears in the power level portion of the right-most display.

When the synthesizer receives a valid trigger signal from the trigger signal source, an RF pulse will appear at the synthesizer RF OUTPUT connector with width and delay parameters set with the **WIDTH** and **DELAY** keys. For example, if the width has been set to 23 ms and delay has been set to 100 μ s, the pulse shown in Figure 3-6 will result upon a valid trigger signal.

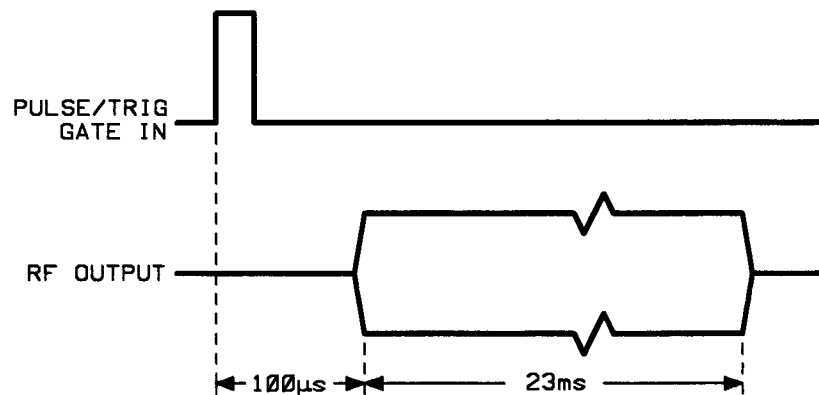

Figure 3-6. Triggered Pulse Mode Timing Example

NOTE

If the synthesizer pulsed RF output is to be connected to average power sensitive circuitry, refer to section "AVG PWR INHIBIT ON/OFF" in Chapter 7 of this manual.

Generating Signals with the Synthesizer

To Generate Externally Triggered Pulse Modulation

Related Tasks

- AVG PWR INHIBIT ON/OFF
- To Generate Repetitive, Internal Pulse Modulation
- To Generate Repetitive, External Pulse Modulation
- To Generate a Doublet Pulse
- To Generate Gated Pulse Modulation
- To Generate Simultaneous Log AM and Pulse Modulation

To Generate Repetitive, External Pulse Modulation

You can generate a repetitive, pulse modulated signal at any carrier frequency within the synthesizer output frequency range. When external pulse modulation is used, the pulsed RF output signal will have pulse width, delay, and pulse repetition frequency parameters set via an external pulse source.

Generating external pulse modulation requires the following external equipment.

Equipment	Requirements
Pulse Source	Must be capable of sourcing a TTL level signal into a 50 Ω load.

CAUTION

The pulse modulating signal must never exceed the range of +5.5 V to -0.5 V or damage to the PULSE/TRIG, GATE IN input can occur.

1. Connect the equipment as shown in Figure 3-7:

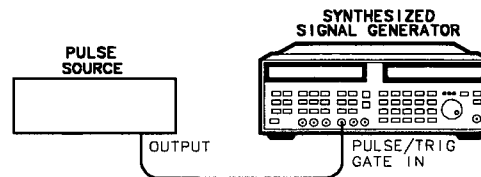

pk64ab

Figure 3-7. External Pulse Modulation Equipment Setup

2. Press **PRESET** to set the synthesizer to the default state.

To Generate Repetitive, External Pulse Modulation

3. Press the **EXT ON/OFF** key to turn external pulse modulation on or press the **SHIFT** key and then the **EXT ON/OFF** (**INVERT**) key to turn inverted external pulse modulation on.

When external pulse modulation is turned on, the **EXT** annunciator will be lit. When inverted external pulse modulation is turned on, the **INVERT EXT** annunciator will be lit.

If inverted external pulse modulation is used, the external pulse modulating signal sense will be inverted before affecting the envelope of the pulse modulated RF output signal.

4. Set the desired carrier frequency.

For example, perform the following procedure to set the carrier frequency to 12.02 GHz.

- a. Press the **FREQ** key.
- b. Press **12.02** on the synthesizer's numeric keypad.
- c. Terminate the carrier frequency entry by pressing the **GHz** key.

5. Set the desired RF output power level.

For example, perform the following procedure to set the output power level to -2 dBm.

- a. Press the **POWER LEVEL** key.
- b. Press **-2** on the synthesizer's numeric keypad.
- c. Terminate the power level entry by pressing the **GHz** (dBm) key.

6. Set the controls of the pulse source for the desired Pulse Repetition Frequency (PRF), width, and delay.

7. If the RF output is currently turned off, press the **RF ON/OFF** key to turn it on.

If the RF output is off, the word **OFF** appears in the power level portion of the right-most display.

The synthesizer will produce a pulsed RF output signal with pulse width, delay, and pulse repetition frequency parameters set with an external pulse source.

NOTE

If the synthesizer pulsed RF output is to be connected to average power sensitive circuitry, refer to section "AVG PWR INHIBIT ON/OFF" in Chapter 7 of this manual.

Related Tasks

- AVG PWR INHIBIT ON/OFF
- To Generate Repetitive, Internal Pulse Modulation
- To Generate Externally Triggered Pulse Modulation
- To Generate a Doublet Pulse
- To Generate Gated Pulse Modulation
- To Generate Simultaneous Log AM and Pulse Modulation

To Generate a Doublet Pulse

You can generate a doublet pulse at any carrier frequency within the synthesizer output frequency range. When a doublet pulse is generated, the synthesizer will generate two RF pulses. The envelope of the first RF pulse will follow a valid (TTL high) pulse provided at the PULSE/TRIG, GATE IN connector. The second RF pulse is generated internally and will have a pulse width and pulse delay as set with the **WIDTH** and **DELAY** keys.

Generating doublet pulses requires the following external equipment.

Equipment	Requirements
Pulse Source	Must be capable of sourcing a TTL level signal into a 50 Ω load.

CAUTION

The pulse modulating signal must never exceed the range of +5.5 V to -0.5 V or damage to the PULSE/TRIG, GATE IN input can occur.

1. Connect the equipment as shown in Figure 3-8:

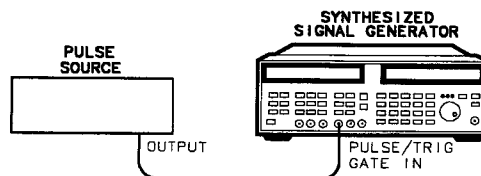

pk64ab

Figure 3-8. Doublet Pulse Equipment Setup

2. Press **[PRESET]** to set the synthesizer to the default state.
3. Press the **[SHIFT]** key and then the **[TRIG ON/OFF]** (DOUBLET) key to turn doublet pulse mode on.

When doublet pulse mode is turned on, the text **DOUBLET** will appear in the PRF/PRI portion of the left-most display.

4. Set the desired carrier frequency.

For example, perform the following procedure to set the carrier frequency to 10 GHz.

- a. Press the **[FREQ]** key.
- b. Press **[10]** on the synthesizer's numeric keypad.
- c. Terminate the carrier frequency entry by pressing the **[GHz]** key.

5. Set the desired RF output power level.

For example, perform the following procedure to set the output power level to -25 dBm.

- a. Press the **[POWER LEVEL]** key.
- b. Press **[-25]** on the synthesizer's numeric keypad.
- c. Terminate the power level entry by pressing the **[GHz]** (dBm) key.

6. Set the desired pulse width.

For example, perform the following procedure to set the pulse width to 1 μ s.

- a. Press the **[WIDTH]** key.
- b. Press **[1]** on the synthesizer's numeric keypad.
- c. Terminate the pulse width entry by pressing the **[MHz]** (μ s) key.

7. Set the desired pulse delay.

For example, perform the following procedure to set the pulse delay to 2 μ s.

- a. Press the **[DELAY]** key.
- b. Press **[2]** on the synthesizer's numeric keypad.
- c. Terminate the pulse delay entry by pressing the **[MHz]** (μ s) key.

Generating Signals with the Synthesizer

To Generate a Doublet Pulse

8. Set the controls of the pulse source to generate the desired pulse.
9. If the RF output is currently turned off, press the **RF ON/OFF** key to turn it on.

If the RF output is off, the word OFF appears in the power level portion of the right-most display.

Delay is measured from the rising edge of the input pulse. By varying the synthesizer delay time, you can vary the off time between the two pulses. This is useful when testing receiver recovery time (shadow time). For example, if the width has been set to $1\ \mu\text{s}$ and delay has been set to $2\ \mu\text{s}$, the pulses shown in Figure 3-9 will result upon a $500\ \text{ns}$ gate signal.

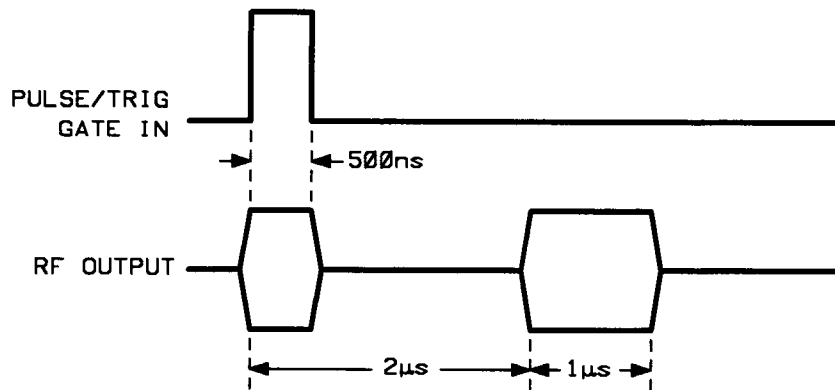

Figure 3-9. Doublet Pulse Mode Timing Example

NOTE

If the synthesizer pulsed RF output is to be connected to average power sensitive circuitry, refer to section "AVG PWR INHIBIT ON/OFF" in Chapter 7 of this manual.

Related Tasks

- AVG PWR INHIBIT ON/OFF
- To Generate Repetitive, Internal Pulse Modulation
- To Generate Externally Triggered Pulse Modulation
- To Generate Repetitive, External Pulse Modulation
- To Generate Gated Pulse Modulation
- To Generate Simultaneous Log AM and Pulse Modulation

To Generate Gated Pulse Modulation

You can generate a gated, pulse modulated signal at any carrier frequency within the synthesizer output frequency range. When gated pulse modulation is used, a valid TTL level gate signal at the PULSE/TRIG, GATE IN connector will cause pulsed RF to appear at the RF OUTPUT connector as long as the gate signal remains at a TTL high level. The pulsed RF output will have a pulse width and pulse repetition frequency as set with the **WIDTH** and **PRI** (PRF) keys.

Generating gated, pulse modulated signals requires the following external equipment.

Equipment	Requirements
Gate Signal Source	Must be capable of sourcing a TTL level signal into a 50 Ω load.

CAUTION

The gate signal must never exceed the range of +5.5 V to -0.5 V or damage to the PULSE/TRIG, GATE IN input can occur.

1. Connect the equipment as shown in Figure 3-10:

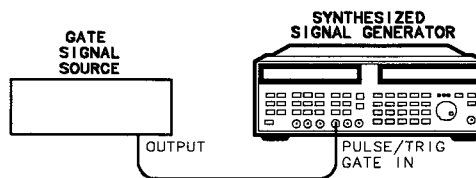

pk65ab

Figure 3-10. Gated Pulse Modulation Equipment Setup

2. Press **PRESET** to set the synthesizer to the default state.
3. Press the **SHIFT** key and then the **INT ON/OFF** (GATED) key to turn gated pulse modulation on.

When gated pulse modulation is turned on, the text GATED will appear in the delay portion of the left-most display.

4. If any of the other modulations are turned on, press the appropriate key to turn them off.
5. Set the desired carrier frequency.

For example, perform the following procedure to set the carrier frequency to 6.67 GHz.

- a. Press the **FREQ** key.
 - b. Press **6.67** on the synthesizer's numeric keypad.
 - c. Terminate the carrier frequency entry by pressing the **GHz** key.
6. Set the desired RF output power level.

For example, perform the following procedure to set the output power level to -45 dBm.

- a. Press the **POWER LEVEL** key.
 - b. Press **-45** on the synthesizer's numeric keypad.
 - c. Terminate the power level entry by pressing the **GHz** (dBm) key.
7. Set the desired pulse width.

For example, perform the following procedure to set the pulse width to 100 μ s.

- a. Press the **WIDTH** key.
- b. Press **100** on the synthesizer's numeric keypad.
- c. Terminate the pulse width entry by pressing the **MHz** (μ s) key.

To Generate Gated Pulse Modulation

8. Set the desired pulse repetition frequency (PRF).
For example, perform the following procedure to set the pulse repetition frequency to 1 kHz.
 - a. Press the **(SHIFT)** key and then the **(PRI)** (PRF) key.
 - b. Press **(1)** on the synthesizer's numeric keypad.
 - c. Terminate the pulse repetition frequency entry by pressing the **(kHz)** key.
9. Set the controls of the gate signal source to generate the desired gate signal.
10. If the RF output is currently turned off, press the **(RF ON/OFF)** key to turn it on.
If the RF output is off, the word OFF appears in the power level portion of the right-most display.

When the gate signal from the gate signal source is at a TTL high level, RF pulses will appear at the synthesizer RF OUTPUT connector for as long as the gate signal remains high. If the gate signal switches to a TTL low level during when a pulse is present at the RF OUTPUT, the last pulse will complete before the pulse train ceases. For example, if the width has been set to 100 μ s and PRF has been set to 1 kHz (PRI set to 1 ms), the pulses shown in Figure 3-11 will result upon a valid gate signal.

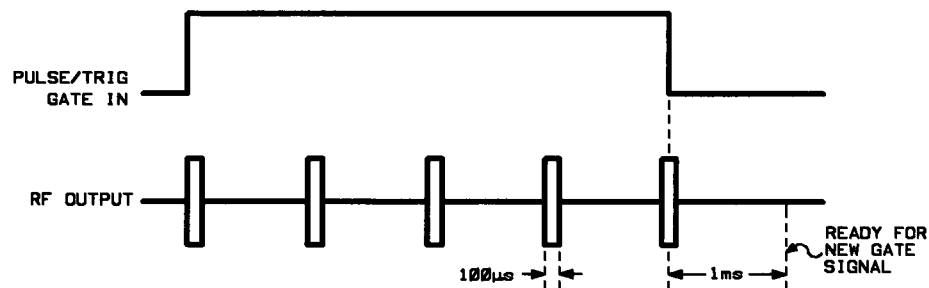

Figure 3-11. Gated Pulse Mode Timing Example

NOTE

If the synthesizer pulsed RF output is to be connected to average power sensitive circuitry, refer to section "AVG PWR INHIBIT ON/OFF" in Chapter 7 of this manual.

Related Tasks

- AVG PWR INHIBIT ON/OFF
- To Generate Repetitive, Internal Pulse Modulation
- To Generate Externally Triggered Pulse Modulation
- To Generate Repetitive, External Pulse Modulation
- To Generate a Doublet Pulse
- To Generate Simultaneous Log AM and Pulse Modulation

To Generate Simultaneous Log AM and Pulse Modulation

You can generate simultaneous logarithmic AM and pulse modulation by applying a voltage waveform to the synthesizer **AM IN** connector while simultaneously applying either internal, external, or gated pulse modulation. The resulting signal at the synthesizer **RF OUTPUT** connector is useful for antenna scan patterns that can be used in radar receiver test applications.

Generating simultaneous logarithmic AM and pulse modulation requires the following external equipment.

Equipment	Requirements
Arbitrary Waveform Generator	Must be capable of producing the desired antenna scan waveform with an amplitude varying from a minimum of 0 V to a maximum up to +6 V, depending on the amount of dynamic range required in the antenna scan pattern. The input impedance of the AM IN connector is 5 k Ω .
Pulse Generator <i>(optional)</i>	Must be capable of sourcing a TTL level signal into a 50 Ω load.

CAUTION

- The antenna scan waveform must never exceed the range of +15.5 V to -15.5 V or damage to the **AM IN** input can occur.
- The pulse modulating signal must never exceed the range of +5.5 V to -0.5 V or damage to the **PULSE/TRIG**, **GATE IN** input can occur.

Generating Signals with the Synthesizer
To Generate Simultaneous Log AM and Pulse Modulation

1. Connect the equipment as shown in Figure 3-12:

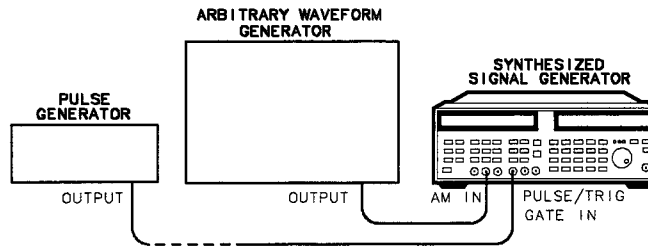

pk66ab

Figure 3-12. Antenna Scan Equipment Setup

2. Press **PRESET** to set the synthesizer to the default state.
3. Choose the type of pulse modulation and set the pulse characteristics as required for your particular application.

Set the synthesizer frequency to the required carrier frequency for the pulsed RF. Set the power level to the power level required at the peak of the main lobe of the scan. You can use one of six pulse modulation modes, depending on your application. The six pulse modes are internal, external, external inverted, gated, doublet, and internal triggered pulse modulation.

4. Press the **LOG/LIN ON/OFF** key twice to turn logarithmic amplitude modulation on.

When logarithmic amplitude modulation is turned on, the LOG AM annunciator will be lit.

5. If the RF output is currently turned off, press the **RF ON/OFF** key to turn it on.

If the RF output is off, the word OFF appears in the power level portion of the right-most display.

To Generate Simultaneous Log AM and Pulse Modulation

6. Set the arbitrary waveform generator to produce a scan waveform with amplitude characteristics that will produce the desired antenna scan with the desired dynamic range.

The antenna scan waveform should vary from a positive voltage to 0 V. For every +1 V at the AM IN connector, the RF output will be attenuated by 10 dB. For example, the waveform shown in Figure 3-13 applied to the AM IN connector will cause the antenna scan pattern shown in Figure 3-14 to appear at the synthesizer RF OUTPUT connector (provided the output level of the synthesizer has been set to -20 dBm).

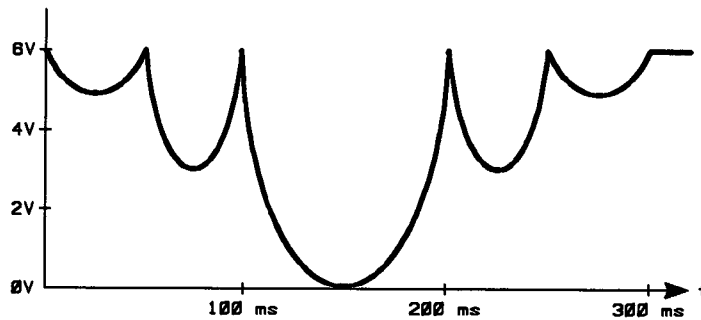

Figure 3-13. Example Antenna Scan Input

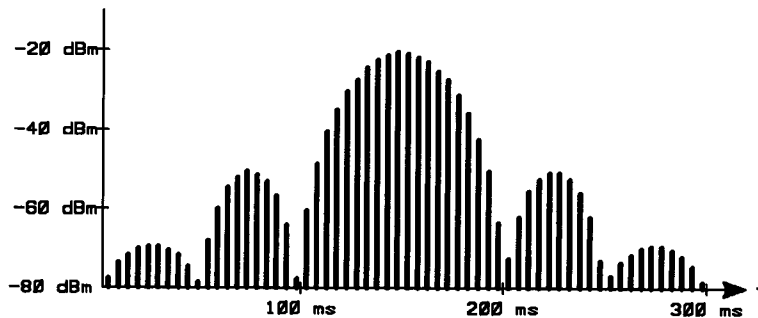

Figure 3-14. Example Modulated Antenna Scan Pattern

When the synthesizer is used to generate antenna scan patterns, the pulsed signal does not have any duty cycle limitations.

NOTE

If the synthesizer pulsed RF output is to be connected to average power sensitive circuitry, refer to section "AVG PWR INHIBIT ON/OFF" in Chapter 7 of this manual.

Related Tasks

- AVG PWR INHIBIT ON/OFF
- To Generate Repetitive, Internal Pulse Modulation
- To Generate Repetitive, External Pulse Modulation
- To Generate Gated Pulse Modulation

To Generate an Internal Linear AM Signal (Option 1E2 Required)

You can generate a linear amplitude modulated signal at any carrier frequency within the synthesizer output frequency range.

When internal linear amplitude modulation is used, you can set the depth (%) and rate (frequency) of the modulated signal output using the synthesizer's front panel keys.

1. Press **PRESET** to set the synthesizer to the default state.
2. Generate a CW signal as described previously in the "To Generate a CW Signal" procedure.
3. Press **LOG/LIN ON/OFF** three times from the off state to access the linear AM function.

(The LIN AM annunciator will be lit.)

4. Press **SHIFT INT DEPTH** to access internal/external modulation mode.
5. Press **SHIFT INT DEPTH** again to access internal AM mode, or press the **↑** key.

(INTERNAL LINEAR AM ON appears in the left-most display.)

6. Press **INT DEPTH** then set the desired depth percentage.

For example, perform the following procedure to set the depth percentage to 50%.

- a. Press **50** on the synthesizer's numeric keypad.
 - b. Terminate the percentage entry by pressing the **Hz** key (%).
7. Press **INT RATE** in the AM key group then set the desired internal AM rate.

For example, perform the following procedure to set the AM rate to 1 kHz.

- a. Press **1** on the synthesizer's numeric keypad.
- b. Terminate the AM rate entry by pressing the **kHz** key.

To Generate an External Linear AM Signal

You can generate a linear amplitude modulated signal at any carrier frequency within the synthesizer output frequency range.

When external linear amplitude modulation is used, the modulated output signal will have depth (%) and rate (frequency) parameters set via an external modulating source.

Equipment	Requirements
Function Generator	Sinewave signal level must be in the range of -1 Vpk to $+1$ Vpk. The frequency must be in the range of DC to 100 kHz.
The input impedance of the AM IN connector is 5 k Ω .	

In addition, you must supply any cables and adapters necessary to connect the equipment.

1. Connect the equipment as shown in Figure 3-15:

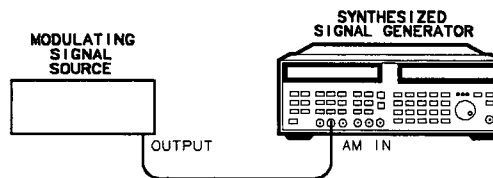

pk611ab

Figure 3-15. External Linear AM Equipment Setup

2. Press **[PRESET]** to set the synthesizer to the default state.
3. Press the **[LOG/LIN ON/OFF]** key three times from the off state to access the external linear AM function.

(EXTERNAL LINEAR AM ON appears in the left-most part of the display, and the LIN AM annunciator will be lit.)

To Generate an External Linear AM Signal

4. Press **SHIFT** then **LOG/LIN ON/OFF** to display the current sensitivity, then press **↑** or **↓** key to change the sensitivity range.

External AM sensitivity range is selectable between 100%/Vpk and 30%/Vpk.

5. Set the controls of the modulating source for the desired depth (peak-to-peak amplitude of sinewave) and rate (frequency).
6. Set the desired carrier frequency.

For example, perform the following procedure to set the carrier frequency to 5 GHz.

- a. Press the **FREQ** key.
- b. Press **5** on the synthesizer's numeric keypad.
- c. Terminate the carrier frequency entry by pressing the **GHz** key.

7. Set the desired RF output power level.

For example, perform the following procedure to set the output power level to -2.5 dBm.

- a. Press the **POWER LEVEL** key.
- b. Press **-2.5** on the synthesizer's numeric keypad.
- c. Terminate the power level entry by pressing the **GHz** (dBm) key.

The synthesizer will produce a linear AM RF output signal.

To Generate an Internal Phase Modulated Signal (Option 1E2 and 800 Required)

You can generate an internal phase modulated signal at a rate of 0.5 Hz to 1 MHz.

When internal phase modulation is used, you can set the deviation (rads) and rate (frequency) of the modulated signal output using the synthesizer's front panel keys.

1. Press **PRESET** to set the synthesizer to the default state.
2. Generate a CW signal as described previously in the "To Generate a CW Signal" procedure.
3. Press the **FM/φM ON/OFF** key three times from the off state.
(The φM annunciator will be lit.)
4. Press **SHIFT** then the **INT DEV** key.
(EXTERNAL PM MOD ON appears in the left-most display, and the φM annunciator will be lit.)
5. Press **SHIFT** then **INT DEV** again, or press the **↑** key.
(INTERNAL PM MOD ON appears in the left-most display.)
6. Press **INT DEV** then set the desired deviation.

For example, perform the following procedure to set the PM deviation to 100 mrad.

- a. Press **1** on the synthesizer's numeric keypad.
 - b. Terminate the PM deviation entry by pressing the **Hz** key (rad).
7. Press **INT RATE** in the FM/φM key group then set the desired rate.
For example, perform the following procedure to set the rate to 100 kHz.
 - a. Press **100** on the synthesizer's numeric keypad.
 - b. Terminate the rate entry by pressing the **kHz** key.

To Generate an External Phase Modulation Signal

NOTE

External phase modulation is only available with Option 800 installed.

You can generate a phase modulated signal at any carrier frequency within the synthesizer output frequency range.

When external phase modulation is used, the modulated output signal will have deviation (rads) and rate (frequency) parameters set via an external phase modulating source.

Equipment	Requirements
Phase Source	Sinewave signal level must be in the range of -4 V to $+4$ V. The frequency must be in the range of DC to 1 MHz.

CAUTION

The modulating signal must never exceed ± 5 V or damage to the input can occur.

In addition, you must supply any cables and adapters necessary to connect the equipment.

Generating Signals with the Synthesizer
To Generate an External Phase Modulation Signal

1. Connect the equipment as shown in Figure 3-16:

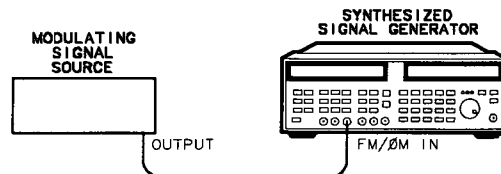

pk612ab

Figure 3-16. External Phase Modulation Equipment Setup

2. Press **PRESET** to set the synthesizer to the default state.
3. Press **FM/φM ON/OFF** three times to access the external phase modulation function.
(EXTERNAL PM ON appears in the left-most part of the display, and the φM annunciator will be lit.)
4. Set the desired carrier frequency.
For example, perform the following procedure to set the carrier frequency to 2 GHz.
 - a. Press the **FREQ** key.
 - b. Press **2** on the synthesizer's numeric keypad.
 - c. Terminate the carrier frequency entry by pressing the **GHz** key.
5. Set the desired RF output power level.
For example, perform the following procedure to set the output power level to -2.5 dBm.
 - a. Press the **POWER LEVEL** key.
 - b. Press **-2.5** on the synthesizer's numeric keypad.
 - c. Terminate the power level entry by pressing the **GHz** (dBm) key.

To Generate an External Phase Modulation Signal

6. Press **SHIFT** then **FM/φM ON/OFF** to display the current sensitivity, then press the **↑** or **↓** key to change the sensitivity range.

External φM sensitivity range is selectable between 1 rad/Vpk and 50 rad/Vpk, for carrier frequencies above 1 GHz.

NOTE

Phase modulation must be turned on to access the φM ranges. The best performance (that is, best phase noise, modulation bandwidth, flatness) is on the 1 rad/V range. Refer to the specifications in Chapter 4.

7. Set the controls of the modulating source for the desired deviation (peak-to-peak amplitude of sinewave) and rate (frequency).

The synthesizer will produce a phase modulated RF output signal.

NOTE

Sensitivity changes for carrier frequencies less than 1 GHz. Refer to the specifications in Chapter 4.

To Generate Millimeter Signals

By using external equipment with the synthesizer, you can generate millimeter-wave signals.

Generating millimeter-wave signals uses the following external equipment.

Equipment	Requirements
Microwave Amplifier	Must be compatible with the HP 8355X Source Module used.
HP 8355X Source Module	Must be capable of generating the desired frequency.

In addition, you must supply any cables and adapters necessary to connect the equipment.

1. Connect the equipment as shown in Figure 3-17:

CAUTION

Turn off the AC power to the microwave amplifier prior to connecting or disconnecting the source module interface cable.

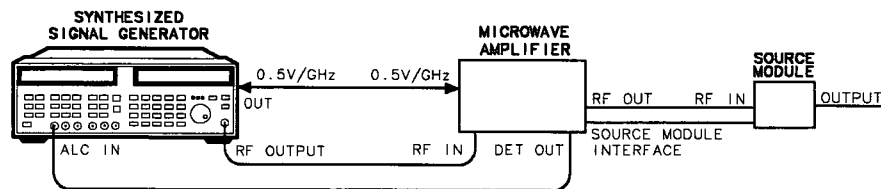

pk67ab

Figure 3-17. Millimeter-Wave Equipment Setup

To Generate Millimeter Signals

2. Enter the proper multiplier value for the HP 8355X Series source module that you are using into the synthesizer.

Perform the following procedure to select and enter the proper multiplier value.

- a. Press the **SHIFT** key.
- b. Press the **FREQ** key.
- c. Press the numeric key on the synthesizer's numeric keypad that corresponds to the proper multiplier value from the following table:

Source Module Model Number	Frequency Band	Multiplier Value
HP 83554A	26.5 - 40 GHz	2
HP 83555A	33 - 50 GHz	3
HP 83556A	40 - 60 GHz	3
HP 83557A	50 - 75 GHz	4
HP 83558A	75 - 110 GHz	6

- d. Terminate the multiplier value entry by pressing the **Hz** (**ENTER**) key.
3. Set the frequency for the desired output signal.

The synthesizer frequency display will show the frequency at the output of the millimeter source module, not the synthesizer RF OUTPUT connector.

For example, if you want to generate a 30 GHz CW only signal, perform the following steps:

- a. Press the **FREQ** key.
- b. Press **30** on the numeric keypad.
- c. Press the **GHz** key to terminate the entry.
4. If the RF output is currently turned off, press the **RF ON/OFF** key to turn it on.
If the RF output is off, the word OFF appears in the power level portion of the right-most display.
5. Press the **INT LEVEL** key to enable internal leveling.

6. Set the approximate desired RF output power at the output of the millimeter source module using the display on the microwave amplifier.

For example, to set the level to 0 dBm, press **POWER LEVEL** and rotate the synthesizer knob until 0 dBm is shown on the microwave amplifier display.

7. Press the **EXT DIODE** key.

8. Set the RF output power level desired at the output of the millimeter source module using the display on the microwave amplifier.

The display on the microwave amplifier shows the power level at the output of the source module to within ± 2 dB. You should use the display on the microwave amplifier, not the synthesizer, when adjusting the RF output power. For example, to set the output power level to 0 dBm, press the **POWER LEVEL** key and rotate the knob until 0 dBm is shown on the microwave amplifier display.

NOTE

The knob resolution can be changed using the **⇒** and **⇐** keys. However, the multiplied signal frequency resolution is further limited due to the multiplier value used. For example, if the multiplier value is set to 3 and the synthesizer baseband resolution is 1 kHz, the resulting resolution is 3 kHz.

NOTE

The following applies when using frequency multiplier:

Actual FM Sensitivity = Displayed FM Sensitivity x Multiplier Value

Actual ϕ M Sensitivity = Displayed ϕ M Sensitivity x Multiplier Value

To Use External Diode Detector Leveling

External diode detector leveling is useful when you desire leveled RF output power from the synthesizer at a point other than the RF OUTPUT connector.

External diode detector leveling uses the following external equipment.

Equipment	Requirements
Diode Detector	Must be specified for use at the desired synthesizer output frequency. Must produce greater than 1 mv of ALC voltage for the power levels present at the sampling point. The detector can be either positive or negative.
Power Splitter <i>or</i> Directional Coupler	Must be specified for use at the desired synthesizer output frequency.
Power Meter <i>(optional)</i>	None.
Power Sensor <i>(optional)</i>	Must be capable of measuring power at the frequency and level present at the sampling point in the leveling loop.
Cables and Adapters	You must supply the cables and adapters necessary to connect the equipment.

NOTE

The power meter and power sensor are not required, but are helpful when adjusting the synthesizer output power for the desired power level at the output.

In addition, you must supply the cables and adapters necessary to connect the equipment.

Generating Signals with the Synthesizer
To Use External Diode Detector Leveling

1. Connect the equipment as shown in Figure 3-18:

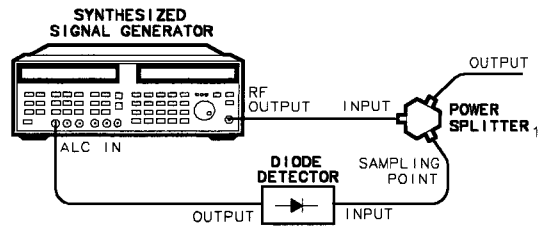

¹ A DIRECTIONAL COUPLER CAN BE USED IN PLACE OF THE POWER SPLITTER.

pk68ab

Figure 3-18. External Diode Detector Leveling Setup

2. Press the **EXT DIODE** key to enable external leveling.

NOTE

When the **EXT DIODE** key is pressed, the synthesizer enters the external diode detector leveling mode. Power is then held at a constant level at the sampling point, regardless of gain changes in the signal path between the synthesizer RF OUTPUT connector and the output.

3. Set the desired output signal frequency using the **FREQ** key and any modulation.
4. If the RF output is currently turned off, press the **RF ON/OFF** key to turn it on.

(If the RF output is off, the word OFF appears in the power level portion of the right-most display.)

Generating Signals with the Synthesizer

To Use External Diode Detector Leveling

5. Adjust the synthesizer output power so that the desired power at the output is attained.

For example, assume that you are using a power splitter and you want -5 dBm at the output of the splitter. In this case, you must set the power at the output to -5 dBm. Perform the following procedure to set the power at the output to -5 dBm.

- a. Temporarily connect the power meter and sensor at the output.
- b. Press the **POWER LEVEL** key.
- c. Rotate the knob until the power meter reads -5 dBm (disregard the synthesizer power level reading).
- d. Disconnect the power meter and sensor from the output and connect the device under test (DUT).

Notes

1. When the **EXT DIODE** key is pressed, the synthesizer output power might change. Therefore, you might want to check the output power and readjust if necessary.
2. External diode detector leveling does not provide temperature compensation, thus, output level recalibration might be required in environments that are not temperature stabilized.
3. External diode detector leveling does not provide proper compensation from square law to linear regions of the detector. Therefore, power level changes may require output level recalibration.

Related Tasks

- To Use External Power Meter Leveling

To Use External Power Meter Leveling

External power meter leveling is useful when you desire leveled RF output power from the synthesizer at a point other than the RF OUTPUT connector.

External power meter leveling requires the following external equipment.

Equipment	Requirements
Power Meter	Must have a recorder output and range hold capability.
Power Sensor	Must be capable of measuring power at the frequency and level present at the sampling point in the leveling loop.
Power Splitter or Directional Coupler	Must be specified for use at the desired synthesizer output frequency.

In addition, you must supply the cables and adapters necessary to connect the equipment.

1. Connect the equipment as shown in Figure 3-19:

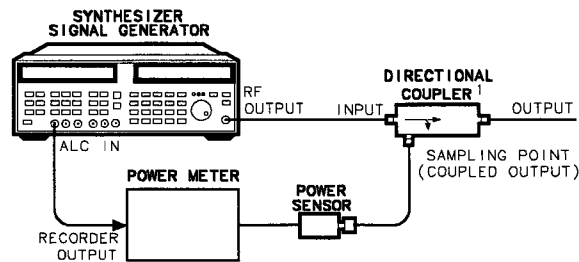

1. A POWER SPLITTER CAN BE USED IN PLACE OF THE DIRECTIONAL COUPLER.

pk69ab

Figure 3-19. External Power Meter Leveling Setup

2. Press the **INT LEVEL** key to enable internal leveling.

To Use External Power Meter Leveling

3. Set the desired output signal frequency using the **FREQ** key and any modulation.
4. Set the desired output power level using the **POWER LEVEL** key.
5. If the RF output is currently turned off, press the **RF ON/OFF** key to turn it on.

If the RF output is off, the word **OFF** appears in the power level portion of the right-most display.

6. Select auto range on the power meter.
7. Modify the synthesizer output power so that the power meter display indicates the power desired at the sampling point.

For example, assume that you are using a directional coupler that has a coupling factor of 22 dB and you want +5 dBm at the output of the coupler. In this case, you must set the power at the sampling point (the coupled output) to -17 dBm. Perform the following procedure to set the power at the sampling point to -17 dBm.

- a. Press the **POWER LEVEL** key.
 - b. Rotate the knob on the synthesizer until the power level displayed on the power meter is -17 dBm. Disregard the power level shown on the synthesizer display.
8. Select range hold on the power meter.
 9. Press the **EXT METER** key on the synthesizer.

When the **EXT METER** key is pressed, the text **RNG-HOLD, POWER XXXdBm** appears in the left-most display, where **XXX** is the last range hold meter value that was entered.

10. Enter the power shown on the power meter display into the synthesizer using the numeric keypad.

The value entered into the synthesizer is called the range hold meter value. For example, if the power meter currently reads -17 dBm, perform the following procedure to enter -17 dBm into the synthesizer:

- a. Press **-17** on the synthesizer numeric keypad.
- b. Terminate the range hold meter value entry by pressing the dBm **GHz** key.

When the range hold meter value is terminated, the synthesizer enters the external power meter leveling mode. Power is then held at a constant level at the sampling point, regardless of gain changes in the signal path between the synthesizer RF OUTPUT connector and the sampling point.

NOTE

External power meter leveling is not recommended with either pulse modulation or AM modulation.

Related Tasks

- To Use External Diode Detector Leveling

To Use the Level Correct Routine

When activated, the level correct function adjusts the synthesizer output power (to compensate for losses or gains) to provide constant, leveled power at output of the external signal path.

When the level correct routine is used, the synthesizer performs a calibration process that corrects for external losses or power variations in an external signal path. When the level correct routine is run, a power meter that is under control of the synthesizer will measure power variations at the output of the external signal path over a user-defined frequency range. The synthesizer then reads back the power level data from the power meter and creates a table of correction values for each frequency point (the level correction table). The level correction table resides in non-volatile memory and up to four level correction tables can be stored for later use. If the power meter is in a favorable range, the level correct routine takes approximately two minutes to run.

NOTE

When using the level correct routine, the external path to the synthesizer must be linear (must have a 1 dB per 1 dB transfer function).

Using the level correct routine requires the following external equipment.

Equipment	Requirements
HP 437B, 438A, 70100A, or SCPI compatible power meter	No substitute.
Power Sensor	Must be compatible with the power meter used. Must be capable of measuring power at the frequencies and levels present at the output of the signal path being leveled.

In addition, you must supply the cables and adapters necessary to connect the equipment.

1. Connect the equipment as shown in Figure 3-20:

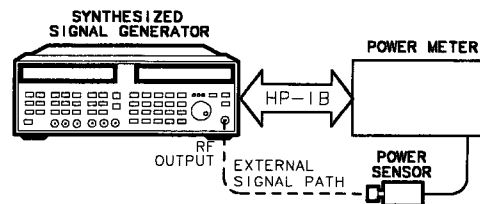

pk610ab

Figure 3-20. Level Correct Routine Equipment Setup

2. Set the address that the synthesizer will use to address the power meter during the level correct routine.

For example, use the following procedure to set the power meter address to 13.

- a. Press the **SPCL** key.
 - b. Press **20** on the synthesizer's numeric keypad.
 - c. Press the **Hz** (ENTER) key. You will be prompted to enter the power meter address.
 - d. Press **13** on the synthesizer's numeric keypad.
 - e. Terminate the power meter address by pressing the **Hz** (ENTER) key.
3. Choose the programming language that the synthesizer will use to communicate with the power meter over the HP-IB.

For example, use the following procedure to choose HP 437B compatible programming language.

- a. Press the **SPCL** key.
 - b. Press **21** on the synthesizer's numeric keypad.
 - c. Press the **Hz** (ENTER) key.
 - d. Press the **↑** or **↓** key until the display reads POWER METER IS HP437B.
4. Press the **POWER LEVEL** key.

To Use the Level Correct Routine

5. Adjust the power level to a level near the center of the power sensor range.
6. Press the **(SHIFT)** key and then the **(INT LEVEL)** (LVL CR) key.
7. Enter the desired level correct start frequency. If the start frequency shown in the display is the desired start frequency, continue with step 8.

For example, use the following procedure to set the level correct start frequency to 3.5 GHz.

- a. Press **(3.5)** on the synthesizer's numeric keypad.
- b. Terminate the level correct start frequency by pressing the **(GHz)** key.

Note that the level correct start frequency remains on the display after it is terminated so that it can be modified using the knob or **(↑)**, **(↓)** keys if desired.

8. Press the **(Hz)** (ENTER) key to begin level correct stop frequency entry.
9. Enter the desired level correct stop frequency. If the stop frequency shown in the display is the desired stop frequency, continue with step 10.

For example, use the following procedure to set the level correct stop frequency to 9.75 GHz.

- a. Press **(9.75)** on the synthesizer's numeric keypad.
- b. Terminate the level correct stop frequency by pressing the **(GHz)** key.

Note that the level correct stop frequency remains on the display after it is terminated so that it can be modified using the knob or **(↑)**, **(↓)** keys if desired.

10. Press the **(Hz)** (ENTER) key to begin the number of points entry.

When the **(Hz)** (ENTER) key is pressed, the words SET NUMBER OF POINTS ******* appear in the left-most display where ******* is the current number of points. A maximum of 401 points can be entered.

11. Enter the desired number of points. If the number of points shown in the display is the desired number of points, continue with step 12.

Note that the start frequency and stop frequency are included in the number of points. Use the following procedure to set the number of points to 100, for example.

- a. Press **100** on the synthesizer's numeric keypad.
- b. Terminate the number of points entry by pressing the **Hz** (ENTER) key.

Note that the number of points entry remains on the display after it is terminated so that it can be modified using the knob or **↑**, **↓** keys if desired.

12. Press the **Hz** (ENTER) key.

When the **Hz** (ENTER) key is pressed, the words RUN CORRECTION?, HIT ENTER appear in the left-most display.

13. Press **Hz** (ENTER) to run the level correct routine.

The level correct routine can be aborted before it begins running by pressing the **LOCAL** key. It can also be aborted any time while it is running by pressing the **LOCAL** key.

As the level correct routine is running, the right-most display will be blanked and the left-most display will show each frequency point and measured power level as each measurement occurs. When the level correct routine has finished running, the left-most display will blank and the frequency and output power level will return to the right-most display.

NOTE

As the routine is running, the synthesizer sends the power meter each frequency point so that the correct calibration factor at each frequency can be used. For best accuracy, the correct calibration factors for the power sensor being used should be entered into the power meter prior to running the level correct routine.

To Use the Level Correct Routine

14. When the level correct routine has finished running, press the **SHIFT** key and then the **POWER LEVEL** (LVL CR ON/OFF) key to enable the synthesizer to use the level correct data when determining the output power level.

When the level correct data has been enabled, the LVL CR annunciator will be lit.

15. Disconnect the power meter and power sensor from the level correct setup.

The output of the external signal path can now be connected to the device under test.

The data stored in non-volatile memory will only be valid for the current external signal path. If the external signal path is changed, the level correct routine will have to be rerun.

NOTE

The table of level correct values should be stored in one of four level correction register locations for later use.

To store the table of level correct values in a level correction register location, perform the following procedure.

1. Press the **SHIFT** key and then the **EXT DIODE** (SAVE CR) key.

The display will show SAVE IN TABLE XXX where XXX is the current level correction register number.

2. Enter the desired level correction register number.

For example, use the following procedure to choose level correction register number 2.

- a. Press **2** on the synthesizer's numeric keypad.
- b. Terminate the level correction register number entry by pressing the **Hz** (ENTER) key.

NOTE

Once the level correction register number entry has been terminated, the current table of level correct values will write over any old level correct data stored at that register location.

Related Tasks

- To Use Previously Stored Level Correct Data

To Use Previously Stored Level Correct Data

When the level correct routine is run, the synthesizer creates a table of correction values for each frequency point in the table. Up to four level correction tables can be stored in the synthesizer memory. If the current signal path at the synthesizer output (the external signal path) is identical to the external signal path on which a level correct routine had been previously run, the level correction table can be recalled from memory and be used at a later time.

1. Verify that the current external signal path is correct for the level correct table you want to recall from memory and use.

The current external signal path must be identical to the external signal path that was calibrated and stored in the level correct table that you wish to recall. If the current external signal path is different, the data can cause inaccurate output power levels at the output of the external signal path.

2. Press the **(SHIFT)** key and then the **(EXT METER)** (RCL CR) key.

The display will show RECALL FRM TABLE XXX where XXX is the last level correction register number recalled.

3. Enter the level correction register number of the register that contains the level correct data you want to use.

For example, use the following procedure to choose level correction register number 2.

- a. Press **(2)** on the synthesizer's numeric keypad.
 - b. Terminate the level correction register number entry by pressing the **(Hz)** (ENTER) key.
4. Press the **(SHIFT)** key and then the **(POWER LEVEL)** (LVL CR ON/OFF) key to enable the synthesizer to use the level correct data when determining the output power level.

When the level correct data has been enabled, the LVL CR annunciator will be lit.

Related Tasks

- To Use the Level Correct Routine

If You Encounter a Problem

If you have a problem generating signals with the synthesizer, check the following list of commonly encountered problems and troubleshooting procedures. If the problem involves data entry, check the section under Chapter 2 entitled, "If You Encounter a Problem." If the problem that you encounter is not in the following list or in Chapter 2, contact the nearest Hewlett-Packard office for assistance.

NOTE

When transporting the product, use original packaging or comparable only.

Annunciators Turned On

If the UNLVL LED annunciator is on:

- Check the leveled power specification to make sure that you have not exceeded the specification.

The maximum power specification is frequency dependent. Typically less maximum power is available as the synthesizer output frequency is increased.

- If external diode detector leveling or external power meter leveling is being used, ensure that the leveling loop is not opened.
- If external diode detector leveling or external power meter leveling is being used, ensure that the synthesizer output is not being forced into an unleveled condition by the leveling circuitry.

If the circuit path before the sampling point has a lot of attenuation, the synthesizer will have to source high power even though the required power at the sampling point seems low. For example, if the circuit before the sampling point has 23 dB of attenuation and the power required at the sampling point is 5 dBm, the synthesizer will need to source 28 dBm, which is more than its maximum specified power level.

If the MSG LED annunciator is on:

If the synthesizer MSG LED annunciator is on, there is a problem with the synthesizer. To determine the error and turn off the MSG LED annunciator, refer to section "To Read the Contents of the Error Queue" in Chapter 2 and the listing of error messages in Chapter 8.

RF Output Problems

If there is no signal at the RF OUTPUT connector:

- Check that the signal at the RF OUTPUT is turned on.

If the RF OUTPUT is turned off, the text OFF will be displayed in place of dBm in the right-most display.

If the signal at the RF OUTPUT is turned off, press the **RF ON/OFF** key once to turn it on.

- If external modulation (log/lin AM, FM, ϕ M, or pulse modes) is being used, check the external modulating signal or external gate/trigger signals for problems.

If modulation is on and the signal is distorted:

- Check that the external modulating signal is within the synthesizer specifications. Refer to the specification table in Chapter 4 for the individual modulating signal input specifications.

If the signal at the RF OUTPUT connector does not appear to be phase locked to the external reference:

- Check that the external reference is within synthesizer specifications. Refer to the specification table in Chapter 4 for the external reference input specifications.
- If FM is being used, check if FM coupling is set to DC.

In order for the synthesizer to generate DC-coupled FM, the internal circuitry is not phase locked. This is a characteristic of DC-coupled FM.





Specifications and Options



Specifications and Options

This chapter contains listings of the synthesizer performance specifications and the mechanical, electrical, warranty, and documentation options that are available.



Specifications

Specifications describe the instrument's warranted performance over the 0 to 55 °C temperature range unless otherwise noted. Supplemental characteristics (indicated by italics) are intended to provide information useful in estimating instrument capability in your application by describing typical, but not warranted, performance.

Frequency

Range: HP 83731B, 1.0 to 20.0 GHz;
HP 83732B, 0.01 to 20 GHz

Resolution: 1 kHz (1 Hz with Option 1E8)

Stability (with high stability timebase, Option 1E5):

Aging Rate: $<1.5 \times 10^{-9}$ /day after 24-hour warm up.
Temperature Effects: $<1 \times 10^{-7}$ over 0 to 55 °C, nominally $<1.4 \times 10^{-9}$ /°C
Line Voltage Effects: $<5 \times 10^{-10}$ for 10% change in line voltage

Stability (without high stability timebase):

Aging Rate: $<1.0 \times 10^{-8}$ /day after 72-hours at 25 °C ±10 °C
Temperature Effects: $<5 \times 10^{-6}$ over 0 to 55 °C referenced to 25 °C

Stability (with external 10 MHz reference):

Same as external
reference.

Frequency Switching Time: <50 ms to within 1 kHz for any frequency step.
For <1 GHz steps, not across 10 GHz band-switch point: <35 ms

RF Output

Maximum Leveled Output Power:

Frequency	Standard	with Option 1E1
0.01–1 GHz	+13 dBm	+13 dBm
1–18 GHz	+11 dBm	+10 dBm
18–20 GHz	+10 dBm	+8 dBm

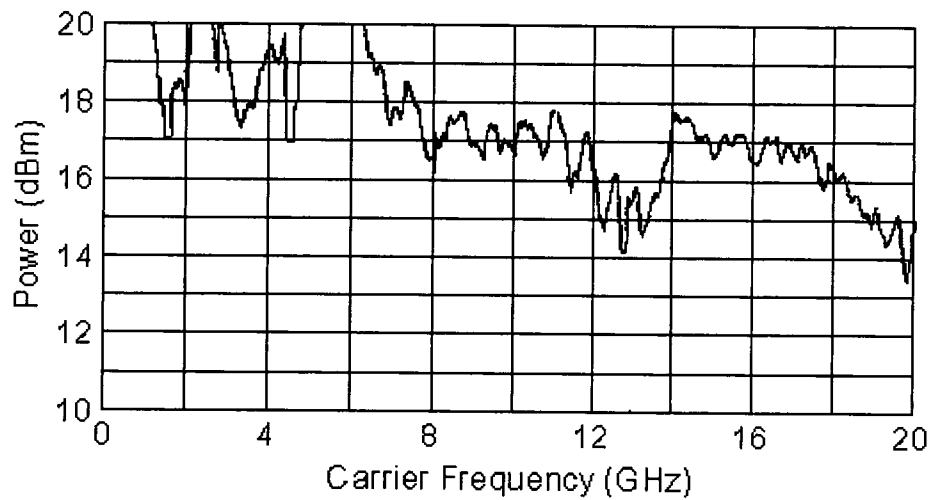

Figure 4-1.
Typical Maximum Available Output Power from 1 to 20 GHz, at 25 °C with Output Step Attenuator (Option 1E1) Installed

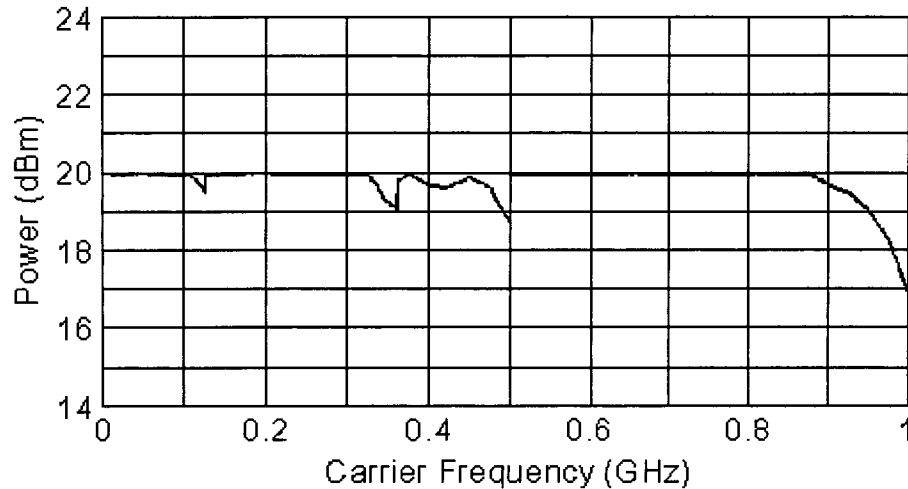

Figure 4-2. Typical Maximum Available Output Power from 0.01 to 1 GHz at 25 °C

Minimum Leveled Output Power -4 dBm; -10 dBm linear AM (-110 dBm with Option 1E1)

Display Resolution: 0.01 dB

Accuracy: ± 1.0 dB, 50 MHz to 20 GHz; ± 1.3 dB, 10 MHz to 50 MHz (-4 dBm to specified maximum leveled output power; with linear AM, -10 dBm to specified maximum leveled output power)

Accuracy (over all power levels)

10 MHz to 50 MHz: ± 2.3 dB (power ≥ -90 dBm)

50 MHz to 20 GHz: ± 2.0 dB (Power ≥ -90 dBm)

10 MHz to 20 GHz ± 2.5 dB (power < -90 dBm)

The use of Type-N RF connectors above 18.0 GHz degrades specification typically by 0.2 dB.

Specifications and Options

Specifications

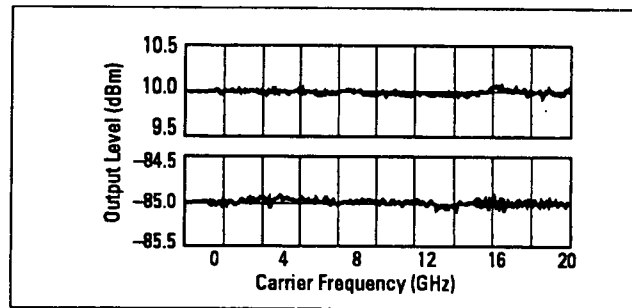

Figure 4-3. Typical Output Level Accuracy and Flatness at +10 and -85 dBm

Flatness: ± 0.5 dB (Power ≥ -90 dBm); ± 0.7 dB (Power < -90 dBm). The use of Type-N RF connectors above 18.0 GHz degrades specification typically by 0.2 dB.

Level Switching Time: Typically < 17 ms (without step attenuator range change).

Attenuator range changes occur at:

- 10 dBm, -20 dBm, -30 dBm, etc. (Linear AM);
 - 4 dBm, -14 dBm, -24 dBm, etc. (all other modes)
- Output SWR: $< 2.0 : 1$ nominal

Spectral Purity

SSB Phase Noise (dBc/Hz):

Carrier Freq.	Offsets			
	100 Hz	1 kHz	10 kHz	100 kHz
500 MHz to <1 GHz	-78	-92	-103	-115
1 GHz to <2 GHz	-73	-83	-92	-107
2 GHz to <5 GHz	-70	-78	-83	-100
5 GHz to <10 GHz	-69	-78	-82	-100
10 GHz to 20 GHz	-65	-73	-76	-100

Phase noise decreases 6 dB/octave below 500 MHz and reaches a floor of <-140 dBc/Hz.

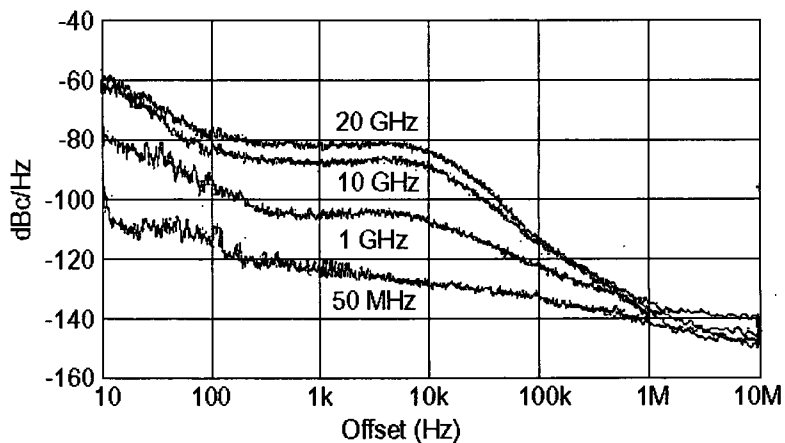

Figure 4-4.

Typical Single-sideband Phase Noise at 50 MHz, 1 GHz, 10 GHz, and 20 GHz, 25 °C, CW Mode.
 Offsets Less than 100 Hz Require the High Stability Timebase, Option 1E5.

Specifications and Options

Specifications

In CW mode, phase noise degrades with frequency or phase modulation:

<i>Modulation type</i>	<i>Degradation @ 20 kHz offset</i>
<i>FM</i>	<i>typically 10 dB</i>
<i>1 rad/V Phase Modulation</i>	<i>typically 5 dB</i>
<i>50 rad/V Phase Modulation</i>	<i>typically 20 dB</i>

Harmonics: < -55 dBc at output levels $< +6$ dBm

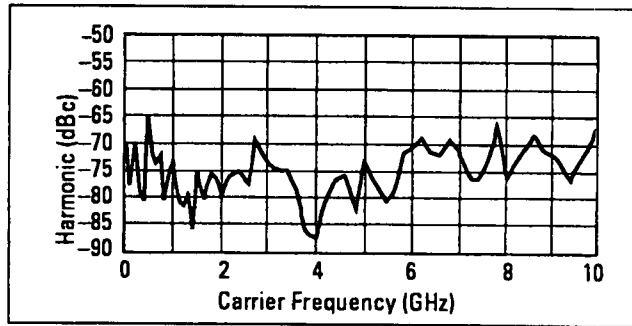

Figure 4-5. Typical 2nd Harmonic Levels Measured at Output Power of +6 dBm

Non-Harmonic Spurious (≥ 3 kHz): < -60 dBc (includes power supply and frequency synthesis spurious).

Non-Harmonic Spurious (< 3 kHz): < -50 dBc

Sub-Harmonics: None

Residual FM:

At 1 GHz, <15 Hz in 50 Hz to 15 kHz bandwidth. Residual FM decreases 6 dB per octave below 1 GHz.

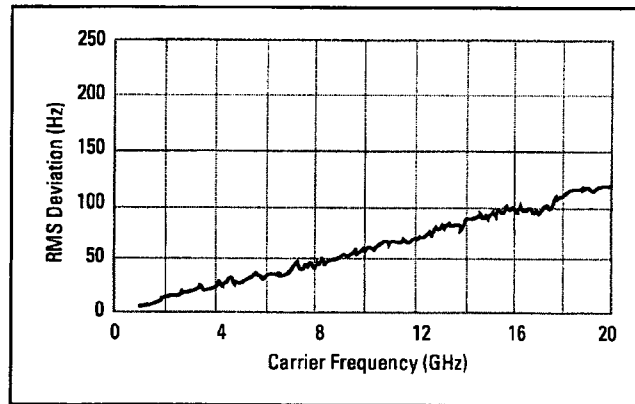

Figure 4-6.

Typical Residual FM Measured in 50 Hz – 15 kHz Bandwidth, CW Mode, with High Stability Timebase (Option 1E5)

AM Noise Floor: (at 0 dBm and offsets greater than 5 MHz from carrier)

<-150 dBm/Hz, 1 GHz to 20 GHz.

<-140 dBm/Hz, 0.01–1 GHz.

Specifications and Options
Specifications

Modulation

Carrier Freq.	<25 MHz	25–<64 MHz	64–<128 MHz	128–<500 MHz	500–<1000 MHz	1–20 GHz
Minimum Pulse Width	<1 μ s		<100 ns		<25 ns <i>Typically <10 ns</i>	
Rise/Fall Time	<500 ns	<350 ns	<50 ns	<35 ns	<20 ns	<10 ns
Video Feedthrough	<2 mV peak-to-peak at 0 dBm					<20 mV peak-to-peak at 0 dBm
Pulse Width Compression	± 150 ns		± 15 ns		± 5 ns	
Pulse Delay (Video out to RF out)	<1 μ s		<200 ns		<125 ns	<100 ns

Pulse Modulation

NOTE

CW power will be present for up to 10 ms when changing frequency or power level.

On/Off Ratio: > 80 dB

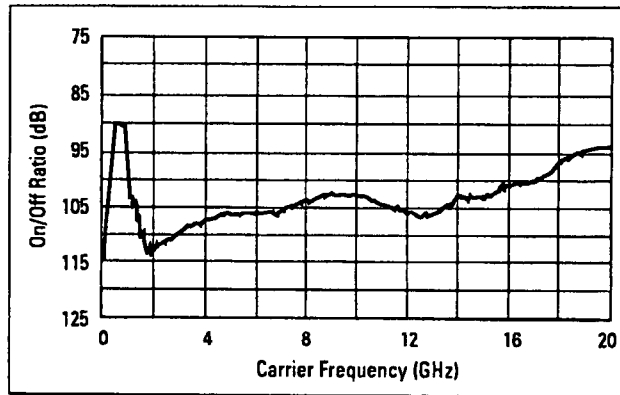
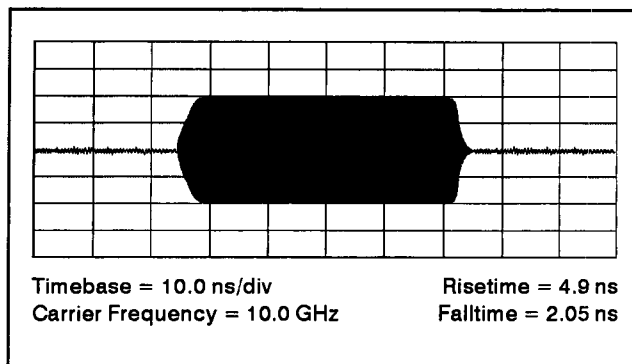

Figure 4-7. Typical Pulse Modulation On/Off Ratio at +8 dBm

- Maximum Pulse Repetition Frequency: > 3 MHz*
- Minimum Pulse Duty Cycle: No restrictions on duty cycle.*
- Pulse Level Accuracy: ± 1.0 dB (relative to CW)*
- Pulse Overshoot: < 10%*
- Input Impedance: 50Ω nominal; TTL drive levels*
- Maximum Leveled Output Power in Pulse Mode: -0.5 dB relative to CW*

Specifications



pk619ab

Figure 4-8.
Typical Pulse Modulation Envelope Illustrates the Fast Rise and Fall Times, Excellent Flatness and Pulse Fidelity

Internal Pulse Source

- Pulse Source Modes: Free-run, triggered with delay, doublet and gated. Triggered with delay, doublet and gated require external trigger source.
- Pulse Repetition Frequency: 3 Hz to >3 MHz
- Pulse Repetition Interval (PRI): 300 ns to 419 ms
- Pulse Width (T_w): 25 ns to 419 ms
- Variable Pulse Delay (free-run mode, T_d): ± 419 ms from synchronizing pulse to video output.
- Variable Pulse Delay (triggered with delay & doublet modes, T_d): 225 ns to 419 ms with ± 25 ns jitter
- Pulse Width/Delay/PRI Resolution: 25 ns
- Pulse Delay (Video to RF, T_m): *Nominally, <20 ns, 1 to 20 GHz*

All pulse modulation specifications and supplemental characteristics apply during use of internal pulse source.

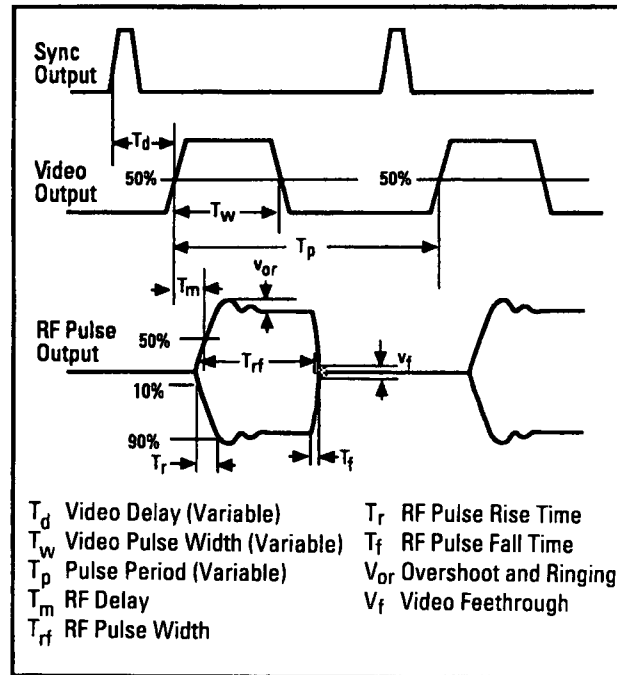

Frequency Modulation

Rates: 1 kHz to 1 MHz
 Flatness: ± 2 dB

Table 4-1. Maximum Deviation (with sinewave modulation only)

Frequency	Maximum Deviation
2 GHz to 20 GHz	10 MHz peak
1 GHz to <2 GHz	5 MHz peak
500 MHz to <1 GHz	2.5 MHz peak
256 MHz to <500 MHz	1.25 MHz peak

Maximum deviation decreases by a factor of 2 for each octave below 256 MHz.

Specifications

Table 4-2. Modulation Index

<i>Frequency</i>	<i>Modulation Index</i>
<i>2 GHz to 20 GHz</i>	<i>>300</i>
<i>1 GHz to <2 GHz</i>	<i>>150</i>
<i>500 MHz to <1 GHz</i>	<i>>75</i>
<i>256 MHz to <500 MHz</i>	<i>>37</i>

Modulation index decreases by a factor of 2 for each octave below 256 MHz.

Sensitivity: 7 ranges, selectable

Frequency	Selectable Sensitivity	Unit
1 GHz to 20 GHz	10, 5, 3, 1, 0.3, 0.1, 0.03	MHz/V
256 MHz to <1 GHz	2500, 1250, 750, 250, 75, 25, 7.5	kHz/V
64 MHz to <256 MHz	625, 312, 187, 62.5, 18.7, 6.25, 1.87	kHz/V
16 MHz to <64 MHz	156, 78.1, 46.8, 15.6, 4.68, 1.56, 0.468	kHz/V
10 MHz to <16 MHz	78.1, 39.0, 23.4, 7.81, 2.34, 0.781, 0.234	kHz/V

FM Sensitivity Accuracy: ±10% typical at 100 kHz

Incidental AM: < 5%

FM Input Impedance: 600Ω nominal

Harmonic Distortion: < 1% (1 MHz peak deviation @ 100 kHz rate)

Linear Amplitude Modulation

Sensitivity: 2 ranges, selectable: 30%/Vpk and 100%/Vpk

Sensitivity Accuracy: (1 KHz) ±8% of value ±2%, (15 to 35 °C)

Maximum Depth: 90%

Bandwidth: (3 dB, 30% depth) DC to 100 kHz

Incidental Phase Modulation: (30% depth) 0.4 radians peak

Maximum Carrier Level in Linear AM Mode (Relative to CW):

<1 GHz	1-4 GHz	>4 GHz
0 dB	-4.5 dB	-1.0 dB

With modulation: degrades up to 6 dB, depending on depth.

Logarithmic Amplitude Modulation (Scan Modulation)

Maximum Depth: > 60 dB
 Sensitivity: -10 dB/V; (0 to +6 V for 0 to -60 dBc)
 Step Response (50 dB change in level): rise and fall < 5μs, 1 GHz to 20 GHz.
 Rise < 10 μs, < 1 GHz. Fall < 20 μs, < 1 GHz
 Input Impedance: 5 kΩ nominal

Maximum Leveled Output Power in Log AM Mode (relative to CW):

<1 GHz	1-4 GHz	>4 GHz
0 dB	-4.5 dB	-1.0 dB

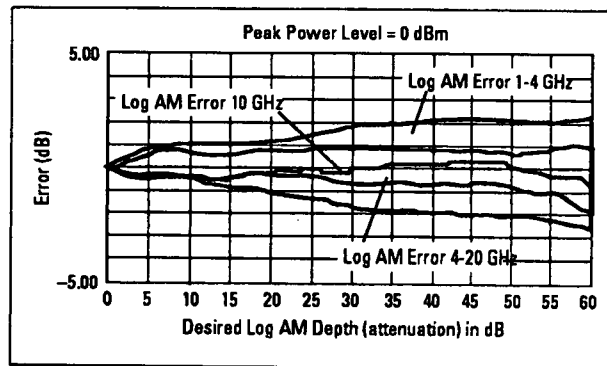

Figure 4-9.
 Typical Log AM Error (deviation from desired depth) at 25 °C for Carrier Frequencies between 1.0 and 20 GHz

Simultaneous Modulations

Full AM bandwidth and depth is available at any pulse rate or width.
 FM/φM is completely independent of AM and pulse modulation.

Specifications and Options

Specifications

Option 800 Phase Modulation

Adds phase modulation. The following specifications apply:
Sensitivity: 2 ranges, selectable:

Frequency	Low Range	High Range
1 GHz to 20 GHz	1 rad/Vpk	50 rad/Vpk
256 MHz to <1 GHz	0.25 rad/Vpk	12.5 rad/Vpk
64 MHz to <256 MHz	0.0625 rad/Vpk	3.12 rad/Vpk
16 MHz to <64 MHz	0.0156 rad/Vpk	0.781 rad/Vpk
10 MHz to <16 MHz	0.00781 rad/Vpk	0.39 rad/Vpk

Accuracy (typical): $\pm 5\%$ typical @ 1 kHz (Low Range); $\pm 10\%$ @ 100 Hz (High Range)

Flatness: DC-100 kHz: ± 1 dB (Low Range); DC-30 kHz: ± 2 dB (High Range)

Bandwidth (typical): 1 MHz (3 dB) (Low Range); useable to 1 MHz (at low deviations) (High Range)

Input Impedance: 600 Ω nominal (Low Range); 600 Ω nominal (High Range)

Maximum Deviation (with sine-wave modulation only):

Frequency	Low Range	High Range
2 GHz to 20 GHz	4 rad	200 rad
1 GHz to <2 GHz	2 rad	100 rad
500 MHz to <1 GHz	1 rad	50 rad
256 MHz to <500 MHz	.5 rad	25 rad

The maximum deviation decreases by a factor of 2 for each octave below 256 MHz.

Option 1E2

Specifications for internal modulation are the same as those for the base instrument, unless noted below:

Waveforms

Sine-wave: 0.5 Hz to 1 MHz rates.
Ramp, square, triangle: 0.5 Hz to 100 kHz rates
Uniform noise, Gaussian noise
Rate accuracy: $< \pm .01\%$

Internal Scan Modulation

Rate: 0.5 Hz to 20 kHz
Rate Resolution: 0.5 Hz (3 digits displayed)
Depth Resolution: 0.01 dB (hardware resolution $< .015$ dB)

Internal Linear AM

Rate: 0.5 Hz to 100 kHz
Rate Resolution: 0.5 Hz (3 digits displayed)
Depth Resolution: 0.1%

Internal FM

Rate: 1 kHz to 1 MHz
Rate Resolution: 0.5 Hz (3 digits displayed)

Specifications and Options

Specifications

Deviation Resolution (3 digits displayed):

Table 4-3. Hardware Resolution

FM Deviation	Nominal Resolution
7.5 MHz to 10 MHz	3.66 kHz
3.75 MHz to <7.5 MHz	1.83 kHz
1.875 MHz to <3.75 MHz	916 Hz
938 kHz to <1.875 MHz	458 Hz
469 kHz to <938 kHz	289 Hz
234 kHz to <469 kHz	114 Hz
117 kHz to <234 kHz	57 Hz
<117 kHz	29 Hz

Flatness: ± 2 dB (1 kHz to 500 kHz)

Internal Phase Modulation (with Option 800 only)

Rate: 0.5 Hz to 1 MHz

Rate Resolution: 0.5 Hz (3 digits displayed)

Deviation Resolution (3 digits displayed):

Table 4-4. ϕ M Hardware Resolution (Low Range)

Internal ϕ M Deviation (Low Range)	Nominal Resolution
3 rad to 4 rad	1.465 mrad
1.5 rad to <3 rad	732 μ rad
0.75 rad to <1.5 rad	366 μ rad
375 mrad to <750 mrad	183 μ rad
188 mrad to <375 mrad	92 μ rad
94 mrad to <188 mrad	46 μ rad
47 mrad to <94 mrad	23 μ rad
<47 mrad	12 μ rad

Table 4-5. ϕ M Hardware Resolution (High Range)

Internal ϕ M Deviation (High Range)	Nominal Resolution
150 rad to 200 rad	73.2 mrad
75 rad to <150 rad	36.6 mrad
37.5 rad to <75 rad	18.3 mrad
18.75 rad to <37.5 rad	9.16 mrad
9.375 rad to <18.75 rad	4.58 mrad
4.688 rad to <9.375 rad	2.89 mrad
2.344 rad to <4.688 rad	1.14 mrad
<2.344 rad	0.57 mrad

Bandwidth (typical): 700 kHz (3 dB) on low range

Specifications

General

Programming

These instruments are fully compatible with the Standard Commands for Programmable Instruments (SCPI). SCPI complies with the IEEE 488.2-1987. In addition, these instruments will emulate most applicable HP 8673 commands, providing general compatibility with ATE systems which include HP 8673 Series Signal Generators. Please consult your HP sales representative for details.

Environmental

Operating Temperature Range: 0° to 55 °C (for indoor use).

Altitude: Up to 15,000 feet (4,572 meters).

Relative Humidity: 80% for temperatures up to 31 °C decreasing linearly to 50% relative humidity at 40 °C.

EMC: Complies with CISPR Publication 11/1990, Class A, Group 1 and MIL-STD-461C, Part 2, Methods CE03 (NB full limits, BB 10 dB relaxation 150 kHz to 500 kHz, full limits elsewhere); CS01; CS02; RE02 (Curve 2 +10 dB); RS03 (1 V/m, 15 kHz to 1 GHz).

This product is designed for use in INSTALLATION CATEGORY II and POLLUTION DEGREE 2, per IEC 1010 and 664 respectively.

Acoustic Noise Emission (Geraeuschemission)

LpA <70 dB(A) per ISO 3744 (LpA <70 dB(A) nach DIN 45635 pt. 1)

LpA Operator position: 44.6 dB, based upon type test per ISO 6081.

(LpA am Arbeitsplatz: 44.6 dB, typpruefungsergebnis nach DIN 45635 pt. 19)

LpA Bystander position: 38.4 dB, based upon type test per ISO 6081.

(LpA fiktiver Arbeitsplatz: 38.4 dB, typpruefungsergebnis nach DIN 45635 pt. 19)

Power Requirements

Power: 90—132 V, 48—440 Hz. 198—264 V, 48—66 Hz.

260 VA maximum.

Physical Dimensions

Net Weight: < 16 kg (35 lb)

Shipping: < 23 kg (49 lb)

Size: 498 mm D × 426 mm W × 133 mm H (19.6" × 16.8" × 5.2")

Transit case available by ordering HP Part Number 9211-2655.

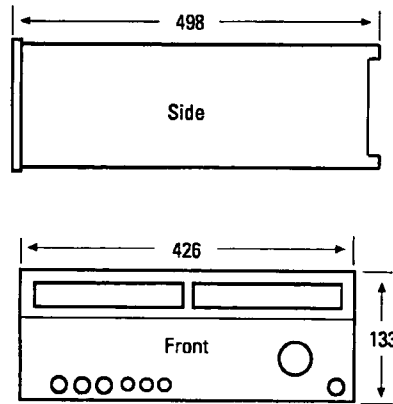

Figure 4-10. Dimensions

Front Panel Connectors

NOTE

For more detailed information about the front panel connectors, refer to Chapter 5.

RF OUTPUT

The standard front panel RF OUTPUT connector is a Type-N precision connector. When Option 1E9 is installed, this front panel connector is a 3.5 mm precision connector. The nominal source impedance is 50 Ω .

ALC IN

This front panel BNC connector allows the synthesizer to be externally leveled. It is used with external power meter leveling or external diode leveling. The leveling signal at this input must be in the $\pm 1\text{V}$ range. The nominal input impedance is 150 k Ω . The damage level is $\geq +12\text{ V}$ or $\leq -12\text{ V}$.

AM IN

Accepts an input signal for external Linear AM or Log AM. Nominal impedance 5 k Ω . Damage level is $\geq +15.5\text{ V}$ or $\leq -15.5\text{ V}$.

FM/ ϕ M IN

Accepts an input signal for external FM or phase modulation (Option 800 only). Nominal impedance is 600 Ω . Damage level is $\geq +5\text{ V}$ or $\leq -5\text{ V}$.

PULSE/TRIG GATE IN

Accepts an input signal for external pulse modulation. Also, it accepts an external trigger pulse input for internal pulse modulation (TTL-level compatible, nominal impedance 50 Ω).

PULSE VIDEO OUT

The output is a signal that follows the RF output in all pulse modes (TTL-level compatible, nominal source impedance 50 Ω).

PULSE SYNC OUT

The output is a synchronizing pulse, nominally 50 ns width, during internal and triggered pulse modulation (TTL-level compatible, nominal source impedance 50 Ω).

Rear Panel Connectors

NOTE

For more detailed information about the rear panel connectors, refer to Chapter 5.

10 MHz Input

Accepts a 10 MHz \pm 100 Hz, 0 to +10 dBm, external reference signal for operation from an external high stability timebase. Nominal input impedance is 50 Ω .

10 MHz Output

Outputs the 10 MHz reference signal, nominally +3 dBm, for use as an external reference signal. Nominal source impedance is 50 Ω .

0.5V/GHz Output

Supplies a voltage proportional to output frequency for use with mm-wave frequency multipliers, including the HP 83550 Series Millimeter Wave Source Modules.

AM Output (Option 1E2 only):

Provides a sample of the modulating signal from the internal AM generator or external AM input.

FM/ ϕ M Output (Option 1E2 only):

Provides a sample of the modulating signal from the internal FM/ ϕ M generator or external FM/ ϕ M input.

Options

The following paragraphs explain the electrical, mechanical, warranty, and documentation options that are available.

Electrical Options

Option 1E1 - Add Output Step Attenuator If Option 1E1 is ordered, an internal step attenuator is included before the **RF OUTPUT** connector. The step attenuator has a range of 0 to 110 dB in 10 dB steps. The correct amount of attenuation is selected automatically by the synthesizer dependent on the output power level selected. If this option is installed, you can select whether or not the step attenuator will automatically switch. This function is useful during certain applications, such as when external automatic level control is used.

Option 1E2 - Add Internal Modulation Generator If Option 1E2 is ordered, internal log/linear AM and FM/ ϕ M sources are provided. These sources are both front panel controllable and programmable using an instrument controller.

NOTE

Option 800 is also required to activate the internal ϕ M source.

Option 1E5 - Add High Stability Timebase If Option 1E5 is ordered, the synthesizer is shipped with a 10 MHz temperature controlled crystal reference oscillator for increased frequency accuracy and stability. If Option 1E5 is installed, the synthesizer must be connected to AC mains power to keep the reference oscillator at operating temperature. If the reference oscillator has not been connected to mains power (the oven is cold), the synthesizer requires 30 minutes to warm up.

Option 1E8 - 1 Hz Frequency Resolution 1 Hz frequency resolution.

Specifications and Options

Options

Option 1E9 - 3.5 mm RF Output Connector If Option 1E9 is ordered, the RF OUTPUT connector is a male APC-3.5 precision connector in place of the standard female Type-N connector.

Option 800 - Phase Modulation If Option 800 is ordered, phase modulation is available. Two phase modulation ranges can be selected: low and high. The low range is from 17 mrad to 4 rads and the high range is from 1.17 rads to 300 rads, depending on CW frequency.

Mechanical Options

There are three mechanical options available for the synthesizer. If these options were not ordered with the original shipment, they can be ordered from the nearest Hewlett-Packard office using the part numbers included in each of the following paragraphs. A handle kit (part number 5062-3989) is included.

These options are as follows:

Option 1CM - Rack Mount Kit The synthesizer can be mounted to an instrument rack using the rack mount kit.

The rack mount kit part number is 5062-3977.

Option 1CP - Rack Mount and Handle Kit The synthesizer can be mounted to an instrument rack using the rack flange kit. In addition, ease of handling is increased when the synthesizer is not rack mounted by using the front panel handles. The rack mount and handle kit part number is 5062-4071 and the front handle kit part number is 5062-3983.

Option 1CR - Rack Slide Kit This kit is useful when the synthesizer is rack mounted. Access to internal circuits and components or the rear panel is possible without removing the synthesizer from the rack. The rack slide kit part number is 1494-0059. If a non-HP rack enclosure is used, rack adapters can be ordered to allow the slide kit to be used with the non-HP rack. The part number for metric rack adapters is 1494-0023 and the part number for standard inch rack adapters is 1494-0061.

Warranty Options

There are two warranty options available for the synthesizer. These options are as follows:

Option W30 - Two
Additional Years
Return-to-HP Service

This option extends the benefits of factory warranty to provide a total of 3 years of customer return repair service.

Option W32 - Three Year
Return to HP Calibration
Service

This option provides 3 years of HP calibration service at HP customer service centers.



Documentation Options

There are four documentation options available for the synthesizer. If the documentation was not ordered with the original shipment and is now desired, it can be ordered from the nearest Hewlett-Packard office using the part numbers included in each of the following paragraphs. These options are as follows:

- Option OBO - Delete Operating Documentation
- If Option OBO is ordered, the shipment deletes a copy of the *HP 83731B/32B Synthesized Signal Generators User's Guide*, *HP 83731A/32A and HP 83731B/32B Synthesized Signal Generators Programming Guide*, *HP 83731A/32A and HP 83731B/32B Synthesized Signal Generators Quick Start Guide*, and the *HP 83711A/12A*, *HP 83711B/12B*, *HP 83731A/32*, and *HP 83731B/32B Signal Generators Calibration Guide*.
- Option OB1 - Extra Operating Documentation
- If Option OB1 is ordered, the shipment includes an *extra* copy of the *HP 83731B/32B Synthesized Signal Generators User's Guide*, *HP 83731A/32A and HP 83731B/32B Synthesized Signal Generators Programming Guide*, *HP 83731A/32A and HP 83731B/32B Synthesized Signal Generators Quick Start Guide*, and the *HP 83711A/12A*, *HP 83711B/12B*, *HP 83731A/32*, and *HP 83731B/32B Signal Generators Calibration Guide*.
- Option OBV - Component-Level Information Packet (CLIP)
- If Option OBV is ordered, the shipment includes a copy of the *HP 83711A/12A*, *HP 83711B/12B*, *HP 83731A/32A*, and *HP 83731B/32B Synthesized Signal Generators Component-Level Information Packet*.
- Option OBW - Service Documentation
- If Option OBW is ordered, the shipment includes a copy of the *HP 83731A/32A and HP 83731B/32B Synthesized Signal Generators Service Guide*.
- Option OBX - Component-Level Information Packet (CLIP)/Service Documentation
- If Option OBV is ordered, the shipment includes a copy of the *HP 83711A/12A and HP 83711B/12B*, *HP 83731A/32A*, and *HP 83731B/32B Synthesized Signal Generators Component-Level Information Packet* and a copy of the *HP 83731A/32A and HP 83731B/32B Synthesized Signal Generators Service Guide*.

Specifications and Options



|





Front/Rear Panel



Front/Rear Panel

This chapter contains detailed information on various aspects of the synthesizer front and rear panel. Information on the synthesizer display, front panel connectors, power cable, etc., can be found in this chapter.



Annunciators

The HP 83731B/32B front panel display contains annunciators that show the status of several of the synthesizer functions and settings.

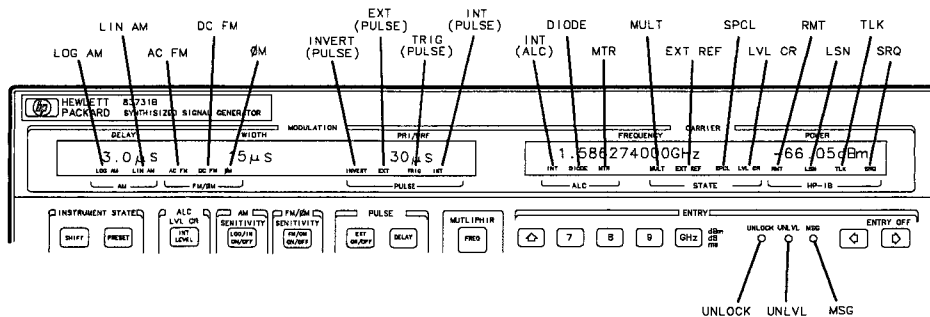

pk6130b

Figure 5-1. Synthesizer Display Annunciators

All annunciators except the UNLOCK, UNLVL, and MSG annunciators are contained on the two fluorescent displays. A description of each of the annunciators follows.

- LOG AM** This annunciator indicates that logarithmic amplitude modulation is enabled.
- LIN AM** This annunciator indicates that linear amplitude modulation is enabled.
- AC FM** This annunciator indicates that AC-coupled frequency modulation is enabled.
- DC FM** This annunciator indicates that DC-coupled frequency modulation is enabled.
- φM** This annunciator indicates that phase modulation is enabled. Phase modulation is only available with Option 800 installed.

Front/Rear Panel
Annunciators

INVERT (PULSE)	This annunciator indicates that inverted external pulse modulation is enabled. When inverted external pulse modulation is enabled, signals at the PULSE/TRIG, GATE IN connector will be inverted. When inverted external pulse modulation is enabled, the INVERT EXT annunciator will be lit.
EXT (PULSE)	This annunciator indicates that the pulse modulating source is external and non-inverted.
TRIG (PULSE)	This annunciator indicates that pulse modulation using the internal pulse modulation source will occur when an external trigger occurs at the PULSE/TRIG, GATE IN connector. When triggered external pulse modulation is enabled, TRIG INT annunciator will be lit.
INT (PULSE)	This annunciator indicates that the internal pulse modulating source is active.
INT (ALC)	This annunciator indicates that internal power leveling is selected.
DIODE (ALC)	This annunciator indicates that external diode power leveling is selected.
MTR (ALC)	This annunciator indicates that external power meter leveling is selected.
MULT	This annunciator indicates that the frequency multiplier function is active.
EXT REF	This annunciator indicates that an external time base is currently being used.
SPCL	This annunciator indicates that one or more special functions are enabled.
LVL CR	This annunciator indicates that the synthesizer output is currently being leveled using stored level correction data.
RMT	This annunciator indicates that the instrument is in the HP-IB remote state, that is, the instrument is under control of an external HP-IB controller.
LSN	This annunciator indicates that the instrument is addressed to listen (accept data or commands).

TLK	This annunciator indicates that the instrument is addressed to talk (output data).
SRQ	This annunciator indicates that the instrument is generating a service request to the external controller.
UNLOCK	This LED annunciator indicates that one or more of the synthesizer frequency control circuits is not phase locked.
UNLVL	This LED annunciator indicates that the synthesizer output power is unlevelled. When the UNLVL annunciator is lit, the power level shown in the right-most display might be incorrect.
MSG	This LED annunciator indicates that uncleared error messages are in the synthesizer front panel error queue.

See Also

Connectors
DC FM ON/OFF
Display
EXT DIODE
EXT METER
EXT ON/OFF
FM/ ϕ M ON/OFF
INT LEVEL
INT ON/OFF
INVERT
LOG/LIN ON/OFF
MSG
MULTIPLIER
SPCL
TRIG ON/OFF

Connectors

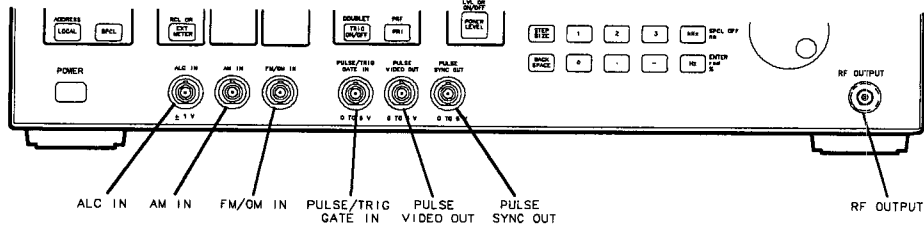

pk618ab

Figure 5-2. Synthesizer Connectors - Front Panel

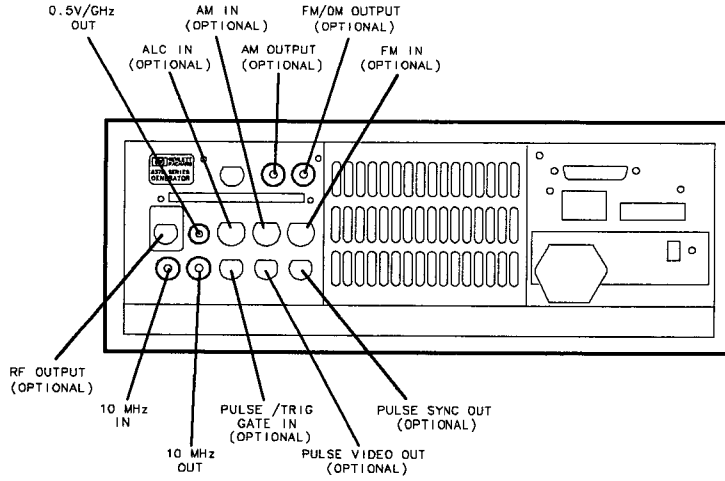

pk617ab

Figure 5-3. Synthesizer Connectors - Rear Panel

Coaxial Connectors

- 0.5 V/GHz OUT This rear panel BNC connector can be used as one of the inputs to a recorder. It produces a DC voltage output that varies linearly with the frequency currently at the RF OUTPUT connector. For example, if the current frequency setting is 5.5 GHz, the voltage at this connector would be 2.75 V. The nominal source impedance is $\leq 250\Omega$.
- 10 MHz IN This rear panel BNC connector accepts a 10 MHz, 0 to +10 dBm reference signal for operation referenced to an external time base. The nominal input impedance of this input is 50Ω . This connector detects when a valid reference signal is connected to it and automatically switches from internal to external reference operation.
- 10 MHz OUT This rear panel BNC connector provides a 3 dBm ± 3 dB, 10 MHz signal derived from the internal frequency standard of the synthesizer. The nominal source impedance is 50Ω .
- AM OUTPUT This rear panel BNC connector provides a buffered baseband AM modulation signal scaled the same as it is generated internally (log AM = -10 dB/Vpk, linear AM = 100% /Vpk), or scaled one-to-one to the external AM signal depending on whether internal or external AM is selected. The AM output connector is only available with Option 1E2.
- FM/ ϕ M OUTPUT This rear panel BNC connector provides a buffered baseband FM or ϕ M modulation signal scaled the same as it is generated internally (FM = 5 MHz/Vpk, ϕ M = 2 radians/Vpk), or scaled one-to-one to the external FM or ϕ M signal depending on whether internal or external FM/ ϕ M is selected. The FM/ ϕ M output connector is only available with Option 1E2.
- ALC IN This front panel BNC connector allows the synthesizer to be externally leveled. It is used with external power meter leveling or external diode leveling. The leveling signal at this input must be in the ± 1 V range. The nominal input impedance is 150 k Ω . The damage level is $\geq +12$ V or ≤ -12 V.

Connectors

- AM IN** This front panel BNC connector provides the amplitude modulating signal input when log AM or linear AM is enabled. The log AM mode changes logarithmically at -10 dB/V. The input range is 0 to +6 V in this mode. Signals less than 0 V have no affect on RF output power. When the level at the AM IN connector is 0 V, RF OUTPUT power is unchanged. In linear AM mode, a 1 Vpk modulating signal causes either 30% or 100% linear AM. The input range is -1 Vpk to +1 Vpk in 100% range, and is -3.3 Vpk to +3.3 Vpk in 30% range. The nominal input impedance is $5\text{ k}\Omega$. The damage level is $\geq +15.5$ V or ≤ -15.5 V.
- FM/ ϕ M IN** This front panel BNC connector provides the frequency modulating signal input when DC or AC FM is enabled. This input accepts a frequency modulating signal between +2 Vpk and -2 Vpk. The FM deviation is proportional to the voltage at the FM/ ϕ M connector. The nominal input impedance of this connector is 600Ω . The damage level is $\geq +5$ V or ≤ -5 V. This front panel BNC connector also provides the phase modulating signal input when ϕ M is enabled. This input accepts a phase modulating signal between -4 Vpk and +4 Vpk.
- PULSE/TRIG, GATE IN** This front panel BNC connector can be used as either an external pulse input or an external trigger pulse input for internal pulse modulation. In either case, it is TTL level compatible and has a nominal input impedance of 50Ω . The damage level is $\geq +5.5$ V or ≤ -0.5 V. A TTL high level ($> +2$ V) enables the selected power level to be at the RF OUTPUT connector, while a TTL low level turns the pulse off. When inverted external pulse modulation is active, these states are inverted. In externally triggered pulse mode, a valid TTL level trigger signal causes pulsed RF to appear at the RF OUTPUT connector with pulse width and delay set by the **WIDTH** and **DELAY** keys.

- PULSE SYNC OUT** This front panel BNC connector provides a synchronizing signal during internal and triggered pulse modulation. The rising edge of this 50 ns pulse defines the time zero reference for the internal pulse mode delay. In triggered pulse mode, a pulse will occur at this connector nominally 225 ns after the leading edge of the external pulse trigger signal. The nominal source impedance is 50 Ω . The pulse amplitude is greater than 2.4 V into a 50 Ω load.
- PULSE VIDEO OUT** This front panel BNC connector provides a synchronizing signal that follows the RF output in all pulse modes. In internal pulse mode, delay is measured from the rising edge of the pulse at the PULSE SYNC OUT connector to the rising edge of the pulse at the PULSE VIDEO OUT connector.
- In triggered pulse mode, delay is measured from the rising edge of the pulse at the PULSE/TRIG, GATE IN connector to the rising edge of the pulse at the PULSE VIDEO OUT connector. The nominal source impedance is 50 Ω . The pulse amplitude is greater than 2.4 V into a 50 Ω load.
- RF OUTPUT** The standard front panel RF OUTPUT connector is a Type-N precision connector. When Option 1E9 is installed, this front panel connector is a 3.5 mm precision connector. The nominal source impedance is 50 Ω .
- When making connections to this connector, carefully align the center conductor elements, then rotate the knurled barrel while mating components remain still. Tighten the barrel until firm contact is made.
- Take care when working with this connector. If the connector is mechanically degraded in any way, high frequency losses can occur. Refer to application note 326, *Coaxial Systems - Principles of microwave connector care* (HP part number 5954-1566) for more information.

HP-IB Connector

This connector allows the synthesizer to be connected to other instruments or devices on the interface bus. Details of this cable are shown in Figure 5-4. HP part numbers for various HP-IB cables that are available are shown in the table following the figure.

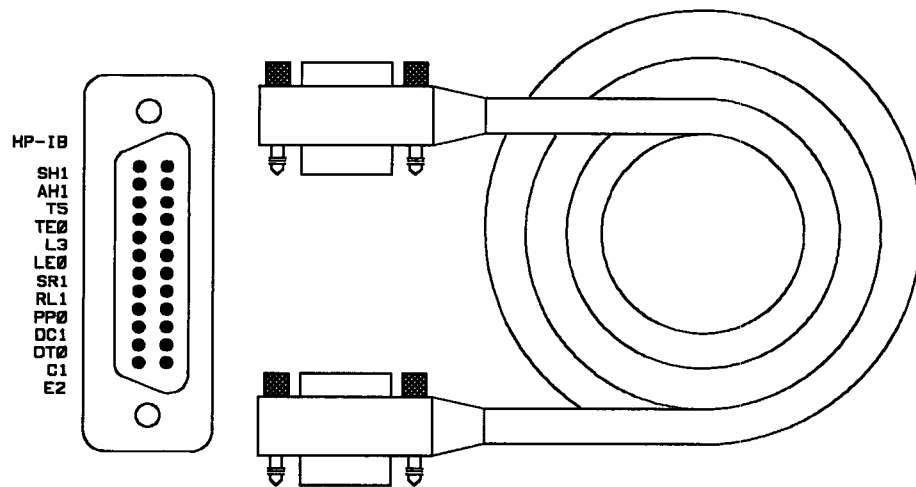

Figure 5-4. HP-IB Connector and Cable

Table 5-1. HP-IB Interface Cables Available

HP-IB Cable Part Number	Length
HP 10833A	1m (3.3 ft)
HP 10833B	2m (6.6 ft)
HP 10833C	4m (13.2 ft)
HP 10833D	0.5m (1.6 ft)

As many as 14 HP-IB instruments can be connected to the synthesizer (15 total instruments in the system). The cables can be interconnected in a star pattern (one central instrument with the HP-IB cables emanating from that instrument like spokes on a wheel), or in a linear pattern (like boxcars on a train), or a combination of the two. There are certain restrictions that must be followed when interconnecting instruments. These restrictions are as follows:

- Each instrument must have a unique HP-IB address, ranging from 0 to 30 (decimal). Refer to “To Set the HP-IB Address” in Chapter 2 for information on setting the synthesizer HP-IB address.
- In a two-instrument system that uses just one HP-IB cable, the cable length must not exceed 4 meters (13.2 ft).
- When more than two instruments are connected on the bus, the cable length to each instrument must not exceed two meters (6.6 ft).
- The total cable length between all instruments must not exceed 20 meters (65 ft).

Hewlett-Packard manufactures HP-IB extender instruments (Models HP 37201A and HP 37204A/B) that overcome the range limitations imposed by the cabling rules. These extenders allow twin pair cable operation up to 1 km (3,280 ft), and telephone modem operation over any distance. HP sales and service offices can provide additional information on the HP-IB extenders.

Connectors

The codes in the following list describe the HP-IB interface capabilities of the synthesizer using IEEE Std. 488.1 compatibility codes (HP-IB, GP-IB, IEEE-488, and IEC-625 are all electrically equivalent). Briefly, the mnemonics translate as follows:

SH1	Source Handshake, complete capability.
AH1	Acceptor Handshake, complete capability.
T5	Talker; capable of basic talker, serial poll, and unaddress if MLA.
TE0	Talker, Extended address; no capability.
L3	Listener; capable of basic listener and unaddress if MTA.
LE0	Listener, Extended address; no capability.
SR1	Service Request, complete capability.
RL1	Remote Local, complete capability.
PP0	Parallel Poll, no capability.
DC1	Device Clear, complete capability.
DT0	Device Trigger, no capability.
C1	Controller capability, system controller.
E2	Electrical specification indicating tri-state outputs.

These codes are described completely in the IEEE Standard 488 (1978), *IEEE Standard Digital Interface for Programmable Instrumentation* or the identical ANSI Standard MC1.1.

Display

The HP 83731B/32B front panel display contains two areas for displaying the current operating parameters of the synthesizer. Front panel annunciators show the status of several of the synthesizer functions and settings.

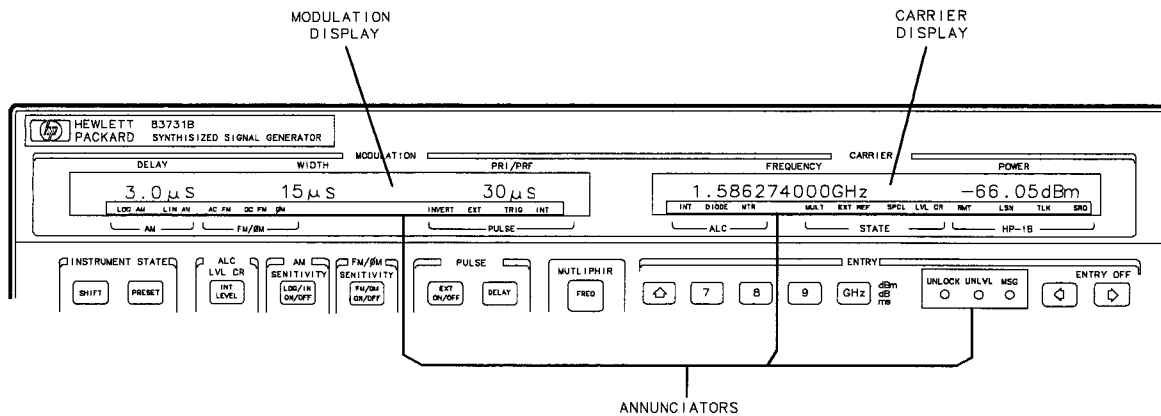

pk614ab



Figure 5-5. Synthesizer Display



A description of the display follows:



Annunciators The front panel annunciators show the status of several of the synthesizer functions and settings. *An annunciator that is in one of the fluorescent displays is not visible if its associated function is not active or selected.* For example, if external pulse modulation is currently selected, the EXT annunciator will be lit, otherwise, it will not be visible. The fluorescent display annunciators are LOG AM, LIN AM, AC FM, DC FM, ϕ M, INVERT, EXT (PULSE), TRIG (PULSE), INT (PULSE), INT (ALC), DIODE (ALC), MTR (ALC), MULT, EXT REF, SPCL, LVL CR, RMT, LSN, TLK, and SRQ.

Front/Rear Panel
Display

The three front panel LED annunciators (UNLOCK, UNLVL, and MSG) will be lit to warn you that an associated condition exists. (For example, if error messages are in the error queue, the MSG annunciator will be lit.) An explanation of each annunciator can be found in the “Annunciators” entry in this section of the manual.

Carrier Display The carrier display is the fluorescent display that is on the right side of the front panel. The primary purpose of this display is to indicate the current setting of the synthesizer output frequency and power level. The display is 24 characters wide. Output frequency always occupies character positions 1 through 14 (starting from the left) and power level occupies character positions 16 through 24. Character position 15 is always blank. If a cursor (▼) appears over one of the digits in the display, this digit will be increased or decreased as the knob is rotated. Note that the cursor indicates that particular parameter is active. The cursor can be moved left or right by pressing the  or  keys. In this manual, the carrier display is referred to as the right-most display.

Modulation Display The modulation display is the fluorescent display that is on the left side of the front panel. The primary purpose of this display is to indicate the current settings of the pulse modulation parameters (“Delay,” “Width,” and “PRI/PRF”) if pulse modulation is active. When parameter entry is initiated, the pulse information in this display will be temporarily replaced with a parameter entry display. Pressing  (ENTER) returns the pulse information to the display. As an example, if the  key is pressed, the text RECALL STATE FROM REG 0 appears in the modulation display.

If a cursor (▼) appears over one of the digits in the display, this digit will be increased or decreased as the knob is rotated. Note that the cursor indicates that particular parameter is active. The cursor can be moved left or right by pressing the  or  keys. In this manual, the modulation display is referred to as the left-most display.

NOTE

When operating the synthesizer in a secure environment, the display can be blanked so that the synthesizer parameters and status cannot be viewed. For more information, refer to the "Clear Display" entry in Chapter 7 of this manual.

See Also



Annunciators
CLEAR DISPLAY
DISPlay[:WINDow][:STATe]
Knob

Knob

The knob is used to increase or decrease parameter values. A cursor (▼) over a digit in the display indicates that digit will be increased or decreased in steps of one as the knob is rotated.

Clockwise rotation of the knob increases the display digit under the cursor and counterclockwise rotation decreases it. Pressing the (←) key moves the display cursor to the left and pressing the (→) key moves the cursor to the right. As the knob is rotated, the display will carry over to the adjacent digit. For example, if the display reads 9.000000000 GHz with the cursor over the “9” digit, clockwise rotation of the knob will cause the displayed frequency to change to 10.000000000 GHz. The cursor will remain over the first digit before the decimal point (the “0” in “10”).

If (SHIFT) (ENTRY OFF) , (⇒) has been enabled, the cursor will disappear from the display and rotating the knob will have no affect on the synthesizer parameters.

Equivalent SCPI Command

There is no equivalent SCPI command for knob rotation, however, the “SYST:KEY 61” command simulates clockwise knob rotation and the “SYST:KEY 62” command simulates counterclockwise knob rotation.

See Also



ENTRY OFF
SYSTem:KEY

POWER Switch

The POWER switch turns power to the synthesizer to either on (I) or standby (⏻).

The HP 83731B/32B POWER switch is located at the bottom left corner of the front panel and is a rocker-type switch. Pressing the I symbol turns the synthesizer on and pressing the ⏻ symbol turns it to standby. When set to standby, most of the synthesizer circuitry is powered off, however, power to the internal timebase is not disconnected.

WARNING

Before turning the synthesizer on, make sure that it is grounded through the protective conductor of the power cable to a mains power receptacle provided with protective earth contact. Any interruption of the protective grounding conductor inside or outside of the synthesizer or disconnection of the protective earth terminal can result in personal injury.

CAUTION

Before turning the synthesizer on, set the line voltage selector to the voltage of the power source. Failure to do this can cause instrument damage when the power cable is plugged in. For information on setting the line voltage selector, refer to "To Install the Synthesizer" in Chapter 1 of this manual.

See Also

To Install the synthesizer
Power Cables

Power Cables

The line power cable is supplied in one of several configurations, depending on the destination of the original shipment.

Each instrument is equipped with a three-wire power cable. When connected to an appropriate AC power receptacle, this cable grounds the instrument chassis.

The type of power cable shipped with each instrument depends on the country of destination. See Figure 5-6, "Power Cable and Line (Mains) Plug Part Numbers," for the part numbers of these power cables. Cables are available in different lengths and some with right-angle plugs to the instrument. Check with your nearest Hewlett-Packard service center for descriptions and part numbers for these cables.

Front/Rear Panel

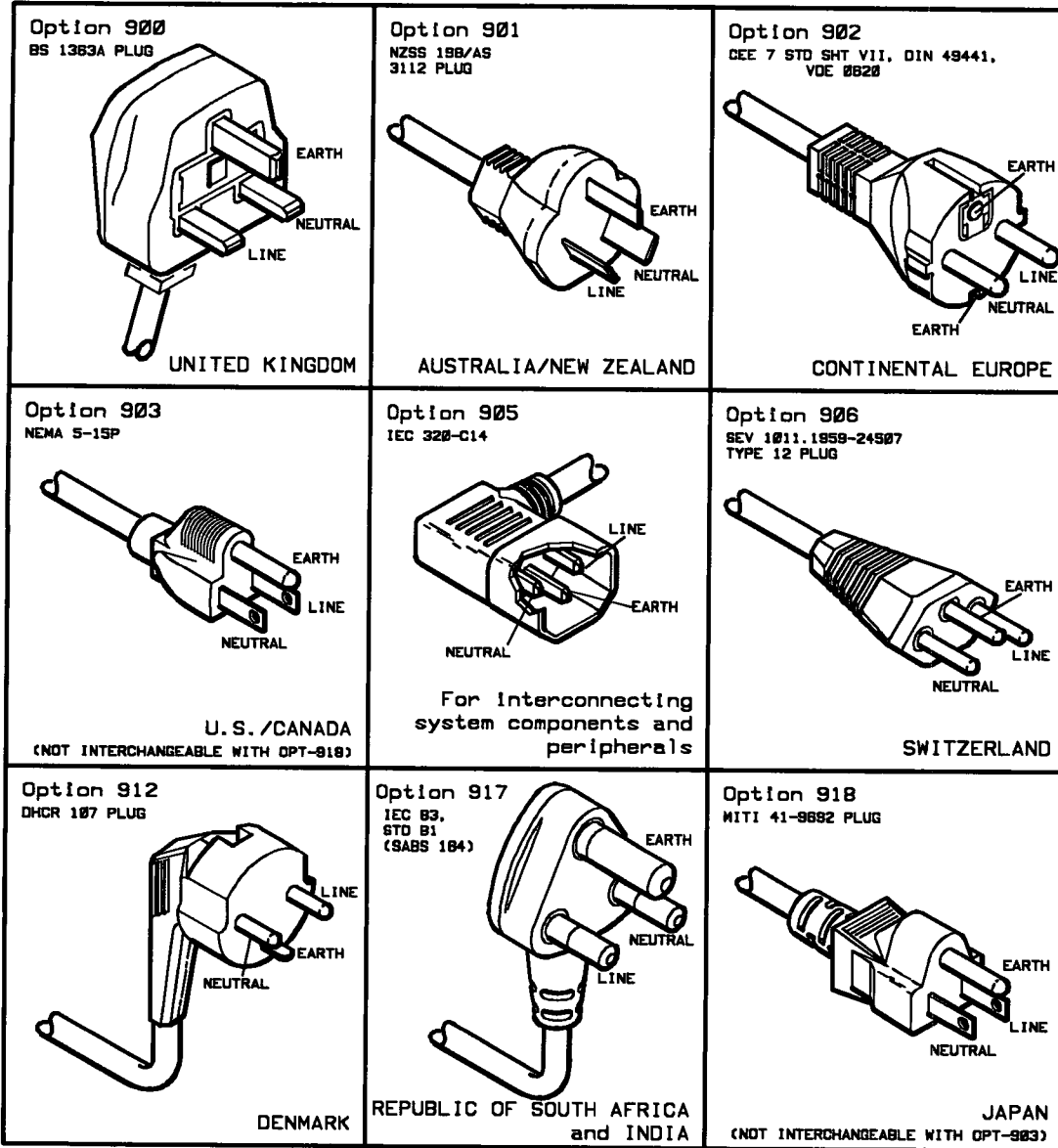

Figure 5-6. Power Cable and Line (Mains) Plug Part Numbers





Keys/Shifted Functions



Keys/Shifted Functions

This chapter contains detailed information on the various keys and shifted functions found on the synthesizer front panel. Key names are printed on the keycap and represent the primary function of the key. The shifted function names appear above certain keys on the synthesizer front panel. Shifted functions are always accessed by pressing the **SHIFT** key and then the key below the shifted function name. If no text appears above a given key, that key has no shifted function associated with it.





The key moves the cursor () that appears over one of the digits in the display to the right one digit each time it is pressed.

The digit that is currently under the cursor will be increased or decreased in steps of one as the knob is rotated. Clockwise rotation of the knob increases the digit under the cursor and counterclockwise rotation decreases it. If pressing the key moves the cursor too far to the right, pressing the key will move the cursor back to the left.

NOTE

The digit under the cursor is affected only by the knob, not the and keys.



If ENTRY OFF (,) has been enabled, the cursor will disappear from the display and rotating the knob will have no effect on the parameter. Note that the cursor indicates that particular parameter is active. For example, if the cursor appears over any digit in the frequency display, the frequency parameter is the active parameter.

If an arrow key is pressed that moves the cursor to a position that is off the display, another cursor will appear next to the original cursor to indicate that the actual cursor position is off the display. For example, if a frequency multiplier of six is entered into the synthesizer, the maximum frequency entry that can be made is 120 GHz (20 GHz×6). The display, however, only has room to display two digits to the left of the decimal point. If you were to attempt to position the cursor three digits to the left of the decimal point, the double cursor would appear, indicating that the actual cursor position is off the display.

Keys/Shifted Functions

⇒

Equivalent SCPI Command

There is no equivalent SCPI command for the  key, however, sending the "SYST:KEY 45" command is effectively the same as pressing the  key.

See Also



ENTRY OFF

Knob

SYSTem:KEY



The key moves the cursor (▼) that appears over one of the digits in the display to the left one digit each time it is pressed.

The digit that is currently under the cursor will be increased or decreased in steps of one as the knob is rotated. Clockwise rotation of the knob increases the digit under the cursor and counterclockwise rotation decreases it. If pressing the key moves the cursor too far to the left, pressing the key will move the cursor back to the right.

NOTE

The digit under the cursor is affected only by the knob, not the and keys.



If ENTRY OFF (,) has been enabled, the cursor will disappear from the display and rotating the knob will have no effect on the parameter. Note that the cursor indicates that particular parameter is active. For example, if the cursor appears over any digit in the frequency display, the frequency parameter is the active parameter.

If an arrow key is pressed that moves the cursor to a position that is off the display, another cursor will appear next to the original cursor to indicate that the actual cursor position is off the display. For example, if a frequency multiplier of six is entered into the synthesizer, the maximum frequency entry that can be made is 120 GHz (20 GHz×6). The display, however, only has room to display two digits to the left of the decimal point. If you were to attempt to position the cursor three digits to the left of the decimal point, the double cursor would appear, indicating that the actual cursor position is off the display.

Keys/Shifted Functions

←

Equivalent SCPI Command

There is no equivalent SCPI command for the  key, however, sending the "SYST:KEY 37" command is effectively the same as pressing the  key.

See Also

ENTRY OFF
Knob
SYSTem:KEY



The key allows you to incrementally add to the current value of a parameter.

Pressing the key will increase the currently active parameter by the increment value set with the **STEP SIZE** key. A parameter can be made active by pressing its associated function key. For example, pressing the **FREQ** key will make frequency the active parameter, pressing the **POWER LEVEL** key will make output power level the active parameter, etc. If no parameter is currently active, or the ENTRY OFF (**SHIFT**,) function has been enabled, pressing the key will have no effect.

If the key is pressed and held down, the key will auto-repeat, that is, the active parameter will automatically increase rapidly in increment value steps.

Equivalent SCPI Commands

There is no equivalent SCPI command for the key, however, the various SCPI commands that send numeric parameter data include an "UP" parameter option. Sending the "UP" parameter in place of the numeric parameter is effectively the same as pressing the key. For example, if you want to increase the output frequency by its current increment value, send the following command:

```
OUTPUT 719; "FREQ UP"
```

Keys/Shifted Functions



See Also



ENTRY OFF

STEP SIZE





The key allows you to incrementally subtract from the current value of a parameter.

Pressing the key will decrease the currently active parameter by the increment value set with the **STEP SIZE** key. A parameter can be made active by pressing its associated function key. For example, pressing the **FREQ** key will make frequency the active parameter, pressing the **POWER LEVEL** key will make output power level the active parameter, etc. If no parameter is currently active, or the ENTRY OFF (**SHIFT**,) function has been enabled, pressing the key will have no effect.

If the key is pressed and held down, the key will auto-repeat, that is, the active parameter will automatically decrease rapidly in increment value steps.

Equivalent SCPI Commands

There is no equivalent SCPI command for the key, however, the various SCPI commands that send numeric parameter data include a "DOWN" parameter option. Sending the "DOWN" parameter in place of the numeric parameter is effectively the same as pressing the key. For example, if you want to decrease the output frequency by its current increment value, send the following command:

```
OUTPUT 719; "FREQ DOWN"
```

Keys/Shifted Functions
↓

See Also

 ENTRY OFF
 STEP SIZE

ADDRESS

Invoking the ADDRESS function (pressing the **SHIFT** key and then the **LOCAL** key) displays and allows you to change the synthesizer HP-IB address.

When **SHIFT**, **LOCAL** is pressed, the current HP-IB address will be displayed across the left-most display in the following format:

HP-IB ADDRESS XX

Where XX is the current HP-IB address. The range for valid addresses is 00 to 30. The HP-IB address is preset at the factory to 19.

Pressing the **PRESET** key has no affect on the HP-IB address. The preset up/down arrow increment value is 1.

Equivalent SCPI Command

`SYST:COMM:GPIB:ADDR address` *sets the synthesizer HP-IB address as defined by the "address" parameter.*

See Also

SYSTem:COMMunicate:GPIB:ADDRes

BACK SPACE

The **BACK SPACE** key allows you to cancel part or all of a parameter during entry.

The **BACK SPACE** key has an effect on the display only after a function key (**FREQ**, **POWER LEVEL**, etc.) is pressed and before the entry is terminated. If **BACK SPACE** is pressed repeatedly so that the whole parameter is canceled, the display reverts back to what it was before the function key was pressed.

Equivalent SCPI Command

There is no equivalent SCPI command for the **BACK SPACE** key, however, sending the "SYST:KEY 54" command is effectively the same as pressing the **BACK SPACE** key.

See Also

SYSTem:KEY

DELAY

The **DELAY** key enables you to modify the pulse delay parameter. Pulse delay is used in internal, internal triggered, or doublet pulse modes.

The delay parameter is displayed under the “DELAY” portion of the left-most display. When the delay is entered, the text DELAY XXX will appear across the left-most display where XXX is the entered value and the appropriate units suffix.

The allowable range for entries is as shown in the following table.

Table 6-1. Allowable Delay Range

Internal Pulse Mode	Triggered or Doublet Pulse Mode
± 419 ms	+225 ns minimum +419 ms maximum ¹

¹ In triggered pulse mode, the sum of pulse width and pulse delay can not exceed 419 ms.

All entries have a resolution of 25 ns; entries with resolution finer than 25 ns will be rounded to the nearest 25 ns. If a delay entry is made that is not within the allowable range, the delay will be set to the upper or lower limit. The preset value for delay is 1 μ s. The allowable range for up/down arrow increments is 25 ns to 419 ms with 25 ns resolution. The preset up/down arrow increment value is 25 ns.

DELAY

Positive/Negative Delay

When in internal pulse modulation mode, the delay parameter can be positive or negative. Delay is the time between the rising edge of the synchronizing pulse at the PULSE SYNC OUT connector and the rising edge of the RF pulse at the RF OUTPUT connector. When the delay is positive, the synchronizing pulse precedes the RF pulse by the value of the delay. When the delay is negative, the RF pulse precedes the synchronizing pulse by the value of the negative delay.

Equivalent SCPI Command

PULS:DEL delay *sets the pulse delay as defined by the “delay” parameter.*

See Also

EXT ON/OFF

INT ON/OFF

INVERT

PRF

PRI

[SOURce[1]:]PULSe:DELay

TRIG ON/OFF

WIDTH

DOUBLET

Invoking the DOUBLET function (pressing the **SHIFT** key and then the **TRIG ON/OFF** key) toggles doublet pulse modulation on and off.

When doublet pulse modulation is turned on, the word **DOUBLET** will appear in the left-most display along with the current value of pulse width and pulse delay.

When the synthesizer is set to the preset state, doublet pulse modulation is turned off.

Doublet Pulse Mode

When doublet pulse modulation is used, each trigger event will produce two pulses at the RF OUTPUT connector. The first pulse will follow the external trigger signal that is applied to the PULSE/TRIG IN, GATE IN connector. The second pulse will have delay and width parameters as set via the front panel or with programming commands. Pulse delay is measured from the leading edge of the external trigger signal. Figure 6-1 summarizes the timing characteristics of doublet pulse mode.

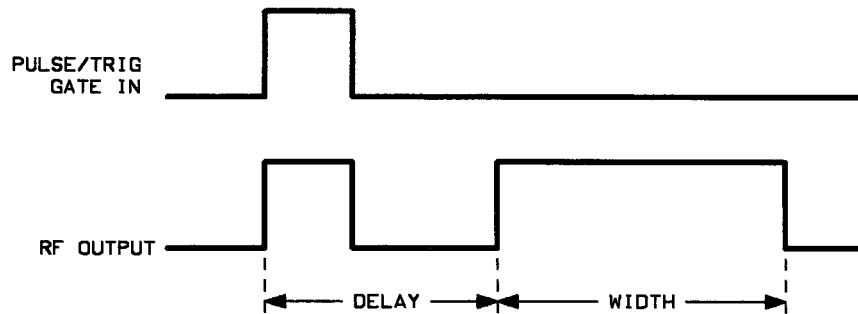

Figure 6-1. Doublet Pulse Mode Timing

Keys/Shifted Functions
DOUBLET

Equivalent SCPI Commands

PULM:SOUR INT *sets pulse source to internal.*
PULS:DOUB ON *turns doublet pulse mode on.*
PULM:STAT ON|OFF *turns pulse modulation on or off.*

See Also

DELAY
[SOURce[1]:]PULM:SOURce
[SOURce[1]:]PULM:STATe
[SOURce[1]:]PULSe:DOUBle[:STATe]
WIDTH

Hz (ENTER)

The ENTER key (actually the secondary function of the **Hz** key) is used to terminate unitless parameter entries. It can also be used to return the display to its default state.

The **Hz** (ENTER) key is used to terminate unitless parameter entries. The unitless parameters are multiplier values, special function numbers, instrument state register numbers, level correction register numbers, and the synthesizer and power meter HP-IB addresses.

The ENTER key can also be used to return the display to its default state. When the display is in the default state, the left-most display is blanked and the right-most display shows frequency and power level. In the display default state, no parameters are active. To use the ENTER key to return the display to the default state, press the ENTER key without first pressing a numeric key (that is, the keys numbered 0 through 9). For example, if a multiplier value of 5 is entered, the left-most display will continue to show FREQUENCY MULTIPLIER 5 after the entry is terminated with the cursor (▼) over the 5. Pressing ENTER again will return the display to the default state mentioned above.

Equivalent SCPI Command

There is no equivalent SCPI command for the ENTER key, however, sending the "SYST:KEY 58" command is effectively the same as pressing the ENTER key.

Keys/Shifted Functions
Hz (ENTER)

See Also

ADDRESS
MULTIPLIER
PWR MTR ADDR
RCL CR
RECALL
SAVE
SAVE CR
SPCL
SYSTEM:KEY

ENTRY OFF

Invoking the ENTRY OFF function (pressing the **SHIFT** key and then the **⇒** key) disables the parameter entry/modification keys. The parameter entry/modification keys include the numeric keypad as well as the **↑**, **↓**, **STEP SIZE**, **←**, and **⇒** keys and the knob.

Once the entry off function has been enabled, it will be canceled as soon as one of the function keys (**FREQ**, **POWER LEVEL**, **WIDTH**, etc.) are pressed.

Equivalent SCPI Command

There is no equivalent SCPI command for the ENTRY OFF function, however, sending the "SYST:KEY 0;KEY 45" command is effectively the same as pressing **SHIFT**, **⇒**.

See Also

SYSTem:KEY

EXT DIODE

The **EXT DIODE** key enables external diode leveling. External diode leveling is a method of automatic level control (ALC) of the output signal using an external diode detector.

When the **EXT DIODE** key is pressed, the **DIODE** annunciator will be lit. If the procedure "To Use External Diode Detector Leveling" in Chapter 3 has been followed correctly, the synthesizer RF output will be externally leveled via the diode detector feedback loop.

External Diode Detector Leveling

The purpose of a leveling circuit is to provide constant power, independent of the load, and minimize power variations versus frequency.

External diode detector leveling is used in applications where it is desired to level the power at some point outside the synthesizer with an external diode detector. When frequency dependent losses are involved, the RF output power at the end of the signal path will not have a constant amplitude over the synthesizer frequency range. For example, if a cable is used at the output of the synthesizer that has a constant 0.5 dB/GHz loss, 5 dB of attenuation at the output of the cable occurs after a 10 GHz frequency increase, even though the power at the input to the cable is constant. By externally leveling power at the output of the cable, the synthesizer would increase power at the input of the cable to produce a constant power level at the output of the cable.

External diode detector leveling requires that external equipment be connected to the synthesizer, as shown in Figure 6-2.

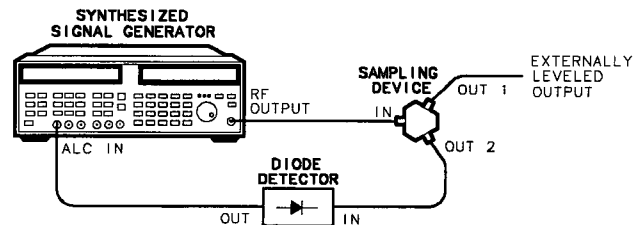

pk615ab

Figure 6-2. External Diode Detector Leveling Setup

When external diode detector leveling is chosen, power is sampled at the external sampling device (either a directional coupler or power splitter) by an external diode detector that is typically operating in the square law region. When the diode detector is operating in the square law region, it will provide a DC voltage that is proportional to the power sampled at the input to the detector. This DC voltage is fed back to the synthesizer via the ALC IN connector. The synthesizer then adjusts its output power level to maintain a constant power level at the input to the external diode detector.

Applications

External leveling can be used when your application requires long cables that will cause frequency-dependent losses. It also enables devices, such as amplifiers, mixers, etc. to be inserted into the RF signal path so that the output of the inserted device is controlled by the synthesizer.

Advantages of Diode Detector Leveling

When diode detector leveling is used, power level correction is continuous.

External diode detector leveling has the advantage of faster settling time than power meter leveling. The settling time is variable and is dependent on the devices in the external leveling loop.

Disadvantages of Diode Detector Leveling

The diode detector must be capable of producing between 1 mV and 1 V of ALC voltage for the power level at the sampling point. This typically restricts the lower limit at which external diode detector leveling will function.

Diode detector leveling might not provide an accurate power display on the synthesizer if the diode detector is operating outside of the square law region. Diode detector leveling also does not provide temperature compensation. Power level recalibration might be required in environments that are not temperature stabilized.

External diode detector leveling requires that external equipment be connected to the synthesizer.

NOTE

Before selecting **EXT DIODE**, you should adjust the synthesizer power level using internal leveling so that the step attenuator is set to the correct setting.

Equivalent SCPI Command

`POW:ALC:SOUR DIOD` *enables external diode detector leveling.*

See Also

`EXT METER`

`INT LEVEL`

`[SOURce[1]:]POWer:ALC:SOURce`

To Use External Diode Detector Leveling

To Use the Level Correct Routine

EXT METER

The **EXT METER** key enables external power meter leveling. External power meter leveling is a method of automatic level control (ALC) of the output signal using an external power meter and power sensor.

When the **EXT METER** key is pressed, you are prompted to put the power meter in the range hold mode and then enter the power meter reading into the synthesizer. After the range hold power meter value is entered, the MTR annunciator will be lit. If the procedure, "To Use External Power Meter Leveling" in Chapter 3 has been followed correctly, the RF output will be externally leveled via the power meter feedback loop.

NOTE

The range hold power meter reading is the power level that is used by the synthesizer to calibrate the recorder output voltage of the power meter versus the synthesizer output power.

External Power Meter Leveling

The purpose of a leveling circuit is to provide constant power, independent of the load, and minimize power variations versus frequency.

External power meter leveling is used in applications where it is desired to level the power at some point outside the synthesizer with an external power meter. When frequency dependent losses are involved, the RF output power at the end of the signal path will not have a constant amplitude over the synthesizer frequency range. For example, if a cable is used at the output of the synthesizer that has a constant 0.5 dB/GHz loss, 5 dB of attenuation at the output of the cable occurs after a 10 GHz frequency increase, even though the power at the input to the cable is constant. By externally leveling power at the output of the cable, the synthesizer would increase power at the input of the cable to produce a constant power level at the output of the cable.

External power meter leveling requires that external equipment be connected to the synthesizer, as shown in Figure 6-3.

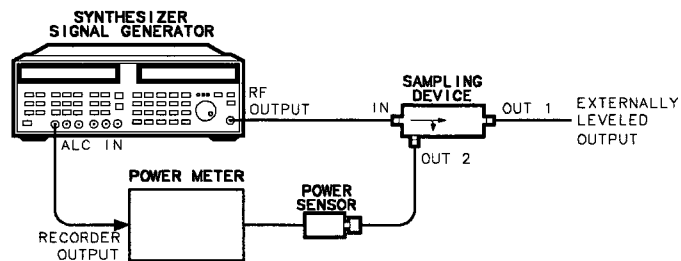

pk616ab

Figure 6-3. External Power Meter Leveling Setup

When external power meter leveling is chosen, power is sampled at the external sampling device (either a directional coupler or power splitter) by the external power sensor. An automatic level control voltage is then generated by the external power meter and fed back to the synthesizer via the ALC IN connector. The synthesizer then adjusts its output power level to maintain a constant power level at the input of the external power sensor.

Applications

External leveling can be used when your application requires long cables that will cause frequency-dependent losses. It also enables devices, such as amplifiers, mixers, etc. to be inserted into the RF signal path so that the output of the inserted device is controlled by the synthesizer.

External Equipment Limitations

Power Meter

The power meter must be capable of producing a 0 V to 1 V output voltage linearly proportional to power over each decade of range. The recorder output of most power meters provides this voltage.

Power Sensor

The power sensor must have a frequency range that is appropriate for the range of frequencies being leveled. The sensor must also have enough dynamic range to measure the level at the output of the directional coupler or power splitter. As an example, to level signals in the -7 dBm to 0 dBm range using a 10 dB coupler, the power sensor must be capable of measuring power in the -17 to -10 dBm range.

Advantages of Power Meter Leveling

When power meter leveling is used, power level correction is continuous.

External power meter leveling has the advantages of better accuracy and temperature stability, and improved vernier linearity over external diode detector leveling. Using a sensitive power sensor allows ALC at levels as low as the power meter and sensor can measure.

Disadvantages of Power Meter Leveling

One disadvantage of power meter leveling is a longer settling time than diode detector or internal leveling. The settling time is dependent on the power range and sensor used. The synthesizer assumes a settling time of four seconds to allow the sensor to reach the correct power level.

Depending on the power sensor and range being used, the power meter might or might not have finished settling. Power is typically settled within four seconds for the two highest ranges of the power meter.

Another disadvantage of external power meter leveling is that it can not be used when the output is being pulse or AM modulated.

External power meter leveling requires that external equipment be connected to the synthesizer.

NOTE

Before selecting **EXT METER**, you should adjust the power level using internal leveling so that the step attenuator is set to the correct setting.

EXT METER

Equivalent SCPI Commands

NOTE

The following is only the command that selects external power meter leveling. External power meter leveling, however, is a multi-step process that involves issuing several commands.

`POW:ALC:PMET pmeter` *sets the power meter range hold value as defined by the "pmeter" parameter.*
`POW:ALC:SOUR PMET` *sets the alc source to power meter.*

See Also

EXT DIODE

INT LEVEL

`[SOURce[1]:]POWer:ALC:PMETer`

`[SOURce[1]:]POWer:ALC:SOURce`

To Use External Power Meter Leveling

EXT ON/OFF

The **EXT ON/OFF** key toggles external pulse modulation on and off.

The type of external pulse modulation that is toggled on and off with the **EXT ON/OFF** key is non-inverted. **SHIFT**, **EXT ON/OFF** toggles external inverted pulse modulation on and off.

When external pulse modulation is turned on, the **EXT (PULSE)** annunciator will be lit.

When the synthesizer is set to the preset state, external pulse modulation is turned off.

Equivalent SCPI Commands

<code>PULM:SOUR EXT</code>	<i>sets pulse source to external.</i>
<code>PULM:EXT:POL NORM</code>	<i>sets external pulse polarity to non-inverted.</i>
<code>PULM:EXT:POL INV</code>	<i>sets external pulse polarity to inverted.</i>
<code>PULM:STAT <u>ON OFF</u></code>	<i>turns pulse modulation on or off.</i>

See Also

Connectors
INVERT
[SOURCE[1]:]PULM:EXTernal:POLarity
[SOURCE[1]:]PULM:SOURce
[SOURCE[1]:]PULM:STATe

FM/ ϕ M ON/OFF (Option 800 Required for ϕ M)

The **FM/ ϕ M ON/OFF** key toggles between frequency and phase modulation.

The **FM/ ϕ M ON/OFF** key cycles between three states, as it is repeatedly pressed:

FM/phase modulation off.

FM modulation on.

Phase modulation on (Option 800 only).

Once this key is pressed, the **↑** and **↓** keys can also be used to cycle between states.

The left-most display shows the current state, which can be either internal or external, depending on the state of the INT/EXT switch in the FM/ ϕ M key group.

When frequency modulation is turned on, either the AC FM or DC FM annunciator will be lit, depending on the status of the DC FM ON/OFF special function.

When phase modulation is turned on, the ϕ M annunciator will be lit.

When the synthesizer is set to the preset state, modulation is turned off.

Equivalent SCPI Command

FM:STAT ON/OFF *turns frequency modulation on or off.*

PM:STAT ON/OFF *turns phase modulation on or off.*

See Also

Connectors
DC FM ON/OFF
SENSITIVITY
[SOURce[1]:]FM: COUPLing
[SOURce[1]:]FM: STATe
[SOURce[1]:]PM: COUPLing
[SOURce[1]:]PM: STATe

FREQ

The **FREQ** (frequency) key allows you to set the output frequency of the synthesizer.

Frequency is displayed in the left-hand position of the right-most display. The frequency entered is the CW frequency if no modulation is chosen, or the carrier frequency of any modulation type that is chosen. The preset value is 3 GHz.

The valid output frequency range differs depending on the synthesizer model:

HP 83731B - 1.0 GHz to 20.0 GHz

HP 83732B - 0.01 GHz to 20.0 GHz

If a frequency entry is made that is outside the allowable range, an error message will be generated and the actual frequency will be set to either its upper or lower limit (whichever is closest to the input frequency). Standard frequency resolution is 1 kHz over the range of 0.01 GHz to 20 GHz.

NOTE

When Option 1E8 is installed, frequency resolution is 1 Hz over the entire frequency range.

The preset up/down arrow increment value is 100 MHz. The increment value will be rounded to the nearest 1 kHz if the output frequency is between 0.01 GHz and 20 GHz.

NOTE

If the Multiplier function is being used, the frequency displayed is the frequency at the output of the multiplier, not the output of the synthesizer.

Equivalent SCPI Command

FREQ freq *sets the synthesizer output frequency as defined by the "freq" parameter.*

See Also

MULTIPLIER
[SOURce[1]:]FREQuency[:CW]:FIXed]

GATED

Invoking the GATED function (pressing the **SHIFT** key and then the **INT ON/OFF** key) toggles internal gated pulse modulation on and off.

When internal gated pulse modulation is turned on, the word GATED will appear in the left-most display along with the current value of pulse width and pulse repetition frequency (PRF).

When the synthesizer is set to the preset state, internal gated pulse modulation is turned off.

Internal Gated Pulse Mode

When the rising edge of a valid gate signal is applied to the PULSE/TRIG/GATE IN connector, a pulse train will appear at the synthesizer RF OUTPUT connector with pulse width and pulse repetition frequency (PRF) parameters as set via the front panel or with programming commands. When the falling edge of the gate signal is sensed at the PULSE/TRIG/GATE IN connector, the pulse train will cease. If the falling edge of the gate signal occurs in the middle of a pulse at the RF OUTPUT connector, the last pulse will complete before the pulse train ceases. Once the falling edge of the gate signal is sensed, a time interval equal to the pulse repetition interval ($\frac{1}{PRF}$) must elapse before another rising edge at the PULSE/TRIG/GATE IN connector will be valid. Figure 6-4 summarizes the critical timing characteristics of internal gated pulse mode.

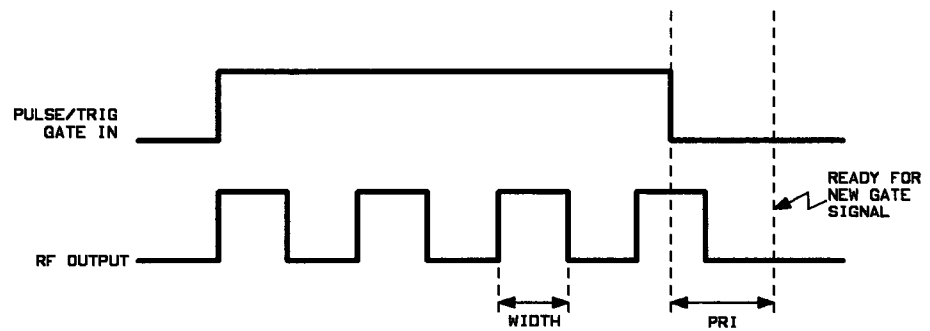

Figure 6-4. Internal Gated Pulse Mode Timing

GATED

Equivalent SCPI Commands

PULM:SOUR INT	<i>sets pulse source to internal.</i>
TRIG:SOUR EXT	<i>sets pulse trigger source to external (triggered).</i>
TRIG:STOP:SOUR EXT	<i>sets pulse trigger stop source to external.</i>
PULS:DOUB OFF	<i>turns doublet pulse mode off.</i>
PULM:STAT <u>ON OFF</u>	<i>turns pulse modulation on or off.</i>

See Also

PRF
(PRI)
[SOURce[1]:]PULM:SOURce
[SOURce[1]:]PULM:STATe
[SOURce[1]:]PULSe:DOUBle[:]STATe
TRIGger[SEQuence[1]|:START]:SOURce
TRIGger:SEQuence2[:]STOP:SOURce
(WIDTH)

INT DEPTH [AM] (Only Available with Option 1E2)

The **INT DEPTH** key enables you to modify internal log or linear AM depth.

When log AM is enabled and this key is pressed, the text INT AM DEPTH XXX dB will appear across the left-most display where XXX is the current value of internal log AM depth in dB.

The accepted range for entries is from a minimum of 0 dB to a maximum of 60 dB. If an internal AM depth entry is made that is not within the allowable range, an error message will be generated and the AM depth will be set to either its upper or lower limit. The resolution is 0.01 dB. The preset value for internal log AM depth is 6 dB. The preset up/down arrow increment value is 3 dB.

NOTE

When the internal AM depth is set between 30 dB and 60 dB, the entry resolution is 0.01 dB, however, the hardware resolution might be slightly greater than 0.01 dB. The hardware resolution will always be less than 0.015 dB.

When linear AM is enabled and this key is pressed, the text INT AM DEPTH XXX% will appear across the left-most display where XXX is the current value of internal linear AM depth in percent.

The accepted range for entries is from a minimum of 0% to a maximum of 100%. If an internal AM depth entry is made that is not within the allowable range, an error message will be generated and the AM depth will be set to either its upper or lower limit. The resolution is 0.1%. The preset value for internal linear AM is 30%.

Keys/Shifted Functions

INT DEPTH [AM] (Only Available with Option 1E2)

Equivalent SCPI Command

AM:DEPT depth *sets the internal AM depth as defined by the “depth” parameter.*

See Also

INT (AM) ON
[SOURce[1]:]AM[:DEPT]h
[SOURce[1]:]AM:TYPE

INT DEV (Only Available with Option 1E2)

FM Internal Deviation
 ϕ M Internal Deviation

FM Internal Deviation

The **INT DEV** key enables you to modify internal FM deviation.

When the **INT DEV** key is pressed and FM modulation is enabled, the text INT FM DEV XXX XXX will appear across the left-most display where XXX XXX is the current value of the internal FM deviation.

The accepted range for entries is from a minimum of 0 Hz to a maximum of 10 MHz. If an internal FM deviation entry is made that is not within the allowable range, an error message will be generated and the FM deviation will be set to either its upper or lower limit. The entry resolution is 0.01 Hz; however, the hardware resolution is limited to three digits and is dependent on the deviation as shown in the following table:

Table 6-2. FM Deviation Resolution

FM Deviation	Resolution
7.5 MHz to 10 MHz	3.66 kHz
3.75 MHz to <7.5 MHz	1.83 kHz
1.875 MHz to <3.75 MHz	916 Hz
938 kHz to <1.875 MHz	458 Hz
469 kHz to <938 kHz	289 Hz
234 kHz to <469 kHz	114 Hz
117 kHz to <234 kHz	57 Hz
<117 kHz	29 Hz

The preset value for internal FM deviation is 1 MHz. The preset up/down arrow increment value is 100 kHz.

NOTE

If you enter a combination of deviation and rate that produces an overmodulation condition, an error message will be generated and will remain until the overmodulation condition is removed.

Equivalent SCPI Command

FM:DEV deviation *sets the internal FM deviation as defined by the "deviation" parameter.*

See Also

INT (FM) ON
 [SOURce[1]:]FM[:DEVIation]:STEP[:INCRement]

ϕ M Internal Deviation (Options 1E2 and 800 Required)

The **INT DEV** key in the FM/ ϕ M key group enables you to modify the internal FM or ϕ M deviation.

To access the internal ϕ M deviation, you first have to turn on phase modulation by pressing the **FM/ ϕ M ON/OFF** key three times. The ϕ M annunciator will be lit indicating phase modulation is active. The left-most display will show either EXTERNAL PM MOD ON or INTERNAL PM MOD ON. If external phase modulation is on, activate internal phase modulation by pressing the **SHIFT** key and **INT DEV** key. Next, press the **↑** or **↓** key to toggle between external and internal phase modulation. Stop when display reads INTERNAL PM MOD ON.

When the **INT DEV** key is pressed, the text INT PM RATE XXX XXX will appear across the left-most display where XXX XXX is the current value of the internal PM deviation.

The accepted range for entries is from a minimum of 0 radians to a maximum of 200 radians. The synthesizer normally operates in low range for deviations from 0 radians to 4 radians and high range for deviations from >4 radians to 200 radians. If an internal ϕ M deviation entry is made that is not within the allowable range, an error message will be generated and the ϕ M deviation will be set to either its upper or lower limit. The entry resolution is 0.01 radians; however, the hardware resolution is limited to three digits and is dependent on the deviation as shown in the following tables:

Table 6-3. ϕ M Deviation Resolution (Low Range)

Internal ϕM Deviation (Low Range)	Resolution
3 rad to 4 rad	1.465 mrad
1.5 rad to <3 rad	732 μ rad
0.75 rad to <1.5 rad	366 μ rad
375 mrad to <750 mrad	183 μ rad
188 mrad to <375 mrad	92 μ rad
94 mrad to <188 mrad	46 μ rad
47 mrad to <94 mrad	23 μ rad
<47 mrad	12 μ rad

Table 6-4. ϕ M Deviation Resolution (High Range)

Internal ϕM Deviation (High Range)	Resolution
150 rad to 200 rad	73.2 mrad
75 rad to <150 rad	36.6 mrad
37.5 rad to <75 rad	18.3 mrad
18.75 rad to <37.5 rad	9.16 mrad
9.375 rad to <18.75 rad	4.58 mrad
4.688 rad to <9.375 rad	2.89 mrad
2.344 rad to <4.688 rad	1.14 mrad
<2.344 rad	0.57 mrad

The preset value for internal rate is 3.00 radians. The preset up/down arrow increment value is 1.00 radian.

NOTE

If you enter a combination of deviation and rate that produces an overmodulation condition, an error message will be generated and will remain until the overmodulation condition is removed.

Equivalent SCPI Command

PM:DEV deviation *sets the internal ϕM deviation as defined by the "deviation" parameter.*

See Also

PM RANGE
[SOURCE{1}]:PM[:DEViation]:STEP[:INCRement]

INT/EXT (Only Available with Option 1E2)

AM Internal/External Function
FM/φM Internal/External Function

AM Internal/External Function

The INT/EXT shifted function in the AM key group (accessed by pressing the **SHIFT** key and then the **INT DEPTH** key) will display the current AM source. Pressing the **↑** or **↓** key toggles the AM source between internal and external.

When **SHIFT** then **INT DEPTH** (INT/EXT) are pressed, the AM source will be displayed across the left-most display in the following format:

```
XXXXXXXX AM YYY
```

Where **XXXXXXXX** is the currently selected AM source (INTERNAL or EXTERNAL) and **YYY** is the current state of the AM circuitry (OFF or ON). With the AM source active in the left-most display, you can change the AM source by pressing the **↑** or **↓** key. The display will toggle between INTERNAL AM YYY and EXTERNAL AM YYY. Stop when the desired source is selected.

Log or linear AM can be selected by using the **LOG/LIN ON/OFF** key.

When the synthesizer is set to the preset state, AM is set to external and AM is turned off.

Equivalent SCPI Commands

AM:SOUR FEED/EXT *sets the AM source to FEED (internal) or EXT (external).*

AM:STAT ON/OFF *turns amplitude modulation on or off.*

See Also

LOG/LIN ON/OFF

[SOURce[1]:]AM: SOURce FEED/EXT

[SOURce[1]:]AM:STATe ON/OFF

FM/ ϕ M Internal/External Function

The INT/EXT shifted function in the FM/ ϕ M key group (accessed by pressing the **SHIFT** key and then the **INT DEV** key) will display the current FM/ ϕ M source. Pressing the **↑** or **↓** key toggles the FM/ ϕ M source between internal and external.

When **SHIFT** then **INT DEV** (INT/EXT) are pressed, the FM/ ϕ M source will be displayed across the left-most display in the following format:

```
XXXXXXXX FM/PM MOD YYY
```

Where **XXXXXXXX** is the currently selected FM/ ϕ M source (INTERNAL or EXTERNAL) and **YYY** is the current state of the FM/ ϕ M circuitry (OFF or ON). With the FM/ ϕ M source active in the left-most display, you can change the FM/ ϕ M source by pressing the **↑** or **↓** key. The display will toggle between INTERNAL FM/PM MOD YYY and EXTERNAL FM/PM MOD YYY. Stop when the desired source is selected.

FM or phase modulation can be selected by using the **FM/ ϕ M ON/OFF** key.

INT/EXT (Only Available with Option 1E2)

When internal or external FM is turned on, either the AC FM or DC FM annunciator will be lit depending on whether AC- or DC-coupled FM is enabled.

When internal or external ϕ M is turned on, the ϕ M annunciator will be lit. Phase modulation is normally DC-coupled. AC-coupled phase modulation is selected through the **SPCL** (special functions) key. (See AC PM COUPLING.)

When the synthesizer is set to the preset state, FM/ ϕ M is set to external and FM/ ϕ M is turned off.

Equivalent SCPI Commands

FM:SOUR FEED/EXT	<i>sets the FM source to FEED (internal) or EXT (external).</i>
AM:STAT ON/OFF	<i>turns frequency modulation on or off.</i>
PM:SOUR FEED/EXT	<i>sets the PM source to FEED (internal) or EXT (external).</i>
PM:STAT ON/OFF	<i>turns phase modulation on or off.</i>

See Also

[SOURce[1]:]FM: SOURce
[SOURce[1]:]FM:STATe
[SOURce[1]:]PM: SOURce
[SOURce[1]:]PM:STATe

INT LEVEL

The **INT LEVEL** key enables internal leveling. Internal leveling uses an internal ALC (automatic level control) detector to provide automatic level control of the output power at the RF OUTPUT connector.

When the **INT LEVEL** key is pressed, the INT (ALC) annunciator will be lit.

Internal leveling is used to control the internal RF signal over a specified range (the vernier range) of -4 to $+10$ dBm. Additional dynamic range is provided by an optional 110 dB step attenuator (Option 1E1) to give an effective dynamic range of -110 to $+8$ dBm.

An ALC unlevelled condition occurs when the internal ALC circuitry cannot maintain leveling. This can occur due to an instrument fault or because the instrument is set to level for an RF output level that is beyond its capability. Calibrated output level is only guaranteed when the UNLVL annunciator is not lit.

When the synthesizer UNLVL annunciator lights, the knob, arrow keys, or the numeric keypad can still be used to change displayed power up to the maximum value. However, the actual output power will *not* increase. Only the displayed value changes.

The internal ALC circuit maintains a constant RF power level over frequency at the RF OUTPUT connector. The ALC circuit is a feedback control system where output power is measured and compared to the desired power level. When output power does not equal the desired power level, the ALC changes the output until the actual and desired levels are equal.

The actual maximum leveled power available is dependent upon the frequency and varies across the range of the synthesizer.

The allowable range for power level entries (using the **POWER LEVEL** key) is -15 dBm to $+30$ dBm for standard configuration instruments and -110 dBm to $+30$ dBm if Option 1E1 is installed.

INT LEVEL

NOTE

The actual maximum internally leveled output power for your instrument at a given frequency can be found by increasing the synthesizer output power until the **UNLVL** annunciator lights.

When the synthesizer is set to the preset state, internal leveling is selected over external diode leveling or external power meter leveling.

Advantages of Internal Leveling

Internal leveling is self-contained; it does not require any external equipment as does external diode leveling or external power meter leveling. Leveled power is specified at the RF OUTPUT connector.

Disadvantages of Internal Leveling

Internal leveling does not compensate for losses or gains in the output signal path.

Equivalent SCPI Commands

POW:ALC:SOUR INT *enables internal leveling.*

See Also

EXT DIODE

EXT METER

POWER LEVEL

[SOURce[1]:]POWer:ALC

“To Use the Level Correct Routine” in Chapter 3

INT ON/OFF

The **INT ON/OFF** key toggles internal pulse modulation on and off.

When internal pulse modulation is turned on, the INT (PULSE) annunciator will be lit.

When the synthesizer is set to the preset state, internal pulse modulation is turned off.

Equivalent SCPI Commands

PULM:SOUR INT	<i>sets pulse source to internal.</i>
TRIG:SOUR IMM	<i>sets pulse trigger source to immediate (non-triggered).</i>
PULS:DOUB OFF	<i>turns doublet pulse mode off.</i>
PULM:STAT <u>ON OFF</u>	<i>turns pulse modulation on or off.</i>

See Also

DELAY
PRF
PRI
[SOURce[1]:]PULM:SOURce
[SOURce[1]:]PULM:STATe
TRIGger[SEQuence[1]:]START]:SOURce
TRIG ON/OFF
WIDTH

INT RATE (Only Available with Option 1E2)

AM Internal Rate
FM Internal Rate
 ϕ M Internal Rate

AM Internal Rate (Option 1E2 Required)

The **INT RATE** key in the AM key group enables you to modify the internal log or linear AM rate.

When the **INT RATE** key is pressed, the text INT AM RATE XXX kHz will appear across the left-most display where XXX is the current value of the internal AM rate in kiloHertz.

The accepted range for entries is from 0.5 Hz to 100 kHz. If an internal AM rate entry is made that is not within the allowable range, an error message will be generated and the AM rate will be set to either its upper or lower limit. The resolution for internal AM rate is 0.5 Hz. The preset value for internal rate is 5.00 kHz. The preset up/down arrow increment value is 1 kHz.

Equivalent SCPI Command

[SOURce[1]:]AM:INT:FREQ

sets the internal AM rate as defined by the "rate" parameter.

SOURce2:FREQuency[:CW|:FIXed]

sets the internal AM rate as defined by the "rate" parameter.

INT RATE (Only Available with Option 1E2)

See Also

[SOURCE[1]:]AM:INT:FREQ:STEP[:INCRement]
SOURCE2:FREQuency[:CW]:FIXed]:STEP

FM Internal Rate (Option 1E2 Required)

The **INT RATE** key under the FM/ ϕ M key group enables you to modify the internal FM.

When the **INT RATE** key is pressed, the text INT FM RATE XXX kHz will appear across the left-most display where XXX is the current value of the internal FM rate in kiloHertz.

The accepted range for entries is from 1 kHz to 1 MHz. If an internal FM rate entry is made that is not within the allowable range, an error message will be generated and the FM rate will be set to either its upper or lower limit. The resolution for internal FM rate is 0.5 Hz. The preset value for internal rate is 100 kHz. The preset up/down arrow increment value is 1 kHz.

Equivalent SCPI Command

[SOURCE[1]:]FM:INT:FREQ	<i>sets the internal FM rate as defined by the "rate" parameter.</i>
SOURCE3:FREQuency[:CW]:FIXed]	<i>sets the internal FM rate as defined by the "rate" parameter.</i>

See Also

[SOURce[1]:]FM:INT:FREQ:STEP[:INCRement]
 SOURce3:FREQuency[:CW]:FIXed]:STEP

ϕ M Internal Rate (Option 1E2 and Option 800 Required)

The **INT RATE** key under the FM/ ϕ M key group enables you to modify the internal ϕ M rate also.

To access the internal ϕ M rate you first have to turn on phase modulation by pressing the **FM/ ϕ M ON/OFF** key three times. The ϕ M annunciator will be lit indicating phase modulation is active. The left-most display will display either EXTERNAL PM MOD ON or INTERNAL PM MOD ON. If external phase modulation is on, activate internal phase modulation by pressing the **SHIFT** key and **INT DEV** key. Next, press the **↑** or **↓** key to toggle between external and internal phase modulation. Stop when display reads INTERNAL PM MOD ON.

Now when you press the **INT RATE** key in the FM/ ϕ M key group, the text INT PM RATE XXX kHz will appear across the left-most display where XXX is the current value of the internal ϕ M rate in kiloHertz.

The accepted range for entries is from 0.5 Hz to 1 MHz if the phase deviation is less than 4 radians. For phase deviations greater than 4 radians the accepted range for entries is from 0.5 Hz to 30 kHz. If an internal ϕ M rate entry is made that is not within the allowable range, an error message will be generated and the ϕ M rate will be set to either its upper or lower limit. The resolution for internal ϕ M rate is 0.5 Hz. The preset value for internal rate is 10 kHz. The preset up/down arrow increment value is 1 kHz.

Keys/Shifted Functions

INT RATE (Only Available with Option 1E2)

Equivalent SCPI Command

[SOURce[1]:]PM:INT:FREQ	<i>sets the internal ϕM rate as defined by the "rate" parameter.</i>
SOURce4:FREQuency[:CW :FIXed]	<i>sets the internal ϕM rate as defined by the "rate" parameter.</i>

See Also

[SOURce[1]:]PM:INT:FREQ:STEP[:INCRement]
SOURce4:FREQuency[:CW|:FIXed]:STEP
PM RANGE
AC PM COUPLING
INT MOD OVERRANG

INVERT

Invoking the INVERT function (pressing the **SHIFT** key and then the **EXT ON/OFF** key) toggles inverted external pulse modulation on and off.

When inverted external pulse modulation is turned on, the INVERT EXT annunciator will be lit. Pulses at the PULSE/TRIG, GATE IN connector will then be inverted before affecting the pulse envelope of the output signal. This means that when the input signal is high, there is no power at the RF OUTPUT connector. When the input signal is low, there is power at the RF OUTPUT connector. Non-inverted external pulse modulation is the opposite of inverted external pulse modulation.

When **SHIFT**, INVERT (**EXT ON/OFF**) is pressed so that the invert function is turned off, non-inverted external pulse modulation remains on.

When the synthesizer is set to the preset state, inverted external pulse modulation is turned off.

Equivalent SCPI Commands

PULM:SOUR EXT	<i>sets pulse source to external.</i>
PULM:EXT:POL INV	<i>sets external pulse polarity to inverted.</i>
PULM:EXT:POL NORM	<i>sets external pulse polarity to non-inverted.</i>
PULM:STAT <u>ON OFF</u>	<i>turns pulse modulation on or off.</i>

Keys/Shifted Functions
INVERT

See Also

Connectors

EXT ON/OFF

[SOURCE[1:]]PULM:EXTernal:POLarity

[SOURCE[1:]]PULM:SOURce

[SOURCE[1:]]PULM:STATe

LOCAL

The **LOCAL** key removes the synthesizer from the remote state.

When the synthesizer is no longer in the remote state, the RMT annunciator in the right-hand display will no longer be lit.

If the instrument is in the local lockout (LLO) state, pressing the **LOCAL** key will not remove the instrument from the remote state. In this case, the only way to return the synthesizer to local operation is either by setting the REN bus control line false or sending the instrument the go-to-local (GTL) bus command.

Equivalent SCPI Command

There is no equivalent SCPI command for the **LOCAL** key, however, sending the "SYST:KEY 8" command is effectively the same as pressing the **LOCAL** key.

See Also

Connectors
SYSTem:KEY

LOG/LIN ON/OFF

The **LOG/LIN ON/OFF** key toggles between logarithmic and linear modulation.

The **LOG/LIN ON/OFF** key cycles between three states, as it is repeatedly pressed:

- AM off.
- Logarithmic AM on.
- Linear AM on.

Once this key is pressed, the **↑** and **↓** keys can also be used to cycle between states.

The left-most display shows the current state, which can be either internal or external, depending on the state of the INT/EXT switch in the AM key group.

When logarithmic AM is turned on, the log AM annunciator will be lit.

Logarithmic amplitude modulation allows you to continuously and exponentially vary the RF OUTPUT of the synthesizer.

When the synthesizer is in external log AM mode, the AM IN input accepts 0 to 6V. For every 1 V input, the RF OUTPUT level decreases by 10 dB. For example, +3 V causes a 30 dB attenuation in the RF output signal. The full range of attenuation varies from 0 dB to 60 dB. Negative voltage inputs have no effect on the RF output signal (that is, 0 dB attenuation).

When the linear AM is turned on, the LIN AM annunciator will be lit.

Linear amplitude modulation allows you to continuously and linearly vary the RF OUTPUT of the synthesizer.

When the synthesizer is in external linear AM mode, the AM IN input accepts -1 Vpk to $+1$ Vpk. Two sensitivity ranges are available: 100%/V and 30%/V. (See SENSITIVITY.) With modulation, the maximum carrier level is degraded by up to 6 dB depending on the depth.

For complete log and linear AM specifications, see Chapter 4, "Specifications and Options."

When the synthesizer is set to the preset state, AM is turned off.

Equivalent SCPI Commands

`AM:STAT ON/OFF` *turns logarithmic or linear AM on or off.*

See Also

INT/EXT
SENSITIVITY (AM SENSITIVITY)
[SOURce[1]:]AM: INT: FREQ
[SOURce[1]:]AM: INT: FREQ STEP
[SOURce[1]:]AM: INT: FUNC
[SOURce[1]:]AM: SENSITIVITY
[SOURce[1]:]AM: TYPE

LVL CR

The LVL CR (level correct) function allows you to calibrate external path losses in the signal path. The level correct function creates a table in synthesizer memory of external path loss values versus frequency.

Invoking the LVL CR (level correct) function (pressing the **SHIFT** key and then the **INT LEVEL** key) causes the synthesizer to prompt you for the start frequency, stop frequency, and number of points in the level correction table. Once the start frequency, stop frequency, and number of points are entered, you are given the option of running the level correct routine.

When **SHIFT**, **INT LEVEL** (LVL CR) is pressed, the synthesizer initially prompts you for the level correct start frequency.

- When **SHIFT**, **INT LEVEL** (LVL CR) is pressed, the text `COR START = XXXGHZ` will be displayed where `XXX` is the current start frequency. At this point, a new start frequency can be entered or the existing start frequency can be modified using the knob or arrow keys. The start frequency is used to determine the beginning frequency for the level correction table. The start frequency is the first frequency point in the table.

NOTE

You do not have to choose a new start frequency (or stop frequency or number of points). To keep the same parameter value, press **Hz** (ENTER) without entering a new parameter and the next parameter in the sequence will be displayed.

Once you have chosen the proper start frequency, pressing any terminator key while a numeric parameter entry is not in progress will cause the synthesizer to go to stop frequency entry mode.

- When in stop frequency entry mode, the synthesizer will display `COR STOP = XXXXGHZ`. Stop frequency entry is identical to start frequency entry.

The stop frequency is used to determine the ending frequency for the level correction table. The stop frequency is the last frequency point in the table.

Once you have chosen the proper stop frequency, pressing any terminator key while a numeric parameter entry is not in progress will cause the synthesizer to go to number of points entry mode.

- When in number of points entry mode, the synthesizer will display `SET NUMBER OF POINTS = XXX`. The number of points value determines how many frequency points will be in the level correct table. The number of points includes the start and stop frequency points. The synthesizer uses the start and stop frequency values and number of points and places evenly spaced frequency points in the level correction table. Note that if the calculated frequency points are not within the synthesizer frequency resolution, they will be rounded.

Once you have chosen the proper number of points, pressing any terminator key while a numeric parameter entry is not in progress will cause the synthesizer to ask if you want to run the level correction routine.

- When the synthesizer is asking if you want to run the level correction routine, the display indicates `RUN CORRECTION?, HIT ENTER`. If you press the ENTER (**HZ**) key, the synthesizer begins collecting new level correction data.

For each frequency point in the table, the synthesizer sends the power meter the frequency, waits for the meter to settle, and then reads the power value from the power meter. As the correction runs, the synthesizer calculates the loss data by subtracting the power meter reading from the current power level. (The synthesizer power level is constant during the level correct routine.)

LVL CR

Notes

1. If the level correction routine is aborted (by pressing the **LOCAL** key), the existing level correction data will be unaffected.
2. After the level correction routine has successfully completed, it will need to be saved to the level correction table chosen by the "SAVE CR" function. If the routine fails, the entered start and stop frequencies, and number of points will remain where they were set. Be aware, however, that the data in the level correct table will still reflect the last successful level correction that was run.

Once the synthesizer has completed the level correct routine and the new level correction table has been generated, it remains resident in synthesizer volatile memory. Pressing **PRESET** will clear this table. The table should be stored in one of four level correction table registers to avoid loss of the correction table.

The start frequency lower limit is equal to the synthesizer lower frequency limit. The start frequency upper limit is equal to the stop frequency minus the minimum frequency resolution at that frequency. The preset value for start frequency increment value is 100 MHz.

The stop frequency lower limit is equal to the start frequency plus the minimum frequency resolution at that frequency. The stop frequency upper limit is 20 GHz. The preset value for stop frequency increment value is 100 MHz.

The allowable range for number of points is 2 to 401. The preset increment value is 1.

Equivalent SCPI Command

There is no equivalent SCPI command for the LVL CR function, however, the commands under the “Level Correction Commands” tab in Chapter 1 of the *HP 83731A/32A and HP 83731B/32B Synthesized Signal Generators Programming Guide* explain how to load data into level correct tables, select tables, turn level correction on, etc.

See Also

LVL CR ON/OFF
PWR MTR ADDRS
RCL CR
SAVE CR
To Use the Level Correct Routine

LVL CR ON/OFF

The LVL CR ON/OFF (level correct on/off) function (**SHIFT**, **POWER LEVEL**) toggles the level correct function on and off.

When the level correct function is on, the LVL COR annunciator is lit and the data in the current level correction table is used to change the power level of the synthesizer. The current level correction table is either the last level correction that was run or the last table recalled from one of the four level correction register locations.

The level correct function compensates for path loss measured during the level correct routine and changes power levels accordingly. Thus, power is flat and leveled over the range of frequency points where data was measured during the routine. For example, assume that the level correction factor at 10 GHz is -4 dB (because there is 4 dB of path loss between the RF OUTPUT connector and the test point). Then, if -10 dBm is desired at 10 GHz (and the level correct function is turned on), the synthesizer actually generates -6 dBm so that the power level at the test point is -10 dBm. Notice that path loss correction is independent of power level. The preset condition for this function is off.

Notes

1. When level correction is activated and more power is required at the RF OUTPUT than the synthesizer can deliver, an error message is generated and the **UNLVL** annunciator lights. This can occur when the external signal path has loss and the power level is set close to maximum leveled power.
2. If the level correct function is on and an output frequency is requested from the synthesizer that is either greater than the stop frequency or less than the start frequency, *an error message will be generated and the level correction factor for the requested frequency will be zero (no correction).*

Equivalent SCPI Commands

`CORR:CSET:SEL FDATtableno` *selects the level correct table as defined by the “tableno” parameter.*
`CORR:STATe ON|OFF` *turns user corrections on or off.*
`CORR:CSET:STAT ON|OFF` *turns level corrections on or off.*

See Also

LVL CR
PWR MTR ADDRS
RCL CR
SAVE CR
[SOURCE[1]:]CORRection:CSET[:SElect]
[SOURCE[1]:]CORRection:CSET[:STATe]
[SOURCE[1]:]CORRection[:STATe]
“To Use the Level Correct Routine” in Chapter 3

MSG

The **MSG** key causes the instrument to display the most recent uncleared error number and a short description of the error to the front panel display.

When uncleared error messages are in the error queue, the front panel MSG annunciator will be lit. The MSG annunciator will remain lit until all error messages in the queue have been cleared. When an error is read using the **MSG** key, it is cleared as long as the error condition no longer exists.

When the **MSG** key is pressed, the most recent error in the error queue will be displayed. Successive presses of the **MSG** key will display any other errors in the queue. Pressing any function key will remove the error from the display.

When the synthesizer is set to the preset state, the error queue is cleared.

Equivalent SCPI Command

`SYST:ERR?` *returns the oldest uncleared error number and message that is in the error queue.*

See Also

Error Messages
SYSTem:ERRor?

MULTIPLIER

Invoking the MULTIPLIER function (pressing the **SHIFT** key and then the **FREQ** key) allows you to enter a multiplier value so that the frequency display will indicate the frequency at the output of a frequency multiplier.

NOTE

External equipment is required for frequency multiplication.

When **SHIFT**, **FREQ** is pressed, the multiplier value will be displayed across the left-most display in the following format:

FREQUENCY MULTIPLIER XXX

Where XXX is the multiplier value. The allowable range for multiplier values is 1 to 100. The preset value is 1 and the preset up/down arrow increment value is 1.

Entering a frequency multiplier value is useful when generating millimeter-wave signals with external multiplier equipment. *The display shows the frequency at the output of the external frequency multiplier, not at the synthesizer RF OUTPUT connector.*

For example, assume a frequency of 30 GHz is required. The synthesizer cannot generate a 30 GHz signal directly, but a frequency doubler can be connected at the RF OUTPUT connector to multiply a 15 GHz signal by two. Setting the multiplier value to two allows you to display the frequency at the output of the multiplier on the synthesizer. Setting the multiplier value to "2" will display 30 GHz, while the synthesizer is actually generating 15 GHz. Entering a new frequency of 32 GHz will set the synthesizer to 16 GHz.

MULTIPLIER

The minimum resolution at the output of the frequency multiplier is the synthesizer minimum resolution multiplied by the frequency multiplier value. As an example, assume a multiplier value of two has been entered and you attempt to enter a frequency of 30,000,001,000 Hz from the numeric keypad. The synthesizer will try to generate 15,000,000,500 Hz. However, the resolution of this signal (assuming Option 1E8 is not installed) is 500 Hz which is finer than the minimum specified resolution of 1,000 Hz. The actual output frequency would be rounded to 15,000,001,000 Hz and the display would show 30,000,002,000 Hz.

NOTE

The following applies when using frequency multiplier:

Actual FM Sensitivity = Displayed FM Sensitivity x Multiplier Value

Actual ϕ M Sensitivity = Displayed ϕ M Sensitivity x Multiplier Value

Equivalent SCPI Command

`FREQ:MULT multiplier` sets the multiplier value as defined by the "multiplier" parameter.

See Also

FREQ

[SOURCE[1]:]FREQuency:MULTiplier
To Generate Millimeter Signals

Numeric Keypad

The numeric keypad is used to enter a value for the current active function. The number is entered (recognized by the synthesizer) when you press the appropriate units terminator key or the **Hz** (ENTER) key.

The numeric keypad consists of the numeric keys **0** through **9**, **.**, **-**, and the units terminator keys **GHz**, **MHz**, **kHz**, and **Hz**. When making an entry, the parameter change will not take effect until a units terminator key is pressed. The **GHz** key also functions as the units terminator key for dBm, dB, and ms entries. The **MHz** key also functions as the units terminator key for μ s entries. The **kHz** key also functions as the units terminator key for ns. The **Hz** key also functions as the terminator key for entries that are unitless (for example, multiplier value entries), for radian entries, and for percent entries.

When the numeric keypad is used, data is entered for the active parameter. A cursor (**▼**) will always appear over one of the digits in the active parameter display. If the cursor is absent from the display, the entry hold function is active and the desired function key must be pressed to re-enable the numeric keypad.

The knob or and **↑**, **↓** keys can also be used to change the currently active parameter.

See Also



ENTER

ENTRY OFF

Knob

“To Enter Data with the Numeric Keypad” in Chapter 2

POWER LEVEL

The **POWER LEVEL** key allows you to set the output power level of the synthesizer.

Power level is displayed in the right-hand position of the right-most display. The allowable range for power level entries is -15 dBm to $+30$ dBm for standard configuration instruments and -120 dBm to $+30$ dBm when Option 1E1 is installed.

NOTE

The actual maximum internally leveled output power for your instrument at a given frequency can be found by increasing the synthesizer output power until the **UNLVL** annunciator lights.

Power level resolution is 0.01 dB. The preset power level value is 0 dBm for standard configuration instruments. For instruments with Option 1E1 installed, the preset power level value is -110.00 dBm. The preset up/down arrow increment value is 1.00 dBm. The minimum increment value is 0.01 dBm.

NOTE

Changing frequency or power level while pulse modulating the output triggers an internal power level calibration. This calibration includes a CW burst for approximately 10 ms to 30 ms. Refer to "AVG PWR INHIBIT ON/OFF" for information on how to protect devices sensitive to CW power.

Three options are available for leveling of the output power. These are internal leveling (**INT LEVEL**), external diode detector leveling (**EXT DIODE**), and external power meter leveling (**EXT METER**). Refer to the respective reference entries in this chapter for information on the different leveling options.

Equivalent SCPI Command

POW level *sets the synthesizer output power level as defined by the "level" parameter.*

See Also

EXT DIODE

EXT METER

INT LEVEL

AVG PWR INHIBIT ON/OFF

[SOURce[1]:]POWer[:]LEVel]

[SOURce[1]:]POWer:UNIT

PRESET

The **PRESET** key sets the synthesizer to a known state.

The preset conditions are shown in the following table:



Table 6-5. PRESET Conditions

Parameter	Condition	Parameter	Condition
:AM:DEPTH	6dB	:PM:COUPLing	AC
:AM:SENSitivity	-10 dB/Volt	:POWer:LEVel	0 dBm ¹
:AM:STATe	OFF	:POWer:ALC:SOURce	INT
:AM:SOURce	EXT	:POWer:ALC:PMETer:LEVel	0 dBm
:AM:TYPE	EXP	:POWer:ATenuation:AUTO	ON
:AM:INternal:FUNC	SIN	:POWer:PROtection:STATe	OFF
:AM:INternal:FREQuency	5 kHz	:PULM:SOURce	EXT
:CORRection:STATe	OFF	:PULM:STATe	OFF
:CORRection:CSET:SElect	FDAT1	:PULM:EXternal:POLarity	NORM
:CORRection:CSET:STATe	OFF	:PULSe:DELay	1 μs
:DISPlay:WINDow:STATe	ON	:PULSe:FREQuency	10 kHz
:FM:DEViation	1 MHz	:PULSe:PERiod	10 μs
:FM:STATe	OFF	:PULSe:DOUble:STATe	OFF
:FM:SOURce	EXT	:PULSe:TRANSition:LEADing	FAST
:FM:COUPLing	AC	:PULSe:TRANSition:STATe	OFF
:FM:SENSitivity	5 MHz/Volt	:PULSe:TRANSition:TRAILing	FAST
:FM:INternal:FUNC	SIN	:PULSe:WIDth	10 μs
:FM:INternal:FREQuency	100 kHz	:OUTPut:STATe	ON
:FREQuency:CW	3 GHz	:OUTPut:PROtection:STATe	
:FREQuency:MULTiplier	1	:SYSTem:COMMunicate:GPIB:ADDRes	19 ²
:MEMory:TABLE:SElect	FDAT1	:SYSTem:COMMunicate:PMETer:ADDRes ²	
:MODulation:OVDR	OFF	:SYSTem:LANGuage	"SCPI" ²
:MODulator:OVDR	OFF	:TRIGger:SEQUence:SOURce	IMM
:PM:DEViation	3 rads	:TRIGger:SEQ2:SOURce	IMM
:PM:INternal:FUNC	SIN	:TRIGger:SEQ2:SLOPe	NEG
:PM:INternal:FREQuency	10 kHz	:UNIT:FREQuency	HZ
:PM:RANGe	AUTO	:UNIT:POWer	DBM
:PM:STATe	OFF	:UNIT:TIME	S
:PM:SOURce	EXT		
:PM:SENSitivity	1rad/Volt		

1 When Option 1E1 is installed, the preset power is -110 dBm.

2 Do not change with preset. These are the default values when RAM memory is lost.

Keys/Shifted Functions
PRESET

Equivalent SCPI Commands

***RST** *sets the synthesizer to a known state.*

or

SYST:PRES

See Also

***RST**

SYSTem:PRESet

PRF

Invoking the PRF function (pressing the **SHIFT** key and then the **PRI** key) enables you to modify the pulse repetition frequency. PRF is used during internal pulse modulation and gated pulse modulation.

The pulse repetition frequency parameter is displayed under the “PRI/PRF” portion of the left-most display. When the pulse repetition frequency is entered, the text PRF XXX will appear across the left-most display where XXX is the entered value and the appropriate units suffix.

The accepted range for entries is from a minimum of 2.5 Hz to a maximum that is limited according to the carrier frequency set with the **FREQ** key. The limits are as follows:

Table 6-6. Maximum Specified PRF

Carrier Frequency	Maximum Specified PRF
10 MHz to 128 MHz	0.1 MHz
128 MHz to 500 MHz	1 MHz
500 MHz and up	3.3 MHz

Notes

1. The maximum PRF limit for the HP 83731B is 3.3 Mhz over the entire carrier frequency range.
2. The value for pulse width can not be greater than the value for $\frac{1}{PRF}$.

PRF

If a PRF entry is made that is not within the allowable range, the pulse characteristics will be out of specification and an error message will be generated. The resolution for PRF can be found by rounding the reciprocal of PRF (1/PRF or PRI) to the nearest 25 ns and then taking the reciprocal of that value.

For example, assume a PRF of 432 kHz is needed. The reciprocal of 432 kHz is 1/432 kHz or 2315 ns. This value rounded to the nearest 25 ns is 2325 ns. Taking the reciprocal of 2325 ns is 1/2325 ns or 430.107526 kHz. Therefore, if you enter a PRF of 432 kHz, the display will show 432 kHz but the actual PRF generated by the instrument will be 430.107526 kHz. The preset value for PRF is 10 kHz. The preset up/down arrow increment value is 100 Hz.

NOTE

Changing the PRF parameter automatically causes the PRI (pulse repetition interval) parameter to change since these two parameters are reciprocals of each other.

Equivalent SCPI Command

PULS:FREQ prf *sets the pulse repetition frequency as defined by the "prf" parameter.*

See Also

DELAY
EXT ON/OFF
INT ON/OFF
INVERT
PRI
[SOURCE[1]:]PULSE:FREQUENCY
TRIG ON/OFF
WIDTH

PRI

The **(PRI)** key enables you to modify the pulse repetition interval. PRI is used during internal pulse modulation and gated pulse modulation.

The pulse repetition interval parameter is displayed under the "PRI/PRF" portion of the left-most display. When the pulse repetition interval is entered, the text **PRI XXX** will appear across the left-most display where **XXX** is the entered value and the appropriate units suffix.

The accepted range for entries is from a maximum of 419 ms to a minimum that is limited according to the carrier frequency set with the **(FREQ)** key. The limits are as follows:

Table 6-7. Minimum Specified PRI

Carrier Frequency	Minimum Specified PRI
10 MHz to 128 MHz	10 μ s
128 MHz to 500 MHz	1 μ s
500 MHz and up	0.3 μ s

Notes

1. The minimum PRI limit for the HP 83731B is 0.3 μ s over the entire carrier frequency range.
2. The value for pulse width can not be greater than the value for PRI.

The resolution for PRI entries is 25 ns; entries with resolution finer than 25 ns will be rounded to the nearest 25 ns. If a PRI entry is made that

is not within the allowable range, the pulse characteristics will be out of specification and an error message will be generated. The preset value for PRI is 100 μ s.

The preset up/down arrow increment value is 1 μ s.

NOTE

Changing the PRI parameter automatically causes the PRF (pulse repetition frequency) parameter to change since these two parameters are reciprocals of each other.

Equivalent SCPI Command

`PULS:PER pri` sets the pulse repetition interval as defined by the “pri” parameter.

See Also

`DELAY`

`EXT ON/OFF`

`INT ON/OFF`

`INVERT`

`PRF`

`[SOURCE[1]:]PULSe:PERiod`

`TRIG ON/OFF`

`WIDTH`

RCL CR

Invoking the RCL CR (recall level correction table) function (pressing the **SHIFT** key and then the **EXT METER** key) allows you to recall a previously stored table of level correction data from one of four level correction register locations.

The allowable range for register locations is 1 through 4. When **SHIFT**, **EXT METER** is pressed, the text RECALL FRM TABLE XXX will be shown on the synthesizer display where XXX is the last level correction register number entered. Once you press a valid numeric key (1 through 4) and terminate the entry by pressing **Hz** (ENTER), the table of level correction data will be recalled from the location indicated by the numeric key pressed. If level correction data has not been previously stored to a level correction register, an error message is generated and no change to the current data takes place if you attempt to recall a level correction table from that register.

NOTE

The four level correction registers are separate from the instrument state registers. Level correction data is not cleared from memory when the synthesizer is set to the preset state and is unaffected if an instrument state is recalled from one of the instrument state registers.

Equivalent SCPI Command

There is no equivalent SCPI command for the RCL CR function, however, the "SOUR1:CORR:CSET:SEL" command is used to select which level correct table is used to correct power at the synthesizer RF OUTPUT connector.

See Also

LVL CR

LVL CR ON/OFF

SAVE CR

"To Use the Level Correct Routine" in Chapter 3

RECALL

The **RECALL** key allows you to recall a previously stored instrument state from one of ten register locations.

The allowable range for register locations is 0 through 9. When **RECALL** is pressed, the text RECALL STATE FROM REG XXXX will be shown on the instrument display where XXXX is the last register number entered.

Once you press a valid numeric key (0 through 9) and terminate the entry, the instrument state will be recalled from the location indicated by the numeric key pressed. If the instrument state has not been previously stored to an instrument state register, the synthesizer will be set to the preset state if you attempt to recall the instrument state from that register.

Equivalent SCPI Command

*RCL register *recalls a previously stored instrument state from the register defined by the "register" parameter.*

See Also

PRESET
*RCL
*SAV
SAVE

RF ON/OFF

The **RF ON/OFF** key toggles the signal at the RF OUTPUT connector on and off.

When the RF OUTPUT is turned off, the text OFF will be indicated in the level display in place of dBm.

When the RF output is turned off, the internal oscillators are turned off and the internal RF power shutdown circuit is turned on.

When the synthesizer is set to the preset state, the signal at the RF OUTPUT connector is turned on.

Equivalent SCPI Command

`OUTP:STAT ON|OFF` *turns the signal at the RF Output connector on or off.*

See Also

`OUTPut[:STATe]`

SAVE

Invoking the SAVE function (pressing the **SHIFT** key and then the **RECALL** key) allows you to save the instrument state in one of ten register locations.

The allowable range for register locations is 0 through 9. When **SHIFT**, **RECALL** is pressed, the text SAVE STATE IN REG XXX will be shown on the instrument display where XXX is the last register number entered. Once you press a valid numeric key (0 through 9) and terminate the entry, the instrument state will be saved to the location indicated by the numeric key pressed. Saving the instrument state to a given register location will write over any instrument state previously stored at that location.

All user settings that are affected when the **PRESET** key is pressed will be saved. Level correction tables, however, will not be saved. For information on saving level correction tables, refer to "SAVE CR" in this chapter.

Equivalent SCPI Command

***SAV register** *saves the instrument state to the register defined by the "register" parameter.*

See Also

RECALL
*SAV
SAVE CR

SAVE CR

Invoking the SAVE CR (save level correction table) function (pressing the **SHIFT** key and then the **EXT DIODE** key) allows you to save the current table of level correction data in one of four level correction register locations.

The allowable range for register locations is 1 through 4. When **SHIFT**, **EXT DIODE** is pressed, the text SAVE IN TABLE *** will be shown on the synthesizer display where *** is the last level correction register number entered. Once you press a valid numeric key (1 through 4) and terminate the entry by pressing **Hz** (ENTER), the table of level correction data will be saved to the location indicated by the numeric key pressed. Saving the table of level correction data to a given level correction register location will write over any level correction data previously stored at that location.

NOTE

The four level correction registers are separate from the instrument state registers. Level correction data is not cleared from memory when the synthesizer is set to the preset state and is unaffected if an instrument state is recalled from one of the instrument state registers.

Keys/Shifted Functions

SAVE CR

Equivalent SCPI Command

There is no equivalent SCPI command for the SAVE CR function, however, the "MEM:TABL:FREQ" and "MEM:TABL:LOSS:MAGN" commands can be used to load frequency and correction factor points into a selected level correct table.

See Also

LVL CR

LVL CR ON/OFF

RCL CR

"To Use the Level Correct Routine" in Chapter 3

SENSITIVITY

AM Sensitivity
FM Sensitivity
ϕM Sensitivity (Option 800 Required)

AM Sensitivity

Invoking the AM SENSITIVITY function in the AM key group by pressing the **SHIFT** key and then the **LOG/LIN ON/OFF** key, enables you to view the current AM sensitivity.

When **SHIFT**, **LOG/LIN ON/OFF** is pressed, the AM sensitivity will be displayed across the left-most display in the following format:

EXT AM SENS = XXX

Where XXX is the AM sensitivity with its appropriate units terminator (either dB/V or %/V). This sensitivity function displays either log or linear AM sensitivity, depending on whether log or linear AM modulation is turned on.

To display log AM sensitivity, you must first turn on log AM by pressing the **LOG/LIN ON/OFF** key twice from the AM off state. Next, press **SHIFT** then **LOG/LIN ON/OFF** to display the log AM sensitivity. Only one sensitivity is available in log AM (-10 dB/Vpk).

To display linear AM sensitivity you must first turn on linear AM by pressing the **LOG/LIN ON/OFF** key three times from the AM off state. Next, press **SHIFT** then **LOG/LIN ON/OFF** to show the linear AM sensitivity. Once active, the linear AM sensitivity can be changed from 100 %/Vpk to 30 %/Vpk by using the **↑** or **↓** key. In either sensitivity range, modulation is limited to 100%. Stop on the desired sensitivity setting.

SENSITIVITY

Equivalent SCPI Command

[SOURce[1]:]AM:SENSitivity sensitivity *sets the AM sensitivity as defined by the "sensitivity" parameter*

See Also

Connectors
LOG/LIN ON/OFF
[SOURce[1]:]AM:SENSitivity?
[SOURce[1]:]AM:TYPE

FM Sensitivity

Invoking the FM SENSITIVITY function in the FM/φM key group by pressing the **(SHIFT)** key and then the **(FM/φM ON/OFF)** key, enables you to view the current FM sensitivity when FM is turned on.

When **(SHIFT)** then **(FM/φM ON/OFF)** (SENSITIVITY) are pressed, the FM sensitivity will be displayed across the left-most display in the following format:

EXT FM SENS XXX

Where XXX is the FM sensitivity with its appropriate units terminator (either Hz, kHz, or MHz).

When the synthesizer is set to the preset state, sensitivity is 5 MHz/Vpk.

FM sensitivity is defined as the ratio of the peak frequency deviation from the carrier per peak voltage of the modulating signal amplitude.

Seven FM sensitivity ranges are available at any given carrier frequency; however, each range is dependent on the carrier frequency currently set with the **(FREQ)** key. (See Table 6-8.)

Table 6-8. FM Sensitivity Ranges

Frequency	Selectable Sensitivity	Unit
1 GHz to 20 GHz	10, 5, 3, 1, 0.3, 0.1, 0.03	MHz/V
256 MHz to <1 GHz	2500, 1250, 750, 250, 75, 25, 7.5	kHz/V
64 MHz to <256 MHz	625, 312, 187, 62.5, 18.7, 6.25, 1.87	kHz/V
16 MHz to <64 MHz	156, 78.1, 46.8, 15.6, 4.68, 1.56, 0.468	kHz/V
10 MHz to <16 MHz	78.1, 39.0, 23.4, 7.81, 2.34, 0.781, 0.234	kHz/V

SENSITIVITY

For example, if the carrier frequency were set to 0.5 GHz, external FM turned on, and a sine wave signal of 0.5 V_{pk} were connected to the FM/φM IN connector; then the carrier would deviate between 497.5 MHz and 502.5 MHz (± 2.5 MHz around 500 MHz). If the carrier were set to 19 GHz in the above example, the carrier would deviate between 18.995 GHz and 19.005 GHz (± 5.0 MHz around 19 GHz). Note that the FM sensitivity shown in Table 6-8 is not the same at the two carrier frequencies used in this example.

Notes

1. FM sensitivity is a function of carrier frequency.
2. When a frequency multiplier is used at the synthesizer output, the sensitivity displayed will *NOT* be multiplied by the multiplier value. As an example, if the multiplier value is set to 2 and the carrier is set to 30 GHz (2x15 GHz), the displayed FM sensitivity would be 5.0 MHz/V. The actual FM sensitivity will be 2x5.0 MHz/V or 10.0 MHz/V.

At any sensitivity setting, the input must be within the range of -2 V to $+2$ V.

Equivalent SCPI Command

`[SOURCE[1]:]FM:SENSitivity sensitivity` *sets the FM sensitivity as defined by the "sensitivity" parameter*

See Also

Connectors
FM/ ϕ M ON/OFF
FREQ
MULTIPLIER
[SOURce[1]:]FM:SENSitivity?

ϕ M Sensitivity

Invoking the ϕ M SENSITIVITY function in the FM/ ϕ M key group by pressing the **(SHIFT)** key and then the **(FM/ ϕ M ON/OFF)** key, enables you to view the current external phase modulation sensitivity when ϕ M is turned on.

Turn on phase modulation by pressing the **(FM/ ϕ M ON/OFF)** key three times from the FM/ ϕ M off state. The ϕ M annunciator will be lit indicating phase modulation is on.

When **(SHIFT)** then **(FM/ ϕ M ON/OFF)** (SENSITIVITY) are pressed, the ϕ M sensitivity will be displayed across the left-most display in the following format:

EXT PM SENS XXX

Where XXX is the ϕ M sensitivity with its appropriate units terminator (either rad or mrad).

When the synthesizer is set to the preset state, sensitivity is 1.0 rad/Vpk.

ϕ M sensitivity is defined as the ratio of the peak phase deviation from the carrier per peak voltage of the modulating signal amplitude.

Two ϕ M sensitivity ranges are available at any given carrier frequency; however, each range is dependent on the carrier frequency currently set with the **(FREQ)** key. (See Table 6-9.)

Table 6-9. ϕ M Sensitivity Ranges

Frequency	Low Range	High Range
1 GHz to 20 GHz	1 rad/Vpk	50 rad/Vpk
256 MHz to <1 GHz	0.25 rad/Vpk	12.5 rad/Vpk
64 MHz to <256 MHz	0.0625 rad/Vpk	3.12 rad/Vpk
16 MHz to <64 MHz	0.0156 rad/Vpk	0.781 rad/Vpk
10 MHz to <16 MHz	0.00781 rad/Vpk	0.39 rad/Vpk

For example, if the carrier frequency were set to 0.5 GHz, ϕ M turned on, and a sine wave signal of 1.0 Vpk were connected to the FM/ ϕ M IN connector;

then the carrier would deviate between -0.25 radian and $+0.25$ radian around 500 MHz. If the carrier were set to 19 GHz in the above example, the carrier would deviate between -1.00 radian and $+1.00$ radian around 19 GHz. Note that the ϕM sensitivity shown in Table 6-9 is not the same at the two carrier frequencies used in this example.

Notes

1. ϕM sensitivity is a function of carrier frequency.
2. When a frequency multiplier is used at the synthesizer output, the sensitivity displayed will *NOT* be multiplied by the multiplier value. As an example, given an initial state of 1 rad/V phase modulation and CW frequency of 15 GHz, then if the multiplier value is set to 2, the carrier would be 30 GHz (2x15 GHz), and the displayed ϕM sensitivity would be 1.0 rad/V. The actual ϕM sensitivity would be 2.0 rad/V (2x1.0 rad/V).

At any sensitivity setting, the input must be within the range of -4 V to $+4$ V.

Keys/Shifted Functions
SENSITIVITY

Equivalent SCPI Command

[SOURce[1]:]PM:SENSitivity sensitivity *sets the PM sensitivity as defined by the "sensitivity" parameter*

See Also

Connectors
FM/φM ON/OFF
FREQ
MULTIPLIER
[SOURce[1]:]PM:SENSitivity?

SHIFT

The **SHIFT** key causes the alternate function of any key pressed directly after it to be executed.

When the **SHIFT** key is pressed, the word **SHIFT** will be displayed in the left-most display. The next key that is pressed after the **SHIFT** key will execute the function that is indicated by the text that is above the key. As an example, note that **PRF** appears directly above the **PRI** key. **PRF** (pulse repetition frequency) is the alternate function of the **PRI** key. Pressing **SHIFT**, **PRI** will enable **PRF** entry mode.

If the **SHIFT** key is pressed prior to pressing a key that has no alternate function, **SHIFT** will be canceled from the display and no action will be taken by the instrument.

If you press the **SHIFT** key accidentally, pressing it again will cancel it without altering synthesizer operation.

Equivalent SCPI Command

There is no equivalent SCPI command for the **SHIFT** key, however, sending the "SYST:KEY 0" command is effectively the same as pressing the **SHIFT** key.

See Also

SYSTem:KEY

SPCL

The **SPCL** key initiates activation of special functions. Once a special function has been activated, it can be turned on or off, or its parameter value can be changed.

When the **SPCL** key is pressed, the left-most display shows the last special function used. Press the **↑** and **↓** keys to scroll through the list until the desired special function is reached, or press the **SPCL** key and a number on the keyboard between 1 and 52, corresponding to the desired special function.

When the desired special function is reached, it can be changed by one of two methods, depending on whether it is an on/off function, or has an associated value.

If the function has only on and off values, it can be changed by pressing the **MHz** (SPCL ON) and **kHz** (SPCL OFF) keys, or by pressing the **HZ** (ENTER) key and using the **↑** and **↓** keys.

If the function has an associated parameter, the parameter can be modified by first pressing **HZ** (ENTER), and then adjusting the parameter by using either the **↑** and **↓** keys, the RPG, or by entering a value from the keyboard. When entering a value from the keyboard, the parameter entry is terminated the same way as any parameter entry.

When the synthesizer is set to the preset state, the currently active special function is set to 1 (SHOW INFO).

Equivalent SCPI Command

There is no equivalent SCPI command for the **SPCL** key, however, sending the "SYST:KEY 9" command is effectively the same as pressing the **SPCL** key.

See Also

Special Function
SPCL ON
SPCL OFF

SPCL OFF (kHz)

The SPCL OFF key (actually the secondary function of the **kHz** key) is used to turn on/off-type special functions off.

The **kHz** (SPCL OFF) key is used to turn on/off-type special functions off when they are displayed in the left-most display. The on/off-type special functions are ATTN HOLD ON/OFF, AVG PWR INHIBIT ON/OFF, CLEAR DISPLAY, and DC FM ON/OFF.

The SPCL OFF key will turn the special function off whether it has been selected via the numeric keypad or by using the knob or **↑**, **↓** keys. When the special function has been turned off, the word OFF will be shown in the right side of the left-most display and the SPCL annunciator will turn off if no other special functions are selected.

Equivalent SCPI Command

There is no equivalent SCPI command for the SPCL OFF key, however, sending the "SYST:KEY 50" command is effectively the same as pressing the SPCL OFF key.

See Also

ATTEN HOLD ON/OFF
AVG PWR INHIBIT ON/OFF
CLEAR DISPLAY
DC FM ON/OFF
SPCL
SPCL ON
SYSTEM:KEY
Special Functions

SPCL ON (MHz)

The SPCL ON key (actually the secondary function of the **MHz** key) is used to turn on/off-type special functions on.

The **MHz** (SPCL ON) key is used to turn on/off-type special functions on when they are displayed in the left-most display. The on/off-type special functions are ATTEN HOLD ON/OFF, AVG PWR INHIBIT ON/OFF, CLEAR DISPLAY, and DC FM ON/OFF.

The SPCL ON key will turn the special function on whether it has been selected via the numeric keypad or by using the knob or **↑**, **↓** keys. When the special function has been turned on, the word **ON** will be shown in the right side of the left-most display and the SPCL annunciator will be lit.

Equivalent SCPI Command

There is no equivalent SCPI command for the SPCL ON key, however, sending the "SYST:KEY 42" command is effectively the same as pressing the SPCL ON key.

See Also

ATTEN HOLD ON/OFF
AVG PWR INHIBIT ON/OFF.
CLEAR DISPLAY
DC FM ON/OFF
SPCL
SPCL OFF
SYSTEM:KEY

STEP SIZE

The **STEP SIZE** key enables you to change the increment value for the current active parameter. The increment value is the value that the current parameter will be increased or decreased by when the **↑** or **↓** keys are pressed.

The preset increment value for each parameter can be found under the pertinent key/function entries in this section.

If the ENTRY OFF (**SHIFT**, **⇒**) function has been enabled, you will not be able to change any increment values using the **STEP SIZE** key and pressing the **↑** or **↓** keys will have no effect on the active parameter.

Equivalent SCPI Commands

<code>AM:INT:FREQ:STEP <u>increment</u></code>	<i>sets increment value for internal AM rate as defined by the "increment" parameter.</i>
<code>FM:INT:FREQ:STEP <u>increment</u></code>	<i>sets increment value for internal FM rate as defined by the "increment" parameter.</i>
<code>PM:INT:FREQ:STEP <u>increment</u></code>	<i>sets increment value for internal phase modulation rate as defined by the "increment" parameter.</i>
<code>FREQ:STEP <u>increment</u></code>	<i>sets frequency increment value as defined by the "increment" parameter.</i>
<code>FREQ:MULT:STEP <u>increment</u></code>	<i>sets multiplier increment value as defined by the "increment" parameter.</i>
<code>PM:INT:FREQ:STEP <u>increment</u></code>	<i>sets increment value for internal ϕM rate as defined by the "increment" parameter.</i>

STEP SIZE

POW:STEP <u>increment</u>	<i>sets power level increment value as defined by the "increment" parameter.</i>
POW:ALC:PMET:STEP <u>increment</u>	<i>sets external power meter leveling increment value as defined by the "increment" parameter.</i>
PULS:DEL:STEP <u>increment</u>	<i>sets pulse delay increment value as defined by the "increment" parameter.</i>
PULS:FREQ:STEP <u>increment</u>	<i>sets pulse repetition frequency increment value as defined by the "increment" parameter.</i>
PULS:PER:STEP <u>increment</u>	<i>sets pulse period increment value as defined by the "increment" parameter.</i>
PULS:WIDTH:STEP <u>increment</u>	<i>sets pulse width increment value as defined by the "increment" parameter.</i>

See Also

ENTRY OFF

TRIG ON/OFF

The **TRIG ON/OFF** key toggles internal triggered pulse modulation on and off.

When internal triggered pulse modulation is turned on, the TRIG INT annunciator will be lit.

When internal triggered pulse modulation is enabled, an RF pulse will occur at the RF OUTPUT connector whenever a valid trigger signal occurs at the PULSE/TRIG IN, GATE IN connector. The RF pulse will have pulse width and delay as set with the **WIDTH** and **DELAY** keys.

Figure 6-5 summarizes the timing characteristics of internal triggered pulse mode.

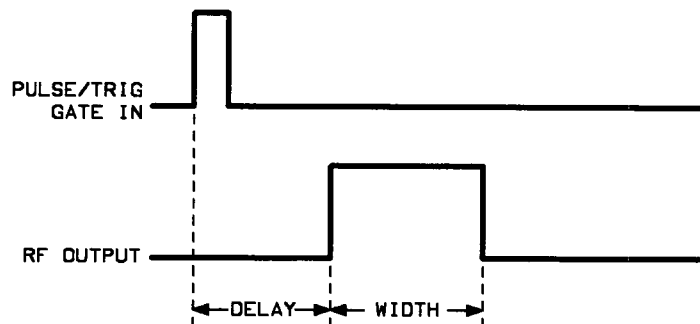

Figure 6-5. Internal Triggered Pulse Mode Timing

When the synthesizer is set to the preset state, internal triggered pulse modulation is turned off.

Equivalent SCPI Commands

PULM:SOUR INT	<i>sets pulse source to internal.</i>
TRIG:SOUR EXT	<i>enables triggered pulse mode.</i>
TRIG:STOP:SOUR IMM	<i>sets the trigger stop source to immediate.</i>
PULS:DOUB OFF	<i>turns doublet pulse mode off.</i>
PULM:STAT <u>ON OFF</u>	<i>turns pulse modulation on or off.</i>

See Also

Connectors

DELAY

[SOURCE[1]:]PULM:SOURce

[SOURCE[1]:]PULM:STATe

TRIGger[:SEQuence[1]:]START]:SOURce

WIDTH

WIDTH

The **WIDTH** key enables you to modify the pulse width parameter. Pulse width is used in internal, triggered internal, gated, and doublet pulse modes.

The pulse width parameter is displayed under the “WIDTH” portion of the left-most display. When the width is entered, the text WIDTH XXX will appear across the left-most display where XXX is the entered value and the appropriate units suffix. The allowable range for entries is 0 ns to 419 ms with a resolution of 25 ns; entries with resolution finer than 25 ns will be rounded to the nearest 25 ns.

If a width entry is made that is greater than the upper limit, the value will be set to the upper limit. The preset value for width is 10 μ s.

Notes

1. In triggered pulse mode, the sum of pulse width and pulse delay can not exceed 419 ms.
2. The value for pulse width can not be greater than the value for PRI.

The allowable range for up/down arrow increments is 25 ns to 419 ms with 25 ns resolution. The preset up/down arrow increment value is 100 ns.

Equivalent SCPI Command

PULS:WIDT width *sets the pulse width as defined by the “width” parameter.*

See Also

DELAY

EXT ON/OFF

INT ON/OFF

INVERT

PRF

PRI

[SOURce[1]:]PULSe:WIDTh

TRIG ON/OFF

Keys/Shifted Functions

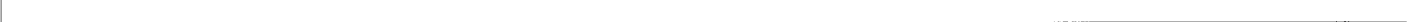





Special Functions



Special Functions

This chapter contains detailed information on the various special functions available for the synthesizer. Special functions are hidden during normal synthesizer operation and can only be invoked by pressing the **SPCL** key and then entering the special function number, or by scrolling through the list using the **↑** and **↓** keys. Note that special functions are organized in this chapter alphabetically by special function name, not by special function number.

SPCL Number	Name
1	SHOW INFO
2	ATTEN HOLD
3	CLEAR DISPLAY
4	ERASE MEMORY
5	SELF TEST
20	PWR MTR ADDRS
21	PWR MTR SELECT
25	REMOTE LANGUAGE
27	AC PM COUPLING
28	POWER METER RANGE
29	INT MOD OVERRANGE
30	DC FM
31	AVG PWR INHIBIT
40	SELECT RISETIME
50	AM WAVEFORM
51	FM WAVEFORM
52	PM WAVEFORM

AC PM COUPLING (Only Available with Option 800)

Invoking the AC PM COUPLING function (pressing **SPCL**, **27**, **Hz** (ENTER)) selects the AC phase modulation coupling function. When this function is turned on, the phase modulation input is AC-coupled. When this function is turned off, the phase modulation input is DC-coupled.

When **SPCL**, **27**, **Hz** (ENTER) is pressed, the left-most display shows the following:

AC PM XXX

Where XXX is the current state of the AC phase modulation coupling function.

Once the AC phase modulation coupling function is enabled, pressing **MHz** (SPCL ON) turns on the AC PM coupling function. The SPCL annunciator will be lit indicating the special function is active. Pressing **kHz** (SPCL OFF) while AC phase modulation coupling is active turns off this function.

When the synthesizer is set to the preset state, the AC phase modulation coupling function is off (DC-coupled).

Advantages

This function allows the user to AC-couple the external phase modulation input. This removes any DC offset the external modulation signal may have and allows calibration of the peak-to-peak amplitude swings for a given phase deviation.

Special Functions

AC PM COUPLING (Only Available with Option 800)

Disadvantages

AC phase modulation coupling limits the lowest input frequency to about 1 kHz while still meeting the phase modulation flatness specifications.

Equivalent SCPI Command

[SOURce[1]:]PM:COUPling *sets either AC- or DC coupling for the FM/φM IN connector.*

See Also

[SOURce[1]:]PM:SOURce

AM WAVEFORM (Only Available with Option 1E2)

Invoking the AM WAVEFORM function (pressing **SPCL**, **50**, **HZ** (ENTER)) selects the AM waveform function. This function allows selection of the internal AM waveform by using the **↑** or **↓** key to step through the waveform types.

When **SPCL**, **50**, **HZ** (ENTER) are pressed, the left-most display shows the following:

AM WAVEFORM = XXX

Where XXX is the currently selected waveform type (SINUSOID, SQUARE, TRIANGLE, RAMP, UNIFORM, GAUSSIAN). Uniform and gaussian refer to the amplitude distribution of the noise generator.

Once the AM waveform function is enabled, you can use the **↑** or **↓** key to choose one of the six waveform types.

When the synthesizer is set to the preset state, the waveform type is set to sinusoid.

Applications

When internal AM is chosen, the rate and depth are set by the front panel **INT RATE** and **INT DEPTH** keys in the AM key group. The choice of waveforms are sinusoid, square, triangle, ramp, uniform noise, and gaussian noise.

- SINUSOID:** The specifications chapter covers the frequency range and depth limits for both linear AM and logarithmic AM (Scan Modulation) with the internal function generator waveform set to sinusoid. The internal generator bandwidth is 1 MHz. Linear AM typically is used in measuring group delay, AM-to-PM, and SINAD.
- SQUARE:** Typical rise and fall times of the internal function generator square wave are 200 ns. However, the AM circuitry limits the typical RF rise and fall times to those stated under the logarithmic AM Step response specifications. Typical rise and fall times for linear AM are 5 μ s.
- TRIANGLE:** Frequency range and depth limits are covered in the specifications chapter. Slew rate limitations of AM circuitry increases distortion at higher frequencies. The triangle waveform coupled with LOG AM can provide a power sweep in both directions.
- RAMP:** This is a negative ramp. That is, the waveform starts at a maximum positive voltage and ramps linearly to the minimum voltage. This is useful for large power sweeps (60 dB) when used in logarithmic AM mode. The output power sweeps from minimum power (set by AM Depth) up to the power set by the vernier. In linear AM mode the power sweeps from maximum power [$20 \cdot \log(1 + \text{depth})$] above vernier power level to minimum power [$20 \cdot \log(1 - \text{depth})$] below vernier power level, where depth is the decimal equivalent of the modulation depth in percent (50% = 0.5).

AM WAVEFORM (Only Available with Option 1E2)

Distortion increases at higher AM rates due to 100 kHz AM bandwidth in linear AM mode and 20 kHz bandwidth in log AM mode. Frequency range and depth limits are covered in the specifications chapter.

UNIFORM NOISE:

This is defined as having an equal probability of output power being somewhere within the output power boundary defined by the AM depth.

Example 1:

If the synthesizer was set to a CW output power of 0 dBm, logarithmic AM selected, 60 dB depth, and uniform noise waveform, this would yield an equal probability of the output power being somewhere between 0 and -60 dBm at any given time.

Example 2:

If the synthesizer CW output power is 0 dBm and linear AM is selected with 50% depth and uniform noise waveform, then the output power would have an equal probability of being somewhere between +3.52 dBm and -6.02 dBm at any given time.

The noise bandwidth of the internal generator is approximately 1 MHz. However, the probability distribution will be altered somewhat by the bandwidth of the AM circuitry. AM rate has no affect when uniform noise waveform is selected.

GAUSSIAN NOISE:

This is similar to the uniform noise in description except the noise and hence the output power assumes a gaussian or normal distribution over the AM depth selected. The internal generator noise bandwidth is approximately 1 MHz. However, the noise bandwidth will be limited further by the bandwidth of the AM circuitry. AM rate has no affect when gaussian noise waveform is selected.

Special Functions

AM WAVEFORM (Only Available with Option 1E2)

Equivalent SCPI Command

[SOURce[1]:]AM:INT:FUNC

[:SINusoid | :SQUAre | :TRIAnge | :RAMP | :NOISe | :GAUSSian]

*selects the waveform type of
the internal AM generator.*

See Also

SOURce2:FUNC

ATTEN HOLD ON/OFF

Invoking the ATTEN HOLD ON/OFF function (pressing **SPCL**, **2**, **Hz** (ENTER)) selects the attenuator hold function. This function toggles between locking and unlocking the 10 dB step attenuator in its current setting.

NOTE

The attenuator hold function is only available if Option 1E1 is installed.

When **SPCL**, **2**, **Hz** (ENTER) is pressed, the left-most display shows the following:

ATTEN HOLD XXX

Where XXX is the current state of the step attenuator (ON=Locked and OFF=Unlocked).

Once the attenuator hold function is enabled, pressing **MHz** (SPCL ON) locks the synthesizer step attenuator at its current setting. Pressing **kHz** (SPCL OFF) unlocks the step attenuator.

When the synthesizer is set to the preset state, the attenuator hold function is turned off.

Application

The attenuator hold function can be used to extend the vernier range to prevent the step attenuator from switching between two attenuator settings. Locking the step attenuator keeps the attenuator from switching between the two levels as leveled power is varied above and below the threshold level, thus saving wear on the attenuator. Refer to the specification table in Chapter 4 for the level at which the attenuator switches.

Advantages

Locking the step attenuator prevents switching between two levels when the leveled output power is set near an attenuator switching threshold.

Disadvantages

When the step attenuator is locked, the output power dynamic range is limited to the vernier range at the current output frequency. Locking the step attenuator typically extends the lower limit of the vernier range by 5 dB. The upper limit of the vernier range is the synthesizer maximum output power which changes with frequency. The minimum dynamic range when the attenuator hold function is on is typically 19 dB.

NOTE

The ATTEN HOLD ON/OFF function will not activate when the synthesizer is in the external diode detector leveling or external power meter leveling mode.

Equivalent SCPI Command

`POW:ATT:AUTO ON|OFF` *turns the attenuator hold function on or off. When the parameter is set to "on," the attenuator hold function is off and when the parameter is set to "off," the attenuator hold function is on.*

See Also

POWER LEVEL
`[SOURCE[1]:]POWER:ATTenuation:AUTO`

AVG PWR INHIBIT ON/OFF

When you select the AVG PWR INHIBIT function (press **[SPCL]**, **[31]**, **[Hz]** (ENTER)) you can set average power inhibit to on or off.

The AVG PWR INHIBIT function is used to protect average power sensitive devices during pulse modulation.

NOTE

This function is not available if Option 1E1 (step attenuator) is not installed.

When **[SPCL]**, **[31]**, **[Hz]** (ENTER) is pressed, the left-most display shows the following:

AVG PWR INHIBIT XXX

Where XXX is the current state of the average power inhibit function (either ON or OFF).

Once the average power inhibit function is enabled, it can be turned on by pressing **[MHz]** (SPCL ON) . Pressing **[kHz]** (SPCL OFF) turns the average power inhibit function off.

When the synthesizer is set to the preset state, the average power inhibit function is turned off.

Application

The average power inhibit function can be used during pulse modulation to protect devices sensitive to high average power. When the output power level or frequency of the synthesizer is changed during pulse modulation, the internal leveling algorithm causes the RF output to be momentarily switched to CW to enable the synthesizer circuitry to sample the signal level and make a correction. If the output of the synthesizer is connected to circuitry that is average power-sensitive, damage to the circuitry could result during this CW calibration. When in internal leveling mode, the CW calibration is approximately 10 to 30 ms.

When the average power inhibit function is off (the preset condition), the CW calibration will follow output power level and frequency changes. The CW calibration will also occur the first time pulse or logarithmic amplitude modulation is enabled. When average power inhibit is on, the internal step attenuator will switch in 110 dB of attenuation during the CW calibration. This will protect power-sensitive circuitry connected to the **RF OUTPUT** connector, but will cause extra wear on the step attenuator. Turning the function on will also cause a momentary drop in signal power (approximately 200 ms) and will lengthen frequency and power level switching times by 70 ms.

Pulsed Power Pre-Calibration Program

Since the average power inhibit function causes the internal step attenuator to switch in 110 dB of attenuation whenever frequency or power level is changed, there is extra wear on the step attenuator. The following program provides an alternative to turning on the average power inhibit function and, therefore, minimizes wear on the step attenuator.

When you know the various frequencies and power levels that you will be using in a test routine, the following program can be used to gather the CW calibration values for frequency/power level pairs. After activating the special pulse modulation mode, calibration values can be sent for each frequency/power level pair and the CW calibration will be eliminated.

When the calibration portion of the program is run, you should disconnect average power sensitive circuitry from the RF OUTPUT to avoid damaging it. During the calibration, using a substitute load with the exact characteristics as the circuit load will preserve the specified CW-to-pulse level accuracy. The calibration should not be performed until the instrument has had sufficient time to warm up (usually 30 minutes). The calibration data remains valid as long as the ambient temperature remains stable. CW-to-pulse level accuracy degrades nominally by 0.07 dB/°C. For best accuracy, the calibration should be repeated whenever the ambient temperature changes.

The time the calibration routine takes to obtain the CW calibration values is equivalent to the normal frequency and power level switching times. In special pulse modulation mode, frequency and power level changes (without an attenuator range change) occur faster than during normal pulsed operation.

When running the following program, once the calibration is complete *and special pulse modulation mode is entered*, the following events will happen during pulsed frequency switching:

- The frequency (“FREQ ”;Freqs(I);“MHZ”) command is sent: This causes the synthesizer to change frequency and the power level will drop to the minimum vernier level. The output power remains pulsed.
- The power level (“POW ”;Powers(I);“DBM”) command is sent: This causes the synthesizer to adjust *only* the attenuator range. The vernier remains at its minimum level.
- The (“DIAG:IBUS 23,”;Verniers(I)) command is sent: This adjusts the vernier level to its correct level. The synthesizer is now pulsing at the correct frequency and power level.

NOTE

The preceding commands must always be executed in the order presented for proper instrument operation. However, there are two cases when use of the frequency and/or power level commands can be minimized.

Case 1 - If the synthesizer will only be operating at one frequency, the frequency command only needs to be sent once.

Case 2 - If the synthesizer will only be operating at one attenuator range, the power level command only needs to be sent once.

Special Functions

AVG PWR INHIBIT ON/OFF

```
10 OPTION BASE 1
20 DIM Freqs(100),Powers(100),Verniers(100)
30 Num_points=4
40 DATA 1000,0,1330,-4,1750,-25,2000,12
50 OUTPUT 719;"*RST"
60 OUTPUT 719;"PULM:SOUR EXT"
70 OUTPUT 719;"PULM:EXT:POL NORM"
80 OUTPUT 719;"PULM:STAT ON"
90 INPUT "DISCONNECT AVERAGE POWER SENSITIVE DEVICES FROM THE RF OUTPUT,
  THEN PRESS ENTER",A.
100 !
110 FOR I=1 TO Num_points
120   READ Freqs(I),Powers(I)
130   OUTPUT 719;"FREQ ";Freqs(I);"MHZ;POW ";Powers(I);"DBM"
140   OUTPUT 719;"DIAG:IBUS? 23"
150   ENTER 719;Verniers(I)
160 NEXT I
170 !
180 OUTPUT 719;"DIAG:IBUS 73,16"
190 INPUT "CONNECT DUT TO RF OUTPUT AND PRESS ENTER.",A
200 PRINT
210 !
220 FOR I=1 TO Num_points
230   OUTPUT 719;"FREQ ";Freqs(I);"MHZ;POW ";Powers(I);"DBM"
240   OUTPUT 719;"DIAG:IBUS 23,";Verniers(I)
250   PRINT "SYNTHESIZER FREQUENCY IS CURRENTLY ";Freqs(I);" MHz, AND
  POWER LEVEL IS CURRENTLY ";Powers(I);" dBm."
260 IF I=Num_points THEN GOTO 300
270   INPUT "PRESS ENTER WHEN YOU ARE READY TO GO TO THE NEXT
  FREQUENCY/POWER LEVEL PAIR.",A
280 NEXT I
290 !
300 INPUT "PRESS ENTER TO EXIT SPECIAL PULSE MODULATION MODE.",A
310 !
320 OUTPUT 719;"*RST"
330 PRINT
340 PRINT "NOTE: CYCLE SYNTHESIZER POWER OFF AND ON TO
  TERMINATE SPECIAL PULSE MODULATION MODE."
350 PRINT
360 PRINT "END OF PROGRAM"
370 END
```

10 Sets the lowest element of all arrays to 1.
20 Dimensions arrays.
30 Sets variable "Num_points" to 4 for this example.
 "Num_points" must be equal to the number of
 frequency/power level pairs in the DATA statement.
40 The frequency/power level pairs to be used by this program.
 The first number and every other number is a frequency; the
 second number and every other number is a corresponding
 power level.
50 Presets the synthesizer.
60 Selects external pulse mode for this example. Modify this
 statement for your desired pulse mode.
70 Selects normal pulse polarity for this example. Modify this
 statement for your desired pulse mode.
80 Turns pulse modulation on.
120 Reads frequency into the "I" position of array "Freqs" and
 power level into the "I" position of array "Powers."
130 Sets synthesizer frequency and power level to the values in the
 arrays specified by "I."
140 Queries the vernier DAC setting at the current
 frequency/power level.
150 Reads vernier DAC setting into the "I" position of array
 "Verniers."
180 Activates special pulse modulation mode.
230 Sets synthesizer frequency and power level to the values in the
 arrays specified by "I."
240 Sets vernier DAC to the value in the "I" position of array
 "Verniers."
320 Presets the synthesizer.

Special Functions

AVG PWR INHIBIT ON/OFF

Equivalent SCPI Command

POW:PROT:STAT ON|OFF *turns the average power inhibit function on or off.*

See Also

POWER LEVEL

[SOURce[1]:]POWer:PROTection:STATe

CLEAR DISPLAY

Invoking the clear display function (pressing **SPCL**, **3**, **Hz** (ENTER)) enables you to turn off the synthesizer fluorescent displays and LED annunciators or turn them on if they are currently turned off.

When **SPCL**, **3**, **Hz** (ENTER) is pressed, the left-most display will display the following:

CLEAR DISPLAY XXX

Where XXX is "ON" if the clear display function is currently on and "OFF" if the clear display function is currently off.

Once the clear display function has been enabled, pressing **SPCL ON** blanks the displays and LED annunciators and **DISPLAY BLANKED** is displayed across the left-most display.

The display state is stored in the instrument state registers along with other instrument state data, so if sensitive instrument settings are stored to a register, the settings are not revealed when the register is recalled.

When the synthesizer is set to the preset state, the display is restored if it had been previously cleared.

NOTE

Cycling the POWER switch off and then on will not restore the display.

Special Functions
CLEAR DISPLAY

Equivalent SCPI Command

DISP:STAT ON|OFF *turns the display on or off.*

See Also

Display
DISPlay[:WINDow][:STATe]

DC FM COUPLING

Invoking the DC FM COUPLING function (pressing **SPCL**, **30**, **Hz** (ENTER)) enables you to set frequency modulation to either AC- or DC-coupling.

When **SPCL**, **30**, **Hz** (ENTER) is pressed, the DC FM on/off function is activated. The display will be as follows:

DC FM XXX

Where XXX is OFF if FM is currently set to AC and ON if FM is currently set to DC.

Once the function has been activated, the status of the DC FM function can be changed by pressing either the **MHz** (SPCL ON), or **kHz** (SPCL OFF) keys. Pressing **MHz** (SPCL ON) sets DC FM on and pressing **kHz** (SPCL OFF) sets DC FM off. The display will change to indicate either DC FM ON or DC FM OFF. In addition, the pertinent annunciator (AC FM or DC FM) will be lit to indicate the current status of the DC FM function when **FM/φM ON/OFF** is set to on.

When the synthesizer is set to the preset state, the DC FM On/Off function is set to off.

When DC FM is off, the synthesizer circuitry is configured so that the FM/φM IN connector will accept a modulating signal with a minimum rate of 1 kHz. When DC FM is on, the FM/φM IN connector will accept a modulating signal with a minimum rate of 0 Hz (DC). Maximum FM deviation does not change.

Advantage

When DC FM is selected, the modulation index is unlimited:

$$\text{modulation index} = \text{peak deviation}/\text{modulation rate}$$

Where modulation rate can range down to 0 Hz (DC).

Special Functions
DC FM COUPLING

Disadvantage

When DC FM is enabled, the internal phase locked loop circuit is disabled, causing the output frequency accuracy and stability to be degraded.

Equivalent SCPI Command

FM:COUP AC|DC *sets frequency modulation to either AC or DC.*

See Also

Annunciators

Connectors

FM/φM ON/OFF

[SOURce[1]:]FM:COUPling

ERASE MEMORY

Invoking the erase memory function (pressing **SPCL**, **4**, **Hz** (ENTER)) clears all application-specific information from synthesizer memory.

When **SPCL**, **4**, **Hz** (ENTER) is pressed, all user settings are set to the preset state, save/recall registers are erased, and level correction tables are cleared. The erase memory function does not clear factory calibration data stored in the EEPROM.

When the erase memory function is invoked, the display will momentarily display the following:

INITIALIZING MEMORY

Application

The erase memory function is useful when removing the synthesizer from a secure area as the setup history of the synthesizer will be erased.

Equivalent SCPI Command

MEM:RAM:INIT *clears synthesizer memory.*

Special Functions
ERASE MEMORY

See Also

PRESET

RCL CR

RECALL

SAVE

SAVE CR

MEMory:RAM:INITialize[:ALL]

FM WAVEFORM (Only Available with Option 1E2)

Invoking the FM WAVEFORM function (pressing **SPCL**, **51**, **HZ** (ENTER)) selects the FM waveform function. This function allows selection of the internal FM waveform by using the **↑** or **↓** key to step through the waveform types.

When **SPCL**, **51**, **HZ** (ENTER) are pressed, the left-most display shows the following:

FM WAVEFORM = XXX

Where XXX is the currently selected waveform type (SINUSOID, SQUARE, TRIANGLE, RAMP, UNIFORM, GAUSSIAN). Uniform and gaussian refer to the amplitude distribution of the noise generator.

Once the FM waveform function is enabled, you can use the **↑** or **↓** key to choose one of the six waveform types.

When the synthesizer is set to the preset state, the waveform type is set to sinusoid.

Applications

When internal FM is chosen, the rate and depth are set by the front panel **INT RATE** and **INT DEV** keys in the FM/φM key group. The choice of waveforms are sinusoid, square, triangle, ramp, uniform noise, and gaussian noise.

- SINUSOID:** The specifications chapter covers the frequency range and deviation limits for FM with the internal function generator waveform set to sinusoid. The internal generator bandwidth is 1 MHz.
- SQUARE:** Useful for demonstrating two-level FSK with rates from 1 kHz to 100 kHz. For rates less than 1 kHz, use DC FM mode.

Special Functions

FM WAVEFORM (Only Available with Option 1E2)

- TRIANGLE:** Provides linear frequency variation around the center frequency within plus and minus the frequency deviation.
- RAMP:** This is a negative ramp. That is, the frequency starts at a maximum frequency and ramps linearly to the minimum frequency. This is useful for negative-going frequency chirps.
- UNIFORM NOISE:** This is defined as having an equal probability of output frequency being somewhere within plus and minus the frequency deviation around the center frequency at any given point in time. The noise bandwidth of the internal generator is approximately 1 MHz. However, the probability distribution will be altered somewhat by the bandwidth of the FM circuitry. FM rate has no affect when uniform noise waveform is selected.
- The message annunciator may be lit at relatively low FM deviations because low frequency components of the noise are present. These low frequency components cause the instantaneous modulation index to exceed the capabilities of the instrument. DC FM mode may be needed if higher FM deviations are needed.
- GAUSSIAN NOISE:** It is similar to the uniform noise in description except the noise and hence the frequency assumes a gaussian or normal distribution over the FM deviation selected.

Equivalent SCPI Command

[SOURce[1]:]FM:INT:FUNC *selects the waveform type of*
[:SINusoid|:SQUAre|:TRIAnge|:RAMP|:NOISe|:GAUSSian] *the internal FM generator.*

See Also

SOURce3:FUNC

INT MOD OVERRANGE (Only Available with Option 1E2)

Invoking the INT MOD OVERRANGE function (pressing **SPCL**, **29**, **HZ** (ENTER)) selects the internal modulation overrange function. This function toggles between "Soft" modulation rate, depth, and deviation limits and "Hard" hardware limits.

When **SPCL**, **29**, **HZ** (ENTER) are pressed, the left-most display shows the following:

INT MOD OVERRANGE XXX

Where XXX is the current state of the overrange function.

Once the internal modulation overrange function is enabled, pressing **MHz** (SPCL ON) turns on the overrange function. This allows internal AM, FM, and ϕ M rates, and deviations to be extended beyond their specified ranges. The SPCL annunciator will be lit indicating the special function is active. Pressing **kHz** (SPCL OFF) while internal modulation overrange is active turns off this function and the internal AM, FM, and ϕ M rates, and deviations are "Soft" limited again.

When the synthesizer is set to the preset state, the internal modulation overrange function is disabled (off).

Advantages

Allows the user to select internal modulation rates beyond the normal specified values and in some cases up to the hardware limits of the instrument. For example:

With INT MOD OVERRANGE OFF the internal AM rate is 0.5 Hz to 100 kHz, but with INT MOD OVERRANGE ON the internal AM rate is 0.5 Hz to 1 MHz.

With INT MOD OVERRANGE OFF the internal FM rate is 1 kHz to 1 MHz, but with INT MOD OVERRANGE ON the internal FM rate is 0.5 Hz to 1 MHz.

With INT MOD OVERRANGE OFF the OM rate is 0.5 Hz to 30 kHz, but with INT MOD OVERRANGE ON the OM rate is 0.5 Hz to 1 MHz (Range 2, 4-200 radian).

Disadvantages

Operation in unspecified ranges of the instrument can produce unexpected results.

Special Functions

INT MOD OVERRANGE (Only Available with Option 1E2)

Equivalent SCPI Command

[SOURce[1]:]MODulation:OVDR *turns internal modulation overdrive range on and off.*

See Also

[SOURce[1]:]AM:INT:FREQ

[SOURce[1]:]FM:INT:FREQ

[SOURce[1]:]PM:INT:FREQ

PM RANGE (Only Available with Options 1E2 and 800)

Invoking the PM RANGE function (pressing **SPCL**, **28**, **HZ** (ENTER)) selects the internal phase modulation range function. When this function is active the user may select between auto range, low range, and high range.

When **SPCL**, **28**, **HZ** (ENTER) is pressed, the left-most display shows the following:

PHASE RANGE XXX

Where XXX is the current state of the phase modulation range function; AUTO, LOW, or HIGH.

Once the phase modulation range function is enabled, pressing the **↑** or **↓** key changes the range selection. There is no indication on the front panel which range selection is in use.

When the synthesizer is set to the preset state, the phase modulation range function is AUTO.

Additional Information

Phase modulation in this instrument has two ranges. Although in the divided frequencies below 1 GHz there are many sensitivities, at any given frequency there are always two ranges to choose from: low and high. Above 1 GHz these ranges are 1 rad/V (low range) and 50 rad/V (high range). Low range offers better SSB phase noise, better flatness, and higher modulation rates. High range has higher SSB phase noise and lower modulation rates but allows higher phase deviations. The following chart shows the internal phase modulation rate versus phase deviation.

PM RANGE (Only Available with Options 1E2 and 800)

Figure 7-1. Phase Deviation vs Phase Modulation Rate from 2–20 GHz

When using internal phase modulation the instrument must sometimes choose between rate and deviation. For example, given a current phase modulation rate of 1 MHz and deviation of 3 radians, the instrument is operating in low range. If the user now enters a deviation of 5 radians, the instrument has a conflict because it is not specified to deliver 5 radians at a 1 MHz rate. PM RANGE AUTO will then reduce the phase modulation rate to the maximum 30 kHz and allow the 5 radian deviation entry. An error message will be generated alerting the user that a conflict has occurred. PM RANGE LOW will keep the range always in the low range, limiting the rate and deviation to the specifications of that range. PM RANGE-HIGH will keep the range always in the high range, limiting the rate and deviation to the specifications of that range. Refer to the INT MOD OVERRANGE special function for possible use with the PM RANGE special function.

Advantages

Allows the user to remain in one phase modulation range when using internal modulation source.

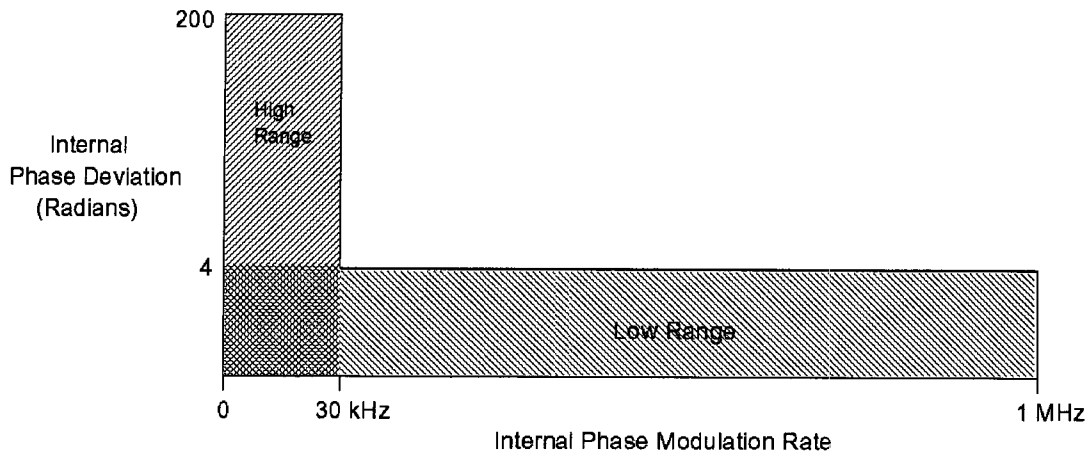
Disadvantages

Limits the user to the rate and deviation of that range.

Equivalent SCPI Command

`[SOURce[1]:]PM:RANGe` *sets the phase modulation range based on the value of phase deviation.*

See Also

INT MOD OVERRANGE
`[SOURce[1]:]MODulation:OVDR`

PM WAVEFORM (Only Available with Options 1E2 and 800)

Invoking the PM WAVEFORM function (pressing **SPCL**, **52**, **HZ** (ENTER)) selects the PM waveform function. This function allows selection of the internal PM waveform by using the **↑** or **↓** key to step through the waveform types.

When **SPCL**, **52**, **HZ** (ENTER) are pressed, the left-most display shows the following:

PM WAVEFORM = XXX

Where XXX is the currently selected waveform type (SINUSOID, SQUARE, TRIANGLE, RAMP, UNIFORM, GAUSSIAN). Uniform and gaussian refer to the amplitude distribution of the noise generator.

Once the PM waveform function is enabled, you can use the **↑** or **↓** key to choose one of the six waveform types.

When the synthesizer is set to the preset state, the waveform type is set to sinusoid.

Applications

When internal PM is chosen, the rate and deviation are set by the front panel **INT RATE** and **INT DEV** keys in the FM/ ϕ M key group. The choice of waveforms are sinusoid, square, triangle, ramp, uniform noise, and gaussian noise.

- SINUSOID:** The specifications chapter covers the frequency range and deviation limits for phase modulation with the internal function generator waveform set to sinusoid. The internal generator bandwidth is 1 MHz.
- SQUARE:** Useful for demonstrating alternating ones and zeros BPSK with rates from 0.5 Hz to 100 kHz. Deviation would be 1.57 radians.
- TRIANGLE:** Provides linear phase variation around the center frequency within plus and minus the phase deviation.
- RAMP:** This is a negative ramp. That is, the phase starts at a maximum phase and ramps linearly to the minimum phase.
- UNIFORM NOISE:** This is defined as having an equal probability of output phase being somewhere within plus and minus the phase deviation around the center phase at any given point in time. The noise bandwidth of the internal generator is approximately 1 MHz. However, the probability distribution will be altered somewhat by the bandwidth of the phase modulation circuitry. The ϕ M rate has no affect when uniform noise waveform is selected.
- The message annunciator may be lit with a PM overmodulation error at relatively low phase deviations because high frequency components of the noise are present. These high frequency components cause the instantaneous frequency deviation to exceed the capabilities of the instruments, generating the error.

PM WAVEFORM (Only Available with Options 1E2 and 800)

GAUSSIAN NOISE: It is similar to the uniform noise in description except the noise, and hence the output phase, assumes a gaussian or normal distribution over the ϕM deviation selected. This is useful in measuring a receiver's immunity to phase noise.

Equivalent SCPI Command

[SOURce[1]:]PM:INT:FUNC *selects the waveform type of*
[:SINusoid[:SQUare[:TRIAngle[:RAMP[:NOISe[:GAUSSian] *the internal PM generator.*

See Also

SOURce4:FUNC

PWR MTR ADDRS

Invoking the PWR MTR ADDRS (power meter address) function (pressing **SPCL**, **20**, **Hz** (ENTER)) changes the HP-IB address that the synthesizer uses when communicating with an external power meter during the level correct routine.

When **SPCL**, **20**, **Hz** is pressed, you will be prompted to enter the address that the synthesizer will use when communicating with the external power meter or when receiving data from the external power meter during the level correct routine. The valid power meter address range is 00 to 30.

The external power meter HP-IB address set at the factory is 13. Setting the synthesizer to the preset state will not modify the address.

NOTE

This function *does not* set the address at the power meter. You should refer to the power meter manual for information on how to change the power meter address.

Equivalent SCPI Command

`SYST:COMM:PMET:ADDR address` *changes the HP-IB address that the synthesizer uses when communicating with an external power meter as defined by the "address" parameter.*

See Also

LVL CR
LVL CR ON/OFF
PWR MTR SELECT
RCL CR
SAVE CR
SYSTem:COMMunicate:PMETer:ADDRes
"To Use the Level Correct Routine" in Chapter 3

PWR MTR SELECT

Invoking the power meter select function (pressing **SPCL**, **21**, **Hz** (ENTER)) allows you to set the programming language that the synthesizer will use when communicating with the power meter during the level correct routine.

When **SPCL**, **21**, **Hz** (ENTER) is pressed, the left-most display shows the following:

```
POWER METER IS  XXX
```

Where XXX is the currently selected power meter language (HP70100A, HP437B, HP438A, or SCPI).

Once the power meter select function is enabled, you can use the **↑** or **↓** keys to choose one of the four power meter language options. When "SCPI" is chosen, the synthesizer will communicate with any SCPI-compatible power meter.

When the synthesizer is set to the preset state, the power meter language chosen with this command is not changed.

Equivalent SCPI Command

There is no equivalent SCPI command for the power meter select function.

Special Functions
PWR MTR SELECT

See Also

LVL CR
LVL CR ON/OFF
PWR MTR ADDRS
RCL CR
SAVE CR
"To Use the Level Correct Routine" in Chapter 3

REMOTE LANGUAGE

Invoking the remote language function (pressing **SPCL**, **25**, **HZ** (ENTER)) allows you to manually choose either SCPI (Standard Commands for Programmable Instruments) or HP 8673-compatible language.

When **SPCL**, **25**, **HZ** (ENTER) is pressed, the left-most display shows the following:

REMOTE LANG IS XXX

Where XXX is the currently selected language (SCPI or HP 8673).

Once the remote language function is enabled, you can use the **↑** or **↓** keys to toggle between SCPI or HP 8673 language options.

When the synthesizer is set to the preset state, the language chosen with this command is not changed. The language will default to SCPI when the ERASE MEMORY function is executed.

Equivalent SCPI Command

`SYSTem:LANGuage "SCPI"|"COMP=8673"` *selects either SCPI or HP 8673-compatible language.*

See Also

ERASE MEMORY

SELECT RISETIME

Invoking the select risetime function (pressing **SPCL**, **40**, **Hz** (ENTER)) allows you to manually choose either a slow, medium, or fast pulse risetime or enable the instrument to automatically select optimum pulse risetime for the selected carrier frequency.

Notes

1. This special function can be selected at any carrier frequency, however, at carrier frequencies above 1 GHz, pulse risetime is fixed at 10 ns.
2. This special function is only available in the HP 83732B.

When **SPCL**, **40**, **Hz** (ENTER) is pressed, the left-most display shows the following:

RISE TIME: XXX SLOPE

Where XXX is the currently selected pulse risetime (SLOW, MEDIUM, or FAST; AUTO indicates the instrument automatically selects optimum pulse risetime).

NOTE

Risetime is not continuously variable, but may be set to one of three different values.

Once the select risetime function is enabled, you can use the **↑** or **↓** keys to change the pulse risetime between the three values or select automatic

pulse risetime. Note that you cannot use the numeric keypad to enter a risetime value; the arrow keys must be used to change the risetime.

When the synthesizer is set to the preset state, pulse risetime is set to AUTO.

NOTE

When you manually set the risetime with this function, the falltime (pulse trailing edge) will be automatically set to the same value. You cannot change the falltime independently of the risetime.

Applications

A series of low-pass filters are used to reduce output harmonics when the synthesizer output frequency is less than 1 GHz. The filter passbands can be narrow enough to induce pulse ringing if the pulse risetime is too fast.

The synthesizer automatically selects a slower pulse risetime (when AUTO is selected) as the carrier frequency is decreased to minimize ringing and video feedthrough caused by the low-pass filtering. The appropriate pulse risetime is automatically selected as follows:

Output Frequency	Pulse Risetime
10 MHz to 64 MHz	300 ns
64 MHz to 500 MHz	30 ns
Greater than 500 MHz	10 ns

SELECT RISETIME

In applications where a faster pulse risetime than that shown in the table is needed at output frequencies less than 1 GHz, you can manually choose a pulse risetime. The disadvantage of choosing a faster pulse risetime is degraded pulse performance.

Equivalent SCPI Command

<code>PULS:TRAN:STAT <u>ON OFF</u></code>	<i>selects either manual (ON) or automatic (OFF) risetime selection.</i>
<code>PULS:TRAN:LEAD <u>SLOW MED FAST</u></code>	<i>selects either a slow, medium, or fast pulse risetime.</i>

See Also

[SOURce[1]:]PULSe:TRANsition[:LEADing]
[SOURce[1]:]PULSe:TRANsition:STATe

SELF TEST

Invoking the self-test function (pressing **SPCL**, **5**, **Hz** (ENTER)) enables you to cause the synthesizer to run a functional verification (self-test) on itself.

When **SPCL**, **5**, **Hz** is pressed, the text SELF TEST?, PRESS ENTER will be shown on the synthesizer display. Pressing **Hz** (ENTER) will then cause all self-test segments to be run. Pressing any key other than **Hz** will cause the self-test not to run.

If any of the self-test segments fail, error messages will be placed in the error queue to explain the failures. The error messages can then be read either via the front panel or using programming commands. If a particular self-test segment failure makes running subsequent self-test segments impossible, the self-tests will abort.

Notes

1. It is recommended that you clear the error queue before running the self-test.
2. For more information on reading the contents of the error queue, refer to "To Read the Contents of the Error Queue" in Chapter 2 of this manual.
3. Refer to the *HP 83711A/12A, HP 83711B/12B, HP 83731A/32A, and HP 83731B/32B Synthesized Signal Generators Calibration Guide* for a listing of the test segments that are run during the self-test.

Equivalent SCPI Command

*TST? *causes the synthesizer to run a functional verification (self-test) on itself.*

See Also

MSG

SYSTem:ERRor?

“To Read the Contents of the Error Queue” in Chapter 2

*TST?

Service-Related Special Functions

The synthesizer firmware contains several service-related routines that can be used when diagnosing faults in its circuitry. Use of these special functions is detailed in the *HP 83711A/12A, HP 83711B/12B, HP 83731A/32A, and HP 83731B/32B Synthesized Signal Generators Calibration Guide*.

The service-related special functions are listed in the following table. They can only be accessed by pressing (SPCL), *f-number*, (Hz) (ENTER) where *f-number* is a number from the first column of the table. Details on how to use each special function can be found in the service guide.

Table 7-1. Service-Related Special Functions

Special Function Number	Special Function Name	Description
60	DIRECT CONTROL	Allows direct manipulation of certain data bits within the synthesizer circuitry.
61	METER NODE	Allows entry of a measurement node where the internal volt/ammeter will take a measurement.
62	LO FREQ	Displays the synthesizer internal LO phase locked loop frequency.
63	OFFSET FREQ	Displays the synthesizer internal Offset phase locked loop frequency.
70	POWER HOLD ON/OFF	Holds the power loop at its current setting.
71	CAL YIG OSC	Recalibrates the YIG oscillator and stores the new tuning curve in EEPROM.

See Also

HP 83711A/12A, HP 83711B/12B, HP 83731A/32A, and HP 83731B/32B Synthesized Signal Generators Calibration Guide.

SHOW INFO

Invoking the SHOW INFO (show information) function (pressing **SPCL**, **1**, **Hz**) (ENTER) displays the software version number and instrument serial number on the synthesizer display.

When **SPCL**, **1**, **Hz** is pressed, the following text will be shown on the synthesizer display:

```
SW: X.X SERIAL: YYYYYYYYYY
```

Where X.X is the version number of the software currently installed in the synthesizer and YYYYYYYYYY is the synthesizer serial number.

Equivalent SCPI Command

There is no equivalent SCPI command for the SHOW INFO function, however, the “*IDN?” query returns the synthesizer model number, serial number, and firmware revision number.

See Also

*IDN?





Error Messages



Error Messages

If an error condition occurs in the synthesizer, it will always be reported to both the front panel and HP-IB error queues. These two queues are viewed and managed separately. The **MSG** key is used to view the contents of the front panel error queue. The HP-IB query "SYSTem:ERRor?" is used to view the contents of the HP-IB error queue.

If there are any error messages in the front panel error queue, the front panel **MSG** annunciator will be lit. Pressing the **MSG** key repeatedly until the **MSG** annunciator turns off will empty the front panel error queue. The **MSG** key has no effect on the HP-IB error queue. Emptying the HP-IB error queue has no effect on the front panel queue, therefore, it will not affect the **MSG** annunciator.

There are some special error types that are called permanent errors. Permanent errors remain in the error queues until the error condition is cleared. Pressing the **MSG** key will empty the front panel error queue, but the permanent errors will be re-reported if the error conditions still exist. In the HP-IB error queue, the permanent errors are re-reported after the message, 0, "No error" is read using the "SYSTem:ERRor?" query or after the "*CLS" command is executed.

Error Messages List

All of the error messages associated with synthesizer operation are listed in this chapter. The following is an example of the error format found in the list of error messages:

2003 -222,Data out of range;CW FREQ(2003)

Select a CW frequency that is within range of the installed options. If other modules or options are installed that extend the CW frequency range of the synthesizer, this frequency range will be extended also.

The following explains each element of an error message listing:

- **Manual Error Number** – The number 2003 to the left and in the parenthesis is called the Manual Error Number. The error message list is organized in ascending order of the manual error number. The manual error number will always be found in the parenthesis contained in the message.
- **Error Message** – The bold text -222, “Data out of range;CW FREQ(2003)” is the error message. When the **MSG** key is pressed, the error message is displayed in the left-most display. The entire message is returned by the HP-IB query “SYSTem:ERRor?”. The error message contains the following parts:
 - **SCPI Error Number** – The standard SCPI error number (-222 in the example) usually differs from the manual error number because the manual error number is unique for every possible message. Standard SCPI error numbers are always negative (except for 0, “No error”). If there is no standard SCPI error number for a message, the manual error number replaces it in the error message.
 - **SCPI Error Message** – The SCPI error message is Data out of range in the example.
 - **Detailed Description** – All information after the semicolon is a detailed description of what exactly caused the error. In the example, CW FREQ tells you that CW frequency was out of range. If no detailed description exists, it will be omitted from the message.

Error Messages

Error Messages List

- **Action Required** – The text that appears below each error message listing contains corrective actions that should be followed in order to correct the error condition.

Notes

1. For more information related to error messages, refer to "To Read the Contents of the Error Queue" in Chapter 2 or the "MSG" reference entry in Chapter 6 of this guide (HP part number 83731-90128) and the "SYSem:ERRor?" reference entry in Chapter 1 of this manual.
2. Error messages related to hardware failures are listed in the *HP 83731A/32A and HP 83731B/32B Synthesized Signal Generators Service Guide* (HP part number 83731-90131).

Messages

The following pages list all error messages:

–440 –440, Query UNTERMINATED after indefinite response;(–440)

Correct the HP-IB controller program so that the query that returns indefinite length block data is the last item on the program line.

–430 –430, Query DEADLOCKED;(–430)

Correct the HP-IB controller program so that no more than eight queries are executed within the same line of the program.

–420 –420, Query UNTERMINATED;(–420)

Correct the HP-IB controller program so that the controller terminates commands with the newline character (NL) before the controller attempts to read query response data.

–410 –410, Query INTERRUPTED;(–410)

Check the HP-IB controller program to see if the controller is programmed to read the entire query response data before issuing a subsequent command.

–400 –400, Query error;(–400)

Some problem occurred while parsing an HP-IB query. Insure that your programming is correct and try the query again. Look at –440 through –400 for types of problems to look for.

–350 –350, Queue overflow

The error queue overflowed at this point and this message replaced the 16th error message. No action is required. Note: To clear the HP-IB error queue, use *CLS.

–330 –330, Self-test failed;(–330)

See the explanation for error number 4000.

–315 –315, Configuration memory lost;(–315)

See error 1803.

Error Messages

Messages

- 314 –314, Save/recall memory lost;(–314)
See error 1803.
- 311 –311, Memory error;(–311)
See error 1803.
- 310 –310, System error;(–310)
Some problem occurred while parsing an HP-IB command or query.
Insure that your programming is correct and try the command again.
- 300 –300, Device specific error;(–300)
A remote command or query could not be executed because an error
occurred in the synthesizer.
- 278 –278, Macro header not found;(–278)
A *GMC? or *RMC macro label could not be found in the list of defined
macro labels. Use *LMC? to get a list of all the currently defined macro
labels.
- 277 –277, Macro redefinition not allowed;(–277)
Indicates that a macro label in the *DMC command could no be defined
because the macro label was already defined.
- 276 –276, Macro recursion error;(–276)
The nesting/recursion of macros is deeper than 4 levels. Don't use
more than 4 levels when defining macros of macros.
- 275 –275, Macro definition too long;(–275)
The macro definition must be 255 characters or less.
- 274 –274, Macro parameter error;(–274)
A macro parameter placeholder was improperly used.
- 273 –273, Illegal macro label;(–273)
Indicates that a macro label defined in the *DMC command has a legal
string syntax; but, it is too long. It is the same as a common command
header, or contain invalid header syntax.

- 272 –272, Macro execution error;(–272)
Indicates that a syntactically legal macro program data sequence could not be executed due to some error in the macro definition.
- 271 –271, Macro syntax error;(–271)
Indicates that a syntax error exists in the macro definition.
- 270 –270, Macro error;(–270)
An error occurred while attempting to define, query or use a macro. Check that the macros are correct using *LMC? and *GMC?.
- 261 –261, Math error in expression;(–261)
An expression could not be evaluated due to a math error; for example, a divide-by-zero was attempted.
- 260 –260, Expression error;(–260)
An expression could not be evaluated because it contains an error.
- 241 –241, Hardware missing;(–241)
The requested hardware does not exist in the synthesizer. Use *OPT? to check which options are installed.
- 240 –240, Hardware error;(–240)
The remote command or query could not be executed because of a hardware error.
- 226 –226, Tables not same length;(–226)
See error 731.
- 225 –225, Out of memory;(–225)
The synthesizer has run out of memory. The memory requested has not been allocated.
- 224 –224, Illegal parameter value;(–224)
Correct the HP-IB controller program so that the data included with the HP-IB command is an acceptable parameter for the command.

Error Messages

Messages

- 223 -223, Too much data;(-223)
Correct the HP-IB controller program so that there is less data on a single command line. The synthesizer does not have enough memory to buffer it all.
- 222 -222, Data out of range;(-222)
The parameter data was out of range. Unlike other -222 errors, details are not known about the command or query which caused this error.
- 221 -221, Settings conflict;(-221)
The current synthesizer state does not allow the remote command or query to be executed.
- 220 -220, Parameter error;(-220)
The parameter included with the remote command or query is incorrect.
- 213 -213, Init ignored;(-213)
Indicates that an initiate was ignored because a trigger was already in progress.
- 212 -212, Arm ignored;(-212)
An arming signal was received and recognized but was ignored.
- 211 -211, Trigger ignored;(-211)
A GET, *TRG or triggering signal was received and recognized but was ignored. Currently, there is no bus trigger capability in the synthesizer.
- 210 -210, Trigger error;(-210)
A trigger error occurred in the synthesizer.
- 201 -201, Invalid while in local;(-201)
The remote command or query cannot be executed when the synthesizer is in local mode.
- 200 -200, Execution error;(-200)
Some problem occurred while executing an HP-IB command or query. Insure that your programming is correct and try the command again.

- 184 –184, Macro parameter error;(–184)
Indicates that a command inside the macro definition had the wrong number or type of parameters.
- 183 –183, Invalid inside macro definition;(–183)
Indicates that the program message sequence sent with *DMC or *DDT command, is syntactically invalid.
- 181 –181, Invalid outside macro definition;(–181)
Indicates that a macro parameter placeholder was encountered outside of the macro definition.
- 180 –180, Macro error;(–180)
An error occurred while attempting to define, query or use a macro. Check that the macros are correct using *LMC? and *GMC?.
- 178 –178, Expression data not allowed;(–178)
Correct the HP-IB controller program so that the data included with the HP-IB command does not contain parentheses.
- 171 –171, Invalid expression;(–171)
The expression contained a syntax error like unmatched parenthesis or an illegal character.
- 170 –170, Expression error;(–170)
The expression contains a syntax error.
- 168 –168, Block data not allowed;(–168)
Correct the HP-IB controller program so that the data included with the HP-IB command does not contain block data (no # character).
- 161 –161, Invalid block data;(–161)
Correct the HP-IB controller program so that it contains a correct block data type. A block data type should begin with “#” followed by a number.
- 160 –160, Block data error;(–160)
The block data contains a syntax error.

Error Messages

Messages

-158 -158, String data not allowed;(-158)

Correct the HP-IB controller program so that the data included with the HP-IB command does not contain string data (no single or double quote characters).

-151 -151, Invalid string data;(-151)

Correct the HP-IB controller program so that the string data included with the HP-IB command is terminated with a single or double quote. The terminating quote must be the same as the leading quote of the string. A string can also be valid if invalid characters are contained in it.

-150 -150, String data error;(-150)

The string data was too long to be buffered in the synthesizer string data area.

-148 -148, Character data not allowed;(-148)

Correct the HP-IB controller program so that the data included with the HP-IB command is not character data.

-144 -144, Character data too long;(-144)

The character data element contains more than 12 characters.

-141 -141, Invalid character data;(-141)

Either the character data element contains an invalid character or the particular element is not valid for the command or query.

-140 -140, Character data error;(-140)

The character data contains a syntax error.

-138 -138, Suffix not allowed;(-138)

Correct the HP-IB controller program so that the decimal data included with the HP-IB command does not use a suffix. Use exponential notation instead.

-134 -134, Suffix too long;(-134)

The suffix contained more than 12 characters.

- 131 –131, Invalid suffix;(–131)
Correct the HP-IB controller program so that the decimal data included with the HP-IB command contains a valid suffix for that command or query.
- 130 –130, Suffix error;(–130)
The suffix contains a syntax error.
- 128 –128, Numeric data not allowed;(–128)
Correct the HP-IB controller program so that the data included with the HP-IB command is not numeric data.
- 124 –124, Too many digits;(–124)
The mantissa of a decimal numeric data element contained more than 255 digits excluding leading zeros.
- 123 –123, Exponent too large;(–123)
The magnitude of the exponent was larger than 32000.
- 121 –121, Invalid character in number;(–121)
Correct the HP-IB controller program so that the decimal data or non-decimal numeric included with the HP-IB command contains the correct numeric characters.
- 120 –120, Numeric data error;(–120)
An invalid numeric or non-decimal numeric was parsed but it was syntactically invalid.
- 114 –114, Header suffix out of range;(–114)
Indicates that a header suffix was too large.
- 113 –113, Undefined header;(–113)
The header is syntactically correct, but it is undefined for the synthesizer.
- 112 –112, Program mnemonic too long;(–112)
The header contains more than 12 characters.
- 111 –111, Header separator error;(–111)
An illegal header separator was encountered while parsing the header.

Error Messages

Messages

- 110 -110, Command header error;(-110)
An error was detected in the header.
- 109 -109, Missing parameter;(-109)
This error indicates that an HP-IB command or query has too few parameters. Correct the HP-IB controller program so that the HP-IB command or query contains the correct number of parameters.
- 108 -108, Parameter not allowed;(-108)
This error indicates that an HP-IB command or query has too many parameters. Correct the HP-IB controller program so that the HP-IB command or query contains the correct number of parameters.
- 105 -105, GET not allowed;(-105)
Correct the HP-IB controller program so that the group execute trigger does not occur within a line of HP-IB program code.
- 104 -104, Data type error;(-104)
The parser recognized a data element different than one allowed. For example, numeric or string data was expected but block data was encountered.
- 103 -103, Invalid separator;(-103)
A separator was expected but an illegal character was encountered. For example, the space is missing from the following: `FREQ.01GHz`.
- 102 -102, Syntax error;(-102)
An unrecognized command or data type was encountered.
- 101 -101, Invalid character;(-101)
A syntactic element contains a character which is invalid for that type. For example, a header containing an ampersand would give this error.
- 100 -100, Command error;(-100)
Some problem occurred while parsing an HP-IB command or query. Insure that your programming is correct and try the command again.
- 0 0, No error
The error queue contains no errors.

- 110 110, EEPROM unprotected;(110)
The PG switch is set to 0 which leaves the EEPROM unprotected. Open up the synthesizer and switch the PG switch to 1. This error message is only a warning.
- 511 511, YTO cal data init error;(511)
The YIG oscillator factory calibration data checksum was incorrect. A new YIG calibration should be performed or else the instrument may be unable to attain lock at some frequencies.
- 600 600, ALC loop went unlevel;(600)
Power is set to a level that is higher than the instrument can supply. This is usually due to attenuator hold and the power is set to a value that requires the vernier to be operating out of its specified range. Change the power level or turn off attenuator hold. This is a "permanent" error.
- 601 601, Hardware driver Power limit;(601)
Due to instrument specials such as attenuator hold, the circuits cannot supply the specified power. Change the power level or turn off attenuator hold. This is a "permanent" error.
- 602 602, Vernier has been set to the limit;(602)
Due to instrument options such as attenuator hold, the circuits cannot supply the specified power. The vernier has been limited to a valid value. Change the power level or turn off attenuator hold. This is a "permanent" error.
- 603 603, RF on/off command not valid;(603)
An invalid request to turn off RF power was ignored by the instrument.
- 604 604, Atten driver error while setting level;(604)
The attenuators could not be set to the range requested. Change output power to a valid setting.
- 605 605, Vernier driver error while setting level;(605)
The vernier value requested was not possible. Change output power to a valid setting.

Error Messages

Messages

- 606 606, Level is not in guaranteed range.:(606)
The power level requested is beyond specifications and may be invalid. This could be due to a very low vernier setting required when attenuator hold is active. This is a “permanent” error.
- 608 608, Attenuator not set before Ext Meter mode;(608)
The attenuator range must match that of the meter range desired for external meter ALC mode. Turn off attenuator hold mode and make sure the power meter is in range hold before entering external power meter mode.
- 610 610, Track and hold failed, level is invalid;(610)
Power level was too high to do a power level setting in pulse or scan AM mode. Try setting power to a lower value.
- 611 611, Track and hold failed, level is invalid;(611)
Power level was too high to do a power level setting in pulse or scan AM mode. Try setting power to a lower value.
- 650 650, PG switch not set to 0;(650)
ALC calibration data was not saved in EEPROM because the PG switch was protecting the EEPROM from “writes”. Open up the synthesizer and switch the PG switch to 0.
- 651 651, Invalid vernier cal data for 1-20 GHz;(651)
Valid vernier calibration data is not available for the 1-20 GHz band. If you need to use this frequency range, see the explanation for error number 4000.
- 652 652, ALC term verification after EEPROM write;(652)
ALC vernier calibration data was not written into EEPROM correctly. Try writing the data into the synthesizer again.
- 653 653, Invalid vernier cal data for 0.01–1 GHz;(653)
Valid vernier calibration data is not available for the 0.01–1 GHz band. If you need to use this frequency range, see the explanation for error number 4000.

- 655 655, PG switch not set to 0;(655)
Factory frequency correction data was not saved in EEPROM because the PG switch was protecting the EEPROM from "writes". Open up the synthesizer and switch the PG switch to 0.
- 656 656, Factory flatness cal data verification;(656)
Factory frequency level calibration data was not written into EEPROM correctly. Try writing the data into the synthesizer again.
- 657 657, Factory flatness cal data is invalid;(657)
A valid factory frequency level calibration is not available for one or more of the frequency bands and/or attenuator settings. See the explanation for error number 4000.
- 670 670, Meter power input is out of range;(670)
The ALC input is not a valid level. The power meter range may be wrong. This is a "permanent" error.
- 700 700, Hardware driver Frequency limit;(700)
The frequency entered cannot be generated by the synthesizer with the set of options available.
- 701 701, Lo synthesizer set error;(701)
The LO synthesizer cannot be set to the level requested. Enter a new frequency.
- 702 702, Offset synthesizer set error;(702)
The offset synthesizer cannot be set to the level requested. Enter a new frequency.
- 704 704, YTO driver set error;(704)
The YIG oscillator cannot be set to the level requested. Enter a new frequency.
- 706 706, Low pass filter set error;(706)
The low pass filter cannot be set to the requested setting. Enter a new frequency.

Error Messages

Messages

- 710 710, LO synthesizer went out of lock;(710)
The LO synthesizer went out of lock. This may be due to hookup or disconnection of an external time base. Enter a different RF frequency and then set the frequency back to the desired value to re-lock. This is a "permanent" error.
- 711 711, Offset synthesizer went out of lock;(711)
The offset synthesizer board was unable to attain lock. Enter a different RF frequency and then set the frequency back to the desired value to re-lock. This is a "permanent" error.
- 712 712, Frequency loop went out of lock;(712)
Enter a different RF frequency and then set the frequency back to the desired value to re-lock. This is a "permanent" error.
- 713 713, Possible FM overmodulation;(713)
Reduce the level of the modulating signal into the FM IN connector.
- 714 714,Possible PM overmodulation (714)
Reduce the level of the modulating signal into the FM/ ϕ IN connector.
- 730 730, Invalid data in level correct table;(730)
The active level correction table has no data in it. Select a level correction table with valid data, perform an automatic level correction to get valid data into the active table, or use HP-IB to load the active table. This is a "permanent" error.
- 731 -226, Tables not same length;Level correct(731)
The active level correction table has a mismatch between the number of frequencies stored and the number of losses stored. Select a level correction table with valid data, perform an automatic level correction to get valid data into the active table, or use HP-IB to load tables with the same length. This is a "permanent" error.
- 732 732, Same frequencies with different losses;(732)
The active level correction table has duplicate frequencies with different losses. Select a level correction table with valid data, perform an automatic level correction to get valid data into the active table, or use HP-IB to load tables with non-duplicate frequencies. This is a "permanent" error.

- 733 733, Frequency table not in ascending order;(733)
The MEM:TABL:FREQ command did not contain frequencies in ascending order. The whole MEM:TABL:FREQ command was rejected, leaving the old selected table unaltered.
- 734 734, Frequency table not in ascending order;(734)
The active level correction table does not contain frequencies in ascending order. Select a level correction table with valid data, perform an automatic level correction to get valid data into the active table, or use HP-IB to load a table with ascending ordered frequencies. This is a “permanent” error.
- 735 735, Level correct points less than 2;(735)
The number of points in a level correction table must be from 2 to 401. Either too few points were entered or duplicate frequencies caused the number of “real” points to shrink below 2.
- 736 736, Factory level corr 1-20 GHz, 1-9 table;(736)
Factory frequency level correction data for 1-20 GHz band, non-thru paths are not valid. If you need to use this frequency range and you are using a step attenuator, see the explanation for error number 4000.
- 737 737, Factory level corr 0.01—1 GHz, 1-9 table;(737)
Factory frequency level correction data for 0.01—1 GHz band, non-thru paths are not valid. If you need to use this frequency range and you are using a step attenuator, see the explanation for error number 4000.
- 738 738, Factory level corr 0.01—1 GHz, 0dB table;(738)
Factory frequency level correction data for 0.01—1 GHz band, thru path is not valid. If you need to use this frequency range and you work with output levels that don't use the step attenuator, see the explanation for error number 4000.
- 739 739, Invalid data in table, not recalled;(739)
This error indicates that a level correction table recall failed. Try selecting the same level correction table again. If this error message persists you will have to recreated the saved table.

Error Messages

Messages

- 740 740, Another controller is on the HP-IB bus;(740)
An automatic level correction was attempted but failed because there is a controller on the HP-IB bus. Remove all controllers from the HP-IB bus and try again.
- 741 741, No HP-IB devices found;(741)
An automatic level correction was attempted but failed to find any other devices on the HP-IB bus. Connect the desired power meter to the HP-IB bus and try again. Check the HP-IB cable(s) for loose connections.
- 742 742, Errors in cleanup of HP-IB;(742)
When exiting the automatic level correction, the synthesizer failed to finish resetting the HP-IB bus and presetting the power meter. Make sure the power meter address matches the power meter address setting on the synthesizer. Check the HP-IB cable(s) for loose connections.
- 743 743, No HP-IB devices found;(743)
An automatic level correction was attempted but failed to find any other devices on the HP-IB bus. Connect the desired power meter to the HP-IB bus and try again. Make sure the power meter address matches the power meter address setting on the synthesizer. Check the HP-IB cable(s) for loose connections.
- 744 744, Cannot find power meter on HP-IB bus;(744)
An automatic level correction was attempted but failed to find a power meter on the HP-IB bus. Connect the desired power meter to the HP-IB bus and try again. Make sure the power meter address matches the power meter address setting on the synthesizer. Check the HP-IB cable(s) for loose connections.
- 745 745, Meter returns error msg +9.0000E+40;(745)
While running the automatic level correction, the power meter returned +9.0000E+40 as the power reading. This number indicates an error within the power meter.

- 746 746, Data measured is invalid or out of range;(746)
While running the automatic level correction, the power meter returned an out of range power reading or the power meter returned a non-number as its power reading. Check that the power meter is reading an appropriate value by looking at it.
- 747 747, Unable to receive msg from meter;(747)
An automatic level correction was attempted but failed to power readings back from the power meter. Make sure the power meter address matches the power meter address setting on the synthesizer. Check the HP-IB cable(s) for loose connections.
- 748 748, Erasing corrupted level correct table;(748)
A level correction table was corrupt and was erased to fix it.
- 749 749, Frequency not within level correct data;(749)
This message is a warning that the current CW frequency is not contained within the frequencies in the active level correction table. Therefore, the correction applied to the output will be 0 dB. This is a "permanent" error.
- 751 751, Parameters cause points to be too large;(751)
The level correction parameters cannot define a new table because they create too many level correction points.
- 752 -222, Data out of range;Data set to minimum(752)
Loss data must be in the range of -40 to +40 dB.
- 753 -222, Data out of range;Data set to maximum(753)
Loss data must be in the range of -40 to +40 dB.
- 754 754, Total points reduced from that requested;(754)
The number of points requested for an automatic level correction has been reduced to avoid duplicate frequencies.
- 755 755, Invalid data in active table, not saved;(755)
This error indicates that a level correction table save failed. Try selecting the same level correction table again. If this error message persists you will have to recreated the table.

Error Messages

Messages

- 756 756, Factory level corr 1-20 GHz, 0dB table;(756)
Factory frequency level correction data for 1-20 GHz band, thru path is not valid. If you need to use this frequency range and you work with output levels that don't use the step attenuator, see the explanation for error number 4000.
- 757 757, Bad attenuator setting parameter;(757)
The attenuator range for looking up factory frequency level correction data, is 0 through 120 (resolution is 10).
- 758 -222, Data out of range;Data set to minimum(758)
Loss data for factory frequency level correction was less than minimum.
- 759 -222, Data out of range;Data set to maximum(759)
Loss data for factory frequency level correction was more than maximum.
- 760 760, Bad index into data table;(760)
A data lookup from a calibration table found that the index data is out of range. Try setting the same synthesizer function again. If this error message persists, run the instrument self-test.
- 761 761, Bad index into offset table;(761)
A data lookup from the factory level correction offset table found that the index data is out of range. Try setting the same synthesizer function again. If this error message persists, run the instrument self-test.
- 763 763, Unable to write to EEPROM;(763)
A calibration table was not loaded into EEPROM because the EEPROM was protected or the EEPROM load did not verify. Open up the synthesizer and switch the PG switch to 0.
- 764 764, Unable to write to RAM;(764)
A write to RAM failed to verify. Run the self-test routine to check RAM for problems.

765 765, Attempt to write to ROM;(765)

There was an attempt to write calibration data to ROM. This should not occur, but if it does, try setting the same synthesizer function again. If this error message persists, run the instrument self-test.

766 766, Number of writes to EEPROM exceeds max;(766)

The number of EEPROM writes has exceeded the maximum allowed. However, the data was written to the EEPROM anyway. This is only a warning; but, you should check to make sure your data was correctly stored in EEPROM.

770 770, YTO cal data invalid;(770)

The YIG oscillator factory calibration data checksum was incorrect. Select the CAL YIG OSC feature to perform a YIG oscillator calibration. If you do not re-calibrate, the synthesizer may be unable to attain lock at some frequencies.

771 771, Invalid YIG DAC value in cal table.:(771)

The YIG oscillator factory calibration data checksum was incorrect. Select the CAL YIG OSC feature to perform a YIG oscillator calibration. If you do not re-calibrate, the synthesizer may be unable to attain lock at some frequencies.

772 772, YTO cal values for Up/Down search vary;(772)

The YIG oscillator factory calibration data checksum was incorrect. Select the CAL YIG OSC feature to perform a YIG oscillator calibration. If you do not re-calibrate, the synthesizer may be unable to attain lock at some frequencies.

774 774, EEPROM protected, YTO cal aborted;(774)

An automatic YIG oscillator calibration was not performed because the PG switch was protecting the EEPROM from "writes". Open up the synthesizer and switch the PG switch to 0.

775 775, Low band yto cal failed;(775)

The low band calibration failed and the data for the calibration was not saved. Re-try the YIG calibration and watch for the default cal points indicated when the DAC value shown for a given point says 'dflt = ' instead of 'DAC = '.

Error Messages

Messages

- 776 776, High band yto cal failed;(776)
The low band calibration failed and the data for the calibration was not saved. Re-try the YIG calibration and watch for the default cal points indicated when the DAC value shown for a given point says 'dflt = ' instead of 'DAC = '.
- 777 777, Low band yto cal could not write EEPROM;(777)
The data for the low band YIG calibration could not be written to EEPROM. Make sure the PG switch on the processor board was closed during the cal and re-try the YIG calibration.
- 778 778, High band yto cal could not write EEPROM;(778)
The data for the low band YIG calibration could not be written to EEPROM. Make sure the PG switch on the processor board was closed during the cal and re-try the calibration.
- 779 779, Only 2 GHz or 10 GHz allowed for YTO Cal;(779)
The start frequency specified for the CAL:YIG:FREQ:START command was not valid. Re-enter the start frequency and start the YIG calibration again.
- 785 785, Cal Data not saved, PG switch is not 0;(785)
The calibration data could not be saved because the PG switch on the microprocessor board was not closed. Close the PG switch and do the calibration again.
- 786 786, Cal Data verification after EEPROM write;(786)
The calibration data was not written correctly after the calibration. Close the PG switch and do the calibration again.
- 787 787, FM cal and Pinchoff cal not initialized;(787)
The YIG calibration has not been done for both YIG bands or else the pinchoff cal values have not been entered yet.
- 790 790, Scan-mod 0.01—1 GHz gain tables bad;(790)
Checksum was invalid for the AM gain tables. If you need to use this frequency range and scan AM modulation, see the explanation for error number 4000.

- 793 793, Scan AM cal not valid, defaults used;(793)
Scan AM level may be in error due to invalid calibration data. If you need to use scan AM modulation, see the explanation for error number 4000.
- 794 794, Scan-mod 1—20 GHz gain tables bad;(794)
Checksum was invalid for the AM scan gain tables. If you need to use this frequency range and scan AM modulation, see the explanation for error number 4000.
- 795 795, Scan-mod 1—20 GHz linear 1 tables bad;(795)
Checksum was invalid for the AM scan linear 1 tables. If you need to use this frequency range and scan AM modulation, see the explanation for error number 4000.
- 796 796, Scan-mod 1—20 GHz linear 2 tables bad;(796)
Checksum was invalid for the AM scan linear 2 tables. If you need to use this frequency range and scan AM modulation, see the explanation for error number 4000.
- 800 800, Options not saved, PG switch is not 0;(800)
The instrument option bit-fields were not saved to EEPROM. Open up the synthesizer, switch the PG switch to 0, and try setting the option bit-fields again.
- 801 801, Serial num not saved, PG switch is not 0;(801)
The instrument serial number was not saved to EEPROM. Open up the synthesizer, switch the PG switch to 0, and try setting the serial number again.
- 802 802, Assembly Revs not saved, PG switch is not 0 (802)
The protection switch on the CPU board is in an incorrect position to change EEPROM data.
- 803 803, EEPROM not cleared, PG switch is not 0 (803)
The protection switch on the CPU board is in an incorrect position to clear EEPROM data.

Error Messages
Messages

- 900 900, PRI increased to fit pulse width;(900)
The current pulse width is too large for the current PRI. The PRI is increased to allow for the pulse width. This is a “permanent” error.
- 901 901, Delay and width decreased to fit max PRI;(901)
The current pulse width plus the current pulse delay is too large because they are greater than the maximum PRI. The delay and/or the width were reduced to fit. This is a “permanent” error.
- 940 940, Oven is cold;(940)
The high stability time base oven is cold. The oven must be allowed to warm up before proper instrument operation will occur. This is a “permanent” error.
- 944 944, Reference synthesizer went out of lock;(944)
The reference synthesizer went out of lock. The out of lock condition may have been due to an external time base being connected or disconnected. Enter a different RF frequency and then set the frequency back to the desired value to re-lock. This is a “permanent” error.
- 1101 1101, Loop number is invalid.:(1101)
If you are using the direct hardware control service feature, you have entered an out of range value. If this error occurs while not using the direct hardware control service feature, low level hardware drivers could not set the requested synthesizer setting. Try setting the synthesizer again. If this error message persists, run the instrument self-test.
- 1102 1102, Start bit is negative.:(1102)
See the explanation for error number 1101.
- 1103 1103, Length less than 0 or more than 32;(1103)
See the explanation for error number 1101.
- 1104 1104, Start bit is invalid for given loop.:(1104)
See the explanation for error number 1101.
- 1105 1105, Length is invalid for given loop;(1105)
See the explanation for error number 1101.

- 1106 1106, Data is too large for given length;(1106)
See the explanation for error number 1101.
- 1107 -222, Data out of range;Bit field number(1107)
See the explanation for error number 1101.
- 1108 -222, Data out of range;Query port field(1108)
If you are using the direct hardware control service feature, you have entered an out of range query address. If this error occurs while not using the direct hardware control service feature, low level hardware drivers could not complete a query. Try setting the synthesizer again. If this error message persists, run the instrument self-test.
- 1109 1109, Query Port mode;(1109)
See the explanation for error number 1108.
- 1462 1462, Keybd processor reports status error;(1462)
A key press was not successful. Try pressing the same key again. If the error message persists, see the explanation for error number 4000.
- 1463 1463, Keybd processor data lines incorrect;(1463)
A key press was not successful. Try pressing the same key again. If the error message persists, see the explanation for error number 4000.
- 1501 -302,8673 command not recognized (1501)
While in HP 8673 emulation mode, an incoming command string was not recognized as being valid. Refer to the front-panel error que for the command sequence.
- 1520 -301,8673 command CT not emulated (1520)
The above command is recognized by the synthesizer in HP 8673 emulation mode, but it is not emulated. The command is thus discarded and no action is taken. Refer to Chapter 4, "HP 8673 Compatibility Guide" for more information.
- 1521 -301,8673 command Nx not emulated (1521)
The above command is recognized by the synthesizer in HP 8673 emulation mode, but it is not emulated. The command is thus discarded and no action is taken. Refer to Chapter 4, "HP 8673 Compatibility Guide" for more information.

Error Messages

Messages

1522 –301,8673 command SU not emulated (1522)

The above command is recognized by the synthesizer in HP 8673 emulation mode, but it is not emulated. The command is thus discarded and no action is taken. Refer to Chapter 4, “HP 8673 Compatibility Guide” for more information.

1523 –301,8673 command SD not emulated (1523)

The above command is recognized by the synthesizer in HP 8673 emulation mode, but it is not emulated. The command is thus discarded and no action is taken. Refer to Chapter 4, “HP 8673 Compatibility Guide” for more information.

1524 –301,8673 command Tx not emulated (1524)

The above command is recognized by the synthesizer in HP 8673 emulation mode, but it is not emulated. The command is thus discarded and no action is taken. Refer to Chapter 4, “HP 8673 Compatibility Guide” for more information.

1525 –301,8673 command TR not emulated (1525)

The above command is recognized by the synthesizer in HP 8673 emulation mode, but it is not emulated. The command is thus discarded and no action is taken. Refer to Chapter 4, “HP 8673 Compatibility Guide” for more information.

1526 –301,8673 command RS not emulated (1526)

The above command is recognized by the synthesizer in HP 8673 emulation mode, but it is not emulated. The command is thus discarded and no action is taken. Refer to Chapter 4, “HP 8673 Compatibility Guide” for more information.

1527 –301,8673 command SM not emulated (1527)

The above command is recognized by the synthesizer in HP 8673 emulation mode, but it is not emulated. The command is thus discarded and no action is taken. Refer to Chapter 4, “HP 8673 Compatibility Guide” for more information.

1528 –301,8673 command_2 not emulated (1528)

The above command is recognized by the synthesizer in HP 8673 emulation mode, but it is not emulated. The command is thus discarded and no action is taken. Refer to Chapter 4, “HP 8673 Compatibility Guide” for more information.

1529 –301,8673 command_3 not emulated (1529)

The above command is recognized by the synthesizer in HP 8673 emulation mode, but it is not emulated. The command is thus discarded and no action is taken. Refer to Chapter 4, “HP 8673 Compatibility Guide” for more information.

1530 –301,8673 command_A not emulated (1530)

The above command is recognized by the synthesizer in HP 8673 emulation mode, but it is not emulated. The command is thus discarded and no action is taken. Refer to Chapter 4, “HP 8673 Compatibility Guide” for more information.

1531 –301,8673 command SV not emulated (1531)

The above command is recognized by the synthesizer in HP 8673 emulation mode, but it is not emulated. The command is thus discarded and no action is taken. Refer to Chapter 4, “HP 8673 Compatibility Guide” for more information.

1532 –301,8673 command OL not emulated (1532)

The above command is recognized by the synthesizer in HP 8673 emulation mode, but it is not emulated. The command is thus discarded and no action is taken. Refer to Chapter 4, “HP 8673 Compatibility Guide” for more information.

1534 –301,8673 command FA not emulated (1534)

The above command is recognized by the synthesizer in HP 8673 emulation mode, but it is not emulated. The command is thus discarded and no action is taken. Refer to Chapter 4, “HP 8673 Compatibility Guide” for more information.

Error Messages

Messages

1535 –301,8673 command FB not emulated (1535)

The above command is recognized by the synthesizer in HP 8673 emulation mode, but it is not emulated. The command is thus discarded and no action is taken. Refer to Chapter 4, “HP 8673 Compatibility Guide” for more information.

1536 –301,8673 command FS not emulated (1536)

The above command is recognized by the synthesizer in HP 8673 emulation mode, but it is not emulated. The command is thus discarded and no action is taken. Refer to Chapter 4, “HP 8673 Compatibility Guide” for more information.

1537 –301,8673 command DF not emulated (1537)

The above command is recognized by the synthesizer in HP 8673 emulation mode, but it is not emulated. The command is thus discarded and no action is taken. Refer to Chapter 4, “HP 8673 Compatibility Guide” for more information.

1538 –301,8673 command DW not emulated (1538)

The above command is recognized by the synthesizer in HP 8673 emulation mode, but it is not emulated. The command is thus discarded and no action is taken. Refer to Chapter 4, “HP 8673 Compatibility Guide” for more information.

1539 –301,8673 command SF not emulated (1539)

The above command is recognized by the synthesizer in HP 8673 emulation mode, but it is not emulated. The command is thus discarded and no action is taken. Refer to Chapter 4, “HP 8673 Compatibility Guide” for more information.

1540 –301,8673 command SP not emulated (1540)

The above command is recognized by the synthesizer in HP 8673 emulation mode, but it is not emulated. The command is thus discarded and no action is taken. Refer to Chapter 4, “HP 8673 Compatibility Guide” for more information.

1541 -301,8673 command IF not emulated (1541)

The above command is recognized by the synthesizer in HP 8673 emulation mode, but it is not emulated. The command is thus discarded and no action is taken. Refer to Chapter 4, "HP 8673 Compatibility Guide" for more information.

1802 1802, Low Battery Voltage;(1802)

The synthesizer battery voltage is low. This could cause loss of RAM data if synthesizer power is turned off. Note: Calibration data will never be lost.

1803 1803, RAM data lost at power on;(1803)

All RAM data was lost. This includes all front panel settings, save/recall registers, level corrections, and other user settable values. This error message can occur when the battery voltage is low, or options change in the synthesizer .

NOTE

Calibration data will never be lost.

1804 1804, Self-test failure, run the self-test;(1804)

The power-on self-test detected an error or warning. See the explanation for error number 4000.

1805 1805, Processor Board or IBUS test Failure;(1805)

The power-on self-test detected an error or warning for the microprocessor board circuits or power supply monitors. See the explanation for error number 4000.

1806 1806, ROM checksum test failure;(1806)

The synthesizer ROM check sum does not match the data in ROM. See the explanation for error number 4000.

Error Messages

Messages

- 1820 –221, Settings conflict; PM DEV (1820)
1. The PM internal deviation setting was reduced because either:
 - a. FreqCw was changed into the low band region, or
 - b. PM internal rate was set above 30 kHz and the PM deviation was above 4 rads.
- 1821 –221, Settings conflict; INT PM FREQ (1821)
- The PM internal deviation setting was decreased because the PM deviation was increased above 4 rads while the PM internal rate was above 30 kHz.
- 1822 –221, Settings conflict; INT FM DEV (1822)
- The FM internal deviation setting was reduced because the FreqCw was changed into a lower divided low band region.
- 2003 –222, Data out of range;CW FREQ(2003)
- Select a CW frequency that is within range of the installed options. If other modules or options are installed that extend the CW frequency range of the synthesizer , this frequency range will be extended also.
- 2006 –222, Data out of range;POWER LEVEL(2006)
- Select a power level within the following ranges:
No attenuator options, –15 dBm to +30 dBm. Option 1E1, –100 dBm to +30 dBm.
- 2012 –224, Illegal parameter value;ALC SOURCE(2012)
- The requested ALC source is not available in the synthesizer . Use *OPT? to check which options are installed.
- 2015 –222, Data out of range;SPECIAL(2015)
- Select a special function number that is available in the synthesizer .
- 2018 –222, Data out of range;FREQ MULTIPLIER INCR(2018)
- Select a frequency multiplier increment from 1 to 99.
- 2021 –224, Illegal parameter value; PULSE PROT STAT (2021)
- This command requires a boolean argument.

2024 –222, Data out of range;CW FREQ INCR(2024)

Select a CW frequency increment from 1 kHz to 19.99 GHz. If other modules or options are installed that extend the CW frequency range of the synthesizer, this frequency range will be extended also. If Option 1E8 is installed the limits will also change to allow for 1 Hz resolution.

2030 –222, Data out of range;DIRECT HW CONTROL(2030)

Select synthesizer direct hardware control values within range. See the service manual for more details on this feature.

2033 –222, Data out of range;POWER LEVEL INCR(2033)

Select a power level within the following ranges:
No attenuator options, 0.01 dBm to +45 dBm. Option 1E1, 0.01 dBm to +130 dBm.

2036 –222, Data out of range;EXT METER LEVEL(2036)

Select an external power meter reading within the following ranges:
No attenuator options, –15 dBm to +30 dBm. Option 1E1, –100 dBm to +30 dBm.

2042 –222, Data out of range;DIAG:IBUS:DIR(2042)

Correct the HP-IB command DIAG:IBUS:DIR or DIAG:IBUS:DIR? so that its parameters are within their appropriate ranges. See the service manual for more details on this HP-IB only feature.

2045 –224, Illegal parameter value; *EMC (2045)

This command requires a 1 or 0 as an argument.

2048 –222, Data out of range;SYST:KEY(2048)

Select a key code available on the synthesizer's front panel.

2051 –161, Invalid block data;SYST:SET bad size(2051)

The "learn string" sent to the synthesizer is corrupt (incorrect number of bytes). Check that the HP-IB controller is sending the string correctly. In addition, insure that the controller loaded the learn string correctly in the first place. Note: The *LRN? query always returns the same length string regardless of the state of the synthesizer; but, the *LRN? response can change if the firmware version changes.

Error Messages

Messages

- 2054 –222, Data out of range;CAL:ALC:CURV(2054)
Correct the HP-IB command CAL:ALC:CURV so that its parameters are within the following ranges:
1st parameter: 0.0 to 4.0
2nd parameter: –2.0 to 2.0
3rd-6th parameter: –1.0 to 1.0
7th parameter: 0.0 to 25.0
- 2057 –222, Data out of range;HP-IB ADDRESS(2057)
Select an HP-IB address for the synthesizer from 0 to 30.
- 2060 –222, Data out of range;SAVE(2060)
Select a save state register number from 0 to 9.
- 2066 –222, Data out of range;RECALL(2066)
Select a recall state register number from 0 to 9.
- 2075 –222, Data out of range;LO FREQ(2075)
Select an LO frequency from 300 MHz to 359.5 MHz.
- 2078 –222, Data out of range;OFFSET FREQ(2078)
Select an offset frequency from 5 MHz to 40 MHz.
- 2081 –222, Data out of range;DIAG:FREQ:CYCL(2081)
Correct the HP-IB command DIAG:FREQ:CYCL so that its parameters are within range. See the service manual for more details on this feature.
- 2087 –222, Data out of range;YIG OSC CAL FREQ(2087)
Correct the HP-IB command CAL:YIG:FREQ:START so that its parameter is 2 GHz or 10 GHz.
- 2090 –222, Data out of range;CAL:YIG(2090)
Correct the HP-IB command CAL:YIG[:DATA] so that all of its parameters are from 0 to 65535.
- 2093 –224, Illegal parameter value; AM STATE (2093)
This command requires a boolean argument.
- 2096 –224, Illegal parameter value;PULSE TRIG SOUR(2096)

The requested pulse trigger source is not available in the synthesizer. Use *OPT? to check which options are installed.

2099 –222, Data out of range;FREQ MULTIPLIER(2099)

Select a frequency multiplier from 1 to 100.

2102 –222, Data out of range;EXT METER INCR(2102)

Select an external power meter reading increment within the following ranges:

No attenuator options, 0.01 dBm to +45 dBm. Option 1E1, 0.01 dBm to +130 dBm.

2105 –222, Data out of range;CAL:ALC:CURV:FREQ(2105)

Correct the HP-IB command CAL:ALC:CURVe:FREQuency:STARt so that its parameter is from 10 MHz to 40 GHz. See the service manual for more details on this feature.

2111 –224, Illegal parameter value; *PSC (2111)

This command requires a 1 or 0 as an argument.

2114 –224, Illegal parameter value;ATTEN LOCK(2114)

The HP-IB command "POWer:ATTenuation:AUTO OFF" can only be used if Option 1E1 is installed.

2123 –222, Data out of range;PULSE WIDTH(2123)

Select a pulse width from 0 to 419ms.

2126 –222, Data out of range;PULSE PRI/PRF(2126)

Select a pulse repetition interval from 419 ms to a minimum depending on the current carrier frequency or select a pulse repetition frequency from 2.5 Hz to a maximum depending on the current carrier frequency.

2132 –224, Illegal parameter value; PULSE STATE (2132)

This command requires a boolean argument.

2135 –224, Illegal parameter value;EXT PULSE INV(2135)

The requested external pulse polarity is not available in the synthesizer. Use *OPT? to check which options are installed.

2138 –224, Illegal parameter value;PULSE SOURCE(2138)

Error Messages

Messages

If the internal pulse source is not installed in the synthesizer, the HP-IB command PULM:SOURce only allows EXTERNAL as a parameter.

2144 –222, Data out of range;PULSE DELAY(2144)

Select a pulse delay from –419 ms to 419 ms. The minimum delay is 0 if external trigger pulse mode is being used.

2147 –224, Illegal parameter value; FM STATE (2147)

This command requires a boolean argument.

2159 –224, Illegal parameter value;AM TYPE(2159)

Expected argument is either EXPONENTIAL or LINEAR.

2162 –222, Data out of range;CAL:AM:GAIN:OFFS (2162)

The value must remain between –128 and +127.

2165 –224, Illegal parameter value;REMOTE LANGUAGE(2165)

Select an HP-IB remote language which is available in the synthesizer. "SCPI" is the default but others are available as options.

2168 –222, Data out of range;PULSE DELAY INCR(2168)

Select a pulse delay increment from 25 ns to 838 ms.

2171 –222, Data out of range;PULSE WIDTH INCR(2171)

Select a pulse width increment from 25 ns to 419 ms.

2174 –222, Data out of range;PULSE PRI/PRF INCR(2174)

Select a pulse repetition interval increment from 25 ns to 419 ms or select a pulse repetition frequency increment from 1 MHz to 3.3 MHz.

2177 –222, Data out of range;CAL:FLAT(2177)

Loss data for factory frequency level correction was out of range.

2180 –224, Illegal parameter value;FM AC DC(2180)

Allowable parameter values are AC or DC only.

2189 –224, Illegal parameter value;DISPLAY STATE(2189)

The display state could not be set to the state requested.

2192 –224, Illegal parameter value; LEV CORR STATE (2192)

This command requires a boolean argument.

- 2198 –224, **Illegal parameter value;EXT REF(2198)**
The reference oscillator could not be set to INTernal because an internal oscillator does not exist or the reference oscillator could not be set to EXTernal because an external oscillator does not exist.
- 2210 –222, **Data out of range;ASSEMBLY REVISION (2210)**
The value must remain between 0 and +254.
- 2216 –222, **Data out of range;NODE MEASURE(2216)**
Select a meter node number within range. See the service manual for more details on this feature.
- 2219 –222, **Data out of range;OPTION WRITE(2219)**
Select an option bit-field number within range. See the service manual for more details on this feature.
- 2225 –222, **Data out of range;FM SENSITIVITY(2225)**
Select an FM sensitivity within its range for the current CW frequency and multiplier.
- 2231 –224, **Illegal parameter value;PULSE RISE TIME(2231)**
The requested pulse rise time is not available in the synthesizer. Use *OPT? to check which options are installed.
- 2237 –222, **Data out of range;OFFSET FREQ INCR(2237)**
Select an offset frequency increment from 1 kHz to 35 MHz. If Option 1E8 is installed the lower limit will change to 1 Hz to allow for 1 Hz resolution.
- 2240 –222, **Data out of range;LO FREQ INCR(2240)**
Select an LO frequency increment from 1 kHz to 359.5 MHz.
- 2243 –222, **Data out of range;DIRECT HW CONTROL INC(2243)**
Select synthesizer direct hardware control increment values within range. See the service manual for more details on this feature.
- 2249 –222, **Data out of range;DIAG:ABUS?(2249)**
Correct the HP-IB query DIAG:ABUS? so that its parameter is within their appropriate range. See the service manual for more details on this HP-IB only feature.

Error Messages

Messages

- 2252 –222, Data out of range;CAL:AM:LIN(2252)
Correct the HP-IB command CAL:AM:LINear[:DATA] so that all of its parameters are from 0 to 255.
- 2255 –222, Data out of range;CAL:AM:LIN:TABL(2255)
Correct the HP-IB command CAL:AM:LINear:TABLE so that its parameter is 1 or 2.
- 2264 –222, Data out of range;CAL:YIG:FM:SENS(2264)
Correct the HP-IB command CAL:YIG:FM:SENSitivity so that all of its parameters are from –80 to 80.
- 2276 –222, Data out of range;CORR:FLAT(2276)
Correct the HP-IB command CORRection:FLATness[:DATA] so that all of its frequency parameters are from 1 GHz to 20 GHz and all of its loss parameters are from –40 dB to +40 dB. If other modules or options are installed that extend the frequency range of the synthesizer, this frequency range will be extended also.
- 2277 2277, CORR:FLAT cannot query empty table;(2277)
The selected level correction table data cannot be queried because it is invalid or it does not exist. Check that MEMory:TABLE:SElect is set to a level correction table that has data.
- 2291 –224, Illegal parameter value;SERIAL NUM(2291)
Correct the HP-IB command SYSTem:SNUMber so that its string parameter is 10 characters or less.
- 2292 –151, Invalid string data;SERIAL NUM bad char(2292)
A serial number can only contain characters from ASCII 32 (space) through ASCII 126 (~). However, ASCII 44 (,) and ASCII 59 (;) cannot be used.
- 2294 –222, Data out of range;POW METER ADDRESS(2294)
Select a power meter address for automatic level correction from 0 to 30. Secondary addresses may be allowed in future firmware revisions.
- 2300 –222, Data out of range;CAL:FLAT:FREQ:START(2300)

Correct the HP-IB command CAL:FLATness:FREQuency:STARt so that its parameter is from 10 MHz to 40 GHz. See the service manual for more details on this feature.

2303 –222, Data out of range;CAL:FLAT:ATT(2303)

Correct the HP-IB command CAL:FLATness:ATTenuation so that its parameter is from 0 dB to 120 dB with a resolution of 10 dB. See the service manual for more details on this feature.

2306 –222, Data out of range;CAL:AM(2306)

Correct the HP-IB command CAL:AM[:DATA] so that all of its parameters are from 0 to 255.

2309 –222, Data out of range;CAL:AM:FREQ:START(2309)

Correct the HP-IB command CAL:AM:FREQuency:STARt so that its parameter is from 10 MHz to 40 GHz. See the service manual for more details on this feature.

2444 –222, Data out of range;LEVEL CORR START FREQ(2444)

Select an automatic level correction start frequency from 1 GHz to 20 GHz. If other modules or options are installed that extend the CW frequency range of the synthesizer, this frequency range will be extended also.

2447 –222, Data out of range;LEVEL CORR STOP FREQ(2447)

Select an automatic level correction start frequency from 1 GHz to 20 GHz. If other modules or options are installed that extend the CW frequency range of the synthesizer, this frequency range will be extended also.

2453 –222, Data out of range; AM SENSitivity (2453)

Sensitivity of 30%/Volt or 100%/Volt is allowed in linear mode;
–10dB/volt is allowed in log mode.

2457 2457, RF on before running level correct;(2457)

The RF must be turned on before running an automatic level correction. Turn RF on and try running the automatic level correction again.

2462 –222, Data out of range;LEVEL CORR START INC(2462)

Error Messages
Messages

Select an automatic level correction start frequency increment from 1 kHz to 19.99 GHz. If other modules or options are installed that extend the CW frequency range of the synthesizer, this frequency range will be extended also. If Option 1E8 is installed the limits will also change to allow for 1 Hz resolution.

2465 –222, Data out of range;LEVEL CORR STOP INC(2465)

Select an automatic level correction stop frequency increment from 1 kHz to 19.99 GHz. If other modules or options are installed that extend the CW frequency range of the synthesizer, this frequency range will be extended also. If the Option 1E8 is installed the limits will also change to allow for 1 Hz resolution.

2471 –222, Data out of range;HP-IB ADDRESS INCR(2471)

Select an HP-IB address increment from 1 to 29.

2474 –222, Data out of range;YIG OSC CAL FREQ INC(2474)

Correct the HP-IB command CAL:YIG:FREQuency:STARt:STEP so that its parameter is from 1 GHz to 10 GHz.

2477 –222, Data out of range;CAL:PULSe:PINCh(2477)

Correct the HP-IB command CAL:PULSe:PINCh[:DATA] so that all of its parameters are from 0 to 255.

2480 –222, Data out of range;CAL:PULS:FREQ:START(2480)

Correct the HP-IB command CAL:PULSe:FREQuency:STARt so that its parameter is 10 MHz.

2522 –222, Data out of range;POW METER ADDRESS INC(2522)

Select a power meter address increment from 1 to 29.

2525 –222, Data out of range;NODE MEASURE INC(2525)

Select a meter node increment within range.

2531 –222, Data out of range;LEVEL CORR POINTS(2531)

Select automatic level correction number of points from 2 to 401.

2534 –222, Data out of range;LEVEL CORR POINTS INC(2534)

Select automatic level correction number of points increment from 1 to 401.

- 2537 –222, Data out of range;LEVEL CORRECT SAVE(2537)
Select an automatic level correction register from 1 to 4.
- 2540 –222, Data out of range;LEVEL CORR SELECT(2540)
Select an automatic level correction register from 1 to 4.
- 2564 –222, Data out of range; PM:COUP (2564)
This command requires a boolean argument.
- 2567 –224, Illegal parameter value;PULSE RISE TIME(2567)
The requested pulse rise time is not available in the synthesizer. Use *OPT? to check which options are installed.
- 2570 –224, Illegal parameter value;POWERMETER TYPE(2570)
The selected power type is not supported by the synthesizer.
- 2576 –224, Illegal parameter value;PULSE STOP SOUR(2576)
The requested pulse trigger stop source is not available in the synthesizer. Use *OPT? to check which options are installed.
- 2579 –224, Illegal parameter value;TRIG:STOP:SLOP(2579)
The requested pulse trigger stop slope is not available in the synthesizer. Use *OPT? to check which options are installed.
- 2582 –222, Data out of range; PM DEV (2582)
The internal modulation setting for phase modulation is beyond instrument capabilities. An absolute upper limit of 200 rads is maintained for frequencies above 2 GHz. At lower frequencies, the upper limit is reduced.
- 2588 –224, Illegal parameter value;MEM:TABL:SEL(2588)
Select an automatic level correction register from 1 to 4.
- 2591 –222, Data out of range;MEM:TABL:FREQ(2591)
Correct the HP-IB command MEMory:TABLE:FREQuency so that all of its parameters are from 1 GHz to 20 GHz. If other modules or options are installed that extend the frequency range of the synthesizer, this frequency range will be extended also.
- 2592 2592, MEM:TABL:FREQ cannot query empty table;(2592)

Error Messages

Messages

- The selected level correction table data cannot be queried because it is invalid or it does not exist. Check that MEMory:TABLE:SElect is set to a level correction table that has data.
- 2597 –222, Data out of range;MEM:TABL:LOSS(2597)
Correct the HP-IB command MEMory:TABLE:LOSS[:MAGnitude] so that all of its parameters are from –40 dB to +40 dB.
- 2598 2598, MEM:TABL:LOSS cannot query empty table;(2598)
The selected level correction table data cannot be queried because it is invalid or it does not exist. Check that MEMory:TABLE:SElect is set to a level correction table that has data.
- 2612 –224, Illegal parameter value;FM SOURCE(2612)
The allowable arguments are EXTernal, FEED, or INTernal. FEED and INTernal are only allowed when Option 1E2 (internal modulation) is installed.
- 2615 –222, Data out of range;INT FM FREQ(2615)
Select an internal FM frequency (rate) from 0.5 Hz to 1 MHz.
- 2618 –222, Data out of range;INT FM FREQ INC(2618)
Select an internal FM frequency (rate) increment from 0.5 Hz to 999.9995 kHz.
- 2621 –222, Data out of range;INT FM DEV(2621)
Select an internal FM deviation from 0 Hz to 10 MHz.
- 2624 –222, Data out of range;INT FM DEV INC(2624)
Select an internal FM deviation increment from 0.01 Hz to 10 MHz.
- 2627 –224, Illegal parameter value;FM:FEED(2657)
Change the FM:FEED input parameter to a source that is available in the synthesizer.
- 2633 –224, Illegal parameter value; PM STATE (2633)
This command requires a boolean argument, or phase modulation is not possible on this instrument, or the phase modulation option is not installed.
- 2636 –224, Illegal parameter value; PM SOURCE (2636)

The allowable arguments are EXTERNAL, FEED, or INTERNAL. FEED and INTERNAL are only allowed when the Option 1E2 (internal modulation) is installed.

2639 –222, Data out of range; FM SENS (2639)

The requested sensitivity exceeds the capabilities of the instrument at the current FREQUENCYCW. The limitation of FmSens are dependent upon FREQUENCYCW.

2642 –224, Illegal parameter value;AM SOURCE(2642)

The allowable arguments are EXTERNAL, FEED, or INTERNAL. FEED and INTERNAL are only allowed when Option 1E2 (internal modulation) is installed.

2645 –222, Data out of range;INT AM FREQ(2645)

Select an internal AM frequency (rate) from 0.5 Hz to 20 kHz.

2648 –222, Data out of range;INT AM FREQ INC(2648)

Select an internal AM frequency (rate) increment from 0.5 Hz to 20 kHz.

2651 –222, Data out of range;INT AM DEPTH(2651)

In log mode, the data value must be between 0 dB and 60 dB. In linear mode, the data value must be between 0% and 100%.

2654 –222, Data out of range;INT AM DEPTH INC(2654)

In log mode, the data value must be between .01 dB and 60 dB. In linear mode, the data value must be between 0.1% and 100%.

2657 –224, Illegal parameter value;AM:FEED(2657)

Change the AM:FEED input parameter to a source that is available in the synthesizer.

2660 –222, Data out of range; INT PM DEV INC (2660)

The value must remain between .01 rads and 10.0 rads.

2663 –222, Data out of range; INT PM FREQ (2663)

The value must remain between 0.5 Hz and 1 MHz, except when PM:RANG:AUTO is set to HIGH. In this case, the value will be restricted to a value between 0.5 Hz and 30 kHz.

Error Messages

Messages

- 2666 –222, Data out of range; INT PM FREQ INC (2666)
The value must remain between 0.5 Hz and 999.9995 kHz.
- 2672 –222, Data out of range;CAL:MODS:AM(2672)
Correct the HP-IB command CAL:MODS:AM[:DATA] so that all of its parameters are from 0 to 255.
- 2678 –222, Data out of range;CAL:MODS:FM(2678)
Correct the HP-IB command CAL:MODS:FM[:DATA] so that all of its parameters are from 0 to 255.
- 2702 –222, Data out of range;ADD OPTION(2702)
Select an option bit number within range. See the service manual for more details on this feature.
- 2705 –222, Data out of range;DELETE OPTION(2705)
Select an option bit number within range. See the service manual for more details on this feature.
- 3500 –221, Settings conflict;PULSE DELAY(3500)
The current pulse delay value was changed because the pulse delay limits changed for the current pulse mode. For example, if pulse delay is –100 ms and the synthesizer is placed into external trigger mode, this error will be reported and the pulse delay will be set to 0 ms.
- 4000 –330, Self-test failed;(4000)
Run the instrument self-test a couple times, checking the error queue each time the self-test is run. If the error message persists, use the Erase Memory feature, press the preset key and cycle the power; try the self-test again. If the error message persists, an instrument failure may have occurred and servicing may be required. If the synthesizer is functioning to your satisfaction, you may wish to ignore the error message.
- 4001 –330, Self-test failed;(4001)
See the explanation for error number 4000.
- 4002 –330, Self-test failed;(4002)
See the explanation for error number 4000.
- 4003 –330, Self-test failed;(4003)

- See the explanation for error number 4000.
- 4004 –330, Self-test failed;(4004)
See the explanation for error number 4000.
- 4005 –330, Self-test failed;(4005)
See the explanation for error number 4000.
- 4006 –330, Self-test failed;(4006)
See the explanation for error number 4000.
- 4007 –330, Self-test failed;(4007)
See the explanation for error number 4000.
- 4008 –330, Self-test failed;(4008)
See the explanation for error number 4000.
- 4009 –330, Self-test failed;(4009)
See the explanation for error number 4000.
- 4010 –330, Self-test failed;(4010)
See the explanation for error number 4000.
- 4011 –330, Self-test failed;(4011)
See the explanation for error number 4000.
- 4012 –330, Self-test failed;(4012)
See the explanation for error number 4000.
- 4013 –330, Self-test failed;(4013)
See the explanation for error number 4000.
- 4014 –330, Self-test failed;(4014)
See the explanation for error number 4000.
- 4015 –330, Self-test failed;(4015)
See the explanation for error number 4000.
- 4016 –330, Self-test failed;(4016)
See the explanation for error number 4000.

Error Messages

Messages

- 4017 –330, Self-test failed;(4017)
See the explanation for error number 4000.
- 4018 –330, Self-test failed;(4018)
See the explanation for error number 4000.
- 4019 –330, Self-test failed;(4019)
See the explanation for error number 4000.
- 4020 –330, Self-test failed;(4020)
See the explanation for error number 4000.
- 4021 –330, Self-test failed;(4021)
See the explanation for error number 4000.
- 4022 –330, Self-test failed;(4022)
See the explanation for error number 4000.
- 4023 –330, Self-test failed;(4023)
See the explanation for error number 4000.
- 4024 –330, Self-test failed;(4024)
See the explanation for error number 4000.
- 4025 –330, Self-test failed;(4025)
See the explanation for error number 4000.
- 4026 –330, Self-test failed;(4026)
See the explanation for error number 4000.
- 4027 –330, Self-test failed;(4027)
See the explanation for error number 4000.
- 4028 –330, Self-test failed;(4028)
See the explanation for error number 4000.
- 4029 –330, Self-test failed;(4029)
See the explanation for error number 4000.
- 4030 –330, Self-test failed;(4030)

- See the explanation for error number 4000.
- 4031 –330, Self-test failed;(4031)
See the explanation for error number 4000.
- 4032 –330, Self-test failed;(4032)
See the explanation for error number 4000.
- 4033 –330, Self-test failed;(4033)
See the explanation for error number 4000.
- 4034 –330, Self-test failed;(4034)
See the explanation for error number 4000.
- 4035 –330, Self-test failed;(4035)
See the explanation for error number 4000.
- 4036 –330, Self-test failed;(4036)
See the explanation for error number 4000.
- 4037 –330, Self-test failed;(4037)
See the explanation for error number 4000.
- 4038 –330, Self-test failed;(4038)
See the explanation for error number 4000.
- 4039 –330, Self-test failed;(4039)
See the explanation for error number 4000.
- 4040 –330, Self-test failed;(4040)
See the explanation for error number 4000.
- 4041 –330, Self-test failed;(4041)
See the explanation for error number 4000.
- 4042 –330, Self-test failed;(4042)
See the explanation for error number 4000.
- 4043 –330, Self-test failed;(4043)
See the explanation for error number 4000.

Error Messages

4044 -330, Self-test failed;(4044)

See the explanation for error number 4000.

4045 -330, Self-test failed;(4045)

See the explanation for error number 4000.

9000 -330, Self-test failed;(9000)

See the explanation for error number 4000.

9500-

9999 **Many different error messages can occur here.**

Errors with a number from 9500 to 9999 are MMS MSIB errors. These errors occur when the synthesizer has some problem with communication over the MSIB bus. See the explanation for error number 4000.



**Legal and Regulatory
Information**



Legal and Regulatory Information

This chapter contains information pertaining to safety and the warranty. The Declaration of Conformity is located at the end of this chapter.



Safety Symbols



Instruction documentation symbol: The product is marked with this symbol when it is necessary for the user to refer to the instruction in the documentation.



Indicates hazardous voltages.



Indicates earth (ground) terminal.

WARNING

The **WARNING** sign denotes a hazard. It calls attention to a procedure which, if not correctly performed or adhered to, could result in personal injury or loss of life. Do not proceed beyond a **WARNING** note until the indicated conditions are fully understood and met.

CAUTION

The **CAUTION** sign denotes a hazard. It calls attention to a procedure that, if not correctly performed or adhered to, could result in damage to or destruction of part the product. Do not proceed beyond a **CAUTION** note until the indicated conditions are fully understood and met.

WARNING

No operator serviceable parts inside. Refer servicing to qualified personnel.

To prevent electrical shock do not remove covers.

Miscellaneous Symbols

- CE The CE symbol is a registered trademark of the European Community (if accompanied by a year, it is when the design was proven).
- ISM 1-A This is a symbol of an Industrial Scientific and Medical Group 1 Class A product.
- CSA The CSA symbol is a registered trademark of the Canadian Standards Association.

Safety Considerations

This product and related documentation must be reviewed for familiarization with safety markings and instructions before operation.

This product is a Safety Class I system (provided with a protective earth terminal).

Before Applying Power

Verify that the product is set to match the available line voltage and the correct fuses are installed.

CAUTION

This product is designed for use in Installation Category II and Pollution Degree 2 per IEC 1010 and 664 respectively.

CAUTION

VENTILATION REQUIREMENTS: When installing the product in a cabinet, the convection into and out of the product must not be restricted. The ambient temperature (outside the cabinet) must be less than the maximum operating temperature of the product by 4°C for every 100 watts dissipated in the cabinet. If the total power dissipated in the cabinet is greater than 800 watts, then forced convection must be used.

Safety Earth Ground

An uninterruptable safety earth ground must be provided from the main power source to the product input wiring terminals through the power cable or supplied power cable set.

Safety Considerations

WARNING

This is a Safety Class I product provided with a protective earthing ground incorporated in the power cord. The mains plug shall only be inserted in a socket outlet provided with a protective earth contact. Any interruption of the protective conductor inside or outside of the product is likely to make the product dangerous. Intentional interruption is prohibited.

Whenever it is likely that the protection has been impaired, the system must be made inoperative and be secured against any unintended operation.

Servicing instructions are for use by service-trained personnel only. To avoid dangerous electric shock, do not perform any servicing unless qualified to do so.

Adjustments described in the manual are performed with power supplied to the system's instruments while protective covers are removed. Energy available at many points may, if contacted, result in personal injury.

Capacitors inside the system's instruments might still be charged even if the system has been disconnected from its source of supply.

For continued protection against fire hazard, replace the line fuses only with 250 V fuses of the same current rating and type (for example, normal blow, time delay, etc.). The use of other fuses or materials is prohibited.

Cleaning the Product

Clean the synthesizer cabinet using a damp cloth only.

Certification

Hewlett-Packard Company certifies that this product met its published specifications at the time of shipment from the factory. Hewlett-Packard further certifies that its calibration measurements are traceable to the United States National Institute of Standards and Technology, (NIST), to the extent allowed by the Institute's calibration facility, and to the calibration facilities of other International Standards Organization members.

Warranty

This Hewlett-Packard instrument product is warranted against defects in material and workmanship for a period of one year from date of shipment. During the warranty period, Hewlett-Packard Company will, at its option, either repair or replace products which prove to be defective.

For warranty service or repair, this product must be returned to a service facility designated by HP. Buyer shall prepay shipping charges to HP and HP shall pay shipping charges to return the product to Buyer. However, Buyer shall pay all shipping charges, duties, and taxes for products returned to HP from another country.

HP warrants that its software and firmware designated by HP for use with an instrument will execute its programming instructions when properly installed on that instrument. HP does not warrant that the operation of the instrument, or software, or firmware will be uninterrupted or error free.

Limitation of Warranty

The foregoing warranty shall not apply to defects resulting from improper or inadequate maintenance by Buyer, Buyer-supplied software or interfacing, unauthorized modification or misuse, operation outside of the environmental specifications for the product, or improper site preparation or maintenance.

NO OTHER WARRANTY IS EXPRESSED OR IMPLIED. HP SPECIFICALLY DISCLAIMS THE IMPLIED WARRANTIES OF MERCHANTABILITY AND FITNESS FOR A PARTICULAR PURPOSE.

Exclusive Remedies

THE REMEDIES PROVIDED HEREIN ARE BUYER'S SOLE AND EXCLUSIVE REMEDIES. HP SHALL NOT BE LIABLE FOR ANY DIRECT, INDIRECT, SPECIAL, INCIDENTAL, OR CONSEQUENTIAL DAMAGES, WHETHER BASED ON CONTRACT, TORT, OR ANY OTHER LEGAL THEORY.

Assistance

Product maintenance agreements and other customer assistance agreements are available for Hewlett-Packard products.

For any assistance, contact your nearest Hewlett-Packard Sales and Service Office shown in Table 9-1.

Table 9-1. Hewlett-Packard Sales and Service Offices

US FIELD OPERATIONS			
Headquarters Hewlett-Packard Co. 19320 Pruneridge Ave. Cupertino, CA 95014 (800) 752-0900	California, Northern Hewlett-Packard Co. 301 E. Evelyn Mountain View, CA 94041 (415) 694-2000	California, Southern Hewlett-Packard Co. 1421 South Manhattan Ave. Fullerton, CA 92631 (714) 999-6700	Colorado Hewlett-Packard Co. 24 Inverness Place, East Englewood, CO 80112 (303) 649-5512
Atlanta Annex Hewlett-Packard Co. 2124 Barrett Park Drive Kennesaw, GA 30144 (404) 648-0000	Illinois Hewlett-Packard Co. 5201 Tollview Drive Rolling Meadows, IL 60008 (708) 255-9800	New Jersey Hewlett-Packard Co. 150 Green Pond Rd. Rockaway, NJ 07866 (201) 586-5400	Texas Hewlett-Packard Co. 930 E. Campbell Rd. Richardson, TX 75081 (214) 231-6101
EUROPEAN FIELD OPERATIONS			
Headquarters Hewlett-Packard S.A. 150, Route du Nant-d'Avril 1217 Meyrin 2/Geneva Switzerland (41 22) 780.8111	France Hewlett-Packard France 1 Avenue Du Canada Zone D'Activite De Courtaboeuf F-91947 Les Ulis Cedex France (33 1) 69 82 60 60	Germany Hewlett-Packard GmbH Hewlett-Packard Strasse 61352 Bad Homburg v.d.H Germany (49 6172) 16-0	Great Britain Hewlett-Packard Ltd. Eskdale Road, Winners Triangle Wokingham, Berkshire RG41 5DZ England (44 734) 696622
INTERCON FIELD OPERATIONS			
Headquarters Hewlett-Packard Company 3495 Deer Creek Road Palo Alto, California, USA 94304-1316 (415) 857-5027	Australia Hewlett-Packard Australia Ltd. 31-41 Joseph Street Blackburn, Victoria 3130 (61 3) 895-2895	Canada Hewlett-Packard (Canada) Ltd. 17500 South Service Road Trans-Canada Highway Kirkland, Quebec H9J 2X8 Canada (514) 697-4232	China China Hewlett-Packard Company 38 Bei San Huan X1 Road Shuang Yu Shu Hai Dian District Beijing, China (86 1) 256-6888
Japan Hewlett-Packard Japan, Ltd. 1-27-15 Yabe, Sagami-hara Kanagawa 229, Japan (81 427) 59-1311	Singapore Hewlett-Packard Singapore (Pte.) Ltd. 150 Beach Road #29-00 Gateway West Singapore 0718 (65) 291-9088	Taiwan Hewlett-Packard Taiwan 8th Floor, H-P Building 337 Fu Hsing North Road Taipei, Taiwan (886 2) 712-0404	

DECLARATION OF CONFORMITY according to ISO/IEC Guide 22 and EN 45014	
Manufacturer's Name:	Hewlett-Packard Co.
Manufacturer's Address:	Microwave Instruments Division 1212 Valley House Drive Rohnert Park, CA 94928 USA
declares that the products	
Product Name:	Synthesized Generators
Model Number:	HP 83711A, HP 83711B, HP 83712A, HP 83712B, HP 83731B, HP 83732B
Product Options:	This declaration covers all options of the above product.
conforms to the following Product specifications:	
Safety: IEC 1010-1:1990 + Am 1:1992/EN 61010-1:1993 CAN/CSA-C22.2 No. 1010.1-1992	
EMC: CISPR 11:1990/EN 55011:1991 Group 1, Class A IEC 801-2:1984/EN 50082-1:1992 4 kV CD, 8 kV AD IEC 801-3:1984/EN 50082-1:1992 3 V/m, 27-500 MHz IEC 801-4:1988/EN 50082-1:1992 0.5 kV Sig. Lines, 1 kV Power Lines IEC 555-2:1982 + A1:1985 / EN 60555-2:1987 IEC 555-3:1982 + A1:1990 / EN 60555-3:1987 + A1:1991	
Supplementary Information:	
These products herewith comply with the requirements of the Low Voltage Directive 73/23/EEC and the EMC Directive 89/336/EEC and carry the CE-marking accordingly.	
Santa Rosa, California, USA	17 June 1997
	 John Hiatt/Quality Engineering Manager
European Contact: Your local Hewlett-Packard Sales and Service Office or Hewlett-Packard GmbH, Department ZQ/Standards Europe, Herrenberger Strasse 130, D-71034 Böblingen, Germany (FAX +49-7031-14-3143) 49-7031-14-3143)	

Notice for Germany: Noise Declaration
LpA < 70 dB
am Arbeitsplatz (operator position)
normaler Betrieb (normal position)
nach DIN 45635 T. 19 (per ISO 7779)

Legal and Regulatory Information







Index



Index

- 0 0.5 V/GHz OUT connector, 5-7

- 1 10 MHz IN connector, 5-7
10 MHz OUT connector, 5-7
1 Hz frequency resolution - option 1E8, 4-25

- 3 3.5 mm RF output connector - option 1E9, 4-25

- 4 488.1 compatibility codes, 5-11

- A AC-coupled FM, 7-21
AC FM annunciator, 5-3
AC FM signal
 generating, 3-6
AC PM COUPLING, 7-3
active parameter, 6-69
add high stability timebase - option 1E5, 4-25
add internal mod generator - option 1E2, 4-25
add output step attenuator - option 1E1, 4-25
address
 setting the HP-IB, 2-12
ADDRESS function, 6-11
advantages
 attenuator hold function, 7-10
 DC FM, 7-21
ALC IN connector, 5-7
ALC unleveled condition, 6-47
AM IN connector, 5-7
AM internal rate, 6-51
AM OUT, 5-7
AM sensitivity, 6-87
AM waveform, 7-5
annunciators, 5-3, 5-13
 AC FM, 5-3
 DC FM, 5-3
 DIODE (ALC), 5-4
 EXT (PULSE), 5-4
 EXT REF, 5-4
 fluorescent display, 5-13

INT (ALC), 5-4
INT (PULSE), 5-4
INVERT (PULSE), 5-3
LED, 5-13
LIN AM, 5-3
LOG AM, 5-3
LSN, 5-4
LVL CR, 5-4
MSG, 5-5
MTR (ALC), 5-4
MULT, 5-4
 ϕ M, 5-3
RMT, 5-4
SPCL, 5-4
SRQ, 5-5
TLK, 5-4
TRIG (PULSE), 5-4
UNLOCK, 5-5
UNLVL, 5-5
ANSI Standard MC1.1, 5-12
antenna scan patterns, 3-32
application
 attenuator hold function, 7-9
 average power inhibit function, 7-13
 erase memory function, 7-23
 select risetime, 7-43
arrow keys
 ↓ (down arrow), 6-9
 ← (left arrow), 6-5
 → (right arrow), 6-3
 ↑ (up arrow), 6-7
 modifying data with, 2-6
ATTEN HOLD ON/OFF, 7-9
attenuator hold function, 7-9
average power inhibit function, 7-12
AVG PWR INHIBIT ON/OFF, 7-12

B **BACK SPACE** key, 6-12
book introduction, vi

- C CLEAR DISPLAY, 7-19
 - coaxial connectors, 5-6-9
 - component-level information packet
 - option OBV, 4-29
 - option OBW, 4-29
 - option OBX, 4-29
 - connector care, 5-9
 - connectors, 5-6
 - coaxial, 5-6-9
 - damage levels, 5-6-9
 - front panel, 5-6
 - HP-IB, 5-10-12
 - impedances, 5-6-9
 - rear panel, 5-6
 - cursor
 - double, 6-3, 6-5
 - cursor, double, 2-3
 - CW signal, generating, 3-3

- D damage
 - electrical, 1-8
 - mechanical, 1-3, 1-8
- data
 - entering with numeric keypad, 2-3
 - modifying with arrow keys, 2-6
 - modifying with knob, 2-4
- data entry problems, 2-13-14
- DC-coupled FM, 7-21
- DC FM annunciator, 5-3
- DC FM COUPLING, 7-21
- declaration of conformity, 9-12
- default state
 - display, 6-17
- delay, 6-13
 - negative, 6-13
 - positive, 6-13
- delete operating documentation - option OB0, 4-29
- DIODE (ALC) annunciator, 5-4
- diode detector leveling
 - advantages, 6-21
 - applications, 6-21
 - disadvantages, 6-22
 - using, 3-46
- diode detector square law region, 6-21, 6-22
- disadvantages
 - attenuator hold function, 7-10
 - DC FM, 7-21
- display, 5-13

- default state, 6-17
- left-most, 5-14
- right-most, 5-14
- documentation options, 4-29
- double cursor, 6-3, 6-5
- DOUBLET function, 6-15
- doublet pulse, 3-24
- doublet pulse modulation timing, 6-15

E earth ground

- for safety, 1-5, 9-5
- electrical options, 4-25
- ENTER, 6-17
- ENTRY OFF, 2-13, 6-19
- ENTRY OFF key, 2-13
- ERASE MEMORY, 7-23
- erase memory function, 7-23
- error message
 - action required, 8-3
 - detailed description, 8-3
 - hardware failures, 8-4
 - manual error number, 8-3
 - SCPI error message, 8-3
 - SCPI error number, 8-3
- error message format, 8-3
- error messages list, 8-5-46
- error queue
 - reading, 2-10
- errors
 - permanent, 8-2
- EXT DIODE, 6-20
- externally triggered pulse modulation, 3-17
- external pulse modulation, 3-21
- EXT METER, 6-24
- EXT ON/OFF, 6-29
- EXT (PULSE) annunciator, 5-4
- extra operating documentation - option OB1, 4-29
- EXT REF annunciator, 5-4

F factory calibration data, 7-23

- failures
 - self test, 1-10
- fan
 - checking, 1-9
- FM
 - AC, 7-21
 - DC, 7-21
- FM internal deviation, 6-39

- FM internal rate, 6-51
- FM/ ϕ M IN connector, 5-8
- FM/ ϕ M ON/OFF, 6-30
- FM/ ϕ M OUT, 5-7
- FM sensitivity, 6-87
- FM signal
 - generating, 3-6
- FM signal, internal, 3-4
- FM waveform, 7-25
- FREQ, 6-32
- fuse
 - checking, 1-8

G gated, 6-34
gated pulse modulation, 3-28
generating a CW signal, 3-3

H HP-IB address

- setting, 2-12

HP-IB connector, 5-10-12
HP-IB extender instruments, 5-11
HP-IB interface capabilities, 5-11
HP-IB restrictions, 5-10

I IEEE Standard 488 (1978), 5-12
increment value, 2-6, 6-102
installing the synthesizer, 1-3
instrument state recall, 6-82
instrument state save, 6-84
INT (ALC) annunciator, 5-4
INT DEPTH, 6-37
INT DEV, 6-39
interface capabilities

- HP-IB, 5-11

internal leveling

- advantages, 6-48
- disadvantages, 6-48

internal linear AM, 3-36
internal power sweep

- generating, 3-9
- use for, 3-9

internal pulse modulation, 3-14
INT/EXT (AM), 6-44
INT/EXT (FM/ ϕ M), 6-44
In This Book, vi
INT LEVEL, 6-47
INT MOD OVERRANGE, 7-28

Index-6

- INT ON/OFF, 6-50
- INT (PULSE) annunciator, 5-4
- INT RATE, 6-51
- introduction
 - book, vi
- INVERT, 6-55
- INVERT (PULSE) annunciator, 5-3

K keypad

- numeric, 6-69
- knob, 5-16
 - modifying data with, 2-4
- knob resolution
 - decreasing, 2-4
 - increasing, 2-4

L left-most display, 5-14

- legal and regulatory information, 9-2
- level correct data
 - using previously stored, 3-58
- level correction register, 6-80, 6-85
- level correct routine, 6-60
 - using, 3-52
- leveling
 - using diode detector, 3-46
 - using power meter, 3-49
- LIN AM annunciator, 5-3
- linear AM signal, external, 3-37
- line voltage selector, 1-5
- LLO, 6-57
- LOCAL, 6-57
- LOCAL key, 2-13
- local lockout, 6-57
- log AM and pulse modulation
 - generating simultaneous, 3-32
- LOG AM annunciator, 5-3
- LOG/LIN ON/OFF, 6-58
- LSN annunciator, 5-4
- LVL CR, 6-60
- LVL CR annunciator, 5-4
- LVL CR ON/OFF, 6-64

- M** mechanical damage, 1-3
- mechanical options, 4-27
- millimeter signals
 - generating, 3-43
- modulation index, 7-21
- MSG, 6-66
- MSG annunciator, 1-10, 3-61, 5-5
- MTR (ALC) annunciator, 5-4
- MULT annunciator, 5-4
- multiplier, 6-67
- multiplier value, 6-67
- multiplier values for HP source modules, 3-44

- N** negative delay, 6-13
- number of points, 6-60
- numeric keypad, 6-69
 - entering data with, 2-3

- O** option 1CM - rack mount kit, 4-27
- option 1CP - rack mount and handle kit, 4-27
- option 1CR - rack slide kit, 4-27
- option 1E1 - add output step attenuator, 4-25
- option 1E2 - add internal mod generator, 4-25
- option 1E5 - add high stability timebase, 4-25
- option 1E8 - 1 Hz frequency resolution, 4-25
- option 1E9 - 3.5 mm RF output connector, 4-25, 5-9
- option 800 - phase modulation, 4-26
- option OB0 - delete operating documentation, 4-29
- option OB1 - extra operating documentation, 4-29
- option OBV - component-level information packet, 4-29
- option OBW - service documentation, 4-29
- option OBX - component-level information packet/service documentation, 4-29
- options, 4-2
 - documentation, 4-29
 - electrical, 4-25
 - mechanical, 4-27
 - warranty, 4-28
- option W30 - two years return-to-HP service, 4-28
- option W32 - three year return-to-HP calibration service, 4-28

P parameter

- active, 6-69
- unitless, 6-17
- permanent errors, 8-2
- phase mod signal, external, 3-40
- phase modulated signal, internal, 3-39
- phase modulation - option 800, 4-26
- ϕ M annunciator, 5-3
- ϕ M internal deviation, 6-39
- ϕ M internal rate, 6-51
- ϕ M sensitivity, 6-87
- PM RANGE, 7-31
- PM WAVEFORM, 7-34
- points
 - number of, 6-60
- positive delay, 6-13
- power cable configurations, 5-19
- power cables, 5-19
- power level, 6-70
- power meter address function, 7-37
- power meter leveling
 - advantages, 6-26
 - applications, 6-26
 - disadvantages, 6-26
 - equipment limitations, 6-26
 - using, 3-49
- power meter select function, 7-39
- power sweep
 - generating, 3-11
 - use for, 3-11
- POWER switch, 5-18
- power-up problems, 1-8-10
- PRESET, 6-72
- preset conditions
 - instrument, 6-72
- PRF, 6-75
- PRI, 6-78
- problems
 - data entry, 2-13-14
 - power-up, 1-8-10
 - programming, 2-14
 - RF output, 3-62
- programming problems, 2-14
- pulsed power pre-calibration program, 7-14
- pulse modulation
 - doublet, 6-15
 - gated, 6-34
 - generating doublet, 3-24
 - generating externally triggered, 3-17

- generating gated, 3-28
- generating repetitive, external, 3-21
- generating repetitive, internal, 3-14
- internal triggered, 6-104
- inverted external, 6-55
- pulse modulation and log AM
 - generating simultaneous, 3-32
- PULSE SYNC OUT connector, 5-9
- PULSE/TRIG, GATE IN connector, 5-8
- PULSE VIDEO OUT connector, 5-9
- PWR MTR ADDR5, 7-37
- PWR MTR SELECT, 7-39

R rack mount and handle kit - option 1CP, 4-27

- rack mount kit - option 1CM, 4-27
- rack slide kit - option 1CR, 4-27
- RCL CR, 6-80
- reading the error queue, 2-10
- RECALL, 6-82
- recalling synthesizer states, 2-8
- remote language, 7-41
- restrictions
 - HP-IB, 5-10
- RF ON/OFF, 6-83
- RF OUTPUT connector, 5-9
- RF output problems, 3-62
- right-most display, 5-14
- RMT annunciator, 2-13, 5-4

S sales and service office table, 9-10

- SAVE, 6-84
- SAVE CR, 6-85
- saving synthesizer states, 2-8
- scan patterns
 - antenna, 3-32
- SELECT RISETIME, 7-42
- select risetime function, 7-42
- self test
 - running, 1-7
- SELF TEST, 7-45
- self test failures, 1-10
- self-test function, 7-45
- SENSITIVITY, 6-87
- serial number, 7-48
- service documentation
 - option OBW, 4-29
- service-related special functions, 7-47
- SHIFT, 6-95

Index-10

- SHOW INFO, 7-48
- show information function, 7-48
- software version number, 7-48
- source modules
 - multiplier values for, 3-44
- SPCL, 6-96
- SPCL annunciator, 5-4
- SPCL OFF, 6-98
- SPCL ON, 6-100
- special functions, 6-96, 7-2
 - service-related, 7-47
- specifications, 4-2, 4-3
- square law region
 - diode detector, 6-21, 6-22
- SRQ annunciator, 5-5
- standby, 5-18
- start frequency, 6-60
- STEP SIZE, 6-102
- STEP SIZE key, 2-7
- stop frequency, 6-60
- supplemental characteristics, 4-3
- synthesizer
 - installing, 1-3
 - synthesizer at a glance, iv
 - synthesizer states
 - saving and recalling, 2-8

T terminator keys, 2-3

- three year return-to-HP calibration service - option W32, 4-28
- timing
 - doublet pulse modulation, 6-15
 - gated pulse modulation, 6-35
 - triggered pulse modulation, 6-104
- TLK annunciator, 5-4
- to generate a doublet pulse, 3-24
- to generate an external LIN AM signal, 3-37
- to generate an externally modulated AC FM signal, 3-6
- to generate an external phase mod signal, 3-40
- to generate an internal FM signal, 3-4
- to generate an internal linear AM signal, 3-36
- to generate an internal phase mod signal, 3-39
- to generate a power sweep using an external function generator, 3-11
- to generate a power sweep using the internal function generator, 3-9
- to generate externally triggered pulse modulation, 3-17
- to generate gated pulse modulation, 3-28
- to generate millimeter signals, 3-43
- to generate repetitive, external pulse modulation, 3-21
- to generate repetitive, internal pulse modulation, 3-14

to generate simultaneous log AM and pulse modulation, 3-32
to use external power meter leveling, 3-49
to use external diode detector leveling, 3-46
to use previously stored level correct data, 3-58
to use the level correct routine, 3-52
triggered pulse modulation timing, 6-104
TRIG ON/OFF, 6-104
TRIG (PULSE) annunciator, 5-4
turn-on sequence, 1-6
two years return-to-HP service - option W30, 4-28

U unitless parameters, 6-17
units terminator keys, 2-3
unleveled condition
 ALC, 6-47
UNLOCK annunciator, 5-5
UNLVL annunciator, 5-5

V verification procedure, 1-7

W warranty options, 4-28
WIDTH, 6-106