

---

# User's Quick Start Guide

Publication number 54846-97001  
November 2001

For Safety information, Warranties, and Regulatory information, see the pages at the end of this manual.

© Copyright Agilent Technologies 2001  
All Rights Reserved

---

## Infiniium Oscilloscopes

---

## In This Book

This book gives you the information you need to begin using the Infiniium Oscilloscopes. It contains four chapters:

**Setting up the Oscilloscope** Chapter 1 contains inspection, power requirements, air flow, and setup information.

**Working in Comfort** Chapter 2 contains recommendations for working comfortably and safely while operating the Infiniium Oscilloscope.

**Using the Oscilloscope** Chapter 3 gives an overview of the front panel and the graphical user interface, and tells you how to perform basic operations with the oscilloscope.

**Using the Built-In Information System** Chapter 4 describes the built-in information system contents and navigation. The built-in information system contains all of the information that is generally found in a User's Guide.

- For detailed information on how the oscilloscope makes measurements and how to use the oscilloscope, see the built-in information system in the oscilloscope.
- For information on programming the oscilloscope using a computer with a GPIB interface card, see the *Infiniium Oscilloscopes Programmer's Reference*.
- For information on testing and servicing the oscilloscope, see either the *Infiniium Service Guide for Models 54845B/46B Oscilloscopes*.

---

### CAUTION

The Infiniium Oscilloscope uses a specially designed Windows 98 application program. While it is possible to access some standard Windows 98 application programs, it is not recommended. All Infiniium Oscilloscope functionality is directly available from within the Infiniium Oscilloscope application. Other application software may or may not function correctly. Windows 98 configuration changes made outside of the Infiniium Oscilloscope application may not work correctly and could cause improper operation of the instrument.

---

---

# Contents

## 1 Setting Up the Oscilloscope

- To inspect package contents 1-3
- To inspect options and accessories 1-5
- To connect power 1-9
- To connect the mouse or other pointing device 1-11
- To connect the keyboard 1-13
- To connect to the LAN card 1-14
-  To connect oscilloscope probes 1-15
- To connect a printer 1-18
- To connect an external monitor 1-21
- To connect a GPIB cable 1-22
- To tilt the oscilloscope upward for easier viewing 1-23
- To turn on the oscilloscope 1-24
- To turn off the oscilloscope 1-25
- To verify basic oscilloscope operation 1-26
- To clean the oscilloscope 1-28

## 2 Working in Comfort

- About Repetitive Strain Injury 2-3
- Mice and Other Input Devices 2-4

## 3 Using the Oscilloscope

- To set the oscilloscope to a known starting condition 3-7
- To start and stop waveform acquisition 3-8
- To clear the waveform display 3-9
- To turn a channel on or off 3-10
- To change input impedance and input coupling 3-11
- To adjust vertical scale and offset 3-12
- To adjust sweep speed and horizontal position 3-13
- To magnify a part of the waveform using delayed sweep 3-14
- To set the oscilloscope to trigger on an edge 3-15
- To use the markers 3-16
- To use the quick measurements 3-17
- To reinitialize the oscilloscope 3-18
- To switch between the graphical interface and full-screen mode 3-30
- To perform basic user interface operations 3-31
- To select a command from the menu bar 3-33
- To select a command from a context-sensitive menu 3-34
- To change the mouse settings 3-36
- To start and stop waveform acquisition 3-37
- To clear the waveform display 3-38
- To print the screen 3-39

## Contents

- To turn a channel on or off 3-40
- To adjust the vertical offset 3-41
- To adjust vertical scaling 3-43
- To access the channel setup 3-44
- To set the horizontal reference point 3-45
- To adjust sweep speed 3-46
- To adjust horizontal position 3-47
- To access the horizontal setup 3-48
- To zoom on a section of the waveform 3-49
- To move the markers using the graphical interface 3-51
- To make a measurement on a waveform 3-52
- To access the trigger setup 3-54
- To set an edge trigger 3-55
- To enable 8.0 GSa/s sampling mode 3-56
- To set dialog box preferences 3-57
- To install the printer software 3-60
- To set up the network 3-68
- To recover your Infiniium hard disk 3-69

## 4 Using the Built-In Information System

- To access the information system 4-4
- To select the built-in information system language 4-10
- To navigate through the information system 4-11
- To access context-sensitive information 4-12

---

## Setting Up the Oscilloscope

---

# Setting Up the Oscilloscope

This chapter shows you how to set up your Infiniium oscilloscope, connect power and accessories, and verify general operation.

## To inspect package contents

❑ Inspect the shipping container for damage.

Keep a damaged shipping container or cushioning material until you have inspected the contents of the shipment for completeness and have checked the oscilloscope mechanically and electrically.

❑ Verify that you received the following items in the Infiniium Oscilloscope packaging.

- Infiniium Oscilloscope (54845B or 54846B)
- USB Optical Mouse
- (4) 1161A 10:1 10-M $\Omega$  passive probes (54845B)
- Accessory Pouch (P/N 54810-68701)
- Front Panel Cover
- Keyboard
- Power cord
- *User's Quick Start Guide*
- *Programmer's Reference*
- *Programmer's Quick Reference Guide*
- *Infiniium Service Guide for Models 54845B/46B Oscilloscope*

See figure 1-1. (See table 1-3 for the power cord.) If anything is missing, contact your nearest Agilent Technologies Sales Office. If the shipment was damaged, contact the carrier, then contact the nearest Agilent Technologies Sales Office.

❑ Inspect the oscilloscope.

- If there is mechanical damage or a defect, or if the oscilloscope does not operate properly or does not pass performance tests, notify your Agilent Technologies Sales Office.
- If the shipping container is damaged, or the cushioning materials show signs of stress, notify the carrier and your Agilent Technologies Sales Office. Keep the shipping materials for the carrier's inspection. The Agilent Technologies Sales Office will arrange for repair or replacement at Agilent's option without waiting for claim settlement.

# Setting Up the Oscilloscope To inspect package contents

**Figure 1-1**

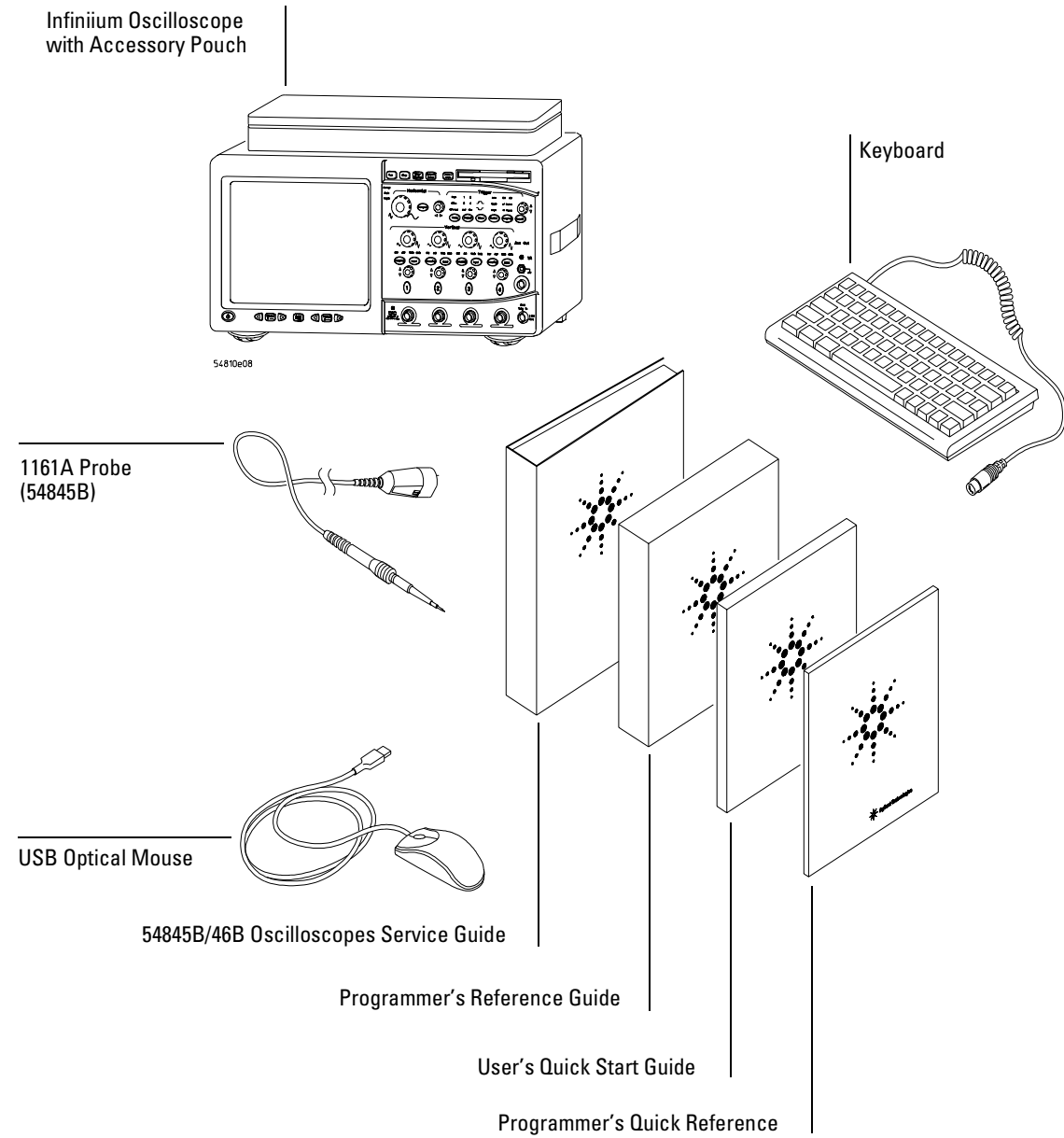

## Package Contents for the Infiniium Oscilloscopes



## To inspect options and accessories

- ❑ Verify that you received the options and accessories you ordered and that none were damaged.

If anything is missing, contact your nearest Agilent Technologies Sales Office. If the shipment was damaged, or the cushioning materials show signs of stress, contact the carrier and your Agilent Technologies Sales Office.

Some of the options available for the Infiniium Oscilloscopes are listed in table 1-1. Contact your Agilent Technologies Sales Office for a complete list of options, or look in the built-in information system under the *Accessories List*.

**Table 1-1**

<b>Infiniium Oscilloscope Options</b>	
<b>Option</b>	<b>Description</b>
001	Add 2 1161A probes
002	Add 1 1162A 1:1 passive probe
003	Add 1 1163A 10:1 500 $\Omega$ , low-C passive probe
004	Add 4 1161A probes for the 54846B only
007	Add 1 wedge kit (E2613A)
008	Add 1 1153A 200 MHz differential probe
009	Add 1 1154A 500 MHz differential probe
010	Add 1 1159A 1 GHz differential probe
011	Add 1 1155A 750 MHz 2-channel, low-mass active probe
012	Add 1 1156A 1.5 GHz active probe
013	Add 1 1157A 2.5 GHz active probe
014	Add 1 1158A 4 GHz active probe
100	Telecommunications Mask Template Kit
016	EZ-Probe <sup>®</sup> Positioner
200	VoiceControl
1CM	Add 1 Rackmount kit (E2609A)
A6J	ANSI Z-540 compliant calibration
AB0	Taiwan <i>User's Quick Start Guide</i>
AB1	Korea <i>User's Quick Start Guide</i>
AB2	PRC <i>User's Quick Start Guide</i>

Setting Up the Oscilloscope  
**To inspect options and accessories**

<b>Option</b>	<b>Description</b>
ABD	German <i>User's Quick Start Guide</i>
ABE	Spanish <i>User's Quick Start Guide</i>
ABF	French <i>User's Quick Start Guide</i>
ABJ	Japanese <i>User's Quick Start Guide</i>
ABZ	Italian <i>User's Quick Start Guide</i>
B30	USB Test Option (E2645A)
UL5	Add 1 Touchpad pointing device (E2612A)
UL9	Add 1 Cordless trackball pointing device (E2647A)
ULA	Add 1 Cordless keyboard and mouse pointing device (E2648A)
W32	3 years calibration service
W34	3 years return standards comp calibration service
W50	5 years return repair service (additional 2 years)
W52	5 years return calibration service
W54	5 years return standards comp cal service

You can order multiple options with the oscilloscope. Also, all model numbers shown in table 1-1 may also be ordered separately, using the model number. Some accessories that will enhance your work with the oscilloscope are listed in table 1-2.

**Table 1-2**

<b>Accessories for the Infiniium Oscilloscopes</b>	
<b>Agilent Model Number</b>	<b>Description</b>
01144-61604	1:2 Probe Power Fan-Out (for use with 1144A and 1145A)
10020A	Resistive Divider Probe Kit
10024A	16-pin IC clip
10076A	4 kV Passive Probe
10211A	24-pin IC clip
10240B	BNC Blocking Capacitor
10450A	SMT Probe Accessory Kit
10833A	GPIB cable, 1 m
10833B	GPIB cable, 2 m
10833C	GPIB cable, 4 m

<b>Agilent Model Number</b>	<b>Description</b>
10833D	GPIB cable, 0.5 m
11094B	75 $\Omega$ Feedthrough Termination
1142A	Probe control and power module
1182A	Testmobile
1250-2427	PC Board Mini-Probe Socket (horizontal mount)
1250-2428	PC Board Mini-Probe Socket (vertical mount)
34398A	RS-232-C printer cable
34399A	RS-232-C Adapter kit
54006A	6 GHz probe, 10:1 (500 $\Omega$ ) or 20:1 (1 k $\Omega$ ), .25 pf
54701A	2.5 GHz probe, 10:1, 100 k $\Omega$ , 0.6 pf Active Probe (need 1143A probe power)
C2950A	Parallel printer cable, 2 m
C2951A	Parallel printer cable, 3 m
1144A	800 MHz Active Probe Requires 1142A power supply—1144-61604 probe power extender also required when using more than two 1144A active probes
1145A	2-channel, 750 MHz SMT active probe requires 1142A power supply
1146A	AC/DC Current Probe
1153A	200 MHz Differential Probe
1154A	500 MHz Differential Probe
1155A	750 MHz 2-Channel, Low-Mass Active Probe
1156A	1.5 GHz Active Probe
1157A	2.5 GHz Active Probe
1158A	4 GHz Active Probe
1159A	1 GHz Differential Probe
1170A	500 MHz Low-Mass, Miniature 10:1 10 M $\Omega$ Passive Probe
1171A	500 MHz Low-Mass, Miniature 10:1 10 M $\Omega$ Passive Probe
1172A	500 MHz Low-Mass, Miniature 20:1 10 M $\Omega$ Passive Probe
1173A	500 MHz Low-Mass, Miniature 20:1 10 M $\Omega$ Passive Probe
1250-1454	BNC to Miniature Probe Adapter
E2621A	75 $\Omega$ terminator
E2622A	100/110/120 $\Omega$ differential terminator
E2625A	Telecommunications Mask Template Kit

Setting Up the Oscilloscope  
**To inspect options and accessories**

<b>Agilent Model Number</b>	<b>Description</b>
E2635A	VoiceControl Retrofit Kit
E2645A	USB Test Option

---

## To connect power

- 1 Position the oscilloscope where it will have sufficient clearance for airflow around the top, back, and sides.

**Figure 1-2**

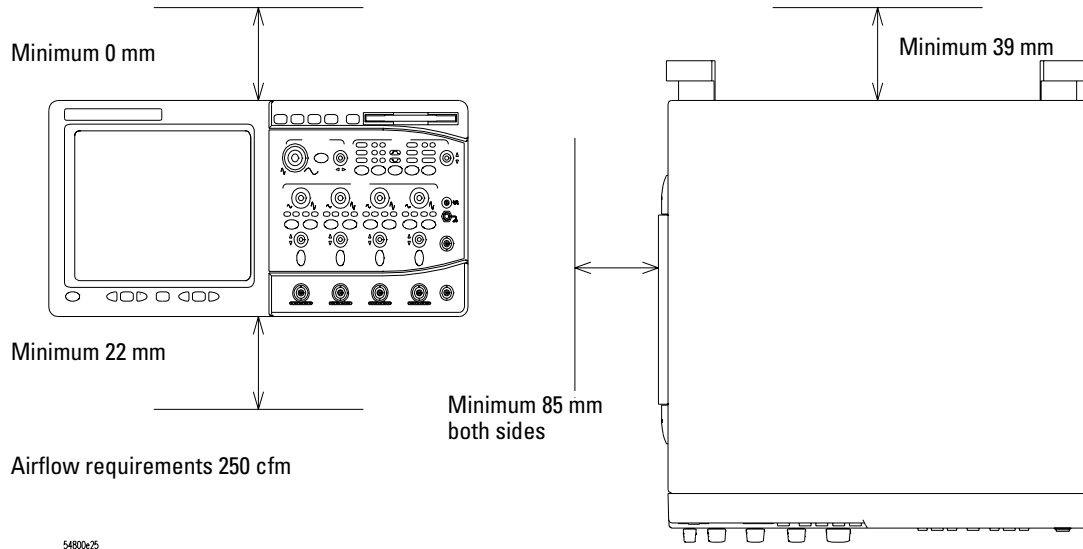

**Positioning the Infiniium Oscilloscope with Sufficient Clearance**

Setting Up the Oscilloscope  
**To connect power**

- 2 Connect the power cord to the rear of the oscilloscope, then to a suitable ac voltage source (100-240 VAC  $\pm$ 10%, 47 to 440 Hz, max power dissipation 306 W).

**Figure 1-3**

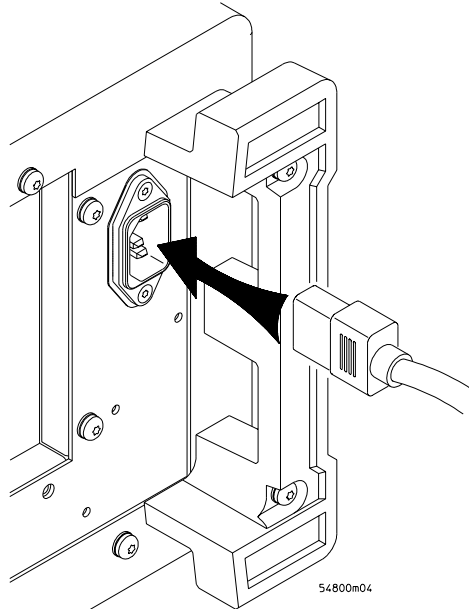







**Infiniium Oscilloscope Power Cord Connection**

The oscilloscope power supply automatically adjusts for line input voltages in the range 100 to 240 VAC. Therefore, you do not need to adjust an input line voltage setting. The line cord provided is matched by Agilent Technologies to the country of origin of the order.

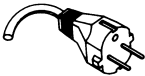
- 3 Ensure that you have the correct line cord. See table 1-3.

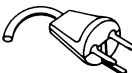
Table 1-3

Power Cords						
	Plug Type	Cable Part No.	Plug Description	Length (in/cm)	Color	Country
250V		8120-1351	Straight *BS1363A	90/228	Gray	United Kingdom, Cyprus, Nigeria, Zimbabwe, Singapore
		8120-1703	90°	90/228	Mint Gray	
250V		8120-1369	Straight *NZSS198/ASC	79/200	Gray	Australia, New Zealand
		8120-0696	90°	87/221	Mint Gray	
250V		8120-1689	Straight *CEE7-Y11	79/200	Mint Gray	East and West Europe, Saudi Arabia, So. Africa, India (unpolarized in many nations)
		8120-1692	90°	79/200	Mint Gray	
		8120-2857	Straight (Shielded)	79/200	Coco Brown	
125V		8120-1378	Straight *NEMA5-15P	90/228	Jade Gray	United States, Canada, Mexico, Philippines, Taiwan
		8120-1521	90°	90/228	Jade Gray	
		8120-1992	Straight (Medical) UL544	96/244	Black	
250V		8120-2104	Straight *SEV1011	79/200	Mint Gray	Switzerland
		8120-2296	1959-24507	79/200	Mint Gray	
220V		8120-2956	Straight *DHCK107	79/200	Mint Gray	Denmark
		8120-2957	90°	79/200	Mint Gray	
250V		8120-4211	Straight SABS164	79/200	Jade Gray	Republic of South Africa India
		8120-4600	90°	79/200	Jade Gray	
100V		8120-4753	Straight MITI	90/230	Dark Gray	Japan
		8120-4754	90°	90/230	Dark Gray	

\* Part number shown for plug is the industry identifier for the plug only. Number shown for cable is the Agilent part number for the complete cable including the plug.

To connect the mouse or other pointing device

Setting Up the Oscilloscope  
**To connect the mouse or other pointing device**

- 1 Plug the mouse into the matching connector on the back panel of the oscilloscope.

**Figure 1-4**

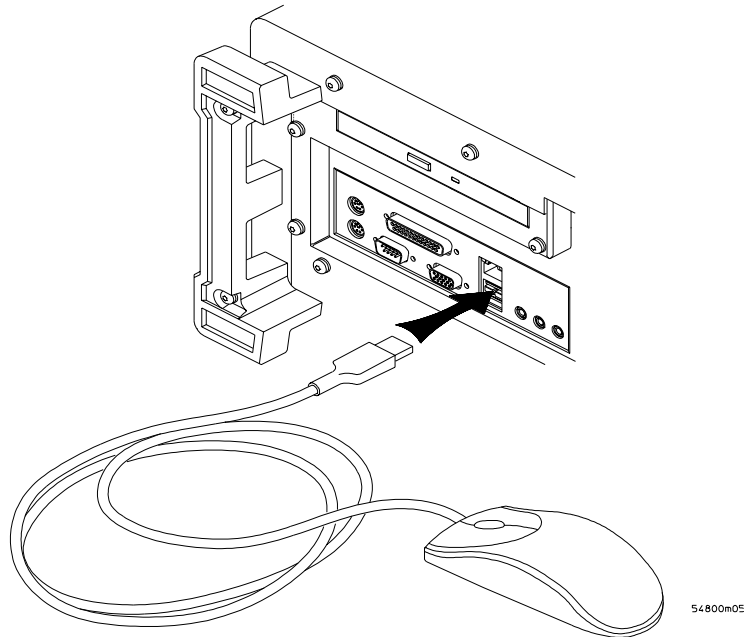

**Connecting the Mouse Cable**

While you can operate many oscilloscope functions using only the front-panel keys and knobs, you will need the mouse to access advanced oscilloscope functions through the graphical interface, or to find out more about the oscilloscope through the built-in information system.

The optional touchpad pointing device connects in exactly the same way as the mouse. The supplied mousepad provides the correct surface for smooth mouse operation.

- 2 To modify the mouse configuration, see “To change the mouse settings” in Chapter 3.



---

## To connect the keyboard

- 1 Plug the keyboard cable into the matching connector on the back panel of the oscilloscope.

Figure 1-5

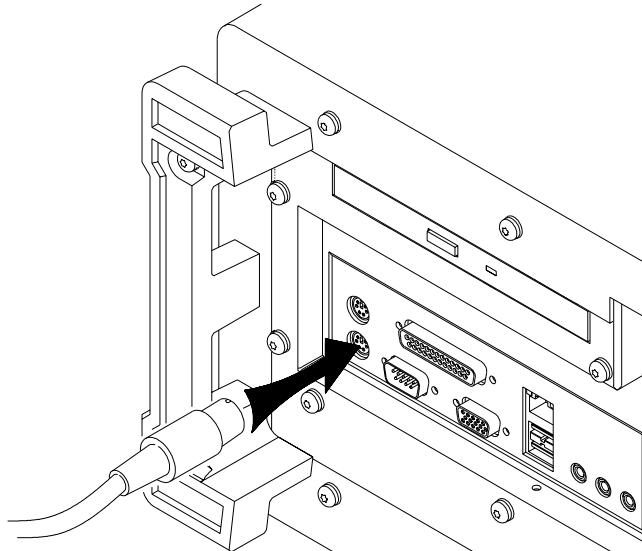

54800m06

### Connecting the Keyboard

The keyboard simplifies some oscilloscope tasks, such as entering file names when you store waveforms and setups to the disk.

- 2 If you need more desk space, place the keyboard on top of the oscilloscope. Do not stack other objects on the keyboard; this will cause self-test failures on power on.

## To connect to the LAN card

- 1 Connect your LAN cable to the RJ-45 connector on the LAN card. Make sure the connection is secure.

Figure 1-6

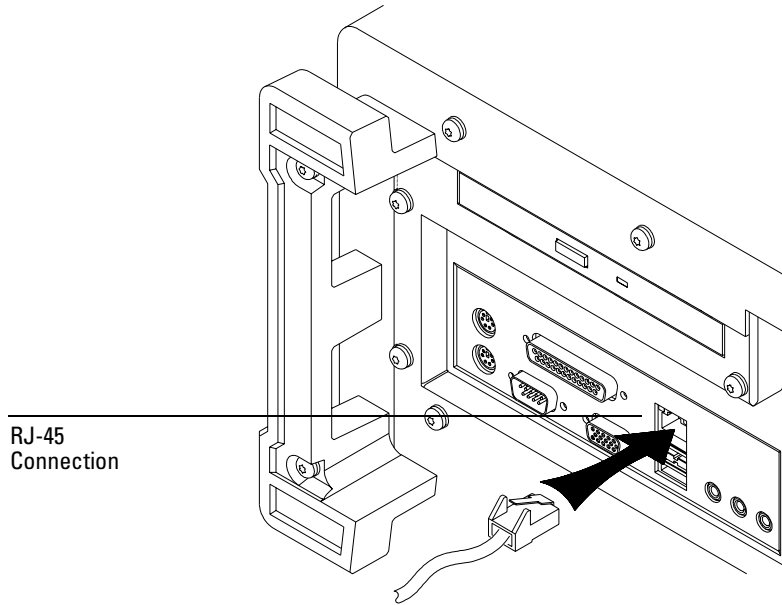

54800m07

### Connecting to the LAN Card

- 2 After you have connected to the LAN card, you must set up the network. Go to “To set up the network” in chapter 3.

---

## To connect oscilloscope probes

- 1 Attach the probe connector to the desired oscilloscope channel or trigger input. Push it straight on until it latches into place.

Figure 1-7

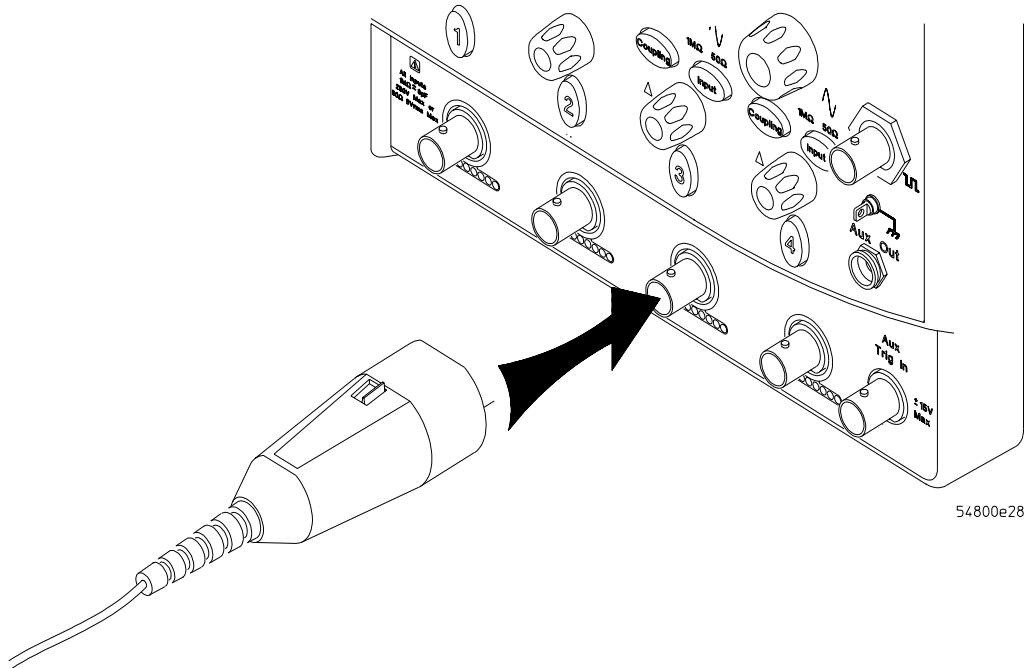

Attaching the Probe Connector

Setting Up the Oscilloscope  
**To connect oscilloscope probes**

- 2 Connect the probe to the circuit of interest using grabbers or other probing aids.

**Figure 1-8**

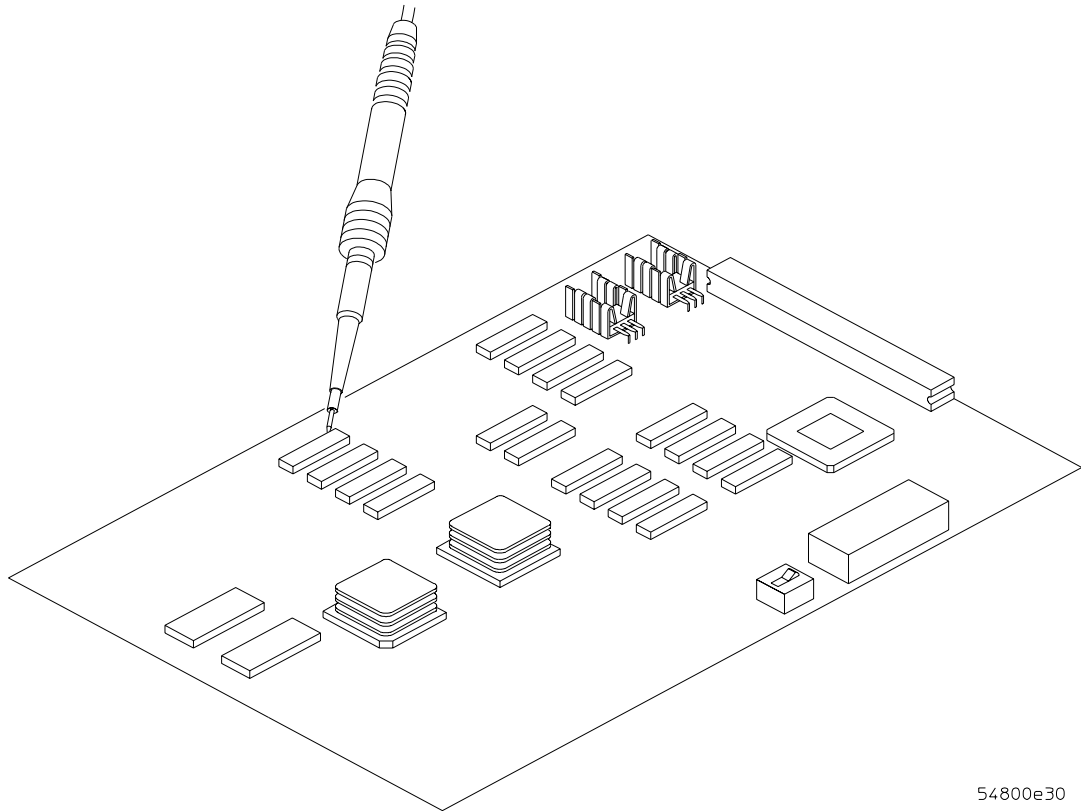

54800e30

**Probing the Circuit**

- 3 To disconnect the probe, push the small latch on top of the probe connector to the left, then pull the connector body away from the front panel of the oscilloscope without twisting it.

Figure 1-9

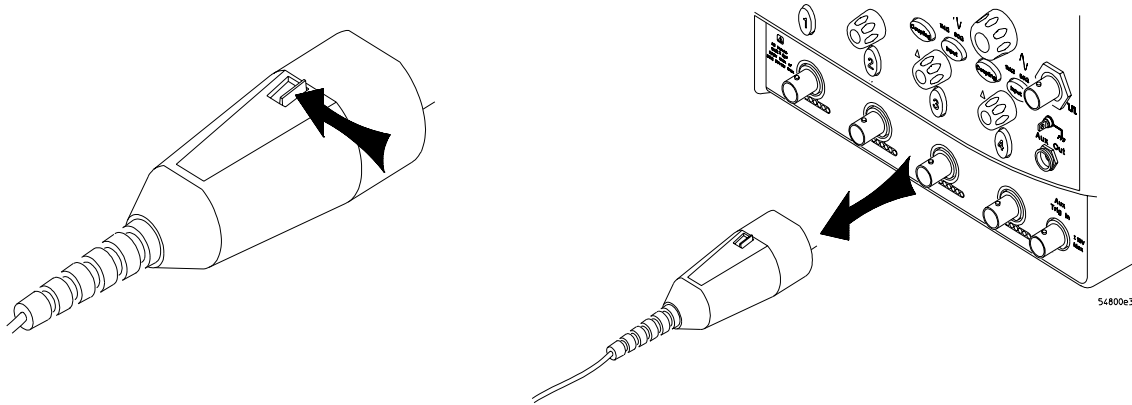

#### Disconnecting the Oscilloscope Probe

---

**CAUTION**

---

Do not attempt to twist the snap-on probes on or off the oscilloscope's BNC connector. Twisting the probe connector body will damage it.

---

**CAUTION**

---



Do not exceed the maximum input voltage rating. The maximum input voltage for 50  $\Omega$  inputs is 5 Vrms, CAT I. Maximum voltage at 1 M $\Omega$  impedance is  $\pm 100$  V (dc + ac) [ac < 10 kHz], CAT I.

## To connect a printer

If you have a parallel (Centronics) printer, you will need a parallel printer cable, such as an C2950A (2 m) or C2951A (3 m) cable. Go to step 1.

If you have a serial printer, you will need a 9-pin to 25-pin serial printer cable, such as an 34398A cable, plus the 34399A adapter kit. Some printers may require other cable configurations, but the oscilloscope has a 9-pin serial connector. Go to step 5.

- 1** Attach the 25-pin small “D” connector to the printer output connector on the rear of the oscilloscope. Tighten the thumbscrews to secure the cable.

Figure 1-10

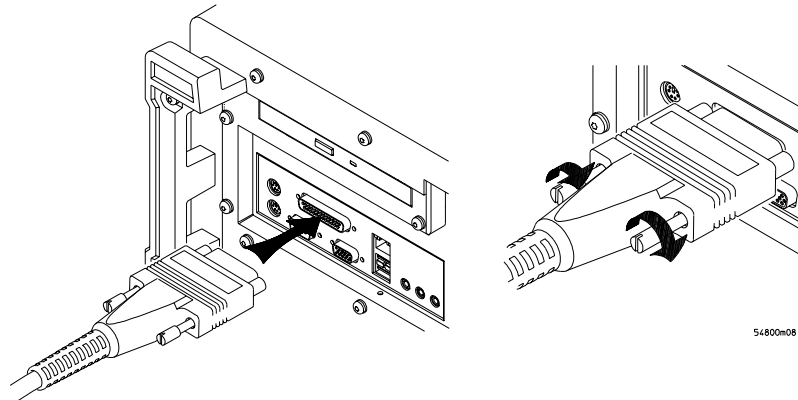

### Attaching the Small “D” Connector

- 2** Attach the larger 36-pin “D” connector to the printer. Latch the wire bails into the tabs on each side of the connector.

Figure 1-11

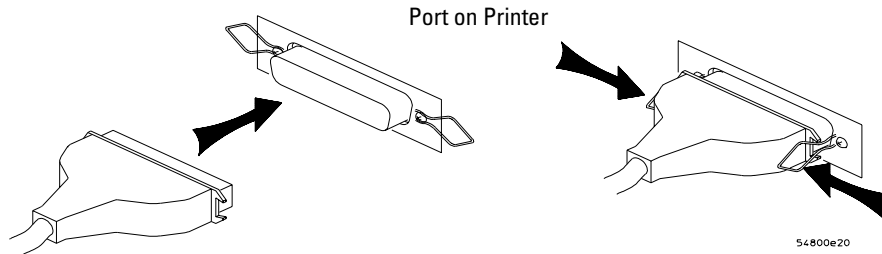

**Attaching the Larger "D" Connector**

- 3 Set the printer configuration to use the "Centronics" or "Parallel" interface, if necessary. See the documentation for your printer.
- 4 Go to "To install the printer software" in Chapter 3.
- 5 Connect the 9-pin "D" connector of the serial printer cable to the serial output port on the rear panel of the oscilloscope. Tighten the thumbscrews to secure the cable.

Figure 1-12

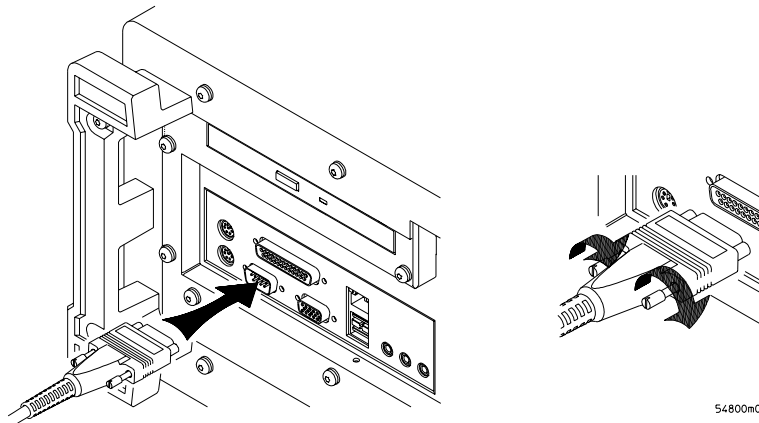

**Attaching the 9-pin "D" Connector**

- 6 Attach the 25-pin “D” connector to the serial input port of the printer. Tighten the thumbscrews to secure the cable.

**Figure 1-13**

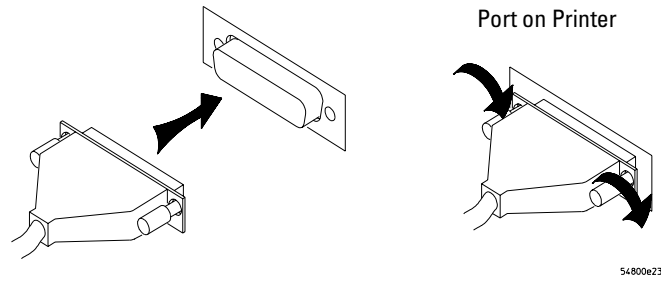

**Attaching the 25-pin “D” Connector**

- 7 Set the printer configuration to use the serial interface. See the documentation for your printer.
- 8 Go to “To install the printer software” in Chapter 3.



---

## To connect an external monitor

You can connect a VGA-compatible monitor to the Infiniium oscilloscope to provide a larger viewing area.

- 1 Connect the monitor cable to the display board video connector at the rear panel of the oscilloscope.
- 2 Tighten the retaining screws.

Figure 1-14

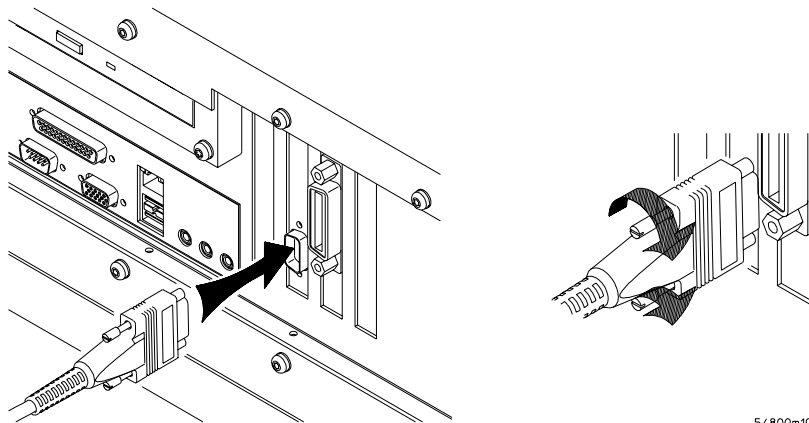

54800m1C

Connecting an External Monitor

## To connect an GPIB cable

- 1 Attach the GPIB connector to the GPIB interface card connector at the rear of the oscilloscope.
- 2 Tighten the thumbscrews on the connector.

Figure 1-15

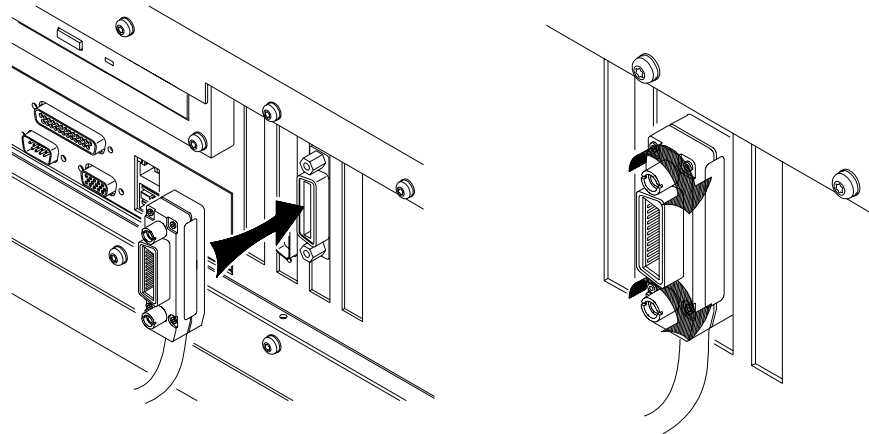

54800m11

Attaching the GPIB Connector

---

## To tilt the oscilloscope upward for easier viewing

- 1 Lift up the front of the oscilloscope, grasp the wire bail near the center, and pull it down and forward until it latches into place.

**Figure 1-16**

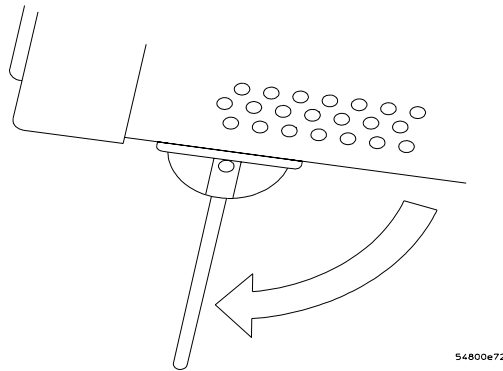

**Latching the Oscilloscope Front Feet**

## To turn on the oscilloscope

- 1 Depress the power switch in the lower left-hand corner of the oscilloscope front panel.

Figure 1-17

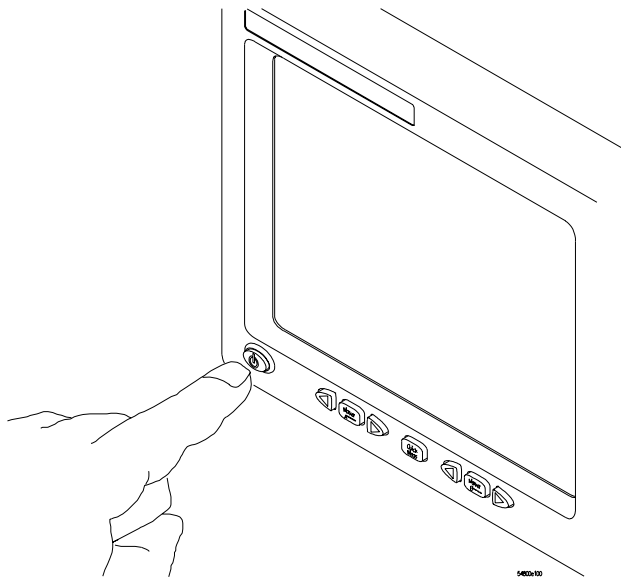

### Turning on the Oscilloscope

After a short initialization period, the oscilloscope display appears. The oscilloscope is ready to use.

- 2 Hook up all cables and accessories before applying power. You can connect and disconnect probes and the keyboard while the oscilloscope is turned on.

#### Screen Saver

The oscilloscope display has a screen saver that turns off the backlight when there has been no front panel or graphical interface activity for a pre-determined period. The default time is 8 hours and is configurable through the Display Setup dialog in the graphical interface. You can turn the display on by moving the mouse, typing on the optional keyboard, pressing a front panel key, or turning a front panel knob.

---

## To turn off the oscilloscope

- 1 Depress the power switch at the lower left-hand corner of the oscilloscope front panel.

Even though the Infiniium oscilloscope is based on the Windows 98 operating system, shutting down the oscilloscope without going through the normal Windows 98 shutdown process is perfectly safe. The Infiniium oscilloscope software was designed making sure not to do anything which requires going through a normal shutdown.

---

## To verify basic oscilloscope operation

- 1 Connect an oscilloscope probe to channel 1.
- 2 Attach the probe to the calibration output on the front panel of the oscilloscope.

Use a probe grabber tip so you do not need to hold the probe. The calibration output is marked with a square wave symbol.

Figure 1-18

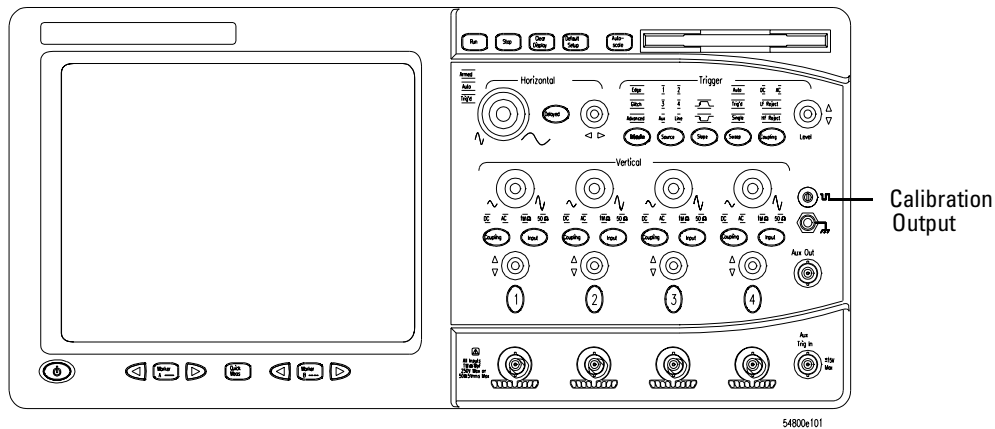

### Verifying Basic Oscilloscope Operation

- 3 Press the Default Setup key on the front panel.  
The display will pause momentarily while the oscilloscope is configured to its default settings.
- 4 Press the Autoscale key on the front panel.  
The display will pause momentarily while the oscilloscope adjusts the sweep speed and vertical scale. You should then see a square wave with peak-to-peak amplitude of approximately 5 divisions and a period of almost 3 divisions. If you do not see the waveform, ensure your power source is adequate, the oscilloscope is properly powered-on, and the probe is connected securely to the front-panel channel input BNC and to the probe calibration output.

- 5 Move the mouse pointer to the graphical interface enable button and click once using the left mouse button.

The graphical interface enable button is in the upper-right corner of the display.

- 6 Move the mouse around the mouse pad and verify that the pointer follows on the screen.

If the pointer does not move, ensure that the mouse is properly connected, that you have clicked the correct button to enable the graphical interface, and that the mouse is on a medium-friction surface such as the mouse pad supplied with the oscilloscope.

Figure 1-19

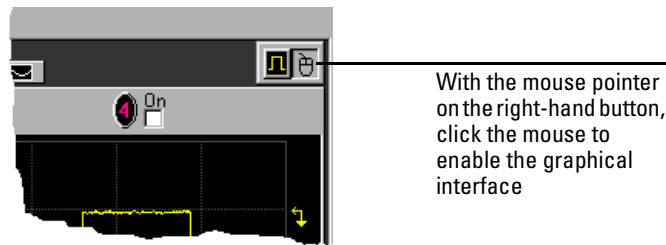

Graphical Interface Enable Button

---

### To clean the oscilloscope

- Clean the oscilloscope with a soft cloth dampened with a mild soap and water solution.

---

**CAUTION**

---

Do not use too much liquid in cleaning the oscilloscope. Water can enter the Infiniium front panel, damaging sensitive electronic components.



---

## Working in Comfort

---

## Introduction

To optimize your comfort and productivity, it is important that you set up your work area correctly and use your Infiniium oscilloscope properly. With that in mind, we have developed some set-up and use recommendations for you to follow based on established ergonomic principles.

Improper and prolonged use of keyboards and input devices are among those tasks that have been associated with repetitive strain injury (RSI) to soft tissues in the hands and arms. If you experience discomfort or pain while using the oscilloscope, discontinue use immediately and consult your physician as soon as possible. For more information on RSI you may wish to consult the *About Repetitive Strain Injury* section.

Please study the recommendations offered here in this chapter. Included there are references to relevant parts of international standards, regulations and guidelines, such as ISO 9241 and the European Community Display Screen Equipment directive. You may also wish to consult your employer's human resources department or other relevant departments for guidance specific to your company.

## About Repetitive Strain Injury

Because your comfort and safety are our primary concern, we strongly recommend that you use the Infiniium oscilloscope in accordance with established ergonomic principles and recommendations. Scientific literature suggests that there may be a relationship between injury to soft tissues—especially in the hands and arms—and prolonged improper use of keyboards or other equipment requiring repeated motions of the hands and forearms. This literature also suggests that there are many other risk factors that may increase the chance of such injury, commonly called Repetitive Strain Injury.

### **What is RSI?**

Repetitive Strain Injury (RSI—also known as cumulative trauma disorder or repetitive motion injury) is a type of injury where soft tissues in the body, such as muscles, nerves, or tendons, become irritated or inflamed. RSI has been a reported problem for those who perform repetitive tasks such as assembly line work, meatpacking, sewing, playing musical instruments, and computer work. RSI also has been observed in those who frequently engage in activities such as carpentry, knitting, housework, gardening, tennis, windsurfing and lifting children.

### **What causes RSI?**

The specific causes of RSI have not been established. Nevertheless, the incidence of RSI has been associated with a variety of risk factors, including:

- Too many uninterrupted repetitions of an activity or motion.
- Performing an activity in an awkward or unnatural posture.
- Maintaining static posture for prolonged periods.
- Failing to take frequent short breaks.
- Other environmental and psychosocial factors.

In addition, there have been reports associating the occurrence of RSI with the use of keyboards, mice, and other input devices. Also, certain medical conditions, such as rheumatoid arthritis, obesity and diabetes, may predispose some people to this type of injury.

### **What if I experience discomfort?**

If you are experiencing any discomfort, seek professional medical advice immediately. Typically, the earlier a problem is diagnosed and treated, the easier it is to resolve.

## Mice and Other Input Devices

Various aspects of using mice and other input devices may increase your risk of discomfort or injury. Observing the following recommendations may reduce that risk.

- Try to keep your hand, wrist, and forearm in a neutral position while using your mouse or other input device.
- If you use your thumb to rotate the ball on a trackball or spaceball, keep it in a relaxed, natural shape, and maintain a neutral posture in your hand, wrist, and forearm.
- Hold the mouse gently by draping your fingers over it. Keep your hand relaxed and fingers loose. Do not grip the mouse tightly.
- It takes very little pressure or force from your fingers to activate the buttons or scroll wheel on your mouse, scrolling mouse, trackball, or other input device. Using too much force can place unnecessary stress on the tendons and muscles in your hands, wrists, and forearms.
- If you are using a scrolling mouse, be sure to keep your fingers and hand in a relaxed, neutral position when activating the scroll wheel. Also, this type of mouse features software that can minimize the number of mouse movements or button clicks.
- When using a mouse, trackball, or other input device, position it as close to the keyboard as possible, and keep it at the same level as you do not have to stretch while using it.
- Use a good quality mouse pad to enable the mouse to work most effectively and reduce unnecessary hand and wrist movements.
- Be sure to keep your mouse and trackball clean. Regular removal of accumulated dust and dirt helps ensure proper tracking and reduces unnecessary hand and wrist motions.

---

## Using the Oscilloscope

---

# Using the Oscilloscope

The Infiniium Oscilloscope is designed to be easy to use.

- The familiar front-panel oscilloscope interface with knobs and keys is optimized for the most common kinds of troubleshooting tasks and basic measurements. See “Using the Front Panel” on page 3-3.
- The graphical interface with menus, windows, dialogs, and toolbars provides easy logical access to dozens of configuration and analysis tools, making it easy for you to set up and make the most complex measurements. The interface also allows you to use the Infiniium oscilloscope’s built-in information system, which gives detailed information on using the oscilloscope to make measurements. See “Using the Graphical Interface” on page 3-19.

---

## Using the Front Panel

The Infiniium Oscilloscope front panel has been designed to give you direct access to the functions needed to perform the most common measurements needed in troubleshooting, using a traditional oscilloscope interface. Knobs and keys are included to enable direct setting of vertical and horizontal parameters. In addition, the front panel has a set of LED (Light-Emitting Diode) indicators; by using these and the display, you can assess the configuration of the oscilloscope at a glance—there is no need to enter a series of keystrokes to navigate through complex menus.

The Infiniium Oscilloscope uses color consistently throughout the front panel and user interface. For example, the color of the knob for channel 1 is the same color as the waveform for channel 1. All the configuration items and values related to channel 1 are displayed in the same color.

## Front Panel

Figure 3-1 shows the Infiniium Oscilloscope front panel.

Figure 3-1

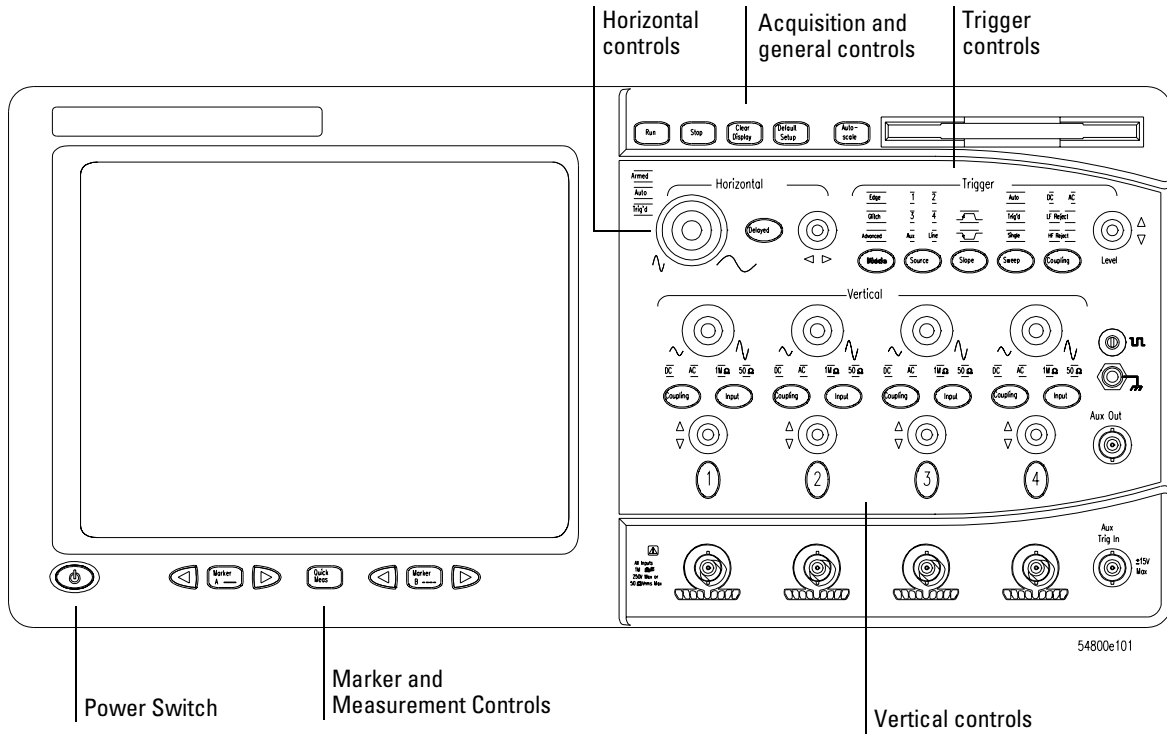

### Infiniium Oscilloscope Front Panel

Using the front panel, you can configure the Infiniium Oscilloscope for most troubleshooting tasks. The control categories are:

- Acquisition and general controls
- Horizontal controls
- Trigger controls
- Vertical controls
- Marker and measurement controls



## **Acquisition and General Controls**

Using the acquisition and general controls, you control whether the oscilloscope is running or stopped. Other keys allow you to reset the oscilloscope to its factory default setup, automatically configure the oscilloscope for the current input signals (Autoscale), or erase the waveforms from the display.

## **Horizontal Controls**

Using the horizontal controls, you configure the oscilloscope's sweep speed (seconds per division) and horizontal position of the waveform. You can also view a magnified section of the waveform using the delayed sweep window, which uses software to expand part of the acquisition memory.

## **Trigger Controls**

Using the trigger controls, you set the conditions on which the oscilloscope will trigger and acquire an input signal. You can set up a variety of trigger conditions. Edge and glitch triggers can be selected from the front panel, and the parameters for edge triggering can be set up here as well. Some glitch trigger parameters (such as glitch width) and all advanced trigger configurations are set up using the graphical interface.

Trigger configuration settings you make using the graphical interface are reflected in the front-panel status indicators, and will remain set unless you change them (either using the front panel or the graphical interface) or press the Default Setup key. See "Using the Graphical Interface" on page 3-19 for information on accessing the graphical interface.

## **Vertical Controls**

Using the vertical controls, you set the vertical scaling (volts per division), vertical offset, input impedance, and input coupling. You can also turn the display on or off for a particular channel.

### **Marker and Measurement Controls**

Using the marker and measurement controls, you control two sets of markers within the oscilloscope graticule. You use markers to make more accurate measurements of waveform events than you could make visually. Both time and voltage differences between the markers are updated continuously on the screen. By default, the markers track the source waveform. Voltage measurements from the markers are the value of the waveform at the time set with the marker arrow keys.

The QuickMeas key initiates four preset measurements on the waveforms. Both quick measurements and markers will function on any input waveform; simply continue to press and release one of the keys (either QuickMeas, Marker A, or Marker B) to cycle through all the waveforms on the screen, then to the off state. You choose which four measurements will be performed by using the measurement configuration commands in the graphical interface.

## To set the oscilloscope to a known starting condition

- Press the Default Setup key.

You can set up the oscilloscope for many different kinds of complex measurements. To easily reset the oscilloscope to a known measurement configuration, use the Default Setup key.

If you use the Default Setup key with the graphical interface enabled, you can select Undo Default Setup from the Control menu to return the oscilloscope to its original configuration.

### **Save the Current Oscilloscope Configuration**

Before using Default Setup, you may want to save the current oscilloscope configuration for later use. See the built-in information system (described in chapter 4) for instructions on saving and recalling setups, and for information on the exact configuration that is set when you press Default Setup.

## To start and stop waveform acquisition

- **To start waveform acquisition, press the Run key.**  
The oscilloscope begins acquiring data. When it receives a trigger signal, it finishes acquiring data, updates the display, then starts another acquisition cycle if it is in triggered or auto trigger mode. If it is in single sweep mode, it stops after updating the display.
- **To stop waveform acquisition, press the Stop key.**  
The oscilloscope stops acquiring data. Whatever data was last acquired remains on the screen.

Figure 3-2

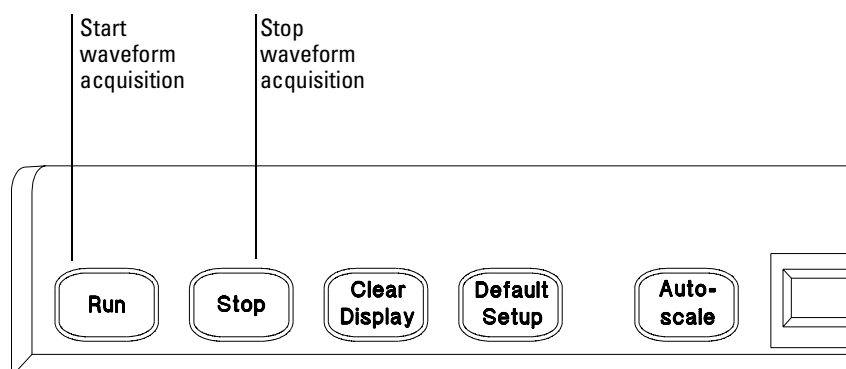

54800e33

Run and Stop Keys

---

## To clear the waveform display

- Press the Clear Display key.

The oscilloscope clears the waveform display. If the oscilloscope is in Run mode and is receiving triggers, it will update the display as it collects new waveform data. Clearing the waveform display also resets averaging, infinite persistence, and color grade persistence, histogram, and mask testing database.

Figure 3-3

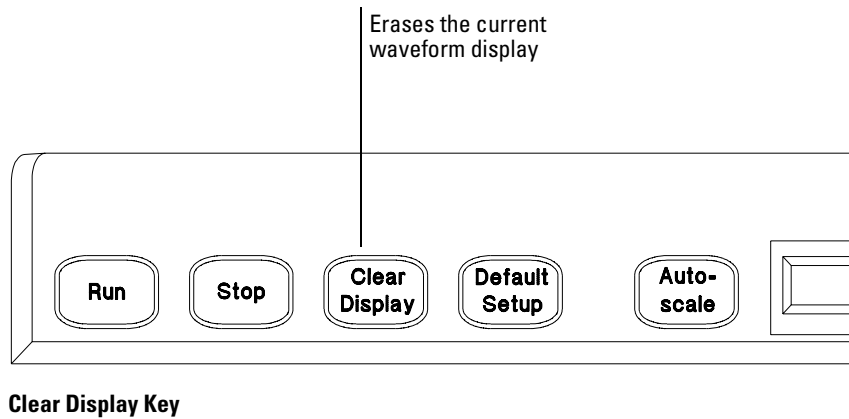

---

## To turn a channel on or off

- To turn a channel on, press the channel number key until it is illuminated. To turn it off, press the channel number key again. If you are not using a particular channel, you can turn it off. This simplifies the waveform display and also increases the display update rate. While a channel is turned off, data acquisition continues for that channel. Thus, you can still use the channel as a source for functions.

### Using a Channel as External Trigger

Any channel can be used as a trigger source. If you need an external trigger but do not need all channels, you can use a channel as an external trigger without displaying it by turning the channel display off.

Figure 3-4

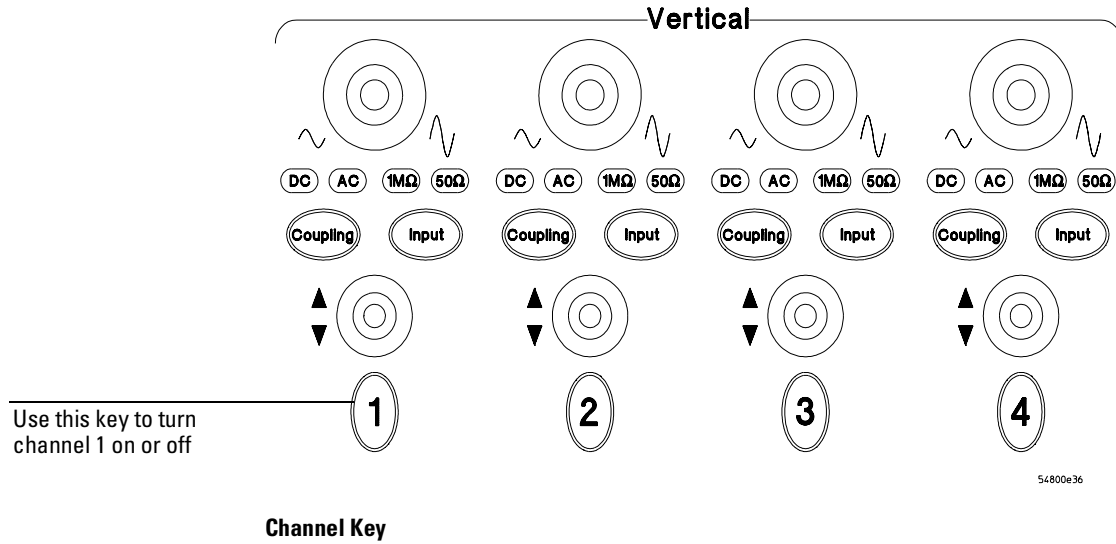

## To change input impedance and input coupling

- To change the input impedance, press the Input key until the LED for the desired impedance is illuminated.  
Choices are 50  $\Omega$  and 1 M $\Omega$ .
- To change the input coupling, press the Coupling key until the LED for the desired coupling is illuminated.  
Choices are AC and DC. If you change the input coupling to AC when 50  $\Omega$  impedance is selected, the input impedance changes to 1 M $\Omega$ . If you change the input impedance to 50  $\Omega$ , the input coupling changes to DC.

Figure 3-5

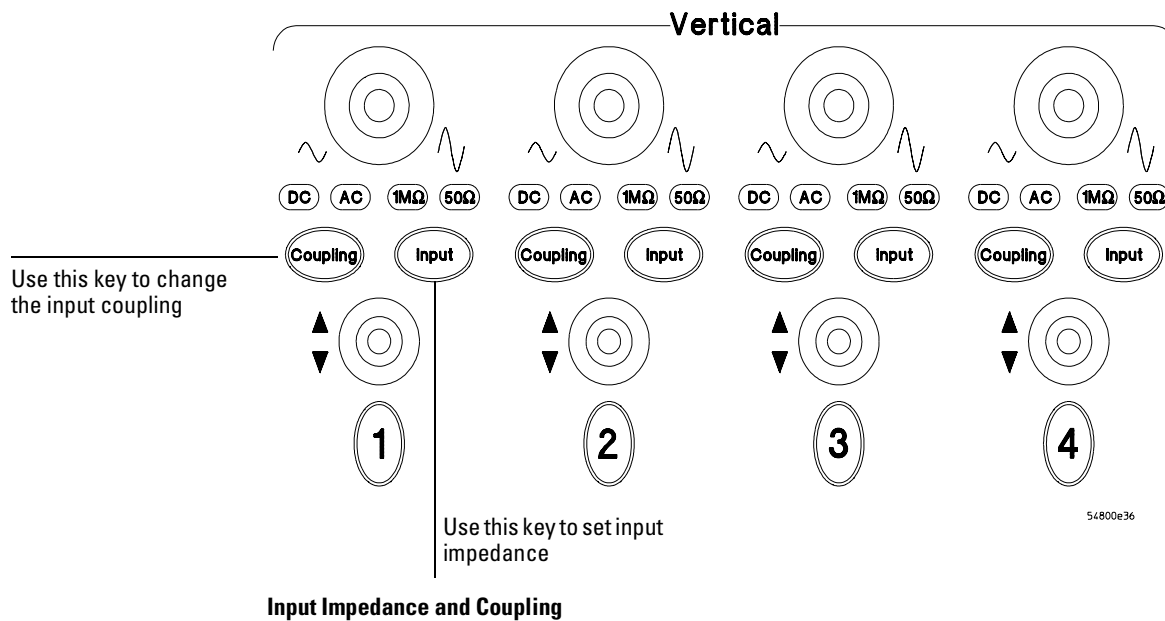

---

## To adjust vertical scale and offset

- To make the waveform bigger, turn the vertical scale knob clockwise. To make it smaller, turn the knob counter-clockwise.

The vertical scale knob is the larger of the two knobs for a channel. It is marked with a set of sine wave symbols. Decreasing the vertical scale makes the waveform bigger. There are fewer volts displayed per division. Increasing the vertical scale makes the waveform smaller. There are more volts displayed per division.

- To move the waveform toward the top of the display, turn the vertical offset knob clockwise. To move it toward the bottom of the display, turn the knob counter-clockwise.

The vertical offset knob is the smaller of the two knobs for a channel. It is marked with a set of arrows.

Figure 3-6

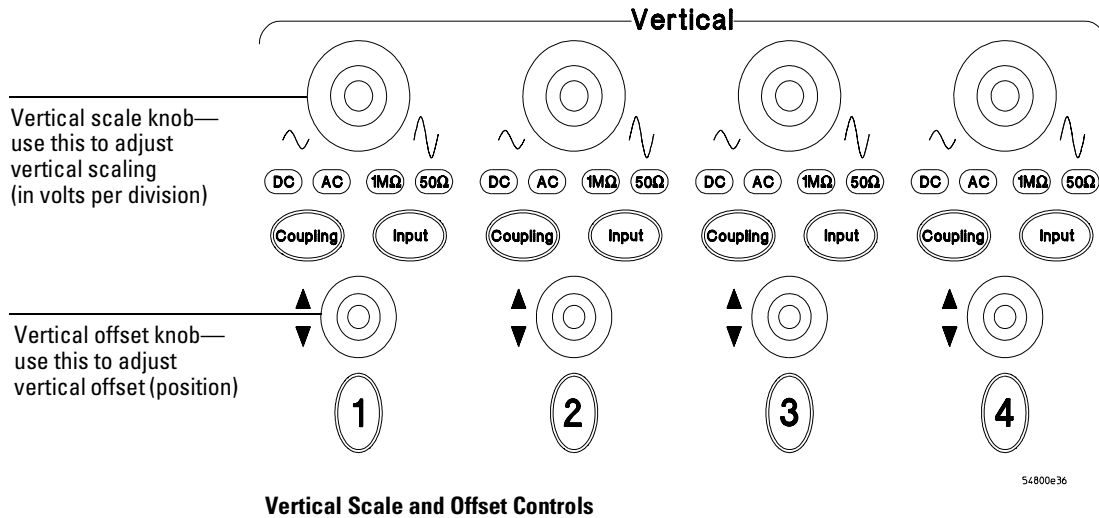

Vertical Scale and Offset Controls



---

## To adjust sweep speed and horizontal position

- To stretch the waveform horizontally, turn the sweep speed knob clockwise. To shrink it horizontally, turn the knob counter-clockwise.

The sweep speed knob is the larger of the two horizontal control knobs. It is marked with a set of sine wave symbols. Stretching the waveform means there are fewer seconds displayed per division. Shrinking the waveform means there are more seconds displayed per division.

- To move the waveform to the right, turn the horizontal position knob clockwise. To move the waveform to the left, turn the horizontal position knob counter-clockwise.

Moving the waveform to the right shows more of the pre-trigger data (data acquired before the trigger event). Moving the waveform to the left shows more of the post-trigger data (data acquired after the trigger event).

The horizontal position knob is the smaller of the two horizontal control knobs. It is marked with a set of arrows. There is a detent programmed into the software so there is a momentary pause at zero while you are turning the knob. Continuing to turn the knob will move the horizontal position through zero.

Figure 3-7

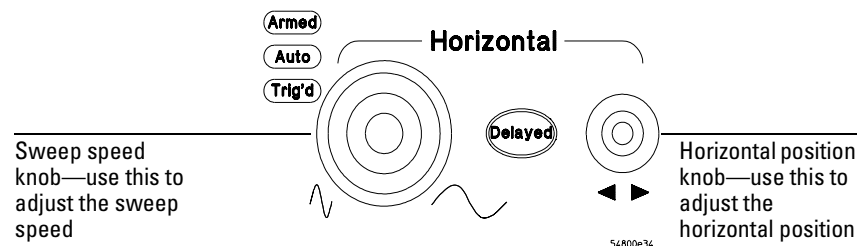

Horizontal Sweep Speed and Position Controls

---

## To magnify a part of the waveform using delayed sweep

- To turn on the delayed sweep, press **Delayed**. To turn it off, press **Delayed** again.

The waveform display area splits into two regions. The top one is the main sweep. The bottom is the delayed sweep, which represents a software expansion of the acquired waveform data. A section of the waveform in the main sweep window is highlighted to indicate the part shown in the delayed sweep window.

The horizontal sweep speed and horizontal position controls now change how the waveform is shown in the delayed sweep window. The sweep speed will change the amount of magnification, while the position will change the part of the waveform in the main sweep window that is shown in the delayed sweep window.

**Figure 3-8**

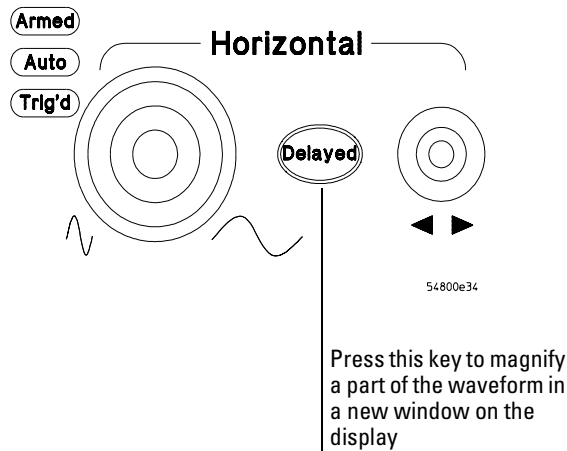

**Magnifying Part of the Waveform with Delayed Sweep**

## To set the oscilloscope to trigger on an edge

- 1 Press and release the Mode key until the Edge LED indicator is illuminated.
- 2 Press and release the Source key until the desired source LED is illuminated.  
You can choose any of the channels or the Aux Trig In (4-channel oscilloscopes) or Ext Trigger as the source for an edge trigger.
- 3 Press the Slope key until the desired slope LED is illuminated.  
You can have an edge trigger on a rising or falling edge.
- 4 Press the Sweep key until the Trig'd LED is illuminated.  
The oscilloscope will wait for the edge before initiating a sweep.
- 5 Select an input coupling for the trigger signal by pressing the Coupling key.  
You can choose DC, AC, LF Reject, or HF Reject. See the built-in Information System for more information on when to use each type of coupling.
- 6 Turn the Level knob to adjust the voltage level at which the oscilloscope will trigger.

Figure 3-9

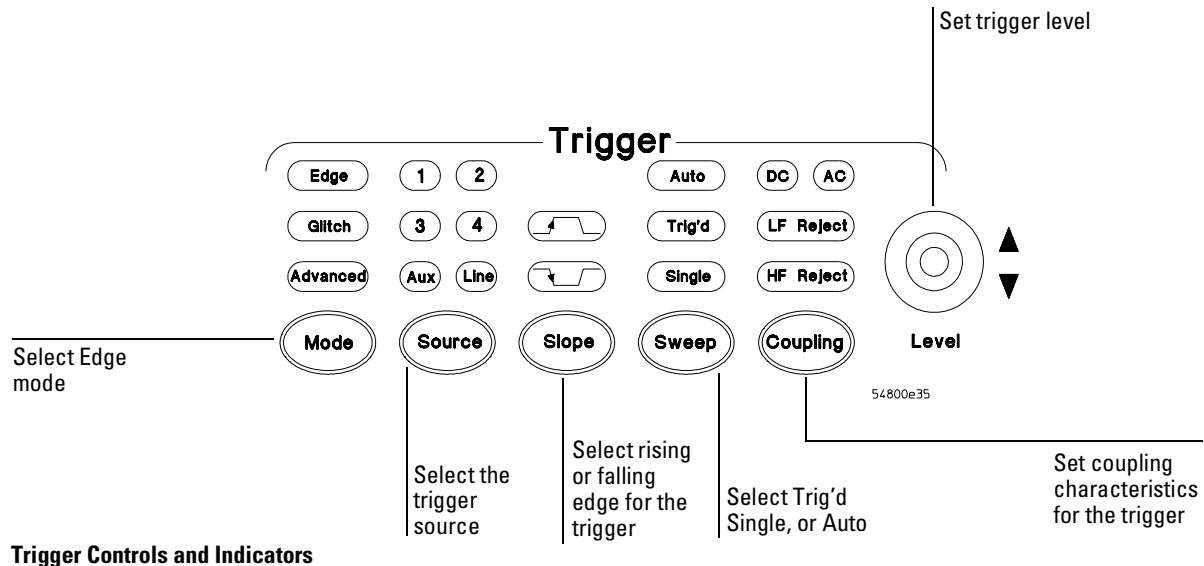

---

## To use the markers

Markers make it easier to make precise measurements because the marker measurement readouts show exact voltage and time positions for the markers. The measurements are based on actual waveform data from the acquisition system, not on approximations based on the display position, so you can be sure that the values are highly accurate.

- **To turn on Marker A, press the Marker A key.**

Marker A has a solid line pattern on the waveform display. It is associated with the first available source on the display. Press the key again to move to the next available source. When there are no more sources, the marker turns off.

- **To turn on Marker B, press the Marker B key.**

Marker B has a dashed line pattern on the waveform display. It is associated with the first available source on the display. Press the key again to move to the next available source. When there are no more sources, the marker turns off.

- **To move a marker on the waveform, press and hold the left arrow or right arrow key next to the desired Marker key. Release the key when the marker is at the desired waveform event.**

The marker snaps to and follows the shape of the waveform on the screen. The voltage value shown for a marker is the value of the waveform at the specified horizontal time, which is set with the marker arrow keys. This is the default mode. You can change the marker mode using the graphical interface. See the built-in information system for details.

Figure 3-10

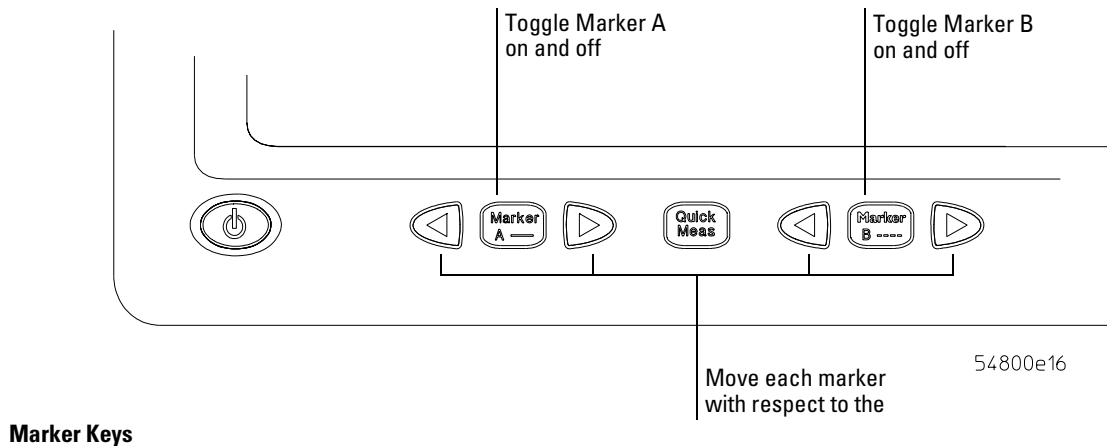

## To use the quick measurements

- To turn on the quick measurement display, press the QuickMeas key. The four preset measurements defined in the Quick Measurement configuration are enabled and results are displayed on the screen for the first waveform source. The default measurements are:  $V_{pp}$ , Period, Frequency, and Rise Time.
- To measure parameters for another waveform, press the QuickMeas key until that waveform is the one shown in the measurement readout. Continuing to press the QuickMeas key cycles through each of the waveforms available.
- To turn off the quick measurement display, press and release the QuickMeas key until the measurements are turned off. The measurement results disappear from the screen. See the built-in information system (described in Chapter 4) for information on how to configure the Quick Measurement capability, using the Customize Measurement feature of the graphical interface.

Figure 3-11

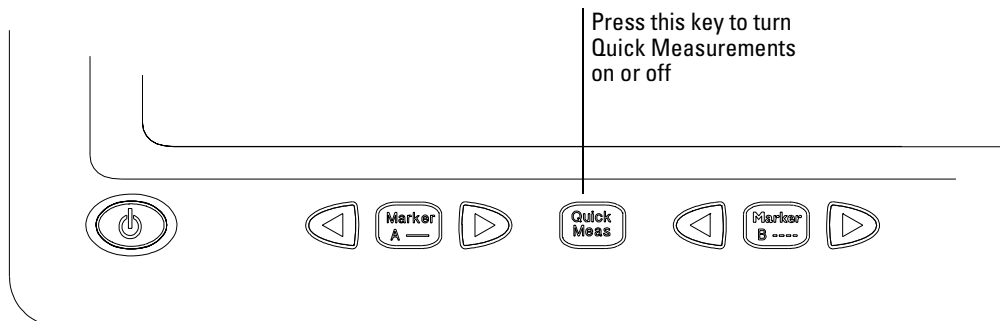

54800e16

Quick Measurement Key

---

## To reinitialize the oscilloscope

When you need to restore the oscilloscope to a known configuration, use the Default Setup key. If you press the Default Setup key and the oscilloscope does not seem to be functioning properly, try cycling power. If the oscilloscope still does not seem to function properly, use the following key-down powerup procedure.

- 1 Turn off the power to the oscilloscope.
- 2 Turn on the power to the oscilloscope.
- 3 Hold down any one of the arrow keys next to the Marker A and Marker B keys.
- 4 When the oscilloscope display appears, release the key you held down in step 3.

A key-down powerup completely reinitializes the oscilloscope, including the configuration RAM. It does not affect saved waveforms or setups, which are stored on the hard disk drive.

Figure 3-12

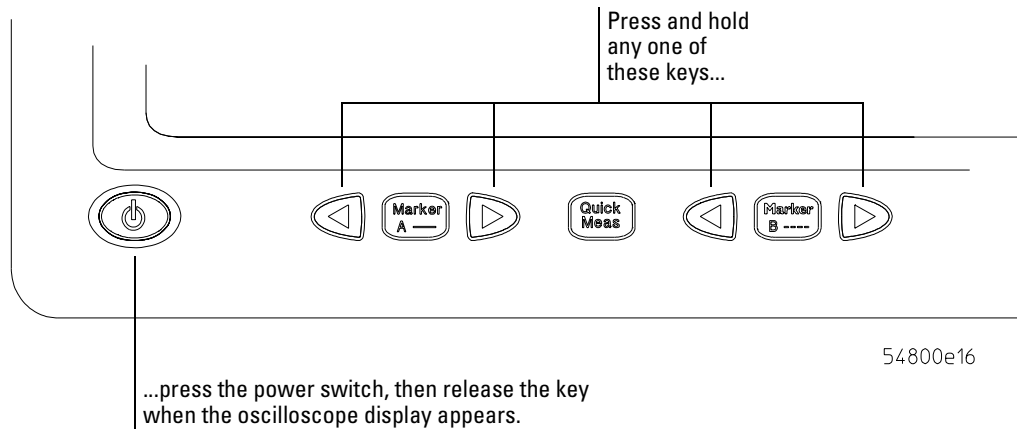

Key-Down Powerup

---

## Using the Graphical Interface

With the graphical interface for the Infiniium Oscilloscope, you can access all the configuration and measurement features of the oscilloscope through an easy-to-use system of menus, tool bars, dialog boxes, icons, and buttons.

### Full-Screen Mode

Full-screen mode maximizes the waveform viewing area and removes the graphical interface menus and toolbars so you can concentrate on your measurement. In full-screen mode, the display looks like the following two figures.

**Figure 3-13**



**Infiniium Oscilloscope Top of Display in Full-Screen Mode**

Figure 3-14

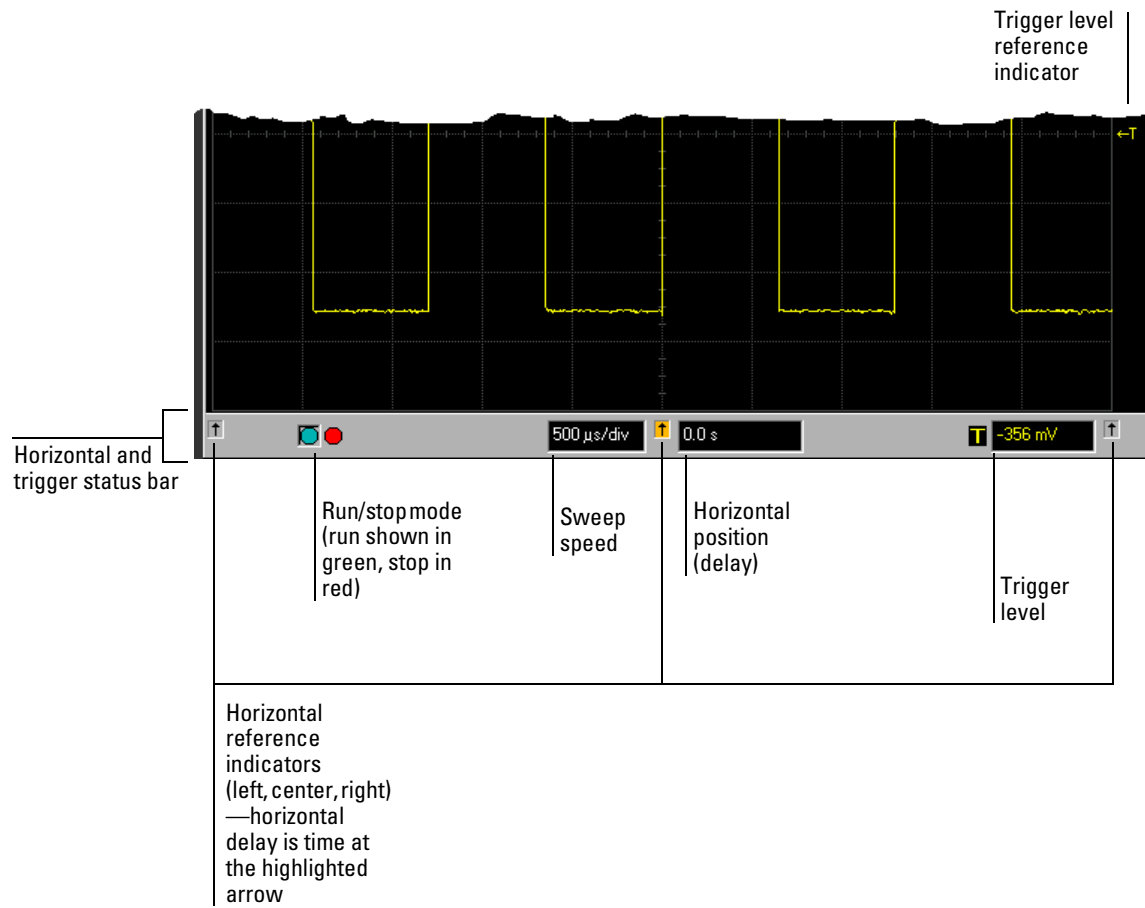

Infiniium Oscilloscope Bottom of Display in Full-Screen Mode



## Graphical Interface Mode

Click the graphical interface enable button to switch to the graphical interface. When the graphical interface is enabled, the display looks like the following two figures. See “To switch between the graphical interface and full-screen mode” on page 3-30.

**Figure 3-15**

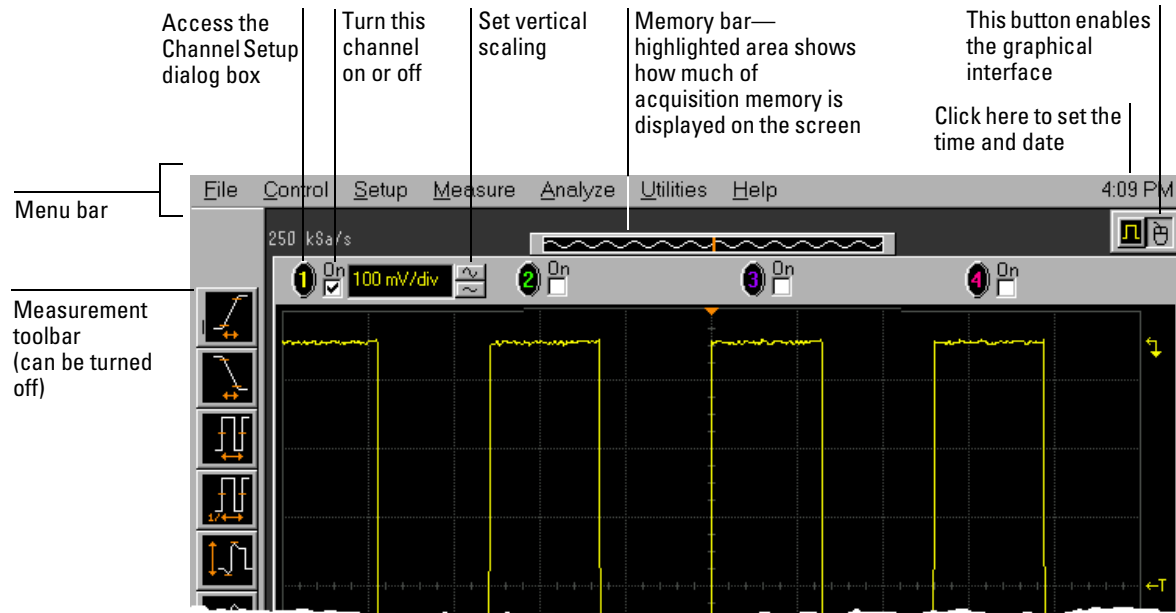

**Infiniium Oscilloscope Top of Display in Graphical Interface Mode**

Figure 3-16

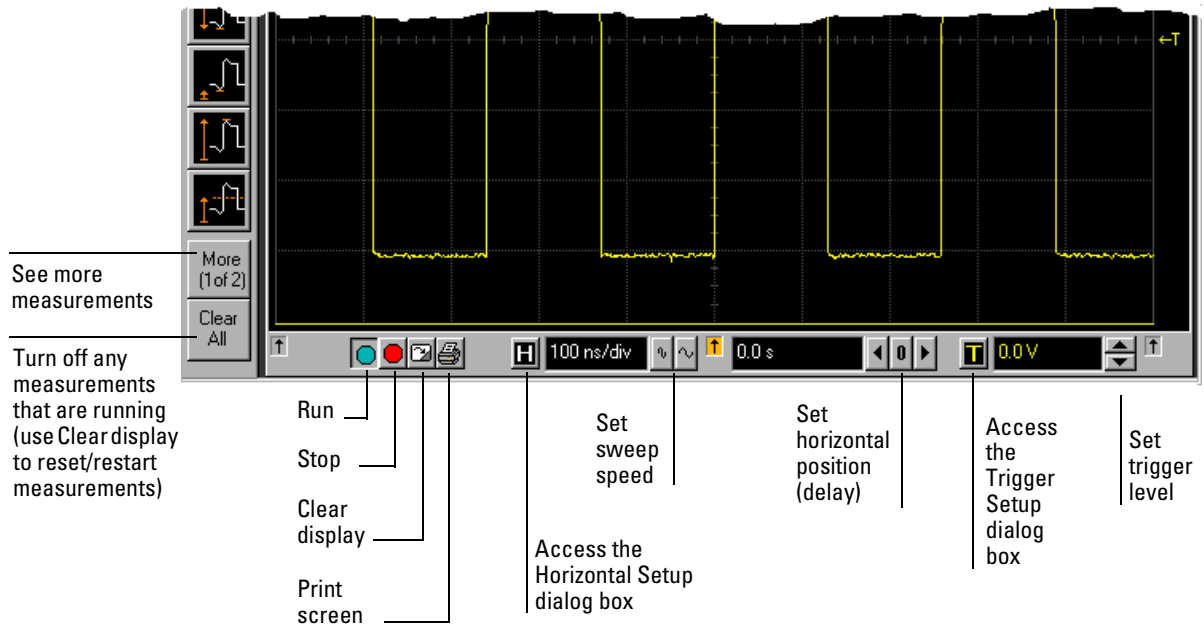

#### Infiniium Oscilloscope Bottom of Display in Graphical Interface Mode

To make it easy to see which controls affect each waveform, the oscilloscope uses color consistently throughout the graphical interface. These colors match the ones used on the front-panel knobs. For example, the color of the waveform for channel 1 matches the color of the knobs for that channel. If channel 1 is the trigger signal, all of the trigger configuration items, including the trigger level reference icon (at the right side of the waveform display area), will match that color. The buttons associated with that channel, vertical scaling and offset settings, ground reference indicator, and measurements done on that channel also have the same color.

You can still use the front panel when the graphical interface is enabled. All changes made to the front-panel settings are reflected in the graphical interface, and changes made using the graphical interface are reflected in the front panel where applicable. Use whichever interface is easiest for you in a particular measurement situation. For example, it might be easiest to set a coarse vertical scale using the knobs, then fine-tune the setting using the graphical interface.

The graphical interface is arranged so the most common functions that affect the waveform display are located around the edge of the waveform display area. These include the measurement toolbar, horizontal and trigger toolbar, and vertical toolbar.

### **Measurement Toolbar**

The measurement toolbar contains icons representing the most commonly used automatic measurements built into the oscilloscope.

**Drag and Drop Measurements** By dragging one of the measurement icons to a waveform in the waveform display area, you can make that measurement on the waveform. As you drag a measurement icon around the screen, the icon outline changes color to match the color of the closest waveform. This makes it easy to see which waveform will be measured when you drop the icon. For those measurements that are done on waveform features, the measurement is made at the feature closest to the location where you dropped the icon. For example, you might want to measure the rise time of the fifth rising edge; dropping the rise time measurement icon at that edge will cause the measurement to be made on that edge.

You can also make a measurement by simply clicking the icon on the measurement toolbar, then selecting the source to be measured in the dialog box that appears. When you start a measurement this way, any measurements on waveform-specific features will measure the first appropriate feature on the waveform. For example, a rise time measurement will measure the first rising edge on the waveform.

Each waveform can have multiple simultaneous measurements and the measurements can all be of the same type, if desired. For example, you can have 3 pulse width measurements on different parts of the same waveform.

**Geometric Measurement Indicators** For each measurement currently running, a geometric indicator at the measurement location on the waveform corresponds to an identical indicator in the measurement results readout. This makes it easy for you to verify that the readout shows results for the correct waveform and the correct feature on that waveform. See figure 3-38 for an example.

**Tool Tips** To find out what a particular measurement tool does, hold the mouse pointer over it for a moment. A small popup will appear that describes the measurement.

**Other Measurement Features** There are more measurements available than will fit on a single toolbar. Click the More (1 of 2) or More (2 of 2) icons to see other measurements. Clicking Clear All will remove all selected measurements from the waveform display area.

You can turn off the measurement toolbar to remove it from the screen and enlarge the waveform viewing area. Use the Customize Display Layout command on the Measure menu.

### Tab Display Area

The tab display area located beneath the waveform viewing area appears when a measurement is on, mask testing is enable, a histogram is enabled, markers are on, or color graded persistence is on.

Figure 3-17

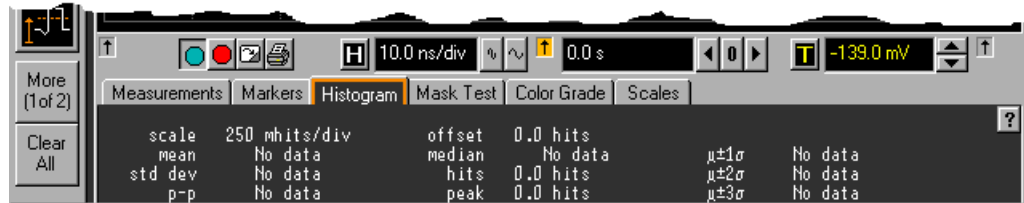

### Tab Display Area

The display area shows information and statistics for the particular tab that is selected. The type of markers that are shown in the waveform viewing area depend on the tab that you have selected. The selected tab has an orange border to reflect the type of markers being displayed. For example, when the Histogram tab is selected, the markers are histogram markers and are used to define the histogram window.

### Waveform Display Area

The waveform display area shows the waveforms, and optionally, the results of your measurements. Several display options, including a grid, are available and can be configured using the graphical interface.

**Waveform Manipulation** When the graphical interface is enabled, two features are available that can simplify your work with waveforms:

- **Direct Manipulation**—you can use the mouse to click and drag waveforms to new vertical positions, which changes the vertical offset, or to new horizontal positions, which changes the horizontal position or delay value.
- **Zoom**—you can click and drag a rectangular area on the display, then click inside it to zoom on that section of the waveforms. The oscilloscope does this in one of two ways. If acquisition is stopped, the magnification is done by the oscilloscope software. If acquisition is running, the oscilloscope automatically adjusts the vertical scaling and offset and the horizontal sweep speed and position to present the zoomed section of the waveforms.

See “To zoom on a section of the waveform” on page 3-49.

**Avoid Overdriving Vertical Input Amplifiers**

When zooming on a waveform with the oscilloscope running, be careful to keep the signal within the screen vertically to avoid overdriving the vertical input amplifiers. This causes waveform distortion and erroneous measurement results.

**Ground Reference Indicators** A small symbol is shown at the right side of the waveform display area for each waveform that is on, including channels, waveform memories, and functions. This symbol represents the ground reference point for each channel; it moves when you change the vertical offset. You can also drag this symbol up and down using the mouse; doing so automatically changes the vertical offset for that waveform.

**Menu Control and Menus**

The graphical interface control button, in the upper right-hand corner of the display, enables the graphical interface of the oscilloscope. When the graphical interface is enabled, the display looks like figure 3-15 and figure 3-16, including a menu bar, measurement toolbar (if enabled), and graphical controls for vertical, horizontal, trigger, and acquisition. You can switch to full-screen mode to maximize the waveform viewing area and eliminate the menu bar, measurement toolbar, and other graphical controls.

You can use the menu bar for most oscilloscope configuration functions. *Context-sensitive* menus, which pop up to provide a selection of commands within particular regions of the user interface, are available in the following regions:

- Memory bar
- Waveform display area
- Measurement toolbar
- Horizontal and acquisition controls

You display a context-sensitive menu by clicking the right mouse button with the pointer in one of these regions. For more information on context-sensitive menus, see “To select a command from a context-sensitive menu” on page 3-34.

### **Vertical Settings and Controls**

The top of the waveform display area includes the vertical settings and controls. In full-screen mode, only channels that are turned on are shown, with the corresponding vertical scaling settings in volts per division. When the graphical interface is enabled, all channels are shown. Each has a checkbox allowing you to turn that channel on or off, and a set of controls allowing you to change the vertical scaling. Clicking directly on the vertical scaling value displays a pop-up numeric keypad allowing you to set a precise vertical scale.

### **Horizontal and Trigger Toolbar**

At the bottom of the waveform display area is the horizontal and trigger toolbar. This includes the run/stop controls, the horizontal controls, and the trigger controls.

**Run/Stop Controls** See figure 3-25. At the left side of the bar are three icons:

- The leftmost is a blue-green octagon. Clicking on this starts an acquisition. (Same as pressing the Run key on the front panel.)
- The middle is a red octagon. Clicking on this stops acquisition. (Same as pressing the Stop key on the front panel.)
- The rightmost is a small windshield wiper. Clicking on this clears acquired waveform data from the display. (Same as pressing the Clear Display key on the front panel.)

**Horizontal settings and controls** The middle of the bar contains the horizontal settings and controls. Leftmost is a button, labeled with an “H.” Clicking on this will display the horizontal setup dialog box.

Next is the current sweep speed. Clicking on this displays a pop-up numeric keypad so you can set a particular sweep speed. Or, you can click on the two icons to the right of the sweep speed setting to cycle through the preset speeds. The leftmost icon shrinks the waveform, which decreases the sweep speed and increases the time per division. The rightmost icon stretches the waveform, which increases the sweep speed and decreases the time per division.

Next is the horizontal position (delay) setting. Clicking on this displays a pop-up numeric keypad that allows you to set a particular position. Or, you can use the three icons to the right. The left arrow moves the waveform to the left, the center “0” resets the delay to zero, and the right arrow moves the waveform to the right.

Across the toolbar are three vertical arrows. These are the left, center, and right horizontal reference indicators. Clicking on one of these arrows moves the horizontal position to the respective horizontal reference position on the display—left, center, or right. Assuming the horizontal position is at zero:

- Left means the information on the display is all post trigger.
- Center means the information to the left of center is pre trigger; to the right is post trigger.
- Right means the information on the display is pre trigger.

The horizontal position value represents the time relative to the trigger at the respective horizontal reference. When you change the horizontal sweep speed, the waveforms expand and contract about this reference position.

**Trigger settings and controls** The right side of the bar contains the trigger settings and controls. These will vary depending on the current trigger configuration, which can be set using the front panel and the graphical interface. Advanced trigger configuration items are available only through the graphical interface. You can click on the button labeled with a “T” to bring up the trigger setup dialog box.

When the scope is set for edge trigger on a particular channel, the trigger level setting is shown. You can click on it to display a pop-up numeric



keypad that allows you to set a particular trigger level. You can also click on the up and down arrows to the right of the setting to increase or decrease the trigger level, respectively. Or, you can click on the trigger reference indicator at the right side of the display and drag it up or down to change the trigger level.

## To switch between the graphical interface and full-screen mode

- To enable graphical interface mode, click on the outlined square wave button in the upper right-hand corner of the display.

The button changes state, and the menus and measurement toolbar appear.

The graphical interface menus let you access all the functions in the oscilloscope, including features that are not available from the front-panel controls. You can also use the oscilloscope's built-in information system.

- To enable full-screen mode, click the larger square wave button in the upper right-hand corner of the display.

The button changes state, and the menus and measurement toolbar disappear. Choosing this option allows you to focus only on the waveform and measurement. You must make changes to the oscilloscope configuration using the front panel.

### Use Knobs and Keys to Configure the Oscilloscope in Full-Screen Mode

In full-screen mode, the range of mouse pointer motion is limited to the area of the button for enabling the interface. You must use the front-panel knobs and keys to configure the oscilloscope.

Figure 3-18

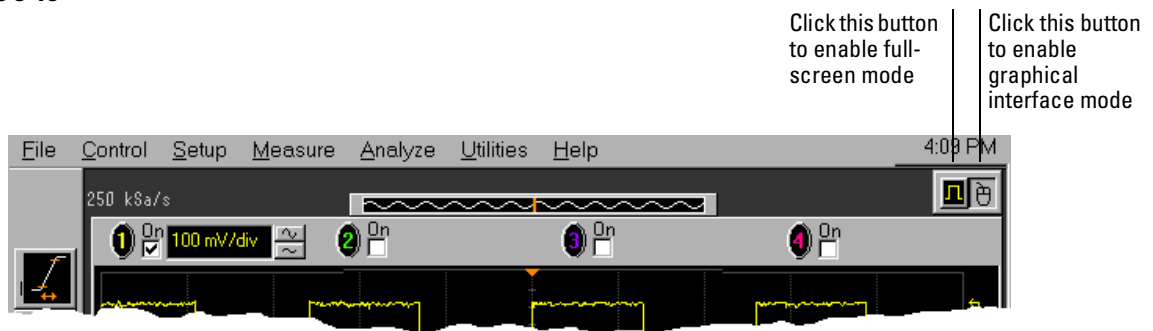

Interface Mode Control Buttons

## To perform basic user interface operations

- To move the mouse pointer on the screen, move the mouse on the mouse pad.  
If you run out of room on the mouse pad surface, pick up the mouse and set it down on the mouse pad where you will have room for motion.
- To *click* on an item in the graphical interface, point at that item with the mouse pointer, then press and release the left mouse button.
- To *right-click* on an item in the graphical interface, point at that item with the mouse pointer, then press and release the right mouse button.  
You use the right-click operation to access context-sensitive menus. See “To select a command from a context-sensitive menu” on page 3-34.
- To use a *radio button*, click to select the desired item.  
Radio buttons appear in many different dialog boxes in the oscilloscope graphical interface. See the Persistence radio buttons in figure 3-19. You can choose only one option at a time.
- To use a *check box*, click the mouse button with the pointer in the box.  
A check mark in the box indicates that item is selected. See the Connect Dots check box in figure 3-19. To clear the selection, click the mouse button with the pointer in the box.
- To use a *drop-down list box*, click the arrow at the right-hand side of the box. Then click on the desired choice to highlight it.  
See the Language selection list box in figure 3-20.
- To use a *spin box*, click the up arrow to increase the value displayed in the box, and the down arrow to decrease it.  
See the Intensity spin box in figure 3-19.
- To move a *dialog box*, press and hold the left mouse button with the pointer in the *title bar*, drag the box to a new position on the screen, then release the mouse button.
- To close a *dialog box*, click the “X” symbol in the upper right-hand corner of the box, or click the Close button in the box.

Figure 3-19

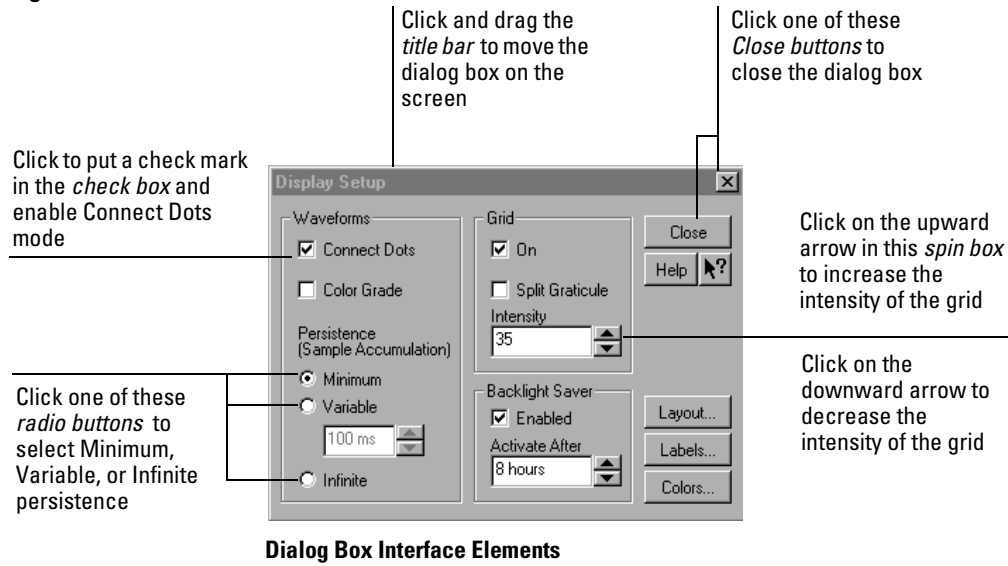
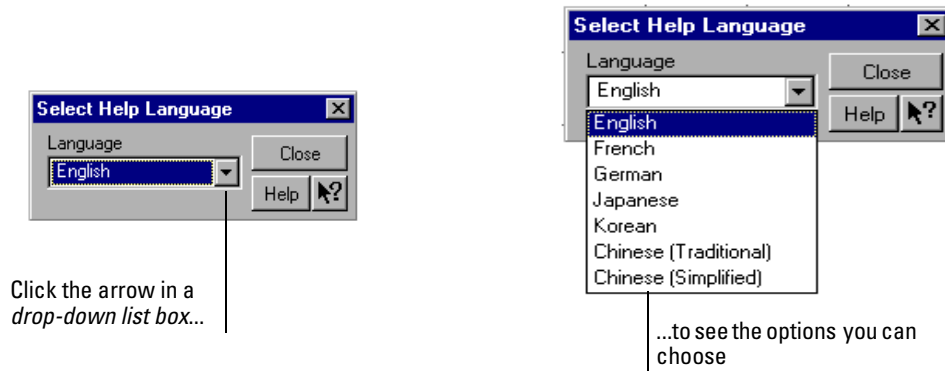

Figure 3-20



---

## To select a command from the menu bar

- 1 Click on a menu bar item.
- 2 Move the pointer to the desired menu item.
- 3 Click the mouse button.

The desired command is executed, or a dialog box is presented for you to configure the oscilloscope.

If you continue to hold the mouse button after step 1, release the button in step 3 to execute the command.

Some menus have submenus. These are indicated by an arrow at the right side of the command. When you move the pointer to one of these menu commands, the submenu automatically appears. You can then move the pointer to the desired command on that submenu and click the mouse button to execute the command.

**Figure 3-21**

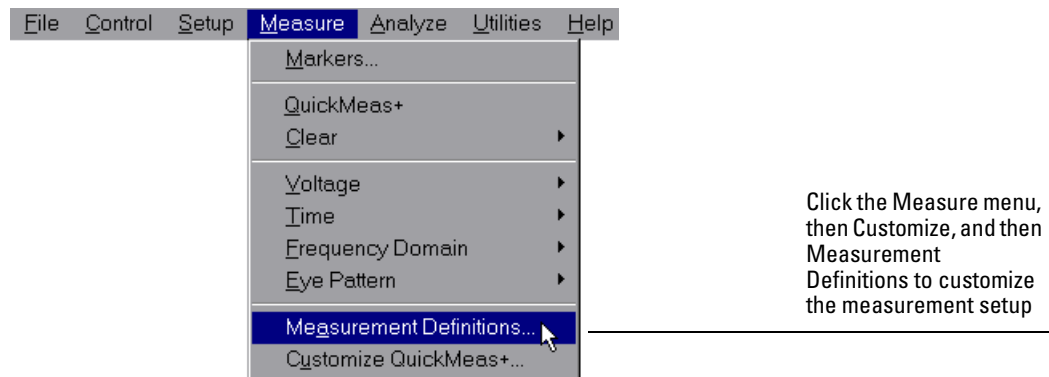

**Selecting a Command from the Menu Bar**

## To select a command from a context-sensitive menu

- 1 Move the mouse pointer to a particular area of the display in which you want to change the oscilloscope configuration.

*Context-sensitive menus* provide quick access to commands and configuration items that relate only to the context of the particular graphical interface item in which they are found. They are available in the following display areas: memory bar, measurement toolbar, waveform display area, and horizontal settings and controls.

- 2 Click the right mouse button.
- 3 Move the pointer to the desired menu item.
- 4 Click the mouse button.

If you continue to hold the mouse button after step 2, release the button in step 4 to execute the command.

**Figure 3-22**

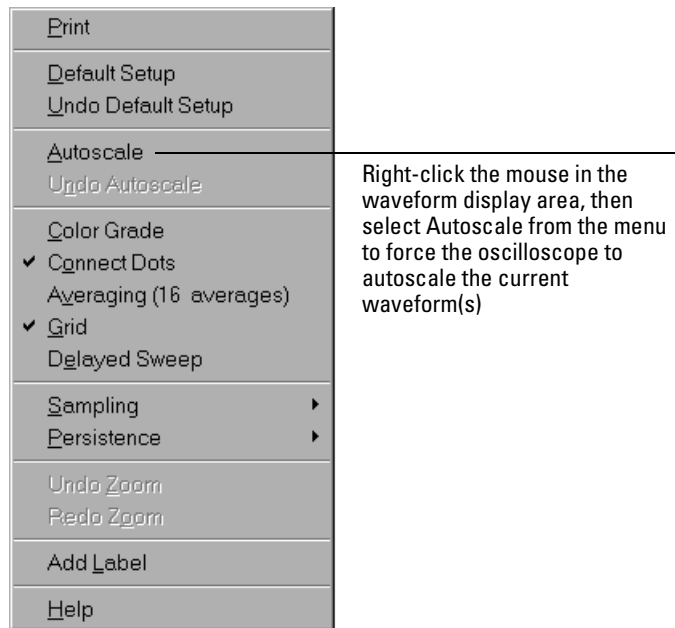

**Selecting a Command from a Context-Sensitive Menu**

Figure 3-23

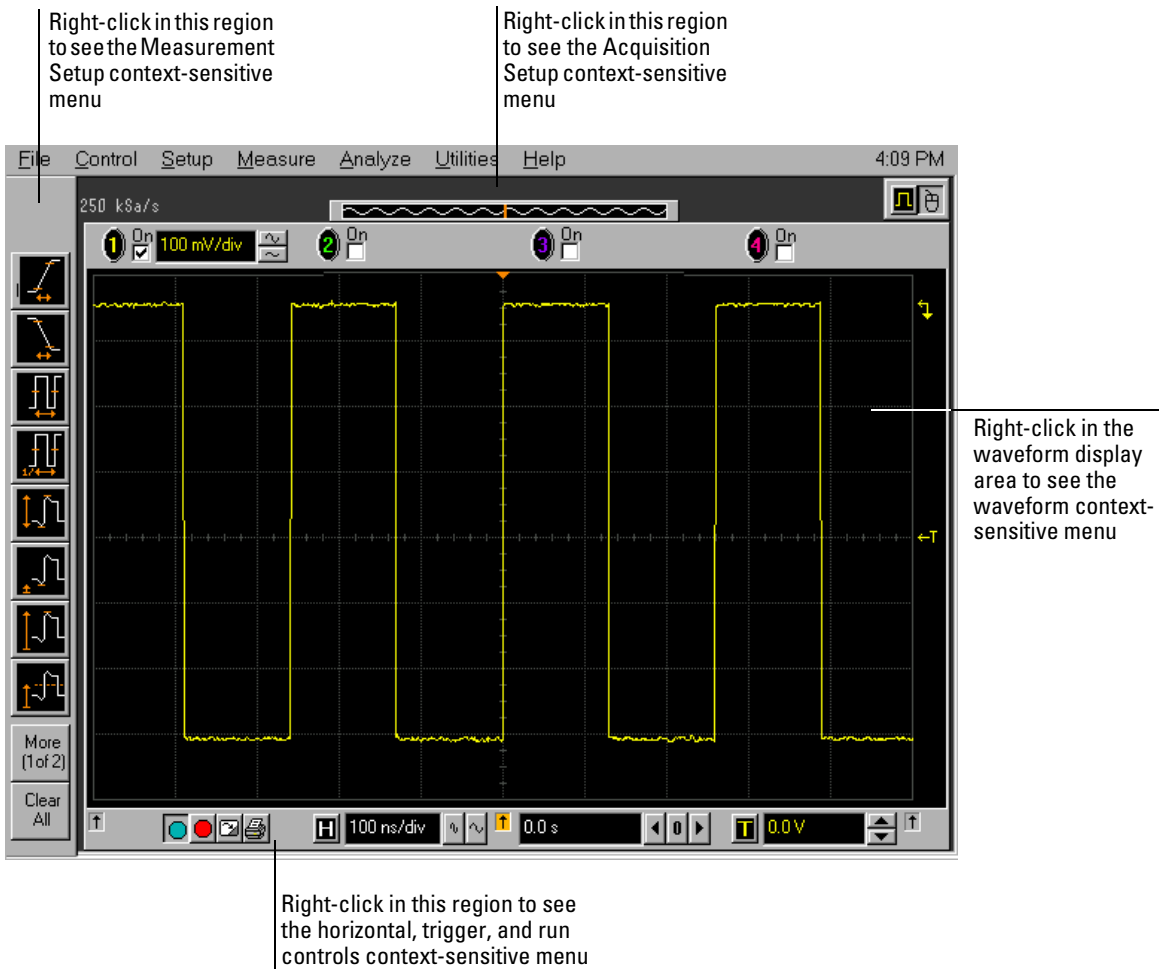

### Location of Context-Sensitive Menus

---

## To change the mouse settings

### 1 Select Utilities, then Preferences, then select Mouse.

You will see the dialog in figure 3-24.

- To swap the functions of the mouse buttons, click the Swap Buttons check box until a check mark appears.
- To change the time for a double-click, use the spin box controls.

### 2 Click Close.

If you are left-handed, or simply find it more comfortable to use the mouse or other pointing device on the left side of the oscilloscope, swapping the functions of the mouse buttons can make the mouse easier to use. Changing the double-click time primarily affects double-clicks in the Open and Save Waveform and Open and Save Setup dialog boxes. See the built-in information system (described in chapter 4) for details.

Figure 3-24

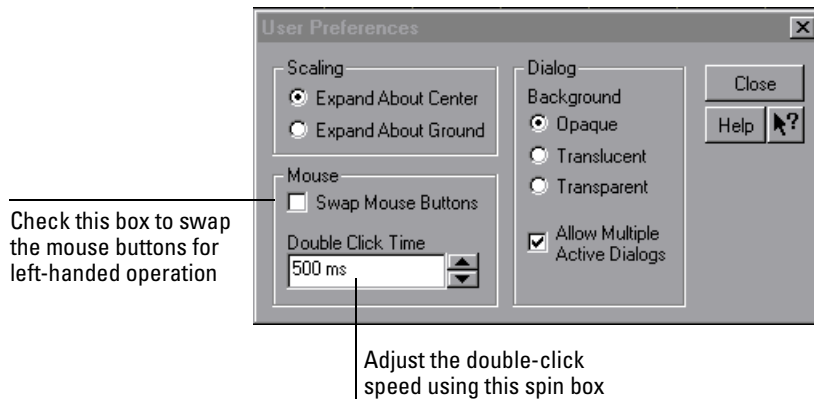

### Changing the Mouse Settings



---

## To start and stop waveform acquisition

- To start waveform acquisition, click the start button at the bottom of the waveform display area.
- To stop waveform acquisition, click the stop button at the bottom of the waveform display area.

See figure 3-25.

You can still use the Run and Stop keys on the front panel while the graphical interface is enabled. However, if you are performing many graphical interface operations, it is easier to start and stop the oscilloscope using the buttons in the interface, so you do not have to remove your hand from the mouse.

Figure 3-25

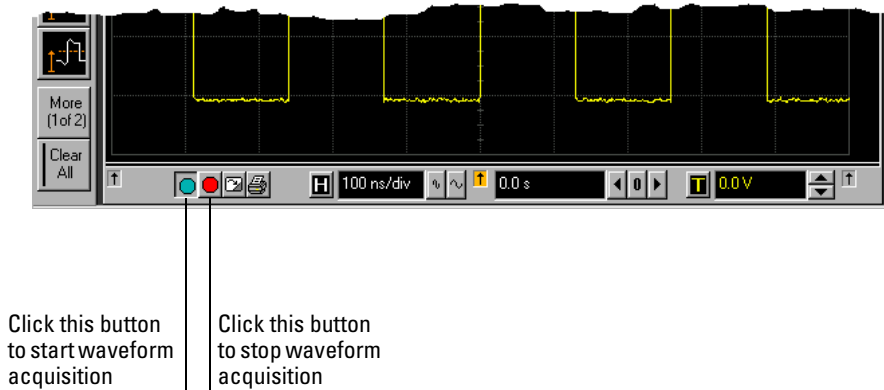

### Start and Stop Icons

---

## To clear the waveform display

- Click the clear display button at the bottom of the waveform display. See figure 3-26.

You can still use the Clear Display key on the front panel while the graphical interface is enabled.

Clearing the display removes all displayed waveform data in preparation for another acquisition. It also resets all automatic measurements and measurement statistics.

**Figure 3-26**

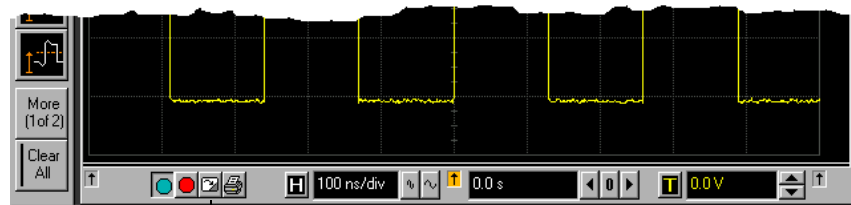

Click this button to clear the waveform display

### Clearing the Display

---

## To print the screen

- Click the print button at the bottom of the waveform display.  
See figure 3-27.

Infiniium prints the screen to the default printer according to the configuration that you have selected in the Printer Setup dialog box.

**Figure 3-27**

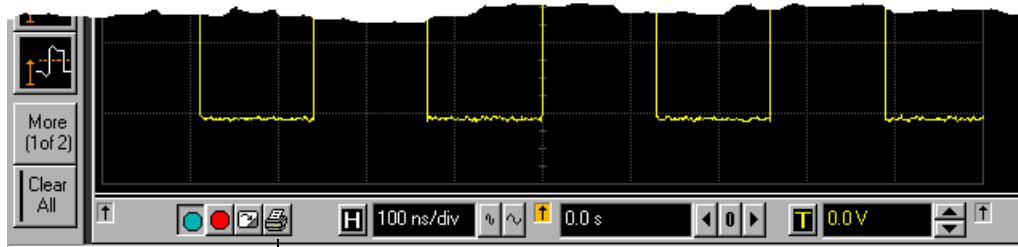

Click this button to  
print the screen

### Printing the Screen

---

## To turn a channel on or off

- To turn a channel on, click the check box next to the channel number so that a check mark appears in the box. To turn a channel off, click the check box again to clear it.

See figure 3-28.

If you are not using a channel, you can turn it off. This simplifies the waveform display and also increases the display update rate. When you turn off a channel, the current vertical scaling factor and vertical scale buttons for that channel disappear. They re-appear when you turn the channel on.

You can also turn a channel on or off by using the Channel Setup dialog box, or by using the front panel key for that channel.

**Figure 3-28**

Turn a channel on by clicking in the On check box until a check mark appears

Turn a channel off by clicking in the On check box until the box is cleared

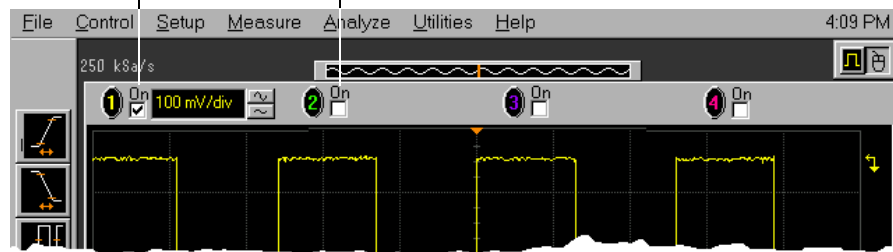

**Turning a Channel On or Off**

## To adjust the vertical offset

- Click and hold the left mouse button on the waveform you want to move, then drag the mouse up or down to move the waveform to the desired offset. Release the mouse button when finished.  
or
- Click and hold the left mouse button on the ground reference indicator for the waveform you want to move, then drag the mouse to move the waveform to the desired offset. Release the mouse button when finished.  
or
- Click the channel button in the vertical toolbar, then set the vertical offset using the spin box control in the Channel Setup dialog box.  
If you leave the mouse pointer on the waveform (without clicking the mouse), the pointer changes into crossed arrows as a visual indicator that you can drag the waveform when you click and hold the mouse button. If you move the mouse up or down, the interface constrains the movement vertically and adjusts vertical offset only. If you initially move the mouse left or right, the interface constrains the movement horizontally and changes the horizontal position setting only.  
You can also adjust the vertical offset through the Channel Setup dialog box. See “To access the channel setup” on page 3-44.

Using the Oscilloscope  
To adjust the vertical offset

Figure 3-29

Click to access the Channel Setup dialog, then set vertical offset using the spin box or numeric keypad...

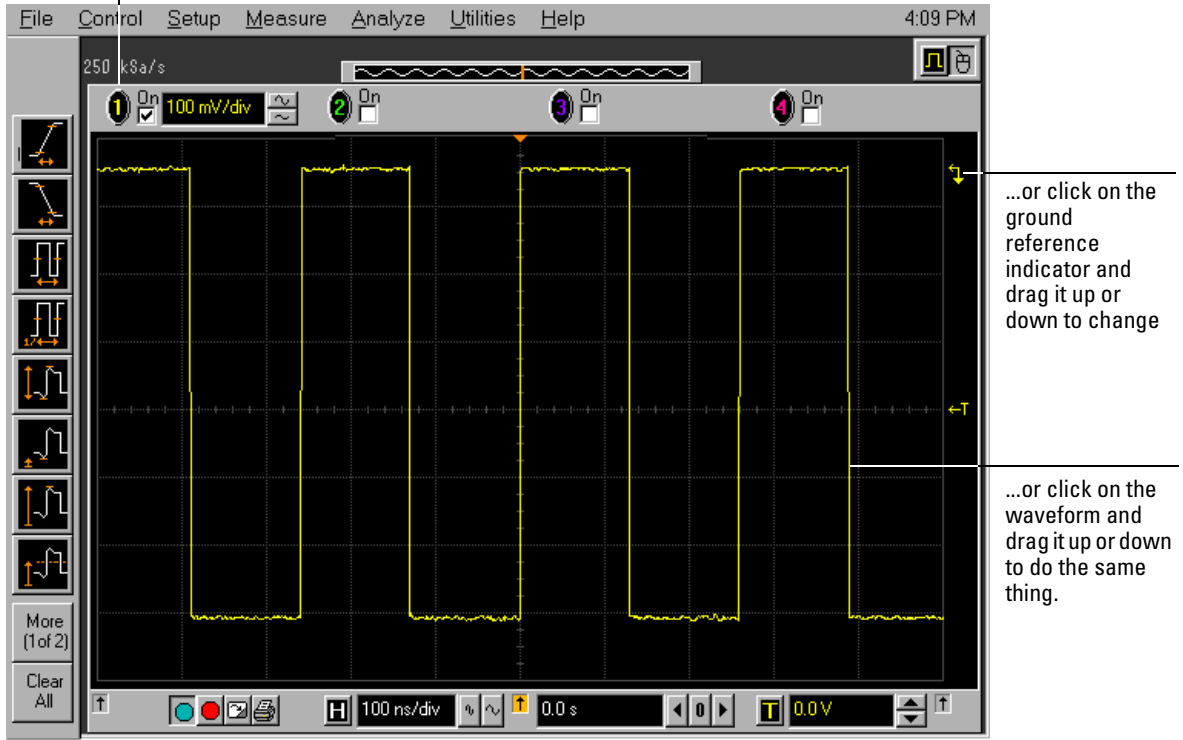

Adjusting Vertical Offset

---

## To adjust vertical scaling

- To make the waveform bigger, click on the larger waveform button next to the channel number near the top of the display. To make the waveform smaller, click on the smaller waveform button.

See figure 3-30. The number of volts per division decreases.

The number of volts per division increases. The current setting in volts per division is shown next to the waveform buttons for the channel. Notice that the setting is color-coded to match the waveform color for easy recognition.

You can also adjust the vertical scaling by clicking on the current setting, which is shown next to the waveform buttons for the channel. This displays a pop-up numeric keypad that allows you to set an exact value for the scaling. Or, you can adjust the vertical scaling through the Channel Setup dialog box. See “To access the channel setup” on page 3-44.

**Figure 3-30**

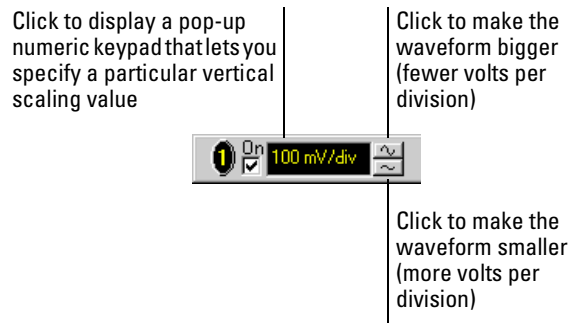

**Adjusting Vertical Scaling**

---

## To access the channel setup

- Click the channel number button at the top of the waveform display.  
or
- Select the desired channel from the Setup menu.

With the channel setup dialog, you can set the vertical scaling, offset, input coupling, and input impedance. It also lets you specify the characteristics of the probe, using the Probes button. You can set attenuation ratio, attenuation units, and measurement units for the probe, or perform a probe calibration. For Agilent Technologies probes that are compatible with the AutoProbe Interface, the oscilloscope will automatically set these characteristics (except for skew) after identifying the probe when it is connected to the channel input.

Figure 3-31

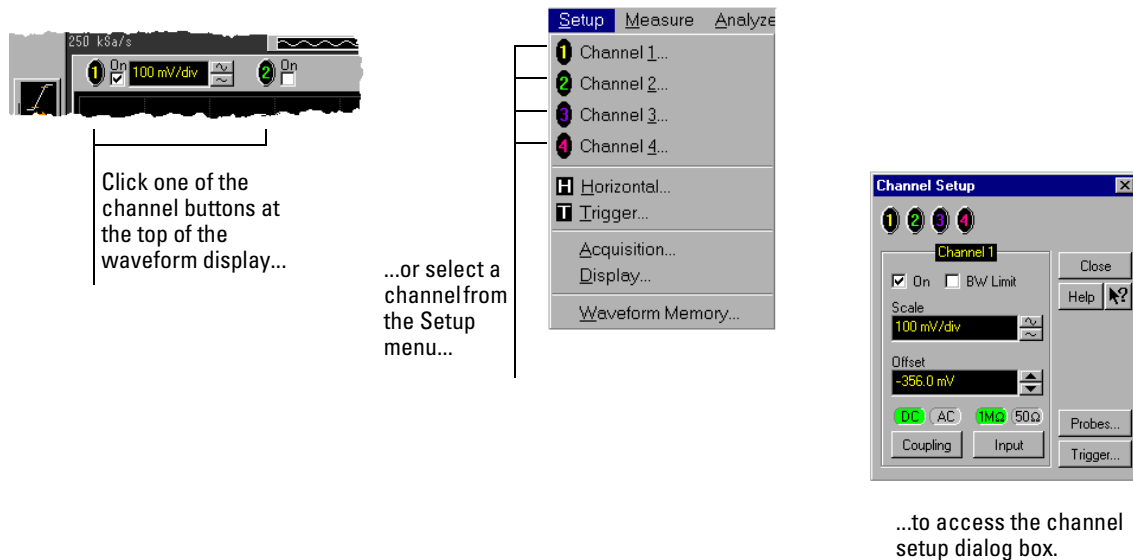

### Accessing the Channel Setup



---

## To set the horizontal reference point

- Click on one of the arrows at the bottom of the waveform display.  
The selected horizontal reference is highlighted.  
The vertical arrows at the bottom of the display correspond to the left, center, and right horizontal reference points. This is the position of the trigger if the horizontal position is set to zero delay. A non-zero horizontal position value is the time relative to the trigger event at the selected horizontal reference point.

Figure 3-32

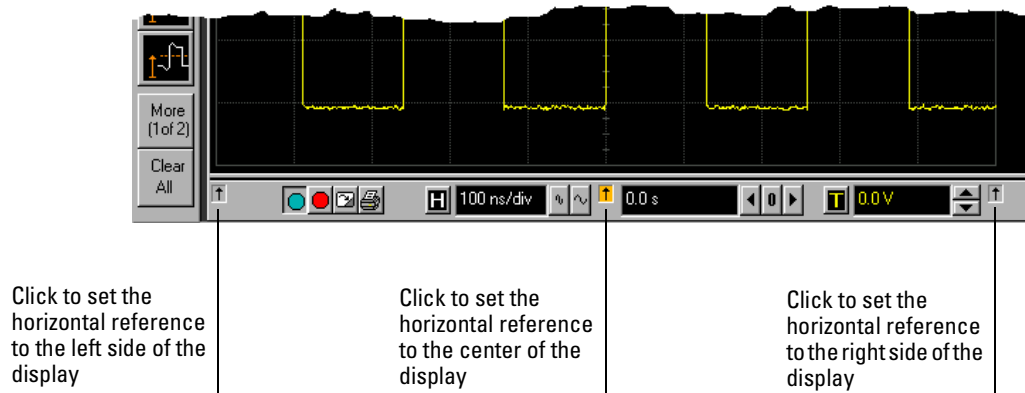

### Horizontal Reference Points

## To adjust sweep speed

- To stretch the waveform horizontally, click the larger waveform button next to the horizontal sweep speed setting at the bottom of the waveform display. To shrink the waveform horizontally, click the smaller waveform button.

See figure 3-33. The oscilloscope decreases or increases the number of seconds per division based on your selection.

You can also adjust the sweep speed by clicking on the current setting. This displays a pop-up numeric keypad that allows you to set an exact value for the sweep speed. Or, you can adjust the sweep speed through the Horizontal Setup dialog box. See “To access the horizontal setup” on page 3-48.

Figure 3-33

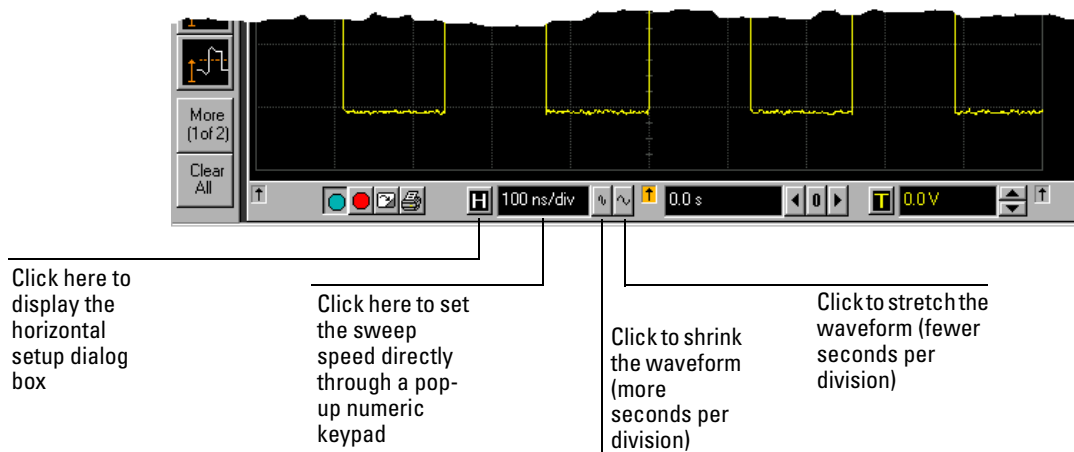

## Adjusting Sweep Speed

## To adjust horizontal position

The *horizontal position* is the time relative to the trigger at the highlighted horizontal reference point.

- To zero the horizontal position, click the 0 button next to the position value at the bottom of the waveform display.

This will position the trigger event at the highlighted horizontal reference point.

- To move the waveform to the right or left, click the right or left arrow next to the position value at the bottom of the waveform display. Or, click and hold the mouse button on the desired waveform and drag the waveform to the right or left. Release the mouse button when the waveform is in the desired position.

When you click and drag a waveform, this changes the horizontal position for all channels and functions on the display, but not that of waveform memories.

You can also adjust the horizontal position through the horizontal setup dialog.

Figure 3-34

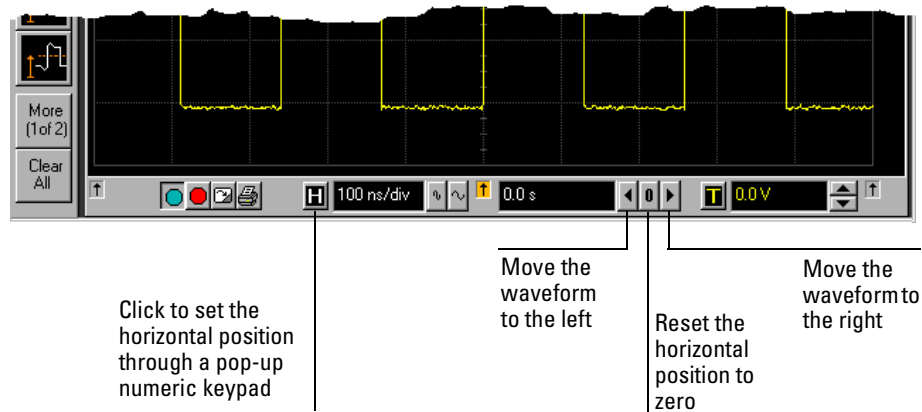

### Adjusting Horizontal Position

---

## To access the horizontal setup

- Click the horizontal setup button at the bottom of the waveform display.  
or
- Select Horizontal from the Setup menu.

See figure 3-35.  
Using the Horizontal Setup menu, you can set sweep speed, position, and the horizontal reference. You can also set up the delayed time base window, which uses software expansion to present a magnified view of an area of the waveform. See the built-in information system (described in chapter 4) for details.

**Figure 3-35**

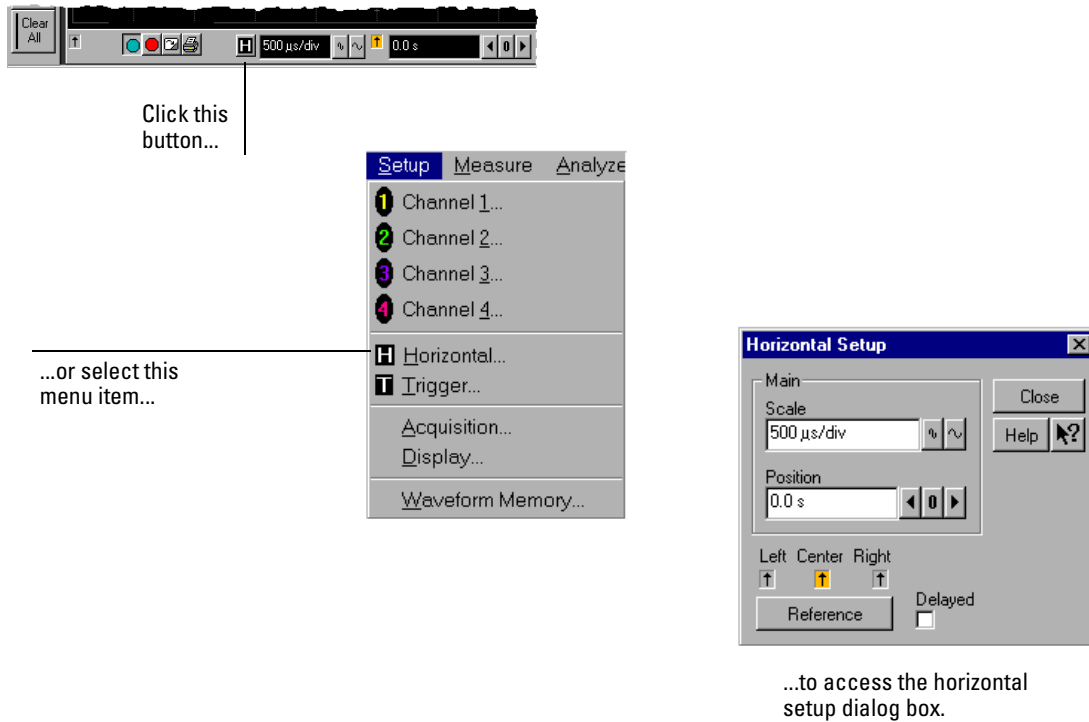

### Accessing the Horizontal Setup

## To zoom on a section of the waveform

- 1 Click and hold the left mouse button in a blank space within the waveform display area, then drag the mouse to draw a rectangle around the areas of interest on the waveform(s). Release the mouse button.
- 2 Click the mouse once anywhere inside the rectangle drawn in step 1.

How the zoom takes place depends on whether acquisition is running or stopped. If running, the oscilloscope adjusts vertical scale, vertical offset, sweep speed, and horizontal position as necessary to best rescale the area you defined in step 1. If stopped, the oscilloscope does a software magnification of the waveform.

In either case, a small dialog box appears in the corner of the screen, with a single “Undo” button; by clicking this button, you will undo the zoom and return the oscilloscope to its previous settings.

### **Avoid Overdriving the Vertical Input Amplifiers**

When the oscilloscope is running, the input waveform can overdrive the vertical input amplifiers if you expand the vertical excessively. The result is distortion of the waveform. Ensure that you select a region that will keep all of the waveform on the screen vertically.

Using the Oscilloscope  
To zoom on a section of the waveform

Figure 3-36

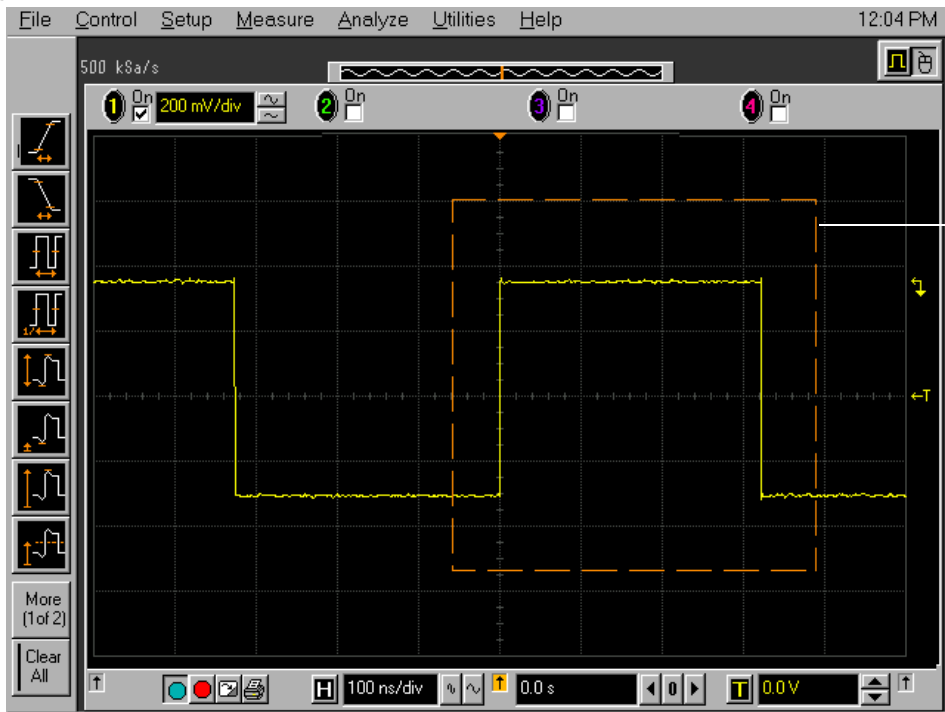

Click and hold the mouse button, drag to create a selection rectangle, then click inside the rectangle to zoom the display on the waveforms inside the rectangle

Zooming on a Section of the Waveform

## To move the markers using the graphical interface

### 1 Turn on the markers.

You can use the Marker A and Marker B keys on the front panel, or select Markers from the Measure menu.

### 2 Click and hold the left mouse button while the mouse pointer is on one of the markers, then drag the marker to the position you want on the waveform. Release the mouse button.

Clicking and dragging a marker makes it easy to quickly move the marker to the desired waveform event. You can use the front-panel arrow keys for fine adjustment. Or, you can select the Markers command from the Measure menu and set the marker position precisely. See the built-in information system for details.

Figure 3-37

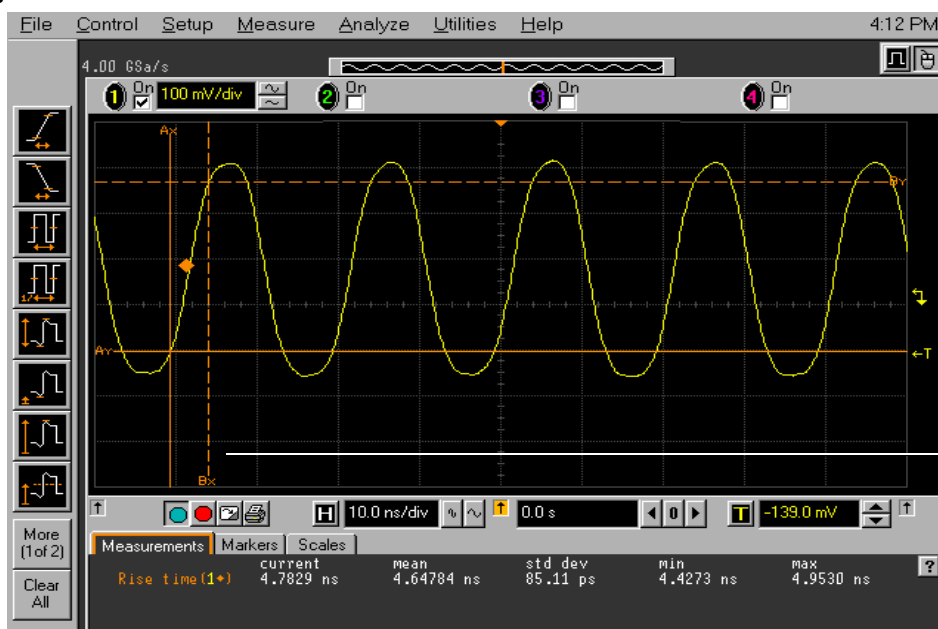

To move a marker, click the mouse with the pointer on the marker, drag the marker to the new position, then release the mouse button

### Moving the Markers

## To make a measurement on a waveform

- Click and hold the mouse button on a measurement icon, then drag the icon to the waveform event you want to measure. Release the mouse button.
- or
- Click on a measurement icon, then specify which source you want to measure in the dialog box that is displayed.

For measurements on waveform features, such as those that involve waveform edges, if you click the measurement icon and specify a source, the measurement defaults to using the first feature it encounters, starting at the left side of the display. When you make the measurement using drag-and-drop, the measurement uses the waveform feature closest to the point where you drop the icon.

The Measurement toolbar is normally displayed at the left side of the screen when the graphical interface is enabled. You can turn off the toolbar, thereby increasing the waveform display area, by selecting Measure, then Customize, then Display Layout.

Only the most commonly used measurements are available on the toolbar. Others are available by selecting them from the Measure menu. A few specialized measurements are available only through the GPIB programming command set to the oscilloscope. See the *Programmer's Reference*.

When you drag and drop a measurement icon on a waveform, notice that the icon outline changes color to match the color of each waveform it touches. This enables you to easily see which waveform will be measured when you release the mouse button. Also, the measurement results are also displayed in color to make it easy to see which waveform source is being measured.

For edge-sensitive measurements, when you drop the measurement icon on a waveform, a geometric icon appears in the waveform marker color. This icon shows exactly where the measurement is being made. The icon is also displayed next to the measurement results readout to associate the readout with the waveform and feature being measured. See figure 3-38. This feature helps you distinguish measurement results from each other when you make multiple measurements on the same waveform, but at different waveform features. For example, a series of rise time measurements on several different edges of the same waveform all have unique geometric icons to show each measurement's location.

The markers default to tracking the last measurement started. The marker position readout defaults to off to reduce clutter, but can be turned on in the Measure menu if desired.



Figure 3-38

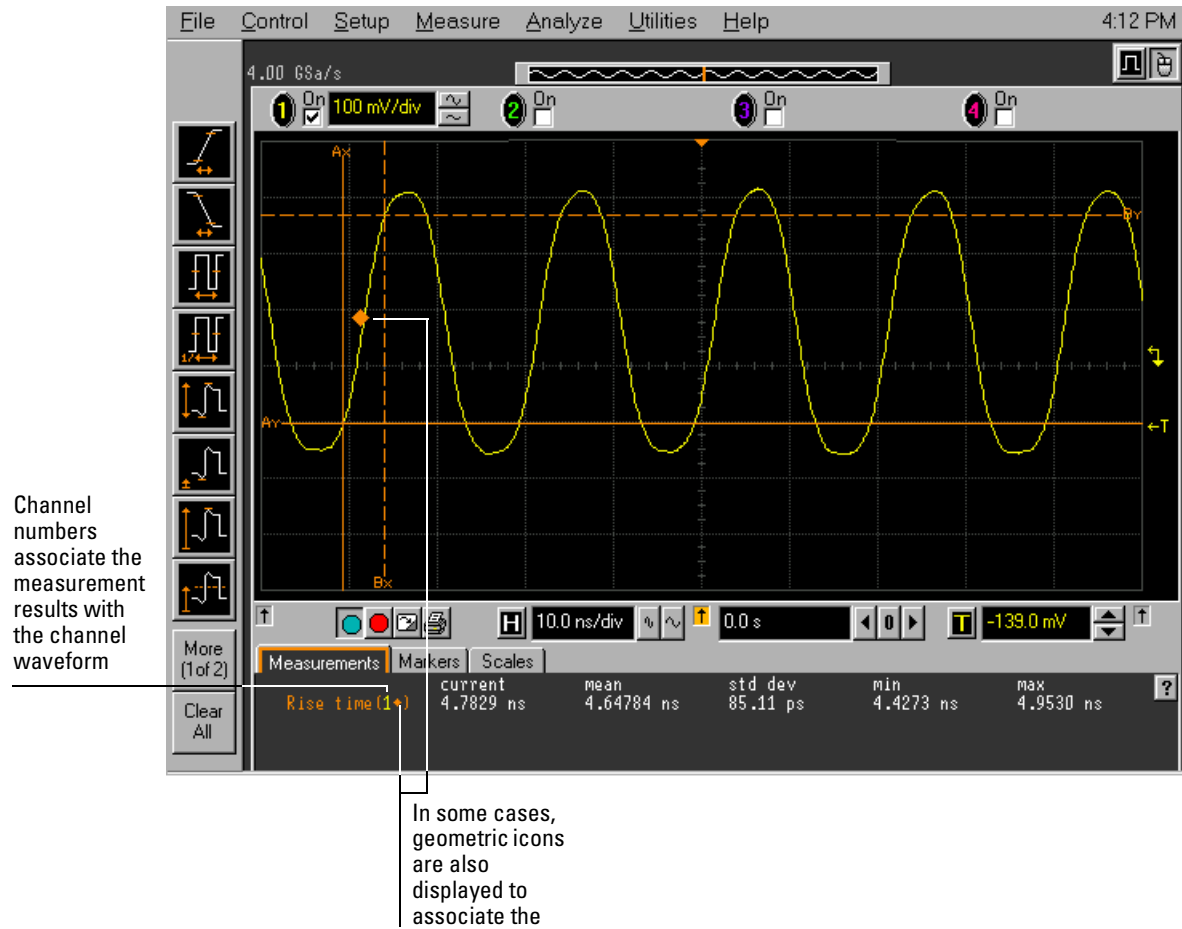

### Waveform Measurements

---

## To access the trigger setup

- Click the trigger setup button at the bottom of the waveform display.  
or
- Select Trigger from the Setup menu.

The trigger setup dialog allows you to select any of the different modes of triggering supported by the oscilloscope—Edge, Glitch, or Advanced, with choices under Advanced of Pattern, State, Delay by Time, Delay by Events, Violation, or Video. You can set the parameters and conditions for each of those trigger modes.

**Figure 3-39**

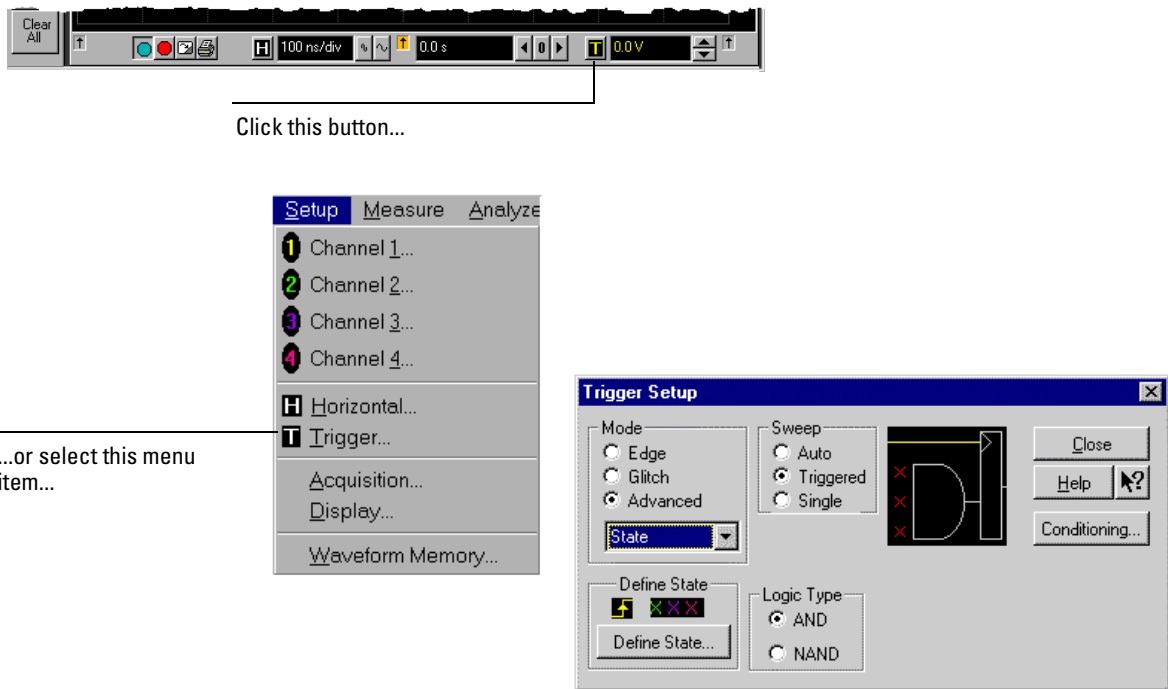

...to access the trigger setup dialog.

### Accessing the Trigger Setup

---

## To set an edge trigger

- 1 Click on the trigger setup button at the bottom of the waveform display. This brings up the trigger configuration dialog. See “To access the trigger setup.”
- 2 Click on Edge.
- 3 Click on the source you want to use for the trigger signal.
- 4 Click to select either the rising or falling edge of the trigger source.
- 5 Set the trigger level using the spin box. You can also click on the trigger level setting to display a pop-up numeric keypad, where you can enter the trigger level directly.

Figure 3-40

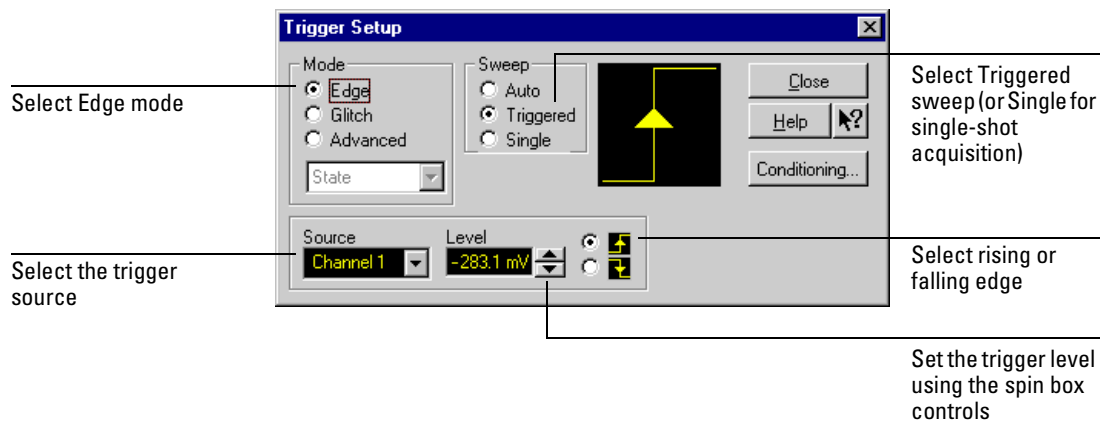

Setting an Edge Trigger

---

## To enable 8.0 GSa/s sampling mode

- 1 Select Acquisition from the Setup menu.
- 2 Click the radio button labeled “8 GSa/s, 64k pts (Channels 1, 3)” under Configuration in the Acquisition Setup dialog box.
- 3 Click Close.

The 54845B and 54846B achieve the maximum 8.0 GSa/s sampling rate by combining acquisition hardware from two channels on a single channel. Thus, in this mode, only channels 1 and 3 are available for input. Because the memory from two channels is combined, the acquisition memory depth is doubled. This can be useful in some measurement situations, even when you do not need the maximum sampling rate of 8.0 GSa/s.

All sampling rates up to and including 8.0 GSa/s are available in this mode. You can select the actual sampling rate used by selecting Manual under Sampling Rate in this dialog box. You can also set the actual memory depth by selecting Manual under Memory Depth in this dialog box.

Return to four-channel operation by clicking the radio button labeled “4 GSa/s, 32k pts (Channels 1, 2, 3, 4).” The maximum sampling rate is then 4.0 GSa/s.

Figure 3-41

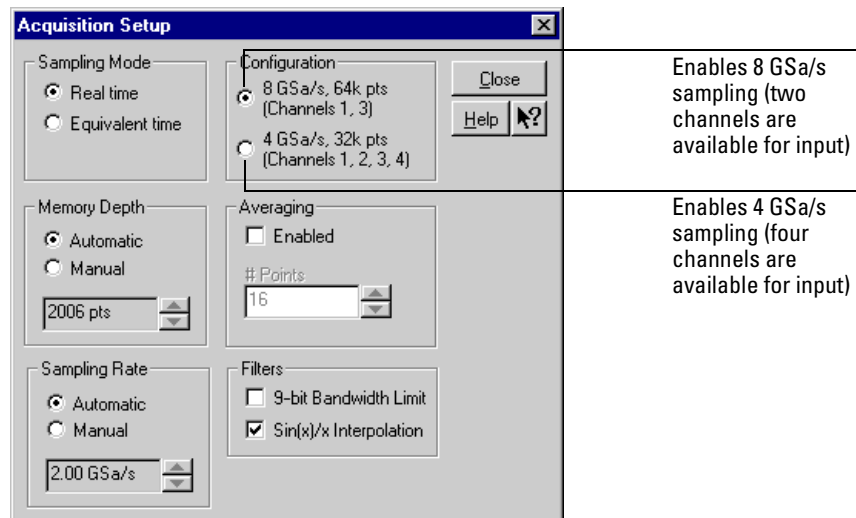

Acquisition Setup for 8.0 GSa/s Sampling

## To set dialog box preferences

- To change the background for the dialog boxes used by the oscilloscope, select **Utilities**, then **User Preferences**. Then select **Opaque**, **Translucent**, or **Transparent** in the **User Preferences** dialog box.

The oscilloscope displays a *dialog box* when it needs information from you to set up a particular aspect of an operation or measurement. You can choose opaque, translucent, or transparent backgrounds for the dialog boxes. Opaque and translucent settings are easier for most users to read and interact with because the dialog box is clearly defined against the oscilloscope display. Translucent and transparent settings make it easier to see the waveform while you are changing the oscilloscope configuration; this allows you to see the results of your changes immediately without closing the dialog box.

### **Windows and Dialog Boxes are Opaque**

Windows and dialog boxes for file operations, error messages, and the built-in information system are always opaque.

- To allow multiple dialog boxes on the screen at a time, select **Utilities**, then **User Preferences**. Then select **Allow Multiple Active Dialogs** in the **User Preferences** dialog box.

Normally, the oscilloscope displays only one dialog box at a time, and you must close that dialog box before opening another. With **Allow Multiple Active Dialogs**, you can change several different aspects of the oscilloscope configuration simultaneously. This option is usually easier to use if you select **Translucent** or **Transparent** dialogs, because it will be easier to see the effects of your changes.

### **Remove Clutter from the Waveform Display**

Having too many dialog boxes on the screen can make it difficult to see the waveform. Close dialog boxes you are not using to remove clutter from the waveform display.

Using the Oscilloscope  
To set dialog box preferences

Figure 3-42

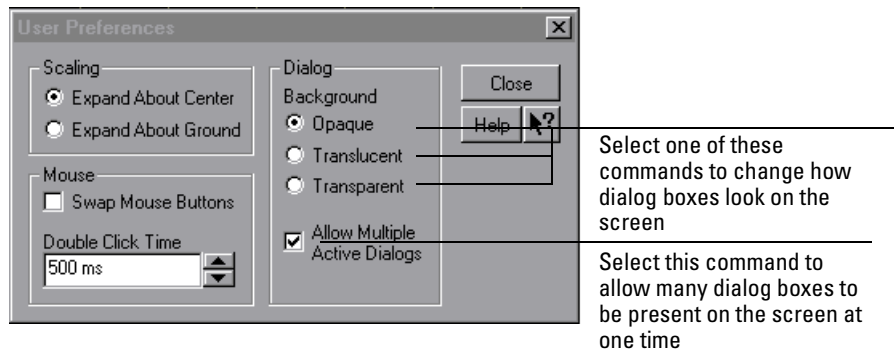
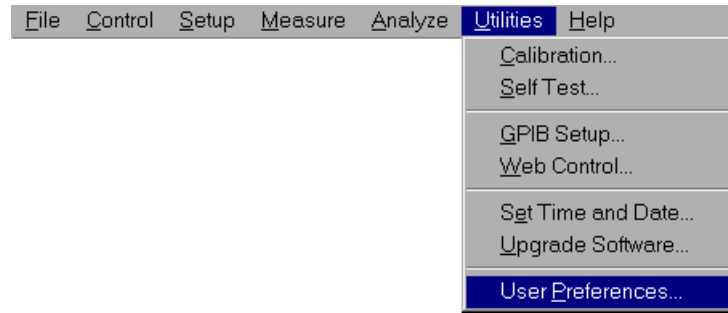

Setting Dialog Box Options

Figure 3-43

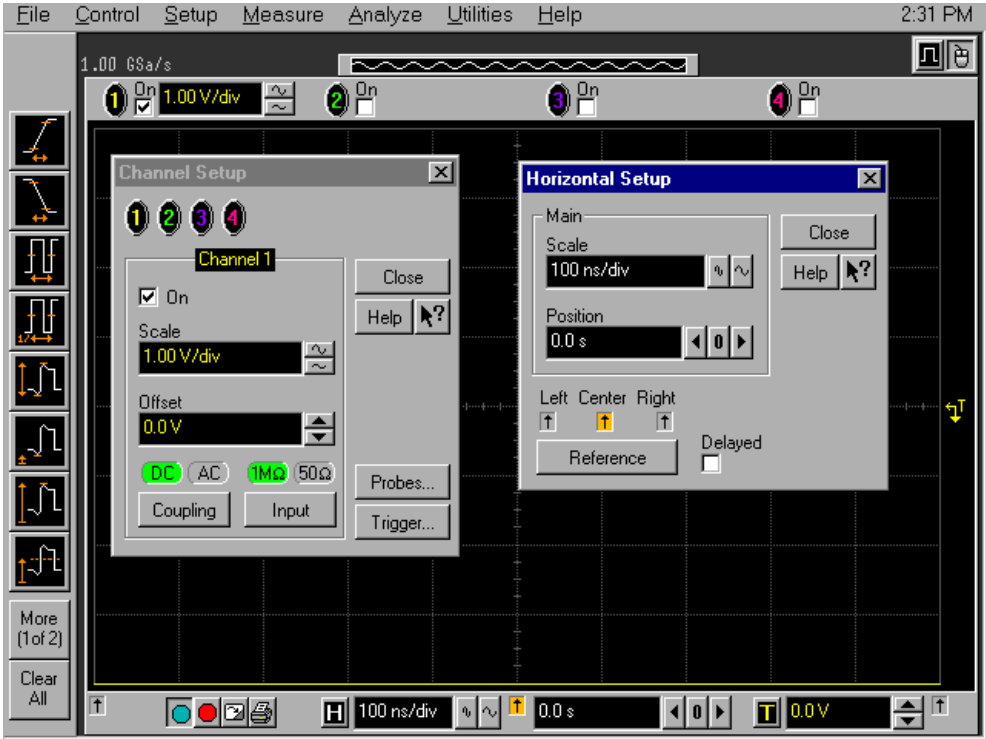

Multiple Active Dialogs (Opaque)

## To install the printer software

When adding a printer or modifying the printer setup, you can either:

- Configure the scope to use the printer attached to your network.  
Before doing this, you must configure the network (see “To set up the network” in this chapter). If you choose to use a network printer, you’ll need the names of the network server and printer. Then you can configure and use the network printer as described here.
- Configure the scope to use a local printer that you will connect to the scope’s printer port.

The instructions here prompt you to select the correct options for the printer you are configuring to use.

- 1** If the scope is not in the graphical interface mode, enable the mode by clicking on the mouse icon in the upper right corner.

This displays the menu options you need to configure the printer setup. See “To switch between the graphical interface and full-screen mode” on page 3-30.

- 2** Select File, Print Setup, and Add Printer.

A window appears with steps that lead you through the process of adding a printer. Be sure to carefully read all of the directions.

Figure 3-44

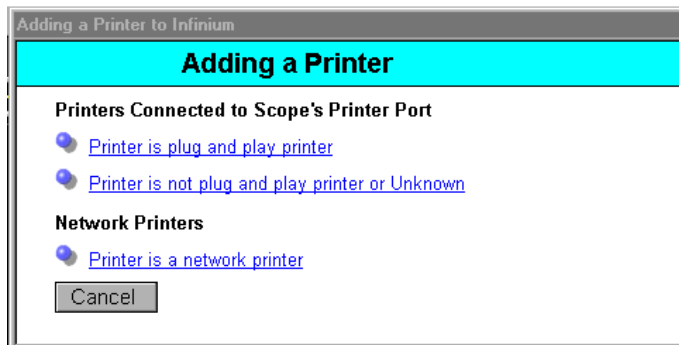

### Selections for Adding a Printer

- 3** If you choose to add either a printer that is not plug and play, or a network printer, no message will be displayed on the oscilloscope screen after the process completes. However, at that point you **MUST** reboot the oscilloscope to have your new printer setup take effect.



If you choose to add a Plug and Play printer, the installation process automatically sets up the printer after you reboot the oscilloscope.

- 4 Read the directions in the Adding a Printer window carefully. Because you will be cycling power on the oscilloscope, you may want to record the instructions in the Adding a Printer window before you continue.
- 5 When you are ready, click the appropriate button.
- 6 After you have followed the instructions on the screen, connected the printer (if appropriate), and cycled power as described in the instructions on the screen, you will complete the printer installation process as described on the screen and on the following pages.
  - If you are adding a plug and play printer, the installation process will automatically continue after powerup. Follow instructions displayed on the screen.
  - If you are adding a printer that is NOT plug and play, or a network printer, after powerup, the scope does not recognize if you already interacted with the Add Printer Wizard before you powered down. So, the scope will prompt you to continue.

**After the Installation Completes, Cycle Power**

When the printer installation process finishes, you **MUST** cycle power on the scope. Your new printer setup will take effect only after you have cycled power.

If you cancel the printer installation, the process stops, and the scope starts up.

When the Add Printer Wizard starts, it displays the following dialog box:



**Add Printer Wizard Startup**

**7** Click Next.

The following printer selection dialog appears:

**Figure 3-45**



**Choose to Set Up Local or Network Printer**

**8** If you are going to use a network printer, click Network printer. If you are going to use a local printer connected to the scope's printer port, go directly to step 12.

You do not have to configure the scope's printer port if you are setting up the scope to use a network printer.

- 9 If you selected Network printer, you'll need to know the names of the network server and the network printer to type in the next dialog box. If you do not know these names, ask your System Administrator now.
- 10 Click Next to access the network printer name dialog box. In the dialog box, type in the network server name and the network printer name using this format: \\server\printer. For example: \\lrnprod\4si\_pcl. In this example, "lrnprod" is the network server name, and "4si\_pcl" is the network printer name.
- 11 Click Yes or No to select whether to use this printer as the default printer. When the process for installing the network printer finishes, you can choose to print a test page if you want.

**You Must Now Cycle Power**  
You must now cycle power on the scope to have your new printer setup take effect.

The remaining steps continue the process of installing a local printer.

- 12 Click Local printer to install the local printer. Then click Next. The following printer selection dialog appears:

Figure 3-46

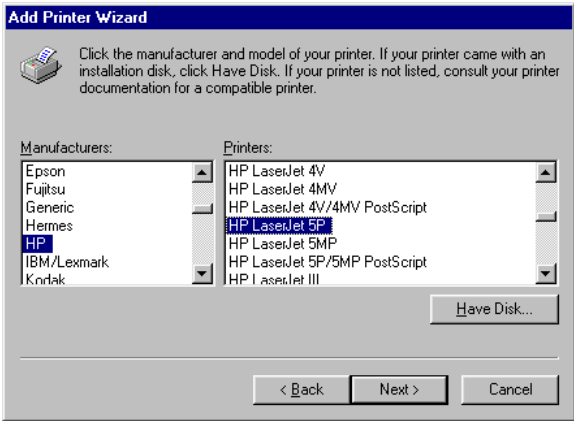

Printer Selection Dialog

- 13 Select the printer manufacturer from the left-hand list. Then select the printer model from the right-hand list. Then skip the next step.

**If Your Printer Is Not Listed**

If your printer model or manufacturer is not listed, you must have the printer driver disk with drivers for Microsoft Windows 98 to load the appropriate driver.

- 14 If your printer is not listed, click Have Disk..., then insert the Windows 98 printer driver disk that came with your printer and load the appropriate driver for your printer.

The oscilloscope now installs the printer drivers. When the printer driver installation process finishes, the scope displays the printer port selection dialog:

Figure 3-47

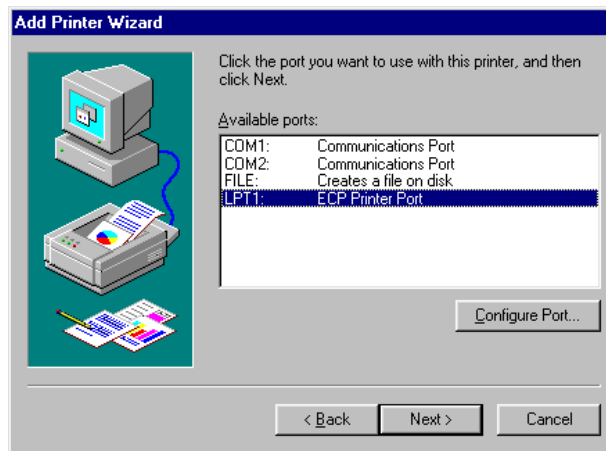

Printer Port Selection Dialog

- 15 If you connected a parallel (Centronics) printer to the oscilloscope, select the LPT1: port. If you connected a serial printer to the oscilloscope, select the COM2: port.
- 16 Click Configure Port... to configure the printer port.

The printer port properties dialog boxes appear, letting you select the appropriate settings for your printer.

- 17 If you are using a serial printer, set the baud rate, data bits, parity, stop bits, and handshake to match the settings for your printer. If you are using a parallel printer, ensure that the checkbox for “Spool MS-DOS print jobs” is cleared, and that “Check port state before printing” is checked.

These dialogs that appear show example settings:

Figure 3-48

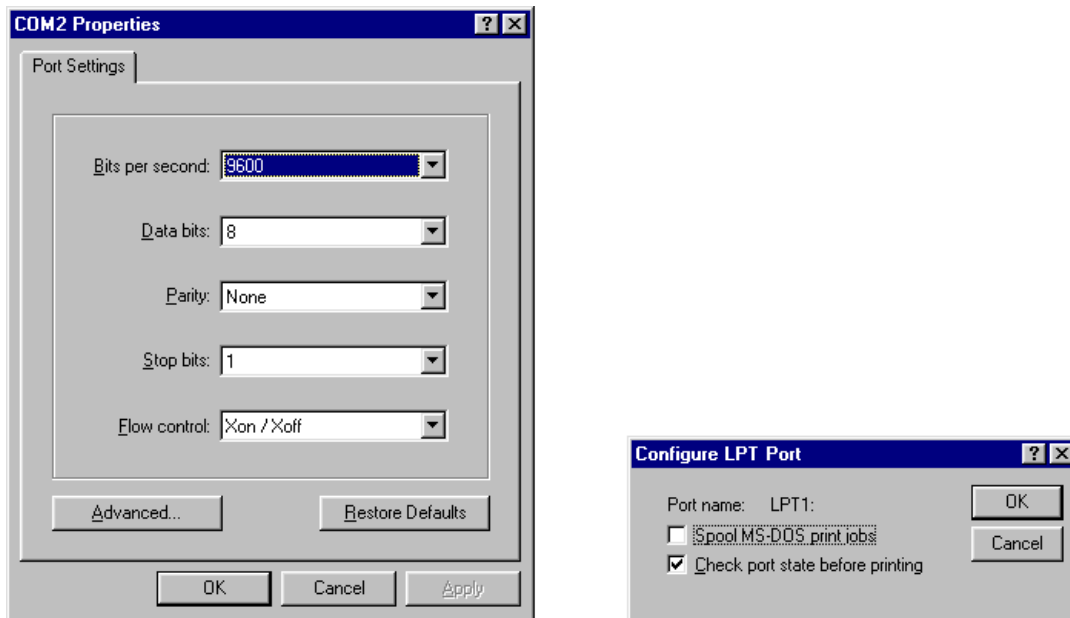

#### Port Configuration Dialogs

- 18 Click OK to return to the printer port selection dialog box. Then click Next.

**Figure 3-49**

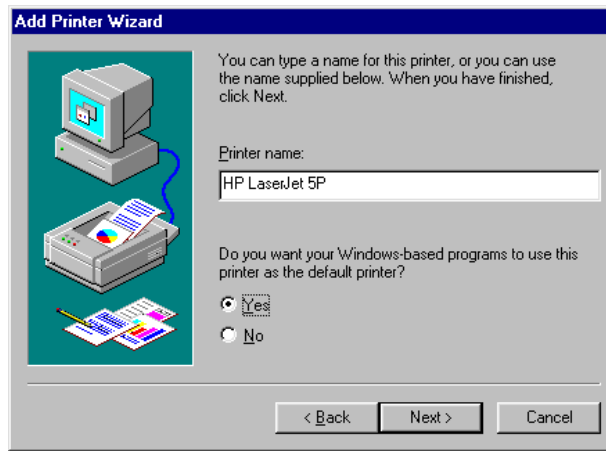

**Printer Name Dialog**

- 19** Type a name for the printer, or accept the default name that is displayed.
- 20** Click Yes to use this printer as the default printer. Then click Next. The Printer Test Page dialog appears.

**Figure 3-50**



**Printer Test Page Dialog**

- 21 Optional — Make sure that your printer is powered on.
- 22 Click Yes to print a test page. Then click Finish.

The oscilloscope sends the printer test page and displays the Test Page Complete dialog.

Figure 3-51

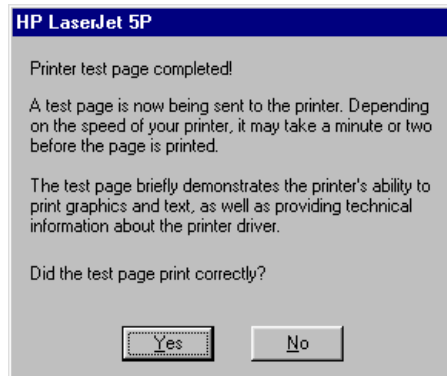

**Test Page Complete**

- 23 If the page printed successfully, click Yes.

If you have a problem with the printer, see the section “When Something Goes Wrong” in the built-in information system. See chapter 4 for more information on accessing and using the built-in information system.

**You Must Now Cycle Power**

You must now cycle power on the scope to have your new printer setup take effect.

## To set up the network

After you have connected your network cable to the LAN card as described in Chapter 1, you must configure the network properties.

- 1 Click **File**. Then select **Network and Properties**.

The following screen is displayed.

**Figure 3-52**

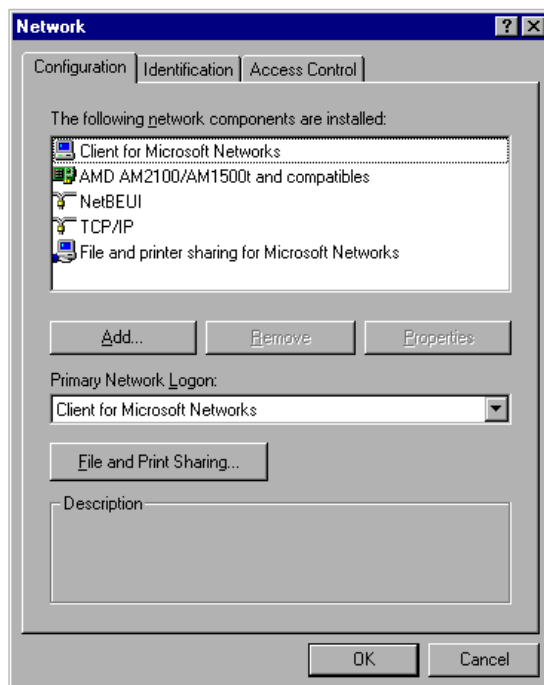

### Network Properties Screen

- 2 Unless you are the System Administrator for your company's network, Agilent Technologies recommends that you have System Administrator configure the network for you.
- 3 When you are done, click **OK**.



## To recover your Infiniium hard disk

Your Infiniium oscilloscope comes with a recovery CD-ROM called the User's Hard Drive Recovery Disk. You should use the recovery CD-ROM to restore your hard drive in the rare event that something may have destroyed the Windows operating system or the Infiniium application software.

The Infiniium hard disk recovery system consists of a CD-ROM containing the Windows operating system and the Infiniium application software. If you have to use the recovery CD-ROM, the Infiniium hard disk is returned to the condition it was in when it left the factory.

- 1** Turn off the Infiniium.
- 2** Put Recovery CD-ROM into the CD-ROM drive located on the rear panel.
- 3** Turn on the Infiniium. Infiniium will boot from Recovery CD-ROM
- 4** Follow the onscreen instructions.
- 5** Once the installation is complete, remove the Recovery CD-ROM from the CD-ROM drive.
- 6** Turn off the Infiniium.
- 7** Turn on the Infiniium.

The Infiniium application software that you just installed is the version that originally came with your Infiniium. There may be a newer version of the Infiniium application software available at our web site that can be ordered for free. The internet address is:

[www.agilent.com/find/infiniium\\_support](http://www.agilent.com/find/infiniium_support)



---

## Using the Built-In Information System

---

# Using the Built-In Information System

Most of the documentation for using the Infiniium Oscilloscope is included in its built-in information system. The built-in information system contains the information generally found in a User's Guide.

The information system is available only when the graphical interface is enabled, and is accessible from the menu bar and from dialog boxes. This chapter explains how to use the system to find the information you need to use the oscilloscope effectively.

The following topics are covered in the information system:

- *Probing* lists the various probes available for the Infiniium Oscilloscope, discusses probing considerations, and explains how to use the probes.
- *Acquiring and Viewing Waveforms* explains how acquisition works, discusses the acquisition and display functions and controls, and tells how to use the run/stop controls.
- *Display Style, Grid, and Format* explains how to alter the display appearance, tells how to improve the display of certain kinds of waveforms, and explains the X-versus-Y display function.
- *Triggering* explains basic triggering concepts, describes the trigger modes available in the Infiniium Oscilloscope, and tells how to use the trigger modes.
- *Saving Waveforms, Saving Setups, Networking, and Printing* explains how to simplify your work with the oscilloscope by saving critical waveforms, measurement results, and the oscilloscope configuration used to obtain them. You can recall the waveforms for viewing later, or recall the setup to repeat the measurement.
- *Measurements, Markers, and Mask Testing* describes the built-in automatic measurement functions of the oscilloscope, explains how they work, and tells how to use them. Describes the markers and how to use them. Describes mask testing and how to use it.
- *Math, FFTs, and Histograms* discusses oscilloscope functions that perform mathematical operations on one or more waveforms, and discusses the built-in Fast-Fourier Transform functions. Describes histograms and how to use them.

- *VoiceControl* discusses the operation and use of VoiceControl which is an option that you can order with you Infiniium oscilloscope.
- *Locating a Control* is a visual guide to the location of every oscilloscope control in the graphical user interface.
- *When Something Goes Wrong* explains what to do when you see an error message or have a problem using the oscilloscope.

Some topics in the information system are important enough to have their own icons.

- A *Setup Guide* explains the steps you take to perform various measurement and configuration tasks using the oscilloscope. Twenty-four different procedures are covered, making it easy for you to make a measurement without having to learn a complex setup process.
- A *Technical Support* page explains how to get help from Agilent Technologies on using or servicing the oscilloscope.
- A *Glossary* defines all the major terms used in the information system and other documentation.
- A *Specifications* page lists all the performance specifications for the oscilloscope.
- An *Accessories List* describes the accessories supplied with the oscilloscope and additional accessories available from Agilent Technologies.

## To access the information system

- Select Contents from the Help menu.

The Contents page for the oscilloscope information system is displayed.

### To Use the Information System

You must select the graphical interface before you can access the information system. Select the graphical interface by clicking the mouse icon in the upper right corner of the scope screen.

Figure 4-1

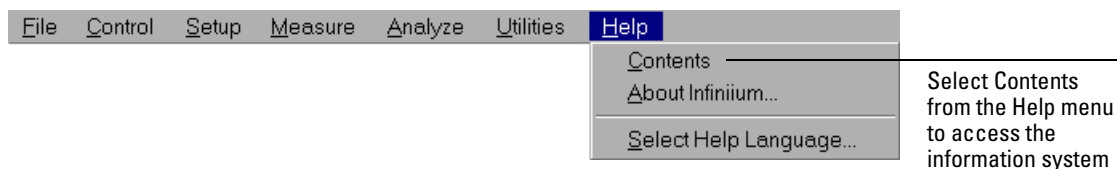

### Help Menu

## Access Methods

The information system provides three methods for finding the information you need. The *Contents* topic is shown when you access the information system from the Help menu. It looks like the following figure.

**Figure 4-2**

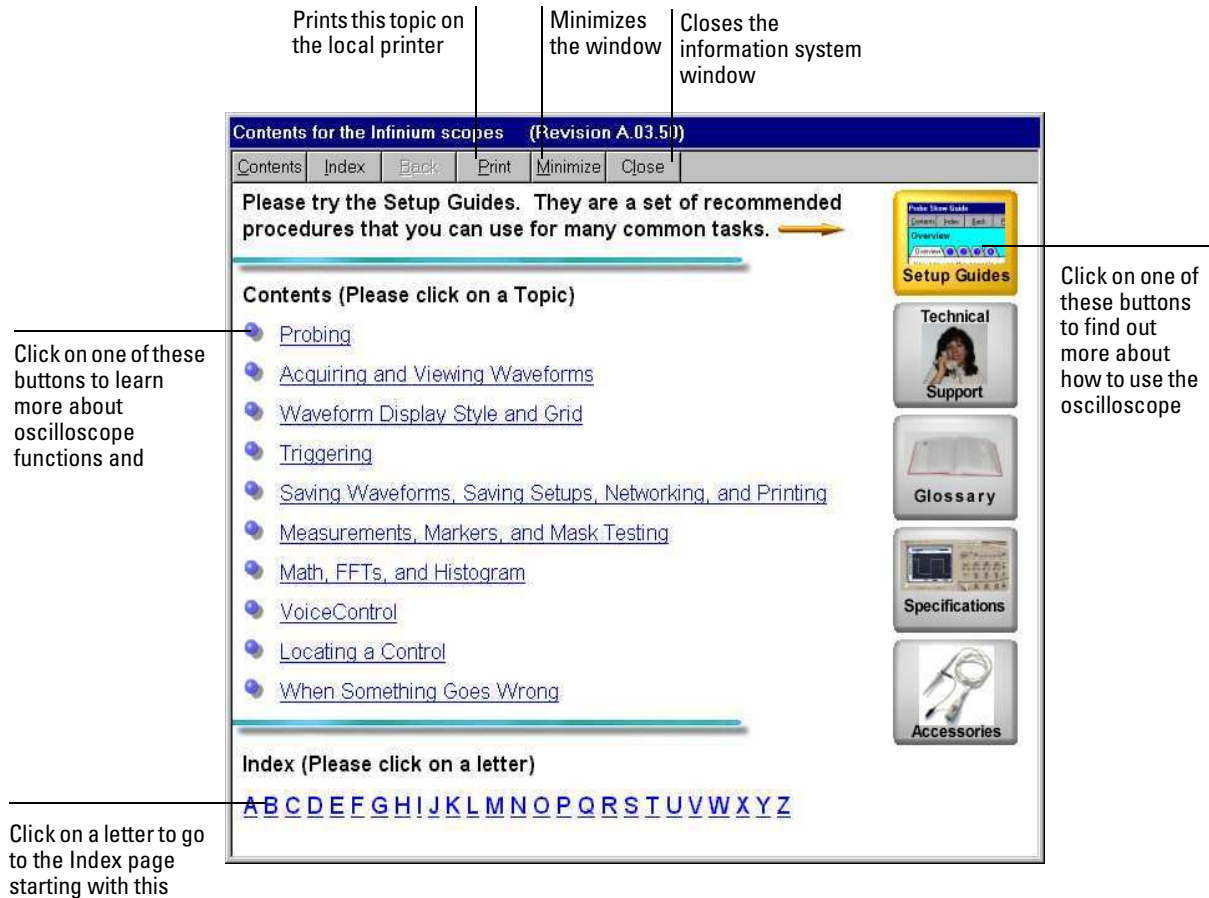

### Contents Topic Page

You can move to the Contents topic from any other information system topic by clicking on the Contents button within that topic.

### Viewing the Information System Window

The Information System window will always stay on top of the interface display, so you can refer to it while working with the oscilloscope. You can move the window around the screen or resize it to make it easier to use.

The *Index* topic is the second method. It is shown whenever you click the *Index* hyperlink in the *Contents* topic or when you click the *Index* button in any information system topic. It looks like the following figure.

Figure 4-3

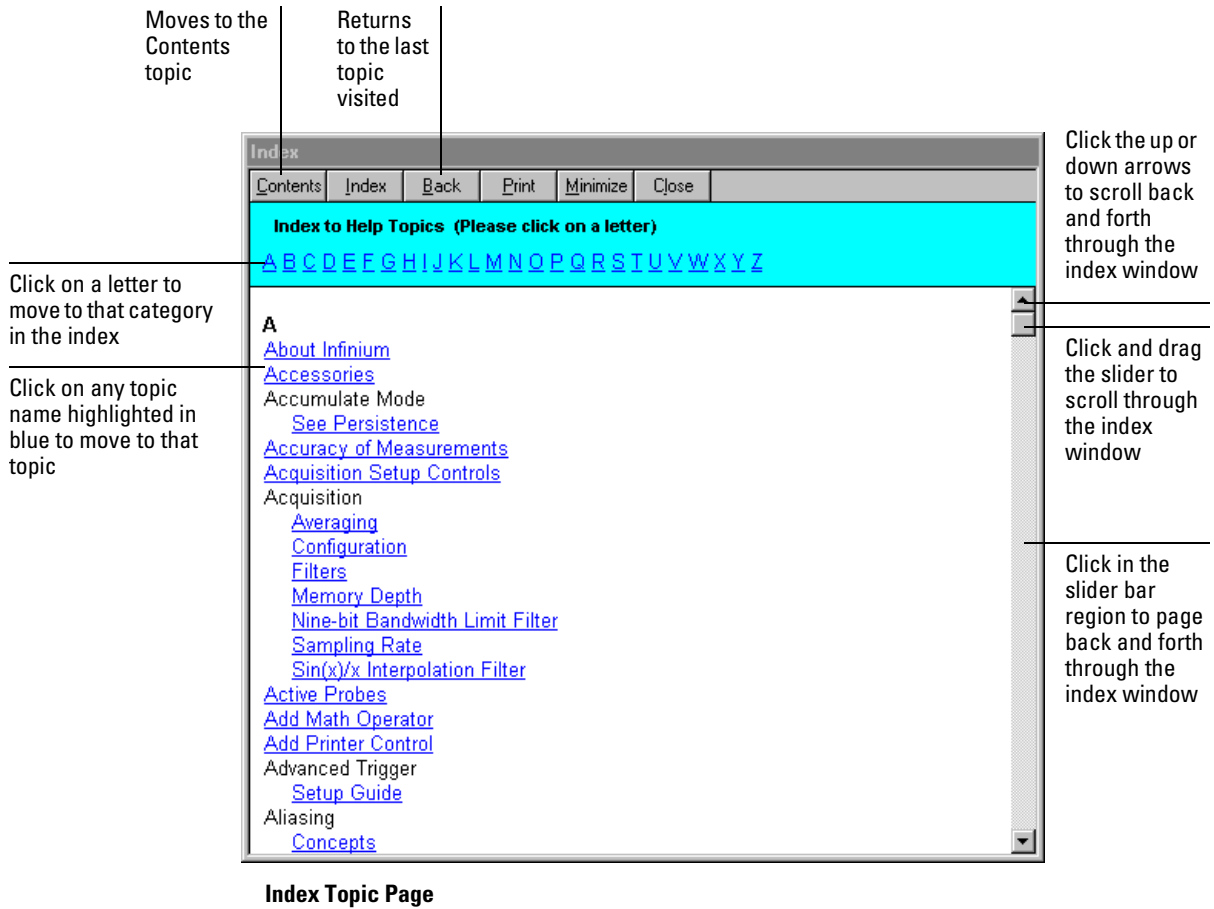



*Hyperlinks* throughout the information system allow you to reach the information you need. Most hyperlinks will be in blue underlined text, but some hyperlinks also have buttons (many of the reference topics) or tabs (in setup guide topics). You can find out whether a particular item has a hyperlink by pointing to it with the mouse; if it is a hyperlink, the pointer will change to a hand icon. Clicking once will follow the hyperlink to display a new topic with the relevant information.

### **Topic Types**

There are two general categories of topics in the information system. First are *reference topics*, which explain what the oscilloscope does, how it does it, or considerations you should observe in setting up or making a measurement. The following figure shows an example.

Figure 4-4

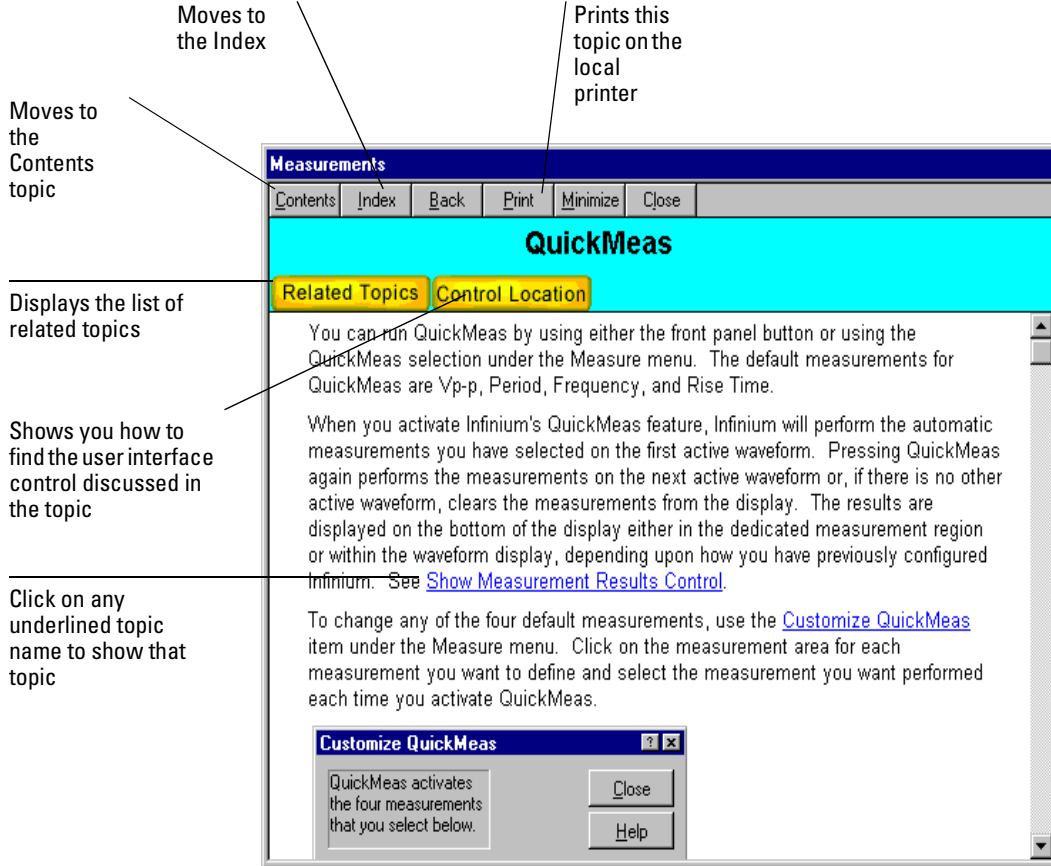

**Reference Topic (Typical)**

The second are *setup guide topics*, which show you the steps to follow to perform a task with the oscilloscope. These are organized as an overview with a set of tabs that show the specific steps for each part in the process. The following figure shows an example.

Figure 4-5

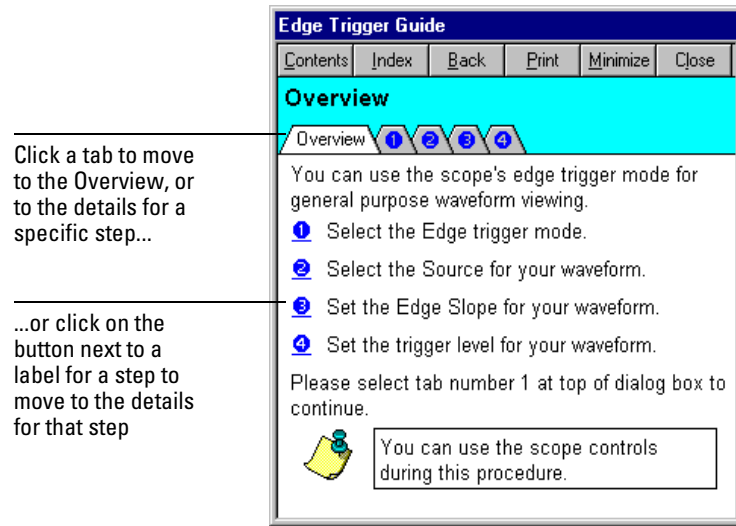

#### Setup Guide Topic

Some setup guide topics have multiple levels because the steps depend on the type of measurement you want to make.

---

## To select the built-in information system language

- 1 Select the Select Help Language command from the Help menu.
- 2 Choose the help language from the drop-down list box options.
- 3 Click the Close button.

Figure 4-6

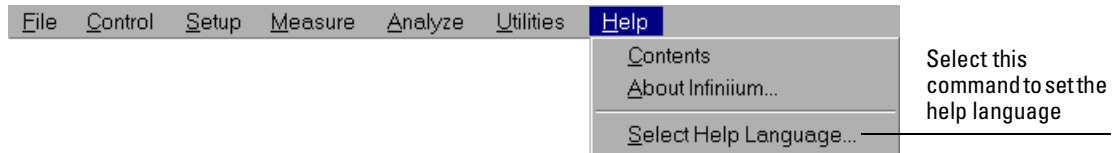

Help Language Command Location

Figure 4-7

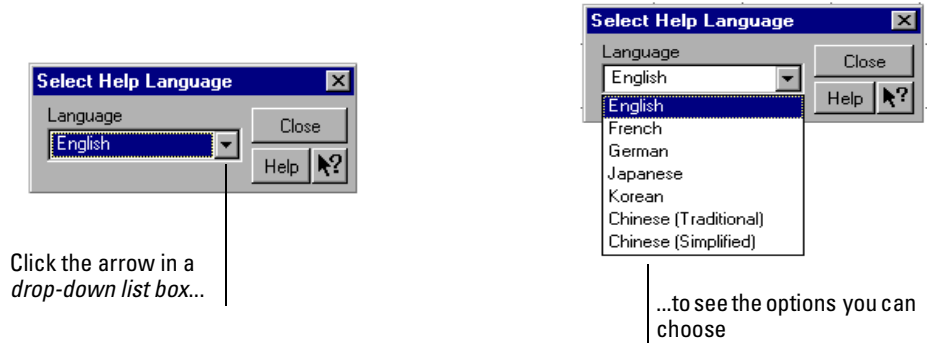

Help Language Selection Dialog

### Available Languages will be Displayed

Only those languages available on your version of the oscilloscope will appear in the drop-down list box.

## To navigate through the information system

Once you are in the help system windows, you may need to navigate through them to find the information you need.

### **For most topics:**

- To display information for another topic or category described in a hyperlink, click on that hyperlink or on the button icon next to it.
- To return to the previously visited topic, click on the Back button near the top of the Help window.

### **For Setup Guide topics:**

- To display information for another topic or category described in a hyperlink, click on that hyperlink or on the button icon next to it.
- To jump to a particular step, click on the hyperlink button next to the description of that step, or click the tab corresponding to that step in the Overview window.

The Overview window is the one you first see when you select a particular Setup Guide topic. It gives an overview of the steps in the task.

- To move to the next step, click on the tab for that step in the step description window.
- To return to the previously visited topic, click the Back button near the top of the Help window.

---

## To access context-sensitive information

- To see overview information for items in a dialog box, click the Help button in that dialog box.
- To get information on a particular user interface element, click on the question mark button at the upper right-hand corner of a dialog box, then point to the element.

The mouse pointer becomes a pointer plus question mark whenever you click the question mark button. After you click on the desired user interface element, a pop-up window appears describing the function or use of the element. To clear the pop-up window, click the mouse button.

### First Access the Graphical Interface

You must select the graphical interface before you can access the information system.

Figure 4-8

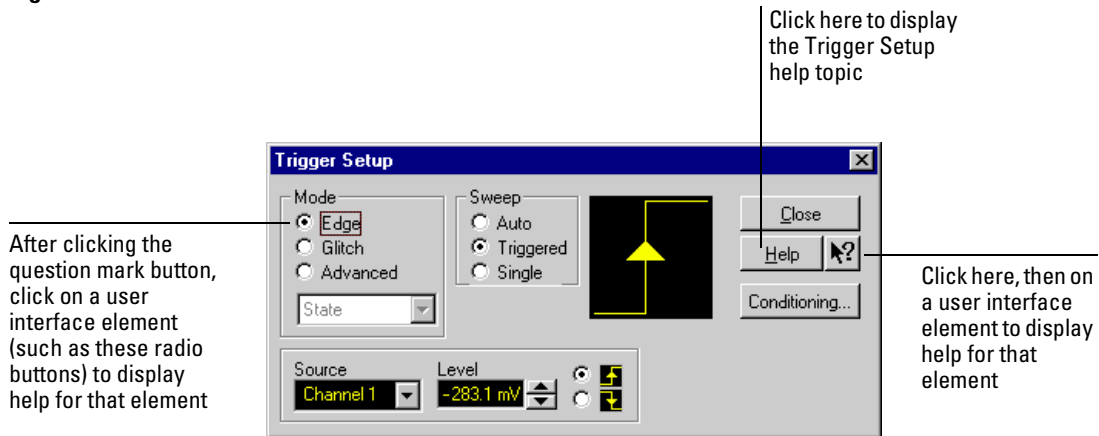

Getting Help on the Trigger Setup Dialog Interface Elements

---

# Index

---

## Numerics

- 54845/46
  - 8.0 GSa/s sampling on 3-56
- 8.0 GSa/s sampling 3-56

## A

- access methods 4-5
- accessing
  - index 4-5, 4-6
  - information system 4-2, 4-4
  - trigger setup 3-54
- accessories 1-6, 4-3
  - and options 1-5
  - supplied 1-3, 1-4
- accurate measurements using markers 3-16
- acquisition
  - and general controls 3-5
  - clearing display before 3-38
  - information system 4-2
  - memory depth 3-56
  - running and stopping 3-5
  - starting and stopping 3-8, 3-27, 3-37
- active dialog boxes
  - allowing multiple 3-57
- adjusting
  - horizontal position 3-26, 3-47
  - sweep speed 3-13, 3-46
  - vertical offset 3-12, 3-26, 3-41, 3-42
  - vertical scaling 3-12, 3-27, 3-43
- advanced trigger 3-5
  - configuration 3-28
  - mode 3-54
- airflow requirements 1-10
- appearance
  - of display 4-2
- applying power 1-24
- arrangement of graphical interface 3-23
- Arrow keys 3-16
- arrows
  - scroll 4-6
- associating measurement results with
  - waveforms 3-52, 3-53
- Autoprobe interface 3-44
- Autoscale 1-26, 3-5

## B

- back panel connections 1-12, 1-13, 1-18,

- 1-19, 1-22
- backlight 1-24
- behavior of information system windows 4-6
- blanking
  - screen 1-24
- BNC connectors 1-17
- built-in information system 4-2
- buttons 3-3
  - as hyperlink 4-7
  - channel setup 3-21, 3-22, 3-44
  - clear display 3-21, 3-22
  - external trigger setup 3-21, 3-22
  - full-screen 3-30
    - mode 3-19, 3-20
  - graphical interface 3-30
  - graphical interface mode 3-21, 3-22
  - help 4-12
  - horizontal setup 3-21, 3-22, 3-48
  - question mark 4-12
  - run 3-21, 3-22
  - stop 3-21, 3-22
  - trigger setup 3-21, 3-22, 3-54, 3-55

## C

- cables 1-6
  - power 1-11
  - printer 1-18
- calibration
  - and repair service 1-6
  - MIL-STD 1-6
  - output 1-26
- categories of information 4-7, 4-8
- cautions
  - cleaning 1-28
  - disconnecting probes 1-17
- center horizontal reference 3-28, 3-45
- Centronics printers, see parallel printers
- Channel keys 3-10
- channel setup
  - accessing 3-44
  - button 3-21, 3-22, 3-44
- channels
  - displayed 3-27
  - turning on or off 3-10, 3-27, 3-40
- characteristics 4-3
- check box 3-31, 3-32
- checking the oscilloscope 1-3

## choosing

- commands 3-33, 3-34
  - list items 3-31
- cleaning the oscilloscope 1-28
- clear display 3-5
  - button 3-21, 3-22
- Clear Display key 3-9
- clearance requirements 1-10
- clearing measurements 3-24
- clearing the display 3-9, 3-27, 3-38
- click 3-31
- closing
  - dialog boxes 3-31, 3-32
- color
  - use of 3-3, 3-22
  - use of in interface 3-52
- command menus 3-21, 3-22
- commands
  - selecting 3-33, 3-34
- common procedures 4-3
- conditions
  - trigger 3-54
- configuration
  - 8.0 GSa/s sampling 3-56
  - Autoscale 3-5
  - channel 3-44
  - default 1-26, 3-5, 3-7
  - dialog boxes 3-57
  - edge trigger 3-15
  - horizontal 3-28, 3-48
  - information system language 4-10
  - ports 3-64, 3-65
  - through menus 3-27
  - trigger 3-5, 3-28, 3-54, 3-55
- configuration instructions 4-3
- configuring
  - printers 1-19, 1-20
  - quick measurements 3-17
- connecting
  - GPIB 1-22
  - keyboard 1-13
  - LAN card 1-14
  - pointing device 1-12
  - power 1-10
  - printers 1-18, 1-19
  - probes 1-17
- constraints on waveform movement 3-41

- 
- contents
    - information system 4-4
    - of oscilloscope package 1-3
  - contents topic 4-5
  - contents, of oscilloscope package 1-4
  - context-sensitive
    - information 4-12
    - menus 3-27, 3-34, 3-35
  - controlling the oscilloscope 1-22
  - controls
    - acquisition and general 3-5
    - graphical interface 4-3
    - horizontal 3-5
    - marker and measurement 3-6
    - trigger 3-5
    - vertical 3-5
  - coupling
    - trigger input 3-15
    - vertical input 3-5
  - Coupling key 3-15
  - customizing display layout 3-24, 3-52
  - cycling
    - markers through channels 3-16
    - measurements through channels 3-17
    - through waveforms 3-6
  - D**
  - default setup 1-26, 3-5
  - Default Setup key 3-7
  - definitions of terms 4-3
  - Delayed key 3-14
  - delayed sweep 3-14, 3-48
  - delayed time base 3-5
  - dialog boxes 3-31, 3-32
    - information on 4-12
    - preferences for 3-57, 3-58
  - direct manipulation of waveforms 3-41, 3-47
  - Disk
    - Hard Disk Recovery 3-69
  - disk
    - printer driver 3-64
  - display
    - clearing 3-5, 3-9, 3-27, 3-38
    - information system 4-2
  - display area
    - waveforms 3-20, 3-25
  - display format 4-2
  - display layout
    - customizing 3-24, 3-52
  - display of channels 3-27
  - display update rate
    - increasing 3-10, 3-40
  - drag-and-drop measurements 3-23, 3-52
  - drag-and-drop waveforms 3-26, 3-41, 3-47
  - drivers
    - installing printer 3-60
  - drop-down list box 3-31, 3-32
  - E**
  - edge trigger 3-5
    - mode 3-54, 3-55
    - setting 3-15
  - erasing the display 3-9, 3-38
  - error messages 4-3
  - external trigger setup button 3-21, 3-22
  - F**
  - feet
    - using 1-23
  - FFT functions
    - information system 4-2, 4-3
  - finding information 4-2, 4-5, 4-11
  - front panel 3-4, 3-6
    - connections 1-17
    - interface 3-2, 3-3
    - using with graphical interface 3-23
  - full-screen
    - mode 3-19, 3-20, 3-30
    - mode button 3-19, 3-20, 3-30
  - functions
    - information system 4-2, 4-3
  - G**
  - general controls 3-5
  - geometric measurement indicators 3-24
  - glitch trigger 3-5
    - mode 3-54
  - glossary 4-3
  - GPIB
    - cables 1-6
    - connecting 1-22
  - graphical interface 3-2, 3-19
    - arrangement of 3-23
    - button 3-30
    - controls 4-3
    - mode 3-21, 3-22, 3-30
    - pointing device for 1-12
    - using with front panel 3-23
  - graticule 3-6
  - grid 3-25
  - ground reference indicator 3-19, 3-20, 3-26, 3-41
  - guide to setup 4-3
  - H**
  - Hard Disk
    - Recovery 3-69
  - help
    - button 4-12
  - help, see also information system
  - high-speed sampling
    - setting for 54845 and 54846 3-56
  - horizontal
    - adjusting position 3-13
    - adjusting sweep speed 3-13
    - controls 3-5
    - delayed sweep 3-14
    - horizontal and trigger toolbar 3-27
    - horizontal position 3-5, 3-19, 3-20, 3-48
      - adjusting 3-13, 3-26, 3-28, 3-47
      - in delayed sweep 3-14
      - setting 3-21, 3-22
      - with respect to horizontal reference 3-45
    - horizontal reference 3-48
      - indicators 3-19, 3-20, 3-28
      - setting 3-45
    - horizontal setup 3-28
      - accessing 3-48
      - button 3-21, 3-22, 3-48
    - horizontal sweep speed 3-19, 3-20, 3-21, 3-22, 3-28
      - adjusting 3-46
    - hyperlinks 4-7
    - index 4-6
    - using to find information 4-11
  - I**
  - icons
    - dragging to waveform 3-23
    - learning functions of 3-24
-



- 
- measurement 3-21, 3-22, 3-23, 3-52, 3-53
  - impedance
    - input 3-5
  - increasing display update rate 3-10, 3-40
  - index
    - accessing 4-5, 4-6
  - indicators
    - ground reference 3-19, 3-20, 3-26, 3-41
    - horizontal reference 3-19, 3-20, 3-28
    - measurement 3-24
    - run/stop mode 3-19, 3-20
    - trigger level 3-19, 3-20
    - trigger level reference 3-29
  - information
    - methods for accessing 4-5
    - on dialog boxes 4-12
  - information system
    - accessing 4-4
    - context-sensitive 4-12
    - index 4-6
    - language 4-10
    - navigating 4-11
    - overview 4-2
    - paging through 4-6
    - scrolling through 4-6
    - topic types 4-7
    - windows 4-6
  - input
    - coupling 3-5, 3-44
    - impedance 3-5, 3-44
  - inspecting the oscilloscope 1-3
  - installing printer software 3-60
  - instructions for setup 4-3
  - instrument controller 1-22
  - instrument, see oscilloscope
  - interface elements
    - information on 4-12
- K**
- keyboard
    - connecting 1-13
  - keys 3-3
    - Arrow 3-16
    - Channel 3-10
    - Clear Display 3-9
    - Coupling 3-15
    - Default Setup 3-7
    - Delayed 3-14
    - marker 3-6
    - Marker A 3-16
    - Marker B 3-16
    - Mode 3-15
    - QuickMeas 3-17
    - Run 3-8
    - Slope 3-15
    - Source 3-15
    - Stop 3-8
    - Sweep 3-15
  - kinds of information 4-7, 4-8
  - knobs 3-3
    - color of 3-22
    - horizontal position 3-13
    - sweep speed 3-13
    - vertical offset 3-12
    - vertical scaling 3-12
- L**
- LAN card 1-14
  - language
    - selecting for information system 4-10
  - learning functions of icons 3-24
  - LED indicators 3-3
  - left horizontal reference 3-28, 3-45
  - level
    - trigger 3-15, 3-19, 3-20, 3-29, 3-55
  - limited pointer motion 3-30
  - line voltage 1-11
  - local printer 3-60
  - locating controls 4-3
  - location of trigger 3-28
- M**
- magnifying
    - a section of the waveform 3-14
    - waveforms 3-5, 3-49, 3-50
  - main sweep 3-14
  - making
    - measurements 3-52
    - oscilloscope easier to view 1-23
    - quick measurements 3-17
    - waveform bigger or smaller 3-12, 3-43
  - manipulating waveforms 3-26, 3-41
  - manuals 1-3, 1-4, 1-5, 1-6
  - Marker A key 3-16
  - marker and measurement controls 3-6
  - marker arrow keys 3-6
  - Marker B key 3-16
  - markers 3-6
    - and measurements 3-52
    - moving 3-51
    - positioning 3-16
    - turning on or off 3-16
  - math functions
    - information system 4-2, 4-3
  - maximizing waveform viewing area 3-19, 3-20
  - measurement icons 3-21, 3-22, 3-23, 3-53
  - measurement indicators
    - geometric 3-24
  - measurement results
    - associating with waveform 3-52, 3-53
  - measurement toolbar 3-21, 3-22, 3-23, 3-52, 3-53
    - removing 3-24
  - measurements 3-6, 3-24, 3-52, 3-53
    - and markers 3-52
    - drag and drop 3-23
    - information system 4-2
    - Quick 3-17
    - quick 3-6
    - reset 3-38
    - using markers 3-16, 3-51
  - memory
    - bar 3-19, 3-20
    - depth 3-56
  - menu bar 3-21, 3-22, 3-26, 3-33
  - menus 3-33
    - context-sensitive 3-27, 3-34, 3-35
  - methods for accessing information 4-5
  - MIL-STD calibration 1-6
  - Mode key 3-15
  - modes
    - edge trigger 3-55
    - full-screen 3-19, 3-20
    - graphical interface 3-21, 3-22
    - switching between graphical interface and full-screen 3-30
    - trigger 3-54
  - mouse
-

- 
- click 3-31
  - connecting 1-12
  - moving 3-31
  - right-click 3-31, 3-34
  - verifying 1-26
  - moving
    - dialog boxes 3-31, 3-32
    - markers 3-16, 3-51
    - mouse 3-31
    - waveform horizontally 3-13, 3-47
    - waveform vertically 3-12
  - multiple active dialog boxes 3-57
- N**
- naming the printer 3-66
  - navigating the information system 4-11
  - network
    - printer 3-60
    - properties 3-68
    - setting up 3-68
  - notes
    - dialog boxes 3-57
    - have disk for printer driver 3-64
    - information system access 4-4, 4-12
    - information system windows 4-6
    - limited pointer motion 3-30
    - overdriving vertical amplifiers 3-49
    - screen saver 1-24
    - zooming 3-26
- O**
- obtaining information within a particular context 4-12
  - offset
    - adjusting vertical 3-12, 3-41, 3-42
    - vertical 3-5
  - opaque dialog boxes 3-57, 3-58
  - opening the information system 4-4
  - operation
    - verifying 1-26
  - options 1-6, 4-3
    - and accessories 1-5
    - display 3-25
    - power cable 1-11
  - oscilloscope
    - cleaning 1-28
    - inspecting 1-3
    - resetting 3-7
    - using 3-2
  - oscilloscope controls 4-3
  - oscilloscope feet 1-23
  - oscilloscope front panel 3-3, 3-4, 3-6
  - oscilloscope graticule 3-6
  - oscilloscope operation
    - verifying 1-26
  - oscilloscope probes, see probes
  - overdriving vertical amplifiers 3-26, 3-49
- P**
- package contents 1-3, 1-4
  - paging in information system 4-6
  - parallel printers 1-18, 1-19
  - parameters
    - trigger 3-54
  - performance specifications 4-3
  - plug and play printer 3-60
  - plugs
    - power 1-11
  - pointer
    - limited motion 3-30
    - moving 3-31
  - pointing device 1-6
    - connecting 1-12
    - verifying operation 1-26
  - ports
    - printer 3-64, 3-65
  - position
    - adjusting horizontal 3-13, 3-28, 3-47
    - adjusting vertical 3-12
    - horizontal 3-19, 3-20, 3-21, 3-22, 3-48
  - positioning markers 3-16
  - power
    - applying 1-24
    - connecting 1-10
    - requirements 1-10
    - turning off 1-25
  - power cables 1-11
  - preferences for dialog boxes 3-57
  - preset measurements 3-17
  - printer
    - cables 1-6, 1-18
    - configuration 1-19, 1-20
    - network 3-60
    - plug and play 3-60
    - ports 3-64, 3-65
    - software
      - installing 3-60
  - printers 1-6
    - connecting 1-18, 1-19
    - naming 3-66
    - test page for 3-66
  - probes 1-5, 1-6
    - connecting 1-17
    - information system 4-2
    - setting characteristics of 3-44
  - probing a circuit 1-17
  - problems
    - information system 4-3
  - properties of network 3-68
- Q**
- question mark button 4-12
  - quick measurements 3-6, 3-17
  - QuickMeas key 3-17
- R**
- radio button 3-31, 3-32
  - recalling waveforms and setups
    - information system 4-2
  - Recovery Disks 3-69
  - reducing screen clutter 3-57
  - reference
    - horizontal 3-45
  - reference topics 4-7
  - removing measurement toolbar 3-24
  - repair and calibration services 1-6
  - Repetitive Strain Injury 2-2
    - Description 2-3
    - Using the Mouse 2-4
  - reset
    - measurements and statistics 3-38
    - oscilloscope 3-7
  - right horizontal reference 3-28, 3-45
  - right-click 3-31, 3-34
  - RJ-45 connector 1-14
    - LAN card 1-14
  - RSI
    - Description 2-3
    - Introduction 2-2
    - Using the Mouse 2-4
  - run 3-37
    - button 3-21, 3-22
  - Run key 3-8
-

- 
- run/stop
    - controls 3-27
    - mode indicators 3-19, 3-20
  - running acquisition 3-5
  - S**
  - sampling rate 3-19, 3-20
    - 8.0 GSa/s 3-56
  - saving waveforms and setups
    - information system 4-2
  - scaling
    - adjusting vertical 3-12, 3-43
    - vertical 3-5, 3-19, 3-20, 3-21, 3-22
  - screen clutter
    - simplifying 3-57
  - screen saver 1-24
  - scrolling in information system 4-6
  - seconds per division
    - adjusting 3-13
    - in delayed sweep 3-14
    - setting 3-46
  - seconds per division setting 3-19, 3-20, 3-21, 3-22
  - selecting
    - commands 3-33, 3-34
    - information system language 4-10
    - waveform features for measurement 3-23
    - waveforms for measurement 3-6
  - serial printers 1-18, 1-19, 1-20
  - service
    - repair and calibration 1-6
  - set up trigger 3-5
  - setting
    - 8.0 GSa/s sampling rate 3-56
    - dialog box preferences 3-57
    - edge trigger 3-15
    - horizontal reference 3-45
    - sweep speed 3-46
    - trigger position 3-45
  - setup
    - channel 3-44
    - default 1-26, 3-5, 3-7
    - dialog boxes 3-57
    - horizontal 3-28, 3-48
    - ports 3-64, 3-65
    - trigger 3-28, 3-54, 3-55
  - Setup Guide 4-3
    - steps 4-11
    - topics 4-8
  - slider 4-6
  - slope
    - trigger 3-15, 3-55
  - Slope key 3-15
  - software
    - installing printer 3-60
  - software magnification of waveforms 3-49
  - solving problems
    - information system 4-3
  - source
    - trigger 3-15, 3-55
  - Source key 3-15
  - specifications 4-3
  - spin box 3-31, 3-32
  - standard accessories 1-3, 1-4
  - starting and stopping acquisition 3-8, 3-37
  - statistics
    - reset 3-38
  - status indicators
    - trigger 3-5
  - steps
    - in Setup Guide 4-11
  - Stop
    - key 3-8
  - stop 3-37
    - button 3-21, 3-22
  - stopping acquisition 3-5
  - stretching and shrinking the waveform 3-13, 3-28, 3-46
  - submenus 3-33, 3-34
  - support information 4-3
  - sweep
    - key 3-15
    - triggered 3-15, 3-55
  - sweep speed 3-5, 3-28, 3-48
    - adjusting 3-13, 3-46
    - horizontal 3-19, 3-20, 3-21, 3-22
    - in delayed sweep 3-14
  - switching between graphical interface and full-screen modes 3-30
  - T**
  - Tab display area 3-25
  - tabs
    - as hyperlink 4-7
  - tasks
    - topics regarding 4-8
  - technical support information 4-3
  - terms
    - defined 4-3
  - testing the printer 3-66
  - tilting the oscilloscope 1-23
  - time base
    - adjusting 3-46
    - see also horizontal
  - time measurements 3-6
  - title bar 3-31, 3-32
  - tool tips 3-24
  - toolbars 3-26
    - horizontal and trigger 3-19, 3-20, 3-27
    - measurement 3-21, 3-22, 3-23, 3-52, 3-53
    - removing measurement 3-24
    - vertical 3-19, 3-20, 3-27
  - topics
    - contents 4-5
    - navigating 4-11
    - reference 4-7
    - Setup Guide 4-8
    - types of 4-7, 4-8
  - touchpad 1-6
    - connecting 1-12
  - trackball 1-6
    - connecting 1-12
  - tracking waveforms
    - using markers 3-16
  - translucent dialog boxes 3-57, 3-58
  - transparent dialog boxes 3-57, 3-58
  - trigger
    - controls 3-5
    - information system 4-2
    - input coupling 3-15
    - level 3-15, 3-19, 3-20, 3-29, 3-55
    - level reference indicator 3-19, 3-20, 3-29
    - location 3-28
    - parameters, where set up 3-5
    - position 3-45
    - setting edge 3-15
    - setup 3-28, 3-54, 3-55
    - setup button 3-21, 3-22, 3-54, 3-55
-

---

- slope 3-15, 3-55
- source 3-15, 3-55
- status indicators 3-5
- triggered sweep 3-15, 3-55
- turning channels on or off 3-10, 3-27, 3-40
- turning markers on and off 3-16
- types of topics 4-7, 4-8

## U

- undo
  - default setup 3-7
- use of color in interface 3-3, 3-52
- user interface
  - front panel 3-3, 3-4, 3-6
  - use of color 3-3, 3-22
- user interface elements 4-12
- using
  - feet 1-23
  - hyperlinks 4-11
  - markers 3-16
  - oscilloscope 3-2

## V

- verifying basic operation 1-26
- vertical amplifiers
  - overdriving 3-49
- vertical controls 3-5
- vertical inputs
  - overdriving 3-26
- vertical offset 3-5, 3-44
  - adjusting 3-12, 3-26, 3-41, 3-42
- vertical scaling 3-5, 3-19, 3-20, 3-21, 3-22, 3-44
  - adjusting 3-12, 3-27, 3-43
- vertical settings 3-27
- vertical toolbar 3-27
- voltage measurements 3-6
- volts per division
  - adjusting 3-12, 3-43
- volts per division setting 3-19, 3-20, 3-21, 3-22

## W

- waveform
  - magnifying 3-5, 3-14
  - stretching and shrinking 3-13
- waveform display area 3-20, 3-25

- waveform features
  - measurements on 3-52
  - moving markers to 3-51
  - selecting for measurement 3-23
- waveforms
  - acquiring 3-8, 3-37
  - adjusting horizontal position 3-47
  - associating with measurement
    - results 3-52, 3-53
  - drag and drop 3-41, 3-47
  - drag-and-drop measurements on 3-52
  - dragging measurement icons to 3-23
  - information system 4-2
  - making bigger or smaller 3-43
  - making quick measurements 3-17
  - manipulating 3-26
  - matching to measurement results 3-24
  - maximizing viewing area 3-19, 3-20
  - measuring using markers 3-16
  - selecting for measurement 3-6
  - stretching and shrinking 3-28, 3-46
  - tracking with markers 3-6
  - turning off 3-10
  - zooming on 3-26, 3-49, 3-50
- window
  - delayed sweep 3-14
- windows
  - information system 4-6
- working with dialog boxes 3-57

## X

- X-versus-Y function 4-2

## Z

- zooming on waveforms 3-26, 3-49, 3-50

# DECLARATION OF CONFORMITY

according to ISO/IEC Guide 22 and CEN/CENELEC EN 45014

**Manufacturer's Name:** Agilent Technologies, Inc.

**Manufacturer's Address:** 1900 Garden of the Gods Road  
Colorado Springs, Colorado  
80907 U.S.A.

**Declares, that the product**

**Product Name:** Digitizing Oscilloscope Family

**Model Number(s):** 54845B and 54846B

**Product Option(s):** This declaration covers all options of the above product

**Conforms to the following product standards:**

EMC	Standard	Limit
	IEC 61326-1:1997+A1:1998/EN 61326-1:1997+A1:1998	
	CISPR 11:1990 / EN 55011:1991	Group 1, Class A <sup>[1]</sup>
	IEC 61000-4-2:1995+A1:1998/EN 61000-4-2:1995	4kV CD, 8kV AD
	IEC 61000-4-3:1995/EN 61000-4-3:1995	3V/m, 80-1000 MHz
	IEC 61000-4-4:1995/EN 61000-4-4:1995	0.5kV signal lines, 1kV power lines
	IEC 61000-4-6:1996/EN 61000-4-6:1996	3V, 0.15-80 MHz
	Canada: ICES-001:1998	
	Australia/New Zealand: AS/NZS 2064.1	
<b>Safety</b>	IEC 61010-1:1990+A1:1992+A2:1995/EN 61010-1:1993+A1:1995	
	Canada: CSA-C22.2 No. 1010.1:1992	

**Conformity/Supplemental Information:**

The product herewith complies with the requirements of the Low Voltage Directive 73/23/EEC and the EMC Directive 89/336/EEC (including 93/68/EEC) and carries the CE-marking accordingly (European Union).

<sup>[1]</sup>This product was tested in a typical configuration with Agilent Technologies test systems.

Date: 09/12/2001

  
\_\_\_\_\_  
Ken Wyatt/Product Regulations Manager

For further information, please contact your local Agilent Technologies sales office, agent, or distributor.

## Product Regulations

EMC		Performance Criteria
	IEC 61326-1:1997+A1:1998/EN 61326-1:1997+A1:1998	
	CISPR 11:1990 / EN 55011:1991	
	IEC 61000-4-2:1995+A1:1998/EN 61000-4-2:1995	B
	IEC 61000-4-3:1995/EN 61000-4-3:1995	B
	IEC 61000-4-4:1995/EN 61000-4-4:1995	A
	IEC 61000-4-6:1996/EN 61000-4-6:1996	A
	Canada: ICES-001:1998	
	Australia/New Zealand: AS/NZS 2064.1	
Safety	IEC 61010-1:1990+A1:1992+A2:1995/EN 61010-1:1994+A4:1995	
	Canada: CSA-C22.2 No. 1010.1:1992	



### Additional Information:

The product herewith complies with the requirements of the Low Voltage Directive 73/23/EEC and the EMC Directive 89/336/EEC (including 93/68/EEC) and carries the CE-marking accordingly (European Union).

### Performance Criteria:

- A Pass - Normal operation, no effect.
- B Pass - Temporary degradation, self recoverable.
- C Pass - Temporary degradation, operator intervention required.
- D Fail - Not recoverable, component damage.

**Sound Pressure Level**    Less than 60 dBA

© Copyright Agilent Technologies 2001. All Rights Reserved.

Reproduction, adaptation, or translation without prior written permission is prohibited, except as allowed under the copyright laws.

#### Document Warranty

The information contained in this document is subject to change without notice.

**Agilent Technologies makes no warranty of any kind with regard to this material, including, but not limited to, the implied warranties of merchantability or fitness for a particular purpose.**

Agilent Technologies shall not be liable for errors contained herein or for damages in connection with the furnishing, performance, or use of this material.

#### Safety

This apparatus has been designed and tested in accordance with IEC Publication 1010, Safety Requirements for Measuring Apparatus, and has been supplied in a safe condition. This is a Safety Class I instrument (provided with terminal for protective earthing). Before applying power, verify that the correct safety precautions are taken (see the following warnings). In addition, note the external markings on the instrument that are described under "Safety Symbols."

#### Warning

- Before turning on the instrument, you must connect the protective earth terminal of the instrument to the protective conductor of the (mains) power cord. The mains plug shall only be inserted in a socket outlet provided with a protective earth contact. You must not negate the protective action by using an extension cord (power cable) without a protective conductor (grounding). Grounding one conductor of a two-conductor outlet is not sufficient protection.
- Only fuses with the required rated current, voltage, and specified type (normal blow, time delay, etc.) should be used. Do not use repaired fuses or short-circuited fuseholders. To do so could cause a shock or fire hazard.

- Service instructions are for trained service personnel. To avoid dangerous electric shock, do not perform any service unless qualified to do so. Do not attempt internal service or adjustment unless another person, capable of rendering first aid and resuscitation, is present.
- If you energize this instrument by an auto transformer (for voltage reduction), make sure the common terminal is connected to the earth terminal of the power source.
- Whenever it is likely that the ground protection is impaired, you must make the instrument inoperative and secure it against any unintended operation.
- Do not operate the instrument in the presence of flammable gasses or fumes. Operation of any electrical instrument in such an environment constitutes a definite safety hazard.
- Do not install substitute parts or perform any unauthorized modification to the instrument.
- Capacitors inside the instrument may retain a charge even if the instrument is disconnected from its source of supply.

#### Safety Symbols



Instruction manual symbol: the product is marked with this symbol when it is necessary for you to refer to the instruction manual in order to protect against damage to the product.



Hazardous voltage symbol.



Earth terminal symbol: Used to indicate a circuit common connected to grounded chassis.

#### WARNING

The Warning sign denotes a hazard. It calls attention to a procedure, practice, or the like, which, if not correctly performed or adhered to, could result in personal injury. Do not proceed beyond a Warning sign until the indicated conditions are fully understood and met.

#### CAUTION

The Caution sign denotes a hazard. It calls attention to an operating procedure, practice, or the like, which, if not correctly performed or adhered to, could result in damage to or destruction of part or all of the product. Do not proceed beyond a Caution symbol until the indicated conditions are fully understood or met.

Agilent Technologies  
P.O. Box 2197  
1900 Garden of the Gods Road  
Colorado Springs, CO 80901

---

### **Product Warranty**

This Agilent Technologies product has a warranty against defects in material and workmanship for a period of three years from date of shipment. During the warranty period, Agilent Technologies will, at its option, either repair or replace products that prove to be defective. For warranty service or repair, this product must be returned to a service facility designated by Agilent Technologies. For products returned to Agilent Technologies for warranty service, the Buyer shall prepay shipping charges to Agilent Technologies and Agilent Technologies shall pay shipping charges to return the product to the Buyer. However, the Buyer shall pay all shipping charges, duties, and taxes for products returned to Agilent Technologies from another country. Agilent Technologies warrants that its software and firmware designated by Agilent Technologies for use with an instrument will execute its programming instructions when properly installed on that instrument. Agilent Technologies does not warrant that the operation of the instrument software, or firmware will be uninterrupted or error free.

### **Limitation of Warranty**

The foregoing warranty shall not apply to defects resulting from improper or inadequate maintenance by the Buyer, Buyer-supplied software or interfacing, unauthorized modification or misuse, operation outside of the environmental specifications for the product, or improper site preparation or maintenance.

**No other warranty is expressed or implied. Agilent Technologies specifically disclaims the implied warranties of merchantability or fitness for a particular purpose.**

### **Exclusive Remedies**

The remedies provided herein are the buyer's sole and exclusive remedies. Agilent Technologies shall not be liable for any direct, indirect, special, incidental, or consequential damages, whether based on contract, tort, or any other legal theory.

### **Assistance**

Product maintenance agreements and other customer assistance agreements are available for Agilent Technologies products. For any assistance, contact your nearest Agilent Technologies Sales Office.

### **Certification**

Agilent Technologies certifies that this product met its published specifications at the time of shipment from the factory. Agilent Technologies further certifies that its calibration measurements are traceable to the United States National Institute of Standards and Technology, to the extent allowed by the Institute's calibration facility, and to the calibration facilities of other International Standards Organization members.

### **About this edition**

This is the *Infiniium Oscilloscopes User's Quick Start Guide*.

Publication number  
54846-97001, Nov. 2001

Print history is as follows:  
54846-97001, Nov. 2001

New editions are complete revisions of the manual. Many product updates do not require manual changes; and, conversely, manual corrections may be done without accompanying product changes. Therefore, do not expect a one-to-one correspondence between product updates and manual updates.

Windows 98 is a trademark of Microsoft Corporation.