

---

# User and Service Guide

Publication number 54615-97019  
June 2000

For Safety Information, Warranties, and Regulatory information,  
see the pages behind the index.

© Copyright Agilent Technologies 1993–1996, 2000  
All Rights Reserved

---

## Agilent 54615B, 54616B, and 54616C Oscilloscopes

---

## A General-Purpose Oscilloscope

The Agilent 54615B, 54616B, and 54616C oscilloscopes offer exceptional waveform viewing and measurements in a small, lightweight package. These dual channel, 500 MHz bandwidth oscilloscopes are designed for use in labs where high speed analog and digital circuits are being tested. These oscilloscopes give you:

- 1 ns peak detect
- 1 GSa/s sample rate (54615B)  
2 GSa/s sample rate (54616B and 54616C)
- 500 MHz bandwidth, and 1 ns/div Main and Delayed time bases
- Selectable input impedance
- Protection of the internal 50 ohm load
- Adjustable time nulling to remove the effects of cabling
- 250 MHz single-shot bandwidth (54615B)  
500 MHz single-shot bandwidth (54616B and 54616C)
- Color display (54616C)

These oscilloscopes are very easy to use because of their familiar controls and real time display. You can discard your viewing hood as these oscilloscopes have none of the viewing problems that are associated with analog oscilloscopes. A bright, crisp display is obtained at all sweep speeds and delayed sweep magnifications. Storage is as simple as pressing a button. View events ahead of the trigger using negative time. Cursors and automatic measurements greatly simplify your analysis tasks.

You can upgrade this oscilloscope for hardcopy or remote control with the addition of an interface module. Unattended waveform monitoring and additional waveform math, such as FFT, can be added with the addition of one of the Measurement/Storage modules.

Bring your scope and PC together with BenchLink software. BenchLink, which runs under Windows, allows easy transfer of scope traces and waveform data to your PC for incorporation into documents or storage.

**Accessories supplied**

- Two 1.5 meter, 10:1 Rugged 500 MHz Passive Probes (10073B)
- Power cord for country of destination
- This *User and Service Guide*
- *Programmer's Guide* with Microsoft Windows Help file, ascii help file, and sample programs.

**Accessories available**

- 34810B BenchLink/Scope Software
- 54650A GPIB Interface Module
- 54652B Serial/Parallel Interface Module
- 54654A Operator's Training Kit
- 54657A GPIB Measurement/Storage Module
- 54659B Serial/Parallel Measurement/Storage Module
- 1185A Carrying Case
- 1186A Rackmount Kit
- 10020A Resistive Divider (1:1 through 100:1) Passive Probe Kit
- 10070B 1.5 meter, 1:1 Passive Probe
- 10076A 100:1 1 MHz High Voltage Passive Divider Probe
- N2771A 1000:1 1 MHz High Voltage Passive Divider Probe
- 1141A 1:1 200 MHz Differential Active Probe. Probe power accessed directly from oscilloscope rear panel.
- 1144A 10:1 800 MHz Active Probe. Probe power accessed directly from oscilloscope rear panel.
- 1145A 10:1 750 MHz Small-Geometry Dual Active Probe for surface mount devices. Probe power accessed directly from oscilloscope rear panel.

**Options available**

- Option 001 RS-03 Magnetic Interference Shielding Added to CRT (54615B and 54616B only)
- Option 002 RE-02 Display Shield Added to CRT (54615B and 54616B only)
- Option 005 Enhanced TV/Video Trigger
- Option 101 Accessory Pouch and Front-Panel Cover
- Option 103 Operator's Training Kit (54654A)
- Option 104 Carrying Case (1185A)
- Option 106 BenchLink/Scope Software (34810B)
- Option 090 Deletes Probes
- Option 1CM Rackmount Kit
- Power Cords (see the table of Replaceable Parts in chapter 4, Service)

---

## In This Book

This is the User and Service Guide for the Agilent 54615B, 54616B, and 54616C Oscilloscopes. This guide contains five chapters.

**First Time Users** Chapter 1 is a quick start guide that gives you a brief overview of the oscilloscope.

**Advanced users** Chapter 2 is a series of exercises that guide you through the operation of the oscilloscope.

**TV/Video triggering** Chapter 3 shows how to use enhanced TV/Video triggering if you have Option 005 installed in your oscilloscope.

**Service technicians** Chapter 4 contains the service information for the oscilloscope. There are procedures for verifying performance, adjusting, troubleshooting, and replacing assemblies in the oscilloscope.

**Reference information** Chapter 5 lists the characteristics of the oscilloscope.


<b>1</b>	<b>The Oscilloscope at a Glance</b>
<b>2</b>	<b>Operating your Oscilloscope</b>
<b>3</b>	<b>Using Option 005 Enhanced TV/Video Trigger</b>
<b>4</b>	<b>Service</b>
<b>5</b>	<b>Performance Characteristics</b>
	<b>Glossary</b>
	<b>Index</b>



---

# Contents

## 1 The Oscilloscope at a Glance

-  To connect a signal to the oscilloscope 1-5
- To display a signal automatically 1-7
- To set up the vertical window 1-8
- To expand the vertical signal 1-10
- To set up the time base 1-11
- To trigger the oscilloscope 1-13
- To use roll mode 1-16
  
- Using Color (54616C only) 1-17
- To select the color palettes and observe colors 1-18
- To print in color 1-20

## 2 Operating Your Oscilloscope

- To use delayed sweep 2-3
- To use storage oscilloscope operation 2-6
- To capture a single event 2-8
- To capture glitches or narrow pulses 2-10
- To trigger on a complex waveform 2-12
- To make frequency measurements automatically 2-14
- To make time measurements automatically 2-16
- To make voltage measurements automatically 2-19
- To make cursor measurements 2-23
- To remove cabling errors from time interval measurements 2-27
- To view asynchronous noise on a signal 2-28
- To reduce the random noise on a signal 2-30
- To save or recall traces 2-33
- To save or recall front-panel setups 2-34
- To reset the instrument setup 2-35
- To use the XY display mode 2-36
- To analyze video waveforms 2-40

## Contents

### 3 Using Option 005 Enhanced TV/Video Trigger

- To select TV display grid 3-4
- To autoscale on a video signal 3-4
- To trigger on a specific line of video 3-5
- To trigger on all TV line sync pulses 3-7
- To trigger on a specific field of the video signal 3-8
- To trigger on all fields of the video signal 3-9
- To trigger on odd or even fields 3-10
- To make cursor measurements 3-12
- To use delayed sweep 3-14
- To analyze video waveforms with Option 005 3-16
- To window in on harmonic distortion using FFT 3-18
- To connect to other instruments 3-20

### 4 Service





- To return the oscilloscope to Agilent Technologies 4-4
  
- Verifying Oscilloscope Performance 4-5
  - To check the output of the CALIBRATOR 4-6
  - To verify voltage measurement accuracy 4-8
  - To verify bandwidth 4-10
  - To verify horizontal  $\Delta t$  and  $1/\Delta t$  accuracy 4-13
  - To verify trigger sensitivity 4-15
  - To verify Vertical Output on Option 005 4-18
  
- Adjusting the Oscilloscope 4-21
  - To adjust the power supply 4-22
  - To perform the self-calibration 4-25
  - To adjust the high-frequency pulse response 4-27
  - To adjust the display (54615B/16B only) 4-29
  - To adjust the Option 005 offset (R15) 4-31



Troubleshooting the Oscilloscope 4-32  
 To construct your own dummy load 4-33  
 To check out the oscilloscope 4-34  
 To clear error messages 4-37  
 To check the Low Voltage Power Supply 4-41  
 To run the internal self-tests 4-42  
 To troubleshoot Option 005 4-45

Replacing Parts in the Oscilloscope 4-45  
 To replace an assembly 4-46  
 To remove the fan 4-47  
 To remove the front panel 4-47  
 To remove the display 4-49  
 To remove the system board 4-49  
 To remove the attenuator 4-50  
 To remove and replace an acquisition hybrid 4-51  
 To remove and replace a hybrid connector 4-53  
 To remove the power supply 4-54  
 To remove the keyboard 4-55  
 To remove the handle 4-56  
 To remove the Option 005 board 4-56  
 To order a replacement part 4-57

## 5 Performance Characteristics

 Vertical System 5-2  
 Horizontal System 5-4  
 Trigger System 5-5  
 TV Functions 5-6  
 XY Operation 5-6  
 Display System 5-6  
 Acquisition System 5-7

## **Contents**

Advanced Functions	5-8
Power Requirements	5-8
General (54615B and 54616B only)	5-9
General (54616C only)	5-11
General (54615B, 54616B, and 54616C)	5-12
Option 005 General Performance Characteristics	5-13
Option 005 Trigger System	5-14

## **Glossary**

## **Index**

**Perform self-calibration first**

For the oscilloscope to perform most accurately in the ambient temperature where it will be used, the self-calibration procedure described on page 4-25 should first be performed. Allow the unit to operate for at least 30 minutes before performing the self-calibration.

---

## The Oscilloscope at a Glance

---

## The Oscilloscope at a Glance

One of the first things you will want to do with your new oscilloscope is to become acquainted with its front panel. Therefore, we have written the exercises in this chapter to familiarize you with the controls you will use most often.

The front panel has knobs, grey keys, and white keys. The knobs are used most often and are similar to the knobs on other oscilloscopes. The grey keys bring up softkey menus on the display that allow you access to many of the oscilloscope features. The white keys are instant action keys and menus are not associated with them.

Throughout this book, the front-panel keys are denoted by a box around the name of the key, and softkeys are denoted by a change in the text type. For example, **Source** is the grey front-panel key labeled Source under the trigger portion of the front panel, and **Line** is a softkey. The word **Line** appears at the bottom of the display directly above its corresponding softkey.

Figure 1-1 is a diagram of the front panel controls and input connectors.

Figure 1-2 is a status line example. The status line, located at the top of the display, lets you quickly determine the setup of the oscilloscope. In this chapter you will learn to read at a glance the setup of the oscilloscope from the status line.

Figure 1-3 is a diagram showing which grey keys to press to bring up the various softkey menus.

Figure 1-1

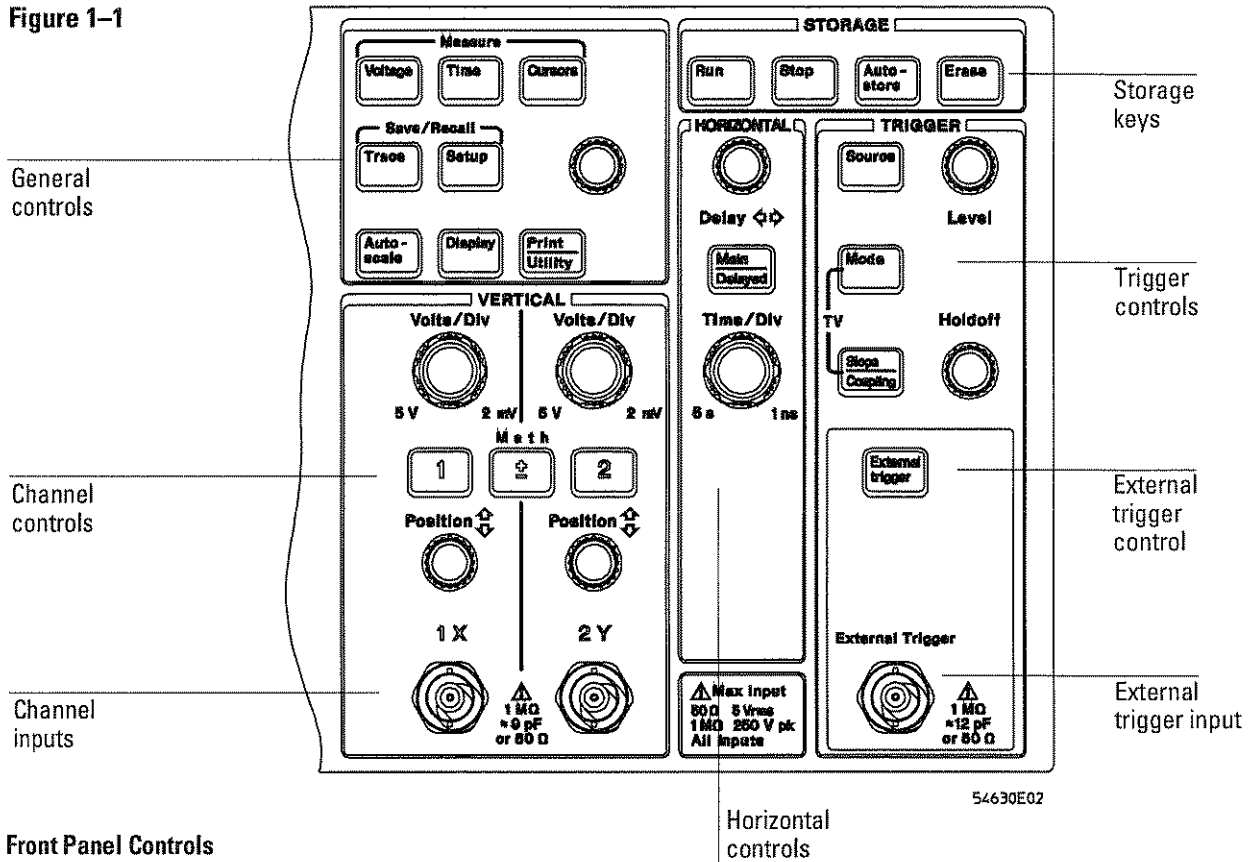
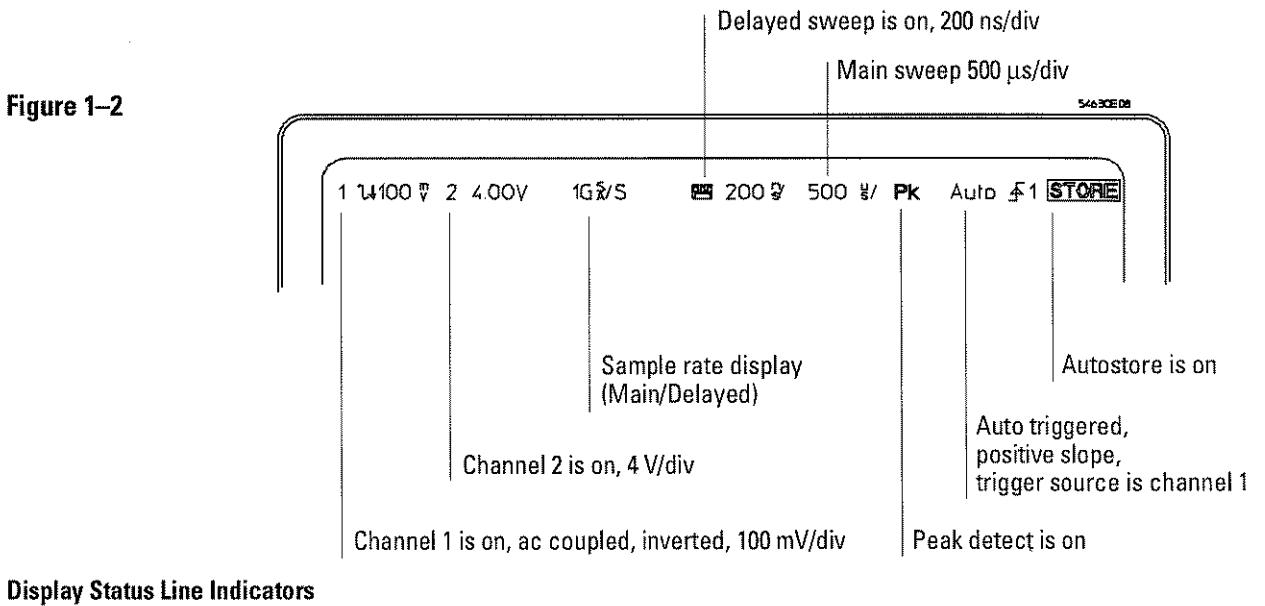


Figure 1-2

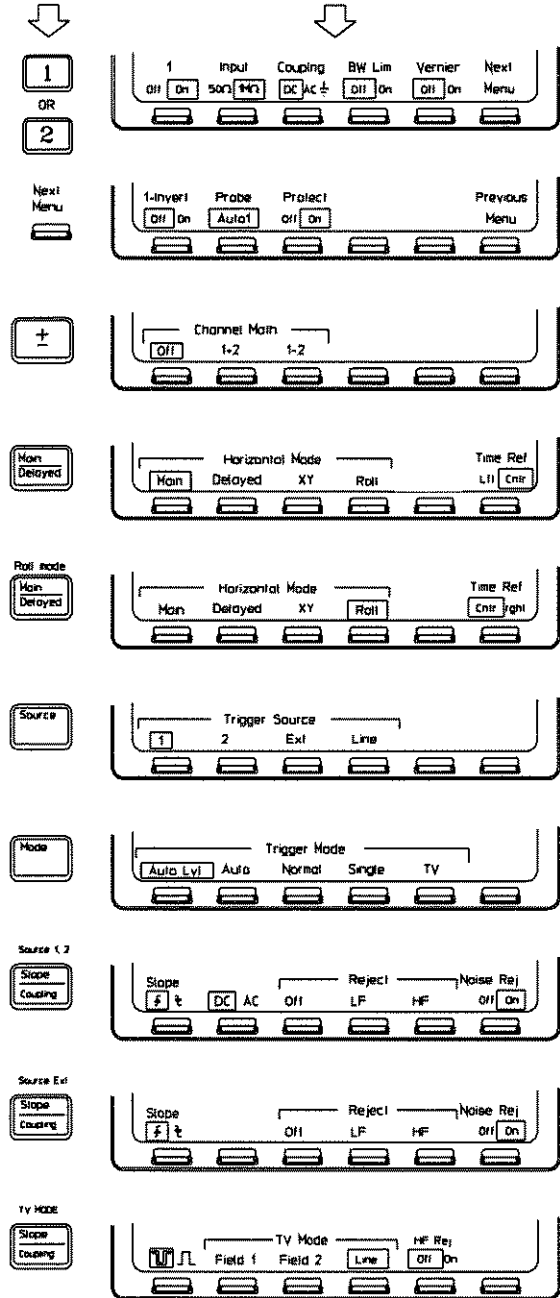


Display Status Line Indicators

Figure 1-3

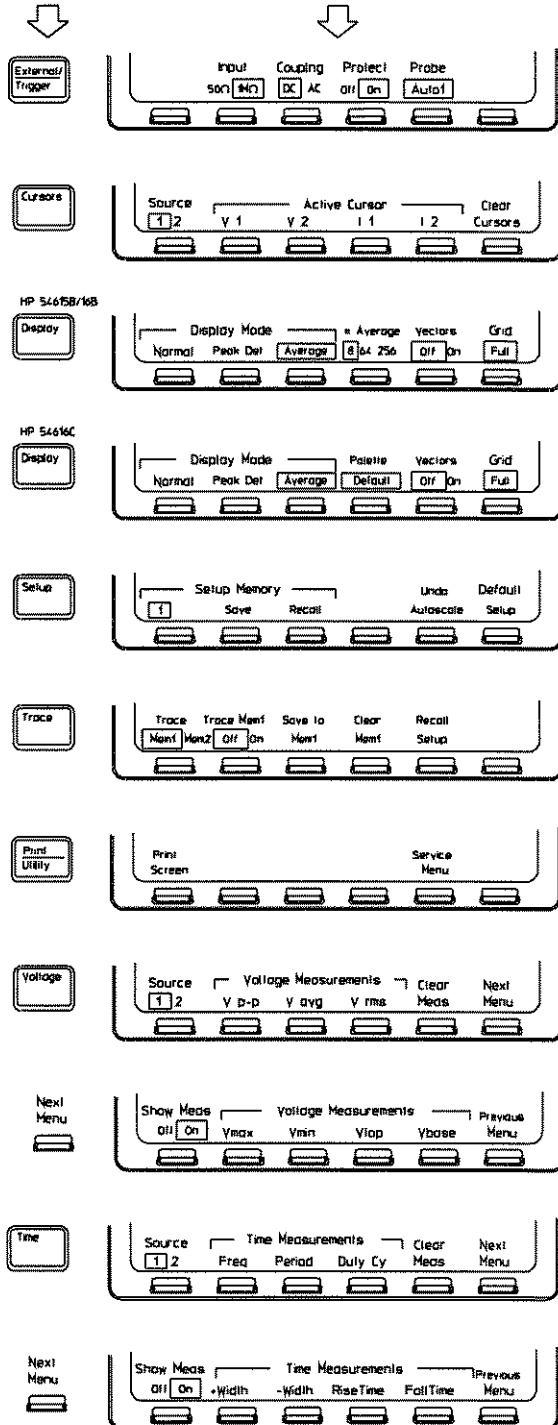
Press this key

To obtain this menu



Press this key

To obtain this menu



54-0002

Softkey Menu Reference

---

## To connect a signal to the oscilloscope

The 54615B is a two-channel, 500 MHz bandwidth, 1 GSa/s sample rate oscilloscope with an external trigger input. The 54616Band 54616C are two-channel, 500 MHz bandwidth, 2 GSa/s sample rate oscilloscopes with an external trigger input. The input impedance of these oscilloscopes is selectable – either 50Ω or 1 MΩ. The 50Ω mode matches 50Ω cables commonly used in making high frequency measurements. This impedance matching gives you the most accurate measurements since reflections are minimized along the signal path. The 1 MΩ mode is for use with probes and for general purpose measurements. The higher impedance minimizes the loading effect of the oscilloscope on the circuit under test. In this exercise you connect a signal to the channel 1 input.

To avoid damage to your new oscilloscope, make sure that the voltage level of the signal you are using is less than or equal to 250 V (dc plus the peak ac). For a complete list of the characteristics see chapter 5, "Performance Characteristics."

---

### CAUTION



Do not exceed 5 Vrms in 50Ω mode. When input protection is enabled in 50Ω mode, the 50Ω load will disconnect if greater than 5 Vrms is detected. However the inputs could still be damaged, depending on the time constant of the signal.

---

### CAUTION

The 50Ω input protection mode only functions when the oscilloscope is powered on.

- Use a cable or a probe to connect a signal to channel 1.
- The oscilloscope has automatic probe sensing . If you are using the probes supplied with the oscilloscope, or other probes with probe sensing, then the input impedance and probe attenuation factors will be automatically set up by the oscilloscope when automatic probe sensing is turned on. The default setting is to have automatic probe sensing on. This is indicated by the selection of **Auto n** under the **Probe** softkey, where **n** is 1, 10, 20, or 100.
- If you are not using automatic probe sensing, then follow these next two steps.

## The Oscilloscope at a Glance

### To connect a signal to the oscilloscope

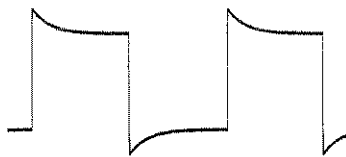
- To set the input impedance, press **1** . Select the desired Input impedance of  $50\Omega$  or  $1M\Omega$ .
- To set the probe attenuation factor press **1** . Select the **Next Menu** softkey. Next toggle the **Probe** softkey to change the attenuation factor to match the probe you are using.

You should compensate 10:1 probes to match their characteristics to the oscilloscope. A poorly compensated probe can introduce measurement errors. To compensate a probe, follow these steps.

- 1 Connect the 10:1 probe from channel 1 to the front-panel probe compensation signal on the oscilloscope.
- 2 Press **Autoscale** .
- 3 Use a nonmetallic tool to adjust the trimmer capacitor on the probe for the flattest pulse possible as displayed on the oscilloscope.

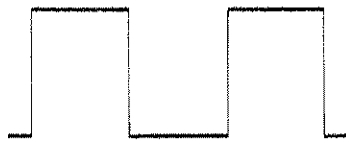
**Figure 1-4**

Overcompensation causes pulse peaking.



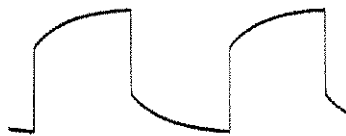
**Figure 1-5**

Correct compensation with a flat pulse top.



**Figure 1-6**

Undercompensation causes pulse rolloff.





---

## To display a signal automatically

The oscilloscope has an Autoscale feature that automatically sets up the oscilloscope to best display the input signal. Using Autoscale requires signals with a frequency greater than or equal to 50 Hz and a duty cycle greater than 0.5%.

When you press **Autoscale**, the oscilloscope turns on and scales all channels that have signals applied, and selects a time base range based on the trigger source. The trigger source is selected from inputs that have a signal applied. The priority of trigger source assignment is External Trigger, input 1, then input 2. Autoscale will, in both 50 $\Omega$  and 1M $\Omega$  impedance modes, reset the **Coupling to DC**, the Bandwidth Limit (**BW Lim**) to **Off**, all **Verniers to Off**, and Signal Inversion (**Invert**) to **Off**. Input protection in 50 $\Omega$  mode is not affected by Autoscale.

- 1 Connect a signal to the oscilloscope.
- 2 Press **Autoscale**.

When you press **Autoscale**, the oscilloscope changes the front-panel setup to display the signal. However, if you pressed **Autoscale** unintentionally, you can use the **Undo Autoscale** feature. To use this feature, perform the following step.

- Press **Setup**, then press the **Undo Autoscale** softkey.

The oscilloscope returns to the configuration in effect before you pressed **Autoscale**.

## To set up the vertical window

The following exercise guides you through the vertical keys, knobs, and status line.

**1 Center the signal on the display with the Position knob.**

The Position knob moves the signal vertically, and it is calibrated. Notice that as you turn the Position knob, a voltage value is displayed for a short time indicating how far the ground reference is located from the center of the screen. Also notice that the ground symbol on the right side of the display moves in conjunction with the Position knob.

**Measurement hints**

If the channel is dc coupled, you can quickly measure the dc component of the signal by simply noting its distance from the ground symbol.

If the channel is ac coupled, the dc component of the signal is removed allowing you to use greater sensitivity to display the ac component of the signal.

**2** Change the vertical setup and notice that each change affects the status line differently.

You can quickly determine the vertical setup from the status line in the display.

- Change the vertical sensitivity with the Volts/Div knob and notice that it causes the status line to change.

- Press **1** .

A softkey menu appears on the display, and the channel turns on (or remains on if it was already turned on).

- Toggle each of the softkeys and notice which keys cause the status line to change.

Channels 1 and 2 have a vernier softkey that allows the Volt/Div knob to change the vertical step size in smaller increments. These smaller increments are calibrated, which results in accurate measurements even with the vernier turned on.

- To turn the channel off, either press **1** a second time or press the left-most softkey.

**Invert operating hint**

When you are triggered on the signal you are inverting, the inversion applies only to the displayed waveform, not to the trigger signal. Therefore, the trigger slope of the displayed waveform is inverted from the trigger slope icon displayed on the status line.

---

## To expand the vertical signal

When changing the Volts/Div for analog channels, you can have the signal expand (or compress) about the center screen or about the ground point.

- To expand the signal about center screen, press  . Then select **System Config** and **Expand Vertical Center**.
- To expand the signal about ground, press  . Then select **System Config** and **Expand Vertical Ground**.

---

## To set up the time base

The following exercise guides you through the time base keys, knobs, and status line.

- 1 Turn the Time/Div knob and notice the change it makes to the status line.

The Time/Div knob changes the sweep speed from 1 ns to 5 s in a 1-2-5 step sequence, and the value is displayed in the status line. The sample rate is also displayed on the status line.

- 2 Change the horizontal setup and notice that each change affects the status line differently.
  - Press **Main/Delayed** .  
A softkey menu appears on the display with six softkey choices.
  - Toggle each of the softkeys and notice which keys cause the status line to change.

## The Oscilloscope at a Glance

### To set up the time base

- Turn the Delay knob and notice that its value is displayed in the status line. The Delay knob moves the main sweep horizontally, and it pauses at 0.00 s, mimicking a mechanical detent. At the top of the graticule is a solid triangle (▼) symbol and an open triangle (∇) symbol. The ▼ symbol indicates the trigger point and it moves in conjunction with the Delay knob. The ∇ symbol indicates the time reference point. If the time reference softkey is set to left, the ∇ is located one graticule in from the left side of the display. If the time reference softkey is set to center, the ∇ is located at the center of the display. The delay number tells you how far the reference point ∇ is located from the trigger point ▼.  
All events displayed left of the trigger point ▼ happened before the trigger occurred, and these events are called pretrigger information or negative time. You will find this feature very useful because you can now see the events that led up to the trigger point. Everything to the right of the trigger point ▼ is called posttrigger information. The amount of delay range (pretrigger and posttrigger information) available is dependent on the sweep speed selected. See "Horizontal System" in chapter 5, for more details.

---

## To trigger the oscilloscope

The following exercise guides you through the trigger keys, knobs, and status line.

- 1 Turn the trigger Level knob and notice the changes it makes to the display.

As you turn the Level knob or press a trigger menu key, for a short time two things happen on the display. First, the trigger level is displayed in inverse video. If the trigger is dc coupled, it is displayed as a voltage. If the trigger is ac coupled or if LF reject was selected, it is displayed as a percentage of the trigger range. Second, if the trigger source is turned on, a line is displayed showing the location of the trigger level (as long as ac coupling or low frequency reject are not selected).

- 2 Change the trigger setup and notice that each change affects the status line differently.

- Press **Source** .

A softkey menu appears on the display showing the trigger source choices.

- Toggle each of the softkeys and notice that each key causes the status line to change.
- Press **External Trigger** .

A softkey menu appears on the display showing the external trigger choices.

## The Oscilloscope at a Glance

### To trigger the oscilloscope

- Press **Mode** .  
A softkey menu appears on the display with five trigger mode choices.
- Toggle the **Single** and **TV** softkeys and notice that they affect the status line differently. (You can only select TV if the trigger source is either channel 1 or 2.)  
When the oscilloscope is triggering properly, the trigger mode portion of the status line is blank.

#### What happens if the oscilloscope loses trigger?

If Auto Level is the trigger mode, Auto flashes in the status line. If dc coupled, the oscilloscope resets the trigger level to the center of the signal. If ac coupled, the oscilloscope resets the trigger level to halfway between the minimum and maximum amplitudes as displayed on the screen. In addition, every time you press the Auto Level softkey, the oscilloscope resets the trigger level.

If Auto is the trigger mode, Auto flashes in the status line and the oscilloscope free runs.

If either Normal or TV is the trigger mode, the trigger setup flashes in the status line.



- Press **Slope/Coupling** .

A softkey menu appears on the display. If you selected Auto level, Auto, Normal, or Single as a trigger mode, six softkey choices are displayed. If you selected TV as a trigger source, five other softkey choices are available.

- Toggle each of the softkeys and notice which keys affect the status line.
- External trigger input coupling (**ac** or **dc**) is selected from the External Trigger menu.

### 3 Adjust the Holdoff knob and observe how it changes the display.

Holdoff keeps the trigger from rearming for an amount of time that you set. Holdoff is often used to stabilize the display of complex waveforms. The Holdoff range is from 300.0 ns to about 13.5 s. When you adjust the Holdoff knob, the current holdoff time is briefly displayed in inverse video near the bottom of the display. For an example of using Holdoff, refer to the section, "To trigger on a complex waveform" on page 2-12.

#### **To set a long holdoff time, go to a slower sweep speed.**

The value used to increment the holdoff depends upon the sweep speed or time/div selection. However, the actual holdoff value is a fixed number; it is not a percentage of sweep speed. For a time/div setting of 5 ns/div, the holdoff increment is 50 ns. For a time/div setting of 5 s/div, the holdoff increment is 100 ms.

## To use roll mode

Roll mode continuously moves data across the display from right to left. Roll mode allows you to see dynamic changes on low frequency signals, such as when you adjust a potentiometer. Two frequently used applications of roll mode are transducer monitoring and power supply testing.

- 1 Press **Mode** . Then press the **Auto Lvl** , **Auto**, or **Normal** softkey.
- 2 Press **Main/Delayed** .
- 3 Press the **Roll** softkey.

The oscilloscope is now untriggered and runs continuously. Also notice that the time reference softkey selection changes to center and right.

- 4 Press **Mode** . Then press the **Single** softkey.

In Single, the oscilloscope fills either 1/2 of the display if **Cntr** is selected for the time reference, or 9/10 of the display if **Right** is selected for the time reference, then it searches for a trigger. As soon as a trigger is found, the display is filled from the reference point (**Cntr** or **Right**) to the right edge of the display. The oscilloscope then stops acquiring data.

You can also make automatic measurements in the roll mode. If time measurements are made while the data is rolling, slight errors are incurred (less than 2%.) The most accurate time measurements are made on rolled data when the acquisition is stopped.

### Roll mode operating hints

- Math functions, averaging, and peak detect are not available in roll mode.
- Holdoff and horizontal delay are not active in roll mode.
- Both a free running (nontriggered) display and a triggered display (available in the single mode only) are available in roll mode.
- Roll mode is available at sweep speeds of 200 ms/div and slower for the 54615B and 54616B. Roll mode is available at sweep speeds of 500 ms/div and slower for the 54616C.

---

## Using Color (54616C only)

With the 54616C color oscilloscope, you can select any of the seven available color palettes to assign colors to channels, cursors, stored waveforms, and text.

The seven color palettes allow additional customization, which allows you to easily distinguish between channel waveforms. In addition, when making measurements on a channel, wherever the channel number appears on screen, it is highlighted in the selected color.

The color palettes are individually named, and you can choose the palette that best suits your needs. You can change from the Default palette to any of the following:

- Alternate 1 works well for people who are colorblind.
- The colors in Alternate 2 are compatible with those used in 545xx-series oscilloscopes.
- Alternate 3 sets the cursors to yellow.
- Inverse 1 works well for hard copies.
- Inverse 2 works well for overhead transparencies.
- A Monochrome palette is also available.

In each palette, different colors are used for cursors, waveforms, softkeys, and Autostore. The background is always black, unless you select the Inverse palettes, which use a white background. Softkeys and the grid are always in white, except in the Inverse palettes, which set them to black.

This section shows you how to:

- Select the color palettes and observe colors
- Print in color

## To select the color palettes and observe colors

- 1 Press **Display** . The name of the selected palette appears under the **Palette** softkey.
- 2 Press the **Palette** softkey. Continue to cycle through the palettes and observe colors applied to the cursors, waveforms, and softkeys.  
Notice that the softkeys are white in all palettes, except the Inverse palettes, where they are black.
- 3 Press the **Grid** softkey until **Full** is displayed.  
The graticule is always white, except in the Inverse palettes, where it is black.
- 4 Toggle the **Grid** softkey until **Frame** is displayed.
- 5 Press **Cursors** . Press **Active Cursor t2** then **Active Cursor V2**.  
A single color shows all the cursors in the display area.
- 6 Press **Autostore** . Turn the Position knob both directions on an active channel and notice the stored waveform.  
The autostored waveforms are displayed in blue when using the Default and Alternate color palettes, cyan in the Inverse color palettes, and white in the MonoChrome palette.
- 7 Press **Autostore** to turn it off. Then press **Erase** .

The following table shows the color palettes and the palette colors mapped to the display components.

**Table 1-1**

**Color Palettes and Mapping of Colors to Display Components**

Palette	Color	Display Component	Palette	Color	Display Component
<b>Default</b>	green	cursors	<b>Alternate 3</b>	yellow	cursors
	yellow	waveform1		magenta	waveform1
	magenta	waveform2		cyan	waveform2
	cyan	functions		green	functions
	white	overlapping waveforms		white	overlapping waveforms
	white	softkeys		white	softkeys
	white	graticule		white	graticule
	blue	autostore		blue	autostore
black	background	black	background		
<b>Alternate 1</b>	red	cursors	<b>Inverse 1</b>	magenta	cursors
	cyan	waveform1		red	waveform1
	yellow	waveform2		blue	waveform2
	magenta	functions		green	functions
	white	overlapping waveforms		black	overlapping waveforms
	white	softkeys		black	softkeys
	white	graticule		black	graticule
	blue	autostore		cyan	autostore
black	background	white	background		
<b>Alternate 2</b>	cyan	cursors	<b>Inverse 2</b>	black	cursors
	yellow	waveform1		red	waveform1
	green	waveform2		blue	waveform2
	magenta	functions		magenta	functions
	white	overlapping waveforms		black	overlapping waveforms
	white	softkeys		black	softkeys
	white	graticule		black	graticule
	blue	autostore		cyan	autostore
black	background	white	background		

In the monochrome palette, all of the display components are in white, except the background, which is black.

## To print in color

- 1 Press **Print/Utility** .

The 54616C can print to an HP DeskJet Color printer when using an Interface Module with either an RS-232 interface or parallel interface (there are no color printers with an GPIB interface.)

- 2 Press the **Hardcopy Menu** softkey. Then press **Format** until **HP DJColor** is displayed.

This selects the HP DeskJet Color Printer format.

- 3 If you are using a 54652B or 54659B serial/parallel interface module, toggle the **Destination** softkey to either **RS-232** or **Parallel**.

- 4 Press the **Previous Menu** softkey, then press the **Print Screen** softkey.

The current display will be sent out the parallel port to the HP DeskJet color printer attached to your oscilloscope, and printed in color.

### See also

Refer to the *Interface Modules for Agilent 54600-Series Instruments I/O Function Guide* for other input/output and printing functions.

---

## Operating Your Oscilloscope

---

## Operating Your Oscilloscope

By now you are familiar with the VERTICAL, HORIZONTAL, and TRIGGER groups of the front-panel keys. You should also know how to determine the setup of the oscilloscope by looking at the status line. If you are unfamiliar with this information, we recommend you read chapter 1, "The Oscilloscope at a Glance."

This chapter takes you through two new groups of front-panel keys: STORAGE, and the group of keys that contains the Measure, Save/Recall, and Display keys. You will also add to your knowledge of the HORIZONTAL keys by using delayed sweep.

We recommend you perform all of the following exercises so you become familiar with the powerful measurement capabilities of your oscilloscope.

### **Perform self-calibration first**

For the oscilloscope to perform most accurately in the ambient temperature where it will be used, the self-calibration procedure described on page 4-25 should first be performed. Allow the unit to operate for at least 30 minutes before performing the self-calibration.




---

## To use delayed sweep

Delayed sweep is a magnified portion of the main sweep. You can use delayed sweep to locate and horizontally expand part of the main sweep for a more detailed (high resolution) analysis of signals. The following steps show you how to use delayed sweep. Notice that the steps are very similar to operating the delayed sweep in analog oscilloscopes.

- 1 Connect a signal to the oscilloscope and obtain a stable display.
- 2 Press **Main/Delayed** .
- 3 Press the **Delayed** softkey.

The screen divides in half. The top half displays the main sweep, and the bottom half displays an expanded portion of the main sweep. This expanded portion of the main sweep is called the delayed sweep. The top half also has two solid vertical lines called markers. These markers show what portion of the main sweep is expanded in the lower half. The size and position of the delayed sweep are controlled by the Time/Div and Delay knobs. The Time/Div next to the  symbol is the delayed sweep sec/div. The delay value is displayed for a short time at the bottom of the display.

- To display the delay value of the delayed time base, either press **Main/Delayed** or turn the Delay knob.
- To change the main sweep Time/Div, you must turn off the delayed sweep.

### Delayed sweep operating hint

When in delayed sweep, the displayed sample rate applies to the main sweep. The delayed sweep sample rate is always equal to or greater than the main sweep sample rate. Main and delayed sweeps are obtained in alternate acquisitions. Single sweep in delayed mode acquires on trigger for main and one trigger for delayed.

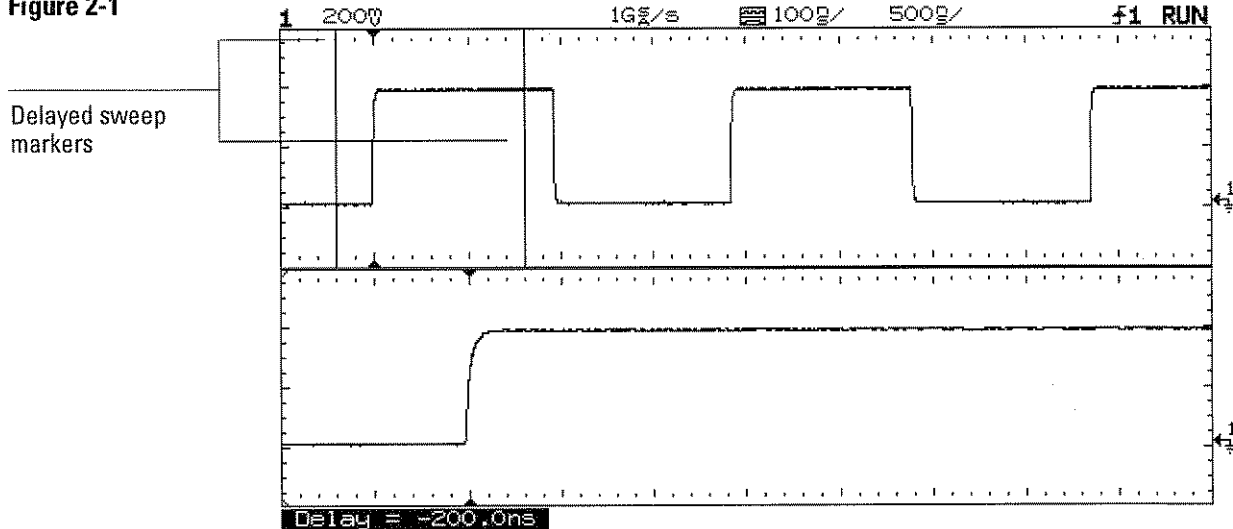
## Operating Your Oscilloscope

### To use delayed sweep

Since both the main and delayed sweeps are displayed, there are half as many vertical divisions so the vertical scaling is doubled. Notice the changes in the status line.

- To display the delay time of the delayed sweep, either press **Main/Delayed** or turn the delay knob. The delay value is displayed near the bottom of the display.
- 4 Set the time reference (**Time Ref**) to either left (**Lft**) or center (**Cntr**).  
Figure 2-1 shows the time reference set to left. The operation is like the delayed sweep of an analog oscilloscope, where the delay time defines the start of the delayed sweep.

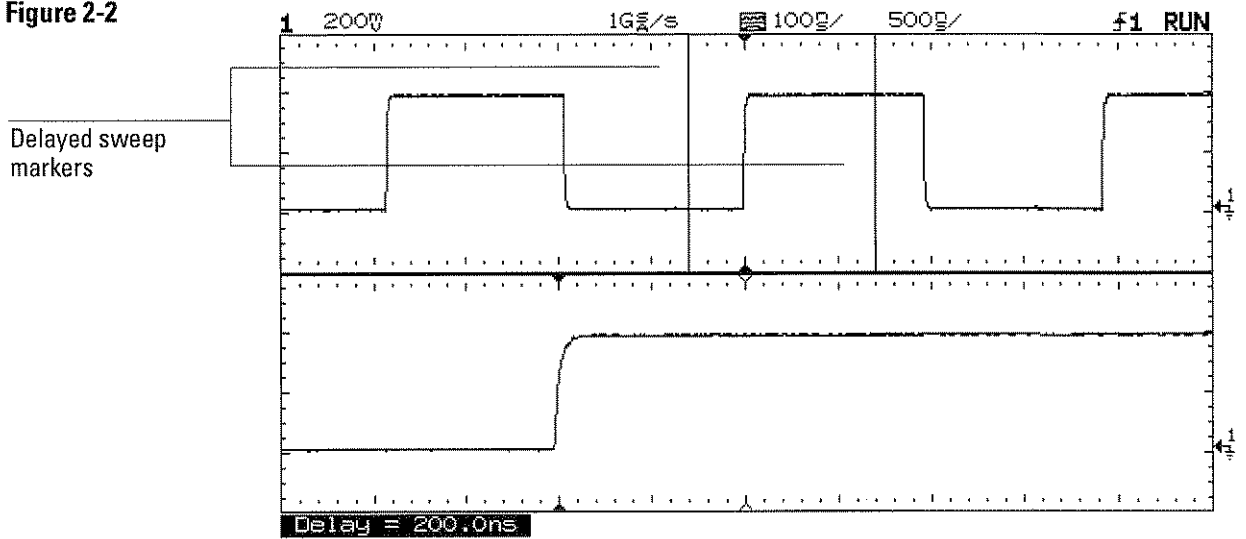
Figure 2-1



Time reference set to left

Figure 2-2 shows the time reference set to center. Notice that the markers expand around the area of interest. You can place the markers over the area of interest with the delay knob, then expand the delayed sweep with the time base knob to increase the resolution.

Figure 2-2



Delayed sweep  
markers

Time reference set to center

## To use storage oscilloscope operation

There are four front-panel storage keys. They are white instant action keys that change the operating mode of the oscilloscope. The following steps demonstrate how to use these storage keys.

- 1 Connect a signal to the oscilloscope and obtain a stable display.
- 2 Press **Autostore** .

Notice that **STORE** replaces **RUN** in the status line.

For easy viewing, the stored waveform is displayed in half bright and the most recent trace is displayed in full bright. Autostore is useful in a number of applications.

- Displaying the worst-case extremes of varying waveforms
- Capturing and storing a waveform
- Measuring noise and jitter
- Capturing events that occur infrequently

- 3 Using the position knob in the Vertical section of the front panel, move the trace up and down about one division.

Notice that the last acquired waveform is in full bright and the previously acquired waveforms are displayed in half bright.

- To characterize the waveforms, use the cursors. See "To make cursor measurements" on page 2-23.
- To clear the display, press **Erase** .
- To exit the Autostore mode, press either **Run** or **Autostore** .

#### Summary of storage keys

*Run* – The oscilloscope acquires data and displays the most recent trace.

*Stop* – The display is frozen.

*Autostore* – The oscilloscope acquires data, displaying the most recent trace in full bright and previously acquired waveforms in half bright.

*Erase* – Clears the display.

## To capture a single event

To capture a single event, you need some knowledge of the signal in order to set up the trigger level and slope. For example, if the event is derived from TTL logic, a trigger level of 2 volts should work on a rising edge. The following steps show you how to use the oscilloscope to capture a single event.

- 1 Connect a signal to the oscilloscope.
- 2 Set up the trigger.
  - Press **Source** . Select a trigger source with the softkeys.
  - Press **Slope/Coupling** . Select a trigger slope with the softkeys.
  - Turn the Level knob to a point where you think the trigger should work.
- 3 Press **Mode** , then press the **Single** softkey.
- 4 Press **Erase** to clear previous measurements from the display.
- 5 Press **Run** .

Pressing the Run key arms the trigger circuit. When the trigger conditions are met, data appears on the display representing the data points that the oscilloscope obtained with one acquisition. Pressing the Run key again rearms the trigger circuit and erases the display.

- 6 If you need to compare several single-shot events, press **Autostore** .

Like the Run key, the Autostore key also arms the trigger circuit. When the trigger conditions are met, the oscilloscope triggers. Pressing the Autostore key again rearms the trigger circuit without erasing the display. All the data points are retained on the display in half bright with each trigger allowing you to easily compare a series of single-shot events.

After you have acquired a single-shot event, pressing a front-panel key, softkey, or changing a knob can erase the event from the display. If you press the Stop key, the oscilloscope will recover the event and restore the oscilloscope settings.

- To clear the display, press **Erase** .
- To exit the Autostore mode, press either **Run** or **Autostore** . Notice that RUN replaces STORE in the status line, indicating that the oscilloscope has exited the Autostore mode.

#### Operating hint

With display vectors on, the maximum single-shot bandwidth is:  
54615B – 250 MHz for single- and two-channel operation (1 GSa/s, normal display, display vectors on.)  
54616B/16C – 500 MHz for single- and two-channel operation (2 GSa/s, normal display, display vectors on.)

With display vectors off, the oscilloscopes display the actual captured samples.

## To capture glitches or narrow pulses

A glitch is a rapid change in the waveform that is usually narrow as compared to the waveform. This oscilloscope has two modes of operation that you can use for glitch capture: peak detect and Autostore.

- 1 Connect a signal to the oscilloscope and obtain a stable display.
- 2 Find the glitch.

Use peak detect for narrow pulses or glitches.

- To select peak detect, press **Display** . Next, press the **Peak Det** softkey.

Peak detect operates at sweep speeds from 5 s/div to 500 ns/div.

When operating, **Pk** is displayed in the status line in inverse video. At sweep speeds faster than 500 ns/div, **Pk** is displayed in normal video, which indicates that peak detect is not operating. However, the acquisition system is sampling at 1 GSa/s so glitches greater than 1 ns will not be missed.

### Peak detect operating hint

In peak detect, the A/D converters are sampling at 1 GSa/s. However, not all samples are written to the display. Only the min and the max samples in each of the waveform graticules's 500 pixel columns are written to the display.



#### Autostore operating hints

Use Autostore for the following cases:

- Waveforms that are changing.
- Waveforms that you want to view and compare with stored waveforms.
- Narrow pulses or glitches that occur infrequently.

- Press **Autostore** .

You can use peak detect and Autostore together. Peak detect captures the glitch, while Autostore retains the glitch on the display in half bright video.

### 3 Characterize the glitch with delayed sweep.

Peak detect functions in both the main sweep and the delayed sweep. To characterize the glitch with delayed sweep follow these steps.

- Press **Main/Delayed** . Next press the **Delayed** softkey.
- To obtain a better resolution of the glitch, expand the time base.
- To set the expanded portion of the main sweep over the glitch, use the Delay knob.
- To characterize the glitch, use the cursors or the automatic measurement capabilities of the oscilloscope.

## To trigger on a complex waveform

The difficulty in viewing a complex waveform is triggering on the signal. Figure 2-3 shows a complex waveform that is not synchronized with the trigger.

The simplest trigger method is to trigger the oscilloscope on a sync pulse that is associated with the waveform. See "To trigger the oscilloscope" on page 1-13. If there is no sync pulse, use the following procedure to trigger on a periodic complex waveform.

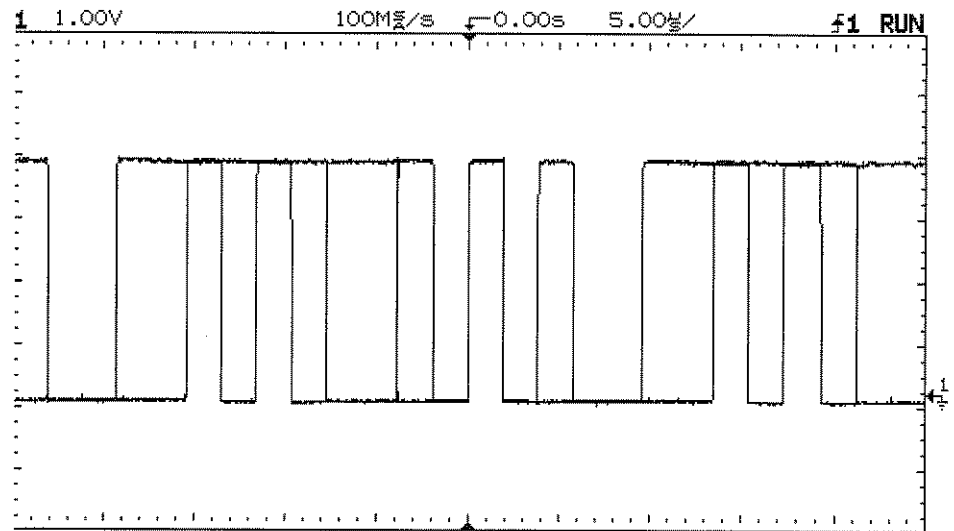
- 1 Connect a signal to the oscilloscope.
- 2 Set the trigger level to the middle of the waveform.
- 3 Adjust the Holdoff knob to synchronize the trigger of the oscilloscope with the complex waveform.

By setting the Holdoff to synchronize the trigger, the oscilloscope ignores the trigger that results in figure 2-3, and waits for the trigger that results in figure 2-4. Also notice in figure 2-3 that the trigger is stable, but the waveform is not synchronized with the trigger.

### **Holdoff operating hints**

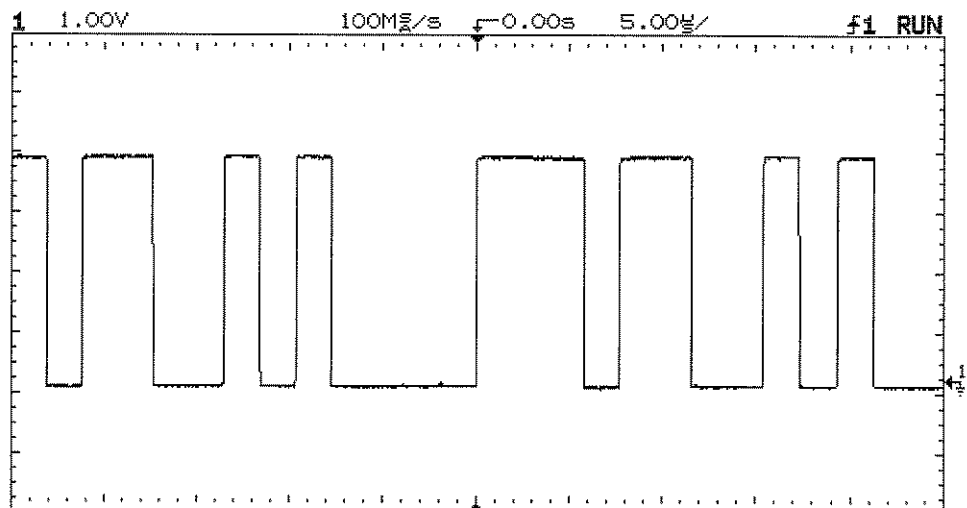
- 1 The advantage of digital holdoff is that it is a fixed number. As a result, changing the time base settings does not affect the holdoff number; so, the oscilloscope remains triggered. In contrast, the holdoff in analog oscilloscopes is a function of the time base setting making it necessary to readjust the holdoff each time you change the time base setting.
- 2 The rate of change of the holdoff adjustment knob depends on the time base setting you have selected. If you need a lengthy holdoff setting, increase the time/div setting on the time base, then make your coarse holdoff adjustment. Now switch back to the original time/div setting and make the fine adjustment to reach the exact amount you want.

Figure 2-3



Stable trigger, but the waveform is not synchronized with the trigger

Figure 2-4



Holdoff synchronizes the waveform with the trigger

In Figure 2-4, the holdoff is set to about 25  $\mu$ s (the duration of the pattern.)

## To make frequency measurements automatically

The automatic measurement capability of the oscilloscope makes frequency measurements easy, as the following steps demonstrate.

- 1 Connect a signal to the oscilloscope and obtain a stable display.
- 2 Press **Time** .

A softkey menu appears with six softkey choices.

- 3 Toggle the **Source** softkey to select a channel for the frequency measurement.
- 4 Press the **Freq** softkey.

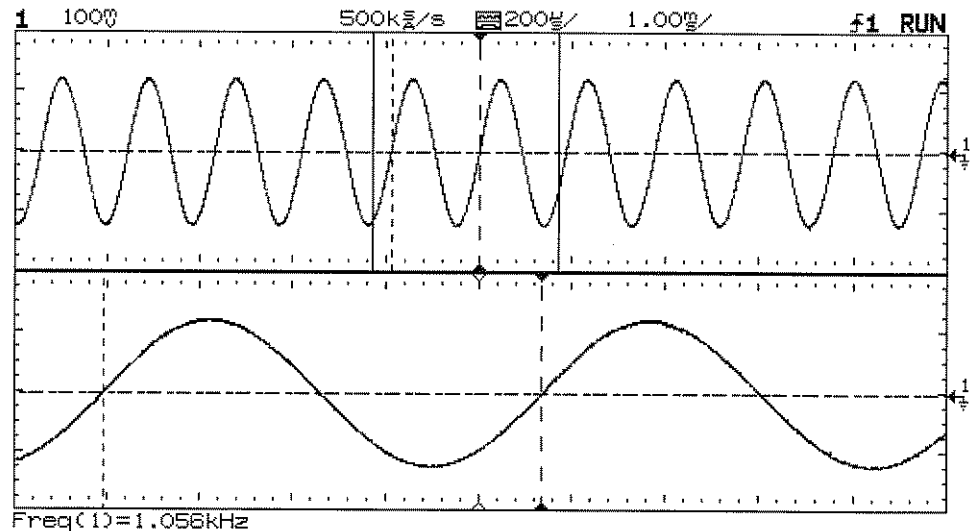
The oscilloscope automatically measures the frequency and displays the result on the lower line of the display. The number in parentheses after the word **Freq** is the number of the channel that the oscilloscope used for the measurement. The oscilloscope retains in memory and displays the three most current selected measurements. If you make a fourth measurement, the left-most is dropped.

If the **Show Meas** softkey is turned on, cursors are displayed on the waveform that show the measurement points for the right-most measurement result. If you select more than one measurement, you can show a previous measurement by reselecting the measurement.

- To find the **Show Meas** softkey, press the **Next Menu** softkey.

The oscilloscope makes automatic measurements on the first displayed event. Figure 2-5 shows how to use delayed sweep to isolate an event for a frequency measurement. If the measurement is not possible in the delayed time base horizontal mode, then the main time base is used. If the waveform is clipped, it may not be possible to make the measurement.

Figure 2-5



Delayed time base isolates an event for a frequency measurement

---

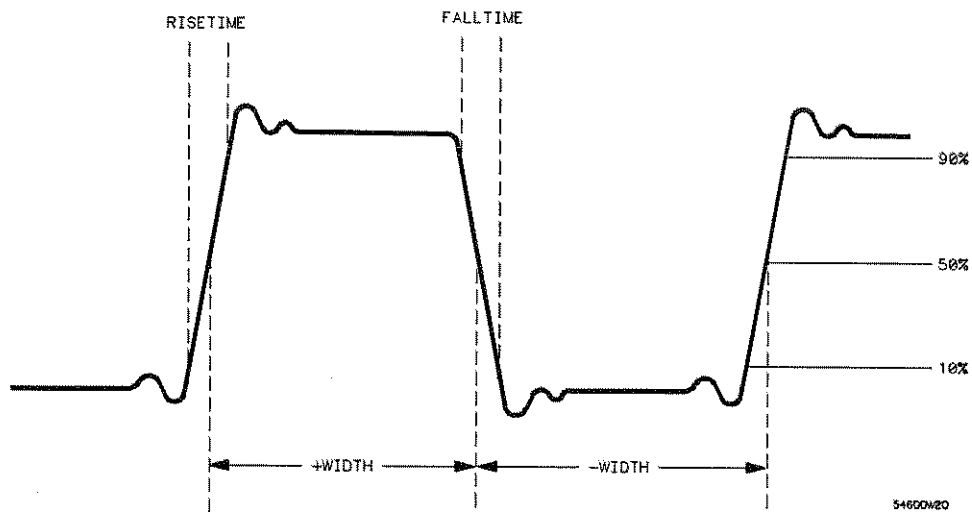
## To make time measurements automatically

You can measure the following time parameters with the oscilloscope: frequency, period, duty cycle, width, rise time, and fall time. The following exercise guides you through the Time keys by making a rise time measurement. Figure 2-6 shows a pulse with some of the time measurement points.

- 1 Connect a signal to the oscilloscope and obtain a stable display.

When the signal has a well-defined top and bottom (see figure 2-8), the rise time and fall time measurements are made at the 10% and 90% levels. If the oscilloscope cannot find a well-defined top or bottom (see figure 2-9), the maximum and minimum levels are used to calculate the 10% and 90% points.

Figure 2-6



2 Press **Time** .

A softkey menu appears with six softkey choices. Three of the softkeys are time measurement functions.

**Source** Selects a channel for the time measurement.

**Time Measurements** Three time measurement choices are available: **Freq** (frequency), **Period**, and **Duty Cy** (duty cycle). These measurements are made at the 50% levels. Refer to figure 2-6.

**Clear Meas** (clear measurement) Erases the measurement results and removes the cursors from the display.

**Next Menu** Replaces the softkey menu with six additional softkey choices.

3 Press the **Next Menu** softkey.

Another time measurement softkey menu appears with six additional choices. Four of the softkeys are time measurement functions.

**Show Meas** (show measurement) Displays the horizontal and vertical cursors where the measurement was taken.

**Time measurement hint**

When making time measurements in roll mode, the most accurate results will be seen when the waveform is stopped.

Operating Your Oscilloscope  
**To make time measurements automatically**

**Time Measurements** Four additional time measurement choices are available; **+Width**, **-Width**, **Rise Time**, and **Fall Time**. Width measurements are made at the 50% levels, whereas rise time and fall time measurements are made at the 10% to 90% levels.

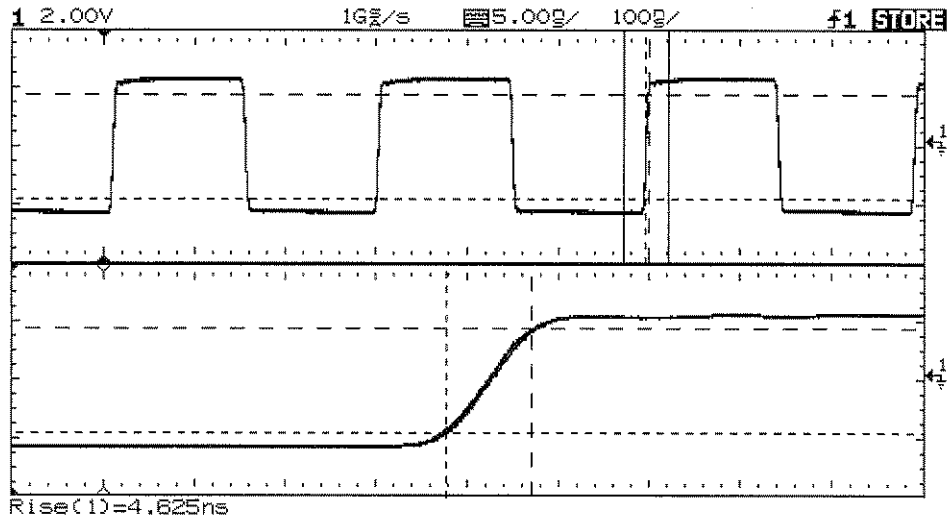
**Previous Menu** Returns to the previous softkey menu.

4 Press the **Rise Time** softkey.

The oscilloscope automatically measures the rise time of the signal and displays the result on the display.

The oscilloscope makes automatic measurements on the first displayed event. Figure 2-7 shows how to use delayed sweep to isolate an edge for a rise time measurement.

Figure 2-7



Delayed sweep isolates a leading edge for a rise time measurement



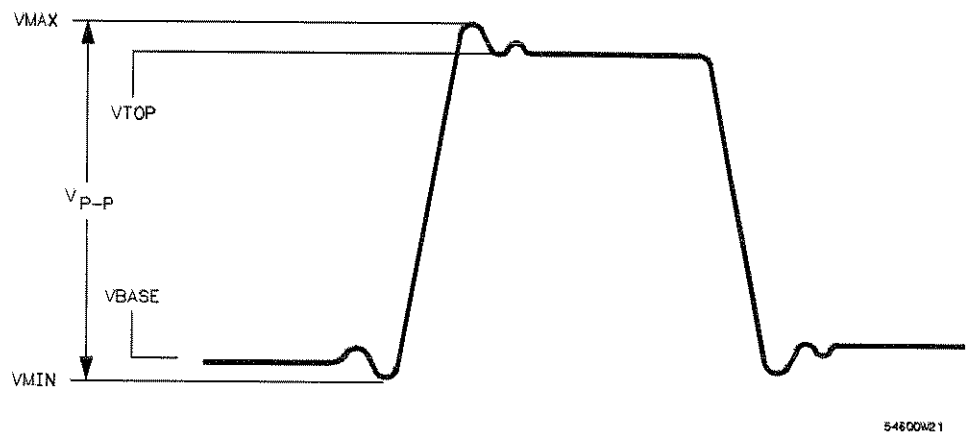




## To make voltage measurements automatically

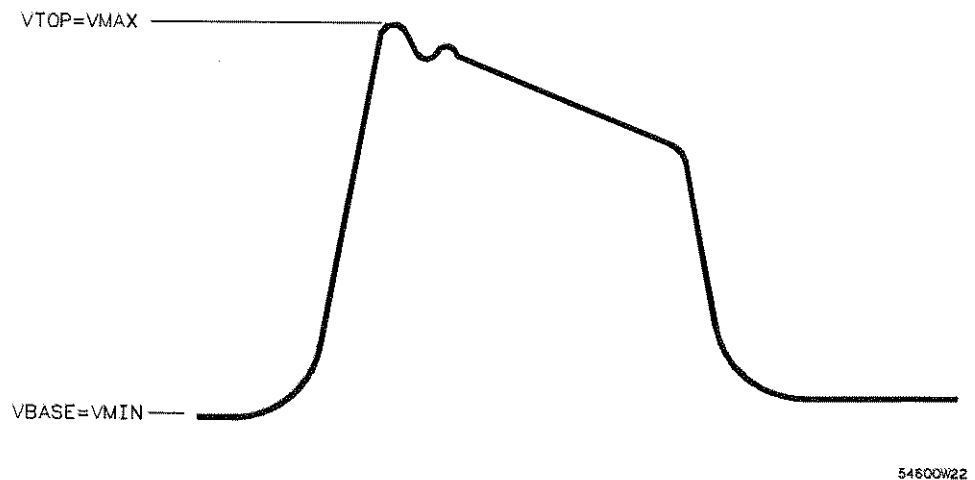
You can measure the following voltage parameters automatically with the oscilloscope: peak-to-peak, average, rms, maximum, minimum, top, and base. The following exercise guides you through the Voltage keys by making an rms voltage measurement. Figures 2-8 and 2-9 show pulses with some of the voltage measurement points.

Figure 2-8



Pulse where the top and bottom are well-defined

Figure 2-9



Pulse where the top and bottom are not well-defined

Operating Your Oscilloscope  
**To make voltage measurements automatically**

- 1 Connect a signal to the oscilloscope and obtain a stable display.
- 2 Press **Voltage** .

A softkey menu appears with six softkey choices. Three of the softkeys are voltage measurement functions.

**Source** Selects a channel for the voltage measurement.

**Voltage Measurements** Three voltage measurement choices are available:

**Vp-p, Vavg, and Vrms** The measurements are determined by voltage histograms of the signal.

**Clear Meas** (clear measurement) Erases any measurement results from the display, and removes the horizontal and vertical cursors from the display.

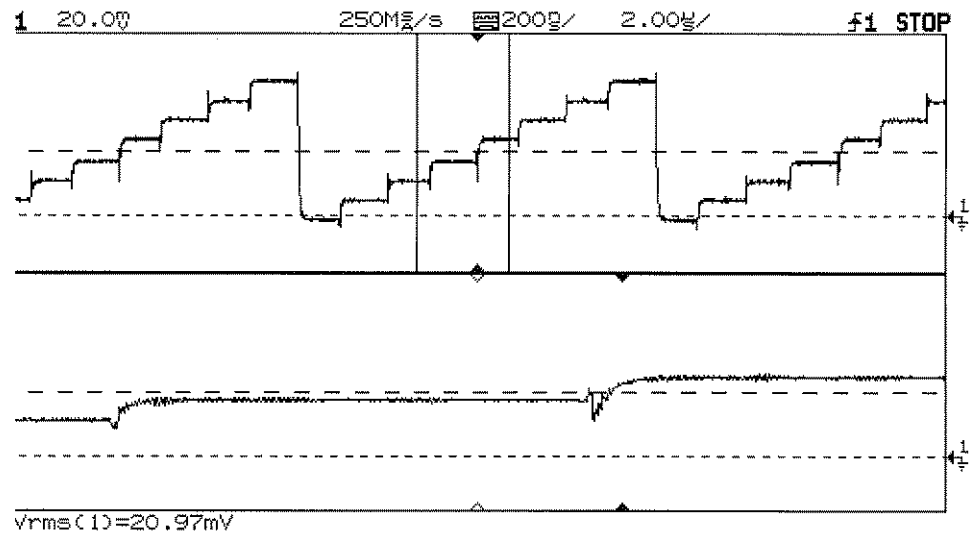
**Next Menu** Replaces the softkey menu with six additional softkey choices.

**3 Press the *Vrms* softkey.**

The oscilloscope automatically measures the rms voltage and displays the result on the display.

The oscilloscope makes automatic measurements on the first pulse or period in the display. If a cycle of the waveform cannot be found as shown in the delayed window in figure 2-10, the measurement is made using the delayed window as the cycle. Figure 2-10 shows how to use delayed sweep to isolate a pulse for an rms measurement.

**Figure 2-10**



**Delayed sweep isolates an area of interest for an rms voltage measurement**

**4** Press the **Next Menu** softkey.

Another voltage measurement softkey menu appears with six additional choices. Four of the softkeys are voltage measurement functions.

**Show Meas** (show measurement) Displays the horizontal and vertical cursors that show where the measurement was taken on the signal.

**Voltage Measurements** Four additional voltage measurement choices are available: **Vmax**, **Vmin**, **Vtop**, **Vbase**.

**Previous Menu** Returns to the previous softkey menu.

---

## To make cursor measurements

The following steps guide you through the front-panel Cursors key. You can use the cursors to make custom voltage or time measurements on the signal. Examples of custom measurements include rise time measurements from reference levels other than 10-90%, frequency and width measurements from levels other than 50%, channel-to-channel delay measurements, and voltage measurements. See figures 2-11 through 2-16 for examples of custom measurements.

- 1 Connect a signal to the oscilloscope and obtain a stable display.
- 2 Press **Cursors** .

A softkey menu appears with six softkey choices. Four of the softkeys are cursor functions.

**Source** Selects a channel for the voltage cursor measurements.

**Active Cursor** There are four cursor choices: **V1**, and **V2** are voltage cursors, while **t1**, and **t2** are time cursors. Use the knob below the **Cursors** key to move the cursors. When you press the **V1** and **V2** softkeys simultaneously, both voltage cursors are selected and the voltage cursors move together. When you press the **t1** and **t2** softkeys simultaneously, both time cursors are selected and the time cursors move together.

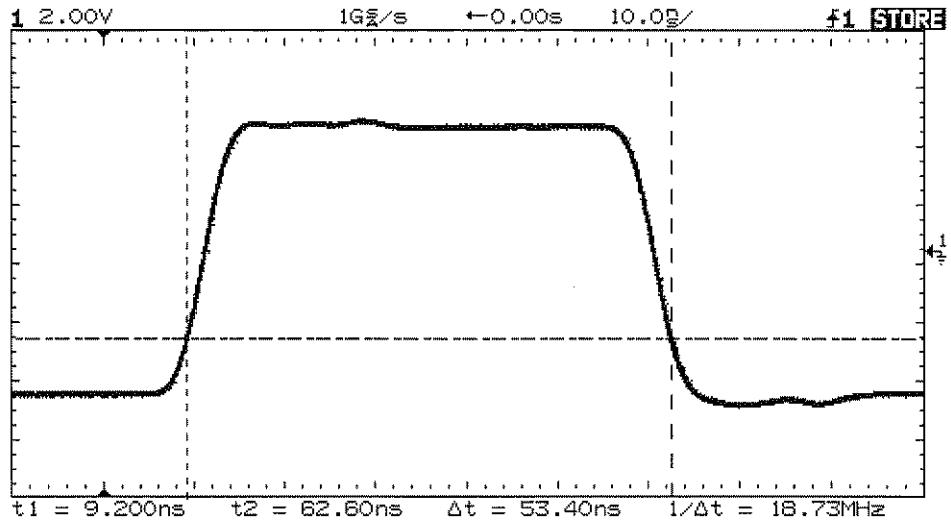
**Clear Cursors** Erases the cursor readings and removes the cursors from the display.

### toggling the Cursor key to select active cursor

If you toggle the front-panel Cursor key, the active cursor will be toggled. For example, if **V1** is selected, pressing the Cursor key will select **V2**. Pressing the cursor key again will select **V1**.

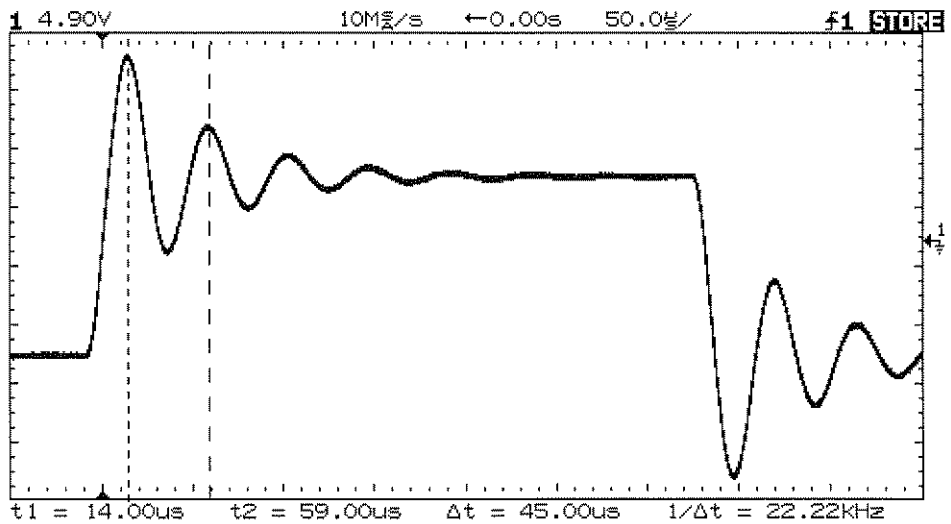
Operating Your Oscilloscope  
To make cursor measurements

Figure 2-11



Cursors used to measure pulse width at levels other than the 50% points

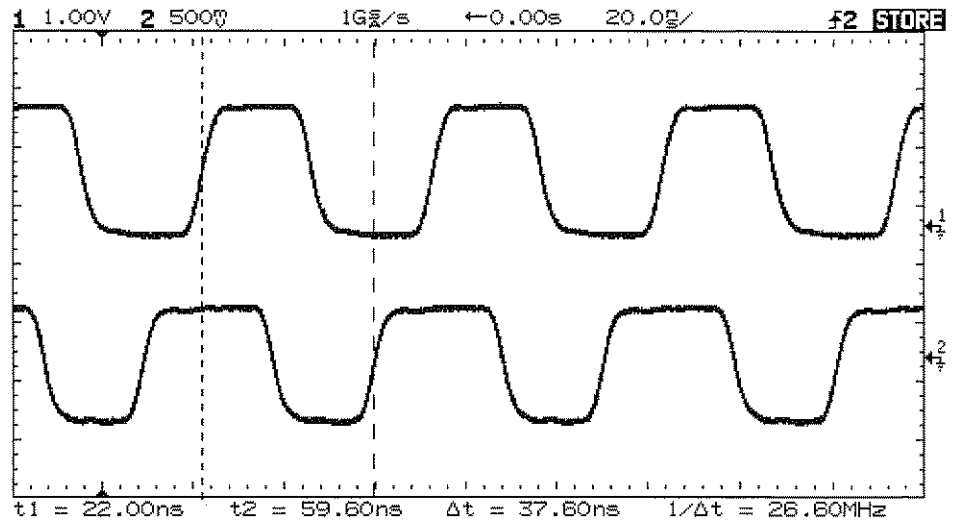
Figure 2-12



Cursors used to measure the frequency of the ringing on a pulse

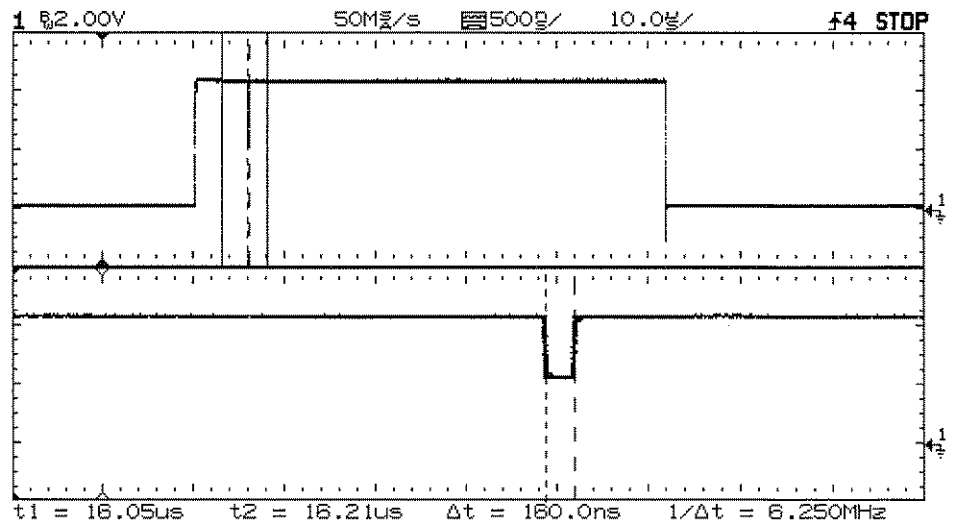


Figure 2-13



Cursors used to make channel-to-channel delay measurements

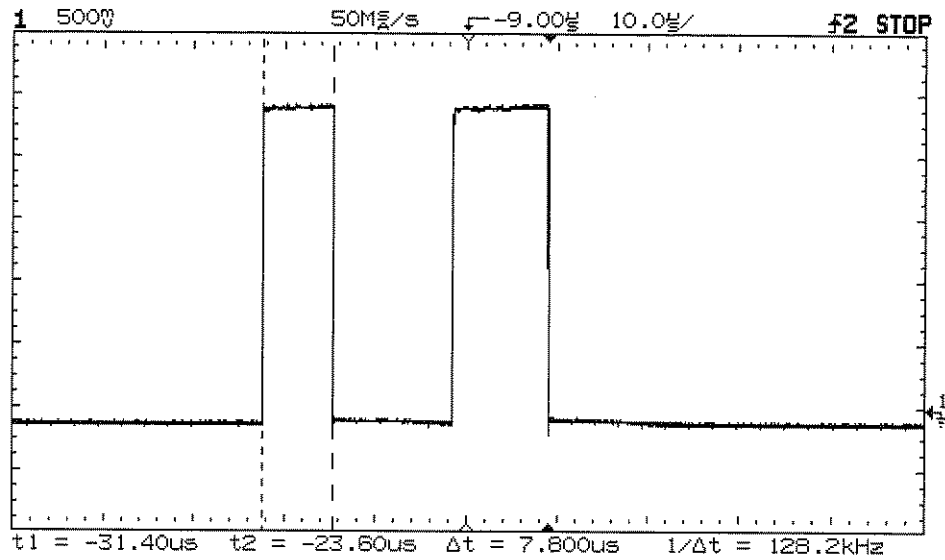
Figure 2-14



The cursors track delayed sweep. Expand the display with delayed sweep, then characterize the event of interest with the cursors.

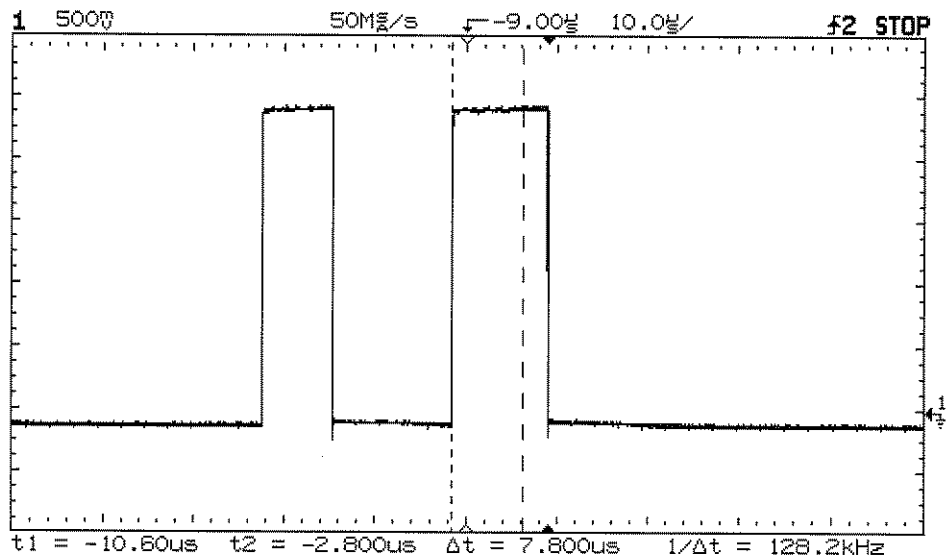
Operating Your Oscilloscope  
To make cursor measurements

Figure 2-15



Pressing t1 and t2 softkeys simultaneously causes the time cursors to move together when the cursor knob is adjusted.

Figure 2-16



By moving the time cursors together, you can check for pulse width variations in a pulse train, as figures 2-15 and 2-16 show.

---

## To remove cabling errors from time interval measurements

When measuring time intervals in the nanosecond range, small differences in cable length can totally obscure the measurement. The following exercise shows how to remove errors that different cable lengths or characteristics introduce to your measurement. The Skew control makes it possible to remove this offset error from your measurement.

This process is also referred to as deskewing.

- 1 Select **Time Reference to Center**, with the Graticule turned on.
- 2 Connect the channels to be nulled to a common test point and obtain a stable display. A fast edge is a good choice.
- 3 Press **Print/Utility**, then select the **Service Menu** softkey, then the **Self Cal Menu** softkey. This gives you access to the calibration and skew adjustments.
- 4 Select **Skew 1 > 2** to adjust channel 2 with respect to channel 1. Rotate the knob to bring the channels into time alignment. This nullifies the cable delay.

This adjustment is not affected by pressing Autoscale. If the default setup is selected or default calibration factors are loaded, the skew value will return to zero seconds.

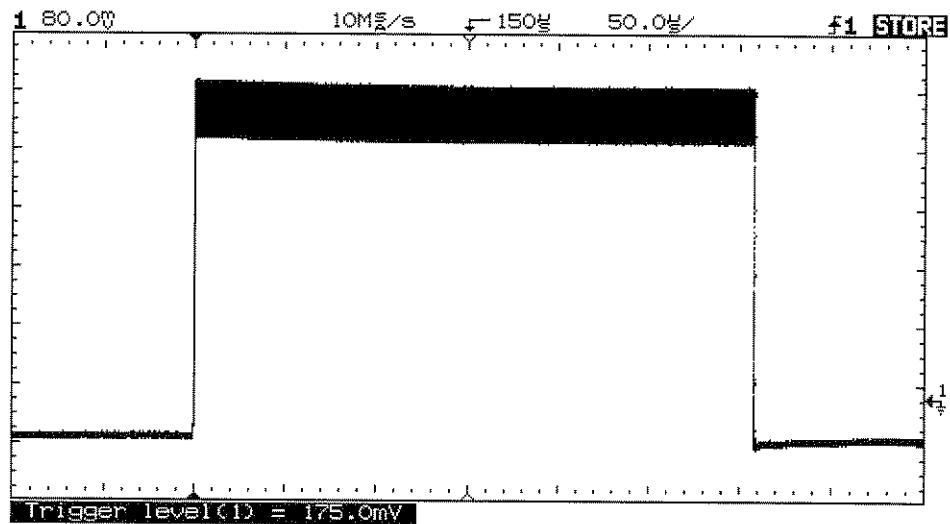
---

## To view asynchronous noise on a signal

The following exercise shows how to use the oscilloscope to view asynchronous noise on a signal that is not synchronous to the period of the waveform.

- 1 Connect a noisy signal to the oscilloscope and obtain a stable display. Figure 2-17 shows a waveform with asynchronous noise at the top of the pulse.

Figure 2-17



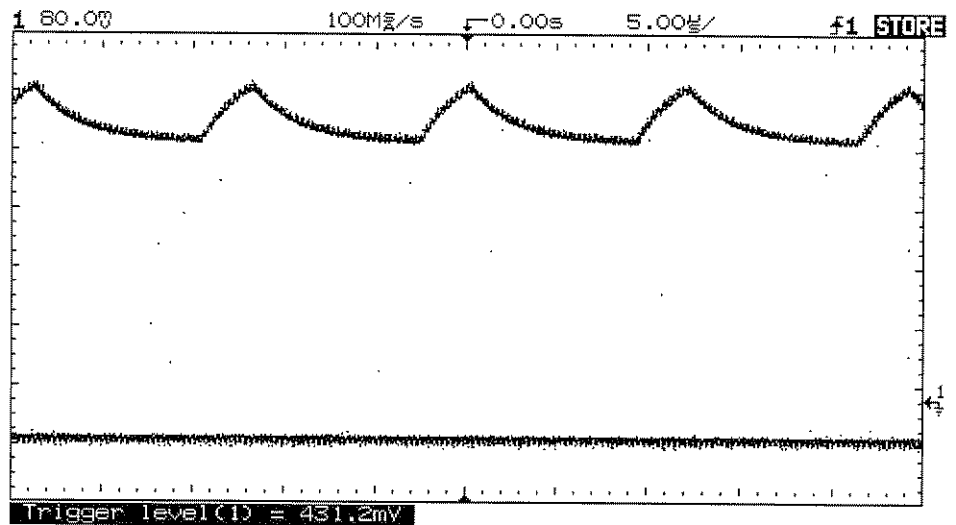
Asynchronous noise at the top of the pulse

- 2 Press **Autostore** .

Notice that **STORE** is displayed in the status line.

- 3 Set the **Trigger Mode** to **Normal**, then adjust the trigger level into the noise region of the signal.
- 4 Decrease the sweep speed for better resolution of the asynchronous noise.
  - To characterize the asynchronous noise signal, use the cursors.

Figure 2-18



This is a triggered view of the asynchronous noise shown in figure 2-17.

---

## To reduce the random noise on a signal

If the signal you are applying to the oscilloscope is noisy (figure 2-21), you can set up the oscilloscope to reduce the noise on the waveform (figure 2-22). First, you stabilize the displayed waveform by removing the noise from the trigger path. Second, you reduce the noise on the displayed waveform.

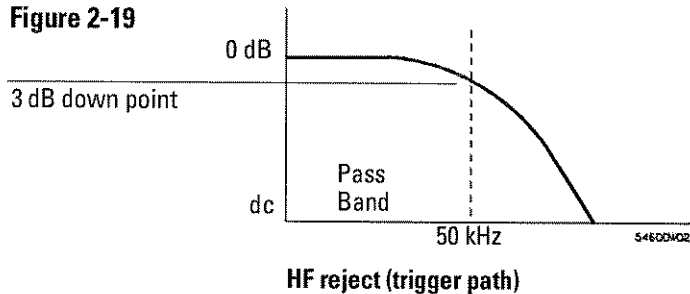
- 1 Connect a noisy signal to the oscilloscope and press

**Autoscale** .

- 2 Obtain a stable display by removing the noise from trigger path; press **Slope/Coupling** , then select either the **LF Reject** softkey or the **HF Reject** softkey.

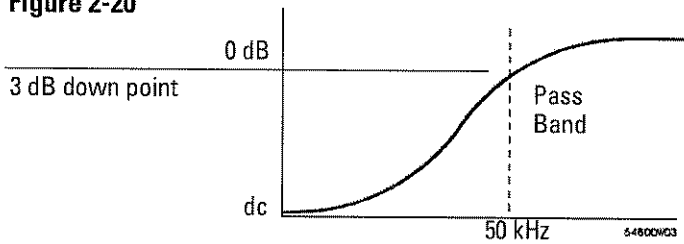
High frequency reject (**HF Reject**) adds a low pass filter with the 3 dB point at 50 kHz (see figure 2-19). You use HF reject to remove high frequency noise such as AM or FM broadcast stations from the trigger path.

Figure 2-19



Low frequency reject (**LF Reject**) adds a high pass filter with the 3-dB point at 50 kHz (see figure 2-20). Use LF reject to remove low frequency signals such as power line noise from the trigger path.

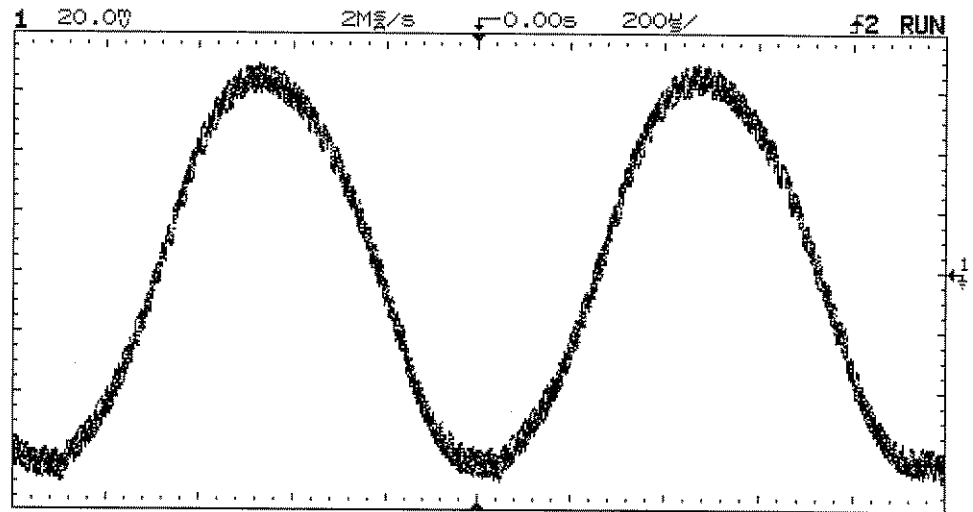
Figure 2-20



LF reject (trigger path)

Noise reject increases the trigger hysteresis band. By increasing the trigger hysteresis band you reduce the possibility of triggering on noise. However, this also decreases the trigger sensitivity so that a slightly larger signal is required to trigger the oscilloscope.

Figure 2-21



Random noise on the displayed waveform

Operating Your Oscilloscope  
To reduce the random noise on a signal

3 Use averaging to reduce noise on the displayed waveform.

To use averaging follow these steps.

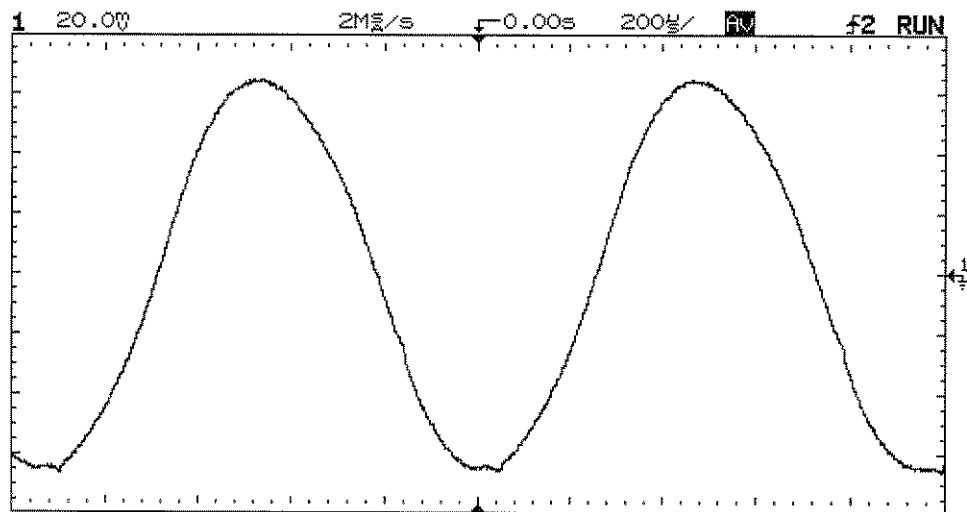
- Press **Display** , then press the **Average** softkey.

Notice that **Av** appears in the status line.

- Toggle the **# Average** softkey to select the number of averages that best eliminates the noise from the displayed waveform.

The **Av** letters in the status line indicate how much of the averaging process is finished by turning to inverse video as the oscilloscope performs averaging. The higher the number of averages, the more noise that is removed from the display. However, the higher the number of averages, the slower the displayed waveform responds to waveform changes. You need to choose between how quickly the waveform responds to changes and how much noise there is on the signal.

Figure 2-22



On this waveform, 256 averages were used to reduce the noise



---

## To save or recall traces

The oscilloscope has two pixel memories for storing waveforms. The following exercise guides you through how to store and recall waveforms from pixel memories.

**1** Connect a signal to the oscilloscope and obtain a stable display.

**2** Press **Trace** .

A softkey menu appears with five softkey selections. Four of the softkeys are trace memory functions.

**Trace** Selects memory 1 or memory 2.

**Trace Mem** Turns on or off the selected memory.

**Save to** Saves the waveform to the selected memory. The front-panel setup is saved to a separate memory location.

**Clear** Erases the selected memory.

**Recall Setup** Recalls the front-panel setup that was saved with the waveform.

**3** Toggle the **Trace** softkey to select memory 1 or memory 2.

**4** Press the **Save to** softkey.

The current display is copied to the selected memory.

**5** Turn on the **Trace Mem** softkey to view the stored waveform.

The trace is copied from the selected trace memory and is displayed in half bright video.

## Operating Your Oscilloscope

### To save or recall front-panel setups

The automatic measurement functions do not operate on stored traces. Remember, the stored waveforms are pictorial information rather than stored data.

- If you have not changed the oscilloscope setup, use the cursors to make the measurements.
- If you have changed the oscilloscope setup, press the **Recall Setup** softkey. Then, use the cursors to make the measurements.

#### Trace memory operating hint

The standard oscilloscope has volatile trace memories. When you add an interface module to the oscilloscope, the trace memories become nonvolatile.

---

## To save or recall front-panel setups

There are 16 memories for storing front-panel setups. Saving front-panel setups can save you time in situations where several setups are repeated many times.

- 1 Press **Setup** .
- 2 To change the selected memory location, press either the left-most softkey or turn the knob closest to the Cursors key.
- 3 Press the **Save** softkey to save a front-panel setup, then press the **Recall** softkey to recall a front-panel setup.

---

## To reset the instrument setup

- 1 To reset the instrument to the default factory-preset configuration, press **Setup** .
- 2 Press the **Default Setup** softkey.
- 3 To reset the instrument to the configuration that was present before pressing **Autoscale**, press the **Undo Autoscale** softkey.

**Table 2-1**

---

### Default Setup configuration settings

---

Configuration Item	Setting
Cursors	Cursors off; time readout is selected; all cursors are set to time/voltage zero.
Trace memories	Both trace memory 1 and 2 are off; trace 1 memory is selected.
Setup memories	Setup memories are off; setup memory 1 is selected.
Graticule	Grid set to Full
Autostore	Off
Time base	Time reference center; main, not delayed sweep; main and delay value 0; 100 $\mu$ s/div main time base; sample rate is 5 MSa/s.
Display	Vectors On, Display Mode Normal.
Channels	Channel 1 on, Position 0 V, Volts/Div 100 mV.
Trigger Mode	Auto Level, Coupling DC, Reject Off, Noise Reject Off.
Trigger Condition	Rising edge of channel 1

**See Also** "To Clear Error Messages" in the troubleshooting section of Service chapter 4.

---

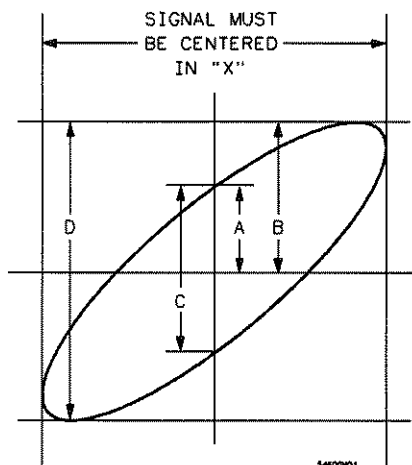
## To use the XY display mode

The XY display mode converts the oscilloscope from a volts versus time display to a volts versus volts display. You can use various transducers so the display could show strain versus displacement, flow versus pressure, volts versus current, or voltage versus frequency. This exercise shows a common use of the XY display mode by measuring the phase shift between two signals of the same frequency with the Lissajous method.

- 1 Connect a signal to channel 1, and a signal of the same frequency but out of phase to channel 2.
- 2 Press **Autoscale** , press **Main/Delayed** , then press the **XY** softkey.
- 3 Center the signal on the display with the Position knobs, and use the Volts/Div knobs and the vertical **Vernier** softkeys to expand the signal for convenient viewing.

$\sin \theta = \frac{A}{B}$  or  $\frac{C}{D}$ , where  $\theta$  = phase shift (in degrees) between the two signals.

Figure 2-23



**XY display mode operating hint**

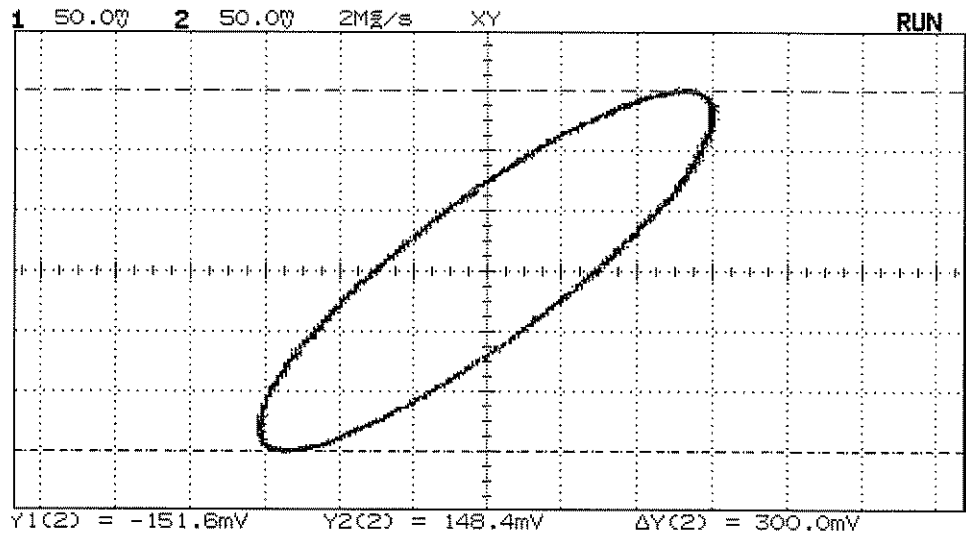
Before entering xy display mode, center both channels on screen in the main sweep and adjust sweep speed to obtain greater than or equal to 1 cycle of the lowest frequency input signal on screen.

When you select the XY display mode, the time base is turned off. Channel 1 is the X-axis input, channel 2 is the Y-axis input.

- 4 Press **Cursors** .
- 5 Set the Y2 cursor to the top of the signal, and set Y1 to the bottom of the signal.

Note the  $\Delta Y$  value at the bottom of the display. In this example we are using the Y cursors, but you could have used the X cursors instead. If you use the X cursors, make sure you center the signal in the Y axis.

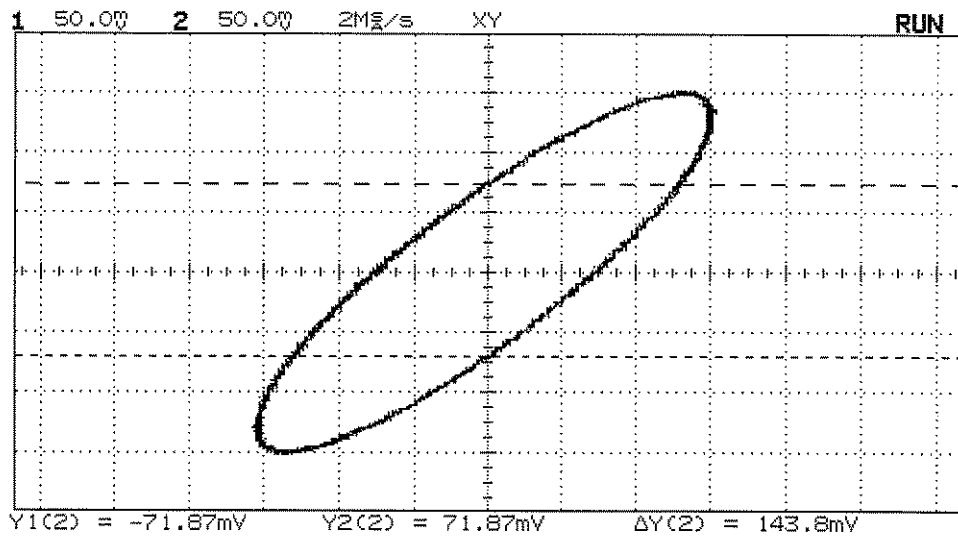
Figure 2-24



Operating Your Oscilloscope  
To use the XY display mode

- 6 Move the Y1 and Y2 cursors to the center of the signal.  
Again, note the  $\Delta Y$  value.

Figure 2-25

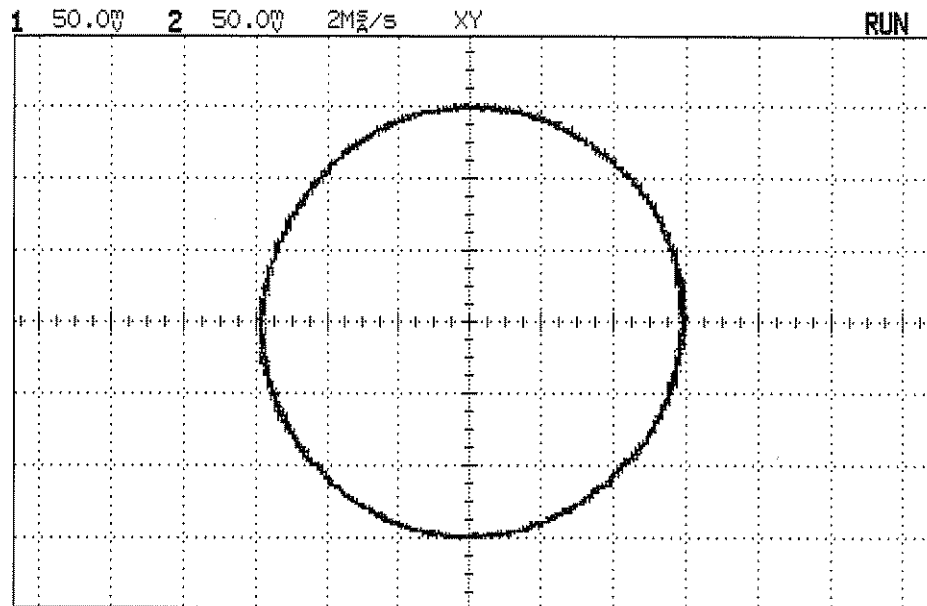


- 7 Calculate the phase difference using formula below.

$$\sin \theta = \frac{\text{second } \Delta Y}{\text{first } \Delta Y} = \frac{143.8}{300.0}$$

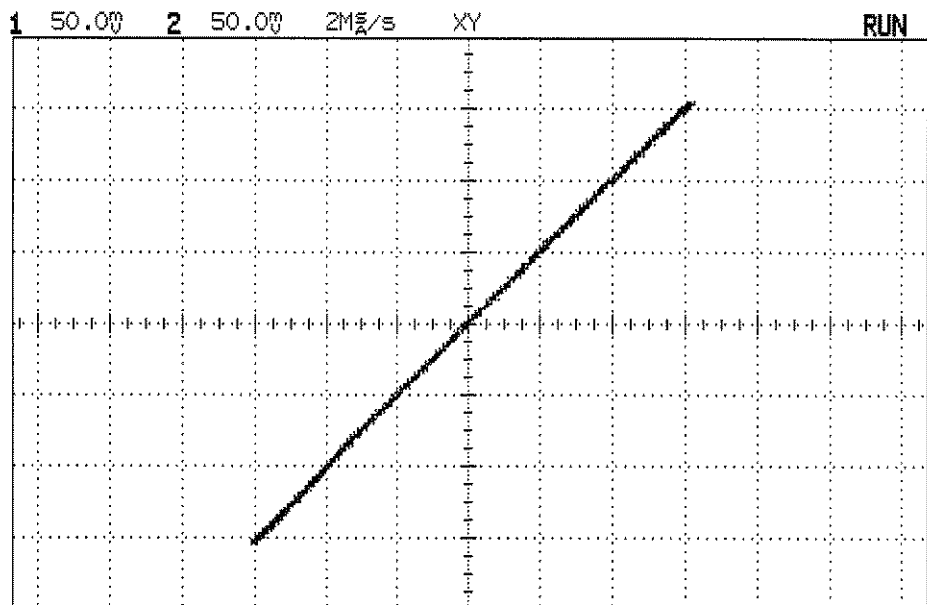
$$\theta = 28.64 \text{ degrees of phase shift}$$

Figure 2-26



Signals are 90° out of phase

Figure 2-27



Signals are in phase

## To analyze video waveforms

### Enhanced TV/Video Trigger

This section discusses basic TV video triggering. If you have Option 005 Enhanced TV/Video Trigger installed in your oscilloscope, refer to Chapter 3 "Using Option 005 Enhanced TV/Video Trigger."

The TV sync separator in the oscilloscope has an internal clamp circuit. This removes the need for external clamping when you are viewing unclamped video signals. TV triggering requires two vertical divisions of display, either channel 1 or channel 2 as the trigger source, and the selection of internal trigger. Turning the trigger level knob in TV trigger does not change the trigger level because the trigger level is automatically set to the sync pulse tips.

For this exercise connect the oscilloscope to the video output terminals on a television. Then set up the oscilloscope to trigger on the start of Field 2. Use the delayed sweep to window in on the vertical interval test signals (VITS), which are in Line 18 for most video standards (NTSC, PAL, SECAM).

- 1 Connect a TV signal to channel 1, then press **Autoscale** .
- 2 Press **Display** , then press the **Peak Det** softkey.
- 3 Press **Mode** , then press the **TV** softkey.
- 4 Press **Slope/Coupling** , then press the **Field 2** softkey.

**Polarity** Selects either positive or negative sync pulses.

**Field 1** Triggers on the field 1 portion of the video signal.

**Field 2** Triggers on the field 2 portion of the video signal.

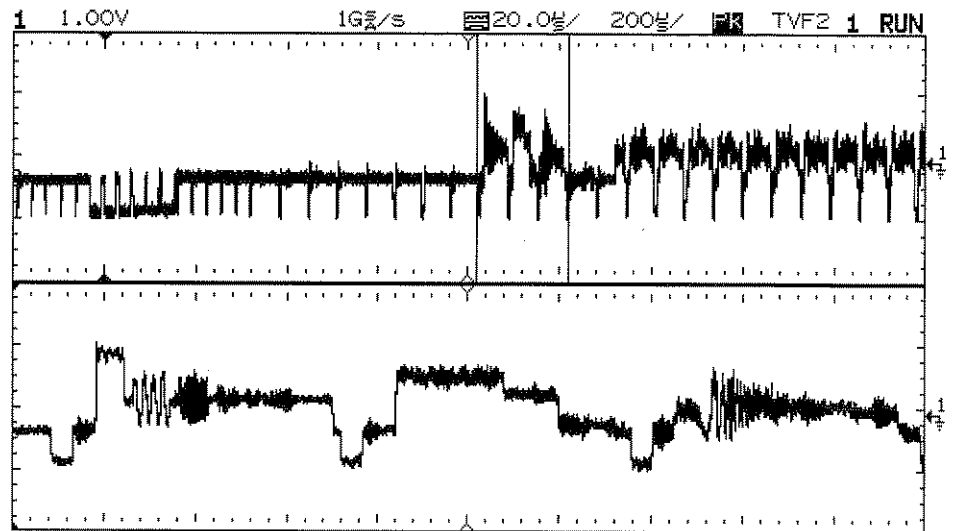
**Line** Triggers on all the TV line sync pulses.

**HF Rej** Controls a 500 kHz low pass filter in the trigger path.



- 5 Set the time base to  $200\ \mu\text{s}/\text{div}$ , then center the signal on the display with the delay knob (delay about  $800\ \mu\text{s}$ ).
- 6 Press **Main/Delayed** , then press the **Delayed** softkey.
- 7 Set the delayed sweep to  $20\ \mu\text{s}/\text{div}$ , then set the expanded portion over the VITS (delay about  $920\ \mu\text{s}$ , dependent on broadcast channel).

Figure 2-28



Frame 2 windowed on the VITS in Line 18

Operating Your Oscilloscope  
To analyze video waveforms

**Delay in TV line units hint**

The oscilloscope has the ability to display delay in TV-line units. Using the TV field trigger mode activates this line-counting feature. When Field 1 or Field 2 is selected as the trigger source, delay can be set in terms of time or line number.

**Both-fields triggering in the oscilloscope hint**

The oscilloscope can trigger on the vertical sync pulse in both TV fields at the same time. This allows you to view noninterlaced video signals which are common in computer monitors. To trigger on both sync pulses, press Field 1 and Field 2 at the same time.

**TV trigger operating hints**

The color burst changes phase between odd (Fields 1 and 3) and even (Fields 2 and 4). It looks double-triggered. Increase the holdoff to greater than the frame width to fine tune your trigger stability. For example, use a holdoff value of around 63 ms for NTSC, and around 76 ms for PAL.

When looking at live video (usually a field), use peak detect to improve the appearance of the display.

When making cursor measurements, use Autostore since you are usually looking for pulse flatness and extremes.

When using line trigger, use minimum holdoff to display all the lines. Due to the relationship between the horizontal and vertical sync frequencies the display looks like it is untriggered, but it is very useful for TV waveform analysis and adjustment because all of the lines are displayed.

---

## Using Option 005 Enhanced TV/Video Trigger

---

## Using Option 005 Enhanced TV/Video Trigger

### Basic TV/video triggering

This section discusses Enhanced TV/Video triggering. If you do not have Option 005 installed in your oscilloscope, refer to the last section in Chapter 2 "To analyze video waveforms" for basic TV triggering procedures.

You can use the Option 005 Enhanced TV/Video trigger with your oscilloscope. One of the first things you will want to do with your oscilloscope's new Option 005 Enhanced TV/Video trigger is to become acquainted with its menu choices. Therefore, we have written the exercises in this chapter to familiarize you with its basic controls.

To use the TV/Video trigger, you must be familiar with your oscilloscope. In summary, the front panel of the oscilloscope has knobs, grey keys, and white keys. The knobs are used most often and are similar to the knobs on other oscilloscopes. The grey keys bring up softkey menus on the display that allow you access to many of the oscilloscope features. The white keys are instant action keys and menus are not associated with them. The status line of the oscilloscope, located at the top of of the display, lets you quickly determine the setup of the oscilloscope.

When Option 005 is installed in your oscilloscope, the **Display** menu has the extra **Grid** (graticule) choice of **TV**.

### Use NTSC Instead of PAL-M

To trigger on a PAL-M signal, use NTSC. The line and field rates are identical.

Option 005 gives you an Enhanced TV/Video Trigger for the oscilloscope, allowing highly detailed analysis of TV waveforms. This option offers:

- NTSC, PAL, PAL-M, SECAM and generic video formats
- Video autoscale
- IRE graticule and IRE cursor readout
- Full bandwidth rear panel output
- Trigger output
- Windowed FFT measurements (with Measurement/Storage module)

Now, in one easy-to-use instrument, you can measure your system's video performance as well as use your oscilloscope for troubleshooting and precision measurements. The oscilloscope's superior display gives you bright, easily viewed displays of any part of the video waveform. No longer do you need to use a viewing hood or to be constantly adjusting intensity and focus controls.

Analysis of video waveforms is simplified by the oscilloscope's ability to trigger on any selected line of the video signal. You can make additional measurements using the **All lines, Field 1, Field 2, All fields** (**Vertical** mode in **GENERIC** standard), or **Line** triggering modes. In addition, you can use the rear-panel, full-bandwidth signal and trigger outputs with a spectrum instrument or frequency counter for additional measurement power.

---

## To select TV display grid

- Press **Display** , then press the **Grid** softkey until **TV** is selected.

---

## To autoscale on a video signal

- 1 Use a cable to connect a TV signal to channel 1.
- 2 Press **Mode** in the TRIGGER section of the front panel, and select the **Trigger Mode TV** softkey.
- 3 To select a TV standard, press **Slope/Coupling** in the TRIGGER section of the front panel, then press the **Standard** softkey to select the TV standard. Your choices are **NTSC**, **PAL**, **SECAM**, and **GENERIC**. **GENERIC** is used for other TV/Video standards. If your TV standard has been previously selected, you may skip this step.

### Use NTSC Instead of PAL-M

To trigger on a PAL-M signal, use NTSC. The line and field rates are identical.

- 4 Press **Mode** , then press the **Video Autoscale** softkey.

### Provide correct source matching

Many TV signals are produced from 75 $\Omega$  sources. To provide correct matching to these sources, an 11094B 75 $\Omega$  load is included as an accessory. For oscilloscopes that have selectable input impedance, the 1 M $\Omega$  input should be used with the 75 $\Omega$  load.

The **Undo Autoscale** softkey in the **Setup** menu resets the instrument to the configuration that was present before pressing **Video Autoscale**.

---

## To trigger on a specific line of video

TV triggering requires greater than 1/4 division of sync amplitude, either channel 1 or channel 2 as the trigger source. Turning the trigger level knob in TV trigger does not change the trigger level because the trigger level is automatically set to the sync pulse tips.

One example of triggering on a specific line of video is looking at the vertical interval test signals (VITS), which are typically in line 18. Another example is closed captioning, which is typically in line 21.

- 1 Select the TV display, TV as the trigger mode, and the appropriate TV standard.
- 2 Press **Slope/Coupling** in the TRIGGER section of the front panel, then press the **Mode** softkey until **Line** appears. Select the number of the line you want to examine by pressing the **Trigger On Line** softkey or by rotating the knob closest to the **Cursors** key.
- 3 Press the **Trigger On** softkey to select the TV field of the line you want to trigger on. Your choices are **Field 1**, **Field 2**, and **Alt Fld** (alternate fields).

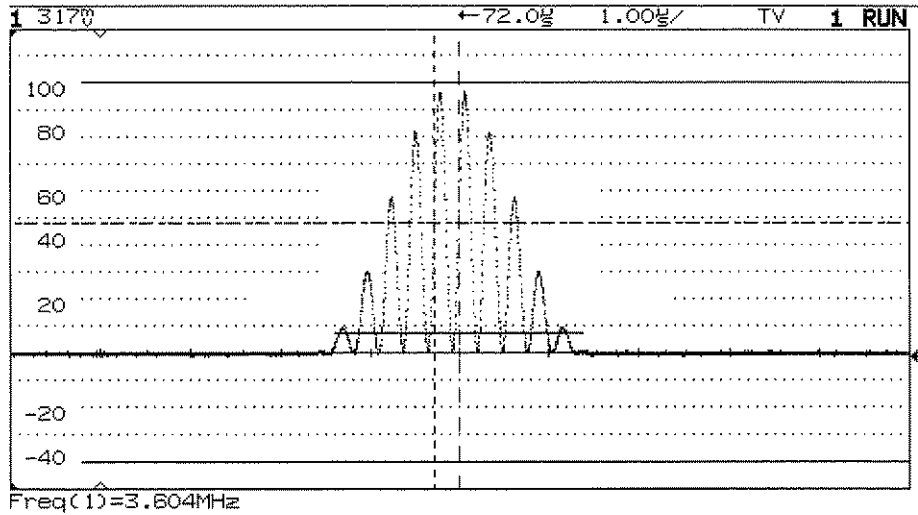
### Alternate triggering

If **Alt Fld** is selected, the oscilloscope will alternately trigger on the selected line number in Field 1 and Field 2. This is a quick way to compare the Field 1 VITS and Field 2 VITS or to check for the correct insertion of the half line at the end of Field 1.

When using **GENERIC** as the TV standard, the **Trigger On** softkey gives you the choices of **Field 1**, **Field 2** and **Vertical**.

Using Option 005 Enhanced TV/Video Trigger  
**To trigger on a specific line of video**

Figure 3-1



Triggering on Line 71

Table 3-1

Line Numbers per Field for Each TV Standard

TV Standard	Field 1	Field 2	Alt Fld
NTSC	1 to 263	1 to 262	1 to 262
PAL	1 to 313	314 to 625	1 to 313
SECAM	1 to 313	314 to 625	1 to 313
GENERIC	1 to 1024	1 to 1024	1 to 1024 (Vertical)

**Line Number Represents Count**

In **GENERIC** mode, the line number represents the number of a count instead of a real line number. This is reflected in the label above the softkey changing from **Line** to **Cnt**. In the **Trigger On** selections, **Field 1**, **Field 2** and **Vertical** are used to indicate where the counting starts. For an interlaced TV system, the counting starts from the rising edge of the first vertical serration pulse of Field 1 and/or Field 2. For a non-interlaced TV system, the counting starts after the rising edge of the vertical sync pulse.



## To trigger on all TV line sync pulses

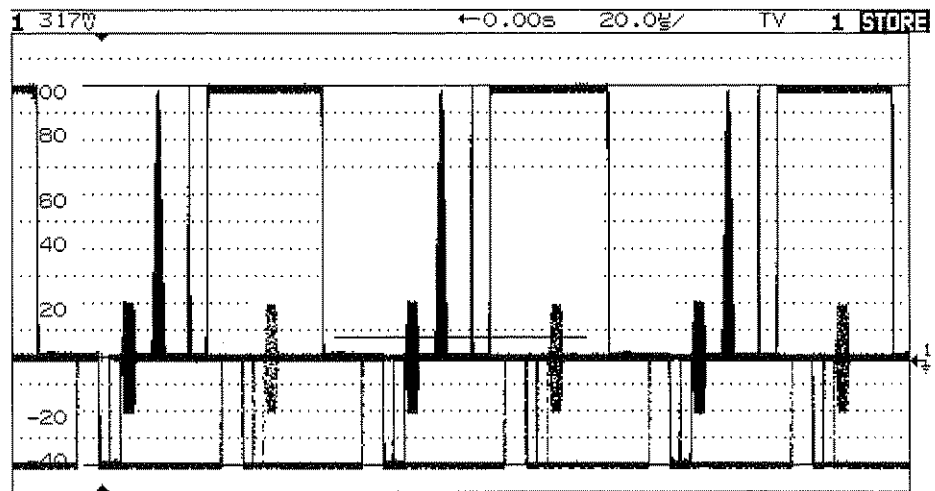
To quickly find maximum video levels, you could trigger on all TV line sync pulses. When All Lines is selected as the TV trigger mode, the oscilloscope will trigger on the first line that it finds when the acquisition starts.

- 1 Select the TV display, TV as the trigger mode, and the appropriate TV standard as described in the previous section, "To autoscale on a video signal."
- 2 Press **Slope/Coupling** in the TRIGGER section of the front panel, then press the **Mode** softkey until **All Lines** appears.

### Vertical interval can be blocked

The 21 lines in the Vertical Interval can be blocked from this display if the **Vert Rej On** mode is selected. The three color sync bursts being displayed inside the white bars are on vertical interval lines. These could be removed by selection of **Vert Rej On**.

Figure 3-2



Triggering on All Lines

Using Option 005 Enhanced TV/Video Trigger  
To trigger on a specific field of the video signal

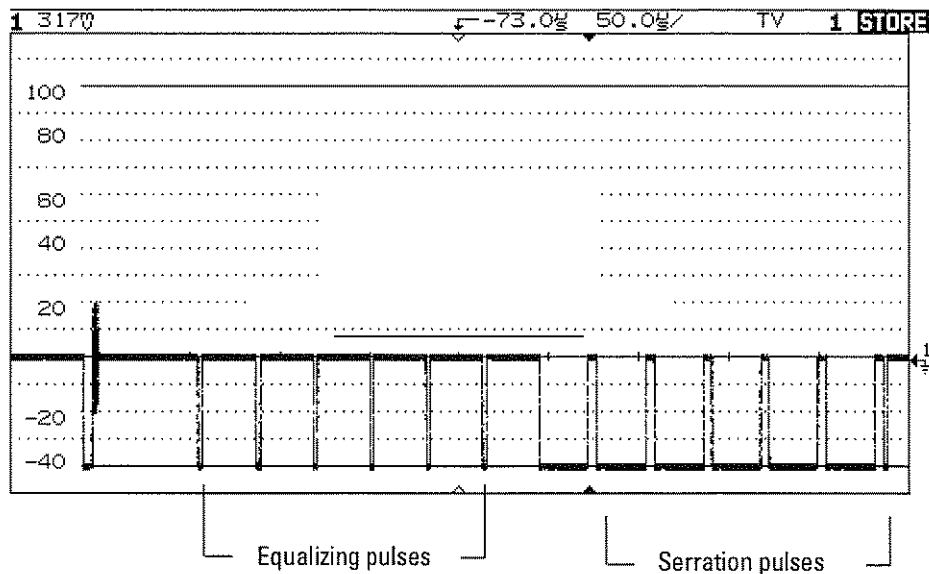
---

## To trigger on a specific field of the video signal

To examine the components of a video signal, trigger on either Field 1 or Field 2. When a specific field is selected, the oscilloscope triggers on the rising edge of the first serration pulse in the vertical sync interval in the specified field (1 or 2).

- 1 Select the TV display, TV as the trigger mode, and the appropriate TV standard as described in the section, "To autoscale on a video signal."
- 2 Press **Slope/Coupling** in the TRIGGER section of the front panel, then press the **Mode** softkey until **Field 1** or **Field 2** appears.

Figure 3-3



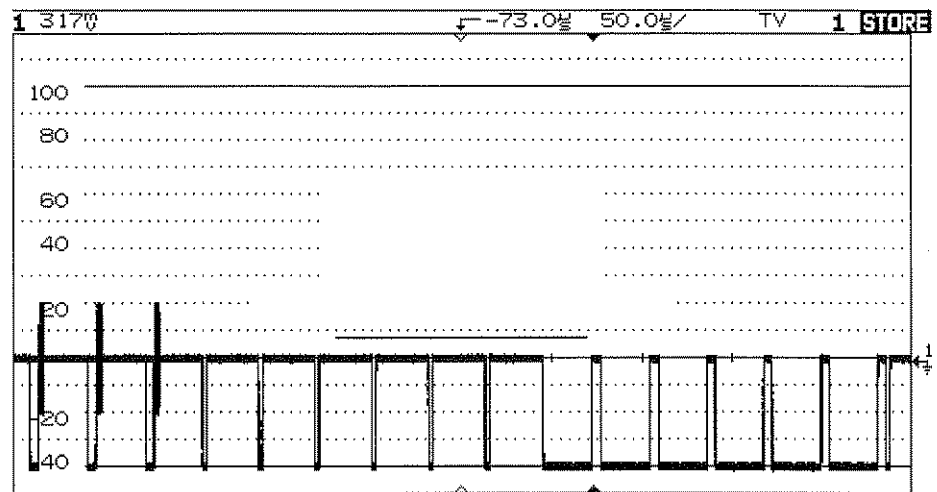
Triggering on Field 1

## To trigger on all fields of the video signal

To quickly and easily view transitions between fields, or to find the amplitude differences between the fields, use the All Fields trigger. The oscilloscope will trigger on the first field it finds at the start of acquisition.

- 1 Select the TV display, TV as the trigger mode, and the appropriate TV standard as described in the section, "To autoscale on a video signal."
- 2 Press **Slope/Coupling** in the TRIGGER section of the front panel, then press the **Mode** softkey until **All Fields** appears.

Figure 3-4



Triggering on All Fields

---

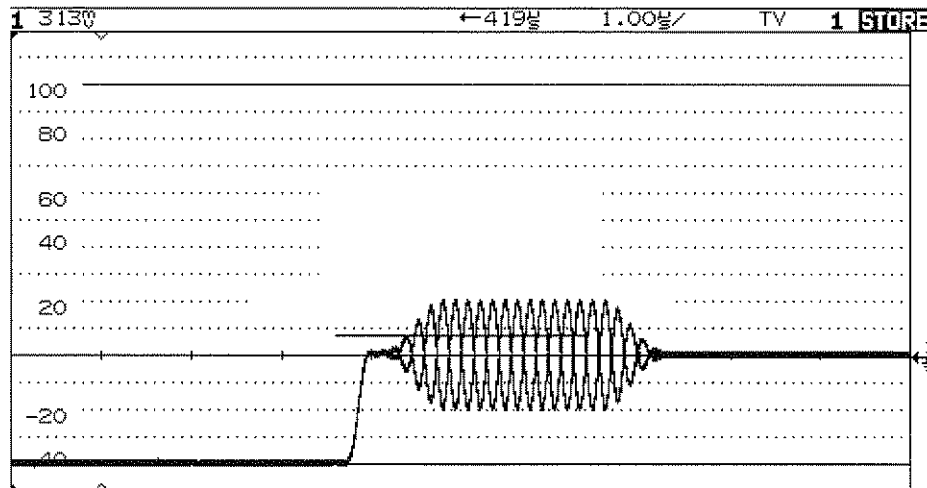
## To trigger on odd or even fields

To check the envelope of your video signals, or to measure worst case distortion, trigger on the odd or even fields. When Field 1 is selected, the oscilloscope triggers on color fields 1 or 3. When Field 2 is selected, the oscilloscope triggers on color fields 2 or 4.

- 1 Select the TV display, TV as the trigger mode, and the appropriate TV standard as described in the section, "To autoscale on a video signal."
- 2 Press **Slope/Coupling** in the TRIGGER section of the front panel, then press the **Mode** softkey until **Field 1** or **Field 2** appears.

The trigger circuits look for the position of the start of Vertical Sync to determine the field. But this definition of field does not take into consideration the phase of the reference subcarrier. When Field 1 is selected, the trigger system will find any field where the vertical sync starts on Line 4. In the case of NTSC video, the oscilloscope will trigger on color field 1 alternating with color field 3 (see the following figure). This setup can be used to measure the envelope of the reference burst.

Figure 3-5



Triggering on Color Field 1 Alternating with Color Field 3

If a more detailed analysis is required, then only one color field should be selected to be the trigger. You can do this by using the oscilloscope's holdoff control. Using the holdoff settings shown in the following table, the oscilloscope will now trigger on color field 1 OR color field 3 when Field 1 is selected. This is known as odd field selection. Even fields will be selected with Field 2.

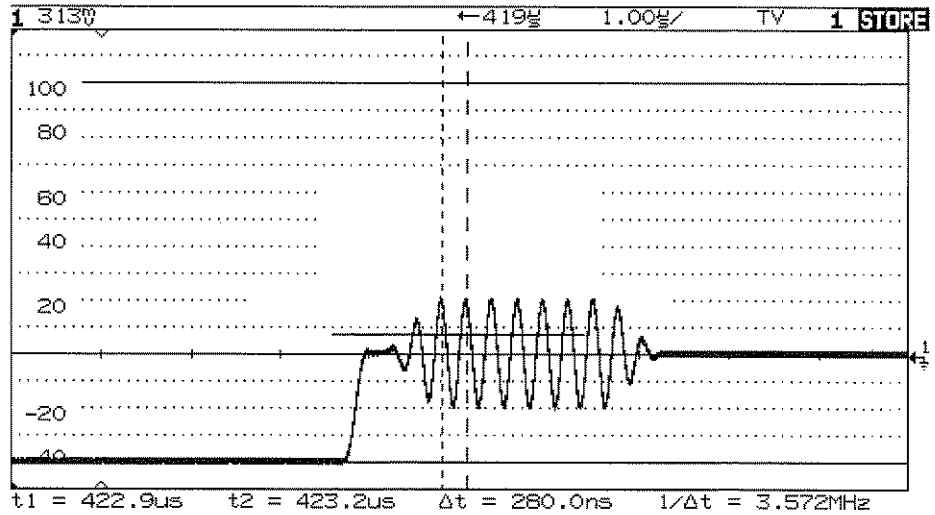
**Table 3-2**

**Holdoff Settings**

Video Standard	Fields/Picture	Holdoff Range
NTSC	4	33.5 ms to 50.0 ms
PAL	8	80.7 ms to 120 ms
SECAM	4	40.4 ms to 60 ms
PAL-M	8	80.4 ms to 120 ms

The holdoff can be more easily set if the sweep speed is set to 5 ms/div. Once you have established your desired holdoff time, return to the desired time base setting. The holdoff setting will remain unchanged.

**Figure 3-6**



**Triggering on Color Field 1 using Holdoff**

---

## To make cursor measurements

The following steps guide you through the front-panel Cursors key. You can use the cursors to make custom voltage or time measurements on the signal. Examples of custom measurements include rise time measurements from reference levels other than 10-90%, frequency and width measurements from levels other than 50%, channel-to-channel delay measurements, and voltage measurements. With Option 005 in your oscilloscope, the cursors can also be calibrated in IRE units.

- 1 Connect a video signal to the oscilloscope and obtain a stable display.
- 2 Press **Display** , then press the **Grid** softkey to select **TV**.
- 3 Press **Mode** , then press the **Video Autoscale** softkey.
- 4 Press **Cursors** .

A softkey menu appears with six softkey choices. Four of the softkeys are cursor functions.

**Source** Selects a channel for the voltage cursor measurements. The cursor is calibrated to the Volts/div of the selected channel.

**Active Cursor** There are four cursor choices: **V1** and **V2** are voltage cursors, **t1** and **t2** are time cursors. Use the knob below the **Cursors** key to move the cursors. To move the cursors together, press the **V1** and **V2** softkeys simultaneously or press the **t1** and **t2** softkeys simultaneously.

**Clear Cursors** Erases the cursor readings and removes the cursors from the display.

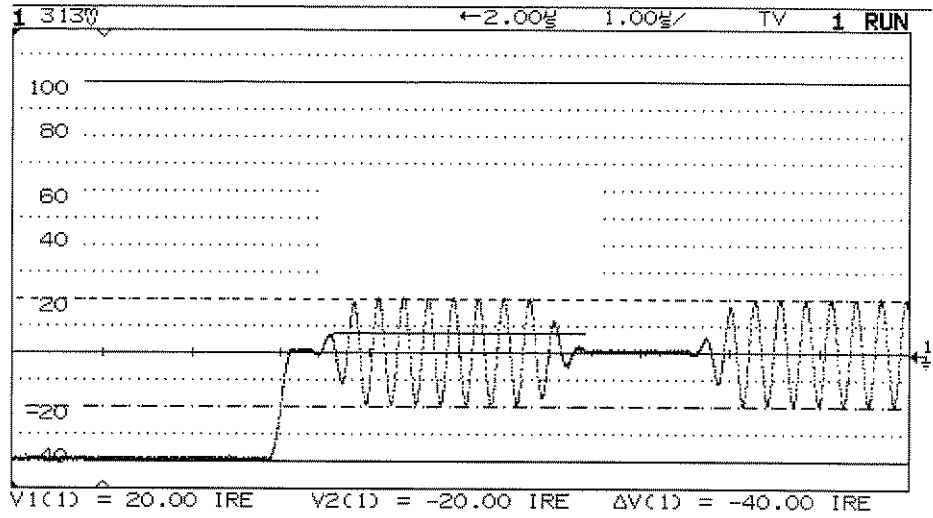
### TV graticule

With the TV graticule ON, the voltage cursors are calibrated in IRE units.

With the TV graticule OFF, the voltage cursors are calibrated in volts.

IRE units only make sense if the video signal is scaled properly, such as after a video autoscale.

Figure 3-7




Color Sync measured with the cursors as 40 IRE

## To use delayed sweep

Delayed sweep is a magnified portion of the main sweep. You can use delayed sweep to locate and horizontally expand part of the main sweep for a more detailed (high resolution) analysis of signals, for example multi-burst frequencies. The following steps show you how to use delayed sweep. Notice that the steps are very similar to operating the delayed sweep in analog oscilloscopes.

- 1 Connect a signal to the oscilloscope and obtain a stable display.
- 2 Press **Main/Delayed** .
- 3 Press the **Delayed** softkey.

The screen divides in half. The top half displays the main sweep, and the bottom half displays an expanded portion of the main sweep. This expanded portion of the main sweep is called the delayed sweep. The top half also has two solid vertical lines called markers. These markers show what portion of the main sweep is expanded in the lower half. The size and position of the delayed sweep are controlled by the Time/Div and Delay knobs. The Time/Div next to the  symbol is the delayed sweep sec/div. The delay value is displayed for a short time at the bottom of the display.

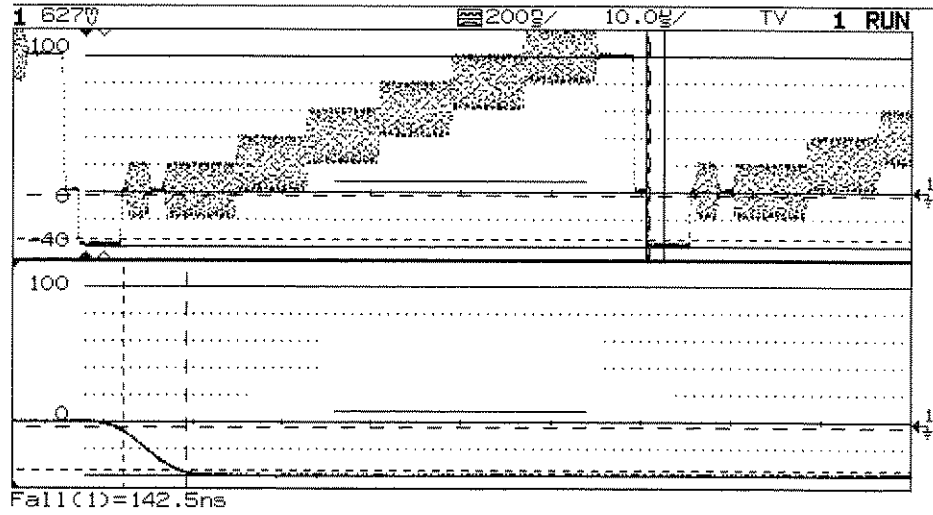
- To display the delay value of the delayed time base, either press **Main/Delayed** or turn the Delay knob.
- To change the main sweep Time/Div, you must turn off the delayed sweep. Since both the main and delayed sweeps are displayed, there are half as many vertical divisions so the vertical scaling is doubled. Notice the changes in the status line.
- To display the delay time of the delayed sweep, either press **Main/Delayed** or turn the delay knob. The delay value is displayed near the bottom of the screen.

If the TV graticule is selected, notice that it is presented in both main and delayed sweeps. For more information on delayed sweep operation, refer to "To use delayed sweep" in chapter 2.

Automatic measurements are controlled by the delayed sweep shown in the following two figures.

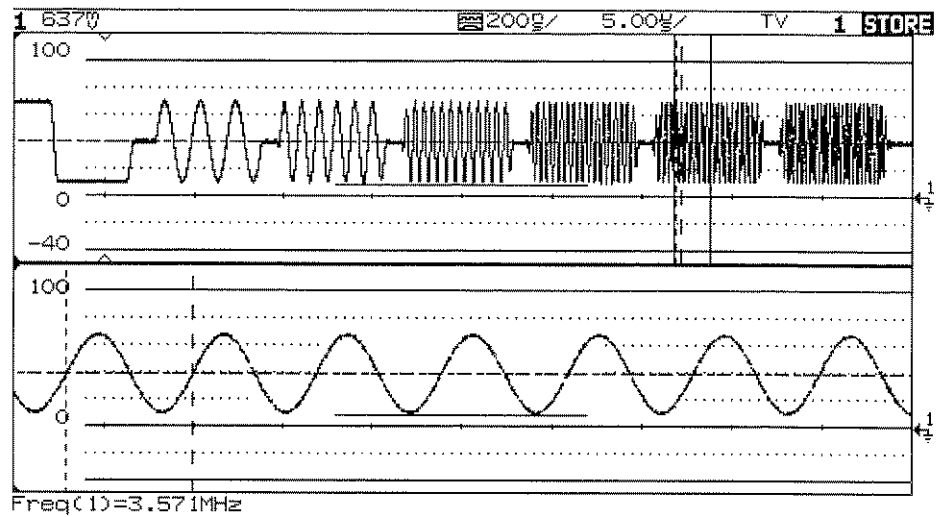


Figure 3-8



Modulated staircase or 5-step, measuring sync pulse fall time with delayed sweep

Figure 3-9



Windowed frequency measurement in a multi-burst by use of delayed sweep

## To analyze video waveforms with Option 005

The combination of the TV trigger, delayed sweep, and automatic measurements allow this oscilloscope to precisely analyze video waveforms. There is no need for external clamping to obtain a stable trigger when you are viewing unclamped video signals. This is because the TV sync separator in the oscilloscope has an internal clamp circuit in the trigger path. Because there is no clamp in the vertical path of your oscilloscope, you will be able to observe any DC level shifts in the video on the oscilloscope display. To eliminate this position shifting as the DC component of the video changes, select AC coupling.

For this exercise, we connect the oscilloscope to the video output terminals on a television. We set up the oscilloscope to view the second vertical interval with delayed sweep windowed on the vertical interval test signals (VITS). Then we make windowed measurements with the delayed sweep.

- 1 Connect a TV signal to channel 1, and select channel 1 as your trigger source.
- 2 Press **Slope/Coupling** in the TRIGGER section of the front panel, then press the **TV** softkey.
- 3 Select the desired TV **Standard**, such as NTSC, PAL, or SECAM.

**Use NTSC instead of PAL-M**

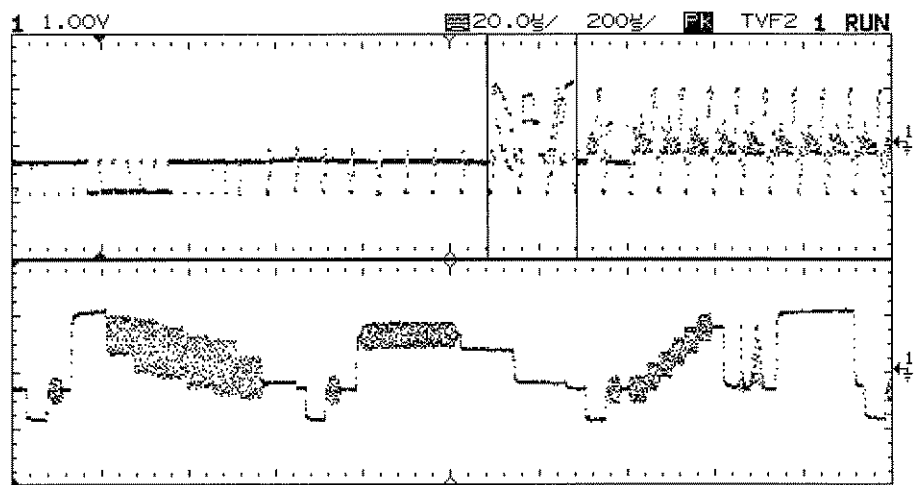
To trigger on a PAL-M signal, use NTSC. The line and field rates are identical.

- 4 Press **Mode** , then press the **Video Autoscale** softkey.

- 5 Set the time base to  $200\ \mu\text{s}/\text{div}$ , then center the signal on the display with the delay knob (delay about  $800\ \mu\text{s}$ ).
- 6 Press **Main/Delayed** , then press the **Delayed** softkey.
- 7 Set the delayed sweep to  $20\ \mu\text{s}/\text{div}$ , then set the expanded portion over the VITS (delay about  $988.8\ \mu\text{s}$ ).

**Figure 3-10**

This figure shows the second vertical interval test signals displayed with delayed sweep.

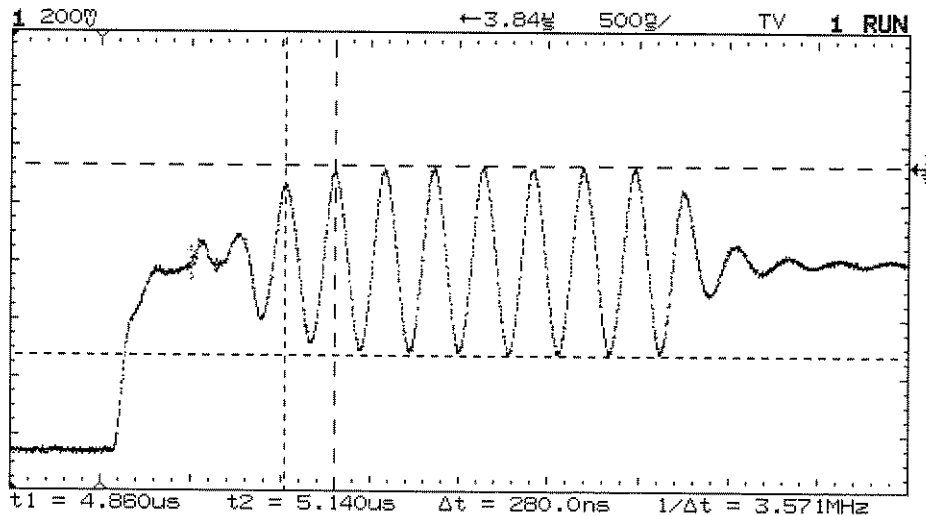


**Second VITS Displayed**

## To window in on harmonic distortion using FFT

Sine waves that are not perfectly shaped in the time domain generate harmonics in the frequency domain. Viewing this distortion in the time domain is usually very difficult, unless the waveform is severely distorted. However, in the frequency domain, these harmonics are very apparent. Your oscilloscope, when used with the 54657A, 54658A, or 54659B Measurement/Storage module, have the ability to perform frequency domain analysis on a time domain waveform using the Fast Fourier Transform (FFT). A special case of measuring the harmonic distortion in a sine wave is found in video applications. The 3.58 MHz color-subcarrier frequency embedded in an NTSC composite video signal has some amount of harmonic distortion associated with the subcarrier frequency. To measure just this signal, the scope's time/division and delay controls are used to zoom in on the color burst in the time domain.

Figure 3-11

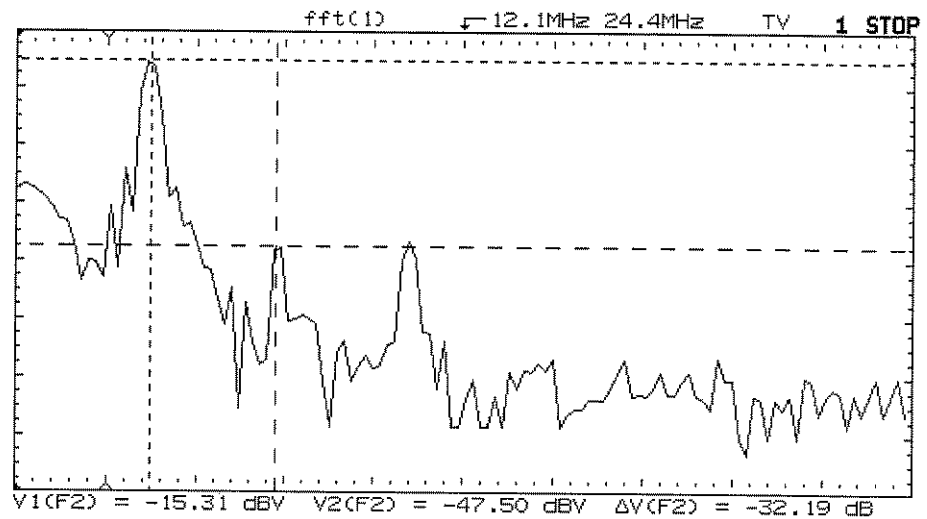


The scope controls are used to zoom in on the color burst in the time domain

Using Option 005 Enhanced TV/Video Trigger  
To window in on harmonic distortion using FFT

The FFT function then shows the harmonic content of the subcarrier in the figure below. Had the time/division and delays controls not been used to zoom in on the desired subcarrier, the entire video signal (with many frequency components) would have appeared in the frequency domain display. These frequency components would have obscured the color subcarrier and its harmonics. This example illustrates a general technique of using the time domain controls of the scope to select specific time intervals for FFT analysis.

Figure 3-12



The FFT function shows that the harmonic content of the color burst is more than 31 dB below the subcarrier

## To connect to other instruments

The rear panel outputs provide an easy way to connect your Option 005-equipped oscilloscope to other instruments such as spectrum analyzers or frequency counters. To use a frequency counter:

- 1 Connect the vertical output of the oscilloscope to the counter's input.
- 2 Connect the frequency to be measured to channel 1.
- 3 Press **Autoscale** , then select the trigger source to be channel 1. Adjust the counter as required.

The amplitude of the vertical output signal is proportional to the amplitude as displayed on the oscilloscope.

The trigger source selection is the control that determines which channel's signal is present at the vertical output (VERT OUT) connector on the rear of the oscilloscope.

---

# 4

Verifying Oscilloscope Performance 4-5  
Adjusting the Oscilloscope 4-21  
Troubleshooting the Oscilloscope 4-32  
Replacing Parts in the Oscilloscope 4-45

---

## Service

---

## Service

If the oscilloscope is under warranty, you must return it to Agilent Technologies for all service work covered by the warranty. See "To return the oscilloscope to Agilent Technologies" on page 4-4. If the warranty period has expired, you can still return the oscilloscope to Agilent Technologies for all service work. Contact your nearest Agilent Technologies Sales Office for additional details on service work.

If the warranty period has expired and you decide to service the oscilloscope yourself, the instructions in this chapter can help you keep the oscilloscope operating at optimum performance.

This chapter is divided into the following four sections:

- Verifying Oscilloscope Performance on page 4-5
- Adjusting the Oscilloscope on page 4-21
- Troubleshooting the Oscilloscope on page 4-32
- Replacing Parts in the Oscilloscope on page 4-45. Service should be performed by trained service personnel only. Some knowledge of the operating controls is helpful, and you may find it helpful to read chapter 1, "The Oscilloscope at a Glance."



Table 4-1

---

**Recommended list of test equipment to service the oscilloscope**


---

Equipment	Critical specifications	Recommended Model/Part	Use <sup>1</sup>
Signal generator	1 to 500 MHz at 200 mV high stability timebase	Agilent 8656B Option 001	P
Digital multimeter	0.1 mV resolution, better than 0.01% accuracy	Agilent 34401A	P, A, T
Oscilloscope	100 MHz, 1 M $\Omega$ input R	Agilent 54600	P, T
Power meter and Power sensor	1 to 500 MHz $\pm$ 3% accuracy	Agilent 436A and Agilent 8482A	P
Power supply	14 mV to 35 Vdc, 0.1 mV resolution	Agilent 6114A	P
Pulse generator	Rise time $\leq$ 700 ps	Agilent 8131A	A
Power splitter	Outputs differ < 0.15 dB	Agilent 11667B	P
Shorting cap	BNC	Agilent 1250-0774	P
Time Mark Generator	Stability 5 ppm after 30 minutes	Tektronix TG501A and TM503B	P
Dummy load <sup>2</sup>	Compatible with power supply	see note 2 below	A
Adapter	SMA (f) to BNC (m)	Agilent 1250-1787	A
Adapter	BNC (f-f)	Agilent 1250-0080	P, A
Adapter	BNC tee (m) (f) (f)	Agilent 1250-0781	P, A
Adapter	N (m) to BNC (f), Qty 3	Agilent 1250-0780	P
Adapter	BNC (f) to dual banana (m)	Agilent 1251-2277	P
Adapter	Type N (m) to BNC (m)	Agilent 1251-0082	P
Cable	BNC, Qty 3	Agilent 10503A	P, A
Cable	BNC, 9 inches, Qty 2	Agilent 10502A	P, A
Cable	Type N (m) 24 inch	Agilent 11500B	P
Adapter <sup>3</sup>	BNC (m) to dual banana post	Agilent 10110B	P

<sup>1</sup> P = Use for Performance Verification.

A = Use for Adjustments.

T = Use for Troubleshooting.

<sup>2</sup> See page 4-33 to construct your own dummy load.

<sup>3</sup> Used for Option 005 only

---

## To return the oscilloscope to Agilent Technologies

Before shipping the oscilloscope to Agilent Technologies, contact your nearest Agilent Technologies Sales Office for additional details.

- 1 Write the following information on a tag and attach it to the oscilloscope.**
  - Name and address of owner
  - Model number
  - Serial number
  - Description of service required or failure indications
- 2 Remove all accessories from the oscilloscope.**

The accessories include the power cord, probes, cables, and any modules attached to the rear of the oscilloscope. Do not ship accessories back to Agilent Technologies unless they are associated with the failure symptoms.
- 3 Protect the control panel with cardboard.**
- 4 Pack the oscilloscope in styrofoam or other shock-absorbing material and place it in a strong shipping container.**

You can use either the original shipping containers, or order materials from an Agilent Technologies Sales Office. Otherwise, pack the oscilloscope in 3 to 4 inches of shock-absorbing material to prevent movement inside the shipping container.
- 5 Seal the shipping container securely.**
- 6 Mark the shipping container as FRAGILE.**

---

## Verifying Oscilloscope Performance

This section shows you how to verify the electrical performance of the oscilloscope, using the performance characteristics in chapter 5 as the standard. The characteristics checked are calibrator, voltage measurement accuracy, bandwidth, horizontal accuracy, and trigger sensitivity.

You should verify the performance of the oscilloscope when you first receive it, and every 12 months or after 2,000 hours of operation. Also, make sure you allow the oscilloscope to operate for at least 30 minutes before you begin the following procedures.

### **Perform self-calibration first**

For the oscilloscope to meet all of the verifications tests in the ambient temperature where it will be used, the self-calibration tests described on page 4-25 should first be performed. Allow the unit to operate for at least 30 minutes before performing the self-calibration.

Each procedure lists the recommended equipment for the test. You can use any equipment that meets the critical specifications. However, the procedures are based on the recommended model or part number.

On page 4-19 of this chapter is a test record for recording the test results of each procedure. Use the test results to gauge the performance of the oscilloscope over time.

Service  
Verifying Oscilloscope Performance

---

## To check the output of the CALIBRATOR

In this test you measure the output of the rear-panel CALIBRATOR output with a multimeter and an oscilloscope. The CALIBRATOR is used for self-calibration of the 54615B, 54616B, and 54616C. The accuracy of the CALIBRATOR is not specified, but it must be within the test limits to provide for accurate self-calibration.

The CALIBRATOR output produces dc voltages between 0 and 5V during vertical calibration, and a square wave during delay calibration.

Test limits:

DC calibrator: 5.000 V  $\pm$ 10 mV and 0.000 V  $\pm$  500  $\mu$ V  
Delay calibrator: Vp-p = 900 mV  $\pm$  150 mV  
Vavg = -450 mV  $\pm$  75 mV  
Frequency = 2.46 kHz  $\pm$  100 Hz (54615B/16B)  
2.08 kHz  $\pm$  100 Hz (54616C)

Table 4-2

---

### Equipment Required

Equipment	Critical specifications	Recommended Model/Part
Digital Multimeter	0.1 mV resolution, better than 0.01% accuracy	Agilent 34401A
Cable	BNC	Agilent 10503A
Oscilloscope	100 MHz, 1 M $\Omega$ input R	Agilent 54600

- 1 Connect a multimeter to the rear-panel CALIBRATOR connector.
- 2 Press **Print/Utility**.
- 3 Press the **Service Menu** softkey, then the **Self Test** softkey, and then the **DAC** softkey.

The multimeter should measure 0.00 V dc  $\pm$  500  $\mu$ V. If the result is not within the test limits, see "Troubleshooting the oscilloscope," on page 4-32.

- 4 Press any key once to advance the test.

The multimeter should read  $5.000\text{ V} \pm 10\text{ mV}$ . If the result is not within the test limits, see "Troubleshooting the oscilloscope," on page 4-32.

- 5 Connect an oscilloscope to the rear-panel CALIBRATOR connector.

- 6 Press any key once to advance the test.

- 7 Obtain a stable display on the oscilloscope.

- 8 Measure  $V_{p-p}$ ,  $V_{avg}$ , and the frequency of the signal.

If the results are not within the Delay Calibrator test limits stated above, see "Troubleshooting the oscilloscope," on page 4-32.

- 9 Press any key once to end this test.

---

## To verify voltage measurement accuracy

In this test you verify the voltage measurement accuracy by measuring the output of a power supply using dual cursors on the oscilloscope, and comparing the results with a multimeter.

Test limits:  $\pm 2.4\%$  of full scale\*

\* Full scale is defined as 56 mV on the 5 mV/div and 2 mV/div ranges. Full scale on all other ranges is defined as 8 divisions times the V/div setting.

Table 4-3

---

### Equipment Required

Equipment	Critical specifications	Recommended Model/Part
Power supply	14 mV to 35 Vdc, 0.1 mV resolution	Agilent 6114A
Digital multimeter	Better than 0.01% accuracy	Agilent 34401A
Cable	BNC, Qty 2	Agilent 10503A
Shorting cap	BNC	Agilent 1250-0774
Adapter	BNC (f) to banana (m)	Agilent 1251-2277
Adapter	BNC tee (m) (f) (f)	Agilent 1250-0781

- 1 Set up the oscilloscope.
  - a Press **Setup** , then press the **Default Setup** softkey.
  - b Adjust the channel 1 Position knob to place the baseline at approximately 0.5 division from the bottom of the display.
  - c Set the Volts/Div to the first line of table 4-4.
  - d Press **Display** , press the **Average** softkey, then set # **Average** softkey to **64**. Wait a few seconds for the measurement to settle; the **Av** letters in the status line indicate how much of the averaging process is finished by turning to inverse video as the oscilloscope performs averaging.
- 2 Press **Cursors** , then press the **V1** softkey.
- 3 Using the cursors knob, set the V1 cursor on the baseline of the signal.

- 4 Connect the power supply to the oscilloscope and to the multimeter, using the BNC tee and cables.
- 5 Adjust the power supply output so that the multimeter reading displays the first Power supply setting value in table 4-4.  
 Wait a few seconds for the measurement to settle.
- 6 Press the **V2** softkey, then position the V2 cursor to the baseline.  
 The  $\Delta V$  value on the lower line of the display should be within the test limits of table 4-4. If a result is not within the test limits, see "Troubleshooting the Oscilloscope," on page 4- 32.
- 7 Continue checking the voltage measurement accuracy with the remaining Power supply setting lines in table 4-4.

**Table 4-4**

**Voltage Measurement Accuracy**

Volts/Div setting	Power supply setting	Test limits		
5 V/Div	35 V	34.04 V	to	35.96 V
2 V/Div	14 V	13.616 V	to	14.384 V
1 V/Div	7 V	6.808 V	to	7.192 V
0.5 V/Div	3.5 V	3.404 V	to	3.596 V
0.2 V/Div	1.4 V	1.3616 V	to	1.4384 V
0.1 V/Div	700 mV	680.8 mV	to	719.2 mV
50 mV/Div	350 mV	340.4 mV	to	359.6 mV
20 mV/Div	140 mV	136.16 mV	to	143.84 mV
10 mV/Div	70 mV	68.08 mV	to	71.92 mV
5 mV/Div*	35 mV	33.66 mV	to	36.34 mV
2 mV/Div*	14 mV	12.66 mV	to	15.34 mV

\*Full scale is defined as 56 mV on the 5 mV/div and 2 mV/div ranges.. Full scale on all other ranges is defined as 8 divisions.

- 8 Disconnect the power supply from the oscilloscope, then repeat steps 1 to 7 for channel 2.

Service  
**Verifying Oscilloscope Performance**

---

## To verify bandwidth

In this test you verify bandwidth by using a power meter and power sensor to set output of a signal generator at 1 MHz and at 500 MHz. You use the peak-to-peak voltage at 1 MHz and at 500 MHz to verify the bandwidth response of the oscilloscope.

Test limits:

all channels ( $\pm 3$  dB)<sup>1</sup>  
dc to 500 MHz  
ac coupled 10 Hz to 500 MHz.

<sup>1</sup> Upper bandwidth reduced 2MHz per degree C above 35 °C.

**Table 4-5**

---

### Equipment Required

Equipment	Critical specifications	Recommended Model/Part
Signal generator	1 to 500 MHz at 200 mV	Agilent 8656B opt 001
Power meter and Power Sensor	1 to 500 MHz $\pm 3\%$ accuracy	Agilent 436A and Agilent 8482A
Power splitter	Outputs differ by < 0.15 dB	Agilent 11667B
Cable	Type N (m), 24 inch	Agilent 11500B
Adapter	Type N (m) to BNC (m)	Agilent 1251-0082



**1** Connect the equipment.

- a Connect the signal generator to the input of the power splitter.
- b Connect the power sensor to one output of the power splitter, and connect channel 1 of the oscilloscope to the other power splitter output. Set the oscilloscope input impedance to 50Ω.

**2** Set up the oscilloscope.

- a Press **Setup** , then press the **Default Setup** softkey.
- b Set the time base to 500 ns/div.
- c Press **1** to select channel 1, then select **50Ω** input and 20 mV/div.
- d Press **Display** , then press the **Average** softkey.
- e Toggle the **# Average** softkey to select **8** averages.

**3** Set the signal generator for 1 MHz at about -8.4 dBm.

Notice that the signal on the display is about 5 cycles and six divisions of amplitude.

**4** Press **Voltage** , then press the **Vp-p** softkey.

Wait a few seconds for the measurement to settle (averaging is complete), then note the Vp-p reading from the bottom of the display.

Vp-p = \_\_\_\_\_ mV.

**5** Set the calibration factor percent of the power meter to the 1 MHz value from the calibration chart on the probe, then press dB (REF) on the power meter to set a 0 dB reference.

**6** Change the frequency of the signal generator to 500 MHz

**7** Set the calibration factor of the power meter to the 500 MHz percent value from the chart on the probe (interpolate the value between 300 MHz and 1 GHz if necessary.)

Adjust the amplitude of the signal generator for a power reading as close as possible to 0.0 dB (REL). Power meter reading = \_\_\_\_\_ dB.

Service  
**Verifying Oscilloscope Performance**

**8** Change the time base to 5 ns/div.

Wait a few seconds for the measurement to settle (the **Av** letters in the status line indicate how much of the averaging process is finished by turning to inverse video as the oscilloscope performs averaging), then note the Vp-p reading from the bottom of the display.

Vp-p = \_\_\_\_\_ mV.

**9** Calculate the response using the following formula.

$$20 \log_{10} \left[ \frac{\text{step 8 result}}{\text{step 4 result}} \right]$$

**10** Correct the result from step 9 with any difference in the power meter reading from step 7. Make sure you observe all number signs.

---

**For example**

Result from step 9 = -2.3 dB

Power meter reading from step 7 = -0.2 dB (REL)

True response = (-2.3) - (-0.2) = -2.1 dB

The true response should be  $\leq \pm 3$  dB.

---

If the result is not  $\leq \pm 3$  dB, see "Troubleshooting the Oscilloscope," on page 4-32.

**11** Repeat steps 1 to 10 for channel 2.

## To verify horizontal $\Delta t$ and $1/\Delta t$ accuracy

In this test you verify the horizontal  $\Delta t$  and  $1/\Delta t$  accuracy by measuring the output of a time mark generator with the oscilloscope.

Test limits:  $\pm 0.005\%$   $\pm 0.2\%$  of full scale  $\pm 100$  ps (same channel)

**Table 4-6**

### Equipment Required

Equipment	Critical specifications	Recommended Model/Part
Time marker generator	Stability 5 ppm after 1/2 hour	TG 501A and TM 503B
Cable	BNC, 3 feet	Agilent 10503A

- 1 Connect the time mark generator to channel 1. Then, set the time mark generator for 0.1 ms markers.
- 2 Setup the oscilloscope.
  - a Press **Setup** , then press the **Default Setup** softkey.
  - b Press **1** , then toggle **Input** softkey to **50 $\Omega$** .
  - c Press **Autoscale** .
  - d Set the time base to 20  $\mu$ s/div.
  - e Press **Main/Delayed** , then press the **Time Ref Lft** softkey.
  - f Adjust the trigger level to obtain a stable display.

- 3 Press **Time** , then press the **Freq** and **Period** softkeys.

You should measure the following:

Frequency 10 kHz, test limits are 9.96 kHz to 10.04 kHz.

Period 100  $\mu$ s, test limits are 99.59  $\mu$ s to 100.41  $\mu$ s.

If the measurements are not within the test limits, see "Troubleshooting the Oscilloscope," on page 4-32.

- 4 Change the time mark generator to 1  $\mu$ s, and change the time base to 200 ns/div. Adjust the trigger level to obtain a stable display.

Service  
**Verifying Oscilloscope Performance**

- 5 Press **Time** , then press the **Freq** and **Period** softkeys.

You should measure the following:

Frequency 1 MHz, test limits are 995.8 kHz to 1.0042 MHz.

Period 1  $\mu$ s, test limits are 995.9 ns to 1.004  $\mu$ s.

If the measurements are not within the test limits, see "Troubleshooting the Oscilloscope," on page 4-32.

- 6 Change the time mark generator to 20 ns, and change the time base to 5 ns/div. Adjust the trigger level to obtain a stable display.

- 7 Press **Time** , then press the **Freq** and **Period** softkeys.

You should measure the following:

Frequency 50 MHz, test limits are 49.50 MHz to 50.51 MHz.

Period 20 ns, test limits are 19.80 ns to 20.20 ns.

If the measurements are not within the test limits, see "Troubleshooting the Oscilloscope," on page 4-32.

- 8 Change the time mark generator to 2 ns, and change the time base to 1 ns/div. Adjust the trigger level to obtain a stable display.

- 9 Press **Time** , then press the **Freq** and **Period** softkeys.

You should measure the following:

Frequency 500 MHz, test limits are 471.67 MHz to 531.94 MHz.

Period 2 ns, test limits are 1.880 ns to 2.120 ns.

If the measurements are not within the test limits, see "Troubleshooting the Oscilloscope," on page 4-32.

## To verify trigger sensitivity

In this test you verify the trigger sensitivity by applying 100 MHz to the oscilloscope. The amplitude of the signal is decreased to the specified levels, then you check to see if the oscilloscope is still triggered. You then repeat the process at the upper bandwidth limit.

Test limits:

Internal trigger

dc to 100 MHz: 0.5 div or 5.0 mV p-p  
100 MHz to 500 MHz: 1 div or 10 mV p-p

External trigger

dc to 100 MHz: <75 mV p-p  
100 MHz to 500 MHz: <150 mV p-p

**Table 4-7**

### Equipment Required

Equipment	Critical specifications	Recommended Model/Part
Signal generator	100 MHz and 500 MHz sine waves	Agilent 8656B Option 001
Power splitter	Outputs differ < 0.15 dB	Agilent 11667B
Cable	BNC, Qty 3	Agilent 10503A
Adapter	N (m) to BNC (f), Qty 3	Agilent 1250-0780
Power meter and Power sensor	1 to 500 MHz $\pm 3\%$	Agilent 436A and Agilent 8482A

Service  
**Verifying Oscilloscope Performance**

**Internal Trig  
Sensitivity**

- 1 Press **Setup** , then press the **Default Setup** softkey.
- 2 Connect the signal generator to channel 1.
- 3 Verify the trigger sensitivity at 100 MHz and 0.5 divisions.
  - a Set the signal generator to 100 MHz and about 50 mV.
  - b Press **Autoscale** .
  - c Press **1** , then toggle **Input** softkey to **50Ω**.
  - d Decrease the output of the signal generator until there is 0.5 vertical divisions of the signal displayed.

The trigger should be stable. If the triggering is not stable, try adjusting the trigger level. If adjusting the trigger level makes the triggering stable, the test still passes. If adjusting the trigger does not help, see "Troubleshooting the Oscilloscope," on page 4-32.
  - e Record the result on the Performance Test Record as Pass or Fail.
- 4 Verify the trigger sensitivity at 500 MHz and 1 division.
  - a Change the output of the signal generator to 500 MHz and set amplitude to about 100 mV.
  - b Press **Autoscale** .
  - c Decrease the output of the signal generator until there is 1 vertical division of the signal displayed.

The trigger should be stable. If the triggering is not stable, try adjusting the trigger level. If adjusting the trigger level makes the triggering stable, the test still passes. If adjusting the trigger does not help, see "Troubleshooting the Oscilloscope," on page 4-32.
  - d Record the result on the Performance Test Record as Pass or Fail.
- 5 Repeat steps 1 through 4 substituting channel 2 for channel 1 in the procedure.

**External Trig  
Sensitivity**

- 6** Verify the external trigger sensitivity at 500 MHz, 150 mV p-p and at 100 MHz, 75 mV p-p.
  - a** Press **Source** , then press the **Ext** softkey.
  - b** Press **External Trigger** , then toggle **Input** softkey to **50Ω**.
  - c** Press **1** then toggle **Input** softkey to **50Ω**.
  - d** Using the power splitter, connect one power splitter to output to the channel 1 input and the other power splitter output to the power sensor.
  - e** Set the power meter Cal Factor to the 500 MHz value from the chart on the power sensor.
  - f** Set signal generator frequency to 500 MHz and adjust the output amplitude to achieve a power meter reading of 0.075 mW. (This corresponds to 150 mV p-p.)
  - g** Set Time/div to 1 ns/div.
  - h** Disconnect power meter from the power splitter and connect the power splitter output to External Trigger Input.
  - i** Check for stable triggering, adjusting trigger level if necessary.
  - j** Record results in the Performance Test Record as Pass or Fail.  
If the test fails, refer to "Troubleshooting the Oscilloscope" on page 4-32.
  - k** Change the signal generator frequency to 100 MHz at output amplitude of 75 mV p-p, as measured with the 54615B/16B/16C (channel 1). Press **Voltage** , then the softkey **Vp-p**.
  - l** Set Time/div to 10 ns/div.
  - m** Check for stable triggering, adjusting trigger level if necessary.
  - n** Record results in the Performance Test Record as Pass or Fail.  
If test fails, refer to "Troubleshooting the Oscilloscope" on page 4-32.

---

## To verify Vertical Output on Option 005

This section applies only to Option 005 Enhanced TV/Video Trigger

In this test we will use the oscilloscope's channel 2 to measure the amplitude of the Vertical Output (VERT OUT connector on rear panel) signal.

Test limits: ~90 mVp-p into 50Ω with a full screen input.

Table 4-8

---

### Equipment Required

Equipment	Critical specifications	Recommended Model/Part
Signal generator	1 to 500 MHz at 200 mV	Agilent 8656B opt 001
Cable	BNC, 48 inch	Agilent 10503A
Cable	Type N (m), 24 inch	Agilent 11500B
Adapter	Type N (m) to BNC (f)	Agilent 1251-0780

- 1 Connect the signal generator to oscilloscope channel 1 input.
- 2 Set the signal generator to equal the full bandwidth of your oscilloscope, and set the output level to 0 dBm.
- 3 Connect the signal generator to oscilloscope channel 1. Set channel 1 **Input** to **50Ω** to correctly terminate the signal generator.
- 4 Press **Autoscale** .
- 5 Adjust the oscilloscope controls and signal generator to obtain an 8-division high display.
- 6 Connect oscilloscope rear-panel VERT OUT to oscilloscope channel 2. Set channel 2 **Input** to **50Ω** mode.
- 7 Measure the peak-to-peak amplitude of channel 2. It should be greater than or equal to 63.6 mVp-p.  
Because the measurement is being made at the full bandwidth of the oscilloscope's channel, the peak-to-peak measurement is corrected for the oscilloscope's high frequency roll off.







---

## Adjusting the Oscilloscope

This section explains how to adjust the oscilloscope so that it is at optimum operating performance. You should perform the hardware adjustments and Self Cal periodically as indicated below.

- Hardware adjustments at 12 months or 2,000 hours of operation
- Perform Self Cal at 6 months or 1000 hours of operation, or if ambient temperature is greater than 10 °C from the calibration temperature, or if the user desires to maximize the measurement accuracy

The amount of use, environmental conditions, and your past experience with other instruments can help you to determine if you need a shorter adjustment interval.

Make sure you allow the oscilloscope to warm up for at least 30 minutes before you start the adjustments.

---

### **WARNING**

The maintenance described in this section is performed with power supplied to the oscilloscope and with the protective covers removed. Only trained service personnel who are aware of the hazards involved should perform the maintenance. Whenever possible, perform the procedures with the power cord removed from the oscilloscope. Read the safety summary at the back of this book before proceeding.

---

### **CAUTION**

Do not disconnect any cables or remove any assemblies with the power applied to the oscilloscope, or damage to the oscilloscope can occur.

---

### **CAUTION**

Do not operate the oscilloscope for more than 45 minutes with its cover removed. Air flow over the samplers is reduced which leads to higher than normal operating temperatures.

Service  
**Adjusting the Oscilloscope**

---

## To adjust the power supply

The power supply has a +5.1 V adjustment and a -5.25 V adjustment. The other voltages are based on the +5.1 V adjustment. In this procedure you use a multimeter to measure the +5.1 V and -5.25 V, and if necessary, adjust the supplies to within tolerance.

**Table 4-9**

---

### Equipment Required

Equipment	Critical specifications	Recommended Model/Part
Digital multimeter	0.1 mV resolution, accuracy $\pm 0.05\%$	Agilent 34401A

- 1 Set up the oscilloscope for the voltage adjustment.
  - a Turn off the oscilloscope and disconnect power cable.
  - b Remove the cover from the oscilloscope as described in "To replace an assembly" on page 4-46 of this chapter.
  - c Place the oscilloscope on its side.
  - d Connect the negative lead of the digital multimeter to a ground point on the oscilloscope chassis.
  - e Reconnect power cable.
  - f Turn on the oscilloscope.

- 2 Measure the power supply voltages at E10 through E15 on the system board.

The test points are not marked on the system board; see figure below for location of test points.

Make sure that the voltage measurements are within the following tolerances.

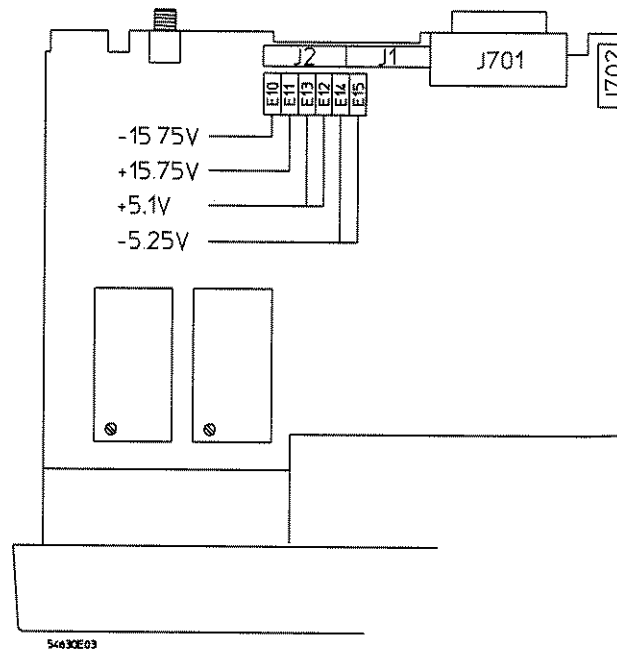
---

**Power Supply Voltage Tolerances**

---

Supply Voltage	Tolerance
+5.1 V	±153 mV (+4.947 V to +5.253 V)
-5.25 V	±158 mV (-5.092 V to -5.408 V)
+15.75 V	+1.260 V, -787 mV (+14.963 V to +17.010 V)
-15.75 V	±787 mV (-14.963 V to -16.537V)

Figure 4-1

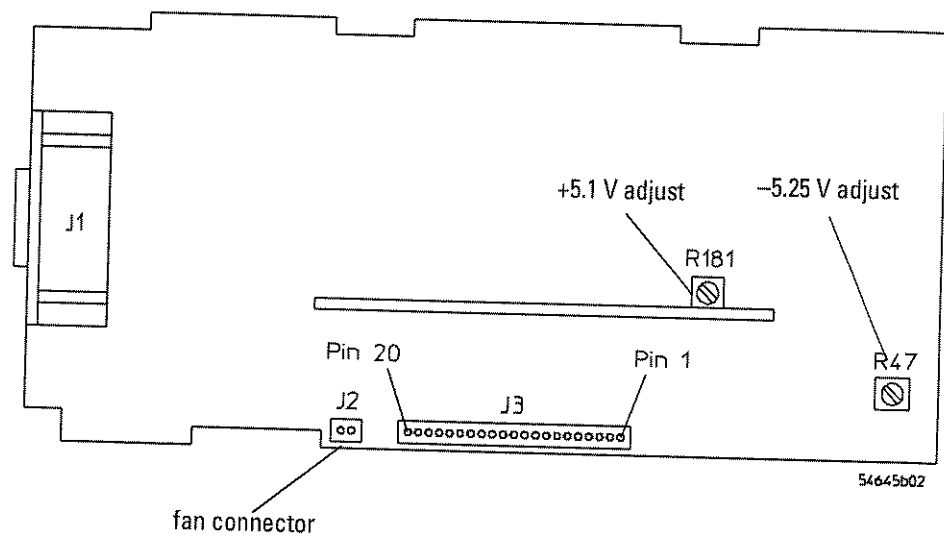


Low Voltage Power Supply voltage test points  
(bottom side of oscilloscope)

## Service Adjusting the Oscilloscope

If the +5.1 V measurement is out of tolerance, adjust the +5.1 V adjustment on the power supply; if the -5.25 V measurement is out of tolerance, adjust the -5.25 V adjustment on the power supply (see figure below). The  $\pm 15.75$  V supplies are not adjustable and are dependent upon the +5.1 V supply. If adjusting the power supply does not bring all the voltages within tolerance, see "Troubleshooting the Oscilloscope," on page 4-32 in this chapter.

Figure 4-2



Low Voltage Power Supply adjustment locations  
(top side of oscilloscope)

## To perform the self-calibration

In this procedure you load the default calibration factors to give a known starting point for the firmware calibration. *However, once the default calibration factors are loaded, you must perform the remainder of the firmware calibration to maintain the accuracy of the oscilloscope.*

Table 4-10

### Equipment Required

Equipment	Critical specifications	Recommended Model/Part
Cable	BNC, 3 feet	Agilent 10503A
Cable	BNC, 9 inches, Qty 2	Agilent 10502A
Adapter	BNC tee (m) (f) (f)	Agilent 1250-0781
Adapter	BNC (f-f)	Agilent 1250-0080

- 1 Check the rear panel CALIBRATOR output level.  
If you are not sure how to check the CALIBRATOR, see "To check the output of the CALIBRATOR," on page 4-6.
- 2 Load the default calibration factors.
  - a Set the rear-panel CALIBRATION switch to UNPROTECTED (up position).
  - b Press **Print/Utility**, then press the **Service Menu** softkey, then press the **Self Cal Menu** softkey.
  - c Press the **Load Defaults** softkey.

#### Self-calibration hint

The instrument is self-calibrated at the factory. However, it should be self-calibrated again in its working environment after a 30-minute warmup to obtain the best accuracy.

Service  
**Adjusting the Oscilloscope**

- Vertical self cal**
- 3 After the message "Default calibration factors loaded" is momentarily displayed on the lower left side of the display, press the **Vertical** softkey.
  - 4 Press the **Continue** softkey and follow the instructions on the display.  
The display prompts you to connect the rear-panel CALIBRATOR output simultaneously to channel 1 and channel 2, then to channel 1 and external trigger. Make these connections using the 3 BNC cables and 2 adapters listed in the equipment required table for this test.
  - 5 When the message "Press Continue to return to calibration menu" appears on the display, press the **Continue** softkey.
- Delay self cal**
- 6 Press the **Delay** softkey, then follow the instructions on the display.  
The display prompts you to connect the rear-panel CALIBRATOR output simultaneously to channels 1 and channel 2, then to channel 1 and external trigger, and finally to channel 2 and and external trigger. Make sure you use the 10502A cables to ensure equal cable lengths.
  - 7 Press the **Continue** softkey to start the delay self calibration.
  - 8 When the message "Press Continue to return to calibration menu" appears on the display, press the **Continue** softkey to exit the self calibration.
  - 9 Set the rear-panel CALIBRATION switch to PROTECTED.



## To adjust the high-frequency pulse response

In this procedure you adjust the high-frequency pulse response for each channel to a nominal setting for optimum performance over all sensitivity settings.

**Table 4-11**

### Equipment Required

Equipment	Critical specifications	Recommended Model/Part
Pulse generator	Rise time $\leq 700$ ps	Agilent 8131A
Cable	50 $\Omega$ BNC (m-m)	Agilent 10503A

- 1 Press **Setup** , press the **Default Setup** softkey, then set the oscilloscope and pulse generator as indicated below.

Pulse Generator		Oscilloscope Channel 1 and Channel 2	
Delay	0 ps	Input	50 $\Omega$
Duty Cycle	50%	Volts/Div	50 mV
Width	50 ns	Display Vectors	Off
High	0.3 V	Display Grid	None
Low	0.0 V		

- 2 Connect the pulse generator output to the Channel 1 input of the oscilloscope , then enable the pulse generator output.
- 3 Press **Autoscale** .
- 4 Press **Cursors** , then press the appropriate **V1** or **V2 Active Cursor** softkey.
- 5 Adjust the V1 cursor to the bottom-base of the waveform and adjust the V2 cursor to the top-base of the waveform.
- 6 Record the  $\Delta V(1)$  value as  $V_{base} = \underline{\hspace{2cm}}$
- 7 Adjust the V1 cursor to the peak of the first excursion above the V2 cursor.

This is the overshoot of the input pulse which is used to optimize the frequency response of the channel.

- 8 Record the  $\Delta V(1)$  value as  $V_{overshoot} = \underline{\hspace{2cm}}$
- 9 Calculate % overshoot =  $(V_{overshoot} / V_{base}) \times 100 \underline{\hspace{2cm}}$

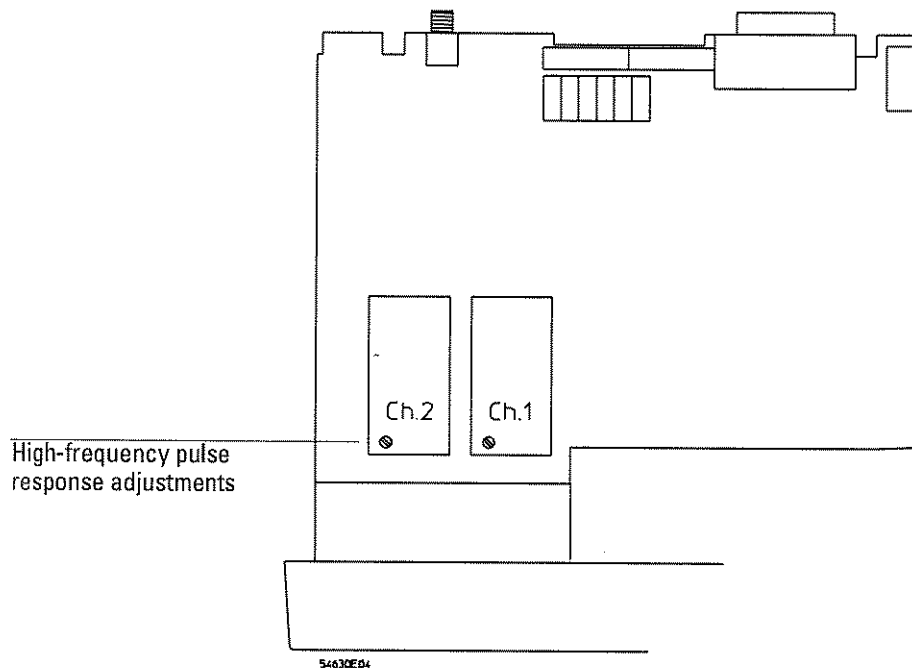
Service  
**Adjusting the Oscilloscope**

- 10 Adjust the channel 1 high-frequency pulse response for an % overshoot of 5% minimum to 7% maximum.

If a low loss 50Ω cable is used (such as 8120-4949), the % overshoot should be 6% minimum to 8% maximum.)

- 11 Repeat steps 2 through 10 substituting Channel 2 for Channel 1 and  $\Delta V(2)$  for  $\Delta V(1)$ .

Figure 4-3



High-frequency pulse response adjustment locations

## To adjust the display (54615B/16B only)

There are no adjustments on the 54616C color display – if the display fails, replace the display assembly.

The display adjustments are optional and normally do not require adjustment. You should use this procedure only for the few cases when the display is obviously out of adjustment.

**Table 4-12**

### Equipment Required

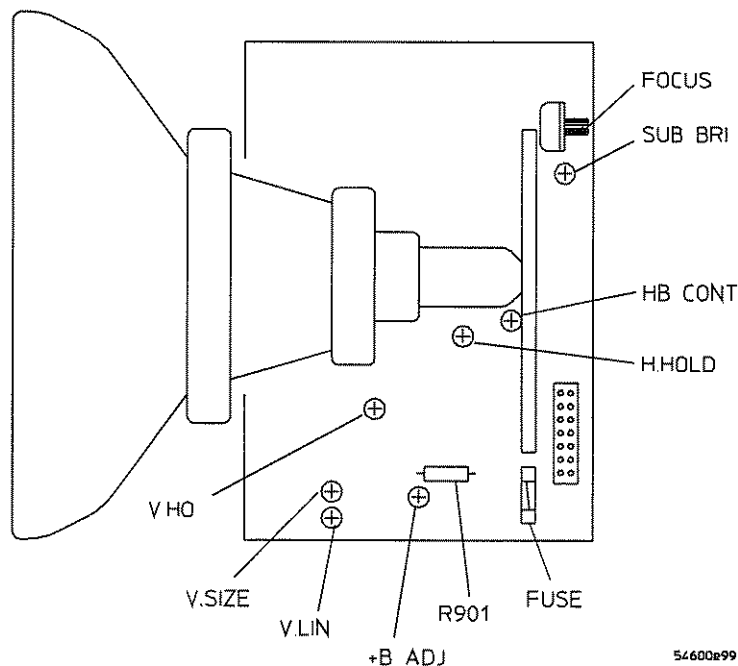
Equipment	Critical specifications	Recommended Model/Part
Digital multimeter	Accuracy $\pm 0.05\%$ , 1 mV resolution	Agilent 34401A

- 1 Connect the digital multimeter to the end of R901 closest to the fuse. See figure next page.
- 2 Adjust +B for +14.00 V.
- 3 Press **Print/Utility**. Press the **Service Menu** softkey, then the **Self Tst Menu** softkey, and then the **Display** softkey.
- 4 Adjust V.HO (vertical hold) for vertical synchronization.
- 5 Set the intensity control (on the front panel) to mid-range.
- 6 Adjust Sub Bri (sub bright) to the lowest setting so that the half bright blocks on the display are visible.
- 7 Increase the intensity control to a comfortable viewing level. This is usually about 3/4 of its maximum range.

Service  
**Adjusting the Oscilloscope**

- 8 Adjust HB Cont (half bright contrast) for the best contrast between the half bright and full bright blocks.  
You can readjust Sub Bri, intensity control, and HB Cont to suit your individual preference.
- 9 Press any key to continue to the next test pattern. Then, adjust H.Hold (horizontal hold) to center the display horizontally.
- 10 Adjust Focus for the best focus.
- 11 Press any key to continue to the normal display pattern. Then adjust V.Lin (vertical linearity) for equal sizing of all four corner squares.
- 12 Adjust V.Size (vertical size) to center the display vertically at the maximum allowable size without losing the text.  
Adjustments V.Lin and V.Size interact so you may need to readjust sizing and vertical centering of the display.

**Figure 4-4**



54600r99

**Display board adjustment locations**

## To adjust the Option 005 offset (R15)

The oscilloscope must be calibrated before performing this adjustment. Refer to "To perform the self-calibration" on page 4-25.

**Table 4-13**

### Equipment Required

Equipment Required	Critical Specification	Recommended Model/Part
Digital Multimeter	0.1 mV resolution, accuracy $\pm 0.05\%$	Agilent 34401A
Adapter	BNC (m) to dual banana post	Agilent 10110B

- 1 Set up the oscilloscope for the voltage adjustment.
  - a Turn off the oscilloscope.
  - b Remove the cabinet from the oscilloscope.
  - c Connect the negative lead of the digital multimeter to a ground point on the oscilloscope.
  - d Connect the oscilloscope rear-panel VERT OUT connector to the voltage inputs of the digital multimeter (DMM) using the DMM's test leads and the BNC to dual banana post adapter.
  - e Turn on the oscilloscope
  - f Setup the digital multimeter for a DC voltage measurement.
  - g Press the **Setup** front panel key on the oscilloscope.
  - h Press the **Default Setup** softkey on the oscilloscope.
- 2 Adjust R15 (below VERT OUT connector) on the Option 005 PC board so that the measured voltage on the digital multimeter is 0 volts  $\pm 1$  mV.

If adjusting R15 does not bring the voltage within tolerance, see "To troubleshoot Option 005" at the end of the troubleshooting section.

---

## Troubleshooting the Oscilloscope

The service policy for this instrument is replacement of defective assemblies. The following procedures can help isolate problems to the defective assembly.

---

### WARNING

The maintenance described in this section is performed with power supplied to the oscilloscope and with the protective covers removed. Only trained service personnel who are aware of the hazards involved should perform the maintenance. Whenever possible, perform the procedures with the power cord removed from the oscilloscope. Read the safety summary at the back of this book before proceeding.

---

### CAUTION

Do not disconnect any cables or remove any assemblies with the power applied to the oscilloscope, or damage to the oscilloscope can occur.

---

### CAUTION

ELECTROSTATIC DISCHARGE (ESD) can damage electronic components. When using any of the procedures in this chapter you should use proper ESD precautions. As a minimum, you should place the instrument on a properly grounded ESD mat and wear a properly grounded ESD strap.

The following equipment is needed for troubleshooting the oscilloscope.

Table 4-14

---

### Equipment Required

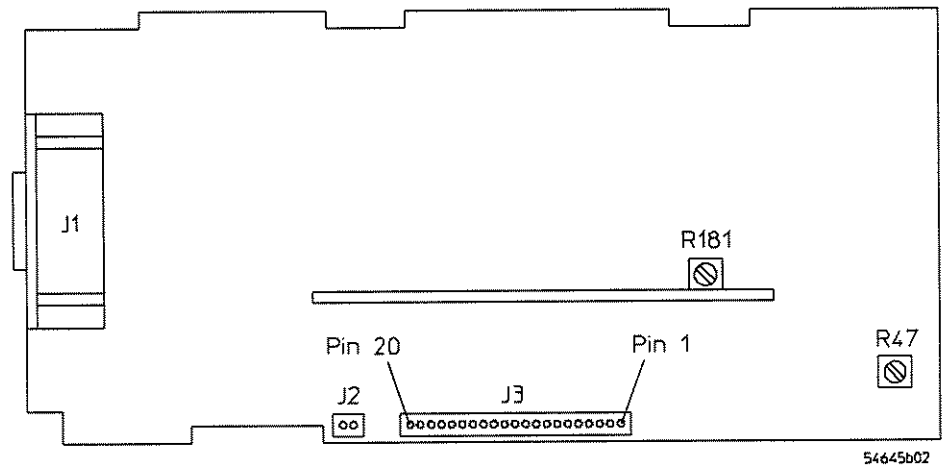
Equipment	Critical specifications	Recommended model/part
Digital multimeter	Accuracy $\pm 0.05\%$ , 1 mV resolution	Agilent 34401A
Oscilloscope	100 MHz, 1 M $\Omega$ input R	Agilent 54600
Dummy load <sup>1</sup>	Compatible with power supply	see note 1 below

<sup>1</sup> See page 4-33 to construct your own dummy load.

## To construct your own dummy load

- 1 Obtain a connector compatible with the connector J3 on the Low Voltage Power Supply (see figure below).
- 2 Connect the following load resistors to the connector.
  - +5.1 V requires a 4 A load, 1.3  $\Omega$  and 20.4 W on pins 9–12.
  - 5.25 V requires a 3 A load, 1.75  $\Omega$  and 15.8 W on pins 15–18.
  - +15.75 V requires a 1.3 A load, 12.2  $\Omega$  and 20.5 W on pins 5–6.
  - 15.75 V requires a 0.8 A load, 19.7  $\Omega$  and 13 W on pin 3.
- 3 Connect the other end of the resistors to ground pins 2, 4, 7, 8, 13, 14, 19, and 20.

Figure 4-5



Low Voltage Power Supply connector J3 pinout

## To check out the oscilloscope

- 1** Is there an interface module connected to the oscilloscope?  
If yes, do the following steps. If not, go to step 2.
  - a** Turn off the oscilloscope.
  - b** Remove the module.
  - c** Turn on the oscilloscope, then check for the failing symptom.  
If the failing symptom disappears, replace the module. If not, go to step 2.
- 2** Turn off the oscilloscope for 30 seconds minimum and then turn on the oscilloscope again.  
If an error message (example: **Vertical cal factors failed checksum test-defaults loaded**) appears within the waveform display area, go to "To clear error messages", on page 4-37. If error messages do not appear, go to step 3.
- 3** Disconnect any external cables from the front panel.
- 4** Disconnect the power cord, then remove the cover.
- 5** Connect the power cord, then turn on the oscilloscope.  
If the display comes on after a few seconds, (logo and copyright text, followed by a graticule with text at top of the display) go to "To check the Low Voltage Power Supply," on page 4-40. If, after checking the Low Voltage Power Supply, the voltages are within the test limits, go to step 9. If not, go to step 7. If the display did not come on, do the steps below.
  - a** Check the intensity knob (54615B/16B only) to see if it is set too low for viewing.
  - b** If there is still no display, disconnect the power cord.
  - c** Check all cable connections.
  - d** Go to "To check the Low Voltage Power Supply," on page 4-40.  
If the voltages are within the limits go to step 6. If not, go to step 7.



- 6 Disconnect the ribbon cable from the display board, then check the following signals on the system board.

**Table 4-15**

**Signals from U609 (54615B and 54616B)**

Signal	Name	Frequency	Pulse width	Voltage
U817 Pin 7	DE	19.72 kHz	38.0 $\mu$ s	5.0 Vp-p
U817 Pin 24	Hsync	19.72 kHz	3.0 $\mu$ s	5.0 Vp-p
J803 Pin 13	Vsync	60.00 Hz	253.5 $\mu$ s	5.0 Vp-p

**Signals from U609 (54616C)**

Signal	Name	Frequency	Pulse width	Voltage
U827 Pin 7	DE	16.67 kHz	48.0 $\mu$ s	5.0 Vp-p
U625 Pin 35	Hsync	16.67 kHz	2.90 $\mu$ s	5.0 Vp-p
U625 Pin 20	Vsync	50.05 Hz	360.0 $\mu$ s	5.0 Vp-p

If the signals are good, replace the display assembly. If not, replace the system board.

- 7 Disconnect the ribbon cable from the display board.
- 8 Go to "To check the Low Voltage Power Supply," on page 4-40.  
 If the voltages are within the test limits, replace the display assembly. If not, do the steps below.
- a Disconnect the power cord.
  - b Disconnect the ribbon cable from the power supply.
  - c Connect the dummy load to the power supply connector.
  - d Connect the power cord, then measure the power supply voltages again (see new tolerances below).

If the voltages are now within the test limits, replace the system board. If not, replace the power supply.

Service  
**Troubleshooting the Oscilloscope**

---

**Low Voltage Power Supply Voltage Tolerances**

---

Supply Voltage	Tolerance
+5.1 V	±153 mV (+4.947 V to +5.253 V)
-5.25 V	±158 mV (-5.092 V to -5.408 V)
+15.75 V	+1.260 V, -787 mV (+14.963 V to +17.010 V)
- 15.75 V	±787 mV (-14.963 V to -16.537V)

**9 Is the fan running?**

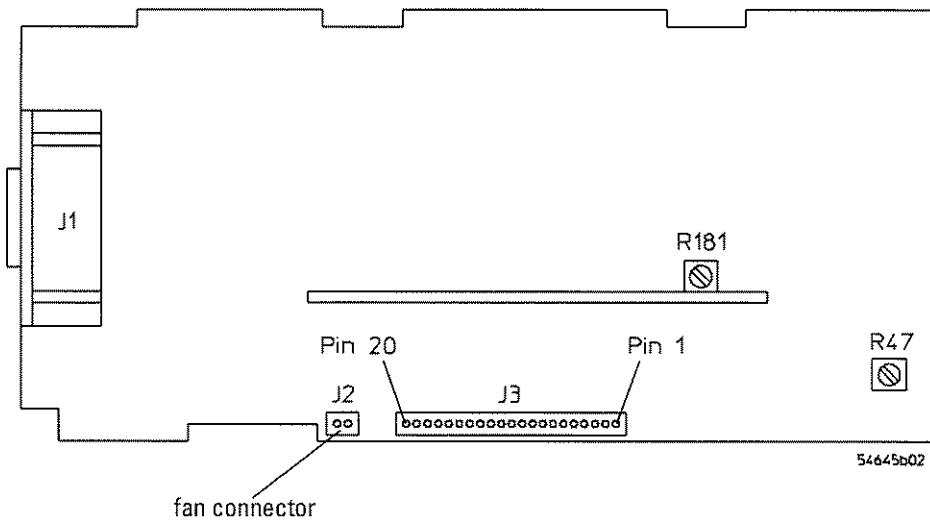
If yes, go to "To run the internal self-tests," on page 4-41. If not, do the steps below.

The Low Voltage Power Supply has a thermal cut-out circuit. If the fan is defective, the Low Voltage Power Supply shuts down when it gets too hot for safe operation.

- a Disconnect the fan cable from the power supply.
- b Measure the fan voltage at the connector on the power supply.

See figure below for location of fan connector. If the fan voltage is approximately +8 Vdc, replace the fan. If not, replace the power supply.

**Figure 4-6**



**Low Voltage Power Supply fan connector location**

---

## To clear error messages

**If any Fail message appears on the display after cycling power:**

- a** Press any menu key and cycle the power on the oscilloscope again.
- b** Hold the menu key down until the message "Key-down power-up executed" or "Keydown power sequence initiated ..." is displayed.
- c** If the original fail message still appears, contact your Agilent Service Center for diagnosis and repair.

***Setup memories and trace memories are cleared after a keydown powerup is performed.***

One or more of the following error messages may appear on the display (within the graticule space) as a result of internal NVRAM (non-volatile random access memory.)

- 1** If the message "Vertical Cal factors failed checksum test-defaults loaded" appears on screen, go to "To perform the self-calibration" on page 4-25, perform steps 1 through 5, then continue to steps below.

This message means that the vertical calibration factors which were stored in NVRAM along with a checksum have been corrupted. This information is written into NVRAM when a vertical self-calibration is run. During powerup, the checksum is recomputed and compared to the one saved when the vertical calibration factors were saved. If the checksums do not match, the error message is displayed.

- a** Cycle the power on the oscilloscope.
- b** If default vertical calibration factors are loaded and error messages remain, contact you Agilent service center for diagnosis and repair.

- 2 If the message "**Delay cal factors failed checksum-defaults loaded,**" appears on screen, go to "To perform the self-calibration," on page 4-25, perform steps 6 through 9, then continue to steps below.

This message means that the horizontal delay calibration factors which were stored in NVRAM along with a checksum have been corrupted. This information is written into NVRAM when the horizontal delay calibration is run. During powerup, the checksum was recomputed and compared against the one saved when the horizontal delay calibration factors were saved. If the checksums do not match, the error message is displayed.

- a Cycle the power of the oscilloscope.
- b If default horizontal delay calibration factors are loaded and error messages remain, contact your Agilent service center for diagnosis and repair.

- 3 If one of the following messages appears on screen:

**"Results from last vertical calibration: Failed"** or  
**"Results from last vertical calibration: Defaulted"** or  
**"Results form last vertical calibration: Aborted",**

go to "To perform the self-calibration," page 4-25 steps 1 through 5, then continue to steps below.

The first message means that the most recent calibration of the vertical subsystem failed.

The second message means that the default vertical factors have been loaded.

The third message means that the default vertical factors have been aborted

- a Cycle the power of the oscilloscope.
- b If default vertical calibration factors are loaded and error messages remain, contact your Agilent service center for diagnosis and repair.

**4** If one of the following messages appear on screen:

"Results from last delay calibration: Failed" or  
"Results from last delay calibration: Defaulted" or  
"Results from last delay calibration: Aborted",

go to "To perform the self-calibration," page 4-25 steps 6 through 9,  
then continue to steps below.

The first message means that the most recent calibration of the horizontal  
delay subsystem failed.

The second message means that the default horizontal delay calibration  
factors have been loaded.

The third message means that the default horizontal delay calibration factors  
have been aborted.

**a** Cycle the power of the oscilloscope.

**b** If default delay calibration factors are loaded and error messages  
remain, contact your Agilent service center for diagnosis and repair.

**5** If either of these messages appear on screen:

"Channel 1 Acquisition Memory Failed" or

"Channel 2 Acquisition Memory Failed"

The first message means an error has developed in the Acquisition memory  
for channel 1, contact your Agilent service center for diagnosis and repair.

The second message means an error has developed in the Acquisition  
memory for channel 2, contact your Agilent service center for diagnosis and  
repair.

**6** Continue with step 3 "To check out the oscilloscope" on page 4-34.

---

## To check the Low Voltage Power Supply

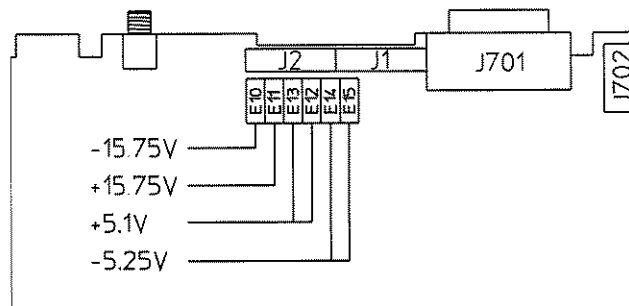
- 1 Disconnect the power cord, then set the oscilloscope on its side.
- 2 Connect the negative lead of the multimeter to a ground point on the oscilloscope. Connect the power cord and turn on the oscilloscope.
- 3 Measure the power supply voltages at E10 through E15 on the system board.

---

### Power Supply Voltage Tolerances

Supply Voltage	Tolerance
+5.1 V	$\pm 153$ mV (+4.947 V to +5.253 V)
-5.25 V	$\pm 158$ mV (-5.092 V to -5.408 V)
+15.75 V	+1.260 V, -787 mV (+14.963 V to +17.010 V)
-15.75 V	$\pm 787$ mV (-14.963 V to -16.537V)

Figure 4-7



### Low Voltage Power Supply voltage test points

If the +5.1 V measurement is out of tolerance, adjust the +5.1 V adjustment on the power supply; if the -5.25 V measurement is out of tolerance, adjust the -5.25 V adjustment on the power supply (see figure 4-2). The  $\pm 15.75$  V supplies are not adjustable and are dependent upon the +5.1 V supply.

#### Blown fuse

If the fuse is blown in the power supply, the power supply is defective. Replace the power supply.

---

## To run the internal self-tests

- 1 Perform the display test (54615B/16B only.)
  - a Press **Print/Utility** .
  - b Press the **Service Menu** softkey, then the **Self Tst Menu** softkey, and then the **Display** softkey.
  - c Do the half bright and full bright squares appear?  
If yes, continue with the steps below. If not, replace the display.
  - d Press any key to continue. Do squares appear in the four corners?  
If yes, the display is good. If not, replace the display.
  - f Press any key to end the test.  
If you still have the failing symptom, replace the system board.
- 2 Perform the display test (54616C only.)
  - a Press **Print/Utility** .
  - b Press the **Service Menu** softkey, then the **Self Tst Menu** softkey, and then the **Display** softkey.
  - c Do 5 rows of characters appear (white, inverse white, red, green, and blue) and 4 rectangles of white, red, green, and blue appear?  
If yes, continue with the steps below. If not, replace the display.
  - d Press any key to continue. Does a black screen appear?  
If yes, the display is good. If not, replace the display.
  - e Press any key to continue. Does a white screen appear?  
If yes, the display is good. If not, replace the display.
  - f Press any key to continue. Does a red screen appear?  
If yes, the display is good. If not, replace the display.
  - g Press any key to continue. Does a green screen appear?  
If yes, the display is good. If not, replace the display.
  - h Press any key to continue. Does a blue screen appear?  
If yes, the display is good. If not, replace the display.
  - i Press any key to end the test.  
If you still have the failing symptom, replace the system board.

- 3** Perform the keyboard test.
  - a** Press the **Keyboard** softkey.

A pictorial diagram of the front panel will appear on the display.
  - b** Press each key, and notice that when you press a key a corresponding block on the display fills in.
  - c** Rotate the knobs (except the intensity) and notice that an arrow appears on the display that points in the direction you rotate the knob.
  - d** Do all the keys and knobs work?

If yes, Press stop two or three times (the display indicates how many times), then go to step 3. If not, replace the keyboard and keyboard assembly.
- 4** Check the output level of the DAC.
  - a** Press the **DAC** softkey.
  - b** Connect a multimeter to the rear panel CALIBRATOR connector.

The multimeter should read  $0\text{ V} \pm 500\ \mu\text{V}$ .
  - c** Press any key to continue.

The multimeter should read  $5\text{ V} \pm 10\text{ mV}$ .
  - d** Are the DAC voltages correct?

If yes, press any key to continue. If not, replace the system board.
  - e** Connect a test oscilloscope to the rear-panel CALIBRATOR connector.
  - f** The test oscilloscope should measure :

$V_{p-p} = 900\text{ mV} \pm 150\text{ mV}$   
 $V_{avg} = -450\text{ mV} \pm 75\text{ mV}$   
Freq =  $2.46\text{ kHz} \pm 100\text{ Hz}$  (54615B/16B)  
 $2.08\text{ kHz} \pm 100\text{ Hz}$  (54616C)
  - g** Are these readings correct?

If yes, press any key to continue. If not, replace the system board.



**5** Perform the ROM test

**a** Press the **ROM** softkey.

**b** Does the display message say "**Test Passed**"?

If yes, go to next test. If not, (the display message says **Test Failed**) replace the system board.

**6** Perform the RAM test.

**a** Press the **RAM** softkey.

**b** Does the display message say "**Test Passed**"?

If yes, self-tests are complete. If not, (the display message says "**Test Failed**") replace the system board.

## To troubleshoot Option 005

To isolate a malfunction to the Option 005 board, do the following:

- 1** Disconnect the three cables that connect the Option 005 board to the system board.
- 2** Verify proper oscilloscope operation, as described in this chapter.
- 3** If the oscilloscope passes the performance verification and the malfunction still occurs when the Option 005 board is reconnected, then you should replace the Option 005 board.

---

## Replacing Parts in the Oscilloscope

This section contains instructions for removing and ordering replaceable assemblies. Also in this section is a parts list for the assemblies and hardware of the oscilloscope that you can order from Agilent.

Before working on the oscilloscope, read the safety summary at the back of this book.

---

**WARNING**

---

Hazardous voltages are on the CRT, power supply, and display sweep board. To avoid electrical shock, disconnect the power cord from the oscilloscope. Wait at least three minutes for the capacitors in the oscilloscope to discharge before you begin disassembling the oscilloscope.

---

**CAUTION**

---

Do not replace assemblies or cables with the oscilloscope turned on or damage to the components can occur.

---

**CAUTION**

---

ELECTROSTATIC DISCHARGE (ESD) can damage electronic components. When using any of the procedures in this chapter you should use proper ESD precautions. As a minimum, you should place the instrument on a properly grounded ESD mat and wear a properly grounded ESD strap.

## To replace an assembly

Refer to the exploded view of the oscilloscope, figure 4-12 (figure 4-14 for Option 005 board), for details on how the oscilloscope fits together. To install an assembly, follow the instructions in reverse order.

You will need the following tools to disassemble the oscilloscope:

- T15 TORX driver to remove the oscilloscope from the cabinet and to remove the fan.
- T10 TORX driver to remove the assemblies from the deck.
- Flat-blade screwdriver to remove the optional modules and the pouch.
- 9/16-inch nut driver or wrench to remove BNC nut at rear of cabinet.
- Torque driver, 0.44 Nm (3.8 in-lbs), 16mm or 5/8-inch hex drive for probe sense nuts.
- Torque driver, 0.23 Nm (2 in-lbs), Torx T6 drive for heatsink and connector of A6 and A7 hybrid assemblies.
- Torque driver, 0.34 Nm (3 in-lbs), 5mm or 3/16-inch hex drive for standoffs of A6 and A7 hybrid assemblies.

### 1 Remove the oscilloscope from the cabinet.

- a Turn off the oscilloscope and disconnect the power cable.
- b If a module is installed, remove it from the oscilloscope.
- c Using the T15 TORX driver, remove the two screws from the rear of the cabinet.
- d Using your thumbs, gently push on the two rear-panel connectors to slide the oscilloscope out of the cabinet.

### 2 Remove the faulty assembly.

You can remove any of the following six assemblies: fan, front panel, display, system board, power supply, and keyboard.

---

### To remove the fan

- 1 Disconnect the fan cable from the power supply board.
- 2 Using the T15 TORX driver, remove the three screws that hold the fan to the deck.

#### **Fan Orientation**

When installing the new fan, face the fan to blow air into the oscilloscope

---

### To remove the front panel

- 1 Remove the intensity knob by pulling straight out.
- 2 Disconnect the keyboard ribbon cable from the system board.
- 3 Remove the probe sense nuts.
- 4 Use a screwdriver to release retainer tab A, and your finger to release retainer tab B. See figure next page.

#### **Releasing front panel from deck of instrument**

When tab B is released, be careful that the sheet metal tab of front-panel ground input clears the softkey circuit board. The circuit board may be depressed slightly with a screwdriver to avoid damage to the circuit board.

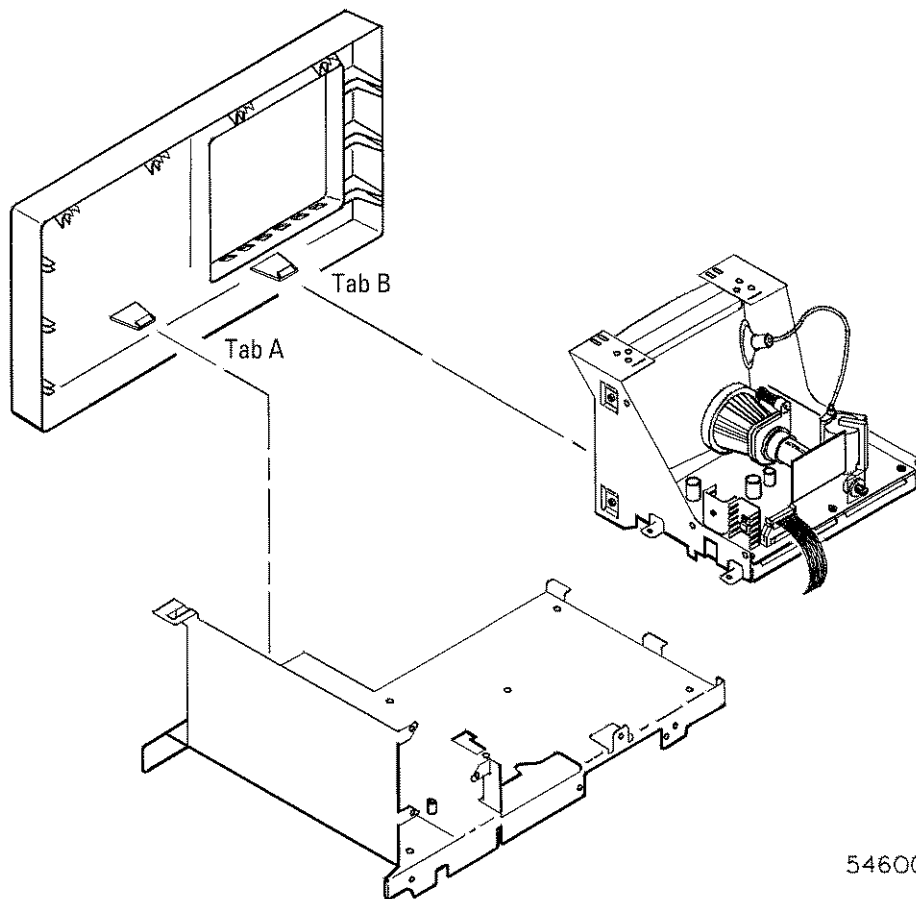
- 5 Rotate the front panel out until the bottom clears the rear of the assembly, then lift the front panel to free the hooks on top.

Service  
**Replacing Parts in the Oscilloscope**

When installing the front panel, make sure that the power switch shaft is aligned with its mating hole in the front panel.

The front panel swings in to engage the two retainer tabs. Before attempting to engage the retainer tabs, make sure that the six hooks on top of the front panel are fully engaged with their mating holes in the sheet metal.

**Figure 4-8**



54600E31

---

### To remove the display

- 1 Remove the front panel.
- 2 Disconnect the ribbon cable and the probe compensation cable from the display.
- 3 Using the T10 TORX driver, remove the two screws that hold the display to the deck.

Make sure that when you reinstall these screws that you use the correct parts. If longer screws are used, they can short the system board to ground.

- 4 As you lift the display, rotate it off the two tabs on the side of the deck.

---

### To remove the system board

- 1 Using the T10 TORX driver, remove the six screws that hold the system board to the deck.

When you reinstall these screws, the long screw and spacer are used between the two large heatsinks.

- 2 Remove the three probe sense nuts from the front panel BNC's.
- 3 Remove the two screws from the rear-panel interface connector and the nut from the rear-panel BNC.
- 4 Disconnect the three ribbon cables and the probe compensation cable.
- 5 As you remove the system board, rotate the system board so that the BNCs clear the front panel.

---

## To remove the attenuator

Use the following procedure to remove the attenuator assembly. When necessary, refer to other removal procedures.

---

### CAUTION

#### ELECTROSTATIC DISCHARGE!

Use grounded wrist straps and mats when servicing the system board. Electrostatic discharge can damage electronic components.

The attenuator is not part of the system board. If the system board is replaced, the attenuator will have to be moved to the replacement board.

- 1 Remove the system board.
- 2 Remove eight screws from the bottom of the system board that secure the attenuator.
- 3 Three 24-pin connectors (located at the rear of and inside the attenuator) connect the attenuator to the system board. With a gentle rocking or prying motion, lift the attenuator from the system board.

#### **If you permanently replace parts**

If you have permanently changed any combination of system board, attenuator, or acquisition hybrid, you will need to adjust the high-frequency pulse response on the affected channels. For example:

- If you permanently swap the acquisition hybrids during troubleshooting, you must adjust both channels.
- If you replace one hybrid, you must adjust that channel.
- If you replace the system board, you must adjust both channels.
- If you replace the attenuator, you must adjust both channels.



## To remove and replace an acquisition hybrid

### CAUTION

#### ELECTROSTATIC DISCHARGE!

Use grounded wrist straps and mats when servicing the system board. Electrostatic discharge can damage electronic components.

The system board does not need to be removed before replacing an acquisition hybrid.

#### To Remove

- 1 Use a T-6 Torx driver to remove two screws that secure the heatsink spring, then remove the heatsink.
- 2 Use a 3/16 hex driver to remove two standoffs that secure the top plate.
- 3 Use a T-6 Torx driver to remove two screws that secure the top plate.
- 4 Lift the hybrid off of the connector assembly.

#### To Replace

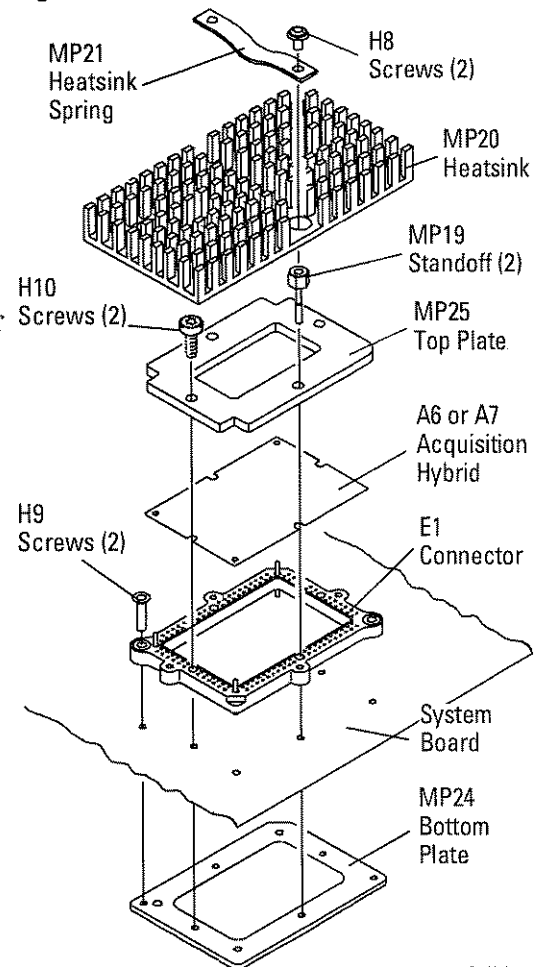
The location of pins and other locator features will guide the alignment of parts. This assembly cannot be assembled incorrectly without forcing.

- 1 Install the hybrid with the three corner holes over the three large locator pins.
- 2 Install the top plate with the three cut-out corners over the three locator pins.

### CAUTION

Tighten the hybrid carefully. Excess force or improper procedure may break the hybrid, which is very expensive to replace.

Figure 4-9



54030606

**Replacing Parts in the Oscilloscope**

- 3 Loosely install the two hex standoffs and two screws through the top plate.
- 4 Use 5 mm (3/16 in) and T6 torque drivers set to 0.34 Nm (3 in-lbs) to tighten the standoffs and screws in the following sequence.
  - a Tighten any standoff or screw to specifications.
  - b Tighten the standoff or screw directly opposite the first one to specifications.
  - c Tighten the remaining two standoffs or screws to specifications.
- 5 Check for the graphite pad on the underside of the heatsink, then install it with the hole that is near one corner toward the front of the instrument.

When the heatsink is installed properly, you will be able to see the adjustment potentiometer through the hole in the heatsink.
- 6 Install the heatsink spring with the curve down.
- 7 Install the two heatsink screws . Use a T6 torque driver set to 0.23 Nm (2 in-lbs) to tighten them.

**If you permanently replace parts**

If you have permanently changed any combination of system board, attenuator, or acquisition hybrid, you will need to adjust the high-frequency pulse response on the affected channels. For example:

- If you permanently swap the acquisition hybrids during troubleshooting, you must adjust both channels.
- If you replace one hybrid, you must adjust that channel.
- If you replace the system board, you must adjust both channels.
- If you replace the attenuator, you must adjust both channels.

---

## To remove and replace a hybrid connector

Two screws (H9) through the hybrid connector (figure 4-9) hold the bottom plate to the underside of the system board. If the hybrid connector is removed, the bottom plate is able to fall away from the board.

### **Disassembly hint**

The bottom plate may stick to the bottom of the board by itself because of adhesives that fasten an insulator to the plate. If the connector is very gently removed and replaced, you may be able to replace the connector without removing the system board. The key is to apply very little pressure while removing the connector screws. Too much pressure will push the plate away from the bottom of the board. If the plate falls from the board, you will have to remove the system board to reinstall the connector.

- 1 Follow the previous procedure to remove the acquisition hybrid.
- 2 Remove the two screws (H9) to remove the hybrid connector.
- 3 Reassemble using a T6 torque driver set to 0.23 Nm (2 in-lbs) to tighten the hybrid connector screws.

---

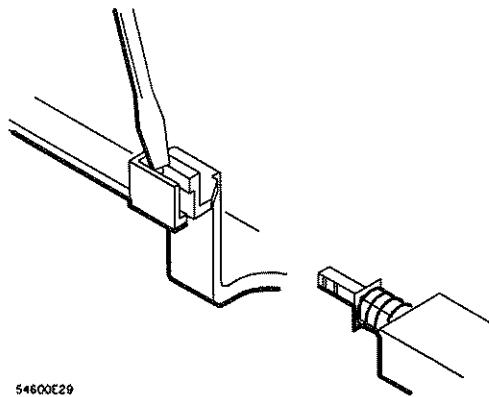
## To remove the power supply

- 1 Remove the fan.
- 2 Disconnect the ground wire (green wire with the yellow stripe) from the deck.
- 3 Disconnect the ribbon cable from the power supply board.

When reconnecting the cable, position both connectors on their mating pieces, then push on one connector at a time. Do not use more force than required.

- 4 Use a screw driver to gently unhook the latch that holds the white shaft to the power switch, then disconnect the shaft from the power switch. After you disconnect the shaft, make sure you position it in the recess along the side of the display bracket.

Figure 4-10



- 5 Using the T10 TORX driver, remove the screw holding the power supply board to the deck.
- 6 Slide the power supply board towards the front panel about a half an inch. Slip the keyhole slots on the power supply board off of the pins on the deck.

---

## To remove the keyboard

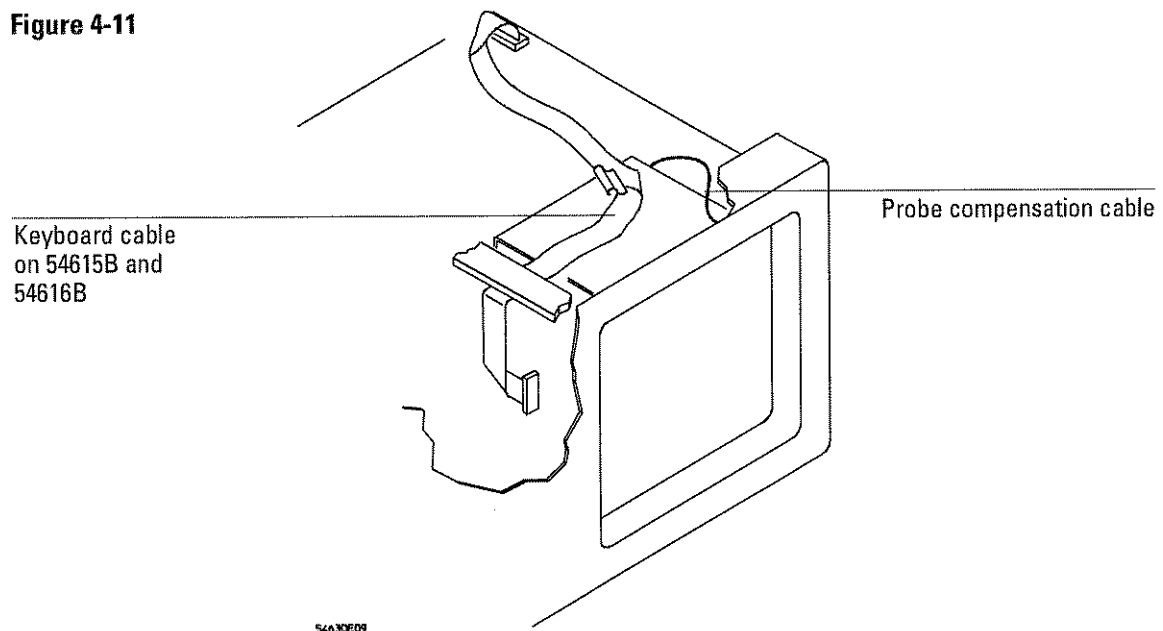
- 1 Remove the front panel.
- 2 Remove all the knobs by pulling straight out.
- 3 Flex the bezel of the front panel to unsnap the small keyboard under the display opening.
- 4 Using the T10 TORX driver, remove the three screws from the large keyboard.

Make sure that when you reinstall these screws that you use the correct parts. If longer screws are used, they can damage the front-panel label.

- 5 Press down on the top of the keyboard, and rotate the bottom of the keyboard out.

When installing the keyboard, make sure that the probe compensation cable is kept away from the keyboard cable or noise can occur in the probe compensation signal. See figure below for positioning the keyboard cable on the 54615B and 54616B.

**Figure 4-11**



**Positioning keyboard cable on 54615B and 54616B**

### To remove the handle

- Rotate the handle down until it is just past the last detent position (about 1/2 inch before the handle touches the bottom of the oscilloscope), then pull the sides of the handle out of the cabinet.
- 

### To remove the Option 005 board

- 1 Remove the oscilloscope from the cabinet.
  - a Turn off the oscilloscope and disconnect the power cable.
  - b If a module is installed in the oscilloscope, remove it.
  - c Using the T15 TORX driver, remove the two screws from the rear of the cabinet.
  - d Using your thumbs, gently push on the two rear-panel connectors to slide the oscilloscope out of the cabinet.
- 2 Remove the faulty Option 005 board.
  - a Using a T10 TORX driver, remove the two screws that lock the Option 005 board to the chassis.
  - b Slide the board back away from the front panel to release it from the keyholes.
  - c Disconnect the three cables attached to the Option 005 board.
  - d Remove the board from the keyholes, and from the oscilloscope.

## To order a replacement part

The system board is part of an exchange program with Agilent Technologies. The exchange program allows you to exchange a faulty assembly with one that has been repaired and performance verified by Agilent Technologies.

After you receive the exchange assembly, return the defective assembly to Agilent Technologies. A United States customer has 30 days to return the defective assembly. If you do not return the faulty assembly within the 30 days, Agilent Technologies will charge you an additional amount. This amount is the difference in price between a new assembly and that of the exchange assembly. For orders not originating in the United States, contact your nearest Agilent Technologies Sales Office for information.

Service

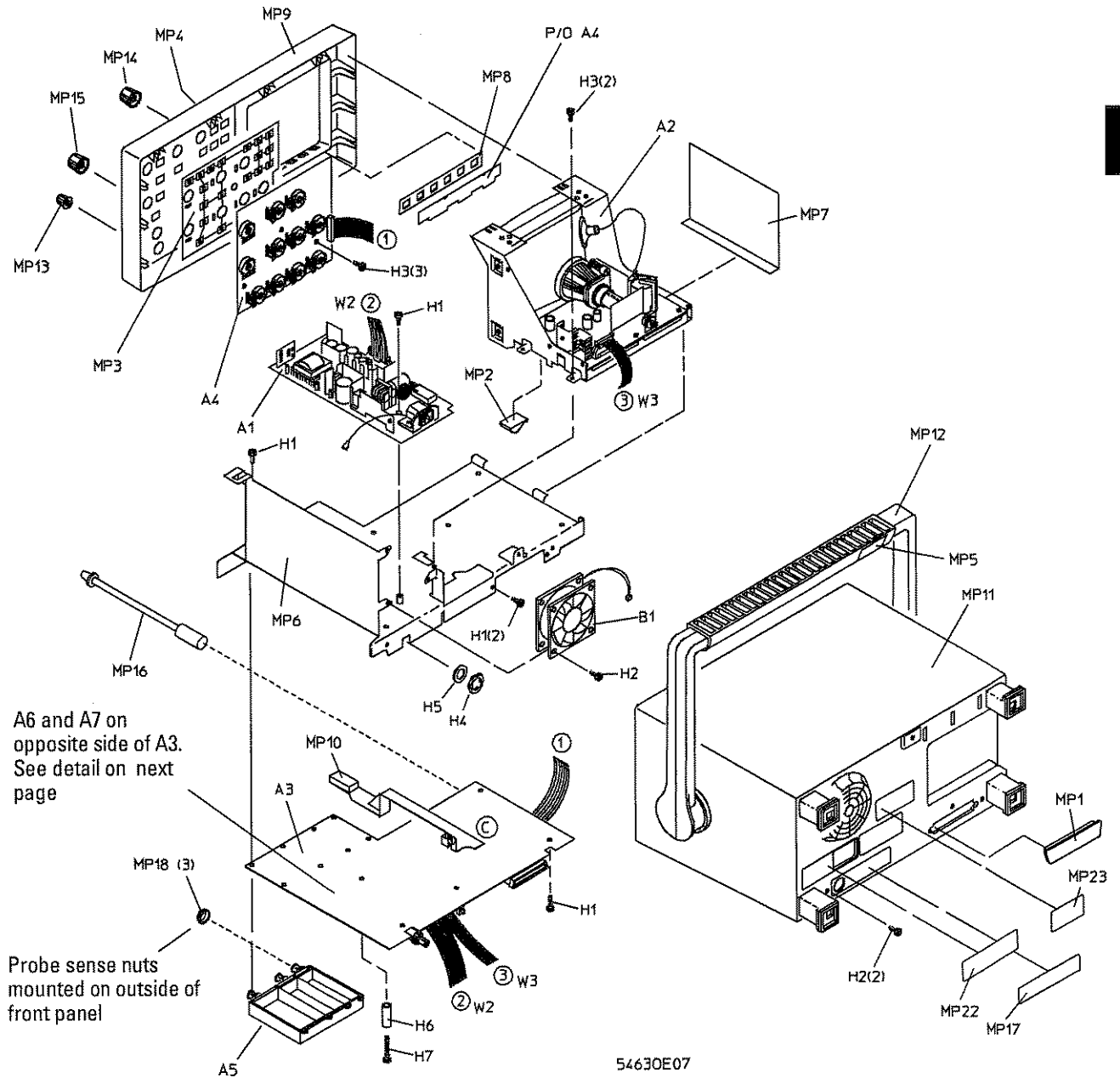
**Replacing Parts in the Oscilloscope**

- To order a part in the material list, quote the Agilent Technologies part number, indicate the quantity desired, and address the order to your nearest Agilent Technologies Sales Office.
- To order a part not listed in the material list, include the model number and serial number of the oscilloscope, a description of the part (including its function), and the number of parts required. Address the order to your nearest Agilent Technologies Sales Office.
- To order using the direct mail order system, contact your nearest Agilent Technologies Sales office.

Within the USA, Agilent Technologies can supply parts through a direct mail order system. The advantages to the system are, direct ordering and shipment from the Agilent Technologies Parts Center in Roseville, California. There is no maximum or minimum on any mail order. (There is a minimum amount for parts ordered through a local Agilent Technologies Sales Office when the orders require billing and invoicing.) Transportation costs are prepaid (there is a small handling charge for each order) and no invoices. In order for Agilent Technologies to provide these advantages, a check or money order must accompany each order. Mail order forms and specific ordering information are available through your local Agilent Technologies Sales Office. Addresses and telephone numbers are located in a separate document shipped with the instrument.



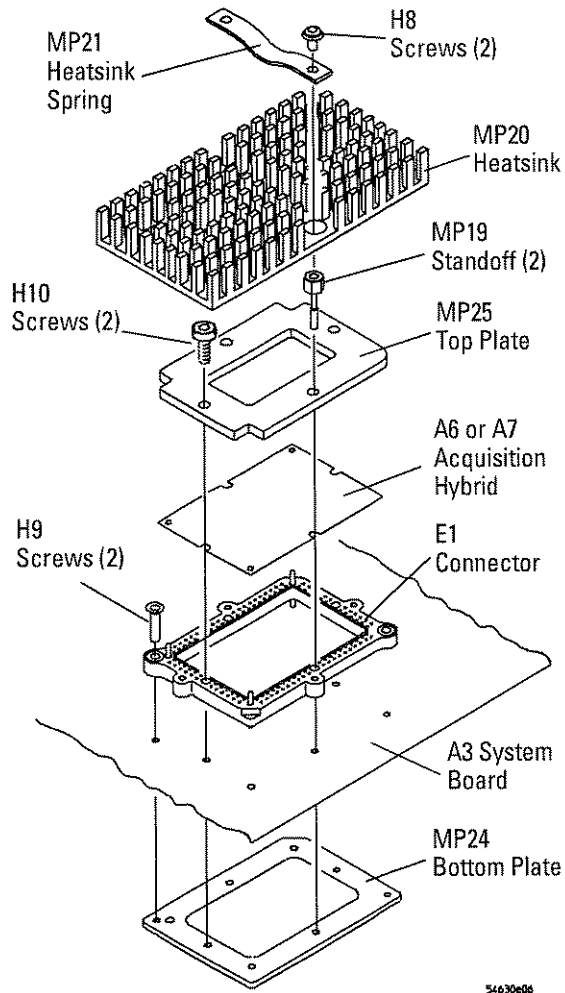
Figure 4-12



Exploded view of oscilloscope

Service  
Replacing Parts in the Oscilloscope

Figure 4-13



A6/A7 Acquisition Hybrid and associated mounting parts

**Table 4-16**

**54615B, 54616B, and 54616C Replaceable Parts**

Reference Designator	Agilent Part Number	Qty	Description
A1	0950-2735	1	Power supply assembly
A2	2090-0316	1	54615B/16B display assembly
A2	54620-68801	1	54616C display assembly
A2	54620-69801	1	54616C exchange display assembly
A3	54630-66501	1	54615B system board (includes Acquisition hybrids A6 and A7, but not attenuators)
A3	54630-69501		54615B exchange system board (includes Acquisition hybrids A6 and A7, but not attenuators)
A3	54616-66501	1	54616B system board (includes Acquisition hybrids A6 and A7, but not attenuators)
A3	54616-69501		54616B exchange system board (includes Acquisition hybrids A6 and A7, but not attenuators)
A3	54615-66505	1	54616C system board (includes Acquisition hybrids A6 and A7, but not attenuators)
A3	54615-69505		54616C exchange system board (includes Acquisition hybrids A6 and A7, but not attenuators)
A4	54600-66502	1	Keyboard
A5	54615-63403	1	Attenuator assembly
A5	54615-69403	1	Attenuator assembly, exchange
A6	1NB7-8353	2	Acquisition hybrid (channel 1)
A7	1NB7-8353		Acquisition hybrid (channel 2)
B1	3160-1006	1	Fan
E1	54542-67601	2	Connector assembly--hybrid mount
H1	0515-0372	16	Machine screw M3 X 8
H2	0515-0380	5	Machine screw M4 X 10
H3	0515-0430	5	Machine screw M3 X 6
H4	1250-2075	1	RF connector nut, 0.56 inch
H5	2190-0068	1	Lock washer

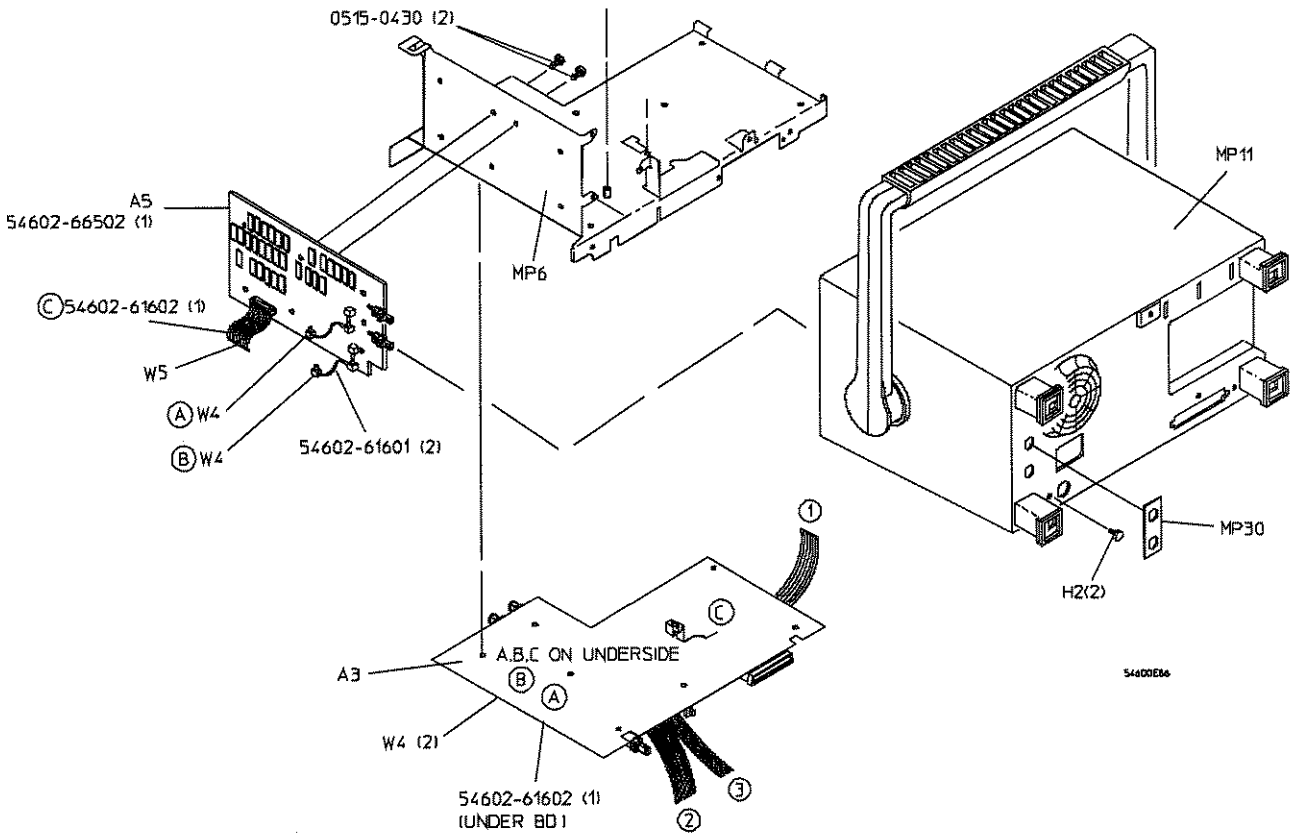
Service  
**Replacing Parts in the Oscilloscope**

Reference Designator	Agilent Part Number	Qty	Description
H6	0380-0912	1	Spacer
H7	0515-1025	1	Machine screw M3 X 26
H8	0515-0365	4	MS M2 X 0.4, 4mm-lg T6 pan head
H9	0515-2363	4	MS M2 X 0.4, 8mm-lg T6 flat head
H10	0515-1908	4	MS M2 X 0.4
MP1	1251-2485	1	Connector dust cover
MP2	1400-1581	1	Cable clamp
MP3	54610-41901	1	Main keypad
MP4	54615-94301	1	54615B front-panel label
MP4	54616-94301	1	54616B front-panel label
MP4	54616-94303	1	54616C front-panel label
MP5	54615-94302	1	54615B handle Label
MP5	54616-94302	1	54616B handle Label
MP5	54616-94304	1	54616C handle Label
MP6	54601-00102	1	Deck
MP7	5081-7741	1	Safety shield sheet
MP8	54601-41902	1	Small rubber keypad
MP9	54601-42201	1	Front panel
MP10	54601-43701	1	Power-switch shaft
MP11	54630-64402	1	Cabinet (comes with handle and feet installed)
MP12	54601-44901	1	Handle
MP13	54601-47401	5	Small knob - light
MP14	54601-47404	1	Small-knob - dark
MP15	54601-47402	3	Large knob - dark
MP16	54601-47403	1	Intensity knob
MP17	54630-94303	1	Cabinet label
MP18	54610-42501	3	Probe sense nut
MP19	54542-22401	4	Heatsink standoff
MP20	54542-21101	2	Heatsink
MP21	54542-09101	2	Heatsink spring
MP22	54630-94305	1	Label - power
MP23	5090-4873	1	Label - CSA
MP24	54542-04101	2	Bottom plate
MP25	54542-04102	2	Top plate

Reference Designator	Agilent Part Number	Qty	Description
W1	8120-1521	1	Standard power cord
W1	8120-1703		Power cord option 900, United Kingdom
W1	8120-0696		Power cord option 901, Australia
W1	8120-1692		Power cord option 902, Europe
W1	8120-0698		Power cord option 904, 250 V, USA/Canada
W1	8120-2296		Power cord option 906, Switzerland
W1	8120-2957		Power cord option 912, Denmark
W1	8120-4600		Power cord option 917, Africa
W1	8120-4754		Power cord option 918, Japan
W2	54630-61602	1	Power supply cable
W3	54630-61601	1	54615B/16B display cable
W3	54620-61602	1	54616C display cable
	<b>10073A</b>	<b>2</b>	<b>Passive probes, 10X</b>
	<b>Option 101</b>		<b>Accessory pouch and front-panel cover.</b>
	5041-9411		Pouch
	54601-44101		Front-panel cover

Service  
Replacing Parts in the Oscilloscope

Figure 4-14



Exploded view of Option 005 and related oscilloscope parts

**Table 4-17**

**Option 005 Replaceable Parts**

Reference Designator	Agilent Part Number	Qty	Description
A3	*	1	System Board (part of standard instrument)
A5	54602-66502	1	Video Trigger Board
H2	0515-0380	5	Machine screw M4 X 10 (part of standard instrument)
H3	0515-0430	7	Machine screw M3 X 6 (+2 screws for Option 005)
MP6	54601-00101	1	Deck (part of standard instrument)
MP11	54602-64402	1	Cabinet (comes with handle and feet installed – replaces standard cabinet)
MP30	54602-94305	1	Label, rear panel video trigger
W4	54602-61601	2	RF cable
W5	54602-61602	1	Ribbon cable
	<b>11094B</b>	<b>1</b>	<b>75Ω Termination</b>

\* See the 54615B, 54616B, and 54616C Replaceable Parts table for the Agilent part number of the A3 System Board.





---

## Performance Characteristics

---

## Performance Characteristics

The performance characteristics describe the typical performance of the new 54615B, 54616B, and 54616C oscilloscopes. You will notice that some of the characteristics are marked as tested, these are values that you can verify with the performance tests under "Verifying Oscilloscope Performance," on page 4-5.

---

### Vertical System

**Bandwidth**<sup>1</sup>

dc to 500 MHz  $\pm 3$  dB

ac coupled, 10 Hz to 500 MHz  $\pm 3$  dB

**Rise time** 700 ps (calculated)

**Dynamic range**  $\pm 12$  divisions from center screen

**Math functions** Channel 1 + or - Channel 2

**Input resistance** 1 M $\Omega$  or 50 $\Omega$  selectable

**Input capacitance**  $\approx 9$  pf



**Maximum input voltage** 250 V [dc + peak ac (<10 kHz)] or  
5 V<sub>rms</sub> in 50 $\Omega$  mode

<sup>1</sup> Tested, see "To verify bandwidth" on page 4-10.

Upper bandwidth reduced 2 MHz per degree C above 35°C

**Sensitivity** 2 mV/div to 5 V/div

**Accuracy**<sup>1</sup>  $\pm 2.0\%$  of full scale

**Verniers**<sup>1</sup> Fully calibrated, accuracy  $\pm 2.0\%$  of full scale

**Cursor accuracy**<sup>1, 2, 3</sup>

Single cursor accuracy: vertical accuracy  $\pm 1.2\%$  of full scale  $\pm 0.5\%$  of position value

Dual cursor accuracy: vertical accuracy  $\pm 0.4\%$  of full scale

**Bandwidth limit**  $\approx 30$  MHz

**Coupling** Ground, ac, and dc

**Inversion** Channel 1 and channel 2

**CMRR (common mode rejection ratio)**  $\geq 20$  dB at 50 MHz

**Probe Sense** Automatic readout of 1X, 10X, 20X and 100X probes

**50 $\Omega$  protection** Protects 50 $\Omega$  load from excessive voltage.

**Time skew** Adjustable over a range of  $\pm 25$  ns to remove effects of cabling and probe delays.

<sup>1</sup> When the temperature is within  $\pm 10$  °C from the calibration temperature.

<sup>2</sup> Magnification is used below 7 mV/div range. Below 7 mV/div full scale is defined as 56 mV.

<sup>3</sup> Tested, see "To verify voltage measurement accuracy" on page 4-8.

## Horizontal System

**Sweep speeds** 5 s/div to 1 ns/div main and delayed

**Accuracy**  $\pm 0.005\%$  of reading

**Horizontal resolution** 20 ps

**Cursor accuracy<sup>1</sup> ( $\Delta t$  and  $1/\Delta t$ )**  $\pm 0.005\% \pm 0.2\%$  of full scale  $\pm 100$  ps

**Delay jitter**  $\leq 1$  ppm

**Pretrigger delay (negative time)**

54615B—The greater of 30  $\mu$ s or 60 divisions, not to exceed 100 s

54616B/16C—The greater of 15  $\mu$ s or 60 divisions, not to exceed 100 s.

**Posttrigger delay (from trigger point to start of sweep)**

The greater of 10 ms or 20,000 divisions, not to exceed 100 s.

**Delayed sweep operation**

Up to 200 times main sweep when main sweep is from 5 s/div to 10 ms/div.

Up to 1 ns/div with main sweep set to 5 ms/div and faster.

**Horizontal modes** Main, Delayed (Alt), X-Y, and Roll

<sup>1</sup> Tested, see "To verify horizontal  $\Delta t$  and  $1/\Delta t$  accuracy," on page 4-13.

---

## Trigger System

**Sources** Channels 1, 2, line, and external

### Internal trigger

**Sensitivity**<sup>1</sup>

dc to 100 MHz: 0.50 div or 5.0 mV  
100 MHz to 500 MHz: 1 div or 10 mV

**Coupling**

ac, dc, LF reject, HF reject, and noise reject  
LF reject attenuates -3 dB for signals below 50 kHz, and  
HF reject attenuates -3 dB for signals above 50 kHz

**Modes** Auto, Autolevel, Normal, Single, and TV

**TV triggering** Available on channels 1 and 2

**TV line and field** 0.5 division of composite sync for stable display

**Holdoff** Adjustable from 300 ns to  $\approx$ 13 s

### External trigger

**Range**  $\pm$ 2 V

**Sensitivity**<sup>1</sup>

dc to 100 MHz: <75 mV  
100 MHz to 500 MHz: <150 mV

**Coupling** ac, dc

**Input resistance** 1 M $\Omega$  or 50 $\Omega$

**Input capacitance**  $\approx$ 12 pf



**Maximum input voltage** 250 V [dc + peak ac(<10 kHz)]

**50 $\Omega$  protection** Protects 50 $\Omega$  load from excessive voltage.

**Probe Sense** Automatic readout of 1X, 10X, 20X, and 100X probes

<sup>1</sup> Tested, see "To verify trigger sensitivity," on page 4-15.

---

## TV Functions

**Line counting** Delay time calibrated in NTSC and PAL line numbers.

**All field trigger** Oscilloscope triggers on the vertical sync pulse in both fields allowing use with non-interlaced video.

---

## XY Operation

**Operating mode** X=Channel 1, Y=Channel 2

**Bandwidths** X-axis and Y-axis same as vertical system

**Phase difference**  $\pm 3$  degrees at 10 MHz

---

## Display System

### Display

54615B/16B — 7-inch raster CRT

54616C — 5.8-inch Active Matrix Color LCD Display. The present state-of-the-art for the color displays allows for some pixel defects to be present. The number of these allowed is no more than six active (those which cannot be turned off), and six inactive (those which cannot be turned on).

**Resolution** 256 vertical by 500 horizontal points

**Controls** Front-panel intensity control (54615B/16B only)

**Graticule**  $8 \times 10$  grid or frame

**Storage Scope** Autostore saves previous sweeps in half bright display and the most recent sweep in full bright display. This allows easy differentiation of current and historic information.

---

## Acquisition System

### Maximum sample rate

54615B – 1 GSa/s simultaneous on 2 channels

54616B/16C – 2 GSa/s simultaneous on 2 channels

### Resolution 8 bits

### Simultaneous channels Channels 1 and 2

### Record length

Vectors off:

5000 points

4000 points (200 ns/div, 54615B)

4000 points (100 ns/div, 54616B/16C)

1000 points (peak detect on)

Vectors on:

2000 points

1000 points (peak detect on)

Roll Mode (vectors off or on):

1000 points

500 points (200 ms/div, channel 1 and 2 on, 54615B/16B)

### Single-shot bandwidth

54615B – 250 MHz on channels 1 and 2 simultaneously (1 GSa/s, display vectors on)

54616B/16C – 500 MHz on channels 1 and 2 simultaneously (2 GSa/s, display vectors on)

### Acquisition modes Normal, Peak Detect, and Average

### Peak detect 1 ns glitch capture

### Average Number of averages selectable at 8, 64, and 256

### Roll Mode At sweep speeds of 200 ms/div and slower (54615B/16B)

At sweep speeds of 500 ms/div and slower (54616C):

waveform data moves across the display from right to left with no dead time. Display can be either free-running (non-triggered) or triggered to stop on a trigger event.

## Advanced Functions

**Automatic measurements** (measurements are continuously updated)

**Voltage** Vavg, Vrms, Vp-p, Vtop, Vbase, Vmin, Vmax

**Time** Frequency, period, + width, - width, duty cycle, rise time, and fall time

**Cursor Measurements** Four cursors can be positioned on the display to make time voltage measurements. The cursors will track changes in position and delay controls. Readout in V, T.

### Setup functions

**Autoscale** Sets vertical and horizontal deflections and trigger level. Requires a signal with a frequency >49 Hz, duty cycle >0.5% and voltage level : channels 1 and 2 > 20 mVp-p,

**Save/Recall** 16 front-panel setups can be stored and recalled from nonvolatile memory.

**Trace memory** Two volatile pixel memories allow storage of multi-valued waveforms.

---

## Power Requirements

**Line voltage range** 100 Vac to 240 Vac

**Line voltage selection** Automatic

**Line frequency** 45 Hz to 440 Hz

**Maximum power consumption** 300 VA

---



---

## General (54615B and 54616B only)

### Environmental characteristics

The instrument meets or exceeds the environmental requirements of MIL-T-28800E for Type III, Class 3, Style D equipment as described below.

**Ambient temperature** (Tested to MIL-T-28800E paragraph 4.5.5.1.1)

**Operating** -10 °C to +55 °C

**Nonoperating** -51 °C to +71 °C

**Humidity** tested to Agilent Technologies environmental specification section 758 paragraphs 4.0, 4.1, and 4.2 for class B-1 products

**Operating** 95% relative humidity at +40 °C for 24 hours

**Nonoperating** 90% relative humidity at +65 °C for 24 hours

**Altitude** (Tested to MIL-T-28800E paragraph 4.5.5.2)

**Operating** to 4,500 m

**Nonoperating** to 15,000 m

### EMI

EMI (commercial) CISPR 11 Group1 Class A

EMI Meets the requirements in accordance with MIL-T-28800E (prior to Interim Amendment 1) and MIL-STD-461C as described below.

**CE01** Part 2 narrow band requirements up to 15 kHz

**CE03** Part 2

**CS01** Part 2

**CS02** Part 2 limited to 100 MHz

**CS06** Part 5 limited to 400 V

---

## Glossary

**This glossary is organized into two parts: oscilloscope and TV/video trigger terms. The TV/video trigger terms apply to oscilloscopes with Option 005 installed.**

### Oscilloscope Terms

**50Ω Input Protection** This only functions when the scope is powered on. The 50Ω load will typically disconnect if greater than 5 Vrms is detected. However, the inputs could still be damaged, depending on the time constant of the signal.

**Auto** A trigger mode that produces a baseline display if the trigger conditions are not met. If the trigger frequency is less than 25 Hz, a free running display will result even if the level and slope conditions are met.

**Auto Level** The oscilloscope sets the trigger point to the 50% amplitude point on the displayed waveform. If there is no signal present, a baseline is displayed.

**Autoscale** Front-panel key that automatically sets up the oscilloscope to display a signal.

**Autostore** displays the stored waveforms in half bright, and the most recent trace is displayed in full bright.

**Baseline** Free running trace on the display when no signal is applied and the trigger mode is set to auto or auto level.

**BW Lim** (Bandwidth Limit) Limits the displayed bandwidth of the selected channel to 30 MHz, and is available for channels 1 and 2 only. This feature is useful for viewing noisy signals

**Coupling** (Coupling) This changes the input coupling. Channels 1 and 2 allow dc, ac, or ground. External Trigger allow dc or ac.

**Cursors** Horizontal and vertical markers used for making custom voltage and time measurements.

**Delay** In main sweep, the delay knob moves the sweep horizontally, and indicates how far the time reference is from the trigger point. In delayed sweep the delay knob moves the starting point of the portion of the main sweep to be expanded by the delayed sweep.

## Glossary

**Delayed** Gives an expanded view of the main sweep.

**Deskewing** The removal of time offset errors between two signals. The error is typically due to differences in either cable lengths or characteristics. Also called Time Null.

**Display** Allows selection of either normal, peak detect, or averaged display modes.

**Erase** Clears the display.

**External Trigger** Extra input to the oscilloscope normally used for triggering.

**Field 1** Triggers on the field 1 portion of the video signal.

**Field 2** Triggers on the field 2 portion of the video signal.

**HF Reject** (high frequency reject) Adds a low pass filter with a 3 dB point at 50 KHz to the trigger path.

**Holdoff** Keeps the trigger from re-arming for an amount of time set by the holdoff knob.

**Internal Trigger** The oscilloscope triggers from a channel input that you choose.

**Invert** Invert changes the polarity of the waveform, and is available for channels 1 and 2. When the oscilloscope is triggered on the signal to be inverted, the trigger is not inverted.

**Level** Front-panel knob that changes the trigger level.

**LF Reject** (low frequency reject) Adds a high pass filter with a 3 dB point at 50 KHz to the trigger path.

**Line** In TV trigger mode, the oscilloscope triggers on the TV line sync pulses. As a trigger source, the oscilloscope triggers off of the power line frequency.

**Main** Sets the oscilloscope to a volts vs time display that displays the main time base sweep.

**Mode** Allows you to select one of five trigger modes, Auto level, Auto, Normal, Single, TV.

**Noise Rej** (noise reject) Decreases the trigger sensitivity to reduce the triggering on signal noise.

**Normal** If a trigger signal is present and the trigger conditions are met, a waveform is displayed. If there is no trigger signal, the oscilloscope does not trigger and the display is not updated.

**Peak Det** (1 ns peak detect) Allows detection of signal extremes as the sample rate is decreased in the 5 s to 500 ns/div time base settings.

**Polarity** Selects either positive or negative TV sync pulses.

**Position** Knob that moves the signal vertically on the display.

**Print/Utility** Allows access to the module menus and service menus.

**Probe** Allows selection of 1, 10, 20, or 100 to match a probe's division ratio so that the vertical scaling and voltage measurements reflect the actual voltage levels at the tip of the probe.

**Probe Sense** Automatically detects the division ratio of the probe.

**Recall** Recalls a selected front-panel setup that you saved to one of 16 memory locations. Memory selection is with either a softkey or the knob closest to the Cursors front-panel key.

**Recall Setup** Recalls the front-panel setup that was saved with a waveform.

**Run** The oscilloscope acquires data and displays the most recent trace.

**Save** Saves the current front-panel setup to one of the possible 16 memory locations. Memory selection is with either a softkey or the knob closest to the Cursors front-panel key.

**Setup** Allows access to front-panel setup keys.

**Single** (single shot) The oscilloscope triggers once when the trigger conditions are met. The oscilloscope must be rearmed before the oscilloscope retriggers by pressing either the Run or Autostore front-panel keys.

## Glossary

**Skew** Time offset between two signals, typically due to differences in either cable lengths or characteristics.

**Slope/Coupling** Allows access to the trigger slope and input coupling menus.

**Slope** Selects either the rising or falling edge of the signal to trigger the oscilloscope.

**Source** Allows you to select a trigger source.

**Stop** Freezes the display.

**Time** Allows access to the automatic time measurement keys.

**Time/Div** Changes the time base in a 1-2-5 step sequence from 1 ns to 5 s.

**Time Null** The removal of time offset errors between two signals. The error is typically due to differences in either cable lengths or characteristics. Also called deskewing.

**Time Ref Lft Cntr** (time reference left or center) Sets the time reference to either one graticule in from the left edge of the display or to center of the display.

**Trace** Allows access to the trace storage keys.

**Trace Mem** (trace memory) One of two pixel memory locations used for storing traces.

**TV** Allows access to the TV or video trigger keys.

**Vernier** Vernier allows a calibrated fine adjustment with the channel 1 and 2 Volts/Div knob.

**Voltage** Allows access to the automatic voltage measurement keys.

**Volts/Div** Changes the vertical scaling in a 1-2-5 step sequence from 2 mV to 5 V.

**XY** Changes the display to a volts versus volts display.

## TV/Video Trigger Terms

**Blanking Level** The level of the composite picture signal that separates the range containing picture information from the range containing synchronizing information. (IEEE Definition)

**Chrominance** That property of light which produces a sensation of color in the human eye apart from any variation in luminance that may be present.

**Chrominance Signal** That portion of the color television signal which contains the color information. (STOC Definition)

**Color Burst** In color systems, this normally refers to a burst of subcarrier frequency (8 to 10 cycles of 3.579545 MHz in NTSC systems) on the back porch of the composite video signal used to establish a frequency and phase reference for the chrominance signal.

**Composite Sync** The line and field rate synchronizing pulses (including the field equalizing pulses), when combined together, form the composite sync signal.

**Composite Video** For color, this consists of blanking, field, and line synchronizing signals, color synchronizing signals, plus chrominance and luminance picture information. These are all combined to form the complete color video signal.

**Equalizing Pulses** Pulses of one half the width of the horizontal sync pulses which are transmitted at twice the rate of the horizontal sync pulses during the portions of the vertical blanking interval immediately preceding and following the vertical sync pulse. These pulses cause the vertical deflection to start at the same time in each interval. They also keep the horizontal sweep circuits in step during the portions of the vertical blanking interval immediately preceding and following the vertical sync pulse.

**Field** One of the two (or more) equal parts of information into which a frame is divided in interlace scanning; alternately, one half of a complete picture (or frame) interval, containing all of the odd, or all of the even, lines of the picture.

**Field 1** Triggers on the field 1 portion of the video signal.

## Glossary

**Field 2** Triggers on the field 2 portion of the video signal.

**Frame** One complete picture consisting of two fields of interlaced scanning lines.

**HF Reject** (high frequency reject) Adds a low pass filter with a 3 dB point at 50 KHz to the trigger path.

**Holdoff** Keeps the trigger from re-arming for an amount of time set by the holdoff knob.

**Internal Trigger** The oscilloscope triggers from a channel input that you choose.

**Invert** Invert shifts the displayed waveform 180 degree, and is available for channels 1 and 2 only. When the oscilloscope is triggered on the signal to be inverted, the trigger is also inverted.

**IRE** An abbreviation for Institute of Radio Engineers.

**IRE Scale** An oscilloscope scale that applies to composite video levels. There are 140 IRE units in one volt.

**Line** In TV trigger mode, the oscilloscope triggers on the TV line sync pulses. As a trigger source, the oscilloscope triggers off of the power line frequency.

**Luminance** The amount of light intensity, which is perceived by the eye as brightness (referred to as "Y")

**Main** Sets the oscilloscope to a volts vs time display that displays the main time base sweep.

**Mode** Allows you to select one of five trigger modes, Auto level, Auto, Normal, Single, TV.

**Noise Rej** (noise reject) Decreases the trigger sensitivity to reduce the triggering on signal noise.

**NTSC** National Television Systems Committee. An industry-wide engineering group which, during 1950-1953, developed the color television specifications now established in the United States, Canada, Japan, and Mexico. A 525 line, 60 Hz field, 4.2 MHz system. Two frames (4 fields) for picture completion.

**PAL** Phase Alternating Line or Phase Alteration Line rate. Color television standards used in Europe. A 625 line, 50 Hz field system. Eight fields for picture completion.

**PAL-M** Phase Alternating Line or Phase Alteration Line rate. A version of the European system adapted to a 525 line, 60 Hz field, 4.2 MHz bandwidth used in Brazil.

**SECAM** SEquentiel Couleur Avec Memoire. An acronym derived from the French phrase meaning Sequential Color with Memory. Color television specifications used primarily in France and the former Soviet Union. A 625 line, 50 Hz field, wide bandwidth system. Two frames (4 fields) required for picture completion

**Sync** An abbreviation for the words "synchronization," "synchronizing," etc. Applies to the synchronization signals, or timing pulses, which lock the electron beam of the picture monitors in step, both horizontally and vertically, with the electron beam of the pickup tube. The color sync signal (NTSC) is known as the color burst.

**Vertical Blanking Interval** The blanking portion at the beginning of each field. It contains the equalizing pulses, the vertical sync pulses, and VITS (if desired). Presently 18 to 21 lines in duration.

**Vertical Interval Reference (VIR)** A signal used as a reference for amplitude and phase characteristics of a color television program (FCC assigned to line 19).

**Vertical Interval Test Signal** A signal which may be included during the vertical blanking interval to permit in-service testing and adjustment of video transmission.





## Performance Characteristics

**General** (54615B and 54616B only)

**RE01** Part 5 measured at 15.24 cm and exceptioned from 19kHz to 50 kHz.

**RE02** Part 2 (limited to 1 GHz) Full limits of class A1C and A1F, with option 002 installed; without option 002 installed 10 dB relaxation, 14 kHz to 100 kHz

**RS03** Part 2, limited to 1 V/meter from 14 kHz to 1 GHz. Slight trace susceptibility from 450 MHz to 600 MHz and at 950 MHz.

### Vibration

**Operating** 15 minutes along each of the 3 major axes; 0.635 mm displacement, 10 Hz to 55 Hz in one-minute cycles. Held for 10 minutes at 55 Hz (4 g at 55 Hz).

**Nonoperating** survival random vibration, 5Hz to 500 Hz at 2.41 grms.

### Shock

**Operating** 30 g, 1/2 sine, 11 ms duration, 3 shocks per axis along major axis. Total of 18 shocks.

---

## General (54616C only)

### Environmental characteristics

These general characteristics apply to the 54616C only. This instrument meets Agilent Technologies environmental specifications (section 750) for class B-1 products.

#### Ambient temperature

**Operating** 0 °C to +55 °C

**Nonoperating** -40 °C to +70 °C

#### Humidity

**Operating** 95% relative humidity at +40 °C for 24 hours

**Nonoperating** 90% relative humidity at +65 °C for 24 hours

#### Altitude

**Operating** to 3,048 m

**Nonoperating** to 12,192 m

### Vibration

**Operating** Random vibration 5-500 Hz, 10 minutes per axis, 0.3 grms.

**Nonoperating** Random vibration 5-500 Hz, 10 minutes per axis, 2.41 grms; Resonant search, 5-500 Hz swept sine, 1 octave/minute sweep rate, 0.75 g, 5-minute resonant dwell at 4 resonances per axis.

### Shock

**Operating** Half-sine pulse, 2.8 meters/second, along all 6 axes.

**Nonoperating** Trapezoidal pulse, 7.4 meters/second, along all 6 axes.

Performance Characteristics  
**General** (54615B, 54616B, and 54616C)

---

**General** (54615B, 54616B, and 54616C)

**Physical characteristics**

Size (excluding handle)  
Height 172 mm  
Width 322 mm  
Depth 317 mm  
Weight: 6.6 kg

**Product Regulations**

**Safety** IEC 1010-1:1990+A1 / EN 61010-1:1993  
UL 3111  
CSA-C22.2 No.1010.1:1993

**EMC** This Product meets the requirement of the European Communities (EC)  
EMC Directive 89/336/EEC.

**Emissions** EN55011/CISPR 11 (ISM, Group 1, Class A equipment)

<b>Immunity</b>	EN50082-1	Code <sup>1</sup>	Notes <sup>2</sup>
	IEC 555-2	1	
	IEC 555-3	1	
	IEC 801-2 (ESD) 8kV AD	1,2	*
	IEC 801-3 (Rad.) 3 V/m	2	
	IEC 801-4 (EFT) 1kV	1,2	*

<sup>1</sup> Performance Codes:

- 1 PASS - Normal operation, no effect.
- 2 PASS - Temporary degradation, self recoverable.
- 3 PASS - Temporary degradation, operator intervention required.
- 4 FAIL - Not recoverable, component damage.

<sup>2</sup> Notes:

- \* Code 1 for 54616C
- Code 2 for 54615B and 54616B

**Sound Pressure Level** Less than 60 dBA

---

## Option 005 General Performance Characteristics

### Video Standards

NTSC  
PAL  
PAL-M  
SECAM  
Generic

### Video Trigger Modes

Line (number) of Field 1  
Field 2  
Alternate Fields

#### All Lines

**Field 1** Defined as that field with the 3 lines of vertical sync starting at line 4. Is actually color field 1 or color field 3.

**Field 2** Defined as that field with the 3 lines of vertical sync starting at the midpoint of line 3. Is actually color field 2 or color field 4.

#### All Fields

---

## Option 005 Trigger System

<b>Internal trigger</b>	<b>Sensitivity</b> Performance remains unchanged
	<b>Coupling</b> Performance remains unchanged
	<b>Modes</b> Performance remains unchanged
	<b>Holdoff</b> Performance remains unchanged
	<b>TV triggering</b> Available on channels 1 and 2 only
	<b>TV line and field</b> 0.5 division of composite sync for stable display
<b>External trigger</b>	Performance remains unchanged
<b>Vertical output</b>	<b>Connector</b> Rear panel BNC (f)
	<b>Source Impedance</b> 50 $\Omega$ (nominal)
	<b>Signal source</b> selected by internal trigger source
	<b>Amplitude</b> approximately 90mVp-p into 50 $\Omega$ for a full scale display at full bandwidth of the oscilloscope
<b>TV Trigger output</b>	<b>Connector</b> Rear panel BNC (f)
	<b>Amplitude</b> TTL
	<b>Pulse width</b> a function of TV trigger mode, Minimum approximately 5 $\mu$ s in line modes to the width of a field in field modes
	<b>Delay from Vertical Output</b> approximately 400ns.

---

# Index

---

## A

ac coupling, 1-8, 1-13, 5-3, 5-5  
accuracy  
  cursors, 5-3 to 5-4  
  horizontal, 5-4  
  vertical, 5-3  
acquisition characteristics, 5-7  
Active Cursor, 2-23  
adjustments  
  display, 4-29 to 4-30  
  high frequency, 4-21 to 4-31  
  low frequency, 4-21 to 4-31  
  power supply, 4-22 to 4-23  
advance functions, 5-8  
All Fields, 3-9  
Alt Fld  
  *See* alternate fields  
Alternate color palettes, 1-17  
alternate fields, 3-5  
altitude characteristics, 5-9, 5-11  
ambient temperature, 4-21, 5-9, 5-11  
assembly replacement, 4-46  
attenuation factor  
  of probe, 1-6  
Auto, 1-14  
auto level, 1-14  
Auto Level softkey, 1-14  
Auto softkey, 1-14  
automatic measurement, 3-14  
automatic measurements  
  time, 2-16 to 2-18  
  voltage, 2-19 to 2-22  
automatic probe sensing, 1-5  
autoscale  
  characteristics, 5-8  
  to autoscale, 1-7  
  Undo, 1-7, 2-35  
  video, 3-4, 3-12, 3-16  
autostore, 2-6 to 2-7, 2-9 to 2-10  
Av, 2-32  
Average softkey, 2-32  
averaging, 2-32, 5-7

## B

bandwidth  
  characteristics, 5-2  
  limit, 5-3  
  single shot, 2-9, 5-7  
  to verify, 4-10  
XY, 5-6

## C

calibration  
  adjustments, 4-21 to 4-31  
  delay, 4-26  
  self, 4-25 to 4-26  
  vertical, 4-26  
Calibrator, 4-6, 4-25  
channel signal connection, 1-5  
channels  
  preset configuration, 2-35  
characteristics, 5-2 to 5-5, 5-8 to 5-10  
clamp circuit  
  internal, 3-16  
clamping  
  external, 3-16  
Clear Cursors softkey, 2-23  
Clear Meas softkey, 2-17  
clear measurement, 2-17  
Clear softkey, 2-33  
clearing error messages, 4-37  
color  
  overview, 1-17  
  selecting palettes, 1-18 to 1-19  
color burst, 2-42  
color palettes, 1-17  
compensation probe, 1-6  
complex waveforms, 2-12  
configuration  
  preset default settings, 2-35  
connect to instrument(s), 3-20  
coupling, 5-14  
  ac, 1-8, 1-13, 5-3, 5-5, 5-14  
  dc, 1-8, 1-13, 5-3, 5-5  
cursor  
  active, 3-12  
  clear, 3-12  
  time, 3-12  
  voltage, 3-12  
cursor measurements, 2-23 to 2-26, 3-12  
  to 3-13

## Cursors

active, 2-23  
clear, 2-23  
  preset configuration, 2-35  
Cursors key, 2-23  
custom measurements, 2-23, 3-12

## D

DAC softkey, 4-6  
dc coupling, 1-8, 1-13, 5-5  
DC level shifts, 3-16  
Default color palette, 1-17  
default setup, 2-35  
delay, 1-12  
delay calibration, 4-26  
Delay knobs, 2-3, 3-14  
Delayed softkey, 2-3, 3-14  
delayed sweep, 3-14, 3-17  
  characteristics, 2-3 to 2-5, 3-14 to 3-15,  
  5-4  
  operation, 2-3 to 2-5, 3-14 to 3-15  
delta t/delta V  
  *See* cursor measurements  
disassembly, 4-46  
display  
  characteristics, 5-6  
  to adjust, 4-29 to 4-30  
  to erase, 2-8  
Display softkey, 4-29  
distortion  
  harmonic, 3-18 to 3-19  
  worst case, 3-10  
domain  
  frequency, 3-18 to 3-19  
  time, 3-18 to 3-19  
Duty Cy softkey, 2-17  
duty cycle, 2-16 to 2-17

## E

EMI, 5-9  
Erase softkey, 2-7 to 2-8  
erasing the display, 2-8  
error messages  
  clearing, 4-37  
  keydown powerup, 4-37  
even field, 3-10 to 3-11  
expand vertical signal, 1-10  
exploded view, 4-59  
external trigger, 1-5, 1-15, 5-5, 5-14

## Index

### F

fail messages  
  clearing, 4-37  
  keydown powerup, 4-37  
fall time, 2-16, 2-18  
Fast Fourier Transform (FFT), 3-18 to 3-19  
Field 1, 3-8  
Field 1 softkey, 2-40  
Field 2, 3-8  
Field 2 softkey, 2-40  
fields  
  all, 3-9  
  alternate, 3-5  
  even, 3-10 to 3-11  
  Field 1, 3-5, 3-10 to 3-11  
  Field 2, 3-5, 3-10 to 3-11  
  Field 3, 3-10 to 3-11  
  Field 4, 3-10  
  odd, 3-10 to 3-11  
firmware calibration, 4-25  
Freq softkey, 2-14  
frequencies  
  multi-burst, 3-14  
frequency  
  measurements, 2-14 to 2-15, 2-17  
  reject, 2-31, 2-40, 5-5  
frequency domain, 3-18 to 3-19  
frequency domain analysis, 3-18  
front-panel keys  
  *See* keys listed by name

### G

general characteristics, 5-9 to 5-10  
GENERIC, 3-4 to 3-6  
glitch capture, 2-10 to 2-11  
graticule  
  preset configuration, 2-35  
  TV, 3-12, 3-14  
grid  
  softkeys, 3-2  
  tv, 3-4

### H

half bright contrast, 4-30  
HF Rej softkey, 2-40  
high frequency pulse response, 4-27  
high frequency reject, 2-40, 5-5  
holdoff, 1-15, 2-12, 3-11  
Holdoff knob, 1-15  
horizontal  
  accuracy, 5-4  
  characteristics, 5-4  
  hold, 4-30  
horizontal system, 1-12  
humidity characteristics, 5-9, 5-11

### I

input  
  capacitance, 5-2, 5-5  
  coupling, 1-8, 1-13, 5-3, 5-5  
  maximum voltage, 1-5, 5-2, 5-5  
  resistance, 5-2, 5-5  
instrument  
  connect to, 3-20  
interlaced TV system, 3-6  
internal trigger, 5-5, 5-14  
interval  
  vertical, 3-8  
Inverse color palettes, 1-17  
invert, 1-9, 5-3  
IRE, 3-12

### K

keydown powerup, 4-37

### L

labels  
  preset configuration, 2-35  
level shifts  
  DC, 3-16  
LF reject, 2-31  
line  
  trigger, 1-13, 5-5, 5-14  
  trigger (TV), 5-5, 5-14  
Line softkey  
  Source, 1-13  
  TV, 2-40  
Load Defaults softkey, 4-25  
low frequency  
  reject, 2-31, 2-40, 5-5

### M

main sweep, 2-3, 3-14  
Main/Delayed key, 2-3, 3-14  
marker, 3-14  
  *See* cursor measurements  
math functions, 5-2  
maximum input voltage  
  trigger, 5-5  
  vertical, 5-2  
measurement  
  automatic, 2-16 to 2-22, 3-14  
  clear, 2-17  
  cursor, 3-12 to 3-13  
  custom, 2-23, 3-12  
  duty cycle, 2-16 to 2-17  
  fall time, 2-16, 2-18  
  frequency, 2-14 to 2-15, 2-17, 3-15  
  period, 2-16 to 2-17  
  phase, 2-36 to 2-38  
  rise time, 2-16, 2-18  
  show, 2-15, 2-17  
  time, 2-16 to 2-18  
  width, 2-16  
  windowed, 3-16  
measurements  
  preset configuration, 2-35  
memory  
  preset configuration, 2-35  
Mode key, 1-14  
Monochrome palette, 1-17  
multi-burst, 3-15  
multi-burst frequencies, 3-14

### N

narrow pulses, 2-10 to 2-11  
negative time, 1-12  
Next Menu softkey, 2-15, 2-17, 2-20  
noise  
  asynchronous signal, 2-28 to 2-29  
noisy signals  
  to remove from display, 2-30 to 2-32  
  to view, 2-28, 2-30 to 2-32  
non-interlaced TV system, 3-6  
nonvolatile memory, 2-33  
Normal softkey, 1-14  
NTSC, 3-4, 3-6, 3-10 to 3-11



- O**  
 odd field, 3-10 to 3-11  
 offset  
   adjusting option 005, 4-31  
 Option 005, 3-2  
   characteristics, 5-13  
   offset adjustment, 4-31  
   replacing circuit board, 4-56  
   trigger system characteristics, 5-14  
   triggering, 3-5  
   troubleshooting, 4-45  
   verify vertical output, 4-18  
 oscilloscope  
   configuration preset, 2-35  
   preset configuration, 2-35  
 oscilloscope maintenance, 4-5 to 4-18  
 output  
   vertical, 3-20  
 outputs  
   rear panel, 3-20
- P**  
 PAL, PAL-M, 3-4, 3-6, 3-11  
 palettes, color, 1-18 to 1-19  
 Peak Det softkey, 2-10  
 peak detect, 2-10  
 peak to peak voltage, 2-20  
 performance  
   tests, 4-5 to 4-18  
   verification, 4-5 to 4-18  
 performance characteristics  
   horizontal, 5-4  
   posttrigger, 5-4  
   pretrigger delay, 5-4  
   vertical, 5-2 to 5-3  
 period measurements, 2-16 to 2-17  
 phase measurement, 2-36 to 2-38  
 Plot  
   *See* User's Guide for optional interface module  
 Polarity softkey, 2-40  
 Position knob, 1-8  
 Power requirements, 5-8  
 power supply  
   to adjust, 4-22 to 4-23  
   voltage measurements, 4-23  
 preset configuration, 2-35  
 Previous Menu softkey, 2-18
- Print  
   *See* User's Guide for optional interface module  
 printing, 1-20  
 probe  
   automatic sensing, 1-5  
   compensation, 1-6  
   connection, 1-5  
   trimmer capacitor, 1-6  
 Probe softkey, 1-6  
 pulse  
   measurements, 2-16 to 2-18  
   sync, 3-7  
 pulse parameters  
   *See* time measurements  
 pulse width, 2-18
- R**  
 rear panel outputs, 3-20  
 rearming trigger, 2-8  
 Recall Setup softkey, 2-33  
 recall waveforms, 2-33  
 replaceable parts list, 4-65  
 replacement  
   list, 4-61, 4-65  
   parts, 4-57  
 reset setup, 2-35  
 reset the instrument, 2-35  
 rise time measurement, 2-16, 2-18  
 Rise Time softkey, 2-18  
 Roll  
   mode, 1-16  
   softkey, 1-16  
 Run, 2-7 to 2-8
- S**  
 sample rate, 5-7  
 save  
   setups, 2-34  
   waveforms, 2-33  
 Save to softkey, 2-33  
 SECAM, 3-4, 3-6, 3-11  
 self-calibrations, 4-25 to 4-26  
 self-test, 4-42  
 settings  
   default configuration, 2-35
- setup  
   default, 2-35  
   reset, 2-35  
   saving, 2-34  
 Show Meas softkey, 2-15, 2-17  
 signal  
   automatic display, 1-7  
   dc component, 1-8  
   noise, 2-28, 2-32  
 single  
   event, 2-8 to 2-9  
   trigger, 2-8 to 2-9  
 single shot  
   bandwidth, 2-9  
   event, 2-9  
 Single softkey, 2-8  
 Slope/Coupling key, 2-8  
 softkey, 1-2  
   *See* keys listed by name  
 Source softkey, 1-14, 2-14, 2-17, 2-20  
 specifications  
   *See* characteristics  
 status line, 1-2, 3-2, 3-14  
 Stop key, 2-7, 2-9  
 storage operation, 2-6 to 2-7  
 sub bright, 4-29  
 subtract waveforms, 5-2  
 sweep  
   delayed, 1-11 to 1-12, 3-14, 3-17, 5-4  
   main, 1-11 to 1-12, 3-14, 5-4  
   roll, 1-16  
   speed, 1-11 to 1-12, 5-4  
 sync  
   amplitude, 3-5  
   burst color, 3-7  
   pulse vertical, 3-6  
   pulses, 3-7  
 sync pulse, 3-15
- T**  
 temperature  
   characteristics, 5-9, 5-11  
   warm up, 4-5, 4-21  
 test  
   vertical interval signal, 3-5  
 test record, 4-19  
 threshold  
   preset configuration, 2-35

## Index

- time
  - negative, 1-12
- time base
  - accuracy, 5-4
  - preset configuration, 2-35
  - range, 1-11, 5-4
  - setup, 1-11 to 1-12
- time cursor, 3-12
- time domain, 3-18 to 3-19
- Time key, 2-14
- time measurements
  - duty cycle, 2-16 to 2-18
  - fall time, 2-16 to 2-18
  - frequency, 2-16 to 2-18
  - period, 2-16 to 2-18
  - rise time, 2-16 to 2-18
  - width, 2-16 to 2-18
- time reference, 2-4
- Time/Div, 2-3, 3-14
- trace
  - memory, 2-33
  - recall, 2-33
  - softkey, 2-33
  - to save, 2-33
- Trace Mem softkey, 2-33
- trigger
  - characteristics, 5-5, 5-14
  - complex waveforms, 2-12
  - external, 5-5, 5-14
  - holdoff, 1-15, 2-12
  - internal, 5-5, 5-14
  - level, 1-13, 2-8
  - loss of, 1-14
  - maximum input voltage, 5-5
  - mode, 1-14 to 1-15
  - point, 1-12
  - posttrigger information, 1-12
  - preset configuration, 2-35
  - pretrigger information, 1-12
  - rearming, 2-8
  - roll, 1-16
  - single, 2-8 to 2-9
  - slope, 2-8
  - source, 1-13, 1-15, 2-8, 3-20
  - to verify, 4-15
  - TV, 1-14, 2-40, 2-42, 3-16
  - TV mode, 2-40
- troubleshooting the oscilloscope, 4-9
- TV
  - display grid, 3-4
  - grid, 3-12
  - trigger, 1-14, 2-40, 2-42, 3-16
  - trigger mode, 2-40
  - trigger-both fields, 2-42
  - vertical sync, 2-42
- TV graticule, 3-12, 3-14
- TV softkeys, 1-14
- U**
  - undo Autoscale, 1-7, 2-35, 3-4
  - using color, 1-17
- V**
  - verifying Vertical Output, 4-18
- vernier
  - accuracy, 5-3
  - horizontal, 5-4
  - vertical, 1-9
- Vernier softkey, 1-9
- Vert Rej, 3-7
- vertical
  - calibration, 4-26
  - characteristics, 5-2 to 5-3
  - expand signal, 1-10
  - interval, 3-7 to 3-8
  - interval reject, 3-7
  - interval test signal (VITS), 3-5, 3-16 to 3-17
  - linearity, 4-30
  - reject, 3-7
  - scaling, 1-9
  - sensitivity, 1-9
  - size, 4-30
  - step size, 1-9
  - sync, 2-42
  - sync interval, 3-8
  - window, 1-8 to 1-9
- Vertical Out, 4-18
- vertical output, 3-20
- Vertical softkey, 4-26
- Vertical Sync, 3-10
- video
  - autoscale, 3-4, 3-16
  - signal, 3-4
  - signal components, 3-8
  - signal envelope, 3-10
  - signal unclamped, 3-16
  - trigger, 2-40, 2-42, 3-16
  - waveforms, 2-40 to 2-41, 3-16 to 3-17
- video autoscale, 3-12
- VITS, 2-40
- voltage
  - adjustment, 4-22
  - maximum input, 1-5, 5-2, 5-5
  - measurement accuracy, 4-8
  - measurements, 2-19 to 2-22
  - peak to peak, 2-20
  - Vavg, 2-20
  - Vbase, 2-22
  - vernier, 1-9
  - Vmax, 2-22
  - Vmin, 2-22
  - Vrms, 2-20 to 2-21
  - Vtop, 2-22
- voltage cursor, 3-12
- volts versus time, 2-36
- volts versus volts, 2-36
- Volts/Div knob, 1-9
- W**
  - waveform
    - complex, 2-12
    - saving, 2-33
    - width, 2-16, 2-18
- X**
- XY
  - characteristics, 5-6
  - cursors, 2-36 to 2-39
  - display mode, 2-36 to 2-39
  - measurements, 2-38
- XY softkey, 2-36

# DECLARATION OF CONFORMITY

according to ISO/IEC Guide 22 and EN 45014

**Manufacturer's Name:** Agilent Technologies  
**Manufacturer's Address:** Colorado Springs Division  
1900 Garden of the Gods Road  
Colorado Springs, CO 80907 USA

declares, that the product

**Product Name:** Digitizing Oscilloscope  
**Model Number(s):** 54615B, 54616B, and 54616C  
**Product Option(s):** All

conforms to the following Product Specifications:

**Safety:** IEC 1010-1:1990+A1 / EN 61010-1:1993  
UL 3111  
CSA-C22.2 No. 1010.1:1993

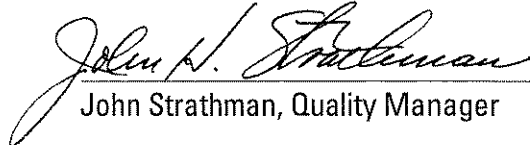
**EMC:** CISPR 11:1990 / EN 55011:1991 Group 1 Class A  
IEC 555-2:1982 + A1:1985 / EN 60555-2:1987  
IEC 555-3:1982 + A1:1990 / EN 60555-3:1987 + A1:1991  
IEC 801-2:1991 / EN 50082-1:1992 4 kV CD, 8 kV AD  
IEC 801-3:1984 / EN 50082-1:1992 3 V/m, {1kHz 80% AM, 27-1000 MHz}  
IEC 801-4:1988 / EN 50082-1:1992 0.5 kV Sig. Lines, 1 kV Power Lines

## Supplementary Information:

The product herewith complies with the requirements of the Low Voltage Directive 73/23/EEC and the EMC Directive 89/336/EEC and carries the CE marking accordingly.

This product was tested in a typical configuration with Agilent Technologies test systems.

Colorado Springs, 04/25/96

  
John Strathman, Quality Manager

European Contact: Your local Agilent Technologies Sales and Service Office or Agilent Technologies GmbH, Department ZQ / Standards Europe, Herrenberger Strasse 130, D-71034 Böblingen Germany (FAX: +49-7031-14-3143)

---

### **Product Warranty**

This Agilent Technologies product has a warranty against defects in material and workmanship for a period of three years from date of shipment. During the warranty period, Agilent Technologies will, at its option, either repair or replace products that prove to be defective.

For warranty service or repair, this product must be returned to a service facility designated by Agilent Technologies.

For products returned to Agilent Technologies for warranty service, the Buyer shall prepay shipping charges to Agilent Technologies and Agilent Technologies shall pay shipping charges to return the product to the Buyer. However, the Buyer shall pay all shipping charges, duties, and taxes for products returned to Agilent Technologies from another country.

Agilent Technologies warrants that its software and firmware designated by Agilent Technologies for use with an instrument will execute its programming instructions when properly installed on that instrument. Agilent Technologies does not warrant that the operation of the instrument software, or firmware will be uninterrupted or error free.

### **Limitation of Warranty**

The foregoing warranty shall not apply to defects resulting from improper or inadequate maintenance by the Buyer, Buyer-supplied software or interfacing, unauthorized modification or misuse, operation outside of the environmental specifications for the product, or improper site preparation or maintenance.

**No other warranty is expressed or implied. Agilent Technologies specifically disclaims the implied warranties of merchantability or fitness for a particular purpose.**

### **Exclusive Remedies**

The remedies provided herein are the buyer's sole and exclusive remedies. Agilent Technologies shall not be liable for any direct, indirect, special, incidental, or consequential damages, whether based on contract, tort, or any other legal theory.

### **Assistance**

Product maintenance agreements and other customer assistance agreements are available for Agilent Technologies products.

For any assistance, contact your nearest Agilent Technologies Sales Office.

### **Certification**

Agilent Technologies certifies that this product met its published specifications at the time of shipment from the factory. Agilent Technologies further certifies that its calibration measurements are traceable to the United States National Institute of Standards and Technology, to the extent allowed by the Institute's calibration facility, and to the calibration facilities of other International Standards Organization members.

### **About this edition**

This is the *Agilent 54615B, 54616B, and 54616C Oscilloscope User and Service Guide*.

Publication number  
54615-97019, June 2000

Print history is as follows:

54615-97009, July 1996  
54615-97008, February 1996  
54615-97000, October 1995  
Printed in USA.

New editions are complete revisions of the manual. Update packages, which are issued between editions, contain additional and replacement pages to be merged into the manual by you. The dates on the title page change only when a new edition is published.

© Copyright Agilent Technologies 1993-1996, 2000 All Rights Reserved.

Reproduction, adaptation, or translation without prior written permission is prohibited, except as allowed under the copyright laws.

#### Document Warranty

The information contained in this document is subject to change without notice.

**Agilent Technologies makes no warranty of any kind with regard to this material, including, but not limited to, the implied warranties of merchantability or fitness for a particular purpose.**

Agilent Technologies shall not be liable for errors contained herein or for damages in connection with the furnishing, performance, or use of this material.

#### Safety

This apparatus has been designed and tested in accordance with IEC Publication 1010, Safety Requirements for Measuring Apparatus, and has been supplied in a safe condition. This is a Safety Class I instrument (provided with terminal for protective earthing). Before applying power, verify that the correct safety precautions are taken (see the following warnings). In addition, note the external markings on the instrument that are described under "Safety Symbols."

#### Warning

- Before turning on the instrument, you must connect the protective earth terminal of the instrument to the protective conductor of the (mains) power cord. The mains plug shall only be inserted in a socket outlet provided with a protective earth contact. You must not negate the protective action by using an extension cord (power cable) without a protective conductor (grounding). Grounding one conductor of a two-conductor outlet is not sufficient protection.
- Only fuses with the required rated current, voltage, and specified type (normal blow, time delay, etc.) should be used. Do not use repaired fuses or short-circuited fuseholders. To do so could cause a shock or fire hazard.

- Service instructions are for trained service personnel. To avoid dangerous electric shock, do not perform any service unless qualified to do so. Do not attempt internal service or adjustment unless another person, capable of rendering first aid and resuscitation, is present.

- If you energize this instrument by an auto transformer (for voltage reduction), make sure the common terminal is connected to the earth terminal of the power source.

- Whenever it is likely that the ground protection is impaired, you must make the instrument inoperative and secure it against any unintended operation.

- Do not operate the instrument in the presence of flammable gasses or fumes. Operation of any electrical instrument in such an environment constitutes a definite safety hazard.

- Do not install substitute parts or perform any unauthorized modification to the instrument.

- Capacitors inside the instrument may retain a charge even if the instrument is disconnected from its source of supply.

- Use caution when exposing or handling the CRT. Handling or replacing the CRT shall be done only by qualified maintenance personnel.

#### Safety Symbols



Instruction manual symbol: the product is marked with this symbol when it is necessary for you to refer to the instruction manual in order to protect against damage to the product.



Hazardous voltage symbol.



Earth terminal symbol: Used to indicate a circuit common connected to grounded chassis.

#### WARNING

The Warning sign denotes a hazard. It calls attention to a procedure, practice, or the like, which, if not correctly performed or adhered to, could result in personal injury. Do not proceed beyond a Warning sign until the indicated conditions are fully understood and met.

#### CAUTION

The Caution sign denotes a hazard. It calls attention to an operating procedure, practice, or the like, which, if not correctly performed or adhered to, could result in damage to or destruction of part or all of the product. Do not proceed beyond a Caution symbol until the indicated conditions are fully understood or met.

Agilent Technologies  
P.O. Box 2197  
1900 Garden of the Gods Road  
Colorado Springs, CO 80901