

## Errata

**Title & Document Type:** 5004A Signature Analyzer Operating and Service Manual

**Manual Part Number:** 05004-90001

**Revision Date:** March 1977

### About this Manual

We've added this manual to the Agilent website in an effort to help you support your product. This manual provides the best information we could find. It may be incomplete or contain dated information, and the scan quality may not be ideal. If we find a better copy in the future, we will add it to the Agilent website.

### HP References in this Manual

This manual may contain references to HP or Hewlett-Packard. Please note that Hewlett-Packard's former test and measurement, life sciences, and chemical analysis businesses are now part of Agilent Technologies. The HP XXXX referred to in this document is now the Agilent XXXX. For example, model number HP8648A is now model number Agilent 8648A. We have made no changes to this manual copy.

### Support for Your Product

Agilent no longer sells or supports this product. You will find any other available product information on the Agilent Test & Measurement website:

[www.agilent.com](http://www.agilent.com)

Search for the model number of this product, and the resulting product page will guide you to any available information. Our service centers may be able to perform calibration if no repair parts are needed, but no other support from Agilent is available.



**Agilent Technologies**

# 5004A SIGNATURE ANALYZER



HEWLETT  PACKARD

HP 5004A



OPERATING AND SERVICE MANUAL

# 5004A SIGNATURE ANALYZER

## SERIAL NUMBERS

This manual applies directly to instruments with serial numbers prefixed 1704.

Copyright      HEWLETT-PACKARD COMPANY      1977  
5301 STEVENS CREEK BLVD., SANTA CLARA, CALIF. 95050

MANUAL PART NO. 05004-90001  
Microfiche Part No. 05004-90002

Printed: MAR 1977

**TABLE OF CONTENTS**

<b>Section</b>	<b>Title</b>	<b>Page</b>
I	GENERAL INFORMATION .....	1-1
	1-1. Introduction .....	1-1
	1-3. Safety Considerations .....	1-1
	1-6. Options (Line Voltages) .....	1-1
	1-8. Instruments Covered by Manual .....	1-1
	1-13. Specifications .....	1-1
	1-15. Description of 5004A Signature Analyzer .....	1-2
	1-17. Signature Analysis .....	1-2
	1-19. Accessories Supplied .....	1-3
	1-21. Recommended Test Equipment .....	1-3
II	INSTALLATION .....	2-1
	2-1. Introduction .....	2-1
	2-3. Initial Inspection .....	2-1
	2-5. Preparation for Use .....	2-1
	2-6. Power Requirements .....	2-1
	2-8. Line Voltage Selection .....	2-1
	2-10. Line Voltage Label .....	2-1
	2-12. Power Cable .....	2-1
	2-14. Operating Environment .....	2-2
	2-18. Storage and Shipment .....	2-3
	2-19. Environment .....	2-3
	2-22. Packaging .....	2-3
III	OPERATION .....	3-1
	3-1. Introduction .....	3-1
	3-3. Panel Features .....	3-1
	3-5. Signature Display .....	3-1
	3-8. Hexadecimal Number System Symbols (Digits) .....	3-1
	3-10. Test Terminal Grabber Connectors .....	3-1
	3-12. Operator's Maintenance .....	3-5
	3-14. Operator Self-Test of 5004A .....	3-5
	3-16. Instruments Compatible with 5004A .....	3-7
	3-18. Operating Instructions .....	3-7
	3-20. Typical Connections of 5004A to Device Under Test .....	3-8
	3-22. Probe, Pod, and Power Cable Storage .....	3-9
	3-24. Troubleshooting with the 5004A Signature Analyzer .....	3-9
IV	PERFORMANCE TESTS .....	4-1
	4-1. Introduction .....	4-1
	4-3. Test Equipment Required .....	4-1
	4-4. Logic Level Performance Test .....	4-1
	4-6. Positive Pulse Performance Test .....	4-2
	4-8. Negative Pulse Performance Test .....	4-3
	4-10. Data Probe Setup Time Performance Test .....	4-3
	4-12. Data Probe Hold Time Performance Test .....	4-5
	4-14. Test Record .....	4-5
V	ADJUSTMENTS .....	5-1
	5-1. Introduction .....	5-1
	5-3. Data Probe Threshold Voltage Check and Adjustments .....	5-1
	5-5. Power Transformer Primary Line Voltage Change Procedure .....	5-1

**TABLE OF CONTENTS (Continued)**

<b>Section</b>	<b>Title</b>	<b>Page</b>
VI	REPLACEABLE PARTS .....	6-1
	6-1. Introduction .....	6-1
	6-4. Ordering Information .....	6-3
	6-6. HP Part Number Organization .....	6-3
	6-8. Component Parts and Materials .....	6-3
	6-11. General Usage Parts .....	6-4
	6-13. Specific Instrument Parts .....	6-4
	6-15. Mechanical Parts .....	6-4
VII	MANUAL CHANGES .....	7-1
	7-1. Introduction .....	7-1
VIII	SERVICE .....	8-1
	8-1. Introduction .....	8-1
	8-3. Safety Considerations .....	8-1
	8-9. Recommended Test Equipment .....	8-1
	8-11. Logic Symbols .....	8-2
	8-13. Logic Concepts .....	8-2
	8-15. Negation .....	8-2
	8-17. Logic Implementation and Polarity Indication .....	8-3
	8-26. Other Symbols .....	8-5
	8-28. Dependency Notation "C" "G" "V" "F" .....	8-6
	8-30. Control Blocks .....	8-7
	8-32. Complex Logic Devices .....	8-8
	8-34. Troubleshooting (Failure Analysis) .....	8-9
	8-38. Troubleshooting Flowchart .....	8-9
	8-40. Major Test Point Signatures .....	8-9
	8-42. Troubleshooting Signatures with SELF-TEST and NORMAL/ SERVICE Switches .....	8-9
	8-44. Disassembly and Reassembly Procedures .....	8-14
	8-46. Data Probe Disassembly and Reassembly .....	8-15
	8-48. Gating Signals Pod Disassembly and Reassembly .....	8-15
	8-50. Block Diagram Description .....	8-16
	8-54. Clock, Start, and Stop Signal Paths .....	8-16
	8-56. Scan/Test Oscillator (Internal Clock) .....	8-16
	8-58. Self-Test .....	8-16
	8-60. Display Scan and Comparator Strobe .....	8-18
	8-62. Service (Troubleshooting) Mode .....	8-18
	8-64. Power Supply .....	8-18
	8-66. Circuit Theory (Principles of Operation) .....	8-18
	8-68. Purpose of 5004A .....	8-18
	8-70. Schematic Diagram .....	8-18
	8-72. Gating Signals Pod .....	8-18
	8-74. Edge Selection .....	8-18
	8-76. ECL-to-TTL Level Converters .....	8-19
	8-78. Gate Control .....	8-19
	8-80. State Diagram .....	8-19
	8-82. Data Signal Flow .....	8-19
	8-86. Pseudo-Random Word Generator (Data Signal Path Continued) .....	8-20
	8-88. Display Control (Data Signal Path Continued) .....	8-21
	8-90. Signature Comparator (UNSTABLE Signature Lamp) .....	8-21
	8-92. Scan/Test Oscillator .....	8-21
	8-94. Display Scan .....	8-21
	8-98. NORMAL/SERVICE Test Switch .....	8-21
	8-100. Input Signal Timing .....	8-21

**LIST OF TABLES**

<b>Table</b>	<b>Title</b>	<b>Page</b>
1-1.	Specifications .....	1-2
1-2.	Recommended Test Equipment .....	1-3
4-1.	Test Equipment Required .....	4-1
4-2.	Performance Test Record .....	4-5a
6-1.	Replaceable Parts .....	6-5
6-2.	Manufacturers Code List .....	6-9
8-1.	Troubleshooting Signatures Major Test Points .....	8-11
8-2.	SELF-TEST and NORMAL/SERVICE Signatures .....	8-13

**LIST OF FIGURES**

<b>Figure</b>	<b>Title</b>	<b>Page</b>
1-1.	Model 5004A Signature Analyzer .....	1-0
2-1.	Power Cable HP Part Numbers Versus Mains Plugs Available .....	2-2
3-1.	Front Panel, Probe, and Pod Features .....	3-2
3-2.	Operator Self-Test .....	3-4
3-3.	Operating Instructions .....	3-6
3-4.	Typical Connections of 5004A to Device Under Test .....	3-8
3-5.	Probe, Pod, and Power Cable Storage .....	3-9
4-1.	Logic Level Performance Test Setup .....	4-2
4-2.	Positive Pulse Performance Test Setup .....	4-2
4-3.	Negative Pulse Performance Test Setup .....	4-3
5-1.	Data Probe $V_{CC}$ — $V_{ref}$ Graph .....	5-2
5-2.	Fuse and Line Voltage Selection .....	5-3
6-1.	Mechanical Parts .....	6-10
8-1.	Troubleshooting Flowchart .....	8-11
8-2.	Heat Sink Screws Locations .....	8-14
8-3.	5004A Circuit Block Diagram .....	8-17
8-4.	Gate Control State Diagram .....	8-20
8-5.	Input Signals Timing .....	8-21
8-6.	Schematic Diagram Notes .....	8-22
8-7.	Probe and Pod (A3 and A4) Component Locations .....	8-24
8-8.	Display Board and Main Board (A1) Component Location .....	8-25
8-9.	Schematic Diagram .....	8-27

## **SAFETY CONSIDERATIONS**

### **GENERAL**

This is a Safety Class I instrument. This instrument has been designed and tested according to IEC Publication 348, "Safety Requirements for Electronic Measuring Apparatus."

### **OPERATION**

**BEFORE APPLYING POWER** verify that the power transformer primary is matched to the available line voltage and the correct fuse is installed (see Section II). Make sure that only fuses with the required rated current and of the specified type (normal blow, time delay, etc.) are used for replacement. The use of repaired fuses and the short-circuiting of fuseholders must be avoided.

### **SERVICE**

Although this instrument has been designed in accordance with international safety standards, this manual contains information, cautions, and warnings which must be followed to ensure safe operation and to retain the instrument in safe condition. Service and adjustments should be performed only by qualified service personnel.

Any adjustment, maintenance, and repair of the opened instrument under voltage should be avoided as much as possible and, when inevitable, should be carried out only by a skilled person who is aware of the hazard involved.

Capacitors inside the instrument may still be charged even if the instrument has been disconnected from its source of supply.

Whenever it is likely that the protection has been impaired, the instrument must be made inoperative and be secured against any unintended operation.

### **WARNING**

**IF THIS INSTRUMENT IS TO BE ENERGIZED VIA AN AUTOTRANSFORMER (FOR VOLTAGE REDUCTION) MAKE SURE THE COMMON TERMINAL IS CONNECTED TO THE EARTHED POLE OF THE POWER SOURCE.**

### **WARNING**

**BEFORE SWITCHING ON THE INSTRUMENT, THE PROTECTIVE EARTH TERMINALS OF THE INSTRUMENT MUST BE CONNECTED TO THE PROTECTIVE CONDUCTOR OF THE (MAINS) POWER CORD. THE MAINS PLUG SHALL ONLY BE INSERTED IN A SOCKET OUTLET PROVIDED WITH A PROTECTIVE EARTH CONTACT. THE PROTECTIVE ACTION MUST NOT BE NEGATED BY THE USE OF AN EXTENSION CORD (POWER CABLE) WITHOUT A PROTECTIVE CONDUCTOR (GROUNDING).**

### **WARNING**

**THE SERVICE INFORMATION FOUND IN THIS MANUAL IS OFTEN USED WITH POWER SUPPLIED AND PROTECTIVE COVERS REMOVED FROM THE INSTRUMENT. ENERGY AVAILABLE AT MANY POINTS MAY, IF CONTACTED, RESULT IN PERSONAL INJURY.**

### **CAUTION**

**BEFORE SWITCHING ON THIS INSTRUMENT:**

- 1. MAKE SURE THE INSTRUMENT IS SET TO THE VOLTAGE OF THE POWER SOURCE.**
- 2. ENSURE THAT ALL DEVICES CONNECTED TO THIS INSTRUMENT ARE CONNECTED TO THE PROTECTIVE (EARTH) GROUND.**
- 3. ENSURE THAT THE LINE POWER (MAINS) PLUG IS CONNECTED TO A THREE-CONDUCTOR LINE POWER OUTLET THAT HAS A PROTECTIVE (EARTH) GROUND. (GROUNDING ONE CONDUCTOR OF A TWO-CONDUCTOR OUTLET IS NOT SUFFICIENT.)**
- 4. MAKE SURE THAT ONLY FUSES WITH THE REQUIRED RATED CURRENT AND OF THE SPECIFIED TYPE (NORMAL BLOW, TIME DELAY, ETC.) ARE USED FOR REPLACEMENT. THE USE OF REPAIRED FUSES AND THE SHORT-CIRCUITING OF FUSE HOLDERS MUST BE AVOIDED.**



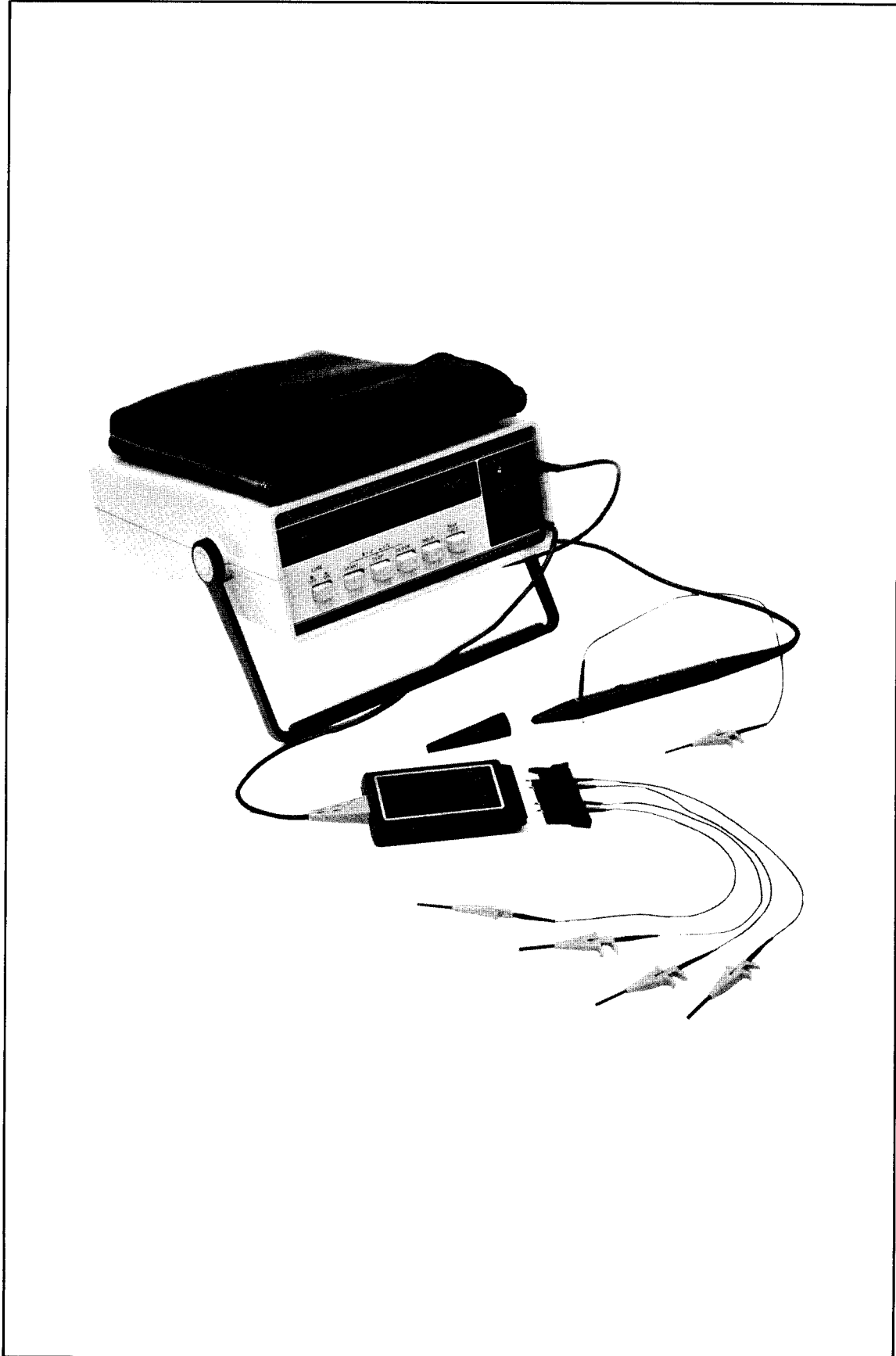

Figure 1-1. Model 5004A Signature Analyzer

## SECTION I GENERAL INFORMATION

### 1-1. INTRODUCTION

1-2. This operating and service manual contains information needed to operate, test, and service the Hewlett-Packard Model 5004A Signature Analyzer. *Figure 1-1* shows the 5004A.

### 1-3. SAFETY CONSIDERATIONS

1-4. The 5004A Signature Analyzer is a Safety Class I instrument. This instrument has been designed according to international safety standards.

1-5. This operating and service manual contains information, cautions, and warnings which must be followed by the user to ensure safe operation and keep the instrument in safe condition.

### 1-6. OPTIONS (LINE VOLTAGES)

1-7. Options for the 5004A are the four possible line voltage settings for the instrument. (Any 5004A may be set for any of the four line voltages, but the cabinet must be opened to change the line voltage setting.) The four option numbers are the same as the corresponding line voltages: 100, 120, 220, and 240, (e.g., Option 120 is for 120 Volt line supply). The procedure to change the line voltage setting is given in Section V.

### 1-8. INSTRUMENTS COVERED BY MANUAL

1-9. Attached to the instrument is a serial number plate. The serial number is in the form: 0000A00000. It is in two parts; the first four digits and the letter are the serial prefix and the last five digits are the suffix. The prefix is the same for all identical instruments; it changes only when a change is made to the instrument. The suffix however, is assigned sequentially and is different for each instrument. The contents of this manual apply to instruments with the serial number prefix(es) listed under SERIAL NUMBERS on the title page.

1-10. An instrument manufactured after the printing of this manual may have a serial number prefix that is not listed on the title page. This unlisted serial number prefix indicates the instrument is different from those described in this manual. The manual for this newer instrument is accompanied by a yellow Manual Changes supplement. This supplement contains "change information" that explains how to adapt the manual to the newer instrument.

1-11. In addition to change information, the supplement may contain information for correcting errors in the manual. To keep this manual as current and accurate as possible, Hewlett-Packard recommends that you periodically request the latest Manual Changes supplement. The supplement for this manual is identified with the manual print date and part number, both of which appear on the manual title page. Complimentary copies of the supplement are available from Hewlett-Packard.

1-12. For information concerning a serial number prefix that is not listed on the title page or in the Manual Changes supplement, contact your nearest Hewlett-Packard office.

### 1-13. SPECIFICATIONS

1-14. Overall specifications for the 5004A are given in *Table 1-1*.

Table 1-1. Specifications

<p><b>DISPLAY:</b> <b>Signature:</b> Four-digit hexadecimal. Characters 0,1,2,3,4,5,6,7,8,9,A,C,F,H,P,U. <b>GATE, UNSTABLE SIGNATURE indicators:</b> Panel Lights. Stretching: 100 milliseconds. <b>Probe-tip indicator:</b> Light indicates high, low, bad-level, and pulsing states. Minimum pulse width: 10 nanoseconds. Stretching: 50 milliseconds.</p> <p><b>PROBABILITY OF CLASSIFYING CORRECT DATA STREAM AS CORRECT:</b> 100%. <b>PROBABILITY OF CLASSIFYING FAULTY DATA STREAM AS FAULTY:</b> 99.998%. <b>MINIMUM GATE LENGTH:</b> One clock cycle. <b>MINIMUM TIMING BETWEEN GATES (from last STOP to next START):</b> One clock cycle.</p> <p><b>DATA PROBE:</b> <b>Input Impedance:</b> 50 K<math>\Omega</math> to 1.4 Volt, nominal. Shunted by 7 pF, nominal. <b>Threshold:</b> Logic one: 2.0 Volt <math>\pm</math>.2 <math>\pm</math>.3. Logic zero: .8 Volt, <math>\pm</math>.3 <math>\pm</math>.2. <b>Setup Time:</b> 15 nanoseconds, with .2 volt over-drive. (Data required to be valid at least 15 nanoseconds before selected clock edge.) <b>Hold Time:</b> 0 nanoseconds. (Data required to be held until occurrence of selected clock edge.)</p> <p><b>GATING INPUT LINES:</b> <b>START, STOP, CLOCK inputs:</b> Input Impedance: 50 K<math>\Omega</math> to 1.4 volt, nominal. Shunted by 7 pF, nominal. Threshold: 1.4 volt <math>\pm</math>.6 (.1 volt hysteresis, typical).</p> <p><b>START, STOP inputs:</b> <b>Setup Time:</b> 25 nanoseconds. (START, STOP to be valid at least 25 nanoseconds before selected clock edge.) <b>Hold Time:</b> Zero nanoseconds (START, STOP to be held until occurrence of selected clock edge.)</p> <p><b>CLOCK INPUT:</b> <b>Maximum clock frequency:</b> 10 MHz. <b>Minimum Clock Time in High or Low State:</b> 50 nanoseconds.</p> <p><b>VOLTAGE OVERLOAD PROTECTION:</b> All inputs <math>\pm</math>150 volts continuous. <math>\pm</math>250 volts intermittent. 250 volts ac for 1 minute.</p> <p><b>OPERATING ENVIRONMENT:</b> <b>Temperature:</b> 0—55°C. <b>Relative Humidity:</b> 95% at 40°C. <b>Altitude:</b> 4,600M.</p> <p><b>POWER REQUIREMENTS:</b> <b>Option 100:</b> 100V ac line, +5%, -10%, 48—440 Hz <b>Option 120:</b> 120V ac line, +5%, -10%, 48—440 Hz <b>Option 220:</b> 220V ac line, +5%, -10%, 48—66 Hz <b>Option 240:</b> 240V ac line, +5%, -10%, 48—66 Hz</p> <p><b>WEIGHT:</b> Net: 2.5 kg, 5.5 lbs. Shipping: 7.7 kg, 17 lbs.</p> <p><b>DIMENSIONS:</b> 90 mm high x 215 mm wide x 300 mm deep (3½ in. x 5½ in. x 12 in.) Dimensions exclude tilt bale, probes, and pouch.</p>
-------------------------------------------------------------------------------------------------------------------------------------------------------------------------------------------------------------------------------------------------------------------------------------------------------------------------------------------------------------------------------------------------------------------------------------------------------------------------------------------------------------------------------------------------------------------------------------------------------------------------------------------------------------------------------------------------------------------------------------------------------------------------------------------------------------------------------------------------------------------------------------------------------------------------------------------------------------------------------------------------------------------------------------------------------------------------------------------------------------------------------------------------------------------------------------------------------------------------------------------------------------------------------------------------------------------------------------------------------------------------------------------------------------------------------------------------------------------------------------------------------------------------------------------------------------------------------------------------------------------------------------------------------------------------------------------------------------------------------------------------------------------------------------------------------------------------------------------------------------------------------------------------------------------------------------------------------------------------------------------------------------------------------------------------------------------------------------------------------------------------------------------------------------------------------------------------------------------------------------------------------------------------------------------------------------------------------------------------------------------------------------------------------------------------------------------------------------------------------------------------------------------------------------------------------------------------------------------------------------------------------------------------------------------------------------------------

## 1-15. DESCRIPTION OF 5004A SIGNATURE ANALYZER

1-16. The HP Model 5004A Signature Analyzer is a test instrument for troubleshooting complex electronic logic circuits. It uses the signature analysis technique of troubleshooting.

## 1-17. Signature Analysis

1-18. Signature analysis is a method of troubleshooting complex electronic logic circuits to the individual component level. To use signature analysis with the 5004A, the unit to be tested must have certain characteristics included with the original design. Typically a logic product

intended for signature analysis troubleshooting will have a programmed controller and a stored short test program that can exercise most of the unit. Usually the test program is started by a “self-test” mode of the instrument. With the test program running, the 5004A (connected to the unit being tested) will display a unique hexadecimal signature for each signature analysis test point in the unit being tested. The 5004A requires four signals from the unit being tested: Clock, Start, Data, and Stop. The CLOCK signal synchronizes the two instruments. The exactly repetitive START and STOP signals define a window during which the DATA signal is being received by the 5004A. After the STOP signal the 5004A displays the unique hexadecimal signature of the data received.

### 1-19. ACCESSORIES SUPPLIED

- 1-20. The accessories supplied with the 5004A are shown in *Figure 1-1*.
- Depending on the customer’s location, the line power cable may be supplied with one of four line (mains) connectors. Refer to the “Power Cable” paragraph in Section II.
  - Five detachable “grabber” test connectors are supplied with the 5004A. Refer to Section III for a description and use.
  - One ground wire for the data probe is supplied with the 5004A.

### 1-21. RECOMMENDED TEST EQUIPMENT

1-22. *Table 1-2* lists recommended test equipment to test, maintain, and troubleshoot the 5004A.

*Table 1-2. Recommended Test Equipment*

INSTRUMENT	CRITICAL SPECS	RECOMMENDED HP MODEL
Pulse Generator	5 ns—100 ns delay	8007B
Pulse Generator	10 MHz, 5 volts pulse	8013B
Oscilloscope with dual-trace vertical amp.	100 MHz	182C, 1805A/1825A
Power Supply	5 volts	6111A
Digital Voltmeter	10 volts	3476A
Resistor	1000Ω 5% 1/4W	0683-1025
Resistor	50Ω 5% 2W	0698-3311
Capacitor	0.1 μF ±20% 25V	0170-0022
Capacitor	10 μF +75 -10% 25V	0180-0059
Logic Probe	TTL compatibility	545A
Logic Pulser	TTL compatibility	546A
Logic Current Tracer	1 ma—1 A Range	547A

## SECTION II INSTALLATION

### 2-1. INTRODUCTION

2-2. This section provides information for inspection, installation, and preparation for use of the 5004A Signature Analyzer.

### 2-3. INITIAL INSPECTION

2-4. Inspect the shipping container for damage. If the shipping container or cushioning material is damaged, it should be kept until the contents of the shipment have been checked for completeness and the instrument has been checked mechanically and electrically. The contents of the shipment should be as shown in *Figure 1-1*; procedures for checking electrical performance are given in Section IV. If the contents are incomplete, if there is mechanical damage or defect, or if the 5004A does not pass the performance tests, notify the nearest Hewlett-Packard office. If the shipping container is damaged, or the cushioning material shows signs of stress, notify the carrier as well as the Hewlett-Packard office. Keep the shipping materials for carrier's inspection. The HP office will arrange for repair or replacement at HP option without waiting for claim settlement.

### 2-5. PREPARATION FOR USE

#### 2-6. Power Requirements

2-7. The 5004A requires a power source as shown in Section I, Specifications.

#### 2-8. Line Voltage Selection

2-9. Changing the 5004A power source voltage setting requires the 5004A cabinet to be opened. Instructions for changing the line voltage setting are given in Section V.

#### 2-10. Line Voltage Label

2-11. The original line voltage setting for each 5004A as manufactured is printed on a label on the back panel of each 5004A. Check this label and compare the voltage (100, 120, 220, or 240) with your local line voltage supply. If you do not have the correct line voltage for your 5004A, notify a qualified technician and refer to Section V of this manual.

#### 2-12. Power Cable

2-13. The 5004A is shipped with a three-wire power cable. When the cable is connected to an appropriate ac power source, this cable grounds internal "grounds" in the 5004A and the two exposed screws on the rear panel heat sink. The type of power cable plug shipped with each instrument depends on the country of destination. Refer to *Figure 2-1* for the part numbers of the power cable and plug configurations available.

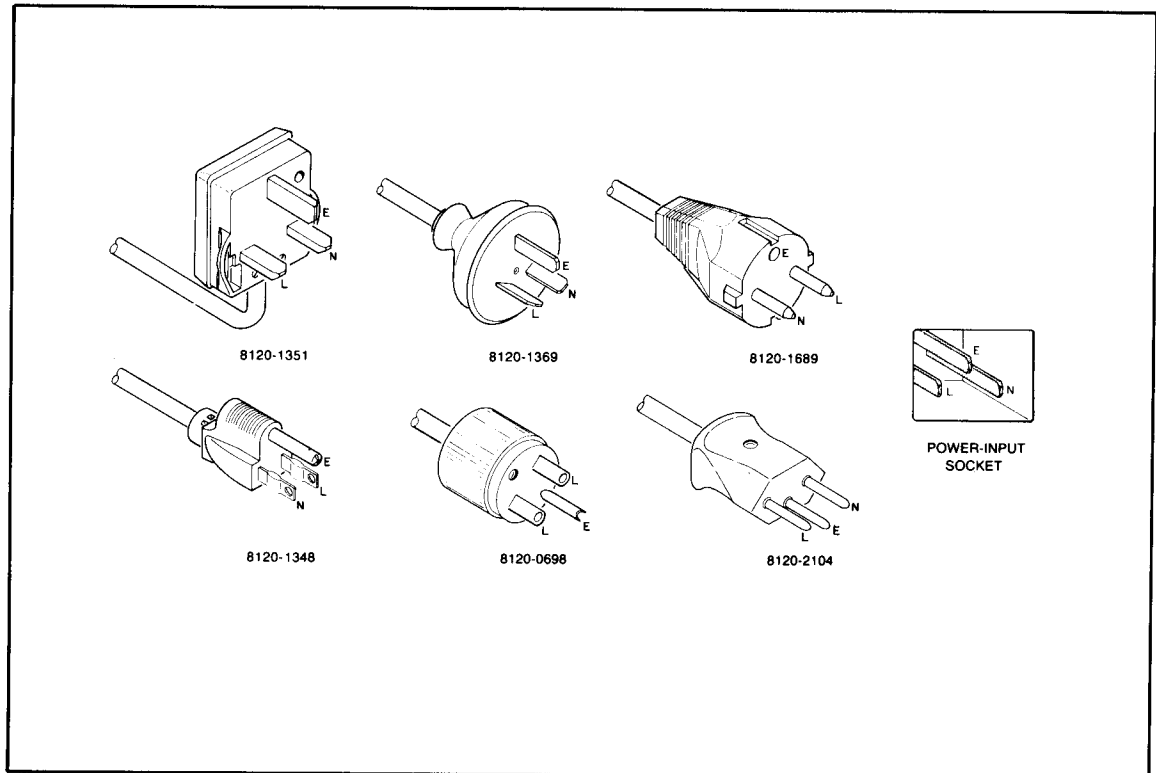

Figure 2-1. Power Cable HP Part Numbers Versus Mains Plugs Available

**WARNING**

**BEFORE SWITCHING ON THIS INSTRUMENT, THE PROTECTIVE EARTH TERMINALS OF THIS INSTRUMENT MUST BE CONNECTED TO THE PROTECTIVE CONDUCTOR OF THE (MAINS) POWER CORD. THE MAINS PLUG SHALL ONLY BE INSERTED IN A SOCKET OUTLET PROVIDED WITH A PROTECTIVE EARTH CONTACT. THE PROTECTIVE ACTION MUST NOT BE NEGATED BY THE USE OF AN EXTENSION CORD (POWER CABLE) WITHOUT A PROTECTIVE CONDUCTOR (GROUNDING).**

## 2-14. Operating Environment

2-15. TEMPERATURE. The 5004A may be operated in temperatures from 0°C to +55°C.

2-16. HUMIDITY. The 5004A may be operated in environments with humidity up to 95%. However, it should be protected from temperature extremes which cause condensation in the instrument.

2-17. ALTITUDE. The 5004A may be operated at altitudes up to 4,600 metres.

## 2-18. STORAGE AND SHIPMENT

### 2-19. Environment

2-20. The instrument may be stored or shipped in environments within the following limits:

Temperature .....	-40°C to +75°C
Humidity .....	Up to 95%
Altitude .....	4,600 meters (15,000 feet)

2-21. The instrument should also be protected from temperature extremes which cause condensation within the instrument.

### 2-22. Packaging

2-23. ORIGINAL PACKAGING. Containers and materials identical to those used in factory packaging are available through Hewlett-Packard offices. If the instrument is being returned to Hewlett-Packard for servicing, attach a tag indicating the type of service required, return address, model number, and full serial number. Also, mark the container FRAGILE to ensure careful handling. In any correspondence, refer to the instrument by model number and full serial number.

2-24. OTHER PACKAGING. The following general instructions should be used for repacking with commercially available materials:

- a. Wrap instrument in heavy paper or plastic. (If shipping to Hewlett-Packard office or service center, attach tag indicating type of service required, return address, model number, and full serial number.)
- b. Use strong shipping container. A double-wall carton made of 350-pound test material is adequate.
- c. Use a layer of shock-absorbing material 70 to 100 mm (3- to 4-inch) thick around all sides of the instrument to provide firm cushioning and prevent movement inside container. Protect control panel with cardboard.
- d. Seal shipping container securely.
- e. Mark shipping container FRAGILE to ensure careful handling.
- f. In any correspondence, refer to instrument by model number and full serial number.

## SECTION III OPERATION

### 3-1. INTRODUCTION

3-2. This section explains the functions of the operating controls, indicators, probe, and test connectors of the 5004A Signature Analyzer. An operator's self-test is given, and the normal operating modes are described.

### 3-3. PANEL FEATURES

3-4. Front panel features of the Signature Analyzer are described in *Figure 3-1*. This figure contains a detailed description of the controls, connectors, and indicators.

### 3-5. SIGNATURE DISPLAY

3-6. The 5004A Signature Analyzer presents digital signatures with a four-character (symbol) display on its front panel. Each character, which can be any one of 16 symbols, is shown on a 7-segment light-emitting-diode display 10 by 7 millimetres. The 16 possible characters are:

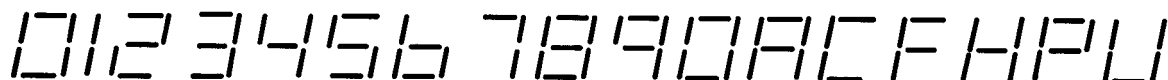

0 1 2 3 4 5 6 7 8 9 A B C F H P U

3-7. The characters presented on the display are a hexadecimal number which is the residue of a count in the 5004A after a START and a STOP signal have been received with some data bits in between.

#### NOTE

No signature appearing on the 5004A display has any particular significance beyond being a correct (expected) signature or an incorrect signature. The number is, however, a count residue in the 5004A converted to and displayed in hexadecimal.

### 3-8. HEXADECIMAL NUMBER SYSTEM SYMBOLS (DIGITS)

3-9. The four-digit front panel display presents numbers in a special set of hexadecimal symbols (see preceding paragraph). Note that the final six symbols are not the common hexadecimal symbols ABCDEF because the seven-segment display of the 5004A can not show a B or D that would be different from an 8 or 0 respectively (and several other symbols could be ambiguous).

### 3-10. TEST TERMINAL GRABBER CONNECTORS

3-11. Five test-terminal grabber-connectors are supplied with the 5004A. The grabbers are push-on pull-off connectors. A grabber can be used on the end of the active test pod test leads to make reliable electrical connections from the 5004A to the instrument being tested. *Figure 3-1* shows grabbers connected to the pod test leads. *Figure 3-4* shows grabbers connected to a device being tested. The removeable ground (common) test lead for the probe also has a grabber.



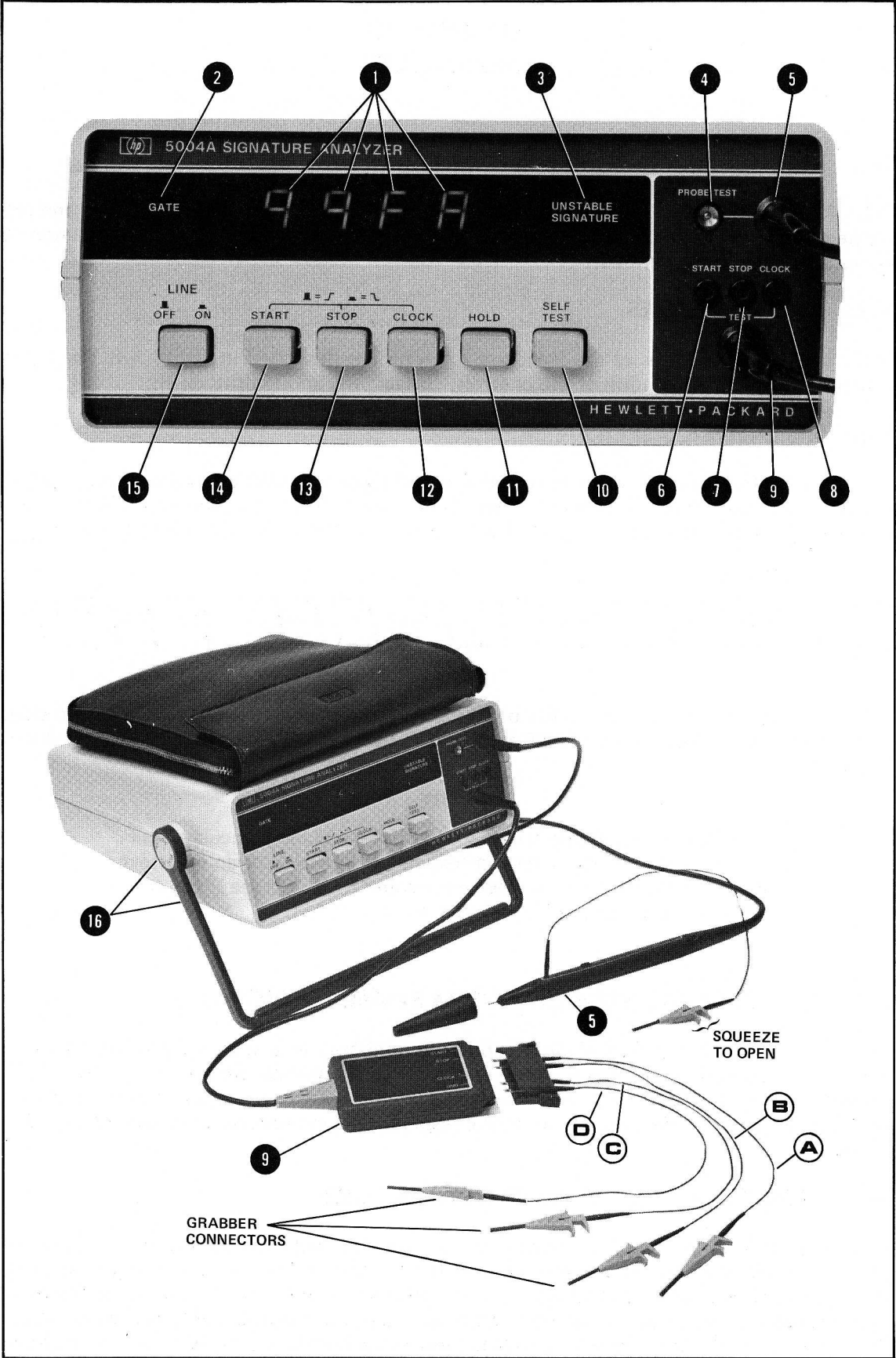

Figure 3-1. Front Panel, Probe, and Pod Features

### FRONT PANEL FEATURES

- 1 **FOUR-DIGIT DISPLAY:** Shows the unique signature stimulated by the input signals.
- 2 **GATE Lamp:** Regular blinking of GATE lamp indicates proper START/STOP gating signals.
- 3 **UNSTABLE SIGNATURE Lamp:** Intermittent or occasional blinking of this lamp indicates a difference between successive signatures inputted to the 5004A.
- 4 **PROBE TEST Connector:** Test point for 5004A data probe in SELF-TEST mode.
- 5 **DATA PROBE:** Point of entry for data from unit being tested by 5004A. Lamp near probe tip indicates logic level at tip: On Bright = High, On Dim = Bad-level, Off = Low, 10 ns or greater pulses are stretched to 100 ms. Note side ground connector for fast circuits and RESET switch.
- 6 **START Test Point:** Test point for the START test connector on the active pod in the SELF-TEST mode.
- 7 **STOP Test Point:** Test point for the STOP test connector on the active pod in the SELF-TEST mode.
- 8 **CLOCK Test Point:** Test point for the CLOCK test connector on the active pod in the SELF-TEST mode.
- 9 **Active Test Pod:** Four test inputs START, STOP, CLOCK, and a common GND (ground) are extended with this active pod for fast rise time signals and low circuit loading.
- A **START Test Lead:** Point of entry for START signal from the unit being tested by the 5004A.
- B **STOP Test Lead:** Point of entry for STOP signal from the unit being tested by the 5004A.
- C **CLOCK Test Lead:** Point of entry for CLOCK signal from the unit being tested by the 5004A.
- D **GND Test Lead:** Common (ground) test lead for connection to unit being tested by the 5004A.

### SWITCH NOTE

The following six switches 10, 11, 12, 13, 14, and 15 are all pushed once to lock in-on and push again to release out-off switches.

- 10 **SELF-TEST Switch:** When pushed and locked in, this test puts the 5004A in the SELF-TEST mode. (See SWITCH NOTE above.)
- 11 **HOLD Signature Switch:** When pushed and locked in, this switch will hold a single, one-time signature for comparison or recording. (See SWITCH NOTE above.)
- 12 13 14 **CLOCK, STOP, and START Switches:** These three switches are set to select either the positive-going (■ = /) (indicates switch position) transition or the negative-going (■ = \) (indicates switch position) transition of the respective signals as the active control for that signal. The CLOCK, STOP, and START switches are respectively the active control switches for the CLOCK, STOP, and START test inputs on the active pod. (See the SWITCH NOTE.)
- 15 **LINE OFF ON Switch:** (Indicates switch position.) This switch controls application of mains line power to the 5004A. Line power is applied when the switch is pushed and locked in. Line power is disconnected when the switch is out. (See SWITCH NOTE.)
- 16 **Handle-Stand:** The combination handle and stand can be rotated by pulling gently at the side pivot points both sides simultaneously and turning the handle to the desired position.

Figure 3-1. Front Panel, Probe, and Pod Features (Continued)

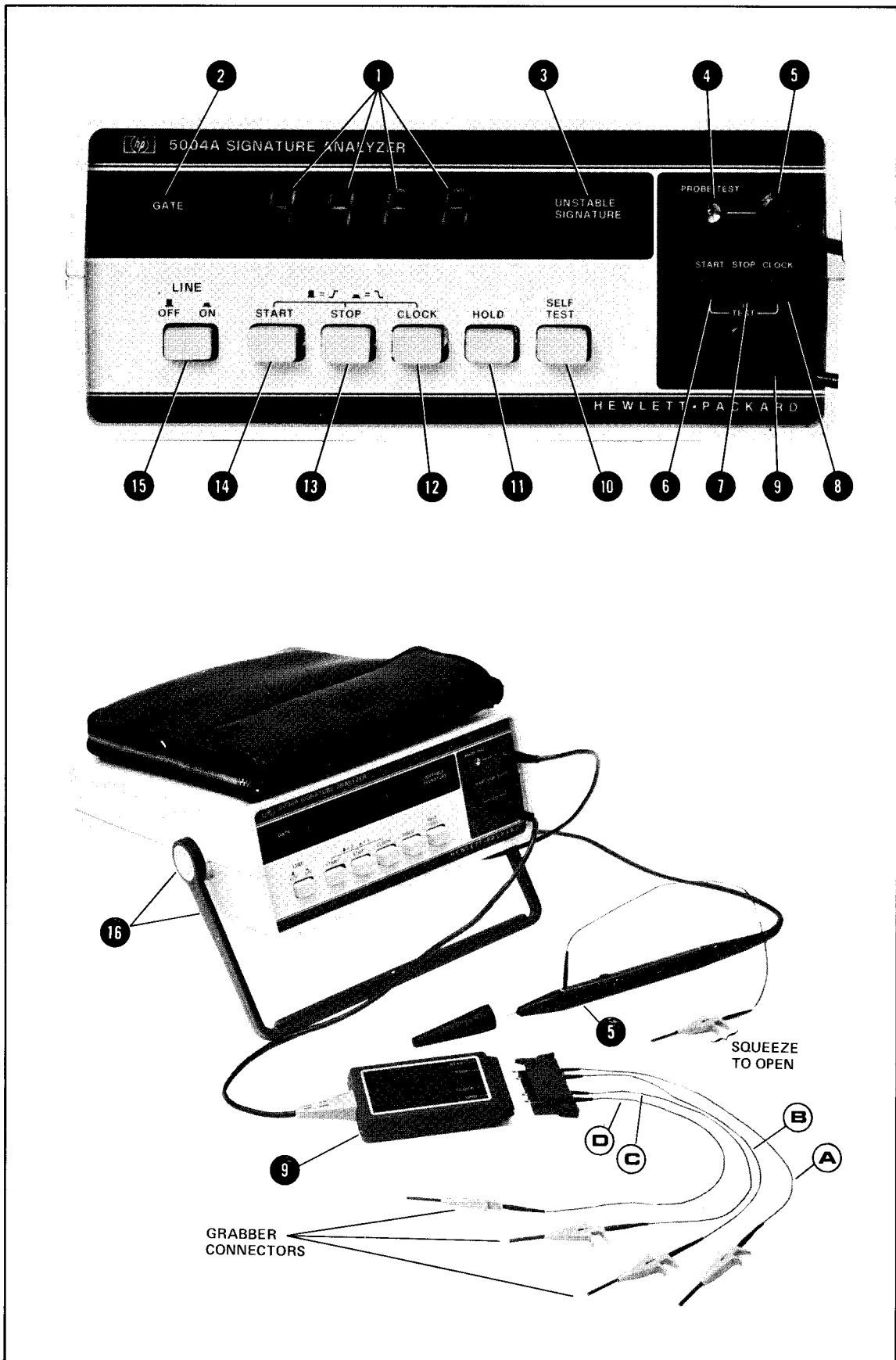

Figure 3-2. Operator Self-Test

### 3-12. OPERATOR'S MAINTENANCE

3-13. There are no operator's maintenance procedures for the 5004A.

#### FUSE NOTE

The 5004A power line fuse is inside the cabinet. If a 5004A seems to NOT operate as if a fuse were blown refer the unit to qualified maintenance personnel.

### 3-14. OPERATOR SELF-TEST of 5004A





3-15. The 5004A Signature Analyzer has a SELF-TEST (front panel switch) mode which can be used to check the condition of the unit thoroughly. Use the procedure in *Figure 3-2* to SELF-TEST a 5004A.

1. Before applying power to the 5004A check that the line (mains) voltage available matches the label on the 5004A rear panel.



#### CAUTION

**THE 5004A HAS INTERNALLY-SWITCHABLE OPTIONAL DIFFERENT POWER LINE VOLTAGES. REFER TO SECTION V FOR LINE VOLTAGE CHANGE PROCEDURE.**

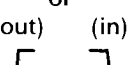
2. Remove the grabber connectors from the pod test leads, and connect the pod (START, STOP, and CLOCK) leads to the matching START, STOP, and CLOCK receptacles on the 5004A front panel.
3. Connect the 5004A data probe to the PROBE TEST receptacle on the 5004A front panel. Push the probe tip point gently and firmly into the PROBE TEST receptacle until the point is held securely.
4. Connect the 5004A power cable to the correct power source and set the 5004A front panel as follows for the displays shown:

Switch Settings			Displays			
START	STOP	CLOCK	Four Seven-Segment (See Note)	GATE	UNSTABLE SIGNATURE	PROBE TIP LIGHT
(in) 	(in) 	or 	UP73 then ACA2	flickers	Flickers except when good signature is on	Flickers when "ACA2" is on
(out) 	(out) 	or (out) (in) 	3951 then 2P61	flickers	Flickers except when good signature is on	Flickers when "2P61" is on

#### NOTE

In SELF-TEST mode, the four 7-segment displays first have all seven segments lit dimly,  , for about 1-second (tests all segments) and then have one of the signature sets listed above for about 1-second. If the probe RESET switch is pressed during the SELF-TEST mode, the four 7-segment-digit displays will show  (all zeroes) except when all segments are dimly lit 

#### CAUTION

**THE 5004A HAS INTERNALLY-SWITCHABLE OPTIONAL DIFFERENT POWER LINE VOLTAGES. REFER TO SECTION V FOR LINE VOLTAGE CHANGE PROCEDURE.**

Figure 3-2. Operator Self-Test (Continued)

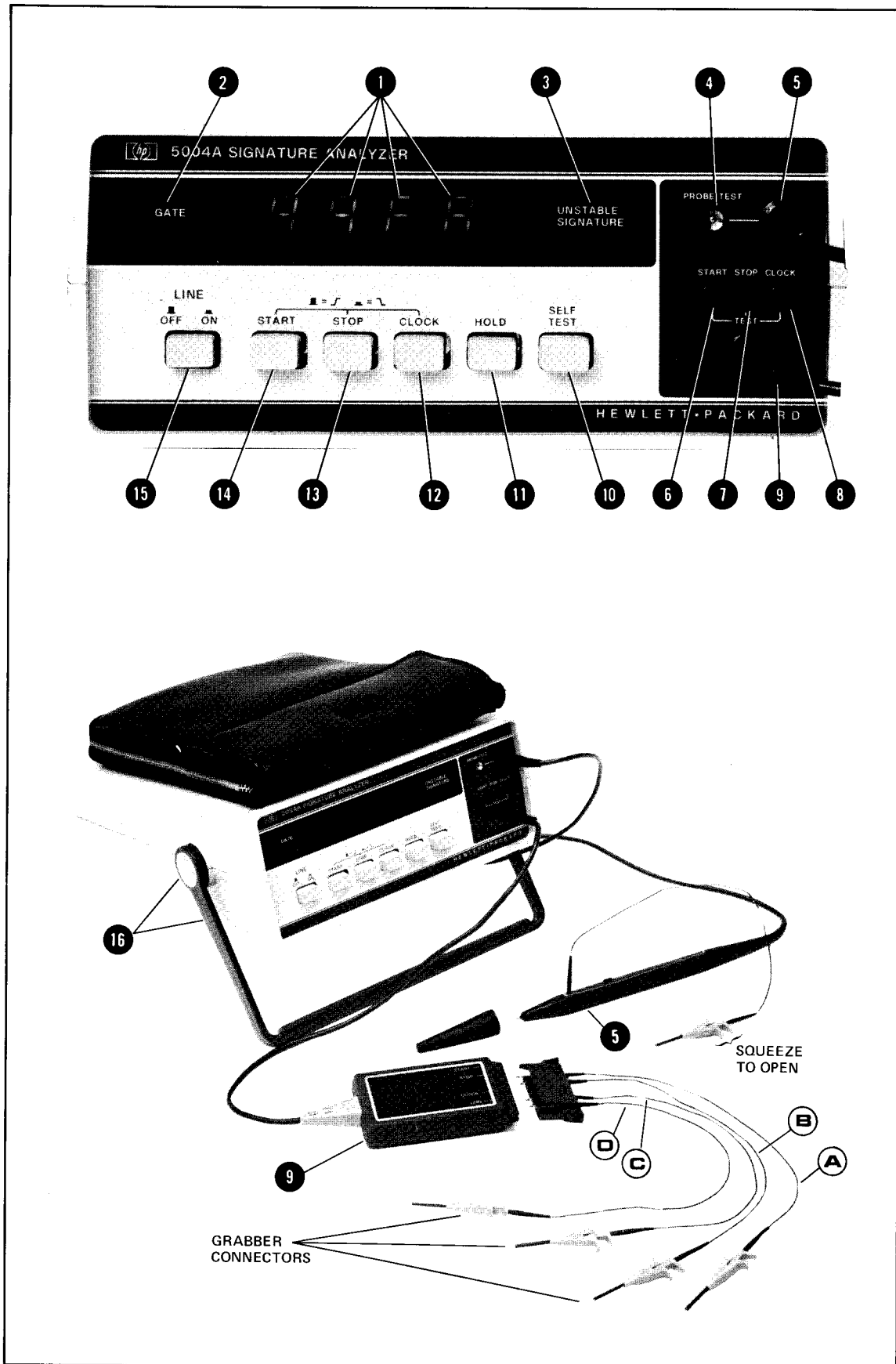

Figure 3-3. Operating Instructions



### 3-16. INSTRUMENTS COMPATIBLE WITH 5004A

3-17. The 5004A is used to check the operation of electronic digital logic instruments with built-in capability to be tested with the signature analysis method. Instruments to be checked by the 5004A must be compatible with the 5004A. Refer to the specifications and other details in Section I of this manual for compatibility information.

### 3-18. OPERATING INSTRUCTIONS

3-19. *Figure 3-3* shows operating procedures for the 5004A Signature Analyzer. Refer to the instruction manual of the instrument to be tested for detailed steps for use of the 5004A Signature Analyzer.

**OPERATING INSTRUCTIONS**

1. Before applying power to the 5004A study and learn the information given in *Figure 3-1*, Front Panel Features and perform the Operators Self-Test in *Figure 3-2*.
2. Refer to the instruction manual for the instrument or system to be tested.

**NOTE**

Correct (expected) "signatures" for the device under test (D.U.T.) must be known for proper use of the 5004A. Signatures will usually be in the troubleshooting section of the D.U.T. manual.

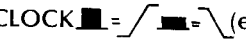
3. Connect the 5004A START, STOP, CLOCK, and GND test inputs **9** on the test pod to the specified test points of the D.U.T. (Refer to D.U.T. manual.)
4. Set the 5004A front panel START **14**, STOP **13**, and **12** CLOCK  (edge select) switches as stated in the D.U.T. manual.

**NOTE**

The edge select switches allow flexibility in selection of START and STOP signals. For example, one long pulse can be used for both START and STOP if the rising edge is START and the falling edge is STOP.

**NOTE**

The (11) HOLD and (10) SELF-TEST switch buttons should normally be in the out position.

5. Use the 5004A Data Probe **5** to check the signature nodes of the D.U.T., and compare the signatures found with the signatures given in the D.U.T. manual.

**NOTE**

Especially when slow clock signals are used, the first one or two signatures displayed may be wrong. Two successive identical signatures indicate the signature of that point.

6. If one or more incorrect signatures are found, refer to the troubleshooting procedures in the DUT manual.

**NOTE**

If most or all signatures are incorrect, check the preliminary settings given in the DUT manual.

**NOTE**

Using the HOLD function (HOLD switch **11** in) allows observation of a signature occurring once. (The DATA PROBE **5** RESET switch will erase a HELD signature.)

*Figure 3-3. Operating Instructions (Continued)*

### 3-20. TYPICAL CONNECTIONS OF 5004A TO DEVICE UNDER TEST

3-21. *Figure 3-4* shows the 5004A Signature Analyzer connected to another device to take "signatures"

#### CAUTION

The black finned heat sink on the rear of the cabinet is "grounded" (connected) to the power line "earth" terminal.

#### NOTE

The bottom of the 5004A is insulating plastic material so it will not cause any electrical short circuits.



*Figure 3-4. Typical Connections of 5004A to Device Under Test*

### 3-22. PROBE, POD, AND POWER CABLE STORAGE

3-23. Figure 3-5 shows the gating signals pod, data probe, line power cable in the recommended storage positions. The storage case on top of the 5004A should be used to store these components when the 5004A is not in use or is being transported.

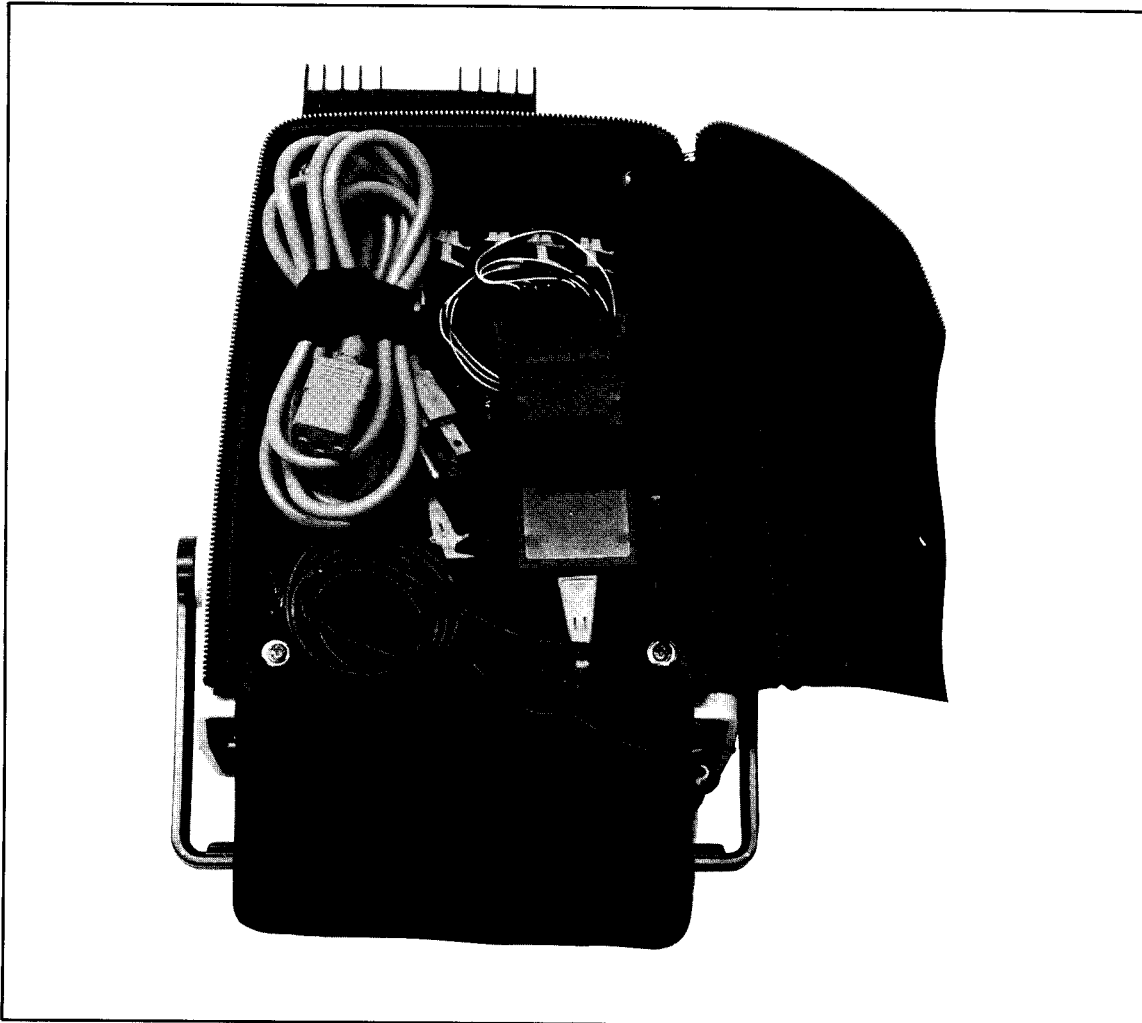

Figure 3-5. Probe, Pod, and Power Cable Storage

### 3-24. TROUBLESHOOTING WITH THE 5004A SIGNATURE ANALYZER

3-25. Digital instruments designed to be serviced with Signature Analysis will have a listing of correct signatures available either in a service manual or in some other form (e.g., a listing of correct signatures and conditions could be printed on an instrument top or bottom cover, or on a card inside the cabinet). Whatever form the list takes the Signature Analyzer can be used in much the same manner as a meter or oscilloscope to trace correct signals.

#### NOTE

A system with signatures will usually be setup so data paths can be signature checked in "signal tracing" fashion.

3-26. The traditional "half-split" method of signal tracing can be used with a Signature Analyzer.



## SECTION IV PERFORMANCE TESTS

### 4-1. INTRODUCTION

4-2. The procedures in this section test the instrument's electrical performance using the specifications of *Table 1-1* as the performance standards. All tests can be performed without access to the interior of the 5004A. A simpler operational test is included in Section III under Operator's Check.

### 4-3. TEST EQUIPMENT REQUIRED (see *Table 4-1*)

*Table 4-1. Required Test Equipment*

INSTRUMENT	CRITICAL SPECS	RECOMMENDED HP MODEL
Pulse Generator	5 ns—100 ns delay	8007B
Pulse Generator	10 MHz, 5 volts pulse	8013B
Oscilloscope with dual-trace vertical amp.	100 MHz	182C, 1805A/1825A
Power Supply	5 volts	6111A
Digital Voltmeter	10 volts	3476A
Resistor	1000 $\Omega$ 5% 1/4W	0683-1025
Resistor	50 $\Omega$ 5% 2W	0698-3311
Capacitor	0.1 $\mu$ F $\pm$ 20% 25V	0170-0022
Capacitor	10 $\mu$ F +75 -10% 25V	0180-0059

### 4-4. LOGIC LEVEL PERFORMANCE TEST

4-5. With test equipment connected as shown in *Figure 4-1*, proceed as follows:

- a. Turn power ON on 5004A, all other switches OUT.
- b. Adjust the 6111A Power Supply to 0 volts. Probe indicator light should be off.
- c. Vary the Power Supply until probe indicator just light up dimly. Probe tip voltage should be +0.8V, +0.3V, -0.2V.
- d. Increase power supply voltage until indicator reaches full brilliance. Probe tip voltage should be 2.0V, +0.2V, -0.3V.
- e. Disconnect test equipment.

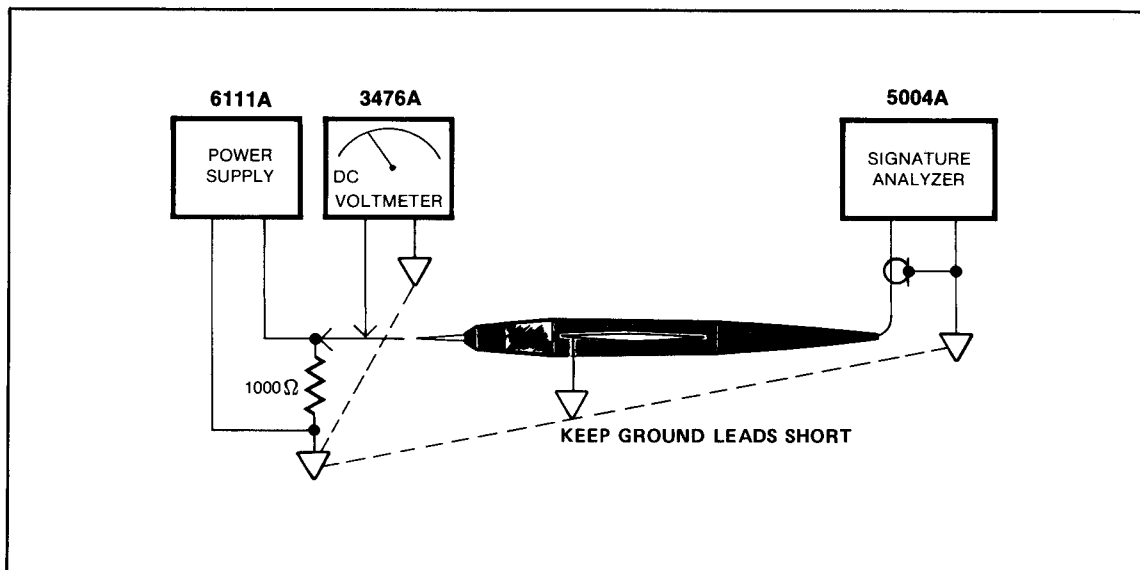

Figure 4-1. Logic Level Performance Test Setup

#### 4-6. POSITIVE PULSE PERFORMANCE TEST

4-7. With test equipment connected as in Figure 4-2, proceed as follows:

- a. Set Pulse Generator to output a positive-going 5-volt/10 ns pulse.
- b. Set Pulse Generator repetition rate to approximately one-pulse-per-second. The probe indicator should flash once every second.
- c. Disconnect test equipment.

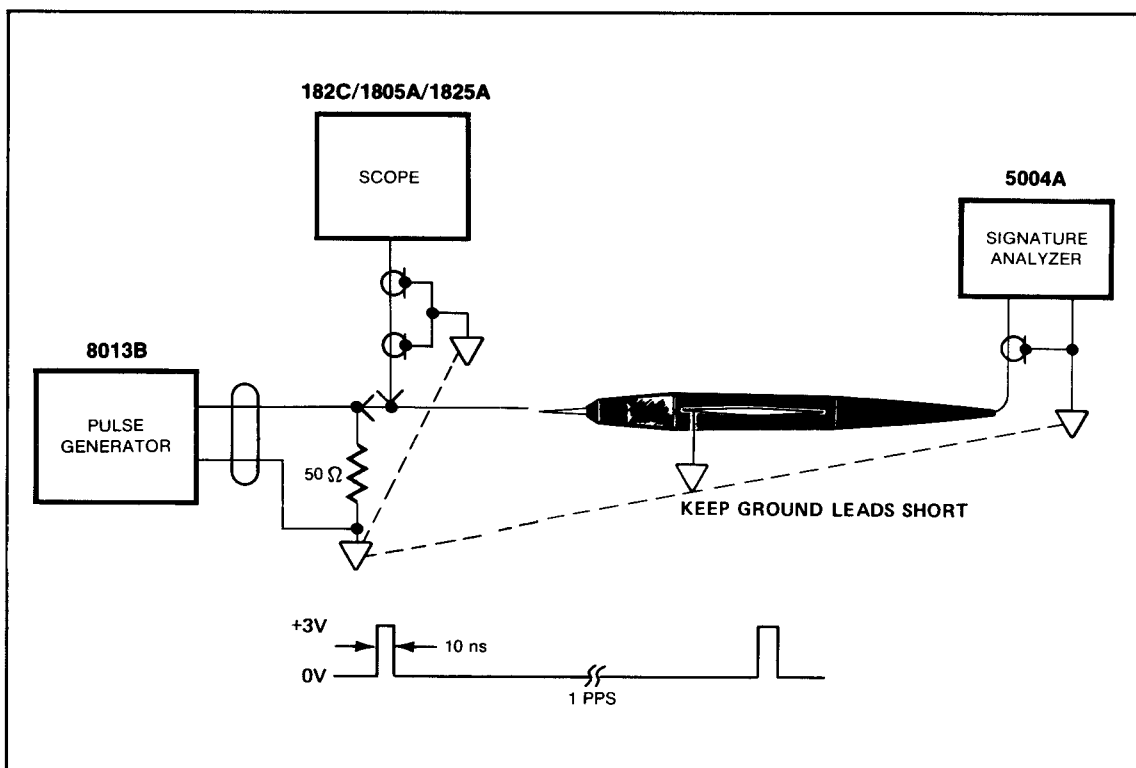

Figure 4-2. Positive Pulse Performance Test Setup

## 4-8. NEGATIVE PULSE PERFORMANCE TEST

- 4-9. With test equipment connected as in *Figure 4-3*, proceed as follows:
- Set pulse generator to output a negative-going pulse.
  - Adjust pulse generator to give waveform at probe tip as shown in *Figure 4-3*, with a repetition rate of one-pulse-per-second. Probe indicator should flash off approximately once per second.
  - Disconnect test equipment.

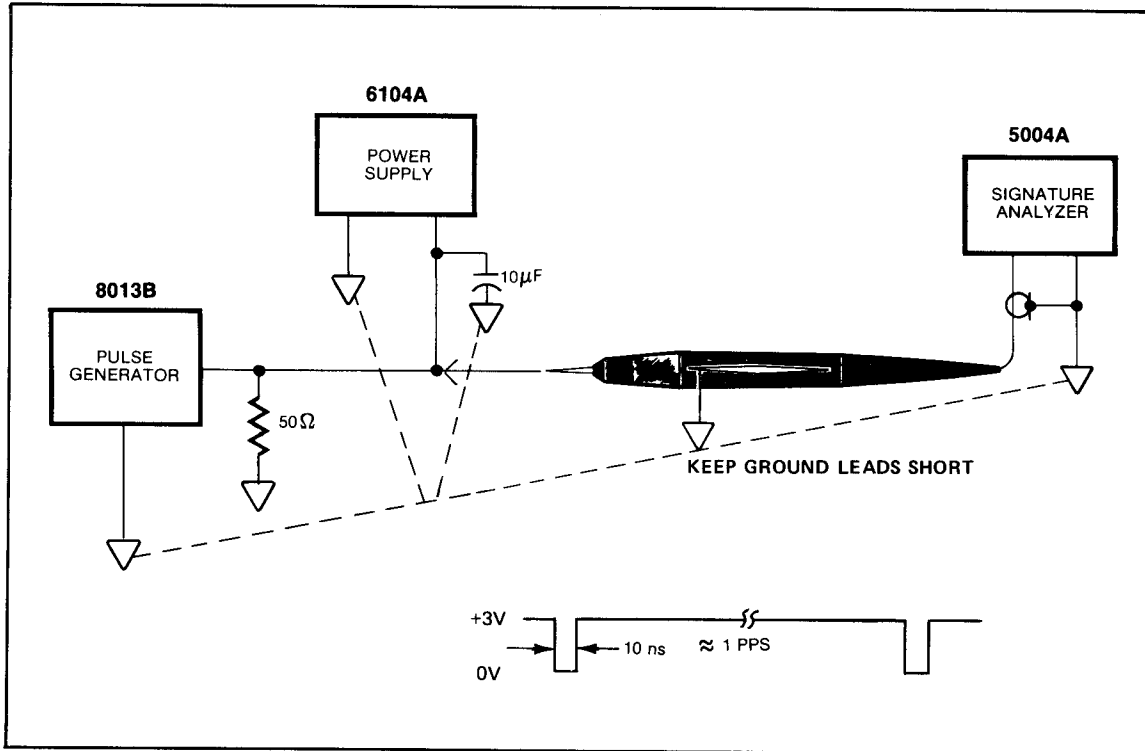

Figure 4-3. Negative Pulse Performance Test Setup

## 4-10. DATA PROBE SETUP TIME PERFORMANCE TEST

- 4-11. Connect the equipment as shown in *Figure 4-4*. Equipment front panel settings:

### 8013B Front Panel Settings:

Pulse period = 200 ns (5 MHz) in 20 n position

Pulse width = square wave

Amplitude = 5V.

### NOTE

Adjust the 8007B pulse width to obtain approximately the same pulse period of 8013B throughout the frequency range.

### 8007B Front Panel Settings:

External Input — Ext. Trigger

Pulse delay — 5.0 ns position

Pulse width — 5.0 ns position

Slope Polarity +

Transition time — 2.0 ns Leading edge: Fully CCW. Trailing edge: Fully CCW

Symm/Norm/Compl — NORM

Amplitude = +5V

Output Pulse Polarity +

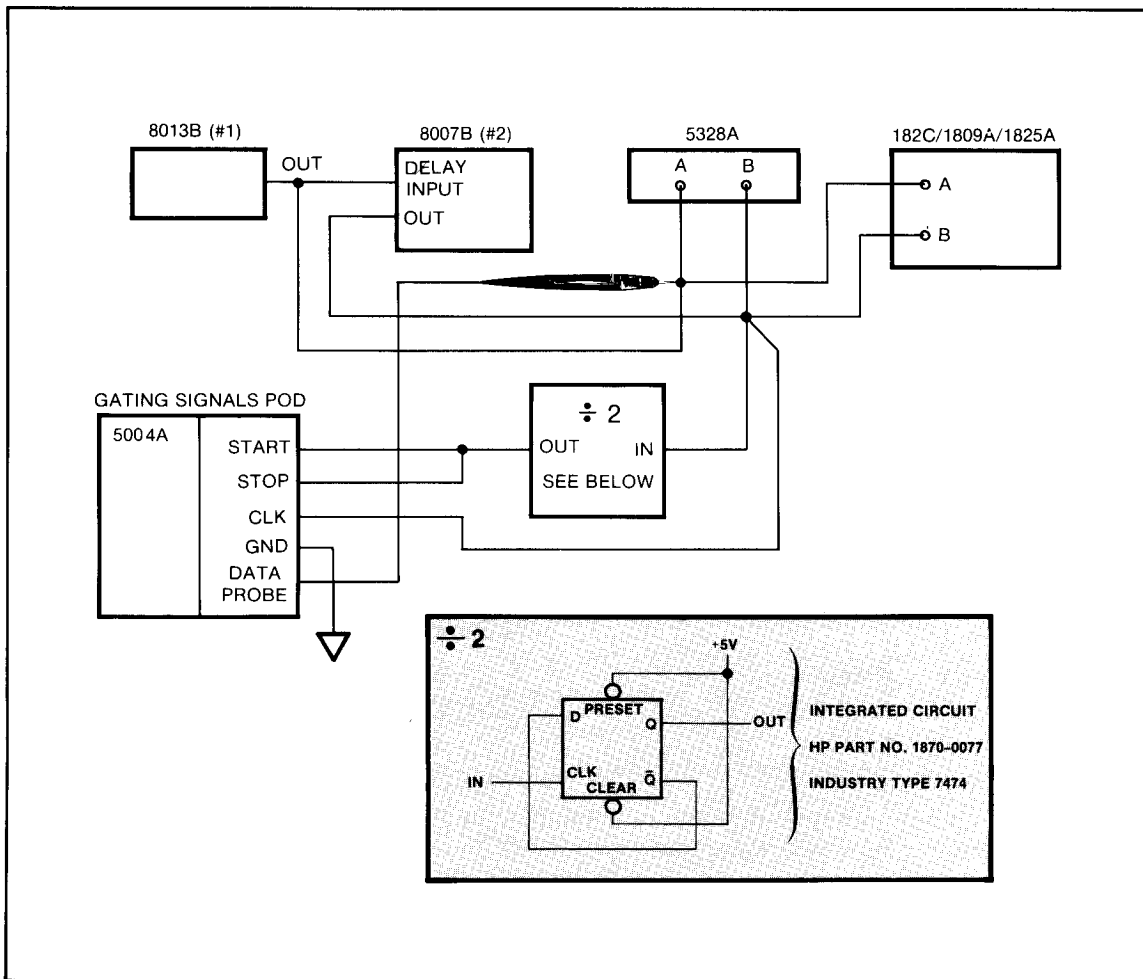

Figure 4-4. Data Probe Setup Time Performance Test

**5328A with Options 040 and 021 Settings:**

Function switch TI AVG A→B

Frequency Resolution  $10^6$

Trigger level 1.40 volts

Slope —

CH A +

CH B +

Attenuator —

CH A X1, DC Trig.

CH B X1, DC Trig.

COM switch — SEP

$Z_{IN}$  — 1 M $\Omega$

**Oscilloscope 182C/1809A/1825A Settings** (the two coax cables must be same length):

Volt/Div — 2V

50 ns/div (positive edge)

50 $\Omega$  termination

**5004A Logic Tracer Settings:**

START, STOP, CLOCK, HOLD, SELF-TEST buttons OUT

LINE OFF/ON — ON

#### Test Procedure:

1. Adjust the 8007A Pulse Width vernier to approximately midrange.
2. Set the 8007B Pulse Delay vernier to a minimum (CCW). The 5004A Signature Analyzer display should be all zeros (0000).
3. Turn the 8007B Pulse Delay vernier slowly clockwise until the display on the 5004A is 0003; the counter display will be <15 ns.
4. On the 5004A Signature Analyzer, push the START and STOP buttons IN. Repeat steps 2 and 3 above. The counter display will be <15 ns.
5. On 5004A Signature Analyzer, push the START or STOP button IN. Repeat step 2. Turn the 8007B Pulse Delay vernier slowly clockwise until the display on the 5004A is 0001; the counter display will be <15 ns. The display is also indicative of the minimum gate time (one clock pulse between START and STOP signals).
6. Set 5328A Universal Counter FUNCTION switch to FREQ A. Set 5004A Signature Analyzer START and STOP switches OUT ( ).
  - a. On 8013B Pulse Generator change the pulse period to 100 ns. Counter display should read 10 MHz.
  - b. Set 5328A Universal Counter FUNCTION switch to TI AVE A→B.
  - c. On 8007B Pulse Generator change the Pulse Delay and Pulse Width switches to the 5 ns position.
  - d. Repeat steps 2 and 3.
7. Vary the frequency of 8013B Pulse Generator from 1 Hz to 10 MHz. Adjust the 8007B Pulse Width to obtain approximately the same pulse width of 8013B throughout the frequency range. Results should be as in step 3.
8. Disconnect test equipment.

#### 4-12. DATA PROBE HOLD TIME PERFORMANCE TEST

4-13. With test equipment connected as in *Figure 4-4*, and settings as in "SETUP TIME PERFORMANCE TEST" proceed as follows:

1. Set the counter's Channel A slope to "-". Set scope's time base to negative edge.
2. Set the 5328A Universal Counter FUNCTION switch to FREQ A position. Set the 8007B Pulse Delay vernier to near midrange; the counter's displays should be 1.00000. The display of the 5004A Signature Analyzer should be 0003. Change 5328A FUNCTION switch to TI AVG A→B. The counter reading should be zero nanoseconds. Turn the Pulse Delay vernier slowly clockwise until the 5004A display reads 0000. The counter will read greater than zero nanosecond, indicating that the data doesn't have to remain valid after the clock pulse occurs.
3. Vary the frequency of 8013B Pulse Generator from 1 Hz to 10 MHz. Adjust the 8007B Pulse Width to obtain approximately the same duty cycle of 8013B throughout the frequency range. Results should be as in step 2.
4. Disconnect test equipment.

#### 4-14. TEST RECORD

4-15. *Table 4-2* is a blank performance test record which may be duplicated and used to keep a permanent periodic record of the performance of a 5004A Signature Analyzer.

Table 4-2. Performance Test Record

HEWLETT-PACKARD COMPANY		Date: _____		
MODEL 5004A SIGNATURE ANALYZER				
SERIAL NUMBER _____		Tested By: _____		
Paragraph Number	Test	Min.	Results Actual	Max.
4-4	Logic Level (Data Probe Light)			
	Voltage applied: Light Off	0	_____	0
	Light Dim	+1.6	_____	+1.1
	Light Bright	+1.7	_____	+2.2
4-6	Positive Pulse (Data Probe Light) Light Flashing	No Spec	_____	No Spec
4-8	Negative Pulse Performance Light Flashing	No Spec	_____	No Spec
4-10	Data Probe Setup Time			
	Step 2	0000	_____	0000
	Step 3	15 ns	_____	<15 ns
	Step 4	15 ns	_____	<15 ns
	Step 5	15 ns	_____	<15 ns
	Step 6a	10 MHz	_____	10 MHz
	Step 6d(2)	0000	_____	0000
Step 6d(3)	15 ns	_____	<15 ns	
Step 7	15 ns	_____	<15 ns	
4-12	Data Probe Hold Time			
	Step 2	0003	_____	0003
		∅ ns	_____	∅ ns
		∅ ns	_____	∅ ns
	Step 3	0003	_____	0003
		∅ ns	_____	∅ ns
		∅ ns	_____	∅ ns

## SECTION V ADJUSTMENTS

### 5-1. INTRODUCTION

5-2. This section describes adjustments that may be made to the 5004A. Only two adjustable functions exist. The power transformer primary is switchable to allow selection several different line voltages, and the data probe input threshold voltage is adjustable to allow the exactly correct value to be set. The 5004A top cover must be removed to change the power transformer primary (line voltage change). The data probe covers must be removed to set the threshold. Refer to disassembly procedures in Section VIII for cover removal information.

#### NOTE

The data probe threshold voltage should be checked when any parts are replaced in the data probe or when the power supply +5-volt regulator is replaced.

### 5-3. DATA PROBE THRESHOLD VOLTAGE CHECK AND ADJUSTMENT

5-4. Use the following procedure to check and adjust the data probe threshold voltage. Refer to the recommended test equipment listed in Section for units necessary in this procedure.

- a. Refer to the disassembly procedures in Section VIII, and remove the data probe covers. Refer to the parts location figure and schematic diagram in Section VIII for other information necessary for this procedure.
- b. Connect the negative test lead of the DVM to the Data Probe U2(1), and connect the positive test lead to U1(7). Record this voltage ( $V_{CC}$ ).
- c. Connect the positive test lead to U1(5). Compare this voltage with the  $V_{ref}$  voltage corresponding to the  $V_{CC}$  (step b) on *Figure 5-1*.
- d. If necessary, adjust potentiometer R4 so the  $V_{ref}$  voltage corresponds to  $V_{CC}$  voltage taken in step b.

#### NOTE

*Figure 5-1* is a graph relating the U1 pin 5 voltage to U1 pin 7 voltage.

- e. Repeat steps b, c, and d.
- f. Disconnect the test equipment, and reassemble the data probe covers.

### 5-5. POWER TRANSFORMER PRIMARY LINE VOLTAGE CHANGE PROCEDURE

5-6. Use the following procedure to change the power transformer primary line voltage switches settings.

- a. Refer to the disassembly procedure in Section VIII, and remove the 5004A top cover.

#### WARNING

**DISCONNECT THE LINE POWER CABLE FROM THE 5004A.**

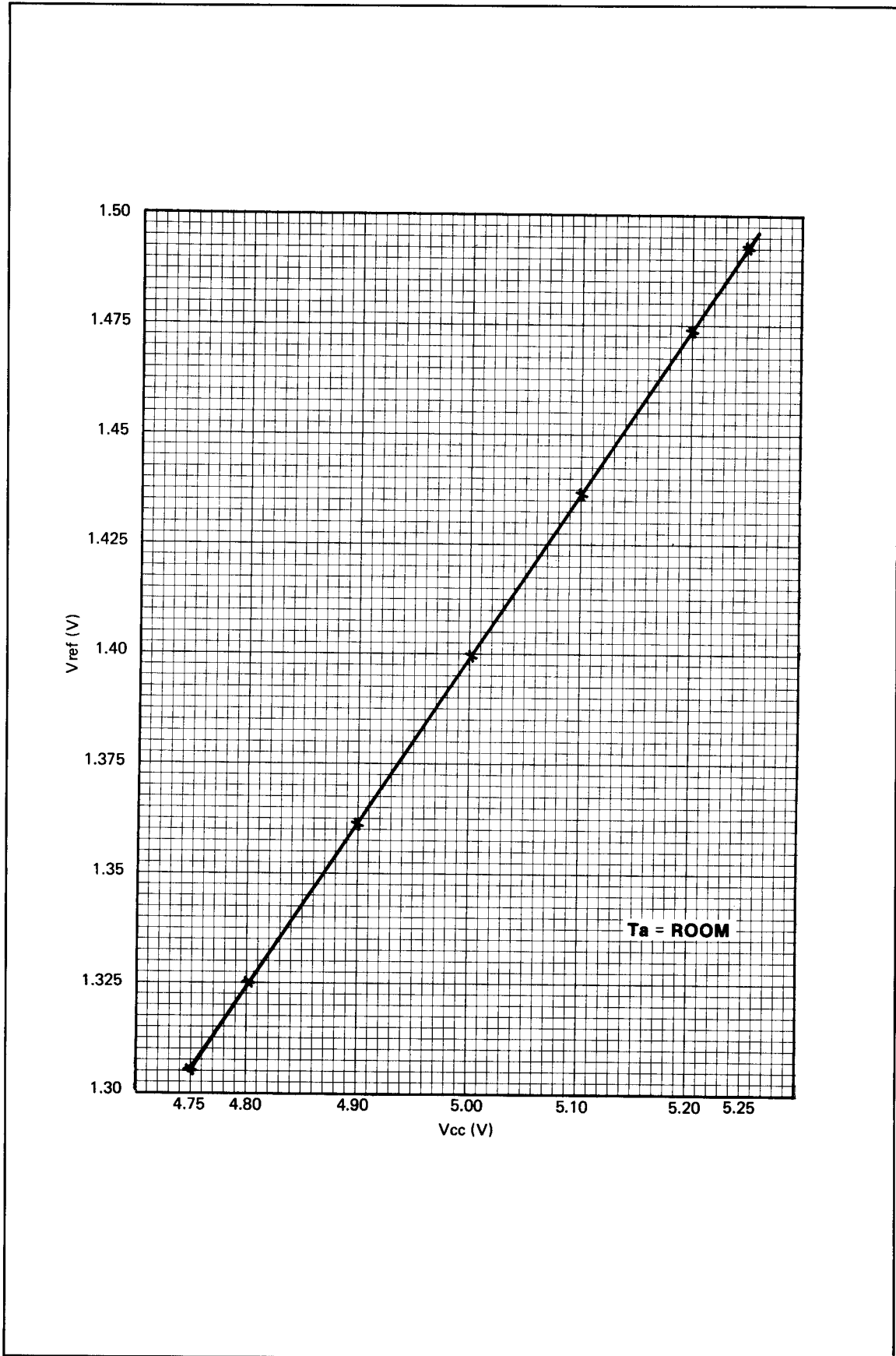

Figure 5-1. Data Probe  $V_{CC}$ — $V_{ref}$  Graph



- b. Refer to *Figure 5-2* which shows the line fuse holder and the line voltage selection switches. Both switch indicators must be set to the line voltage selection marks to match the available line voltage.

**NOTE**

The possible line voltage range are listed in Section I, Specifications. Refer to this list to decide where the selection switches should be set.

- c. Set the line voltage switches to appropriate positions for the available line voltage.

**CAUTION**

**Check the line fuse, F1. It must correspond to the line voltage selected. Refer to the specifications in Section VI for the correct value fuse.**

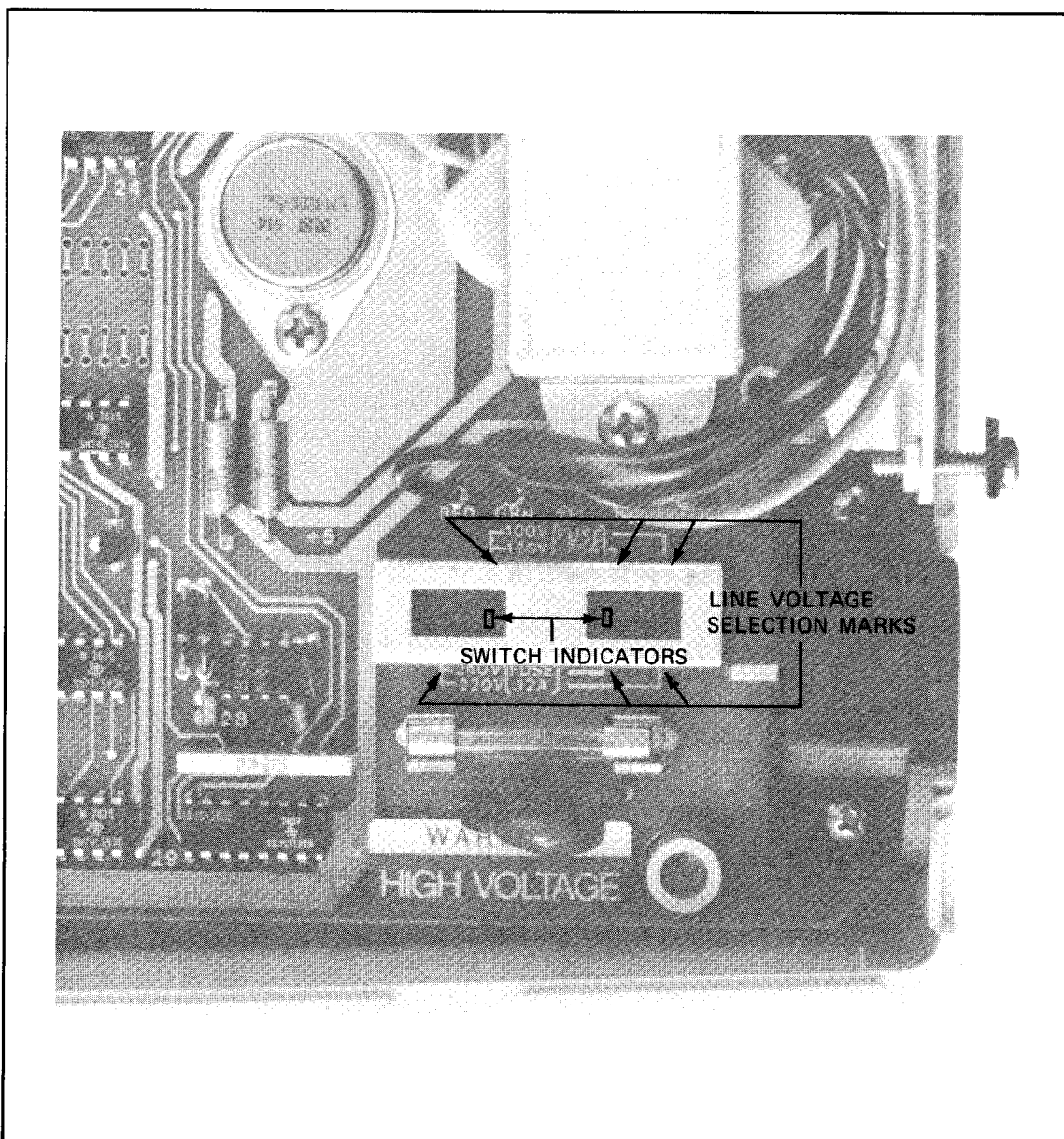

*Figure 5-2. Fuse and Line Voltage Selection*

## SECTION VI REPLACEABLE PARTS

### 6-1. INTRODUCTION

6-2. This section contains information for ordering replacement parts. *Table 6-1* lists parts in alphanumerical order of their reference designators and indicates the description and HP Part Number of each part, together with any applicable notes. The table includes the following information.

- a. Description of part (see abbreviaions below).
- b. Typical manufacturer of the part in a five-digit code; see list of manufactureres in *Table 2*.
- c. Manufacturer's part number.
- d. Total quantity used in the instrument (Qty column).

REFERENCE DESIGNATIONS					
<p><b>A</b> = assembly</p> <p><b>AT</b> = attenuator; isolator; termination</p> <p><b>B</b> = fan, motor</p> <p><b>BT</b> = battery</p> <p><b>C</b> = capacitor</p> <p><b>CP</b> = coupler</p> <p><b>CR</b> = diode; diode thyristor; varactor</p> <p><b>DC</b> = directional coupler</p> <p><b>DL</b> = delay line</p> <p><b>DS</b> = annunciator; signaling device (audible or visual); lamp; LED</p>	<p><b>E</b> = micellaneous electrical part</p> <p><b>F</b> = fuse</p> <p><b>FL</b> = filter</p> <p><b>H</b> = hardware</p> <p><b>HY</b> = circulator</p> <p><b>J</b> = electrical connector (stationary portion); jack</p> <p><b>K</b> = relay</p> <p><b>L</b> = coil; inductor</p> <p><b>M</b> = meter</p> <p><b>MP</b> = miscellaneous mechanical part</p>	<p><b>P</b> = electrical connector (movable portion); plug</p> <p><b>Q</b> = transistor; SCR; triode thyristor</p> <p><b>R</b> = resistor</p> <p><b>RT</b> = thermistor</p> <p><b>S</b> = switch</p> <p><b>T</b> = transformer</p> <p><b>TB</b> = terminal board</p> <p><b>TC</b> = thermocouple</p> <p><b>TP</b> = test point</p> <p><b>U</b> = integrated circuit; microcircuit</p>	<p><b>V</b> = electron tube</p> <p><b>VR</b> = voltage regulator; breakdown diode</p> <p><b>W</b> = cable; transmission path; wire</p> <p><b>X</b> = socket</p> <p><b>Y</b> = crystal unit-piezo-electric</p> <p><b>Z</b> = tuned cavity; tuned circuit</p>		
ABBREVIATIONS					
<p><b>A</b> = ampere</p> <p><b>ac</b> = alternating current</p> <p><b>ACCESS</b> = accessory</p> <p><b>ADJ</b> = adjustment</p> <p><b>A/D</b> = analog-to-digital</p> <p><b>AF</b> = audio frequency</p> <p><b>AFC</b> = automatic frequency control</p> <p><b>AGC</b> = automatic gain control</p> <p><b>AL</b> = aluminum</p> <p><b>ALC</b> = automatic level control</p> <p><b>AM</b> = amplitude modulation</p> <p><b>AMPL</b> = amplifier</p> <p><b>APC</b> = automatic phase control</p> <p><b>ASSY</b> = assembly</p> <p><b>AUX</b> = auxiliary</p> <p><b>avg</b> = average</p> <p><b>AWG</b> = american wire gauge</p>	<p><b>BAL</b> = balance</p> <p><b>BCD</b> = binary coded decimal</p> <p><b>BD</b> = board</p> <p><b>BE CU</b> = beryllium copper</p> <p><b>BFO</b> = beat frequency oscillator</p> <p><b>BH</b> = binder head</p> <p><b>BKDN</b> = breakdown</p> <p><b>BP</b> = bandpass</p> <p><b>BPF</b> = bandpass filter</p> <p><b>BRS</b> = brass</p> <p><b>BWO</b> = backward-wave oscillator</p> <p><b>CAL</b> = calibrate</p> <p><b>ccw</b> = counterclockwise</p> <p><b>CER</b> = ceramic</p> <p><b>CHAN</b> = channel</p> <p><b>cm</b> = centimeter</p> <p><b>CMO</b> = coaxial</p>	<p><b>COEF</b> = coefficient</p> <p><b>COM</b> = common</p> <p><b>COMP</b> = composition</p> <p><b>COMPL</b> = complete</p> <p><b>CONN</b> = connector</p> <p><b>CP</b> = cadmium plate</p> <p><b>CRT</b> = cathode-ray tube</p> <p><b>CTL</b> = complementary transistor logic</p> <p><b>CW</b> = continuous wave</p> <p><b>cw</b> = clockwise</p> <p><b>D/A</b> = digital-to-analog</p> <p><b>dB</b> = decibel</p> <p><b>dBm</b> = decibel referred to 1 mW</p> <p><b>dc</b> = direct current</p> <p><b>deg</b> = degree (temperature interval or difference)</p> <p><b>...°</b> = degree (plane angle)</p>	<p><b>°C</b> = degree Celsius (centigrade)</p> <p><b>°F</b> = degree Fahrenheit</p> <p><b>°K</b> = degree Kelvin</p> <p><b>DEPC</b> = deposited carbon</p> <p><b>DET</b> = detector</p> <p><b>diam</b> = diameter</p> <p><b>DIA</b> = diameter (used in parts list)</p> <p><b>DIFF</b> = differential amplifier</p> <p><b>AMPL</b> = division</p> <p><b>div</b> = division</p> <p><b>DPDT</b> = double-pole, double-throw</p> <p><b>DR</b> = drive</p> <p><b>DSB</b> = double sideband</p> <p><b>DTL</b> = diode transistor logic</p> <p><b>DVM</b> = digital voltmeter</p> <p><b>ECL</b> = emitter coupled logic</p>		

**ABBREVIATIONS (CONTINUED)**

EMF = electromotive force	mH = millihenry	PIN = positive-intrinsic-negative	TERM = terminal
EDP = electronic data processing	mho = mho	PIV = peak inverse voltage	TFT = thin-film transistor
ELECT = electrolytic	MIN = minimum	pk = peak	TGL = toggle
ENCAP = encapsulated	min = minute (time)	PL = phase lock	THD = thread
EXT = external	... = minute (plane angle)	PLO = phase lock oscillator	THRU = through
F = farad	MINAT = miniature	PM = phase modulation	Ti = titanium
FET = field-effect transistor	mm = millimeter	PNP = positive-negative-positive	TOL = tolerance
F/F = flip-flop	MOD = modulator	P/O = part of	TRIM = trimmer
FH = flat head	MOM = momentary	POLY = polystyrene	TSTR = transistor
FOL H = fillister head	MOS = metal-oxide semiconductor	PORC = porcelain	TTL = transistor-transistor logic
FM = frequency modulation	ms = millisecond	POS = positive position(s) (used in parts list)	TV = television
FP = front panel	MTG = mounting	POSN = position	TVI = television interference
FREQ = frequency	MTR = meter (indicating device)	POT = potentiometer	TWT = traveling wave tube
FXD = fixed	mV = millivolt	p-p = peak-to-peak	U = micro (10 <sup>-6</sup> ) (used in parts list)
g = gram	mVac = millivolt, ac	PP = peak-to-peak (used in parts list)	UF = microfarad (used in parts list)
GE = germanium	mVdc = millivolt, dc	PPM = pulse-position modulation	UHF = ultrahigh frequency
GHz = gigahertz	mVpk = millivolt, peak	PREAMPL = preamplifier	UNREG = unregulated
GL = glass	mVp-p = millivolt, peak-to-peak	PRF = pulse-repetition frequency	V = volt
GND = ground(ed)	mVrms = millivolt, rms	PRR = pulse repetition rate	VA = voltampere
H = henry	mW = milliwatt	ps = picosecond	Vac = volts ac
h = hour	MUX = multiplex	PT = point	VAR = variable
HET = heterodyne	MY = mylar	PTM = pulse-time modulation	VCO = voltage-controlled oscillator
HEX = hexagonal	μA = microampere	PWM = pulse-width modulation	Vdc = volts dc
HD = head	μF = microfarad	PWV = peak working voltage	VDCW = volts dc, working (used in parts list)
HDW = hardware	μH = microhenry	RC = resistance capacitance	V(F) = volts, filtered
HF = high frequency	μmho = microhmho	RECT = rectifier	VFO = variable-frequency oscillator
HG = mercury	μs = microsecond	REF = reference	VHF = very-high frequency
HI = high	μV = microvolt	REG = regulated	Vpk = volts peak
HP = Hewlett-Packard	μVac = microvolt, ac	REPL = replaceable	Vp-p = Volts peak-to-peak
HPF = high pass filter	μVdc = microvolt, dc	RF = radio frequency	Vrms = volts rms
HR = hour (used in parts list)	μVpk = microvolt, peak	RFI = radio frequency interference	VSWR = voltage standing wave ratio
HV = high voltage	μVp-p = microvolt, peak-to-peak	RH = round head; right hand	VTO = voltage-tuned oscillator
Hz = Hertz	μVrms = microvolt, rms	RLC = resistance-inductance-capacitance	VTVM = vacuum-tube voltmeter
IC = integrated circuit	μW = microwatt	RMO = rack mount only	V(X) = volts, switched
ID = inside diameter	nA = nanoampere	rms = root-mean-square	W = watt
IF = intermediate frequency	NC = no connection	RND = round	W/ = with
IMPG = impregnated	N/C = normally closed	ROM = read-only memory	WIV = working inverse voltage
in = inch	NE = neon	R&P = rack and panel	WW = wirewound
INCD = incandescent	NEG = negative	RWV = reverse working voltage	W/O = without
INCL = include(s)	nF = nanofarad	S = scattering parameter	YIG = yttrium-iron-garnet
INP = input	NI PL = nickel plate	s = second (time)	Zo = characteristic impedance
INS = insulation	N/O = normally open	... = second (plane angle)	
INT = internal	NOM = nominal	S-B = slow-blow (fuse (used in parts list))	
kg = kilogram	NORM = normal	SCR = silicon controlled rectifier; screw	
kHz = kilohertz	NPN = negative-positive-negative	SE = selenium	
kΩ = kilohm	NPO = negative-positive zero (zero temperature coefficient)	SECT = sections	
kV = kilovolt	NRFR = not recommended for field replacement	SEMICON = semiconductor	
lb = pound	NSR = not separately replaceable	SHF = superhigh frequency	
LC = inductance-capacitance	ns = nanosecond	SI = silicon	
LED = light-emitting diode	nW = nanowatt	SIL = silver	
LF = low frequency	OBD = order by description	SL = slide	
LG = long	OD = outside diameter	SNR = signal-to-noise ratio	
LH = left hand	OH = oval head	SPDT = single-pole, double-throw	
LIM = limit	OP AMPL = operational amplifier	SPG = spring	
LIN = linear taper (used in parts list)	OPT = option	SR = split ring	
lin = linear	OSC = oscillator	SPST = single-pole, single-throw	
LK WASH = lockwasher	OX = oxide	SSB = single sideband	
LO = low; local oscillator	oz = ounce	SST = stainless steel	
LOG = logarithmic taper (used in parts list)	Ω = ohm	STL = steel	
log = logarithm(ic)	P = peak (used in parts list)	SQ = square	
LPF = low pass filter	PAM = pulse-amplitude modulation	SWR = standing-wave ratio	
LV = low voltage	PC = printed circuit	SYNC = synchronize	
m = meter (distance)	PCM = pulse-code modulation; pulse-count modulation	T = timed (slow-blow fuse)	
mA = milliampere	PDM = pulse-duration modulation	TA = tantalum	
MAX = maximum	pF = picofarad	TC = temperature compensating	
MΩ = megohm	PH BRZ = phosphor bronze	TD = time delay	
MEG = meg (10 <sup>6</sup> ) (used in parts list)	PHL = Phillips		
MET FLM = metal film			
MET OX = metal oxide			
MF = medium frequency; microfarad (used in parts list)			
MFR = manufacturer			
mg = milligram			
MHz = megahertz			

**NOTE**

All abbreviations in the parts list will be in upper case.

**MULTIPLIERS**

Abbreviation	Prefix	Multiple
T	tera	10 <sup>12</sup>
G	giga	10 <sup>9</sup>
M	mega	10 <sup>6</sup>
k	kilo	10 <sup>3</sup>
da	deka	10
d	deci	10 <sup>-1</sup>
c	centi	10 <sup>-2</sup>
m	milli	10 <sup>-3</sup>
μ	micro	10 <sup>-6</sup>
n	nano	10 <sup>-9</sup>
p	pico	10 <sup>-12</sup>
f	femto	10 <sup>-15</sup>
a	atto	10 <sup>-18</sup>

## 6-4. ORDERING INFORMATION

6-5. To obtain replacement parts, address order or inquiry to your local Hewlett-Packard Sales and Service Office (see lists at rear of this manual for addresses). Identify parts by their Hewlett-Packard part numbers.

- a. Instrument model number.
- b. Instrument serial number.
- c. Description of the part.
- d. Function and location of the part.

## 6-6. HP PART NUMBER ORGANIZATION

6-7. Following is a general description of the HP part number system.

## 6-8. Component Parts and Materials

6-9. Generally, the prefix of HP part numbers identifies the type of device. Eight-digit part numbers are used, where the four-digit prefix identifies the type of component, part, or material and the four-digit suffix indicates the specific type. Following is a list of some of the more commonly used prefixes for component parts. The list includes HP manufactured parts and purchased parts.

Prefix	Component/Part/Material
0121-	Capacitors, Variable (mechanical)
0122-	Capacitors, Voltage Variable (semiconductor)
0140-	Capacitors, Fixed
0150-	Capacitors, Fixed
0160-	Capacitors, Fixed
0180-	Capacitors, Fixed Electrolytic
0330-	Insulating Materials
0340-	Insulators, Formed
0370-	Knobs, Control
0380-	Spacers and Standoffs
0410-	Crystals
0470-	Adhesives
0490-	Relays
0510-	Fasteners
0674- thru 0778-	Resistors, Fixed (non wire wound)
0811- thru 0831-	Resistors (wire wound)
1200-	Sockets for components
1205-	Heat Sinks
1250-	Connectors (RF and related parts)
1251-	Connectors (non RF and related parts)
1410-	Bearings and Bushings
1420-	Batteries
1820-	Monolithic Digital Integrated Circuits
1826-	Monolithic Linear Integrated Circuits
1850-	Transistors, Germanium PNP
1851-	Transistors, Germanium NPN
1853-	Transistors, Silicon PNP
1854-	Transistors, Silicon NPN
1855-	Field-Effect-Transistors
1900- thru 1912-	Diodes
1920- thru 1952-	Vacuum Tubes
1990-	Semiconductor Photosensitive and Light-Emitting Diodes
3100- thru 3106-	Switches
8120-	Cables
9100-	Transformers, Coils, Chokes, Inductors, and Filters

6-10. For example, 1854-0037, 1854-0221, and 1851-0192 are all NPN transistors. The first two are silicon and the last is germanium.

### 6-11. General Usage Parts

6-12. The following list gives the prefixes for HP manufactured parts used in several instruments, e.g., side frames, feet, top and bottom covers, etc. these are eight-digit part numbers with the four-digit prefix identifying the type of parts as shown below:

Type of Part	Prefix
Sheet Metal	5000- to 5019-
Machined	5020- to 5039-
Molded	5040- to 5059-
Assemblies	5060- to 5079-
Components	5080- to 5099-

### 6-13. Specific Instrument Parts

6-14. These are HP manufactured parts for use in individual instruments or series of instruments. For these parts, the prefix indicates the instrument and the suffix indicates the type of part. For example, 05004-60003 is an assembly used in the 5004A. Following is a list of suffixes commonly used.

Type of Part	P/N Suffix
Sheet Metal	-00000 to -00499
Machined	-20000 to -20499
Molded	-40000 to -40499
Assembly	-60000 to -60499
Component	-80000 to -80299
Documentation	-90000 to -90249

### 6-15. Mechanical Parts

6-16. The major mechanical parts of the 5004A are shown in *Figure 6-1*, at the rear of this section. The parts are listed in the miscellaneous part section of the parts list under MP numbers.



Table 6-1. Replaceable Parts

Reference Designation	HP Part Number	Qty	Description	Mfr Code	Mfr Part Number
A1	05004-60007	1	BOARD ASSEMBLY, MAIN	28480	05004-60007
A1C1	0180-0210	1	CAPACITOR-FXD 3.3UF±20% 15VDC TA	04200	150D335X0015A2
A1C2	0180-0490	2	CAPACITOR-FXD 68UF±10% 6VDC TA	04200	194D686X9006KA1
A1C3	0180-0490		CAPACITOR-FXD 68UF±10% 6VDC TA	04200	194D686X9006KA1
A1C4	0160-2055	16	CAPACITOR-FXD .01UF +80-20% 100VDC CER	28480	0160-2055
A1C5	0160-2055		CAPACITOR-FXD .01UF +80-20% 100VDC CER	28480	0160-2055
A1C6	0160-2055		CAPACITOR-FXD .01UF +80-20% 100VDC CER	28480	0160-2055
A1C7	0160-2055		CAPACITOR-FXD .01UF +80-20% 100VDC CER	28480	0160-2055
A1C8	0160-2055		CAPACITOR-FXD .01UF +80-20% 100VDC CER	28480	0160-2055
A1C9	0160-2055		CAPACITOR-FXD .01UF +80-20% 100VDC CER	28480	0160-2055
A1C10	0160-2055		CAPACITOR-FXD .01UF +80-20% 100VDC CER	28480	0160-2055
A1C11	0160-2055		CAPACITOR-FXD .01UF +80-20% 100VDC CER	28480	0160-2055
A1C12	0160-2055		CAPACITOR-FXD .01UF +80-20% 100VDC CER	28480	0160-2055
A1C13	0160-2055		CAPACITOR-FXD .01UF +80-20% 100VDC CER	28480	0160-2055
A1C14	0180-0374	4	CAPACITOR-FXD 10UF±10% 20VDC TA	04200	150D106X9020B2
A1C15	0160-2055		CAPACITOR-FXD .01UF +80-20% 100VDC CER	28480	0160-2055
A1C16	0180-0374		CAPACITOR-FXD 10UF±10% 20VDC TA	04200	150D106X9020B2
A1C17	0160-2055		CAPACITOR-FXD .01UF +80-20% 100VDC CER	28480	0160-2055
A1C18	0160-2055		CAPACITOR-FXD .01UF +80-20% 100VDC CER	28480	0160-2055
A1C19	0180-2414	1	CAPACITOR-FXD 2900UF±75-10% 40VDC AL	04200	36D2926040AA2A
A1C20	0160-2055		CAPACITOR-FXD .01UF +80-20% 100VDC CER	28480	0160-2055
A1C21	0160-2055		CAPACITOR-FXD .01UF +80-20% 100VDC CER	28480	0160-2055
A1C22	0180-0374		CAPACITOR-FXD 10UF±10% 20VDC TA	04200	150D106X9020B2
A1C23	0180-0374		CAPACITOR-FXD 10UF±10% 20VDC TA	04200	150D106X9020B2
A1C24	0160-2055		CAPACITOR-FXD .01UF +80-20% 100VDC CER	28480	0160-2055
A1C25	0180-2413	1	CAPACITOR-FXD 7500UF±75-10% 15VDC AL	04200	36DX7526015AA2A
A1C26	0160-3043	1	CAPACITOR-FXD 5000PF/5000PF ±20%	28480	0160-3043
A1C27	0160-0576	7	CAPACITOR-FXD .1UF ±20% 50VDC CER	28480	0160-0576
A1C28			NOT ASSIGNED		
A1C29			NOT ASSIGNED		
A1C30			NOT ASSIGNED		
A1C31	0160-0576		CAPACITOR-FXD .1UF ±20% 50VDC CER	28480	0160-0576
A1CR1	1901-0040	5	DIODE-SWITCHING 30V 50MA 2NS DO-35	28480	1901-0040
A1CR2	1901-0028	2	DIODE-PWR RECT 400V 750MA DO-29	02713	MP493
A1CR3	1901-0028		DIODE-PWR RECT 400V 750MA DO-29	02713	MP493
A1CR4	1901-0782	2	DIODE-SCHOTTKY 1N5821 30V 3A	02037	1N5821
A1CR5	1901-0782		DIODE-SCHOTTKY 1N5821 30V 3A	02037	1N5821
A1J1	1251-4776	1		28480	1251-4776
A1J2	1251-4777	1		28480	1251-4777
A1Q1	1858-0014	4	TRANSISTOR ARRAY	28480	1858-0014
A1Q2	1858-0014		TRANSISTOR ARRAY	28480	1858-0014
A1Q3	1858-0014		TRANSISTOR ARRAY	28480	1858-0014
A1Q4	1858-0014		TRANSISTOR ARRAY	28480	1858-0014
A1Q5	1854-0215	2	TRANSISTOR NPN SI PD=350MHZ FT=300MHZ	02037	8P8 3611
A1Q6	1854-0215		TRANSISTOR NPN SI PD=350MHZ FT=300MHZ	02037	8P8 3611
A1R1	0683-2215	9	RESISTOR 220 5% .25W FC TC=-400/+600	01607	CB2215
A1R2	0683-2215		RESISTOR 220 5% .25W FC TC=-400/+600	01607	CB2215
A1R3	0683-2215		RESISTOR 220 5% .25W FC TC=-400/+600	01607	CB2215
A1R4	0683-2215		RESISTOR 220 5% .25W FC TC=-400/+600	01607	CB2215
A1R5	0683-2215		RESISTOR 220 5% .25W FC TC=-400/+600	01607	CB2215
A1R6	0683-2215		RESISTOR 220 5% .25W FC TC=-400/+600	01607	CB2215
A1R7	0683-2215		RESISTOR 220 5% .25W FC TC=-400/+600	01607	CB2215
A1R8	0683-1615	5	RESISTOR 160 5% .25W FC TC=-400/+600	01607	CB1615
A1R9	0683-1615		RESISTOR 160 5% .25W FC TC=-400/+600	01607	CB1615
A1R10	1810-0047	2	NETWORK-RES 5-PIN=81P .15-PIN=8PC6	28480	1810-0047
A1R11	0683-2425	2	RESISTOR 2.4K 5% .25W FC TC=-400/+700	01607	CB2425
A1R12	0683-1525	2	RESISTOR 1.5K 5% .25W FC TC=-400/+700	01607	CB1525
A1R13	0683-1025	4	RESISTOR 1K 5% .25W FC TC=-400/+600	01607	CB1025
A1R14	0683-2235	2	RESISTOR 22K 5% .25W FC TC=-400/+800	01607	CB2235
A1R15	0683-4315	5	RESISTOR 430 5% .25W FC TC=-400/+600	01607	CB4315
A1R16	0683-2235		RESISTOR 22K 5% .25W FC TC=-400/+800	01607	CB2235
A1R17	0683-1025		RESISTOR 1K 5% .25W FC TC=-400/+600	01607	CB1025
A1R18	0683-2215		RESISTOR 220 5% .25W FC TC=-400/+600	01607	CB2215
A1R19	0683-4315		RESISTOR 430 5% .25W FC TC=-400/+600	01607	CB4315
A1R20	0683-2215		RESISTOR 220 5% .25W FC TC=-400/+600	01607	CB2215
A1R21	0683-1025		RESISTOR 1K 5% .25W FC TC=-400/+600	01607	CB1025
A1R22	0683-1525		RESISTOR 1.5K 5% .25W FC TC=-400/+700	01607	CB1525
A1R23	0683-4315		RESISTOR 430 5% .25W FC TC=-400/+600	01607	CB4315
A1R24	0683-1025		RESISTOR 1K 5% .25W FC TC=-400/+600	01607	CB1025
A1R25	0683-4315		RESISTOR 430 5% .25W FC TC=-400/+600	01607	CB4315

See introduction to this section for ordering information

Table 6-1. Replaceable Parts (Continued)

Reference Designation	HP Part Number	Qty	Description	Mfr Code	Mfr Part Number
A1R26	0663-7525	4	RESISTOR 7.5K 5% .25W FC TC=400/+700	01607	C87525
A1R27	0663-4725	2	RESISTOR 4.7K 5% .25W FC TC=400/+700	01607	C84725
A1R28	1810-0047		NETWORK-RES 5-PIN-8IP .15-PIN-8PCG	28480	1810-0047
A1R29	0663-1615		RESISTOR 160 5% .25W FC TC=400/+600	01607	C81615
A1R30	0663-1615		RESISTOR 160 5% .25W FC TC=400/+600	01607	C81615
A1R31	0663-3315	2	RESISTOR 330 5% .25W FC TC=400/+600	01607	C83315
A1R32	0663-1615		RESISTOR 160 5% .25W FC TC=400/+600	01607	C81615
A1R33	0663-3315		RESISTOR 330 5% .25W FC TC=400/+600	01607	C83315
A1R34	0663-4725		RESISTOR 4.7K 5% .25W FC TC=400/+700	01607	C84725
A1R35	0663-4315		RESISTOR 430 5% .25W FC TC=400/+600	01607	C84315
A1R36	0663-7525		RESISTOR 7.5K 5% .25W FC TC=400/+700	01607	C87525
A1R37	0663-2225	1	RESISTOR 2.2K 5% .25W FC TC=400/+700	01607	C82225
A1R38	0663-1825	1	RESISTOR 1.8K 5% .25W FC TC=400/+700	01607	C81825
A1R39	0663-2425		RESISTOR 2.4K 5% .25W FC TC=400/+700	01607	C82425
A1R40	0663-2035	1	RESISTOR 20K 5% .25W FC TC=400/+800	01607	C82035
A1R41	1810-0135	2	NETWORK-RES 6-PIN-8IP .15-PIN-8PCG	28480	1810-0135
A1R42	0663-7525		RESISTOR 7.5K 5% .25W FC TC=400/+700	01607	C87525
A1R43	0663-7525		RESISTOR 7.5K 5% .25W FC TC=400/+700	01607	C87525
A1R44	1810-0135		NETWORK-RES 6-PIN-8IP .15-PIN-8PCG	28480	1810-0135
A181	3101-0555	1	SWITCH-P8 DPDT ALTNQ 4A 250VAC	28480	3101-0555
A182	3101-2178	5	SWITCH ASSEMBLY, 5-8STATION	28480	3101-2178
A183	3101-2178		SWITCH ASSEMBLY, 5-8STATION	28480	3101-2178
A184	3101-2178		SWITCH ASSEMBLY, 5-8STATION	28480	3101-2178
A185	3101-2178		SWITCH ASSEMBLY, 5-8STATION	28480	3101-2178
A186	3101-2178		SWITCH ASSEMBLY, 5-8STATION	28480	3101-2178
A187	3101-2177	1	SWITCH-BL 4PDT-N8 MINTR .01A 5VDC PC	28480	3101-2177
A188	3101-0693	1	SWITCH-BL 2-DPDT-N8 STD 1.5A 250VAC PC	28480	3101-0693
A1TP1	1251-4707	5	CONNECTOR-SGL CONT PIN .031-IN-B8C-8Z	28480	1251-4707
A1TP2	1251-4707		CONNECTOR-SGL CONT PIN .031-IN-B8C-8Z	28480	1251-4707
A1TP3	1251-4707		CONNECTOR-SGL CONT PIN .031-IN-B8C-8Z	28480	1251-4707
A1TP4	1251-4707		CONNECTOR-SGL CONT PIN .031-IN-B8C-8Z	28480	1251-4707
A1TP5	1251-4707		CONNECTOR-SGL CONT PIN .031-IN-B8C-8Z	28480	1251-4707
A1TP6	1251-0600	3	CONTACT-COHN U/W-POST-TYPE MALE DP8LDR	28480	1251-0600
A1TP7	1251-0600		CONTACT-COHN U/W-POST-TYPE MALE DP8LDR	28480	1251-0600
A1TP8	1251-0600		CONTACT-COHN U/W-POST-TYPE MALE DP8LDR	28480	1251-0600
A1U1	1820-1195	1	IC FF TTL L8 D-TYPE P08-EDGE-TRIG COM	01698	8N74LS175N
A1U2	1820-1285	1	IC GATE TTL L8 AND-OR-INV 4-INP	01698	8N74LS84N
A1U3	1820-1052	2	IC XLTR ECL/TTL ECL-TO-TTL QUAD 2-INP	02037	MC10125L
A1U4	1820-0691	1	IC GATE TTL 8 AND-OR-INV	01698	8N74864N
A1U5	1820-1204	1	IC GATE TTL L8 NAND DUAL 4-INP	01698	8N74LS20N
A1U6	1820-1140	1	IC GEN TTL 8 PAR GEN 9-BIT	02910	N82862A
A1U7	1820-1144	1	IC GATE TTL L8 NOR QUAD 2-INP	01698	8N74LS02N
A1U8	1820-1197	1	IC GATE TTL L8 NAND QUAD 2-INP	01698	8N74LS00N
A1U9	1820-0629	1	IC FF TTL 8 J-K NEG-EDGE-TRIG	01698	8N748112N
A1U10	1820-1199	1	IC INV TTL L8 HEX 1-INP	01698	8N74LS04N
A1U11	1820-0685	1	IC GATE TTL 8 NAND TPL 3-INP	01698	8N74810N
A1U12	1820-1052		IC XLTR ECL/TTL ECL-TO-TTL QUAD 2-INP	02037	MC10125L
A1U13	1820-1885	4	IC, TTL 74LS173	03406	DM74LS173N
A1U14	1820-1885		IC, TTL 74LS173	03406	DM74LS173N
A1U15	1820-1885		IC, TTL 74LS173	03406	DM74LS173N
A1U16	1820-1885		IC, TTL 74LS173	03406	DM74LS173N
A1U17	1820-1198	1	IC GATE TTL L8 NAND QUAD 2-INP	01698	8N74LS03N
A1U18	1820-1281	1	IC DCDR TTL L8 2-TO-4-LINE DUAL 2-INP	01698	8N74LS139N
A1U19	1816-1006	1	IC, ROM 32 X 8, CC	28480	1816-1006
A1U20	1820-1001	1	IC, ROM 32 X 8, CC	28480	1820-1001
A1U21	1820-1433	2	IC 8HP-RGTR TTL L8 R-8 SERIAL-IN PRL OUT	01698	8N74LS164N
A1U22	1820-1447	1	IC 8N74LS670N 16-BIT RAM TTL	01698	8N74LS670N
A1U23	1820-1419	1	IC COMPTR TTL L8 MAGTD 4-BIT	01698	8N74LS85N
A1U24	1820-1433		IC 8HP-RGTR TTL L8 R-8 SERIAL-IN PRL OUT	01698	8N74LS164N
A1U25	1820-1476	3	IC CNTR TTL L8 BIN ASYNCRD	01698	8N74LS93N
A1U26	1820-1476		IC CNTR TTL L8 BIN ASYNCRD	01698	8N74LS93N
A1U27	1820-1476		IC CNTR TTL L8 BIN ASYNCRD	01698	8N74LS93N
A1U28	1826-0180	1	IC 555	02910	NE555V
A1U29	1816-1007	1	IC, ROM 32 X 8, CC	28480	1816-1007
A1U30	1826-0173	1	IC V RGLTR	03406	LM320K-5,2
			A1 MISCELLANEOUS		
		5	BRACKET, 90 DEGREE	28480	0510-0741
		2	FUSEHOLDER-CLIP-TYPE .25FUSE	28480	2110-0269
		1	RECEPTACLE, AC POWER	28480	5040-8013
A2	05004-60002	1	BOARD ASSEMBLY, DISPLAY	28480	05004-60002
A2CR1	1990-0325	2	LED-VISIBLE LUM-INT=800UCD IF=50MA-MAX	01542	5082-4403
A2CR2	1990-0540	4	DISPLAY-NUM SEG 1-CHAR .43-H	01542	5082-7650
A2CR3	1990-0540		DISPLAY-NUM SEG 1-CHAR .43-H	01542	5082-7650
A2CR4	1990-0540		DISPLAY-NUM SEG 1-CHAR .43-H	01542	5082-7650
A2CR5	1990-0540		DISPLAY-NUM SEG 1-CHAR .43-H	01542	5082-7650

See introduction to this section for ordering information

Table 6-1. Replaceable Parts (Continued)

Reference Designation	HP Part Number	Qty	Description	Mfr Code	Mfr Part Number
A2CR6	1990-0325		LED-VISIBLE LUM=INT=800UCD IF=50MA=MAX	01542	5082-4403
A2J1	1251-3768	18	CONTACT-CONN U/W-POST-TYPE MALE DP8LDR	28480	1251-3768
A2J2	1251-3768		CONTACT-CONN U/W-POST-TYPE MALE DP8LDR	28480	1251-3768
A2J3	1251-3768		CONTACT-CONN U/W-POST-TYPE MALE DP8LDR	28480	1251-3768
A2J4	1251-3768		CONTACT-CONN U/W-POST-TYPE MALE DP8LDR	28480	1251-3768
A2J5	1251-3768		CONTACT-CONN U/W-POST-TYPE MALE DP8LDR	28480	1251-3768
A2J6	1251-3768		CONTACT-CONN U/W-POST-TYPE MALE DP8LDR	28480	1251-3768
A2J7	1251-3768		CONTACT-CONN U/W-POST-TYPE MALE DP8LDR	28480	1251-3768
A2J8	1251-3768		CONTACT-CONN U/W-POST-TYPE MALE DP8LDR	28480	1251-3768
A2J9	1251-3768		CONTACT-CONN U/W-POST-TYPE MALE DP8LDR	28480	1251-3768
A2J10	1251-3768		CONTACT-CONN U/W-POST-TYPE MALE DP8LDR	28480	1251-3768
A2J11	1251-3768		CONTACT-CONN U/W-POST-TYPE MALE DP8LDR	28480	1251-3768
A2J12	1251-3768		CONTACT-CONN U/W-POST-TYPE MALE DP8LDR	28480	1251-3768
A2J13	1251-3768		CONTACT-CONN U/W-POST-TYPE MALE DP8LDR	28480	1251-3768
A2J14	1251-3768		CONTACT-CONN U/W-POST-TYPE MALE DP8LDR	28480	1251-3768
A2J15	1251-3768		CONTACT-CONN U/W-POST-TYPE MALE DP8LDR	28480	1251-3768
A2J16	1251-3768	CONTACT-CONN U/W-POST-TYPE MALE DP8LDR	28480	1251-3768	
A2J17	1251-3768	CONTACT-CONN U/W-POST-TYPE MALE DP8LDR	28480	1251-3768	
A2J18	1251-3768	CONTACT-CONN U/W-POST-TYPE MALE DP8LDR	28480	1251-3768	
A2TP1	1251-4714	1		28480	1251-4714
A2W1	1251-4750	3	CONNECTOR=8GL CONT PIN ,03-IN=88C-8Z RND	28480	1251-4750
A2W2	1251-4750		CONNECTOR=8GL CONT PIN ,03-IN=88C-8Z RND	28480	1251-4750
A2W3	1251-4750		CONNECTOR=8GL CONT PIN ,03-IN=88C-8Z RND	28480	1251-4750
			A2 MISCELLANEOUS		
	0400-0010	1	GROMMET/VINYL 0,250" ID	00000	08D#
A3	05004-60005	1	PROBE ASSEMBLY	28480	05004-60005
MP13	7120-5919	1	LABEL, PROBE, TOP	28480	7120-5919
MP12	7120-5920	1	LABEL, PROBE, BOTTOM	28480	7120-5920
MP11	5060-0418	1	PIN TIP ASSEMBLY	28480	5060-0418
MP8	00545-20203	1	BODY, BOTTOM HALF	28480	00545-20203
MP10	00546-40002	1	WINDSH	28480	00546-40002
	00547-40005	1	COVER, TIP	28480	00547-40005
MP9	05004-20204	1	BODY, TOP HALF	28480	05004-20204
	05004-20205	1	SWITCH, PUSHBUTTON	28480	05004-20205
	05004-60103	1	CABLE ASSEMBLY, PROBE	28480	05004-60103
A3A1	05004-60003	1	BOARD ASSEMBLY, PROBE	28480	05004-60003
A3A1C1	0160-0576		CAPACITOR=FXD .1UF +-20% 50VDC CER	28480	0160-0576
A3A1C2	0160-0576		CAPACITOR=FXD .1UF +-20% 50VDC CER	28480	0160-0576
A3A1C3	0150-0088	1	CAPACITOR=FXD 3.9PF +--.25PF 500VDC	28480	0150-0088
A3A1CR1	1901-0040		DIODE=SWITCHING 30V 50MA 2N8 DO-35	28480	1901-0040
A3A1DS1	2140-0346	1	LAMP=INCAND 7210 5VDC 30MA T-1=BULB	04504	7210(ANSI 7210)
A3A1R1	0698-7225	1	RESISTOR 348 1% .05W F TC=0+-100	03292	C3-1/8-T0-348R-G
A3A1R2	0698-8875	1	RESISTOR 27.4 1% .05W F TC=0+-100	03292	C3
A3A1R3	0698-8874	1	RESISTOR 127 1% .05W F TC=0+-100	03292	C3
A3A1R4	2100-1986	1	RESISTOR=TRMR 1K 10% C TOP=ADJ 1-TRN	04566	62-206-1
A3A1R5	0698-7262	1	RESISTOR 12.1K 1% .05W F TC=0+-100	03292	C3-1/8-T0-1212-G
A3A1R6	0757-0849	1	RESISTOR 36.5K 1% .5W F TC=0+-100	02995	MF7C1/2-T0-3652-F
A3A1S1	00546-00001	1	SWITCH, CONTACT	28480	00546-00001
A3A1U1	1820-0919	3	IC COMPTR ECL A/D DUAL	02037	MC1650L
			A3A1 MISCELLANEOUS		
	1251-4259	1	CONNECTOR=8GL CONT PIN .031-IN=88C-8Z	28480	1251-4259
	00545-20202	1	STUD, TIP	28480	00545-20202
A4	05004-60006	1	POD ASSEMBLY	28480	05004-60006
MP14	0624-0306	4	SCREW=TPG 2-28 .5-IN-LG PAN=HD=POZI STL	28480	0624-0307
	7120-5921	1	LABEL, POD INST.	28480	7120-5921
	5040-0563	1	CONNECTOR, CLIP	28480	5040-0563
MP6	5040-8125	1	COVER, POD	28480	5040-8125
MP7	05004-20201	1	HALF=BOTTOM POD	28480	05004-20201
	05004-60101	1	CABLE ASSEMBLY, POD	28480	05004-60101
	05004-60004	1	BOARD ASSEMBLY, POD	28480	05004-60004
A4A1C1	0160-2550	2	CAPACITOR=FXD 1PF +- .1PF 500VDC	28480	0160-2550
A4A1C2	0160-2235	1	CAPACITOR=FXD .75PF +- .25PF 500VDC	28480	0160-2235
A4A1C3	0160-2550		CAPACITOR=FXD 1PF +- .1PF 500VDC	28480	0160-2550
A4A1C4	0160-0576		CAPACITOR=FXD .1UF +-20% 50VDC CER	28480	0160-0576
A4A1C5	0180-0155	1	CAPACITOR=FXD 2.2UF+-20% 20VDC TA	04200	150D225X0020A2

See introduction to this section for ordering information



Table 6-1. Replaceable Parts (Continued)

Reference Designation	HP Part Number	Qty	Description	Mfr Code	Mfr Part Number
A4A1C6	0160-0576		CAPACITOR-PXD .1UF +-20% 50VDC CER	28480	0160-0576
A4A1C7	0160-0576		CAPACITOR-PXD .1UF +-20% 50VDC CER	28480	0160-0576
A4A1CR1	1901-0040		DIODE-SWITCHING 30V 50MA 2N8 DO-35	28480	1901-0040
A4A1CR2	1901-0040		DIODE-SWITCHING 30V 50MA 2N8 DO-35	28480	1901-0040
A4A1CR3	1901-0040		DIODE-SWITCHING 30V 50MA 2N8 DO-35	28480	1901-0040
A4A1R1	0757-1100	3	RESISTOR 600 1% .125W F TC=0+-100	03292	C4-1/8-T0=601-F
A4A1R2	0757-1100		RESISTOR 600 1% .125W F TC=0+-100	03292	C4-1/8-T0=601-F
A4A1R3	0698-3423	3	RESISTOR 46.4K 1% .5W F TC=0+-100	05524	MFF-1/2-10
A4A1R4	0698-3423		RESISTOR 46.4K 1% .5W F TC=0+-100	05524	MFF-1/2-10
A4A1R5	0698-3423		RESISTOR 46.4K 1% .5W F TC=0+-100	05524	MFF-1/2-10
A4A1R6	0757-1100		RESISTOR 600 1% .125W F TC=0+-100	03292	C4-1/8-T0=601-F
A4A1R7	0757-0438	3	RESISTOR 5.11K 1% .125W F TC=0+-100	03292	C4-1/8-T0=5111-F
A4A1R8	0757-0438		RESISTOR 5.11K 1% .125W F TC=0+-100	03292	C4-1/8-T0=5111-F
A4A1R9	0698-3153	1	RESISTOR 3.83K 1% .125W F TC=0+-100	03292	C4-1/8-T0=3831-F
A4A1R10	0757-1094	1	RESISTOR 1.47K 1% .125W F TC=0+-100	03292	C4-1/8-T0=1471-F
A4A1R11	0757-0438		RESISTOR 5.11K 1% .125W F TC=0+-100	03292	C4-1/8-T0=5111-F
A4A1U1	1820-0493	1	IC OP AMP	03406	LM307N
A4A1U2	1820-0919		IC COMPTN ECL A/D DUAL	02037	MC1650L
A4A1U3	1820-0919		IC COMPTN ECL A/D DUAL	02037	MC1650L
A4A1U4	1826-0215	1	IC V RGLTR	02037	MC7905.2CT
			A4A1 MISCELLANEOUS		
	1460-1473	4	SPRING (SH MET) BE CU	28480	1460-1473
			5004A SIGNATURE ANALYZER		
F1	2110-0201	1	FUSE .25A 250V SLO-BLO 1.25X.25 UL IEC	04703	313.250
F1	2110-0318	1	FUSE .125A 250V SLO-BLO 1.25X.25 UL IEC	04703	313.125
T1	9100-3063	1	TRANSFORMER, POWER	28480	9100-3063
U1	1826-0181	1	IC V RGLTR	03406	LM323K
W1	8120-1378	1	CABLE ASBY 18AWG 3-CNDCT JGK-JKT .25-OD	28480	8120-1378
			MISCELLANEOUS PARTS		
	0380-0007	3	SPACER-RND .438LG .18ID .250D BR8 NI-PL	28480	0380-0008
	0510-0592	6	RETAINER-PUSH ON TUB EXT .14-DIA	28480	0510-0592
	0510-0741		BRACKET-RTANG .344-LG X .407-LG .312-WD	28480	0510-0741
	1205-0319	1	HEAT SINK 80L TO-3-PKG	28480	1205-0319
	1400-0082	2	CLAMP-CA .125-DIA .375-WD NYL	05448	HP-2N
MP5	2360-0391	4	SCREW, MACH 6-32 X 1.75 PAN PH	28480	2360-0391
	1540-0457	1	CASE-CRYG PVC 10LG 7.125WD 1.5DP	28480	1540-0457
	2950-0072	2	NUT-HEX-DBL-CHAM 1/4-32-TMD .062-IN-TMK	28480	2950-0075
MP1	4040-1125	1	SHELL, BOTTOM	28480	4040-1125
MP4	7101-0447	1	PANEL, FRONT	28480	7101-0447
	7120-3731	2	LABEL, HV WARNING	28480	7120-3731
	7120-5370	2	LABEL, HANDLE	28480	7120-5370
	7120-5955	1	LABEL, LINE VOLTAGE	28480	7120-5955
	7120-5956	1	LABEL, INFO	28480	7120-5956
	7120-6078	1	LABEL, INFO	28480	7120-6078
	7122-0097	1	NAMEPLATE	28480	7122-0097
MP3	5040-8044	4	SPACER	28480	5040-8044
	5040-8058	1	HANDLE	28480	5040-8058
	5041-0268	6	KEYCAP, PEARL GRAY	28480	5041-0268
	5061-1215	1	CABLE ASSEMBLY, GND BLACK	28480	5061-1215
	5061-1219	1	CABLE ASSEMBLY, STOP W/R	28480	5061-1219
	5061-1221	1	CABLE ASSEMBLY, CLK W/Y	28480	5061-1221
	5061-1222	1	CABLE ASSEMBLY, START W/GN	28480	5061-1222
	05048-60101	1	CABLE ASSEMBLY, POWER	28480	05048-60101
	05004-00001	1	BRACKET, HEAT SINK	28480	05004-00001
	05004-00002	1	SHIELD, HEAT SINK	28480	05004-00002
MP2	05004-20202	1	SHELL, TOP HALF	28480	05004-20202
	05004-20203	3	BEZEL, TEST POINT	28480	05004-20203
	05004-90001	1	MANUAL-OPERATING	28480	05004-90001
	10230-62101	5	GRABBER	28480	10230-62101

See introduction to this section for ordering information

Table. 6-2. Manufacturers Code List

Mfr. No.	MANUFACTURER NAME	ADDRESS	ZIP CODE
01542	HP DIV 01 OPTOELECTRONICS, PALO ALTO, CA		
01607	ALLEN-BRADLEY CO., MILWAUKEE, WI		
01698	TEXAS INSTRU INC SEMICONDC CMPNT DIV, DALLAS, TX		
02037	MOTOROLA SEMICONDUCTOR PRODUCTS, PHOENIX, AZ		
02713	GENERAL INSTR CORP SEMIDON PROD GP., HICKSVILL, NY		
02910	SIGNETICS CORP, SUNNYVALE, CA		
02995	MEPCO/ELECTRA CORP, MINERAL WELLS, TX		
03292	CORNING GLASS WORKS (BRADFORD), BRADFORD, PA		
03406	NATIONAL SEMICONDUCTOR CORP, SANTA CLARA, CA		
04200	SPRAGUE ELECTRIC CO., NORTH ADAMS, MA		
04504	CHICAGO MINIATURE/DRAKE, CHICAGO, IL		
04568	BECKMAN INSTRUMENTS INC HELIPOT DIV., FULLERTON, CA		73138
04703	LITTELFUSE INC., DES PLAINS, IL		
05448	BURNDY ENGINEERING, LATHRUP VILLAGE, MI		
05524	DALE ELECTRONICS INC., COLUMBUS, NE		
28480	HEWLETT-PACKARD CO CORPORATE HQ., PALO ALTO, CA		94304

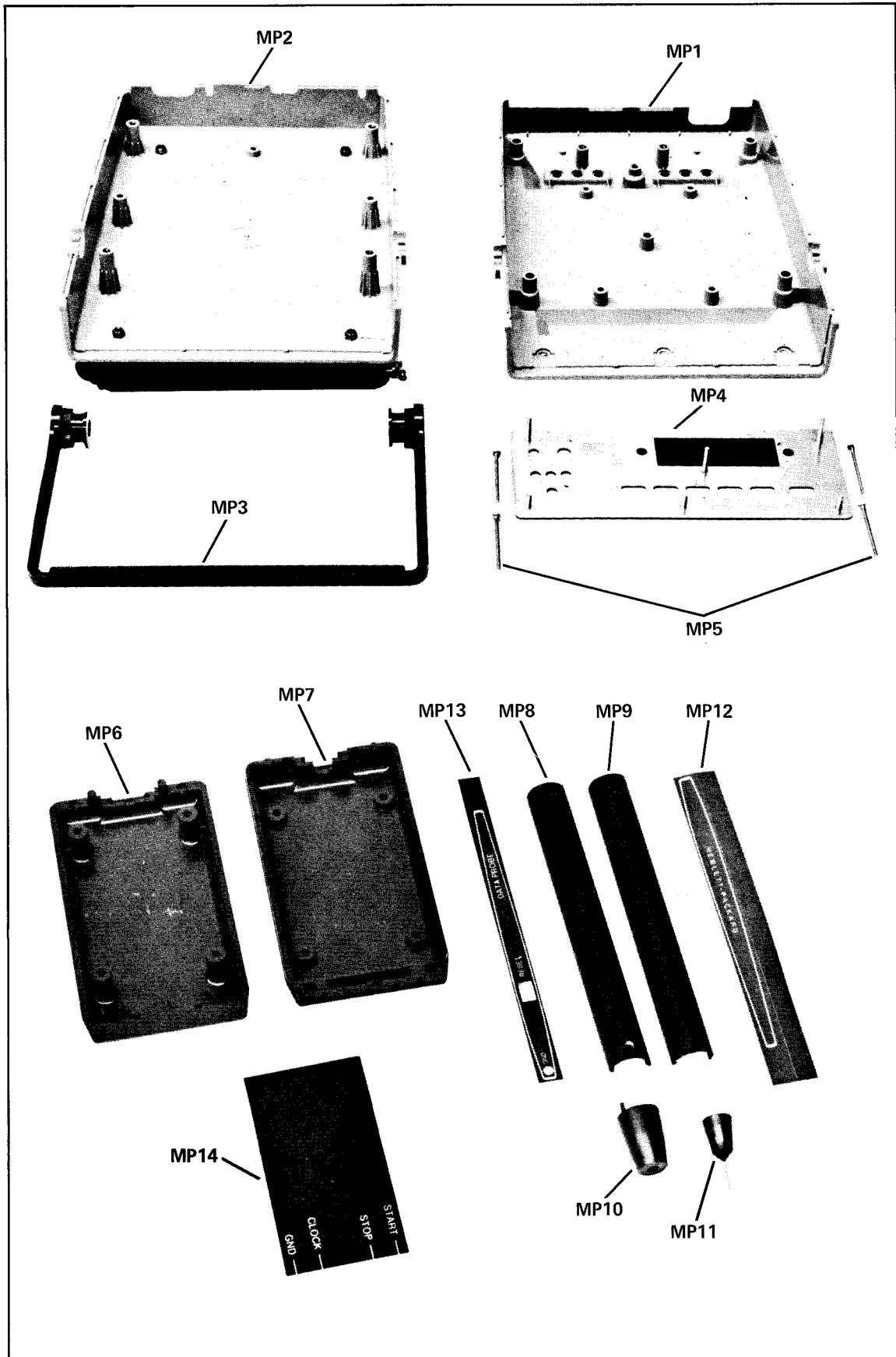

Figure 6-1. Mechanical Parts

## **SECTION VII MANUAL CHANGES**

### **7-1. INTRODUCTION**

7-2. This section normally contains information for adapting this manual to instruments for which the content does not apply directly. Since this manual does apply directly to instruments having serial numbers listed on the title page, no change information is given here. Refer to INSTRUMENTS COVERED BY MANUAL in Section I for additional important information about serial number coverage.

MANUAL DESCRIPTION	
INSTRUMENT:	5004A Signature Analyzer Operating and Service Manual
SERIAL PREFIX:	1704A
DATE PRINTED:	MARCH 1977
HP PART NO:	05004-90001
MICROFICHE NO:	05004-90002

**CHANGE DATE** April 24, 1979

(This change supersedes all earlier dated changes)

- Make all changes listed as ERRATA.
- Check the following table for your instrument's serial prefix or serial number and make listed change(s) to manual.

IF YOUR INSTRUMENT HAS SERIAL PREFIX OR SERIAL NUMBER	MAKE THE FOLLOWING CHANGES TO YOUR MANUAL	IF YOUR INSTRUMENT HAS SERIAL PREFIX OR SERIAL NUMBER	MAKE THE FOLLOWING CHANGES TO YOUR MANUAL
1736A	1	1824A	1, 2, 3, 4
1808A	1, 2		
1816A	1, 2, 3		

**NEW OR REVISED ITEM**

The following Service Notes are available from your local HP Sales and Service Office.

MODEL	DESCRIPTION
5004A-1B	Data Probe Threshold Voltage Adjustment and Compensation
5004A-2	Signature Analyzer Operational Verification (All Prefixes)
5004A-3	Resistor Changes to meet Narrow Negative Pulse Specification (Serial Prefix 1808 and below)

**ERRATA**

Page 6-7, Table 6-1, Replaceable Parts:

Change A2TP1 from 1251-4714 to 05004-20206; 1; TEST POINT; 28480; 05004-20206.

Change A2W1, W2, and W3 from 1251-4750 to 1251-4965 in the HP and Mfr Part Number columns.

Change MP8 reference designation to MP9 and MP9 to MP8 so MP9 identifies the bottom half of the body and MP8 the top half.

Change MP9 from 00545-20203 to 00547-20201 in HP and Mfr Part Number columns.

Add MP15; 1600-0506; RING, GROUNDING; 28480; 1600-0506; as part of probe assembly A3. This ring mounts on the rear end of the probe body and connects the body to circuit board common.

Change A3A1C3 from 0150-0088 (3.9 PF) to A3A1C3\*; 0160-2249; CAPACITOR-FXD 4.7 PF ± .25 PF 500 VDC; 28480; 0160-2249. \*FACTORY SELECTED VALUE BETWEEN 4.6 AND 4.9 PF.

Page 8-11, Figure 8-1, Troubleshooting Flowchart:

Change step 1 of "PRELIMINARY STEPS" to the following:

"1. SET FRONT-PANEL SWITCHES AS FOLLOWS: SELF-TEST-IN; START, STOP, CLOCK, AND HOLD-OUT."

Change Table 8-1 NORMAL signature for "Test Point 4" to A446.

Change Table 8-1 SERVICE signature for "Test Point 7" to 6P6F.

Change flow chart in three places to agree with the partial diagram shown in Figure 1.

Inside Title Page:

Change sentence under SERIAL NUMBERS to read "This manual applies directly to instruments with a Serial Number Prefix of 1704A."

Page 1-3, Table 1-2, Recommended Test Equipment:

Add Signature Analyzer, HP Model 5004A with Critical Specs of 15 nanosecond data setup time, START-STOP gating with setup time of 25 microseconds, and TTL compatibility.

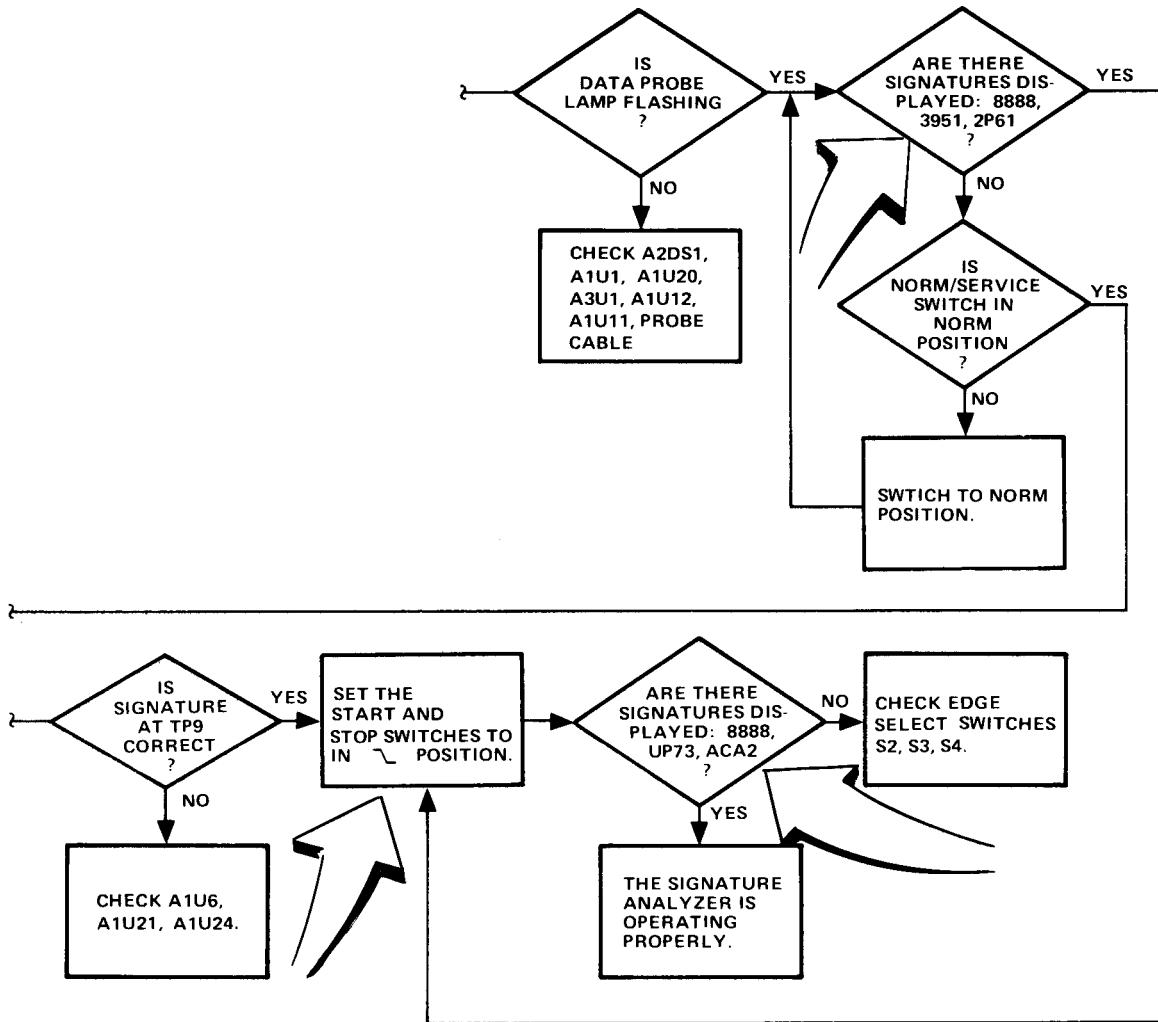

FIGURE 1. FLOWCHART CORRECTIONS

**ERRATA (Cont'd)**

Page 3-1, Paragraph 3-6, Character Illustration:

Delete the □ character between □ and □ .

Page 6-1, Paragraph 6-2b:

Change "Table 2", at end of sentence, to "Table 6-2".

Page 8-3, Examples 1 through 4:

Change examples to read as follows:

EXAMPLE 1 says that Z is not true if A is true and B is true or that Z is true if A and B are not both true.  $\bar{Z} = AB$  or  $Z = \overline{AB}$ . This is frequently referred to as NAND (for NOT AND).

EXAMPLE 2 says that Z is true if A is not true or if B is not true  $Z = \bar{A} + \bar{B}$ . Note that this truth table is identical to that of Example 1. The logic equation is merely .... etc.

EXAMPLE 3  $\bar{Z} = A + B$  or  $Z = \overline{A + B}$  and,

EXAMPLE 4  $Z = \bar{A} \bullet \bar{B}$ , also share a common truth table and are equivalent transformations of .... etc.

**ERRATA (Cont'd)**

Page 8-3, Paragraph 8-21:

Change third word to "symbols" in place of "cymbols".

Change positive logic symbol for DEVICE 2 to



Page 8-4, Negative Logic Symbol, Device 1:

Change negative logic symbol to



Page 8-4, Mixed Logic, NOR Gates for Examples 6 and 7:

Change notation inside both NOR symbols to " $\geq 1$ " in place of " $\leq 1$ ".

Page 8-9, Paragraph 8-36, Second Sentence:

Change NORMAL SERVICE to NORMAL/SERVICE.

Page 8-21, Paragraph 8-95:

Change 8-95 paragraph number under **Display Scan** to 8-97.

Add the following between paragraphs 8-94 and 8-97:

"8-95. The U28 oscillator output is applied to counter U26, and the output of U26 is applied to display scan decoder U18A. Output from U18A controls register drivers U15, U16, U13, and U14 plus the four transistor switches in U31. Outputs from U15, U16, U13, U14, and U31 control seven-segment displays DS1 through DS4.

**8-96. Self Test"**

Page 8-27, Figure 8-9, Schematic Diagram:

Change connection for BLK/RED wire to power transformer primary winding. Disconnect wire from present connection on S8. Reconnect to center contact of same section in S8 along with the wire from the upper contact of LINE switch S1.

Page 6-5, Table 6-1, A1 (05004-60007) Replaceable Parts:

Add A1J1; 1251-4743; RECEPTACLE, AC POWER; 28480; 1251-4743.

Change A1J1 to A1J2; 1251-4778; CONNECTOR 10-PIN PUSH-ON.

Change A1J2 to A1J3; 1251-4777; CONNECTOR 9-PIN PUSH-ON.

Page 6-6, Table 6-1, A1 MISCELLANEOUS Parts:

Delete entire listing for HP Part No. 5040-8013 power receptacle.

Page 8-25, Figure 8-8, A1 Component Locations:

Add "J1" beside power receptacle in upper right corner.

Change J1 (bottom right corner) to J2 and J2 to J3.

Page 8-27, Figure 8-9, Overall Schematic Diagram:

Change connector on A1 for A3 Data Probe connections from J1 to J2.

Change connector on A1 for A4 Gating Signal Pod from J2 to J3.

Change pin 10 on A1J3 (-11V) to pin 9.

Change pin 11 on A1J3 (common) to pin 7.

Change pin 2 on A1J3 (+5V) to pin 8.

Change pin 11 (common) on A4 pod board to pin 7.

Page 6-7, Table 6-1, Replaceable Parts:

Add "MP16" in Reference Designation column for HP Part No. 5040-0563.

NOTE – This "clip" holds the pod cables in place on the front of the pod.

Page 6-8, Table 6-1, Miscellaneous Replaceable Parts:

Change MP1 part number in "HP" and "Mfr" columns from 4040-1125 to 4040-1463.

**ERRATA (Cont'd)**

Page 8-27, Figure 8-9, A1 Schematic Diagram:

Change HP Part Number at top of A1 MAIN (MOTHER) BOARD from 05004-60001 to 05004-60007.

Change A1R38 from 1500 to 1800 ohms.

Change reference designator of resistor connected to the base of A8Q6 from "R36" to R40.

Page 6-6, Table 6-1, A1 (05004-60007) Replaceable Parts:

Change A1U28 from 1826-0180 (NE555V) to 1826-0355; IC TIMER; 28480; 1826-0355.

The 1826-0355 timer should be used for replacement in all instruments.

Page 6-5, Table 6-1, A1 Replaceable Parts:

Delete A1Q1, A1Q2, A1Q3, and A1Q4.

Page 6-6, Table 6-1, A1 Replaceable Parts:

Add A1U31; 1858-0014; 1; TRANSISTOR-ARRAY PNP; 28480; 1858-0014.

Page 8-13, Figure 8-2, Table 8-2 SERVICE SIGNATURES:

Delete "2946" signatures for U25 pin 4.

Change both signatures for U10 pin 12 to "T36F".

Delete "472A" signatures for U18 pin 13.

Change N signature for U19 pin 5 to "068C".

Add "2946" signature for N at U25 pin 9.

Page 1-2, Table 1-1, Specifications:

Change DATA PROBE Threshold to "Logic one: 2.0 Volt+0.1V-0.4V. Logic zero: 0.8 Volt+0.4V-0.0V."

Page 4-1, Paragraph 4-5, Steps c and d:

Change "+0.8V, +0.3V-0.2V" to +0.8V+0.4V-0.0V.

Page 4-5a, Table 4-2, Performance Test Record:

Change "Data Probe Light" test limits for Light Dim to +0.8 for "Min"; +1.2 for "Max".

Change limits for Light Bright to +1.6 for "Min"; +2.1 for "Max".

► Page 8-13, Table 8-2, Self-Test Normal/Service Signatures:

Change signatures in Table 8-2 as shown in following table:

IC	PIN NO.	MODE	SIGNATURE
U2	6	S	C2CF
U4	10	S	P40F
U5	11	N	472A
U6	9	N	466H
U6	10	N	F94H
U10	1	N	472A
U10	1	S	472A
U10	2	N	0000
U10	2	S	0000
U10	12	N	P36F
U10	12	S	P36F
U11	1	N	7CA7
U11	1	S	7CA7
U11	2	N	7CA7
U11	2	S	7CA7
U11	13	N	7CA7
U11	13	S	7CA7
U13	11	S	FUHU
U24	5	N	475F
U25	4	N	472A
U25	4	S	472A



**CHANGE 1 (1736A)**

Page 6-7, Table 6-1, A3 (05004-60005) Probe Assembly:

Add SERIES 1736 to Description of A3 (05004-60005) PROBE ASSEMBLY.

Change MP9 PROB BODY BOTTOM HALF from 00547-20201 to 05004-20207 in "HP Part Number" and "Mfr Part Number" columns of Table 6-1.

Change MP8 PROBE BODY TOP HALF from 05004-20204 to 05004-20208 in "HP Part Number" and "Mfr Part Number" columns of Table 6-1.

Change SWITCH, PUSHBUTTON from 05004-20205 to 00546-40004 in HP and Mfr Part Number columns in Table 6-1.

Add SERIES 1736 to Description of A3A1 (05004-60003).

Change A3A1S1 from 00546-00001 to 00546-00002 in HP and Mfr Part Number columns.

Add to "A3A1 MISCELLANEOUS" HP Part No. 00546-40003; RETAINER, SWITCH A3A1S1; 28480; 00546-40003.

Add to "A3A1 MISCELLANEOUS" HP Part No. 0624-0340; SCREW, SELF TAPPING 0-80 x .188" (for A3A1S1 mounting); 28480; 0624-0340.

Change A3A1C3 from 0160-2249 (4.7 pF Factory Selected Value) to 0121-0505; CAPACITOR-VAR 2.5-10 pF CER (SQUARE ADJ. HOLE); 28480; 0160-2249.

Change A3A1R1 from 0698-7225 (348 $\Omega$ ) to 0698-7222; RESISTOR-FXD 261 $\Omega$  1% .05W F TC=0+-100; 28480; 0698-7222.

Change A3A1R2 from 0698-8875 (27.4 $\Omega$ ) to 0698-7195; RESISTOR-FXD 19.6 $\Omega$  1% .05W F TC=0+-100; 28480; 0698-7195.

Change A3A1R3 from 0698-8874 (127 $\Omega$ ) to 0698-7214; RESISTOR-FXD 121 $\Omega$  1% .05W F TC=0+-100; 28480; 0698-7214.

Page 6-7, Table 6-1, A3 (05004-60005) Probe Assembly:

Change A3A1R4 from 2100-1986 (1000 $\Omega$  VAR) to 2100-1788; RESISTOR-VAR 500 $\Omega$  10% C TOP-ADJ 1-TURN; 28480; 2100-1788.

Change A3A1R6 from 0757-0849 (36.5K $\Omega$ ) to 0699-0105; RESISTOR-FXD 36.5K $\Omega$  1% .5W C; 28480; 0699-0105.

Add A3A1R7; 2100-1984; RESISTOR-VAR 100 $\Omega$  10% C TOP-ADJ 1-TURN; 28480; 2100-1984.

Add A3A1R8; 0698-7228; RESISTOR-FXD 464 $\Omega$  1% .05W F TC=0+-100; 28480; 0698-7228.

Change A3A1U1 from 1820-0919 to 05004-80001; IC COMPTR ECL A/D DUAL (SELECTED); 28480; 05004-80001.

Add to "A3A1 MISCELLANEOUS" HP Part No. 8710-1177; TOOL, ADJUSTMENT SQUARE SHANK (for A3A1C3); 28480; 8710-1177.

Page 8-24, Figure 8-7, Probe A3 Component Locator:

Replace A3 component locator with attached Figure 2 component locator for the SERIES 1736 Probe.

Page 8-27, Figure 8-9, Schematic Diagram:

Replace A3 (05004-60003 SERIES 1704) schematic diagram of probe with attached Figure 2 diagram for SERIES 1736.

**ADJUSTMENT PROCEDURE (FOR A3 SERIES 1736 PROBE)**

The series 1736 probe has three adjustments which are factory set and will need adjustment only after repair of the circuit board. Adjustment must be made with the probe covers in place. The covers have access holes under the probe labels. Special adjustment tool 8710-1177 is required for setting variable capacitor C3.

If probe adjustment is necessary, contact your local HP Sales/Service Office or field engineer for a copy of Service Note 5004A-1A for the recommended adjustment procedure.

Page 6-8, Table 6-1, A4 (05004-60006) Replaceable Parts:

Change A4A1U2 and U3 from 1820-0919 to 05004-80002; IC COMPTR ECL A/D DUAL (SELECTED MC1650L); 28480; 05004-80002.

**CHANGE 2 (1808A)**

Page 6-5, Table 6-1, A1 (05004-60007) Replaceable Parts:

Add "SERIES 1808" to A1 Description.

Change A1CR4 and CR5 from 1901-0782 (IN5821) to 1901-0673; DIODE-PWR RECT 5US 100V 5A; 03508; A15A.

Page 8-27, Figure 8-9, A1 (05004-60007) Schematic Diagram:

Change A1 series number (top of diagram) from 1704 to 1808.

**CHANGE 3 (1816A)**

Pages 6-5 and 6-6, Table 6-1, A1 (05004-60001) Replaceable Parts:

Change A1 series number from 1808 to 1816.

Change A1R37 from 0683-2225 (2200 $\Omega$ ) to 0683-2215, 220 ohms 5% 1/4W; Mfr Part No. CB2215.

Change A1R38 from 0683-1825 (1800 $\Omega$ ) to 0683-1815; 180 ohms 5% 1/4W; Mfr Part No. CB1815.

Page 8-27, Figure 8-9, A1 (05004-60007) Schematic Diagram:

Change A1 series number (top of schematic) from 1808 to 1816.

Change A1R37 from 2200 to 220 ohms.

Change A1R38 from 1800 to 180 ohms.

NOTE: Serial Prefix 1808A instruments with serial numbers of 00602, 00615, 00617, 00618, 00619, 00622, 00625, 00641, 00660, 00662, 00666, and 00674 have the above change for A1R37 and A1R38. The series number on the A1 circuit boards in these instruments is 1808.

**CHANGE 4 (1824A)**

Page 6-5, Table 6-1, A1 (05004-60007) Replaceable Parts:

Change the series number from 1816 to 1824.

Change A1C25 from 0180-2413 to 0180-2908; CAPACITOR-FXD 6300UF  $\pm$ 20% 28WVDC; 28480; 0180-2908.

Page 8-27, Figure 8-9, A1 (05004-60007) schematic diagram:

Change C25 from 7500UF to 6300UF.

Change A1 series number from 1816 to 1824.

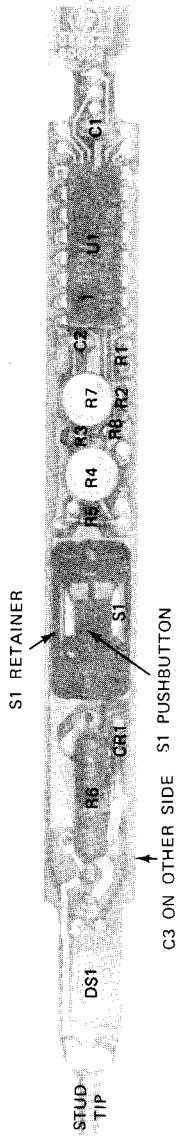

FIGURE 2. COMPONENT LOCATOR FOR A3 SERIES 1736 PROBE

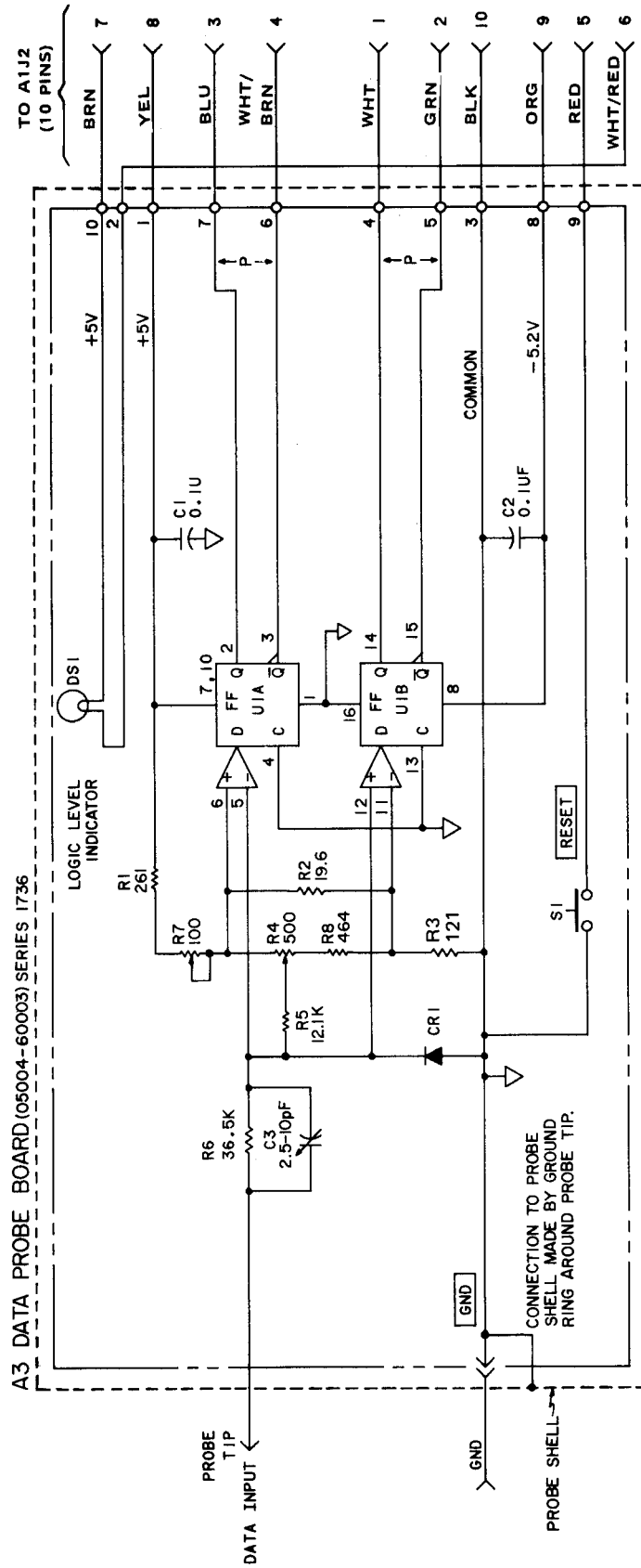

FIGURE 3. A3 SCHEMATIC DIAGRAM FOR SERIES 1736

## SECTION VIII SERVICE

### 8-1. INTRODUCTION

8-2. This section provides safety considerations, logic symbols, troubleshooting procedures, block diagram and description, circuit theory, component location photos, and schematic diagram (service information).

### 8-3. SAFETY CONSIDERATIONS

8-4. Although this instrument has been designed in accordance with international safety standards, this manual contains information, cautions, and warnings which must be followed to ensure safe operation and to retain the instrument in safe condition (see Sections II, III, and V). Service and adjustments should be performed only by qualified service personnel.

#### **WARNING**

**ANY INTERRUPTION OF THE PROTECTIVE (GROUNDING) CONDUCTOR (INSIDE OR OUTSIDE THE INSTRUMENT) OR DISCONNECTION OF THE PROTECTIVE EARTH TERMINAL IS LIKELY TO MAKE THE INSTRUMENT DANGEROUS. INTENTIONAL INTERRUPTION IS PROHIBITED.**

8-5. Any adjustment, maintenance, and repair of the opened instrument under voltage should be avoided as much as possible and, when inevitable, should be carried out only by a skilled person who is aware of the hazard involved.

8-6. Capacitors inside the instrument may still be charged even if the instrument has been disconnected from its source of supply.

8-7. Make sure that only fuses with the required rated current and of the specified type (normal blow, time delay, etc.) are used for replacement. The use of repaired fuses and the short-circuiting of fuseholders must be avoided.

8-8. Whenever it is likely that this protection has been impaired, the instrument must be made inoperative and be secured against any unintended operation.

#### **WARNING**

**THE SERVICE INFORMATION IS OFTEN USED WITH LINE POWER SUPPLIED AND PROTECTIVE COVERS REMOVED FROM THE INSTRUMENT. ENERGY AVAILABLE AT MANY POINTS MAY, IF CONTACTED, RESULT IN PERSONAL INJURY.**

## 8-9. RECOMMENDED TEST EQUIPMENT

8-10. Test equipment and test equipment accessories required to maintain the 5004A are listed in *Table 1-2*. Equipment other than that listed may be used if it meets the listed critical specifications.

## 8-11. LOGIC SYMBOLS

8-12. Logic symbols used in this manual conform to the American National Standard ANSI Y32.14-1973 (IEE Std. 91-1973). This standard supersedes MIL-STD-806B. In the following paragraphs logic symbols are described.

## 8-13. Logic Concepts

8-14. The binary numbers 1 and 0 are used in pure logic where 1 represents true, yes, or active and 0 represents false, no, or inactive. These terms should not be confused with the physical quantity (e.g., voltage) that may be used to implement the logic, nor should the term "active" be confused with a level that turns a device on or off. A truth table for a relationship in logic shows (implicitly or explicitly) all the combinations of true and false input conditions and the result (output). There are only two basic logic relationship, AND and OR. The following illustrations assume two inputs (A and B), but these can be generalized to apply to more than two inputs.

**AND** Y is true if and only if A is true and B is true (or more generally, if all inputs are true).  
Y=1 if and only if A=1 and B=1.  
Y=A•B

**OR** Y is true if and only if A is true or B is true (or more generally, if one or more input(s) is (are) true).  
Y=1 if and only if A=1 or B=1.  
Y=A+B

TRUTH TABLE

A	B	Y
1	1	1
1	0	0
0	1	0
0	0	0

EQUIVALENT SYMBOLS

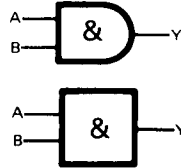

TRUTH TABLE

A	B	Y
1	1	1
1	0	1
0	1	1
0	0	0

EQUIVALENT SYMBOLS

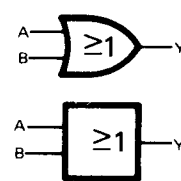

## 8-15. Negation

8-16. In logic symbology, the presence of the negation indication symbol  $\bigcirc$  provides for the representation of logic function inputs and outputs in terms *independent* of their physical values; the 0-state of the input or output being the 1-state of the symbol referred to by the symbol description.

EXAMPLE 1



TRUTH TABLE

A	B	Z
1	1	0
1	0	1
0	1	1
0	0	1

EXAMPLE 2



TRUTH TABLE

A	B	Z
1	1	0
1	0	1
0	1	1
0	0	1

EXAMPLE 3



TRUTH TABLE

A	B	Z
1	1	0
1	0	0
0	1	0
0	0	1

EXAMPLE 4

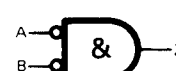

TRUTH TABLE

A	B	Z
1	1	0
1	0	0
0	1	0
0	0	1

EXAMPLE 1 says that Z is *not* true if A is true *and* B is true or that Z is true if A *and* B are *not* both true.  $Z = \overline{AB}$  or  $Z = \overline{A} + \overline{B}$ . This is frequently referred to as NAND (for NOT AND).

EXAMPLE 2 says that Z is true if A is *not* true or if B is *not* true.  $Z = \overline{A} + \overline{B}$ . Note that this truth table is identical to that of Example 1. The logic equation is merely a De Morgan's transformation of the equations in Example 1. The symbols are equivalent.

EXAMPLE 3  $Z = A + B$  or  $Z = \overline{\overline{A} \cdot \overline{B}}$  and,

EXAMPLE 4  $Z = A \cdot B$ , also share common truth table and are equivalent transformations of each other. The NOT OR form (Example 3) is frequently referred to as NOR.

**NOTE**

In this manual the logic negation symbol is NOT used.

**8-17. Logic Implementation and Polarity Indication**

8-18. Devices that can perform the basic logic functions, AND and OR, are called gates. Any device that can perform one of these functions can also be used to perform the other if the relationship of the input and output voltage levels to the logic variables 1 and 0 is redefined suitably.

8-19. In describing the operation of electronic logic devices, the symbol H is used to represent a "high level," which is a voltage within the more-positive (less-negative) of the two ranges of voltages used to represent the binary variables. L is used to represent a "low level," which is a voltage within the less-positive (more-negative) range.

8-20. A function table for a device shows (implicitly or explicitly) all the combinations of input conditions and the resulting output conditions.

8-21. In graphic symbols, inputs or outputs that are active when at the high level are shown without polarity indication. The polarity indicator symbol  $\triangleleft$  denotes that the active (one) state of an input or output *with respect to the symbol to which it is attached* is the low level.

**NOTE**

The polarity indicator symbol " $\triangleleft$ " is used in this manual.

EXAMPLE 5

Assume two devices having the following function tables.

DEVICE #1  
FUNCTION TABLE

A	B	Y
H	H	H
H	L	L
L	H	L
L	L	L

DEVICE #2  
FUNCTION TABLE

A	B	Y
H	H	H
H	L	H
L	H	H
L	L	L

POSITIVE LOGIC

By assigning the relationships H=1, L=0 at both input and output, Device #1 can perform the AND function and Device #2 can perform the OR function. Such a consistent assignment is referred to as positive logic. The corresponding logic symbols would be:

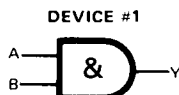

**NEGATIVE LOGIC**

Alternatively, by assigning the relationship H=0, L=1 at both input and output, Device #1 can perform the OR function and Device #2 can perform the AND function. Such a consistent assignment is referred to as negative logic. The corresponding logic symbols would be:



8-22. **MIXED LOGIC.** The use of the polarity indicator symbol ( $\nabla$ ) automatically invokes a mixed-logic convention. This is, positive logic is used at the input and outputs that do not have polarity indicators, negative logic is used at the inputs and outputs that have polarity indicators.

**EXAMPLE 6  
FUNCTION TABLE**

A	B	Z
H	H	L
H	L	H
L	H	H
L	L	H

**EXAMPLE 7  
FUNCTION TABLE**

A	B	Z
H	H	L
H	L	L
L	H	L
L	L	H

This may be shown either of two ways:



This may be shown either of two ways:

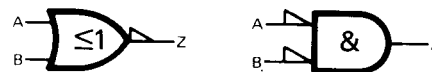

Note the equivalence of these symbols to examples 1 and 2 and the fact that the function table is a positive-logic translation (H=1, L=0) of the NAND truth table, and also note that the function table is the negative-logic translation (H=0, L=1) of the NOR truth table, given in Example 3.

Note the equivalence of these symbols to examples 3 and 4 and the fact that the function table is a positive-logic translation (H=1, L=0) of the NOR truth table, and also note that the function table is the negative-logic translation (H=0, L=1) of the NAND truth table, given in Example 1.

8-23. It should be noted that one can easily convert from the symbology of positive-logic merely by substituting a polarity indicator ( $\nabla$ ) for each negative indicator ( $\circ$ ) while leaving the distinctive shapes alone. To convert from the symbology of negative logic, a polarity indicator ( $\nabla$ ) is substituted for each negation indicator ( $\circ$ ) and the OR shape is substituted for the AND shape or vice versa.

8-24. It was shown that any device that can perform OR logic can also perform AND logic and vice versa. De Morgan's transformation is illustrated in Examples 1 through 7. The rules of the transformation are:

1. At each input or output having a negation ( $\circ$ ) or polarity ( $\nabla$ ) indicator, delete the indicator.
2. At each input or output not having an indicator, add a negation ( $\circ$ ) or polarity ( $\nabla$ ) indicator.
3. Substitute the AND symbol ( $\square$ ) for the OR symbol ( $\cup$ ) or vice versa.

These steps do not alter the assumed convention; positive-logic stays positive, negative-logic stays negative, and mixed-logic stays mixed.

8-25. The choice of symbol may be influenced by these considerations: (1) The operation being performed may best be understood as AND or OR. (2) In a function more complex than a basic gate, the inputs will usually be considered as inherently active high or active low (e.g., the J and K inputs of a J-K flip-flop are active high and active low, respectively). (3) In a chain of logic, understanding and the writing of logic equations are often facilitated if active-low or negated outputs feed into active-low or negated inputs.

## 8-26. Other Symbols

8-27. More symbols are required to depict complex logic diagrams. Some of the other symbols are as follows:



Dynamic input activated by transition from a low level to a high level. The opposite transition has no effect at the output.



Dynamic input activated by transition from a high level to a low level. The opposite transition has no effect at the output.

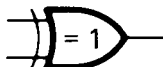

Exclusive OR function. The output will assume its indicated active level if and only if one and only one of the two inputs assumes its indicated active level.

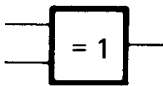

Inverting function. The output is low if the input is high and it is high if the input is low. The two symbols shown are equivalent.



Noninverting function. The output is high if the input is high and it is low if the input is low. The two symbols shown are equivalent.



OUTPUT DELAY. The output signal is effective when the input signal returns to its opposite state.

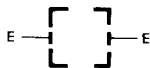

EXTENDER. Indicates when a logic function increases (extends) the number of inputs to another logic function.



FLIP-FLOP. A binary sequential element with two stable states: a set (1) state and a reset (0) state. Outputs are shown in the 1 state when the flip-flop is set. In the reset state the outputs will be opposite to the set state.



RESET. A 1 input will reset the flip-flop. A return to 0 will cause no further effect.



SET. A 1 input will set the flip-flop. A return to 0 will cause no further action.



TOGGLE. A 1 input will cause the flip-flop to change state. A return to 0 will cause no further action.





J INPUT. Similar to the S input except if both J and K (see below) are at 1, the flip-flop changes state.



K INPUT. Similar to the R input (see above).



D INPUT (Data). Always dependent on another input (usually C). When the C and D inputs are at 1, the flip-flop will be set. When the C is 1 and the D is 0, the flip-flop will reset.



Address symbol has multiplexing relationship at inputs and demultiplexing relationship at outputs.

## 8-28. Dependency Notation “C” “G” “V” “F”

8-29. Dependency Notation is a way to simplify symbols for complex IC elements by defining the existence of an AND relationship between inputs, or by the AND conditioning of an output by an input without actually showing all the elements and interconnections involved. The following examples use the letter “C” for control and “G” for gate. The dependent input is labeled with a number that is either prefixed (e.g., 1X) or subscripted (e.g., X<sub>1</sub>). They both mean the same thing. The letter V is used to indicate an OR relationship between inputs or between inputs and outputs with this letter (V). The letter F indicates a connect-disconnect relationship. If the F (free dependency) inputs or outputs are active (1) the other usual normal conditions apply. If one or more of the F inputs are inactive (0), the related F output is disconnected from its normal output condition (it floats).



The input that controls or gates other inputs is labeled with a “C” or a “G”, followed by an identifying number. The controlled or gated input or output is labeled with the same number. In this example, “1” is controlled by “G1.”

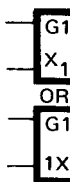

When the controlled or gated input or output already has a functional label (X is used here), that label will be prefixed or subscripted by the identifying number.



If a particular device has only one gating or control input then the identifying number may be eliminated and the relationship shown with a subscript.

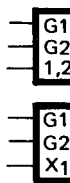

If the input or output is affected by more than one gate or control input, then the identifying numbers of each gate or control input will appear in the prefix or subscript, separated by commas. In this example “X” is controlled by “G1” and “G2.”

## 8-30. Control Blocks

8-31. A class of symbols for complex logic are called control blocks. Control blocks are used to show where common control signals are applied to a group of functionally separate units. Examples of types of control blocks follow.

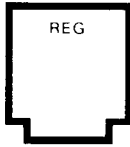

Register control block. This symbol is used with an associated array of flip-flop symbols to provide a point of placement for common function lines, such as a common clear.

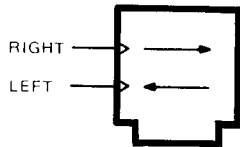

Shift register control block. These symbols are used with any array of flip-flop symbols to form a shift register. An active transition at the inputs causes left or right shifting as indicated.

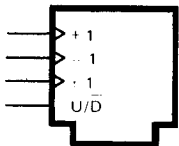

Counter control block. The symbol is used with an array of flip-flops or other circuits serving as a binary or decade counter. An active transition at the +1 or -1 input causes the counter to increment one count upward or downward, respectively. An active transition at the  $\pm 1$  input causes the counter to increment one count upward or downward depending on the input at an up/down control.

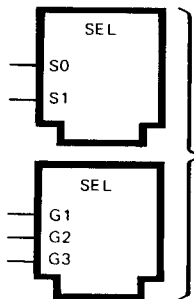

Selector control block. These symbols are used with an array of OR symbols to provide a point of placement for selection (S) or gating (G) lines. The selection lines enable the input designated 0, 1, ..., n of each OR function by means of a binary code where S0 is the least-significant digit. If the 1 level of these lines is low, polarity indicators ( $\nabla$ ) will be used. The gating lines have an AND relation with the respective input of each OR function: G1 with the inputs numbered 1, G2 with the input numbered 2, and so forth. If the enabling levels of these lines is low, polarity indicators ( $\nabla$ ) will be used.

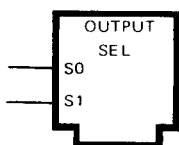

Output selector control block. This symbol is used with a block symbol having multiple outputs to form a decoder. The selection lines enable the output designated 0, 1, ..., n of each block by means of a binary code where S0 is the least-significant digit. If the 1 level of these lines is low, polarity indicators ( $\nabla$ ) will be used.

## 8-32. Complex Logic Devices

8-33. Logic elements can be combined to produce very complex devices that can perform more difficult functions. A control block symbol can be used to simplify understanding of many complex devices. Several examples of complex devices are given here.

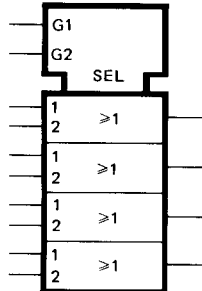

Selector Control Block used to simplify AND portion of a quad AND-OR select gate. When G1 is high, the data presented at the "1" inputs will be gated through. When G2 is high, the data presented at the "2" inputs will be gated through.

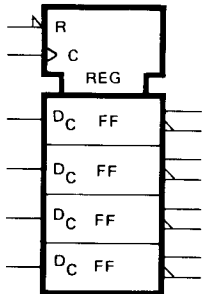

Register control block used to illustrate a quad D-type latch. There is a common active-low reset (R), and a common edge-triggered control input (C). Since there is only one dependency relationship, the controlling input is not numbered and the controlled functions (D) are subscripted with a C.

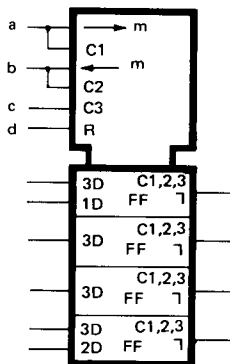

Shift Register Control Block used to show common inputs to a bidirectional shift register. Notice that " $-m$ " means shift the contents to the right or down by " $m$ " units. And " $+m$ " means shift the contents to the left or up by " $m$ " units. Note: If  $m=1$ , it may be omitted. Inputs "a" and "b" are each single IC pins that have two functions. Input "a" enables one of the inputs to the top D-type flip-flop (1D), and also shifts the register contents down one unit. Input "b" enables one of the inputs to the bottom flip-flop (2D), and also shifts the register contents up one unit. Input "c" loads all four flip-flops in parallel (3D). Input "d" is a common reset. The output delay indicator is used because these are master-slave flip-flops.

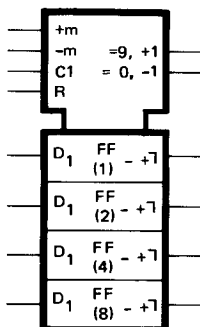

Counter Control Block used to show common inputs to a Presettable Decade Up/Down Counter. Notice that " $+m$ " means count up (increment the count) by " $m$ ;" " $-m$ " means count down by " $m$ ." Note: if  $m=1$ , it may be omitted. Since the D-type flip-flops are master-slave, the output delay indicator is used. The " $=9, +1$ " and " $=9, -1$ " notation defines when the carry and borrow outputs are generated. They also define it, as a decade counter; a binary counter would have carry indicated with " $=15, +1$ ." Flip-flop weighting is indicated in parenthesis.

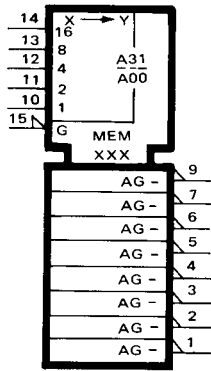

Read Only Memory (ROM) with 32 addresses. Address selection is determined by the five upper inputs which are decoded into 32 possible addresses (A00 through A31) corresponding to the weighting modifiers at the inputs. Input modifier G (pin 15) gates the outputs. Stored data will be read from the selected memory address if G is active (low). The output data pins (1—7 and 9) are active low. The “—” indicator shows the 8 outputs are capable of supplying low outputs only. A high output is usually supplied by a resistor to a “high” voltage.

### 8-34. TROUBLESHOOTING (FAILURE ANALYSIS)

8-35. Information to help locate a fault or trouble in the 5004A is given in the following material.

8-36. Several troubleshooting aids are permanently built-in the 5004A. The SELF-TEST front panel switch is one. The main assembly (motherboard) NORMAL SERVICE switch is another. The front panel GATE lamp is another. The four-front panel seven-segment digit displays are another. The front panel UNSTABLE SIGNATURE is another.

8-37. The front panel SELF-TEST switch operation is described in Section III of this manual.

### 8-38. Troubleshooting Flowchart

8-39. *Figure 8-1*, the troubleshooting flowchart may be used to locate a faulty component. A suggested sequence for troubleshooting is:

- a. Perform the Operator’s Self-Test (see in Section III).
- b. If the 5004A does not pass the Operators Self-test, perform the steps given in the troubleshooting flowchart (*Figure 8-1*).

### 8-40. Major Test Point Signatures

8-41. *Table 8-1* lists the signatures for the major test points.

### 8-42. Troubleshooting Signatures with SELF-TEST and NORMAL/SERVICE Switches

8-43. *Table 8-2* is a listing of signatures taken from a correctly operating 5004A with a second correctly operating 5004A. These signatures may be used to locate the cause of a malfunction in a 5004A Signature Analyzer. To take most of the signatures listed requires that the top cover of the 5004A be removed. Refer to the disassembly procedures before attempting to remove the top cover.

**WARNING**

**IF THE 5004A TOP COVER IS REMOVED, DANGEROUS VOLTAGES ARE EXPOSED. ONLY QUALIFIED ELECTRONIC SERVICE TECHNICIANS SHOULD ATTEMPT TO SERVICE THE 5004A WITH COVERS REMOVED.**

Table 8-1. Troubleshooting Signatures Major Test Points

Test Point*	Location	Signature	
		NORMAL	SERVICE
1	U25(11)	FUFU	←
2	U29(1)	54PH	←
3	U29(2)	0155	←
4	U29(3)	HH4b	←
5	U29(4)	HFLI	←
6	U9(5)	595F	←
7	U11(8)	U36U	6P6F
8	U7(4), U24(9)	4C4F	125P
9	U24(13), U6(10)	F94H	CFU5

\*Test point numbers are shown on the schematic diagram for the 5004A.

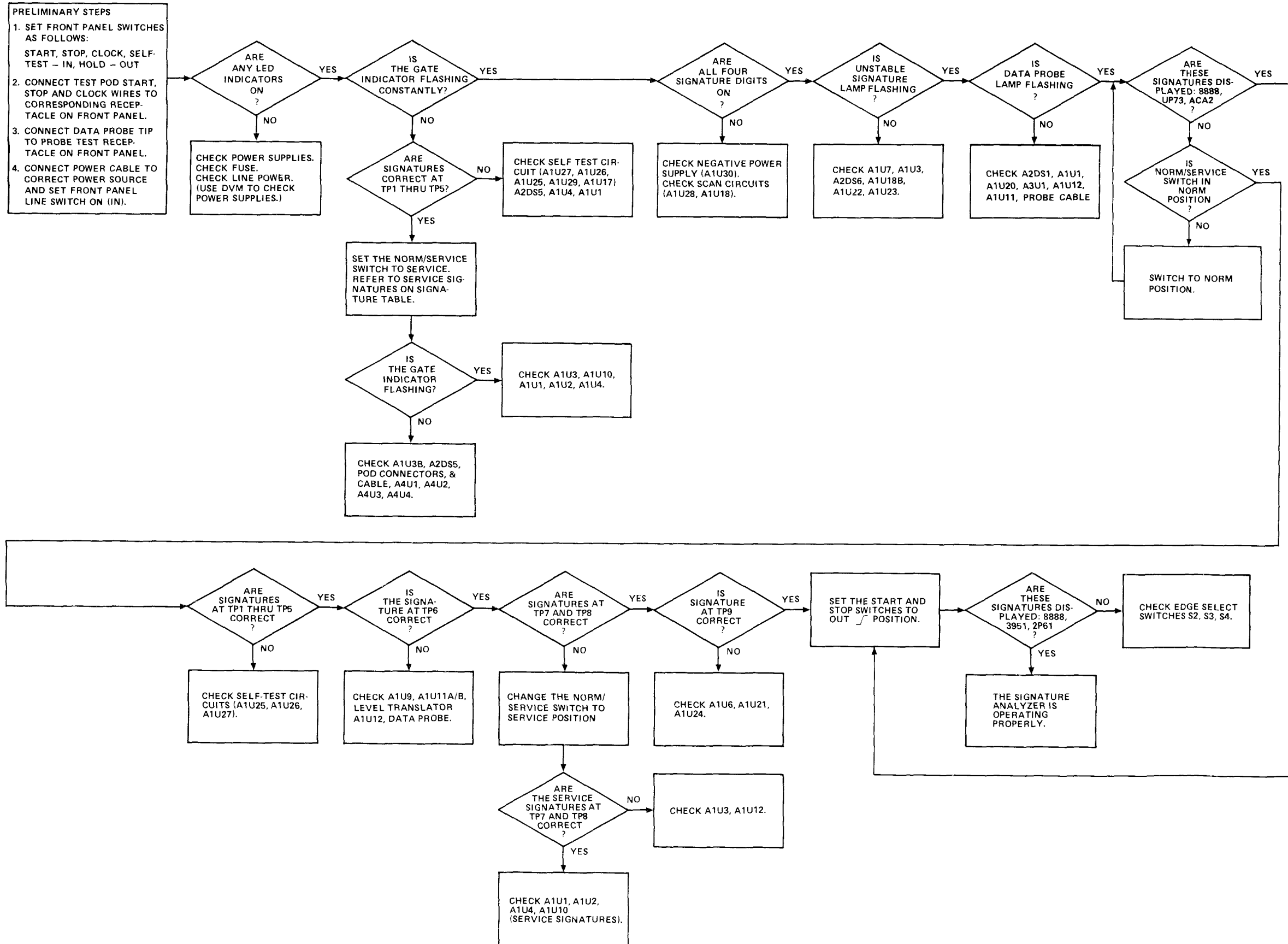
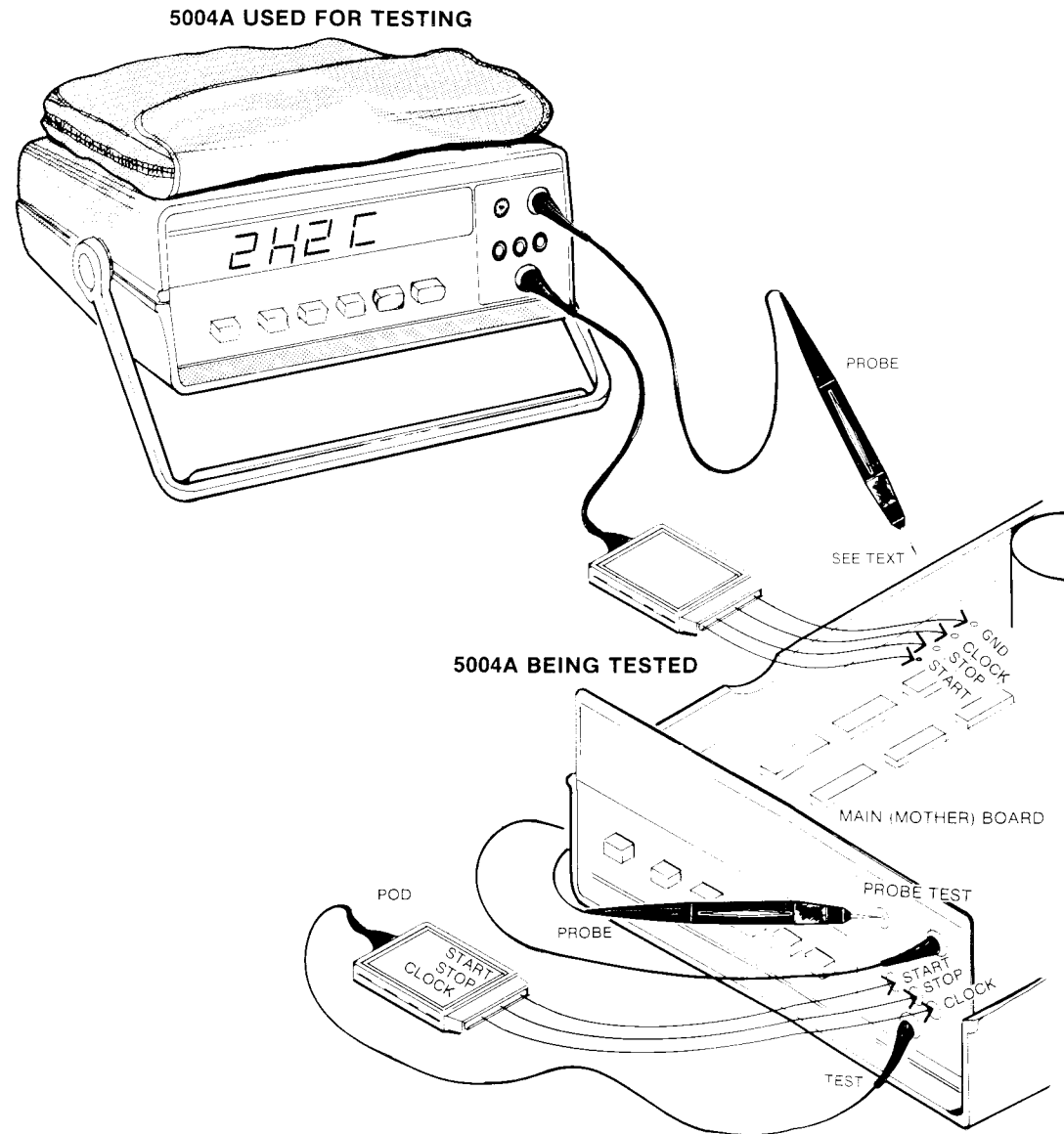

Table 8-2. SELF-TEST and NORMAL SERVICE Signatures



PINS	L1	L2	L3	L4	L5	L6	L7	L8	L9	L10	PIN
1 N	472A	5A22		1H08	5A22	472A	F517	UCP9	472A	7CA7	1
S	472A	94A3		H389	94A3	472A	P7AA	PF43	472A	7CA7	
2 N	A326	A326		09P3	472A	472A	0000	P36F	3F8H	7CA7	2
S	A326	A326		09P3	472A	472A	0000	P36F	3F8H	7CA7	
3 N	P40F	UCP9		1H08	472A	472A	823H	CHF3	7CA7	472A	3
S	P40F	PF43		H389	472A	A080	AC69	7CA7	472A	472A	
4 N	464F	UCP9		UCP9	P40F	472A	4C3F	CHF3	472A	0000	4
S	464F	PF43		PF43	P40F	472A	125P	AC69	472A	0000	
5 N	13F7	UCP9		UCP9	5829	596F	0F66	66P0	596F	472A	5
S	13F7	PF43		PF43	A427	596F	5574	6606	596F	472A	
6 N	4PF9	3P06		UCP9	1H4L0	0147	0000	UCP9	1P46	0000	6
S	4PF9	62CF		PF43	6H73	42L6	0000	PF43	1P46	0000	
7 N	09P3	0000		0000	0000	0000	0000	0000	0000	0000	7
S	09P3	0000		0000	0000	0000	0000	0000	0000	0000	
8 N	0000	0000		C445	66P0	0000	1H4L0	472A	0000	13F7	8
S	0000	0000		1669	6606	0000	6H73	472A	0000	13F7	
9 N	0000	5829		5829	5829	0000	HAU1	FLFL		54PH	9
S	0000	A427		A427	A427		HAU1	FLFL		54PH	
10 N		4PF9		P40F	P40F	F944	0F66	0863		464F	10
S		4PF9		P40F	P40F	CFU5	5574	0863		464F	
11 N	5829	4PF9		5829	P40F	ALF8	4596	7CA7		0166	11
S	A427	4PF9		A427		HHH5	4596	7CA7		0166	
12 N	3P06	4PF9	54PH	1H08	5A22	2CAL	2946	7A33		0166	12
S	F61C	4PF9	54PH	H389	94A3	6PAH	2946	7A33		0166	
13 N	C445	A326	0166	H08	P36F	1501	90FP	4596		A446	13
S	2946	A326	0166	H389	P36F	1417	90FP	4596		A446	
14 N	1H08	472A		472A	472A	472A	472A	472A		472A	14
S	H389	472A		472A	472A	472A	472A	472A		472A	
15 N	5A22							472A			15
S	94A3							472A			
16 N	472A							472A			16
S	472A							472A			

N = NORMAL  
S = SERVICE position of S7.

To get the signatures given in this table, set the two 5004A's controls as follows:

5004A Being Tested  
LINE:OFF; START:OUT; STOP:OUT; HOLD:OUT; SELF-TEST:IN.

5004A Used to Test  
Same as above except SELF-TEST:OUT

Make the connections shown between the two 5004A's.

PIN	L11	L12	L13	L14	L15	L16	L17	L18	L19	L20	PIN
1 N	7CA7						90FP	0000	6892		1
S	7CA7						90FP	0000	802C		
2 N	7CA7						HH53		443F		2
S	7CA7						HH53		80CH		
3 N	3F8H		75U6	75U6	75U6	75U6	75U6		2CHF		3
S	3F8H		0261	0261	0261	0261	0261		99L2		
4 N	3F8H	0000	A096	A096	A096	A096		4C78	27L3		4
S	3F8H	0000	92PC	92PC	92PC	92PC		9H02			
5 N	3F8H	472A	3A0L	3A0L	3A0L	3A0L	0863	25CF	069C		5
S	3F8H	472A	9664	9664	9664	9664		25CF	0H1AH		
6 N	7CA7		FL22	FL22	FL22	FL22	A096	7661	78CP		6
S	7CA7		C152	C152	C152	C152		92PC	PH0C		
7 N	0000						0000	5L8L	P73H		7
S	0000						0000	5L8L	CH2L		
8 N	U36L		0000	0000	0000	0000	FL22				8
S	6P6F		0000	0000	0000	0000	C152	0000			
9 N	C445		0000	0000	0000	0000	7A33			9	
S	2946		0000	0000	0000	0000	7A33	472A			
10 N	C445		0000	0000	0000	0000					10
S	2946		0000	0000	0000	0000					
11 N	472A		FH33	C826	F94H	ALF8	3A0L	0000			11
S	472A		FLAL	PL7H	CFL5	HHH5	9664	0000			
12 N	3F8H	3F8H	1501	6C7H	929A	475F	29PP	472A			12
S	3F8H	3F8H	1417	5553	U242	3003	29PP	472A			
13 N	7CA7	7CA7	APH9	5F97	2535	9FU2	472A				13
S	7CA7	7CA7	3AAA	C822	U600	7282	472A				
14 N	472A		54F8	94FH	52A7	2CAL	472A	0000	0000		14
S	472A		UPLF	7CCH	67A8	6PAH	472A	0000	0000		
15 N			0000	0000	0000	0000		0000	0000		15
S			0000	0000	0000	0000		0000	0000		
16 N			472A	472A				472A	472A		16
S			472A	472A				472A	472A		

PIN	L21	L22	L23	L24	L25	L26	L27	L28	L29	L30	PIN
1 N	0147				F61C	0000	HH53		54PH		1
S	596F				F61C	0000	HH53		54PH		
2 N	0147				0000	0000	0000		0166		2
S	596F				0000	0000	0000		0166		
3 N	94FH			2CAL	0000	0000	0000		A446		3
S	7CCH			6PAH	0000	0000	0000		A446		
4 N	5F97	29PP		9FU2	2946				HAU1		4
S	C822	29PP		7282	2946				HAU1		
5 N	6C7H	7A33		47F5							5
S	5553	7A33		3003							
6 N	C826	14HA		ALF8							6
S	PL7H	7782		HHH5							
7 N	0000	29H7		0000							7
S	0000	P5L1		0000							
8 N					4596	29PP	3A9A				8
S					4596	29PP	3A9A				
9 N		207P				7A33	H10F				9
S		A5C9			2946	7A33	H10F				
10 N	54F8	F2P7	F2P7	52A7					29PP		10
S	UPLF	OFC1	OFC1	67A8					29PP		
11 N	APH9	0000		2535	FLFL	0863	0108		0863		11
S	3AAA	0000		U600	FLFL	0863	0108		0863		
12 N	1501	472A	207P	929A	F61C	0000	HH53				12
S	1417	472A	A5C9	U242	F61C	0000					
13 N	FH33	29PP	29H7	F94H							13
S	FLHL	29PP	P5L1	CFU5							
14 N	472A			472A	0108	0000	0863				14
S	472A			472A	0108	0000	0863				
15 N			14HA								15
S			7782								
16 N											16
S											

Table 8-2. SELF-TEST and NORMAL/SERVICE Signatures



## 8-44. DISASSEMBLY AND REASSEMBLY PROCEDURES

8-45. To remove the 5004A covers, use the following procedure:

### WARNING

**WHEN THE COVERS ARE REMOVED FROM THE 5004A, LINE VOLTAGES WHICH ARE DANGEROUS AND MAY CAUSE SERIOUS INJURY WHEN TOUCHED. DO NOT REMOVE THE COVERS UNLESS IT IS NECESSARY.**

1. Disconnect the power cable from the rear panel of the 5004A.
2. Turn the 5004A over with the cable case down. Four screws are exposed.
3. On the back panel of the 5004A loosen the two screws at the ends of the heat sink three or four turns (see *Figure 8-2*).

### NOTE

DO NOT loosen the transistor retaining screws (see *Figure 8-2*).

4. Remove the four screws near the four corners of the cabinet bottom.
5. Hold the top and bottom covers together and turn the 5004A right side up.
6. Carefully lift the top cover off.

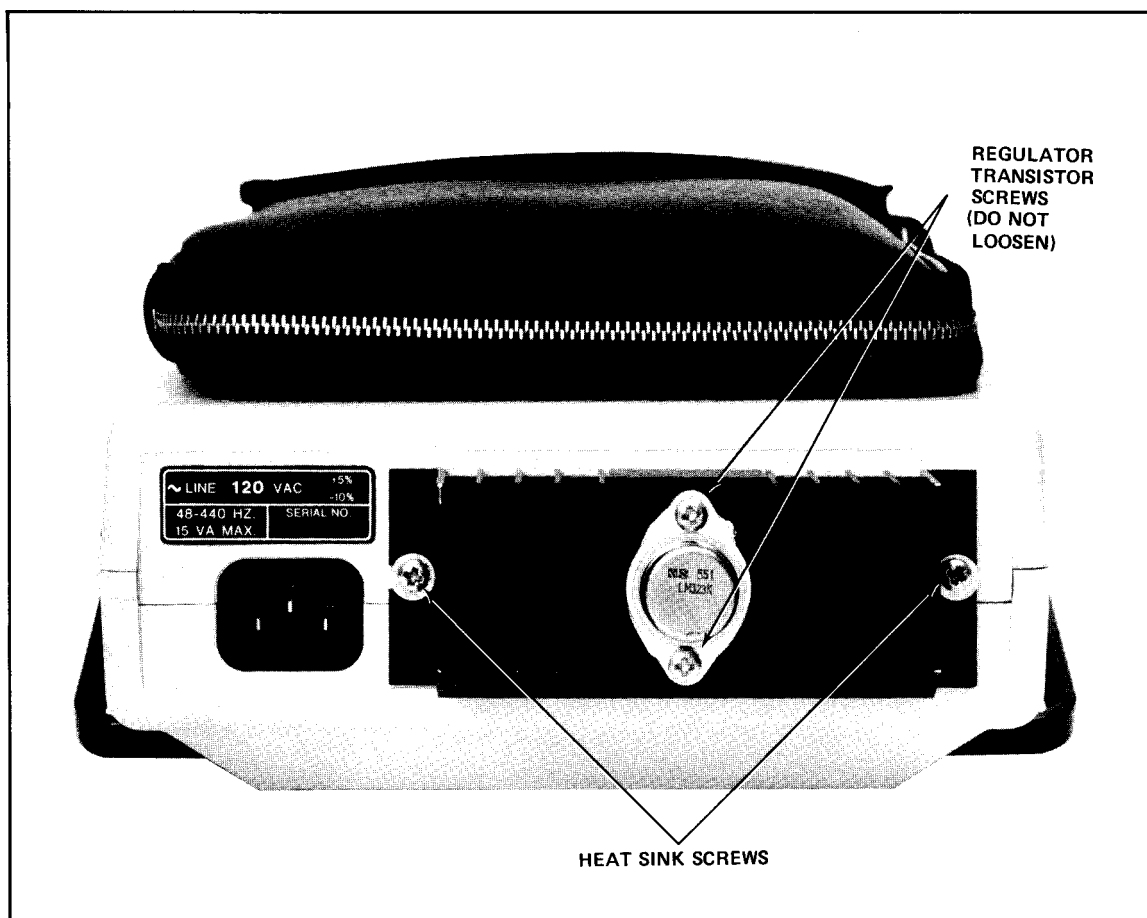

Figure 8-2. Heat Sink Screws Locations

**NOTE**

If the heat sink on the rear panel is still holding the cover together, loosen the sink screws a few more turns.

**WARNING**

**BE CAREFUL OF EXPOSED LINE VOLTAGE POINTS.**

7. If necessary the bottom cover can be removed.
8. To reassemble the 5004A reverse the preceding steps.

**8-46. Data Probe Disassembly and Reassembly**

8-47. To disassemble the data probe, use the following procedure.

1. Disconnect the power cable from the 5004A. Remove the GND wire from the probe.

**NOTE**

*Figure 6-1* shows the mechanical parts of the probe. *Figure 8-7* shows the probe with its covers removed.

2. Remove the probe tip by turning it with fingers counterclockwise.

**NOTE**

The red window has a projecting stud that fits in the body of the probe near the GND pin (off-set slightly).

3. Carefully pull the red window off the probe tip.
4. Slide the two half covers carefully off the probe printed circuit board.

**NOTE**

The two body shells interlock to cover the printed circuit board.

5. Reverse the preceding steps to reassemble the data probe.

**8-48. Gating Signals Pod Disassembly and Reassembly**

8-49. To disassemble the gating signals pod, use the following procedure.

1. Disconnect the power cable from the 5004A.

**NOTE**

*Figure 6-1* shows the mechanical parts of the pod. *Figure 8-7* shows the probe with its covers removed.

2. Squeeze the ends of the pod test leads connector and pull the connector off the pod.
3. Remove the four screws from the bottom cover of the pod, and carefully remove the top cover. The bottom cover can also be removed if necessary.

**NOTE**

The pod cable has a strain protector which fits in a slot in the covers of the pod.

4. Reverse the above procedure to reassemble the pod.

## **8-50. BLOCK DIAGRAM DESCRIPTION**

8-51. In the following paragraphs a description of the 5004A Signature Analyzer is given to match *Figure 8-3* the block diagram in this section. A more detailed description of the 5004A is given in the paragraphs following the heading: CIRCUIT THEORY (PRINCIPLES OF OPERATION) (SCHEMATIC DIAGRAM DESCRIPTION).

8-52. A 5004A Signature Analyzer requires four input signals: START, STOP, CLOCK, and DATA. START, CLOCK, and STOP inputs are applied to the 5004A through the GATING SIGNALS POD.

8-53. Data Signal Path. DATA input is through the DATA PROBE. Signals applied to the DATA PROBE are connected to dual paths which trigger at high and low voltage levels respectively. The output of these level detectors is at ECL level and drive a pair of ECL to TTL converters on the main assembly. A logic level detector across the ECL converters provides the drive for the logic level indicator at the data probe tip. The outputs of the ECL converters is translated from a possible three levels (high, bad (middle), and low) to standard high or low levels at the selected clock. (When a bad level appears at the input of the data probe, it is converted to whatever the previous data level was: (either high or low.) Data from the 3-to-2 level converter is applied to the pseudo-random word generator with corresponding gate and clock signals. For each different clocked data stream (series of bits) bracketed by a start and stop signal, a different word (signature) is generated by the word generator. Each signature is sent to the display latches which supply them to the decoder-driver and the signature comparator. The decoder-driver translates the signature to a special-form hexadecimal number which is applied to the display. Each succeeding signature is compared with the preceding signature in the signature comparator which will activate the UNSTABLE SIGNATURE lamp if two succeeding signatures are different. The RESET function for the entire 5004A is part of the DATA probe. RESET is activated by a switch (labeled RESET) on the DATA probe.

## **8-54. Clock, Start, and Stop Signal Paths**

8-55. External CLOCK, START, and STOP signals are applied to the 5004A through the gating signals pod. Input CLOCK, START, and STOP signals are amplified, and connected to operator-controlled edge-select circuits. After edge-selection the CLOCK, START, and STOP signals are combined to form a gating (gate) control signal. (The external CLOCK signal is also buffered and used to time other sections of the 5004A.) The gate signal is presented on the front panel with a GATE indicator lamp. The gate signal is for on-off (start-stop) control of the word generator.

## **8-56. Scan/Test Oscillator (Internal Clock)**

8-57. A .6 kilohertz signals is generated in the 5004A for display scan and test use. The scan signal controls switching the displays on and off (fast enough to be not noticeable) to lower power consumption and reduce the size of drive circuit components. In the SELF-TEST and NORMAL/SERVICE (troubleshooting) modes the internal test signal is used as a substitute for the external clock normally applied to the gating signals pod.

## **8-58. Self-Test**

8-57. Part of the 5004A is a circuit used only for self-test of the signature analyzer. The self-test function is controlled by a front panel switch. In the self-test mode special signatures are generated using the internal test signal frequency divider output (ROM). If there is a defect in the 5004A the self-test signature will not be correct.

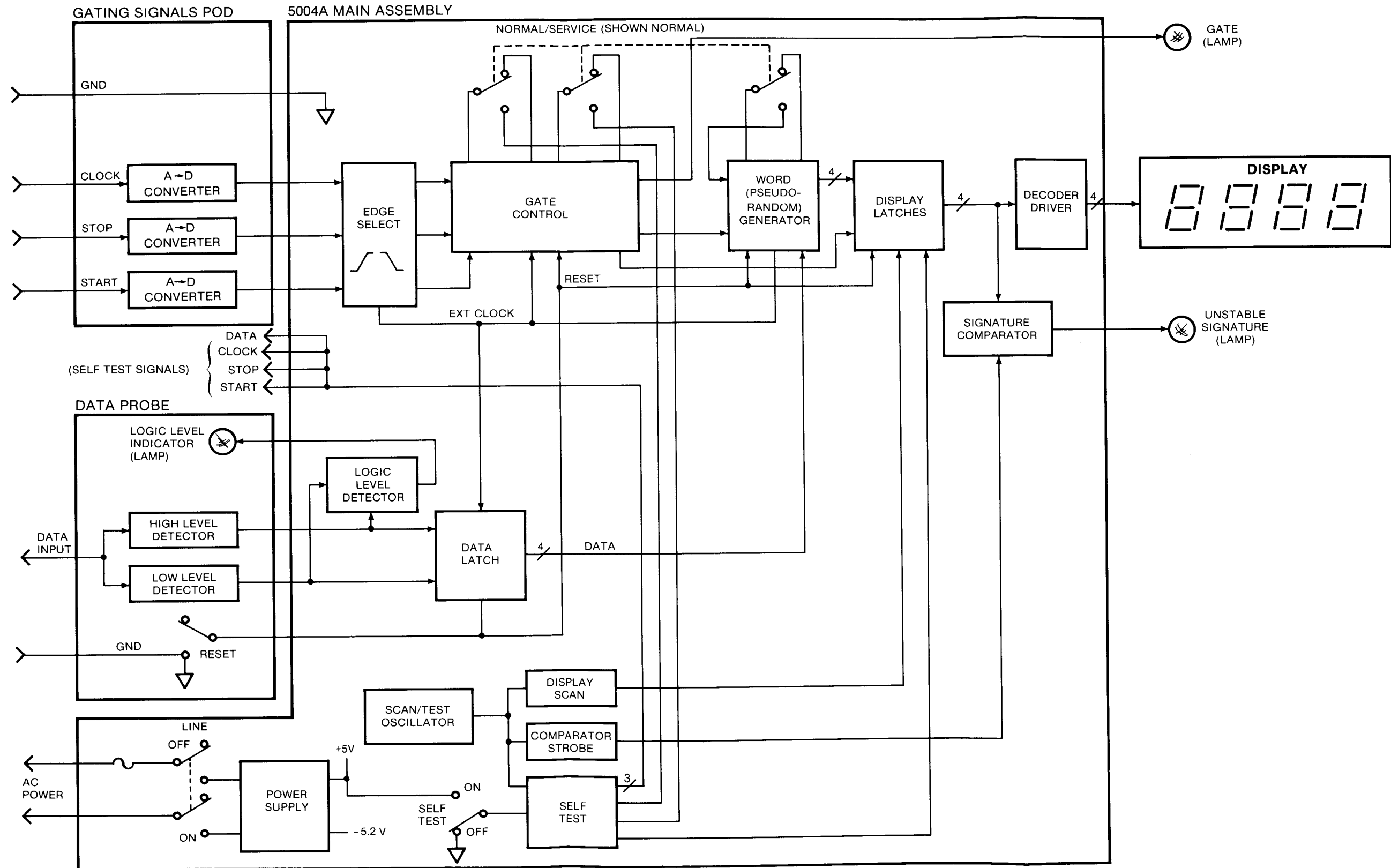

Figure 8-3  
5004A CIRCUIT BLOCK DIAGRAM

## **8-60. Display Scan and Comparator Strobe**

8-61. The clock signal is used to time both the display scan and signature comparator strobe circuits. The digit display lamps are enabled less than full-time to conserve power.

### **NOTE**

The NORMAL/SERVICE switch is separate but related to the front panel SELF-TEST switch.

## **8-62. Service (Troubleshooting) Mode**

8-63. On the main assembly of the 5004A a two-position switch, labeled NORMAL/SERVICE, can be used during fault locating (troubleshooting) procedures if the 5004A is not operating correctly.

## **8-64. Power Supply**

8-65. Alternating current line supply (mains) voltage is converted to the two positive and negative regulated direct current voltages required in the 5004A by the power supply circuit.

## **8-66. CIRCUIT THEORY (PRINCIPLES OF OPERATION)**

8-67. The following paragraphs give the circuit theory (principles of operation) for the 5004A Signature Analyzer to explain the schematic diagram. A previous section describes the 5004A at the block diagram level. This BLOCK DIAGRAM DESCRIPTION should be studied and learned before the following paragraphs are studied.

## **8-68. Purpose of 5004A**

8-69. The 5004A Signature Analyzer is designed to be used in testing the correctness of operation of certain complex digital logic electronic instruments or systems. A technique of testing called signature analysis is used with the 5004A and compatible instruments. Refer to the paragraph titled Signature Analysis in Section I for an explanation of signature analysis.

## **8-70. Schematic Diagram**

8-71. The 5004A schematic diagram is presented with the four inputs on the left side, and the flow of signals is generally from the left to the right side where the output indicators are presented. Outputs are four digits (seven-segment LED's) and two single-LED function/condition indicators. Refer to the schematic diagram notes for an explanation of the schematic symbol system used. The ac line power input and dual-voltage (regulated) power supply are on the lower left side of the schematic.

## **8-72. Gating Signals Pod**

8-73. The gating signals pod is the input for the CLOCK, START, and STOP signals to the 5004A. Requirements for these signals are given in Section I. A voltage regulator, U4, for -5.2V on the pod board reduces power dissipation in the main assembly. Amplifier, U1, is used as a voltage follower to provide the 1.4-volt reference level for the three input amplifier-converters. All three input signals are each applied to three separate identical circuits. The input amplifier-converters produce high-speed complementary-output ECL-level signals for the main assembly.

## **8-74. Edge Selection**

8-75. The three ECL-level pulse signals from the pod (START, STOP, and CLOCK) are applied separately to three front-panel switches which may be used to select the polarity of any input signal. Changing the polarity of a signal effectively selects the opposite edge of the input signal as the control for that channel.

## 8-76. ECL-to-TTL Level Converters

8-77. After the edge select switches the gating signals are applied to four separate ECL-to-TTL level converters. (The CLOCK signal is applied to two separate converters, U12A and B, for two separate paths.) The outputs of the START and STOP level converters are applied to latches which are controlled by the CLOCK signal. The latches outputs are applied to the gate control circuit.

## 8-78. Gate Control

8-79. The input START and STOP signals are processed in the gate control circuit to produce a definite time window during which data is received by the word generator (described later). Operation of the gate control circuit is described in the following paragraph.

## 8-80. State Diagram

8-81. *Figure 8-4* is a state diagram of the functioning of the gate control circuits. NOTE: Positive-true logic is used. The INITIAL state normally occurs: when the 5004A has power switched on, or when the data probe RESET switch is pressed, or when a STOP and START pulse are received in RUN mode. In the INITIAL state, if START is 0 the state will change to ARMED. In the ARMED state the 5004A is ready to receive a START pulse and proceed to either RUN mode. (Note that if a STOP pulse is received, the state will be intermediate RUN; and to progress to full RUN, STOP must be 0.) From full RUN the state will return to INITIAL if START and STOP pulses are received. If START remains at 0 and a STOP pulse is received, the state returns to ARMED. The HOLD state occurs when the HOLD switch is in and a STOP pulse is received in the full RUN mode. In the HOLD state, the data probe RESET switch must be pressed to return to the INITIAL state. All modes except HOLD have no-change conditions. For example in the ARMED state if the START line remains at 0, the 5004A will not change to RUN. With proper START, STOP, and CLOCK signals the gate control proceeds through the states repetitively. The gate control circuit output starts and stops the word generator, and provides the on-off control of the GATE lamp to show when the START and STOP signals are received and implemented.

## 8-82. Data Signal Flow

8-83. In normal operation, data signals from the unit being tested are applied to the 5004A high-speed data probe. The data probe (A3) discriminates whether the input TTL level is high or low or bad (middle level). If the input level is high it is detected by U1A, if it is low it is detected by U1B. The input signal is converted to a pair of two-line differential (complementary) ECL signals and sent to the main assembly. At the input to the main assembly the data signal is converted from a pair of two-line (differential) ECL signals to a pair of signals at TTL level.

8-84. The pair of data signals at pins 6 and 12 of U11 (A and B) are applied to the data latch, U9. If the data input signal is a high level or a low level it is clocked out of the data latch on pin 5. If it is a bad (middle) level signal the previous level signal is clocked out of the data latch. (A bad level appears as tow lows at the U9J and K inputs.)

8-85. In the main assembly the data TTL signals at the junction of R37 and R38 are applied to U20, a logic level detector. The detector responds to the combined TTL level (or pulses) of the input signal, and it controls the indication of the logic level indicator lamp, DS1, in the data probe. The two TTL data signals are applied to the data latch, J9. Data from U9(5) is applied to U6(5), an "exclusive-OR" gate. This is the input of the pseudo-random word generator.

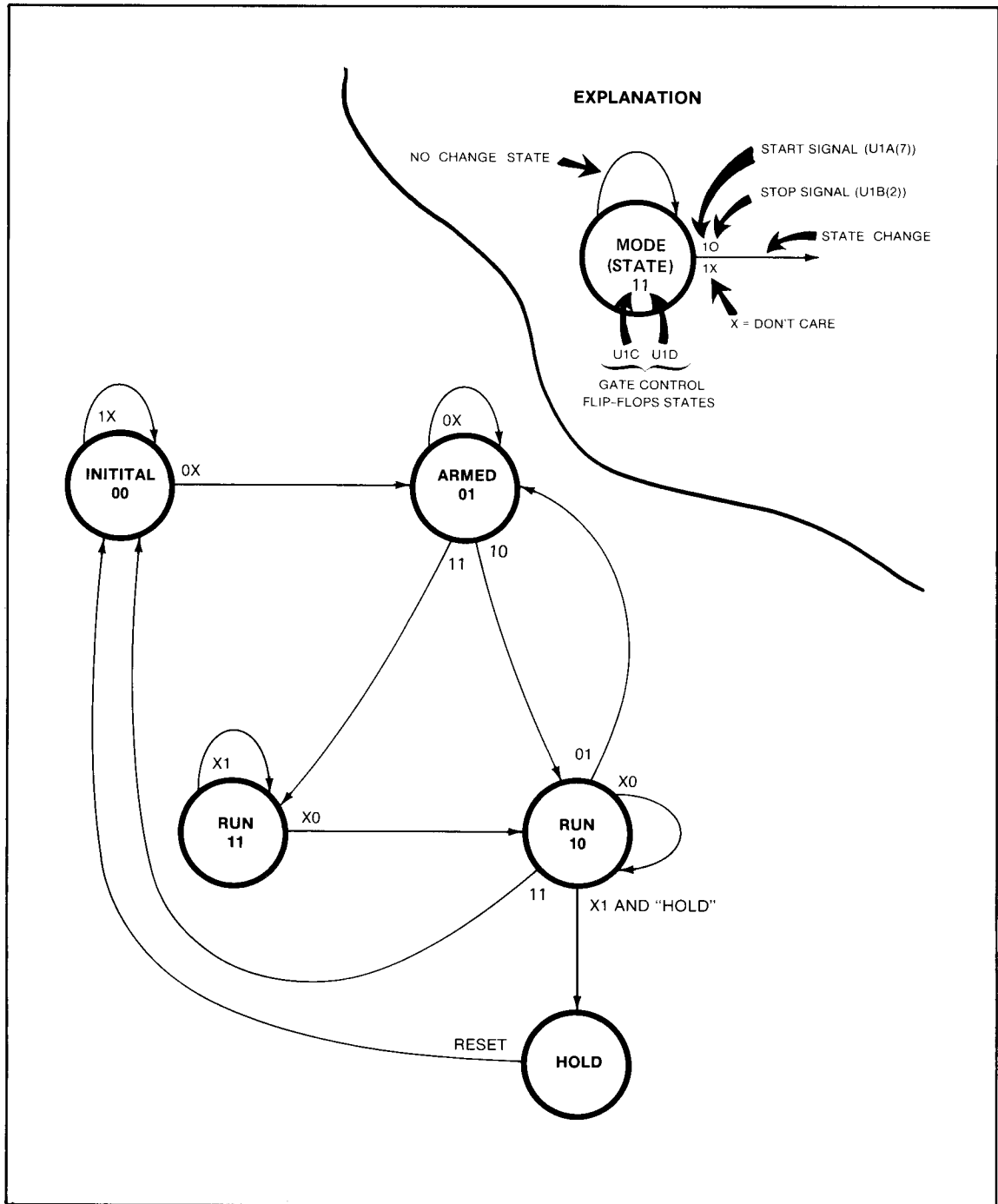

Figure 8-4. Gate Control State Diagram











### 8-86. Pseudo-Random Word Generator (Data Signal Path Continued)

8-87. The pseudo-random word generator is the central principle of the signature analysis method. A shift register with some outputs fed back is used to generate a pseudo-random word (signature) output. Input data goes through U6 to shift register U21. From U21(13) the data goes to U24(1 and 2) input. One output from U21 (pin 12) and three outputs from U24 (pins 3, 6, and 13) are fed back to the U6 inputs to combine with the input data and modify the resultant output of the shift registers. The outputs of the two shift registers (U24 and U21) are the unique "signatures."

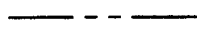
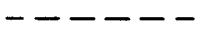

### SCHEMATIC DIAGRAM NOTES

Resistance in ohms, capacitance in picofarads, inductance in millihenries unless otherwise noted.

- \* Asterisk denotes a factory-selected value. Value shown in typical. Part may be omitted.
-  Tool-aided adjustment.  Manual control.
-  Encloses front-panel caption.
-  Encloses rear-panel caption.
-  Encloses interior or printed-circuit board caption.
-  Circuit assembly borderline.
-  Other assembly borderline. Also used to indicate mechanical interconnection (ganging).
-  Wiper moves toward CW with clockwise rotation of control (as viewed from shaft or knob).
-  Numbered Test Point.  
Measurement aid provided
-  Lettered Test Point.  
No measurement aid provided.
-  A direct conducting connection to the earth, or a conducting connection to a structure that has a similar function (e.g., the frame of an air, sea, or land vehicle).
-  A conducting connection to a chassis or frame.
-  Common connections. All like-designated points are connected.

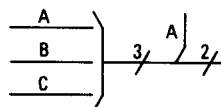

Indicates multiple paths represented by only one line. Letters or names identify individual paths. Numbers indicate number of paths represented by the line.

#### Integrated Circuit Power Terminals

Unless noted otherwise\*, +5 volts is applied to each integrated circuit as given below:

14-Pin Units	Power	16-Pin Units
Pin 14	+5V	Pin 16
Pin 7	Return	Pin 8
<b>Exceptions</b> <b>U25, U26, U27</b>		
Pin 14	+5V	
Pin 10	Return	

#### NOTE

Several integrated circuits use the -5.2V power. The -5.2V pins are shown on the schematic diagram.

Figure 8-6. Schematic Diagram Notes



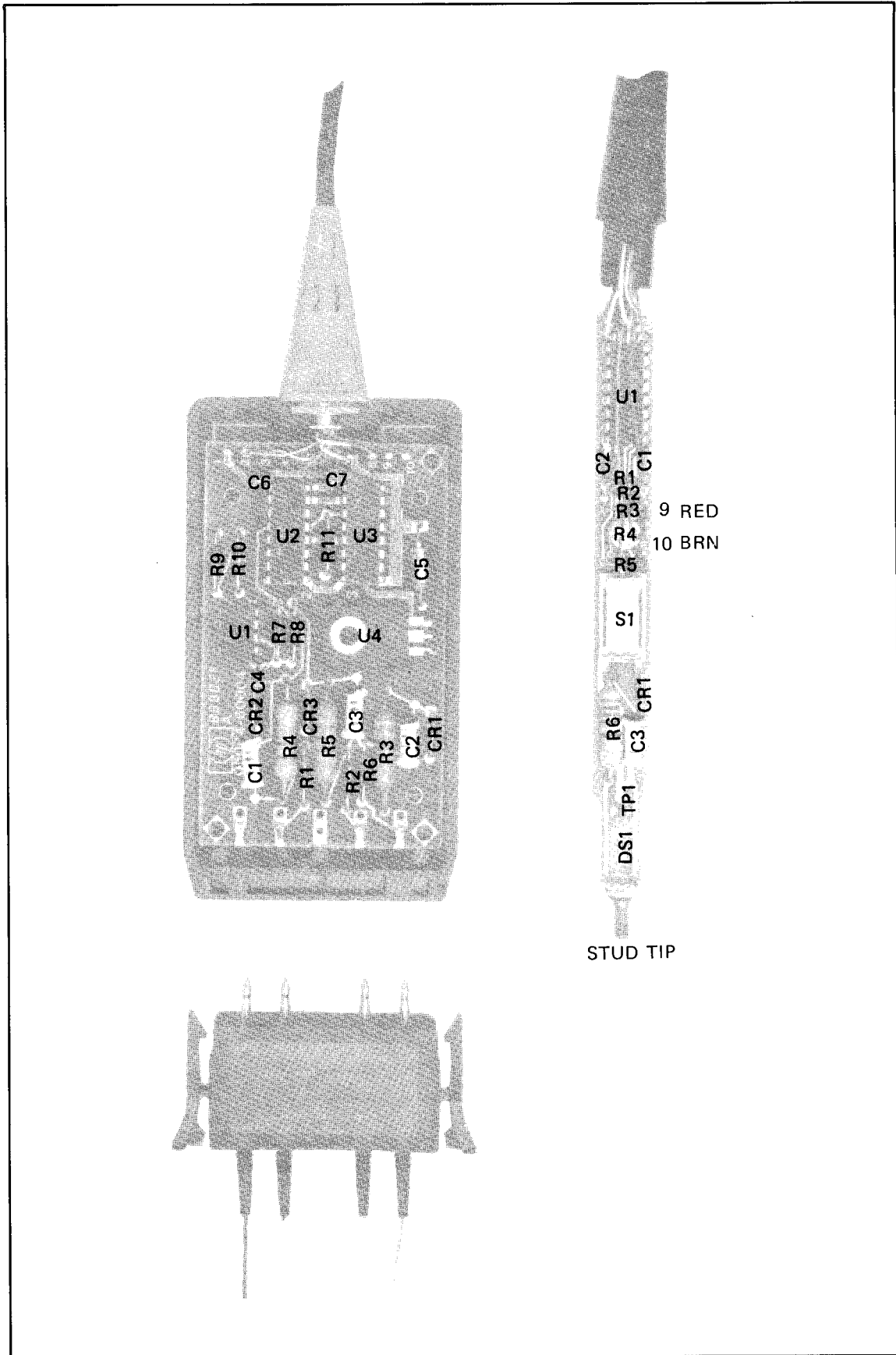

Figure 8-7. Probe and Pod (A3 and A4) Component Locations

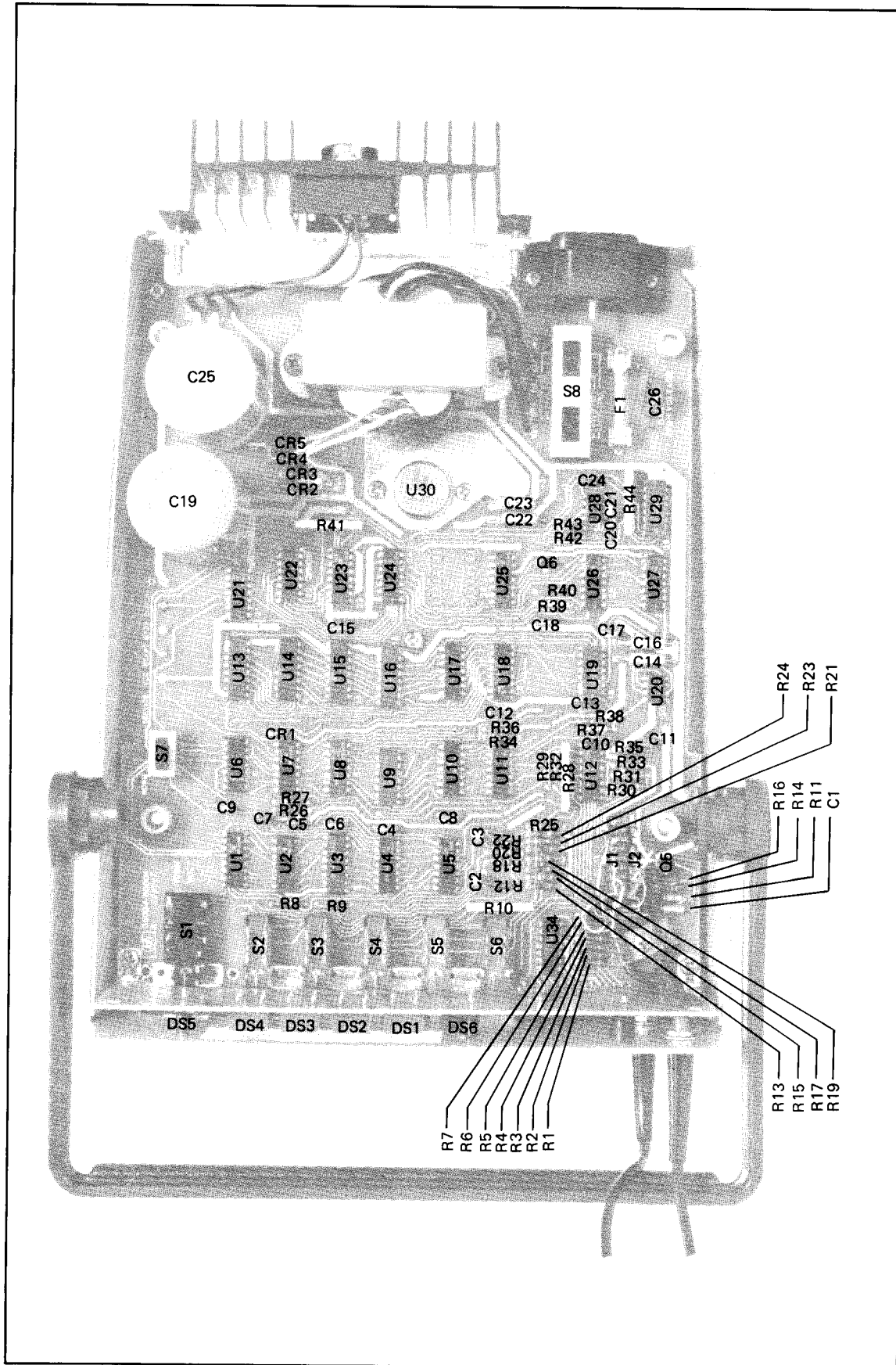
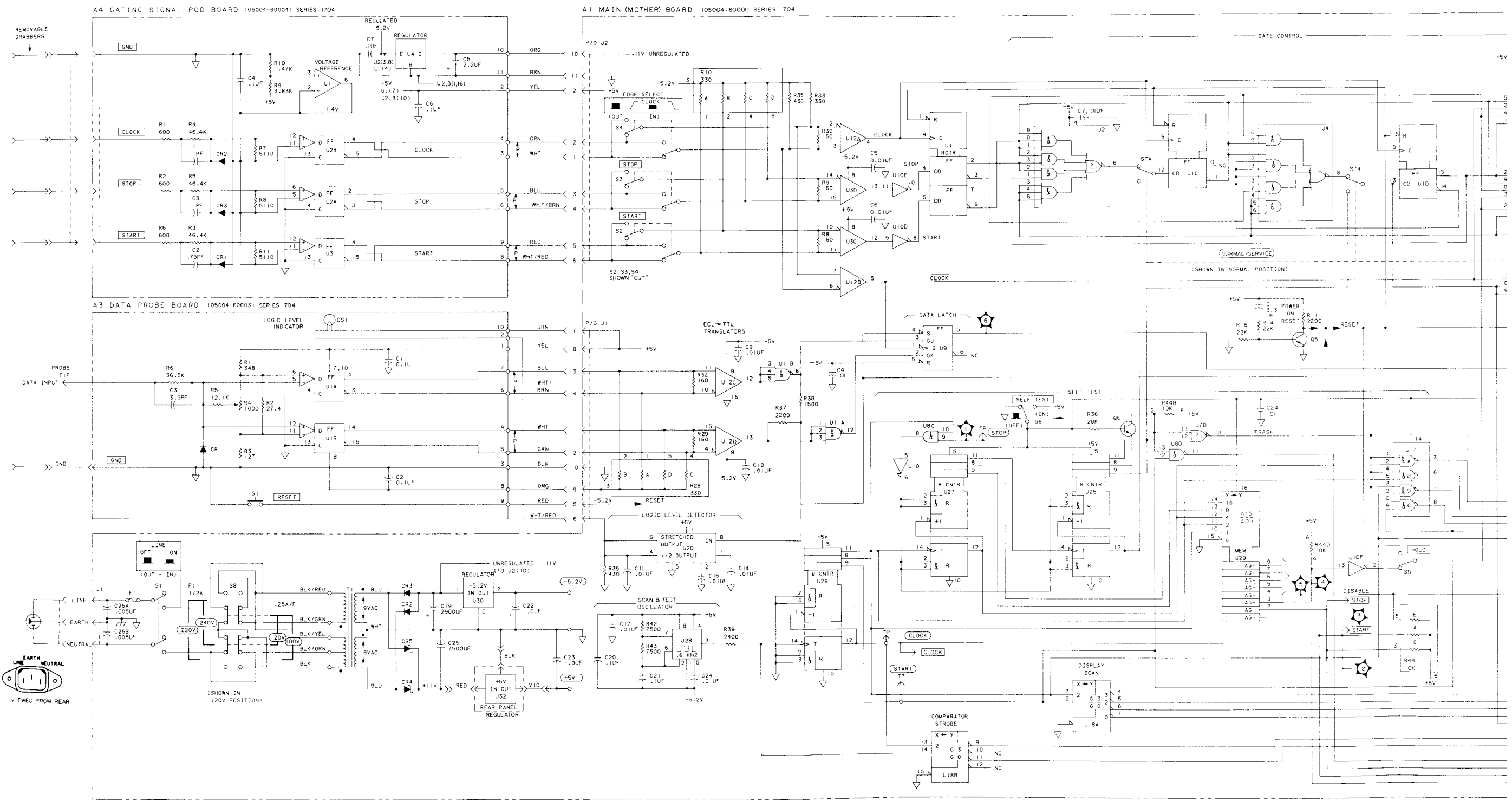
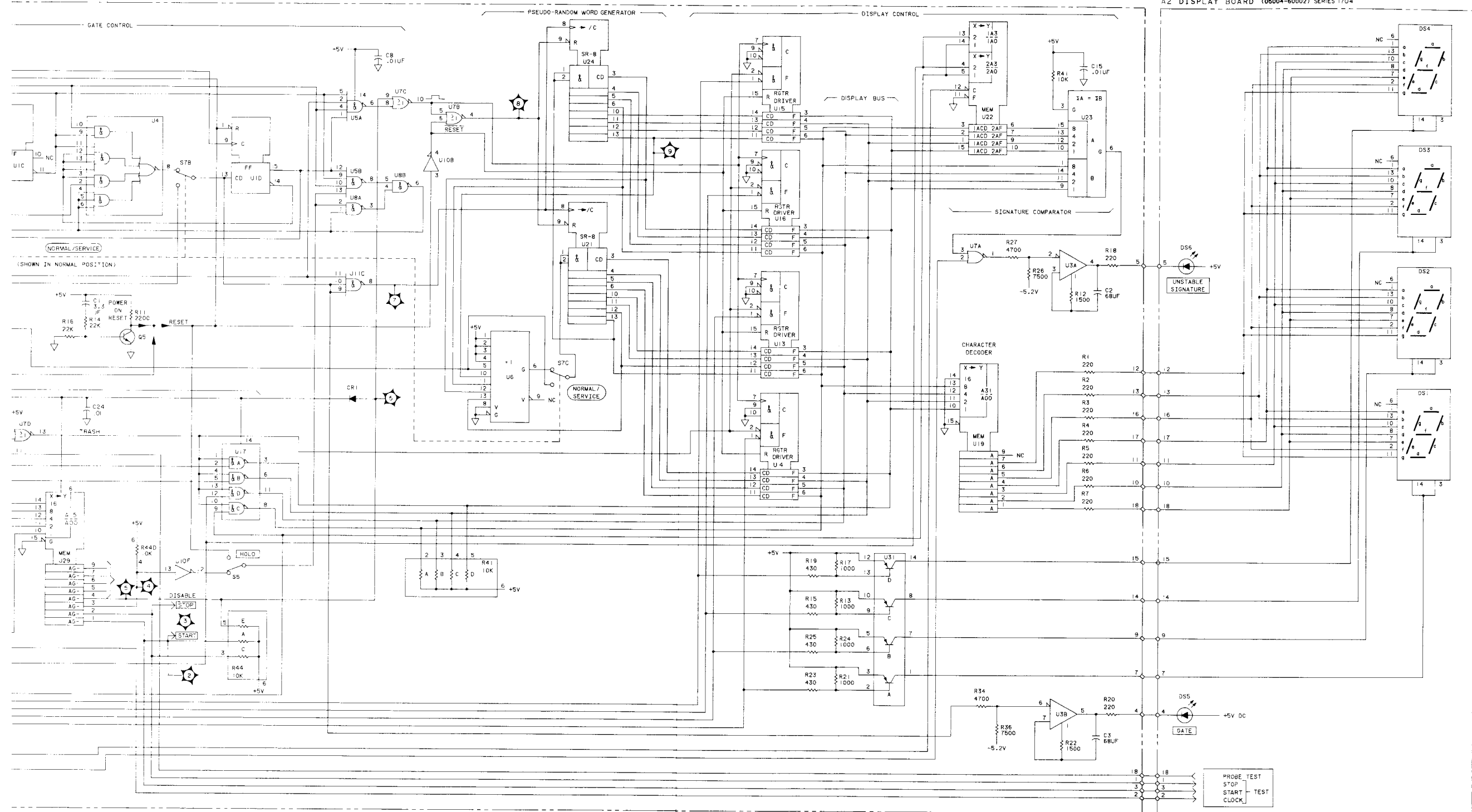

Figure 8-8. Display Board and Main Board (A1) Component Locations







**HP MODEL 5004A SIGNATURE ANALYSER**

Supersedes:

5004A-1A

**Serial Prefix 1736 and above****DATA PROBE THRESHOLD VOLTAGE  
ADJUSTMENT AND COMPENSATION**

These adjustments will only be necessary if repairs have been done on the A3 data probe assembly. This note replaces the adjustment procedure in 5004A Operating and Service Manual for probes with this applicable serial prefix.

This instrument is adjusted at the factory prior to shipment and no periodic calibration is necessary

The following equipment is needed for these adjustment procedures:

Instrument	HP Recommended
1. Function Generator	HP 3312A
2. Oscilloscope	HP 1720A
3. Digital Voltmeter	HP 3465A
4. Pulse Generator	HP 8007B
5. Power Supply	HP 6114A

**DATA PROBE THRESHOLD VOLTAGE ADJUSTMENT**

The voltage adjustment is to compensate for the effect on Input Threshold Voltage due to  $V_{CC}$  and comparator input bias current variations.

Proceed as follows:

- a. Remove data probe tip by turning it with fingers counterclockwise; carefully pull the red window off the probe tip; slide the two half covers carefully off the probe printed circuit board.
- b. Connect digital voltmeter leads between A3U1(11) and A3U1(1), and adjust A3R7 until digital voltmeter reads . . . 1.320 volts.
- c. Connect DVM leads between A3U1(12) and A3U1(1), and adjust A3R4 until DVM reads . . . 1.425 volts. Disconnect DVM leads.

KG/ka/WO

8/78-02

05004-90004



For more information contact a local Hewlett-Packard Office. (Hewlett-Packard has 200 Sales and Service Offices in 75 countries).  
Or write: Hewlett-Packard, 1501 Page Mill Road, Palo Alto, California 94304, U.S.A.

Printed in U.S.A.

### DATA PROBE COMPENSATION

The data probe compensation is to ensure minimum distortion of a very narrow pulse that could result in a wrong signature being displayed. To properly compensate the data probe, perform the following steps:

- a. Set Function Generator to output a 3 volts peak-to-peak triangular waveform ( $\cong 300$  Hz). (No offset.)
- b. Replace data probe tip. Connect Function Generator output to scope's vertical input (Channel A) and also to the data probe. Connect A3U1(14) to the scopes horizontal input (Channel B).

Note: For the 1720A oscilloscope, operate in X-Y mode. Channel A and B are the vertical and horizontal inputs, respectively.

Observe the hysteresis loop similar to Figure 1 below:

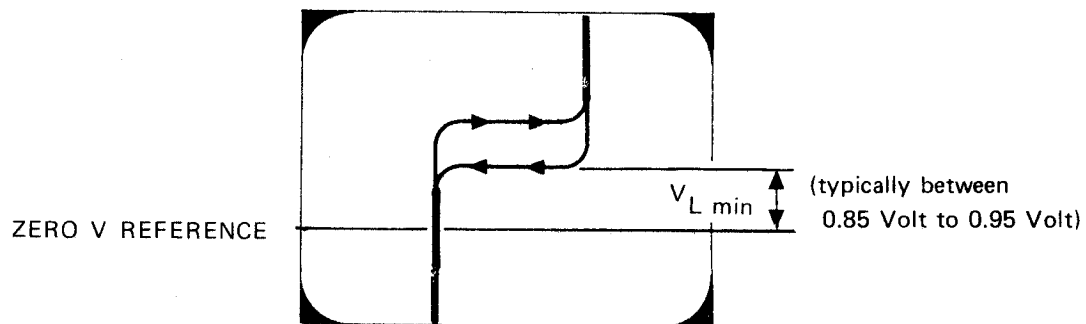

FIGURE 1

Record  $V_{L \text{ min}}$  and remove input from scope. Switch scope back to normal horizontal sweep mode.

- c. Turn on power supply and set output to  $V_{L \text{ min}}$  (recorded in b above). (This dc voltage is used to establish a reference line on the scope.) Apply this voltage to scope channel A. Using vertical position control, move trace to center line. After this center line reference is set, do not readjust the vertical control.
- d. Set pulse generator to output a 50 nanosecond pulsewidth, at 5 MHz, 3 volts peak-to-peak and a rise time  $\leq 2$  nanoseconds. Connect channel A to pulse generator output.
- e. Adjust pulse generator offset so the bottom of the pulse is 100 millivolts below center reference line (see Figure 2).



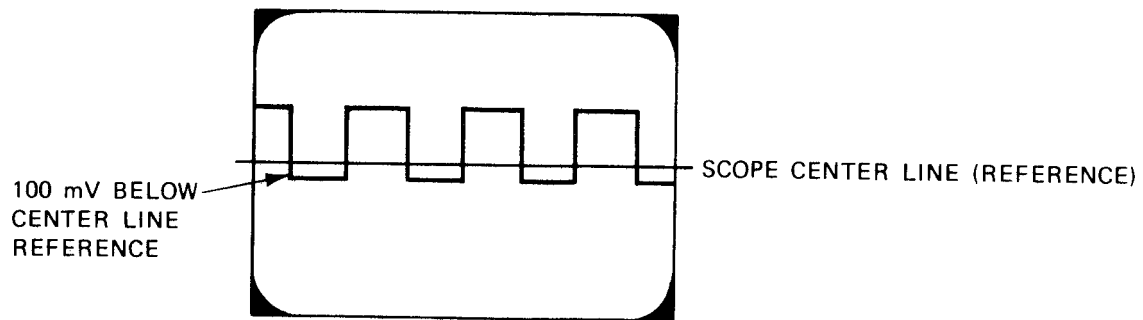

FIGURE 2

- f. Reassemble the data probe.
- g. Insert special adjusting tool (8710-1177) through hole in bottom probe shell, and adjust Data Probe trimmer capacitor very slowly until Data Probe lamp indicator flashes constantly.
- h. Verify adjustment by raising pulse generator offset until probe lamp stops flashing; bottom of pulse should be  $< 100$  mV from original position.
- i. Repeat steps e and g if necessary.