

**Agilent 41941A/B
Impedance Probe Kit for Agilent 4194A
Operation Note**

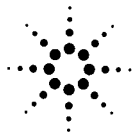
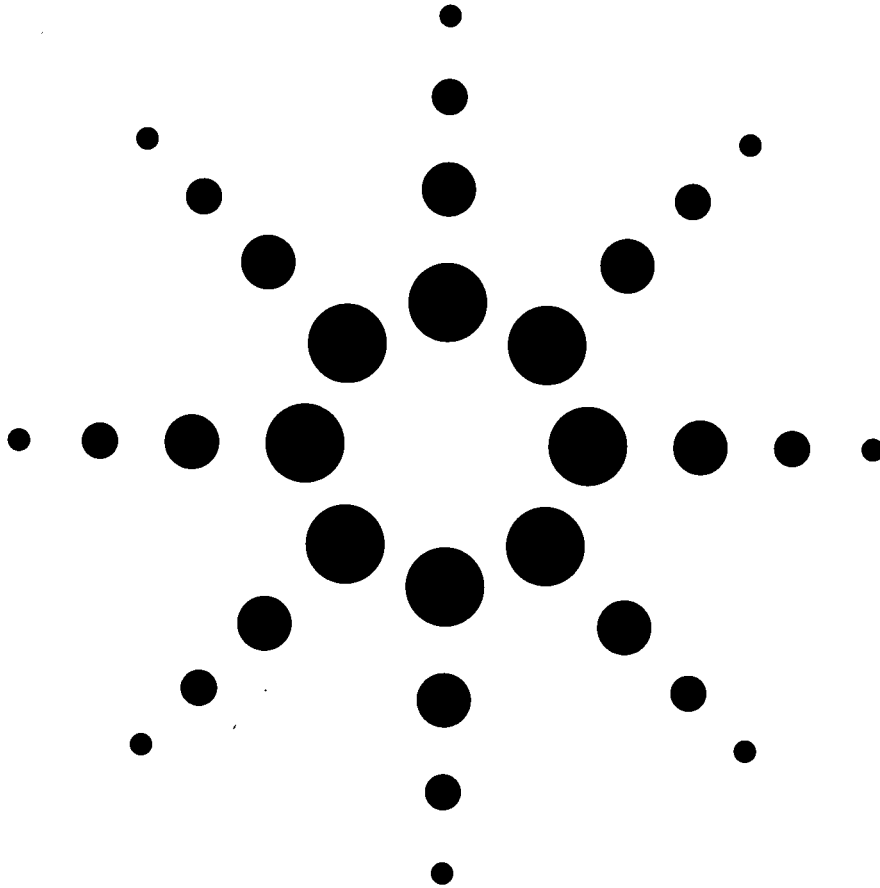

Agilent Technologies

**Agilent 41941A/B
Impedance Probe Kit for Agilent 4194A**

MANUAL IDENTIFICATION

Model Number: 41941A/B
Date Printed: May 2000
Part Number: 41941-90010

Operation Note

This supplement contains information for correcting manual errors and for adapting the manual to newer instruments that contains improvements or modifications not documented in the existing manual.

To use this supplement

1. Make all ERRATA corrections
2. Make all appropriate serial-number-related changes listed below

SERIAL PREFIX OR NUMBER CHANGES	MAKE MANUAL
All	1

SERIAL PREFIX OR NUMBER CHANGES	MAKE MANUAL

◆ New Item

CHANGES 1

CHANGE 1 contains the information needed to adapt the 41941A/B's manual.

Page 1-1, 1-2. DESCRIPTION

Change the 'dc bias voltage' as follows.

Maximum Voltage : $\pm 40V$ peak max. (AC + DC)

Page 1-5, Table 1-3. Specifications (Sheet 1 of 3)

Add the following information after the 'Usable Frequency Range:'

Maximum Voltage : $\pm 40V$ peak max. (AC + DC)

Change the 'DC Bias Range:' as follows.

DC Bias Current Range: $\pm 0.5A$

Maximum DUT power consumption must not exceed 25W

Page 3-4, 3-5-2. External DC Bias

Change the description as follows.

When external dc bias is used, the maximum voltage should not exceed $\pm 40V$ peak max. (AC + DC).

External dc current bias can be used up to $\pm 500mA$.

NOTE

Manual change supplement are revised as often as necessary to keep manuals as current and accurate as possible. Agilent Technologies recommends that you periodically request the latest edition of this supplement. Free copies are available from all Agilent Technologies offices. When requesting copies, quote the manual identification information from your supplement, or the model number and print date from the title page of the manual.

MANUAL CHANGES

41941A

Impedance Probe Kit

MANUAL IDENTIFICATION

Model Number: 41941A
 Date Printed: August 1989
 Part Number: 41941-90000

This supplement contains information for correcting manual errors and for adapting the manual to newer instruments that contain improvements or modifications not documented in the existing manual.

To use this supplement

1. Make all ERRATA corrections
2. Make all appropriate serial-number-related changes listed below

SERIAL PREFIX OR NUMBER	MAKE MANUAL CHANGES	SERIAL PREFIX OR NUMBER	MAKE MANUAL CHANGES
All	1		

► **New Item**

► **ERRATA**

Page 1-11, Figure 1-3

Correct the note for C Accuracy as given below.

where $|Z_c| = 1 + (2 \times \pi \times f \times C_m)$, f is frequency in Hz and C_m is the measured C. A, B, and C are obtained from the preceding graph.

► **CHANGE 1**

All through the operation note

Change all information that describes about the compatibility for the HP 4194A from "HP 4194A ROM (firmware) version 2.2" to "HP 4194A ROM (firmware) version 2.2 or above".

NOTE

Manual change supplements are revised as often as necessary to keep manuals as current and accurate as possible. Hewlett-Packard recommends that you periodically request the latest edition of this supplement. Free copies are available from all HP offices. When requesting copies, quote the manual identification information from your supplement, or the model number and print date from the title page of the manual.

Date/Div: August 23, 1989/33

Page: 1 of 1



PRINTED IN JAPAN

Agilent 41941A/B Impedance Probe Kit for Agilent 4194A

Operation Note

Third Edition

(Including Options 350 and 375)

SERIAL NUMBERS

This operation note applies directly to 41941As and 41941Bs with 2617J- prefixed serial numbers.



Agilent Technologies

HP Part No. 41941-90010

May 2000

Printed in Japan

Notices

The information contained in this document is subject to change without notice.

This document contains proprietary information that is protected by copyright. All rights are reserved. No part of this document may be photocopied, reproduced, or translated to another language without the prior written consent of the Agilent Technologies.

Agilent Technologies Japan, Ltd.

Component Test PGU-Kobe

1-3-2, Murotani, Nishi-Ku, Kobe-shi, Hyogo, 651-2241 Japan

Copyright © Agilent Technologies Japan, Ltd. 1989, 1998, 2000

Manual Printing History

The manual's printing date and part number indicate its current edition. The printing date changes when a new edition is printed. (Minor corrections and updates that are incorporated at reprint do not cause the date to change.) The manual part number changes when extensive technical changes are incorporated.

August 1989	First Edition (part number : 41941-90000)
November 1998	Second Edition (part number : 41941-90010)
May 2000	Third Edition (part number : 41941-90010)

Safety Summary

The following general safety precautions must be observed during all phases of operation, service, and repair of this instrument. Failure to comply with these precautions or with specific WARNINGS elsewhere in this manual may impair the protection provided by the equipment. In addition it violates safety standards of design, manufacture, and intended use of the instrument.

Agilent Technologies assumes no liability for the customer's failure to comply with these requirements.

- **Ground The Instrument**

To avoid electric shock hazard, the instrument chassis and cabinet must be connected to a safety earth ground by the supplied power cable with earth blade.

- **DO NOT Operate In An Explosive Atmosphere**

Do not operate the instrument in the presence of flammable gasses or fumes. Operation of any electrical instrument in such an environment constitutes a definite safety hazard.

- **Keep Away From Live Circuits**

Operating personnel must not remove instrument covers. Component replacement and internal adjustments must be made by qualified maintenance personnel. Do not replace components with the power cable connected. Under certain conditions, dangerous voltages may exist even with the power cable removed. To avoid injuries, always disconnect power and discharge circuits before touching them.

- **DO NOT Service Or Adjust Alone**

Do not attempt internal service or adjustment unless another person, capable of rendering first aid and resuscitation, is present.

- **DO NOT Substitute Parts Or Modify Instrument**

Because of the danger of introducing additional hazards, do not install substitute parts or perform unauthorized modifications to the instrument. Return the instrument to a Agilent Technologies Sales and Service Office for service and repair to ensure that safety features are maintained.

- **Dangerous Procedure Warnings**

Warnings, such as the example below, precede potentially dangerous procedures throughout this manual. Instructions contained in the warnings must be followed.

WARNING

Dangerous voltages, capable of causing death, are presenting this instrument. Use extreme caution when handling, testing, and adjusting this instrument.

Certification

Agilent Technologies certifies that this product met its published specifications at the time of shipment from the factory. Agilent Technologies further certifies that its calibration measurements are traceable to the United States National Institute of Standards and Technology, to the extent allowed by the Institution's calibration facility, or to the calibration facilities of other International Standards Organization members.

Warranty

This Agilent Technologies instrument product is warranted against defects in material and workmanship for a period corresponding to the individual warranty periods of its component products. Instruments are warranted for a period of one year. Fixtures and adapters are warranted for a period of 90 days. During the warranty period, Agilent Technologies Company will, at its option, either repair or replace products that prove to be defective.

For warranty service or repair, this product must be returned to a service facility designated by Agilent Technologies. Buyer shall prepay shipping charges to Agilent Technologies and Agilent Technologies shall pay shipping charges to return the product to Buyer. However, Buyer shall pay all shipping charges, duties, and taxes for products returned to Agilent

Technologies from another country.

Agilent Technologies warrants that its software and firmware designated by Agilent Technologies for use with an instrument will execute its programming instruction when properly installed on that instrument. Agilent Technologies does not warrant that the operation of the instrument, or software, or firmware will be uninterrupted or error free.

Limitation of Warranty

The foregoing warranty shall not apply to defects resulting from improper or inadequate maintenance by Buyer, Buyer-supplied software or interfacing, unauthorized modification or misuse, operation outside the environmental specifications for the product, or improper site preparation or maintenance.

IMPORTANT

No other warranty is expressed or implied. Agilent Technologies specifically disclaims the implied warranties of merchantability and fitness for a particular purpose.

Exclusive Remedies

The remedies provided herein are buyer's sole and exclusive remedies. Agilent Technologies shall not be liable for any direct, indirect, special, incidental, or consequential damages, whether based on contract, tort, or any other legal theory.

Assistance

Product maintenance agreements and other customer assistance agreements are available for Agilent Technologies products.

For any assistance, contact your nearest Agilent Technologies Sales and Service Office. Addresses are provided at the back of this manual.

TABLE OF CONTENTS

Section	Title	Page
1. GENERAL INFORMATION		
1-1.	INTRODUCTION	1-1
1-2.	DESCRIPTION	1-1
1-3.	SPECIFICATIONS	1-2
1-4.	SAFETY CONSIDERATIONS	1-2
1-5.	UNITS COVERED BY THIS MANUAL	1-2
1-6.	OPTIONS	1-3
1-7.	CONTENTS	1-3
1-8.	ACCESSORIES AVAILABLE	1-4
2. INSTALLATION		
2-1.	INTRODUCTION	2-1
2-2.	INITIAL INSPECTION	2-1
2-3.	INTERCONNECTIONS	2-1
2-4.	STORAGE ENVIRONMENT	2-2
2-5.	PACKING	2-2
3. OPERATION		
3-1.	INTRODUCTION	3-1
3-2.	COMPENSATION CONSIDERATION	3-1
3-2-1.	Calibration	3-1
3-2-2.	Offset	3-2
3-2-3.	Supplied Calibration Standards	3-2
3-3.	USE OF FURNISHED PROBE ADAPTER	3-3
3-4.	TEST SIGNAL LEVEL AND OUTPUT IMPEDANCE	3-3
3-5.	DC BIAS	3-4
3-5-1.	Internal DC Bias	3-4
3-5-2.	External DC Bias	3-4
4. PERFORMANCE TEST/OPERATION CHECK		
4-1.	INTRODUCTION	4-1
4-2.	EQUIPMENT REQUIRED	4-1
4-3.	TEST RECORD	4-1
4-4.	CALIBRATION CYCLE	4-2
4-5.	IMPEDANCE MEASUREMENT ACCURACY TEST	4-3
4-6.	PROBE OPERATION CHECK	4-6
5. MANUAL CHANGES		
5-1.	INTRODUCTION	5-1
5-2.	MANUAL CHANGES	5-1
6. MAINTENANCE		
6-1.	INTRODUCTION	6-1
6-2.	SCHEMATICS AND REPLACEABLE PARTS	6-1

SECTION 1

GENERAL INFORMATION

1-1. INTRODUCTION

This operating note provides the information necessary to use the HP 41941A/B Impedance Probe Kit with the HP 4194A Impedance/Gain-Phase Analyzer. Refer to the 4194A's Operating Manual for specific 4194A operating procedures.

1-2. DESCRIPTION

The 41941A/B Impedance Probe Kits are accessories for the 4194A. The 41941A has a 1.5m cable and the 41941B has a 3m cable. Figure 1-1 shows the 41941 A and B.

Note

The 41941A/B are usable only with 4194As with ROM Version 2.2 and cannot be used with ROM Versions 2.1 and below.

The combination of the 41941A/B probe with the 'IMP with Z PROBE' function expands the 4194A's measurement capability as shown below.

Frequency range:	up to 100MHz
Grounded device:	can be measured
dc bias voltage:	up to $\pm 150V$ (with an external power supply)
dc bias current:	up to $\pm 0.5A$ (with an external power supply)

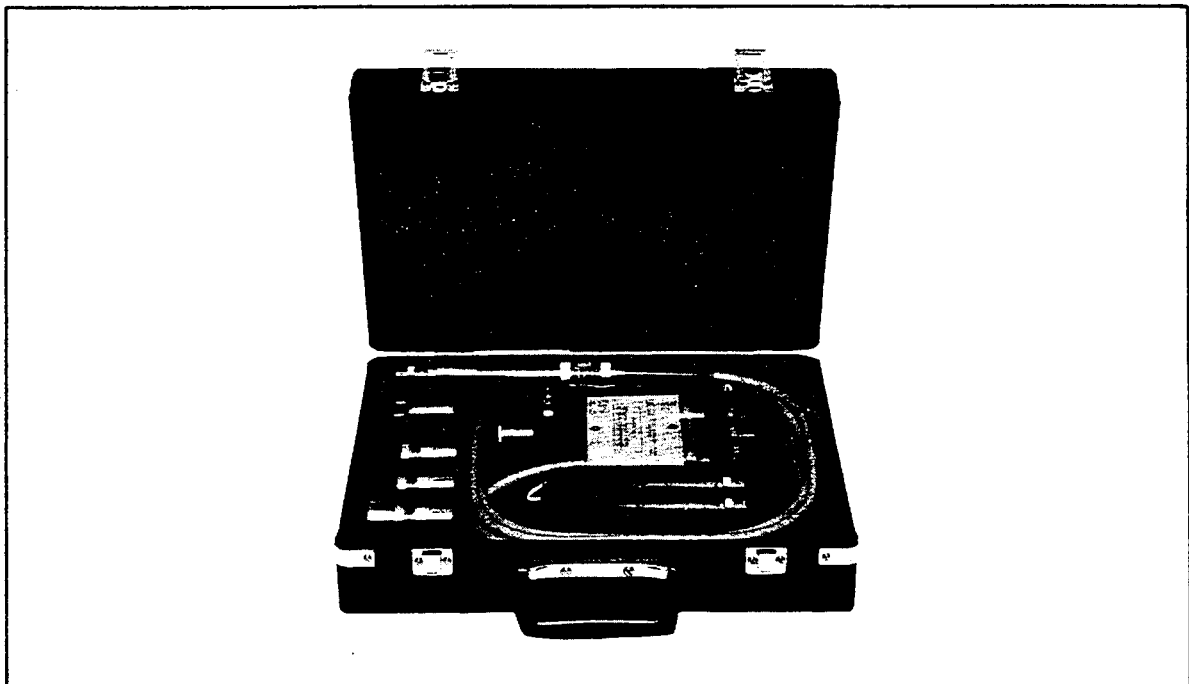

Figure 1-1. Model 41941A/B

In addition to change information, the supplement may contain information for correcting errors (Errata) in previous manuals. To keep this operation note as current and accurate as possible, Hewlett-Packard recommends that you periodically request the latest Manual Change supplements. The supplement for this operation note is identified by the **Print Date** and **Part Number**, both of which appear on the operation note's title page (see Section 5, **Manual Changes**).

For information concerning the serial number prefixes not listed on the title page or in the Manual Change supplements, contact your nearest Hewlett-Packard Sales office.

1-6. OPTIONS

Options are modifications to standard instruments that implement special requirements for minor functional changes. Table 1-1 lists the options available for the 41941A/B.

Table 1-1. Options

Option Number	Description
350	50Ω Set *
375	75Ω Set *

* Option 350 or 375 must be specified, depending on the input impedance of the 4194A being used.

1-7. CONTENTS

Table 1-2 lists the contents.

Table 1-2. Contents

Description	HP Part Number
Probe Assembly	See Section 6
0Ω calibration standard	PN 41941-65001
50Ω calibration standard	PN 41941-65002
0S calibration standard	PN 41941-65003
Probe Socket	PN 04193-21008
Spare pin set (standard)	PN 16095-60012
Spare clip set	PN 04193-60151
Spare pin set (N-type)	PN 04193-60153
BNC Adapter	PN 04193-61152
Component Adapter	PN 04193-61153
Ground Adapter	PN 04193-61154
Ground lead	PN 04193-61629
Carrying case	See Section 6

Note

Two kinds of pins are furnished with the 41941A/B. The pin which comes as standard is used for connecting the probe to furnished adapters and calibration standards when making general purpose measurements. The N-type pin is only used when connecting the probe to an N-type connector. An adapter for connecting the probe to an N-type connector is not supplied, if you need this type of connector, you must make an adapter (refer to paragraph 3-4).

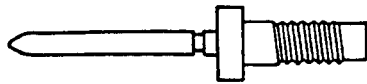

Standard Pin

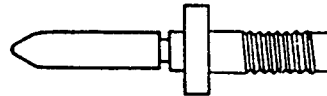

N-type Pin

1-8. AVAILABLE ACCESSORIES

For making certain types of measurements and for convenience in connecting samples, five accessories are available. Each is designed to meet the various measurement requirements of a variety of test devices. All accessories are developed with careful consideration to accuracy, reliability, and ease of use. A brief description and a photo of each available accessory is given in Table 1-4.

Table 1-3. Specifications (Sheet 1 of 3)

41941A/B Specifications

Usable Frequency Range:

10kHz to 100MHz

DC Bias Range:

$\pm 150V$, $\pm 0.5A$
Maximum DUT power consumption must not exceed 25W

Test Cable Length:

1.5m (41941A)
3.0m (41941B)

Dimensions:

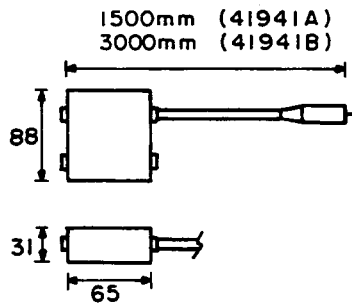

Weight:

Approx. 1.7kg (41941A)
Approx. 0.5kg (41941A's probe only)
Approx. 2.0kg (41941B)
Approx. 0.8kg (41941B's probe only)

Operation Environment:

$-20^{\circ} C$ to $65^{\circ} C$
 $\leq 95\% RH$ at $40^{\circ} C$

Storage Environment:

$-40^{\circ} C$ to $65^{\circ} C$

Table 1-3. Specifications (Sheet 2 of 3)

41941A/B Specifications

The following specifications apply to the 4194A when used with the 41941A or 41941B.

Measurement Parameter:

|Z|, |Y|, θ , R, X, G, B, L, C, D, Q(=1/D)

Test Frequency:

Range; 10kHz to 100MHz
Others; same as 4194A's specifications

Test Signal Level:

Maximum	1.26Vrms (Opt 350) or 1.54Vrms (Opt 375) at 15dBm setting
Minimum (usable)	10mVrms
Minimum (selectable)	126 μ Vrms (Opt 350) or 154 μ Vrms (Opt 375) at -65dBm setting
Resolution	3 digits for V unit or 0.1dB for dBm and dBV units
Flatness	+1dB/-1.6dB (41941A) or +1dB/-3.0dB (41941B) at 15dBm setting Add 0.2dB for more than 5dBm or add 0.02dB \times (15dBm - OSC setting)
Others	Same as 4194A's Gain/Phase measurement specifications

Note

The test signal levels are specified for open terminations. If the probe tip is terminated with an output impedance (25 Ω or 37.5 Ω), the test signal level will decrease by one-half (-6dB).

Output Impedance:

25 Ω (Opt 350) or
37.5 Ω (Opt 375)

DC Bias (Internal):

Voltage Range	-40V to 40V
Resolution	10mV
Accuracy	$\pm(0.12\%+12mV)$ at 23 $^{\circ}$ C $\pm 5^{\circ}$ C
Maximum Current	$\pm 20mA$

Table 1-3. Specifications (Sheet 3 of 3)

Measurement Range and Highest Resolution:

Parameter	Range	Resolution
Z , R, X	0.1Ω to 1MΩ	1mΩ
Y , G, B	1μS to 10S	1μS
θ	-180° to 180°	0.01°
L	1nH to 1H	10pH
C	10fF to 100μF	1fF
D	0.001 to 10	0.0001
Q	0.1 to 1000	0.01

Measurement Accuracy:

Measurement accuracy is specified at the top surface of the probe pin flange, under the following conditions:

- 1) Warm up Time: >30 minutes
- 2) Ambient Temperature: 23° C ±5° C
the temperature at which 4194A Auto Calibration was performed
- 3) Auto Calibration; ON

Figure 1-3 shows the impedance measurement accuracy.

Test Signal Level Monitor:

Voltage Range	0 to 1.26Vrms (Opt 350) or 0 to 1.54Vrms (Opt 375)
Current Range	0 to 52mA (Opt 350) or 0 to 42mA (Opt 375)
Resolution	3 digits
Accuracy	Specified for the frequency range over 100kHz. See Figure 1-4 through 1-7.

Temperature Coefficient of Measurement Accuracy:

$$\leq \pm 300\text{ppm}/^\circ\text{C} (\geq 1\text{MHz})$$

$$\leq \pm (300/f)\text{ppm}/^\circ\text{C} (< 1\text{MHz})$$

f: frequency in MHz

Temperature Coefficient of Level Monitor Accuracy:

$$\leq \pm 300\text{ppm}/^\circ\text{C}$$

(at -20° C to +65° C)

41941A/B Accuracy

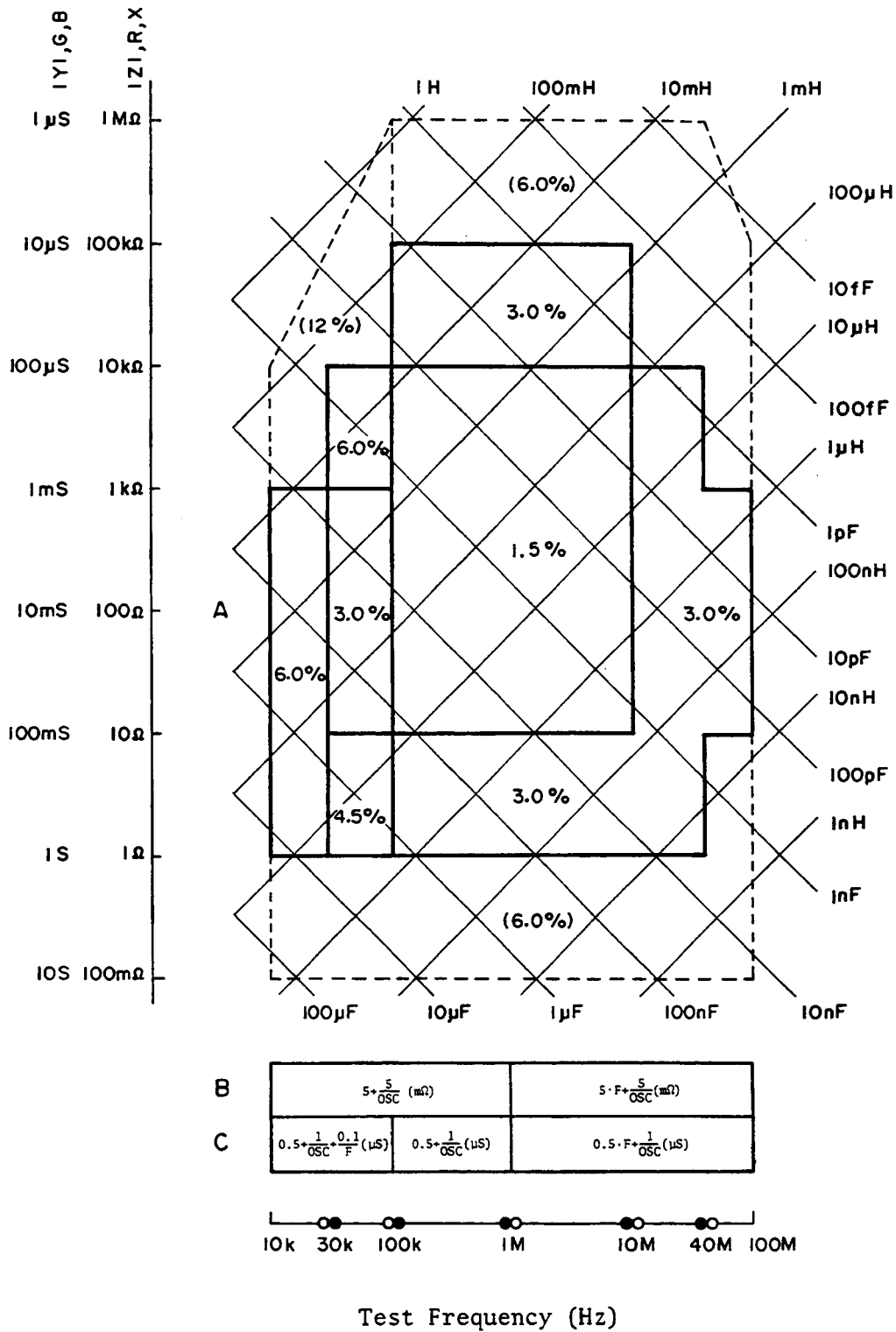

Figure 1-3. Impedance Measurement Accuracy (sheet 1 of 4)

- * On the graph, F is the test signal frequency in MHz.
- * OSC is the OSC level setting in volts (Vrms). Measurement accuracy is not specified for values less than 10mVrms.
- * Measurements enclosed by solid lines are specified.
- * Measurements enclosed by dotted lines are supplemental performance characteristics (not guaranteed).
- * Measurements not enclosed will be displayed but are not specified.
- * When dc bias is used, add the following error.

$$1.5 \times I_{\text{bias}} (\%) (\geq 1\text{MHz})$$

$$6.0 \times I_{\text{bias}}/F (\%) (< 1\text{MHz})$$

where I_{bias} is bias current in amperes (A) and F is the test signal frequency in MHz

|Z| - θ Accuracy:

|Z| accuracy $Z_a = A + (B/|Z_m| + C \times |Z_m|) \times 100 (\%)$

θ accuracy $\theta_a = \sin^{-1}(Z_a/100)$

where $|Z_m|$ is $|Z|$ measured. A, B and C are obtained from the graph above.

For example, $|Z_m| = 1\text{k}\Omega$, $F = 2\text{MHz}$,
 OSC = 0.5Vrms
 then $A = 1.5\%$, $B = 5 \times 2 + 5/0.5 = 20\text{m}\Omega$,
 $C = 0.5 \times 2 + 1/0.5 = 3\mu\text{S}$
 so $Z_a = 1.5 + (20\text{m}/1\text{k} + 3\mu \times 1\text{k}) \times 100 = 1.8(\%)$
 $\theta_a = \sin^{-1}(1.8/100) = 1.03^\circ$

|Y| - θ Accuracy:

|Y| accuracy $Y_a = A + (B \times |Y_m| + C/|Y_m|) \times 100 (\%)$

θ accuracy $\theta_a = \sin^{-1}(Y_a/100)$

where $|Y_m|$ is $|Y|$ measured. A, B and C are obtained from the graph above.

For example, $|Y_m| = 1\text{mS}$, $F = 2\text{MHz}$,
 OSC = 0.5Vrms
 then $A = 1.5\%$, $B = 5 \times 2 + 5/0.5 = 20\text{m}\Omega$,
 $C = 0.5 \times 2 + 1/0.5 = 3\mu\text{S}$
 so $Z_a = 1.5 + (20\text{m} \times 1\text{m} + 3\mu/1\text{m}) \times 100 = 1.8(\%)$
 $\theta_a = \sin^{-1}(1.8/100) = 1.03^\circ$

Figure 1-3. Impedance Measurement Accuracy (sheet 2 of 4)

R, X Accuracy (depends on D):

	$D \leq 0.2$	$0.2 < D \leq 5$	$5 < D$
Ra	$\pm X_m \cdot \frac{Z_a(X)}{100} (\Omega)$	$\frac{Z_a(R)}{\cos\theta} (\%)$	Za(R) (%)
Xa	Za(X) (%)	$\frac{Z_a(X)}{\sin\theta} (\%)$	$\pm R_m \cdot \frac{Z_a(R)}{100} (\Omega)$

D can be calculated as R/X,
 $R/(2 \times \pi \times f \times L_s)$ or $R \times 2 \times \pi \times f \times C_s$

θ can be calculated as $\tan^{-1}(X/R)$,
 $\tan^{-1}(2 \times \pi \times f \times L_s/R)$ or
 $\tan^{-1}(1/(R \times 2 \times \pi \times f \times C_s))$

$Z_a(R) = A + (B/|R_m| + C \times |R_m|) \times 100 (\%)$

$Z_a(X) = A + (B/|X_m| + C \times |X_m|) \times 100 (\%)$

R_m and X_m are the measured R and X, respectively. A, B and C are obtained from the preceding graph.

G, B Accuracy (depends on D):

	$D \leq 0.2$	$0.2 < D \leq 5$	$5 < D$
Ga	$\pm B_m \cdot \frac{Y_a(B)}{100} (S)$	$\frac{Y_a(G)}{\cos\theta} (\%)$	$Y_a(G)$
Ba	$Y_a(B) (\%)$	$\frac{Y_a(B)}{\sin\theta} (\%)$	$\pm G_m \cdot \frac{Y_a(G)}{100} (S)$

D can be calculated as G/B,
 $G/(2 \times \pi \times f \times C_p)$ or $G \times 2 \times \pi \times f \times L_p$

θ can be calculated as $\tan^{-1}(B/G)$,
 $\tan^{-1}(2 \times \pi \times f \times C_p/G)$ or
 $\tan^{-1}(1/(G \times 2 \times \pi \times f \times L_p))$

$Y_a(G) = A + (B \times |G_m| + C/|G_m|) \times 100 (\%)$

$Y_a(B) = A + (B \times |B_m| + C/|B_m|) \times 100 (\%)$

G_m and B_m are measured G and B, respectively. A, B and C are obtained from the preceding graph.

D Accuracy:

	$D \leq 0.2$	$0.2 < D$
Da	$Z_a/100$	$(Z_a/100) \times (1 + D^2)$

where Z_a is $|Z|$ accuracy

Figure 1-3. Impedance Measurement Accuracy (sheet 3 of 4)

L Accuracy (depends on D):

	$D \leq 0.2$	$0.2 < D$
La	La	La x (1+D)

where

$$La = A + (B/|Zl| + C \times |Zl|) \times 100 (\%)$$

where $|Zl| = 2 \times \pi \times f \times Lm$, f is frequency in Hz and Lm is measured L. A, B and C are obtained from the preceding graph.

C Accuracy (depends on D):

	$D \leq 0.2$	$0.2 < D$
Ca	Ca	Ca x (1+D)

where

$$Ca = A + (B/|Zc| + C \times |Zc|) \times 100 (\%)$$

where $|Zc| = 1/2 \times \pi \times f \times Cm$, f is frequency in Hz and Cm is the measured C. A, B and C are obtained from the preceding graph.

The accuracy values given above apply only when the **INTEG TIME** is set to **MED** or **LONG** (for any **AVERAGING** setting). When the **INTEG TIME** is set to **SHORT**, multiply the accuracy by the following factors.

$$\text{SHORTaccuracy} = \text{Accuracy} \times 1.5 \text{ (AVERAGING } \geq 4)$$

$$\text{SHORTaccuracy} = \text{Accuracy} \times 2.0 \text{ (AVERAGING 1 or 2)}$$

Figure 1-3. Impedance Measurement Accuracy (sheet 4 of 4)

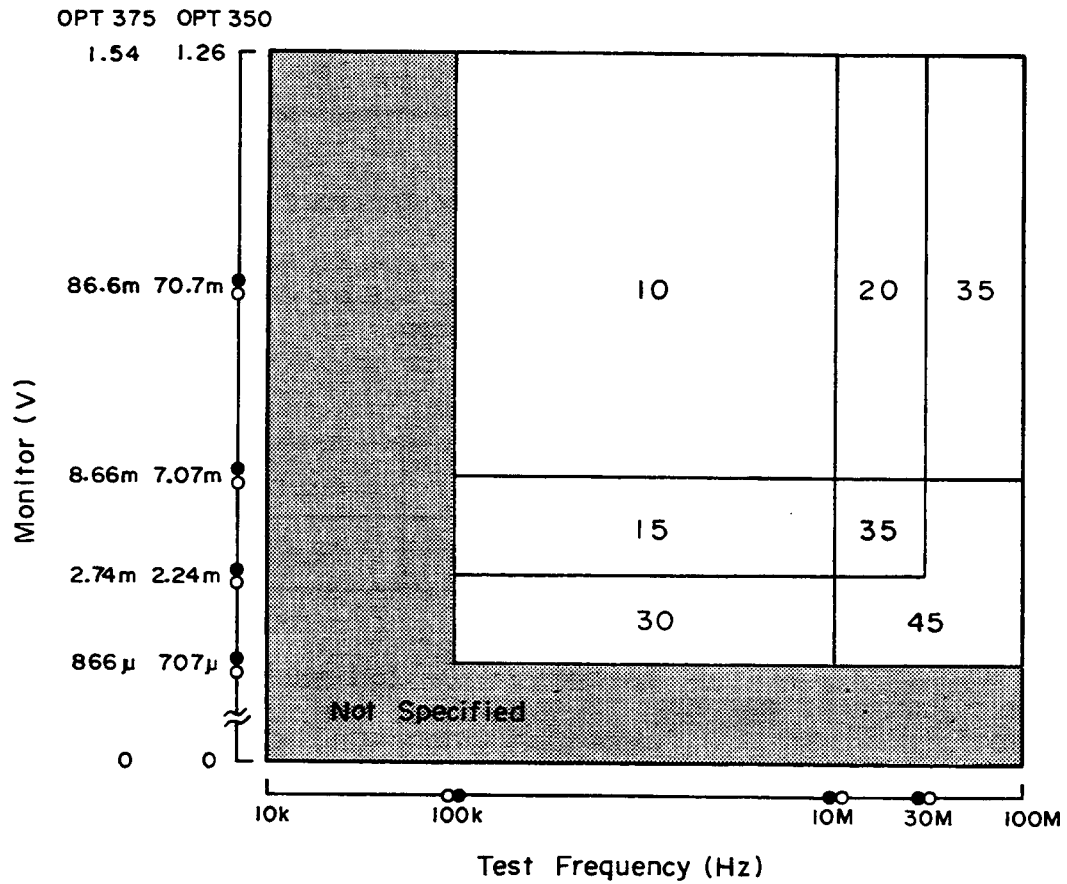

Accuracy = $\pm(A\%$ of reading) + 100 μ V (MED or LONG) or
 Accuracy = $\pm((A+10)\%$ of reading) + 100 μ V (SHORT)

A is obtained from the above Graph.

The voltage level monitor displays the total voltage across the DUT, and the voltage across the residual impedance (typically 0.25 Ω + 10nH for option 350, and 0.375 Ω + 10nH for option 375) of the probe.

Figure 1-4. HP 41941A Voltage Monitor Accuracy

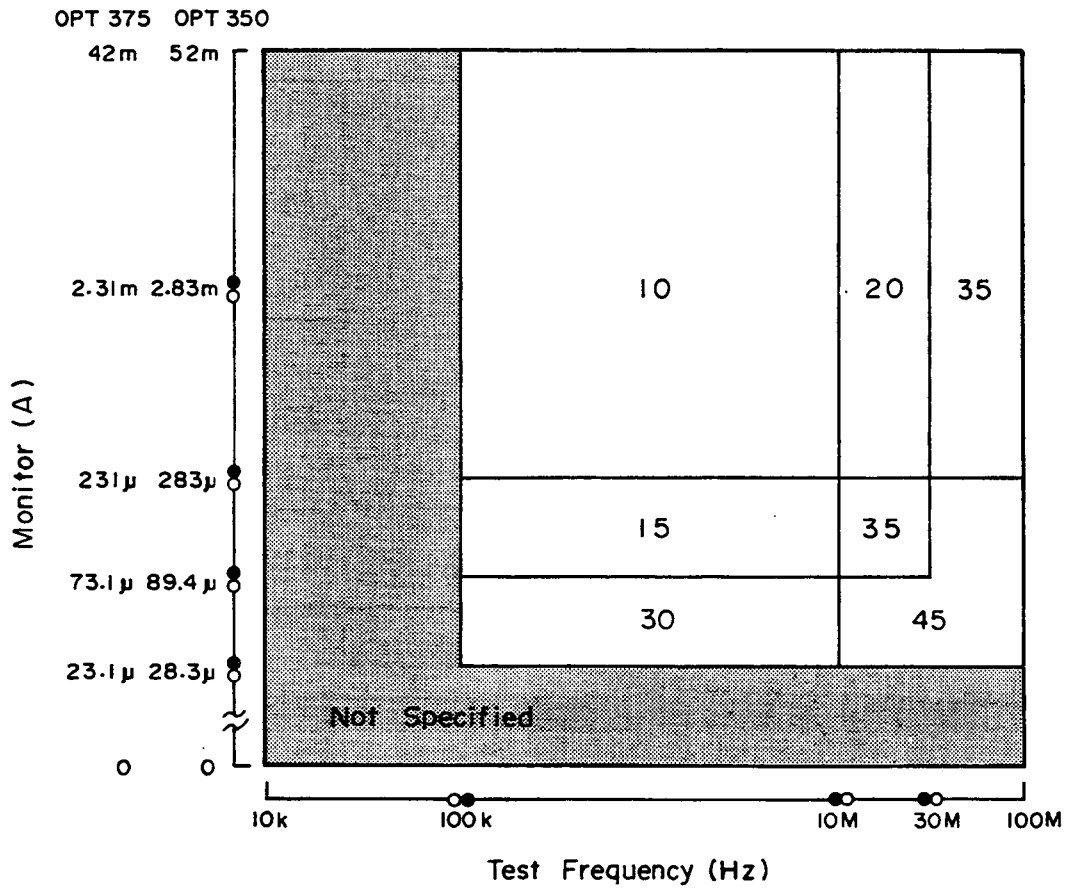

Accuracy = $\pm(A\% \text{ of reading}) + 4\mu\text{A}$ (MED or LONG) or
 Accuracy = $\pm((A+10)\% \text{ of reading}) + 4\mu\text{A}$ (SHORT)

A is obtained from the graph above.

The current level monitor displays the total current through the the DUT and through the stray capacitance (typically 0.27pF) of the probe.

Figure 1-5. HP 41941A Current Monitor Accuracy

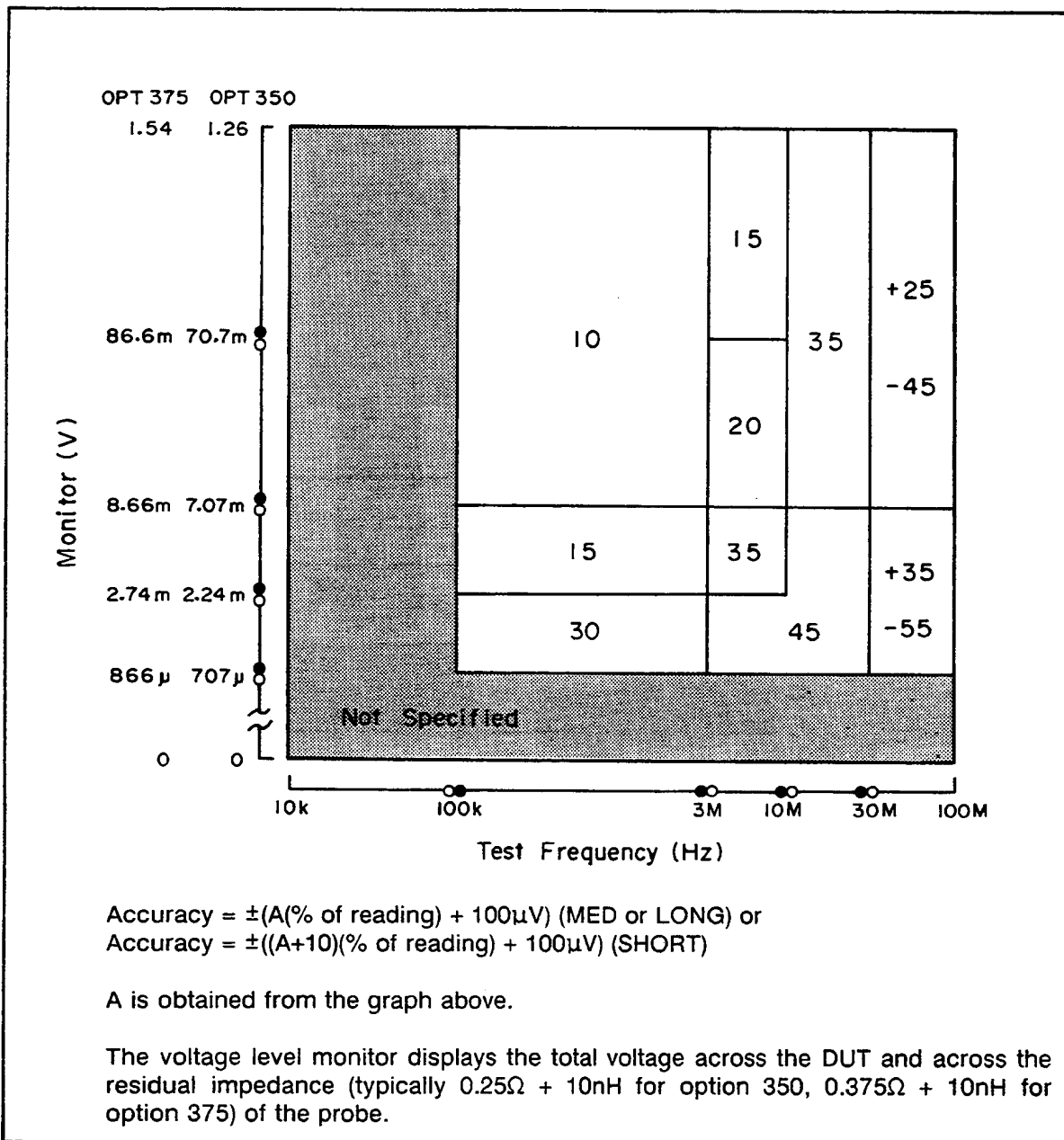

Figure 1-6. HP 41941B Voltage Monitor Accuracy

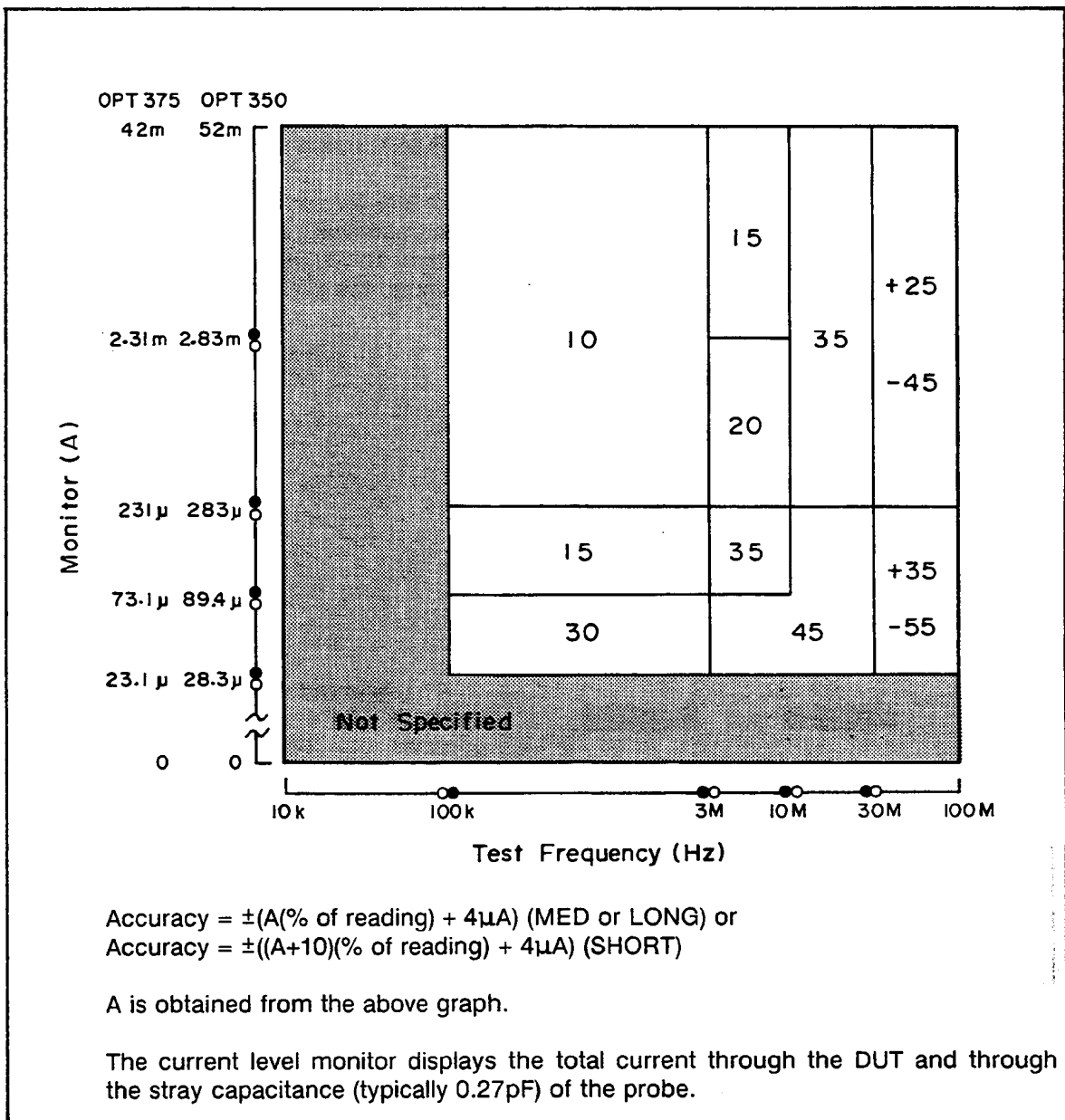

Figure 1-7. HP 41941B Current Monitor Accuracy

Table 1-4. Available Accessories (Sheet 1 of 2)

Model	Description
<p data-bbox="375 254 526 281">HP 16092A</p> 	<p data-bbox="898 260 1284 289">HP 16092A Spring Clip Fixture</p> <p data-bbox="898 323 1446 449">Test fixture for connecting axial and radial lead components, and lead-less chip components. The spring clip contacts can be adjusted to the dimensions given below.</p>  <p data-bbox="889 863 1442 1016">A slide gauge provides direct read-out of the length of the test sample. Maximum applicable dc bias is $\pm 150\text{V}/\pm 0.5\text{A}$. The 16099A Test Fixture Adapter is required when using this fixture.</p>
<p data-bbox="370 1079 516 1106">HP 16093A</p> 	<p data-bbox="889 1085 1295 1115">HP 16093A Binding Post Fixture</p> <p data-bbox="889 1148 1442 1337">A test fixture used when measuring miniature axial and radial lead components. Two binding post terminals at intervals of 7mm on the terminal deck ensure optimum contact of terminals and the test sample leads.</p>  <p data-bbox="883 1661 1442 1757">The maximum dc bias that can be applied is $\pm 150\text{V}/\pm 0.5\text{A}$. The 16099A Test Fixture Adapter is required when using this fixture.</p>

Table 1-4. Accessories Available (Sheet 2 of 2)

<p>HP 16093B</p>  <p>A photograph of the HP 16093B Binding Post Fixture, a rectangular metal device with three binding post terminals on the right side and a circular terminal deck on the left. A separate circular terminal deck is shown below the main device.</p>	<p>HP 16093B Binding Post Fixture</p> <p>A Test fixture for connecting common axial and radial lead components. Three binding post terminals are located on the terminal deck as shown below.</p>  <p>A technical diagram of the terminal deck showing three binding post terminals. The distance between the centers of the two outer terminals is 15 mm. The distance between the center of the left terminal and the center of the right terminal is 18 mm. The diameter of each terminal is 10.5 mm.</p> <p>The maximum dc bias that can be applied is $\pm 150\text{V}/\pm 0.5\text{A}$. The 16099A Test Fixture Adapter is required when using this fixture.</p>
<p>HP 16099A</p>  <p>A photograph of the HP 16099A Test Fixture Adapter, a rectangular metal device with two vertical binding post terminals on the left and a circular terminal deck on the right.</p>	<p>HP 16099A Test Fixture Adapter</p> <p>A Test Fixture adapter for connecting the 41941A or B to the 16092A, 16093A, or 16093B.</p>
<p>HP 16345A</p>  <p>A photograph of the HP 16345A Probe Type Calibration Box, an open rectangular metal box with a lid. The interior of the box contains ten probe-insertable standards arranged in two rows of five.</p>	<p>HP 16345A Probe Type Calibration Box. Calibration standards used when performance testing of the 4194A with the 41941A/B. Includes ten probe-insertable standards: OPEN, SHORT, 10Ω, 50Ω, 100Ω, 180Ω, $1\text{k}\Omega$, $1.8\text{k}\Omega$, $10\text{k}\Omega$ and 5pF.</p>

SECTION 2

INSTALLATION

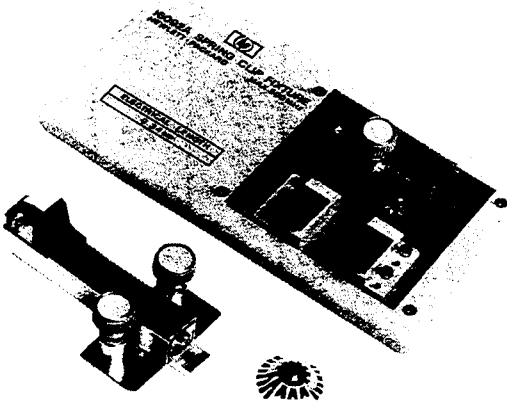
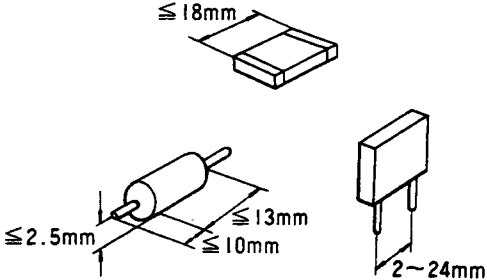
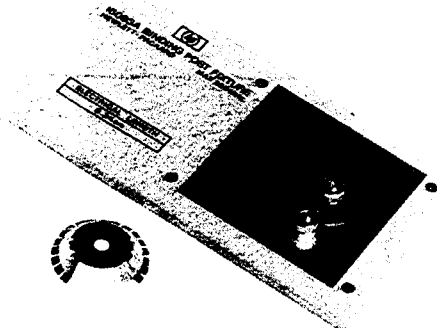
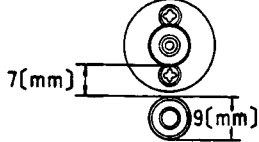
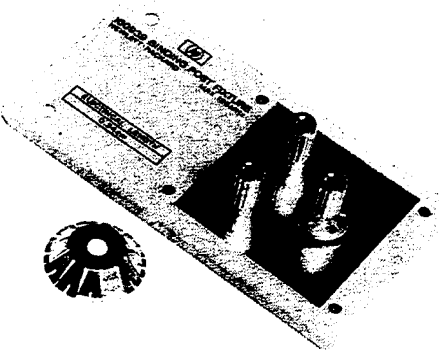
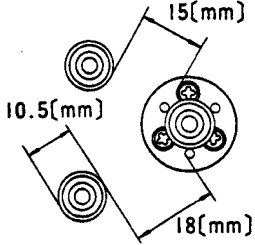
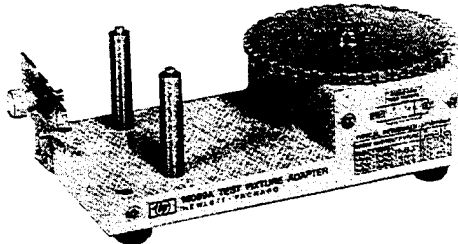
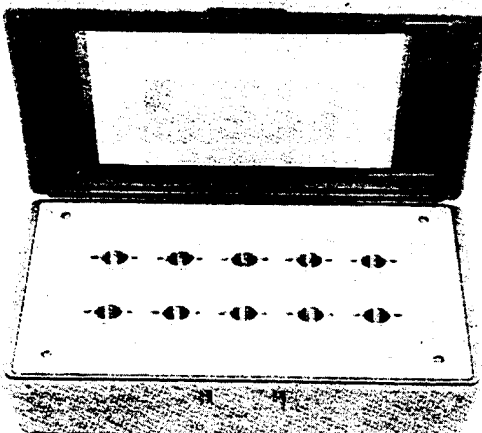
2-1. INTRODUCTION

This section provides installation instructions for the HP 41941A/B Impedance Probe. It also includes information on the initial inspection, damage claims, preparation for using the 41941A or 41941B, packaging, storage, and shipment.

2-2. INITIAL INSPECTION

The 41941A/B Impedance Probe Kits meet all of the specifications listed in Table 1-3. Upon receipt, inspect the shipping container for damage. If the shipping container or the cushioning material has been damaged, keep the container and packing material until the contents have been checked for completeness and the probe has been checked out mechanically and electrically. The contents should be as shown in Figure 1-1. The procedures for checking the general electrical operation and checking the 41941A/B against the specifications are given in Section 4.

If anything is missing, damaged (scratches, dents, broken connectors, etc.), or if performance does not meet the performance tests limits, notify the nearest HP Sales office (see the list at the back of this operation note). The HP Sales Office will immediately arrange for repair or replacement without waiting for a claim settlement.

2-3. INTERCONNECTIONS

Connect the probe's two male BNC connectors, located on the connection box, to the 4194A's GAIN-PHASE terminals. The BNC connector located on the left side, labeled TO OUTPUT SINGLE, is connected to the 4194A's SINGLE OUTPUT connector. Connect the two BNC cables from the connection box to the 4194A's INPUT terminals. The shorter cable (white and labeled as R) is for the REFERENCE CHANNEL and the longer cable (black and labeled as T) is for the TEST CHANNEL INPUT.

When the dc bias supplied from the 4194A is used, connect the 41941A/B's DC BIAS INPUT connector and the 4194A's UNKNOWN HCUR connector with a BNC cable. The BNC cable supplied with the 4194A can be used.

When dc bias supplied from an external dc power supply is used, connect the power supply's output to 41941A/B's DC BIAS INPUT connector. Note that the outer conductor of the DC BIAS INPUT connector is grounded.

2-4. STORAGE ENVIRONMENT

The 41941A/B may be stored or shipped under the following environmental conditions.

Temperature -45° C to 65° C

The unit must be protected from temperature extremes which can cause condensation.

2-5. PACKING

Original Packing.

Containers and packing material identical to those used in factory packaging are available from Hewlett-Packard. If the unit is being returned to Hewlett-Packard for servicing, attach a tag indicating the type of service required, return address, model number and the full serial number.

Other Packing.

The following general instructions should be used for repacking with commercially available materials:

- a. Wrap the unit in heavy paper or plastic. If shipping to a Hewlett-Packard Sales Office or Service Center, attach a tag indicating the type of service required, return address, model number and the full serial number.
- b. Use a strong shipping container. A double-walled carton made of 350 pound test material is adequate.
- c. Use enough shock absorbing material (a 3 to 4 inch layer) around all sides of the unit to provide a firm cushion and to prevent the unit from moving inside the container.
- d. Seal the shipping container securely.
- e. Mark the shipping container **FRAGILE** to ensure careful handling.
- f. In any correspondence, refer to unit by its model number and the full serial number.

Note

If you ever need to return the 41941A/B for servicing, HP recommends that you return your 4194A also so that system performance can be verified after repairs are made.

SECTION 3

OPERATION

3-1. INTRODUCTION

This section provides the information necessary to use the 41941A/B. **WARNINGS, CAUTIONS**, and **Notes** are given throughout, and they should be followed to insure operator safety and serviceability of the unit.

Note

For detailed information on 4194A operation, refer to the 4194A's Operation Manual.

3-2. COMPENSATION CONSIDERATIONS

The 4194A has two compensation methods, calibration and offset. Calibration compensates for measurement errors caused by the measurement instrument and the probe. Offset compensates for measurement errors caused by residual impedance and stray admittance between the calibration plane and the DUT.

3-2-1. Calibration

Calibration is required to compensate for measurement errors due to the frequency characteristics of the probe. When the probe is calibrated using the supplied calibration standards, the calibration plane of the probe extends to the fringe of the pin's top plane as shown in Figure 3-1. The calibration plane is the point at which impedance can be correctly measured.

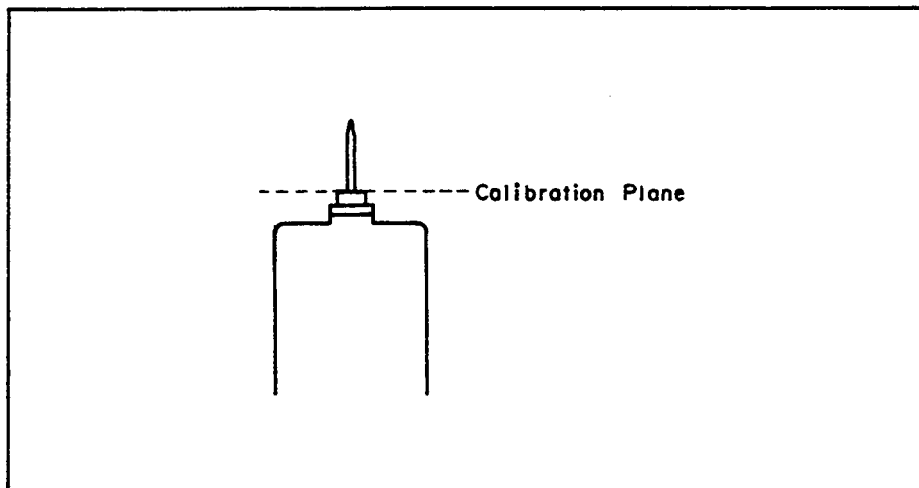

Figure 3-1. 41941A/B's Calibration Plane

3-2-2. Offset

Offset compensates for the residual impedance and stray admittance at the calibration plane. The stray admittance and the residual impedance of the probe pin must be offset.

Note

The probe pin or test fixture must be configured the same as it will be for performing compensation and for making a measurement.

3-2-3. Furnished Calibration Standards

The reference values of the furnished calibration standards are listed in Table 3-1.

Table 3-1. Reference Values for Calibration Standards

Standard	Reference Value
0S admittance	$0S + j \times \omega \times 0.31\text{pF}$
0 Ω impedance	$0\Omega + j \times \omega \times 0H$
50 Ω impedance	$50\Omega + j \times \omega \times 5.75\text{nH}$

0.31pF of the 0S standard includes the stray capacitance inside of the probe and around the standard pin. The impedance of the 0 Ω and 50 Ω standards does not include the residual impedance of the standard or the N-type pins.

These values are stored in the 4194A's EEPROM as the calibration reference values.

Note

The standard pin must be used when calibrating the probe, because the calibration standards are made to match the standard pin.

Note

If you extend the measurement point beyond the probe tip, and you have accurate standards that can be connected to the end of the extension, calibration will be accurate to the end of the extension. Refer to Appendix F of the 4194A Operation Manual for the procedure for entering the reference values of your standards.

3-3. USING PROBE ADAPTERS

Four probe adapters are furnished to facilitate connection to a wide range of DUT's. The probe adapters are listed in Table 3-2.

Table 3-2. Furnished Probe Adapters

Adapter	HP Part Number
BNC Adapter	04193-61152
Component Adapter	04193-61153
Ground Adapter	04193-61154
Probe Socket	04193-21008

A BNC Adapter is provided for input and output impedance measurements on circuits equipped with BNC female connectors. The Component Mounting Adapter is used for measurements on discrete axial or radial-lead components. The Probe Socket is for use with fabricated test fixtures, as shown in Figure 3-2. It is available for supporting the probe, which is attached to the user-built fixture and connected to ground.

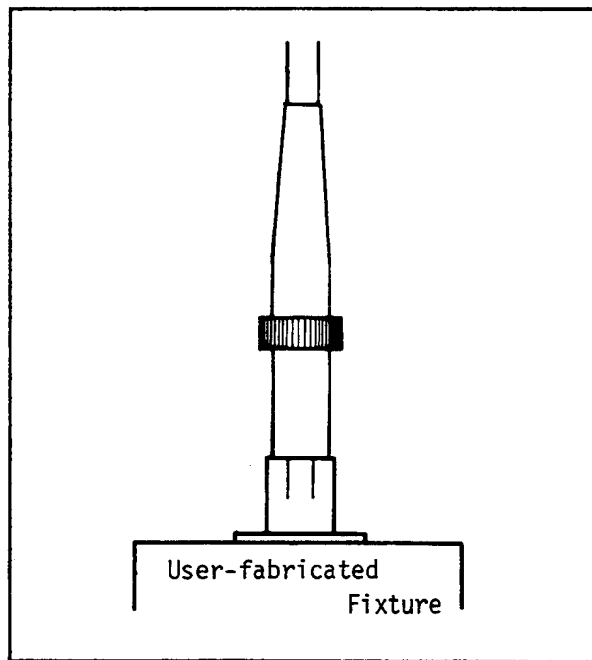

Figure 3-2. Probe Socket

3-4. TEST SIGNAL LEVEL AND OUTPUT IMPEDANCE

When using the 41941A/B, the output impedance of the test signal source will be one-half the output of the 4194A's (25Ω for option 350 units, and 37.5Ω for option 375 units). The actual test signal level applied to the DUT will be different from the signal level output applied from the UNKNOWN terminals, even with the same OSC level setting. Test signal level examples are shown in Table 3-3.

Table 3-3. Actual Test Signal Level

DUT Impedance	Option 350		Option 375	
	1.00V	15dBm	1.00V	15dBm
infinite	1.00V	1.26V	1.00V	1.54V
1k Ω	0.98V	1.23V	0.96V	1.48V
100 Ω	0.80V	1.01V	0.73V	1.12V

3-5. DC BIAS

3-5-1. Internal DC Bias

To use the 4194A's internal dc bias capability, connect a BNC cable between the 4194A's UNKNOWN Hcur connector and the 41941A/B's DC BIAS INPUT connector.

3-5-2. External DC Bias

External dc bias can be used up to $\pm 150V$ and $\pm 500mA$.

WARNING

ELECTRICAL SHOCK HAZARD! DANGEROUS VOLTAGE ARE PRESENT AT THE PROBE PIN AND THE MEASUREMENT TERMINALS TO WHICH THE PROBE IS CONNECTED.

CAUTION

DO NOT SHORT THE PROBE'S CENTER PIN TO GROUND WHEN AN EXTERNAL DC BIAS IS APPLIED, OR YOU WILL BLOW THE FUSE IN THE CONNECTION BOX.

CAUTION

DO NOT PERFORM A CALIBRATION MEASUREMENT WHILE AN EXTERNAL DC BIAS IS APPLIED. THE CALIBRATION STANDARDS MAY BE DAMAGED IF YOU DO.

SECTION 4

PERFORMANCE TEST/OPERATING CHECK

4-1. INTRODUCTION

This section contains performance test procedures used to verify that the 41941A/B meets the specifications listed in Table 1-3, and basic operational checkout procedures. All tests can be performed without access to the interior of the 41941A/B. The performance test can be used for incoming inspection of the probe and for verifying that the probe still meets performance specifications after repair. The measurement accuracy specifications listed in Table 1-1 apply only when the 41941A/B is used with a 4194A. The impedance options for the 4194A and 4194A/B must be the same. Without a 4194A, this performance test cannot be performed. Operational checks are provided to check the 41941A/B's operation after repairs have been made, if a 4194A is not available. If performance or basic operational check indicates that the probe is operating outside of its specified limits, check to see if the test setup and settings are correct. If they are, proceed with troubleshooting.

4-2. EQUIPMENT REQUIRED

The equipment required to perform the performance tests and basic operational checks is listed in Table 4-1. Any equipment that satisfies or exceeds the critical specifications listed in the table may be used as a substitute for the recommended models.

Note

Components used as standards should be calibrated with an instrument whose specifications are traceable to the NBS or an equivalent standards group, or calibrated directly by an authorized calibration organization such as the NBS. The calibration cycle should be in accordance with the stability specifications for each component.

4-3. TEST RECORD

Performance test results should be recorded on the Test Record at the completion of the test. The Test Record is at the end of this section and it lists all of the specifications tested and their acceptable limits. Test results recorded at incoming inspection can be used for comparison during periodic maintenance, troubleshooting, and after repair or adjustment.

4-4. CALIBRATION CYCLE

The 41941A/B requires periodic performance verification. Depending on the conditions under which the 41941A/B is used, e.g., environmental conditions or frequency of use, the probe should be checked with the performance test described here **AT LEAST ONCE A YEAR**. To keep down-time to a minimum and to insure optimum operation, preventive maintenance should be performed **AT LEAST TWICE A YEAR**.

Table 4-1. Recommended Test Equipment

Equipment	Critical Specifications	Recommended Model/Note	Use*
Impedance/ Gain-Phase Analyzer	Network measurement at 10kHz to 100MHz frequency range	HP 4194A Ver. 2.2 (same impedance option as the 41941A/B tested)	P
Probe Type Cal. Box	10 Ω , 100 Ω , 1k Ω and 10k Ω	HP 16345A	P
Oscillator	Frequency: 1MHz \pm 10%	HP 3335A Amplitude: 0.5Vrms \pm 5% Zout: 50 Ω \pm 5%	C
Oscilloscope	Sensitivity: 10mV/Div	HP 1740A Zin: 50 Ω \pm 5%	C

* P: Performance Test, C: Basic Operating Check

Note

The ROM version of the 4194A to be used should have Version 2.2, and the 4194A should meet its calibration specifications.

4-5. IMPEDANCE MEASUREMENT ACCURACY TEST

This test verifies the measurement accuracy of the 41941A/B when used with the 4194A is within the limits specified.

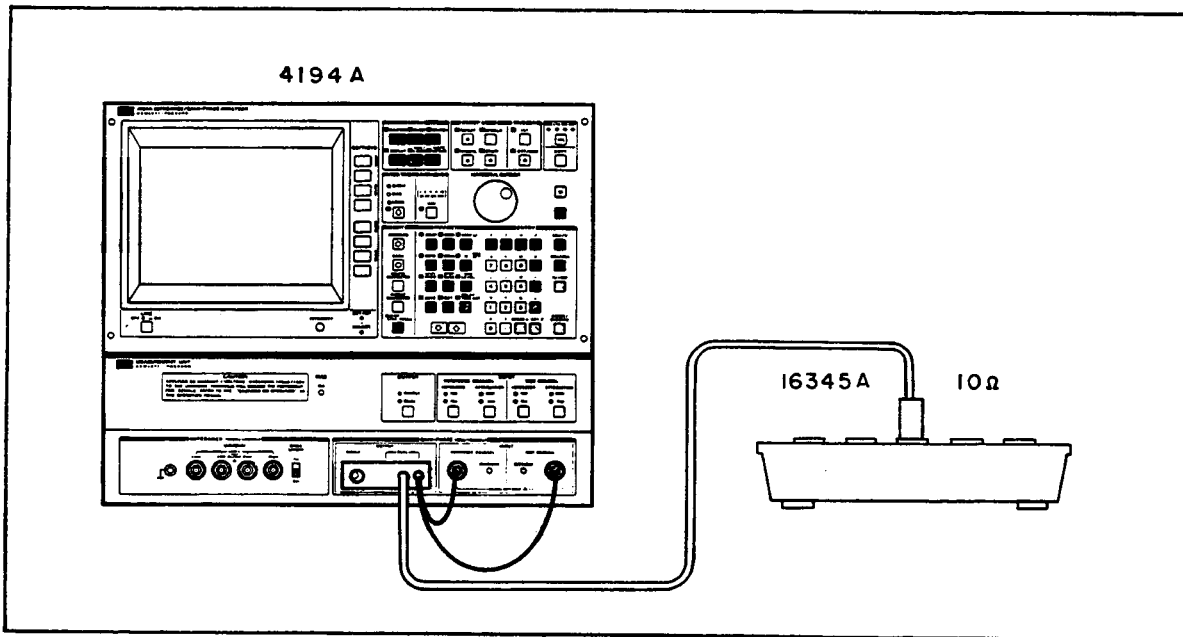

Figure 4-1. Impedance Measurement Accuracy Test Setup

EQUIPMENT:

Impedance/Gain-Phase Analyzer
Probe Type Calibration Box

HP 4194A
HP 16345A

PROCEDURE:

1. Connect 41941A/B to the 4194A and set 4194A's control as follows.

FUNCTION	IMP with Z PROBE
SWEEP	LOG
SWEEP MODE	SINGLE
INTEG TIME	MED
NOP	9
DISPLAY	TABLE
other settings	initial setting (AVERAGING; 1) (COMPEN; INTPOL)

2. Calibrate the 4194A with the supplied 0S, 0 Ω , and 50 Ω calibration standards. Steps 2-1 through 2-7 describes the calibration procedure. If you don't need an explanation for the procedure, go to step 3.
 - 1) Connect supplied 0S standard to the probe.
 - 2) Press **COMPEN**, 'more 1/3', 'more 2/3', '0S CAL' and **ENTER/EXECUTE**.
 - 3) Disconnect the 0S standard and connect the 0 Ω standard to the probe.
 - 4) Press '0 Ω CAL' and **ENTER/EXECUTE**.
 - 5) Disconnect the 0 Ω standard and connect the 50 Ω standard to the probe.
 - 6) Press 'STD CAL' and **ENTER/EXECUTE**.
 - 7) Make sure that 'CAL on/off' softkey is activated.
3. Connect the probe to the 16345A's 10 Ω standard.
4. Press 4194A's **SWEEP MODE START** key.
5. Press the 4194A's **MORE MENUS** key, 'EQV CKT', 'CKT B', 'more 1/2' softkeys.
6. Enter the 10 Ω 's calibrated R as 'EQVR', calibrated Ls as 'EQVL', and Zero as 'EQVCA'.
7. Press the 4194A's 'SIMULATE f CHAR' softkey, the **DISPLAY** key and the 'TABLE' softkey.
8. Enter and execute $A = (A - C) / C * 100$; $B = B - D$ on the 4194A's keyboard input line.
9. Confirm that the displayed values are within the test limits in Table 4-2.
10. Repeat steps 3 through 9 with 16345A's 100 Ω , 1k Ω , and 10k Ω . Use 'CKT C', enter R and Cp values as EQVR and EQVCA and 0 as EQVL in step 5.

If the 4194A and 41941A/B failed this test, recalibrate using the 16345A's 50 Ω standard and repeat this test. Then they pass this test, replace the furnished 50 Ω calibration standard. If it still fails, troubleshoot the probe.

Table 4-2. Impedance Measurement Accuracy Test Limits

16345A's Resistor	Frequency [Hz]	Limit for A	Limit for B
10.0Ω	10 000.000	±6.2	±3.55
	31 622.777	±3.2	±1.83
	100 000.000	±1.7	±970m
	316 227.766	±1.7	±970m
	1 000 000.000	±1.7	±970m
	3 162 277.660	±1.8	±1.03
	10 000 000.000	±2.1	±1.20
	31 622 776.602	±4.7	±2.69
	100 000 000.000	±7.3	±4.19
100.0Ω	10 000.000	±6.0	±3.44
	31 622.777	±3.0	±1.72
	100 000.000	±1.5	±860m
	316 227.766	±1.5	±860m
	1 000 000.000	±1.5	±860m
	3 162 277.660	±1.5	±860m
	10 000 000.000	±1.6	±920m
	31 622 776.602	±3.2	±1.83
	100 000 000.000	±4.0	±2.29
1.0kΩ	10 000.000	±7.3	±4.19
	31 622.777	±3.6	±2.06
	100 000.000	±1.8	±1.03
	316 227.766	±1.8	±1.03
	1 000 000.000	±1.8	±1.03
	3 162 277.660	±1.9	±1.09
	10 000 000.000	±2.2	±1.26
	31 622 776.602	±4.7	±2.69
	100 000 000.000	±7.4	±4.24
10.0kΩ	31 622.777	±11.7	±6.72
	100 000.000	±4.0	±2.29
	316 227.766	±4.0	±2.29
	1 000 000.000	±4.0	±2.29
	3 162 277.660	±5.0	±2.87
	10 000 000.000	±7.5	±4.30
31 622 776.602	±11.2	±6.40	

4-6. PROBE OPERATION CHECK

This check verifies operation of the probe. This check cannot guarantee the 41941A's specifications, but will determine if it is operational. This check is useful if a 4194A is not available.

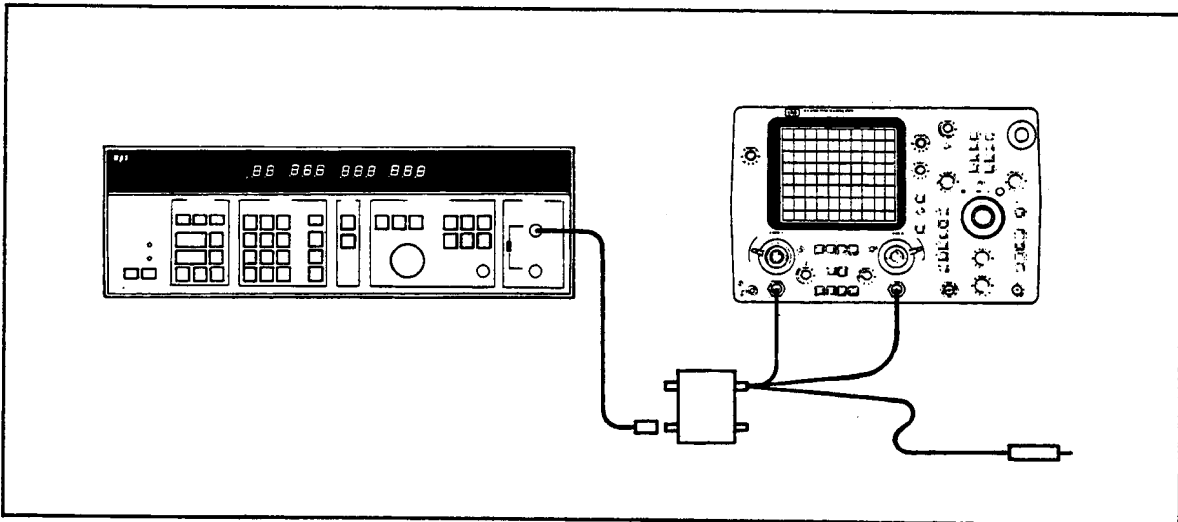

Figure 4-2. Probe Operation Check Setup

EQUIPMENT:

Oscillator	HP 3335A
Oscilloscope	HP 1740A
BNC-to-BNC Cable	PN 8120-1839
BNC(f)-to-BNC(f) Adapter	PN 1250-0080

PROCEDURE:

1. Set the oscilloscope as follows.

DISPLAY	ALT
CHAN A	5mV/Div, DC, 50 Ω
CHAN B	500mV/Div, DC, 50 Ω
TRIGGER	CHAN B
TIME BASE	500ns/Div

2. Set the oscillator as follows.

FREQUENCY	1MHz
AMPLITUDE	0.5Vrms into 50 Ω load
OUTPUT	50 Ω

3. Connect the oscillator output to 41941A or B **TO OUTPUT SINGLE** connector, 41941A or B's shortest (white) cable to oscilloscope's **CHAN A**, the longest (black) cable to **CHAN B** as shown in Figure 4-2. Leave the probe tip open.

4. Confirm that the amplitude of the trace on **CHAN A** is too small to observe, and the amplitude of the trace on **CHAN B** is between 1.3Vpp and 1.6Vpp.
5. Change the oscilloscope settings as follows.

CHAN A	100mV/Div, DC, 50 Ω
CHAN B	100mV/Div, DC, 50 Ω
TRIGGER	CHAN A

6. Connect the furnished 0 Ω calibration standard to the probe.
7. Confirm that the amplitude of the trace shown on CHAN A is between 60mVpp and 80mVpp (75mVpp and 95mVpp), and the amplitude of the trace on CHAN B trace is less than 100mVpp.

Note

Limits in parentheses are for 41941A/B Option 375 units only.

If the the check in step 4 or 6 fails, troubleshoot the 41941A/B.

PERFORMANCE TEST RECORD

Hewlett-Packard
 Model 41941____
 Impedance Probe Kit
 Serial Number_____

Tested by _____
 Date _____

Test		Minimum	Actual	Maximum
16345A's Resistor	Frequency [Hz]			
10.0Ω	10 000.000 Z	-6.2	_____	6.2
	θ	-3.55	_____	3.55
	31 622.777 Z	-3.2	_____	3.2
	θ	-1.83	_____	1.83
	100 000.000 Z	-1.7	_____	1.7
	θ	-970m	_____	970m
	316 227.766 Z	-1.7	_____	1.7
	θ	-970m	_____	970m
	1 000 000.000 Z	-1.7	_____	1.7
	θ	-970m	_____	970m
	3 162 277.660 Z	-1.8	_____	1.8
	θ	-1.03	_____	1.03
10 000 000.000 Z	-2.1	_____	2.1	
θ	-1.20	_____	1.20	
31 622 776.602 Z	-4.7	_____	4.7	
θ	-2.69	_____	2.69	
100 000 000.000 Z	-7.3	_____	7.3	
θ	-4.19	_____	4.19	
100.0Ω	10 000.000 Z	-6.0	_____	6.0
	θ	-3.44	_____	3.44
	31 622.777 Z	-3.0	_____	3.0
	θ	-1.72	_____	1.72
	100 000.000 Z	-1.5	_____	1.5
	θ	-860m	_____	860m
	316 227.766 Z	-1.5	_____	1.5
	θ	-860m	_____	860m
	1 000 000.000 Z	-1.5	_____	1.5
	θ	-860m	_____	860m
	3 162 277.660 Z	-1.5	_____	1.5
	θ	-860m	_____	860m
10 000 000.000 Z	-1.6	_____	1.6	
θ	-920m	_____	920m	
31 622 776.602 Z	-3.2	_____	3.2	
θ	-1.83	_____	1.83	
100 000 000.000 Z	-4.0	_____	4.0	
θ	-2.29	_____	2.29	

PERFORMANCE TEST RECORD

1.0kΩ	10 000.000	Z	-7.3	_____	7.3
		θ	-4.19	_____	4.19
	31 622.777	Z	-3.6	_____	3.6
		θ	-2.06	_____	2.06
	100 000.000	Z	-1.8	_____	1.8
		θ	-1.03	_____	1.03
	316 227.766	Z	-1.8	_____	1.8
		θ	-1.03	_____	1.03
	1 000 000.000	Z	-1.8	_____	1.8
		θ	-1.03	_____	1.03
	3 162 277.660	Z	-1.9	_____	1.9
		θ	-1.09	_____	1.09
	10 000 000.000	Z	-2.2	_____	2.2
		θ	-1.26	_____	1.26
31 622 776.602	Z	-4.7	_____	4.7	
	θ	-2.69	_____	2.69	
100 000 000.000	Z	-7.4	_____	7.4	
	θ	-4.24	_____	4.24	
10.0kΩ	31 622.777	Z	-11.7	_____	11.7
		θ	-6.72	_____	6.72
	100 000.000	Z	-4.0	_____	4.0
		θ	-2.29	_____	2.29
	316 227.766	Z	-4.0	_____	4.0
		θ	-2.29	_____	2.29
	1 000 000.000	Z	-4.0	_____	4.0
		θ	-2.29	_____	2.29
	3 162 277.660	Z	-5.0	_____	5.0
		θ	-2.87	_____	2.87
	10 000 000.000	Z	-7.5	_____	7.5
		θ	-4.30	_____	4.30
	31 622 776.602	Z	-11.2	_____	11.2
		θ	-6.40	_____	6.40

SECTION 5

MANUAL CHANGES

5-1. INTRODUCTION

This section contains information for adapting this manual to instruments to which its contents do not directly apply. The following paragraphs explain how to adapt this manual to older instruments which have a serial prefix/number lower than that given on the title page.

5-2. MANUAL CHANGES

To adapt this manual to your instrument, refer to Table 5-1 and make all of the manual changes listed opposite your instrument's serial number. Perform these changes in the sequence shown.

If your instrument serial number is not listed on the title page of this manual or in Table 5-1, it may be documented in a yellow MANUAL CHANGES supplement. For additional information about serial number coverage, refer to UNITS COVERED BY THIS MANUAL in Section 1.

Table 5-1. Manual Changes by Serial Number

Serial Prefix or Number	Make Manual Changes

SECTION 6

SERVICE

6-1. INTRODUCTION

This section provides the information required to service the 41941A/B Impedance Probe. Included are Schematics and Replaceable Parts Lists.

6-2. SCHEMATICS AND REPLACEABLE PARTS

Figure 6-1 shows the schematic diagram of 41941A/B.

The 41941A/B's probe assembly is repaired as a lower level component replacement. Other accessories are repaired by replacing the defective accessory.

Figure 6-2 shows the interior of the connection box of the probe assembly. Figure 6-3 shows the exploded view of the probe cable assembly. Figure 6-4 shows the replaceable accessories. Table 6-1 lists electrical replaceable parts. Table 6-2 lists the connection box's replaceable parts of the probe assembly. Table 6-3 lists the replaceable parts of the probe cable assembly. Table 6-4 lists accessories other than the probe assembly.

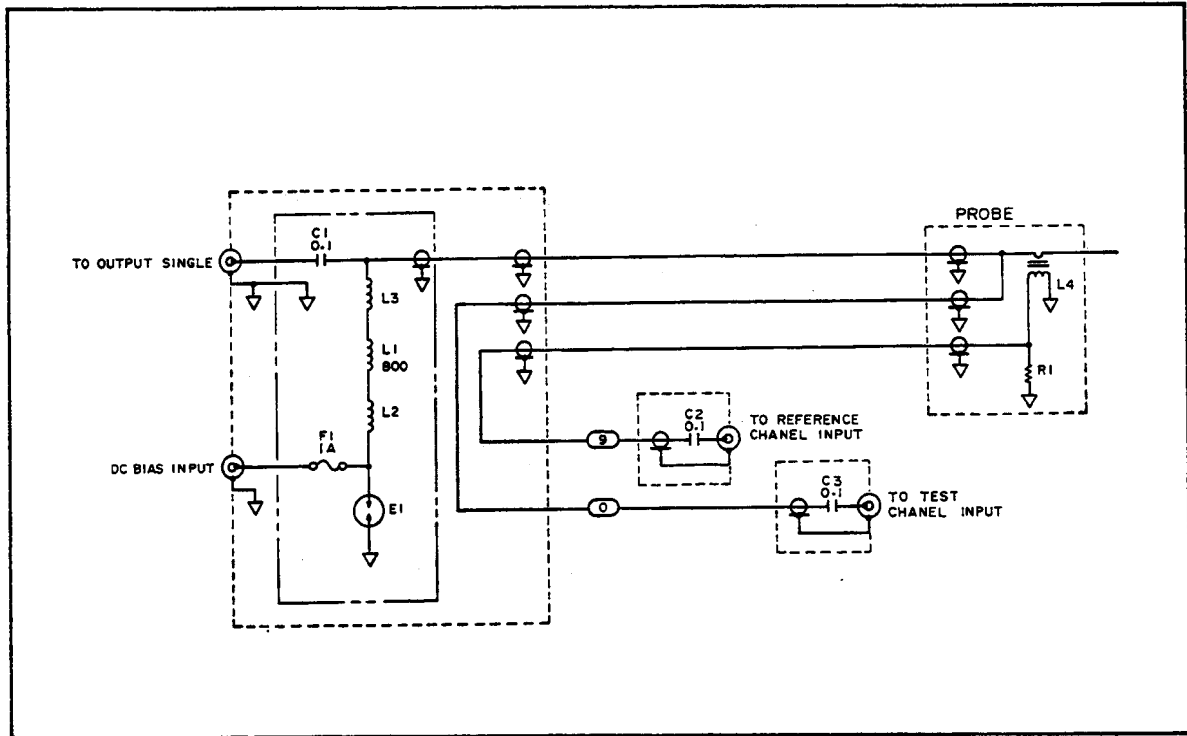

Figure 6-1. Schematic Diagram

Table 6-1. Electrical Replaceable Parts of the Probe Assembly

Ref. Desig.	Part Number	CD	QTY	Description
	41941-66501	4	1	PC Board Assembly
	41941-26501	0	1	PC Board Blank
C1	0170-0019	2	3	Capacitor 0.1μF 200V
C2	0170-0019	2		Capacitor 0.1μF 200V
C3	0170-0019	2		Capacitor 0.1μF 200V
E1	0837-0337	1	1	Arrester
F1	2110-0007	4	1	Fuse 1A 250V
L1	9140-0344	2	1	Inductor 800μH
L2	9170-1365	2	4	Core Magnetic
L3	9170-1365	2		Core Magnetic
L4	04194-61501	0	1	Coil Assembly
R1	0757-0277	8	1	Resistor 49.9Ω for Opt 350
	0757-0398	4	1	Resistor 75.0Ω for Opt 375

Note

L2 and L3 use two magnetic cores (9170-1365) for each.

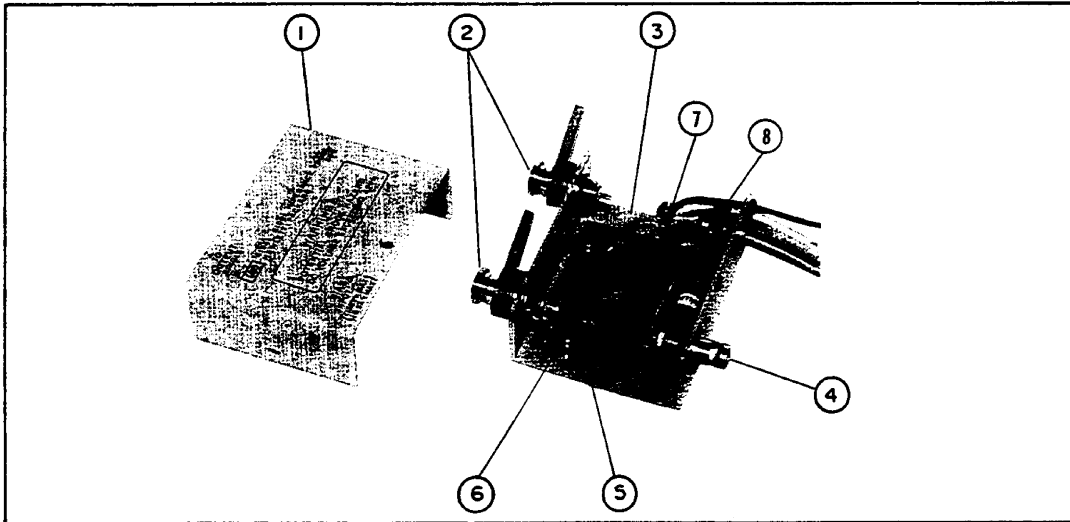

Figure 6-2. Disassembled Probe Assembly (Connection Box)

Table 6-2. Probe Assembly (Connection Box) Replaceable Parts

Ref. Desig.	Part Number	CD	QTY	Description
1	41941-04001	9	1	Cover Top (41941A Opt 350)
	41941-04011	1	1	Cover Top (41941A Opt 375)
	41941-04003	1	1	Cover Top (41941B Opt 350)
	41941-04013	3	1	Cover Top (41941B Opt 375)
2	16012-7122	2	2	BNC Assembly (4194A side)
	2190-0016	3	3	WSHR-LK INTL T
	2950-0001	8	3	Nut Hex
	0360-1190	5	1	Terminal Solder
3	41941-04002	0	1	Cover Bottom
4	1250-0083	1	1	BNC Assembly (DC BIAS INPUT)
	2190-0016	3		WSHR-LK INTL T
	2950-0001	8		Nut Hex
5	0515-0914	8	4	Screw (for top cover)
6	0515-1550	0	3	Screw (for PC board)
7	1400-0249	0	1	Cable Tie
8	1400-0493	6	1	Cable Tie

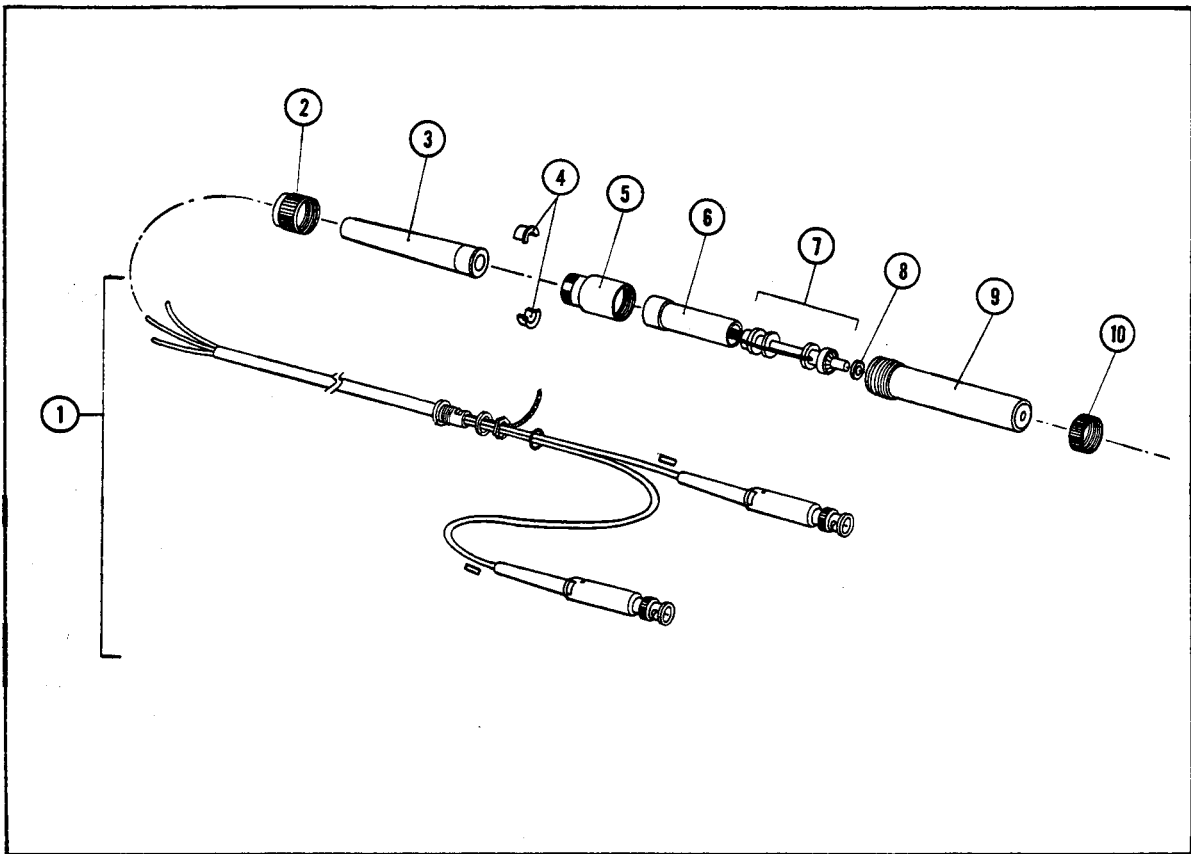

Figure 6-3. Probe Cable Assembly Exploded View

Table 6-3. Probe Cable Assembly Replaceable Parts (1 of 2)

Ref. Desig.	Part Number	CD	QTY	Description
	41941-65051	7	1	Probe Cable Assembly (41941A Opt 350)
	41941-65061	9	1	Probe Cable Assembly (41941A Opt 375)
	41941-65052	8	1	Probe Cable Assembly (41941B Opt 350)
	41941-65062	0	1	Probe Cable Assembly (41941B Opt 375)
1	41941-61601	5	1	Cable Assembly (41941A Opt 350)
	41941-61611	7	1	Cable Assembly (41941A Opt 375)
	41941-61602	6	1	Cable Assembly (41941B Opt 350)
	41941-61612	8	1	Cable Assembly (41941B Opt 375)
2	04193-24013	1	1	Nut Strain-relief
3	04193-40013	5	1	Boot Cable
4	04193-40012	4	2	Collar Cable
5	04193-24011	9	1	Nut Probe
	41941-87105	8	1	Label Warning
6	41941-24001	1	1	Spacer
7	41941-65054	0	1	Partition (Include L4, not include R1)
8	3050-1080	8	1	Washer

Table 6-3. Probe Cable Assembly Replaceable Parts (2 of 2)

Ref. Desig.	Part Number	CD	QTY	Description
9	41941-65053	9	1	Housing Probe
10	04193-24012	0	1	Lock Housing
	7121-4926	2	1	Wire Marker R
	7121-4927	3	1	Wire Marker T
	1400-0249	0	1	Cable Tie

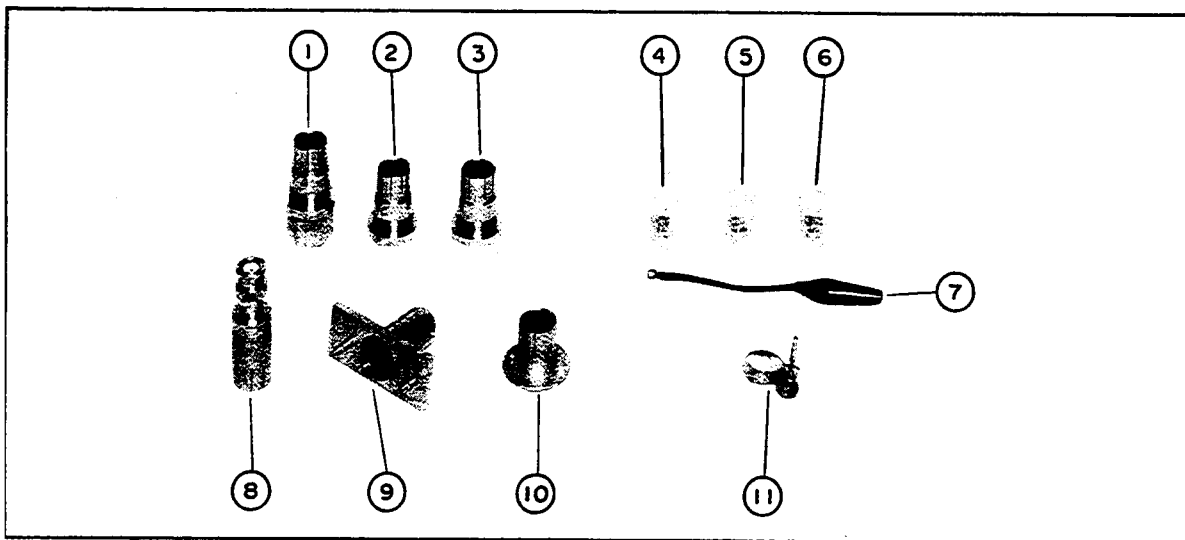

Figure 6-4. Replaceable Accessories

Table 6-4. Replaceable Accessories

Ref. Desig.	Part Number	CD.	QTY.	Description
1	41941-65002	8	1	50Ω Calibration Standard
2	41941-65001	7	1	0Ω Calibration Standard
3	41941-65003	9	1	0S Calibration Standard
4	16095-60012	2	1	Spare Pin Set (standard)
5	04193-60153	6	1	Spare Pin Set (N-type)
6	04193-60151	4	1	Spare Clip Set
7	04193-61629	3	1	Ground Lead
8	04193-61152	7	1	BNC Adapter
9	04193-61153	8	1	Component Adapter
10	04193-21008	8	1	Probe Socket
11	04193-61154	9	1	Ground Adapter

Note

When you want to replace the carrying case, contact your nearest Hewlett-Packard service office. The carrying case cannot be purchased separately using a part number because the serial number is labeled on the carrying case.



41941-90010

© Copyright Agilent Technologies, Inc.

1989, 1998, 2000

Printed in Japan 5/2000

Reorder No. 41941-90010

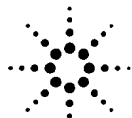

Agilent Technologies

www.valuetronics.com