

Errata

Title & Document Type: 4191A RF Impedance Analyzer Operation and Service Manual

Manual Part Number: 04191-90012

Revision Date: August 1, 1981

HP References in this Manual

This manual may contain references to HP or Hewlett-Packard. Please note that Hewlett-Packard's former test and measurement, semiconductor products and chemical analysis businesses are now part of Agilent Technologies. We have made no changes to this manual copy. The HP XXXX referred to in this document is now the Agilent XXXX. For example, model number HP8648A is now model number Agilent 8648A.

About this Manual

We've added this manual to the Agilent website in an effort to help you support your product. This manual provides the best information we could find. It may be incomplete or contain dated information, and the scan quality may not be ideal. If we find a better copy in the future, we will add it to the Agilent website.

Support for Your Product

Agilent no longer sells or supports this product. You will find any other available product information on the Agilent Test & Measurement website:

www.tm.agilent.com

Search for the model number of this product, and the resulting product page will guide you to any available information. Our service centers may be able to perform calibration if no repair parts are needed, but no other support from Agilent is available.





OPERATION AND SERVICE MANUAL

MODEL 4191A
RF IMPEDANCE ANALYZER
(Including Options 002 and 004)

SERIAL NUMBERS

This manual applies directly to instruments with
serial numbers prefixed 1930J- and above.

COPYRIGHT: YOKOGAWA-HEWLETT-PACKARD, LTD., 1980
9-1, TAKAKURA-CHO, HACHIOJI-SHI, TOKYO, JAPAN

Manual Part No. **04191-90012**
Microfiche Part No. **04191-90062**

Printed : AUG. 1981

TABLE OF CONTENTS

Section	Title	Page	Section	Title	Page
	PREFACE	1-0		Initial Auto-calibration	3-25
I	GENERAL INFORMATION	1-1		General	3-25
1-1.	Introduction	1-1		Calibration Procedure	3-26
1-4.	About The Model 4191A	1-2		Selective Calibration	3-29
1-5.	Specifications	1-4		Continuous Memorization of	
1-7.	Safety Considerations	1-7		Control Settings	3-46
1-10.	Instruments Covered by Manual	1-7	3-25.	Accuracy	3-47
1-15.	Options	1-13	3-29.	Actual Measuring Circuit	3-48
1-17.	Option 001	1-13	3-31.	Residual Parameter Effects	3-48
1-19.	Option 004	1-13	3-33.	Characteristics of Test Fixtures	3-50
1-21.	Other Options	1-13	3-34.	Considerations in Certain	
1-24.	Accessories Supplied	1-13		Measurements	3-50
1-26.	Accessories Available	1-13	3-36.	Elimination of Residual Parameter	
				Effects in Test Fixture	3-51
II	INSTALLATION	2-1	3-39.	Unknown Terminal Conversion	3-52
2-1.	Introduction	2-1	3-41.	Standing Wave Ratio Measurement	3-52
2-3.	Initial Inspection	2-1	3-43.	Extension of Test Port	3-53
2-5.	Preparation for Use	2-1	3-45.	Setting Open Capacitance Data	3-55
2-6.	Power Requirements	2-1	3-47.	Internal DC Bias	3-56
2-8.	Line Voltage and Fuse Selection	2-1		Recording Swept Frequency/Bias	
2-10.	Power Cable	2-3		Measurements	3-60
2-14.	Interconnections	2-3		Using External Signal Source	3-65
2-16.	Operating Environment	2-3	3-49.	External Triggering	3-68
2-19.	Installation Instructions	2-3		Cleaning APC-7 Connectors	3-68
2-21.	Installation of Options		3-51.	Options	3-69
	907, 908 and 909	2-3	3-53.	Option 002 High Resolution	
2-23.	Storage and Shipment	2-3		Test Frequency	3-69
2-24.	Environment	2-3	3-55.	Option 004	
2-26.	Packaging	2-3		Analog Recorder Output	3-69
III	OPERATION	3-1	3-57.	Use of Strip Chart Recorder	3-71
3-1.	Introduction	3-1	3-59.	Option 101 HP-IB Interface	3-73
3-3.	Panel Features	3-1	3-61.	Connection to HP-IB	3-73
3-5.	Self Test	3-1	3-63.	HP-IB Status Indicators	3-73
3-7.	Measurement Functions	3-13	3-65.	Local Switch	3-73
3-9.	Deviation Measurement Function	3-13	3-67.	HP-IB Control Switch	3-73
3-11.	Displays	3-14	3-69.	HP-IB Interface Capability	
3-13.	Digit Shift	3-14		of 4191A	3-74
3-15.	Test Frequency Signal	3-15	3-71.	Remote Program Code	3-74
3-17.	Ranging	3-15	3-73.	Parameter Setting	3-74
3-19.	Measurement Ranges	3-15	3-75.	Data Output	3-77
3-21.	Measurement Resolution	3-21	3-77.	Service Request Status Byte	3-78
3-23.	Circuit Mode	3-18	3-79.	Programming Guide for 4191A	3-78
	The 4191A Measurement Principles	3-19		APPENDIX I Applications of Smith Chart	3-A
	Measurement Parameter			APPENDIX II Characteristics of Transmission	
	Relationships	3-20		Line	3-B

Section	Title	Page	Section	Title	Page
IV	PERFORMANCE TESTS	4-1	5-47.	Opt. 002 Test Frequency Synthesizer Final VTO Adjustment	5-25
4-1.	Introduction	4-1	5-49.	Opt. 004 Analog Recorder Output Adjustment	5-25
4-3.	Equipment Required	4-1	VI	REPLACEABLE PARTS	6-1
4-5.	Test Record	4-1	6-1.	Introduction	6-1
4-7.	Calibration Cycle	4-1	6-3.	Abbreviations	6-1
	Accuracy Test Considerations	4-2	6-5.	Replaceable Parts List	6-1
4-9.	Measurement Signal Frequency Accuracy Test	4-7	6-7.	Ordering Information	6-2
4-11.	Measurement Signal Level Test	4-9	6-10.	Spare Parts Kit	6-2
4-13.	Measurement Signal Purity Test	4-10	6-12.	Direct Mail Order System	6-2
4-15.	Auto Calibration Test	4-11	VII	MANUAL CHANGES	7-1
4-17.	Error Correction Function Test	4-13	7-1.	Introduction	7-1
4-19.	Accuracy Test	4-14	7-3.	Manual Changes	7-1
4-21.	DC Bias Voltage Accuracy Test	4-15	VIII	SERVICE	8-1
4-23.	Battery Memory Back-up Function Test	4-17	8-1.	Introduction	8-1
4-25.	Analog Recorder Output Test (Opt. 004)	4-18	8-3.	Safety Considerations	8-1
4-27.	HP-IB Interface Test	4-20	8-5.	Theory of Operation	8-1
V	ADJUSTMENT	5-1	8-7.	Recommended Test Equipment	8-1
5-1.	Introduction	5-1	8-9.	Troubleshooting	8-1
5-3.	Safety Requirements	5-1	8-11.	Repair	8-2
5-7.	Equipment Required	5-1	8-13.	Basic Theory	8-2
5-9.	Factory Selected Components	5-1	8-14.	Block Diagram Discussion	8-4
5-11.	Adjustment Relationships	5-1	8-15.	Analog Section Block Diagram Discussion	8-4
5-13.	Adjustment Locations	5-1	8-16.	Synthesizer Signal Source	8-4
5-15.	Initial Operating Procedure	5-4	8-22.	Vector Ratio Detector Section	8-8
5-17.	DC Power Supply Voltage Adjustments	5-6	8-28.	Options	8-16
5-19.	Test Frequency Synthesizer VTO Adjustments	5-8	8-30.	Option 002 High Resolution Test Frequency	8-16
5-21.	Test Signal Frequency Adjustment	5-10	8-34.	Option 004 Analog Recorder Output	8-18
5-23.	Voltage Tunable Filter Tuning Voltage Adjustment	5-12	8-36.	Digital Control Section	8-21
5-25.	Test Signal Level Adjustment	5-13	8-38.	A21 Microprocessor Digital Control	8-21
5-27.	Sampling Diode Bias Voltage Adjustment	5-14	8-53.	A22 Display and Keyboard Control	8-24
5-29.	Sampling Efficiency Compensation Adjustment	5-15	8-58.	Circuit Operating Theory	8-26
5-31.	Sampling Frequency Search Control Adjustment	5-16	8-60.	Troubleshooting	8-28
5-33.	Sampling Frequency VTO Adjustment	5-17	8-62.	Signal Level Diagram Analog and Digital Section Isolation Procedure	8-29 8-32
5-35.	A-D Converter Offset Adjustment	5-18	8-64.	Diagnostic Messages	8-35
5-37.	Phase Detector Reference Phase Adjustment	5-19	8-66.	Error Messages Relating to Failures in the Analog Measurement Circuit	8-38
5-39.	Microprocessor Clock Frequency Adjustment	5-20	8-68.	Analog Measurement Section Troubleshooting Guide	8-39
5-41.	DC Bias Voltage Adjustment	5-21	8-70.	Signature Analysis Test	8-43
5-43.	RF Directional Bridge Temperature Adjustment	5-22	8-72.	Repair	8-70
5-45.	Opt. 002 Test Frequency Synthesizer Local VTO Adjustment	5-24			

Section	Title	Page	Section	Title	Page
8-73.	A21 Microprocessor Digital Control Board, and A43 Battery and Charger Board Disassembly	8-70		A15 Sampling Pulse Generator Circuit Operating Test	8-105
8-75.	A22 Display and Keyboard Control Board Disassembly	8-70	8-95.	A12 PLL Sampling Controller Circuit Operating Test	8-109
8-77.	A23 Power Supply Board Disassembly	8-71		A12 PLL Sampling Controller	8-111
8-79.	A9 Directional Bridge Board Disassembly	8-72		A13 PLL Sampling Frequency VTO Circuit Operating Test	8-115
8-81.	Product Safety Checks	8-73	8-97.	A16 IF Amp./Process Amplifier Circuit Operating Test	8-119
	A1 VTO Circuit Operating Test	8-80		A16 IF Amp./Process Amplifier	8-120
8-83.	A1 VTO	8-80	8-99.	A17 Phase Detector/A-D Converter Circuit Operating Test	8-123
	A2 Programmable Divider Circuit Operating Test	8-82		A17 Phase Detector/A-D Converter	8-124
8-85.	A2 Programmable Divider	8-83	8-101.	VRD Section	8-124
	A3 Synthesizer Phase Detector Circuit Operating Test	8-84	8-102.	Detection Phase Generator Section	8-124
	A4 Programmable Switch Control Driver Functional Test	8-89		A18 Clock Generator/Doubler Circuit Operating Test	8-128
	A5 Frequency Converter Circuit Operating Test	8-92	8-103.	A18 100MHz Clock Generator/Doubler	8-128
8-87.	A5 Frequency Converter	8-94		A25 Heater Controller Circuit Operating Test	8-150
	A6 Frequency Doubler Circuit Operating Test	8-96		A25 Board Troubleshooting Guide	8-150
8-89.	A6 Frequency Doubler	8-97		A30 VTO Circuit Operating Test	8-152
	A7 Selectable Filter Circuit Operating Test	8-98		A31 Programmable Divider Circuit Operating Test	8-154
	A7 Board Troubleshooting Guide	8-99		A32 Summing Loop Circuit Operating Test	8-156
8-91.	A7 Selectable Filter	8-99		A33 VTO Circuit Operating Test	8-157
	A9 Directional Bridge Circuit Operating Test	8-102	8-105.	A32 Summing Loop Circuit (Opt. 002 Only)	8-158
	A9 Board Troubleshooting Guide	8-102		A40 DC Bias Supply Circuit Operating Test	8-160
	A10 and A11 Sampler Circuit Operating Test	8-103		A41 Analog Recorder Output Circuit Operating Test	8-162
	A10 and A11 Board Troubleshooting Guide	8-103			
8-93.	A10 (A11) Sampler	8-104			

LIST OF TABLES

Number	Title	Page	Number	Title	Page
1-1.	Specifications	1-5	5-1.	Adjustable Components	5-2
1-2.	Supplemental Performance Characteristics	1-10	5-2.	Factory Selected Components	5-3
1-3.	Accessories Available	1-14	5-3.	Adjustment Requirements	5-5
3-1.	Test Frequency Setting Ranges	3-15	5-4.	DC Power Supply Voltage Adjustments	5-7
3-2.	Measurement Circuit Mode	3-18	5-5.	VTO Spurious Signal Test	5-9
3-3.	Parallel-Series Equivalent Circuit Conversion	3-18	5-6.	Frequency Accuracy Checks	5-11
3-4.	Parameter Conversion Formulas	3-21	5-7.	Tuning Voltage Adjustments	5-12
3-5.	Bias Voltage Setting Ranges	3-56	5-8.	Output Offset Zero Adjustments	5-26
3-6.	Annunciation Display Meanings	3-66	5-9.	Full Scale Output Adjustments	5-26
3-7.	X-Y Recorder Cabling Method	3-71	6-1.	List of Reference Designators and Abbreviations	6-1
3-8.	HP-IB Interface Capabilities	3-74	6-2.	Manufacturers Code List	6-2
3-9.	Remote Program Code	3-74	6-3.	Replaceable Parts	6-3
3-10.	Program Code for Parameter Setting	3-76	7-1.	Manual Changes by Serial Number	7-1
3-11.	Data Output Codes	3-78	8-1.	Front Panel Troubleshooting Guide	8-29
3-12.	Sample Program using 9825A/9835A	3-78	8-2.	16341A Diagnostic Test Error Messages	8-36
4-1.	Recommended Test Equipment	4-A	8-3.	Selection of Signature Analysis Test Programs	8-43
4-2.	Frequency Accuracy Test Limits	4-8	8-4.	Signature Analysis Test Setups	8-46
4-3.	Additional Tests for Option 002	4-8	8-5.	Meanings of Self Test Error Messages	8-130
4-4.	Simplified Test Limits	4-12		Test Points on A20 (A21) Board	8-131
4-5.	Accuracy Test Limits	4-15		Uses of Jumper Wires on A20 (A21) Board	8-138
4-6.	DC Bias Voltage Accuracy Test Limits	4-16		4191A Memory Map	8-138
4-7.	Analog Recorder Output Test Limits	4-19			
4-8.	HP-IB Interface Test Procedure	4-23			

LIST OF ILLUSTRATIONS

Number	Title	Page	Number	Title	Page
1-1.	Model 4191A and Accessories	1-1	4-3.	Measurement Signal Purity Test Setup	4-10
1-2.	Serial Number Plate	1-4	4-4.	Calibration Data Test Limits	4-12
2-1.	Line Voltage and Fuse Selection	2-1	4-5.	Internal Bias Voltage Accuracy Test Setup	4-15
2-2.	Power Cables Supplied	2-2	4-6.	Recorder Output Voltage Accuracy Test Setup	4-18
2-3.	Rack Mount Kits	2-4	4-7.	HP-IB Interface Test Setup	4-20
3-1.	Front Panel Features	3-2	4-8.	HP-IB Interface Test Program	4-21
3-2.	Rear Panel Features	3-11	5-1.	Test Frequency Synthesizer VTO Adjustment Setup	5-8
3-3.	Test Signal Level	3-15	5-2.	Test Signal Frequency Adjustment Setup	5-10
3-4.	Measurement Ranges	3-16	5-3.	Voltage Tunable Filter Tuning Voltage Adjustment Setup	5-12
3-5.	Initial Mode Settings	3-22	5-4.	Test Signal Level Adjustment Setup	5-14
3-6.	DUT Connection	3-31	5-5.	Sampler Diode Bias Voltage Adjustment Setup	5-14
	16091A	3-31	5-6.	Sampling Frequency Search Control Adjustment Setup	5-16
	16092A	3-33	5-7.	Sampling Frequency VTO Adjustment Setup	5-17
	16093A/B	3-35	5-8.	A-D Converter Offset Adjustment Setup	5-18
	16094A	3-36	5-9.	DC Bias Voltage Adjustment Setup	5-18
3-7.	Basic Operating Procedure	3-38	5-10.	RF Directional Bridge Temperature Adjustment Setup	5-22
3-8.	Deviation Measurement	3-40	5-11.	Opt. 002 Test Frequency Synthesizer VTO Adjustment Setup	5-24
3-9.	Auto-sweep Frequency Measurement	3-42	5-12.	Opt. 004 Analog Recorder Output Adjustment Setup	5-25
3-10.	Reflection Coefficient and Impedance Relationship	3-47	6-1.	Electrical and Mechanical Parts of the Directional Bridge Assembly – Exploded View (sheet 1 of 2)	6-49
3-11.	Residual Parameters in Measuring Circuit	3-48	6-2.	Electrical and Mechanical Parts of the Directional Bridge Assembly – Exploded View (sheet 2 of 2)	6-50
3-12.	Effect of Resonance in Sample	3-49	6-3.	Cable Assemblies of the Directional Bridge Assembly – Exploded View	6-51
3-13.	Terminal Converter Impedance	3-52	6-4.	Major Mechanical Parts on the Instrument Exterior – Exploded View	6-52
3-14.	Fixed Bias Voltage Measurement	3-57	6-5.	Major Mechanical Parts – Exploded View	6-53
3-15.	Swept Bias Voltage Measurement	3-58			
3-16.	External DC Bias Circuits	3-61			
3-17.	RF Transistor Measurements	3-63			
3-18.	Pulse Bias Measurements with External Triggering for Programmed Bias Magnitudes	3-68			
3-19.	Smith Chart Illustrations of the Loci of Various Impedance Elements	3-72			
3-20.	HP-IB Control Switch	3-73			
3-21.	Data Output Format for the 4191A	3-77			
3-22.	Status Byte for the 4191A	3-79			
3-23.	Sample Program 1 using 9825A/9835A	3-80			
3-24.	Sample Program 2 using 9825A/9835A	3-81			
4-1.	Measurement Frequency Accuracy Test Setup	4-7			
4-2.	Measurement Signal Level Test Setup	4-9			

Number	Title	Page	Number	Title	Page
8-1.	Basic Block Diagram	8-2	8-30.	A3 Synthesizer Phase Detector Board Troubleshooting Flow Diagram	8-86
8-2.	Analog Measurement Section Block Diagram — Signal Source Section . . .	8-5	8-31.	A2 100kHz Step Programmable Divider Board Assembly Component Locations	8-86
8-3.	Directional Bridge Operating Principle	8-6	8-32.	A3 Synthesizer Phase Detector Board Assembly Component Locations	8-86
8-4.	Principle of the Vector Measurement	8-11	8-33.	A2 100kHz Step Programmable Divider and A3 Synthesizer Phase Detector Board Assembly Schematic Diagram	8-87
8-5.	Analog Measurement Section Block Diagram — Vector Ratio Detector Section	8-15	8-34.	A4 Programmable Switch Control Driver Board Troubleshooting Flow Diagram	8-88
8-6.	Option 002 Circuit Basic Block Diagram	8-16	8-35.	A4 Programmable Switch Control Driver Board Assembly Component Locations	8-91
8-7.	Option 002 Circuit Block Diagram . . .	8-19	8-36.	A4 Programmable Switch Control Driver Board Assembly Schematic Diagram	8-91
8-8.	Option 004 Analog Recorder Output Block Diagram	8-18	8-37.	A5 Frequency Converter Board Troubleshooting Flow Diagram	8-92
8-9.	Address Timing Control	8-21	8-38.	A5 Frequency Converter Board Assembly Component Locations	8-95
8-10.	Microport Internal Register Configuration	8-24	8-39.	A5 Frequency Converter Board Assembly Schematic Diagram	8-95
8-11.	Digital Control Section Block Diagram	8-26	8-40.	A6 Frequency Doubler Board Troubleshooting Flow Diagram	8-96
8-12.	How to Use Troubleshooting Guide . . .	8-28	8-41.	A6 Frequency Doubler Board Assembly Component Locations	8-100
8-13.	Connection of 16341A I/O Cables . . .	8-30	8-42.	A7 Selectable Filter Board Assembly Component Locations	8-100
8-14.	Turn-on Reset and Clock Generator Troubleshooting Flow Diagram	8-31	8-43.	A6 Frequency Doubler Board and A7 Selectable Filter Board Assembly Schematic Diagram	8-101
8-15.	Analog and Digital Section Isolation Procedure Using the 16341A	8-32	8-44.	A15 Sampling Pulse Generator Board Troubleshooting Flow Diagram	8-102
8-16.	Automatic Diagnostic Test Routine of the 16341A Program ROM	8-37	8-45.	Sampler Output Signal	8-104
8-17.	Signal Level Diagram	8-41	8-46.	Sampling Pulse Waveform	8-104
8-18.	Signature Analysis Troubleshooting Flow Diagrams	8-49	8-47.	A9 RF Directional Bridge Circuit Board Assembly Component Locations	8-106
8-18.	A20 (A21) Microprocessor Digital Control Board Troubleshooting Flow Diagrams	8-49	8-48.	A10 Ref Channel Sampler and A11 Test Channel Sampler Board Assembly Component Locations	8-106
8-19.	A22 Display and Keyboard Control Board Troubleshooting Flow Diagrams	8-67	8-49.	A15 Sampling Pulse Generator Board Assembly Component Locations	8-106
8-20.	A22 Display and Keyboard Control Board Disassembly	8-70			
8-21.	A23 Power Supply Board Disassembly	8-71			
8-22.	A9 Directional Bridge Board Disassembly	8-72			
8-23.	SMC Connector Cables	8-74			
8-24.	Assembly Locations	8-75			
8-25.	Schematic Diagram Notes	8-76			
8-26.	A1 VTO Board Troubleshooting Flow Diagram	8-78			
8-27.	A1 VTO (250-500MHz) Board Assembly Component Locations	8-81			
8-28.	A1 VTO (250-500MHz) Board Assembly Schematic Diagram	8-81			
8-29.	A2 Programmable Divider Board Troubleshooting Flow Diagram	8-82			

Number	Title	Page	Number	Title	Page
8-50.	A9 RF Directional Bridge, A10 Ref. Channel Sampler, A11 Test Channel Sampler and A15 Sampling Pulse Generator Board Assembly Schematic Diagram	8-107	8-68.	A18 100MHz Clock Generator/Doubler Board Assembly Schematic Diagram	8-129
8-51.	A12 PLL Sampling Controller Board Troubleshooting Flow Diagram ..	8-108		A20 (A21) S2 Test Switch Functions	8-132
8-52.	Sampling Controller Timing Diagram	8-112		A20 (A21) S3 Option Selection Switch Functions	8-133
8-53.	A12 PLL Sampling Controller Board Assembly Component Locations	8-113	8-69.	A20 (A21) Microprocessor Digital Control Board, and A43 Battery and Charger Board Assembly Component Locations	8-134
8-54.	A12 PLL Sampling Controller Board Assembly Schematic Diagram	8-113	8-70.	A20 (A21) Microprocessor Digital Control Board Assembly Schematic Diagram (sheet 1 of 4)	8-135
8-55.	A13 PLL Sampling Frequency VTO Board Troubleshooting Flow Diagram	8-114		A20 (A21) S4 Signature Analysis Test Switch Functions	8-136
8-56.	A13 PLL Sampling Frequency VTO Board Assembly Component Locations	8-117	8-71.	A20 (A21) Microprocessor Digital Control Board Assembly Schematic Diagram (sheet 2 of 4)	8-137
8-57.	A13 PLL Sampling Frequency VTO Board Assembly Schematic Diagram	8-117	8-72.	A43 Battery and Charger Board Troubleshooting Flow Diagram ..	8-138
8-58.	A16 IF Amp./Process Amplifier Board Troubleshooting Flow Diagram	8-118	8-73.	A20 (A21) Microprocessor Digital Control Board Assembly Schematic Diagram (sheet 3 of 4) and A43 Battery and Charger Board Assembly Schematic Diagram	8-139
8-59.	A16 IF Amp./Process Amplifier Board Assembly Component Locations	8-121	8-74.	A20 (A21) Microprocessor Digital Control Board Assembly Schematic Diagram (sheet 4 of 4) ..	8-141
8-60.	A16 IF Amp./Process Amplifier Board Assembly Schematic Diagram	8-121	8-75.	A22 Display and Keyboard Control Board Assembly Component Locations	8-143
8-61.	A17 Phase Detector/A-D Converter Board Troubleshooting Flow Diagram	8-122	8-76.	A22 Display and Keyboard Control Board Assembly Schematic Diagram (sheet 1 of 2)	8-143
8-62.	C _S /G _S Circuit Simplified Circuit Diagram	8-125	8-77.	A22 Display and Keyboard Control Board Assembly Schematic Diagram (sheet 2 of 2)	8-145
8-63.	Vector Ratio Detection Timing Diagram	8-125		Components Mounted on the DC Power Supply Assembly Plate (inside the protective cover)	8-146
8-64.	A17 Phase Detector/A-D Converter Board Assembly Component Locations	8-127	8-78.	A23 Power Supply Board Assembly Component Locations	8-147
8-65.	A17 Phase Detector/A-D Converter Board Assembly Schematic Diagram	8-127	8-79.	A23 Power Supply Board Assembly Schematic Diagram	8-147
8-66.	A18 100MHz Clock Generator/Doubler Board Troubleshooting Flow Diagram	8-128	8-80.	A24 Motherboard Assembly Component Locations	8-149
8-67.	A18 100MHz Clock Generator/Doubler Board Assembly Component Locations	8-129	8-81.	A25 Heater Controller Board Assembly Component Locations ..	8-151
			8-82.	A25 Heater Controller Board Assembly Schematic Diagram	8-151
			8-83.	A30 VTO (100-110MHz) Board Troubleshooting Flow Diagram ..	8-152

Number	Title	Page	Number	Title	Page
8-84.	A30 VTO (100-110MHz) Board Assembly Component Locations ..	8-153	8-92.	A32 Summing Loop Circuit Board and A33 VTO Board Assembly Schematic Diagram	8-159
8-85.	A30 VTO (100-110MHz) Board Assembly Schematic Diagram	8-153	8-93.	A40 DC Bias Supply Board Assembly Troubleshooting Flow Diagram	8-160
8-86.	A31 100Hz Step Programmable Divider Board Troubleshooting Flow Diagram	8-154	8-94.	A40 DC Bias Supply Board Assembly Component Locations ..	8-161
8-87.	A31 100Hz Step Programmable Divider Board Assembly Component Locations	8-155	8-95.	A40 DC Bias Supply Board Assembly Schematic Diagram	8-161
8-88.	A31 100Hz Step Programmable Divider Board Assembly Schematic Diagram	8-155	8-96.	A41 Analog Recorder Output Board Troubleshooting Flow Diagram	8-162
8-89.	A32 Summing Loop Circuit Board Troubleshooting Flow Diagram ..	8-156	8-97.	A41 Analog Recorder Output Board Assembly Component Locations	8-163
8-90.	Frequency Detector Block Diagram	8-158	8-98.	A41 Analog Recorder Output Board Assembly Schematic Diagram	8-163
8-91.	A32 Summing Loop Circuit Board Assembly Component Locations ..	8-159			

PREFACE

In response to the demand for new impedance measuring instruments which can contribute to the development of high quality devices operating in the radio frequency region, to the increased depth of research of electronic materials, to rf circuit design and to efficient experimental evaluation in production quality control, Hewlett-Packard has developed the Model 4191A RF Impedance Analyzer.

The 4191A's extended measurement capabilities deliver the advantages of certain rf impedance measurements beyond the level of pre-existing instruments. Its improved accuracy, high resolution, multiple measurement parameter capability and wide range are innovations beyond the prevailing concepts in rf impedance measurements. Microprocessor based instrument design provides fully automatic measurement and ease of operation (embodied in the control functions which are all accessible through the keyboard). In addition, new 4191A operability enhances both reliability and efficiency in all its measurement applications.

SECTION I GENERAL INFORMATION

1-1. INTRODUCTION.

1-2. This operation and service manual contains the information required to install, operate, test, adjust and repair the Hewlett-Packard Model 4191A RF Impedance Analyzer. Figure 1-1 shows the instrument and supplied accessories. This section covers specifications, instrument identification, description, options, accessories, and other basic information.

1-3. Listed on the title page of this manual is a microfiche part number. This number can be used to order 4 x 6 inch microfilm transparencies of the manual. Each microfiche contains up to 60 photo-duplicates of the manual pages. The microfiche package also includes the latest manual changes supplement as well as all pertinent service notes. To order an additional manual, use the part number listed on the title page of this manual.

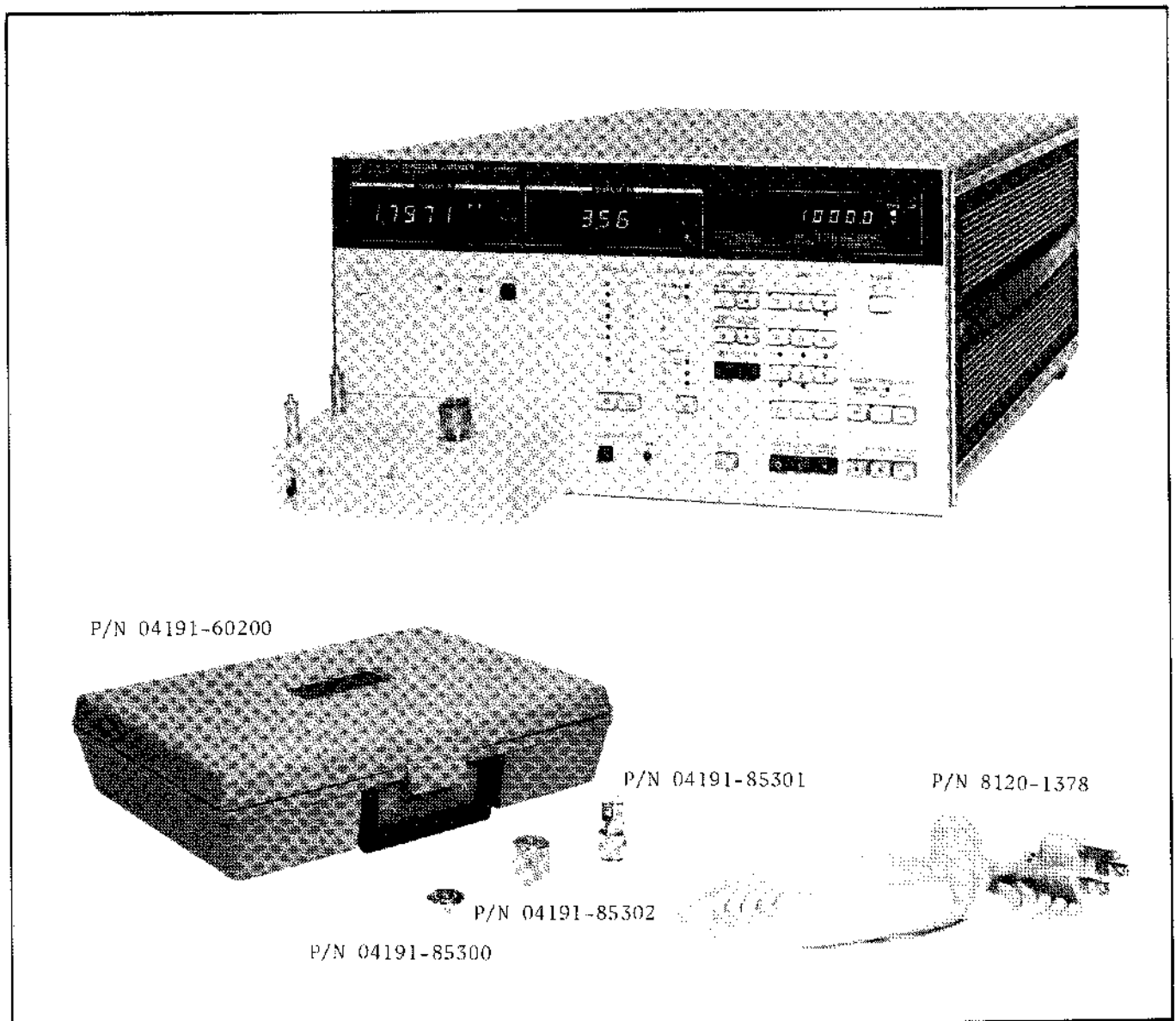

Figure 1-1. Model 4191A and Accessories.

1-4. ABOUT THE MODEL 4191A.

MULTIPLE PARAMETER FEATURES

The HP Model 4191A RF Impedance Analyzer is a fully automatic, high performance test instrument designed to measure diverse impedance parameter values of electronic devices and materials at extended frequencies ranging from MF to the UHF region. The 4191A measures resistance (R), reactance (X), conductance (G), susceptance (B), inductance (L), capacitance (C), dissipation factor (D), quality factor (Q) and, in addition, the absolute values of impedance ($|Z|$) and admittance ($|Y|$), along with phase angle (θ) over wide frequency and measurement ranges at high speed. Furthermore, the 4191A can make reflection parameter measurements (absolute value $|\Gamma|$ with phase angle θ , real Γ_x and imaginary part Γ_y) of the sample which is terminated at a single 50Ω test port. These multiple measurement parameters of the 4191A enable straight forward measurement of the desired parameter values obviating the necessity of complex parameter conversion calculations which are usually time-consuming processes in RF vector measurements.

TEST FREQUENCY (1-1000 MHz)

Measurement frequency is keyboard controlled at 100kHz resolution from 1MHz to 500MHz and at 200kHz resolution for the higher frequencies (to 1000 MHz). Optionally, the frequency is selectable at 100 Hz resolution for the same frequency range (200 Hz resolution for frequencies above 500 MHz). The internal synthesizer test frequency signal is accurate to 3 ppm which satisfies stability and spectral purity requirements for measurement of resonators, high selectivity filtering devices and other components. The built-in test signal source also provides swept frequency measurement convenience (a feature of the 4191A). The 4191A is capable of dual mode digital sweep operations – linear and logarithmic sweep measurements in response to start, stop and step parameters programmed through its control keys. By the use of an external signal source of higher frequency resolution, the test frequency can be exactly tuned to the desired test frequency, for example, the resonance point of a crystal resonator.

WIDE RANGE CAPABILITIES

The measurement ranges were established with respect to acceptable measurement result inaccuracies. The practicable measurement range for impedance and resistance spans $100m\Omega$ to $20k\Omega$, admittance from $100\mu S$ to $10S$, conductance from $20\mu S$ to $10S$, inductance from $0.1 nH$ to $5 mH$, capacitance from $0.1 pF$ to $1 \mu F$, all of which are dependent on the test frequency, and reflection coefficient from $.0000$ to ± 1.0000 . Either reactance, susceptance, equivalent series resistance, conductance, dissipation factor, quality factor or phase angle can be selected as subordinate choices to the $|Z|$, $|Y|$, R, G, L, C or Γ measurement. The practicable range for reactance is from $100m\Omega$ to $20k\Omega$, susceptance and conductance from $20\mu S$ to $10S$, equivalent series resistance from $100m\Omega$ to $20k\Omega$, dissipation factor and quality factor from 0.001 to 1000 , and phase angle from $\pm 0.01^\circ$ to $\pm 180.00^\circ$.

**HIGH SPEED OR
AVERAGING**

The two measurement display sections provide simultaneous readouts for the selected measurement parameters by 4-1/2 digit numeric segments along with appropriate units. In normal mode operation, the 4191A displays a running average of the five preceding measurements at about an 800 ms measuring rate. A high speed measurement mode implements the instantaneous display of measurement data taken at about 250 ms.

HIGH ACCURACY

The basic accuracy is 1% for measurements of nearly 50Ω impedance elements, and the instrument has an improved accuracy over its full range. The 4191A must be calibrated at the desired frequency range or for the entire frequency range before taking measurements. The calibration is performed under automatic settings of both the test parameter and frequency(ies) using three kinds of reference terminations (supplied accessories). As a result of such automatic calibration, the measurement accuracy is optimized and the frequency of periodic maintenance can be reduced.

OPERABILITY

Microprocessor based design of the hardware pushes this universal impedance analyzer towards simple operation yet adds advanced performance. Desired test parameters are fully programmable through the front panel control keys or by HP-IB control capability furnished in the standard unit. Two delta (Δ) key functions eliminate the inconvenience of deviation measurement calculations. These arithmetic functions make possible the direct readout of the measured values minus a reference value or of the percentage that the measurement deviates from the reference. The reference value can be taken from either the measurement of a reference sample or from program data input. The microprocessor augments the high reliability design of the 4191A. Convenient operational diagnosis is feasible by merely pressing a panel pushbutton. This confirms functional operation of the instrument. Ease of operation is further enhanced by the "save" function for continuous memorization of control settings sustained by battery memory backup capability. A continuous memory also preserves the auto-calibration data and saves calibration time prior to measurements.

INTERNAL BIAS

Internal dc bias up to $\pm 40V$ by keyboard control action and swept voltage bias provide convenience for bias applications. Precise voltage setting capability enables control of bias voltage in constant 10mV minimum steps (to 40V) with basic voltage accuracy of 0.1%. The programmability and ease of control by keyboard action provide new dc bias operability obviating the need of an external bias supply and a bias controller.

**FLEXIBILITY AND
EXTENDED USE**

The versatility and operability of the 4191A are maximized by the availability of versatile test fixtures. The installation of options which can provide high resolution test frequency and analog recorder output capabilities – both of which can be combined in one unit, augment these capabilities. Test fixtures are designed with careful consideration for enhancing the reliability of measurement across broad frequency and impedance ranges. The high resolution test frequency option multiplies the frequency resolution of the synthesizer test signal source by 1000 times. Analog recorder output permits the graphic recording of measurement data on an X-Y recorder in swept frequency/bias measurements. In reflection parameter measurements (in particular), the recorder output can draw swept parameter data on a Smith Chart.

1-5. SPECIFICATIONS.

1-6. Complete specifications of the Model 4191A Impedance Analyzer are given in Table 1-1. These specifications are the performance standards or limits against which the instrument is tested. The test procedures for the specifications are covered in Section IV Performance Tests. Table 1-2 lists supplemental performance characteristics. Supplemental performance characteristics are not specifications but are typical characteristics included as additional information for the operator. When the 4191A RF Impedance Analyzer is shipped from the factory, it meets the specifications listed in Table 1-1.

1-7. SAFETY CONSIDERATIONS.

1-8. The Model 4191A RF Impedance Analyzer has been designed to conform to the safety requirements of an IEC (International Electromechanical Committee) Safety Class I instrument and is shipped from the factory in a safe condition.

1-9. This operating and service manual contains information, cautions, and warnings which must be followed by the user to ensure safe operation and to maintain the instrument in a safe condition.

1-10. INSTRUMENTS COVERED BY MANUAL.

1-11. Hewlett-Packard uses a two-section nine character serial number which is marked on the serial number plate (Figure 1-2) attached to the instrument rear panel. The first four digits and the letter are the serial prefix and the last five digits are the suffix. The letter placed between the two sections identifies country where instrument was

manufactured. The prefix is the same for all identical instruments; it changes only when a change is made to the instrument. The suffix, however, is assigned sequentially and is different for each instrument. The contents of this manual apply to instruments with the serial number prefix(es) listed under SERIAL NUMBERS on the title page.

1-12. An instrument manufactured after the printing of this manual may have a serial number prefix that is not listed on the title page. This unlisted serial number prefix indicates the instrument is different from those described in this manual. The manual for this new instrument may be accompanied by a yellow Manual Changes supplement or have a different manual part number. This supplement contains "change information" that explains how to adapt the manual to the newer instrument.

1-13. In addition to change information, the supplement may contain information for correcting errors (called Errata) in the manual. To keep this manual as current and accurate as possible, Hewlett-Packard recommends that you periodically request the latest Manual Changes supplement. The supplement for this manual is identified with this manual's print date and part number, both of which appear on the manual's title page. Complementary copies of the supplement are available from Hewlett-Packard. If the serial prefix or number of an instrument is lower than that on the title page of this manual, see Section VII Manual Changes.

1-14. For information concerning a serial number prefix that is not listed on the title page or in the Manual Change supplement, contact your nearest Hewlett-Packard office.

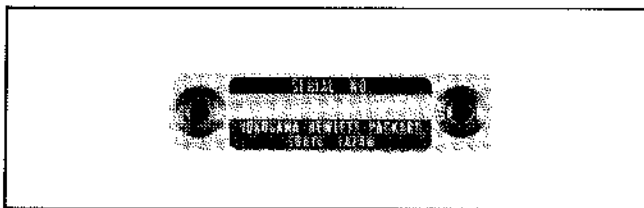



Figure 1-2. Serial Number Plate.

Table 1-1. Specifications (Sheet 1 of 5).

SPECIFICATIONS

Parameters Measured:

Z	θ (radian/degree)
Y	
Γ	
R	X
G	B
Γ_x	Γ_y
L C	 R, G, D, Q

Δ (unit deviation) and $\Delta\%$ (percent deviation) for all parameters.

Test Signal (Internal): 1 to 1000 MHz

Characteristics ¹	1–500 MHz	500–1000 MHz
Level (50 Ω load)	-20 \pm 3 dBm	-20 \pm 3 dBm
Frequency Resolution	100 kHz	200 kHz
Frequency Accuracy at 23°C	3 ppm	3 ppm

1. After 40 minute warm-up,
Temperature: 23°C \pm 5°C.

External Test Signal:

Frequency : 1 MHz to 1000 MHz
Input Level : 0 dBm typ., -3 to +3 dBm.
(Test level: -17 to -23 dBm at 50 Ω load)

Sweep Characteristics:

Sweep mode :

Auto: Single sweep from programmed start to stop frequency (or in reverse direction). Sweep pause at desired frequency step is feasible.

Manual: Bidirectional step shift (up-down) of frequency between start and stop frequencies.

Sweep span: Maximum 1 MHz to 1000 MHz, selectable in 100 kHz minimum frequency step intervals.

Frequency step:

Linear sweep: Selectable in 100 kHz minimum step frequency intervals (to 999 MHz).

Logarithmic sweep: A total of 50 step frequencies (51 spot frequencies) automatically selected at logarithmically regular intervals, minimum 100 kHz (rounds off fractional frequency to 100 kHz).

Fast sweep: Manual sweep by 10 times programmed step frequency intervals in linear sweep mode, or by 1/5 of frequency points in logarithmic sweep mode.

Measurement Accuracy and Resolution:

Accuracies apply under the following measurement operating conditions:

- 1) Specifies reflection coefficient accuracy ($|\Gamma| - \theta$ and $\Gamma_x - \Gamma_y$ measurement accuracies). Accuracies for other parameter measurements are given as typical values in Supplemental Performance Characteristics.
- 2) Warm-up time: at least 40 minutes.
- 3) Auto-calibration properly completed using standard reference terminations.
- 4) Measurement frequency identical to auto-calibration frequency points (51 spots).
- 5) Environmental temperature: 23°C \pm 5°C (allows temperature variation). 0°C ~ 55°C (at the constant temperature at which auto-calibration is completed).
- 6) Measurement taken at UNKNOWN connector (without using test port extension).

Table 1-1. Specifications (Sheet 2 of 5).

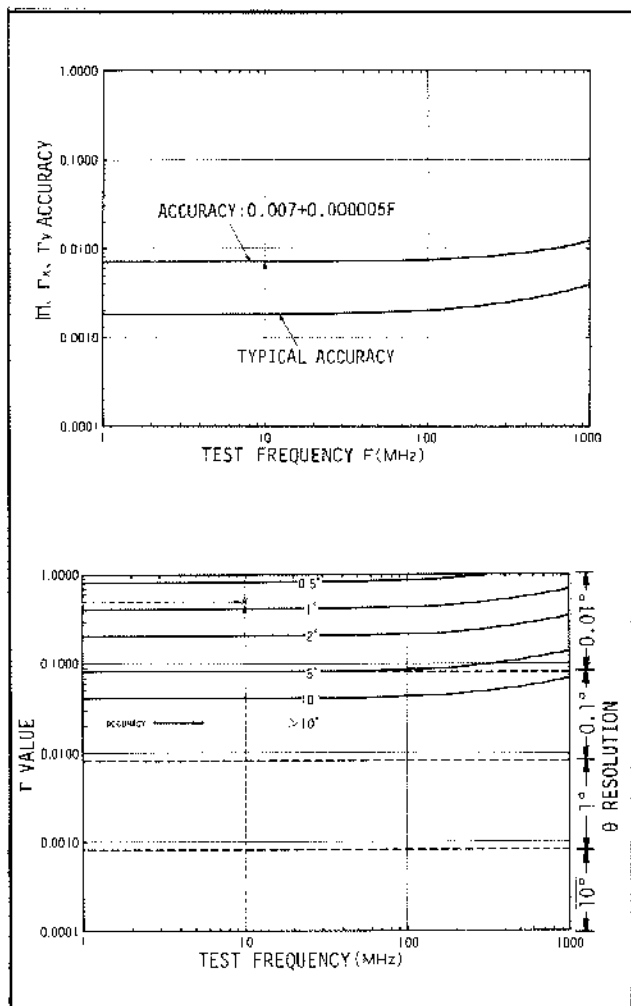

Measurement Range:

$|\Gamma|, \Gamma_x, \Gamma_y$: 0.0001 to 1.0000
 θ : 0.00 to $\pm 180.00^\circ$
 (0 to $\pm \pi$ radian)

Display: 4-1/2 digit maximum, simultaneous display of two parameter values, maximum display 19999. (Number of display digits changes depending on measurement frequency and range).

Digit Shift: Number of desired display digits (less than the maximum display digits) is selectable by control key.

Range Modes: Auto and Hold.

Measurement Terminal: Single test port, APC-7 connector terminal.

Deviation Measurement: A measurement display value or a desired value entered by DATA input keys can be stored as a reference value. Next, pressing Δ or $\Delta\%$ button enables the difference between the referenced value and subsequent result to be displayed. (Deviation spread in counts is -19999 to 19999 or from -1999.9% to 1999.9%).

Electrical Length Correction: The effects in phase of the reflection coefficient particular to the test fixture used can be automatically corrected by entering electrical length number of the test fixture with DATA input keys.

Input data range: 0 to 99.99 cm

Automatic Calibration: Memorizes measurement results of reference termination impedances and automatically performs corrections to optimize measurement accuracy in subsequent measurements.

Reference termination impedances: 0 Ω , 50 Ω and 0S.

Calibration frequency: 51 spot frequencies automatically selected from within the frequency range of 1MHz to 1000MHz or of programmed start to stop frequencies.

Calibration data at frequencies other than the selected calibration frequency points are obtained by using cubic interpolation approximations.

Self Test: Performs cyclic operation of internal function tests and displays diagnostic code sets (when any abnormality is detected).

Internal Bias: Internal dc bias source manually or remotely controllable from 0V to $\pm 40V$ in 10mV (minimum) steps.

Bias control range and accuracy (23°C \pm 5°C):

Bias Voltage Control Range	Accuracy
-40.00V — 40.00V	$\pm(0.1\%$ of setting +10mV)*

* $\pm(0.4\% + 20mV)$ at 0°C to 55°C

Bias output characteristics:

1390 $\Omega \pm 10\%$, 7.2mA max. ($\pm 10\%$).

Table 1-1. Specifications (Sheet 3 of 5).

Control: Manual control by front panel keys or remote control by HP-IB controller. Bias voltage sweep is also feasible.

Sweep characteristics:

Sweep Mode:

Auto: Single sweep from programmed start to stop voltages or in reverse direction. Sweep pause at desired voltage step is feasible.

Manual: Bidirectional step shift (up-down) of bias voltage between start and stop bias voltages.

Sweep span: Maximum -40 to +40V (linear sweep). Maximum +0.01 to +40V (logarithmic sweep). Selectable in 0.01V minimum voltage step intervals.

Voltage step:

Linear sweep: Selectable in 0.01V (minimum) step voltage intervals (to $\pm 40V$).

Logarithmic sweep: A total of 50 step voltages (51 spot voltages) automatically selected at logarithmically regular intervals, minimum 0.01V (rounds off fractional voltage to 0.01V).

Fast sweep: Manual sweep at 10 times programmed step voltage intervals in linear sweep mode, or by 1/5 of voltage points in logarithmic sweep mode.

DC bias monitor: Bias voltage monitor output (common to external dc bias input), BNC connector, output impedance $1k\Omega \pm 10\%$.

Save Function: Continuous memorization of one or two desired control settings states powered by stand-by battery. Memorized setting data is preserved in event that instrument loses operating power and can be restored as actual control setting anytime by pressing control keys. Memorizes the following data and control settings:

- 1) Front panel pushbutton control settings (except SELF TEST function).
- 2) Automatic calibration data (restored just after the instrument is turned on).
- 3) Reference values in deviation measurement.

External DC Bias: External DC bias input connector on rear panel (common to internal dc bias voltage monitor connector), maximum $\pm 40V$.

Bias input characteristics: $390\Omega \pm 10\%$, 100mA max.

Trigger: Internal, external and manual.

HP-IB Compatibility: HP-IB interface capability (data output and remote control per IEEE-STD-488-1975 and ASCII-MC 1.1).

Remotely controllable functions:

- 1) DISPLAY A functions ($|Z|$, $|Y|$, $|F|$, R, G, F_x , L and C).
- 2) DISPLAY B functions (θ , X, B, F_y , R, G, D and Q).
- 3) Test signal frequency (SPOT).
- 4) Frequency sweep functions (START, STOP and STEP frequencies, LOG SWEEP, MANUAL STEP, AUTO START, PAUSE and SWEEP ABORT).
- 5) Deviation functions (Δ , $\Delta\%$, REF A, REF B, and STORE DSPL A/B).
- 6) High speed.
- 7) Range hold.
- 8) Digit shift (DSPL A and DSPL B).
- 9) Electrical length.
- 10) Open capacitance.
- 11) Automatic calibration.
- 12) Save functions (SAVE 1, SAVE 2, RCL 1 and RCL 2).
- 13) Self test.
- 14) Trigger.
- 15) DC bias voltage (SPOT).
- 16) Bias voltage sweep functions (START, STOP and STEP voltages, LOG SWEEP, MANUAL STEP, AUTO START, PAUSE and SWEEP ABORT).
- 17) X-Y recorder control functions (LL, UR and INTRPL) (option 004 only).

Table 1-1. Specifications (Sheet 4 of 5).

Data output:

- 1) $|Z|$, $|Y|$ or $|\Gamma|$ with θ ; R with X; G with B; Γ_X with Γ_Y ; L or C with R, G, D or Q.
- 2) Test frequency in swept frequency measurement.
- 3) Frequency in automatic calibration.
- 4) Bias voltage in swept bias voltage measurement.

Internal function allowable subsets:

SH1, AH1, T5, L4, SR1, RL1, DC1 and DT1.

Data output format: Either of two formats may be selected (switchable on rear panel).

Format A.

1. Stationary (fixed) frequency/bias measurement:

$\frac{\frac{X}{1} \frac{X}{2} \frac{X}{3} \pm \frac{NNN}{4} . \frac{NNE}{5} \pm \frac{NN}{6}}{\frac{X}{7} \frac{X}{8} \frac{X}{9} \pm \frac{NNN}{10} . \frac{NNE}{11} \pm \frac{NN}{12}} \text{ (CR)(LF)}$

2. Swept frequency/bias measurement or auto-calibration:

$\frac{\frac{X}{1} \pm \frac{NNNN}{2} . \frac{NNNN}{3}}{\frac{X}{4} \pm \frac{NNN}{5} . \frac{NNE}{6} \pm \frac{NN}{7}} , \frac{\frac{X}{8} \frac{X}{9} \frac{X}{10} \pm \frac{NNN}{11} . \frac{NNE}{12} \pm \frac{NN}{13}}{\frac{X}{14} \frac{X}{15} \frac{X}{16} \pm \frac{NNN}{17} . \frac{NNE}{18} \pm \frac{NN}{19}} \text{ (CR)(LF)}$

Format B.

1. Stationary (fixed) frequency/bias measurement:

$\frac{\frac{X}{1} \frac{X}{2} \frac{X}{3} \pm \frac{NNN}{4} . \frac{NNE}{5} \pm \frac{NN}{6}}{\frac{X}{7} \frac{X}{8} \frac{X}{9} \pm \frac{NNN}{10} . \frac{NNE}{11} \pm \frac{NN}{12}} \text{ (CR)(LF)}$

$\frac{\frac{X}{7} \frac{X}{8} \frac{X}{9} \pm \frac{NNN}{10} . \frac{NNE}{11} \pm \frac{NN}{12}}{\frac{X}{13} \frac{X}{14} \frac{X}{15} \pm \frac{NNN}{16} . \frac{NNE}{17} \pm \frac{NN}{18}} \text{ (CR)(LF)}$

2. Swept frequency/bias measurement or auto-calibration:

$\frac{\frac{X}{1} \pm \frac{NNNN}{2} . \frac{NNNN}{3}}{\frac{X}{4} \pm \frac{NNN}{5} . \frac{NNE}{6} \pm \frac{NN}{7}} \text{ (CR)(LF)}$

$\frac{\frac{X}{8} \frac{X}{9} \frac{X}{10} \pm \frac{NNN}{11} . \frac{NNE}{12} \pm \frac{NN}{13}}{\frac{X}{14} \frac{X}{15} \frac{X}{16} \pm \frac{NNN}{17} . \frac{NNE}{18} \pm \frac{NN}{19}} \text{ (CR)(LF)}$

$\frac{\frac{X}{7} \frac{X}{8} \frac{X}{9} \pm \frac{NNN}{10} . \frac{NNE}{11} \pm \frac{NN}{12}}{\frac{X}{13} \frac{X}{14} \frac{X}{15} \pm \frac{NNN}{16} . \frac{NNE}{17} \pm \frac{NN}{18}} \text{ (CR)(LF)}$

- (1) Space.
- (2) Data status of DISPLAY A.
- (3) Function of DISPLAY A or calibration condition.
- (4) Deviation measurement mode of DISPLAY A.
- (5) Value of DISPLAY A (decimal point position is coincident with display).
- (6) Comma (data delimiter).
- (7) Data status of DISPLAY B.
- (8) Function of DISPLAY B or calibration condition.
- (9) Deviation measurement mode of DISPLAY B.
- (10) Value of DISPLAY B (decimal point position is coincident with display).
- (11) Data terminator.
- (12) Sweep parameter.
- (13) Measurement frequency or bias voltage (decimal point position is coincident with display).

GENERAL

Operating Temperature and Humidity:
0°C to 55°C at 95% RH (to 40°C).

Power Requirements: 100/120/220V \pm 10%, 240V
-5% +10%, 48-66Hz.

Power Consumption: 150VA max with any option.

Dimensions:
425.5 (W) x 230 (H) x 574 (D) mm
(16-3/4" x 9-1/16" x 22-5/8")

Weight: Approximately 24 kg (Std).

Table 1-1. Specifications (Sheet 5 of 5).

OPTIONS	ACCESSORIES
<p>Option 002: Provides test signal frequencies selectable at 100 Hz resolution to 500 MHz and at 200 Hz resolution to 1000 MHz.</p>	<p>Accessories Supplied: Reference terminations for calibrating the 4191A. Three kinds of terminations are included:</p> <ul style="list-style-type: none"> 0 Ω reference termination (short), (HP P/N 04191-85300). 50 Ω reference termination, (HP P/N 04191-85301). 0S reference termination (open), (HP P/N 04191-85302).
<p>Option 004: Analog voltage outputs for graphically recording sweep measurement data on an X-Y recorder. Three channel BNC output connectors on rear panel.</p>	<p>Additionally, accessory box (HP P/N 04191-60200) which accommodates these terminations and all the available test fixtures is furnished.</p>
<p>DISPLAY A connector: Outputs voltage proportional to three lesser significant digit numbers of DISPLAY A display outputs (1 mV/count).</p>	<p>Operating booklet (HP P/N 04191-90100).</p>
<p>DISPLAY B connector: Outputs voltage proportional to DISPLAY B display outputs in the same manner as that for DISPLAY A connector outputs.</p>	<p>Power Cord (HP P/N 8120-1378).</p>
<p>FREQ/BIAS connector: Outputs voltage proportional to test frequency or bias voltage as: Start frequency/voltage : 0V Stop frequency/voltage : 1V</p>	<p>Accessories Available: [Accessories, other than primary accessories, are outlined in Table 1-2.]</p>
<p>Reference recorder voltages: Lower Left (LL) : 0, 0, 0 V Upper Right (UR) : +1, +1, +1V</p>	<p>16091A: Coaxial Fixture set, direct coupled, two types of sample holders, coaxial termination structure, with APC-7 connectors. For mounting cylindrical sample piece in inner cavity chamber. Usable on all 4191A ranges to 1000 MHz.</p>
<p>Voltage accuracy: $\pm (0.5\% + 2 \text{ mV})$ at $23^\circ\text{C} \pm 5^\circ\text{C}$ $\pm (1\% + 5 \text{ mV})$ at 0°C to 55°C</p>	<p>16092A: Spring Clip Fixture, direct coupled, for holding axial or radial lead components or leadless chip elements. Either slide clip contact or twin clip contacts can be attached on the terminal deck with APC-7 connector. Usable on all ranges at frequencies below 500 MHz.</p>
<p>Interpolation function: Smoothing of recorder outputs by arithmetic interpolation of measurement data, selectable by control key.</p>	<p>16093A: Binding Post Fixture, direct coupled, two binding posts on terminal deck with APC-7 connector, for holding axial or radial lead components, 7 mm terminal post interval. Usable on all ranges at frequencies below 250 MHz.</p>
<p>Option 907: Front handle kit, for front handle installation</p>	<p>16093B: Binding Post Fixture, direct coupled, three binding posts (including a guard terminal) on terminal deck with APC-7 connector, 18 mm terminal post interval (15 mm to guard). Usable on all ranges at frequencies below 125 MHz.</p>
<p>Option 908: Rack flange kit, for mounting in IEC standard rack.</p>	<p>16094A: Probe fixture, two-needle probe adapter, compatible with APC-7 connector test cable, for in-circuit testing of components, variable needle span (15 mm max.). Usable on all ranges at frequencies below 125 MHz.</p>
<p>Option 909: Rack flange & handle kit, for rack mounting and handle installation.</p>	
<p>Option 910: Extra operating manual.</p>	
<p>Option 91S: Extra service manual.</p>	

Table 1-2. Supplemental Performance Characteristics (Sheet 1 of 3).

SUPPLEMENTAL PERFORMANCE CHARACTERISTICS

Measurement accuracy:

$|Z| - \theta$, $|Y| - \theta$ measurement

○ $|Z|$ accuracy at $\theta = 45^\circ$:

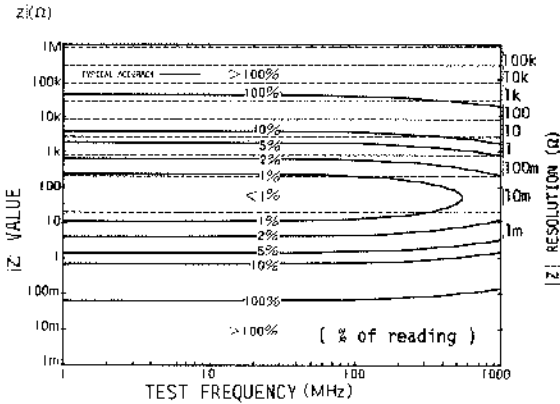

○ $|Y|$ accuracy at $\theta = 45^\circ$:

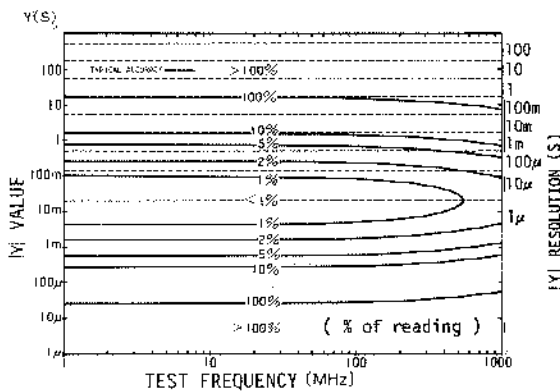

○ θ accuracy at $\theta = 45^\circ$:

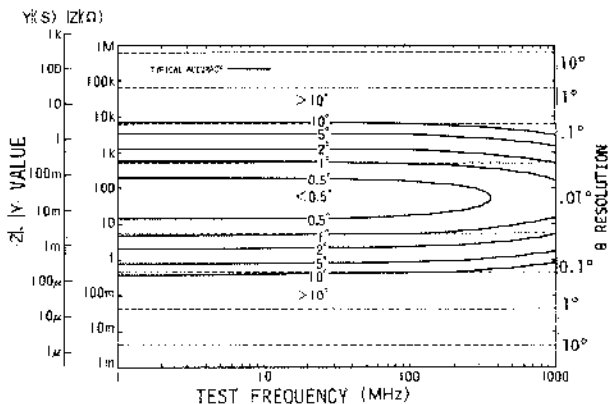

R-X, G-B measurement

○ R-X accuracy at $D = 1$:

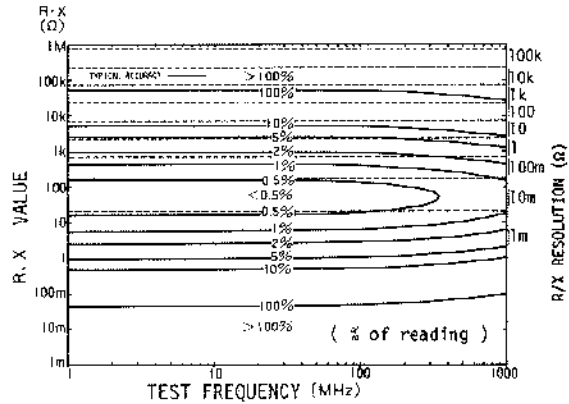

○ G-B accuracy at $D = 1$:

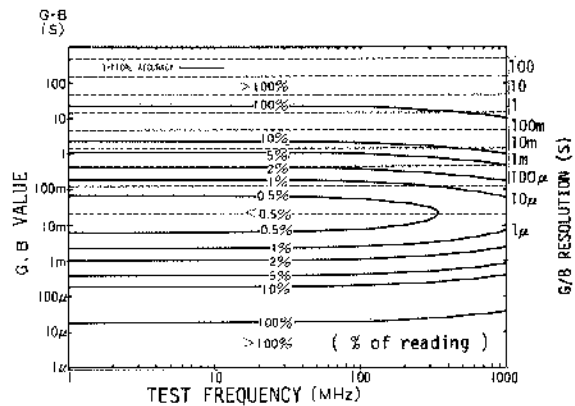

L-R/G/D/Q, C-R/G/D/Q measurement:

○ L accuracy at $D \leq 0.01$:

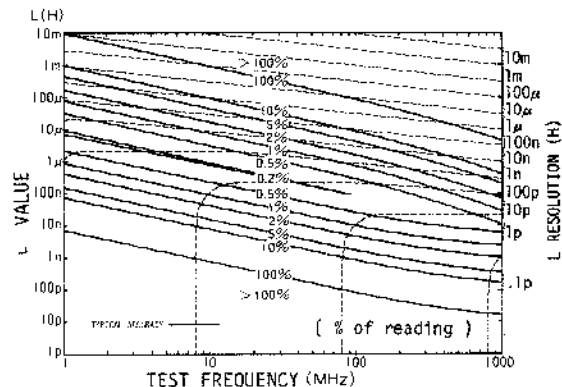
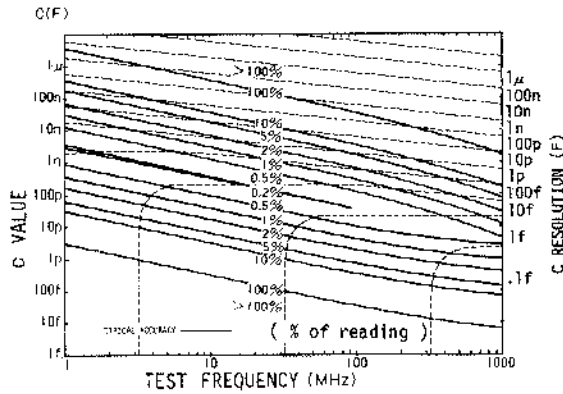
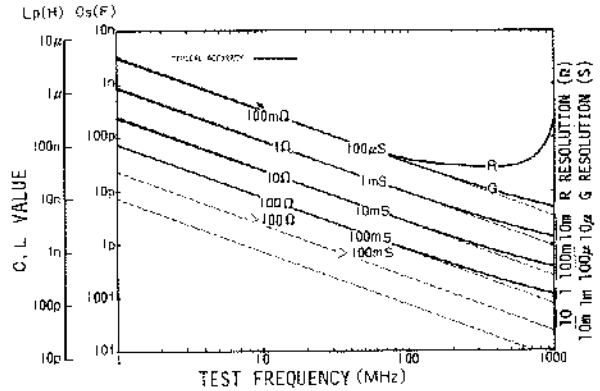

Table 1-2. Supplemental Performance Characteristics (Sheet 2 of 3).

○ C accuracy at $D \leq 0.01$:



○ (C-)R, (L-)G accuracies at $D \leq 0.01$:



D (=1/Q) measurement range: 0.0001 to 1000

○ D (=1/Q) accuracy at $D \leq 0.01$:

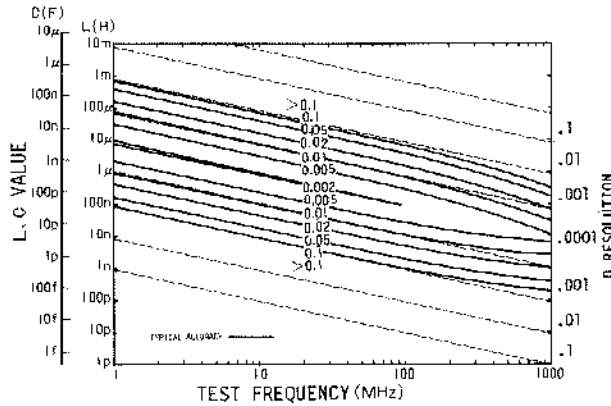

$|\Gamma|-\theta$ and $\Gamma_x-\Gamma_y$ accuracy temperature coefficient:

$|\Gamma|, \Gamma_x, \Gamma_y$: $0.0001/^\circ\text{C}$ ($23 \pm 5^\circ\text{C}$)

: $0.0004 (1 + 0.01f)/^\circ\text{C}$ ($0 \sim 55^\circ\text{C}$)

θ : $0.0001/|\Gamma|$ radian/ $^\circ\text{C}$ ($23 \pm 5^\circ\text{C}$)

: $0.0004 (1 + 0.01f)/|\Gamma|$ radian/ $^\circ\text{C}$ ($0 \sim 55^\circ\text{C}$)

(f = measurement frequency in MHz)

Test Signal:

Characteristics ¹	1-500MHz	500-1000MHz
Frequency Stability	0.2 ppm/ $^\circ\text{C}$	0.2 ppm/ $^\circ\text{C}$
Harmonics, THD	<-30dB ²	<-30dB ²
Residual FM	<30Hz ^{3,4}	<60Hz ³
Spurious Level	<-30dB ²	<-30dB ²

R measurement range: 20mΩ to 100kΩ

G measurement range: 10μS to 50S

○ (L-)R, (C-)G accuracies at $D \leq 0.01$:

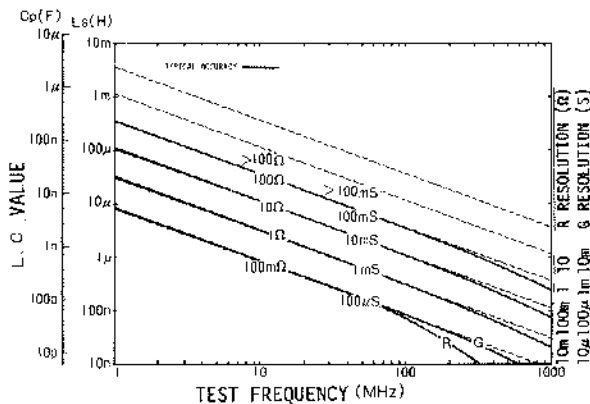

1. After 40 minute warm-up,

Temperature: $23^\circ\text{C} \pm 5^\circ\text{C}$

2. Level below fundamental.

3. Averaged rms deviation at 3kHz bandwidth.

4. <15 Hz at 250MHz and below.

Test signal settling time

Time for test signal to settle when measurement frequency is changed.

Less than 200ms

Sweep time

Frequency sweep:

Linear sweep:

Number of sweep steps x 1.1 seconds (typical).

Logarithmic sweep:

58 seconds for 50 steps (typical).

Table 1-2. Supplemental Performance Characteristics (Sheet 3 of 3).

Bias voltage sweep:

Linear sweep:

Number of sweep steps x 0.84 seconds (typical).

Logarithmic sweep:

44 seconds for 50 steps (typical).

Measurement time

Normal mode: Less than 800ms

(Displays arithmetic running average of five preceding measurement values.)

High speed mode: Less than 250ms

(Displays measured values for each trigger.)

Auto-calibration time

Approximately 48 seconds for each reference termination impedance.

Bias voltage settling time

Internal bias : Less than 100ms

External bias : Less than 10ms

Open capacitance compensation

Typical open stray capacitance (0.082 pF) of *UNKNOWN connector is continuously memorized for subtracting from measured values. The memorized capacitance value can be temporarily changed by concealed controls.

Input capacitance value range: 0 to 1.000 pF

*APC-7 connector

AVAILABLE ACCESSORIES

[Accessories and parts associated with options or which are usable for special applications or as spares. For primary accessories, refer to Table 1-1 Specifications.]

RF connector for external signal source:

HP Part Number 04191-65001

HP-IB Interface Cable: HP 10631A (1m)

HP 10631B (2m)

HP 10631C (4m)

HP 10631D (0.5m)

Front Handle Kit:

Kit Part Number 5061-0091

Rack Flange Kit:

Kit Part Number 5061-0079

Rack Flange Handle Kit:

Kit Part Number 5061-0085

Line Fuse:

HP Part Number 2110-0304 (100/120V)

HP Part Number 2110-0360 (220/240V)

Internal power supply fuses:

HP Part Number	Rating	Use
2110-0003	3A	+ 5V
2110-0055	4A	+ 5V
2110-0094	1.25A	+12V
2110-0094	1.25A	-12V
2110-0004	0.25A	+46V
2110-0004	0.25A	-46V
2110-0513	0.125A	+36V
2110-0513	0.125A	-36V

Protective fuse (for dc bias):

HP Part Number 2110-0011 (0.062A)

Service Parts

APC-7 connector center spring contact:

HP Part Number 1250-0907

Exchange tool : HP Part Number : 8710-0932

1-15. OPTIONS.

1-16. Options are standard modifications to instrument that implement user's special requirements for minor functional changes. A total of seven options for the Model 4191A are available for adding the following capabilities:

Option 002: High Resolution Test Frequency. Test frequency selectable at 100Hz resolution to 500MHz and at 200Hz resolution to 1000MHz.

Option 004: X-Y Recorder Output: Analog output for graphic recording of measurement data (with an X-Y recorder).

Options 907, 908 and 909 are handle or rack mount kits. See paragraph 1-22 for details.

Options 910 and 91S add the following to provide an extra manual or additional information on the 4191A:

Option 910: Extra Operating Manual

Option 91S: Extra Service Manual

Note: Options 002 and 004 can be simultaneously installed in a 4191A unit.

A brief description for each option is given in the paragraphs below.

1-17. OPTION 002.

1-18. The 4191A Option 002 provides test frequency selection capability at the high resolution of 100Hz in frequency range of 1MHz to 500MHz and at 200Hz resolution to 1000MHz frequency instead of standard frequency resolution.

1-19. OPTION 004.

1-20. The 4191A Option 004 provides analog recorder outputs for graphically recording measurement data in swept frequency (or bias voltage) measurements. Two, from among the three output connectors, provide voltages directly proportional to the three lesser significant digit numbers of the respective measurement display outputs (DISPLAY A and DISPLAY B) in the ratio of 1mV to one count. The other output connector affords a voltage of 0 to 1 volt in proportion to the swept frequency (bias voltage) from start to stop frequency (voltage).

1-21. OTHER OPTIONS.

1-22. The following options provide the mechanical parts necessary for rack mounting and hand carrying:

Option 907: Front Handle Kit. Furnishes carrying handles for both ends of front panel.

Option 908: Rack Flange Kit. Furnishes flanges for rack mounting for both ends of front panel.

Option 909: Rack Flange and Front Handle Kit. Furnishes both front handles and rack flanges for instrument.

Installation procedures for these options are detailed in Section II.

1-23. The 4191A Option 910 adds an extra copy of the operating manual and Option 91S provides a service manual.

1-24. ACCESSORIES SUPPLIED.

1-25. Figure 1-1 shows the HP Model 4191A Impedance Analyzer, three reference terminations (HP Part Numbers 04191-85300, -85301 and -85302) with accessory box (HP Part Number 04191-60200), and power cord (HP Part Number 8120-1378). The reference terminations, accessory box and power cord are furnished accessories. Additionally, a fuse (HP Part Number 2110-0304 or 2110-0306) is supplied as a service part.

1-26. ACCESSORIES AVAILABLE.

1-27. For certain measurements and for convenience in connecting sample, four styles of test fixtures are available. Each accessory is designed to meet the various measurement requirements and types of DUT.

All accessories were developed with careful consideration to accuracy, reliability and ease of measurement. Primary accessory model numbers and names are listed in Table 1-1 (other associated accessories are listed in Table 1-2). A brief description for each of these test fixtures is given in Table 1-3.

Table 1-3 Accessories Available (sheet 1 of 3).

Model	Description																
<p>HP16091A Coaxial Fixtures.</p> 	<p>Test Fixtures (coaxial termination type) for holding a piece of sample material or a small component. Screw-mount sample holders accommodate a cylindrical sample in their respective inner chambers. Two kinds of fixtures fit samples dimensions given below:</p> <table border="1" data-bbox="860 535 1409 772"> <thead> <tr> <th>Sample</th> <th>Fixture</th> <th colspan="2">Max. dimensions</th> </tr> </thead> <tbody> <tr> <td rowspan="2">  </td> <td rowspan="2">04191-85302</td> <td>d</td> <td>7 mm</td> </tr> <tr> <td>ℓ</td> <td>20 mm</td> </tr> <tr> <td rowspan="2"></td> <td rowspan="2">16091-60012</td> <td>d</td> <td>10 mm</td> </tr> <tr> <td>ℓ</td> <td>20 mm</td> </tr> </tbody> </table> <p>Usable frequency range: DC to 1000MHz. Electrical length: 1.87 cm (typ.). Maximum applied dc bias voltage: ± 40V.</p> <p><i>Note: The 16091A fixture of 7mm inner diameter (P/N 04191-85302) is actually the same as the 0S standard termination. Thus, this fixture is not supplied with the 16091A fixture set since the furnished 0S termination can be used.</i></p>	Sample	Fixture	Max. dimensions			04191-85302	d	7 mm	ℓ	20 mm		16091-60012	d	10 mm	ℓ	20 mm
Sample	Fixture	Max. dimensions															
	04191-85302	d	7 mm														
		ℓ	20 mm														
	16091-60012	d	10 mm														
		ℓ	20 mm														
<p>HP16092A Spring Clip Fixture.</p> 	<p>Test Fixture (direct attachment type) for measurement of both axial and radial lead components and lead-less chip elements. Spring clip contacts are capable of holding samples of dimensions given below:</p>  <p>A combined slide gauge provides direct readouts of the physical length of the sample tested. Usable frequency range: DC to 500MHz. Electrical length : 0.34 cm (typ.). Maximum applied dc bias voltage: ± 40V.</p>																

Table 1-3 Accessories Available (sheet 2 of 3).

Model	Description
<p data-bbox="207 310 584 340">HP16093A Binding Post Fixture</p> 	<p data-bbox="899 310 1448 472">Test Fixtures (direct attachment type) for measurement of both axial and radial lead miniature components. Two binding post terminals at an interval of 7mm on the terminal deck ensure optimum contact of terminals and sample leads.</p>  <p data-bbox="899 772 1372 865">Usable frequency range: DC to 250MHz. Electrical length : 0.34 cm (typ.). Maximum applied dc bias voltage: ± 40V.</p>
<p data-bbox="207 1155 576 1184">HP16093B Binding Post Fixture</p> 	<p data-bbox="899 1150 1448 1276">Test Fixture (direct attachment type) for general measurement of both axial and radial lead components. Three binding post terminals are located on the terminal deck as shown below:</p>  <p data-bbox="899 1675 1372 1768">Usable frequency range: DC to 125MHz. Electrical length : 0.34 cm (typ.). Maximum applied dc bias voltage: ± 40V.</p>

Table 1-3 Accessories Available (sheet 3 of 3).

Model	Description
<p data-bbox="164 317 461 344">HP16094A Probe Fixture</p> 	<p data-bbox="849 317 1395 642">Test Fixture for measurement of circuit impedances and components mounted on circuit assemblies. The probe adapter unit can be attached at the tip of an extension line connected to the test port. The probe connector fits APC-7 connector of a coaxial test cable or a flexible air line. Probe needle interval is variable from 1mm to 15mm. Electrical length compensation in the instrument must be adjusted for probe cable length (refer to paragraph 3-44).</p> <p data-bbox="849 684 1333 779">Useable frequency range: DC to 125 MHz. Electrical length : 2.32 cm (typ). Maximum applied dc bias voltage: ± 40 V.</p>

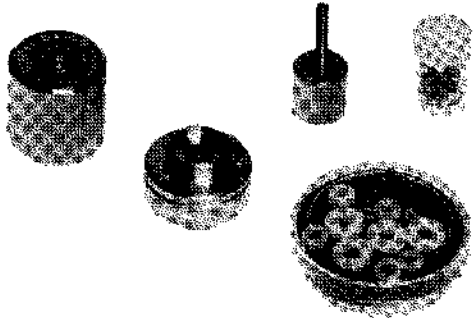
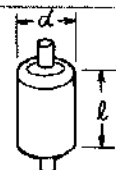
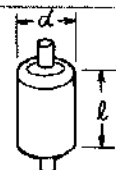
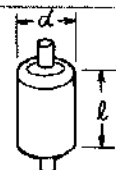
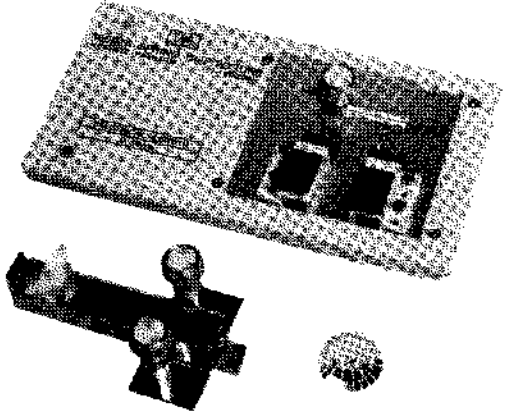
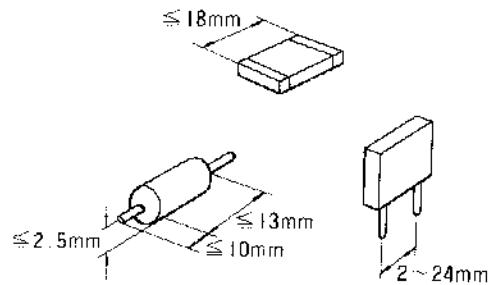
SECTION II INSTALLATION

2-1. INTRODUCTION.

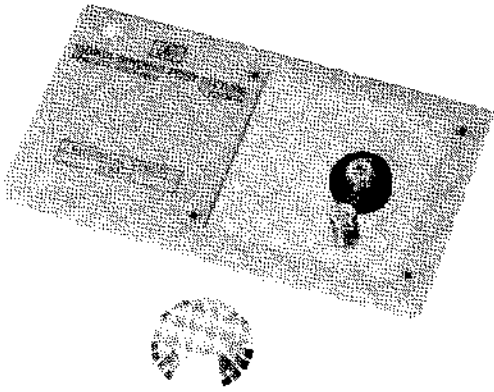
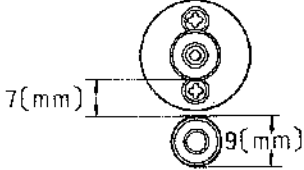
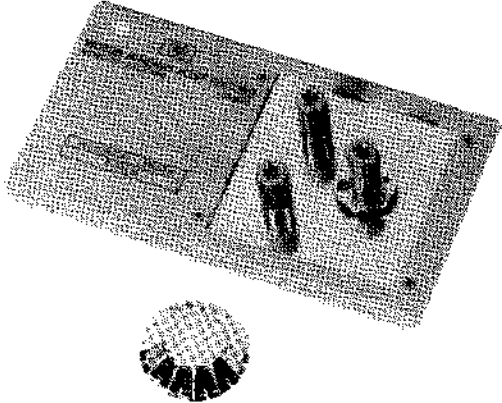
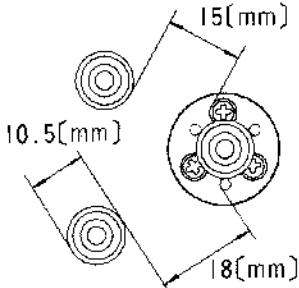
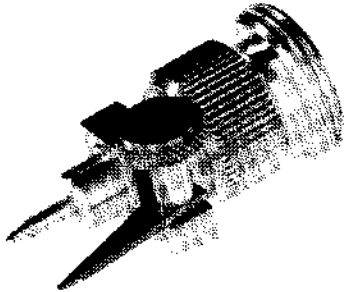
2-2. This section provides installation instructions for the Model 4191A Impedance Analyzer. The section also includes information on initial inspection and damage claims, preparation for using the 4191A, packaging, storage, and shipment.

2-3. INITIAL INSPECTION.

2-4. The 4191A Impedance Analyzer, as shipped from the factory, meets all the specifications listed in Table 1-1. On receipt, inspect the shipping container for damage. If the shipping container or cushioning material is damaged, notify the carrier as well as the Hewlett-Packard office and be sure to keep the shipping materials for carrier's inspection until the contents of the shipment have been checked for completeness and the instrument has been checked mechanically and electrically. The contents of the shipment should be as shown in Figure 1-1. The procedures for checking the general electrical operation are given in Section III (Paragraph 3-5 Self Test) and the procedures for checking the 4191A Impedance Analyzer against its specifications are given in Section IV. Firstly, do the self test. If the 4191A Impedance Analyzer is electrically questionable, then do the Performance Tests to determine whether the 4191A has failed or not.

If contents are incomplete, if there is mechanical damage or defects (scratches, dents, broken switches, etc.) or if the performance does not meet the self test or performance tests, notify the nearest Hewlett-Packard office (see list at back of this manual). The HP office will arrange for repair or replacement without waiting for claim settlement.

2-5. PREPARATION FOR USE.

2-6. POWER REQUIREMENTS.

2-7. The 4191A requires a power source of 100, 120, 220 Volts ac $\pm 10\%$, or 240 Volts ac $+5\% - 10\%$, 48 to 66 Hz single phase; power consumption is 150 VA maximum.

WARNING:

If this instrument is to be energized via an external auto-transformer for voltage reduction, be sure that the common terminal of the instrument is connected to the earth pole of the power source.

2-8. LINE VOLTAGE AND FUSE SELECTION.

Caution: Before turning the 4191A line switch to on, verify that the instrument is set to the voltage of the power supplied.

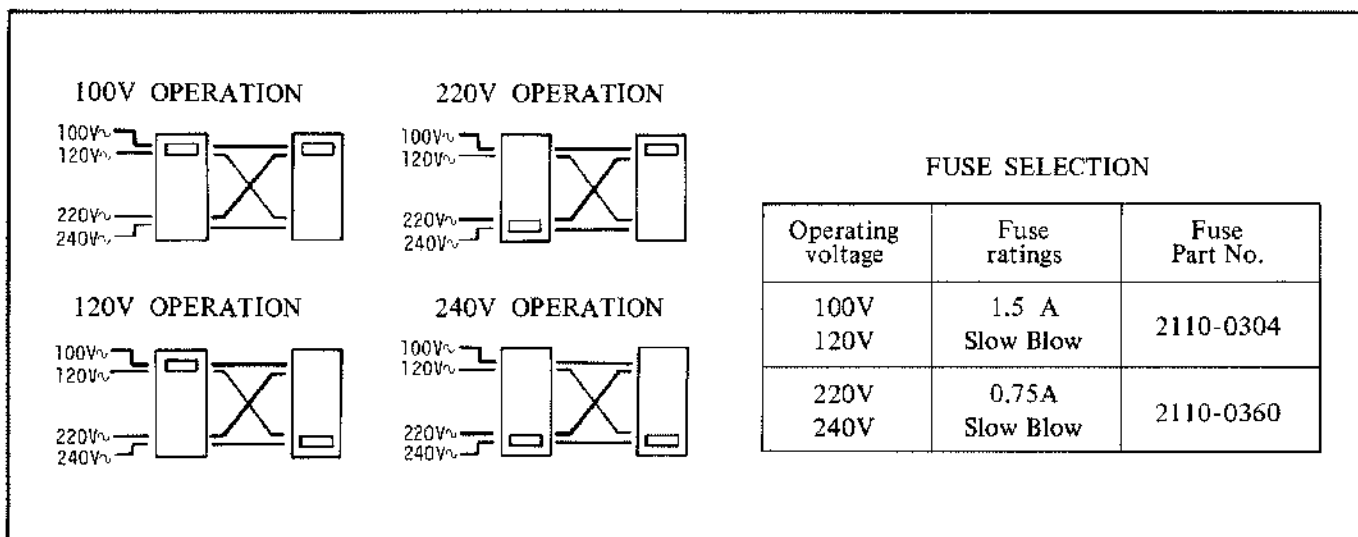

Figure 2-1. Line Voltage and Fuse Selection.

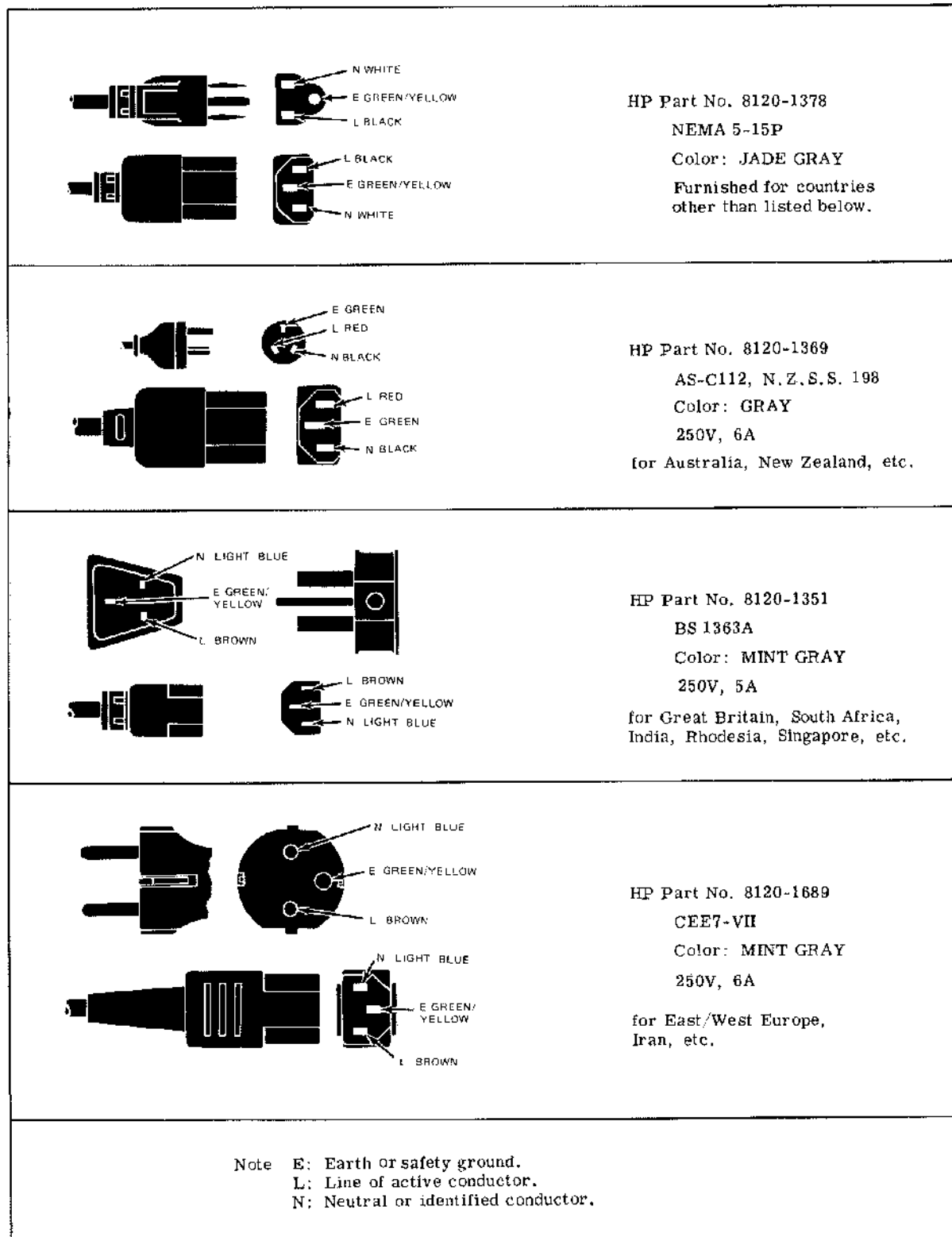

Figure 2-2. Power Cables Supplied.

2-9. Figure 2-1 provides instructions for line voltage and fuse selection. The line voltage selection switch and the proper fuse are factory installed for 100 or 120 volts ac operation.

Caution:

1. Use proper fuse for line voltage selected.
2. Make sure that only fuses for the required rated current and of the specified type are used for replacement. The use of mended fuses and the short-circuiting of fuse-holders must be avoided.

2-10. POWER CABLE.

2-11. To protect operating personnel, the National Electrical Manufacturer's Association (NEMA) recommends that the instrument panel and cabinet be grounded. The Model 4191A is equipped with a three-conductor power cable which, when plugged into an appropriate receptacle, grounds the instrument. The offset pin on the power cable is the ground wire.

2-12. To preserve the protection feature when operating the instrument from a two contact outlet, use a three prong to two prong adapter (HP Part No. 1251-0048) and connect the green pigtail on the adapter to power line ground.

Caution:

The mains plug must only be inserted in a socket outlet provided with a protective earth contact. The protective action must not be negated by the use of an extension cord (POWER CABLE) without protective conductor (GROUNDING).

2-13. Figure 2-2 shows the available power cords, which may be used in various countries including the standard power cord furnished with the instrument. HP Part number, applicable standards for power plug, power cord color, electrical characteristics and countries using each power cord are listed in the figure. If assistance is needed for selecting the correct power cable, contact nearest Hewlett-Packard office.

2-14. INTERCONNECTIONS.

2-15. When external bias is to be used, set rear panel DC BIAS INT EXT switch to EXT position. The output of the external dc bias source should be connected to EXT INPUT/INT MONITOR connector. For coupling the 4191A with an external controller and/or output device using HP-IB interface capability (IEEE-488-1975), connect HP-IB interface cable between rear panel HP-IB connectors of the instruments.

2-16. OPERATING ENVIRONMENT.

2-17. Temperature. The instrument may be operated in temperatures from 0°C to +55°C.

2-18. Humidity. The instrument may be operated in environments with relative humidities to 95% to 40°C. However, the instrument should be protected from temperature extremes which cause condensation within the instrument.

2-19. INSTALLATION INSTRUCTIONS.

2-20. The HP Model 4191A can be operated on the bench or in a rack mount. The 4191A is ready for bench operation as shipped from the factory. For bench operation, a two-leg instrument stand is used. For use, the instrument stands are designed to be pulled towards the front of instrument.

2-21. INSTALLATION OF OPTIONS 907, 908 and 909.

2-22. The 4191A can be installed in a rack and be operated as a component of a measurement system. Rack mounting information for the 4191A is presented in Figure 2-3.

2-23. STORAGE AND SHIPMENT.

2-24. ENVIRONMENT.

2-25. The instrument may be stored or shipped in environments within the following limits:

Temperature	-55°C to +65°C
Humidity	to 95%
Altitude	50,000 ft

The instrument should be protected from temperature extremes which cause condensation inside the instrument.

2-26. PACKAGING.

2-27. Original Packaging. Containers and materials identical to those used in factory packaging are available through Hewlett-Packard offices. If the instrument is being returned to Hewlett-Packard for servicing, attach a tag indicating the type of service required, return address, model number, and full serial number. Also mark the container FRAGILE to assure careful handling. In any correspondence, refer to the instrument by model number and full serial number.

2-28. Other Packaging. The following general instructions should be used for re-packing with commercially available materials:

- a. Wrap instrument in heavy paper or plastic. If shipping to Hewlett-Packard office or service center, attach tag indicating type of service required, return address, model number, and full serial number.
- b. Use strong shipping container. A double-wall carton made of 350 pound test material is adequate.
- c. Use enough shock absorbing material (3 to 4 inch layer) around all sides of instrument to provide firm cushion and prevent movement inside container. Protect control panel with cardboard.

- d. Seal shipping container securely.
- e. Mark shipping container FRAGILE to ensure careful handling.
- f. In any correspondence, refer to instrument by model number and full serial number.

Option	Kit Part Number	Parts Included	Part Number	Q'ty	Remarks
907	Handle Kit 5061-0091	Front Handle Trim Strip # 8-32 x 3/8 Screw	③ 5060-9901 ④ 5060-8898 2510-0195	2 2 8	9.525mm
908	Rack Flange Kit 5061-0079	Rack Mount Flange # 8-32 x 3/8 Screw	② 5020-8864 2510-0193	2 8	9.525mm
909	Rack Flange & Handle Kit 5061-0085	Front Handle Rack Mount Flange # 8-32 x 5/8 Screw	③ 5060-9901 ⑤ 5020-8876 2510-0194	2 2 8	15.875mm

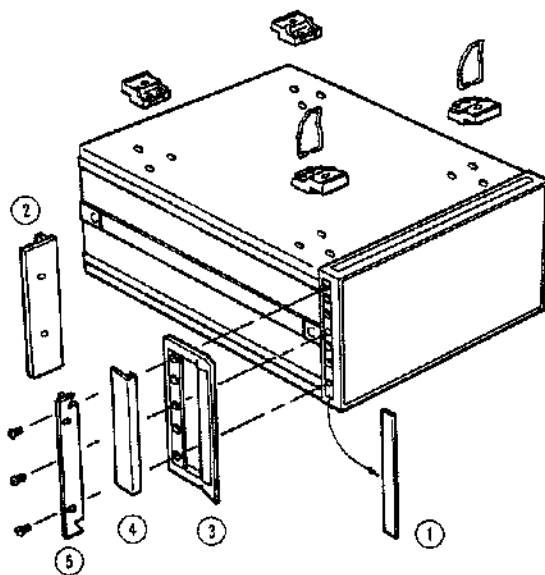

1. Remove adhesive-backed trim strip ① from sides at right and left front of instrument.
2. HANDLE INSTALLATION: Attach front handle ③ to sides at right and left front of instrument with screws provided and attach trim ④ to handle.
3. RACK MOUNTING: Attach rack mount flange ② to sides at right and left front of instrument with screws provided.
4. HANDLE AND RACK MOUNTING: Attach front handle ③ and rack mount flange ⑤ together to sides at right and left front of instrument with screws provided.
5. When rack mounting (3 and 4 above), remove all four feet (lift bar at inner side of foot, and slide foot towards the bar).

Figure 2-3. Rack Mount Kits.

SECTION III OPERATION

3-1. INTRODUCTION.

3-2. This manual section provides the operating instructions for acquainting the user with the Model 4191A RF Impedance Analyzer. Instructions for panel controls, functions, operating procedures, basic measuring techniques for the various applications, operational check of the fundamental electrical functions and option information are included in this section. Operating precautions given throughout the text should be carefully observed.

3-3. PANEL FEATURES.

3-4. Front and rear panel features for the 4191A are described in Figures 3-1 and 3-2. Reference numbers in the photos are keyed to the associated descriptions. Other detailed information for panel displays and controls is covered in paragraphs 3-5 and those which follow.

3-5. SELF TEST

3-6. The 4191A has self-diagnostic functions which are automatically performed or can be done any time desired to confirm the normal operation of the instrument. During the diagnostic test, the instrument is checked for normal operation of the memorized measurement se-

quences stored in the internal program memory. This automatic test is initially performed each time the LINE button is pushed to turn instrument on. If any abnormality is detected, one of the sixteen error message codes among E-20 through 23, E-30 through 40 or E-50 is displayed in DISPLAY B as illustrated below:

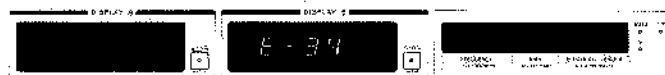

When no abnormality is detected during the diagnostic test routine, the DISPLAY B is normally blank. SELF TEST function key on the front panel allows the diagnostic test to be done at any desired time. Pressing blue key and the SELF TEST key activates the self diagnostic function (same as the initial automatic test). If a failure is not detected, the alphabetic annunciation figure "PASS" is displayed in DISPLAY B. This test is repeated until these keys are again pushed to release the SELF TEST.

Note: Display outputs other than those given in DISPLAY B section have no meaning in diagnostic test results.

DISPLAYS

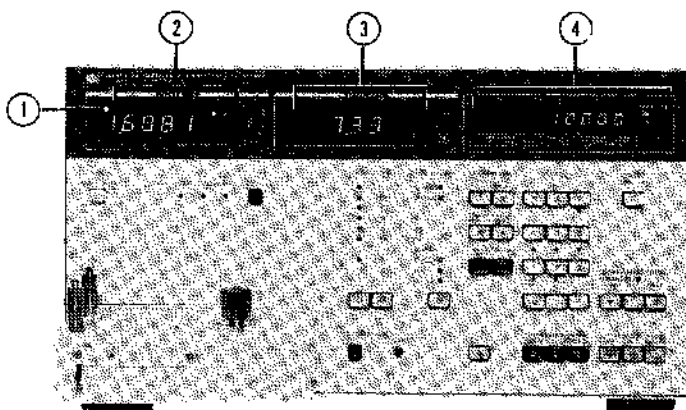

① **Trigger Lamp:** Turns on during sample measuring period. Turns off during period when instrument is not taking measurement. There is thus one lamp turn-on-and-off cycle per measurement. When TRIGGER ⑭ is set to INT (pushbutton lamp lights), the trigger lamp flashes repeatedly at internal measuring rate.

② **DISPLAY A:** Displays absolute values of vector impedance, admittance, or reflection coefficient or, alternately, resistance, conductance, real part of reflection coefficient, inductance, or capacitance values ($|Z|$, $|Y|$, $|\Gamma|$, R, G, Γ_x , L or C) in a maximum 4-1/2 digit decimal number from 0000 to 19999 (the number of digits change depending on instrument control settings). Simultaneously, decimal point and appropriate unit are displayed to indicate the multiple and the base parameter quantity of the measured sample value.

If measurement is not achieved because of incorrect panel control settings or because of an inappropriate sample value, an alphabetic annunciation figure (either -OF- or E-06) appears. Otherwise, during the CALIBRATION ⑮ function, a "CAL" or "Conn", figure is presented in the display.

③ **DISPLAY B:** Displays phase angle, reactance, susceptance, imaginary part of vector reflection coefficient, resistance, conductance, dissipation factor or quality factor value (θ , X, B, Γ_y , R, G, D or Q) in a maximum 4-1/2 digit decimal number from

0000 to 19999 (the number of digits change depending on instrument control settings) along with decimal point and appropriate unit.

If measurement is not achieved, an error annunciation figure (either -OF- or E-06) appears similar to that given in DISPLAY A. During the calibration function, either "0 Ω ", "0S", "50 Ω " or "END" annunciation display is provided in conjunction with the indications in DISPLAY A ②. Test results for diagnostic SELF TEST ⑳ are also displayed.

④ **Test Parameter Data Display:** Displays spot test frequency, swept frequency measurement parameters (start, stop and step frequencies), test fixture electrical length or reference value (for deviation measurement) to be employed in the measurement in maximum 5 digit decimal number including decimal point. Spot bias voltage and swept voltage bias parameter data (start, stop and step voltage setting data) are also contained in the selectable parameter data displays. The appropriate unit (MHz, cm or V) is indicated by unit lamp indicator adjacent to the numeric display.

If option 002 is installed, the test frequency display expands to a maximum of 7 digits. If an inappropriate test parameter input operation is made, -OF- or one of eleven error annunciation displays (E-01 to E-12 except E-10) provides specific information about the nature of the operating error.

Figure 3-1. Front Panel Features (Sheet 1 of 9).

BASIC CONTROLS

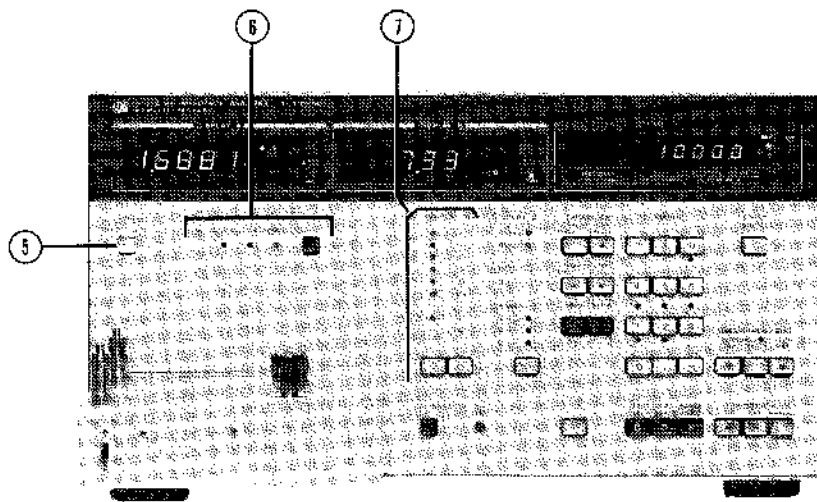

- ⑤ **LINE ON/OFF:** Turns instrument on and readies instrument for measurement.
- ⑥ **HP-IB Status Indicators and LOCAL key:** Four LED lamps for SRQ, LISTEN, TALK and REMOTE indicate the status of interface between the 4191A and HP-IB controller. LOCAL key enables front panel control instead of remote control from HP-IB line (when controller does not set the instrument to local lockout status).
- ⑦ **DISPLAY A function selector and indicators:** Two pushbutton keys select the primary measurement parameter to be measured from among a total of eight parameters shown in the indicator above the selector keys.

⏴ (down) key selects the parameter positioned next lower in the stack (than the indicated parameter) to be selected each time the key is pushed. ⏵ (up) key selects the next upper stack parameter in like manner.

An appropriate indicator lamp lights to indicate the selected parameter.

Parameters measured:

$|Z|$: Absolute value of vector impedance ($|Z|$) together with phase angle (θ) in degrees or radians. The combination of these two parameter values is the vector impedance expression ($|Z| \angle \theta$) of the sample.

$|Y|$: Absolute value of vector admittance ($|Y|$) together with phase angle (θ) in degrees or radians as the vector admittance expression ($|Y| \angle \theta$) of the sample.

$|\Gamma|$: Absolute value of vector reflection coefficient of the sample which is terminated in 50Ω UNKNOWN test port (31). Phase angle (θ) is simultaneously selectable in degrees or radians as representation of the vector reflection coefficient ($|\Gamma| \angle \theta$).

R: Resistance (R) together with reactance (X). These two parameter values represent the real and imaginary components, respectively, of the vector impedance ($Z = R + jX$) of the sample.

Figure 3-1. Front Panel Features (Sheet 2 of 9).

BASIC CONTROLS

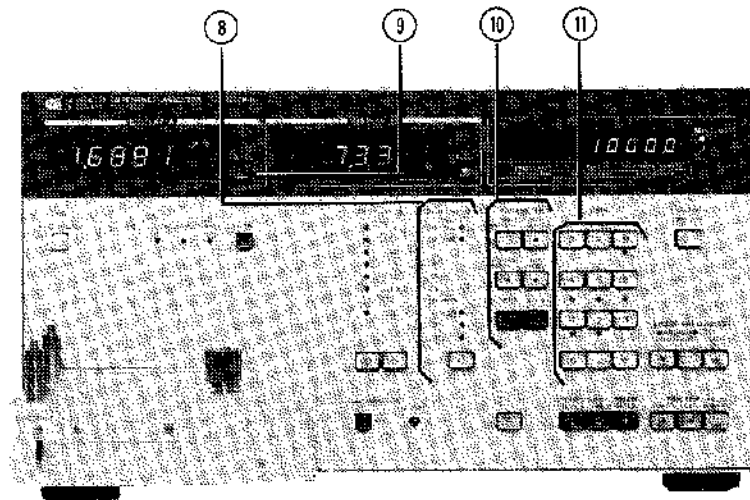





G: Conductance (G) together with susceptance (B). These two parameter values represent the real and imaginary components, respectively, of the vector admittance ($Y = G + jB$) of the sample.

Γ_x : Real part (Γ_x) of vector reflection coefficient together with imaginary part (Γ_y). These two parameter values are a complex number expression of the vector reflection coefficient ($\Gamma = \Gamma_x + j\Gamma_y$) of the sample.

L: Inductance together with subordinate parameter – equivalent series resistance (R), parallel conductance (G), dissipation factor (D) or quality factor (Q).

C: Capacitance together with one of the subordinate measurement parameters (same as those available for inductance measurement).

Note: Parameter selection circles from bottom to top (or top to bottom) as long as the same directional ( or ) key is pressed (that is, it moves in the same direction).

 **DISPLAY B function selector and indicator:**  (down) key selects the subordinate measurement parameter to be simultaneously combined with the primary parameter (set by the DISPLAY A function selector ). The parameter positioned next lower than the indicated parameter in the stack is selected each time the key is pushed. Parameter choice circles from top to bottom and back to top. The indicator lamp lit identifies the selected parameter.

θ (deg): Phase angle (θ) in degrees together with impedance ($|Z|$), admittance ($|Y|$) or reflection coefficient ($|\Gamma|$) measurement.

θ (rad): Phase angle (θ) in radians instead of degrees.

X: Reactance (X) together with resistance (R) measurement.

B: Susceptance (B) together with conductance (G) measurement.

Γ_y : Imaginary part (Γ_y) with real part (Γ_x) of vector reflection coefficient measurement.

Figure 3-1. Front Panel Features (Sheet 3 of 9).

BASIC CONTROLS

- R: Resistance (R) together with inductance (L) or capacitance (C) measurement in a series equivalent circuit representation of the sample.
- G: Conductance (G) together with inductance (L) or capacitance (C) measurement in a parallel equivalent circuit representation of the sample.
- D: Dissipation factor (D) together with inductance (L) or capacitance (C) measurement.
- Q: Quality factor together with inductance (L) or capacitance (C) measurement.

⑨ $\Delta/\Delta\%$: These keys enable taking deviation measurements, respectively, for DISPLAY A and DISPLAY B parameter values. Measurement range is automatically fixed during the period from initiation to the release of deviation measurement.

Δ (delta): Difference between the measured value of the sample under test and previously stored reference value is displayed by pressing this key. The deviation calculation follows the formula:

$$A - B$$

Where, A is measured value of the sample. B is reference value.

$\Delta\%$: The difference in percent deviation of a measured value from the reference value is displayed (this function is enabled by pressing **Blue** key prior to pressing this button). The percent deviation calculation follows the formula:

$$\frac{A - B}{B} \times 100 (\%)$$

⑩ **PARAMETER – SPOT, STEP, START, STOP FREQ and REF A, REF B**: These keys assign the parameters for the test frequency parameter data and reference values which are input numerically by DATA input keys ⑪.

SPOT: A spot frequency is entered by successively setting a frequency number with DATA keys.

STEP: A step interval frequency for a swept frequency measurement is entered by successively setting a frequency number. This function is automatically deactivated when **LOG SWEEP** ⑫ mode of function is set.

START: A frequency for sweep start point in a swept frequency measurement is entered by successively setting a frequency number.

STOP: A frequency for sweep stop point in a swept frequency measurement is entered by successively setting a frequency number.

REF A: A reference value for DISPLAY A parameter in deviation measurements is entered by successively setting a reference number.

REF B: A reference value for DISPLAY B parameter is entered similarly to that for DISPLAY A parameter.

To change or to release the function, press another **PARAMETER** key.



⑪ **DATA input keys**: These numeric keys set the values of the test frequency (1.0 to 1000.0 MHz, or 1.0000 to 1000.0000 MHz in an Option 002 unit), electrical length (0.00 to 99.99 cm) or reference (for deviation measurements) employed in the measurement in conjunction with **PARAMETER** ⑩ key. The input data is displayed in Test Parameter Data Display ④. These keys have other control functions which are denoted by blue labels above each individual key on the panel.

Figure 3-1. Front Panel Features (Sheet 4 of 9).

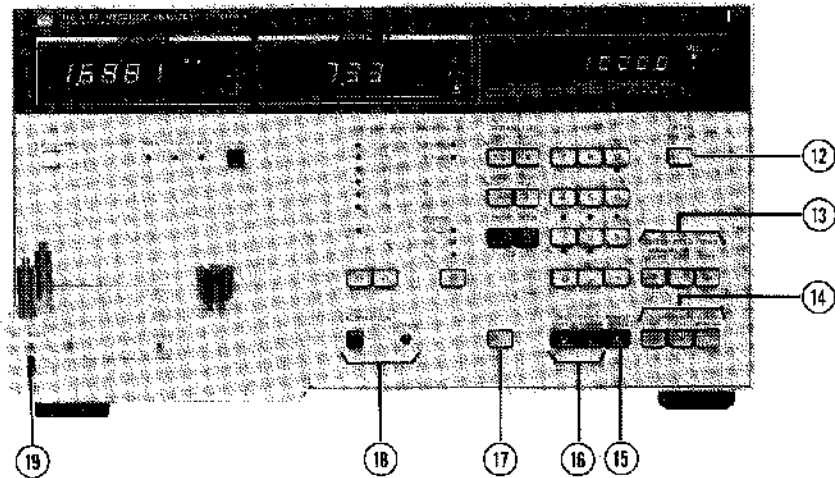
BASIC CONTROLS



⑫ **ENTER:** This key actuates the instrument to read test parameter data set by the PARAMETER ⑩ and DATA ⑪ input keys. A test frequency, an electrical length or dc bias voltage input data can be actuated as an instrument control setting just after this key is pushed.

⑬ **SWEEP FREQ/BIAS (MANUAL):** In a swept frequency measurement, the test frequency shifts to a lower or higher frequency, respectively, at the step frequency intervals (previously programmed) each time the STEP  or  key is pushed. The test frequency continues to shift digitally as long as either of these keys is being depressed and held. When the STEP key is pressed simultaneously with FAST key, the step frequency interval is expanded to ten times the programmed value (in linear sweep mode) or to one-fifth the frequency points (in logarithmic sweep mode). Consequently, the test frequency is swept in a shorter time (at a sacrifice of frequency resolution in the measurement results). These keys also function to provide similar control input demands for a swept voltage bias measurement.

⑭ **TRIGGER:** These keys select trigger mode for triggering measurement (Internal, External or Hold/Manual):

INT: Internal trigger signal enables instrument to make repeated automatic measurements at a measuring rate of approximately 800 ms (250 ms in high speed mode).

EXT: Measurement is triggered by external trigger signal through rear panel EXT TRIGGER input connector.

HOLD/MANUAL: Measurement is triggered each time this key is pushed. Measurement data is held until the key is again pushed.

⑮ **RANGE HOLD:** This key fixes measurement range (even if sample is changed). Otherwise, the range is automatically fixed when DIGIT SHIFT ⑯ key is pushed or when a deviation or a swept frequency/bias measurement is being taken.

Figure 3-1. Front Panel Features (Sheet 5 of 9).

BASIC CONTROLS

- ⑫ **DIGIT SHIFT DSPL A and DSPL B:** Numeric figures of the display output in DISPLAY A ② shifts in a left-to-right direction by one character each time DSPL A key is pushed. Thus, display output is extinguished in this order beginning with the least significant digit. DISPL B key actuates the display output of DISPLAY B ③ in like manner. Measurement range is concurrently held with the first stroke of the key. Fractional parts below the least significant digit (LSD) displayed are automatically rounded to the LSD. When the instrument is equipped with Option 004, this function enables analog recorder output proportionate to the appropriate three element digit numbers of the display output. This function is released by pressing RANGE HOLD ⑮ key.
- ⑬ **Blue key:** This key is pressed prior to pressing a blue label function key to interchange a normal key function with a blue label function.
- ⑭ **CALIBRATION:** This key performs automatic calibration in accordance with the self calibration program routine memorized in the instrument. Calibration is done by taking measurements with three kinds of standard terminations (0Ω , $0S$ and 50Ω , which are supplied accessories) at a total of 51 spot frequencies. During the calibration mode of operation, indications for the standard termination to be connected to UNKNOWN ⑳ are timely given on displays. Concurrently, other functions, unnecessary for the calibration, are deactivated. If calibration data is not being memorized, the instrument must initially be calibrated to optimize subsequent measurements after the power is turned on. This function is released by again pressing the key (after the calibration is completed).
- START button** --- This pushbutton starts calibration subroutine running when an appropriate termination (0Ω , $0S$ or 50Ω) is connected.
- ⑰ **DC BIAS switch:** This switch is set to ON to enable application of an internal or external dc bias voltage to the sample connected at UNKNOWN ⑳, and is set to OFF to disable bias application when dc bias is not needed.

Figure 3-1. Front Panel Features (Sheet 6 of 9).

BLUE LABEL FUNCTIONS

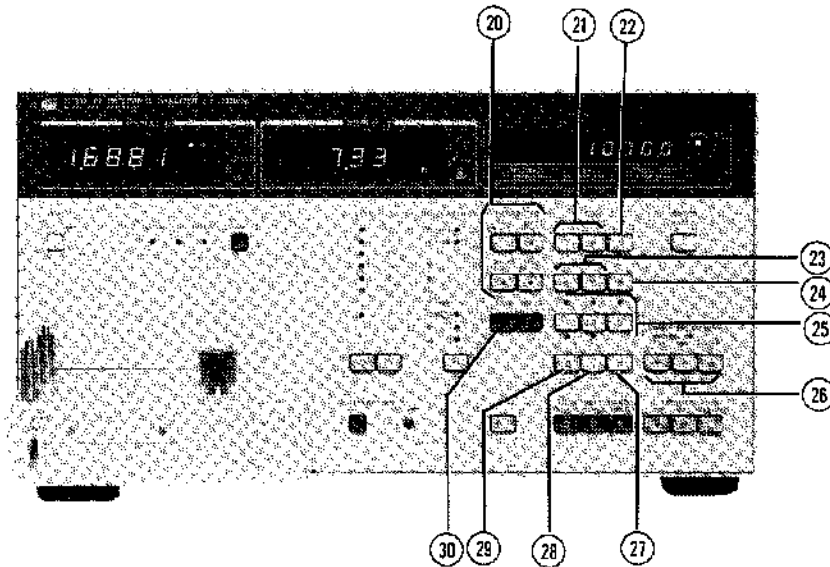

[The blue label functions are secondary selectable modes of dual function keys and require that the **Blue** key be pressed beforehand to activate the desired mode.]

- ②① **PARAMETER – SPOT, STEP, START, STOP BIAS:** These keys assign the parameters of bias parameter data similar to the functions for setting test frequency parameters (as described in item ⑩). Spot bias voltage or the voltage value for step interval, start or stop points to be employed for swept bias voltage measurement are entered by successively setting the voltage number through DATA input keys ⑪. To release the function, press another PARAMETER key.
- ②② **STORE DSPL A/B:** This key simultaneously memorizes both measured values of the sample displayed in DISPLAY A ② and DISPLAY B ③ as reference values for a deviation measurement.
- ②③ **RCL 1 and RCL 2:** These keys recall the panel control settings memorized by the SAVE 1 or SAVE 2 function ②①.
- ②④ **SELF TEST:** This key performs an automatic check for diagnosing the functional operation of the instrument. An indicator lamp above the key lights during the test. The diagnostic test repeats until this key is again pushed to release the SELF TEST (after pressing **Blue** key). If the instrument is faulty, an error message code appears in DISPLAY B ③ to identify the point where the abnormality is occurring.
- ②⑤ **SAVE 1 and SAVE 2:** These keys continuously memorize the desired front panel control settings including reference values for deviation measurement and electrical length input value. SAVE 1 and SAVE 2 keys are individually capable of memorizing different settings. Sweep mode (AUTO/manual, linear/LOG SWEEP), self test and analog recorder output function (Option 004) settings can not be stored in the memory.
- ②⑥ **X-Y RECORDER function:** (Option 004 only). These keys provide for analog recorder reference output voltages for X-Y

Figure 3-1. Front Panel Features (Sheet 7 of 9).





BLUE LABEL FUNCTIONS

recorder full scale and zero scale adjustments, and additionally, the capability to smooth recorder output in swept frequency (or swept voltage bias) measurement. An indicator lamp above each individual key lights to indicate that the function is set. These functions are released by again pressing the key (after pressing **Blue** key):

INTRPL: Graphic recording or recorder output is automatically smoothed by arithmetic interpolations of the measured values when this key is pressed.

LL: Provides a reference voltage (0V) for recorder zero scale adjustment for each rear panel recorder output (A, B and C). Positions recorder pen at lower left corner of the scale area.

UR: Provides a reference voltage (1V) for recorder full scale adjustment. Positions recorder pen at upper right corner of the scale area.

- ②⑥ **SWEEP FREQ/BIAS (AUTO):** These keys control implementation of an auto sweep mode of operation. **START**  key starts a single swept frequency measurement from a lower frequency towards upper frequency in the previously programmed sweep range (Start and Stop frequencies).  key moves the frequency sweep in a lower direction (from a higher frequency towards a lower frequency). When either of these keys is pushed, the AUTO indicator lamp above the keys lights to indicate that the instrument is set to auto sweep mode of operation. **PAUSE** key temporarily stops sweep frequency at a desired frequency step point until either  or  key is again pushed (after pressing **Blue** key).

These keys also function for a swept voltage bias measurement in like manner.

During swept measurement mode of opera-

tion, functions, other than these controls, are automatically deactivated. The swept measurement is released when the measurement is completed or when **SWEEP ABORT** key ②⑦ is pressed (after pressing **Blue** key).

- ②⑦ **SWEEP ABORT:** This key releases auto sweep frequency (bias voltage) measurement and activates a stationary frequency measurement at the frequency (voltage) point where the sweep mode is released.
- ②⑧ **LOG SWEEP:** Swept frequency measurement sweeps the 51 spot (50 step) frequencies which are automatically selected at logarithmically regular frequency intervals over the range of the programmed start to stop frequencies. Step frequency program input data has no effect on the measurement.

Logarithmic sweep is also feasible in swept voltage bias measurement. An indicator lamp above the key lights to indicate that this function is set. This function is released by again pressing the key (after pressing **Blue** key).

- ②⑨ **HIGH SPEED:** This key provides display output of measured values at an accelerated measuring rate of approximately 250ms. The high speed measurement is achieved at the sacrifice of the averaging measurements (averages five measurements) with its resultant improved stability for readouts on the lowest or highest measurement ranges. An indicator lamp above the key lights to indicate that this function is set.

This function is released by again pressing the key (after pressing **Blue** key).

- ③⑩ **ELEC LG:** This key is pushed to enter an electrical length number particular to the test fixture used (before taking measurements). An appropriate electrical length number must be successively inputted through **DATA** keys ①① (electrical length is indispensable in optimizing measurements).

Figure 3-1. Front Panel Features (Sheet 8 of 9).

UNKNOWN CONNECTOR

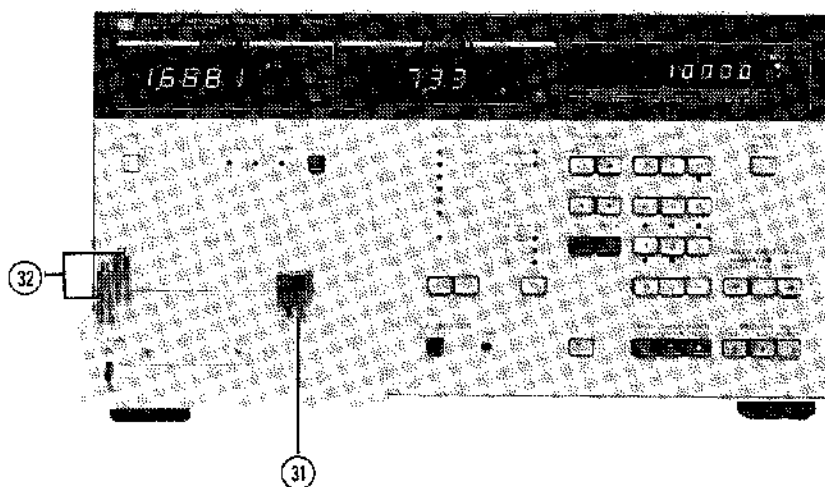

31 UNKNOWN connector: This connector provides the capability for connecting and installing an accessory test fixture specially matched to the 4191A or a user-built test fixture. The APC-7 connector test port, of two terminal configuration, has a characteristic impedance of 50Ω which is equal to the base impedance in reflection coefficient measurements. This base impedance represents the reference in the normalized impedance calculations for multiple parameter derivations.

32 Test Fixture Mounting Posts: These two mounting posts help to securely install the test fixture in conjunction with the UNKNOWN 31 connector. The mounting posts fit twin holes on the 16092A, 16093A or 16093B Test Fixture terminal decks for firm installation (not used for 16091A and 16094A).

TEST FIXTURE INSTALLATION

Accessory test fixture installations on the UNKNOWN terminal deck are illustrated at left:

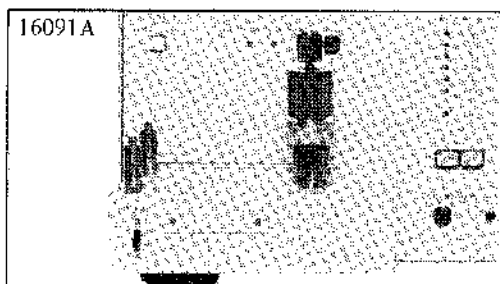

16091A Coaxial Fixtures:

The coaxial fixture is installed on the UNKNOWN connector with a special coaxial adapter (for interconnecting the two connectors). The coaxial adapter protects the UNKNOWN connector contact surface from any damage incident to attachment of sample.

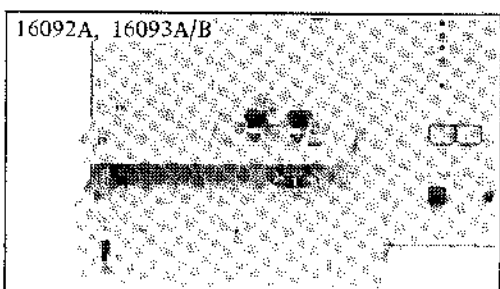

16092A Spring Clip Fixture,

16093A/B Binding Post Fixtures:

A connector coupling screw on the underside of the test fixture terminal deck is coupled to the UNKNOWN connector. The test fixture mounting posts of the 4191A are set into the twin locating holes at the corner of the deck.

Note: For detailed instructions for usage of test fixtures, refer to paragraphs entitled "DUT CONNECTION" (pages 3-31 through 3-35).

Figure 3-1. Front Panel Features (Sheet 9 of 9).

REAR PANEL FUNCTIONS

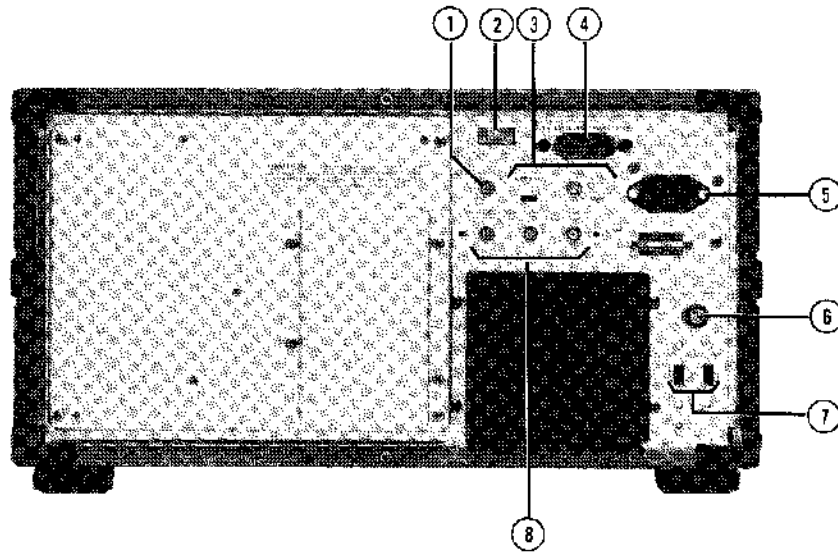

① **EXT TRIGGER Connector:** This connector is used for externally triggering the instrument by inputting an external trigger signal. TRIGGER key on front panel should be set to EXT.

② **HP-IB Address Switch:** This switch sets the HP-IB address number for the instrument and, additionally, data output format, and control capability to Talk Only or to Addressable.

③ **DC BIAS Selector Switch and Connector:**
INT EXT switch: This switch selects between internal or an external dc bias source:

INT - Internal dc bias voltage is applied to the sample.

EXT - External dc bias voltage can be applied to the sample up to a maximum of ± 40 volts through EXT INPUT/INT MONITOR connector.

EXT INPUT/INT MONITOR connector:
External dc bias voltage can be applied to sample up to a maximum of 40 volts (100mA max) through this connector. When internal dc bias is used, the bias voltage can be monitored by connecting a voltmeter (DVM) to this connector.

Input impedance: $390\Omega \pm 10\%$.

④ **HP-IB Connector:** HP-IB interface cable can be connected to this connector to intercommunicate with other HP-IB devices through the bus line cable.

⑤ **~ LINE Input receptacle:** AC power cord is connected to this receptacle and ac power line.

⑥ **FUSE Holder:** Instrument power-line fuse is installed in this holder:

100/120V operation:
1.6AT (P/N 2110-0304)
220/240V operation:
800mAT (P/N 2110-0306)

⑦ **VOLTAGE SELECTOR Switches:** These switches select appropriate ac operating power voltage from among 100, 120, 220V $\pm 10\%$ and 240V $-5\%+10\%$, 48-66 Hz.

⑧ **RECORDER OUTPUTS (OPT 004) Connector:** With Option 004, these connectors output analog voltages in proportion to measurement display outputs and test frequency (or internal dc bias voltage) for graphically recording a sweep measurement with an X-Y recorder.

Figure 3-2. Rear Panel Features (Sheet 1 of 2).

REAR PANEL FUNCTIONS

FREQ/BIAS Connector: Outputs analog voltage in proportion to test frequency or internal dc bias voltage from 0V at start frequency (voltage) to 1V at stop frequency (voltage) point. The output voltage is proportional to the logarithm of the frequency (voltage) when LOG SWEEP function is set.

DISPLAY B Connector: Outputs analog voltage in proportion to the three lesser significant digit numbers of DISPLAY B display output (1 mV per 1 count of display from -999 to 999 counts).

DISPLAY A Connector: Outputs analog voltage in proportion to DISPLAY A display outputs in the same manner as for DISPLAY B connector output.

Figure 3-2. Rear Panel Features (Sheet 2 of 2).

3-7. MEASUREMENT FUNCTIONS.



3-8. The model 4191A makes simultaneous measurement of two independent, complementary parameters in each measurement cycle. This combination of measurement parameters represent both the resistive and reactive characteristics of the sample. A total of 16 measurement parameters (two among them are duplicates) constitute the 14 selectable combinations of the parameters. These measurement functions are classified, for display purpose, into two groups: DISPLAY A and DISPLAY B functions.

DISPLAY A function group comprises primary measurement parameters including those tabulated below:

DISPLAY A functions	
Z	Absolute value of vector impedance.
Y	Absolute value of vector admittance.
Γ	Absolute value of vector reflection coefficient.
R	Resistance.
G	Conductance.
Γ _x	Real part of vector reflection coefficient.
L	Inductance.
C	Capacitance.

Measured values are displayed in DISPLAY A section at top left on the front panel.

DISPLAY B functions include a group of subordinate parameters, the availability of which are partially dependent on the primary function selected. The measurement parameters included in the DISPLAY B functions are listed in the tabulation below:

DISPLAY B functions	
θ (deg)	Phase angle in degrees.
θ (rad)	Phase angle in radians.
X	Reactance.
B	Susceptance.
Γ _y	Imaginary part of vector reflection coefficient.
R _{eq} 	Equivalent series resistance.
G _{eq} 	Parallel conductance.
D	Dissipation factor.
Q	Quality factor.

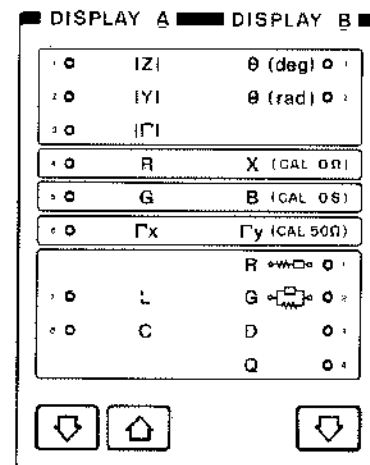

The relationship of the combinability of subordinate parameters to major measurement parameters are represented in the function indicator on the front panel (these panel markings are shown in above-right figure). The DISPLAY B parameters selectable together with the DISPLAY A function are discriminated by rectangular block lines outlining the parameter labels. That is, the divisions shown for the particular function indicator signify the available combinations of the measurement parameters (as defined below):

	Combinable functions					
DISPLAY A	Z , Y , Γ	R	G	Γ _x	L, C	
DISPLAY B	θ(deg), θ(rad)	X	B	Γ _y	R, G, D, Q	

Measured values are displayed in DISPLAY B section (at top center of the front panel).

3-9. DEVIATION MEASUREMENT FUNCTION.

3-10. The 4191A is capable of deviation measurements associated with both DISPLAY A and DISPLAY B functions. This function enables displaying unit deviation or percent deviation of the sample values from a reference value stored in the internal memory. When the store mode operation is enabled, the instrument memorizes the measured values for DISPLAY A and/or DISPLAY B parameters, or otherwise the data input numbers as the reference value(s). The difference between the subsequent measurement and the reference value is displayed in the form of a subtraction as a Δ (delta) measurement or as a percent deviation Δ% (delta percent) measurement. The deviation measurement procedure is described in Figure 3-8.

3-11. DISPLAYS.

3-12. Two primary display sections and a subdisplay section provide visual data output of measurement results as well as of the test parameter values employed for the measurement.

1. DISPLAY A

DISPLAY A provides a readout of the measured impedance, admittance, reflection coefficient (absolute values) as well as for resistance, conductance, the real part of vector reflection coefficient, and the inductance or capacitance values ($|Z|$, $|Y|$, $|\Gamma|$, R, G, Γ_x , L or C) in a maximum 4-1/2 digit decimal number with decimal point and appropriate unit. The trigger lamp located at the left in display flashes in synchronism with measuring rate.

If the sample value exceeds full count display number on the selected range or an inappropriate DIGIT SHIFT control setting is set, an -OF- (Over Flow) figure appears in this display. If an inappropriate panel control operation is made, an error annunciation figure E-06 (Error 6) is displayed until the erroneous measurement arrangement is corrected (refer to Table 3-6 for the annunciation display meanings). When an auto-calibration needs to be performed, "CAL" (CALibration) or "Conn" (Connect) annunciation display provides an instruction for the succeeding calibration procedure in association with collateral indications in DISPLAY B.

2. DISPLAY B

DISPLAY B gives subordinate measurement data such as phase angle (θ) in $|Z|$, $|Y|$ or $|\Gamma|$ measurements; reactance (X) in R measurements; susceptance (B) in G measurements; imaginary part of vector reflection coefficient (Γ_y) in conjunction with real Γ_x measurements; equivalent series resistance, parallel conductance dissipation factor or quality factor (R, G, D or Q) in L or C measurements.

If sample value for selected DISPLAY B function is inappropriate or if an incorrect panel control operation is made, an -OF- or an error annunciation figure is displayed similar to that which appears in DISPLAY A. During calibration function, an "0 Ω ", "0S", "50 Ω " or "END" figure appears providing information relevant to the display in DISPLAY A. When a diagnostic SELF TEST is performed, displays of the test results are exclusively provided in DISPLAY B.

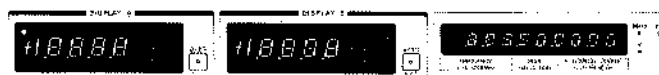

3. Test Parameter Data Display

Test Parameter Data Display at front panel upper right provides readouts for the test parameter values that correspond with those particular data input operations, and affords a selectable display of the data for the test parameter settings employed in the measurement. These display parameter data are:

- Spot test frequency
- Sweep frequency parameters (start, stop and step frequencies)
- Spot bias voltage
- Sweep bias voltage parameters (start, stop and step frequencies)
- Electrical length value
- Reference values (in deviation measurements)

The display is given in a maximum 4-1/2 digit decimal number along with an adjacent unit indication (MHz, cm or V) at the right side. Option 002 unit offers a maximum 7 digit readout to permit the full digits of the test frequency setting number to be displayed at 0.0001 MHz resolution. An example is given below:



If an unacceptable input parameter number is set or if an inappropriate control operation is made, -OF- or an error message (E-01 to E-12 except E-10) is displayed until the control input demand is automatically released or the erroneous measurement setup is corrected.

3-13. DIGIT SHIFT.

3-14. DIGIT SHIFT control function permits the number of display digits for DISPLAY A and DISPLAY B to be independently set as desired instead of an automatic setting for the optimum number of digits (selectable number of display digits can not exceed those of an automatic setting). The numeric figures of the display output move to the right by one character each time the DIGIT SHIFT DSPL A or DSPL B  key is pushed. The primary usage of this function is to proportion the analog recorder output to an appropriate three element digit number output of the display. For detailed information on the recorder output, refer to paragraph 3-56.

3-15. TEST FREQUENCY SIGNAL

3-16. The sinusoidal wave test signal incident on the test sample is fed at a signal level of -14 dBm (approximately 45 mV rms) from the internal frequency synthesizer signal source with 3 ppm frequency accuracy. The programmable, microprocessor controlled, synthesizer signal source provides sweep frequency measurement capability with a simple key board operating procedure. Coupling the powerful control and computation capability of an external calculating instrument (HP desktop computer) through the HP-IB line, enables the 4191A to make more creative, sophisticated use of the swept measurement functions. A control program will permit, for example, an automatic search for the resonance points of a sample device in the test frequency range and provides measurement readouts of the resonant frequencies, impedance values of the extremes, quality factor for each individual resonance and other useful analysis data. The controllable test frequency and sweep frequency parameters of the internal test signal are shown in Table 3-1.

Table 3-1. Test Frequency Setting Ranges.

Instrument option		Standard	Opt. 002
Spot frequency		1.0 - 1000.0 MHz	1.0000 - 1000.0000 MHz
Sweep frequency parameters	Step	0.1 - 999.0 MHz	0.0001 - 999.0000 MHz
	Start	1.0 - 1000.0 MHz	1.0000 - 1000.0000 MHz
	Stop	1.0 - 1000.0 MHz	1.0000 - 1000.0000 MHz
Frequency resolution	≤ 500 MHz	100 kHz	100 Hz
	> 500 MHz	200 kHz	200 Hz

Test Signal Settling Time.

It takes about 200 milliseconds (maximum) for the test signal to stabilize after changing frequency. In swept frequency measurements, this settling time is automatically set before a measurement can be taken (at each sweep step frequency).

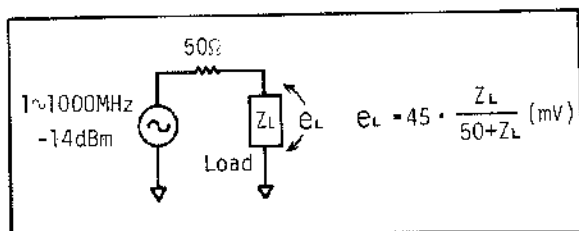

Figure 3-3. Test Signal Level.

3-17. RANGING

3-18. The 4191A measures sample values on one range for whichever measurement parameter is selected. Each of the selectable measurement parameters is derived from reflection coefficient measurements using parameter conversion calculations (performed by the 4191A). The reflection coefficients are always measured as values in the range of $|\Gamma| = 0$ and $|\Gamma| = 1$ for any impedance element (from 0Ω to infinity - $\infty\Omega$). Thus, measurement values are covered by one reflection coefficient range and range control function need not be provided.

However, autoranging control is seemingly performed for display output purposes in measurements of parameter values except for reflection coefficients. When the delta ($\Delta/\Delta\%$) function is set to perform deviation measurements, the display output value range is automatically fixed. RANGE HOLD key function allows fixing the multiplier and decimal point displays to represent measured values in the desired display format.

Note: To supplement the outline of the ranging described above, refer to the expanded explanation of 4191A measurement principle (page 3-19).

3-19. MEASUREMENT RANGES

3-20. The 4191A is, in measurement principle, capable of measuring samples of all impedance values from zero to infinity (∞ ohms) as the measurement parameter values are translated from reflection coefficient measurements. However, the practical measurement range is defined in relation to accuracy and resolution both of which are reduced in the both low and high impedance regions. The practicable measurement range is therefore dependent on the accuracy requirements of the measurement purpose. Figure 3-4 shows each parameter measurement range in which sample values can be measured at accuracies better than $\pm 5\%$.

Because the reflection coefficient parameter measurement capability spans its entire range ($|\Gamma| = 0$ and $|\Gamma| = 1$) at almost constant accuracy at any test frequency, a reflection coefficient range graph is omitted.

3-21. MEASUREMENT RESOLUTION

3-22. In reflection coefficient ($|\Gamma|-\theta$, $\Gamma_x-\Gamma_y$) measurements, measurement display outputs are provided at a 4 digit constant resolution from 0.0000 to 1.0000 over the entire test frequency range. As other parameter values are calculated from the measured reflection coefficient values, the resolution for these parameter measurements depends on the number of significant digits developed in the parameter conversion calculation results. The significant digits of converted parameter values decrease as reflection coefficient values increase (near 1). The 4191A automatically changes the number of display digits to provide appropriate measurement readouts in conjunction with the resolution and measurement inaccuracy. Additionally, to facilitate reading the significance of the display outputs, the 4191A differentiates between the lesser significant digits displayed and the more significant digit display outputs (see note below).

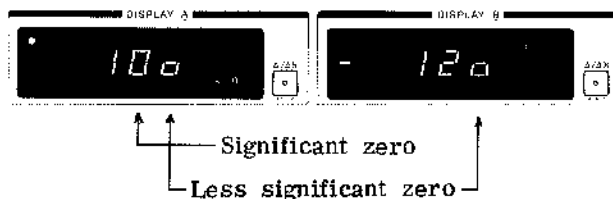

(Less significant digit data identifies the meaningless numbers related to the uncertainty of the measurement result.)

Note: Numeric segments of lesser significant display digits indicate zero figures. The lesser significant digit data (zero) are represented by small zeroes (o) figure to differentiate them from significant figures which are represented by large zeroes (O).

When a high impedance sample is measured, the measurement readout displays, other than for reflection coefficients, will skip some numbers owing to the change in significant digits. For example, an impedance value of sample which is somewhat greater than 150 k Ω is displayed as either 150 k Ω or 200k Ω (the values 160, 170, 180, and 190k Ω are not displayed). This skip in readout display also occurs when a measurement is taken for high dissipation factor or high quality factor values.

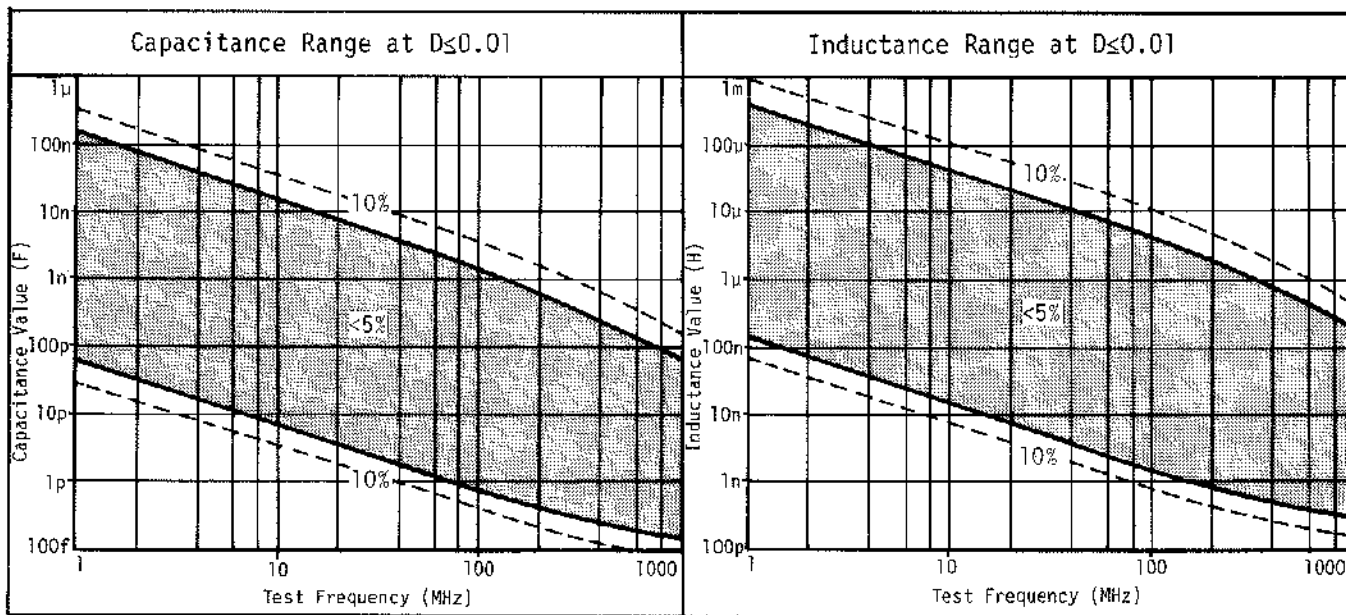

Figure 3-4. Measurement Ranges (Sheet 1 of 2).

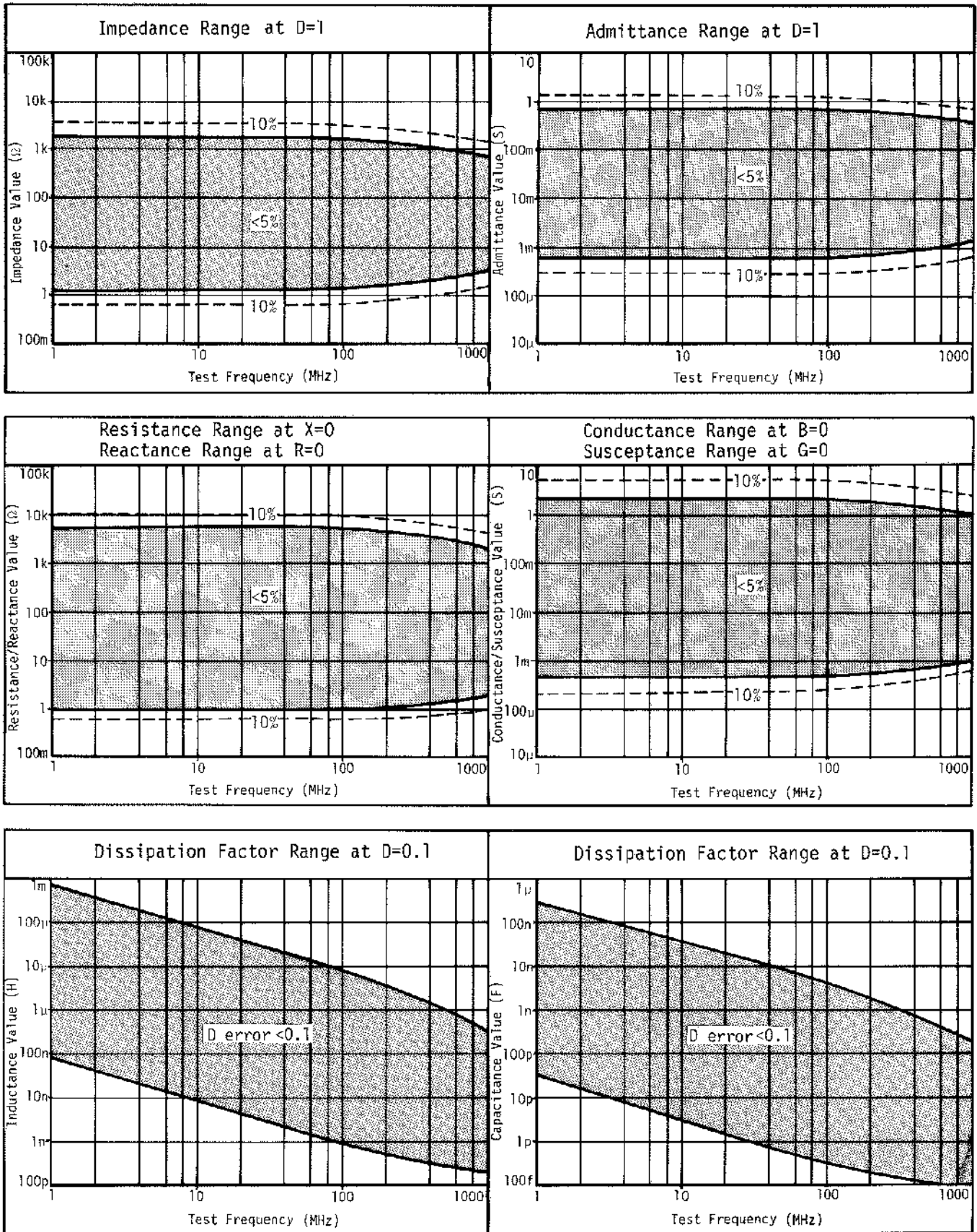

Figure 3-4. Measurement Ranges (Sheet 2 of 2).

3-23. CIRCUIT MODE

3-24. An impedance element can be represented by a simple equivalent circuit comprised of resistive and reactive elements each connected in series with or in parallel with the other. This representation is possible by either of the equivalents (series or parallel) because both have identical impedances at the selected measurement frequency by properly establishing the values of the equivalent circuit elements.

The 4191A employs an equivalent measurement circuit which is predetermined for each of the selectable combinations for both DISPLAY A and DISPLAY B measurement parameters. The display outputs are given as the resistive and reactive element values in the equivalent circuit for each measurement parameter set as shown in Table 3-2.

Parameter values for a component measured in a parallel equivalent circuit and that measured in a series equivalent circuit are different from each other. The difference in measured values is related to the loss factor of the sample to be measured. If no series resistance or parallel conductance is present, the two equivalent circuits are identical.

However, the sample value measured in a parallel measurement circuit can be correlated with that of a series circuit by a simple conversion formula which considers the effect of dissipation factor. See Table 3-3. The dissipation factor of a component always has the same value at a given frequency for both parallel and series equivalents.

Table 3-2. Measurement Circuit Mode.

DISPLAY A	DISPLAY B	Circuit Mode
R	X	
G	B	
L	G	
	R, D, Q	
C	R	
	G, D, Q	

Note: Impedance, admittance, reflection coefficient and phase angle values are identical for both the series and parallel equivalent circuit representations. Such equivalents are thus omitted.

Table 3-3. Parallel-Series Equivalent Circuit Conversion.

$$\frac{R_s}{R_s^2 + X_s^2} = G$$

$$-j \frac{X_s}{R_s^2 + X_s^2} = jB$$

$$Y_p = \frac{1}{Z_p} = G + jB$$

$$Z_s = R_s + jX_s$$

$$(D_s = R_s/X_s) \quad (D_p = G/B = R_s/X_s)$$

When the conditions for the above equations are satisfied, the parallel and series circuits have equal impedance (at a particular frequency point). Note that the dissipation factor is the same in both equivalent circuit representations.

Dissipation Factor Equations.

Circuit Mode	Dissipation Factor	Conversion to other modes
C	 $D = \frac{1}{2\pi f C_p R_p} = \frac{1}{Q}$	$C_s = (1 + D^2) C_p$ $R_s = \frac{D^2}{1 + D^2} R_p$
	 $D = 2\pi f C_s R_s = \frac{1}{Q}$	$C_p = \frac{1}{1 + D^2} C_s$ $R_p = \frac{1 + D^2}{D^2} R_s$
L	 $D = \frac{2\pi f L_p}{R_p} = \frac{1}{Q}$	$L_s = \frac{1}{1 + D^2} L_p$ $R_s = \frac{D^2}{1 + D^2} R_p$
	 $D = \frac{R_s}{2\pi f L_s} = \frac{1}{Q}$	$L_p = (1 + D^2) L_s$ $R_p = \frac{1 + D^2}{D^2} R_s$

THE 4191A MEASUREMENT PRINCIPLES

RF impedance measuring techniques necessitate a distinctly different architecture from the design techniques popularly used in the circuitry and mechanical composition of a low frequency (kilohertz region) LCR measuring instrument; (these include considerations for such elements as the test cables, the auto-balancing bridge circuit and other critical design areas).

Residual impedances, phase shift, propagation losses and other unwanted effects incident to "lumped constant measuring circuit" configurations are indeterminable factors in rf vector measurements. These effects increase with test frequency causing unacceptable, significant measurement errors to occur and narrow the practicable measurement and frequency ranges.

Thus, a vector measurement in the rf region is more conveniently handled by a "distributed constant measuring circuit" arrangement. Its advantage is that an equality in characteristics of the circuit over a broad frequency range can be realized; and, consequently, that the vector test signal detected can be exactly represented by a simple mathematic form with respect to the measuring circuit.

Instead of the usual vector-voltage-current-ratio measurement method (useable at low frequencies), the reflection and/or transmission coefficient parameter values are measured to obtain the desired characteristics of the sample.

The 4191A applies a measurement frequency test signal to the sample which is terminated at the test port and detects the vector-voltage-ratio of the reflected wave to the incident wave from/to the sample to measure the reflection coefficient. The reflection coefficient Γ is defined as:

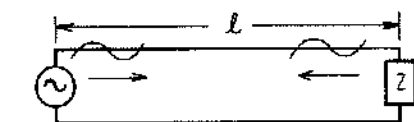

$$\Gamma = \frac{V_{ref}}{V_{inc}} = \Gamma_x + j\Gamma_y$$

$$= |\Gamma| (\cos \theta + j \sin \theta) = |\Gamma| \angle \theta$$

Where, V_{ref} is voltage of the reflected wave.
 V_{inc} is voltage of the incident wave.

As the phases of both the incident and reflected waves differ at each point on the test signal propagation line (measuring circuit), the reflection coefficient is a function of the propagation line length. The reflection coefficient measured at distance l from the termination point is represented as:

$$\Gamma_l = \Gamma e^{-2j\beta l} \quad (\beta = \frac{2\pi}{\lambda} = \frac{\omega}{c})$$

Where, λ is wave length of the test signal in the propagation line.

Γ is reflection coefficient value when $l = 0$.

Note: Attenuation coefficient of the test signal propagation line is neglected in this discussion.

In practice, the measuring point where the reference terminations are connected for auto-calibration (normally the UNKNOWN connector contact surface) is taken as the reference of the line length l .

Therefore the l value corresponds to the propagation line length between the test port and the contact point of the sample to be tested. The l value of the particular test fixture used is provided as the electrical length value in the performance characteristics data and is entered at the keyboard before taking measurements.

All measurement results automatically compensate for the electrical length effect of the test fixture using correction calculations based on the above equation.

The reflection coefficient value and the impedance value of the sample is interrelated, each with the other, by the following formulas:

$$\Gamma = \frac{Z_r - 1}{Z_r + 1}$$

$$Z_r = \frac{1 + \Gamma}{1 - \Gamma}$$

Where, Z_r is normalized impedance of the sample defined as: $Z_r = Z_x/Z_0$

The base impedance Z_0 is identical with the characteristic impedance of the test port, that is, 50Ω .

The impedance value of the sample can therefore be derived as:

$$Z_x = Z_0 \frac{1 + \Gamma}{1 - \Gamma} (\Omega)$$

$$= |Z| (\cos \theta + j \sin \theta) = |Z| \angle \theta$$

$$= R + jX$$

Resistance (R) and reactance (X) sample values are derived as:

$$R = Z_0 \frac{1 - \Gamma_x^2 - \Gamma_y^2}{(1 - \Gamma_x)^2 + \Gamma_y^2}$$

$$X = Z_0 \frac{2\Gamma_y}{(1 - \Gamma_x)^2 + \Gamma_y^2}$$

Other measurement parameter values are calculated from the resistive and/or reactive component(s) of the impedance value.

Measurement Parameter Relationships

Vector impedance and vector reflection coefficient values are represented in orthogonal or polar coordinates as follows:

$$\Gamma = \Gamma_x + j\Gamma_y = |\Gamma| (\cos \phi + j \sin \phi)$$

$$= |\Gamma| \angle \phi \quad |\Gamma| = \sqrt{\Gamma_x^2 + \Gamma_y^2}$$

$$Z = R + jX = |Z| (\cos \theta + j \sin \theta)$$

$$= |Z| \angle \theta \quad |Z| = \sqrt{R^2 + X^2}$$

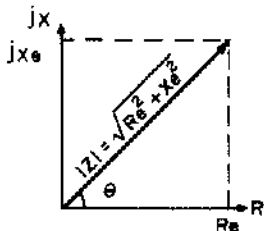

Measured reflection coefficient values and impedance values are correlated by the following equations:

$$\Gamma = \frac{Z_x - Z_0}{Z_x + Z_0} \quad Z_x = Z_0 \frac{1 + \Gamma}{1 - \Gamma}$$

Where, Z_x is impedance value of sample.
 Z_0 is characteristic impedance of the measurement circuit.

Because 4191A measurement circuit impedance is 50Ω , the above equations can be represented as:

$$\Gamma = \frac{Z_x - 50}{Z_x + 50} = \frac{Z_r - 1}{Z_r + 1}$$

$$Z_x = 50 \cdot \frac{1 + \Gamma}{1 - \Gamma}$$

Where, Z_r (normalized impedance) is given as:

$$Z_r = Z_x/Z_0 = Z_x/50 = \frac{R}{50} + \frac{jX}{50} = R_r + jX_r$$





$$\Gamma_x = \frac{R_r^2 + X_r^2 - 1}{(R_r + 1)^2 + X_r^2} \quad \Gamma_y = \frac{2X_r}{(R_r + 1)^2 + X_r^2}$$





$$R = 50 \frac{1 - \Gamma_x^2 - \Gamma_y^2}{(1 - \Gamma_x)^2 + \Gamma_y^2} \quad X = 50 \frac{2\Gamma_y}{(1 - \Gamma_x)^2 + \Gamma_y^2}$$

Other measurement parameter values are correlated with the resistance and reactance values by the equations tabulated below:

DISPLAY A Parameters		DISPLAY B Parameters	
$ Z $	$\sqrt{R^2 + X^2}$	θ	$\tan^{-1} \frac{X}{R}$
$ Y $	$\frac{1}{\sqrt{R^2 + X^2}}$	θ	$\tan^{-1} \frac{X}{R} \left(= \tan^{-1} \frac{B}{G} \right)$
G	$\frac{R}{R^2 + X^2}$	B	$\frac{X}{R^2 + X^2}$
L	$\frac{R^2 + X^2}{2\pi fX} \left(= \frac{1}{2\pi fB} \right)$	G	$\frac{R}{R^2 + X^2}$
		R	R
C	$\frac{X}{2\pi f(R^2 + X^2)} \left(= \frac{B}{2\pi f} \right)$	D, Q	$\frac{R}{X} \left(= \frac{1}{Q} \right)$
		R	R
		G	$\frac{R}{R^2 + X^2}$
D, Q	$\frac{R}{X} \left(= \frac{1}{Q} \right)$		

Table 3-4. Parameter Conversion Formulas

Sample	DISPLAY A parameters					
	Z	Y	R	G	L	C
	$\sqrt{\frac{1}{\omega^2 C^2} + R^2}$	$\frac{\omega C}{\sqrt{1 + \omega^2 C^2 R^2}}$	R	$\frac{\omega^2 C^2 R}{1 + \omega^2 C^2 R^2}$	—	C*
	$\frac{1}{\sqrt{\omega^2 C^2 + G^2}}$	$\sqrt{\omega^2 C^2 + G^2}$	$\frac{G}{G^2 + \omega^2 C^2}$	G	—	C*
	$\sqrt{\omega^2 L^2 + R^2}$	$\frac{1}{\sqrt{\omega^2 L^2 + R^2}}$	R	$\frac{R}{R^2 + \omega^2 L^2}$	L*	—
	$\frac{\omega L}{\sqrt{1 + \omega^2 L^2 G^2}}$	$\sqrt{\frac{1}{\omega^2 L^2} + G^2}$	$\frac{\omega^2 L^2 G}{1 + \omega^2 L^2 G^2}$	G	L*	—

Sample	DISPLAY B parameters					
	θ	X	B	R	G	D (1/Q)
	$-\tan^{-1} \frac{1}{\omega CR}$	$-\frac{1}{\omega C}$	$\frac{\omega C}{1 + \omega^2 C^2 R^2}$	R	$\frac{\omega^2 C^2 R}{1 + \omega^2 C^2 R^2}$	ωCR
	$-\tan^{-1} \frac{\omega C}{G}$	$-\frac{\omega C}{G^2 + \omega^2 C^2}$	ωC	$\frac{G}{G^2 + \omega^2 C^2}$	G	$\frac{G}{\omega C}$
	$\tan^{-1} \frac{\omega L}{R}$	ωL	$-\frac{\omega L}{R^2 + \omega^2 L^2}$	R	$\frac{R}{R^2 + \omega^2 L^2}$	$\frac{R}{\omega L}$
	$\tan^{-1} \frac{1}{\omega LG}$	$\frac{\omega L}{1 + \omega^2 L^2 G^2}$	$-\frac{1}{\omega L}$	$\frac{\omega^2 L^2 G}{1 + \omega^2 L^2 G^2}$	G	ωLG

* Note: Measured value for measurement circuit mode is same as equivalent circuit of sample.

INITIAL MODE SETTINGS

Initial impedance analyzer operation begins with an automatic self diagnostic test which checks functional operation of the instrument when the instrument is turned on. This test is accomplished within 1 second. If any abnormality is detected in the diagnostic test period, an error message figure will appear in DISPLAY B and/or the sequential operation will not proceed to the next option annunciation display.

OPTION ANNUNCIATIONS

The instrument first displays the HP-IB address number to be used when interfacing with other HP-IB equipment. Simultaneously, installed option content is, if Option 002 and/or 004 is installed, displayed in the front panel display to let users know what option is available in the instrument. The HP-IB address number and option annunciation are respectively given in abbreviated code as illustrated below:

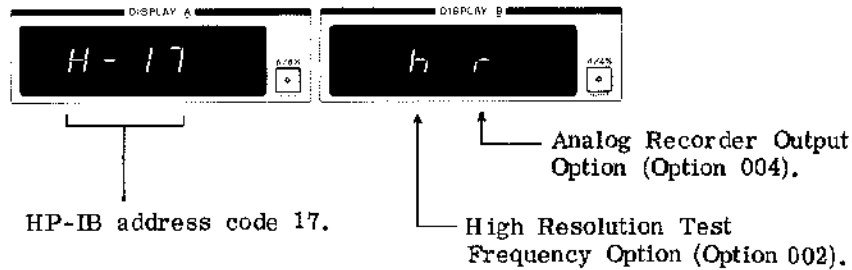

10 MINUTE WARM-UP

An internal timer delays instrument operation for the 10 minute warm-up time needed to stabilize the temperature controlled circuit block in the instrument. During the preparatory warm-up operation, the option annunciation figures are continuously displayed. If any panel control key is pressed before the 10 minutes warm-up time is complete, an error message figure (E-07) will appear in Test Parameter Data Display.

- Notes:
1. Perform a running warm-up of at least 40 minutes to settle instrument into its specified performance.
 2. If ac operating power is momentarily lost after warm-up, the measurement can be resumed by passing over the initial warm-up time. To omit the regular warm-up time, press any arbitrary panel control key (E-07 will be displayed), and again press a key. The instrument will proceed to its initial control settings.

Figure 3-5. Initial Mode Settings (Sheet 1 of 3).

INITIAL MODE SETTINGS**INITIAL CONTROL SETTINGS**

The 4191A front panel control key functions and test parameter data are automatically set as follows:

DISPLAY A function	Z
DISPLAY B function	θ (deg)
$\Delta/\Delta\%$ (DISPLAY A)	off
$\Delta/\Delta\%$ (DISPLAY B)	off
SPOT FREQ	1.0 MHz
STEP FREQ	1.0 MHz
START FREQ	1.0 MHz
STOP FREQ	1000.0 MHz
REF A	0Ω ($ Z $)
REF B	0 deg (θ)
ELEC LG	.00 cm
SELF TEST	off
HIGH SPEED	off
LOG SWEEP	off
TRIGGER	INT
RANGE HOLD	off
CALIBRATION	off
SPOT BIAS	0V
STEP BIAS	.01V
START BIAS	-40V
STOP BIAS	40V

INITIAL CALIBRATION

Calibration data for the entire 4191A frequency range (1MHz to 1000 MHz) is present in the instrument's continuous memory (when the instrument is shipped from factory). Accordingly, the instrument can usually begin taking measurements using these initial control settings. Thus, the impedance value of a sample can be measured by merely connecting the sample (using an appropriate test fixture) at the memorized 1 MHz test frequency.

If a CAL annunciation figure appears in DISPLAY A and/or DISPLAY B, such display indicates that the instrument is in either of the following states:

1. Auto-calibration data memorized by instrument is for a defined frequency range which does not include the spot frequency (1 MHz). That is, the spot frequency is out of the calibrated (and memorized) frequency range.
2. Calibration data has been lost (owing to incomplete calibration or because memory backup battery is exhausted).

Figure 3-5. Initial Mode Settings (Sheet 2 of 3).

INITIAL MODE SETTINGS

REQUIRED OPERATION

Set the upper limit frequency number of the desired test frequency range with the DATA input keys and, next, press ENTER key.

(Example) Upper limit frequency = 100 MHz

Key strokes:

Note: If PARAMETER SPOT FREQ/BIAS key indicator lamp is not lighted, first press this key.

Check whether the CAL annunciation display occurs or not. Next, set the lower limit test frequency number in like manner.

If CAL annunciation is displayed when either the upper or lower frequency limit is set, the instrument must be recalibrated to cover a frequency range which includes the desired test frequencies. The auto-calibration procedure is described in the paragraph which follows.

Note

For optimum calibration accuracy, it is recommended that the instrument be calibrated at the specific frequency range used rather than for the full range.

Figure 3-5. Initial Mode Settings (Sheet 3 of 3).

INITIAL AUTO-CALIBRATION

GENERAL

To optimize measurements, the 4191A must initially have memorized automatic calibration data for the entire test frequency range to be used before beginning measurements. By pressing CALIBRATION key, the 4191A goes into its automatic calibration operating mode. Through the calibration routine, trial measurements with definitive reference terminations* (0Ω , $0S$ and 50Ω) are made to calculate the correction factors based on measurement deviation results from the reference values. The 4191A memorizes its own calibration data and applies appropriate corrections to all measurements. The instrument's intelligent microprocessor capabilities do the memorization and produce the necessary sophisticated correction computations at high speed for each measurement. Consequently, any constitutional errors, particular to the instrument, are eliminated from any subsequent measurement results almost to the level of the inaccuracies inherent in the reference terminations.

**Note: The reference terminations are supplied accessories (HP part numbers are 04191-85300 for 0Ω , 04191-85301 for 50Ω , and 04191-85302 for $0S$ termination).*

Note: The 0Ω , $0S$ and 50Ω reference termination devices provide references for exact $\Gamma = 1L\pi$, $1L0$ and 0 reflection coefficient representations, respectively. On a Smith Chart plane, these reference points represent the intersections on the circumference of the $|\Gamma| = 1$ circle, the R axis ($x = 0$), and the center of the chart. Auto-calibration optimizes measurements using these references so that measured values are exactly coordinated with the proper points on the chart. The virtual (supposed) coordinated system of the instrument, related to measurements, is compensated for any possible distortion and, consequently, any measurement parameter value can be represented correctly by the optimized coordinate.

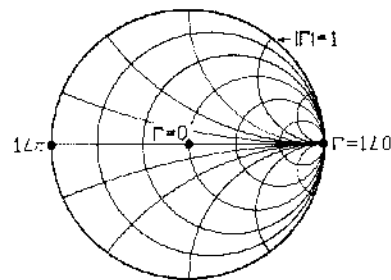

Calibration Points on Smith Chart

ACCURACY AND TRACEABILITY

The above discussion emphasizes that the 4191A measurement accuracy substantially depends on the accuracies of the standard terminations used. In practice, the comprehensive accuracies of the standards is dominant in both actual and specified measurement accuracies of the instrument. Thus, the measurement accuracy is further enhanced if high quality terminations, that is, more idealistic reference terminations which embody high standard impedance accuracies, are available and used.

As a result of the preparatory calibrations with the use of standards whose values are certifiable by national standard/calibration entities, definite traceability for the 4191A to NBS, NRC or other, equivalent, standards groups is provided.

INITIAL AUTO-CALIBRATION

CALIBRATION PROCEDURE

Auto-calibration of the 4191A instrument is performed by using reference terminations under automatic settings of the measurement parameter (reflection coefficient) and of the test frequency as it sweeps the programmed frequency range. This paragraph firstly describes the basic calibration procedure for calibrating the instrument over its entire test frequency range and, secondly, describes selective calibration (for a defined frequency range):

1. Depress LINE button to turn instrument on.
After the 10 minute warm-up time is fulfilled, the instrument controls are automatically set (initial control settings).
2. Press CALIBRATION key (key lamp lights).
Instrument controls are automatically set as follows:

DISPLAY A and DISPLAY B R-X
 CALIBRATION on
 Start frequency 1.0 MHz
 Stop frequency 1000.0 MHz
 TRIGGER INT

(Measurement parameters are now, in actuality, set to an $\Gamma_x - \Gamma_y$ measurement.)

The indicator lamps for the above functions (except for start and stop frequencies) and SPOT FREQ/BIAS key lamp light. Concurrently, "Conn" "0 Ω " figures appear in the displays to indicate that the 0 Ω reference termination should be connected to UNKNOWN connector, as illustrated below:



Note

The above "Conn 0 Ω " annunciation figure does not appear when complete calibration data, used in previous measurements, has been memorized. Also, the "Conn 0S" and "Conn 50 Ω " annunciation figures (steps 7 and 11) are not displayed.

0 Ω CALIBRATION

3. Rotate UNKNOWN connector coupling nut clockwise until the coupling sleeve screw fully protrudes.

Caution: Do not touch the terminal contact surface with fingers (to maintain optimum electrical contact).

4. Carefully couple the 0 Ω termination to the UNKNOWN connector so that each is face-to-face with the other.

Caution: Carefully handle the termination so as not to impair its precision contact surface.

INITIAL AUTO-CALIBRATION

5. Rotate the 0Ω termination cap nut clockwise until it is firm (termination is mated with the UNKNOWN connector).
6. Press CALIBRATION START button.
 Test frequency display succeedingly changes in a higher frequency direction in the order of the programmed 51 spot frequencies (which are automatically predetermined in regular *20MHz frequency intervals to 1000MHz). Measurement data taken for the 0Ω termination is simultaneously displayed as illustrated below:



After an interval of approximately 50 seconds, the 0Ω calibration ends at 1000.0MHz test frequency.

**Note: 19.98MHz for option 002 units.*

0S CALIBRATION

7. “Conn” “0S” figures appear in the displays to indicate that the 0S standard termination should be connected to UNKNOWN connector, as illustrated below:



Measurement parameter indication changes as follows:

DISPLAY A and DISPLAY B G-B

8. Rotate the 0Ω termination cap nut counter-clockwise and remove the 0Ω termination.
9. Carefully couple the 0S reference termination to the UNKNOWN connector and rotate the termination cap nut clockwise until it firmly mates with the connector.
10. Press CALIBRATION START button.
 Test frequency display is reset to 1MHz and restarts (succeedingly shifting in the higher frequency direction). Measurement data (Γx and Γy values) for the 0S termination is displayed similar to that for 0Ω calibration. The 0S calibration ends at the 1000.0 MHz test frequency approximately 50 seconds from the start.

50Ω CALIBRATION

11. “Conn” “50Ω” figures appear in the displays to indicate that the 50Ω reference termination should be connected to UNKNOWN connector, as illustrated below:



Measurement parameter indication changes as follows:

DISPLAY A and DISPLAY B Γx-Γy

INITIAL AUTO-CALIBRATION

12. Rotate the 0S termination cap nut counter-clockwise and remove the termination.
13. Rotate 50Ω reference termination coupling nut counter-clockwise (as viewed from contact side) until the coupling sleeve screw is at its innermost free position.
14. Carefully couple the 50Ω reference termination to the UNKNOWN connector and rotate the termination coupling nut clockwise until it firmly mates with the connector.
15. Press CALIBRATION START button.
Test frequency display is reset to 1MHz and restarts (succeedingly shifting to higher frequencies). Measurement data (Γ_x and Γ_y values) for the 50Ω termination is displayed similar to that for 0Ω and 0S calibrations. The 50Ω calibration ends after approximately 50 seconds. Concluding "CAL" "END" annunciation figures appear in the displays to indicate that the calibration is completed.
16. To release the calibration function, press CALIBRATION button. The instrument is automatically set to $|Z|-\theta$ (deg) measurement mode of operation.

Caution: After use, keep the termination coupling sleeve screw protruding to prevent the termination surface from possible impairment.

- Notes:*
1. If calibration can not be achieved for either 0Ω, 0S or 50Ω standard, "CAL END" annunciation display will not appear.
 2. Correction factors at frequencies other than at the calibration frequency points are automatically calculated using cubic interpolation approximations.
 3. Typical value of the UNKNOWN connector stray capacitance (0.082pF) is continuously memorized in the internal memory and is used for the correction factor calculations (with nothing connected to the UNKNOWN, the 4191A thus displays approximately 0.08pF).
 4. Electrical length input data has no effect on the calibration results.
 5. The measurement data displayed for the individual terminations are approximately equal to the values listed in the table below:

Termination	0Ω	0S	50Ω
DISPLAY A	-0.7 ~ -1.1	0.7 ~ 1.1	-0.1 ~ 0.1
DISPLAY B	-0.3 ~ 0.3	-0.3 ~ 0.3	-0.1 ~ 0.1

If a displayed value exceeds the normal value range, check the UNKNOWN connector and the termination connector surfaces for dirt.

Note

The calibration data is stored in the internal memory and retained by virtue of the battery memory backup capability (until new calibration data is taken and stored to update the previously memorized data).

INITIAL AUTO-CALIBRATION



SELECTIVE CALIBRATION

If a calibration fails to be achieved or if it is desired to calibrate in a particular test frequency range (using narrower calibration frequency step intervals), the calibration can be again performed with respect to the 0Ω, 0S or 50Ω reference impedance terminations (separately) or to the desired frequency range.

Note: If the CALIBRATION function is released before the calibration completed, the memory of memorized calibration data is lost and the instrument must be again calibrated for all reference terminations.



● **0Ω, 0S or 50Ω Calibration.**

When the instrument needs to be calibrated at the 0Ω reference impedance, perform the following procedures:

1. Connect the 0Ω reference termination to the UNKNOWN connector.
2. Set measurement parameter to R-X by pressing DISPLAY A parameter selector ( ) keys.
3. Press CALIBRATION START button.

0S and 50Ω calibration procedures are similar to the above 0Ω calibration procedures. Set measurement parameter to G-B or Γx-Γy in accord with the calibration setup procedures summarized in the tabulation below:

Individual Termination Calibration Setup Procedures.

Reference termination	Operating procedure		
	1	2	3
0Ω	Connect reference termination	Select R-X	Press 
0S		Select G-B	Press 
50Ω		Select Γx-Γy	Press 

● **Calibration on a defined frequency range.**

To define the calibration frequency range, set its bottom and top frequencies as the Start and Stop frequencies, respectively, in accord with the following procedure:

Setting upper limit frequency.

1. Press PARAMETER STOP FREQ/BIAS key.
2. Set the upper limit frequency number (in MHz) of the desired calibration frequency range with the DATA input keys. The frequency setting is displayed in Test Parameter Data display.
3. Press ENTER key.

INITIAL AUTO-CALIBRATIONSetting lower limit frequency.

1. Press PARAMETER START FREQ/BIAS key.
2. Set the lower limit frequency number (in MHz) of the desired calibration frequency range with the DATA input keys.
3. Press ENTER key.

Press CALIBRATION key to activate calibration function.

- Notes:*
1. Step frequency is automatically determined so as to total 50 steps (51 calibration frequency points) at regular frequency intervals from the start to stop frequencies (and can not be selected manually).
 2. When LOG SWEEP function is set (LOG SWEEP key is pressed after pressing Blue key), the calibration frequency points are taken at logarithmically regular frequency intervals.
 3. If measurement is attempted at a test frequency out of the defined calibration frequency range, a CAL (CALibration) annunciation figure appears in DISPLAY A or DISPLAY B.
 4. Setting the START and STOP frequencies to an identical value allows calibration in a shorter time for measurement at that particular SPOT frequency.
 5. When the calibration frequency range is narrower than 5 MHz (5 kHz for option 002), the number of calibration frequency points decreases, owing to the minimum selectable step frequency.

**DUT CONNECTION
- WITH 16091A**

The 16091A Coaxial Termination Fixture set offers a sample holding capability specifically suitable for making accurate measurements at high frequencies. Two types of fixtures are included in the fixture set to provide flexibility and wide adaptability to various sizes of samples.

Each fixture is coupled to the UNKNOWN test port with the sample device mounted in its inner cavity chamber. Owing to this unique construction, the sample to be tested can be measured immediately at the test port. This decreases, to a great extent, the residual parameters of the component leads and of the measuring circuits. Additionally, the complete shielding effect of the test fixture, a cavity chamber prevents measurement errors sometimes contributed by the free radiation of the test signal from the sample. This 16091A fixture, consequently, features high accuracy with a useable frequency range beyond 1000MHz.

The 16091A fixture set is suited to the measurement of lead-less material samples or small size, axial lead components whose leads can be shortened. The maximum dimensions of the sample which the test fixture can accommodate are shown in the tabulation below:

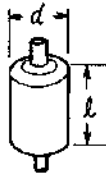
Sample	Fixture	Maximum dimensions	
	04191-85302	d	7 mm
	16091-60012	d	10 mm
		l	20 mm

Sample mounting procedure

- 1) Rotate the 4191A UNKNOWN connector coupling nut counter-clockwise until the coupling sleeve screw is at its innermost free position.
- 2) Attach the 16091A special coaxial coupling adapter to the UNKNOWN connector.

Caution:

Be sure to use the coupling adapter to protect the precision-built UNKNOWN connector from possible damage.

- 3) Set the test sample and the movable, skirted, electrode onto the coupling adapter as illustrated below:

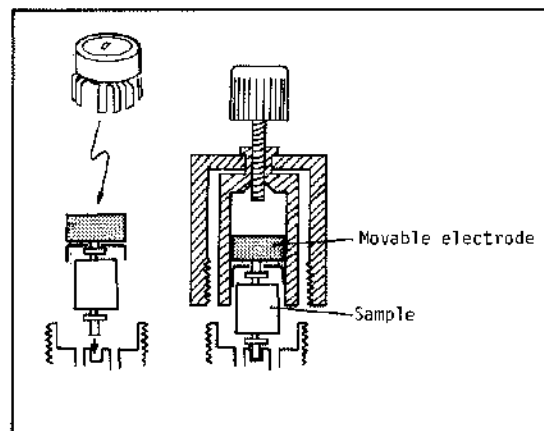

Figure 3-6. DUT Connection (Sheet 1 of 7).

DUT CONNECTION
— WITH 16091A

- 4) Carefully couple the coaxial fixture (housing the test sample) to the coupling adapter attached to the UNKNOWN connector. Rotate the coaxial fixture coupling nut clockwise until it is snug.
- 5) Insert the electrode adjustment screw into the head spindle of the coaxial fixture used (see illustration). Rotate the adjustment screw knob clockwise until the click stop knob begins to idle.

Notes:

1. To properly set test sample into the coaxial fixture chamber, solder miniature tubing (disposable part supplied) near the element on the sample leads. Cut off the excess portion of the leads. See illustration below:

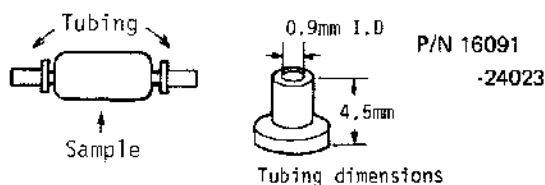

2. For lead-less chip components, solder tubing directly to the electrodes of the sample.

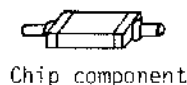

3. Set Electrical Length input data to 1.87 cm.
 4. To optimize measurement accuracy with respect to the 16091A test fixture, perform auto-calibration at the protective connection port of the coaxial adapter attached to the UNKNOWN.
- Set Electrical Length input data to 0.00 cm. (This calibration data is specific to the coaxial adapter of the 16091A used. Therefore, the instrument must be re-calibrated exclusive of the adapter when another type of test fixture is used).

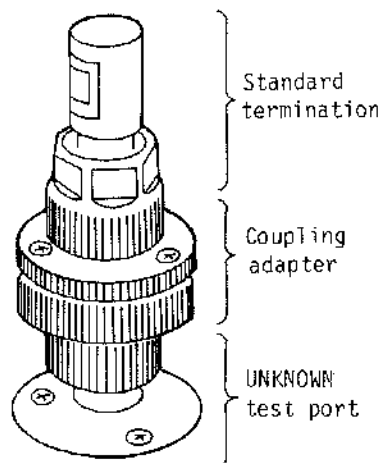

Model 16091A Residual Parameters

Stray C	Residual L	Residual R	Stray G
0.082pF	*0.0nH	*0mΩ	0μS

*When auto-calibration is performed at the protective connection port of the coaxial coupling adapter.

Model 16091 A accessories:

- Coupling adapter: P/N 16091-60010
- Latchet screw: P/N 16091-60011
- Movable electrodes: P/N 16091-60014 (10mm)
P/N 16091-60013 (7mm)
- Tubing: P/N 16091-60023 (200ea.)

Figure 3-6. DUT Connection (Sheet 2 of 7).

DUT CONNECTION
– WITH 16092A

The 16092A Spring Clip Test Fixture provides a convenient capability for easily connecting and disconnecting samples and has a broad useable frequency operating range up to 500 MHz. Two types of spring contact assemblies (furnished) permit selecting the fixture configuration appropriate to the shape of the sample. The slide clip contact assembly is designed specifically for holding lead-less chip components such as chip capacitors. The twin clip contact assembly is suited for measuring general radial lead components and axial short lead components. Its ground contact, which is slidable on the fixture deck, permits proper adjustment of the distance between sample lead contacts. The contact distance can be gauged with the 1 mm pitch scale on the deck (maximum measurable device dimension = 13 mm). Appropriate sample connection procedures are outlined below:

Chip components

- 1) Rotate the 4191A UNKNOWN connector coupling nut counter-clockwise until the coupling sleeve screw is at its innermost free position.
 - 2) Couple the connector coupling screw on the underside of the 16092A test fixture deck to the 4191A UNKNOWN connector, and set the test fixture mounting posts of the 4191A into the twin holes at the corners of the deck.
 - 3) Rotate the UNKNOWN connector coupling nut counter-clockwise until it is firm.
 - 4) Attach the slide clip contact assembly to the test fixture deck ((1), (2) or (3)) with the captive screws provided (see illustration below).
Use deck positioning holes appropriate to size of sample to be measured.
 - 5) Securely attach the contact assembly to the deck with the two captive knob screws.
 - 6) Pull spring slide contact back and clip in sample.
- Note: Set electrical length input data to 0.34 cm.*

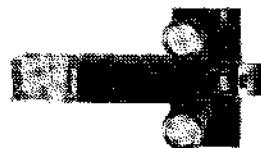
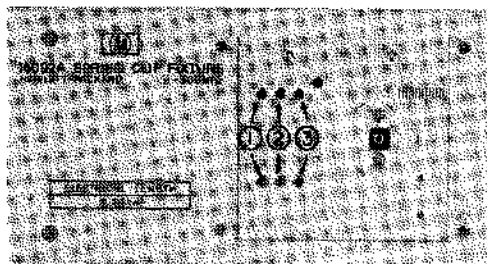

Slide clip contact assembly

Figure 3-6. DUT Connection (Sheet 3 of 7).

DUT CONNECTION
– WITH 16092A

Short lead radial and axial lead components

- 1) Perform steps 1, 2 and 3 of the above procedure to install the 16092A test fixture deck to the 4191A.
- 2) Attach single clip module of the twin clip contact assembly to the test fixture deck with its two retaining screws (screw into deck positioning holes (5) – see illustration).
- 3) Attach ground contact slide module of the twin clip contact assembly so that its slide guide mounts on the two guide posts (6) of the deck.

- 4) Fasten contact module on the deck with its knob screw and leave screw loose.
- 5) Set an appropriate contact distance and tighten contact module to deck with its knob screw.
- 6) Press spring clip lever down and clip in sample.

Note: Set electrical length input data to 0.34 cm.

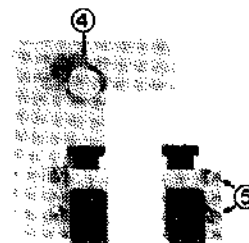
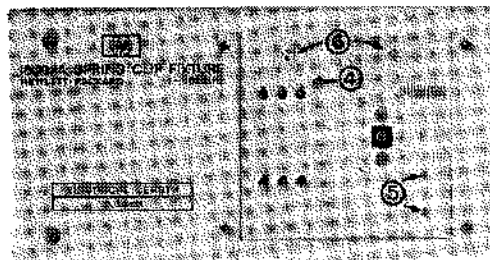

Twin clip contact assembly

Model 16092A Residual Parameters

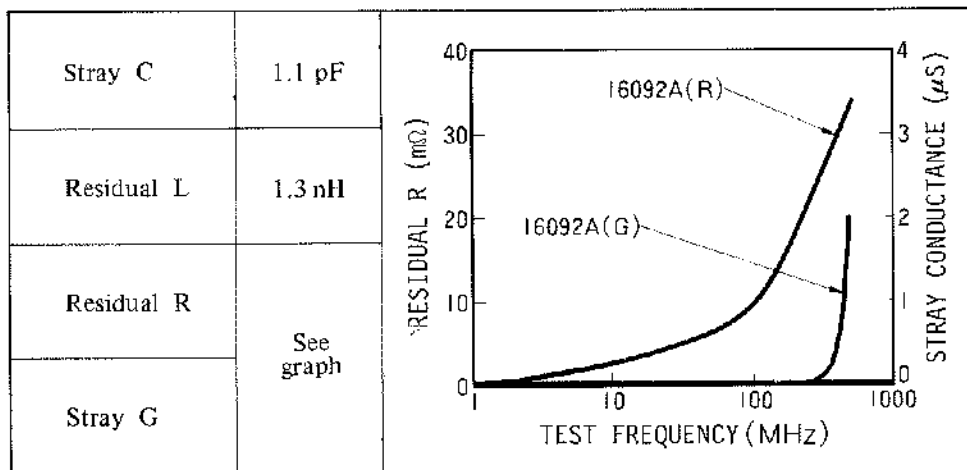
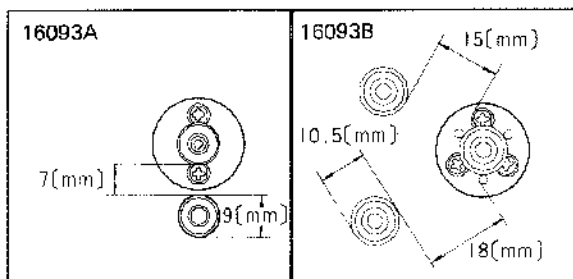

Figure 3-6. DUT Connection (Sheet 4 of 7).

DUT CONNECTION
- WITH 16093A/B

The 16093A/B Binding Post Test Fixtures are suited for the measurement of relatively large size, axial and radial lead components or devices which do not fit the 16091A or 16092A. The 16093A is provided with two small binding post measurement terminals set at 7 mm intervals on the terminal deck. These short post terminals afford the advantage of low stray capacitance with low stray conductance and, therefore, offer a broad, useable frequency operating range (up to 250 MHz). The 16093B employs a common type three binding post terminal arrangement which includes an extra guard post terminal. The measurement terminal interval is 15 mm (the terminal configuration is same as that of the current HP Q meter). The 16093B is suitable for the measurement of relatively high value capacitors, high value inductors and resistor samples at frequencies below 125 MHz.

Terminal Structures



Installation and DUT connection procedure:

- 1) Rotate the 4191A UNKNOWN connector coupling nut counter-clockwise until the coupling sleeve screw is at its innermost free position.
- 2) Couple the connector coupling screw on the underside of the 16093A (or 16093B) test fixture deck to the 4191A UNKNOWN connector, and set the test fixture mounting posts of the 4191A into the twin holes at the corners of the deck.
- 3) Rotate the UNKNOWN connector coupling nut counter-clockwise until it is firm.
- 4) Loosen binding post terminal nut and connect sample leads. Tighten the nut. For samples with banana plugs, plug the banana plugs into the binding post terminal holes.

Model 16093A/B Residual Parameters

	Stray C	Residual L	Residual R	Stray G
16093A	1.8 pF	1.8 nH	See graph below	
16093B	5.5 pF	1.4 nH		

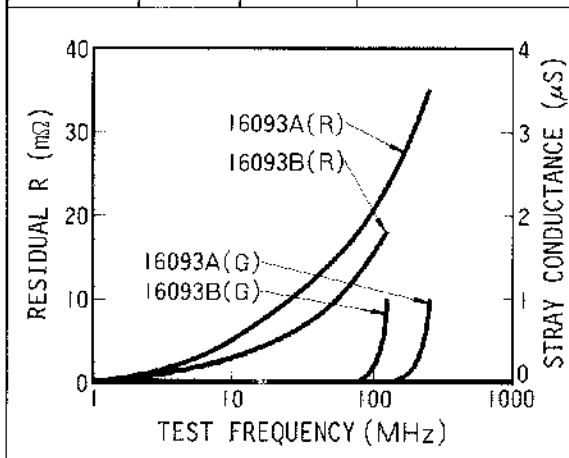

Notes:

1. Set electrical length input data to 0.34 cm (identical for both 16093A and 16093B).
2. A special, skirted, grounding terminator furnished with both the 16093A and B provides an optimum shorting configuration for test fixture terminals. For the use of these terminators, refer to paragraph 3-37.

Figure 3-6. DUT Connection (Sheet 5 of 7).

DUT CONNECTION

– WITH 16094A

The 16094A Probe Test Fixture provides probing capability for measuring circuit impedances and components mounted on circuit assemblies. The 16094A permits easy access to test point locations when it is attached to an appropriate test cable (connected to the 4191A test port). This probe fixture unit can be combined with a coaxial test cable or flexible air line which has an APC-7 connector. The probe needles (consisting of sense and ground terminals) permit setting to appropriate distances from 1mm (min.) to 15 mm (max.) for fitting dimensions of device/material to be measured. The 16094A is suitable for measurements at frequencies below 125 MHz.

Note: Use of a probe cable requires that the electrical length compensator of the instrument be adjusted to optimize measurement accuracy at that particular measurement configuration. Replace the normal electrical length compensator cable with a longer cable appropriate to the probe cable used. For the electrical length compensation adjustment method, refer to paragraph 3-44.

Installation and measurement setup procedure:

- 1) Build the electrical length compensator cable appropriate to the probe cable (or air line) used and install it in place of the normal compensator cable.
- 2) Rotate the UNKNOWN connector coupling nut clockwise until the coupling sleeve screw fully protrudes.
- 3) Couple the probe cable connector coupling nut to the 4191A UNKNOWN connector and rotate the coupling nut clockwise until it is snug
- 4) Connect reference termination at the tip of the probe cable and perform auto-calibration for each of the 0Ω , $0S$ and 50Ω termination impedances.
- 5) Disconnect reference termination and connect 16094A (at the tip of test cable).

Notes:

1. *Set electrical length input data to 2.32 cm.*
2. *A bent coaxial probe cable causes a slight change in its physical and electrical length from that in its straight form. This has a low order effect on the measured reflection coefficient phase angle and this effect increases at high frequencies. To maximize measurement accuracy, the auto-calibration should be performed with the cable shape (form) near that used in the actual measurement.*

Figure 3-6. DUT Connection (Sheet 6 of 7).

Model 16094A Residual Parameters

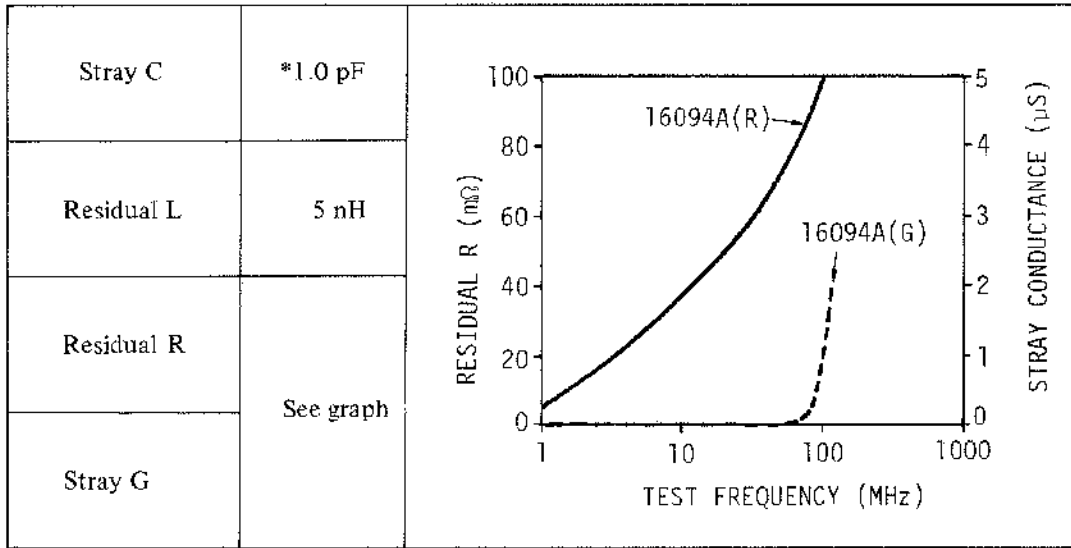

* Typical value when needles are set at a distance of 15 mm.

Note: The 16094A Probe Fixture causes, as do other general hand held probes, unavoidable change in contact resistance and stray admittance depending on the contact pressure applied and the tilt of the probe at the measurement object. Accordingly, consideration of exact residual parameter values is not practicable.

Associated accessory:

Coaxial cable with APC-7 connector (62 cm long): P/N 8120-2291
 Model 11605A Flexible Arm (maximum extendability 64.8 cm).

Figure 3-6. DUT Connection (Sheet 7 of 7).

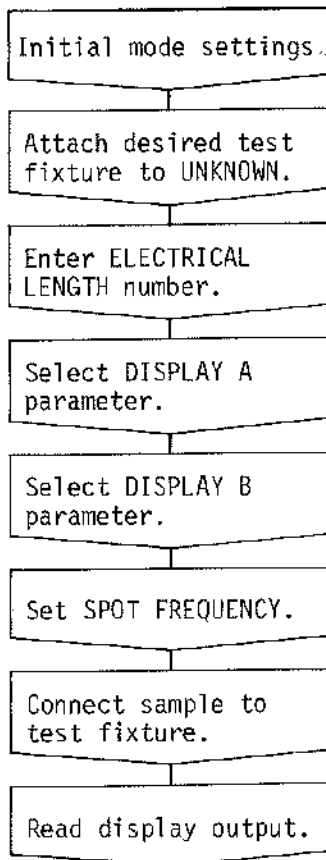

BASIC OPERATING PROCEDURE

Basic operating procedures for measuring general components and electronic materials at a desired frequency point are described in these paragraphs. Instructions and operating procedures for semiconductor measurements, deviation measurements, swept frequency applications, with external dc bias or with an external test signal source are provided in separate paragraphs, including information for the appropriate setup arrangement and the special care needed for making a reliable measurement.

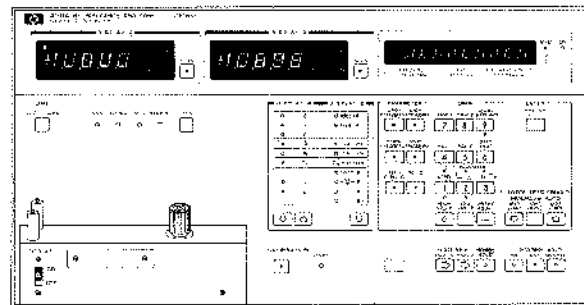

PROCEDURE

1. Press LINE button to turn instrument on. In accordance with instructions in "Initial Mode Settings" (Figure 3-5), prepare to take measurements with the 4191A. The preparatory operations include the following sequential operating procedures and prerequisite setups:
 - 1) Option annunciation
 - 2) 10 minute warm-up
 - 3) Initial control settings
 - 4) Initial calibration (as necessary)

2. If initial calibration is performed and is complete, release the calibration function by pressing CALIBRATION key (key lamp is extinguished).

Note: Test frequency (Spot frequency) stays at the frequency point where the calibration ended. Verify that trigger lamp continues flashing.

3. Attach a 16092A, 16093A or 16093B Test Fixture on the 4191A test fixture installation deck mounting posts with UNKNOWN connector. If the 16091A Coaxial Fixture is used, attach its special coaxial coupling adapter to UNKNOWN connector. Attachment and mounting procedures are described in Figure 3-6.

Figure 3-7. Basic Operating Procedure (Sheet 1 of 2).

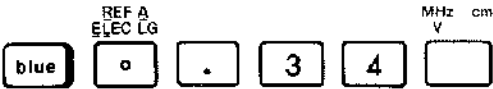

4. Press **Blue** key and then ELEC LG key to activate electrical length data input function. Enter the electrical length number particular for the installed test fixture through the DATA input keys, then press ENTER key.

(Example) Electrical length = 0.34 cm.

Key strokes 

An electrical length setting number of .34 will be displayed in Test Parameter Data Display.

Note: If an undesired number has been set by an inadvertent key stroke or if it is needed to change the input data, repeat the key stroke procedure using appropriate number value.

5. Select the desired DISPLAY A parameter by pushing  or  (up-down) key. Parameter indicator lamp lights on the selected parameter.
6. If necessary, select the desired DISPLAY B parameter (compatible with the DISPLAY A parameter selected in step 5) by pressing  key.
7. Press PARAMETER SPOT FREQ/BIAS key to activate test frequency setting function. Enter the desired test frequency number through the DATA input keys. Press ENTER key.

(Example) Test frequency 10.7 MHz.

Key strokes 

A test frequency setting of 10.7 will be displayed in Test Parameter Data Display.

Note: The test frequency can be set for 0.1MHz minimum step resolution in the standard unit and for 0.0001 MHz step resolution in option 002 units (0.2 MHz and 0.0002 MHz for frequencies above 500 MHz).

8. Connect the sample to be tested to Test Fixture.

Note: The appropriate sample holding method for each individual accessory test fixture is outlined in Figure 3-6.

Caution: Do not connect a charged capacitor as DUT or internal circuitry may be damaged.

9. The 4191A will automatically display measured values of unknown.

Notes:

1. If -OF- display occurs, the sample value exceeds measurement range limit of the selected measurement parameter. In such an occurrence, select another measurement parameter capable of being measured for the sample tested (the reflection coefficient or a reciprocal parameter, for example, $|Y|$ instead of $|Z|$ or D instead of Q).
2. If an error annunciation display occurs, try again to set the instrument using appropriate procedure. Annunciation display meanings are summarized in Table 3-6.
3. If it is desired to change test frequency, key in new frequency value with DATA input keys. If SPOT FREQ/BIAS key lamp is lit, this key need not be pressed.

Figure 3-7. Basic Operating Procedure (Sheet 2 of 2).

DEVIATION MEASUREMENT

When many components of similar value are to be tested, it is sometimes more practicable to measure the difference between the value of the sample and a predetermined reference value. Besides, when the measurement purpose is to observe sample values versus the variance of the sample per degree temperature, unit time or other test variables, a direct measurement of this difference makes examination much more meaningful and easier. The deviation measurement function permits such repetitive calculations of the difference between the reference and each individual sample and displays those results instead of the sample values. The 4191A can make a deviation measurement for either or both DISPLAY A and/or DISPLAY B parameter measurements. Reference value(s) can be taken from a measurement for a reference sample or from input data through the DATA keys.

PROCEDURE

1. Perform appropriate procedures to make a normal measurement for the sample(s) to be tested in accord with the Basic Operating Procedure (refer to Figure 3-7).

Setting reference value

2. Enter reference value(s) for DISPLAY A and/or DISPLAY B parameter deviation measurements using procedure A or B described below:

A: Reference sample data input.

- a. Connect the reference sample to Test Fixture and take one measurement of the sample.
- b. Press Blue key, then press STORE DSPL A/B key.

Key strokes

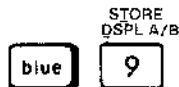

B: Reference value data input.

- a. Press REF A key to enable memorizing reference value for DISPLAY A parameter. If a deviation measurement is desired for a DISPLAY B parameter only, press REF B function key.

Note: When reference value data has not previously been memorized for the selected measurement parameter, an Err-06 annunciation figure will appear in Test Parameter Data Display. This error message display disappears simultaneously with the first DATA key stroke for entering a reference value.

- b. Set reference value number on the Test Parameter Data Display through the DATA input keys.
- c. Press ENTER key.

(Example) Reference value 20.5 (Ω).

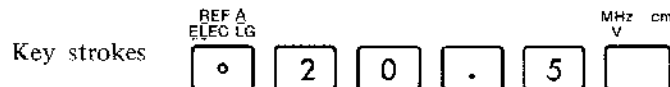

Figure 3-8. Deviation Measurement (Sheet 1 of 2).

- d. If necessary, set reference value number for DISPLAY B parameter similar to that for DISPLAY A.

Deviation mode selection

3. Activate $\Delta/\Delta\%$ function to make deviation or percent deviation measurement for the desired measurement parameter using procedure A or B described below:

A: Deviation measurement (Δ)

Press $\Delta/\Delta\%$ key located alongside either DISPLAY A or DISPLAY B (or press both keys) to initiate deviation measurement for the sample(s) to be tested.

The deviation calculation follows the equation below:

$$D = M - R$$

Where, D is deviation to be displayed.

M is measured value of the sample.

R is reference value.

B: Percent deviation measurement ($\Delta\%$)

Press **Blue** key, then press $\Delta/\Delta\%$ key located alongside either DISPLAY A or DISPLAY B (or press both keys).

The percent deviation calculation follows the equation below:

$$D = \frac{M - R}{R} \times 100 (\%)$$

Where, variables D, M and R are the same as those in procedure A above.

Release

4. To release the Δ or $\Delta\%$ function mode of operation, again press the delta key(s):

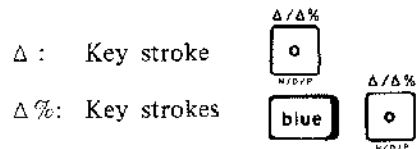

- Notes: 1. When the $\Delta/\Delta\%$ function key is pressed, the measurement range is automatically fixed (RANGE HOLD key lamp lights). The range hold function continues holding the range even after the deviation measurement function is released. To restore to auto ranging mode of operation, again press RANGE HOLD key.
2. The reference input data can be monitored on the Test Parameter Data Display by pressing REF A or REF B key.

Figure 3-8. Deviation Measurement (Sheet 2 of 2).

SWEPT FREQUENCY MEASUREMENT

A swept frequency measurement permits measuring sample values over a band of test frequencies and, in addition, offers other useful data which can be obtained only by an examination of the variations in sample values relative to its dependency on the measurement frequency. Some swept measurement advantages are, for example, that it provides significant clues in analyzing the properties of material, that it enables the detection of behavior peculiarities of samples and, that it facilitates the evaluation of quality or of the performance limits of devices. This paragraph describes the procedures for making a swept frequency measurement using the digital frequency sweep capability of the 4191A.

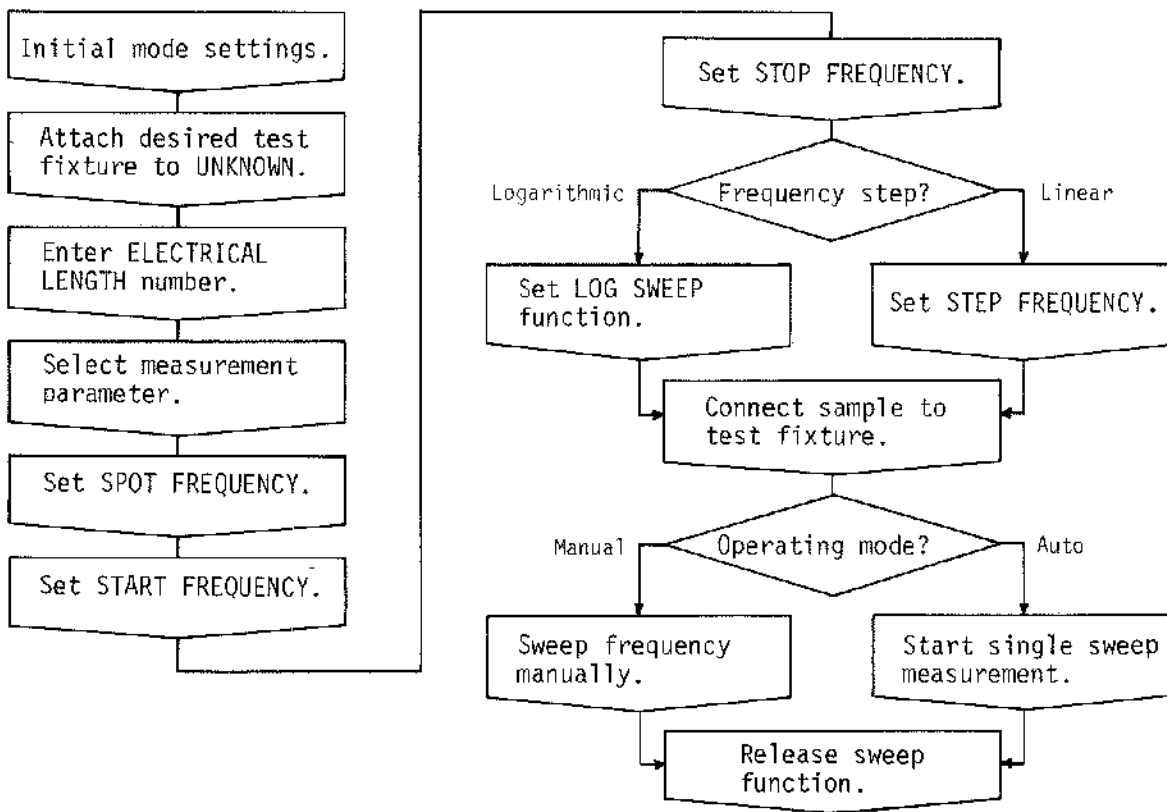

PROCEDURE

1. Press LINE button to turn instrument on.
2. In accordance with instructions in "Initial Mode Settings" (Figure 3-5), prepare to take measurements with the 4191A.
3. Set 4191A controls and do measurement setup according to Basic Operating Procedures (Figure 3-7) steps 3 through 7.

Figure 3-9. Auto-sweep Frequency Measurement (Sheet 1 of 5).

START FREQUENCY

4. Press PARAMETER START FREQ/BIAS key.
Set the lowest (bottom) frequency number of the desired sweep frequency range with DATA input keys. Press ENTER key.

(Example) Start frequency = 5.0MHz



A start frequency setting of 5.0 is displayed in Test Parameter Data Display.

Note: All sweep frequency parameter values can be set with 0.1MHz minimum step resolution in the standard unit and with 0.0001MHz step resolution in Option 002 units.

STOP FREQUENCY

5. Press PARAMETER STOP FREQ/BIAS key.
Set the highest (top) frequency number of the desired sweep frequency range with DATA input keys. Press ENTER key.

(Example) Stop frequency = 600.0MHz

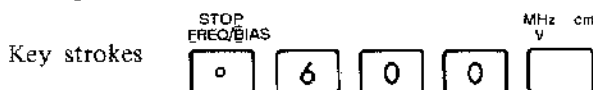

A stop frequency setting of 600.0 is displayed in Test Parameter Data Display.

STEP FREQUENCY

6. Perform procedure a or b depending on the desired sweep mode.

– LINEAR SWEEP –

- a. Press PARAMETER STEP FREQ/BIAS key.
Set the desired step interval frequency number with DATA input keys.
Press ENTER key.

Note: Measurement is taken, in turn, at the frequency points arranged at the regular step frequency intervals while the swept frequency measurement proceeds.

(Example) Step frequency = 2.5 MHz

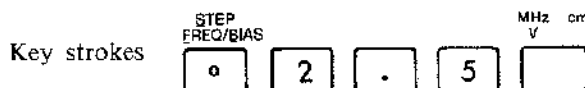

A step frequency setting of 2.5 is displayed in Test Parameter Data Display.

Figure 3-9. Auto-sweep Frequency Measurement (Sheet 2 of 5).

Note: When step frequency setting is 0.1MHz (100 Hz in Option 002 unit), the test frequency is swept in 0.2MHz (200Hz) step intervals at frequencies above 500MHz (because maximum frequency resolution qualifies the useable step frequency).

— LOGARITHMIC SWEEP —

- b. PRESS **Blue** key to actuate the blue label function. Next press LOG SWEEP key (DATA input decimal point key). An indicator lamp above the key lights.

Key strokes **blue** 

Note: Logarithmically swept frequency measurements are taken at a total of 51 frequency points which are automatically selected at logarithmically regular frequency intervals in the start and stop setting frequency range (STEP FREQ function is deactivated).

CORRECTION OF FREQUENCY SETTING

If an undesired frequency number has been set by an inadvertent key strokes or if it is needed to change a preset frequency, repeat the procedure for entering start, stop or step frequencies (steps 4, 5, or 6) using correct frequency number. Logarithmic sweep mode of function can be released by again pressing the **Blue** key and LOG SWEEP key.

Note: If either the start, stop or step frequency input number exceeds the selectable frequency range limits, an error annunciation figure appears in Test Parameter Data Display and the inappropriate control input demand is automatically released.

- 7. Connect the sample to be tested to Test Fixture.

MANUAL or AUTOMATIC SWEEP

— (MANUAL SWEEP) —









- 8. Press SWEEP FREQ/BIAS STEP  or  key to initiate measurement. Pressing and holding the STEP  or  key advances the sweep frequency measurement to a higher or lower frequency direction (from the programmed spot frequency), respectively. If the spot frequency is outside the programmed sweep range, E-04 annunciation is displayed. The test frequency can also be shifted in step frequency intervals each time the key is pushed. A reverse direction sweep is also feasible.



Figure 3-9. Auto-sweep Frequency Measurement (Sheet 3 of 5).

Note: When FAST key is pressed simultaneously with the STEP  or  key, the step frequency interval is expanded to ten times its programmed value in linear sweep mode or to one-fifth the frequency points in logarithmic sweep mode.

– (AUTO SWEEP) –

9. Press  key, then press SWEEP FREQ/BIAS  or  key to initiate an automatic sweep frequency measurement.

Key strokes   or  





AUTO sweep indicator lamp above the  key lights simultaneously and stays lit while the auto sweep mode of function is being set. Pressing  key starts a single sweep frequency measurement from the programmed start frequency (bottom frequency) in the higher frequency direction. The frequency sweep ends at the stop frequency point (top frequency of the sweep range).

Pressing  key advances frequency sweep in the reverse direction (from the top frequency towards a lower frequency).

Note: RANGE HOLD function is automatically set.



Swept test frequency is displayed in the test parameter data display.

SWEEP PAUSE

If it is needed to temporarily stop the swept frequency measurement at the desired frequency step point, press  key, then press PAUSE key. To restart the measurements, again press  or  key after pressing  key.

The test frequency is successively swept.

Note: Sweep parameter value and sweep mode settings (linear, logarithmic, auto or manual) can be changed when the PAUSE function is set.

Pressing  or  key sweeps frequency manually ("AUTO" sweep indicator lamp stays lit until SWEEP ABORT key is pressed or until the frequency reaches start or stop frequency point).

While automatic sweep advances, panel control keys except for SWEEP FREQ/BIAS and SWEEP ABORT keys are deactivated.

Figure 3-9. Auto-sweep Frequency Measurement (Sheet 4 of 5).

SWEEP ABORT

Auto-sweep frequency measurement of operation is automatically released when a single swept measurement ends. To release the swept frequency mode of operation before the measurement is complete, press **Blue** key, then press SWEEP ABORT key.

Key strokes: **blue** 

Note: SPOT frequency is automatically set to the frequency point where the swept frequency measurement function is released.

Figure 3-9. Auto-sweep Frequency Measurement (Sheet 5 of 5).

CONTINUOUS MEMORIZATION OF CONTROL SETTINGS (SAVE FUNCTION)

The 4191A's continuous memory capability permits retaining the memory of desired instrument control settings. Front panel control settings which are especially used for a particular application or are frequently used can be memorized by the instrument for repeated use of the same settings. Stored memory data for the control settings are continuously held in event the instrument loses its operating power.

Note: Auto-calibration data prerequisite to measurements, test parameter values for sweep measurements and reference values in deviation measurements are also stored in the continuous memory.

The memorized control settings and test parameter input data can, at anytime, be again set into the instrument as its actual settings by merely pressing two control keys. Two pairs of SAVE and RCL functions allow one or two kinds of such specific settings to be independently memorized and restored. For storing the desired settings in the memory, proceed as follows:

- 1) Set front panel controls and test parameter input data as appropriate for making the desired measurement.
- 2) Press **Blue** key and, next, press SAVE 1 or SAVE 2 key. The instrument has now memorized this particular set of control settings.

- 3) To restore the memorized control settings in place of temporary setting, press **Blue** key and, next, press RCL 1 or RCL 2 key (to actuate memory of SAVE 1 or SAVE 2 function, respectively).

Note: Auto-calibration data is automatically stored in the memory in place of the preceding calibration data each time the calibration is newly implemented (irrespective of the SAVE function).

STAND-BY BATTERY

Rechargeable stand-by batteries provide long term memory protection. The installed batteries have the following capabilities:

Operating time: Battery operating time, capable of continuously protecting the memory, is 7500 hours (typical) after a full charge.

Recharge: Rechargeable to full rate in 24 hours after battery voltage falls below the operating low limit.

Lifetime: 5 years (at 25°C)

The batteries are being charged anytime the instrument is being operated from an AC power line (LINE button is depressed).

3-25. ACCURACY

3-26. Accuracies for all measurement parameters are dependent on the impedance accuracies of the reference terminations (0Ω, 0S and 50Ω) employed for initial auto-calibration. The total possible instrument error consists of the errors related to instrument performance limitations and the calibration errors which are dominated by the particular quality of the individual reference terminations. For achieving the best accuracy of the instrument, the special coaxial terminations furnished with the 4191A were all developed with careful consideration for both their impedance accuracy and frequency dependency and are ready for use as calibration standards. The 50Ω termination (HP Part No. 04191-85301) of the accessory Reference Termination Set, for example, embodies as its typical vector reflection coefficient, a value of 0 and an accuracy to within $\pm(0.0025 + j0.00025)$ at any test frequency when it is connected to the UNKNOWN connector. The specified 4191A accuracy is subject to calibration of the instrument with the three reference terminations supplied.

Note:

The accuracies are typical values that apply when calibration is done with the supplied accessory terminations (vector reflection coefficient accuracies specify the coefficient in maximum test limit values). If other terminations which have more accurate reference impedance values are available, the measurement accuracies can be enhanced.

3-27. The 4191A accuracies, as shown in Table 1-2, are graphic representations of each measurement parameter. The accuracy graphs, other than the reflection coefficient graph, show a characteristic common to all the measurement parameters. The reason for this common characteristic is explained as follows:

The relationship of the reflection coefficient value to the impedance value of the sample is graphically represented in Figure 3-10. To simplify the discussion, the reflection coefficient curve given in the graph presupposes that the sample is resistive. As indicated by the graph, the variation in reflection coefficient values being detected per difference (ratio) in sample impedance becomes smaller at both higher and lower impedance values referenced to 50Ω (note: for both low and high impedance values, $|\Gamma| \approx 1$). Thus the accuracy is optimum for measurements of nearly 50Ω impedance ($|\Gamma| \approx 0$). Towards both the higher and lower impedances, the accuracy drops at a continuous gradient to the ends of the practicable range limits.

3-28. The 4191A accuracies are specified under the following measurement operating conditions:

- 1) Specifies reflection coefficient accuracy ($|\Gamma| - \theta$ and $\Gamma_x - \Gamma_y$ measurement accuracies). Accuracies for other parameter measurements are given as typical values in supplemental performance characteristics.
- 2) Warm-up time: at least 40 minutes.
- 3) Auto-calibration properly completed using standard reference terminations.
- 4) Test frequencies identical to auto-calibration frequency points (51 spots).
- 5) Environmental temperature:
 - 23°C \pm 5°C (allows temperature variation).
 - 0°C to 55°C (at the constant temperature at which auto-calibration is completed).
- 6) Measurement taken at UNKNOWN connector (without using test port extension).

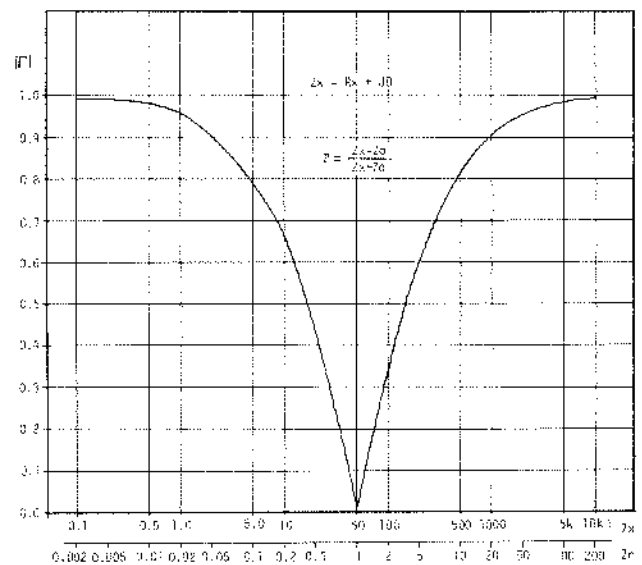

Figure 3-10. Relationship of Reflection Coefficient to Impedance.

3-29. ACTUAL MEASURING CIRCUIT.

3-30. The measuring circuit for connecting a test sample to the UNKNOWN test port (that is, test fixture) actually becomes part of the sample which the instrument measures. Furthermore, component leads, which should essentially be of negligibly low impedance, also influence the measured sample values because of the presence of certain parasitic impedances. Diverse parasitic impedances existing in the measuring circuit between the UNKNOWN test port and the unknown device affect the measurement result. These parasitic impedances are present as resistive or reactive factors in parallel or in series with the sample device. Furthermore, in the high frequency region, the equivalent electrical length of the measuring circuit, including component leads, rotates the measured impedance vector as function of the test signal wavelength. Let's discuss these effects which increase measurement uncertainties.

3-31. RESIDUAL PARAMETER EFFECTS.

3-32. Figure 3-11 shows an equivalent circuit model of the measuring circuit which includes unknown component and parasitic parameters (usually called residual parameters). These residual parameter effects cause two kinds of measurement errors, which are described in the paragraphs below.

1) Simple additive errors

When a component having a low value is measured at relatively low frequencies, the measured value becomes the sum of the sample value and the residual parameter values. The effects of the residual factors are:

$$\begin{aligned} C_m &= C_x + C_{st} \\ L_m &= L_x + L_{res} \\ R_m &= R_x + R_{res} \\ G_m &= G_x + G_{res} \end{aligned}$$

where, subscripts are:

- m : measured value
- x : value of sample
- st : stray capacitance
- res : residual inductance
(residual resistance)
(residual conductance)

Residual resistance and conductance affect dissipation factor and quality factor measurements because they are included in the measured values as an additional loss.

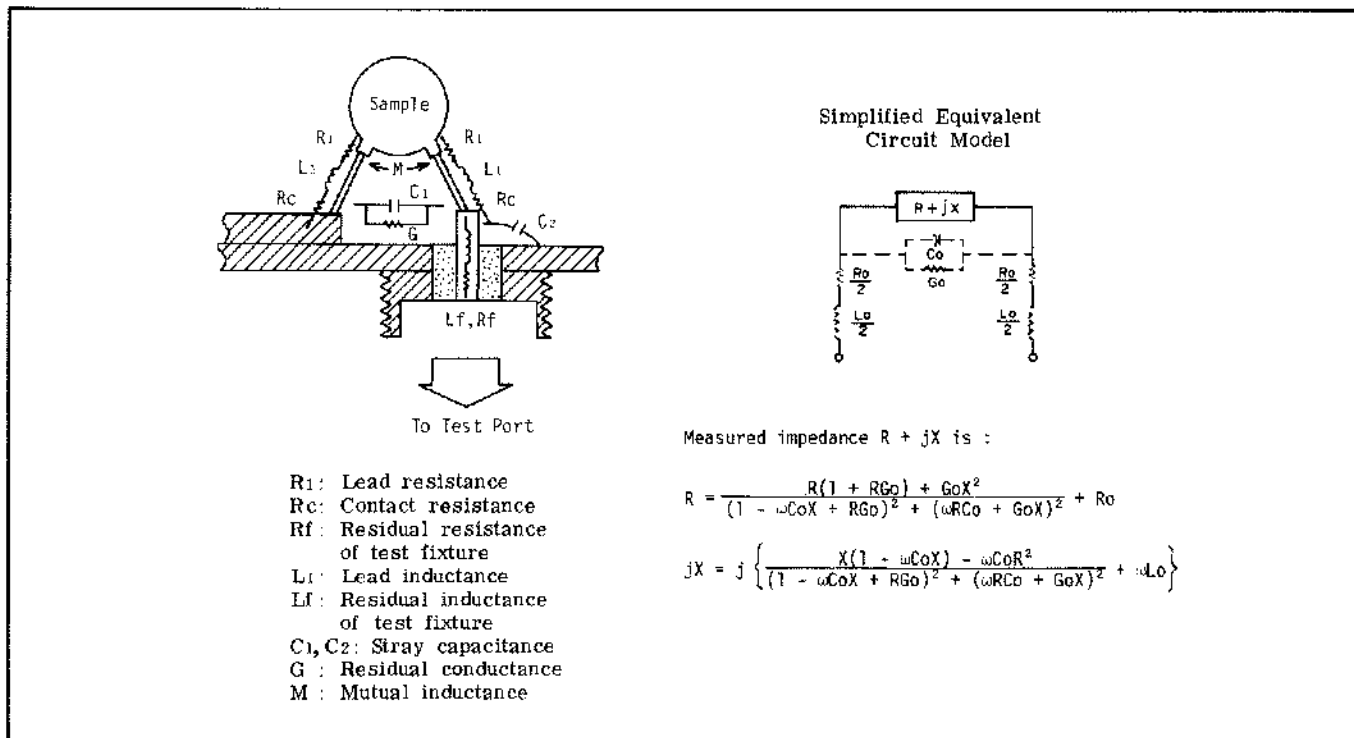

Figure 3-11. Residual Parameters in the Measuring Circuit.

2) Reactive parameter interaction

Generally, residual inductance resonates with the capacitance of sample (series resonance) and stray capacitance resonates with inductance of sample (parallel resonance), respectively, at a specific high frequency. Thus, the impedance of sample will have some extremes corresponding to the resonant peaks as shown in Figure 3-12. The presence of residual inductance and stray capacitance causes measurement errors as the phase of the measured (reflected) test signal varies over the broad frequency region about the resonant frequencies. Additional errors due to this resonance increase in proportion to the square of the measurement frequency (below resonant frequency) and can be theoretically approximated by the following equations:

$$L_m \approx \frac{L_x}{1 - \omega^2 L_x C_{st}} \quad \text{or} \quad \frac{L_m - L_x}{L_m} \approx \omega^2 L_x C_{st}$$

$$C_m \approx \frac{C_x}{1 - \omega^2 C_x L_{res}} \quad \text{or} \quad \frac{C_m - C_x}{C_m} \approx \omega^2 C_x L_{res}$$

where, $\omega = 2\pi f$ (f : test frequency)
 C_x = Capacitance value of sample
 L_x = Inductance value of sample

At the resonant frequency, the phase angle of the measured impedance vector is 0° (resistive impedance). If the test frequency exceeds the resonant frequency point, the measured inductance or capacitance of sample becomes a negative value. In such frequency region, the residual inductance or stray capacitance dominates the actual measurement value.

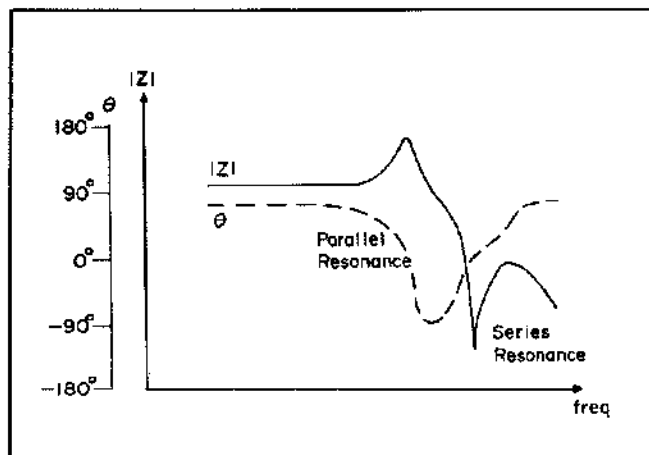

Figure 3-12. Effect of Resonance in Sample (example).

3-33. CHARACTERISTICS OF TEST FIXTURES

1) Electrical Length

The test fixtures are basically composed of two major components – a coaxial coupling terminal and contact electrodes (terminals) combined in one unit. The electrical length value specified for each type of the fixtures are calculated for the coaxial coupling terminal and does not include the electronic factors in the electrodes.

As the coaxial coupling terminal section of the fixtures is a “distributed constant” circuit design (50Ω), this fixture section is virtually an extension of the test port. The inherent effect in the coaxial coupling terminal on the phase of the measured reflection coefficient value is represented by the electrical length value particular to the test fixture. On the other hand, the contact section, that is, the spring clip contacts (16092A) and binding post terminals (16093A) have individually different characteristics from the 50Ω “distributed constant” test port.

2) Residual Parameters

The contact electrode (terminal) section can not be deemed as part of the “distributed constant” measuring circuit. The portion of the measurement circuit length which includes the test fixture contacts and sample leads will also cause a phase shift in the measured reflection coefficient vector. Then, how should this effect be considered?

Generally, the “electrical length” concept should apply to lines of equable “distributed constant” characteristics such as coaxial lines and parallel feeder lines. The phase shift due to the signal propagation length of the contacts or terminals can be considered to be a virtual increase in the residual inductance of the fixture. Actually, this effect can not be easily discriminated from the residual inductance effect. Various effects in the test fixture contacts and terminals are considered as residual impedance factors which contribute to measurement errors.

The coaxial terminals of the fixtures also have measurement signal propagation losses in addition to rotating the phase of the signal. As a correction calculation performed on the basis of the electrical length input value (by the 4191A) does not compensate for the residual loss factors in the coaxial coupling terminal, these propagation losses contribute to measurement errors (in particular, in low impedance measurements). The residual factors in test fixtures are illustrated in Figure 3-11.

Measured sample values may differ depending on the test fixture employed for the measurement. The difference in measurement results will increase in both low impedance (below $100m\Omega$) and high impedance (above 100Ω) measurements. However, all of those differences may occur unless measurements are properly corrected for the residual impedances inherent in the test fixture used.

3-34. CONSIDERATIONS IN CERTAIN MEASUREMENTS

3-35. To minimize measurement uncertainties, considerations should be taken for decreasing the residual parameters to the lowest possible magnitude. To further reduce the residual parameter effect contributing to measurement errors, various correction methods and calculations can be used with respect to the measured sample value. These are outlined below:

- 1) Component lead impedance is a lower value for a shorter lead length. Connect sample to test fixture contacts (terminals) so that lead length is minimum.
- 2) Additional measurement errors due to residual parameters inherent in the test fixture can be compensated for by using correction calculations. When the effects are simple additive errors, a subtraction measurement should be used. The practical correction method for these kinds of errors is outlined in paragraph 3-37.

Note:

Basically, an attempt to correct the measured values for all existing residual parameter effects is not practicable. This is because some parameters, such as lead impedance and stray capacitance, are peculiar to the component measured. Their values depend on component lead length and on the distance between the sample and test fixture. The measurement results, then, are substantially the sample values including the parasitic impedances present under the conditions necessary to connect and hold the sample.

3-36. ELIMINATION OF RESIDUAL PARAMETER EFFECTS IN TEST FIXTURE

3-37. The measuring circuit for dealing with an impedance vector in the rf region employs a two terminal DUT connection configuration. Since the two terminal connection method includes composite residual impedances in its measuring circuit arrangement, its applicability in precise, low frequency impedance measurements is limited to a narrow range in both sample value and frequency. On the other hand, for measurements at rf test signal frequencies, the two terminal method has the advantages of accuracy with ease of handling which comes with the simplicity of the DUT connection arrangement. Contact resistance, distributed admittance (stray capacitance and conductance) and electrode impedance (residual resistance and inductance) of the test fixture used still affect the measurement in the rf region. The additional measurement errors inherent in the test fixture should be considered when evaluating actual measurement accuracy. The residual parameter effects are outlined in paragraph 3-32.

All 4191A accessory test fixtures are designed with careful consideration of the residuals to ensure minimum incremental measurement error. The characteristics of these fixtures exhibit low level residual impedances and broad usable frequency ranges as well terminal structures suitable for the particular use of the individual fixture. Reliability of the measurement can be further enhanced if proper compensation is made for the residual impedances peculiar to the test fixture used. Typical residual parameter values for each individual test fixture are given in Figure 3-6. The compensation subtracts the error value from the measured values using appropriate correction calculations for the given residual parameter data (refer to paragraph 3-32).

Note: The 16091A Coaxial Fixtures need no compensation.

3-38. Actual values of the residuals can be approximately ascertained by taking measurements when the test fixture terminals (contacts) are appropriately terminated in their short or open conditions. To facilitate shorting the fixture at minimum impedance, a special grounding terminator is furnished with each of the 16092A and 16093A/B Test Fixtures.

1) Distributed admittance

For stray capacitance and distributed conductance, take a measurement in the C-G (capacitance-conductance) mode with nothing connected to the test fixture. When the 16092A Spring Clip Test Fixture is used, set contact distance near to the dimension of the sample to be mounted in the fixture.

2) Electrode impedance

Residual resistance and inductance are measured in the L-R (inductance-series resistance) mode when the test fixture is short-circuited.

16092A: Remove slide clip contact (twin clip contact) assembly from the test fixture deck. Attach the special grounding electrode, with its concave side down, to test fixture positive contact post with its screw.

16093A/B: Remove binding post nut of the drive potential (positive) terminal and attach the special grounding electrode with its concave side down. Tighten the electrode to the terminal with the binding post nut.

Note: The measured resistance and inductance values are approximate values of the electrode impedance.

The measured residual parameter values can be offset from the measurement readouts for a sample of like parameter measurements. The deviation (Δ) function facilitates the subtraction measurement. Store the measured residual parameter values as reference values of the deviation measurement. The deviation provides display outputs of correct sample values as the measured value minus the memorized residual parameter value. This correction method can only eliminate the simple additive errors.

Note: The residual factors can be cancelled only for like parameter measurements (for example, stray capacitance can be subtracted only in capacitance measurements).

Measurement errors due to interaction of residual reactive elements, which increase in proportion to the square of the test frequency, can not be cancelled by the method outlined above.

3-39. UNKNOWN TERMINAL CONVERSION.

3-40. When the measurement objective is to test communication devices such as rf circuit modules and antennas, an appropriate terminal conversion adapter is sometimes needed to interconnect such a device to the UNKNOWN connector. To adapt the test port to N type, BNC, SMA (SMB, SMC), GR900, GR874 or other type connectors of the device to be measured, attach an adequate terminal converter to the UNKNOWN connector. Possible insertion losses, phase shift and/or a reflection of the test signal in the terminal converter used are all undesirable factors which contribute to incremental measurement errors. The effects of these error factors can be eliminated from the measurement results by performing an auto-calibration with the precise terminations combinable with the terminal converter. The terminations used should be of an impedance accuracy equivalent to the accessory reference terminations in the required calibration frequency range. If the test port needs to be extended (in addition to the conversion of the UNKNOWN connector), perform an auto-calibration at the tip of the extension line (refer to paragraph 3-44 for extension of the test port).

Note:

1. If appropriate precise terminations with the desired coupling connectors are unavailable, calibrate the instrument with the reference terminations and then attach the terminal converter. Enter the rated value or the measured value of the electrical length for the terminal converter. To minimize incremental measurement errors, use a terminal converter which has a low inherent VSWR* value.

* VSWR value of terminal converter causes, if not properly compensated, additional measurement error increase.

2. Generally, characteristic impedances of terminal converters (also, ordinary connectors and lines) vary their values in the relatively low frequency region. Figure 3-13 shows an example of terminal converter impedance characteristics. At low frequencies, the impedance increases as the frequency decreases. The impedance approaches a constant value (nominal value) at higher frequencies.

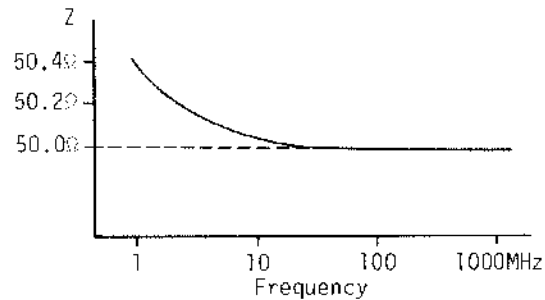

3-41. STANDING WAVE RATIO MEASUREMENT.

3-42. An incident wave traveling along a propagation line toward the load interferes with the returned wave as the result of partial reflection at the load. This interference of the incident and reflected waves produces a standing wave which is distributed along the line. To represent the magnitude of the standing wave, a VSWR (Voltage Standing Wave Ratio) value is used. The VSWR is defined as the ratio of the amplitude at the antinode to the wave node of the standing wave.

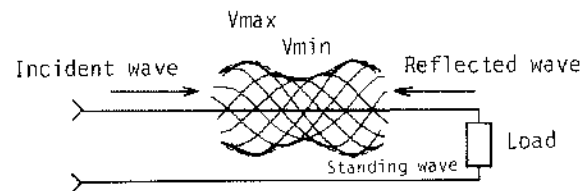

$$VSWR = \frac{V_{max}}{V_{min}}$$

The VSWR measurement is popular, in particular, for evaluations of antenna efficiency. As the magnitude of the standing wave depends on the density of the reflected wave, the VSWR values correlate with the reflection coefficient values. This relationship is represented by the following equation:

$$VSWR = \frac{1 + |\Gamma|}{1 - |\Gamma|} (\geq 1)$$

when $|\Gamma|$ value is 0, a reflected wave is not produced and, thus the VSWR value is 1.

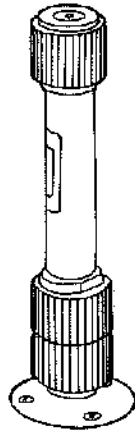

3-43. EXTENSION OF TEST PORT

3-44. Occasionally the test port needs to be extended to the DUT measurement point such as when measuring coaxial switches, wide band attenuators, antennas, rf amplifiers, integrated microcircuits, semiconductor devices and other devices which cannot be directly connected to the UNKNOWN connector or to the accessory test fixture. In these cases, the measurement can be accomplished with a simple modification to the procedure and to the setup arrangement without the need for correction calculations to the measured values for the effects of the test port extension. The operating procedure, here outlined, is an example using a 50Ω air line extension.

Notes:

1. To minimize any drop in measurement accuracy, the air line used must have a VSWR (voltage standing wave ratio) value of 1 at a high accuracy when it is connected to the UNKNOWN connector. Any impedance mismatch incident to the connection causes measurement error, to a certain extent, to increase.

2. Test port should not be extended more than 1 m.

When an air line extension whose electrical length number (rated value) is ℓ is connected to the UNKNOWN connector, perform the following procedures to take a measurement of the sample connected to the other end of the air line:

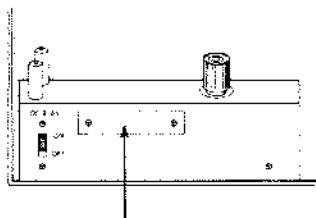

Electrical length compensator.
 (inside panel).

Electrical length compensation

When the electrical length (ℓ) of the air line extension exceeds either 1/8 wavelength of the test frequency signal or 10 cm (approximately), calibration error increases because of a phase shift in the test signal (incident and reflected waves) propagating in the air line. Thus, measurement error increases. It appears as an artificial undulating fluctuation of reflection coefficients in the normal frequency-reflection coefficient locus.

To minimize the measurement errors, a semi-rigid cable electrical length compensator housed in the test fixture installation deck is interchanged with a longer cable assembly:

- 1) Prepare semi-rigid cable with miniature SMA connectors measuring 1.4ℓ long plus 5.3 cm as illustrated.
- 2) Remove the two retaining screws and remove blind panel on the deck. The semi-rigid cable compensator will appear in the panel hole.
- 3) Loosen rigid cable connector coupling nuts (two) and pull cable out.
- 4) Connect the long semi-rigid cable in place of the existing cable assembly. The blind panel can not be attached while the extended compensation cable is being used.

Note: The 1.4ℓ length is the product of two times ℓ (sum of air line electrical length for an incident wave and that of the reflected wave) multiplied by the ratio of the wavelength in semi-rigid cable to that in a vacuum (approximately 0.7). Thus, the electrical length of the semi-rigid cable compensator is equivalent to that of an air line extension.

The cable length of the semi-rigid cable compensator need not be a precisely calculated value (within ± 2 cm).

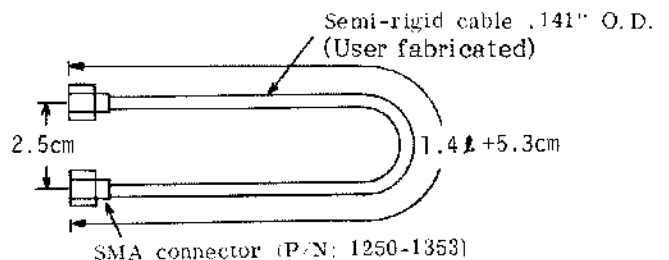

SMA connector (P/N: 1250-1353)
 Semi-rigid cable E/L compensator.

Calibration

Perform auto-calibration with each termination (0Ω, 0S and 50Ω) connected to the air line extension.

Electrical length data input

Enter the electrical length number of the test fixture connected to the air line (the value for the air line should not be used).

Note: When reflection coefficient (Γ_0), measured at the UNKNOWN connector, is taken as a reference, the reflection coefficient measured at the air line end is theoretically represented by the following equation:

$$\Gamma_\ell = \Gamma_0 e^{-2(\alpha + j\beta)\ell}$$

Where, phase constant β is

$$\beta = \frac{2\pi}{\lambda} \quad (\lambda = \text{test signal wavelength})$$

α is the attenuation coefficient of the air line.

The above equation indicates that the magnitude of the vector reflection coefficient is attenuated by $e^{-2\alpha\ell}$ as well as its phase angle shifts by $2\beta\ell = 4\pi\ell/\lambda$ (radians).

When a calibration is performed at the end of the air line, the reflection coefficients $1 \angle 0$ (0Ω) and $1 \angle \pi$ (0S) references shift by the attenuation and the phase angle ($2\beta\ell$) as illustrated in the Smith Chart below:

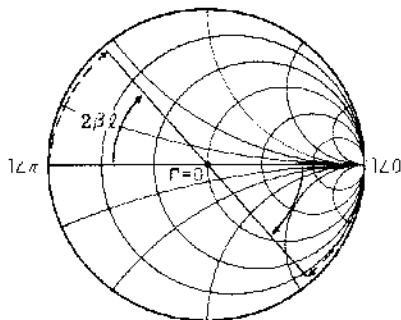

As the auto-calibration detects both the attenuation and the phase shift, measured values are automatically compensated for these effects in the air line extension.

However, a large shift in the phase angle increases compensation errors. The semi-rigid cable electrical length compensator acts to cancel the effects of the air line extension by modifying the measuring circuit.

CONFIRMATION OF PROPER ELECTRICAL LENGTH COMPENSATION

A user constructed electrical length compensator can be easily checked to determine whether it can fit the extended measurement circuit. Proceed as follows:

- 1) Perform auto-calibration for the desired test frequency range without using air line extension.
- 2) Connect air line extension to be used and the electrical length compensator to the 4191A.
- 3) Set the 4191A function to $|\Gamma| - \theta$ measurement mode.
- 4) With 0S standard termination connected at the tip of the air line extension, perform a swept frequency measurement at 20MHz step frequency intervals (in the calibrated frequency range).
- 5) Monitor DISPLAY B display outputs. The display readouts should be within -90.00 ± 90 degrees at any step frequency point. If a displayed value exceeds 90.00 counts, a shorter electrical length compensator should be used and, if it exceeds a negative 90.00 counts, a longer compensator cable will provide a more appropriate compensation magnitude.

Note

MEASUREMENT WITHOUT E/L COMPENSATOR

If measurement condition allows using the test frequencies identical to the auto-calibration frequency points, it is possible to make accurate measurements without replacing the electrical length compensator. Perform as follows:

- 1) Connect reference termination at the tip of the extended test port and perform the auto-calibration for each of the 0Ω, 0S and 50Ω termination impedances.
- 2) Connect test fixture at the tip of the extension line.
- 3) Enter the specified electrical length value for the test fixture used.
- 4) Select the desired test frequencies from among the auto-calibration frequencies and perform measurements.

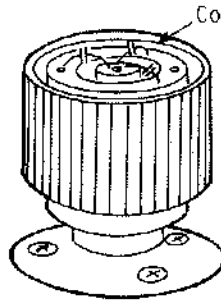

3-45. SETTING OPEN CAPACITANCE DATA

3-46. To eliminate the effects of stray capacitance present at the center and outer conductors of the UNKNOWN connector from the parameter values measured, the stray capacitance value is used in the error correction calculations which are based on auto-calibration data. The 4191A stores a typical capacitance value of the "open" connector--0.082 pF in its continuous memory.

When the open capacitance value is changed from its typical value by using a terminal converter or when special test apparatus is connected to the UNKNOWN, a new appropriate value can be temporarily memorized to be used instead of the programmed value. A concealed-open capacitance input function allows setting the capacitance value up to 1.000 pF in 0.001 pF (minimum) steps.

Note: The open capacitance data should not be changed to a different value for each accessory test fixture. The typical stray capacitance value of the test fixture should be considered as a residual factor contributing to measurement error.

PROCEDURE

- 1) Push LINE button to turn instrument off.
- 2) Loosen top cover retaining screw at rear center of the cover and remove top cover.
- 3) Turn the two captive fasteners of the top shielding panel 90 degrees counter-clockwise to unlock the panel. The fasteners are located at the front side of the panel.
- 4) Lift up front side of the hinged top shielding panel on its hinged pivots. Set panel at its rear stop position. Note the major circuit board at the underside of the panel.

- 5) Change the second bit switch of switch S3 (labeled "C" on the circuit board) to its opposite position as illustrated below:

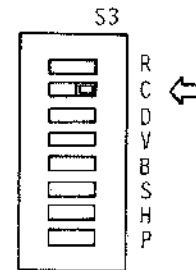

Caution: Do not change other bit switch positions.

- 6) Push LINE button to turn instrument on and perform 10 minute warm-up.
- 7) Press front panel Blue key. Next, press REF B key.
- 8) Set the appropriate capacitance value (≤ 1 pF) with DATA input keys. Press ENTER key. This enters the capacitance input value.

The volatile memory of the capacitance input data is lost when the instrument is turned off.

Note: The open capacitance value can also be set by HP-IB control/data input command.

3-47. INTERNAL DC BIAS (0–± 40V)

3-48. The 4191A is equipped with an internal programmable dc bias supply controllable from 0.00V to ± 40.00V. This provides step bias voltage control in 10mV increments over the entire controllable range as well as providing an accurate voltage setting capability (±0.1%) to facilitate up-to-date utility in uses which demand precision bias voltage control such as in applications for the analysis of material properties and semiconductor testing. The bias can be programmed and bias parameters memorized, further enhancing utility of the internal bias supply.

In step bias control or bias voltage sweep measurement applications, programmed bias control provides for automatic measurements without the necessity of an external bias source and bias controller.

Bias voltage setting and bias parameter programming can be done either at panel control keys or via an HP-IB controller. This paragraph describes operating procedures for the internal dc bias supply when using panel control keys. For dc bias applications using HP-IB control, refer to paragraph 3-59 HP-IB Compatibility.

Table 3-5. Bias Voltage Setting Ranges.

Spot bias voltage		-40.00 – 40.00V
Sweep bias voltage parameters	Step	0.01 – 40.00V
	Start	-40.00* – 40.00V
	Stop	-40.00* – 40.00V

**Note: When LOG SWEEP function is used, both the Start and Stop voltage settings should be positive values (above 0.01 volts). Stop voltage should be higher than Start voltage value.*

Note

When a conductive sample is to be measured, actual dc bias voltage applied to sample is lower because of internal loading of bias circuit (approximately 1.4kΩ). A maximum current of 7.2mA can flow through sample which has a low resistance (about 0Ω).

PREPARATIONS FOR DC BIAS OPERATION

Caution: Set dc bias switch to its off position.

1. Press LINE button to turn instrument on.
2. Set 4191A controls and do measurement setup according to Basic Operating Procedures (Figure 3-7 steps 1 through 9).
3. Set rear panel DC BIAS INT EXT switch to its INT position.
4. Set DC BIAS switch on the 4191A test fixture installation deck to its ON position.

Note: Internal dc bias voltage applied to sample is automatically set to 0 volts when the instrument is turned on (initial settings).

Caution: When RCL 1 or RCL 2 function is activated, a memorized bias voltage setting for previous measurement is restored. To avoid a harmful voltage from being inadvertently applied to sample, monitor the voltage setting value by pressing Blue key and “PARAMETER SPOT FREQ/BIAS” key before setting the DC BIAS switch!

Note: To monitor actual dc bias voltage applied to sample, connect a DVM at rear panel DC BIAS EXT INPUT/INT MONITOR connector.

USE OF STATIONARY (FIXED) VOLTAGE BIAS

To apply a stationary (fixed) bias voltage to sample, set the desired bias voltage in accord with the following procedure:

Note: Test frequency can be swept while using the internal dc bias set to desired (spot) voltage.

1. Press **Blue** key and PARAMETER SPOT FREQ/BIAS key to activate bias voltage setting function.
2. Set the desired bias voltage number with DATA input keys. Press ENTER key.

(Example) Bias Voltage = 15.05 V

Key strokes: **blue** **SPOT FREQ/BIAS** **0** **1** **5** **.** **0** **5** **MHz cm V**

A spot bias voltage of 15.05 will be displayed on Test Parameter Data Display.

Note: The internal dc bias voltage is applied to the sample just after the bias voltage value is set by the front panel control keys (requires no trigger signal).

DC BIAS SETTling TIME

It takes a maximum 100ms for dc bias voltage to reach more than 90% of the voltage setting value when a 1 μ F capacitor sample is measured.

3. To change the bias voltage, repeat steps 1 and 2 to enter new voltage value.

Note: If dc bias is not needed, set front panel DC BIAS switch to OFF.

Figure 3-14. Fixed Bias Voltage Measurement.

BIAS VOLTAGE SWEEP

The desired internal bias voltage range can be digitally swept in step voltage intervals set by bias parameter input data. The operating procedures for setting the sweep voltage parameter data and the control of sweep mode operation are similar to those for a swept frequency measurement (described in Figure 3-9). The appropriate procedures for using bias voltage sweep functions are outlined below:













Note: Bias voltage cannot be swept while a swept frequency measurement is in process.

START, STOP, STEP VOLTAGES

1. Press **Blue** key and PARAMETER START FREQ/BIAS key. Enter the low (bottom) voltage number of the desired sweep bias voltage range with DATA input keys. Press ENTER key. The start voltage setting is displayed in Test Parameter Data Display.

Note: When logarithmic sweep function is used, a positive voltage number (above 0.01) must be entered as the start voltage.

Similarly, enter Stop, Step and Spot voltage numbers in accord with the key stroke tabulation below:

Parameter	Key strokes		
	Function key	DATA key input	Enter
Start	 	Enters low voltage number of sweep voltage range.	MHz cm V 
Stop	 	Enters high voltage number of sweep voltage range.	MHz cm V 
*Step	 	Step interval voltage number.	MHz cm V 
Spot	 	Desired voltage number between Start and Stop voltages.	MHz cm V 

Note: If the start voltage is a negative number, the start voltage should be lower than stop voltage as illustrated below:

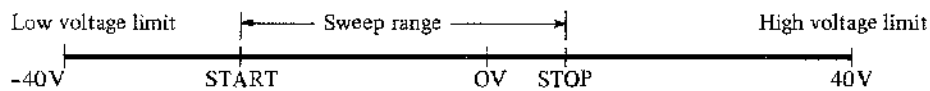

**Note: Step voltage number need not be entered when logarithmic sweep function is used.*

Figure 3-15. Swept Bias Voltage Measurement (Sheet 1 of 3).

– LOGARITHMIC SWEEP –





Press **Blue** key and LOG SWEEP key (DATA input decimal point key). Indicator lamp above the key lights.



Note: Logarithmic sweep bias voltage measurements are taken at a total of 51 voltage points which are automatically selected at logarithmically regular voltage intervals in the start and stop setting voltage range. (STEP VOLTAGE function is deactivated).

MANUAL or AUTOMATIC SWEEP





2. Bias voltage can be swept manually or automatically using the following procedure:

– (MANUAL SWEEP) –

- a. Press SWEEP FREQ/BIAS STEP  or  key to initiate measurement. Pressing and holding the STEP  or  key advances the sweep bias voltage measurement in a higher or lower voltage direction (from the programmed spot bias voltage), respectively. If the spot voltage is outside the programmed sweep range, E-04 annunciation is displayed. The bias voltage can also be shifted in step voltage intervals each time the key is pushed. A reverse direction sweep is also feasible.

Note: When FAST key is pressed simultaneously with the STEP  or  key, the step voltage interval is expanded to ten times its programmed value in linear sweep mode or to one-fifth the voltage points in logarithmic sweep mode.

– (AUTO SWEEP) –

- a. Press **Blue** key, then press SWEEP FREQ/BIAS  or  key to initiate an automatic sweep bias voltage measurement. AUTO sweep indicator lamp above the  key lights simultaneously and stays lit while the auto sweep mode function is being set. Pressing  key starts a single sweep bias voltage measurement from the programmed start voltage. The voltage sweep ends at the stop voltage point. Pressing  key advances voltage sweep in the reverse direction (from the stop voltage towards start voltage).

Note: RANGE HOLD function is automatically set.

SWEEP PAUSE



If needed to temporarily stop a sweep bias voltage measurement at a desired voltage step point, press **Blue** key, then press PAUSE key. To restart the measurement, press **Blue** key and again press  or  key. The bias voltage is successively swept.

Figure 3-15. Swept Bias Voltage Measurement (Sheet 2 of 3).

Note: Sweep parameter value and sweep mode settings (linear, logarithmic, auto or manual) can be changed when the PAUSE function is set. AUTO sweep indicator lamp stays lit until SWEEP ABORT key is pressed or until the bias voltage reaches start or stop voltage point.

While automatic sweep is advancing, panel control keys except SWEEP FREQ/BIAS and SWEEP ABORT keys are deactivated.

SWEEP ABORT

Auto-sweep bias voltage measurement of operation is automatically released when a single sweep measurement ends. To release the bias voltage sweep mode of operation before the measurement is complete, press **Blue** key, then press SWEEP ABORT key.

Note: Spot bias voltage is automatically set to the voltage point where a sweep bias voltage measurement function is released.





Figure 3-15. Swept Bias Voltage Measurement (Sheet 3 of 3).

RECORDING SWEPT FREQUENCY/BIAS MEASUREMENTS

Measured value of swept frequency (or bias voltage) measurements can be recorded in graphic format with an X-Y recorder (analog recorder output option) or with a plotting instrument interfaced with an HP-IB controller. To proportion the analog recorder output for display output and to prevent the instrument from changing range during recording, the RANGE HOLD function is set. This fixes the decimal point position during an auto-sweep measurement.

On the other hand, display output (and recorder output) may overflow the selected range when measuring a sample whose values vary greatly (such as varactor diodes, resonators, etc.). In such cases, the RANGE HOLD function may be manually released. Auto-ranged measurement output data can be processed by an HP-IB computing controller into an appropriate format for plotting with a graphic recorder.

To release the RANGE HOLD function in auto-sweep measurement, perform the following:

- 1) Press **Blue** key and SWEEP FREQ/BIAS PAUSE key to temporarily stop sweep operation just after the auto-sweep measurement is initiated (AUTO sweep indicator lamp lights).
- 2) If test frequency or bias voltage has advanced a few step intervals, reset it to the sweep start point by pressing SWEEP FREQ/BIAS  or  key.
- 3) Press RANGE HOLD key to release the function (key indicator lamp is extinguished).
- 4) Press **Blue** key and  or  key to restart the sweep measurement.

EXTERNAL DC BIAS OPERATION ($\leq 40V$)

To make measurements of capacitance, inductance or resistance samples using external dc bias voltages up to $\pm 40V$, connect an external dc bias supply as shown in diagram.

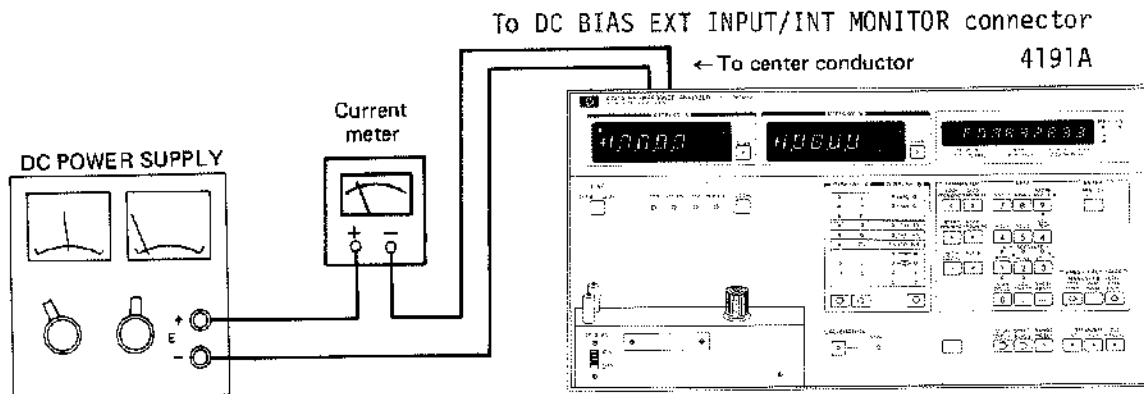

PROCEDURE

Caution: Initially set DC BIAS switch on the 4191A test fixture installation deck to its OFF position.

1. Set 4191A rear panel DC BIAS INT EXT switch to EXT position.
2. Connect an external dc bias supply to rear panel DC BIAS EXT INPUT/INT MONITOR connector as illustrated.

Caution: External dc bias supply output voltage should be set at zero volts.

3. Depress LINE button to turn instrument on.
4. In accordance with instructions in "Initial Mode Settings" (Figure 3-5), prepare to take measurements with the 4191A.
5. Set 4191A controls in accord with Basic Operating Procedure (Figure 3-7) steps 3 through 7.
6. Connect sample to test fixture.

Caution: Do not connect a charged capacitor as DUT or internal circuitry may be damaged.

7. Set DC BIAS switch on 4191A test fixture installation deck to its ON position.
8. Set dc bias supply for the desired output voltage (below $\pm 40V$).

Caution: Never apply an external dc bias over $\pm 40V$.

9. Read 4191A display output.

Figure 3-16. External DC Bias Circuits (Sheet 1 of 2).

BIAS VOLTAGE SETTLING TIME

The bias voltage settling time required for a dc voltage across a capacitor sample to reach more than 90% of the applied bias voltage, is less than 1ms for a 1 μ F capacitor.

DC BIAS VOLTAGE MONITOR

When it is desired to monitor actual dc voltage across the conductive sample being measured, read bias current flowing through the sample on a current meter connected between dc bias supply and the rear panel DC BIAS input connector. The effective bias voltage can be calculated by the following equation:

$$E_b = E_o - 0.39 \cdot I_m \text{ (V)}$$

where, E_b is dc voltage across the sample.

E_o is dc bias supply output voltage.

I_m is current meter reading in mA.

Inaccuracy of the calculated current value is $\pm 0.04 \cdot I_m$ (disregarding current meter accuracy).

Note: Maximum bias current which can flow through sample is 100mA (when bias input voltage is 40V).

Figure 3-16. External DC Bias Circuits (Sheet 2 of 2).

RF TRANSISTOR MEASUREMENTS

The use of accessory transistor fixtures with the 4191A will facilitate the input/output impedance measurements of bipolar and field effect transistors and will enhance measurement accuracy and resolution at frequencies up to 1000 MHz. HP models 11600B, 11602B and 11608A Transistor Fixtures are especially matched to the 4191A and are useful in making measurement of transistors packaged in TO-5, TO-12, TO-18, TO-71 type or micro strip-line structures. The 4191A can measure transistor characteristic parameters corresponding to S (Scattering) parameter elements S_{11} and S_{22} with the fixture. To cause the desired operating current to flow the sample transistor, an external auxiliary bias supply can be used in combination with the internal bias supply.

Note: S parameter elements S_{12} and S_{21} can not be measured (these parameters are enabled by another instrument capable of measuring transmission coefficients).

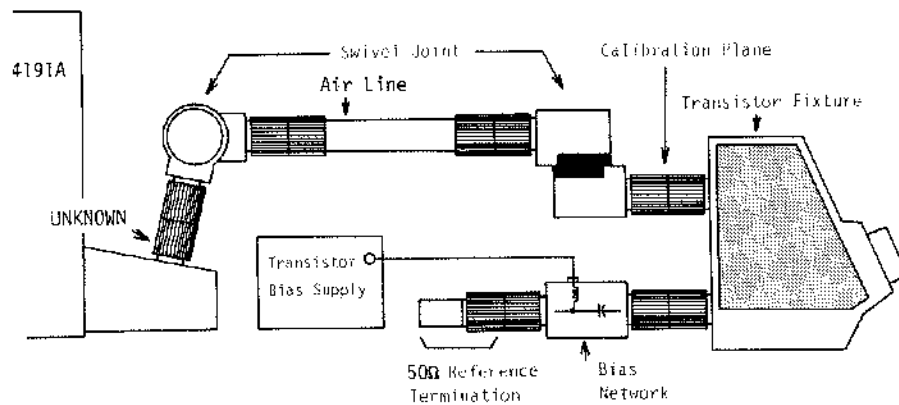

Recommended test fixtures

Accessories	Model	Characteristics
Transistor Fixture	11600B	For TO-18 and TO-72 transistors
	11602B	For TO-5 and TO-12 transistors
	11608A	For strip line transistors
Bias Network	85426A	0.1 to 500MHz, 70V max, 750mA max.
	11589A	100 to 3000MHz, 100V max, 500mA max.
Air Line Extension	11566A	APC-7 connector, 10 cm
Coaxial Swivel Joint	11588A	APC-7 connector
Transistor Bias Supply	8717B	100V max, 1A max.

Figure 3-17. RF Transistor Measurements (Sheet 1 of 2).

PROCEDURE

1. Connect two 11588A Coaxial Swivel Joints and 11566A Air Line Extension as shown in figure.
2. Depress LINE button to turn instrument on.
3. Perform auto-calibration with 0Ω , $0S$ and 50Ω reference terminations. Connect the termination at the tip of the 11588A swivel joint.
4. Attach 11600B (or 11602B or 11608A) Transistor Fixture, 85426A Bias Network and 50Ω termination as shown in figure.
5. Appropriately set transistor fixture snap-on dial to select the desired transistor socket.
6. Connect short-circuit termination (an accessory of the transistor fixture) to the 11600B transistor socket.
7. Enter a trial electrical length number in the 4191A and repeatedly try with other numbers so that phase angle display output in $|Z|-\theta$ measurement approaches zero (a minimum value).
8. Remove the short-circuit termination and connect sample transistor to the appropriate socket for the fixture.
9. Set internal bias and external bias voltage output to the desired voltage (current) value.
Note: Set 4191A rear panel DC BIAS INT/EXT switch to INT position and front panel DC BIAS switch to ON.
10. Read impedance values of the sample in $|Z|-\theta$ or R-X measurement mode.

Note

For detailed operating procedures and associated information on the recommended transistor fixtures, refer to operating and service manual for each individual transistor fixture.

Figur 3-17. RF Transistor Measurements (Sheet 1 of 2).

USING EXTERNAL SIGNAL SOURCE

GENERAL

The requirements for analysis of sharp, complex perturbations such as those inherent in electromechanical absorption and resonance of materials, may sometimes necessitate higher measurement frequency resolution. The use of an external, high resolution frequency synthesizer enables the 4191A to respond to these special requirements. The improved measurement accuracy and resolution of the 4191A permits the detection of small, adjacent peaks and drops in change of sample values making the most of the effects of an increase in the test frequency resolution. The equipment setup and operating procedure for making such measurement are outlined below:

Note: Using an external signal source requires a simple modification by a technical person to the internal circuitry of the instrument. For the details, refer to Service Manual.

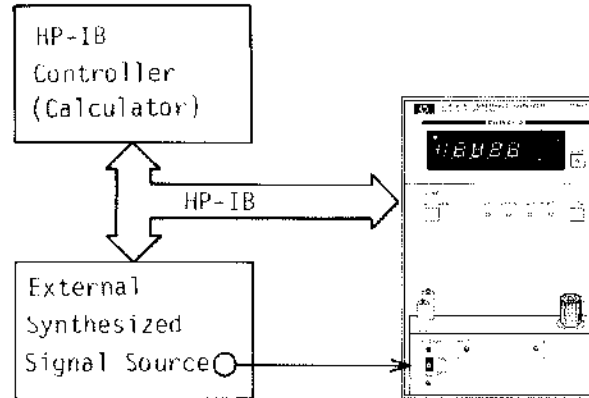

PROCEDURE

- 1) Connect the 4191A and the desired synthesizer signal source to an HP-IB computing controller to achieve remote control and data transfer through the HP-IB interface cables as illustrated above.
- 2) Set 4191A measurement function to $\Gamma_x - \Gamma_y$ mode.
- 3) Program the following equations to calculate calibration data values:

$$e_{00} = \Gamma_{50}, e_{11} = \frac{\Gamma_{\infty} + \Gamma_0}{\Gamma_{\infty} - \Gamma_0}$$

$$e_{01} = (\Gamma_{50} - \Gamma_0)(1 + e_{11})$$

where, Γ_{50} is measured Γ value for 50Ω reference termination.
 Γ_{∞} is measured Γ value for OS reference termination.
 Γ_0 is measured Γ value for 0Ω reference termination.

- 4) Remotely control the frequency of both the 4191A and the signal source simultaneously with the HP-IB controller. Measure Γ_{50} , Γ_{∞} and Γ_0 values using reference terminations at the desired test frequency points and store the measured values in the memory of the HP-IB controller.
- 5) Calculate e_{00} , e_{11} and e_{01} values for each test frequency point from the memorized Γ_{50} , Γ_{∞} and Γ_0 values. Store the calibration data in the controller.
- 6) Attach appropriate test fixture to 4191A UNKNOWN connector.
- 7) Connect sample to test fixture. Take measurements at the calibration frequencies and memorize the measured sample values.

Note: Measurement can only be taken at the calibration frequency points.

- 8) Correct the measured values using the memorized calibration data and the following equation:

$$\Gamma_{true} = \frac{\Gamma_m - e_{00}}{e_{11}(\Gamma_m - e_{00}) + e_{01}}$$

where, Γ_{true} is correct Γ value of sample.
 Γ_m is measured Γ value of sample.

- 9) Convert the corrected Γ values to the desired parameter values by using equations given in Measurement Parameter Relationships (Page 3-20).

Table 3-6. Annunciation Display Meanings (Sheet 1 of 2).

Annunciation figure	Display section	Indicated Condition	What to Do	Display format
CAL	A or B	Error in auto-calibration operation. <ol style="list-style-type: none"> 1. Measurement is attempted before calibration is complete. 2. Test frequency was set at a frequency point outside the calibration frequency range. 	Perform calibration for the selected frequency point. Otherwise, select another test frequency for which the calibration is complete.	C
E-01	p	Error in test parameter data input. Test frequency, electrical length or bias voltage setting number exceeds the selectable range limit.	Enter the test parameter data again using an appropriate number.	A
E-02	p	Error in bias voltage parameter data input. A negative voltage number was entered as test parameter input data for a swept bias voltage measurement in logarithmic sweep mode.	Enter the bias voltage setting data again using a positive number (not zero).	A
E-03	p	Error in sweep frequency/bias parameter data input. A stop frequency (voltage) number lower than start frequency (voltage) setting was entered. (This error message is displayed just after the sweep measurement is initiated).	Enter the start or stop frequency (voltage) data again so that the frequency settings follow the regular high and low frequency (voltage) relationship.	A
E-04	p	Error in spot frequency (bias voltage) data input. Spot frequency (voltage) setting is outside the preset sweep range.	Enter the spot frequency (voltage) data again using an appropriate number.	A
E-05	p	Error in deviation measurement control operation. <ol style="list-style-type: none"> 1. STORE DSPL A/B function was actuated while an error message was displayed. 2. STORE DSPL A/B function was actuated without releasing Δ or $\Delta\%$ measurement function. 	Restore the instrument to normal measuring conditions. Then actuate the STORE DSPL A/B function again.	A
E-06	A or B	Error in deviation measurement control operation. Δ or $\Delta\%$ function was actuated without previously storing reference value for the selected measurement parameter.	Perform operating procedure necessary for entering reference value, then actuate the Δ or $\Delta\%$ function again.	C
	p	REF A or REF B function was actuated despite that the reference data has not been entered (for the selected measurement parameter).	Press another PARAMETER key to release the input demand. Otherwise, enter an appropriate reference number.	C

Table 3-6. Annunciation Display Meanings (Sheet 2 of 2).

Annunciation figure	Display section	Indicated Condition	What to Do	Display format
E-07	p	Error in initial operation. A panel control key is pushed even though the instrument is not ready to take measurements (warm-up time is not yet fulfilled).	Do not push any control keys again. Error message display will disappear just after warm-up is complete.	C
E-08	p	Error in X-Y recorder control operation. An X-Y recorder control function was actuated despite that X-Y recorder output option (Opt. 004) is not installed.	The X-Y recorder control function should not be actuated again.	A
E-09	p	Error in continuous memory function. 1. Memory data to be continuously preserved has been lost. 2. Stand-by battery for continuous memory operation is exhausted.	The instrument requires servicing.	B
E-11	p	Abnormality in the instrument. (An instrument failure).	The instrument requires servicing.	C
E-12				
E-NN	B	NN: Numbers above 20. Refer to Paragraph 3-5 SELF TEST.		C
-OF-	A or B	Measured value to be displayed exceeds the upper range limit.	Select another measurement parameter at which the sample can be measured.	C
	p	Error in reference value input data. Reference value input number for REF A or REF B exceeds the maximum display value on the selected range.	Enter the reference value input data again using an appropriate number.	

Abbreviation Notes

Display section	A	DISPLAY A
	B	DISPLAY B
	p	Test Parameter Data Display
Display format	A	Duration of Display is about 2 seconds. The inappropriate control input demand is automatically released.
	B	Duration of Display is about 2 seconds. The panel controls are automatically set to the normal initial control setting status.
	C	Continuously displayed until the erroneous setup is removed.

3-49. EXTERNAL TRIGGERING.

3-50. For making a synchronized measurement with an auxiliary instrument, for taking a measurement using a particular occurrence as the start, or for generating measurement data at a preset time in a data logging system, an external trigger will facilitate properly timed measurements with the 4191A. To accept external trigger signals, the front panel EXT TRIGGER key must be pressed. Connect the external triggering device to the rear panel EXT TRIGGER connector with a BNC cable. Triggering requires a TTL level signal that changes from low (0V) to high (+5V) level. The trigger pulse width must be greater than 10µs. Shorting and opening (alternately) the center conductor of the EXT TRIGGER connector to ground (chassis) also effectively triggers a measurement.

Note: The center conductor of the EXT TRIGGER connector is normally at high level (no input).

Figure 3-18 shows an example of external triggering as used with programmed bias magnitudes.

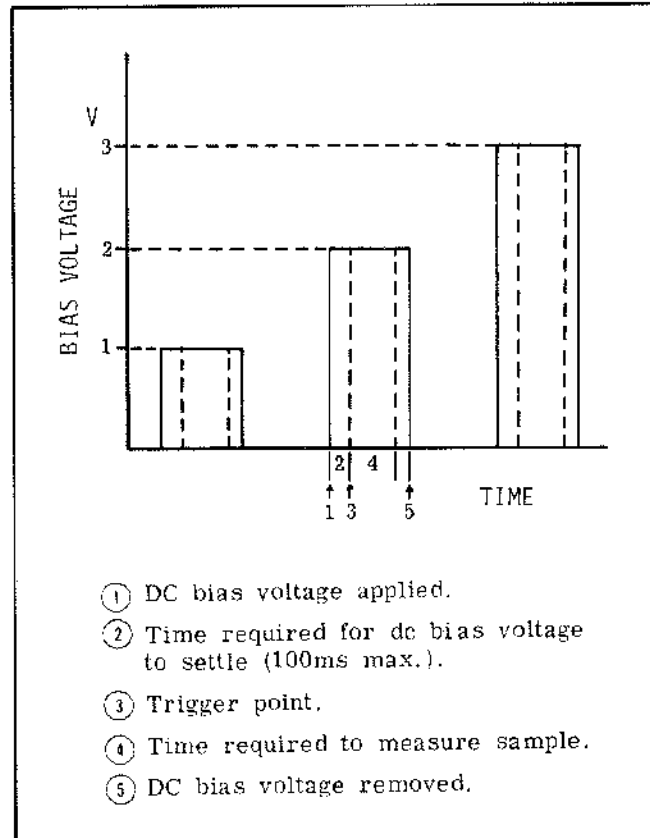

Figure 3-18. Pulse Bias Measurements with External Triggering for Programmed Bias Magnitudes.

Trigger rate

Maximum external trigger input rates for normal and high speed measurement modes are listed in the table below:

Measurement Mode	Max. Trigger rate
Normal	810 ms
High Speed	260 ms

In normal measurement mode of operation, five measurements are automatically taken (to perform and display an average of the measurements) each time the instrument is triggered. If the trigger input rate is too fast, measurement data is not provided because subsequent trigger signals always initialize the measurement sequence of the instrument before measurement ends.

Cleaning APC-7 Connectors

APC-7 connector contact surfaces of the UNKNOWN terminal, terminations and test fixtures must be kept free of spots, dust, oil and adhesives which invite poor connector contact.

To maintain clean contact surfaces, it is recommended that the operator perform periodic cleaning as necessary.

Use lint-free cloth and, if a cleaning fluid is needed, use isopropyl alcohol.

Caution:

Do not use aromatic or chlorinated hydrocarbons, esters, ethers, terpenes, higher alcohols, ketones, or ether-alcohols such as benzene, toluene, turpentine, dioxane, gasoline, cellulose acetate, or carbon tetrachloride.

Keep exposure of the connector parts to both the cleaning fluid and its vapors as brief as possible.

3-51. OPTIONS.

3-52. Options are standard modifications to the instrument that implement user's special requirements for minor functional changes. Operating instructions for the 4191A options (except for rack mount and handle installation kit options) and associated information are described in the following paragraphs.

3-53. OPTION 002 HIGH RESOLUTION TEST FREQUENCY.

3-54. The 4191A Option 002 provides an internal frequency synthesizer test signal resolution selectable at 100Hz (to 500MHz) and at 200Hz (to 1000MHz) instead of the standard frequency resolution. The selectable frequencies for the spot, start, stop and step frequency settings are shown in Table 3-1. To provide test frequency readouts up to 1000MHz in conjunction with the improved resolution, the Test Parameter Data Display is extended to 7 digits (maximum display 1000.0000MHz). Other control functions and operating performance, except for the test frequency resolution, are identical to the standard unit.

The high resolution frequency setting capability as well as the excellent frequency stability (residual FM noise is below 30Hz rms at 500MHz) facilitate, in particular, analysis of devices whose characteristic values vary sharply with changes in frequency, such as crystal resonators and high selectivity band-pass/rejection filters. In addition, the programmable test frequency sweep capability and HP-IB compatibility permits automating such measurements which usually entail taking measurement data at numerous test frequency points.

3-55. OPTION 004 ANALOG RECORDER OUTPUT

3-56. The 4191A Option 004 is equipped with three analog RECORDER OUTPUT (BNC) connectors on the rear panel. These connectors output accurate voltages for recording measured sample values in terms of test frequency or internal dc bias voltage in swept frequency or swept bias voltage measurements. The recorder output voltages are provided in the following manner:

FREQ/BIAS connector: Output voltage is proportional to the test frequency or internal dc bias voltage setting and is given by the following equation:

$$E_0 = \frac{f_{\text{spot}} - f_{\text{start}}}{f_{\text{stop}} - f_{\text{start}}} \text{ OR } \frac{V_{\text{spot}} - V_{\text{start}}}{V_{\text{stop}} - V_{\text{start}}} \text{ (V)}$$

The voltage value of E_0 is within the range of 0V and 1V. When LOG SWEEP function is set, the output voltage is proportional to logarithm of test frequency or of dc bias voltage.

DISPLAY A connector: Output voltage is proportional to the three lesser significant digit numbers of DISPLAY A display outputs (see illustration). 1mV per 1 count, ± 999 mV at full count display (± 999 counts).

DISPLAY B connector: Output voltage is proportional to DISPLAY B display output in the same manner as that for DISPLAY A connector output.

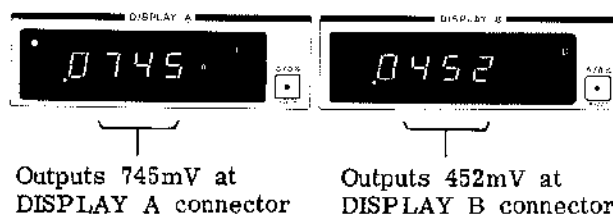
**Notes:**

1. When displayed number exceeds ± 1000 counts, the recorder output voltage is $-1V$ or $+1V$.
2. The recorder voltages are outputted only when the RANGE HOLD function is set automatically or manually.

Chart Paper Coordinates

Use chart paper coordinates appropriate for the measurement parameter from among illustrations below:

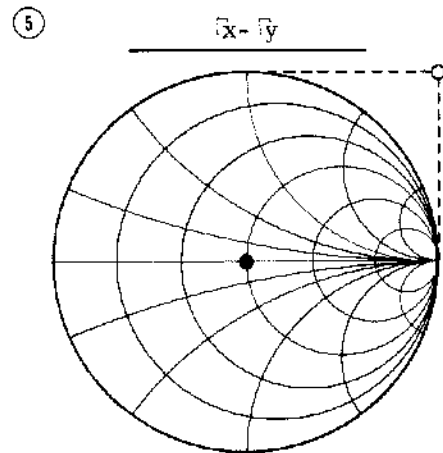
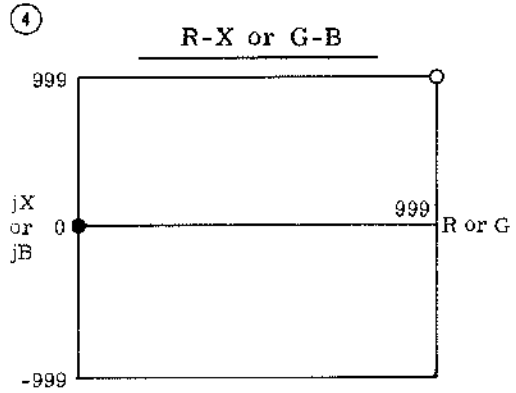
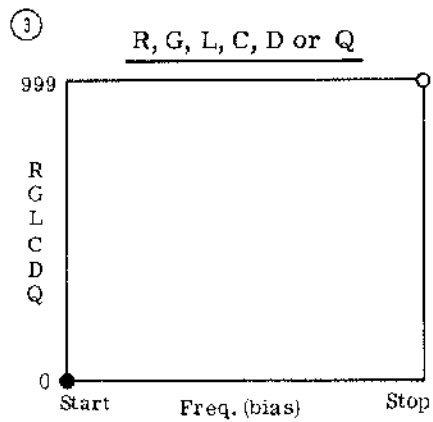
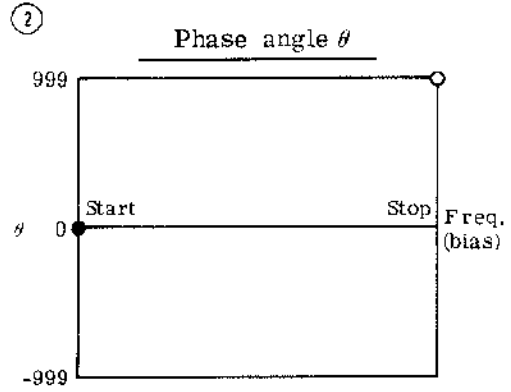
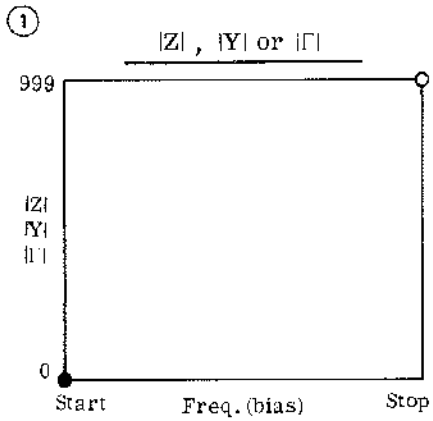

Black spot (•) \sqrt{LL}
 White spot (o) \sqrt{UR}
 Scales indicate in counts
 (999 signifies 999, 99.9,
 9.99, 0.999 or 0.0999).

Recording on Orthogonal X-Y Coordinates

Measurement parameter: $|Z|$, $|Y|$, $|\Gamma|$, R, G, L, C, D, Q
 θ , R-X, G-B

- 1) Connect X-Y recorder X input and Y input terminals, respectively, to the appropriate RECORDER OUTPUTS on 4191A rear panel. Use shielded cables with BNC connectors. See table 3-7 for cabling method.
- 2) Place recording paper on X-Y recorder platen and set paper hold down function to on. Lift recorder pen up and hold it until recording starts.
- 3) Press **Blue** key and \downarrow LL key (DATA input "2" key on the 4191A front panel). The indicator lamp above the \downarrow LL key will light.
- 4) Adjust X-Y recorder zero adjustment controls (independently for X and Y channels) so that the recorder pen is positioned just above the chart paper coordinates denoted by black spot (•) in the illustration.
- 5) Press **Blue** key and UR \rightarrow \uparrow key (DATA input "3" key) on the 4191A front panel. The indicator lamp above the UR \rightarrow \uparrow key will light.
- 6) Adjust X-Y recorder sensitivity adjustment controls (for X and Y channels) so that the recorder pen is positioned just above the chart paper coordinates denoted by white spot (◊) in the illustration.
- 7) Again press blue key and UR \rightarrow \uparrow key to release the zero adjustment function.
- 8) Perform a trial sweep measurement for sample to verify the minimum and maximum display read-outs.

Table 3-7. X-Y Recorder Cabling Method.

Recording parameters		X-Y recorder input connections		
X	Y	FREQ/BIAS	DSPL B	DSPL A
Freq or bias	$ Z , Y $ or $ \Gamma $	X	—	Y
Freq or bias	θ	X	Y	—
Freq or bias	R,G,L or C	X	—	Y
Freq or bias	D or Q	X	Y	—
R or Q	X or B	—	Y	X
Γ_x	Γ_y	—	Y	X

- 9) Change number of display digits to properly set the recording value range by pressing DIGIT SHIFT DSPL A or DSPL B key.
- 10) Set the 4191A frequency or bias voltage at the sweep start point and set X-Y recorder pen down.

Note: If smooth recorder tracing to variations in measured sample values is desired, press blue key and INTRPL key.

- 11) Start sweep measurement.

Recording on Smith Chart

Measurement parameter: $\Gamma_x - \Gamma_y$

Reflection coefficient locus in sweep frequency measurement offers graphic data quite useful in various applications when it is recorded on a Smith Chart. As the reflection coefficient values are represented in the form of orthogonal X-Y coordinates on the Smith Chart plane, its locus can be recorded by using the same procedure as that for other parameter values (described above). For X-Y recorder sensitivity and zero scale adjustments, find the locations of the two spots illustrated in figure 5; the black spot denotes the coordinates $(\Gamma_x, \Gamma_y) = (0, 0)$ and the white spot is identical to the virtual coordinates $(\Gamma_x, \Gamma_y) = (1, 1)$.

Note: To find the location of the white spot for sensitivity adjustment, construct two tangential lines of $|\Gamma| = 1$ circle at points $(\Gamma_x, \Gamma_y) = (1, 0)$ and $(\Gamma_x, \Gamma_y) = (0, 1)$, respectively, (as illustrated in figure 5).

3-57. Use of Strip Chart Recorder.

3-58. The analog recorder output also provides the convenience of monitoring drift or vibrations in sample values with time. To automate such time consuming tests, a strip chart recorder can perform the recording of measurement data without continuous monitoring by the operator. A single channel strip chart recorder permits recording either DISPLAY A or DISPLAY B measurement data outputs. A two channel recorder can simultaneously graph both data outputs on the chart paper.

Recorder sensitivity should be set so that the maximum displacement of the writing pen is within the chart paper span and, in addition, so that the change in measured values is readable on the chart.

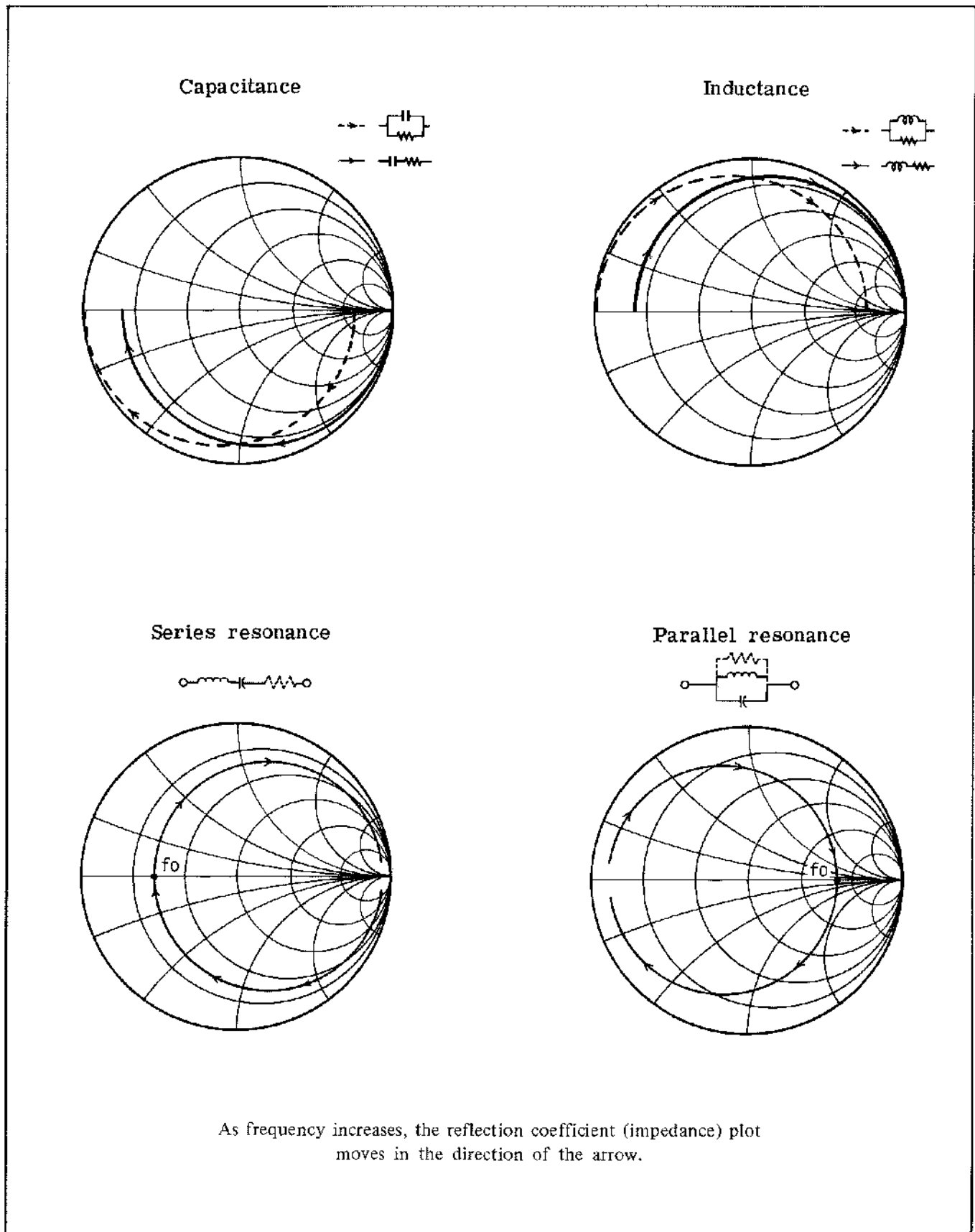

Figure 3-19. Smith Chart Illustrations of the Loci of Various Impedance Elements.

3-59. HP-IB INTERFACE

3-60. The Model 4191A can be remotely controlled by means of the HP-IB which is a carefully defined instrumentation interfacing method that simplifies the integration of instruments and a calculator, or computer into a system.

Note: HP-IB is Hewlett-Packard's implementation of IEEE Std. 488-1975 Standard Digital Interface for Programmable Instrumentation.

3-61. CONNECTION TO HP-IB

3-62. The 4191A may be connected into an HP-IB bus configuration with or without a controller (e.g. with or without an HP calculator). In an HP-IB system without a controller, the 4191A can function as a Talk Only unit (refer to paragraph 3-67).

3-63. HP-IB STATUS INDICATORS

3-64. The HP-IB Status Indicators are four LED lamps on the front panel. These lamps show the status of the 4191A in an HP-IB system as follows:

- SRQ: SRQ signal on HP-IB line from 4191A (refer to paragraph 3-77).
- LISTEN: The 4191A is set to be listener.
- TALK: The 4191A is set to be talker.
- REMOTE: The 4191A is remotely controlled.

3-65. LOCAL SWITCH

3-66. The LOCAL switch disables remote control from HP-IB control and enables setting measurement conditions at front panel controls (pushbutton switches). REMOTE HP-IB status indicator lamp turns off when LOCAL switch is depressed. This function can not be used when the 4191A is set to local lockout status by controller.

3-67. HP-IB CONTROL SWITCH

3-68. The HP-IB Control Switch on rear panel controls seven digits and three capabilities as follows:

- (1) Bit 1 ~ 5: The HP-IB address is established by these five digits of the control switch.
- (2) Bit 6 (delimiter form bit): This bit determines delimiter forms of output data which are:
 - 0: Format A (comma)
 - 1: Format B (carriage return, line feed).
- (3) Bit 7 (talk only bit): This bit determines instrument capabilities which are:
 - 0: Addressable
 - 1: Talk Only

Note: The 4191A is set at the factory as given in Figure 3-20.

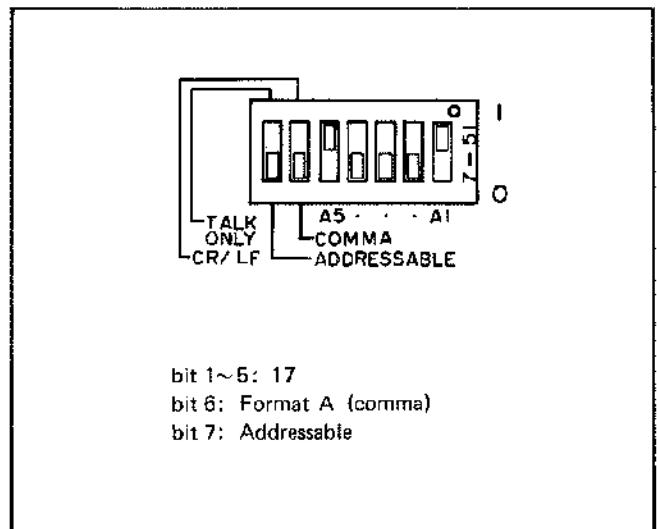

Figure 3-20. HP-IB Control Switch.

3-69. HP-IB INTERFACE CAPABILITY OF 4191A

3-70. The interface of a device connected to the HP-IB is specified by the interface functions built into the device. The 4191A has eight HP-IB interface functions as given in Table 3-8.

3-71. REMOTE PROGRAM CODE

3-72. Remote program codes for the 4191A are listed in Table 3-9.

Table 3-8. HP-IB Interface Capabilities.

Code	Interface Function* (HP-IB Capabilities)
SH1**	Source Handshake.
AH1	Acceptor Handshake.
T5	Talker (basic talker, serial poll, talk only mode, unaddress to talk if addressed to listen).
L4	Listener (basic listener, unaddress to listen if addressed to talk).
SR1	Service Request.
RL1	Remote-Local (with local lockout).
DC1	Device Clear.
DT1	Device Trigger.
<p>* Interface functions provide the means for a device to receive, process and transmit messages over the bus.</p> <p>** The suffix number of the interface code indicates the limitation of the function capability as defined in Appendix C of IEEE Std. 488-1975.</p>	

Table 3-9. Remote Program Code (Sheet 1 of 3).

	Control	Program Code	Description
Display A Function	Z	A1	Combinations of A and B are listed in the table below:
	Y	A2	
	Γ	A3	
	R	A4	
	G	A5	
	Γx	A6	
	L	A7	
	C	A8	
Display B Function	θ (deg)	B1, B3, B4	"AUTO RANGE" mode is automatically set when these program codes are transmitted.
	θ (rad)	B2	
	R	B1	
	G	B2	
	D	B3	
	Q	B4	

A \ B	1	2	3	4
1	Zl- θ (deg)	Zl- θ (rad)	Zl- θ (deg)	
2	Y- θ (deg)	Y- θ (rad)	Y- θ (deg)	
3	Γ- θ (deg)	Γ- θ (rad)	Γ- θ (deg)	
4	R - X			
5	G - B			
6	Γx - Γy			
7	L - R	L - G	L - D	L - Q
8	C - R	C - G	C - D	C - Q

Table 3-9. Remote Program Code (Sheet 2 of 3).

	Control	Program Code	Description
Deviation Measurement of Display A	OFF Δ $\Delta\%$	AN AD AP	Deviation measurement can not be done if reference data is not stored.
Deviation Measurement of Display B	OFF Δ $\Delta\%$	BN BD BP	“RANGE HOLD” mode is automatically set when AD, AP, BD or BP is assigned.
Displayed Value Input	STORE DISPLAY A/B	TD	
Key Status Memory	SAVE 1 SAVE 2	V1 V2	
Recall Saved Key Status	RCL 1 RCL 2	L1 L2	
Display A Multiplier	$\times 10^3$ (k) $\times 10^0$ $\times 10^{-3}$ (m) $\times 10^{-6}$ (μ) $\times 10^{-9}$ (n) $\times 10^{-12}$ (p)	P1 P2 P3 P4 P5 P6	
Display B Multiplier	$\times 10^3$ (k) $\times 10^0$ $\times 10^{-3}$ (m) $\times 10^{-6}$ (μ) $\times 10^{-9}$ (n)	Q1 Q2 Q3 Q4 Q5	
Display A Digit Shift	0 1 2 3 4	M0 M1 M2 M3 M4	
Display B Digit Shift	0 1 2 3 4	L0 L1 L2 L3 L4	
Manual Sweep	STEP \uparrow STEP \downarrow	SU SD	
Auto Sweep	START \uparrow START \downarrow PAUSE ABORT	WU WD PS AB	
High Speed	OFF ON	H0 H1	
Log Sweep	OFF ON	G0 G1	
Calibration	OFF ON START	C0 C1 CS	

Table 3-9. Remote Program Code (Sheet 3 of 3).

	Control	Program Code	Description
Trigger Mode	INT	T1	
	EXT	T2	
	HOLD/ MANUAL	T3	
Range Hold	OFF	R0	
	ON	R1	
Execute		EX	
Data Ready	OFF	D0	
	ON	D1	
Self Test	OFF	S0	
	ON	S1	
Recorder Control	OFF	XY	
	LL	LL	
	UR	UR	
Interpolation	OFF	I0	
	ON	I1	

3-73. PARAMETER SETTING

3-74. A 4191A can be set to twelve parameters (refer to Table 3-10) by remote programming as follows:

XX±NNNN.NNNNEN
(1) (2) (3)

- (1) Program code for parameter setting (refer to Table 3-10).
- (2) Setting value (numeric or space).
- (3) Parameter terminator.

Table 3-10. Program Code for Parameter Setting.

Parameter	Program Code	Setting Value
SPOT FREQUENCY (MHz)	FR	1.0 ~ 1000.0 (1.0000 ~ 1000.0000)
STEP FREQUENCY (MHz)	SF	0.1 ~ 999.0 (0.0001 ~ 999.0000)
START FREQUENCY (MHz)	TF	1.0 ~ 1000.0 (1.0000 ~ 1000.0000)
STOP FREQUENCY (MHz)	PF	1.0 ~ 1000.0 (1.0000 ~ 1000.0000)
SPOT BIAS (V)	BI	-40.00 ~ +40.00
STEP BIAS (V)	SB	0.01 ~ 40.00
START BIAS (V)	TB	-40.00 ~ +40.00
STOP BIAS (V)	PB	-40.00 ~ +40.00
DISPLAY A REFERENCE	RA	-199.99 ~ +199.99
DISPLAY B REFERENCE	RB	-199.99 ~ +199.99
ELECTRICAL LENGTH (cm)	EL	0.00 ~ 99.99
OPEN CAPACITANCE (pF)	OC	-1.000 ~ +1.000

3-75. DATA OUTPUT

3-76. Data outputted by the 4140A includes data statuses, measured parameters, deviation measured modes and measured values for displays A and B. Moreover,

swept parameter and swept frequency or bias value are outputted by the 4191A in auto sweep or calibration mode. These data are outputted in format as shown in Figure 3-21.

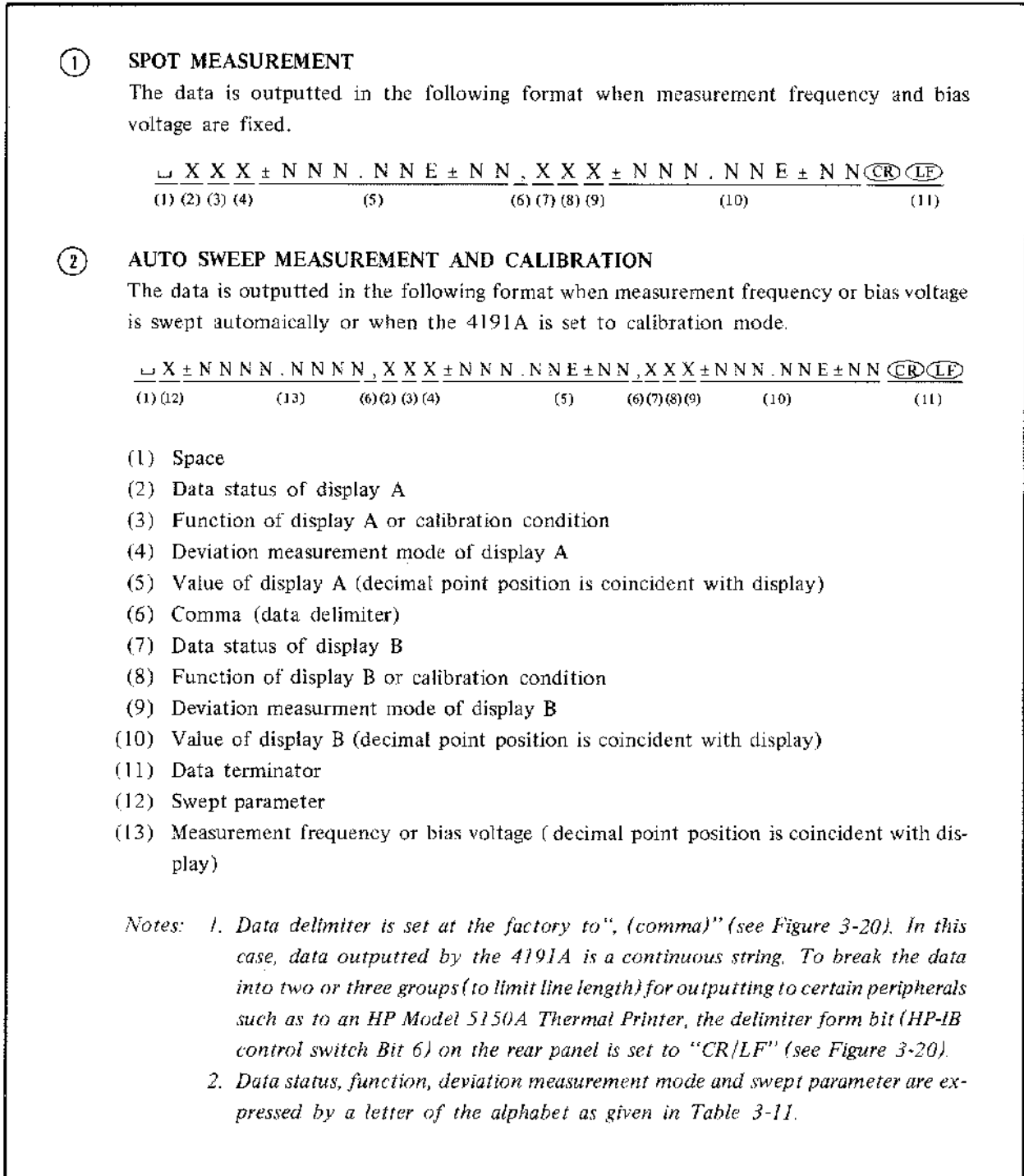

Figure 3-21. Data Output Format for the 4191A.

Table 3-11. Data Output Codes.

	Information	Code
Data Status	Normal	N
	Overflow	O
	Deviation Measurement impossible	D
	Needs Calibration	U
Display A Function	Z	Z
	Y	Y
	Γ	M
	R	R
	G	G
	Γx	X
	L	L
Display B Function	C	C
	θ (deg)	D
	θ (rad)	R
	X	X
	B	B
	Γy	Y
	R	R
Calibration Condition	G	G
	D	D
	Q	Q
Calibration Condition	0Ω	S
	0S	O
	50Ω	T
Deviation Measurement	Normal Measurement	N
	Deviation Measurement	D
	Deviation Measurement in Percent	P
Swept Parameter	Frequency	F
	Bias Voltage	V

3-77. SERVICE REQUEST STATUS BYTE

3-78. The 4191A sends RQS (request service) signal whenever one of bits 1 thru 4 or 6 is set. Figure 3-22 shows the Status Byte make up of the 4191A.

3-79. PROGRAMMING GUIDE FOR 4191A.

3-80. Sample Programs for HP Model 9825A/9835A Desktop Computers are provided in Figures 3-23 and 3-24. These programs are listed in Table 3-12.

Notes:

1. Specific information for HP-IB programming with the 9825A or 9835A are provided in the 9825A or 9835A programming manuals.
2. The equipment required for these sample programs include:
 - 4191A RF Impedance Analyzer
 - 98034A HP-IB Interface Card
 - 9825A Desktop Computer with 98210A String-Advanced Programming ROM
 - 98213A General I/O + Extended I/O ROM.

or

 - 9835A Desktop Computer with
 - 98332A General I/O ROM

Table 3-12. Sample Program using 9825A/9835A

Sample Program	Figure	Description
1	3-23	Remote control and data output in spot measurement.
2	3-24	Remote control and data output in auto sweep measurement.

Bit	8	7	6	5	4	3	2	1
Information	0	0/1	0/1	0/1	0/1	0/1	0/1	0/1

Signal bit 7 (RQS signal) establishes whether or not service request exists.

Signal bits 1 thru 4 and 6 identifies character of the service request states.

Service request states of the 4191A:

- (1) Bit 1: ① If Data Ready is set to ON, this state is set when measurement data is provided.
② If Self Test is set to ON, this state is set when Self Test is completed.
- (2) Bit 2: ① When the 4191A receives an erroneous remote program code, this state is set.
② If Bit 6 is set, this state is set when Vector Ratio Detector is defective.
- (3) Bit 3: ① When the 4191A receives an illegal front panel control setting program, this state is set.
② If Bit 6 is set, this state is set when phase locked loop is defective.
- (4) Bit 4: ① When the 4191A receives trigger signal before last measurement is completed, this state is set.
② When the 4191A provides measurement data before last measurement data is outputted, this state is set.
③ If Self Test is set to ON, this state is set when Self Test is faulty.
- (5) Bit 6: ① If Vector Ratio Detector is defective, this state is set. Bit 2 is also set.
② If Phase Locked Loop is defective, this state is set. Bit 3 is also set.

Signal bit 5 is independent of bit 7 (RQS signal). When auto sweep or calibration is being performed, this bit is set.

Figure 3-22. Status Byte for the 4191A.

Sample Program 1

Description:

This program is a remote control and data output program in spot measurement.

The program has three capabilities which are:

- (1) Control of the 4191A via HP-IB.
- (2) Trigger of the 4191A via HP-IB.
- (3) Data output from the 4191A in spot measurement via HP-IB.

9825A Program

```

0: flt4
1: wrt717,"A1BIT3"
      (1) (2) (3)
2: wrt717,"FR10EN"
      (4) (5)
3: wrt717,"EX"
      (6)
4: red717,A,B
5: dspA,B
6: prtA,B
7: end
    
```

9835A Program

```

10: FLOAT4
20: OUTPUT717;"A1BIT3"
      (1) (2) (3)
30: OUTPUT717;"FR10EN"
      (4) (5)
40: OUTPUT717;"EX"
      (6)
50: ENTER717;A,B
60: DISPA,B
70: PRINTA,B
80: END
    
```

- (1) Select code of 98034A.
- (2) Address code of 4191A.
- (3) Program codes of the 4191A (refer to Table 3-9).
- (4) Program codes for parameter setting of the 4191A (refer to Table 3-10).
- (5) Parameter terminator of the 4191A (refer to paragraph 3-73).
- (6) This line means the same as following program:

```

9825A: trg717
9835A: TRIGGER717
    
```

By using string variables, complete output information from the 4191A is stored by the following programs:

9825A Program:

```

0: dimAS[50]
1: wrt717,"A1BIT3"
2: wrt717,"FR10EN"
3: wrt717,"EX"
4: red717,A,$
5: dspAS
6: prtAS
7: end
    
```

9835A Program:

```

10: DIMAS{50}
20: OUTPUT717;"A1BIT3"
30: OUTPUT717;"FR10EN"
40: OUTPUT717;"EX"
50: ENTER717;AS
60: DISPAS
70: PRINTAS
80: END
    
```

Figure 3-23. Sample Program 1 using 9825A/9835A.

Sample Program 2**Description:**

This program is a remote control and data output program in auto sweep measurement.

The program has three capabilities which are:

- (1) Control of auto sweep measurement of the 4191A via HP-IB.
- (2) Auto sweep of the 4191A via HP-IB.
- (3) Data output from the 4191A via HP-IB.

9825A Program:

```

0: dimAS[100,50]
      (1)
1: wrt717,"A1BIT3"
2: wrt717,"SF1ENTF1ENPF100EN"
3: wrt717,"WU"
4: 0→I
5: I+1→I
6: red717;AS[I]
7: dspAS[I]
8: prtAS[I]
9: rds(717)→A
      (2)
10: if bit(A,4);gto5
      (3)
11: end

```

9835A Program:

```

10: DIMAS(100){50}
      (1)
20: OUTPUT717;"A1BIT3"
30: OUTPUT717;"SF1ENTF1ENPF100EN"
40: OUTPUT717;"WU"
50: I=0
60: I=I+1
70: ENTER717;AS(I)
80: DISP AS(I)
90: PRINT AS(I)
100: STATUS717;A
      (2)
110: IF BIT(A,4)THEN60
      (3)
120: END

```

- (1) Establishes a dimensional array parameter that is greater than number of measurement points.
- (2) Inputs 4191A SRQ Status Byte to variable A.
- (3) When auto sweep being performed, bit 4 of variable A (bit 5 of SRQ Status Byte) is set to "1".

Figure 3-24. Sample Program 2 using 9825A/9835A.

SMITH CHART APPLICATIONS

The Smith Chart is a convenient artifice for facilitating rf vector impedance calculations which are sometimes needed to correct measured values for change of electrical length or other test parameters. This paragraph offers a brief outline of the Smith Chart for the users who are not familiar with its use:

Figure A shows the Smith Chart plane of impedance coordinates. On the Smith Chart plane, the coordinate scales signify the following impedance component quantities:

The circles tangent at point (a) are the scales for which resistance values are constant. The arcs which cross at point (a) along with intersecting the circles at right angles are the scales for which reactance values are constant.

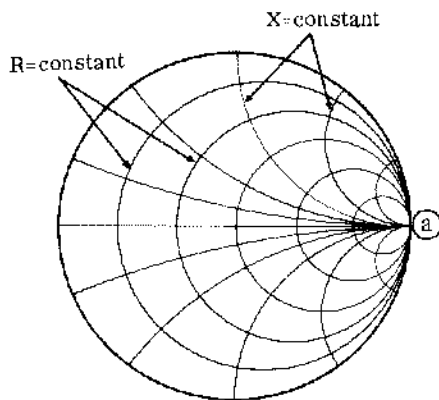

Figure A. Smith Chart.

These resistance and reactance scale values are the normalized values which are calculated by sample impedance ($Z_x = R_x + jX_x$) divided by the characteristic impedance ($Z_0 = 50\Omega$) of the measuring circuit, that is:

$$\text{Normalized impedance } R_r + jX_r = \frac{Z_x}{Z_0} = \frac{R_x}{50} + \frac{jX_x}{50}$$

A sample impedance value is represented on the Smith Chart as a point coordinated with the scales corresponding to its normalized impedance (see figure B). The base impedance Z_0 (characteristic impedance) is located at the center of the Smith Chart plane. The radius vector $\vec{Z_0 \cdot Z_r}$ represents the reflection coefficient value $|\Gamma| \angle \theta$ of the sample (in this case, the electrical length of the transmission line is not being taken into consideration). The phase angle scales for the reflection coefficient vector are provided along the outer circumference of the Smith Chart. The phase angle of the reflection coefficient can

be read from the phase angle scale as indicated by an extension of the vector $\vec{Z_0 \cdot Z_r}$. The absolute value of the reflection coefficient $|\Gamma|$ is constant at any point on the circle of the radius $Z_0 Z_r$.

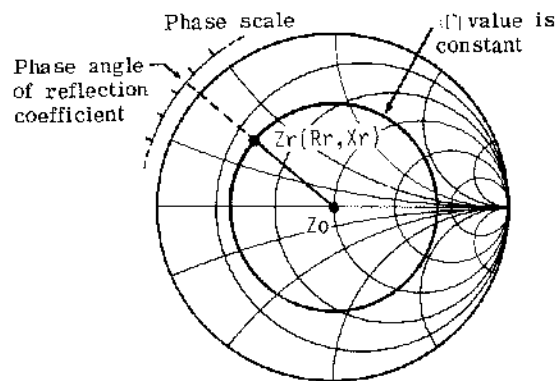

Figure B. Smith Chart.

When a parallel transmission line (coaxial line) of line length ℓ is terminated by the sample, the impedance value of the sample measured at the other end of the line is derived as follows:

First, the difference in phase angle of the reflection coefficient value Γ produced by the lead length ℓ is calculated using the following equation:

$$\theta = \frac{4\pi\ell}{\lambda} \quad (\lambda: \text{wave length of test signal})$$

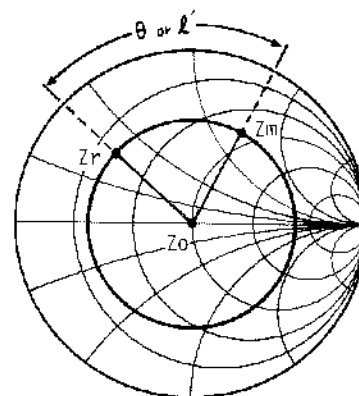

Figure C. Smith Chart.

Next, radius vector $Z_0 \cdot Z_x$ is rotated clockwise (towards the generator) by the calculated phase angle θ . The measured impedance value (normalized impedance) coincides with the scale reading at point Z_m . See Figure C.

Generally, a Smith Chart has wavelength scales for reading the phase difference in the ratio dimension of the line length to the wavelength. That is:

$$\ell' = \frac{2\ell}{\lambda}$$

The rotational angle may be measured as ℓ' on the wavelength scales instead of θ .

On the contrary, if a measured impedance value is Z_m , the true impedance value of sample is found as Z_r by rotating the radius vector $\overline{Z_0 \cdot Z_m}$ counter-clockwise.

Notes:

1. The above discussion assumes that the test signal propagation loss in the line is negligibly low. Actually, the propagation losses may be neglected when the measuring circuit length is short.
2. When the transmission line has a certain level of propagation loss, the radius vector of the measured reflection coefficient shortens by $1/e^{-2\alpha\ell}$ (α = attenuation coefficient of the line).

TRANSMISSION LINE CHARACTERISTICS

When the test port is specially extended to gain access to the device tested, the extended measuring circuit should maintain the equality of the measuring circuit characteristic impedance. A discontinuity in characteristic impedance of measuring circuit, if not properly compensated, will cause differences between the measured values and true sample values. When a sample needs be measured together with the unknown cable connected to the sample or when the extension line used produces an impedance mismatch with the test port, how can the sample values be measured? In such cases, the actual sample values can be calculated from measured values if the characteristics of the extra transmission line is ascertained. To discuss this problem, let's look at the characteristics of a transmission line.

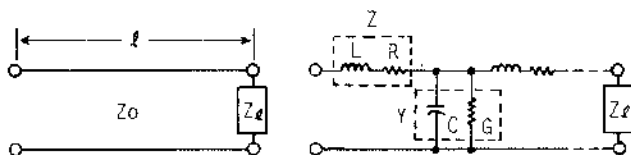

- L: distributed inductance per unit length.
- R: distributed resistance per unit length.
- C: stray capacitance per unit length.
- G: stray conductance per unit length.

- 1) The above figure shows a lumped constant equivalent circuit model of a parallel or a coaxial transmission line. The characteristic impedance (Z_0) of this line is represented by the following equation:

$$Z_0 = \sqrt{\frac{Z}{Y}} = \sqrt{\frac{R + j\omega L}{G + j\omega C}}$$

where, R, L, G and C are the equivalent circuit elements of the distributed constants. Propagation constant (γ) of this line is given as:

$$\gamma = \sqrt{ZY} = \sqrt{(R + j\omega L)(G + j\omega C)} = \alpha + j\beta$$

where, attenuation constant α and phase constant β represent the attenuation of the signal amplitude and the phase shift, respectively, per unit line length.

When the Z_0 and γ values of the transmission line are unknown, these constant values can be experimentally derived by measuring impedance as the line is terminated at open-circuit and short-circuit conditions:

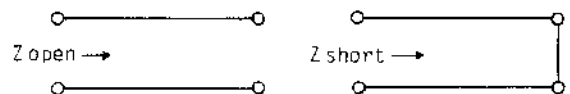

$$Z_0 = \sqrt{Z_{open} \cdot Z_{short}}$$

$$\gamma = \frac{1}{\ell} \tan^{-1} \sqrt{\frac{Z_{short}}{Z_{open}}}$$

$$= \frac{1}{2\ell} \log \frac{Z_{open} + \sqrt{Z_{short} \cdot Z_{open}}}{Z_{open} - \sqrt{Z_{short} \cdot Z_{open}}}$$

$$Z = Z_0 \gamma$$

$$Y = \gamma / Z_0$$

2) When an impedance element Z_ℓ is connected to the tip of the line, the measured impedance value at the other end of the line is given by the following equation:

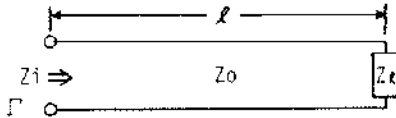

$$Z_i = Z_0 \frac{Z_\ell + Z_0 \tanh \gamma \ell}{Z_\ell \tanh \gamma \ell + Z_0}$$

Measured reflection coefficient is:

$$\Gamma = \Gamma_0 e^{-2\gamma \ell} = \frac{Z_\ell - Z_0}{Z_\ell + Z_0} e^{-2\gamma \ell}$$

The sample impedance value is therefore calculated as:

$$Z_\ell = Z_0 \frac{Z_0 \tanh \gamma \ell - Z_i}{Z_i \tanh \gamma \ell - Z_0}$$

$$\text{or } Z_\ell = Z_0 \frac{1 + \Gamma e^{-2\gamma \ell}}{1 - \Gamma e^{-2\gamma \ell}}$$

3) If the transmission line is ideal, – that is, it has no loss ($R = 0, G = 0$), the equations which represent the values for Z_0, γ, Z_i and Z_ℓ are simplified as follows:

$$Z_0 = \sqrt{\frac{L}{C}}, \quad \gamma = j\omega \sqrt{LC} \quad (\alpha = 0, \beta = \omega \sqrt{LC})$$

$$Z_i = Z_0 \frac{Z_\ell + jZ_0 \tan \beta \ell}{Z_0 + jZ_\ell \tan \beta \ell}$$

$$Z_\ell = Z_0 \frac{Z_i - jZ_0 \tan \beta \ell}{Z_0 - jZ_i \tan \beta \ell}$$

$$\text{or } Z_\ell = Z_0 \frac{1 + \Gamma e^{-2j\beta \ell}}{1 - \Gamma e^{-2j\beta \ell}}$$

4) With a cascade connection of different transmission lines as illustrated below, the impedance value of the sample can be calculated by using the given equations as follows:

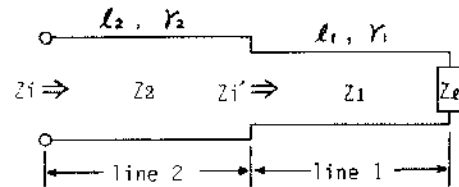

$$Z_\ell = Z_1 \frac{Z_1 \tanh \gamma_1 \ell_1 - Z_i'}{Z_i' \tanh \gamma_1 \ell_1 - Z_1}$$

$$Z_i' = Z_2 \frac{Z_2 \tanh \gamma_2 \ell_2 - Z_i}{Z_i \tanh \gamma_2 \ell_2 - Z_2}$$

where, Z_i' is impedance value measured at the input of line 1 (Z_1, ℓ_1, γ_1).
 Z_i is impedance value measured at the input of line 2 (Z_2, ℓ_2, γ_2).

As the above equations have the identical form of the equation terms, a programmed calculation can facilitate the procedure by repetitive use of the same basic equation.

Table 4-1. Recommended Test Equipment.

Equipment	Critical Specifications	Recommended Model	Use
Frequency Counter	Frequency: 1 GHz Sensitivity: -35dBm Accuracy : $\leq 1 \times 10^{-7}$	HP 5340A	P A
Attenuator	10dB to 1 GHz, 50 Ω	HP 8491A	P A
Cable	N type connector cable	HP 11500B	P A
Cable	BNC to dual alligator clip cable		A
Terminal Converter	N type female to APC-7	HP 11524A	P A
Terminal Converter	SMC female to N type female	-hp- 1250 - 1153	A
RF Power Meter	Frequency: 1 GHz Sensitivity: -20 to 0dBm f.s. Accuracy : ± 0.5 dB	HP 436A	P A
Power Sensor	1 μ W min. to 1 GHz, 50 Ω	HP 8482A	P A
Digital Multimeter	DC Voltage Range: 1mV to 100V Resistance Range : 100 Ω f.s. min Voltage Accuracy : 0.01%	HP 3455A	P A T
Test Leads	Dual banana to alligator clip leads	HP 11002A	A T
Test cable	BNC to dual banana plug cable	HP 11001A	P
Terminal Converter	APC-7 to BNC female		P
Spectrum Analyzer	Frequency Range: 1MHz to 1 GHz Resolution : 100 Hz Dynamic Range : > -90 dB	HP 141T w/8554B w/8552B	P A
Oscilloscope	Bandwidth : 100MHz Sensitivity : 5mV min.	HP 1740A	A T
Probe	10M Ω , 10 : 1	HP 10006D	A T
DC Power Supply	Output Voltage: 0V to 20V Resolution : 0.01V	HP 6224B	A T
Thermometer	Temperature Range: 15°C to 30°C Accuracy : ± 0.5 °C	HP 2802A	A
Probe	Thermister Sensor	HP 18641A	A
Reference Terminations	0 Ω 50 Ω 0S ($\infty\Omega$) Coaxial Capacitor (318pF at 10MHz)	HP 16342A (Calibration Equip- ment Kit)	P A
Reference Air Line	20cm long (HP 11567A calibrated)		

Table 4-1. Recommended Test Equipment (cont'd).

Equipment	Critical Specifications	Recommended Model	Use
Calculator		HP 9825A w/98210A w/98216A	P
Interface Cable		HP 98034A	P
Logic Test Box	(Special electronic tool for troubleshooting digital control board using a signature analyzer)	HP 16341A	T
Signature Analyzer		HP 5004A	T
Extender Board	10 pin dual in-line 10 pin single in-line	-hp-04191-66560 -hp-04191-66561	A T

P: Performance Test, A: Adjustment, T: Troubleshooting

SECTION IV

PERFORMANCE TESTS

4-1. INTRODUCTION

4-2. This section describes the tests and procedures used to verify the instrument specifications listed in Table 1-1. All tests can be performed without access to the interior of the instrument. A simpler, automatic operational test is presented in Section III under Self Test (paragraph 3-5). The performance tests described here can also be used when performing incoming inspection of the instrument and when verifying that the instrument meets specified performance after troubleshooting and/or adjustment. If the performance tests indicate that the instrument is operating outside specified limits, check that the controls on the instruments used in the test and the test set-up itself are correct and then proceed with adjustments and/or troubleshooting.

Note: To ensure proper test results and instrument operation, Hewlett-Packard suggests a 40 minute warm-up and stabilization period before performing any of the performance tests.

4-3. EQUIPMENT REQUIRED

4-4. Equipment required to perform all of the performance tests is listed in Table 4-1. Any equipment that satisfies or exceeds the critical specifications listed in the table may be used as a substitute for the recommend models. Accuracy checks described in this section use the HP Model 16342A Calibration Equipment Kit. The characteristics of the equipment in this kit satisfy the performance requirements for the accuracy checks and are especially suited for use as the 4191A's accuracy test standards.

Notes:

1. Included in the 16342A is the 4191A Test Program Tape. This tape contains programs that, when used with the HP Model 9825A Desktop Computer, automatically perform the performance tests described here. For more information on the test programs, refer to the 4191A Test Program Tape User's Guide.
2. Components used as standards should be calibrated by an instrument whose accuracy is traceable to NBS or an equivalent standards group; or calibrated directly by an authorized calibration organization such as NBS. The calibration cycle should be in accordance with stability specifications of each component.

4-5. TEST RECORD

4-6. Performance test results can be recorded on the Test Record at the completion of the test. The Test Record lists all the tested specifications and their acceptable limits. Test results recorded at incoming inspection can be used for comparison in periodic maintenance, troubleshooting, and after repairs or adjustments.

4-7. CALIBRATION CYCLE

4-8. This instrument requires periodic verification of performance. Depending on the conditions under which the instrument is used, e.g., environmental conditions or frequency of use, the instrument should be checked, with the performance tests described here, at least once a year. To keep instrument down-time to a minimum and to insure optimum operation, preventive maintenance should be performed at least twice a year.

ACCURACY TEST CONSIDERATIONS

GENERAL

Measurement accuracy of the 4191A is specified for the reflection coefficient which is the direct measurement parameter of the measuring circuit used. The accuracy of the other available measurement parameters are, if low order errors related to the significant digits in the parameter conversion calculations are disregarded, equivalent to the accuracy of the reflection coefficient parameter. The auto-calibration function of the 4191A implements error correction calculations for all measured reflection coefficients using calibration data obtained from measurements of three reference terminations, and reduces the errors to the level of inaccuracies inherent in those reference terminations. Consequently, if auto-calibration is performed in accordance with the programmed routine, errors inherent in the measurement circuit will have little or no effect on the resultant accuracy.

Theoretical background of the auto-calibration

The reflection coefficient vectors for the reference terminations are located on the axis corresponding to $\Gamma_y = 0$ on the Smith Chart shown in Figure A. These vectors are:

$$\begin{aligned} 0\Omega: \Gamma_x &= -1, \Gamma_y = 0 \quad (\Gamma = 1 \angle \pi) \\ 0S: \Gamma_x &= 1, \Gamma_y = 0 \quad (\Gamma = 1 \angle 0) \\ 50\Omega: \Gamma_x &= 0, \Gamma_y = 0 \quad (\Gamma = 0) \end{aligned}$$

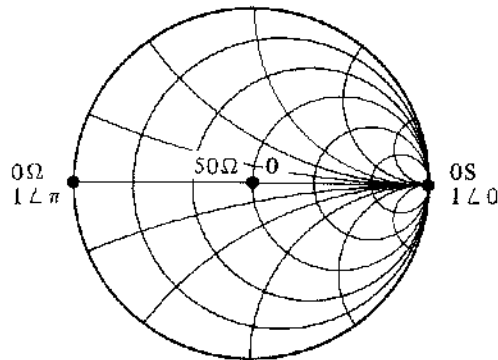

Figure A. Reference Termination Vectors.

During acquisition of calibration data, the reflection coefficients for these references are measured to verify the particular characteristics of the measurement circuit causing measurement errors. The measured Γ values provide the individual values of three dominant error factors, which are represented by the following equations:

$$\left. \begin{aligned} e_{00} &= \Gamma_{50} \\ e_{11} &= \frac{\Gamma_{\infty} + \Gamma_0}{\Gamma_{\infty} - \Gamma_0} \\ e_{01} &= (\Gamma_{50} - \Gamma_0)(1 + e_{11}) \end{aligned} \right\} \dots (4-1)$$

where; e_{00} is the reflection crosstalk (directivity) error of the directional bridge measuring circuit.

e_{01} is the linear tracking error (full scale error).

e_{11} is the (unwanted) reflection port mismatch error.

Γ_0 , Γ_{∞} and Γ_{50} are measured Γ values for 0Ω , $0S$ and 50Ω reference terminations, respectively.

ACCURACY TEST CONSIDERATIONS

All the measured DUT values are corrected for the effects of these errors using the following calculation:

$$\Gamma_{true} = \frac{\Gamma_m - e_{00}}{e_{11} (\Gamma_m - e_{00}) + e_{01}} \dots (4-2)$$

where; Γ_{true} is the actual Γ value of the DUT.
 Γ_m is the measured Γ value of the DUT.

Since e_{00} , e_{01} and e_{11} can be determined by making trial measurements of the desired three reflection coefficient points on Smith Chart, the three reference terminations used in auto-calibration are sufficient for obtaining the complete calibration data required for the correction calculations. Because the Γ_y values of the reference terminations are essentially zero, these terminations do not seem to offer the necessary reference vector(s) for taking correction data regarding Γ_y component vectors of the measured DUT's. Then, how does the auto-calibration make corrections on all the measured values as stated above? The answer is that, these dominant error factors are constant values irrespective of the reflection coefficient phase of the measured DUT. The errors related to the Γ_y components also deviate the measured values for the reference terminations from their nominal values and are included in the calibration data. Thus, error correction can be achieved on all measured vectors without additional reference.

The discussion that follows is related to the conditions that must be satisfied when performing an optimum calibration to maximize measurement accuracy. Figure B is a block diagram of the 4191A measurement section. A reflected vector signal from the DUT, which is represented by the directional bridge circuit, is phase-detected to separate its orthogonal phase (Γ_x and Γ_y) component from the signal. Inherent errors in the directional bridge, possible gain error and phase shift in the frequency converter and amplifier stages are included in the calibration data as equivalent factors. The auto-calibration minimizes these comprehensive errors in the measurement results. However, only the phase detection error is left uncorrected because it causes inaccuracy of the calibration data to occur. Accordingly, the phase detector must be operating at optimum detection accuracy. As the same phase detector circuit acts for both Γ_x and Γ_y vector components, the errors with respect to detection efficiency are equal for both and are eliminated from the measured values as a portion of the linear tracking error (e_{01}) by the auto-calibration function. Thus, the phase accuracy of the 0° and 90° detection phase signals eventually dominates the measurement accuracy.

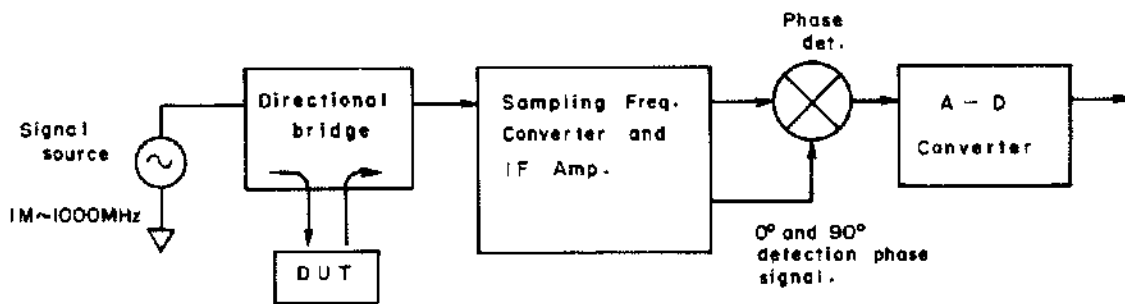

Figure B. 4191A Measurement Section.

ACCURACY TEST CONSIDERATIONS

Using a coaxial capacitor connected to the UNKNOWN connector, the detection phase signals are adjusted to be exactly 90 degrees out of the phase with each other. This special capacitive termination is included in the 16342A Calibration Equipment Kit. At the 10MHz test frequency, the 318 pF coaxial capacitor has a reflection coefficient equal to $\Gamma = 0 - j1$ (i.e. $Z = -j50\Omega$). Because of its structure and characteristics, the coaxial capacitor makes it easy to test the detection phase accuracy.

When performing auto-calibration over the entire frequency range, the measured vectors for the reference terminations will exhibit certain loci on the Smith Chart plane, as shown in Figure C. Deviations in magnitude of the measured vectors from the reference points represent basic errors, including various effects equivalent to internal losses in the measuring circuit (such as propagation losses, amplification and attenuation errors). On the other hand, those related to phase angle are electrical length (compensation) errors. If a measured reflection coefficient differs more than a certain extent from the reference termination value, calibration error increases. The individual vector loci should be within the ranges indicated by the shaded areas in Figure C.

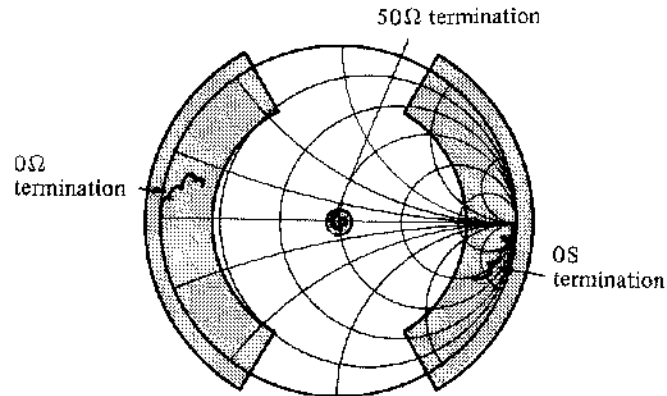

Figure C. Reflection Coefficient Loci of Calibration Data.

For further confirmation of the accuracy, the precision reference air line, included in the 16342A, permits tests that compare various reflection coefficient vectors with measured values. Instead of using several standard devices of ordinary design which cover only a narrow frequency range, a rotative vector developed by the air line provides a more practical means of testing over the entire 4191A measurement frequency range. When making a measurement with the reference air line connected to the UNKNOWN connector, the phase angle of the measured reflection coefficient is determined by the frequency and the electrical length of the air line. By sweeping the measurement frequency, the measured vector can turn around nearly 360 degrees on Smith Chart plane. For comparison, the inherent reflection coefficients of the air line at a total of 51 frequency points (identical to the 4191A calibration frequencies) are theoretically calculated from characteristic values. The requisite characteristic data for the calculation and the performance requirements of the reference air line are:

- 1) VSWR value (lower than 1.002).
- 2) Mechanical dimensions (accuracy higher than 0.2%).
- 3) Plating conditions on the surface (gold over silver plating).

ACCURACY TEST CONSIDERATIONS

The electrical length value is calculated from the mechanical dimensions and the propagation loss is determined by the quality of the plating. The theoretical calibration data of the air line is given in the test program cartridge tape furnished with the 16342A (HP-IB automatic test procedure). There is a close interrelation between the test with the coaxial capacitor and that with the air line. That is, an abnormality detected in either of the tests affects the result of the other test.

Accuracy test methods

Through the discussion for the basic theory of the auto-calibration, it is recognized that the measurement accuracy of the 4191A is assured by three different tests as listed below:

- 1) The test for verification of normal auto-calibration function, described in Para 4-15. Auto-calibration test.
- 2) The test for calibration data range, described in Para 4-17. Error correction function test.
- 3) The test for verification of phase detection accuracy, described in Para 4-19. Accuracy test.

REFERENCE TERMINATION ACCURACY

The accuracy of the 0Ω , $0S$ and 50Ω termination impedances of the three reference terminations determines the accuracy of the auto-calibration, and the measurement accuracy obtainable by using those terminations. To ensure the specified measurement accuracy of the 4191A, accurate termination impedances are achieved by precise design of the reference terminations using theoretical analysis for the actual termination impedances.

The theoretical background for the reliability of the reference terminations is outlined in the following paragraph.

0Ω Reference Termination:

The 0Ω Reference Termination (Part No. 04191-85300) has a gold plated, plane contact which short-circuits the test port to an accurate 0Ω impedance when connected to the UNKNOWN terminal of the 4191A. As the measurement signal current flows between the center and outer conductor of the terminal through the gold plated surface and across the contact plane of the 0Ω termination, the additive resistance to the 0Ω is extremely low. Moreover, the structure of the termination yields radial vectors of the measurement current flowing from the center towards the outer conductor (or the reverse direction), thus, there must be an opposite vector relating to an arbitrary current vector in the radial direction. Because the induced magnetic fluxes of the opposing current vectors cancel each other out, the sum of the integrated magnetic fluxes comes to nearly zero, and consequently, the residual inductance is also minimum. Accordingly, the 0Ω reference termination has 0Ω with a very low residual impedance (less than $2m\Omega$) at frequencies up to 1GHz. This residual impedance does not affect the values above the least significant digit of the measurement display output in the practical measurement ranges.

ACCURACY TEST CONSIDERATIONS

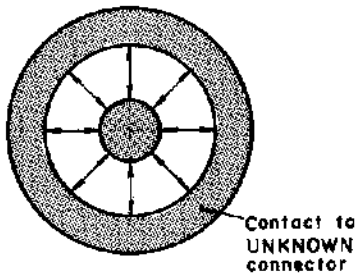

Radial vectors of the measurement signal current on the 0Ω termination surface.

50 Ω Reference Termination:

The 50 Ω Reference Termination (Part No. 04191-85301) has a non-reactive impedance of 50 Ω with an accuracy of $\pm 250\text{m}\Omega$ over the entire measurement frequency range of the 4191A and is traceable to the National Bureau of Standards (NBS). The termination impedance of 50 Ω is guaranteed to meet the specified accuracy $*|\Gamma| \leq 0.0025$ when shipped with the 4191A instrument from the factory. The accuracy of the 50 Ω termination should be checked when performing the biannual calibration of the 4191A.

**Note: The accuracy of the 50 Ω termination is specified for the reflection coefficient. This accuracy corresponds to $50 \pm 0.25\Omega$ in impedance representation (not specified).*

0S Reference Termination:

When the 0S termination (Part No. 04191-85302) is connected to the UNKNOWN terminal, the stray conductance and the stray capacitance around the terminal are extremely low, thus the 0S termination realizes a termination admittance fairly close to 0S. As the considerable factor of the stray admittance, the fringe capacitance present between the center and outer conductors of the UNKNOWN terminal slightly turns the reflection coefficient vector from that of the true 0S. This fringe capacitance is theoretically calculated to be between 0.081 pF and 0.083 pF from the dimensions of the termination structure, and the most reliable value is 0.082 pF. To compensate the calibration data, obtained from the 0S Reference Termination, for the effect of the fringe capacitance, the value of 0.082 pF is continuously stored in the 4191A and is used in the calculation of the calibration data. When the actual fringe capacitance differs from the stored value, the error on the measured reflection coefficient phase angle is represented by the following equation:

$$\theta = 2 \tan^{-1} \frac{\pi \cdot f \cdot \Delta C_f}{10000}$$

where, θ is the phase angle.

f is the measurement frequency in MHz.

ΔC_f is the error of fringe capacitance in pF.

The ± 0.001 pF error of the stored 0.082 pF causes a negligible error, less than 0.0006, in reflection coefficient measurements, even at 1 GHz.

PERFORMANCE TESTS

4-9. MEASUREMENT SIGNAL FREQUENCY ACCURACY TEST

4-10. This test verifies that measurement signal frequencies of the 4191A meet the specified frequency accuracy.

Frequency accuracy:
3 ppm at 23°C

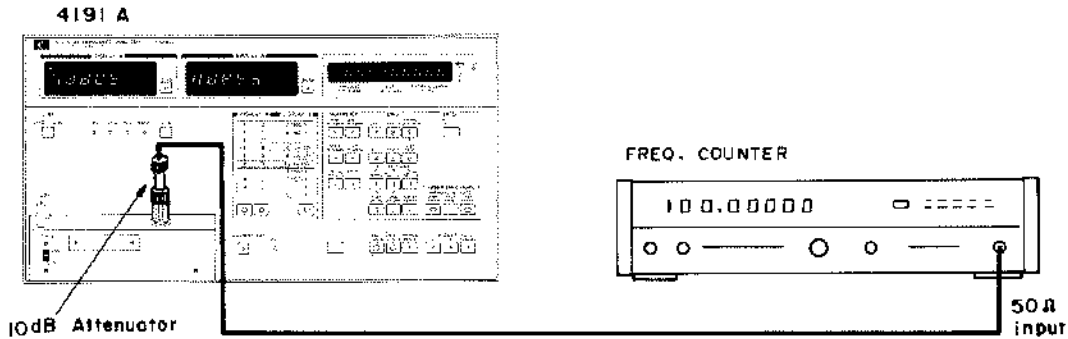

Figure 4-1. Measurement Frequency Accuracy Test Setup.

EQUIPMENT:

Frequency Counter	HP 5340A
10dB Attenuator	HP 8491A
Test Cable	N type connector cable
Terminal Converter	N type female to APC-7 connector (HP 11524A)

PROCEDURE:

1. Connect the 10dB attenuator and the connection cable between the frequency counter input and the 4191A UNKNOWN connector as illustrated in Figure 4-1.
2. Set 4191A SPOT frequency to 100 MHz.
3. Set frequency counter display resolution to 10 Hz.
4. Frequency counter display readout should be between 99.99970MHz and 100.00030MHz.
5. Set 4191A SPOT frequency in accordance with Table 4-2. Frequency counter readouts should satisfy the test limits listed in Table 4-2 at all test frequency settings.

Note: For units with option 002 (high resolution test frequency), also check at the frequencies listed in Table 4-3.

PERFORMANCE TESTS

Table 4-2. Frequency Accuracy Test Limits.

SPOT Freq.	Test limits	SPOT Freq.	Test limits
1.0MHz	± 20Hz	405.0MHz	±1200Hz
32.0	± 80Hz	405.1	±1200Hz
32.1	± 80Hz	450.0	±1340Hz
33.0	± 90Hz	450.1	±1340Hz
62.5	± 170Hz	500.0	±1490Hz
62.6	± 170Hz	500.2	±1490Hz
125.0	± 360Hz	528.0	±1570Hz
125.1	± 360Hz	528.2	±1570Hz
250.0	± 740Hz	556.0	±1650Hz
250.1	± 740Hz	556.2	±1650Hz
264.0	± 780Hz	588.0	±1750Hz
264.1	± 780Hz	588.2	±1750Hz
278.0	± 820Hz	630.0	±1880Hz
278.1	± 820Hz	630.2	±1880Hz
294.0	± 870Hz	680.0	±2030Hz
294.1	± 870Hz	680.2	±2030Hz
315.0	± 930Hz	744.0	±2220Hz
315.1	± 930Hz	744.2	±2220Hz
340.0	±1010Hz	810.0	±2420Hz
340.1	±1010Hz	810.2	±2420Hz
372.0	±1100Hz	900.0	±2690Hz
372.1	±1100Hz	900.2	±2690Hz
		1000.0	±2990Hz

Table 4-3. Additional Tests for Option 002.

SPOT Freq.	Test limits	SPOT Freq.	Test limits
10.0111MHz	± 20Hz	360.0666MHz	±1070Hz
100.0111	±290Hz	400.0777	±1190Hz
251.0000	±740Hz	440.0123	±1310Hz
270.0111	±800Hz	500.0000	±1490Hz
300.0999	±890Hz	800.0222	±2390Hz
330.0333	±980Hz		

PERFORMANCE TESTS

4-11. MEASUREMENT SIGNAL LEVEL TEST

4-12. This test verifies that the measurement signal level at the 4191A UNKNOWN connector meets the specified value range at all measurement frequency settings.

Signal Level: $-20 \pm 3 \text{ dBm}$

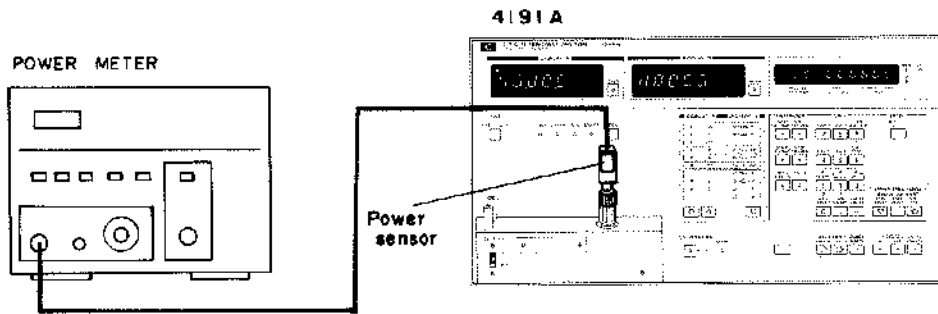

Figure 4-2. Measurement Signal Level Test Setup.

EQUIPMENT:

- Power Meter HP 436A
- Power Sensor HP 8482A

PROCEDURE:

1. Connect the power sensor between the 4191A UNKNOWN connector and RF power meter input as illustrated in Figure 4-2.
2. Set power meter controls to measure a power level of approximately -20 dBm at 100 MHz .
3. Set 4191A SPOT frequency to frequencies from 1 MHz to 1000 MHz in 50 MHz increments ($1, 50, 100, \dots, 900, 950$ and 1000 MHz). Verify that the power meter display readout is within $-20 \pm 3 \text{ dBm}$ at each SPOT frequency setting.

- Notes:*
1. Adjust power meter CAL FACTOR dial control for the calibration factor value plotted on the power sensor.
 2. To set the SPOT frequency easier, set the STEP frequency to 50 MHz and use the manual frequency sweep function.

PERFORMANCE TESTS

4-13. MEASUREMENT SIGNAL PURITY TEST

4-14. This test verifies that the harmonics and any spurious signals included in the measurement signal are lower than the level given in the supplemental performance characteristics of the 4191A.

Supplemental performance characteristic data:

- Harmonics : <-30dB below fundamental
- Spurious Level: <-30dB below fundamental

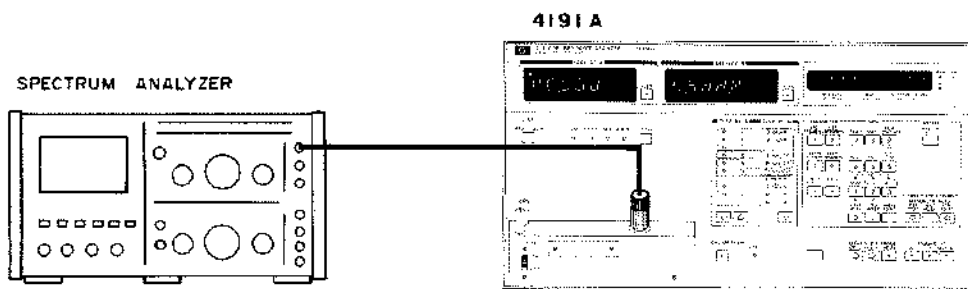

Figure 4-3. Measurement Signal Purity Test Setup.

EQUIPMENT:

- Spectrum Analyzer HP 141T
 w/ 8554B
 w/ 8552B
- Test Cable N type connector cable
- Terminal Converter N type female to APC-7
 connector (HP 11524A)

PROCEDURE:

1. Connect an N type connector cable to the 4191A UNKNOWN connector and to the spectrum analyzer input as illustrated in Figure 4-3 (Use an APC-7 to N type terminal converter).
2. Set the spectrum analyzer controls as follows:
 - Center frequency 500MHz
 - Bandwidth 300kHz
 - Scan width 100MHz
 - Input attenuation 0dB
 - Scan time 10 msec
 - Log ref level 0dBm
 - Display scale 10dB LOG
 - Scan trigger AUTO

PERFORMANCE TESTS

3. Set 4191A controls as follows:

- START frequency 1 MHz
- STOP frequency 1000 MHz
- STEP frequency 5 MHz

4. Start auto frequency sweep from 1 MHz (press **blue** key and SWEEP FREQ/BIAS  key).

5. The second and the third harmonic signal levels should be less than -30 dB from the fundamental (at each sweep frequency point) on the spectrum analyzer CRT.

- Notes:*
1. Check for low order (1/2 and 3/2) harmonic signals at frequency points above 500 MHz (instead of the second and the third harmonics).
 2. Verify that the magnitude of the fundamental is greater than -23 dBm at all frequencies.

6. Restart auto frequency sweep. Spurious signals should be less than -30 dB from the fundamental on the CRT.

4-15. AUTO CALIBRATION TEST

4-16. This test verifies that the electrical length compensator is appropriately adjusted to optimize measurement accuracy.

EQUIPMENT:

- Printer HP 5150A
- Reference Terminations
 - 0Ω } HP 16342A
 - 0S } Calibration
 - 50Ω } Equipment Kit

Note: The accessory reference terminations (0Ω: 04191-85300, 0S: 04191-85302, 50Ω: 04191-85301) supplied with the instrument may be used instead of the 16342A.

PROCEDURE:

1. Connect the 0Ω reference termination to the 4191A's UNKNOWN connector. And, connect an HP-IB cable between the Printer and the HP-IB connector on the rear panel. Set the TALKER bit of the ADDRESS switch to on.

2. Set 4191A controls as follows :

- START FREQ 1 MHz
- STOP FREQ 1000 MHz

3. Press the CALIBRATION key (key indicator lamp lights).

4. Press the CALIBRATION-START button.

5. Monitor calibration data (measured Γ_x and Γ_y values) printed out for individual calibration frequencies. The print outputs should be within the test limits given in Figure 4-4.

6. Perform auto-calibration again using the 0S and 50Ω reference terminations. Verify that the print outputs are within the test limits for the respective termination (in Figure 4-4).

PERFORMANCE TESTS

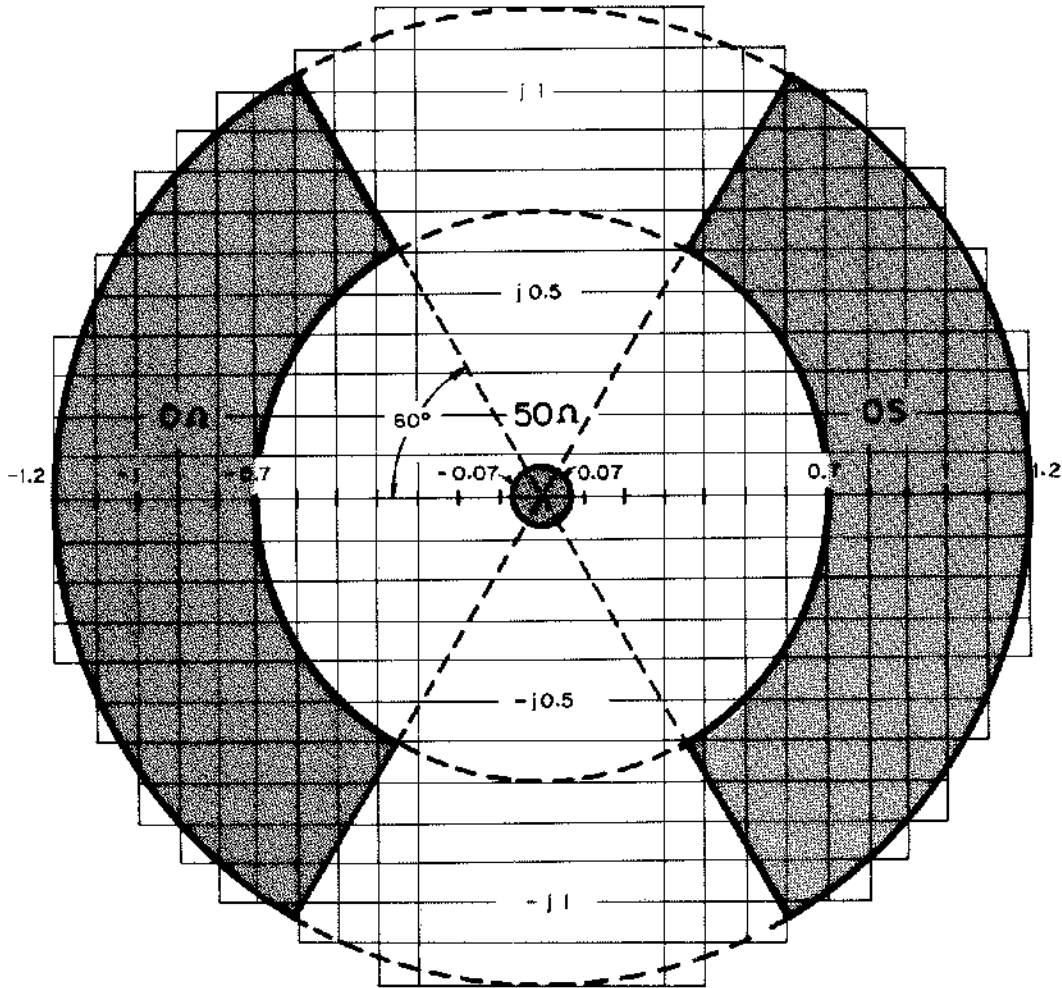

Figure 4-4. Calibration Data Test Limits.

Table 4-4. Simplified Test Limits

0Ω	∞S	50Ω
$-1.1 \leq \Gamma_x \leq -0.7$	$0.7 \leq \Gamma_x \leq 1.1$	$-0.05 \leq \Gamma_x \leq 0.05$
$-0.5 \leq \Gamma_y \leq 0.5$	$-0.5 \leq \Gamma_y \leq 0.5$	$-0.05 \leq \Gamma_y \leq 0.05$

Note: If a printer is not available, compare the auto-calibration data, displayed on the DISPLAY A and DISPLAY B, with the test limits given here (easy to remember) and recheck only the critical test results for Figure 4-4.

PERFORMANCE TESTS

4-17. ERROR CORRECTION FUNCTION TEST

4-18. This test confirms the functions of the auto-calibration test including calibration data acquisition, memory and correction calculations for unartificial measurement data.

Note: It is recommended that the auto-calibration test described in Para. 4-16 be performed before this test.

EQUIPMENT:

0Ω reference termination: (Use the same termination that was used in Auto-Calibration).

PROCEDURE:

1. Connect the 0Ω reference termination to the 4191A UNKNOWN connector.

2. Set 4191A controls as follows:

DISPLAY A and B parameters Γ_x - Γ_y
 START FREQ 1MHz
 STOP FREQ 1000MHz
 STEP FREQ *20MHz

**Note: For units with option 002, set the STEP frequency to 19.98MHz.*

3. Start the auto frequency sweep measurement from the programmed START frequency (1MHz). Monitor the measurement display values on DISPLAY A and DISPLAY B.

4. The display outputs should be within the test limits given below:

DISPLAY A (Γ_x values) : -1.0000 ±10 counts.
 DISPLAY B (Γ_y values) : 0.0000 ±10 counts.

Note: If this test fails, recalibrate the instrument and re-run this test.

PERFORMANCE TESTS

4-19. ACCURACY TEST

4-20. This test measures a precision air line at various frequencies and compares the measured values with the calibrated values of the air line to verify that the 4191A meets its specified accuracy.

Note: This test also confirms the measurement accuracy of the reflection coefficient vectors which are out of phase with the reference termination vectors (in auto-calibration). Accuracy equivalent to that of the reference termination vectors is established for any phase vector if an accurate vector phase detection is achieved. This can be assured by measuring a precision air line that causes the measured reflection coefficient vector to turn 360 degrees as the measurement frequency increases.

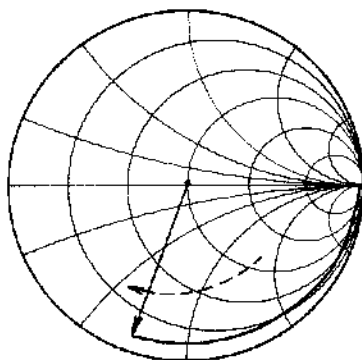

The reflection coefficient vector of the air line develops its locus along the circumference of the Smith Chart as the measurement frequency increases, and allows testing accuracy for all the vectors.

EQUIPMENT:

Reference Air Line	} HP 16342A Calibration Equipment Kit.
Terminations: 0S	
0Ω	

PROCEDURE:

Note: The test program tape included in the 16342A Calibration Equipment Kit automatically performs the data acquisition, comparison, printouts and plotting involved in the accuracy test procedure. For details on the use of the test program, refer to the Test Program User's Guide included in the Kit. This paragraph provides an outline of the test procedure.

1. If the memorized calibration data is not useable in the 1MHz to 1000MHz frequency range, perform auto-calibration for the full frequency range.
2. Connect the calibrated air line (20cm long) to 4191A UNKNOWN connector.
Caution: Do not touch the precision contact surface of the air line.
3. Connect the 0S reference termination to the tip of the air line.

PERFORMANCE TESTS

4. Set 4191A DISPLAY A and DISPLAY B parameters as follows:
 DISPLAY A $|\Gamma|$
 DISPLAY B θ (rad)
5. Measure the open ended air line at frequencies identical to the auto-calibration frequencies. Note DISPLAY A and DISPLAY B readouts ($|\Gamma| - \theta$ values).
6. Connect the 0Ω reference termination in place of the $0S$ termination.
7. Measure the short ended air line at the auto-calibration frequencies. Note DISPLAY A and DISPLAY B readouts.
8. Compare the measurement data obtained in steps 5 and 7 with the calibration data of the air line. The difference between measured values and the calibrated values should be within the test limits given in Table 4-5.

Table 4-5. Accuracy Test Limits.

Parameter	Test limits
$ \Gamma $	C.V. $\pm (70 + 0.05f)$ counts
θ (rad)	C.V. $\pm (70 + 0.05f)$ counts

C.V. = Calibrated value of the air line

f = Test frequency in MHz

Note: The difference between the reflection coefficients measured at adjacent calibration frequencies should not be more than ± 20 counts.

4-21. DC BIAS VOLTAGE ACCURACY TEST

4-22. This test verifies that the internal dc bias voltages of the 4191A meet the specified voltage accuracy.

Bias voltage accuracy: $\pm (0.1\% \text{ of setting} + 10\text{mV})$

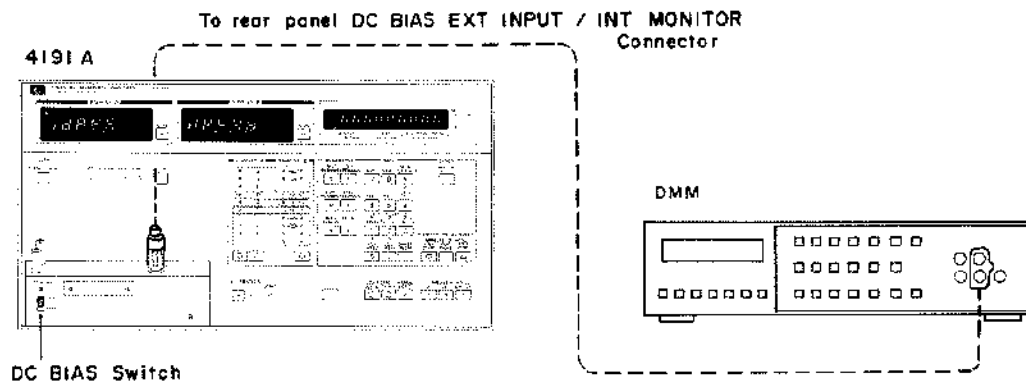

Figure 4-5. Internal Bias Voltage Accuracy Test Setup.

PERFORMANCE TESTS

EQUIPMENT:

Digital Multimeter HP 3455A
 Test Cable BNC to dual banana plug cable
 Terminal Converter BNC to PAC-7 connector

PROCEDURE:

1. Connect the BNC to dual banana plug cable to the DC BIAS EXT INPUT/INT MONITOR connector on the 4191A rear panel and to DMM input. See Figure 4-5.
2. Set the DC BIAS INT EXT switch on the rear panel to the INT position.
3. Set the DC BIAS switch on the UNKNOWN terminal deck to the ON position. Connect nothing to the UNKNOWN connector.
4. Set 4191A SPOT BIAS voltage in accordance with Table 4-6. DMM display readouts should be within the test limits given in the table.

Table 4-6. DC Bias Voltage Accuracy Test Limits

Voltage setting	Test limits	Voltage setting	Test limits
0.01V	0.00V min ~ 0.02V max	- 0.01V	0.00V min ~ - 0.02V max
0.03V	0.02V ~ 0.04V	- 0.03V	- 0.02V ~ - 0.04V
0.07V	0.06V ~ 0.08V	- 0.07V	- 0.06V ~ - 0.08V
0.15V	0.14V ~ 0.16V	- 0.15V	- 0.14V ~ - 0.16V
0.31V	0.30V ~ 0.32V	- 0.31V	- 0.30V ~ - 0.32V
0.63V	0.62V ~ 0.64V	- 0.63V	- 0.62V ~ - 0.64V
1.27V	1.26V ~ 1.28V	- 1.27V	- 1.26V ~ - 1.28V
2.55V	2.538V ~ 2.562V	- 2.55V	-2.538V ~ - 2.562V
5.11V	5.095V ~ 5.125V	- 5.11V	-5.095V ~ - 5.125V
10.23V	10.21V ~ 10.25V	-10.23V	-10.21V ~ -10.25V
20.47V	20.44V ~ 20.50V	-20.47V	-20.44V ~ -20.50V
40.00V	39.95V ~ 40.05V	-40.00V	-39.95V ~ -40.05V

PERFORMANCE TESTS

Confirmation check

This check verifies that correct dc bias voltage is applied to the UNKNOWN terminal.

1. Using an APC-7 to BNC terminal converter, connect the DMM input cable to the UNKNOWN connector.
2. Set SPOT BIAS voltage in accordance with the table below and verify that the DMM display readouts meet the test limits given in the table.

Voltage setting	Test limits
40.00V	39.95V min ~ 40.05V max
-40.00V	-39.95V min ~ -40.05V max
0.00V	-0.01V ~ 0.01V

4-23. BATTERY MEMORY BACK-UP FUNCTION TEST

4-24. This test verifies that the front panel control settings, memorized by the SAVE function, can be continuously preserved by the internal stand-by battery if instrument power is lost.

EQUIPMENT:

No test equipment is required.

PROCEDURE:

1. Set 4191A controls as follows:
 - DISPLAY A/B parameters Γx – Γy
 - SPOT FREQ 100MHz
 - STEP FREQ 20MHz
 - HIGH SPEED on
2. Press blue key and STORE DSPL A/B key (to enter the displayed numbers as reference values).
3. Press DISPLAY A Δ/Δ% and DISPLAY B Δ/Δ% keys.
4. Press blue key and SAVE 1 key (to memorize these control settings).
5. Turn the instrument off, wait a few second and turn it back on. Repeat this procedure 5 times.
6. Press any key. An E-07 error message will occur. Press another key to cause the instrument to skip the programmed 10 minutes initial warm-up time. The 4191A will go into its automatic initial control settings.
7. Press blue key and RCL 1 key. Verify that the control settings memorized in step 4 are restored as the actual control settings.

PERFORMANCE TESTS

4-25. ANALOG RECORDER OUTPUT TEST (OPT. 004)

4-26. This test verifies that the analog recorder output voltages, available with option 004, are proportional to the measurement display values with a specified voltage accuracy.

Output voltage accuracy: $\pm (0.5\% + 2\text{mV})$

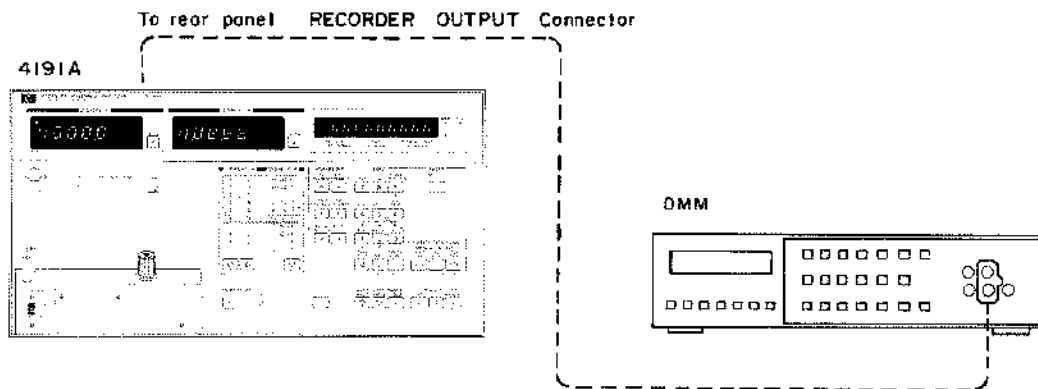

Figure 4-6. Recorder Output Voltage Accuracy Test Setup.

EQUIPMENT:

- Digital Multimeter HP 3455A
- Test Cable BNC to dual banana plug cable

PROCEDURE:

1. Press **blue** key and \downarrow LL key on the 4191A front panel.
2. Connect the BNC to dual banana plug cable between RECORDER OUTPUTS DISPLAY A connector on the rear panel and DMM input. See Figure 4-6.
3. DMM readout should be within $0\text{V} \pm 2\text{mV}$ dc.
4. Connect DMM input cable to RECORDER OUTPUTS DISPLAY B and FREQ/BIAS connector. DMM readout should satisfy the test limits given in Table 4-7.
5. Press **blue** key and UR \rightarrow key.
6. Measure dc voltages at RECORDER OUTPUTS connectors as in steps 2, 3 and 4. DMM readout should satisfy the test limits given in Table 4-7.

PERFORMANCE TESTS

7. Set 4191A controls as follows:

DISPLAY A/B function $\Gamma_x - \Gamma_y$
 TRIGGER HOLD/MANUAL
 RANGE HOLD on
 START FREQ 1.0MHz
 STOP FREQ 1000.0MHz
 SPOT FREQ 99.9MHz

8. Read DISPLAY A output as X and DISPLAY B output as Y.

9. Calculate $X-0.0100$ as $0.x_1 x_2 x_3 x_4$ and $Y-0.0100$ as $0.y_1 y_2 y_3 y_4$ value.

10. Enter the calculated numbers as the reference input numbers for REF A and REF B functions:

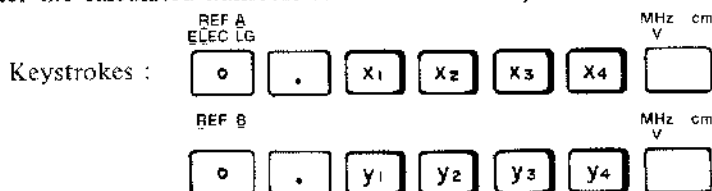

11. Press DISPLAY A $\Delta/\Delta\%$ and DISPLAY B $\Delta/\Delta\%$ keys. DISPLAY A and DISPLAY B readouts will change to .0100.
12. Measure the dc voltage at RECORDER OUTPUTS connectors. DMM display outputs should satisfy the test limits given in Table 4-7.
13. Press DISPLAY A $\Delta/\Delta\%$ and DISPLAY B $\Delta/\Delta\%$ keys to release these functions. Calculate $X + 0.0100$ and $Y + 0.0100$. Enter the calculated numbers as the reference input numbers using the procedures described in steps 8, 9 and 10.
14. Press DISPLAY A $\Delta/\Delta\%$ and DISPLAY B $\Delta/\Delta\%$ keys. DISPLAY A and DISPLAY B readouts will change to -0.0100 .
15. Measure the dc voltage at the DISPLAY A and DISPLAY B connectors. DMM readouts should be within $-100\text{mV} \pm 2\text{mV}$ for both connector outputs.

Table 4-7. Analog Recorder Output Test Limits.

Control setting	Output voltage test limits		
	DISPLAY A	DISPLAY B	FREQ/BIAS
\downarrow LL	$0 \pm 2\text{mV}$	$0 \pm 2\text{mV}$	$0 \pm 2\text{mV}$
UR \uparrow	$1000\text{mV} \pm 7\text{mV}$	$1000\text{mV} \pm 7\text{mV}$	$1000\text{mV} \pm 7\text{mV}$
DISPLAY A : 100 counts DISPLAY B : 100 counts SPOT FREQ: 99.9MHz	$100\text{mV} \pm 2\text{mV}$	$100\text{mV} \pm 2\text{mV}$	$100\text{mV} \pm 2\text{mV}$

PERFORMANCE TESTS

4-27. HP-IB INTERFACE TEST

4-28. This test verifies that the 4191A can be remotely controlled and can transfer measurement data to/from an external device via the HP-IB. The following HP-IB handshake functions for intercommunication with an HP-IB controller (desktop computer) are tested.

- 1) Talk only/Addressable modes.
- 2) Listener.
- 3) Talker.
- 4) Remote/Local capability.
- 5) Interface clear.
- 6) Device clear.
- 7) Device trigger.
- 8) EOI (End Or Identify).
- 9) Service request.

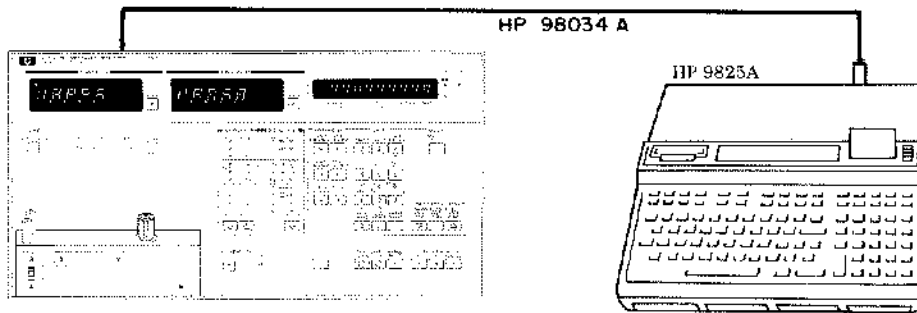

Figure 4-7. HP-IB Interface Test Setup.

EQUIPMENT:

- Desktop Computer HP 9825A
w/98210A
w/98216A
- Interface Cable HP 98034A

PROCEDURE:

1. Connect HP 98034A HP-IB Interface to the HP 9825A Desktop Computer, equipped with I/O ROM's 98210A/98216A, and to the HP-IB connector on the rear panel of the 4191A.
2. Load the test program listed in Figure 4-8 into the 9825A and run the program.
3. Set 4191A controls and follow the instructions displayed on the 9825A SLD in accordance with Table 4-8 and proceed with the programmed test routines.
4. Verify that "HP-IB TEST COMPLETED" is displayed on the 9825A SLD at test end.

Note: The data output and remote control functions are not tested for all the available functions in the above test procedure.

PERFORMANCE TESTS

5. Try the sample programs given in Figures 3-23 and 3-24 of Section III. Compare the output data with the specified data format and measured DUT values.

```

0: "***** 4191A HP-IB CHECK PROGRAM ***** ";
1: dim A$(50),B$(50),D$(32),E$(32)
2: spc ;prt "#10..HP-IB TEST..";spc
3: 0)U)V)E;cmpU)U
4: "4191A HP-IB CHECK PROGRAM"}E$;gsb "SLOWDSP"
5: "DIO LINE CHECK"}E$;gsb "SLOWDSP"
6: dsp "SET MEAS,Z,DEG,INT";stp
7: dsp "SET ADDRESS SW TO TALK ONLY";stp
8: 0)E
9: time 2000;on err "ERR"
10: 0)E
11: rds(7,J,J,R)}J
12: if bit(7,R);gsb "EOIF3"
13: if E;stp ;goto 5
14: dsp "DIO LINE CHECK"
15: for I=1 to 50
16: gsb "GETDIO"
17: next I
18: gsb "TRNS"
19: if D$(1,15)="H X X X X X X X";goto "PASS"
20: gsb "PRTDIO"
21: stp ;goto 3
22: "PASS";dsp "      *** PASS ***";wait 500;goto "L3"
23:
24: "GETDIO";rdb(700)}R
25: band(R,U)}U;ior(R,V)}V;ret
26: "ERR";prt E$,"HANDSHAKE ERROR"
27: prt " ";prt " ";stp ;end
28: "PRTDIO";
29: prt "*** DIO LINES ***"
30: prt "8-7-6-5-4-3-2-1"
31: prt D$(1,15)
32: prt " ";prt " ";ret
33: "TRNS";
34: eor(U,V)}U
35: "X X X X X X X X"}D$(1,15)
36: for I=0 to 7
37: 15-2*I}K

38: if bit(I,U)=1;goto 41
39: "H"}D$(K,K)
40: if bit(I,R);"L"}D$(K,K)
41: next I
42: ret
43: end
44: "L3";
45: 0)U)V;cmpU)U
46: cli 7
47: lcl 7
48: rem 7
49: dsp "SET ADDRESS SW to ADDRESSABLE";stp
50:
51: 17}Y;700+Y}Y
52: "LISTENER CHECK"}E$;gsb "SLOWDSP"
53: dsp " LISTEN,REMOTE,C,D,INT on ?";wrt Y,"C0T1A8B3"
54: stp
55: 0)E;rds(7,K,L,M)}N;if bit(7,M)=1;gsb "EOIF3"
56: if E=1;goto 52
57: "TALKER CHECK"}E$;gsb "SLOWDSP"
58: dsp "TALK on & REMOTE off ?";lcl 7;red Y,A,B;stp
59: "IFC LINE CHECK"}E$;gsb "SLOWDSP";cli 7

```

Figure 4-8. HP-IB Interface Test Program (sheet 1 of 2).

PERFORMANCE TESTS

```

60: dsp "TALK off ?";stp
61: "DEVICE CLEAR CHECK (AUTO)"E$;0E;gsb "SLOWDSP"
62: clr Y
63:
64: "TENT";wrt Y,"T1"
65:
66: red Y,A$;gsb "DELSP"
67: if A$[2,2]="Z" and A$[17,17]="D";dsp " *** PASS ***";wait 300;gto 70
68: prt "DEVICE CLEAR"
69: prt "FAIL:",A$;stp ;gto 61
70: "TRIGGER CHECK (AUTO)"E$;gsb "SLOWDSP"
71: wrt Y,"ABR3T3";trg Y
72: red Y,A$
73: gsb "DELSP"
74: if A$[2,21]="C" and A$[17,17]="D";dsp " *** PASS ***";wait 300;gto "L1"
75: prt "TRIGGER CHECK";prt "FAIL:",A$
76: "L1":
77: "EOI CHECK (AUTO)"E$;gsb "SLOWDSP"
78: 0JE
79: wrt Y,"T1"
80: if rdb(Y)#13;jmp 0
81: if bit(0,rds(7,M,M,MD)P)-1;gsb "EOIF1"
82: if E=1;stp ;gto 77
83: if rdb(Y)#10;jmp 0
84: if bit(0,rds(7,M,M,MD)Q)=0;gsb "EOIF2"
85: if E=1;stp ;gto 77
86: dsp " *** PASS ***";wait 300
87: "L2":
88: "SRQ LINE CHECK (AUTO)"E$;gsb "SLOWDSP"
89: 0JE
90:
91: clr Y
92: gsb "GETBUS"
93: if bit(5,R)=1;gsb "SRQF1"
94: if E=1;stp ;gto 88
95: wrt Y,"illegal code"
96: gsb "GETBUS"
97: if bit(5,R)=0;gsb "SRQF2"
98: if E=1;stp ;gto 88
99: dsp " *** PASS ***";wait 300
100: prt " .....PASS.....";spc
101: dsp "* 4191A HP-IB TEST COMPLETED *";beep;stp
102: gto 3
103: "EOIF1":prt "FAIL:EOI LOW FOR ICR1";1E;ret
104: "EOIF2":prt "FAIL:EOI HIGH FOR ICF";1E;ret
105: "EOIF3":prt "FAIL:EOI LINE LOW";1E;ret
106: "SRQF1":prt "FAIL:SRQ LINE LOW";1E;ret
107: "SRQF2":prt "FAIL:SRQ LINE HIGH";1E;ret
108: "SLOWDSP";D$;len(C$)}W;for W=1 to len(C$);E$[W,W]}D$[W,W];dsp D$
109: wait 30;next W;wait 600;ret
110: "GETBUS":rds(7,P,Q,R)}S;ret
111: band(R,U)}U;ior(R,V)}V;ret
112: "DELSP":
113: if A$[1,1]=" ";for U=1 to 32;A$[U+1,U+1]}A$[U,U];next U;jmp 0
114: ret
115: "TRNS":
116: eor(U,V)}U
117: "X X X X X X X X"}D$[1,15]
118: for I=0 to 7
119: 15-2*I}K
120: if bit(I,U)=1;gto 101
121: "0"}D$[K,K]

122: if bit(I,R);"1"}D$[K,K]
123: next I
124: prt D$[1,15];ret
125: "#10":end
*776

```

Figure 4-8. HP-IB Interface Test Program (sheet 2 of 2).

PERFORMANCE TESTS

Table 4-8. HP-IB Interface Test Procedure.

Step	Controller instruction (display)	Required operation
1	4191A HP-IB CHECK PROGRAM	(See note)
2	DIO LINE CHECK	
3	SET MEAS, [Z], DEG, INT	Set the 4191A controls as follows: DISPLAY A Z DISPLAY B $\angle\theta$ (deg) Trigger INT Press <input type="button" value="CONTINUE"/> .
4	SET ADDRESS SW TO TALK ONLY	Set HP-IB address switch on the 4191A rear panel to TALK ONLY mode.  TALK ONLY (Set this switch to up position) Verify that the TALK lamp on the front panel is lit. Press <input type="button" value="CONTINUE"/> .
5	*** PASS ***	
6	SET ADDRESS SW TO ADDRESSABLE	Reset HP-IB address switch on the 4191A rear panel to ADDRESSABLE mode (set the switch to down position). <i>Note: TALK lamp may be extinguished.</i> Press <input type="button" value="CONTINUE"/> .
7	LISTENER CHECK	
8	LISTEN, REMOTE, C, D, INT on?	Verify that the following indicator lamps on the 4191A front panel are lit. 1) LISTEN 2) REMOTE 3) DISPLAY A parameter "C" 4) DISPLAY B parameter "D" 5) INT TRIGGER <i>Note: SRQ lamp may light.</i> Press <input type="button" value="CONTINUE"/> . If any of these lamps are not lit, troubleshoot the instrument.
9	TALKER CHECK	
10	TALK on & REMOTE off?	Verify that the REMOTE lamp is extinguished and that the TALK lamp is lit. Press <input type="button" value="CONTINUE"/> . If otherwise, troubleshoot the instrument.
11	IFC LINE CHECK	

PERFORMANCE TESTS

Table 4-8. HP-IB Interface Test Procedure (continued)

Step	Controller instruction (display)	Required operation
12	TALK off?	Verify that the TALK lamp is extinguished. Press  . If otherwise, troubleshoot the instrument.
13	DEVICE CLEAR CHECK (AUTO)	<i>Note: The remaining tests are performed automatically. No manual operation is required for the subsequent tests.</i>
14	*** PASS ***	
15	TRIGGER CHECK (AUTO)	
16	*** PASS ***	
17	EOI CHECK (AUTO)	
18	*** PASS ***	
19	SRQ LINE CHECK (AUTO)	
20	*** PASS ***	
21	*4191A HP-IB TEST COMPLETED*	<i>Note: The 9825A will simultaneously print out the message: " #10 HP-IB PASS".</i>

Note: Messages in steps 1, 2, 7, 9, 11, 13, 15, 17 and 19 appear on the 9825A SLD from right to left.

PERFORMANCE TEST RECORD

Hewlett-Packard
 Model 4191A
 RF Impedance Analyzer
 Serial No. _____

Tested by _____
 Date _____

Paragraph Number	Test	Minimum	Results Actual	Maximum
4-10	MEASUREMENT SIGNAL FREQUENCY ACCURACY TEST Frequency setting:			
	1.0MHz	0.99998MHz	_____	1.00002MHz
	32.1MHz	32.09992MHz	_____	32.10008MHz
	33.0MHz	32.99991MHz	_____	33.00009MHz
	62.5MHz	62.49983MHz	_____	62.50017MHz
	62.6MHz	62.59983MHz	_____	62.60017MHz
	125.0MHz	124.99964MHz	_____	125.00036MHz
	125.1MHz	125.09964MHz	_____	125.10036MHz
	250.0MHz	249.99926MHz	_____	250.00074MHz
	250.1MHz	250.09926MHz	_____	250.10074MHz
	264.0MHz	263.99922MHz	_____	264.00078MHz
	264.1MHz	263.09922MHz	_____	264.10078MHz
	278.0MHz	277.99918MHz	_____	278.00082MHz
	278.1MHz	278.09918MHz	_____	278.10082MHz
	294.0MHz	293.09913MHz	_____	294.00087MHz
	294.1MHz	294.09913MHz	_____	294.10087MHz
	315.0MHz	314.99907MHz	_____	315.00093MHz
	315.1MHz	315.09907MHz	_____	315.10093MHz
	340.0MHz	339.99899MHz	_____	340.00101MHz
	340.1MHz	340.09899MHz	_____	340.10101MHz
	372.0MHz	371.99890MHz	_____	372.00110MHz
	372.1MHz	372.09890MHz	_____	372.10110MHz
	405.0MHz	404.99880MHz	_____	405.00120MHz
	405.1MHz	405.09880MHz	_____	405.10120MHz
	450.0MHz	449.99866MHz	_____	450.00134MHz
	450.1MHz	450.09866MHz	_____	450.10134MHz
	500.0MHz	499.99851MHz	_____	500.00149MHz
	500.2MHz	500.19851MHz	_____	500.20149MHz
	528.0MHz	527.99843MHz	_____	528.00157MHz
	528.2MHz	528.19843MHz	_____	528.20157MHz
	556.0MHz	555.99835MHz	_____	556.00165MHz
	556.2MHz	556.19835MHz	_____	556.20165MHz
588.0MHz	587.99825MHz	_____	588.00175MHz	
588.2MHz	588.19825MHz	_____	588.20175MHz	

Paragraph Number	Test	Minimum	Results Actual	Maximum
	630.0MHz	629.99812MHz	_____	630.00188MHz
	630.2MHz	630.19812MHz	_____	630.20188MHz
	680.0MHz	679.99797MHz	_____	680.00203MHz
	680.2MHz	680.19797MHz	_____	680.20203MHz
	744.0MHz	743.99788MHz	_____	744.00222MHz
	744.2MHz	744.19788MHz	_____	744.20222MHz
	810.0MHz	809.99758MHz	_____	810.00242MHz
	810.2MHz	810.19758MHz	_____	810.20242MHz
	900.0MHz	899.99731MHz	_____	900.00269MHz
	900.2MHz	900.19731MHz	_____	900.20269MHz
	1000.0MHz	999.99701MHz	_____	1000.00299MHz
	Frequency setting for Option 002:			
	10.0111MHz	10.01108MHz		10.01112MHz
	100.0111MHz	100.01081MHz		100.01139MHz
	251.0000MHz	250.99926MHz		251.00074MHz
	270.0111MHz	270.01030MHz		270.01190MHz
	300.0999MHz	300.09901MHz		300.10079MHz
	330.0333MHz	330.03232MHz		330.03428MHz
	360.0666MHz	360.06553MHz		360.06767MHz
	400.0777MHz	400.07651MHz		400.07889MHz
	440.0123MHz	440.01099MHz		440.01361MHz
	500.0000MHz	499.99851MHz		500.00149MHz
	800.0222MHz	800.01981MHz		800.02459MHz

Paragraph Number	Test	Minimum	Results Actual	Maximum
4-12	MEASUREMENT SIGNAL LEVEL TEST Frequency setting: 1.0MHz 50.0MHz 100.0MHz 150.0MHz 200.0MHz 250.0MHz 300.0MHz 350.0MHz 400.0MHz 450.0MHz 500.0MHz 550.0MHz 600.0MHz 650.0MHz 700.0MHz 750.0MHz 800.0MHz 850.0MHz 900.0MHz 950.0MHz 1000.0MHz	-17.0dBm		-23.0dBm
4-14	MEASUREMENT SIGNAL PURITY TEST Maximum harmonic level (below fundamental) and test frequency Maximum spurious signal level (below fundamental) and test frequency		dB MHz dB MHz	
4-16	AUTO CALIBRATION TEST Test result (Pass/Fail) 0Ω 0S 50Ω			
4-18	ERROR CORRECTION FUNCTION TEST Test result (Pass/Fail)			

Paragraph Number	Test	Minimum	Results Actual	Maximum
4-20	ACCURACY TEST Test result (Pass/Fail) <i>Note: To make a complete record of the test results, use the test program cartridge type that is part of the 16342A Calibration Equipment Kit and keep the plotted chart.</i>			
4-22	DC BIAS VOLTAGE ACCURACY TEST Voltage setting			
	0.01V	0.00V		0.02V
	0.03V	0.02V		0.04V
	0.07V	0.06V		0.08V
	0.15V	0.14V		0.16V
	0.31V	0.30V		0.32V
	0.63V	0.62V		0.64V
	1.27V	1.26V		1.28V
	2.55V	2.538V		2.562V
	5.11V	5.095V		5.125V
	10.23V	10.21V		10.25V
	20.47V	20.44V		20.50V
	40.00V	39.95V		40.05V
	-0.01V	0.00V		-0.02V
	-0.03V	-0.02V		-0.04V
	-0.07V	-0.06V		-0.08V
	-0.15V	-0.14V		-0.16V
	-0.31V	-0.30V		-0.32V
	-0.63V	-0.62V		-0.64V
	-1.27V	-1.26V		-1.28V
	-2.55V	-2.538V		-2.562V
	-5.11V	-5.095V		-5.125V
	-10.23V	-10.21V		-10.25V
	-20.47V	-20.44V		-20.50V
	-40.00V	-39.95V		-40.05V
4-24	BATTERY MEMORY BACK-UP FUNCTION TEST Test result (Pass/Fail)			

Paragraph Number	Test	Minimum	Results Actual	Maximum
4-26	<p>ANALOG RECORDER OUTPUT TEST</p> <p>Control setting : \downarrow LL</p> <p>DISPLAY A output -0.2mV</p> <p>DISPLAY B output -0.2mV</p> <p>FREQ/BIAS output -0.2mV</p> <p>Control setting : UR \rightarrow</p> <p>DISPLAY A output 993mV</p> <p>DISPLAY B output 993mV</p> <p>FREQ/BIAS output 993mV</p> <p>Control setting :</p> <p>DISPLAY A: 100 counts</p> <p>DISPLAY B: 100 counts</p> <p>SPOT FREQ: 99.9MHz</p> <p>DISPLAY A output 98mV</p> <p>DISPLAY B output 98mV</p> <p>FREQ/BIAS output 98mV</p> <p>Control setting:</p> <p>DISPLAY A: -100 counts</p> <p>DISPLAY B: -100 counts</p> <p>DISPLAY A output -98mV</p> <p>DISPLAY B output -98mV</p>			<p>0.2mV</p> <p>0.2mV</p> <p>0.2mV</p> <p>1007mV</p> <p>1007mV</p> <p>1007mV</p> <p>102mV</p> <p>102mV</p> <p>102mV</p> <p>-100mV</p> <p>-100mV</p>
4-28	<p>HP-IB INTERFACE TEST</p> <p>Test result (Pass/Fail)</p>			

SECTION V ADJUSTMENT

5-1. INTRODUCTION

5-2. This section describes the adjustments and checks required to return the 4191A to the specifications listed in Table 1-1 after repairs have been made. These adjustments and checks can also be performed along with periodic maintenance to keep the instrument in optimum operating condition. The recommended adjustment cycle for the 4191A is twice a year. All adjustable components referred to in the adjustment procedures are listed in Table 5-1. If proper performance cannot be achieved after adjustment, refer to the troubleshooting procedures described in Section VIII.

Note: To ensure proper results and instrument operation, Hewlett-Packard suggests a 40 minute warm-up and stabilization period before performing any of the adjustments described here.

5-3. SAFETY REQUIREMENTS

5-4. Although the 4191A was designed in accordance with international safety standards, this manual contains information, cautions, and warnings which must be followed to ensure operator safety and to keep the instrument in a safe and serviceable condition. Adjustments described in this section should be performed by qualified service personnel only.

WARNING

ANY INTERRUPTION OF THE PROTECTIVE (GROUNDED) CONDUCTOR (INSIDE OR OUTSIDE THE INSTRUMENT) OR DISCONNECTION OF THE PROTECTIVE EARTH TERMINAL IS LIKELY TO MAKE THE INSTRUMENT DANGEROUS. INTENTIONAL INTERRUPTION, FOR ANY REASON, IS PROHIBITED.

5-5. The removal or opening of covers for removal or adjustment of parts, other than those which are accessible by hand, will expose live parts.

5-6. Capacitors in the instrument may still be charged even if the instrument has been disconnected from the power source (AC line) for an extended period of time.

WARNING

ADJUSTMENTS DESCRIBED IN THIS SECTION ARE PERFORMED WITH POWER SUPPLIED AND PROTECTIVE COVERS REMOVED. EN-

ERGY EXISTING AT MANY POINTS MAY, IF CONTACTED, RESULT IN SERIOUS PERSONAL INJURY.

5-7. EQUIPMENT REQUIRED

5-8. All the equipment required to perform the adjustments described in this section are listed in Table 4-1 on page 4-A. Each piece of equipment listed in Table 4-1 should be calibrated to satisfy its own specifications, as well as those of the required characteristics. If the recommended model is not available, any instrument that equals or surpasses the specifications of the recommended model may be used instead.

5-9. FACTORY SELECTED COMPONENTS

5-10. Factory selected components are identifiable by an asterisk (*) adjacent to the reference designator on the schematic diagrams in Section VIII (only nominal values are given). Table 5-2 lists the reference designators of all factory selected components. Also listed in Table 5-2 are the nominal value range of each component and a brief description of how each component affects instrument performance.

Adjustable components, with reference designators, are listed in Table 5-1. This table also lists the name of the adjustment and its purpose.

5-11. ADJUSTMENT RELATIONSHIPS

5-12. The adjustment procedures described in this section, beginning with paragraph 5-17, are interactive and therefore should be performed in the sequence given. Ignoring or changing the order of the procedures may make it impossible to obtain optimum instrument performance. Table 5-3 lists the necessary adjustment procedures to follow after the instrument has been repaired.

5-13. ADJUSTMENT LOCATIONS

5-14. To help locate the appropriate adjustment points, the locations of the components to be adjusted are illustrated throughout the adjustment procedures. The locations of factory selected components, connectors, and other components related to the adjustments are shown in the individual board assembly-component illustrations (fold out service sheets) in Section VIII.

Table 5-1. Adjustable Components (sheet 1 of 2).

Reference Designator	Name of Control	Adjustment Purpose
A1C18 (Para 5-19)	FREQ ADJ	To properly set the oscillator frequency variable range.
A1R16 (Para 5-19)	BIAS ADJ	To set the oscillator amplification gain to ensure stable oscillation over the entire frequency control range.
A4R1 R2 R3 R4 (Para 5-23)		To set the tuning control voltages for the voltage tunable filter on the A6 board
A10R18 (Para 5-27)	BIAS	To set the reverse bias voltage for the sampler diodes.
A10R19 (Para 5-29)	FB	To properly set the compensation magnitude for variations in sampling efficiency and to equalize the sampler output level at all test frequencies.
A11R18 (Para 5-27)	BIAS	To set the reverse bias voltage for the sampler diodes.
A11R19 (Para 5-29)	FB	To properly set the compensation magnitude for variations in sampling efficiency and to equalize the sampler output level at all test frequencies.
A12R1 (Para 5-31)	SH RANGE ADJ	To set the sampling frequency search control range.
A12R2 (Para 5-31)	CENT ADJ	To set the center frequency of the sampling frequency search control range.
A13C1 (Para 5-33)	FREQ ADJ	To properly set the sampling frequency variable range.
A16R1 (Para 5-25)		To adjust the amplitude of the ALC test signal to the appropriate level.
A17C12 (Para 5-37)		To adjust the detection phase of the phase detector.
A17R6 (Para 5-35)		To eliminate residual dc offset voltage from the phase detector circuit.
A18C3 C36 (Para 5-21)	100MHz ADJ	To adjust the clock frequency to exactly 100MHz and to maximize accuracy of the test signal frequency.
A21C58 (Para 5-39)		To set the microprocessor clock generator frequency.
A23R8 (Para 5-17)		To set $\pm 12V$ power supply voltage.
A23R41 (Para 5-17)		To set +5V (3A) power supply voltage.
A23R42 (Para 5-17)		To set +5V (2A) power supply voltage.
A25R1 (Para 5-43)		To properly set the operating temperature of the directional bridge circuit.

Table 5-1. Adjustable Components (sheet 2 of 2).

Reference Designator	Name of Control	Adjustment Purpose
A30C1 (Para 5-45)	FREQ ADJ	To properly set the oscillator frequency variable range. (Opt. 002 only)
A33C18 (Para 5-47)	FREQ ADJ	To properly set the oscillator frequency variable range. (Opt. 002 only)
A33R16 (Para 5-47)	BIAS ADJ	To set the oscillator amplification gain to ensure stable oscillation over the entire frequency control range. (Opt. 002 only)
A40R1 R3 (Para 5-41)	-0 +0	To set the zero bias voltage to exactly zero volts.
A40R2 (Para 5-41)	-FS	To set the maximum negative bias output voltage to exactly -40V and to maximize bias voltage accuracy.
A40R4 (Para 5-41)	+FS	To set the maximum positive bias output voltage to exactly +40V and to maximize bias voltage accuracy.
A41R1 R2 R4 R5 R7 (Para 5-49)	+A0 -A0 +B0 -B0 C0	To eliminate any residual dc offset voltages from the analog recorder output amplifiers. (Opt. 004 only)
A41R3 R6 R8 (Para 5-49)	A. F. S B. F. S C. F. S	To adjust analog output voltage at full scale display counts to maximize output voltage accuracy. (Opt. 004 only)

Table 5-2. Factory Selected Components.

Component	Nominal Value Range	Affect on Performance
	At the time this manual was printed, there were no factory selected components. Refer to Manual Changes sheet supplement for a list of the factory selected components that may have been added after publication.	

5-15. INITIAL OPERATING PROCEDURE

5-16. Before proceeding with the adjustments described starting in paragraph 5-17, perform the following three preliminary steps. This procedure provides access to the various adjustment points and facilitates a thoroughgoing adjustment.

[BASIC OPERATING CHECK]

Check that the instrument's line voltage selector switches, located on the rear panel, are set to the positions appropriate for the local line voltage. This should be performed before proceeding with any of the adjustments.

After the recommended 40 minute warm-up period, the instrument should pass the SELF TEST (no error message should appear), and the initial control settings listed in Figure 3-5 should be automatically set in preparation for measurements. If the instrument displays an error message or does not have the correct initial control settings, refer to the troubleshooting procedures given in Section VIII.

[TOP/BOTTOM COVER REMOVAL]

- a. Remove the two plastic instrument feet located at the upper corners of the rear panel.
- b. Fully loosen the top cover retaining screw located at the rear of the top cover.
- c. Slide the top cover towards the rear and lift off. The top shield case, housing the A21 microprocessor digital control board, will be visible.

By first setting the instrument on its side, the same procedure can be used to remove the bottom cover.

[OPENING THE TOP SHIELD CASE]

The top shield case is hinged at the rear and opens much like the hood of an automobile. It is secured by a retaining screw, located at the center of the case, and by two fasteners, located at the front corners.

- a. Fully loosen the retaining screw located at the center of top shield case.
- b. Loosen the two fasteners located at the front of the case.
- c. Raise the top shield case from the front and continue until it comes to rest on the rear frame. The top shieldplates of the various circuit board assemblies, housed in their own shielded cases, will be visible. Test points and adjustable components are accessible through the holes in the shield plates.

WARNING

AS A SAFETY PRECAUTION AGAINST POSSIBLE ELECTRICAL SHOCK HAZARDS AND RESULTANT INJURY, USE INSULATED TOOLS FOR ALL ADJUSTMENTS.

Caution:

Allowing the top shield case to slam down, when opening or closing, could damage the sensitive microprocessor mounted on the A21 board inside the case.

- d. Remove the A21 board access-cover, located on the underside of the top shield case, by loosening the four retaining screws.

Table 5-3. Adjustment Requirements.

Assembly repaired or replaced	Required adjustment(s)
A1 04191-66501 (VTO)	Para. 5-19.
A2 04191-66502 A3 04191-66503	None
A4 04191-66504 (Programmable Switch Control Driver)	Para. 5-23
A5 04191-66505 A6 04191-66506 A7 04191-66507 A9 04191-66509	None.
A10 04191-66510 A11 04191-66510	Para. 5-27, 5-29.
A12 04191-66512 (PLL Sampling Controller)	Para. 5-31.
A13 04191-66513 (PLL Sampling Frequency VTO)	Para. 5-33.
A15 04191-66515	None
A16 04191-66516 (IF Ampl./Process Amplifier)	Para. 5-25.
A17 04191-66517 (Phase Detector/A-D Converter)	Para. 5-35, 5-37.
A18 04191-66518 (100MHz Clock Generator/Doubler)	Para. 5-21.
A21 04191-66520 (Microprocessor Digital Control)	Para. 5-39.
A22 04191-66522	None
A23 04191-66523 (Power Supply)	Para. 5-17.
A25 04191-66525 (Heater Controller)	Para. 5-43.
A30 04191-66530 (VTO: 100–110MHz)	Para. 5-45.

Assembly repaired or replaced	Required adjustment(s)
A31 04191-66531 A32 04191-66532	None.
A33 04191-66533 (VTO: 250–500MHz)	Para. 5-47.
A40 04191-66540 (DC Bias Supply)	Para. 5-41.
A41 04191-66541 (Analog Recorder Output)	Para. 5-49.

ADJUSTMENTS

5-17. DC POWER SUPPLY VOLTAGE ADJUSTMENTS

5-18. This adjustment sets the output voltages of the internal dc power supply to their levels to ensure that the instrument is functioning under the proper operating voltage levels.

Note: Before proceeding with the dc power supply voltage adjustment, first measure the voltage levels of TP1 through 7 on the mother board. If the measured voltages are within the limits listed in the table below, the dc power supply does not require adjustment. These test points are accessible from the top of the instrument after the top shield case has been raised. They are located on the right side of the mother board, about 4 cm from the instrument frame.

TP	Lower Limit	Upper Limit
1	5V	5.35V
2	12V	12.2V
3	-11.9V	-12.25V
4	45V	48V
5	-45V	-48V
6	30V	40V
7	-30V	-40V

EQUIPMENT:

Digital Voltmeter (DMM) HP 3455A
Voltmeter input cable Dual banana to dual alligator clip cable.

PROCEDURE:

1. Remove the four screws that secure the dc power supply assembly plate, located on the rear panel, as shown in the figure below.

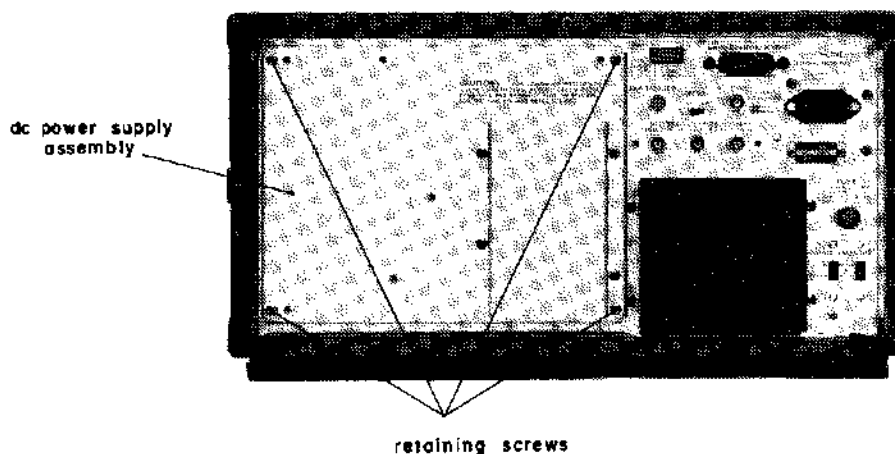

The A23 dc power supply board is mounted on the reverse side of the plate.

ADJUSTMENTS**WARNING**

REMOVING THE DC POWER SUPPLY ASSEMBLY EXPOSES THE BLADES OF THE INSTRUMENT FAN. SERIOUS INJURY MAY RESULT IF FINGERS, HANDS, OR ADJUSTMENT TOOLS COME IN CONTACT WITH THE MOVING BLADES. OBSERVE EXTREME CAUTION.

- Lower the dc power supply assembly until all components and test points are accessible. If necessary, remove the cable clamp located on the inside of the rear panel, above the instrument fan, to facilitate access to the A23 board.

Caution: Do not force the cables connected between the A23 board and mainframe.

- Connect the positive input of the dc voltmeter to TP8 (+12V) on the A23 board and the negative input to the instrument chassis.
- Set the voltmeter to a range appropriate for measuring +12V.
- Adjust potentiometer A23R8 until the display on the voltmeter is between 11.4V and 12.2V.
- Connect the positive input of the voltmeter to the other test points listed in Table 5-4 and adjust the indicated potentiometer until the display on the voltmeter is within the limits listed in the table.

Table 5-4. DC Power Supply Voltage Adjustments.

Test Point	Potentiometer	Voltage Limits
A23 TP8	A23 R8	11.4 to 12.2V
TP3	R42	4.9 to 5.25V
TP5	R41	4.9 to 5.25V

- Return the cable clamp and dc power supply assembly to their original positions.

ADJUSTMENTS

5-19. TEST FREQUENCY SYNTHESIZER VTO ADJUSTMENT

5-20. This adjustment sets the controllable frequency range of the A1VTO to ensure generation of test frequency signals free of signal dead zone and parasitic oscillation at all test frequency settings.

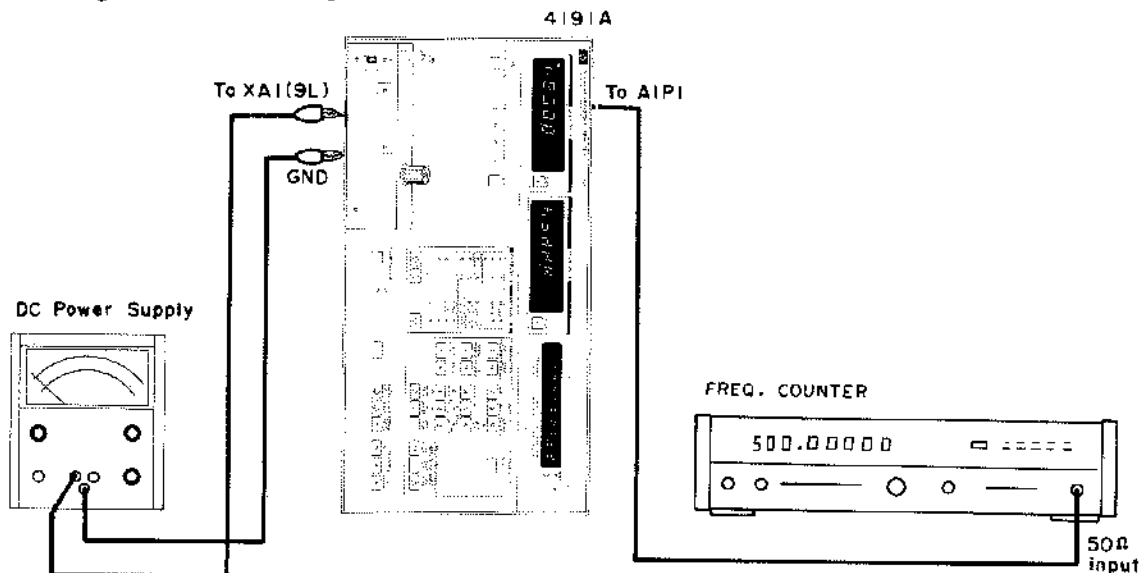

Figure 5-1. Test Frequency Synthesizer VTO Adjustment Setup.

EQUIPMENT:

- Frequency Counter HP 5340A
- Spectrum Analyzer HP141T/8554B/8552B
- Connection Cable N type connector cable
- Terminal Converter:
 - N type female to SMC female -hp- 1250-1153
- DC Power Supply HP 6224B
- Power Supply Output Cable Dual banana to dual alligator clip cable

PROCEDURE:

1. Stand the 4191A on its right side.
2. Set switch S2 on the A21 board as shown below:

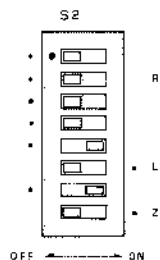

3. Disconnect the SMC connector (P1) from the A3 board top plate.
4. Remove the A3 board.

Caution: Set the dc power supply to zero (0) volts before performing step 5.

ADJUSTMENTS

5. Connect the dual banana to alligator clip cable between XA1 pin 9L (board connector) of the 4191A and the positive output of the dc power supply, as shown in Figure 5-1.
6. Disconnect the SMC connector from A1P1.
7. Connect the frequency counter input to A1P1.
8. Set the 4191A SPOT frequency to 500.0MHz.
9. Set the dc power supply output voltage to $+20V \pm 0.1V$.
10. Adjust trimmer capacitor A1C18 until the display on the frequency counter reads $502.0MHz \pm 0.1MHz$.
11. Disconnect the SMC connector from A1P2. Connect the spectrum analyzer input to A1P2. Set the controls of the spectrum analyzer as follows:
 - Input attenuation 10 dB
 - Scan Width 100MHz/div
 - Center Frequency 500MHz
 - Bandwidth 300kHz
12. Vary the dc power supply output voltage from 0V to +20V and observe the spectrum analyzer CRT. Verify that there are no parasitic oscillation signals at any VTO frequency. If there are parasitic oscillation signals present, adjust potentiometer A1R16 until they have been eliminated.
13. Re-perform step 12 at each SPOT frequency listed in Table 5-5.

Table 5-5. VTO Spurious Signal Test

SPOT freq. setting	VTO frequency variable range		Frequency Band
	Minimum	Maximum	
500MHz	$\leq 440MHz$	$\geq 502MHz$	500 ~ 450MHz
450	≤ 400	≥ 452	450 ~ 405
400	≤ 365	≥ 407	405 ~ 372
350	≤ 335	≥ 374	372 ~ 340
320	≤ 310	≥ 342	340 ~ 315
300	≤ 290	≥ 316	315 ~ 294
280	≤ 275	≥ 295	294 ~ 278
270	≤ 260	≥ 279	278 ~ 264
260	≤ 245	≥ 264.5	264 ~ 250

14. Disconnect the frequency counter, spectrum analyzer and dc power supply from the 4191A.
15. Reconnect the SMC connectors to A1P1 and A1P2.
16. Replace the A3 board to its normal position and reconnect the SMC connector.
17. Reset switch A21S2 to its normal position.

ADJUSTMENTS

5-21. TEST SIGNAL FREQUENCY ADJUSTMENT

5-22. This adjustment sets the frequency of the clock frequency generator on the A18 board to a precise 100MHz to maximize test signal frequency accuracy.

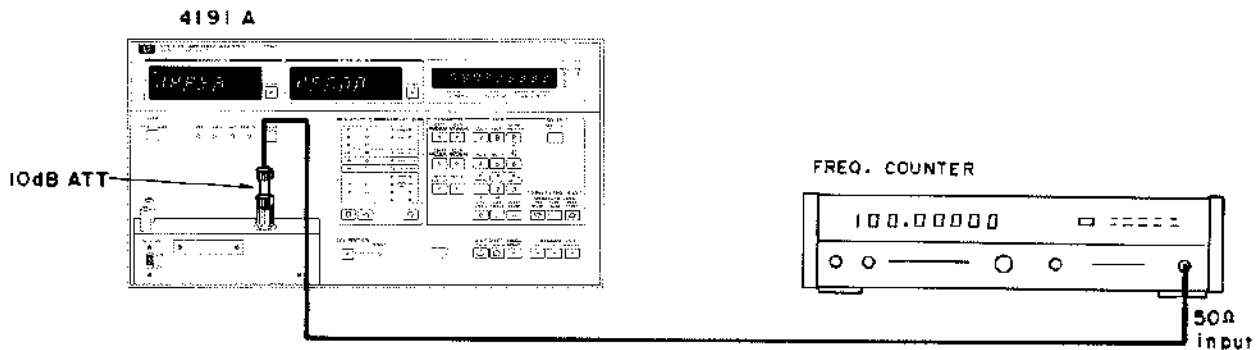

Figure 5-2. Test Signal Frequency Adjustment Setup.

EQUIPMENT:

Frequency Counter	HP 5340A
10dB Attenuator	HP 8491A
Connection Cable	N-type connector cable
Terminal Converter	N-type female to APC-7, HP 11524A

PROCEDURE:

1. Set the 4191A SPOT frequency to 100.0MHz.
2. Disconnect the SMC connector cable from A13P1 (E-12 will appear on the 4191A display).
3. Connect the 10dB attenuator and connection cable between the frequency counter input and the 4191A UNKNOWN connector as shown in Figure 5-2.
4. Remove the A18 board and re-install with an extender board.
5. Set the frequency counter to a frequency range appropriate for measuring 100MHz (10Hz resolution).
6. Set trimmer capacitor A18C3 to its mechanical center position.
7. Adjust trimmer capacitor A18C36 until the display on the frequency counter is 100.00000MHz \pm 20 counts.
8. Remove the extender board and return the A18 board to its normal position.
9. Adjust trimmer capacitor A18C3 until the display on the frequency counter is 100.00000MHz \pm 1 count.

Note: Confirmation check procedure should be performed after this adjustment.

10. Reconnect the SMC connector cable to A13P1 (E-12 will disappear from the 4191A display).

ADJUSTMENTS

Confirmation Check

Set the 4191A SPOT frequency in accordance with Table 5-6. Frequency counter readouts should meet the test limits at all test frequency settings.

Table 5-6. Frequency Accuracy Checks.

Test freq.	Test limits	Test freq.	Test limits
1.0MHz	± 11 Hz	405.0MHz	± 415Hz
32.0	± 42 Hz	405.1	± 415Hz
32.1	± 42 Hz	450.0	± 460Hz
33.0	± 43 Hz	450.1	± 460Hz
62.5	± 72Hz	500.0	± 510Hz
62.6	± 72 Hz	500.2	± 510Hz
125.0	±135 Hz	528.0	± 538Hz
125.1	±135 Hz	528.2	± 538Hz
250.0	±260Hz	556.0	± 566Hz
250.1	±260Hz	556.2	± 566Hz
264.0	±274 Hz	588.0	± 598Hz
264.1	±274 Hz	588.2	± 598Hz
278.0	±288 Hz	630.0	± 640 Hz
278.1	±288 Hz	630.2	± 640 Hz
294.0	±304 Hz	680.0	± 690 Hz
294.1	±304 Hz	680.2	± 690 Hz
315.0	±325 Hz	744.0	± 754 Hz
315.1	±325 Hz	744.2	± 754 Hz
340.0	±350Hz	810.0	± 820 Hz
340.1	±350Hz	810.2	± 820 Hz
372.0	±382 Hz	900.0	± 910 Hz
372.1	±382 Hz	900.2	± 910 Hz
		1000.0	±1010Hz

ADJUSTMENTS

5-23. VOLTAGE TUNABLE FILTER TUNING VOLTAGE ADJUSTMENT

5-24. This adjustment sets the tuning control output voltages for the voltage tunable filter (on the A6 board) to establish the appropriate frequency pass bands.

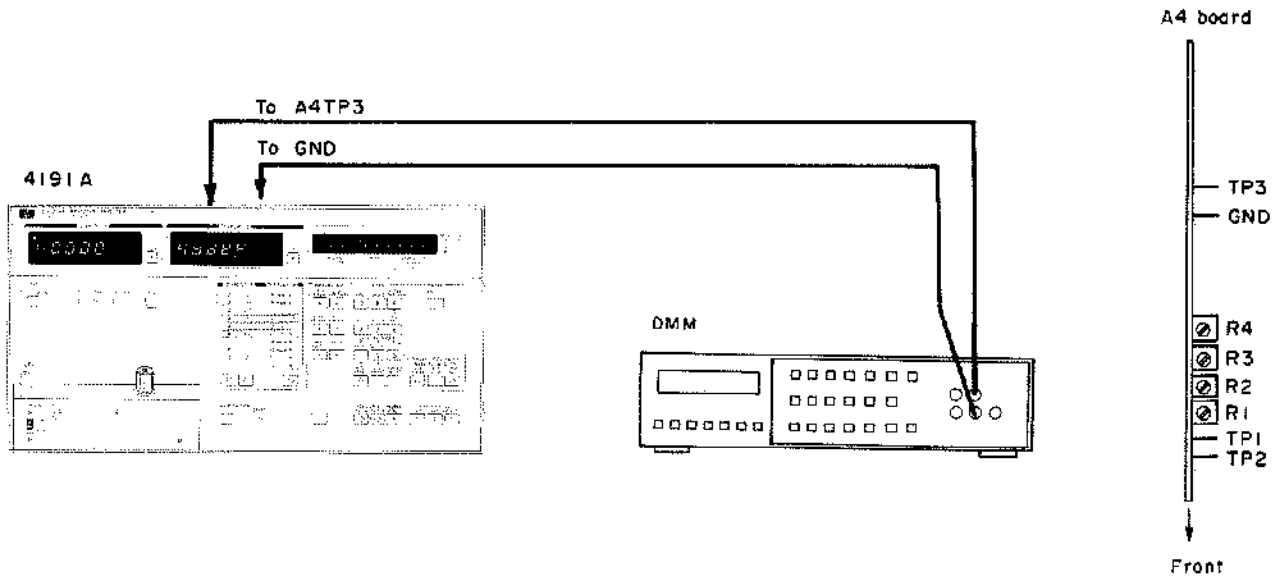

Figure 5-3. Voltage Tunable Filter Tuning Voltage Adjustment Setup.

EQUIPMENT:

- Digital Voltmeter HP 3455A
- Voltmeter input leads Dual banana to dual alligator clip leads

PROCEDURE:

1. Connect the DC voltmeter input leads to TP3 and GND pin on the A4 board as shown in Figure 5-3.
2. Set the 4191A SPOT frequency to 520MHz.
3. Adjust potentiometer A4R4 until the voltmeter display reads $-3.2V \pm 0.1V$.
4. Set the 4191A SPOT frequency in accordance with Table 5-7. Adjust potentiometers R3, R2, and R1 until the voltmeter readouts are within the voltage limits given in the table.

Table 5-7. Tuning Voltage Adjustments.

Frequency setting	Potentiometer	Voltage limits
520MHz	A4 R4	$-3.2 \pm 0.1V$
730MHz	R3	$-8.6 \pm 0.1V$
800MHz	R2	$-9.8 \pm 0.1V$
900MHz	R1	$-11.4 \pm 0.1V$

ADJUSTMENTS

5-25. TEST SIGNAL LEVEL ADJUSTMENT

5-26. This adjustment sets the test frequency signal level to meet specified value range.

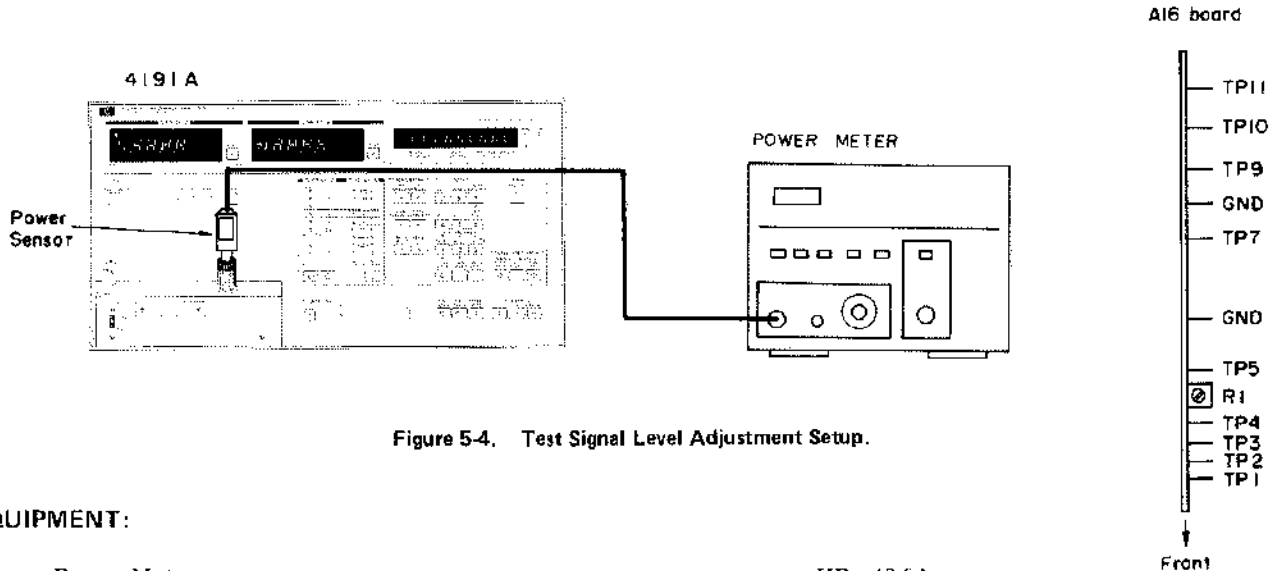

Figure 5-4. Test Signal Level Adjustment Setup.

EQUIPMENT:

- Power Meter HP 436A
- Power Sensor HP 8482A

PROCEDURE:

1. Set switch S2 on the A21 board as shown below:

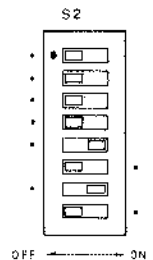

- 2. Disconnect the SMC connector cable from A15P2.
- 3. Set the 4191A SPOT frequency to 100.0 MHz.

4. Connect the power sensor between the 4191A UNKNOWN connector and RF power meter input as shown in Figure 5-4.

5. Adjust potentiometer A16R1 for a $-20.50\text{dB} \pm 0.05\text{dBm}$ reading on the power meter.

Note: Confirmation check procedure should be performed after this adjustment.

- 6. Reconnect the SMC connector cable to A15P2.
- 7. Reset switch A21S2 to its normal position.

Confirmation Check

Set 4191A test signal frequency at various settings from 1MHz to 1000MHz in 5MHz steps. Power meter display should be $-20\text{dBm} \pm 2\text{dBm}$ at all the test frequency settings. If the unit under adjustment fails this confirmation check, re-perform the Voltage Tunable Filter Tuning Voltage Adjustment (Para. 5-23) using a tolerance of $\pm 1\text{V}$ (instead of $\pm 0.1\text{V}$).

ADJUSTMENTS

5-27. SAMPLING DIODE BIAS VOLTAGE ADJUSTMENT

5-28. This adjustment sets the applied bias voltages of the A10 and A11 Sampler circuits to an appropriate value to prevent the transient ringing of the sampling pulse signal (see illustration) from activating the sampler.

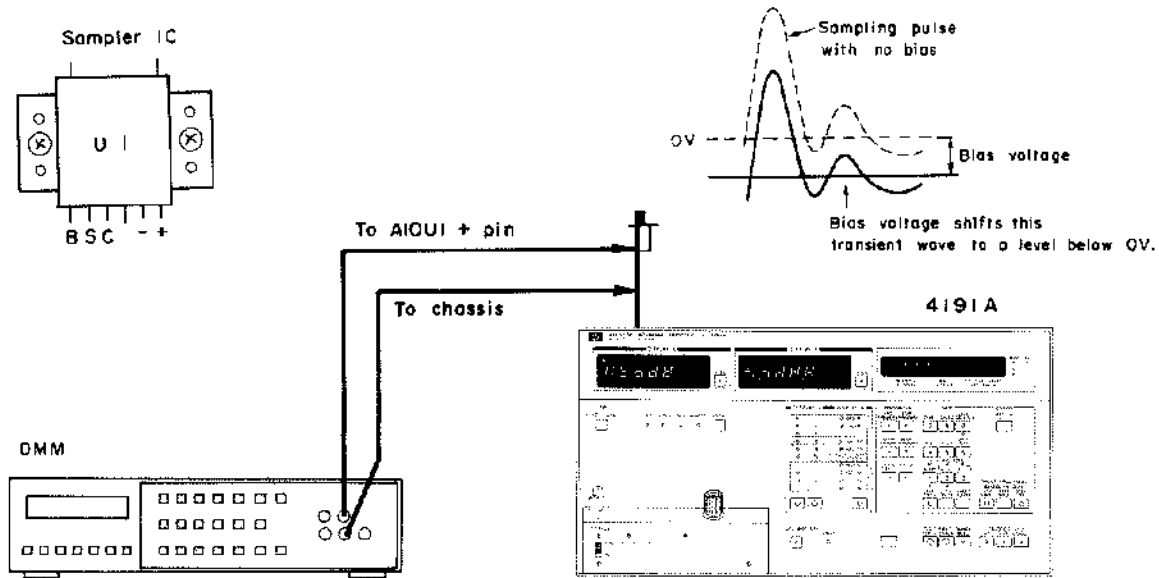

Figure 5-5. Sampler Diode Bias Voltage Adjustment Setup.

EQUIPMENT:

Digital Voltmeter (DMM) HP 3455A
Voltmeter input cable Dual banana to dual alligator clip cable

PROCEDURE:

1. Disconnect the SMC connector cables from A10P1 and P2.
2. Remove the A10 board from its shield box and re-install with an extender board.
3. Connect the dc voltmeter (DMM) input cable to test point "+" on the A10 board and instrument chassis as shown in Figure 5-5.
4. Adjust potentiometer A10R18 (labeled bias) until the voltmeter display reads $1.2V \pm 0.01V$.

Note: Verify that dc voltage at "-" test point on the A10 board is $-1.2V \pm 0.01V$. If this check fails, readjust A10R18.

5. Connect the dc voltmeter (DMM) input cable to A11 board test point "+" and instrument chassis, and adjust potentiometer A11R18 using the procedure described in steps 1 through 4.
6. Re-install the A10 and A11 boards to their normal positions.
7. Reconnect the SMC connector cables to their normal positions.

ADJUSTMENTS

5-29. SAMPLING EFFICIENCY COMPENSATION ADJUSTMENT



5-30. This adjustment sets the compensation for decreases in sampling efficiency at lower frequency region of the sampling frequency control range. Because a maximum change in the sampling frequency (and efficiency) occurs when the measurement frequency shifts between 11.1MHz and 11.2MHz, this adjustment is performed using these specific measurement frequency settings.

EQUIPMENT:

No equipment is required for this adjustment.

PROCEDURE:

1. Stand the 4191A on its right side.
2. Remove the bottom cover from the instrument.
3. Set 4191A controls as follows:

SPOT FREQ	11.1 MHz
STEP FREQ1 MHz
DISPLAY A/B function	$\Gamma_x - \Gamma_y$
4. Make a note of the readouts on DISPLAY A and DISPLAY B.
5. Press the SWEEP FREQ/BIAS STEP  key to set the test frequency to 11.2MHz.
6. Adjust potentiometer A11R19 so that both DISPLAY A and DISPLAY B readouts approximate the values noted in step 4. Potentiometer A11R19 is accessible through the adjustment hole (labeled FB) on the instrument motherboard.
7. Press the SWEEP FREQ/BIAS STEP  key to reset the test frequency to 11.1MHz. Repeat A11R19 adjustment (steps 3, 4, 5 and 6) until the difference in display readouts is less than ± 10 counts.
8. If adjustment of A11R19 can not satisfy the test limits, adjust potentiometer A10R19 using the same procedure as that for A11R19 adjustment (steps 3, 4, 5, 6 and 7). Potentiometer A10R19 is accessible through the adjustment hole (labeled FB) on the instrument motherboard.

Note: If the difference in display readouts can not be decreased to less than ± 50 counts, troubleshoot A10 and A11 boards. If it does not exceed ± 50 counts, proceed to the next adjustment procedure.

ADJUSTMENTS

5-31. SAMPLING FREQUENCY SEARCH CONTROL ADJUSTMENT

5-32. This adjustment sets the output voltage variable range of the A12 PLL Sampling Controller to establish a sampling frequency control span sufficient for converting any measurement frequency signal to a 100kHz IF signal in the Sampler.

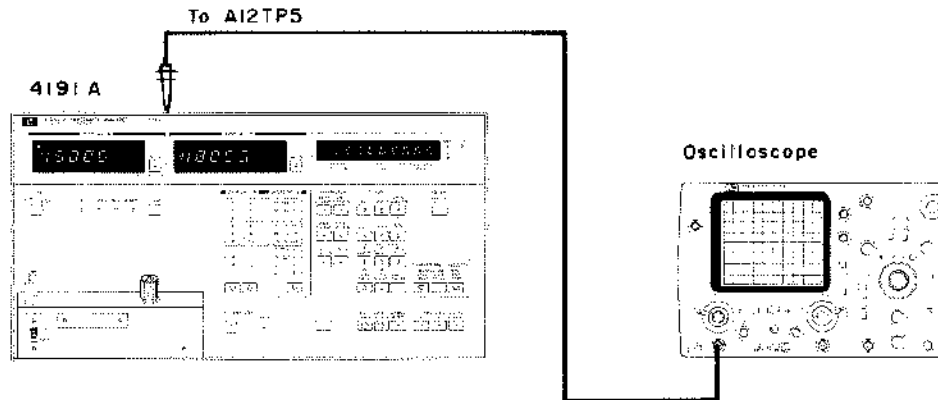

Figure 5-6. Sampling Frequency Search Control Adjustment Setup.

EQUIPMENT:

- Oscilloscope HP 1740A
- Oscilloscope probe HP 10006D (10 M Ω , 10:1)

PROCEDURE:

1. Disconnect the SMC connector (P1) from the A13 board top plate.
2. Connect oscilloscope input probe (10:1) to test point A12TP5.
3. Set the oscilloscope controls as follows:
 - Vertical sensitivity5 V/div
 - Sweep time 10 ms/div
4. Adjust potentiometers A12R1 (SH RANGE ADJ) and R2 (CENT ADJ) so that the amplitude of the sawtooth waveform on the CRT is greater than 20Vp-p. See waveform illustration below:

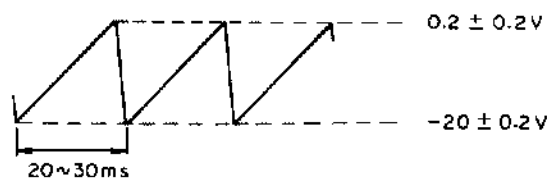

5. Reconnect the SMC connector to A13P1.

ADJUSTMENTS

5-33. SAMPLING FREQUENCY VTO ADJUSTMENT

5-34. This adjustment sets the maximum oscillation frequency of the A13 Sampling Frequency VTO to cover the required sampling frequency variable range (in conjunction with the Sampling Frequency Search Control Adjustment).

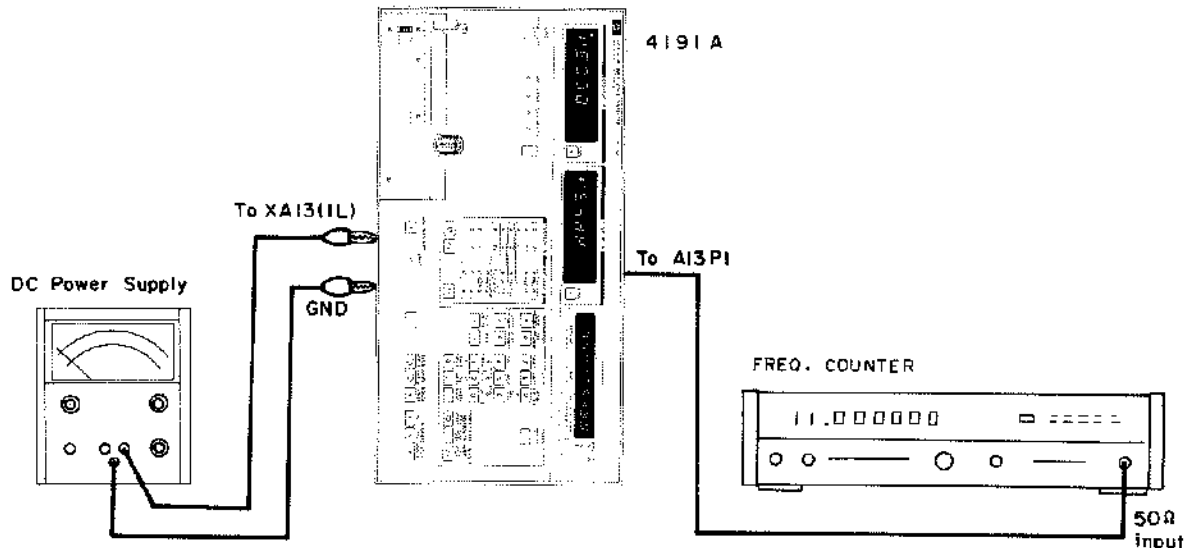

Figure 5-7. Sampling Frequency VTO Adjustment Setup.

EQUIPMENT:

- Frequency Counter HP 5340A
- Connection Cable N type connector cable
- Terminal Converter:
 - N type female to SMC female hp- 1250-1153
- DC Power Supply HP 6224B
- Power Supply Output Cable Dual banana to dual alligator clip cable

PROCEDURE:

1. Set 4191A test signal frequency to 11.0 MHz.
2. Remove the A12 board.
3. Stand the 4191A on its right side.
4. Remove the bottom cover from the instrument.
5. Connect the dual banana to alligator clip cable between 4191A XA13 pin 1L (board connector) and dc power supply output as shown in Figure 5-7.

Caution: Set dc power supply output voltage to zero before connecting output cable.

6. Disconnect the SMC connector cable from A13P1.

ADJUSTMENTS

7. Connect the frequency counter input cable to A13P1.
8. Set the dc power supply output voltage to $-18.9V \pm 0.1V$ (voltage at XA13 pin 1L is negative.).
9. Adjust trimmer capacitor A13C1 until the frequency counter display is within 11.30 and 11.33 MHz.
Note: Use a non-metallic tool for this adjustment.
10. Disconnect the power supply output cable and the frequency counter input cable.
11. Re-install the A12 board to its normal position.
12. Reconnect the SMC connector cable to A13P1.

5-35. A-D CONVERTER OFFSET ADJUSTMENT

5-36. This adjustment eliminates any residual dc offset voltage from the phase detector output to minimize its affect on the accuracy.

Note: The residual dc offset voltage does not significantly affect the accuracy because of the automatic offset compensation period achieved at initiation of the measurement sequence. This adjustment further increases the accuracy of the offset compensation.

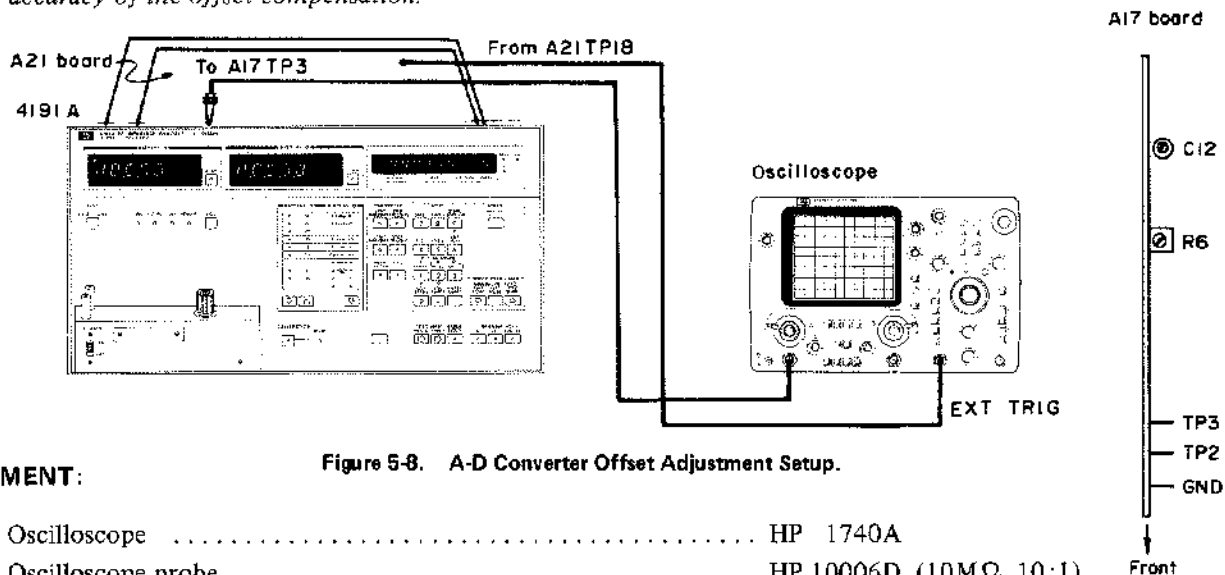

Figure 5-8. A-D Converter Offset Adjustment Setup.

EQUIPMENT:

- | | |
|--------------------------|------------------------|
| Oscilloscope | HP 1740A |
| Oscilloscope probe | HP 10006D (10MΩ, 10:1) |

PROCEDURE:

1. Connect oscilloscope input probe to A17TP3. Trigger the oscilloscope externally from A21TP18 (labeled RKEY).
2. Observe integrator output waveform for phase I period (see illustration below).

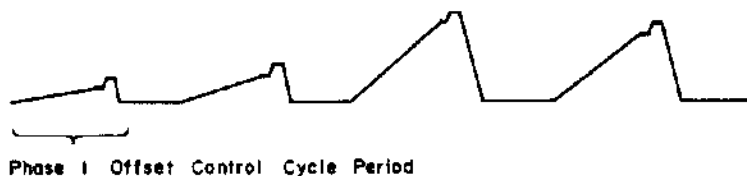

ADJUSTMENTS

3. Set oscilloscope TIME/DIV to 10 ms. Magnify waveform for phase 1 period on CRT.
4. Adjust potentiometer A17R6 so that the amplitude of the charge waveform (positive going ramp) is minimum.

Note: The small charge waveform (A) (see illustration) shown for the integrator output waveform should appear in the positive domain. If the primary charge waveform is a negative going ramp, the small charge waveform will appear in the negative domain.

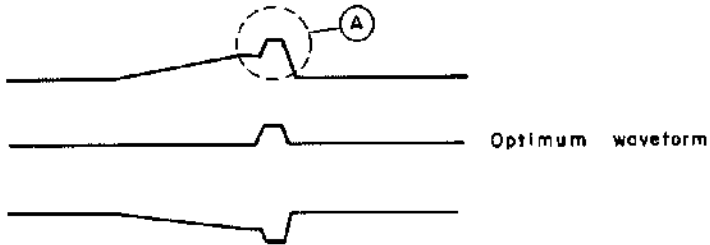

5-37. PHASE DETECTOR REFERENCE PHASE ADJUSTMENT

5-38. This adjustment sets the 90° detection phase signal input of the phase detector to an accurate 90 degrees in phase referenced to the 0° detection phase signal and maximizes measurement accuracy.

EQUIPMENT:

Reference Terminations:

0Ω	} HP 16342A Calibration Equipment Kit
0S	
50Ω	
Capacitance termination (318 pF)	

PROCEDURE:

1. Perform auto-calibration using the 0Ω, 0S, and 50Ω reference terminations.
Note: Use the terminations provided in the Calibration Equipment Kit (kit number: Model 16342A).
2. Release the CALIBRATION function (by re-pressing the CALIBRATION key).
3. Connect the reference coaxial capacitor (318 pF at 10MHz) of the Calibration Equipment Kit to the UNKNOWN connector.

Note: The reference capacitor is calibrated in reference to the same 50Ω termination supplied in the kit.

4. Set 4191A controls as follows:

DISPLAY A function |Γ|
 DISPLAY B function θ (deg)
 SPOT FREQ 10.0MHz
 DC BIAS switch OFF

5. Adjust trimmer capacitor A17C12 until DISPLAY B readout (phase angle) is the reference value of the reference capacitor (approximately 90°) within ±2 counts (±0.02°).

Note: Verify that DISPLAY A readout is within 0.9960 and 1.0000. If otherwise, check the reference capacitor and troubleshoot the instrument.

ADJUSTMENTS

5-39. MICROPROCESSOR CLOCK FREQUENCY ADJUSTMENT

5-40. This adjustment properly sets the frequency of the microprocessor operating clock as well as the execution times for various functions (frequency sweep, auto calibration, etc.) to their nominal values.

EQUIPMENT:

Frequency Counter HP 5340A
Connection Cable BNC to dual alligator clip cable

PROCEDURE:

1. Connect frequency counter input cable to A21TP25 and TP7 (GND). Use BNC to dual alligator clip cable. The A21 board is inside the top shield case.
2. Adjust trimmer capacitor A21C58 until the frequency counter display reads $975 \text{ kHz} \pm 20 \text{ kHz}$.

Note: Use a non-metallic tool for this adjustment.

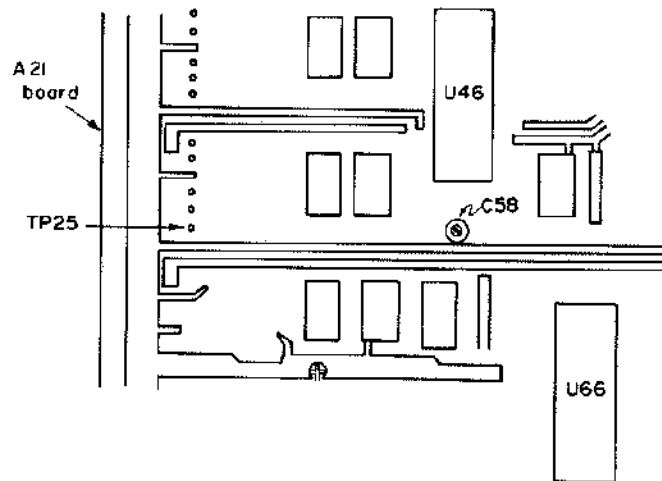

ADJUSTMENTS

5-41. DC BIAS VOLTAGE ADJUSTMENT

5-42. This adjustment eliminates any residual dc offset voltages from the A40 internal dc bias voltage supply circuit and sets the maximum bias output voltage to the specified value to optimize bias voltage accuracy.

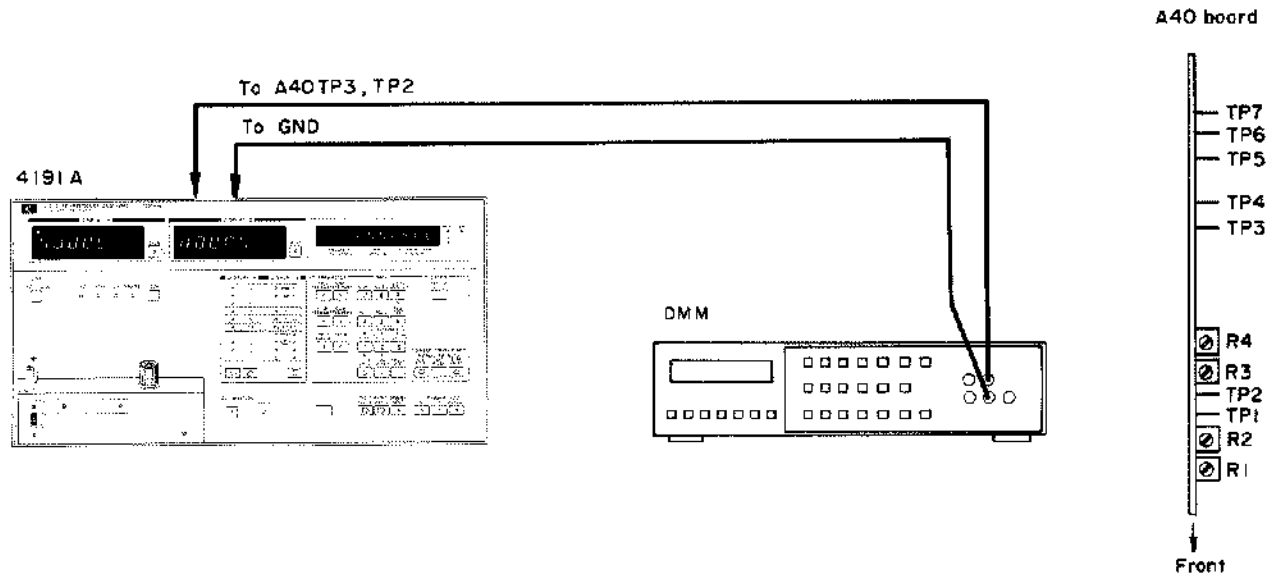

Figure 5-9. DC Bias Voltage Adjustment Setup.

EQUIPMENT:

- Digital Voltmeter (DMM) HP 3455A
- Voltmeter input cable Dual banana to dual alligator clip cable

PROCEDURE:

1. Set the 4191A internal dc bias voltage to 0V.
2. Connect the dc voltmeter (DMM) input to A40TP3.
3. Adjust potentiometer A40R3 (ZERO ADJ) for a 0V ±1mV readout on the dc voltmeter display.
4. Connect the dc voltmeter input to A40TP2.
5. Adjust potentiometer A40R1 (ZERO ADJ) for a 0V ±1mV readout on the dc voltmeter display.
6. Set the 4191A internal dc bias voltage to 40V.
7. Adjust potentiometer A40R2 (-FS ADJ) for a -40V ±1mV readout on the dc voltmeter display.
8. Connect the dc voltmeter input to A40TP3.
9. Adjust potentiometer A40R4 (+FS ADJ) for a 40V ±1mV readout on the dc voltmeter display.

ADJUSTMENTS

5-43. RF DIRECTIONAL BRIDGE TEMPERATURE ADJUSTMENT

5-44. This adjustment sets the stabilization control temperature of the A25 Heater Controller which regulates the operating temperature of the A9 RF Directional Bridge circuit assembly.

Note: This adjustment should be performed only when the A25 Heater Controller board has been repaired or when the posister heater or thermister temperature sensor has been replaced.

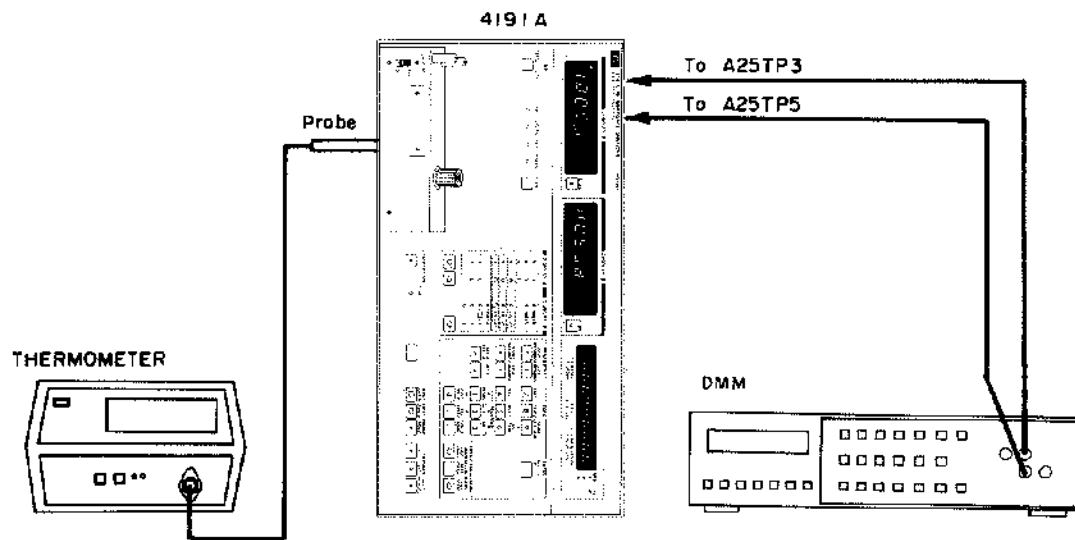

Figure 5-10. RF Directional Bridge Temperature Adjustment Setup.

EQUIPMENT:

Digital Multimeter	HP 3455A
Test lead	Dual banana to dual alligator clip lead
Thermometer	HP 2802A
Thermometer probe	HP 18641A

PROCEDURE:

Caution: Be sure to turn instrument off before proceeding with the adjustment setups. Disconnect power cable plug from instrument socket.

1. Stand the 4191A on its right side.
2. Remove the bottom cover from the UNKNOWN terminal deck.
3. Remove the A25 board and disconnect the cables from A25J1 and J2.

Note: Allow at least 30 minutes for the temperature of the directional bridge assembly to stabilize.

4. Hold the thermometer probe to the center of the directional bridge assembly (see illustration).

ADJUSTMENTS

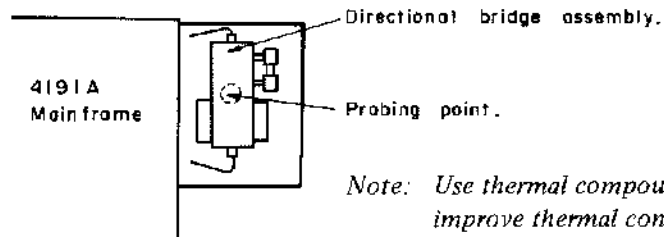

5. Make a note of the thermometer readout as T_m with 0.1°C least significant digit resolution.
6. Connect the DMM test leads to pins 2 and 4 of J2 plug. Measure the resistance at an accuracy higher than $\pm 10\Omega$ and make a note of the DMM readout as R_m .

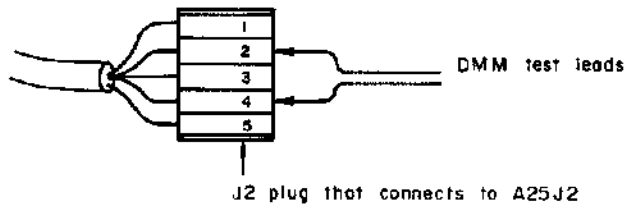

7. Calculate the center value of the optimum setting range of the temperature adjustment potentiometer A25R1 using the following equation:

$$R_a = R_m \cdot \exp -0.044 \times (30 - T_m) \times 1.237 (\Omega)$$
8. Connect the DMM positive input lead to A25TP3 and the negative input lead to circuit common.
9. Adjust potentiometer A25R1 for the calculated R_a value, $\pm 50\Omega$ on the DMM display.
10. Reconnect cable plugs J1 and J2 to their normal positions on the A25 board.
11. Turn instrument power on.

WARNING

Electrical shock hazard!
AC power line voltage is exposed. Do not touch A25 PC board patterns.

12. Verify that the LED indicator lamp on the A25 board begins flashing.

Note: The indicator lamp will not light when the ambient temperature is greater than 28°C (the Heater Controller stops functioning).

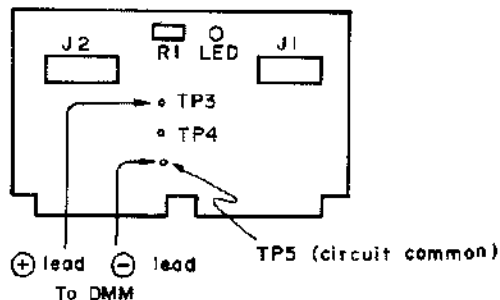

ADJUSTMENTS

5-45. OPT 002 TEST FREQUENCY SYNTHESIZER LOCAL VTO ADJUSTMENT

5-46. This adjustment sets the maximum oscillation frequency of the A30 Test Frequency Synthesizer VTO so that the VTO covers the required frequency controllable range.

Note: A board frequency range on the VTO ensures coverage of the required frequency variable range by properly setting the maximum frequency.

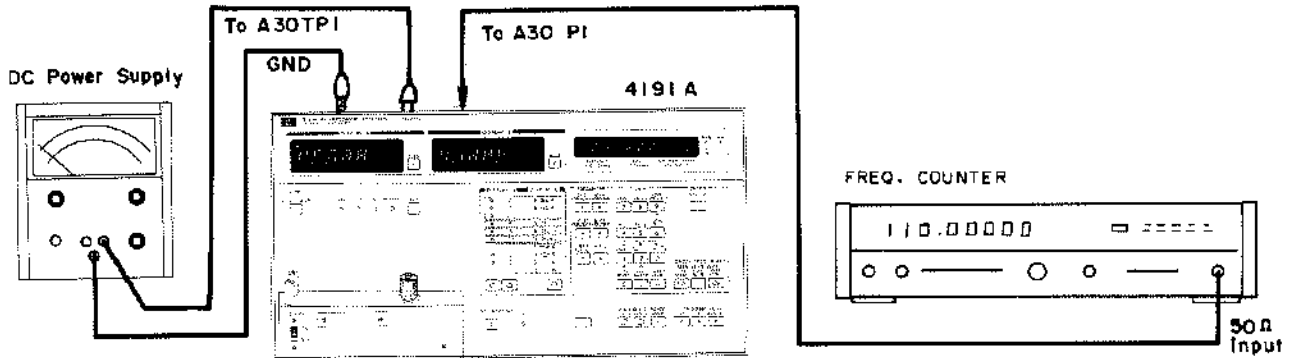

Figure 5-11. Opt. 002 Test Frequency Synthesizer VTO Adjustment Setup.

EQUIPMENT:

Frequency Counter	HP 5340A
Connection Cable	N type connector cable
Terminal Converter:	
N type female to SMC female	-hp- 1250-1153
DC Power Supply	HP 6224B
Power Supply output cable	Dual banana to dual alligator clip cable

PROCEDURE:

1. Remove boards A3 and A31.
2. Connect the dual banana to dual alligator clip cable between A30TP1 and the dc power supply output as shown in Figure 5-11.

Caution: Set dc power supply output voltage to zero before connecting output cable.

3. Disconnect the SMC connector cable from A30P1.
4. Connect the frequency counter input cable to A30P1.
5. Set the dc power supply output voltage to within 10.0 and 10.1V.

Caution: Do not apply a negative dc voltage.

6. Adjust trimmer capacitor A30C1 until the frequency counter display readout is within 111.5 and 112.0MHz.

Note: Use a non-metallic tool for this adjustment.

7. Reinstall A3 and A31 boards in their normal positions.
8. Reconnect the SMC connector cable to A30P1.

ADJUSTMENTS

5-47. OPT 002 TEST FREQUENCY SYNTHESIZER FINAL VTO ADJUSTMENT

5-48. This adjustment sets the controllable frequency range of the A33 VTO to ensure generation of test frequency signals free of signal dead zones and parasitic oscillation at any test frequency setting.

EQUIPMENT AND PROCEDURE:

The A33 VTO board is identical to the A1 board of the basic instrument and has a different part number because of the option 002 circuit.

Adjustment can therefore be performed using the same equipment and procedure as for the A1 board adjustment. Follow the Test Frequency Synthesizer Adjustment in Paragraph 5-19 and, to make the procedure applicable to the A33 board, change portions of the adjustment procedure as follows:

- 1) Change the board number A1 in all the steps to read A33.
- 2) At steps 3 and 4, disconnect the SMC connectors (P1, P2 and P3) from the A32 board top plate and remove the A32 board.
- 3) At step 5, connect the alligator clip cable to XA33 pin 9L (instead of XA1 pin 9L).

5-49. OPT 004 ANALOG RECORDER OUTPUT ADJUSTMENT

5-50. This adjustment eliminates any residual dc offset voltages from the analog recorder outputs and sets the maximum output voltages to the specified values to maximize output voltage accuracy.

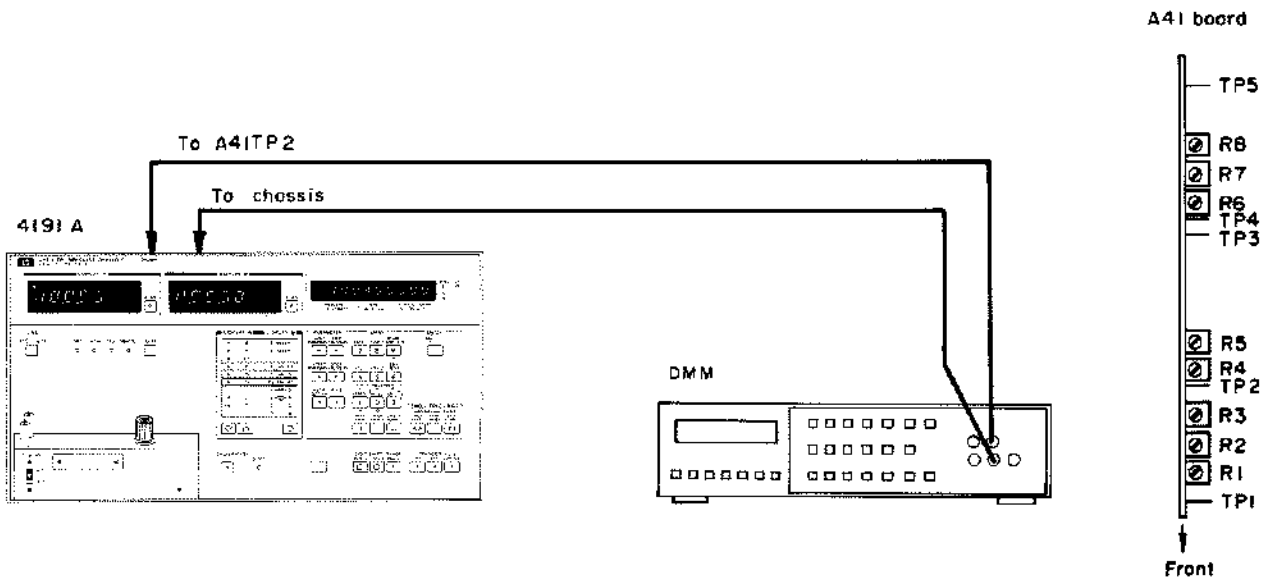

Figure 5-12. Opt. 004 Analog Recorder Output Adjustment Setup.

EQUIPMENT:

- DC Voltmeter (DMM) HP 3455A
- Voltmeter input cable Dual banana to dual alligator clip cable

ADJUSTMENTS

PROCEDURE:

1. Press the blue key and $\downarrow \leftarrow$ LL key on the 4191A front panel.
2. Connect the dual banana plug to alligator clip cable to the DMM input and A41TP2 (connect negative lead to instrument chassis).
3. Connect a short clip lead to A41TP1 and to the chassis (ground TP1).
4. Adjust potentiometer A41R2 (-A θ) for a 0 ± 0.5 mV dc readout on the DMM display.
5. Connect the DMM input positive lead to A41TP4.
6. Disconnect the short clip lead from TP1 and connect it to TP3 (ground TP3).
7. Adjust potentiometer A41R5 (-B θ) for a 0 ± 0.5 mV dc readout on the DMM display.
8. Remove the short clip lead.
9. Connect the DMM input positive lead to TP5, TP1 and TP3. Adjust potentiometers R7, R1, and R4 until the DMM display readout meets the test limits given in Table 5-8.

Table 5-8. Output Offset Zero Adjustments.

DMM input connection point	Adjustment potentiometer	Test limits	Adjustment condition
TP2	R2 (-A θ)	0 ± 0.5 mV	Ground TP1
TP4	R5 (-B θ)	0 ± 0.5 mV	Ground TP3
TP5	R7 (C θ)	0 ± 0.5 mV	—
TP1	R1 (+A θ)	0 ± 0.5 mV	—
TP3	R4 (+B θ)	0 ± 0.5 mV	—

10. Press the blue key and UR $\rightarrow \uparrow$ key.
11. Connect the DMM input positive lead in accordance with Table 5-9 and adjust potentiometers R6, R3 and R8 for the test limits given in the table.

Table 5-9. Full Scale Output Adjustments.

DMM input connection point	Adjustment potentiometer	Test limits
TP3	R6 (B. F. S)	$1000\text{mV} \pm 0.5\text{mV}$
TP1	R3 (A. F. S)	$1000\text{mV} \pm 0.5\text{mV}$
TP5	R8 (C. F. S)	$1000\text{mV} \pm 0.5\text{mV}$

SECTION VI REPLACEABLE PARTS

6-1. INTRODUCTION.

6-2. This section contains information for ordering parts. Table 6-1 lists abbreviations used in the parts list and throughout the manual. Table 6-3 lists all replaceable parts in reference designator order. Table 6-2 contains the names and addresses that correspond to the manufacturer's code numbers.

6-3. ABBREVIATIONS.

6-4. Table 6-1 lists abbreviations used in parts list, schematics and throughout the manual. In some cases, two forms of abbreviations are used, one in all capital letters, and one in partial capitals or no capitals. This occurs because the abbreviations in parts list are always all capitals. However, in the schematic and in other parts of the manual, other abbreviation forms with both lower case and upper case letters are used.

6-5. REPLACEABLE PARTS LIST.

6-6. Table 6-3 is a list of replaceable parts and is organized as follows:

- a. Electrical assemblies and their components in alphanumeric order by reference designation.
- b. Chassis-mounted parts in alphanumeric order by reference designation.
- c. Miscellaneous parts.
- d. Illustrated parts breakdowns, if appropriate.

The information for each part includes:

- a. The Hewlett-Packard part number.
- b. The total quantity (Qty) in the instrument.
- c. A description of the part.
- d. A typical manufacturer of the part in a five-digit code.
- e. The manufacturer's number for the part.

Table 6-1. List of Reference Designators and Abbreviations.

REFERENCE DESIGNATORS			
A = assembly B = motor BT = battery C = capacitor CP = coupler CR = diode DL = delay line DS = device signaling (lamp)	E = misc electronic part F = fuse FL = filter J = jack K = relay L = inductor M = meter MP = mechanical part	P = plug Q = transistor R = resistor RT = thermistor S = switch T = transformer TB = terminal board TP = test point	U = integrated circuit V = vacuum, tube, neon bulb, photorell, etc. VR = voltage regulator W = cable X = socket Y = crystal
ABBREVIATIONS			
A = amperes A. F. C. = automatic frequency control AMPL = amplifier B. F. O. = beat frequency oscillator BE CU = beryllium copper BH = binder head BP = bandpass BR5 = brass BWO = backward wave oscillator CCW = counter-clockwise CER = ceramic CMO = cabinet mount only COEF = coefficient COM = common COMP = composition COMPL = complete CONN = connector CP = cadmium plate CRT = cathode-ray tube CW = clockwise DEPC = deposited carbon DR = drive ELECT = electrolytic ENCAP = encapsulated EXT = external F = farads f = femto = 10 ⁻¹⁵ FH = flat head FIL H = filletter head FXD = fixed G = giga = 10 ⁹ GE = germanium GL = glass GRD = ground(ed)	H = henries HEX = hexagonal HG = mercury HR = hour(s) Hz = hertz IF = intermediate freq. IMPG = impregnated INCD = incandescent INCL = include(s) INS = insulation(ed) INT = internal k = kilo = 1000 LH = left hand LIN = linear taper LK WASH = lock washer LOG = logarithmic taper LPF = low pass filter m = milli = 10 ⁻³ M = meg = 10 ⁶ MET FLM = metal film MET OX = metallic oxide MFR = manufacturer MINAT = miniature MOM = momentary MTC = mounting MY = "mylar" n = nano = 10 ⁻⁹ N/C = normally closed NE = neon NI PL = nickel plate N/O = normally open NPO = negative positive zero (zero temperature coefficient)	NPN = negative-positive-negative NRFR = not recommended for field replacement NSR = not separately replaceable OBD = order by description OH = oval head OX = oxide P = peak PC = printed circuit p = pico = 10 ⁻¹² PH BRZ = phosphor bronze PHL = Phillips PIV = peak inverse voltage PNP = positive-negative-positive P/O = part of POLY = polystyrene PORC = porcelain POS = position(s) POT = potentiometer PP = peak-to-peak PT = point PWV = peak working voltage RECT = rectifier RF = radio frequency RH = round head or right hand RMO = rack mount only RMS = root-mean square	RWV = reverse working voltage S-B = slow-blow SCR = screw SE = selenium SECT = section(s) SEMICON = semiconductor SI = silicon SIL = silver SL = slide SPG = spring SPL = special SST = stainless steel SR = split ring STL = steel TA = tantalum TD = time delay TGL = toggle THD = thread TI = titanium TOL = tolerance TRIM = trimmer TWT = traveling wave tube μ = micro = 10 ⁻⁶ VAR = variable VDCW = dc working volts W / = with W = watts WIV = working inverse voltage WW = wirewound W/O = without

0001-9700

The total quantity for each part is given only once – at the first appearance of the part number in the list.

6-7. ORDERING INFORMATION.

6-8. To order a part listed in the replaceable parts table, give the Hewlett-Packard part number, indicate the quantity required, and address the order to the nearest Hewlett-Packard office.

6-9. To order a part that is not listed in the replaceable parts table, state the full instrument model and serial number, the description and function of the part, and the number of parts required. Address your order to the nearest Hewlett-Packard office.

6-10. SPARE PARTS KIT.

6-11. Stocking spare parts for an instrument is often done to insure quick return to service after a malfunction occurs. Hewlett-Packard has a Spare Parts Kit available for this purpose. The kit consists of selected replaceable assemblies and components for this instrument. The contents of the kit and the Recommended Spares List are based on failure reports and repair data, and parts support for one year. A complimentary Recommended

Spares List for this instrument may be obtained on request and the Spare Parts Kit may be ordered through your nearest Hewlett-Packard office.

6-12. DIRECT MAIL ORDER SYSTEM.

6-13. Within the USA, Hewlett-Packard can supply parts through a direct mail order system. Advantages of using the system are:

- a. Direct ordering and shipment from the HP Parts Center in Mountain View, California.
- b. No maximum or minimum on any mail order (there is a minimum order amount for parts ordered through a local HP Office when the orders require billing and invoicing).
- c. Prepaid transportation (there is a small handling charge for each order).
- d. No invoices – to provide these advantages, a check or money order must accompany each order.

6-14. Mail order forms and specific ordering information is available through your local HP Office. Addresses and phone numbers are located at the back of this manual.

Table 6-2. Manufacturers Code Lists.

MFR NO.	MANUFACTURER NAME	ADDRESS	ZIP CODE
00533	AKTIEBOLAGET RIFA	BROMMA SE	
00000	ANY SATISFACTORY SUPPLIER		
0003J	NIPPON ELECTRIC CO		
01121	ALLER-BRADLEY CO	MILWAUKEE WI	53204
01295	TEXAS INSTR INC SEMICOND CMPNT DIV	DALLAS TX	75222
0192B	RCA CORP SOLID STATE DIV	SOMERVILLE NJ	08876
02114	FERROXCUBE CORP	SAUGERTIES NY	12477
0352B	JOHANSON DIELECTRICS INC	BURBANK CA	91510
04713	MOTOROLA SEMICONDUCTOR PRODUCTS	PHOENIX AZ	85062
06665	PRECISION MONOLITHICS INC	SANTA CLARA CA	95050
07263	FAIRCHILD SEMICONDUCTOR DIV	MOUNTAIN VIEW CA	94042
11236	CTS OF BERNE INC	BERNE IN	46711
12954	SIEMENS CORP COMPONENTS GROUP	SCOTTSDALE AZ	85252
19701	MEPCO/ELECTRA CORP	MINERAL WELLS TX	76057
20932	EMCON DIV ITW	SAN DIEGO CA	92129
24546	CORNING GLASS WORKS (BRADFORD)	BRADFORD PA	16701
25403	AMPEREX ELEK CORP SEMICON & MC DIV	SLATERSVILLE RI	02876
27034	NATIONAL SEMICONDUCTOR CORP	SANTA CLARA CA	95051
28480	HEWLETT-PACKARD CO CORPORATE HQ	PALO ALTO CA	94304
32293	INTERSIL INC	CUPERTINO CA	95014
32997	BOURNS INC TRIMPOT PROD DIV	RIVERSIDE CA	92507
34335	ADVANCED MICRO DEVICES INC	SUNNYVALE CA	94086
61642	CENTRE ENGINEERING INC	STATE COLLEGE PA	16801
52648	PLESSEY SEMICONDUCTORS	SANTA ANA CA	92705
52763	STETTNER-TRUSH INC	CAZENOVIA NY	13035
56289	SPRAGUE ELECTRIC CO	NORTH ADAMS MA	01247
72136	ELECTRO MOTIVE CORP SUB IEC	WILLIMANTIC CT	06226
74970	JOHNSON E F CO	WASECA MN	56093
75915	LITTELFUSE INC	DES PLAINES IL	60016
8E175	BURR BROWN CO	HUNTSVILLE AL	35801

Table 6-3. Replaceable Parts

Reference Designation	HP Part Number	C D	Qty	Description	Mfr Code	Mfr Part Number
A1	04191-66501	8	1	VTO (250-500MHz) BOARD ASSEMBLY	28480	04191-66501
A1C1	0160-2055	9	153	CAPACITOR-FXD .01UF +80-20% 100VDC CER	28480	0160-2055
A1C2	0160-2055	9		CAPACITOR-FXD .01UF +80-20% 100VDC CER	28480	0160-2055
A1C3	0160-2055	9		CAPACITOR-FXD .01UF +80-20% 100VDC CER	28480	0160-2055
A1C4	0160-2055	9		CAPACITOR-FXD .01UF +80-20% 100VDC CER	28480	0160-2055
A1C5	0160-2055	9		CAPACITOR-FXD .01UF +80-20% 100VDC CER	28480	0160-2055
A1C6	0160-2055	9		CAPACITOR-FXD .01UF +80-20% 100VDC CER	28480	0160-2055
A1C7	0160-2055	9		CAPACITOR-FXD .01UF +80-20% 100VDC CER	28480	0160-2055
A1C8	0160-2055	9		CAPACITOR-FXD .01UF +80-20% 100VDC CER	28480	0160-2055
A1C9	0160-2055	9		CAPACITOR-FXD .01UF +80-20% 100VDC CER	28480	0160-2055
A1C10	0160-3878	6	36	CAPACITOR-FXD 1000PF +-20% 100VDC CER	28480	0160-3878
A1C11	0160-3878	6		CAPACITOR-FXD 1000PF +-20% 100VDC CER	28480	0160-3878
A1C12	0160-3878	6		CAPACITOR-FXD 1000PF +-20% 100VDC CER	28480	0160-3878
A1C13	0160-3878	6		CAPACITOR-FXD 1000PF +-20% 100VDC CER	28480	0160-3878
A1C14	0160-3878	6		CAPACITOR-FXD 1000PF +-20% 100VDC CER	28480	0160-3878
A1C15	0160-3878	6		CAPACITOR-FXD 1000PF +-20% 100VDC CER	28480	0160-3878
A1C16	0160-3878	6		CAPACITOR-FXD 1000PF +-20% 100VDC CER	28480	0160-3878
A1C17	0160-3878	6		CAPACITOR-FXD 1000PF +-20% 100VDC CER	28480	0160-3878
A1C18	0121-0493	6	1	CAPACITOR-V TRMR-AIR 1.3-5.4PF 250V	74970	187-0303-105
A1C19	0122-0072	6	7	DIODE-VVC 2.2PF 5% C3/C25-MIN64.5	04713	881058
A1C19	0160-3878	6		CAPACITOR-FXD 1000PF +-20% 100VDC CER	28480	0160-3878
A1C20	0160-3879	7	39	CAPACITOR-FXD .01UF +-20% 100VDC CER	28480	0160-3879
A1C21	0160-3877	5	35	CAPACITOR-FXD 100PF +-20% 200VDC CER	28480	0160-3877
A1C22	0160-3873	1	5	CAPACITOR-FXD 4.7PF +-5% 200VDC CER	28480	0160-3873
A1C23	0160-3874	2	10	CAPACITOR-FXD 10PF +-5% 200VDC CER	28480	0160-3874
A1C24	0160-3872	0	8	CAPACITOR-FXD 2.2PF +-5% 200VDC CER	28480	0160-3872
A1C25	0160-2236	8	4	CAPACITOR-FXD 1PF +-25% 500VDC CER	28480	0160-2236
A1C26	0160-2055	9		CAPACITOR-FXD .01UF +80-20% 100VDC CER	28480	0160-2055
A1C26	0160-2979	8	10	CAPACITOR-FXD 220UF +-20% 16VDC AL	28480	0160-2979
A1C28	0160-3879	7		CAPACITOR-FXD .01UF +-20% 100VDC CER	28480	0160-3879
A1C29	0160-3879	7		CAPACITOR-FXD .01UF +-20% 100VDC CER	28480	0160-3879
A1C30	0160-3877	5		CAPACITOR-FXD 100PF +-20% 200VDC CER	28480	0160-3877
A1C31	0160-3877	5		CAPACITOR-FXD 100PF +-20% 200VDC CER	28480	0160-3877
A1C32	0160-2244	1	1	CAPACITOR-FXD 3PF +-25% 500VDC CER	28480	0160-2244
A1C32	0160-2236	2	1	CAPACITOR-FXD 9.1PF +-25% 500VDC CER	28480	0160-2236
A1C33	0160-3878	6		CAPACITOR-FXD 1000PF +-20% 100VDC CER	28480	0160-3878
A1C34	0160-3879	7		CAPACITOR-FXD .01UF +-20% 100VDC CER	28480	0160-3879
A1C35	0160-2253	9	1	CAPACITOR-FXD 4.8PF +-25% 500VDC CER	28480	0160-2253
A1C36	0160-3877	5		CAPACITOR-FXD 100PF +-20% 200VDC CER	28480	0160-3877
A1C37	0160-3879	7		CAPACITOR-FXD .01UF +-20% 100VDC CER	28480	0160-3879
A1C39	0160-3878	6		CAPACITOR-FXD 1000PF +-20% 100VDC CER	28480	0160-3878
A1C40	0160-3875	3	8	CAPACITOR-FXD 22PF +-5% 200VDC CER 0+-30	28480	0160-3875
A1C41	0160-3877	5		CAPACITOR-FXD 100PF +-20% 200VDC CER	28480	0160-3877
A1C42	0160-3877	5		CAPACITOR-FXD 100PF +-20% 200VDC CER	28480	0160-3877
A1C43	0160-3874	2		CAPACITOR-FXD 10PF +-5% 200VDC CER	28480	0160-3874
A1C44	0160-2241	5	1	CAPACITOR-FXD 2.2PF +-25% 500VDC CER	28480	0160-2241
A1C45	0160-3877	5		CAPACITOR-FXD 100PF +-20% 200VDC CER	28480	0160-3877
A1C46	0160-3879	7		CAPACITOR-FXD .01UF +-20% 100VDC CER	28480	0160-3879
A1C47	0160-3878	6		CAPACITOR-FXD 1000PF +-20% 100VDC CER	28480	0160-3878
A1C48	0160-3874	2		CAPACITOR-FXD 10PF +-5% 200VDC CER	28480	0160-3874
A1C49	0160-2055	9		CAPACITOR-FXD .01UF +80-20% 100VDC CER	28480	0160-2055
A1C50	0160-2055	9		CAPACITOR-FXD .01UF +80-20% 100VDC CER	28480	0160-2055
A1C51	0160-2979	8	80	CAPACITOR-FXD 220UF +-20% 16VDC AL	28480	0160-2979
A1C52	0160-1083	3		CAPACITOR-FXD 33UF -10%+75% 25WVDC AL	28480	0160-1083
A1C53	0160-2979	8		CAPACITOR-FXD 220UF +-20% 16VDC AL	28480	0160-2979
A1C54	0160-3879	7		CAPACITOR-FXD .01UF +-20% 100VDC CER	28480	0160-3879
A1C55	0160-3879	7		CAPACITOR-FXD .01UF +-20% 100VDC CER	28480	0160-3879
A1C56	0160-3879	7		CAPACITOR-FXD .01UF +-20% 100VDC CER	28480	0160-3879
A1C61	0122-0109	0	13	DIODE VVC High Q 28Vmax 11pF(Vr=3V)	28480	0122-0109
A1C62	0122-0109	0		DIODE VVC High Q 28Vmax 11pF(Vr=3V)	28480	0122-0109
A1C63	0122-0109	0		DIODE VVC High Q 28Vmax 11pF(Vr=3V)	28480	0122-0109
A1C64	0122-0109	0		DIODE VVC High Q 28Vmax 11pF(Vr=3V)	28480	0122-0109
A1C65	0122-0109	0		DIODE VVC High Q 28Vmax 11pF(Vr=3V)	28480	0122-0109
A1C66	0122-0109	0		DIODE VVC High Q 28Vmax 11pF(Vr=3V)	28480	0122-0109
A1C67	0122-0109	0		DIODE VVC High Q 28Vmax 11pF(Vr=3V)	28480	0122-0109
A1C68	0122-0109	0		DIODE VVC High Q 28Vmax 11pF(Vr=3V)	28480	0122-0109
A1L1	9100-2247	4	40	COIL-MLD 100NH 10% 0#34 .0950X.25LG-NQM	28480	9100-2247
A1L2	9100-2247	4		COIL-MLD 100NH 10% 0#34 .0950X.25LG-NQM	28480	9100-2247
A1L3	9100-2247	4		COIL-MLD 100NH 10% 0#34 .0950X.25LG-NQM	28480	9100-2247
A1L4	9100-2247	4		COIL-MLD 100NH 10% 0#34 .0950X.25LG-NQM	28480	9100-2247
A1L5	9100-2247	4		COIL-MLD 100NH 10% 0#34 .0950X.25LG-NQM	28480	9100-2247

See introduction to this section for ordering information
*Indicates factory selected value

Table 6-3. Replaceable Parts

Reference Designation	HP Part Number	C D	Qty	Description	Mfr Code	Mfr Part Number
A1L6	9100-2247	4		COIL=MLD 100NH 10% 0034 .095DX,25LB=NOM	28480	9100-2247
A1L7	9100-2247	4		COIL=MLD 100NH 10% 0034 .095DX,25LB=NOM	28480	9100-2247
A1L8	9100-2247	4		COIL=MLD 100NH 10% 0034 .095DX,25LB=NOM	28480	9100-2247
A1L9	9100-2247	4		COIL=MLD 100NH 10% 0034 .095DX,25LB=NOM	28480	9100-2247
A1L10	9100-2247	4		COIL=MLD 100NH 10% 0034 .095DX,25LB=NOM	28480	9100-2247
A1L11	9100-2247	4		COIL=MLD 100NH 10% 0034 .095DX,25LB=NOM	28480	9100-2247
A1L12	9140-0098	3	5	COIL=MLD 2.2UH 10% 0033 .135DX,375LB=NOM	28480	9140-0098
A1L13	9170-0029	3	9	CORE=SHIELDING BEAD	28480	9170-0029
A1MP1	0380-1007	5	27	STANDOFF=RV1=DN .430-IN-LG 4-40TWD	00000	ORDER BY DESCRIPTION
A1MP2	2190-0124	4	21	NASHER=LK INTL T NO. 10 .195-IN-ID	28480	2190-0124
A1MP3	2200-0142	4	40	SCREW=MACH 4-40 .312-IN-LG 100 DEG	00000	ORDER BY DESCRIPTION
A1MP4	2360-0115	4	44	SCREW=MACH 6-32 .312-IN-LG PAN-HD=POZI	00000	ORDER BY DESCRIPTION
A1MP5	2950-0078	4	21	NUT=HEX=OBL=CHAM 10-32=TWD .067-IN-THK	28480	2950-0078
A1MP6	5001-0173	7	14		28480	5001-0173
A1MP7	04191-00601	1	1	SHIELD=BOX	28480	04191-00601
A1MP8	04191-00602	2	3	SHIELD=BOX	28480	04191-00602
A1MP9	04191-00000	0	1	COVER	28480	04191-00000
A1P1	1250-1220	0	21	CONNECTOR=RF BNC M PC 50=OHM	28480	1250-1220
A1P2	1250-1220	0		CONNECTOR=RF BNC M PC 50=OHM	28480	1250-1220
A1Q1	1854-0130	9	12	TRANSISTOR NPN S1 PD=350MH FT=4.5GHZ	28480	1854-0130
A1Q2	1855-0124	5	1	TRANSISTOR FET N-CHAN MOS S1	28480	1855-0124
A1Q3	1854-0345	8	9	TRANSISTOR NPN 2N5179 S1 T0=72 PDR200MH	04713	2N5179
A1Q4	1854-0130	9	9	TRANSISTOR NPN S1 PD=350MH FT=4.5GHZ	28480	1854-0130
A1Q5	1853-0020	4	20	TRANSISTOR PNP S1 PDR300MH FT=150MHZ	28480	1853-0020
A1R1	0683-2215	1	19	RESISTOR 220 5% .25W FC TC=400/+600	01121	C82215
A1R2	0683-2215	1		RESISTOR 220 5% .25W FC TC=400/+600	01121	C82215
A1R3	0683-2215	1		RESISTOR 220 5% .25W FC TC=400/+600	01121	C82215
A1R4	0683-2215	1		RESISTOR 220 5% .25W FC TC=400/+600	01121	C82215
A1R5	0683-2215	1		RESISTOR 220 5% .25W FC TC=400/+600	01121	C82215
A1R6	0683-2215	1		RESISTOR 220 5% .25W FC TC=400/+600	01121	C82215
A1R7	0683-2215	1		RESISTOR 220 5% .25W FC TC=400/+600	01121	C82215
A1R8	0683-2215	1		RESISTOR 220 5% .25W FC TC=400/+600	01121	C82215
A1R9	0683-2215	1		RESISTOR 220 5% .25W FC TC=400/+600	01121	C82215
A1R10	0683-1035	1	38	RESISTOR 10K 5% .25W FC TC=400/+700	01121	C81035
A1R11	0698-3155	1	4	RESISTOR 4.64K 1% .125W F TC=0/+100	24546	C4=1/8-T0=464L-F
A1R12	0757-0220	3	19	RESISTOR 1K 1% .125W F TC=0/+100	24546	C4=1/8-T0=1001-F
A1R13	0757-0220	3		RESISTOR 1K 1% .125W F TC=0/+100	24546	C4=1/8-T0=1001-F
A1R14	0757-0220	3		RESISTOR 1K 1% .125W F TC=0/+100	24546	C4=1/8-T0=1001-F
A1R15	0698-3155	1		RESISTOR 4.64K 1% .125W F TC=0/+100	24546	C4=1/8-T0=464L-F
A1R16	2100-2521	1	1	RESISTOR=TRMR 2K 10% C SIDE=ADJ I=TRN	28480	2100-2521
A1R17	0757-0420	0	4	RESISTOR 750 1% .125W F TC=0/+100		
A1R18	0698-7193	5	8	RESISTOR 16.2 1% .05W F TC=0/+100	24546	C3=1/8-T0=16R2=6
A1R19	0683-3305	2	4	RESISTOR 33 5% .25W FC TC=400/+500	01121	C83305
A1R20	0698-7193	5		RESISTOR 16.2 1% .05W F TC=0/+100	24546	C3=1/8-T0=16R2=6
A1R21	0698-3439	4	2	RESISTOR 178 1% .125W F TC=0/+100	24546	C4=1/8-T0=178R-F
A1R22	0757-0420	4	7	RESISTOR 1.62K 1% .125W F TC=0/+100		
A1R23	0698-7205	0	9	RESISTOR 51.1 1% .05W F TC=0/+100	24546	C3=1/8-T0=51H1=0
A1R24	0757-0278	4	5	RESISTOR 1.78K 1% .125W F TC=0/+100	24546	C4=1/8-T0=1781-F
A1R25	0757-0278	5	6	RESISTOR 6.19K 1% .125W F TC=0/+100	19701	MFNC1/8-T0=6191-F
A1R26	0757-0017	8	3	RESISTOR 562 1% .125W F TC=0/+100	24546	C4=1/8-T0=562R-F
A1R27	0757-0278	9		RESISTOR 1.78K 1% .125W F TC=0/+100	24546	C4=1/8-T0=1781-F
A1R28	0757-0278	5		RESISTOR 6.19K 1% .125W F TC=0/+100	19701	MFNC1/8-T0=6191-F
A1R29	0698-3447	4	1	RESISTOR 422 1% .125W F TC=0/+100	24546	C4=1/8-T0=422R-F
A1R30	0698-7193	5		RESISTOR 16.2 1% .05W F TC=0/+100	24546	C3=1/8-T0=16R2=6
A1R31	0698-7188	8	7	RESISTOR 10 1% .05W F TC=0/+100	24546	C3=1/8-T0=10R=6
A1R32	0698-7193	5		RESISTOR 16.2 1% .05W F TC=0/+100	24546	C3=1/8-T0=16R2=6
A1R33	0757-0420	0	5	RESISTOR 750 1% .125W F TC=0/+100		
A1R34	0698-7193	5		RESISTOR 16.2 1% .05W F TC=0/+100	24546	C3=1/8-T0=16R2=6
A1R35	0683-3315	4	8	RESISTOR 330 5% .25W FC TC=400/+600	01121	C83315
A1R36	0757-0220	3		RESISTOR 1K 1% .125W F TC=0/+100	24546	C4=1/8-T0=1001-F
A1R37	0698-4020	1	1	RESISTOR 9.53K 1% .125W F TC=0/+100	24546	C4=1/8-T0=9531-F
A1R38	0683-3305	2		RESISTOR 33 5% .25W FC TC=400/+500	01121	C83305
A1R39	0757-0420	4		RESISTOR 1.62K 1% .125W F TC=0/+100		
A1R40	0698-3439	4		RESISTOR 178 1% .125W F TC=0/+100	24546	C4=1/8-T0=178R-F
A1U1	1826-0372	2	2	IC=LINEAR SUPPORT CHIP F=2MHZ	28480	1826-0372
A1U2	1826-0372	2		IC=LINEAR SUPPORT CHIP F=2MHZ	28480	1826-0372
A2	04191-66502	9	1	100KHZ STEP PROGRAMMABLE DIVIDER BD ASSY	28480	04191-66502
A2C1	0160-3879	7		CAPACITOR=FXD .01UF +/-20% 100VDC CER	28480	0160-3879
A2C2	0160-0291	3	18	CAPACITOR=FXD 1UF +/-10% 35VDC TA	58289	1500105X9035A2
A2C3	0160-3879	7		CAPACITOR=FXD .01UF +/-20% 100VDC CER	28480	0160-3879
A2C4	0160-3878	6		CAPACITOR=FXD 1000PF +/-20% 100VDC CER	28480	0160-3878
A2C5	0160-0291	3		CAPACITOR=FXD 1UF +/-10% 35VDC TA	58289	1500105X9035A2

See introduction to this section for ordering information
*Indicates factory selected value

Table 6-3. Replaceable Parts

Reference Designation	HP Part Number	C D	Qty	Description	Mfr Code	Mfr Part Number
A2C6	0160-3879	7		CAPACITOR-FXD .01UF +-20% 100VDC CER	28480	0160-3879
A2C7	0180-0291	3		CAPACITOR-FXD 1UF+-10% 35VDC TA	56289	150D105X9035A2
A2C8	0160-3879	7		CAPACITOR-FXD .01UF +-20% 100VDC CER	28480	0160-3879
A2C9	0160-3879	6		CAPACITOR-FXD 1000PF +-20% 100VDC CER	28480	0160-3879
A2C10	0160-3879	7		CAPACITOR-FXD .01UF +-20% 100VDC CER	28480	0160-3879
A2C11	0180-0291	3		CAPACITOR-FXD 1UF+-10% 35VDC TA	56289	150D105X9035A2
A2C12	0160-3875	3		CAPACITOR-FXD 22PF +-5% 200VDC CER 0+-30	28480	0160-3875
A2C13	0180-0291	3		CAPACITOR-FXD 1UF+-10% 35VDC TA	56289	150D105X9035A2
A2C14	0160-3879	7		CAPACITOR-FXD .01UF +-20% 100VDC CER	28480	0160-3879
A2C15	0160-3878	6		CAPACITOR-FXD 1000PF +-20% 100VDC CER	28480	0160-3878
A2C16	0160-3879	7		CAPACITOR-FXD .01UF +-20% 100VDC CER	28480	0160-3879
A2C17	0180-0291	3		CAPACITOR-FXD 1UF+-10% 35VDC TA	56289	150D105X9035A2
A2C18	0160-3879	7		CAPACITOR-FXD .01UF +-20% 100VDC CER	28480	0160-3879
A2C19	0160-3879	7		CAPACITOR-FXD .01UF +-20% 100VDC CER	28480	0160-3879
A2C20	0160-2055	9		CAPACITOR-FXD .01UF +-20% 100VDC CER	28480	0160-2055
A2C21	0160-3878	6		CAPACITOR-FXD 1000PF +-20% 100VDC CER	28480	0160-3878
A2C22	0180-1051	5	6	CAPACITOR, FXD 100 UF 16V M	28480	0180-1051
A2C23	0180-1051	5		CAPACITOR, FXD 100 UF 16V M	28480	0180-1051
A2C24	0160-2055	9		CAPACITOR-FXD .01UF +-20% 100VDC CER	28480	0160-2055
A2C25	0160-2055	9		CAPACITOR-FXD .01UF +-20% 100VDC CER	28480	0160-2055
A2C26	0160-3456	6	16	CAPACITOR-FXD 1000PF +-10% 1KVDC CER	28480	0160-3456
A2C27	0160-3875	3		CAPACITOR-FXD 22PF +-5% 200VDC CER 0+-30	28480	0160-3875
A2C28	0160-3875	3		CAPACITOR-FXD 22PF +-5% 200VDC CER 0+-30	28480	0160-3875
A2C41	1901-0518	8	10	DIPDE-SCHMITTKY	28480	1901-0518
A2C42	1901-0518	8		DIPDE-SCHMITTKY	28480	1901-0518
A2L1	9140-0158	6	40	COIL=MLD 1UM 10X 032 .0950X.25LG=NDM	28480	9140-0158
A2L2	9100-1748	6	7	CHOK=HIDE BAND ZMAX=630 OHMS 180 MHZ	02110	VK200 20748
A2M1	0360-1715	0	4	TERMINAL=STUD 3DL=PIN PRESS=MT8	28480	0360-1715
A2M2	0380-0741	2	12	BTANDOFF=RYT=ON .187-IN=LG 6-32TMD	00000	ORDER BY DESCRIPTION
A2M3	2190-0124	4	2	WASHER=LK INTL Y NO. 10 .195-IN=ID	28480	2190-0124
A2M4	2200-0108	4	7	SCREW=NACH 6-40 .312-IN=LG PAN=HD=PDZI	00000	ORDER BY DESCRIPTION
A2M5	2300-0115	4	4	SCREW=NACH 6-32 .312-IN=LG PAN=HD=PDZI	00000	ORDER BY DESCRIPTION
A2M6	2950-0076	9		NUT=HEX=DBG=CHAM 10-32=THD .067-IN=THK	28480	2950-0076
A2M7	5001-0173	7			28480	5001-0173
A2M8	04191-09000	2	1	HEAT SINK	28480	04191-09000
A2M9	04191-60001	1	3	COVER	28480	04191-60001
A2P1	1250-1220	0		CONNECTOR-RF 8MC M PC 50-OHM	28480	1250-1220
A2R1	0698-3441	8	4	RESISTOR 215 1% .125W F TC0+-100	24546	C0=1/8-T0=215R-F
A2R2	0698-7212	0	22	RESISTOR 100 1% .05W F TC0+-100	24546	C0=1/8-T0=100R-F
A2R3	0698-7229	6	3	RESISTOR 511 1% .05W F TC0+-100	24546	C0=1/8-T0=511R-F
A2R4	0757-0401	0	4	RESISTOR 100 1% .125W F TC0+-100	24546	C0=1/8-T0=101R-F
A2R5	0698-7205	0		RESISTOR 51.1 1% .05W F TC0+-100	24546	C0=1/8-T0=51.1R-F
A2R6	0698-7205	0		RESISTOR 51.1 1% .05W F TC0+-100	24546	C0=1/8-T0=51.1R-F
A2R7	0698-7229	6		RESISTOR 511 1% .05W F TC0+-100	24546	C0=1/8-T0=511R-F
A2R8	0698-7329	5		RESISTOR 511 1% .05W F TC0+-100	24546	C0=1/8-T0=511R-F
A2R9	0757-0416	7	4	RESISTOR 511 1% .125W F TC0+-100	24546	C0=1/8-T0=511R-F
A2R10	0683-1525	4	11	RESISTOR 1.5K 5% .25W FC TC=400/+700	01121	C01525
A2R11	0683-1525	4		RESISTOR 1.5K 5% .25W FC TC=400/+700	01121	C01525
A2R12	0757-0441	0		RESISTOR 100 1% .125W F TC0+-100	24546	C0=1/8-T0=101R-F
A2R13	0683-1525	4		RESISTOR 1.5K 5% .25W FC TC=400/+700	01121	C01525
A2R14	0683-1525	4		RESISTOR 1.5K 5% .25W FC TC=400/+700	01121	C01525
A2R15	0683-1025	9	43	RESISTOR 1K 5% .25W FC TC=400/+600	01121	C01025
A2R16	0757-0416			RESISTOR 511 1% .125W TC=0+-100		
A2U1	1820-0888	1	1	IC GATE TTL 3 NAND DUAL 4-INP	01295	SN74820N
A2U2	1820-0693	4	1	IC FF TTL 3 D-TYPE POS-EDGE-TRIG	01295	SN74874N
A2U3	1820-0661	4	1	IC GATE TTL 3 NAND QUAD 2-INP	01295	SN74800N
A2U4	1820-1888	5	1	IC PRESCA ECL	04713	MC7013L
A2U5	1820-1373	3	4	IC CNTR TTL 3 BCD SYNCHRD POS-EDGE-TRIG	07263	SN74100C
A2U6	1820-1373	3		IC CNTR TTL 3 BCD SYNCHRD POS-EDGE-TRIG	07263	SN74100C
A2U7	1820-1373	3		IC CNTR TTL 3 BCD SYNCHRD POS-EDGE-TRIG	07263	SN74100C
A2U9	1820-1433	6	9	IC SHF-RGTR TTL LS R=8 SERIAL-IN PRL-OUT	01295	SN74LS164N
A2U10	1820-1433	6		IC SHF-RGTR TTL LS R=8 SERIAL-IN PRL-OUT	01295	SN74LS164N
A2U11	1820-1416	5	4	IC SCHMITT-TRIG TTL LS 14V HEX 1-INP	01295	SN74LS14N
A3	04191-66503	0	1	SYNTHESIZER PHASE DETECTOR BOARD 889Y	28480	04191-66503
A3C1	0180-1083	3		CAPACITOR-FXD 33uF -10%+75% 25WVDC ALM	28480	0180-1083
A3C2	0180-2220	0	2	CAPACITOR-FXD 1200PF +-5% 300VDC MICA	28480	0180-2220
A3C3	0180-0158	9	4	CAPACITOR-FXD 5600PF +-10% 200VDC POLYE	28480	0180-0158
A3C4	0180-0158	9		CAPACITOR-FXD 5600PF +-10% 200VDC POLYE	28480	0180-0158
A3C5	0180-1083	3		CAPACITOR-FXD 33uF -10%+75% 25WVDC ALM	28480	0180-1083
A3C6	0180-1083	3		CAPACITOR-FXD 33uF -10%+75% 25WVDC ALM	28480	0180-1083
A3C7	0180-0889	1	2	CAPACITOR-FXD .33UF +-10% 80VDC POLYE	28480	0180-0889
A3C8	0180-0889	4	4	CAPACITOR-FXD 100UF+-75%+-10% 25VDC AL	56289	30010780250D2
A3C9	0160-2055	9		CAPACITOR-FXD .01UF +-20% 100VDC CER	28480	0160-2055
A3C10	0160-2055	9		CAPACITOR-FXD .01UF +-20% 100VDC CER	28480	0160-2055

See introduction to this section for ordering information
*Indicates factory selected value

Table 6-3. Replaceable Parts

Reference Designation	HP Part Number	C D	Qty	Description	Mfr Code	Mfr Part Number
A3C11	0160-2055	9	33	CAPACITOR-FXD .01UF +80-20% 100VDC CER	28480	0160-2055
A3C12	0160-2055	9		CAPACITOR-FXD .01UF +80-20% 100VDC CER	28480	0160-2055
A3C13	0160-0090	4		CAPACITOR-FXD 100UF+75-10% 25VDC AL	56289	30D107G025002
A3C14	0160-0121	5		CAPACITOR-FXD .1UF +80-20% 50VDC CER	28480	0160-0121
A3C15	0160-3456	9		CAPACITOR-FXD 1000PF +-10% 1KVDC CER	28480	0160-3456
A3C16	0160-2055	9	CAPACITOR-FXD .01UF +80-20% 100VDC CER	28480	0160-2055	
A3C17	0160-2055	9	CAPACITOR-FXD .01UF +80-20% 100VDC CER	28480	0160-2055	
A3C18	0160-2055	9	CAPACITOR-FXD .01UF +80-20% 100VDC CER	28480	0160-2055	
A3C19	0160-2055	9	CAPACITOR-FXD .01UF +80-20% 100VDC CER	28480	0160-2055	
A3C20	0160-2055	9	CAPACITOR-FXD .01UF +80-20% 100VDC CER	28480	0160-2055	
A3C21	0160-2055	9	CAPACITOR-FXD .01UF +80-20% 100VDC CER	28480	0160-2055	
A3C22	0180-1083	5	CAPACITOR-FXD 33UF -10%+75% 25WVDC ALM	28480	0180-1083	
A3C21	1902-3104	4	2	DIODE-ZNR 5.62V 5% DO-7 PDM,4W TCM+.016%	28480	1902-3104
A3C22	1902-3149	9		DIODE-ZNR 9.09V 5% DO-7 PDM,4W TCM+.057%	28480	1902-3149
A3C23	1902-3256	9		DIODE-ZNR 23.7V 5% DO-7 PDM,4W TCM+.074%	28480	1902-3256
A3L1	9100-1661	4	15	COIL-MLD 2.2MH 5% QP70 .2150X.56LG-NOM	28480	9100-1661
A3L2	9140-0137	1		COIL-MLD 1MH 5% Q660 .190X.44LG-NOM	28480	9140-0137
A3L3	9140-0137	1		COIL-MLD 1MH 5% Q660 .190X.44LG-NOM	28480	9140-0137
A3L4	9140-0137	1		COIL-MLD 1MH 5% Q660 .190X.44LG-NOM	28480	9140-0137
A3L5	9140-0137	1		COIL-MLD 1MH 5% Q660 .190X.44LG-NOM	28480	9140-0137
A3L6	9140-0158	5	2	COIL-MLD 1UH 10% Q632 .0750X.25LG-NOM	28480	9140-0158
A3L7	9100-1629	4		COIL-MLD 47UH 5% Q655 .1350X.375LG-NOM	28480	9100-1629
A3L8	9100-1788	6		CHOKER-WIDE BAND ZMAX660 OHMS 180 MHZ	02114	YK200 20/48
A3L9	9170-0029	3		CDRE-SHIELDING BEAD	28480	9170-0029
A3MP1	2190-0124	4	1	WASHER-LH INTL T NO. 10 .195-IN-ID	28480	2190-0124
A3MP2	2360-0115	9		SCREW-MACH #32 .312-IN-LG PAN-RO-POZI	00000	ORDER BY DESCRIPTION
A3MP3	2950-0078	9		NUT-MEX=DBL-CHAM 10#32-THD .067-IN-THK	28480	2950-0078
A3MP4	04191-60002	2		COVER	28480	04191-60002
A3P1	1250-1220	0	CONNECTOR-RF SMC M PC 50-OHM	28480	1250-1220	
A3Q1	1854-0071	7	19	TRANSISTOR NPN 5I PDM300MH FV=200MHZ	28480	1854-0071
A3Q2	1854-0071	7		TRANSISTOR NPN 5I PDM300MH FV=200MHZ	28480	1854-0071
A3R1	0683-1015	7	68	RESISTOR 100 5% .25W FC TCM=400/+500	01121	C81015
A3R2	0683-1025	9		RESISTOR 1K 5% .25W FC TCM=400/+600	01121	C81025
A3R3	0757-0280	3		RESISTOR 1K 1% .125W F TCM=+100	24546	C4=1/8-T0=1001-F
A3R4	0757-0280	3		RESISTOR 1K 1% .125W F TCM=+100	24546	C4=1/8-T0=1001-F
A3R5	0698-0081	8		RESISTOR 1.0K 1% .125W F TCM=+100	24546	C4=1/8-T0=1981-F
A3R6	0683-1025	9		RESISTOR 1K 5% .25W FC TCM=400/+600	01121	C81025
A3R7	0757-0424	1		RESISTOR 1.02K 1% .125W F TCM=+100	24546	C4=1/8-T0=1621-F
A3R8	0698-3154	0		RESISTOR 4.22K 1% .125W F TCM=+100	24546	C4=1/8-T0=4221-F
A3R9	0683-1025	9		RESISTOR 1K 5% .25W FC TCM=400/+600	01121	C81025
A3R10	0683-1015	7		RESISTOR 100 5% .25W FC TCM=400/+500	01121	C81015
A3R11	0683-1015	7		RESISTOR 100 5% .25W FC TCM=400/+500	01121	C81015
A3R12	0683-1025	9		RESISTOR 1K 5% .25W FC TCM=400/+600	01121	C81025
A3R13	0683-1025	9		RESISTOR 1K 5% .25W FC TCM=400/+600	01121	C81025
A3R14	0683-5605	9		RESISTOR 56 5% .25W FC TCM=400/+500	01121	C85605
A3R15	0757-0424	7		RESISTOR 1.1K 1% .125W F TCM=+100	24546	C4=1/8-T0=1101-F
A3R16	0698-3153	9	35	RESISTOR 3.03K 1% .125W F TCM=+100	24546	C4=1/8-T0=3031-F
A3R17	0683-5615	1		RESISTOR 560 5% .25W FC TCM=400/+600	01121	C85615
A3R18	0683-1225	1		RESISTOR 1.2K 5% .25W FC TCM=400/+700	01121	C81225
A3R19	0683-5615	1		RESISTOR 560 5% .25W FC TCM=400/+600	01121	C85615
A3R20	0683-5615	1		RESISTOR 560 5% .25W FC TCM=400/+600	01121	C85615
A3R22	0683-5605	9	RESISTOR 56 5% .25W FC TCM=400/+500	01121	C85605	
A3R23	0683-5615	1	RESISTOR 560 5% .25W FC TCM=400/+600	01121	C85615	
A3U1	1820-0630	3	2	IC MISC TTL	04713	MC6004P
A3U2	1826-0229	8		IC OP AMP LOW-DRIFT TO-99	08665	OP-05CJ
A3U3	1820-1383	5		IC CNTR ECL 8CD PDS-EDBE-TRIG	04713	MC18138L
A3U4	1820-1199	1		IC INV TTL LS HEX 1-INP	01295	SN74LS04N
A3U5	1820-1042	7		IC CNTR TTL LS DECD ASYNCHRD	01295	SN74LS290N
A3U6	1820-1042	7	IC CNTR TTL LS DECD ASYNCHRD	01295	SN74LS290N	
34	04191-66504	1	PROGRAMMABLE SWITCH CONTROL DRIVER BD AY	28480	04191-66504	
A4C1	0160-2055	9	3	CAPACITOR-FXD .01UF +80-20% 100VDC CER	28480	0160-2055
A4C2	0180-1049	1		CAPACITOR-FXD 4700PF -10+50% 16WVDC ALM	28480	0180-1049
A4C3	0180-1083	3		CAPACITOR-FXD 33UF -10%+75% 25WVDC ALK	28480	0180-1083
A4C4	0180-1083	3		CAPACITOR-FXD 33UF -10%+75% 25WVDC ALM	28480	0180-1083
A4C5	0180-1083	3		CAPACITOR-FXD 33UF -10%+75% 25WVDC ALM	28480	0180-1083
A4C7	0180-2980	1	5	CAPACITOR-FXD 1000UF+-20% 35VDC AL	28480	0180-2980
A4C8	0180-1083	3		CAPACITOR-FXD 33UF -10%+75% 25WVDC ALM	28480	0180-1083
A4C9	0150-0121	5		CAPACITOR-FXD .1UF +80-20% 50VDC CER	28480	0150-0121
A4C10	0160-2055	9		CAPACITOR-FXD .01UF +80-20% 100VDC CER	28480	0160-2055
A4C11	0180-2984	5		CAPACITOR-FXD 47UF+-20% 50VDC AL	28480	0180-2984

See introduction to this section for ordering information
*Indicates factory selected value

Table 6-3. Replaceable Parts

Reference Designation	HP Part Number	C D	Qty	Description	Mfr Code	Mfr Part Number
A4C12	0180-1051	5		CAPACITOR, FXD 100 UF 16V M	28480	0180-1051
A4C12	0180-2984	5		CAPACITOR-FXD 47UF+-20% 50VDC AL	28480	0180-2984
A4C13	0180-1051	5		CAPACITOR, FXD 100 UF 16V M	28480	0180-1051
A4C14	0160-2055	9		CAPACITOR-FXD .01UF +80-20% 100VDC CER	28480	0160-2055
A4C15	0180-1083	3		CAPACITOR-FXD 33UF -10%+75% 25WVDC ALM	28480	0180-1083
A4C16	0160-2055	9		CAPACITOR-FXD .01UF +80-20% 100VDC CER	28480	0160-2055
A4C17	0160-2055	9		CAPACITOR-FXD .01UF +80-20% 100VDC CER	28480	0160-2055
A4C18	0160-2055	9		CAPACITOR-FXD .01UF +80-20% 100VDC CER	28480	0160-2055
A4C19	0160-2055	9		CAPACITOR-FXD .01UF +80-20% 100VDC CER	28480	0160-2055
A4C20	0160-2055	9		CAPACITOR-FXD .01UF +80-20% 100VDC CER	28480	0160-2055
A4C21	0160-2055	9		CAPACITOR-FXD .01UF +80-20% 100VDC CER	28480	0160-2055
A4CR1	1902-3286	3	1	DIODE-ZNR 26.1V 5% DO-7 PDS .6W TC=+.07%K	28480	1902-3286
A4CR2	1902-3082	9	2	DIODE-ZNR 4.84V 5% DO-7 PDS .6W TC=+.023K	28480	1902-3082
A4CR3	1901-0040	1	63	DIODE-SWITCHING 30V 50MA 2NS DO-35	28480	1901-0040
A4CR4	1901-0040	1		DIODE-SWITCHING 30V 50MA 2NS DO-35	28480	1901-0040
A4CR5	1901-0040	1		DIODE-SWITCHING 30V 50MA 2NS DO-35	28480	1901-0040
A4CR6	1901-0040	1		DIODE-SWITCHING 30V 50MA 2NS DO-35	28480	1901-0040
A4CR7	1901-0040	1		DIODE-SWITCHING 30V 50MA 2NS DO-35	28480	1901-0040
A4CR8	1901-0040	1		DIODE-SWITCHING 30V 50MA 2NS DO-35	28480	1901-0040
A4CR9	1901-0040	1		DIODE-SWITCHING 30V 50MA 2NS DO-35	28480	1901-0040
A4CR10	1901-0040	1		DIODE-SWITCHING 30V 50MA 2NS DO-35	28480	1901-0040
A4CR11	1901-0040	1		DIODE-SWITCHING 30V 50MA 2NS DO-35	28480	1901-0040
A4L1	9140-0137	1		COIL-MLD 1MH 5% 0660 .190X.04LG-NDM	28480	9140-0137
A4L2	9100-1788	6		CHOK-NIDE 6AND 2MAX=660 OHM@ 160 MHZ	02114	VK200 20/48
A4MP1	4040-0116	9	2	EXTR-PC 8D BLK POLYC .062-8D-TMKN8	28480	4040-0116
A4MP2	4040-0748	3	1	EXTR-PC 8D YEL POLYC .062-8D-TMKN8	28480	4040-0748
A4MP3	4040-0752	9	1	EXTR-PC 8D YEL POLYC .062-8D-TMKN8	28480	4040-0752
A4Q1	1853-0020	9	1	TRANSISTOR PNP 2N2907A 51 TD-16 PDS400MH	04713	2N2907A
A4Q2	1854-0071	7		TRANSISTOR NPN 31 PDS300MH FT=150MHZ	28480	1854-0071
A4Q3	1853-0020	4		TRANSISTOR PNP 31 PDS300MH FT=150MHZ	28480	1853-0020
A4Q4	1853-0020	4		TRANSISTOR PNP 31 PDS300MH FT=150MHZ	28480	1853-0020
A4Q5	1853-0020	4		TRANSISTOR PNP 31 PDS300MH FT=150MHZ	28480	1853-0020
A4Q6	1853-0020	4		TRANSISTOR PNP 31 PDS300MH FT=150MHZ	28480	1853-0020
A4Q7	1853-0020	4		TRANSISTOR PNP 31 PDS300MH FT=150MHZ	28480	1853-0020
A4R1	2100-2489	2	3	RESISTOR-TRMR 5K 10% C SIDE-ADJ 1-TRN	28480	2100-2489
A4R2	2100-2514	1	3	RESISTOR-TRMR 20K 10% C SIDE-ADJ 1-TRN	28480	2100-2514
A4R3	2100-2522	7		RESISTOR-TRMR 10K 5% .25W F TC=400/+500	28480	2100-2522
A4R4	2100-2489	9	2	RESISTOR-TRMR 5K 1% .125W F TC=0/+100	28480	2100-2489
A4R5	0698-3156	2	5	RESISTOR 14.7K 1% .125W F TC=0/+100	24546	C4=1/8-T0-3HT2-F
A4R6	0683-1015	7		RESISTOR 100 5% .25W FC TC=400/+500	01121	C81015
A4R7	0683-1015	7		RESISTOR 100 5% .25W FC TC=400/+500	01121	C81015
A4R8	1810-0269	3	18	NETWORK-RES 9-8[P10.0K OHM X 8	28480	1810-0269
A4R9	1810-0269	3		NETWORK-RES 9-8[P10.0K OHM X 8	28480	1810-0269
A4R10	0683-3319	4		RESISTOR 330 5% .25W FC TC=400/+600	01121	C83319
A4R11	0698-3450	9	2	RESISTOR 42.2K 1% .125W F TC=0/+100	24546	C4=1/8-T0-4222-F
A4R12	0698-3450	9		RESISTOR 42.2K 1% .125W F TC=0/+100	24546	C4=1/8-T0-4222-F
A4R13	0698-4497	6	1	RESISTOR 48.7K 1% .125W F TC=0/+100	24546	C4=1/8-T0-4872-F
A4R14	0698-3136	8	1	RESISTOR 17.8K 1% .125W F TC=0/+100	24546	C4=1/8-T0-1782-F
A4R15	0757-0419	4		RESISTOR 6.81K 1% .125W F TC=0/+100	24546	C4=1/8-T0-6811-F
A4R16	0757-0444	1	7	RESISTOR 12.1K 1% .125W F TC=0/+100	24546	C4=1/8-T0-1212-F
A4R17	0757-0290	5		RESISTOR 6.19K 1% .125W F TC=0/+100	19701	MF4C1/8-T0-6191-F
A4R18	0757-0443	9	1	RESISTOR 11K 1% .125W F TC=0/+100	24546	C4=1/8-T0-1102-F
A4R19	1810-0037	3	2	NETWORK-RES 16-DIPL.0K OHM X 8	11236	761-3-R1K
A4R20	0683-1025	1		RESISTOR 10K 5% .25W FC TC=400/+700	01121	C81025
A4R21	0683-1025	9		RESISTOR 1K 5% .25W FC TC=400/+600	01121	C81025
A4R22	1810-0037	3		NETWORK-RES 16-DIPL.0K OHM X 8	11236	761-3-R1K
A4R23	0683-1025	9		RESISTOR 1K 5% .25W FC TC=400/+600	01121	C81025
A4R24	0683-1025	9		RESISTOR 1K 5% .25W FC TC=400/+600	01121	C81025
A4R25	0683-1025	9		RESISTOR 1K 5% .25W FC TC=400/+600	01121	C81025
A4R26	1810-0231	9	2	NETWORK-RES 8-8[P2.2K OHM X 7	01121	208A222
A4R27	0683-3305	2		RESISTOR 33 5% .25W FC TC=400/+500	01121	C83305
A4R28	0683-1025	9		RESISTOR 1K 5% .25W FC TC=400/+600	01121	C81025
A4R29	0698-3159	5	2	RESISTOR 26.1K 1% .125W F TC=0/+100	24546	C4=1/8-T0-2612-F
A4R30	0698-3245	0	1	RESISTOR 20.5K 1% .125W F TC=0/+100	24546	C4=1/8-T0-2052-F
A4R31	0683-8205	1	2	RESISTOR 82 5% .25W FC TC=400/+500	01121	C88205
A4R32	0683-1025	9		RESISTOR 1K 5% .25W FC TC=400/+600	01121	C81025
A4R33	0683-1025	9		RESISTOR 1K 5% .25W FC TC=400/+600	01121	C81025
A4R34	0683-1025	9		RESISTOR 1K 5% .25W FC TC=400/+600	01121	C81025
A4R35	0683-1025	9		RESISTOR 1K 5% .25W FC TC=400/+600	01121	C81025
A4R36	0683-1015	7		RESISTOR 100 5% .25W FC TC=400/+500	01121	C81015
A4R37	0683-1015	7		RESISTOR 100 5% .25W FC TC=400/+500	01121	C81015
A4R38	0683-1015	7		RESISTOR 100 5% .25W FC TC=400/+500	01121	C81015
A4R39	0683-2225	3	10	RESISTOR 2.2K 5% .25W FC TC=400/+700	01121	C82225
A4R40	0683-2225	3		RESISTOR 2.2K 5% .25W FC TC=400/+700	01121	C82225

See introduction to this section for ordering information
*Indicates factory selected value

Table 6-3. Replaceable Parts

Reference Designation	HP Part Number	C D	Qty	Description	Mfr Code	Mfr Part Number
A4R1	0683-2225	3		RESISTOR 2.2K 5% .25W FC TC=400/+700	01121	CB2225
A4R2	0683-2225	3		RESISTOR 2.2K 5% .25W FC TC=400/+700	01121	CB2225
A4R3	0683-2225	3		RESISTOR 2.2K 5% .25W FC TC=400/+700	01121	CB2225
A4R4	0683-2225	3		RESISTOR 2.2K 5% .25W FC TC=400/+700	01121	CB2225
A4R5	069A-3359	5		RESISTOR 26.1K 1% .125W P TC=40/+100	24546	C4=1/8-T0-2612-F
A4R6	0695-3156	2		RESISTOR 14.7K 1% .125W P TC=40/+100	24546	C4=1/8-T0-1472-F
A4R7	181A-0231	9		NETWORK RES 8-BTP2.2K OHM X 7	01121	208A222
A4R8	2100-3207	1		RESISTOR-TMR 5K 10% C SIDE=ADJ 1-TRN	28480	2100-3207
A4R9	2100-3353	5	2	RESISTOR-TMR 20K 10% C SIDE=ADJ 1-TRN	32997	3366X-V46-203
A4TP1	1251-0600	0	9	CONNECTOR-SGL CONT PIN 1,14=MM=89C-8Z 3Q	28480	1251-0600
A4TP2	1251-0600	0		CONNECTOR-SGL CONT PIN 1,14=MM=89C-8Z 3Q	28480	1251-0600
A4TP3	1251-0600	0		CONNECTOR-SGL CONT PIN 1,14=MM=89C-8Z 3Q	28480	1251-0600
A4TP4	1251-0600	0		CONNECTOR-SGL CONT PIN 1,14=MM=89C-8Z 3Q	28480	1251-0600
A4U1	1820-1112	8	8	IC FF TTL LB D-TYPE POS=EDGE-TRIG	01295	8N74LS74AN
A4U2	1820-1433	6		IC SHF-RGTR TTL LB R=5 SERIAL-IN PRL-DUT	01295	8N74LS164N
A4U3	1820-1433	6		IC SHF-RGTR TTL LS R=5 SERIAL-IN PRL-DUT	01295	8N74LS164N
A4U4	1820-1433	6		IC SHF-RGTR TTL LB R=5 SERIAL-IN PRL-DUT	01295	8N74LS164N
A4U5	1820-0043	4	5	IC OP AMP GP T0=99	01298	CA3077
A4U6	1820-0668	7	1	IC DFR TTL NON-INV HEX 1=INP	01295	8N7407N
A4U7	1858-0038	4	0	TRANSISTOR ARRAY	28480	1858-0038
A4U8	1858-0038	4		TRANSISTOR ARRAY	28480	1858-0038
A4U9	1858-0038	4		TRANSISTOR ARRAY	28480	1858-0038
A4U10	1826-0138	8	2	IC COMPARTOR GP QUAD 14=DIP-P	01295	LM339N
A4U11	1858-0038	4		TRANSISTOR ARRAY	28480	1858-0038
A4U12	1826-0138	8		IC COMPARTOR GP QUAD 14=DIP-P	01295	LM339N
AS	04191-66505	2	1	FREQUENCY CONVERTER BOARD ASSEMBLY	28480	04191-66505
ASC1	0160-2055	9		CAPACITOR-FXD .01UF +80=20% 100VDC CER	28480	0160-2055
ASC2	0160-2055	8		CAPACITOR-FXD 220UF+20% 16VDC AL	28480	0160-2055
ASC3	0160-2055	4		CAPACITOR-FXD 220UF+20% 16VDC AL	28480	0160-2055
ASC4	0160-2055	9		CAPACITOR-FXD .01UF +80=20% 100VDC CER	28480	0160-2055
ASC5	0150-0121	5		CAPACITOR-FXD .1UF +80=20% 50VDC CER	28480	0150-0121
ASC6	0160-3879	7		CAPACITOR-FXD .01UF +20% 100VDC CER	28480	0160-3879
ASC7	0160-3879	7		CAPACITOR-FXD .01UF +20% 100VDC CER	28480	0160-3879
ASC8	0160-3879	7		CAPACITOR-FXD .01UF +20% 100VDC CER	28480	0160-3879
ASC9	0150-0121	5		CAPACITOR-FXD .1UF +80=20% 50VDC CER	28480	0150-0121
ASC10	0160-2055	9		CAPACITOR-FXD .01UF +80=20% 100VDC CER	28480	0160-2055
ASC11	0160-3878	6		CAPACITOR-FXD 1000PF +20% 100VDC CER	28480	0160-3878
ASC12	0160-0570	9	3	CAPACITOR-FXD 220PF +20% 100VDC CER	20932	5024EM100R0221M
ASC13	0160-2055	9		CAPACITOR-FXD .01UF +80=20% 100VDC CER	28480	0160-2055
ASC14	0160-2055	9		CAPACITOR-FXD .01UF +80=20% 100VDC CER	28480	0160-2055
ASC15	0160-2055	9		CAPACITOR-FXD .01UF +80=20% 100VDC CER	28480	0160-2055
ASC16	0160-3877	5		CAPACITOR-FXD 100PF +20% 200VDC CER	28480	0160-3877
ASC17	0160-2055	9		CAPACITOR-FXD .01UF +80=20% 100VDC CER	28480	0160-2055
ASC18	0160-2055	9		CAPACITOR-FXD .01UF +80=20% 100VDC CER	28480	0160-2055
ASC19	0160-2055	9		CAPACITOR-FXD .01UF +80=20% 100VDC CER	28480	0160-2055
ASC20	0160-3879	7		CAPACITOR-FXD .01UF +20% 100VDC CER	28480	0160-3879
ASC21	0160-3878	6		CAPACITOR-FXD 1000PF +20% 100VDC CER	28480	0160-3878
ASC22	0160-3877	5		CAPACITOR-FXD 100PF +20% 200VDC CER	28480	0160-3877
ASC23	0160-3874	2		CAPACITOR-FXD 10PF +-5PF 200VDC CER	28480	0160-3874
ASC24	0160-3874	2		CAPACITOR-FXD 10PF +-5PF 200VDC CER	28480	0160-3874
ASC25	0160-3877	5		CAPACITOR-FXD 100PF +20% 200VDC CER	28480	0160-3877
ASC26	0160-3877	5		CAPACITOR-FXD 100PF +20% 200VDC CER	28480	0160-3877
ASC27	0160-2055	9		CAPACITOR-FXD .01UF +80=20% 100VDC CER	28480	0160-2055
ASC28	0160-3879	7		CAPACITOR-FXD .01UF +20% 100VDC CER	28480	0160-3879
ASC29	0160-3878	6		CAPACITOR-FXD 1000PF +20% 100VDC CER	28480	0160-3878
ASC30	0160-3877	5		CAPACITOR-FXD 100PF +20% 200VDC CER	28480	0160-3877
ASC31	0160-3877	5		CAPACITOR-FXD 100PF +20% 200VDC CER	28480	0160-3877
ASC32	0160-3873	1		CAPACITOR-FXD 4.7PF +-5PF 200VDC CER	28480	0160-3873
ASC33	0160-3874	2		CAPACITOR-FXD 10PF +-5PF 200VDC CER	28480	0160-3874
ASC34	0160-2055	9		CAPACITOR-FXD .01UF +80=20% 100VDC CER	28480	0160-2055
ASC35	0160-2055	9		CAPACITOR-FXD .01UF +80=20% 100VDC CER	28480	0160-2055
ASC36	0150-0121	5		CAPACITOR-FXD .1UF +80=20% 50VDC CER	28480	0150-0121
ASC37	0160-1063	3		CAPACITOR-FXD 33UF -10+75% 25VDC AL	28480	0160-1063
ASC38	0160-2055	9		CAPACITOR-FXD .01UF +80=20% 100VDC CER	28480	0160-2055
ASC39	0160-2055	9		CAPACITOR-FXD .01UF +80=20% 100VDC CER	28480	0160-2055
ASC40	0160-2055	9		CAPACITOR-FXD .01UF +80=20% 100VDC CER	28480	0160-2055
ASC41	0160-3879	7		CAPACITOR-FXD .01UF +20% 100VDC CER	28480	0160-3879
ASC42	0160-2055	9		CAPACITOR-FXD .01UF +80=20% 100VDC CER	28480	0160-2055
ASC43	0160-2055	9		CAPACITOR-FXD .01UF +80=20% 100VDC CER	28480	0160-2055
ASC44	0160-3878	6		CAPACITOR-FXD 1000PF +20% 100VDC CER	28480	0160-3878
ASC45	0160-3878	6		CAPACITOR-FXD 1000PF +20% 100VDC CER	28480	0160-3878
ASC46	0160-3878	6		CAPACITOR-FXD 1000PF +20% 100VDC CER	28480	0160-3878
ASC47	0160-2055	9		CAPACITOR-FXD .01UF +80=20% 100VDC CER	28480	0160-2055
ASC48	0160-2055	9		CAPACITOR-FXD .01UF +80=20% 100VDC CER	28480	0160-2055
ASC49	0160-0570	9		CAPACITOR-FXD 220PF +20% 100VDC CER	20932	5024EM100R0221M
ASC50	0160-3878	6		CAPACITOR-FXD 1000PF +20% 100VDC CER	28480	0160-3878

See introduction to this section for ordering information
*Indicates factory selected value

Table 6-3. Replaceable Parts

Reference Designation	HP Part Number	C D	Qty	Description	Mfr Code	Mfr Part Number
A5C51	0160-3874	2		CAPACITOR-FXD 10PF +-5PF 200VDC CER	28480	0160-3874
A5C52	0160-3878	6		CAPACITOR-FXB 1000PF +-20% 100VDC CER	28480	0160-3878
A5C53	0160-3879	7		CAPACITOR-FXD .01UF +-20% 100VDC CER	28480	0160-3879
A5C54	0160-3879	7		CAPACITOR-FXD .01UF +-20% 100VDC CER	28480	0160-3879
A5C55	0160-3875	3		CAPACITOR-FXD 22PF +-5% 200VDC CER 0+-30	28480	0160-3875
A5C56	0160-2055	9		CAPACITOR-FXD .01UF +-50-20% 100VDC CER	28480	0160-2055
A5C57	0160-2055	9		CAPACITOR-FXD .01UF +-50-20% 100VDC CER	28480	0160-2055
A5C58	0160-3879	7		CAPACITOR-FXD .01UF +-20% 100VDC CER	28480	0160-3879
A5C59	0160-2055	9		CAPACITOR-FXD .01UF +-50-20% 100VDC CER	28480	0160-2055
A5C60	0160-3875	3		CAPACITOR-FXD 22PF +-5% 200VDC CER 0+-30	28480	0160-3875
A5C61	0160-2055	9		CAPACITOR-FXD .01UF +-50-20% 100VDC CER	28480	0160-2055
A5C62	0160-2055	9		CAPACITOR-FXD .01UF +-50-20% 100VDC CER	28480	0160-2055
A5C63	0160-3874	2		CAPACITOR-FXD 10PF +-5PF 200VDC CER	28480	0160-3874
A5C64	0160-3877	5		CAPACITOR-FXD 100PF +-20% 200VDC CER	28480	0160-3877
A5C65	0160-2055	9		CAPACITOR-FXD .01UF +-50-20% 100VDC CER	28480	0160-2055
A5C66	0160-3878	6		CAPACITOR-FXD 1000PF +-20% 100VDC CER	28480	0160-3878
A5C67	0160-3876	4	1	CAPACITOR-FXD 47PF +-20% 200VDC CER	28480	0160-3876
A5C68	0160-3879	7		CAPACITOR-FXD .01UF +-20% 100VDC CER	28480	0160-3879
A5C69	0160-2055	9		CAPACITOR-FXD .01UF +-50-20% 100VDC CER	28480	0160-2055
A5C70	0160-3879	7		CAPACITOR-FXD .01UF +-20% 100VDC CER	28480	0160-3879
A5C71	0160-2055	9		CAPACITOR-FXD .01UF +-50-20% 100VDC CER	28480	0160-2055
A5C72	0160-2055	9		CAPACITOR-FXD .01UF +-50-20% 100VDC CER	28480	0160-2055
A5C73	0160-0127	2	6	CAPACITOR-FXD 1UF +-20% 25VDC CER	28480	0160-0127
A5C74	0160-0127	2		CAPACITOR-FXD 1UF +-20% 25VDC CER	28480	0160-0127
A5C75	0150-0121	5		CAPACITOR-FXD .1UF +-50-20% 50VDC CER	28480	0150-0121
A5C76	0160-1063	3		CAPACITOR-FXD 33uF -10%+75% 25MVDC AL	28480	0160-1063
A5C77	0150-0121	5		CAPACITOR-FXD .1UF +-50-20% 50VDC CER	28480	0150-0121
A5C78	0150-0121	5		CAPACITOR-FXD .1UF +-50-20% 50VDC CER	28480	0150-0121
A5C79	0160-2206	2	2	CAPACITOR-FXD 160PF +-5% 300VDC MICA	28480	0160-2206
A5C80	0160-0199	6	6	CAPACITOR-FXD 240PF +-5% 300VDC MICA	72136	0160-0199
A5C81	0160-2206	2		CAPACITOR-FXD 160PF +-5% 300VDC MICA	28480	0160-2206
A5C82	0160-2254	0	3	CAPACITOR-FXD 7.5PF +-25PF 500VDC CER	28480	0160-2254
A5C83	0160-2055	9		CAPACITOR-FXD .01UF +-50-20% 100VDC CER	28480	0160-2055
A5C84	0160-2055	9		CAPACITOR-FXD .01UF +-50-20% 100VDC CER	28480	0160-2055
A5C85	0160-3877	5		CAPACITOR-FXD 100PF +-20% 200VDC CER	28480	0160-3877
A5C86	0160-3877	5		CAPACITOR-FXD 100PF +-20% 200VDC CER	28480	0160-3877
A5C87	0160-2258	4	0	CAPACITOR-FXD 11PF +-5% 500VDC CER 0+-30	28480	0160-2258
A5C88	0160-2258	4		CAPACITOR-FXD 11PF +-5% 500VDC CER 0+-30	28480	0160-2258
A5C89	0160-2262	0	2	CAPACITOR-FXD 16PF +-5% 500VDC CER 0+-30	28480	0160-2262
A5C90	0160-2262	0		CAPACITOR-FXD 16PF +-5% 500VDC CER 0+-30	28480	0160-2262
A5C91	0160-2258	4		CAPACITOR-FXD 11PF +-5% 500VDC CER 0+-30	28480	0160-2258
A5C92	0160-2258	4		CAPACITOR-FXD 11PF +-5% 500VDC CER 0+-30	28480	0160-2258
A5C93	0160-3877	5		CAPACITOR-FXD 100PF +-20% 200VDC CER	28480	0160-3877
A5C94	0160-3875	3		CAPACITOR-FXD 22PF +-5% 200VDC CER 0+-30	28480	0160-3875
A5C95	0160-2247	1	3	CAPACITOR-FXD 3.5PF +-25PF 500VDC CER	28480	0160-2247
A5C96	0160-3877	5		CAPACITOR-FXD 100PF +-20% 200VDC CER	28480	0160-3877
A5C97	0160-3877	5		CAPACITOR-FXD 100PF +-20% 200VDC CER	28480	0160-3877
A5CR1	1901-0040	1	21	DIODE-SWITCHING 30V 50MA 2N8 DO-35	28480	1901-0040
A5CR2	1901-0179	7		DIODE-SWITCHING 15V 50MA 750PB DO-7	28480	1901-0179
A5CR3	1901-0179	7		DIODE-SWITCHING 15V 50MA 750PB DO-7	28480	1901-0179
A5CR4	1901-0179	7		DIODE-SWITCHING 15V 50MA 750PB DO-7	28480	1901-0179
A5CR5	1901-0040	1		DIODE-SWITCHING 30V 50MA 2N8 DO-35	28480	1901-0040
A5CR6	1901-0040	1		DIODE-SWITCHING 30V 50MA 2N8 DO-35	28480	1901-0040
A5CR7	1901-0639	4	6	DIODE-PIN 110V	28480	5082-3080
A5CR8	1901-0639	4		DIODE-PIN 110V	28480	5082-3080
A5CR9	1901-0639	4		DIODE-PIN 110V	28480	5082-3080
A5CR10	1901-0639	4		DIODE-PIN 110V	28480	5082-3080
A5CR11	1901-0040	1		DIODE-SWITCHING 30V 50MA 2N8 DO-35	28480	1901-0040
A5CR12	1901-0179	7		DIODE-SWITCHING 15V 50MA 750PB DO-7	28480	1901-0179
A5CR13	1901-0179	7		DIODE-SWITCHING 15V 50MA 750PB DO-7	28480	1901-0179
A5CR14	1901-0040	1		DIODE-SWITCHING 30V 50MA 2N8 DO-35	28480	1901-0040
A5CR15	1901-0179	7		DIODE-SWITCHING 15V 50MA 750PB DO-7	28480	1901-0179
A5CR16	1901-0040	1		DIODE-SWITCHING 30V 50MA 2N8 DO-35	28480	1901-0040
A5CR17	1901-0518	8		DIODE-SCHOTTKY	28480	1901-0518
A5CR18	1901-0179	7		DIODE-SWITCHING 15V 50MA 750PB DO-7	28480	1901-0179
A5CR19	1901-0639	4		DIODE-PIN 110V	28480	5082-3080
A5CR20	1901-0179	7		DIODE-SWITCHING 15V 50MA 750PB DO-7	28480	1901-0179
A5CR21	1901-0179	7		DIODE-SWITCHING 15V 50MA 750PB DO-7	28480	1901-0179
A5CR22	1901-0179	7		DIODE-SWITCHING 15V 50MA 750PB DO-7	28480	1901-0179
A5E1	1906-0235	6	1	DIODE-MIXER	28480	1906-0235
A5L1	9100-1788	6		CHOKER-WIDE BAND ZVAX0680 OHMS 180 MHZ	02114	VK200 20/48
A5L2	9100-1788	6		CHOKER-WIDE BAND ZVAX0680 OHMS 180 MHZ	02114	VK200 20/48
A5L3	9140-0158	6		COIL-MLD 1UM 10% Q32 .095DX,25LG-NOM	28480	9140-0158
A5L4	9140-0158	6		COIL-MLD 1UM 10% Q32 .095DX,25LG-NOM	28480	9140-0158
A5L5	9140-0158	6		COIL-MLD 1UM 10% Q32 .095DX,25LG-NOM	28480	9140-0158

See introduction to this section for ordering information
*Indicates factory selected value

Table 6-3. Replaceable Parts

Reference Designation	HP Part Number	C D	Qty	Description	Mfr Code	Mfr Part Number
ASL6	9140-0114	4	9	COIL-MLD 100H 10% QW55 .155DX,25LG-NOM	28480	9140-0114
ASL7	9100-2247	4		COIL-MLD 100NH 10% QW34 .095DX,25LG-NOM	28480	9100-2247
ASL8	9140-0158	6		COIL-MLD 1UM 10% QW32 .095DX,25LG-NOM	28480	9140-0158
ASL9	9140-0158	6		COIL-MLD 1UM 10% QW32 .095DX,25LG-NOM	28480	9140-0158
ASL10	9140-0158	6		COIL-MLD 1UM 10% QW32 .095DX,25LG-NOM	28480	9140-0158
ASL11	9100-2247	4		COIL-MLD 100NH 10% QW34 .095DX,25LG-NOM	28480	9100-2247
ASL12	9100-2247	4		COIL-MLD 100NH 10% QW34 .095DX,25LG-NOM	28480	9100-2247
ASL13	9100-2247	4		COIL-MLD 100NH 10% QW34 .095DX,25LG-NOM	28480	9100-2247
ASL14	9100-2247	4		COIL-MLD 100NH 10% QW34 .095DX,25LG-NOM	28480	9100-2247
ASL15	9100-2247	4		COIL-MLD 100NH 10% QW34 .095DX,25LG-NOM	28480	9100-2247
ASL16	9100-2247	4		COIL-MLD 100NH 10% QW34 .095DX,25LG-NOM	28480	9100-2247
ASL17	9140-0158	6		COIL-MLD 1UM 10% QW32 .095DX,25LG-NOM	28480	9140-0158
ASL19	9140-0158	6		COIL-MLD 1UM 10% QW32 .095DX,25LG-NOM	28480	9140-0158
ASL19	9140-0158	6		COIL-MLD 1UM 10% QW32 .095DX,25LG-NOM	28480	9140-0158
ASL20	9140-0158	6		COIL-MLD 1UM 10% QW32 .095DX,25LG-NOM	28480	9140-0158
ASL21	9140-0158	6		COIL-MLD 1UM 10% QW32 .095DX,25LG-NOM	28480	9140-0158
ASL22	9140-0158	6		COIL-MLD 1UM 10% QW32 .095DX,25LG-NOM	28480	9140-0158
ASL23	9100-2247	4		COIL-MLD 100NH 10% QW34 .095DX,25LG-NOM	28480	9100-2247
ASL24	9140-0158	6		COIL-MLD 1UM 10% QW32 .095DX,25LG-NOM	28480	9140-0158
ASL25	9140-0158	6		COIL-MLD 1UM 10% QW32 .095DX,25LG-NOM	28480	9140-0158
ASL26	9100-2252	1	2	COIL-MLD 270NH 10% QW30 .095DX,25LG-NOM	28480	9100-2252
ASL27	9100-2252	1		COIL-MLD 270NH 10% QW30 .095DX,25LG-NOM	28480	9100-2252
ASL28	9140-0158	6		COIL-MLD 1UM 10% QW32 .095DX,25LG-NOM	28480	9140-0158
ASL29	9140-0158	6		COIL-MLD 1UM 10% QW32 .095DX,25LG-NOM	28480	9140-0158
ASL30	9100-2247	4		COIL-MLD 100NH 10% QW34 .095DX,25LG-NOM	28480	9100-2247
ASMP1	2190-0124	4		WASHER-LK INTL Y ND. 10 .195-IN-ID	28480	2190-0124
ASMP2	2360-0115	4		SCREW-MACH 6-32 .312-IN-LG PAN-HEAD POZI	00000	ORDER BY DESCRIPTION
ASMP3	2950-0078	4		NUT-HEX-DBL-CHAM 10-32-THD .067-IN-YMK	28480	2950-0078
ASMP4	5001-0173	7		STRAP GROUND	28480	5001-0173
ASMP5	04191-60004	4	1	COVER	28480	04191-60004
ASP1	1250-1220	0		CONNECTOR-RF 8MC M PC 50-OMH	28480	1250-1220
ASP2	1250-1220	0		CONNECTOR-RF 8MC M PC 50-OMH	28480	1250-1220
ASP3	1250-1220	0		CONNECTOR-RF 8MC M PC 50-OMH	28480	1250-1220
ASP4	1250-1220	0		CONNECTOR-RF 8MC M PC 50-OMH	28480	1250-1220
ASD1	1854-0130	9	2	TRANSISTOR PNP SI PD=200MH FT=500MHZ	28480	1854-0130
ASD2	1853-0015	7		TRANSISTOR NPN SI PD=350MH FT=4.56HZ	28480	1853-0015
ASD3	1854-0130	9		TRANSISTOR NPN SI PD=350MH FT=4.56HZ	28480	1854-0130
ASD4	1854-0130	9		TRANSISTOR NPN SI PD=350MH FT=4.56HZ	28480	1854-0130
ASD5	1854-0247	9	5	TRANSISTOR NPN SI TC=39 PD=1N FT=600MHZ	28480	1854-0247
ASD6	1854-0345	8		TRANSISTOR NPN 2N5179 SI TC=72 PD=200MH	04713	2N5179
ASD7	1854-0130	9		TRANSISTOR NPN SI PD=350MH FT=4.56HZ	28480	1854-0130
ASD8	1854-0130	9		TRANSISTOR NPN SI PD=350MH FT=4.56HZ	28480	1854-0130
ASD9	1854-0247	9		TRANSISTOR NPN SI TC=39 PD=1N FT=600MHZ	28480	1854-0247
ASR1	0698-0438	3	5	RESISTOR 5.1K 1% .125W F TC=0+100	24546	C4=1/8-T0=5111-F
ASR2	0698-3444	1	2	RESISTOR 316 1% .125W F TC=0+100	24546	C4=1/8-T0=316H-F
ASR3	0683-2215	1		RESISTOR 220 5% .25W FC TC=400/+600	01121	C82215
ASR4	0698-7205	0		RESISTOR 51.1 1% .05W F TC=0+100	24546	C3=1/8-T00=5111-F
ASR5	0698-7205	0		RESISTOR 51.1 1% .05W F TC=0+100	24546	C3=1/8-T00=5111-F
ASR6	0698-7205	0		RESISTOR 51.1 1% .05W F TC=0+100	24546	C3=1/8-T00=5111-F
ASR7	0698-3150	2	1	RESISTOR 2.37K 1% .125W F TC=0+100	24546	C4=1/8-T0=2371-F
ASR8	0698-1437	6	1	RESISTOR 153 1% .125W F TC=0+100	24546	C4=1/8-T0=153H-F
ASR9	0683-1025	9		RESISTOR 1K 5% .25W FC TC=400/+600	01121	C81025
ASR10	0698-7212	9		RESISTOR 100 1% .05W F TC=0+100	24546	C3=1/8-T0=100M-F
ASR11	0683-6815	5	1	RESISTOR 680 5% .25W FC TC=400/+600	01121	C86815
ASR12	0683-2215	1		RESISTOR 220 5% .25W FC TC=400/+600	01121	C82215
ASR13	0698-7188	8		RESISTOR 10 1% .05W F TC=0+100	24546	C3=1/8-T00=10R-F
ASR14	0698-7208	3	1	RESISTOR 68.1 1% .05W F TC=0+100	24546	C3=1/8-T00=6811-F
ASR15	0698-7194	6	9	RESISTOR 17.8 1% .05W F TC=0+100	24546	C3=1/8-T00=178H-F
ASR16	0683-2215	1		RESISTOR 220 5% .25W FC TC=400/+600	01121	C82215
ASR17	0683-1025	9		RESISTOR 1K 5% .25W FC TC=400/+600	01121	C81025
ASR18	0698-7188	8		RESISTOR 10 1% .05W F TC=0+100	24546	C3=1/8-T00=10R-F
ASR19	0698-7194	6		RESISTOR 17.8 1% .05W F TC=0+100	24546	C3=1/8-T00=178H-F
ASR20	0683-2215	1		RESISTOR 220 5% .25W FC TC=400/+600	01121	C82215
ASR21	0683-1025	9		RESISTOR 1K 5% .25W FC TC=400/+600	01121	C81025
ASR22	0683-1015	7		RESISTOR 100 5% .25W FC TC=400/+500	01121	C81015
ASR23	0683-2225	3		RESISTOR 2.2K 5% .25W FC TC=400/+700	01121	C82225
ASR24	0683-1015	7		RESISTOR 100 5% .25W FC TC=400/+500	01121	C81015
ASR25	0683-2215	1		RESISTOR 220 5% .25W FC TC=400/+600	01121	C82215
ASR26	0683-5615	1		RESISTOR 560 5% .25W FC TC=400/+600	01121	C85615
ASR27	0683-1035	1		RESISTOR 10K 5% .25W FC TC=400/+700	01121	C81035
ASR28	0683-2215	1		RESISTOR 220 5% .25W FC TC=400/+600	01121	C82215
ASR29	0683-2215	1		RESISTOR 220 5% .25W FC TC=400/+600	01121	C82215
ASR30	0683-2225	3		RESISTOR 2.2K 5% .25W FC TC=400/+700	01121	C82225
ASR31	0683-1015	7		RESISTOR 100 5% .25W FC TC=400/+500	01121	C81015
ASR32	0698-7212	9		RESISTOR 100 1% .05W F TC=0+100	24546	C3=1/8-T0=100M-F
ASR33	0683-2215	1		RESISTOR 220 5% .25W FC TC=400/+600	01121	C82215
ASR34	0683-1035	1		RESISTOR 10K 5% .25W FC TC=400/+700	01121	C81035

See introduction to this section for ordering information
*Indicates factory selected value

Table 6-3. Replaceable Parts

Reference Designation	HP Part Number	C D	Qty	Description	Mfr Code	Mfr Part Number
ASR15	0683-5615	1		RESISTOR 560 5% .25W FC TCR=400/+600	01121	CB5615
ASR16	0698-7194	6		RESISTOR 17.8 1% .05W F TCR=+100	24546	C3=1/8-T00=17R8-G
ASR17	0757-0418	9	1	RESISTOR 419 1% .125W F TCR=+100	24546	C4=1/8-T0=619R-F
ASR18	0757-0278	9		RESISTOR 1.78K 1% .125W F TCR=+100	24546	C4=1/8-T0=1781-F
ASR19	0683-1015	7		RESISTOR 100 5% .25W FC TCR=400/+500	01121	CB1015
ASR40	0683-2225	3		RESISTOR 2.2K 5% .25W FC TCR=400/+700	01121	CB2225
ASR41	0683-5615	1		RESISTOR 560 5% .25W FC TCR=400/+600	01121	CB5615
ASR42	0683-3915	0	4	RESISTOR 390 5% .25W FC TCR=400/+600	01121	CB3915
ASR43	0683-1035	1		RESISTOR 10K 5% .25W FC TCR=400/+700	01121	CB1035
ASR44	0698-7212	9		RESISTOR 100 1% .05W F TCR=+100	24546	C3=1/8-T0=100R-G
ASR45	0683-5615	1		RESISTOR 560 5% .25W FC TCR=400/+600	01121	CB5615
ASR46	0683-5615	1		RESISTOR 560 5% .25W FC TCR=400/+600	01121	CB5615
ASR47	0698-7217	4	2	RESISTOR 162 1% .05W F TCR=+100	24546	C3=1/8-T0=162R-G
ASR48	0683-1015	7		RESISTOR 100 5% .25W FC TCR=400/+500	01121	CB1015
ASR49	0683-1035	1		RESISTOR 10K 5% .25W FC TCR=400/+700	01121	CB1035
ASR50	0698-7212	9		RESISTOR 100 1% .05W F TCR=+100	24546	C3=1/8-T0=100R-G
ASR51	0683-1035	1		RESISTOR 10K 5% .25W FC TCR=400/+700	01121	CB1035
ASR52	0683-1015	7		RESISTOR 100 5% .25W FC TCR=400/+500	01121	CB1015
ASR53	0683-5615	1		RESISTOR 560 5% .25W FC TCR=400/+600	01121	CB5615
ASR54	0698-7212	9		RESISTOR 100 1% .05W F TCR=+100	24546	C3=1/8-T0=100R-G
ASR55	0683-5615	1		RESISTOR 560 5% .25W FC TCR=400/+600	01121	CB5615
ASR56	0698-7217	4		RESISTOR 162 1% .05W F TCR=+100	24546	C3=1/8-T0=162R-G
ASR57	0683-1035	1		RESISTOR 10K 5% .25W FC TCR=400/+700	01121	CB1035
ASR58	0683-1015	7		RESISTOR 100 5% .25W FC TCR=400/+500	01121	CB1015
ASR59	0698-7194	6		RESISTOR 17.8 1% .05W F TCR=+100	24546	C3=1/8-T00=17R8-G
ASR60	0698-7212	9		RESISTOR 100 1% .05W F TCR=+100	24546	C3=1/8-T0=100R-G
ASR61	0698-7212	9		RESISTOR 100 1% .05W F TCR=+100	24546	C3=1/8-T0=100R-G
ASR62	0683-5615	1		RESISTOR 560 5% .25W FC TCR=400/+600	01121	CB5615
ASR63	0698-7212	9		RESISTOR 100 1% .05W F TCR=+100	24546	C3=1/8-T0=100R-G
ASR64	0683-5615	1		RESISTOR 560 5% .25W FC TCR=400/+600	01121	CB5615
ASR65	0698-7194	6		RESISTOR 17.8 1% .05W F TCR=+100	24546	C3=1/8-T00=17R8-G
ASR66	0683-2225	3		RESISTOR 2.2K 5% .25W FC TCR=400/+700	01121	CB2225
ASR67	0683-5615	1		RESISTOR 560 5% .25W FC TCR=400/+600	01121	CB5615
ASR68	0683-1035	1		RESISTOR 10K 5% .25W FC TCR=400/+700	01121	CB1035
ASR69	0683-0715	0	5	RESISTOR 470 5% .25W FC TCR=400/+600	01121	CB4715
ASR70	0683-1015	7		RESISTOR 100 5% .25W FC TCR=400/+500	01121	CB1015
ASR71	0698-7205	0		RESISTOR 51.1 1% .05W F TCR=+100	24546	C3=1/8-T00=51R1-G
ASR72	0698-7212	9		RESISTOR 100 1% .05W F TCR=+100	24546	C3=1/8-T0=100R-G
ASR73	0683-1015	7		RESISTOR 100 5% .25W FC TCR=400/+500	01121	CB1015
ASR74	0698-3440	7	7	RESISTOR 196 1% .125W F TCR=+100	24546	C4=1/8-T0=196R-F
ASR75	0698-3442	9	1	RESISTOR 237 1% .125W F TCR=+100	24546	C4=1/8-T0=237R-F
ASR76	0698-7197	0	2	RESISTOR 23.7 1% .05W F TCR=+100	24546	C3=1/8-T00=23R7-G
ASR77	0683-2225	3		RESISTOR 2.2K 5% .25W FC TCR=400/+700	01121	CB2225
ASR78	0698-7197	9		RESISTOR 23.7 1% .05W F TCR=+100	24546	C3=1/8-T00=23R7-G
ASR79	0683-5615	1		RESISTOR 560 5% .25W FC TCR=400/+600	01121	CB5615
ASR80	0683-4725	2	12	RESISTOR 4.7K 5% .25W FC TCR=400/+700	01121	CB4725
ASR81	0757-0395	1	1	RESISTOR 56.2 1% .125W F TCR=+100	24546	C4=1/8-T0=56R2-F
ASR82	0683-3325	6	8	RESISTOR 1.3K 5% .25W FC TCR=400/+700	01121	CB3325
ASR83	0683-3315	4		RESISTOR 330 5% .25W FC TCR=400/+600	01121	CB3315
ASR84	0683-4725	2		RESISTOR 4.7K 5% .25W FC TCR=400/+700	01121	CB4725
ASR85	0683-5615	1		RESISTOR 560 5% .25W FC TCR=400/+600	01121	CB5615
ASR86	0698-7194	6		RESISTOR 17.8 1% .05W F TCR=+100	24546	C3=1/8-T00=17R8-G
ASR87	0698-7223	2	5	RESISTOR 287 1% .05W F TCR=+100	24546	C3=1/8-T0=287R-G
ASR88	0698-7223	2		RESISTOR 287 1% .05W F TCR=+100	24546	C3=1/8-T0=287R-G
ASR89	0698-7216	3	2	RESISTOR 147 1% .05W F TCR=+100	24546	C3=1/8-T0=147R-G
ASR90	0698-7202	7	1	RESISTOR 38.3 1% .05W F TCR=+100	24546	C3=1/8-T00=38R3-G
ASR91	0698-7216	3		RESISTOR 147 1% .05W F TCR=+100	24546	C3=1/8-T0=147R-G
ASR92	0698-7223	2		RESISTOR 287 1% .05W F TCR=+100	24546	C3=1/8-T0=287R-G
ASR93	0698-7194	6		RESISTOR 17.8 1% .05W F TCR=+100	24546	C3=1/8-T00=17R8-G
ASR94	0698-7223	2		RESISTOR 287 1% .05W F TCR=+100	24546	C3=1/8-T0=287R-G
ASR95	0683-1025	9		RESISTOR 1K 5% .25W FC TCR=400/+600	01121	CB1025
ASR96	0698-7194	6		RESISTOR 17.8 1% .05W F TCR=+100	24546	C3=1/8-T00=17R8-G
ASR97	0698-7205	0		RESISTOR 51.1 1% .05W F TCR=+100	24546	C3=1/8-T00=51R1-G
ASR98	0698-7205	0		RESISTOR 51.1 1% .05W F TCR=+100	24546	C3=1/8-T00=51R1-G
ASR99	0683-3915	0		RESISTOR 390 5% .25W FC TCR=400/+600	01121	CB3915
ASR100	0683-1025	9		RESISTOR 1K 5% .25W FC TCR=400/+600	01121	CB1025
ASR101	0683-1025	9		RESISTOR 1K 5% .25W FC TCR=400/+600	01121	CB1025
ASR102	0698-3438	3	3	RESISTOR 147 1% .125W F TCR=+100	24546	C4=1/8-T0=147R-F
ASR103	0698-3438	0	1	RESISTOR 38.3 1% .125W F TCR=+100	24546	C4=1/8-T0=38R3-F
ASR104	0698-3438	3		RESISTOR 147 1% .125W F TCR=+100	24546	C4=1/8-T0=147R-F
ASU1	1820-0817	8	1	IC FF ECL D-M/B DUAL	04713	MC10131F
ASU2	1820-0794	0	1	IC FF ECL D-M/B	04713	MC1870L
ASU3	1820-2106	2	1	IC FF ECL D-M/B PCB=EDGE-TRIG	07243	F11C06DC

See introduction to this section for ordering information
*Indicates factory selected value

Table 6-3. Replaceable Parts

Reference Designation	HP Part Number	C D	Qty	Description	Mfr Code	Mfr Part Number
A6	04191-66506	3	1	FREQUENCY DOUBLER BOARD ASSEMBLY	28480	04191-66506
A6C1	0160-3877	5		CAPACITOR-FXD 100PF +-20% 200VDC CER	28480	0160-3877
A6C2	0160-2055	9		CAPACITOR-FXD .01UF +-80-20% 100VDC CER	28480	0160-2055
A6C3	0160-3877	5		CAPACITOR-FXD 100PF +-20% 200VDC CER	28480	0160-3877
A6C4	0160-3872	0		CAPACITOR-FXD 2.2PF +-25PF 200VDC CER	28480	0160-3872
A6C5	0160-3873	1		CAPACITOR-FXD 4.7PF +-5PF 200VDC CER	28480	0160-3873
A6C6	0160-3872	0		CAPACITOR-FXD 2.2PF +-25PF 200VDC CER	28480	0160-3872
A6C7	0160-3872	0		CAPACITOR-FXD 2.2PF +-25PF 200VDC CER	28480	0160-3872
A6C8	0160-3879	7		CAPACITOR-FXD .01UF +-20% 100VDC CER	28480	0160-3879
A6C9	0150-0121	5		CAPACITOR-FXD .1UF +-80-20% 50VDC CER	28480	0150-0121
A6C10	0160-3879	7		CAPACITOR-FXD .01UF +-20% 100VDC CER	28480	0160-3879
A6C11	0160-3879	7		CAPACITOR-FXD .01UF +-20% 100VDC CER	28480	0160-3879
A6C12	0150-0121	5		CAPACITOR-FXD .1UF +-80-20% 50VDC CER	28480	0150-0121
A6C13	0160-3879	7		CAPACITOR-FXD .01UF +-20% 100VDC CER	28480	0160-3879
A6C14	0160-3879	7		CAPACITOR-FXD .01UF +-20% 100VDC CER	28480	0160-3879
A6C15	0150-0121	5		CAPACITOR-FXD .1UF +-80-20% 50VDC CER	28480	0150-0121
A6C16	0160-2055	9		CAPACITOR-FXD .01UF +-80-20% 100VDC CER	28480	0160-2055
A6C17	0160-0116	1	1	CAPACITOR-FXD 5.6UF+-10% 35VDC T1	56289	150D685X901882
A6C18	0160-2055	9		CAPACITOR-FXD .01UF +-80-20% 100VDC CER	28480	0160-2055
A6C19	0160-2055	9		CAPACITOR-FXD .01UF +-80-20% 100VDC CER	28480	0160-2055
A6C20	0160-3872	0		CAPACITOR-FXD 2.2PF +-25PF 200VDC CER	28480	0160-3872
A6C21	0160-3875	3		CAPACITOR-FXD 22PF +-5% 200VDC CER 9+-30	28480	0160-3875
A6C22	0160-3878	6		CAPACITOR-FXD 1000PF +-20% 100VDC CER	28480	0160-3878
A6C23	0160-2055	9		CAPACITOR-FXD .01UF +-80-20% 100VDC CER	28480	0160-2055
A6C24	0160-3878	6		CAPACITOR-FXD 1000PF +-20% 100VDC CER	28480	0160-3878
A6C25	0160-3878	6		CAPACITOR-FXD 1000PF +-20% 100VDC CER	28480	0160-3878
A6C26	0160-0570	9		CAPACITOR-FXD 220PF +-20% 100VDC CER	28480	5024EM100RD221M
A6C27	0160-3879	7		CAPACITOR-FXD .01UF +-20% 100VDC CER	28480	0160-3879
A6C28	0160-3874	2		CAPACITOR-FXD 10PF +-5PF 200VDC CER	28480	0160-3874
A6C29	0160-3872	0		CAPACITOR-FXD 2.2PF +-25PF 200VDC CER	28480	0160-3872
A6C30	0160-3879	7		CAPACITOR-FXD .01UF +-20% 100VDC CER	28480	0160-3879
A6C31	0160-3878	6		CAPACITOR-FXD 1000PF +-20% 100VDC CER	28480	0160-3878
A6C32	0160-3878	6		CAPACITOR-FXD 1000PF +-20% 100VDC CER	28480	0160-3878
A6C33	0160-3878	6		CAPACITOR-FXD 1000PF +-20% 100VDC CER	28480	0160-3878
A6C34	0160-3878	6		CAPACITOR-FXD 1000PF +-20% 100VDC CER	28480	0160-3878
A6C35	0160-3879	7		CAPACITOR-FXD .01UF +-20% 100VDC CER	28480	0160-3879
A6C36	0160-3878	6		CAPACITOR-FXD 1000PF +-20% 100VDC CER	28480	0160-3878
A6C37	0160-3878	6		CAPACITOR-FXD 1000PF +-20% 100VDC CER	28480	0160-3878
A6C38	0160-3878	6		CAPACITOR-FXD 1000PF +-20% 100VDC CER	28480	0160-3878
A6C39	0160-1051	5		CAPACITOR, FXD 100 UF 16V M	28480	0160-1051
A6C40	0160-1051	5		CAPACITOR, FXD 100 UF 16V M	28480	0160-1051
A6C41	1901-0639	4		DIODE-PIN 110V	28480	5082-3080
A6C42	1901-0639	4		DIODE-PIN 110V	28480	5082-3080
A6C43	1901-0639	4		DIODE-PIN 110V	28480	5082-3080
A6C44	0122-0072	6		DIODE-VVC 2.2PF 5% C3/C25-MIN=4.5	04713	881058
A6C45	0122-0072	6		DIODE-VVC 2.2PF 5% C3/C25-MIN=4.5	04713	881058
A6C46	0122-0072	6		DIODE-VVC 2.2PF 5% C3/C25-MIN=4.5	04713	881058
A6C47	0122-0072	6		DIODE-VVC 2.2PF 5% C3/C25-MIN=4.5	04713	881058
A6C48	0122-0072	6		DIODE-VVC 2.2PF 5% C3/C25-MIN=4.5	04713	881058
A6C49	0122-0072	6		DIODE-VVC 2.2PF 5% C3/C25-MIN=4.5	04713	881058
A6L1	9140-0158	6		COIL-MLD 1UH 10% Q32 ,095DX,25LG-NOM	28480	9140-0158
A6L2	9140-0114	4		COIL-MLD 10UH 10% Q855 ,155DX,375LG-NOM	28480	9140-0114
A6L3	9140-0158	6		COIL-MLD 1UH 10% Q32 ,095DX,25LG-NOM	28480	9140-0158
A6L4	9140-0158	6		COIL-MLD 1UH 10% Q32 ,095DX,25LG-NOM	28480	9140-0158
A6L5	9140-0158	6		COIL-MLD 1UH 10% Q32 ,095DX,25LG-NOM	28480	9140-0158
A6L6	9140-0158	6		COIL-MLD 1UH 10% Q32 ,095DX,25LG-NOM	28480	9140-0158
A6L7	9140-0158	6		COIL-MLD 1UH 10% Q32 ,095DX,25LG-NOM	28480	9140-0158
A6L8	9100-2247	4		COIL-MLD 100NH 10% Q634 ,095DX,25LG-NOM	28480	9100-2247
A6L9	9140-0137	1		COIL-MLD 1MH 5% Q660 ,19DX,40LG-NOM	28480	9140-0137
A6MP1	0380-1007	5		STANDOFF-RIVET-QN	00000	ORDER BY DESCRIPTION
A6MP2	2190-0124	4		WASHER-LK INVL 7 NO. 10 ,195-IN-ID	28480	2190-0124
A6MP3	2200-0142	4		SCREW-MACH 4-40 ,312-IN-LG 100 DEG	00000	ORDER BY DESCRIPTION
A6MP4	2360-0115	0		SCREW-MACH 6-32 ,312-IN-LG PAN-HEAD-POZI	00000	ORDER BY DESCRIPTION
A6MP5	2950-0078	9		NUT-MEX-DBL-CHAM 10-32-TND ,067-IN-THK	28480	2950-0078
A6MP6	04191-00602	2		SHIELD-BOX	28480	04191-00602
A6MP7	04191-00612	2	2	SHIELD-BOX	28480	04191-00612
A6MP8	04191-00613	5	2	SHIELD-BOX	28480	04191-00613
A6MP9	04191-00614	6	2	SHIELD	28480	04191-00614
A6MP10	04191-00005	5	1	COVER	28480	04191-00005
A6P1	1250-1220	0		CONNECTOR-RF 5MC M PC 50-OHM	28480	1250-1220
A6P2	1250-1220	0		CONNECTOR-RF 5MC M PC 50-OHM	28480	1250-1220
A6P3	1250-1220	0		CONNECTOR-RF 5MC M PC 50-OHM	28480	1250-1220
A6P4	1250-1220	0		CONNECTOR-RF 5MC M PC 50-OHM	28480	1250-1220

See introduction to this section for ordering information
*Indicates factory selected value

Table 6-3. Replaceable Parts

Reference Designation	HP Part Number	C D	Qty	Description	Mfr Code	Mfr Part Number
A601	1854-0720	3	1	TRANSISTOR NPN S1 PD=300MW FT=0.6GHZ	28480	1854-0720
A602	1854-0632	6	1	TRANSISTOR NPN S1 PD=150MW FT=0.6GHZ	28480	1854-0632
A603	1853-0020	4		TRANSISTOR PNP S1 PD=300MW FT=150MHZ	28480	1853-0020
A604	1853-0020	4		TRANSISTOR PNP S1 PD=300MW FT=150MHZ	28480	1853-0020
A605	1854-0130	9		TRANSISTOR NPN S1 PD=350MW FT=4.5GHZ	28480	1854-0130
A606	1854-0130	9		TRANSISTOR NPN S1 PD=350MW FT=4.5GHZ	28480	1854-0130
A607	1854-0130	9		TRANSISTOR NPN S1 PD=350MW FT=4.5GHZ	28480	1854-0130
A608	1854-0130	9		TRANSISTOR NPN S1 PD=350MW FT=4.5GHZ	28480	1854-0130
A609	1854-0130	9		TRANSISTOR NPN S1 PD=350MW FT=4.5GHZ	28480	1854-0130
A6R1	0757-0280	3		RESISTOR 1K 1% .125W F TC0+/-100	24546	C4=1/8=TC0=1001-F
A6R2	0498-7188	8	1	RESISTOR 10 1% .05W F TC0+/-100	24546	C3=1/8=TC0=100R-G
A6R3	0498-7196	8		RESISTOR 21.5 1% .05W F TC0+/-100	24546	C3=1/8=TC0=21R5-G
A6R4	0698-7223	2		RESISTOR 287 1% .05W F TC0+/-100	24546	C3=1/8=TC0=287M-G
A6R5	0698-7194	8		RESISTOR 17.8 1% .05W F TC0+/-100	24546	C3=1/8=TC0=17R8-G
A6R7	0698-7212	9		RESISTOR 100 1% .05W F TC0+/-100	24546	C3=1/8=TC0=100H-G
A6R8	0698-7212	9		RESISTOR 100 1% .05W F TC0+/-100	24546	C3=1/8=TC0=100R-G
A6R9	0698-7212	9		RESISTOR 100 1% .05W F TC0+/-100	24546	C3=1/8=TC0=100R-G
A6R10	0698-7212	9		RESISTOR 100 1% .05W F TC0+/-100	24546	C3=1/8=TC0=100R-G
A6R11	0698-7212	9		RESISTOR 100 1% .05W F TC0+/-100	24546	C3=1/8=TC0=100R-G
A6R12	0698-7212	9		RESISTOR 100 1% .05W F TC0+/-100	24546	C3=1/8=TC0=100R-G
A6R13	0698-7212	9		RESISTOR 100 1% .05W F TC0+/-100	24546	C3=1/8=TC0=100R-G
A6R14	0698-7212	9		RESISTOR 100 1% .05W F TC0+/-100	24546	C3=1/8=TC0=100R-G
A6R15	0698-7212	9		RESISTOR 100 1% .05W F TC0+/-100	24546	C3=1/8=TC0=100R-G
A6R16	0698-7212	9		RESISTOR 100 1% .05W F TC0+/-100	24546	C3=1/8=TC0=100R-G
A6R17	0698-7212	9		RESISTOR 100 1% .05W F TC0+/-100	24546	C3=1/8=TC0=100R-G
A6R18	0698-7212	9		RESISTOR 100 1% .05W F TC0+/-100	24546	C3=1/8=TC0=100R-G
A6R19	0698-3441	8		RESISTOR 215 1% .125W F TC0+/-100	24546	C4=1/8=TC0=215R-F
A6R20	0603-1025	0		RESISTOR 1K 5% .25W FC TC=400/+600	01121	C81025
A6R21	0698-3441	8		RESISTOR 215 1% .125W F TC0+/-100	24546	C4=1/8=TC0=215R-F
A6R22	0603-1025	9		RESISTOR 1K 5% .25W FC TC=400/+600	01121	C81025
A6R23	0757-0401	0		RESISTOR 100 1% .125W F TC0+/-100	24546	C4=1/8=TC0=101-F
A6R24	0757-0180	2	1	RESISTOR 31.6 1% .125W F TC0+/-100	24546	0757-0180
A6R25	0498-0467	0	1	RESISTOR 1.05K 1% .125W F TC0+/-100	24546	C4=1/8=TC0=1051-F
A6R26	0757-0438	3		RESISTOR 5.11K 1% .125W F TC0+/-100	24546	C4=1/8=TC0=5111-F
A6R27	0698-3441	8		RESISTOR 215 1% .125W F TC0+/-100	24546	C4=1/8=TC0=215R-F
A6R28	0757-0276	7	1	RESISTOR 61.9 1% .125W F TC0+/-100	24546	C4=1/8=TC0=6192-F
A6R30	0698-7260	7	3	RESISTOR 10K 1% .05W F TC0+/-100	24546	C3=1/8=TC0=1002-G
A6R31	0603-1025	9		RESISTOR 1K 5% .25W FC TC=400/+600	01121	C81025
A6R32	0698-7260	7		RESISTOR 10K 1% .05W F TC0+/-100	24546	C3=1/8=TC0=1002-G
A6R33	0698-7260	7		RESISTOR 10K 1% .05W F TC0+/-100	24546	C3=1/8=TC0=1002-G
A6R34	0603-1015	0		RESISTOR 100 5% .25W FC TC=400/+500	01121	C81015
A6R35	0757-0394	0	1	RESISTOR 51.1 1% .125W F TC0+/-100	24546	C4=1/8=TC0=51R1-F
A6R36	0603-1325	6		RESISTOR 3.3K 5% .25W FC TC=400/+700	01121	C83325
A6R37	0603-1015	7		RESISTOR 100 5% .25W FC TC=400/+500	01121	C81015
A6R38	0603-2235	5	10	RESISTOR 22K 5% .25W FC TC=400/+800	01121	C82235
A6R39	0698-3440	1		RESISTOR 316 1% .125W F TC0+/-100	24546	C4=1/8=TC0=316R-F
A6R40	0698-7188	8		RESISTOR 10 1% .05W F TC0+/-100	24546	C3=1/8=TC0=10R-G
A6R41	0757-0279	0		RESISTOR 3.16K 1% .125W F TC0+/-100	24546	C4=1/8=TC0=3161-F
A6R42	0757-0279	0		RESISTOR 3.16K 1% .125W F TC0+/-100	24546	C4=1/8=TC0=3161-F
A6R43	0757-0416	7		RESISTOR 511 1% .125W F TC0+/-100	24546	C4=1/8=TC0=511H-F
A6R44	0698-7188	8		RESISTOR 10 1% .05W F TC0+/-100	24546	C3=1/8=TC0=10R-G
A6R45	0698-3440	7		RESISTOR 196 1% .125W F TC0+/-100	24546	C4=1/8=TC0=196H-F
A6R46	0698-3440	7		RESISTOR 196 1% .125W F TC0+/-100	24546	C4=1/8=TC0=196H-F
A6R47	0698-7188	8		RESISTOR 10 1% .05W F TC0+/-100	24546	C3=1/8=TC0=10R-G
A6R48	0757-0416	7		RESISTOR 511 1% .125W F TC0+/-100	24546	C4=1/8=TC0=511H-F
A6R49	0698-4421	6	1	RESISTOR 249 1% .125W F TC0+/-100	24546	C4=1/8=TC0=249H-F
A6R50	0698-4460	3	2	RESISTOR 649 1% .125W F TC0+/-100	24546	C4=1/8=TC0=649H-F
A6R51	0698-7193	5		RESISTOR 16.2 1% .05W F TC0+/-100	24546	C3=1/8=TC0=16R2-G
A6R52	0698-4460	3		RESISTOR 649 1% .125W F TC0+/-100	24546	C4=1/8=TC0=649H-F
A6T1	08552-6024	9	1	TRANSFORMER-RF, YELLOW	28080	08552-6024
A7	04191-66507	4	1	SELECTABLE FILTER BOARD ASSEMBLY	28080	04191-66507
A7C1	0140-0194	1	4	CAPACITOR-FXD 110PF +-5% 300VDC MICA	72136	DM15F111J0300V1C8
A7C2	0140-0205	1	4	CAPACITOR-FXD 62PF +-5% 300VDC MICA	72136	DM15E20J0300V1C8
A7C3	0140-0205	1	4	CAPACITOR-FXD 62PF +-5% 300VDC MICA	72136	DM15E20J0300V1C8
A7C4	0140-0197	4	2	CAPACITOR-FXD 180PF +-5% 300VDC MICA	72136	DM15F181J0300V1C8
A7C5	0140-0194	1		CAPACITOR-FXD 110PF +-5% 300VDC MICA	72136	DM15F111J0300V1C8
A7C6	0140-0193	0	2	CAPACITOR-FXD 82PF +-5% 300VDC MICA	72136	DM15E82J0300V1C8
A7C7	0140-0197	1		CAPACITOR-FXD 180PF +-5% 300VDC MICA	72136	DM15F181J0300V1C8
A7C8	0140-0194	1		CAPACITOR-FXD 110PF +-5% 300VDC MICA	72136	DM15F111J0300V1C8
A7C9	0140-0193	1		CAPACITOR-FXD 82PF +-5% 300VDC MICA	72136	DM15E82J0300V1C8
A7C10	0140-0194	1		CAPACITOR-FXD 110PF +-5% 300VDC MICA	72136	DM15F111J0300V1C8
A7C11	0140-0205	5		CAPACITOR-FXD 62PF +-5% 300VDC MICA	72136	DM15E62J0300V1C8
A7C12	0140-0205	5		CAPACITOR-FXD 62PF +-5% 300VDC MICA	72136	DM15E62J0300V1C8
A7C13	0150-0121	5		CAPACITOR-FXD .1UF +-20% 50VDC CER	28080	0150-0121
A7C14	0160-2055	9		CAPACITOR-FXD .01UF +-20% 100VDC CER	28080	0160-2055
A7C15	0160-2055	9		CAPACITOR-FXD .01UF +-20% 100VDC CER	28080	0160-2055

See introduction to this section for ordering information
*Indicates factory selected value

Table 6-3. Replaceable Parts

Reference Designation	HP Part Number	C D	Qty	Description	Mfr Code	Mfr Part Number
A7C17	0160-2266	4	2	CAPACITOR-FXD 24PF +-5% 500VDC CER 0+-30	28480	0160-2266
A7C19	0160-2246	0	1	CAPACITOR-FXD 3.6PF +--.25PF 500VDC CER	28480	0160-2246
A7C21	0160-2201	7	1	CAPACITOR-FXD 51PF +-5% 300VDC MICA	28480	0160-2201
A7C23	0160-2199	2	2	CAPACITOR-FXD 30PF +-5% 300VDC MICA	28480	0160-2199
A7C25	0160-2201	7		CAPACITOR-FXD 51PF +-5% 300VDC MICA	28480	0160-2201
A7C27	0160-2199	2		CAPACITOR-FXD 30PF +-5% 300VDC MICA	28480	0160-2199
A7C29	0160-2266	4		CAPACITOR-FXD 24PF +-5% 500VDC CER 0+-30	28480	0160-2266
A7C31	0160-2261	9	5	CAPACITOR-FXD 15PF +-5% 500VDC CER 0+-30	28480	0160-2261
A7C32	0160-2055	9		CAPACITOR-FXD .01UF +80-20% 100VDC CER	28480	0160-2055
A7C33	0160-2055	9		CAPACITOR-FXD .01UF +80-20% 100VDC CER	28480	0160-2055
A7C34	0160-2055	9		CAPACITOR-FXD .01UF +80-20% 100VDC CER	28480	0160-2055
A7C35	0160-2254	0		CAPACITOR-FXD 7.5PF +--.25PF 500VDC CER	28480	0160-2254
A7C36	0160-2257	3		CAPACITOR-FXD 10PF +-5% 500VDC CER 0+-60	28480	0160-2257
A7C38	0160-2251	7	8	CAPACITOR-FXD 5.6PF +--.25PF 500VDC CER	28480	0160-2251
A7C39	0160-2251	7		CAPACITOR-FXD 5.6PF +--.25PF 500VDC CER	28480	0160-2251
A7C41	0160-2251	7		CAPACITOR-FXD 5.6PF +--.25PF 500VDC CER	28480	0160-2251
A7C43	0160-2261	9		CAPACITOR-FXD 15PF +-5% 500VDC CER 0+-30	28480	0160-2261
A7C44	0160-2261	9		CAPACITOR-FXD 15PF +-5% 500VDC CER 0+-30	28480	0160-2261
A7C46	0160-2257	3		CAPACITOR-FXD 10PF +-5% 500VDC CER 0+-60	28480	0160-2257
A7C47	0160-2257	3		CAPACITOR-FXD 10PF +-5% 500VDC CER 0+-60	28480	0160-2257
A7C49	0160-2251	7		CAPACITOR-FXD 5.6PF +--.25PF 500VDC CER	28480	0160-2251
A7C50	0160-2246	0		CAPACITOR-FXD 3.6PF +--.25PF 500VDC CER	28480	0160-2246
A7C52	0160-2261	9		CAPACITOR-FXD 15PF +-5% 500VDC CER 0+-30	28480	0160-2261
A7C53	0160-2261	9		CAPACITOR-FXD 15PF +-5% 500VDC CER 0+-30	28480	0160-2261
A7C55	0160-2257	3		CAPACITOR-FXD 10PF +-5% 500VDC CER 0+-60	28480	0160-2257
A7C56	0160-2257	3		CAPACITOR-FXD 10PF +-5% 500VDC CER 0+-60	28480	0160-2257
A7C58	0160-2251	7		CAPACITOR-FXD 5.6PF +--.25PF 500VDC CER	28480	0160-2251
A7C59	0160-2246	0		CAPACITOR-FXD 3.6PF +--.25PF 500VDC CER	28480	0160-2246
A7C61	0160-2254	0		CAPACITOR-FXD 7.5PF +--.25PF 500VDC CER	28480	0160-2254
A7C62	0160-2257	3		CAPACITOR-FXD 10PF +-5% 500VDC CER 0+-60	28480	0160-2257
A7C64	0160-2251	7		CAPACITOR-FXD 5.6PF +--.25PF 500VDC CER	28480	0160-2251
A7C65	0160-2251	7		CAPACITOR-FXD 5.6PF +--.25PF 500VDC CER	28480	0160-2251
A7C67	0160-2251	7		CAPACITOR-FXD 5.6PF +--.25PF 500VDC CER	28480	0160-2251
A7C69	0160-2055	9		CAPACITOR-FXD .01UF +80-20% 100VDC CER	28480	0160-2055
A7C70	0160-2055	9		CAPACITOR-FXD .01UF +80-20% 100VDC CER	28480	0160-2055
A7C71	0160-2055	9		CAPACITOR-FXD .01UF +80-20% 100VDC CER	28480	0160-2055
A7CR1	1901-0040	1		DIODE-SWITCHING 30V 50MA 2N8 00-35	28480	1901-0040
A7CR2	1901-0040	1		DIODE-SWITCHING 30V 50MA 2N8 00-35	28480	1901-0040
A7CR3	1901-0040	1		DIODE-SWITCHING 30V 50MA 2N8 00-35	28480	1901-0040
A7CR4	1901-0040	1		DIODE-SWITCHING 30V 50MA 2N8 00-35	28480	1901-0040
A7CR5	1901-0040	1		DIODE-SWITCHING 30V 50MA 2N8 00-35	28480	1901-0040
A7CR6	1901-0040	1		DIODE-SWITCHING 30V 50MA 2N8 00-35	28480	1901-0040
A7CR7	1901-0040	1		DIODE-SWITCHING 30V 50MA 2N8 00-35	28480	1901-0040
A7CR8	1901-0040	1		DIODE-SWITCHING 30V 50MA 2N8 00-35	28480	1901-0040
A7CR9	1901-0040	1		DIODE-SWITCHING 30V 50MA 2N8 00-35	28480	1901-0040
A7CR10	1901-0040	1		DIODE-SWITCHING 30V 50MA 2N8 00-35	28480	1901-0040
A7CR11	1901-0179	7		DIODE-SWITCHING 15V 50MA 750P8 00-7	28480	1901-0179
A7CR12	1901-0179	7		DIODE-SWITCHING 15V 50MA 750P8 00-7	28480	1901-0179
A7CR13	1901-0179	7		DIODE-SWITCHING 15V 50MA 750P8 00-7	28480	1901-0179
A7CR14	1901-0179	7		DIODE-SWITCHING 15V 50MA 750P8 00-7	28480	1901-0179
A7CR15	1901-0179	7		DIODE-SWITCHING 15V 50MA 750P8 00-7	28480	1901-0179
A7CR16	1901-0179	7		DIODE-SWITCHING 15V 50MA 750P8 00-7	28480	1901-0179
A7CR17	1901-0040	1		DIODE-SWITCHING 30V 50MA 2N8 00-35	28480	1901-0040
A7CR18	1901-0040	1		DIODE-SWITCHING 30V 50MA 2N8 00-35	28480	1901-0040
A7CR19	1901-0040	1		DIODE-SWITCHING 30V 50MA 2N8 00-35	28480	1901-0040
A7CR20	1901-0040	1		DIODE-SWITCHING 30V 50MA 2N8 00-35	28480	1901-0040
A7CR21	1901-0179	7		DIODE-SWITCHING 15V 50MA 750P8 00-7	28480	1901-0179
A7CR22	1901-0179	7		DIODE-SWITCHING 15V 50MA 750P8 00-7	28480	1901-0179
A7CR23	1901-0040	1		DIODE-SWITCHING 30V 50MA 2N8 00-35	28480	1901-0040
A7CR24	1901-0040	1		DIODE-SWITCHING 30V 50MA 2N8 00-35	28480	1901-0040
A7CR25	1901-0040	1		DIODE-SWITCHING 30V 50MA 2N8 00-35	28480	1901-0040
A7CR26	1901-0040	1		DIODE-SWITCHING 30V 50MA 2N8 00-35	28480	1901-0040
A7CR27	1901-0040	1		DIODE-SWITCHING 30V 50MA 2N8 00-35	28480	1901-0040
A7CR28	1901-0040	1		DIODE-SWITCHING 30V 50MA 2N8 00-35	28480	1901-0040
A7CR29	1901-0040	1		DIODE-SWITCHING 30V 50MA 2N8 00-35	28480	1901-0040
A7CR30	1901-0040	1		DIODE-SWITCHING 30V 50MA 2N8 00-35	28480	1901-0040
A7CR31	1901-0040	1		DIODE-SWITCHING 30V 50MA 2N8 00-35	28480	1901-0040
A7CR32	1901-0040	1		DIODE-SWITCHING 30V 50MA 2N8 00-35	28480	1901-0040
A7CR33	1901-0040	1		DIODE-SWITCHING 30V 50MA 2N8 00-35	28480	1901-0040
A7CR34	1901-0040	1		DIODE-SWITCHING 30V 50MA 2N8 00-35	28480	1901-0040
A7CR35	1901-0040	1		DIODE-SWITCHING 30V 50MA 2N8 00-35	28480	1901-0040
A7CR36	1901-0179	7		DIODE-SWITCHING 15V 50MA 750P8 00-7	28480	1901-0179
A7CR37	1901-0179	7		DIODE-SWITCHING 15V 50MA 750P8 00-7	28480	1901-0179
A7CR38	1901-0179	7		DIODE-SWITCHING 15V 50MA 750P8 00-7	28480	1901-0179

See introduction to this section for ordering information
*Indicates factory selected value

Table 6-3. Replaceable Parts

Reference Designation	HP Part Number	C D	Qty	Description	Mfr Code	Mfr Part Number
A7L1	9100-2251	0	3	COIL-MLD 220NH 10% Q#32 .095DX,25LG-NOM	28480	9100-2251
A7L2	9100-2249	6	4	COIL-MLD 150NH 10% Q#34 .095DX,25LG-NOM	28480	9100-2249
A7L3	9100-2247	4		COIL-MLD 100NH 10% Q#34 .095DX,25LG-NOM	28480	9100-2247
A7L4	9100-2251	0		COIL-MLD 220NH 10% Q#32 .095DX,25LG-NOM	28480	9100-2251
A7L5	9100-2249	6		COIL-MLD 150NH 10% Q#34 .095DX,25LG-NOM	28480	9100-2249
A7L6	9100-2248	5	1	COIL-MLD 120NH 10% Q#34 .095DX,25LG-NOM	28480	9100-2248
A7L7	9100-2251	0		COIL-MLD 220NH 10% Q#32 .095DX,25LG-NOM	28480	9100-2251
A7L8	9100-2249	6		COIL-MLD 150NH 10% Q#34 .095DX,25LG-NOM	28480	9100-2249
A7L9	9100-2247	4		COIL-MLD 100NH 10% Q#34 .095DX,25LG-NOM	28480	9100-2247
A7L10	9140-0179	1	3	COIL-MLD 220UH 10% Q#75 .155DX,375LG-NOM	28480	9140-0179
A7L11	9140-0158	6		COIL-MLD 1UH 10% Q#32 .095DX,25LG-NOM	28480	9140-0158
A7L12	9140-0158	6		COIL-MLD 1UH 10% Q#32 .095DX,25LG-NOM	28480	9140-0158
A7L19	9140-0158	6		COIL-MLD 1UH 10% Q#32 .095DX,25LG-NOM	28480	9140-0158
A7L20	9140-0158	6		COIL-MLD 1UH 10% Q#32 .095DX,25LG-NOM	28480	9140-0158
A7L21	9100-3922	4	4	COIL-FIXED 120-1300 MZ	28480	9100-3922
A7L22	9100-2247	4		COIL-MLD 100NH 10% Q#34 .095DX,25LG-NOM	28480	9100-2247
A7L23	9140-0158	6		COIL-MLD 1UH 10% Q#32 .095DX,25LG-NOM	28480	9140-0158
A7L24	9140-0179	1		COIL-MLD 220UH 10% Q#75 .155DX,375LG-NOM	28480	9140-0179
A7L25	9100-3922	4		COIL-FIXED 120-1300 MZ	28480	9100-3922
A7L26	9100-3922	4		COIL-FIXED 120-1300 MZ	28480	9100-3922
A7L27	9100-2247	4		COIL-MLD 100NH 10% Q#34 .095DX,25LG-NOM	28480	9100-2247
A7L28	9140-0158	6		COIL-MLD 1UH 10% Q#32 .095DX,25LG-NOM	28480	9140-0158
A7L29	9140-0179	1		COIL-MLD 220UH 10% Q#75 .155DX,375LG-NOM	28480	9140-0179
A7L30	9100-2247	4		COIL-MLD 100NH 10% Q#34 .095DX,25LG-NOM	28480	9100-2247
A7L40	9100-2247	4		COIL-MLD 100NH 10% Q#34 .095DX,25LG-NOM	28480	9100-2247
A7L43	9100-2247	4		COIL-MLD 100NH 10% Q#34 .095DX,25LG-NOM	28480	9100-2247
A7MP1	2190-0124	4		WASHER-LK INTL 7 NO. 10 .195-IN-ID	28480	2190-0124
A7MP2	2360-0115	4		SCREW-MACH 6-32 .312-IN-LG PAN-HEAD-PDZ1	00000	ORDER BY DESCRIPTION
A7MP3	2950-0078	4		NUT-HEX-OSL-DIAM 10-32-FMD .067-IN-THK	28480	2950-0078
A7MP4	5001-0173	7			28480	5001-0173
A7MP5	04191-66006	6	1	COVER	28480	04191-66006
A7P1	1250-1220	0		CONNECTOR-RF 8MC M PC 50-OHM	28480	1250-1220
A7P2	1250-1220	0		CONNECTOR-RF 8MC M PC 50-OHM	28480	1250-1220
A7P3	1250-1220	0		CONNECTOR-RF 8MC M PC 50-OHM	28480	1250-1220
A7R1	0683-6805	7		RESISTOR 100 5% .25W FC TC=400/+500	01121	068305
A7R2	0683-6805	2		RESISTOR 33 5% .25W FC TC=400/+500	01121	068305
A7R3	0683-6805	3	10	RESISTOR 68 5% .25W FC TC=400/+500	01121	068305
A7R4	0683-6805	3		RESISTOR 68 5% .25W FC TC=400/+500	01121	068305
A7R5	0683-6805	3		RESISTOR 68 5% .25W FC TC=400/+500	01121	068305
A7R6	0683-6805	3		RESISTOR 68 5% .25W FC TC=400/+500	01121	068305
A7R7	0683-6805	3		RESISTOR 68 5% .25W FC TC=400/+500	01121	068305
A7R8	0683-6805	3		RESISTOR 68 5% .25W FC TC=400/+500	01121	068305
A7R9	0683-6805	3		RESISTOR 68 5% .25W FC TC=400/+500	01121	068305
A7R10	0683-6805	3		RESISTOR 68 5% .25W FC TC=400/+500	01121	068305
AB				NOT ASSIGNED		
A9	04191-66509	6	1	RF DIRECTIONAL BRIDGE CIRCUIT BD ASSY	28480	04191-66509
A9C1	0160-0686	8	6	CAPACITOR-FXD .47UF +/-20% 50VDC CER	03528	50547M474MP
A9C2	0160-0686	8		CAPACITOR-FXD .47UF +/-20% 50VDC CER	03528	50547M474MP
A9C3	0160-0686	8		CAPACITOR-FXD .47UF +/-20% 50VDC CER	03528	50547M474MP
A9C4	0160-0686	8		CAPACITOR-FXD .47UF +/-20% 50VDC CER	03528	50547M474MP
A9C5	0160-0686	8		CAPACITOR-FXD .47UF +/-20% 50VDC CER	03528	50547M474MP
A9C6	0160-0686	8		CAPACITOR-FXD .47UF +/-20% 50VDC CER	03528	50547M474MP
A9L1	9170-0953	2	1	CORE-TOROID	28480	9170-0953
A9L2	9170-0499	1		CORE-TOROID	28480	9170-0499
A9L3	9100-3922	4		COIL-FIXED 120-1300 MZ	28480	9100-3922
A9L4	9140-0129	1	5	COIL-MLD 220UH 5% Q#65 .155DX,375LG-NOM	28480	9140-0129
A9R1	0698-7153	3	5	RESISTOR 50 .1% .1W F TC=0/+50	24546	0698-7153
A9R2	0698-7153	3		RESISTOR 50 .1% .1W F TC=0/+50	24546	0698-7153
A9R3	0698-7153	3		RESISTOR 50 .1% .1W F TC=0/+50	24546	0698-7153
A9R4	0698-7222	1	4	RESISTOR 261 1% .05W F TC=0/+100	24546	C3=1/8-T0=261R=0
A9R5	0698-7222	1		RESISTOR 261 1% .05W F TC=0/+100	24546	C3=1/8-T0=261R=0
A9R6	0698-7193	5		RESISTOR 16.2 1% .05W F TC=0/+100	24546	C3=1/8-T0=16R2=0
A9R7	0698-7193	5		RESISTOR 16.2 1% .05W F TC=0/+100	24546	C3=1/8-T0=16R2=0
A9R8	0698-7222	1		RESISTOR 261 1% .05W F TC=0/+100	24546	C3=1/8-T0=261R=0
A9R9	0698-7222	1		RESISTOR 261 1% .05W F TC=0/+100	24546	C3=1/8-T0=261R=0
A9R10	0698-7189	9	12	RESISTOR 11 1% .05W F TC=0/+100	24546	C3=1/8-T0=11R0=0
A9R11	0698-7189	9		RESISTOR 11 1% .05W F TC=0/+100	24546	C3=1/8-T0=11R0=0
A9R13	0698-7189	9		RESISTOR 11 1% .05W F TC=0/+100	24546	C3=1/8-T0=11R0=0
A9R14	0698-7189	9		RESISTOR 11 1% .05W F TC=0/+100	24546	C3=1/8-T0=11R0=0
A9R16	0698-7189	9		RESISTOR 11 1% .05W F TC=0/+100	24546	C3=1/8-T0=11R0=0
A9R17	0698-7189	9		RESISTOR 11 1% .05W F TC=0/+100	24546	C3=1/8-T0=11R0=0

See introduction to this section for ordering information
*Indicates factory selected value

Table 6-3. Replaceable Parts

Reference Designation	HP Part Number	C D	Qty	Description	Mfr Code	Mfr Part Number
A9R18	0698-7227	6	3	RESISTOR 422 1% .05W F TC90±100	24544	C3=1/8=10=022R-G
A9R19	0698-7189	9		RESISTOR 11 1% .05W F TC90±100	24544	C3=1/8=100=11R0-G
A9R20	0698-7189	9		RESISTOR 11 1% .05W F TC90±100	24544	C3=1/8=100=11R0-G
A9R21	0698-7227	6		RESISTOR 422 1% .05W F TC90±100	24544	C3=1/8=10=022R-G
A9R23	0698-7513	3		RESISTOR 50 1% .1W F TC90±50	28480	0698-7513
A9R24	0698-7513	3	RESISTOR 50 1% .1W F TC90±50	28480	0698-7513	
A9R25	0698-7189	9	RESISTOR 11 1% .05W F TC90±100	24544	C3=1/8=100=11R0-G	
A9R26	0698-7189	9	RESISTOR 11 1% .05W F TC90±100	24544	C3=1/8=100=11R0-G	
A9R27	0698-7227	6	RESISTOR 422 1% .05W F TC90±100	24544	C3=1/8=10=022R-G	
A9R28	0698-7189	9	RESISTOR 11 1% .05W F TC90±100	24544	C3=1/8=100=11R0-G	
A9R29	0698-7189	9	RESISTOR 11 1% .05W F TC90±100	24544	C3=1/8=100=11R0-G	
A10	04191-66510	9	2	REF CHANNEL SAMPLER BOARD ASSEMBLY	28480	04191-66510
A10C1	0180-1745	4	6	CAPACITOR=FXD 1.5UF±10% 20VDC TA	56289	150D15X9020A2
A10C2	0180-1745	4		CAPACITOR=FXD 1.5UF±10% 20VDC TA	56289	150D15X9020A2
A10C4	0180-1745	4		CAPACITOR=FXD 1.5UF±10% 20VDC TA	56289	150D15X9020A2
A10C5	0180-0199	6		CAPACITOR=FXD 240PF ±5% 300VDC MICA	72136	DM15F241J0300HV1CR
A10C6	0180-3879	7		CAPACITOR=FXD .01UF ±20% 100VDC CER	28480	0180-3879
A10C7	0180-1743	2		2	CAPACITOR=FXD 1UF±10% 35VDC TA	56289
A10C8	0180-0197	8	CAPACITOR=FXD 2.2UF±10% 20VDC TA		56289	150D22X9020A2
A10C9	0180-0197	8	CAPACITOR=FXD 2.2UF±10% 20VDC TA		56289	150D22X9020A2
A10C10	0180-0291	3	CAPACITOR=FXD 1UF±10% 35VDC TA		56289	150D10X9035A2
A10L1	9140-0129	1	1	NOT ASSIGNED		
A10L2	9140-0129	1		COIL=MLD 220UH 5% Q665 .155DX,375LG=NOM	28480	9140-0129
A10L3	9140-0129	1		COIL=MLD 220UH 5% Q665 .155DX,375LG=NOM	28480	9140-0129
A10MP1	2300-0115	4	4	SCREW=MACH 6-32 .312-IN-LG PAN=HD=POZI	00000	ORDER BY DESCRIPTION
A10MP2	04191-24004	8		SPACER	28480	04191-24004
A10MP3	04191-29000	4		COVER	28480	04191-29000
A10P1	1250-0829	3	4	CONNECTOR=RF SMC M 8GL=HOLE=FR 50=OHM	28480	1250-0829
A10P2	1250-0829	3		CONNECTOR=RF SMC M 8GL=HOLE=FR 50=OHM	28480	1250-0829
A10R1	1853-0020	4	7	TRANSISTOR NPN 81 PD=300MW FT=150MHZ	28480	1853-0020
A10R2	1854-0071	4		TRANSISTOR NPN 81 PD=300MW FT=200MHZ	28480	1854-0071
A10R3	1854-0071	7		TRANSISTOR NPN 81 PD=300MW FT=200MHZ	28480	1854-0071
A10R1	0757-0280	3	3	RESISTOR 1K 1% .125W F TC90±100	24546	C4=1/8=10=1001-F
A10R2	0757-0280	3		RESISTOR 1K 1% .125W F TC90±100	24546	C4=1/8=10=1001-F
A10R3	0757-0439	4		RESISTOR 4.81K 1% .125W F TC90±100	24546	C4=1/8=10=0811-F
A10R4	0693-1025	9		RESISTOR 1K 5% .25W FC TC=400/+600	01121	CB1025
A10R5	0698-3155	1		RESISTOR 4.64K 1% .125W F TC90±100	24546	C4=1/8=10=4641-F
A10R6	0757-0439	4		RESISTOR 4.81K 1% .125W F TC90±100	24546	C4=1/8=10=0811-F
A10R7	0693-2235	9		RESISTOR 22K 5% .25W FC TC=400/+600	01121	CB2235
A10R8	0693-3315	4		RESISTOR 330 5% .25W FC TC=400/+600	01121	CB3315
A10R9	0693-2235	9	RESISTOR 22K 5% .25W FC TC=400/+600	01121	CB2235	
A10R10	0693-2725	8	10	RESISTOR 2.7K 5% .25W FC TC=400/+700	01121	CB2725
A10R11	0693-2725	8	RESISTOR 2.7K 5% .25W FC TC=400/+700	01121	CB2725	
A10R12	0757-0440	7	2	RESISTOR 7.5K 1% .125W F TC90±100	24546	C4=1/8=10=7501-F
A10R13	0757-0441	8		RESISTOR 8.25K 1% .125W F TC90±100	24546	C4=1/8=10=08251-F
A10R14	0693-5625	3		RESISTOR 5.6K 5% .25W FC TC=400/+700	01121	CB5625
A10R15	0757-0439	3		RESISTOR 5.11K 1% .125W F TC90±100	24546	C4=1/8=10=5111-F
A10R16	0693-5615	1	2	RESISTOR 560 5% .25W FC TC=400/+600	01121	CB5615
A10R17	0693-1015	7		RESISTOR 100 5% .25W FC TC=400/+500	01121	CB1015
A10R18	2100-2216	6		RESISTOR=TRMR 5K 10% C TOP=ADJ 1=TRN	28480	2100-2216
A10R19	2100-2522	2		RESISTOR=TRMR 10K 10% C 9IDE=ADJ 1=TRN	28480	2100-2522
A10UT	04191-85100	3	2	SAMPLER-MIC	28480	04191-85100
A11	04191-66510	9	9	TEST CHANNEL SAMPLER BOARD ASSEMBLY	28480	04191-66510
A11C1	0180-1745	4	6	CAPACITOR=FXD 1.5UF±10% 20VDC TA	56289	150D15X9020A2
A11C2	0180-1745	4		CAPACITOR=FXD 1.5UF±10% 20VDC TA	56289	150D15X9020A2
A11C4	0180-1745	4		CAPACITOR=FXD 1.5UF±10% 20VDC TA	56289	150D15X9020A2
A11C5	0180-0199	6		CAPACITOR=FXD 240PF ±5% 300VDC MICA	72136	DM15F241J0300HV1CR
A11C6	0180-3879	7		CAPACITOR=FXD .01UF ±20% 100VDC CER	28480	0180-3879
A11C7	0180-1743	2		2	CAPACITOR=FXD 1UF±10% 35VDC TA	56289
A11C8	0180-0197	8	CAPACITOR=FXD 2.2UF±10% 20VDC TA		56289	150D22X9020A2
A11C9	0180-0197	8	CAPACITOR=FXD 2.2UF±10% 20VDC TA		56289	150D22X9020A2
A11C10	0180-0291	3	CAPACITOR=FXD 1UF±10% 35VDC TA		56289	150D10X9035A2
A11L1	9140-0129	1	1	NOT ASSIGNED		
A11L2	9140-0129	1		COIL=MLD 220UH 5% Q665 .155DX,375LG=NOM	28480	9140-0129
A11L3	9140-0129	1		COIL=MLD 220UH 5% Q665 .155DX,375LG=NOM	28480	9140-0129
A11MP1	2300-0115	4	4	SCREW=MACH 6-32 .312-IN-LG PAN=HD=POZI	00000	ORDER BY DESCRIPTION
A11MP2	04191-24004	8		SPACER	28480	04191-24004
A11MP3	04191-29000	4		COVER	28480	04191-29000

See introduction to this section for ordering information
*Indicates factory selected value

Table 6-3. Replaceable Parts

Reference Designation	HP Part Number	C D	Qty	Description	Mfr Code	Mfr Part Number
A11P1	1250-0829	3		CONNECTOR-RF 8MC M 8GL-HOLE-FR 50-OHM	28480	1250-0829
A11P2	1250-0829	3		CONNECTOR-RF 8MC M 8GL-HOLE-FR 50-OHM	28480	1250-0829
A11Q1	1853-0020	4		TRANSISTOR PNP SI PDM300MH FT=150MHZ	28480	1853-0020
A11Q2	1854-0071	7		TRANSISTOR NPN SI PDM300MH FT=200MHZ	28480	1854-0071
A11Q3	1854-0071	7		TRANSISTOR NPN SI PDM300MH FT=200MHZ	28480	1854-0071
A11R1	0757-0280	3		RESISTOR 1K 1% .125W F TC=0+/-100	24546	C4=1/8-T0=1001-F
A11R2	0757-0280	3		RESISTOR 1K 1% .125W F TC=0+/-100	24546	C4=1/8-T0=1001-F
A11R3	0757-0439	4		RESISTOR 6.81K 1% .125W F TC=0+/-100	24546	C4=1/8-T0=8811-F
A11R4	0683-1025	9		RESISTOR 1K 5% .25W FC TC=400/+600	01121	CB1085
A11R5	0698-3155	1		RESISTOR 8.64K 1% .125W F TC=0+/-100	24546	C4=1/8-T0=4641-F
A11R6	0757-0439	4		RESISTOR 6.81K 1% .125W F TC=0+/-100	24546	C4=1/8-T0=8811-F
A11R7	0683-2235	5		RESISTOR 22K 5% .25W FC TC=400/+600	01121	CB2235
A11R8	0683-3315	4		RESISTOR 330 5% .25W FC TC=400/+600	01121	CB3315
A11R9	0683-2235	5		RESISTOR 22K 5% .25W FC TC=400/+600	01121	CB2235
A11R10	0683-2725	8		RESISTOR 2.7K 5% .25W FC TC=400/+700	01121	CB2725
A11R11	0683-2725	8		RESISTOR 2.7K 5% .25W FC TC=400/+700	01121	CB2725
A11R12	0757-0440	7		RESISTOR 7.5K 1% .125W F TC=0+/-100	24546	C4=1/8-T0=7501-F
A11R13	0757-0441	8		RESISTOR 8.25K 1% .125W F TC=0+/-100	24546	C4=1/8-T0=8251-F
A11R14	0683-5625	3		RESISTOR 5.6K 5% .25W FC TC=400/+700	01121	CB5625
A11R15	0757-0418	3		RESISTOR 5.11K 1% .125W F TC=0+/-100	24546	C4=1/8-T0=5111-F
A11R16	0683-5615	1		RESISTOR 560 5% .25W FC TC=400/+600	01121	CB5615
A11R17	0683-1015	7		RESISTOR 100 5% .25W FC TC=400/+600	01121	CB1015
A11R18	2100-2216	2		RESISTOR-TMR 5K 10% C TOP=ADJ 1-TRN	28480	2100-2216
A11R19	2100-2522	2		RESISTOR-TMR 16K 10% C SIDE=ADJ 1-TRN	28480	2100-2522
A11U1	04191-65100	3		BAMPLER-MIC	28480	04191-65100
A1Z	04191-66512	1	1	PLL SAMPLING CONTROLLER BOARD ASSEMBLY	28480	04191-66512
A12C1	0180-2205	3	1	CAPACITOR-FXD .33UF +/-10% 35VDC TA	56289	1500354X033A2
A12C2	0150-0121	5		CAPACITOR-FXD .1UF +/-20% 50VDC CER	28480	0150-0121
A12C3	0180-0116	6	1	CAPACITOR-FXD 6.8UF +/-10% 30VDC TA		
A12C4	0180-1083	3		CAPACITOR-FXD 33UF -10%+75% 25WVDC ALM	28480	0180-1083
A12C5	0180-1083	3		CAPACITOR-FXD 33UF -10%+75% 25WVDC ALM	28480	0180-1083
A12C6	0180-1083	3		CAPACITOR-FXD 33UF -10%+75% 25WVDC ALM	28480	0180-1083
A12C7	0150-0121	5		CAPACITOR-FXD .1UF +/-20% 50VDC CER	28480	0150-0121
A12C8	0180-0200	0	2	CAPACITOR-FXD 390PF +/-5% 300VDC MICA	72136	DM15F591J0300MV1CR
A12C9	0150-0121	5		CAPACITOR-FXD .1UF +/-20% 50VDC CER	28480	0150-0121
A12C10	0180-1083	3		CAPACITOR-FXD 33UF -10%+75% 25WVDC ALM	28480	0180-1083
A12C11	0150-0121	5		CAPACITOR-FXD .1UF +/-20% 50VDC CER	28480	0150-0121
A12C12	0180-1083	3		CAPACITOR-FXD 33UF -10%+75% 25WVDC ALM	28480	0180-1083
A12C13	0140-0198	1	1	CAPACITOR-FXD 560PF +/-2% 300VDC MICA	72136	DM15F561J0300MV1CR
A12C14	0160-0939	4	1	CAPACITOR-FXD 430PF +/-5% 300VDC MICA	28480	0160-0939
A12C15	0140-0198	5	1	CAPACITOR-FXD 200PF +/-5% 300VDC MICA	72136	DM15F201J0300MV1CR
A12C19	0180-1083	3		CAPACITOR-FXD 33UF -10%+75% 25WVDC ALM	28480	0180-1083
A12C20	0180-1083	3		CAPACITOR-FXD 33UF -10%+75% 25WVDC ALM	28480	0180-1083
A12C21	0180-1083	3		CAPACITOR-FXD 33UF -10%+75% 25WVDC ALM	28480	0180-1083
A12C22	0180-1083	3		CAPACITOR-FXD 33UF -10%+75% 25WVDC ALM	28480	0180-1083
A12C23	0160-0889	3		CAPACITOR-FXD .33UF +/-10% 50VDC POLYE	28480	0160-0889
A12C24	0160-0158	9		CAPACITOR-FXD 5600PF +/-10% 200VDC POLYE	28480	0160-0158
A12C25	0160-2220	0		CAPACITOR-FXD 1200PF +/-5% 300VDC MICA	28480	0160-2220
A12C27	0180-1083	3		CAPACITOR-FXD 33UF -10%+75% 25WVDC ALM	28480	0180-1083
A12C28	0180-1083	3		CAPACITOR-FXD 33UF -10%+75% 25WVDC ALM	28480	0180-1083
A12C29	0180-1083	3		CAPACITOR-FXD 33UF -10%+75% 25WVDC ALM	28480	0180-1083
A12C30	0180-1083	3		CAPACITOR-FXD 33UF -10%+75% 25WVDC ALM	28480	0180-1083
A12C31	0180-2985	6	4	CAPACITOR-FXD 33UF +/-20% 43VDC AL	28480	0180-2985
A12C32	0160-0158	9		CAPACITOR-FXD 5600PF +/-10% 200VDC POLYE	28480	0160-0158
A12CR1	1901-0518	8		DIODE-SCHOTTKY	28480	1901-0518
A12CR2	1901-0518	8		DIODE-SCHOTTKY	28480	1901-0518
A12CR3	1901-0040	1		DIODE-SWITCHING 30V 50MA 2N8 00-35	28480	1901-0040
A12CR4	1901-0040	1		DIODE-SWITCHING 30V 50MA 2N8 00-35	28480	1901-0040
A12CR5	1901-0040	1		DIODE-SWITCHING 30V 50MA 2N8 00-35	28480	1901-0040
A12CR6	1901-0040	1		DIODE-SWITCHING 30V 50MA 2N8 00-35	28480	1901-0040
A12CR7	1901-0518	8		DIODE-SCHOTTKY	28480	1901-0518
A12CR8	1901-0518	8		DIODE-SCHOTTKY	28480	1901-0518
A12CR9	1901-0518	8		DIODE-SCHOTTKY	28480	1901-0518
A12CR11	1902-0041	0	1	DIODE-ZNR 5.11V 5% 00-7 PDM .4W TC=+.009%	28480	1902-0041
A12CR12	1902-3256	9		DIODE-ZNR 23.7V 5% 00-7 PDM .4W TC=+.076%	28480	1902-3256
A12L1	9140-0114	0		COIL-MLD 100H 10% Q655 .1550X.375LG-NOM	28480	9140-0114
A12L2	9140-0114	0		COIL-MLD 100H 10% Q655 .1550X.375LG-NOM	28480	9140-0114
A12L3	9140-0114	0		COIL-MLD 100H 10% Q655 .1550X.375LG-NOM	28480	9140-0114
A12L4	9100-1661	0		COIL-MLD 2.2MH 5% Q670 .2150X.56LG-NOM	28480	9100-1661
A12L5	9100-1647	6	2	COIL-MLD 470UH 5% Q665 .19DX.44LG-NOM	28480	9100-1647

See introduction to this section for ordering information
*Indicates factory selected value

Table 6-3. Replaceable Parts

Reference Designation	HP Part Number	C/D	Qty	Description	Mfr Code	Mfr Part Number
A12L6	9100-1647	6		COIL=MLD 470UM 5% 8065 ,19DX,44LC=NOM	28480	9100-1647
A12L7	9100-1644	3	1	COIL=MLD 330UM 5% 8065 ,19DX,44LC=NOM	28480	9100-1644
A12L8	9140-0210	1	1	COIL=MLD 100UM 5% 8065 ,195DX,375LB=NOM	28480	9140-0210
A12L9	9140-0114	4		COIL=MLD 10UM 10% 8065 ,195DX,375LB=NOM	28480	9140-0114
A12MP1	04191-60007	7	1	COVER	28480	04191-60007
A12Q1	1853-0020	4		TRANSISTOR PNP 2I PD=300MH FT=150MHZ	28480	1853-0020
A12Q2	1853-0062	8	1	TRANSISTOR J=JET N=CHAN D=MODE 2I	28480	1853-0062
A12R1	2100-2516	0	2	RESISTOR=TRMR 100K 10% C 8IDE=ADJ 1=TRN	28480	2100-2516
A12R2	2100-2514	0	2	RESISTOR=TRMR 20K 10% C 8IDE=ADJ 1=TRN	28480	2100-2514
A12R3	0757-0199	5	4	RESISTOR 21.5K 1% .125W F TC=0+100	24546	C4=1/8-T0-2152-F
A12R4	0483-0425	2	2	RESISTOR 4.7K 5% .25W FC TC=400/+700	01121	C84725
A12R5	0757-0199	3	3	RESISTOR 21.5K 1% .125W F TC=0+100	24546	C4=1/8-T0-2152-F
A12R6	0683-1035	1		RESISTOR 10K 5% .25W FC TC=400/+700	01121	C81035
A12R7	0757-0461	2	1	RESISTOR 48.1K 1% .125W F TC=0+100	24546	C4=1/8-T0-4812-F
A12R8	0683-5605	9		RESISTOR 50 5% .25W FC TC=400/+500	01121	C85605
A12R9	0683-1025	4		RESISTOR 1K 5% .25W FC TC=400/+600	01121	C81025
A12R10	0683-1035	1		RESISTOR 10K 5% .25W FC TC=400/+700	01121	C81035
A12R11	0757-0447	4	2	RESISTOR 16.2K 1% .125W F TC=0+100	24546	
A12R12	0683-4725	2	2	RESISTOR 4.7K 5% .25W FC TC=400/+700	01121	C84725
A12R13	0683-1055	0	3	RESISTOR 1M 5% .25W FC TC=400/+900	01121	C81055
A12R14	0683-2735	5	1	RESISTOR 27K 5% .25W FC TC=400/+800	01121	C82735
A12R15	0683-5625	3		RESISTOR 5.6K 5% .25W FC TC=400/+700	01121	C85625
A12R16	0757-0460	1	2	RESISTOR 61.9K 1% .125W F TC=0+100	24546	C4=1/8-T0-6192-F
A12R17	0683-5625	3		RESISTOR 5.6K 5% .25W FC TC=400/+700	01121	C85625
A12R18	0757-0517	0		RESISTOR 502 1% .125W F TC=0+100	24546	C4=1/8-T0-502H-F
A12R18	0757-0199	3		RESISTOR 21.5K 1% .125W F TC=0+100	24546	C4=1/8-T0-2152-F
A12R23	0757-0199	3		RESISTOR 21.5K 1% .125W F TC=0+100	24546	C4=1/8-T0-2152-F
A12R24	0683-1438	3		RESISTOR 147 1% .125W F TC=0+100	24546	C4=1/8-T0-147H-F
A12R25	0683-1025	4		RESISTOR 1K 5% .25W FC TC=400/+600	01121	C81025
A12R30	0683-1015	7		RESISTOR 100 5% .25W FC TC=400/+500	01121	C81015
A12R31	0683-1015	7		RESISTOR 100 5% .25W FC TC=400/+500	01121	C81015
A12R32	0757-0485	0	1	RESISTOR 681K 1% .125W F TC=0+100	24546	0757-0485
A12R33	0757-0280	3		RESISTOR 1K 1% .125W F TC=0+100	24546	C4=1/8-T0-1001-F
A12R34	0757-0460	1		RESISTOR 61.9K 1% .125W F TC=0+100	24546	C4=1/8-T0-6192-F
A12R35	0683-5625	3		RESISTOR 5.6K 5% .25W FC TC=400/+700	01121	C85625
A12R36	0683-1005	5	7	RESISTOR 10 5% .25W FC TC=400/+500	01121	C81005
A12R37	0683-1525	4		RESISTOR 1.5K 5% .25W FC TC=400/+700	01121	C81525
A12R38	0683-1235	3	1	RESISTOR 32K 5% .25W FC TC=400/+800	01121	C81235
A12R39	0683-1615	5	1	RESISTOR 180 5% .25W FC TC=400/+600	01121	C81615
A12R40	0683-4705	8	1	RESISTOR 47 5% .25W FC TC=400/+500	01121	C84705
A12R41	0683-1005	5		RESISTOR 10 5% .25W FC TC=400/+500	01121	C81005
A12R42	0683-2225	3		RESISTOR 2.2K 5% .25W FC TC=400/+700	01121	C82225
A12S1	3101-2125		2	SWITCH=BL SPDT SUBMIN .3A 125VAC PC	28480	3101-2125
A12S2	3101-2125		2	SWITCH=BL SPDT SUBMIN .3A 125VAC PC	28480	3101-2125
A12U1	1820-0261		1	IC MV TTL MONOSTBL	01295	8N74121N
A12U2	1820-1423		1	IC MV TTL LS MONOSTBL RETRIG DUAL	01295	8N74LS123N
A12U3	1820-1112		1	IC FF TTL LS D-TYPE Q08=EDGE=TRIG	01295	8N74LS74N
A12U4	1820-0139		1	IC OP AMP SP DUAL 8=OIP=P	01428	CA14580
A12U5	1820-1112		8	IC FF TTL LS D-TYPE Q08=EDGE=TRIG	01295	8N74LS74AN
A12U6	1820-1197		5	IC GATE TTL LS NAND QUAD 2=INP	01295	8N74LS00N
A12U7	1820-1197		5	IC GATE TTL LS NAND QUAD 2=INP	01295	8N74LS00N
A12U8	1820-0210		3	IC COMPARATOR MS 14=OIP=P	27014	LM361N
A12U9	1820-0630			IC MISC TTL	00713	MC6040P
A12U10	1820-0319		3	IC OP AMP TD=99	27014	LF350H
A13	04191-66513	2	1	PLL SAMPLING FREQUENCY VTD BOARD ASSY	28480	04191-66513
A13C1	0121-0036	0	2	CAPACITOR=V TRMR=CER 5.5=16PF 350V	52763	104324 5.5/16PF NPO
A13C2	0160-2055			CAPACITOR=FXD .01UF +80=20% 100VDC CER	28480	0160-2055
A13C3	0160-3873			CAPACITOR=FXD 4.7PF +/-5PF 200VDC CER	28480	0160-3873
A13C4	0160-3874			CAPACITOR=FXD 10PF +/-5PF 200VDC CER	28480	0160-3874
A13C5	0160-3873			CAPACITOR=FXD 4.7PF +/-5PF 200VDC CER	28480	0160-3873
A13C6	0160-4493	3		CAPACITOR=FXD 27PF +/-5% 200VDC CER 0+=30	51642	200=200=NPO=270J
A13C7	0160-2204	1	1	CAPACITOR=FXD 100PF +/-5% 300VDC MICA	28480	0160-2204
A13C8	0160-2055	9		CAPACITOR=FXD .01UF +80=20% 100VDC CER	28480	0160-2055
A13C9	0160-3456	6		CAPACITOR=FXD 1000PF +/-10% 1KVDC CER	28480	0160-3456
A13C10	0160-3456	6		CAPACITOR=FXD 1000PF +/-10% 1KVDC CER	28480	0160-3456
A13C11	0160-3456	6		CAPACITOR=FXD 1000PF +/-10% 1KVDC CER	28480	0160-3456
A13C12	0160-3456	6		CAPACITOR=FXD 1000PF +/-10% 1KVDC CER	28480	0160-3456
A13C13	0160-3456	6		CAPACITOR=FXD 1000PF +/-10% 1KVDC CER	28480	0160-3456
A13C14	0160-2055	9		CAPACITOR=FXD .01UF +80=20% 100VDC CER	28480	0160-2055
A13C15	0160-2055	9		CAPACITOR=FXD .01UF +80=20% 100VDC CER	28480	0160-2055
A13C16	0180-2981	2	2	CAPACITOR=FXD 220UF +/-20% 10VDC AL	28480	0180-2981
A13C17	0180-2981	2	2	CAPACITOR=FXD 220UF +/-20% 10VDC AL	28480	0180-2981
A13C18	0180-1063	3		CAPACITOR=FXD 33uF -10%+75% 25WVDC ALH	28480	0180-1063
A13C19	0160-3878	6		CAPACITOR=FXD 1000PF +/-20% 100VDC CER	28480	0160-3878
A13C20	0160-3456	6		CAPACITOR=FXD 1000PF +/-10% 1KVDC CER	28480	0160-3456

See introduction to this section for ordering information
*Indicates factory selected value

Table 6-3. Replaceable Parts

Reference Designation	HP Part Number	C D	Qty	Description	Mfr Code	Mfr Part Number
A13C21	0160-2055	9		CAPACITOR-FXD .01UF +80-20% 100VDC CER	28480	0160-2055
A13C22	0160-2055	9		CAPACITOR-FXD .01UF +80-20% 100VDC CER	28480	0160-2055
A13C23	0160-3456	6		CAPACITOR-FXD 1000PF +/-10% 1KVDC CER	28480	0160-3456
A13C24	0180-1083	3		CAPACITOR-FXD 33uF -10%+75% 25WVDC ALM	28480	0180-1083
A13C25	0180-1083	3		CAPACITOR-FXD 33uF -10%+75% 25WVDC ALM	28480	0180-1083
A13C26	0160-2055	9		CAPACITOR-FXD .01UF +80-20% 100VDC CER	28480	0160-2055
A13C27	0160-2055	9		CAPACITOR-FXD .01UF +80-20% 100VDC CER	28480	0160-2055
A13C28	0160-2055	9		CAPACITOR-FXD .01UF +80-20% 100VDC CER	28480	0160-2055
A13C29	0160-2055	9		CAPACITOR-FXD .01UF +80-20% 100VDC CER	28480	0160-2055
A13C30	0160-2055	9		CAPACITOR-FXD .01UF +80-20% 100VDC CER	28480	0160-2055
A13C31	0180-2984	5		CAPACITOR-FXD 47UF+/-20% 50VDC AL	28480	0180-2984
A13C32	0180-2985	6		CAPACITOR-FXD 33UF+/-20% 63VDC AL	28480	0180-2985
A13C33	0160-2055	9		CAPACITOR-FXD .01UF +80-20% 100VDC CER	28480	0160-2055
A13C34	0160-2055	9		CAPACITOR-FXD .01UF +80-20% 100VDC CER	28480	0160-2055
A13C35	0150-0121	5		CAPACITOR-FXD .1UF +80-20% 50VDC CER	28480	0150-0121
A13C36	0180-1083	3		CAPACITOR-FXD 33uF -10%+75% 25WVDC ALM	28480	0180-1083
A13C37	0160-2055	9		CAPACITOR-FXD .01UF +80-20% 100VDC CER	28480	0160-2055
A13C38	0180-1083	3		CAPACITOR-FXD 33uF -10%+75% 25WVDC ALM	28480	0180-1083
A13C39	0160-2055	9		CAPACITOR-FXD .01UF +80-20% 100VDC CER	28480	0160-2055
A13CR1	0122-0109	0		DIODE VVC High Q 28Vmax 11pF(Vr=3V)	28480	0122-0109
A13CR2	0122-0109	0		DIODE VVC High Q 28Vmax 11pF(Vr=3V)	28480	0122-0109
A13CR3	0122-0109	0		DIODE VVC High Q 28Vmax 11pF(Vr=3V)	28480	0122-0109
A13CR4	0122-0109	0		DIODE VVC High Q 28Vmax 11pF(Vr=3V)	28480	0122-0109
A13CR5	0122-0109	0		DIODE VVC High Q 28Vmax 11pF(Vr=3V)	28480	0122-0109
A13CR6	1902-3082	9		DIODE-ZNR 4.00V 5% DO-7 PGM,4W TCR=+.023%	28480	1902-3082
A13CR7	1902-3256	9		DIODE-ZNR 23.7V 5% DO-7 PGM,4W TCR+0.07%	28480	1902-3256
A13L6	9170-0029	3		CORE-SHIELDING BEAD	28480	9170-0029
A13L7	9140-0014	4		COIL-MLD 10UH 10% Q=55 .1550X,375LG-NOM	28480	9140-0014
A13L8	9170-0029	3		CORE-SHIELDING BEAD	28480	9170-0029
A13L9	9140-0015	6		COIL-MLD 1UH 10% Q=32 .0950X,25LG-NOM	28480	9140-0015
A13L10	9140-0098	3		COIL-MLD 2.2UH 10% Q=33 .1550X,375LG-NOM	28480	9140-0098
A13L11	9140-0098	3		COIL-MLD 2.2UH 10% Q=33 .1550X,375LG-NOM	28480	9140-0098
A13L12	9140-0098	3		COIL-MLD 2.2UH 10% Q=33 .1550X,375LG-NOM	28480	9140-0098
A13L13	9140-0098	3		COIL-MLD 2.2UH 10% Q=33 .1550X,375LG-NOM	28480	9140-0098
A13L14	9140-0158	6		COIL-MLD 1UH 10% Q=32 .0950X,25LG-NOM	28480	9140-0158
A13L15	9170-0029	3		CORE-SHIELDING BEAD	28480	9170-0029
A13L16	9140-0158	6		COIL-MLD 1UH 10% Q=32 .0950X,25LG-NOM	28480	9140-0158
A13L17	9140-0114	4		COIL-MLD 10UH 10% Q=55 .1550X,375LG-NOM	28480	9140-0114
A13L18	9140-0114	4		COIL-MLD 10UH 10% Q=55 .1550X,375LG-NOM	28480	9140-0114
A13MP1	0380-1007	5		STANDOFF-RIVET=ON	00000	ORDER BY DESCRIPTION
A13MP2	2190-0124	4		WASHER-LK INFL T NO. 10 .195-IN-ID	28480	2190-0124
A13MP3	2200-0142	9		SCREW-MACH 4-40 .312-IN-LG 100 DEG	00000	ORDER BY DESCRIPTION
A13MP4	2360-0115	4		SCREW-MACH 6-32 .312-IN-LG PAN-HEAD-POZI	00000	ORDER BY DESCRIPTION
A13MP5	2950-0078	9		NUT-MEX-DBL-CHAM 10-32-THD .067-IN-TMK	28480	2950-0078
A13MP6	5001-0173	7			28480	5001-0173
A13MP7	04191-00603	3	1	SHIELD-BOX	28480	04191-00603
A13MP8	04191-00604	4	1	SHIELD-BOX	28480	04191-00604
A13MP9	04191-00000	8	1	COVER	28480	04191-00000
A13P1	1250-1220	0		CONNECTOR-RF 5MC 4 PC 50-OMM	28480	1250-1220
A13Q1	1854-0345	8		TRANSISTOR NPN 2N5179 SI T0-72 PDR200MW	04713	2N5179
A13Q2	1855-0081	1	1	TRANSISTOR J-FET N-CHAN D-MODE SI	01295	2N5245
A13Q3	1854-0345	8		TRANSISTOR NPN 2N5179 SI T0-72 PDR200MW	04713	2N5179
A13Q4	1854-0071	7		TRANSISTOR NPN SI PDR300MW FT=200MHZ	28480	1854-0071
A13Q5	1854-0019	3	2	TRANSISTOR NPN SI T0-18 PDR360MW	28480	1854-0019
A13Q6	1854-0019	3		TRANSISTOR NPN SI T0-18 PDR360MW	28480	1854-0019
A13R1	0683-5605	9		RESISTOR 56 5% .25W FC TCR=400/+500	01121	C85605
A13R2	0683-1025	9		RESISTOR 1K 5% .25W FC TCR=400/+600	01121	C81025
A13R3	0683-2725	8		RESISTOR 2.7K 5% .25W FC TCR=400/+700	01121	C82725
A13R4	0683-2725	8		RESISTOR 2.7K 5% .25W FC TCR=400/+700	01121	C82725
A13R5	0683-5625	8		RESISTOR 5.6K 5% .25W FC TCR=400/+700	01121	C85625
A13R6	0683-5605	9		RESISTOR 56 5% .25W FC TCR=400/+500	01121	C85605
A13R7	0683-1525	4		RESISTOR 1.5K 5% .25W FC TCR=400/+700	01121	C81525
A13R8	0683-1005	3	10	RESISTOR 100K 5% .25W FC TCR=400/+800	01121	C81045
A13R9	0683-3325	6		RESISTOR 3.3K 5% .25W FC TCR=400/+700	01121	C83325
A13R10	0683-2725	8		RESISTOR 2.7K 5% .25W FC TCR=400/+700	01121	C82725
A13R11	0683-2725	8		RESISTOR 2.7K 5% .25W FC TCR=400/+700	01121	C82725
A13R12	0757-0438	3		RESISTOR 5.11K 1% .125W F TCR=+100	24546	C4-1/8-T0-5111-F
A13R13	1810-0269	3		NETWORK-RES 9-RIP10,0K OHM X 8	28480	1810-0269
A13R14	0683-5615	1		RESISTOR 560 5% .25W FC TCR=400/+600	01121	C85615
A13R15	0683-5615	1		RESISTOR 560 5% .25W FC TCR=400/+600	01121	C85615
A13R16	0683-5615	1		RESISTOR 560 5% .25W FC TCR=400/+600	01121	C85615
A13R17	0683-5615	1		RESISTOR 560 5% .25W FC TCR=400/+600	01121	C85615
A13R18	0683-2215	1		RESISTOR 220 5% .25W FC TCR=400/+600	01121	C82215
A13R19	0683-0205	1		RESISTOR 82 5% .25W FC TCR=400/+500	01121	C88205
A13R20	0683-1035	1		RESISTOR 10K 5% .25W FC TCR=400/+700	01121	C81035

See introduction to this section for ordering information
*Indicates factory selected value

Table 6-3. Replaceable Parts

Reference Designation	HP Part Number	C D	Qty	Description	Mfr Code	Mfr Part Number
A13R21	0683-1015	7	5	RESISTOR 100 5% .25W FC TC=400/+500	01121	C81015
A13R22	0683-1515	2		RESISTOR 150 5% .25W FC TC=400/+600	01121	C81515
A13R23	0683-1525	9		RESISTOR 1.5K 5% .25W FC TC=400/+700	01121	C81525
A13R24	0683-5615	1		RESISTOR 560 5% .25W FC TC=400/+600	01121	C85615
A13R25	0683-1015	7		RESISTOR 100 5% .25W FC TC=400/+500	01121	C81015
A13R26	0683-1015	7	RESISTOR 100 5% .25W FC TC=400/+500	01121	C81015	
A13R27	0683-1035	1	RESISTOR 10K 5% .25W FC TC=400/+700	01121	C81035	
A13R28	0683-1525	9	RESISTOR 1.5K 5% .25W FC TC=400/+700	01121	C81525	
A13R29	0698-3153	9	RESISTOR 3.93K 1% .125W F TC=0/+100	24546	C4=1/8-T0=3831-F	
A13R30	0683-5615	1	RESISTOR 560 5% .25W FC TC=400/+600	01121	C85615	
A13R31	0757-0424	7	RESISTOR 1.1K 1% .125W F TC=0/+100	24546	C4=1/8-T0=1101-F	
A13R32	0683-1015	7	RESISTOR 100 5% .25W FC TC=400/+500	01121	C81015	
A13R33	0683-1025	9	RESISTOR 1K 5% .25W FC TC=400/+600	01121	C81025	
A13R34	0683-5615	1	RESISTOR 560 5% .25W FC TC=400/+600	01121	C85615	
A13R35	1810-0269	3	NETWORK-RES 9-81P10.0K OHM X R	20080	1810-0269	
A13U1	1820-0038	8	TRANSISTOR ARRAY	20480	1820-0038	
A13U2	1820-1112	8	IC FF TTL LB D-TYPE PDS-EDGE-TRIG	01295	8N7QL374AN	
A13U3	1820-1433	6	IC 3H-RGTR TTL LS R-3 SERIAL-IN PRL-OUT	01295	SN74LS164N	
A13U4	1820-0821	8	IC CMR ECL BIN UP/DOWN SYNCHRO	04713	MC10136L	
A13U5	1820-1225	8	IC FF ECL D-H/S DUAL	04713	MC10231P	
A14			NOT ASSIGNED			
A15	04191-66515	4	1	SAMPLING PULSE GENERATOR BOARD ASSEMBLY	20480	04191-66515
A15C1	0160-3872	0	3	CAPACITOR-FXD 2.2PF +/-25PF 200VDC CER	20480	0160-3872
A15C2	0160-3872	0		CAPACITOR-FXD 2.2PF +/-25PF 200VDC CER	20480	0160-3872
A15C3	0150-0121	5		CAPACITOR-FXD .1UF +/-80-20% 50VDC CER	20480	0150-0121
A15C4	0160-1061	7		CAPACITOR-FXD 220UF 20% 16VDC ALM	20480	0160-1061
A15C5	0150-0121	5		CAPACITOR-FXD .1UF +/-80-20% 50VDC CER	20480	0150-0121
A15C6	0150-0121	5	CAPACITOR-FXD .1UF +/-80-20% 50VDC CER	20480	0150-0121	
A15C7	0160-1063	3	CAPACITOR-FXD 33UF -10%+75% 25WVDC ALM	20480	0160-1063	
A15C8	0150-0121	5	CAPACITOR-FXD .1UF +/-80-20% 50VDC CER	20480	0150-0121	
A15C9	0150-0121	5	CAPACITOR-FXD .1UF +/-80-20% 50VDC CER	20480	0150-0121	
A15C10	0150-0121	5	CAPACITOR-FXD .1UF +/-80-20% 50VDC CER	20480	0150-0121	
A15C11	0150-0121	5	CAPACITOR-FXD .1UF +/-80-20% 50VDC CER	20480	0150-0121	
A15C12	0150-0121	5	CAPACITOR-FXD .1UF +/-80-20% 50VDC CER	20480	0150-0121	
A15C13	0150-0121	5	CAPACITOR-FXD .1UF +/-80-20% 50VDC CER	20480	0150-0121	
A15CR1	1901-0518	8	1	DIODE-SCHOTTKY	20480	1901-0518
A15CR2	1901-0518	8		DIODE-SCHOTTKY	20480	1901-0518
A15CR3	1901-0457	4		DIODE-8STEP RCVY 30V DO-7	20480	1901-0457
A15L1	9100-2247	4	3	COIL-MLD 100NH 10% 9R34 .095DX.25LG-NOM	20480	9100-2247
A15L2	9140-0158	6		COIL-MLD 1UH 10% 8R32 .095DX.25LG-NOM	20480	9140-0158
A15L3	9170-0029	3		CORE-9MIELDING BEAD	20480	9170-0029
A15L4	9170-0029	3		CORE-9MIELDING BEAD	20480	9170-0029
A15L5	9170-0029	3		CORE-9MIELDING BEAD	20480	9170-0029
A15L6	9170-0029	3	CORE-9MIELDING BEAD	20480	9170-0029	
A15L7	9100-1788	6	CHOKE-WIDE BAND 2MAX=600 OHM@ 180 MHZ	02114	VK200 20/48	
A15MP1	1205-0011	0	2	HEAT SINK TO-S/TD=39-C8	20480	1205-0011
A15MP2	2190-0124	4		WASHER-LX INTL Y NO. 10 .195-IN-ID	20480	2190-0124
A15MP3	2360-0115	4		SCREW-MACH 6-32 .312-IN-LG PAN-ND-POZI	00000	ORDER BY DESCRIPTION
A15MP4	2950-0078	9		NUT-MEX-DBL-CHAM 10-32-THD .067-IN-TMR	20480	2950-0078
A15MP5	5001-0173	7			20480	5001-0173
A15MP6	04191-60009	9	1	COVER	20480	04191-60009
A15P1	1250-1220	0	0	CONNECTOR-RF 8MC M PC 50-0HM	20480	1250-1220
A15P2	1250-1220	0		CONNECTOR-RF 8MC M PC 50-0HM	20480	1250-1220
A15P3	1250-1220	0		CONNECTOR-RF 8MC M PC 50-0HM	20480	1250-1220
A15Q1	1854-0247	9	1	TRANSISTOR NPN 8I TD=39 PDM1W FT=800MHZ	20480	1854-0247
A15Q2	1854-0247	9		TRANSISTOR NPN 8I TD=39 PDM1W FT=800MHZ	20480	1854-0247
A15Q3	1854-0247	9		TRANSISTOR NPN 8I TD=39 PDM1W FT=800MHZ	20480	1854-0247
A15Q4	1854-0092	2		TRANSISTOR NPN 8I PDM200MW FT=600MHZ	20480	1854-0092
A15Q5	1854-0345	8		TRANSISTOR NPN 2N5179 8I TD=72 PDM200MW	04713	2N5179
A15Q6	1853-0015	7	TRANSISTOR PNP 8I PDM200MW FT=500MHZ	20480	1853-0015	
A15R1	0698-3400	7	3	RESISTOR 196 1% .125W F TC=0/+100	24546	C4=1/8-T0=196R-F
A15R2	0698-3400	7		RESISTOR 196 1% .125W F TC=0/+100	24546	C4=1/8-T0=196R-F
A15R3	0757-0346	2		RESISTOR 10 1% .125W F TC=0/+100	24546	C4=1/8-T0=10R0-F
A15R4	0757-0346	2		RESISTOR 10 1% .125W F TC=0/+100	24546	C4=1/8-T0=10R0-F
A15R5	0698-3400	7		RESISTOR 196 1% .125W F TC=0/+100	24546	C4=1/8-T0=196R-F
A15R6	0698-3400	9	2	RESISTOR 147 1% .5W F TC=0/+100	20480	0698-3400
A15R7	0698-3400	9		RESISTOR 147 1% .5W F TC=0/+100	20480	0698-3400
A15R8	0683-5685	9		RESISTOR 56 5% .25W FC TC=400/+500	01121	C85605
A15R9	0683-5685	9		RESISTOR 56 5% .25W FC TC=400/+500	01121	C85605
A15P10	0683-3915	0		RESISTOR 390 5% .25W FC TC=400/+600	01121	C83915

See introduction to this section for ordering information
*Indicates factory selected value

Table 6-3. Replaceable Parts

Reference Designation	HP Part Number	C D	Qty	Description	Mfr Code	Mfr Part Number
A15R1	0683-1025		4	RESISTOR 1K 5% .25W FC TC=400/+500	01121	C81025
A15R2	0683-1005		5	RESISTOR 10 5% .25W FC TC=400/+500	01121	C81005
A15R3	0683-2215		1	RESISTOR 220 5% .25W FC TC=400/+500	01121	C82215
A15R4	0683-5615		1	RESISTOR 560 5% .25W FC TC=400/+500	01121	C85615
A15R5	0683-2725		8	RESISTOR 2.7K 5% .25W FC TC=400/+700	01121	C82725
A15R16	0683-5605		4	RESISTOR 56 5% .25W FC TC=400/+500	01121	C85605
A15R17	0683-3315		4	RESISTOR 330 5% .25W FC TC=400/+500	01121	C83315
A15R18	0683-1005		5	RESISTOR 10 5% .25W FC TC=400/+500	01121	C81005
A15R19	0683-8215		3	RESISTOR 820 5% .25W FC TC=400/+500	01121	C88215
A15R20	0683-2725		8	RESISTOR 2.7K 5% .25W FC TC=400/+700	01121	C82725
A36	04191-66516		5	1 IF AND PROCESS AMPLIFIER BOARD ASSEMBLY	26480	04191-66516
A16C1	0160-1083		3	CAPACITOR-FXD 33uF -10%+75% 25WVDC ALN	26480	0160-1083
A16C2	0150-0121		5	CAPACITOR-FXD .1uF +80+20% 50VDC CER	26480	0150-0121
A16C3	0160-0291		3	CAPACITOR-FXD 1uF+10% 35VDC TA	56289	150D105X9035A2
A16C4	0160-2055		4	CAPACITOR-FXD .01uF +80+20% 100VDC CER	26480	0160-2055
A16C5	0160-2055		4	CAPACITOR-FXD .01uF +80+20% 100VDC CER	26480	0160-2055
A16C6	0160-1083		3	CAPACITOR-FXD 33uF -10%+75% 25WVDC AL	26480	0160-1083
A16C7	0160-1083		3	CAPACITOR-FXD 33uF -10%+75% 25WVDC AL	26480	0160-1083
A16C8	0160-2224		4	CAPACITOR-FXD 1800PF +-5% 300VDC MICA	26480	0160-2224
A16C9	0160-2230		2	CAPACITOR-FXD 3300PF +-5% 300VDC MICA	26480	0160-2230
A16C10	0150-0121		5	CAPACITOR-FXD .1uF +80+20% 50VDC CER	26480	0150-0121
A16C11	0160-1083		3	CAPACITOR-FXD 33uF -10%+75% 25WVDC AL	26480	0160-1083
A16C12	0160-1083		3	CAPACITOR-FXD 33uF -10%+75% 25WVDC AL	26480	0160-1083
A16C13	0160-1083		3	CAPACITOR-FXD 33uF -10%+75% 25WVDC AL	26480	0160-1083
A16C14	0160-2224		4	CAPACITOR-FXD 1800PF +-5% 300VDC MICA	26480	0160-2224
A16C15	0160-2230		2	CAPACITOR-FXD 3300PF +-5% 300VDC MICA	26480	0160-2230
A16C16	0160-2219		7	CAPACITOR-FXD 1100PF +-5% 300VDC MICA	26480	0160-2219
A16C17	0160-2219		7	CAPACITOR-FXD 1100PF +-5% 300VDC MICA	26480	0160-2219
A16C18	0160-2230		2	CAPACITOR-FXD 3300PF +-5% 300VDC MICA	26480	0160-2230
A16C19	0160-0127		2	CAPACITOR-FXD 1uF +-20% 25VDC CER	26480	0160-0127
A16C20	0160-0127		2	CAPACITOR-FXD 1uF +-20% 25VDC CER	26480	0160-0127
A16C21	0160-2243		7	CAPACITOR-FXD 2.7PF +-25PF 500VDC CER	26480	0160-2243
A16C22	0160-2230		2	CAPACITOR-FXD 3300PF +-5% 300VDC MICA	26480	0160-2230
A16C23	0160-2224		4	CAPACITOR-FXD 1800PF +-5% 300VDC MICA	26480	0160-2224
A16C24	0160-0291		3	CAPACITOR-FXD 1uF+10% 35VDC TA	56289	150D105X9035A2
A16C25	0160-1083		3	CAPACITOR-FXD 33uF -10%+75% 25WVDC AL	26480	0160-1083
A16C26	0160-1083		3	CAPACITOR-FXD 33uF -10%+75% 25WVDC AL	26480	0160-1083
A16C27	0160-1083		3	CAPACITOR-FXD 33uF -10%+75% 25WVDC AL	26480	0160-1083
A16C28	0160-2224		4	CAPACITOR-FXD 1800PF +-5% 300VDC MICA	26480	0160-2224
A16C29	0160-1083		3	CAPACITOR-FXD 33uF -10%+75% 25WVDC AL	26480	0160-1083
A16C30	0160-1083		3	CAPACITOR-FXD 33uF -10%+75% 25WVDC AL	26480	0160-1083
A16C31	0160-1083		3	CAPACITOR-FXD 33uF -10%+75% 25WVDC AL	26480	0160-1083
A16C32	0160-1083		3	CAPACITOR-FXD 33uF -10%+75% 25WVDC AL	26480	0160-1083
A16C33	0160-1083		3	CAPACITOR-FXD 33uF -10%+75% 25WVDC AL	26480	0160-1083
A16C34	0160-1083		3	CAPACITOR-FXD 33uF -10%+75% 25WVDC AL	26480	0160-1083
A16C35	0160-1083		3	CAPACITOR-FXD 33uF -10%+75% 25WVDC AL	26480	0160-1083
A16C36	0160-0291		3	CAPACITOR-FXD 1uF+10% 35VDC TA	56289	150D105X9035A2
A16C37	0160-1083		3	CAPACITOR-FXD 33uF -10%+75% 25WVDC AL	26480	0160-1083
A16C38	0160-1083		3	CAPACITOR-FXD 33uF -10%+75% 25WVDC AL	26480	0160-1083
A16C39	0160-0291		3	CAPACITOR-FXD 1uF+10% 35VDC TA	56289	150D105X9035A2
A16C40	0160-0291		3	CAPACITOR-FXD 1uF+10% 35VDC TA	56289	150D105X9035A2
A16CR1	1901-0040		1	DIODE-SWITCHING 30V 50MA 2N8 00-35	26480	1901-0040
A16CR2	1902-0840		1	DIODE-SWITCHING 30V 50MA 2N8 00-35	26480	1902-0840
A16CR3	1901-0040		1	DIODE-SWITCHING 30V 50MA 2N8 00-35	26480	1901-0040
A16CR4	1901-0040		1	DIODE-SWITCHING 30V 50MA 2N8 00-35	26480	1901-0040
A16L1	9140-0137		1	COIL-MLD 1MH 5% Q860 .190X.44LG=NDM	26480	9140-0137
A16L2	9140-0137		1	COIL-MLD 1MH 5% Q860 .190X.44LG=NDM	26480	9140-0137
A16L3	9140-0137		1	COIL-MLD 1MH 5% Q860 .190X.44LG=NDM	26480	9140-0137
A16L4	9140-0137		1	COIL-MLD 1MH 5% Q860 .190X.44LG=NDM	26480	9140-0137
A16L5	9140-0137		1	COIL-MLD 1MH 5% Q860 .190X.44LG=NDM	26480	9140-0137
A16L6	9140-0137		1	COIL-MLD 1MH 5% Q860 .190X.44LG=NDM	26480	9140-0137
A16L7	9140-0137		1	COIL-MLD 1MH 5% Q860 .190X.44LG=NDM	26480	9140-0137
A16L8	9140-0137		1	COIL-MLD 1MH 5% Q860 .190X.44LG=NDM	26480	9140-0137
A16AP1	4040-0116		8	FIN-GRV .062-IN-DIA .25-IN-LG STL	26480	4040-0116
A16AP2	4040-0749		4	EXTR-PC 80 BRN POLYC .062=80=THKNS	26480	4040-0749
A16AP3	4040-0754		1	EXTR-PC 80 BLU POLYC .062=80=THKNS	26480	4040-0754
A16Q1	1855-0091		3	TRANSISTOR J-FET N-CHAN D-MODE 81	26480	1855-0091
A16Q2	1855-0091		3	TRANSISTOR J-FET N-CHAN D-MODE 81	26480	1855-0091
A16Q3	1855-0091		3	TRANSISTOR J-FET N-CHAN D-MODE 81	26480	1855-0091
A16Q4	1855-0091		3	TRANSISTOR J-FET N-CHAN D-MODE 81	26480	1855-0091
A16Q5	1855-0091		3	TRANSISTOR J-FET N-CHAN D-MODE 81	26480	1855-0091
A16Q6	1855-0091		3	TRANSISTOR J-FET N-CHAN D-MODE 81	26480	1855-0091
A16Q7	1854-0071		7	TRANSISTOR NPN 81 PD=300MW FT=200MHZ	26480	1854-0071
A16Q8	1854-0477		7	TRANSISTOR NPN 2N2222A 81 Y0=15 PD=500MW	04713	2N2222A
A16Q9	1854-0071		7	TRANSISTOR NPN 81 PD=300MW FT=200MHZ	26480	1854-0071
A16Q10	1853-0020		4	TRANSISTOR PNP 81 PD=300MW FT=150MHZ	26480	1853-0020

See introduction to this section for ordering information
*Indicates factory selected value

Table 6-3. Replaceable Parts

Reference Designation	HP Part Number	C	D	Qty	Description	Mfr Code	Mfr Part Number
A16011	1854-0020	4			TRANSISTOR PNP SI PDM300MH FT#150MHZ	26480	1854-0020
A16012	1854-0071	7			TRANSISTOR NPN SI PDM300MH FT#200MHZ	26480	1854-0071
A16013	1854-0071	7			TRANSISTOR NPN SI PDM300MH FT#200MHZ	26480	1854-0071
A16014	1854-0071	7			TRANSISTOR NPN SI PDM300MH FT#200MHZ	26480	1854-0071
A16015	1854-0071	7			TRANSISTOR NPN SI PDM300MH FT#200MHZ	26480	1854-0071
A16016	1854-0071	7			TRANSISTOR NPN SI PDM300MH FT#200MHZ	26480	1854-0071
A16R1	2100-2574	6		1	RESISTOR TRMR 500 10% C SIDE=ADJ I-TRN	26480	2100-2574
A16R2	0757-0416	7			RESISTOR 511 1% .125W F TC#0+100	24546	C4=1/8*TO=511R=F
A16R3	0757-0465	6		1	RESISTOR 100K 1% .125W F TC#0+100	24546	C4=1/8*TO=1003=F
A16R4	0757-0461	6			RESISTOR 100 1% .125W F TC#0+100	24546	C4=1/8*TO=101=F
A16R5	0698-0053	0			RESISTOR 1.96K 1% .125W F TC#0+100	24546	C4=1/8*TO=1961=F
A16R6	0757-0276	9			RESISTOR 1.79K 1% .125W F TC#0+100	24546	C4=1/8*TO=1791=F
A16R7	0698-3154	0			RESISTOR 4.22K 1% .125W F TC#0+100	24546	C4=1/8*TO=4221=F
A16R8	0757-0276	9			RESISTOR 1.79K 1% .125W F TC#0+100	24546	C4=1/8*TO=1791=F
A16R9	0757-0280	3			RESISTOR 1K 1% .125W F TC#0+100	24546	C4=1/8*TO=1001=F
A16R10	0683-1015	7			RESISTOR 100 5% .25W FC TC#400/+500	01121	CB1015
A16R11	0683-1015	7			RESISTOR 100 5% .25W FC TC#400/+500	01121	CB1015
A16R12	0757-0444	1			RESISTOR 12.1K 1% .125W F TC#0+100	24546	C4=1/8*TO=1212=F
A16R13	0683-4715	0			RESISTOR 470 5% .25W FC TC#400/+600	01121	CB4715
A16R14	0698-3440	7			RESISTOR 196 1% .125W F TC#0+100	24546	C4=1/8*TO=196R=F
A16R15	0683-1035	1			RESISTOR 19K 5% .25W FC TC#400/+700	01121	CB1035
A16R16	0683-4725	2			RESISTOR 4.7K 5% .25W FC TC#400/+700	01121	CB4725
A16R17	0683-1015	7			RESISTOR 100 5% .25W FC TC#400/+500	01121	CB1015
A16R18	0683-1015	7			RESISTOR 100 5% .25W FC TC#400/+500	01121	CB1015
A16R19	0683-1045	3			RESISTOR 100K 5% .25W FC TC#400/+800	01121	CB1045
A16R20	0683-1045	3			RESISTOR 100K 5% .25W FC TC#400/+800	01121	CB1045
A16R21	0683-1045	3			RESISTOR 100K 5% .25W FC TC#400/+800	01121	CB1045
A16R22	0683-1045	3			RESISTOR 100K 5% .25W FC TC#400/+800	01121	CB1045
A16R23	0683-1045	3			RESISTOR 100K 5% .25W FC TC#400/+800	01121	CB1045
A16R24	0683-1045	3			RESISTOR 100K 5% .25W FC TC#400/+800	01121	CB1045
A16R25	0683-1045	3			RESISTOR 100K 5% .25W FC TC#400/+800	01121	CB1045
A16R26	0683-4715	0			RESISTOR 470 5% .25W FC TC#400/+600	01121	CB4715
A16R27	0699-0275	0		6	RESISTOR-FXD 1k +/-0.1% .1W	26480	
A16R28	0699-0275	0		6	RESISTOR-FXD 1k +/-0.1% .1W	26480	
A16R29	0683-5615	1			RESISTOR 560 5% .25W FC TC#400/+600	01121	CB5615
A16R30	0683-1015	7			RESISTOR 100 5% .25W FC TC#400/+500	01121	CB1015
A16R31	0698-7611	2		1	RESISTOR 536 1% .125W F TC#0+25	19701	MF4C1/8*TO=536R=F
A16R32	0699-0486	5		4	RESISTOR 2K 1% .125W F TC#0+25	26480	
A16R33	0699-0275	0		6	RESISTOR-FXD 1k +/-0.1% .1W	26480	
A16R34	0699-0486	5		4	RESISTOR 2K 1% .125W F TC#0+25	26480	
A16R35	0757-0420	3		1	RESISTOR 750 1% .125W F TC#0+100	24546	C4=1/8*TO=751=F
A16R36	0683-2225	3			RESISTOR 2.2K 5% .25W FC TC#400/+700	01121	CB2225
A16R37	0683-1025	9			RESISTOR 1K 5% .25W FC TC#400/+600	01121	CB1025
A16R38	0699-0275	0		6	RESISTOR-FXD 1k +/-0.1% .1W	26480	
A16R39	0699-0486	0		6	RESISTOR 2K 1% .125W F TC#0+25	26480	
A16R40	0698-3549	7		1	RESISTOR 2.09K 1% .125W F TC#0+25	26480	0698-3549
A16R41	0683-2225	3			RESISTOR 2.2K 5% .25W FC TC#400/+700	01121	CB2225
A16R42	0683-1015	7			RESISTOR 100 5% .25W FC TC#400/+500	01121	CB1015
A16R43	0683-1015	7			RESISTOR 100 5% .25W FC TC#400/+500	01121	CB1015
A16R44	0683-1035	1			RESISTOR 10K 5% .25W FC TC#400/+700	01121	CB1035
A16R45	0683-1015	7			RESISTOR 100 5% .25W FC TC#400/+500	01121	CB1015
A16R46	0683-1025	7		3	RESISTOR 1.8K 5% .25W FC TC#400/+700	01121	CB1825
A16R47	0757-0286	9		1	RESISTOR 100 1% .125W F TC#0+25	19701	MF4C1/8*TO=101-F
A16R48	0698-6335	5		1	RESISTOR 900 1% .125W F TC#0+25	26480	0698-6335
A16R49	0683-5615	1			RESISTOR 560 5% .25W FC TC#400/+600	01121	CB5615
A16R50	0683-1025	9			RESISTOR 1K 5% .25W FC TC#400/+600	01121	CB1025
A16R51	0699-0486	5			RESISTOR 2K 1% .125W F TC#0+25	26480	
A16R52	0757-0280	3			RESISTOR 1K 1% .125W F TC#0+100	24546	C4=1/8*TO=1001=F
A16R53	0699-0486	5			RESISTOR 2K 1% .125W F TC#0+25	26480	
A16R54	0683-1035	1			RESISTOR 10K 5% .25W FC TC#400/+700	01121	CB1035
A16R55	0683-1015	7			RESISTOR 100 5% .25W FC TC#400/+500	01121	CB1015
A16R56	0683-4725	2			RESISTOR 4.7K 5% .25W FC TC#400/+700	01121	CB4725
A16R57	0683-1015	7			RESISTOR 100 5% .25W FC TC#400/+500	01121	CB1015
A16R58	0699-0275	0			RESISTOR-FXD 1k +/-0.1% .1W	26480	
A16R59	0683-1015	7			RESISTOR 100 5% .25W FC TC#400/+500	01121	CB1015
A16R60	0683-1015	7			RESISTOR 100 5% .25W FC TC#400/+500	01121	CB1015
A16R61	0683-2225	3			RESISTOR 2.2K 5% .25W FC TC#400/+700	01121	CB2225
A16R62	0757-0280	3			RESISTOR 1K 1% .125W F TC#0+100	24546	C4=1/8*TO=1001=F
A16R63	0683-1015	7			RESISTOR 100 5% .25W FC TC#400/+500	01121	CB1015
A16R64	0683-1015	7			RESISTOR 100 5% .25W FC TC#400/+500	01121	CB1015
A16R65	0683-4725	2			RESISTOR 4.7K 5% .25W FC TC#400/+700	01121	CB4725
A16R66	0683-1015	7			RESISTOR 100 5% .25W FC TC#400/+500	01121	CB1015
A16R67	0683-1015	7			RESISTOR 100 5% .25W FC TC#400/+500	01121	CB1015
A16R68	0757-0280	3			RESISTOR 1K 1% .125W F TC#0+100	24546	C4=1/8*TO=1001=F
A16R69	0698-3156	0			RESISTOR 23.7K 1% .125W F TC#0+100	24546	C4=1/8*TO=2372=F

See introduction to this section for ordering information
*Indicates factory selected value

Table 6-3. Replaceable Parts

Reference Designation	HP Part Number	C D	Qty	Description	Mfr Code	Mfr Part Number
A16U1	1826-0081	0	6	IC OP AMP WS TO-99	27014	L4318H
A16U2	1826-0547	3	2	IC OP AMP DUAL 8-DIP-P	01295	TL072ACP
A16U3	1826-0547	3		IC OP AMP DUAL 8-DIP-P	01295	TL072ACP
A16UR	1826-0081	0		IC OP AMP WS TO-99	27014	L4318H
A17	04191-66517	8	1	PHASE DETECTOR & A-D CONVERTER BD ASSY	28480	04191-66517
A17C1	0160-0134	1	2	CAPACITOR-FXD 220PF +/-5% 100VDC MICA	28480	0160-0134
A17C2	0160-1674	6	1		28480	0160-1674
A17C3	0180-1049	1			28480	0180-1049
A17C4	0180-1049	1			28480	0180-1049
A17C5	0160-0302	5	1	CAPACITOR-FXD .018UF +/-10% 200VDC POLYE	28480	0160-0302
A17C6	0180-0291	3		CAPACITOR-FXD 1UF+/-10% 35VDC TA	56289	150D105X9035A2
A17C7	0180-1083	3		CAPACITOR-FXD 33UF -10%+75% 25WVDC AL	28480	0180-1083
A17C8	0180-1083	3		CAPACITOR-FXD 33UF -10%+75% 25WVDC AL	28480	0180-1083
A17C9	0180-1083	3		CAPACITOR-FXD 33UF -10%+75% 25WVDC AL	28480	0180-1083
A17C10	0180-1083	3		CAPACITOR-FXD 33UF -10%+75% 25WVDC AL	28480	0180-1083
A17C11	0180-0291	3		CAPACITOR-FXD 1UF+/-10% 35VDC TA	56289	150D105X9035A2
A17C12	0121-0105	4	1	CAPACITOR-V TRMR=CER 9-35PF 200V PC-MTG	52743	304324 9/35PF N650
A17C13	0160-2218	6	2	CAPACITOR-FXD 1000PF +/-5% 300VDC MICA	28480	0160-2218
A17C14	0160-2009	3		CAPACITOR-FXD 520PF +/-5% 300VDC MICA	28480	0160-2009
A17C15	0180-1083	3		CAPACITOR-FXD 33UF -10%+75% 25WVDC AL	28480	0180-1083
A17C16	0180-1083	3		CAPACITOR-FXD 33UF -10%+75% 25WVDC AL	28480	0180-1083
A17C17	0180-1083	3		CAPACITOR-FXD 33UF -10%+75% 25WVDC AL	28480	0180-1083
A17C18	0180-1083	3		CAPACITOR-FXD 33UF -10%+75% 25WVDC AL	28480	0180-1083
A17C19	0180-1083	3		CAPACITOR-FXD 33UF -10%+75% 25WVDC AL	28480	0180-1083
A17C20	0180-1083	3		CAPACITOR-FXD 33UF -10%+75% 25WVDC AL	28480	0180-1083
A17C21	0150-0121	5		CAPACITOR-FXD .1UF +50-20% 50VDC CER	28480	0150-0121
A17C22	0180-1083	3		CAPACITOR-FXD 33UF -10%+75% 25WVDC AL	28480	0180-1083
A17C23	0180-1083	3		CAPACITOR-FXD 33UF -10%+75% 25WVDC AL	28480	0180-1083
A17C24	0180-1083	3		CAPACITOR-FXD 33UF -10%+75% 25WVDC AL	28480	0180-1083
A17C25	0180-1083	3		CAPACITOR-FXD 33UF -10%+75% 25WVDC AL	28480	0180-1083
A17C26	0180-1083	3		CAPACITOR-FXD 33UF -10%+75% 25WVDC AL	28480	0180-1083
A17C27	0180-1083	3		CAPACITOR-FXD 33UF -10%+75% 25WVDC AL	28480	0180-1083
A17C28	0180-1083	3		CAPACITOR-FXD 33UF -10%+75% 25WVDC AL	28480	0180-1083
A17C29	0180-1083	3		CAPACITOR-FXD 33UF -10%+75% 25WVDC AL	28480	0180-1083
A17C30	0180-0291	3		CAPACITOR-FXD 1UF+/-10% 35VDC TA	56289	150D105X9035A2
A17C31	0180-0291	3		CAPACITOR-FXD 1UF+/-10% 35VDC TA	56289	150D105X9035A2
A17C32	0180-0291	3		CAPACITOR-FXD 1UF+/-10% 35VDC TA	56289	150D105X9035A2
A17C33	0160-2218	6		CAPACITOR-FXD 1000PF +/-5% 300VDC MICA	28480	0160-2218
A17C34	0180-1083	3		CAPACITOR-FXD 33UF -10%+75% 25WVDC AL	28480	0180-1083
A17C35	0180-1083	3		CAPACITOR-FXD 33UF -10%+75% 25WVDC AL	28480	0180-1083
A17C36	0180-1083	3		CAPACITOR-FXD 33UF -10%+75% 25WVDC AL	28480	0180-1083
A17C37	0180-1083	3		CAPACITOR-FXD 33UF -10%+75% 25WVDC AL	28480	0180-1083
A17C38	0180-1083	3		CAPACITOR-FXD 33UF -10%+75% 25WVDC AL	28480	0180-1083
A17CR1	1901-0040	1		DIODE-SWITCHING 30V 50MA 2NS DO-35	28480	1901-0040
A17CR2	1901-0040	1		DIODE-SWITCHING 30V 50MA 2NS DO-35	28480	1901-0040
A17CR3	1901-0040	1		DIODE-SWITCHING 30V 50MA 2NS DO-35	28480	1901-0040
A17CR4	1901-0040	1		DIODE-SWITCHING 30V 50MA 2NS DO-35	28480	1901-0040
A17CR5	1901-0040	1		DIODE-SWITCHING 30V 50MA 2NS DO-35	28480	1901-0040
A17CR6	1901-0040	1		DIODE-SWITCHING 30V 50MA 2NS DO-35	28480	1901-0040
A17CR7	1902-3104	6		DIODE-ZNR 5.62V 5% DO-7 PDA=4n TC=+.016%	28480	1902-3104
A17WP1	4040-0749	8		PIN-GRV .062-IN DIA .25-IN LG STL	28480	4040-0749
A17WP2	4040-0749	4		EXTR-PC BD BRN POLYC .062=BD=THKNS	28480	4040-0749
A17WP3	4040-0755	2	1	EXTR-PC BD V10 POLYC .062=BD=THKNS	28480	4040-0755
A17B1	1855-0091	3		TRANSISTOR JFET N-CHAN D=MODE SI	28480	1855-0091
A17B2	1855-0091	3		TRANSISTOR JFET N-CHAN D=MODE SI	28480	1855-0091
A17B3	1853-0020	4		TRANSISTOR PNP SI PDB300MH FT=150MHZ	28480	1853-0020
A17B4	1853-0020	4		TRANSISTOR PNP SI PDB300MH FT=150MHZ	28480	1853-0020
A17B5	1853-0020	4		TRANSISTOR PNP SI PDB300MH FT=150MHZ	28480	1853-0020
A17B6	1853-0020	4		TRANSISTOR PNP SI PDB300MH FT=150MHZ	28480	1853-0020
A17B7	1855-0125	4	2	TRANSISTOR N-CHAN JFET SI	28480	1855-0125
A17B8	1855-0125	4		TRANSISTOR N-CHAN JFET SI	28480	1855-0125
A17B9	1853-0020	4		TRANSISTOR PNP SI PDB300MH FT=150MHZ	28480	1853-0020
A17B10	1855-0091	3		TRANSISTOR JFET N-CHAN D=MODE SI	28480	1855-0091
A17B11	1855-0091	3		TRANSISTOR JFET N-CHAN D=MODE SI	28480	1855-0091
A17R1	0683-4725	2		RESISTOR 4.7K 5% .25W FC TC=400/+700	01121	C84725
A17R2	0683-4725	2		RESISTOR 4.7K 5% .25W FC TC=400/+700	01121	C84725
A17R3	0683-1835	9	1	RESISTOR 18K 5% .25W FC TC=400/+600	01121	C81835
A17R4	0698-3226	7	1	RESISTOR 6.49K 1% .125W F TC=0/+100	24546	C8=1/8WTC=6491-F
A17R5	0683-1055	5		RESISTOR 1M 5% .25W FC TC=800/+900	01121	C81055
A17R6	2100-2516	0		RESISTOR-TRMR 100K 10% C SIDE=ADJ 1-TRN	28480	2100-2516
A17R7	0683-1015	7		RESISTOR 100 5% .25W FC TC=400/+500	01121	C81015
A17R8	0683-1015	7		RESISTOR 100 5% .25W FC TC=400/+500	01121	C81015
A17R9	0757-0442	9		RESISTOR 10K 1% .125W F TC=0/+100	24546	C8=1/8WTC=1002-F
A17R10	0757-0250	3		RESISTOR 1K 1% .125W F TC=0/+100	24546	C8=1/8WTC=1001-F

See introduction to this section for ordering information
*Indicates factory selected value

Table 6-3. Replaceable Parts

Reference Designation	HP Part Number	C D	Qty	Description	Mfr Code	Mfr Part Number
A17R11	0683-0280	3		RESISTOR 1K 1% .125W F TC=0+/-100	24546	C4-1/8-T0=1001-F
A17R12	0683-4725	2		RESISTOR 4.7K 5% .25W FC TC=400/+700	01121	CB4725
A17R13	0683-2235	5		RESISTOR 22K 5% .25W FC TC=400/+800	01121	CB2235
A17R14	0683-1035	1		RESISTOR 10K 5% .25W FC TC=400/+700	01121	CB1035
A17R15	0683-1035	1		RESISTOR 10K 5% .25W FC TC=400/+700	01121	CB1035
A17R16	0683-1015	7		RESISTOR 100 5% .25W FC TC=400/+500	01121	CB1015
A17R17	0683-1015	7		RESISTOR 100 5% .25W FC TC=400/+500	01121	CB1015
A17R18	0683-1015	7		RESISTOR 100 5% .25W FC TC=400/+500	01121	CB1015
A17R19	0683-1015	7		RESISTOR 100 5% .25W FC TC=400/+500	01121	CB1015
A17R20	0683-1015	7		RESISTOR 100 5% .25W FC TC=400/+500	01121	CB1015
A17R21	0683-1025	9		RESISTOR 1K 5% .25W FC TC=400/+600	01121	CB1025
A17R22	0683-1045	3		RESISTOR 100K 5% .25W FC TC=400/+800	01121	CB1045
A17R23	0683-1015	7		RESISTOR 100 5% .25W FC TC=400/+500	01121	CB1015
A17R24	0683-1015	7		RESISTOR 100 5% .25W FC TC=400/+500	01121	CB1015
A17R25	0683-1025	9		RESISTOR 1K 5% .25W FC TC=400/+600	01121	CB1025
A17R26	0696-3156	2		RESISTOR 14.7K 1% .125W F TC=0+/-100	24546	C4-1/8-T0=1472-F
A17R27	0683-1015	7		RESISTOR 100 5% .25W FC TC=400/+500	01121	CB1015
A17R28	0683-1015	7		RESISTOR 100 5% .25W FC TC=400/+500	01121	CB1015
A17R29	0757-0280	3		RESISTOR 1K 1% .125W F TC=0+/-100	24546	C4-1/8-T0=1001-F
A17R30	0683-1025	9		RESISTOR 1K 5% .25W FC TC=400/+600	01121	CB1025
A17R31	0683-4715	0		RESISTOR 470 5% .25W FC TC=400/+600	01121	CB4715
A17R32	0683-2225	3		RESISTOR 2.2K 5% .25W FC TC=400/+700	01121	CB2225
A17R33	0683-2225	3		RESISTOR 2.2K 5% .25W FC TC=400/+700	01121	CB2225
A17R34	0683-2225	3		RESISTOR 2.2K 5% .25W FC TC=400/+700	01121	CB2225
A17R35	0683-2225	3		RESISTOR 2.2K 5% .25W FC TC=400/+700	01121	CB2225
A17R36	0683-6825	7	3	RESISTOR 6.8K 5% .25W FC TC=400/+700	01121	CB6825
A17R37	0683-1035	1		RESISTOR 10K 5% .25W FC TC=400/+700	01121	CB1035
A17R38	0683-1035	1		RESISTOR 10K 5% .25W FC TC=400/+700	01121	CB1035
A17R39	0683-1035	1		RESISTOR 10K 5% .25W FC TC=400/+700	01121	CB1035
A17R40	0683-1035	1		RESISTOR 10K 5% .25W FC TC=400/+700	01121	CB1035
A17R41	0683-1035	1		RESISTOR 10K 5% .25W FC TC=400/+700	01121	CB1035
A17R42	0683-3925	2	3	RESISTOR 3.9K 5% .25W FC TC=400/+700	01121	CB3925
A17R43	0683-1525	4		RESISTOR 1.5K 5% .25W FC TC=400/+700	01121	CB1525
A17R44	0696-3156	2		RESISTOR 14.7K 1% .125W F TC=0+/-100	24546	C4-1/8-T0=1472-F
A17R45	0696-3156	2		RESISTOR 14.7K 1% .125W F TC=0+/-100	24546	C4-1/8-T0=1472-F
A17R46	0683-1015	7		RESISTOR 100 5% .25W FC TC=400/+500	01121	CB1015
A17R47	0683-1015	7		RESISTOR 100 5% .25W FC TC=400/+500	01121	CB1015
A17R48	0696-0084	9	4	RESISTOR 2.15K 1% .125W F TC=0+/-100	24546	C4-1/8-T0=2151-F
A17R49	0696-0084	9		RESISTOR 2.15K 1% .125W F TC=0+/-100	24546	C4-1/8-T0=2151-F
A17R50	0696-0084	9		RESISTOR 2.15K 1% .125W F TC=0+/-100	24546	C4-1/8-T0=2151-F
A17R51	0696-0084	9		RESISTOR 2.15K 1% .125W F TC=0+/-100	24546	C4-1/8-T0=2151-F
A17R52	0683-1015	7		RESISTOR 100 5% .25W FC TC=400/+500	01121	CB1015
A17R53	0683-1015	7		RESISTOR 100 5% .25W FC TC=400/+500	01121	CB1015
A17R54	0757-0290	5		RESISTOR 6.19K 1% .125W F TC=0+/-100	19701	MF4C1/8-T0=6191-F
A17R55	0683-1035	1		RESISTOR 10K 5% .25W FC TC=400/+700	01121	CB1035
A17R56	0757-0290	5		RESISTOR 6.19K 1% .125W F TC=0+/-100	19701	MF4C1/8-T0=6191-F
A17R57	0757-0306	2		RESISTOR 10 1% .125W F TC=0+/-100	24546	C4-1/8-T0=10R0-F
A17T1	9100-0855	6	4	TRANSFORMER-PULSE	28480	9100-0855
A17T2	9100-0855	6		TRANSFORMER-PULSE	28480	9100-0855
A17T3	9100-0855	6		TRANSFORMER-PULSE	28480	9100-0855
A17U1	1A26-0210	7		IC COMPARATOR HS 14-DIP-P	27014	LM361N
A17U2	1A26-0319	7		IC OP AMP T0=99	27014	LF356N
A17U3	1A26-0081	0		IC OP AMP HS T0=99	27014	LM318N
A17U4	1A26-0319	7		IC OP AMP T0=99	27014	LF356N
A17U5	1A26-0081	0		IC OP AMP HS T0=99	27014	LM318N
A17U6	1A26-0174	2	2	IC COMPARATOR GP QUAD 14-DIP-P	28480	1A26-0174
A17U7	1A20-1730	0	1	IC FF TTL LS D-TYPE POS-EDGE-TRIG CDM	01295	SN74LS273N
A17U8	1A20-1433	6		IC SHIF-REGTR TTL LS R-S SERIAL-IN PAR-OUT	01295	SN74LS164N
A17U9	1A20-1199	1		IC INV TTL LS HEX 1-INP	01295	SN74LS04N
A17U10	1A26-0174	2		IC COMPARATOR GP QUAD 14-DIP-P	28480	1A26-0174
A17U11	1A26-0081	0		IC OP AMP HS T0=99	27014	LM318N
A17U12	1A26-0210	7		IC COMPARATOR HS 14-DIP-P	27014	LM361N
A17U13	1A26-1244	7	1	IC MUXR/DATA-BEL TTL LS 4-T0=1-LINE DUAL	01295	SN74LS153N
A17U14	1A26-0222	1	1	IC OP AMP GP QUAD 14-DIP-P	07263	UA4136PC
A17U15	1A26-0081	0		IC OP AMP HS T0=99	27014	LM318N
A1B	04191-6651R	7	1	100MHZ CLOCK GENERATOR & DOUBLER 80 ASBY	28080	04191-6651R
A1C1	0160-2055	9		CAPACITOR-FXD .01UF +80-20% 100VDC CER	28480	0160-2055
A1C2	0160-3466	0	2	CAPACITOR-FXD 100PF +50% 1KVDC CER	28480	0160-3466
A1C3	0121-0430	8		CAPACITOR-V TRMR-CER 1.8-8.8PF 350V		
A1C4	0160-2055	9		CAPACITOR-FXD .01UF +80-20% 100VDC CER	28480	0160-2055
A1C5	0160-2055	9		CAPACITOR-FXD .01UF +80-20% 100VDC CER	28480	0160-2055
A1C6	0160-2055	9		CAPACITOR-FXD .01UF +80-20% 100VDC CER	28480	0160-2055
A1C7	0160-2055	9		CAPACITOR-FXD .01UF +80-20% 100VDC CER	28480	0160-2055
A1C8	0160-2261	8	1	CAPACITOR-FXD 15PF +5% 500VDC CER	28480	
A1C9	0140-0199	6		CAPACITOR-FXD 200PF +5% 300VDC MICA	72130	0M19P241J0300+V1CR
A1C10	0160-2055	9		CAPACITOR-FXD .01UF +80-20% 100VDC CER	28480	0160-2055

See introduction to this section for ordering information
*Indicates factory selected value

Table 6-3. Replaceable Parts

Reference Designation	HP Part Number	C D	Qty	Description	Mfr Code	Mfr Part Number
A18C11	0160-3466	8		CAPACITOR-FXD 100PF +/-10% 1KVDC CER	28480	0160-3466
A18C12	0160-2055	9		CAPACITOR-FXD .01UF +80-20% 100VDC CER	28480	0160-2055
A18C13	0160-2055	9		CAPACITOR-FXD .01UF +80-20% 100VDC CER	28480	0160-2055
A18C14	0160-2055	9		CAPACITOR-FXD .01UF +80-20% 100VDC CER	28480	0160-2055
A18C15	0160-2237	9	2	CAPACITOR-FXD 1,2PF +/-25PF 500VDC CER	28480	0160-2237
A18C16	0160-2055	9		CAPACITOR-FXD .01UF +80-20% 100VDC CER	28480	0160-2055
A18C17	0160-2055	9		CAPACITOR-FXD .01UF +80-20% 100VDC CER	28480	0160-2055
A18C18	0160-3456	6		CAPACITOR-FXD 1000PF +/-10% 1KVDC CER	28480	0160-3456
A18C19	0160-2241	8		CAPACITOR-FXD 2,2PF +/-25PF	28480	
A18C20	0160-4387	4	2	CAPACITOR-FXD 47PF +/-5% 200VDC CER 0+-30	28480	0160-4387
A18C21	0160-4386	3	2	CAPACITOR-FXD 33PF +/-5% 200VDC CER 0+-30	51642	200-200-NP0-330J
A18C22	0160-2241	8		CAPACITOR-FXD 2,2PF +/-25PF	28480	
A18C23	0160-4387	4		CAPACITOR-FXD 47PF +/-5% 200VDC CER 0+-30	28480	0160-4387
A18C24	0160-4386	3		CAPACITOR-FXD 33PF +/-5% 200VDC CER 0+-30	51642	200-200-NP0-330J
A18C25	0160-2241	8		CAPACITOR-FXD 2,2PF +/-25PF	28480	
A18C26	0160-2237	9		CAPACITOR-FXD 1,2PF +/-25PF 500VDC CER	28480	0160-2237
A18C27	0160-3456	6		CAPACITOR-FXD 1000PF +/-10% 1KVDC CER	28480	0160-3456
A18C28	0160-2055	9		CAPACITOR-FXD .01UF +80-20% 100VDC CER	28480	0160-2055
A18C29	0160-3456	6		CAPACITOR-FXD 1000PF +/-10% 1KVDC CER	28480	0160-3456
A18C30	0160-2055	9		CAPACITOR-FXD .01UF +80-20% 100VDC CER	28480	0160-2055
A18C31	0160-2055	9		CAPACITOR-FXD .01UF +80-20% 100VDC CER	28480	0160-2055
A18C32	0160-2055	9		CAPACITOR-FXD .01UF +80-20% 100VDC CER	28480	0160-2055
A18C33	0160-2055	9		CAPACITOR-FXD .01UF +80-20% 100VDC CER	28480	0160-2055
A18C34	0160-3456	6		CAPACITOR-FXD 1000PF +/-10% 1KVDC CER	28480	0160-3456
A18C35	0160-1083	5		CAPACITOR-FXD 33UF -10%/75% 250VDC AL	28480	0160-1083
A18C36	0121-0432			CAPACITOR-TRIM 2.1-13.3PF		
A18C37	1961-0040	1		DIODE-SWITCHING 30V 50MA 2NB PD=35	28480	1961-0040
A18L1	9140-0158	6		COIL-MLD 1UH 10% Q#32 .095DX.25LG-NOM	28480	9140-0158
A18L2	9140-0158	6		COIL-MLD 1UH 10% Q#32 .095DX.25LG-NOM	28480	9140-0158
A18L3	9100-2249	6		COIL-MLD 150NH 10% Q#34 .095DX.25LG-NOM	28480	9100-2249
A18L5	9140-0158	6		COIL-MLD 1UH 10% Q#32 .095DX.25LG-NOM	28480	9140-0158
A18L6	9140-0158	6		COIL-MLD 1UH 10% Q#32 .095DX.25LG-NOM	28480	9140-0158
A18L7	9100-2247	4		COIL-MLD 100NH 10% Q#34 .095DX.25LG-NOM	28480	9100-2247
A18L8	9100-2247	4		COIL-MLD 100NH 10% Q#34 .095DX.25LG-NOM	28480	9100-2247
A18L9	9100-2251	6	3	INDUCTOR-FXD 220NH +/-10% RF CHOKE-MOLDED	28480	
A18L10	9100-2251	6		INDUCTOR-FXD 220NH +/-10% RF CHOKE-MOLDED	28480	
A18L11	9100-2251	6		INDUCTOR-FXD 220NH +/-10% RF CHOKE-MOLDED	28480	
A18L12	9100-2247	4		COIL-MLD 100NH 10% Q#34 .095DX.25LG-NOM	28480	9100-2247
A18L13	9100-2247	4		COIL-MLD 100NH 10% Q#34 .095DX.25LG-NOM	28480	9100-2247
A18L14	9140-0158	6		COIL-MLD 1UH 10% Q#32 .095DX.25LG-NOM	28480	9140-0158
A18L15	9140-0158	6		COIL-MLD 1UH 10% Q#32 .095DX.25LG-NOM	28480	9140-0158
A18L16	9140-0158	6		COIL-MLD 1UH 10% Q#32 .095DX.25LG-NOM	28480	9140-0158
A18L17	9100-1788	6		CHDKE-WIDE BAND ZMAX=680 OHMS 180 MHZ	02114	VK200 20/48
A18MP1	2190-0124	4		WASHER-MLN INTL Y NO. 10 .195-IN-ID	28480	Z190-0124
A18MP2	2300-0115	4		SCREW-MACH #x32 .312-IN-LEN PAN-HEAD-POZI	00000	ORDER BY DESCRIPTION
A18MP3	2950-0078	9		NUT-HEX-OBL-CHAN 10-32-THD .067-IN-TMK	28480	2950-0078
A18MP4	5001-0173	7			28480	5001-0173
A18MP5	04191-60003	3	1	COVER	28480	04191-60003
A18P1	1250-1220	0		CONNECTOR-RF SMC M PC 50-OHM	28480	1250-1220
A18P2	1250-1220	0		CONNECTOR-RF SMC M PC 50-OHM	28480	1250-1220
A18Q1	1854-0345	8		TRANSISTOR NPN 2N5179 SI TO-72 PD=200MH	04713	2N5179
A18Q2	1854-0345	8		TRANSISTOR NPN 2N5179 SI TO-72 PD=200MH	04713	2N5179
A18Q3	1854-0345	8		TRANSISTOR NPN 2N5179 SI TO-72 PD=200MH	04713	2N5179
A18Q4	1854-0345	8		TRANSISTOR NPN 2N5179 SI TO-72 PD=200MH	04713	2N5179
A18Q5	1854-0071	7		TRANSISTOR NPN SI PD=300MH FT=200MHZ	28480	1854-0071
A18Q6	1854-0071	7		TRANSISTOR NPN SI PD=300MH FT=200MHZ	28480	1854-0071
A18R1	0683-2715	6	2	RESISTOR 270 5% .25W FC TC=400/+600	01121	C82715
A18R2	0683-1805	3	1	RESISTOR 18 5% .25W FC TC=400/+500	01121	C81805
A18R3	0683-2715	6		RESISTOR 270 5% .25W FC TC=400/+600	01121	C82715
A18R4	0683-1015	7		RESISTOR 100 5% .25W FC TC=400/+500	01121	C81015
A18R5	0683-1015	7		RESISTOR 100 5% .25W FC TC=400/+500	01121	C81015
A18R6	0683-5615	1		RESISTOR 560 5% .25W FC TC=400/+600	01121	C85615
A18R7	0683-3325	0		RESISTOR 3.3K 5% .25W FC TC=400/+700	01121	C83325
A18R8	0683-1525	4		RESISTOR 1.5K 5% .25W FC TC=400/+700	01121	C81525
A18R9	0757-0417	8		RESISTOR 562 1% .125W F TC=0/+100	24546	C4-1/8-T0-562R-F
A18R10	0683-5625	1		RESISTOR-FXD 5.6K +/-5% .25W 250VDC CARBON	01121	
A18R11	0683-5615	1		RESISTOR 560 5% .25W FC TC=400/+600	01121	C85615
A18R12	0683-3325	1		RESISTOR 3.3K 5% .25W FC TC=400/+700	01121	C83325
A18R13	0757-0417	1		RESISTOR-FXD 562 --1% .125W	01121	
A18R14	0683-3315	4		RESISTOR 330 5% .25W FC TC=400/+600	01121	C83315
A18R15	0683-1505	0	1	RESISTOR 15 5% .25W FC TC=400/+500	01121	C81505
A18R16	0683-3315	4		RESISTOR 330 5% .25W FC TC=400/+600	01121	C83315
A18R17	0683-1225	1		RESISTOR 1.2K 5% .25W FC TC=400/+700	01121	C81225
A18R18	0683-0805	3		RESISTOR 80 5% .25W FC TC=400/+500	01121	C80805
A18R19	0683-3925	2		RESISTOR 3.9K 5% .25W FC TC=400/+700	01121	C83925
A18R20	0683-1225	1		RESISTOR 1.2K 5% .25W FC TC=400/+700	01121	C81225

See introduction to this section for ordering information
*Indicates factory selected value

Table 6-3. Replaceable Parts

Reference Designation	HP Part Number	C D	Qty	Description	Mfr Code	Mfr Part Number
A18R21	0683-5605	9		RESISTOR 56 5% .25W FC TCM=400/+500	01121	C85605
A18R22	0683-1525	4		RESISTOR 1.5K 5% .25W FC TCM=400/+700	01121	C81525
A18R23	0683-1015	7		RESISTOR 100 5% .25W FC TCM=400/+500	01121	C81015
A18R24	0683-5605	9		RESISTOR 56 5% .25W FC TCM=400/+500	01121	C85605
A18R25	0683-6805	3		RESISTOR 68 5% .25W FC TCM=400/+500	01121	C86805
A18R26	0683-3925	2		RESISTOR 3.9K 5% .25W FC TCM=400/+700	01121	C83925
A18R27	0683-3325	0		RESISTOR 3.3K 5% .25W FC TCM=400/+700	01121	C83325
A18R28	0683-1035	1		RESISTOR 10K 5% .25W FC TCM=400/+700	01121	C81035
A18R29	0683-5635	1		RESISTOR-FXD 56K +5% .25W 250VDC FTLM	01121	C81035
A18U1	1820-0804	8	1	IC MCMV ECL LINE RCVR QUAD 2-INP	04713	MC10115P
A18Y1	0410-0773	7	1	CRYSTAL-QUARTZ 100MHZ	28480	0410-0773
	8159-0005	0	1	WIRE 22AWG W PVC 1X22 80C	28480	8159-0005
A19				NOT ASSIGNED		
A20	04191-66520		1	MICROPROCESSOR DIGITAL CONTROL BD ASS'Y	28480	04191-66520
A21	04191-66521	1	1	MICROPROCESSOR DIGITAL CONTROL BD ASS'Y	28480	04191-66521
A20C1	0160-2055	9		CAPACITOR-FXD .01UF +80-20% 100VDC CER	28480	0160-2055
A20C2	0160-2055	9		CAPACITOR-FXD .01UF +80-20% 100VDC CER	28480	0160-2055
A20C3	0160-2055	9		CAPACITOR-FXD .01UF +80-20% 100VDC CER	28480	0160-2055
A20C4	0160-2055	9		CAPACITOR-FXD .01UF +80-20% 100VDC CER	28480	0160-2055
A20C5	0160-2055	9		CAPACITOR-FXD .01UF +80-20% 100VDC CER	28480	0160-2055
A20C6	0160-2055	9		CAPACITOR-FXD .01UF +80-20% 100VDC CER	28480	0160-2055
A20C7	0160-2055	9		CAPACITOR-FXD .01UF +80-20% 100VDC CER	28480	0160-2055
A20C8	0160-2055	9		CAPACITOR-FXD .01UF +80-20% 100VDC CER	28480	0160-2055
A20C9	0160-2055	9		CAPACITOR-FXD .01UF +80-20% 100VDC CER	28480	0160-2055
A20C10	0160-2055	9		CAPACITOR-FXD .01UF +80-20% 100VDC CER	28480	0160-2055
A20C11	0160-2055	9		CAPACITOR-FXD .01UF +80-20% 100VDC CER	28480	0160-2055
A20C13	0160-1083	3		CAPACITOR-FXD 33uF -10%+75% 25WVDC AL	28480	0160-1083
A20C14	0160-1083	3		CAPACITOR-FXD 33uF -10%+75% 25WVDC AL	28480	0160-1083
A20C15	0160-2055	9		CAPACITOR-FXD .01UF +80-20% 100VDC CER	28480	0160-2055
A20C16	0160-2055	9		CAPACITOR-FXD .01UF +80-20% 100VDC CER	28480	0160-2055
A20C18	0140-0199	6		CAPACITOR-FXD 240PF +5% 300VDC MICA	72136	DM15F241J0300V1CR
A20C19	0140-0199	6		CAPACITOR-FXD 240PF +5% 300VDC MICA	72136	DM15F241J0300V1CR
A20C21	0160-2055	9		CAPACITOR-FXD .01UF +80-20% 100VDC CER	28480	0160-2055
A20C22	0160-2055	9		CAPACITOR-FXD .01UF +80-20% 100VDC CER	28480	0160-2055
A20C23	0160-2055	9		CAPACITOR-FXD .01UF +80-20% 100VDC CER	28480	0160-2055
A20C24	0160-2055	9		CAPACITOR-FXD .01UF +80-20% 100VDC CER	28480	0160-2055
A20C25	0160-2055	9		CAPACITOR-FXD .01UF +80-20% 100VDC CER	28480	0160-2055
A20C26	0160-2055	9		CAPACITOR-FXD .01UF +80-20% 100VDC CER	28480	0160-2055
A20C27	0160-2055	9		CAPACITOR-FXD .01UF +80-20% 100VDC CER	28480	0160-2055
A20C28	0160-2055	9		CAPACITOR-FXD .01UF +80-20% 100VDC CER	28480	0160-2055
A20C29	0160-2055	9		CAPACITOR-FXD .01UF +80-20% 100VDC CER	28480	0160-2055
A20C30	0160-2055	9		CAPACITOR-FXD .01UF +80-20% 100VDC CER	28480	0160-2055
A20C31	0160-2055	9		CAPACITOR-FXD .01UF +80-20% 100VDC CER	28480	0160-2055
A20C32	0160-2055	9		CAPACITOR-FXD .01UF +80-20% 100VDC CER	28480	0160-2055
A20C33	0160-2055	9		CAPACITOR-FXD .01UF +80-20% 100VDC CER	28480	0160-2055
A20C34	0140-0200	0		CAPACITOR-FXD 390PF +5% 300VDC MICA	72136	DM15F391J0300V1CR
A20C35	0160-1083	3		CAPACITOR-FXD 33uF -10%+75% 25WVDC AL	28480	0160-1083
A20C36	0160-1083	3		CAPACITOR-FXD 33uF -10%+75% 25WVDC AL	28480	0160-1083
A20C37	0160-2055	9		CAPACITOR-FXD .01UF +80-20% 100VDC CER	28480	0160-2055
A20C38	0160-2055	9		CAPACITOR-FXD .01UF +80-20% 100VDC CER	28480	0160-2055
A20C39	0160-2055	9		CAPACITOR-FXD .01UF +80-20% 100VDC CER	28480	0160-2055
A20C40	0160-2055	9		CAPACITOR-FXD .01UF +80-20% 100VDC CER	28480	0160-2055
A20C41	0160-2055	9		CAPACITOR-FXD .01UF +80-20% 100VDC CER	28480	0160-2055
A20C42	0160-2055	9		CAPACITOR-FXD .01UF +80-20% 100VDC CER	28480	0160-2055
A20C43	0160-0228	6	1	CAPACITOR-FXD 22UF+10% 15VDC TA	56249	150C226X901582
A20C44	0160-0127	2		CAPACITOR-FXD 1UF +20% 25VDC CER	28480	0160-0127
A20C45	0160-2150	5	2	CAPACITOR-FXD 33PF +5% 300VDC MICA	28480	0160-2150
A20C46	0140-0192	9	2	CAPACITOR-FXD 68PF +5% 300VDC MICA	72136	DM15F68J0300V1CR
A20C47	0160-2055	9		CAPACITOR-FXD .01UF +80-20% 100VDC CER	28480	0160-2055
A20C48	0160-2055	9		CAPACITOR-FXD .01UF +80-20% 100VDC CER	28480	0160-2055
A20C49	0160-2055	9		CAPACITOR-FXD .01UF +80-20% 100VDC CER	28480	0160-2055
A20C50	0160-2055	9		CAPACITOR-FXD .01UF +80-20% 100VDC CER	28480	0160-2055
A20C51	0160-2055	9		CAPACITOR-FXD .01UF +80-20% 100VDC CER	28480	0160-2055
A20C52	0160-2055	9		CAPACITOR-FXD .01UF +80-20% 100VDC CER	28480	0160-2055
A20C53	0160-0127	2		CAPACITOR-FXD 1UF +20% 25VDC CER	28480	0160-0127
A20C54	0160-2150	5		CAPACITOR-FXD 33PF +5% 300VDC MICA	28480	0160-2150
A20C55	0140-0192	9		CAPACITOR-FXD 68PF +5% 300VDC MICA	72136	DM15F68J0300V1CR
A20C56	0160-2055	9		CAPACITOR-FXD .01UF +80-20% 100VDC CER	28480	0160-2055
A20C57	0160-2201	7		CAPACITOR-FXD 51PF +5% 300VDC MICA	28480	0160-2201
A20C58	0121-0046	2	1	CAPACITOR-V TRMRCER 9-35PF 200V PC=HTD	98763	304322 9/35PF N690

See introduction to this section for ordering information
*Indicates factory selected value

Table 6-3. Replaceable Parts

Reference Designation	HP Part Number	C D	Qty	Description	Mfr Code	Mfr Part Number
A20C59	0160-2055	9		CAPACITOR-FXD .01UF +80-20% 100VDC CER	28480	0160-2055
A20C60	0160-2055	9		CAPACITOR-FXD .01UF +80-20% 100VDC CER	28480	0160-2055
A20C61	0160-2055	9		CAPACITOR-FXD .01UF +80-20% 100VDC CER	28480	0160-2055
A20C62	0160-2055	9		CAPACITOR-FXD .01UF +80-20% 100VDC CER	28480	0160-2055
A20C63	0160-2055	9		CAPACITOR-FXD .01UF +80-20% 100VDC CER	28480	0160-2055
A20C64	0180-1061	3	1	CAPACITOR-FXD 150PF +-5% 300VDC MICA	72138	0M15F151J0300MV1CH
A20C65	0180-1061	3		CAPACITOR-FXD 33uF -10%+75% 25WVDC AL	28480	0180-1061
A20C66	0160-2055	9		CAPACITOR-FXD .01UF +80-20% 100VDC CER	28480	0160-2055
A20C67	0160-2055	9		CAPACITOR-FXD .01UF +80-20% 100VDC CER	28480	0160-2055
A20C68	0160-2055	9		CAPACITOR-FXD .01UF +80-20% 100VDC CER	28480	0160-2055
A20C69	0180-1061	7		CAPACITOR-FXD 220uF 20% 16WVDC ALM	28480	0180-1061
A20C70	0180-1061	7		CAPACITOR-FXD 220uF 20% 16WVDC ALM	28480	0180-1061
A20C71	0180-0094	4		CAPACITOR-FXD 100UF+75-10% 25VDC AL	96289	10D1070025002
A20C72	0180-0094	4		CAPACITOR-FXD 100UF+75-10% 25VDC AL	96289	30D1070025002
A20CR1	1901-0040	1		DIODE-SWITCHING 30V 50MA 2N8 00-35	28480	1901-0040
A20CR2	1901-0040	1		DIODE-SWITCHING 30V 50MA 2N8 00-35	28480	1901-0040
A20CR3	1901-0040	1		DIODE-SWITCHING 30V 50MA 2N8 00-35	28480	1901-0040
A20CR4	1901-0040	1		DIODE-SWITCHING 30V 50MA 2N8 00-35	28480	1901-0040
A20CR5	1901-0040	1		DIODE-SWITCHING 30V 50MA 2N8 00-35	28480	1901-0040
A20DB1	1990-0046	6	43	LED-VISIBLE LUM-INTW1MCO IF=20MA=MAX	28480	5052-0680
A20J1	1200-0830	1	11	SOCKET-IC 24-CONT DIP DIP-SOLDER	28480	1200-0830
A20J2	1200-0830	1		SOCKET-IC 24-CONT DIP DIP-SOLDER	28480	1200-0830
A20J3	1200-0830	1		SOCKET-IC 24-CONT DIP DIP-SOLDER	28480	1200-0830
A20J4	1200-0830	1		SOCKET-IC 24-CONT DIP DIP-SOLDER	28480	1200-0830
A20J5	1200-0830	1		SOCKET-IC 24-CONT DIP DIP-SOLDER	28480	1200-0830
A20J6	1200-0830	1		SOCKET-IC 24-CONT DIP DIP-SOLDER	28480	1200-0830
A20J7	1200-0830	1		SOCKET-IC 24-CONT DIP DIP-SOLDER	28480	1200-0830
A20J8	1200-0830	1		SOCKET-IC 24-CONT DIP DIP-SOLDER	28480	1200-0830
A20J9	1200-0830	1		SOCKET-IC 24-CONT DIP DIP-SOLDER	28480	1200-0830
A20J10	1200-0830	1		SOCKET-IC 24-CONT DIP DIP-SOLDER	28480	1200-0830
A20J11	1200-0830	1		SOCKET-IC 24-CONT DIP DIP-SOLDER	28480	1200-0830
A20J12	1251-3646	4	1	CONNECTOR 5-PIN M POST TYPE	28480	1251-3646
A20J17	1200-0654	1	1	SOCKET INTEGRATED CIRCUIT 40CONTACTS	28480	1200-0654
A20J18	1200-0639	8	1	SOCKET-IC 20-CONT DIP-SOLDER	28480	1200-0639
A20J20	1251-0541	8	1	CONNECTOR 34-PIN M RECTANGULAR	28480	1251-0541
A20J21	1251-3141	0	1	CONNECTOR 50-PIN M RECTANGULAR	28480	1251-3141
A20J22	1200-0607	0	1	SOCKET-IC 16-CONT DIP-SOLDER	28480	1200-0607
A20J23	1251-4959	0	1	CONNECTOR 2-PIN M POST TYPE	28480	1251-4959
A20L1	9140-0401	2	1	COIL 60UH	28480	9140-0401
A20L2	9100-1629	4		COIL-MLO 47UH 5% 0455 .155DX.375LG=NOM	28480	9100-1629
A20R2	1810-0269	3		NETWORK-RES 9-SIP10.0K OHM X B	28480	1810-0269
A20R3	1810-0269	3		NETWORK-RES 9-SIP10.0K OHM X B	28480	1810-0269
A20R4	0883-4735	4	2	RESISTOR 47K 5% .25W FC TC=400/+800	01121	C84735
A20R5	0883-4735	4		RESISTOR 47K 5% .25W FC TC=400/+800	01121	C84735
A20R7	1810-0269	3		NETWORK-RES 9-SIP10.0K OHM X B	28480	1810-0269
A20R8	1810-0269	3		NETWORK-RES 9-SIP10.0K OHM X B	28480	1810-0269
A20R9	0883-1015	7		RESISTOR 100 5% .25W FC TC=400/+500	01121	C81015
A20R10	0883-5615	1		RESISTOR 560 5% .25W FC TC=400/+500	01121	C85615
A20R11	0883-6215	3		RESISTOR 620 5% .25W FC TC=400/+500	01121	C86215
A20R12	0883-1045	3		RESISTOR 100K 5% .25W FC TC=400/+500	01121	C81045
A20R13	1810-0269	3		NETWORK-RES 9-SIP10.0K OHM X B	28480	1810-0269
A20R14	1810-0269	3		NETWORK-RES 9-SIP10.0K OHM X B	28480	1810-0269
A20R15	0883-1045	5		RESISTOR 10 5% .25W FC TC=400/+500	01121	C81045
A20R16	0883-2205	9	2	RESISTOR 22 5% .25W FC TC=400/+500	01121	C82205
A20R17	0883-1025	9		RESISTOR 1K 5% .25W FC TC=400/+500	01121	C81025
A20R18	0883-4725	2		RESISTOR 4.7K 5% .25W FC TC=400/+700	01121	C84725
A20R19	0883-1035	1		RESISTOR 10K 5% .25W FC TC=400/+700	01121	C81035
A20R20	1810-0269	3		NETWORK-RES 9-SIP10.0K OHM X B	28480	1810-0269
A20R21	0883-1015	7		RESISTOR 100 5% .25W FC TC=400/+500	01121	C81015
A20R22	0883-1015	7		RESISTOR 100 5% .25W FC TC=400/+500	01121	C81015
A20R23	0883-1005	5		RESISTOR 10 5% .25W FC TC=400/+500	01121	C81005
A20R24	0883-2205	9		RESISTOR 22 5% .25W FC TC=400/+500	01121	C82205
A20R25	0883-1025	9		RESISTOR 1K 5% .25W FC TC=400/+500	01121	C81025
A20R26	0883-4725	2		RESISTOR 4.7K 5% .25W FC TC=400/+700	01121	C84725
A20R27	0883-1035	1		RESISTOR 10K 5% .25W FC TC=400/+700	01121	C81035
A20R28	0883-3915	0		RESISTOR 390 5% .25W FC TC=400/+500	01121	C83915
A20R29	1810-0269	3		NETWORK-RES 9-SIP10.0K OHM X B	28480	1810-0269
A20R30	1810-0269	3		NETWORK-RES 9-SIP10.0K OHM X B	28480	1810-0269
A20R31	0883-5605	9		RESISTOR 56 5% .25W FC TC=400/+500	01121	C85605
A20R32	0883-1035	1		RESISTOR 10K 5% .25W FC TC=400/+700	01121	C81035
A20R33	0883-5605	9		RESISTOR 56 5% .25W FC TC=400/+500	01121	C85605
A20R34	1810-0269	3		NETWORK-RES 9-SIP10.0K OHM X B	28480	1810-0269
A20R35	0883-1015	7		RESISTOR 100 5% .25W FC TC=400/+500	01121	C81015
A20R36	0883-5615	1		RESISTOR 560 5% .25W FC TC=400/+500	01121	C85615
A20R37	0883-1035	1		RESISTOR 10K 5% .25W FC TC=400/+700	01121	C81035

See introduction to this section for ordering information
*Indicates factory selected value

Table 6-3. Replaceable Parts

Reference Designation	HP Part Number	C D	Qty	Description	Mfr Code	Mfr Part Number
A20R36	0483-3325	6		RESISTOR 3.3K 5% .25W FC TC=+200/+700	01121	CB3325
A20S1	3101-1273	0	1	SWITCH=8L UPDT SUBMIN 2A 120VAC PC	28480	3101-1273
A20S2	3101-1856	5	3	SWITCH=8L 8-1A DIP=8LIDE=ASSY .1A 50VDC	28480	3101-1856
A20S3	3101-1856	5		SWITCH=8L 8-1A DIP=8LIDE=ASSY .1A 50VDC	28480	3101-1856
A20S4	3101-1856	5		SWITCH=8L 8-1A DIP=8LIDE=ASSY .1A 50VDC	28480	3101-1856
A20U1	04191-85001	3	1	IC PROM=PROGRAMMED	28480	04191-85001
A20U2	04191-85002	4	1	IC PROM=PROGRAMMED	28480	04191-85002
A20U3	04191-85003	5	1	IC PROM=PROGRAMMED	28480	04191-85003
A20U4	04191-85004	6	1	IC PROM=PROGRAMMED	28480	04191-85004
A20U5	04191-85005	7	1	IC PROM=PROGRAMMED	28480	04191-85005
A20U6	04191-85006	8	1	IC PROM=PROGRAMMED	28480	04191-85006
A20U7	04191-85007	9	1	IC PROM=PROGRAMMED	28480	04191-85007
A20U8	04191-85008	0	1	IC PROM=PROGRAMMED	28480	04191-85008
A20U9	04191-85009	1	1	IC PROM=PROGRAMMED	28480	04191-85009
A20U9	1820-1199	1	1	IC INV TTL LS HEX 1=INP	01295	8N74LS04N
A20U13	1820-0661	0	1	IC GATE TTL OR QUAD 2=INP	01295	8N7432N
A20U15	1818-1350	1	4	IC M58981S-30	28480	
A20U16	1818-1350	1	1	IC M58981S-30	28480	
A20U17	1820-1216	3	7	IC ODDR TTL LS 3=TO=8=LINE 3=INP	01295	8N74LS138N
A20U18	1820-1216	5		IC ODDR TTL LS 3=TO=8=LINE 3=INP	01295	8N74LS138N
A20U20	1820-1201	6	5	IC GATE TTL LS AND QUAD 2=INP	01295	8N74LS08N
A20U21	1820-1112	8		IC FF TTL LS D=TYPE POS=EDGE=TRIG	01295	8N74LS74AN
A20U22	1820-1216	3		IC ODDR TTL LS 3=TO=8=LINE 3=INP	01295	8N74LS138N
A20U24	1818-1350	1		IC M58981S-30	28480	
A20U25	1818-1350	1		IC M58981S-30	28480	
A20U26	1820-2075	4	2	IC MISC TTL LS	01295	8N74LS245N
A20U27	1820-1197	9		IC GATE TTL LS NAND QUAD 2=INP	01295	8N74LS00N
A20U28	1820-1208	3	1	IC GATE TTL LS OR QUAD 2=INP	01295	8N74LS32N
A20U29	1820-1144	6	1	IC GATE TTL LS NOR QUAD 2=INP	01295	8N74LS02N
A20U30	1820-1217	4	1	IC MUX/DATA=SEL TTL LS 8=TO=1=LINE	01295	8N74LS151N
A20U31	1820-2255	2	1	IC CNTR CMOS DECD 6=INP	28480	1820-2255
A20U32	1820-1112	8		IC FF TTL LS D=TYPE POS=EDGE=TRIG	01295	8N74LS74AN
A20U33	1820-1425	6	1	IC SCHMITT=TRIG TTL LS NAND QUAD 2=INP	01295	8N74LS132N
A20U34	1820-1112	8		IC FF TTL LS D=TYPE POS=EDGE=TRIG	01295	8N74LS74AN
A20U35	1820-1202	7	2	IC GATE TTL LS NAND TPL 3=INP	01295	8N74LS10N
A20U36	1820-1794	2	5	IC BFR TTL LS NON=INV OCTL	27014	DM61L895N
A20U37	1820-1794	2		IC BFR TTL LS NON=INV OCTL	27014	DM61L895N
A20U38	1820-1973	1	1	IC BHF=RCGR TTL LS NEG=EDGE=TRIG PRL=IN	01295	8N74LS165N
A20U39	1820-2340	6	1	IC MPU SUPPORT CHIP F=2MHZ	28480	1820-2340
A20U40	1820-1794	2		IC BFR TTL LS NON=INV OCTL	27014	DM61L895N
A20U41	1820-1196	8	2	IC FF TTL LS D=TYPE POS=EDGE=TRIG COM	01295	8N74LS174N
A20U42	1820-1196	8		IC FF TTL LS D=TYPE POS=EDGE=TRIG COM	01295	8N74LS174N
A20U43	1820-1794	2		IC BFR TTL LS NON=INV OCTL	27014	DM61L895N
A20U44	1820-1804	5	1	IC BFR NMOS CLOCK DRVR	04713	MC68842
A20U45	1820-1201	6		IC GATE TTL LS AND QUAD 2=INP	01295	8N74LS08N
A20U46	1820-1480	3	1	IC MICPROC NMOS 8-BIT	04713	MC6800L
A20U47	1820-2075	4		IC MISC TTL LS	01295	8N74LS245N
A20U48	1820-1202	7		IC GATE TTL LS NAND TPL 3=INP	01295	8N74LS10N
A20U49	1820-1216	3		IC ODDR TTL LS 3=TO=8=LINE 3=INP	01295	8N74LS138N
A20U50	1820-1216	3		IC ODDR TTL LS 3=TO=8=LINE 3=INP	01295	8N74LS138N
A20U51	1820-1147	9		IC GATE TTL LS NAND QUAD 2=INP	01295	8N74LS00N
A20U52	1820-2024	3	1	IC DRVR TTL LS LINE DRVN OCTL	01295	8N74LS244N
A20U53	1820-0511	9	1	IC GATE TTL AND QUAD 2=INP	01295	8N7408N
A20U54	1820-1199	1		IC INV TTL LS HEX 1=INP	01295	8N74LS04N
A20U55	1820-1568	6	1	IC BFR TTL LS BUS QUAD	01295	8N74LS125AN
A20U56	1820-1794	2		IC BFR TTL LS NON=INV OCTL	27014	DM61L895N
A20U57	1820-1991	1	1	IC CNTR TTL LS DECD DUAL 4=BIT	01295	8N74LS140N
A20U58	1820-1195	7	1	IC FF TTL LS D=TYPE POS=EDGE=TRIG COM	01295	8N74LS175N
A20U59	1820-1216	3		IC ODDR TTL LS 3=TO=8=LINE 3=INP	01295	8N74LS138N
A20U60	1820-1216	3		IC ODDR TTL LS 3=TO=8=LINE 3=INP	01295	8N74LS138N
A20U61	1820-1432	5	1	IC CNTR TTL LS 8IN SYNCRD POS=EDGE=TRIG	01295	8N74LS163AN
A20U62	1820-1416	5		IC SCHMITT=TRIG TTL LS INV HEX 1=INP	01295	8N74LS14N
A20U63	1820-1830	3	1	IC CNTR TTL LS 8IN SYNCRD POS=EDGE=TRIG	01295	8N74LS161AN
A20U64	1820-0054	5	1	IC GATE TTL NAND QUAD 2=INP	01295	8N7400N
A20U65	1820-1816	5		IC SCHMITT=TRIG TTL LS INV HEX 1=INP	01295	8N74LS14N
A20U66	1820-2113	1	1	IC MICPROC=ACCESS NMOS	04713	MC68458L
A20U67	1820-1199	1		IC INV TTL LS HEX 1=INP	01295	8N74LS04N
A20U68	1820-1199	1		IC INV TTL LS HEX 1=INP	01295	8N74LS04N
A20U69	1820-1199	1		IC INV TTL LS HEX 1=INP	01295	8N74LS04N
A20U70	1820-1199	1		IC INV TTL LS HEX 1=INP	01295	8N74LS04N
A20U71	1820-1112	8		IC FF TTL LS D=TYPE POS=EDGE=TRIG	01295	8N74LS74AN
A20U72	1820-1199	1		IC INV TTL LS HEX 1=INP	01295	8N74LS04N
A20U73	1820-1201	6		IC GATE TTL LS AND QUAD 2=INP	01295	8N74LS08N
A20U74	1820-2058	3	6	IC MISC TTL 8 QUAD	28480	1820-2058
A20U75	1820-2058	3		IC MISC TTL 8 QUAD	28480	1820-2058

See introduction to this section for ordering information
*Indicates factory selected value

Table 6-3. Replaceable Parts

Reference Designation	HP Part Number	C D	Qty	Description	Mfr Code	Mfr Part Number
A20U76	1820-2058	3	1	IC MISC TTL S QUAD	28480	1820-2058
A20U77	1820-2058	3		IC MISC TTL S QUAD	28480	1820-2058
A20U78	1820-1204	9		IC GATE TTL LB NAND DUAL 4=JNP	01295	8N74L820N
A22	04191-06522	3	1	DISPLAY & KEY CONTROL BD ASSEMBLY	28480	04191-06522
A22C1	0160-2055	9		CAPACITOR-FXD .01UF +80-20% 100VDC CER	28480	0160-2055
A22C2	0160-1083	3		CAPACITOR-FXD 330PF -10%+75% 250VDC AL	28480	0160-1083
A22C3	0160-2055	9		CAPACITOR-FXD .01UF +80-20% 100VDC CER	28480	0160-2055
A22C4	0160-2055	9		CAPACITOR-FXD .01UF +80-20% 100VDC CER	28480	0160-2055
A22C5	0160-2055	9		CAPACITOR-FXD .01UF +80-20% 100VDC CER	28480	0160-2055
A22C6	0160-2055	9		CAPACITOR-FXD .01UF +80-20% 100VDC CER	28480	0160-2055
A22C7	0160-0134	1		CAPACITOR-FXD 220PF +-5% 300VDC MICA	28480	0160-0134
A22C8	0160-2055	9		CAPACITOR-FXD .01UF +80-20% 100VDC CER	28480	0160-2055
A22C9	0160-3456	6		CAPACITOR-FXD 1000PF +-10% 1KVDC CER	28480	0160-3456
A22C10	0160-3456	6		CAPACITOR-FXD 1000PF +-10% 1KVDC CER	28480	0160-3456
A22C11	0160-3456	6	CAPACITOR-FXD 1000PF +-10% 1KVDC CER	28480	0160-3456	
A22D81	1990-0486	6	2	LED-VISIBLE LUM-INT3MCD IF=20MA=MAX	28480	5082-4654
A22D82	1990-0681	3		DISPLAY-AN=SEG 1=CHAR .408-H RED	28480	5082-7650
A22D83	1990-0540	3	21	DISPLAY-NUM=SEG 1=CHAR .43-H	28480	5082-7650
A22D84	1990-0540	3		DISPLAY-NUM=SEG 1=CHAR .43-H	28480	5082-7650
A22D85	1990-0540	3		DISPLAY-NUM=SEG 1=CHAR .43-H	28480	5082-7650
A22D86	1990-0540	3		DISPLAY-NUM=SEG 1=CHAR .43-H	28480	5082-7650
A22D87	1990-0517	4		LED-VISIBLE LUM-INT3MCD IF=20MA=MAX	28480	5082-4655
A22D88	1990-0517	4		LED-VISIBLE LUM-INT3MCD IF=20MA=MAX	28480	5082-4655
A22D89	1990-0517	4		LED-VISIBLE LUM-INT3MCD IF=20MA=MAX	28480	5082-4655
A22D90	1990-0517	4		LED-VISIBLE LUM-INT3MCD IF=20MA=MAX	28480	5082-4655
A22D91	1990-0517	4		LED-VISIBLE LUM-INT3MCD IF=20MA=MAX	28480	5082-4655
A22D92	1990-0517	4		LED-VISIBLE LUM-INT3MCD IF=20MA=MAX	28480	5082-4655
A22D93	1990-0517	4	LED-VISIBLE LUM-INT3MCD IF=20MA=MAX	28480	5082-4655	
A22D94	1990-0517	4	LED-VISIBLE LUM-INT3MCD IF=20MA=MAX	28480	5082-4655	
A22D95	1990-0517	4	LED-VISIBLE LUM-INT3MCD IF=20MA=MAX	28480	5082-4655	
A22D96	1990-0517	4	LED-VISIBLE LUM-INT3MCD IF=20MA=MAX	28480	5082-4655	
A22D97	1990-0486	6	LED-VISIBLE LUM-INT3MCD IF=20MA=MAX	28480	5082-4654	
A22D98	1990-0681	3	DISPLAY-AN=SEG 1=CHAR .408-H RED	28480	5082-7650	
A22D99	1990-0540	3	DISPLAY-NUM=SEG 1=CHAR .43-H	28480	5082-7650	
A22D00	1990-0540	3	DISPLAY-NUM=SEG 1=CHAR .43-H	28480	5082-7650	
A22D01	1990-0540	3	DISPLAY-NUM=SEG 1=CHAR .43-H	28480	5082-7650	
A22D02	1990-0517	4	LED-VISIBLE LUM-INT3MCD IF=20MA=MAX	28480	5082-4655	
A22D03	1990-0517	4	LED-VISIBLE LUM-INT3MCD IF=20MA=MAX	28480	5082-4655	
A22D04	1990-0517	4	LED-VISIBLE LUM-INT3MCD IF=20MA=MAX	28480	5082-4655	
A22D05	1990-0517	4	LED-VISIBLE LUM-INT3MCD IF=20MA=MAX	28480	5082-4655	
A22D06	1990-0517	4	LED-VISIBLE LUM-INT3MCD IF=20MA=MAX	28480	5082-4655	
A22D07	1990-0517	4	LED-VISIBLE LUM-INT3MCD IF=20MA=MAX	28480	5082-4655	
A22D08	1990-0517	4	LED-VISIBLE LUM-INT3MCD IF=20MA=MAX	28480	5082-4655	
A22D09	1990-0517	4	LED-VISIBLE LUM-INT3MCD IF=20MA=MAX	28480	5082-4655	
A22D10	1990-0517	4	LED-VISIBLE LUM-INT3MCD IF=20MA=MAX	28480	5082-4655	
A22D11	1990-0517	4	LED-VISIBLE LUM-INT3MCD IF=20MA=MAX	28480	5082-4655	
A22D12	1990-0517	4	LED-VISIBLE LUM-INT3MCD IF=20MA=MAX	28480	5082-4655	
A22D13	1990-0517	4	LED-VISIBLE LUM-INT3MCD IF=20MA=MAX	28480	5082-4655	
A22D14	1990-0486	6	LED-VISIBLE LUM-INT3MCD IF=20MA=MAX	28480	5082-4654	
A22D15	1990-0531	2	5	DISPLAY-NUM=SEG 1=CHAR .3-H	28480	5082-7610
A22D16	1990-0531	2		DISPLAY-NUM=SEG 1=CHAR .3-H	28480	5082-7610
A22D17	1990-0531	2		DISPLAY-NUM=SEG 1=CHAR .3-H	28480	5082-7610
A22D18	1990-0531	2		DISPLAY-NUM=SEG 1=CHAR .3-H	28480	5082-7610
A22D19	1990-0531	2		DISPLAY-NUM=SEG 1=CHAR .3-H	28480	5082-7610
A22D20	1990-0486	6	LED-VISIBLE LUM-INT3MCD IF=20MA=MAX	28480	5082-4654	
A22K01	5041-0384	6	3	KEY CAP=QUARTER, SMOKE GRAY	28480	5041-0384
A22K02	5041-0384	6		KEY CAP=QUARTER, SMOKE GRAY	28480	5041-0384
A22K03	5041-0375	5		KEY CAP=QUARTER, SMK	28480	5041-0375
A22K04	5041-0286	7		KEY CAP=HALF, L, PRL	28480	5041-0286
A22K05	5041-0286	7		KEY CAP=HALF, L, PRL	28480	5041-0286
A22K06	5041-0818	0	1	KEY CAP=HALF, SMK=SMST	28480	5041-0818
A22K07	5041-0818	1		KEY CAP=HALF, SMK=SMST	28480	5041-0818
A22K08	5041-0814	9		KEY CAP=HALF, SMK=SMST	28480	5041-0814
A22K09	5041-0284	7		KEY CAP=HALF, SMST	28480	5041-0284
A22K10	5041-0286	7		KEY CAP=HALF, L, PRL	28480	5041-0286
A22K11	5041-0286	7		KEY CAP=HALF, L, PRL	28480	5041-0286
A22K12	5041-0814	7		KEY CAP=HALF, SMK=SMST	28480	5041-0814
A22K13	5041-0815	8		KEY CAP=HALF, SMK=SMST	28480	5041-0815
A22K14	5041-0816	9		KEY CAP=HALF, SMK=SMST	28480	5041-0816
A22K15	5041-0385	7		KEY CAP=HALF, L, SMOKE	28480	5041-0385
A22K16	5041-0385	7	KEY CAP=HALF, L, SMOKE	28480	5041-0385	
A22K17	5041-0811	0	1	KEY CAP=HALF, SMK=SMST	28480	5041-0811
A22K18	5041-0812	5		KEY CAP=HALF, SMK=SMST	28480	5041-0812
A22K19	5041-0813	6		KEY CAP=HALF, SMK=SMST	28480	5041-0813
A22K20	5041-0855	6		KEY CAP=HALF, EBY=PRL	28480	5041-0855

See introduction to this section for ordering information
*Indicates factory selected value

Table 6-3. Replaceable Parts

Reference Designation	HP Part Number	C D	Qty	Description	Mfr Code	Mfr Part Number
A22K21	5041-0855	6		KEY CAP=HALF, EBY=PRL	28480	5041-0855
A22K22	5041-0855	6		KEY CAP=HALF, EBY=PRL	28480	5041-0855
A22K23	5041-0819	2	1	KEY CAP	28480	5041-0819
A22K24	5041-0808	2		KEY CAP=HALF, SHK=SHST	28480	5041-0808
A22K25	5041-0758	8	1	KEY CAP=HALF, SHK=SHST	28480	5041-0758
A22K26	5041-0059	2	2	KEY CAP=PALM=BRN=PRL	28480	5041-0059
A22K27	5041-0277	6	1	KEY CAP=HALF, PRL	28480	5041-0277
A22K28	5041-0059	2		KEY CAP=PALM=BRN=PRL	28480	5041-0059
A22K29	5041-0384	6		KEY CAP=QUARTER, SMOKE GRAY	28480	5041-0384
A22K30	5041-0442	7	1	KEY CAP=HALF, S, BLU	28480	5041-0442
A22K31	5041-1000	5	2	KEY CAP=HALF, SHK=SHST	28480	5041-1000
A22K32	5041-1000	5		KEY CAP=HALF, SHK=SHST	28480	5041-1000
A22K33	5041-0385	7		KEY CAP=HALF, L, SMOKE	28480	5041-0385
A22K34	5041-0319	7	3	KEY CAP=HALF, L, PTY	28480	5041-0319
A22K35	5041-0319	7		KEY CAP=HALF, L, PTY	28480	5041-0319
A22K36	5041-0319	7		KEY CAP=HALF, L, PTY	28480	5041-0319
A22MP2	04191-40002	0	2	INSULATOR	28480	04191-40002
A22MP3	04191-40003	1	2	LAMP HOUSE	28480	04191-40003
A22MP4	04191-40004	2	2	SPACER	28480	04191-40004
A22MP5	04262-40001	5	1	INSULATOR	28480	04262-40001
A22R1	0683-1515	2		RESISTOR 150 5% .25W FC TC=400/+600	01121	C81515
A22R2	0683-1515	2		RESISTOR 150 5% .25W FC TC=400/+600	01121	C81515
A22R3	0683-1515	2		RESISTOR 150 5% .25W FC TC=400/+600	01121	C81515
A22R4	0683-1515	2		RESISTOR 150 5% .25W FC TC=400/+600	01121	C81515
A22R5	1810-0269	3		NETWORK=RES 9=81P10.0K OHM X 8	28480	1810-0269
A22R6	1810-0325	2	2	NETWORK=RES 10=01P150.0 OHM X 8	01121	3168151
A22R7	1810-0302	5	3	NETWORK=RES 8=81P47.0 OHM X 8	01121	2088470
A22R8	1810-0302	5		NETWORK=RES 8=81P47.0 OHM X 8	01121	2088470
A22R9	1810-0302	5		NETWORK=RES 8=81P47.0 OHM X 4	01121	2088470
A22R10	1810-0325	2		NETWORK=RES 10=01P150.0 OHM X 8	01121	3168151
A22R11	1810-0269	3		NETWORK=RES 9=81P10.0K OHM X 8	28480	1810-0269
A22R12	1810-0269	3		NETWORK=RES 9=81P10.0K OHM X 8	28480	1810-0269
A22R13	1810-0269	3		NETWORK=RES 9=81P10.0K OHM X 8	28480	1810-0269
A22R14	0683-4715	0		RESISTOR 470 5% .25W FC TC=400/+600	01121	C84715
A22R15	0683-1035	1		RESISTOR 10K 5% .25W FC TC=400/+700	01121	C81035
A22R16	0683-1035	1		RESISTOR 10K 5% .25W FC TC=400/+700	01121	C81035
A22R17	0683-1035	1		RESISTOR 10K 5% .25W FC TC=400/+700	01121	C81035
A22S1	5060-9436	7	36	PUSHBUTTON SWITCH P.C. MOUNT	28480	5060-9436
A22S2	3101-1074	9	1	SWITCH=PUSHBUTTON SPRT NO	28480	3101-1074
A22S3	5060-9436	7		PUSHBUTTON SWITCH P.C. MOUNT	28480	5060-9436
A22S4	5060-9436	7		PUSHBUTTON SWITCH P.C. MOUNT	28480	5060-9436
A22S5	5060-9436	7		PUSHBUTTON SWITCH P.C. MOUNT	28480	5060-9436
A22S6	5060-9436	7		PUSHBUTTON SWITCH P.C. MOUNT	28480	5060-9436
A22S7	5060-9436	7		PUSHBUTTON SWITCH P.C. MOUNT	28480	5060-9436
A22S8	5060-9436	7		PUSHBUTTON SWITCH P.C. MOUNT	28480	5060-9436
A22S9	5060-9436	7		PUSHBUTTON SWITCH P.C. MOUNT	28480	5060-9436
A22U1	1858-0038	4		TRANSISTOR ARRAY	28480	1858-0038
A22U2	1858-0038	4		TRANSISTOR ARRAY	28480	1858-0038
A22U3	1858-0038	4		TRANSISTOR ARRAY	28480	1858-0038
A22U4	1858-0038	4		TRANSISTOR ARRAY	28480	1858-0038
A22U5	1820-1624	4	2	IC 8FR TTL 3 OCTL 1=INP	01295	8N748241N
A22U6	1820-1624	7		IC 8FR TTL 3 OCTL 1=INP	01295	8N748241N
A22U7	1820-1461	0	3	IC FF TTL D=TYPE POS=EDGE=TRIG CLEAR	01295	8N74273
A22U8	1820-1461	0		IC FF TTL D=TYPE POS=EDGE=TRIG CLEAR	01295	8N74273
A22U9	1820-1416	5		IC SCHMITT=TRIG TTL LS INV HEX 1=INP	01295	8N74L814N
A22U10	1820-0495	6	2	IC DCOR TTL 4=TO=16=LINE 4=INP	01295	8N74L814N
A22U11	1820-1461	0		IC FF TTL D=TYPE POS=EDGE=TRIG CLEAR	01295	8N74273
A22U12	1816-0913	6	3	IC TTL 8 64=BIT RAM 110=NS 0=C	34335	A431L01PC
A22U13	1816-0913	6		IC TTL 8 64=BIT RAM 110=NS 0=C	34335	A431L01PC
A22U14	1816-0913	6		IC TTL 8 64=BIT RAM 110=NS 0=C	34335	A431L01PC
A22U15	1820-1433	6		IC 8MF=RCR TTL LS R=8 SERIAL=IN PRL=OUT	01295	8N74L814N
A22U16	1820-1278	7	2	IC CNTR TTL LS 8IN UP/DOWN SYNCHRD	01295	8N74L8191N
A22U17	1820-0495	8		IC DCOR TTL 4=TO=16=LINE 4=INP	01295	8N74L814N
A22U18	1820-1278	8		IC CNTR TTL LS 8IN UP/DOWN SYNCHRD	01295	8N74L8191N
A22U19	1820-1415	4	1	IC SCHMITT=TRIG TTL LS NAND DUAL 4=INP	01295	8N74L813N
A22U20	1820-1433	6		IC 8MF=RCR TTL LS R=8 SERIAL=IN PRL=OUT	01295	8N74L814N
A22U21	1820-1201	6		IC GATE TTL LS AND QUAD 2=INP	01295	8N74L808N
A22U22	1820-1199	1		IC INV TTL LS HEX 1=INP	01295	8N74L804N
A22U23	1820-1197	9		IC GATE TTL LS NAND QUAD 2=INP	01295	8N74L800N
A22U24	1820-1201	6		IC GATE TTL LS AND QUAD 2=INP	01295	8N74L808N
	04140-40002	4	1	INSULATOR	28480	04140-40002

See introduction to this section for ordering information
*Indicates factory selected value

Table 6-3. Replaceable Parts

Reference Designation	HP Part Number	C D	Qty	Description	Mfr Code	Mfr Part Number
A23	04191-00523	0	1	POWER SUPPLY BOARD ASSEMBLY	28480	04191-00523
A23C1	0180-1071	9	1	CAPACITOR-FXD 15000pF -10+30% 16VDC ALM	28480	0180-1071
A23C2	0180-1073	1	1	CAPACITOR-FXD 22000pF -10+30% 16VDC ALM	28480	0180-1073
A23C3	0180-2986	7	6	CAPACITOR-FXD 330UF+20% 50VDC AL	28480	0180-2986
A23C4	0180-2986	7	6	CAPACITOR-FXD 330UF+20% 50VDC AL	28480	0180-2986
A23C5	0180-2986	7	6	CAPACITOR-FXD 330UF+20% 50VDC AL	28480	0180-2986
A23C6	0180-2986	7	6	CAPACITOR-FXD 330UF+20% 50VDC AL	28480	0180-2986
A23C7	0180-2986	7	6	CAPACITOR-FXD 330UF+20% 50VDC AL	28480	0180-2986
A23C8	0180-2986	7	6	CAPACITOR-FXD 330UF+20% 50VDC AL	28480	0180-2986
A23C9	0180-2982	3	2	CAPACITOR-FXD 330UF+50-10% 100VDC AL	28480	0180-2982
A23C10	0180-2982	3	2	CAPACITOR-FXD 330UF+50-10% 100VDC AL	28480	0180-2982
A23C11	0180-2983	4	2	CAPACITOR-FXD 4700UF+30-10% 25VDC AL	28480	0180-2983
A23C12	0180-2983	4	2	CAPACITOR-FXD 4700UF+30-10% 25VDC AL	28480	0180-2983
A23C13	0180-2984	5	5	CAPACITOR-FXD 47UF+20% 50VDC AL	28480	0180-2984
A23C14	0180-2979	8	8	CAPACITOR-FXD 220UF+20% 16VDC AL	28480	0180-2979
A23C15	0180-0121	5	5	CAPACITOR-FXD .1UF +80-20% 50VDC CER	28480	0180-0121
A23C16	0180-0121	5	5	CAPACITOR-FXD .1UF +80-20% 50VDC CER	28480	0180-0121
A23C17	0180-1083	3	3	CAPACITOR-FXD 33UF -10+75% 25WVDC AL	28480	0180-1083
A23C18	0180-0121	5	5	CAPACITOR-FXD .1UF +80-20% 50VDC CER	28480	0180-0121
A23C19	0180-2984	5	5	CAPACITOR-FXD 47UF+20% 50VDC AL	28480	0180-2984
A23C20	0180-2979	8	8	CAPACITOR-FXD 220UF+20% 16VDC AL	28480	0180-2979
A23C21	0180-2979	8	8	CAPACITOR-FXD 220UF+20% 16VDC AL	28480	0180-2979
A23C22	0180-2979	8	8	CAPACITOR-FXD 220UF+20% 16VDC AL	28480	0180-2979
A23C23	0180-2979	8	8	CAPACITOR-FXD 220UF+20% 16VDC AL	28480	0180-2979
A23C24	0180-2985	6	6	CAPACITOR-FXD 33UF+20% 63VDC AL	28480	0180-2985
A23C25	0180-2985	6	6	CAPACITOR-FXD 33UF+20% 63VDC AL	28480	0180-2985
A23C26	0180-0121	5	5	CAPACITOR-FXD .1UF +80-20% 50VDC CER	28480	0180-0121
A23C27	1906-0096	7	4	DIODE-FW BRDG 200V 2A	04713	MUA202
A23C28	1906-0096	7	4	DIODE-FW BRDG 200V 2A	04713	MUA202
A23C29	1902-3256	9	9	DIODE-ZNR 23.7V 5% DO-7 PDB, 4W TC=+.076%	28480	1902-3256
A23C30	1906-0096	7	4	DIODE-FW BRDG 200V 2A	04713	MUA202
A23C31	1906-0096	7	4	DIODE-FW BRDG 200V 2A	04713	MUA202
A23C32	1901-0062	3	2	DIODE-PWR RECT 100V 6A	04713	MR751
A23C33	1901-0062	3	2	DIODE-PWR RECT 100V 6A	04713	MR751
A23C34	1902-3256	9	9	DIODE-ZNR 23.7V 5% DO-7 PDB, 4W TC=+.076%	28480	1902-3256
A23C35	1902-0049	2	2	DIODE-ZNR 8.19V 5% DO-7 PDB, 4W TC=+.022%	28480	1902-0049
A23C36	1902-0049	2	2	DIODE-ZNR 8.19V 5% DO-7 PDB, 4W TC=+.022%	28480	1902-0049
A23C37	1901-0040	1	7	DIODE-SWITCHING 30V 50MA 2NS DO-35	28480	1901-0040
A23C38	1902-1232	7	2	DIODE-ZNR 1N3997RA 5.6V 5% DO-4 PDB10W	04713	1N3997RA
A23C39	1902-1232	7	2	DIODE-ZNR 1N3997RA 5.6V 5% DO-4 PDB10W	04713	1N3997RA
A23C40	1902-1200	9	2	DIODE-ZNR 1N2908B 16V 5% DO-4 PDB10W	12954	1N2908B
A23C41	1902-1200	9	2	DIODE-ZNR 1N2908B 16V 5% DO-4 PDB10W	12954	1N2908B
A23C42	1902-0045	4	2	DIODE-ZNR 1N2907B 31V 5% DO-4 PDB10W	04713	1N2907B
A23C43	1902-0045	4	2	DIODE-ZNR 1N2907B 31V 5% DO-4 PDB10W	04713	1N2907B
A23C44	1901-0040	1	7	DIODE-SWITCHING 30V 50MA 2NS DO-35	28480	1901-0040
A23F1	2110-0003	0	2	FUSE 3A 250V 1.25X.25 UL	75915	312003
A23F2	2110-0003	0	2	FUSE 3A 250V 1.25X.25 UL	75915	312003
A23F3	2110-0094	9	2	FUSE 1.25A 250V 1.25X.25 UL IEC	28480	2110-0094
A23F4	2110-0094	9	2	FUSE 1.25A 250V 1.25X.25 UL IEC	28480	2110-0094
A23F5	2110-0004	1	2	FUSE .25A 250V 1.25X.25 UL	28480	2110-0004
A23F6	2110-0004	1	2	FUSE .25A 250V 1.25X.25 UL	28480	2110-0004
A23F7	2110-0513	7	2	FUSE .125A 125V .348X.25 UL	75915	273.125
A23F8	2110-0513	7	2	FUSE .125A 125V .348X.25 UL	75915	273.125
A23J1	1251-4683	6	1	CONNECTOR 12-PIN M POST TYPE	28480	1251-4683
A23J2	1251-4683	7	10	CONNECTOR-SGL CONT 8KT .04-IN=B8C=8Z RND	28480	1251-4683
A23J3	1251-4683	7	10	CONNECTOR-SGL CONT 8KT .04-IN=B8C=8Z RND	28480	1251-4683
A23J4	1251-4683	7	10	CONNECTOR-SGL CONT 8KT .04-IN=B8C=8Z RND	28480	1251-4683
A23J5	1251-4683	7	10	CONNECTOR-SGL CONT 8KT .04-IN=B8C=8Z RND	28480	1251-4683
A23J6	1251-4683	7	10	CONNECTOR-SGL CONT 8KT .04-IN=B8C=8Z RND	28480	1251-4683
A23J7	1251-4683	7	10	CONNECTOR-SGL CONT 8KT .04-IN=B8C=8Z RND	28480	1251-4683
A23J8	1251-4683	7	10	CONNECTOR-SGL CONT 8KT .04-IN=B8C=8Z RND	28480	1251-4683
A23J9	1251-4683	7	10	CONNECTOR-SGL CONT 8KT .04-IN=B8C=8Z RND	28480	1251-4683
A23J10	1251-4683	7	10	CONNECTOR-SGL CONT 8KT .04-IN=B8C=8Z RND	28480	1251-4683
A23J11	1251-4683	7	10	CONNECTOR-SGL CONT 8KT .04-IN=B8C=8Z RND	28480	1251-4683
A23J12	1251-3090	8	1	CONNECTOR 50-PIN M RECTANGULAR	28480	1251-3090
A23M1	0380-0741	2	10	STANDOFF-RVY 10M 187-IN=LG 6-32TMD	00000	ORDER BY DESCRIPTION
A23M2	0380-0744	5	10	SPACER-RND .093-IN=LG .89-IN=ID	28480	0380-0744
A23M3	0590-0526	6	5	THREADED INSERT-NUT 4-40 .065-IN=LG 88T	28480	0590-0526
A23M4	0590-1054	7	1	THREADED INSERT-NUT 6-32 .065-IN=LG 88T	28480	0590-1054
A23M5	1205-0211	2	2	HEAT SINK 10-66-CS	28480	1205-0211
A23M6	1251-1998	3	4	CONNECTOR-SGL CONT 8KT .025-IN=B8C=8Z	28480	1251-1998
A23M7	2200-0105	4	1	SCREW-MACH 4-40 .312-IN=LG PAN=HD=POZI	00000	ORDER BY DESCRIPTION
A23M8	2740-0003	5	6	NUT-MEX=K/LH 10-32-TMD .125-IN=THK	00000	ORDER BY DESCRIPTION
A23M9	3050-0307	0	1	WASHER-FL MTLG NO. 6 .143-IN=ID	28480	3050-0307
A23M10	04191-24003	7	6	SPACER	28480	04191-24003

See introduction to this section for ordering information
*Indicates factory selected value

Table 6-3. Replaceable Parts

Reference Designation	HP Part Number	C D	Qty	Description	Mfr Code	Mfr Part Number
A23Q1	1854-0311	8	1	TRANSISTOR NPN 2N4240 SI TO-18 PD=35W	01925	2N4240
A23Q2	1854-0474	4	1	TRANSISTOR NPN 2N4240 SI TO-18 PD=35W	04713	2N4240
A23Q3	1854-0474	4	1	TRANSISTOR NPN 2N4240 SI TO-18 PD=35W	04713	2N4240
A23Q4	1854-0474	4	1	TRANSISTOR NPN 2N4240 SI TO-18 PD=35W	04713	2N4240
A23Q5	1853-0336	5	1	TRANSISTOR PNP 2N6423 SI TO-18 PD=35W	04713	2N6423
A23Q6	1853-0336	5	1	TRANSISTOR PNP 2N6423 SI TO-18 PD=35W	04713	2N6423
A23Q7	1853-0336	5	1	TRANSISTOR PNP 2N6423 SI TO-18 PD=35W	04713	2N6423
A23Q8	1853-0336	5	1	TRANSISTOR PNP 2N6423 SI TO-18 PD=35W	04713	2N6423
A23Q9	1853-0252	7	1	TRANSISTOR PNP 2N6423 SI TO-18 PD=35W	04713	2N6423
A23Q10	1854-0063	7	1	TRANSISTOR NPN 2N4240 SI TO-18 PD=35W	04713	2N4240
A23Q11	1854-0071	4	1	TRANSISTOR NPN 2N4240 SI TO-18 PD=35W	04713	2N4240
A23Q12	1854-0071	4	1	TRANSISTOR NPN 2N4240 SI TO-18 PD=35W	04713	2N4240
A23Q13	1853-0020	4	1	TRANSISTOR PNP 2N6423 SI TO-18 PD=35W	04713	2N6423
A23Q14	1853-0020	4	1	TRANSISTOR PNP 2N6423 SI TO-18 PD=35W	04713	2N6423
A23R1	0683-5625	3	1	RESISTOR 5.6K 5% .25W FC TC=400/+700	01121	C85625
A23R2	0683-5625	3	1	RESISTOR 5.6K 5% .25W FC TC=400/+700	01121	C85625
A23R3	0683-2235	5	1	RESISTOR 22K 5% .25W FC TC=400/+700	01121	C82235
A23R4	0683-2235	5	1	RESISTOR 22K 5% .25W FC TC=400/+700	01121	C82235
A23R5	0683-2235	5	1	RESISTOR 22K 5% .25W FC TC=400/+700	01121	C82235
A23R6	0683-5625	3	1	RESISTOR 5.6K 5% .25W FC TC=400/+700	01121	C85625
A23R7	0683-5625	3	1	RESISTOR 5.6K 5% .25W FC TC=400/+700	01121	C85625
A23R8	2100-1788	5	1	RESISTOR-TRMR 500 10% C TOP=ADJ 1=TRN	28480	2100-1788
A23R9	0683-1025	9	1	RESISTOR 1K 5% .25W FC TC=400/+700	01121	C81025
A23R10	0683-5625	3	1	RESISTOR 5.6K 5% .25W FC TC=400/+700	01121	C85625
A23R11	0683-6825	7	1	RESISTOR 6.8K 5% .25W FC TC=400/+700	01121	C86825
A23R12	0683-1035	1	1	RESISTOR 10K 5% .25W FC TC=400/+700	01121	C81035
A23R13	0683-1035	1	1	RESISTOR 10K 5% .25W FC TC=400/+700	01121	C81035
A23R14	0683-1025	9	1	RESISTOR 1K 5% .25W FC TC=400/+700	01121	C81025
A23R15	0683-1025	9	1	RESISTOR 1K 5% .25W FC TC=400/+700	01121	C81025
A23R16	0683-5615	1	1	RESISTOR 560 5% .25W FC TC=400/+700	01121	C85615
A23R17	0683-1025	9	1	RESISTOR 1K 5% .25W FC TC=400/+700	01121	C81025
A23R18	0683-5625	3	1	RESISTOR 5.6K 5% .25W FC TC=400/+700	01121	C85625
A23R19	0683-5615	1	1	RESISTOR 560 5% .25W FC TC=400/+700	01121	C85615
A23R20	0683-1025	9	1	RESISTOR 1K 5% .25W FC TC=400/+700	01121	C81025
A23R21	0683-5625	3	1	RESISTOR 5.6K 5% .25W FC TC=400/+700	01121	C85625
A23R22	0683-5625	3	1	RESISTOR 5.6K 5% .25W FC TC=400/+700	01121	C85625
A23R23	0757-0444	1	2	RESISTOR 12.1K 1% .125W F TC=0/+100	28480	C4=1/8-T0=1212-F
A23R24	0757-0123	3	2	RESISTOR 34.8K 1% .125W F TC=0/+100	28480	0757-0123
A23R25	0683-0475	1	2	RESISTOR 4.7 5% .25W FC TC=400/+500	01121	C84705
A23R26	0811-3413	6	2	RESISTOR .68 5% .5W PW TC=0/+150	28480	0811-3413
A23R27	0757-0444	1	2	RESISTOR 12.1K 1% .125W F TC=0/+100	28480	C4=1/8-T0=1212-F
A23R28	0757-0290	5	2	RESISTOR 6.19K 1% .125W F TC=0/+100	19701	MF4C1/8-T0=6191-F
A23R29	0811-3413	6	2	RESISTOR .68 5% .5W PW TC=0/+150	28480	0811-3413
A23R30	0757-0444	1	2	RESISTOR 12.1K 1% .125W F TC=0/+100	28480	C4=1/8-T0=1212-F
A23R31	0757-0444	1	2	RESISTOR 12.1K 1% .125W F TC=0/+100	28480	C4=1/8-T0=1212-F
A23R32	0683-6825	7	1	RESISTOR 6.8K 5% .25W FC TC=400/+700	01121	C86825
A23R33	0683-1035	1	1	RESISTOR 10K 5% .25W FC TC=400/+700	01121	C81035
A23R34	0683-1035	1	1	RESISTOR 10K 5% .25W FC TC=400/+700	01121	C81035
A23R35	0683-1025	9	1	RESISTOR 1K 5% .25W FC TC=400/+700	01121	C81025
A23R36	0683-1025	9	1	RESISTOR 1K 5% .25W FC TC=400/+700	01121	C81025
A23R37	0683-5625	3	1	RESISTOR 5.6K 5% .25W FC TC=400/+700	01121	C85625
A23R38	0757-0444	1	2	RESISTOR 12.1K 1% .125W F TC=0/+100	28480	C4=1/8-T0=1212-F
A23R39	0757-0123	3	2	RESISTOR 34.8K 1% .125W F TC=0/+100	28480	0757-0123
A23R40	0683-0475	1	2	RESISTOR 4.7 5% .25W FC TC=400/+500	01121	C84705
A23R41	2100-1984	3	2	RESISTOR-TRMR 100 10% C TOP=ADJ 1=TRN	28480	2100-1984
A23R42	2100-1984	3	2	RESISTOR-TRMR 100 10% C TOP=ADJ 1=TRN	28480	2100-1984
A23U1	1826-0276	5	1	IC 78L05A V RGLTR TO-92	04713	MC78L05ACP
A23U2	1826-0043	4	1	IC OP AMP GP TO-99	01928	CA307T
A23U3	1826-0099	0	1	IC V RGLTR TO-220	07263	7812UC
A23U4	1826-0043	4	1	IC OP AMP GP TO-99	01928	CA307T
A23U5	1826-0043	4	1	IC OP AMP GP TO-99	01928	CA307T
A23U6	1826-0043	4	1	IC OP AMP GP TO-99	01928	CA307T
A23XF1	2110-0269	0	14	FUSEHOLDER-CLIP TYPE .250-FUSE	28480	2110-0269
A24	04191-66524	5	1	MOTHER BOARD ASSEMBLY (BASIC UNIT)	28480	04191-66524
A24C1	0160-2437	1	28	CAPACITOR-FDTHRU 5000PF +80 -20% 200V	28480	0160-2437
A24C2	0160-2437	1	28	CAPACITOR-FDTHRU 5000PF +80 -20% 200V	28480	0160-2437
A24C3	0160-2437	1	28	CAPACITOR-FDTHRU 5000PF +80 -20% 200V	28480	0160-2437
A24C4	0160-2437	1	28	CAPACITOR-FDTHRU 5000PF +80 -20% 200V	28480	0160-2437
A24C5	0160-2437	1	28	CAPACITOR-FDTHRU 5000PF +80 -20% 200V	28480	0160-2437
A24C6	0160-2437	1	28	CAPACITOR-FDTHRU 5000PF +80 -20% 200V	28480	0160-2437
A24C7	0160-2437	1	28	CAPACITOR-FDTHRU 5000PF +80 -20% 200V	28480	0160-2437
A24C8	0160-2437	1	28	CAPACITOR-FDTHRU 5000PF +80 -20% 200V	28480	0160-2437
A24C9	0160-2437	1	28	CAPACITOR-FDTHRU 5000PF +80 -20% 200V	28480	0160-2437
A24C10	0160-2437	1	28	CAPACITOR-FDTHRU 5000PF +80 -20% 200V	28480	0160-2437

A24 BOARD FOR OPT
002 UNIT IS LISTED
ON PAGES 6-43 AND
6-44.

See introduction to this section for ordering information
*Indicates factory selected value

Table 6-3. Replaceable Parts

Reference Designation	HP Part Number	C D	Qty	Description	Mfr Code	Mfr Part Number
A24C11	0160-2437	1		CAPACITOR=FDTHRU 5000PF +80 -20% 200V	28480	0160-2437
A24C12	0160-2437	1		CAPACITOR=FDTHRU 5000PF +80 -20% 200V	28480	0160-2437
A24C13	0160-2437	1		CAPACITOR=FDTHRU 5000PF +80 -20% 200V	28480	0160-2437
A24C14	0160-2437	1		CAPACITOR=FDTHRU 5000PF +80 -20% 200V	28480	0160-2437
A24C15	0160-2437	1		CAPACITOR=FDTHRU 5000PF +80 -20% 200V	28480	0160-2437
A24C16	0160-2437	1		CAPACITOR=FDTHRU 5000PF +80 -20% 200V	28480	0160-2437
A24C17	0160-2437	1		CAPACITOR=FDTHRU 5000PF +80 -20% 200V	28480	0160-2437
A24C18	0160-2437	1		CAPACITOR=FDTHRU 5000PF +80 -20% 200V	28480	0160-2437
A24C19	0160-2437	1		CAPACITOR=FDTHRU 5000PF +80 -20% 200V	28480	0160-2437
A24C20	0160-3877	5		CAPACITOR=FXD 100PF +-20% 200VDC CER	28480	0160-3877
A24C21	0160-3877	5		CAPACITOR=FXD 100PF +-20% 200VDC CER	28480	0160-3877
A24C22	0160-3877	5		CAPACITOR=FXD 100PF +-20% 200VDC CER	28480	0160-3877
A24C23	0160-3877	5		CAPACITOR=FXD 100PF +-20% 200VDC CER	28480	0160-3877
A24C24	0160-3877	5		CAPACITOR=FXD 100PF +-20% 200VDC CER	28480	0160-3877
A24C25	0160-3877	5		CAPACITOR=FXD 100PF +-20% 200VDC CER	28480	0160-3877
A24C26	0160-2437	1		CAPACITOR=FDTHRU 5000PF +80 -20% 200V	28480	0160-2437
A24C27	0160-2437	1		CAPACITOR=FDTHRU 5000PF +80 -20% 200V	28480	0160-2437
A24C28	0160-2437	1		CAPACITOR=FDTHRU 5000PF +80 -20% 200V	28480	0160-2437
A24C29	0160-2437	1		CAPACITOR=FDTHRU 5000PF +80 -20% 200V	28480	0160-2437
A24C30	0160-2437	1		CAPACITOR=FDTHRU 5000PF +80 -20% 200V	28480	0160-2437
A24C31	0160-3877	5		CAPACITOR=FXD 100PF +-20% 200VDC CER	28480	0160-3877
A24C32	0160-3877	5		CAPACITOR=FXD 100PF +-20% 200VDC CER	28480	0160-3877
A24C33	0160-3877	5		CAPACITOR=FXD 100PF +-20% 200VDC CER	28480	0160-3877
A24C34	0160-3877	5		CAPACITOR=FXD 100PF +-20% 200VDC CER	28480	0160-3877
A24C35	0160-3877	5		CAPACITOR=FXD 100PF +-20% 200VDC CER	28480	0160-3877
A24C36	0160-3877	5		CAPACITOR=FXD 100PF +-20% 200VDC CER	28480	0160-3877
A24C37	0160-3877	5		CAPACITOR=FXD 100PF +-20% 200VDC CER	28480	0160-3877
A24C38	0160-3877	5		CAPACITOR=FXD 100PF +-20% 200VDC CER	28480	0160-3877
A24C39	0160-2437	1		CAPACITOR=FDTHRU 5000PF +80 -20% 200V	28480	0160-2437
A24C40	0160-2437	1		CAPACITOR=FDTHRU 5000PF +80 -20% 200V	28480	0160-2437
A24C41	0160-2437	1		CAPACITOR=FDTHRU 5000PF +80 -20% 200V	28480	0160-2437
A24C42	0160-2437	1		CAPACITOR=FDTHRU 5000PF +80 -20% 200V	28480	0160-2437
A24L1	9100-2247	4		COIL=MLO 100NH 10X 0#34 .095DX.25LG=NOM	28480	9100-2247
A24L2	9100-2247	4		COIL=MLO 100NH 10X 0#34 .095DX.25LG=NOM	28480	9100-2247
A24L3	9100-2247	4		COIL=MLO 100NH 10X 0#34 .095DX.25LG=NOM	28480	9100-2247
A24L4	9100-2247	4		COIL=MLO 100NH 10X 0#34 .095DX.25LG=NOM	28480	9100-2247
A24L5	9100-2247	4		COIL=MLO 100NH 10X 0#34 .095DX.25LG=NOM	28480	9100-2247
A24L6	9100-2247	4		COIL=MLO 100NH 10X 0#34 .095DX.25LG=NOM	28480	9100-2247
A24L7	9100-2247	4		COIL=MLO 100NH 10X 0#34 .095DX.25LG=NOM	28480	9100-2247
A24MP1	0380-0111	0	2	STANDOFF=RVY=DN .25-IN=LG 6=32TMD	00000	ORDER BY DESCRIPTION
A24MP2	0380-1007	0	5	STANDOFF=RVY=DN .438-IN=LG 4=40TMD	00000	ORDER BY DESCRIPTION
A24MP3	0590-1142	4	44	THREADED INSERT=NUT 6=32 .1=LG CARB=STL	28480	0590-1142
A24MP4	2190-0749	9	36	WASHER=FL MTLN NO. 8 .172-IN-ID	28480	2190-0749
A24MP5	2360-0118	4		SCREEN=MACH 6=32 .312-IN=LG PAN=MC=POZI	00000	ORDER BY DESCRIPTION
A24MP6	2360-0125	6	6	SCREEN=MACH 6=32 .75-IN=LG PAN=MC=POZI	00000	ORDER BY DESCRIPTION
A24MP7	3050-0139	6	4	WASHER=FL MTLN NO. 8 .172-IN-ID	28480	3050-0139
A24MP8	04140-40001	8	2	GUIDE	28480	04140-40001
A24XA1A	1251-2034	8	20	CONNECTOR=PC EDGE 10=CONT/ROW 2=ROWS	28480	1251-2034
A24XA2A	1251-2034	8		CONNECTOR=PC EDGE 10=CONT/ROW 2=ROWS	28480	1251-2034
A24XA3L	1251-2034	8		CONNECTOR=PC EDGE 10=CONT/ROW 2=ROWS	28480	1251-2034
A24XA3R	1251-2034	8		CONNECTOR=PC EDGE 10=CONT/ROW 2=ROWS	28480	1251-2034
A24XA4L	1251-2034	8		CONNECTOR=PC EDGE 10=CONT/ROW 2=ROWS	28480	1251-2034
A24XA4R	1251-2034	8		CONNECTOR=PC EDGE 10=CONT/ROW 2=ROWS	28480	1251-2034
A24XA5L	1251-2034	8		CONNECTOR=PC EDGE 10=CONT/ROW 2=ROWS	28480	1251-2034
A24XA5R	1251-2034	8		CONNECTOR=PC EDGE 10=CONT/ROW 2=ROWS	28480	1251-2034
A24XA6	1251-0195	8	3	CONNECTOR=PC EDGE 10=CONT/ROW 1=ROW	28480	1251-0195
A24XA7	1251-0195	8		CONNECTOR=PC EDGE 10=CONT/ROW 1=ROW	28480	1251-0195
A24XA10A	1251-2034	8		CONNECTOR=PC EDGE 10=CONT/ROW 2=ROWS	28480	1251-2034
A24XA11A	1251-2034	8		CONNECTOR=PC EDGE 10=CONT/ROW 2=ROWS	28480	1251-2034
A24XA12L	1251-2034	8		CONNECTOR=PC EDGE 10=CONT/ROW 2=ROWS	28480	1251-2034
A24XA12R	1251-2034	8		CONNECTOR=PC EDGE 10=CONT/ROW 2=ROWS	28480	1251-2034
A24XA13A	1251-2034	8		CONNECTOR=PC EDGE 10=CONT/ROW 2=ROWS	28480	1251-2034
A24XA15	1251-0195	8		CONNECTOR=PC EDGE 10=CONT/ROW 1=ROW	28480	1251-0195
A24XA16L	1251-2034	8		CONNECTOR=PC EDGE 10=CONT/ROW 2=ROWS	28480	1251-2034
A24XA16R	1251-2034	8		CONNECTOR=PC EDGE 10=CONT/ROW 2=ROWS	28480	1251-2034
A24XA17L	1251-2034	8		CONNECTOR=PC EDGE 10=CONT/ROW 2=ROWS	28480	1251-2034
A24XA17R	1251-2034	8		CONNECTOR=PC EDGE 10=CONT/ROW 2=ROWS	28480	1251-2034
A24XA18A	1251-2034	8		CONNECTOR=PC EDGE 10=CONT/ROW 2=ROWS	28480	1251-2034
A24XA40A	1251-2034	8		CONNECTOR=PC EDGE 10=CONT/ROW 2=ROWS	28480	1251-2034
A24XA41A	1251-2034	8		CONNECTOR=PC EDGE 10=CONT/ROW 2=ROWS	28480	1251-2034
A25	04191-66525	6	1	HEATER CONTROLLER BD ASSEMBLY	28480	04191-66525

See introduction to this section for ordering information
*Indicates factory selected value

Table 6-3. Replaceable Parts

Reference Designation	HP Part Number	C D	Qty	Description	Mfr Code	Mfr Part Number
A25C1	0160-0259	9	2	CAPACITOR=FXD .22UF +/-10% 250VAC(RMS)	00633	#ME271M622
A25C2	0160-0259	0		CAPACITOR=FXD .22UF +/-10% 250VAC(RMS)	00633	#ME271M622
A25C3	0160-0292	5	1	CAPACITOR=FXD 220UF +/-20% 25VDC 4L	28480	0160-0292
A25C4	0160-0301	4	1	CAPACITOR=FXD .012UF +/-10% 200VDC POLYE	28480	0160-0301
A25C5	0160-0380	9	1	CAPACITOR=FXD .22UF +/-10% 200VDC POLYE	28480	0160-0380
A25CR1	1884-0286	9	1	THYRISTOR=TRIAC	0003J	AC03D6M
A25CR2	1902-3002	3	1	DIODE=ZNR 2.37V 5% DO-7 P08.4W TC=-.074X	28480	1902-3002
A25CR3	1901-0025	2	1	DIODE=GEN PRP 100V 200MA DO-7	28480	1901-0025
A25CR4	1901-0028	5	1	DIODE=PWR RECT 400V 750MA DO-29	28480	1901-0028
A25D81	1990-0486	6		LED=VISIBLE LUM=INTNIMCD IF=20MA=MAX	28480	5082-0684
A25F1	2110-0007	4	1	FUSE 1A 250V 1.25X.25 UL	7591B	313001
A25J1	1251-0599	6	1	CONNECTOR 3=PIN M POST TYPE	28480	1251-0599
A25J2	1251-3414	0	1	CONNECTOR 5=PIN M POST TYPE	28480	1251-3414
A25L1	9100-3139	5	1	COIL 75UH 15% .5DX.875LG=NDM	28480	9100-3139
A25MP1	0380-0156	3	4	STANDOFF=RYT=DN .375=IN=LG 6=32TND	00000	ORDER BY DESCRIPTION
A25MP2	0380-0832	2	1	STANDOFF=RYT=DN .5=IN=LG 4=40TMD	00000	ORDER BY DESCRIPTION
A25MP3	1480-0116	0		PIN=GRV .062=IN=DIA .25=IN=LG STL	28480	1480-0116
A25MP4	2110-0269	0		FUSEHOLDER=CLIP TYPE .250=FUSE	28480	2110-0269
A25MP5	2300-0115	4		SCREW=MACH 6-32 .312=IN=LG PAN=HD=POZI	00000	ORDER BY DESCRIPTION
A25MP6	4040-0750	7	1	EXTR=PC 8D RED POLYLC .062=8D=THKNS	28480	4040-0750
A25MP7	4040-0751	0	1	EXTR=PC 8D GRN POLYLC .062=8D=THKNS	28480	4040-0751
A25MP8	04191-04019	3	1	COVER	28480	04191-04019
A25R1	2100-2489	1		RESISTOR=TRMR 5K 10% C SIDE=ADJ 1=TRN	28480	2100-2489
A25R2	0683-1005	5		RESISTOR 10 5% .25W FC TC=+400/+500	01121	C81005
A25R3	0764-0044	2	3	RESISTOR 8.2K 5% 2W MD TC=0/+200	28480	0764-0044
A25R4	0764-0044	2		RESISTOR 8.2K 5% 2W MD TC=0/+200	28480	0764-0044
A25R5	0764-0044	2		RESISTOR 8.2K 5% 2W MD TC=0/+200	28480	0764-0044
A25R6	0683-3325	6		RESISTOR 3.3K 5% .25W FC TC=+400/+700	01121	C83325
A25R7	0683-1055	5		RESISTOR 1M 5% .25W FC TC=+400/+900	01121	C81055
A25R8	0698-3421	4	1	RESISTOR 38.3K 1% .5W F TC=0/+100	28480	0698-3421
A25T1	9100-0855	6		TRANSFORMER=PULSE	28480	9100-0855
A25TP1	1251-0600	0		CONNECTOR=SGL CONT PIN 1.14=MM=88C=8Z 50	28480	1251-0600
A25TP2	1251-0600	0		CONNECTOR=SGL CONT PIN 1.14=MM=88C=8Z 50	28480	1251-0600
A25TP3	1251-0600	0		CONNECTOR=SGL CONT PIN 1.14=MM=88C=8Z 50	28480	1251-0600
A25TP4	1251-0600	0		CONNECTOR=SGL CONT PIN 1.14=MM=88C=8Z 50	28480	1251-0600
A25TP5	1251-0600	0		CONNECTOR=SGL CONT PIN 1.14=MM=88C=8Z 50	28480	1251-0600
A25U1	1826-0676	9	1	IC 8=DIP=P	52648	8L441A
A26				NOT ASSIGNED		
A27				NOT ASSIGNED		
A28				NOT ASSIGNED		
A29				NOT ASSIGNED		

See introduction to this section for ordering information
*Indicates factory selected value

Table 6-3. Replaceable Parts

Reference Designation	HP Part Number	C D	Qty	Description	Mfr Code	Mfr Part Number
A30	04191-66530	3	1	VTO(100-110MHZ) BOARD ASSEMBLY (OPTION 002 UNIT ONLY)	28486	04191-66530
A30C1	0121-0059	7	1	CAPACITOR-V TRMR-CER 2-8PF 350V PC-MTG	28763	304324 2/8PF NPO
A30C2	0160-3456	6	11	CAPACITOR-FXD 1000PF +-10% 1KVDC CER	28480	0160-3456
A30C3	0160-3456	6		CAPACITOR-FXD 1000PF +-10% 1KVDC CER	28480	0160-3456
A30C4	0160-3456	6		CAPACITOR-FXD 1000PF +-10% 1KVDC CER	28480	0160-3456
A30C5	0160-3456	6		CAPACITOR-FXD 1000PF +-10% 1KVDC CER	28480	0160-3456
A30C6	0160-2249	3	1	CAPACITOR-FXD 4.7PF +-25PF 500VDC CER	28480	0160-2249
A30C7	0160-3456	6		CAPACITOR-FXD 1000PF +-10% 1KVDC CER	28480	0160-3456
A30C8	0160-2257	3	1	CAPACITOR-FXD 10PF +-5% 500VDC CER 0+-60	28480	0160-2257
A30C9	0160-2204	6	1	CAPACITOR-FXD 100PF +-5% 300VDC MICA	28480	0160-2204
A30C10	0160-2265	3	1	CAPACITOR-FXD 22PF +-5% 500VDC CER 0+-30	28480	0160-2265
A30C11	0160-3456	6		CAPACITOR-FXD 1000PF +-10% 1KVDC CER	28480	0160-3456
A30C12	0160-3456	6		CAPACITOR-FXD 1000PF +-10% 1KVDC CER	28480	0160-3456
A30C13	0160-3456	6		CAPACITOR-FXD 1000PF +-10% 1KVDC CER	28480	0160-3456
A30C14	0160-3456	6		CAPACITOR-FXD 1000PF +-10% 1KVDC CER	28480	0160-3456
A30C15	0160-3456	6		CAPACITOR-FXD 1000PF +-10% 1KVDC CER	28480	0160-3456
A30C16	0160-3456	6		CAPACITOR-FXD 1000PF +-10% 1KVDC CER	28480	0160-3456
A30C17	0160-2055	9	10	CAPACITOR-FXD .01UF +80-20% 100VDC CER	28480	0160-2055
A30C18	0160-1083	3	7	CAPACITOR-FXD 33UF -10%+75% 25WVDC AL	28480	0160-1083
A30C19	0160-2055	9		CAPACITOR-FXD .01UF +80-20% 100VDC CER	28480	0160-2055
A30C20	0160-2055	9		CAPACITOR-FXD .01UF +80-20% 100VDC CER	28480	0160-2055
A30C21	0160-2055	9		CAPACITOR-FXD .01UF +80-20% 100VDC CER	28480	0160-2055
A30C22	0160-2055	9		CAPACITOR-FXD .01UF +80-20% 100VDC CER	28480	0160-2055
A30C23	0160-2055	9		CAPACITOR-FXD .01UF +80-20% 100VDC CER	28480	0160-2055
A30C24	0160-1083	3		CAPACITOR-FXD 33UF -10%+75% 25WVDC AL	28480	0160-1083
A30C25	0150-0121	5	2	CAPACITOR-FXD .1UF +80-20% 50VDC CER	28480	0150-0121
A30C26	0160-0291	3	1	CAPACITOR-FXD .1UF+-10% 35VDC TA	56289	150D105X90354Z
A30C27	0150-0121	5		CAPACITOR-FXD .1UF +80-20% 50VDC CER	28480	0150-0121
A30C28	0160-1083	3		CAPACITOR-FXD 33UF -10%+75% 25WVDC AL	28480	0160-1083
A30C29	0160-1083	3		CAPACITOR-FXD 33UF -10%+75% 25WVDC AL	28480	0160-1083
A30C30	0160-1083	3		CAPACITOR-FXD 33UF -10%+75% 25WVDC AL	28480	0160-1083
A30C31	0160-1083	3		CAPACITOR-FXD 33UF -10%+75% 25WVDC AL	28480	0160-1083
A30C32	0160-2055	9		CAPACITOR-FXD .01UF +80-20% 100VDC CER	28480	0160-2055
A30C33	0160-1083	3		CAPACITOR-FXD 33UF -10%+75% 25WVDC AL	28480	0160-1083
A30C34	0160-2055	9		CAPACITOR-FXD .01UF +80-20% 100VDC CER	28480	0160-2055
A30C35	0160-2055	9		CAPACITOR-FXD .01UF +80-20% 100VDC CER	28480	0160-2055
A30C36	0160-2055	9		CAPACITOR-FXD .01UF +80-20% 100VDC CER	28480	0160-2055
A30C37	0160-2264	9		CAPACITOR-FXD 20PF +-5%		
A30CR1	0122-0109	0	1	DIODE-VDC 40mA 0.25Vmax 11pF(40-30)	28480	0122-0109
A30CR2	1901-0040	1	1	DIODE-SWITCHING 30V 50MA 2NS DD-35	28480	1901-0040
A30CR3	1902-0041	4	1	DIODE-ZNR 5.11V 5K DD-7 PWR 4W TC=+009%	28480	1902-0041
A30L1				NOT ASSIGNED		
A30L2	9140-0158	6	4	COIL-MLD 1UH 10% Q=32 .0950X,25LG-NOM	28480	9140-0158
A30L3	9140-0158	6		COIL-MLD 1UH 10% Q=32 .0950X,25LG-NOM	28480	9140-0158
A30L4	9140-0158	6		COIL-MLD 1UH 10% Q=32 .0950X,25LG-NOM	28480	9140-0158
A30L5	9140-0158	6		COIL-MLD 1UH 10% Q=32 .0950X,25LG-NOM	28480	9140-0158
A30L6	9140-0114	4	2	COIL-MLD 10UH 10% Q=55 .1550X,375LG-NOM	28480	9140-0114
A30L7	9140-0114	4		COIL-MLD 10UH 10% Q=55 .1550X,375LG-NOM	28480	9140-0114
A30L8	9100-2247			INDUCTOR-FXD 100NH +-10% RF CHOKE-MOLDED		
A30MP1	0380-0093	3	4	STANDOFF-RVT-0N .473-IN-LD 4-40TND	28480	0380-0093
A30MP2	2190-0124	4	2	WASHER-LK INTL T NO. 10 .195-IN-ID	28480	2190-0124
A30MP3	2200-0142	9	6	SCREW-MACH 4-40 .312-IN-LG 100 DEG	00000	ORDER BY DESCRIPTION
A30MP4	2360-0115	4	3	SCREW-MACH 6-32 .312-IN-LG PAN-HD-POZ1	00000	ORDER BY DESCRIPTION
A30MP5	2950-0078	9	2	NUT-HEX-DBL-CHAN 10-32-T+D .067-IN-THK	28480	2950-0078
A30MP6	5001-0173	7	2		28480	5001-0173
A30MP7	04191-00603	3	1	SHIELD-BOX	28480	04191-00603
A30MP8	04191-00604	4	1	SHIELD-BOX	28480	04191-00604
A30MP9	04191-00012	4	1	COVER	28480	04191-00012
A30P1	1250-1220	0	2	CONNECTOR-RF BMC M PC 50-DHM	28480	1250-1220
A30P2	1250-1220	0		CONNECTOR-RF BMC M PC 50-DHM	28480	1250-1220
A30Q1	1854-0092	2	2	TRANSISTOR NPN SI PD=200MH FT=600MHZ	28480	1854-0092
A30Q2	1854-0345	8	2	TRANSISTOR NPN 2N5179 SI T0=72 PD=200MH	04713	2N5179
A30Q3	1855-0041	1	1	TRANSISTOR J-FET N-CHAN 0-MODE SI	01295	2N5245
A30Q4	1854-0345	8	2	TRANSISTOR NPN 2N5179 SI T0=72 PD=200MH	04713	2N5179
A30Q5	1854-0092	2		TRANSISTOR NPN SI PD=200MH FT=600MHZ	28480	1854-0092
A30Q6	1854-0019	3	1	TRANSISTOR NPN SI T0=18 PD=360MH	28480	1854-0019
A30R1	0683-2715	6	1	RESISTOR 270 5% .25W FC TC=400/+600	01121	068715
A30R2	0683-1805	3	1	RESISTOR 18 5% .25W FC TC=400/+500	01121	0681805
A30R3	0683-1035	1	9	RESISTOR 10K 5% .25W FC TC=400/+700	01121	0681035
A30R4	0683-1025	9	3	RESISTOR 1K 5% .25W FC TC=400/+600	01121	0681025
A30R6	0683-1015	7	5	RESISTOR 100 5% .25W FC TC=400/+500	01121	0681015

See introduction to this section for ordering information
*Indicates factory selected value

Table 6-3. Replaceable Parts

Reference Designation	HP Part Number	C D	Qty	Description	Mfr Code	Mfr Part Number
A30R7	0683-1035	1	4	RESISTOR 10K 5% .25W FC TCR=400/+700	01121	C81035
A30R8	0683-1035	1		RESISTOR 10K 5% .25W FC TCR=400/+700	01121	C81035
A30R9	0683-3325	6		RESISTOR 3.3K 5% .25W FC TCR=400/+700	01121	C83325
A30R10	0683-3325	6		RESISTOR 3.3K 5% .25W FC TCR=400/+700	01121	C83325
A30R11	0683-3325	6		RESISTOR 3.3K 5% .25W FC TCR=400/+700	01121	C83325
A30R12	0683-3325	6	RESISTOR 3.3K 5% .25W FC TCR=400/+700	01121	C83325	
A30R13	0683-1035	1	RESISTOR 10K 5% .25W FC TCR=400/+700	01121	C81035	
A30R14	0683-1035	1	RESISTOR 10K 5% .25W FC TCR=400/+700	01121	C81035	
A30R15	0683-1035	1	RESISTOR 10K 5% .25W FC TCR=400/+700	01121	C81035	
A30R16	0683-1035	1	RESISTOR 10K 5% .25W FC TCR=400/+700	01121	C81035	
A30R17	0683-1035	1	RESISTOR 10K 5% .25W FC TCR=400/+700	01121	C81035	
A30R18	0683-1015	7	RESISTOR 100 5% .25W FC TCR=400/+500	01121	C81015	
A30R19	0683-1025	4	RESISTOR 1K 5% .25W FC TCR=400/+600	01121	C81025	
A30R20	0683-5605	9	RESISTOR 56 5% .25W FC TCR=400/+500	01121	C85605	
A30R21	0683-1015	7	RESISTOR 100 5% .25W FC TCR=400/+500	01121	C81015	
A30R22	0683-5615	1	RESISTOR 560 5% .25W FC TCR=400/+600	01121	C85615	
A30R23	0683-5605	9	RESISTOR 56 5% .25W FC TCR=400/+500	01121	C85605	
A30R24	0683-1035	1	RESISTOR 10K 5% .25W FC TCR=400/+700	01121	C81035	
A30R25	0683-2225	3	RESISTOR 2.2K 5% .25W FC TCR=400/+700	01121	C82225	
A30R26	0683-5615	1	RESISTOR 560 5% .25W FC TCR=400/+600	01121	C85615	
A30R27	0683-5615	1	RESISTOR 560 5% .25W FC TCR=400/+600	01121	C85615	
A30R28	0658-3441	7	RESISTOR 215 1% .125W F TCR=0+-100			
A30R29	0757-0420	9	RESISTOR 750 1% .125W F TCR=0+-100			
A30R30	0683-1025	4	RESISTOR 1K 5% .25W FC TCR=400/+600	01121	C81025	
A30R31	0683-6625	7	RESISTOR 6.6K 5% .25W FC TCR=400/+700	01121	C86625	
A30R32	0683-6615	5	RESISTOR 660 5% .25W FC TCR=400/+600	01121	C86615	
A30R33	0683-6615	5	RESISTOR 660 5% .25W FC TCR=400/+600	01121	C86615	
A30R34	0683-1015	7	RESISTOR 100 5% .25W FC TCR=400/+500	01121	C81015	
A30R35	0683-1235	3	RESISTOR 12K 5% .25W FC TCR=400/+800	01121	C81235	
A30R36	0683-1525	4	RESISTOR 1.5K 5% .25W FC TCR=400/+700	01121	C81525	
A30R37	0683-1515	2	RESISTOR 150 5% .25W FC TCR=400/+600	01121	C81515	
A30R38	0683-1015	7	RESISTOR 100 5% .25W FC TCR=400/+500	01121	C81015	
A30R39	0683-5625	3	RESISTOR 5.6K 5% .25W FC TCR=400/+700	01121	C85625	
A30U1	1820-1442	7	2	IC CNTR TTL LS DECO ASYNCHRD	01295	SN74LS290M
A30U2	1820-1383	5	1	IC CNTR ECL 8CD PDS-EDGE+TRIG	04713	MC10138L
A30U3	1820-0630	3	1	IC MISC TTL	04713	MC10040P
A30U4	1820-1442	7	2	IC CNTR TTL LS DECO ASYNCHRD	01295	SN74LS290M
A30U5	1820-0319	7	1	IC OP AMP TG-99	27014	LF356M

See introduction to this section for ordering information
*Indicates factory selected value

Table 6-3. Replaceable Parts

Reference Designation	HP Part Number	C D	Qty	Description	Mfr Code	Mfr Part Number
A31	04191-66531	4	1	100HZ STEP PROGRAMMABLE DIVIDER (OPTION 002 UNIT ONLY)	28480	04191-66531
A31C1	0160-3456	6	12	CAPACITOR=FXD 1000PF +/-10% 1KVDC CER	28480	0160-3456
A31C2	0160-3456	6		CAPACITOR=FXD 1000PF +/-10% 1KVDC CER	28480	0160-3456
A31C3	0160-3456	6		CAPACITOR=FXD 1000PF +/-10% 1KVDC CER	28480	0160-3456
A31C4	0160-3456	6		CAPACITOR=FXD 1000PF +/-10% 1KVDC CER	28480	0160-3456
A31C5	0160-3456	6		CAPACITOR=FXD 1000PF +/-10% 1KVDC CER	28480	0160-3456
A31C6	0160-3456	6		CAPACITOR=FXD 1000PF +/-10% 1KVDC CER	28480	0160-3456
A31C7	0160-3456	6		CAPACITOR=FXD 1000PF +/-10% 1KVDC CER	28480	0160-3456
A31C8	0160-3456	6		CAPACITOR=FXD 1000PF +/-10% 1KVDC CER	28480	0160-3456
A31C9	0160-3456	6		CAPACITOR=FXD 1000PF +/-10% 1KVDC CER	28480	0160-3456
A31C10	0160-3456	6		CAPACITOR=FXD 1000PF +/-10% 1KVDC CER	28480	0160-3456
A31C11	0160-3456	6		CAPACITOR=FXD 1000PF +/-10% 1KVDC CER	28480	0160-3456
A31C12	0160-3456	6		CAPACITOR=FXD 1000PF +/-10% 1KVDC CER	28480	0160-3456
A31C13	0160-2055	9	1	CAPACITOR=FXD .01UF +/-20% 100VDC CER	28480	0160-2055
A31C14	0180-1083	3	1	CAPACITOR=FXD 33uF -10%+75% 25WVDC AL	28480	0180-1083
A31CR1	1901-0040	1	2	DIODE=SWITCHING 30V 50MA 2NB DO=35	28480	1901-0040
A31CR2	1901-0040	1		DIODE=SWITCHING 30V 50MA 2NB DO=35	28480	1901-0040
A31L1	0140-0158	6	1	COIL=MLD 1UH 10X 0.32 .005DX.25LG=NDM	28480	0140-0158
A31WP10	2190-0124	4	1	WASHER=LK INTL 7 NO. 10 .195-IN-ID	28480	2190-0124
A31WP11	2360-0115	4	3	SCREEN=MACH 6-32 .312-IN-LG PAN=NO=POZI	00000	ORDER BY DESCRIPTION
A31WP12	2950-0078	9	1	NUT=HEX=OBL=CHAM 10-32-THD .067-IN-THK	28480	2950-0078
A31WP13	5001-0173	7	2		28480	5001-0173
A31WP14	04191-60013	5	1	COVER	28480	04191-60013
A31P1	1250-1220	0	1	CONNECTOR=RF 8MC M PC 50-OHM	28480	1250-1220
A31A1	0683-5605	9	1	RESISTOR 50 5% .25W FC TC=+400/+500	01121	C85605
A31A2	0683-2225	3	1	RESISTOR 2.2K 5% .25W FC TC=+400/+700	01121	C82225
A31A3	0683-5625	3	1	RESISTOR 5.6K 5% .25W FC TC=+400/+700	01121	C85625
A31U1	1820-1848	5	1	IC PRESCR ECL	04713	MC12013L
A31U2	1820-1204	9	1	IC GATE TTL LS NAND DUAL 4-INP	01295	SN74LS20N
A31U3	1820-1112	6	1	IC FF TTL LS D-TYPE POS-EDGE-TRIG	01295	SN74LS74AN
A31U4	1820-1431	4	5	IC CNTR TTL LS DECO SYNCHRD	01295	SN74LS162AN
A31U5	1820-1431	4		IC CNTR TTL LS DECO SYNCHRD	01295	SN74LS162AN
A31U6	1820-1431	4		IC CNTR TTL LS DECO SYNCHRD	01295	SN74LS162AN
A31U7	1820-1431	4		IC CNTR TTL LS DECO SYNCHRD	01295	SN74LS162AN
A31U8	1820-1433	6	2	IC SHF=RGTR TTL LS N=8 SERIAL-IN PRL=OUT	01295	SN74LS164N
A31U9	1820-1433	6		IC SHF=RGTR TTL LS N=8 SERIAL-IN PRL=OUT	01295	SN74LS164N
A31U10	1820-1431	4		IC CNTR TTL LS DECO SYNCHRD	01295	SN74LS162AN
A31U11	1820-1416	5	1	IC SCHMITT-TRIG TTL LS INV HEX 1-INP	01295	SN74LS14N

See introduction to this section for ordering information
*Indicates factory selected value

Table 6-3. Replaceable Parts

Reference Designation	HP Part Number	C D	Qty	Description	Mfr Code	Mfr Part Number
A12	00191-66532	5	1	BUMMING LOOP CIRCUIT BOARD ASSEMBLY (OPTION 002 UNIT ONLY)	28480	04191-66532
A32C1	0180-2091	3	1	CAPACITOR-FXD 1UF+-10% 35VDC TA	28480	150D105X9015A2
A32C2	0180-2308	5	1	CAPACITOR-FXD 36PF +-5% 300VDC MICA	28480	0180-2308
A32C3	0180-2055	9	10	CAPACITOR-FXD .01UF +80-20% 100VDC CER	28480	0180-2055
A32C4	0180-1083	3	10	CAPACITOR-FXD 33uF -10%+75% 25WVDC AL	28480	0180-1083
A32C5	0180-1083	3	10	CAPACITOR-FXD 33uF -10%+75% 25WVDC AL	28480	0180-1083
A32C6	0180-1083	3	10	CAPACITOR-FXD 33uF -10%+75% 25WVDC AL	28480	0180-1083
A32C7	0180-1083	3	10	CAPACITOR-FXD 33uF -10%+75% 25WVDC AL	28480	0180-1083
A32C8	0180-2055	9	10	CAPACITOR-FXD .01UF +80-20% 100VDC CER	28480	0180-2055
A32C9	0180-2055	9	10	CAPACITOR-FXD .01UF +80-20% 100VDC CER	28480	0180-2055
A32C10	0180-3456	6	3	CAPACITOR-FXD 1000PF +-10% 1KVDC CER	28480	0180-3456
A32C11	0180-3456	6	3	CAPACITOR-FXD 1000PF +-10% 1KVDC CER	28480	0180-3456
A32C12	0180-2055	9	10	CAPACITOR-FXD .01UF +80-20% 100VDC CER	28480	0180-2055
A32C13	0180-1083	3	10	CAPACITOR-FXD 33uF -10%+75% 25WVDC AL	28480	0180-1083
A32C14	0180-1083	3	10	CAPACITOR-FXD 33uF -10%+75% 25WVDC AL	28480	0180-1083
A32C15	0180-1083	3	10	CAPACITOR-FXD 33uF -10%+75% 25WVDC AL	28480	0180-1083
A32C16	0180-2055	9	10	CAPACITOR-FXD .01UF +80-20% 100VDC CER	28480	0180-2055
A32C17	0180-2055	9	10	CAPACITOR-FXD .01UF +80-20% 100VDC CER	28480	0180-2055
A32C18	0180-3456	6	3	CAPACITOR-FXD 1000PF +-10% 1KVDC CER	28480	0180-3456
A32C19	0150-0121	5	1	CAPACITOR-FXD .1UF +80-20% 50VDC CER	28480	0150-0121
A32C20	0180-2055	9	10	CAPACITOR-FXD .01UF +80-20% 100VDC CER	28480	0180-2055
A32C21	0180-1083	3	10	CAPACITOR-FXD 33uF -10%+75% 25WVDC AL	28480	0180-1083
A32C22	0180-0889	3	1	CAPACITOR-FXD .33UF +-10% 80VDC POLYE	28480	0180-0889
A32C23	0180-2055	9	10	CAPACITOR-FXD .01UF +80-20% 100VDC CER	28480	0180-2055
A32C24	0180-2055	9	10	CAPACITOR-FXD .01UF +80-20% 100VDC CER	28480	0180-2055
A32C25	0180-2055	9	10	CAPACITOR-FXD .01UF +80-20% 100VDC CER	28480	0180-2055
A32C26	0180-1083	3	10	CAPACITOR-FXD 33uF -10%+75% 25WVDC AL	28480	0180-1083
A32C27	0180-2055	9	10	CAPACITOR-FXD .01UF +80-20% 100VDC CER	28480	0180-2055
A32C28	0180-2055	9	10	CAPACITOR-FXD .01UF +80-20% 100VDC CER	28480	0180-2055
A32C29	0180-2055	9	10	CAPACITOR-FXD .01UF +80-20% 100VDC CER	28480	0180-2055
A32C30	0180-2055	9	10	CAPACITOR-FXD .01UF +80-20% 100VDC CER	28480	0180-2055
A32C31	0180-1083	3	10	CAPACITOR-FXD 33uF -10%+75% 25WVDC AL	28480	0180-1083
A32C32	0180-1083	3	10	CAPACITOR-FXD 33uF -10%+75% 25WVDC AL	28480	0180-1083
A32C33	0180-2055	9	10	CAPACITOR-FXD .01UF +80-20% 100VDC CER	28480	0180-2055
A32C34	0180-2055	9	10	CAPACITOR-FXD .01UF +80-20% 100VDC CER	28480	0180-2055
A32C35	0180-1083	3	10	CAPACITOR-FXD 33uF -10%+75% 25WVDC AL	28480	0180-1083
A32C36	0180-1083	3	10	CAPACITOR-FXD 33uF -10%+75% 25WVDC AL	28480	0180-1083
A32C37	0180-1083	3	10	CAPACITOR-FXD 33uF -10%+75% 25WVDC AL	28480	0180-1083
A32C38	0180-2055	9	10	CAPACITOR-FXD .01UF +80-20% 100VDC CER	28480	0180-2055
A32C39	0180-2225	5	2	CAPACITOR-FXD 2000PF +-5% 300VDC MICA	28480	0180-2225
A32C40	0180-2225	5	2	CAPACITOR-FXD 2000PF +-5% 300VDC MICA	28480	0180-2225
A32C41	0180-2055	9	10	CAPACITOR-FXD .01UF +80-20% 100VDC CER	28480	0180-2055
A32C42	0180-2055	9	10	CAPACITOR-FXD .01UF +80-20% 100VDC CER	28480	0180-2055
A32C43	0180-2055	9	10	CAPACITOR-FXD .01UF +80-20% 100VDC CER	28480	0180-2055
A32CR1	1901-0040	1	6	DIODE-SWITCHING 30V 50MA 2MS DO-35	28480	1901-0040
A32CR2	1902-0041	4	1	DIODE-ZNR 5.11V 5% DO-7 PDM, 4W TC=-.009%	28480	1902-0041
A32CR3	1902-3149	9	2	DIODE-ZNR 9.09V 5% DO-7 PDM, 4W TC=+.057%	28480	1902-3149
A32CR4	1901-0040	1	6	DIODE-SWITCHING 30V 50MA 2MS DO-35	28480	1901-0040
A32CR5	1901-0040	1	6	DIODE-SWITCHING 30V 50MA 2MS DO-35	28480	1901-0040
A32CR6	1901-0040	1	6	DIODE-SWITCHING 30V 50MA 2MS DO-35	28480	1901-0040
A32CR7	1901-0040	1	6	DIODE-SWITCHING 30V 50MA 2MS DO-35	28480	1901-0040
A32CR8	1901-0040	1	6	DIODE-SWITCHING 30V 50MA 2MS DO-35	28480	1901-0040
A32CR9	1902-3256	9	1	DIODE-ZNR 23.7V 5% DO-7 PDM, 4W TC=+.07%	28480	1902-3256
A32CR10	1902-3149	9	2	DIODE-ZNR 9.09V 5% DO-7 PDM, 4W TC=+.057%	28480	1902-3149
A32E1	1906-0235	6	1	DIODE MIXER	28480	1906-0235
A32L1	9140-0158	6	1	COIL-MLD 1UH 10% Q=32 .099DX, 25LG-NOM	28480	9140-0158
A32L2	9100-2247	6	1	COIL-MLD 100NH 10% Q=34 .095DX, 25LG-NOM	28480	9100-2247
A32L3	9140-0114	4	3	COIL-MLD 10UH 10% Q=55 .155DX, 375LG-NOM	28480	9140-0114
A32L4	9140-0114	4	3	COIL-MLD 10UH 10% Q=55 .155DX, 375LG-NOM	28480	9140-0114
A32L5	9100-1618	1	2	COIL-MLD 5.6UH 10% Q=45 .155DX, 375LG-NOM	28480	9100-1618
A32L6	9140-0114	4	3	COIL-MLD 10UH 10% Q=55 .155DX, 375LG-NOM	28480	9140-0114
A32L7	9100-1618	1	2	COIL-MLD 5.6UH 10% Q=45 .155DX, 375LG-NOM	28480	9100-1618
A32MP1	2190-0124	4	2	WASHER-LK INTL 7 NO. 10 .195-IN-ID	28480	2190-0124
A32MP2	2380-0115	4	3	SCREW-MACH 6-32 .312-IN-LEN PAN-HEAD-POZI	00000	ORDER BY DESCRIPTION
A32MP3	2950-0078	9	2	NUT-HEX-OBL-CMAM 10-32-TMD .067-IN-TMK	28480	2950-0078
A32MP4	5001-0173	7	2		28480	5001-0173
A32MP5	04191-60011	3	1	CDVER	28480	04191-60011
A32P1	1250-1220	0	3	CONNECTOR-RF 8MC M PC 50-0HM	28480	1250-1220
A32P2	1250-1220	0	3	CONNECTOR-RF 8MC M PC 50-0HM	28480	1250-1220
A32P3	1250-1220	0	3	CONNECTOR-RF 8MC M PC 50-0HM	28480	1250-1220

See introduction to this section for ordering information
*Indicates factory selected value

Table 6-3. Replaceable Parts

Reference Designation	HP Part Number	C D	Qty	Description	Mfr Code	Mfr Part Number
A3201	1854-0130	4	1	TRANSISTOR NPN SI PD=350MW FT=4.5GHZ	28480	1854-0130
A3202	1854-0071	7	2	TRANSISTOR NPN SI PD=300MW FT=200MHZ	28480	1854-0071
A3203	1853-0020	4	1	TRANSISTOR NPN SI PD=300MW FT=150MHZ	28480	1853-0020
A3204	1854-0071	7	2	TRANSISTOR NPN SI PD=300MW FT=200MHZ	28480	1854-0071
A32R1	0683-1035	1	8	RESISTOR 10K 5% .25W FC TC=400/+700	01121	CB1035
A32R2	0683-1035	1	8	RESISTOR 10K 5% .25W FC TC=400/+700	01121	CB1035
A32R3	0683-1025	0	5	RESISTOR 1K 5% .25W FC TC=400/+600	01121	CB1025
A32R4	0683-4725	2	1	RESISTOR 4.7K 5% .25W FC TC=400/+700	01121	CB4725
A32R5	0683-1515	2	3	RESISTOR 150 5% .25W FC TC=400/+600	01121	CB1515
A32R6	0683-3905	8	1	RESISTOR 39 5% .25W FC TC=400/+500	01121	CB3905
A32R7	0683-1515	2	3	RESISTOR 150 5% .25W FC TC=400/+600	01121	CB1515
A32R8	0683-1025	9	1	RESISTOR 1K 5% .25W FC TC=400/+600	01121	CB1025
A32R9	0683-3325	6	1	RESISTOR 3.3K 5% .25W FC TC=400/+700	01121	CB3325
A32R10	0683-4735	4	1	RESISTOR 47K 5% .25W FC TC=400/+800	01121	CB4735
A32R11	0683-2735	0	5	RESISTOR 27K 5% .25W FC TC=400/+800	01121	CB2735
A32R12	0683-2735	0	5	RESISTOR 27K 5% .25W FC TC=400/+800	01121	CB2735
A32R13	0683-1055	5	1	RESISTOR 1M 5% .25W FC TC=800/+900	01121	CB1055
A32R14	0683-1515	2	3	RESISTOR 150 5% .25W FC TC=400/+600	01121	CB1515
A32R15	0683-1015	7	12	RESISTOR 100 5% .25W FC TC=400/+500	01121	CB1015
A32R16	0683-1035	1	8	RESISTOR 10K 5% .25W FC TC=400/+700	01121	CB1035
A32R17	0683-1025	9	1	RESISTOR 1K 5% .25W FC TC=400/+600	01121	CB1025
A32R18	0683-1015	7	12	RESISTOR 100 5% .25W FC TC=400/+500	01121	CB1015
A32R19	0683-6845	1	1	RESISTOR 680K 5% .25W FC TC=800/+900	01121	CB6845
A32R20	0683-1045	5	1	RESISTOR 100K 5% .25W FC TC=400/+800	01121	CB1045
A32R21	0683-4715	0	2	RESISTOR 470 5% .25W FC TC=400/+600	01121	CB4715
A32R22	0683-3615	1	1	RESISTOR 360 5% .25W FC TC=400/+600	01121	CB3615
A32R23	0683-2725	8	2	RESISTOR 2.7K 5% .25W FC TC=400/+700	01121	CB2725
A32R24	0683-3925	2	1	RESISTOR 3.9K 5% .25W FC TC=400/+700	01121	CB3925
A32R25	0683-1015	7	12	RESISTOR 100 5% .25W FC TC=400/+500	01121	CB1015
A32R26	0683-6815	5	1	RESISTOR 680 5% .25W FC TC=400/+600	01121	CB6815
A32R27	0683-2205	9	1	RESISTOR 22 5% .25W FC TC=400/+500	01121	CB2205
A32R28	0683-2205	9	1	RESISTOR 22 5% .25W FC TC=400/+500	01121	CB2205
A32R29	0683-2205	9	1	RESISTOR 22 5% .25W FC TC=400/+500	01121	CB2205
A32R30	0683-1015	7	12	RESISTOR 100 5% .25W FC TC=400/+500	01121	CB1015
A32R31	0683-1035	1	8	RESISTOR 10K 5% .25W FC TC=400/+700	01121	CB1035
A32R32	0683-1935	6	1	RESISTOR 15K 5% .25W FC TC=400/+800	01121	CB1935
A32R33	0683-1035	1	8	RESISTOR 10K 5% .25W FC TC=400/+700	01121	CB1035
A32R34	0683-2235	5	2	RESISTOR 22K 5% .25W FC TC=400/+800	01121	CB2235
A32R35	0683-2735	0	5	RESISTOR 27K 5% .25W FC TC=400/+800	01121	CB2735
A32R36	0683-1025	9	1	RESISTOR 1K 5% .25W FC TC=400/+600	01121	CB1025
A32R37	0683-4715	0	2	RESISTOR 470 5% .25W FC TC=400/+600	01121	CB4715
A32R38	0683-1015	7	12	RESISTOR 100 5% .25W FC TC=400/+500	01121	CB1015
A32R39	0683-1015	7	12	RESISTOR 100 5% .25W FC TC=400/+500	01121	CB1015
A32R40	0683-3915	0	1	RESISTOR 390 5% .25W FC TC=400/+600	01121	CB3915
A32R41	0683-1005	5	1	RESISTOR 10 5% .25W FC TC=400/+500	01121	CB1005
A32R42	0683-2725	8	2	RESISTOR 2.7K 5% .25W FC TC=400/+700	01121	CB2725
A32R43	0683-1035	1	8	RESISTOR 10K 5% .25W FC TC=400/+700	01121	CB1035
A32R44	0683-1035	1	8	RESISTOR 10K 5% .25W FC TC=400/+700	01121	CB1035
A32R45	0683-8205	1	2	RESISTOR 82 5% .25W FC TC=400/+500	01121	CB8205
A32R46	0683-1015	7	12	RESISTOR 100 5% .25W FC TC=400/+500	01121	CB1015
A32R47	0683-8205	1	2	RESISTOR 82 5% .25W FC TC=400/+500	01121	CB8205
A32R48	0683-2715	6	4	RESISTOR 270 5% .25W FC TC=400/+600	01121	CB2715
A32R49	0683-1805	3	2	RESISTOR 18 5% .25W FC TC=400/+500	01121	CB1805
A32R50	0683-2715	6	4	RESISTOR 270 5% .25W FC TC=400/+600	01121	CB2715
A32R51	0683-1025	9	1	RESISTOR 1K 5% .25W FC TC=400/+600	01121	CB1025
A32R52	0683-2735	0	5	RESISTOR 27K 5% .25W FC TC=400/+800	01121	CB2735
A32R53	0683-2735	0	5	RESISTOR 27K 5% .25W FC TC=400/+800	01121	CB2735
A32R54	0683-1035	1	8	RESISTOR 10K 5% .25W FC TC=400/+700	01121	CB1035
A32R55	0683-2235	5	2	RESISTOR 22K 5% .25W FC TC=400/+800	01121	CB2235
A32R56	0683-1015	7	12	RESISTOR 100 5% .25W FC TC=400/+500	01121	CB1015
A32R57	0683-1015	7	12	RESISTOR 100 5% .25W FC TC=400/+500	01121	CB1015
A32R58	0683-1525	4	1	RESISTOR 1.5K 5% .25W FC TC=400/+700	01121	CB1525
A32R59	0683-1235	3	1	RESISTOR 12K 5% .25W FC TC=400/+800	01121	CB1235
A32R60	0683-1015	7	12	RESISTOR 100 5% .25W FC TC=400/+500	01121	CB1015
A32R61	0683-1015	7	12	RESISTOR 100 5% .25W FC TC=400/+500	01121	CB1015
A32R62	0683-5605	9	1	RESISTOR 56 5% .25W FC TC=400/+500	01121	CB5605
A32R63	0683-2715	6	4	RESISTOR 270 5% .25W FC TC=400/+600	01121	CB2715
A32R64	0683-1805	3	2	RESISTOR 18 5% .25W FC TC=400/+500	01121	CB1805
A32R65	0683-2715	6	4	RESISTOR 270 5% .25W FC TC=400/+600	01121	CB2715
A32U1	1820-1423	4	1	IC MV TTL LS MONDSTBL RETRIG DUAL	01295	8N74LS123N
A32U2	1820-0630	3	1	IC MISC TTL	04713	MC4040P
A32U3	1826-0210	7	1	IC COMPARATOR HS 14-DIP=P	27014	LM301A
A32U4	1820-1112	8	1	IC FF TTL LS D-TYPE POS-EDGE-TRIG	01295	8N74LS74AN
A32U5	1826-0224	8	2	IC OP AMP LOW-DRIFT TO=99	06665	OP-05CJ

See introduction to this section for ordering information
*Indicates factory selected value

Table 6-3. Replaceable Parts

Reference Designation	HP Part Number	C D	Qty	Description	Mfr Code	Mfr Part Number
A32J6 A32J7	1R26-0119 1R26-0229	9 8	1	IC OP AMP GP DUAL 8-DIP-P IC OP AMP LOW-DRIFT TO-99	01928 06665	CA1488C OP-05CJ

See introduction to this section for ordering information
*Indicates factory selected value

Table 6-3. Replaceable Parts

Reference Designation	HP Part Number	C D	Qty	Description	Mfr Code	Mfr Part Number
A33	04191-66533	6	1	VTO (250-500MHZ) BOARD ASSEMBLY (OPTION 002 UNIT ONLY)	26480	04191-66533
A33C1	0160-2055	9	13	CAPACITOR-FXD .01UF +80-20% 100VDC CER	26480	0160-2055
A33C2	0160-2055	9		CAPACITOR-FXD .01UF +80-20% 100VDC CER	26480	0160-2055
A33C3	0160-2055	9		CAPACITOR-FXD .01UF +80-20% 100VDC CER	26480	0160-2055
A33C4	0160-2055	9		CAPACITOR-FXD .01UF +80-20% 100VDC CER	26480	0160-2055
A33C5	0160-2055	9		CAPACITOR-FXD .01UF +80-20% 100VDC CER	26480	0160-2055
A33C6	0160-2055	9		CAPACITOR-FXD .01UF +80-20% 100VDC CER	26480	0160-2055
A33C7	0160-2055	9		CAPACITOR-FXD .01UF +80-20% 100VDC CER	26480	0160-2055
A33C8	0160-2055	9		CAPACITOR-FXD .01UF +80-20% 100VDC CER	26480	0160-2055
A33C9	0160-2055	9		CAPACITOR-FXD .01UF +80-20% 100VDC CER	26480	0160-2055
A33C10	0160-3878	6	12	CAPACITOR-FXD 1000PF +-20% 100VDC CER	26480	0160-3878
A33C11	0160-3878	6		CAPACITOR-FXD 1000PF +-20% 100VDC CER	26480	0160-3878
A33C12	0160-3878	6		CAPACITOR-FXD 1000PF +-20% 100VDC CER	26480	0160-3878
A33C13	0160-3878	6		CAPACITOR-FXD 1000PF +-20% 100VDC CER	26480	0160-3878
A33C14	0160-3878	6		CAPACITOR-FXD 1000PF +-20% 100VDC CER	26480	0160-3878
A33C15	0160-3878	6		CAPACITOR-FXD 1000PF +-20% 100VDC CER	26480	0160-3878
A33C16	0160-3878	6		CAPACITOR-FXD 1000PF +-20% 100VDC CER	26480	0160-3878
A33C17	0160-3878	6		CAPACITOR-FXD 1000PF +-20% 100VDC CER	26480	0160-3878
A33C18	0121-0453	5	1	CAPACITOR-V TMR-ADR 1,3-5,4PF 250V	74970	187-0303-105
A33C19	0160-3878	6		CAPACITOR-FXD 1000PF +-20% 100VDC CER	26480	0160-3878
A33C20	0160-3879	7	9	CAPACITOR-FXD .01UF +-20% 100VDC CER	26480	0160-3879
A33C21	0160-3877	5	7	CAPACITOR-FXD 100PF +-20% 200VDC CER	26480	0160-3877
A33C22	0160-3873	1	1	CAPACITOR-FXD 4.7PF +-5PF 200VDC CER	26480	0160-3873
A33C23	0160-3874	2	3	CAPACITOR-FXD 10PF +-5PF 200VDC CER	26480	0160-3874
A33C24	0160-3872	0	1	CAPACITOR-FXD 2.2PF +-25PF 200VDC CER	26480	0160-3872
A33C25	0160-2236	8	1	CAPACITOR-FXD 1PF +-25PF 500VDC CER	26480	0160-2236
A33C26	0160-2055	9		CAPACITOR-FXD .01UF +80-20% 100VDC CER	26480	0160-2055
A33C26	0160-2979	8	3	CAPACITOR-FXD 220UF+-20% 16VDC AL	26480	0160-2979
A33C28	0160-3879	7		CAPACITOR-FXD .01UF +-20% 100VDC CER	26480	0160-3879
A33C29	0160-3879	7		CAPACITOR-FXD .01UF +-20% 100VDC CER	26480	0160-3879
A33C30	0160-3877	5		CAPACITOR-FXD 100PF +-20% 200VDC CER	26480	0160-3877
A33C31	0160-3877	5		CAPACITOR-FXD 100PF +-20% 200VDC CER	26480	0160-3877
A33C32	0100-2244	8	1	CAPACITOR-FXD 3PF +-25PF 500VDC CER	26480	0160-2244
A33C33	0160-3878	6		CAPACITOR-FXD 1000PF +-20% 100VDC CER	26480	0160-3878
A33C34	0160-3879	7		CAPACITOR-FXD .01UF +-20% 100VDC CER	26480	0160-3879
A33C35	0160-2253	9	1	CAPACITOR-FXD 6.8PF +-25PF 500VDC CER	26480	0160-2253
A33C36	0160-3877	5		CAPACITOR-FXD 100PF +-20% 200VDC CER	26480	0160-3877
A33C37	0160-3879	7		CAPACITOR-FXD .01UF +-20% 100VDC CER	26480	0160-3879
A33C38	0160-2236	2	1	CAPACITOR-FXD 9.1PF +-25PF 500VDC CER	26480	0160-2236
A33C39	0160-3878	6		CAPACITOR-FXD 1000PF +-20% 100VDC CER	26480	0160-3878
A33C40	0160-3875	3	1	CAPACITOR-FXD 22PF +-5% 200VDC CER 0-130	26480	0160-3875
A33C41	0160-3877	5		CAPACITOR-FXD 100PF +-20% 200VDC CER	26480	0160-3877
A33C42	0160-3877	5		CAPACITOR-FXD 100PF +-20% 200VDC CER	26480	0160-3877
A33C43	0160-3874	2		CAPACITOR-FXD 10PF +-5PF 200VDC CER	26480	0160-3874
A33C44	0160-2241	5	1	CAPACITOR-FXD 2.2PF +-25PF 500VDC CER	26480	0160-2241
A33C45	0160-3877	5		CAPACITOR-FXD 100PF +-20% 200VDC CER	26480	0160-3877
A33C46	0160-3879	7		CAPACITOR-FXD .01UF +-20% 100VDC CER	26480	0160-3879
A33C47	0160-3878	6		CAPACITOR-FXD 1000PF +-20% 100VDC CER	26480	0160-3878
A33C48	0160-3874	2		CAPACITOR-FXD 10PF +-5PF 200VDC CER	26480	0160-3874
A33C49	0160-2055	9		CAPACITOR-FXD .01UF +80-20% 100VDC CER	26480	0160-2055
A33C50	0160-2055	9		CAPACITOR-FXD .01UF +80-20% 100VDC CER	26480	0160-2055
A33C51	0160-2979	8		CAPACITOR-FXD 220UF+-20% 16VDC AL	26480	0160-2979
A33C52	0160-1083	3	1	CAPACITOR-FXD 33UF -10%+75% 25WVDC AL	26480	0160-1083
A33C53	0160-2979	8		CAPACITOR-FXD 220UF+-20% 16VDC AL	26480	0160-2979
A33C54	0160-3879	7		CAPACITOR-FXD .01UF +-20% 100VDC CER	26480	0160-3879
A33C55	0160-3879	7		CAPACITOR-FXD .01UF +-20% 100VDC CER	26480	0160-3879
A33C56	0160-3879	7		CAPACITOR-FXD .01UF +-20% 100VDC CER	26480	0160-3879
A33CR1	0122-0109	0	8	DIODE VVC High Q 28Vmax 11pF(Vr=3V)	26480	0122-0109
A33CR2	0122-0109	0		DIODE VVC High Q 28Vmax 11pF(Vr=3V)	26480	0122-0109
A33CR3	0122-0109	0		DIODE VVC High Q 28Vmax 11pF(Vr=3V)	26480	0122-0109
A33CR4	0122-0109	0		DIODE VVC High Q 28Vmax 11pF(Vr=3V)	26480	0122-0109
A33CR5	0122-0109	0		DIODE VVC High Q 28Vmax 11pF(Vr=3V)	26480	0122-0109
A33CR6	0122-0109	0		DIODE VVC High Q 28Vmax 11pF(Vr=3V)	26480	0122-0109
A33CR7	0122-0109	0		DIODE VVC High Q 28Vmax 11pF(Vr=3V)	26480	0122-0109
A33CR8	0122-0109	0		DIODE VVC High Q 28Vmax 11pF(Vr=3V)	26480	0122-0109
A33CR9	0122-0072	6	1	DIODE-VVC 2.2PF 5% C3/C25-MIN=4.5	04713	881058
A33L1	9100-2247	4	11	COIL-MLD 100NH 10% Q#34 .095DX.25LG-NQM	26480	9100-2247
A33L2	9100-2247	4		COIL-MLD 100NH 10% Q#34 .095DX.25LG-NQM	26480	9100-2247
A33L3	9100-2247	4		COIL-MLD 100NH 10% Q#34 .095DX.25LG-NQM	26480	9100-2247
A33L4	9100-2247	4		COIL-MLD 100NH 10% Q#34 .095DX.25LG-NQM	26480	9100-2247
A33L5	9100-2247	4		COIL-MLD 100NH 10% Q#34 .095DX.25LG-NQM	26480	9100-2247

See introduction to this section for ordering information
*Indicates factory selected value

Table 6-3. Replaceable Parts

Reference Designation	HP Part Number	C D	Qty	Description	Mfr Code	Mfr Part Number
A33L6	9100-2247	0	4	COIL-MLD 100NH 10% QM34 .0950X.25LG-NOM	28480	9100-2247
A33L7	9100-2247	0	4	COIL-MLD 100NH 10% QM34 .0950X.25LG-NOM	28480	9100-2247
A33L8	9100-2247	0	4	COIL-MLD 100NH 10% QM34 .0950X.25LG-NOM	28480	9100-2247
A33L9	9100-2247	0	4	COIL-MLD 100NH 10% QM34 .0950X.25LG-NOM	28480	9100-2247
A33L10	9100-2247	0	4	COIL-MLD 100NH 10% QM34 .0950X.25LG-NOM	28480	9100-2247
A33L11	9100-2247	0	4	COIL-MLD 100NH 10% QM34 .0950X.25LG-NOM	28480	9100-2247
A33L12	9140-0098	3	1	COIL-MLD 2.2UM 10% QM33 .155DX.375LG-NOM	28480	9140-0098
A33L13	9170-0029	3	1	CORE-EMIELDING BEAD	28480	9170-0029
A33MP1	0350-1007	5	5	STANDOFF-RIVET-ON	00000	ORDER BY DESCRIPTION
A33MP2	2190-0124	4	2	WASHER-LK INTL 7 NO. 10 .195-IN-ID	28480	2190-0124
A33MP3	2200-0142	9	9	SCREW-MACH 4-40 .312-IN-LG 100 DEG	00000	ORDER BY DESCRIPTION
A33MP4	2300-0115	4	4	SCREW-MACH 6-32 .312-IN-LG PAN-ND-POZI	00000	ORDER BY DESCRIPTION
A33MP5	2950-0078	4	2	NUT-HEX-DBL-CHAN 10-32-THD .667-IN-THK	28480	2950-0078
A33MP6	5001-0173	7	2		28480	5001-0173
A33MP7	04191-00601	1	1	SHIELD-BOX	28480	04191-00601
A33MP8	04191-00602	2	1	SHIELD-BOX	28480	04191-00602
A33MP9	04191-00010	2	1	COVER	28480	04191-00010
A33P1	1250-1220	0	2	CONNECTOR-RF 8MC M PC 50-OHM	28480	1250-1220
A33P2	1250-1220	0	2	CONNECTOR-RF 8MC M PC 50-OHM	28480	1250-1220
A33Q1	1854-0130	9	2	TRANSISTOR NPN S1 PD=350MW FT=4.66GHZ	28480	1854-0130
A33Q2	1855-0124	3	1	TRANSISTOR FET N-CHAN MOS S1	28480	1855-0124
A33Q3	1854-0345	6	1	TRANSISTOR NPN 2N5179 SI TO-72 PD=200MW	04713	2N5179
A33Q4	1854-0130	9	2	TRANSISTOR NPN S1 PD=350MW FT=4.5GHZ	28480	1854-0130
A33Q5	1853-0020	4	1	TRANSISTOR PNP SI PD=300MW FT=150MHZ	28480	1853-0020
A33R1	0683-2215	1	9	RESISTOR 220 5% .25W FC TC=400/+600	01121	CR2215
A33R2	0683-2215	1	9	RESISTOR 220 5% .25W FC TC=400/+600	01121	CR2215
A33R3	0683-2215	1	9	RESISTOR 220 5% .25W FC TC=400/+600	01121	CR2215
A33R4	0683-2215	1	9	RESISTOR 220 5% .25W FC TC=400/+600	01121	CR2215
A33R5	0683-2215	1	9	RESISTOR 220 5% .25W FC TC=400/+600	01121	CR2215
A33R6	0683-2215	1	9	RESISTOR 220 5% .25W FC TC=400/+600	01121	CR2215
A33R7	0683-2215	1	9	RESISTOR 220 5% .25W FC TC=400/+600	01121	CR2215
A33R8	0683-2215	1	9	RESISTOR 220 5% .25W FC TC=400/+600	01121	CR2215
A33R9	0683-2215	1	9	RESISTOR 220 5% .25W FC TC=400/+600	01121	CR2215
A33R10	0683-1035	1	1	RESISTOR 10K 5% .25W FC TC=400/+700	01121	CR1035
A33R11	0698-3155	1	2	RESISTOR 4.64K 1% .125W F TC=0/+100	24546	C4=1/8-T0=4641-F
A33R12	0757-0280	3	4	RESISTOR 1K 1% .125W F TC=0/+100	24546	C4=1/8-T0=1001-F
A33R13	0757-0280	3	4	RESISTOR 1K 1% .125W F TC=0/+100	24546	C4=1/8-T0=1001-F
A33R14	0757-0280	3	4	RESISTOR 1K 1% .125W F TC=0/+100	24546	C4=1/8-T0=1001-F
A33R15	0698-3155	1	2	RESISTOR 4.64K 1% .125W F TC=0/+100	24546	C4=1/8-T0=4641-F
A33R16	2100-3273	1	1	RESISTOR-TMR 2K 10% C SIDE=ADJ 1-TMR	28480	2100-3273
A33R17	0757-0279	0	2	RESISTOR 3.16K 1% .125W F TC=0/+100	24546	C4=1/8-T0=3161-F
A33R18	0698-7193	5	5	RESISTOR 16.2 1% .05W F TC=0/+100	24546	C3=1/8-T0=16R2=0
A33R19	0683-3305	2	2	RESISTOR 33 5% .25W FC TC=400/+500	01121	CR3305
A33R20	0698-7193	5	5	RESISTOR 16.2 1% .05W F TC=0/+100	24546	C3=1/8-T0=16R2=0
A33R21	0698-3439	4	2	RESISTOR 178 1% .125W F TC=0/+100	24546	C4=1/8-T0=178R-F
A33R22	0757-0439	4	2	RESISTOR 6.81K 1% .125W F TC=0/+100	24546	C4=1/8-T0=6811-F
A33R23	0698-7193	0	1	RESISTOR 91.1 1% .05W F TC=0/+100	24546	C3=1/8-T0=91R1=0
A33R24	0757-0278	9	2	RESISTOR 1.78K 1% .125W F TC=0/+100	24546	C4=1/8-T0=1781-F
A33R25	0757-0290	5	2	RESISTOR 6.19K 1% .125W F TC=0/+100	19701	MF4C1/8-T0=6191-F
A33R26	0757-0417	6	1	RESISTOR 562 1% .125W F TC=0/+100	24546	C4=1/8-T0=562R-F
A33R27	0757-0278	9	2	RESISTOR 1.78K 1% .125W F TC=0/+100	24546	C4=1/8-T0=1781-F
A33R28	0757-0290	5	2	RESISTOR 6.19K 1% .125W F TC=0/+100	19701	MF4C1/8-T0=6191-F
A33R29	0698-3447	4	1	RESISTOR 422 1% .125W F TC=0/+100	24546	C4=1/8-T0=422R-F
A33R30	0698-7193	5	5	RESISTOR 16.2 1% .05W F TC=0/+100	24546	C3=1/8-T0=16R2=0
A33R31	0698-7188	8	1	RESISTOR 10 1% .05W F TC=0/+100	24546	C3=1/8-T0=10R=0
A33R32	0698-7193	5	5	RESISTOR 16.2 1% .05W F TC=0/+100	24546	C3=1/8-T0=16R2=0
A33R33	0757-0279	0	2	RESISTOR 3.16K 1% .125W F TC=0/+100	24546	C4=1/8-T0=3161-F
A33R34	0698-7193	5	5	RESISTOR 16.2 1% .05W F TC=0/+100	24546	C3=1/8-T0=16R2=0
A33R35	0683-3315	4	1	RESISTOR 330 5% .25W FC TC=400/+600	01121	CR3315
A33R36	0757-0280	3	1	RESISTOR 1K 1% .125W F TC=0/+100	24546	C4=1/8-T0=1001-F
A33R37	0698-0080	1	1	RESISTOR 9.53K 1% .125W F TC=0/+100	24546	C4=1/8-T0=9531-F
A33R38	0683-3305	2	2	RESISTOR 33 5% .25W FC TC=400/+500	01121	CR3305
A33R39	0757-0439	4	2	RESISTOR 6.81K 1% .125W F TC=0/+100	24546	C4=1/8-T0=6811-F
A33R40	0698-3439	4	2	RESISTOR 178 1% .125W F TC=0/+100	24546	C4=1/8-T0=178R-F
A33U1	1826-0372	2	2	IC-LINEAR SUPPORT CHIP F=2MHZ	28480	1826-0372
A33U2	1826-0372	2	2	IC-LINEAR SUPPORT CHIP F=2MHZ	28480	1826-0372

See introduction to this section for ordering information
*Indicates factory selected value

Table 6-3. Replaceable Parts

Reference Designation	HP Part Number	C D	Qty	Description	Mfr Code	Mfr Part Number
A24	04191-66534	7	1	MOTHER BOARD ASSEMBLY (OPTION 002 UNIT ONLY)	28480	04191-66534
A24C1	0160-2437	1	40	CAPACITOR-FDTHRU 5000PF +80 -20% 200V	28480	0160-2437
A24C2	0160-2437	1		CAPACITOR-FDTHRU 5000PF +80 -20% 200V	28480	0160-2437
A24C3	0160-2437	1		CAPACITOR-FDTHRU 5000PF +80 -20% 200V	28480	0160-2437
A24C4	0160-2437	1		CAPACITOR-FDTHRU 5000PF +80 -20% 200V	28480	0160-2437
A24C5	0160-2437	1		CAPACITOR-FDTHRU 5000PF +80 -20% 200V	28480	0160-2437
A24C6	0160-2437	1		CAPACITOR-FDTHRU 5000PF +80 -20% 200V	28480	0160-2437
A24C7	0160-2437	1		CAPACITOR-FDTHRU 5000PF +80 -20% 200V	28480	0160-2437
A24C8	0160-2437	1		CAPACITOR-FDTHRU 5000PF +80 -20% 200V	28480	0160-2437
A24C9	0160-2437	1		CAPACITOR-FDTHRU 5000PF +80 -20% 200V	28480	0160-2437
A24C10	0160-2437	1		CAPACITOR-FDTHRU 5000PF +80 -20% 200V	28480	0160-2437
A24C11	0160-2437	1		CAPACITOR-FDTHRU 5000PF +80 -20% 200V	28480	0160-2437
A24C12	0160-2437	1		CAPACITOR-FDTHRU 5000PF +80 -20% 200V	28480	0160-2437
A24C13	0160-2437	1		CAPACITOR-FDTHRU 5000PF +80 -20% 200V	28480	0160-2437
A24C14	0160-2437	1		CAPACITOR-FDTHRU 5000PF +80 -20% 200V	28480	0160-2437
A24C15	0160-2437	1		CAPACITOR-FDTHRU 5000PF +80 -20% 200V	28480	0160-2437
A24C16	0160-2437	1		CAPACITOR-FDTHRU 5000PF +80 -20% 200V	28480	0160-2437
A24C17	0160-2437	1		CAPACITOR-FDTHRU 5000PF +80 -20% 200V	28480	0160-2437
A24C18	0160-2437	1		CAPACITOR-FDTHRU 5000PF +80 -20% 200V	28480	0160-2437
A24C19	0160-2437	1		CAPACITOR-FDTHRU 5000PF +80 -20% 200V	28480	0160-2437
A24C20	0160-3877	5	10	CAPACITOR-FXD 100PF +/-20% 200VDC CER	28480	0160-3877
A24C21	0160-3877	5		CAPACITOR-FXD 100PF +/-20% 200VDC CER	28480	0160-3877
A24C22	0160-3877	5		CAPACITOR-FXD 100PF +/-20% 200VDC CER	28480	0160-3877
A24C23	0160-3877	5		CAPACITOR-FXD 100PF +/-20% 200VDC CER	28480	0160-3877
A24C24	0160-3877	5		CAPACITOR-FXD 100PF +/-20% 200VDC CER	28480	0160-3877
A24C25	0160-3877	5		CAPACITOR-FXD 100PF +/-20% 200VDC CER	28480	0160-3877
A24C26	0160-2437	1		CAPACITOR-FDTHRU 5000PF +80 -20% 200V	28480	0160-2437
A24C27	0160-2437	1		CAPACITOR-FDTHRU 5000PF +80 -20% 200V	28480	0160-2437
A24C28	0160-2437	1		CAPACITOR-FDTHRU 5000PF +80 -20% 200V	28480	0160-2437
A24C29	0160-2437	1		CAPACITOR-FDTHRU 5000PF +80 -20% 200V	28480	0160-2437
A24C30	0160-2437	1		CAPACITOR-FDTHRU 5000PF +80 -20% 200V	28480	0160-2437
A24C31	0160-3877	5		CAPACITOR-FXD 100PF +/-20% 200VDC CER	28480	0160-3877
A24C32	0160-3877	5		CAPACITOR-FXD 100PF +/-20% 200VDC CER	28480	0160-3877
A24C33	0160-3877	5		CAPACITOR-FXD 100PF +/-20% 200VDC CER	28480	0160-3877
A24C34	0160-3877	5		CAPACITOR-FXD 100PF +/-20% 200VDC CER	28480	0160-3877
A24C35	0160-3877	5		CAPACITOR-FXD 100PF +/-20% 200VDC CER	28480	0160-3877
A24C36	0160-3877	5		CAPACITOR-FXD 100PF +/-20% 200VDC CER	28480	0160-3877
A24C37	0160-3877	5		CAPACITOR-FXD 100PF +/-20% 200VDC CER	28480	0160-3877
A24C38	0160-3877	5		CAPACITOR-FXD 100PF +/-20% 200VDC CER	28480	0160-3877
A24C39	0160-2437	1		CAPACITOR-FDTHRU 5000PF +80 -20% 200V	28480	0160-2437
A24C40	0160-2437	1		CAPACITOR-FDTHRU 5000PF +80 -20% 200V	28480	0160-2437
A24C41	0160-2437	1		CAPACITOR-FDTHRU 5000PF +80 -20% 200V	28480	0160-2437
A24C42	0160-2437	1		CAPACITOR-FDTHRU 5000PF +80 -20% 200V	28480	0160-2437
A24C43	0160-2437	1		CAPACITOR-FDTHRU 5000PF +80 -20% 200V	28480	0160-2437
A24C44	0160-2437	1		CAPACITOR-FDTHRU 5000PF +80 -20% 200V	28480	0160-2437
A24C45	0160-2437	1		CAPACITOR-FDTHRU 5000PF +80 -20% 200V	28480	0160-2437
A24C46	0160-2437	1		CAPACITOR-FDTHRU 5000PF +80 -20% 200V	28480	0160-2437
A24C47	0160-2437	1		CAPACITOR-FDTHRU 5000PF +80 -20% 200V	28480	0160-2437
A24C48	0160-2437	1		CAPACITOR-FDTHRU 5000PF +80 -20% 200V	28480	0160-2437
A24C49	0160-2437	1		CAPACITOR-FDTHRU 5000PF +80 -20% 200V	28480	0160-2437
A24C50	0160-2437	1		CAPACITOR-FDTHRU 5000PF +80 -20% 200V	28480	0160-2437
A24C51	0160-2437	1		CAPACITOR-FDTHRU 5000PF +80 -20% 200V	28480	0160-2437
A24C52	0160-2437	1		CAPACITOR-FDTHRU 5000PF +80 -20% 200V	28480	0160-2437
A24C53	0160-2437	1		CAPACITOR-FDTHRU 5000PF +80 -20% 200V	28480	0160-2437
A24C54	0160-2437	1		CAPACITOR-FDTHRU 5000PF +80 -20% 200V	28480	0160-2437
A24C55	0160-2437	1		CAPACITOR-FDTHRU 5000PF +80 -20% 200V	28480	0160-2437
A24C56	0160-2437	1		CAPACITOR-FDTHRU 5000PF +80 -20% 200V	28480	0160-2437
A24C57	0160-2437	1		CAPACITOR-FDTHRU 5000PF +80 -20% 200V	28480	0160-2437
A24C58	0160-2437	1		CAPACITOR-FDTHRU 5000PF +80 -20% 200V	28480	0160-2437
A24L1	9100-2247	4	7	COIL-MLD 100NH 10% 0#34 .095DX.25LG-NOM	28480	9100-2247
A24L2	9100-2247	4		COIL-MLD 100NH 10% 0#34 .095DX.25LG-NOM	28480	9100-2247
A24L3	9100-2247	4		COIL-MLD 100NH 10% 0#34 .095DX.25LG-NOM	28480	9100-2247
A24L4	9100-2247	4		COIL-MLD 100NH 10% 0#34 .095DX.25LG-NOM	28480	9100-2247
A24L5	9100-2247	4		COIL-MLD 100NH 10% 0#34 .095DX.25LG-NOM	28480	9100-2247
A24L6	9100-2247	4		COIL-MLD 100NH 10% 0#34 .095DX.25LG-NOM	28480	9100-2247
A24L7	9100-2247	4		COIL-MLD 100NH 10% 0#34 .095DX.25LG-NOM	28480	9100-2247
A24MP1	0380-0111	0	2	STANDOFF-RVT=ON .25-IN-LG 6-32TMO	00000	ORDER BY DESCRIPTION
A24MP2	0380-1007	5	2	STANDOFF-RIVET=ON	00000	ORDER BY DESCRIPTION
A24MP3	0590-1142	4	44	THREADED INSERT-NUT 6-32 .1-LG CARB-8TL	28080	0590-1142
A24MP4	2190-0749	9	44	WASHER-FL #TLC NO. 6 .172-IN-ID	28080	2190-0749
A24MP5	2360-0115	4	2	SCREW-MACH 6-32 .312-IN-LG PAN=HD=POZI	00000	ORDER BY DESCRIPTION

See introduction to this section for ordering information
*Indicates factory selected value

Table 6-3. Replaceable Parts

Reference Designation	HP Part Number	C D	Qty	Description	Mfr Code	Mfr Part Number
A244P6	2360-0125	B	6	SCREW-MACH 6-32 .75-IN-LO PAN-HP-POZI	00000	ORDER BY DESCRIPTION
A244P7	3050-0139	B	4	WASHER-FL MILC NO. 8 .172-IN-10	28480	3050-0139
A244P8	04140-40001	B	2	GUIDE	28480	04140-40001
A244A1	1251-2034	B		CONNECTOR-PC EDGE 10=CONT/ROW 2=ROWS	28480	1251-2034
A244A2	1251-2034	B		CONNECTOR-PC EDGE 10=CONT/ROW 2=ROWS	28480	1251-2034
A244A3L	1251-2034	B	26	CONNECTOR-PC EDGE 10=CONT/ROW 2=ROWS	28480	1251-2034
A244A3R	1251-2034	B		CONNECTOR-PC EDGE 10=CONT/ROW 2=ROWS	28480	1251-2034
A244A4L	1251-2034	B		CONNECTOR-PC EDGE 10=CONT/ROW 2=ROWS	28480	1251-2034
A244A4R	1251-2034	B		CONNECTOR-PC EDGE 10=CONT/ROW 2=ROWS	28480	1251-2034
A244A5L	1251-2034	B		CONNECTOR-PC EDGE 10=CONT/ROW 2=ROWS	28480	1251-2034
A244A5R	1251-2034	B		CONNECTOR-PC EDGE 10=CONT/ROW 2=ROWS	28480	1251-2034
A244A6	1251-0195	B	3	CONNECTOR-PC EDGE 10=CONT/ROW 1=ROW	28480	1251-0195
A244A7	1251-0195	B		CONNECTOR-PC EDGE 10=CONT/ROW 1=ROW	28480	1251-0195
A244A10	1251-2034	B		CONNECTOR-PC EDGE 10=CONT/ROW 2=ROWS	28480	1251-2034
A244A11	1251-2034	B		CONNECTOR-PC EDGE 10=CONT/ROW 2=ROWS	28480	1251-2034
A244A12L	1251-2034	B		CONNECTOR-PC EDGE 10=CONT/ROW 2=ROWS	28480	1251-2034
A244A12R	1251-2034	B		CONNECTOR-PC EDGE 10=CONT/ROW 2=ROWS	28480	1251-2034
A244A13	1251-2034	B		CONNECTOR-PC EDGE 10=CONT/ROW 2=ROWS	28480	1251-2034
A244A15	1251-0195	B		CONNECTOR-PC EDGE 10=CONT/ROW 1=ROW	28480	1251-0195
A244A16L	1251-2034	B		CONNECTOR-PC EDGE 10=CONT/ROW 2=ROWS	28480	1251-2034
A244A16R	1251-2034	B		CONNECTOR-PC EDGE 10=CONT/ROW 2=ROWS	28480	1251-2034
A244A17L	1251-2034	B		CONNECTOR-PC EDGE 10=CONT/ROW 2=ROWS	28480	1251-2034
A244A17R	1251-2034	B		CONNECTOR-PC EDGE 10=CONT/ROW 2=ROWS	28480	1251-2034
A244A18	1251-2034	B		CONNECTOR-PC EDGE 10=CONT/ROW 2=ROWS	28480	1251-2034
A244A30L	1251-2034	B		CONNECTOR-PC EDGE 10=CONT/ROW 2=ROWS	28480	1251-2034
A244A30R	1251-2034	B		CONNECTOR-PC EDGE 10=CONT/ROW 2=ROWS	28480	1251-2034
A244A31	1251-2034	B		CONNECTOR-PC EDGE 10=CONT/ROW 2=ROWS	28480	1251-2034
A244A32L	1251-2034	B		CONNECTOR-PC EDGE 10=CONT/ROW 2=ROWS	28480	1251-2034
A244A32R	1251-2034	B		CONNECTOR-PC EDGE 10=CONT/ROW 2=ROWS	28480	1251-2034
A244A33	1251-2034	B		CONNECTOR-PC EDGE 10=CONT/ROW 2=ROWS	28480	1251-2034
A244A40	1251-2034	B		CONNECTOR-PC EDGE 10=CONT/ROW 2=ROWS	28480	1251-2034
A244A41	1251-2034	B		CONNECTOR-PC EDGE 10=CONT/ROW 2=ROWS	28480	1251-2034

See introduction to this section for ordering information
*Indicates factory selected value

Table 6-3. Replaceable Parts

Reference Designation	HP Part Number	C D	Qty	Description	Mfr Code	Mfr Part Number
A40	04191-66540	5	1	OC BIAS SUPPLY BOARD	28480	04191-66540
A40C1	0160-2219	7	2	CAPACITOR-FXD 1100PF +-5% 300VDC NICA	28480	0160-2219
A40C2	0160-2055	9	2	CAPACITOR-FXD .01UF +80-20K 100VDC CER	28480	0160-2055
A40C3	0160-0161	4	3	CAPACITOR-FXD .01UF +-10% 200VDC POLYE	28480	0160-0161
A40C4	0160-2219	7	2	CAPACITOR-FXD 1100PF +-5% 300VDC NICA	28480	0160-2219
A40C5	0160-2055	9	2	CAPACITOR-FXD .01UF +80-20K 100VDC CER	28480	0160-2055
A40C6	0160-0161	4	3	CAPACITOR-FXD .01UF +-10% 200VDC POLYE	28480	0160-0161
A40C7	0170-8040	9	1	CAPACITOR-FXD .047UF +-10% 200VDC POLYE	28480	0170-8040
A40C8	0180-1083	3	7	CAPACITOR-FXD 33UF -10%+75% 25WVDC AL	28480	0180-1083
A40C9	0180-1083	3	3	CAPACITOR-FXD 33UF -10%+75% 25WVDC AL	28480	0180-1083
A40C10	0180-1083	3	3	CAPACITOR-FXD 33UF -10%+75% 25WVDC AL	28480	0180-1083
A40C11	0180-1083	3	3	CAPACITOR-FXD 33UF -10%+75% 25WVDC AL	28480	0180-1083
A40C12	0180-1083	3	3	CAPACITOR-FXD 33UF -10%+75% 25WVDC AL	28480	0180-1083
A40C13	0180-1083	3	3	CAPACITOR-FXD 33UF -10%+75% 25WVDC AL	28480	0180-1083
A40C14	0180-1083	3	3	CAPACITOR-FXD 33UF -10%+75% 25WVDC AL	28480	0180-1083
A40C15	0180-1054	8	4	CIFND AL ELECT 47 UF 100VDCW	28480	0180-1054
A40C16	0180-1054	8	4	CIFND AL ELECT 47 UF 100VDCW	28480	0180-1054
A40C17	0180-1054	8	4	CIFND AL ELECT 47 UF 100VDCW	28480	0180-1054
A40C18	0180-1054	8	4	CIFND AL ELECT 47 UF 100VDCW	28480	0180-1054
A40C19	0160-2055	9	2	CAPACITOR-FXD .01UF +80-20K 100VDC CER	28480	0160-2055
A40CR1	1901-0040	1	3	DIODE-SWITCHING 30V 50MA 2MS D0-35	28480	1901-0040
A40CR2	1902-0041	4	2	DIODE-ZNR 5.11V 5% D0-7 P0W.4W TC=+.009K	28480	1902-0041
A40CR3	1901-0040	1	3	DIODE-SWITCHING 30V 50MA 2MS D0-35	28480	1901-0040
A40CR4	1901-0040	1	3	DIODE-SWITCHING 30V 50MA 2MS D0-35	28480	1901-0040
A40CR5	1902-0041	4	2	DIODE-ZNR 5.11V 5% D0-7 P0W.4W TC=+.009K	28480	1902-0041
A40CR6	1902-3336	6	2	DIODE-ZNR 47.5V 5% D0-7 P0W.4W TC=+.081K	28480	1902-3336
A40CR7	1902-3336	6	2	DIODE-ZNR 47.5V 5% D0-7 P0W.4W TC=+.081K	28480	1902-3336
A40CR8	1902-0048	9	1	DIODE-ZNR 6.81V 5% D0-7 PD=.4W	28480	1902-0048
A40CR9	1902-0048	0	1	DIODE-ZNR 6.81V 5% D0-7 PD=.4W	28480	1902-0048
A40F1	2110-0011	0	1	FUSE .002A 250V 1.25X.25 UL	28480	2110-0011
A40J1	1251-4959	0	1	CONNECTOR 2-PIN * POST TYPE	28480	1251-4959
A40K1	0490-0243	2	2	RELAY-REED	28480	0490-0243
A40K2	0490-0243	2	2	RELAY-REED	28480	0490-0243
A40L1	9140-0114	4	4	COIL-MLO 100M 10% Q855 .155DX.375LG-NOM	28480	9140-0114
A40L2	9140-0114	4	4	COIL-MLO 100M 10% Q855 .155DX.375LG-NOM	28480	9140-0114
A40L3	9140-0114	4	4	COIL-MLO 100M 10% Q855 .155DX.375LG-NOM	28480	9140-0114
A40L4	9140-0114	4	4	COIL-MLO 100M 10% Q855 .155DX.375LG-NOM	28480	9140-0114
A40MP1	0590-0526	6	1	THREADED INSERT-NUT 4-40 .065-LG STL	28480	0590-0526
A40MP2	1480-0116	8	2	PIN-GRV .062-IN-DIA .25-IN-LG STL	28480	1480-0116
A40MP3	2110-0269	0	2	FUSEHOLDER-CLIP TYPE.250-FUSE	28480	2110-0269
A40MP4	7200-0103	2	1	SCREW-MACH 4-40 .25-IN-LG PAN-HD-POZI	00000	ORDER BY DESCRIPTION
A40MP5	4040-0748	3	1	EXTR-PC 8D BLK POLYC .062-8D-TMKNS	28480	4040-0748
A40MP6	4040-0752	9	1	EXTR-PC 8D YEL POLYC .062-8D-TMKNS	28480	4040-0752
A40Q1	1853-0012	4	1	TRANSISTOR PNP 2N2904A 5I TC=39 PD=600MW	01295	2N2904A
A40Q2	1854-0022	8	1	TRANSISTOR MPN 8I TC=39 PD=700MW	07263	8I7643
A40R1	2100-2413	5	1	RESISTOR-TRMR 200 10% C SIDE=ADJ 1-TRN	28480	2100-2413
A40R2	2100-2489	1	1	RESISTOR-TRMR 5K 10% C SIDE=ADJ 1-TRN	28480	2100-2489
A40R3	2100-2514	8	1	RESISTOR-TRMR 20K 10% C SIDE=ADJ 1-TRN	28480	2100-2514
A40R4	2100-2633	7	1	RESISTOR-TRMR 1K 10% C SIDE=ADJ 1-TRN	28480	2100-2633
A40R5	0699-0558	4	1	RESISTOR-FXD 24.3K +-1% .1W	28480	0699-0558
A40R6	0683-3925	2	2	RESISTOR 3.9K 5% .25W FC TC=400/+700	01121	C83925
A40R7	0698-6358	2	2	RESISTOR 100K 1% .125W F TC=0/+25	28480	0698-6358
A40R8	0757-0839	8	4	RESISTOR 10K 1% .5W F TC=0/+100	28480	0757-0839
A40R9	0757-0839	8	4	RESISTOR 10K 1% .5W F TC=0/+100	28480	0757-0839
A40R10	0683-4715	0	2	RESISTOR 470 5% .25W FC TC=400/+600	01121	C84715
A40R11	0757-0346	2	2	RESISTOR 10 1% .125W F TC=0/+100	28480	C4=1/8-T0=10R0=F
A40R12	0757-0346	2	2	RESISTOR 10 1% .125W F TC=0/+100	28480	C4=1/8-T0=10R0=F
A40R13	0683-2265	1	1	RESISTOR 22M 5% .25W FC TC=700/+1200	01121	C62265
A40R14	0699-0563	4	1	RESISTOR-FXD 32.5K +-1% .1W	28480	
A40R15	0683-3925	2	2	RESISTOR 3.9K 5% .25W FC TC=400/+700	01121	C83925
A40R16	0698-6358	2	2	RESISTOR 100K 1% .125W F TC=0/+25	28480	0698-6358
A40R17	0757-0839	8	4	RESISTOR 10K 1% .5W F TC=0/+100	28480	0757-0839
A40R18	0757-0839	8	4	RESISTOR 10K 1% .5W F TC=0/+100	28480	0757-0839
A40R19	0683-4715	0	2	RESISTOR 470 5% .25W FC TC=400/+600	01121	C84715
A40R20	0757-0444	1	2	RESISTOR 12.1K 1% .125W F TC=0/+100	28480	C4=1/8-T0=1212=F
A40R21	0757-0444	1	2	RESISTOR 12.1K 1% .125W F TC=0/+100	28480	C4=1/8-T0=1212=F
A40R22	0757-0159	5	1	RESISTOR 1K 1% .5W F TC=0/+100	28480	0757-0159
A40R23	0683-6805	2	2	RESISTOR 68 5% .25W FC TC=400/+500		
A40R24	0683-6805	2	2	RESISTOR 68 5% .25W FC TC=400/+500		

See introduction to this section for ordering information
*Indicates factory selected value

Table 6-3. Replaceable Parts

Reference Designation	HP Part Number	C D	Qty	Description	Mfr Code	Mfr Part Number
A40U1	1820-0223	0	2	IC OP AMP GP TO-99	04713	ML4301AG
A40U2	1820-0223	0		IC OP AMP GP TO-99	04713	ML4301AG
A40U3	1813-0105	2	1	IC CONV 12-B-D/A 20-DIP-C	81175	DAC80-CBI-V
A40U4	1826-0106	9	1	IC 7815 V RGLTR		
A40U5	1826-0218	1	1	IC V RGLTR TO-220	04713	MC7915CT
A40U6	1820-1060	9	2	IC SNF-RGTR TTL SERIAL-IN PRL-OUT 8-BIT	01295	SN74164N
A40U7	1820-1461	0	1	IC FF TTL D-TYPE PCB-EDGE-TRIG CLEAR	01295	SN74273
A40U8	1820-1060	9		IC SNF-RGTR TTL SERIAL-IN PRL-OUT 8-BIT	01295	SN74164N

See introduction to this section for ordering information
*Indicates factory selected value

Table 6-3. Replaceable Parts

Reference Designation	HP Part Number	C D	Qty	Description	Mfr Code	Mfr Part Number
A41	04191-06541	6	1	ANALOG RECORDER OUTPUT BOARD ASSEMBLY (OPTION 004 UNIT ONLY)	28480	04191-06541
A41C1	0160-2055	9	8	CAPACITOR-FXD .01UF +80-20% 100VDC CER	28480	0160-2055
A41C2	0160-2055	9		CAPACITOR-FXD .01UF +80-20% 100VDC CER	28480	0160-2055
A41C3	0160-2055	9		CAPACITOR-FXD .01UF +80-20% 100VDC CER	28480	0160-2055
A41C4	0160-2055	9		CAPACITOR-FXD .01UF +80-20% 100VDC CER	28480	0160-2055
A41C5	0160-2055	9		CAPACITOR-FXD .01UF +80-20% 100VDC CER	28480	0160-2055
A41C6	0160-2055	9	3	CAPACITOR-FXD .01UF +80-20% 100VDC CER	28480	0160-2055
A41C7	0160-2055	9		CAPACITOR-FXD .01UF +80-20% 100VDC CER	28480	0160-2055
A41C8	0180-1061	7		CAPACITOR-FXD 220UF 20% 16VDC AL	28480	0180-1061
A41C9	0180-1061	7		CAPACITOR-FXD 220UF 20% 16VDC AL	28480	0180-1061
A41C10	0160-2055	9		CAPACITOR-FXD .01UF +80-20% 100VDC CER	28480	0160-2055
A41C11	0150-0121	5	1	CAPACITOR-FXD .1UF +80-20% 50VDC CER	28480	0150-0121
A41C12	0180-1061	7	1	CAPACITOR-FXD 220UF 20% 16VDC ALM	28480	0180-1061
A41C13	0180-1061	3	1	CAPACITOR-FXD 33UF -10%+75% 25WVDC AL	28480	0180-1061
A41CR1	1902-0041	4	1	DIODE-ZNR 5.11V 5% 50=7 80B, 8W TCR=+.002%	28480	1902-0041
A41J1	1251-5382	5	1	CONNECTOR 4-PIN M METRIC POST TYPE	28480	1251-5382
A41L1	9140-0114	4	1	COIL-MLD 10UH 10% 0855 .155DX, 375LG-NOM	28480	9140-0114
A41L2	9100-1629	4	2	COIL-MLD 47UH 5% 0855 .155DX, 375LG-NOM	28480	9100-1629
A41L3	9100-1629	4	2	COIL-MLD 47UH 5% 0855 .155DX, 375LG-NOM	28480	9100-1629
A41MP1	4040-0749	4	2	PIN-GRV .062-IN-DIA .25-IN-LG 57L	28480	4040-0749
A41MP2	4040-0749	4	2	EXTR-PC 8D BRN POLYC .062-80-TXKNS	28480	4040-0749
A41MP3	4040-0752	9	1	EXTR-PC 8D YEL POLYC .062-80-TXKNS	28480	4040-0752
A41R1	2100-2489	1	3	RESISTOR-TRMR 5K 10% C SIDE-ADJ 1-TRN	28480	2100-2489
A41R2	2100-2489	1		RESISTOR-TRMR 5K 10% C SIDE-ADJ 1-TRN	28480	2100-2489
A41R3	2100-2413	9		RESISTOR-TRMR 200 10% C SIDE-ADJ 1-TRN	28480	2100-2413
A41R4	2100-2489	1		RESISTOR-TRMR 5K 10% C SIDE-ADJ 1-TRN	28480	2100-2489
A41R5	2100-2489	1		RESISTOR-TRMR 5K 10% C SIDE-ADJ 1-TRN	28480	2100-2489
A41R6	2100-2413	9	2	RESISTOR-TRMR 200 10% C SIDE-ADJ 1-TRN	28480	2100-2413
A41R7	2100-2489	1		RESISTOR-TRMR 5K 10% C SIDE-ADJ 1-TRN	28480	2100-2489
A41R8	2100-2413	9		RESISTOR-TRMR 200 10% C SIDE-ADJ 1-TRN	28480	2100-2413
A41R9	0698-5674	6		RESISTOR 2.87K .5% .125W F TCR=+50	19701	MF4C1/B-72-2671-D
A41R10	0698-5674	3		RESISTOR 5.62K 1% .125W F TCR=+25	28480	0698-5674
A41R11	0698-5348	0	4	RESISTOR 1K .1% .125W F TCR=+25	28480	0698-5348
A41R12	0698-5348	0		RESISTOR 3K .1% .125W F TCR=+25	28480	0698-5348
A41R13	0683-1025	9		RESISTOR 1K 5% .25W FC TCR=400/+600	01121	CB1025
A41R14	0683-1015	7		RESISTOR 100 5% .25W FC TCR=400/+500	01121	CB1015
A41R15	0698-5674	6		RESISTOR 2.87K .5% .125W F TCR=+50	19701	MF4C1/B-72-2671-D
A41R16	0698-5674	3	2	RESISTOR 5.62K 1% .125W F TCR=+25	28480	0698-5674
A41R17	0698-5348	0		RESISTOR 1K .1% .125W F TCR=+25	28480	0698-5348
A41R18	0698-5348	0		RESISTOR 3K .1% .125W F TCR=+25	28480	0698-5348
A41R19	0683-1025	9		RESISTOR 1K 5% .25W FC TCR=400/+600	01121	CB1025
A41R20	0683-1015	7		RESISTOR 100 5% .25W FC TCR=400/+500	01121	CB1015
A41R21	0757-0317	7	1	RESISTOR 1.33K 1% .125W F TCR=+100	24546	C4-1/B-T0-1331-F
A41R22	0757-0348	3		RESISTOR 5.11K 1% .125W F TCR=+100	24546	C4-1/B-T0-5111-F
A41R23	0683-1015	7		RESISTOR 100 5% .25W FC TCR=400/+500	01121	CB1015
A41R24	0757-0317	3		RESISTOR 5.11K 1% .125W F TCR=+100	24546	C4-1/B-T0-5111-F
A41R25	0757-0348	2		RESISTOR 10 1% .125W F TCR=+100	24546	C4-1/B-T0-10R0-F
A41R26	0757-0348	2	1	RESISTOR 10 1% .125W F TCR=+100	24546	C4-1/B-T0-10R0-F
A41R27	0757-0448	1		RESISTOR 12.1K 1% .125W F TCR=+100	24546	C4-1/B-T0-1212-F
A41R28	0683-1035	1		RESISTOR 10K 5% .25W FC TCR=400/+700	01121	CB1035
A41R29	0683-1035	1		RESISTOR 10K 5% .25W FC TCR=400/+700	01121	CB1035
A41R30	0683-1035	1		RESISTOR 10K 5% .25W FC TCR=400/+700	01121	CB1035
A41R31	0683-1035	1	1	RESISTOR 10K 5% .25W FC TCR=400/+700	01121	CB1035
A41R32	0683-1225	1		RESISTOR 1.2K 5% .25W FC TCR=400/+700	01121	CB1225
A41R33	0683-1325	2		RESISTOR 1.9K 5% .25W FC TCR=400/+700	01121	CB1325
A41R34	0683-5315	0		RESISTOR 330 5% .25W FC TCR=400/+600	01121	CB3315
A41U1	1826-0139	9		3	IC OP AMP GP DUAL 8-DIP-P	01928
A41U2	1826-0139	9	IC OP AMP GP DUAL 8-DIP-P		01928	CA14580
A41U3	1826-0139	9	IC OP AMP GP DUAL 8-DIP-P		01928	CA14580
A41U4	1826-1325	5	IC SWITCH ANLG QUAD 14-DIP-P		01928	CD4066AE
A41U5	1826-0197	9	IC CONV 10-B/D/A 16-DIP-C		06665	DAC-100CC03
A41U6	1826-1730	4	2	IC FF TTL LS D-TYPE POS-EDGE-TRIG COM	01295	SN74LS273N
A41U7	1826-0197	9		IC CONV 10-B/D/A 16-DIP-C	06665	DAC-100CC03
A41U8	1826-0197	9		IC CONV 10-B/D/A 16-DIP-C	06665	DAC-100CC03
A41U9	1826-1730	9		IC FF TTL LS D-TYPE POS-EDGE-TRIG COM	01295	SN74LS273N
A41U10	1826-0174	2		IC COMPARTOR GP QUAD 14-DIP-P	28480	1826-0174
A41U11	1826-1433	6	4	IC SHF-RSTR TTL LS R=8 SERIAL-IN PRL=OUT	01295	SN74LS164N
A41U12	1826-1433	6		IC SHF-RSTR TTL LS R=5 SERIAL-IN PRL=OUT	01295	SN74LS164N
A41U13	1826-1433	6		IC SHF-RSTR TTL LS R=8 SERIAL-IN PRL=OUT	01295	SN74LS164N
A41U14	1826-1433	6		IC SHF-RSTR TTL LS R=5 SERIAL-IN PRL=OUT	01295	SN74LS164N
A02				NOT ASSIGNED		

See introduction to this section for ordering information
*Indicates factory selected value

Table 6-3. Replaceable Parts

Reference Designation	HP Part Number	C D	Qty	Description	Mfr Code	Mfr Part Number
A43	04191-66543	8	1	STANDBY BATTERY BOARD ASSEMBLY	28480	04191-66543
A43B1	1420-0126	4	2	BATTERY-NI-CD	28480	1420-0126
A43B2	1420-0126			BATTERY NI-CD 1.25VDC		
A43C1	0160-0127	4	1	CAPACITOR-FXD 100UF+75-10% 25VDC AL	56289	30D107G0250V2
A43C2	0160-0127	2	1	CAPACITOR-FXD 1UF +20% 25VDC CER	28480	0160-0127
A43C91	1901-0023	2	1	DIODE-GEN PRP 100V 200MA DO-7	28480	1901-0023
A43D1	1853-0010	2	1	TRANSISTOR PNP 81 TO-18 PD=360MW	28480	1853-0010
A43D2	1854-0023	7	2	TRANSISTOR NPN 81 TO-18 PD=360MW	28480	1854-0023
A43D3	1854-0023	9		TRANSISTOR NPN 81 TO-18 PD=360MW	28480	1854-0023
A43E1	0683-1215	9	1	RESISTOR 120 5% .25W FC TC=400/+600	01121	C81215
A43E2	0683-2235	5	1	RESISTOR 22K 5% .25W FC TC=400/+600	01121	C82235
A43E3	0683-3345	0	1	RESISTOR 330K 5% .25W FC TC=400/+900	01121	C83345
A43E4	0683-3925	2	1	RESISTOR 3.9K 5% .25W FC TC=400/+700	01121	C83925
A43E5	0757-0442	9	1	RESISTOR 10K 1% .125W F TC=0/+100	24546	C4=1/R=70-1002=PF
A43E6	0698-3160	8	1	RESISTOR 31.6K 1% .125W F TC=0/+100	24546	C4=1/D=70-3162=PF
A43E7	0683-1055	5	1	RESISTOR 1K 5% .25W FC TC=400/+900	01121	C81055
A43E8	0683-5615	1	1	RESISTOR 560 5% .25W FC TC=400/+600	01121	C85615
A43U1	1826-0408	5	1	IC 8-DIP-P	32293	ICL8212CP1
A43A1	04191-61612	2	1	CABLE ASSEMBLY	28480	04191-61612
A44	04262-66503	6	1	HP-16 CONNECTOR BOARD ASSEMBLY	28480	04262-66503
A44P1	0361-0079	9	2	RIVET-SEMITUBULAR AL	28480	0361-0079
A44P2	1530-1098	4	2	CLEVIS 0.070-IN H SLT; 0.454-IN PIN CTR	00000	ORDER BY DESCRIPTION
A44J1	1251-3283	1	1	CONNECTOR 24-PIN F MICRORIBBON	28480	1251-3283
A44J2	1200-0485	2	1	SOCKET-IC 14-CONT DIP DIP-BLDR	28480	1200-0485
A44391	3101-1973	7	1	SWITCH-8L 7-1A DIP=SLIDE=ASSY .1A 50VDC	28480	3101-1973
A443W1	8120-0363	2	1	CABLE ASSEMBLY	28480	8120-0363

See introduction to this section for ordering information
*Indicates factory selected value

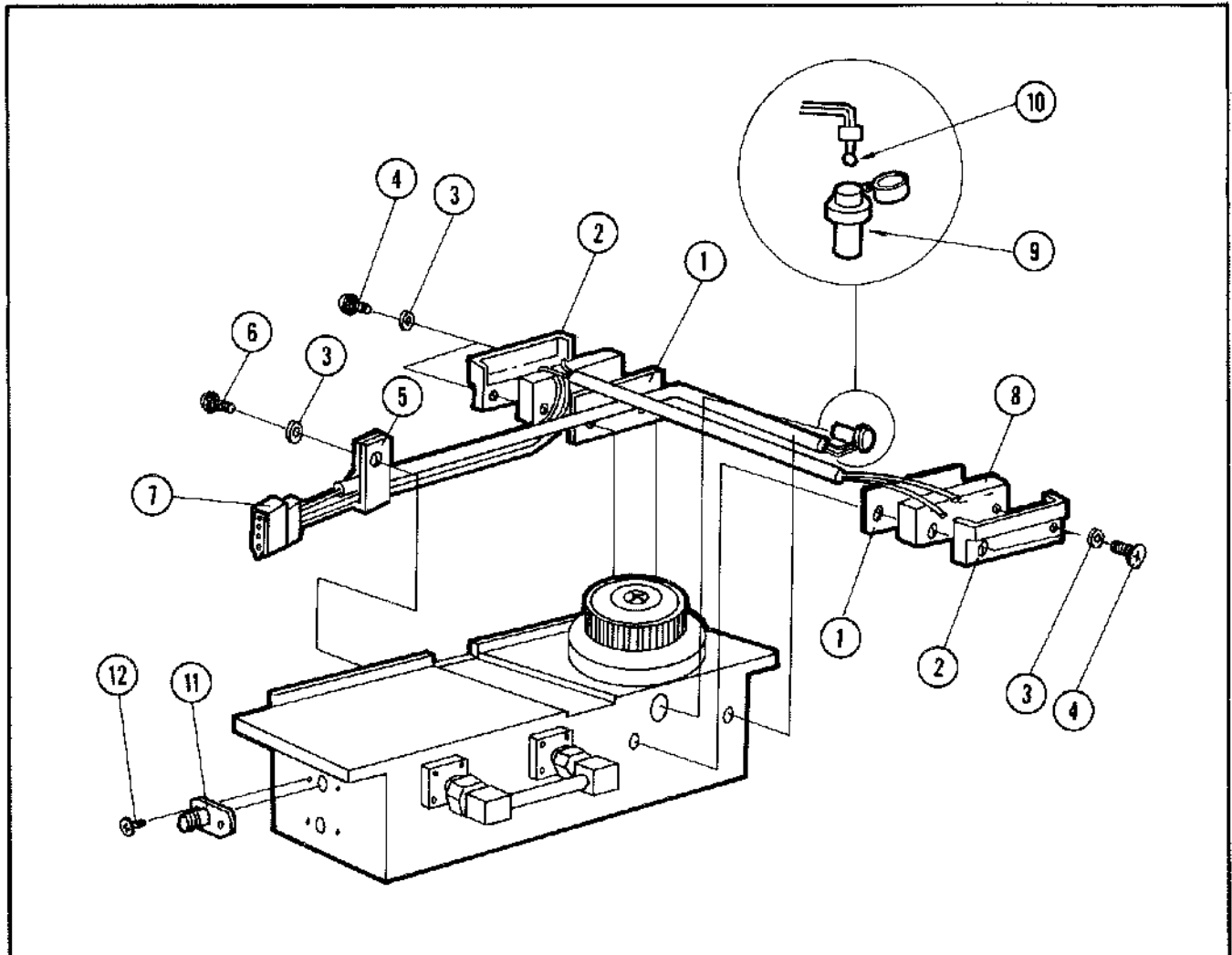

Reference	HP Part No.	Qty	Description
1	0340-0926	2	INSULATOR
2	04191-40006	2	COVER, HEATER
3	2190-0749	5	WASHER
4	2360-0123	4	SCREW
5	1400-0053	1	CABLE CLAMP
6	2360-0115	1	SCREW
7	04191-61615	1	CABLE ASS'Y
8	0837-0182	2	HEATER POSISTER
9	04191-40007	1	CAPSULE
10	0837-0035	1	THERMISTER
11	1250-1001	3	CONNECTOR, SMA
12	0520-0173	19	SCREW

Figure 6-1. Electrical and Mechanical Parts of the Directional Bridge Assembly – Exploded View (sheet 1 of 2).

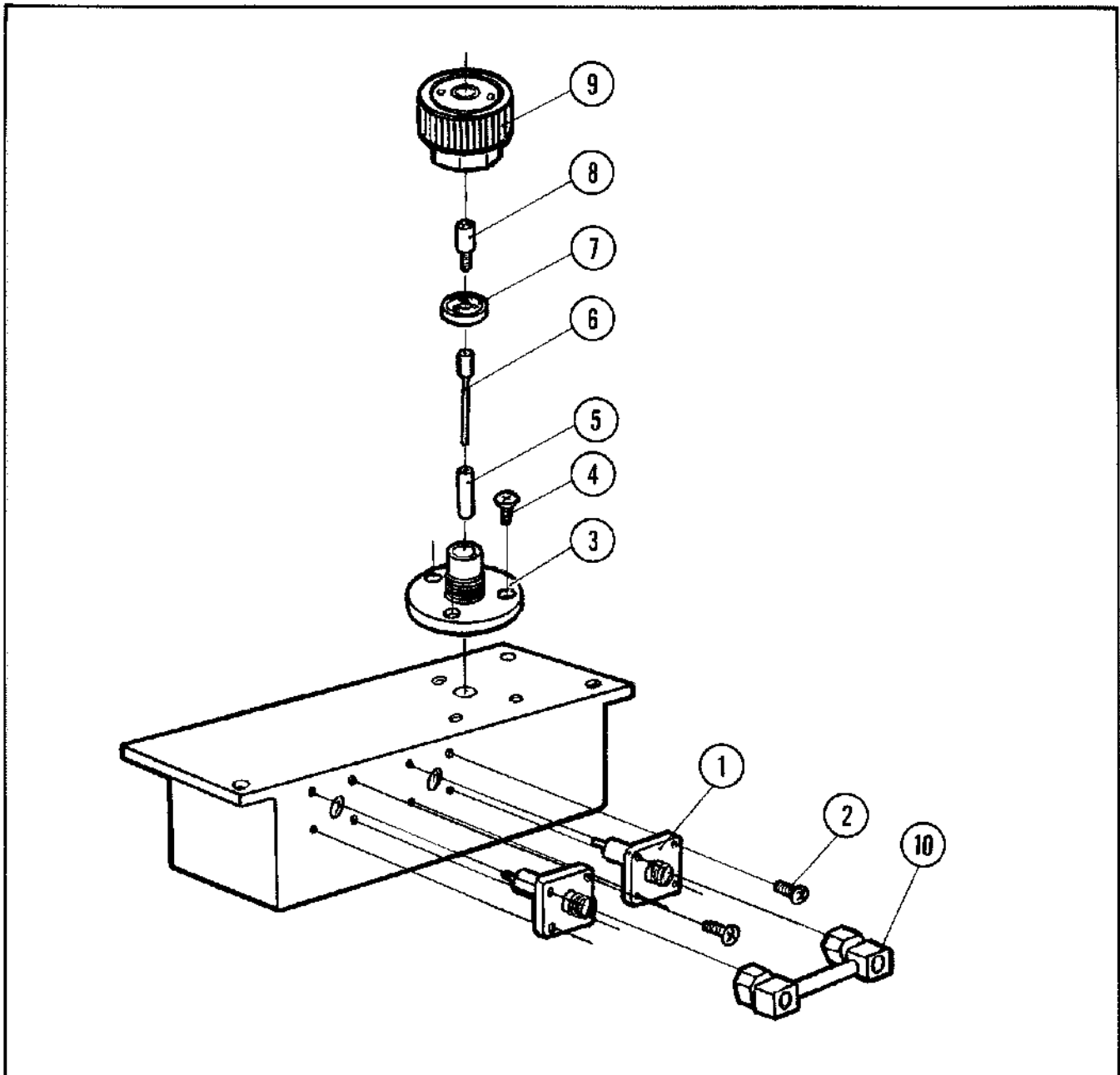

Reference	HP Part No.	Qty	Description
1	1250-0520	2	CONNECTOR, SMA
2	0520-0173	8	SCREW
3	04191-21000	1	FRANGE
4	2200-0167	3	SCREW
5	04191-25002	1	INSULATOR
6	04191-23001	1	CENTER PIN
7	5040-0306	1	INSULATOR
8	1250-0816	1	CONTACT, CENTER
9	1250-1466	1	CONNECTOR APC-7
10	04191-61609	1	CABLE ASS'Y

Figure 6-2. Electrical and Mechanical Parts of the Directional Bridge Assembly – Exploded View (sheet 2 of 2).

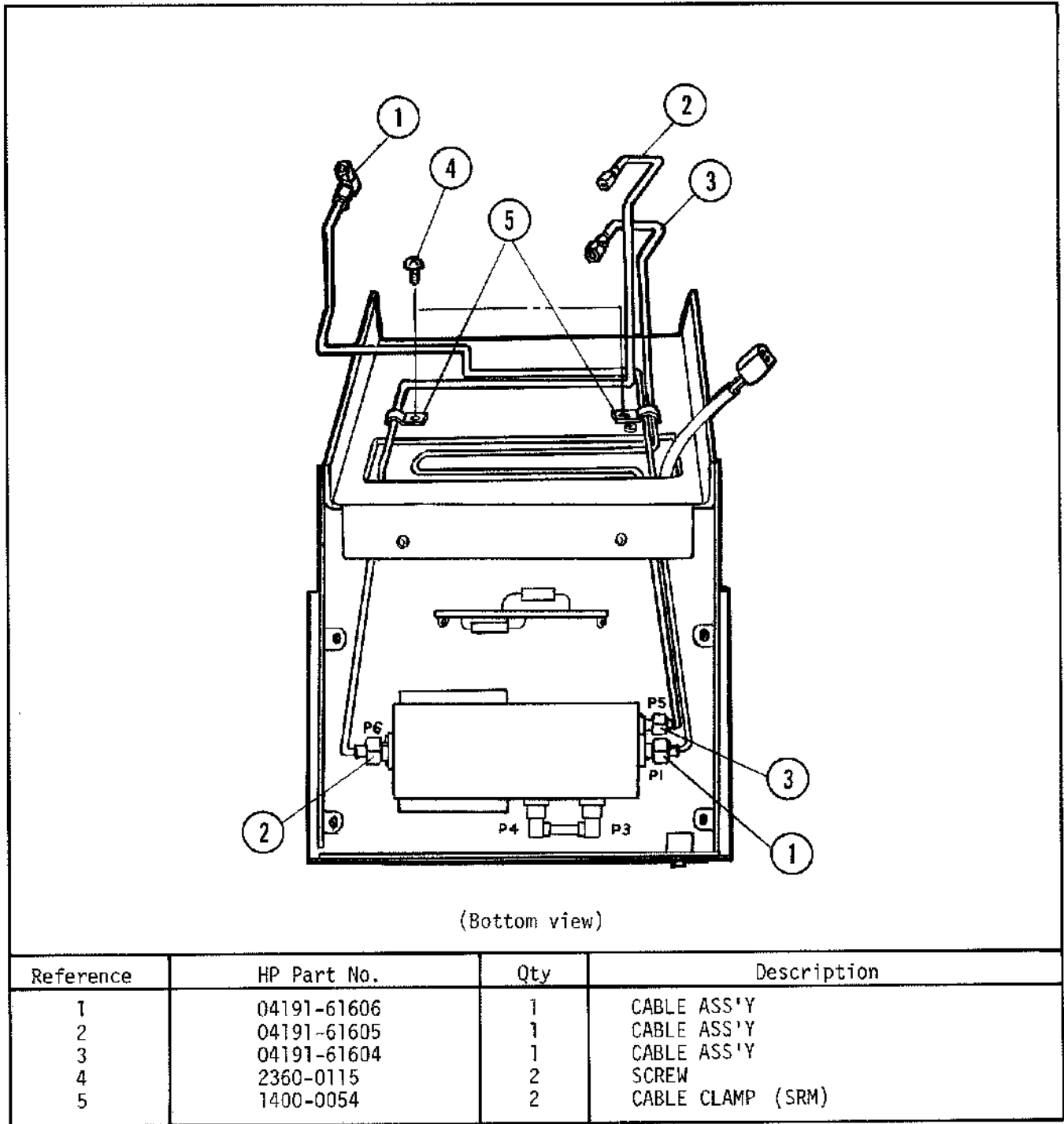
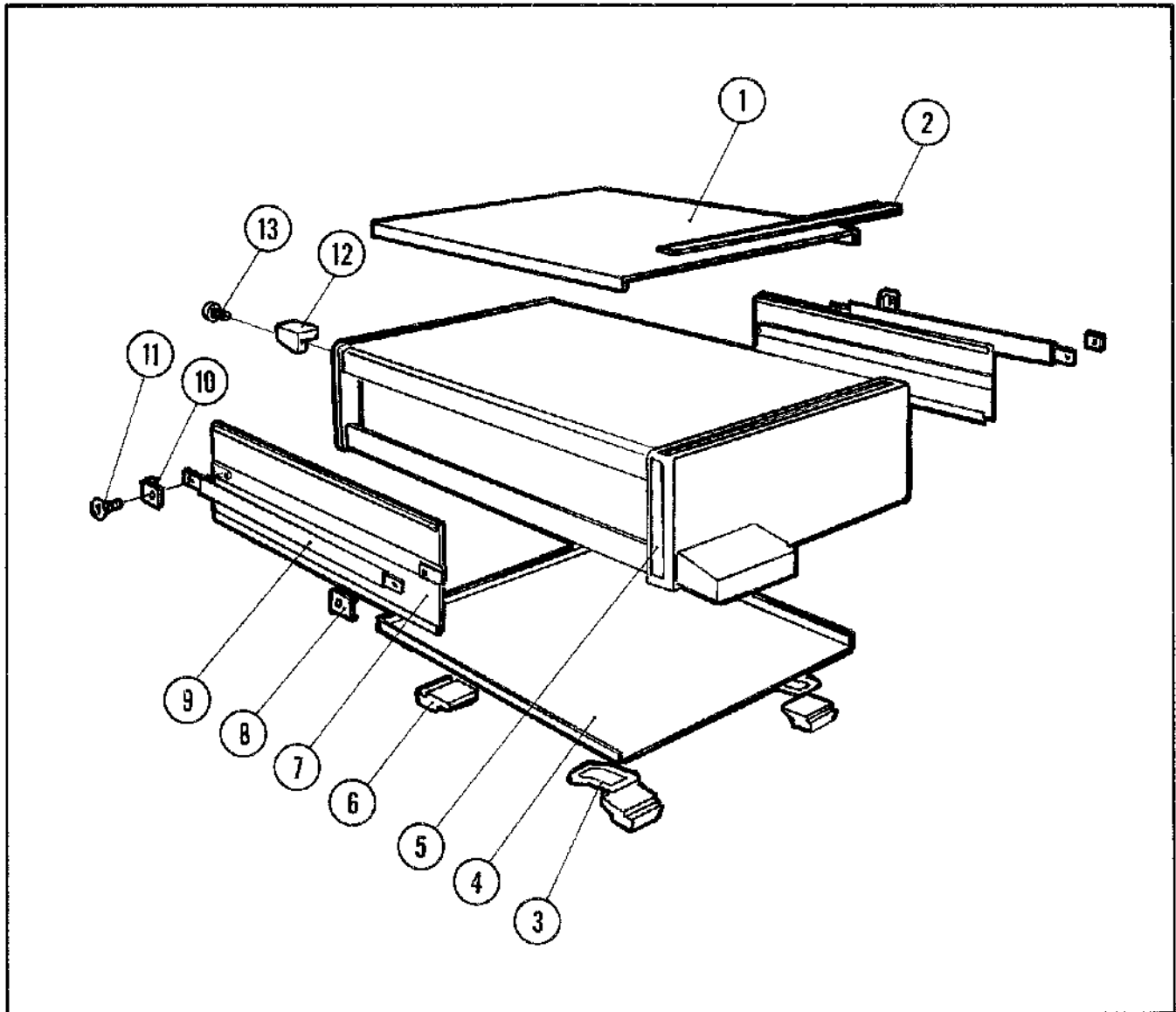

Figure 6-3. Cable Assemblies of the Directional Bridge Assembly - Exploded View.



Reference	HP Part No.	Qty	Description
1	5060-9836	1	TOP COVER
2	5040-7202	1	TOP TRIM
3	1460-1345	2	STAND
4	5060-9848	1	BOTTOM COVER
5	5001-0441	2	SIDE TRIM
6	5040-7201	4	FOOT, BOTTOM
7	5060-9948	2	SIDE COVER
8	5040-7219	2	FRONT CAP, HANDLE
9	5060-9805	2	HANDLE
10	5040-7220	2	REAR CAP, HANDLE
11	2680-0172	4	SCREW
12	5040-7221	4	FOOT, REAR
13	2360-0195	4	SCREW

Figure 6-4. Major Mechanical Parts on the Instrument Exterior
— Exploded View.

Table 6-3. Replaceable Parts

Reference Designation	HP Part Number	C D	Qty	Description	Mfr Code	Mfr Part Number
1	5040-7219		2	FRONT CAP		
2	5060-9948		2	SIDE COVER		
3	5060-9805		2	HANDLE		
4	5020-8838		4	STRUT		
5	2360-0115		6	SCREW		
6	04274-40002		3	GUIDE		
7	04191-00101		1	SIDE PLATE		
8	04191-01205		1	ANGLE		
9	5040-7220		2	REAR CAP		
10	2680-0172		4	SCREW		
11	2110-0569		1	NUT		
12	3101-2216		1	SWITCH		
13	2110-0564		1	FUSEHOLDER		
	2110-0565		1	CAP		
14	2110-0304		1	FUSE		
15	3101-0070		1	SWITCH		
16	2950-0043		1	NUT		
17	2190-0016		1	WASHER		
18	1250-0118		2	CONNECTOR BNC		
19	2360-0175		1	SCREW		
20	1906-0227		1	DIODE		
21	04191-04018		1	COVER		
22	9100-0885		1	TRANSFORMER		
23	3160-0311		1	FAN		
24	2200-0105		5	SCREW		
25	04191-00207		1	REAR PANEL		
26	2360-0117		8	SCREW		
27	2360-0113		4	SCREW		
28	5020-8808		1	REAR FRAME		
29	04191-00609		1	PLATE		
30	1390-0047		2	FASTENER		
31	04191-60101		1	CASE		
32	04191-1204		2	ANGLE		
33	2360-0333		6	SCREW		
34	5020-8807		1	FRONT FRAME		
35	04191-00201		1	SUB PANEL		
36	04191-25000		2	WINDOW		
37	04191-25001		1	WINDOW		
38	04191-00600		1	PLATE		
39	04191-00209		1	FRONT PANEL (HP)		
	04191-00208		1	FRONT PANEL (YHP)		
40	7120-1254		1	NAME PLATE (HP)		
	7120-0478		1	NAME PLATE (YHP)		
41	04191-00202		1	PANEL TOP		
42	1250-1466		1	CONNECTOR APC7		
43	04191-00204		1	PANEL SIDE		
44	04191-40001		1	GUIDE		
45	2200-0165		1	SCREW		
46	04191-00200		1	PLATE		
47	04191-24000		2	STUD		
48	04191-61900		1	SWITCH ASSY		
49	2200-0165		2	SCREW		
50	04191-00100		1	DECK		
51	04191-00203		1	PANEL SIDE		
52	6960-0002		1	PLUG		
53	04191-00200		1	BEZEL		
54	2200-0165		1	SCREW		
55	04191-00206		1	SUB PANEL		
56	2360-0115		6	SCREW		
57	5041-0564		1	KNOB		
58	04274-40001		1	ROD		
59	5040-7201		4	FOOT		
60	1460-1345		2	STAND		

See introduction to this section for ordering information
*Indicates factory selected value

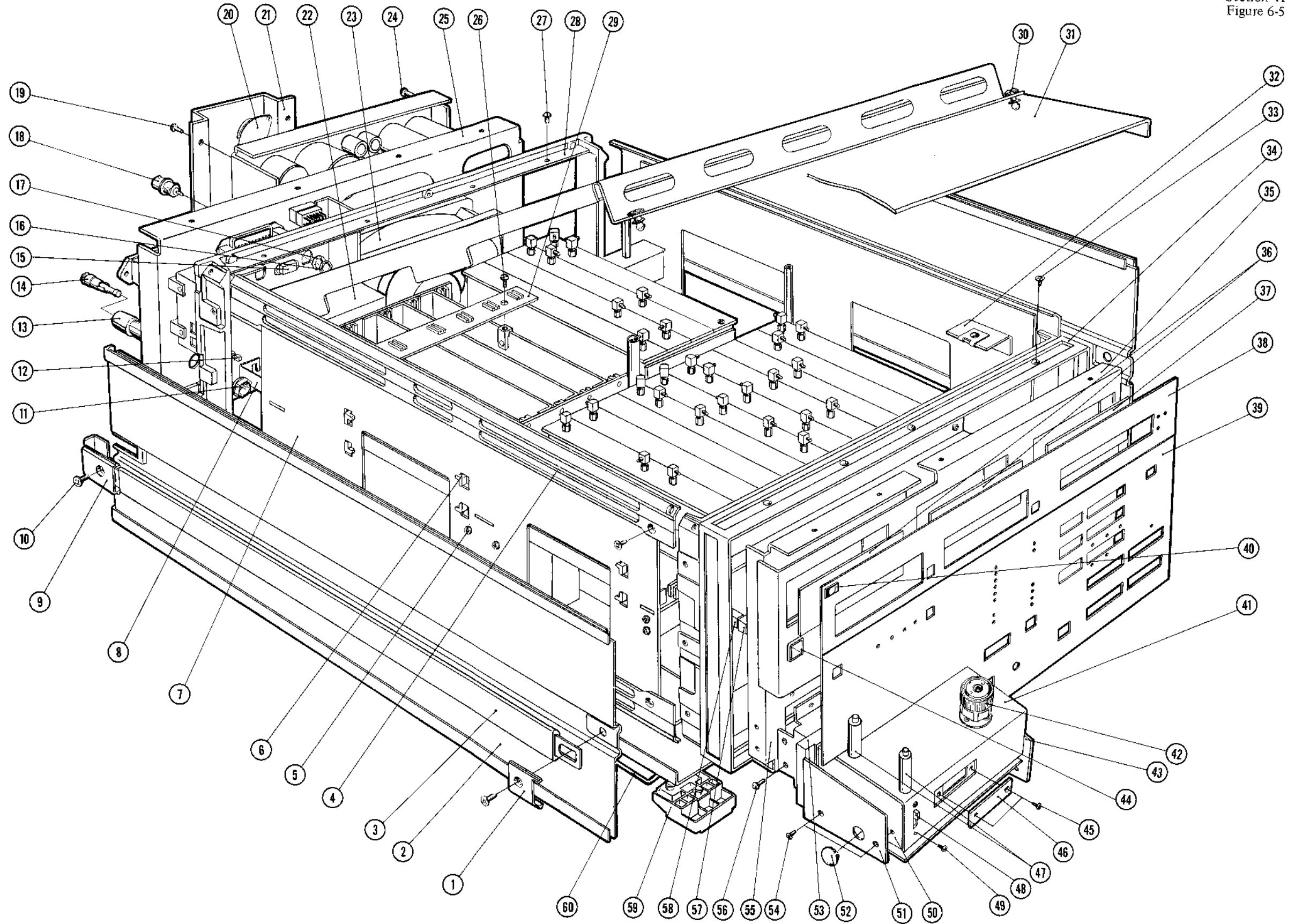

Figure 6-5. Major Mechanical Parts – Exploded View.

SECTION VII MANUAL CHANGES

7-1. INTRODUCTION.

7-2. This section contains information for adapting this manual to instruments to which the contents do not directly apply. The following paragraphs explain how to adapt this manual to apply to older instruments with a lower serial prefix.

7-3. MANUAL CHANGES.

7-4. To adapt this manual to your particular instrument, refer to Table 7-1 and make all of the manual changes listed opposite your instrument serial number. Perform these changes in the summary by assembly.

7-5. If your instrument serial number is not listed on the title page of this manual or in Table 7-1 to the right, it may be documented in a yellow MANUAL CHANGES supplement. For additional information about serial number coverage, refer to INSTRUMENT COVERED BY MANUAL in Section I.

Table 7-1. Manual Changes by Serial Number.

Serial Prefix or Number	Make Manual Changes

SECTION VIII

SERVICE

8-1. INTRODUCTION.

8-2. This section provides the information and instructions required to service the Model 4191A RF Impedance Analyzer. Included are the Theory of Operation and Troubleshooting Guide with Circuit Schematics. The Theory of Operation describes fundamental principles and circuit operating theory of the 4191A with block diagrams. Circuit schematics, locator illustrations, troubleshooting guide, circuit analysis and other technical data necessary for repairs are integrated into the service sheet foldouts. An illustration of the instrument interior is shown in Figure 8-24.

Note: When the instrument circuitry includes expanded capabilities provided by optional equipment, refer to paragraph entitled OPTIONS for specific option service information.

8-3. SAFETY CONSIDERATIONS.

8-4. This section contains warnings and cautions that must be followed for your protection and to avoid damage to the equipment.

WARNING

MAINTENANCE DESCRIBED HEREIN IS PERFORMED WITH POWER SUPPLIED TO THE INSTRUMENT AND PROTECTIVE COVERS REMOVED. SUCH MAINTENANCE SHOULD BE PERFORMED ONLY BY SERVICE-TRAINED PERSONNEL WHO ARE AWARE OF THE HAZARDS INVOLVED (FOR EXAMPLE, FIRE AND ELECTRICAL SHOCK). WHERE MAINTENANCE CAN BE PERFORMED WITHOUT POWER APPLIED, THE POWER SHOULD BE REMOVED. BEFORE ANY REPAIR IS COMPLETED, ENSURE THAT ALL SAFETY FEATURES ARE INTACT AND FUNCTIONING AND THAT ALL NECESSARY PARTS ARE CONNECTED TO THEIR MEANS OF PROTECTIVE GROUNDING.

8-5. THEORY OF OPERATION.

8-6. The theory of operation discussion is organized into three sections: basic theory, block diagram discussion, and circuit analysis. The basic theory, beginning with paragraph 8-13, explains the concepts and fundamental theory of the 4191A instrument technique adapted for accurately measuring the DUT and for fully achieving automated measurement performance. The block diagram discussion describes the overall circuit operating theory of the 4191A with block-to-block signal flow. Included are block and timing diagrams. The circuit analysis provides a detailed description of how the circuit on each board functions. For reference convenience when servicing the instrument, a circuit description is included in the service sheets.

8-7. RECOMMENDED TEST EQUIPMENT.

8-8. The test equipment required to perform operations outlined in this section is listed in Table 4-1. The table includes: type of instrument required, critical specifications, use, and recommended model. If the recommended model is not available, equipment which meets or exceeds critical specifications listed may be substituted.

8-9. TROUBLESHOOTING.

8-10. This troubleshooting guide provides instructions and information for locating a faulty circuit component. All instructions consider the safety of service personnel performing the procedures. These diagnostic guides are in the form of step-by-step procedures with flow diagrams. The board level troubleshooting diagrams are the procedures for isolating the problem to an individual malfunctioning circuit board assembly. The guides for locating a defective component are given on the individual board service sheets and integrate service support data--test point locations, waveform illustrations, voltage data, timing diagrams, and other technical information in addition to providing schematic diagrams for each board. To facilitate easy troubleshooting of the 4191A digital section, the troubleshooting guide for the logic circuit employs a signature analysis technique incorporating the concept of data stream analysis. A guideline to signature analysis is provided in Figure 8-18.

8-11. REPAIR.

8-12. Repair explanations tell how to replace defective circuit components. The recommended replacement procedures for components and parts which require special repair, replacement tools, or test equipment should be observed. Correct disassembly and the exchange procedures for such special parts are outlined in Paragraphs 8-72 through 8-80. To prevent damage from improper repair procedure, refer to the appropriate manual section before proceeding with repair.

8-13. BASIC THEORY

The basic theory of the measurement technique used in the model 4191A is outlined in the following paragraph. The primary part of the description is on page 8-3. As an aid to understanding the discussion, the Block Diagram in Figure 8-1 is referred to throughout the description.

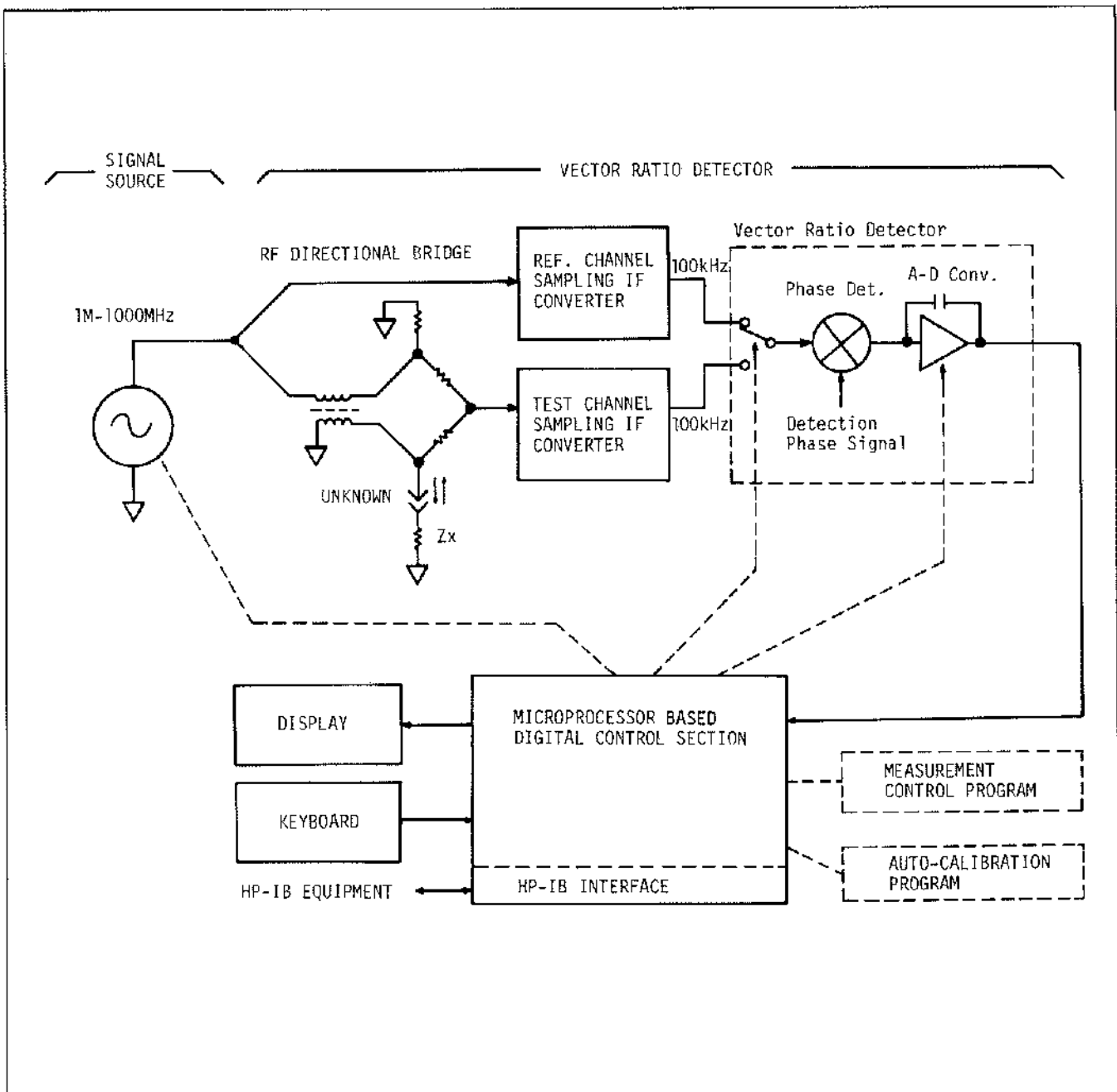

Figure 8-1. 4191A Block Diagram.

BASIC THEORY

The basic measurement circuit of the model 4191A consists of the measurement signal source and the vector voltage ratio detector. The measurement signal source produces a 1MHz to 1000MHz sinusoidal signal from the output of a crystal oscillator using a special frequency synthesis technique. The directional bridge circuit has a test port to connect the DUT and provides an output signal proportional to the vector reflection coefficient of the DUT. The measurement signal from the test port is applied to the DUT, and a part of the incident signal is reflected from the DUT. The reflected signal, which returns to the directional bridge, varies the signal current flowing in the bridge circuit and determines the impedance of the bridge arm at the test port (that is, the impedance of the DUT measured at the test port). The vector voltage ratio of the two bridge circuit output signals – the reference and the test channel outputs – represents the reflection coefficient of the DUT in the measuring circuit test port which has a 50Ω characteristic impedance.

To achieve accurate vector ratio measurements, the frequency of the directional bridge output signal is converted to 100kHz by the sampling IF converter. Using state-of-the-art technology for the low frequency vector measurement, the vector ratio of the reference and test channel IF signals is detected for both of the real and imaginary component vectors, which coincide with the components of the measured vector reflection coefficient. The other measurement parameter values are calculated from the values of the measured vector components.

The directivity errors in the bridge circuit, undesired reflections of the measurement signal in the line between the test port and the DUT, electrical length error, and other factors related to the inaccuracy of the measurement circuit will result in considerable errors in the measured vectors. The measurement values involving these errors are automatically corrected by determining the error vectors at the frequencies where the measurements are taken. The auto-calibration function of the 4191A calculates the error vectors from the measurements of the three reference terminations; 0Ω, 0S, and 50Ω. The calibration data obtained from the reflection coefficient measurements for the reference terminations is stored in the memory of the 4191A and is used to correct the measured vectors of the DUT's.

The microprocessor based digital control circuit controls the operations of the analog measurement circuit in accordance with the programs stored in the ROM. The measurement program contains the routines for vector conversion calculations to derive the various parameter values from the measured reflection coefficient vectors. To improve measurement speed, including the time required for auto-calibration and parameter conversion calculations, the digital control circuit employs an APU (Algorithmic Processing Unit) which performs the arithmetic operations. The HP-IB interface circuit, which is part of the digital control circuit, provides a means to connect the instrument to other HP-IB compatible equipment.

8-14. BLOCK DIAGRAM DISCUSSION

8-15. ANALOG SECTION BLOCK DIAGRAM DISCUSSION

8-16. Synthesizer Signal Source

8-17. Figure 8-2 is a block diagram of the signal source section. The A1, A2 and A3 boards compose the PLL synthesized signal generator which produces output frequencies from 250MHz to 500MHz in 100kHz steps. The output frequency is governed by the nine frequency bands of the A1 VTO and the tuning control input voltage fed from the A3 board. One of the two VTO outputs is sent to the A5 Frequency Converter to extend the frequency range down to 1MHz and up to 1000MHz. The other output is counted down to 100kHz by the A2 Programmable Divider. Divisor N of the programmable divider is automatically set to the following value:

$$N = F \times 10 \quad (2500 \leq N \leq 5000)$$

Where, F is the frequency required from the VTO (in MHz) to produce the measurement frequency.

The A3 Synthesizer Phase Detector compares the programmable divider output with the accurate 100kHz reference signal and supplies a dc voltage proportional to the difference in their frequencies (phases) as the VTO frequency control signal. This tuning control automatically locks the VTO frequency to the value given by the following equation:

$$f_{VTO} = N \times 100\text{kHz} \\ (250.0\text{MHz} \leq f_{VTO} \leq 500.0\text{MHz})$$

Because the PLL fixes the VTO frequency to N times the 100kHz reference frequency, the accuracy of the measurement frequency is almost equal to that of the 100kHz reference signal.

8-18. The A5 Frequency Converter outputs a 1M to 500MHz signal by converting the signal output from the VTO. For frequencies lower than 250MHz, two methods of frequency conversion are employed: One for frequencies from 32.1M to 250MHz, and the other for frequencies from 1M to 32MHz.

For frequencies from 32.1M to 250MHz, the input signal from the A1 VTO is applied to a three stage frequency divider ($\div 2$, $\div 4$, $\div 8$), which outputs a 125M to 250MHz signal, 62.6M to 125MHz signal, or 32.1M to 62.5MHz signal.

For frequencies from 1M to 32MHz, an accurate 200MHz signal is subtracted from the 201M to 232MHz signal output from the first stage of the frequency divider.

For frequencies between 500M and 1000MHz, the signal output from the A1 VTO is routed to the A6 Frequency Doubler via the A5 Frequency Converter.

8-19. The A7 Selectable Filter eliminates the harmonics from the signal output from the frequency converter to reduce distortion of the measurement signal. The filter circuits are switched to the filter channel with the appropriate roll-off frequency. The filter channel used depends on the frequency of the frequency converter output. For the 500M to 1000MHz frequency signal, the voltage tunable filter on the A6 board filters out the harmonics included in the frequency doubler output. The A7 Selectable Filter transmits the frequency doubler output to the power amplifier (A6) without filtering. The output of the A7 board feeds the low-distortion 1M to 1000MHz signal to the power amplifier on the A6 board. The wide band power amplifier supplies a power of about 3dBm to the A9 RF Directional Bridge.

8-20. The A18 100MHz Clock Generator/Doubler supplies an accurate 100MHz signal for use as the frequency source of the 100kHz reference signal used for the PLL synthesized signal generator. This 100MHz signal is counted down to 100kHz by the frequency divider on the A3 board. The frequency doubler on the A18 board produces a 200MHz signal from the 100MHz clock to provide the necessary (subtraction) frequency for obtaining the 1M to 32MHz measurement frequencies.

8-21. The A4 Programmable Switch Control Driver converts the frequency control and the filter switch control data transferred from the digital section to the individual control signals for each switch circuit. These control signals select the VTO frequency band, set the divisor of the programmable divider, switch the frequency converter circuits, and determine the selectable filter channel to be used. The D-A converter on the A4 board accepts the VTO frequency band selection signals as input and provides the dc voltage required to set the tuning frequency of the voltage tunable filter on the A6 board. Thus, the filter is automatically tuned to one of the nine frequency bands corresponding to twice the frequency of the VTO output (the frequency of the frequency doubler output). The programmable switch control data are transferred, with proper timing, from the A21 microprocessor digital control board through the S DATA 2 line (a serial data transmission line). CLK SS2, SS3 and SS4 signals enable the appropriate serial to parallel decoder to have access to the transferred data.

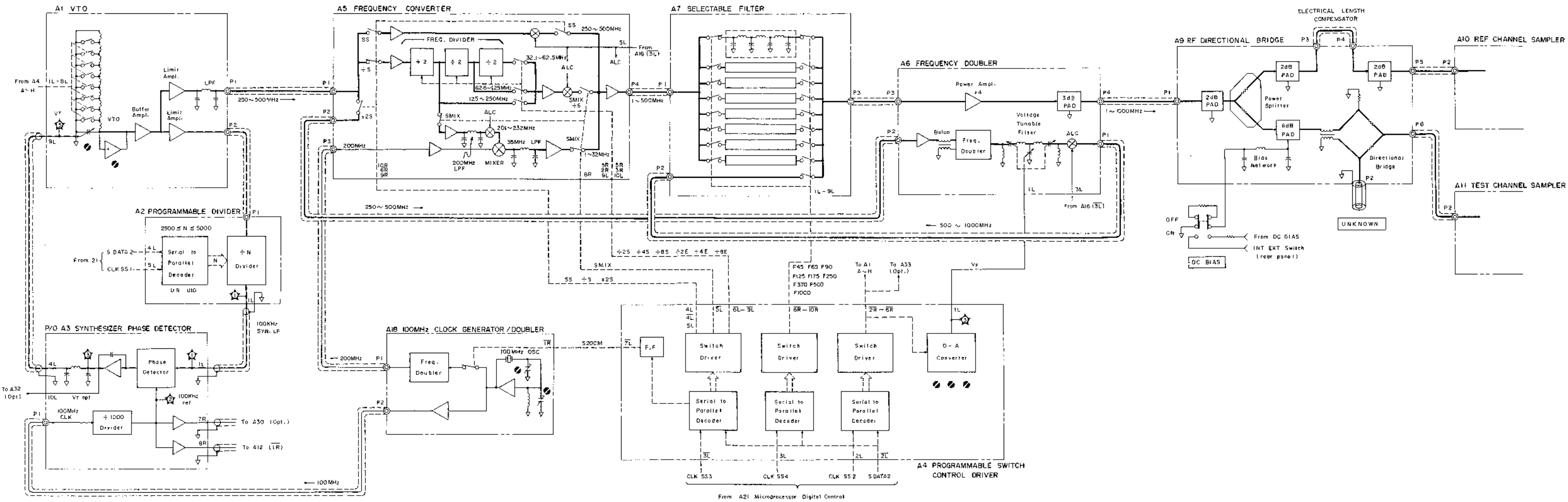

Figure 8-2. Analog Measurement Section Block Diagram - Signal Source Section

DIRECTIONAL BRIDGE OPERATING THEORY

The basic circuit of the directional bridge is composed of five fixed value resistors and the unknown impedance element to be measured, as shown in Figure A. All the resistor elements have the same Z value as the characteristic impedance of the measuring circuit; in the 4191A, both are 50Ω . The other bridge arm Z_x is the DUT connected to the test port. The test signal is applied with an amplitude e_1 in the direction of i_1 . The signal currents in this circuit can be arithmetically represented by equation 8-1. Here, we'll show that the current i_4 (or the voltage drop $e_2 = Zi_4$) is proportional to the reflection coefficient of the DUT. Kirchhoff's law gives the following equations for the circuit in Figure A.

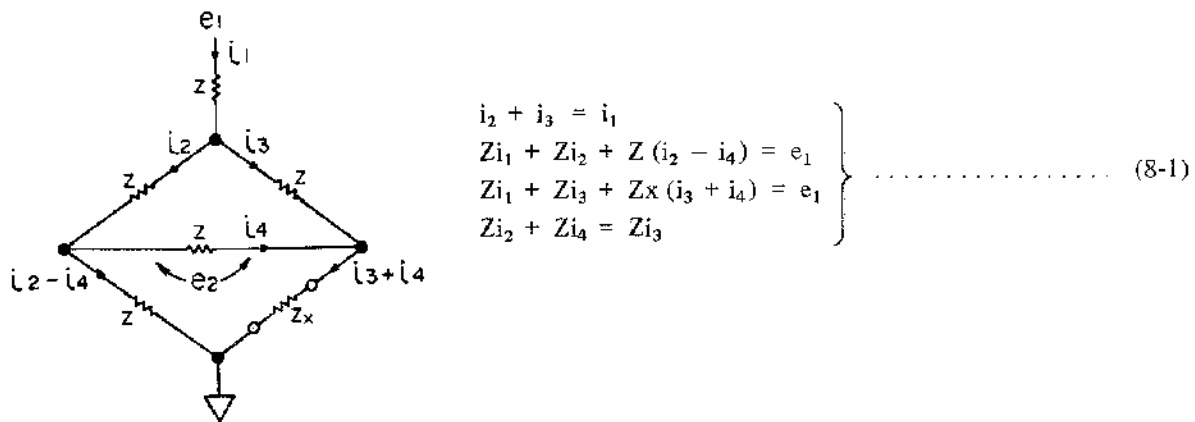

Figure A. Basic Directional Bridge Circuit

These simultaneous equations are solved for i_4 , as follows:

$$Zi_4 = e_2 = \frac{1}{8} \cdot \frac{Z - Zx}{Z + Zx} e_1 \dots\dots\dots (8-2)$$

Thus, the ratio of e_2 to e_1 given in equation 8-3 can be used to calculate the reflection coefficient of the DUT.

$$\frac{e_2}{e_1} = \frac{1}{8} \cdot \frac{Z - Zx}{Z + Zx} = \frac{1}{8} \Gamma \dots\dots\dots (8-3)$$

$$\left(\Gamma = \frac{Z - Zx}{Z + Zx} \right)$$

In a practical directional bridge circuit, such as the one employed in the 4191A, the bridge arm for i_4 is replaced with an RF transformer to obtain the vector voltage e_2 , as shown in Figure B (left figure).

Figure 8-3. Directional Bridge Operating Principle (sheet 1 of 2).

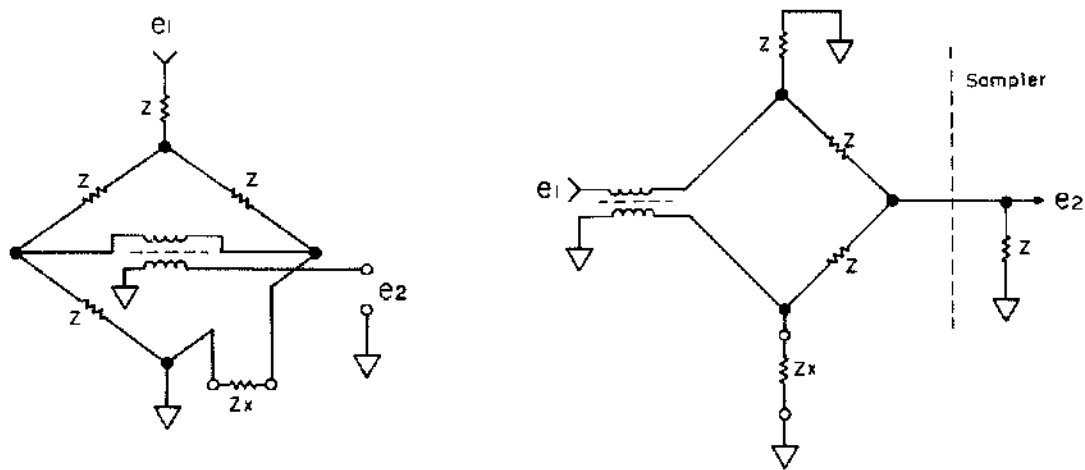

Figure B. Directional Bridge Circuit of the 4191A.

Because the directional bridge circuit is substantially reversible, the input e_1 and output e_2 may be interchanged. That is, the circuit may be modified so as to apply the measurement signal to the RF transformer, and take the output from the basic input circuit, as shown in the right schematic in Figure B. The 4191A actually employs this circuit configuration. To measure the vector ratio of e_1 and e_2 , the other measurement frequency signal, routed to the reference channel, is substituted for e_1 . Thus, the vector ratio measurement is made for the reference channel signal (substituted for e_1) and the test channel signal e_2 .

Figure 8-3. Directional Bridge Operating Principle (sheet 2 of 2).

8-22. Vector Ratio Detector Section

8-23. The Block diagram of the vector ratio detector (VRD) section is shown in Figure 8-5. The VRD section consists of the A9 Directional Bridge, A10 and A11 Samplers, A12 PLL Sampling Controller, A13 Sampling Frequency VTO, A15 Sampling Pulse Generator, A16 IF Amp/Process Amplifier and A17 Phase Detector/A-D Converter. The A9 RF Directional Bridge has a test port to measure DUT's and provides two outputs – the reference channel output and the test channel output – whose vector ratio is proportional to the reflection coefficient of the DUT. A measurement frequency signal applied to the input (P1) of the A9 section is divided at the power splitter, and flows to the test channel and the reference channel circuits. The reference channel signal provides the amplitude and phase references for the test channel signal to be measured. The test channel signal is input to the RF directional bridge network to be applied to the DUT. The signal travels from the test port to the DUT and the reflected signal (at DUT) returns to the test port. The bridge yields a vector voltage output in response to the reflection vector representing the electronic characteristics of the DUT. Details of the directional bridge operating theory are described in Figure 8-3.

The electrical length compensator cable in the reference channel of the directional bridge is used to equalize the transmission line lengths of both channels. This makes the relative phase shift between the reference and the test channel signals small, and keeps measurement errors to a minimum.

Note: Auto-Calibration eliminates the affects of a comprehensive phase shift in the measuring circuit on the measurement results. Electrical length compensation minimizes approximation errors in the cubic interpolation approximation calculation applied to the calibration data.

The directional bridge circuit is kept at a constant 30°C by the A25 Heater Controller. The temperature sensor on the A9 board sends a control signal to the heater controller when the directional bridge circuit temperature drops below 30°C. The heater controller then supplies power to the heater attached to the directional bridge assembly. This stabilizes the directional bridge, and expands the applicable temperature range of the auto-calibration data.

8-24. To enable accurate measurements of the vector ratio between the test channel and reference channel outputs at all test frequencies, both outputs are converted into 100kHz IF signals. This permits the use of state-of-the-art technology in the low frequency vector measurements, such as a precision phase detector, to enable improved accuracy in the rf vector measurements. Additionally, the conversion into one frequency facilitates optimizing the operating performance of the various circuits to achieve accurate vector measurements.

The A10 and A11 Samplers perform the frequency conversion for the wide band measurement frequency signals. The sampling frequency conversion is made using the simultaneous sampling pulses for both the reference channel and the test channel signals. Thus, the exact phase relationship between the vector signals is maintained in the IF output signals. As a result of this frequency conversion, all the measurement frequency vectors are replaced by equivalent, single frequency (IF) vectors.

8-25. The sampling pulse frequency is automatically controlled so that the IF signal frequency is exactly 100kHz. When the measurement frequency is changed, the A12 PLL Sampling Controller and the A13 Sampling Frequency VTO monitor the transient IF signal frequency shifted from the normal 100kHz and vary the sampling frequency until the normal IF signal frequency is produced. This sampling frequency control is made in the following manner:

When the front panel measurement frequency setting is changed, the A13 LOCK ENABLE signal is set by the digital control section. The LOCK ENABLE signal actuates the search generator in the A12 board to release the free running oscillation of the circuit from the static balance condition. The search generator outputs a sawtooth signal causing the A13 sampling frequency VTO to sweep the output frequency. A control signal from the digital control section sets the VTO frequency band and the divisor of the frequency divider so that the sampling frequency is swept at the appropriate search range. Limiting the search range reduces the time required to recover the normal IF signal and eliminates the possibility of selecting a sampling frequency that has an overtone which may produce the IF signal.

In response to the swept VTO frequency, the frequency of the A15 sampling pulse generator output -- a 300ps pulse shaped by the step recovery diode, varies with the sawtooth ramp rate (frequency modulation). Thereby, the IF signal frequency approaches 100kHz from a higher frequency. The frequency detector on the A12 board continuously compares the IF signal (shaped to a square wave) with its own oscillation frequency which is slightly higher than 100kHz, and when the IF frequency is nearly close to 100kHz, the frequency detector signals the search control circuit to stop the search generator sawtooth signal. While the IF signal returns to the top frequency (during the reverse ramp period of the sawtooth), the search control circuit closes the gate to stop frequency detector output. Accordingly, the sampling frequency control function captures the normal IF signal frequency during the period of the slower sawtooth ramp.

After the sawtooth stops, the phase detector on the A12 board controls the IF signal frequency to make it an accurate 100kHz. The phase detector performs this control using the 100kHz reference signal supplied from the A3 board. The integrator in the search generator circuit smooths the phase detector output. The VTO control voltage is slightly corrected in response to the phase detector output so that the IF signal frequency coincides with the reference 100kHz.

Note: The following relationship exists between the sampling pulse frequency f_s and the measurement signal frequency f_m .

$$Nf_s - f_m = 100\text{kHz}$$

Where, N is an integer determined by the digital control circuit.

8-26. The A16 IF Amplifier/Process Amplifier combines the signal selector switches, the IF amplifiers with LPF, and the ALC circuit. The signal selector switches transfer, in sequence, the reference channel and the test channel IF signals to the IF amplifiers so that the IF signals are alternately phase detected (on the A17 board) to separate the real and the imaginary components of the reflection coefficient vectors. The two low pass filters in the IF amplifier have a 100kHz roll-off frequency and filter out undesired high frequency components (harmonics and noise) of the IF signal. The ALC circuit detects the level of the reference channel IF signal instead of the measurement frequency signal. In response to the detected magnitude of the IF signal, the ALC output (dc) varies the attenuation of the modulators (on the A5 and

A6 boards) to suppress the variation of the measurement signal. This automatic level control maintains the measurement signal level almost constant against the frequency response of the filters, frequency converters, amplifiers and other circuits. During the sampling frequency search control operation, the ALC DSBL circuit on the A12 board increases the ALC voltage and lowers the measurement signal level. Because the level of the IF signal also decreases, this eliminates the possibility that the sampling frequency controller will be activated by a harmonic of the IF signal (for instance, the second harmonic of a 50kHz IF).

8-27. The A17 Phase Detector /A-D Converter separately measures the magnitudes of the in-phase and the right angle phase components of the IF reflection coefficient vectors. The basic principle of the vector measurement is described in Figure 8-4. The phase detector chops each cycle of the vector IF input signal using exactly the same frequency. The phase detector output is proportional to the magnitude of the vector component, which is in-phase with the periodic chopping operation.

Note: When the timing of the phase detection has a phase θ in reference to the input signal, the average voltage of the output waveform segments is given by the equation:

$$e_o = e_i \cos \theta$$

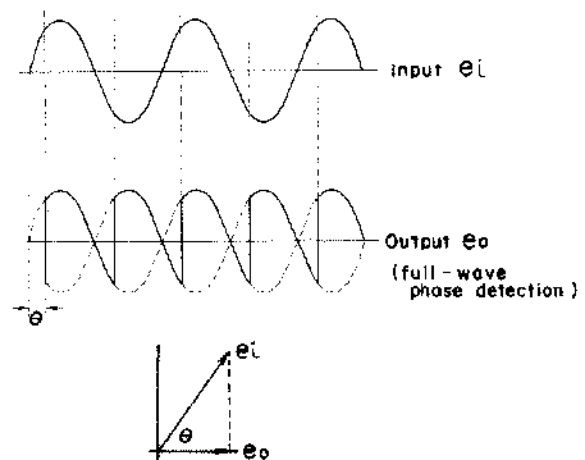

To determine the phase components of the input vectors, the phase detector is operated alternately using 0° and 90° detection phase signals (these signals are a pair of the symmetrical square pulses). The integrator charges and discharges, using the appropriate vector component

voltages, four times per measurement. The integrator outputs provide the vector ratios converted into time intervals for counting them in the digital section. The slope amplifier magnifies the integrator output waveform to ensure detection of the discharge slope when it crosses the zero level. The zero detector sends a pulse signal to the microprocessor each time the integrator output crosses the zero level.

The C_sG_s circuit on the A17 board produces 0° and 90° detection phase signals which are precisely 90 degrees out of phase with each other. The C_s circuit shifts the phase of the IF input signal by 90 degrees. The G_s circuit provides the 0° detection phase adjusted to have an accurate right angle phase in reference to the C_s circuit signal. The waveform converter, composed of a waveshaper and comparator, converts both detection phase signals to square waves. The polarity switches can invert the detection phase signals, and, consequently, four detection phases (0° , 90° , 180° and 270°) can be used. When the detection phase is inverted, the phase detector output signal will have the same voltage, with opposite polarity, as the non-inverted detection phase signal. Using this polarity control, the integrator can develop the necessary triangular output for the voltage ratio measurement, either with the charge input is positive or negative.

Note: When the charge input is a negative voltage, the integrator output is a positive going ramp. Suppose the 0° detection phase is used to discharge the integrator by positive output voltage of the phase detector; if the charge input is a positive voltage which produces a negative going ramp, the 180° detection phase (the opposite polarity) is used to discharge the integrator by the negative output voltage of the phase detector. To control the detection phase, the microprocessor monitors the polarity of the ramp in the integrator charge period.



Detection phase for integration in the positive domain.

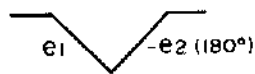

Detection phase for integration in the negative domain.

PRINCIPLE OF THE VECTOR MEASUREMENT

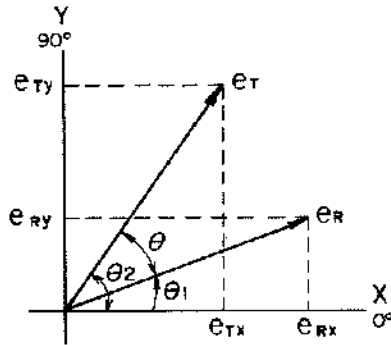

e_T : A11 test channel vector referenced to the detection phases.

e_R : A10 reference channel vector referenced to the detection phases.

The subscripts x and y are:

x : 0° phase component of the vector.

y : 90° phase component of the vector.

Figure A. Reflection Coefficient Vectors.

The vector diagram in Figure A represents the relationship between the IF signal vectors and the detection phases of the phase detector. According to this representation, the vector reflection coefficient is calculated as the ratio of vector e_R to vector e_T . The X axis and Y axis coincide in phase with the 0° and 90° detection phases, respectively. The vector ratio measurement consists of three measurement periods as shown in Figure B.

Note: The voltage ratio measurement is made using a dual slope integration technique as follows:

The e_1 input charges the integrator for time T_1 . The e_2 input then fully discharges the integrator in time T_2 . The resultant integrator output is the triangle wave shown in the figure below.

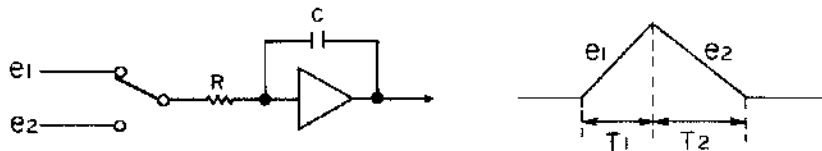

As the sum of the charge and discharge quantities must be zero, the following equation is established:

$$ke_1T_1 + ke_2T_2 = 0$$

Where, k is the integration constant determined by the values of the integrator circuit constants.

Thus, the ratio of e_2 to e_1 is given as:

$$\frac{e_2}{e_1} = -\frac{T_1}{T_2}$$

Since charge time T_1 is constant, the value of e_2/e_1 can be calculated by measuring time T_2 .

Figure 8-4. Principle of the Vector Measurement (sheet 1 of 3).

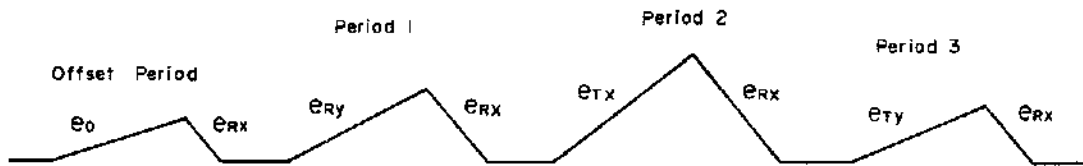

Figure B. Vector Component Measurement Sequence.

- Period 1: The 90° phase component of the e_R signal is detected by the 90° detection phase. The e_{RY} component charges the integrator for a constant time T₁. Next, the 0° phase component e_{RX} discharges the integrator. Thus, the value of e_{RY}/e_{RX} is calculated as the tangent of the phase angle θ₁.
- Period 2: The 0° phase components of the e_T and e_R signals (e_{TX} and e_{RX}) are detected to obtain the value of e_{TX}/e_{RX} in the same manner as period 1.
- Period 3: The 90° phase component of the e_T signal and the 0° phase component of the e_R signal are detected to obtain the value of e_{TY}/e_{RX}.

To simplify the calculations for derivation of the reflection coefficient value (e_R/e_T), the values obtained in periods 1, 2 and 3 are replaced with B, C and D respectively.

$$\frac{e_{RY}}{e_{RX}} = B$$

$$\frac{e_{TX}}{e_{RX}} = C$$

$$\frac{e_{TY}}{e_{RX}} = D$$

The absolute values of e_R and e_T are given by the following equations:

$$|e_R| = \frac{1}{e_{RX}} \sqrt{1 + B^2}$$

$$|e_T| = \frac{1}{e_{RX}} \sqrt{C^2 + D^2}$$

Figure 8-4. Principle of the Vector Measurement (sheet of 2 of 3).

Therefore, the absolute value of the reflection coefficient is calculated as:

$$\left| \frac{e_R}{e_T} \right| = \sqrt{\frac{C^2 + D^2}{1 + B^2}} = k \cdot \frac{1}{|\Gamma|} \quad (k: \text{constant})$$

Note: Actually, the reciprocal of the reflection coefficient is calculated; not the reflection coefficient itself.

The phase angle of the reflection coefficient is:

$$\theta = \tan^{-1} A = \cos^{-1} \frac{1}{\sqrt{1 + A^2}} = \sin^{-1} \frac{A}{\sqrt{1 + A^2}}$$

Where, $A = \frac{D - BC}{C + BD}$

The real and the imaginary components of the vector reflection coefficient are:

$$\Gamma_X = |\Gamma| \cos \theta$$

$$\Gamma_Y = |\Gamma| \sin \theta$$

To eliminate integrator operating errors caused by residual offset voltages in the phase detector and integrator circuits, an offset measurement period precedes the three vector component measurement periods. During this period, the integrator charges with the residual offset voltage and discharges with the e_{RX} component voltage. Thus, the relative magnitude of the residual offset voltage e_O vs the e_{RX} is measured (as $\Delta = e_O/e_{RX}$). The effects of this offset voltage are eliminated from the values of B, C and D using the following compensation calculations:

$$B' = B - \Delta = \frac{e_{RY}}{e_{RX}} - \frac{e_O}{e_{RX}}$$

$$C' = C - \Delta = \frac{e_{TX}}{e_{RX}} - \frac{e_O}{e_{RX}}$$

$$D' = D - \Delta = \frac{e_{TY}}{e_{RX}} - \frac{e_O}{e_{RX}}$$

Figure 8-4. Principle of the Vector Measurement (sheet 3 of 3).

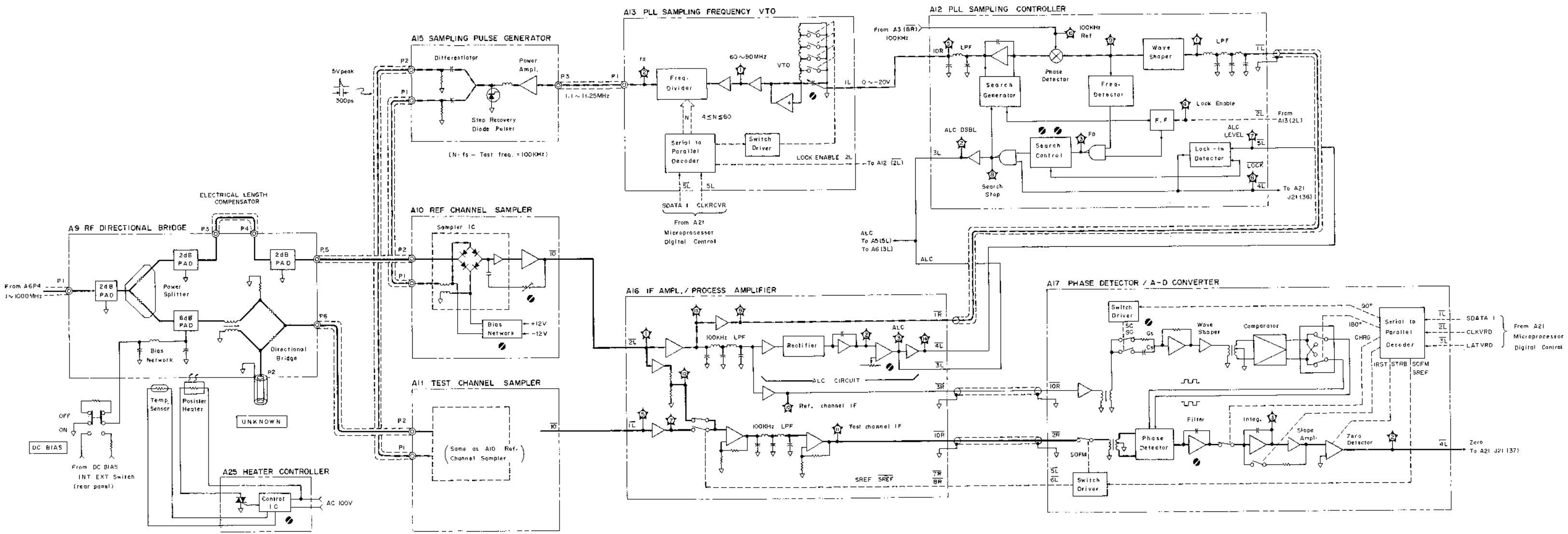

Figure 8-5. Analog Measurement Section Block Diagram - Vector Ratio Detector Section.

8-28. OPTIONS

8-29. The theory of operation for the 4191A optional circuits is described in the following paragraphs using block diagrams. Option 002, High Resolution Test Frequency, and Option 004, Analog Recorder Output, are included in the descriptions (the other options are electrically the same as the basic instrument).

8-30. OPTION 002 HIGH RESOLUTION TEST FREQUENCY.

8-31. Option 002 adds four circuit boards – A30 VTO, A31 Programmable Divider, A32 Summing Loop Circuit, and A33 VTO – to the signal source section of the 4191A. Figure 8-7 is the block diagram of the option 002 circuit section. To make the discussion easier, a further simplified block diagram is given in Figure 8-6.

The A30 VTO and A31 Programmable Divider develop 1.0000M to 1.0999MHz signals using a PLL frequency synthesizer technique similar to the A1, A2 and A3 boards (main synthesizer) of the basic instrument. The summing loop circuit adds the 1.0000M to 1.0999MHz local synthesizer frequency to the main synthesizer frequency (249.0M to 499.0MHz). The summing loop output frequency is given by the following equation:

$$F_S + F_L = F_M$$

Where, F_S is the main synthesizer frequency;
 249.0M to 499.0MHz

F_L is the local synthesizer frequency;
 1.0000M to 1.0999MHz

F_M is the summing loop output frequency;
 250.0000M to 500.0000MHz.

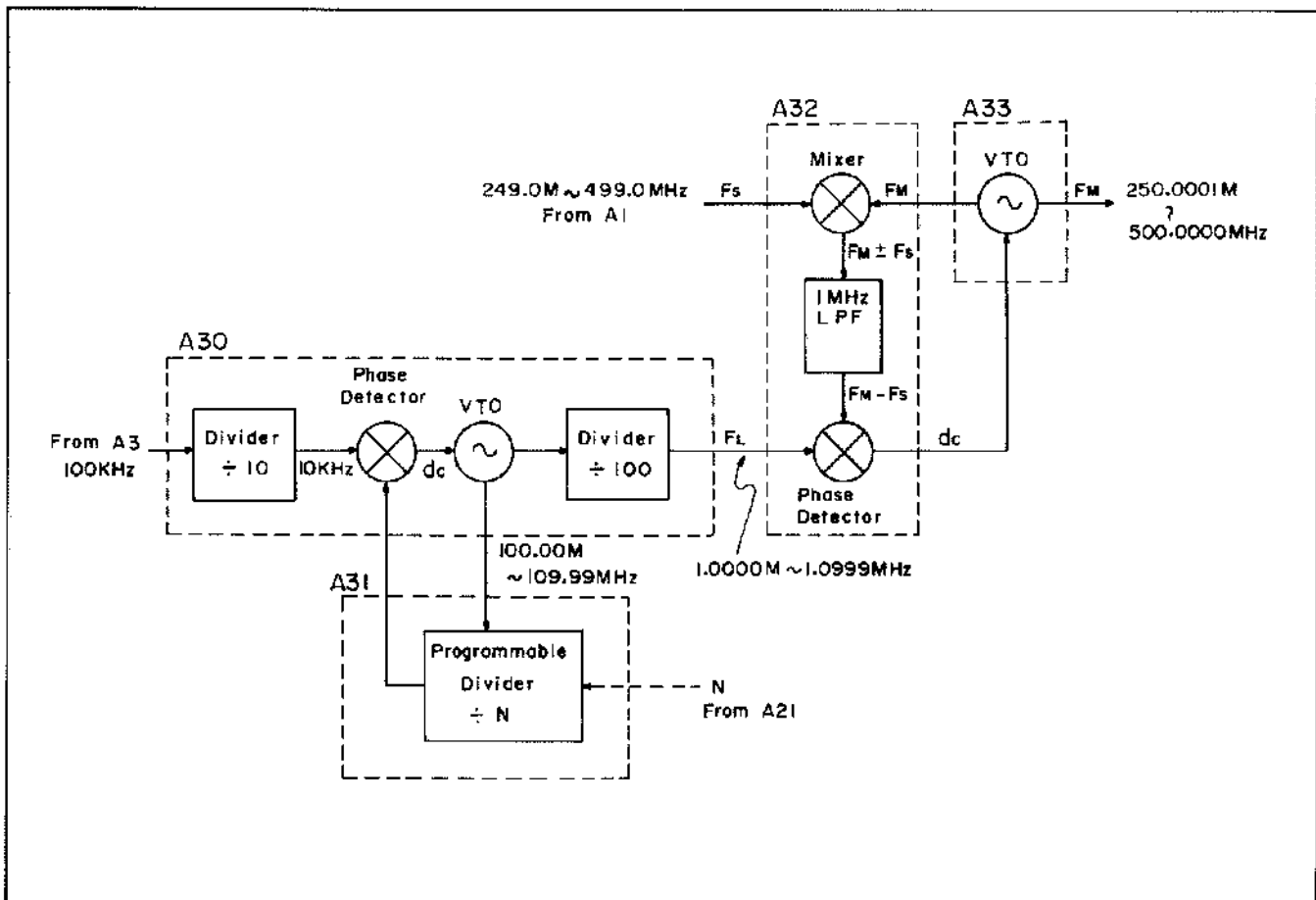

Figure 8-6. Option 002 Circuit Basic Block Diagram.

By means outlined above, the option 002 circuit offers the 250M to 500MHz frequencies synthesized at 100Hz resolution instead of the 100kHz resolution of the basic instrument. Ordinary frequency mixing operation for adding two frequencies yields two side band frequencies corresponding to the sum and the difference between them, as follows:

$$F_M = F_S \pm F_L$$

Because the sidebands are very close to each other, it is difficult to filter out the $F_S - F_L$ to obtain $F_S + F_L$ only. Therefore, the summing loop circuit incorporates a special circuit operating principle to produce the $F_S + F_L$ frequency only, as described in the following paragraphs.

8-32. The A30 VTO board includes a VTO which covers the 100M to 110MHz range and a phase detector which supplies the tuning control voltage for locking the VTO at 10kHz frequency steps. The VTO has two outputs: one for PLL control and another for input to the summing loop circuit. The PLL output is counted down to 10kHz by the A31 programmable divider. The programmable divisor N is automatically set to the value given by the following equation:

$$N = 10000 + X \quad (10000 \leq N \leq 10999)$$

Where, X is a three digit number for the measurement frequency setting of the 10kHz, 1kHz and 100Hz digits. The phase detector compares the programmable divider output frequency with the 10kHz reference frequency, and applies a tuning control voltage to the VTO. This feedback tuning control locks the VTO frequency to the value given by the following equation:

$$f_{VTO} = N \times 10\text{kHz} \\ (100.00\text{MHz} \leq f_{VTO} \leq 109.99\text{MHz})$$

The other VTO output is counted down to 1.0000M to 1.0999MHz, and is called the local synthesizer output. This local synthesizer output (F_L) provides the measurement frequency setting capability extended towards the less significant digits.

8-33. The A33 VTO has the same circuit configuration as the A1 board, and covers 250M to 500MHz frequency range. The A32 summing loop circuit fixes the frequency of the A33 VTO to the sum of the frequencies of the local and main synthesizer outputs. This frequency control is performed in the following manner:

The mixer on the A32 board outputs the beat frequencies $F_M \pm F_S$ of the VTO frequency F_M and the main synthesizer frequency F_S . As $F_M + F_S$ is a high frequency (above 500MHz), the 1MHz LPF passes the $F_M - F_S$ frequency only and blocks the $F_M + F_S$. The phase detector on the A32 board applies a tuning control voltage to the A33 VTO in response to the two input frequencies, F_L and $F_M - F_S$. This PLL control loop locks the VTO output frequency F_M to the value given by the following equation:

$$F_M - F_S = F_L$$

Thus, the VTO frequency F_M is:

$$F_M = F_S + F_L$$

Accordingly, the frequency of the A33 VTO coincides with the sum of the main synthesizer frequency and the local synthesizer frequency.

Note: Switch S3-7 on the A20 (A21) board must be set to ON to enable function of Option 002. Refer to the figure on page 8-133.

8-34. OPTION 004 ANALOG RECORDER OUTPUT

8-35. Option 004 adds the A41 Analog Recorder Output board to the basic instrument. Figure 8-8 is the block diagram of the A41 board. The measurement values for DISPLAY A and DISPLAY B parameters, along with the measurement frequency or bias voltage data, are transferred as serial data to the serial to parallel data decoder from the A21 Microprocessor Digital Control board. This data is stored in the appropriate decoders until new data is delivered through the S DATA 1 line. The individual D-A converters for the three recorder output channels generate a dc current set by the 10 bit parallel data of the decoder outputs. The current to voltage converter ampli-

fier at the output stage of each D-A converter provides a voltage output proportional to the current output of the D-A converter. The inverting amplifiers in the DISPLAY A and DISPLAY B channels provide negative output voltages whose absolute values are equal to the positive inputs. The polarity switches select the positive or negative voltage to be output at the RECORDER OUTPUT connectors depending on the sign (plus or minus) of the measurement display values.

Note: Switch S3-1 on the A20 (A21) board must be set to ON to enable function of Option 004. Refer to the figure on page 8-133.

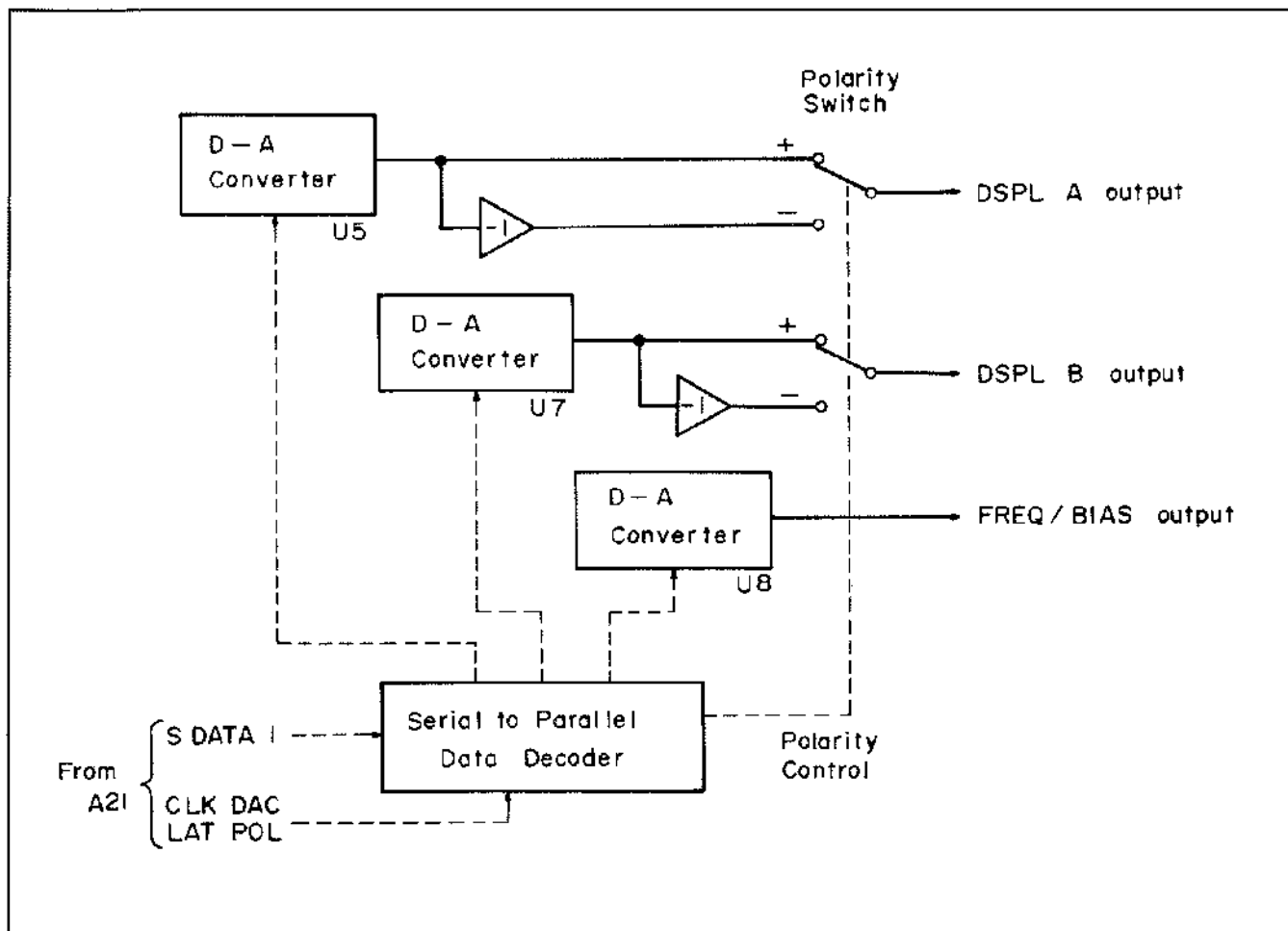

Figure 8-8. Option 004 Analog Recorder Output Block Diagram.

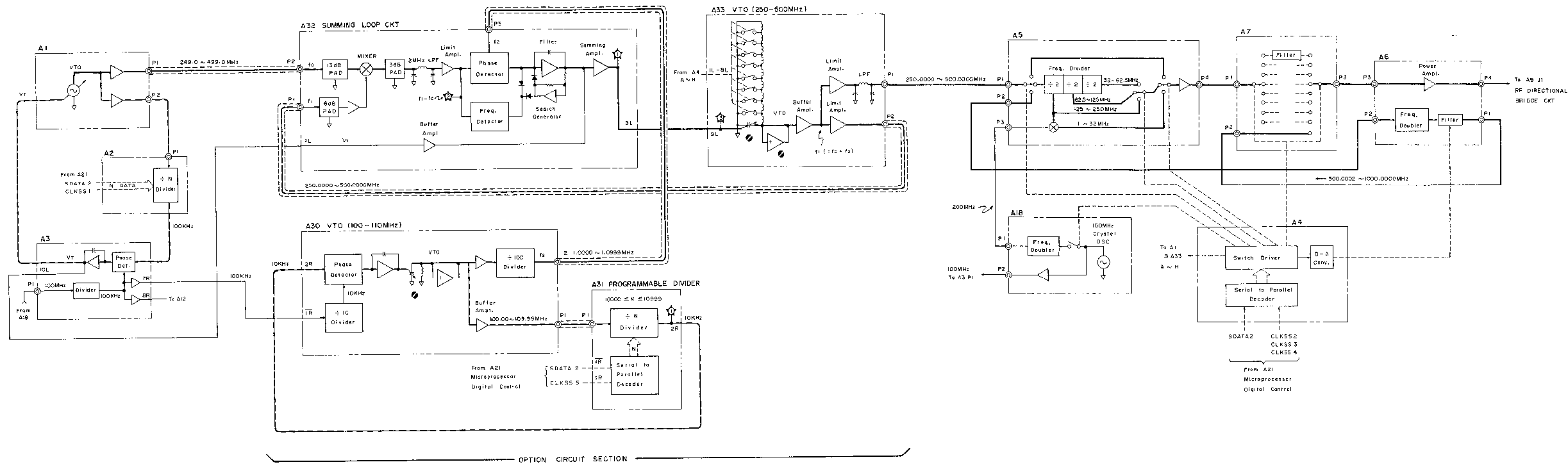

Figure 8-7. Option 002 Circuit Block Diagram.

8-36. DIGITAL CONTROL SECTION

8-37. Figure 8-11 is the block diagram of the 4191A digital control section. The digital control section consists of the A21 Microprocessor Digital Control board and A22 Display and Keyboard Control board assemblies.

Note: The assembly number of the Microprocessor Digital Control Board is either A20 or A21 depending on the type of ROM's mounted on the board as follows:

- A20 (P/N 04191-66520): P-ROM's
- A21 (P/N 04191-66521): Masked ROM's

The programs stored in the ROM's and the functions of the circuits are identical. When the actual assembly is A20, change A21 in the following descriptions to read A20.

8-38. A21 Microprocessor Digital Control

8-39. The A21 board contains the following circuits: MPU (Micro-Processor Unit), APU (Algorithmic Processing Unit), Memory, HP-IB, VRD Control, Serial Port, and Front Panel Control. The MPU section is the heart of the A21 board. It controls the timing of the digital circuits, the process of programmed measurements, and the response to input commands. An outline of the MPU circuit operating theory follows.

8-40. The U33B Turn-On Reset Circuit initializes the Microprocessor after a 1 second (0.5 to 1.5 second) delay when the instrument is turned on. The Microprocessor then accesses the program ROM to read the stored data. The program is run one step at a time, synchronized with two complementary 1MHz clock signals (CLK ϕ 1 and CLK ϕ 2) supplied by the Clock Generator. The relationship between the high and low periods of each signal is shown in Figure 8-9. Timing of circuit operations in the digital section is controlled by the ϕ 2, 100k, 2M and 10M clock signals output from the Clock Generator.

8-41. The Microprocessor is interfaced with other devices via the Control Bus Line, Data Bus Line and Address Bus Line. The Microprocessor handles all digital data processing as well as providing timing control for the analog measurement circuit. The bus lines have the following functions:

Data Bus Line (8 bit): Bidirectional bus line for transfer of program and measurement data to and from the Microprocessor.

Address Bus Line (16 bit): Unidirectional bus line from the Microprocessor for addressing program ROM's and data RAM's. Additionally, sets APU, HP-IB Microport, or one of the data registers to enable data transfer to and from the Microprocessor via the Data Bus Line.

Control Bus Line (VMA, R/W, DBE, ϕ 2): Unidirectional bus line for transfer of digital section control signals. The VMA (valid memory address) line controls synchronous access timing of RAM's, ROM's and Microport in conjunction with the appropriate clock signal. R/W (read/write) control line sets the RAM's, ROM's and Microport to "Read" or "Write" operating mode to control the direction of data transfer (time sharing) on the Data Bus Line to or from the Microprocessor (R/W control logic is further described in paragraph 8-45). The ϕ 2 clock signal line provides a 1MHz clock pulse for timing control in the digital control circuit. The DBE (Data Bus Enable) line syncs the "write" control of the RAM's to the appropriate timing of the clock (see Figure 8-9).

8-42. The Bus Drivers connected to the Microprocessor I/O bus lines enable/disable the functions of the Data Bus and the Address Bus lines. The Address Bus line is enabled when the BA (Bus Available) signal is HIGH. The Data Bus Driver (U47) takes the required direction for the Microprocessor to read or write data via the Data Bus line. The VMA and the R/W control signals determine the direction of the Data Bus Driver.

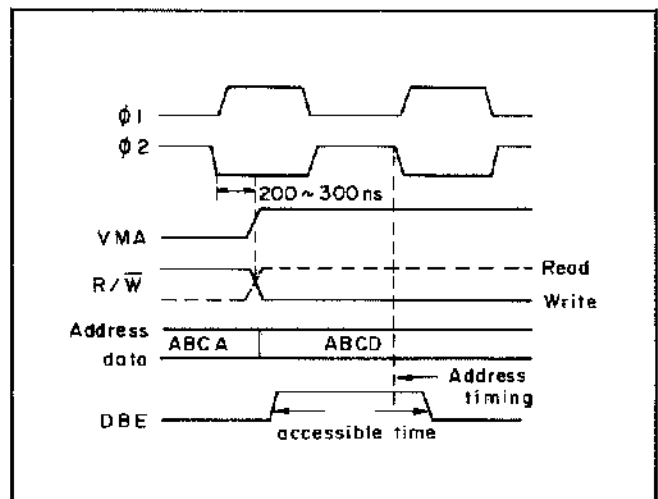

Figure 8-9. Address Timing Control.

8-43. The Program Control ROM has an 18K byte capacity and contains the analog section control programs and digital data processing routines (counting, calculation, data transfer and storage). To accept the measurement control instructions from the Program ROM, the Microprocessor sequentially addresses the ROM through the Address Bus line. The ROM Address Decoder decodes address bits 11 through 15 to the 12 bit chip select signals (CS0 ~ CS11) which cause the appropriate ROM to write out stored data onto the Data Bus line. The measurement control instructions, output from the ROM, are stored in the Serial Register of the Serial Port Circuit or the data register in the VRD Control Circuit.

8-44. The Microprocessor also addresses the Data RAM and bus line control devices (address registers and microport) to sequentially execute microprocessor program steps in accordance with the program stored in the ROM. The Data RAM is used to momentarily store front panel control setting data, measurement results and temporary data yielded from calculations. The RAM Address Decoder decodes address bits 10, 11, 12 and 15 to the 3 bit chip select signals (CA0, CA1 and CA2) which cause the appropriate RAM to store the data transferred via the data bus line from the memory data buffer. The DBE signal ensures the complete memorization of the input data by preventing incorrect timing for the RAM. The Standby Battery on the A43 board preserves the data stored in the RAM when there is an ac power loss. Simultaneously, the Charger/Controller disables addressing of the RAM to prevent storage of random data at the instant power is lost. During normal operation, the Charger/Controller re-charges the battery from a +5V dc voltage source.

8-45. The Read/Write (R/\overline{W}) timing control signal is sent to the various storage devices, registers, decoders and microport (HP-IB interface adapter) to control the transfer of data as follows:

Read: Causes a selected register or storage device to output stored data or sets bus driver or Microport to the driver mode. Microprocessor accesses (reads) the data sent from the addressed device.

Write: Enables a selected register or RAM to store data, or sets decoder or Microport to the receiver mode. Microprocessor sends (writes) data to the enabled device.

Read/Write control is performed in conjunction with the appropriate address signals to enable the correct device for the data transfer.

8-46. The U49 and U50 Timing Control Decoders decode address bits 3, 4, 11, 12 and 15 to 16 bit timing control signals which control the operation of the APU and the various digital devices (registers, counters, drivers and flip-flops) in the VRD Control, Serial Port and Interrupt Control circuits. These timing control signals are functionally similar to the R/\overline{W} control signal; they enable/disable individual devices in each circuit section in accordance with the programmed sequence.

8-47. The U35A IRQ gate signals the input of an IRQ (Interrupt Request) to the Microprocessor. The three IRQ control lines (\overline{KBDINT} , \overline{EXTINT} and $\overline{HPIBINT}$) transmit the request to the function control input from the keyboard, the external trigger circuit or the HP-IB control line. When a 4191A function is selected or changed, the IRQ line goes LOW. Normal measurement sequence control of the Microprocessor immediately pauses, except during integrator operating periods (dual slope A-D conversion operation), to determine the nature of the control input. Program address then jumps to the IRQ service routine to control the function control prior to program processing. The IRQ control line is always active to allow servicing of interrupt requests.

8-48. The Serial Register in the Serial Port circuit momentarily stores the (static) control data to initiate the measurement frequency signal and dc bias voltage entered from the keyboard or via HP-IB remote control. When the instrument is equipped with Option 004, Analog Recorder Output, the serial register also stores data for setting the analog output voltages. This control data designates the states of the analog switches to be set for the temporary measurement phase. The stored data is transferred to the latches in the analog measurement section (and the A40 dc bias supply) through the SDATA 1 or SDATA 2 serial data line. This data transfer is made to the appropriate latch in the following manner:

First, the control data is sent to the U38 Serial Register and the WSPT signal is set to store the input data in the register. Next, address bits 0, 1, 2 and 5, given by the program data, are stored in the register (U58). The Decoder/Multiplexer decodes this address data to the 11 bit analog control clock signals (CLKRCVR, CLKBIAS, CLKVRD, CLKDAC, and CLKSS1 through CLKSS6).

These clock signals cause specific latch(es) to store the data and to output the control signals to individual analog switches. Additionally, the Decoder/Multiplexer enables the Display Data RAM, on the A22 Display and keyboard Control board, to store the measurement display data transferred from the Microprocessor. The U61 Octal Counter simultaneously drives both the Decoder/Multiplexer and the Serial Register. Thus, transfer of the control data in the serial register is synchronized with the analog control clock pulse.

8-49. The VRD Control circuit controls the measurement functions in the A17 Phase Detector/A-D Converter to measure the vector ratio of the IF vector signals. Additionally, this circuit counts 10MHz clock during the discharge period of the integrator, and stops counting when the ZERO signal is received from the A-D converter. As A-D conversion requires accurate timing control for correct circuit operation, the sequential time periods of the control signals are developed from the integration time counter which counts the number of input clock pulses, from the 10MHz clock, as directed by the Microprocessor. The counter determines the 10ms period of the integrator charge time as follows:

To start counting, the Microprocessor resets the U21 flip-flop causing the U20B counter input gate to open. The counter outputs a pulse and is automatically reset when the total number of input pulses reaches 1000, and then restarts counting. This counter operation is continuously repeated, thus the counter outputs a pulse with a 0.1ms period (1000 times the 0.1 μ s clock pulse period). The Microprocessor continuously monitors the counter output until the generated pulses total 99. The Microprocessor then stops monitoring the counter, and actuates the CPU Switch circuit to cause the counter input gate to close when the counter outputs the 100th pulse. Therefore, the time between the start and stop of the counter is an accurate 10ms (0.1 ms \times 100).

The discharge time interval of the integrator is counted as follows: The Microprocessor opens the counter input gate and simultaneously closes the integrator input switch for the discharge. When the decay slope of the integrator output reaches zero volts, the ZERO signal (A-D converter output) actuates the CPU Switch circuit to cause the counter input gate to close. The Microprocessor detects the incoming ZERO signal via the Data Bus line and sends a periodic scan signal to read the state of the data register in the counter device. Thereby, the counter writes out, in sequence, the counted number of the clock pulses in LSD to MSD order. The data for each digit is

output in a 4 bit code onto the Data Bus line. The Microprocessor reads the counter outputs generated each time an integrator operating cycle is completed (four times per measurement).

The control data for the A-D Converter is transferred to the latch on the A17 board via SDATA 1 line. The LATVRD signal causes the latch to output the analog switch drive signals, with correct timing, when the states of individual switches are to be changed.

8-50. The U39 Algorithmic Processing Unit performs auto-calibration calculations and data parameter conversion of measured values. The APU performs the trigonometrical, logarithmic, square root and other mathematic functions with high speed. Address bits A3, A4 and A15 enable the APU to access input data on the Data Bus line for the required calculation. Address bit A0 (C/ \bar{D} signal) discriminates between numeric data and command data for selecting the mathematic function. When entering data into the APU, C/ \bar{D} signal goes LOW to indicate that the input data is numeric, i.e. not a command. The RAPU signal is set LOW to cause the APU to store the given data. Command data for setting the mathematic function is also provided on the Data Bus line and, at that time, the C/ \bar{D} signal is HIGH. The APU outputs the calculation result onto the Data Bus line when the WAPU signal is set LOW.

8-51. All HP-IB interface functions are handled by the U66 Microport (Interface Adapter). The Microport controls the "handshake" between the Microprocessor and external HP-IB equipment on an HP-IB program basis. The architecture of the microport circuit is shown in Figure 8-10. The 8 pairs of registers in the Microport store data transferred to/from external equipment as directed by asynchronous operation of the Control Bus signals. Each register pair stores one bit of the data on the 8 bit data bus line. When the instrument is turned on, the Microport sets the \overline{ASE} control line LOW. The Microprocessor accesses the HP-IB address data in register U56 to display the instrument address number on the front panel display. The Microprocessor accesses the Microport when address bits 13, 14 and 15 are H, H and L, respectively. Address bits 0, 1 and 2 select the internal register of the Microport which is to store or to write out the data. An interrupt control request from the external HP-IB controller pulls down the \overline{IRQ} output line of the Microport causing the $\overline{HPIBINT}$ input of the IRQ gate U35A to go LOW. Thus, the Microprocessor is requested to respond to the interrupt input.

8-52. The Front Panel Control section mediates the data transferred from the A22 Display and Keyboard Control. The external trigger circuit and the option selection switch circuit are also included in this section. When a control key on the front panel is pressed, the $\overline{\text{KEYINT}}$ input signal causes the $\overline{\text{KBDINT}}$ (keyboard interrupt request) output of flip-flop U71A to go LOW. This causes the $\overline{\text{KBDINT}}$ input of the IRQ gate U35A to go LOW, and, thereby, the interrupt request from the keyboard is input to the Microprocessor. While a keyboard switch is on, the state of the KBD bus line (KBD0 ~ KBD6) represents the address of the key actuated.

The RKEY signal then enables the U52 bus driver so that the Microprocessor accesses the KBD signals via the Data Bus line. The FP CLOCK generator counts down the 100kHz input clock to a 70 μ s (100kHz/7) periodic pulse which is used to drive the display and the address identification for the keyboard. The pulse waveform has a 10 μ s high period and a 60 μ s low period for each cycle so as to periodically blank the displays. This prevents the display segments, which are off, from dimly lighting (by a transitional effect in the display drive devices) without using additional blanking control. The $\overline{\text{PON}}$ signal closes the FP CLOCK output gate to hold the FPCLK line HIGH for a brief period after the instrument is turned on. This prevents meaningless data from being displayed. To recognize the installed options, the Microprocessor reads the setting of the S3 option selection switch when the RSW signal enables the U43 driver to output the data.

An external trigger input signal causes the $\overline{\text{EXTINT}}$ output of the U71B flip-flop to go LOW. Thus the U35A IRQ gate outputs the interrupt request to the microprocessor simultaneously with the $\overline{\text{EXTINT}}$ signal.

8-53. A22 Display and Keyboard Control.

8-54. The A22 board is divided into two sections: The Display section and the Keyboard Control section. The display section consists of four major circuits: Display Data RAM's, Display Scan Counter, Display Drivers and the various numeric displays and indicators. The Display Data RAM/Address Registers, U15 and U20, convert measured data to be displayed and address data that sets the state of the Display Scan Counter. These data are serially transferred via the SDATA line and are then converted into parallel data at the output of the Display Data RAM/Address Register. The U12, U13 and U14 Display Data RAM's store a complete set of display data which determines the on-off combinations of all the display elements. Before beginning transfer of the measurement display data, the address data, which determines the initial state of the Display Scan Counter output (A0 ~ A3), is sent to the U20 Display Data RAM/Address Register. This selects the RAM address for initial storage of the transferred display data. Successively, the display data is sent to the Display Data RAM (after first going through serial to parallel conversion by U15). The Display Scan Counter simultaneously advances the RAM address from the preceding address for every 8 bits

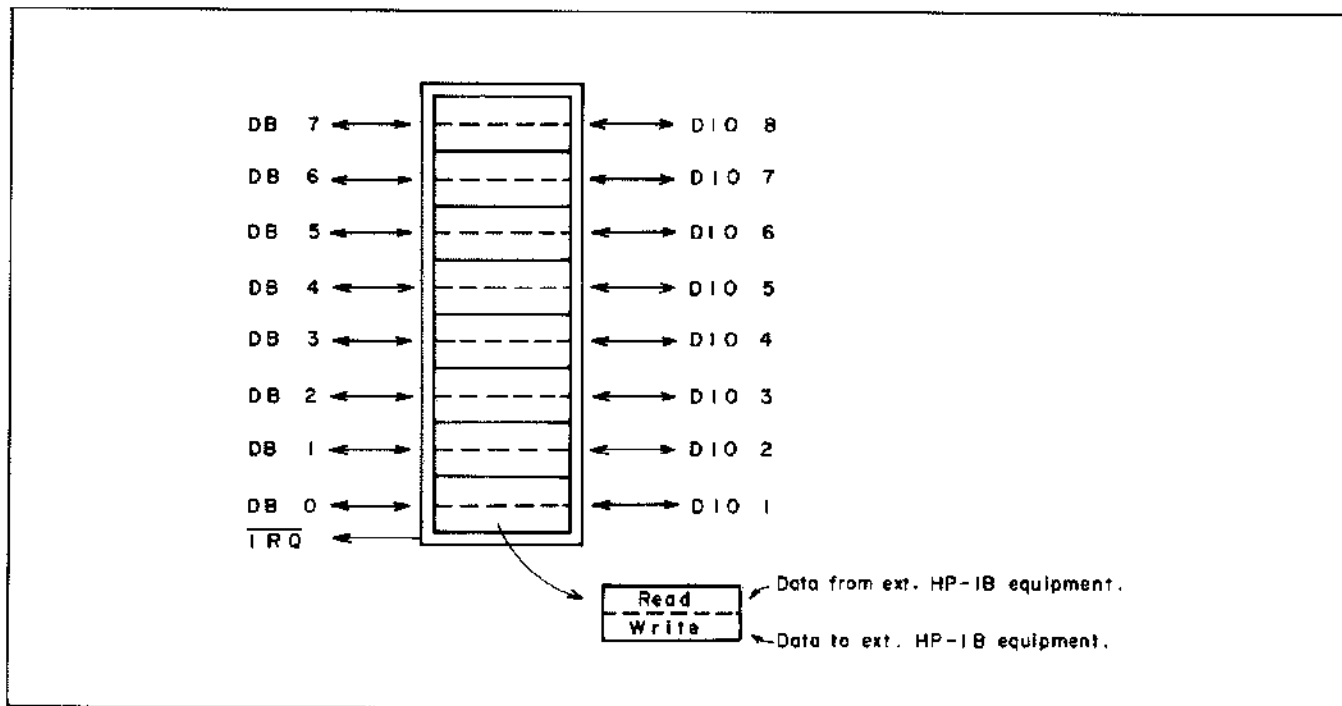

Figure 8-10. Microport Internal Register Configuration.

of incoming display data. The 8 bit display data is previously coded by the Microprocessor as appropriate for driving the seven segment displays (or indicator lamps) when the data is, in turn, written out from the RAM. The three 4 bit RAM's store the 8 bit display data in the following manner:

- U12 and U13: Stores 7 segment numeric display data for DISPLAY A, DISPLAY B and TEST PARAMETER DATA DISPLAY.
- U14: Stores display data for lamp indicators and for MSD's of both DISPLAY A and DISPLAY B.

The serial display data also includes data which enables the appropriate RAM(s) for the data store period. Since the Display Scan Counter starts counting from the desired address number, it is possible to change part of the memory in the RAM to new display data.

8-55. Each Display Data RAM stores 16 sets of 8 bit display data. When $\overline{\text{WRTDSP}}$ signal is LOW, the RAM writes out the stored data as addressed by the Display Scan Counter. The address advances in the reverse direction of the memory store mode. To display numeric data, the RAM outputs the display segment signals which illuminate the numeric figure of each measured count digit of the displays. The RAM address signals are simultaneously decoded by the U10 Anode Decoder to periodic anode scan signals which activate, in sequence, each digit. Synchronous operation of the Display Data RAM and the Anode Decoder accomplishes matrix drive of the display. The ramp indicators are also controlled in the same manner.

Note: To improve the brightness, the unit indicators are illuminated by the constant drive currents fed from the U7, U8 and U11 Unit Data Latches.

8-56. The FPCLK signal drives the Display Scan Counter with a $70\mu\text{s}$ periodic rate as well as the Key Scan Counter. When the display RAM is set to "Write" mode, the Write Pulse Generator output pulse simultaneously disables the Anode Decoder and blanks the display. After the instrument is turned on, the FPCLK line is held HIGH to blank the display until all circuits are settled in their normal conditions.

8-57. The U18 Key Scan Counter outputs periodic KBD signals (KBD0 ~ KBD3) synchronized with the FPCLK input signal. These 4 bit output signals are decoded by the U17 Decoder to keyboard scan signals which, in turn, enable the individual keys of three key groups. Each control key in the key group is enabled, in sequence, to perform its specific function. When a key (for example, "SPOT" key) is pressed, one of the keyboard output lines KBD4, KBD5 or KBD6 goes LOW at the moment the pushbutton switch input is pulled down (set low) by the keyboard scan signal. In this example, the KBD6 line goes LOW when the U17 Decoder sets its KBD6 control output line to LOW. The output of the gate U19 goes HIGH and subsequently the Key Scan Counter stops. The states of the Key Scan Counter outputs (KBD0 ~ KBD3) and the keyboard output states given by KBD4, KBD5 and KBD6 signals are coordinated with the address of the key depressed. Simultaneously, the $\overline{\text{KEYINT}}$ line goes LOW causing the IRQ gate on the A21 board to issue an interrupt request. The Microprocessor reads the scan counter and the keyboard output data to identify the pushbutton function actuated.

8-58. CIRCUIT OPERATING THEORY

8-59. The operating theory of the analog measurement circuits is described starting in the paragraph 8-83 (on the service sheet foldouts). The discussions are based on the schematic diagram foldouts at the end of the manual and are mainly related to those circuits which necessitate more detailed information than can be given in a block diagram discussion. The circuits described are: A1, A2, A5, A6, A7, A10, A12, A16, A17, A18 and A32 boards.

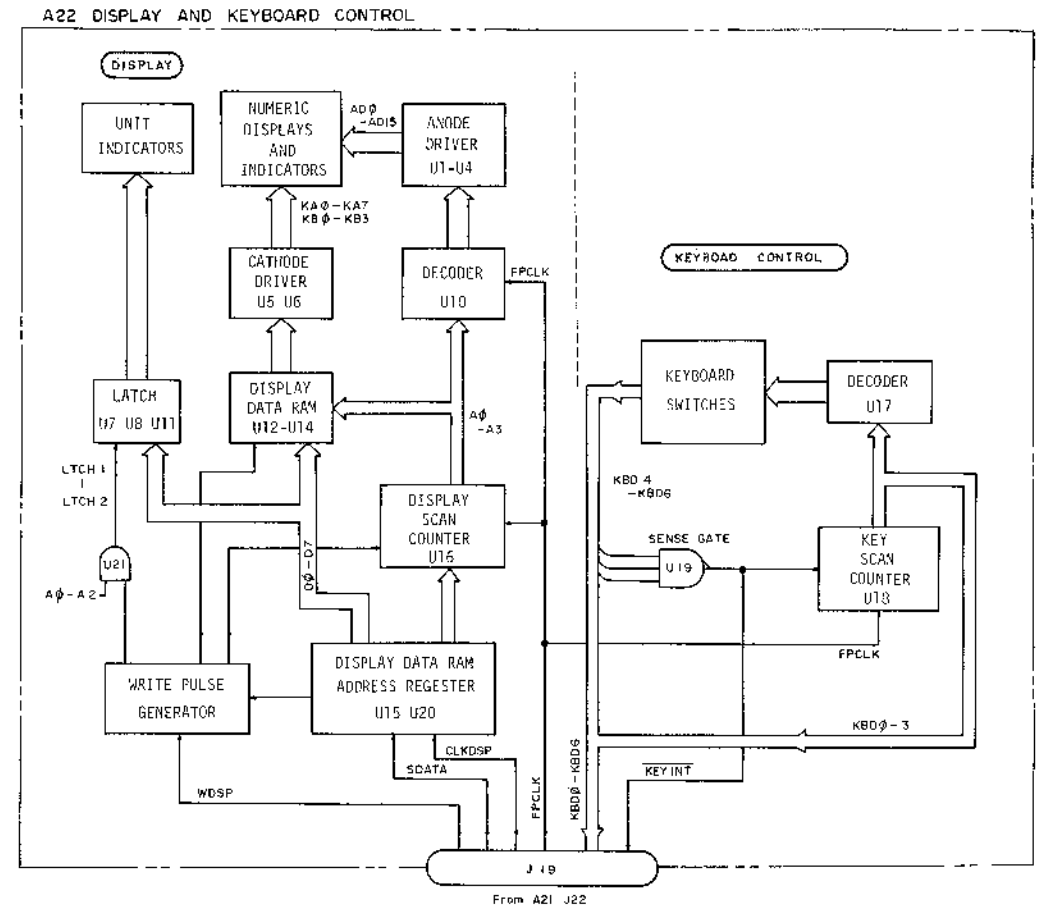
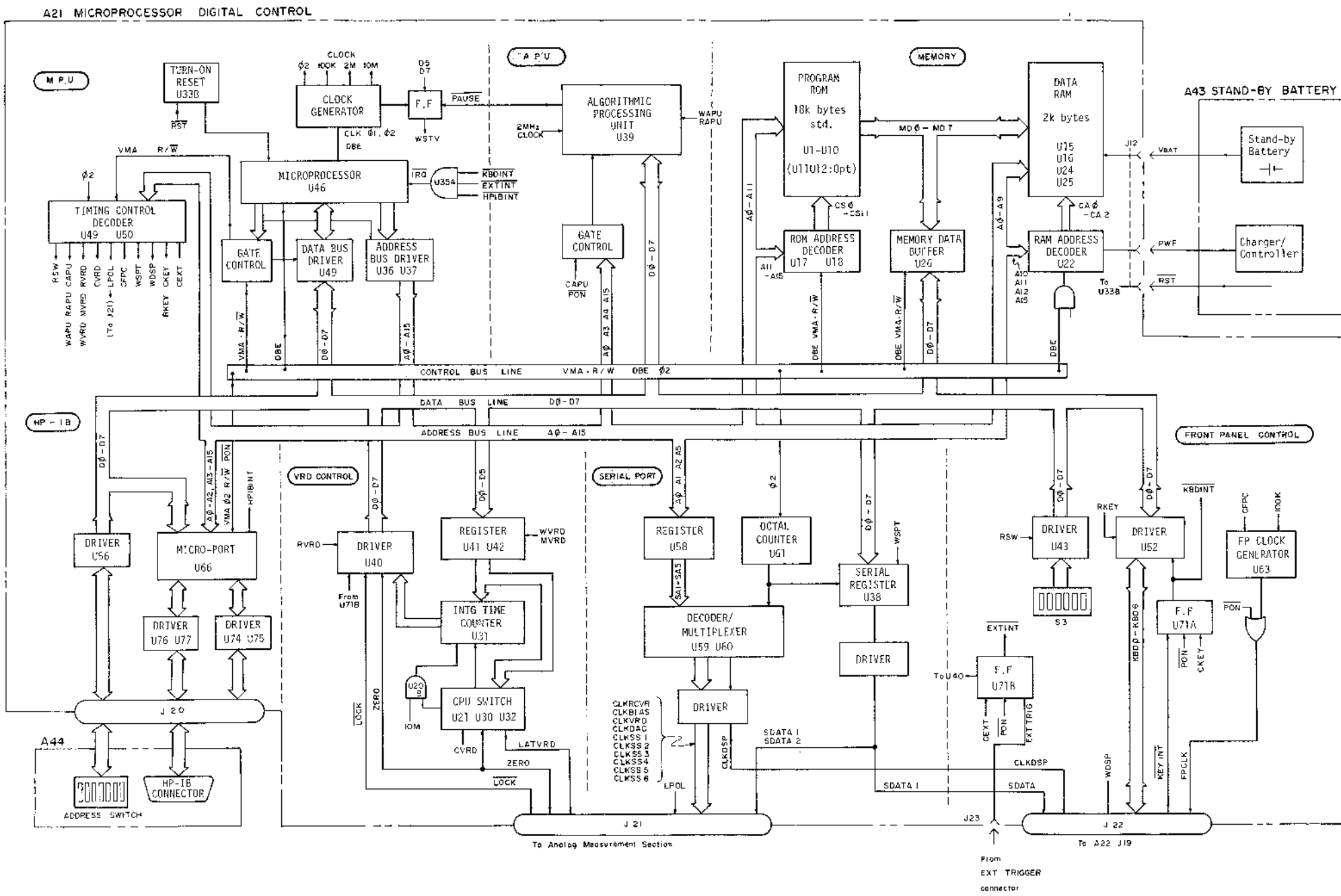

Figure 8-11. Digital Control Section Block Diagram.

8-60. TROUBLESHOOTING.

Caution:

The opening of covers or removal of parts, except those to which access can be gained by hand, is likely to expose live parts; in addition, accessible terminals may also be live.

The apparatus shall be disconnected from all voltage sources before any adjustment, parts replacement or maintenance/repair is performed for which the instrument must be opened.

If afterwards, any adjustment, maintenance or repair of the opened apparatus under voltage is required, it should be performed only by qualified service personnel who are aware of the hazards involved.

8-61. Figure 8-12 "How to Use Troubleshooting Guides" is helpful when starting to troubleshoot the 4191A.

- 1) First, verify the symptom on the instrument. If the displays or control settings in the initial operating sequence does not occur just after the instrument is turned on, measure dc power supply voltages and, if an abnormality is found, troubleshoot the power supply section. If all the power supply voltages are normal, troubleshoot the turn-on reset and clock generator circuits in the digital control section using Figure 8-14. If an error message display occurs, refer to Table 8-5 for the meaning of the message.

- 2) Use Figure 8-15 "Analog and Digital Section Isolation Procedure Using the 16341A" to determine whether the failure is in the analog measurement section or in the digital control section. The "Front Panel Troubleshooting Guide" given in Table 8-1 lists the probable causes of failures related to typical symptoms on the front panel controls and displays. This Guide is helpful in finding the location of failures at the level of the analog and digital section isolation.
- 3) If the failure is in the analog section, proceed to Figure 8-68 "Analog Section Troubleshooting to Assembly Level". If the failure is identified in the digital control section, refer to paragraph 8-64 Diagnostic Messages, and then, proceed to paragraph 8-70 Signature Analysis Test.
- 4) Perform troubleshooting for component level on each board. The troubleshooting guides for the analog circuit boards are provided on the Service Sheet foldouts for each individual board assembly. The signature analysis troubleshooting procedure for the overall digital control section (to component level) is given in Figures 8-18 and 8-19.

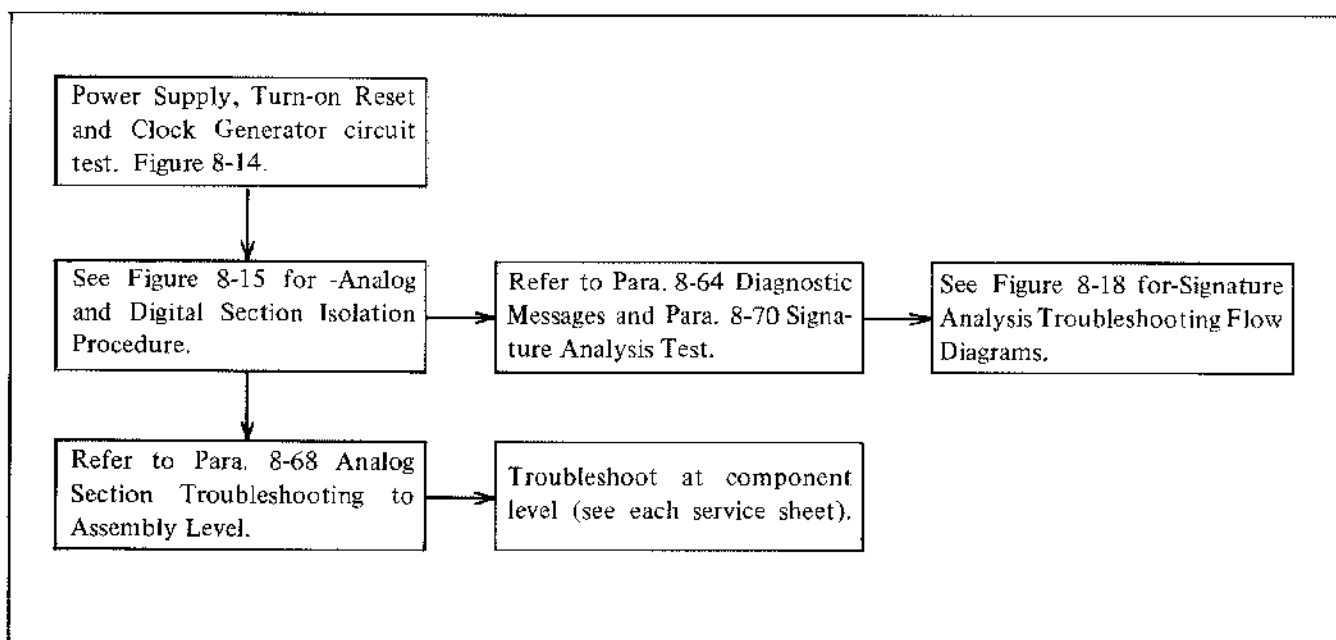

Figure 8-12. How to Use Troubleshooting Guides

WARNING

WHENEVER IT IS LIKELY THAT THE PROTECTION PROVIDED BY THE FUSES HAS BEEN IMPAIRED, THE INSTRUMENT MUST BE MADE INOPERATIVE AND MUST BE SECURED AGAINST ANY UNINTENDED OPERATION.

Caution:

Capacitors inside the instrument may maintain a charge even if the instrument has been disconnected from all voltage sources for an extended period. Be sure that only fuses of the required rated current and of the specified type are used for replacement. The use of mended fuses or short-circuiting of fuse holders must be avoided.

8-62. SIGNAL LEVEL DIAGRAM.

8-63. The Signal Level Diagram shown in Figure 8-17 is helpful when troubleshooting the analog measurement section. This diagram indicates the normal levels of the measurement frequency signal or the IF signal at the input and output of each board. The signal levels are given in dBm measured with an RF power meter, using a 50Ω input power sensor, or in volts measured with a DVM. If a measured signal level is too high or too low, a failure is located in a previous circuit board with respect to the direction of the signal flow. Use the Signal Level Diagram as an aid to isolating failures to a board assembly level.

Table 8-1. Front Panel Troubleshooting Guide

Symptom	Probable faulty board
E-12 appears on DISPLAY B at frequencies above 500MHz only.	A6, A5, A7
E-12 appears on DISPLAY B at frequencies below 32MHz only.	A5 A18
E-12 appears on DISPLAY B at one or more of the following frequency ranges: 125M to 250 MHz 62.6M to 125 MHz 32.1M to 62.5MHz	A5
E-11 appears on DISPLAY B.	A16, A17
Reflection coefficient display outputs for auto-calibration are out of normal value range.	A10, A11, A9
An error message other than either E-11 and E-12 appears on DISPLAY B.	A21 (A20)
No display appears after the instrument is turned on.	A23, A21 (A20)
A meaningless display occurs after the instrument is turned on.	A21 (A20), A22
Trigger lamp does not flash (i.e. does not light or stays lit).	A21 (A20), A22
An indicator lamp does not light or stays lit (even when the function is set or released).	A22
Pushbutton controls do not function properly (always invalid).	A21 (A20), A22

CONNECTION OF THE 16341A I/O CABLES.

PROCEDURE

1. Remove rear feet and top cover from the 4191A.
2. Loosen the two fasteners securing the top shield case and fully loosen the retaining screw located at the center of the case.
3. Raise the top shield case from the front and continue until it comes to rest on the rear frame.
4. Loosen the four screws securing the shield plate at the bottom side of the top shield case and remove the shield plate.
5. Disconnect the flat cables and the trigger cable from A21J20, J21, J22 and J23 connectors.
6. Place the 16341A Logic Test Box across the 4191A as shown in the figure.
7. Connect the three flat cables and trigger cable (labeled ① through ④ in the figure) of the 16341A to the appropriate connectors on the A21 board in accordance with the instructions labeled on the 16341A.

Note: The 16341A is useable on both the A20 and A21 type boards (the difference between these two boards is outlined in paragraph 8-37). The labels on the 16341A indicate connection of the cables to the A20 board. The reference designators J20, J21, J22 and J23 are the same for the A21 board.

8. Connect the flat cables (labeled ⑤ and ⑥ in the figure) of the 4191A (normally connected to A21J21 and J22 respectively) to the connectors on the 16341A as shown in the figure.
9. Disconnect the power supply cable of the A43 Battery and Charger board from A21J12 (labeled ⑦ in the figure), and connect the shorting connector, supplied with the 16341A, to the A21J12.
10. Insert the test program ROM, supplied with the 16341A, into the A21J11 socket (labeled ⑧ in the figure).

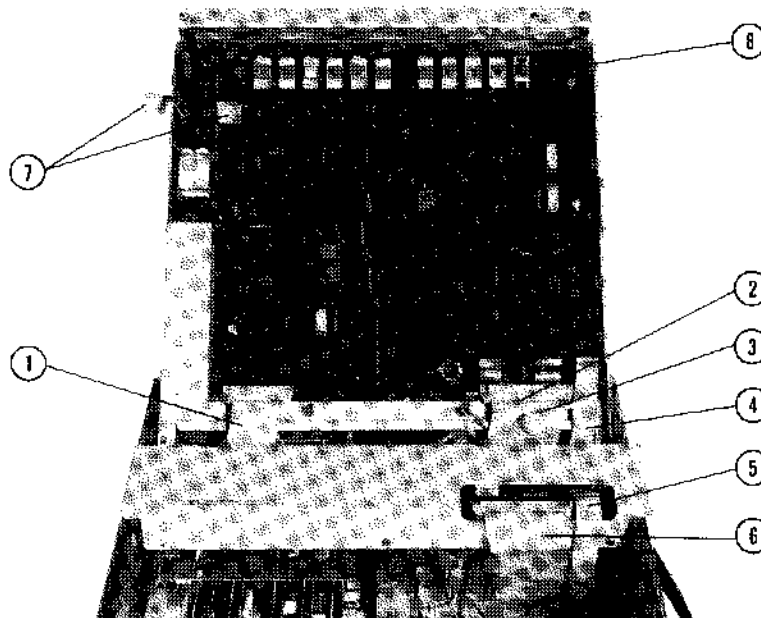

Figure 8-13. Connection of 16341A I/O cables.

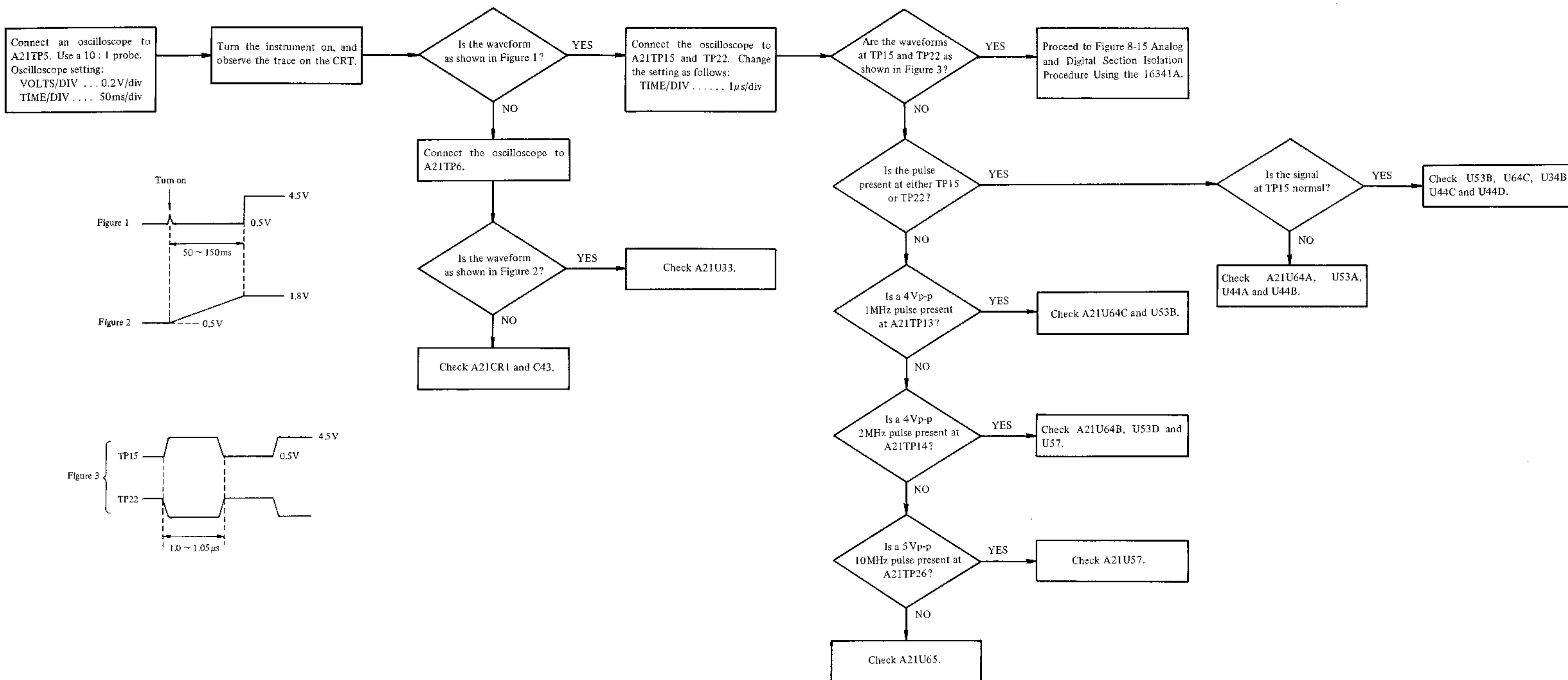

Figure 8-14. Turn-on Reset and Clock Generator Troubleshooting Flow Diagram.

Analog and Digital Section Isolation Procedure Using the 16341A.

The flow diagram that follows has two functions. The first is to isolate abnormalities to either the analog circuit or the digital control circuit, and the second is to provide troubleshooting instruction for abnormalities in the digital control circuit. The digital control circuit consists of the A21 Microprocessor Digital Control Board and the A22 Display and Keyboard Control Board. If, after performing the procedure given in the flow diagram, "End" is displayed on DISPLAY B, the digital control circuit is functioning normally; thus the trouble is in the analog measurement circuit. However, if the digital control circuit does not respond correctly to the input signals from the 16341A and test program ROM, signature analysis testing will begin automatically. In this case, proceed to the troubleshooting flow diagram given in Figure 8-18.

The meaning of any error messages displayed on DISPLAY B during the isolation/diagnostic procedure can be found in paragraph 8-64, Diagnostic Messages. Additional information on the signature analysis tests can be found in paragraph 8-70, Signature Analysis Test.

Note: This flow diagram procedure does not check for trouble related to poor contact in a front panel key or unlighted indicator lamps or numeric displays on the A22 Display and Keyboard Control board. If the instrument exhibits either of these symptoms, perform the following isolation procedure to confirm that the trouble is in the A22 board and not in another board assembly, then proceed to the troubleshooting flow diagram in Figure 8-19.

Test setup:

Perform the test setup procedure described below to connect the 16341A to the A21 board of the 4191A. Remove the top cover and the shield plate on the A21 microprocessor digital control board. For instructions on removal of the top cover and shield plate, refer to paragraph 8-73. Connect the 16341A I/O cables to the A21 board as illustrated in Figure 8-13.

Confirmation Check

There may be cases where isolation and diagnostic procedures indicate an error, but troubleshooting procedures fail to turn up any abnormalities. In these cases, the procedure given in the flow diagram must be altered to inhibit the automatic jump to signature analysis testing and force the program to test all portions of the digital control circuit. To achieve this, set the lowest bit switch (labeled P) on A21S3 to the ON position at Setting B in the flow diagram, and continue with the rest of the procedure without changing the setting of this bit switch.

With the switch set in this position, the program will display, for two seconds, the error message for any abnormality it detects. And if the abnormality is not related to a ROM or RAM, Interrupt Request (IRQ) function, or the HP-IB section, the program will continue the test on all portions of the circuit and display additional error messages when an abnormality is detected.

Ignore the first error message, and proceed with troubleshooting for the second error message as described in Flow Diagram A. As additional information, a flow diagram of the program stored in the 16341A test program ROM is given in Figure 8-16.

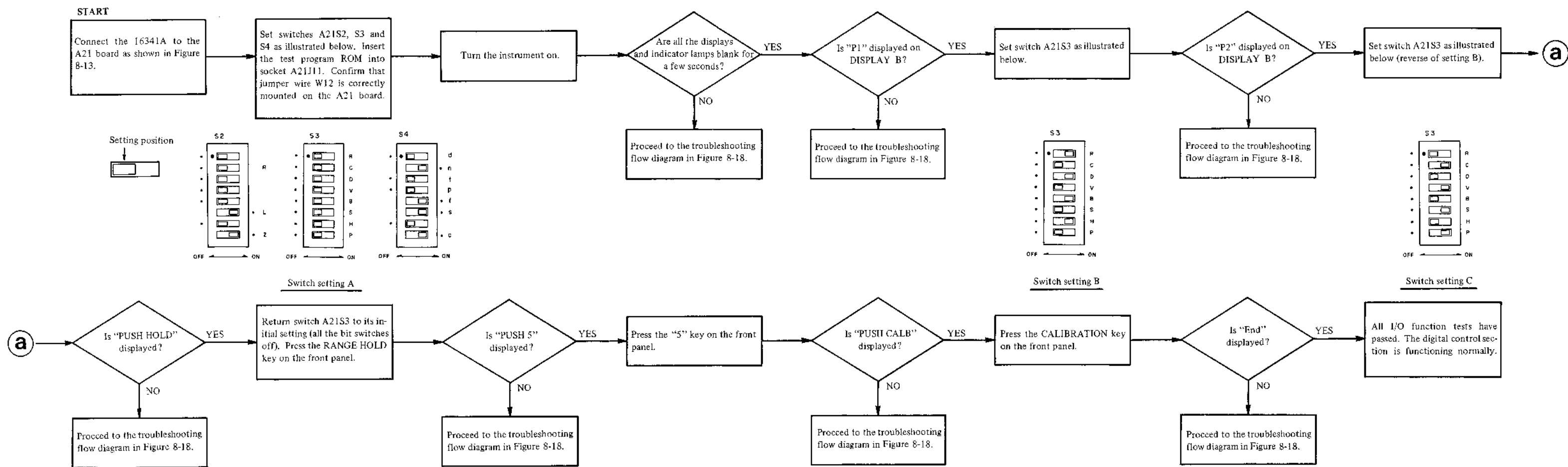

Figure 8-15. Analog and Digital Section Isolation Procedure Using the 16341A.

8-64. DIAGNOSTIC MESSAGES

8-65. The 16341A manipulates the circuit sections to be tested using proper control test signals as directed by the test program ROM and monitors the response of the circuit. The diagnostic tests are sequentially performed for the individual circuit sections and control functions on the A21 board. If a circuit fails, an error message is displayed on DISPLAY B of the 4191A to identify the circuit or function that did not respond correctly to the test. There are a total of 56 error messages and they are divided into eight categories. Each message is displayed as the letter E followed by a two digit number. Each message, along with the related function or component, is listed in Table 8-2.

The error codes can be used to determine the circuit area to troubleshoot (e.g. E-60 through E-71 indicate that the Analog Measurement Circuit Control is faulty, E-82 through E-85 indicate that the IRQ circuit is faulty, etc.) as well as the necessary setups for the signature analysis programs.

Note: The table also lists the components tested in relation to the error message. This does not mean, however, that the listed component is faulty. To locate the failing component, perform signature analysis troubleshooting.

Table 8-2. 16341A Diagnostic Test Error Messages.

Error code	Function or component tested	Error code	Function or component tested		
E20	RAM (U16)	E72 E73 E74 E75 E76 E77 E78 E79 E86 E87 E88 E89	HP-IB control HP-IB REN (U66, U74) HANDSHAKE (U66, U74, U75) EOI (U66, U75) SRQ (U66, U74) LISTEN DATA (U66, U76, U77) TALK DATA (U66) ADDRESS (U56, U66) MY ADDRESS (U66) Byte Input (U66, U76, U77) Byte Output (U66) CHIP RESET (U66) IFC (U66, U74)		
E21	RAM (U25)				
E22	RAM (U15)				
E23	RAM (U24)				
E31	ROM (U 1)				
E32	ROM (U 2)				
E33	ROM (U 3)				
E34	ROM (U 4)				
E35	ROM (U 5)				
E36	ROM (U 6)				
E37	ROM (U 7)				
E38	ROM (U 8)				
E39	ROM (U 9)			E80 E81	Keyboard input (U52, U71) EXT TRIG (U41, U71)
E40	ROM (U10)				
E41	ROM (U11)	E82 E83 E84 E85	IRQ EXTINT-EXTERNAL trigger IRQ (U71, U73) KEYINT-Keyboard IRQ (U71, U73) HP-IB INT (U66) IRQ		
E50	APU (U39)				
E60 E61 E62 E63 E64 E65 E66 E67 E68 E69 E70 E71	Analog Measurement Circuit Control Master reset (U21, U40) CPU switch disable (U21, U30) CPU switch disable (U21, U30) ZERO input (U30, U40, U41) ZERO input (U30, U41) CLRVRD (U20, U21, U40) Integrator charge control (U31, U32, U41, U42, U20) Counter stop (U31, U32, U51) Integrator precharge control (U31) Counter start (U41) Counter output data (U31) Lock (U40, U62)			E90 E91 E92 E93 E94 E95 E96 E97 E98 E99	Serial Port CLKSS2 (U38, U51, U58, U60, U61, U70, U72) CLKVRD (U58, U60, U69) CLKDAC (U58, U60, U69) CLKRCVR (U60, U69) CLKBIAS (U60, U69) CLKSS5 (U59, U70) CLKSS6 (U59, U70) CLKSS3 (U60, U70) CLKSS4 (U59, U70) CLKSS1 (U60, U70)

8-66. ERROR MESSAGES RELATING TO FAILURES IN THE ANALOG MEASUREMENT CIRCUIT.

8-67. Error messages displayed by the 4191A include messages for two kinds of failures related to the circuit operation of the analog measurement section. The 4191A continuously monitors two signals in the measurement circuit, and, if an abnormality is detected in either of these signals, E-11 or E-12 is displayed. These error message codes indicate the nature of the failure as follows:

- E-11: The zero signal, normally output from the vector ratio detector (A17 board), was not generated.
- E-12: Normal IF signal was not produced (more accurately, the $\overline{\text{LOCK}}$ signal (A12TP6) was not at the normal state when the IF signal frequency was locked at 100kHz).

The E-11 distinguishes between a failure in the test channel IF amplifier circuit on the A16 or A17 board from other preceding circuit stages. Since detection of E-12 related failures occurs prior to those related to E-11, determining the actual cause of the failures is possible even if the symptom relates to both errors, i.e., when the measurement frequency is lost. In such cases, when E-12 is displayed, the trouble is in the signal source or sampling IF converter section (A10, A12, A13 or A15 board).

When an E-11 or E-12 related failure is detected, the microprocessor stops accepting control setting input commands until the cause of the failure is eliminated. This makes it impossible to use various control settings as a means to track down the possible causes of the failure. To override this condition and to restore normal control functions, the error message function can be deactivated by setting switch A21S2-5, 6, 7 and 8 to the test mode position as shown below. This will allow operation of the front panel controls, when an E-11 or E-12 error condition exists.

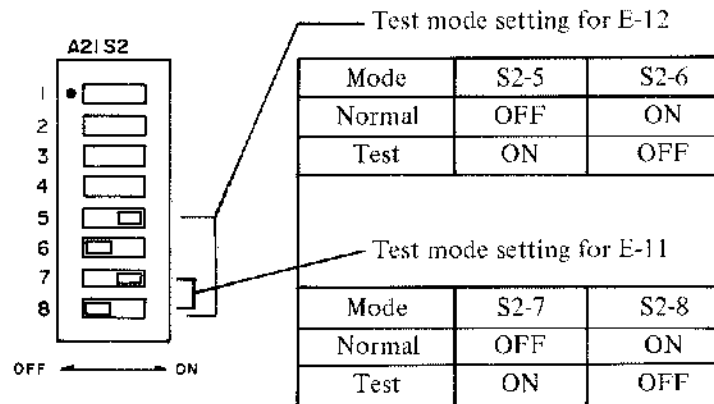

Caution: Do not set both S2-5 and S2-6 to the ON position at the same time. The same is also true for S2-7 and S2-8.

If error message E-11 is displayed, set S2-7 and S2-8 to the test mode position. For error message E-12, set S2-5, -6, -7 and -8 to the test mode position. This must also be done when performing adjustments that require disconnecting signal cable(s) or removing a specific board assembly.

Note: Be sure to reset switch A21S2 to its normal mode position after completion of adjustments or repair.

8-68. ANALOG MEASUREMENT SECTION TROUBLESHOOTING GUIDE.

8-69. This paragraph outlines the basic procedures used to troubleshoot the analog measurement section. The information included facilitates successful isolation of the trouble to board assembly level, with simple, short procedures. When it is determined that the trouble is in the analog measurement section, follow the troubleshooting instructions given below. After isolating the board assembly that is causing the trouble, refer to the foldout troubleshooting guide for that particular board assembly.

Note: Before proceeding with the board isolation procedure, refer to the instructions for error message codes in paragraph 8-67.

- 1) Read the error message displayed on the DISPLAY B. Skip the 10 minute warm-up. The error message indicates the failing circuit as follows:

E-11: The A11, A16, or A17 board is faulty.

E-12: The trouble is in the signal source section or in the sampling IF converter section.

If E-11 appears, refer to step 2 which outlines the procedures for isolating the faulty board (A11, A16 or A17).

If E-12 appears, skip step 2 and proceed to step 3.

- 2) Observe the 100kHz IF signals at A16TP5, TP10 and TP11 with an oscilloscope. The amplitude of the signal should be fairly close to the following values (when no DUT is connected):

TP5 : 30mVp-p

TP10 : 720mVp-p

TP11 : 2.5mVp-p

If the signal at TP5 is abnormal, check the A11 board. If the signals at both TP10 and TP11 are normal, the A16 board is functioning normally. Check the A17 board.

- 3) Connect a frequency counter to the UNKNOWN connector. The frequency counter readout should be within the tolerance of the specified test signal frequency accuracy (± 3 ppm). Disconnect the frequency counter and connect a spectrum analyzer in its place. Verify that the fundamental spectrum display is -20 ± 3 dBm. If the symptom occurs only at a specific frequency setting (range), perform these tests at that frequency. If both tests pass, the signal source section is operating normally. Check the sampling IF converter section (A10, A12, A13 and A15 boards) using steps 4 through 7. If either test fails, proceed to step 8.

Sampling IF Converter Isolation Procedure (A10, A12, A13 and A15)

- 4) Set switch A12S2 to the Test (T) position. The A12 PLL Sampling Controller will cause the output of the A13 PLL Sampling Frequency VTO to repeatedly sweep the entire frequency controllable range. Verify that the waveform at A12TP5 is a sawtooth with an amplitude from -20 V to 0 V and a 40ms period. If otherwise, check the A12 board.
- 5) Observe the square wave at A13TP2. The frequency of the signal should be swept between 1.1MHz and 11.25MHz. If the waveform does not vary over a 0.5 octave (for instance, 5 to 7.5 MHz) synchronously with the sawtooth at A12TP5, check the A13 board.
- 6) To determine whether or not the A10 Sampler is operating normally, swap the A10 and A11 boards. Reset switch A12S2 to the normal (N) position. If the E-12 error message does not appear, the A10 board is faulty. If the error persists, check the A15 board and continue to step 7.

- 7) If all the tests upto step 6 have passed, check the VTO frequency band selection signals and the frequency divider control signals on the A13 board. If the A13 board is operating normally, check the search control, the frequency detector, and the lock-in detector circuits on the A12 board.

Measurement Signal Source Isolation Procedure (A1 thru A7)

Note: If the instrument is equipped with Option 002, High Resolution Test Frequency, use the Option 002 Circuit Section Isolation Procedure before proceeding to step 8.

- 8) If the fundamental spectrum level, measured at step 3, is too high or too low, check the ALC voltage at A16 (3L). The ALC output voltage will differ from its typical value of about 4V as follows:

When the measurement signal level is too high:

ALC voltage will be close to +12V.

When the measurement signal level is too low:

ALC voltage will be close to 0V.

If the ALC voltage does not exhibit the expected change, check the ALC circuit on the A16 board.

- 9) Connect the frequency counter first to A18P1, and then P2. The frequency counter readout should be 200MHz and 100MHz (within ± 3 ppm) respectively. If otherwise, check the A18 board.
- 10) Connect the frequency counter to A1P1. Set switch A21S2 to the test mode position (refer to para. 8-67). Set the SPOT frequency to 250.0MHz, and then 500.0MHz. The frequency counter readouts should be identical to the SPOT frequency settings within the specified tolerance and accuracy. If otherwise, check the A1, A2, A3 boards individually using the circuit operating test procedures provided on their respective service sheet foldouts. Reconnect the SMC connector cable to A1P1.
- 11) Connect the frequency counter to A5P4. Manually sweep the measurement signal frequency from 1.0MHz to 500.0MHz in 5MHz steps. Verify that the frequency counter readouts are identical to those on the 4191A display. Disconnect the frequency counter and connect the spectrum analyzer in its place. Sweep the measurement signal frequency automatically in the same frequency range. The fundamental spectrum level should be greater than -6dBm at all the frequency points. If any abnormality occurs, check the A5 board. Also check the switch control driver outputs on the A4 board.
- 12) Connect the spectrum analyzer to A6P4. Sweep the measurement signal frequency automatically from 1.0MHz to 1000.0MHz in 2MHz steps. Verify that the fundamental spectrum level is 3 ± 3 dBm at all frequency points. If this test passes, check the A9 board. If otherwise, perform step 13.
- 13) Connect the spectrum analyzer to A7P3. Sweep the measurement signal frequency automatically from 1.0MHz to 1000.0MHz in 2MHz steps. Verify that the fundamental spectrum level is within -6 ± 5 dBm at all test frequency points. If an abnormality occurs at a frequency region between 1.0MHz and 500.0MHz, check the A7 board. Also check the switch control driver output on the A4 board. If the symptom occurs only at frequencies between 500.2MHz and 1000.0MHz, check the A6 board. Also check the control voltage of the voltage tunable filter at A4TP3.

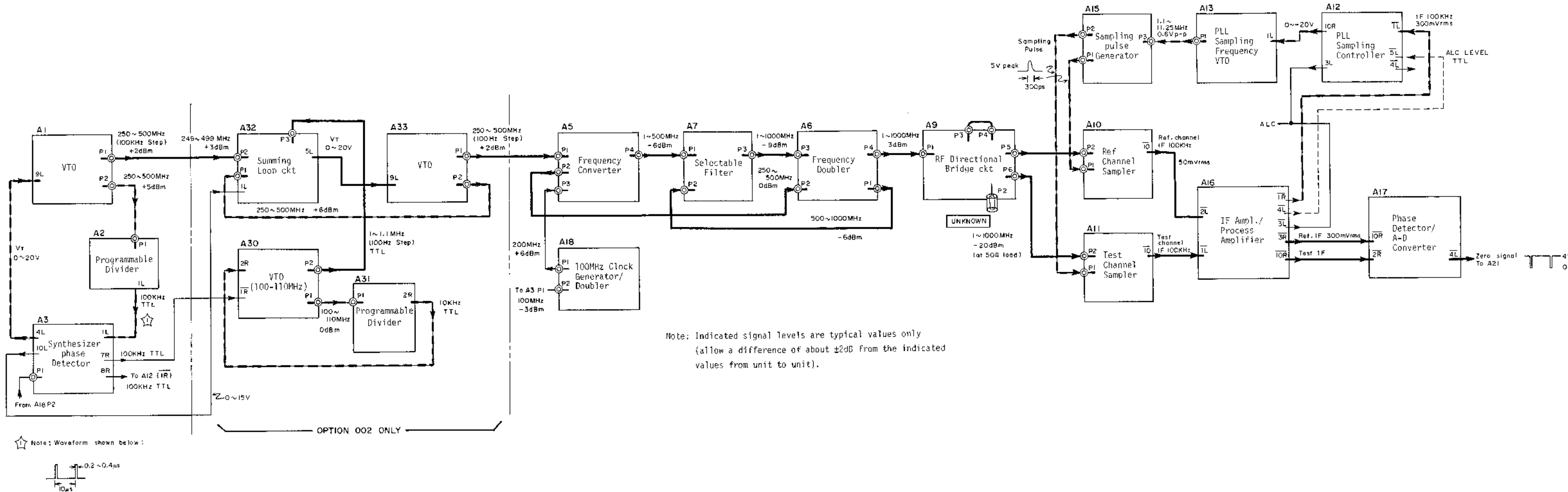

Figure 8-17. Signal Level Diagram.

8-70. SIGNATURE ANALYSIS TEST

8-71. There are eight, independent, signature analysis test programs. The independent configuration permits the selection of one program to troubleshoot a partial section of the digital control circuit; thus, greatly reducing the time required to troubleshoot a failure. The error message displayed on DISPLAY B determines which signature analysis test program should be selected.

Switch S3, on the A21 board, is used to select the appropriate signature analysis test program. The settings of the 8 bit-switches on A21S3 are related to the error messages and the signature test areas of circuit as listed in Table 8-3. Perform the troubleshooting procedures beginning with flow diagram A in Figure 8-18 and follow the instructions given in the flow diagrams. The signature analysis test setups used in the flow diagrams are listed in Table 8-4.

Bit assignments for A21S3 are as follows:

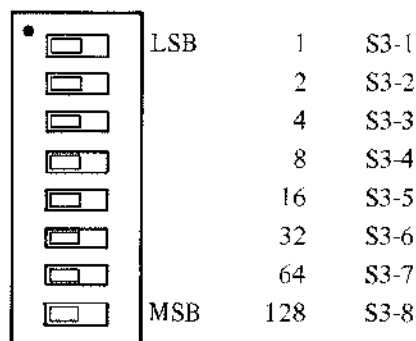

Table 8-3. Selection of Signature Analysis Test Programs.

Error message	Signature test area of circuit	Bit switch setting
E20 - E23	RAM (write) RAM (read)	00000000 (0) 00000001 (1)
E31 - E41	ROM	(See Note 1)
E50	APU (write) APU (read)	00000100 (4) 00000101 (5)
E60 - E71	Analog measurement circuit control (write) (read)	00000110 (6) 00000111 (7)
E72 - E79 E86 - E89	HP-IB control (listen) (talk)	00001010 (10) 00001011 (11)
E80 - E81	Keyboard and external trigger circuits	00000011 (3)
E82 - E85	Interrupt request control	00000010 (2)
E90 - E99	Serial port	00001000 (8)

- 1: Set the third bit of A21S4 to 1.
- 2: Numbers enclosed in parentheses to the right of each setting are the decimal equivalents.
- 3: Selection of the programs is possible anytime (it is not necessary to turn the instrument off).

Digital Section Troubleshooting Using Signature Analyzer.

The advantage of troubleshooting based on "Signature Analysis" is accuracy and ease in finding failures. It is generally difficult to search for an error by means of observing waveforms on an oscilloscope for the reason that bit trains in a digital circuit seem to be much the same whichever is observed. Specifically, to find the errors in a stream of large bit size (or word length) data takes much time and requires the use of an instrument such as a logic state analyzer. Hewlett-Packard has proposed a method called "Signature Analysis" which recognizes the bit pattern measured in a 4 digit hexa-decimal code (signature) for running an easy diagnostic test program. With the Signature Analyzer (HP 5004A), the signatures are displayed in a readable 4 digit-figure set of alphanumeric figures (0 1 2 3 4 5 6 7 8 9 A C F H P U). The signature analysis is based the usual signal tracing method followed in troubleshooting an analog circuit. According to signature analysis, devices in a digital circuit are checked with the signal analyzer by comparing signal input and output signatures to and from each device for the "correct" signature denoted in the service manual signature map. If a signature is not identical, the troubleshooter need only trace the bit train in opposite direction to the signal flow and, when a device is noted which generates an erratic signature despite a correct input, the component may be regarded as faulty.

Signature Analysis for the 4191A

To perform signature analysis, the Model 16341A Logic Test Box and a test program ROM, supplied with the 16341A, are required. The test box and ROM are connected to the A21 (A20) MPU/Digital Control board of the 4191A to perform signature analysis. There are eight (8) signature analysis test programs for troubleshooting the individual circuit sections. To select the appropriate program, a DSA (Data Stream Analysis) switch is provided on the A21 (A20) board of the 4191A. Instructions for signature analysis test setups, selection of the test programs, correct signatures and troubleshooting procedure are given in the paragraphs following 8-70 and in Figures 8-18 and 8-19 in the form of flow diagrams.

SIGNATURE ANALYZER TECHNIQUE

An active digital hand-held logic tracer coupled with an active pod (with four miniature clip connection leads) is sufficient for detecting the test signal and for development of the signature on the Signature Analyzer display. The active probe has access to the desired node in the circuit being tested and transfers this input data to the analyzer. The four input leads of the test cable active pod connect the gate signals --- START, STOP and CLOCK --- from the instrument being tested to the analyzer. The remaining lead is connected to instrument GND. The START signal is an open "window" (measurement gate) signal which causes the signature analyzer to prepare for receiving data via the active probe. The STOP signal causes the window to close. The CLOCK is taken from the time base of the instrument and permits receiving input data and gate signals in synchronization. Polarity of the gate signal active (enable) edges (positive or negative) can be selected by the front panel controls of the signature analyzer. Probing points and connection locations of START, STOP and CLOCK leads are designated on the troubleshooting flow diagrams.

Figure 8-18. Signature Analysis Guide.

SIGNATURE ANALYSIS TROUBLESHOOTING FLOW DIAGRAM NOTES

The troubleshooting flow diagrams are constructed from a primary flow diagram which guides you to the appropriate signature analysis test routine and the branch flow diagrams of the individual signature analysis tests. The procedure given in the primary flow diagram A, is similar to the Analog and Digital Section Isolation Procedure (Figure 8-15) and contains additional instructions on error messages, along with signature analysis troubleshooting details. Thus, it is necessary to perform the isolation procedure before starting troubleshooting with flow diagram A. Find the branch flow diagram suitable for the error message symptom using flow diagram A, then proceed to the pertinent signature analysis procedure in the secondary flow diagrams, B through P. Abbreviations, symbols, and special notation used in the signature analysis test programs are explained below.

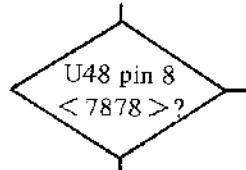
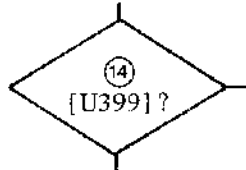
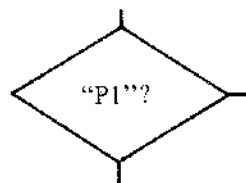

Setup	:	
S3	:	00000000
S4-3	:	1 (on)
WND	:	U17-7 ($\overline{CS7}$)
CLK	:	TP13 (1M)
START	:	
STOP	:	
CLOCK	:	

1) Characters enclosed in quotation marks " " represent a display on DISPLAY B of the 4191A.

2) The circled number 14 indicates the signature analysis test setting listed in Table 8-4. Characters enclosed in brackets [] are the correct signature analyzer display output for the window test (signature for high level).

3) The probing point of the signature analyzer is A21U48 pin 8. Characters enclosed in < > are the correct signature analyzer display output.

4) Take the signatures using the setup listed. The example shown at left prompts the following setup conditions:

S3 : Set A21S3 to 00000000.

S4-3 : Set the third bit switch of A21S4 to 1 (ON).

WND : Connect the START and STOP input clip leads of the signature analyzer to A21U17 pin 7 (to take the window signal from $\overline{CS7}$ signal).

CLK : Connect the CLOCK input clip lead of the signature analyzer to A21TP13 (to take the clock from 1M signal).

START, STOP, CLOCK : Set the signature analyzer front panel controls (to select the slope of the trigger edge) as follows:

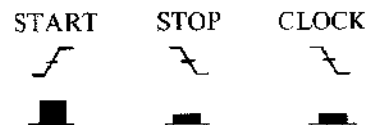





Table 8-4. Signature Analysis Test Setups (window tests)

Setting number	Signature test area	A21S3 setting	A21S4 setting	Signature Ana. gate signals		Signature Ana. settings			Window test	Note
				START/STOP	CLOCK	START	STOP	CLOCK		
1	I/O functions	00000000	Normal setting	TP17 (WND)	TP13 (1M)					
2	Address free run	"	S4-3: ON	TP2 (A15)	"				0001	
3	ROM (U1)	"	"	U17 pin 7 (CS7)	"				826P	
4	ROM (U2)	"	"	U17 pin 9 (CS6)	"	"	"	"	"	
5	ROM (U3)	"	"	U17 pin 10 (CS5)	"	"	"	"	"	
6	ROM (U4)	"	"	U17 pin 11 (CS4)	"	"	"	"	"	
7	ROM (U5)	"	"	U17 pin 12 (CS3)	"	"	"	"	"	
8	ROM (U6)	"	"	U17 pin 13 (CS2)	"	"	"	"	"	
9	ROM (U7)	"	"	U17 pin 14 (CS1)	"	"	"	"	"	
10	ROM (U8)	"	"	U17 pin 15 (CS0)	"	"	"	"	"	
11	ROM (U9)	"	"	U18 pin 7 (CS11)	"	"	"	"	"	
12	ROM (U10)	"	"	U18 pin 9 (CS10)	"	"	"	"	"	
13	ROM (U11)	"	"	U18 pin 10 (CS9)	"	"	"	"	"	
14	P1 test	"	S4-3: OFF	TP17 (WND)	"				U399	
15	Window test	"	"	U17 pin 15 (CS0)	TP14 (2M)	"	"	"	5456	
16	P2 test	"	"	TP17 (WND)	TP13 (1M)	"	"	"	UFP6	
17	Display function	"	"	"	"	"	"	"	U57F	
18	RAM	"	"	"	"	"	"	"	1UFP	1
19	Interrupt function	00000010	"	"	"	"	"	"	4058	2
20	Keyboard function	00000010 00000011	"	"	"	"	"	"	099P	3
21	Ext. trigger function	00000010	"	"	"	"	"	"	4058	2
22	APU	00000100	"	"	"	"	"	"	A546	2
23	APU	"	"	U57 pin 3 (1M)	TP26 (10M)	"	"	"	03U9	
24	APU	00000101	S4-4: ON	TP17 (WND)	TP13 (1M)	"	"	"	0F45	

Table 8-4. Signature Analysis Test Setups (continued).

Setting number	Signature test area	A21S3 setting	A21S4 setting	Signature Ana. gate signals		Signature Ana. settings			Window test	Note
				START/STOP	CLOCK	START	STOP	CLOCK		
25	APU	00000101	S4-4: OFF	TP17 (WND)	TP13 (1M)				9P10	
26	Analog meas. control	00000110	"	"	"	"	"	"	F886	
27	Analog meas. control	00000111	"	"	"	"	"	"	378F	
28	LOCK circuit	"	"	"	"	"	"	"	"	
29	Serial port	00001000	"	"	"	"	"	"	153H	
30	HP-IB function	00001010	"	"	"	"	"	"	69PP	
31	HP-IB function	00001011	"	"	"	"	"	"	916U	

- Notes:*
1. To run the signature analysis test program, momentarily connect A21TP9 (NMI) to the chassis.
 2. If the signature display for the window test is not identical to the listed signature, perform the procedure described in Note 1.
 3. Set A21S3 first to 00000010, then to 00000011.

SIGNATURE ANALYSIS TROUBLESHOOTING FLOW DIAGRAMS**A20 (A21) Microprocessor/Digital Control Board**

Flow Diagram A	8-49
Flow Diagram B	8-50
Flow Diagrams B-1 and B-6	8-51
Flow Diagram B-2	8-52
Flow Diagrams B-3, B-4 and B-5	8-53
Flow Diagram B-7	8-54
Flow Diagrams C, D, D-1 and E	8-55
Flow Diagrams F and F-1	8-56
Flow Diagrams F-2 and G	8-57
Flow Diagram G-1	8-58
Flow Diagrams H, H-1 and H-2	8-59
Flow Diagram I	8-60
Flow Diagrams J and K	8-61
Flow Diagram L	8-62
Flow Diagrams L-1 and M	8-63
Flow Diagram N	8-64
Flow Diagram P	8-65
Flow Diagram P-1	8-66

A22 Display and Keyboard Control Board

Flow Diagram Q	8-67
Flow Diagrams R and S	8-68
Flow Diagram T	8-69

Initial Setup:

- 1) Connect the 16241A to the A21 header
- 2) Install the test program ROM in socket A211
- 3) Check the 5V voltages at A7, TP25 and TP30. The voltages should be +12V and +5V, respectively. If otherwise, troubleshoot the CC power supply.
- 4) Observe the clock at A21TP5. The period of the clock should be between 1.0µs and 1.05µs. If otherwise, troubleshoot the microprocessor clock circuit.

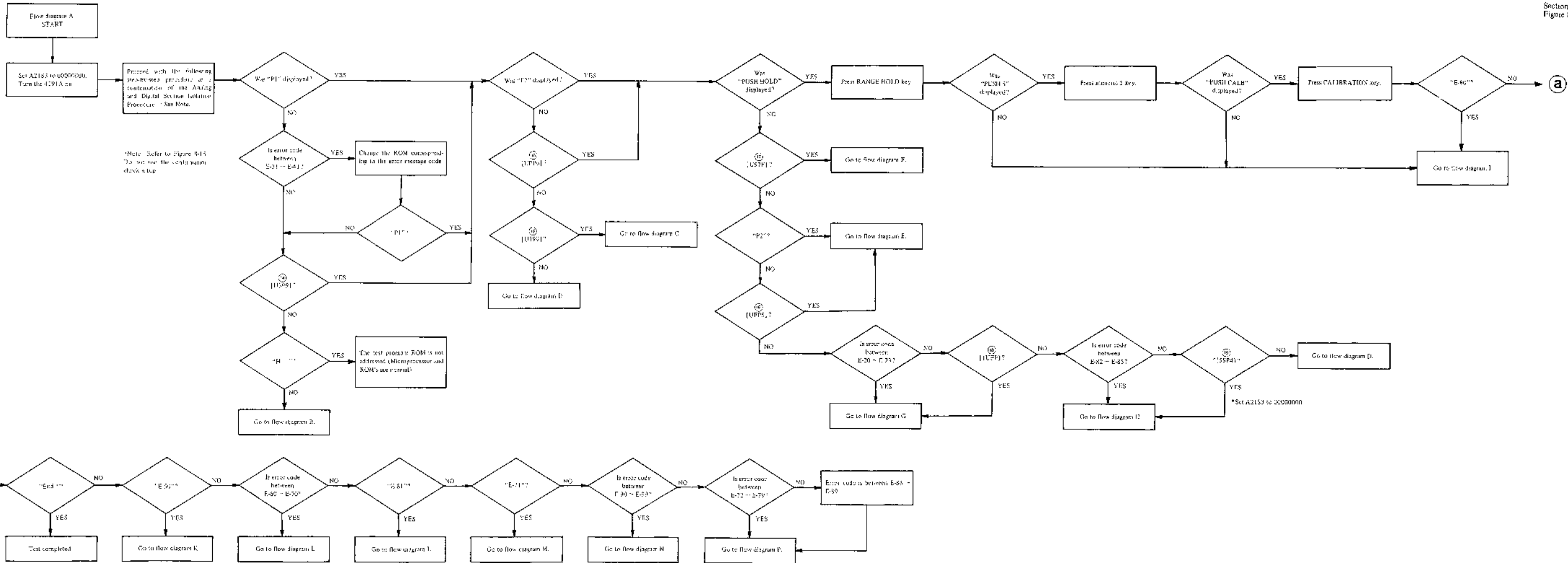

Figure 8-18. A20 (A21) Board Signature Analysis Troubleshooting Flow Diagram A.

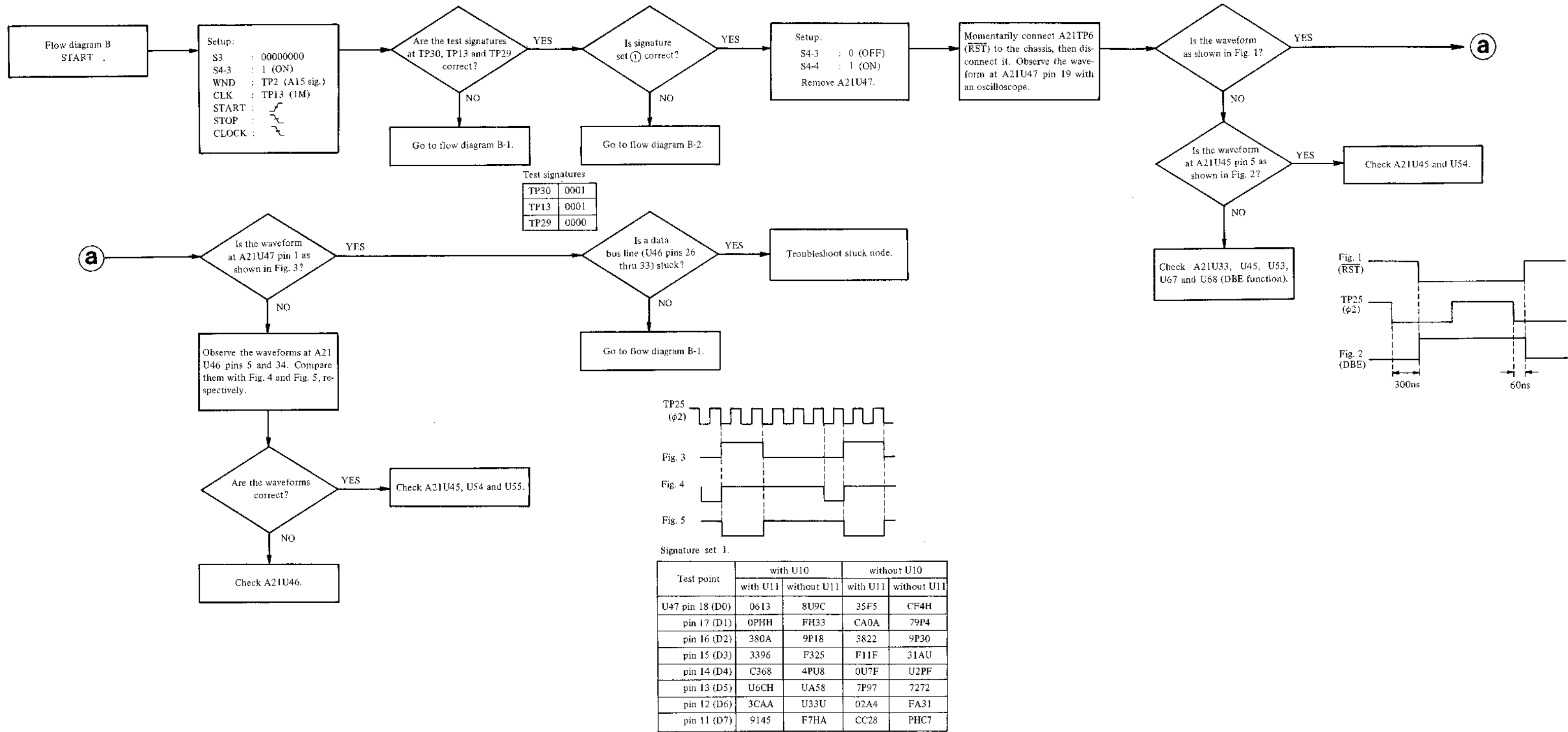

Figure 8-18.

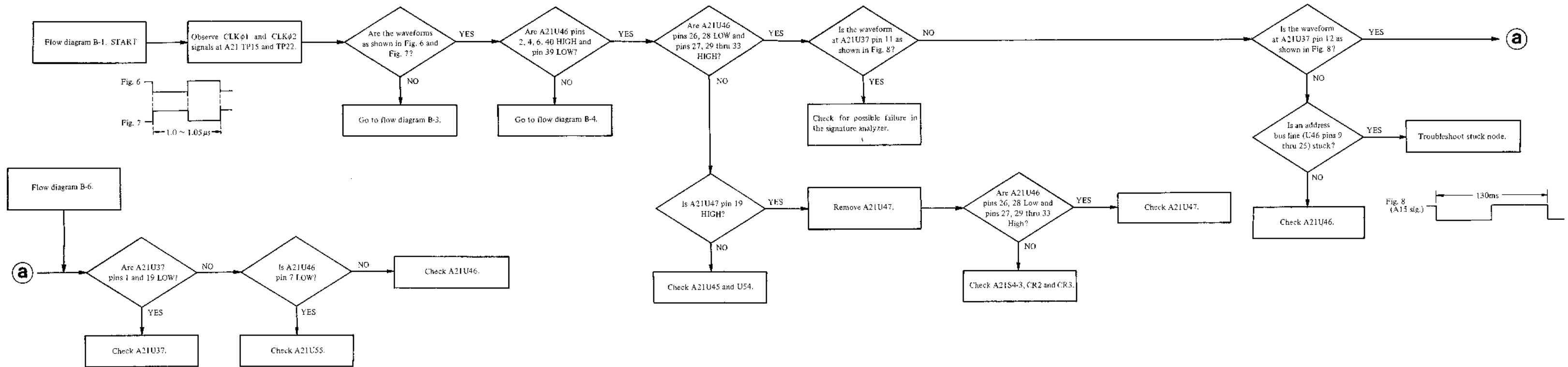
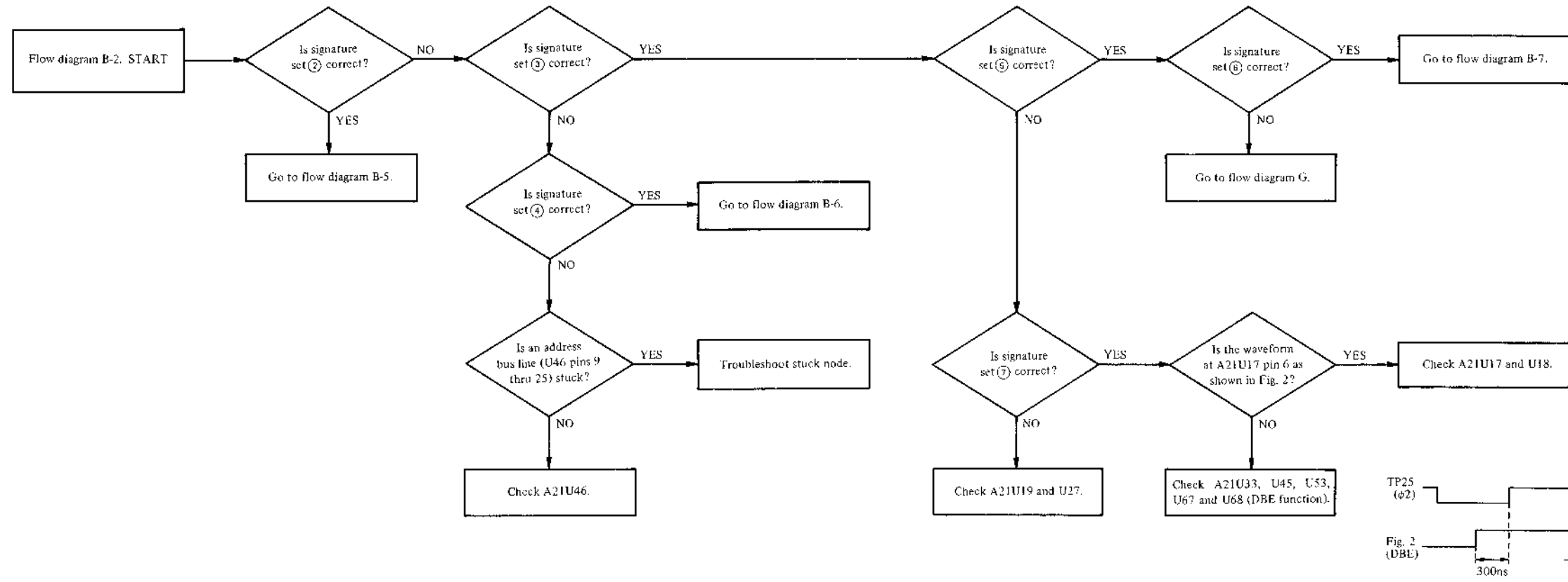

Figure 8-18. A20 (A21) Board Signature Analysis Troubleshooting Flow Diagrams B-1 and B-6.



Signature set 2.

	with U10	without U10
U26 pin 18 (D0)	0613	8U9C
pin 17 (D1)	0PHH	FH33
pin 16 (D2)	380A	9P18
pin 15 (D3)	3396	F325
pin 14 (D4)	C368	4P18
pin 13 (D5)	U6CH	UAS8
pin 12 (D6)	3CAA	U33U
pin 11 (D7)	9145	F7HA

Signature sets 3 and 4.

Ad. bus	Set 3	Set 4	Signature
A15	U37 pin 11	U37 pin 12	0001
A14	pin 13	pin 14	755U
A13	pin 15	pin 16	3827
A12	pin 17	pin 18	3C96
A11	pin 9	pin 8	HAP7
A10	pin 7	pin 6	1293
A 9	pin 5	pin 4	HPPO
A 8	pin 3	pin 2	2H70
A 7	U36 pin 11	U36 pin 12	HC89
A 6	pin 13	pin 14	52F8
A 5	pin 15	pin 16	UPFH
A 4	pin 17	pin 18	0AFA
A 3	pin 9	pin 8	5H21
A 2	pin 7	pin 6	7F7F
A 1	pin 5	pin 4	CCCC
A 0	pin 3	pin 2	5555

Signature set 5.

U17 pin 15 (CS0)	CA11
pin 14 (CS1)	H759
pin 13 (CS2)	A3UH
pin 12 (CS3)	AA6A
pin 11 (CS4)	A711
pin 10 (CS5)	54F5
pin 9 (CS6)	603C
pin 7 (CS7)	826U
U18 pin 11 (CS8)	-
pin 10 (CS9)	57HH
pin 9 (CS10)	96F8
pin 7 (CS11)	546U

Signature set 6.

U13 pin 8 (CA0)	0001
pin 11 (CA1)	0001
pin 3 (CA2)	0001

Signature set 7.

U17 pin 1	HAP7
pin 2	3C96
pin 3	3827
pin 4	755P
pin 5	0000
U18 pin 4	755U

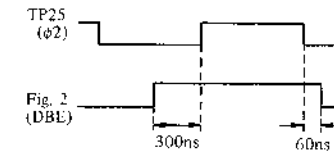

Figure 8-18. A20 (A21) Board Signature Analysis Troubleshooting Flow Diagram B-2.

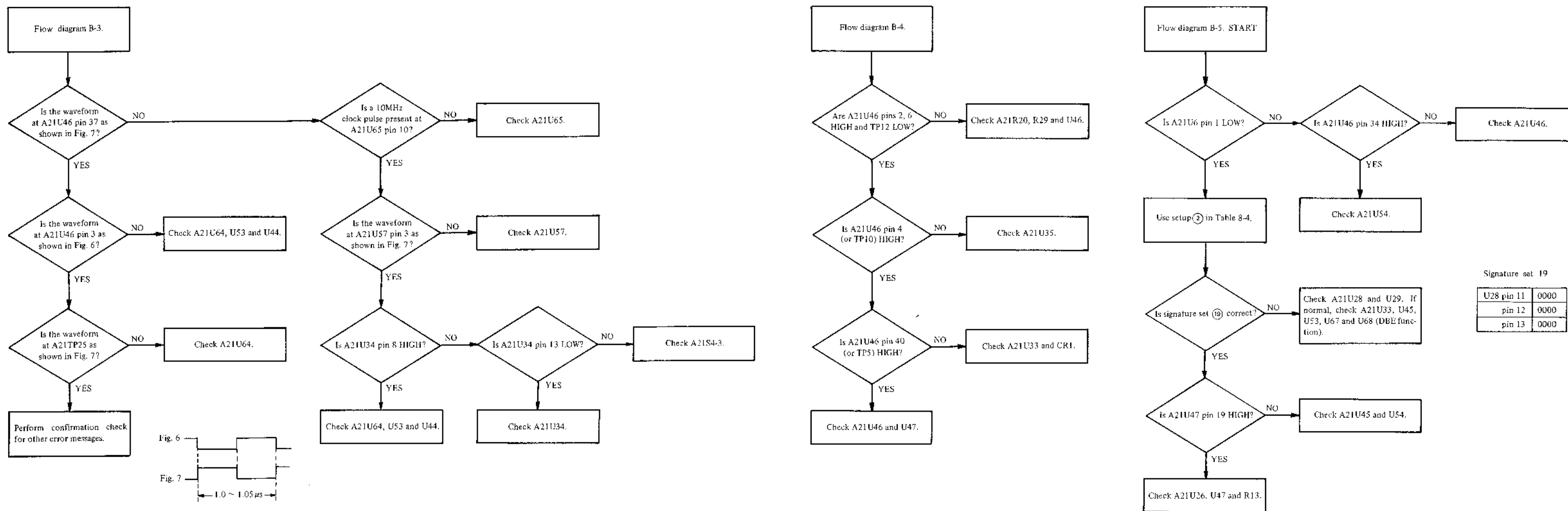
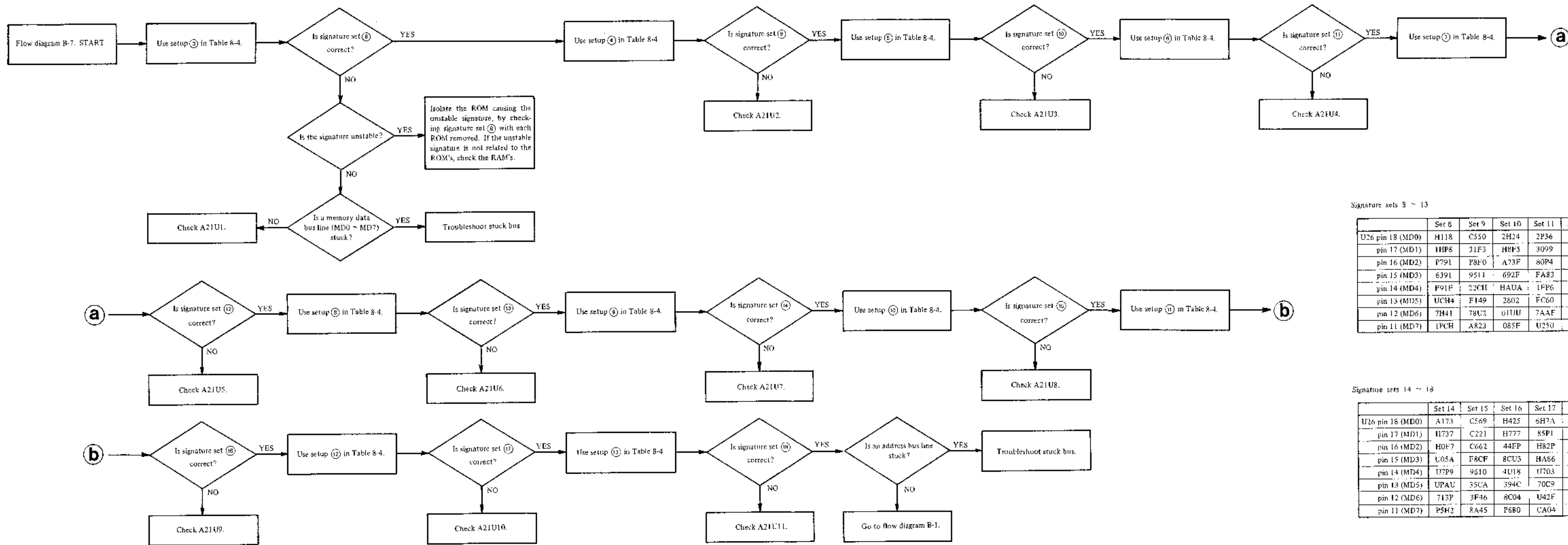

Figure 8-18. A20 (A21) Board Signature Analysis Troubleshooting Flow Diagrams B-3, B-4 and B-5.



Signature sets 8 ~ 13

	Set 8	Set 9	Set 10	Set 11	Set 12	Set 13
U26 pin 18 (MD0)	H118	C550	2H24	2P36	7HAH	PPPP
pin 17 (MD1)	1HP8	31F5	H8F5	3099	9689	U30P
pin 16 (MD2)	P791	P8F0	A73F	80P4	1202	COUP
pin 15 (MD3)	6391	9511	692F	FA83	3C65	2PFH
pin 14 (MD4)	F91F	22CH	HADA	1FP6	P6P3	3HCH
pin 13 (MD5)	UCH4	F149	2802	FC60	APHP	9743
pin 12 (MD6)	7H41	78C3	01UU	7AAF	AF8A	98FI
pin 11 (MD7)	1PKH	A823	085F	U250	36UF	0C50

Signature sets 14 ~ 18

	Set 14	Set 15	Set 16	Set 17	Set 18
U26 pin 18 (MD0)	A173	C569	H425	6H7A	C091J
pin 17 (MD1)	11737	C221	H777	85P1	A273
pin 16 (MD2)	H0F7	C662	44FP	H82P	H5P8
pin 15 (MD3)	U05A	F8CF	8C03	HA86	F2C0
pin 14 (MD4)	U7P9	9610	4U18	U7D3	F424
pin 13 (MD5)	DPAU	35CA	394C	70C9	5531
pin 12 (MD6)	713P	3P46	8C04	U42F	4405
pin 11 (MD7)	P5H2	8A45	P6B0	CA04	8UF6

Figure 8-18. A20 (A21) Board Signature Analysis Troubleshooting Flow Diagram B-7.

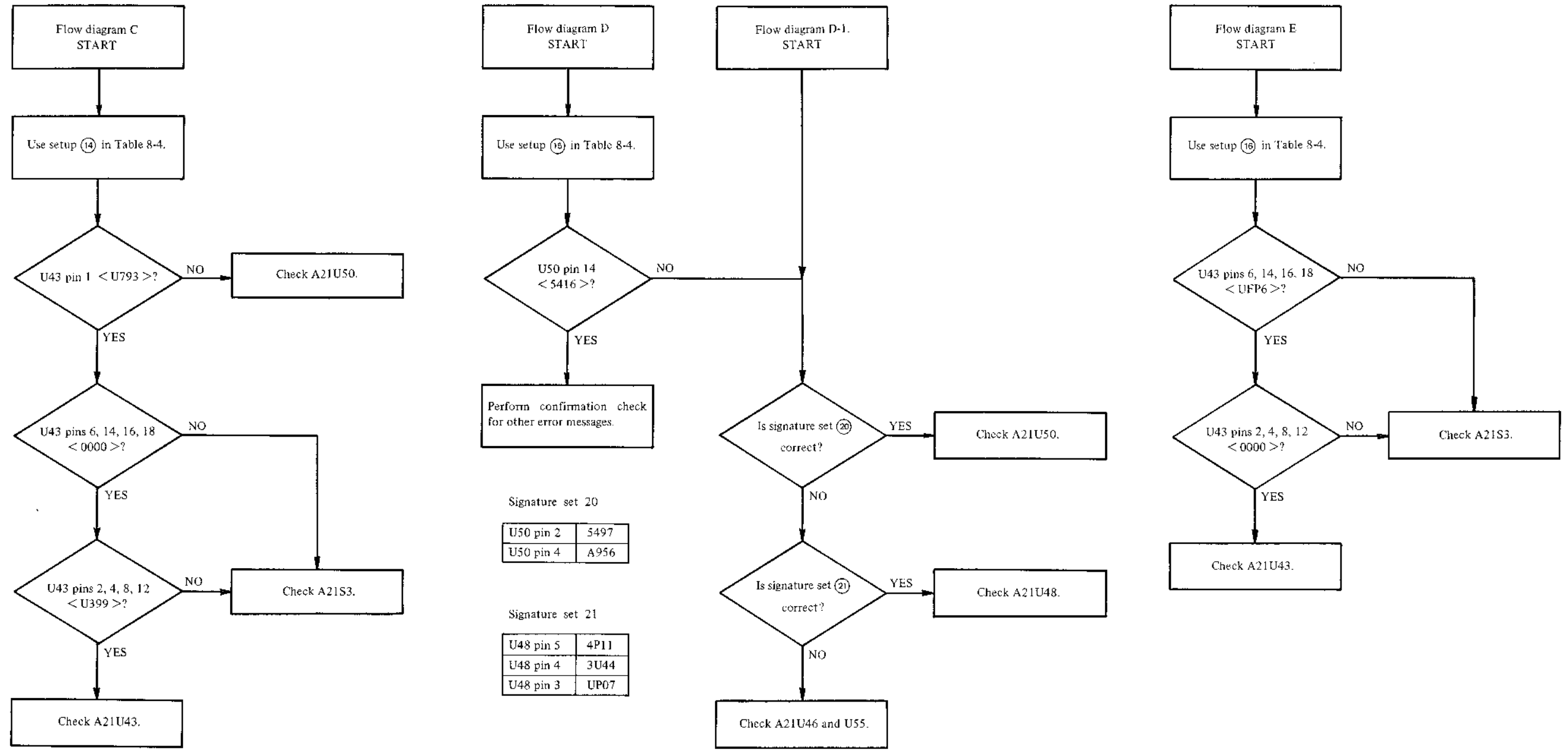

Figure 8-18. A20 (A21) Board Signature Analysis Troubleshooting Flow Diagrams C, D, D-1 and E.

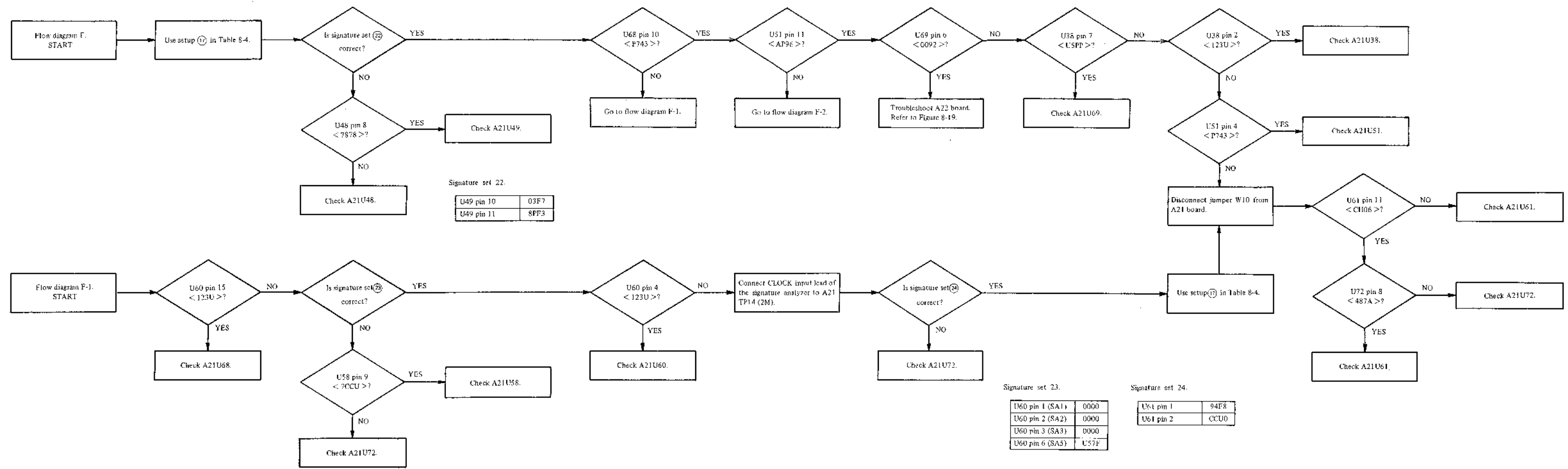
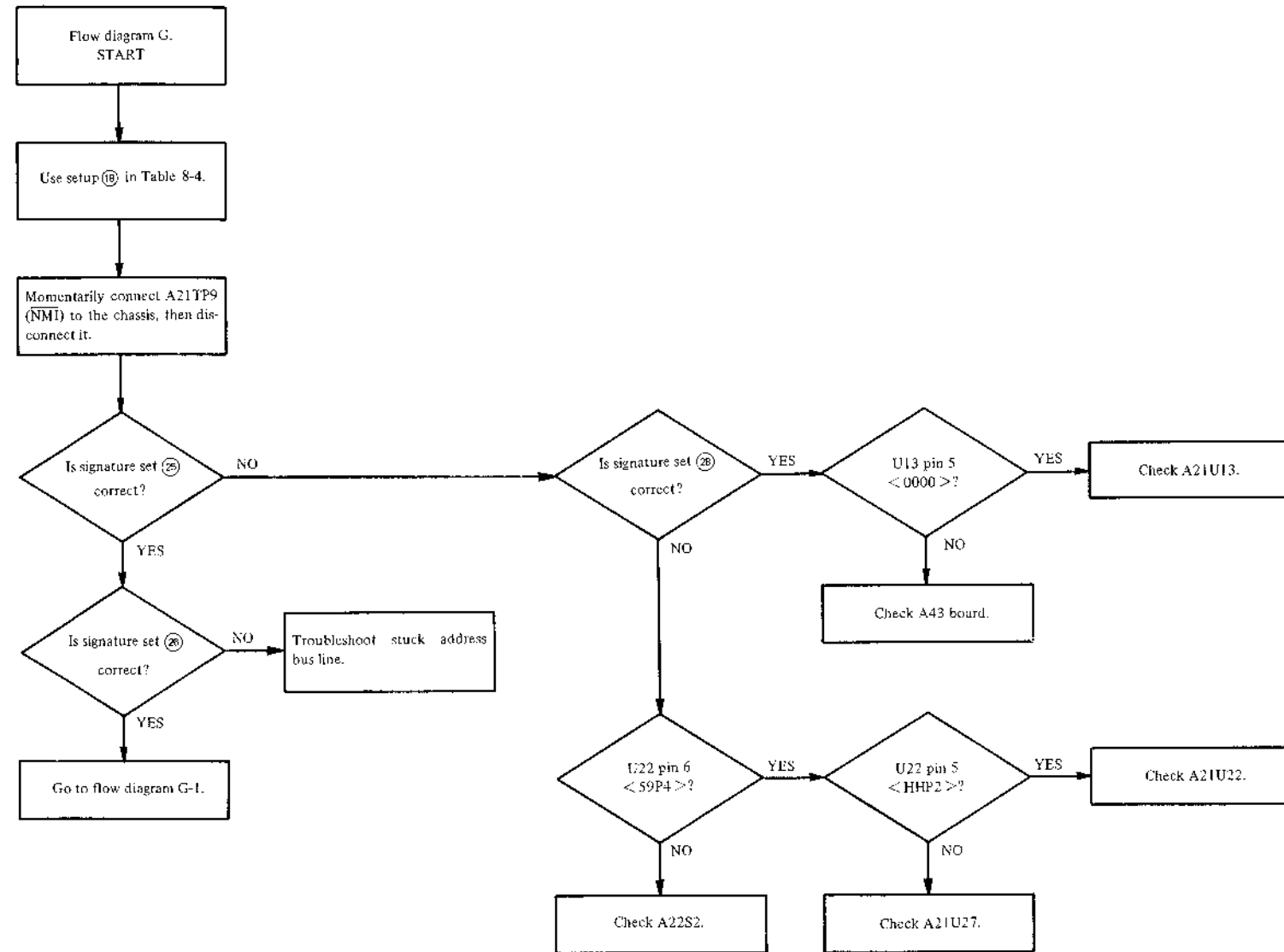
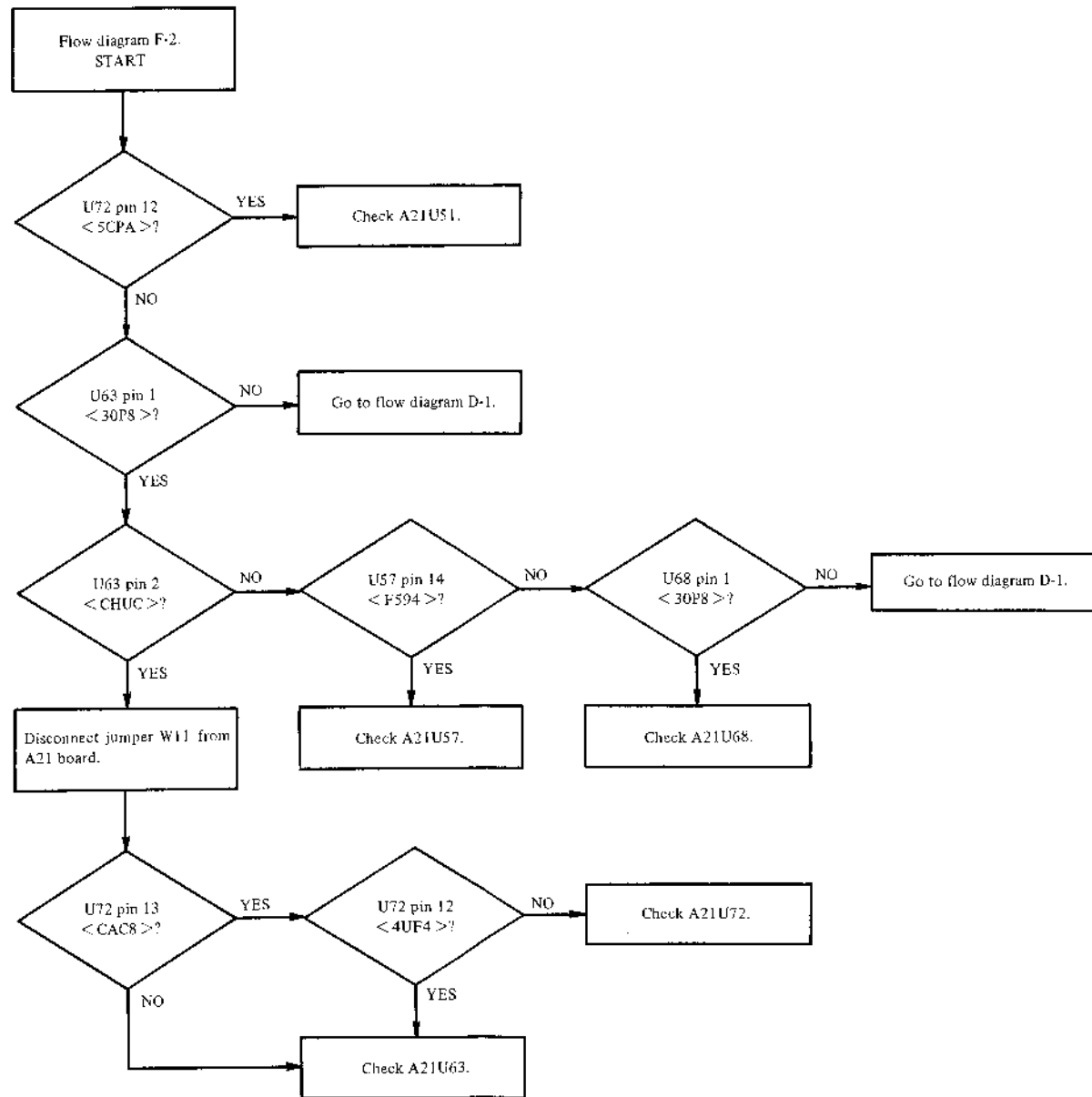

Figure 8-18. A20 (A21) Board Signature Analysis Troubleshooting Flow Diagrams F and F-1.



Signature Set 25.

U13 pin 8 (CA0)	755H
U13 pin 11 (CA1)	0H4F
U13 pin 3 (CA2)	H444

Signature set 28.

U22 pin 15	755H
U22 pin 14	0H4F
U22 pin 13	H444

Signature set 26.

U16 pin 1 (A6)	5U74
pin 2 (A5)	FPHU
pin 3 (A4)	F2PP
pin 4 (A3)	99611
pin 5 (A0)	1HCH
pin 6 (A1)	HH38
pin 7 (A2)	5A96
pin 15 (A9)	4PF9
pin 16 (A8)	PC26
pin 17 (A7)	H86H

Figure 8-18. A20 (A21) Board Signature Analysis Troubleshooting Flow Diagrams F-2 and G.

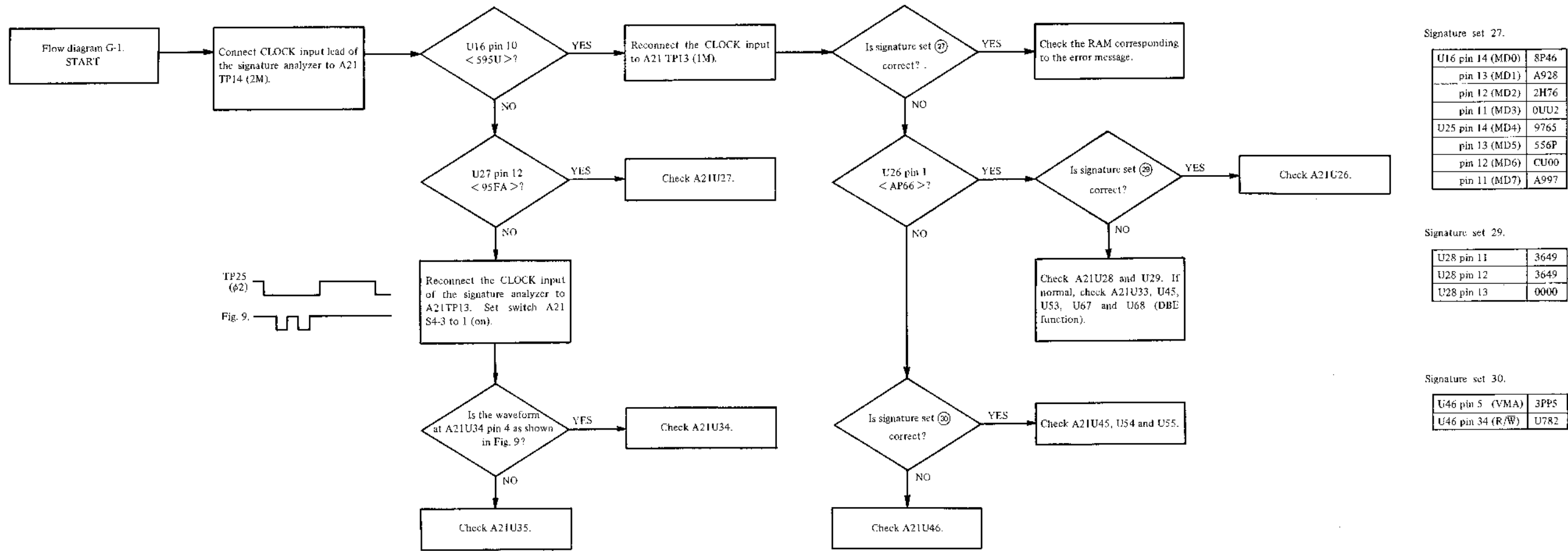

Signature set 27.

U16 pin 14 (MD0)	8P46
pin 13 (MD1)	A928
pin 12 (MD2)	2H76
pin 11 (MD3)	0UU2
U25 pin 14 (MD4)	9765
pin 13 (MD5)	556P
pin 12 (MD6)	CU00
pin 11 (MD7)	A997

Signature set 29.

U28 pin 11	3649
U28 pin 12	3649
U28 pin 13	0000

Signature set 30.

U46 pin 5 (VMA)	3PP5
U46 pin 34 (R/W)	U782

Figure 8-18. A20 (A21) Board Signature Analysis Troubleshooting Flow Diagram G-1.

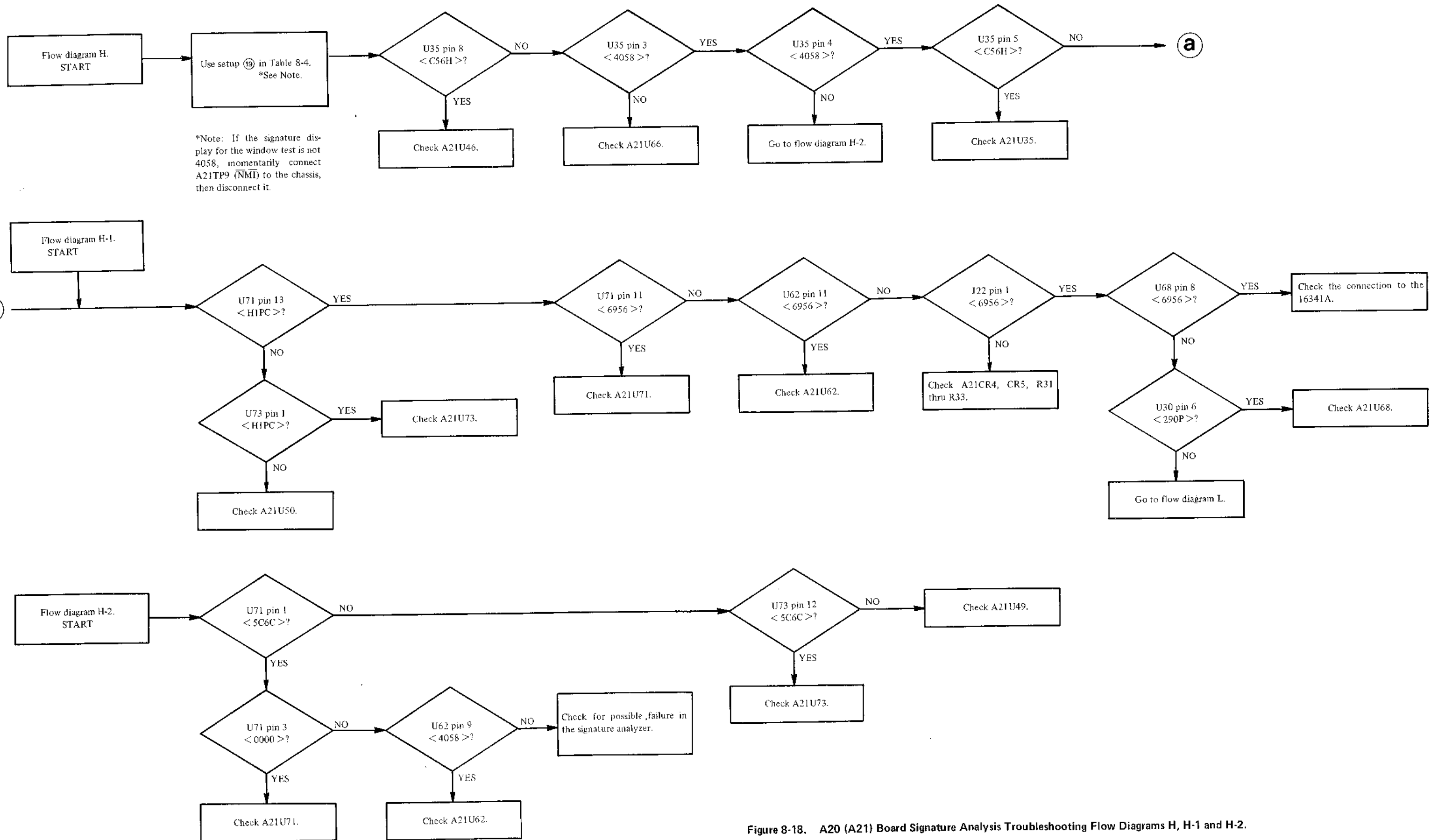

Figure 8-18. A20 (A21) Board Signature Analysis Troubleshooting Flow Diagrams H, H-1 and H-2.

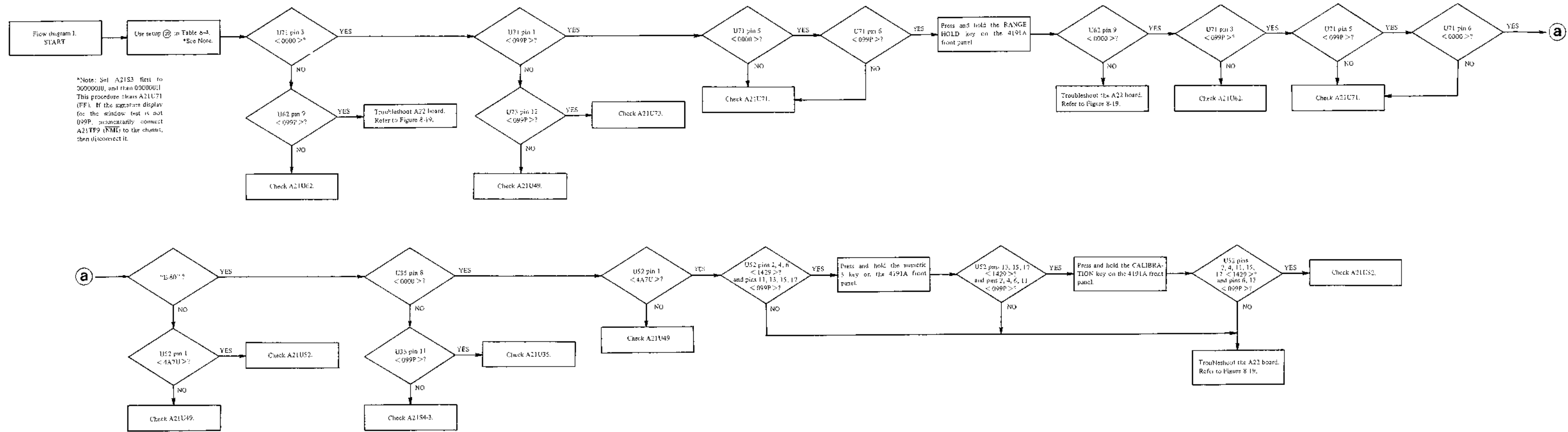

Figure 8-18. A20 (A21) Board Signature Analysis Troubleshooting Flow Diagram 1.

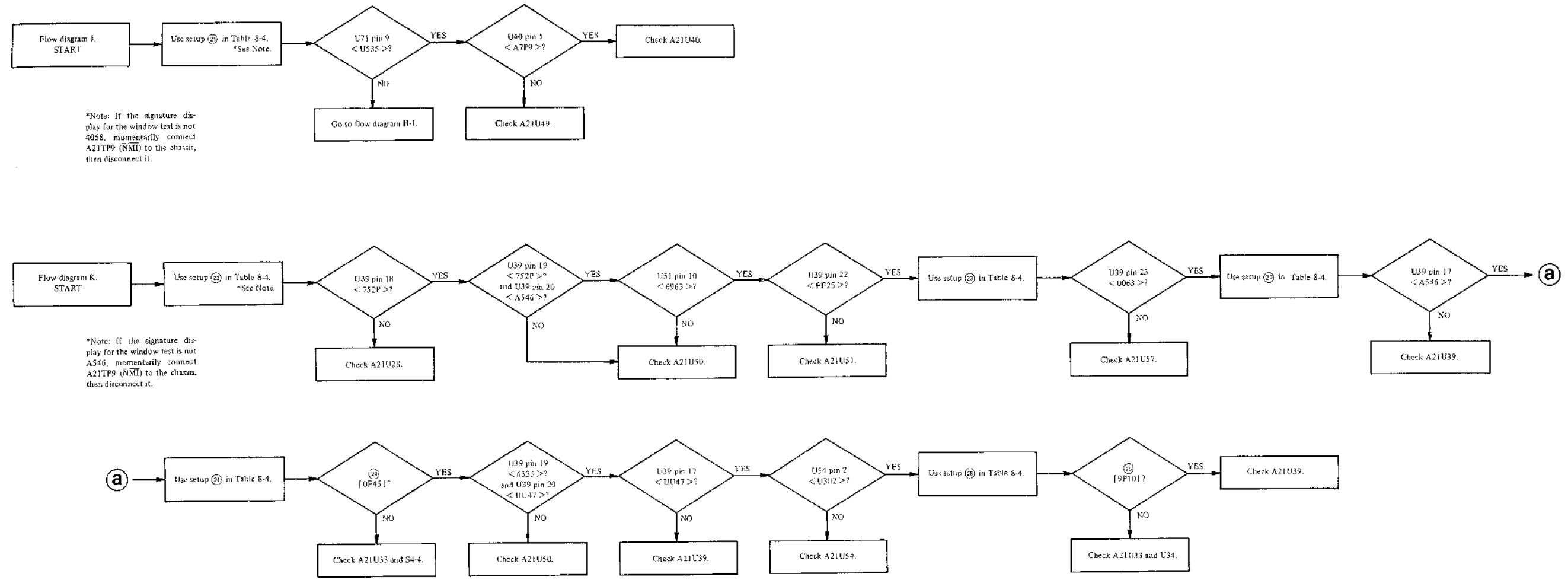
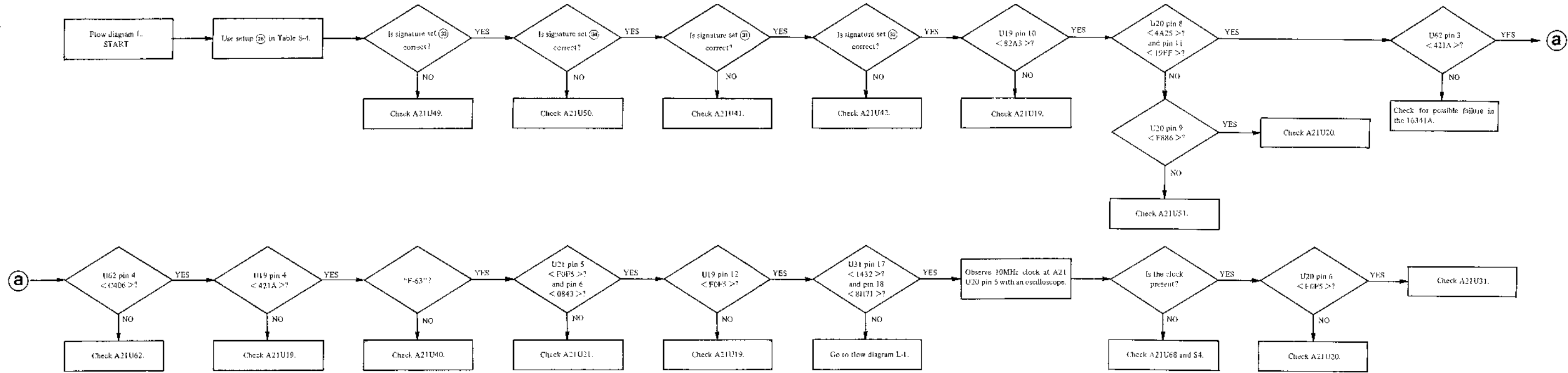

Figure 8-18. A20 (A21) Board Signature Analysis Troubleshooting Flow Diagrams J and K.



Signature set 31.

U41 pin 2	37F5
pin 5	F73P
pin 7	9AF1
pin 10	H393
pin 12	A884
pin 15	H4P7

Signature set 32.

U42 pin 2	9688
pin 5	U40P
pin 7	1F77
pin 10	HAF2
pin 12	S652
pin 15	4A25

Signature set 33.

U49 pin 7	F886
pin 9	F886
pin 10	F886
pin 11	9C4P
pin 12	9C6U
pin 13	4285
pin 14	4A69
pin 15	18AU

Signature set 34.

U50 pin 7	F886
pin 9	F886
pin 10	9F7C
pin 11	F886
pin 12	A0AA
pin 13	F886
pin 14	6443
pin 15	F886

Figure 8-18. A20 (A21) Board Signature Analysis Troubleshooting Flow Diagram L.

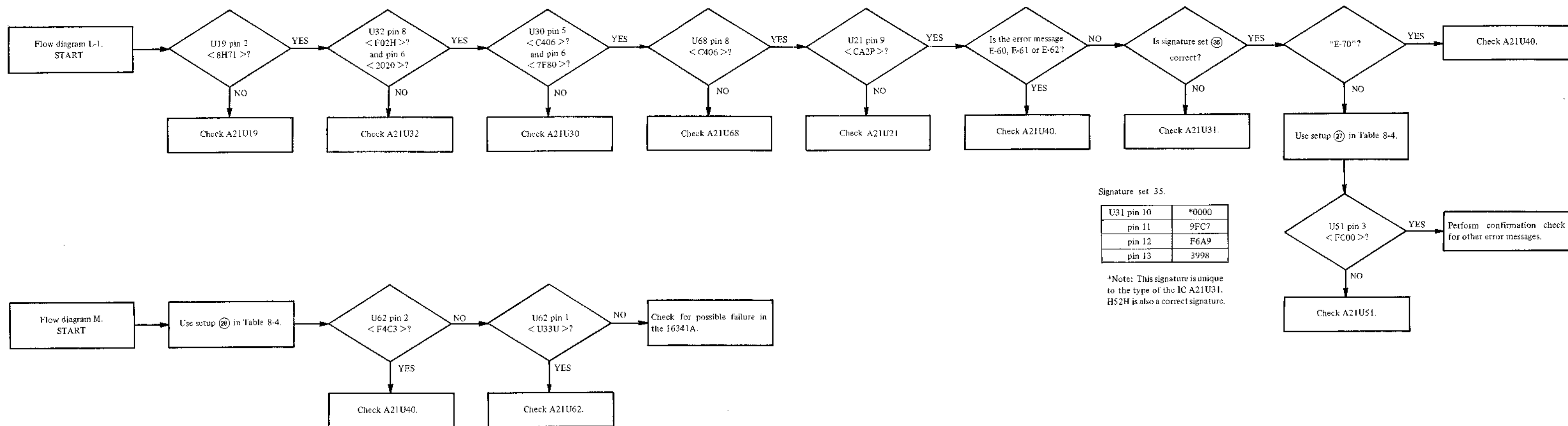

Figure 8-18. A20 (A21) Board Signature Analysis Troubleshooting Flow Diagrams L-1 and M.

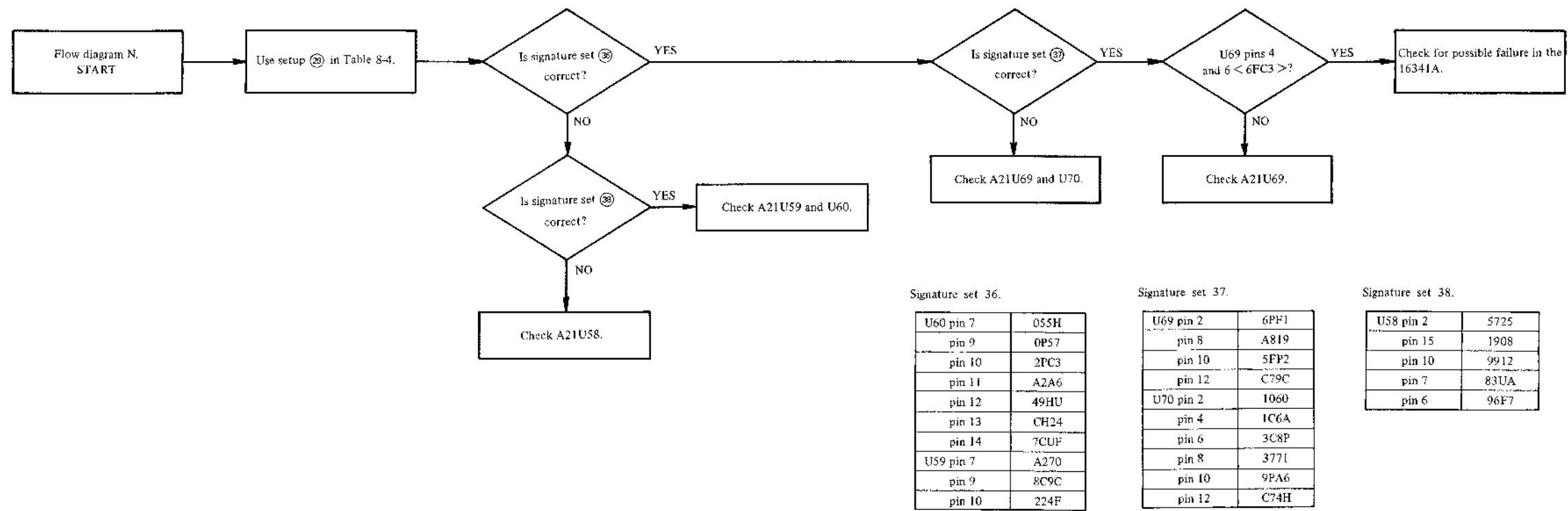
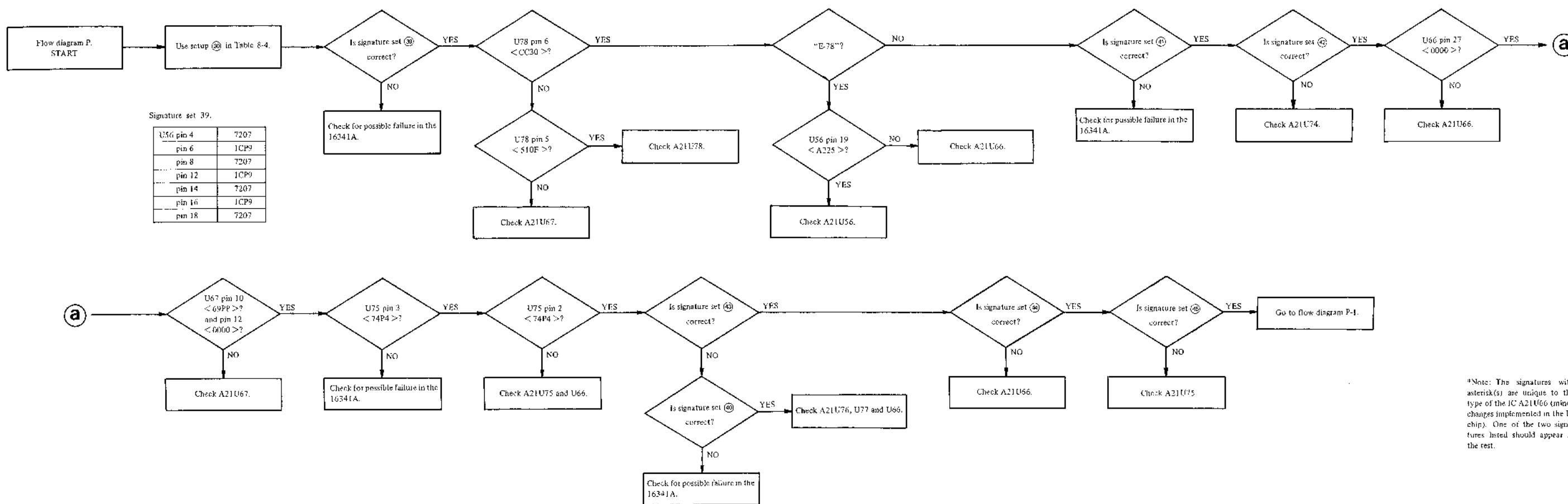

Figure 8-18. A20 (A21) Board Signature Analysis Troubleshooting Flow Diagram N.



Signature set 39.

U56 pin 4	7207
pin 6	1CP9
pin 8	7207
pin 12	1CP9
pin 14	7207
pin 16	1CP9
pin 18	7207

Signature sets 40 and 43.

Set 40	Set 43	Signature
U77 pin 3	U77 pin 2	U4PP
pin 13	pin 14	8SP9
pin 5	pin 6	U4PP
pin 11	pin 10	8SP9
U76 pin 3	U76 pin 2	2A95
pin 13	pin 14	5C92
pin 5	pin 6	2A95
pin 11	pin 10	5742

Signature set 41.

U74 pin 5	CU51
pin 11	F91A
pin 13	P8HA

Signature set 42.

U74 pin 6	CU51
pin 10	F91A
pin 14	P8HA

Signature set 44.

U75 pin 15	0000	
pin 6	*3169	*1H99
pin 10	P76C	
pin 14	69PP	

Signature set 45.

U75 pin 5	*3169	*1H99
pin 11	P76C	
pin 13	69PP	

*Note: The signatures with asterisk(s) are unique to the type of the IC A21U66 (minor changes implemented in the IC chip). One of the two signatures listed should appear in the rest.

Figure 8-18. A20 (A21) Board Signature Analysis Troubleshooting Flow Diagram P.

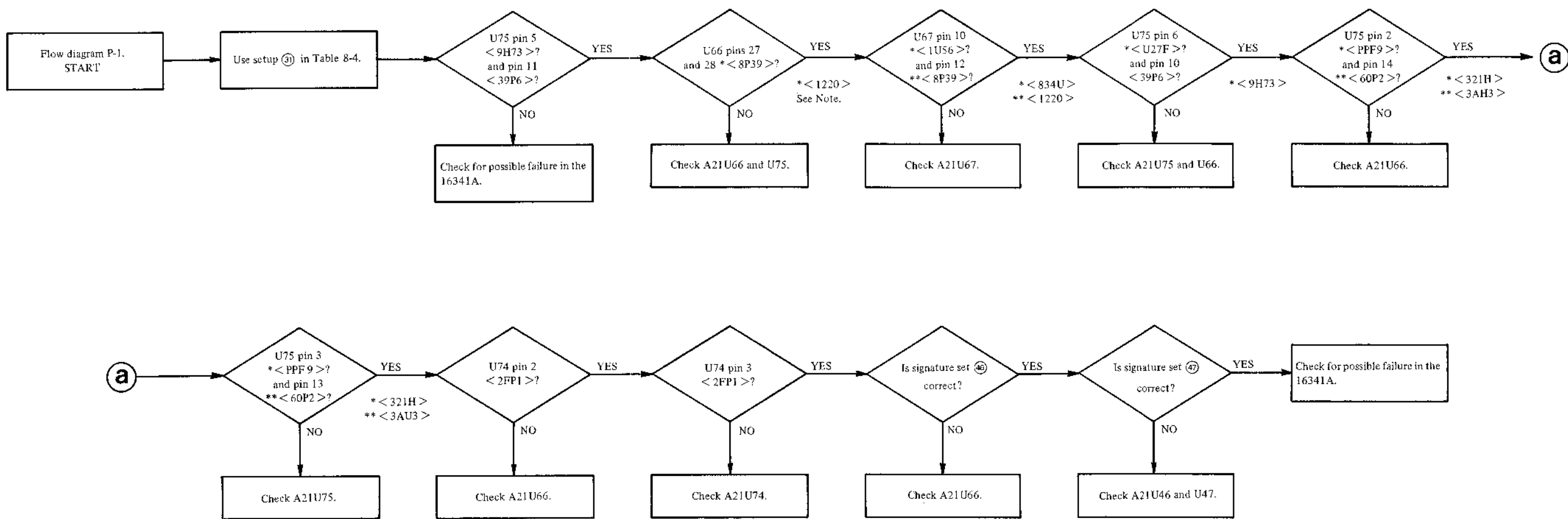

Signature set 46.

U77 pin 2	AC10	
pin 14	1CU9	
pin 6	AC10	
pin 10	1CU9	
U76 pin 2	7F93	
pin 14	FF7A	
pin 6	*P801	*7418
pin 10	FF7A	

Signature set 47.

U77 pin 3	AC10	
pin 13	1CU9	
pin 5	AC10	
pin 11	1CU9	
U76 pin 3	7F93	
pin 13	FF7A	
pin 5	*P801	*7418
pin 11	FF7A	

*Note: The signatures with asterisk(s) are unique to the type of the IC A21U66 (minor changes implemented in the IC chip). One of the two signatures listed should appear in the test.

Figure 8-18. A20 (A21) Board Signature Analysis Troubleshooting Flow Diagram P-1.

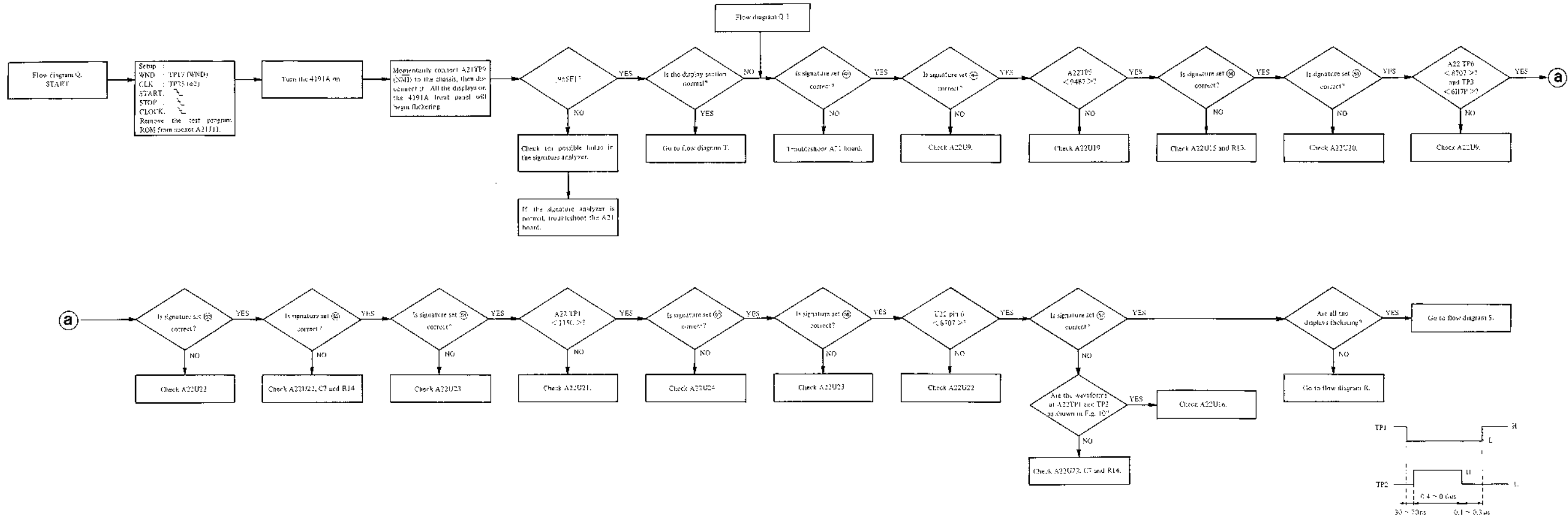

Signature set 46.

U9 pin 1	115C
pin 3	9487
pin 9	1K22
pin 11	U510U

Signature set 53.

U22 pin 3	115C
pin 4	8707
pin 12	115C

Signature set 49.

U9 pin 4	0210C
pin 5	6385
pin 6	U510U

Signature set 54.

U23 pin 8	6013
pin 11	7C13

Signature set 50.

U:5 pin 3	U5D3
pin 4	U98F
pin 5	755H
pin 6	86F5
pin 9	965F
pin 10	CA09
pin 11	870A
pin 12	2095
pin 13	1JF69

Signature set 55.

U24 pin 3	5172
pin 4	3838
pin 9	8707
pin 11	CU5U

Signature set 56.

U23 pin 3	4P74
pin 6	762F

Signature set 51.

U10 pin 3	HCA8
pin 4	CHF3
pin 5	524C
pin 6	EP56
pin 10	1P41U
pin 12	U66U

Signature set 57.

U18 pin 2	24AF
pin 5	3F15
pin 6	4596
pin 7	F85U

Signature set 52.

U22 pin 8	8707
pin 9	115C
pin 10	115C

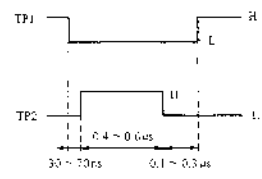
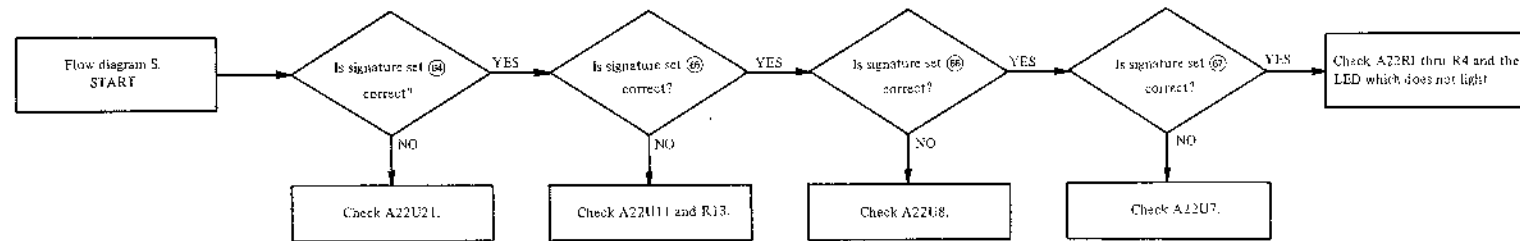
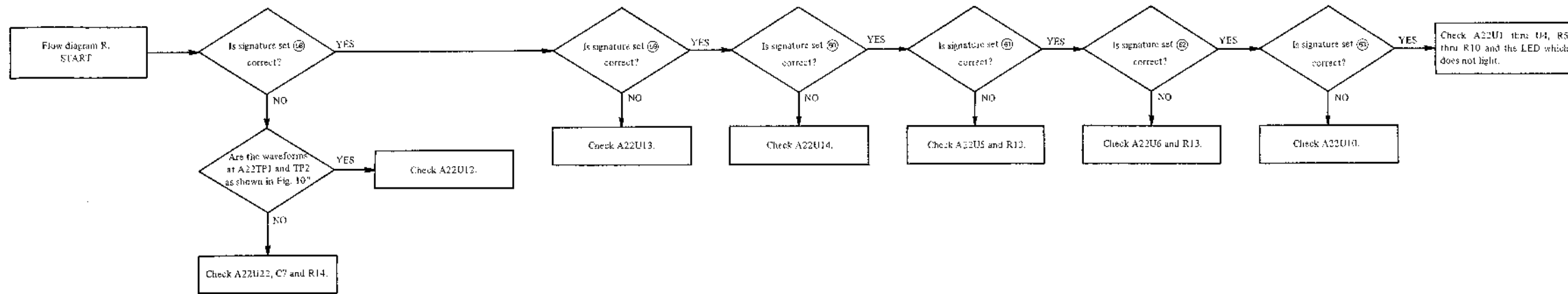

Figure 10.

Figure 8-19. A22 Board Signature Analysis Troubleshooting Flow Diagram Q.



Signature set 58.

U12 pin 5	376A
pin 7	033U
pin 9	5P26
pin 11	F378

Signature set 59.

U13 pin 5	CC05
pin 7	2C48
pin 9	1F61
pin 11	F207

Signature set 60.

U14 pin 5	F81F
pin 7	FC02
pin 9	F3P9
pin 11	23C0

Signature set 61.

U5 pin 3	376A
pin 5	033U
pin 7	5P26
pin 9	F378
pin 12	F207
pin 13	1F61
pin 16	2C48
pin 18	CC05
pin 19	965F

Signature set 62.

U6 pin 12	23C0
pin 14	F3P9
pin 16	FC02
pin 18	F81F
pin 19	965F

Signature set 63.

U10 pin 1	6F85
pin 2	9PFA
pin 3	746A
pin 4	A199
pin 5	A805
pin 6	1P63
pin 7	8BGP
pin 8	50U1
pin 9	F1192
pin 10	AF39
pin 11	H9U5
pin 13	76LC
pin 14	1PH8
pin 15	4H02
pin 16	1252
pin 17	812U

Signature set 64.

U51 pin 3	FLUC
pin 6	F33A
pin 8	7PA4

Signature set 65.

U1 pin 1	965F
pin 2	3AP1
pin 5	311A
pin 6	C1PH
pin 9	7HC3
pin 12	78U6
pin 15	5PH0
pin 19	H3P7

Signature set 66.

U8 pin 2	66P7
pin 5	6FH4
pin 6	6329
pin 9	099F
pin 12	4UAU
pin 15	5589
pin 16	9P11
pin 19	82PH

Signature set 67.

U7 pin 2	89UU
pin 5	0121
pin 9	2PRC
pin 12	00P2
pin 15	56FH
pin 16	0493
pin 19	H24U

Figure 8-19. A22 Board Signature Analysis Troubleshooting Flow Diagrams R and S.

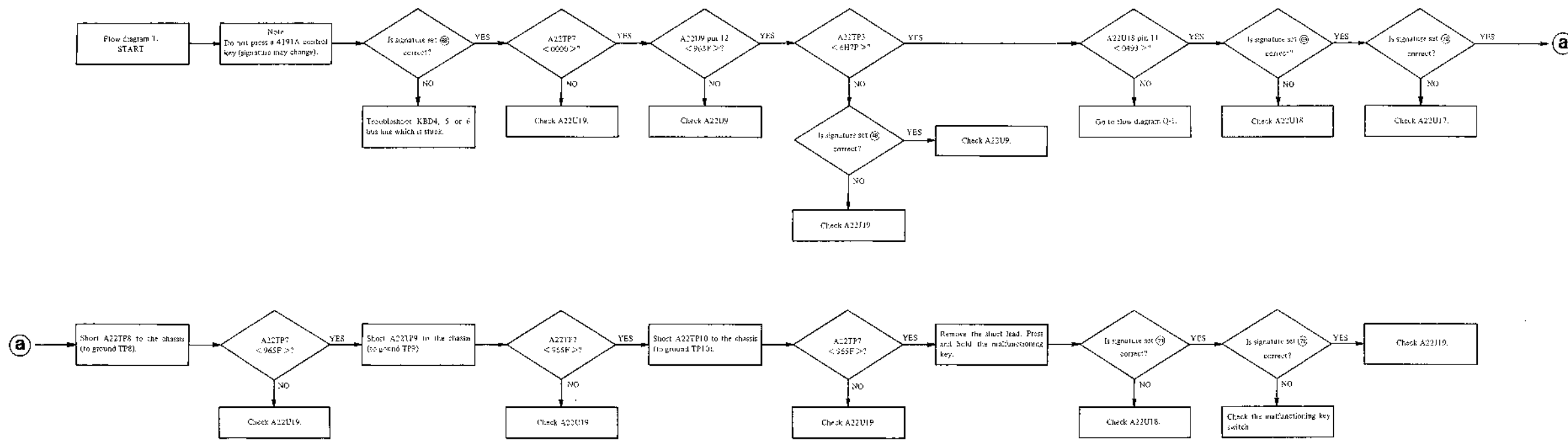

Signature set 48

U7 pin 1	135C
pin 3	94A7
pin 9	0C22
pin 11	05H0

Signature set 68

TP8	965F
TP9	965F
TP10	965F

Signature set 69

U18 pin 2	2H64
pin 5	9FA0
pin 6	03A7
pin 7	0569

Signature set 70

U17 pin 1	224E
pin 2	036H
pin 3	H11b
pin 4	H021
pin 5	3E2H
pin 6	953P
pin 7	1425
pin 8	647H
pin 9	0808
pin 10	K002
pin 11	97A2
pin 13	AC40
pin 14	3810
pin 15	0864
pin 16	P31P
pin 17	H904

Signature set 71					Signature set 72	
Key switch	U8 pin 2	U18 pin 3	U18 pin 6	U18 pin 7	Test point	
A22 S1	1A25	0720	921F	7210	TP9	1364
S2	9F0H	0074	921F	7210	TP9	844F
S3	PF0F	7264	P00F	0000	TP9	0629
S4	0000	0000	0900	0000	TP8	0000
S5	0000	3F90	0900	0000	TP8	AAFF
S6	PF0H	7264	P00F	0000	TP10	0F2F
S7	9F0H	0074	921F	7210	TP10	844F
S8	9F0H	8008	921F	7210	TP10	0020
S9	PF0F	PA11	P00F	0000	TP9	1A25
S10	807P	CFPP	0000	0000	TP8	1622
S11	807P	726F	0000	0000	TP8	5HPP
S12	6072	9750	P00F	0000	TP10	7650
S13	6072	6660	P00F	0000	TP10	6762
S14	PF0F	PA11	P00F	0000	TP10	1A25
S15	6072	9750	P00F	0000	TP8	7650
S16	807P	CFPP	0000	0000	TP9	1622
S17	0000	3E90	0000	0000	TP10	AAFF
S18	807P	CFPP	0000	0000	TP10	1622
S19	807P	726F	0000	0000	TP10	5HPP
S20	807P	726F	0000	0000	TP9	5HPP
S21	6072	9750	P00F	0000	TP9	7650
S22	6072	6660	P00F	0000	TP9	6762
S23	0000	0000	0000	0000	TP10	0000
S24	1A25	0230	921F	7210	TP10	1364
S25	9F0H	8008	921F	7210	TP9	0020
S26	1A25	3084	921F	7210	TP8	AC95
S27	1A25	3084	921F	7210	TP9	AC95
S28	1A25	3084	921F	7210	TP10	AC95
S29	0000	0000	0000	0000	TP9	0000
S30	0000	3E90	0000	0000	TP9	AAFF
S31	A002	8A43	27HC	7210	TP8	239C
S32	9F0H	0074	921F	7210	TP8	844F
S33	9F0H	8008	921F	7210	TP8	0020
S34	1A25	0230	921F	7210	TP8	1364
S35	6072	6660	P00F	0000	TP8	6762
S36	PF0F	PA11	P00F	0000	TP8	1A25
S37	PF0F	7264	P00F	0000	TP8	0F20
All release	7664	9FA0	03A7	0569	TP8	965F
					TP9	965F
					TP10	965F

Figure 8-19. A22 Board Signature Analysis Troubleshooting Flow Diagram T.

8-72. REPAIR

WARNING

BEFORE PROCEEDING WITH REPAIR, BE SURE THAT THE INSTRUMENT IS DISCONNECTED FROM THE POWER LINE.

8-73. A21 MICROPROCESSOR DIGITAL CONTROL BOARD, AND A43 BATTERY AND CHARGER BOARD DISASSEMBLY.

8-74. To troubleshoot or replace a component on the A21 Microprocessor Digital Control board or A43 Battery and Charger board, perform the following procedure:

- a. Remove the two feet located at the left and right corners of the top cover.
- b. Fully loosen the top cover retaining screw located at the rear of the instrument and lift off the top cover.
- c. Loosen the two fasteners located at the corners (front side) of the top shield case. Turning the fastener 90 degrees counter-clockwise unlocks the top shield case.
- d. Fully loosen the screw located at the center of the case.
- e. Raise the top shield case from the front and continue until it comes to rest on the rear frame.

f. Loosen the four screws securing the shield plate at the bottom side of the top shield case and remove the shield plate. The A21 board is inside the top shield case. The A43 board is located to the left of the A21 board.

g. If it is necessary to remove the A21 board, disconnect all the cables from the board and remove the eleven screws securing the board. To remove the A43 board, remove the three screws.

8-75. A22 DISPLAY AND KEYBOARD CONTROL BOARD DISASSEMBLY.

8-76. To troubleshoot or replace a component on the A22 Display and Keyboard Control board, perform the following procedure:

- a. Remove the two feet located at the left and right rear corners of the top cover.
- b. Fully loosen the top cover retaining screw located at the rear of the instrument and lift the cover off.
- c. Carefully remove the top trim strip from the front frame (use a screwdriver to lift out the trim).
- d. Remove the two right-most screws from the top side of the front frame.
- e. Remove adhesive-backed trim strip from left side (near the ON/OFF switch) of the front frame.

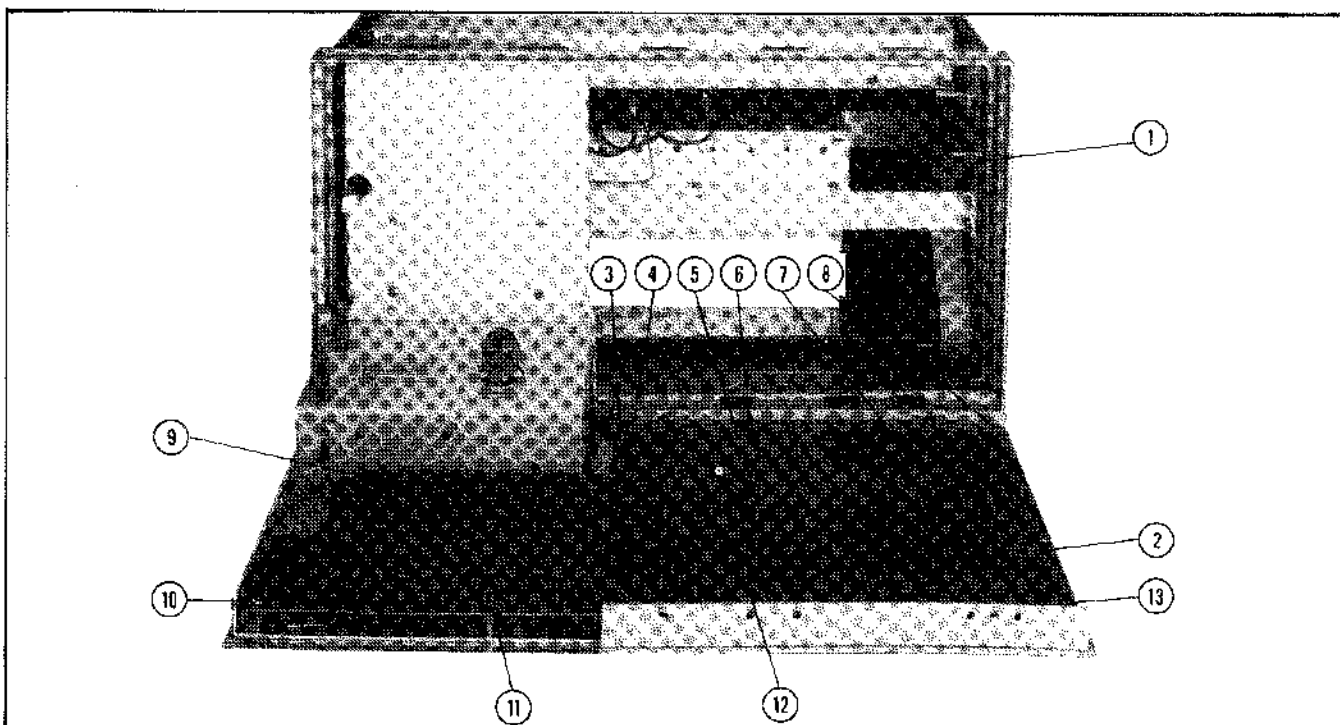

Figure 8-20. A22 Display and Keyboard Control Board Disassembly.

- f. Remove the two screws.
- g. Stand the instrument on end.
- h. Remove the two right-most screws from the bottom side of the front frame (do not remove the two screws near the UNKNOWN terminal deck).
- i. Disconnect the flat cable ① (shown in Figure 8-20) from the socket ② on the A22 board.
- j. Carefully push the back of the A22 board forward; the front panel assembly will come out.
- k. Remove the eleven screws ③ through ⑬ in Figure 8-20) securing the A22 board to the front panel.

8-77. A23 POWER SUPPLY BOARD DISASSEMBLY.

8-78. To adjust, troubleshoot or replace a component on the A23 Power Supply board, perform the following procedure:

- a. Remove the four screws securing the A23 dc power supply assembly plate located on the rear panel.
- b. To facilitate access to the components on the A23 board, unfasten the cable clamp shown in Figure 8-21 (by removing the retaining screw).
- c. Lay the dc power supply assembly on the working desk as shown in the figure.

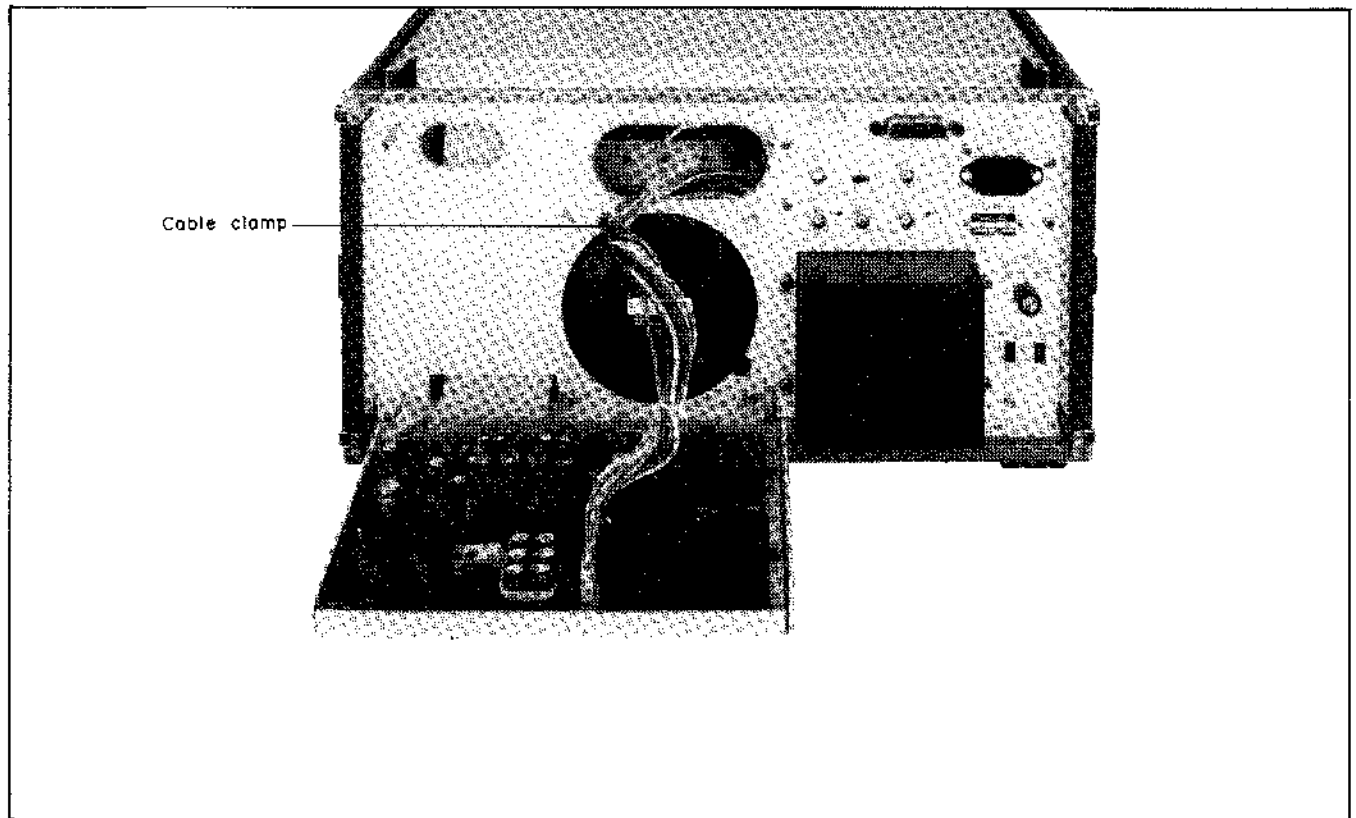

Figure 8-21. A23 Power Supply Board Disassembly.

8-79. A9 DIRECTIONAL BRIDGE BOARD DISASSEMBLY.

8-80. To troubleshoot or replace a component on the A22 RF Directional Bridge board, perform the following procedure:

- a. Turn instrument upside down.
- b. Remove the four screws from the bottom of the UNKNOWN terminal deck and remove the bottom cover. The directional bridge assembly is located inside the terminal deck as shown in Figure 8-22.
- c. Unsolder and disconnect the purple and orange colored leads (labeled ① and ② in figure) from the terminals on the assembly.
- d. Disconnect the SMC connectors ③, ④ and ⑤.
- e. Disconnect the nylon connector ⑥.
- f. Remove the three screw ⑦, ⑧ and ⑨ securing the assembly shield box to the terminal deck. Carefully lift the directional bridge assembly up and out.
- g. Remove the six screws retaining the shield plate of the assembly (three of the screws, labeled ⑩, ⑪ and ⑫, are shown in the figure). All the components on the A9 board are easily accessible after removing the shield plate with the heater module ⑬).

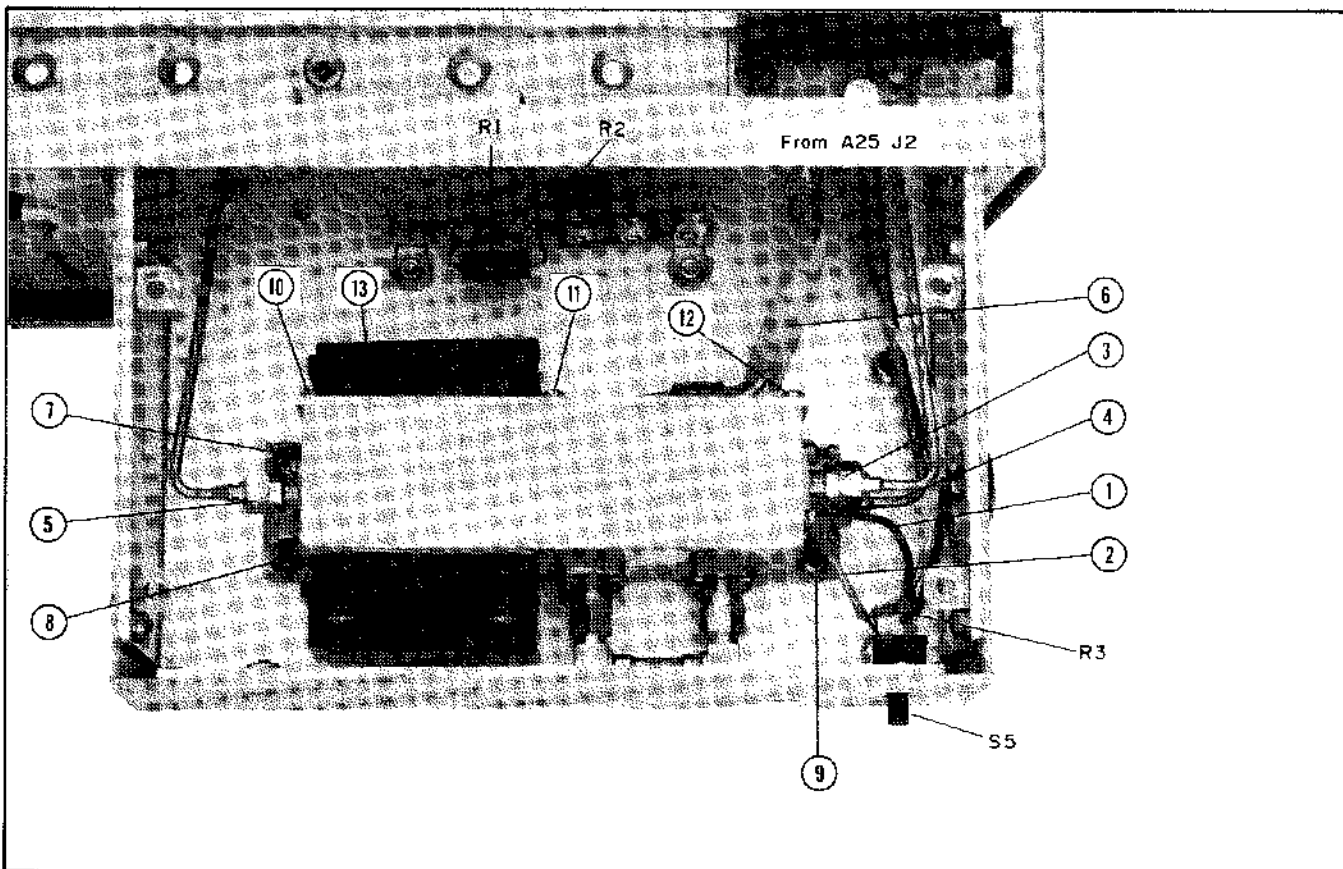

Figure 8-22. A9 Directional Bridge Board Disassembly.

8-81. PRODUCT SAFETY CHECKS**WARNING**

WHENEVER IT APPEARS LIKELY THAT SAFETY PROTECTIVE PROVISIONS HAVE BEEN IMPAIRED, THE APPARATUS SHALL BE MADE INOPERATIVE AND BE SECURED AGAINST ANY UNINTENDED OPERATION. THE PROTECTION IS LIKELY TO BE COMPROMISED IF, FOR EXAMPLE:

- THE APPARATUS SHOWS VISIBLE DAMAGE.
- THE INSTRUMENT FAILS TO PERFORM THE INTENDED MEASUREMENT.
- THE UNIT HAS UNDERGONE PROLONGED STORAGE UNDER UNFAVORABLE CONDITIONS.
- THE INSTRUMENT HAS SUFFERED SEVERE TRANSPORT STRESS.

8-82. The following five checks are recommended to verify the product safety of the 4191A instrument (these checks may also be done to check for product safety after troubleshooting and repair). When such checks are needed, perform the following:

1. Visually inspect interior of instrument for any signs of abnormal internally generated heat, such as discolored printed circuit boards or components, damaged insulation, or evidence of arcing. Determine and remedy cause of any such condition.
2. Using a suitable ohmmeter, check resistance from instrument enclosure to ground pin on power cord plug. The reading must be less than 0.5 ohm. Flex the power cord while making this measurement to determine whether intermittent discontinuities exist.
3. Check GUARD terminal on front panel using procedure (2).
4. Disconnect instrument from power source. Turn power switch to on. Check resistance from instrument enclosure to line and neutral (tied together). The minimum acceptable resistance is two megohms. Replace any component which fails or causes a failure.
5. Check line fuse to verify that a correctly rated fuse is installed.

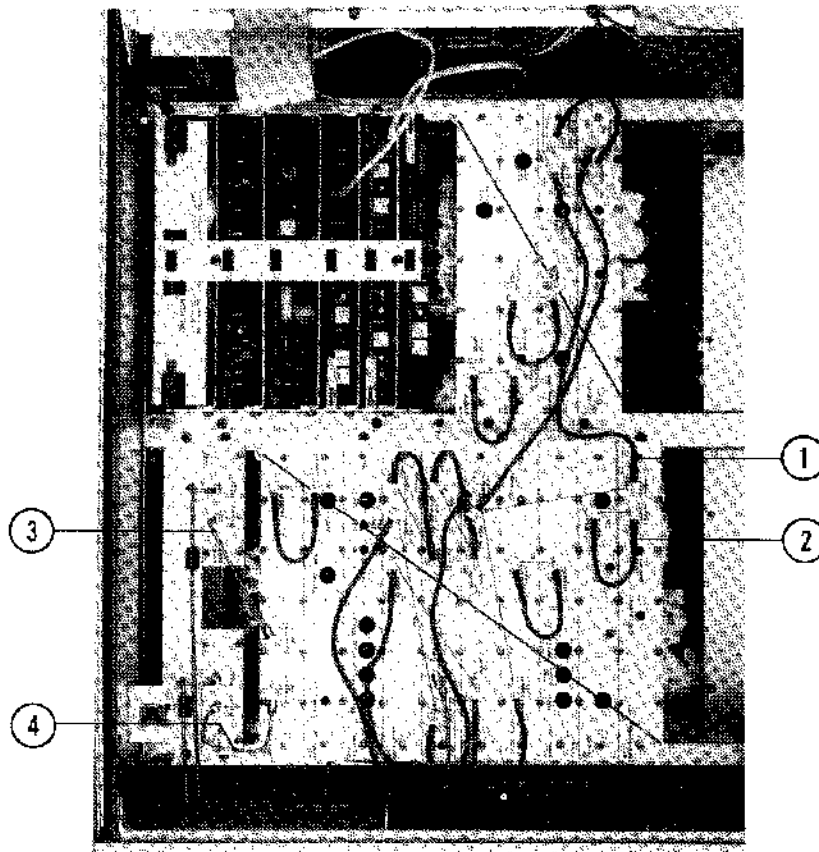

No.	HP Part Number	Description
1	04191-61621	Flexible cable, red, 25 cm long
2	04191-61622	Flexible cable, blue, 12 cm long
3	04191-61607	Semi-rigid cable, 11 cm long
4	04191-61608	Semi-rigid cable, 11 cm long

Figure 8-23. SMC Connector Cables.

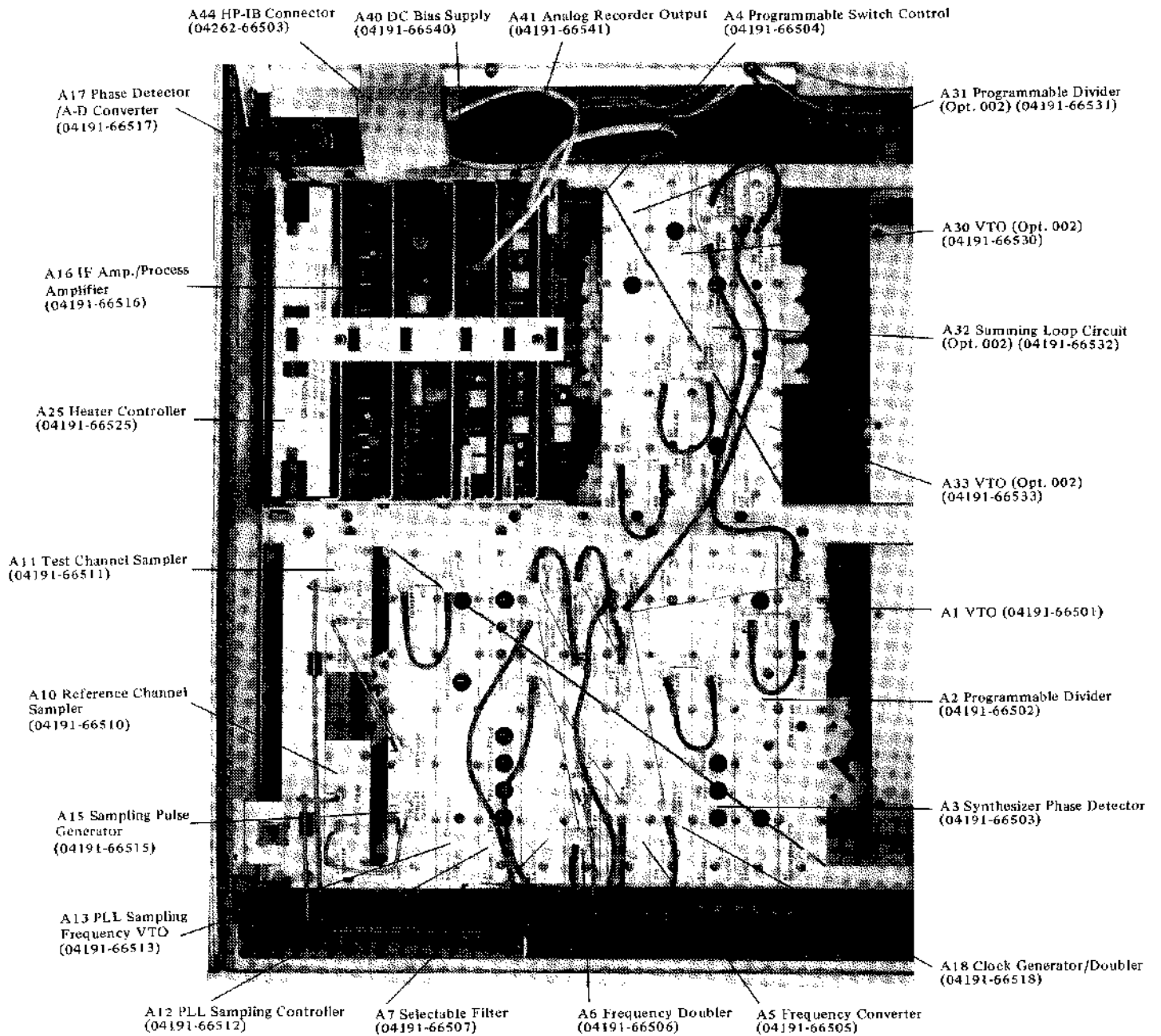

Figure 8-24. Assembly Locations.

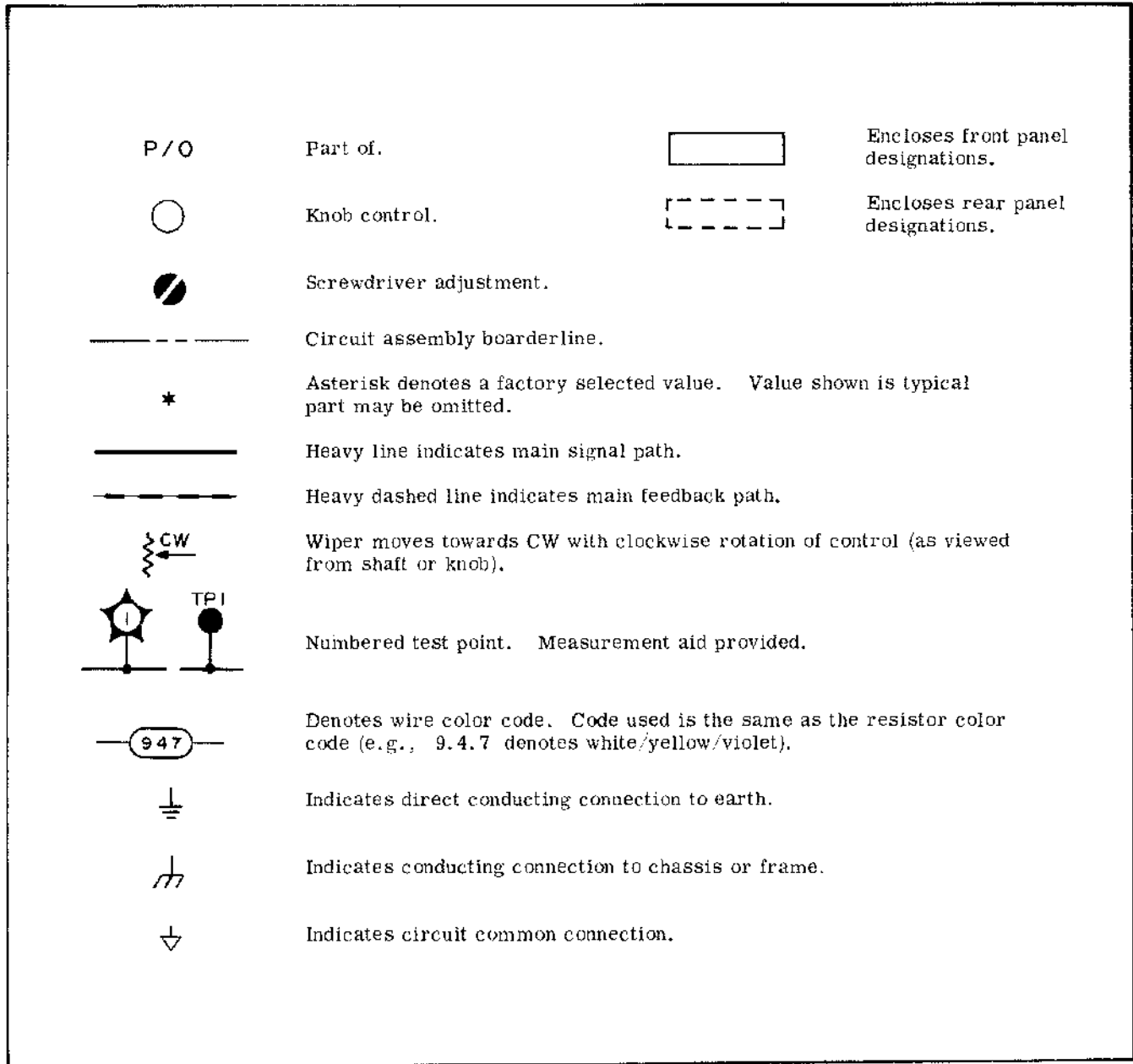

Figure 8-25. Schematic Diagram Notes.

Model 4191A

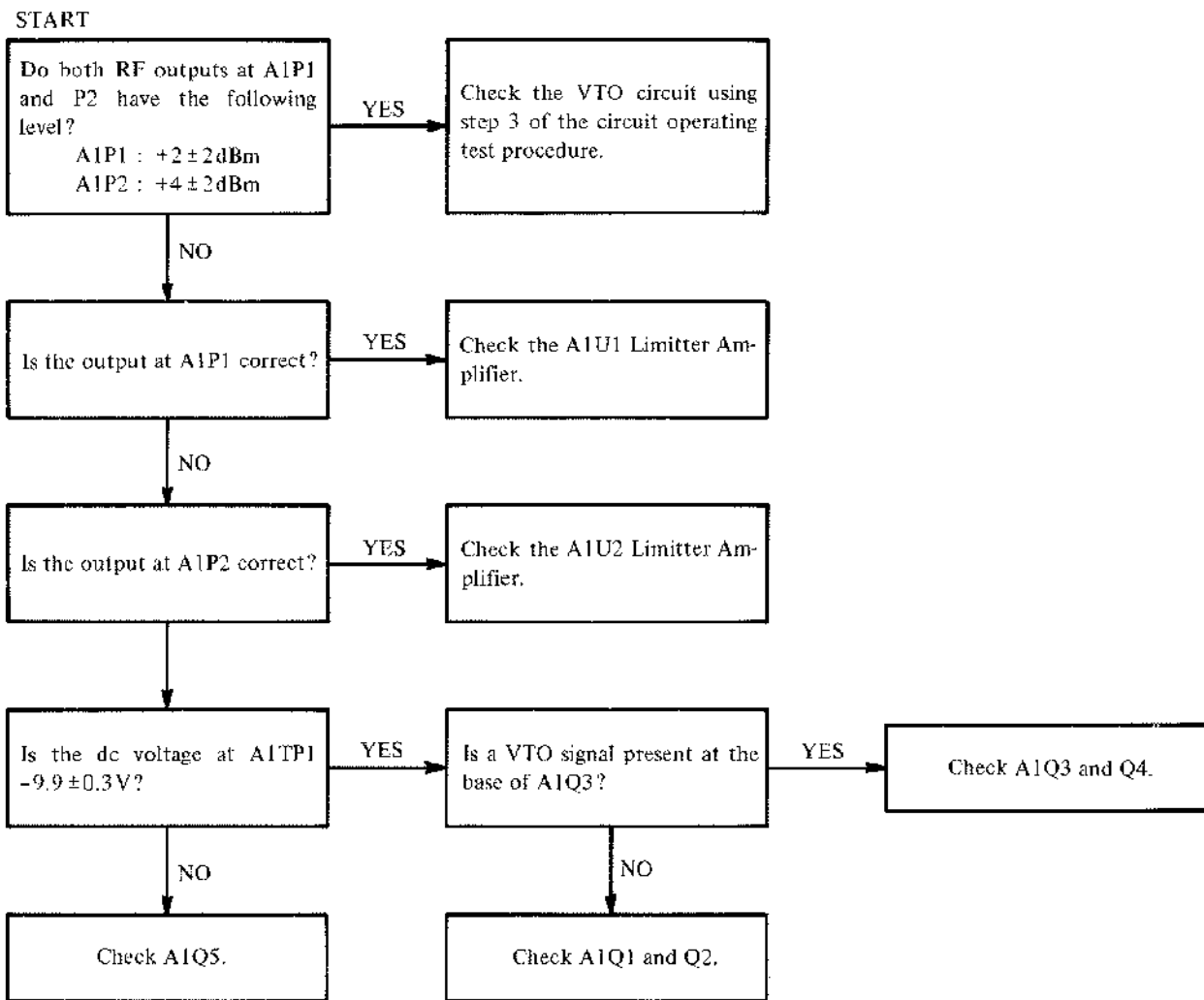
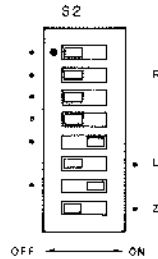

Figure 8-26. A1 VTO Board Troubleshooting Flow Diagram.

A1 VTO CIRCUIT OPERATING TEST

Circuit operation of the A1 VTO is checked using the procedure outlined below:

Setup: Set switch A21S2 as shown below:



1. Be sure that the two shield plates housing the VTO circuit on the A1 board are firmly secured and that all screws are in place.
2. DC voltages at A1TP1 and TP2 should be $-9.9V (\pm 0.3V)$ and $-9.7V (\pm 0.5V)$, respectively.
3. The upper and lower frequency limits for each of the nine VTO frequency bands are checked using the following procedure:

Setup: Connect a frequency counter to A1P2 and a spectrum analyzer to A1P1. Remove the A3 board. Connect a dc power supply, controllable from 0 volts to 20 volts, to A1TP3.

Set the SPOT frequency in accordance with the table below. Verify that the frequency counter readout satisfies the test limits given in the table when the dc power supply output is swept between 0V and +20V, and that no abnormal spectrum display, due to parasitic oscillation, appears at any VTO frequency.

VTO Frequency Band Test

SPOT frequency	VTO frequency band		VTO frequency	
			f min at Vt = 0V	f max at Vt = 20V
500MHz	A	500 – 450MHz	≤ 440MHz	≥ 502MHz
450MHz	B	450 – 405MHz	≤ 400MHz	≥ 452MHz
400MHz	C	405 – 372MHz	≤ 365MHz	≥ 407MHz
350MHz	D	372 – 340MHz	≤ 335MHz	≥ 374MHz
320MHz	E	340 – 315MHz	≤ 310MHz	≥ 342MHz
300MHz	F	315 – 294MHz	≤ 290MHz	≥ 316MHz
280MHz	G	294 – 278MHz	≤ 275MHz	≥ 295MHz
270MHz	H	278 – 264MHz	≤ 261MHz	≥ 279MHz
260MHz	I	264 – 250MHz	≤ 247MHz	≥ 264.5MHz

If the minimum or maximum oscillation frequency at a specific frequency band does not meet the test limit values, shift the connection point of the appropriate frequency band switch diode (A1CR1 through CR8) on the PC board pattern inductor as illustrated below:

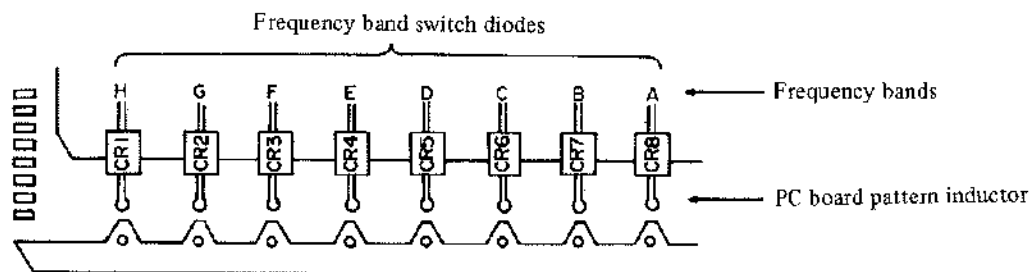

Shifting the connection point 1mm to the left (in the figure) lowers the VTO frequency by about 1MHz and shifting to the right increases the frequency by about 1MHz. If the maximum frequency at A band is not higher than 502MHz, decrease the capacitance of A1C22 (from 4.7pF to 3pF).

If parasitic oscillation is shown on the spectrum analyzer CRT, adjust A1R16 until it disappears.

Note: The voltage levels of the VTO frequency band selection signals are given in the table below:

VTO Frequency Band Selection Signals

Voltage check point	VTO frequency band								
	A	B	C	D	E	F	G	H	I
A1 8L						+	+	+	
7L					+	+	+		
6L				+	+	+			
5L			+	+	+				
4L	+	+	+	+					
3L	+	+	+						
2L	+	+							
1L	+								

“+” indicates +3.8V, all others are -25V.

- The output signal levels at A1P1 and P2 should satisfy the following test limits at all VTO frequencies:

P1 : $+2 \pm 2\text{dBm}$

P2 : $+4 \pm 2\text{dBm}$

Note: These levels are measured using a spectrum analyzer which has an input impedance of 50Ω.

8-83. A1 VTO

8-84. The resonator circuit of the VTO is composed of the capacitance of the reverse biased varactor diode CR9 and the distributed inductance of the PC board pattern L*. The 250MHz to 500MHz oscillation frequency range is divided into nine frequency bands selectable with diode switches CR1 through CR8. The varactor diodes used as the switches come on with a lower resistance than the typical resistance of general switching diodes when forward biased by the band selection signals (inputs A to H).

Each frequency range of the selectable frequency bands is shown in the A1 board schematic diagram. When all the diode switches are off, the resonator circuit is set to the lowest frequency band (250.0 to 264.0MHz). The tuning capacitance of the CR9 varies with the tuning control input voltage V_T so that the oscillation frequency locks to the value set by the microprocessor. The dual gate FET (Q2) circuit employs positive feedback without lowering the high Q of the resonator circuit and causes the oscillator amplifier Q1 to continue oscillation.

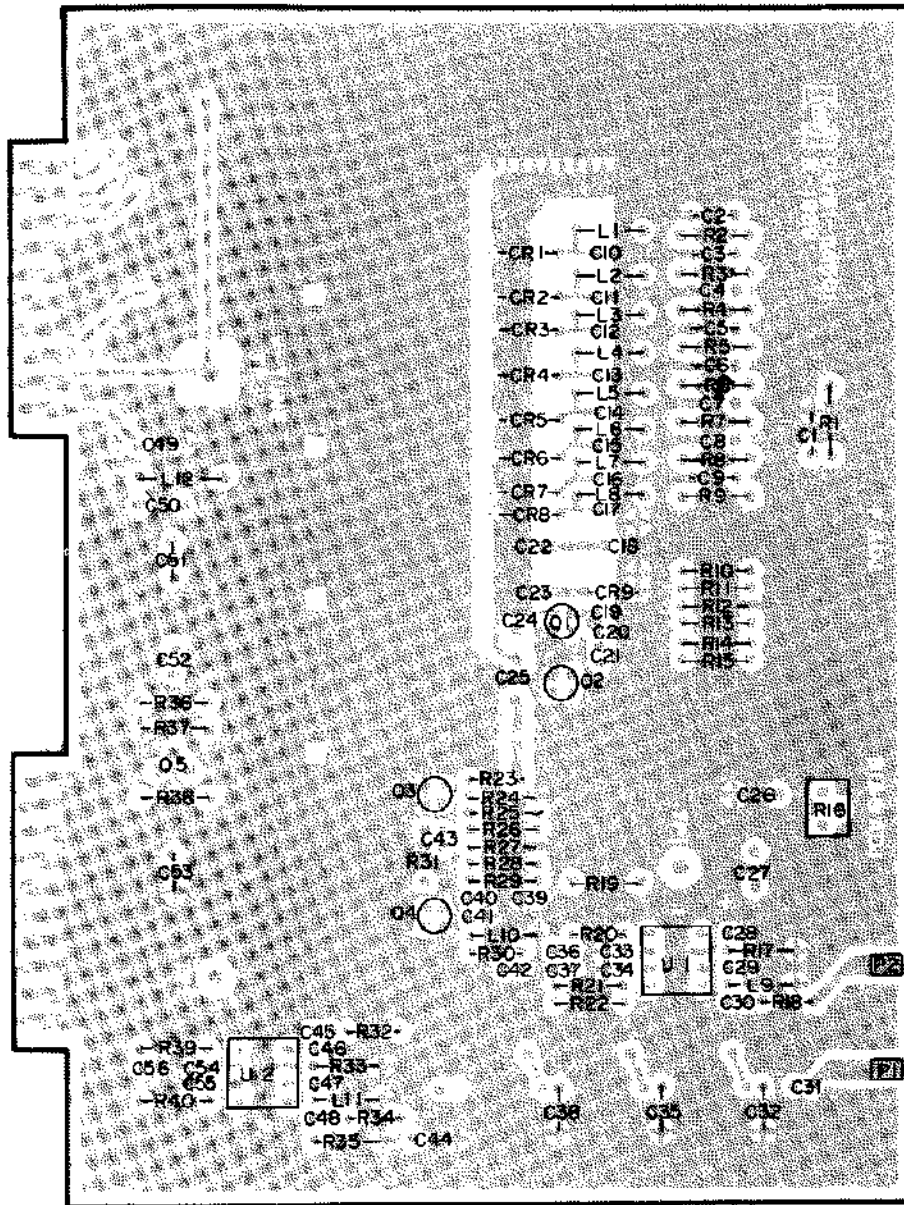

Figure 8-27. A1 VTO (250-500MHz) Board Assembly Component Locations.

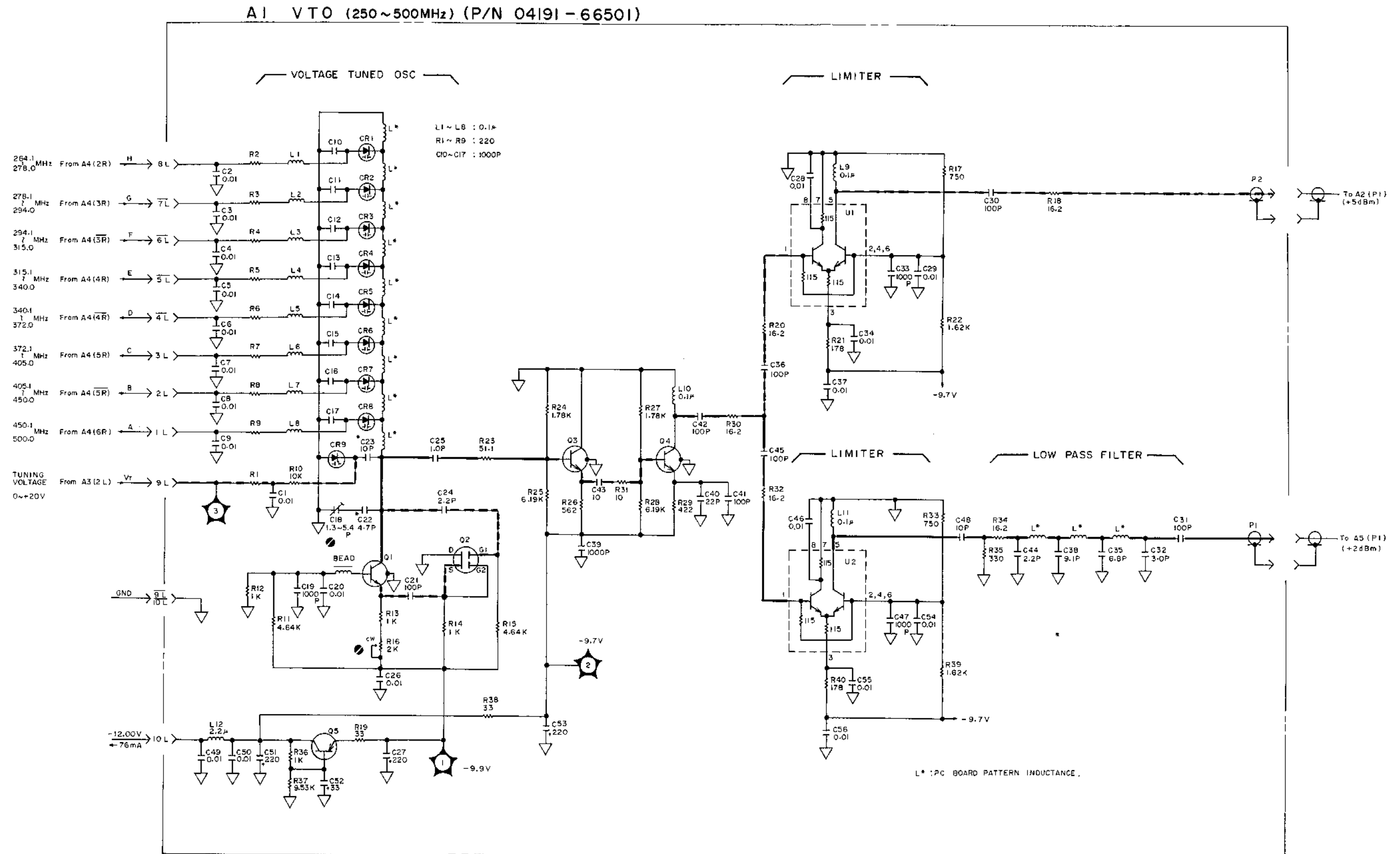

Figure 8-28. A1 VTO (250-500MHz) Board Assembly Schematic Diagram.

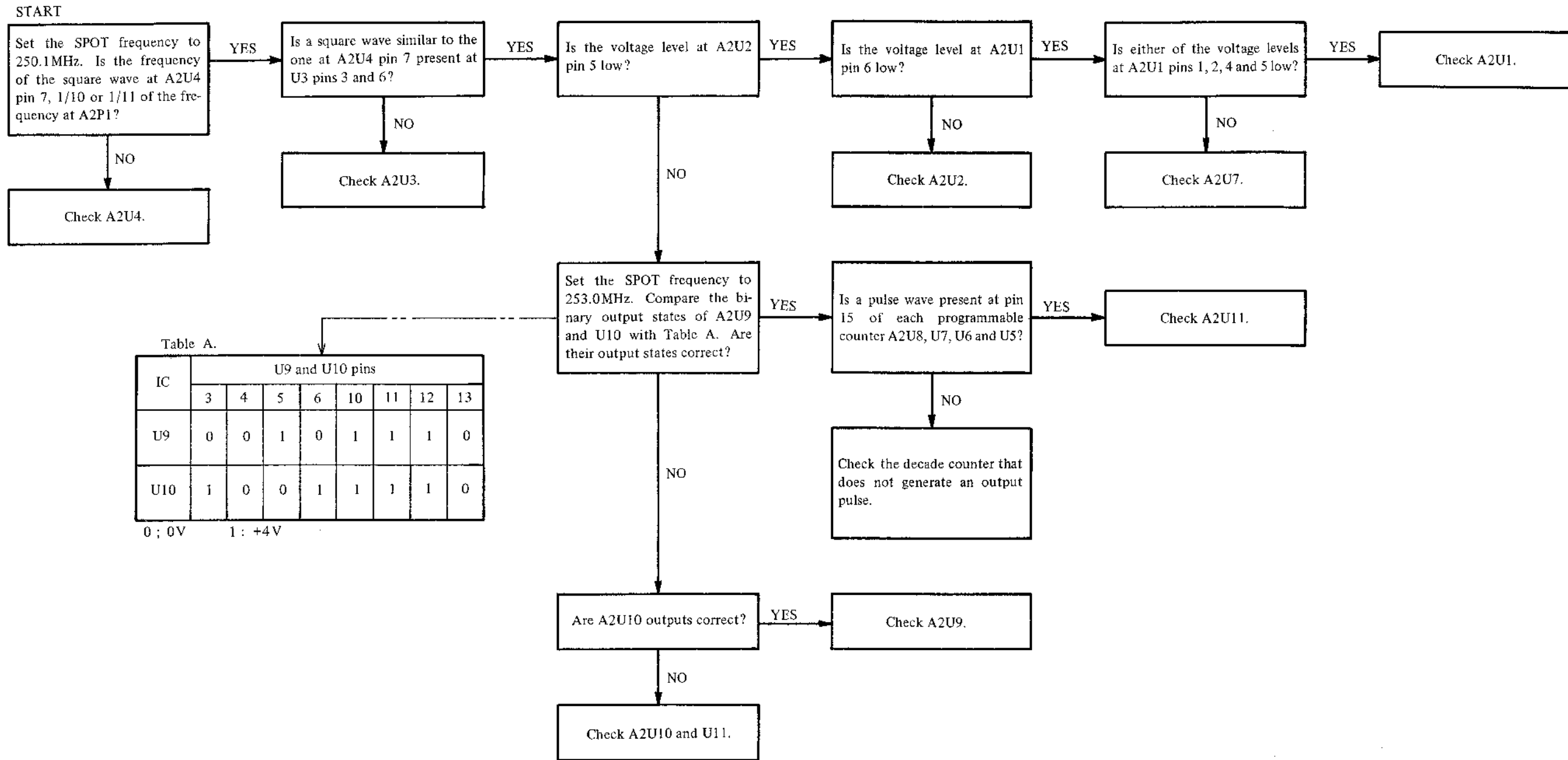

Figure 8-29. A2 Programmable Divider Board Troubleshooting Flow Diagram.



A2 PROGRAMMABLE DIVIDER CIRCUIT OPERATING TEST

Circuit operation of the A2 programmable divider is checked using the procedure outlined below:

Setup: Set switch A2IS2 as shown below:

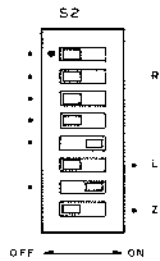

1. Connect an oscilloscope to A2TP1. The pulse waveform observed on the oscilloscope CRT must have the time intervals and peak voltage shown below:

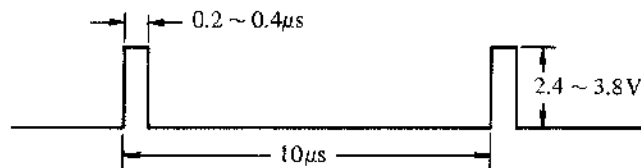

If the PLL frequency synthesizer (consisting of A1, A2 and A3 boards) has not been locked at the normal frequency, the pulse cycle period will not be 10 μs, but will still be between 5 μs and 20 μs. If the pulse signal does not appear or if the cycle period is outside the normal value range, the programmable divider is faulty.

Note: This test presupposes that the output frequency of the A1 VTO is within the normal 250MHz and 500MHz range.

2. To verify whether or not the frequency count-down operation is accomplished using the correct divisor (programmed), perform the following:

Measure the frequencies of the signals at A1P1 and A3TP1 with a frequency counter. Verify that the following relationship exists between the measured frequencies and the SPOT frequency settings:

$$f_1 = f_2/10N \quad (\text{MHz})$$

where, f_1 is the frequency of the signal at A3TP1.

f_2 is the frequency of the signal at A1P1.

N is the SPOT frequency setting in MHz.

Set the SPOT frequency in accordance with the table below and check that the measured frequency f_1 is correct for all SPOT frequency settings:

100MHz step	10MHz step	1 MHz step	0.1MHz step
500.0MHz	480.0MHz	498.0MHz	499.8MHz
400.0MHz	440.0MHz	494.0MHz	499.4MHz
300.0MHz	420.0MHz	492.0MHz	499.2MHz
	410.0MHz	491.0MHz	499.1 MHz

Note: If the frequency at A1P1 is unstable, connect the output of an external signal generator to A2P1 (in place of the SMC connector cable) and compare the frequency at A3TP1 (f_1) with the signal generator output frequency (f_2).

3. If it is necessary to perform a complete operating check for all the possible divisors, reconnect the SMC connector cable to A2P1 and sweep the test frequency automatically from 250.1MHz to 500.0MHz in 0.1MHz steps. If an abnormality occurs, the frequency sweep operation will stop at that particular frequency point.
4. If the programmable divider causes a self oscillation to occur, check for increased impedance of the common line or dc power line on the board (due to a failure in the by-pass circuit).

Note: When an oscilloscope probe is applied to a desired check point, the input capacitance of the probe may distort the pulse signal being observed, and as a result, the divider circuit may not function normally.

8-85. A2 PROGRAMMABLE DIVIDER

8-86. The programmable divider circuit counts down the frequency of the VTO signal by the number set in the Serial to Parallel Decoder (U9 and U10). The divisor data is serially transferred to U9 and U10 where it is converted into parallel data and output to U5, U6, U7 and U8.

U5 through U8 programmable counter IC's receive the program input data (number between 0 to 9) synchronized with the CP input pulse. When the preset program number is X, the counter IC counts 9-X cycle periods of the input signal and outputs a pulse when counting is complete. Actually, the preset program number for each digit counter is the complement (that is 9-X) of the requisite frequency count down number X (when the required frequency count down number is, for example, 3456, the preset program data for the counter is 6543). Accordingly, the counter output frequency coincides with the result of the required frequency count down operation. Since the required frequency count down numbers are from 2500 to 5000, the preset program data includes numbers from 4999 to 7499.

The programmable divider functions in the following manner:

- 1) After the tens, hundreds and thousands counters reach 996 counts, divisor data is set in the programmable counter IC's while the U2 ternary counter does three counts. As the U4 prescaler is operating in decade ($\div 10$) counting mode at this time, 30 cycles of the VTO signal advance the ternary counter by three counts. The $\div 10/\div 11$ prescaler counter divides the frequency of the input signal by 10 when one or both E4 and E5 inputs are HIGH. When both inputs are LOW, the frequency is divided by 11.

- 2) After the divisor data is set, the prescaler begins dividing the frequency of the input signal by 11. Assuming the required frequency count down number N to be $1000A + 100B + 10C + D$, the prescaler output pulse advances the U8 units counter by D counts. During this period, the total cycle number of the VTO output signal is $D \times 11$.
- 3) The units counter automatically resets itself and disables input count until new program data is entered into the counters. Simultaneously, the prescaler returns to decade ($\div 10$) operating mode. Then, the tens, hundreds and thousands counters advance by the following count:

$$(100A + 10B + C) - D - 3$$

The total count number N of the programmable divider is thus the sum of the cycle number of VTO signal in steps 1), 2) and 3) and is calculated as follows:

$$\begin{aligned} N &= 30 + 11 \times D + 10 \\ &\quad \times \{ (100A + 10B + C) - D - 3 \} \\ &= 1000A + 100B + 10C + D \end{aligned}$$

As indicated by the above equation, the actual divisor of the counter coincides with the required frequency count down number of the preset data.

A3 SYNTHESIZER PHASE DETECTOR CIRCUIT OPERATING TEST

Circuit operation of the A3 Synthesizer Phase Detector is checked using the procedure outlined below:

Setup: Set switch A21S2 as shown below:

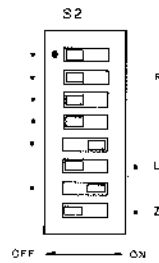

1. Connect an oscilloscope to A3TP2. A TTL level 100kHz square wave must be observed on the oscilloscope CRT.
2. The waveforms of the signals at 7R and 8R (edge connector of the board) should be similar to that at TP2.
3. Connect a frequency counter to A3TP2. Use the $1M\Omega$ input of the frequency counter and set the frequency resolution to 10Hz. Frequency counter readout should be $100.00\text{kHz} \pm 1$ count.
4. Set the SPOT frequency to 250.1MHz, and then to 500.0MHz. The dc voltage at TP3 should agree with those listed below:

SPOT freq. setting	Voltage at TP3
250.1 MHz	$+2 \pm 1.5$ V
500.0MHz	$+18 \pm 2$ V

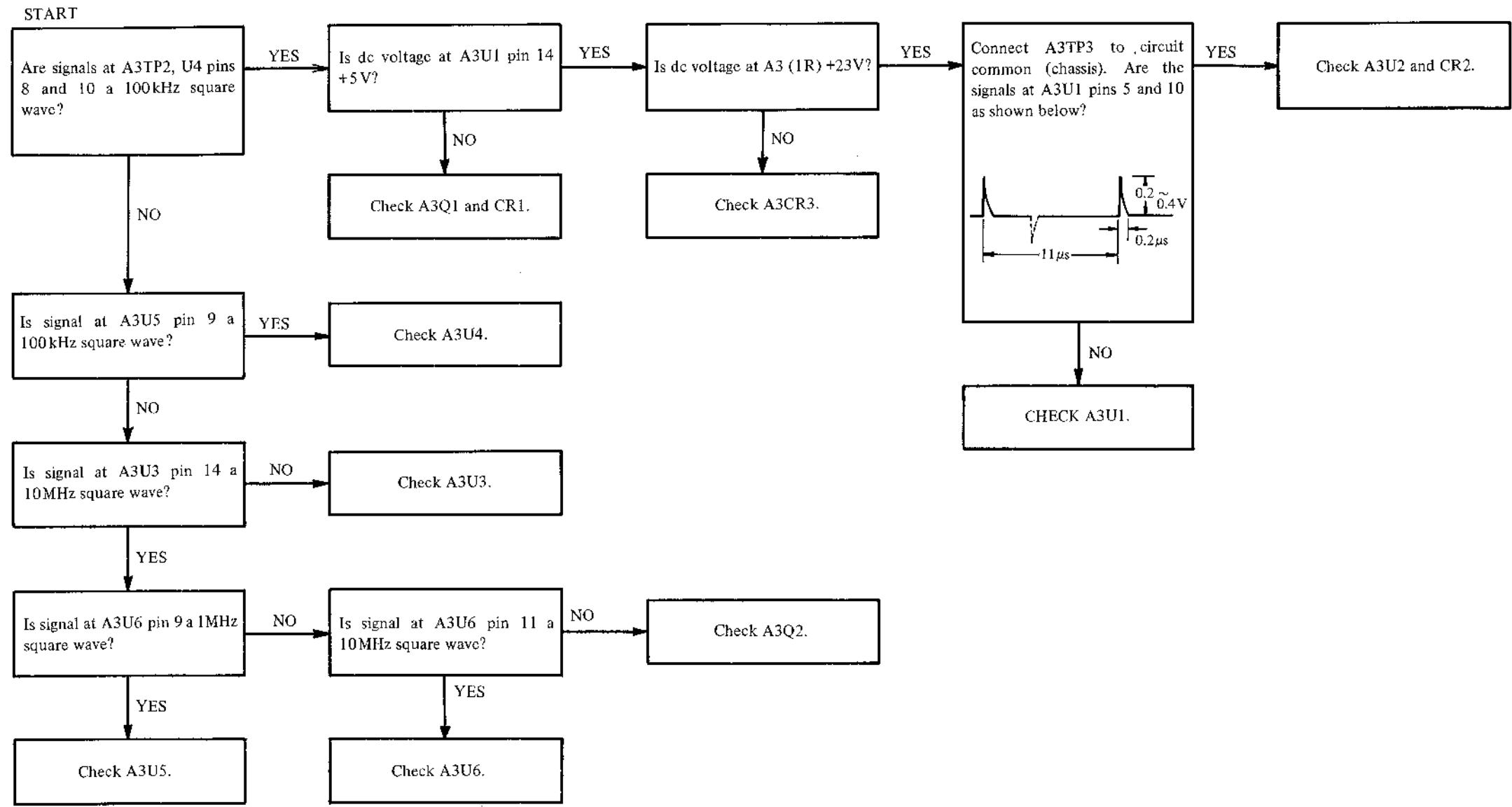

Figure 8-30. A3 Synthesizer Phase Detector Board Troubleshooting Flow Diagram.

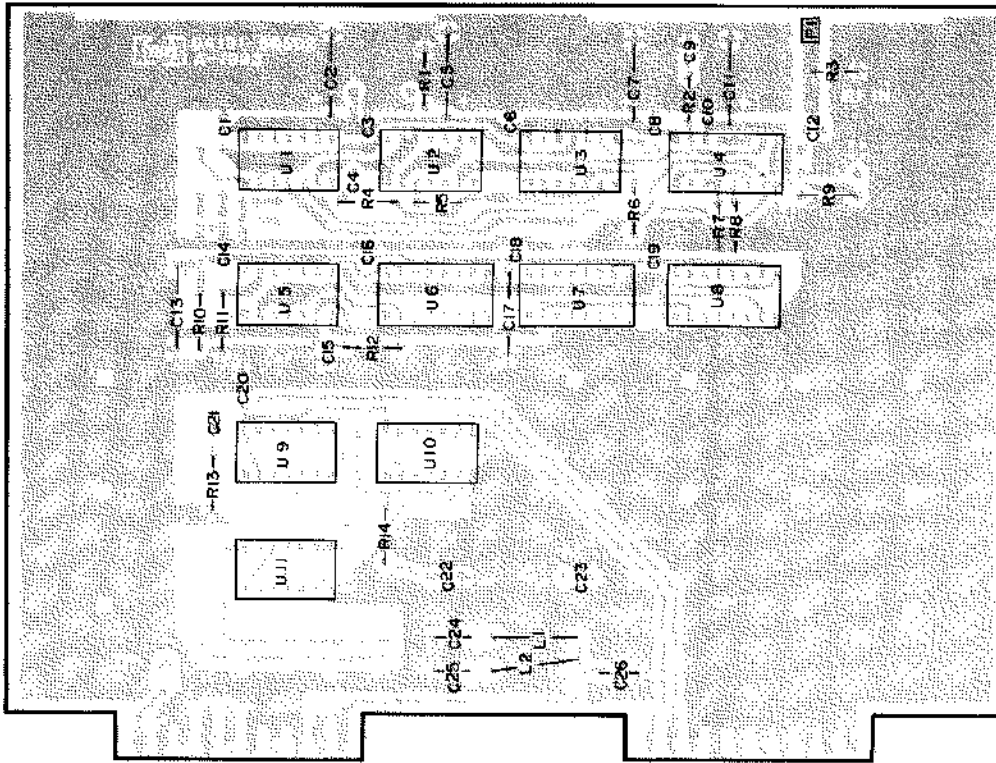

Figure 8-31. A2 100KHz Step Programmable Divider Board Assembly Component Locations.

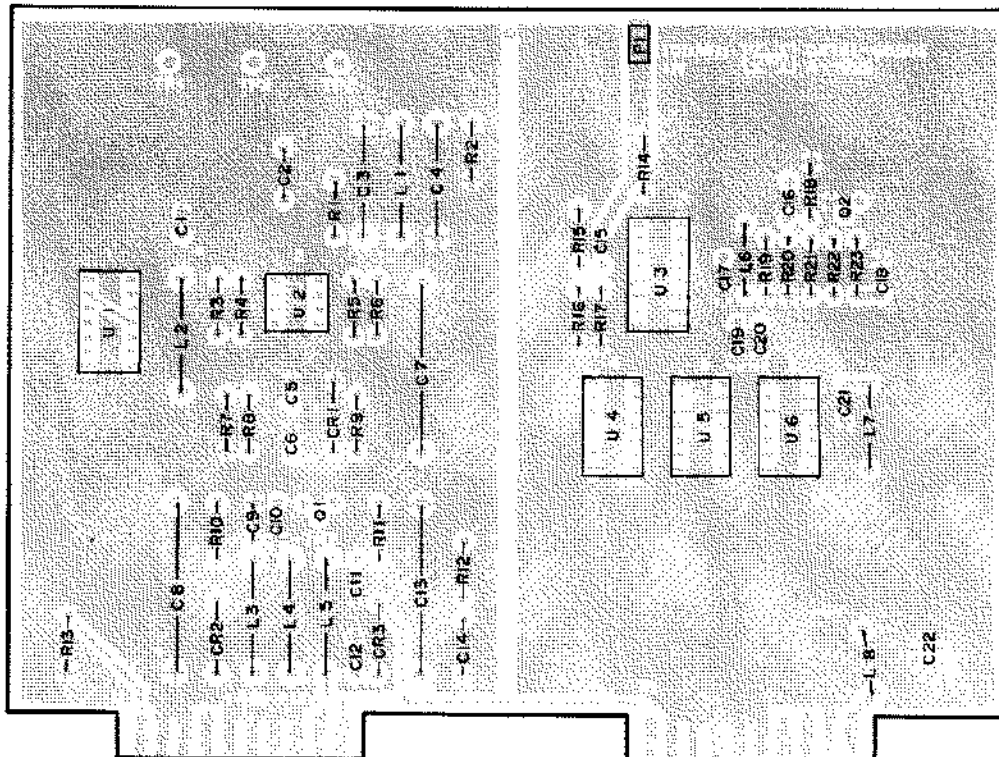

Figure 8-32. A3 Synthesizer Phase Detector Board Assembly Component Locations.

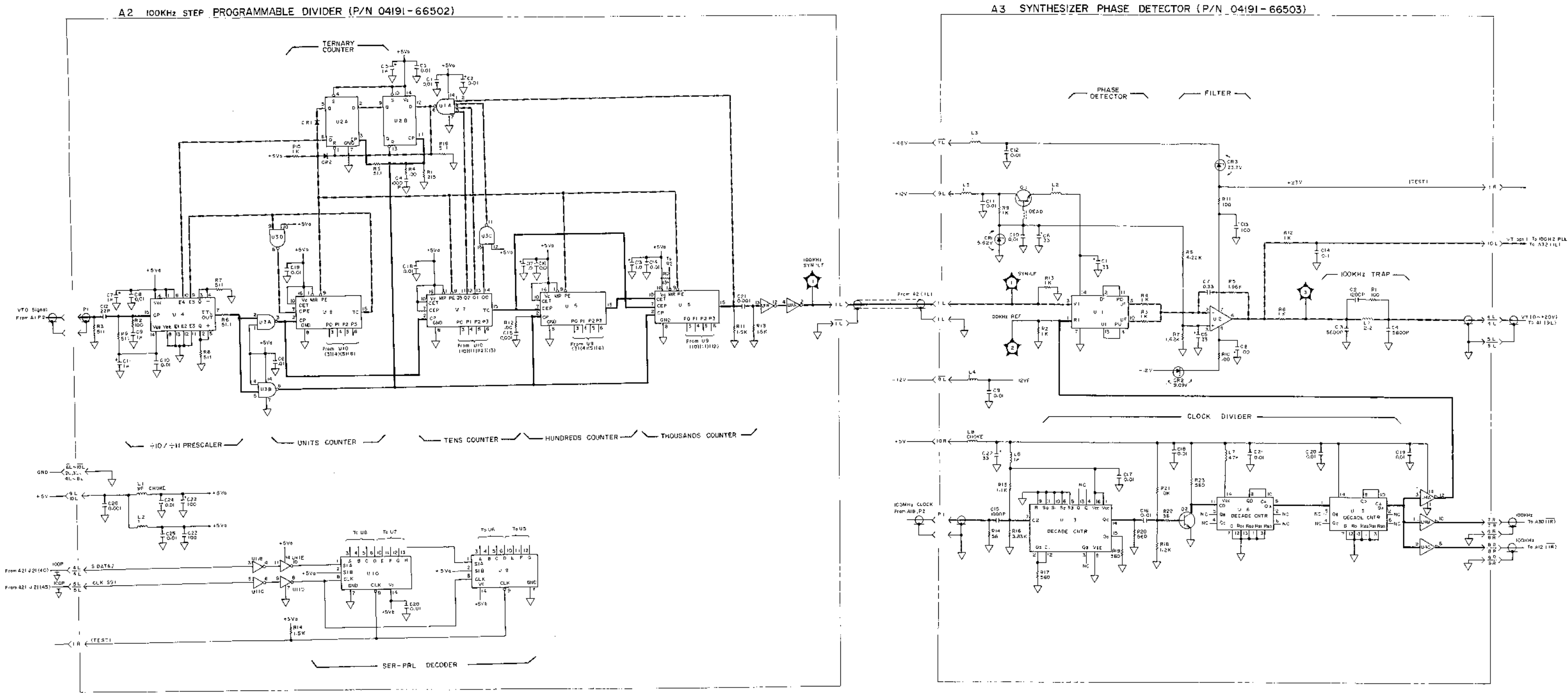

Figure 8-33. A2 100 kHz Step Programmable Divider Board and A3 Synthesizer Phase Detector Board Assembly Schematic Diagram.

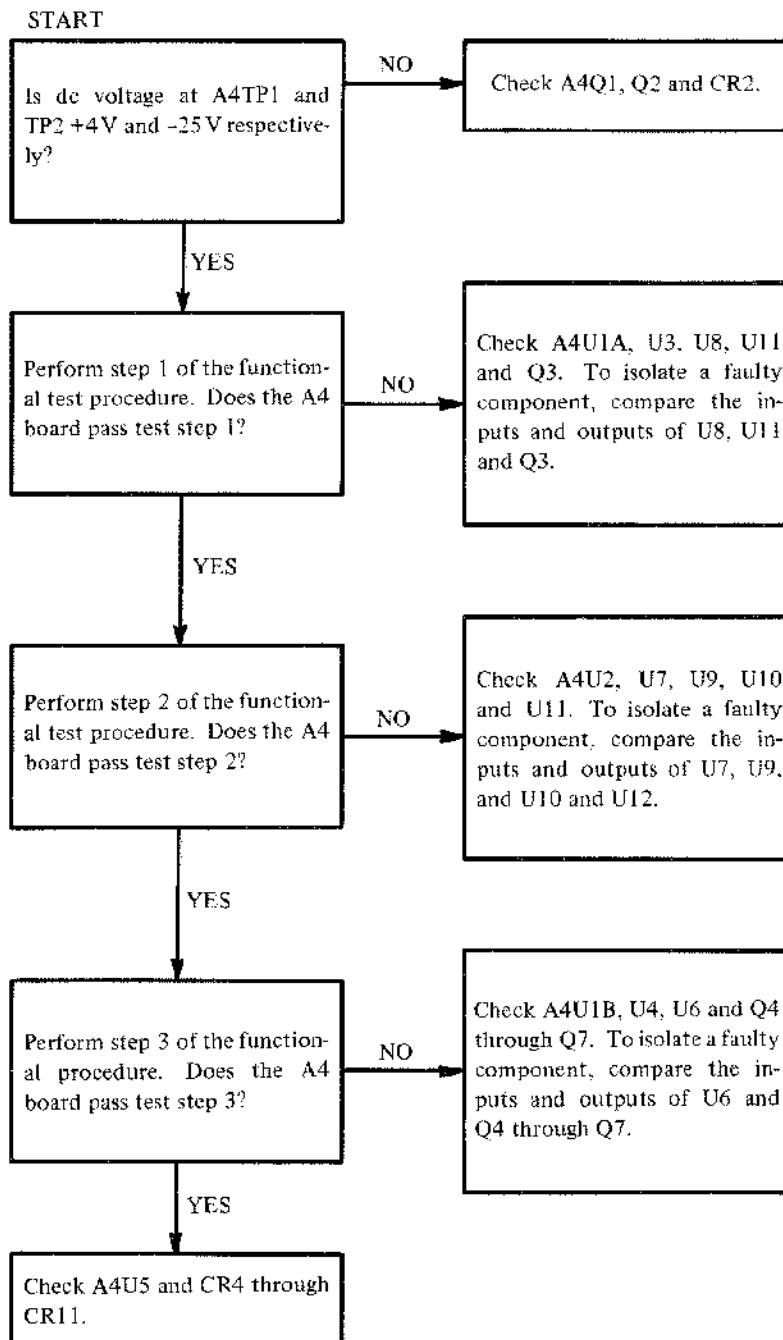
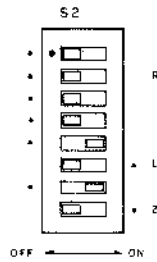

Figure 8-34. A4 Programmable Switch Control Driver Board Troubleshooting Flow Diagram.

A4 PROGRAMMABLE SWITCH CONTROL DRIVER FUNCTIONAL TEST

Circuit operation and the functions of the A4 Programmable Switch Control Driver are checked using the procedure outlined below:

Setup: Set switch A21S2 as shown below:



1. Set the SPOT frequency in accordance with the table below and verify that the filter switch driver output signals (at edge connector pins $\overline{6R}$ through $\overline{10R}$ on the A4 board) have the voltage levels given in the table:

SPOT frequency	Output signal level								
	$\overline{6R}$	7R	$\overline{7R}$	8R	$\overline{8R}$	9R	$\overline{9R}$	10R	$\overline{10R}$
1.0MHz	+								
50.0MHz		+							
80.0MHz			+						
100.0MHz				+					
150.0MHz					+				
200.0MHz						+			
300.0MHz							+		
500.0MHz								+	
600.0MHz									+

Note: "+" indicates +5V (-12V at $\overline{6R}$ only), all others are -1V.

2. Set SPOT frequency in accordance with the table below and verify that the VTO switch driver output signals (at edge connector pins 2R through 6R on the A4 board) have the voltage levels given in the table:

SPOT frequency	Output signal level							
	2R	3R	$\overline{3R}$	4R	$\overline{4R}$	5R	$\overline{5R}$	6R
250.0MHz								
265.0MHz	+							
280.0MHz	+	+						
300.0MHz	+	+	+					
330.0MHz		+	+	+				
350.0MHz			+	+	+			
400.0MHz				+	+	+		
440.0MHz					+	+	+	
500.0MHz					+	+	+	+

Note: "+" indicates +3.2V, all others are -25V.

3. Set the SPOT frequency in accordance with the table below and verify that the frequency converter switch driver output signals (at edge connector pins 4L through 9L on the A4 board) have the voltage levels given in the table:

SPOT frequency	Output signal level										
	4L	4L	5L	5L	6L	7L	8L	8L	9L	9L	7L
1.0MHz			+	+	H	H	H	L	H	H	(H)
50.0MHz			+		H	H	L	L	L	L	L
80.0MHz			+		H	L	H	L	L	H	L
200.0MHz			+		L	H	H	L	H	H	L
300.0MHz		+			H	H	H	H	H	H	L
600.0MHz	+				H	H	H	H	H	H	L

Note: Symbols in the table are as follows:

H : TTL open collector High level (+3.8 to 5.0V).

L : TTL Low level.

(H) : TTL High level.

+ : +3.0 to 5.0V.

blank : -2V

4. Set the SPOT frequency in accordance with the table below and verify that the dc voltage at A4TP3 meets the test limits given in the table.

SPOT frequency	DC voltage at TP3	
	Typical value	Tolerance
520.0MHz	- 3.2V	±0.3V
550.0MHz	- 4.0V	
580.0MHz	- 4.8V	
600.0MHz	- 5.5V	
650.0MHz	- 6.5V	
730.0MHz	- 8.6V	
800.0MHz	- 9.8V	
900.0MHz	-11.4V	
950.0MHz	-13.8V	
500.0MHz	+ 3.8V	

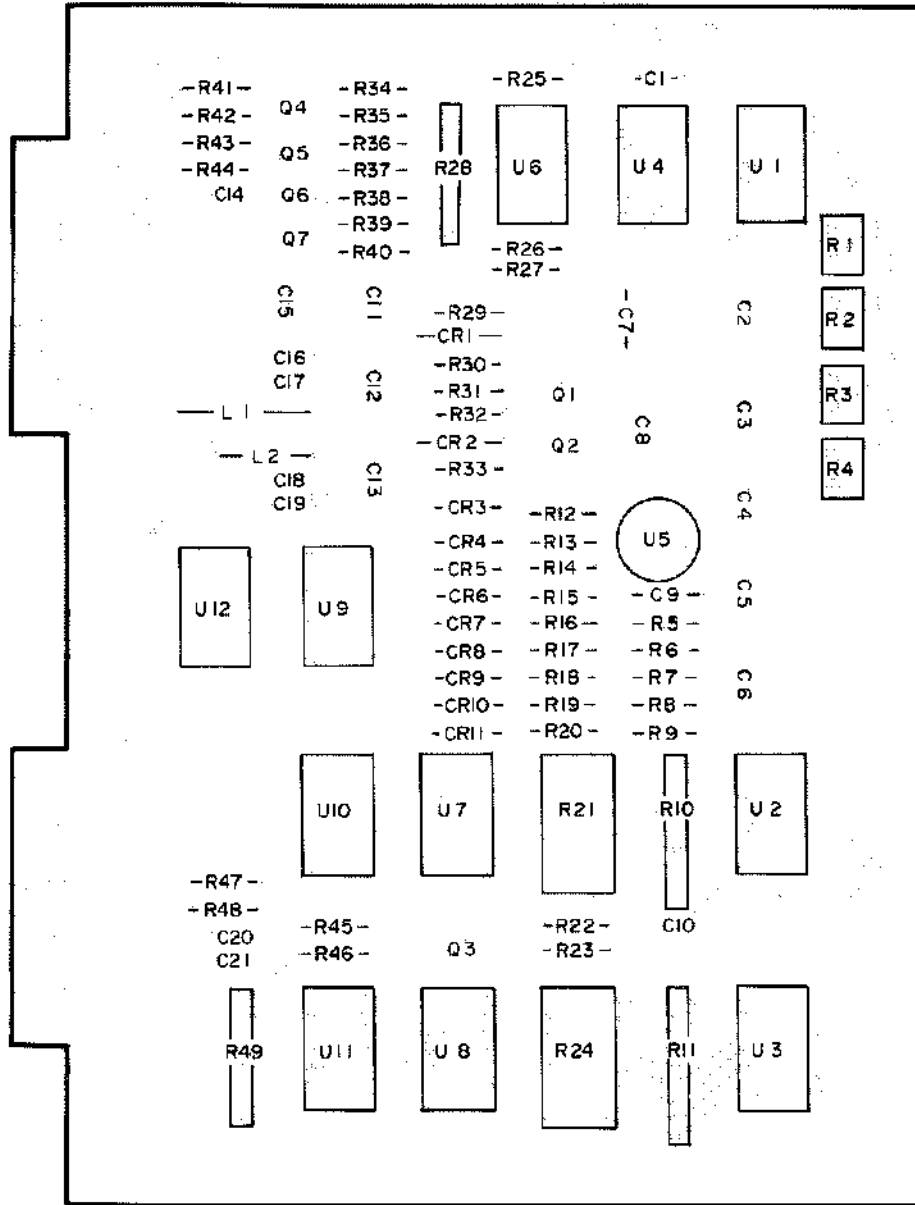

Figure 8-35. A4 Programmable Switch Control Driver Board Assembly Component Locations.

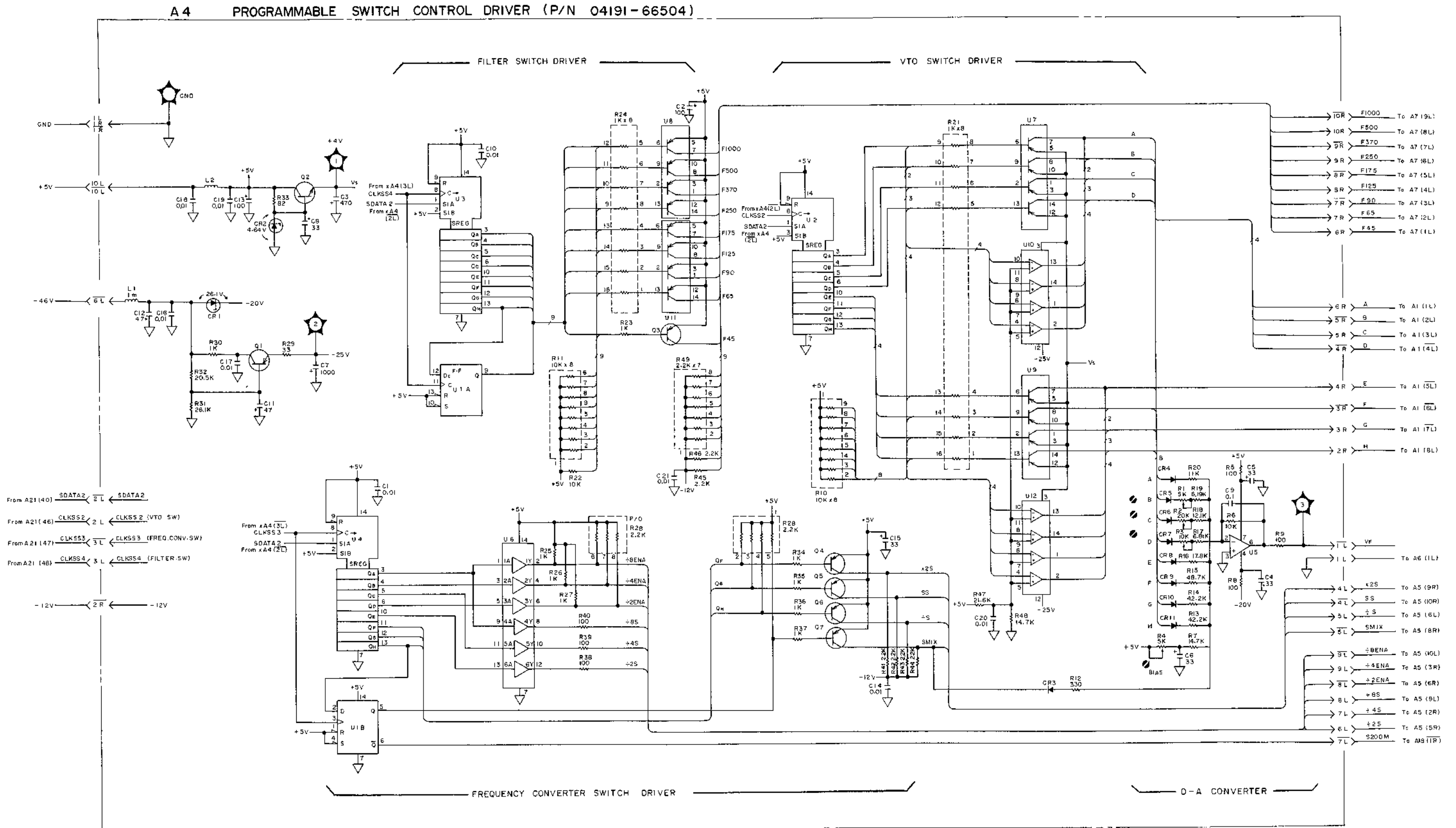

Figure 8-36. A4 Programmable Switch Control Driver Board Assembly Schematic Diagram.

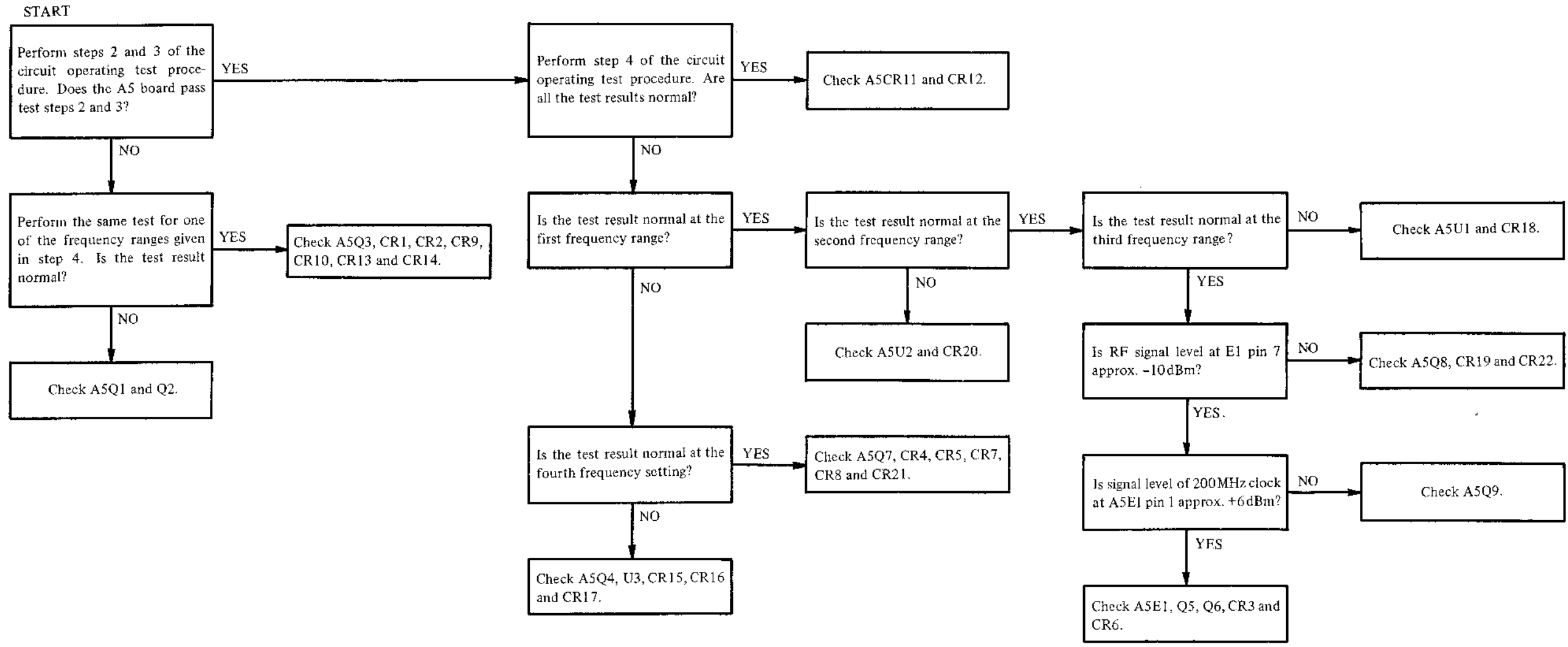
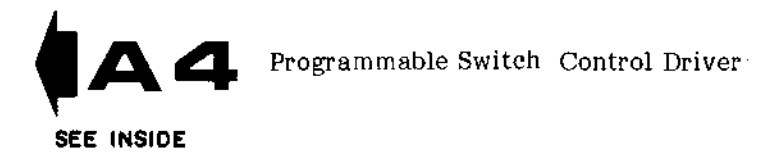

Figure 8-37. A5 Frequency Converter Board Troubleshooting Flow Diagram.



A5 FREQUENCY CONVERTER CIRCUIT OPERATING TEST

Circuit operation of the A5 Frequency Converter is checked using the procedure outlined below:

Setup: Set switch A21S2 as shown below:

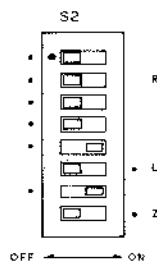

1. Connect a spectrum analyzer to A5P2. Set the SPOT frequency to 1000MHz and 500MHz. Verify that the fundamental spectrum level on the spectrum analyzer CRT satisfies the test limits given in the table below:

SPOT frequency	Test limits
1000.0MHz	> -5 dBm
500.0MHz	< -20dBm

Note: The difference between the spectrum levels at 1000.0MHz and 500.0MHz should be greater than 16dBm.

2. Connect the spectrum analyzer to A5P4. Remove the A12 and A16 boards. Connect A5(5L) to circuit common to disable ALC. Sweep the test frequency from 250.1 to 500.0MHz in 2.0MHz steps using the following control settings.

START FREQ: 250.1MHz

STOP FREQ: 500.0MHz

STEP FREQ: 2.0MHz

Verify that the following conditions are satisfied at all the frequency points:

- 1) Fundamental spectrum level is greater than -6dBm.
 - 2) The difference between the maximum and minimum values of the fundamental spectrum level is less than 8dB.
 - 3) The low order harmonic spectrum levels are less than -55dB below the fundamental.
3. Remove the connection between A5(5L) and circuit common. Apply +10V to A5(5L) from an external dc power supply. Re-perform frequency sweep. Verify that the attenuation of the fundamental spectrum level is greater than 10dB when compared to the level obtained in step 2.

- Using the same procedures as outlined in steps 3 and 4 (only the frequency control settings are different), perform the test for the other test frequency ranges listed in the table below:

Freq. range	Frequency control settings		
	START	STOP	STEP
1	125.1 MHz	250.0MHz	1.0MHz
2	62.6MHz	125.0MHz	1.0MHz
3	32.1 MHz	62.5 MHz	0.5 MHz
*4	1.0MHz	32.0MHz	0.5 MHz

**Note: The high order harmonic spectrum levels should be less than -30dB from the fundamental.*

If the difference between the maximum and minimum levels of the fundamental exceeds 8dB, check the by-pass capacitors used at the emitters of A5Q3, Q5, Q6 and Q7. If the low order harmonics are greater than the test limit, A5U1, U2 or U3 may not be correctly disabled.

- Connect the frequency counter to A5P4 in place of the spectrum analyzer. Set the frequency counter resolution to 1kHz. Remove the external dc power supply and connect A5 (5L) to circuit common. Set the SPOT frequency in accordance with the table below and verify that the frequency counter readout is within the test limits given in the table.

SPOT frequency	Test limits
250.0MHz	250.000MHz
125.1 MHz	125.100MHz
125.0MHz	125.000MHz
62.6 MHz	62.600MHz
62.5 MHz	62.500MHz
32.1 MHz	32.100MHz
32.0 MHz	32.000MHz
1.0MHz	1.000MHz

} ±10 counts
} ±1 counts

8-87. A5 FREQUENCY CONVERTER

8-88. The frequency converter develops a 1MHz to 500MHz signal from the VTO signal (250MHz to 500MHz) using frequency dividers and a mixer. These circuits, which make up the frequency converter, are properly switched and are interconnected in different configurations for each of the following frequency bands:

- 1) 250.1 to 500.0MHz
- 2) 125.1 to 250.0MHz
- 3) 62.6 to 125.0MHz
- 4) 32.1 to 62.5MHz
- 5) 1.0 to 32.0MHz

Selection of the appropriate frequency band is made by the diode switches at the input and output stages of those circuit sections. Each diode switch comes on when it is forward biased by the switch control signal. These control signals are denoted as SS, $\div S$, $\times 2S$, $\div 2S$, $\div 4S$, $\div 8S$ and SMIX on the A5 board schematic diagram. The frequency dividers are, when not required by the selected frequency (band), disabled by the $\div 2E$, $\div 4E$ and/or $\div 8E$ control signals. The circuit operation at each frequency band is outlined below:

- 1) 250.0 to 500.0MHz
The SS control signal turns the CR13 and CR2 diode switches on (CR14 and CR1 are off). The VTO signal is amplified by Q3 and the buffer amplifier (Q1 and Q2), then output without converting the frequency.
- 2) 125.1 to 250.0MHz
The $\div S$ control signal turns the CR15 and CR4 diode switches on (CR16 and CR5 are off), and the $\div 2S$ signal turns the CR21 diode switch on. The $\div 2E$ ($\div 2ENA$) control line goes LOW to enable the U3 frequency divider. The frequency of the VTO signal is divided by 2 (125.1 to 250.0 MHz) by U3. The output signal of U3 is transmitted to the buffer amplifier Q7 and then to the output buffer amplifier (Q1 and Q2).
- 3) 62.6 to 125.0MHz
The $\div S$ control signal turns the CR15 and CR4 diode switches on (CR16 and CR5 are off), and the $\div 4S$ signal turns the CR20 diode switch on. The $\div 2E$ and $\div 4E$ control lines go LOW to enable the U3 and U2 frequency dividers. The frequency of the VTO signal is divided by 4 (62.6 to 125.0 MHz) by the series connected U3 and U2.
- 4) 32.1 to 62.5MHz
The $\div S$ control signal turns the CR15 and CR4 diode switches on (CR16 and CR5 are off), and

the $\div 8S$ signal turns the CR18 diode switch on. The $\div 2E$, $\div 4E$ and $\div 8E$ control lines go LOW to enable the U3, U2 and U1 frequency dividers. The frequency of the VTO signal is divided by 8 (32.1 to 62.5MHz) by the series connected U3, U2 and U1A.

- 5) 1.0 to 32.0MHz
The $\div S$ control signal turns the CR15 diode switch on, and the SMIX signal turns the CR22 and CR3 diode switches on. The $\div 2E$ control line goes LOW to enable the U3 frequency divider. The output of U3 (half the VTO signal frequency) is fed to the Q8 buffer amplifier and passes the 250MHz LPF to eliminate undesired harmonics from the signal. At this frequency band, the VTO provides frequencies in the range of 402.0MHz and 464.0MHz. Thus, the frequency of the signal applied to the E1 mixer is between 201.0 and 232.0MHz. The other input of the mixer, supplied from the Q9 buffer amplifier, is the 200 MHz output from clock generator on the A18 board. The E1 mixer simultaneously outputs the sum (401.0MHz to 432.0MHz) and difference (1.0M to 32.0MHz) of the two input frequencies. The 35 MHz LPF at the output stage of the mixer filters out the unnecessary high frequency signals and allows only signals between 1.0MHz and 32MHz to be output to the pre-amplifier (Q6 and Q5). Because the diode switch CR21 is off, the output signal of the U3 frequency divider does not appear at the input of the buffer amplifier (Q1 and Q2).

Note: When the measurement frequency setting is above 500.1MHz, the $\times 2S$ control signal turns the CR12 diode switch on to transmit the VTO signal to the A6 Frequency Doubler.

The ALC signal controls the attenuation factor of the modulator (voltage controlled attenuator) circuit to maintain the amplitude of the measurement signal at a constant level. The modulator utilizes PIN diodes CR7 through CR10 and CR19 as variable resistance elements to control the attenuation in response to the ALC signal voltage (dc). When the amplitude of the measurement signal decreases, the ALC voltage shifts to a lower level (towards 0V). The ALC current flowing through each PIN diode decreases causing the ESR (equivalent series resistance) of the diode to increase. Thereby, the signal in the modulator is attenuated by a lower factor, and, consequently, the measurement signal is maintained at normal amplitude. Similarly, the ALC circuit suppresses (increases in the amplitude of the measurement signal) by decreasing the resistance of the PIN diodes (a greater ALC current flows through the individual diodes).

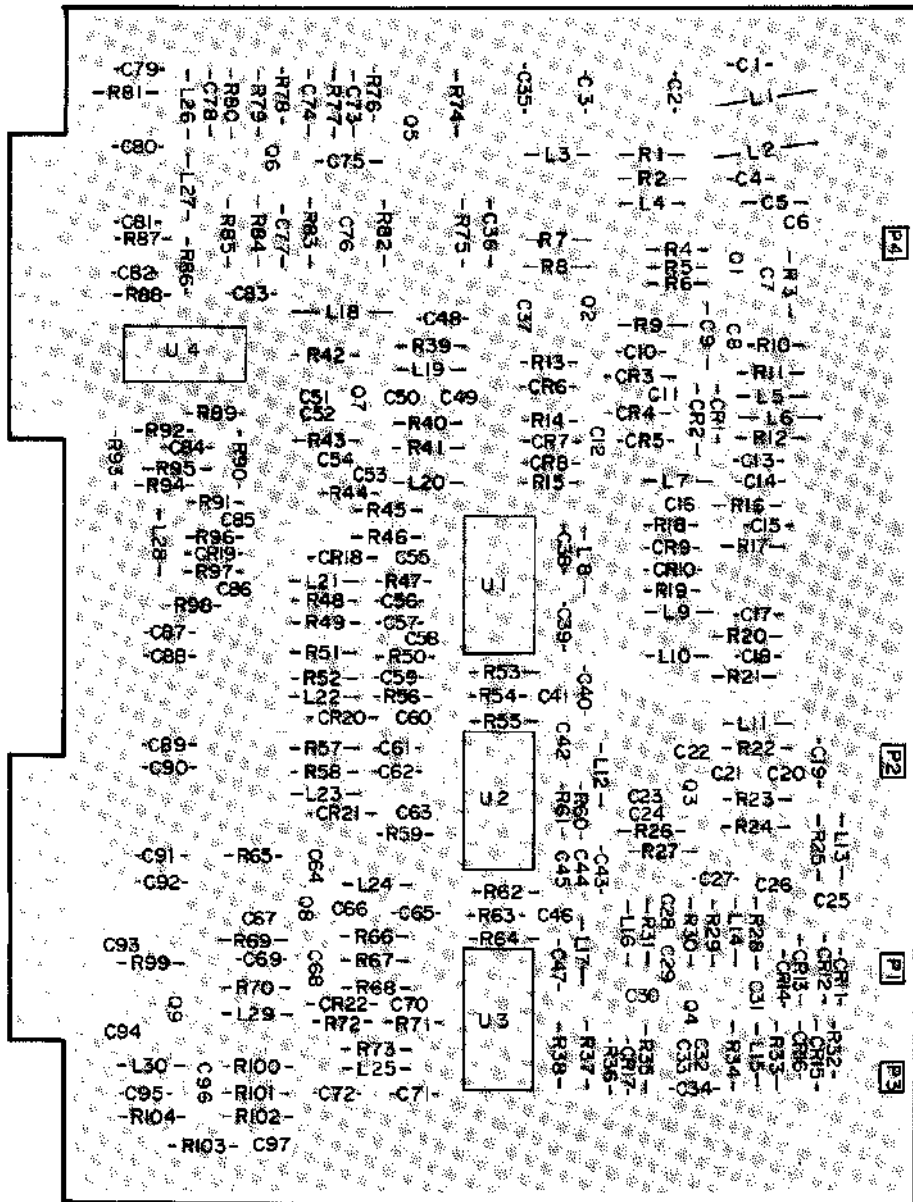

Figure 8-38. A5 Frequency Converter Board Assembly Component Locations.

A5 FREQUENCY CONVERTER (P/N 04191-66505)

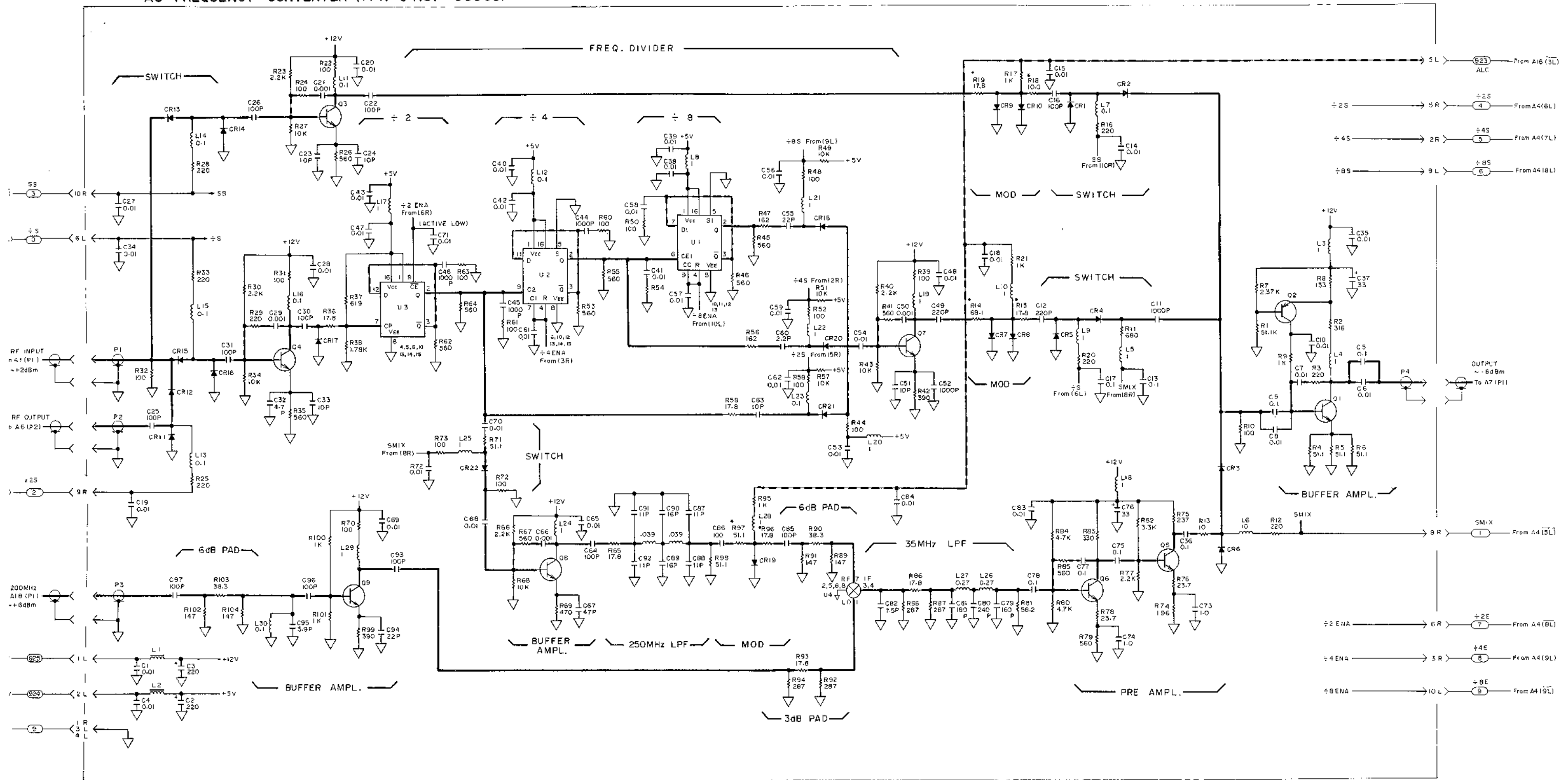

Figure 8-39. A5 Frequency Converter Board Assembly Schematic Diagram.

Section VIII
Figure 8-40

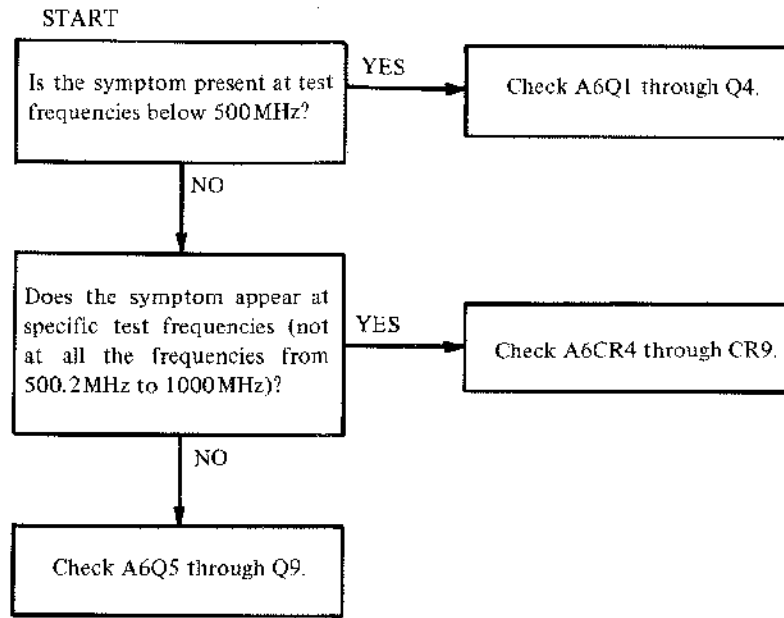
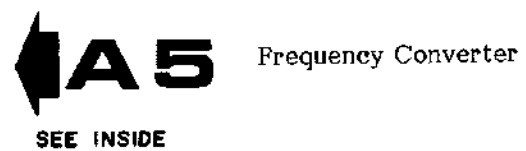

Figure 8-40. A6 Frequency Doubler Board Troubleshooting Flow Diagram.



A6 FREQUENCY DOUBLER CIRCUIT OPERATING TEST

Circuit operation of the A6 Frequency Doubler is checked using the procedure outlined below:

Setup: Set switch A21S2 as shown below:

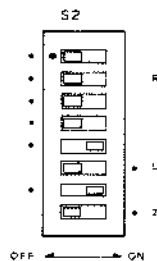

Remove the A12 and A16 boards.

1. Connect A6 (3L) to circuit common to disable ALC. Connect a spectrum analyzer to A6P1. Sweep the test frequency from 500.2MHz to 1000.0MHz in 2.0MHz steps using the following control settings:

START FREQ : 500.2MHz
 STOP FREQ : 1000.0MHz
 STEP FREQ : 2.0MHz

Verify that the following conditions are satisfied at all the test frequencies:

- 1) Fundamental spectrum is greater than -7dBm.
 - 2) The difference between the maximum and minimum values of the fundamental spectrum level is less than 8dB.
 - 3) The second harmonic level is less than -30dB below fundamental.
 - 3) The spectrum levels of the low order harmonics are less than -40dB below the fundamental.
2. Remove the connection between A6 (3L) and circuit common. Apply +10V to A6 (3L) from an external dc power supply. Re-perform frequency sweep. Verify that the attenuation of the fundamental spectrum level is greater than 15dB at all test frequencies.
 3. Set the dc voltage at A6 (3L) to 0V. Set the START and SPOT frequencies to 500.0MHz. Verify that all spectrum levels on the CRT are less than -50dBm.

If the fundamental spectrum level is less than -7dBm at specific frequencies, check whether or not the voltage tunable filter has the appropriate pass band in response to normal tuning voltage input. Using a higher resistance for A6R3 increases the ALC attenuation ratio and using a lower resistance for R2 increases the output at A6P1.

4. Connect an external signal generator to A6P3. The output signal level of this signal generator should have a flat frequency characteristic (± 0.5 dB) over the 1MHz to 1000MHz range. Set the output signal level to -20dBm. Connect the spectrum analyzer to A6P4. Vary the signal generator frequency from 1MHz to 1000MHz and verify that the fundamental level on the spectrum analyzer CRT satisfies the following test limits:

Test frequency	Test limits
1.0 – 50.0MHz	-10 \pm 2dBm
50.1 – 600.0MHz	- 8 \pm 2dBm
600.1 – 1000.0MHz	- 7 \pm 3dBm

Harmonic spectrum levels should be less than -30dB below the fundamental. If a suitable signal generator is not available, check the power amplifier gain using the procedure outlined in step 5. If the A6 board fails this test, refer to the note given at the end of step 5.

5. Connect the spectrum analyzer to A7P3. Reconnect the SMC connector cable to A6P1. Sweep the test frequency from 1.0MHz to 1000.0MHz in 2MHz steps to verify the input signal frequency characteristic at A6P3 (set the SCAN TIME of the spectrum analyzer to 0.2 seconds/div and store the spectrum display on the CRT).

Connect the spectrum analyzer to A6P4. Reconnect the SMC connector cable to A7P3. Re-perform test frequency sweep and verify that the following conditions are satisfied at all test frequencies:

- 1) Amplifier gain (measured output signal level at A6P4 in reference to the input signal level at A7P3) is within the test limits given in the table below:

Test frequency	Test limits
1.0 -- 50.0MHz	10 ± 2 dB
52.0 -- 600.0MHz	12 ± 2 dB
602.0 -- 1000.0MHz	13 ± 3 dB

- 2) Harmonic spectrum levels are less than -30dB below the fundamental.

Note: If the amplifier gain frequency response exhibits an abnormal peak value at 1000MHz, check for a parasitic resonance caused by an improperly secured shield plate. Capacitance values of A6C5, C6 and C7 may be selected to optimize the amplifier frequency compensation. If harmonic distortion of the amplifier output is excessive, change the values of A6R24 and R28 to lower the distortion.

8-89. A6 FREQUENCY DOUBLER

8-90. The frequency doubler consists of a transistor full-wave rectifier and a voltage tunable filter. The 250M to 500MHz input signal yields a pair of the signals, which are 180° out of phase with each other, at the outputs of the T1 transformer. Thus, the Q6 and Q7 transistors alternately drive the class "B" bias amplifiers composed of Q8 and Q9. As the outputs of the Q8 and Q9 amplifiers appear only during the positive half cycle of the respective inputs, and are summed at their common collector load, the output waveform is a full-wave rectified sinusoidal signal. This output contains the primary spectral frequency component, which is double the input signal frequency, and many harmonics. The voltage tunable filter allows only the component of double the frequency to pass through the filter network and eliminates the undesired harmonics from the rectifier output. The distributed inductances of the printed circuit pattern lines (denoted by the rectangular symbols in the schematic diagram) compose the LC filter network in conjunction with the capacitances of the varactor

diodes (CR4 through CR9). The band pass frequency of the filter is set by the VF tuning control voltage applied to the varactor diodes, and concurrently changes with the control signals for selecting the VTO frequency bands. Hence, the appropriate filter frequency is automatically set from among the nine frequency bands related to the individual VTO frequency bands. The PIN modulator varies the attenuation of the filter output signal in response to the ALC current through CR2 and CR3. This keeps the amplitude of the measurement signal almost constant at the 500 to 1000MHz region. The wide band power amplifier (Q1 through Q4) has a 12dB voltage gain over the entire measurement frequency range. Q1 and Q2 of the two stage amplifier each employ a multiple parallel connection of the emitter bias resistors to raise the high frequency performance limits by reducing the residual inductance present in the emitter circuit. The C5 and C7 capacitors connected in parallel with the emitter bias resistors are used as peaking compensation to optimize the frequency flatness at frequencies near 1GHz.

A7 SELECTABLE FILTER CIRCUIT OPERATING TEST

Circuit operation of the A7 Selectable Filter is checked using the procedure outlined below:

Setup: Set switch A21S2 as shown below:

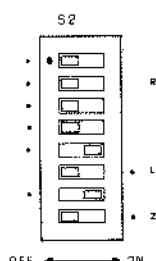

Connect an external 1MHz to 1000MHz signal generator to A7P1. Connect a spectrum analyzer to A7P3.

1. Set the SPOT frequency to select the filter frequency band to be tested in accordance with Table A. Set the signal generator output to -6dBm and the output frequency to the ten frequency points listed in the table. Read the fundamental spectrum level on the spectrum analyzer at each frequency. Check that the attenuations of the fundamental level, when compared to the signal generator output level, satisfy the test limits at all test frequency points listed in the table.

Notes: a. Perform the test on the frequency band related to the channel filter circuit being repaired or to the performance test that failed.

b. For the test at filter frequency band 9, connect the signal generator to A7P2.

c. Keep the signal generator output level constant with the level control of the instrument.

2. Verify that the difference between the maximum and minimum attenuation at the frequencies below the filter roll-off frequency is less than 4dB. The filter roll-off frequency is identical to the SPOT frequency setting.

Table A. Selectable Filter Circuit Operating Test.

Freq. band	SPOT frequency	Signal generator frequency (MHz)	
1	45MHz	1.0, 8.3, 15.7, 23.0, 30.3, 37.7, 45.0	67.5, 90.0, 135.0
2	65MHz	45.0, 48.3, 51.7, 55.0, 58.3, 61.7, 65.0	97.5, 130.0, 195.0
3	90MHz	65.0, 69.2, 73.3, 77.5, 81.7, 85.8, 90.0	135.0, 180.0, 270.0
4	125MHz	90.0, 95.8, 101.7, 107.5, 113.3, 119.2, 125.0	187.5, 250.0, 375.0
5	175MHz	125.0, 133.3, 141.7, 150.0, 158.3, 166.7, 175.0	262.5, 350.0, 525.0
6	250MHz	175.0, 187.5, 200.0, 212.5, 225.0, 237.5, 250.0	375.0, 500.0, 750.0
7	370MHz	250.0, 270.0, 290.0, 310.0, 330.0, 350.0, 370.0	555.0, 740.0, 1000.0
8	500MHz	370.0, 391.7, 413.3, 435.0, 456.7, 478.3, 500.0	750.0, 1000.0
9	1000MHz	500.0, 555.6, 611.1, 666.7, 722.2, 777.8, 833.3, 888.9, 944.4, 1000.0	—
Attenuation		< 8dB	> 40dB

A7 BOARD TROUBLESHOOTING GUIDE

The A7 board troubleshooting procedure is described below:

1. Perform the circuit operating test procedure to identify the filter channel on which the symptom appears. Check the filter circuit of the defective channel.
2. Check the diodes related to the defective filter channel. If the symptom appears only at frequencies above 500.2MHz or below 500MHz, check A7CR20, CR21 or CR22.

8-91. A7 SELECTABLE FILTER

8-92. The selectable filter consists of an eight channel, passive LC filter network, each with a different roll-off frequency as shown in the schematic diagram. The filter channels are automatically selected by the diode switches depending on the measurement signal frequency. When the measurement frequency is, for example, 100 MHz, F125 control line goes HIGH and turns on the CR3

and CR30 diode switches in the 125MHz filter channel. This filter channel is selected for frequencies between 90.1MHz and 125.0MHz (the other filter channels are also selected in the same manner). For frequencies above 500.1MHz, the voltage tunable filter on the A6 board achieves the required spectral purity of the measurement signal. Thus, signals at this frequency region pass through the A7 board without being filtered.

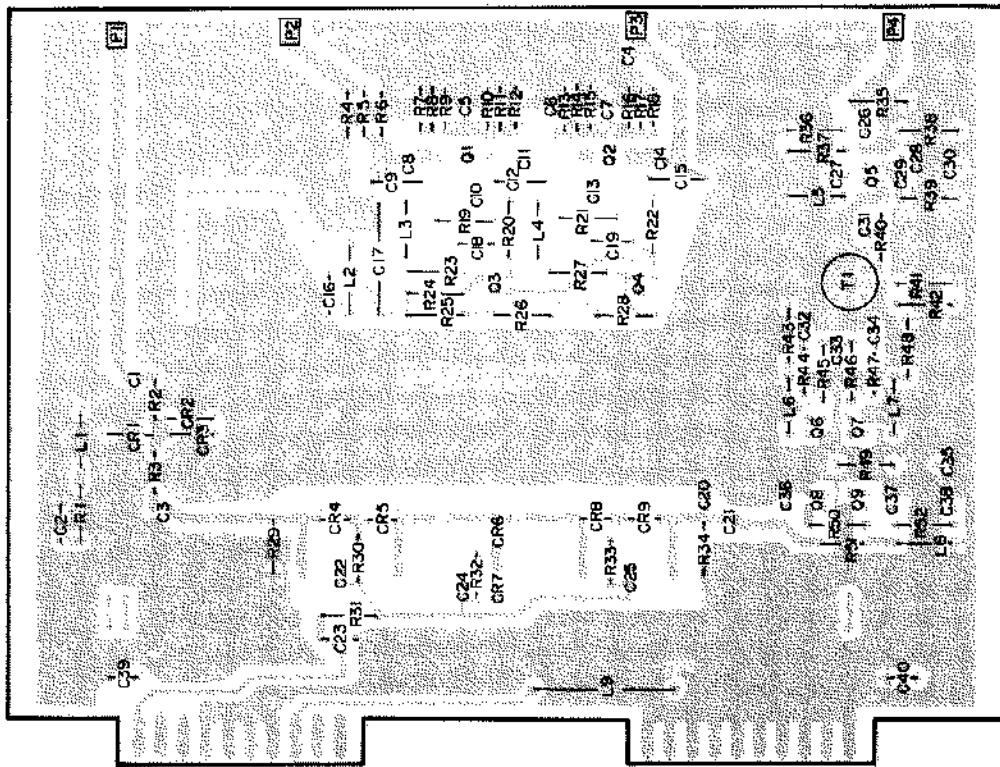

Figure 8-41. A6 Frequency Doubler Board Assembly Component Locations.

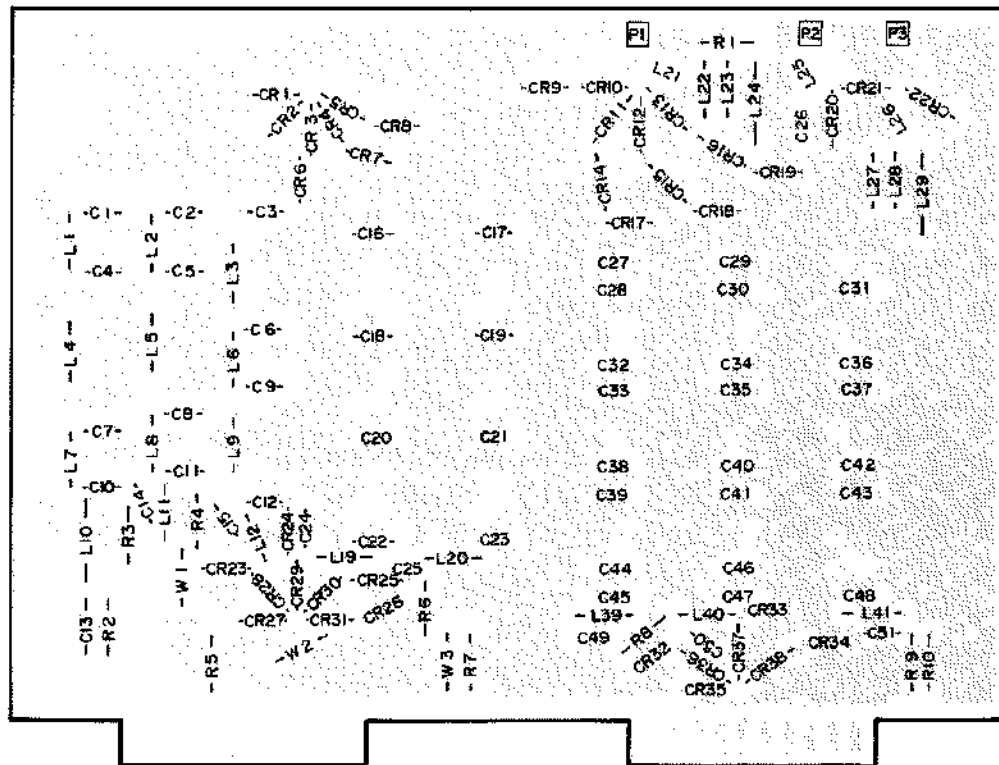

Figure 8-42. A7 Selectable Filter Board Assembly Component Locations.

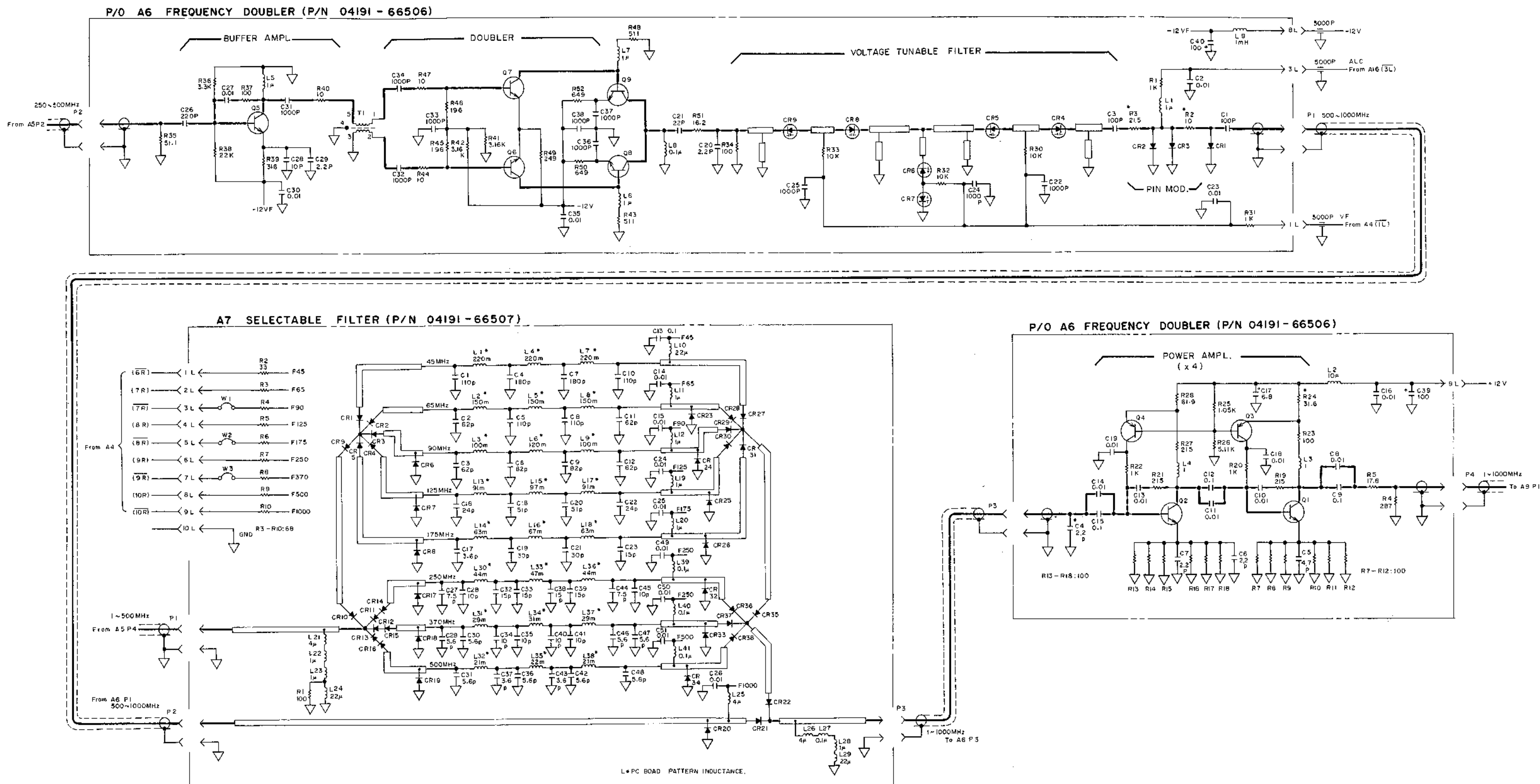

Figure 8-43. A6 Frequency Doubler Board and A7 Selectable Filter Board Assembly Schematic Diagram.

Section VIII
Figure 8-44

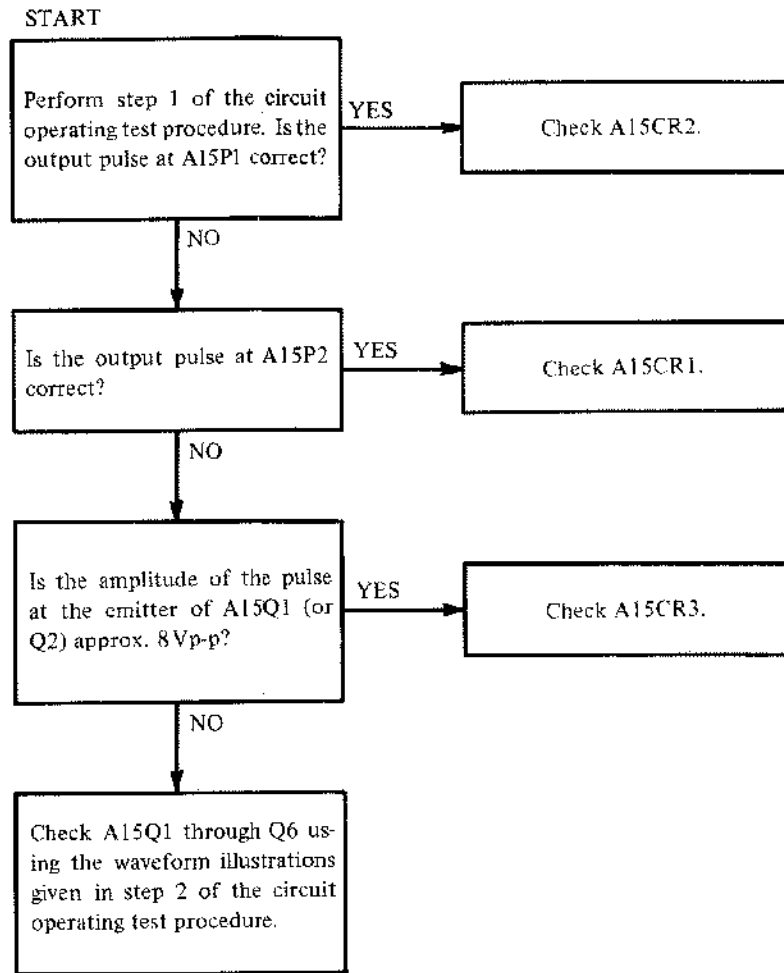

Figure 8-44. A15 Sampling Pulse Generator Board Troubleshooting Flow Diagram.



Frequency Doubler
Selectable Filter

SEE INSIDE

A9 DIRECTIONAL BRIDGE CIRCUIT OPERATING TEST

Circuit operation of the A9 Directional Bridge is checked using the procedure outlined below:

1. Disconnect the lead from the bias input terminal of the A9 board. Measure the dc resistance between the bias input terminal and the UNKNOWN connector center conductor with a DMM.

Caution: Be careful not to damage the precise contact surface of the UNKNOWN connector.

The measured resistance should be within 70Ω and 100Ω . Verify that the resistance between the following terminals satisfies the required conditions:

Test terminals	Condition
Bias input – A9P6	$> 1\text{M}\Omega$
Bias input – A9P1	$> 1\text{M}\Omega$
Bias input – Shield case	$> 1\text{M}\Omega$

2. The operating performance test at RF region requires another 4191A. Proceed as follows:
 - a) Remove the A9 assembly module from the instrument being tested.
 - b) Perform auto-calibration of the second 4191A over the entire frequency range.
 - c) Connect A9P2 (UNKNOWN) on the A9 board assembly, removed in step a, to the UNKNOWN connector of the second 4191A. Terminate A9P6 using the 50Ω termination and the SMC to APC-7 terminal converter. Measure the reflection coefficient ($|\Gamma|-\theta$) at frequencies from 1.0MHz to 1000.0MHz in 50MHz steps. Verify that the measured $|\Gamma|$ values are less than 0.10 at all the test frequencies.

A9 BOARD TROUBLESHOOTING GUIDE

The A9 board troubleshooting procedure is described below:

Measure the dc resistances of the circuit components mounted on the A9 board with a DMM. If a measured value is different from the value indicated on the circuit schematic, replace that component.

Repair notes:

1. When replacing precision resistor R3, cut the leads of the replacement part to the same length of the leads on the old part and re-mount in the exact same position. Be careful not to allow excessive solder to remain on the leads soldered to the PC board.
2. When replacing an SMC connector, be careful not to allow excessive solder to remain on the center conductor soldered to the PC board.

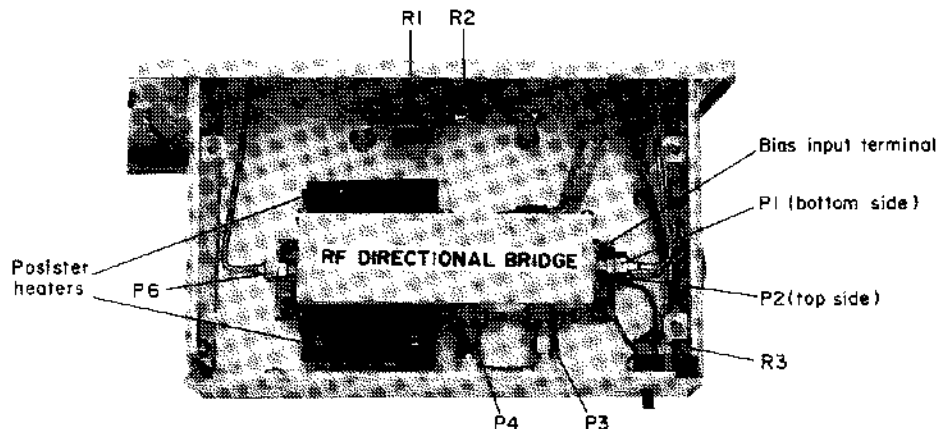

A10 AND A11 SAMPLER CIRCUIT OPERATING TEST

Circuit operation of both the A10 and A11 Samplers is checked using the procedure outlined below:

1. Observe the sampler output at A10 pin (10) with an oscilloscope. A 100kHz IF signal should appear with an amplitude of about 50mVrms (150mVp-p) on the CRT. When a low measurement frequency (about 1 MHz) is set, the sampler output is a sinusoidal staircase wave because of low frequency operation of the sampler. To perform the test for the A11 sampler, use the same procedure used to test the A10 sampler.
2. Measure the dc voltages at the bias input pins of the sampler IC with a DMM. If the measured voltages differ significantly from the values previously set by the adjustment, the sampler IC may not be operating normally. Normal bias voltage levels are:

$$+ \text{BIAS} : 1.20\text{V} \pm 0.01\text{V}$$

$$- \text{BIAS} : -1.20\text{V} \pm 0.01\text{V}$$

3. Measure the dc voltages at the B, S, C and F.B pins of the sampler IC.

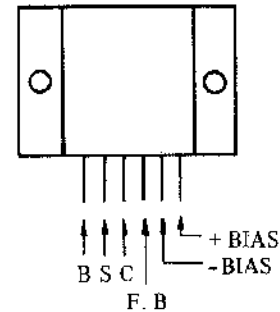

Typical values of the measured voltages are as follows:

Check point	Voltage
B	5.3 to 5.9V
S	0 to 3V
C	8 to 9V

If a measured voltage is not within the nominal value range, the sampler IC may not be operating normally.

Note: The dc parameter checks are not sufficient for testing critical operating performance but are an effective means of identifying circuit operating abnormalities.

A10 AND A11 BOARDS TROUBLESHOOTING GUIDE

The A10/A11 board troubleshooting procedure is described below:

1. Measure the dc voltage at the "S" pin of A10U1 (or A11U1). If the measured voltage is not within 0.5V and 2.5V, check A10U1 (A11U1).
2. If the sampling diode bias voltage can not be adjusted, or if the bias voltage will not stay at the adjusted value, check A10U1 (A11U1).
3. If no IF signal appears at A10 (A11) pin 10, measure dc bias voltages of A10 (A11) Q1, Q2, and Q3. Check the transistor which has a bias voltage significantly different from the following typical values:

- A10Q1 Base : +8.5V
- A10Q1 Collector : +0.6V
- A10Q2 Emitter : 0V
- A10Q3 Emitter : -0.6V

8-93. A10 (A11) SAMPLER

8-94. A periodic sampling pulse applied to the P1 input of the sampler causes the four sampling diodes (bridge connection), housed in the hybrid IC (U1), to turn on during the 300ps (approx.) of the pulse width for each cycle. During this period the sampling diode switch is on, the "hold" capacitor at the input stage of the FET impedance converter (in U1) charges with the instantaneous voltage of the RF measurement input signal (output of the directional bridge). The hold capacitor can discharge only a small portion of its charge during the "off" period of the sampling diode switch because of the high input impedance of the impedance converter. Thus, the capacitor retains the charge voltage until the subsequent sampling pulse turns the sampling switch on, and the capacitor concurrently charges with the instantaneous voltage at that time. Consequently, the sampler output signal is a sinusoidal staircase as shown in Figure 8-45.

When the measurement signal frequency is relatively high (above 10MHz), the output signal includes many staircase steps in each cycle so the waveform is undistinguishably sinusoidal.

The bias circuit sets the basic dc operating level of all the sampling diodes at a shallow, reverse bias condition. This prevents the diodes from being activated by a ringing wave incident to the sampling pulse (see Figure 8-46). As the sampling pulse period is longer at lower measurement frequencies, the hold capacitor discharges a little more completely than at high frequencies. To compensate for a decrease in the sampler output level at low frequencies, a positive feedback signal, applied to the FB input of U1, increases the capacitance of the hold capacitor when the amplitude of the sampler output decreases.

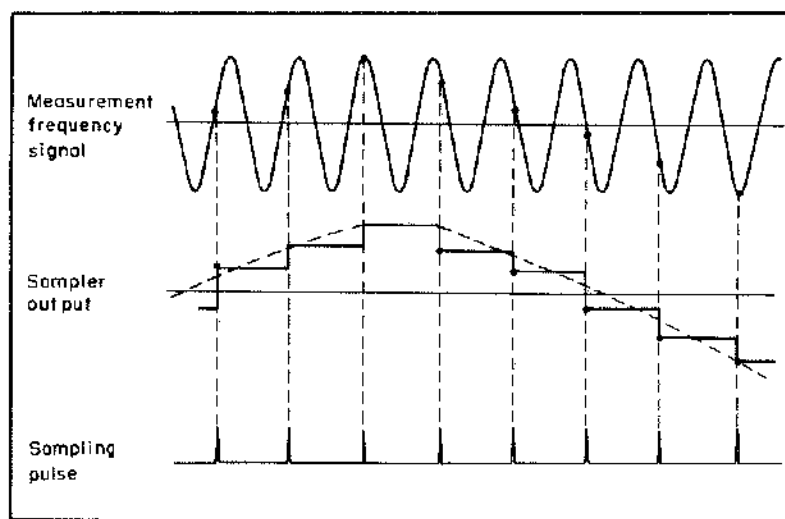

Figure 8-45. Sampler Output Signal

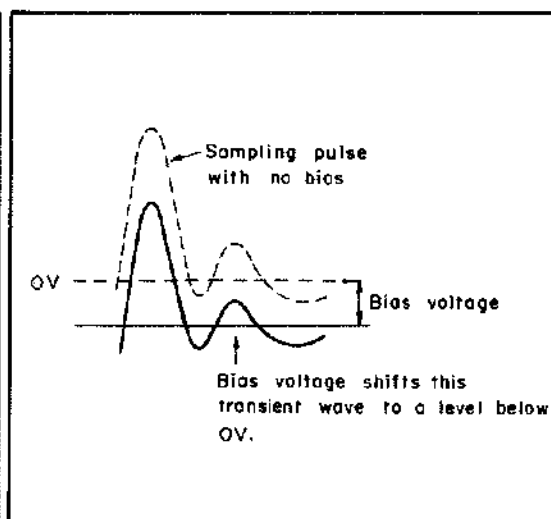

Figure 8-46. Sampling Pulse Waveform.

A15 SAMPLING PULSE GENERATOR CIRCUIT OPERATING TEST

Circuit operation of the A15 Sampling Pulse Generator is checked using the procedure outlined below:

Test equipment

A sampling oscilloscope (HP 1811A w/1430C) covering 18GHz frequency range is required for this test.

Setup: Set switch A21S2 as shown below:

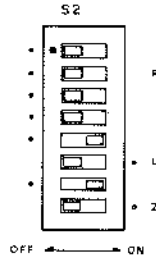

Remove the A12 board.

1. Disconnect SMC connector cables from A15P1 and P2. Set the SPOT frequency to 5MHz. Observe the output pulse signals at A15P1 and P2 with the oscilloscope. Both the output pulses should have the following peak voltage on the CRT.

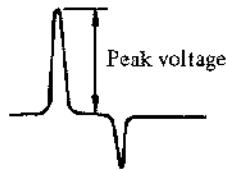

50MHz oscilloscope : 0.4V peak
 100MHz oscilloscope : 1V peak

2. Observe the correct waveform of the pulses at A15P1 and P2 with the sampling oscilloscope. The waveform on the CRT should be as shown below:

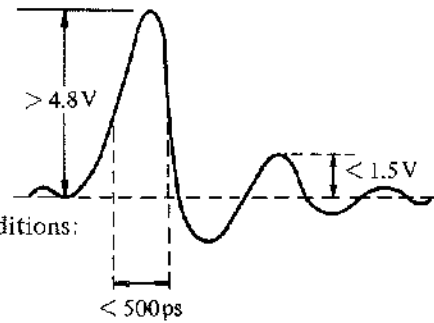

Verify that both waveforms (at P1 and P2) satisfy the following conditions:

- Amplitude : greater than 4.8V peak
- Pulse width : less than 500 ps
- Amplitude of reflection pulse : less than 1.5V peak

If parasitic oscillation occurs, try to shift the L6 ferrite bead inductor on the Q3 Emitter lead (from Q4 Base) to stop the oscillation. Be sure that the shield plate is firmly secured and all screws in place.

Note: Typical dc operating voltages and waveforms are summarized in the table below:

Check point	*DC voltage	Waveform
Q6 Base	-5.7V	—
Q5 Base	-8.5V	4Vp-p
Q5 Collector	-4.0V	8Vp-p
Q1 Emitter	-6.0V	7Vp-p

*Disconnect input from A15P3.

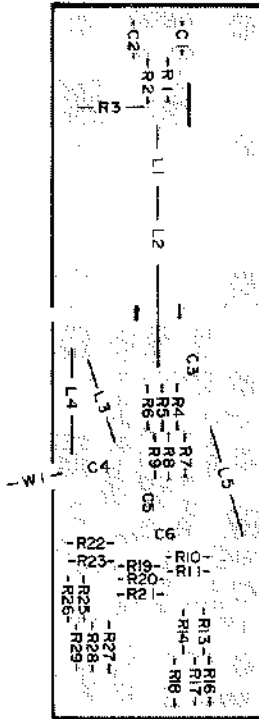

Figure 8-47. A9 RF Directional Bridge Circuit Assembly Component Locations.

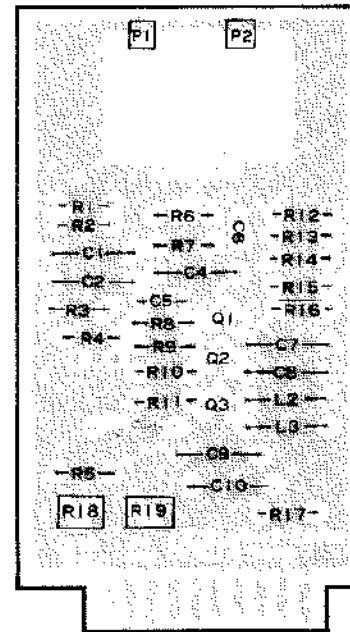

Figure 8-48. A10 Ref Channel Sampler/A11 Test Channel Sampler Board Assembly Component Locations.

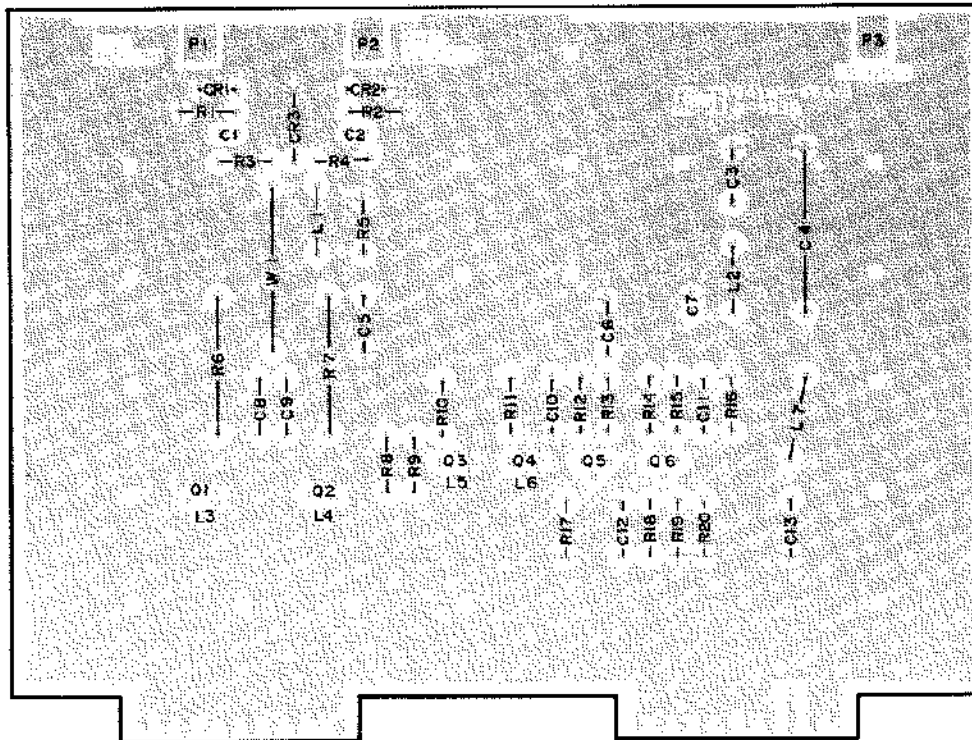

Figure 8-49. A15 Sampling Pulse Generator Board Assembly Component Locations.

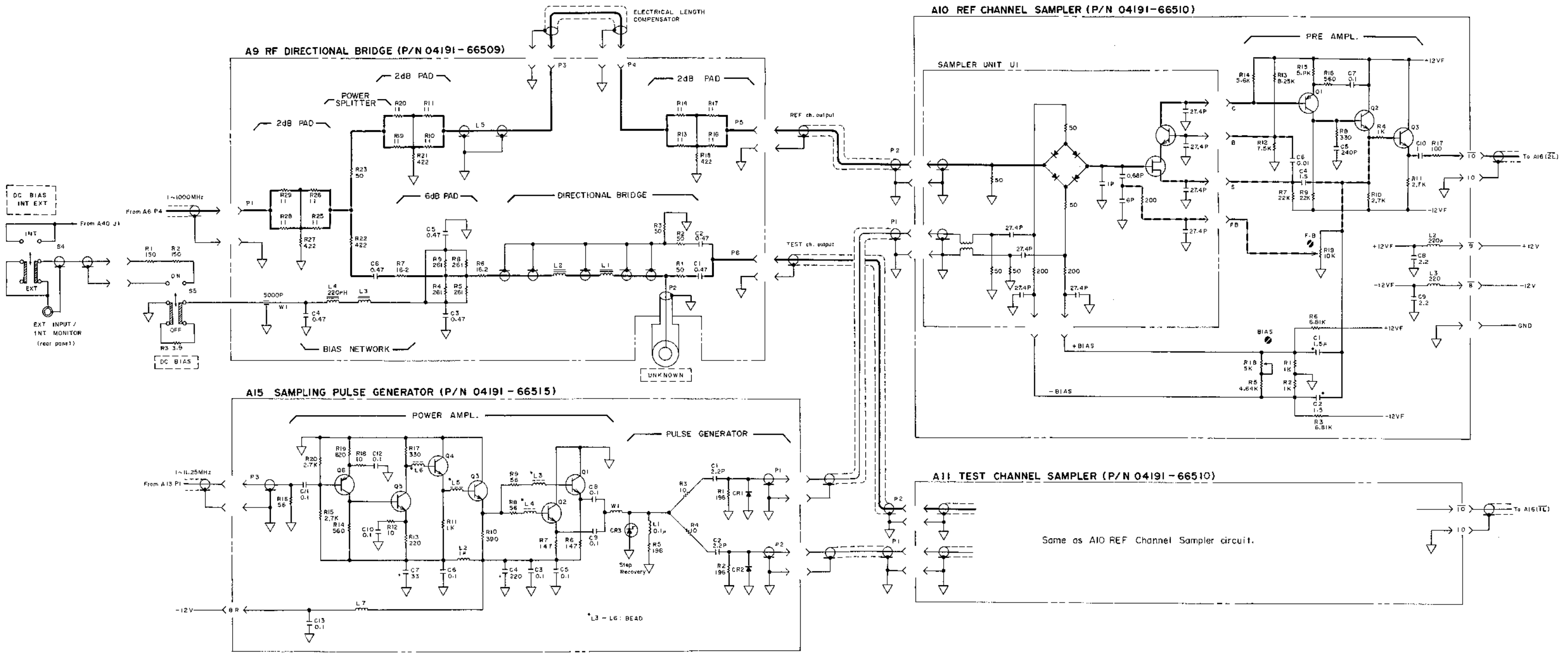

Figure 8-50. A9 RF Directional Bridge, A10 Ref. Channel Sampler, A11 Test Channel Sampler and A15 Sampling Pulse Generator Board Assembly Schematic Diagram.

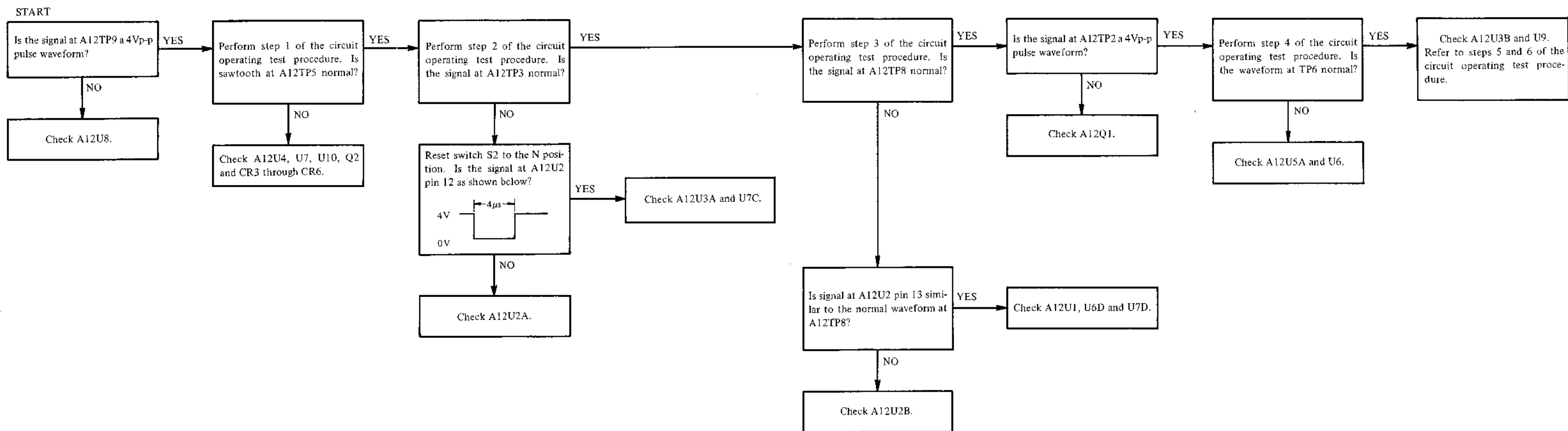

Figure 8-51. A12 PLL Sampling Controller Board Troubleshooting Flow Diagram.

A9, A10, A11, A15
 RF Directional Bridge
 Sampler
 Sampling Pulse Generator
 SEE INSIDE

A12 PLL SAMPLING CONTROLLER CIRCUIT OPERATING TEST

Circuit operation for the A12 PLL Sampling Controller is checked using the procedure outlined below:

Setup: Set switch A21S2 as shown below:



1. Set switch A12S2 to the T (TEST) position. Connect an oscilloscope to A12TP5 to observe the search generator output. Verify that the sawtooth waveform on the CRT has the voltage levels and period illustrated below:

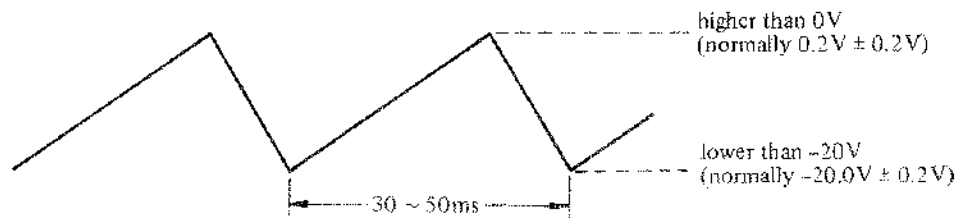

If the sawtooth is not correct, the search generator is faulty.

2. Set the SPOT frequency to 1MHz (initial setting) and the leave switch A12S2 in the T position. Observe the signal at A12TP3 with an oscilloscope. The waveform on the CRT should be as shown below:

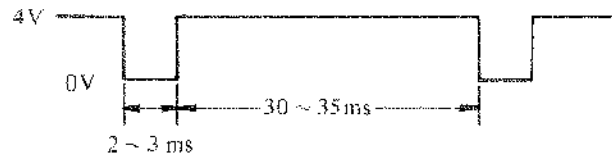

If the waveform is not correct, the frequency detector or the wave shaper is faulty.

3. Using the same frequency and switch control setting as in step 2, observe the signal at A12TP8. The waveform on the CRT should be as shown below:

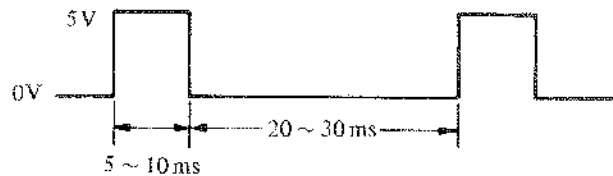

If the waveform is not correct, the search control circuit is faulty.

- Set switch A12S2 to the N (NORM) position. Observe the dc voltage levels at TP2 and TP6 with a dual trace oscilloscope. Change the SPOT frequency setting to a desired value. The voltage level (TTL) at these test points should change immediately after changing the frequency as follows:

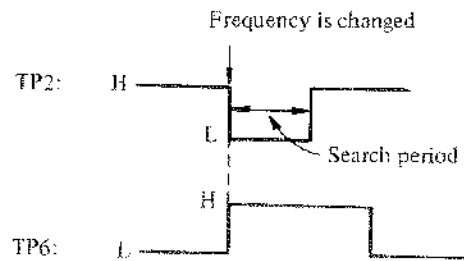

If the waveform at TP6 is not correct, the lock-in detector is faulty.

- Observe the waveforms at TP4 and TP5 with a dual trace oscilloscope. Change the SPOT frequency setting to a desired value. The waveforms on the CRT should be as shown in the figure below:

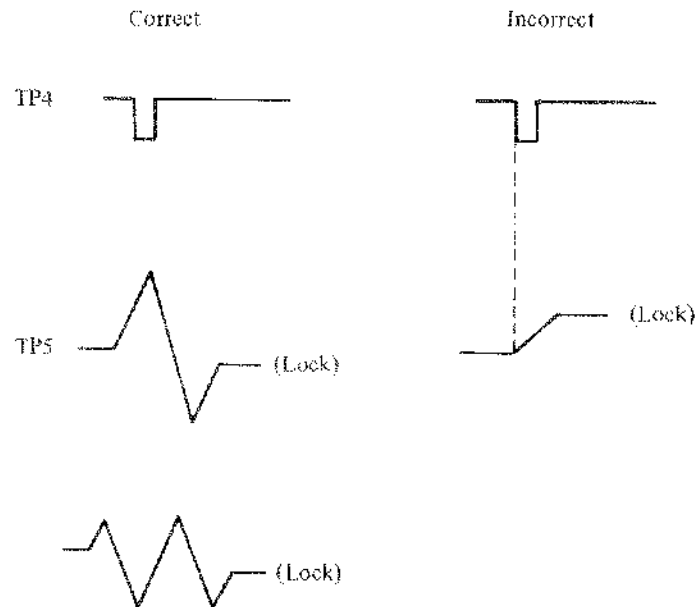

If the waveform at TP5 is not correct, A12U3B is faulty.

- The phase detector (U9) input and output relationship is as follows:

Input		Output	
pin 1 (TP9)	pin 3 (TP10)	pin 5	pin 10
H	L	1.4V	2.0V
L	H	0.8V	1.4V

8-95. A12 PLL SAMPLING CONTROLLER

8-96. In repetitive measurements (i.e., control settings are not changed), the PLL Sampling Controller stops the operation of all circuits except the Wave Shaper, Phase Detector and Loop Filter circuits. These three circuits continuously act to maintain the IF signal frequency at an accurate 100kHz by controlling the sampling frequency for the sampling IF converter. The U9 phase detector compares the frequency of the incoming IF signal (routed from the reference channel IF amplifier circuit on A16 board) with the 100kHz of the reference frequency signal supplied from the A3 board (originated by the A18 clock generator). The LPF and the U8 wave shaper eliminates fluctuation and noise from the IF signal to be input to the phase detector. The U10 integrator converts the phase detector output into the V_T tuning control voltage (dc) proportional to the average level of the pulse output. The V_T voltage is always locked at such a level as to produce the sampling frequency required to generate the IF signal frequency equal to the 100kHz reference signal.

When the measurement frequency setting is changed, the Frequency Detector, Lock-in Detector, Search Control, Search Generator and ALC disable circuits are operated to quickly restore the normal IF signal frequency. An outline of the circuit operating sequence in this transient control period follows:

Figure 8-52 shows the timing diagram of the signals related to this discussion. The microprocessor transfers the LOCK ENABLE signal to the U3B flip flop via the A13 board just after the measurement frequency setting is changed. The U3B is cleared at the leading edge (\nearrow) of the LOCK ENABLE signal, generating a pulse to reset the U5A Lock-in Detector and the U2B Search Control. The $\overline{F_D}$ control line (at TP3) goes HIGH and, concurrently, the SH STOP signal (at TP8) goes LOW. This enables the Search Generator circuit to sweep the V_T voltage. First, Q2 applies a positive current to the input of the U10 integrator. The integrator produces a negative going ramp instead of a tuning control voltage. The integrator output turns to a positive going ramp at -20V. At this moment, the U2B, U3B and U5A flip flops are set to their initial states. The sampling frequency is then swept from the highest frequency towards a lower frequency in response to the positive going ramp of the integrator. When the frequency of the IF signal (approaching 100 kHz) falls below the detection frequency of the frequency detector (about 150kHz), the U3A flip flop pulls down

the $\overline{F_D}$ signal at TP3 to LOW. The U2B flip flop outputs a 50ms pulse signal synchronized with the trailing edge of the $\overline{F_D}$ control signal (delayed more than 4ms after the positive going ramp starts). Simultaneously, the SH STOP signal at TP8 goes HIGH causing the Search Generator to stop the positive going ramp.

To stop the frequency sweep at the proper IF frequency near 100kHz, the ALC LEVEL monitor signal, in addition to the $\overline{F_D}$ frequency detector output signal, actuate the Search Generator. When the IF signal frequency comes into the pass band of the low pass IF filter on the A16 board, the ALC LEVEL monitor signal goes HIGH. The U5A Lock-in Detector outputs the LOCK signal causing the SH STOP signal to go HIGH (this stops the Search Generator). If the ALC LEVEL signal does not go HIGH within 50ms of the U2B output pulse period, the SH STOP signal returns to LOW and the Search Generator successively generates the ramp (restarts frequency sweep).

After the Search Generator stops the ramp output, the V_T tuning control voltage is precisely controlled by the U9 Phase Detector to bring the IF signal frequency to an accurate 100kHz. The Phase Detector continues monitoring the 100kHz IF signal frequency until the measurement signal frequency is changed. The output of U7A represents the polarity of the search generator ramp output (HIGH: positive going ramp, LOW: negative going ramp). The U1 one shot Multivibrator is triggered by the U7A output when the polarity of the ramp changes from negative to positive. The output of U1 is a 4ms single shot pulse. During this pulse period, U2B is reset and the sampling frequency sweep operation does not stop even if the $\overline{F_D}$ signal goes LOW.

The ALC DISABLE circuit pulls up the ALC voltage (output from the A16 board) when the sampling frequency is being swept. This decreases the amplitude of the IF signal as well as that of the measurement signal, and prevents the sampling controller from receiving the 100kHz harmonic component of a lower IF signal (for instance, the second harmonic of a 50kHz IF signal).

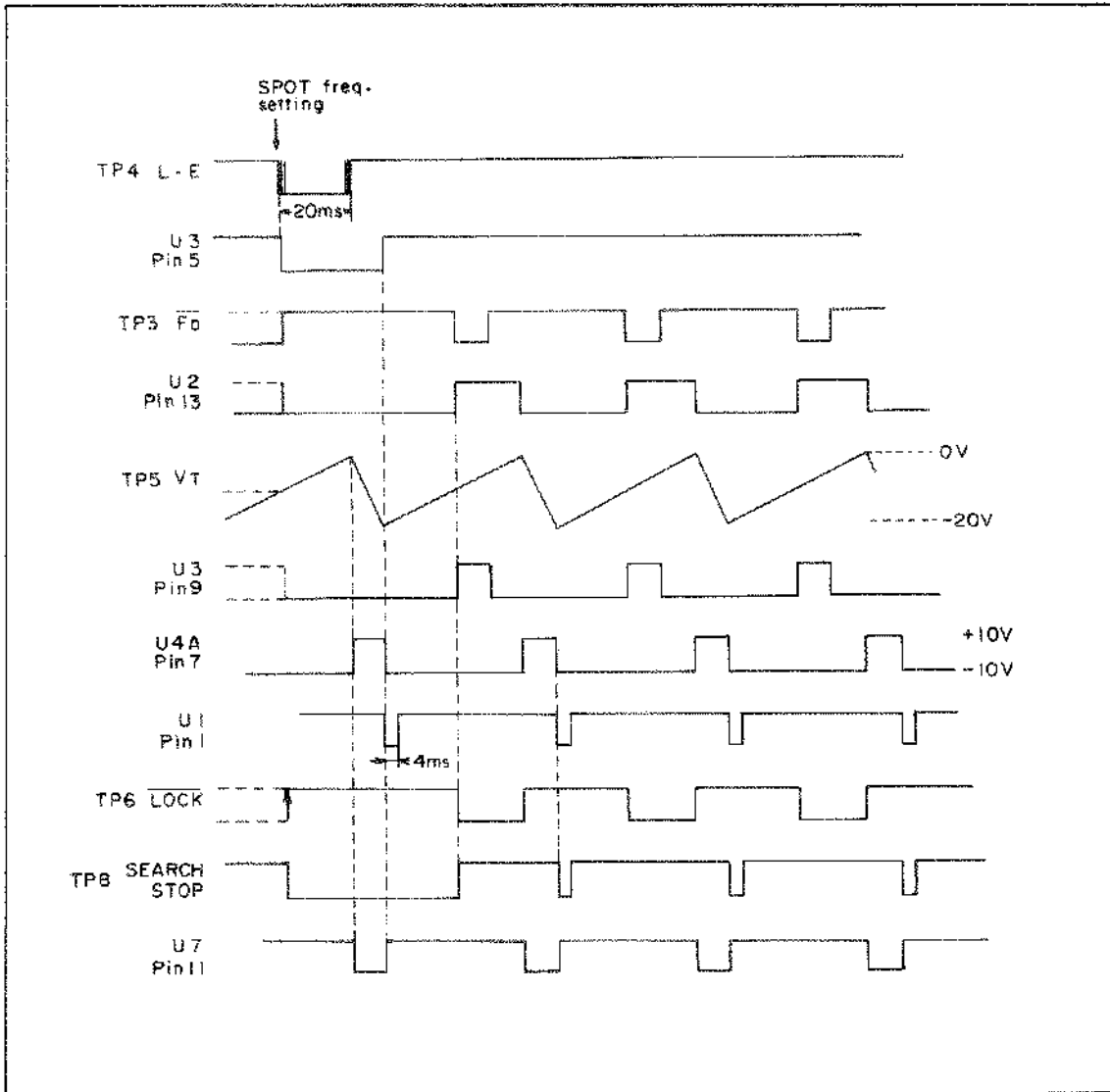

Figure 8-52. Sampling Controller Timing Diagram.

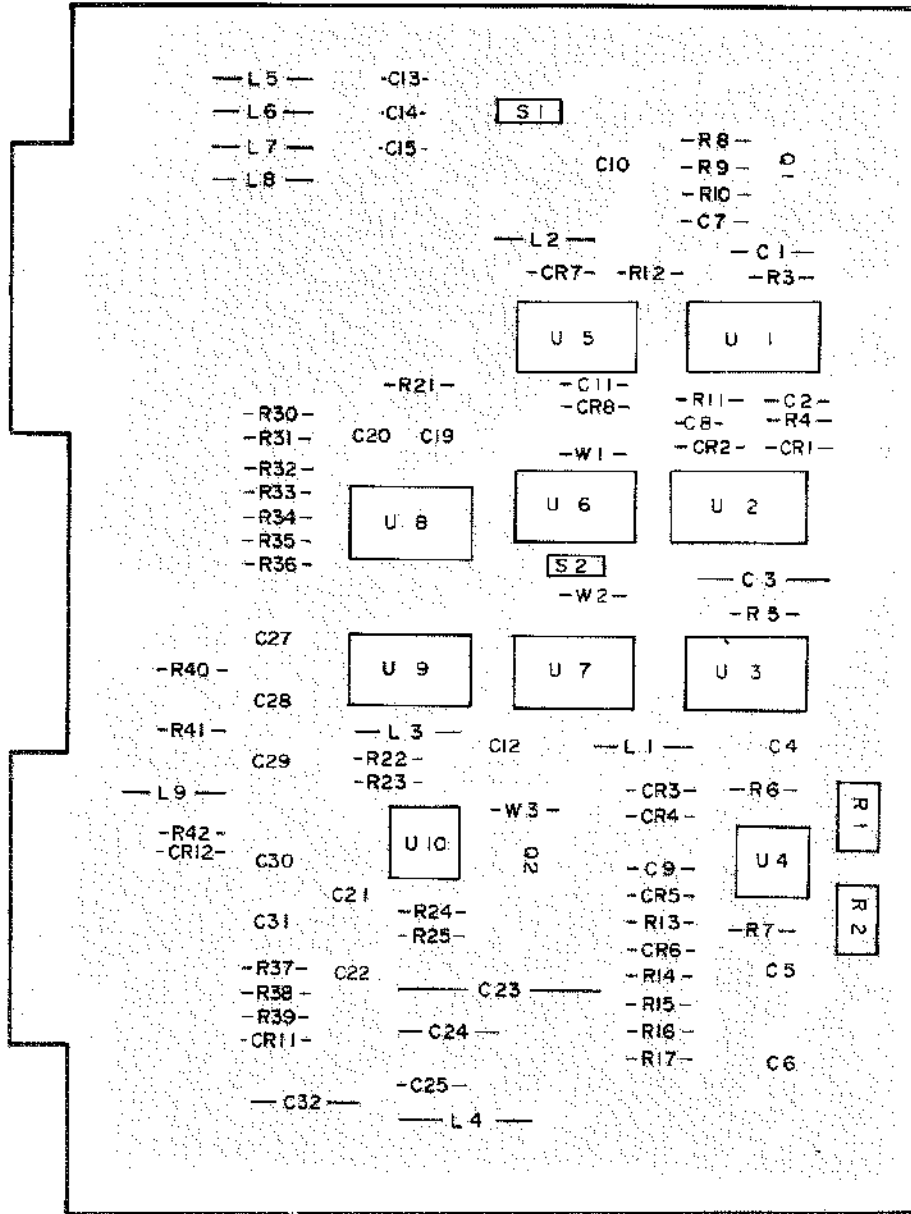

Figure 8-53. A12 PLL Sampling Controller Board Assembly Component Locations.

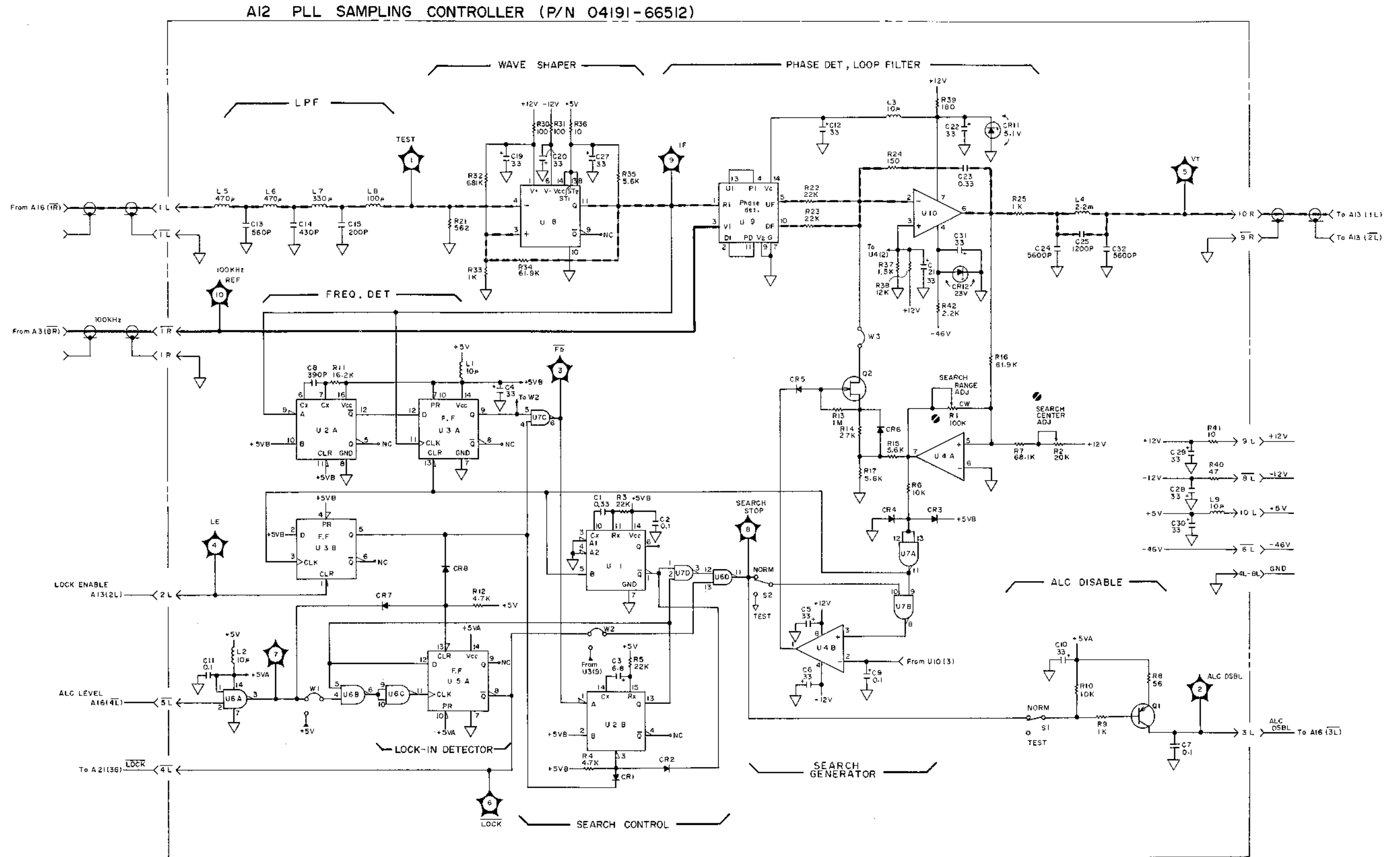

Figure 8-54. A12 PLL Sampling Controller Board Assembly Schematic Diagram.

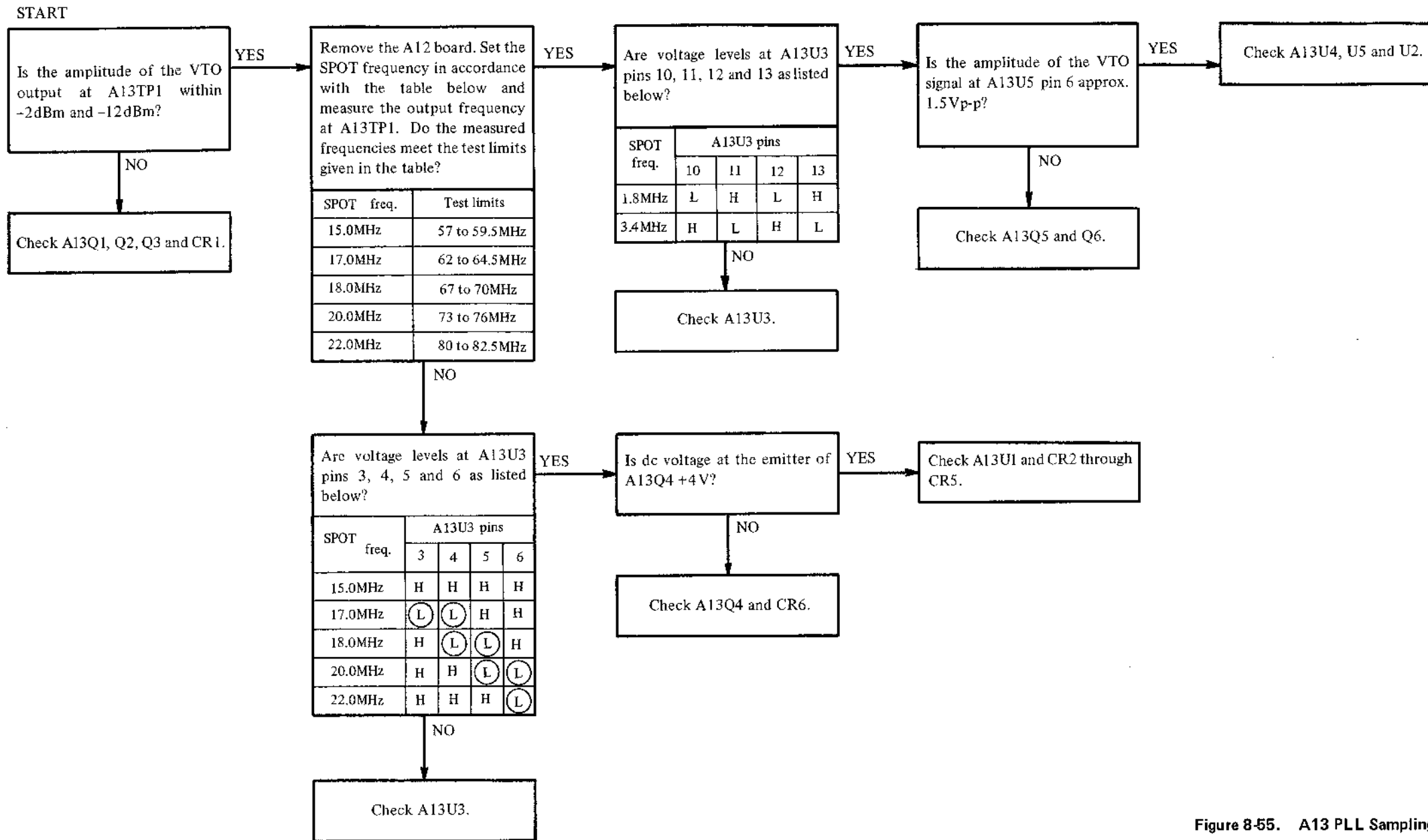

Figure 8-55. A13 PLL Sampling Frequency VTO Board Troubleshooting Flow Diagram.



A13 PLL SAMPLING FREQUENCY VTO CIRCUIT OPERATING TEST

Circuit operation of the A13 PLL Sampling Frequency VTO is checked using the procedure outlined below:

Setup: Set switch A21S2 as shown below:

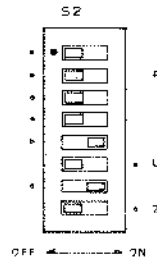

Remove the A12 board.

1. Remove the A13 board and reinstall with an extender board. Connect a frequency counter to A13PI. Apply a dc voltage of -20V (±0.1V) to A13 (1L) from an external dc power supply. Verify that the frequency counter readout meets the test limits given in the table below when the SPOT frequency is set in accordance with the table. Also check the frequency with no dc voltage applied to A13 (1L) (set dc power supply output to zero) and verify that the test limits listed in the table are satisfied.

SPOT frequency	DC voltage at A13 (1L)	Test limits
15.0MHz	-20V	≥ 8.17MHz
17.0MHz		≥ 8.86MHz
18.0MHz		≥ 9.61MHz
20.0MHz		≥ 10.42MHz
22.0MHz		≥ 11.51MHz
7.2MHz		7.667MHz to 7.70MHz
4.2MHz	4.60 MHz to 4.62MHz	
2.3MHz	2.556MHz to 2.567MHz	
15.0MHz	0V	≤ 7.43MHz
17.0MHz		≤ 8.04MHz
18.0MHz		≤ 8.72MHz
20.0MHz		≤ 9.47MHz
22.0MHz		≤ 10.27MHz

2. If it is necessary to test circuit operation of the frequency divider (U2 and U3), apply a dc voltage of $-18.9\text{V} \pm 0.1\text{V}$ to A13 (1L) and set the SPOT frequency in accordance with the table below. The frequency counter (connected to A13P1) should read the frequencies within the test limits given in the table.

SPOT frequency	Division fraction	Test limits	
1.3MHz	60	1.508MHz	to 1.510MHz
1.5MHz	56	1.614MHz	to 1.618MHz
1.6MHz	52	1.738MHz	to 1.742MHz
1.7MHz	48	1.883MHz	to 1.888MHz
1.8MHz	44	2.055MHz	to 2.059MHz
2.0MHz	40	2.260MHz	to 2.265MHz
2.3MHz	36	2.511MHz	to 2.517MHz
2.5MHz	32	2.825MHz	to 2.831MHz
2.9MHz	28	3.229MHz	to 3.236MHz
3.4MHz	24	3.767MHz	to 3.775MHz
4.2MHz	20	4.520MHz	to 4.530MHz
5.2MHz	16	5.650MHz	to 5.663MHz
7.2MHz	12	7.533MHz	to 7.550MHz
11.0MHz	8	11.300MHz	to 11.325MHz

If a measured frequency is outside the test limits, first check the VTO frequency at A13TP1 (should be within 90.45 and 90.60MHz).

3. Connect a spectrum analyzer to A13P1. Slowly change the dc voltage applied to A13 (1L) from -20V to 0V . Verify that no abnormal spectrum display due to parasitic oscillation appears on the CRT at any VTO frequency.

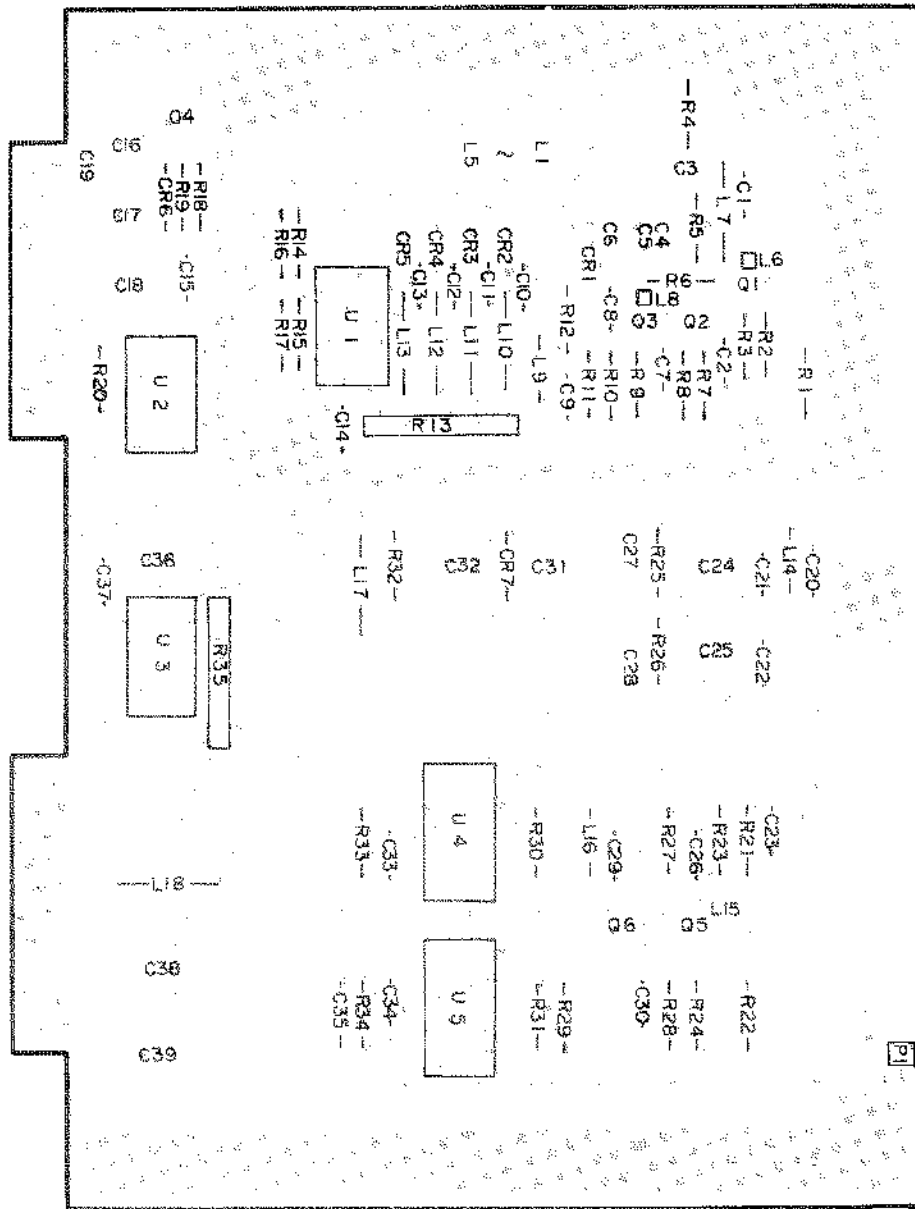

Figure 8-56. A13 PLL Sampling Frequency VTO Board Assembly Component Locations.

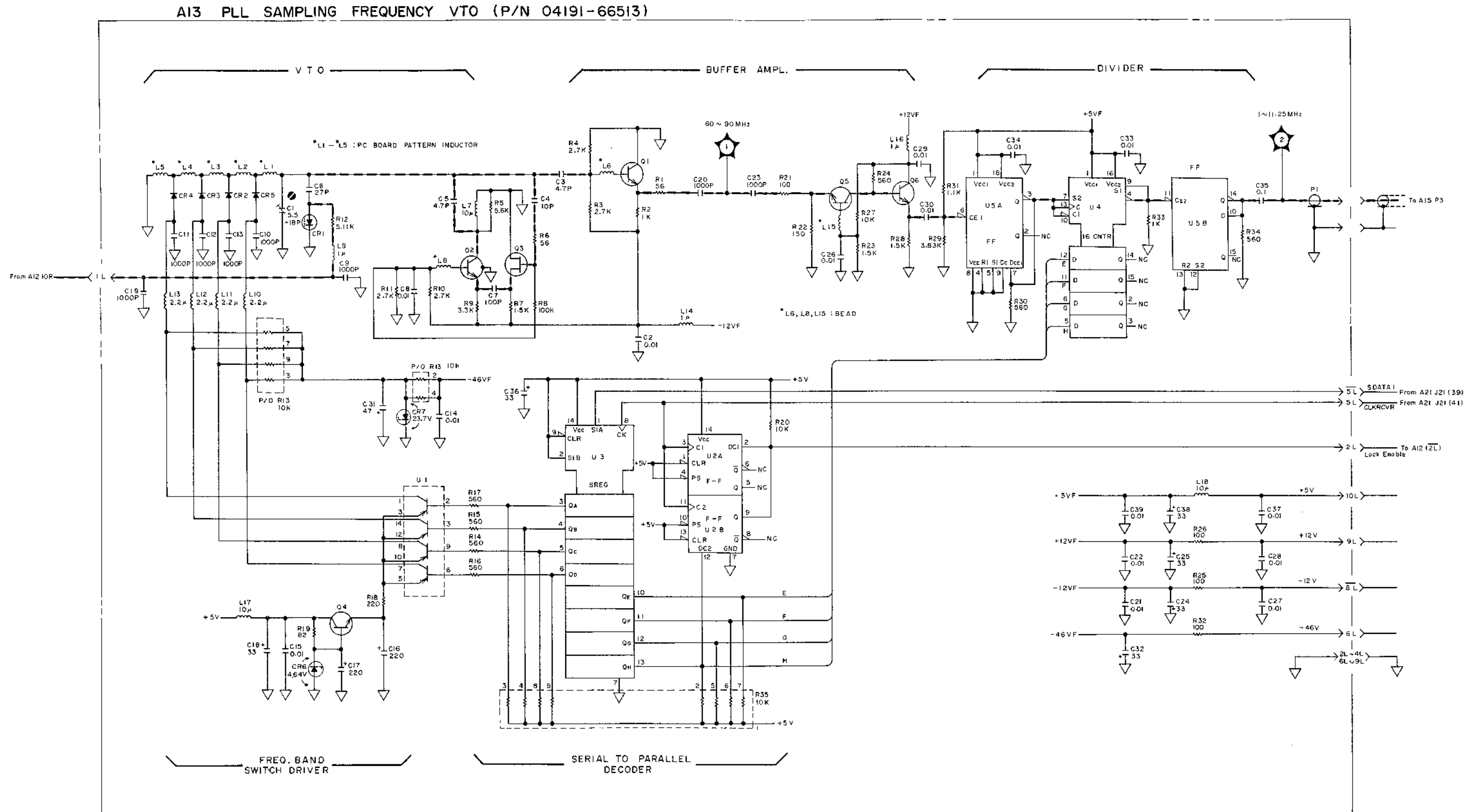

Figure 8-57. A13 PLL Sampling Frequency VTO Board Assembly Schematic Diagram.

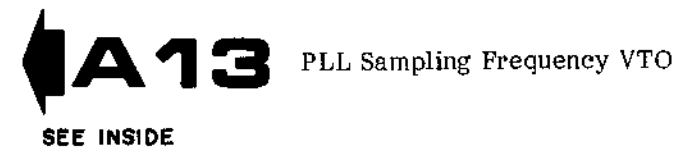
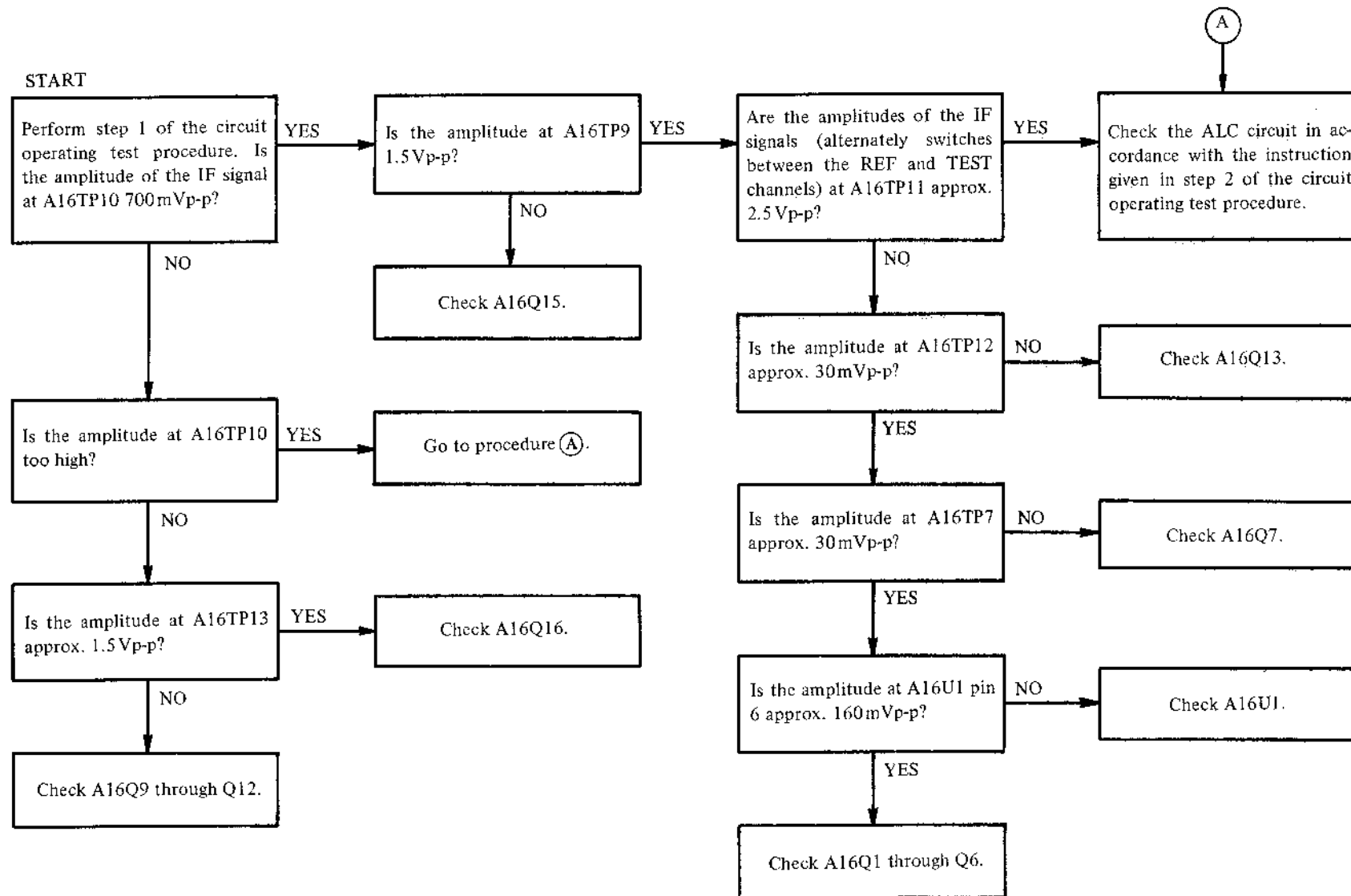
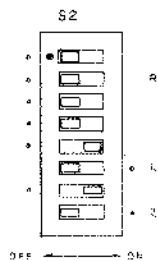

Figure 8-58. A16 IF Amp. and Process Amplifier Board Troubleshooting Flow Diagram.

A16 IF AMP./PROCESS AMPLIFIER CIRCUIT OPERATING TEST

Circuit operation of the A16 IF Amp/Process Amplifier is checked using the procedure outlined below:

Setup: Set switch A21S2 as shown below:



Set the SPOT frequency to 10MHz. Connect nothing to the UNKNOWN connector.

1. Connect an oscilloscope to the test points listed in the table below and observe the amplitude of the 100kHz intermediate frequency signal at each test point.

Test point	Typical amplitude
A16TP9	1.5Vp-p
A16TP10	700mVp-p
A16TP11	*2.5Vp-p

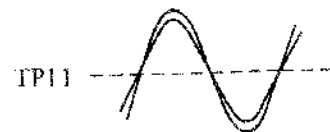

**Note: The test channel and reference channel IF signals with similar amplitudes overlap on the CRT.*

If no output is present at TP9, the $\times 10$ amplifier (Q9 through Q12) or the buffer amplifier Q15 is faulty. In this case, the frequency of the IF signal at TP1 (and the other test points) will not be locked to the normal 100kHz frequency because the search generator function on the A12 board causes the sampling frequency to sweep repeatedly until the normal IF signal is restored.

Note: Typical IF signal voltages at the other test points and circuits are listed in the table below:

Test point	Typical voltage
TP1	150mVp-p
TP5	30mVp-p
TP7	30mVp-p
TP12	30mVp-p
TP13	1.5Vp-p
Q16 Base	700mVp-p
U1 pin 6	160mVp-p
U4 pin 3	100mVp-p

2. Measure the ALC voltage (dc) at A16TP3 with a DMM. The ALC voltage varies with the level control of the measurement frequency signal, and typical voltage is about 4V. If the measured voltage is always about 0V or 12V (at any SPOT frequency setting), the ALC circuit is faulty.

Note: Typically, the voltage at A16TP2 is -0.4V when the IF signal voltage is 700mVp-p at A16TP10.

8-97. A16 IF AMP./PROCESS AMPLIFIER

8-98. The test channel and reference channel sampler IF outputs are sequentially selected at the input stage of the two stage IF amplifier (U1 and U4). Selection of the IF signals is performed in accordance with the timing required to accomplish the vector measurement in the A17 Phase Detector/A-D Converter. Signal Selector (Q1 through Q6) feeds either of the two channel IF input signals to the IF amplifier as directed by the SREF signal from the digital control section. The timing of the SREF signal is shown in Figure 8-63.

The low pass filter between U1 and U4 filters out the undesired harmonics and the sampling pulse noise included in the IF signal. The reference channel IF signal provides the following three outputs in addition to the reference vector measurement signal:

- 1) IF signal output to the A17 board: The IF signal is filtered by an LPF and is sent from Q16 to the A17 board to produce the detection phase signals for the phase detector.
- 2) IF signal output to the A12 board: The IF signal output from Q15 is sent to the A12 board of the PLL sampling frequency control loop circuit. The difference in the frequency of the IF signal from 100kHz is detected by the A12 board to control the sampling frequency.
- 3) ALC output: The ALC voltage is proportional to the amplitude of the IF signal detected by the ALC circuit which consists of the U3 full wave rectifier and the U2B level comparator. The IF monitor signal is taken from the input of Q16 via the U2A buffer amplifier. The U3A and U3B rectifier circuit produces a negative dc voltage proportional to the amplitude of the IF signal. The U2B level comparator compares the dc voltage of the rectifier output with an adjustable, reference voltage and develops the appropriate ALC voltage. The LEVEL output at TP14 signals that the IF frequency has come into the pass band of the LPF when the sampling frequency is swept.

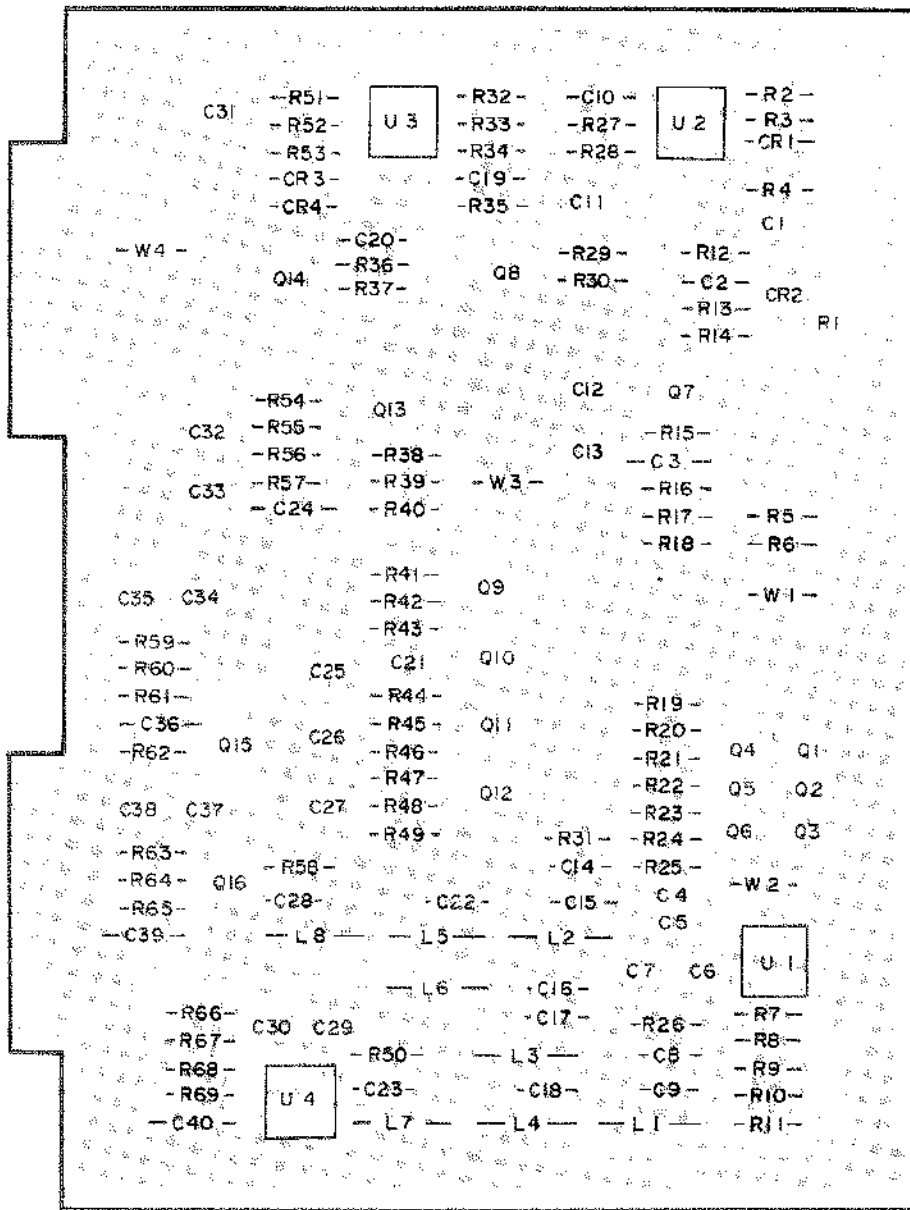

Figure 8-59. A16 IF Amp./Process Amplifier Board Assembly Component Locations.

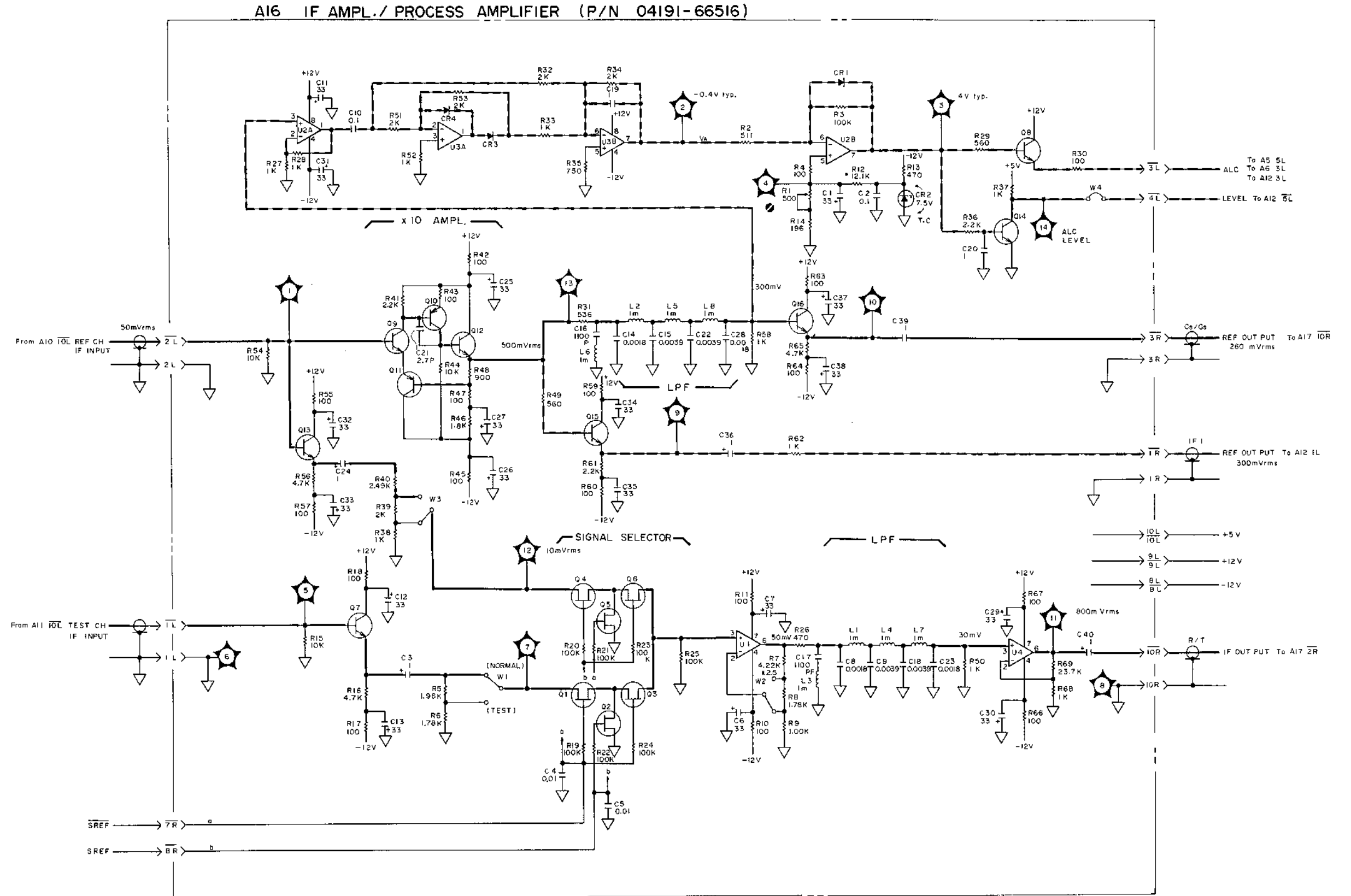

Figure 8-60. A16 IF Amp./Process Amplifier Board Assembly Schematic Diagram.

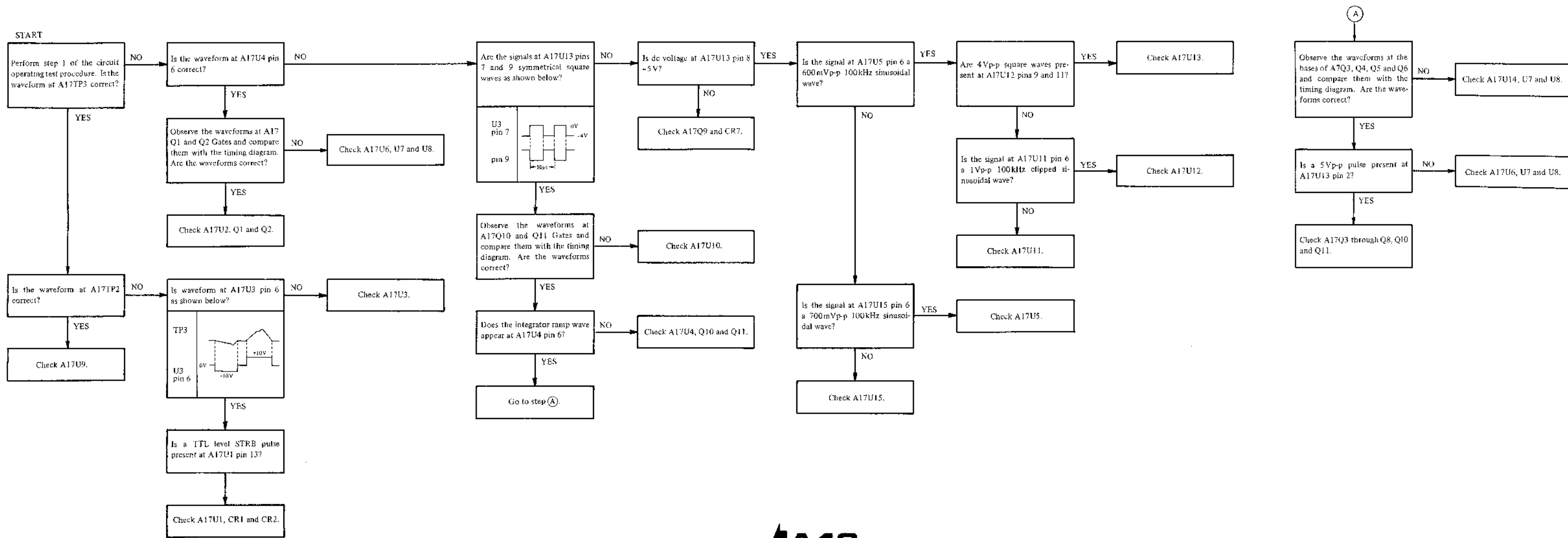

Figure 8-61. A17 Phase Detector/A-D Converter Board Troubleshooting Flow Diagram.



A17 PHASE DETECTOR/A-D CONVERTER CIRCUIT OPERATING TEST

Circuit operation of the A17 phase detector/A-D converter is checked using the procedure outlined below:

Setup: Set the switch A21S2 as shown below:

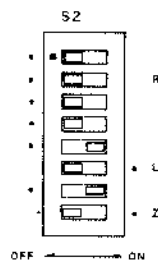

Connect nothing to the UNKNOWN connector.

1. Observe the waveforms at A17TP3 and $\overline{(4L)}$ with a dual trace oscilloscope. The waveforms on the CRT should be as shown below:

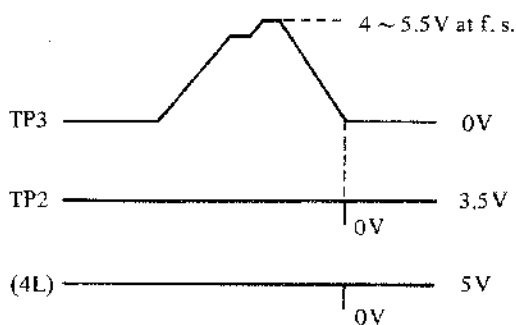

Verify that the amplitude of the maximum triangular wave (among four sequential waves developed in one measurement) is between 4.0V and 5.5V.

If the waveform at TP3 is not normal, observe the waveform at U4 pin 6. The waveform on the CRT should be as shown below:

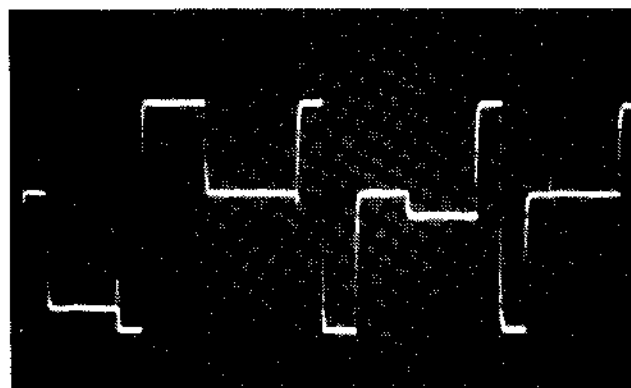

20ms/div.
0.5V/div.

8-99. A17 PHASE DETECTOR/A-D CONVERTER

8-100. The A17 board is divided into two circuit sections: The Detection Phase Generator and the Vector Ratio Detector (VRD). The circuit operating theory of each section is described in the following paragraphs.

8-101. VRD Section

The test channel and reference channel IF vector signals are, in turn, fed from the A16 board to the Phase Detector in accordance with the programmed control sequence. Figure 8-63 is the timing diagram of the vector ratio detection. The SREF signal selects the reference channel IF signal when it is HIGH and the test channel when it is LOW (selection of the IF signals is performed in the A16 board). The Q7 and Q8 Phase Detector, driven by two detection phase signals which are 180° out of phase, separates the orthogonal phase components from the vector IF signal. The S_C ($\overline{S_C}$) and 180° phase selection signals determine the detection phase as follows:

Phase Selection Signals			Detection Phase
S_C ($\overline{S_C}$)	S_G ($\overline{S_G}$)	180°	
5V	-12V	0V	180°
		-5V	0°
-12V	5V	0V	-90°
		-5V	90°

The U4 integrator outputs a dc voltage proportional to the magnitude of the detected vector component to the integrating A-D converter (U2 and U3). The A-D converter translates the ratio of two vector components into an equivalent ratio of the time periods using a dual-slope integration technique (popular in digital voltmeters). The U2 Integrator performs charge and discharge with the phase detector output voltages four times per measurement, as shown in the timing diagram. To eliminate the effects of the dc offset voltages on the Phase Detector and the Integrator from the measurement results, an offset measurement is performed before the three vector ratio measurement periods. During the offset measurement period, the SOFM control signal turns the Q11 FET switch off and Q10 on to block the IF input signal. The U2 Integrator charges with the dc offset voltages of the phase detector output and the integrator itself, and then discharges with the 0° component of the reference channel IF signal; e_{ref} (0°). Thereby, the ratio of the magnitude of the offset voltage to e_{ref} (0°) is measured. During the charge period of a vector ratio measurement, the Q2 input switch is closed for a constant 10ms period

and the U2 Integrator develops a positive or negative going ramp with a vector component voltage. A short hold time is provided before beginning the charge period and before beginning the discharge period. During the hold time, the CHRG signal opens the Q2 integrator input switch to intercept any transient response signals incident to switching of measurement vector signal (phase detector output). A short precharge, made by the $*e_{ref}$ (0°) voltage before going into the discharge period, improves the accuracy of the A-D conversion when input signal is of extremely low level. The Integrator discharges at a constant ramp rate with the $*e_{ref}$ (0°) component voltage until the ramp voltage reaches zero volts.

**Note: When a negative going ramp is developed in the charge period, e_{ref} (180°) signal is used instead of the e_{ref} (0°) signal to achieve a dual slope integration in the negative domain.*

The U1 Zero Detector reverses output logic the moment the integrator output crosses the zero level. This signals completion of the discharge to the digital control section. The STRB (Strobe) control signal enables the Zero Detector only during the discharge ramp period and eliminates the possibility of detecting noise incident in the control of the integrator switches. The U3 Slope Amplifier combined with the integrator magnifies the integrator output waveform to facilitate detection of crossing the zero level point with minimum time error. The Q1 feedback loop switch closes to keep the integrator discharged except when dual slope integration is being performed.

8-102. Detection Phase Generator Section

The detection phase, which is in-phase or 90° out of phase with the reference channel IF input signal, originates in the C_S/G_S circuit. A simplified circuit diagram of the C_S/G_S circuit is shown in Figure 8-62. The 90° control signal sent from the digital control section determines the states of the S_C , $\overline{S_C}$, S_G and $\overline{S_G}$ signals which control the phase selection switches (Q3 through Q6) of the C_S/G_S circuit. When the 90° control signal is HIGH, the S_C and $\overline{S_G}$ signals go to -12V causing the Q4 and Q6 switches to turn on (Q3 and Q5 are off). The IF input signal flows through the C_S circuit (C14) and the output of the U5 I-V converter amplifier is 90° out of phase with the input of the C_S/G_S circuit (Actually, as the U5 amplifier inverts the phase, the phase is shifted by -90°). Conversely, when the 90° control signal is LOW, the S_G and $\overline{S_C}$ signals turn the Q5 and Q3 switches on (Q4 and Q6 are off). Then, the IF signal flows through the G_S circuit (R11 and R10) maintaining the same phase

as that at the input of the C_S/G_S circuit. The C12 phase adjustment capacitor permits adjustment of the difference in phase between the C_S and G_S circuit signals for an accurate 90° .

To cause the Q7 and Q8 phase detector switches to turn on and off with high speed and accurate timing, the detection phase signal is transformed into a square wave by the U11 Wave Shaper and the U12 dual comparator. The dual comparator simultaneously produces two detection phase signals that are 180° out of phase with each other. The U13 Phase Selector switch can reverse the detection phase signals transferred to the Phase Detector with each other. The 180° control signal actuates the U13 Phase Selector to control the polarity of the phase detector output. Thus, four detection phases (90° , 0° , -90° and 180°) can be used to achieve the vector ratio measurement for any vector measurement signals.

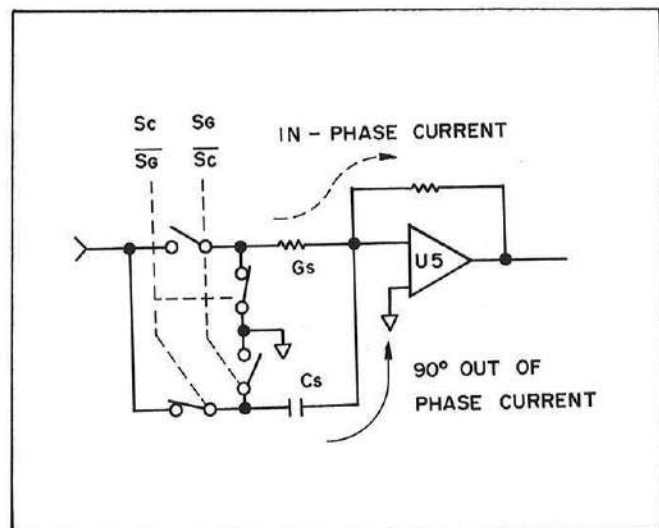

Figure 8-62. C_S/G_S Circuit Simplified Circuit Diagram.

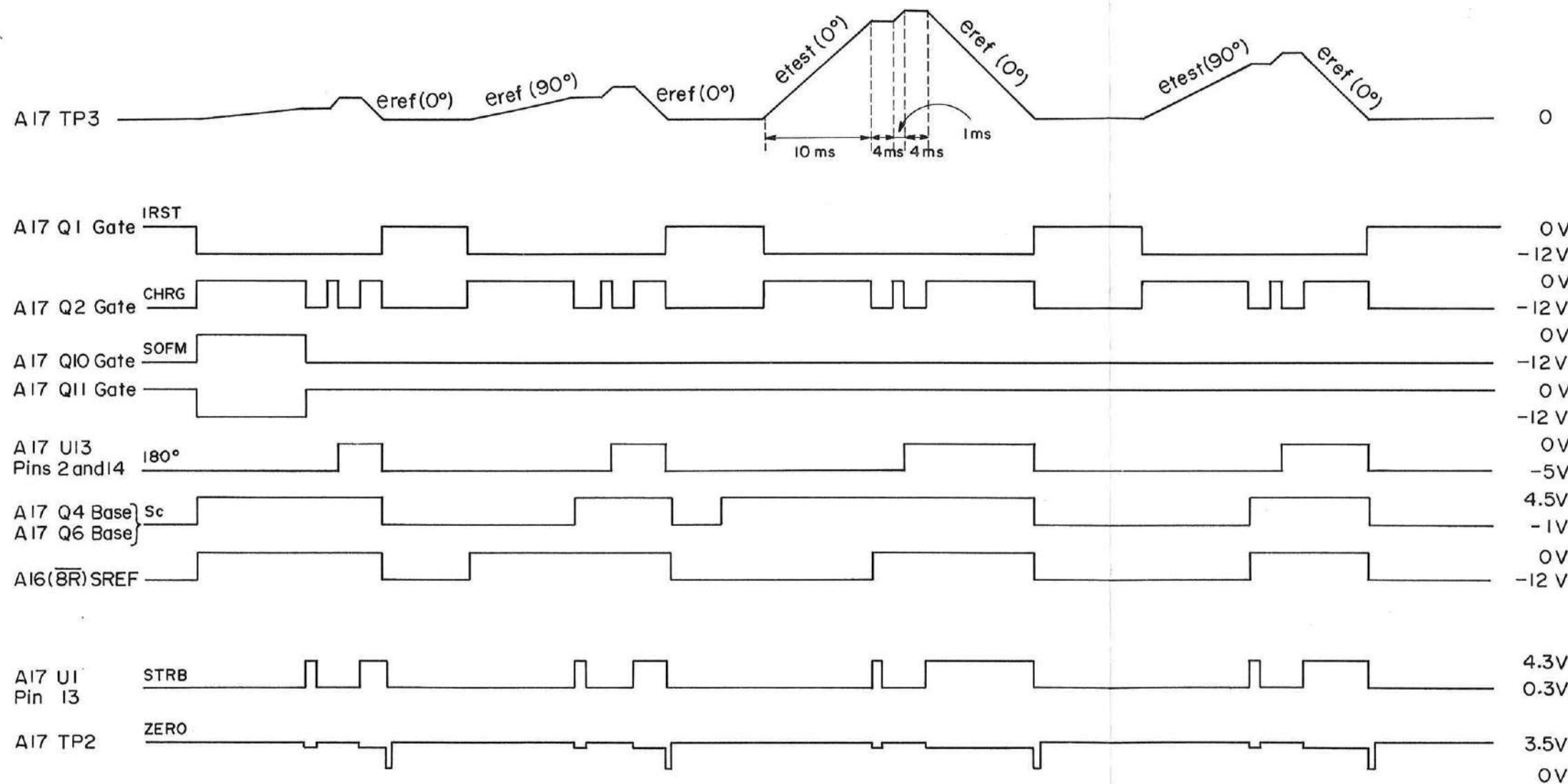

Figure 8-63. Vector Ratio Detection Timing Diagram.

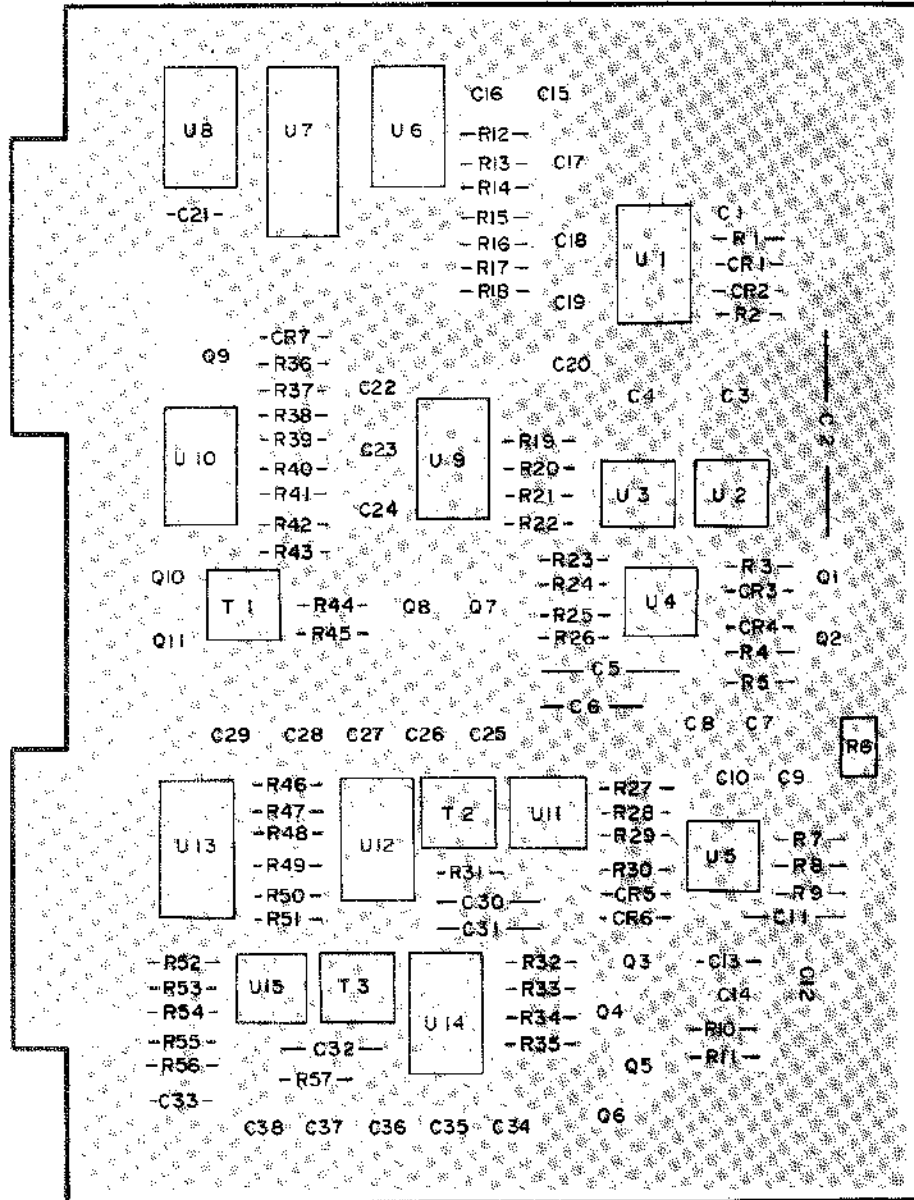

Figure 8-64. A17 Phase Detector/A-D Converter Board Assembly Component Locations.

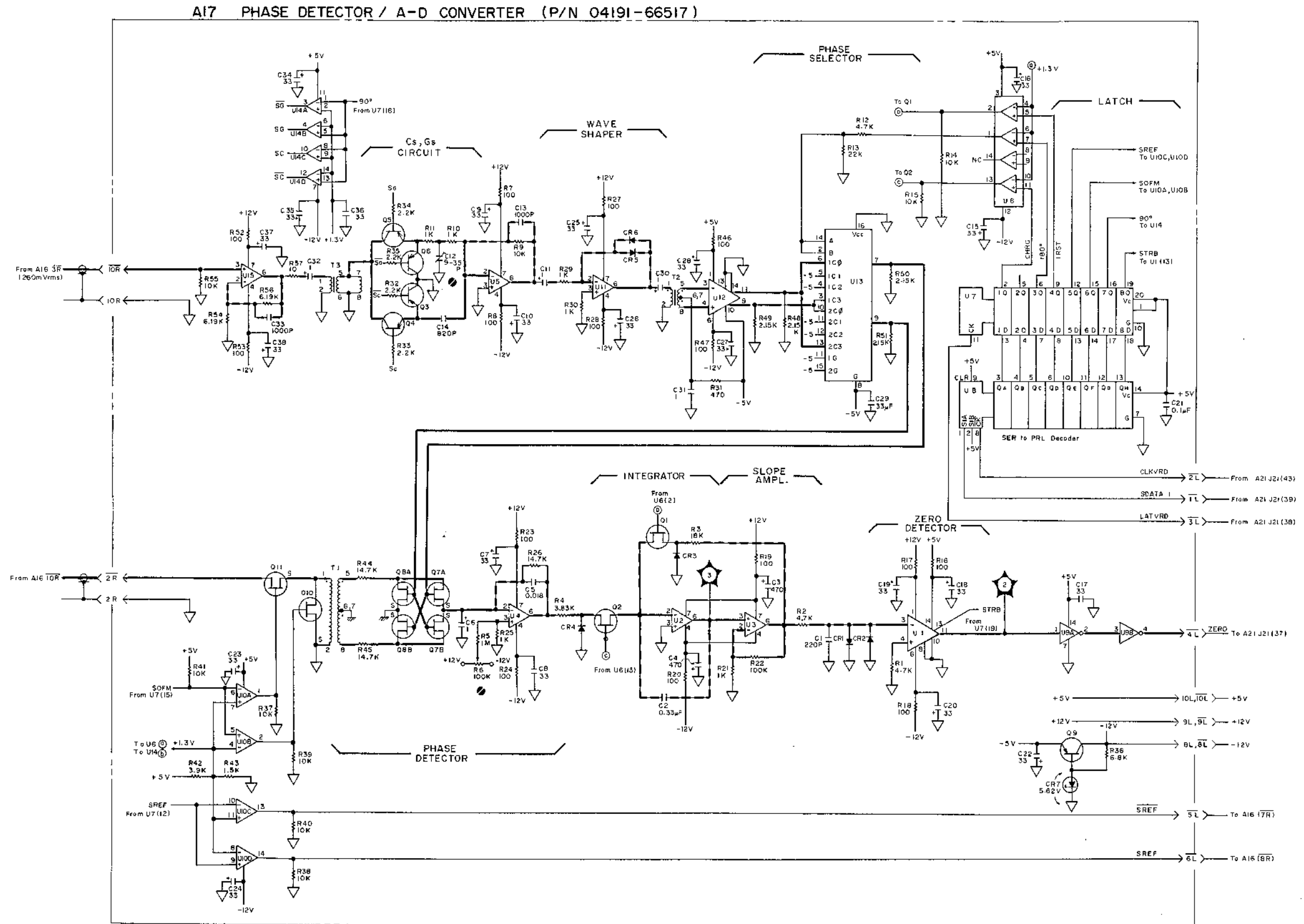
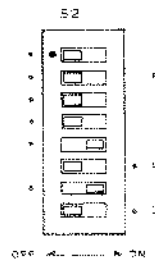

Figure 8-65. A17 Phase Detector/A-D Converter Board Assembly Schematic Diagram.

A18 CLOCK GENERATOR/DOUBLER CIRCUIT OPERATING TEST

Circuit operation of the A18 Clock Generator and Doubler is checked using the procedure outlined below:

Setup: Set switch A21S2 as shown below:



1. Set the SPOT frequency to 10.0MHz. Connect a spectrum analyzer to A18P2. Observe the fundamental spectrum level and approximate frequency of the 100MHz clock signal on the CRT. Verify that no abnormal spectrum display, due to parasitic oscillation appears. Next, connect the spectrum analyzer to A18P1 to observe the 200MHz clock signal. Set the SPOT frequency to 1.0MHz. The spectrum display on the CRT should satisfy the test limits given in the table below:

Connector	Fundamental level	Frequency
P2	> -4dBm	100MHz
P1	> +5dBm	200MHz

2. Set the SPOT frequency to 100MHz and observe the signal level at A18P1. The 200MHz clock signal must be attenuated to a level lower than -45dBm.
3. Connect a frequency counter to A18P2. The frequency counter readout must be 100.0000MHz \pm 3 counts (in 100Hz resolution).

8-103. A18 100MHz CLOCK GENERATOR/DOUBLER

8-104. The A18 board generates accurate 100MHz and 200MHz clock signals which determine the frequency accuracy of the measurement signal developed in the synthesized signal source. The 100MHz signal originates from the U1A quartz oscillator. The Q1 grounded base amplifier supplies the 100MHz signal to the A3 board. To develop the 200MHz signal, the 100MHz oscillator signal is routed to the frequency doubler via the Q4

amplifier. The Q3 amplifier of the frequency doubler outputs a distorted signal involving the second harmonic of the 100MHz input. The band pass filter between the Q3 and Q4 amplifiers keeps the 200MHz frequency (the second harmonic) only and eliminates the other frequency components. At measurement frequencies above 32.1MHz, the 200MHz signal is not used, so the S200M control signal closes the U1D gate of the 200MHz disable circuit to stop the 200MHz output.

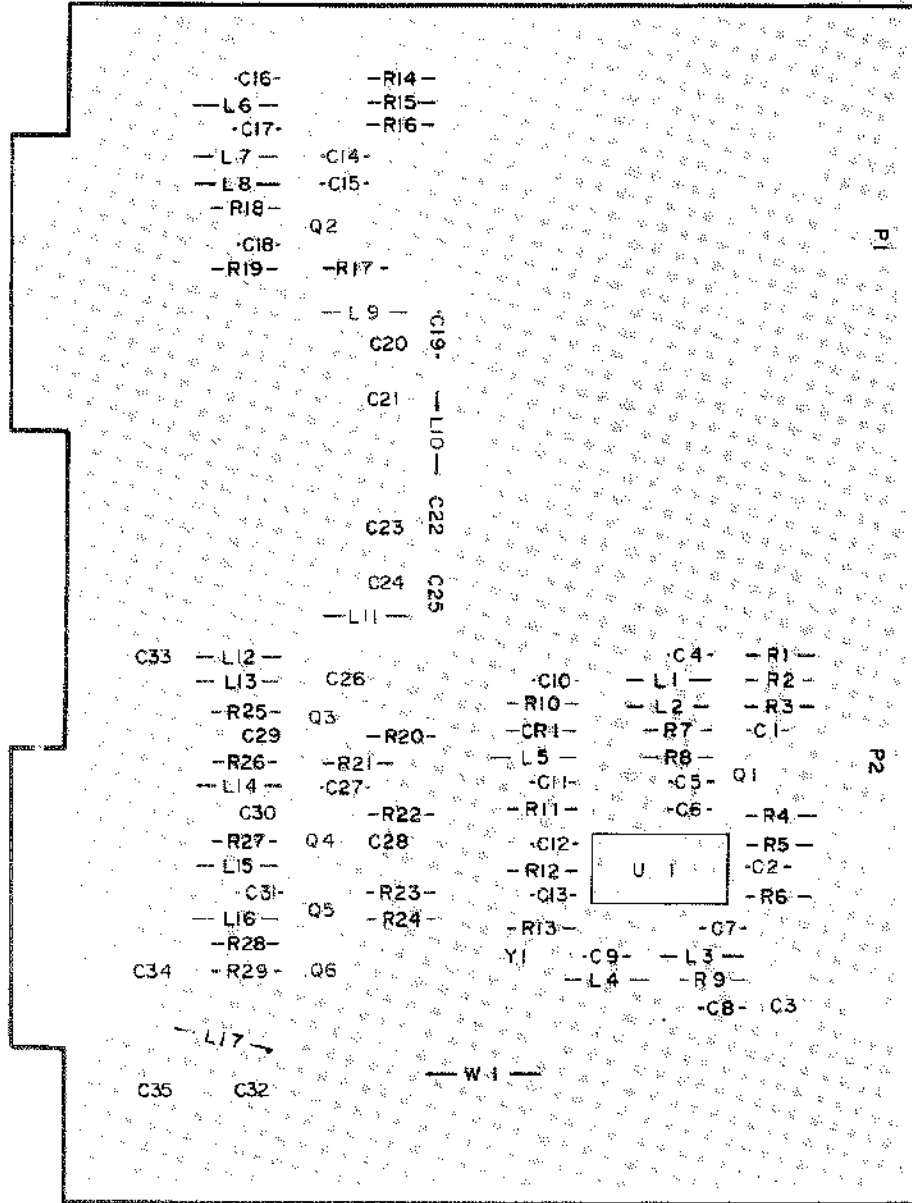

Figure 8-67. A18 100MHz Clock Generator/Doubler Board Assembly Component Locations.

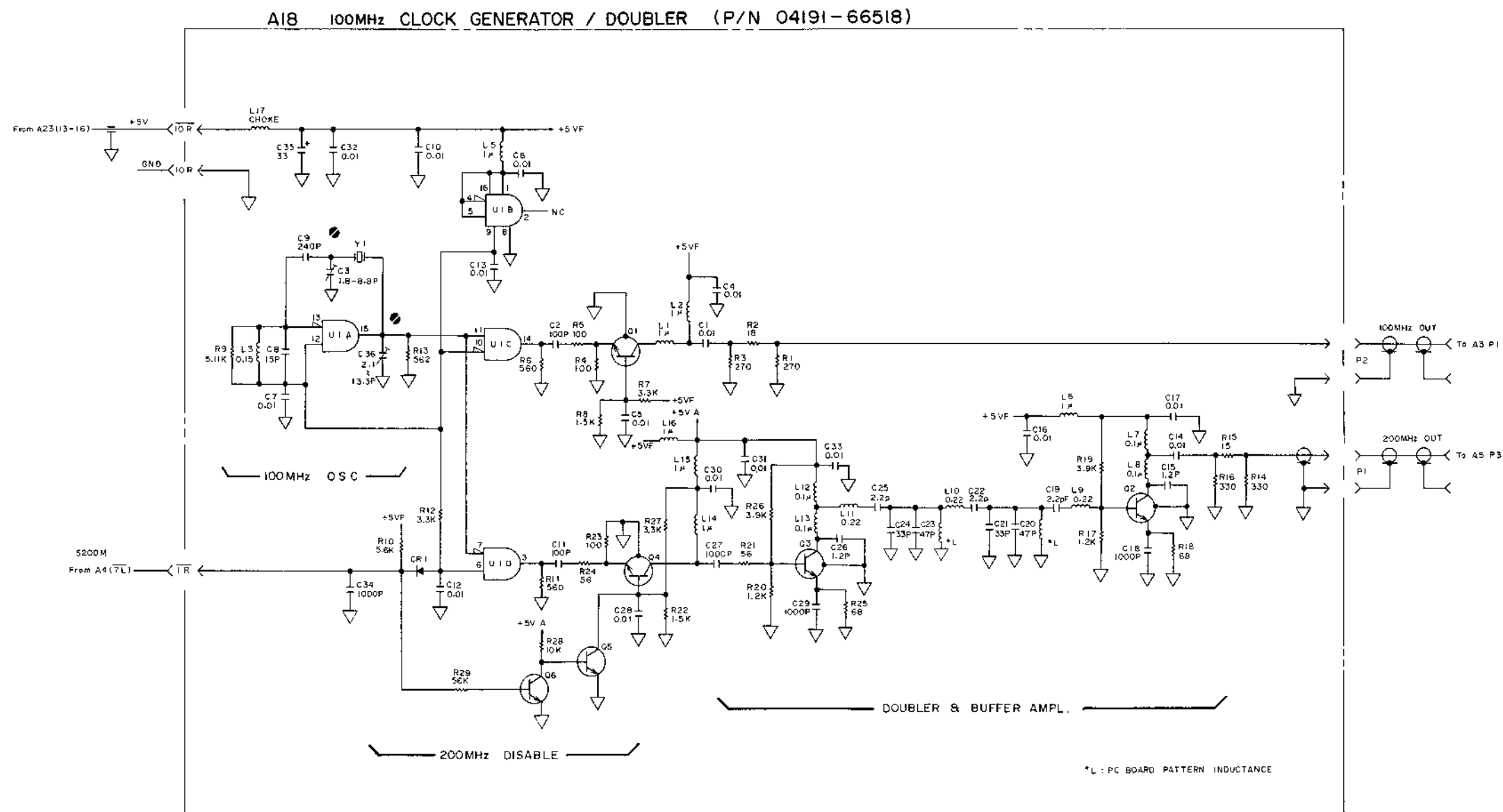
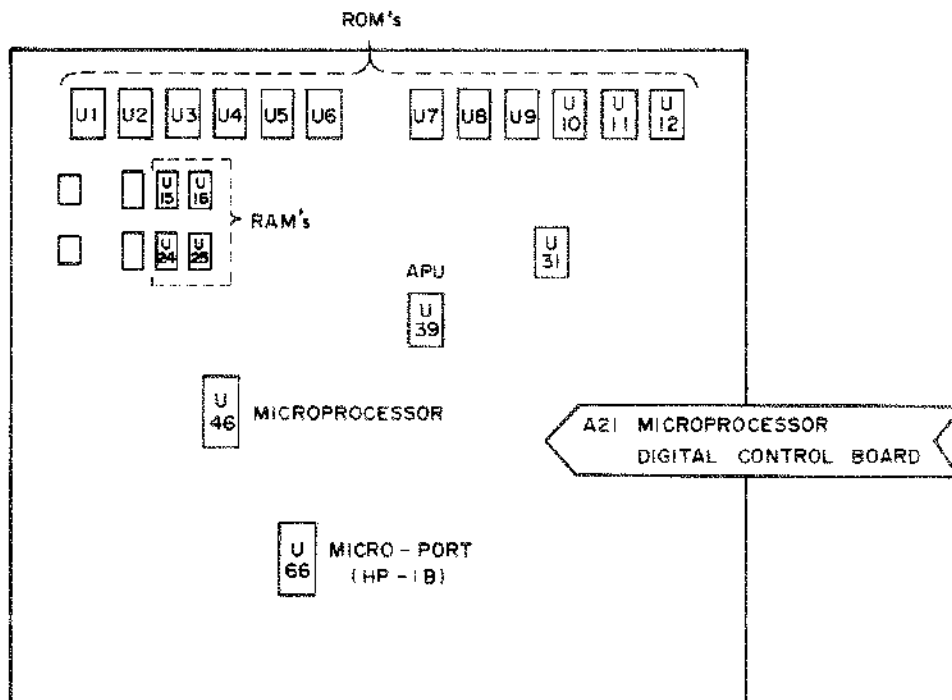

Figure 8-68. A18 100MHz Clock Generator/Doubler Board Assembly Schematic Diagram.

Table 8-5. Meanings of Self Test Error Messages.

Error message	Defective device
E-20	A21 U16 RAM
E-21	U25 RAM
E-22	U15 RAM
E-23	U24 RAM
E-31	U 1 ROM
E-32	U 2 ROM
E-33	U 3 ROM
E-34	U 4 ROM
E-35	U 5 ROM
E-36	U 6 ROM
E-37	U 7 ROM
E-38	U 8 ROM
E-39	U 9 ROM
E-40	U10 ROM
E-41	U11 ROM
E-50	U39 APU



TEST POINTS ON A20 (A21) BOARD.

TP No.	Label	Signal at test point
1	GND	
2	A15	Bit 15 of Address Bus signal (used for signature analyzer window setting).
3	$\overline{\text{WE}}$	Write Enable signal to store data into RAM's.
4	DBE	Data Bus Enable signal.
5	$\overline{\text{PON}}$	Power-on reset signal.
6	$\overline{\text{RST}}$	Reset signal.
7	GND	
8	GND	
9	$\overline{\text{NMI}}$	Non-Maskable Interrupt signal (used to start signature analysis test program).
10	$\overline{\text{IRQ}}$	Interrupt Request signal.
11	GND	
12	TST	Test signal (used for signature analysis test in microprocessor free running mode).
13	1M	1 MHz clock frequency signal
14	2M	2 MHz clock frequency signal
15	CLK ϕ 1	Microprocessor clock signal (ϕ 1)
16	VMA	Valid Memory Address output signal of the microprocessor.
17	WND	Window signal (for signature analyzer window setting).
18	RKEY	Read key signal to transfer the keyboard input data to the microprocessor.
19	LOCK	Lock signal transferred from the PLL Sampling Controller (A12).
20	ZERO	ZERO signal transferred from the Phase Detector/A-D Converter (A17).
21	$\overline{\text{PAUS}}$	PAUSE signal (Pause control of the clock generator by APU)
22	CLK ϕ 2	Microprocessor clock signal (ϕ 2)
23	R/ $\overline{\text{W}}$	Read/Write control signal to control data transfer to/from the microprocessor.
24	BA	Bus Available signal (controls Bus Drivers).
25	ϕ 2	ϕ 2 clock signal converted into a TTL signal.
26	10M	10MHz clock frequency signal.
27	GND	
28	+12V	+12V dc (APU operating power voltage).
29	GND	
30	+5V	+5V dc

A20 (A21) S2 TEST SWITCH FUNCTIONS

The A20 (A21) S2 switch facilitates adjustment of the analog measurement section and has the following functions:

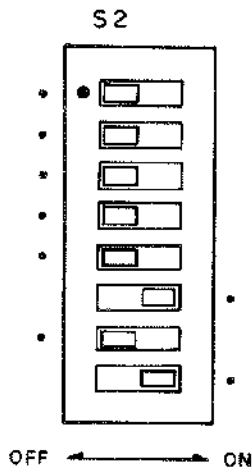

Switch	Function												
S2-1	Not used												
S2-2	Disables the RAM chips to be addressed. Test . . . ON Normal . . . OFF												
S2-3 S2-4	Not used												
S2-5 S2-6	Switches $\overline{\text{LOCK}}$ input signal as follows: <table border="1" style="margin: 10px auto;"> <thead> <tr> <th>S2-5</th> <th>S2-6</th> <th>Mode</th> <th>Input Signal</th> </tr> </thead> <tbody> <tr> <td>OFF</td> <td>ON</td> <td>NORMAL</td> <td>$\overline{\text{LOCK}}$ signal from A12</td> </tr> <tr> <td>ON</td> <td>OFF</td> <td>TEST</td> <td>(ground)</td> </tr> </tbody> </table> <p style="text-align: center;">CAUTION Do not set both S2-5 and S2-6 to the ON position.</p>	S2-5	S2-6	Mode	Input Signal	OFF	ON	NORMAL	$\overline{\text{LOCK}}$ signal from A12	ON	OFF	TEST	(ground)
S2-5	S2-6	Mode	Input Signal										
OFF	ON	NORMAL	$\overline{\text{LOCK}}$ signal from A12										
ON	OFF	TEST	(ground)										
S2-7 S2-8	Switches ZERO input signal as follows: <table border="1" style="margin: 10px auto;"> <thead> <tr> <th>S2-7</th> <th>S2-8</th> <th>Mode</th> <th>Input Signal</th> </tr> </thead> <tbody> <tr> <td>OFF</td> <td>ON</td> <td>NORMAL</td> <td>ZERO signal from A17</td> </tr> <tr> <td>ON</td> <td>OFF</td> <td>TEST</td> <td>1 ms counter output (A21)</td> </tr> </tbody> </table> <p style="text-align: center;">CAUTION Do not set both S2-7 and S2-6 to the ON position.</p>	S2-7	S2-8	Mode	Input Signal	OFF	ON	NORMAL	ZERO signal from A17	ON	OFF	TEST	1 ms counter output (A21)
S2-7	S2-8	Mode	Input Signal										
OFF	ON	NORMAL	ZERO signal from A17										
ON	OFF	TEST	1 ms counter output (A21)										

A20 (A21) S3 OPTION SELECTION SWITCH FUNCTIONS

The A20 (A21) S3 switch selects the control programs to enable the optional functions and/or special operating modes listed below:

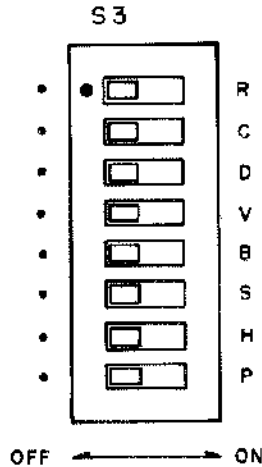

Switch	Function
S3-1	Enables Analog Recorder Output Option (Opt. 004). A21U10 ROM must be installed.
S3-2	Enables the desired open capacitance value to be entered from the DATA input keys. Refer to Para. 3-45.
S3-3	Enables the measurement values to be displayed without automatic error corrections.
S3-4 S3-5	Not used (set to OFF).
S3-6	Adapts the Analog Recorder Outputs to the requirements of the slow response recorders. This function is valid only when the INTRPL function is set.
S3-7	Enables High Resolution Test Frequency Option (Opt. 002).
S3-8	Not used (set to OFF).

Note: The A21S3 switch is also used to set the functions related to signature analysis.

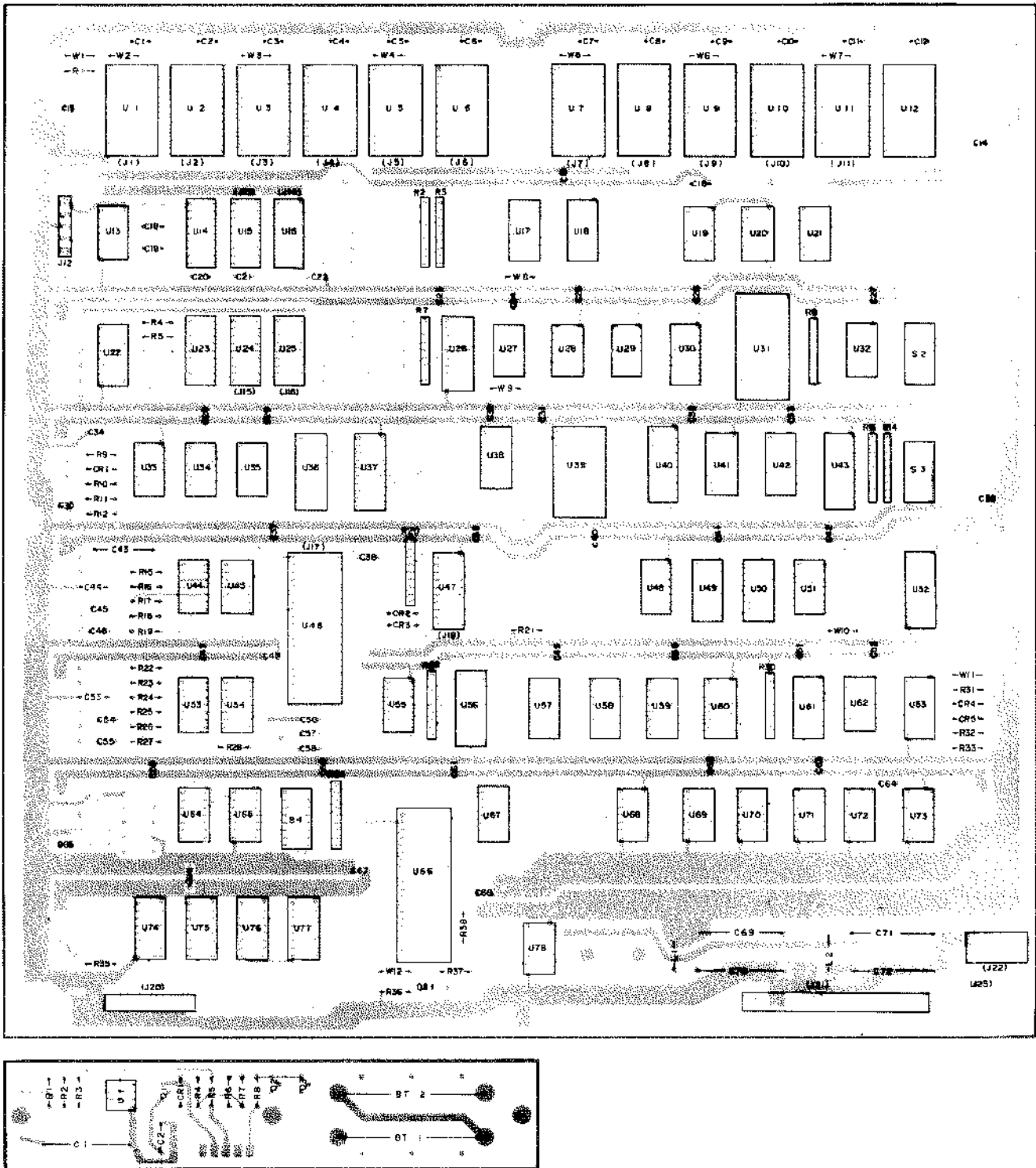

Figure 8-69. A20 (A21) Microprocessor Digital Control Board Assembly Component Locations.
A43 Battery and Charger Board Assembly Component Locations.

A20 (A21) MICROPROCESSOR DIGITAL CONTROL (P/N 04191-66520)(P/N 04191-66521) 1 OF 4

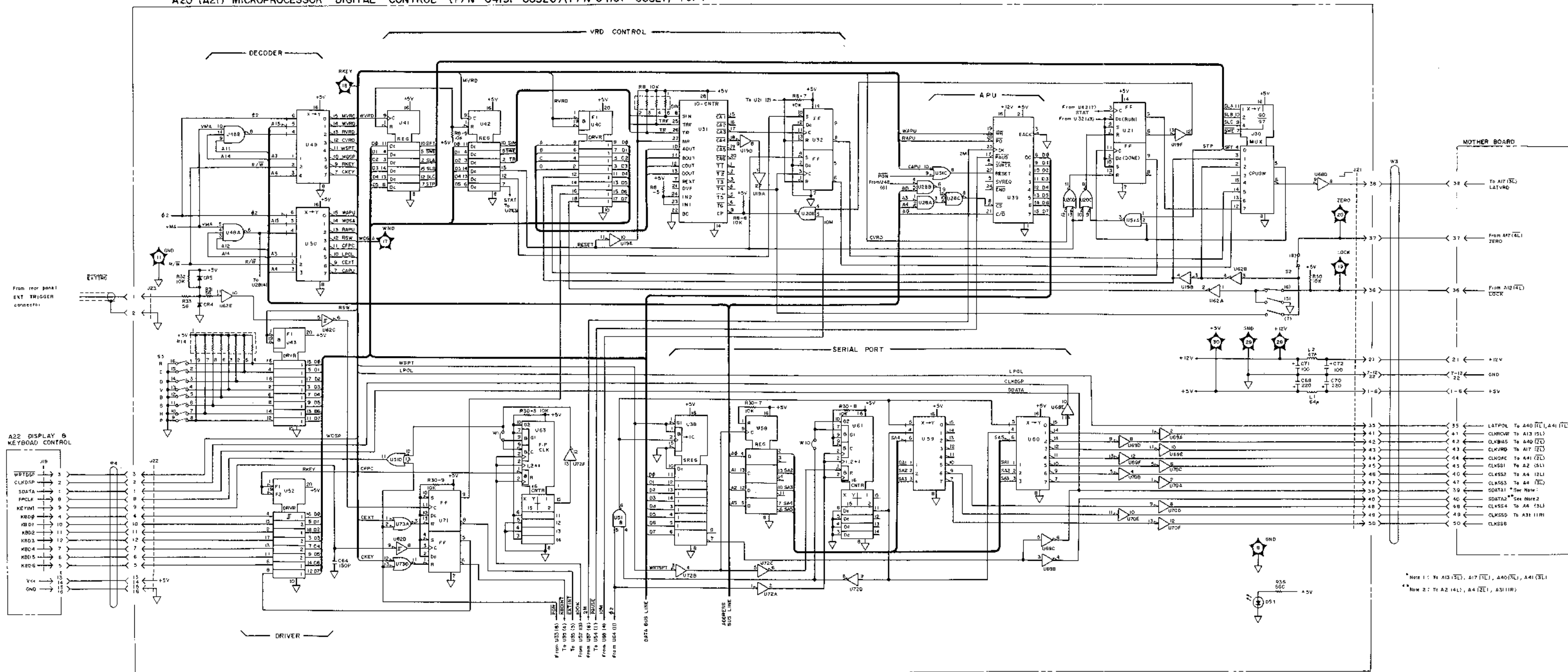
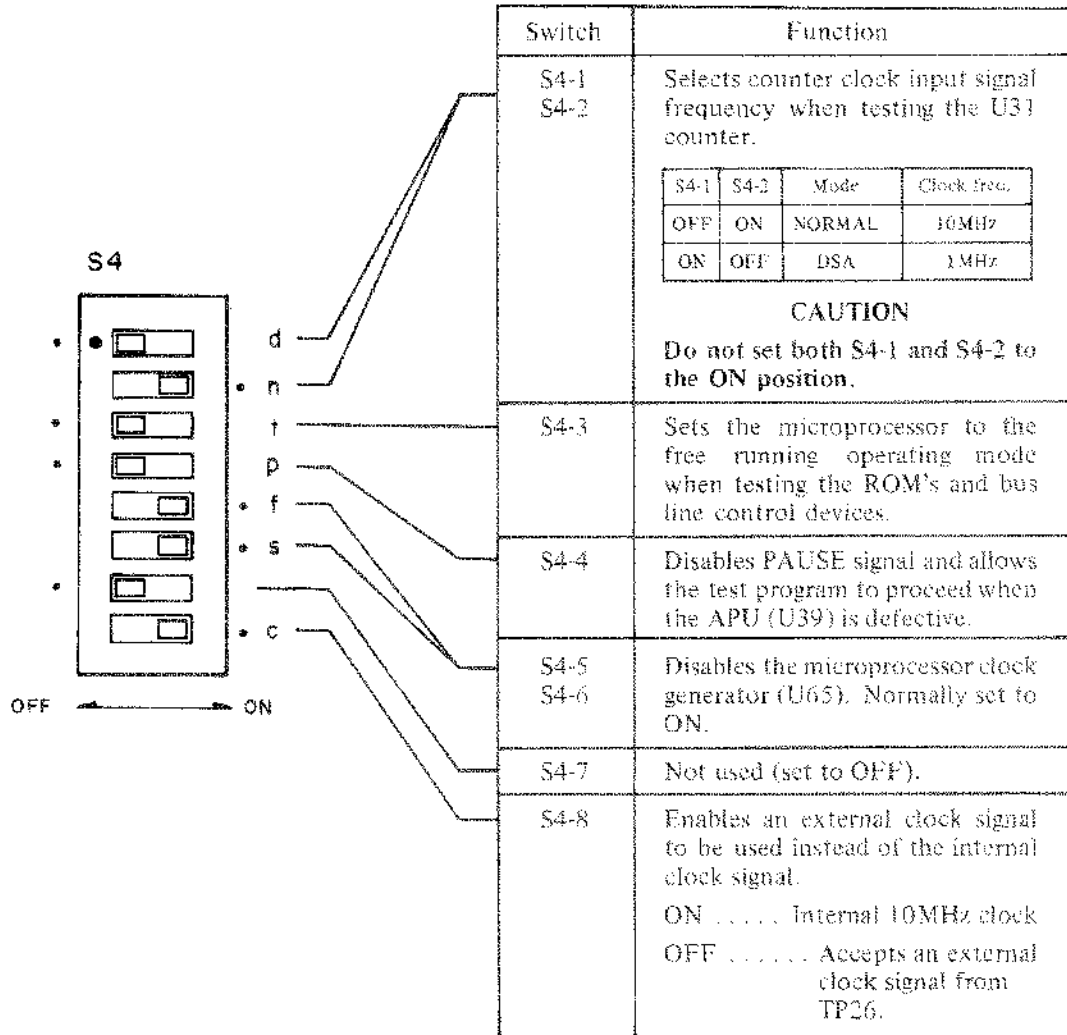

Figure 8-70. A20 (A21) Microprocessor Digital Control Board Assembly Schematic Diagram (sheet 1 of 4).

A20 (A21) S4 SIGNATURE ANALYSIS TEST SWITCH FUNCTIONS

The A20 (A21) S4 switch sets the circuits to the operating modes required for testing with a signature analyzer.



A20 (A21) MICROPROCESSOR DIGITAL CONTROL (P/N 04191-66520) (P/N 04191-66521) 2 OF 4

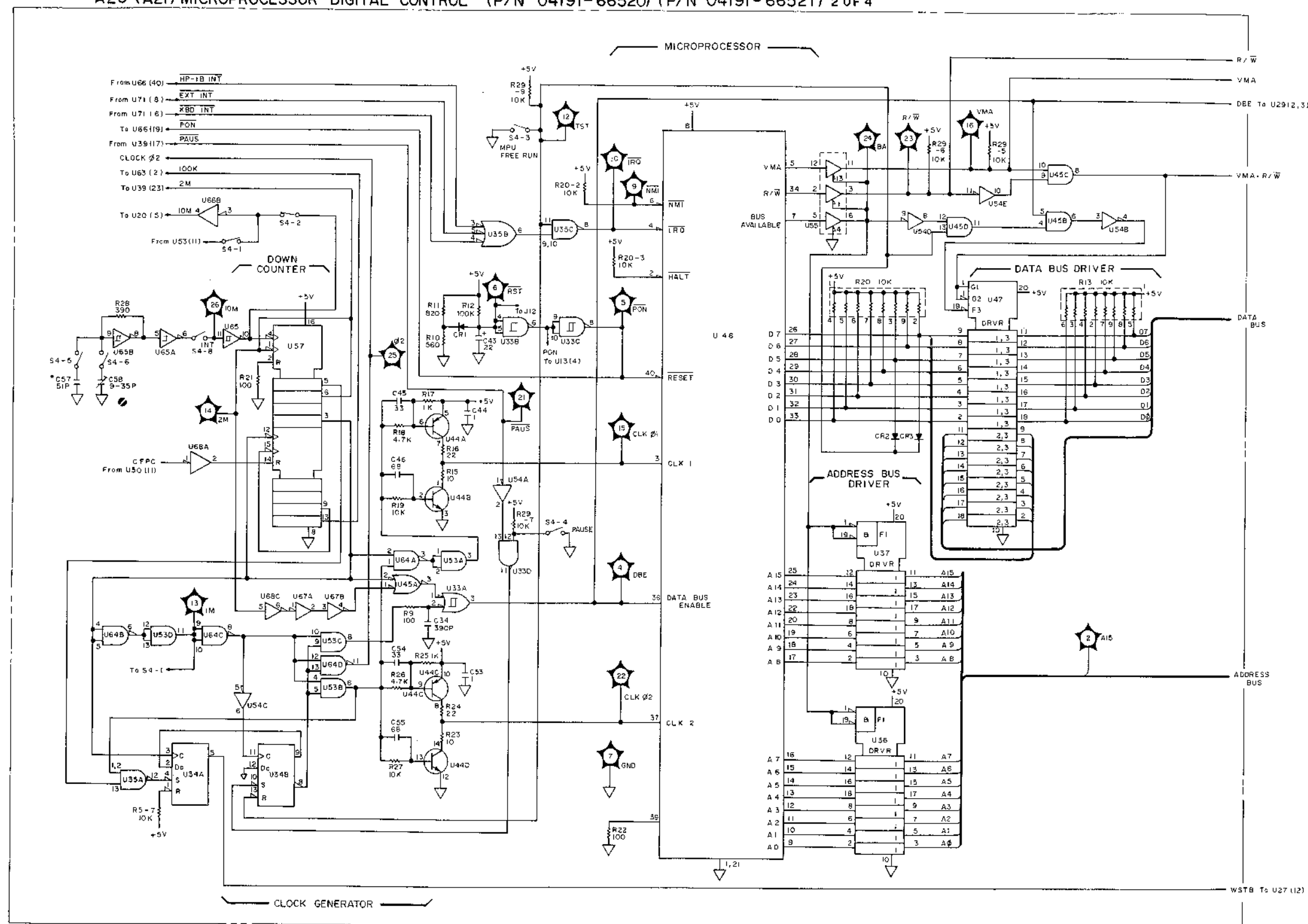

Figure 8-71. A20 (A21) Microprocessor Digital Control Board Assembly Schematic Diagram (sheet 2 of 4).

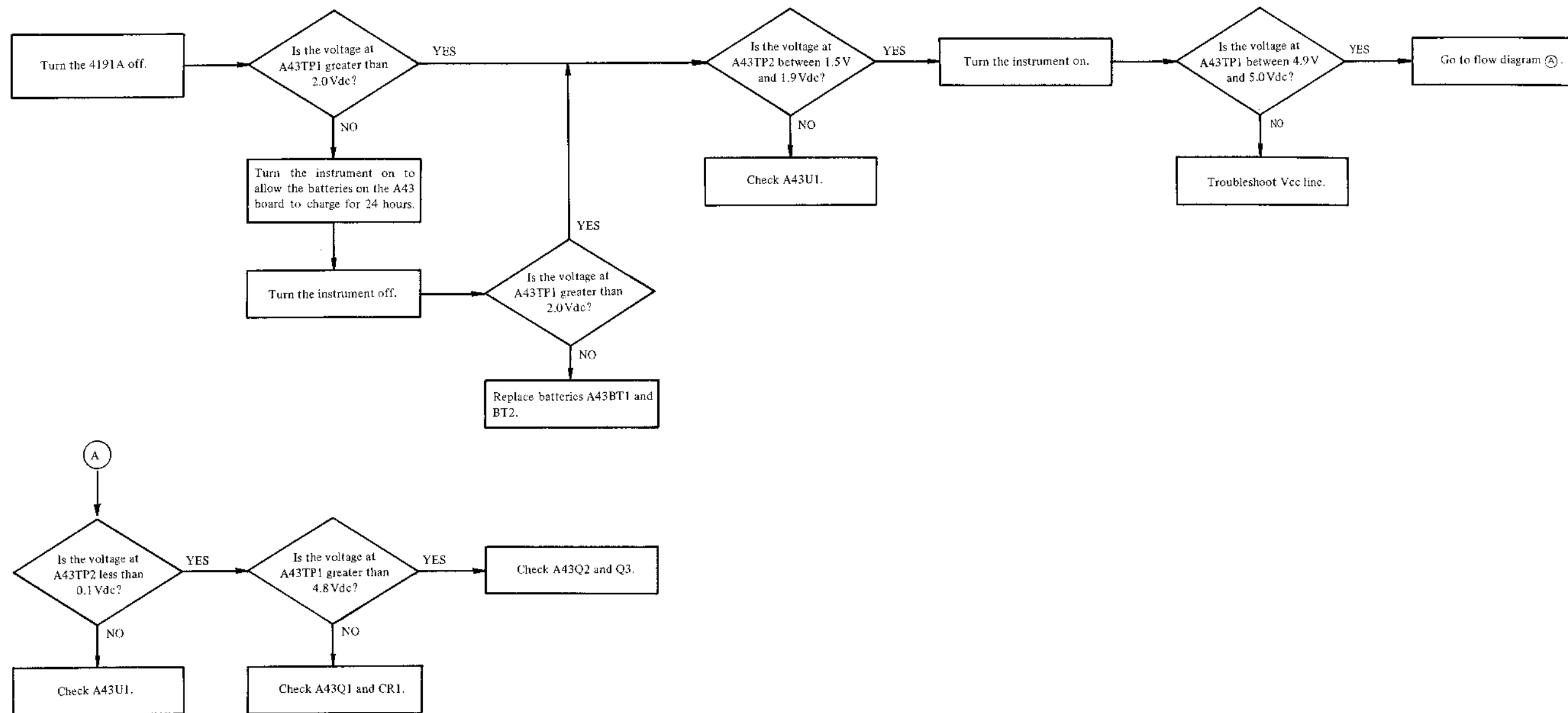
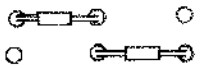

Figure 8-72. A43 Battery and Charger Board Troubleshooting Flow Diagram.

USES OF JUMPER WIRES ON A20 (A21) BOARD

Designation	Use
A21 W1	Connected when PROM type memory devices are employed. Not used for Masked ROM's.
W2 W3 W4 W5 W6 W7	Shifts the connection positions depending on the memory size of the individual ROM's as follows: 
W8	Connected when 2 kilobyte ROM's are employed. Not used for 4 kilobyte ROM's.
W9	Must be connected at all times.
W10	Disconnected to open the serial port counter (U61) loop circuit when signature analysis test is performed.
W11	Disconnected to open the EPCLK counter (U63) loop circuit when signature analysis test is performed.
W12	Enables or disables output of the EOI signal (toward the HP-IB bus line). W12 connected EOI signal is output together with LF signal. W12 disconnected Disables EOI signal to be output.

4191A MEMORY MAP

Address	Area	Primary memory contents
FFFF ~ F800	ROM U1	Error correction calculation program. Self test program.
F7FF ~ F000	ROM U2	Algorithmic subroutines.
EFFF ~ E800	ROM U3	Data parameter conversion subroutines.
E7FF ~ E000	ROM U4	Display and keyboard data processing programs.
DFFF ~ D800	ROM U5	Data parameter conversion calculation programs.
D7FF ~ D000	ROM U6	Measurement function and parameter setting programs.
CFFF ~ C800	ROM U7	Sweep measurement control programs.
C7FF ~ C000	ROM U8	Analog measurement circuits sequence control program.
BFFF ~ B800	ROM U9	HP-IB handshake program.
B7FF ~ B000	ROM U10	Analog recorder output control program (Opt. 004 only.)
AFFF ~ A800	ROM U11	Signature analysis test programs. (Service use only)
6007 ~ 4800	I/O	Measurement data transfer control, APU control and HP-IB interface control programs.
07FF ~ 02E7	RAM	Auto calibration data. Data storage for SAVE function.
02E6 ~ 02AE		Measurement data memory area.
02AD ~ 0000		Buffer, flag, scratch memory area.

A20 (A21) MICROPROCESSOR DIGITAL CONTROL (P/N 04191 - 66520) (P/N 04191 - 66521) 3 OF 4

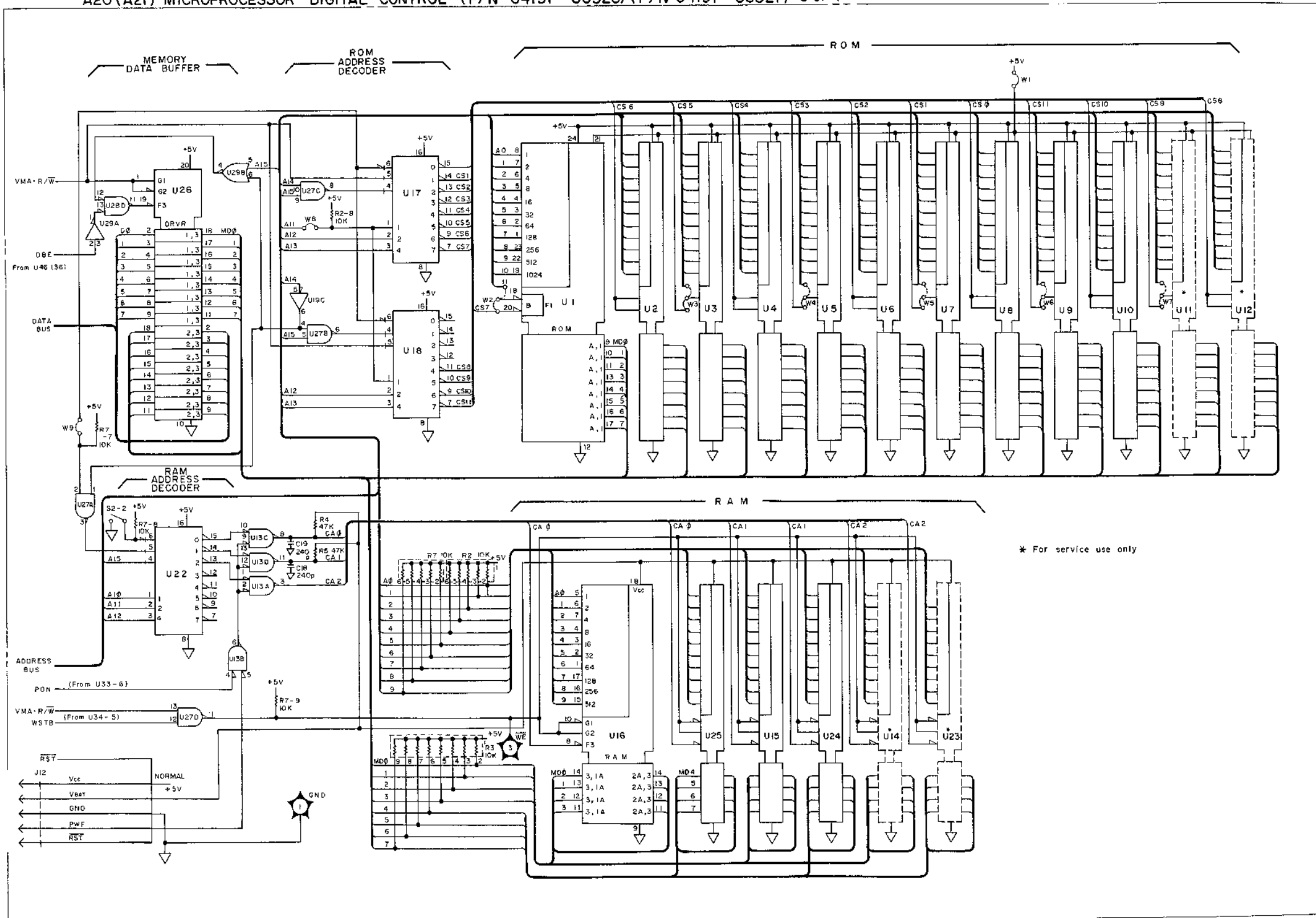
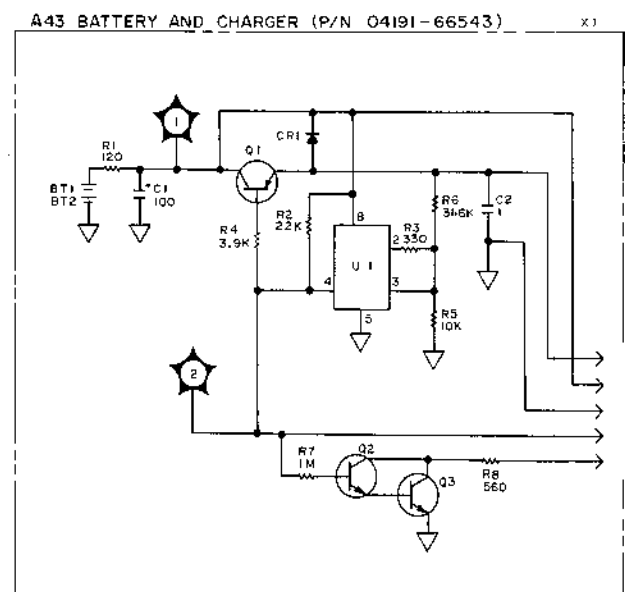

Figure 8-73. A20 (A21) Microprocessor Digital Control Board Assembly Schematic Diagram (sheet 3 of 4) and A43 Battery and Charger Board Assembly Schematic Diagram.

A20 (A21) MICROPROCESSOR DIGITAL CONTROL (P/N 04191-66520) (P/N 04191-66521) 4 OF 4

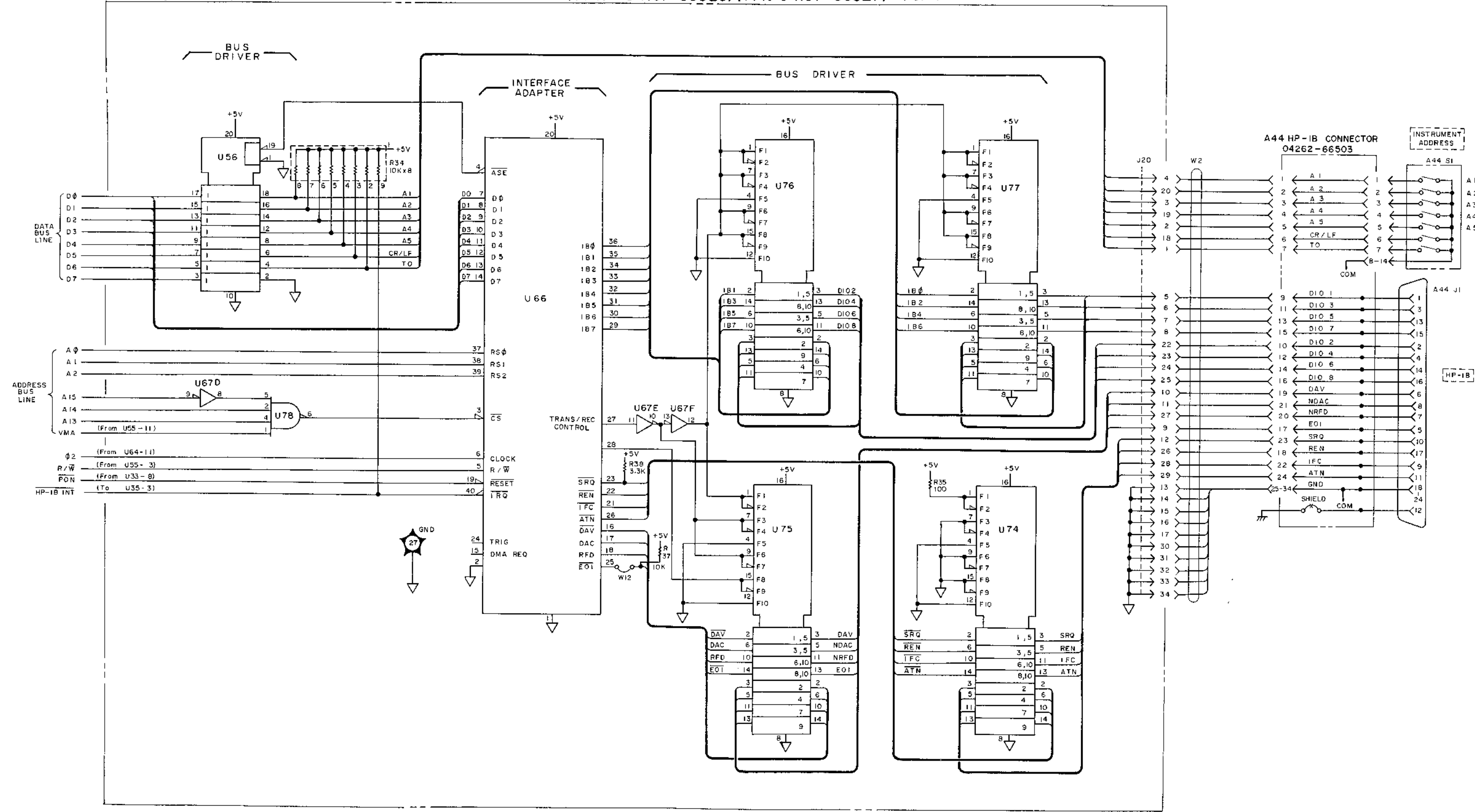

Figure 8-74. A20 (A21) Microprocessor Digital Control Board Assembly Schematic Diagram (sheet 4 of 4).

A20(A21)

SEE INSIDE

Microprocessor Digital Control (sheet 4 of 4)

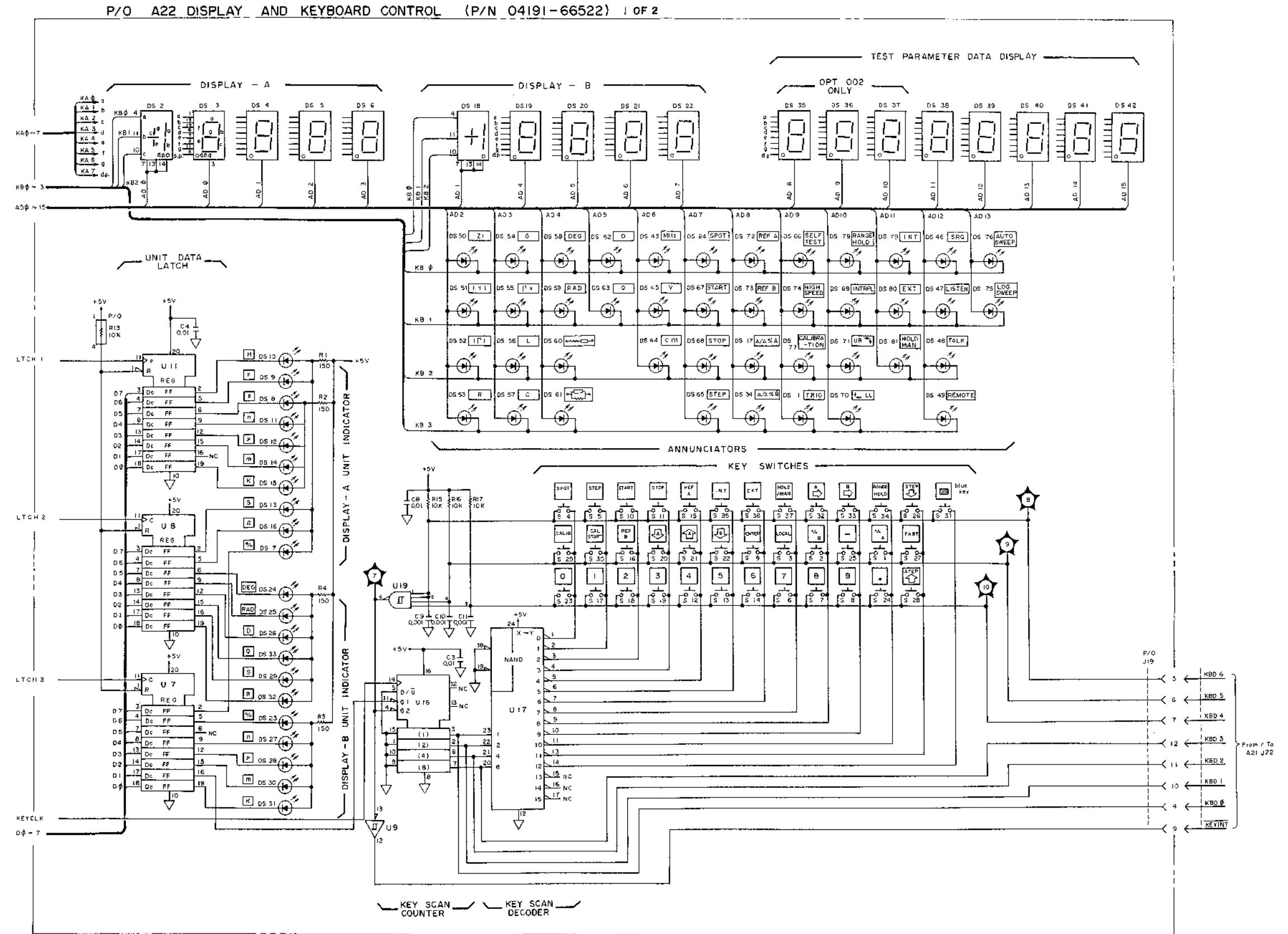

Figure 8-76. A22 Display and Keyboard Control Board Assembly Schematic Diagram (sheet 1 of 2).



Display and Keyboard Control (sheet 1 of 2)

P/O A22 DISPLAY AND KEYBOARD CONTROL (P/N 04191-66522) 2 OF 2

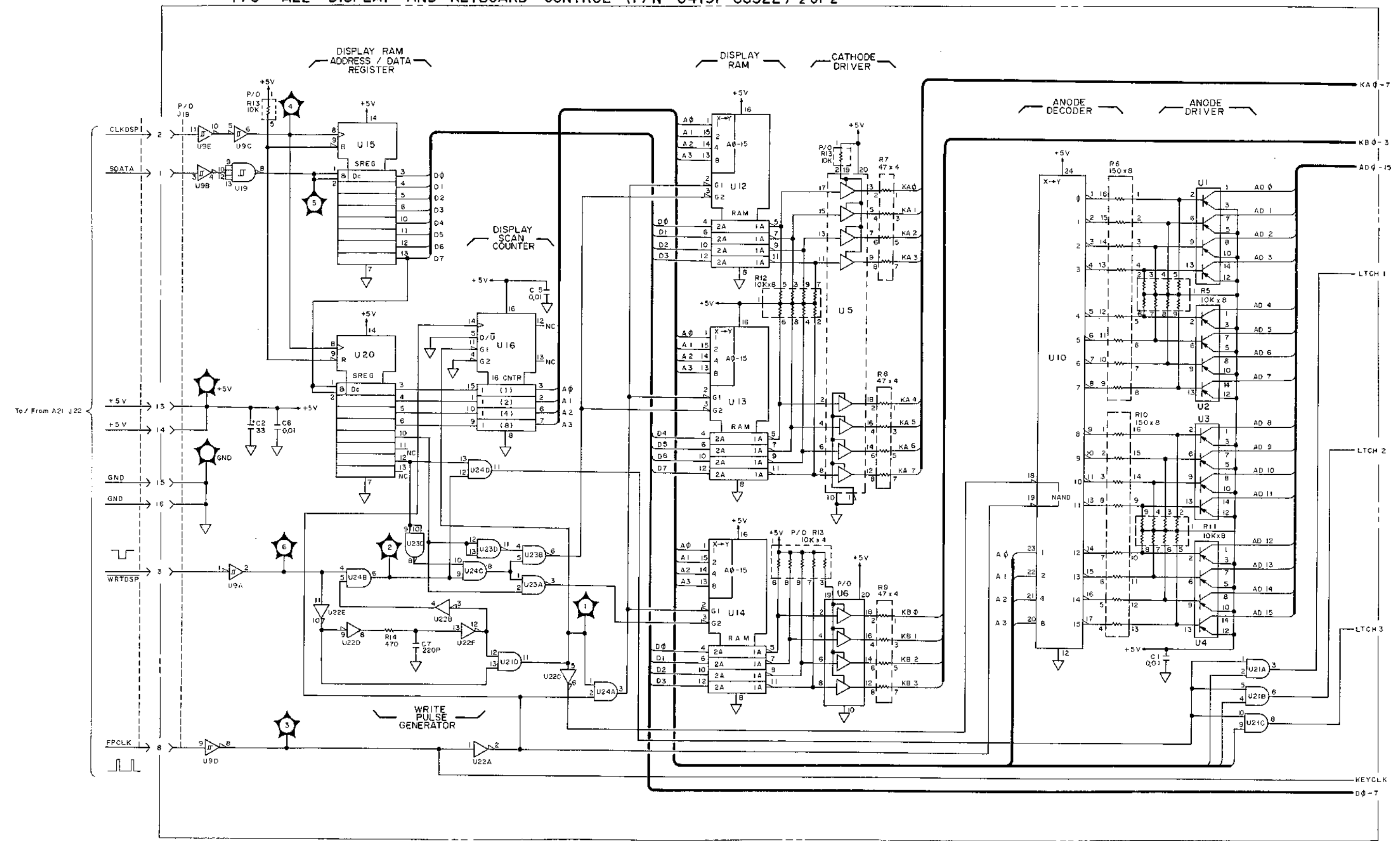
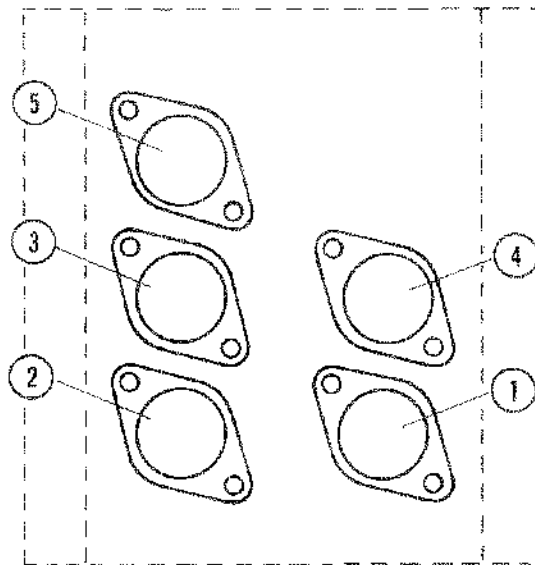

Figure 8-77. A22 Display and Keyboard Control Board Assembly Schematic Diagram (sheet 2 of 2).



SEE INSIDE

Display and Keyboard Control (sheet 2 of 2)



Reference	HP Part No.	Qty	Description
1	U7	2	IC: REGULATOR 5V
2	U8	2	IC: REGULATOR 5V
3	Q10	1	TRANSISTOR NPN 60V PD=115W
4	Q9	1	TRANSISTOR PNP 80V PD=150W
5	CR7	1	DIODE: RECTIFIER 30A

Components mounted on the DC Power Supply Assembly Plate
(inside the protective cover).

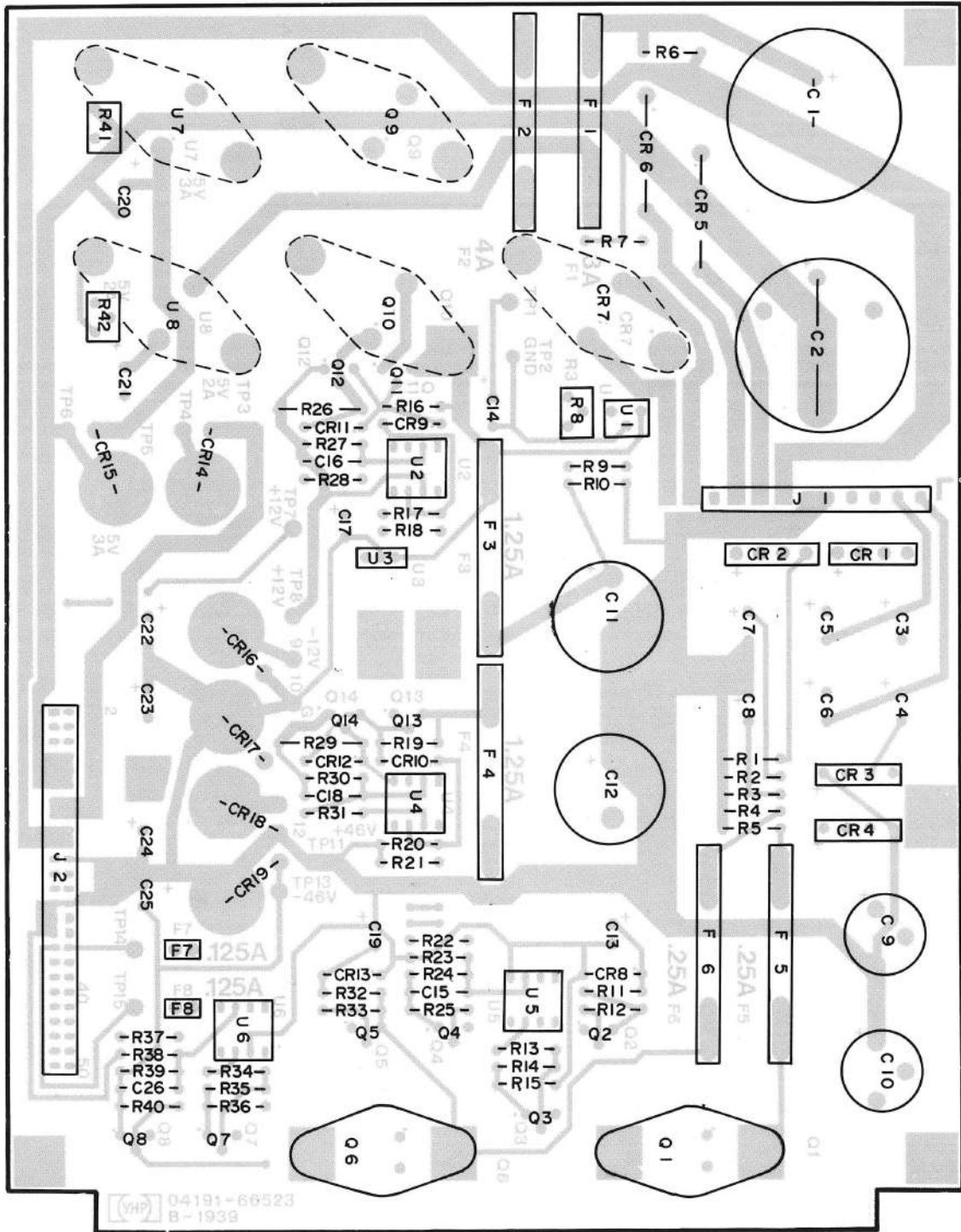

Figure 8-78. A23 Power Supply Board Assembly Component Locations.

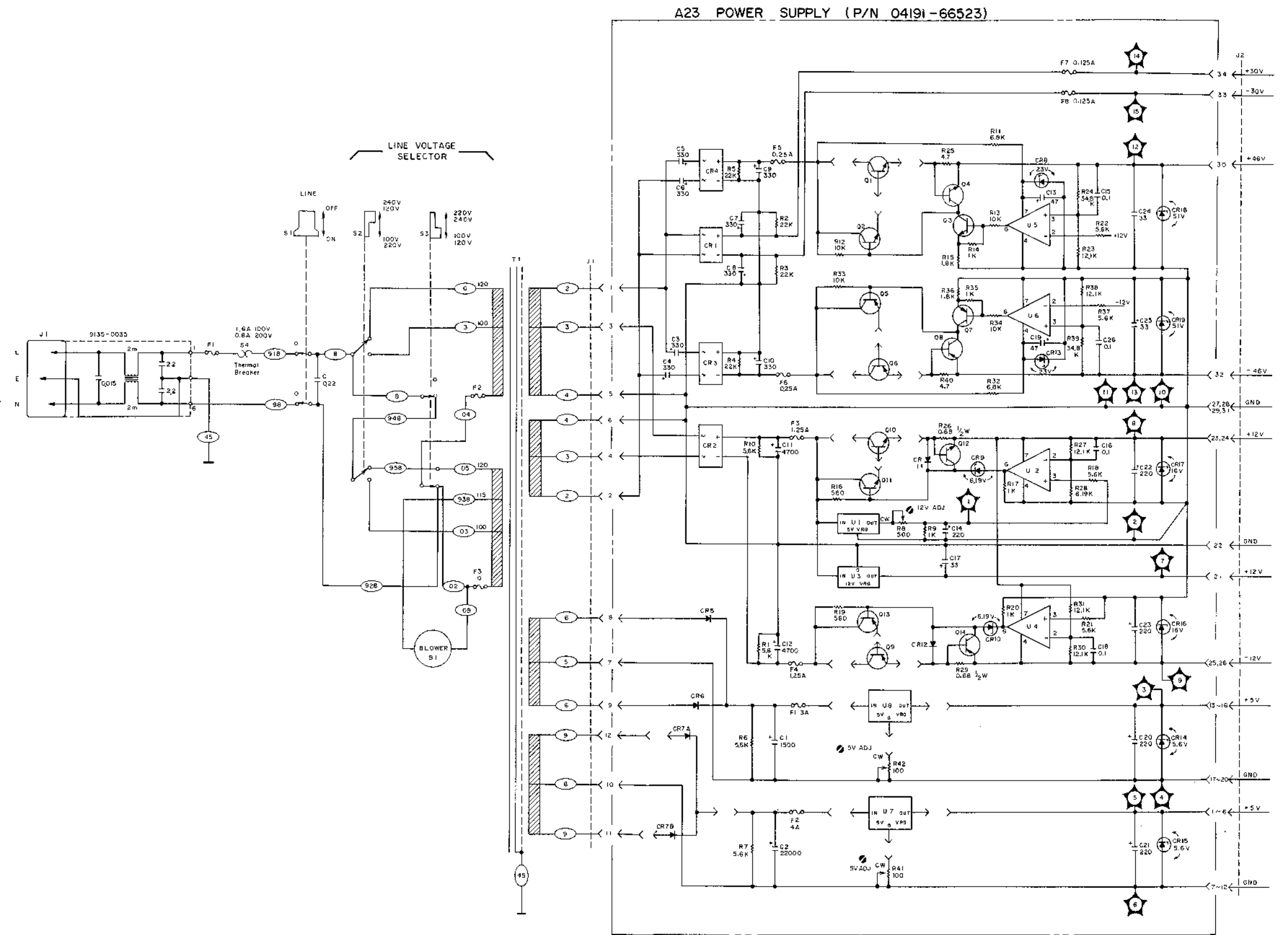

Figure 8-79. A23 DC Power Supply Board Assembly Schematic Diagram.



DC Power Supply

SEE INSIDE

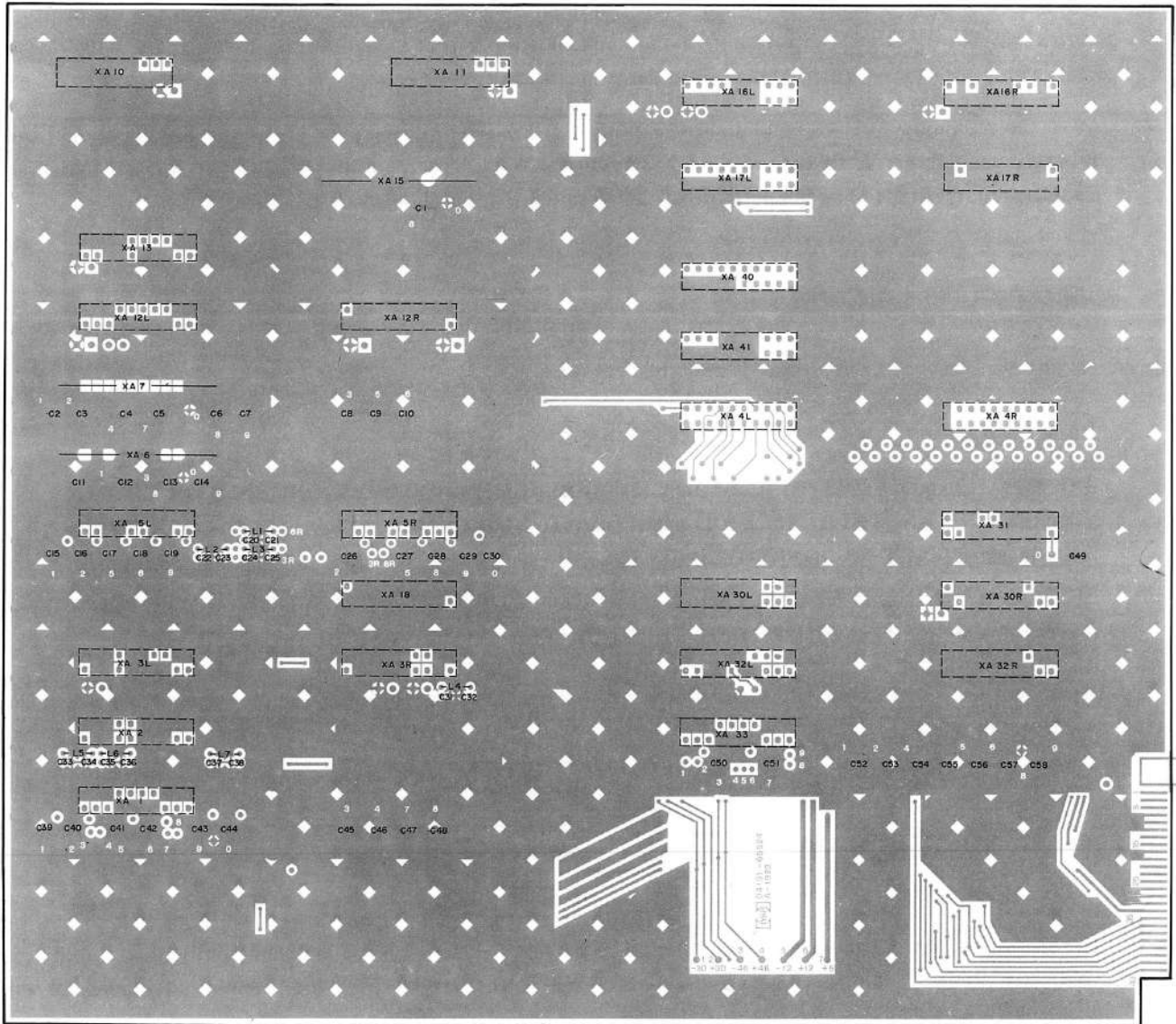

Figure 8-80. A24 Motherboard Assembly Component Locations.

A25 HEATER CONTROLLER CIRCUIT OPERATING TEST

Circuit operation of the A25 Heater Controller is checked using the procedure outlined below:

1. Turn the instrument on and observe the flashing LED (A25DS1) on the A25 board. This LED is visible through a hole in the top shield plate covering the A25 board.
The LED will flash at an initial rate of a few times per second and will gradually slow down as the instrument warms-up. The LED will stop flashing if the ambient temperature is higher than 28°C. If the LED does not light or stays lit (does not flash), the heater controller is faulty.
2. After the recommended warm-up time (40 minutes), measure the temperature of the RF directional bridge assembly module (refer to Para. 5-43 RF Directional Bridge Temperature Adjustment for the temperature measurement method). The temperature of the assembly module should not be above 31°C.

A25 BOARD TROUBLESHOOTING GUIDE

The A25 board troubleshooting procedure is described below:

WARNING

DO NOT CONNECT A25TP5 (COMMON) TO INSTRUMENT CHASSIS (GROUND) OR TO THE GROUND OF ANOTHER PIECE OF EQUIPMENT. THE GROUND LEAD OF OSCILLOSCOPE PROBE MUST NOT BE CONNECTED TO TP5.

IF THIS WARNING IS NEGLECTED, A DANGEROUSLY HIGH CURRENT MAY FLOW FROM THE 100V AC INPUT TO GROUND THROUGH TP5.

1. Disconnect the J2 from the A25 board and measure the dc resistance between the plug connectors with a DMM as illustrated below:

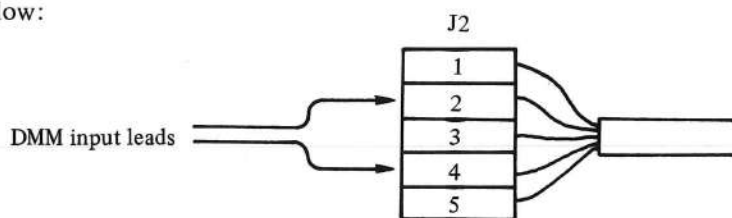

The resistance between these two points should be between 3 k Ω and 10 k Ω at an ambient temperature range of 10°C and 30°C. If the measured value is outside the normal range, check the thermister temperature sensor attached to the RF Directional Bridge assembly.

Note: The DMM test current should be low so as to not affect the resistance of the thermister.

2. If the LED (DS1) stays lit (does not flash), check A25CR1.
3. Observe the waveform at A25TP2 with an oscilloscope (connect ground lead of the probe to instrument chassis). One cycle of 280 V_{p-p} line frequency voltage will appear on the CRT when the LED flashes.

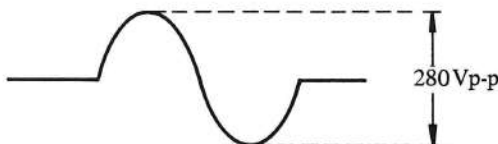

If otherwise, check A25U1, CR1 and CR3.

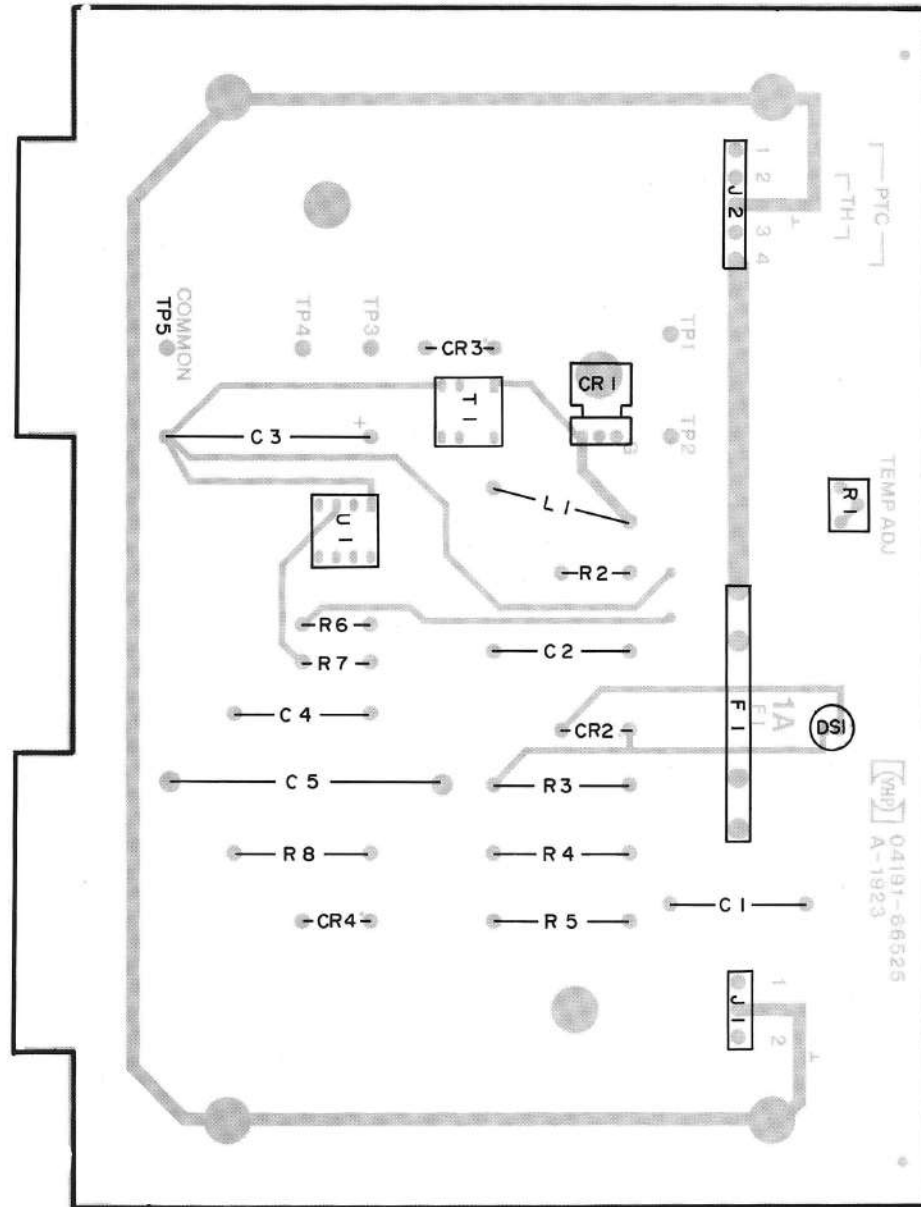

Figure 8-81. A25 Heater Controller Board Assembly Component Locations.

A25 HEATER CONTROLLER (P/N 04191-66525)

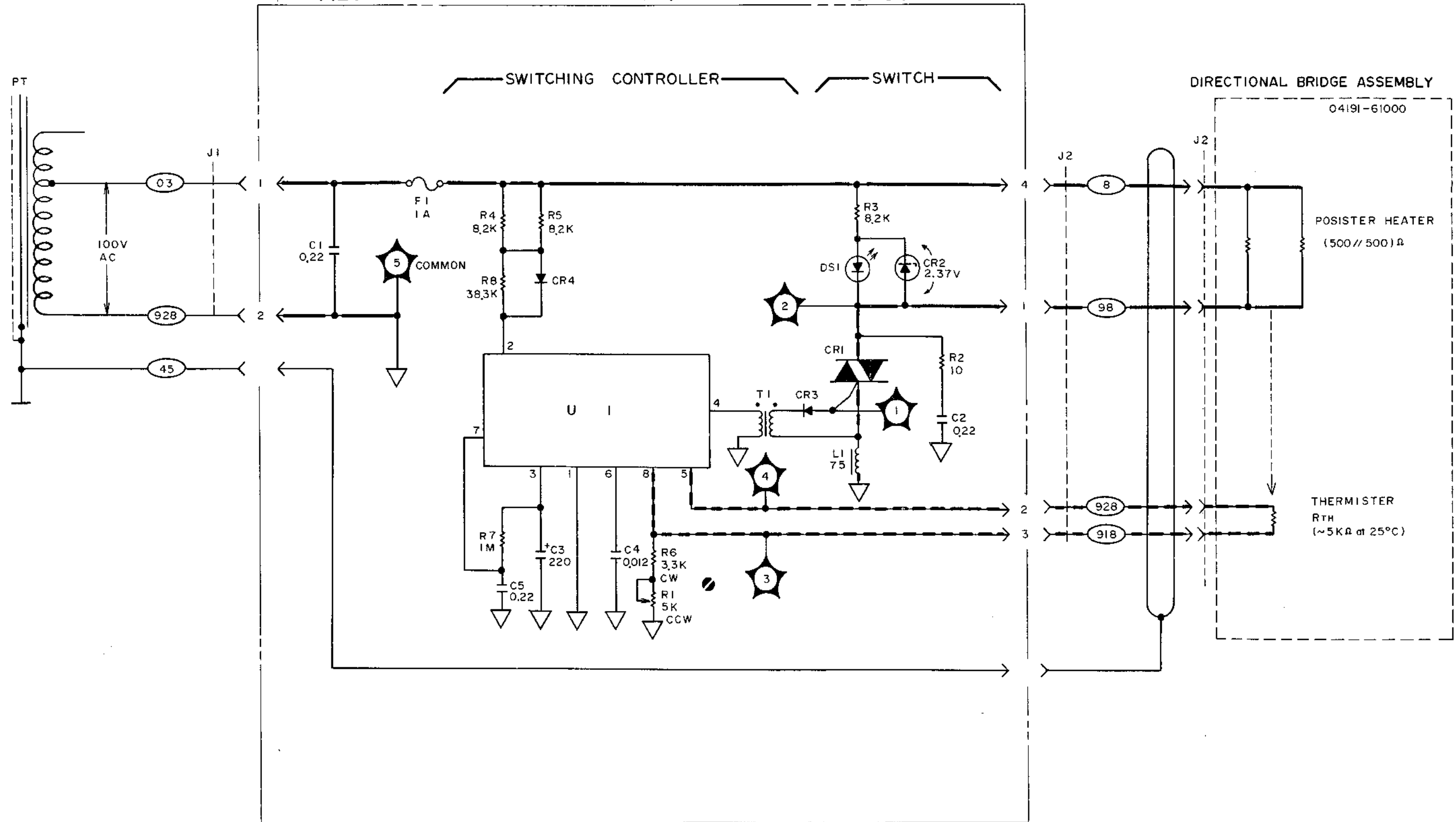

Figure 8-82. A25 Heater Controller Board Assembly Schematic Diagram.

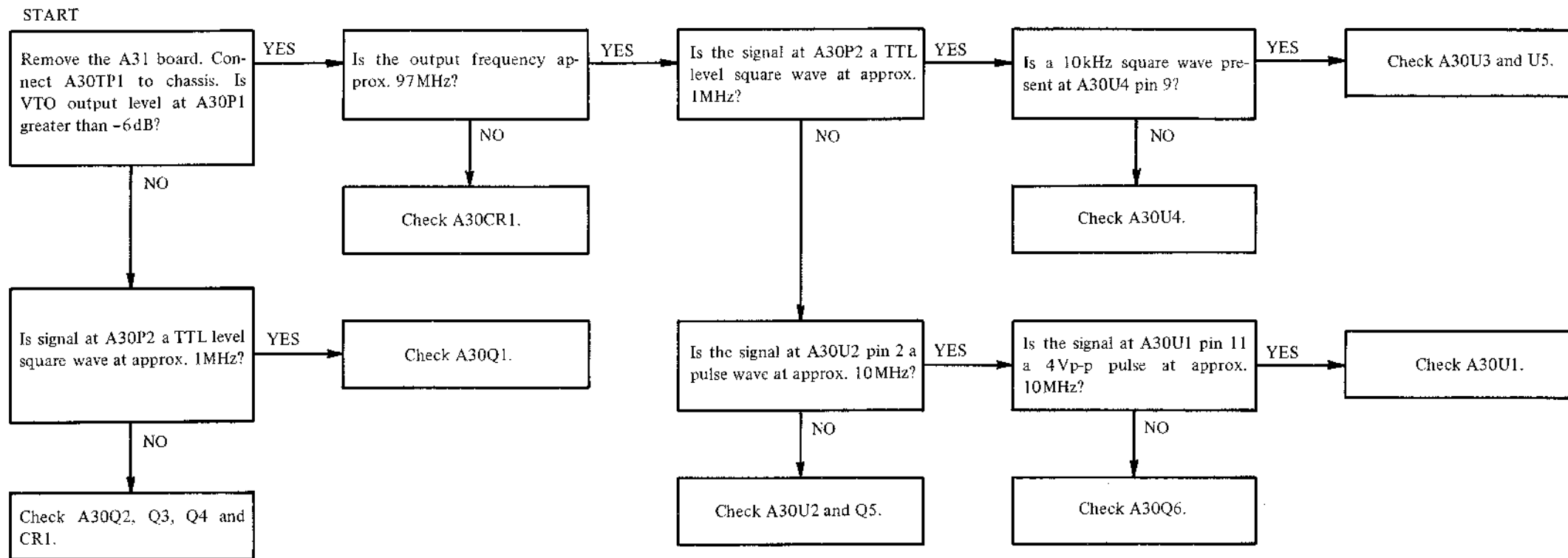

Figure 8-83. A30 VTO (100-110MHz) Board Troubleshooting Flow Diagram.



A30 VTO CIRCUIT OPERATING TEST

Circuit operation of the A30 VTO is checked using the procedures outlined below:

Setup: Set switch A21S2 as shown below:

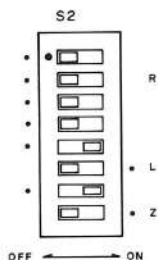

Remove the A31 board.

1. Remove the A30 board and re-install with an extender board. Connect a spectrum analyzer to A30P1. Apply +10V dc to A30TP1 from an external dc power supply. Verify that the fundamental spectrum level on the CRT is greater than -6dBm. Vary the dc power supply output voltage from 0V to +10V. Verify that no abnormal spectrum display due to parasitic oscillation appears on the CRT at any dc voltage setting. The spectrum level must also be greater than -6dBm at 0V.
2. Connect a frequency counter to A30P1 in place of the spectrum analyzer. Apply +10.1V dc ($\pm 0.1V$) to A30TP1 and read the frequency counter display. Next, set the dc supply voltage (at TP1) to 0V. Frequency counter readout should satisfy the test limits given in the table below:

Voltage at TP1	Test limits
10.1V	111.5MHz to 112.0MHz
0V	< 97.0MHz

3. Connect the frequency counter to A30P2. Verify that the frequency counter readout is exactly 1/100 of the readout at A30P1.

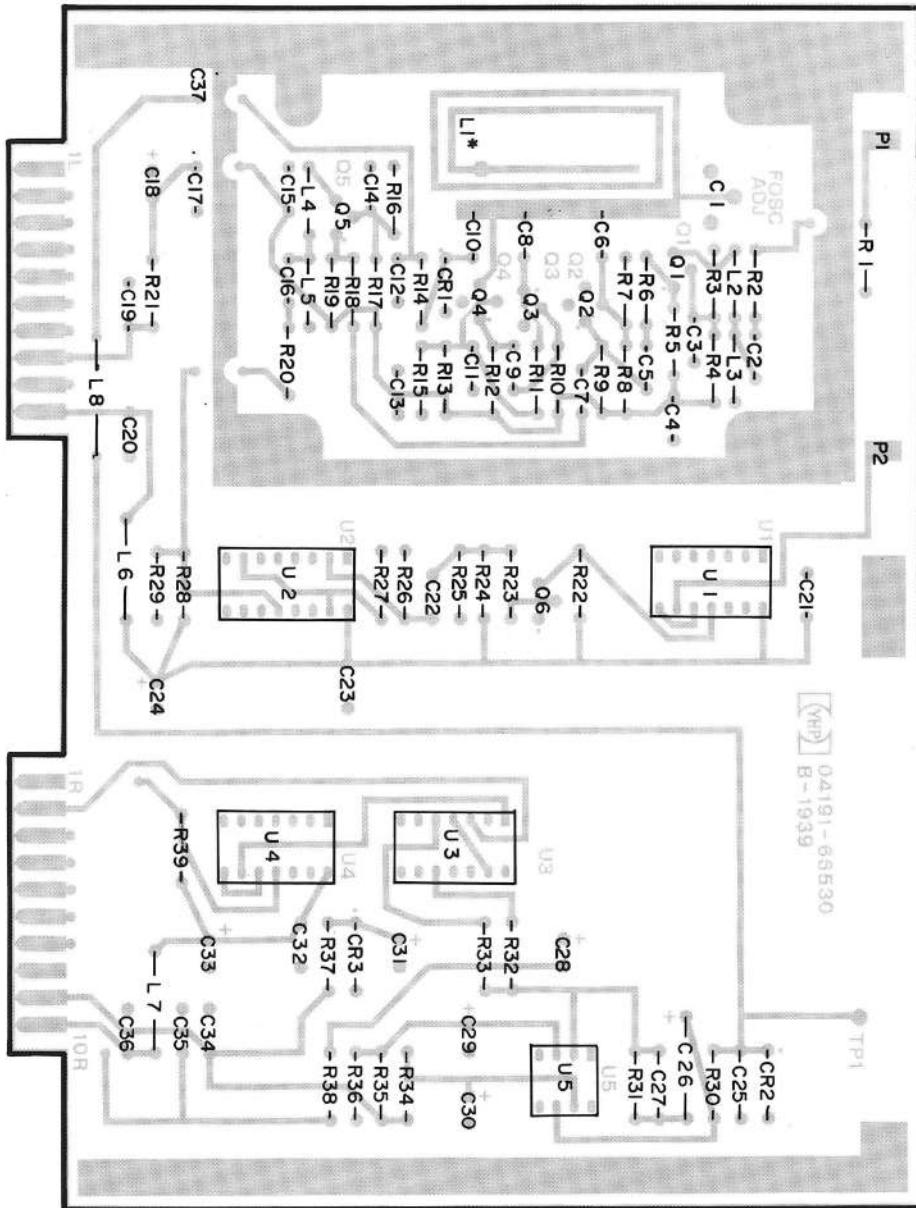

Figure 8-84. A30 VTO (100-110MHz) Board Assembly Component Locations.

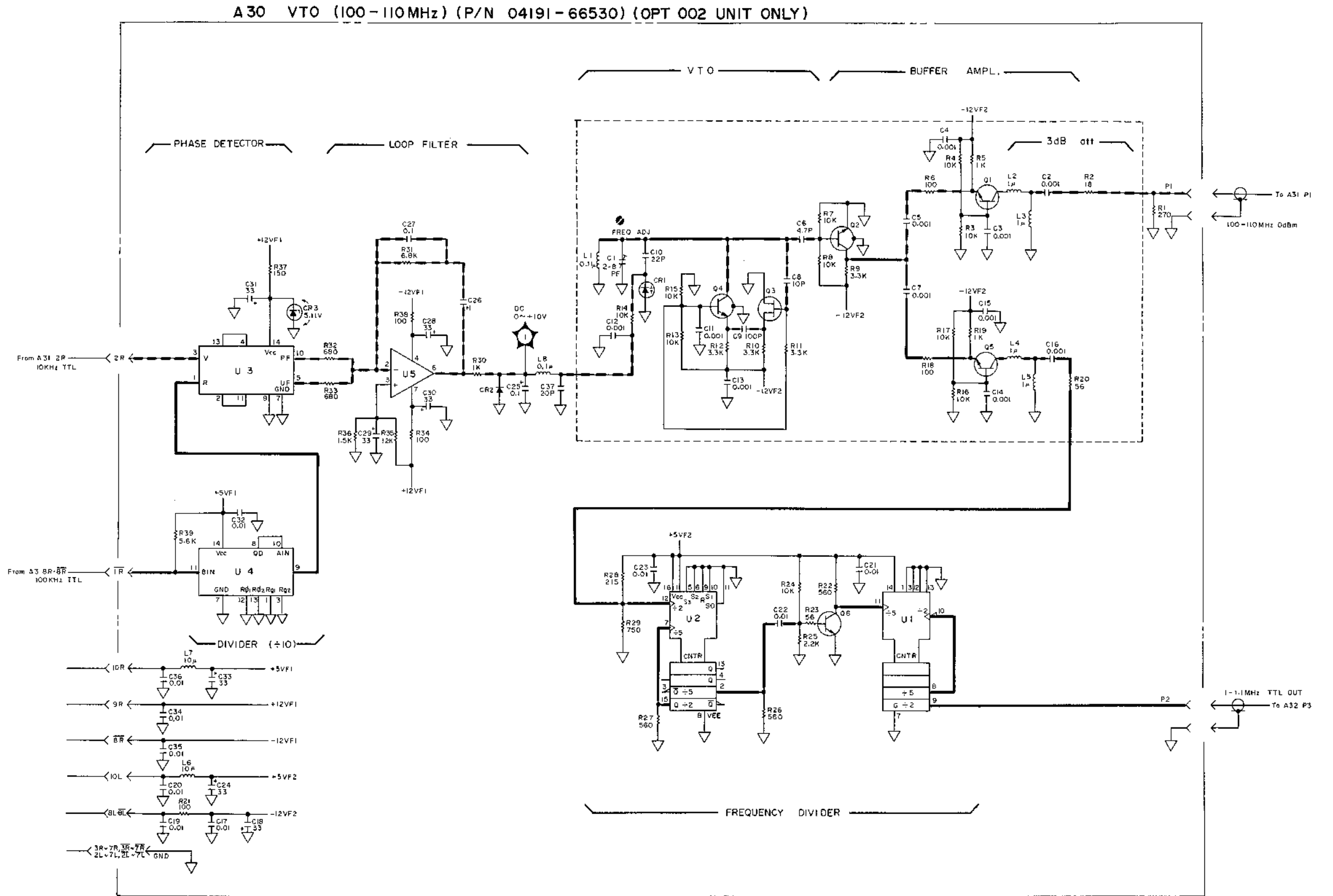

Figure 8-85. A30 VTO (100-110MHz) Board Assembly Schematic Diagram.

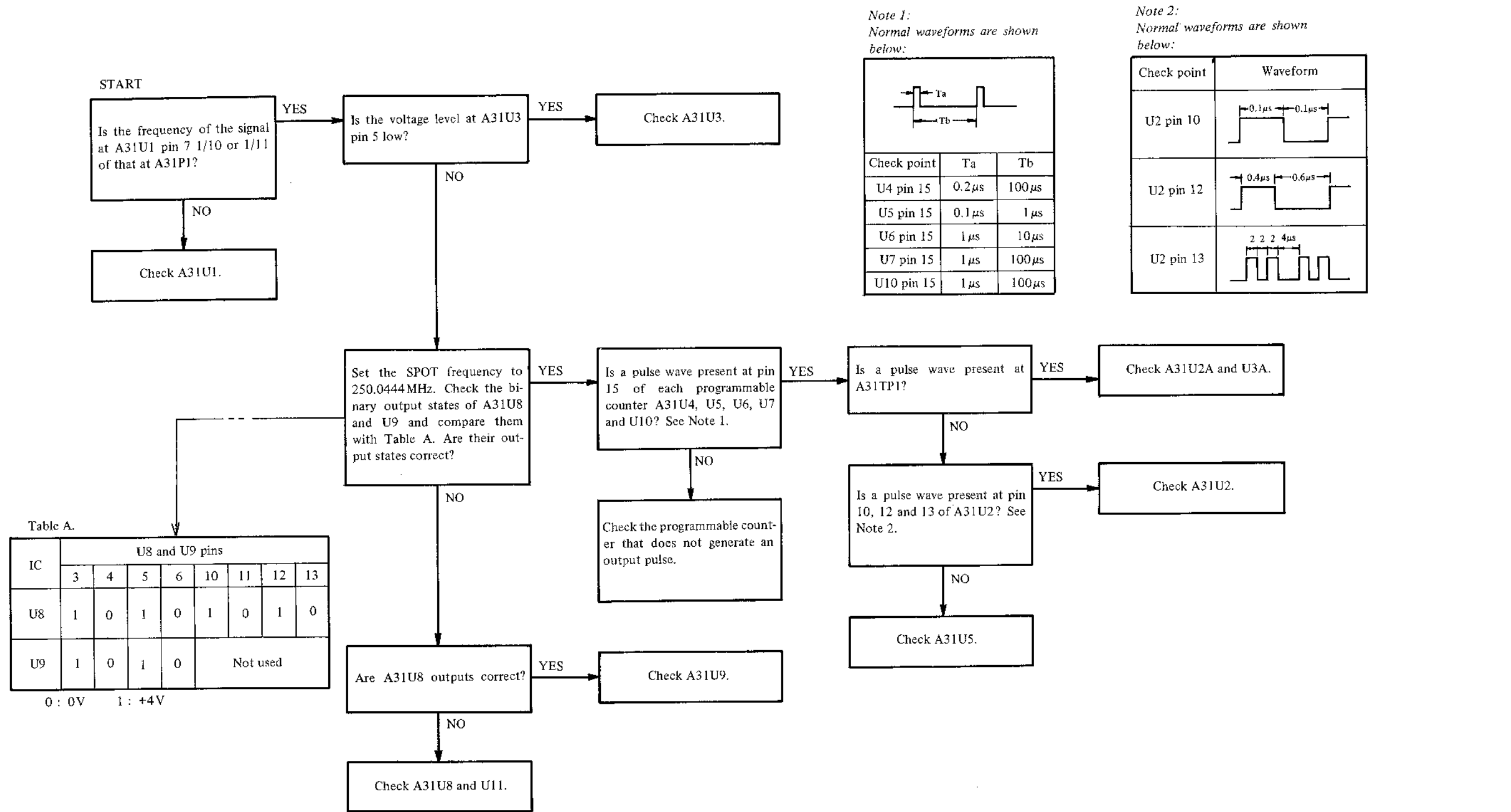
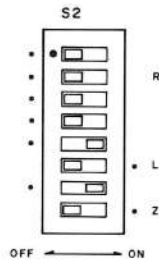

Figure 8-86. A31 100Hz Step Programmable Divider Board Troubleshooting Flow Diagram.

A31 PROGRAMMABLE DIVIDER CIRCUIT OPERATING TEST

Circuit operation of the A31 Programmable Divider is checked using the procedures outlined below:

Setup: Set switch A21S2 as shown below:



Connect an external signal generator to A31P1. Connect a frequency counter to A31TP1 (using a BNC to dual alligator clip cable).

Set the signal generator output to 0dBm at 100.000MHz.

1. Set the SPOT frequency of the 4191A and signal generator frequency in accordance with the table below. Verify that the frequency counter readout is within 10.000MHz ± 1 count at all test frequency settings.

Note: Set the STEP frequency to 0.0111MHz and use manual sweep function to facilitate SPOT frequency setting.

SPOT frequency setting	Signal generator frequency setting
250.0000MHz	100.000MHz
250.0111	101.110
250.0222	102.220
250.0333	103.330
250.0444	104.440
250.0555	105.550
250.0666	106.660
250.0777	107.770
250.0888	108.880
250.0999	109.990

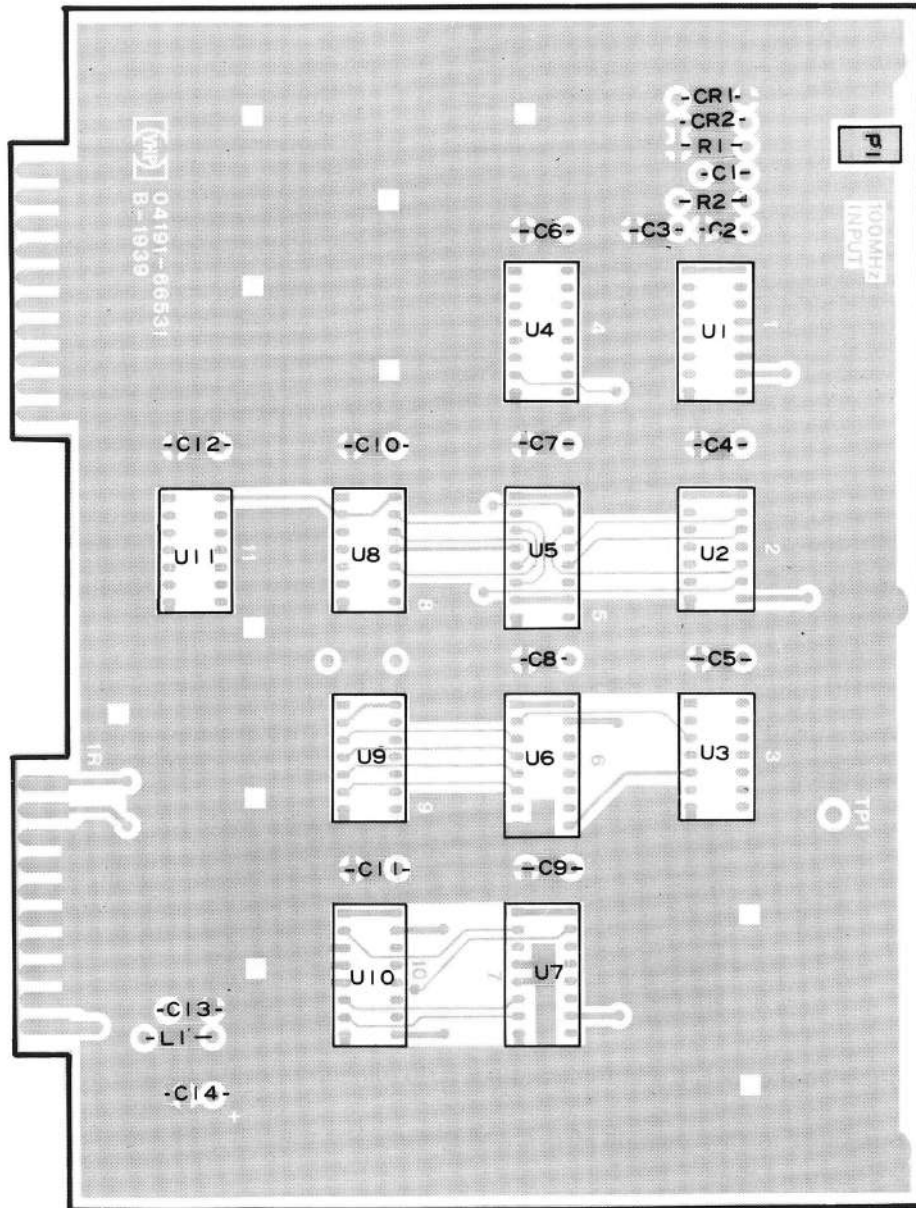

Figure 8-87. A31 100Hz Step Programmable Divider Board Assembly Component Locations.

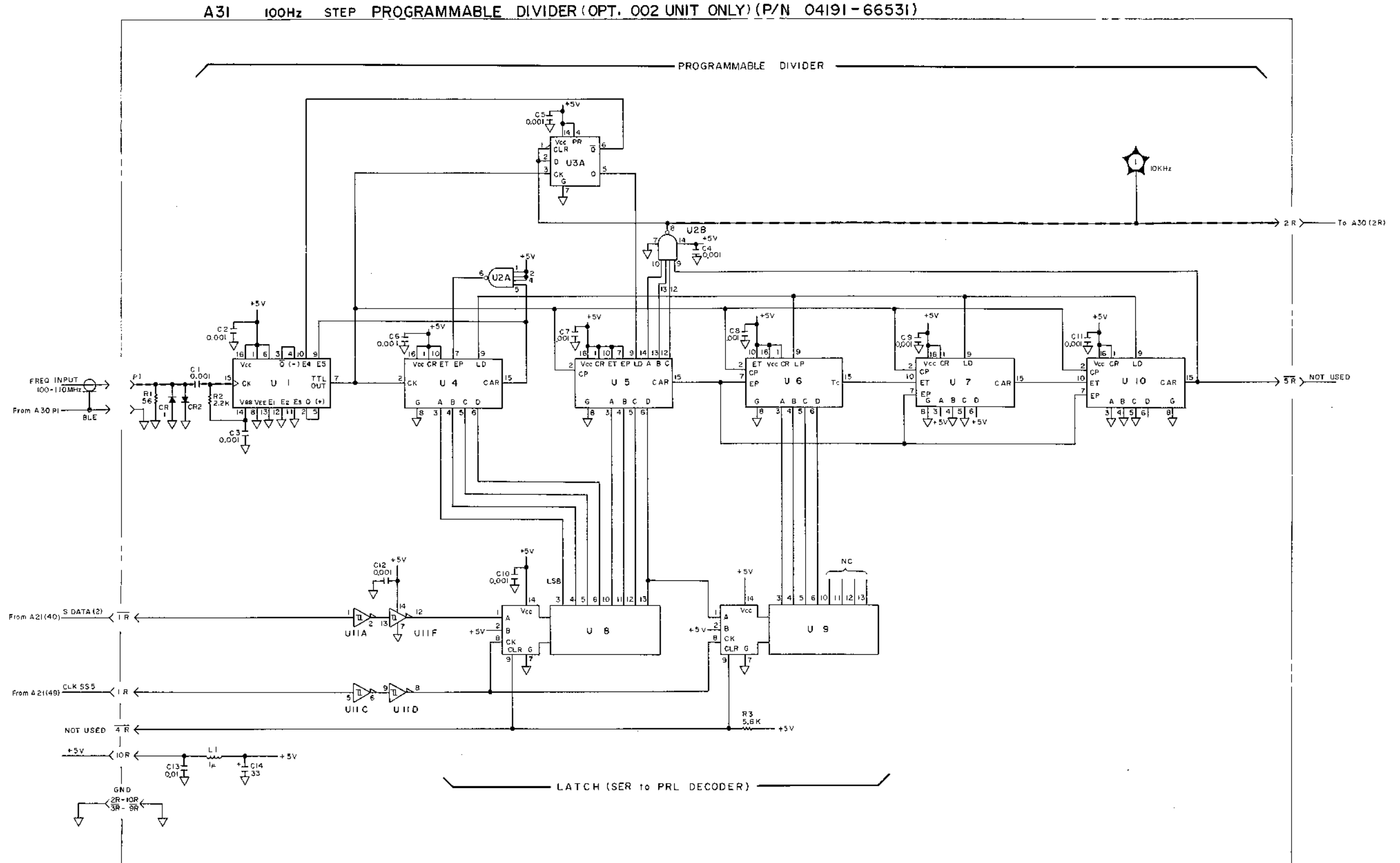

Figure 8-88. A31 100Hz Step Programmable Divider Board Assembly Schematic Diagram.

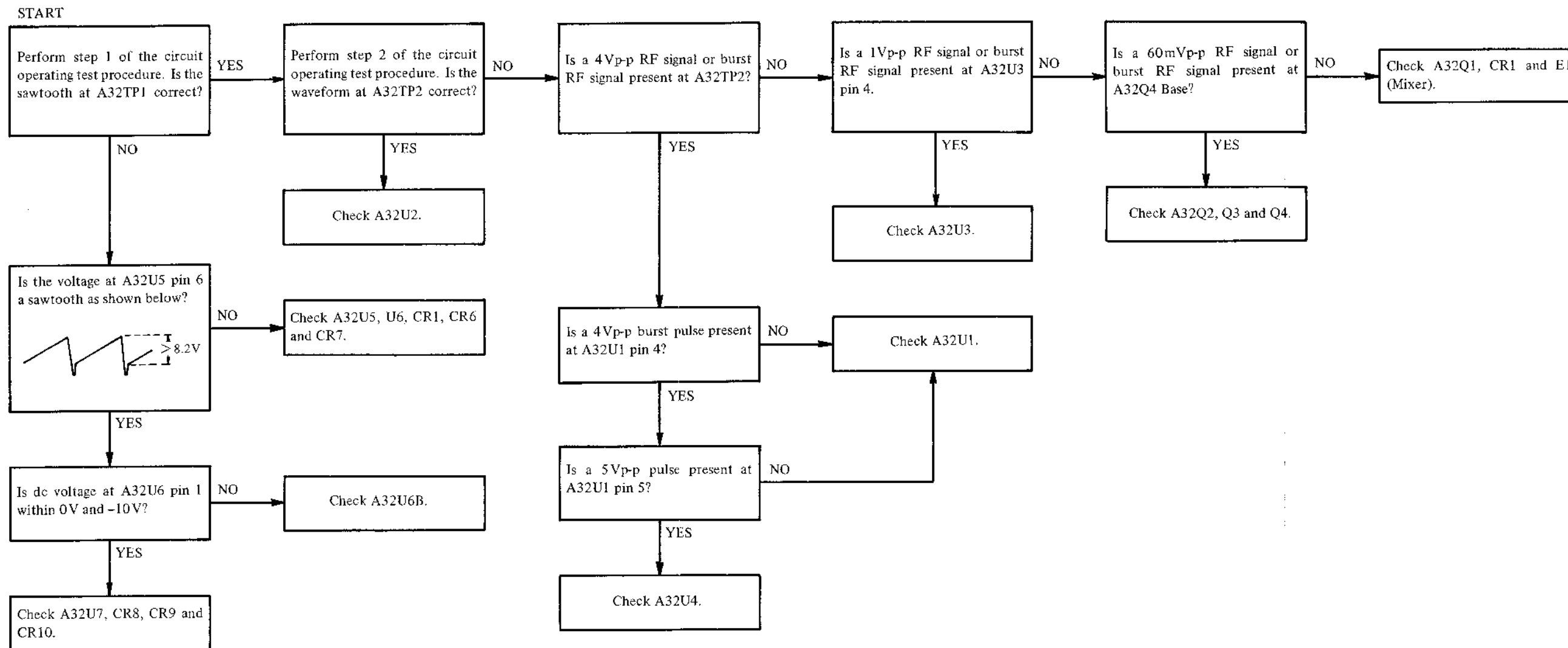

Figure 8-89. A32 Summing Loop Circuit Board Troubleshooting Flow Diagram.



A32 SUMMING LOOP CIRCUIT OPERATING TEST

Circuit operation of the A32 Summing Loop is checked using the procedure outlined below:

Setup: Set switch A21S2 as shown below:

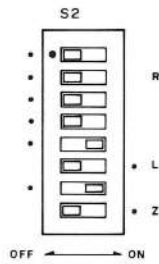

1. Disconnect the SMC connector cable from A32P2. Connect an oscilloscope to A32TP1. Verify that the waveform on the CRT is a sawtooth greater than 10Vp-p (the sawtooth plus dc may be between 0V and +20V).

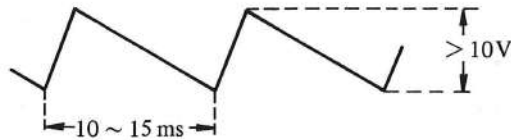

If the sawtooth does not appear, observe the waveform at A32U5 pin 6. If a similar sawtooth (inverted) appears on the CRT, the summing amplifier is faulty. If no signal appears, the loop filter/search generator is faulty.

2. Reconnect the SMC connector to A32P2 and disconnect the SMC connector from P3. Connect the oscilloscope to A32TP2. Verify that a burst wave periodically appears on the CRT at timing synchronous with the sawtooth at TP1, as shown below:

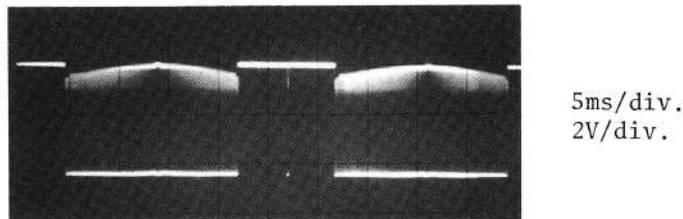

If no signal appears on the CRT, the buffer amplifier (Q1), the mixer, or the limiter amplifier is faulty.

3. Leave SMC connectors as they were in step 2, and observe the waveform at A32TP1. The waveform on the CRT should be as shown below:

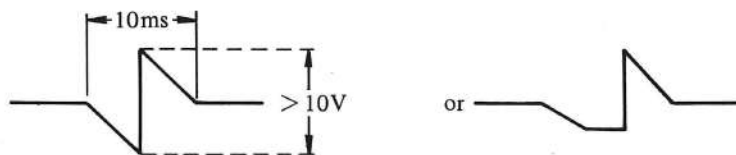

If the trace on the CRT is different from this waveform, the frequency detector circuit is faulty.

4. Reconnect the SMC connector cable to A32P3. Verify that a pulse appears at A32TP3 just after the SPOT frequency is changed (the pulse width is approximately 10ms).

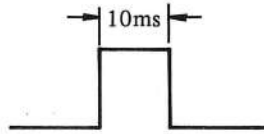

5. Verify that the dc voltage at U6B pin 1 is about -0.7 of the input voltage at XA32 (1L). If otherwise, the buffer amplifier (U6B) is faulty.

A33 VTO CIRCUIT OPERATING TEST

The circuit configuration of the A33 VTO board is identical to that of the A1 board. Thus, the A33 circuit operating test can be performed using the same procedure described for the A1 board.

To apply the test procedure described for the A1 board to the A33 board, make the following changes to the A1 board test procedure.

1. Change all board designations (A1) in the instructions to read A33.
2. At step 3, remove the A32 board instead of the A3 board.

The A1 board troubleshooting procedure can also be applied to the A33 board. Change A1 in the troubleshooting flow diagram to read A33.

8-105. A32 SUMMING LOOP CIRCUIT (OPT. 002 ONLY)

8-106. The A32 board controls the V_F tuning control voltage at TP1 so that the frequency of the P1 input signal, determined by V_F , is identical to the sum of the frequencies of the P2 and P3 input signals. The E1 mixer develops the sum and difference between the frequencies of the P1 and P2 input signals simultaneously. The 2MHz LPF blocks the "sum" signal which is always above 500 MHz and passes the "difference" signal when it goes below 2MHz. The U2 Phase Detector compares the frequency of the limiter amplifier output with the 1.0000M to 1.0999MHz frequency of the P3 input signal. The U5 integrator produces the V_F control voltage averaging the phase detector output.

The Frequency Detector and the Loop Filter/Search Generator restores the Summing Loop circuit to its normal phase-locked condition when the measurement frequency is changed. Figure 8-90 shows a block diagram of the Frequency Detector. The Frequency Detector is a window comparator operating in the frequency domain. The U1A one-shot multivibrator clears the U4B comparator when the T_f period of the limit amplifier output (about $1\mu s$) is shorter than the time constant T_2 determined by C_1 and R_1 . This releases the Loop Filter/Search Generator from its static balance condition and,

the U5 integrator produces a negative going ramp as the VTO frequency (P1 input frequency) sweeps towards lower frequencies. When the T_f period becomes longer than the time constant T_1 of the U1B one-shot multivibrator, the U1B sets the U4B comparator to stop the frequency sweep operation. At this time, the limiter amplifier output frequency is within the frequency range of normal PLL control by the Phase Detector and the U5 integrator.

The U7 Summing Amplifier adds the V_T tuning control voltage of the main synthesizer, which is fed from the A3 board, to the V_F control voltage of this local synthesizer. An outline of the function of this additive operation follows: The main synthesizer frequency (P2 input frequency) is close to the frequency of the A33 VTO (P1 input frequency) when the Summing Loop circuit is phase locked (difference in the frequency is identical to the P3 input frequency and, at most 1.0999MHz). Additionally, because the A33 board is identical to the A1 VTO of the main synthesizer, the tuning control voltages for the A1 and A33 boards are much the same (at the abovementioned condition). Accordingly, the V_T input voltage approximates the V_F voltage to a new value for settling the Summing Loop operation after the measurement frequency is changed. This shortens the transient control period of the Frequency Detector and the Loop Filter/Search Generator circuits.

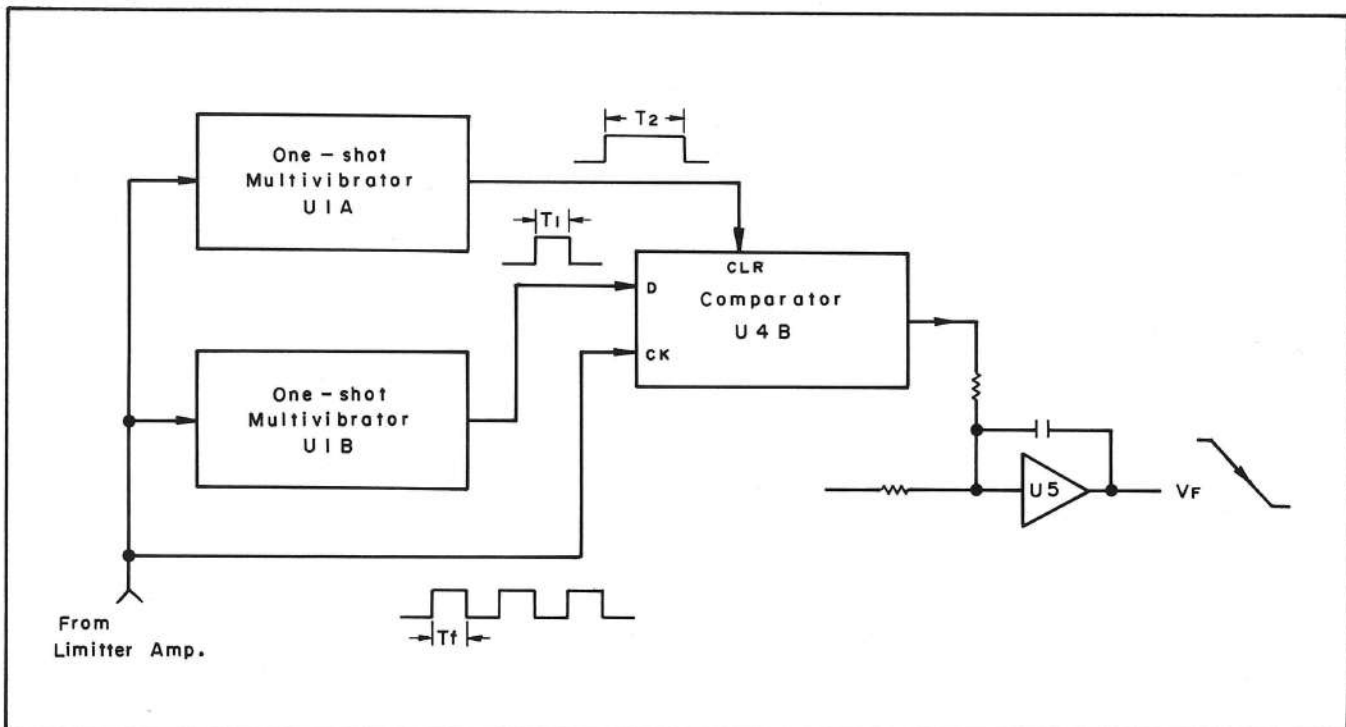

Figure 8-90. Frequency Detector Block Diagram.

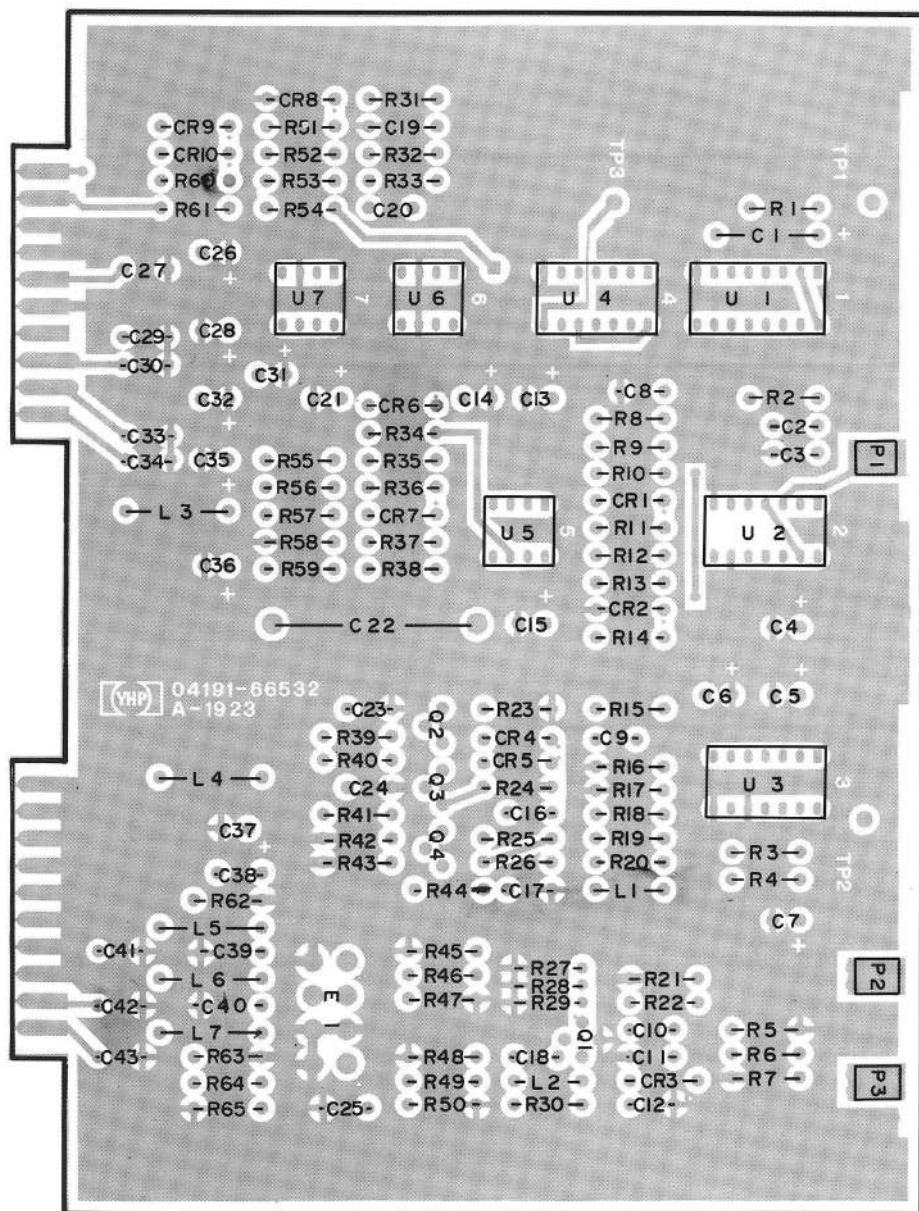

Figure 8-91. A32 Summing Loop Circuit Board Assembly Component Locations.

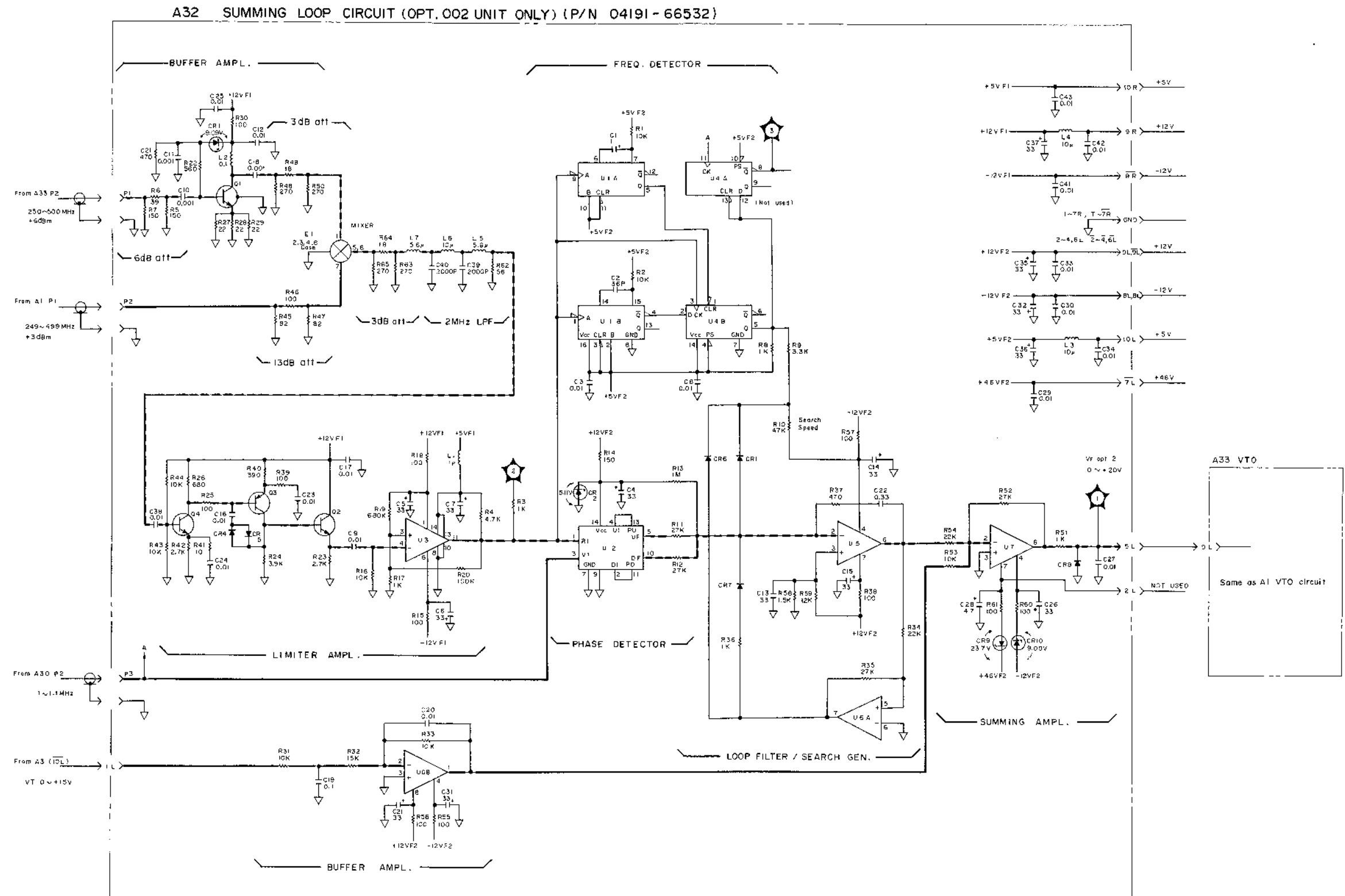

Figure 8-92. A32 Summing Loop Circuit Board and A33 VTO Board Assembly Schematic Diagram.

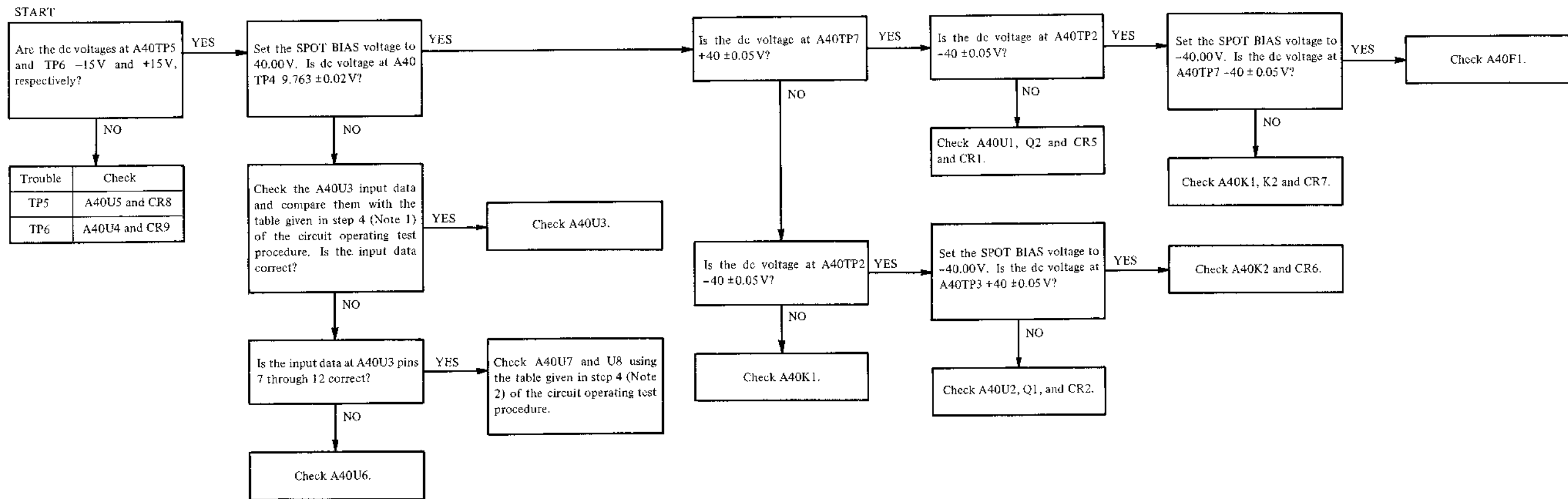

Figure 8-93. A40 DC Bias Supply Board Troubleshooting Flow Diagram.

A40 DC BIAS SUPPLY CIRCUIT OPERATING TEST

Circuit operation of the A40 DC Bias Supply is checked using the procedure outlined below:

1. Visually check that the A40F1 fuse has not blown.
2. Set the SPOT BIAS voltage to +40.00V. Connect a DMM to A40TP7. The voltage readout should be $+40 \pm 0.05$ V.
3. Set the SPOT BIAS voltage to -40.00V. The voltage readout should be -40 ± 0.05 V.
4. If steps 1 and 2 do not provide the proper results, check that the dc voltage at A40TP4 is $9.763 \text{ V} \pm 0.02 \text{ V}$ (for both SPOT BIAS voltage settings).

Note 1. D-A converter control input data at A40U3 pins 1 through 12 are as follows:

SPOT BIAS setting	A40U3 pins											
	1	2	3	4	5	6	7	8	9	10	11	12
0V	1	1	1	1	1	1	1	1	1	1	1	1
40V	0	0	0	0	0	1	0	1	1	1	1	1

0 : 0V 1 : +5V

Note 2. The data latch inputs at A40U7 pins 3, 4, 7, 8, 13, 14, 17 and 18 have the following voltage levels:

SPOT BIAS setting	U7 pins							
	3	4	7	8	13	14	17	18
0V	1	1	1	1	1	1	1	0
-40V	1	0	0	0	0	0	0	1

0 : 0V 1 : +5V

Note 3. At zero bias voltage setting, the polarity switches A40K1 and K2 are set to the following states:

K1 : off

K2 : on

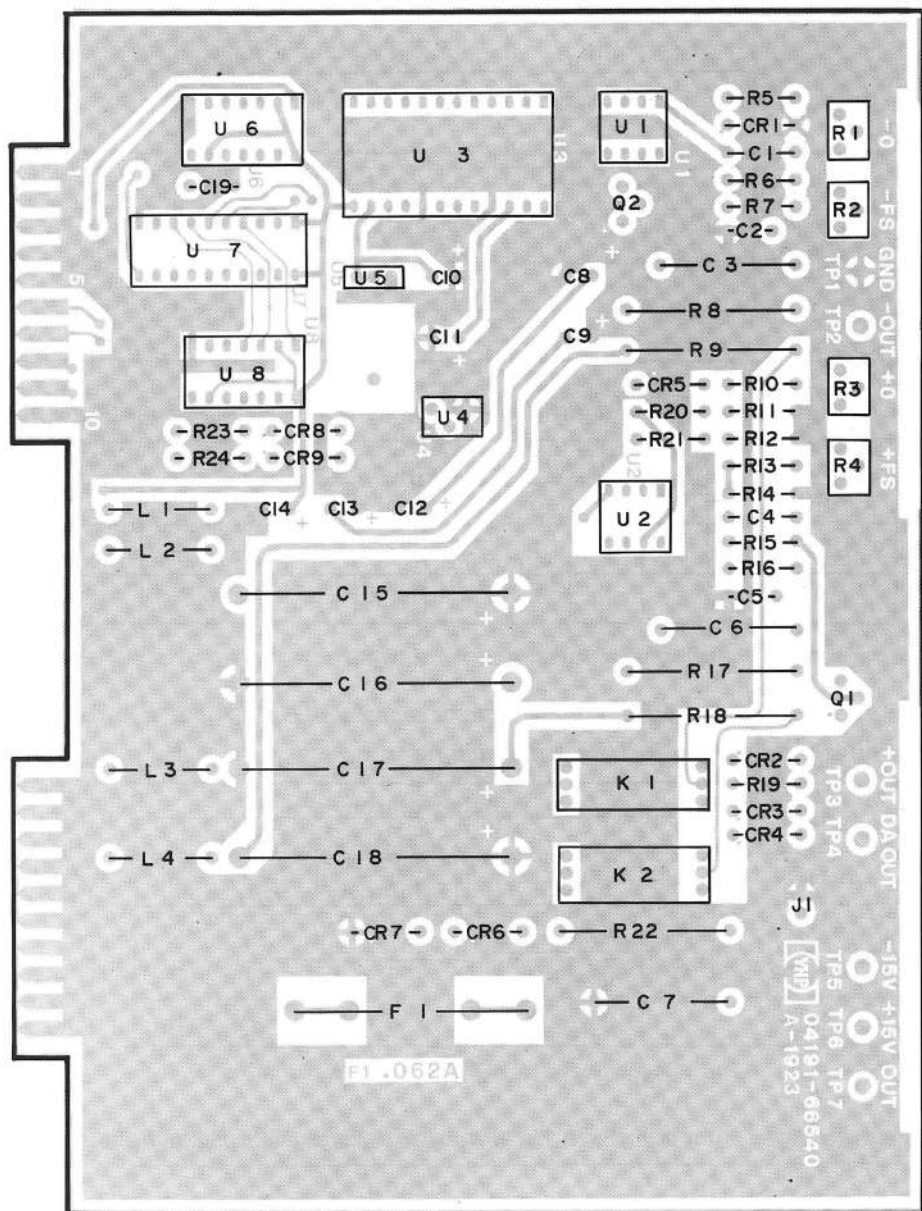

Figure 8-94. A40 DC Bias Supply Board Assembly Component Locations.

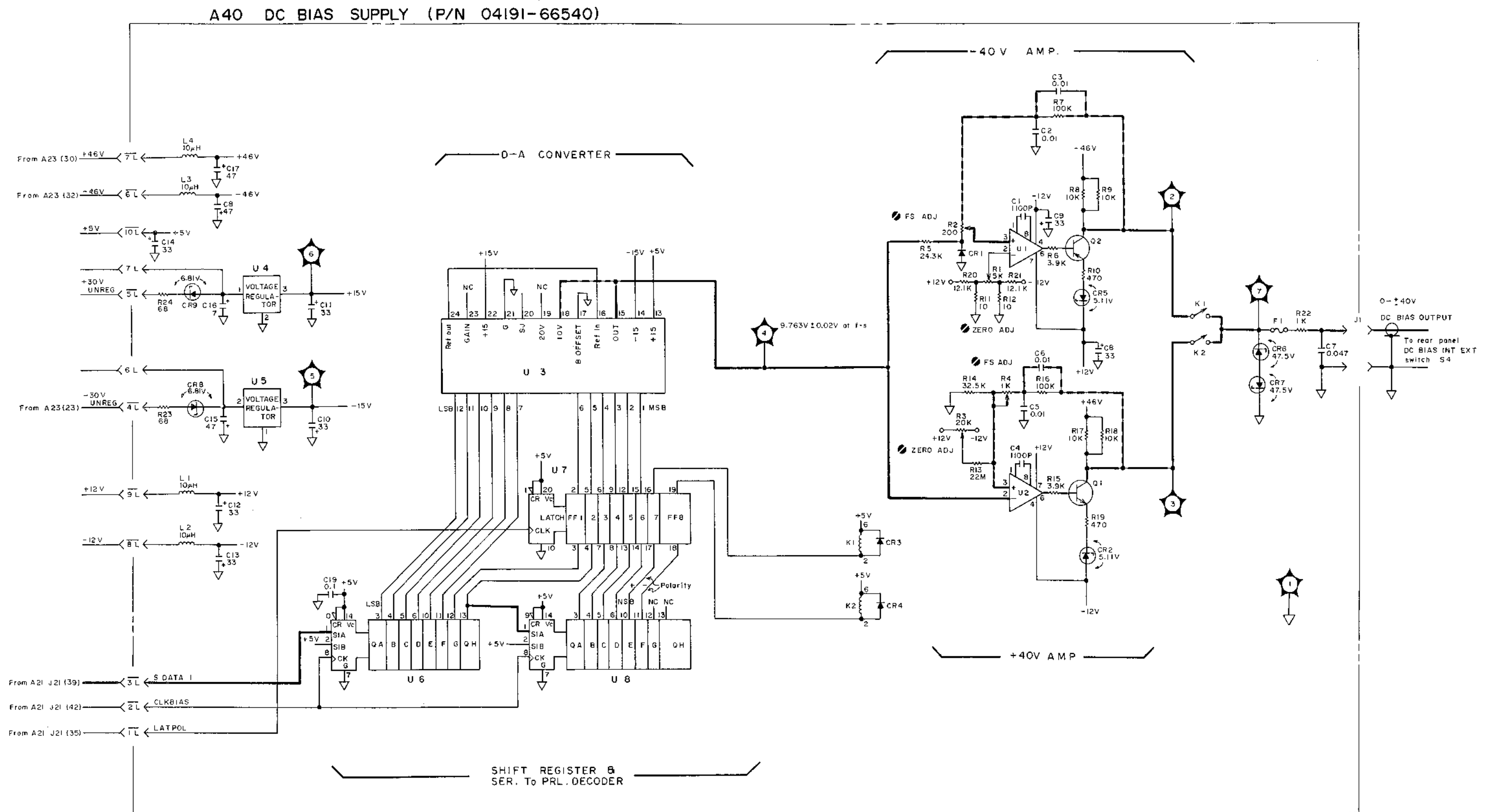

Figure 8-95. A40 DC Bias Supply Board Assembly Schematic Diagram.

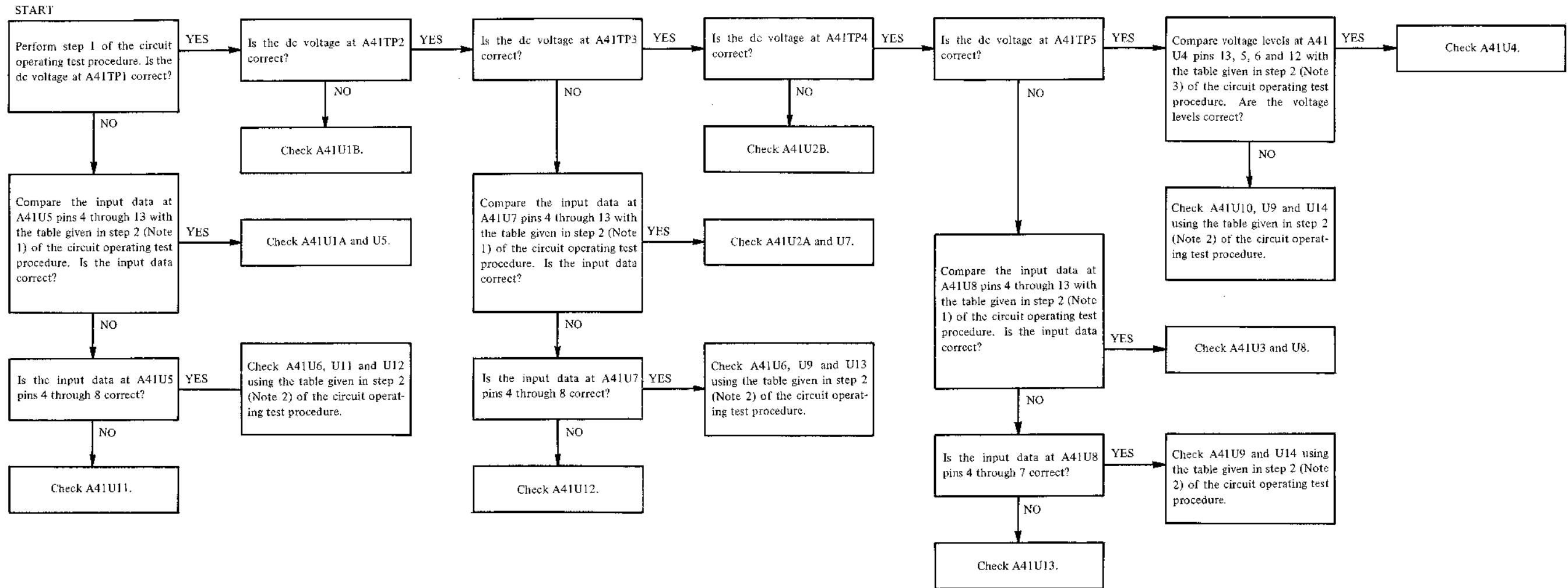

Figure 8-96. A41 Analog Recorder Output Board Troubleshooting Flow Diagram.

A41 ANALOG RECORDER OUTPUT CIRCUIT OPERATING TEST

Circuit operation of the A41 analog recorder output is checked using the procedure outlined below:

1. Press the **blue** key and UR $\rightarrow\uparrow$ key on the 4191A front panel. Measure the voltages at test points A41TP1 through TP5 with a DVM. Verify that the DVM readouts meet the test limits given in the table below:

Test point	Test limits
TP1	1000mV \pm 7mV
TP2	-1000mV \pm 7mV
TP3	1000mV \pm 7mV
TP4	-1000mV \pm 7mV
TP5	1000mV \pm 7mV

2. Press the **blue** key and $\downarrow\leftarrow$ key. Verify that the dc voltages at test points A41TP1 through TP5 are 0 \pm 2mV.

Note: 1. D-A converter control input data at A41U5, U7, and U8 (pins 4 through 7) are as follows:

Function setting	U5, U7, U8 pins									
	4	5	6	7	8	9	10	11	12	13
UR $\rightarrow\uparrow$	1	1	1	0	1	0	0	0	0	0
$\downarrow\leftarrow$ LL	1	1	1	1	1	1	1	1	1	1

0 : 0V 1 : +5V

Note: 2. The outputs of the serial to parallel data decoders (A41U11, U12, U13 and U14) have the following voltage levels when the UR $\rightarrow\uparrow$ function is set.

IC	Pin number							
	3	4	5	6	10	11	12	13
A41U11	1	1	1	0	1	0	0	0
A41U12	0	0	1	1	1	0	1	0
A41U13	0	0	0	0	1	1	1	0
A41U14	1	0	0	0	0	0	0	0

0 : 0V 1 : +5V

When the $\downarrow\leftarrow$ LL function is set, the outputs of the serial to parallel data decoders are as follows:

IC	Pin number							
	3	4	5	6	10	11	12	13
A41U11	1	1	1	1	1	1	1	1
A41U12	1	1	1	1	1	1	1	1
A41U13	1	1	1	1	1	1	1	1
A41U14	1	1	1	1	1	1	0	0

0 : 0V 1 : +5V

Note: 3. The polarity switch control inputs at A41U4 pins 13, 5, 6 and 12 are as follows:

Polarity	U4 pins			
	13	5	6	12
Positive or zero	+4V	-4V	+4V	-4V
Negative	-4V	+4V	-4V	+4V

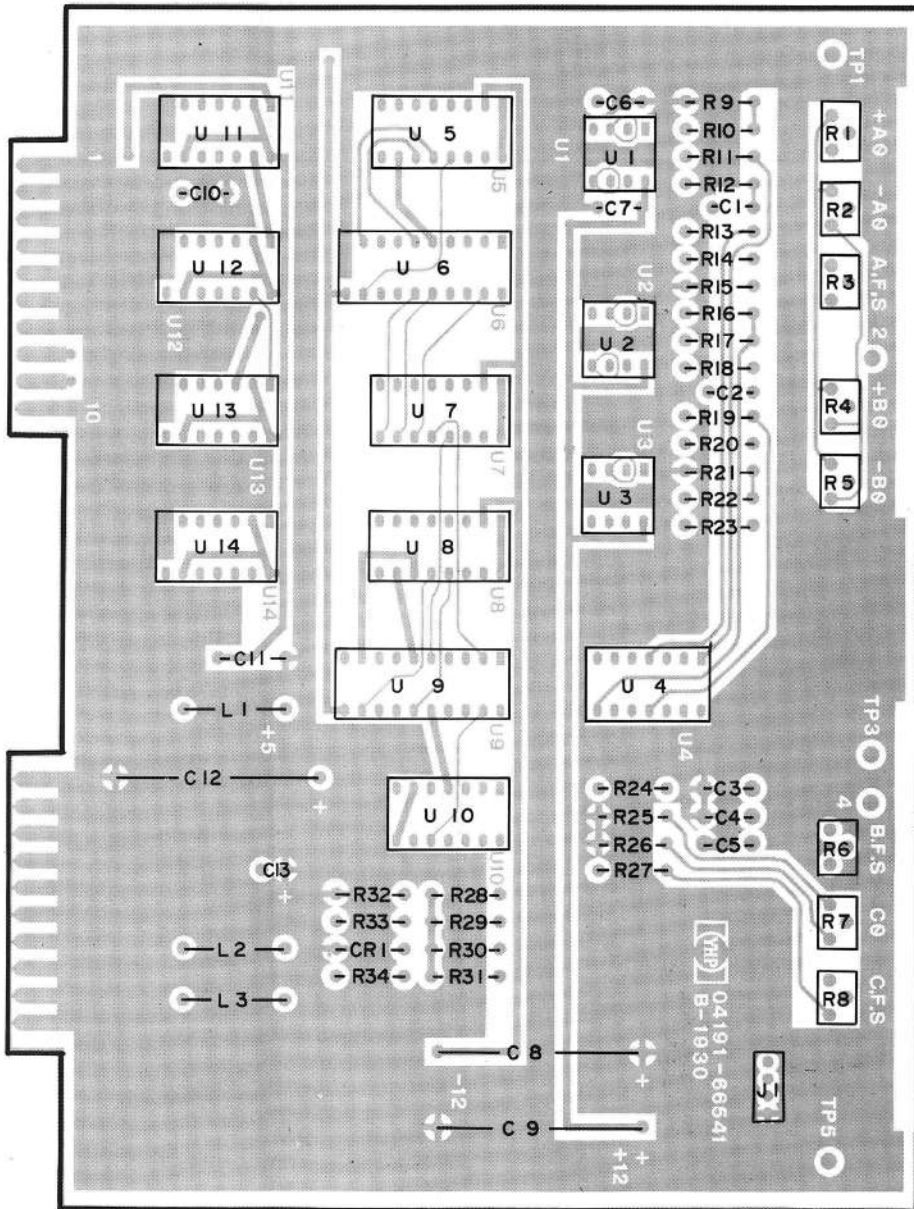

Figure 8-97. A41 Analog Recorder Output Board Assembly Component Locations.

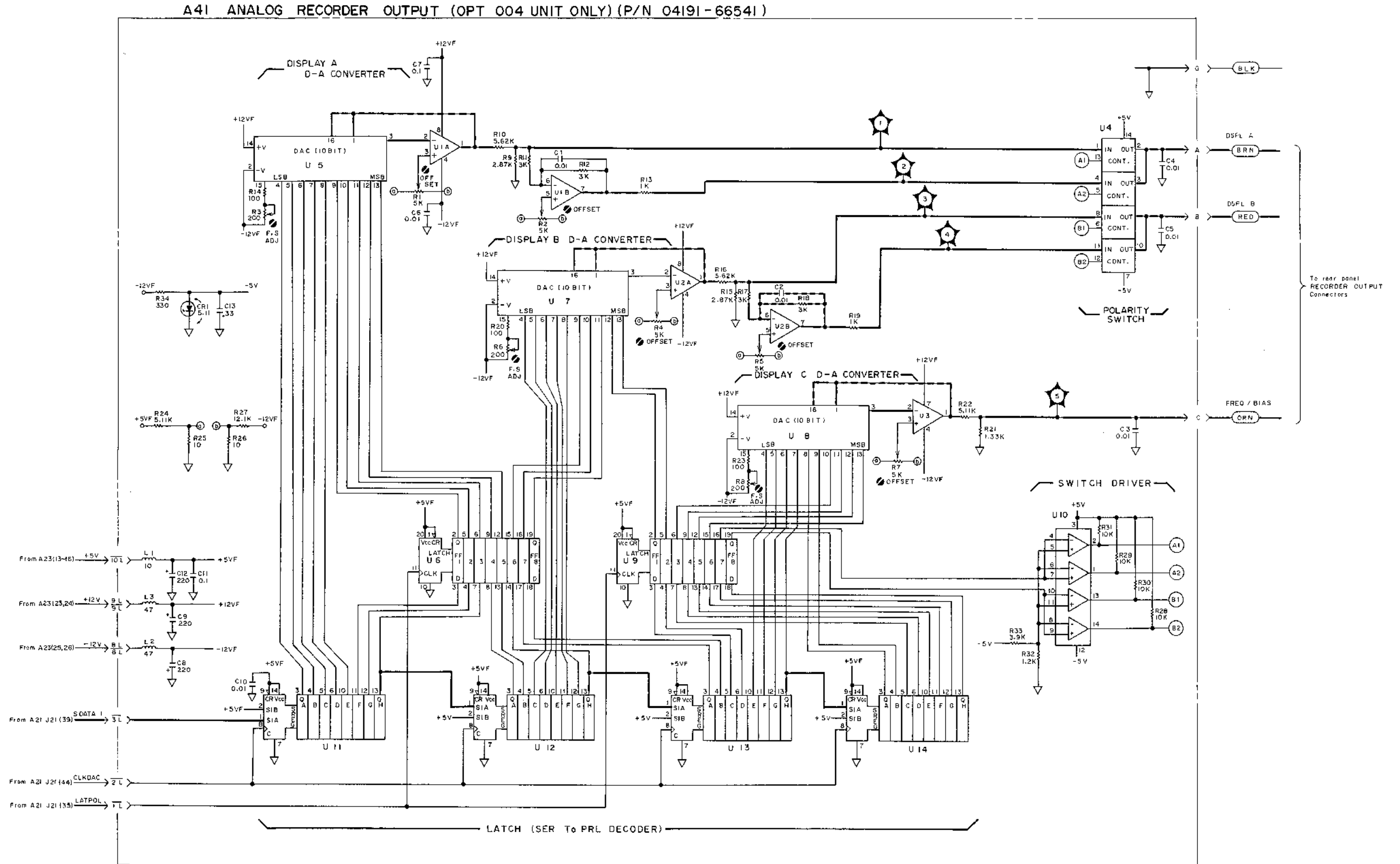

Figure 8-98. A41 Analog Recorder Output Board Assembly Schematic Diagram.