

Errata

Title & Document Type: 37717B PDH/SDH Test Set Calibration Manual

Manual Part Number: 37717-90084

Revision Date: July 1995

HP References in this Manual

This manual may contain references to HP or Hewlett-Packard. Please note that Hewlett-Packard's former test and measurement, semiconductor products and chemical analysis businesses are now part of Agilent Technologies. We have made no changes to this manual copy. The HP XXXX referred to in this document is now the Agilent XXXX. For example, model number HP8648A is now model number Agilent 8648A.

About this Manual

We've added this manual to the Agilent website in an effort to help you support your product. This manual provides the best information we could find. It may be incomplete or contain dated information, and the scan quality may not be ideal. If we find a better copy in the future, we will add it to the Agilent website.

Support for Your Product

Agilent no longer sells or supports this product. You will find any other available product information on the Agilent Test & Measurement website:

www.tm.agilent.com

Search for the model number of this product, and the resulting product page will guide you to any available information. Our service centers may be able to perform calibration if no repair parts are needed, but no other support from Agilent is available.





HP 37717B
PDH/SDH Test Set
Calibration Manual



HP 37717B PDH/SDH test set
CALIBRATION MANUAL

SERIAL NUMBERS

This manual applies directly to instruments
with serial numbers GB00000101 and above.



HP Part No. 37717-90084
Printed in U.K. July 1995

CERTIFICATION

Hewlett-Packard Company certifies that this product met its published specifications at the time of shipment from the factory. Hewlett-Packard further certifies that its calibration measurements are traceable to the United States National Bureau of Standards, to the extent allowed by the Bureau's calibration facility and to the calibration facilities of other International Standards Organization members.

ASSISTANCE

Product maintenance agreements and other customer assistance agreements are available for Hewlett-Packard products.

For any assistance, contact your Hewlett-Packard Sales and Service Office.

Addresses are provided at the back of this manual.

NOTICE

The information contained in this document is subject to change without notice.

Hewlett-Packard shall not be liable for errors contained herein or for incidental or consequential damages in connection with the furnishing, performance or use of this material.

This document contains proprietary information which is protected by copyright. All rights are reserved. No part of this document may be photocopied or reproduced without the prior written consent of Hewlett-Packard Ltd.

PRINTING HISTORY

First Edition July 1995

Copyright © Hewlett-Packard Ltd. (1995)

WARNING

READ THE FOLLOWING NOTES BEFORE INSTALLING OR SERVICING ANY INSTRUMENT.

1. IF THIS INSTRUMENT IS TO BE ENERGISED VIA AN AUTO-TRANSFORMER MAKE SURE THAT THE COMMON TERMINAL OF THE AUTO-TRANSFORMER IS CONNECTED TO THE NEUTRAL POLE OF THE POWER SOURCE.
2. THE INSTRUMENT MUST ONLY BE USED WITH THE MAINS CABLE PROVIDED. IF THIS IS NOT SUITABLE, CONTACT YOUR NEAREST HP SERVICE OFFICE. THE MAINS PLUG SHALL ONLY BE INSERTED IN A SOCKET OUTLET PROVIDED WITH A PROTECTIVE EARTH CONTACT. THE PROTECTIVE ACTION MUST NOT BE NEGATED BY THE USE OF AN EXTENSION CORD (POWER CABLE) WITHOUT A PROTECTIVE CONDUCTOR (GROUNDING).
3. BEFORE SWITCHING ON THIS INSTRUMENT:
 - a. Ensure that all devices connected to this instrument are connected to the protective (earth) ground.
 - b. Ensure that the line power (mains) plug is connected to a three-conductor line power outlet that has a protective (earth) ground. (Grounding one conductor of a two-conductor outlet is not sufficient).
 - c. Check correct type and rating of the instrument fuse(s).



Contents

1. General Information	
Specifications	1-1
Safety Considerations	1-2
Manual Safety Markings	1-2
Instrument Safety Markings	1-2
Laser Safety	1-3
Laser Warning Symbols	1-4
ESD Precautions	1-4
Product Regulations	1-5
Operators Maintenance	1-5
Cleaning	1-5
Optical Fibre Cleaning	1-6
Instruments Covered By Manual	1-7
Options	1-7
Accessories	1-10
Specifications	1-11
2. Installation	
Initial Inspection	2-1
Preparation for Use	2-2
Power Requirements	2-2
Power Cord	2-3
Operators Maintenance	2-4
Fuse Replacement	2-4
Line Voltage Selector Switch	2-5
Hewlett-Packard Interface Bus	2-5
HP-IB Address Selection	2-7
Operating Environment	2-7
Storage and Shipment	2-7
Repackaging for Shipment	2-8

3. Performance Tests	
Introduction	3-1
Equipment Required	3-1
Performance Test Record	3-1
Calibration Cycle	3-1
Recall Default Settings	3-2
Self Test	3-5
Description	3-5
Self Test Loopbacks	3-5
Procedure	3-6
PDH Internal Transmitter Clocks	3-7
Specifications	3-7
Description	3-7
Equipment	3-7
Procedure	3-8
Frequency Offsets	3-9
PDH Transmitter Output	3-11
Specifications	3-11
Description	3-11
Equipment	3-12
Procedure	3-12
Multiple PDH Transmitter Outputs (Option UHC[US6])	3-25
Specifications	3-25
Description	3-25
Equipment	3-26
Procedure	3-26
PDH Frame Analysis	3-41
Specifications	3-41
Equipment	3-41
Description	3-41
Procedure	3-42
2 Mb/s Frame Analysis	3-43
8 Mb/s Frame Analysis	3-44
34 Mb/s Frame Analysis	3-46
140 Mb/s Frame Analysis	3-47
PDH Receiver Equalization	3-49
Specifications	3-49
Description	3-49

Equipment	3-49
Procedure	3-49
PDH Receiver Monitor Levels (Option UKK[USB] only)	3-53
Specification	3-53
Description	3-53
Equipment	3-53
Procedure	3-53
SPDH Receiver Monitor Levels (Options UKJ,[USA] and UKL,[USC])	3-56
Specifications	3-56
Description	3-56
Equipment	3-56
Procedure	3-57
External 2Mb/s Mux/Demux (Options UKJ, [USA])	3-60
Specifications	3-60
Description	3-60
Equipment	3-61
Procedure	3-61
External 2Mb/s Demux (Options UKL, [USC])	3-67
Specifications	3-67
Description	3-67
Equipment	3-67
Procedure	3-68
PDH Receiver Monitor Levels (Special Option 808)	3-73
Specification	3-73
Description	3-73
Equipment	3-73
Procedure	3-73
PDH Error Output	3-77
Specifications	3-77
Description	3-77
Equipment	3-77
Procedure	3-77
PDH Frequency Measurement and Looped Clock	3-79
Specifications	3-79
Description	3-79
Equipment	3-79
Procedure	3-79

Internal SDH Transmitter Clock (Options US1[US5], A1T[A1U])	3-83
Specifications	3-83
Description	3-83
Equipment	3-83
Procedure	3-83
SDH Frequency Offsets (Options US1[US5], A1T[A1U])	3-85
Specifications	3-85
Description	3-85
Equipment Required	3-85
Procedure	3-85
External MTS Clock (Options US1[US5], A1T[A1U])	3-88
Specifications	3-88
Description	3-88
Equipment Required	3-88
Procedure	3-88
STM-1 Transmitter Output Waveshape (Options US1[US5], A1T[A1U])	3-91
Specifications	3-91
Description	3-91
Equipment Required	3-91
Procedure	3-91
STM-1 Receiver Monitor Input (Options US1[US5], A1T[A1U])	3-99
Specification	3-99
Description	3-99
Equipment Required	3-99
Procedure	3-99
STM-1 Receiver Monitor Input (Special Option 808)	3-101
Specification	3-101
Description	3-101
Equipment Required	3-101
Procedure	3-101
STM-1 Receiver Input Equalization (Options US1[US5], A1T[A1U])	3-103
Specification	3-103
Description	3-103
Equipment Required	3-103
Procedure	3-103
STM-1 Optical Interface (Option UH1)	3-104

Specification (Transmitter)	3-104
Specification (Receiver)	3-104
Description	3-104
Equipment Required	3-104
Procedure	3-105
STM-1/4 Optical Interface (Option UH2)	3-107
Specification (Transmitter)	3-107
Specification (Receiver)	3-107
Description	3-107
Equipment Required	3-107
Procedure	3-108
STM-1/4, 1550nm Optical Interface (Option URU)	3-111
Specification (Transmitter)	3-111
Specification (Receiver)	3-111
Description	3-111
Equipment Required	3-112
Procedure	3-112
Transmitted Jitter Amplitude Accuracy (Option UHK)	3-117
Specifications	3-117
Description	3-118
Equipment	3-118
Pre-Adjustment Setup	3-118
Procedure	3-120
Received Jitter Accuracy (Option UHN[US9])	3-125
Specifications	3-125
Description	3-125
Equipment	3-126
Pre-Adjustment Setup	3-126
Jitter Generation Module Calibration Procedure	3-127
Received Jitter Accuracy Procedure	3-129
Fitting A Jitter Generation Module	3-132
Wander/Slips Measurement (Option UHN[US9])	3-134
Specifications	3-134
Description	3-134
Equipment	3-135
Procedure	3-135
Performance Test Record	3-140

A. Default Settings

B. Self Test Fail Numbers

Index

Contents-6

Figures

1-1. Serial Number Plate	1-7
2-1. Power Cord Part Numbers	2-4
2-2. HP-IB Connections and Logic Levels	2-6
3-1. Self Test RS-232 port loopback connections	3-5
3-2. 704 kb/s Pulse Criteria	3-13
3-3. 2 Mb/s Pulse Mask	3-14
3-4. 2 Mb/s Isolated Positive Pulse	3-15
3-5. 2 Mb/s Isolated Negative Pulse	3-16
3-6. 8 Mb/s Pulse Mask	3-17
3-7. 8 Mb/s Isolated Positive Pulse	3-18
3-8. 8 Mb/s Isolated Negative Pulse	3-18
3-9. 34 Mb/s Pulse Mask	3-19
3-10. 34 Mb/s Isolated Positive Pulse	3-20
3-11. 34 Mb/s Isolated Negative Pulse	3-21
3-12. 140 Mb/s Pulse Mask All 1's	3-22
3-13. 140 Mb/s All Ones Pulse	3-23
3-14. 140 Mb/s Pulse Mask All 0's	3-24
3-15. 140 Mb/s All Zeros Pulse	3-24
3-16. 704 kb/s Pulse Criteria	3-27
3-17. 2 Mb/s Pulse Mask	3-29
3-18. 8 Mb/s Pulse Mask	3-32
3-19. 34 Mb/s Pulse Mask	3-35
3-20. 140 Mb/s Pulse Mask All 1's	3-38
3-21. 140 Mb/s Pulse Mask All 0's	3-39
3-22. PDH Receiver Equalization Test Setup	3-50
3-23. PDH Receiver Monitor Levels Test Setup	3-54
3-24. SPDH Receiver Monitor Input	3-57
3-25. External 2 Mb/s Mux/Demux	3-61
3-26. 2 Mb/s Pulse Mask	3-64
3-27. 2 Mb/s Isolated Positive Pulse	3-65

3-28. 2 Mb/s Isolated Negative Pulse	3-66
3-29. External 2mb/s Demux	3-68
3-30. 2 Mb/s Pulse Mask	3-70
3-31. 2 Mb/s Isolated Positive Pulse	3-71
3-32. 2 Mb/s Isolated Negative Pulse	3-72
3-33. PDH Receiver Monitor Levels Test Setup	3-74
3-34. Receiver Frequency Measurement Test Setup	3-80
3-35. STM-1 Transmitter Output Waveshape, Test Setup	3-92
3-36. STM-1 All Ones Pattern	3-94
3-37. STM-1 All Ones Mask	3-95
3-38. STM-1 All Zeros Pattern	3-96
3-39. STM-1 All Zeros Mask	3-97
3-40. STM-1 Eye Diagram Pattern	3-98
3-41. STM-1 Eye Diagram Mask	3-98
3-42. STM-1 Receiver Monitor Input	3-100
3-43. STM-1 Receiver Monitor Input	3-102
3-44. TX Jitter Accuracy Test Setup	3-121
3-45. Bessel Null Example	3-122
3-46. TX Jitter Accuracy Test Setup	3-128
3-47. Self Test RS-232 port loopback connections	3-133
3-48. Slips and Wander Test Setup	3-137

Tables

1-1. Recommended Test Equipment	1-29
2-1. Fuses	2-2
2-2. HP-IB Interconnecting Cables	2-5
3-1. Recommended Test Equipment	3-3
3-2. Transmitter Clock Offset	3-10
3-3. Measured Offset	3-82
3-4. Range 1 Tx Jitter Amplitude Accuracy	3-122
3-5. Range 10 Tx Jitter Amplitude Accuracy	3-124
B-1. PDH Tests, Option UKK (75 Ω Unbal Back to Back)	B-1
B-2. PDH Tests, Option UKK (120 Ω Bal Back to Back)	B-2
B-3. PDH Tests, Option UKK (Offset, Frequency Measurement)	B-2
B-4. PDH Tests, Option UKK (Error Add/Error Count)	B-3
B-5. PDH Tests, Option UKK (Clock Recovery)	B-3
B-6. PDH Tests, Option UKK (FAS Word)	B-3
B-7. SPDH Tests, Option UKJ (Line Code 75 Ω Unbal Back to Back)	B-4
B-8. SPDH Tests, Option UKJ (Line Code 120 Ω Bal Back to Back)	B-4
B-9. SPDH Tests, Option UKJ (Offset, Frequency Measurement)	B-4
B-10. SPDH Tests, Option UKJ (34 Mb/s, Error Add/Error Count)	B-6
B-11. SPDH Tests, Option UKJ (Framing/Unframed)	B-7
B-12. SPDH Tests, Option UKJ (Structured Payloads)	B-7
B-13. SPDH Tests, Option UKJ (Patterns)	B-8
B-14. SPDH Tests, Option UKJ (Drop/Insert)	B-8
B-15. SPDH Tests, Option UKJ (Round Trip Delay)	B-8
B-16. SDH Tests Option A1T (STM-1)	B-10
B-17. SDH Tests Option A1T (STM-1 Frequency Offset)	B-10
B-18. SDH Tests Option A1T (STM-1, Overhead)	B-10
B-19. SDH Tests Option A1T (Frame Error Add)	B-11
B-20. SDH Tests Option A1T (140 Mb/s Payload)	B-11
B-21. SDH Tests Option A1T (TU3 Payload)	B-11

B-22. SDH Tests Option A1T (TU12 Payload Overhead)	B-12
B-23. SDH Tests Option A1T (Payload Pattern)	B-12
B-24. SDH Tests Option A1T (TU2 Payload Bit Error Add)	B-13
B-25. SDH Tests Option A1T (Freq Offset/Pointer Movements)	B-13
B-26. SDH Tests Option A1T (Thru Mode and DCC)	B-14
B-27. SDH Tests Option US1 (STM-1)	B-14
B-28. SDH Tests Option US1 (STM-1, Frequency Offset)	B-14
B-29. SDH Tests Option US1 (STM-1, 140 Mb/s Payload/Overhead)	B-14
B-30. SDH Tests Option US1 (STM-1, 34 Mb/s Payload/Overhead)	B-15
B-31. SDH Tests Option US1 (STM-1, 2 Mb/s Payload/Overhead)	B-15
B-32. SDH Tests Option US1 (Payload/Background Patterns)	B-15
B-33. SDH Tests Option US1 (Alarm Detect)	B-16
B-34. Optical Tests Option UH1 (STM-1)	B-17
B-35. Optical Tests Options UH2, URU (STM-1)	B-17
B-36. JITTER Generator Tests (Opt UHK)	B-19
B-37. JITTER Receiver Tests (Opt UHN)	B-19
B-38. JITTER Back to Back Tests (Opt UHK and UHN)	B-21
B-39. STM-1 Electrical JITTER Receiver Tests (Opt A1M)	B-22
B-40. ATM Alarms, Back to Back Tests (Opt UKN)	B-24
B-41. ATM Bandwidth, Back to Back Tests (Opt UKN)	B-24
B-42. ATM Distribution, Back to Back Tests (Opt UKN)	B-25
B-43. ATM Error Add, Back to Back Tests (Opt UKN)	B-25
B-44. ATM Headers, Back to Back Tests (Opt UKN)	B-27
B-45. ATM Payloads, Back to Back Tests (Opt UKN)	B-29
B-46. ATM Test Cell, Back to Back Tests (Opt UKN)	B-29
B-47. ATM Trail Trace, Back to Back Tests (Opt UKN)	B-30

General Information

This section contains general information concerning the HP 37717B PDH/SDH test set.

SPECIFICATIONS

SAFETY CONSIDERATIONS

PRODUCT REGULATIONS

OPERATORS MAINTENANCE

INSTRUMENTS COVERED BY MANUAL

OPTIONS

ACCESSORIES

Specifications

The instrument specifications are listed on Pages 1-11 to 1-28. These specifications are the performance standard or limits, against which the instrument is tested.

The recommended test equipment required to carry out the performance tests is listed in Table 1-1.

Safety Considerations

The HP 37717B PDH/SDH test set is a Safety Class 1 (IEC) product (provided with a protective earthing ground incorporated in the power cord).

This instrument has been designed and tested in accordance with IEC Publication 348, Safety Requirements for Electronic Measuring Apparatus, and has been supplied in a safe condition. The instruction documentation contains information and warnings which must be followed by the user to ensure safe operation and to maintain the instrument in a safe condition.

Manual Safety Markings

Warning



THE WARNING SIGN DENOTES A HAZARD TO THE OPERATOR. IT CALLS ATTENTION TO A PROCEDURE, PRACTICE, OR THE LIKE, WHICH IF NOT CORRECTLY PERFORMED OR ADHERED TO, COULD RESULT IN INJURY OR LOSS OF LIFE. DO NOT PROCEED BEYOND A WARNING SIGN UNTIL THE INDICATED CONDITIONS ARE FULLY UNDERSTOOD AND MET.

Caution



The CAUTION sign denotes a hazard to the instrument. It calls attention to an operating or maintenance procedure, practice, or the like, which if not correctly performed or adhered to, could result in damage to or destruction of part or all of the instrument. Do not proceed beyond a CAUTION sign until the indicated conditions are fully understood and met.

Instrument Safety Markings



Refer To Service Manual : This symbol on the instrument means the user must refer to the instrument Service Manual to protect the instrument from damage.



Protective Earth Ground : Indicates protective earth ground terminal of the ac power source on the instrument. All exposed metal surfaces on the instrument must connect to a protective earth ground terminal.



Frame or Chassis Terminal : This symbol identifies a terminal that is normally common to all exposed metal surfaces on the instrument.

Warning



NO OPERATOR SERVICEABLE PARTS INSIDE. REFER SERVICING TO QUALIFIED PERSONNEL. TO PREVENT ELECTRICAL SHOCK DO NOT REMOVE COVERS.

Laser Safety

The HP 37717B Option UH1, UH2 and URU Optical modules are classified as Class 1 (non-hazardous) laser products. These products comply with the United States Food and Drug Administration (FDA) Standard 21 CFR Ch.1 1040.10 and EN 60825.

To avoid exposure to hazardous laser radiation, it is recommended that the following practices are observed during system operation:

- **ALWAYS DEACTIVATE THE LASER BEFORE CONNECTING OR DISCONNECTING OPTICAL CABLES.**
- When connecting or disconnecting optical cables between the module and device-under-test, observe the connection sequences given below.
 - Connecting** : Connect the optical cable to the input of the device-under-test **before** connecting to the module's *Optical Out* connector.
 - Disconnecting** : Disconnect the optical cable from the module's *Optical Out* connector **before** disconnecting from the device-under-test. Always ensure the shutter closes properly and covers the laser aperture.
- **NEVER** examine or stare into the open end of a broken, severed, or disconnected optical cable when it is connected to the module's *Optical Out* connector.
- Arrange for service-trained personnel, who are aware of the hazards involved, to repair optical cables.

Laser Warning Symbols

The optical module's front panel contains the following label:

CLASS 1 LASER PRODUCT

This label indicates that the radiant energy present in this instrument is non-hazardous.

ESD Precautions

Caution



The module contains components sensitive to electrostatic discharge. To prevent component damage, carefully follow the handling precautions presented below.

The smallest static voltage most people can feel is about 3500 volts. It takes less than one tenth of that (about 300 volts) to destroy or severely damage static sensitive circuits. Often, static damage does not immediately cause a malfunction but significantly reduces the component's life. Adhering to the following precautions will reduce the risk of static discharge damage.

- Keep the module in its conductive storage box when not installed in the Mainframe. Save the box for future storage of the module.
- Before handling the module, select a work area where potential static sources are minimized. Avoid working in carpeted areas and non-conductive chairs. Keep body movement to a minimum. Hewlett-Packard recommends that you use a controlled static workstation.
- Handle the module by its front-panel. Avoid touching any components or edge connectors. When you install the module, keep one hand in contact with the protective bag as you pick up the module with your other hand. Then, before installing the module, make contact with the metal surface of the Mainframe with your free hand to bring you, the module, and the mainframe to the same static potential. **This also applies whenever you connect/disconnect cables on the front-panel.**

Caution

The connectors on the front-panel of the module remain susceptible to ESD damage while the module is installed in the Mainframe, as indicated by the label:



Product Regulations**ElectroStatic Discharge**

When 3 pin Siemens cables are connected to any of the HP 37717B 120 Ω Balanced IN or OUT ports, and air discharge is applied to the measurement cards in accordance with IEC 801_2, 1991, occasional errors may be counted by the HP 37717B.

When a telephone handset cable is connected to the HANDSET port of the HP 37717B, and air discharge is applied to the measurement cards in accordance with IEC 801_2, 1991, occasional errors may be counted by the HP 37717B.

Operators Maintenance**Warning**

NO OPERATOR SERVICEABLE PARTS INSIDE. REFER SERVICING TO QUALIFIED PERSONNEL. TO PREVENT ELECTRICAL SHOCK DO NOT REMOVE COVERS.

Cleaning

Clean the cabinet using a dry cloth only.

Optical Fibre Cleaning

It is recommended that the optical connectors be cleaned at regular intervals using the following materials :

Description	HP Part Number
Blow Brush	9300-1131
Isopropyl Alcohol	8500-5344
Lens Cleaning Paper	9300-0761
Adhesive Tape Kit	15475-68701

Caution



Do not insert any tool or object into the IN or OUT ports of the instrument as damage to or contamination of the optical fibre may result.

1. Recall Default settings (STORED SETTINGS 0) and remove the power from the HP 37717B.
2. Remove the adapters from the IN and OUT ports.
3. Using the blow brush with the brush removed blow through the ferrule of the standard flexible connector and the adapter.

Caution



If the optical fibre of the fixed connector requires further cleaning this entails disassembly of the module which should only be carried out by suitably trained service personnel.

4. Apply some isopropyl alcohol to a piece of the cleaning paper and clean the barrel of the adapter. Using a new piece of cleaning paper, clean the face of the adapter. Repeat this operation, using a new piece of cleaning paper each time.
5. Lightly press the adhesive side of the tape provided against the front of the adapter, then remove it quickly - repeat twice. This removes any particles of cleaning paper which may be present.
6. Replace the adapters on the flexible connector.

1-6 General Information

Instruments Covered By Manual

Attached to the rear panel of the instrument is a serial number plate. The serial number plate has a two letter reference denoting country of origin (GB = Great Britain) and an eight digit serial number. The serial number is unique to each instrument and should be quoted in all correspondence with Hewlett-Packard, especially when ordering replacement parts.

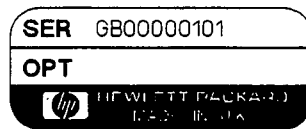

Figure 1-1. Serial Number Plate

Options

The options available in the HP 37717B PDH/SDH test set allow the instrument to be configured to fit a wide range of applications. The options available are :

- | | |
|----------------------------|---|
| UKK (BNC)
USB (Siemens) | Unstructured PDH module - Provides PDH interfaces at 704 kb/s, 2.048 Mb/s, 8.448 Mb/s, 34.368 Mb/s and 139.264 Mb/s. Frequency offset at all rates and FAS measurement at 2.048 Mb/s. |
| UKJ (BNC)
USA (Siemens) | Structured PDH Module - Provides structured PDH interfaces at 2.048 Mb/s, 8.448 Mb/s, 34.368 Mb/s and 139.264 Mb/s. Frequency offset and FAS measurement at all rates. |
| UKL (BNC)
USC (Siemens) | Structured PDH Receive only Module - Provides receive only features of Option UKJ. |
| UKN (BNC)
USE (Siemens) | ATM module. Provides ATM generation and measurement at 34.368 Mb/s and 155.52 Mb/s. |
| UHC (BNC)
US6 (Siemens) | Multiple Outputs - Provides 3 additional data outputs which are a replica of Signal Out but delayed by a defined amount. |

US1 (BNC) US5 (Siemens)	SDH Module and Frequency Offset - Provides SDH electrical interfaces at STM-1 and SDH Frequency Offset. In addition provides the capability to generate SDH Alarms and Errors.
A1T (BNC) A1U (Siemens)	STM-1 Overhead and Stress testing - SDH Module and Frequency Offset - Provides SDH electrical interfaces at STM-1 and SDH Frequency Offset. In addition provides the capability to generate SDH Alarms and Errors, Pointer sequences and provides access to overhead.
UH1	STM-1 Optical - Provides STM-1 Optical interfaces for the SDH module.
UH2	STM-1/STM-4 Optical - Provides STM-1 and STM-4 Optical interfaces for the SDH module.
URU	1550 nm STM-1/STM-4 Optical - Provides a STM-1/STM-4 optical interface at 1550 nm, for long reach applications, to the SDH options.
UH4	FC/PC optical adaptor for options UH1, UH2 and URU.
UH5	DIN47256 optical adaptor for options UH1, UH2 and URU.
UH6	ST optical adaptor for options UH1, UH2 and URU.
UH7	Biconic optical adaptor for options UH1, UH2 and URU.
UH8	NEC D4 optical adaptor for options UH1, UH2 and URU.
UHK	Jitter Generation - Adds Jitter generation at all PDH rates except 704 kb/s. If Option US1 is fitted adds Jitter generation at STM-1/STM-4.
UHN (BNC) US9 (Siemens)	PDH Jitter Receiver + Wander and Estimated Slips measurement- Adds PDH Jitter measurement at all PDH rates except 704 kb/s. Adds Wander and Estimated Slips measurement at 2.048 Mb/s.
A1M	SDH Jitter Receiver - Adds SDH jitter measurement at STM-1 (electrical) rate.
A1N	SDH Jitter Receiver - Adds SDH jitter measurement at STM-1 (optical) rate.

1-8 General Information

A1P	SDH Jitter Receiver - Adds SDH jitter measurement at STM-1 (optical) and STM-4 (optical) rates.
1CW	RS-232-C Remote Control/Printer - Allows remote control of all instrument functions via the RS-232-C interface. Alternatively allows the connection of an external RS-232-C printer.
1A8	HP-IB Remote Control - Allows remote control of all instrument functions via the HP-IB interface. Alternatively allows the connection of an external HP-IB printer.
1F7	LAN Remote Control - Allows remote control of all instrument functions via the Local Area Network (LAN) interface.
UHE	Virtual Remote - Allows remote control of up to 12 instruments via a simulation of the instruments front panel. A workstation connected via, RS-232-C, a Modem or a LAN (Local area Network) is required for this configuration. See <i>15580A Virtual Remote Installation and Operation Manual</i> HP p/n 15580-90000.
OB2	Provides one additional operating manual.
OBF	Provides one additional remote control manual.
OB3	Provides a service manual.
W30	Provides two additional years of hardware support beyond the standard one year warranty.

Accessories

The following accessory is supplied with the HP 37717B PDH/SDH test set :

Power Cable See Figure 2-1 for HP part number

The following accessories are available but are not supplied with the HP 37717B PDH/SDH test set :

Optical Power Splitter	HP 15744A
Soft Carrying Case	HP 15910A
Transit Case	HP 15772A
Rack Mount Kit	HP 15770A
Protective Probe	HP 15510A
Protective Probe (Balanced)	HP 15511A



Specifications

Except where otherwise stated, the following parameters are warranted performance specifications. Parameters described as "typical" or "nominal" are supplemental characteristics which provide a useful indication of typical but non-warranted performance characteristics.

Unframed PDH (Option UKK)

Transmitter

PDH Bit rates: 704 kb/s, 2.048 Mb/s, 8.448 Mb/s, 34.368 Mb/s, 139.264 Mb/s

Frequency offset: Up to ± 100 ppm

Interface: Meets ITU-T G.703

Connectors: BNC 75 Ω unbalanced
3 pin Siemens 120 Ω balanced

Test patterns

PRBS: $2^{15}-1$, $2^{23}-1$ at all rates (ITU-T O.151)

Word: User-defined 16 bit word, all ones, all zeros, 1010, 1000.

Output:

704 kb/s, 2.048 Mb/s: HDB3 or AMI balanced/unbalanced.

8.448 Mb/s: HDB3 or AMI unbalanced.

34.368 Mb/s: HDB3 unbalanced.

139.264 Mb/s: CMI unbalanced.

Bit error add: 1 in 10^3 or single error

Clock timing Internal: All rates

Recovered (loop timed): From 704 kb/s or 2.048 Mb/s receiver input.

Receiver

Input:

704 kb/s, 2.048 Mb/s: ± 100 ppm, balanced/unbalanced.

8.448 Mb/s: ± 100 ppm, unbalanced.

34.368 Mb/s: ± 100 ppm, unbalanced.

139.264 Mb/s: ± 100 ppm, unbalanced.

Line codes: As transmitter.

Autosetup: Bit rate, code, test pattern, framing and level of an incoming signal.

Jitter tolerance: To ITU-T Rec G.823.

Synchronization: Sync loss when BER $\geq 1:16$ over 100 ms. Sync gain when BER $< 1:16$.

Equalization: To ITU-T Rec G.703.

Monitor point compensation:

704 kb/s, 2.048 Mb/s, 8.448 Mb/s: 26 to 30 dB.

34.368, 139.264 Mb/s: 26 dB.

Frame Formats

2 Mb/s: PCM30 CAS with or without CRC4.

PCM31 with or without CRC4.

8 Mb/s, 34 Mb/s, 140 Mb/s: Framed.

Structured PDH (Options UKJ, UKL)
Option UKJ provides Structured PDH generation and measurement at standard bit rates. Option UKL provides measurement **only** at standard bit rates.

Transmitter (Option UKJ)

Interface Bit rates: 2.048 Mb/s, 8.448 Mb/s, 34.368 Mb/s and 139.264 Mb/s.

Frequency offset: Up to ± 100 ppm

Interface: Meets ITU-T G.703

Connectors: BNC 75 Ω unbalanced
3 pin Siemens 120 Ω balanced

Test patterns

PRBS: 2^9-1 , $2^{11}-1$, $2^{15}-1$, $2^{23}-1$ at all rates.

Word: User-defined 16 bit word, all ones, all zeros, 1010, 1000.

Output:

2.048 Mb/s: HDB3 or AMI balanced/unbalanced.

8.448 Mb/s: HDB3 or AMI unbalanced.

34.368 Mb/s: HDB3 unbalanced.

139.264 Mb/s: CMI unbalanced.

Bit error add: 1 in 10^3 , 1 in 10^4 , 1 in 10^5 , 1 in 10^6 , 1 in 10^7 or single error

Frame error add: 1 in 10^3 , 1 in 10^4 , 1 in 10^5 , 1 in 10^6 , 1 in 10^7 or error 1 to 4 consecutive frames

Code error add: (2, 8, 34 Mb/s) 1 in 10^3 , 1 in 10^4 , 1 in 10^5 , 1 in 10^6 , 1 in 10^7 or single error

Clock timing Internal: All rates

Recovered (loop timed): From 2.048 Mb/s receiver input.

Test signal rates: N X 64 kb/s, 64 kb/s, 2.048 Mb/s, 8.448 Mb/s, 34.368 and 139.264 Mb/s.

Frame Formats

All Rates: Unframed, Framed or Structured.

2 Mb/s, and 64 kb/s Framing: PCM30 CAS with or without CRC4, PCM31 with or without CRC4. As ITU-T Rec. G.704

8 Mb/s Framing: As ITU-T Rec. G.742

34 Mb/s Framing: As ITU-T Rec. G.751

140 Mb/s Framing: As ITU-T Rec. G.751

Background Patterns: Unframed 2^9-1 PRBS, AIS or same pattern as test signal.

External 2 Mb/s Mux I/P: Meets ITU-T Rec. G.703, unbalanced HDB3 signal only.

Receiver (Option UKJ, UKL)

Interface bit rate:

2.048 Mb/s: ± 100 ppm balanced/unbalanced.

8.448 Mb/s: ± 100 ppm unbalanced.

34.368 Mb/s: ± 100 ppm unbalanced.

139.264 Mb/s: ± 100 ppm unbalanced.

Line codes: As transmitter.

Autosetup: Bit rate, code, test pattern, framing and level of an incoming signal.

1-12 General Information



Synchronization: Sync loss when BER $\geq 20\%$ over 100 ms for PRBS or $\geq 4\%$ over 100 ms for word patterns. Sync gain when 32 consecutive error free bits received.

Equalization at f/2:
2.048 Mb/s, 8.448 Mb/s: 6 dB 34.368 Mb/s, 139.264 Mb/s: 12 dB

Monitor point compensation:
2.048 Mb/s, 8.448 Mb/s: 20 dB, 25 dB or 30 dB.
34.368, 139.264 Mb/s: 20 dB or 25 dB.

Frame Formats: As transmitter.

Frame Alignment 2 Mb/s: As ITU-T Rec. G.706.

Frame Alignment 2 Mb/s CRC4: As ITU-T Rec. G.706.

Frame Alignment 2 Mb/s CAS: As ITU-T Rec. G.732.

Frame Alignment 8 Mb/s: As ITU-T Rec. G.742.

Frame Alignment 34 Mb/s: As ITU-T Rec. G.751.

Frame Alignment 140 Mb/s: As ITU-T Rec. G.751.

Frame Gain 2 Mb/s: 1 correct sequence of FAS-NFAS-FAS.

Frame Loss 2 Mb/s: 3 consecutive incorrect FAS or NFAS words.

Frame Gain 2 Mb/s CAS: 1 correct CAS multiframe and the previous CAS word is not 0000.

Frame Loss 2 Mb/s CAS: 2 consecutive errored CAS multiframe patterns or 16 frames with CAS word 0000.

SDH MODULE: Option US1.

Adds SDH STM-1 electrical transmit and receive capability, frequency offset capability, and error and alarm generation.

SDH Transmit and Receive

SDH rate: 155.52 Mb/s

Frequency Offset: up to ± 999 ppm.

Interface: Meets ITU-T G.703.

Connector: BNC, 75 Ω unbalanced.

Payload:

140 Mb/s: Unframed, mapped into VC-4 according to ITU-T G.709 Figures 5.2 and 5.3.

34 Mb/s: Unframed, mapped into VC-3 according to ITU-T G.709 Figure 5.5. Mapping route is C3 - VC-3 - TU-3 - TUG3 - VC-4.

The TU-3 pointer value is 0 with normal New Data Flag in all TU-3's. SS bits "10". Background TU pointers are the same as the foreground. The two background VC-3's are filled with a fixed byte value "10101010".

2 Mb/s: Unframed, mapped into VC-12 according to ITU-T G.709 Figure 5.8.

Mapping route is C12 - VC-12 - TU-12 - TUG2 - TUG3 - VC-4. All

background TU-12's have mapped 2⁹-1 PRBS payload and the same overhead values as the foreground.

Test patterns:

PRBS: $2^{15}-1$, $2^{23}-1$ at all payload rates (ITU-T O.151).

Word: User-defined 16 bit word, all ones, all zeros, 1010, 1000.

Bit error add: 1 in 10^3 or single error.

Clock timing: Internal or recovered or external MTS.

Recovered: From received SDH signal.

EXT MTS: Data or clock format as ITU-T G.811.

TX Overhead

Regenerator section overhead:

A1A2 contains pattern F628 (hexadecimal)

C1 is set to "00000001".

B1 is the BIP-8 parity (using even parity) calculated over the entire previous frame, after scrambling.

E1 is transmitted as all zeros.

F1 is transmitted as all zeros.

D1-D3 are transmitted as all zeros.

All other bytes are all zero's.

Multiplexer section overhead:

H1,H2 - H2 and the 2 least significant bits of H1 indicate an in-range pointer value. The 4 most significant bits of H1 are set to 0110 indicating normal New Data Flag. The SS bits are set to 10.

H3 is transmitted as all zeros.

B2 is the BIP-24 parity (using even parity) calculated over the MSOH bytes and the VC-4 capacity.

K1,K2 are transmitted as all zeros.

D4 - D12 are transmitted as all zeros.

Z1,Z2 are transmitted as all zeros.

E2 is transmitted as all zeros.

All other bytes are all zero's.

User programmable

K1,K2 - Can only program 1 byte at a time ie. K1 or K2.

S1 - Bits 5 - 8 only.

VC-4 path overhead:

J1 - a unique ASCII message is transmitted :

"HEWLETT-PACKARD, HP37717B PDH/SDH FIELD TEST SET, 0000U00000". Terminated by CR,LF.

B3 is the BIP-8 parity (using even parity) calculated over the previous VC-4, before scrambling.

C2 is transmitted as Hexadecimal 12 (140 Mb/s Mapping) or 02 (2 Mb/s & 34 Mb/s Mapping),

G1 is transmitted as all zeros.

F2 is transmitted as all zeros.

H4 is transmitted as all zeros unless a TU-12 payload is selected, in which case the reduced H4 sequence defined in ITU-T Rec. G.709 is transmitted.

Z3 - Z5 are transmitted as all zeros.

All other bytes are all zero's.

VC-3 path overhead:

J1 - a unique ASCII message is transmitted :

"HEWLETT-PACKARD, HP37717B PDH/SDH FIELD TEST SET, 0000U00000". Terminated by CR,LF.

B3 is the BIP-8 parity (using even parity) calculated over the previous VC-3, before scrambling.

C2 is transmitted as Hexadecimal 04 (34 Mb/s mapping).

G1 is transmitted as all zeros.

F2 is transmitted as all zeros.

H4 is transmitted as all zeros.

Z3 - Z5 are transmitted as all zeros.

All other bytes are all zero's.

TU-12 overhead:

V1,V2 - V2 and the 2 least significant bits of V1 are 0 indicating a pointer value of 0. The 4 most significant bits of V1 are 0110 indicating normal New Data Flag. The SS bits are 10 indicating TU-12 payload.

V5 - Bits 1 and 2 are the BIP-2 parity of the previous VC-12 including V5 but excluding V1 - V4. The VC-12 spans 4 frames. Bits 5 - 7 are set to 010 indicating Async mapping. All other bits are set to 0.

Pointer detection

AU-4 pointer value, TU-3 pointer value and TU-12 pointer value.

Alarm generation

Loss of frame (LOF) STM-1 Only, AU-4 Loss Of Pointer (AU-4 LOP), Multiplexer Section (MS AIS), Multiplexer Section FERF (MS FERF), AU-4 Path AIS, AU-4 Path FERF, TU-3 Path AIS, TU-3 Path FERF, TU-3 LOP, TU-12 Path AIS, TU-12 Path FERF and TU-12 LOP.

Equalization: Automatic for cable loss up to 12 dB at half the bit rate.

Monitor point compensation: 20 dB

Error generation

Error type	Single	Rate 10 ^{-N}	Other
Frame A1A2	*		N in 4 frame words (STM-1 Only)
B1	*	4 - 9	STM-1 Only
B2	*	3 - 9	STM-1 Only
B3	*	4 - 9	
Path FEBE	*	4 - 9	
VC-3 Path BIP	*	3 - 9	
VC-3 Path FEBE	*	3 - 9	
V5 BIP-2	*	3 - 9	
V5 FEBE	*	4 - 9	
Payload Bit	*	3 - 9	

OVERHEAD and SRESS TEST SDH MODULE: Option A1T.

Adds SDH STM-1 electrical transmit and receive capability, frequency offset capability, error and alarm generation, pointer sequence generation and overhead access.

SDH Transmit and Receive

SDH rate: 155.52 Mb/s

Frequency Offset: up to ± 999 ppm.

Interface: Meets ITU-T G.703.

Connector: BNC, 75 Ω unbalanced.

Clock timing: Internal or recovered or external MTS.

Recovered: From received SDH signal.

EXT MTS: Data or clock format as ITU-T G.811.

Payload capability:

Payload mappings: 139.264 Mb/s mapped into VC-4 according to ITU-T G.709

34.368 Mb/s mapped into VC-3 according to ITU-T G.709

2.048 Mb/s (asynchronous) mapped into VC-12 according to ITU-T G.709.

2.048 Mb/s (Floating byte synchronous) mapped into VC-12 according to ITU-T G.709.

VC-2 bulk loaded and mapped into TU-2 and TU-2-Nc (for N = 2-6) according to ITU-T G.709.

Payload Data:

PRBS: 2⁹-1, 2¹¹-1, 2¹⁵-1, 2²³-1 (ITU-T O.151).

Word: User-defined 16 bit word, all ones, all zeros, 1010, 1000.

Framed and structured payloads are available in conjunction with the Structured PDH option UKJ/UKN.

Payload framing: 139.264, 34.368, and 2.048 Mb/s Unframed. TU-2 Unframed.

139.264, 34.368, and 2.048 Mb/s framed and structured signals are available in conjunction with the Structured PDH option UKJ/UKN.

External payload data: 139.264 and 34.368 Mb/s data may be inserted and dropped via the IN/OUT ports of the Structured PDH option UKJ/UKN. 2.048 Mb/s data may be inserted and dropped via the 2 Mb/s drop/insert ports of the Structured PDH option UKJ/UKN.

TX Overhead

User programmable bytes:

RSOH: A1,A2, C1, E1, F1, D1 to D3 and access to bytes reserved for national use plus all unmarked bytes reserved for future international standardization.

MSOH: K1, K2, D4 to D12, S1, M1, Z1, Z2, E2 and access to bytes reserved for national use plus all unmarked bytes reserved for future international standardization.

VC-4 and VC-3 POH: J1, C2, G1, F2, H4, Z3 to Z5.

J1 Path Trace: 64 byte or 16 byte, ITU-T E.164 sequence or user defined byte.

VC-12 POH: J2 , V5 signal label.

J2 Path Trace: 16 byte ITU-T E.164 sequence or user defined byte.

1-16 General Information

Pointer adjustment generation:

Increment/Decrement: The adjust pointer key provides a burst selectable between 1 and 10 pointer adjustments (between 1 and 5 for TU-12 and TU-2 pointer).

Frequency offset: these 87:3 pointer sequences are generated by offsetting the frequencies of the AU-4 (or TU-3, TU-12, TU-2) and the line rate relative to each other.

Range: ± 100 ppm in 0.1 ppm steps.

New pointer value: The AU-4, TU-3, TU-12 or TU-2 moves to a selectable new location in a single jump, with or without an accompanying new data flag (NDF).

ITU-T G.783 sequences: Bursts of periodic single adjustments with added or cancelled adjustments. Polarity is selectable.

Bursts of periodic double adjustments with pairs alternating in polarity.

In all cases the interval between adjustments or pairs of adjustments is programmable.

Error generation

Error type	Single	Rate 10 ^{-N}	Other
Frame A1A2	*		N in 4 frame words (STM-1 Only)
B1	*	4 - 9	STM-1 Only
B2	*	3 - 9	STM-1 Only
AU-4 Path BIP	*	4 - 9	
MS FEBE	*	3 - 9	
AU-4 Path FEBE	*	4 - 9	
AU-4 Path IEC	*	4 - 9	
TU-3 Path BIP	*	3 - 9	
TU-3 Path FEBE	*	3 - 9	
TU-2 Path BIP	*	4 - 9	
TU-2 Path FEBE	*	5 - 9	
TU-12 BIP	*	3 - 9	
TU-12 FEBE	*	4 - 9	
Payload Bit	*	3 - 9	

Alarm generation

Loss of signal (LOS), Loss of frame (LOF) STM-1 Only, Out of frame (OOF), AU-4 Loss Of Pointer (AU-4 LOP), AU-4 path unequipped, AU-4 Path AIS, AU-4 Path FERF, Multiplexer Section (MS AIS), Multiplexer Section FERF (MS FERF), TU-3 Path AIS, TU-3 path unequipped, TU-3 Path FERF, TU-3 LOP, TU-2 path AIS, TU-2 path FERF, TU-2 LOP, TU-2 path unequipped, TU-12 path unequipped, TU-12 Path AIS, TU-12 Path FERF and TU-12 LOP.

Overhead sequence generation: A single overhead channel is overwritten with a single or repeated sequence of programmed values. Alternatively a BER test can be performed on a selected byte of regenerator, multiplexer section or path overhead.

MSP message generation: Messages are displayed in text form as per ITU-T G.783. Also user programmed sequences.

DCC insert/drop: Data supplied to the DCC port can be inserted into either the regenerator section (192 kb/s) or multiplexer section (576 kb/s) communications channel. Similarly, data can be dropped from either. Data may be inserted/dropped MSB or LSB first.

STM-1 optical interface stress test: 2 to 259 bytes of the payload are overwritten with a block of zeros (or ones for NRZ systems) after scrambling. Alternatively the ITU-T G.958 test can be selected.

1-18 General Information

STM-1 thru mode:

Transparent mode: The signal is passed through the instrument unaltered.

Overhead overwrite mode: The test features associated with MSOH and POH can be enabled in order to control one single or multi byte overhead channel.

AU-4 overwrite mode: Overwrite the complete AU-4 with the internally generated payload. This enables the SOH to be looped through while a new payload is inserted. All of the test features which affect the VC-4 and/or the POH are enabled.

Equalization: Automatic for cable loss up to 12 dB at half the bit rate.

Monitor point compensation: 20 or 26 dB

Pointer detection

AU-4, TU-3 and TU-12 pointer values.

STM-1 OPTICAL INTERFACE:

Option UH1.

Rate: 155.52 Mb/s

Line code: NRZ

Connectors: Adaptors to which a range of interfaces can be attached.

Transmit:

Wavelength: 1280 - 1330 nm

Fibre power output: nominal -9 dBm

Safety classification: Class 1, FDA 21 CFR Ch.1 1040.10 and EN 60825

Receive:

Wavelength: 1200 - 1600 nm

Sensitivity: -28 dB minimum (with 1300 nm wavelength, 100% modulation depth, BER of 10^{-10} and 2^{23} PRBS)

Maximum input power: -8 dBm (for BER of 10^{-10}) **Alarms detected:** Loss of optical signal.

STM-1/STM-4 OPTICAL

INTERFACE: Option UH2.

Rate: 155.52 Mb/s, 622.08 Mb/s

Line code: NRZ

Connectors: Adaptors to which a range of interfaces can be attached.

Transmit:

Wavelength: 1280 - 1330 nm

Fibre power output: nominal -10 dBm

Safety classification: Class 1, FDA 21

CFR Ch.1 1040.10 and EN 60825

Receive:

Wavelength: 1200 - 1600 nm

Sensitivity: -26 dB minimum (with 1300 nm wavelength, 100% modulation depth, BER of 10^{-10} and 2^{23} PRBS)

Maximum input power: -8 dBm (for BER of 10^{-10})

Alarms detected: Loss of optical signal.

Background STM-1 overhead:

A1,A2 contains pattern F628 (hexadecimal)

C1 - 00000001 to 00000100

Unused C1 bytes - AA (hexadecimal)

B1 - Correct BIP-8 parity

H1,H2 - 6A and 0A (hexadecimal),

Y=93 (hexadecimal)

B2 - Correct BIP-24 parity

B3 - Correct BIP-8 parity

H4 is transmitted as all zero's unless a

TU-12 payload is selected, in which

case the reduced H4 sequence defined

in ITU-T Rec. G.709 is transmitted.

All other overhead bytes are

transmitted as all zero's.

STM-1/STM-4 OPTICAL

INTERFACE: Option URU.

Rate: 155.52 Mb/s, 622.08 Mb/s

Line code: NRZ

Connectors: Adaptors to which a range of interfaces can be attached.

Transmit:

Wavelength: 1520 - 1565 nm

Fibre power output: nominal -1 dBm

Safety classification: Class 1, FDA 21

CFR Ch.1 1040.10 and EN 60825

Receive:

Wavelength: 1200 - 1600 nm

Sensitivity: -26 dB minimum (with 1300 nm wavelength, 100% modulation depth, BER of 10^{-10} and 2^{23} PRBS)

Maximum input power: -8 dBm (for BER of 10^{-10})

Alarms detected: Loss of optical signal.

Background STM-1 overhead:

A1,A2 contains pattern F628 (hexadecimal)

C1 - 00000001 to 00000100

Unused C1 bytes - AA (hexadecimal)

B1 - Correct BIP-8 parity

H1,H2 - 6A and 0A (hexadecimal),

Y=93 (hexadecimal)

B2 - Correct BIP-24 parity

B3 - Correct BIP-8 parity

H4 is transmitted as all zero's unless a

TU-12 payload is selected, in which

case the reduced H4 sequence defined

in ITU-T Rec. G.709 is transmitted.

All other overhead bytes are

transmitted as all zero's.

Protected monitor point input:

Level: nominal 150 mV to 800 mV
pk-pk

**DUAL WAVELENGTH STM-1/STM-4
OPTICAL INTERFACE: Option USN**

Rate: 155.52 Mb/s, 622.08 Mb/s

Line code: NRZ

Connectors: Adaptors to which a range of interfaces can be attached.

Transmit:

Wavelength: 1280 - 1330 nm and 1520 - 1565 nm

Fibre power output: nominal -10 dBm (1280 - 1330 nm)
nominal -1 dBm (1520 - 1565 nm).

Safety classification: Class 1, FDA 21 CFR Ch.1 1040.10 and EN 60825

Receive:

Wavelength: 1200 - 1600 nm

Sensitivity: -26 dB minimum (with 1300 nm wavelength, 100% modulation depth, BER of 10^{-10} and 2^{23} PRBS)

Maximum input power: -8 dBm (for BER of 10^{-10})

Alarms detected: Loss of optical signal.

Protected monitor point input:

Level: nominal 150 mV to 800 mV pk-pk

JITTER GENERATION: Option UHK

Adds Jitter generation at all standard PDH rates with the exception of 704 kb/s. If Option US1 is fitted adds Jitter generation at STM-1 and STM-4.

Data rates: 2.048 Mb/s, 8.448 Mb/s, 34.368 Mb/s, 139.264 Mb/s, 155.52 Mb/s (STM-1), 622.08 Mb/s (STM-4).

At STM-1 and STM-4 a jittered 139.264 Mb/s clock is used to jitter the SDH clock. The UI transfer function is 1:1 at STM-1 and 1:4 at STM-4.

Jitter modulation

Frequency: 2 Hz to 4 MHz

Frequency accuracy: $\pm 1\%$

Frequency resolution:

2 to 499 Hz in 1 Hz steps.

500 Hz to 4.99 kHz in 10 Hz steps

5 kHz to 49.9 kHz in 100 Hz steps

50 kHz to 499 kHz in 1 kHz steps

500 kHz to 990 kHz in 10 kHz steps

1 MHz to 4 MHz in 100 kHz steps.

The actual corner frequencies of the jitter generator will be beyond those in the ITU-T mask.

2.048 Mb/s: Corner frequency 13 kHz,
Cut-off frequency 102 kHz

8.448 Mb/s: Corner frequency 50 kHz,
Cut-off frequency 422 kHz

34.368 Mb/s: Corner frequency 210 kHz,
Cut-off frequency 840 kHz

139.264 Mb/s: Corner frequency 5 kHz,
Cut-off frequency 4 MHz

Amplitude: To ITU-T O.171

Amplitude ranges:

0.00 to 1.00 UI - Range 1

0.0 to 10.0 UI - Range 10

Range accuracy:

Range 1 - 0.01 UI

Range 10 - 0.1 UI

Intrinsic jitter:

2.048 Mb/s - 0.02 UI
8.448 Mb/s - 0.02 UI
34.368 Mb/s - 0.03 UI
139.264 Mb/s - >10 kHz - 0.02 UI
5 kHz to 10 kHz - 0.05 UI
200 Hz to 5 kHz - 0.10 UI
Values are pk-pk jitter measured with HP1 filter present.

Amplitude accuracy: $\pm 5\%$ \pm range
accuracy \pm intrinsic jitter.

Fixed jitter tolerance masks:

4 pre-programmed jitter tolerance masks with pk-pk jitter amplitudes and modulating frequencies in accordance with ITU-T Rec. G.823 Table 2, covering low and high Q systems. The masks can be used to measure tolerance to jitter amplitude at spot jitter frequencies or can be swept in 20% frequency increments.

When generating an SDH signal the masks available are those specified in ITU-T Rec. G.958. A choice of type A or B masks is available at STM-1 and STM-4.

Automatic jitter tolerance test:

The mask is swept in 20% frequency increments and at each frequency the jitter amplitude is increased until errors (of any type) are detected.

JITTER RECEIVER:

Options UHN, A1M, A1N, A1P.

Option UHN adds PDH jitter measurement at all standard PDH rates with the exception of 704 kb/s.

Adds Wander and Estimated slips measurements at 2.048 Mb/s.

Option A1M adds SDH Jitter measurement at 155.52 Mb/s (STM-1 electrical).

Option A1N adds SDH Jitter measurement at 155.52 Mb/s (STM-1 optical).

Option A1P adds SDH Jitter measurement at 155.52/622.08 Mb/s (STM-1/STM-4 optical).

Jitter:

Data rates: 2.048 Mb/s, 8.448 Mb/s, 34.368 Mb/s, 139.264 Mb/s, 155.52 Mb/s, 622.08 Mb/s.

Jitter measurement ranges:

Range 1.6 - 0 to 1.6 UI

Range 16 - 0 to 16 UI

These ranges fulfill the measurement requirements of ITU-T Rec. O.171 Table 3.

Range accuracy: Range 1.6 - ± 0.01 UI

Range 16 - ± 0.03 UI

Intrinsic jitter:

Range 1.6, 2, 8, 34, 140 Mb/s, Clock - ± 0.02 UI

Range 1.6, 2, 8, 34, 140, 155.52 Mb/s (electrical), PRBS - ± 0.02 UI

Range 1.6, 155.52 Mb/s (optical), PRBS - ± 0.03 UI

Range 1.6, 622.08 Mb/s (optical),

PRBS - ± 0.04 UI Range 16, 2, 8, 34, 140 Mb/s, Clock - ± 0.07 UI

Range 16, 2, 8, 34, 140, 155.52 Mb/s, PRBS - ± 0.1 UI

Range 16, 622.08 Mb/s, PRBS - ± 0.2 UI

Values are pk-pk jitter measured with HP1 filter present.

Measurement accuracy: Range 1.6, 0 to 0.2UI - $\pm 10\%$ \pm range accuracy \pm intrinsic jitter for pk jitter.

$\pm 10\% \pm 2$ X range accuracy \pm intrinsic jitter for pk-pk jitter.

Range 1.6, 0.21 to 1.6UI - $\pm 5\%$ \pm range accuracy \pm intrinsic jitter for pk jitter.
 $\pm 5\%$ \pm range accuracy \pm intrinsic jitter for pk-pk jitter.

Range 16, 0 to 0.2UI - $\pm 10\%$ \pm range accuracy \pm intrinsic jitter for pk jitter.
 $\pm 10\% \pm 2$ X range accuracy \pm intrinsic jitter for pk-pk jitter.

Range 16, 0.21 to 16UI - $\pm 5\%$ \pm range accuracy \pm intrinsic jitter for pk jitter.
 $\pm 5\%$ \pm range accuracy \pm intrinsic jitter for pk-pk jitter.

Jitter threshold resolution:

Range 1.6 - steps of 0.01 UI

Range 16 - steps of 0.1 UI

Internal filters: Provided to band limit the demodulated jitter signal before jitter amplitude measurement as specified in ITU-T Rec. O.171.

Nominal 3 dB corner frequencies:

2.048 Mb/s: HP1 - 20 Hz, HP2 - 18 kHz, LP - 100 kHz

8.448 Mb/s: HP1 - 20 Hz, HP2 - 80 kHz, LP - 400 kHz

34.368 Mb/s: HP1 - 100 Hz, HP2 - 10 kHz, LP - 800 kHz

139.264 Mb/s: HP1 - 200 Hz, HP2 - 10 kHz, LP - 3.5 MHz

155.52 Mb/s: HP1 - 500 Hz, LP - 1.3 MHz

622.08 Mb/s: HP1 - 1000 Hz, LP - 5 MHz

1-22 General Information

For high pass (HP) filters the slope below the 3 dB point is 20 dB/decade.

For low pass (LP) filters the slope above the 3 dB point is 60 dB/decade.

The following combinations of filters are available: Off (no filters), LP only, HP1 only, HP2 only, LP + HP1, LP + HP2. HP2 is not available at 155.52 Mb/s and 622.08 Mb/s

Demodulated jitter output:

Range 1.6 - 1.0 V/UI

Range 16 - 0.1 V/UI

Wander (Option UHN only):

Timing reference input: External MTS clock as ITU-T Rec. G.811.

Bit rate: 2.048 Mb/s

Format: Clock or HDB3 data

Impedance: 75 Ω unbalanced (nominal) or 120 Ω balanced (nominal).

Peak level: 3V $\pm 10\%$ (balanced)

2.37V $\pm 10\%$ (unbalanced).

Connectors: BNC (unbalanced).

3 pin Siemens audio (balanced).

Wander measurement:

Bandwidth: Low pass response -3dB at 10Hz (nominal).

Resolution: 0.125 UI

Range: ± 99999 UI. If no reference signal is present "NO REF" is displayed.

Accuracy: ± 0.125 UI $\pm 0.5\%$ of reading. Valid up to 1 Hz wander frequency.

ATM (Option UKN)

Option UKN provides ATM generation and measurement at standard bit rates.

ATM Transmitter

Physical Interface Bit rates: 34.368 Mb/s and 155.52 Mb/s.

Physical Interface: Meets ITU-T G.703

Frequency offset 34.368 Mb/s: Up to \pm 100 ppm

Frequency offset 155.52 Mb/s: Up to \pm 999 ppm

Connectors: BNC 75 Ω unbalanced

Error add: Bit, Single HEC or Double HEC - 1 in 10^3 or single error

Alarm generation: Virtual path FERF, virtual path AIS, virtual channel FERF, virtual channel AIS.

Clock timing Internal: All rates

Recovered (loop timed): From STM-1 receiver input (155.52 Mb/s only).

34.368 Mb/s Overhead: As ITU-T Rec. G.832

Error Monitoring (EM) - correct BIP-8 Trail Trace (TR) - "HP37717B" padded with spaces and the correct CRC added.

Maintenance Adaptation (MA) - 011 hexadecimal.

Network Operator (NR) - All Zeroes
General Communications (GC) - All Zeroes.

155.52 Mb/s Overhead: As SDH module Option US1

Frame Formats

34.368 Mb/s Framing: As ITU-T Rec. G.832

155.52 Mb/s Framing: As SDH module Option US1

Cell layer modes: UNI, NNI

Cell layer headers: VPI, VCI, GFC, PTI, CLP.

Foreground cells:

34.368 Mb/s bandwidth: 100 to 80,000 cells/second.

155.52 Mb/s bandwidth: 100 to 353,207 cells/second.

Distribution: Periodic, Burst.

Periodic: A single cell is transmitted at regular intervals determined by the cell rate. Also allows a single burst of up to 2047 consecutive cells to be added.

Burst: User specified burst of up to 2047 consecutive cells added at intervals determined by the cell rate.

Payload: Cross Cell PRBS, Single Cell PRBS, User Byte, Test Cell.

Test cell format:

Bytes 0 to 4 - Cell header

Bytes 5 to 7 - Sequence number to allow Misinsertion and Loss measurements.

Bytes 8 to 9 - CRC16 over bytes 5 - 9.

Bytes 10 to 13 - Timestamp to allow Delay measurements.

Bytes 14 to 17 - Copy of header bytes, allows tracing through switches.

Bytes 18 to 50 - Free running $2^{23}-1$ PRBS as ITU-T Rec. O.151.

Bytes 51 to 52 - CRC16 over bytes 10 to 52.

Background cells:

Number of backgrounds: 3

Background density: Individually settable from 0 to maximum after foreground allocation in 1% steps.

Distribution: Periodic as for Constant Bit Rate service.

Payload: Fixed byte.

Fill cells: Idle or Unassigned. Payload All Zeroes.

ATM Receiver

Interface bit rate:

34.368 Mb/s: \pm 100 ppm unbalanced.

General Information 1-23

155.52 Mb/s: ± 999 ppm unbalanced.

Pattern Synchronization:

Sync loss: BER $\geq 20\%$ over 100 ms for PRBS or $\geq 4\%$ over 100 ms for word patterns.

Sync gain: 32 consecutive error free bits received.

Equalization at $f/2$: 12 dB

Monitor point compensation:

34.368 Mb/s: 20 dB or 26 dB.

155.52 Mb/s: 20 dB

Frame Formats: As transmitter.

Frame Alignment: Out of Frame after 4 consecutive errored framing patterns.

Frame regain after 2 consecutive error free framing patterns.

Loss Of Frame -At detection of Out Of Frame a 3 ms window is started. If the system remains Out of Frame for the duration of the window then Loss Off Frame is activated. If in frame is detected during the 3 mS window the timer is reset.

Cell layer modes: UNI, NNI

Cell layer headers: VPI, VCI, GFC, PTI, CLP.

Payload: Cross Cell PRBS, Single Cell PRBS, User Byte, Test Cell, Live Traffic.

Test cell format: as transmitter.

Test cell synchronization:

Sync loss: 7 consecutive errored cells.

Sync gain: 6 consecutive error free cells.

REMOTE CONTROL:

HP-IB option 1A8.

RS-232-C option 1CW.

LAN interface option 1F7.

Virtual Remote option UHE

1-24 General Information

PDH MULTIPLE OUTPUTS: Option UHC.

Provides three additional output signals (BNC connectors).

Specifications same as for unbalanced signal output. Bit delay relative to main output:

704 kb/s, 2 Mb/s, 8 Mb/s, 34 Mb/s:

O/P 2 - 4 bits

O/P 3 - 8 bits

O/P 4 - 12 bits

140 Mb/s: No bit delay.

MEASUREMENTS and ANALYSIS

Test timing: Manual, single fixed, timed start

Timed start: Single test period starts at a preset time.

Duration: 1 hour, 24 hours, 72 hours, 7 days, user-defined

User-defined: 1 to 99 - seconds, minutes, hours, days

Real-time clock: Date, time and elapsed test time.

Trouble Scan: Up to four prioritised non-zero error results are displayed in extra-large characters.

Received frequency

Frequency in Hz, resolution 1 Hz

Offset from internal clock rate (ppm), (Hz)

UNFRAMED PDH (Option UKK)

Out of Service analysis

Errors: Bit, Code - error count and ratio

G.821 analysis (including Annex D)

Severely errored seconds

Percentage severely errored seconds

Errored seconds

Percentage errored seconds

Error-free seconds
Percentage error-free seconds
Unavailability
Percentage unavailability
Unavailable seconds
Degraded minutes
Percentage degraded minutes
Code error seconds
Elapsed time

M.2100 error analysis
Same as G.821 (Bit errors only).

Alarm indication: AIS, signal loss, pattern sync loss, errors present.
Alarm seconds: All the above plus power loss.

In-service frame error analysis
Errors (all rates): Frame, bit - error count and ratio
Code - error count and ratio (not 140 Mb/s)
CRC4 - error count and ratio (2 Mb/s only)
REBE (E-bits) - error count and ratio (2 Mb/s only)

G.821-type analysis:
On frame bit errors (all rates)
On CRC errors (2 Mb/s only)
On REBE errors (2 Mb/s only)
Spare bit display: At all rates

M.2100 error analysis: Tx error seconds, Tx severely errored seconds, Rx error seconds, Rx severely errored seconds, Unavailability.

Alarm indication: All rates: AIS, frame loss, signal loss, remote alarm, Errors present.
2 Mb/s only: CAS/CRC multiframe loss, remote multiframe alarm.
Alarm seconds: All the above plus power loss.

STRUCTURED PDH (Option UKJ or UKL)

Errors: Bit, Code, Frame, CRC, REBE - error count and ratio

G.821 analysis - Bit, Frame, CRC

REBE (including Annex D)

Severely errored seconds
Percentage severely errored seconds
Errored seconds

Percentage errored seconds

Error-free seconds

Percentage error-free seconds

Unavailability

Percentage unavailability

Unavailable seconds

Degraded minutes

Percentage degraded minutes

Code error seconds

Elapsed time

Unframed PDH M.2100 error analysis:
Same as G.821 (Bit errors only).

Framed PDH M.2110/M.2120 error analysis (8, 34 & 140 Mb/s): Tx error seconds, Tx errored second ratio, Tx unavailable seconds, Tx path unavailable seconds, Tx severely errored seconds, Tx severely errored seconds ratio, Rx error seconds, Rx errored seconds ratio, Rx unavailable seconds, Rx path unavailable seconds, Rx severely errored seconds, Rx severely errored seconds ratio.

Framed PDH M.2110/M.2120 error analysis (2 Mb/s): All the above plus Tx errored block count, Tx background block error count, Tx background block error ratio, Rx errored block count, Rx background block error count, Rx background block error ratio.

Alarm indication: AIS, signal loss, pattern sync loss, frame loss, remote alarm, multiframe loss, errors present.

General Information 1-25

Alarm seconds: Power loss, AIS, signal loss, pattern sync loss, 140 Mb/s frame loss, 34 Mb/s frame loss, 8 Mb/s frame loss, 2 Mb/s frame loss, remote alarm, multiframe loss, remote multiframe alarm.

Alarm Scan: The interface rate and all lower levels in the hierarchy are scanned for occurrences of AIS, frame loss and RAI. Any occurrence of these alarms is displayed in graphical form.

Round trip delay: Measures up to 2 seconds delay between transmit and receive.

Resolution: - 10 μ s

SDH (Options US1 and A1T) Error results: RSOH BIP-8 (B1), MSOH BIP-24 (B2), POH BIP-8 (B3), Path FEBE, VC-3 Path BIP, VC-3 FEBE, VC-5 BIP-2, VC-5 FEBE, Bit (PDH Payload), Frame (A1,A2), MS FEBE, AU-4 path IEC, TU-2 path FEBE, TU-2 path BIP.

Error analysis per ITU-T G.826: For all the errors listed above. Errored seconds, Errored seconds ratio, Severely errored seconds, Errored blocks, Unavailable seconds, Block error count, Severely errored seconds ratio, background block error ratio. (G.821 and M.2100/M.2110/M.2120 for PDH payload)

Alarm indication: Loss of signal (LOS), loss of frame (LOF), out of frame (OOF), AU-4, TU-3, TU-12, TU-2 loss of pointer (LOP), MS and path AIS, pattern loss, MS FERF, Path FERF, TU-3, TU-12, TU-2 path AIS, TU-3, TU-12, TU-2 path FERF, H4 multiframe sync loss, clock loss and errors (any type).

1-26 General Information

Pointer results: AU pointer value, AU NDF seconds, AU Missing NDF seconds, AU +ve Adjustment count, AU +ve Adjustment seconds, AU -ve Adjustment count, AU -ve Adjustment seconds, Implied VC-4 offset, TU pointer value, TU NDF seconds, TU Missing NDF seconds, TU +ve Adjustment count, TU +ve Adjustment seconds, TU -ve Adjustment count, TU -ve Adjustment seconds.

Alarm seconds: All the above, except clock loss, plus power loss and missing new data flag.

Received overhead snapshot: A1T only. SOH and POH of received STM-1 signal.

Overhead sequence capture: A1T only. Any one overhead channel is selected. After a manual or programmed trigger, the captured values are displayed together with the number of consecutive frames containing the value.

Pointer location graph: A1T only. A display that shows the variation with time of the pointer location is available.

Implied VC offset: The total positive and negative pointer movements since the start of the measurement period are summed and the implied VC offset calculated from this total.

Overhead BER measurement: Error count, error ratio, error free seconds and % error free seconds.

JITTER (Options UHN, A1M, A1N, A1P)

Results: Jitter hit count, Jitter hit seconds, Jitter hit free seconds, +ve peak amplitude, -ve peak amplitude, peak-peak amplitude.

After a swept jitter tolerance measurement (using Option UHK, Jitter Generation) the results are presented graphically to show measured jitter against the ITU-T mask.

Alarms: Jitter loss and Jitter out of range.

WANDER (Option UHN)

Results: +ve peak amplitude, -ve peak amplitude, peak-peak amplitude, peak-peak amplitude 15 minutes, peak-peak amplitude 24 hours, Time interval error, Estimated frame slips, Estimated bit slips.

The current Wander measurements are available in graphical form on the **RESULTS** display. Three +ve and -ve sliding graphs, each of ± 1 UI, ± 16 UI and ± 256 UI are provided.

Alarms: No reference and excess wander. If Wander is >5 UI then the status message "Excess Wander" is displayed and is updated once per minute.

ATM Measurement (Option UKN)

34.368 Mb/s error results:

Physical Layer: EM BIP (ITU-T Rec. G832), FEBE (ITU-T Rec. G832).

ATM Layer: Received cells, Corrected HEC, Non-corrected HEC, Cell loss, Errored cells, Misinserted cells, Bit, Mean Cell Transfer Delay.

155.52 Mb/s error results:

Physical Layer: RS B1 Bip, MS B2 Bip, Path B3 Bip, Path FEBE.

ATM Layer: Received cells, Corrected HEC, Non-corrected HEC, Cell loss, Errored cells, Misinserted cells, Bit, Mean Cell Transfer Delay.

34 Mb/s Error analysis per ITU-T

G.826: Errored Blocks, Errored seconds, Severely errored seconds, Unavailability, Path unavailable seconds, Block error count, Error second ratio, Severely errored second ratio, Background block error ratio for EM BIP and FEBE.

155.52 Mb/s Error analysis per ITU-T

G.826: Errored Blocks, Errored seconds, Severely errored seconds, Unavailability, Path unavailable seconds, Block error count, Error second ratio, Severely errored second ratio, Background block error ratio for RS B1 BIP, MS B2 BIP, Path B3 BIP and Path FEBE.

34.368 Mb/s Alarm indication:

Physical Layer: Signal Loss, Pattern Loss, Loss of Frame, FERF, AIS.

ATM Layer: Loss of cell sync, Selected cell not received, Congestion experienced, Test cell loss, VP AIS, VP FERF, VC AIS, VC FERF.

34.368 Mb/s Alarm seconds:

Physical Layer: Power Loss, Loss of Signal, Loss of Frame, AIS, FERF.

ATM Layer: Power Loss, Loss of cell sync, Selected cell not received, Congestion experienced, Test cell loss, Pattern Loss, VP AIS, VP FERF, VC AIS, VC FERF.

155.52 Mb/s Alarm indication:

Physical Layer: Loss of Signal, Loss of pointer, Loss of frame, Out of frame, MS and path FERF, MS and path AIS, Pattern loss, TU loss of pointer, TU path AIS, TU path FERF.

ATM Layer: Loss of cell sync, Selected cell not received, Congestion experienced, Test cell loss, VP AIS, VP FERF, VC AIS, VC FERF.

155.52 Mb/s Alarm seconds:

Physical Layer: Loss of power, Loss of Signal, Loss of frame, Out of frame, Loss of pointer, MS and path AIS, MS and path FERF, TU loss of pointer, TU path AIS, TU path FERF.

ATM Layer: Power Loss, Loss of cell sync, Selected cell not received, Congestion experienced, Test cell loss, Pattern Loss, VP AIS, VP FERF, VC AIS, VC FERF.

GRAPHICS and PRINTING

Graphic display or printout:

Barchart (results versus 60 time periods) for current or stored measurement period.

Bar resolution: 1, 15, 60 minutes.

Unframed PDH bar graphs: Bit error count, code error count, frame error count, CRC error count, REBE error count and PDH alarms.

Structured PDH bar graphs: Bit error count, code error count, frame error count, CRC error count, REBE error count and SPDH alarms.

SDH bar graphs: B1 BIP error count, B2 BIP error count, B3 BIP error count, FEBE error count, TU BIP error count, TU FEBE error count and SDH alarms.

Jitter bar graphs: Jitter hit count.

Wander bar graphs: Frame slip count and Bit slip count.

ATM bar graphs: EM BIP count, FEBE error count, Corrected HEC count, Non corrected HEC count, Bit error count, Cell loss count, Received cells count, Misinserted cell count, Errored cell count.

Printer

Internal: 24-column thermal printer.

External: 80-column HP 550C Deskjet printer with option 1A8.

RS-232-C HP 550C Deskjet printer or 40 column or 80 column printer with option 1CW.

Printing: Results, time, date and instrument control settings.

Print triggers: Power up, manual, start of test period, turning printer on during test period, any alarm or error second, start of new day.

Print period: 10 minutes, 1 hour, 24 hours, user-defined (10 to 99 minutes or 1 to 99 hours).

GENERAL

Dimensions mm (inch): 190 (7.5) high, 340 (14) wide, 420 (17) deep (including cover).

Weight: 11 kg (24 lb) fully loaded.

Supply: 95 to 240 V ac. 300 VA (maximum). 48 to 66 Hz (nominal).

Temperature:

0 to +45° C operating.

-20 to +70° C storage.



Table 1-1. Recommended Test Equipment

Instrument	Critical Specification	Recommended Model
Oscilloscope	400 MHz Bandwidth, 1 M Ω Input Termination	HP 54100D
Spectrum Analyser	200 MHz Bandwidth, 75 Ω Input, -70 to +20 dBm	HP 8568B Opt 001
Frequency Synthesizer	75 Ω Output, Sinewave to 80 MHz, Amplitude to 2.5 V pk-pk, 1 Hz resolution	HP 3335A Opt 001
Frequency Synthesizer	Sinewave to 2.5 MHz, Amplitude to 5V pk-pk, 1 Hz Resolution	HP 3325B (Qty 2)
Frequency Counter	Range 0 to 200 MHz, 2 channels with accuracy <0.1 ppm. (Ratio Mode)	HP 5335A Opt 010
Optical Power Meter and Sensor Module	Range -8 dBm to -15 dBm, Wavelength 1270-1340 nm	HP 8153A and HP 81536A
Dual Power Supply	\pm 12V	HP 6253A
Lightwave Receiver	Wavelength 1300 to 1560 nm, Conversion Gain 750 volts/watt, Frequency Response < 3 dB down at 1 GHz.	HP 83422A
Optical Attenuator	Wavelength 1200 - 1600 nm, Range 0 - 30 dB	
FC/PC Optical Interface Connector	Unique	HP 81000FI
Optical Cables	Unique	HP 11871A (Qty 2)
Digital Transmission Frame Generator	Unique	HP 37729A
PDH Structured Test Set	Unique	HP 37717B Opt UKJ
Jitter Generation Module	Unique	HP 37717B Opt UHK

Table 1-1. Recommended Test Equipment (continued)

Instrument	Critical Specification	Recommended Model
ThinkJet Printer	HP-IB Interface	HP 2225A
Attenuator	6 dB, 50 Ω , 0 to 200 MHz	HP 8491A Opt 006
Attenuator	3 dB, 50 Ω , 0 to 200 MHz	HP 8491A Opt 003
Cable Simulator #1	80 metres of 75 Ω coaxial cable (8120-0049)	
Cable Simulator #2	60 metres of 75 Ω coaxial cable (8120-0049)	
Cable Simulator #3	70 metres of 75 Ω coaxial cable (8120-0049)	
Cable Simulator #4	30 metres of 75 Ω coaxial cable (8120-0049)	
Converter	75 Ω Unbalanced to 120 Ω Balanced	HP 15508C
Blocking Capacitor	0.18 uf	HP 10240A
Cable Attenuator	Unique	HP 8120-0039 (70 m)
75 Ω /50 Ω Matching Pad	Insertion Loss 5.7 dB	HP 11852B (Qty 2)
75 Ω Termination	0 to 200 MHz	HP 15522-80010
T Connector	BNC to Dual BNC	HP 1250-0781
Adaptor	N Type (f) to BNC (m)	1250-1534 (Qty 2)
Adaptor	N Type (m) to N Type (m)	1250-1475 (Qty 2)
Adaptor	SMA to BNC	1250-1787 (Qty 2)
RS-232-C Loopback	Unique (See Figure 3-1)	5060-4462

Installation

This section contains information and instructions required to prepare the HP 37717B PDH/SDH test set for use. Included in this section are the initial inspection procedures, power and grounding requirements, fuse selection procedure, installation information, operators maintenance and instructions on repackaging for shipment.

INITIAL INSPECTION

PREPARATION FOR USE

OPERATORS MAINTENANCE

HEWLETT-PACKARD INTERFACE BUS

OPERATING ENVIRONMENT

STORAGE and SHIPMENT

Initial Inspection

Warning



TO AVOID HAZARDOUS ELECTRICAL SHOCK, DO NOT PERFORM ELECTRICAL TESTS WHEN THERE ARE SIGNS OF SHIPPING DAMAGE TO ANY PORTION OF THE OUTER ENCLOSURE (COVERS, PANELS, METERS).

Inspect the shipping container for damage. If the shipping container or cushioning material is damaged, it should be kept until the contents of the shipment have been checked for completeness and the instrument has been checked both mechanically and electrically. Procedures for checking electrical operation are given in Section 3 of this manual. If the contents of the

shipment are incomplete, if there is mechanical damage or defect, notify the nearest Hewlett-Packard Office. If the instrument does not pass the electrical performance tests given in Section 3, notify the nearest Hewlett-Packard office. If the shipping container is also damaged, or the cushioning material shows signs of stress, notify the carrier as well as the nearest Hewlett-Packard office. Keep the shipping materials for the carrier's inspection. The Hewlett-Packard office will arrange for repair or replacement without waiting for claim settlement.

Preparation for Use

Warning



IF THIS INSTRUMENT IS NOT USED AS SPECIFIED, THE PROTECTION PROVIDED BY THE EQUIPMENT COULD BE IMPAIRED. THIS INSTRUMENT MUST BE USED IN A NORMAL CONDITION (IN WHICH ALL MEANS OF PROTECTION ARE INTACT) ONLY.

Warning



FOR CONTINUED PROTECTION AGAINST FIRE HAZARD REPLACE FUSE ONLY WITH SAME TYPE AND RATINGS (SEE TABLE 2-1).

Power Requirements

The HP 37717B PDH/SDH test set requires a power source of 90 V to 264 V at a frequency between 47 Hz and 63 Hz (nominal).

Total power consumption is 450 VA (maximum).

The fuse rating for the power source is given in Table 2-1.

Table 2-1. Fuses

Line Voltage	Fuse Rating	HP Part Number
90V to 264V	5A Timed, 250V	2110-1120

2-2 Installation

Power Cord

The power cord supplied with each instrument varies with the country of destination. Figure 2-1 illustrates the standard power plug and cord configurations that are commonly used. The part number shown beneath each plug is the part number of the appropriate power cord and plug. If the appropriate power cord is not included with the instrument notify the nearest Hewlett-Packard office and a replacement will be provided.

Warning



TO AVOID THE POSSIBILITY OF INJURY OR DEATH, THE FOLLOWING PRECAUTIONS MUST BE FOLLOWED BEFORE THE INSTRUMENT IS SWITCHED ON :-

(a) Note that the protection provided by grounding the instrument cabinet may be lost if any power cable other than the three-pronged type is used to couple the ac line voltage to the instrument.

(b) If this instrument is to be energized via an auto-transformer to reduce or increase the line voltage, make sure that the common terminal is connected to the neutral pole of the power source.

(c) The power cable plug shall only be inserted into a socket outlet provided with a protective ground contact. The protective action must not be negated by the use of an extension cord without a protective conductor (grounding).



						
8120-2104	8120-1369	8120-1689	8120-1351	8120-1378 US 8120-4753 JAP	8120-2956	8120-4211

Figure 2-1. Power Cord Part Numbers

Operators Maintenance

Fuse Replacement

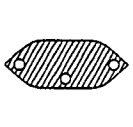
Only the ac line fuse located at the rear of the instrument may be replaced by the operator.

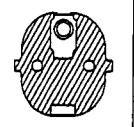
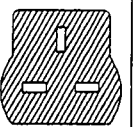
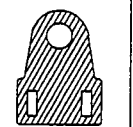
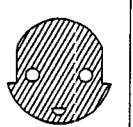
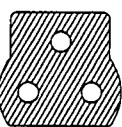
Warning



ALL OTHER FUSE REPLACEMENT SHOULD ONLY BE CARRIED OUT BY SUITABLY TRAINED SERVICE PERSONNEL AWARE OF THE HAZARDS INVOLVED.

BEFORE REMOVING THE FUSE, THE AC LINE POWER CORD SHOULD BE DISCONNECTED FROM THE POWER SOURCE AND THE OTHER END DISCONNECTED FROM THE INSTRUMENT.

ONLY USE A FUSE OF THE CORRECT RATING AS LISTED IN TABLE 2-1.

The fuse is removed by inserting a suitable flat bladed tool into the slot in the fuse cap and turning anti-clockwise. The cap and the fuse can then be removed

2-4 Installation

and the fuse changed for another of the correct rating. The fuse rating and HP part number are listed in Table 2-1.

Line Voltage Selector Switch

The Line Voltage Selector switch has 2 positions:

100 - 120V
200 - 240V

Caution

Before switching on this instrument, make sure that the line voltage selector switch is set to the voltage of the power supply. Ensure the supply voltage is in the specified range.

Hewlett-Packard Interface Bus

The HP 37717B PDH/SDH test set (Option 1A8) is connected to the HP-IB by means of an appropriate HP-IB cable. The HP-IB interconnecting cables available are listed in Table 2-2.

Table 2-2. HP-IB Interconnecting Cables

Length	Accessory Number
1 meter	HP 10833A
2 meters	HP 10833B
4 meters	HP 10833C
0.5 meter	HP 10833D

To achieve interface design performance standards, restrictions are placed on the HP-IB system cable lengths. These restrictions allow the bus interface electronics to maintain correct line voltage levels and timing relationships.

When connecting an HP-IB system the following rules should be observed :

The total HP-IB cable length used must be less than or equal to 20 meters (65.6 feet).

The total HP-IB cable length used must be less than or equal to 2 meters (6 feet) × the total number of devices connected to the bus.

A standard HP-IB connector is provided on the instrument rear panel. The connections and HP-IB logic levels are shown in Figure 2-2. The mating connector part number is HP 1251-0293 or Amphenol 57-30240.

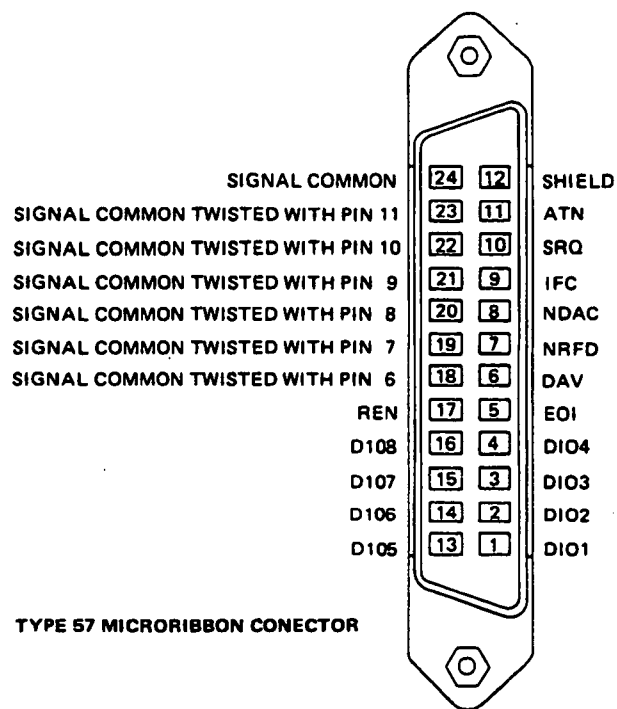



Figure 2-2. HP-IB Connections and Logic Levels

2-6 Installation

HP-IB Address Selection

The HP 37717B (Option 1A8) HP-IB address is accessed on the **OTHER** display under the COMMS CONTROL function.

The address can be set to any value between 0 and 30 inclusive using ,  and the display softkeys.

Operating Environment

The instrument may be operated in temperatures within the range 0 degrees to +45 degrees centigrade at altitudes up to 4,500 meters (15,000 feet). At all times the instrument should be protected from temperature extremes and environments which could condensation within the instrument.

Caution



VENTILATION REQUIREMENTS: When installing the instrument in a cabinet, the convection into and out of the instrument must not be restricted. The ambient temperature (outside the cabinet) must be less than the maximum operating temperature of the instrument by 4°C for every 100 watts dissipated in the cabinet. If the total power dissipated in the cabinet is greater than 800 watts, then forced convection must be used.

Storage and Shipment

The instrument may be stored or shipped in environments within the following limits :

Temperature -40° C to +65° C

Altitude Up to 15,200 meters (50,000 feet)

The instrument should also be protected from temperature extremes which could cause condensation within the instrument.

Repackaging for Shipment

Tagging for Service. If the instrument is being returned to Hewlett-Packard for service, please complete a repair tag and attach it to the instrument.

Original Packaging. Containers and materials identical to those used in factory packaging are available from Hewlett-Packard offices. If the instrument is being returned to Hewlett-Packard for servicing, attach a tag indicating the type of service required, return address, model number, and full serial number. Mark the container FRAGILE to ensure careful handling. In any correspondence, refer to the instrument by model number and full serial number.

Other Packaging. The following general instructions should be followed when repackaging with commercially available materials :

Wrap instrument in heavy paper or plastic. If the instrument is being shipped to Hewlett-Packard, attach a tag indicating the type of service required, return address, model number and full serial number.

Use a strong shipping container. A double wall carton made of 350 pound test material is adequate.

Use a layer of shock absorbing material 70 to 100 mm (3 to 4 inch) thick, around all sides of the instrument to provide firm cushioning and prevent movement inside the container. Protect the Front Panel controls and Rear Panel connectors with cardboard.

Seal shipping container securely.

Mark shipping container FRAGILE to ensure careful handling.

In any correspondence, refer to instrument by model number and full serial number.



Performance Tests

Introduction

The procedures given in this Section, test the HP 37717B electrical performance using the Specifications listed in Section 1, General Information, as performance standards. Each test is self contained and, therefore, may be performed as a stand-alone test or as part of full instrument calibration.

Equipment Required

Equipment required for the Performance Tests, is listed in Table 3-1, Recommended Test Equipment. Any equipment which meets or exceeds the critical specification of the equipment listed, may be substituted.

Performance Test Record



The results of the Performance Tests may be recorded on the Performance Test Record at the end of this Section. The Performance Test Record lists all the tested specifications and the acceptable limits. The results recorded at incoming inspection may be used for comparison during periodic maintenance, troubleshooting or after repair or adjustment.

Calibration Cycle

This instrument requires periodic verification of performance. Depending on use and environmental conditions, the instrument should be checked approximately once a year, using these Performance Tests.

Recall Default Settings

The Performance Tests require the HP 37717B to be set to a pre-defined (default) state at the beginning of each test. The pre-defined default settings are listed in Appendix A.

1. Using **OTHER**; display softkeys;  and  set up the **OTHER** **STORED SETTINGS** display as shown opposite.

2. Press **RECALL** to recall the instrument default settings.

The instrument display will blank for a few seconds while the settings are recalled and the status display will indicate stored settings number 0 recalled.

FUNCTION		[STORED SETTINGS]
STORED SETTING NUMBER		[0]
ACTION		[RECALL]
SETTING		
0	FACTORY DEFAULT SETTINGS	
1	[PAYLOAD..MAPPING.....]	
2	[.....]	
3	[.....]	
4	[.....]	
5	[.....]	
6	[.....]	
7	[.....]	
8	[.....]	
9	[.....]	
STATUS:		
OFF	RECALL	

Table 3-1. Recommended Test Equipment

Instrument	Critical Specification	Recommended Model
Oscilloscope	400 MHz Bandwidth, 1 M Ω Input Termination	HP 54100D
Spectrum Analyser	200 MHz Bandwidth, 75 Ω Input, -70 to +20 dBm	HP 8568B Opt 001
Frequency Synthesizer	75 Ω Output, Sinewave to 80 MHz, Amplitude to 2.5 V pk-pk, 1 Hz resolution	HP 3335A Opt 001
Frequency Synthesizer	Sinewave to 2.5 MHz, Amplitude to 5V pk-pk, 1 Hz Resolution	HP 3325B (Qty 2)
Frequency Counter	Range 0 to 200 MHz, 2 channels with accuracy <0.1 ppm. (Ratio Mode)	HP 5335A Opt 010
Optical Power Meter and Sensor Module	Range -8 dBm to -15 dBm, Wavelength 1270-1340 nm	HP 8153A and HP 81536A
Dual Power Supply	\pm 12V	HP 6253A
Lightwave Receiver	Wavelength 1300 to 1560 nm, Conversion Gain 750 volts/watt, Frequency Response < 3 dB down at 1 GHz.	HP 83422A
Optical Attenuator	Wavelength 1200 - 1600 nm, Range 0 - 30 dB	
FC/PC Optical Interface Connector	Unique	HP 81000FI
Optical Cables	Unique	HP 11871A (Qty 2)
Digital Transmission Frame Generator	Unique	HP 37729A
PDH Structured Test Set	Unique	HP 37717B Opt UKJ
Jitter Generation Module	Unique	HP 37717B Opt UHK
ThinkJet Printer	HP-IB Interface	HP 2225A

Table 3-1. Recommended Test Equipment (continued)

Instrument	Critical Specification	Recommended Model
Attenuator	6 dB, 50 Ω , 0 to 200 MHz	HP 8491A Opt 006
Attenuator	3 dB, 50 Ω , 0 to 200 MHz	HP 8491A Opt 003
Cable Simulator #1	80 metres of 75 Ω coaxial cable (8120-0049)	
Cable Simulator #2	60 metres of 75 Ω coaxial cable (8120-0049)	
Cable Simulator #3	70 metres of 75 Ω coaxial cable (8120-0049)	
Cable Simulator #4	30 metres of 75 Ω coaxial cable (8120-0049)	
Converter	75 Ω Unbalanced to 120 Ω Balanced	HP 15508C
Blocking Capacitor	0.18 uf	HP 10240A
Cable Attenuator	Unique	HP 8120-0039 (70 m)
75 Ω /50 Ω Matching Pad	Insertion Loss 5.7 dB	HP 11852B (Qty 2)
75 Ω Termination	0 to 200 MHz	HP 15522-80010
T Connector	BNC to Dual BNC	HP 1250-0781
Adaptor	N Type (f) to BNC (m)	1250-1534 (Qty 2)
Adaptor	N Type (m) to N Type (m)	1250-1475 (Qty 2)
Adaptor	SMA to BNC	1250-1787 (Qty 2)
RS-232-C Loopback	Unique (See Figure 3-1)	5060-4462

3-4 Performance Tests

Self Test

Description

The instrument self test is run to verify the functionality of the instrument prior to carrying out the performance tests.

Ensure the following loopbacks are in place before running the Self Test.

Self Test Loopbacks

75 Ω Signal IN port to 75 Ω Signal OUT port.

120 Ω Signal IN port to 120 Ω Signal OUT port.

If Option UKJ, Structured PDH Module, is fitted - MUX port to DEMUX port.

If Option US1 or A1T, SDH Module, is fitted - STM-1 OUT port to STM-1 IN port.

If Option UH1, STM-1 Optical interface, or Option UH2 or URU, STM-1/STM-4 Optical Interface, is fitted - IN port to OUT port.

If Option 1CW, RS-232-C Remote Control/Printer, is fitted connect an RS-232-C loopback connector 5060-4462 to the RS-232-C port. Alternatively make the following connection :

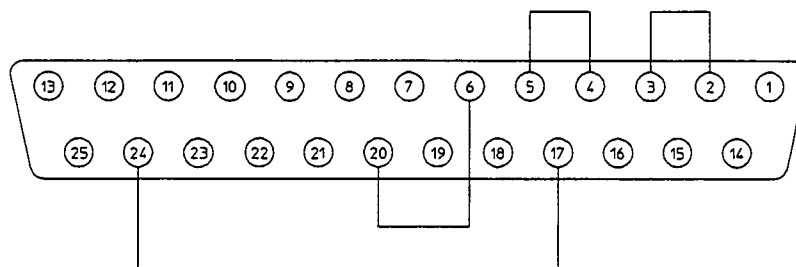



Figure 3-1. Self Test RS-232 port loopback connections

Procedure

1. Using **OTHER**, **MORE**, **SELF TEST**,  and  set up the display as shown opposite.
2. Press **RUN/STOP** to start the self test.
3. The tests will take approximately 20 minutes to complete. If a failure occurs a FAIL number will be displayed. Refer to Appendix B for a list of FAIL numbers.
4. The display will occasionally blank during the self test as a new group of sub-tests is started.

FUNCTION	[SELF TEST]		
TEST TYPE	[ALL TESTS]		
TEST NUMBER	..		
SUBTEST NUMBER	..		
TEST STATUS			
PRESS THE RUN/STOP KEY TO START TESTING.			
THIS SELECTION WILL RUN ALL SELF-TESTS.			
FOLLOW SETUP INSTRUCTIONS FOR EACH INDIVIDUAL SELF-TEST.			
STATUS:			
ALL TESTS	CPU TESTS	FDH TESTS	SDH TESTS

Note



If Options A1N or A1P (Optical Line Jitter) are fitted the optical jitter tests are not included under ALL TESTS. These require different connections as detailed on the **OTHER SELF TEST** display.

PDH Internal Transmitter Clocks

Specifications

Bit Rate

Bit Rate	Option	Specification
139.264 MHz	UKJ[USA], UKK[USB]	139.264 MHz \pm 974.848 Hz
34.368 MHz	UKJ[USA], UKK[USB]	34.368 MHz \pm 240.576 Hz
8.448 MHz	UKJ[USA], UKK[USB]	8.448 MHz \pm 59.136 Hz
2.048 MHz	UKJ[USA], UKK[USB]	2.048 MHz \pm 14.336 Hz
704 kHz	UKK[USB]	704 kHz \pm 4.928 Hz

Description

This test verifies that the PDH transmit data rates are within limits. These limits assume the instrument is within the annual calibration cycle. The Frequency Offset capability (deviation from Standard Bit Rate) is also tested here.

The test uses a Frequency Counter connected to the PDH Signal Out port to measure the data rate on an "all ones" pattern. This gives an indirect measure of the internal transmitter clock frequency as the data is clocked by the internal clock oscillator. Because the Frequency Counter triggers from the positive pulses only, the frequency count will be half the selected data rate.

Equipment

Frequency Counter : HP 5335A Option 010
75 Ohm Termination : HP 15522-80010
T Connector : HP 1250-0781

Procedure

1. Recall the HP 37717B DEFAULT SETTINGS as shown on Page 3-2.
2. Connect the 75Ω Unbalanced SIGNAL OUT port to the Frequency Counter. Terminate the Frequency Counter input in 75Ω (use the T connector).
3. Set the frequency counter to :
FUNCTION - FREQ A
ATTEN - X10

Note Steps 4 and 5 are only valid for Option UKK[USB].



4. Press **TRANSMIT** and set up the display as shown opposite.
5. Adjust the Frequency Counter ATTEN and Trigger Level to obtain a stable reading and ensure that the Frequency Counter reads between 351997.53 Hz and 352002.46 Hz.

TRANSMITTER OUTPUT	PDH
SIGNAL	[204 KHz]
CLOCK SYNC	[INTERNAL]
FREQUENCY OFFSET	[OFF]
CODE	[HDB3]
PATTERN	[ALL ONES]
TERMINATION	[75Ω UNBAL]
STATUS:	
140 Mb/s	84 Mb/s
8 Mb/s	2 Mb/s
2 Mb/s	204 KHz

6. Select SIGNAL [2 Mb/s], adjust the Frequency Counter ATTEN and Trigger Level to obtain a stable reading and ensure that the Frequency Counter reads between 1023992.8 Hz and 1024007.2 Hz.
7. Select signal [8 Mb/s], adjust the Frequency Counter ATTEN and Trigger Level to obtain a stable reading and ensure that the Frequency Counter reads between 4223970.4 Hz and 4224029.6 Hz.
8. Select SIGNAL [34 Mb/s], adjust the Frequency Counter ATTEN and Trigger Level to obtain a stable reading and ensure that the Frequency Counter reads between 17183879.7 Hz and 17184120.3 Hz.

3-8 Performance Tests

9. Select SIGNAL [140 Mb/s], adjust the Frequency Counter ATTEN and Trigger Level to obtain a stable reading and ensure that the Frequency Counter reads between 69631512.6 Hz and 69632487.4 Hz.

Frequency Offsets

10. Press **TRANSMIT** and set up the display as shown opposite.
11. Adjust the Frequency Counter ATTEN and Trigger Level to obtain a stable reading and ensure that the Frequency Counter reads between 69632557.05 Hz and 69633531.91 Hz.

TRANSMITTER OUTPUT	PDH
SIGNAL	[140 Mb/s]
CLOCK SYNC	INTERNAL
FREQUENCY OFFSET	[-15 PPM]
CODE	CM1
PATTERN	[ALL ONES]
TERMINATION	75Ω UNBAL
STATUS:	
OFF	+15 PPM
	-15 PPM
	USER OFFSET

Note



At each step wait for the Status message "VCXO output Bit Rate settling" to clear from the bottom line of the display before reading the frequency counter.

12. Select TX CLOCK OFFSET: [-15PPM], adjust the Frequency Counter Trigger Level to obtain a stable reading and ensure that the Frequency Counter reads between 69629980.67 Hz and 69631930.33 Hz.
13. Select TX CLOCK OFFSET: [USER OFFSET] [+100PPM] and ensure that the Frequency Counter reads between 69638475.53 Hz and 69639450.47 Hz.
14. Select TX CLOCK OFFSET: [USER OFFSET] [-100PPM], adjust the Frequency Counter Trigger Level to obtain a stable reading and ensure that the Frequency Counter reads between 69624549.12 Hz and 69625523.88 Hz.
15. Select each BIT RATE and TX CLOCK OFFSET listed in Table 3-2 below.

16. For each selection adjust the Frequency Counter ATTEN and Trigger Level to obtain a stable reading and ensure that the Frequency Counter reads between the limits listed in Table 3-2.

Table 3-2. Transmitter Clock Offset

Bit Rate	Offset	Option	Counter Reading Hz (minimum)	Counter Reading Hz (maximum)
34 Mbit/s	+20 ppm	UKJ[USA], UKK[USB]	17184223.4	17184464.0
34 Mbit/s	-20 ppm	UKJ[USA], UKK[USB]	17183536.0	17183776.6
8 Mbit/s	+30 ppm	UKJ[USA], UKK[USB]	4224097.2	4224156.3
8 Mbit/s	-30 ppm	UKJ[USA], UKK[USB]	4223843.7	4223902.8
2 Mbit/s	+50 ppm	UKJ[USA], UKK[USB]	1024044.0	1024058.4
2 Mbit/s	-50 ppm	UKJ[USA], UKK[USB]	1023941.6	1023956.0
704 kbit/s	+50 ppm	UKK[USB]	352015.1	352020.1
704 kbit/s	-50 ppm	UKK[USB]	351979.9	351984.9



PDH Transmitter Output

Specifications

Pulse Shape As per CCITT Rec. G.703

Pulse Amplitude :

120 Ω Balanced (704 kb/s & 2 Mb/s)	:	3.00V \pm 10%
75 Ω Unbalanced (704 kb/s, 2 Mb/s & 8 Mb/s)	:	2.37V \pm 10%
75 Ω Unbalanced (34 Mb/s)	:	1.00V \pm 10%
75 Ω Unbalanced (140 Mb/s)	:	0.50V \pm 10%

Note 704 kb/s is only valid when Option UKK[USB] is fitted.



Description

This test verifies that the PDH transmitter output level and pulse shape meet required CCITT specifications for all rates. The SIGNAL OUT Port is connected to a Digitizing Oscilloscope and the waveform is checked for required amplitude and duty cycle at the nominal mid-points. The waveform shape is also checked by comparison with the special CCITT masks. These may be obtained from the oscilloscope memory (if this feature is fitted) or can be traced from the attached figures and compared with a printout of the oscilloscope waveform.

Note that a Balanced to unbalanced Converter is required to test the Balanced output port. The 3V peak at the output is reduced to 2.37V peak on the oscilloscope by this device. The oscilloscope must be terminated in 75 Ω for both balanced and unbalanced outputs.

Equipment

Oscilloscope : HP 54100D
120Ω/75Ω Balanced to Unbalanced Converter : HP 15508C
75Ω/50Ω Matching Pad : HP 11825B
ThinkJet Printer : HP 2225A

Procedure

704 kb/s Unbalanced Output

1. Recall the HP 37717B DEFAULT SETTINGS as shown on Page 3-2.
2. Connect the Unbalanced 75Ω SIGNAL OUT port to the Oscilloscope Input 1 via the 75Ω/50Ω Matching Pad. Set the oscilloscope termination to 50Ω.

Note



1. To compensate for the matching pad attenuation, set the oscilloscope Channel 1 Input (Probe) Attenuation factor to X 2.40 (equivalent to 7.6 dB).
2. Steps 3 to 10 are only valid for Option UKK[USB].

3. Press **TRANSMIT** and set up the display as shown opposite.
4. Press **AUTOSCALE** on the oscilloscope.
5. Adjust the Oscilloscope Timebase and Delay to position the positive peak pulse amplitude at mid-pulse-width point in the centre of the screen.

TRANSMITTER OUTPUT	PDH
SIGNAL	[704 kb/s]
CLOCK SYNC	INTERNAL
FREQUENCY OFFSET	[OFF]
CODE	[AMI]
PATTERN	[USER WORD]
TERMINATION	[10000000000000] [75Ω UNBAL]
STATUS:	
1-0 No.1	54 No.2
8 No.3	2 No.4
704 kb/s	

6. Verify the Pulse meets the following criteria :

Pulse Amplitude	2.133V to 2.607V
Pulse Width	639 ns to 781 ns
Overshoot	≤0.474V
Undershoot	≤0.474V

3-12 Performance Tests

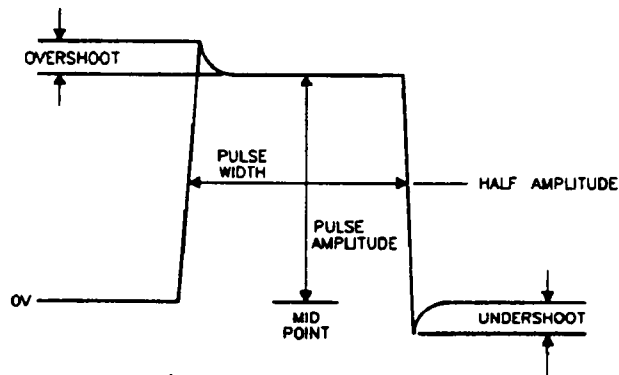

Figure 3-2. 704 kb/s Pulse Criteria

7. Adjust the Oscilloscope Delay to position the negative peak pulse amplitude at mid-pulse-width point in the centre of the screen and verify that the negative pulse meets the criteria listed in step 6.

704 kb/s Balanced Output

8. Connect the Balanced to Unbalanced Converter between the HP 37717B 120 Ω Balanced SIGNAL OUT port and the Oscilloscope, leaving the 75 Ω /50 Ω Matching Pad in place.
9. Select TERMINATION [120 Ω BAL] on the **TRANSMIT** display.
10. Repeat steps 4 through 7.

2.048 Mb/s Unbalanced Output

11. Select SIGNAL [2 Mb/s] ; TERMINATION [75 Ω UNBAL].
12. Connect the Unbalanced 75 Ω SIGNAL OUT port to the Oscilloscope Input 1 via the 75 Ω /50 Ω Matching Pad. Set the oscilloscope termination to 50 Ω and press **AUTOSCALE** on the oscilloscope.
13. Adjust the Oscilloscope Timebase and Delay to position the positive peak pulse amplitude at mid-pulse-width point in the centre of the screen.
14. Measure the peak pulse amplitude at mid-pulse-width using the Oscilloscope and verify that this is between 2.133V and 2.607V.
15. Select the 2Mb G.703 mask on the oscilloscope and store it on the display.

16. Press SHIFT **AUTOSCALE** on the oscilloscope to automatically align the pulse to the mask. Verify that the pulse falls within the mask as shown in Figure 3-4.

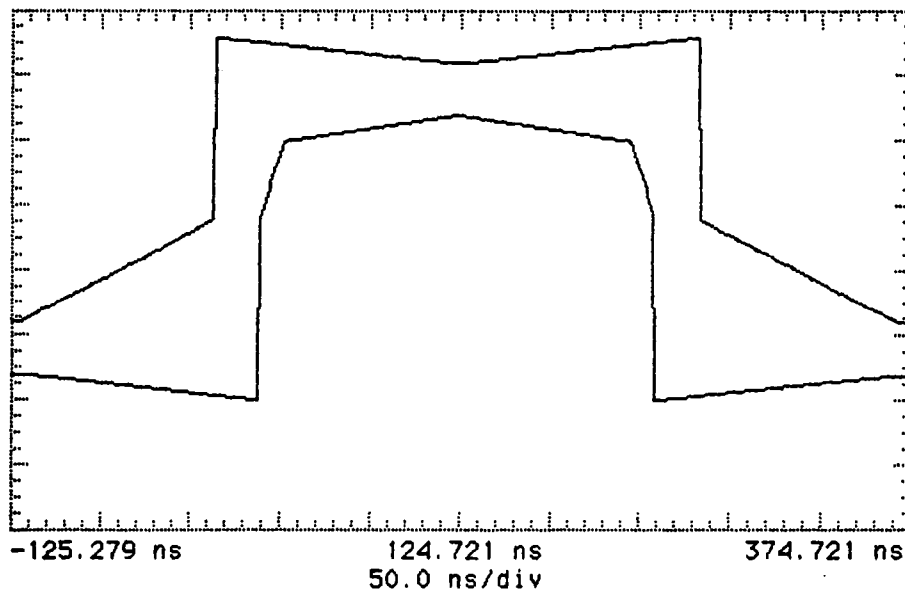

Figure 3-3. 2 Mb/s Pulse Mask

Note



If your oscilloscope does not have the Mask feature, obtain a printout of the displayed pulse. Place the mask, shown in Figure 3-3, over the pulse and ensure that the pulse falls within the mask. (A transparent copy of the mask should be used).

hp running

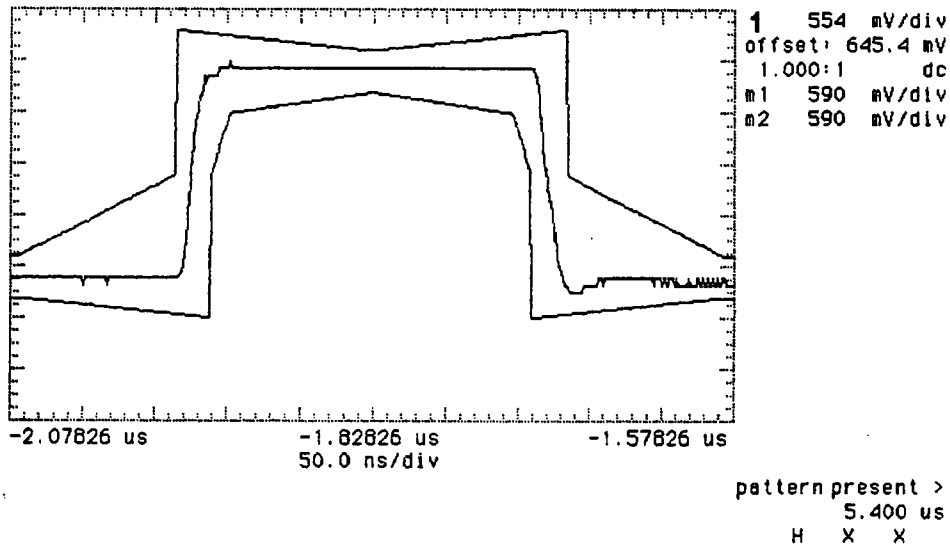

Figure 3-4. 2 Mb/s Isolated Positive Pulse

17. Press **AUTOSCALE** on the oscilloscope to display the full waveform.
18. Use the following sequence to display the isolated negative pulse.
 - Select **TRIG** menu.
 - Set trigger level to middle of negative pulse.
 - Set trigger to pattern.
 - Set sequence to H X X.
19. Use the oscilloscope **STORE INVERT** to display an inverted mask on the oscilloscope.
20. Adjust the oscilloscope timebase and vertical sensitivity controls to verify that the pulse meets the mask as shown in Figure 3-5. Use the displayed settings as a guide.
21. Measure the peak pulse amplitude at mid-pulse-width using the Oscilloscope and verify that this is between 2.133V and 2.607V.

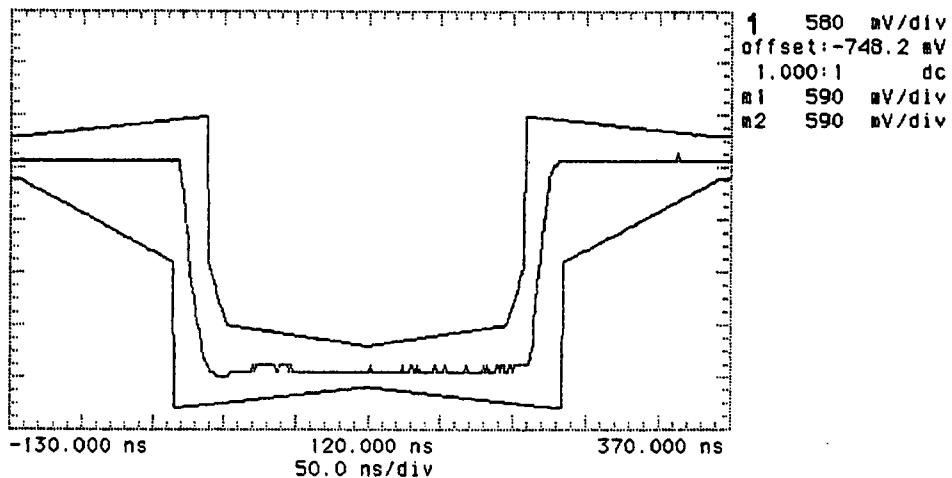

Figure 3-5. 2 Mb/s Isolated Negative Pulse

22. Ensure that the ratio of +ve and -ve pulse amplitudes is between 0.95 and 1.05.
23. Ensure that the ratio of +ve and -ve pulse widths is between 0.95 and 1.05.

2.048 Mb/s Balanced Output

24. Connect the Balanced to Unbalanced Converter between the HP 37717B 120 Ω Balanced SIGNAL OUT port and the Oscilloscope, leaving the 75 Ω /50 Ω Matching Pad in place.
25. Select TERMINATION [120 Ω BAL] on the **TRANSMIT** display.
26. Repeat steps 13 through 23.

8.448 Mb/s Unbalanced Output

27. Select SIGNAL [8 Mb/s] and TERMINATION [75 Ω UNBAL] on the **TRANSMIT** display.

3-16 Performance Tests

28. Connect the Unbalanced 75 Ω SIGNAL OUT port to the Oscilloscope Input 1 via the 75 Ω /50 Ω Matching Pad. Set the oscilloscope termination to 50 Ω and press **AUTOSCALE** on the oscilloscope.
29. Select the 8 Mb G.703 mask on the oscilloscope and store it on the display.
30. Repeat steps 13 through 23 to verify the 8 Mb/s unbalanced output.

Note

If your oscilloscope does not have the Mask feature, obtain a printout of the displayed pulse. Place the mask, shown in Figure 3-6, over the pulse and ensure that the pulse falls within the mask. (A transparent copy of the mask should be used).

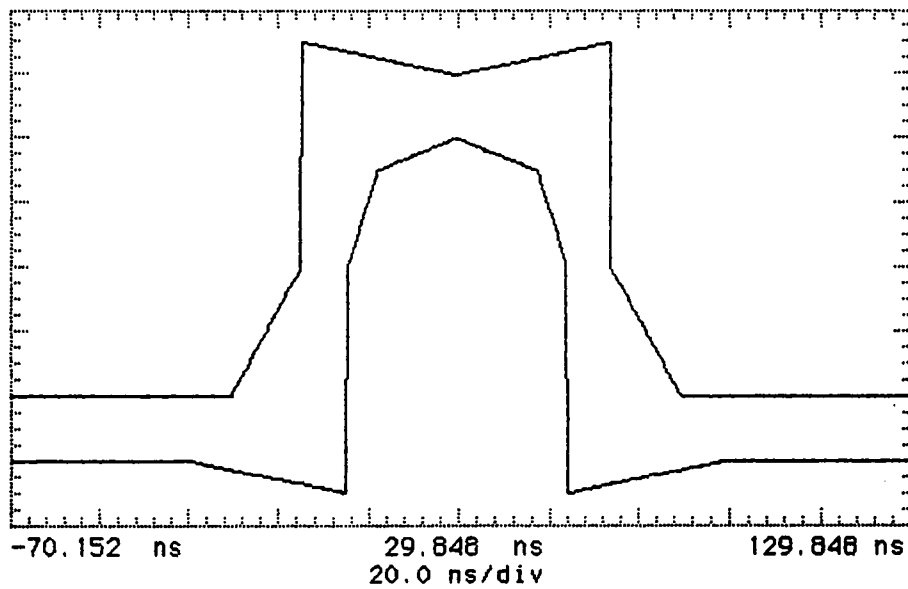

Figure 3-6. 8 Mb/s Pulse Mask

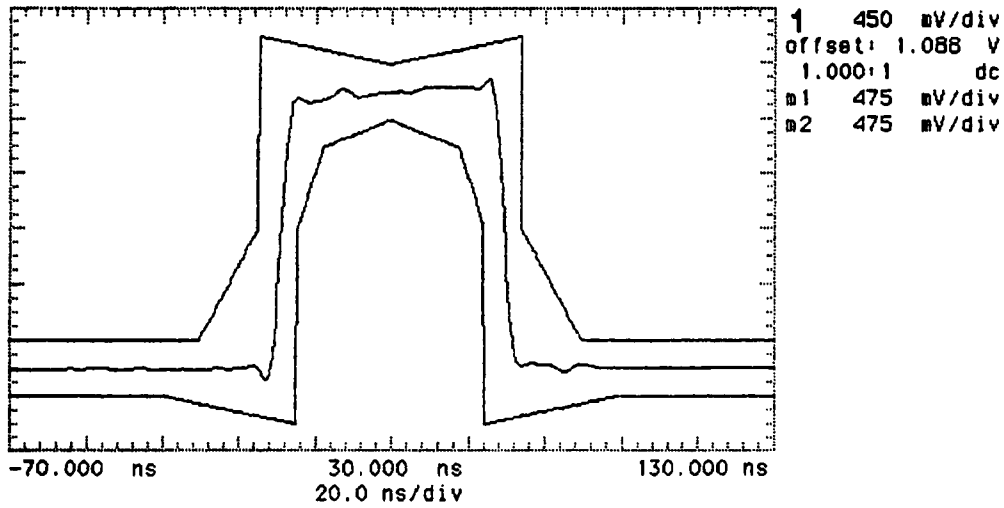

Figure 3-7. 8 Mb/s Isolated Positive Pulse

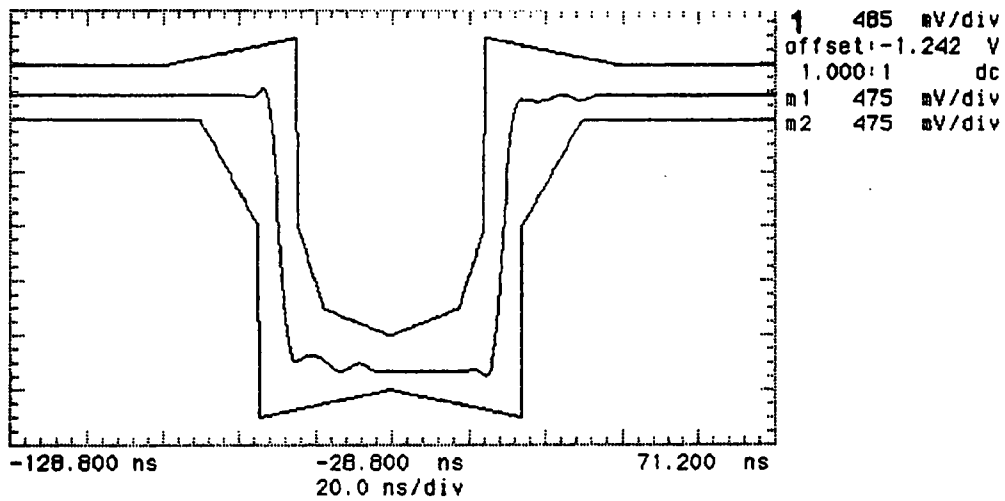

Figure 3-8. 8 Mb/s Isolated Negative Pulse

34.368 MB/s Unbalanced Output

31. Press **TRANSMIT** and set up the display as shown opposite.
32. Press **AUTOSCALE** on the oscilloscope.
33. Select the 34 Mb G.703 mask on the oscilloscope and store it on the display.

TRANSMITTER OUTPUT	PDH
SIGNAL	[34 Mb/s]
CLOCK SYNC	[INTERNAL]
FREQUENCY OFFSET	[OFF]
CODE	HDB3
PATTERN	[1000]
TERMINATION	75Ω UNBAL
STATUS:	
1010	1000
USER	HOLD
[] [] [] [] [] []	

34. Repeat steps 13 through 23 (in step 21 ensure the peak pulse amplitude is 0.9V to 1.1V) to verify the 34 Mb/s unbalanced output.

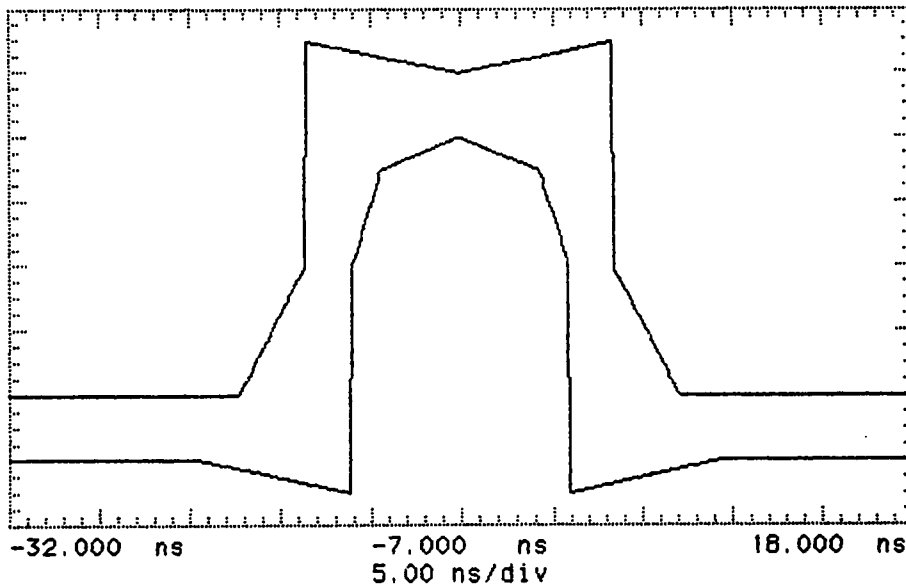

Figure 3-9. 34 Mb/s Pulse Mask

Note



If your oscilloscope does not have the Mask feature, obtain a printout of the displayed pulse. Place the mask, shown in Figure 3-9, over the pulse and ensure that the pulse falls within the mask. (A transparent copy of the mask should be used).

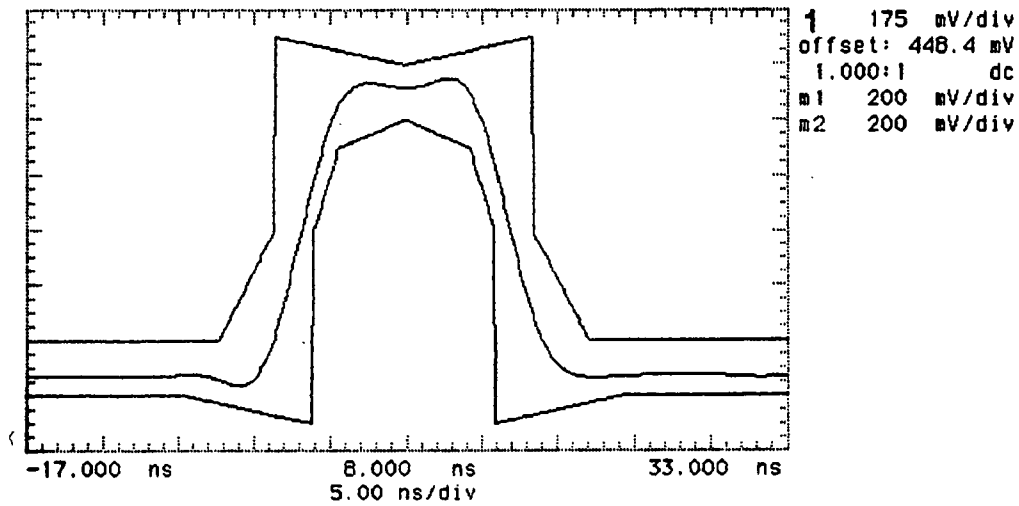

Figure 3-10. 34 Mb/s Isolated Positive Pulse



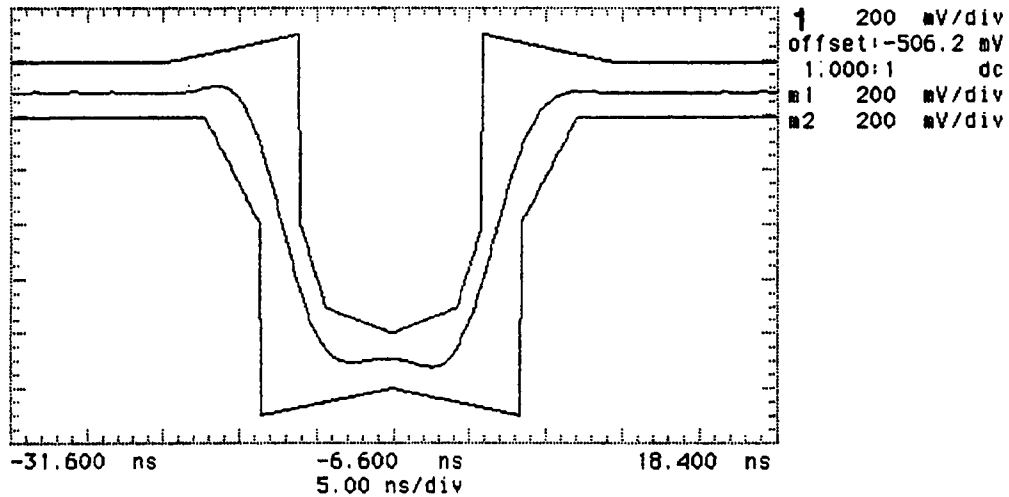

Figure 3-11. 34 Mb/s Isolated Negative Pulse

139.264 Mb/s Unbalanced Output

35. Press **TRANSMIT** and set up the display as shown opposite.
36. Press **AUTOSCALE** on the oscilloscope.
37. Select the BIN1 140 Mb G.703 mask on the oscilloscope and store it on the display.

TRANSMITTER OUTPUT	PDH
SIGNAL	[140 Mb/s]
CLOCK SYNC	[INTERNAL]
FREQUENCY OFFSET	[OFF]
CODE	[CHI]
PATTERN	[ALL ONES]
TERMINATION	[75Ω UNBAL]
STATUS:	
140 Mb/s	34 Mb/s
8 Mb/s	2 Mb/s
704 kb/s	

38. Adjust the Oscilloscope Delay to position the positive peak pulse amplitude at mid-pulse-width point in the centre of the screen.
39. Measure the peak pulse amplitude at mid-pulse-width using the Oscilloscope and verify that this is between 0.900V and 1.100V.

40. Press SHIFT **AUTOSCALE** on the oscilloscope to automatically align the pulse to the mask. Verify that the pulse falls within the mask as shown in Figure 3-12.

Note



If your oscilloscope does not have the Mask feature, obtain a printout of the displayed pulse. Place the mask, shown in Figure 3-12, over the pulse and ensure that the pulse falls within the mask. (A transparent copy of the mask should be used).

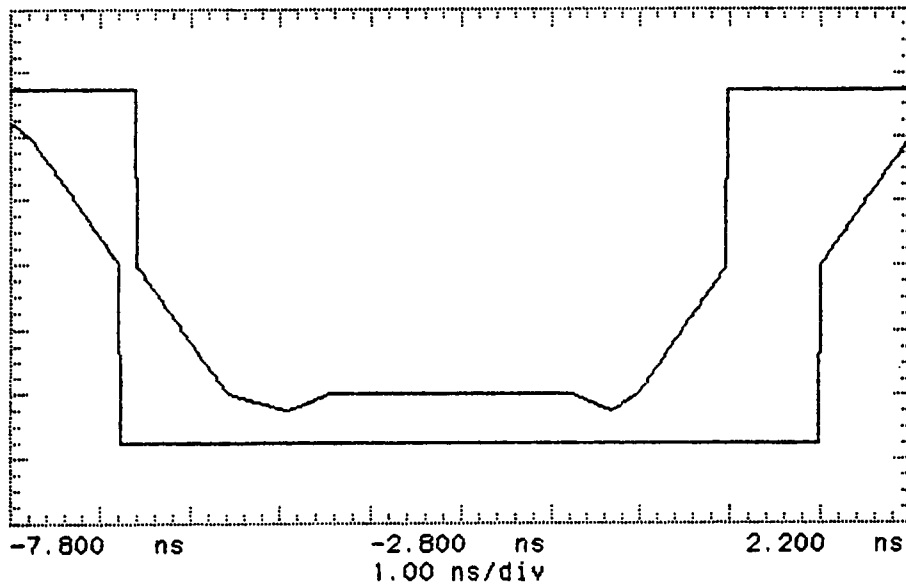

Figure 3-12. 140 Mb/s Pulse Mask All 1's

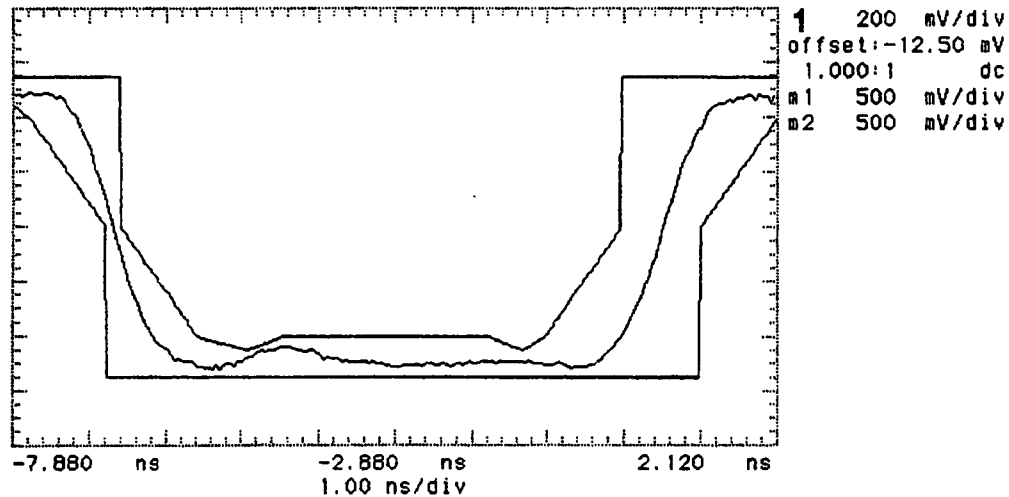

Figure 3-13. 140 Mb/s All Ones Pulse

41. Select PATTERN [ALL ZEROS] on the **TRANSMIT** display.
42. Select BIN0 140 Mb/s G.703 mask on the oscilloscope and store it on the display.
43. Adjust the Oscilloscope Delay to position the positive peak pulse amplitude at mid-pulse-width point in the centre of the screen.
44. Measure the peak pulse amplitude at mid-pulse-width using the Oscilloscope and verify that this is between 0.900V and 1.100V.
45. Press SHIFT **AUTOSCALE** on the oscilloscope to automatically align the pulse to the mask. Verify that the pulse falls within the mask as shown in Figure 3-15.

Note



If your oscilloscope does not have the Mask feature, obtain a printout of the displayed pulse. Place the mask, shown in Figure 3-14, over the pulse and ensure that the pulse falls within the mask. (A transparent copy of the mask should be used).

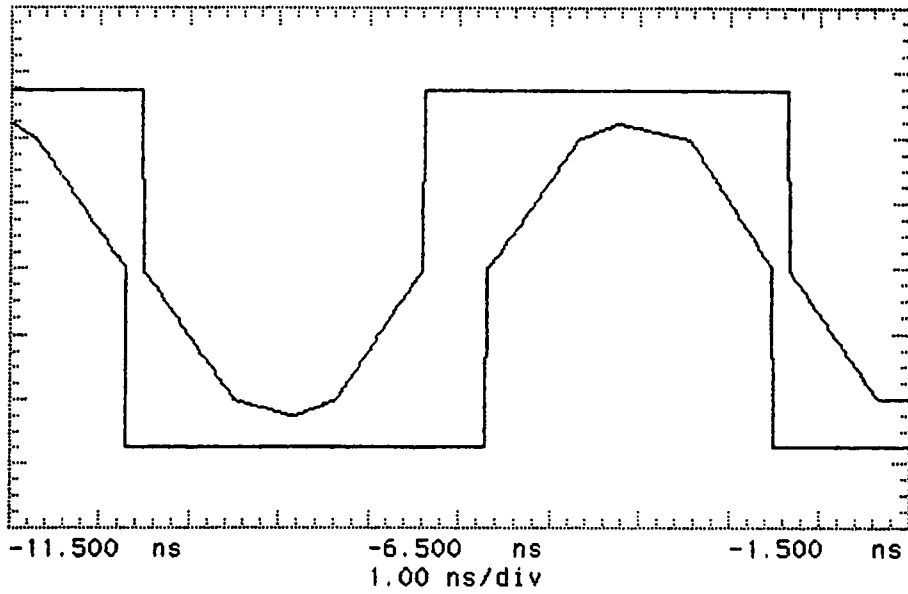

Figure 3-14. 140 Mb/s Pulse Mask All 0's

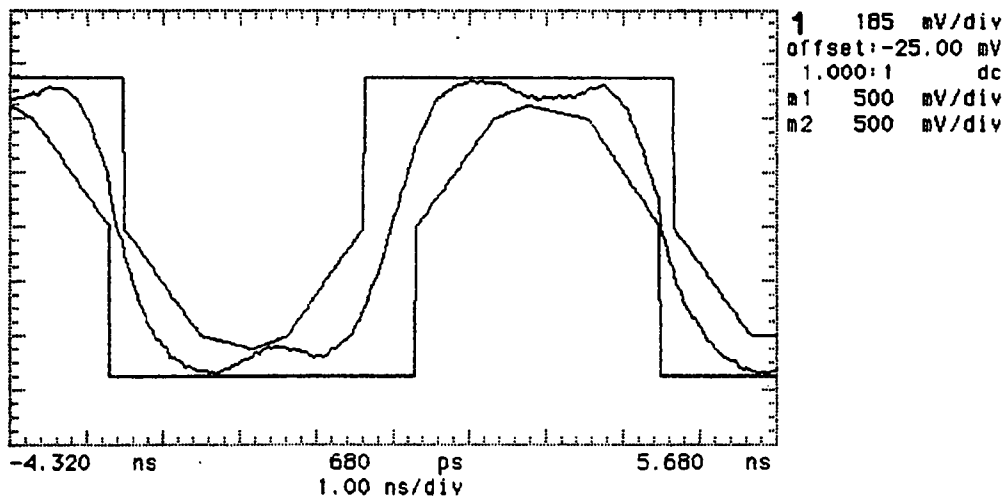

Figure 3-15. 140 Mb/s All Zeros Pulse

3-24 Performance Tests



Multiple PDH Transmitter Outputs (Option UHC[US6])

Specifications

Pulse Shape As per CCITT Rec. G.703

Pulse Amplitude :

704 kb/s	:	2.37V \pm 10%
2 Mb/s	:	2.37V \pm 10%
8 Mb/s	:	2.37V \pm 10%
34 Mb/s	:	1.00V \pm 10%
140 Mb/s	:	0.50V \pm 10%

Additional Outputs Delay :

704 kb/s, 2, 8 and 34 Mb/s	Signal Out 2	4 bits
704 kb/s, 2, 8 and 34 Mb/s	Signal Out 3	8 bits
704 kb/s, 2, 8 and 34 Mb/s	Signal Out 4	12 bits
140 Mb/s	Signal Out 2, 3, 4	No delay

Note 704 kb/s is only valid when Option UKK[USB] is fitted.



Description

This test verifies that the 3 additional PDH transmitter outputs meet CCITT pulse shape and level specifications for all rates. Each PDH Signal Out Port is connected to a Digitizing Oscilloscope terminated in 75 Ω and the waveform is checked for required amplitude and duty cycle at the nominal mid-points. The waveform shape is also checked by comparing with the special CCITT masks. These may be obtained from the oscilloscope memory (if this feature is fitted) or can be traced from the attached figures and compared with a printout of the oscilloscope waveform. The relative delay at each output is also verified using the second channel of the oscilloscope.

Equipment

Oscilloscope : HP 54100D
120/75Ω Bal/Unbal Converter :HP 15508C
75Ω/50Ω Matching Pad (Qty 2) : HP 11825B
ThinkJet Printer : HP 2225A

Procedure

1. Recall the HP 37717B DEFAULT SETTINGS as shown on Page 3-2.

704 kb/s Output Pulse

2. Connect the PDH SIGNAL OUT 2 port to the Oscilloscope Channel 1 via the 75Ω/50Ω Matching Pad. Set the Oscilloscope termination to 50Ω.

Note



1. To compensate for the matching pad attenuation, set the oscilloscope Channel 1 Probe Attenuation factor to X 2.40 (equivalent to 7.6 dB).

2. Steps 3 to 16 are only valid for Option UKK[USB].

3. Press **TRANSMIT** and set up the display as shown opposite.

4. Press **AUTOSCALE** on the oscilloscope.

5. Adjust the Oscilloscope Timebase and Delay to position the positive peak pulse amplitude at mid-pulse-width point in the centre of the screen.

TRANSMITTER OUTPUT	PDH
SIGNAL	[704 kb/s]
CLOCK SYNC	[INTERNAL]
FREQUENCY OFFSET	[OFF]
CODE	[AMI]
PATTERN	[USER WORD]
TERMINATION	[75Ω UNBAL]

STATUS:
[1.40 Mb/s] [84 Mb/s] [8 Mb/s] [2 Mb/s] [704 kb/s]

6. Verify the Pulse meets the following criteria :

Pulse Amplitude : 2.133V to 2.607V
Pulse Width : 639 ns to 781 ns
Overshoot : ≤0.474V
Undershoot : ≤0.474V

3-26 Performance Tests

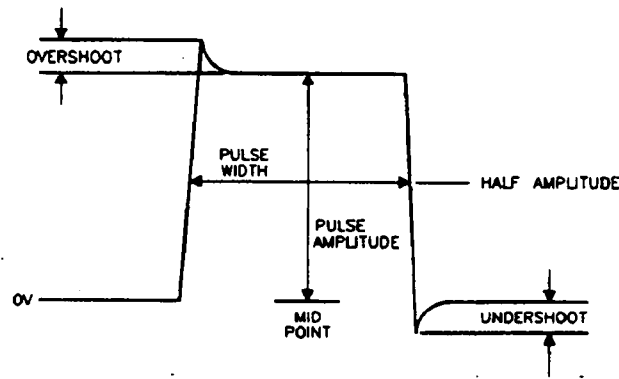

Figure 3-16. 704 kb/s Pulse Criteria

7. Repeat steps 5 and 6 with the Oscilloscope Channel 1 connected to **SIGNAL OUT 3** and **SIGNAL OUT 4** in turn via the 75Ω/50Ω Matching Pad.
8. Adjust the Oscilloscope Timebase and Delay to position the negative peak pulse amplitude at mid-pulse-width point in the centre of the screen and verify that the negative pulse meets the criteria listed in step 6.
9. Repeat step 8 with the Oscilloscope Channel 1 connected to **SIGNAL OUT 2** and **SIGNAL OUT 3** in turn via the 75Ω/50Ω Matching Pad.

704 kb/s Additional Outputs Delay

10. Connect the **PDH SIGNAL OUT 1** port to the Oscilloscope Channel 1 via the 75Ω/50Ω Matching Pad. Set the Oscilloscope termination to 50Ω and Probe Attenuation to X 2.40.
11. Connect the **PDH SIGNAL OUT 2** port to the Oscilloscope Channel 2 via the 75Ω/50Ω Matching Pad. Set the Oscilloscope termination to 50Ω and Probe Attenuation to X 2.40.
12. Check that the pulse on Channel 2 is 4 bits delayed with respect to the pulse on Channel 1.
13. Disconnect the **SIGNAL OUT 2** port from the oscilloscope and connect the **SIGNAL OUT 3** port to the oscilloscope Channel 2 via the 75Ω/50Ω Matching Pad.

14. Check that the pulse on Channel 2 is 8 bits delayed with respect to the pulse on Channel 1.
15. Disconnect the **SIGNAL OUT 3** port from the oscilloscope and connect the **SIGNAL OUT 4** port to the oscilloscope Channel 2 via the 75Ω/50Ω Matching Pad.
16. Check that the pulse on Channel 2 is 12 bits delayed with respect to the pulse on Channel 1.

2.048 Mb/s Output Pulse

17. Connect the **PDH SIGNAL OUT 2** port to the Oscilloscope Channel 1 via the 75Ω/50Ω Matching Pad. Set the Oscilloscope termination to 50Ω.

Note



To compensate for the matching pad attenuation, set the oscilloscope Channel 1 Probe Attenuation factor to X 2.40 (equivalent to 7.6 dB).

18. Press **TRANSMIT** and set up the display as shown opposite.
19. Press **AUTOSCALE** on the oscilloscope.
20. Adjust the Oscilloscope Timebase and Delay to position the positive peak pulse amplitude at mid-pulse-width point in the centre of the screen.

TRANSMITTER OUTPUT	PDH
SIGNAL	[2.048 Mb/s]
CLOCK SYNC	[INTERNAL]
FREQUENCY OFFSET	[OFF]
CODE	[AMI]
PATTERN	[USER WORD]
TERMINATION	[100000000000000]
	[75Ω UNBAL]
STATUS:	
140 Mb/s	64 Mb/s
8 Mb/s	2 Mb/s
2 Mb/s	704 KHz

21. Measure the peak pulse amplitude at mid-pulse-width using the Oscilloscope and verify that this is between 2.133V and 2.607V.
22. Select the 2Mb/s G703 Mask on the oscilloscope and store it on the Display.
23. Press **SHIFT** **AUTOSCALE** on the oscilloscope to automatically align the pulse to the mask. Verify that the pulse falls within the mask as shown in Figure 3-17.

3-28 Performance Tests

Note



If your oscilloscope does not have the Mask feature, obtain a printout of the displayed pulse. Place the mask shown in Figure 3-17 over the pulse and ensure that the pulse falls within the mask (a transparent copy of the mask should be used).

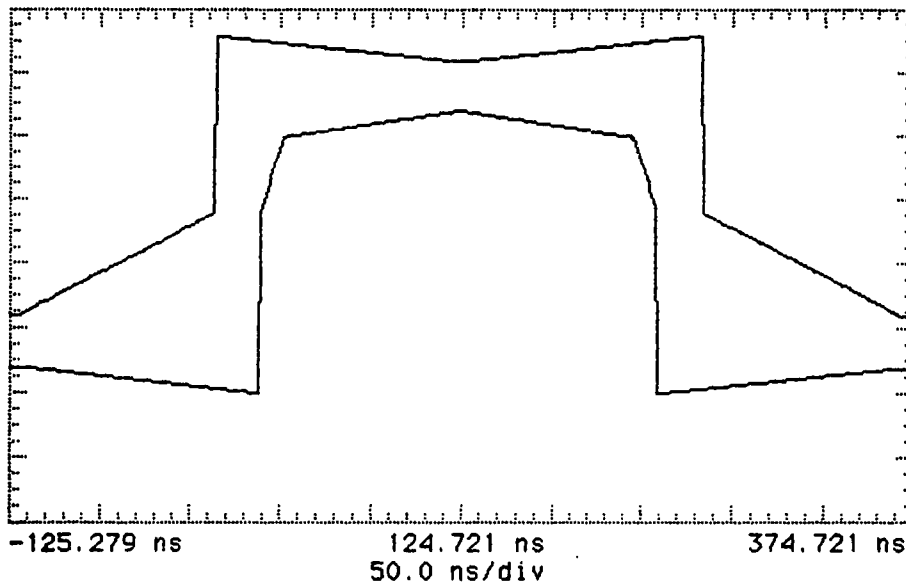

Figure 3-17. 2 Mb/s Pulse Mask

24. Repeat steps 20 to 23 with the Oscilloscope Channel 1 connected to **SIGNAL OUT 3** and **SIGNAL OUT 4** in turn via the 75Ω/50Ω Matching Pad.
25. Press **AUTOSCALE** on the oscilloscope to display the full waveform and use the following sequence to display the isolated negative pulse:
 - Select **TRIG** menu.
 - Set trigger level to middle of negative pulse.
 - Set Trigger to **Pattern**.
 - Set Sequence to **H X X**.

26. Use the oscilloscope **STORE INVERT** function to display an inverted pulse mask on the oscilloscope.
27. Adjust the oscilloscope timebase, delay and vertical sensitivity controls to verify that the pulse meets the mask as shown in Figure 3-17. Use the displayed settings as a guide.
28. Measure the peak pulse amplitude at mid-pulse-width using the Oscilloscope and verify that this is between 2.133V and 2.607V.
29. Repeat steps 27 and 28 with the Oscilloscope Channel 1 connected to **SIGNAL OUT 2** and **SIGNAL OUT 3** in turn via the 75Ω/50Ω Matching Pad.

2.048 Mb/s Additional Output Delay

30. Connect the **PDH SIGNAL OUT 1** port to the Oscilloscope Channel 1 via the 75Ω/50Ω Matching Pad. Set the Oscilloscope termination to 50Ω and Probe Attenuation to X 2.40.
31. Connect the **PDH SIGNAL OUT 2** port to the Oscilloscope Channel 2 via the 75Ω/50Ω Matching Pad. Set the Oscilloscope termination to 50Ω and Probe Attenuation to X 2.40.
32. Check that the pulse on Channel 2 is 4 bits delayed with respect to the pulse on Channel 1.
33. Disconnect the **SIGNAL OUT 2** port from the oscilloscope and connect the **SIGNAL OUT 3** port to the oscilloscope Channel 2 via the 75Ω/50Ω Matching Pad.
34. Check that the pulse on Channel 2 is 8 bits delayed with respect to the pulse on Channel 1.
35. Disconnect the **SIGNAL OUT 3** port from the oscilloscope and connect the **SIGNAL OUT 4** port to the oscilloscope Channel 2 via the 75Ω/50Ω Matching Pad.
36. Check that the pulse on Channel 2 is 12 bits delayed with respect to the pulse on Channel 1.
37. Ensure that the ratio of +ve and -ve pulse amplitudes is between 0.95 and 1.05.
38. Ensure that the ratio of +ve and -ve pulse widths is between 0.95 and 1.05.

3-30 Performance Tests



8.448 Mb/s Output Pulse

39. Connect the **PDH SIGNAL OUT 2** port to the Oscilloscope Channel 1 via the 75Ω/50Ω Matching Pad.

Note



To compensate for the matching pad attenuation, set the oscilloscope Channel 1 Probe Attenuation factor to X 2.40 (equivalent to 7.6 dB).

40. Press **TRANSMIT** and set up the display as shown opposite.
41. Press **AUTOSCALE** on the oscilloscope.
42. Adjust the Oscilloscope Timebase and Delay to position the positive peak pulse amplitude at mid-pulse-width point in the centre of the screen.

TRANSMITTER OUTPUT	PDH
SIGNAL	[8 Mb/s]
CLOCK SYNC	INTERNAL
FREQUENCY OFFSET	[OFF]
CODE	[AMI]
PATTERN	[USER WORD]
TERMINATION	[1000000000000000] 75Ω UNBAL

STATUS:
140 Mb/s 64 Mb/s 8 Mb/s 2 Mb/s 704 P.B.2

43. Measure the peak pulse amplitude at mid-pulse-width using the Oscilloscope and verify that this is between 2.133V and 2.607V.
44. Select the 8Mb/s G703 Mask on the oscilloscope and store it on the Display.
45. Press **SHIFT** **AUTOSCALE** on the oscilloscope to automatically align the pulse to the mask. Verify that the pulse falls within the mask as shown in Figure 3-18.

Note



If your oscilloscope does not have the Mask feature, obtain a printout of the displayed pulse. Place the mask shown in Figure 3-18 over the pulse and ensure that the pulse falls within the mask (a transparent copy of the mask should be used).

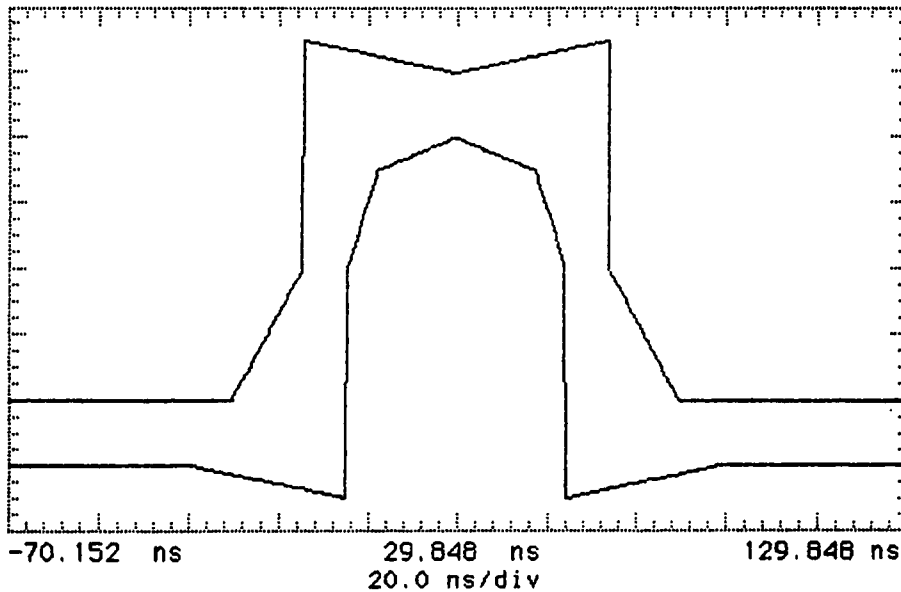

Figure 3-18. 8 Mb/s Pulse Mask

46. Repeat steps 42 to 45 with the Oscilloscope Channel 1 connected to **SIGNAL OUT 3** and **SIGNAL OUT 4** in turn via the 75Ω/50Ω Matching Pad..
47. Press **AUTOSCALE** on the oscilloscope to display the full waveform and use the following sequence to display the isolated negative pulse:
 - Select **TRIG** menu.
 - Set trigger level to middle of negative pulse.
 - Set Trigger to **Pattern**.
 - Set Sequence to **H X X**.
48. Use the oscilloscope **STORE INVERT** function to display an inverted pulse mask on the oscilloscope.
49. Adjust the oscilloscope timebase, delay and vertical sensitivity controls to verify that the pulse meets the mask as shown in Figure 3-18. Use the displayed settings as a guide.

3-32 Performance Tests



50. Measure the peak pulse amplitude at mid-pulse-width using the Oscilloscope and verify that this is between 2.133V and 2.607V.
51. Repeat steps 49 and 50 with the Oscilloscope Channel 1 connected to **SIGNAL OUT 2** and **SIGNAL OUT 3** in turn via the 75Ω/50Ω Matching Pad.

8.448 Mb/s Additional Output Delay

52. Connect the **PDH SIGNAL OUT 1** port to the Oscilloscope Channel 1 via the 75Ω/50Ω Matching Pad. Set the Oscilloscope termination to 50Ω and Probe Attenuation to X 2.40.
53. Connect the **PDH SIGNAL OUT 2** port to the Oscilloscope Channel 2 via the other 75Ω/50Ω Matching Pad. Set the Oscilloscope termination to 50Ω and Probe Attenuation to X 2.40.
54. Check that the pulse on Channel 2 is 4 bits delayed with respect to the pulse on Channel 1.
55. Disconnect the **SIGNAL OUT 2** port from the oscilloscope and connect the **SIGNAL OUT 3** port to the oscilloscope Channel 2 via the 75Ω/50Ω Matching Pad.
56. Check that the pulse on Channel 2 is 8 bits delayed with respect to the pulse on Channel 1.
57. Disconnect the **SIGNAL OUT 3** port from the oscilloscope and connect the **SIGNAL OUT 4** port to the oscilloscope Channel 2 via the 75Ω/50Ω Matching Pad.
58. Check that the pulse on Channel 2 is 12 bits delayed with respect to the pulse on Channel 1.
59. Ensure that the ratio of +ve and -ve pulse amplitudes is between 0.95 and 1.05.
60. Ensure that the ratio of +ve and -ve pulse widths is between 0.95 and 1.05.

34.368 Mb/s Output Pulse

61. Connect the **PDH SIGNAL OUT 2** port to the Oscilloscope Channel 1 via the 75Ω/50Ω Matching Pad.

Note

To compensate for the matching pad attenuation, set the oscilloscope Channel 1 Probe Attenuation factor to X 2.40 (equivalent to 7.6 dB).

62. Press **TRANSMIT** and set up the display as shown opposite.
63. Press **AUTOSCALE** on the oscilloscope.
64. Adjust the Oscilloscope Timebase and Delay to position the positive peak pulse amplitude at mid-pulse-width point in the centre of the screen.

TRANSMITTER OUTPUT	PDM
SIGNAL	[34 Mb/s]
CLOCK SYNC	[INTERNAL]
FREQUENCY OFFSET	[OFF]
CODE	HDB3
PATTERN	[1000]
TERMINATION	75Ω UNBAL
STATUS:	
1010	1000
USER	MARK

65. Measure the peak pulse amplitude at mid-pulse-width using the Oscilloscope and verify that this is between 0.900V and 1.100V.
66. Select the 34Mb/s G703 Mask on the oscilloscope and store it on the Display.
67. Press SHIFT **AUTOSCALE** on the oscilloscope to automatically align the pulse to the mask. Verify that the pulse falls within the mask as shown in Figure 3-19.

Note

If your oscilloscope does not have the Mask feature, obtain a printout of the displayed pulse. Place the mask shown in Figure 3-19 over the pulse and ensure that the pulse falls within the mask (a transparent copy of the mask should be used).

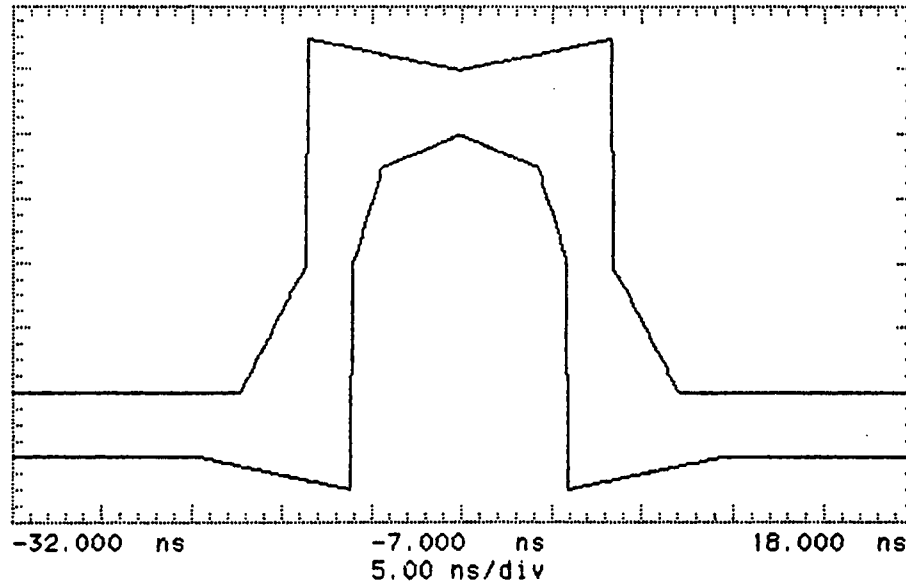

Figure 3-19. 34 Mb/s Pulse Mask

68. Repeat steps 64 to 67 with the Oscilloscope Channel 1 connected to **SIGNAL OUT 3** and **SIGNAL OUT 4** in turn via the 75Ω/50Ω Matching Pad.
69. Press **AUTOSCALE** on the oscilloscope to display the full waveform and use the following sequence to display the isolated negative pulse:
 - Select **TRIG** menu.
 - Set trigger level to middle of negative pulse.
 - Set Trigger to **Pattern**.
 - Set Sequence to **H X X**.
70. Use the oscilloscope **STORE INVERT** function to display an inverted pulse mask on the oscilloscope.
71. Adjust the oscilloscope timebase, delay and vertical sensitivity controls to verify that the pulse meets the mask as shown in Figure 3-19. Use the displayed settings as a guide.

72. Measure the peak pulse amplitude at mid-pulse-width using the Oscilloscope and verify that this is between 0.900V and 1.100V.
 73. Repeat steps 71 and 72 with the Oscilloscope Channel 1 connected to **SIGNAL OUT 2** and **SIGNAL OUT 3** in turn via the 75Ω/50Ω Matching Pad.
- 34.368 Mb/s Additional Outputs Delay**
74. Connect the **PDH SIGNAL OUT 1** port to the Oscilloscope Channel 1 via the 75Ω/50Ω Matching Pad. Set the Oscilloscope termination to 50Ω and Probe Attenuation to X 2.40.
 75. Connect the **PDH SIGNAL OUT 2** port to the Oscilloscope Channel 2 via the other 75Ω/50Ω Matching Pad. Set the Oscilloscope termination to 50Ω and Probe Attenuation to X 2.40.
 76. Set the Transmitter Output PATTERN to USER WORD 111111110001000 and check that the pulse on Channel 2 is 4 bits delayed with respect to the pulse on Channel 1.
 77. Disconnect the **SIGNAL OUT 2** port from the oscilloscope and connect the **SIGNAL OUT 3** port to the oscilloscope Channel 2 via the 75Ω/50Ω Matching Pad.
 78. Check that the pulse on Channel 2 is 8 bits delayed with respect to the pulse on Channel 1.
 79. Disconnect the **SIGNAL OUT 3** port from the oscilloscope and connect the **SIGNAL OUT 4** port to the oscilloscope Channel 2 via the 75Ω/50Ω Matching Pad.
 80. Check that the pulse on Channel 2 is 12 bits delayed with respect to the pulse on Channel 1.
 81. Ensure that the ratio of +ve and -ve pulse amplitudes is between 0.95 and 1.05.
 82. Ensure that the ratio of +ve and -ve pulse widths is between 0.95 and 1.05.
- 139.264 Mb/s Output Pulse**
83. Connect the **PDH SIGNAL OUT 2** port to the Oscilloscope Channel 1 via the 75Ω/50Ω Matching Pad.

3-36 Performance Tests

Note

To compensate for the matching pad attenuation, set the oscilloscope Channel 1 Probe Attenuation factor to X 2.40 (equivalent to 7.6 dB).

84. Press **TRANSMIT** and set up the display as shown opposite.
85. Press **AUTOSCALE** on the oscilloscope.
86. Select the BIN1 140 Mb G.703 mask on the oscilloscope and store it on the display.

TRANSMITTER OUTPUT	PDH			
SIGNAL	[140 Mb/s]			
CLOCK SYNC	INTERNAL			
FREQUENCY OFFSET	[OFF]			
CODE	CM1			
PATTERN	[ALL ONES]			
TERMINATION	75Ω UNBAL			
STATUS:				
140 Mb/s	84 Mb/s	8 Mb/s	2 Mb/s	704 Mb/s

87. Adjust the Oscilloscope Timebase and Delay to position the positive peak pulse amplitude at mid-pulse-width point in the centre of the screen.
88. Measure the peak pulse amplitude at mid-pulse-width using the Oscilloscope and verify that this is between 0.900V and 1.100V.
89. Press **SHIFT** **AUTOSCALE** on the oscilloscope to automatically align the pulse to the mask. Verify that the pulse falls within the mask as shown in Figure 3-20.
90. Repeat steps 87 to 89 with the Oscilloscope Channel 1 connected to **SIGNAL OUT 3** and **SIGNAL OUT 4** in turn via the 75Ω/50Ω Matching Pad.

Note

If your oscilloscope does not have the Mask feature, obtain a printout of the displayed pulse. Place the mask shown in Figure 3-20 over the pulse and ensure that the pulse falls within the mask (a transparent copy of the mask should be used).

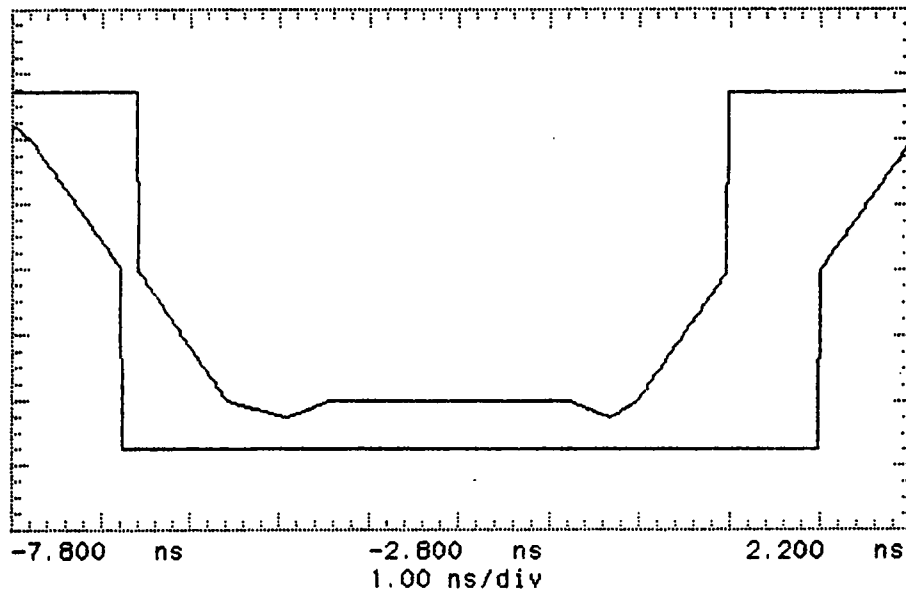

Figure 3-20. 140 Mb/s Pulse Mask All 1's

91. Select PATTERN [ALL ZEROS] on the **TRANSMIT** display.
92. Select the BIN 0 140Mb/s G703 Mask on the oscilloscope and store it on the Display.
93. Adjust the Oscilloscope Timebase and Delay to position the positive peak pulse amplitude at mid-pulse-width point in the centre of the screen.
94. Measure the peak pulse amplitude at mid-pulse-width using the Oscilloscope and verify that this is between 0.900V and 1.100V.
95. Press SHIFT **AUTOSCALE** on the oscilloscope to automatically align the pulse to the mask. Verify that the pulse falls within the mask as shown in Figure 3-21.

Note



If your oscilloscope does not have the Mask feature, obtain a printout of the displayed pulse. Place the mask shown in Figure 3-21 over the pulse and ensure that the pulse falls within the mask (a transparent copy of the mask should be used).



101. Check that the pulse on Channel 1 is in phase with the pulse on Channel 2.
102. Disconnect the **SIGNAL OUT 3** port from the oscilloscope and connect the **SIGNAL OUT 4** port to the oscilloscope Channel 2 via the 75Ω/50Ω Matching Pad.
103. Check that the pulse on Channel 1 is in phase with the pulse on Channel 2.
104. Disconnect the test equipment.



PDH Frame Analysis

Specifications

140 Mb/s	Frame Loss - 4 consecutive incorrect FAS words. Frame Gain - 3 consecutive correct FAS words (1111010000).
34 Mb/s	Frame Loss - 4 consecutive incorrect FAS words. Frame Gain - 3 consecutive correct FAS words (1111010000).
8 Mb/s	Frame Loss - 4 consecutive incorrect FAS words. Frame Gain - 3 consecutive correct FAS words (1111010000).
2 Mb/s	Frame Loss - 3 consecutive incorrect FAS words or NFAS words. Frame Gain - 1 correct sequence of FAS - NFAS - FAS words.
2 Mb/s CRC	MultiFrame Loss - 3 out of 4 MultiFrame sequences in error. MultiFrame Gain - 2 out of 4 MultiFrame sequences are correct.
2 Mb/s CAS	MultiFrame Loss - 2 consecutive MultiFrame patterns in error. MultiFrame Gain - 1 correct MultiFrame pattern is correct.

Equipment

Frame Generator HP 37729A

Description

An HP 37729A Frame Generator is used to generate the appropriate Frame Alignment Signals (FAS) which are used to test the HP 37717B In-Service Analysis at all bit rates with this capability.

Procedure

1. Recall the HP 37717B Default settings as shown on Page 3-2.

Option UKK[USB] Unstructured PDH

2. Setup the **RECEIVE** Display as shown below.

RECEIVER INPUT	PDH
SIGNAL	[2 Mb/s]
TEST MODE	[IN SERVICE]
FRAMING CODE	[PCN30]
	[HDB3]
PATTERN	LIVE TRAFFIC
TERMINATION	[75Ω UNBAL]
STATUS:	
PCN30	PCN31 PCN31CPC PCN30CPC

3. Setup the **RESULTS** display as shown below.

RESULTS [PDH]	[SHORT TERM]
ERROR SOURCE	[FRAME]
SHORT TERM PERIOD	[1 SECOND]
TEST TIMING	[MANUAL]
STORAGE	[OFF]
ERR COUNT	
ERR RATIO	
ELAPSED TIME	
STATUS:	
FRAME	CODE

Option UKJ[USA] Structured PDH

2. Setup the **RECEIVE** Display as shown below.

RECEIVER INPUT SETTINGS	PDH [MAIN]
SIGNAL	[2 Mb/s]
TERMINATION	[75Ω UNBAL]
LINE CODE	[HDB3]
PAYLOAD TYPE	[PCN30]
PATTERN	[LIVE TRAFFIC]
STATUS:	
UNFRAED	PCN30 PCN31 PCN30CPC MORE

3. Setup the **RESULTS** display as shown below.

RESULTS [PDH]	[CUMULATIVE]
	[FAS 2 Mb/s]
TEST TIMING	[MANUAL]
STORAGE	[OFF]
FAS 2M EC	
FAS 2M ER	
ELAPSED TIME	
STATUS:	
CODE	FAS 2 Mb/s

2 Mb/s Frame Analysis

1. Set the HP 37729A Frame Generator parameters as follows:
OUTPUT : FREQ [2] ; CODE [HDB3]
Press the [MENU] key to select the MENU display.
Use **▲** and **▼** to select [ALIGNMENT].
Press **ENTER** to select the ALIGNMENT parameters.
Use **PAGE UP** and **PAGE DOWN** to select ALIGNMENT [2M].
FAS [10011011]
NFAS [01011111]
Press **SELECT** until all the 2048 Kbit/s Led's are OFF.
2. Connect the Frame Generator AMI/HDB3 output to the HP 37717B 75Ω SIGNAL IN port.
3. Press **RUN/STOP** on the HP 37717B to start the measurement.
4. Check that all PDH Alarm Led's are OFF. Error Count and Error Ratio should be 0.

CAS Multiframe

5. Press the Frame Generator 2048 Kbit/s **SELECT** key until the CAS MFL Led is flashing.
6. Press the Frame Generator 2048 Kbit/s **ON/OFF** key and check that the HP 37717B PDH Multiframe Loss Alarm Led is ON.
7. Press the Frame Generator 2048 Kbit/s **ON/OFF** key and ensure all HP 37717B Alarm Led's are OFF.
8. Press **RUN/STOP** on the HP 37717B to stop the measurement.

CRC Multiframe

9. Select FRAMING [PCM30CRC] on the HP 37717B **RECEIVE** display.
10. Select ERROR SOURCE [CRC] on the HP 37717B **RESULTS** display.
11. Press **RUN/STOP** on the HP 37717B to start the measurement.

12. Use the Frame Generator **SELECT** and **ON/OFF** keys to select and enable CRC MFL.
13. Check that the HP 37717B displays a CRC errors count and that the Errors Led is ON.
14. Check that after several seconds, the HP 37717B CRC error count stops and the PDH Frame Loss and Multiframe Loss Alarm Led's are ON.
15. Press the Frame Generator 2048 Kbit/s **ON/OFF** key and check that the PDH Frame Loss and Multiframe Loss Alarm Led's are now OFF.

Error Detection

16. Use the Frame Generator 2048 Kbit/s **SELECT** and **ON/OFF** keys to select and enable BIT ERROR 2Mb/s.
17. Check that the HP 37717B counts FRAME (FAS), CRC and REBE errors. A minimum of 1 REBE error should occur in a 1 minute period. The CODE Error Count should be 0.

Alarm Detection

18. Use the Frame Generator 2048 Kbit/s **SELECT** and **ON/OFF** keys to select and enable DF (Remote Alarm) and check that the HP 37717B Remote Alarm Led is ON.
19. Press the Frame Generator 2048 Kbit/s **ON/OFF** key.
20. Use the Frame Generator 2048 Kbit/s **SELECT** and **ON/OFF** keys to select and enable DMF (Remote Multiframe Alarm) and check that the HP 37717B Remote Multiframe Alarm Led is ON.
21. Press the Frame Generator 2048 Kbit/s **ON/OFF** key.
22. Press **RUN/STOP** on the HP 37717B once to stop the measurement.

8 Mb/s Frame Analysis

1. Select SIGNAL [8 Mb/s] on the HP 37717B **RECEIVE** display then return to **RESULTS** Display.
2. Set the HP 37729A Frame Generator parameters as follows:
OUTPUT : FREQ [8] ; CODE [HDB3]
ALIGNMENT [8M]

3-44 Performance Tests

SB [00]

FAS [1111010000]

Press the **SELECT** key until all 8448 Kbit/s ERROR and AIS Led's are OFF.

3. Press **RUN/STOP** on the HP 37717B to start a measurement and check that all Alarm Led's are OFF on the HP 37717B. The Error Count and Error Ratio should be 0.

Error Detection

4. Use the Frame Generator 8448 Kbit/s **SELECT** and **ON/OFF** keys to select and enable BIT ERROR.
5. Check that HP 37717B Errors and Remote alarm Led's are ON (may be flashing).
6. Check that the HP 37717B counts Frame (FAS) Errors. The Code Error count should be 0.
7. Press the Frame Generator 8448 Kbit/s **ON/OFF** key and check that the FRAME (FAS) Error Count is 0 and all Alarm Led's are now OFF.

Alarm Detection

8. Set the Frame Generator SB parameter to [10].
9. Check that the HP 37717B Remote Alarm Led is ON. Error Count and Error Ratio should be 0.
10. Reset the Frame Generator SB parameter to [00].

FAS Error and AIS

11. Use the Frame Generator 8448 Kbit/s **SELECT** and **ON/OFF** keys to select and enable FAS ERROR.
12. Check that the HP 37717B Frame Loss alarm Led is ON.
13. Press the Frame Generator 8448 Kbit/s **ON/OFF** key and check that the FRAME (FAS) Error Count is 0 and all Alarm Led's are now OFF.
14. Use the Frame Generator 8448 Kbit/s **SELECT** and **ON/OFF** keys to select and enable AIS OUT.
15. Check that the HP 37717B Frame Loss and AIS alarm Led's are ON.

16. Press the Frame Generator 8448 Kbit/s **ON/OFF** key and check that the FRAME (FAS) Error Count is 0 and all Alarm Led's are now OFF.
17. Press **RUN/STOP** on the HP 37717B once to stop the measurement.

34 Mb/s Frame Analysis

1. Select SIGNAL [34 Mb/s] on the HP 37717B **RECEIVE** display then return to **RESULTS** Display.
2. Set the HP 37729A Frame Generator parameters as follows:
OUTPUT : FREQ [34] ; CODE [HDB3]
ALIGNMENT [34M]
SB [00]
FAS [1111010000]
Press the 34368 Kbit/s **SELECT** key until all 34368 Kbit/s ERROR and AIS Led's are OFF.
3. Press **RUN/STOP** on the HP 37717B to start a measurement and check that all HP 37717B Alarm Led's are OFF. The Error Count and Error Ratio should be 0.

Error Detection

4. Press the 34368 Kbit/s **SELECT** key until all 34368 Kbit/s ERROR and AIS Led's are OFF.
5. Use the Frame Generator 34368 Kbit/s **SELECT** and **ON/OFF** keys to select and enable BIT ERROR.
6. Check that Errors and Remote alarm Led's are ON.
7. Check that the HP 37717B counts Frame (FAS) Errors. The Code Error count should be 0.
8. Press the Frame Generator 34368 Kbit/s **ON/OFF** key and check that the FRAME (FAS) Error Count is 0 and all Alarm Led's are now OFF.

Alarm Detection

9. Set the Frame Generator SB parameter to [10].

3-46 Performance Tests

10. Check that the HP 37717B Remote Alarm Led is ON. Error Count and Error Ratio should be 0.

11. Reset the Frame Generator SB parameter to [00].

FAS Error and AIS

12. Use the Frame Generator 34368 Kbit/s **SELECT** and **ON/OFF** keys to select and enable FAS ERROR.

13. Check that the HP 37717B Frame Loss alarm Led is ON.

14. Press the Frame Generator 34368 Kbit/s **ON/OFF** key and check that the FRAME (FAS) Error Count is 0 and all Alarm Led's are now OFF.

15. Use the Frame Generator 34368 Kbit/s **SELECT** and **ON/OFF** keys to select and enable AIS OUT.

16. Check that the HP 37717B Frame Loss and AIS alarm Led's are ON.

17. Press the Frame Generator 34368 Kbit/s **ON/OFF** key and check that the FRAME (FAS) Error Count is 0 and all Alarm Led's are now OFF.

18. Press **RUN/STOP** on the HP 37717B once to stop the measurement.

140 Mb/s Frame Analysis

1. Select SIGNAL: [140 Mb/s] on the HP 37717B **RECEIVE** display then return to **RESULTS** Display.

2. Set the HP 37729A Frame Generator parameters as follows:

OUTPUT : FREQ [139] ; CODE [CMI]

ALIGNMENT [140M]

SB [0000]

FAS [111110100000]

Press the 139264 Kbit/s **SELECT** key until all the 139264 Kbit/s ERROR and AIS Led's are OFF.

3. Connect the Frame Generator CMI/NRZ output to the HP 37717B 75Ω SIGNAL IN port.

4. Press **RUN/STOP** on the HP 37717B to start a measurement and ensure all Alarm Led's are OFF. Check that the HP 37717B Error Count and Error Ratio is 0.

Error Detection

5. Use the Frame Generator 139264 Kbit/s **SELECT** and **ON/OFF** keys to select and enable BIT ERROR.
6. Check that Errors and Remote alarm Led's are ON.
7. Check that the HP 37717B counts Frame (FAS) Errors. The Code Error count should be 0.
8. Press the Frame Generator **ON/OFF** key and check that the FRAME (FAS) and CODE error count is 0 and the Alarm Led's are OFF.

Alarm Detection

9. Set the Frame Generator SB parameter to [1000].
10. Check that the HP 37717B Remote Alarm Led is ON. Check that the Error Count and Error Ratio is 0.
11. Reset the Frame Generator SB parameter to [0000].

FAS Error and AIS

12. Use the Frame Generator 139264 Kbit/s **SELECT** and **ON/OFF** keys to select and enable FAS ERROR.
13. Check that the HP 37717B Frame Loss alarm Led is ON.
14. Press the Frame Generator 139264 Kbit/s **ON/OFF** key and check that the FRAME (FAS) Error Count is 0 and all Alarm Led's are now OFF.
15. Use the Frame Generator 139264 Kbit/s **SELECT** and **ON/OFF** keys to select and enable AIS OUT.
16. Check that the HP 37717B Frame Loss and AIS alarm Led's are ON.
17. Press the Frame Generator 139264 Kbit/s **ON/OFF** key and check that the FRAME (FAS) Error Count is 0 and all Alarm Led's are now OFF.
18. Press **RUN/STOP** on the HP 37717B once to stop the measurement.
19. Disconnect the test equipment.

3-48 Performance Tests

PDH Receiver Equalization

Specifications

Bit Rate	Option	Equalization at 1/2 Bit Rate
704 kb/s	UKK[USB]	6dB
2.048 Mb/s	UKK[USB], UKJ[USA]	6dB
8.448 Mb/s	UKK[USB], UKJ[USA]	6dB
34.368 Mb/s	UKK[USB], UKJ[USA]	12dB
139.264 Mb/s	UKK[USB], UKJ[USA]	12dB

Description

The PDH receiver equalization is checked using a Synthesizer set for a sinewave at half the data rate. This sinewave corresponds to a ternary all ones signal and the HP 37717B receiver should sync up with no errors if PATTERN [ALL ONES] is selected. The amplitude of the synthesiser signal is set to the specified maximum loss for each bit rate. At that amplitude no errors should result.

Equipment

Synthesizer : HP 3335A option 001
Oscilloscope : HP 54100D

Procedure

1. Recall the HP 37717B Default settings as shown on Page 3-2.
2. Connect up the equipment as shown in Figure 3-22.
3. Set the oscilloscope :
TERMINATION - 1 M Ω
PROBE - 1:1

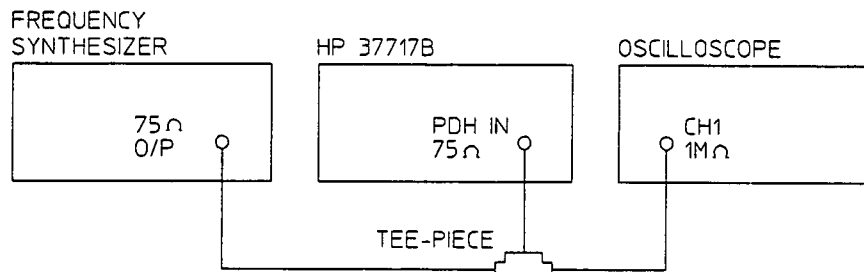

Figure 3-22. PDH Receiver Equalization Test Setup

704 kB/s

Note Steps 4 to 7 are only valid if Option UKK[USB] is fitted.



4. Press **RECEIVE** and set up the display as shown below.

RECEIVER INPUT	PDH
SIGNAL	[704 kb/s]
CODE	[MDB9]
PATTERN	[ALL ONES]
TERMINATION	[75Ω UNBAL]
STATUS:	
[2 13-1]	[2 28-1]
[ALL ZEP03]	[ALL ONES]
[NONE]	[]

5. Press **RESULTS** and set up the display as shown below.

RESULTS [PDH]	[CUMULATIVE]
TEST TIMING	[SINGLE] [5 SECS]
STORAGE	[OFF]
BIT EC	
BIT ER	
CODE EC	
CODE ER	
ELAPSED TIME	
STATUS:	
[NATURAL]	[SINGLE]
[]	[TIMED]

6. Set the Synthesizer to :
 FREQUENCY - 352 KHz sinewave
 AMPLITUDE - 2.37 V pk-pk (6dB down) as measured on the oscilloscope.

3-50 Performance Tests

7. Press **RUN/STOP** and verify that no errors are displayed at the end of the test period (5 seconds).

2.048 MB/s

8. Press **RECEIVE** and set up the display as shown below.

RECEIVER INPUT SETTINGS	PDM [MAIN]
SIGNAL	[2 Mb/s]
TERMINATION	[75Ω UNBAL]
LINE CODE	[HDDB]
PAYLOAD TYPE	[UNFRAMED]
PATTERN	[ALL ONES]
STATUS:	
ALL ONES	ALL ZEROS
1010	1000
1000	1000
1000	1000

9. Press **RESULTS** and set up the display as shown below.

RESULTS [PDM]	[CUMULATIVE]
	[BIT]
TEST TIMING	[SINGLE] [5 SECS]
STORAGE	[OFF]
BIT EC	
BIT ER	
ELAPSED TIME	
STATUS:	
MANUAL	SINGLE
TIMED	

10. Set the Synthesizer to :
 FREQUENCY - 1024 KHz sinewave
 AMPLITUDE - 2.37 V pk-pk (6dB down) as measured on the oscilloscope.
11. Press **RUN/STOP** and verify that no errors are displayed at the end of the test period (5 seconds).

8.448 MB/s

- 11 Select SIGNAL [8 Mb/s] on the **RECEIVE** display.
12. Set the Synthesizer to :
 FREQUENCY - 4224 KHz sinewave
 AMPLITUDE - 2.37 V pk-pk (6dB down) as measured on the oscilloscope.
13. Press **RUN/STOP** and verify that no errors are displayed at the end of the test period (5 seconds).

34.368 MB/s

14. Select SIGNAL [34 Mb/s] on the **RECEIVE** display.
15. Set the Synthesizer to :
FREQUENCY - 17184 KHz sinewave
AMPLITUDE - 0.5 V pk-pk (12dB down) as measured on the oscilloscope.
16. Press **RUN/STOP** and verify that no errors are displayed at the end of the test period (5 seconds).

139.264 MB/s

17. Select SIGNAL [140 Mb/s] on the **RECEIVE** display.
18. Set the Synthesizer to :
FREQUENCY - 69632 KHz sinewave
AMPLITUDE - 0.25 V pk-pk (12dB down) as measured on the oscilloscope.
19. Press **RUN/STOP** and verify that no errors are displayed at the end of the test period (5 seconds).



PDH Receiver Monitor Levels (Option UKK[USB] only)

Specification

Bit Rate	Nominal Loss
704 kb/s	26 to 30dB
2.048 Mb/s	26 to 30dB
8.448 Mb/s	26 to 30dB
34.368 Mb/s	26dB
139.264 Mb/s	26dB

Description

The PDH receiver Monitor levels are checked by attenuating the synthesizer output level by an amount equivalent to the extra gain provided by the Monitor Amplifier. The synthesiser is set to generate a sinewave at half the bit rate which corresponds to a ternary all ones signal. The receiver should sync up with no errors if PATTERN [ALL ONES] is selected.

Equipment

Synthesizer : HP 3335A option 001 (75 Ω)
oscilloscope : HP 54100D

Procedure

1. Recall the HP 37717B Default settings as shown on Page 3-2.
2. Connect up the equipment as shown in Figure 3-23.
3. Set the oscilloscope to :
TERMINATION - 1 M Ω
PROBE - 1:1

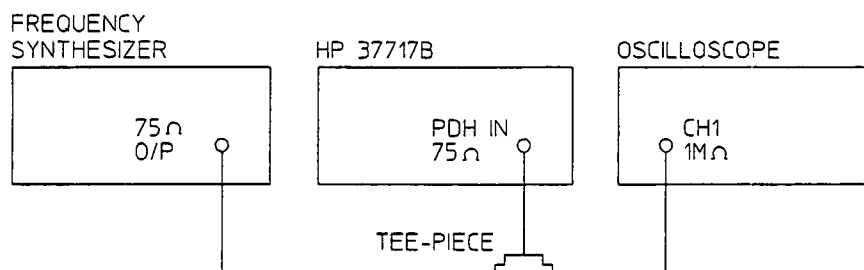

Figure 3-23. PDH Receiver Monitor Levels Test Setup

704 kB/s

4. Press **RECEIVE** and set up the display as shown below.

Press **SIGNAL IN** until the Monitor led is lit.

RECEIVER INPUT	PDH
SIGNAL	[704 kb/s]
CODE	[HDB3]
PATTERN	[ALL ONES]
TERMINATION	[75Ω UNBAL]
STATUS:	
2 ¹⁵ -1	2 ³⁸ -1
ALL DEPOS	ALL ONES
	NOPE

5. Press **RESULTS** and set up the display as shown below.

RESULTS [PDH] [CUMULATIVE]
TEST TIMING [SINGLE] [5 SECS]
STORAGE [OFF]
BIT EC
BIT ER
CODE EC
CODE ER
ELAPSED TIME
STATUS:
NORMAL SINGLE TIME

6. Set the Synthesizer to :

FREQUENCY - 352 KHz sinewave

AMPLITUDE - 150 mV pk-pk (30dB down) as measured on the oscilloscope.

7. Press **RUN/STOP** and verify that no errors are displayed at the end of the test period (5 seconds).

2.048 MB/s

8. Select SIGNAL [2 Mb/s] on the **RECEIVE** display.

3-54 Performance Tests

9. Set the Synthesizer to :
FREQUENCY - 1024 KHz sinewave
AMPLITUDE - 150 mV pk-pk (30dB down) as measured on the oscilloscope.
 10. Press **RUN/STOP** and verify that no errors are displayed at the end of the test period (5 seconds).
- 8.448 MB/s**
11. Select SIGNAL [8 Mb/s] on the **RECEIVE** display.
 12. Set the Synthesizer to :
FREQUENCY - 4224 KHz sinewave
AMPLITUDE - 150 mV pk-pk (30dB down) as measured on the oscilloscope.
 13. Press **RUN/STOP** and verify that no errors are displayed at the end of the test period (5 seconds).
- 34.368 MB/s**
14. Select SIGNAL [34 Mb/s] on the **RECEIVE** display.
 15. Set the Synthesizer to :
FREQUENCY - 17184 KHz sinewave
AMPLITUDE - 100 mV pk-pk (26dB down) as measured on the oscilloscope.
 16. Press **RUN/STOP** and verify that no errors are displayed at the end of the test period (5 seconds).
- 139.264 MB/s**
17. Select SIGNAL [140 Mb/s] on the **RECEIVE** display.
 18. Set the Synthesizer to :
FREQUENCY - 69632 KHz sinewave
AMPLITUDE - 50 mV pk-pk (26dB down) as measured on the oscilloscope.
 19. Press **RUN/STOP** and verify that no errors are displayed at the end of the test period (5 seconds).

SPDH Receiver Monitor Levels (Options UKJ,[USA] and UKL,[USC])

Specifications

Bit Rate	Nominal Loss	Equalization at 1/2 Bit Rate
2.048 Mb/s	20, 26, 30dB	3dB
8.448 Mb/s	20, 26, 30dB	3dB
34.368 Mb/s	20, 26dB	6dB
139.264 Mb/s	20, 26dB	6dB

Description

The signal from the HP 37717B PDH Transmitter is applied to the PDH Receiver after attenuating by an amount equal to the selected Receiver Flat Loss plus the specified Cable Loss. The Flat Loss is obtained by inserting a number of 50 Ω , fixed attenuators in series with a 75/50 Ω Matching Pad at one end and a 50/75 Ω Matching Pad at the other end. The loss of the two Matching Pads is included in the overall attenuation equation. The Cable Loss is supplied by inserting the correct Cable Simulators for each bit rate in the attenuation path.

Equipment

Cable Simulator #1 :80 metres (262 ft) of 75 Ω coaxial cable (8120-0049)
Cable Simulator #2 :60 metres (197 ft) of 75 Ω coaxial cable (8120-0049)
Cable Simulator #3 :70 metres (230 ft) of 75 Ω coaxial cable (8120-0049)
Cable Simulator #4 :30 metres (98 ft) of 75 Ω coaxial cable (8120-0049)
Fixed Attenuator (Qty 2) : HP 8491A Option 006 (6dB; 50 ohm)
Fixed Attenuator (Qty 2) : HP 8491A Option 003 (3dB; 50 ohm)
Matching Pad 75/50 Ω (7.6dB loss) : HP 11852B
Matching Pad 50/75 Ω (4.2dB loss) : HP 11852B

Procedure

1. Recall the HP 37717B DEFAULT SETTINGS as shown on Page 3-2.
2. Connect the equipment as shown in Figure 3-24 .
3. Press **SIGNAL IN** until the Monitor led is lit.

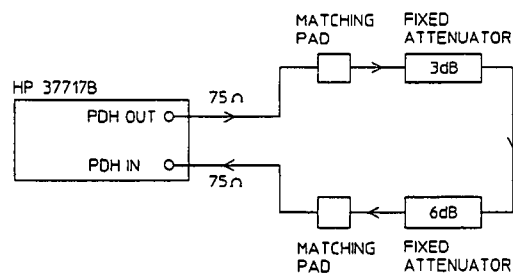

Figure 3-24. SPDH Receiver Monitor Input

2.048 Mb/s

4. Press **TRANSMIT** and set up the MAIN SETTINGS display as shown below.
5. Press **RECEIVE** and set up the MAIN SETTINGS display as shown below.

TRANSMITTER OUTPUT SETTINGS	PDH [MAIN]
SIGNAL	[2 Mb/s]
CLOCK SYNC	[INTERNAL]
TERMINATION	[75Ω UNBAL]
LINE CODE	[HDB3]
FREQUENCY OFFSET	[OFF]
PAYLOAD TYPE	[UNFRAMED]
PATTERN	[2 ¹⁵ -1 PRBS]
PRBS POLARITY	[INV] CCITT
STATUS:	
MODES	PHI

RECEIVER INPUT SETTINGS	PDH [MAIN]
SIGNAL	[2 Mb/s]
TERMINATION	[75Ω UNBAL]
LINE CODE	[HDB3]
GAIN	[30dB]
EQUALIZER	[OFF]
PAYLOAD TYPE	[UNFRAMED]
PATTERN	[2 ¹⁵ -1 PRBS]
PRBS POLARITY	[INV] CCITT
STATUS:	
30dB	20dB
4E	4E

6. Press **RESULTS**; **TROUBLE SCAN**. Press **RUN/STOP** to start the measurement.
7. Ensure that NO TROUBLE is displayed on the **RESULTS** display after 30 seconds. Press **RUN/STOP** to stop the measurement.

8. Press **RECEIVE** and select EQUALIZATION [ON].
9. Connect Cable Simulator #1 between the PDH OUT Port and the Matching Pad.
10. Press **RESULTS**; **TROUBLE SCAN**. Press **RUN/STOP** to start the measurement.
11. Ensure that NO TROUBLE is displayed on the **RESULTS** display after 30 seconds. Press **RUN/STOP** to stop the measurement.
12. Connect the second 6dB Fixed Attenuator in the signal path to give a total path attenuation of 26.8dB (7.6+3+6+6+4.2).
13. Press **RECEIVE** and set MONITOR LEVEL [26dB].
14. Press **RESULTS**; **TROUBLE SCAN**. Press **RUN/STOP** to start the measurement.
15. Ensure that NO TROUBLE is displayed on the **RESULTS** display after 30 seconds. Press **RUN/STOP** to stop the measurement.
16. Remove Cable Simulator #1 from the signal path.
17. Press **RECEIVE** and select EQUALIZATION [OFF].
18. Press **RESULTS**; **TROUBLE SCAN**. Press **RUN/STOP** to start the measurement.
19. Ensure that NO TROUBLE is displayed on the [RESULTS] display after 30 seconds. Press **RUN/STOP** to stop the measurement.
20. Connect the second 3dB Fixed Attenuator in the signal path to give a total path attenuation of 29.8dB (7.6+3+3+6+6+4.2).
21. Press **RECEIVE** and set MONITOR LEVEL [30dB].
22. Press **RESULTS**; **TROUBLE SCAN**. Press **RUN/STOP** to start the measurement.
23. Ensure that NO TROUBLE is displayed on the **RESULTS** display after 30 seconds. Press **RUN/STOP** to stop the measurement.
24. Press **RECEIVE** and select EQUALIZATION [ON].
25. Connect Cable Simulator #1 between the PDH OUT Port and the Matching Pad.
26. Press **RESULTS**; **TROUBLE SCAN**. Press **RUN/STOP** to start the measurement.

3-58 Performance Tests

27. Ensure that NO TROUBLE is displayed on the **RESULTS** display after 30 seconds. Press **RUN/STOP** to stop the measurement.

8.448 Mb/s

28. Repeat steps 1 to 26 (20dB, 26dB and 30dB tests) with the HP 37717B **TRANSMIT** and **RECEIVE** displays set to SIGNAL [8 Mb/s] and Cable Simulator #2 fitted in place of Cable Simulator #1.

34.368 Mb/s

29. Repeat steps 1 to 18 (20dB and 26dB tests) with the HP 37717B **TRANSMIT** and **RECEIVE** displays set to SIGNAL [34 Mb/s] and Cable Simulator #3 fitted in place of Cable Simulator #2.

139.264 Mb/s

30. Repeat steps 1 to 18 (20dB and 26dB tests) with the HP 37717B **TRANSMIT** and **RECEIVE** displays set to SIGNAL [140 Mb/s] and Cable Simulator #4 fitted in place of Cable Simulator #3.

31. Disconnect all test equipment.

External 2Mb/s Mux/Demux (Options UKJ, [USA])

Specifications

Multiplexer

Frequency	2.048 Mb/s
Interface	Meets CCITT Rec. G.703, for unbalanced coaxial pair. HDB3 line coding only.
Source	Accepts a 2 Mb/s signal conforming to CCITT Rec. G.703, Unbalanced only.

De-Multiplexer

Frequency	2.048 Mb/s
Interface	Meets section 6 of CCITT Rec. G.703, for unbalanced coaxial pair. HDB3 line coding only.

Description

This test verifies operation of the SPDH Mux and demux hardware and confirms the output characteristics of the external demux port on the SPDH Receiver.

The *PDH Test Set* is set up to transmit an Unbalanced 75 Ω unframed 2Mb/s pattern. This is applied to the HP 37717B INSERT Port. The 2Mb/s signal is multiplexed into a 140Mb/s data stream. The HP 37717B transmitter and receiver are looped. The unframed 2Mb/s signal is Demultiplexed from the 140Mb/s data stream to the HP 37717B DROP port. The DROP Port signal is then applied to the *PDH Test Set* and a BER test is performed to verify the integrity of the 2 Mb/s signal.

The output from the DROP Port is then applied to an oscilloscope, and the waveform characteristics are checked to ensure they meet specifications.

Equipment

Oscilloscope : HP 54100D
PDH Test Set : HP 37717B Option UKJ, [USB] or equivalent
75 Ω Termination : HP 15522-80010
50/75 Ω Matching Pad : HP 11852B
T Connector : HP 1250-0781

Note



The *Test Set* used in this procedure is an HP 37717B Option UKJ. Any other PDH Test Set, capable of generating and measuring at 2 Mb/s unframed, can be used.

Procedure

1. Recall the HP 37717B DEFAULT SETTINGS as shown on Page 3-2.
2. Recall the *Test Set* DEFAULT SETTINGS as shown on Page 3-2.
3. Connect the equipment as shown in Figure 3-25.

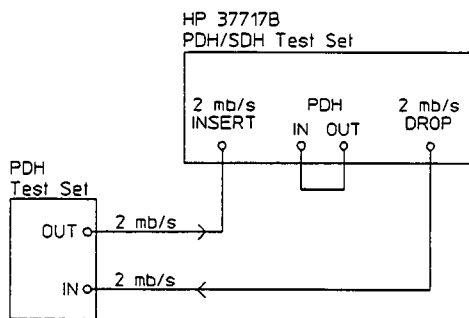

Figure 3-25. External 2 Mb/s Mux/Demux

4. Press **TRANSMIT** on the *Test Set* and set up the display as shown below.

TRANSMITTER OUTPUT SETTINGS	PDH [MAIN]
SIGNAL	[2 Mb/s]
CLOCK SYNC	[INTERNAL]
TERMINATION	[75Ω UNBAL]
LINE CODE	[HDB3]
FREQUENCY OFFSET	[OFF]
PAYLOAD TYPE	[UNFRAMED]
PATTERN	[USER WORD] [1000000010000000]
STATUS:	
UNFRAMED	PC030 PC031 PC030PC0

5. Press **RECEIVE** on the *Test Set* and set up the display as shown below.

RECEIVER INPUT SETTINGS	PDH [MAIN]
SIGNAL	[2 Mb/s]
TERMINATION	[75Ω UNBAL]
LINE CODE	[HDB3]
PAYLOAD TYPE	[UNFRAMED]
PATTERN	[USER WORD] [1000000010000000]
STATUS:	
140 Mb/s	34 Mb/s 8 Mb/s 2 Mb/s

6. Press **TRANSMIT** on the HP 37717B and set up the MAIN SETTINGS display as shown below.

TRANSMITTER OUTPUT SETTINGS	PDH [MAIN]
SIGNAL	[140 Mb/s]
CLOCK SYNC	[INTERNAL]
TERMINATION	[75Ω UNBAL]
LINE CODE	[CMI]
FREQUENCY OFFSET	[OFF]
PAYLOAD TYPE	[STRUCTURED]
TO SET TEST SIGNAL, FIRST SET 'SETTINGS' TO 'STRUCTURED SETTINGS'	
STATUS:	
MAIN SETTINGS	STRUCT'D TEST FUNCTION

7. Press **TRANSMIT** on the HP 37717B and set up the STRUCTURED SETTINGS display as shown below.

TRANSMITTER OUTPUT SETTINGS	PDH [STRUCTURED]
TEST SIGNAL	[2 Mb/s]
2M PAYLOAD	[INSERT 200.3]
34Mb	8Mb 2Mb
[1]	[1] [1]
B/G PATTERN	[AIS]
STATUS:	
PC030PC0	INSERT 2 Mb/s

8. Press **RECEIVE** on the HP 37717B and set up the MAIN SETTINGS display as shown below.

RECEIVER INPUT SETTINGS	PDH [140]
SIGNAL	[140 Mb/s]
TERMINATION LINE CODE	75Ω UNBAL CMI
PAYLOAD TYPE	[STRUCTURED]
TO SET TEST SIGNAL, FIRST SET 'SETTINGS' TO 'STRUCTURED SETTINGS'	
STATUS:	
DATA SETTINGS	STRUCT'D SETTINGS

9. Press **RECEIVE** on the HP 37717B and set up the STRUCTURED SETTINGS display as shown below.

RECEIVER INPUT SETTINGS	PDH [STRUCTURED]
TEST SIGNAL	[2 Mb/s]
2M PAYLOAD	[100% 300%]
	94Mb 8Mb 2Mb
	[1] [1] [1]
STATUS:	
UNFORMED	PC150
PC181	PC180CF0
MORE	

- Press **RESULTS** **PDH** on the Test Set and ensure that the Bit Error Count and Code Error Count are both zero.
- Press **SINGLE** error add key on the Test Set and ensure the Bit Error count increments by one each time the key is pressed.
- Disconnect the UUT Drop Port from the Test Set and connect this to the oscilloscope Input 1 via 75/50Ω Matching Pad. Set the oscilloscope termination to 50Ω and press **AUTOSCALE**.
- Adjust the Oscilloscope Timebase and Delay to position the positive peak pulse amplitude at mid-pulse-width point in the centre of the screen.
- Measure the peak pulse amplitude at mid-pulse-width using the Oscilloscope and verify that this is between 2.133V and 2.607V.
- Select the 2Mb G.703 mask on the oscilloscope and store it on the display.
- Press **SHIFT** **AUTOSCALE** on the oscilloscope to automatically align the pulse to the mask. Verify that the pulse falls within the mask as shown in Figure 3-27.

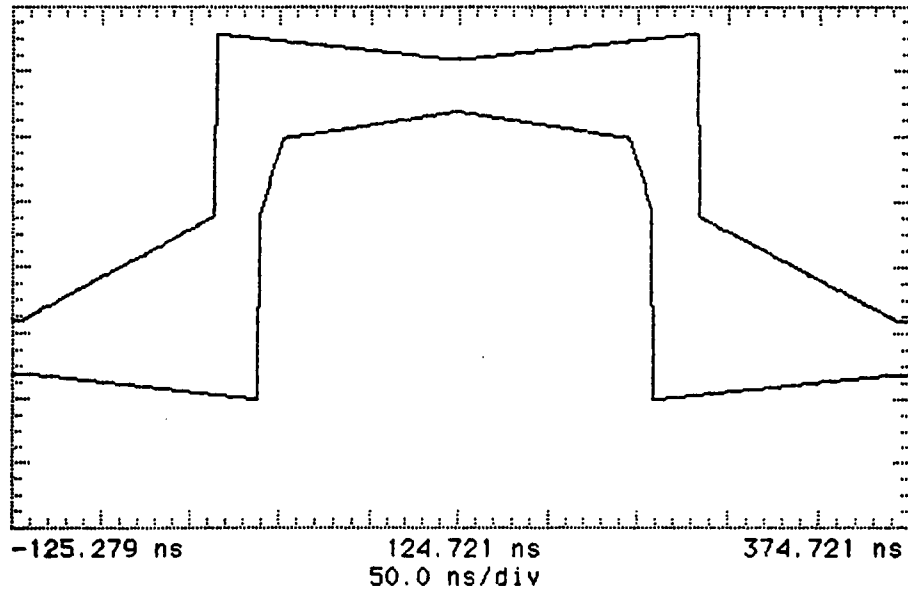

Figure 3-26. 2 Mb/s Pulse Mask

Note



If your oscilloscope does not have the Mask feature, obtain a printout of the displayed pulse. Place the mask, shown in Figure 3-26, over the pulse and ensure that the pulse falls within the mask. (A transparent copy of the mask should be used).

17. Press **AUTOSCALE** on the oscilloscope to display the full waveform.
18. Use the following sequence to display the isolated negative pulse.
 - Select **TRIG** menu.
 - Set trigger level to middle of negative pulse.
 - Set trigger to pattern.
 - Set sequence to H X X.



hp running

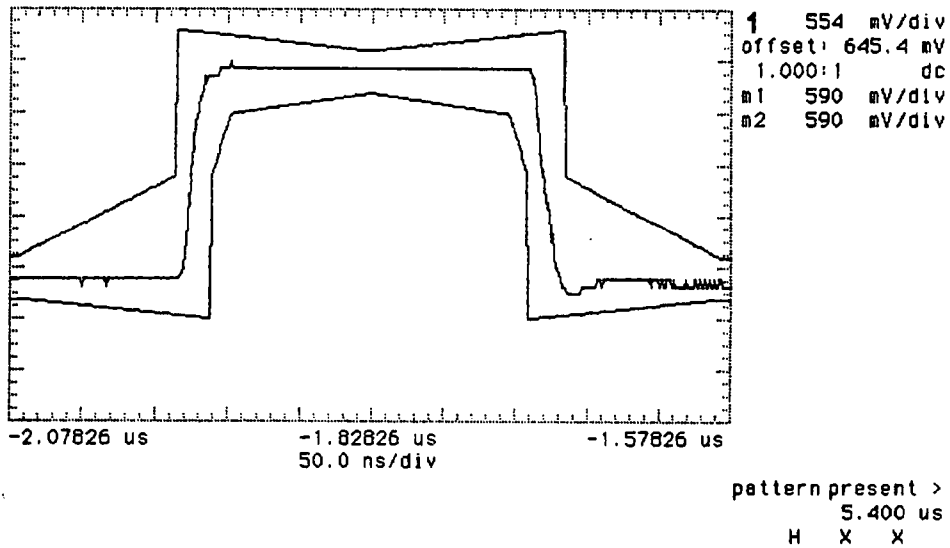

Figure 3-27. 2 Mb/s Isolated Positive Pulse

19. Use the oscilloscope **STORE INVERT** to display an inverted mask on the oscilloscope.
20. Adjust the oscilloscope timebase and vertical sensitivity controls to verify that the pulse meets the mask as shown in Figure 3-28. Use the displayed settings as a guide.
21. Measure the peak pulse amplitude at mid-pulse-width using the Oscilloscope and verify that this is between 2.133V and 2.607V.

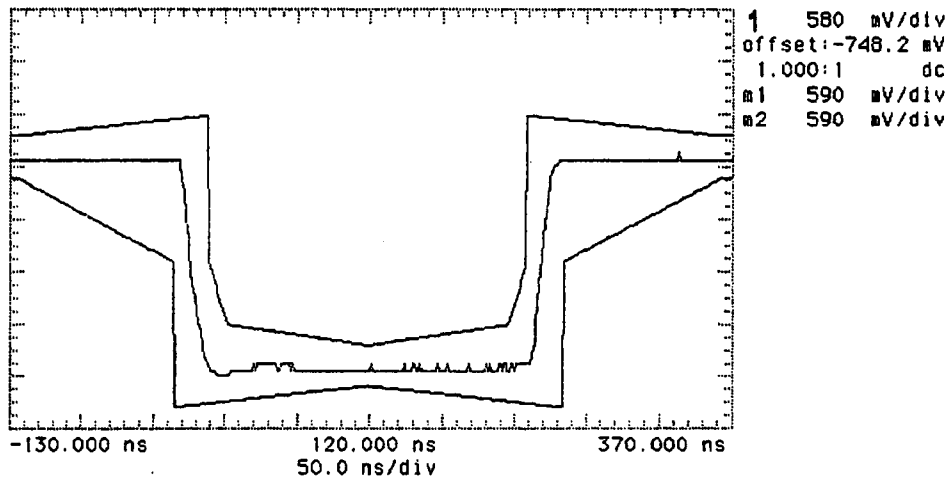

Figure 3-28. 2 Mb/s Isolated Negative Pulse

22. Ensure that the ratio of +ve and -ve pulse amplitudes is between 0.95 and 1.05.
23. Ensure that the ratio of +ve and -ve pulse widths is between 0.95 and 1.05.
24. Disconnect all test equipment.



External 2Mb/s Demux (Options UKL, [USC])

Specifications

Frequency	2.048 Mb/s
Interface	Meets section 6 of CCITT Rec. G.703, for unbalanced coaxial pair. HDB3 line coding only.

Description

This test verifies operation of the demux hardware and confirms the output characteristics of the external demux port on the SPDH Receive Only option.

The *Structured PDH Test Set* is set up to transmit a structured 140Mb/s signal containing an unframed 2Mb/s pattern. This is applied to the HP 37717B PDH IN Port. The unframed 2Mb/s signal is Demultiplexed from the 140Mb/s data stream to the HP 37717B DROP port. The DROP Port signal is then applied to the *Structured PDH Test Set* and a BER test is performed to verify the integrity of the 2 Mb/s signal.

The output from the DROP Port is then applied to an oscilloscope, and the waveform characteristics are checked to ensure they meet specifications.

Equipment

Oscilloscope	: HP 54100D
PDH Test Set	: HP 37717B Option UKJ or equivalent (See Note)
75 Ω Termination	: HP 15522-80010
50/75 Ω Matching Pad	: HP 11852B
T Connector	: HP 1250-0781

Note



The *Test Set* used in this procedure is an HP 37717B Option UKJ. Any other Structured PDH Test Set, capable of generating an unframed 2 Mb/s signal within a structured 140 Mb/s, can be used.

Procedure

1. Recall the HP 37717B DEFAULT SETTINGS as shown on Page 3-2.
2. Recall the HP 37717B *Test Set* DEFAULT SETTINGS as shown on Page 3-2.
3. Connect the equipment as shown in Figure 3-29.

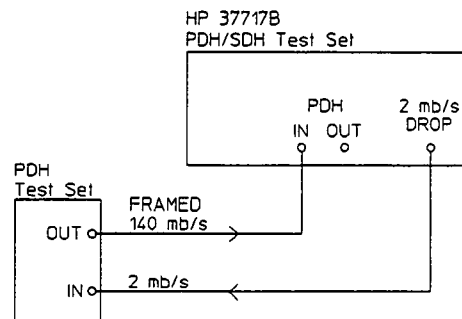

Figure 3-29. External 2mb/s Demux

4. Press **TRANSMIT** on the *Test Set* and set up the MAIN SETTINGS display as shown below.
5. Press **TRANSMIT** on the *Test Set* and set up the STRUCTURED SETTINGS display as shown below.

TRANSMITTER OUTPUT SETTINGS	PDH [MAIN]		
SIGNAL	[140 Mb/s]		
CLOCK SYNC	INTERNAL		
TERMINATION	75Ω UNBAL		
LINE CODE	CM1		
FREQUENCY OFFSET	[OFF]		
PAYLOAD TYPE	[STRUCTURED]		
TO SET TEST SIGNAL, FIRST SET 'SETTINGS' TO 'STRUCTURED SETTINGS'			
STATUS:			
[140 Mb/s]	[8 Mb/s]	[2 Mb/s]	[2 Mb/s]

TRANSMITTER OUTPUT SETTINGS	PDH [STRUCTURED]				
TEST SIGNAL	[2 Mb/s]				
2M PAYLOAD	[UNFRAMED]				
	34Mb 8Mb 2Mb				
	[1] [1] [1]				
PATTERN	[USER WORD]				
B/B PATTERN	[1000000010000000]				
	[AIS]				
STATUS:					
[34 Mb/s]	[8 Mb/s]	[2 Mb/s]	[34 Mb/s]	[8 Mb/s]	[2 Mb/s]

6. Press **RECEIVE** on the *Test Set* and set up the MAIN SETTINGS display as shown below.

RECEIVER INPUT SETTINGS	PDH [MAIN]
SIGNAL	[2 Mb/s]
TERMINATION LINE CODE	[75Ω UNBAL] [HDB3]
PAYLOAD TYPE	[UNFRAMED]
PATTERN	[USER WORD] [1000000010000000]
STATUS:	
UNFRAMED	PC030 PC031 PC030CF0 MORE

7. Press **RECEIVE** on the HP 37717B and set the MAIN SETTINGS display as shown below.

RECEIVER INPUT SETTINGS	PDH [MAIN]
SIGNAL	[140 Mb/s]
TERMINATION LINE CODE	75Ω UNBAL CMI
PAYLOAD TYPE	[STRUCTURED]
TO SET TEST SIGNAL, FIRST SET 'SETTINGS' TO 'STRUCTURED SETTINGS'	
STATUS:	
DATA SETTINGS	STRUCT'D SETTINGS

8. Press **RECEIVE** on the HP 37717B and set the STRUCTURED SETTINGS display as shown opposite.

RECEIVER INPUT SETTINGS	PDH [STRUCTURED]
TEST SIGNAL	[2 Mb/s]
2M PAYLOAD	[DROP 2M]
	34Mb 8Mb 2Mb
	[1] [1] [1]
STATUS:	
UNFRAMED	PC030 PC031 PC030CF0 MORE

9. Press **RESULTS** **PDH** on the *Test Set* and ensure that the Bit Error Count and Code Error Count are both zero.

10. Press **SINGLE** error add key on the *Test Set* and ensure the Bit Error count increments by one each time the key is pressed.

11. Disconnect the Drop Port from the *Test Set* and connect it to the oscilloscope Input 1 via 75/50 ohm Matching Pad. Set the oscilloscope termination to 50Ω and press **AUTOSCALE**.
12. Adjust the Oscilloscope Timebase and Delay to position the positive peak pulse amplitude at mid-pulse-width point in the centre of the screen.
13. Measure the peak pulse amplitude at mid-pulse-width using the Oscilloscope and verify that this is between 2.133V and 2.607V.
14. Select the 2Mb G.703 mask on the oscilloscope and store it on the display.

15. Press SHIFT **AUTOSCALE** on the oscilloscope to automatically align the pulse to the mask. Verify that the pulse falls within the mask as shown in Figure 3-31.

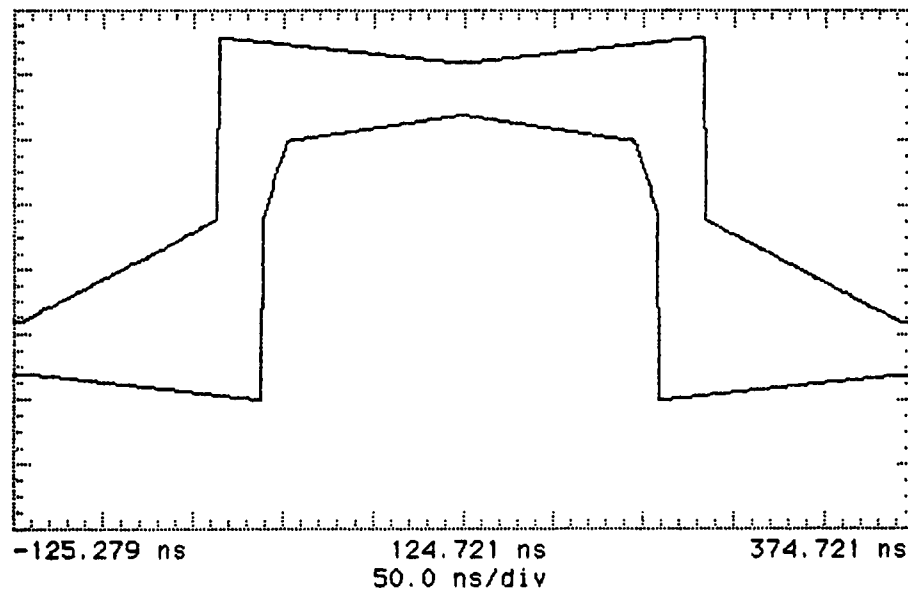

Figure 3-30. 2 Mb/s Pulse Mask

Note



If your oscilloscope does not have the Mask feature, obtain a printout of the displayed pulse. Place the mask, shown in Figure 3-30, over the pulse and ensure that the pulse falls within the mask. (A transparent copy of the mask should be used).

16. Press **AUTOSCALE** on the oscilloscope to display the full waveform.
17. Use the following sequence to display the isolated negative pulse.
- Select **TRIG** menu.
 - Set trigger level to middle of negative pulse.
 - Set trigger to pattern.
 - Set sequence to H X X.

3-70 Performance Tests



hp running

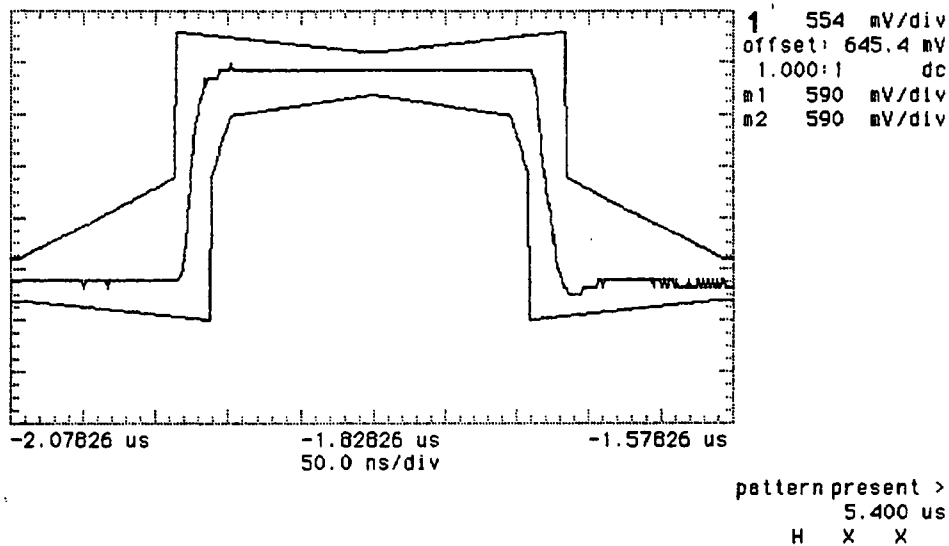

Figure 3-31. 2 Mb/s Isolated Positive Pulse

18. Use the oscilloscope **STORE INVERT** to display an inverted mask on the oscilloscope.
19. Adjust the oscilloscope timebase and vertical sensitivity controls to verify that the pulse meets the mask as shown in Figure 3-32. Use the displayed settings as a guide.
20. Measure the peak pulse amplitude at mid-pulse-width using the Oscilloscope and verify that this is between 2.133V and 2.607V.

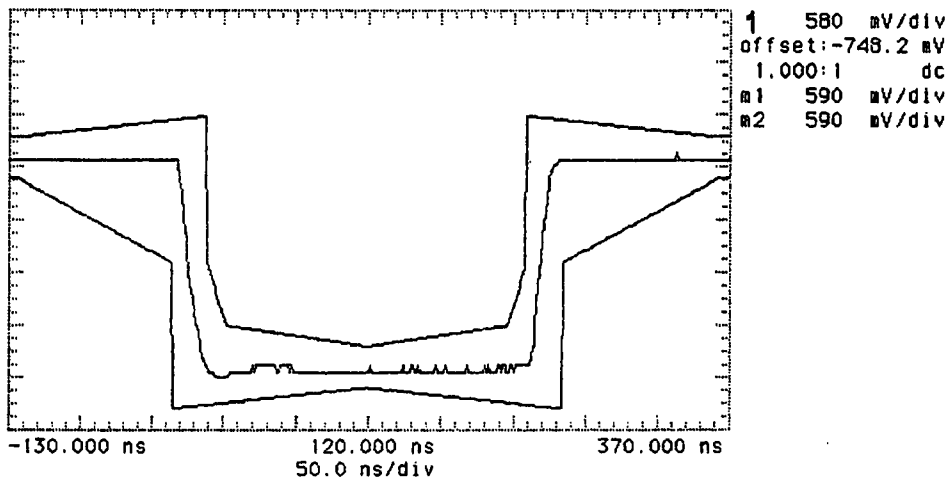

Figure 3-32. 2 Mb/s Isolated Negative Pulse

21. Ensure that the ratio of +ve and -ve pulse amplitudes is between 0.95 and 1.05.
22. Ensure that the ratio of +ve and -ve pulse widths is between 0.95 and 1.05.
23. Disconnect all test equipment.

3-72 Performance Tests



PDH Receiver Monitor Levels (Special Option 808)

Specification

Bit Rate	Nominal Loss	Equalization at 1/2 Bit Rate
704 kb/s	20dB Flat	3dB
2.048 Mb/s	20dB Flat	3dB
8.448 Mb/s	20dB Flat	3dB
34.368 Mb/s	20dB Flat	6dB
139.264 Mb/s	20dB Flat	6dB

Description

Option 808 provides an equalized Monitor input. This is checked by attenuating the synthesizer output level by an amount equivalent to the extra gain provided by the Monitor Amplifier. The synthesizer is set to generate a sinewave at half the bit rate which corresponds to a ternary all ones signal. The receiver should sync up with no errors if PATTERN [ALL ONES] is selected.

Equipment

Synthesizer : HP 3335A option 001 (75 Ω)
oscilloscope : HP 54100D

Procedure

1. Recall the HP 37717B Default settings as shown on Page 3-2.
2. Connect up the equipment as shown in Figure 3-33.
3. Set the oscilloscope to :
TERMINATION - 1 M Ω
PROBE - 1:1

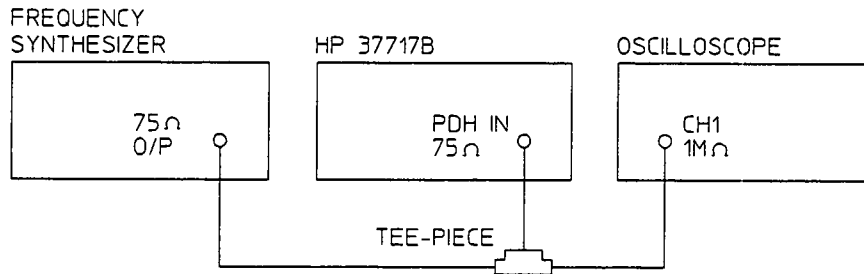

Figure 3-33. PDH Receiver Monitor Levels Test Setup

704 kB/s

4. Press **RECEIVE** and set up the display as shown below.

Press **SIGNAL IN** until the Monitor led is lit.

5. Press **RESULTS** and set up the display as shown below.

RECEIVER INPUT	PDH
SIGNAL	[704 kb/s]
CODE	[HDDB]
PATTERN	[ALL ONES]
TERMINATION	[75R UNBAL]
STATUS:	
2 15-1	3 33-1
ALL ZEROS	ALL ONES
	NOPE

RESULTS [PDH]	[CUMULATIVE]
TEST TIMING	[SINGLE] [5 SECS]
STORAGE	[OFF]
BIT EC	
BIT ER	
CODE EC	
CODE ER	
ELAPSED TIME	
STATUS:	
INITIAL	SINGLE
	TIMED

- Set the Synthesizer to :
 FREQUENCY - 352 KHz sinewave
 AMPLITUDE - 237.5 mV pk-pk (26dB down) as measured on the oscilloscope.
- Press **RUN/STOP** and verify that no errors are displayed at the end of the test period (5 seconds).

3-74 Performance Tests

2.048 MB/s

8. Select SIGNAL [2 Mb/s] on the **RECEIVE** display.
9. Set the Synthesizer to :
FREQUENCY - 1024 KHz sinewave
AMPLITUDE - 237.5 mV pk-pk (26dB down) as measured on the oscilloscope.
10. Press **RUN/STOP** and verify that no errors are displayed at the end of the test period (5 seconds).

8.448 MB/s

11. Select SIGNAL [8 Mb/s] on the **RECEIVE** display.
12. Set the Synthesizer to :
FREQUENCY - 4224 KHz sinewave
AMPLITUDE - 237.5 mV pk-pk (26dB down) as measured on the oscilloscope.
13. Press **RUN/STOP** and verify that no errors are displayed at the end of the test period (5 seconds).

34.368 MB/s

14. Select SIGNAL [34 Mb/s] on the **RECEIVE** display.
15. Set the Synthesizer to :
FREQUENCY - 17184 KHz sinewave
AMPLITUDE - 71 mV pk-pk (29dB down) as measured on the oscilloscope.
16. Press **RUN/STOP** and verify that no errors are displayed at the end of the test period (5 seconds).

139.264 MB/s

17. Select SIGNAL [140 Mb/s] on the **RECEIVE** display.
18. Set the Synthesizer to :
FREQUENCY - 69632 KHz sinewave
AMPLITUDE - 50 mV pk-pk (26dB down) as measured on the
oscilloscope.
19. Press **RUN/STOP** and verify that no errors are displayed at the end of the test
period (5 seconds).



PDH Error Output

Specifications

Output	1 pulse per error
Output During Sync Loss	Continuous pulses at 16 Clock period intervals
Pulse Width	Nominal 8 clock periods
Level	Nominal ECL

Description

The HP 37717B Transmitter generates a 2Mb/s Bit stream with injected errors. These errors are counted by the receiver and the signal appearing at the Error Output Port is checked to verify that error pulses are present at the correct rate. The Error Output signal is also checked with Pattern Sync Loss to verify that pulses are still present at 16 Clock Period intervals.

Equipment

Oscilloscope : HP 54100D
Blocking Capacitor : HP 10240B

Procedure

1. Recall the HP 37717B Default settings as shown on Page 3-2.
2. Connect the HP 37717B SIGNAL OUT 75 Ω port to the SIGNAL IN 75 Ω port.
3. Connect the HP 37717B ERROR OUT port to the Oscilloscope Channel 1 via the Blocking Capacitor (terminate scope in 1 M Ω).
4. Select SIGNAL [2 Mb/s] on the **TRANSMIT** and **RECEIVE** displays.

5. Press **RESULTS** and set up the display as shown opposite.
6. Press **RUN/STOP** to start a measurement.
7. Check that the displayed BIT EC result is 0.

RESULTS [PDH]	[SHORT TERM]
SHORT TERM PERIOD [1 SECOND]	
TEST TIMING [MANUAL]	
STORAGE [OFF]	
BIT EC	
BIT ER	
CODE EC	
CODE ER	
ELAPSED TIME	
STATUS:	
COUL- RTIVE	SHORT TERM
ERROR ANALYSIS	ALARM SECONDS
FREQ- QUENCY	

8. Press **1E-3** to add errors to the signal and check that the BIT ER result is 1 in 10^{-3} .

Error Output Signal

9. Adjust the Timebase and Range of the Oscilloscope to display two pulses.
10. Check that the pulse period is approximately 488uS (1 pulse per error - 1000 clock periods).
11. Press **1E-3** to stop the error add and check that pulses are no longer present on the Oscilloscope.
12. Select PATTERN [2^23-1] on the **RECEIVE** display and check that the Pattern Loss LED is lit.
13. Adjust the Timebase and Range of the Oscilloscope to display a single pulse.
14. Check that the pulse period is 7.8uS (continuous pulses).
15. Disconnect all the equipment.

3-78 Performance Tests

PDH Frequency Measurement and Looped Clock

Specifications

Accuracy	± 7 ppm
Measured Offset	± 100 ppm

Description

This test verifies that the HP 37717B Receiver Frequency Measurement is within specified limits. These limits assume the instrument is within the annual calibration cycle.

A Synthesizer is used to generate a sinewave at half the data rate. This is applied to the HP 37717B Receiver Signal In port. As this signal corresponds to an *All Ones Ternary Signal*, the HP 37717B receiver should sync up with no errors if set to PATTERN [ALL ONES]. The Frequency Measurement accuracy of the HP 37717B can be determined by comparison with the frequency displayed on the Synthesizer. Frequency Offset Measurement is also verified during this test as the HP 37717B will display deviation from the expected Signal In frequency in ppm. The PDH transmitter recovered clock function is also verified at 2 Mb/s using the frequency counter in RATIO mode.

Equipment

Synthesizer : HP 3335A Option 010 (75 Ω)
Frequency Counter : HP 5335A Option 010

Procedure

1. Recall the HP 37717B Default settings as shown on Page 3-2.
2. Connect up the equipment as shown in Figure 3-34.

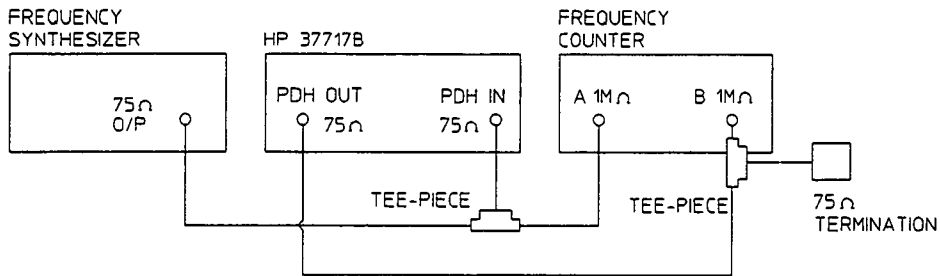

Figure 3-34. Receiver Frequency Measurement Test Setup

3. Set the Synthesizer to :
 FREQUENCY - 1024.000 KHz sinewave
 AMPLITUDE - +10dBm.
4. Set the frequency counter to RATIO A/B.
5. Press **TRANSMIT** and set up the display as shown below.
6. Press **RECEIVE** and set up the display as shown below.

TRANSMITTER OUTPUT	PDH
SIGNAL	[2 Mb/s]
CLOCK SYNC	[RECOVERED]
FREQUENCY OFFSET	[OFF]
CODE	[HD39]
PATTERN	[ALL ONES]
TERMINATION	[75Ω UNBAL]
STATUS:	
INTERNAL	RECOVERED

RECEIVER INPUT	PDH
SIGNAL	[2 Mb/s]
TEST MODE	[OUT OF SRVC]
CODE	[HD39]
PATTERN	[ALL ONES]
TERMINATION	[75Ω UNBAL]
STATUS:	
140 Mb/s	8 Mb/s
8 Mb/s	8 Mb/s
8 Mb/s	904 kb/s

7. Press **RESULTS** and set up the display as shown opposite.

8. Verify that the **FREQUENCY** displayed is between 2047986 Hz and 2048014 Hz.

9. Verify that the Offset displayed between +7 ppm and -7 ppm.

RESULTS [PDH]	[FREQUENCY]			
TEST TIMING	[MANUAL]			
STORAGE	[OFF]			
FREQUENCY	Hz			
OFFSET	Hz			
	ppm			
STATUS:				
SHORT	CORRE-	ERROR	ALARM	FREQ-
TERM	CTIVE	ANALYSIS	SECONDS	QUENCY

10. Set the synthesiser frequency to 1024.102 kHz and verify that the frequency displayed on the **RESULTS** display is between 2048.190 kHz and 2048.219 kHz.

11. Verify that the Offset displayed is between 93 ppm and 107 ppm. The frequency counter should read 1.00.

12. Set the synthesiser frequency to 1023.898 kHz and verify that the frequency displayed on the **RESULTS** display is between 2047.781 kHz and 2047.810 kHz.

13. Verify that the Offset displayed is between -93 ppm and -107 ppm. The frequency counter should read 1.00.

14. Set the synthesiser and the HP 37717B to the settings given in Table 3-3 and verify the displayed Offset at each point.

Table 3-3. Measured Offset

Option	HP 37717B Receive Frequency	Synthesiser Frequency	Synthesiser Level	Displayed Offset
UKK(USB) only	704 kb/s	352.000 kHz	+10 dBm	-7 to +7 ppm
UKK(USB) only	704 kb/s	351.965 kHz	+10 dBm	-93 to -107 ppm
UKK(USB) only	704 kb/s	352.035 kHz	+10 dBm	+93 to +107 ppm
UKK(USB), UKJ(USA)	8 Mb/s	4224.000 kHz	+10 dBm	-7 to +7 ppm
UKK(USB), UKJ(USA)	8 Mb/s	4223.578 kHz	+10 dBm	-93 to -107 ppm
UKK(USB), UKJ(USA)	8 Mb/s	4224.422 kHz	+10 dBm	+93 to +107 ppm
UKK(USB), UKJ(USA)	34 Mb/s	17,184.000 kHz	+10 dBm	-7 to +7 ppm
UKK(USB), UKJ(USA)	34 Mb/s	17,182.282 kHz	+10 dBm	-93 to -107 ppm
UKK(USB), UKJ(USA)	34 Mb/s	17,185.718 kHz	+10 dBm	+93 to +107 ppm
UKK(USB), UKJ(USA)	140 Mb/s	69,632.000 kHz	+4 dBm	-7 to +7 ppm
UKK(USB), UKJ(USA)	140 Mb/s	69,625.036 kHz	+4 dBm	-93 to -107 ppm
UKK(USB), UKJ(USA)	140 Mb/s	69,638.963 kHz	+4 dBm	+93 to +107 ppm

Internal SDH Transmitter Clock (Options US1[US5], A1T[A1U])

Specifications

Bit Rate	Accuracy
155.52 Mb/s	±4.5 ppm

Description

The test uses a Frequency Counter connected to the SDH Signal Out port to measure the STM-1 All Ones data rate. This gives an indirect measure of the transmitter clock frequency as the data is clocked by the internal 10MHz clock oscillator. The test limits assume the instrument is within the annual calibration cycle. The STM-1 Framing is disabled for this test using the

OTHER **DEBUG FUNCTION** of the HP 37717B.

Equipment

Frequency Counter : HP 5335A Option 010
75Ω Termination : HP 15522-80010
T Connector : HP 1250-0781

Procedure

1. Recall the HP 37717B DEFAULT SETTINGS as shown on Page 3-2.
2. Connect the HP 37717B STM-1 OUT port to the Frequency Counter Input A, terminated in 75Ω (use the T Connector).

3. Press **TRANSMIT** and set up the display as shown opposite.

TRANSMITTER OUTPUT		[SOH]
SIGNAL		STM-1
CLOCK SYNC	[INTERNAL]	
FREQUENCY OFFSET	[OFF]	
PAYLOAD	[140 Mb/s]	
PATTERN	[ALL ONES]	
STATUS:		
FDH		SOH

4. Make the following key sequence on the HP 37717B to obtain the special MODULE DEBUG display.

Press **OTHER** ;  ; **MORE** ;  ; **MORE** ;  ; **MORE** ; **OTHER**.

Press **MORE** until MODULE DEBUG appears in the softkey menu.

Press **MODULE DEBUG** and set up the display as shown opposite.

FUNCTION		[MODULE DEBUG]
MODULE		[SOH MODULE]
DOWNLOAD LCA DESIGN	[..]	
INTO H/W SITE NUMBER	[..]	
TOGGLE TO DOWNLOAD TO ACTION	[OFF]	
STM-1 TEST PATTERN	[ALL ONES]	
TU ASIC REGISTER [0000]		
IMAGE	0101010101010101	
ODL (ODL_GEN)	TXFRM (TPAT)	
RXPAT (BLANK_42)	TXMAP (MAP_139)	
RXFRM (RPRBS)	BKGD (BLANK_42)	
RXMAP (DMP_139)	DISCRIM (STF_139)	
TXPAT (BLANK_42)		
STATUS:		
OFF	ALL ONES	ALL ZEROS

Caution



When using the MODULE DEBUG display, ONLY modify the STM-1 TEST PATTERN. Altering other parameters can damage instrument firmware - exit this display after setup to eliminate any possibility of accidental modification.

- Adjust the Frequency Counter Trigger Level to obtain a stable reading and ensure that the Frequency Counter reads between 77.759650 MHz and 77.760350 MHz.
- Disconnect all the test equipment.

3-84 Performance Tests

SDH Frequency Offsets (Options US1[US5], A1T[A1U])

Specifications

Range	: ±999 ppm
Resolution	: 0.1 ppm
Accuracy	: 0.02 ppm

Description

The SDH Transmitter Offset Clock is checked for range and accuracy using a Frequency Counter to measure the STM-1 Data rate. This gives an indirect measure of the transmitter clock frequency as the data is clocked by the internal 10MHz clock oscillator. A measurement with no offset is performed to establish a reference Clock frequency. The frequency accuracy is then measured over the specified offset range. The STM-1 Framing is disabled during this test using the **OTHER** **DEBUG FUNCTION** of the HP 37717B

Equipment Required

Frequency Counter	: HP 5335A Opt 010
T Connector	: HP 1250-0781

Procedure

1. Recall the HP 37717B DEFAULT SETTINGS as shown on Page 3-2.
2. Connect the STM-1 OUT port to the Frequency Counter terminated in 75Ω (use the T connector).

3. Press **TRANSMIT** and set up the display as shown opposite.

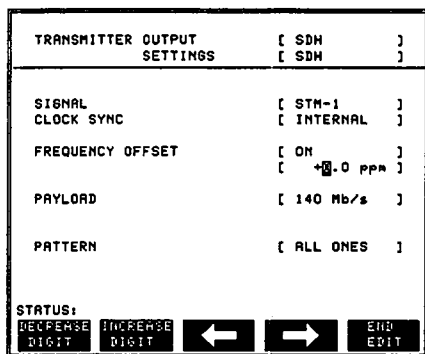

4. Make the following key sequence on the HP 37717B to obtain the special MODULE DEBUG display.

Press **OTHER** ; **↑** ; **MORE** ; **↑** ;
MORE ; **↑** ; **MORE** ; **OTHER**.

Press **MORE** until MODULE DEBUG appears in the softkey menu.

Press **MODULE DEBUG** and set up the display as shown opposite.

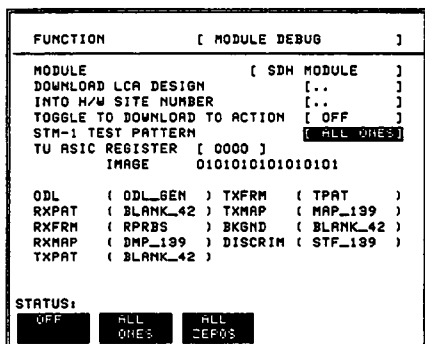

Caution



When using the MODULE DEBUG display, ONLY modify the STM-1 TEST PATTERN. Altering other parameters can damage instrument firmware - exit this display after setup to eliminate any possibility of accidental modification.

5. Adjust the Frequency Counter Trigger Level to obtain a stable reading.
6. Take note of the measured frequency (MF).

7. Select the frequency offset settings given in the table below and verify the frequency at each step against the measured frequency (MF) noted in step 6.

Option	Offset (ppm)	Min Expected Frequency	Max Expected Frequency
US1, A1T	-100ppm	$MF - (0.00010002 \times MF)$	$MF - (0.00009998) \times MF$
US1, A1T	-66.6ppm	$MF - (0.00006662 \times MF)$	$MF - (0.00006658) \times MF$
US1, A1T	+33.3ppm	$MF + (0.00003328 \times MF)$	$MF + (0.00003332) \times MF$
US1, A1T	+100ppm	$MF + (0.00009998 \times MF)$	$MF + (0.00010002) \times MF$
US1, A1T	+999ppm	$MF + (0.00998998 \times MF)$	$MF + (0.00999002) \times MF$
US1, A1T	-999ppm	$MF - (0.00999002 \times MF)$	$MF - (0.00998998) \times MF$

8. Disconnect all the test equipment.

External MTS Clock (Options US1[US5], A1T[A1U])

Specifications *USE ALTERNATE PROCEDURE PER 37717C MANUAL, Page 3-86, USES ANOTHER 37717*

Accepts Timing Reference as per CCITT G.811

Description

This test verifies that signal integrity is maintained when the EXT MTS clock is used as a reference.

Equipment Required

Synthesizer : HP 3335A option 001 (75Ω)
Frame Generator : HP 37729A
75/120Ω BAL/UNBAL Converter : HP 15508C

Procedure

1. Connect the STM-1 OUT port to the STM-1 IN port.
2. Press **TRANSMIT** and set up the display as shown opposite.
3. Connect the HP 37729A Frame Generator Clock Output to the HP 37717B Unbalanced 75Ω 2M REF IN port.

TRANSMITTER OUTPUT	[SDH]	
SIGNAL	STM-1	
CLOCK SYNC	[EXT MTS]	
FORMAT	[2MHz CLOCK]	
FREQUENCY OFFSET	[OFF]	
PAYLOAD	[140 Mb/s]	
PATTERN	[2^23-1]	
STATUS:		
INTERNAL	EXTERNAL	STM-1
MTS	RECEIVE	

- Set the HP 37729A Frame Generator parameters as follows:

OUTPUT : FREQ [2] ; CODE [HDB3]

Press **MENU** on the HP 37729A to select the MENU display.

Use **▲** and **▼** to select [ALIGNMENT].

Press **ENTER** to select the ALIGNMENT parameters.

Use **PAGE UP** and [PAGE DOWN] to select ALIGNMENT: [2M].

NFAS [01011111]

FAS [10011011]

Press **SELECT** until all the 2048 Kbit/s Led's are OFF.

- Press **RECEIVE** and set up the display as shown opposite.

- Press **RESULTS** ; **TROUBLE SCAN**.

- Press **RUN/STOP**, check that the display reads NO TROUBLE and all the Alarm leds are off.

- Press **RUN/STOP** to halt the measurement.

RECEIVER INPUT	[500]
SIGNAL	STM-1
PAYLOAD	[140 Mb/s]
PATTERN	[2^23-1]
STATUS:	
FINH	30H

External MTS Clock - 2MHz Data

- Disconnect the HP 37729A Frame Generator Clock Output from the HP 37717B 75Ω 2M REF IN port
- Connect the HP 37729A Frame Generator AMI/HDB3 output to the HP 37717B Unbalanced 75Ω 2M REF IN Port (EXT MTS Clock).
- Select CLOCK SYNC FORMAT [2Mb/s DATA] on the HP 37717B **TRANSMIT** Display.
- Press **RESULTS** **TROUBLE SCAN** then **RUN/STOP** on the HP 37717B
- Check that the HP 37717B Display reads NO TROUBLE and all the Alarm LEDS are off. Press **RUN/STOP** to halt the measurement.

14. Disconnect the HP 37729A Frame Generator AMI/HDB3 output from the HP 37717B 75 Ω 2M REF IN Port.
15. Connect the HP 37729A Frame Generator AMI/HDB3 output to the HP 37717B Balanced 120 Ω 2M REF IN Port via the 75/120 Ω Unbalanced/Balanced Converter.
16. Press **RESULTS** **TROUBLE SCAN** then **RUN/STOP** on the HP 37717B
17. Check that the HP 37717B Display reads NO TROUBLE and all the Alarm LEDs are off. Press **RUN/STOP** to halt the measurement.

External MTS Clock - STM-1 Receive Data

18. Select CLOCK SYNC [STM-1 RECEIVE] ON THE HP 37717B **TRANSMIT** display.
19. The SDH Clock Loss Alarm led should be lit on the HP 37717B.
20. Disconnect the Frame Generator from the HP 37717B 75 Ω EXT MTS Clock port
21. Connect the Synthesizer to the 75 Ω STM-1 IN port.
22. Set the Synthesizer frequency to 77.760MHz and amplitude to +10dBm.
23. Ensure that the SDH Clock Loss Alarm Led is not lit.
24. Disconnect all the equipment.

STM-1 Transmitter Output Waveshape (Options US1[US5], A1T[A1U])

Specifications

Meets CCITT Recommendation G.703

Description

An oscilloscope is connected to the HP 37717B Transmitter STM-1 output and used to view the waveforms with All Ones and All Zeros patterns selected in turn. The displayed waveshape is checked against the relevant CCITT G.703 mask. The STM-1 Framing is disabled during this test using the **OTHER** **DEBUG FUNCTION** of the HP 37717B.

Equipment Required

Oscilloscope	: HP 54100D
ThinkJet Printer	: HP 2225A
75Ω Termination	: HP 15522-80010
T Connector	: HP 1250-0781

Procedure

CMI All Ones Waveshape

1. Connect up the equipment as shown in Figure 3-35.

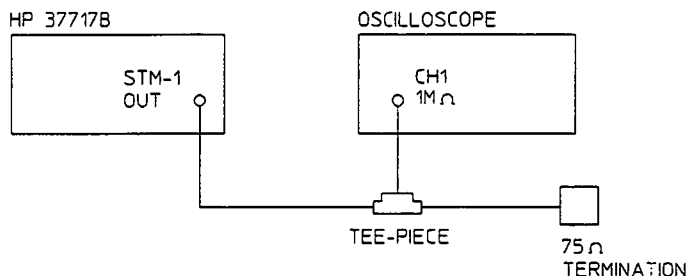
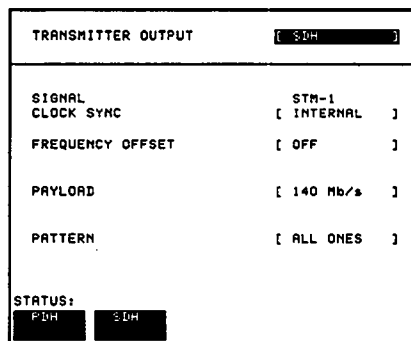

Figure 3-35. STM-1 Transmitter Output Waveshape, Test Setup

2. Press **TRANSMIT** and set up the display as shown opposite.



3. Make the following key sequence on the HP 37717B to obtain the special MODULE DEBUG display.

Press **OTHER**; **↑**; **MORE**; **↑**;
MORE; **↑**; **MORE**; **OTHER**.

Press **MORE** until MODULE DEBUG appears in the softkey menu.

Press **MODULE DEBUG** and set up the display as shown opposite.

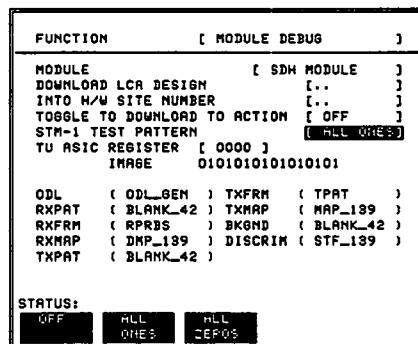

Caution

When using the MODULE DEBUG display, ONLY modify the STM-1 TEST PATTERN. Altering other parameters can damage instrument firmware - exit this display after setup to eliminate any possibility of accidental modification.

4. Adjust the Oscilloscope controls to display the waveform as shown in Figure 3-36, STM-1 All Ones Pattern.
-

Note

To compensate for the matching pad attenuation, set the oscilloscope Channel 1 Probe Attenuation factor to X 2.40 (equivalent to 7.6 dB).

5. Use the Oscilloscope PRINT function to obtain a printout of the STM-1 waveform on the external printer.
 6. Ensure this printout fits the STM-1 Mask of Figure 3-37.
-

Note

If a mylar mask is not available, the figure shown may be traced or photocopied onto a transparency.

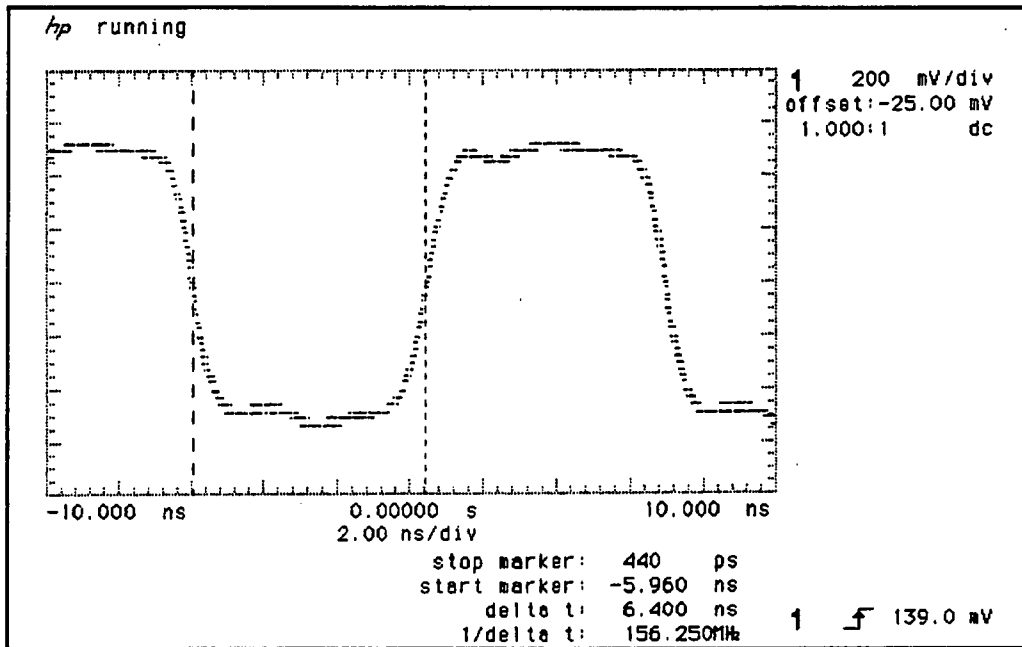
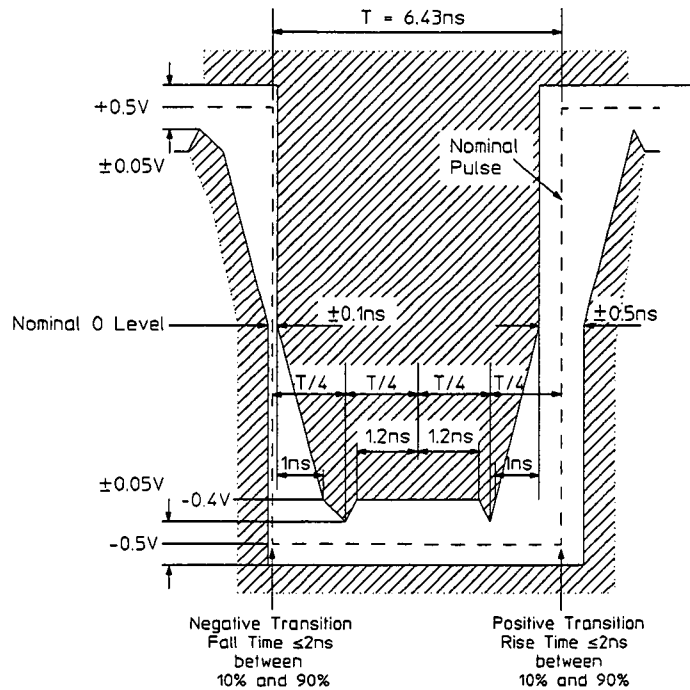

Figure 3-36. STM-1 All Ones Pattern



Note 1. The mask does not include the over/undershoot tolerance of 10%.

Note 2. The nominal zero level can be adjusted by $\pm 0.05\text{V}$ to meet the limits of the mask.

Note 3. The mask is applicable to the inverse pulse.

Figure 3-37. STM-1 All Ones Mask

CMI All Zeros Waveshape

7. Select PATTERN [ALL ZEROS] on the **OTHER** **DEBUG FUNCTION** display.
8. Adjust the Oscilloscope controls to display the waveform as shown in Figure 3-38, STM-1 All Zeros Pattern Example.
9. Use the Oscilloscope PRINT function to obtain a printout of the STM-1 waveform on the external printer.
10. Ensure this printout fits the STM-1 Mask of Figure 3-39.

Note



If a mylar mask is not available, the figure shown may be traced or photocopied onto a transparency.

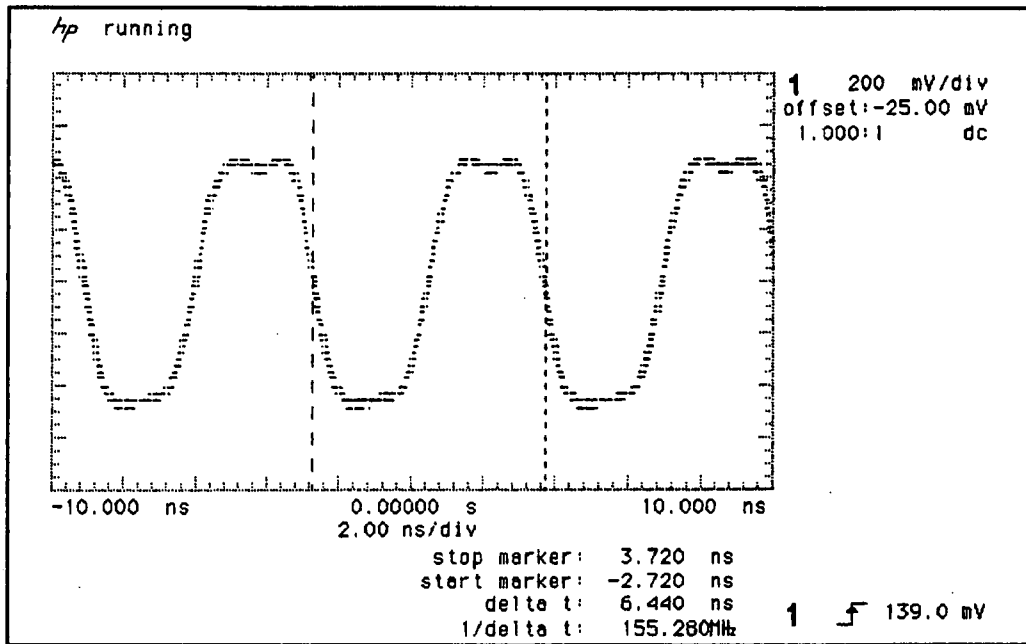
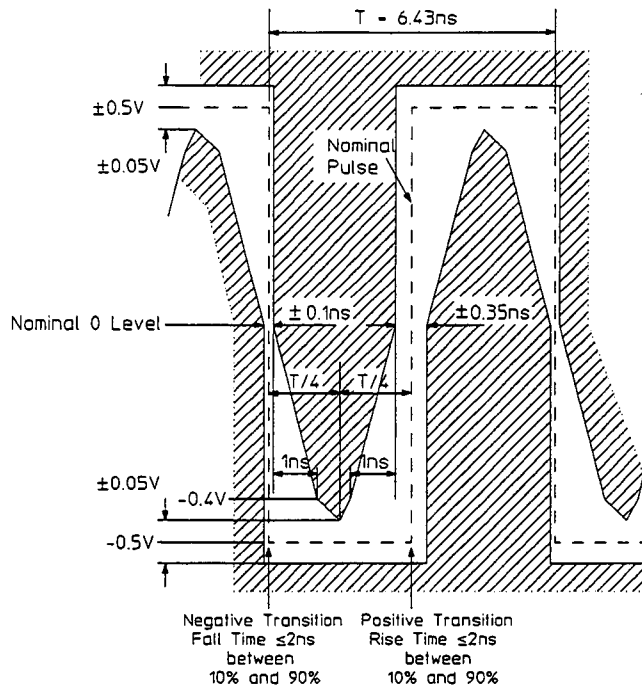

Figure 3-38. STM-1 All Zeros Pattern



Note 1. The mask does not include the over/undershoot tolerance of 10%.

Note 2. The nominal zero level can be adjusted by $\pm 0.05\text{V}$ to meet the limits of the mask.

Figure 3-39. STM-1 All Zeros Mask

11. Select STM-1 TEST PATTERN [OFF] on the **OTHER** **DEBUG FUNCTION** display.
12. Select PATTERN [2²³-1] on the **TRANSMIT** display.
13. Adjust the Oscilloscope controls to display the eye diagram as shown in Figure 3-40, STM-1 Eye Diagram Example. Check that the waveform meets the STM-1 eye diagram mask. It may be necessary to adjust the V/div gain on the Oscilloscope.

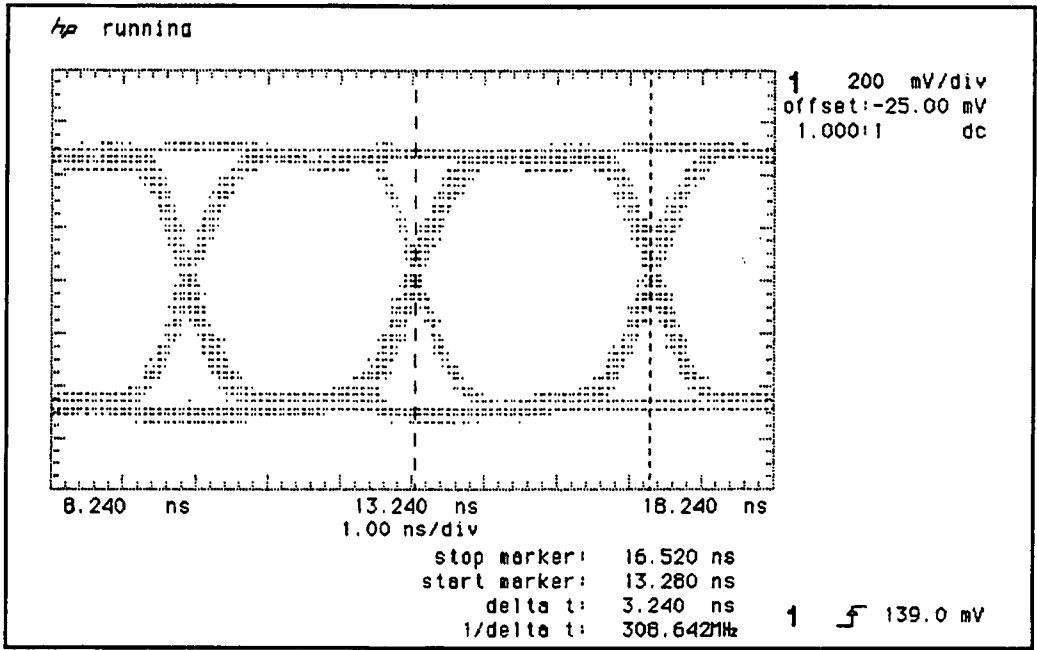

Figure 3-40. STM-1 Eye Diagram Pattern

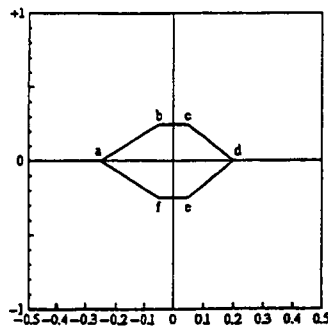

Figure 3-41. STM-1 Eye Diagram Mask

Note



If the mask is not available then Figure 3-41 may be traced/copied and compared with the Oscilloscope print out.

STM-1 Receiver Monitor Input (Options US1[US5], A1T[A1U])

Specification

Receiver Monitor Mode : 20 dB of flat gain, no equalization

Description

An attenuator is inserted between the STM-1 OUT port and the STM-1 IN port. The Receiver monitor mode is verified by attenuating the signal by 20 dB and checking for error-free operation.

Equipment Required

3 dB Attenuator (N-type)	: HP 8491A Option 003
6 dB Attenuator (N-type)	: HP 8491A Option 006
75/50 Ω Matching Pad (N-type)	: HP 11852B (Qty 2)
N-type (f) to BNC (f) Adaptor	: HP 1250-1536 (Qty 2)
N-type (m) to N-type (f) Adaptor	: HP 1250-1475

Procedure

1. Recall the HP 37717B Default settings as shown on Page 3-2.
2. Select TRANSMITTER OUTPUT [SDH] and RECEIVER INPUT [SDH].
3. Connect up the equipment as shown in Figure 3-42.

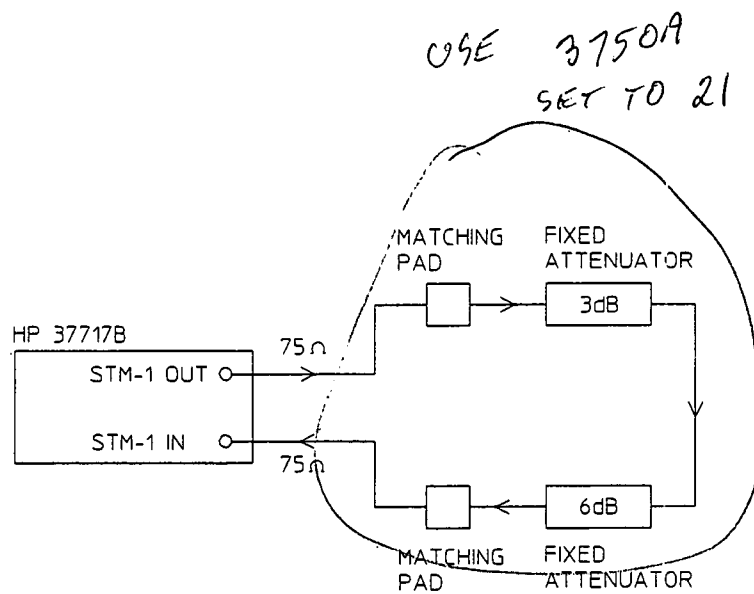

Figure 3-42. STM-1 Receiver Monitor Input

4. Press **SIGNAL IN** until the Monitor led above the key is lit.
5. Verify that all the front panel ALARM leds are off.
6. Press **RESULTS** ; **TROUBLE SCAN** and **RUN/STOP** and check that the display indicates NO TROUBLE.
7. Press **RUN/STOP** to halt the measurement.
8. Disconnect all the test equipment.

STM-1 Receiver Monitor Input (Special Option 808)

Specification

Receiver Monitor Mode : 20 dB of flat gain
6dB Equalization at 1/2 Bit Rate

Description

A fixed attenuator and a special cable attenuator are inserted between the STM-1 OUT port and the STM-1 IN port. The Receiver monitor mode is verified by attenuating the signal by 20dB, along with the cable attenuator, and checking for error-free operation.

Equipment Required

3 dB Attenuator (N-type)	: HP 8491A Option 003
6 dB Attenuator (N-type)	: HP 8491A Option 006
75/50Ω Matching Pad (N-type)	: HP 11852B (Qty 2)
N-type (f) to BNC (f) Adaptor	: HP 1250-1536 (Qty 2)
N-type (m) to N-type (f) Adaptor	: HP 1250-1475
Cable Attenuator (35m)	: HP 8120-0049

Procedure

1. Recall the HP 37717B Default settings as shown on Page 3-2.
2. Select TRANSMITTER OUTPUT [SDH] and RECEIVER INPUT [SDH].
3. Connect up the equipment as shown in Figure 3-43 with the cable attenuator connected between STM-1 OUT and the Matching Pad.

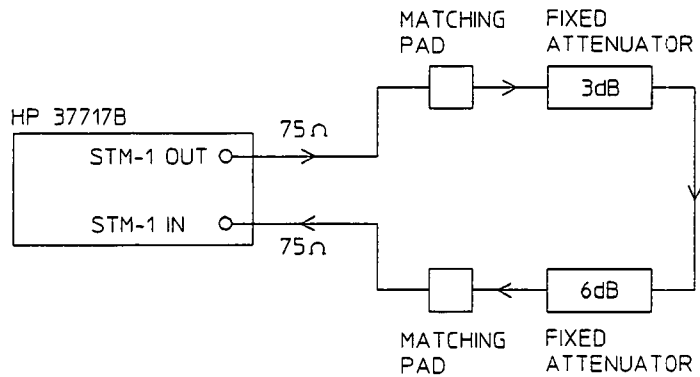

Figure 3-43. STM-1 Receiver Monitor Input

4. Press **SIGNAL IN** until the Monitor led above the key is lit.
5. Verify that all the front panel ALARM leds are off.
6. Press **RESULTS** ; **TROUBLE SCAN** and **RUN/STOP** and check that the display indicates NO TROUBLE.
7. Press **RUN/STOP** to halt the measurement.
8. Disconnect all the test equipment.



STM-1 Receiver Input Equalization (Options US1[US5], A1T[A1U])

Specification

Receiver Equalization : Automatic for cable loss up to 12dB at half the bit rate.

Description

Receiver Equalization is verified by inserting the special Cable between the STM-1 OUT port and the STM-1 IN port and checking for error-free operation.

Equipment Required

Cable Attenuator (70 m) : HP 8120-0049

Procedure

1. Recall the Default settings as shown on Page 3-2.
2. Select TRANSMITTER OUTPUT [SDH] and RECEIVER INPUT [SDH].
3. Connect the STM-1 OUT port to the STM-1 IN port, via the Cable Attenuator.
4. Verify that all the front panel Alarm leds are off.
5. Press **RESULTS** : **TROUBLE SCAN** : **RUN/STOP** and check that the display indicates NO TROUBLE.
6. Press **RUN/STOP** to halt the measurement.
7. Disconnect all the test equipment.

STM-1 Optical Interface (Option UH1)

Specification (Transmitter)

Wavelength	1280 nm to 1330 nm
Fiber Power Output	-9 dBm nominal
Line Coding	NRZ
Safety Class	Class 1, FDA 21 CFR Ch.1 1040.10 and EN 60825
Data Rate	155.52 Mb/s (Nominal)

Specification (Receiver)

Wavelength	1200 nm to 1600 nm
Maximum Input Power	-8 dBm (for BER of $1.0E^{-10}$)
Line Coding	NRZ
Dynamic Range	20 dB minimum
Sensitivity	-28 dBm Minimum (wavelength=1300nm, Modulation=100%, Data= $2^{23}-1$, BER= $1.0E^{-10}$)

Description

The 155 Mb/s output of the optical transmitter is checked for power level.

The receiver sensitivity is verified by attenuating the transmitter output and checking for no errors in a back to back mode.

Equipment Required

Power Meter	HP 8153A
Power Meter Sensor Module	HP 81536A
FC/PC Connector Interface	HP 81000FI
Optical Attenuator	HP 8157A
Optical Cables (Qty. 2)	HP 11871A

3-104 Performance Tests

Warning

Safety precautions must be observed when handling the HP 37717B Optical Modules as these generate laser signals which can cause serious injury. The guidelines below must be followed;

- **Check the connector configuration of the Fiber Optic Interfaces. If these are fitted with a connector interface other than FC/PC then remove the existing connector interface and fit the FC/PC connector interface.**
 - **Check for any damage to the HP 37717B Fiber Optic Interface spring loaded aperture covers and connectors. Do not power up the instrument if in any doubt about the integrity of these connectors.**
 - **Make all connections to the HP 37717B Fiber Optic Interfaces before powering up the instrument.**
-

Procedure

1. Connect the STM-1 Optical Out Port to the HP 8153A (ensure that all connections are tight and that the cable has no twists).
2. Switch on the HP 37717B and check that immediately on power up the LASER ON led on the front panel illuminates for a few seconds.
3. Recall default settings on the HP 8153A :
Press **Mode** to select MENU mode on the HP 8153A.
Press **System** to display RECALL.

Press **Edit**, select 0→A and press **Exec** to recall the default settings (wavelength = 1300 nm, measurement time = 200 ms, autorange).
4. Press **Mode** then **dBm W** to select the Power Level measurement on the HP 8153A.
5. Press **TRANSMIT** on the HP 37717B and select SIGNAL [STM-1 OPT].
6. Verify that the front panel LASER ON led is on indicating the laser is enabled.

7. Check the HP 8153A Power Meter reading is between -15 dBm and -8 dBm (Typically -9 dBm)
8. Press **OTHER**, select STORED SETTINGS NUMBER [0] (Default Settings) and press **RECALL**.
9. Verify that the front panel LASER ON led is off before continuing.
10. Connect the Optical Attenuator between the Power Meter and the HP 37717B Optical Out port (ensure that all connections are tight and that the cable has no twists).
11. Press **TRANSMIT** on the HP 37717B and select SIGNAL [STM-1 OPT].
12. Adjust the Optical Attenuator to obtain a reading of -28 dBm on the Power Meter.
13. Press **OTHER**, select STORED SETTINGS NUMBER [0] (Default Settings) and press **RECALL**.
14. Verify that the front panel LASER ON led is off before continuing.
15. Disconnect the Optical Attenuator Output from the HP 8153A and connect to the HP 37717B Optical In Port.
16. Press **OTHER** then **SETTINGS CONTROL** and select TRANSMITTER AND RECEIVER [COUPLED].
17. Press **TRANSMIT** and select SIGNAL [STM-1 OPT].
18. Press **RESULTS** **TROUBLE SCAN**, and then **RUN/STOP** to start a measurement.
19. After 5 minutes check that NO TROUBLE is displayed on the **RESULTS** display.
20. Press **OTHER**, select STORED SETTINGS NUMBER [0] (Default Settings) and press **RECALL**.
21. Verify that the front panel LASER ON led is off.
22. Disconnect the test equipment.

3-106 Performance Tests

STM-1/4 Optical Interface (Option UH2)

Specification (Transmitter)

Wavelength	1280 nm to 1330 nm
Power Output	-10 dBm (Nominal)
Line Coding	NRZ
Safety Class	Class 1, FDA 21 CFR Ch.1 1040.10 and EN 60825
Data Rate	155.52 Mb/s or 622.08 Mb/s (Nominal)

Specification (Receiver)

Wavelength	1200 nm to 1600 nm
Maximum Input Power	-8 dBm (for BER of $1.0E^{-10}$)
Line Coding	NRZ
Sensitivity	-26 dBm Minimum (wavelength=1300nm, Modulation=100%, Data= $2^{23}-1$, BER= $1.0E^{-10}$)

Description

The 155.52/622.08 MHz output of the optical transmitter is checked for power level.

The receiver is verified with a loop back check.

Equipment Required

Power Meter	HP 8153A
Power Meter Sensor Module	HP 81536A
FC/PC Connector Interface	HP 81000FI
Optical Attenuator	HP 8157A
Optical Cables (Qty. 2)	HP 11871A

Performance Tests 3-107

Warning

Safety precautions must be observed when handling the HP 37717B Optical Modules as these generate laser signals which can cause serious injury. The guidelines below must be followed;

- Check the connector configuration of the Fiber Optic Interfaces. If these are fitted with a connector interface other than FC/PC then remove the existing connector interface and fit the FC/PC connector interface.
 - Check for any damage to the HP 37717B Fiber Optic Interface spring loaded aperture covers and connectors. Do not power up the instrument if in any doubt about the integrity of these connectors.
 - Make all connections to the HP 37717B Fiber Optic Interfaces before powering up the instrument.
-

Procedure

1. Connect the STM-4 Optical Out Port to the HP 8153A (ensure that all connections are tight and that the cable has no twists).
2. Switch on the HP 37717B and check that immediately on power up the LASER ON led on the front panel illuminates for a few seconds.
3. Recall default settings on the HP 8153A:
 - Press **Mode** to select MENU mode on the HP 8153A.
 - Press **System** to display RECALL.
 - Press **Edit**, select 0—▶A and press **Exec** to recall the default settings (wavelength = 1300 nm, measurement time = 200 ms, autorange).
4. Press **Mode** then **dBm W** to select the Power Level measurement on the HP 8153A.
5. Press **TRANSMIT** on the HP 37717B and select SIGNAL [STM-1 OPT].
6. Verify that the front panel LASER ON led is on, indicating the laser is enabled.

7. Check the HP 8153A Power Meter reading is between -15 dBm and -8 dBm (Typically -9 dBm).
8. Press **TRANSMIT** on the HP 37717B and select SIGNAL [STM-4 OPT].
9. Repeat steps 6 and 7.
10. Press **OTHER**, select STORED SETTINGS NUMBER [0] (Default Settings) and press **RECALL**.
11. Verify that the front panel LASER ON led is off before continuing.
12. Connect the Optical Attenuator between the Power Meter and the HP 37717B Optical Out port (ensure that all connections are tight and that the cable has no twists).
13. Press **TRANSMIT** on the HP 37717B and select SIGNAL [STM-1 OPT].
14. Adjust the Optical Attenuator to obtain a reading of -26 dBm on the Power Meter.
15. Press **OTHER**, select STORED SETTINGS NUMBER [0] (Default Settings) and press **RECALL**.
16. Verify that the front panel LASER ON led is off before continuing.
17. Disconnect the Optical Attenuator Output from the HP 8153A and connect to the HP 37717B Optical In Port.
18. Press **OTHER** then **SETTINGS CONTROL** and select TRANSMITTER AND RECEIVER [COUPLED].
19. Press **TRANSMIT** and select SIGNAL [STM-1 OPT].
20. Press **RESULTS** **TROUBLE SCAN**, and then **RUN/STOP** to start a measurement.
21. After 5 minutes check that NO TROUBLE is displayed on the **RESULTS** display.
22. Press **OTHER**, select STORED SETTINGS NUMBER [0] (Default Settings) and press **RECALL**.
23. Verify that the front panel LASER ON led is off before continuing.

24. Repeat steps 12 through 23, selecting SIGNAL [STM-4 OPT] in steps 13 and 19.
25. Disconnect the test equipment.



STM-1/4, 1550nm Optical Interface (Option URU)

Specification (Transmitter)

Wavelength	1520 nm to 1565 nm
Power Output	-1 dBm (Nominal)
Line Coding	NRZ
Safety Class	Class 1, FDA 21 CFR Ch.1 1040.10 and EN 60825
Data Rate	155.52 Mb/s or 622.08 Mb/s (Nominal)

Specification (Receiver)

Wavelength	1200 nm to 1600 nm
Maximum Input Power	-8 dBm (for BER of $1.0E^{-10}$)
Line Coding	NRZ
Sensitivity	-26 dBm Minimum (wavelength=1550nm, Modulation=100%, Data= $2^{23}-1$, BER= $1.0E^{-10}$)
PMP Electrical Input	150mV (Nominal)
PMP Impedance	Nominal 50Ω

Description

Minimum and maximum Optical Rx Input levels are verified by looping the Optical Tx and Rx ports through the Optical Attenuator and checking for error-free operation with identical Tx and Rx patterns selected. The signal level to the Optical Rx input is measured using the Power Meter and adjusted using the Optical Attenuator for the required minimum and maximum levels.

The Protected Monitor Point (PMP) functionality is verified by looping the HP 37717B Optical Output to the PMP input via an Optical Attenuator and Optical to Electrical Converter, then checking for error-free operation with identical Tx and Rx patterns selected. The specified electrical level for the PMP input is obtained by adjusting the optical signal level to the O/E Converter using the Optical Attenuator.

Equipment Required

Power Meter	HP 8153A
Power Meter Sensor Module	HP 81536A
Oscilloscope	HP 54100D
Dual Power Supply (+/-12V)	HP 6253A
Lightwave Receiver	HP 83442A opt 012
Optical Attenuator	HP 8157A
FC/PC Connector Interface	HP 81000FI
Optical Cables (qty 2)	HP 11871A
Adaptor (SMA to BNC)	HP 1250-1787

Caution



The performance of Optical Interfaces will be seriously impaired if any dirt or contamination is present on the interface connectors. Always cover the ends of optical cables and connectors with protective caps when not in use.

Always examine the ends of each fibre optic cable before use and if visible contamination is present DO NOT USE - Dirt is easily transferred to the Optical Module connector causing permanent damage. The cable should be replaced or cleaned - If cleaning, refer to Hewlett-Packard booklet *Lightwave Connection Techniques for better measurements*. HP Part Number 08703-90028.

Procedure

1. Connect the HP 37717B STM1/4 Optical Out Port to the HP 8153A Power Meter via the HP 8157A Optical Attenuator - ensure that all connections are tight and that optical cables have no twists or tight bends..
2. Setup the HP 8153A as follows:
 - a. Press [PARAM] key to display wavelength [λ]
 - b. Using [\leftarrow],[\rightarrow] [\uparrow] and [\downarrow] keys, set the wavelength to 1550nm.
 - c. Press [PARAM] key to display Time [t]
 - d. Using [\leftarrow],[\rightarrow] [\uparrow] and [\downarrow] keys, set the time to 200mS.

3-112 Performance Tests

- e. Press [PARAM] key to display REF.
 - f. Using [←],[⇒] [↑] and [↓] keys, set the REF to 0.000dBm.
 - g. Press [PARAM] key to display CAL.
 - h. Using [←],[⇒] [↑] and [↓] keys, set the CAL to 0.000dBm.
 - i. Cover the end of the Power Meter Optical Input connector with a protective cap.
 - j. Press the [ZERO] key on the Power Meter to calibrate - the Power Meter is now ready.
3. Switch on the HP 37717B and check that immediately on power-up the Optical Module LASER ON led illuminates for a few seconds.

4. Press [TRANSMIT] on the HP 37717B and set up the display as shown opposite.

5. Verify that the Optical Module LASER ON led is lit indicating that the laser is enabled.

6. Set the Optical Attenuator Wavelength to 1550nm and adjust the level to obtain a reading of -8dBm on the Power Meter. Typically around 6dB of attenuation will be required to achieve this reading.

TRANSMITTER OUTPUT		[SDH]
SIGNAL		[STM-4 OPT]
CLOCK SYNC		[INTERNAL]
FREQUENCY OFFSET		[OFF]
STM-1 UNDER TEST		[1]
PAYLOAD		[140 Mb/s]
PATTERN		[2^28-1]
STATUS:		
STM-1	STM-1	STM-4
OPTICAL	OPTICAL	OPTICAL

7. Press [TRANSMIT] on the HP 37717B and select SIGNAL [STM-1].
8. Verify that the Optical Module LASER ON led is NOT lit indicating that the laser is disabled before continuing.
9. Disconnect the optical cable from the Power Meter and connect to the HP 37717B STM1/4 Optical Rx Input.

10. Press [RECEIVE] on the HP 37717B and set up the display as shown opposite.

11. Press [TRANSMIT] on the HP 37717B and select SIGNAL [STM-4 OPT].

12. Press [RESULTS] TROUBLE SCAN then [RUN/STOP] to start the measurement.

13. After 5 minutes, check that NO TROUBLE is displayed on the HP 37717B [RESULTS] display. Press [RUN/STOP] to stop the measurement.

RECEIVER INPUT	[SDH]
SIGNAL INTERFACE	[STM-4 OPT] [OPTICAL]
STM-1 UNDER TEST PAYLOAD	[1] [140 Mb/s]
PATTERN	[2^23-1]
STATUS:	[OPTICAL] [MONITOR]

14. Press [TRANSMIT] on the HP 37717B and select SIGNAL [STM-1].

15. Verify that the Optical Module LASER ON led is NOT lit indicating that the laser is disabled before continuing.

16. Reconnect the HP 37717B STM1/4 Optical Out Port to the HP 8153A Power Meter via the HP 8157A Optical Attenuator.

17. Press [TRANSMIT] on the HP 37717B and select SIGNAL [STM-4 OPT].

18. Adjust the Optical Attenuator level to obtain a reading of -26dBm on the Power Meter.

19. Press [TRANSMIT] on the HP 37717B and select SIGNAL [STM-1].

20. Verify that the Optical Module LASER ON led is NOT lit indicating that the laser is disabled before continuing.

21. Disconnect the optical cable from the Power Meter and connect to the HP 37717B STM1/4 Optical Rx Input.

22. Press [TRANSMIT] on the HP 37717B and select SIGNAL [STM-4 OPT].

23. Press [RESULTS] TROUBLE SCAN then [RUN/STOP] to start the measurement.

24. After 5 minutes, check that NO TROUBLE is displayed on the HP 37717B [RESULTS] display. Press [RUN/STOP] to stop the measurement.

25. Press [TRANSMIT] on the HP 37717B and select SIGNAL [STM-1].

3-114 Performance Tests

26. Verify that the Optical Module LASER ON led is NOT lit indicating that the laser is disabled before continuing.
27. Disconnect the optical cable from the HP 37717B STM1/4 Optical Rx Input and connect to the HP 83442A Optical/Electrical Converter input.
28. Connect the output from the Optical /Electrical Converter to the Oscilloscope using the SMA/BNC adaptor and 50 ohm BNC cable.
29. Set the Dual Power Supply to +12V and -12V, then connect to the HP 83442A O/E Converter and switch on.

Caution

Take care to connect the supply correctly as incorrect voltage or polarity could result in damage to the HP 83442A. Refer to HP83442A Operating Instructions, HP p/n 5091-6448A.

30. Press [TRANSMIT] on the HP 37717B and select SIGNAL [STM-4 OPT].
31. Press [AUTOSCALE] on the oscilloscope and adjust the Timebase and Range to obtain an STM-4 waveform.
32. Measure the amplitude of this STM-4 waveform using the oscilloscope and adjust the Optical Attenuator until the amplitude is 150mV.

Note

If the input power is greater than -8 dBm then the Optical/Electrical converter is liable to saturate.

33. Disconnect the output of the O/E Converter from the oscilloscope and connect instead to the HP 37717B STM1/4 Optical Module Monitor Input.

34. Press [RECEIVE] on the HP 37717B and set up the display as shown opposite.

35. Press [RESULTS] TROUBLE SCAN then [RUN/STOP] to start the measurement.

36. After 5 minutes, check that NO TROUBLE is displayed on the HP 37717B [RESULTS] display. Press [RUN/STOP] to stop the measurement.

RECEIVER INPUT	[SDH]
SIGNAL INTERFACE	[STM-4 OPT] [MONITOR]
STM-1 UNDER TEST PAYLOAD	[1] [140 Mb/s]
PATTERN	[2^29-1]
STATUS:	
OPTICAL	MONITOR

37. Recall the HP 37717B Default Settings as shown on Page 3-2.
38. Verify that the Optical Module LASER ON led is NOT lit indicating that the laser is disabled before continuing.
39. Repeat steps 1 to 38 but with [STM-1 OPT] selected on the HP 37717B Tx and Rx display parameters instead of [STM-4 OPT] .
40. Disconnect all Test equipment.

Transmitted Jitter Amplitude Accuracy (Option UHK)

Specifications

Data Rates : 2.048 Mb/s, 8.448 Mb/s, 34.368 Mb/s, 139.264 Mb/s, 155.52 Mb/s (STM-1), 622.08 Mb/s (STM-4)

Amplitude Accuracy

Overall Accuracy : $\pm 5\%$ \pm range accuracy \pm intrinsic jitter

Range 1 : ± 0.01 UI

Range 10 : ± 0.1 UI

Intrinsic Jitter 2 Mb/s : ± 0.02 UI

Intrinsic Jitter 8 Mb/s : ± 0.02 UI

Intrinsic Jitter 34 Mb/s : ± 0.03 UI

Intrinsic Jitter 140 Mb/s : 200 Hz to 5 kHz - ± 0.10 UI
5 kHz to 10 kHz - ± 0.05 UI
>10 kHz - ± 0.02 UI

Modulation Frequency

Range : 2 Hz to 4 MHz

Accuracy : $\pm 1\%$

Corner and Cut-off Frequencies

Data Rate	Corner Frequency	Cut-off Frequency
2 Mb/s	13 kHz	102 kHz
8 Mb/s	50 kHz	422 kHz
34 Mb/s	210 kHz	840 kHz
140 Mb/s	5 kHz	4 MHz

Description

The HP 37717B Transmitter Unbalanced PDH Output is connected to the Spectrum Analyzer. The HP 37717B Jitter modulation frequency is set to the specified maximum for 10UI at the selected Bit Rate and the Spectrum Analyzer set to optimise the displayed spectrum centred at this bit rate. The HP 37717B jitter Modulation amplitude is set to the level at which a **Bessel Null** is expected, then fine-tuned to maximize the null. The jitter Amplitude (UI pk-pk) displayed on the HP 37717B is checked to ensure it is within specified limits.

Equipment

Spectrum Analyzer : HP 8568B Opt 001
Oscilloscope : HP 54100D
75 Ω /50 Ω Matching Pad : HP 11825B

Pre-Adjustment Setup

Before carrying out any adjustments to the HP 37717B Jitter Transmitter Module, perform the following pre-adjustment setup.

Caution



This procedure uses the special MODULE DEBUG display on the HP 37717B. When using the MODULE DEBUG display, **ONLY** modify the parameters shown. Altering other parameters can damage instrument firmware - exit the MODULE DEBUG display after setup to prevent accidental damage.

1. Remove the Jitter Receiver module from the instrument and fit the 37717-60006 assembly on the extender card.

2. Setup the HP 37717B **OTHER** display as shown opposite.

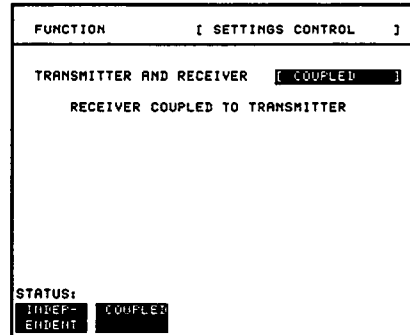

3. Make the following key sequence on the HP 37717B to obtain the special **MODULE DEBUG** display.

Press **OTHER** ;  ; **MORE** ;  ; **MORE** ;  ; **MORE** ; **OTHER**.

Press **MORE** until **MODULE DEBUG** appears in the softkey menu.

Press **MODULE DEBUG** and set up the display as shown opposite.

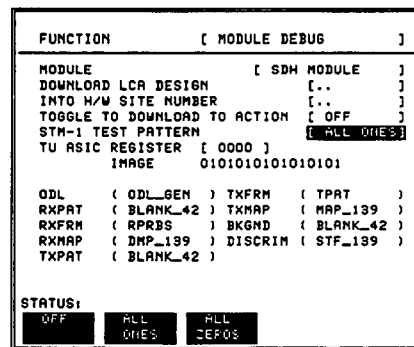

Caution



The sequence above must be performed each time the power is cycled on the HP 37717B, as all **MODULE DEBUG** parameters adopt **DEFAULT** values when power is cycled.

Procedure

1. Recall the HP 37717B DEFAULT SETTINGS as shown on Page 3-2.

Transmitted Jitter Amplitude Accuracy on Range 1

2. Setup the HP 37717B **TRANSMIT** display as shown opposite.

TRANSMITTER OUTPUT SETTINGS	[PDH]
SIGNAL	[2 Mb/s]
CLOCK SYNC	[INTERNAL]
FREQUENCY OFFSET	[OFF]
CODE	[HD33]
PATTERN	[ALL ONES]
TERMINATION	[75Ω UNBAL]
STATUS:	
3 15-1	3 23-1
ALL	ALL
CEPOS	ONES

3. Select TRANSMITTER OUTPUT SETTINGS [JITTER] and setup the display as shown opposite.

TRANSMITTER OUTPUT SETTINGS	PDH [JITTER]
JITTER	[ON]
SIGNAL FREQUENCY	[2 Mb/s]
JITTER MASK	[OFF]
MODULATION FREQUENCY	[0002400 Hz]
RANGE	[1.0 UI]
AMPLITUDE	[0.7 UI]
STATUS:	
DECREASE	INCREASE
DIGIT	DIGIT
←	→
END	EDIT

4. Set the Spectrum Analyzer as follows :

Centre Frequency - 2048 kHz

Frequency Span - 25 kHz

Reference Level - 0 dBm

Sweep Time - 1.0 s

Video Bandwidth - 1 kHz

Resolution Bandwidth - 100Hz

5. Connect up the equipment as shown in Figure 3-44.

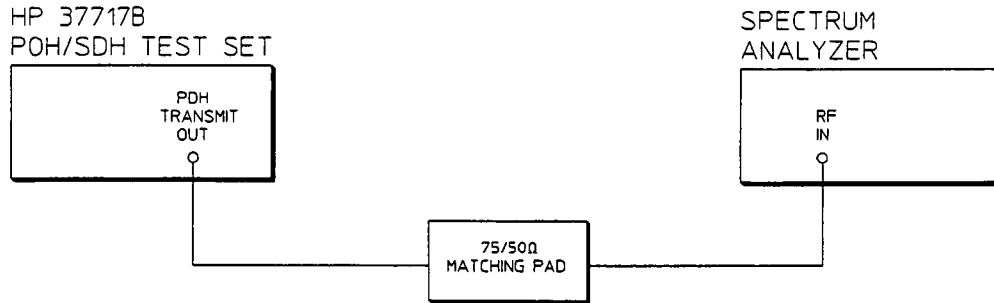

Figure 3-44. TX Jitter Accuracy Test Setup

6. Adjust the HP 37717B jitter amplitude until the first **Bessel Null** is observed on the Spectrum Analyzer i.e first dip in the carrier level (see Figure 3-45).
7. Ensure the Jitter amplitude displayed on the HP 37717B is between the minimum and maximum limits given in Table 3-4.
8. Check the Jitter accuracy for each value in Table 3-4. In each case, set the HP 37717B Rate and Spectrum Analyzer Center Frequency to the value given in column 1 of the table (**Set the HP 37717B PATTERN to ALL ONES and jitter AMPLITUDE to minimum after each change of Bit Rate**). Set the HP 37717B Jitter Modulation Frequency and Amplitude to the values given in columns 2 and 3 of the table. Fine-tune the amplitude to obtain the lowest carrier level on the Spectrum Analyzer display and check that the jitter amplitude displayed on the HP 37717B is between the limits given in columns 4 and 5 of Table 3-4.

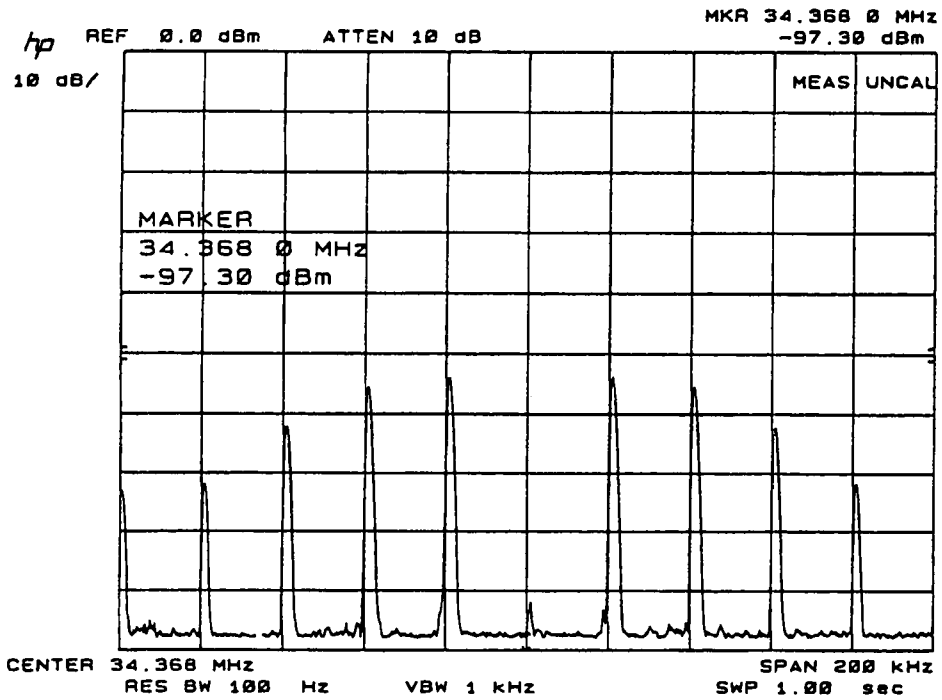

Figure 3-45. Bessel Null Example

Table 3-4. Range 1 Tx Jitter Amplitude Accuracy

Bit Rate/Center Frequency	Modulation Frequency	Jitter Amplitude (UI)	Minimum Jitter (UI)	Maximum Jitter (UI)
2048kHz	2400Hz	0.77	0.69	0.83
8448kHz	10700Hz	0.77	0.69	0.83
34368kHz	4000Hz	0.77	0.69	0.83
139264kHz	4000Hz	0.77	0.68	0.84

Transmitted Jitter Accuracy on Range 10

9. Setup the HP 37717B **TRANSMIT** display as shown below.

TRANSMITTER OUTPUT SETTINGS	[PDH]
SIGNAL	[2 Mb/s]
CLOCK SYNC	[INTERNAL]
FREQUENCY OFFSET	[OFF]
CODE	[M0B3]
PATTERN	[ALL ONES]
TERMINATION	[75Ω UNBAL]
STATUS:	
2 ¹³ -1	2 ²³ -1
ALL ZEROS	ALL ONES

10. Select TRANSMITTER OUTPUT SETTINGS [JITTER] and setup the display as shown below.

TRANSMITTER OUTPUT SETTINGS	PDH [JITTER]
JITTER	[0M]
SIGNAL FREQUENCY	[2 Mb/s]
JITTER MASK	[OFF]
MODULATION FREQUENCY	[0002400 Hz]
RANGE	[10 UI]
AMPLITUDE	[01.8 UI]
STATUS:	
REF FREQ	IMP FREQ
RIGHT	RIGHT
←	→
END	EDIT

11. Set the Spectrum Analyzer as follows :

Centre Frequency - 2048 kHz

Frequency Span - 25 kHz

Reference Level - 0 dBm

Sweep Time - 1.0 s

Video Bandwidth - 1 kHz

Resolution Bandwidth - 100Hz

12. Adjust the HP 37717B jitter amplitude until the second Bessel Null is observed on the Spectrum Analyzer i.e second dip in the carrier level (see Figure 3-45).
13. Ensure the Jitter amplitude displayed on the HP 37717B is between the minimum and maximum limits given in Table 3-5.
14. Check the Jitter accuracy for each value in Table 3-5. In each case, set the HP 37717B Rate and Spectrum Analyzer Center Frequency to the value given in column 1 of the table (Set the HP 37717B PATTERN to ALL ONES and the jitter AMPLITUDE to minimum after each change of Bit Rate). Set the HP 37717B Jitter Modulation Frequency and Amplitude to the values given in columns 2 and 3 of the table. Fine-tune the amplitude to obtain the lowest carrier level on the Spectrum Analyzer display and

check that the jitter amplitude displayed on the HP 37717B is between the limits given in columns 4 and 5 of Table 3-5.

Table 3-5. Range 10 Tx Jitter Amplitude Accuracy

Bit Rate/Center Frequency	Modulation Frequency	Jitter Amplitude (UI)	Minimum Jitter (UI)	Maximum Jitter (UI)
2048kHz	2400Hz	1.8	1.5	2.0
2048kHz	2400Hz	4.8	4.4	5.1
2048kHz	2400Hz	8.8	8.2	9.3
8448kHz	10700Hz	1.8	1.5	2.0
8448kHz	10700Hz	5.8	5.3	6.2
8448kHz	10700Hz	8.8	8.2	9.3
34368kHz	4000Hz	2.8	2.5	3.0
34368kHz	4000Hz	6.8	6.2	7.3
34368kHz	4000Hz	8.8	8.2	9.3
139264kHz	4000Hz	3.8	3.3	4.2
139264kHz	4000Hz	7.8	7.1	8.4
139264kHz	4000Hz	8.8	8.1	9.4

Received Jitter Accuracy (Option UHN[US9])

Specifications

Data Rates : 2.048 Mb/s, 8.448 Mb/s, 34.368 Mb/s, 139.264 Mb/s, 155.52 Mb/s
(STM-1), 622.08 Mb/s (STM-4)

Demodulated Jitter Output

Range 1.6 : 1.0V/UI $\pm 10\%$
Range 16 : 0.1V/UI $\pm 10\%$

Overall Accuracy

Peak Jitter : $\pm 5\% \pm \text{range accuracy} \pm \text{intrinsic jitter}$
Peak_peak Jitter : $\pm 5\% \pm \text{intrinsic jitter}$

Amplitude Range Accuracy

Range 1.6 : $\pm 0.01 \text{ UI}$
Range 16 : $\pm 0.1 \text{ UI}$

Intrinsic Jitter

Range	Clock/PRBS	Intrinsic Jitter
1.6	Clock	$\pm 0.02 \text{ UI}$
1.6	PRBS	$\pm 0.1 \text{ UI}$
16	Clock	$\pm 0.2 \text{ UI}$
16	PRBS	$\pm 0.25 \text{ UI}$

Description

The HP 37717B Jitter Receiver performance is verified using a special internal instrument calibration routine. This routine is automatic and tests all parameters except Hit Count and Demodulated Jitter Output.

Hit Count is tested by connecting PDH Signal Out to PDH Signal In with the transmitted jitter amplitude just exceeding the receiver Hit Threshold

and a check made to ensure the Hit count is within the modulation frequency accuracy limits.

The Demodulated Jitter Output is verified for accuracy by measuring the amplitude on an oscilloscope.

Equipment

Spectrum Analyser	: HP 8568B
75Ω/50Ω Matching Pad	: HP 11825B
Calibrated Jitter Generation Module	: See Note.
Oscilloscope	: HP 54100D
75 Ohm Termination	: HP 15522-80010

Note



The Jitter Receiver calibration routine used in this test requires a calibrated Jitter Generation Module (Option UHK) fitted in the HP 37717B. If a Jitter Generation module is to be fitted refer to *Fitting a Jitter Generation Module* at the end of this test.

Pre-Adjustment Setup

Before carrying out any adjustments to the HP 37717B Jitter Transmitter Module, perform the following pre-adjustment setup.

Caution



This procedure uses the special MODULE DEBUG display on the HP 37717B. When using the MODULE DEBUG display, **ONLY** modify the parameters shown. Altering other parameters can damage instrument firmware - exit the MODULE DEBUG display after setup to prevent accidental damage.

1. Remove the Jitter Receiver module from the instrument and fit the 37717-60006 assembly on the extender card.

2. Setup the HP 37717B **OTHER** display as shown opposite.

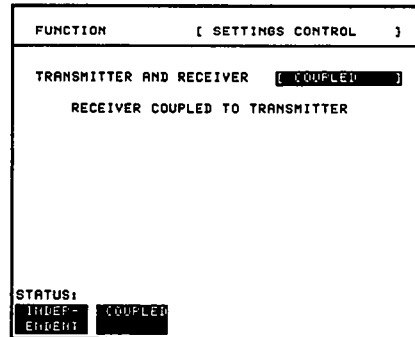

3. Make the following key sequence on the HP 37717B to obtain the special **MODULE DEBUG** display.

Press **OTHER** ; ; **MORE** ; ; **MORE** ; ; **OTHER**.

Press **MORE** until **MODULE DEBUG** appears in the softkey menu.

Press **MODULE DEBUG** and set up the display as shown opposite.

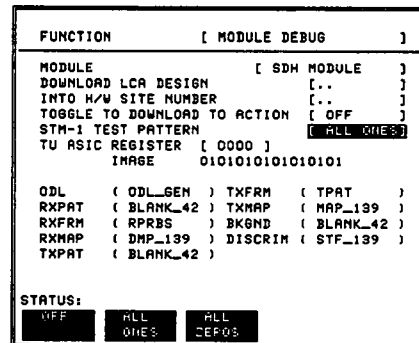

Caution



The sequence above must be performed each time the power is cycled on the HP 37717B, as all **MODULE DEBUG** parameters adopt **DEFAULT** values when power is cycled.

Jitter Generation Module Calibration Procedure

1. Connect up the equipment as shown in Figure 3-46.
2. Set the Spectrum Analyzer as follows :

Centre Frequency - 2048 kHz

Frequency Span - 100 kHz

Reference Level - 0 dBm

Sweep Time - 1.0 s

Video Bandwidth - 1 kHz

Resolution Bandwidth - 100Hz

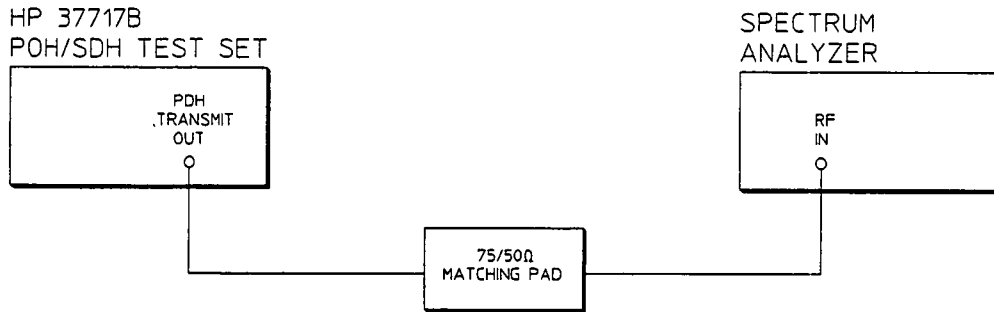
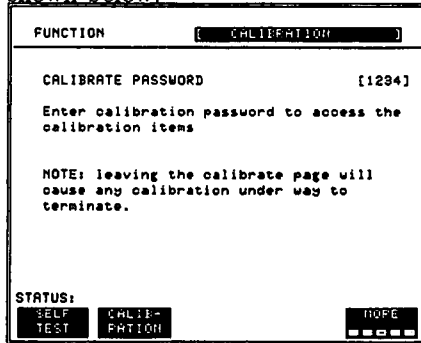

Figure 3-46. TX Jitter Accuracy Test Setup

3. Setup the HP 37717B **OTHER** display as shown below.



4. Set CALIBRATE PASSWORD [1243].

5. Select CALIBRATION ITEM [JITTER TX] and press **RUN/STOP**.

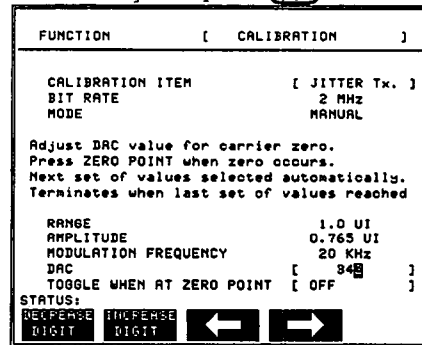

6. Adjust the DAC value (using only the least significant bit) until the carrier level displayed on the Spectrum Analyser is at a minimum (Bessel Null).

7. When a Bessel Null is reached move the cursor to TOGGLE WHEN AT ZERO POINT and press **ZERO POINT**. This stores the value for the modulation frequency and the routine automatically moves on to the next calibration value.

8. Repeat steps 6 and 7 for each new calibration value. At each change of displayed BIT RATE set the Spectrum Analyzer Center Frequency to the new BIT RATE and adjust the SPAN to optimise the spectrum around the carrier.
9. When finished, the HP 37717B display will indicate CALIBRATION PROCESS COMPLETE. Press **OTHER** to return to normal operation.

Received Jitter Accuracy Procedure

1. Connect the HP 37717B Unbalanced 75Ω PDH Signal Out to PDH Signal In.
2. Setup the HP 37717B **OTHER** display as shown opposite.
3. Set CALIBRATE PASSWORD [1234].

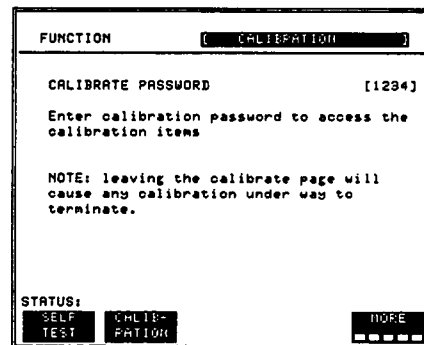

4. Select CALIBRATION ITEM [JITTER RX] and press **RUN/STOP**.

The test is automatic and takes approximately 30 minutes.

When completed the HP 37717B display will indicate CALIBRATION PROCESS COMPLETE.

Press **OTHER** to return to normal operation.

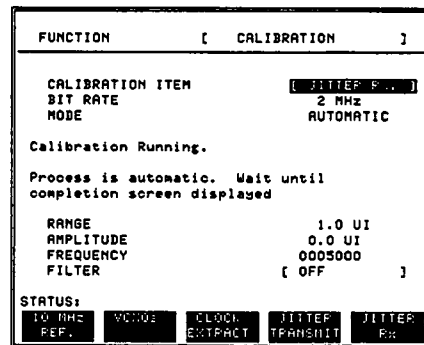

Hit Count

5. Recall the HP 37717B DEFAULT SETTINGS as shown on Page 3-2.

6. Setup the HP 37717B **RECEIVE** display as shown below.

RECEIVER INPUT SETTINGS	PDM [PDM]
SIGNAL	[8 Mb/s]
TEST MODE	[OUT OF SRVC]
CODE	[HDB3]
PATTERN	[ALL ONES]
TERMINATION	75Ω UNBAL
STATUS:	
2 15-1	2 23-1 ALL ZEROS ALL ONES

7. Select RECEIVER INPUT SETTINGS [JITTER] and setup the display as shown below.

RECEIVER INPUT SETTINGS	PDM [JITTER]
SIGNAL FREQUENCY	8 Mb/s
RECEIVER RANGE	[16 UI]
HIT THRESHOLD	[5.0 UI]
FILTER	[HP1]
WANDER AVAILABLE AT 2MB/S ONLY	
STATUS:	
1.6 UI	16 UI

8. Setup the 37717B **TRANSMIT** display as shown below.

RECEIVER INPUT SETTINGS	[PDM] [PDM]
SIGNAL	[2 Mb/s]
TEST MODE	[OUT OF SRVC]
CODE	[HDB3]
PATTERN	[ALL ONES]
TERMINATION	[75Ω UNBAL]
STATUS:	
2 15-1	2 23-1 ALL ZEROS ALL ONES

9. Select TRANSMIT OUTPUT SETTINGS [JITTER] and setup the display as shown below.

TRANSMITTER OUTPUT SETTINGS	PDM [JITTER]
JITTER	[ON]
SIGNAL FREQUENCY	8 Mb/s
JITTER MASK	[OFF]
MODULATION FREQUENCY	[0010700 Hz]
RANGE	[10 UI]
AMPLITUDE	[04.0 UI]
STATUS:	
DECREASE DIGIT	INCREASE DIGIT ← → END EDIT

10. Set up the HP 37717B **RESULTS** as shown opposite.

Press **RUN/STOP** to start the measurement.

When the measurement is complete check the displayed Hit Count is between 211,860 and 216,140.

RESULTS [JITTER]	[SHORT TERM]
SHORT TERM PERIOD [1 SECOND]	
TEST TIMING [SINGLE]	[10 SECS]
STORAGE [OFF]	
+VE PEAK UI	
-VE PEAK UI	
PEAK-PEAK UI	
ELAPSED TIME 00d 00h 00m 15s	
STATUS:	
MANUAL	SINGLE
TIMER	

Demodulated Jitter Output

11. Connect the HP 37717B Demodulated Jitter Output to the oscilloscope terminated in 75Ω.
12. Check that the amplitude of the 10.7 kHz displayed waveform is between 435mV pk_pk and 565mV pk_pk.
13. Disconnect all test equipment.

Fitting A Jitter Generation Module

1. Switch off the HP 37717B and disconnect the power cord.
2. Remove the rear panel feet.
3. If an SDH Optical Module is fitted (Option UH1 or UH2) unscrew the optical shield from the input and output connectors.
4. Withdraw the outer cabinet sleeve back and out of the instrument.

Caution



Modules must be removed and fitted in the correct sequence to prevent damage.

From Front to back when removing.

From back to front when fitting.

5. Unscrew the clamp screws securing the two modules nearest the front of the instrument.
6. Withdraw these modules from the unit using the two knobs to aid in removal.
7. Unscrew and remove the blanking plate fitted in the third module slot.
8. Fit the new Jitter Transmit Module into this slot and secure with the two clamp screws.
9. Refit the other two modules into their appropriate slots.
10. Replace the outer cabinet sleeve, optical module shields and rear panel feet - this is a reversal of the removal procedure.
11. The instrument self test is run to verify the functionality of the instrument prior to carrying out the performance test.

Ensure the following loopbacks are in place before running the Self Test :

75 Ω Signal IN port to 75 Ω Signal OUT port.

120 Ω Signal IN port to 120 Ω Signal OUT port.

If Option UKJ, Structured PDH Module, is fitted - MUX port to DEMUX port.

If Option US1 or A1T SDH Module, is fitted - STM-1 OUT port to STM-1 IN port.

If Option UH1, STM-1 Optical interface, or Option UH2, STM-1/STM-4 Optical Interface, is fitted - IN port to OUT port.

If Option 1CW, RS-232-C Remote Control/Printer, is fitted connect an RS-232-C loopback connector 5060-4462 to the RS-232-C port. Alternatively make the following connection :

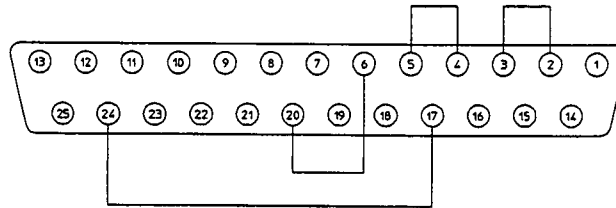

Figure 3-47. Self Test RS-232 port loopback connections

12. Using **OTHER**, **MORE**, **SELF TEST**, **↑** and **↓** set up the display as shown opposite.

13. Press **RUN/STOP** to start the self test.

14. The tests will take approximately 20 minutes to complete. If a failure occurs a FAIL number will be displayed. Refer to Appendix B for a list of FAIL numbers.

15. The display will occasionally blank during the self test as a new group of sub-tests is started.

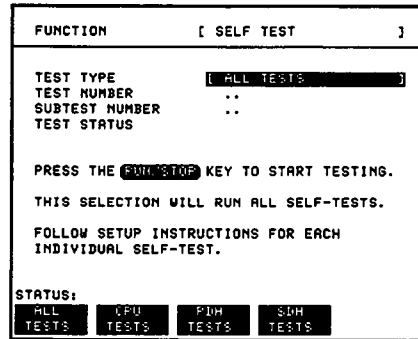

Wander/Slips Measurement (Option UHN[US9])

Specifications

Timing Reference Input

Type	:	External MTS Clock as per CCITT G.811.
Rate	:	2.048Mb/s \pm 100 ppm
Format	:	Clock or HDB3 Data.
Impedance	:	75 Ω Unbalanced (nominal); 120 Ω Balanced (nominal).
Peak Level	:	2.37V \pm 10% (unbalanced), 3V \pm 10% (balanced).
Indication	:	If no reference input signal is present NO REF is displayed.
Connectors	:	BNC (unbalanced); 3-pin Siemens audio (balanced).

Wander Measurement

Bandwidth	:	Low pass response -3dB at 10Hz (nominal)
Resolution	:	0.125 UI
Accuracy	:	\pm 0.125 UI \pm 0.5% of reading valid up to 1Hz wander frequency.
Range	:	\pm 99999 UI.
Alarm Indication	:	"Excess Wander" displayed if $>$ 5UI
Wander Measurements	:	Positive Peak, Negative Peak, Peak to Peak 15 mins, Peak to Peak 24 hours, Time Interval Error
Slips Measurements	:	Estimated Bit Slips, Estimated Frame Slips

Description

In the first part of the test the HP 37717B Transmitter output is connected to the Receiver Data and Reference Inputs simultaneously. The Wander measurement result should be zero with this configuration since both inputs are effectively in phase at the same frequency. This tests the wander measurement accuracy and the Timing Reference Input circuitry (Balanced and Unbalanced data) as the wander counters are latched by a division of the Reference Input and used to count the received input bits.

In the second part of the test Wander and Slips measurements are verified using two Clock Sources - one as input to the Receiver port and the other as input to the Reference port. The sources are locked together but with one source offset by a known frequency. This provides a known number of Bit Slips

which are counted and displayed by the HP 37717B as Frame/Bit Slips and Wander.

Equipment

Synthesizer (2 off) : HP 3325B
 120/75Ω Bal/Unbal Converter : HP 15508C
 T Connector : HP 1250-0781

Procedure

1. Recall the HP 37717B DEFAULT SETTINGS as shown on Page 3-2.

Wander Accuracy

2. Press **TRANSMIT** and set up the display as shown below.

TRANSMITTER OUTPUT SETTINGS	PDH [PDH]
SIGNAL	[2 Mb/s]
CLOCK SYNC	[INTERNAL]
FREQUENCY OFFSET	[OFF]
CODE	[HDB3]
PATTERN	[2 ⁿ -1]
TERMINATION	[75Ω UNBAL]
STATUS:	
PDH	JITTER

3. Press **RECEIVE** and set up the display as shown below.

RECEIVER INPUT SETTINGS	PDH [JITTER]
SIGNAL FREQUENCY	2 Mb/s
RECEIVER RANGE	[1.6 UI]
HIT THRESHOLD	[1.00 UI]
FILTER	[OFF]
WANDER REFERENCE	[75Ω UNBAL]
WANDER REF. FORMAT	[HDB3 DATA]
STATUS:	
HDB3	CLOCK
DATA	

4. Press **RESULTS** and set up the display as shown opposite.

RESULTS [WANDER] [WANDER]	
TEST TIMING	[MANUAL]
STORAGE	[OFF]
+VE PEAK	0.000 BITS
-VE PEAK	0.000 BITS
PEAK-PEAK	0.000 BITS
PEAK-PEAK (15 MIN) BITS
PEAK-PEAK (24 HOURS) BITS
TIME-INTERVAL ERROR	0.000 BITS
ELAPSED TIME	..d..h..m..s
STATUS:	
WANDER	BIT SLIPS
END	GRAPH

5. Connect the unbalanced 75Ω PDH OUT port to the unbalanced 75Ω PDH IN port and the unbalanced 75Ω TIMING REF INPUT simultaneously using the T-piece.
6. Press **RUN/STOP** and verify that the display shows POSITIVE PEAK WANDER and NEGATIVE PEAK WANDER readings of 0.000 ± 0.125 BITS.
7. Press **RUN/STOP** to stop the measurement.
8. Disconnect the PDH OUT port from the unbalanced 75Ω TIMING REF INPUT and connect to the balanced 120Ω TIMING REF INPUT via the HP 15508C Balanced to Unbalanced Converter.
9. Press **RECEIVE** and select WANDER REFERENCE [120Ω BAL].
10. Press **RUN/STOP** and verify that the display shows POSITIVE PEAK WANDER and NEGATIVE PEAK WANDER readings of 0.000 ± 0.125 BITS.
11. Remove the input from the TIMING REF port and check that the display indicates **NO REF**.
12. Press **RUN/STOP** to stop the measurement.

Slips and Wander

13. Connect up the equipment as shown in Figure 3-48.

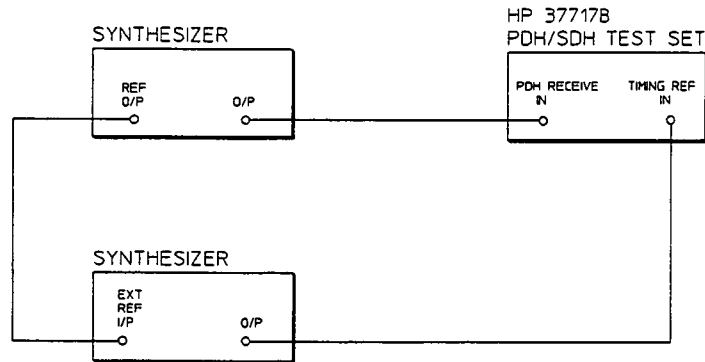

Figure 3-48. Slips and Wander Test Setup

14. Press **RECEIVE** and set up the Display as shown below.

RECEIVER INPUT SETTINGS	PDH [PDH]
SIGNAL	[3 Mb/s]
TEST MODE	[OUT OF SRVC]
CODE	[AMI]
PATTERN	[ALL ONES]
TERMINATION	[75Ω UNBAL]
STATUS:	
140 Mb/s	84 Mb/s
8 Mb/s	2 Mb/s
604 Kb/s	

15. Select **RECEIVER INPUT SETTINGS [JITTER]** and set up the display as shown below.

TRANSMITTER OUTPUT SETTINGS	PDH [PDH]
[JITTER]	
JITTER	[ON]
SIGNAL FREQUENCY	[2 Mb/s]
JITTER MASK	[OFF]
MODULATION FREQUENCY	[1000]
RANGE	[1.0 UI]
AMPLITUDE	[1.00 UI]
QUIET MODE	[OFF]
STATUS:	
OFF	ON
	AUTO TOLERANCE

16. Press **RESULTS** and set up the Display as shown opposite.

17. Set both Synthesizers amplitude to 10dBm.

18. Set the Synthesizer connected to PDH IN to generate a sinewave at 1,024,094.4Hz and the Synthesizer connected to the TIMING REF INPUT to generate a sinewave at 2,048,204.8Hz.

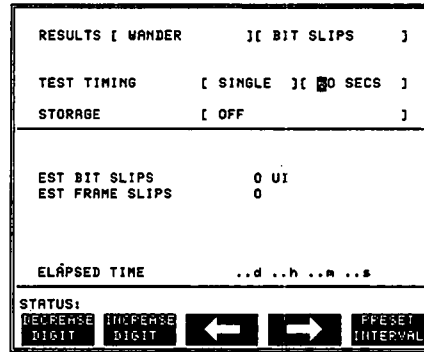

19. Press **RUN/STOP** and verify that the Display shows the following at the end of the test period :

ESTIMATED BIT SLIPS : -955 TO -964 BITS
ESTIMATED FRAME SLIPS : -3 to -4

20. Press **RESULTS**, select DISPLAY [WANDER] and verify that the display shows the following :

POSITIVE PEAK : 0.000 BITS
NEGATIVE PEAK : 955.125 to 964.875 BITS
PEAK TO PEAK : 955.125 to 964.875 BITS
PEAK TO PEAK 15 MINUTES :.... BITS
PEAK TO PEAK 24 HOURS :.... BITS
TIME INTERVAL ERROR : -955.125 to -964.875 BITS

21. Press **RESULTS** and select DISPLAY [SLIPS].

22. Set The Synthesizer connected to PDH IN to generate 1,023,889.6Hz and the Synthesizer connected to the TIMING REF INPUT to generate 2,047,795.2Hz and repeat steps 18 to 20.

23. Set The Synthesizer connected to PDH IN to generate 1,023,905.6Hz

3-138 Performance Tests

24. Press **RUN/STOP** and verify that the display shows the following at the end of the test period :

ESTIMATED BIT SLIPS : 955 to 964
ESTIMATED FRAME SLIPS : 3 to 4

25. Press **RESULTS**, select DISPLAY [WANDER] and verify that the display shows the following :

POSITIVE PEAK : 955.125 to 964.875 BITS
NEGATIVE PEAK : 0.000 BITS
PEAK TO PEAK : 955.125 TO 964.875 BITS
PEAK TO PEAK 15 MINUTE :.... BITS
PEAK TO PEAK 24 HOURS :.... BITS
TIME INTERVAL ERROR : 955.125 to 964.875 BITS

Performance Test Record

<i>Hewlett-Packard Model 37717B PDH/SDH Test Set</i>	
<i>Location:</i>	<i>Serial No.:</i>
	<i>Tested by:</i>
<i>Temperature:</i>	<i>Certified by:</i>
<i>Humidity:</i>	<i>Date:</i>

Performance Test Record

Page No.	Test Description	Result		
		Min	Actual	Max
	<i>Self Test</i>			
3-6	Step 3 All Tests		Pass/Fail	
	<i>Internal Transmitter Clocks</i>			
3-8	Step 5: 704 kb/s (UKK only)	351.99753 kHz		352.00246 kHz
	Step 6: 2 Mb/s	1.0239928 MHz		1.0240072 MHz
	Step 7: 8 Mb/s	4.2239704 MHz		4.2240296 MHz
	Step 8: 34 Mb/s	17.1838797 MHz		17.1841203 MHz
3-9	Step 9: 140 Mb/s	69.6315126 MHz		69.6324874 MHz
	<i>Frequency Offset Bit Rates</i>			
	140 Mb/s			
	Step 11: + 15 ppm	69.63255705 MHz		69.63353191 MHz
	Step 12: - 15 ppm	69.62998067 MHz		69.63193033 MHz
	Step 13: + 100 ppm	69.63847553 MHz		69.63945047 MHz
	Step 14: - 100 ppm	69.62454912 MHz		69.62552388 MHz

Performance Test Record (continued)

Page No.	Test Description	Result		
		Min	Actual	Max
3-10	<i>Frequency Offset</i>			
	34 Mb/s			
	Step 16: + 20 ppm	17.1842234 MHz		17.1844640 MHz
	- 20 ppm	17.1835360 MHz		17.1837766 MHz
	8 Mb/s			
	+ 30 ppm	4.2240972 MHz		4.2241563 MHz
	- 30 ppm	4.2238437 MHz		4.2239028 MHz
	2 Mb/s			
	+ 50 ppm	1.0240440 MHz		1.0240584 MHz
	- 50 ppm	1.0239416 MHz		1.0239560 MHz
	704 kb/s (UKK only)			
	+ 50 ppm	352.0151 kHz		352.0201 kHz
- 50 ppm	351.9799 kHz		351.9849 kHz	
3-12	<i>Transmitter Output</i>			
	Unbal 704 kb/s (UKK only)			
	Step 6: +ve Pulse Amp	2.133 V pk		2.607 V pk
	+ve Pulse Width	639 ns		781 ns
	Overshoot			0.474 V
3-13	Undershoot			0.474 V
	Step 7: -ve Pulse Amp	2.133 V pk		2.607 V pk
	-ve Pulse Width	639 ns		781 ns
	Overshoot			0.474 V
	Undershoot			0.474 V

Performance Test Record (continued)

Page No.	Test Description	Result			
		<i>Min</i>	<i>Actual</i>	<i>Max</i>	
3-13	Step 10:	Bal 704 kb/s (UKK only)			
		+ve Pulse Amp	2.133 V pk		2.607 V pk
		+ve pulse Width	639 ns		781 ns
		Overshoot			0.474 V
		Undershoot			0.474 V
		-ve Pulse Amp	2.133 V pk		2.607 V pk
		-ve Pulse Width	639 ns		781 ns
		Overshoot			0.474 V
		Undershoot			0.474 V
				Unbal 2 Mb/s	
	Step 14:	+ve Pulse Amp	2.133 V pk		2.607 V pk
3-14	Step 16:	+ve Pulse Mask		Pass/Fail	
3-15	Step 20:	-ve Pulse Mask		Pass/Fail	
	Step 21:	-ve Pulse Amp	2.133 V pk		2.607 V pk
3-16	Step 22:	Pulse Amplitude Ratio	0.95		1.05
	Step 23:	Pulse Width Ratio	0.95		1.05
		Bal 2 Mb/s			
	Step 26:	+ve Pulse Amp	2.133 V pk		2.607 V pk
		+ve Pulse Mask		Pass/Fail	
		-ve Pulse Amp	2.133 V pk		2.607 V pk
		-ve Pulse Mask		Pass/Fail	
		Pulse Amplitude Ratio	0.95		1.05
		Pulse Width Ratio	0.95		1.05
		Unbal 8 Mb/s			
3-17	Step 30:	+ve Pulse Amp	2.133 V pk		2.607 V pk
		+ve Pulse Mask		Pass/Fail	
		-ve Pulse Amp	2.133 V pk		2.607 V pk
		-ve Pulse Mask		Pass/Fail	
		Pulse Amplitude Ratio	0.95		1.05
		Pulse Width Ratio	0.95		1.05

Performance Test Record (continued)

Page No.	Test Description	Result					
		Min	Actual	Max			
3-19	Step 34: Unbal 34 Mb/s +ve Pulse Amp +ve Pulse Mask -ve Pulse Amp -ve Pulse Mask Pulse Amplitude Ratio Pulse Width Ratio Unbal 140 Mb/s (All Ones)	0.900 V pk	Pass/Fail	1.100 V pk			
		0.900 V pk		1.100 V pk			
		0.95		1.05			
		0.95		1.05			
		3-21		Step 39: +ve Pulse Amp	0.900 V pk	Pass/Fail	1.100 V pk
					3-22		Step 40: +ve Pulse Mask Unbal 140 Mb/s (All Zeros)
		3-23		Step 44: -ve Pulse Amp Step 45: -ve Pulse Mask <i>Multiple Transmitter Outputs</i>		0.900 V pk	
3-26	Step 6: 704 kb/s Out 2 (UKK only) +ve Pulse Amp +ve Pulse Width Overshoot Undershoot 704 kb/s Out 3 (UKK only)		2.133 V pk		Pass/Fail		2.607 V pk
		639 ns	781 ns				
			0.474 V				
			0.474 V				
		3-27	Step 7: +ve Pulse Amp +ve Pulse Width Overshoot Undershoot 704 kb/s Out 4 (UKK only) +ve Pulse Amp +ve Pulse Width Overshoot Undershoot Step 8: -ve Pulse Amp -ve Pulse Width Overshoot Undershoot	2.133 V pk		Pass/Fail	2.607 V pk
639 ns	781 ns						
	0.474 V						
	0.474 V						
2.133 V pk	2.607 V pk						
639 ns	781 ns						
	0.474 V						
	0.474 V						
2.133 V pk	2.607 V pk						
639 ns	781 ns						
	0.474 V						
	0.474 V						

Performance Test Record (continued)

Page No.	Test Description	Result			
		Min	Actual	Max	
3-27	Step 9:	704 kb/s Out 3 (UKK only)			
		-ve Pulse Amp	2.133 V pk	2.607 V pk	
		-ve Pulse Width	639 ns	781 ns	
		Overshoot		0.474 V	
		Undershoot		0.474 V	
	3-28	Step 12: Step 14: Step 16:	704 kb/s Out 2 (UKK only)	Min	Actual
			-ve Pulse Amp	2.133 V pk	2.607 V pk
			-ve Pulse Width	639 ns	781 ns
			Overshoot		0.474 V
			Undershoot		0.474 V
Delay 1 to 2				4 bits	
3-29	Step 21: Step 23: Step 24:	2 Mb/s Out 2			
		+ve Pulse Amp	2.133 V pk	2.607 V pk	
		+ve Pulse Mask		Pass/Fail	
		2 Mb/s Out 3			
3-30	Step 27: Step 28: Step 29:	+ve Pulse Amp	2.133 V pk	2.607 V pk	
		+ve Pulse Mask		Pass/Fail	
		2 Mb/s Out 4			
		+ve Pulse Amp	2.133 V pk	2.607 V pk	
		+ve Pulse Mask		Pass/Fail	
		-ve Pulse Mask		Pass/Fail	
		-ve Pulse Amp	2.133 V pk	2.607 V pk	
		2 Mb/s Out 3			
3-30	Step 29:	-ve Pulse Mask		Pass/Fail	
		-ve Pulse Amp	2.133 V pk	2.607 V pk	
		2 Mb/s Out 2			
		-ve Pulse Mask		Pass/Fail	
		-ve Pulse Amp	2.133 V pk	2.607 V pk	

Performance Test Record (continued)

Page No.	Test Description	Result		
		<i>Min</i>	<i>Actual</i>	<i>Max</i>
3-30	2 Mb/s Out 2 Cont			
	Step 32: Delay 1 to 2		4 bits	
	Step 34: Delay 1 to 3		8 bits	
	Step 36: Delay 1 to 4		12 bits	
	Step 37: Pulse Amplitude Ratio	0.95		1.05
	Step 38: Pulse Width Ratio	0.95		1.05
3-31	8 Mb/s Out 2			
	Step 43: +ve Pulse Amp	2.133 V pk		2.607 V pk
	Step 45: +ve Pulse Mask		Pass/Fail	
3-32	8 Mb/s Out 3			
	Step 46: +ve Pulse Amp	2.133 V pk		2.607 V pk
	+ve Pulse Mask		Pass/Fail	
3-33	8 Mb/s Out 4			
	+ve Pulse Amp	2.133 V pk		2.607 V pk
	+ve Pulse Mask		Pass/Fail	
	Step 49: -ve Pulse Mask		Pass/Fail	
	Step 50: -ve Pulse Amp	2.133 V pk		2.607 V pk
	8 Mb/s Out 3			
	Step 51: -ve Pulse Mask		Pass/Fail	
	-ve Pulse Amp	2.133 V pk		2.607 V pk
3-34	8 Mb/s Out 2			
	-ve Pulse Mask		Pass/Fail	
	-ve Pulse Amp	2.133 V pk		2.607 V pk
	Step 54: Delay 1 to 2		4 bits	
	Step 56: Delay 1 to 3		8 bits	
	Step 58: Delay 1 to 4		12 bits	
	Step 59: Pulse Amplitude Ratio	0.95		1.05
	Step 60: Pulse Width Ratio	0.95		1.05
34 Mb/s Out 2				
Step 65: +ve Pulse Amp	0.900 V pk		1.100 V pk	
Step 67: +ve Pulse Mask		Pass/Fail		

Performance Test Record (continued)

Page No.	Test Description	Result			
		Min	Actual	Max	
3-35	Step 68:	34 Mb/s Out 3 +ve Pulse Amp +ve Pulse Mask	0.900 V pk	Pass/Fail	1.100 V pk
	Step 68:	34 Mb/s Out 4 +ve Pulse Amp +ve Pulse Mask	0.900 V pk	Pass/Fail	1.100 V pk
3-36	Step 71:	-ve Pulse Mask		Pass/Fail	
	Step 72:	-ve Pulse Amp	0.900 V pk		1.100 V pk
3-36	Step 73:	34 Mb/s Out 3 -ve Pulse Mask -ve Pulse Amp	0.900 V pk	Pass/Fail	1.100 V pk
	Step 73:	34 Mb/s Out 2 -ve Pulse Mask -ve Pulse Amp	0.900 V pk	Pass/Fail	1.100 V pk
3-37	Step 76:	Delay 1 to 2		4 bits	
	Step 78:	Delay 1 to 3		8 bits	
	Step 80:	Delay 1 to 4		12 bits	
	Step 81:	Pulse Amplitude Ratio	0.95		1.05
	Step 82:	Pulse Width Ratio	0.95		1.05
3-37	Step 88:	140 Mb/s Out 2 Pulse Amp	0.900 V pk		1.100 V pk
	Step 89:	All 1's Pulse Mask		Pass/Fail	
3-38	Step 90:	140 Mb/s Out 3 Pulse Amp All 1's Pulse Mask	0.900 V pk	Pass/Fail	1.100 V pk
	Step 90:	140 Mb/s Out 4 Pulse Amp All 1's Pulse Mask	0.900 V pk	Pass/Fail	1.100 V pk
3-38	Step 94:	Pulse Amp	0.900 V pk		1.100 V pk
	Step 95:	All 0's Pulse Mask		Pass/Fail	
3-39	Step 96:	140 Mb/s Out 3 Pulse Amp All 0's Pulse Mask	0.900 V pk	Pass/Fail	1.100 V pk

3-146 Performance Tests



Performance Test Record (continued)

Page No.	Test Description	Result		
		<i>Min</i>	<i>Actual</i>	<i>Max</i>
3-39	Step 96: Pulse Amp	0.900 V pk		1.100 V pk
	All 0's Pulse Mask		Pass/Fail	
3-40	Step 99: Delay 1 to 2		0 bits	
	Step 101: Delay 1 to 3		0 bits	
	Step 103: Delay 1 to 4		0 bits	
3-43	<i>PDH Frame Analysis</i>			
	2 Mb/s			
	Step 4: Alarms Off		Pass/Fail	
	Step 6: Multiframe Loss		Pass/Fail	
3-44	Step 7: Alarms Off		Pass/Fail	
	Step 13: CRC Errors		Pass/Fail	
	Step 14: Alarms On		Pass/Fail	
	Step 15: Alarms Off		Pass/Fail	
	Step 17: Error Count		Pass/Fail	
	Step 18: Remote Alarm		Pass/Fail	
	Step 20: Remote M'frame Alarm		Pass/Fail	
	8 Mb/s			
3-45	Step 3: Alarms Off		Pass/Fail	
	Step 5: Remote Alarm		Pass/Fail	
	Step 6: Frame Errors		Pass/Fail	
	Step 7: Alarms Off		Pass/Fail	
	Step 9: Remote Alarm		Pass/Fail	
	Step 12: Frame Loss		Pass/Fail	
	Step 13: Alarms Off		Pass/Fail	
	Step 15: AIS & Frame Loss		Pass/Fail	
3-46	Step 16: Alarms Off		Pass/Fail	
	34 Mb/s			
	Step 3: Alarms Off		Pass/Fail	
	Step 6: Remote Alarm		Pass/Fail	
	Step 7: Frame Errors		Pass/Fail	
	Step 8: Alarms Off		Pass/Fail	

Performance Test Record (continued)

Page No.	Test Description	Result		
		<i>Min</i>	<i>Actual</i>	<i>Max</i>
3-47	Step 10: Remote Alarm		Pass/Fail	
	Step 13: Frame Loss		Pass/Fail	
	Step 14: Alarms Off		Pass/Fail	
	Step 16: AIS & Frame Loss		Pass/Fail	
	Step 17: Alarms Off		Pass/Fail	
3-48	34 Mb/s Cont			
	Step 4: Alarms Off		Pass/Fail	
	Step 6: Remote Alarm		Pass/Fail	
	Step 7: Frame Errors		Pass/Fail	
	Step 8: Alarms Off		Pass/Fail	
	Step 10: Remote Alarm		Pass/Fail	
	Step 13: Frame Loss		Pass/Fail	
	Step 14: Alarms Off		Pass/Fail	
	Step 16: AIS & Frame Loss		Pass/Fail	
	Step 17: Alarms Off		Pass/Fail	
3-51	140 Mb/s			
	Step 7: 704 kb/s (-6 dB) UKK only		Pass/Fail	
	Step 10: 2 Mb/s (-6 dB)		Pass/Fail	
3-52	Step 13: 8 Mb/s (-6 dB)		Pass/Fail	
	Step 16: 34 Mb/s (-6 dB)		Pass/Fail	
3-54	Step 19: 140 Mb/s (-6 dB)		Pass/Fail	
	<i>PDH Receiver Monitor Levels UKK only</i>			
	Step 7: 704 kb/s (-30 dB)		Pass/Fail	
	Step 10: 2 Mb/s (-30 dB)		Pass/Fail	
	Step 13: 8 Mb/s (-30 dB)		Pass/Fail	
3-55	Step 16: 34 Mb/s (-26 dB)		Pass/Fail	
	Step 19: 140 Mb/s (-26 dB)		Pass/Fail	
	<i>SPDH Receiver Monitor Levels UKJ only</i>			
3-57	Step 7: Trouble Scan		Pass/Fail	
3-58	Step 11: Trouble Scan		Pass/Fail	
	Step 15: Trouble Scan		Pass/Fail	
	Step 19: Trouble Scan		Pass/Fail	

3-148 Performance Tests

Performance Test Record (continued)

Page No.	Test Description	Result		
		Min	Actual	Max
	<i>SPDH Receiver Monitor Levels UKJ Cont</i>			
3-58	Step 23: Trouble Scan		Pass/Fail	
3-59	Step 27: Trouble Scan		Pass/Fail	
	Step 28: Trouble Scan (20 dB)		Pass/Fail	
	Trouble Scan (20 dB, Equalized)		Pass/Fail	
	Trouble Scan (26 dB, Equalized)		Pass/Fail	
	Trouble Scan (26 dB)		Pass/Fail	
	Trouble Scan (30 dB)		Pass/Fail	
	Trouble Scan (30 dB, Equalized)		Pass/Fail	
	Step 29: Trouble Scan (20 dB)		Pass/Fail	
	Trouble Scan (20 dB, Equalized)		Pass/Fail	
	Trouble Scan (26 dB, Equalized)		Pass/Fail	
	Trouble Scan (26 dB)		Pass/Fail	
	Trouble Scan (30 dB)		Pass/Fail	
	Trouble Scan (30 dB, Equalized)		Pass/Fail	
	Step 30: Trouble Scan (20 dB)		Pass/Fail	
	Trouble Scan (20 dB, Equalized)		Pass/Fail	
	Trouble Scan (26 dB, Equalized)		Pass/Fail	
	Trouble Scan (26 dB)		Pass/Fail	
	Trouble Scan (30 dB)		Pass/Fail	
	Trouble Scan (30 dB, Equalized)		Pass/Fail	
	<i>External 2 Mb/s Mux/Demux UKJ only</i>			
3-63	Step 10: Bit & Code EC		Pass/Fail	
	Step 11: Bit Error Add		Pass/Fail	
	Step 14: +ve Pulse Amp	2.133 V pk		2.607 V pk
	Step 16: +ve Pulse Mask		Pass/Fail	
3-65	Step 20: -ve Pulse Mask		Pass/Fail	
	Step 21: -ve Pulse Amp	2.133 V pk		2.607 V pk
3-66	Step 22: Pulse Amplitude Ratio	0.95		1.05
	Step 23: Pulse Width Ratio	0.95		1.05
	<i>External 2 Mb/s /Demux UKL only</i>			
3-69	Step 9: Bit & Code EC		Pass/Fail	
	Step 11: Bit Error Add		Pass/Fail	

Performance Tests 3-149

Performance Test Record (continued)

Page No.	Test Description	Result		
		Min	Actual	Max
	<i>External 2 Mb/s /Demux UKL Cont</i>			
3-69	Step 13: +ve Pulse Amp	2.133 V pk		2.607 V pk
3-70	Step 15: +ve Pulse Mask		Pass/Fail	
3-71	Step 19: -ve Pulse Mask		Pass/Fail	
	Step 20: -ve Pulse Amp	2.133 V pk		2.607 V pk
3-72	Step 21: Pulse Amplitude Ratio	0.95		1.05
	Step 22: Pulse Width Ratio	0.95		1.05
	<i>PDH RX Mon Levels (Special Option 808)</i>			
3-74	Step 7: 704 kb/s (-26 dB)		Pass/Fail	
3-75	Step 10: 2 Mb/s (-26 dB)		Pass/Fail	
	Step 13: 8 Mb/s (-26 dB)		Pass/Fail	
	Step 16: 34 Mb/s (-29 dB)		Pass/Fail	
3-76	Step 19: 140 Mb/s (-26 dB)		Pass/Fail	
	<i>PDH Error Output</i>			
3-78	Step 7: Bit EC		Pass/Fail	
	Step 8: Bit ER		Pass/Fail	
	Step 10: Pulse Period		Pass/Fail	
	Step 11: No Pulses		Pass/Fail	
	Step 12: Alarms On		Pass/Fail	
	Step 14: Pulse Period		Pass/Fail	
	<i>PDH Frequency Meas & Looped Clock</i>			
3-81	Step 8: Frequency	2.047986MHz		2.048014 MHz
	Step 9: Offset (0 ppm)	-7 ppm		+7 ppm
	Step 10: Frequency	2.048190MHz		2.048219 MHz
	Step 11: Offset (+100 ppm)	+93 ppm		+107 ppm
	Step 12: Frequency	2.047781MHz		2.047810 MHz
	Step 13: Offset (-100 ppm)	-93 ppm		-107 ppm
	Frequency Counter		Pass/Fail	
	Step 14: 704 kb/s (0 ppm) UKK only	-7 ppm		+7 ppm
	704 kb/s (-100 ppm) UKK only	-93 ppm		-107 ppm
	704 kb/s (+100 ppm) UKK only	+93 ppm		+107 ppm

3-150 Performance Tests



Performance Test Record (continued)

Page No.	Test Description	Result		
		Min	Actual	Max
3-81	<i>PDH Frequency Meas & Looped Clock Cont</i>			
	Step 14:	Offset 8 Mb/s (0 ppm)	-7 ppm	+7 ppm
		Offset 8 Mb/s (-100 ppm)	-93 ppm	-107 ppm
		Offset 8 Mb/s (+100 ppm)	+93 ppm	+107 ppm
		Offset 34 Mb/s (0 ppm)	-7 ppm	+7 ppm
		Offset 34 Mb/s (-100 ppm)	-93 ppm	-107 ppm
		Offset 34 Mb/s (+100 ppm)	+93 ppm	+107 ppm
		Offset 140 Mb/s (0 ppm)	-7 ppm	+7 ppm
		Offset 140 Mb/s (-100 ppm)	-93 ppm	-107 ppm
	Offset 140 Mb/s (+100 ppm)	+93 ppm	+107 ppm	
	<i>Internal SDH Transmitter Clock</i>			
3-84	Step 5:	Frequency	77.759650 MHz	77.760350 MHz
	<i>SDH Frequency Offsets</i>			
3-87	Step 7:	-100 ppm	Pass/Fail	
		-66.6 ppm	Pass/Fail	
		+33.3 ppm	Pass/Fail	
		+100 ppm	Pass/Fail	
		+999 ppm	Pass/Fail	
		-999 ppm	Pass/Fail	
	<i>External MTS Clock</i>			
3-89	Step 7:	Trouble Scan	Pass/Fail	
	Step 13:	Trouble Scan	Pass/Fail	
3-90	Step 17:	Trouble Scan	Pass/Fail	
	Step 19:	Clock Loss	Pass/Fail	
	Step 23:	No Clock Loss	Pass/Fail	
	<i>STM-1 Transmitter Output Waveshape</i>			
3-93	Step 6:	ALL ONES Mask	Pass/Fail	
3-95	Step 10	ALL ZEROS Mask	Pass/Fail	
3-97	Step 13:	Eye Diagram Mask	Pass/Fail	

Performance Test Record (continued)

Page No.	Test Description	Result		
		Min	Actual	Max
3-100	<i>STM-1 Receiver Monitor Input</i>			
	Step 6: Alarms Off		Pass/Fail	
	Step 7: Trouble Scan		Pass/Fail	
3-102	<i>STM-1 RX Mon I/P (Special Option 808)</i>			
	Step 5: Alarms Off		Pass/Fail	
	Step 6: Trouble Scan		Pass/Fail	
3-103	<i>STM-1 Receiver Input Equalization</i>			
	Step 4: Alarms Off		Pass/Fail	
	Step 5: Trouble Scan		Pass/Fail	
3-105	<i>STM-1 Optical Interface</i>			
	Step 6: Laser Active Led On		Pass/Fail	
3-106	Step 7: Optical Power	-15 dBm		-8 dBm
	Step 9: Laser Active Led Off		Pass/Fail	
	Step 14: Laser Active Led Off		Pass/Fail	
	Step 19: Trouble Scan		Pass/Fail	
	Step 21: Laser Active Led Off		Pass/Fail	
3-108	<i>STM-1/STM-4 Optical Interface Option UH2</i>			
	Step 6: Laser Active Led On		Pass/Fail	
3-109	Step 7: Optical Power STM-1	-15 dBm		-8 dBm
	Step 9: Optical Power STM-4	-15 dBm		-8 dBm
	Step 11: Laser Active Led Off		Pass/Fail	
	Step 16: Laser Active Led Off		Pass/Fail	
	Step 21: Trouble Scan		Pass/Fail	
3-110	Step 23: Laser Active Led Off		Pass/Fail	
	Step 24: Laser Active Led Off		Pass/Fail	
	Trouble Scan		Pass/Fail	
	Laser Active Led Off		Pass/Fail	
3-113	<i>STM-1/STM-4 Optical Interface Option URU</i>			
	Step 5: Laser Active Led On		Pass/Fail	
3-114	Step 13: Trouble Scan STM-4		Pass/Fail	
	Step 24: Trouble Scan STM-4		Pass/Fail	
3-116	Step 36: Trouble Scan STM-4		Pass/Fail	

3-152 Performance Tests

Performance Test Record (continued)

Page No.	Test Description	Result		
		<i>Min</i>	<i>Actual</i>	<i>Max</i>
3-116	<i>Optical Interface Option URU Cont</i>			
	Step 39: Laser Active Led On		Pass/Fail	
	Laser Active Led On		Pass/Fail	
	Trouble Scan STM-1		Pass/Fail	
	Trouble Scan STM-1		Pass/Fail	
	<i>TX Jitter Amplitude Accuracy</i>			
	Range 1			
3-120	Step 7: 2048 kHz	0.69 UI		0.83 UI
	Step 8: 8448 kHz	0.69 UI		0.83 UI
	34368 kHz	0.69 UI		0.83 UI
	139264 kHz	0.68 UI		0.84 UI
	2 Mb/s Range 10			
3-121	Step 13: 1.8 UI	1.5 UI		2.0 UI
3-122	Step 14: 4.8 UI	4.4 UI		5.1 UI
	8.8 UI	8.2 UI		9.3 UI
	8 Mb/s, Range 10			
	1.8 UI	1.5 UI		2.0 UI
	5.8 UI	5.3 UI		6.2 UI
	8.8 UI	8.2 UI		9.3 UI
	34 Mb/s, Range 10			
	2.8 UI	2.5 UI		3.0 UI
	6.8 UI	6.2 UI		7.3 UI
	8.8 UI	8.2 UI		9.3 UI
	140 Mb/s, Range 10			
	3.8 UI	3.3 UI		4.2 UI
	7.8 UI	7.1 UI		8.4 UI
	8.8 UI	8.1 UI		9.4 UI
	<i>RX Jitter Accuracy</i>			
3-125	Step 4: CAL Complete		Pass/Fail	

Performance Test Record (continued)

Page No.	Test Description	Result		
		Min	Actual	Max
3-128	Step 10: Jitter Hit Count Hit Count	211860		216140
	Demodulated Jitter O/P Step 12: Amplitude	435 mV pk_pk		565 mV pk_pk
<i>Wander/Slips Accuracy</i>				
3-133	Step 6: 75Ω REF		Pass/Fail	
	Step 10: 120Ω REF		Pass/Fail	
	Step 11: NO REF		Pass/Fail	
3-135	Step 19: Bit Slips	-955		-964
	Frame Slips	-3		-4
	Step 20: +ve Peak		Pass/Fail	
	-ve Peak	955.125		964.875
	Peak-Peak	955.125		964.875
3-136	Time Interval Error	-955.125		-964.875
	Step 24: Bit Slips	955		964
	Frame Slips	3		4
	Step 25: +ve Peak	955.125		964.875
	-ve Peak		Pass/Fail	
	Peak-Peak	955.125		964.875
	Time Interval Error	955.125		964.875

3-154 Performance Tests

A

Default Settings

It is often desirable to store measurement settings which are used regularly and be able to recall those settings at a moments notice. This capability is provided in the HP 37717B on the **OTHER** **STORED SETTINGS** display.

One preset store is provided which cannot be overwritten, STORED SETTING NUMBER [0], and is used to set the HP 37717B to a known state. The known state is the FACTORY DEFAULT SETTINGS as listed below.

TRANSMIT display (UPDH Option UKK)

Signal	140 Mb/s	Clock Sync	Internal
Code	CMI	Pattern	$2^{23}-1$
Termination	75 Ω Unbal		

TRANSMIT display (SPDH Option UKJ)

Settings	Main	Signal	140 Mb/s
Clock Sync	Internal	Termination	75 Ω Unbal
Line Code	CMI	Frequency Offset	Off
Payload Type	Unframed	Pattern	$2^{23}-1$
PRBS Polarity	INV	Test Signal	34 Mb/s
34M Payload	Unframed	2M Payload	Unframed
2M Payload	Unframed	34 Mb	1
8 Mb	1	2 Mb	1
64 kb	1	BG Pattern	AIS
User Word	1111111111111111	Error Add	Bit
Error Add Rate	None		

TRANSMIT display (SDH)

Signal	STM-1	Clock Sync	Internal
Payload	140 Mb/s	Payload Pattern	2 ²³ -1
TUG3	1	TUG2	1
TU	1	2 Mb/s Pattern	2 ¹⁵ -1

TRANSMIT display (ATM Option UKN)

Signal	34 Mb/s, Internal	Clock Sync	Internal
Code	HDB3	Termination	75 Ω Unbal
Cell Stream	Distribution	F/G Bandwidth	80,000 c/s
B/G 1 Bandwidth	0	B/G 2 Bandwidth	0
B/G 3 Bandwidth	0	F/G Distribution	Burst
Burst Size	1 Cell	Interface	UNI
F/G Payload	Cross Cell, 2 ¹⁵ -1	B/G Stream	1
B/G Payload	00000001	Fill Cells	Idle

RECEIVE display (UPDH Option UKK)

Signal	140 Mb/s	Test Mode	Out of Service
Code	CMI	Pattern	2 ²³ -1
Termination	75 Ω Unbal		

RECEIVE display (SPDH Option UKJ, UKL)

Settings	Main	Signal	140 Mb/s
Termination	75 Ω Unbal	Line Code	CMI
Gain	20 dB	Equalizer	Off
Payload Type	Unframed	Pattern	2 ²³ -1
PRBS Polarity	INV	Test Signal	34 Mb/s
34M Payload	Unframed	8M Payload	Unframed
2M Payload	Unframed	34 Mb	1
8 Mb	1	2 Mb	1
64 kb	1		

A-2 Default Settings

RECEIVE display (SDH)

Signal	STM-1	Payload	140 Mb/s
Payload Pattern	2 ²³ -1	TUG3	1
TUG2	1	TU	1

RECEIVE display (ATM Option UKN)

Signal	34 Mb/s	Termination	75 Ω Unbal
Code	HDB3	Interface	UNI
Test Cell	All User	Cell Payload	Cross Cell, 2 ¹⁵ -1

RESULTS display

Results	Trouble Scan	Short Term Period	1 Second
Test Timing	Manual	Single Test Duration	1 Hour
Storage	OFF	SDH Results	Short Term, RS B1 BIP
PDH Results	Short Term		

OTHER display

Stored Setting Lock	On	Stored Setting Number	0
Printer	Internal	Printing	Off
Print Period	OFF	Print Error Seconds	OFF
Print Mode	Normal	Print Speed	9600 Baud
Clock Mode	Run	Keyboard lock	OFF
Beep On Error	OFF	Analysis Display Mode	G.821
Suspend Test on LOS	OFF	Self Test	All Tests
Settings Control	Independent		

Status Registers

Register	+ve Transition	-ve Transition	Enable
ESR	All 1's	All 0's	All 1's
QUES	All 1's	All 0's	All 0's
OPER	All 1's	All 0's	All 0's
INST	All 1's	All 0's	All 1's
DATA	All 1's	All 0's	All 1's
PDH	All 1's	All 0's	All 1's
FAS	All 1's	All 0's	All 1's
SDH	All 1's	All 0's	All 1's
SDH2	All 1's	All 0's	All 1's
SPDH	All 1's	All 0's	All 1's
M140	All 1's	All 0's	All 1's
M34	All 1's	All 0's	All 1's
M8	All 1's	All 0's	All 1's
M2	All 1's	All 0's	All 1's

A-4 Default Settings

B

Self Test Fail Numbers

When self test is run fail numbers may be displayed. The fail numbers and a description are listed below.

Table B-1. PDH Tests, Option UKK (75 Ω Unbal Back to Back)

No.	Description	No.	Description
2010	140 Mb/s, PRBS - Signal Loss	2011	140 Mb/s, PRBS - Pattern loss
2014	140 Mb/s, PRBS - Errors	2020	34 Mb/s, PRBS - Signal Loss
2021	34 Mb/s, PRBS - Pattern loss	2024	34 Mb/s, PRBS - Errors
2030	8 Mb/s, PRBS - Signal Loss	2031	8 Mb/s, PRBS - Pattern loss
2034	8 Mb/s, PRBS - Errors	2040	2 Mb/s, HDB3, PRBS - Signal Loss
2041	2 Mb/s, HDB3, PRBS - Pattern loss	2044	2 Mb/s, HDB3, PRBS - Errors
2050	2 Mb/s, AMI, PRBS - Signal Loss	2051	2 Mb/s, AMI, PRBS - Pattern loss
2054	2 Mb/s, AMI, PRBS - Errors	2060	704 kb/s, HDB3, PRBS - Signal Loss
2061	704 kb/s, HDB3, PRBS - Pattern loss	2064	704 kb/s, HDB3, PRBS - Errors
2070	704 kb/s, AMI, PRBS - Signal Loss	2071	704 kb/s, AMI, PRBS - Pattern loss
2074	704 kb/s, AMI, PRBS - Errors	2080	140 Mb/s, WORD - Signal Loss
2081	140 Mb/s, WORD - Pattern loss	2084	140 Mb/s, WORD - Errors
2090	140 Mb/s, AIS WORD - Signal Loss	2091	140 Mb/s, AIS WORD - Pattern Loss
2094	140 Mb/s, AIS WORD - Errors	2100	704 kb/s, AMI, WORD - Signal Loss
2101	704 kb/s, AMI, WORD - Pattern Loss	2104	704 kb/s, AMI, WORD - Errors

Table B-2. PDH Tests, Option UKK (120 Ω Bal Back to Back)

No.	Description	No.	Description
2110	2 Mb/s, HDB3, PRBS - Signal Loss	2111	2 Mb/s, HDB3, PRBS - Pattern Loss
2114	2 Mb/s, HDB3, PRBS - Errors	2120	704 kb/s, AMI, WORD - Signal Loss
2121	704 kb/s, AMI, WORD - Pattern Loss	2124	704 kb/s, AMI, WORD - Errors

**Table B-3.
PDH Tests, Option UKK (Offset, Frequency Measurement)**

No.	Description	No.	Description
2130	704 kHz, 0 ppm - Signal Loss	2133	704 kHz, 0 ppm - Frequency Low
2134	704 kHz, 0 ppm - Frequency High	2140	2 MHz, 0 ppm - Signal Loss
2143	2 MHz, 0 ppm - Frequency Low	2144	2 MHz, 0 ppm - Frequency High
2150	8 MHz, 0 ppm - Signal Loss	2153	8 MHz, 0 ppm - Frequency Low
2154	8 MHz, 0 ppm - Frequency High	2160	8 MHz, -100 ppm - Signal Loss
2163	8 MHz, -100 ppm - Frequency Low	2164	8 MHz, -100 ppm - Frequency High
2170	8 Mb/s, +100 ppm - Signal Loss	2173	8 MHz, +100 ppm - Frequency Low
2174	8 Mb/s, +100 ppm - Frequency High	2180	34 MHz, 0 ppm - Signal Loss
2183	34 MHz, 0 ppm - Frequency Low	2184	34 MHz, 0 ppm - Frequency High
2190	34 MHz, -100 ppm - Signal Loss	2193	34 MHz, -100 ppm - Frequency Low
2194	34 MHz, -100 ppm - Frequency High	2200	34 MHz, +100 ppm - Signal Loss
2203	34 MHz, +100 ppm - Frequency Low	2204	34 MHz, +100 ppm - Frequency High
2210	140 MHz, 0 ppm - Signal Loss	2213	140 MHz, 0 ppm - Frequency Low
2214	140 MHz, 0 ppm - Frequency High	2220	140 MHz, -100 ppm - Signal Loss
2223	140 MHz, -100 ppm - Frequency Low	2224	140 MHz, -100 ppm - Frequency High
2230	140 MHz, +100 ppm - Signal Loss	2233	140 MHz, +100 ppm - Frequency Low
2234	140 MHz, +100 ppm - Frequency High		

B-2 Self Test Fail Numbers

Table B-4. PDH Tests, Option UKK (Error Add/Error Count)

No.	Description	No.	Description
2243	140 Mb/s, No Error - Count Low	2244	140 Mb/s, No Error - Count High
2253	140 Mb/s, 5 Errors - Count Low	2254	140 Mb/s, 5 Errors - Count High
2263	140 Mb/s, Error All - Count Low	2264	140 Mb/s, Error All - Count High

Table B-5. PDH Tests, Option UKK (Clock Recovery)

No.	Description	No.	Description
2273	704 kb/s - Result Low	2274	704 kb/s - Result High
2283	2 Mb/s - Result Low	2284	2 Mb/s - Result High
2293	8 Mb/s - Result Low	2294	8 Mb/s - Result High
2303	34 Mb/s - Result Low	2304	34 Mb/s - Result High
2313	140 Mb/s - Result Low	2314	140 Mb/s - Result High

Table B-6. PDH Tests, Option UKK (FAS Word)

No.	Description	No.	Description
2320	FAS register write error	2330	FAS 2 Mb/s - Signal Loss
2335	FAS 2 Mb/s - Not Locked	2340	FAS 8 Mb/s - Signal Loss
2341	FAS Word 8 Mb/s - Not Locked	2344	FAS Word 8 Mb/s - Errors
2345	Non FAS Word 8 Mb/s - Locked	2350	FAS Word 34 Mb/s - Signal Loss
2351	FAS Word 34 Mb/s - Not Locked	2354	FAS Word 34 Mb/s - Errors
2355	Non FAS Word 34 Mb/s - Locked	2360	FAS Word 140 Mb/s - Signal Loss
2361	FAS Word 140 Mb/s - Not Locked	2364	FAS Word 140 Mb/s - Errors
2365	Non FAS Word 140 Mb/s - Locked		

Table B-7.
SPDH Tests, Option UKJ (Line Code 75Ω Unbal Back to Back)

No.	Description	No.	Description
3010	140 Mb/s, PRBS - Signal Loss	3011	140 Mb/s, PRBS - Pattern loss
3014	140 Mb/s, PRBS - Errors	3020	140 Mb/s, AIS WORD - Signal Loss
3021	140 Mb/s, AIS WORD - Pattern loss	3024	140 Mb/s, AIS WORD - Errors
3030	140 Mb/s, WORD - Signal Loss	3031	140 Mb/s, WORD - Pattern loss
3034	140 Mb/s, WORD - Errors	3040	34 Mb/s, PRBS - Signal Loss
3041	34 Mb/s, PRBS - Pattern loss	3044	34 Mb/s, PRBS - Errors
3050	8 Mb/s, PRBS - Signal Loss	3051	8 Mb/s, PRBS - Pattern loss
3054	8 Mb/s, PRBS - Errors	3060	2 Mb/s, HDB3, PRBS - Signal Loss
3061	2 Mb/s, HDB3, PRBS - Pattern loss	3064	2 Mb/s, HDB3, PRBS - Errors
3070	2 Mb/s, AMI, PRBS - Signal Loss	3071	2 Mb/s, AMI, PRBS - Pattern loss
3074	2 Mb/s, AMI, PRBS - Errors		

Table B-8.
SPDH Tests, Option UKJ (Line Code 120Ω Bal Back to Back)

No.	Description	No.	Description
3080	2 Mb/s, HDB3, PRBS - Signal Loss	3081	2 Mb/s, HDB3, PRBS - Pattern Loss
3084	2 Mb/s, HDB3, PRBS - Errors	3090	2 Mb/s, AMI, PRBS - Signal Loss
3091	2 Mb/s, AMI, PRBS - Pattern Loss	3094	2 Mb/s, AMI, PRBS - Errors

Table B-9.
SPDH Tests, Option UKJ (Offset, Frequency Measurement)

No.	Description	No.	Description
3100	140 MHz, 0 ppm - Signal Loss	3102	140 MHz, 0 ppm - VXCO not settled
3103	140 MHz, 0 ppm - Frequency Low	3104	140 MHz, 0 ppm - Frequency High
3110	140 MHz, +100 ppm - Signal Loss	3112	140 MHz, +100 ppm - VXCO not settled
3113	140 MHz, +100 ppm - Frequency Low	3114	140 MHz, +100 ppm - Frequency High

B-4 Self Test Fail Numbers

**Table B-9.
SPDH Tests, Option UKJ (Offset, Frequency Measurement)
(continued)**

No.	Description	No.	Description
3120	140 MHz, -100 ppm - Signal Loss	3122	140 MHz, -100 ppm - VXCO not settled
3123	140 MHz, -100 ppm - Frequency Low	3124	140 MHz, -100 ppm - Frequency High
3130	34 MHz, 0 ppm - Signal Loss	3132	34 MHz, 0 ppm - VXCO not settled
3133	34 MHz, 0 ppm - Frequency Low	3134	34 MHz, 0 ppm - Frequency High
3140	34 MHz, +100 ppm - Signal Loss	3142	34 MHz, +100 ppm - VXCO not settled
3143	34 MHz, +100 ppm - Frequency Low	3144	34 MHz, +100 ppm - Frequency High
3150	34 MHz, -100 ppm - Signal Loss	3152	34 MHz, -100 ppm - VXCO not settled
3153	34 MHz, -100 ppm - Frequency Low	3154	34 MHz, -100 ppm - Frequency High
3160	8 MHz, 0 ppm - Signal Loss	3162	8 MHz, 0 ppm - VXCO not settled
3163	8 MHz, 0 ppm - Frequency Low	3164	8 MHz, 0 ppm - Frequency High
3170	8 MHz, +100 ppm - Signal Loss	3172	8 MHz, +100 ppm - VXCO not settled
3173	8 MHz, +100 ppm - Frequency Low	3174	8 MHz, +100 ppm - Frequency High
3180	8 MHz, -100 ppm - Signal Loss	3182	8 MHz, -100 ppm - VXCO not settled
3183	8 MHz, -100 ppm - Frequency Low	3184	8 MHz, -100 ppm - Frequency High
3190	2 MHz, 0 ppm - Signal Loss	3192	2 MHz, 0 ppm - VXCO not settled
3193	2 MHz, 0 ppm - Frequency Low	3194	2 MHz, 0 ppm - Frequency High
3200	2 MHz, +100 ppm - Signal Loss	3202	2 MHz, +100 ppm - VXCO not settled
3203	2 MHz, +100 ppm - Frequency Low	3204	2 MHz, +100 ppm - Frequency High
3210	2 MHz, -100 ppm - Signal Loss	3212	2 MHz, -100 ppm - VXCO not settled
3213	2 MHz, -100 ppm - Frequency Low	3214	2 MHz, -100 ppm - Frequency High

Table B-10.
SPDH Tests, Option UKJ (34 Mb/s, Error Add/Error Count)

No.	Description	No.	Description
3223	Framed, Code, No Error - Count Low	3224	Framed, Code, No Error - Count High
3226	Framed, Code, No Error - Invalid result	3233	Framed, Code, 1 Error - Count Low
3234	Framed, Code, 1 Error - Count High	3236	Framed, Code, No Error - Invalid result
3243	Framed, Code, 1 in 10 ³ - Count Low	3244	Framed, Code, 1 in 10 ³ - Count High
3246	Framed, Code, 1 in 10 ³ - Invalid result	3253	Framed, Frame, No Error - Count Low
3254	Framed, Frame, No Error - Count High	3256	Framed, Frame, No Error - Invalid result
3263	Framed, Code, 1 Error - Count Low	3264	Framed, Code, 1 Error - Count High
3266	Framed, Code, 1 Error - Invalid result	3273	Framed, Code, 1 in 10 ³ - Count Low
3274	Framed, Code, 1 in 10 ³ - Count High	3276	Framed, Code, 1 in 10 ³ - Invalid result
3283	Framed, Bit, No Error - Count Low	3284	Framed, Bit, No Error - Count High
3286	Framed, Bit, No Error - Invalid result	3293	Framed, Frame, 1 Error - Count Low
3294	Framed, Bit, 1 Error - Count High	3296	Framed, Bit, 1 Error - Invalid result
3303	Framed, Bit, 1 in 10 ³ Error - Count Low	3304	Framed, Bit, 1 in 10 ³ Error - Count High
3306	Framed, Bit, 1 in 10 ³ - Error - Invalid result	3313	Structured, Frame, No Error - Count Low
3314	Structured, Frame, No Error - Count High	3316	Structured, Frame, No Error - Invalid result
3323	Structured, Frame, 1 Error - Count Low	3324	Structured, Frame, 1 Error - Count High
3326	Structured, Frame, 1 Error - Invalid result	3333	Structured, Frame, 1 in 10 ³ Error - Count Low
3334	Structured, Frame, 1 in 10 ³ Error - Count High	3336	Structured, Frame, 1 in 10 ³ Error - Invalid result
3343	Structured, Bit, No Error - Count Low	3344	Structured, Bit, No Error - Count High
3346	Structured, Bit, No Error - Invalid result	3353	Structured, Frame, 1 Error - Count Low
3354	Structured, Bit, 1 Error - Count High	3356	Structured, Bit, 1 Error - Invalid result

B-6 Self Test Fail Numbers

**Table B-10.
SPDH Tests, Option UKJ (34 Mb/s, Error Add/Error Count)
(continued)**

No.	Description	No.	Description
3363	Structured, Bit, 1 in 10 ³ Error - Count Low	3364	Structured, Bit, 1 in 10 ³ Error - Count High
3366	Structured, Bit, 1 in 10 ³ - Error - Invalid result		

Table B-11. SPDH Tests, Option UKJ (Framing/Unframed)

No.	Description	No.	Description
3377	140 Mb/s Unframed - Frame Loss	3387	140 Mb/s Framed - Frame Loss
3397	2 Mb/s Unframed - Frame Loss	3407	2Mb/s, PCM30 - Frame Loss
3408	2Mb/s, PCM30 - MultiFrame Loss	3417	2Mb/s, PCM31 - Frame Loss
3427	2Mb/s, PCM30CRC - Frame Loss	3428	2Mb/s, PCM30CRC - MultiFrame Loss
3437	2Mb/s, PCM31CRC - Frame Loss	3447	2 Mb/s, Drop - Frame Loss

Table B-12. SPDH Tests, Option UKJ (Structured Payloads)

No.	Description	No.	Description
3451	140 Mb/s ; 34 Mb/s - Pattern Loss	3454	140 Mb/s ; 34 Mb/s - Errors
3461	140 Mb/s ; 8 Mb/s - Pattern Loss	3464	140 Mb/s ; 8 Mb/s - Errors
3471	140 Mb/s ; 2 Mb/s - Pattern Loss	3474	140 Mb/s ; 2 Mb/s - Errors
3481	140 Mb/s ; 64 kb/s - Pattern Loss	3484	140 Mb/s ; 64 kb/s - Errors
3491	140 Mb/s ; N X 64 kb/s (odd channels) - Pattern Loss	3494	140 Mb/s ; N X 64 kb/s (odd channels) - Errors
3501	140 Mb/s ; N X 64 kb/s (even channels) - Pattern Loss	3504	140 Mb/s ; N X 64 kb/s (even channels) - Errors
3511	34 Mb/s ; 8 Mb/s - Pattern Loss	3514	34 Mb/s ; 8 Mb/s - Errors
3521	34 Mb/s ; 2 Mb/s - Pattern Loss	3524	34 Mb/s ; 2 Mb/s - Errors
3531	8 Mb/s ; 2 Mb/s - Pattern Loss	3534	8 Mb/s ; 2 Mb/s - Errors

Table B-13. SPDH Tests, Option UKJ (Patterns)

No.	Description	No.	Description
3541	140 Mb/s, Inverted PRBS9 - Pattern Loss	3544	140 Mb/s, Inverted PRBS9 - Errors
3551	140 Mb/s, PRBS11 - Pattern Loss	3554	140 Mb/s, PRBS11 - Errors
3561	140 Mb/s, Inverted PRBS15 - Pattern Loss	3564	140 Mb/s, Inverted PRBS15 - Errors
3571	140 Mb/s, PRBS23 - Pattern Loss	3574	140 Mb/s, PRBS23 - Errors
3581	140 Mb/s, WORD - Pattern Loss	3584	140 Mb/s, WORD - Errors
3591	2 Mb/s, PRBS9 - Pattern Loss	3594	2 Mb/s, PRBS9 - Errors
3601	2 Mb/s, Inverted PRBS11 - Pattern Loss	3604	2 Mb/s, Inverted PRBS11 - Errors
3611	2 Mb/s, PRBS15 - Pattern Loss	3614	2 Mb/s, PRBS15 - Errors
3621	2 Mb/s, Inverted PRBS23 - Pattern Loss	3624	2 Mb/s, Inverted PRBS23 - Errors
3631	2 Mb/s, WORD - Pattern Loss	3634	2 Mb/s, WORD - Errors

Table B-14. SPDH Tests, Option UKJ (Drop/Insert)

No.	Description	No.	Description
3640	Insert Port Loss of Signal	3641	Insert Port Excess Frequency Offset
3642	Drop Port Excess Frequency Offset		

Table B-15. SPDH Tests, Option UKJ (Round Trip Delay)

No.	Description	No.	Description
3651	140 Mb/s, 1 μ s - Pattern Loss	3653	140 Mb/s, 1 μ s - Result Low
3654	140 Mb/s, 1 μ s - Result High	3661	140 Mb/s, 2s - Pattern Loss
3663	140 Mb/s, 2s - Result Low	3664	140 Mb/s, 2s - Result High
3671	34 Mb/s, 1 μ s - Pattern Loss	3673	34 Mb/s, 1 μ s - Result Low
3674	34 Mb/s, 1 μ s - Result High	3681	34 Mb/s, 2s - Pattern Loss
3683	34 Mb/s, 2s - Result Low	3684	34 Mb/s, 2s - Result High

B-8 Self Test Fail Numbers

Table B-15.
SPDH Tests, Option UKJ (Round Trip Delay) (continued)

No.	Description	No.	Description
3691	8 Mb/s, 1 μ s - Pattern Loss	3693	8 Mb/s, 1 μ s - Result Low
3694	8 Mb/s, 1 μ s - Result High	3701	8 Mb/s, 2s - Pattern Loss
3703	8 Mb/s, 2s - Result Low	3704	8 Mb/s, 2s - Result High
3711	2 Mb/s, 1 μ s - Pattern Loss	3713	2 Mb/s, 1 μ s - Result Low
3714	2 Mb/s, 1 μ s - Result High	3721	2 Mb/s, 2s - Pattern Loss
3723	2 Mb/s, 2s - Result Low	3724	2 Mb/s, 2s - Result High
3731	STM-1, 140 Mb/s, 1 μ s - Pattern Loss	3733	STM-1, 140 Mb/s, 1 μ s - Result Low
3734	STM-1, 140 Mb/s, 1 μ s - Result High	3741	STM-1, 140 Mb/s, 2s - Pattern Loss
3743	STM-1, 140 Mb/s, 2s - Result Low	3744	STM-1, 140 Mb/s, 2s - Result High
3751	STM-1, 34 Mb/s, 1 μ s - Pattern Loss	3753	STM-1, 34 Mb/s, 1 μ s - Result Low
3754	STM-1, 34 Mb/s, 1 μ s - Result High	3761	STM-1, 34 Mb/s, 2s - Pattern Loss
3763	STM-1, 34 Mb/s, 2s - Result Low	3764	STM-1, 34 Mb/s, 2s - Result High
3771	STM-1, 2 Mb/s, 1 μ s - Pattern Loss	3773	STM-1, 2 Mb/s, 1 μ s - Result Low
3774	STM-1, 2 Mb/s, 1 μ s - Result High	3781	STM-1, 2 Mb/s, 2s - Pattern Loss
3783	STM-1, 2 Mb/s, 2s - Result Low	3784	STM-1, 2 Mb/s, 2s - Result High

Table B-16. SDH Tests Option A1T (STM-1)

No.	Description	No.	Description
721	Sync Loss	724	Bit Errors
731	Monitor, False Sync	741	Rx loss of Signal

Table B-17. SDH Tests Option A1T (STM-1 Frequency Offset)

No.	Description	No.	Description
751	STM-1 - Signal Loss	753	STM-1, 0 ppm - Frequency Low
754	STM-1, 0 ppm - Frequency High	761	STM-1, +100 ppm - Signal Loss
763	STM-1, +100 ppm - Offset Low	764	STM-1, +100 ppm - Offset High
771	STM-1, -100 ppm - Signal Loss	773	STM-1, -100 ppm - Offset Low
774	STM-1 -100 ppm - Offset High	781	Clock Ref, Clock Loss
791	Clock Ref, false lock		

Table B-18. SDH Tests Option A1T (STM-1, Overhead)

No.	Description	No.	Description
7101	Overhead processor failed	7102	Path Overhead fail
7104	section Overhead fail	7111	VC4 J1 fail
7121	B1 Error Add, Sync Loss	7123	B1 Errors, Result Low
7124	B1 Errors, Result High	7131	B2 Error Add, Sync Loss
7133	B2 Errors, Result Low	7134	B2 Errors, Result High
7141	B3 Error Add, Sync Loss	7143	B3 Errors, Result Low
7144	B3 Errors, Result High	7151	MS FEBE Error Add, Sync Loss
7153	MS FEBE Errors, Result Low	7154	MS FEBE Errors, Result High
7161	PIEC Error Add, Sync Loss	7163	PIEC Errors, Result Low
7164	PIEC Errors, Result High		

B-10 Self Test Fail Numbers

Table B-19. SDH Tests Option A1T (Frame Error Add)

7171	Error Add Off - Loss of Frame	7172	Error Add 1 in 4 - Loss of Frame
7173	Error Add 2 in 4 - Loss of Frame	7174	Error Add 3 in 4 - Loss of Frame
7175	Error Add 4 in 4 - Frame Sync	7176	Error Add 3 in 4 - Frame Sync
7177	Error Add 2 in 4 - Loss of Frame	7178	Error Add 1 in 4 - Loss of Frame
7179	Error Add Off - Loss of Frame		

Table B-20. SDH Tests Option A1T (140 Mb/s Payload)

7181	Bit Errors - Sync Loss	7183	Bit Errors - Result Low
7184	Bit Errors - Result High	7191	Error Add 1E3, Offset +100 ppm - Sync Loss
7193	Error Add 1E3, Offset +100 ppm - Result Low	7194	Error Add 1E3, Offset +100 ppm - Result High
7201	Error Add 1E3, Offset -100 ppm - Sync Loss	7203	Error Add 1E3, Offset -100 ppm - Result Low
7204	Error Add 1E3, Offset -100 ppm - Result High		

Table B-21. SDH Tests Option A1T (TU3 Payload)

7211	VC3 J1 Fail	7221	VC3 B3 Single Error - Sync Loss
7223	VC3 B3 Single Error - Result Low	7224	VC3 B3 Single Error - Result High
7231	VC3 FEBE Single Error - Sync Loss	7233	VC3 FEBE Single Error - Result Low
7234	VC3 FEBE Single Error - Result High	7241	Payload Bit Single Error - Sync Loss
7243	Payload Bit Single Error - Result Low	7244	Payload Bit Single Error - Result High
7251	Background Pattern - RX False Sync	7261	Background Pattern - TUG 1 Pattern Loss
7262	Background Pattern - TUG 3 Pattern Loss		

Table B-22. SDH Tests Option A1T (TU12 Payload Overhead)

7271	Async - A1,A2 Sync Loss	7284	Async - B1 Errors
7294	Async - B2 errors	7304	Async - B3 Errors
7314	Async - FEBE Errors	7324	Async - V5 BIP2 Errors
7334	Async - V5 FEBE Errors	7341	Floating Byte - A1,A2 Sync Loss
7354	Floating Byte - B1 Errors	7364	Floating Byte - B2 Errors
7374	Floating Byte - B3 Errors	7384	Floating Byte - FEBE Errors
7394	Floating Byte - V5 BIP2 Errors	7404	Floating Byte - V5 FEBE Errors
7411	Async V5 BIP2 Add - Sync Loss	7413	Async V5 BIP2 Add - Result Low
7414	Async V5 BIP2 Add - Result High	7421	Async V5 FEBE Add - Sync Loss
7423	Async V5 FEBE Add - Result Low	7424	Async V5 FEBE Add - Result High
7431	Async Payload Bit Add - Sync Loss	7433	Async Payload Bit Add - Result Low
7434	Async Payload Bit Add - Result High	7431	Floating Byte Payload Bit Add - Sync Loss
7433	Floating Byte Payload Bit Add - Result Low	7434	Floating Byte Payload Bit Add - Result High

Table B-23. SDH Tests Option A1T (Payload Pattern)

7451	140 Mb/s, PRBS23 - Sync Loss	7453	140 Mb/s, PRBS23 - Result Low
7454	140 Mb/s, PRBS23 - Result High	7461	TU3, PRBS15 - Sync Loss
7463	TU3, PRBS15 - Result Low	7464	TU3, PRBS15 - Result High
7471	TU12, WORD - Sync Loss	7473	TU12, WORD - Result Low
7474	TU12, WORD - Result High	7481	TU2, PRBS9 - Sync Loss
7483	TU2, PRBS9 - Result Low	7484	TU2, PRBS9 - Result High
7491	Background PRBS9 - False Pattern Sync TUG1	7501	Background PRBS9 - False Pattern Sync TUG2

B-12 Self Test Fail Numbers

Table B-24. SDH Tests Option A1T (TU2 Payload Bit Error Add)

7511	Sync Loss	7513	Result Low
7514	Result High		

**Table B-25.
SDH Tests Option A1T (Freq Offset/Pointer Movements)**

7521	140 Mb/s, A1,A2 - Sync Loss	7531	140 Mb/s, H1,H2 - Loss of Pointer
7544	140 Mb/s, B1 - Errors	7554	140 Mb/s, B2 - Errors
7564	140 Mb/s, B2 - Errors	7573	140 Mb/s, +100 ppm - Implied VC Offset Low
7574	140 Mb/s, +100 ppm - Implied VC Offset High	7583	140 Mb/s, -100 ppm - Implied VC Offset Low
7584	140 Mb/s, -100 ppm - Implied VC Offset High	7591	TU3, A1,A2 - Sync Loss
7601	TU3, H1,H2 - Loss of Pointer	7614	TU3, B1 - Errors
7624	TU3, B2 - Errors	7634	TU3, B3 - Errors
7644	TU3, TU BIP - Errors	7653	TU3, +100 ppm - Implied VC Offset Low
7654	TU3, +100 ppm - Implied VC Offset High	7663	TU3, -100 ppm - Implied VC Offset Low
7664	TU3, -100 ppm - Implied VC Offset High	7671	TU12, A1,A2 - Sync Loss
7681	TU12, H1,H2 - Loss of Pointer	7694	TU12, B1 - Errors
7704	TU12, B2 - Errors	7714	TU12, B3 - Errors
7724	TU12, TU BIP - Errors	7733	TU12, +100 ppm - Implied VC Offset Low
7734	TU12, +100 ppm - Implied VC Offset High	7743	TU12, -100 ppm - Implied VC Offset Low
7744	TU12, -100 ppm - Implied VC Offset High		

Table B-26. SDH Tests Option A1T (Thru Mode and DCC)

7751	Thru Mode - H4 Frame Sync Loss	7761	RS DCC Loopback Fail
7771	MS DCC Loopback Fail		

Table B-27. SDH Tests Option US1 (STM-1)

No.	Description	No.	Description
821	Signal Loss	831	Sync Loss
834	Bit Errors		

Table B-28. SDH Tests Option US1 (STM-1, Frequency Offset)

No.	Description	No.	Description
841	STM-1 - Signal Loss	843	STM-1, 0 ppm - Frequency Low
844	STM-1, 0 ppm - Frequency High	851	STM-1, +100 ppm - Signal Loss
853	STM-1, +100 ppm - Offset Low	854	STM-1, +100 ppm - Offset High
861	STM-1, -100 ppm - Signal Loss	863	STM-1, -100 ppm - Offset Low
864	STM-1 -100 ppm - Offset High		

**Table B-29.
SDH Tests Option US1 (STM-1, 140 Mb/s Payload/Overhead)**

No.	Description	No.	Description
871	A1,A2 Sync Loss	884	B1 BIP Errors
894	B2 BIP Errors	8104	Path B3 BIP Errors
8114	Path FEBE Errors	8121	VC-4 J1 Byte Error
8131	B1 Errored - Sync Loss	8133	B1 Errors - Count Low
8134	B1 Errors - Count High	8141	B2 Errored - Sync Loss
8143	B2 Errors - Count Low	8144	B2 Errors - Count High
8151	B3 Errored - Sync Loss	8153	B3 Errors - Count Low
8161	Payload Errored - Sync Loss	8163	Payload Errored - Bit Errors Low
8164	Payload Errored - Bit Errors High		

B-14 Self Test Fail Numbers

Table B-30.
SDH Tests Option US1 (STM-1, 34 Mb/s Payload/Overhead)

No.	Description	No.	Description
8171	A1,A2 Sync Loss	8184	B1 BIP Errors
8194	B2 BIP Errors	8204	VC-3 B3 BIP Errors
8214	VC-3 FEBE Errors	8221	VC-3 J1 Byte Error
8231	VC3 FEBE Errored - Sync Loss	8233	VC-3 FEBE - Error Rate Low
8234	VC-3 FEBE - Error Rate High	8241	Payload Errored - Sync loss
8243	Payload Errored - Error Rate Low	8244	Payload Errored - Error Rate High

Table B-31.
SDH Tests Option US1 (STM-1, 2 Mb/s Payload/Overhead)

No.	Description	No.	Description
8251	A1,A2 Sync Loss	8264	B1 BIP Errors
8274	B2 BIP Errors	8284	B3 BIP Errors
8294	Path FEBE Errors	8304	V5 BIP-2 Errors
8314	V5 FEBE Errors	8321	V5 BIP-2 Errored - Sync Loss
8323	V5 BIP-2 - Error Rate Low	8324	V5 BIP-2 - Error Rate High
8331	V5 FEBE Errored - Sync Loss	8333	V5 FEBE - Error Rate Low
8334	V5 FEBE - Error Rate High	8341	Payload Errored - Sync Loss
8343	Payload Errored - Error Rate Low	8344	Payload Errored - Error Rate High

Table B-32.
SDH Tests Option US1 (Payload/Background Patterns)

No.	Description	No.	Description
8351	140 Mb/s PRBS $2^{23}-1$ - Sync Loss	8354	140 Mb/s PRBS $2^{23}-1$ - Bit Errors
8361	34 Mb/s PRBS $2^{23}-1$ - Sync Loss	8364	34 Mb/s PRBS $2^{23}-1$ - Bit Errors
8371	2 Mb/s PRBS $2^{23}-1$ - Sync Loss	8374	2 Mb/s PRBS $2^{23}-1$ - Bit Errors

Table B-32.
SDH Tests Option US1 (Payload/Background Patterns)
(continued)

No.	Description	No.	Description
8381	2 Mb/s PRBS 2 ¹⁵ -1 - Sync Loss	8384	2 Mb/s PRBS 2 ¹⁵ -1 - Bit Errors
8391	34 Mb/s PRBS 2 ¹⁵ -1 - Sync Loss	8394	34 Mb/s PRBS 2 ¹⁵ -1 - Bit Errors
8401	140 Mb/s PRBS 2 ¹⁵ -1 - Sync Loss	8404	140 Mb/s PRBS 2 ¹⁵ -1 - Bit Errors
8411	2 Mb/s All Ones - Sync Loss	8414	2 Mb/s All Ones - Bit Errors
8421	34 Mb/s All Zeros - Sync Loss	8424	34 Mb/s All Zeros - Bit Errors
8431	140 Mb/s All Ones - Sync Loss	8434	140 Mb/s All Ones - Bit Errors
8441	140 Mb/s 1010 - Sync Loss	8444	140 Mb/s 1010 - Bit Errors
8451	140 Mb/s 16 bit WORD - Sync Loss	8454	140 Mb/s 16 bit WORD - Bit Errors
8461	34 Mb/s 16 bit WORD - Sync Loss	8464	34 Mb/s 16 bit WORD - Bit Errors
8471	2 Mb/s 16 bit WORD - Sync Loss	8474	2 Mb/s 16 bit WORD - Bit Errors
8481	2 Mb/s Background - Sync Loss	8491	2 Mb/s Background - No Sync Loss

Table B-33. SDH Tests Option US1 (Alarm Detect)

No.	Description	No.	Description
8511	STM-1 Out of Frame	8512	STM-1 Frame Loss
8521	STM-1 Frame Move - No OOF History	8522	STM-1 Frame Move - LOF History
8531	STM-1 Out of Frame	8532	STM-1 Frame Loss
8541	STM-1 MS AIS - Sync Loss	8553	STM-1 MS AIS - No Alarm
8564	STM-1 MS AIS - Alarm Not Canceled	8571	STM-1 MS FERF - Sync Loss
8583	STM-1 MS FERF - No Alarm	8594	STM-1 MS FERF - Alarm Not Canceled
8601	STM-1 Path AIS - Sync Loss	8613	STM-1 Path AIS - No Alarm
8624	STM-1 Path AIS - Alarm Not Canceled	8661	STM-1 TU3 Path AIS - Sync Loss
8673	STM-1 TU3 Path AIS - No Alarm	8684	STM-1 TU3 Path AIS - Alarm Not Canceled

B-16 Self Test Fail Numbers

Table B-33. SDH Tests Option US1 (Alarm Detect) (continued)

No.	Description	No.	Description
8691	STM-1 TU3 Path FERF - Sync Loss	8703	STM-1 TU3 Path FERF - No Alarm
8714	STM-1 TU3 Path FERF - Alarm Not Canceled	8721	STM-1 TU12 Path AIS - Sync Loss
8733	STM-1 TU12 Path AIS - No Alarm	8744	STM-1 TU12 Path AIS - Alarm Not Canceled
8751	STM-1 TU12 Path FERF - Sync Loss	8763	STM-1 TU12 Path FERF - No Alarm
8774	STM-1 TU12 Path FERF - Alarm Not Canceled	8781	STM-1 Internal Ref - Clock Loss
8791	STM-1 Internal Ref - No Clock Loss	8801	STM-1 VC3 Path B3 - Sync Loss
8803	STM-1 VC-3 B3 - Error Rate Low	8804	STM-1 VC-3 B3 - Error Rate High

Table B-34. Optical Tests Option UH1 (STM-1)

No.	Description	No.	Description
911	Signal Loss	921	Alarms Present
931	Pattern Sync Loss	934	Bit Errors
941	Error Add - Pattern Sync Loss	943	Error Add - Bit Error Rate Low
944	Error Add - Bit Error Rate High	951	TX OFF - No Signal Loss

Table B-35. Optical Tests Options UH2, URU (STM-1)

No.	Description	No.	Description
9101	STM-1 - Signal Loss	9111	STM-1 - Alarms Present
9121	STM-1 - Pattern Sync Loss	9124	STM-1 - Bit Errors
9131	STM-1, Error Add - Pattern Sync Loss	9133	STM-1, Error Add - Bit Error Rate Low
9134	STM-1, Error Add - Bit Error Rate High	9141	STM-1 TX OFF - No Signal Loss
9151	STM-1 #1 - Signal Loss	9161	STM-1 #1 - Alarms Present
9171	STM-1 #1 - Pattern Sync Loss	9174	STM-1 #1 - Bit Errors

Table B-35. Optical Tests Options UH2, URU (STM-1) (continued)

No.	Description	No.	Description
9181	STM-1 #1, Error Add - Pattern Sync Loss	9183	STM-1 #1, Error Add - Error Rate Low
9184	STM-1 #1, Error Add - Error Rate High	9191	STM-1 #1, TX OFF - No Signal Loss
9201	STM-1 #2 - Signal Loss	9211	STM-1 #2 - Alarms Present
9221	STM-1 #2 - Pattern Sync Loss	9224	STM-1 #2 - Bit Errors
9231	STM-1 #2, Error Add - Pattern Sync Loss	9233	STM-1 #2, Error Add - Error Rate Low
9234	STM-1 #2, Error Add - Error Rate High	9241	STM-1 #2, TX OFF - No Signal Loss
9251	STM-1 #3 - Signal Loss	9261	STM-1 #3 - Alarms Present
9271	STM-1 #3 - Pattern Sync Loss	9274	STM-1 #3 - Bit Errors
9281	STM-1 #3, Error Add - Pattern Sync Loss	9283	STM-1 #3, Error Add - Error Rate Low
9284	STM-1 #3, Error Add - Error Rate High	9291	STM-1 #3, TX OFF - No Signal Loss
9301	STM-1 #4 - Signal Loss	9311	STM-1 #4 - Alarms Present
9321	STM-1 #4 - Pattern Sync Loss	9324	STM-1 #4 - Bit Errors
9331	STM-1 #4, Error Add - Pattern Sync Loss	9333	STM-1 #4, Error Add - Error Rate Low
9334	STM-1 #4, Error Add - Error Rate High	9341	STM-1 #4, TX OFF - No Signal Loss
9351	Frame or Pointer Sync Loss	9364	RS B1 BIP Errors
9374	MS B2 BIP Errors		

B-18 Self Test Fail Numbers

Table B-36. JITTER Generator Tests (Opt UHK)

No.	Description	No.	Description
1411	140 Mb/s PDH, 2 kHz - Errors	1419	140 Mb/s PDH, 2 kHz - VCO not Settling
1421	140 Mb/s PDH, 5 kHz - Errors	1431	34 Mb/s PDH, 2 kHz - Errors
1439	34 Mb/s PDH, 2 kHz - VCO not Settling	1441	34 Mb/s PDH, 5 kHz - Errors
1452	34 Mb/s PDH, 100 kHz - No Errors	1461	8 Mb/s PDH, 2 kHz - Errors
1469	8 Mb/s PDH, 2 kHz - VCO not Settling	1471	8 Mb/s PDH, 5 kHz - Errors
1482	8 Mb/s PDH, 50 kHz - No Errors	1491	2 Mb/s PDH, 2 kHz - Errors
1499	2 Mb/s PDH, 2 kHz - VCO not Settling	14102	2 Mb/s PDH, 5 kHz - No Errors
14111	140 Mb/s SDH, 2 kHz - Errors	14121	140 Mb/s SDH, 5 kHz - Errors

Table B-37. JITTER Receiver Tests (Opt UHN)

No.	Description	No.	Description
14133	Intrinsic Jitter 140 Mb/s, PRBS - Result Low	14134	Intrinsic Jitter 140 Mb/s, PRBS - Result High
14138	Intrinsic Jitter 140 Mb/s, PRBS - Jitter Unlock	14139	Intrinsic Jitter 140 Mb/s - VCO not Settling
14143	Intrinsic Jitter 140 Mb/s, All 0's - Result Low	14144	Intrinsic Jitter 140 Mb/s, All 0's - Result High
14148	Intrinsic Jitter 140 Mb/s, All 0's - Jitter Unlock	14153	Intrinsic Jitter 140 Mb/s, 1000 - Result Low
14154	Intrinsic Jitter 140 Mb/s, 1000 - Result High	14158	Intrinsic Jitter 140 Mb/s, 1000 - Jitter Unlock
14163	Intrinsic Jitter 140 Mb/s, All 1's - Result Low	14164	Intrinsic Jitter 140 Mb/s, All 1's - Result High
14168	Intrinsic Jitter 140 Mb/s, All 1's - Jitter Unlock	14173	Intrinsic Jitter 34 Mb/s, PRBS - Result Low
14174	Intrinsic Jitter 34 Mb/s, PRBS - Result High	14178	Intrinsic Jitter 140 Mb/s, PRBS - Jitter Unlock
14179	Intrinsic Jitter 34 Mb/s - VCO not Settling	14183	Intrinsic Jitter 34 Mb/s, All 0's - Result Low

Table B-37. JITTER Receiver Tests (Opt UHN) (continued)

No.	Description	No.	Description
14184	Intrinsic Jitter 34 Mb/s, All 0's - Result High	14188	Intrinsic Jitter 34 Mb/s, All 0's - Jitter Unlock
14193	Intrinsic Jitter 34 Mb/s, 1000 - Result Low	14194	Intrinsic Jitter 34 Mb/s, 1000 - Result High
14198	Intrinsic Jitter 34 Mb/s, 1000 - Jitter Unlock	14203	Intrinsic Jitter 34 Mb/s, All 1's - Result Low
14204	Intrinsic Jitter 34 Mb/s, All 1's - Result High	14208	Intrinsic Jitter 34 Mb/s, All 1's - Jitter Unlock
14213	Intrinsic Jitter 8 Mb/s, PRBS - Result Low	14214	Intrinsic Jitter 8 Mb/s, PRBS - Result High
14218	Intrinsic Jitter 8 Mb/s, PRBS - Jitter Unlock	14219	Intrinsic Jitter 8 Mb/s - VCO not Settling
14223	Intrinsic Jitter 8 Mb/s, All 0's - Result Low	14224	Intrinsic Jitter 8 Mb/s, All 0's - Result High
14228	Intrinsic Jitter 8 Mb/s, All 0's - Jitter Unlock	14233	Intrinsic Jitter 8 Mb/s, 0001 - Result Low
14234	Intrinsic Jitter 8 Mb/s, 1000 - Result High	14238	Intrinsic Jitter 8 Mb/s, 1000 - Jitter Unlock
14243	Intrinsic Jitter 8 Mb/s, All 1's - Result Low	14244	Intrinsic Jitter 8 Mb/s, All 1's - Result High
14248	Intrinsic Jitter 8 Mb/s, All 1's - Jitter Unlock	14253	Intrinsic Jitter 2 Mb/s, PRBS - Result Low
14254	Intrinsic Jitter 2 Mb/s, PRBS - Result High	14258	Intrinsic Jitter 2 Mb/s, PRBS - Jitter Unlock
14259	Intrinsic Jitter 8 Mb/s, - VCO not Settling	14263	Intrinsic Jitter 2 Mb/s, All 0's - Result Low
14264	Intrinsic Jitter 2 Mb/s, All 0's - Result High	14268	Intrinsic Jitter 2 Mb/s, All 0's - Jitter Unlock
14273	Intrinsic Jitter 2 Mb/s, 1000 - Result Low	14274	Intrinsic Jitter 2 Mb/s, 1000 - Result High

B-20 Self Test Fail Numbers

Table B-37. JITTER Receiver Tests (Opt UHN) (continued)

No.	Description	No.	Description
14278	Intrinsic Jitter 2 Mb/s, 1000 - Jitter Unlock	14283	Intrinsic Jitter 2 Mb/s, All 1's - Result Low
14284	Intrinsic Jitter 2 Mb/s, All 1's - Result High	14288	Intrinsic Jitter 2 Mb/s, All 1's - Jitter Unlock

Table B-38. JITTER Back to Back Tests (Opt UHK and UHN)

No.	Description	No.	Description
14293	140 Mb/s, 0 UI, 10 Hz - Result Low	14294	140 Mb/s, 0 UI, 10 Hz - Result High
14298	140 Mb/s, 0 UI, 10 Hz - Jitter Unlock	14299	140 Mb/s - VCO not Settling
14303	140 Mb/s, 10 UI, 100 Hz - Result Low	14304	140 Mb/s, 10 UI, 100 Hz - Result High
14308	140 Mb/s, 10 UI, 100 Hz - Jitter Unlock	14313	140 Mb/s, 1 UI, 10 kHz - Result Low
14314	140 Mb/s, 1 UI, 10 kHz - Result High	14318	140 Mb/s, 1 UI, 10 kHz - Jitter Unlock
14323	140 Mb/s, 0.6 UI, 3 MHz - Result Low	14324	140 Mb/s, 0.6 UI, 3 MHz - Result High
14328	140 Mb/s, 0.6 UI, 3 MHz - Jitter Unlock	14333	34 Mb/s, 0 UI, 10 Hz - Result Low
14334	34 Mb/s, 0 UI, 10 Hz - Result High	14338	34 Mb/s, 0 UI, 10 Hz - Jitter Unlock
14339	34 Mb/s - VCO not Settling	14343	34 Mb/s, 10 UI, 100 Hz - Result Low
14344	34 Mb/s, 10 UI, 100 Hz - Result High	14348	34 Mb/s, 10 UI, 100 Hz - Jitter Unlock
14353	34 Mb/s, 1 UI, 200 kHz - Result Low	14354	34 Mb/s, 1 UI, 200 kHz - Result High
14358	34 Mb/s, 1 UI, 200 kHz - Jitter Unlock	14363	34 Mb/s, 0.6 UI, 500 kHz - Result Low
14364	34 Mb/s, 0.6 UI, 500 kHz - Result High	14368	34 Mb/s, 0.6 UI, 500 kHz - Jitter Unlock
14373	8 Mb/s, 0 UI, 10 Hz - Result Low	14374	8 Mb/s, 0 UI, 10 Hz - Result High
14378	8 Mb/s, 0 UI, 10 Hz - Jitter Unlock	14379	8 Mb/s - VCO not Settling
14383	8 Mb/s, 10 UI, 100 Hz - Result Low	14384	8 Mb/s, 10 UI, 100 Hz - Result High
14388	8 Mb/s, 10 UI, 100 Hz - Jitter Unlock	14393	8 Mb/s, 1 UI, 100 kHz - Result Low
14394	8 Mb/s, 1 UI, 100 kHz - Result High	14398	8 Mb/s, 1 UI, 100 kHz - Jitter Unlock

Table B-38.
JITTER Back to Back Tests (Opt UHK and UHN) (continued)

No.	Description	No.	Description
14403	8 Mb/s, 0.6 UI, 300 kHz - Result Low	14404	8 Mb/s, 0.6 UI, 300 kHz - Result High
14408	8 Mb/s, 0.6 UI, 300 kHz - Jitter Unlock	14413	2 Mb/s, 0 UI, 10 Hz - Result Low
14414	2 Mb/s, 0 UI, 10 Hz - Result High	14418	2 Mb/s, 0 UI, 10 Hz - Jitter Unlock
14419	2 Mb/s - VCO not Settling	14423	2 Mb/s, 10 UI, 100 Hz - Result Low
14424	2 Mb/s, 10 UI, 100 Hz - Result High	14428	2 Mb/s, 10 UI, 100 Hz - Jitter Unlock
14433	2 Mb/s, 1 UI, 25 kHz - Result Low	14434	2 Mb/s, 1 UI, 25 kHz - Result High
14438	2 Mb/s, 1 UI, 25 kHz - Jitter Unlock	14443	2 Mb/s, 0.6 UI, 80 kHz - Result Low
14444	2 Mb/s, 0.6 UI, 80 kHz - Result High	14448	2 Mb/s, 0.6 UI, 80 kHz - Jitter Unlock

Table B-39. STM-1 Electrical JITTER Receiver Tests (Opt A1M)

No.	Description	No.	Description
14493	Intrinsic Jitter, Range 1_6, PRBS - Result Low	14494	Intrinsic Jitter, Range 1_6, PRBS - Result High
14496	Intrinsic Jitter Range 1_6, PRBS - Loss of Signal	14498	Intrinsic Jitter Range 1_6, PRBS - Jitter Unlock
14499	Intrinsic Jitter Range 1_6, PRBS - VCO not Settling	14503	Intrinsic Jitter Range 1_6, All 0's - Result Low
14504	Intrinsic Jitter, Range 1_6, All 0's - Result High	14506	Intrinsic Jitter, Range 1_6, All 0's - Loss of Signal
14508	Intrinsic Jitter, Range 1_6, All 0's - Jitter Unlock	14513	Intrinsic Jitter Range 1_6, All 1's - Result Low
14514	Intrinsic Jitter, Range 1_6, All 1's - Result High	14516	Intrinsic Jitter, Range 1_6, All 1's - Loss of Signal
14518	Intrinsic Jitter, Range 1_6, All 1's - Jitter Unlock	14523	Intrinsic Jitter Range 16, PRBS - Result Low

B-22 Self Test Fail Numbers

Table B-39.
STM-1 Electrical JITTER Receiver Tests (Opt A1M) (continued)

No.	Description	No.	Description
14524	Intrinsic Jitter, Range 16, PRBS - Result High	14526	Intrinsic Jitter, Range 16, PRBS - Loss of Signal
14528	Intrinsic Jitter, Range 16, PRBS - Jitter Unlock	14533	Intrinsic Jitter Range 16, All 0's - Result Low
14534	Intrinsic Jitter, Range 16, All 0's - Result High	14536	Intrinsic Jitter, Range 16, All 0's - Loss of Signal
14538	Intrinsic Jitter, Range 16, All 0's - Jitter Unlock	14543	Intrinsic Jitter Range 16, All 1's - Result Low
14544	Intrinsic Jitter, Range 16, All 1's - Result High	14546	Intrinsic Jitter, Range 16, All 1's - Loss of Signal
14548	Intrinsic Jitter, Range 16, All 1's - Jitter Unlock	14553	Jitter Off - Result Low
14554	Jitter Off - Result High	14556	Jitter Off - Loss of Signal
14558	Jitter Off - Jitter Unlock	14563	Jitter 5 UI, 100 Hz - Result Low
14564	Jitter 5 UI, 100 Hz - Result High	14566	Jitter 5 UI, 100 Hz - Loss of Signal
14568	Jitter 5 UI, 100 Hz - Jitter Unlock	14573	Jitter 5 UI, 1 kHz - Result Low
14574	Jitter 5 UI, 1 kHz - Result High	14576	Jitter 5 UI, 1 kHz - Loss of Signal
14578	Jitter 5 UI, 1 kHz - Jitter Unlock	14583	Jitter 1 UI, 10 kHz - Result Low
14584	Jitter 1 UI, 10 kHz - Result High	14586	Jitter 1 UI, 10 kHz - Loss of Signal
14588	Jitter 1 UI, 10 kHz - Jitter Unlock	14593	Jitter 1 UI, 100 kHz - Result Low
14594	Jitter 1 UI, 100 kHz - Result High	14596	Jitter 1 UI, 100 kHz - Loss of Signal
14598	Jitter 1 UI, 100 kHz - Jitter Unlock	14603	Jitter 0.5 UI, 1 MHz - Result Low
14604	Jitter 0.5 UI, 1 MHz - Result High	14606	Jitter 0.5 UI, 1 MHz - Loss of Signal
14608	Jitter 0.5 UI, 1 MHz - Jitter Unlock	14613	Jitter Hits 1 UI - Result Low
14614	Jitter Hits 1 UI - Result High	14616	Jitter Hits 1 UI - Loss of Signal
14618	Jitter Hits 1 UI - Jitter Unlock		

Table B-40. ATM Alarms, Back to Back Tests (Opt UKN)

No.	Description	No.	Description
15016	Pattern Loss not detected	15017	Pattern Loss detected
15026	Loss of Frame not detected	15027	Loss of Frame detected
15036	FERF not detected	15037	FERF detected
15046	AIS not detected	15047	AIS detected
15056	Cell Sync Loss not detected	15057	Cell Sync Loss detected
15066	Sel Cell not Rx'ed not detected	15067	Sel Cell not Rx'ed detected
15076	Congestion Experienced not detected	15077	Congestion Experienced detected
15086	VP AIS not detected	15087	VP AIS detected
15096	VP FERF not detected	15097	VP FERF detected
15106	VC AIS not detected	15107	VC AIS detected
15116	VC FERF not detected	15117	VC FERF detected
15126	Test Cell Loss not detected	15127	Test Cell Loss detected

Table B-41. ATM Bandwidth, Back to Back Tests (Opt UKN)

No.	Description	No.	Description
15133	F/G, 8000 c/s - Result Low	15134	F/G, 8000 c/s - Result High
15136	F/G, 8000 c/s - Result Invalid	15143	F/G, 4000 c/s - Result Low
15144	F/G, 4000 c/s - Result High	15146	F/G, 4000 c/s - Result Invalid
15153	F/G, 100 c/s - Result Low	15154	F/G, 100 c/s - Result High
15156	F/G, 100 c/s - Result Invalid	15163	F/G, 24000 c/s - Result Low
15164	F/G, 24000 c/s - Result High	15166	F/G, 24000 c/s - Result Invalid
15173	B/G 1, 70 % - Result Low	15174	B/G 1, 70 % - Result High
15176	B/G 1, 70 % - Result Invalid	15183	B/G 1, 25 % - Result Low
15184	B/G 1, 25 % - Result High	15186	B/G 1, 25 % - Result Invalid
15193	B/G 2, 45 % - Result Low	15194	B/G 2, 45 % - Result High

B-24 Self Test Fail Numbers

**Table B-41.
ATM Bandwidth, Back to Back Tests (Opt UKN) (continued)**

No.	Description	No.	Description
15196	B/G 2, 45 % - Result Invalid	15203	B/G 2, 20 % - Result Low
15204	B/G 2, 20 % - Result High	15206	B/G 2, 20 % - Result Invalid
15213	B/G 3, 25 % - Result Low	15214	B/G 3, 25 % - Result High
15216	B/G 3, 25 % - Result Invalid	15223	B/G 3, 15 % - Result Low
15224	B/G 3, 15 % - Result High	15226	B/G 3, 15 % - Result Invalid
15233	Fill (Idle), 10 % - Result Low	15234	Fill (Idle), 10 % - Result High
15236	Fill (Idle), 10 % - Result Invalid		

Table B-42. ATM Distribution, Back to Back Tests (Opt UKN)

No.	Description	No.	Description
15243	Periodic, SCNR Off - Result Low	15244	Periodic, SCNR Off - Result High
15245	Periodic, SCNR Off - Result Invalid	15246	Periodic, SCNR Off - SCNR alarm
15253	Burst, SCNR On - Result Low	15254	Burst, SCNR On - Result High
15255	Burst, SCNR On - Result Invalid	15256	Burst, SCNR OOn - No SCNR alarm
15243	Periodic + Burst, SCNR Off - Result Low	15244	Periodic + Burst, SCNR Off - Result High
15245	Periodic + Burst, SCNR Off - Result Invalid	15246	Periodic + Burst, SCNR Off - SCNR alarm

Table B-43. ATM Error Add, Back to Back Tests (Opt UKN)

No.	Description	No.	Description
15273	EMBIP, Error Add Off - Result Low	15274	EMBIP, Error Add Off - Result High
15276	EMBIP, Error Add Off - Result Invalid	15283	EMBIP, Error Add Single - Result Low
15284	EMBIP, Error Add Single - Result High	15286	EMBIP, Error Add Single - Result Invalid
15293	FEBE, Error Add Off - Result Low	15294	FEBE, Error Add Off - Result High

Table B-43.
ATM Error Add, Back to Back Tests (Opt UKN) (continued)

No.	Description	No.	Description
15296	FEBE, Error Add Off - Result Invalid	15303	FEBE, Error Add On - Result Low
15304	FEBE, Error Add On - Result High	15306	FEBE, Error Add On - Result Invalid
15313	Single HEC, Error Add Off - Result Low	15314	Single HEC, Error Add Off - Result High
15316	Single HEC, Error Add Off - Result Invalid	15323	Single HEC, Error Add Single - Result Low
15324	Single HEC, Error Add Single - Result High	15326	Single HEC, Error Add Single - Result Invalid
15333	Single HEC, Error Add Single - Result Low	15334	Single HEC, Error Add Single - Result High
15336	Single HEC, Error Add Single - Result Invalid	15343	Single HEC, Error Add 1 in 10 ³ - Result Low
15344	Single HEC, Error Add 1 in 10 ³ - Result High	15346	Single HEC, Error Add 1 in 10 ³ - Result Invalid
15353	Double HEC, Error Add Off - Result Low	15354	Double HEC, Error Add Off - Result High
15356	Double HEC, Error Add Off - Result Invalid	15363	Double HEC, Error Add Single - Result Low
15364	Double HEC, Error Add Single - Result High	15366	Double HEC, Error Add Single - Result Invalid
15373	Double HEC, Error Add Single - Result Low	15374	Double HEC, Error Add Single - Result High
15376	Double HEC, Error Add Single - Result Invalid	15383	Double HEC, Error Add 1 in 10 ³ - Result Low
15384	Double HEC, Error Add 1 in 10 ³ - Result High	15386	Double HEC, Error Add 1 in 10 ³ - Result Invalid
15393	Bit, Error Add Off - Result Low	15394	Bit, Error Add Off - Result High
15396	Bit, Error Add Off - Result Invalid	15403	Bit, Error Add Single - Result Low
15404	Bit, Error Add Single - Result High	15406	Bit, Error Add Single - Result Invalid

B-26 Self Test Fail Numbers

**Table B-43.
ATM Error Add, Back to Back Tests (Opt UKN) (continued)**

No.	Description	No.	Description
15413	Bit, Error Add Single - Result Low	15414	Bit, Error Add Single - Result High
15416	Bit, Error Add Single - Result Invalid	15423	Bit, Error Add 1 in 10 ³ - Result Low
15424	Bit, Error Add 1 in 10 ³ - Result High	15426	Bit, Error Add 1 in 10 ³ - Result Invalid

Table B-44. ATM Headers, Back to Back Tests (Opt UKN)

No.	Description	No.	Description
15433	F/G GFC=1 - Result Low	15434	F/G GFC=1 - Result High
15436	F/G GFC=1 - Result Invalid	15443	F/G GFC=15 - Result Low
15444	F/G GFC=15 - Result High	15446	F/G GFC=15 - Result Invalid
15453	F/G VPI=1 - Result Low	15454	F/G VPI=1 - Result High
15456	F/G VPI=1 - Result Invalid	15463	F/G VPI=255 - Result Low
15464	F/G VPI=255 - Result High	15466	F/G VPI=255 - Result Invalid
15473	F/G VPI=4095 - Result Low	15474	F/G VPI=4095 - Result High
15476	F/G VPI=4095 - Result Invalid	15483	F/G VCI=16 - Result Low
15484	F/G VCI=16 - Result High	15486	F/G VCI=16 - Result Invalid
15493	F/G VCI=65535 - Result Low	15494	F/G VCI=65535 - Result High
15496	F/G VCI=65535 - Result Invalid	15503	F/G PTI=000 - Result Low
15504	F/G PTI=000 - Result High	15506	F/G PTI=000 - Result Invalid
15513	F/G PTI=010 - Result Low	15514	F/G PTI=010 - Result High
15516	F/G PTI=010 - Result Invalid	15523	F/G CLP=0 - Result Low
15524	F/G CLP=0 - Result High	15526	F/G CLP=0 - Result Invalid
15533	F/G CLP=1 - Result Low	15534	F/G CLP=1 - Result High
15536	F/G CLP=1 - Result Invalid	15543	RX GFC=X - Result Low

**Table B-44.
ATM Headers, Back to Back Tests (Opt UKN) (continued)**

No.	Description	No.	Description
15544	RX GFC=X - Result High	15546	RX GFC=X - Result Invalid
15553	RX GFC=2 - Result Low	15554	RX GFC=2 - Result High
15556	RX GFC=2 - Result Invalid	15563	RX GFC=4 - Result Low
15564	RX GFC=4 - Result High	15566	RX GFC=4 - Result Invalid
15573	RX VPI=X - Result Low	15574	RX VPI=X - Result High
15576	RX VPI=X - Result Invalid	15583	RX VPI=0 - Result Low
15584	RX VPI=0 - Result High	15586	RX VPI=0 - Result Invalid
15593	RX VPI=255 - Result Low	15594	RX VPI=255 - Result High
15596	RX VPI=255 - Result Invalid	15603	RX VCI=X - Result Low
15604	RX VCI=X - Result High	15606	RX VCI=X - Result Invalid
15613	RX VCI=16 - Result Low	15614	RX VCI=16 - Result High
15616	RX VCI=16 - Result Invalid	15623	RX VCI=17 - Result Low
15624	RX VCI=17 - Result High	15626	RX VCI=17 - Result Invalid
15633	RX PTI=XXX - Result Low	15634	RX PTI=XXX - Result High
15636	RX PTI=XXX - Result Invalid	15643	RX PTI=0XX - Result Low
15644	RX PTI=0XX - Result High	15646	RX PTI=0XX - Result Invalid
15653	RX PTI=X1X - Result Low	15654	RX PTI=X1X - Result High
15656	RX PTI=X1X - Result Invalid	15663	RX PTI=XX0 - Result Low
15664	RX PTI=XX0 - Result High	15666	RX PTI=XX0 - Result Invalid
15673	RX CLP=X - Result Low	15674	RX CLP=X - Result High
15676	RX CLP=X - Result Invalid	15683	RX CLP=0 - Result Low
15684	RX CLP=0 - Result High	15686	RX CLP=0 - Result Invalid
15693	RX CLP=1 - Result Low	15694	RX CLP=1 - Result High
15696	RX CLP=1 - Result Invalid		

B-28 Self Test Fail Numbers

Table B-45. ATM Payloads, Back to Back Tests (Opt UKN)

No.	Description	No.	Description
15704	Cross Cell PRBS15 - Bit Errors	15714	Cross Cell PRBS23 - Bit Errors
15724	Single Cell PRBS9 - Bit Errors	15734	User Word 00000000 - Bit Errors
15744	User Word 11111111 - Bit Errors	15754	User Word 01010101 - Bit Errors
15764	Test Cell - Errored Cell Count		

Table B-46. ATM Test Cell, Back to Back Tests (Opt UKN)

No.	Description	No.	Description
15773	Single HEC Inject - Result Low	15774	Single HEC Inject - Result High
15776	Single HEC Inject - Result Invalid	15783	Double HEC Inject - Result Low
15784	Double HEC Inject - Result High	15786	Double HEC Inject - Result Invalid
15793	100 ms Double HEC Inject - Result Low	15794	100 ms Double HEC Inject - Result High
15796	100 ms Double HEC Inject - Result Invalid	15803	Misinserted Cell (a) - Result Low
15804	Misinserted Cell (a) - Result High	15806	Misinserted Cell (a) - Result Invalid
15807	Misinserted Cell (a) - Errored Cell Count Low	15808	Misinserted Cell (a) - Errored Cell Count High
15809	Misinserted Cell (a) - Errored Cell Count - Invalid	15813	Misinserted Cell (b) - Result Low
15814	Misinserted Cell (b) - Result High	15816	Misinserted Cell (b) - Result Invalid
15817	Misinserted Cell (b) - Errored Cell Count Low	15818	Misinserted Cell (b) - Errored Cell Count High
15819	Misinserted Cell (b) - Errored Cell Count Invalid	15823	Misinserted Cell (c) - Result Low
15824	Misinserted Cell (c) - Result High	15826	Misinserted Cell (c) - Result Invalid
15827	Misinserted Cell (c) - Errored Cell Count Low	15828	Misinserted Cell (c) - Errored Cell Count High

**Table B-46.
ATM Test Cell, Back to Back Tests (Opt UKN) (continued)**

No.	Description	No.	Description
15829	Misinserted Cell (c) - Errored Cell Count Invalid	15833	No Transfer Delay - Result Low
15834	No Transfer Delay - Result High	15843	Test Transfer Delay - Result Low
15844	Test Transfer Delay - Result High	15853	Error Add Off - Result Low
15854	Error Add Off - Result High	15856	Error Add Off - Result Invalid
15863	Error Add Single - Result Low	15864	Error Add Single - Result High
15866	Error Add Single - Result Invalid	15873	Error Add 1 in 10 ³ - Result Low
15874	Error Add 1 in 10 ³ - Result High	15876	Error Add 1 in 10 ³ - Result Invalid

Table B-47. ATM Trail Trace, Back to Back Tests (Opt UKN)

No.	Description	No.	Description
15888	String Incorrect		

B-30 Self Test Fail Numbers



Index

A

Accessories, 1-10

E

Environment, 2-7

External MTS Clock, 3-88-90

F

Fail Numbers, B-1

Fuse Rating, 2-2

Fuse Replacement, 2-4

H

HP-IB Address, 2-7

HP-IB Connection, 2-5

I

Internal SDH Transmitter Clock, 3-83-84

M

Multiple PDH Transmitter Outputs
(Option UHC), 3-25-40

O

Option List, 1-7

P

PDH Error Output, 3-77-78

PDH Frame Analysis, 3-41-48

PDH Frequency Measurement and
Looped Clock, 3-79-82

PDH Internal Transmitter Clocks,
3-7-10

PDH Receiver Equalization, 3-49-52

PDH Receiver Monitor Levels, 3-53-55

PDH Transmitter Output, 3-11-24

Performance Test Record, 3-140-154

Power Cord, 2-4

Power Requirements, 2-2

R

Recall Default Settings, 3-2

Recommended Test Equipment, 1-29,
3-2

Repackaging, 2-8

S

Safety Considerations, 1-2

Instrument Markings, 1-2

Manual Markings, 1-2

safety symbols, 1-4

SDH Frequency Offsets, 3-85-87

Self Test, 3-5-6

Serial Number Plate, 1-7

Shipping Container Inspection, 2-1

SPDH Receiver Monitor Levels, 3-56-59

Specifications, 1-11-29

STM-1/4 Optical Interface (Option
UH2), 3-107-110

STM-1 Optical Interface (Option UH1),
3-104-106

STM-1 Receiver Input Equalization,
3-103

STM-1 Receiver Monitor Input, 3-99-100
STM-1 Transmitter Output Waveshape,
3-91-99

W
Wander/Slips Measurements, 3-134-139
warning symbols, 1-4

