

Errata

Title & Document Type: 3585A Spectrum Analyzer Operating Manual

Manual Part Number: 03585-90003

Revision Date: February 1979

HP References in this Manual

This manual may contain references to HP or Hewlett-Packard. Please note that Hewlett-Packard's former test and measurement, semiconductor products and chemical analysis businesses are now part of Agilent Technologies. We have made no changes to this manual copy. The HP XXXX referred to in this document is now the Agilent XXXX. For example, model number HP8648A is now model number Agilent 8648A.

About this Manual

We've added this manual to the Agilent website in an effort to help you support your product. This manual provides the best information we could find. It may be incomplete or contain dated information, and the scan quality may not be ideal. If we find a better copy in the future, we will add it to the Agilent website.

Support for Your Product

Agilent no longer sells or supports this product. You will find any other available product information on the Agilent Test & Measurement website:

www.tm.agilent.com

Search for the model number of this product, and the resulting product page will guide you to any available information. Our service centers may be able to perform calibration if no repair parts are needed, but no other support from Agilent is available.



OPERATING MANUAL

SPECTRUM ANALYZER

3585A

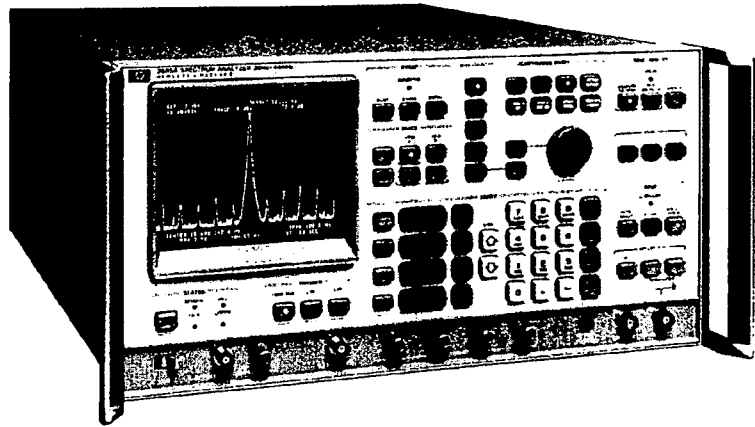



OPERATING MANUAL

MODEL 3585A

SPECTRUM ANALYZER

Serial Numbers: 1750A00101 and greater

WARNING

To help minimize the possibility of electrical fire or shock hazards, do not expose this instrument to rain or excessive moisture.

Manual Part No. 03585-90003

Microfiche Part No. 03585-90053

©Copyright Hewlett-Packard Company 1978
P.O. Box 301, Loveland, Colorado 80537 U.S.A.

Printed: February 1979

TABLE OF CONTENTS

Section	Page	
I. GENERAL INFORMATION	1-1	Chapter 1:
1-1. Introduction.....	1-1	Bandwidth and Sweep Time Functions... 3-1-16
1-5. Specifications.....	1-1	Marker/Continuous Entry Functions... 3-1-18
1-7. Instrument and Manual Identification.....	1-1	Sweep and Trigger Functions..... 3-1-22
1-11. Description.....	1-2	HP-IB Status Functions..... 3-1-23
1-19. Options.....	1-3	Automatic Calibration..... 3-1-24
1-21. Accessories Supplied.....	1-3	Rear-Panel Features..... 3-1-30
1-23. Accessories Available.....	1-4	Plotter Functions..... 3-1-34
1-25. Recommended Test Equipment....	1-5	Chapter 2: Basic Operating Procedures
Section II. INSTALLATION AND INTERFACING	2-1	Six Step Operating Procedure..... 3-2-1
2-1. Introduction.....	2-1	Step 1: Press Instrument Preset..... 3-2-1
2-3. Initial Inspection.....	2-1	Step 2: Select the Desired Input and Connect the Signal Source..... 3-2-3
2-5. Power Requirements.....	2-1	Step 3: Adjust the Frequency Parameters..... 3-2-5
2-7. Power Cables.....	2-2	Step 4: Adjust Resolution Bandwidth and/or Video Bandwidth..... 3-2-11
2-9. Grounding Requirements.....	2-2	Step 5: Select Amplitude Display Units and Adjust Reference Level..... 3-2-13
2-11. Environmental Requirements.....	2-2	Step 6: Measure Frequency and Amplitude of On-Screen Responses Using The Tunable Marker..... 3-2-17
2-12. Operating Environment.....	2-2	Absolute Measurements..... 3-2-17
2-14. Storage and Shipping Environment.....	2-3	Relative Frequency and Amplitude Measurements..... 3-2-19
2-16. Cooling System.....	2-3	Special Measurement Techniques..... 3-2-22
2-18. Thermal Cutout.....	2-3	Measure Random Noise Spectral Density..... 3-2-22
2-20. Installation.....	2-3	Measure Signal-To-Noise Ratio..... 3-2-23
2-21. Mounting.....	2-3	Step the Center Frequency to Measure Equally Spaced Portions of the Spectrum..... 3-2-24
2-26. Instrument Turn On.....	2-6	Measuring Harmonic Distortion..... 3-2-24
2-27. HP-IB Connections And Interfacing.....	2-9	Measuring Modulation Side Frequencies..... 3-2-26
2-31. HP-IB Address Selection.....	2-10	Improving the Noise-Free and Distortion-Free Dynamic Range..... 3-2-29
2-33. HP-IB Descriptions.....	2-10	Overdrive to Improve Noise-Free Dynamic Range..... 3-2-29
2-35. Repackaging For Shipment.....	2-12	Underdrive to Optimize Distortion-Free Dynamic Range..... 3-2-31
2-36. Original Packaging.....	2-12	Amplitude Frequency-Response Measurements Using the Tracking Generator..... 3-2-34
2-38. Other Packaging.....	2-12	Tracking Generator..... 3-2-34
Section III Operating Instructions	Page	General Measurement Procedures..... 3-2-37
Introduction.....	3-0	Chapter 3: Operation In The Manual Mode
Part One: Front-Panel Operation.....	3-0	Introduction to the Manual Mode..... 3-3-1
Preface.....	3-0	Manual Key Functions..... 3-3-3
Chapter 1: Overview and General Operating Information		The Manual Measurement Point..... 3-3-4
Performance Summary and Description.....	3-1-2	Setting the Manual Frequency..... 3-3-5
Turn On and Warmup.....	3-1-4	The Marker..... 3-3-6
Operational Verification.....	3-1-5	Independent Marker Tuning..... 3-3-8
A Tour of the Front Panel.....	3-1-6	Offset Measurements..... 3-3-9
The Green Button.....	3-1-7	
Full Sweep Preset.....	3-1-8	
The Beeper.....	3-1-8	
Input Functions.....	3-1-9	
CRT Display Overview.....	3-1-10	
Display Adjustments and Trace Functions.....	3-1-12	
Keyboard Entry Functions.....	3-1-13	
Save (Off) Recall (On) Functions.....	3-1-14	

TABLE OF CONTENTS (Cont'd)

Chapter 3:

Using the Counter in the Manual Mode	3-3-10
Marker at Manual Measurement Point	3-3-10
Marker Not at Manual Measurement Point	3-3-12
Offset Counter Measurements	3-3-13
Using the Noise Level Function	3-3-15
Noise Measurement Techniques	3-3-16
Step the Manual Frequency to Measure Equally-Spaced Signals	3-3-17
Measuring Equally-Spaced Signals Over a Wide Span	3-3-17
Measuring Low-Level Harmonic Distortion	3-3-20
Step the Manual Frequency by Stepping the Center Frequency	3-3-23
Measuring Harmonic Distortion by Stepping the Center Frequency	3-3-23
Stepping the Center Frequency to Measure IM Distortion Products	3-3-26

Chapter 4: Input And Range Functions

Inputs	3-4-2
Terminated Input	3-4-3
Overvoltage Protection	3-4-4
High-Impedance Input	3-4-5
Overvoltage Protection	3-4-6
Probe Power Jack	3-4-6
Range	3-4-7
Range Readout	3-4-7
Auto Range Operation	3-4-9
Manual Ranging	3-4-9
Overload Indicator	3-4-10
Reference Level Track Function	3-4-11/3-4-12

Chapter 5: Major Operating Parameters and Entry Functions

The Major Parameters	3-5-1
Overview of Entry Methods	3-5-2
Parameter Definitions	3-5-3
Entry Keys	3-5-10
Parameter Readouts	3-5-12
Step Entries	3-5-14
Numeric Entries	3-5-15
Numeric Entry Constraints	3-5-20

Chapter 6: CRT Display And Trace Functions

Introduction and Overview	3-6-1
The Graphic Presentation	3-6-6
Display Graticule	3-6-6
Horizontal Axis	3-6-7
Vertical Axis	3-6-8
Introduction to Digital Storage	3-6-9
The Digital Storage Concept	3-6-10
Frequency Resolution	3-6-11

Chapter 6:

Amplitude Resolution	3-6-12
Peak Detection	3-6-13
Peak Detection and Sweep Dynamics	3-6-14
Effects of Peak Detection and Time Interval	3-6-16
Trace Functions	3-6-19
Alphanumeric Readouts	3-6-25

Chapter 7: Bandwidth and Sweep Time Coupling

Overview	3-7-1
Introduction to Coupling	3-7-2
Operation with Optimized Coupling	3-7-3
Detailed Aspects of Operation	3-7-3
Bandwidth Coupling	3-7-4
Sweep Time Coupling	3-7-5

Chapter 8: Marker/Continuous Entry Functions

Overview	3-8-1
Detailed Aspects of Operation	3-8-3
Continuous Entry Functions	3-8-3
Continuous Entry Control	3-8-3
Continuous Entry Function Keys	3-8-3
Marker Function	3-8-4
Manual Sweep Function	3-8-6
Reference Level Function	3-8-6
Center Frequency Function	3-8-7
Display Line Functions	3-8-7
Marker Functions	3-8-9
Marker Function Keys	3-8-9
Counter Function	3-8-10
Marker to Center Frequency Function	3-8-13
Marker to Reference Level Function	3-8-15
Offset Function	3-8-17
Offset to Span Function	3-8-25
Marker-Offset to Step Function	3-8-27
Noise Level Function	3-8-28

Section	Page
III. REMOTE OPERATION	3-9-1
3-2-1. HP-IB Operation	3-9-1
3-2-3. General HP-IB Description	3-9-1
3-2-8. Definition of HP-IB Terms and Concepts	3-9-1
3-2-9. Basic Device Communication Capability	3-9-3
3-2-11. Message Definitions	3-9-3
3-2-13. 3585A Response to Messages	3-9-5
3-2-15. HP-IB Work Sheet	3-9-5
3-2-17. HP-IB Addressing	3-9-6
3-2-20. 3585A Remote Programming	3-9-6
3-2-21. 3585A HP-IB Capabilities	3-9-6
3-2-23. Developing an HP-IB Program	3-9-6
3-2-28. Universal and Addressed Commands	3-9-8

TABLE OF CONTENTS (Cont'd)

Section	Page	Section	Page
3-2-30.	Placing The 3585A In Remote... 3-9-9	4-21.	Program Failures... 4-6
3-2-33.	3585A Data Message Formats... 3-9-9	4-23.	Running Individual Semi- Automatic Performance Tests... 4-6
3-2-35.	Settling Time... 3-9-10	4-25.	HP-IB Address Switch Settings... 4-7
3-2-37.	HP-IB Instruction Definitions... 3-9-23	4-27.	Manual Tests... 4-8
3-2-38.	Programming Output Functions... 3-9-23	4-29.	Frequency Accuracy... 4-8
3-2-40.	Data Dump Modes... 3-9-23	4-31.	1 M Ohm Input Impedance Test... 4-9
3-2-43.	Programming Trigger Modes... 3-9-29	4-33.	Semi-Automatic Performance Test Equipment Set-up... 4-12
3-2-45.	Programming Range... 3-9-30	4-35.	Semi-Automatic Performance Test Procedure... 4-12
3-2-47.	Programming Marker Position... 3-9-30	4-36.	Source Accuracy Program... 4-13
3-2-49.	Programming Special Display Modes... 3-9-31	4-40.	Using the Source Accuracy Program... 4-14
3-2-56.	Special Function Modes... 3-9-33	4-43.	Operational Verification Tests... 4-22
3-2-60.	Test Modes... 3-9-35	4-45.	Synthesizer Reference Connections... 4-22
3-2-63.	Binary Data Mode... 3-9-36	4-47.	Frequency Accuracy... 4-23
3-2-68.	Instrument Status Messages... 3-9-38	4-49.	Calibrator Test... 4-24
3-2-72.	Programming the 3585A for Maximum Speed... 3-9-39	4-51.	Cal Offset Test... 4-25
APPENDICES			
3-A.	Programming Examples Using the -hp- 9825A Calculator.	4-53.	Range Calibration... 4-26
3-B.	Meta Messages Block Diagrammed.	4-55.	Amplitude Linearity Test... 4-27
		4-57.	Reference Level Accuracy... 4-28
		4-59.	50/75Ω Frequency Response Test... 4-29
		4-61.	1 M Ohm Frequency Response Test... 4-30
		4-63.	Return Loss Tests... 4-32
		4-65.	1 M Ohm Input Impedance Test... 4-34
		4-67.	Marker Accuracy... 4-36
		4-69.	Noise... 4-37
		4-71.	Zero Response... 4-38
		4-73.	Low Frequency Responses... 4-38
		4-75.	Local Oscillator Sidebands... 4-41
		4-77.	Residual Spurs... 4-42
		4-79.	Harmonic Distortion... 4-43
		4-81.	Intermodulation Distortion Test... 4-46
		4-83.	Bandwidth Tests... 4-49
		4-85.	Fractional N API Spur Test... 4-51
		4-87.	Tracking Generator Flatness Test... 4-51
		4-89.	HP-IB Check (Optional)... 4-52

LIST OF ILLUSTRATIONS

Figure	Page	Figure	Page
1-1.	Accessories Supplied.....	1-4	
2-1.	Power Cables.....	2-2	
2-2.	Rack Mount and Handle Kits.....	2-4	
2-3.	Front-Panel Functions Activated At Turn-On.....	2-7	
2-4.	Turn-On Display.....	2-8	
2-5.	HP-IB Connector.....	2-9	
2-6.	Address Selection.....	2-11	
3-2-1.	Interface Connections and Bus Structure.....	3-9-1	
3-2-2.	First Status Word For Dump Mode 6.....	3-9-25	
3-2-3.	CRT Trace Word In Binary Mode.....	3-9-37	
3-2-4.	Status Byte.....	3-9-39	
4-1.	Frequency Accuracy Test.....	4-9	
4-2.	1 M Ohm Input Impedance Test.....	4-10	
4-3.	Semi-Automatic Performance Test Equipment Set-Up.....	4-11	
4-4.	HP 9825A Calculator.....	4-12	
4-5.	HP-IB Interface Cable Switch Setting.....	4-13	
4-6.	Source Accuracy Program Flowchart.....	4-15	
4-7.	Thermal Converter Output Calibration.....	4-16	
4-8.	Measurement of Frequency Synthesizer For Calibration Data.....	4-16	
4-9.	9825A Cassette Tape.....	4-17	
4-10.	50 ohm Return Loss Test (Automatic Tests).....	4-17	
4-11.	75 ohm Return Loss Test (Automatic Tests).....	4-18	
4-12.	Tracking Generator Return Loss Test (Automatic Tests).....	4-18	
4-13.	Terminated Input Return Loss Test (Automatic Tests).....	4-19	
4-14.	Harmonic Distortion Test.....	4-20	
4-15.	Intermodulation Distortion Test.....	4-21	
4-16.	50 Ω Return Loss Test (Operational Verification).....	4-33	
4-17.	75 Ω Return Loss Test (Operational Verification).....	4-34	
4-18.	1 M Ohm Input Impedance Test.....	4-36	
4-19.	9 MHz Low Pass Filter.....	4-45	
4-20.	Approximate Filter Response.....	4-45	
4-21.	Harmonic Distortion Test.....	4-45	
4-22.	Frequency Summer.....	4-48	
4-23.	Intermodulation Distortion Test.....	4-48	
4-24.	IM Distortion Response.....	4-49	

LIST OF TABLES

Table	Page	Table	Page
1-1.	Specifications.....	1-5	
1-2.	Recommended Test Equipment.....	1-11/1-12	
3-2-1.	General Interface Management Lines.....	3-9-2	
3-2-2.	Definition of Meta Messages.....	3-9-4	
3-2-3.	3585A Implementation of Messages.....	3-9-5	
3-2-4.	Interface Functions.....	3-9-6	
3-2-5.	Settling Times.....	3-9-10	
3-2-6.	Summary of 3585A Programming Mnemonics, Delimiters and Times.....	3-9-10	
3-2-7.	Programming Codes.....	3-9-14	
3-2-8.	Second Status Word for Dump Mode 6.....	3-9-26	
3-2-9.	Key Codes for Special Function Modes "EE" and "EQ".....	3-9-34	
3-2-10.	Summary of Programming Mnemonics.....	3-9-40	
4-1.	Recommended Test Equipment.....	4-2	
4-2.	Summary of Programs Used For Semi-Automatic Performance Testing.....	4-4	
4-3.	Semi-Automatic Performance Test Equipment List.....	4-5	
4-4.	HP-IB Address Switch Settings.....	4-7	
4-5.	List of Operations.....	4-15	
4-6.	Cal Offset Settings.....	4-25	
4-7.	Amplitude Linearity Test.....	4-28	
4-8.	Reference Level Accuracy Tests.....	4-29	
4-9.	Noise Test.....	4-38	
4-10.	Low Frequency Responses.....	4-41	
4-11.	Residual Spur Test Frequencies.....	4-43	
4-12.	Bandwidth Control Settings.....	4-51	
4-13.	HP-IB Error Definitions.....	4-53	
4-14.	HP-IB Check Program Listing For The 9825A Calculator.....	4-54	



**HEWLETT
PACKARD**

SAFETY SUMMARY

The following general safety precautions must be observed during all phases of operation, service, and repair of this instrument. Failure to comply with these precautions or with specific warnings elsewhere in this manual violates safety standards of design, manufacture, and intended use of the instrument. Hewlett-Packard Company assumes no liability for the customer's failure to comply with these requirements. This is a Safety Class 1 instrument.

GROUND THE INSTRUMENT

To minimize shock hazard, the instrument chassis and cabinet must be connected to an electrical ground. The instrument is equipped with a three-conductor ac power cable. The power cable must either be plugged into an approved three-contact electrical outlet or used with a three-contact to two-contact adapter with the grounding wire (green) firmly connected to an electrical ground (safety ground) at the power outlet. The power jack and mating plug of the power cable meet International Electrotechnical Commission (IEC) safety standards.

DO NOT OPERATE IN AN EXPLOSIVE ATMOSPHERE

Do not operate the instrument in the presence of flammable gases or fumes. Operation of any electrical instrument in such an environment constitutes a definite safety hazard.

KEEP AWAY FROM LIVE CIRCUITS

Operating personnel must not remove instrument covers. Component replacement and internal adjustments must be made by qualified maintenance personnel. Do not replace components with power cable connected. Under certain conditions, dangerous voltages may exist even with the power cable removed. To avoid injuries, always disconnect power and discharge circuits before touching them.

DO NOT SERVICE OR ADJUST ALONE

Do not attempt internal service or adjustment unless another person, capable of rendering first aid and resuscitation, is present.

USE CAUTION WHEN EXPOSING OR HANDLING THE CRT

Breakage of the Cathode-ray Tube (CRT) causes a high-velocity scattering of glass fragments (implosion). To prevent CRT implosion, avoid rough handling or jarring of the instrument. Handling of the CRT shall be done only by qualified maintenance personnel using approved safety mask and gloves.

DO NOT SUBSTITUTE PARTS OR MODIFY INSTRUMENT

Because of the danger of introducing additional hazards, do not install substitute parts or perform any unauthorized modification to the instrument. Return the instrument to a Hewlett-Packard Sales and Service Office for service and repair to ensure that safety features are maintained.

DANGEROUS PROCEDURE WARNINGS

Warnings, such as the example below, precede potentially dangerous procedures throughout this manual. Instructions contained in the warnings must be followed.

WARNING

Dangerous voltages, capable of causing death, are present in this instrument. Use extreme caution when handling, testing, and adjusting.

SAFETY SYMBOLS

General Definitions of Safety Symbols Used On Equipment or In Manuals.



Instruction manual symbol: the product will be marked with this symbol when it is necessary for the user to refer to the instruction manual in order to protect against damage to the instrument.



Indicates dangerous voltage (terminals fed from the interior by voltage exceeding 1000 volts must be so marked).

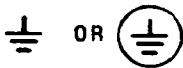

Protective conductor terminal. For protection against electrical shock in case of a fault. Used with field wiring terminals to indicate the terminal which must be connected to ground before operating equipment.



Low-noise or noiseless, clean ground (earth) terminal. Used for a signal common, as well as providing protection against electrical shock in case of a fault. A terminal marked with this symbol must be connected to ground in the manner described in the installation (operating) manual, and before operating the equipment.



Frame or chassis terminal. A connection to the frame (chassis) of the equipment which normally includes all exposed metal structures.



Alternating current (power line).



Direct current (power line).



Alternating or direct current (power line).

DANGER

The DANGER sign denotes a hazard. It calls attention to an operating procedure, practice, condition or the like, which could result in injury or death to personnel even during normal operation.

WARNING

The WARNING sign denotes a hazard. It calls attention to a procedure, practice, condition or the like, which, if not correctly performed or adhered to, could result in injury or death to personnel.

CAUTION

The CAUTION sign denotes a hazard. It calls attention to an operating procedure, practice, condition or the like, which, if not correctly performed or adhered to, could result in damage to or destruction of part or all of the product.

NOTE:

The NOTE sign denotes important information. It calls attention to procedure, practice, condition or the like, which is essential to highlight.

SECTION I

GENERAL INFORMATION

1-1. INTRODUCTION.

1-2. This Operating Manual contains information necessary to install, operate, and test the Hewlett-Packard Model 3585A Spectrum Analyzer.

1-3. This manual is divided into four sections, each covering a specific topic or aspect of the instrument:

Section	Topic
I	General Information
II	Installation and Interfacing
III	Front Panel and Remote Operation
IV	Performance Tests

1-4. This section of the manual contains the performance specifications and general operating characteristics of the 3585A. Also listed are available options and accessories, and instrument and manual identification information.

1-5. SPECIFICATIONS.

1-6. Operating specifications for the 3585A are listed in Table 1-1. These specifications are the performance standards or limits against which the instrument is tested. Any changes in specifications due to manufacturing, design or traceability to the U.S. National Bureau of Standards are included in Table 1-1 of this manual. Specifications listed in this manual supersede all previous specifications for the Model 3585A.

1-7. INSTRUMENT AND MANUAL IDENTIFICATION.

1-8 The instrument identification serial number is located on the rear panel. Hewlett-Packard uses a two-section serial number consisting of a four-digit prefix and a five-digit suffix separated by a letter designating the country in which the instrument was manufactured. (A = U.S.A.; G = West Germany; J = Japan; U = United Kingdom.) The prefix is the same for all identical instruments and changes only when a major instrument change is made. The suffix, however, is assigned sequentially and is unique to each instrument.

1-9. This manual applies to instruments with serial numbers indicated on the title page. If changes have been made in the instrument since this manual was printed, a yellow "Manual Changes" supplement supplied with the manual will define these changes and explain how to adapt the manual to the newer instruments. In addition, backdating information contained in Section VII adapts the manual to instruments with serial numbers lower than those listed on the title page.

1-10. On the title page of this manual following the Operating and Service Manual and Operating Information Supplement part numbers are Microfiche part numbers for these publications. These numbers can be used to order 4 x 6 inch microfilm transparencies of these publications. The Microfiche package includes the latest Manual Changes supplement and all pertinent Service Notes.

1-11. DESCRIPTION.

1-12. The 3585A is a 20 Hz to 40.1 MHz, microcomputer controlled spectrum analyzer. It may be utilized for spectrum analysis or network analysis (amplitude only) applications. As a spectrum analyzer, the 3585A provides a graphic display of the spectral components of the input signal. For network analysis measurements, the 3585A Tracking Generator can be used as a drive signal for the network under test. The network's output can then be applied to the 3585A input to obtain a graphic display of the network's amplitude versus frequency response.

1-13. The 3585A is structured as a conventional triple-conversion, swept super-heterodyne spectrum analyzer. The addition of microcomputer hardware control and data manipulation greatly enhances the analytical power of the 3585A. Flexible control of the displayed trace is obtained through dedicated key subroutines that produce optimum displayed results in a minimum amount of time.

1-14. Microcomputer control gives the 3585A several unique features. The most obvious feature is the keyboard entry of parameters which replaces more conventional knobs. The input attenuation and mixer levels are automatically set by the 3585A's Auto Range feature to maintain the specified dynamic range. Other microcomputer controlled features include: coupling of Frequency Span, Bandwidth and Sweep Time; centering of signals; moving signals to the Reference Level and storage and measurement of frequency and amplitude Offsets. Microcomputer control further allows the operator to over-ride the automatic features of the 3585A.

1-15. The 3585A's Local Oscillator is fully synthesized using -hp-'s patented Fractional N technique. This provides frequency settability of 0.1 Hz over the 20 Hz to 40.1 MHz range. Beyond the advantage of high system resolution, the 3585A's Synthesized Local Oscillator allows stable, repeatable frequency measurements. The advanced design of the 3585A's Fractional N synthesized Local Oscillator also results in phase-continuous, linear sweeps with low spurious sidebands.

1-16. The amplitude accuracy of the 3585A is enhanced by an Automatic Calibration system, through which internal analog offsets and errors are removed using the internal 10 MHz reference as a level and frequency standard and the Tracking Generator with an internal calibrator as a flatness standard. The calibration system measures and corrects errors caused by IF frequency and gain shifts, and input gain and flatness deviations. It also corrects the Tracking Generator frequency.

1-17. The trace information displayed on the 3585A CRT is digitally stored in memory. As a result, flicker-free, non-blooming displays are maintained independent of sweep time. Marker information and Entry parameters are displayed above and below the CRT graticule to give the operator the present instrument status. Prefaced parameters are intensified for easy data entry.

1-18. The 3585A keyboard controls are completely HP-IB programmable. In addition, commands are available to output information such as: active or stored keyboard settings; instrument status; A or B trace in marker amplitudes or normalized binary data; marker amplitude and frequency and CRT alphanumerics. A 50-character line of annotation or six 50-character lines of instructional messages can be displayed on the 3585A using the HP-IB. Finally, the keyboard may be configured as a limited data input terminal, with each key having a unique, numeric code. When coupled with the instructional message capability, this can provide a calculator based system where operator decisions can be entered on the 3585A keyboard. When used in this manner, the operator is not required to understand the calculator language, only answer the questions on the 3585A display.

1-19. OPTIONS.

1-20. The following options are available for use with the Model 3585A:

	-hp- Part Number
Option 907: Front Handle Kit.....	5061-0091
Option 908: Rack Mounting Kit.....	5061-0079
Option 909: Front Handle and Rack Mounting Kit.....	5061-0085
Option 910: Additional Set of Operating.....	03585-90000
and Service Manuals.....	03585-90001

1-21. Accessories Supplied.

1-22. The following is a list of accessories included with the 3585A:

Item	Quantity	-hp- Part Number
Accessory Kit	1 each	03585-84401
Includes the following:		
Cable Assembly Extender	5 each	03585-61601
Cable Assembly Adapter	1 each	03585-61616
Jack to Jack Adapter	3 each	1250-0669
PC Extender Boards:		
43-pin	1 each	03585-66591
36-pin	1 each	03585-66590
18-pin	1 each	03585-66592
15-pin	1 each	03585-66595
15-pin	1 each	03585-66596
10-pin	1 each	03585-66593
6-pin	1 each	03585-66594

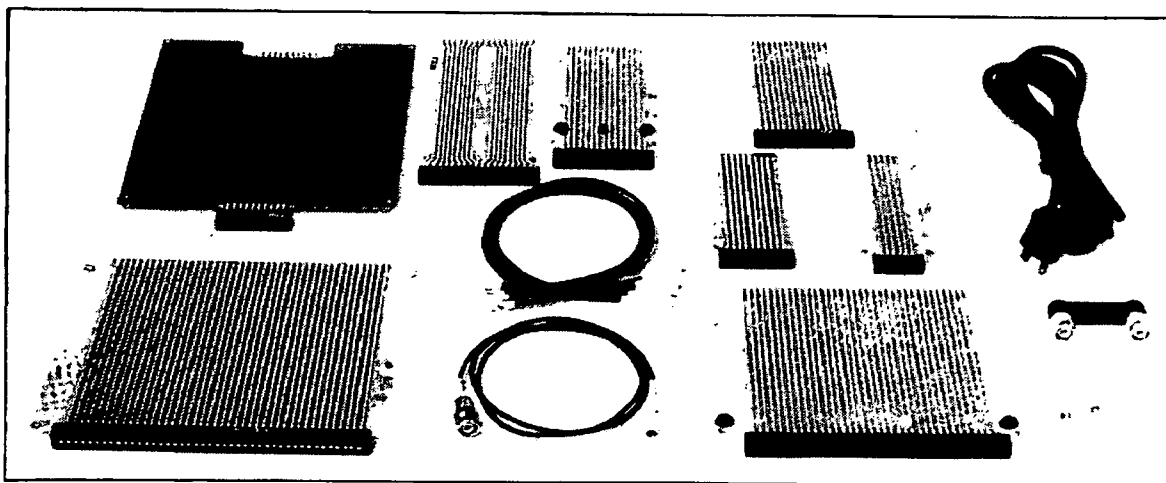

Figure 1-1. Accessories Supplied

1-23. ACCESSORIES AVAILABLE.

1-24. The following is a list of accessories available for use with the Model 3585A.

a. Input Probes.

1. 1120A 1:1 active probe provides 100 k Ω shunted by 3 pf.
2. 10021A 1:1 passive probe for 50 Ω or 1 M Ω shunted by 70 pf.
3. 10040A 10:1 passive probe provides 1 M Ω shunted by 9 pf.

b. Balancing Transformers.

1. 11473A 75 Ω to 600 Ω WECO 310.
2. 11473B 75 Ω to 600 Ω Siemens 9 REL STP-6AC.
3. 11474A 75 Ω WECO 241.
4. 11475A 75 Ω to 150 Ω Siemens 9 REL STP-6AC.
5. 11476A 75 Ω to 124 Ω WECO 408A.

c. Preamplifiers.

1. 461A 20 dB or 40 dB gain 1 kHz to 150 MHz.
2. 465A 20 dB or 40 dB gain 5 Hz to 1 MHz.

d. VHF Switch.

1. 59307A provides one pair of single throw 4-pole switches.

e. Permanent Records.

1. CRT Camera.
 - 197A Option 006 provides 3 1/4" x 4 1/4" Polaroid photographs.
2. X-Y Recorder
 - 7044A provides permanent 11" x 17" plots.

1-25. Recommended Test Equipment.

1-26. Equipment required to maintain the Model 3585A is listed in Table 1-2. Other equipment may be substituted if it meets the requirements listed in the table.

Table 1-1. Specifications.

NOTE	
<i>Specifications are guaranteed only when the Auto Calibration is on, the OVEN REF OUT is connected to the EXT REF IN and the instrument has warmed up at least 20 minutes at the ambient temperature.</i>	
FREQUENCY:	
Measurement Range:	20 Hz to 40.1 MHz
Displayed Range:	
Frequency Span:	0 Hz to 40.1 MHz Settable with 0.1 Hz resolution 10 Hz to 40 MHz in 1, 2, 5 steps
Accuracy:	-0% +0.2% of Frequency Span setting
Marker:	
Readout Accuracy:	$\pm 0.2\%$ of Frequency Span \pm Resolution Bandwidth
Counter Accuracy:	± 0.3 Hz $\pm 1 \times 10^{-7}$ /month of counted frequency for a signal 20 dB greater than other signals and noise in the IF filter skirts.
Manual Frequency Accuracy:	± 0.1 Hz $\pm 1 \times 10^{-7}$ /month using the internal reference.
Resolution:	
Resolution Bandwidths	3 dB bandwidths of 3 Hz to 30 kHz in a 1, 3, 10 sequence
Accuracy	$\pm 20\%$ at the 3 dB points
Selectivity (Shape Factor)	60 dB/3dB < 11:1

Table 1-1. Specifications (Cont'd).

AMPLITUDE:

Measurement Range:
 Terminated (50/75Ω) input
 -137 dBm to + 30 dBm or equivalent level in dBV or volts
 High Impedance (1 MΩ) input
 31 nV to 22V

Displayed Range:
Vertical Scale:
 10 division CRT settable to 10, 5, 2 and 1 dB/division relative to the Reference Level (which is represented by the top graticule line)
Input Range:
 -25 dBm to + 30 dBm in 5 dB steps
Reference Level (relative to Input Range):
 Settability
 -100 dB to + 10 dB; 0.1 dB resolution
 Accuracy (at Center Frequency for Sweep Time
 ≥ 2 steps above auto setting or at Manual Frequency, 1 or 2 dB/Div.)
 Add 0.1 dB for auto sweep setting
 Add 0.1 dB for 5 or 10 dB/Div.
 Terminated (50/75Ω) input

+ 10 dB	-50 dB	-70 dB	-90 dB
± 0.4 dB	± 0.7 dB	± 1.5 dB	

High Impedance(1 MΩ) input—add to above

20 Hz	10 MHz	40.1 MHz
± 0.7 dB	± 1.5 dB	

Amplitude Linearity (referred to Reference Level):

0 dB	-20 dB	-50 dB	-80 dB	-95 dB
± 0.3 dB	± 0.6 dB	± 1.0 dB	± 2.0 dB	

Frequency Response (referred to center of span):
 Terminated (50/75Ω) input ± .5 dB
 High Impedance (1 MΩ) input

20Hz	10 MHz	40.1 MHz
± 0.7 dB	± 1.5 dB	

Table 1-1. Specifications (Cont'd).

Marker:**Amplitude Accuracy:**

Center Frequency or Manual frequency at the Reference Level: Use Reference Level accuracy from +30 dBm to -115 dBm, add Amplitude Linearity below -115 dBm.

To Calculate Marker Accuracy:**Terminated (50/75Ω) input**

At the Center or Manual Frequency and at the Reference Level - use Reference Level Accuracy.

At the Center or Manual Frequency and NOT at the Reference Level - add Reference Level Accuracy and Amplitude Linearity.

NOT at the Center or Manual Frequency and NOT at the Reference Level - add Reference Level Accuracy, Amplitude Linearity and Frequency Response.

High Impedance (1 MΩ) input

Calculate the Marker Accuracy according to the Terminated Input rules above, *then* add 1 MΩ Reference Level Accuracy.

INPUT:**Signal Inputs:**

Terminated (50/75Ω) input; > 26 dB return loss, DC coupled, BNC connector. Applied dc voltage must be \leq ten times the RANGE setting in volts for full specification compliance.

High Impedance (1 MΩ) Input; $\pm 3\%$ shunted by < 30 pf, BNC connector

Maximum Input Level:

Terminated (50/75Ω) input; 13 V peak ac plus dc, relay protected against overloads to 42 V peak.

High Impedance (1 MΩ) input; 42 V peak ac plus dc (derate ac by a factor of two for each octave above 5 MHz).

External Reference Input:

10 MHz (or subharmonic to 1 MHz), 0 dBm to +15 dBm/50Ω

Required frequency accuracy, $\pm 5 \times 10^{-6}$. When an external reference is used the $\pm 1 \times 10^{-7}$ /month specification on the Counter and Manual frequency accuracy is replaced by the accuracy of the external reference.

Table 1-1. Specifications (Cont'd).

DYNAMIC RANGE:

Spurious Responses: (which includes image, out of band and harmonic distortion) referred to a single signal whose amplitude is \leq RANGE setting and whose frequency is \geq ten times the Resolution Bandwidth.

Terminated (50/75 Ω) input

< -80 dB

High Impedance (1 M Ω) input

< -80 dB; except second harmonic distortion, < -70 dB

Intermodulation Distortion: for two signals, each at least 6 dB below the RANGE setting and separated in frequency by at least 100 Hz, referred to the larger of the two signals.

Terminated (50/75 Ω) input

< -80 dB; except 2nd order IM with one or both of the input signals within the range of 10 MHz to 40 MHz, < -70 dB

High Impedance (1 M Ω) input

< -70 dB

Residual Responses (no signal at input, -25 dBm Range)

< -120 dBm

Lo Feed Through:

< -15 dB with respect to Range

Average Noise Level (-25 dBm Range), 50/75 Ω input)

AVERAGE NOISE LEVEL

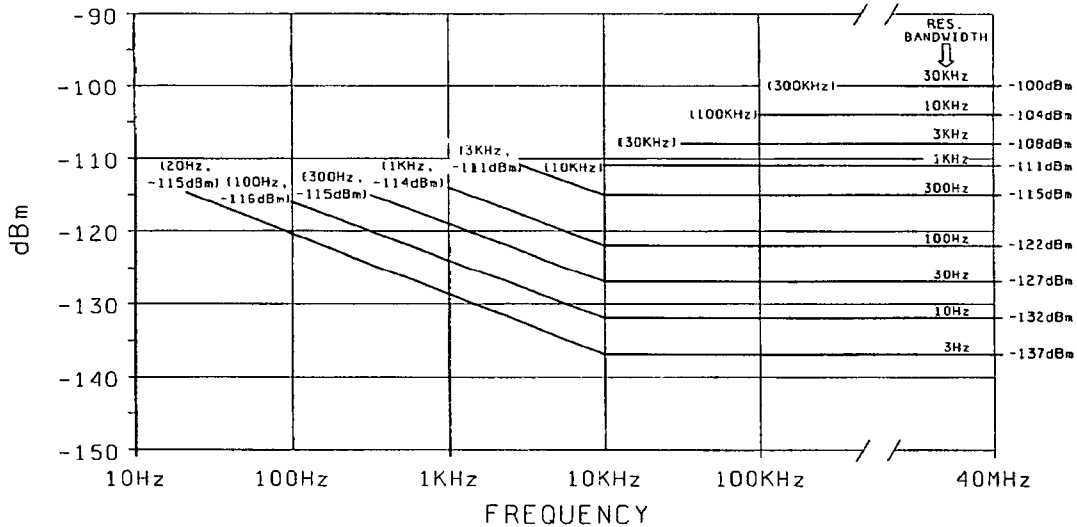

1 M Ω input: Below 500 kHz add 12 dB to above.

Average Noise Level at 40 Hz (3 Hz Res. BW) using the Noise Level Key -123 dBm (1 Hz)

Table 1-1. Specifications (Cont'd).

DISPLAY:**Trace:**

Two memories, A and B, each 1001 data points horizontally by 1024 data points vertically are displayed on the CRT at a flicker free rate.

Memory A - updated at the rate of the analyzer sweep time.

Memory B - updated by transfer from A (Store A-B).

Max Hold - retains in Memory A the largest signal level at each horizontal point over successive sweeps.

A-B - updates Memory A with sweep data minus Memory B data at each corresponding horizontal point.

Trace Detection:

A linear envelope detector is used to obtain video information from the IF signal. Peak signal excursions between horizontal sweep data points are retained and displayed at the left-hand data point. This assures that no signal responses are missed.

OUTPUT:**Tracking Generator:****Level**

0 dBm to -11 dBm/50 Ω with a single turn knob, continuously variable

Frequency Accuracy

± 1 Hz relative to analyzer tuning

Frequency Response

± 0.7 dB

Impedance

50 Ω ; > 14 dB return loss

Probe Power:

+ 15 Vdc, -12.6 Vdc; 150 ma max.

Suitable for powering HP 1120A Active Probe

External Display

X, Y: 1 volt full deflection

Z; < 0V to > 2.4 V.

Recorder:

X Axis: minimum of + 10 Vdc full scale

Y Axis: + 10 Vdc full scale

Z—penlift output (TTL levels)

IF:

350 kHz, -14.0 dBV \pm 2.0 dBV at the reference level

Video:

+ 10 Vdc at the reference level

Frequency Reference:

10.000 MHz $\pm 1 \times 10^{-7}$ /mo., > + 5 dBm into 50 Ω

Table 1-1. Specifications (Cont'd).

<p>SWEEP:</p> <p>Modes: Continuous, Single or Manual</p> <p>Trigger: Free Run, Line, or External</p> <p>Time: Resolution: 0.2 sec Minimum: 0.2 sec Maximum: Frequency Span/minimum sweep rate limit The minimum sweep rate limit is: ≥ 10 KHz Res BW - 10 sec/Hz of Frequency Span or 0.1 Hz/sec ≤ 3 kHz Res BW - 200 sec/Hz of Frequency Span or 0.005 Hz/sec</p> <p>GENERAL:</p> <p>Environmental: Temperature: Operating 0°C to 55°C Humidity: 95% RH except 300 Hz Res. BW, 40% RH</p> <p>Warm-up Time: 20 minutes at ambient temperature</p> <p>Power Requirements: 115 V (+ 11% - 25%), 48-440 Hz 230 V (+ 11% - 18%), 48-66Hz < 180 watts, 3A max.</p> <p>Weight: 39.9 kg (88 lb)</p> <p>Dimensions: 22.9 cm (9 in) H x 42.6 cm (16.75 in) W x 63.5 cm (25 in) D</p> <p>Remote Operation: Compatible with IEEE Standard 488-1975 "Standard Digital Interface for Programmable Instrumentation"</p>

Table 1-2. Recommended Test Equipment.

Instrument	Required Characteristics	Usage		Recommended Model
		Semi-Automatic Performance Test	Operational Verification Tests	
Audio Oscillator	Frequency: 1kHz Distortion: ≤ -90 dB Amplitude: 0.1Vrms	x	x	-hp- 339 or -hp- 239
Attenuator: Variable 10dB/Step Variable 1dB/Step See Note 1	Range: 0 - 120dB Range: 0 - 12dB	x x	x x	-hp- 355D -hp- 355C
Bridge: Directional 50 Ω 75 Ω See Note 2, 3	Frequency: 0.1 - 40 MHz Return Loss > 30dB Directivity > 40dB	x x	x x	-hp- 8721A -hp- 8721A Option 008
Calculator	Compatible with -hp- 9825A Software and I/O	x		-hp- 9825
Calculator ROM's	HP-IB* and -hp- 9825A Compatible	x		-hp- 98210A and -hp- 98213A
Filter: 9MHz Low Pass	See Figure 4-14	x	x	
Frequency Counter	Range: 5 to 10 MHz Resolution: 0.1 Hz Accuracy: ± 1 count, $\pm 5 \times 10^{-10}$ /day	x	x	-hp- 5328A Option 010
Frequency Synthesizer	Freq. Range: 200 Hz to 40.1 MHz Amp. Range: +10 to -85 dBm Amplitude Accuracy: ± 0.25 dBm	x	x	hp- 3335A
Frequency Synthesizer	Freq. Range: 1 kHz to 33 MHz Amplitude Range: -25 dBm Amplitude Accuracy: ± 0.4 dB	x	x	-hp- 3330B
Function Generator See Note 3	Frequency: 1.2kHz Square Wave: 100ns rise time dc Offset: ± 1 V	x		-hp- 3311A
HP-IB* Interconnection Cables		x		-hp- 10631
HP-IB* Interface Cable	-hp- 9825A Compatible	x		-hp- 98034A
Impedance Matching Network (50 Ω to 75 Ω Minimum Loss Pad)	Frequency: 0.1 to 40 MHz VSWR < 1.05	x	x	-hp- 8542B
Mixer: Double Balanced See Note 3	Frequency: 0.1 - 40MHz	x		-hp- 10534
Oscilloscope See Note 2	Vertical Scale: ≥ 5 mV/Div. Horizontal Scale: ≥ 50 nsec/Div. Voltage range: 0 - 10 V DC		x	-hp- 1740A
Power Supply: DC See Note 4		x		-hp- 6213A
Printer: Impact Summer	Plotter Capability See Figure 4-15	x x	x	-hp- 9871A
Termination: Feedthrough 50 Ω 75 Ω	± 0.1 ohm, 1 Watt	x x	x x	-hp- 11048C -hp- 11094C
Thermal Voltage Converter: 50 Ω , 0.5 V See Note 4	Frequency: 0.1 - 60MHz Calibration Data	x		-hp- 11051A Option 01
Voltage Divider: 10 to 1 Terminated in 50 Ω See Note 4	See Figure 4-7	x		
Voltmeter: Digital See Note 4	Full Scale Range: 1Vdc Accuracy: ± 0.004 % Resolution: 6 Digits Input Resistance: > 1 M Ω	x		-hp- 3455A

NOTES

1. Attenuator must be calibrated by standards lab. Correction factors are required for the Operational Verification Tests.
2. Required for the Operation Verification Return Loss Test.
3. Required for the Semi-Automatic Performance Test Return Loss procedure.
4. Required to run the calibrator accuracy program.

* Hewlett-Packard Interface Bus.

SECTION II

INSTALLATION AND INTERFACING

2.1. INTRODUCTION.

2-2. This section contains instructions for installing and interfacing the Model 3585A Spectrum Analyzer. Included are initial inspection procedures, power and grounding requirements, environmental requirements, installation instructions, turn-on and interfacing procedures and instructions for repackaging for shipment.

2-3. INITIAL INSPECTION.

2-4. This instrument was carefully inspected both mechanically and electrically before shipment. It should be free of marks or scratches and in perfect electrical order upon receipt. To confirm this, carefully inspect the instrument for signs of physical damage incurred in transit, check for supplied accessories (Paragraph 1-21) and test the electrical performance using the Performance Test procedures given in Section IV. If there is physical damage, if the contents are incomplete or if the instrument does not pass the Performance Tests, notify the nearest -hp- Sales and Service Office. If the shipping container is damaged or the cushioning material shows signs of stress, notify the carrier as well as the Hewlett-Packard Office. Keep the shipping materials for the carrier's inspection.

WARNING

To avoid the possibility of dangerous electrical shock, do not apply ac line power to the 3585A if there are signs of shipping damage to any portion of the outer enclosure.

2-5. POWER REQUIREMENTS.

2-6. The Model 3585A requires a single-phase ac power source of:

86V to 127V, 48Hz to 440Hz (115V Voltage Selector Setting)
189V to 255V, 48Hz to 66Hz (230V Voltage Selector Setting)

Maximum power consumption is less than 180 watts; maximum line current is 3 amperes. Refer to Paragraph 2-26 for the Instrument Turn On procedure.

CAUTION

Before applying ac line power to the 3585A, be sure that the VOLTAGE SELECTOR switch is set for the proper line voltage and the correct line fuse is installed in the rear-panel line FUSE holder. (See Paragraph 2-26.)

2-7. Power Cables.

2-8. Figure 2-1 illustrates the standard power-plug configurations that are used for -hp- power cables. The -hp- part number directly below each drawing is the part number for a power cable equipped with a power plug of that configuration. The type of power cable that is shipped with each instrument is determined by the country of destination. If the appropriate power cable is not included with your instrument, contact the nearest -hp- Sales and Service Office and the proper cable will be provided.

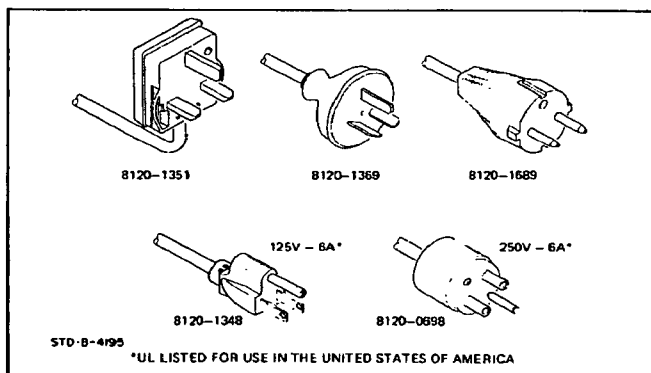

Figure 2-1. Power Cables.

2-9. GROUNDING REQUIREMENTS.

2-10. To protect operating personnel, the instrument's panel and cabinet must be grounded. The Model 3585A is equipped with a three-wire power cord which, when plugged into an appropriate receptacle, grounds the instrument. The offset pin on the power plug is the ground connection.

2-11. ENVIRONMENTAL REQUIREMENTS.

WARNING

To prevent potential electrical or fire hazard, do not expose equipment to rain or moisture.

2-12. Operating Environment.

2-13. In order for the 3585A to meet the specifications listed in Table 1-1, the operating environment must be within the following limits:

- Temperature.....0°C to + 55°C(+ 32°F to + 131°F)
- Relative Humidity..... ≤ 95%*
- Altitude..... ≤ 15,000 feet
- Magnetic Field Strength..... ≤ 0.1 gauss

*Except 300Hz Res. BW, 40%

2-14. Storage and Shipping Environment.

2-15. The 3585A should be stored in a clean, dry environment. The following environmental limitations apply to both storage and shipment:

Temperature.....	- 40°C to + 75°C (- 40°F to + 158°F)
Relative Humidity.....	≤ 95%
Altitude.....	≤ 25,000 feet

In high-humidity environments, the instrument must be protected from temperature variations that could cause internal condensation.

2-16. Cooling System.

2-17. The 3585A uses a forced-air cooling system to maintain the proper internal operating temperature. The cooling fan is located on the rear panel. Air, drawn through the rear-panel fan filter, is circulated through the instrument and exhausted through holes in the side panels. The instrument should be mounted to permit as much air circulation as possible, with at least one inch of clearance at the rear and on each side. The filter for the cooling fan should be removed and cleaned at least once every 30 days. To clean the fan filter, simply flush it with soapy water, rinse and then air dry.

2-18. Thermal Cutout.

2-19. The 3585A is equipped with a thermal cutout switch which automatically disables the power supplies when the internal temperature exceeds + 65°C (external temperature approximately + 55°C). To reset the thermal cutout, set the LINE switch to OFF, allow time for the instrument to cool and then set the LINE switch to ON. (The thermal cutout will *not* reset automatically; the LINE switch must be turned off and then back on.) If a thermal cutout occurs, check for fan stoppage, clogged fan ports and other conditions that could obstruct air flow or cause excessive heating.

2-20. INSTALLATION.**2-21. Mounting.**

2-22. Bench Mounting. The 3585A is shipped with plastic feet attached to the bottom panel, ready for use as a bench instrument. The feet are shaped to make full-width modular instruments self align when they are staked. Because of its weight, the 3585A is not equipped with a tilt stand. It is recommended that a Front Handle Kit (Option 907, -hp- Part No. 5061-0091) be installed for ease of handling the instrument on the bench.

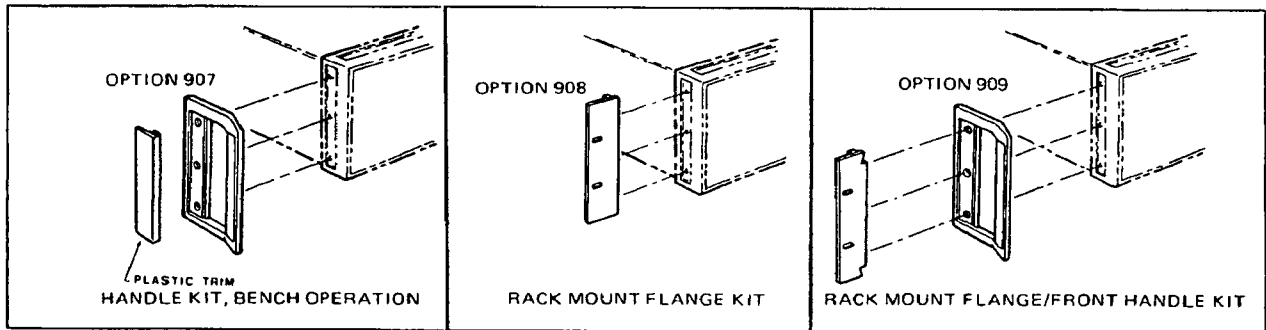

Figure 2-2. Rack Mount and Handle Kits.

2-23. Rack Mounting. The 3585A can be rack mounted either with or without slides using the following procedures.

2-24. Rack Mounting Without Slides.

- a. Remove the plastic trim (Figure 2-2) and front handles from the 3585A if it is so equipped.
- b. Remove the plastic feet from the bottom of the 3585A.
- c. Install the Rack Flange Kit with or without handles according to the instructions included in the kit:

Rack Flange Kit (no handles) Option 908, -hp- Part Number 5061-0079
 Rack Flange & Front Handle Kit Option 909, -hp- Part Number 5061-0085

- d. Install an Instrument Support Rail on each side of the instrument rack. (The Instrument Support Rails, used to support the weight of the instrument, are included with -hp-rack-mount cabinets.)

WARNING

1. The weight of the 3585A must be supported by Instrument Support Rails inside the instrument rack. Do not under any circumstances attempt to rack mount the 3585A using only the front flanges.

2. The 3585A is heavy for its size (approximately 88 lbs, 40 kg.). Use extreme care when lifting it to avoid personal injury.

- e. Using *two* people, lift the 3585A to its position in the rack on *top* of the Instrument Support Rails.
- f. Using the appropriate screws, fasten the 3585A's Rack-Mount Flanges to the front of the instrument rack.

2-25. Rack Mounting With Slides.

NOTE

To rack mount the 3585A with slides, the following items are required:

<i>Quantity</i>	<i>Description</i>
1	<i>Rack Flange Kit (Option 908, -hp- 5061-0079)</i> <i>OR</i> <i>Rack Flange & Handle Kit (Option 909, -hp- 5061-0085)</i>
1	<i>Heavy-Duty Slide Kit (-hp- Part No. 1494-0016)</i>
2	<i>Side Covers (-hp- Part No. 5060-9948)</i>

- a. Perform Steps a through d of the previous procedure (Paragraph 2-24).

NOTE

Instrument Support Rails are not absolutely necessary when rack mounting with slides. However, they do relieve a considerable amount of strain from the slides and provide an extra measure of safety.

- b. Remove the 3585A side covers and replace them with the side covers listed at the beginning of this procedure.
- c. Attach a slide inner-member bracket to each side of the 3585A.
- d. Attach the slide's outer members to the instrument rack according to the instructions included with the slides.
- e. If your instrument rack has extension legs on the front, *be sure* that they are extended at this time.

WARNING

- 1. *The weight of the 3585A can overturn your instrument rack when the mounting slides are fully extended. Physical injury can result.*
- 2. *The 3585A is heavy for its size (approximately 88 lbs., 40 kg.). Use extreme care when lifting it to avoid personal injury.*

- f. Using *two* people, lift the 3585A to its position in the rack and mate the two sections of the slides together. *Do not* rest the full weight of the 3585A on the extended slides until you are *sure* the instrument rack will not overturn.
- g. Slide the 3585A into the rack. Using the appropriate screws, fasten the 3585A's Rack-Mount Flanges to the front of the rack.

2-26. Instrument Turn On.

a. Before connecting ac power to the 3585A:

1. Set the rear-panel VOLTAGE SELECTOR switch to the position that corresponds to the power-line voltage to be used:

Voltage Selector	Line Voltage
115V	86V to 127V (48-440Hz)
230V	189V to 255V (48-66Hz)

WARNING

To avoid serious injury, be sure that the ac power cord is disconnected before removing or installing the ac line fuse.

2. Verify that the proper line fuse is installed in the rear-panel FUSE holder:

Voltage Selector	Fuse Type	-hp- Part No.
115V	3A, 250V Normal Blo	2110-0003
230V	1.5A, 250V Normal Blo	2110-0043

WARNING

To protect operating personnel, the 3585A chassis and cabinet must be grounded. The 3585A is equipped with a three-wire power cord which, when plugged into an appropriate receptacle, grounds the instrument. The offset pin on the power plug is the ground connection. To preserve this protection feature, the power plug shall only be inserted in a three-terminal receptacle having a protective earth ground contact. The protective action must not be negated by the use of an extension cord or adapter that does not have the required earth ground connection. Grounding one conductor of a two-conductor outlet is not sufficient protection.

Ensure that all devices connected to the 3585A are also connected to the protective earth ground.

b. Verify that the BNC-to-BNC jumper (supplied with the instrument) is connected between the rear-panel OVEN REF OUT and EXT REF IN connectors. (For information concerning the use of an external frequency reference, see Chapter 1 of Section III, Part One.)

c. Set the front-panel LINE switch to the OFF position.

d. Connect the ac power cord to the rear-panel LINE connector. Plug the other end of the power cord into a three-terminal *grounded* power outlet.

- e. Set the front-panel INTENSITY control to the OFF (fully CCW) position.
- f. Set the LINE switch to the ON position.

NOTE

The instrument's beeper will sometimes sound as a result of the local oscillator initially being unlocked during the turn-on sequence. This initial "beep" may be ignored.

g. Things to check:

1. Verify that the cooling fan (located on the rear panel) is operating.
2. Verify that the activated front-panel functions on your instrument correspond to those shown in Figure 2-3.
3. Verify that the front-panel SWEEPING light is flashing.

If any of the above conditions is not met, turn the instrument off immediately and contact the nearest -hp- Sales and Service Office or a qualified service technician.

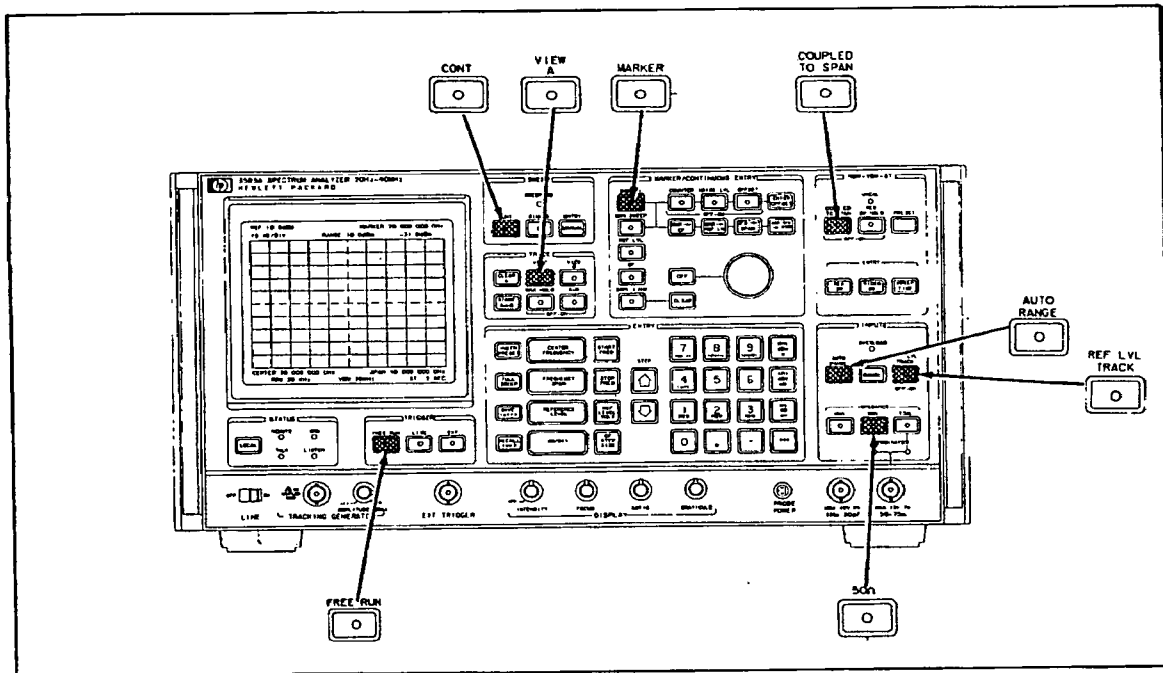

Figure 2-3. Front-Panel Functions Activated At Turn-On.

h. Adjust the front-panel INTENSITY control to obtain the desired intensity on the CRT screen. Adjust the FOCUS and ASTIG controls as follows:

1. Set the FOCUS control to midrange.
2. Adjust the ASTIG (Astigmatism) control for the sharpest trace possible.
3. Adjust the FOCUS control for the sharpest and clearest trace possible.
4. Repeat Steps 2 and 3 until optimum adjustment is obtained. If, after several iterations a sharp, clear presentation cannot be obtained, internal adjustments are probably required. These adjustments must be performed by a qualified service technician.

i. The CRT display should now appear as shown in Figure 2-4.

Verify that the Zero Response is present and is aligned with the first vertical line on the left-hand side of the CRT graticule.

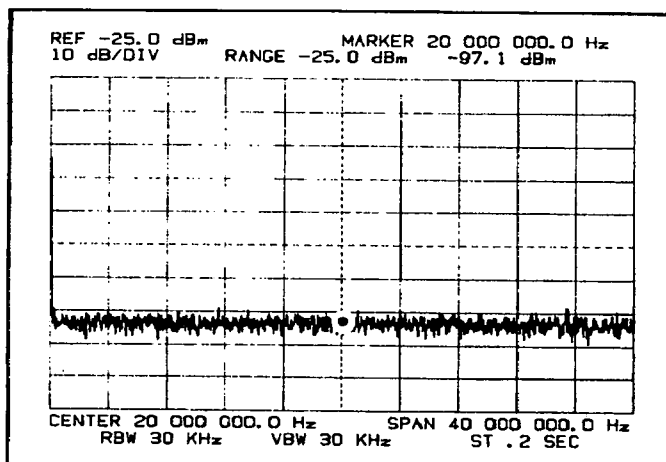



Figure 2-4. Turn-On Display.

j. Press the front-panel  key. (This will force an internal verification test and Automatic Calibration. The "CALIBRATING" message will appear on the CRT screen.)

If the beeper sounds and/or a Calibration Error Code (e.g., "CALIBRATION ERROR 03") appears on the CRT screen, the instrument is either defective or in need of adjustment. Turn the instrument off and contact -hp- or a qualified service technician.

k. The 3585A's specifications are met after a 20-minute warmup at the ambient operating temperature.

NOTE

When the internal Oven Reference is enabled (about ten minutes after turn on), the beeper will sound and the "LOCAL OSC. UNLOCKED" message will momentarily appear on the CRT screen.

2-27. HP-IB Connections And Interfacing.*

2-28. The 3585A HP-IB connector (Figure 2-5) is compatible with the -hp- 10631 (A, B, C or D) HP-IB Cables. The 3585A uses all of the HP-IB lines. The HP-IB system allows you to interconnect up to fourteen HP-IB compatible instruments (including the controller). The HP-IB Cables have identical "piggyback" connectors on both ends so that several cables can be connected to a single source without special adapters or switch boxes. You can interconnect system components and devices in virtually any configuration you desire. There must, of course, be a path from the calculator (or other controller) to every device operating on the bus. As a practical matter, avoid stacking more than three or four cables on any one connector. If the stack gets too long, the force on the stack can produce sufficient leverage to damage the connector mounting. Be sure that each connector is firmly screwed in place to keep it from working loose (see CAUTION in Figure 2-5).

2-29. Cable Length Restrictions. To achieve design performance with the HP-IB, proper voltage levels and timing relationships must be maintained. If the system cables are too long, the lines cannot be driven properly and consequently, the system will fail to perform. When interconnecting an HP-IB system, observe the following rules:

- a. The total cable length for the system must be less than or equal to 20 meters (65 feet).
- b. The total cable length for the system must be less than or equal to 2 meters (6 feet) times the total number of devices connected to the bus.

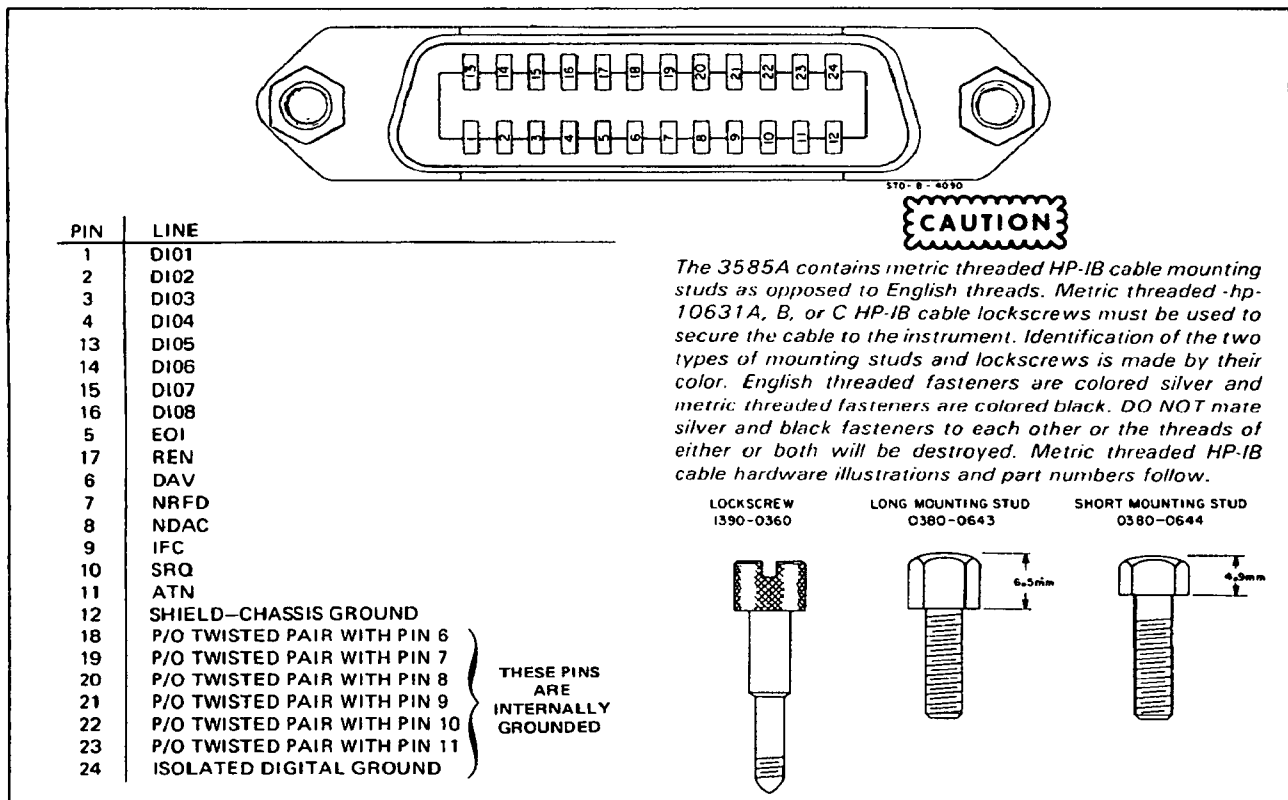

Figure 2-5. HP-IB Connector.

*Hewlett-Packard Interface Bus (HP-IB) is -hp-'s implementation of IEEE Standard 488-1975, "Digital Interface for Programmable Instrumentation".

2-30. Calculator Interfacing. Instructions for interfacing the 3585A to -hp- calculators are included in the following HP-IB Users Guides:

- a. For -hp- Model 9820A/9821A Calculators:

HP-IB Users Guide, -hp- Stock Number 59300-90001

- b. For -hp- Model 9825A Calculators:

-hp- 9825A Calculator General I/O Programming, -hp- Stock Number 09825-90024.

- c. For -hp- Model 9830A Calculators:

HP-IB Users Guide, -hp- Stock Number 59300-90002

These users guides can be ordered from the nearest -hp- Sales and Service Office.

2-31. HP-IB Address Selection.

2-32. The 3585A is shipped from the factory with an ASCII listen address of “+” and a talk address of “K”. This corresponds to a Select Code of eleven. You will probably want to leave the addresses as they are; but they can be changed if the need arises. The procedure can be found in the Service Manual under HP-IB Address Selection.

2-33. HP-IB Descriptions.

2-34. A description of the HP-IB is included in Part Two of Section III of this manual. A study of this information will be helpful if you are not familiar with the HP-IB concept. A good basic description of the HP-IB, along with -hp-'s line of compatible instruments and accessories, can be found in the 1978 edition of the -hp- Instrumentation and Systems Catalog. More detailed information concerning the design criteria and operation of the bus is given in IEEE Standard 488-1975, entitled “Digital Interface For Programmable Instrumentation”.

2-35. REPACKAGING FOR SHIPMENT.

2-36. Original Packaging.

2-37. If at all possible, repackage the instrument in the original container, which is specially designed to accommodate the weight of the 3585A. Containers and materials equivalent to those used in factory packaging are available through -hp- Sales and Service Offices. Place the instrument in the container with appropriate (3 to 4 inches) packing material and seal well with strong tape or metal bands. Also mark the container “FRAGILE” to insure careful handling.

NOTE

If the instrument is to be returned to -hp- for service, attach a tag indicating the type of service required. Include any symptoms or details that may be of help to the service technician. Also include your return address, the instrument's model number and full serial number. In any correspondence, identify the instrument by model number and full serial number.

2-38. Other Packaging.

2-39. The following general instructions should be used for repackaging with commercially-available materials:

- a. Wrap the instrument in heavy paper or plastic. (If shipping to a Hewlett-Packard office or service center, attach a tag indicating the type of service required, return address, model number, and full serial number.)
- b. Use a strong shipping container. A doublewall carton made of 250-pound test material is adequate.
- c. Use enough shock-absorbing material (3-to-4 inch layer) around all sides of the instrument to provide firm cushion and prevent movement inside the container. Protect the control panel with cardboard.
- d. Seal the shipping container securely.
- e. Mark the shipping container **FRAGILE** to assure careful handling.

SECTION III

OPERATING INSTRUCTIONS

INTRODUCTION.

This Section provides complete operating and programming instructions for the -hp- Model 3585A Spectrum Analyzer. It is divided into two parts:

Part One. Front-Panel Operation

This eight-chapter subsection covers both the basic and detailed aspects of operating the 3585A from the front panel.

Part Two. Remote Operation.

The ninth chapter is a subsection devoted entirely to remotely programming the 3585A via the Hewlett-Packard Interface Bus (HP-IB). The programming information is intended for those who are thoroughly familiar with the front-panel operation of the instrument.

PART ONE

FRONT-PANEL OPERATION

PREFACE.

This first portion of Section III contains information and procedures to assist you in learning to operate the 3585A from the front panel. It is divided into eight chapters:

- Chapter 1. Overview And General Operating Information**
- Chapter 2. Basic Operating Procedures**
- Chapter 3. Operation In The Manual Mode**
- Chapter 4. Input And Range Functions**
- Chapter 5. Major Operating Parameters And Entry Functions**
- Chapter 6. CRT Display And Trace Functions**
- Chapter 7. Bandwidth And Sweep Time Coupling**
- Chapter 8. Marker/Continuous-Entry Functions**

This subsection has been made as comprehensive as possible in an effort to provide a useful and informative operational reference for the instrument, and is not intended to be read from cover-to-cover. The chapters are overlapping and, in some cases, deliberately redundant to allow you to read about a specific function and any related or interactive functions with a minimum of cross referencing. Most of the information that you will need to use the instrument is included in Chapters 1, 2 and 3.

After you have worked with the 3585A for awhile, you may have questions concerning some of its performance capabilities and operating features. While no printed manual can pretend to answer all questions or cover all situations, the answers to most of your questions can be found in Chapters 4 through 8, which cover some of the more subtle and detailed aspects of operation.

CHAPTER 1

OVERVIEW AND GENERAL OPERATING INFORMATION

This chapter provides an overview of the 3585A and general information concerning its major performance capabilities and operating features. Contents are as follows:

Performance Summary and Description.....	Page 3-1-2
Turn On and Warmup.....	Page 3-1-4
A Tour Of The Front Panel.....	Page 3-1-6
Automatic Calibration.....	Page 3-1-24
Rear-Panel Features.....	Page 3-1-30
Plotter Functions.....	Page 3-1-34

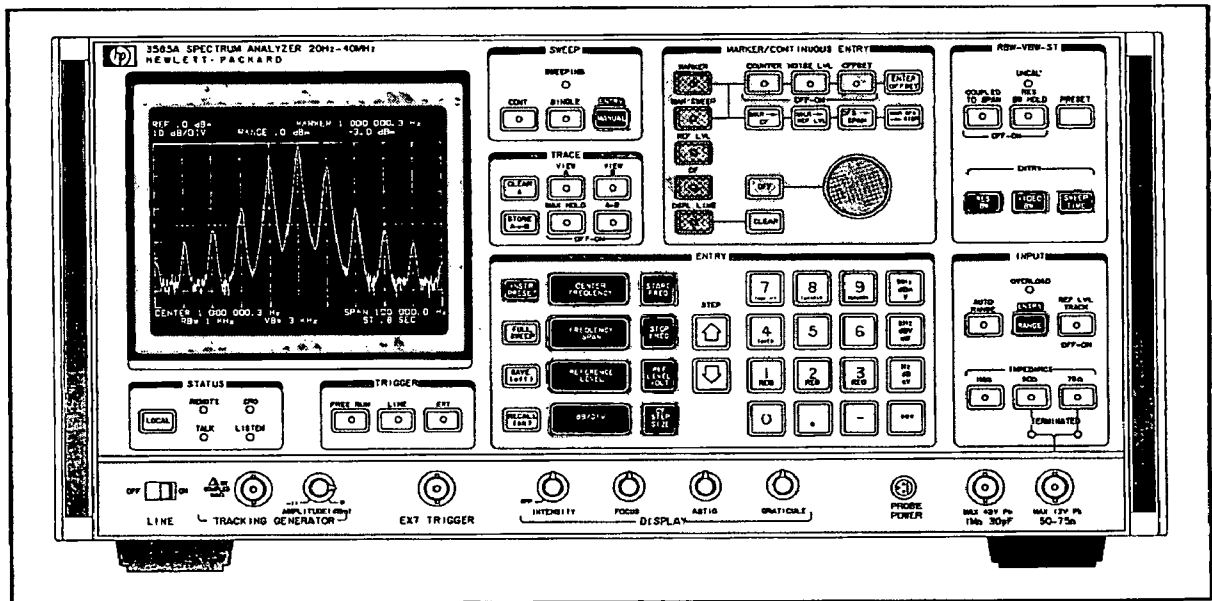

The 3585A Front Panel*

*A front-Panel foldout is included at the end of Section III.

PERFORMANCE SUMMARY/DESCRIPTION

PERFORMANCE SUMMARY AND DESCRIPTION

The Model 3585A is a high-performance, easy-to-use spectrum analyzer, covering the 20 Hz to 40.1 MHz frequency range. It can be used as a stand-alone bench instrument for signal-analysis and network-analysis applications; or, through its HP-IB interface, it can be linked to a computing controller and up to thirteen other HP-IB instruments to form a powerful automatic measurement system.*

3585A PERFORMANCE SUMMARY

FREQUENCY:

Measurement Range:

20 Hz to 40.1 MHz

Displayed Range:

0 Hz to 40.1 MHz full span

Resolution:

3 dB bandwidths of 3 Hz to 30 kHz in a 1, 3, 10 sequence

Accuracy**Manual Frequency:**

$\pm 0.1 \text{ Hz} \pm 1 \times 10^{-7}/\text{mo.}$

Marker:

Normal $\pm 0.2\%$ of Frequency Span
 \pm Resolution Bandwidth

Counter $\pm 0.3 \text{ Hz} \pm 1 \times 10^{-7}/\text{mo.}$

AMPLITUDE:

Measurement Range:

-137 dBm to +30 dBm (50 Ω or 75 Ω)

Displayed Range:

10, 5, 2, 1 dB/DIV over a 10 division scale

Dynamic Range:

Harmonic distortion and third order inter-modulation distortion > 80 dB below signal \leq to the Range Setting..

Average Noise Level:

< -137 dBm in the 3 Hz Resolution Bandwidth

Accuracy:

Best achievable accuracy over the measurement range is $\pm 0.4 \text{ dB}$ to $\pm 1.3 \text{ dB}$ depending on the level.

SWEEP:

Time:

0.2 sec. to 59,652 hrs.

INPUT:

Signal Inputs:

Terminated 50/75 Ω ; return loss > 26 dB

High-Impedance 1 M Ω ; $\pm 3\%$ shunted by < 30 pF

Max. Input Level:

50/75 Ω ; +30 dBm (1 watt)

1 M Ω ; 42 V Peak

OUTPUTS:

Tracking Generator:

0 dBm to -11 dBm (50 ohms)

Display:

X, Y, and Z outputs for auxiliary CRT display

Plotter:

Horizontal sweep output (x), video output (y), and penlift/blanking output to drive an X-Y recorder.

INSTRUMENT STATE STORAGE:

Up to three sets of user-defined control settings may be saved and recalled.

REMOTE OPERATION:

All analyzer control settings (with the exception of line, tracking generator amplitude and display) can be programmed via the Hewlett-Packard Interface Bus (HP-IB).*

*Hewlett-Packard Interface Bus (HP-IB) is -hp-'s implementation of IEEE Standard 488-1975 and identical ANSI Standard MCI.1, "Digital Interface for Programmable Instrumentation". HP-IB operation is described in Section III, Part 2.

Only a few years ago, a spectrum analyzer having the performance capabilities and operating features of the 3585A would have been a rack-mounted system, consisting of four or five individual instruments under the control of a minicomputer. Today, however, due to the latest advances in -hp- technology and the innovative design efforts of -hp- engineers, the 3585A has emerged as a self-contained, "intelligent" spectrum-analyzer system, featuring unsurpassed performance and operating convenience.

At least three major technological contributions have gone into the design of the 3585A:

- microprocessor control
- synthesizer tuning
- high-performance analog design

Microprocessor Control

The 3585A is controlled by three internal microprocessors; one Central Processor and two smaller, control-oriented processors - all products of -hp-'s advanced Microcomputer/LSI technology.

Microprocessor control provides a number of automatic features which make the 3585A extremely versatile and easy to use; yet, it also affords complete operating flexibility for specialized measurements. The computational power of the microprocessor has made it possible to incorporate features such as Automatic Calibration and Synthesizer Tuning which enhance both the performance and usability of the instrument. The power of the microprocessor is further evidenced by the 3585A's comprehensive CRT display, its front-panel keyboard and its HP-IB Input/Output capabilities.

Synthesizer Tuning

The 3585A's frequency tuning is controlled by an internal frequency synthesizer, whose operation is based on a revolutionary frequency synthesis technique called Fractional "N". With synthesizer tuning, the Center-Frequency accuracy is determined entirely by the accuracy of the internal or external frequency reference; and all frequency parameters are settable within the range of 0 Hz to 40.1 MHz with 0.1 Hz resolution. The sidebands produced by the Fractional "N" system are very low, enabling the 3 Hz Resolution Bandwidth to be used throughout the entire spectrum. Power-line sidebands more than 80 dB below a signal can be easily resolved and measured.

High-Performance Analog Design

If the 3585A were stripped of its digital embellishments, it would still outperform most other spectrum analyzers by virtue of its superior analog design. Although it is a digitally-controlled system, the 3585A is fundamentally a swept superhetrodyne spectrum analyzer. As such, it has conventional operating parameters and makes the same basic measurements as any other analyzer. Digital processing is used to minimize amplitude and frequency offsets in the analog section; but it does nothing to improve the swept-receiver characteristics such as frequency response, scale linearity, frequency selectivity and noise-free/distortion-free dynamic range. The 3585A's outstanding performance capabilities are the result of combining microcomputer control and digital frequency synthesis with the very best in analog circuit-design.

TURN ON AND WARMUP

TURN ON AND WARMUP

Before applying ac line power to the 3585A, make certain that the rear-panel VOLTAGE SELECTOR switch is in the position that corresponds to the voltage and frequency of the ac power source. Also verify that the proper line fuse is installed in the rear-panel fuse holder (see Section II).

The 3585A specifications are met after a 20-minute warmup at the ambient operating temperature.

Frequency Reference

The 3585A can be operated using its own internal Oven Reference or an external frequency reference. The internal or external frequency reference must be connected to the rear-panel EXT REF IN connector.

Internal Oven Reference

The 3585A is equipped with a temperature-stabilized, crystal-controlled 10 MHz reference oscillator, whose output is available at the rear-panel OVEN REF OUT connector. The frequency accuracy of this internal Oven Reference is expressed as a time coefficient of $10 \text{ MHz} \pm 1 \times 10^{-7}$ per month, relative to the time the instrument is shipped from the factory or the reference frequency is adjusted using the procedure outlined in the 3585A Service Manual. The Oven Reference time coefficient is included in the Counter and Manual frequency accuracy specifications.

To use the internal Oven Reference, connect the BNC to BNC jumper (supplied with the instrument) between the rear-panel OVEN REF OUT and EXTERNAL REF IN connectors.

NOTES

1. Power is applied to the internal reference oven only when the LINE switch is in the ON position. The 3585A does not have a "standby" mode.

2. The output of the internal Oven Reference is **disabled** until the oven reaches the proper operating temperature. During the oven warmup cycle, there is no signal applied to the EXT REF IN connector; so the 3585A's master oscillator runs in the open-loop mode in which the frequency accuracy is unspecified. When the oven reaches the proper operating temperature (about ten minutes after turn on), the Oven Reference is automatically enabled. At that time, the beeper sounds and the message, "L.O. UNLOCKED" momentarily appears on the CRT screen. The message disappears as soon as the master oscillator is phase-locked to the Oven Reference.

External Reference

For applications requiring optimum frequency accuracy, the 3585A can be phase locked to an external frequency standard. The external reference frequency must be 10 MHz or any subharmonic down to 1 MHz (± 5 ppm); and the amplitude must be within the range of 0 dBm to +15 dBm (50 ohms). The frequency accuracy of the external reference may be substituted for the Oven Reference time coefficient in the Counter and Manual frequency-accuracy specifications. To avoid performance degradation, the phase noise and spurious content of the external reference signal must be at least -110 dBc (1 Hz) relative to 10 MHz at a 20 Hz to 1 kHz offset.

To use an external reference:

1. Remove the jumper from between the rear-panel OVEN REF OUT and EXTERNAL REF IN connectors.

(To keep from losing the jumper, you may connect one end of it to any unused rear-panel connector.)

2. Using a shielded cable equipped with BNC connectors, connect your external reference to the EXTERNAL REF IN connector.

(When the reference is initially connected, the beeper will sound and the "L.O. UNLOCKED" message will appear on the screen. The message will continue to be displayed until the master oscillator is properly phase-locked to the external reference.)

Operational Verification

The 3585A automatically performs an internal operational verification test and calibration during its turn-on sequence and also when the  key is pressed. This internal test verifies that most of the analog and digital circuitry is operating properly; but it does not verify that the 3585A meets its published specifications. In the event of a test failure, the instrument's beeper will sound and, in most cases, a Calibration Error Code or failure message will appear on the CRT screen.

NOTE

The beeper will sometimes sound as a result of the local oscillator being unlocked during the instrument's turn-on sequence; but this initial "beep" does not constitute a test failure. To perform the verification test, allow the instrument to warmup for about two minutes and then press . If this causes the beeper to sound, the instrument is either defective or in need of adjustment. Contact a qualified service technician or return the 3585A to -hp- for service.

FRONT-PANEL TOUR

A TOUR OF THE FRONT PANEL

Even a casual glance at the front panel reveals that the 3585A is more than just an ordinary spectrum analyzer. One of the first things you will observe is that the front panel is almost completely devoid of the normal “analog” controls and dials found on traditional instruments. In place of these controls are pushbutton keys which are used to activate the various instrument functions and change the values of the operating parameters. The keys are conveniently arranged in functional groups called “control blocks”. Each control block is labeled to assist the operator in locating the keys that are related to a specific parameter or function.

With its vast array of front-panel functions, the 3585A may at first appear to be quite complicated and difficult to operate. It is, of course, a very compact and sophisticated piece of equipment, having 70 keys, one knob and a large CRT screen in about 124 square inches of front panel. Despite its appearance, however, you will quickly discover that the 3585A is very easy (and fun) to operate. It is actually easier to use than most oscilloscopes and almost as straightforward as an auto-ranging digital voltmeter.

You will have no trouble learning to operate the 3585A regardless of your range of experience with spectrum analyzers. By taking full advantage of the 3585A’s automatic features, the inexperienced user can confidently make almost any type of signal-analysis measurement using a simple six-step procedure outlined in Chapter 2.

If you are experienced in the use of traditional spectrum analyzers, you will immediately recognize most of the 3585A’s operating parameters. While you may have some initial reservations about automatic features and the keyboard control over what is actually an “analog” instrument, your reservations will soon diminish as you discover the ease with which you can make sophisticated measurements and, at the same time, have complete flexibility and finger-tip control over every operating parameter and function. You will also appreciate the “human engineering” aspects that have carefully been incorporated in the design of the 3585A.



THE GREEN BUTTON

If there is any one key that stands out among all the rest, it is the green INSTR PRESET (Instrument Preset) key, located in the ENTRY control block. This key represents one of the most important aspects of operation and is probably the key that is most frequently used. It is neither a “panic button” nor a device to reset the processors, although it could perform these functions if they were required. Its primary purpose is simply to provide a convenient starting point for almost any type of measurement that you wish to perform. Even the most experienced operators (including the instrument’s designers) normally begin their measurements with .

The  key performs the following functions:*

- Forces all parameters and functions to their turn-on states.
- Restores a full 0 Hz to 40 MHz Frequency Span, with Resolution and Video Bandwidths of 30 kHz and a 0.2-second continuous sweep.
- Activates all automatic and coupled functions.
- Optimizes the Reference Level coupling and the Bandwidth/Sweep-Time coupling.
- Activates the Terminated input and selects the 50-ohm IMPEDANCE setting.
- Initiates an internal test sequence and an Automatic Calibration.

Presetting does not destroy the trace that is stored in Trace Memory “B”; and it does not erase the instrument-state storage registers in which control settings may have previously been stored.

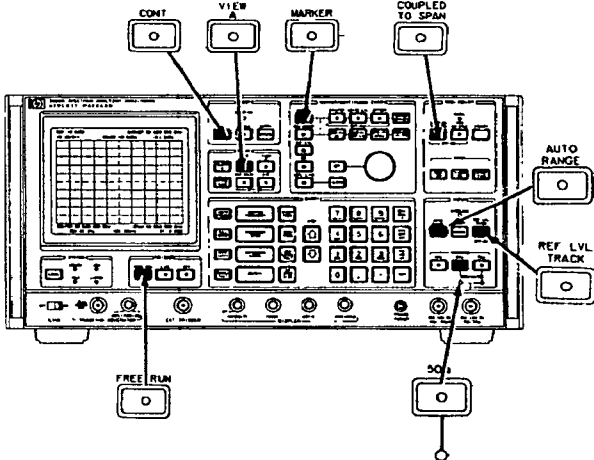
Parameters	Functions
Range + 30 dBm *	
Reference Level (REF) + 30dBm	
Vertical Scale (dB/DIV) 10dB/DIV	
Frequency Span (SPAN) 40 MHz	
Center Frequency (CENTER or CF) 20 MHz	
Start Frequency (START) 0.0Hz	
Stop Frequency (STOP) 40 MHz	
Resolution Bandwidth (RBW) 30 kHz	
Video Bandwidth (VBW) 30 kHz	
Sweep Time (ST) 0.2 SEC.	
Marker Frequency 20 MHz	
Offset Register 0 Hz; 0 dBV	

*With no input signal, the instrument automatically downranges to -25 dBm. With REF LVL TRACK activated, the Reference Level changes along with the Range setting.

Parameters and Functions Selected By

*The  function is also used to activate instrument Test Modes and “pop” the instrument’s Central Processor for certain types of diagnostic tests. These functions are fully described in the 3585A Service Manual.



FRONT-PANEL TOUR Beeper

FULL SWEEP PRESET



After completing a measurement with a narrow Frequency Span, it is sometimes desirable to return to a full 0 Hz to 40 MHz Span to locate the next signal to be measured without presetting the entire instrument. This can be done by pressing . The FULL SWEEP function does nothing but set the Center Frequency to 20 MHz and the Frequency Span to 40 MHz. It does not change the Marker position, erase Offsets, activate or deactivate any front-panel functions or change the values of the operating parameters. (With activated, the RBW, VBW and Sweep Time parameters are coupled to Frequency Span and may, therefore, change when is pressed. The change in Center Frequency and/or Resolution Bandwidth caused by pressing initiates an Automatic Calibration.)

THE BEEPER

The 3585A communicates with the operator via alphanumeric messages that appear on the CRT screen. To call the operator's attention to these messages, it is equipped with an audible alerting device, called the "beeper", which produces a gentle (yet penetrating) high-pitched "beep" tone. The beeper sounds a single "beep" whenever a message of importance initially appears on the screen; and "beeps" again whenever the condition that produces the message is repeated. The beeper also sounds whenever an error is detected in the internal test routine that is performed during the turn-on sequence and each time the instrument is preset.

The beeper is automatically enabled by . It can be disabled by entering ; and reenabled by entering .

INPUT FUNCTIONS*

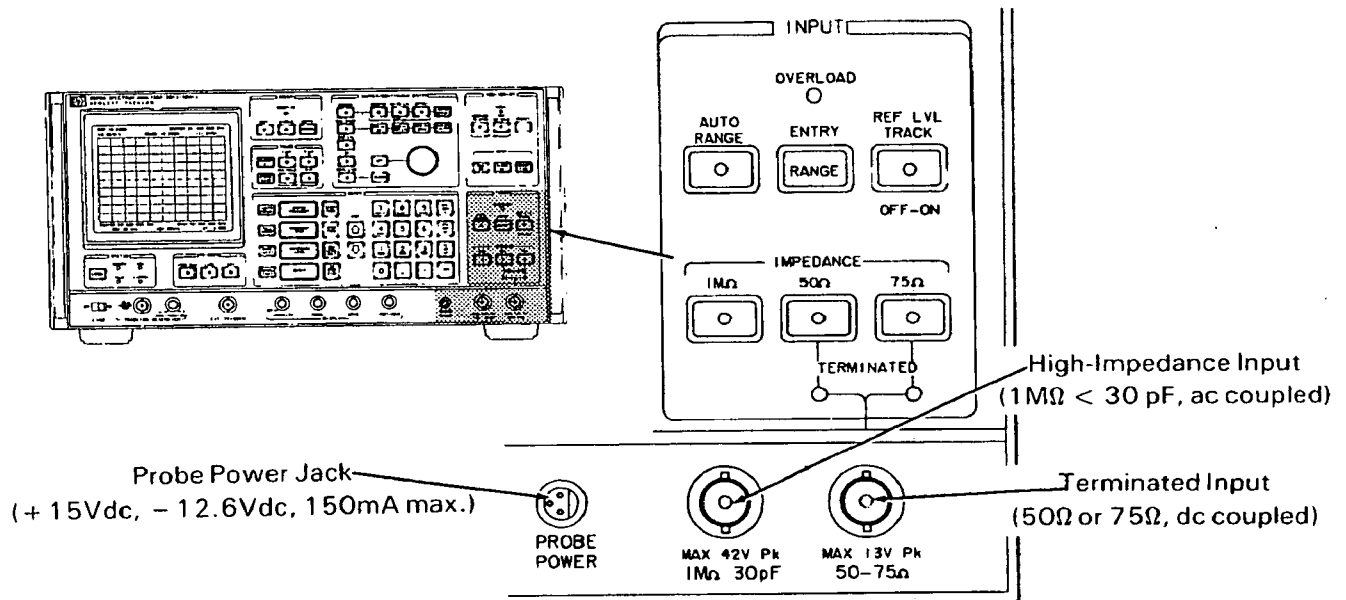

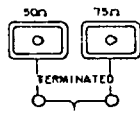

CAUTION

1. The Terminated input is dc coupled.. Peak (combined ac/dc input levels exceeding ± 13 volts will "trip" the internal protection circuit causing the input to open; but may also damage the input circuitry.
2. RF input levels exceeding ± 5.25 volts peak may damage the High-Impedance input circuitry. The combined ac/dc input level applied to the High-Impedance input must not exceed ± 42 volts peak.



- 

Activate Terminated input and select 50Ω or 75Ω dc-coupled termination. Also used to select 50Ω or 75Ω calibration impedance for dBm measurements at the High-Impedance input

Lights indicate that Terminated input is terminated in 50Ω or 75Ω, and also indicate the calibration impedance.
- 

Activates High-Impedance input; deactivates Terminated input.
- 

Sets RANGE automatically as a function of the composite ac input-signal level.
- 

Deactivates  ; prefaces RANGE, enabling it to be changed with STEP keys.
- 

Lights when ac input-signal level exceeds RANGE setting.
- 

Couples Reference Level (amplitude of top graticule line) to RANGE. Initially sets Reference Level equal to RANGE to maintain on-screen display. The Reference Level can be set equal to RANGE at any time by turning  off and then back on.

*See Chapter 4 for further information.

FRONT-PANEL TOUR
 CRT Display

CRT DISPLAY OVERVIEW*

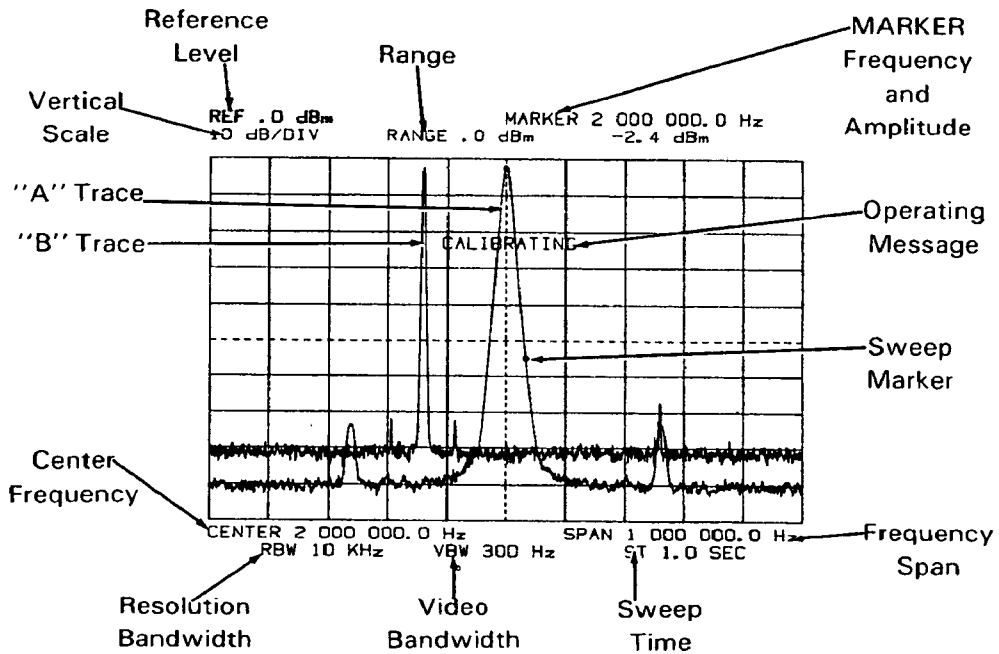

The CRT (Cathode Ray Tube) displays:





a. Graphic traces of amplitude-versus-frequency:

Two digitally-stored graphic traces, read out of Trace Memories "A" and/or "B", are written onto the CRT screen at a rapid, flicker-free rate. Each trace is a point-by-point plot, consisting of 1,001 equally-spaced points, connected by straight lines. Trace Memory "A", containing the Current ("A" or "A-B") Trace, is updated by the frequency sweep or at the Manual measurement point by real-time video samples taken at the Manual frequency. Trace Memory "B" is updated only by transfer from Trace Memory "A" with  .

*See Chapter 6 for further information.

b. Markers:

1. Tunable Marker:

Positioned with   ,   , or by otherwise changing the Manual frequency. Used for direct measurement of on-screen responses; or for real-time measurements in the Manual mode.



2. Stationary (Offset) Marker

With  activated, the stationary marker appears at the point on the CRT trace that represents the Offset reference frequency.

3. Sweep Marker:

Displayed when Sweep Time is ≥ 1 second, to indicate the position of the frequency sweep.

c. Display Line:

When the  function is activated, a horizontal Display Line appears on the CRT screen. The Display-Line amplitude can be adjusted with   to measure the trace amplitude in "dB" relative to the Reference Level (top graticule line).

d. Measurement Data:

The Frequency/Amplitude readout, in the top-right corner of the CRT screen, displays the Marker, Counter, Manual or Offset frequency and amplitude; or the Display-Line amplitude, depending on which MARKER/CONTINUOUS ENTRY functions are activated.

e. Current values of all pertinent operating parameters.

f. Operating Messages:

1. Status Messages; e.g., "CALIBRATING"
2. Entry Requests; e.g., "ENTER REG. NUMBER"
3. Operator Error Messages; e.g., "OUT OF RANGE"
4. Calibration Error Codes; e.g., "CALIBRATION ERROR 01"

g. Externally-generated graphics and alphanumerics, remotely entered via the HP-IB.

DISPLAY ADJUSTMENTS AND TRACE FUNCTIONS*

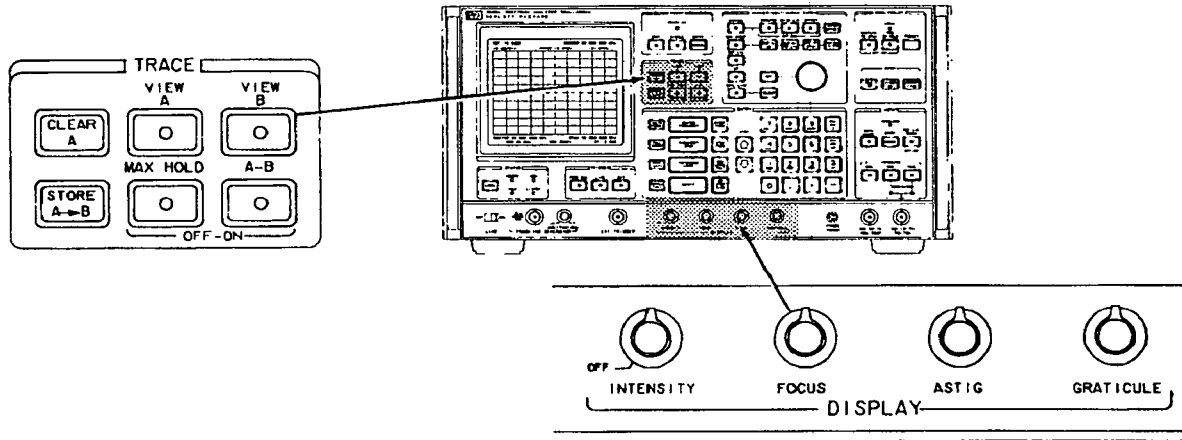

Display Adjustments:



Controls the intensity of all CRT writing. Minimum intensity (OFF) blanks the CRT.

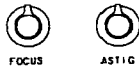

Adjust for optimum sharpness and clarity of CRT image.



Controls background illumination.

Trace Functions:



Displays Current ("A" or "A-B") Trace stored in Trace Memory "A".



Nondestructively transfers the Current Trace to Trace Memory "B" where it is safely kept until a different trace is stored or the instrument is turned off.



Displays trace that is stored in Trace Memory "B".



Erases Trace Memory "A". Resets and automatically rearms Continuous sweep; terminates Single sweep.



Subtracts "B" Trace from current "A" Trace and writes the difference into Trace Memory "A" to produce the "A-B" Trace.



Causes the Current Trace to retain the maximum positive video amplitude that occurs over successive frequency sweeps or at the Manual measurement point.

*See Chapter 6 for further information.



KEYBOARD ENTRY FUNCTIONS*

Entry Keys

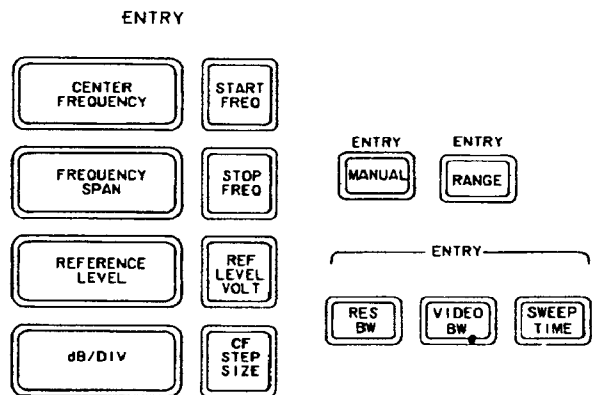
Each of the 3585A's major operating parameters has a dark brown ENTRY key which, when pressed, prefaces that parameter. The prefaced parameter is highlighted on the CRT screen to indicate that its value can be changed using the STEP keys or the Number/Units keyboard.



Step Keys

The STEP keys increment  or decrement  the value of the prefaced parameter. Each press of a STEP key produces a single step; multiple step changes can be made without reprefacing. Step sizes for all parameters except Center Frequency and Manual frequency are internally defined to either produce an appropriate amount of change or select the next available setting. Center and Manual frequency steps are equal to the Center-Frequency Step Size which can be set to any value within the range of 0 Hz to 40.1 MHz with 0.1 Hz resolution. Steps that would exceed the upper or lower limit of a parameter are not accepted.



Number/Units Keyboard





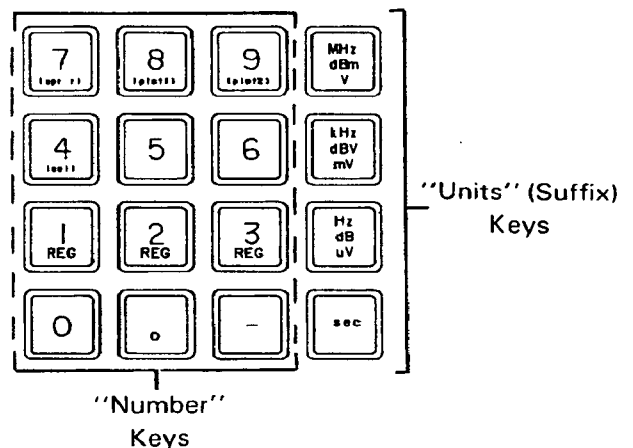



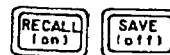















The value of any prefaced parameter (except RANGE) can be set exactly using the Number/Units keyboard. To numerically change the value of a prefaced parameter, simply enter the desired number using the "Number" keys and then terminate the entry by pressing the appropriate suffix (Units) key. The 3585A's free-entry format allows you to make your entries in the units that are the most convenient. Entries that exceed the limits of a parameter or attempt to select unavailable settings are not accepted.



*See Chapter 5 for further information.



SAVE (off)/RECALL (on) FUNCTIONS

	or		followed by		,		or		, saves or recalls instrument state in Register 1, 2 or 3.
				disables Auto. Cal.*					
				enables Auto. Cal. and forces Auto. Cal. cycle.					
				disables beeper.*					
				enables beeper and causes beeper to sound.					
				initiates Instrument Test Mode entry sequence (Chapter 6).					
				does nothing.					
					,		and		are plotter functions (see Page 34).
*Auto. Cal. and beeper are automatically enabled by  .									



Instrument-State Storage

To save time when making a series of measurements requiring different control settings, the SAVE key can be used to store the current operating parameters and states of the front-panel functions in Register 1, 2 or 3. The stored parameters and functions can then be recalled at any time using the RECALL key. The contents of the Instrument-State Storage Registers are retained until different settings are stored or the instrument is turned off.

Example:

Save the current instrument state in Register 1 by pressing  .

Press  or otherwise change the instrument state.

Recall the stored settings by pressing  .

Things That Are Saved:

a. Operating Parameters:

Range (if  deactivated)
Reference Level (and amplitude display units)
Vertical Scale (dB/DIV)

Frequency Span
Center Frequency
Manual frequency (if in Manual mode)
Center-Frequency Step Size

Resolution Bandwidth
Video Bandwidth
Sweep Time

b. States of all front-panel functions having LED indicators.

c. Marker position

d. Display-Line amplitude

e. Offset reference frequency and amplitude (whether or not  on)

Things That Are Not Saved:

a. CRT traces

b. "On" states of momentary-contact functions; e.g., 

d. Other  /  functions:

Calibration disabled
Beeper disabled
Test modes
Plotter functions

e. Prefaced parameter

f. HP-IB Status (as indicated by STATUS lights)

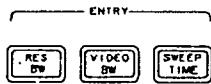
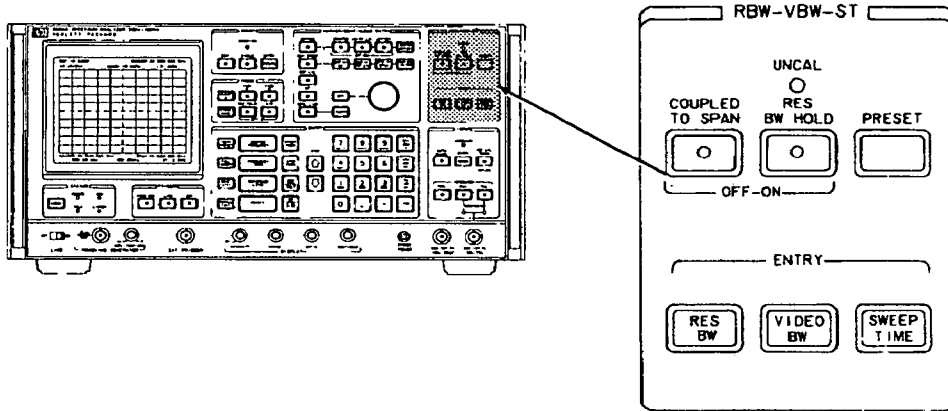

FRONT-PANEL TOUR
Bandwidth/Sweep Time

BANDWIDTH AND SWEEP TIME FUNCTIONS*



The ENTRY keys preface the Resolution Bandwidth (RBW), Video Bandwidth (VBW) or Sweep Time (ST) parameter. The prefaced parameter can be changed by Step Entry or Numeric Entry.



Couples RBW to Frequency Span; couples VBW to RBW; automatically adjusts Sweep Time according to RBW, VBW and Frequency Span. (The **INSTR PRESET** function activates , deactivates  and optimizes the RBW, VBW ST coupling.)



Prevents RBW and VBW from changing as a function of Frequency Span. Also prevents RBW (but not VBW) from changing when PRESET key is pressed. (Does not prevent Step or Numeric RBW/VBW changes.)





Restores optimum RBW, VBW and Sweep Time settings. (If  is activated, the PRESET key restores the optimum VBW and Sweep time; but does not affect the RBW).



Lights when manually-selected sweep rate too fast to maintain calibration. (Accuracy specifications are met *only* when this light is out.)

*See Chapter 7 for further information.

OPERATION WITH BANDWIDTH/SWEEP TIME COUPLING:



To begin a measurement, the operator normally presses . This activates , deactivates  and sets the Frequency Span to 40 MHz. It also sets the RBW and VBW to 30 kHz and the Sweep Time to 0.2 seconds. These are the preferred or "optimum" settings for the full 40 MHz Span.

After connecting the signal source, the operator adjusts the Center Frequency and Frequency Span (or Start and Stop Frequencies) to display the signals of interest. During this process, the Resolution Bandwidth is automatically narrowed as a function of Frequency Span to maintain a good aspect ratio and provide an appropriate amount of frequency resolution. Since the Video Bandwidth is coupled to Resolution Bandwidth, it changes along with the RBW to maintain proportional display smoothing. The Sweep Time is mathematically calculated according to the RBW, VBW and Frequency Span, and is automatically adjusted to maintain the maximum-calibrated sweep rate or the analyzer's minimum Sweep Time of 0.2 seconds.

Once the frequency parameters have been set, the operator can freely adjust the RBW and/or VBW settings to obtain the required resolution, sensitivity and display smoothing. With optimized Sweep Time coupling, the Sweep Time is automatically adjusted to maintain the optimum sweep rate. If desired, the Sweep Time can be increased from the optimum setting to minimize the effects of sweep dynamics; or it can be decreased (at the cost of calibration) to quickly survey the spectrum of interest.

The coupling system is very flexible and will allow the operator to select any available RBW, VBW, Sweep Time combination. It will then remember and, where possible, maintain the relationships established by the operator. The optimum settings can be restored by pressing the  key.

For applications such as horizontal expansion, it is desirable to maintain a specific RBW setting and adjust the Frequency Span, while allowing the coupling system to automatically adjust the Sweep Time. This can be done by activating the  function.

If the operator does not wish to use the coupling system, it can be completely disabled by deactivating the  function. (The UNCAL indicator and PRESET key are operative whether or not the  function is activated.)



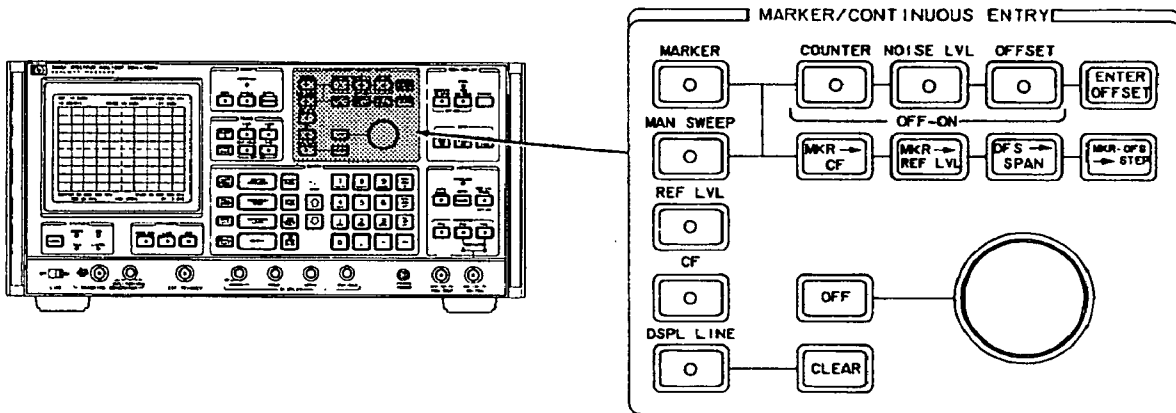

MARKER/CONTINUOUS ENTRY FUNCTIONS*

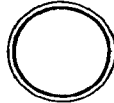

Continuous Entry Functions



The Continuous Entry control is a multi-purpose "digital potentiometer" whose function is selected using the Continuous Entry keys. (Only one Continuous Entry Function can be activated at a time.) It can be used with:

-  to position the tunable Marker for measurement of on-screen responses.
-  to tune the Manual frequency.
-  to adjust the Reference Level.
-  to adjust the Center Frequency.
-  to adjust the Display-Line amplitude.

Continuous Entry Functions

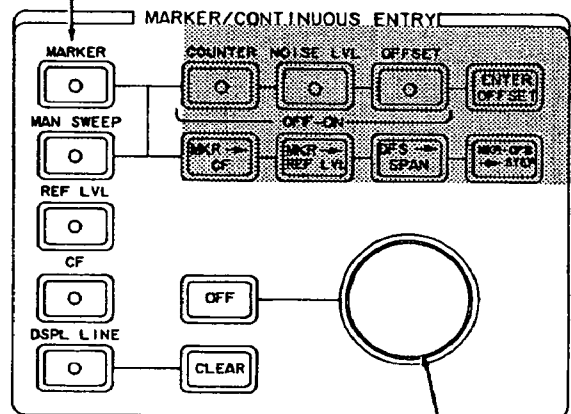

Continuous Entry Control

*See Chapter 8 for further information.

Marker/Manual Measurement Functions

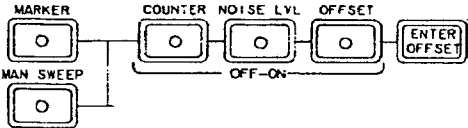

Marker

Measure absolute frequency and amplitude of on-screen responses with  .

(The Marker amplitude can be displayed in dBm (50Ω or 75Ω), dBV or rms volts. The Marker's frequency resolution and accuracy is limited by the point-by-point display and sweep dynamics.)

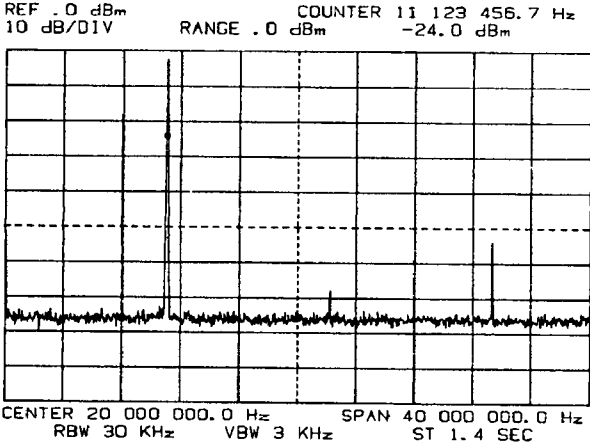
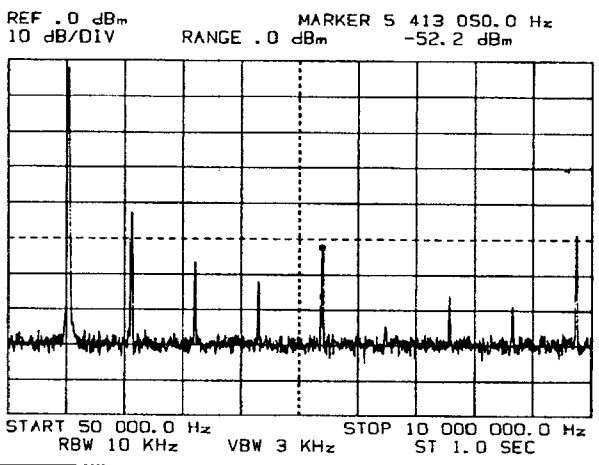

Counter

Use the  function to precisely measure the frequency of the signal that is producing the response on which the Marker is positioned.

(The Counter, unaffected by display resolution and sweep dynamics, displays the true frequency at the peak of the response. The Marker does not need to be at the peak of the response, but it must be at least 20 dB above the noise and 20 dB above any unresolved signal.)

Noise Level



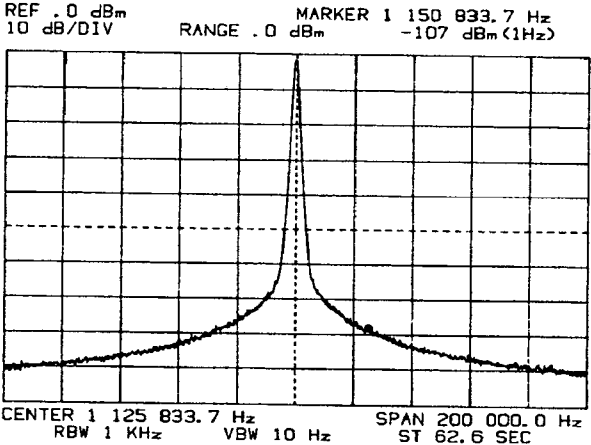

The  function provides a direct real-time reading of the rms random noise spectral density at the Marker or Manual frequency, normalized to a 1 Hz noise power bandwidth. All correction factors are included in the internal noise-measurement routine.

(Absolute noise level readings are displayed in "dBm (1 Hz)", "dBV (1 Hz)" or "V $\sqrt{\text{Hz}}$ ". Relative (Offset) noise readings are displayed in "dB (1 Hz)". Noise measurement times range from 0.3 seconds to 33 seconds, depending on the Resolution Bandwidth setting.)







FRONT-PANEL TOUR
Marker/Continuous Entry

Offset Function

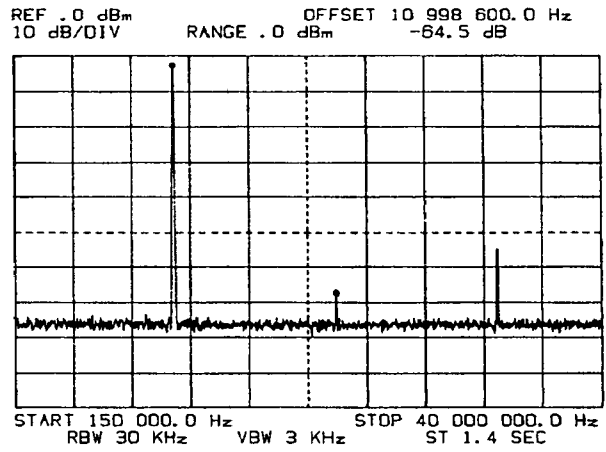
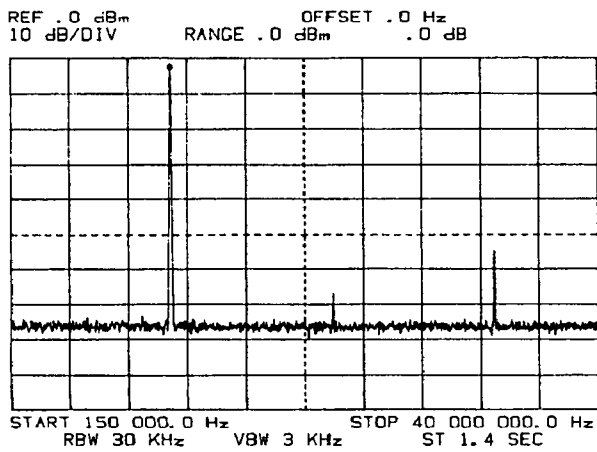
The  function allows you to quickly and easily measure the relative frequency and amplitude between two signals of interest or between any two points within the measurement range of the instrument. It can be used in conjunction with the  or  function to make relative measurements at the Marker or Manual frequency; it will operate with the  function to count the frequency difference between two signals; and it will also operate in conjunction with the  function to measure signal-to-noise ratio.

For example, to measure the frequency and amplitude of a harmonic relative to the fundamental:



- a. Set the Marker to the peak of the fundamental response with   activate  and then press .

- b. Set the Marker to the peak of the harmonic response with  observe the "OFFSET" reading.

(Offset amplitude readings are displayed only in "dB". A stationary marker remains at the point on the CRT trace that represents the Offset reference frequency.)

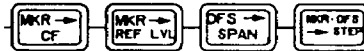

Marker/Offset Entry Functions



The Marker/Offset entry functions are time-saving, single-key operating aids which allow the operator to quickly perform frequently-used manipulations such as centering a signal and moving it to the top of the screen. They also make it easy to enter an arbitrary Frequency Span, “zoom-in” on a signal of interest or enter the Center-Frequency Step size:



Sets the Center-Frequency equal to the current Marker, Counter or Manual frequency, and moves Marker to the Center-Frequency point on the CRT trace.

(To quickly move a response to the center of the screen, set the Marker to the peak of the response with  and then press  .)





Sets Reference Level equal to Marker amplitude.

(To move a response to the top of the screen, simply set the Marker to the peak of the response and press  .)



Sets Frequency Span equal to displayed “Offset” frequency. Operates only when OFFSET function is activated.

(Set the Marker to the desired Start Frequency, activate , press  ; move the Marker to the desired Stop Frequency and press  .)



Sets the Center-Frequency Step Size (also Manual frequency step size) equal to the Marker, Counter, Manual or Offset frequency, whichever is being displayed.

FRONT-PANEL TOUR
Sweep/Trigger

SWEEP AND TRIGGER FUNCTIONS

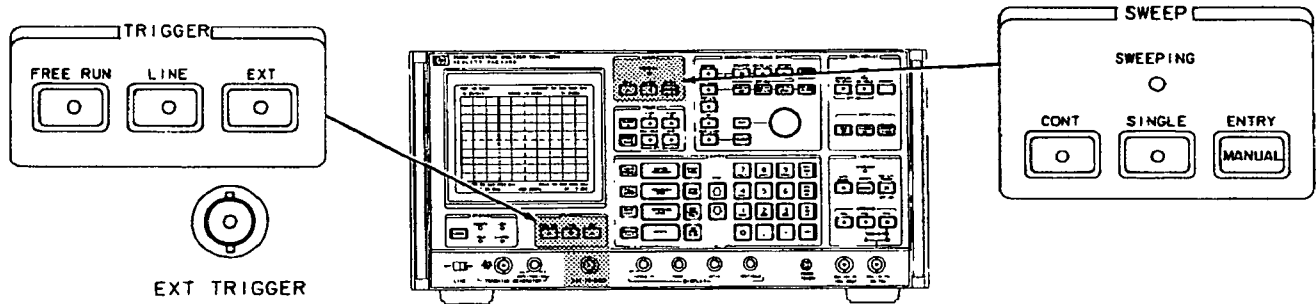

Sweep Functions:



Lights to indicate that a frequency sweep is in progress. Goes out between sweeps and during mid-sweep interruptions.



Repetitive frequency sweeps synchronized by sweep trigger. Upon completion of each sweep, the sweep is automatically rearmed and a new sweep is initiated on receipt of a sweep trigger. Pressing resets the sweep that is currently in progress (except when switching from Single).



Single frequency sweep initiated by sweep trigger. Once a Single sweep has terminated, it resets to the Start Frequency to await rearming. Pressing (except when switching from Cont.) resets and/or rearms the sweep, enabling a new sweep to be initiated by a sweep trigger.*



Selects Manual mode; automatically activates ; sets Manual frequency equal to current Marker frequency; prefaces Manual frequency, enabling it to be changed by Step or Numeric Entry.

Trigger Functions:



Sweep automatically triggered after rearming.



Sweep internally triggered at power-line frequency (48 Hz to 440 Hz).



Sweep triggered by High-to-Low transition or contact closure at EXT TRIG input.*



High = open or +2.0V to +35V; Low = short to ground (outer shell) or +1.3V to -35V. Sweep triggered by High-to-Low transition; triggers are accepted only after the sweep has been rearmed. (Rearming time ranges from about 25 milliseconds to 2.4 seconds, depending on RBW/VBW settings.) Triggers applied during a sweep or during rearming are ignored.

*Sweep rearming and triggering operations are inhibited during Automatic Calibrations and also while operating parameters are being changed.

HP-IB STATUS FUNCTIONS*

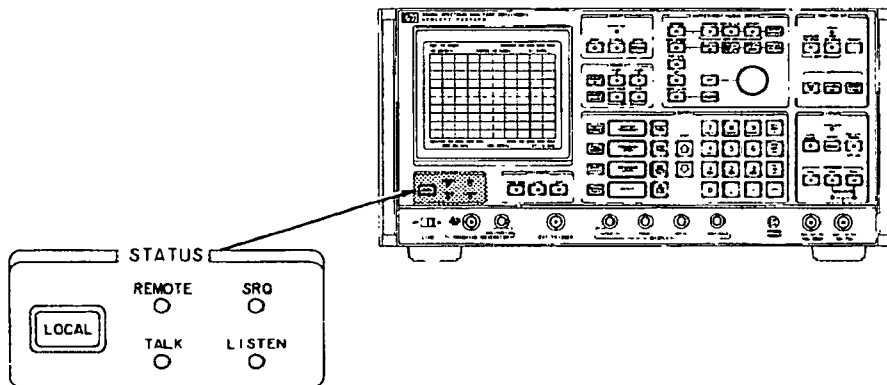

REMOTE
○

Lights to indicate that the 3585A is in the Remote control mode. This mode can be entered only via the HP-IB.

(When the 3585A is in Remote, all front-panel functions except the LINE switch, the DISPLAY controls, the Tracking Generator AMPLITUDE control and the LOCAL key are disabled. Pressing any key (except LOCAL or INSTRUMENTS) or rotating the Continuous Entry control will cause the beeper to sound and the message, "HP-IB REMOTE SET" to appear on the CRT screen.)

LOCAL
□

Returns the 3585A to Local and reenables all front-panel functions. An HP-IB Local Lockout will disable LOCAL until a remote Return To Local command is given, or the LINE switch is turned off and then back on.

(Pressing LOCAL during an HP-IB Local Lockout causes the beeper to sound and the message, "HP-IB LOCAL LOCKOUT" to appear on the CRT screen.)

LISTEN
○

Lights to indicate that the 3585A is addressed to listen.**

TALK
○

Lights to indicate that 3585A is addressed to talk.

SRQ
○

Lights to indicate that the 3585A is generating an HP-IB Service Request.

*HP-IB operation is fully described in Section III, Part 2.

**The LISTEN or TALK light will remain on (even in Local) until the 3585A is unaddressed via the HP-IB or is turned off and then back on.

AUTOMATIC CALIBRATION

AUTOMATIC CALIBRATION

One of the major features of the 3585A is its ability to calibrate automatically, thus eliminating the need for external calibration adjustments. The purpose of Automatic Calibration (Auto. Cal.) is to compensate for minor amplitude and frequency offsets that are normally present in the instrument's analog section. It is also used to compensate for frequency drift in the Tracking Generator to insure that the Tracking-Generator frequency is always within ± 1 Hz of the analyzer's tuned frequency. The Automatic Calibration is performed by the 3585A's Central Processor, in conjunction with the Tracking Generator and a highly accurate internal calibration source.

During each Auto. Cal. cycle, the output of the internal calibrator is switched into the Terminated input channel and a 50 Ω or 75 Ω dummy load is switched across the Terminated input to maintain the proper input termination. Amplitude errors appearing at the Reference Level and Center Frequency or Manual frequency are then minimized or eliminated by the adjustment of internally-programmable parameters such as the local-oscillator frequency, IF gain and video level. Attenuator errors, and any residual amplitude errors that cannot be adjusted out, are stored in memory as Auto. Cal. constants and are corrected mathematically.

The following is a list of common questions and answers concerning the 3585A's Automatic Calibration feature. A review of this list should provide you with sufficient information to use the instrument:

QUESTION:

When does the Automatic Calibration take place?

ANSWER:

- a. About two seconds after the instrument is turned on and at two-minute intervals, thereafter.
- b. About two seconds after  is pressed, or immediately after the instrument is preset by remote control.
- c. Whenever the Center Frequency, Manual frequency, Resolution Bandwidth or IMPEDANCE setting is changed.

(During front-panel operation, the calibration occurs about two seconds after the parameter is changed or immediately if the instrument is in the Manual mode. In Remote, the calibration is performed immediately after the parameter is changed. These parameter-initiated calibrations are inhibited when the Center Frequency or Manual frequency is lower than 150 kHz. Changing the Manual frequency by Continuous Entry does not initiate a calibration.)

- d. The operator can force an Automatic Calibration at any time by entering



QUESTION:

How does the operator know that a calibration is being performed?

ANSWER:

The "CALIBRATING" message appears on the CRT screen.

QUESTION:

What will happen if the instrument is unable to calibrate properly?

ANSWER:

The beeper will sound and a Calibration Error Code, e.g., "CALIBRATION ERROR 03", will appear on the CRT screen.

(Calibration Error Codes are defined in the 3585A Service Manual.)

QUESTION:

What should the operator do if a calibration error occurs?

ANSWER:

The recommended procedure is as follows:





- a. First, write down the Calibration Error Code and the control settings that are currently being used.

(This information may be of help to the service technician if the condition is intermittent.)

- b. Deactivate  and then store the current instrument state in Register 1 by entering  .

- c. Press  :

1. If a Calibration Error Code appears on the screen and/or the beeper sounds, the instrument is either defective or in need of adjustment. Contact a qualified service technician or return the instrument to -hp- for service or repair.

2. If presetting does not produce a Calibration Error Code or "beep", return to the original control settings by entering   . (If the instrument does not calibrate automatically, force a calibration by entering   .)

AUTOMATIC CALIBRATION

If a Calibration Error Code does not appear, the original error was probably the result of a transient or other nonrepeatable phenomenon; in which case, you may continue to use the instrument. Keep in mind, however, that the problem may return. If the calibration error is repeatable, there is definitely something wrong. Again, contact a qualified service technician or return the instrument to -hp-.

QUESTION:

How long does it take to perform an Automatic Calibration?

ANSWER:

The Automatic Calibration time ranges from about 0.1 second to 10 seconds, depending primarily on the Resolution Bandwidth setting. Narrow bandwidths require longer settling times and, therefore, take longer to calibrate.

The initial calibrations that take place after turn on usually take the longest, because there are no previous calibration constants to use as references. Calibration time is also longer during the instrument's warmup cycle since the circuit parameters are continually changing.

QUESTION:

Does a successful Automatic Calibration verify that the 3585A meets its published specifications?

ANSWER:

No. Instrument performance must be tested using the Performance Test procedures outlined in Section IV of this manual. A calibration error is usually a definite indication that something is wrong; but the absence of a calibration error does not begin to verify that the 3585A meets its specifications.

A successful Automatic Calibration is, of course, a good sign that the 3585A is operating properly. However, the corrections that are made during an Automatic Calibration are relative to the instrument's own internal calibration source which could conceivably be out of tolerance. Also, the Automatic Calibration system has no way of testing specified parameters such as noise and distortion levels, spurious responses, scale linearity and frequency response - all of which are important to the overall performance of the instrument.

QUESTION:

Does Automatic Calibration compensate for full-span frequency response deviations and vertical scale errors?

ANSWER:

No. The Automatic Calibration applies only to the Reference Level amplitude at the Center Frequency or Manual frequency.

The calibration is performed at the Center Frequency or Manual frequency if that frequency is 150 kHz or higher. Otherwise, the calibration is performed at 150 kHz. Since the 3585A's response is extremely flat in the 20 Hz to 150 kHz range, the calibration at 150 kHz applies to all Center or Manual frequency settings within that range. For measurements at frequencies other than the Center or Manual frequency and amplitudes other than the Reference Level, the Frequency Response and Amplitude Linearity specifications must be added to the Reference Level and Marker accuracy specifications.

QUESTION:

Is the CRT graticule calibrated?

ANSWER:

No. Since the CRT graticule is not internally generated, the calibration system has no way of calibrating to a specific graticule line. The Reference Level amplitude is represented by the top graticule line and, similarly, the Center Frequency is represented by the middle vertical line. However, the correlation between the Reference Level, Center Frequency and CRT graticule is determined entirely by the CRT trace alignment which is not specified. To obtain the specified amplitude and frequency accuracy, you must make your measurements using the tunable Marker rather than the CRT graticule. The Marker accuracy is relative to the Reference-Level accuracy at the calibration frequency.

QUESTION:

Is the High-Impedance (1 M Ω) input calibrated?

ANSWER:

Not completely. The Automatic Calibration is performed through the Terminated input channel, regardless of which input is being used. The High-Impedance input channel itself is not calibrated, but all circuitry following the input channel is calibrated in the normal manner. Since the calibration is performed through the Terminated input channel, the Terminated input provides higher amplitude accuracy than the High-Impedance input.

AUTOMATIC CALIBRATION

QUESTION:

Can the operating parameters be changed during an Automatic Calibration cycle?

ANSWER:

Yes; but only from the front panel. Remote entries are inhibited during Automatic Calibrations. Changing the Center Frequency, Manual frequency, Resolution Bandwidth or IMPEDANCE setting will abort an Automatic Calibration cycle that is currently in progress. A new calibration will be initiated about two seconds after the parameter is changed.

QUESTION:

Does an Automatic Calibration inhibit measurements and interrupt the frequency sweep?

ANSWER:





Yes. During an Automatic Calibration cycle, all measurements and all instrument functions such as Auto. Range are inhibited and the frequency sweep is stopped. However, the Auto. Cal. will not interrupt a frequency sweep unless the Sweep Time is 22 seconds or longer or the calibration is initiated by a change in parameters. If a Noise-Level calculation is in progress when a normal Auto. Cal. cycle is initiated, the calibration is held-off until the Noise Level measurement is complete.

QUESTION:

How can the Automatic Calibration be disabled?

ANSWER:

Automatic Calibration can be disabled by pressing (or remotely entering)

  . It can be reenabled by pressing  or entering  

(When the Auto. Cal. is disabled, the “CALIBRATION DISABLED” message is displayed in place of the “CALIBRATING” message, each time a calibration cycle would normally occur.)

QUESTION:

When should the Automatic Calibration be disabled?

ANSWER:

There are three cases where it may be necessary or desirable to deactivate the Automatic Calibration system:

- a. During nonrepeatable real-time measurements where an Auto. Cal. interrupt would cause vital information to be lost.
- b. To save time when remotely entering a string of parameters that would cause successive calibrations to occur, it is generally preferable to deactivate the Auto. Cal., enter the parameter string and then reactivate the Auto. Cal. to force a calibration.
- c. When making X-Y recordings using the rear panel VIDEO OUTPUT or IF OUTPUT. (These outputs go to their full-scale levels during calibrations.)

The 3585A's accuracy specifications apply for only two minutes after an Automatic Calibration cycle. If it is necessary to operate with the calibration disabled, always force a calibration before deactivating Auto. Cal. and try to maintain a two-minute calibration interval during your measurement.

REAR PANEL

REAR-PANEL FEATURES

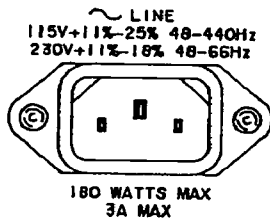
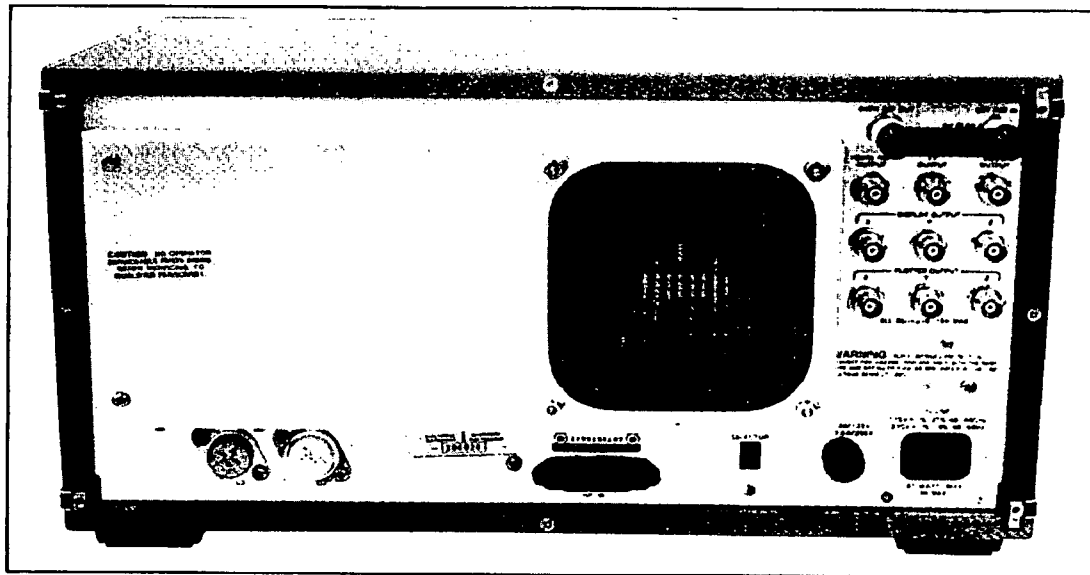

AC Line Input Connector: Accepts power cord supplied with instrument.

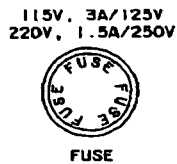

AC Line Fuseholder.



Line Voltage Selector Switch.

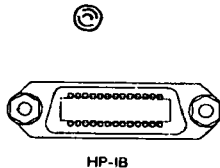

HP-IB Connector: Used to interface the instrument with the Hewlett-Packard Interface Bus (HP-IB) for remote operation. Remote operation is described in Section III, Part 2.



Supplies a $10 \text{ MHz} \pm 1 \times 10^{-7}$ per month sinusoidal frequency reference from an internal crystal oscillator, located in a temperature-controlled oven. The output is ac coupled and the output impedance is 50 ohms. The nominal output level is +10 dBm/50 ohms. The output is disabled during the oven's warmup cycle. To use the internal Oven Reference, this output must be connected to the EXT REF IN jack.

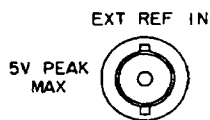

This input allows the 3585A's master oscillator to be phase locked to the internal Oven Reference or an external frequency standard. The input is ac coupled and the input impedance is 50 ohms. The frequency of the reference signal applied to this input must be 10 MHz or any subharmonic down to 1 MHz (± 5 ppm), and the amplitude must be within the range of 0 dBm to +15 dBm (50 ohms). Dynamic range performance will be degraded unless the phase noise and spurious content of the reference signal is ≤ -110 dBc (1 Hz) referred to 10 MHz at a 20 Hz to 1 kHz offset.



To use the internal Oven Reference, connect this BNC-to-BNC jumper between the OVEN REF OUT connector and the EXTERNAL REF IN connector.

10MHz REF
OUTPUT

Supplies a 10 MHz square wave that is phase locked to the reference frequency applied to the EXTERNAL REF IN connector. When the internal Oven Reference is used, the frequency accuracy is $10 \text{ MHz} \pm 1 \times 10^{-7}$ per month. The output is transformer coupled, the output impedance is 50 ohms and the nominal output level is +20 dBm/50 ohms. This reference output can be used to phase lock an external signal source or another analyzer to the 3585A's frequency reference.

IF OUTPUT



This output is taken from a voltage divider which connects directly to the output of the 3585A's final IF filter. The output signal is a 350 kHz (nominal) sine wave, whose amplitude is linearly proportional to the amplitude of the input-signal component to which the 3585A is tuned. The output is ac coupled and the output impedance is approximately 450 ohms. When the signal amplitude is equal to the Reference Level and the Reference Level is +10 dB to -56 dB relative to the Range setting, the full-scale IF output level ranges from approximately 247 mV rms (-12.0 dBV) to 157 mV rms (-16.0 dBV), depending on the internal IF gain setting. The IF gain settability is limited to 4 dB steps and, because of the variable offsets that are introduced by the Automatic Calibration system, the IF gain and full-scale IF output level is not always the same for a given Reference Level setting. The full-scale IF output level will vary (over a 4 dB range) as a function of Reference Level, Range, Impedance and Resolution Bandwidth. Before using the IF Output in a critical measurement application, select the required operating parameters, force an Automatic Calibration and then *measure* the full-scale IF output level.

The IF Output can be used to drive an external detector (e.g., a voltmeter or wave analyzer) to obtain a linear video output which, in turn, can be used for audio monitoring in radio surveillance applications, or applied to the vertical input of a storage scope or X-Y Recorder for applications requiring a linear amplitude scale. The IF Output can also be connected to a true rms voltmeter, such as the -hp- Model 3403A, for making rms noise-level measurements.

(The 3585A's equivalent noise bandwidth is approximately 1.2 times the 3 dB bandwidth established by the Resolution Bandwidth setting. The 3 dB bandwidth has a specified tolerance of $\pm 20\%$ and must, therefore, be measured to obtain accurate results.)

REAR PANEL

NOTES

1. The IF Output goes to its full-scale level (270 mV to 190 mV) during Automatic Calibration cycles.
2. The Video Output level is +10 Vdc during Automatic calibrations.
3. If the video amplitude is more than ten divisions below the Reference Level, the Video Output will go negative. Maximum negative output levels are typically as follows:

<i>dB/DIV</i>	<i>Maximum Negative Output</i>
10	- 0.5 Vdc
5	- 10.5 Vdc
2 or 1	- 13.5 Vdc

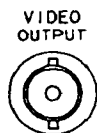

Supplies a dc output voltage (prior to peak detection and digitizing) that is proportional to the "A" Trace video amplitude on the CRT screen. The Video Output is scaled to one volt per division, and the nominal output level ranges from +10.0 Vdc at the Reference Level to 0.0 Vdc at ten divisions below the Reference Level. The output resistance is 1 kilohm, nominal. The output is diode clamped to ± 15 Vdc and is internally fused at 62 mA, N.B.

The Video Output can be applied to an external analog-to-digital converter or digital voltmeter to obtain higher amplitude resolution than is provided by the CRT readouts; it can be used in conjunction with the "X" and "Z" PLOTTER outputs to make oscilloscope plots or X-Y recordings of the non peak-detected video signal; and, when connected to a high-impedance headset or amplifier through a coupling capacitor, it can be used to monitor the audio on an amplitude-modulated carrier. (Since the video amplitude is logarithmic, the audio obtained from the Video Output is quite distorted although intelligible enough for monitoring purposes.)

Display Outputs

The DISPLAY outputs allow all of the CRT information to be displayed on an auxiliary CRT monitor, such as the -hp- Model 1310A Large Screen Display:

	Output Level (nominal)	Output Resistance (nominal)	Protection
	0V to +1 Vdc	1 kilohm	diode clamped to ± 15 Vdc; internally fused at 62 mA, N.B.
	Beam Off: -0.5 Vdc* Beam On: +4.3 Vdc	47 ohms	diode clamped to ground and +5 Vdc; internally fused at 62 mA, N.B.

*The "Z" output is strictly a beam off/on function; there is no intensity modulation.

Plotter Outputs

The PLOTTER outputs operate in conjunction with the 3585A's Plotter functions (described later) to allow the CRT traces to be plotted with an external X-Y recorder or storage 'scope:

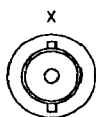

Supplies a dc voltage that corresponds to the position of the 3585A's special Plotter sweep or the frequency sweep, depending on which Plotter function is being used. The output voltage ranges from 0 Vdc for the left edge to approximately +10 Vdc for the right edge. The maximum slew rate is about 0.6 volts per second, corresponding to a minimum Sweep Time of 17 seconds.

The output resistance is 1 kilohm, nominal. The output is diode clamped to ± 15 Vdc and is internally fused at 62 mA, N.B.

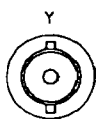

Supplies a dc voltage that is proportional to the peak-detected CRT trace data read out of Trace Memory "A" or "B". The output voltage ranges from 0 Vdc at the bottom of the screen, to approximately +10.4 Vdc at the Reference Level, or about +10.64 Vdc at the upper limit of the vertical scale.

The output resistance is 1 kilohm, nominal. The output is diode clamped to ± 15 Vdc and is internally fused at 62 mA, N.B.

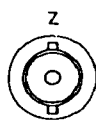

Pen down drive output supplies a polarized closure to ground (outer shell) through a silicon NPN transistor. The output is TTL compatible and is also capable of directly driving penlift coils that require a closure to ground for pen down.

Pen Down Output: +0.2 Vdc; 225 mA into +42 Vdc, maximum.

Pen Up Output: +4.4 Vdc, nominal.

(The output is internally pulled up to +5 Vdc through an isolation diode and a 4.7 kilohm resistor. Positive input voltages greater than +4.4 Vdc will reverse bias the isolation diode, causing the output to appear as an open circuit.)

The "Z" Output is protected by a 54-volt Zener diode to ground and is internally fused at 225 mA, N.B. Input voltages exceeding -0.6 Vdc or +54 Vdc will blow the fuse.

The X-Y recorder pen, connected to the "Z" Output, will go down approximately two seconds after the Plot 1 or Plot 2 function is activated, and will remain down until the end of the plot. If both traces are to be plotted (Plot 1 function) the pen goes up during retrace.













NOTE

The pen is not lifted during Automatic Calibration cycles. If you are plotting with the VIDEO OUTPUT or IF OUTPUT (externally detected) where the output goes to full-scale during Automatic Calibrations, it will be necessary to deactivate the Auto. Cal. to prevent your plot from being defaced when an Auto. Cal. occurs. The PLOTTER outputs are not affected by the Auto. Cal.

PLOTTER FUNCTIONS

PLOTTER FUNCTIONS

The rear-panel PLOTTER outputs are controlled by the 3585A's four special Plotter functions which can be selected from the front panel or by remote control:

		} Deactivates the Plot function that is currently activated; sets the "X" and "Y" PLOTTER outputs to 0 Vdc and the "Z" Output high (pen up). This "off" mode is used to align the pen with the lower left-hand corner of the grid.	
OR			
OR			
		Sets the "X" output to +10.0 Vdc and the "Y" output to +10.4 Vdc (full scale) to allow the pen to be aligned with the upper right-hand corner of the grid. The pen lifts when this function is activated.	
		Activates the 3585A's Plot 1 function (see following text).	
		Activates the Plot 2 function.	

NOTES

1. Pressing  deactivates the Upper Right, Plot 1 or Plot 2 function, lifts the pen and sets the "X" and "Y" PLOTTER outputs to 0 Vdc (Lower Left).
2. The Plotter functions are mutually exclusive. Activating a Plotter function will automatically deactivate the function that is currently activated.
3. The two X-Y recorders that are recommended for use with the 3585A are the -hp-Models 7035B (low cost; 8½" x 11") and 7044A (11" x 17").
4. The low-cost -hp- Model 7015B Recorder is equipped with input filters which make it too slow to operate with the 3585A.

Plot 1 Function

The Plot 1 function is used in conjunction with the 3585A's PLOTTER outputs to plot the peak-detected graphic traces that are stored in the trace memories. The X-axis drive for the Plot 1 function is totally independent of the frequency sweep. The plotting time for one trace ranges from approximately 17 seconds to 12 minutes, depending on the magnitude, slope and number of vertical lines in the trace. The horizontal axis of the plot is divided into 1,001 discrete points, just as it is on the CRT trace. However, to maintain a vertical slew rate that is compatible with most X-Y recorders, the Y-axis amplitude at each point is incremented to its final value in steps of approximately 0.33 volts. The minimum time for each amplitude step is 17 milliseconds, and the maximum number of steps is 32. Thus, the minimum time for a full-scale change in amplitude is approximately:





$$17 \text{ milliseconds} \times 32 \text{ steps} = 0.544 \text{ seconds}$$



This yields a maximum slew rate of about 18.4 volts per second, which will easily allow a ten-inch vertical plot to be made with a recorder having a slew rate (and compatible bandwidth) of 20 inches per second.



A general procedure for using the Plot 1 function is as follows:

- a. Connect the X-Y recorder to the 3585A's rear-panel PLOTTER outputs. Select the appropriate "X" and "Y" Gain settings and place the plotting paper on the recorder.

(The "X" output is 0 V to +10 V; the "Y" output is 0 V to approximately +10.4 V.)

- b. Enter   .
- c. Adjust the recorder's "X" and "Y" Zero controls to align the pen with the lower left-hand corner of the grid.
- d. Enter   .
- e. Adjust the recorder's "X" and "Y" Gain controls to align the pen with the upper right-hand corner of the grid.
- f. Using the 3585A TRACE functions, display the trace or traces that you wish to be plotted.

(When the  and  functions are both activated, the Plot 1 function first plots the "B" Trace and then, after a delay of about two seconds, resets and plots the "A" or "A-B" Trace.)

- g. To minimize the plotting time, stop the frequency sweep by activating the  TRIGGER function and pressing the  key twice.

(The Plot 1 function is independent of the frequency sweep. Processing interruptions that occur during a frequency sweep increase the plotting time.)

- h. Start the plot by entering   .

(Upon completion of the plot, the pen will lift and move to the upper right-hand corner of the grid.)

PLOTTER FUNCTIONS

Plot 2 Function

The Plot 2 function is used to plot the Current Trace from the "Y" PLOTTER output or the "A" Trace from the VIDEO output, in synchronism with the frequency sweep. To properly use this function, the 3585A Sweep Time must be at least 20 seconds, and the sweep rate must be slow enough to allow the X-Y recorder to fully respond to the amplitude variations. (Unlike the Plot 1 function, the Plot 2 function does not limit the vertical slew rate.) A Sweep Time of 30 seconds is generally adequate for plotting gently-changing spectra; and, in keeping with the response capabilities of most X-Y recorders, a Sweep Time of 50 to 100 seconds is sufficiently slow for the vast majority of applications. The "optimum" Sweep Time for a given X-Y recording can be determined empirically by starting with a long Sweep Time and then decreasing the Sweep Time until the recorder begins to compress the amplitude response.



A general procedure for using the Plot 2 function is as follows:

- a. Connect the X-Y recorder to the 3585A's rear-panel PLOTTER outputs. Select the appropriate "X" and "Y" Gain settings and place the plotting paper on the recorder.

- b. Enter   .



- c. Adjust the recorder's Zero controls to align the pen with the lower left-hand corner of the grid.

- d. 1. To plot the peak detected "A" or "A-B" Trace from the "Y" PLOTTER output:

Enter   . Adjust the recorder's "X" and "Y" Gain controls to align the pen with the upper right-hand corner of the grid.



2. To plot the non peak-detected "A" Trace information from the VIDEO output:

Connect the recorder's "Y" input to the 3585A's rear-panel VIDEO output.

Set the Marker to 0 Hz with   .

Press  .

Adjust the Reference Level so that the peak of the 0 Hz response is at the top of the CRT screen. (The Reference Level should be set equal to the "MANUAL" amplitude reading, ± 0.1 dB.)

Enter   . Adjust the recorder's "X" and "Y" Gain controls to align the pen with the upper right-hand corner of the grid.



- e. Adjust the 3585A's operating parameters just as you ordinarily would to display the signals of interest on the CRT screen.



NOTE

The Plot 2 sweep can only be updated at a rate that is equal to or slower than the CRT refresh. The CRT is refreshed approximately every 17 to 30 milliseconds, depending on the amount of information that is being displayed. If the frequency sweep is faster than the CRT refresh and moves ahead of the plotter sweep, the plotter sweep will stop and wait for another frequency sweep. With each successive frequency sweep, the plotter sweep will try to catch up; but will be unable to do so. As a result, each frequency sweep will cause the plotter to move forward in successively smaller increments until it finally reaches the end of the plot. This effect can be avoided by displaying only the Current Trace (leave VIEW B deactivated) and using a Sweep Time of 20 seconds or longer.

- f. Activate the  SWEEP function. Set the Sweep Time so that the sweep rate is slow enough to allow the recorder to respond properly.

(As previously stated, the Sweep Time should be 20 seconds or longer. The 3585A UN-CAL indicator must be off.)

- g. Activate the  TRIGGER function. Reset and arm the frequency sweep by pressing .

- h. Select the Plot 2 function by entering  .
- Wait until the plotter moves to the starting point and the pen goes down.

- i. Start the sweep and plot by activating the  TRIGGER function or by applying a sweep trigger to the EXT TRIGGER IN connector.

(Upon completion of the Single sweep, the pen will lift and move to the upper right-hand corner of the grid.)

- j. To initiate a new plot, repeat Steps g through i.

Manual Mode Plotting

The Plot 2 function can also be used in the Manual mode:

- a. Select the desired Manual frequency.
- b. Activate the Plot 2 function.

(The plotter will move to the Manual frequency point and then the pen will go down.)

- c. Tune the Manual frequency with   or by Step or Numeric Entry.

(The plotter will track the Manual frequency as it is tuned by Continuous Entry; or will slew to the new Manual frequency selected by Step or Numeric Entry. The pen will stay down and remain at a constant amplitude until the plotter reaches the new Manual frequency.)

CHAPTER 2

BASIC OPERATING PROCEDURES

This chapter describes a basic six-step procedure for making swept signal-analysis measurements using the 3585A. Additional topics include:

Special Measurement Techniques

Improving Noise-Free And Distortion-Free Dynamic Range

Amplitude Frequency-Response (Network Analysis) Measurements Using the Tracking Generator

SIX STEP OPERATING PROCEDURE

Most signal-analysis measurements can be made in six easy steps:

1. Press .
2. Select the desired input and connect the signal source.
3. Adjust the frequency parameters to obtain the desired frequency display range.
4. If necessary, adjust the Resolution Bandwidth and/or Video Bandwidth parameters to obtain the required sensitivity, resolution and display smoothing.
5. Select amplitude display units and, if necessary, adjust the Reference Level.
6. Measure frequency and amplitude of on-screen responses using the tunable Marker.

The detailed aspects of each step are given in the following paragraphs.

STEP 1: Press



The  function provides a convenient starting point for nearly all measurements. Presetting forces all parameters to their turn-on states and initiates an Automatic Calibration cycle. The preset operation does not erase portions of memory in which the "B" Trace, control settings and calibration constants are stored.

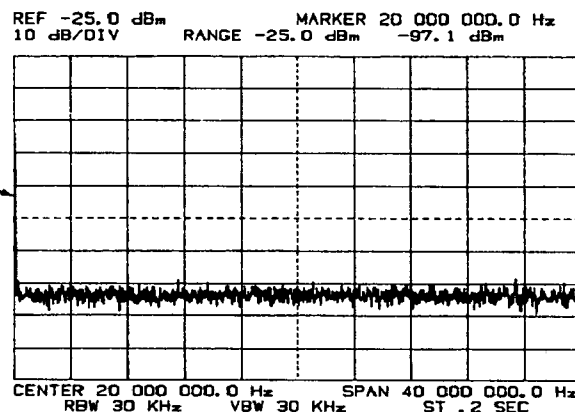

With full span, zero response may mask low-frequency signals.





CRT Display After  (no input signal)

 **STEP 1**

In the preset state, the  and  functions are activated and the 50-ohm Terminated input is selected. Both Range and Reference Level are initially preset to +30 dBm. (With no signal applied to the input, the instrument automatically downranges to -25 dBm.) With  activated, the Reference Level is coupled to Range and, therefore, remains equal to the Range setting.



Presetting establishes a full 0 Hz to 40 MHz Frequency Span with a Center Frequency of 20 MHz and a 0.2-second continuous sweep. This provides a broad “instant” view of the entire spectrum which, in most cases, will allow you to quickly locate and “zoom-in” on the major signals of interest. The peak detection system that is used in the 3585A insures that the peak of any response that protrudes through the noise is retained and displayed at a point on the CRT trace. Therefore, if a response is present anywhere in the span, you will be able to see it unless it is masked by the analyzer’s zero response which appears at 0 Hz. If the signal that you wish to measure is lower than about 300 kHz, the full span may not provide the resolution needed to separate it from the zero response. This situation can be quickly remedied by simply decrementing the Stop Frequency (with  ) until the signal becomes distinguishable.

The Resolution Bandwidth and Video Bandwidth parameters are preset to 30 kHz and the Sweep Time is preset to 0.2 seconds. These Bandwidth and Sweep Time settings are the preferred or “optimum” settings for the full 40 MHz span. Once these settings are established, the  function (also activated by ) will automatically set the Resolution Bandwidth and Video Bandwidth to maintain proportional resolution and display smoothing as the Frequency Span is narrowed. It will also automatically adjust the Sweep Time according to the Frequency Span and Bandwidth settings to maintain the maximum-calibrated sweep rate. This convenient coupling arrangement allows the operator to initially concentrate on adjusting the frequency parameters to obtain the desired frequency display range. Once the frequency parameters have been set, the Bandwidth and Sweep Time parameters can be individually adjusted to meet specific requirements and, where necessary, the coupling can be deactivated. The UNCAL indicator, located in the RBW, VBW, ST control block, lights whenever the manually-selected sweep rate is too fast to maintain calibration.

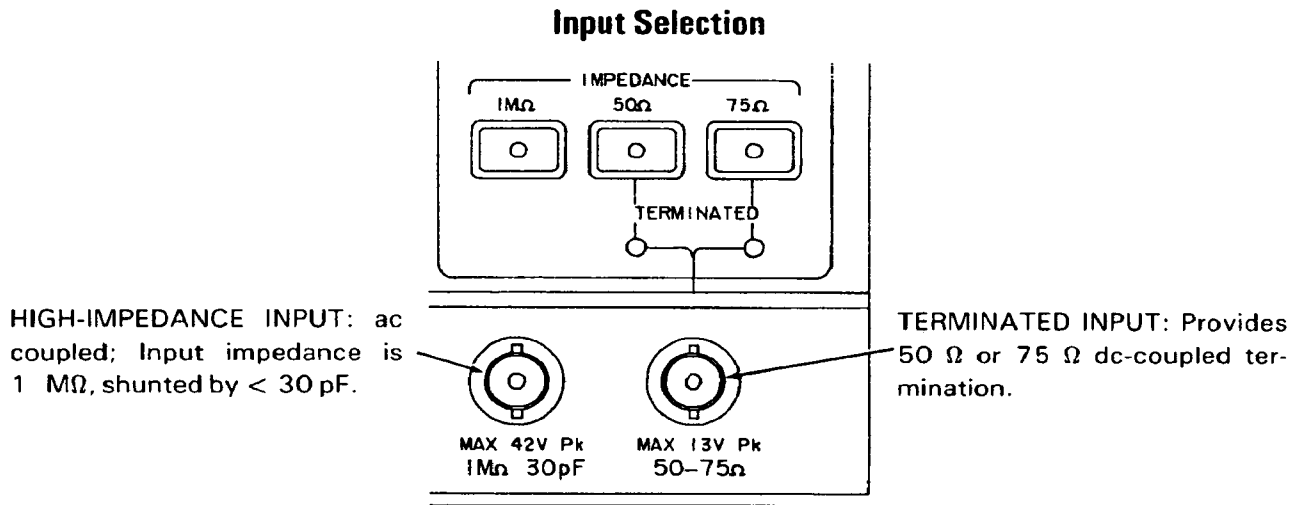

If you require specific Bandwidth and Sweep Time settings, you may, of course, select them at the onset of the measurement. In most cases, however, it is best to start out using the automatic settings and then make any fine adjustments needed to obtain the required results.

STEP 2: Select the desired input and connect the signal source.







To use the Terminated input, select the desired terminating impedance by pressing the  or  IMPEDANCE key. ( automatically activates the Terminated input and selects the 50 ohm termination.) The IMPEDANCE key will light to indicate that the Terminated input is activated; the TERMINATED light, directly below the IMPEDANCE key, will light to indicate that the input is terminated. The TERMINATED light also indicates the impedance to which the instrument is automatically calibrated for dBm measurements (i.e., dBm/50 Ω or dBm/75 Ω).

To use the High-Impedance input:

- a. Select the desired calibration impedance by pressing  OR .

(The calibration impedance is the impedance to which the instrument is automatically calibrated for dBm measurements; i.e., dBm/50 Ω or dBm/75 Ω. For measurements in dBV or volts, the IMPEDANCE setting is arbitrary.)

- b. Activate the High-Impedance input by pressing .

The  key will light to indicate that the High-Impedance input is activated. The  or  key will go out but the 50 Ω or 75 Ω TERMINATED light will stay on to indicate the calibration impedance and also to indicate that the Terminated input is terminated with a 50 Ω or 75 Ω dummy load.

STEP 2



Connect Signal Source





*The Terminated input is dc coupled. Peak (combined ac/dc) input levels exceeding ± 13 volts will activate the protection circuit but may still damage the input circuitry. **

RF input levels exceeding ± 5.25 V peak at the High-Impedance input may damage the input circuitry (see Chapter 4 for details). The peak (combined ac/dc) input level applied to the High-Impedance input must not exceed ± 42 volts.

Connect The Signal Source To The Selected Input

With  activated, the 3585A will automatically select the proper Range according to the amplitude of the ac input signal. With  also activated, the Reference Level will automatically change in 5 dB increments along with the Range setting. Since the Reference Level was initially set equal to the Range with , it will remain equal to the Range until it is manually changed. Unless the input-signal level is well below -25 dBm, this will automatically place the largest input-signal component at or near the top of the screen.

With  activated, Reference Level automatically set equal to RANGE. Largest input-signal response at or near top of screen.  sets RANGE automatically according to input-signal amplitude.

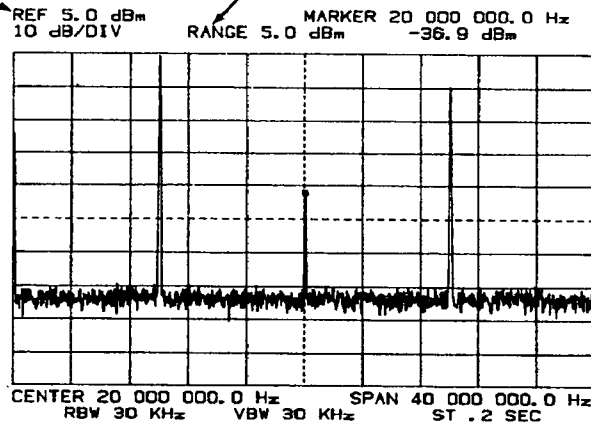

Input Signal Applied

*When the Protection circuit is activated, the Terminated input opens and the 50 Ω or 75 Ω TERMINATED light goes out. To reset the Protection Circuit, disconnect the signal source and then press any of the IMPEDANCE keys.

STEP 3: Adjust the frequency parameters to obtain the desired frequency display range.

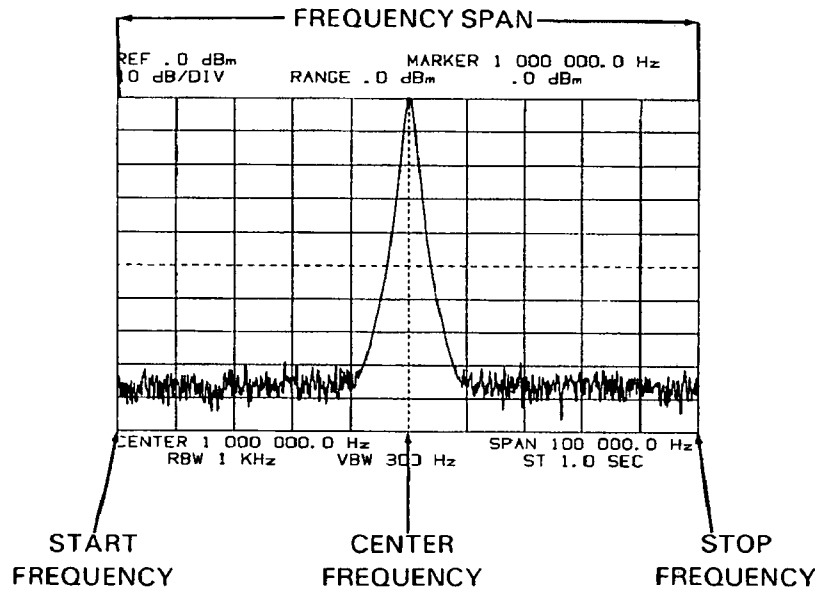

There are two basic methods for setting the frequency display range:

1. Enter Center Frequency and Frequency Span
- OR
2. Enter Start Frequency and Stop Frequency

STEP 3

Center Frequency Entries



Entering Center Frequency and Frequency Span

Center Frequency and Frequency Span entries are generally used to display and measure a specific component within the input-signal spectrum or to examine a group of closely spaced signals such as a modulated carrier and its side frequencies; IM distortion products, noise sidebands, etc.

Center Frequency



The first step is to set the Center Frequency so that the major signal of interest is in the center of the screen. This can be done using any of three entry methods:

1. Marker/Counter Entry:

Marker Entry: With  activated, set the Marker to the peak of the signal of interest with . Then, press . (This sets the Center Frequency equal to the Marker frequency.)

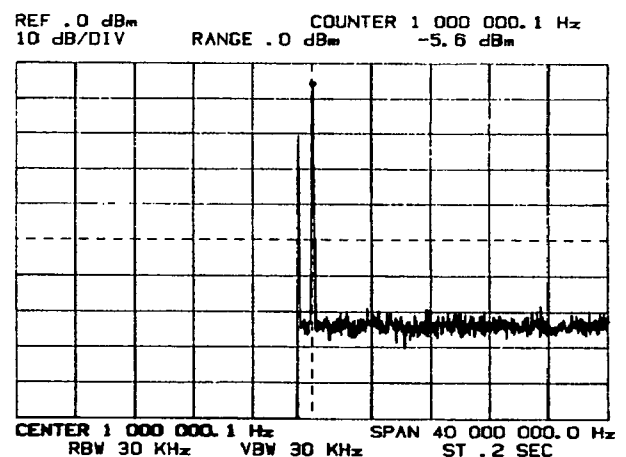
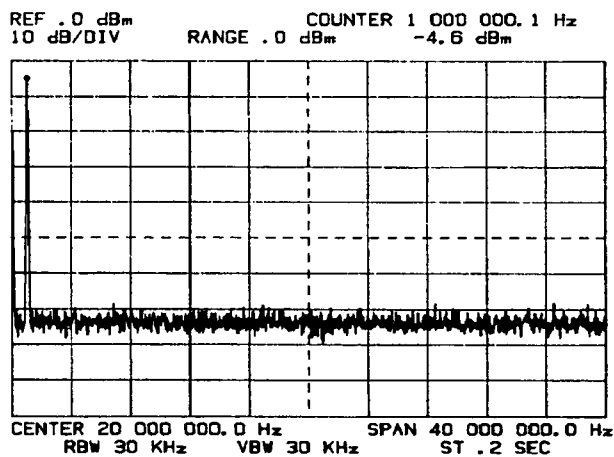
Counter Entry: Because of the limited frequency resolution and accuracy of the Marker, a response that has been moved to the center of the screen by Marker Entry may move off center as the Frequency Span is narrowed. This effect can be avoided by using the COUNTER function:







a. With  and  activated, set the Marker at least 20 dB above the noise floor on the skirt (or peak) of the response that is to be moved to the center of the screen. Allow time for the "COUNTER" reading to appear in the top-right corner of the screen.

b. Press .
(This sets the Center Frequency equal to the "COUNTER" frequency.)

(The "COUNTER" reading indicates the true signal frequency at the *peak* of the response on which the Marker is positioned.)

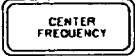

2. Continuous Entry

Activate  ; then move signal of interest to center of screen with  . Continuous Entry resolution is 0.1% of Frequency Span; i.e., 40 kHz for a 40 MHz Span.

3. Numeric Entry:  

Center Frequency is settable within the range of 0 Hz to 40.1 MHz with 0.1 Hz resolution.

NOTES

1. *If the frequency of the signal to be measured is lower than about 300 kHz, the full Span will not provide the resolution needed to separate that signal from the zero response on the CRT screen. To improve the resolution, simply decrement the Stop Frequency ( ) until the signal becomes distinguishable.*

2. *With a 40 MHz Frequency Span, a Center Frequency change greater than -0.1 Hz will set the Start Frequency lower than 0 Hz; and a change greater than $+100$ kHz will set the Stop Frequency higher than 40.1 MHz. When the Start or Stop frequency limit is exceeded the "out of range" portion of the CRT trace is blanked and the "SWEEP SPAN LIMITED" message appears on the screen. This effect can be ignored since the limited sweep span condition will be corrected when the Frequency Span is narrowed in the following step.*

STEP 3
Frequency Span Entries

Frequency Span

Once the signal has been moved to the center of the screen, the Frequency Span can be narrowed to display the frequency range of interest above and below that signal. As the Frequency Span is narrowed, the Resolution Bandwidth and Video Bandwidth settings are automatically narrowed to maintain proportional resolution and noise averaging; the Sweep Time is automatically adjusted to maintain the maximum-calibrated sweep rate.



NOTE

Changing the Frequency Span changes the displayed frequency range symmetrically about the Center Frequency and, therefore, does not affect the Center Frequency setting. Frequency Span refers to the total displayed frequency range; divide by 10 to determine Frequency Span per division.

The Frequency Span can be narrowed using either of two methods:

1. Step Entry:   

Steps change the Frequency Span to the next value in a 1, 2, 5, 10 sequence.

2. Numeric Entry:  

Frequency Span is settable within the range of 0 Hz to 40.1 MHz with 0.1 Hz resolution.

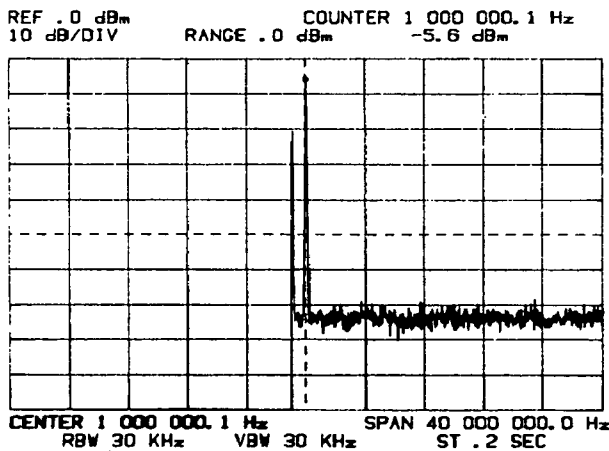

a. Signal in center of screen with limited sweep span.

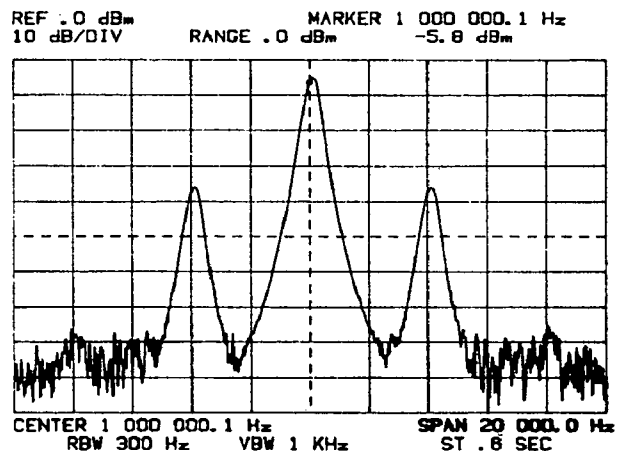



b. Frequency Span narrowed about Center frequency to obtain required resolution. RBW, VBW and ST parameters are set automatically.

(Observe that the peak of the response is skewed slightly off center. This frequency skew, caused by sweep dynamics, can be minimized by increasing the Sweep Time.)

Entering Start and Stop Frequencies

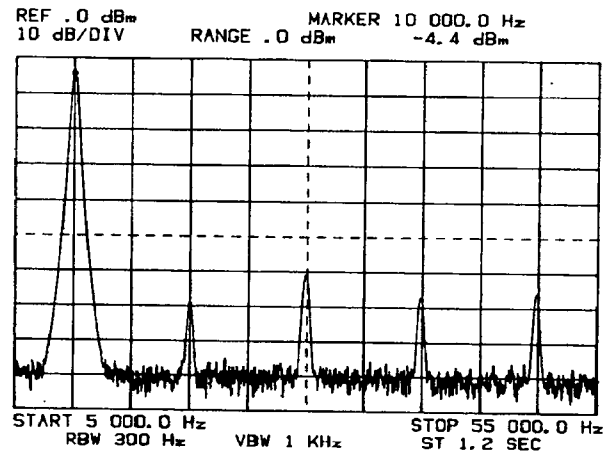

Start and Stop frequency entries provide a convenient way to display a specific range of frequencies. For example, a Start Frequency of 5 kHz and a Stop Frequency of 55 kHz can be used to fully display the fundamental through fifth harmonics of a 10 kHz signal:



Prefacing the Start Frequency or Stop Frequency automatically displays the Start and Stop frequencies in place of Center and Span. The Start and Stop frequencies will continue to be displayed until Center Frequency, Frequency Span or CF Step Size is prefaced; Center Frequency is changed by Marker or Continuous Entry; a Manual frequency is entered or  or  is pressed.

Changing the Start Frequency and/or Stop Frequency changes both the Center Frequency and the Frequency Span. The 3585A will automatically calibrate at the Center Frequency and will automatically set the Resolution Bandwidth, Video Bandwidth and Sweep Time according to the Frequency Span.*

Start and Stop frequencies can be entered three ways:

1. Numeric Entry:  OR  

The Start Frequency and Stop Frequency parameters are settable within the range of 0 Hz to 40.1 MHz with 0.1 Hz resolution.

2. Step Entry:  OR   

Steps change the Start Frequency or Stop Frequency such that the Frequency Span is at the next value in a 1, 2, 5, 10 sequence.

3. Offset Entry:

Offset entries allow you to quickly set Start and Stop frequencies or “zoom in” on a signal of interest using the Marker.

*If the Center Frequency is lower than 150 kHz, the calibration is performed at 150 kHz.

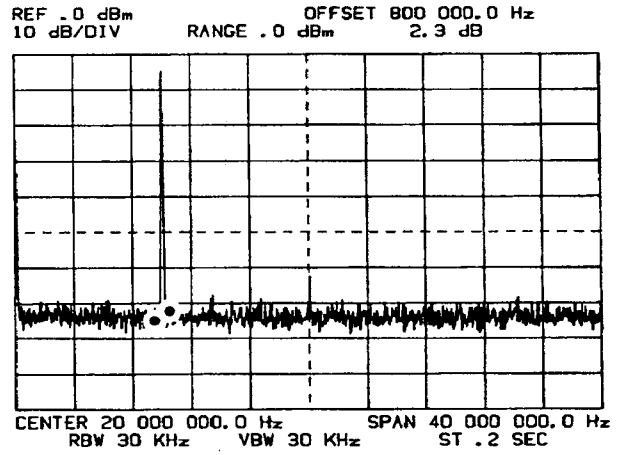
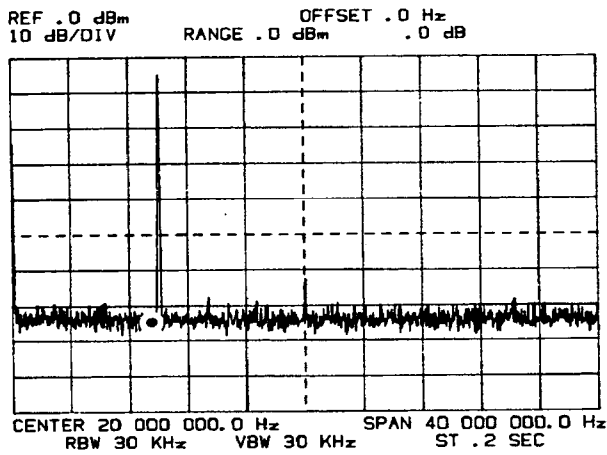

STEP 3
Start/Stop Entries

Example Offset Entry*



a. Set the Marker to the desired Start (or Stop)

Frequency with  .

Activate  and then press  .

b. Set the Marker to the desired Stop (or Start)

Frequency with  .

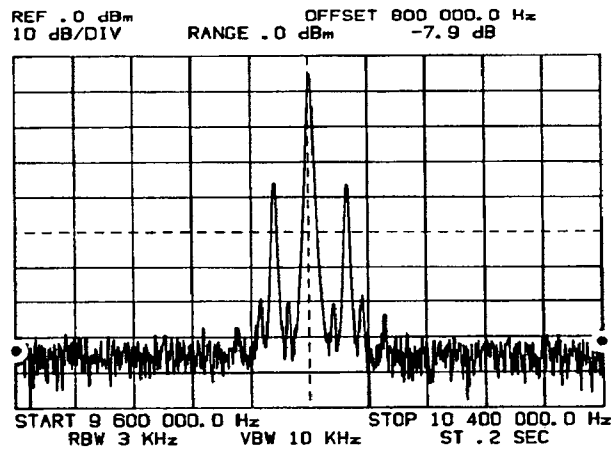



c. Press  .

(This sets the Start and Stop frequencies equal to the left and right Marker frequencies, respectively; and sets the Frequency Span equal to the "OFFSET" frequency displayed in top-right corner of screen. Note that the Markers can be placed at either end of the Span. Pressing  automatically displays "START" and "STOP" in place of "CENTER" and "SPAN".)

*After entering Start and Stop frequencies with Offset to Span, deactivate Offset so that the Marker readout will indicate absolute frequency and amplitude.

STEP 4: If necessary, adjust the Resolution Bandwidth (RBW) and/or Video Bandwidth (VBW) parameters to obtain the required sensitivity, frequency resolution and display smoothing.

Resolution Bandwidth

The Resolution Bandwidth settings that are selected automatically generally provide adequate resolution and a good aspect ratio. However, the automatic RBW settings may not provide the noise-free dynamic range required for your specific measurement or the resolution needed to separate closely spaced signals within the selected frequency span. To improve the sensitivity and frequency resolution, simply narrow the RBW one or two steps by pressing  . (Narrowing the RBW one step reduces the noise level by about 4.5 dB.) When the RBW is narrowed, the Sweep Time will automatically increase to maintain absolute calibration.

NOTE

With  activated, VBW is coupled to RBW. Therefore, a change in the RBW setting will also change the VBW setting. Changing the VBW does not affect the RBW.

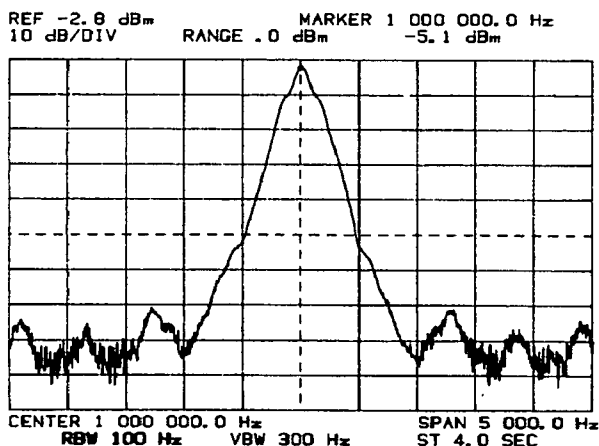

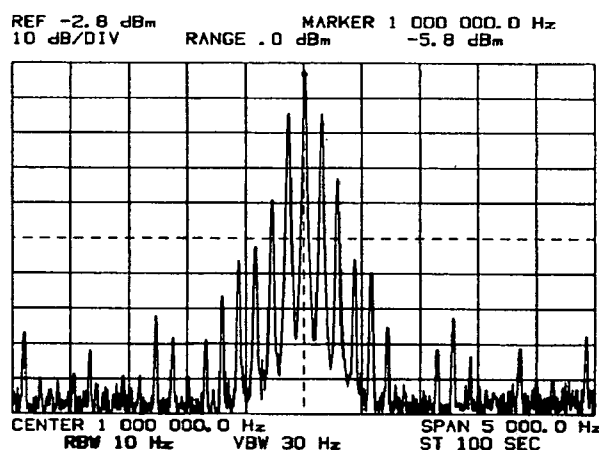

Closely spaced signals in 5 kHz Span unresolved with 100 Hz RBW (automatically selected).



Signals resolved by narrowing RBW to 10 Hz (two steps); VBW tracks RBW; ST increases to 100 seconds to maintain absolute calibration.

STEP 4
Adjust VBW

Video Bandwidth

The Video Bandwidth (VBW) settings that are selected automatically provide a minimum amount of video filtering. To measure low-level signals that are near the noise floor, it is generally necessary to narrow the VBW at least one or two steps below the automatic setting. This can be done by pressing   or by Numeric Entry. The most effective video filtering is obtained when the VBW is 10% to 1% of the Resolution Bandwidth. Narrowing the VBW automatically increases the Sweep Time.

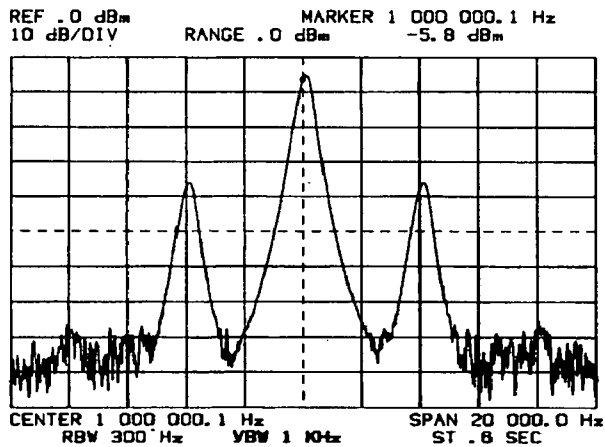

Low level harmonics masked by noise with 1 kHz VBW (automatically selected).

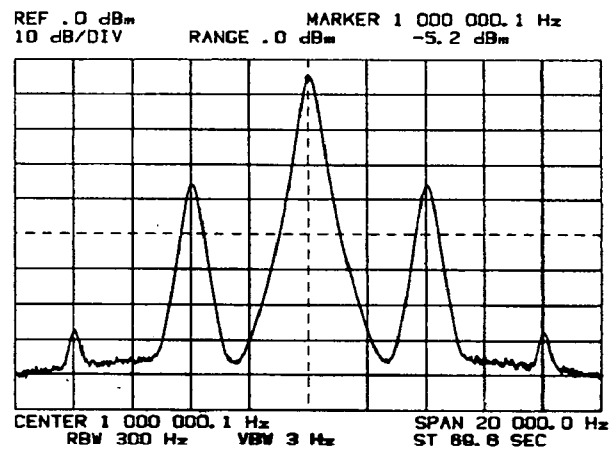

Narrowing VBW to 3 Hz (1% of RBW) reduces the noise variations, making it easy to see the low-level harmonics. (This also increased the Sweep Time and eliminated the frequency skew.)



NOTES

- 1. To measure impulse noise, the Video Bandwidth must be equal to or wider than the Resolution Bandwidth.*
- 2. When measuring random noise spectral density using the 3585A NOISE LVL function, the Video Bandwidth setting is arbitrary. (The 3585A internally selects the 100 Hz VBW during its noise measurement routine.)*
- 3. To measure the rms value of the average noise appearing on the CRT, the VBW must be narrowed to 1% of the Resolution Bandwidth (or narrower). Add +2.5 dB to the displayed average noise level to compensate for the instrument's log converter and average-responding detector.*

STEP 5: Select amplitude display units and, if necessary, adjust the Reference Level.

Select Amplitude Display Units

At this point, the Reference Level, Range and Marker amplitude are displayed in dBm/50 ohms or dBm/75 ohms, depending on the calibration impedance you selected in Step 1. If you wish to make measurements in dBV or rms volts:

1. Convert the readouts to dBV by pressing  .
2. Convert the readouts to rms volts by pressing .

NOTES

1. Converting the Reference Level readout to volts does not redefine the vertical scale. The 3585A vertical scale is always in logarithmic units of "dB" relative to the Reference Level; the 3585A does not have a linear scale. Reference Level voltage settability is limited to 0.1 dB (approximately 1%).

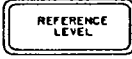
2. Pressing  returns the readouts to "dBm" or "dBV".

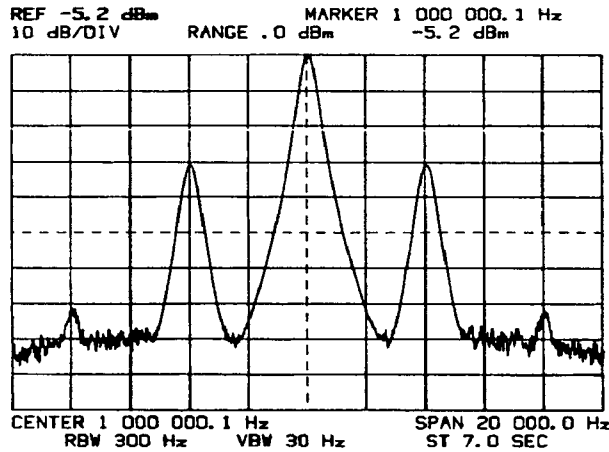

Displays REF, RANGE and Marker amplitude in "dBm" (50 Ω or 75 Ω).

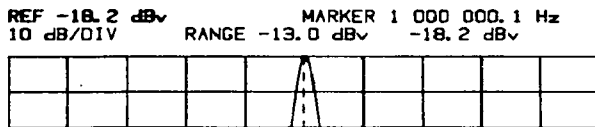

Displays REF, RANGE and Marker amplitude in "dBV" (1 V rms = 0 dBV).

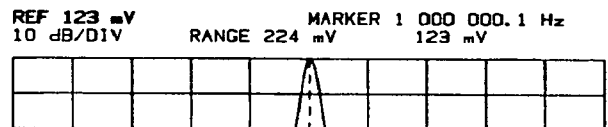

Displays REF, RANGE and Marker amplitude in rms volts.

STEP 5
Adjust Reference Level

Reference Level Adjustment

The 3585A Reference Level is settable from 100 dB below the RANGE setting to 10 dB above the RANGE setting (0.1 dB resolution). The ability to adjust the Reference Level makes it possible to move any response within the 110 dB adjustment range to the top of the screen for measurement. There are two major reasons for doing this:

1. The amplitude accuracy at the top of the screen is substantially better than it is at lower levels.
2. Signals at the top of the screen can be expanded vertically by reducing the Vertical Scale (dB/DIV) setting. Vertical expansion improves the amplitude resolution and accuracy.

Also, with a narrow Resolution Bandwidth the noise level may be so low that it is below the bottom line of the CRT graticule. By lowering the Reference Level, the noise floor and any low-level signals can be moved onto the screen for measurement.

For general-purpose measurements where optimum amplitude accuracy is not required, the Reference Level is normally adjusted so that the peak of the largest response to be measured is at the top of the screen. This minimizes scale errors within the measurement range being used and provides maximum vertical display range. For applications requiring high amplitude accuracy, the individual signals of interest are moved to the center of the screen (by adjusting the Center Frequency) and are then moved to the top of the screen by adjusting the Reference Level. The most accurate point on the CRT display is the Reference Level at the Center Frequency or Manual frequency (i.e., the frequency at which the Automatic Calibration is performed).

NOTES

Points on the CRT trace will not respond to a change in Reference Level (or any other parameter) until they are updated by the frequency sweep. For this reason, it may be beneficial to adjust the Reference Level before making RBW/VBW adjustments that will increase the Sweep Time.



Lowering the Reference Level (rotating  CCW) moves low-level signals closer to the top of the screen.

The Reference Level can be set equal to the RANGE at any time by simply turning  off and then back on.



The Reference Level can be adjusted using any of four different techniques:

1. Continuous Entry:

Activate  and move the signal of interest to the top of the screen using the Continuous Entry control . Continuous Entry resolution is 0.1 dB.

2. Marker Entry:

With  activated, set the tunable Marker to the peak of the response that is to be moved to the top of the screen; and then press . (This sets the Reference Level equal to the Marker amplitude.)

3. Step Entry:  OR   

Steps change Reference Level by 5% of amplitude display range; i.e., 5 dB, 2.5 dB, 1 dB or 0.5 dB, depending on Vertical Scale setting.

4. Numeric Entry:   OR  

Settability is 100 dB below Range to 10 dB above Range, 0.1 dB resolution.

Vertical Expansion



Reducing the Vertical Scale (dB/DIV) setting expands the vertical scale downward from the Reference Level. Vertical expansion improves the amplitude resolution on the CRT trace and also improves the Marker amplitude resolution and accuracy.

The 3585A has four Vertical Scale settings; 10 dB, 5 dB, 2 dB and 1 dB per division. With ten vertical divisions, these settings provide a display range of 100 dB, 50 dB, 20 dB or 10 dB, respectively:

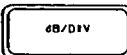

Vertical Scale	Display Range	Marker Amplitude Resolution	Reference Level Accuracy Degradation*
10 dB/DIV	100 dB	0.1 dB	± 0.1 dB
5 dB/DIV	50 dB	0.05 dB	± 0.1 dB
2 dB/DIV	20 dB	0.02 dB	none
1 dB/DIV	10 dB	0.01 dB	none

* When the Marker is at the top of the screen, the Marker amplitude accuracy is equal to the Reference Level accuracy. When using the 10 dB/DIV or 5 dB/DIV Vertical Scale setting, add ± 0.1 dB to the Reference Level (and Marker) amplitude accuracy specification.

The Vertical Scale setting can be changed two ways:

1. Step Entry:   

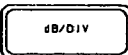
Steps select next available setting.

2. Numeric Entry:  

Enter specific setting. (Entries that select unavailable settings are not accepted.)

STEP 5
Vertical Expansion

Here is a technique for moving a signal of interest to the top of the screen and expanding it vertically:

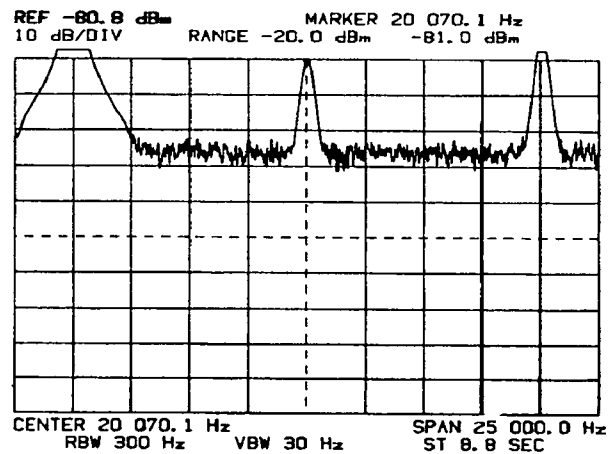
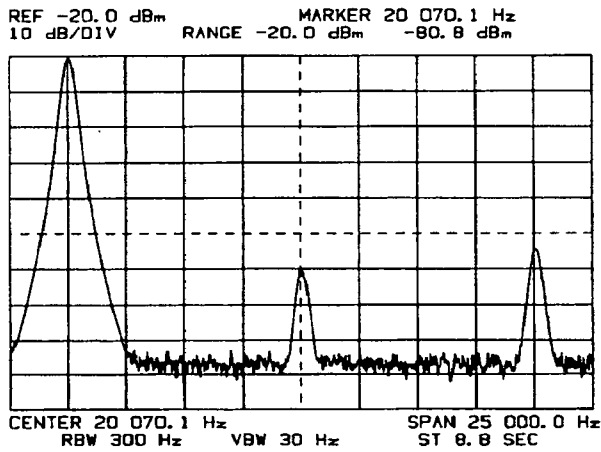

a. Set Marker to peak of signal with 

b. Move signal to top of screen by pressing



(This could also be done by Continuous, Step or Numeric Entry.)

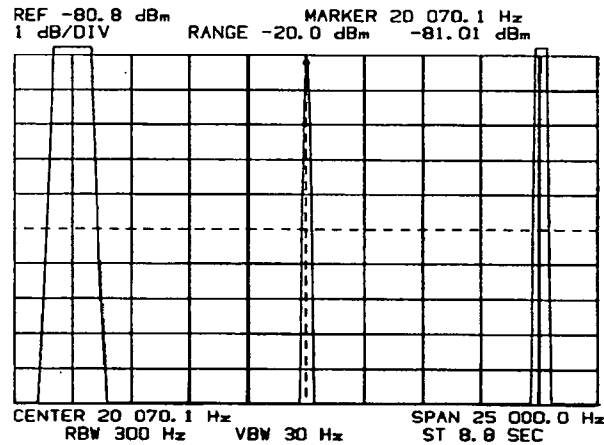

c. Reduce the Vertical Scale with   or by Numeric Entry.



(Observe that "MARKER" amplitude readout now has two fractional digits. With 1 dB/DIV, Marker amplitude resolution is 0.01 dB.)

NOTE

Signals that are above the Reference Level will overdrive the display as shown. This will not damage the instrument nor degrade its performance.

STEP 6: Measure frequency and amplitude of on-screen responses using the tunable Marker.

Absolute Measurements

With  activated, set the tunable Marker to the point of interest on the CRT trace using the Continuous Entry control . Read the absolute frequency and amplitude directly from the "MARKER" readout in the upper right-hand corner of the screen.

Precise Frequency Measurement Using The Counter

The Marker's frequency resolution and accuracy is limited by the point-by-point display and sweep dynamics. To precisely measure the frequency of a signal that is producing a response, use the COUNTER function:

1. Set the Marker at least 20 dB above the noise floor on the skirt (or peak) of the response to be measured.
2. Activate ; allow time for the COUNTER reading to appear in the upper right-hand corner of the CRT screen. (The COUNTER reading does not appear until the frequency sweep passes through the Marker frequency.)
3. The COUNTER reading indicates the true signal frequency at the *peak* of the response on which the Marker is positioned. The Marker does not need to be at the peak of the response.

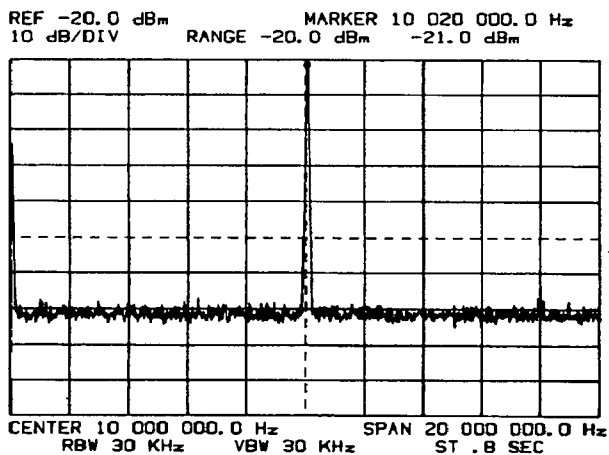

a. Peak of 10.035 MHz response displayed at 10.02 MHz point on CRT trace as indicated by "MARKER" frequency readout.

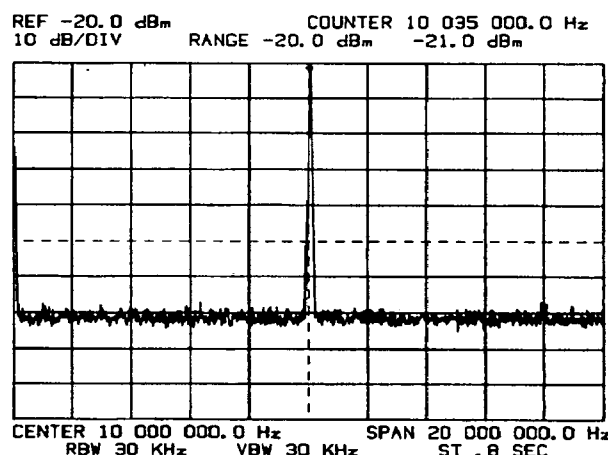

b. "COUNTER" frequency readout indicates true frequency at peak of response.





STEP 6
Optimizing Amplitude Accuracy

NOTES

- 1. The "COUNTER" amplitude readout indicates the Marker's amplitude on the CRT trace which is not necessarily the amplitude at the peak of the response. To measure the peak amplitude of a response, the Marker must be set to the peak of that response.*
- 2. The counting operation, performed each time the frequency sweep passes through the marker frequency, will sometimes produce dynamic "glitching" on the skirt of the response whose frequency is being counted. This does not affect the frequency or amplitude accuracy.*
- 3. To obtain accurate, stable Counter readings, the Marker must be at least 20 dB above the noise floor and at least 20 dB above any unresolved signal that is inside the IF filter skirts.*
- 4. While the Marker is being tuned, the Counter is inhibited and the readout displays the "MARKER" frequency and amplitude. When the Marker becomes stationary, the "COUNTER" reading reappears after the frequency sweep passes through the Marker frequency.*

Optimizing Amplitude Accuracy

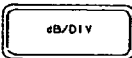
To measure the absolute amplitude of a response with high accuracy, perform the following steps:





- a. Move the response to the center of the screen by adjusting the Center Frequency.
- b. Increase the Sweep Time *two* steps by pressing    .
- c. Move the Response to the top of the screen by adjusting the Reference Level.
- d. Reduce the Vertical Scale to 1 dB/DIV with   or by Numeric Entry.
- e. Set the Marker to the peak of the response and observe the amplitude reading.

Relative Frequency And Amplitude Measurements

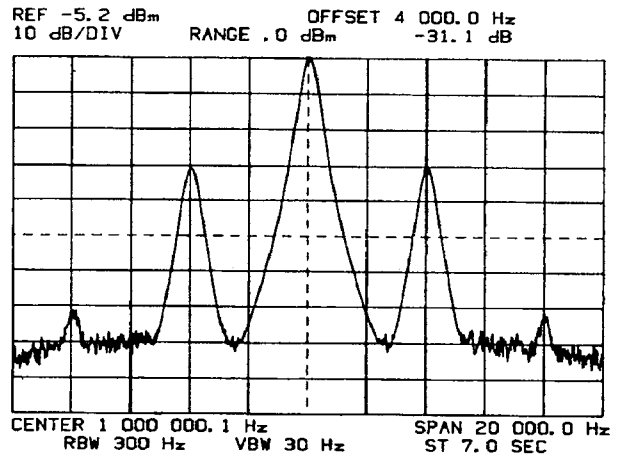
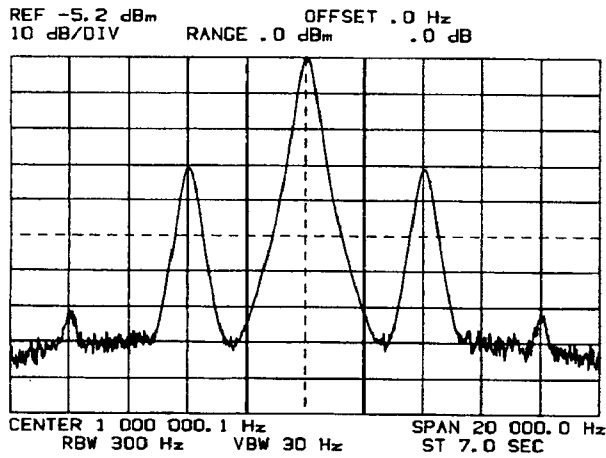
The 3585A OFFSET function can be used to measure the relative frequency and amplitude between any two points on the CRT trace.

EXAMPLE: Measure the frequency and amplitude of AM sidebands relative to the carrier:



- a. First, set the Marker to the peak of the carrier with  . Then activate  and press .

- b. Set the Marker to the peak of the upper (or lower) sideband with . (A stationary marker remains at the carrier frequency.) The "OFFSET" reading indicates the frequency and amplitude of the sideband relative to the carrier.*

NOTE

The "OFFSET" amplitude is always displayed in "dB". It cannot be displayed in volts.





*Modulation percentage can be calculated by: $200 \times \log^{-1} (\text{dB}/20)$. Where: "dB" = amplitude of one sideband relative to carrier.

Offset Counter Measurements

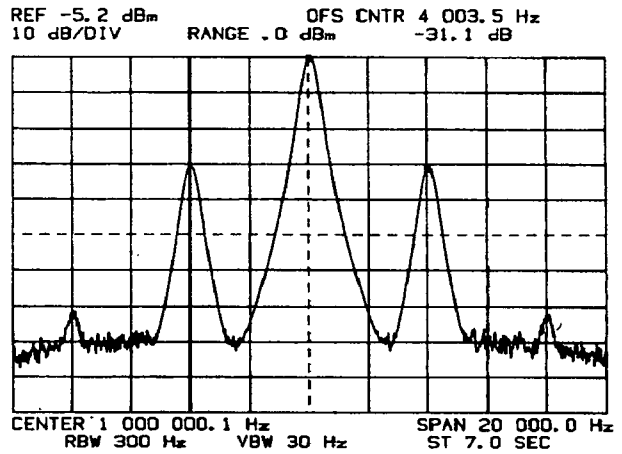
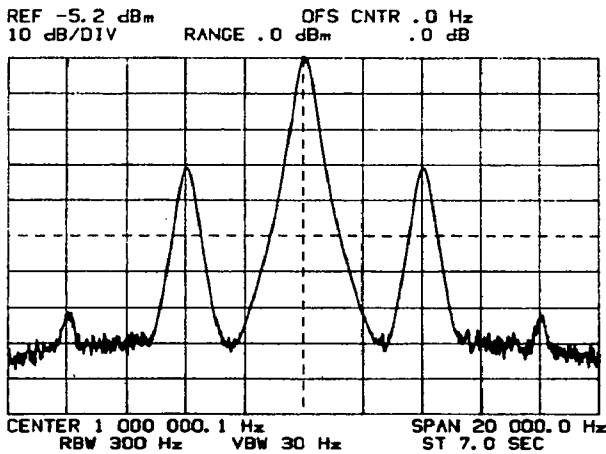
The COUNTER function can be used in conjunction with the OFFSET function to very accurately measure the frequency difference between two signals.

EXAMPLE: use the Counter to precisely measure the frequencies of the AM sidebands relative to the carrier. (This is a more accurate version of the AM measurement given in the preceding example.)



- a. With  and  activated, set the Marker to the peak of the carrier with . Allow time for the "COUNTER" reading to appear in the top-right corner of the screen. Then activate  and press .

(The "COUNTER" reading indicates the true absolute carrier frequency. Pressing  stores the "COUNTER" reading in the Offset Register.)



- b. Set the Marker to the peak of the upper (or lower) sideband with . Allow time for the "OFS CNTR" reading to appear. As indicated by the "OFS CNTR" reading, the true difference frequency is 4,003.5 Hz as opposed to the 4,000.0 Hz reading obtained in the preceding example.

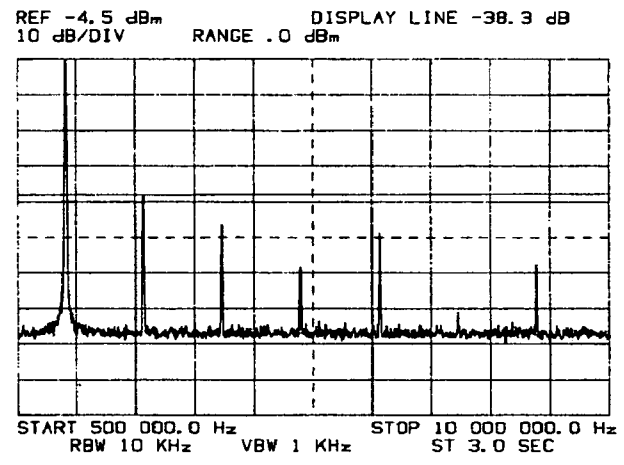
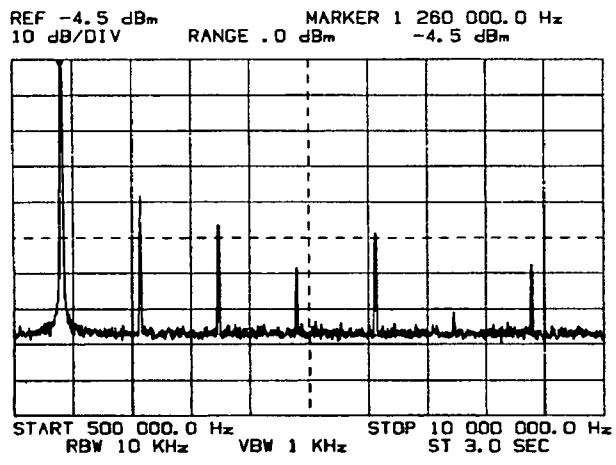

(The 'OFS CNTR' reading indicates the difference between the carrier frequency in the Offset Register and the counted frequency of the upper sideband.)

Measure Signals In "dB" Relative To Reference Level Using Display Line







EXAMPLE: Measure harmonics in "dB" relative to the fundamental:



a. Set Marker to peak of fundamental with .
. Move fundamental to top of screen by pressing .

b. Activate . Set Display Line to peak of harmonic to be measured with . The "DISPLAY LINE" readout indicates the harmonic's amplitude in "dB" relative to the fundamental; i.e., the Reference Level.

NOTE

When  is activated, the Marker disappears from the screen and the "DISPLAY LINE" amplitude is displayed in place of the "MARKER" (or other) reading in the upper-right-hand corner of the screen. Pressing the Display Line  key clears the Display Line and its readout from the screen; but it does not return the Marker to the screen. To restore the Marker and its readout, activate  or  or  or press .



SPECIAL MEASUREMENT TECHNIQUES

Measure Random Noise Spectral Density Using The  Function

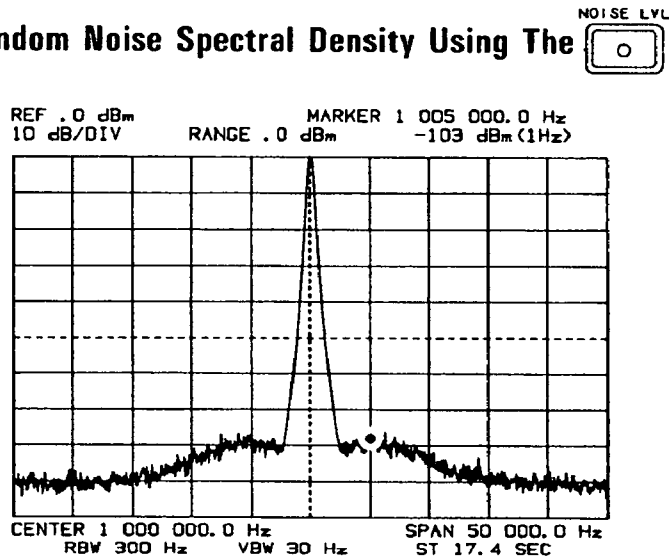





Set the Marker to the point of interest on the noise floor. Activate  and allow time for the noise level (“dBm (1 Hz)”, “dBV (1 Hz)”; or “ \sqrt{V} Hz”) to appear in place of the Marker amplitude in the upper right-hand corner of the screen. The noise level reading indicates the rms random noise spectral density at the Marker, normalized to a 1 Hz noise power bandwidth.

NOTES

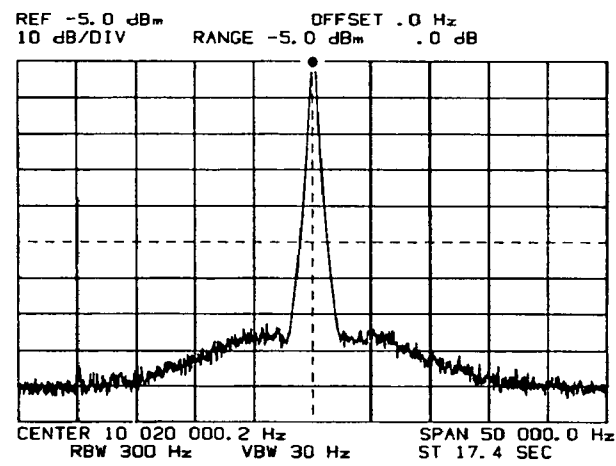

1. When the analyzer is sweeping, the sweep stops at the Marker frequency to permit the noise reading to be calculated. While the noise reading is being calculated, the suffix of the current amplitude or noise level reading is displayed brighter than normal. At the end of the noise calculation, the sweep resumes and the suffix returns to normal brightness to indicate that a valid noise level reading is available. The noise measurement time varies from approximately 0.3 seconds to 33 seconds, depending on the RBW setting. Narrow bandwidths require longer measurement periods.
2. The noise being measured must be random noise. The NOISE LVL function cannot be used to measure impulse noise or other signals containing discrete, phase-coherent frequency components.
3. To obtain accurate noise level readings, the RBW must be narrow enough to resolve a relatively flat portion of the noise spectrum.
4. The requirements for using the NOISE LVL and COUNTER functions are conflicting—If the Marker is on the noise, the Counter will not operate properly; if the Marker is on a signal, the noise reading will be inaccurate. Therefore, deactivate the COUNTER when using the NOISE LVL function (and vice-versa).
5. Changing the Marker frequency or any of the frequency or amplitude parameters will abort the noise calculation (if any) currently in progress.

Measure Signal-To-Noise Ratio Using The  And  Functions

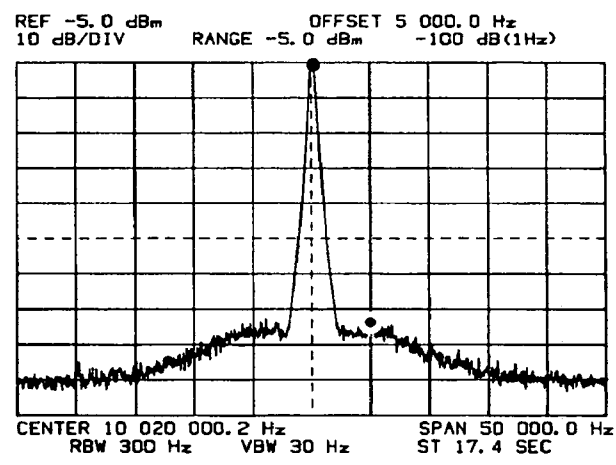

- a. Set the Marker to the peak of the signal with  . Activate  and press .











- b. Set the Marker to the point of interest on the noise floor with . Activate  and wait for the "dB (1 Hz) reading to appear.

(The "dB (1 Hz) reading indicates the rms noise spectral density at the Marker in a 1 Hz bandwidth *relative* to the carrier amplitude.)

SPECIAL MEASUREMENT TECHNIQUES
 Step CF Measuring Harmonic Distortion

Step The Center Frequency To Measure Equally Spaced Portions Of The Spectrum





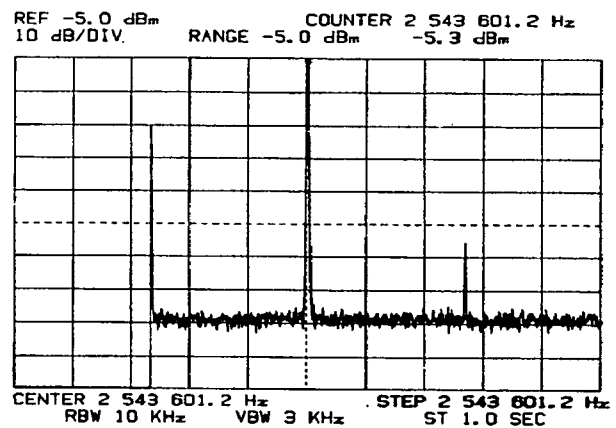
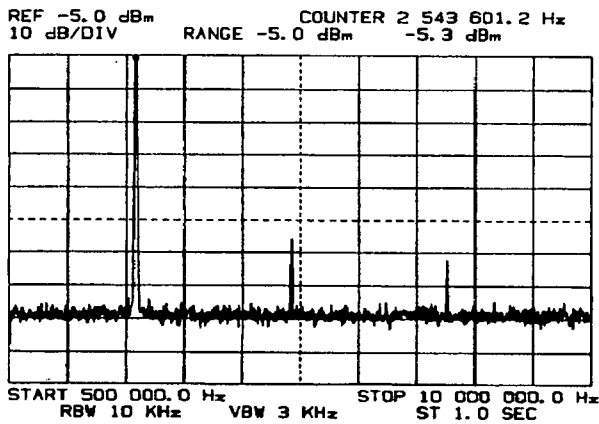

Pressing   OR  changes the Center Frequency in steps equal to the Center Frequency Step Size. The Center Frequency Step Size is settable within the range of 0 Hz to 40.1 MHz with 0.1 Hz resolution. It can be changed by Marker/Offset Entry, Step Entry or Numeric Entry:

- Marker/Offset:  Sets CF Step Size equal to the current Marker, Counter, Offset or Manual frequency (whichever is being displayed).
- Step Entry:    Changes CF Step Size to next value in a 1, 2, 5, 10 sequence.
- Numeric Entry:   Selects a specific step size; 0 Hz to 40.1 MHz, 0.1 Hz resolution.

The ability to step the Center Frequency makes it possible to survey a wide frequency range in sequential pieces with high resolution. This is particularly useful for close-in observation of equally-spaced signals such as distortion products, modulation side frequencies, communication channels, etc. Here are some examples:

Measuring Harmonic Distortion



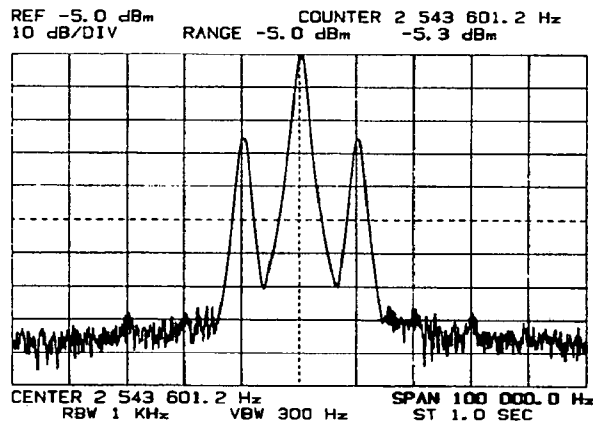

- a. Set the Marker to the peak of the fundamental with  . Move the fundamental to the top of the screen by pressing . Activate  to precisely measure the fundamental frequency.
- b. Move the fundamental to the center of the screen by pressing  (or by numerically setting the Center Frequency equal to "COUNTER"). Set the Center Frequency Step Size equal to the fundamental frequency (i.e., "COUNTER" frequency) by pressing  or by Numeric Entry.

SPECIAL MEASUREMENT TECHNIQUES
Measuring Harmonic Distortion



- c. Narrow the Frequency Span about the Center Frequency to obtain the required resolution. If necessary, reposition the Marker to the peak of the response.

(Due to the changes in Bandwidth and Sweep Time, the response may have moved slightly off center.)

If you wish to measure the succeeding harmonics in "dB" relative to the fundamental, activate  and press .

NOTE

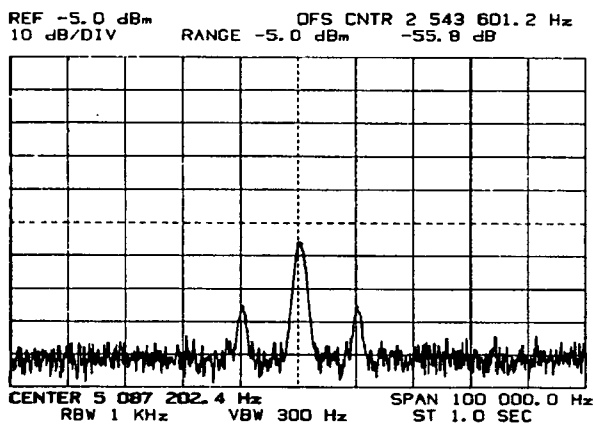

If the harmonics to be measured are not at least 20 dB above the noise, deactivate .

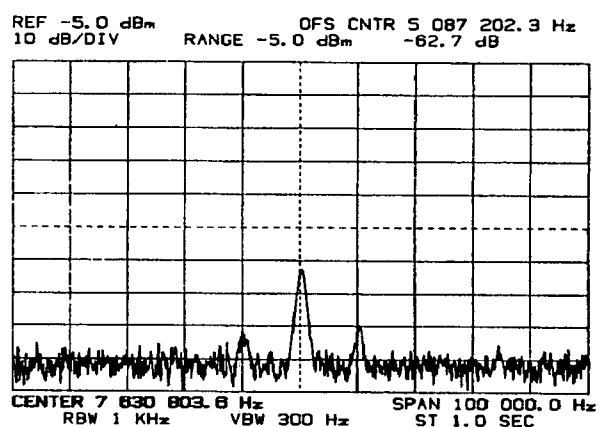

Second Harmonic



Third Harmonic

- d. Press   to display and measure succeeding harmonics.

(If desired, individual harmonics can be moved to the top of the screen by pressing . Also, the VBW can be narrowed to obtain better noise averaging.)

SPECIAL MEASUREMENT TECHNIQUES
 Measuring Modulation Side Frequencies



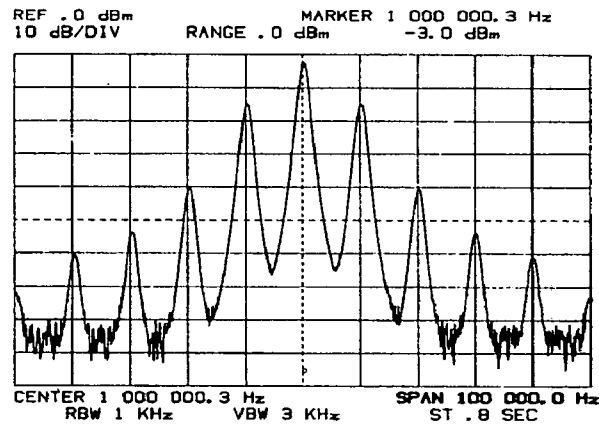

Measuring Modulation Side Frequencies

A 100 kHz span displays a 1 MHz carrier that is amplitude modulated by a signal whose frequency is approximately 10 kHz. The display shows the carrier and the upper and lower sidebands, containing the fundamental modulation side frequencies and their harmonics.

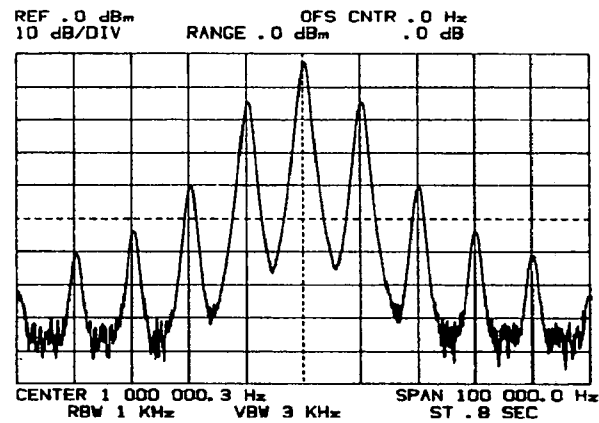

To individually measure the modulation side frequencies and harmonics with high resolution:



- a. Set the Marker to the peak of the carrier with  . Activate  to precisely measure the carrier frequency. Store the carrier frequency and amplitude in the Offset Register by activating  and pressing .

SPECIAL MEASUREMENT TECHNIQUES

Measuring Modulation Side Frequencies

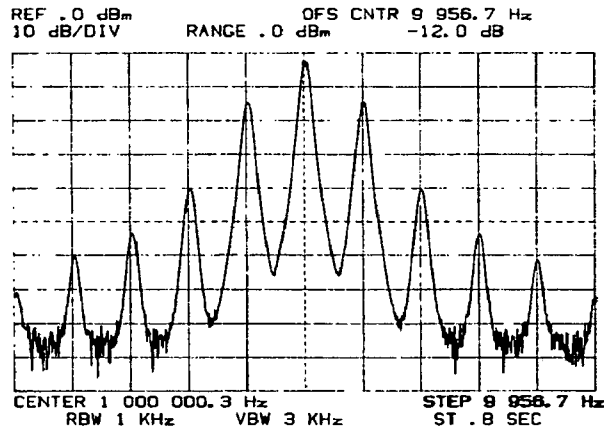

- b. Set the Marker to the peak of the upper (or lower) side frequency. The "OFS CNTR" (Offset Counter) reading indicates the difference between the carrier frequency in the Offset Register and the counted side frequency on which the Marker is positioned. The amplitude readout indicates that the side frequency is 12 dB below the carrier.

Set the Center Frequency Step Size exactly equal to the "OFS CNTR" frequency by pressing  or by Numeric Entry.

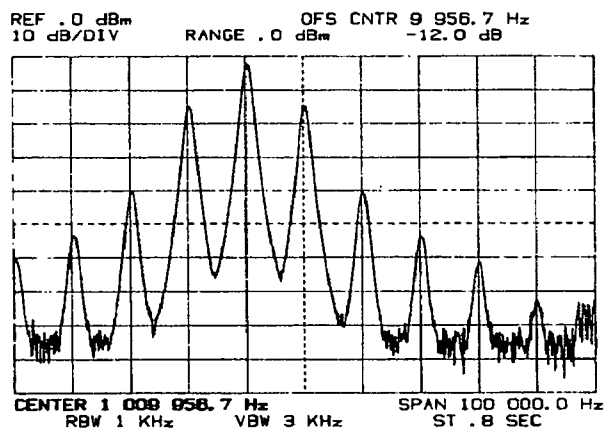

- c. Move the upper side frequency to the center of the screen by pressing .

(This sets the Center frequency exactly equal to the *absolute* Counter frequency.)



Deactivate .

(The Counter is no longer needed and some of the higher order harmonics are too near the noise to be measured with the Counter.)

SPECIAL MEASUREMENT TECHNIQUES

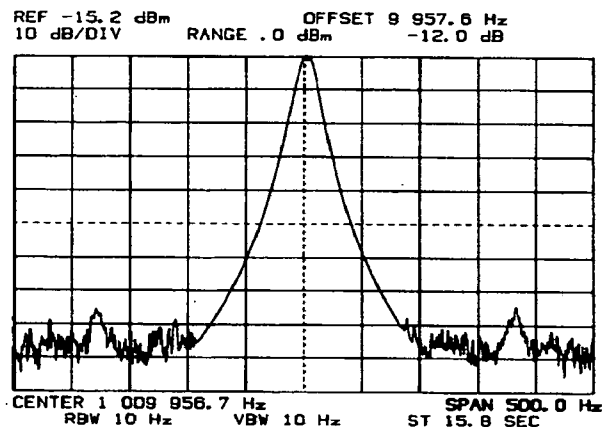
Measuring Modulation Side Frequencies



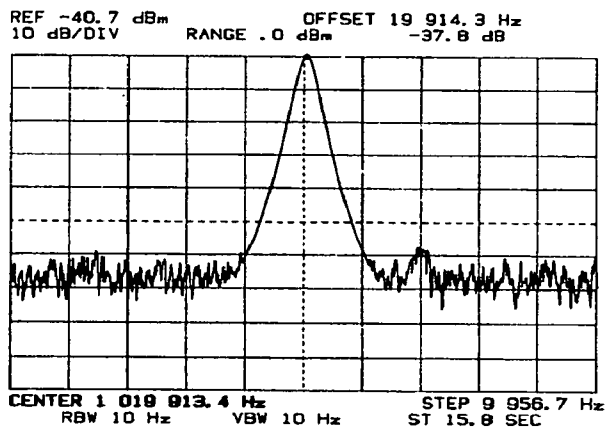

- d. Narrow the Frequency Span about the Center Frequency to obtain the required resolution. Due to the change in Bandwidth and Sweep Time, the response may be skewed slightly off center, making it necessary to reposition the Marker. With the marker set to the peak of the response, move the response to the top of the screen by pressing . If you wish to measure succeeding harmonics in "dB" relative to the fundamental (rather than the carrier) press .

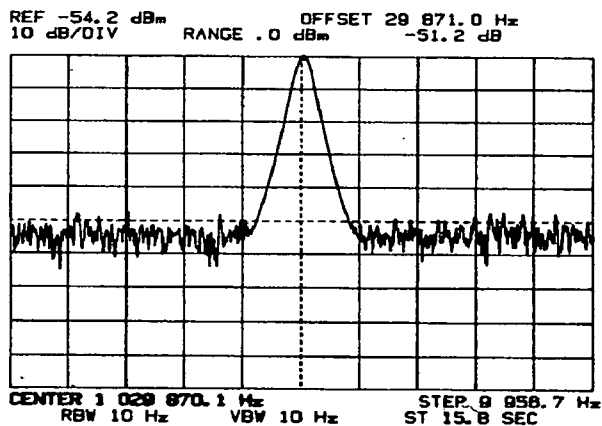

Second Harmonic



Third Harmonic

- e. Press   to display and measure succeeding harmonics. If desired, press  to move each response to the top of the screen for measurement.

IMPROVING THE NOISE-FREE AND DISTORTION-FREE DYNAMIC RANGE

NOTE

The following procedures for improving the noise-free and distortion-free dynamic range are intended primarily for use with the Terminated input. The distortion characteristics of the High-Impedance input vary according to the specific Range setting that is being used and, therefore, do not conform to the distortion characteristics referred to in these procedures. The procedure for overdriving to improve the noise-free dynamic range can be applied to the High-Impedance input at frequencies above 200 kHz. (At lower frequencies, the noise-vs.-Range characteristics of the High-Impedance input vary as a function of frequency and source resistance.)

Overdrive To Improve Noise-Free Dynamic Range

When measuring the low-level spurious components or noise of an external source, it is sometimes beneficial to decrement the Range one or two steps below the optimum (automatic) setting. This overdrives the input circuitry (OVERLOAD light on) and increases the internal distortion; but it also improves the internal signal-to-noise ratio, making it possible to measure low-level signals that would otherwise be affected by the analyzer's internal noise.

Overdriving will not damage the instrument as long as the input-signal level is below the maximum input level printed on the front panel. The 3585A is designed to permit the inputs to be overdriven up to 12.3 dB above the Range setting.

Decreasing the Range one step (5 dB) increases the internal signal level by 5 dB and provides a corresponding 5 dB increase in the signal-to-noise ratio.

In the 12.3 dB overdrive region (Terminated input), the internal distortion increases predictably as a function of the internal signal level. A 5 dB increase in the internal signal level will increase the internal second-harmonic and second-order IM distortion by about 5 dB; and will increase the third-harmonic and third-order IM distortion by about 10 dB. The overdrive mode can be used to *locate* low-level distortion products; but it *must not* be used to measure distortion since the analyzer's internal distortion may significantly contribute to the measurement.

IMPROVING DYNAMIC RANGE

Overdriving

Example Of Overdriving

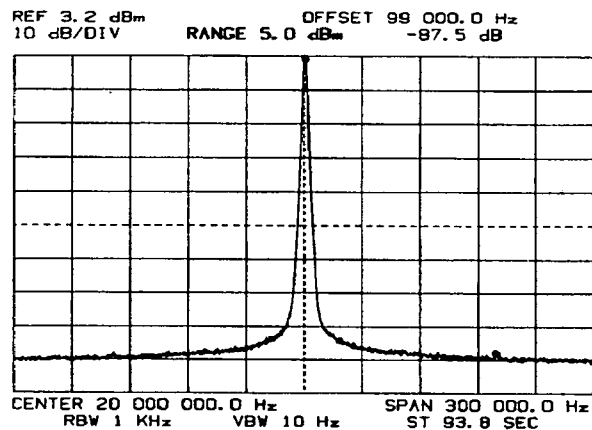

With RANGE set to +5 dBm, low-level spurious responses masked by the analyzer's internal noise *and* the noise of the external source are difficult to see and measure even with a narrow VBW.

NOTE

To keep the signal at the top of the screen, deactivate  before changing the Range setting. If downranging causes the noise to drop below the bottom of the screen, it will be necessary to lower the Reference Level to display the noise and the low-level responses. This will not affect the overdrive measurement.

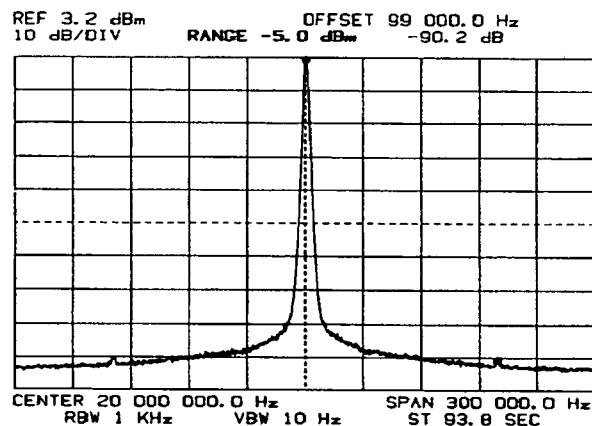

Decrementing the RANGE to -5 dBm (10 dB) reduces the internal noise level by 10 dB, providing a substantial improvement in the signal-to-noise ratio. The low-level spurious responses are still near the noise level of the external source; but the analyzer's internal noise is no longer contributing to the measurement.

Because of the decrease in noise, the relative amplitude of the response being measured is about 3 dB *lower* than it was previously. If downranging *increases* the amplitude of a response (with respect to the signal) that response is a *distortion* product.

Underdrive To Optimize Distortion-Free Dynamic Range

Downranging increases the internal signal level and improves the signal-to-noise ratio at the cost of higher distortion. Upranging, on the other hand, decreases the internal signal level and decreases the internal distortion but also decreases the signal-to-noise ratio.

By initially selecting a narrow Resolution Bandwidth and compatible Video Bandwidth to reduce the noise, the distortion-free dynamic range can be optimized by simply upranging until the distortion products being measured either remain at a constant amplitude (with respect to the fundamental or driving signal) or converge with the noise:

- a. If the relative amplitude of a distortion product does not change significantly when the Range is incremented, the measurement is free of internal distortion.
- b. If upranging causes the relative amplitude of a distortion product to decrease, internal distortion is contributing to the measurement. If a distortion product disappears in the noise and the Resolution Bandwidth is already set to 3 Hz, nothing more can be done to reduce the noise; but the measurement at least reveals that the distortion is below the noise level.

Example Low-Level Distortion Measurement *

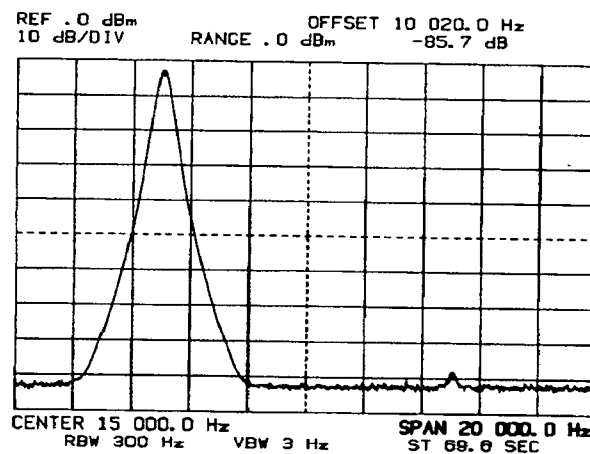

- a. A 20 kHz Span displays the fundamental and low-level second harmonic of a 10 kHz signal source whose specified second harmonic distortion is 90 dB below the fundamental. As indicated by the "OFFSET" reading, however, the harmonic appears to be only 85.7 dB down. The 3585A's internal second harmonic distortion is specified to be at least 80 dB below the signal; so, in this case, internal distortion could be contributing to the measurement. One way to find out is to "zoom-in" on the second harmonic, narrow the Span and Bandwidth and then increment the Range to optimize the distortion-free dynamic range.

*This same measurement could be made much more efficiently using the 3585A's "Manual mode" which is described in the following chapter. The techniques illustrated in this example can be used in the Manual mode and can also be applied when making IM distortion measurements. Internal distortion is generally not a concern unless you are measuring second or third harmonic distortion that is more than 80 dB below the fundamental; second-order IM products that are more than 70 dB below the larger of the two driving signals; or third-order IM products that are more than 80 dB below the larger of the two driving signals.

IMPROVING DYNAMIC RANGE

Underdriving.

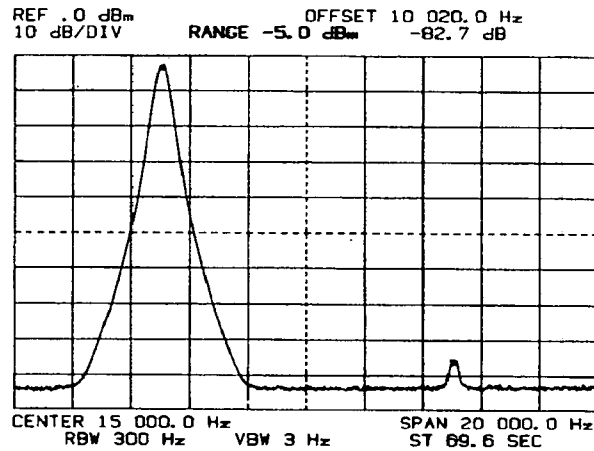

- b. Downranging one step (with REF LVL TRACK deactivated) decreases the internal noise level and increases the internal second-harmonic distortion making it easy to pinpoint the second-harmonic response.
-

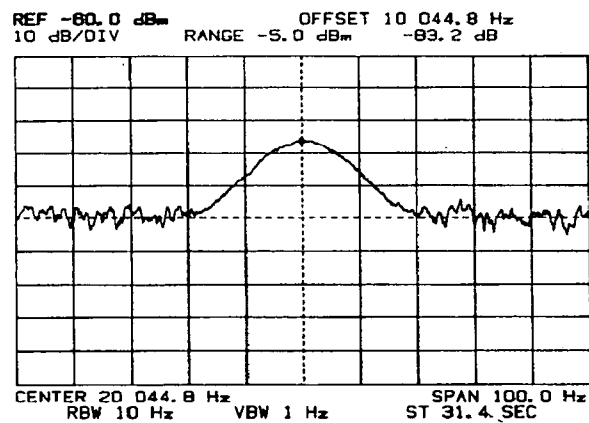

- c. Second-harmonic response moved to center of screen and displayed with 100 Hz Span and 10 Hz RBW. Reference Level lowered to -60 dBm to display signal and noise in upper portion of CRT screen.

(The 3 Hz RBW would provide a lower noise level; but the 10:1 RBW/VBW ratio, unobtainable with the 3 Hz RBW, provides better noise averaging.)

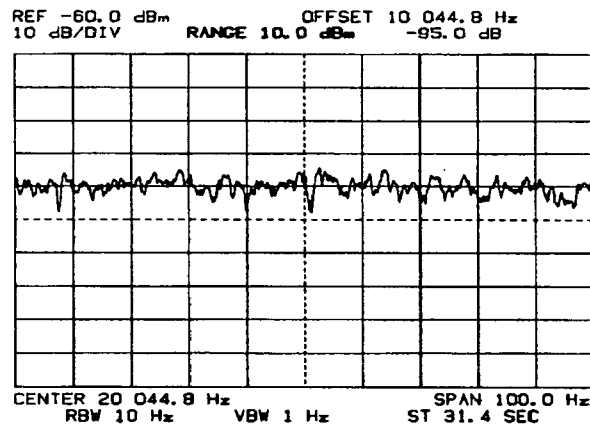
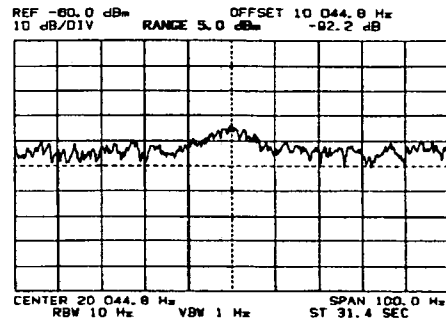
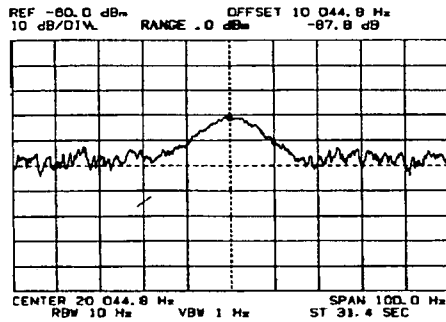

- d. Incrementing the Range decreases the harmonic's amplitude, indicating that internal distortion is contributing to the measurement.

(As shown in the figures, the second harmonic finally converged with the noise when the Range was incremented to + 10 dBm. With the signal buried in noise, it was impossible to obtain an exact reading. However, the average noise level at that point was about 97 dB below the fundamental; so we were able to conclude that the harmonic was at least 97 dB down and certainly well-within its 90 dB specification. The signal source, incidently, is the -hp- Model 239A Oscillator.)

TRACKING GENERATOR

AMPLITUDE FREQUENCY-RESPONSE MEASUREMENTS USING THE TRACKING GENERATOR

Tracking Generator



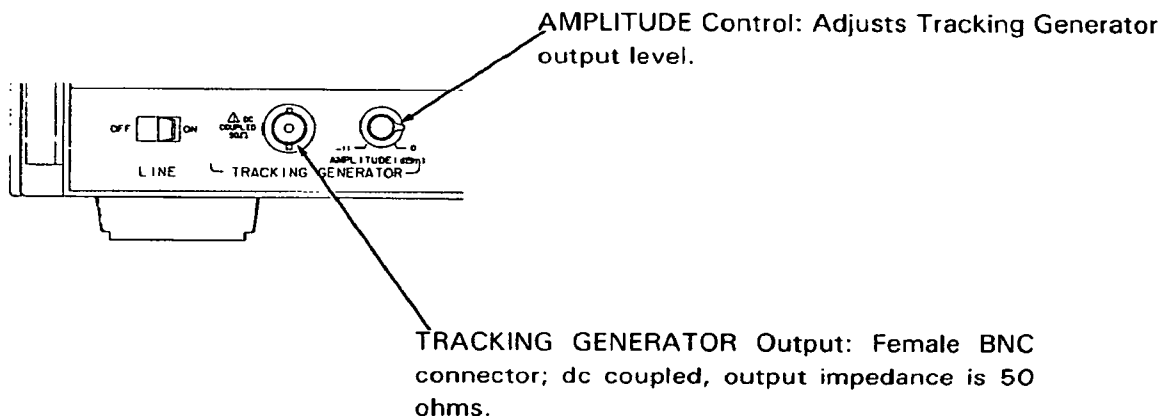





The 3585A TRACKING GENERATOR output supplies a 20 Hz to 40.1 MHz sinusoidal output signal whose frequency follows or “tracks” the swept or manually-tuned frequency of the instrument. The frequency accuracy of the Tracking Generator output signal is ± 1 Hz, relative to the instrument’s tuned frequency. Amplitude flatness is ± 0.7 dB over the 20 Hz to 40.1 MHz frequency range. The Tracking Generator output is dc coupled; its output impedance is 50 ohms; and the return loss is >20 dB. When terminated in a 50-ohm load, the Tracking Generator output level can be adjusted from approximately -11 dBm/50 Ω to 0 dBm/50 Ω using the front panel AMPLITUDE control. (The output level cannot be programmed remotely.)



The TRACKING GENERATOR output is dc coupled. Peak (combined ac/dc levels exceeding ± 0.1 volts applied to this output will affect the bias of the output amplifier and prevent it from operating properly. Peak input levels exceeding ± 3 volts may damage the output circuitry.

Frequency Offset

The Tracking Generator frequency can be offset up to 1.5 kHz *above* the analyzer's tuned frequency using instrument Test Mode 07. The offset procedure is as follows:

- a. Press  .
- b. Enter  .
- c. Press .
- d. By Numeric Entry, set the Center-Frequency Step Size equal to the desired frequency offset (i.e., 0 Hz to 1.5 kHz; 0.1 Hz resolution).
- e. Force an Automatic Calibration by pressing  .
- f. After completing your measurement, deactivate the Test Mode by pressing .

Closed-Loop Measurement Configuration

The 3585A Tracking Generator output can be used to make “closed-loop” amplitude frequency-response measurements as typified by this setup:

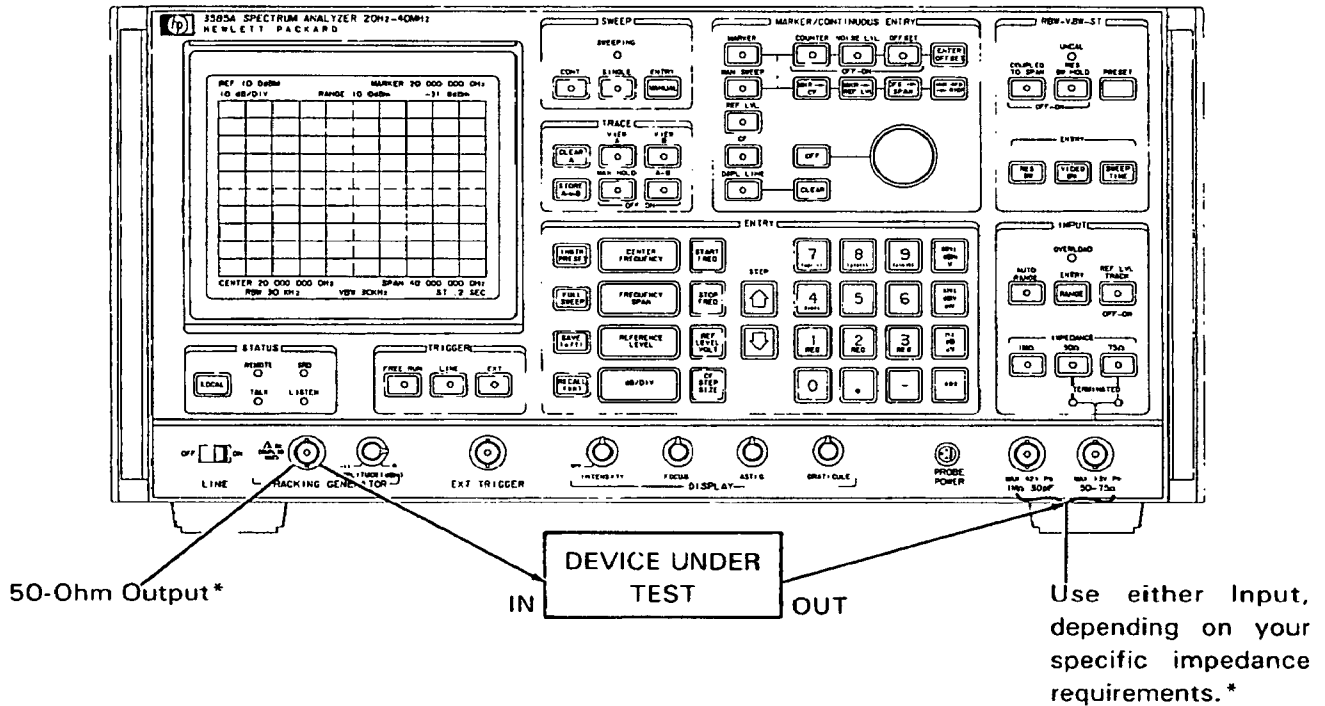

* External impedance matching networks and/or terminations may be required.

TRACKING GENERATOR

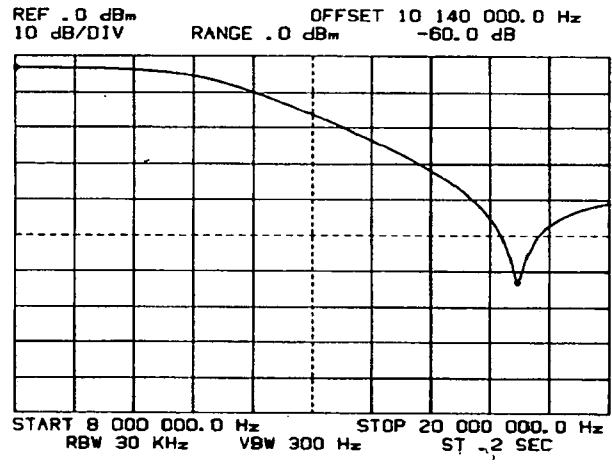

Closed-Loop Measurements

In the closed-loop configuration, the 3585A functions as a network analyzer for measuring the amplitude-vs.-frequency characteristics of two-port networks such as filters, amplifiers, mixers, attenuators, etc. The network or device to be characterized is inserted between the Tracking Generator output and the Terminated or High-Impedance input. The Tracking Generator output then serves as an excitation source or "stimulus" for the network under test and the 3585A measures the response. As the analyzer's frequency is swept or manually tuned over the band of interest, the amplitude variations introduced by the network are measured and retained on the CRT, yielding an amplitude-vs.-frequency plot of the network.



A frequency sweep from 8 MHz to 20 MHz displays the stopband response of a 9 MHz low-pass filter.

NOTE

When making swept frequency response measurements, always deactivate the  function. (With  activated, the instrument automatically upranges and downranges in response to the amplitude variations introduced by the Tracking Generator and network under test.)

General Measurement Procedures

The following are general procedures for making two basic types of amplitude frequency-response measurements:













1. **General Device Characterization:**

For general-purpose measurements where the device or network (e.g., a filter) exhibits relatively large amplitude variations and the frequency response deviations of the 3585A and Tracking Generator are insignificant.

2. **Insertion Loss and Flatness Measurements:**



To precisely measure the insertion loss (or gain) and flatness characteristics of a device by subtracting the analyzer's frequency response deviations from the measurement using the "A-B" TRACE function.

General Device Characterization



- a. Press  . Select the desired input impedance and activate the Input that is to be used for measurements. Enter the desired Start and Stop frequencies.
- b. If you wish to adjust the Tracking Generator output level before connecting the device or network to be tested, proceed as follows; if not, go to Step c.
 1. Increment the Range to 0 dBm with   . Leave the  function deactivated.
 2. To set the Tracking Generator level in dBV or volts, press   or  .
 3. Connect the Tracking Generator output (externally terminated if necessary) to the Input that is to be used for measurements.
 4. Using the Tracking Generator AMPLITUDE control, set the Tracking Generator output to the desired level. (The level can be read directly from the "MARKER" amplitude readout in the upper right-hand corner of the CRT screen.)
- c. With   , set the Marker to a frequency that will produce the maximum output level of the device or network under test.
 1. Press  .
 2. Insert the device or network to be tested between the Tracking Generator output and the Input that is to be used for measurements. (Use external impedance matching networks and/or terminations if required.)
 3. With  activated, allow the instrument to automatically select the appropriate Range setting. (At this point, you may also adjust the Tracking Generator AMPLITUDE control to obtain the required signal level as indicated by the "MANUAL" amplitude readout.)
 4. Deactivate the  function.

TRACKING GENERATOR

General Device Characterization





- d. Activate the  or  SWEEP function. After a complete frequency sweep has been made, the network's response curve will be displayed on the CRT. You may then use the tunable Marker to measure the response in absolute units of dBm, dBV or rms volts; or use the OFFSET function to measure the relative frequency and amplitude between any two points on the curve.

OPERATING HINTS







1. To improve the noise-free dynamic range, deactivate  and downrange two steps (if possible) from the Range that was selected automatically. If you are only interested in observing the stopband of a filter's response, you may reactivate  and continue to downrange all the way to -25 dBm. (The OVERLOAD indicator will light to indicate that the input is being overdriven and that the instrument will no longer meet its distortion specifications. During network-analysis measurements, however, the analyzer does not "see" internal or external distortion products. As long as the input is not overdriven to the point where excessive amplitude compression occurs in the region you wish to observe, the effects of overdriving are totally beneficial. Excessive amplitude compression begins to occur when the input level is greater than 12.3 dB above the Range setting.)

2. To further improve the noise-free dynamic range, narrow the Resolution Bandwidth and, for good noise averaging, set the Video Bandwidth to 1% of the RBW.

3. For network-analysis measurements, the Sweep Time can be substantially reduced from the automatic setting without degrading performance. The "optimum" Sweep Time must be determined empirically:

- a. Sweep one time across the spectrum using a relatively slow sweep rate.
- b. Store the trace in "B" by pressing  .
- c. While visually comparing the "A" Trace to the stored "B" Trace, decrease the Sweep Time with   until the "A" Trace begins to show signs of amplitude compression and/or frequency skew (ignore the UNCAL light). Then, increase the Sweep Time one step with  .

4. When the RBW is 3 kHz or narrower and the Sweep Time is 3.8 seconds or longer, the frequency sweep is interrupted at 1 MHz intervals to permit the instrument's local oscillator to be reprogrammed. These interruptions cause phase discontinuities in the Tracking-Generator output. This effect can be avoided by selecting instrument Test Mode 06 at the onset of the measurement:

- a. Press   .
- b. Enter   .
- c. Press  . (Do not preset again until you have completed your measurement.)
- d. To deactivate the Test Mode, press  .

5. When the 3585A automatically calibrates, the Terminated input is internally switched to a 50-ohm or 75-ohm dummy load. During this switching operation, the input is open for an instant during which the stored energy in a resonant circuit may produce a voltage transient that is large enough to "trip" the internal protection circuit. When the protection circuit is activated, the input opens and the yellow TERMINATED light goes out. To reset the protection circuit, disconnect the signal source and then press any of the IMPEDANCE keys.

TRACKING GENERATOR



Insertion Loss/Flatness Measurements

Insertion Loss And Flatness Measurements





Procedure 1: Insertion loss (or gain) and flatness of unity-gain networks.

The following procedure can be used to very accurately measure the insertion loss/gain and flatness of unity-gain (± 5 dB) networks such as 1:1 passive or active probes, buffer stages and unity voltage gain power amplifiers.





a. Press .

1. Select the desired input impedance and activate the Input that is to be used for measurements.
2. Increment the Range to 0 dBm with  . Leave  deactivated.
3. Enter the desired Start and Stop frequencies.

b. Connect the Tracking Generator output (externally terminated if necessary) to the Input that is to be used for measurements.

1. With  , reduce the Vertical Scale to 1 dB/DIV.
2. Set the Marker to the frequency that you wish to use as the reference frequency for your measurement. (This is typically the Start Frequency.)
3. Using the Tracking Generator AMPLITUDE control, set the Tracking generator output to the desired level as indicated by the "MARKER" amplitude readout. (The level can be set in dBm, dBV or volts, whichever is the most convenient.)
4. Store the trace in "B" by pressing .
5. If you do not want to display the "B" Trace, deactivate the  function.

c. Insert the network to be tested between the Tracking Generator output and the Input that is to be used for measurements. (Use external impedance matching networks and/or terminations if required.)



1. Activate the  function. (Leave  activated.)
2. With the "A-B" function activated, the frequency response deviations of the 3585A's Tracking Generator and input channel (stored in "B") are subtracted from the network's response that is currently being written into "A". The "A-B" Trace, referenced to the middle horizontal line on the CRT graticule, indicates the insertion loss (or gain) of the network as a function of frequency. The amplitude of the "A-B" Trace, displayed *only* in "dB", can be read directly from the "MARKER" readout. To measure the *flatness* of the response curve, set the Marker to the reference frequency; activate , press  and then tune the Marker to the specific frequencies of interest.

Procedure 2: Precise flatness measurements for amplifiers and attenuators.



a. Press .

1. Select the desired input impedance and activate the Input that is to be used for measurements.
2. Enter the desired Start and Stop frequencies.
3. Set the Tracking Generator AMPLITUDE control fully counterclockwise. (If a specific drive level is required, set the Range to 0 dBm; connect the Tracking generator output to the 3585A Input and then adjust the AMPLITUDE control for the desired level as indicated by the "MARKER" amplitude readout.)

b. 1. For Amplifiers:



With  , manually select the Range that is to be used for measurements. (Select a Range that is high enough to accommodate the maximum output level of the amplifier.)

2. For Attenuators:

With  , set the range to -20 dBm.

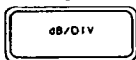

c. Connect the Tracking Generator output (externally terminated if necessary) to the Input that is to be used for measurements.



1. Adjust the Reference Level so that the response curve is within the top one or two divisions of the CRT graticule.*

2. With  , reduce the Vertical Scale according to the maximum expected peak-to-peak flatness variations of the amplifier or attenuator to be tested:

Maximum Flatness Variation	Vertical Scale
10 dB	1 dB/DIV
20 dB	2 dB/DIV
50 dB	5 dB/DIV

3. Adjust the Reference Level so that the response curve is on the screen, preferably about mid-screen.

4. Store the trace in "B" by pressing . If you do not want to display the "B" Trace, deactivate .



*A convenient way to adjust the Reference Level for this application is with  . If the Tracking Generator output is not terminated in 50 ohms, the signal level may be higher than 10 dB above the RANGE setting, in which case there will not be enough Reference Level adjustment range to move the response curve onto the screen. To correct this situation, increment the RANGE one or two steps.

TRACKING GENERATOR



Insertion Loss/Flatness Measurements

- d. Insert the amplifier or attenuator to be tested between the Tracking Generator output and the Input that is to be used for measurements. (Use external impedance matching networks and/or terminations if required.)

1. For Amplifiers:

If you wish to adjust for a specific output level, set the Marker to the frequency of interest with   ; and adjust the Tracking Generator AMPLITUDE control and/or amplifier gain to obtain the required level as indicated by the "MARKER" amplitude readout. Adjust the Reference Level as required to maintain an on-screen display. (The input may be overdriven up to 12.3 dB above the Range setting; so if the OVERLOAD indicator lights, you may ignore it.)

2. For Attenuators:



To adjust for a specific output level, set the Marker to the frequency of interest with   ; and adjust the Tracking Generator AMPLITUDE control and/or external attenuation to obtain the required level as indicated by the "MARKER" amplitude readout. Adjust the Reference Level as required to maintain an on-screen display.





OR

If the attenuator under test can withstand an 11 dB increase in the drive level and the output level is irrelevant, rotate the AMPLITUDE control fully clockwise. Adjust the Reference Level to maintain an on-screen display.

(Increasing the drive level will improve the signal-to-noise ratio; the OVERLOAD light may be ignored. If the attenuator's response curve is noisy, narrow the VBW to obtain good noise averaging and, if necessary, narrow the RBW to improve the noise-free dynamic range. As indicated in the preceding "OPERATING HINTS", the Sweep Time can be decreased from the automatic setting without degrading performance.)

- f. Adjust the Reference Level so that the response curve is about mid-screen or otherwise aligned as closely as possible with the "B" Trace. (This is done so that the "A-B" trace will initially appear about mid-screen.)

- g. Activate the  TRACE function (leave  activated).

1. If necessary, adjust the Reference Level so that the entire response curve is on the screen.
2. To measure the flatness of the response curve, set the Marker to the reference frequency with   ; activate  , press  and then tune the Marker to the specific frequencies of interest with  .

CHAPTER 3

OPERATION IN THE MANUAL MODE

The purpose of this chapter is to familiarize you with the 3585A's "Manual mode" and the various manipulative sequences that can be used to set the Manual frequency and perform real-time amplitude and frequency measurements.

Introduction To The Manual Mode

Most spectrum analyzers have a "manual sweep" mode which allows the operator to deactivate the frequency sweep and manually tune the analyzer's frequency with a knob or frequency dial. Notwithstanding, the 3585A also has a "Manual mode" which provides this same basic capability. Unlike traditional instruments, however, the 3585A has synthesizer tuning, automatic calibration, and Marker/Counter functions which greatly enhance the useability of the Manual mode. In fact, the Manual mode adds a complete new dimension to the 3585A's operating capabilities. Once you become familiar with it, you will find that it is one of the most efficient ways to use the instrument; whether you are operating from the front panel or remotely programming via the HP-IB.

In the Manual mode, the 3585A functions as a tunable receiver or "selective voltmeter" which can be set to any frequency within the Frequency Span. The frequency to which the analyzer is tuned in the Manual mode is referred to as the "Manual frequency". The Manual frequency can be manually tuned or "swept" using the Continuous Entry control; but more importantly, it can also be entered numerically with 0.1 Hz resolution; it can be incremented or decremented in user-defined steps using the STEP keys; or it can be set using the instrument's tunable Marker. The ability to precisely set the Manual frequency allows you to make real-time, high-resolution measurements at the specific frequencies of interest without waiting for a frequency sweep.

Responses retained on screen after Manual mode measurement appear as vertical lines:

Fundamental

When prefaced, Manual frequency displayed here

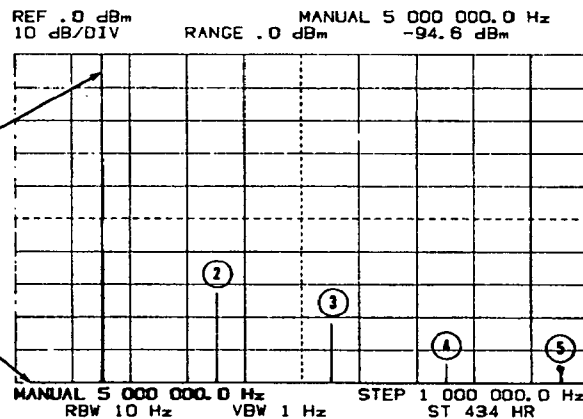

Low-Level harmonics of 1 MHz signal quickly measured with narrow bandwidth by stepping Manual frequency. Fifth harmonic is 94.6 dB below fundamental.

INTRODUCTION TO MANUAL MODE





One point on the CRT trace is used to represent the Manual frequency. That point is referred to as the "Manual measurement point". The Manual measurement point is continuously updated to reflect the real-time signal amplitude within the analyzer's passband at the Manual frequency. When the Marker is at the Manual measurement point, the Manual frequency and real-time signal amplitude can be read directly from the "MANUAL" readout which appears (in place of the "MARKER" readout) in the upper right-hand corner of the CRT screen.

Narrowing the Resolution Bandwidth increases the selectivity, making it possible to separate signals that are closely spaced in frequency. This also reduces the internal noise level which, in turn, improves the analyzer's sensitivity or ability to discern low-level signals. Narrow bandwidths require slow sweep rates and are impractical to use when sweeping over a wide frequency range. In the Manual mode, however, the analyzer can be quickly tuned to the exact frequencies of the signals that you wish to measure. Narrow bandwidths can be used to resolve and precisely measure any signals within the analyzer's dynamic range and Frequency Span.

Another important advantage of the Manual mode is that it provides a substantial improvement in amplitude measurement accuracy. In the Manual mode, the 3585A automatically calibrates at the Manual frequency rather than the Center Frequency of the Span.* This virtually eliminates frequency response errors that are normally encountered when the instrument is sweeping. The Manual mode also eliminates amplitude compression (and frequency skew) caused by sweep dynamics.

*When the Manual frequency is lower than 150 kHz, the Automatic Calibration is performed at 150 kHz.

Manual Key Functions

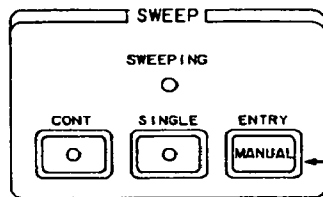

The Manual mode can be selected by pressing the  key, located in the SWEEP control block; or by activating the  function, located in the MARKER/CONTINUOUS ENTRY control block. Pressing either key initially sets the Manual frequency equal to the current Marker frequency. The instrument will remain in the Manual mode until the  or  SWEEP function is activated or  is pressed.





MANUAL Entry key:

- Selects Manual mode and *automatically activates* .
- Prefaces Manual frequency, enabling it to be changed by Step Entry or Numeric Entry.
- Sets the Manual frequency equal to the current Marker frequency.*

MANUAL SWEEP key:

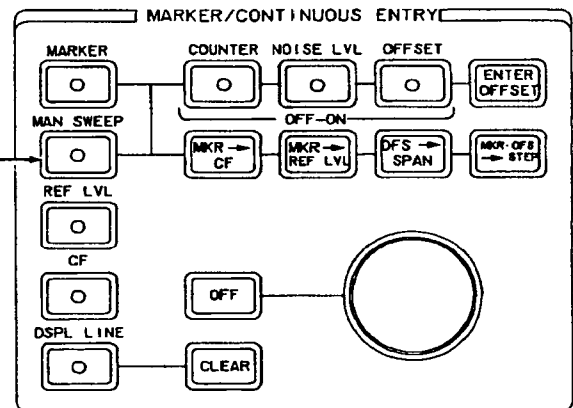
- Selects Manual mode and sets Manual frequency equal to current Marker frequency.*
- Couples the Continuous Entry Control to the Manual frequency to permit manual frequency tuning. Once the instrument is in the Manual mode, this function can be deactivated by pressing the Continuous Entry  key or by activating  or any of the other Continuous Entry functions. Any of the MARKER/CONTINUOUS ENTRY functions can be used in the Manual mode.



*If the instrument is already in the Manual mode and the Marker is at the Manual measurement point on the CRT trace, pressing  or activating  will not change the Manual frequency.

MANUAL MEASUREMENT POINT

The Manual Measurement Point

The CRT trace is a point-by-point plot consisting of 1,001 equally spaced points. In the Manual mode, one of the points on the trace must be used to represent the Manual frequency. That point is referred to as the "Manual measurement point".

With 1,001 equally-spaced points, the frequency spacing between points is equal to the Frequency Span divided by 1,000. For example, if the Frequency Span is 40 MHz, the frequency spacing between points is $40 \text{ MHz}/1,000 = 40 \text{ kHz}$. Therefore, if the Frequency Span is 40 MHz and the Start Frequency is 0 Hz, there will be points at 0 Hz, 40 kHz, 80 kHz, 120 kHz, etc.

Since the Manual frequency is settable anywhere in the Span with 0.1 Hz resolution, the Manual frequency may either correspond to the frequency of a specific point or be between two points. For instance, the Manual frequency could be set to exactly 40 kHz, corresponding to the 40 kHz point; or it could be set to 49,123.4 Hz which is between the 40 kHz and 80 kHz points. When the Manual frequency corresponds to the frequency of a specific point, that point automatically becomes the Manual measurement point. When the Manual frequency is between two points, the Manual measurement point is typically the first point to the left of the Manual frequency.

The Manual measurement point on the Current ("A" or "A-B") Trace displays the real-time input-signal amplitude at the Manual frequency. The Manual measurement point is the only point on the trace that will reflect a change in the signal amplitude. It is updated at the CRT refresh rate of approximately 60 times per second.

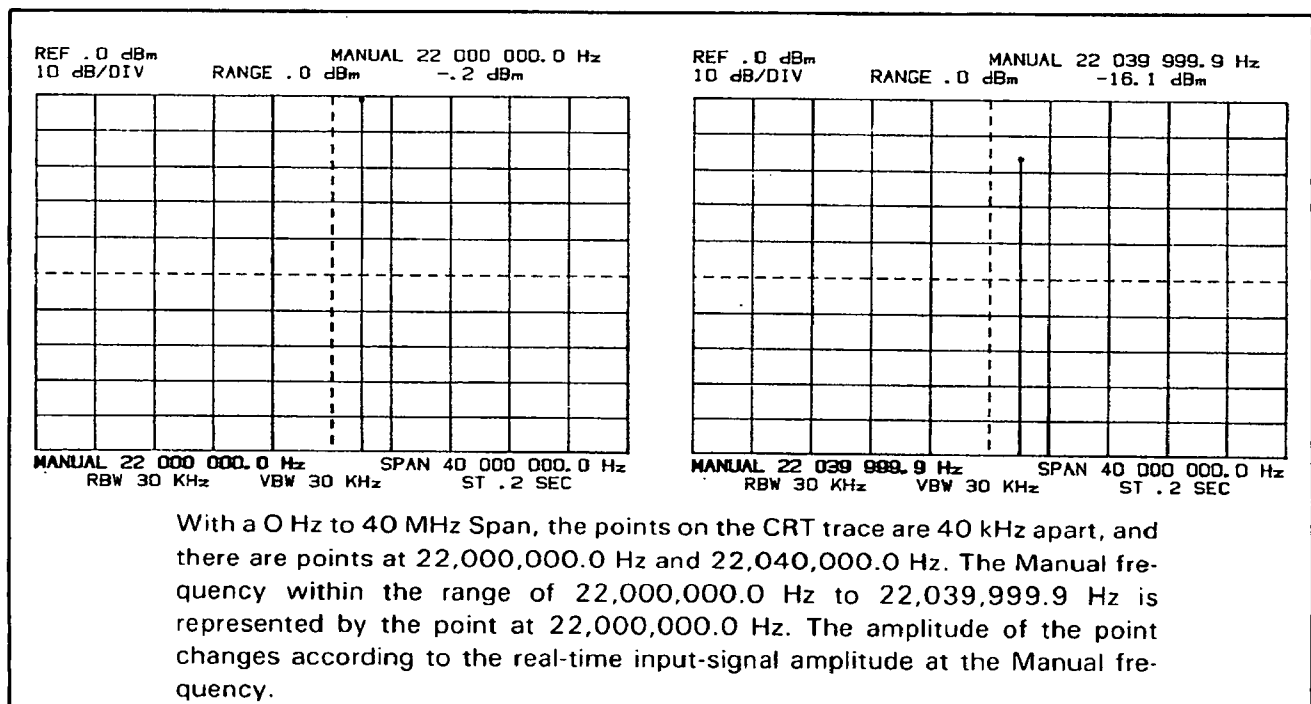





The Manual Measurement Point

Setting The Manual Frequency

The Manual Frequency can be set using any of five entry methods:

a. Marker Entry:



Set the Marker to the desired Manual frequency with  . Then, press  or activate . Marker frequency resolution is 0.1% of the Frequency Span.

b. Marker To Center Frequency:

Pressing  sets the Center Frequency equal to the Marker, Counter or Manual frequency (whichever is being displayed). If the Center Frequency is set equal to the Manual frequency, the Manual frequency does not change; but the Manual measurement point appears in the center of the screen. If the Center Frequency is set equal to the Marker or Counter frequency, the Manual frequency is automatically set equal to the Center Frequency.

c. Step Entry:    *

Changes Manual Frequency in steps equal to the Center Frequency Step Size. CF Step size is settable within the range of 0 Hz to 40.1 MHz with 0.1 Hz resolution.

d. Continuous Entry:  

Continuous adjustment of Manual frequency; used primarily for fine tuning to the peak of a response. As the frequency is manually tuned, the Marker dot jumps from point-to-point along the horizontal axis and deflects vertically to indicate the signal amplitude at the Manual frequency. The resulting trace is plotted and retained on the CRT screen.

Continuous Entry resolution is approximately 3% of the RBW or 0.1% of the Frequency Span (whichever is smaller). Maximum resolution is 0.1 Hz.

e. Numeric Entry:  

Manual frequency is settable to any frequency within the Frequency Span with 0.1 Hz resolution. Maximum Span is 0 Hz to 40.1 MHz.

*The Manual frequency can also be stepped by stepping the Center Frequency. This technique is described later in the chapter.



SETTING THE MANUAL FREQUENCY

Marker

NOTES

- 1. Changing any of the frequency parameters (i.e., Start, Stop, Center or Span) will automatically change the Manual frequency. The Manual measurement point does not move when the frequency parameters are changed. Therefore, a change in the frequency parameters redefines the frequency of the Manual measurement point and produces a corresponding change in the Manual frequency. (When the Manual frequency is equal to the Center Frequency, a change in Frequency Span will not affect the Manual frequency.)*
- 2. Changing the Manual frequency by Marker, Step or Numeric entry initiates an Automatic Calibration cycle. The calibration is performed immediately after the change is made at the new Manual frequency. (These calibrations are inhibited when the Manual frequency is lower than 150 kHz. Manual tuning by Continuous Entry does not initiate a calibration cycle.)*
- 3. When the Manual frequency is changed by Marker, Step or Numeric entry, the Marker immediately moves to the new Manual measurement point. However, an amplitude reading is not taken until the end of the Automatic Calibration cycle and the instrument's internal settling period. Settling times range from about 25 milliseconds to 2.5 seconds, depending on the RBW and VBW settings. (Narrow bandwidths require longer settling times.)*
- 4. When the Manual frequency is prefaced, the highlighted "MANUAL" frequency is displayed in place of "CENTER" or "START" in the lower left-hand corner of the CRT screen. This allows the operator to display the Manual frequency along with the Marker, Counter, Offset or Display Line information which may be displayed in place of the Manual frequency in the upper right-hand corner of the screen.*

The Marker

Pressing  and/or activating  automatically sets the Manual frequency equal to the current Marker frequency (i.e., the frequency of the point on which the Marker is positioned; *not* the Counter frequency). When the Manual frequency is changed, the Marker either moves to the new Manual measurement point or, if the Manual measurement point does not change, remains at the same point on the CRT trace. In either case, the Marker is always at the Manual measurement point immediately following a change in the Manual frequency.

When the Marker is at the Manual measurement point and the COUNTER, OFFSET and NOISE LVL functions are deactivated, the "MANUAL" readout in the upper right-hand corner of the screen indicates the Manual frequency and the real-time signal amplitude within the passband established by the Resolution Bandwidth setting.

NOTE



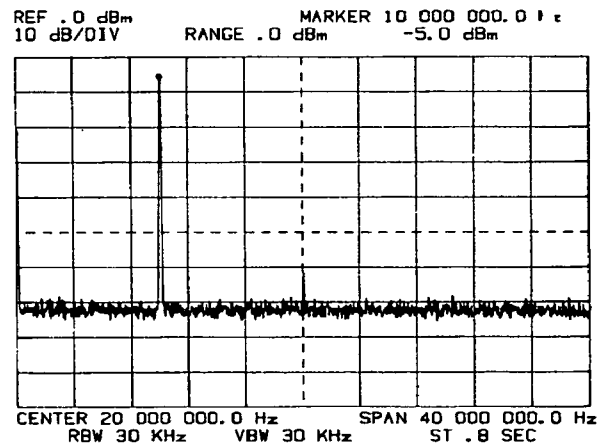

The CRT trace at the Manual measurement point is updated at the CRT refresh rate of approximately 60 times per second. However, the "MANUAL" amplitude readout is updated at a much slower rate of about five readings per second. This slower rate permits the operator to visually capture the amplitude variations of an unstable signal.

SETTING THE MANUAL FREQUENCY Marker

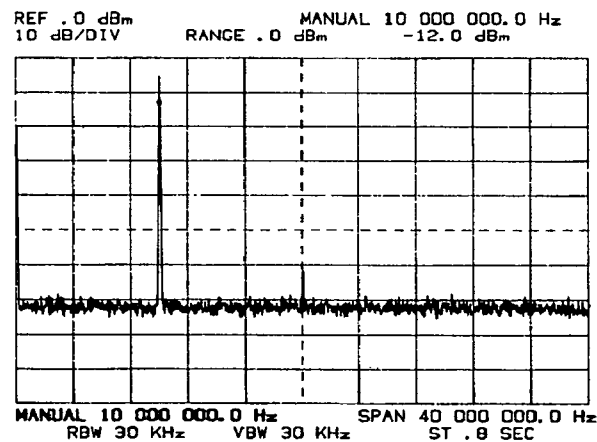

Marker at peak of 10.02 MHz response. During frequency sweep, peak displayed at 10.00 MHz point as indicated by "MARKER" readout.









Pressing  or  selects Manual mode and sets Manual frequency equal to Marker frequency. "MANUAL" readout in top-right corner indicates Manual frequency and real-time signal amplitude at Manual frequency. (The true frequency of the signal is 10.02 MHz rather than 10.00 MHz. To measure its peak amplitude, the Manual frequency must be fine tuned to 10.02 MHz. This can be done with  .)

SETTING THE MANUAL FREQUENCY

Independent Marker Tuning

Independent Marker Tuning

Once the desired Manual frequency has been selected, the Marker can be independently tuned with  and . When the Marker is moved away from the Manual measurement point, the readout reverts to "MARKER" to indicate the Marker's frequency and amplitude on the CRT trace. The Manual measurement point continues to be updated to reflect the signal amplitude at the Manual frequency; but the CRT trace is *not updated* at the Marker frequency. The Marker amplitude readout indicates the Marker's amplitude on the trace that is retained on the CRT and may, therefore, be totally unrelated to the input-signal amplitude. When the Marker is moved back to the Manual measurement point, the readout returns to "MANUAL" to indicate the Manual frequency and amplitude.

To quickly tune to a signal of interest in the Manual mode, activate  and set the Marker to the approximate frequency using . Then press  or activate  to set the Manual frequency equal to the Marker frequency. Fine tune to the peak of the signal with . Here is an example:

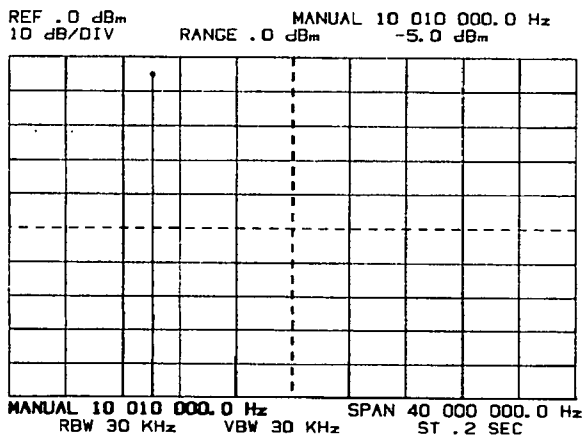

a. Measure Fundamental.

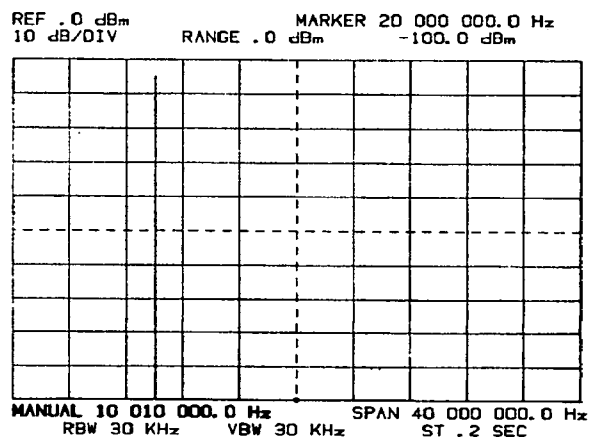

b. Move Marker to approximate frequency of second harmonic with  .

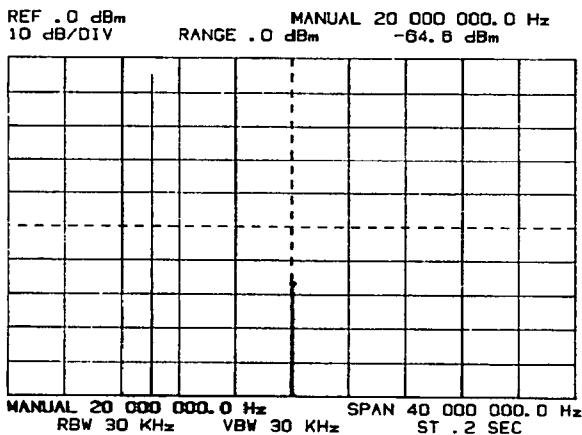

c. Press  or activate  to set Manual frequency equal to Marker frequency.

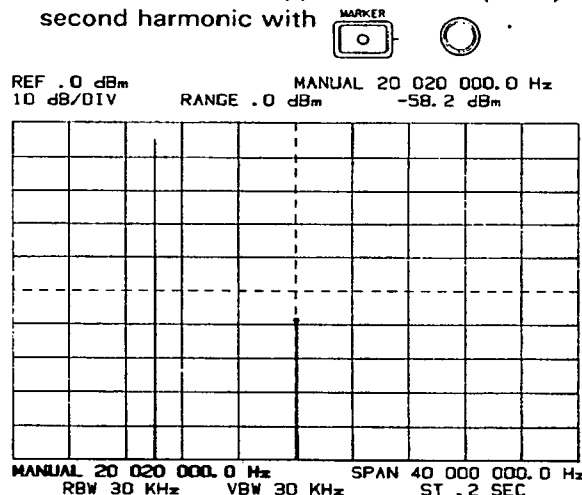

d. Fine tune to peak of second harmonic response with .

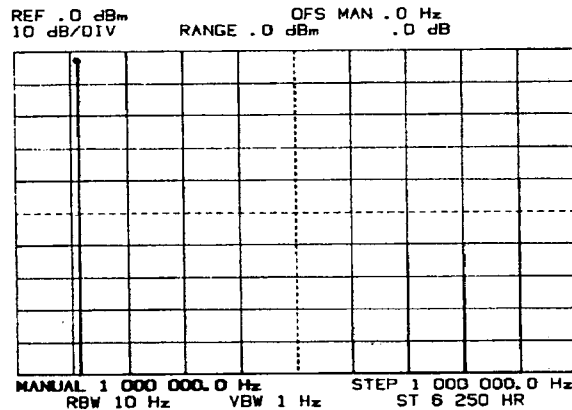

Offset Measurements

The  function can be used in the Manual mode to measure the relative frequency and amplitude between two signals. For example, to measure the amplitude of a harmonic in “dB” relative to the fundamental:





- a. Tune to the peak of the fundamental.

Set the CF Step Size equal to the fundamental (i.e., Manual) frequency by pressing  or by Numeric Entry.

Activate  and then press .

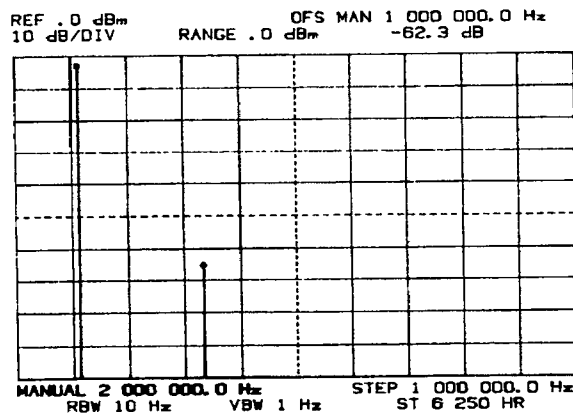
(This stores the current Manual frequency and amplitude in the Offset Register.)



- b. Step to the second harmonic by pressing  .



(A stationary Marker remains at the peak of the fundamental response; i.e., the point where  pressed. The “OFS MAN” (Offset Manual) readout indicates the difference between the current Manual frequency and the frequency in the Offset Register. The amplitude readout indicates the harmonic’s amplitude in “dB” relative to the amplitude in the Offset Register which, in this case, is the amplitude at the peak of the fundamental response.)

Using The Counter In The Manual Mode

When the instrument is in the Manual mode and the  function is activated, the “COUNTER” frequency is displayed in place of the “MANUAL” or “MARKER” frequency in the upper right-hand corner of the CRT screen. Counter readings are updated continuously at a rate proportional to the Counter period.

NOTES

1. If you wish to display the Manual frequency and Counter frequency simultaneously, preface the Manual frequency by pressing . The highlighted Manual frequency will then appear in the lower left-hand corner of the CRT screen.

2. Tuning the Manual frequency or Marker with  or  and , overrides the Counter, causing the readout to display “MANUAL” or “MARKER”. When the tuning stops, the frequency of the input signal about the Manual or Marker frequency is counted and then the “COUNTER” frequency reappears in place of “MANUAL” or “MARKER”.

There are two basic ways to make Counter measurements in the Manual mode:

- a. At the Manual frequency with the Marker at the Manual measurement point.
- b. At the Marker frequency with the Marker independently tuned away from the Manual measurement point.

Marker At Manual Measurement Point

When the Marker is at the Manual measurement point, the Counter reading indicates the absolute frequency of the input-signal component about which the analyzer is tuned. To obtain an accurate, stable counter reading, the signal amplitude at the Manual measurement point must be at least 20 dB above the noise and at least 20 dB above any unresolved signal that is inside the IF filter skirts.

To accurately measure the amplitude of a signal in the Manual mode, the Manual frequency must be set almost exactly equal to the frequency of that signal. This is particularly important when a narrow Resolution Bandwidth is being used. For instance, if the Resolution Bandwidth is 3 Hz, and the Manual frequency is ± 1.5 Hz away from the signal, the amplitude reading will be about 3 dB too low.

One convenient way to precisely tune to the peak of a response is to first set the Manual frequency approximately equal to the signal frequency, measure the signal frequency using the Counter and then set the Manual frequency equal to the Counter frequency. This can be done by Numeric Entry or by simply pressing . * In many cases, a relatively wide Resolution Bandwidth can be used to quickly locate, count and tune to the signal of interest. Once the analyzer is tuned to the true signal frequency, the Resolution Bandwidth can be narrowed to obtain the required resolution and sensitivity.

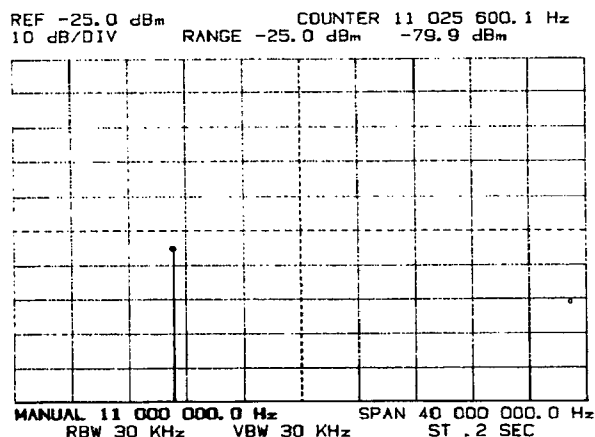



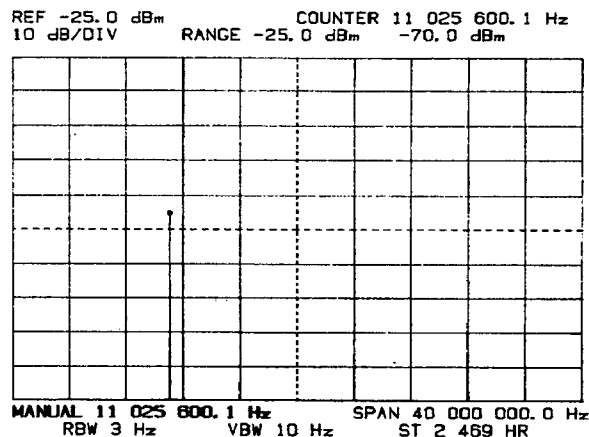

Signal quickly located and counted using 30 kHz RBW.



Manual frequency set equal to Counter frequency; signal measured with 3 Hz RBW.



Tuning To The Peak Of A Response Using The Counter



Another technique that can be used to quickly tune to the peak of a response is:

- a. Set the Manual frequency approximately equal to the signal frequency.
- b. Activate  to accurately measure the signal frequency.
- c. Press  to set the Center-Frequency Step Size equal to the Counter frequency.
- d. Set the Manual frequency to 0 Hz Numeric Entry.
- e. Press   .

*In the Manual mode, the  key sets the Center Frequency equal to the absolute Marker, Counter or Manual frequency (whichever is being displayed). It also sets the Manual frequency equal to the Center frequency and places the Marker at the Manual measurement point. Therefore, if the Counter function is activated, the Manual frequency is set equal to the Counter frequency and is displayed at the Center Frequency point on the CRT screen.

Marker Not At Manual Measurement Point

When  is activated and the Marker is tuned away from the Manual measurement point (using  ), the instrument's frequency tuning internally alternates between the Manual frequency and the Marker frequency. At the Manual frequency, the Manual measurement point on the CRT trace is updated to reflect the real-time input-signal amplitude. At the Marker frequency, the CRT trace is *not updated*; but the analyzer does actually sample the input signal to obtain a valid, real-time Counter reading. If a sufficiently large input-signal response is detected at the Marker frequency, the Counter reading will accurately indicate the frequency of the signal that is producing the response. If there is no input-signal response at the Marker frequency or if the response is too near the noise or is mixed with another signal, the Counter reading will be unstable.

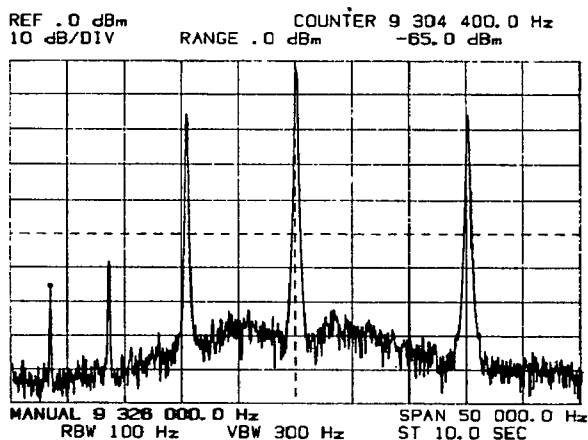

The independent Marker tuning and Counter feature provides a convenient way to count the frequencies of input-signal responses without waiting for successive frequency sweeps. One way to use this feature is to first sweep one time across the input-signal spectrum so that the signals of interest are displayed on the CRT. Then, select the Manual mode (the Manual frequency is arbitrary), activate  and  and tune the Marker to the peaks of the responses that you wish to measure using . (Do not disconnect the input signal or change the amplitude or frequency parameters.) As long as the input-signal spectrum is the same as when the trace was plotted, the real-time Counter readings will indicate the true frequencies of the responses on which the Marker is positioned. The amplitude readout will accurately indicate the Marker's amplitude on the stored CRT trace; but since the trace is not updated at the Marker frequency, the amplitude readout will not reflect any real-time changes in the input-signal amplitude.





Signals of interest can be quickly measured in Manual mode using



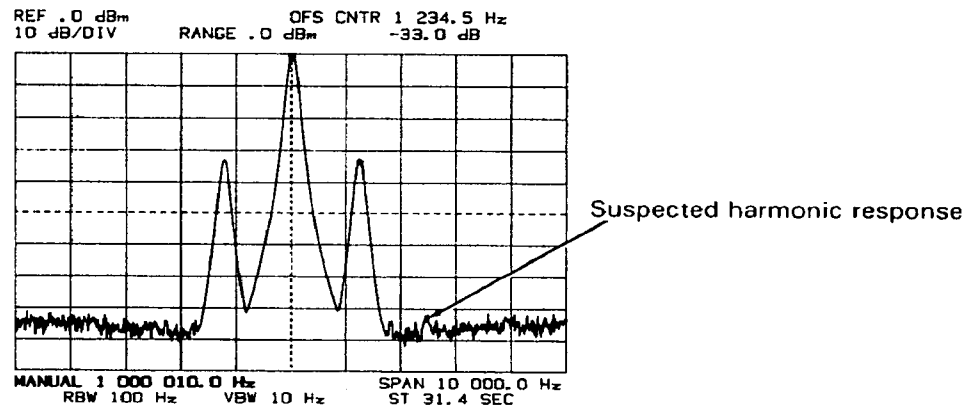

Offset Counter Measurements



The  function can be used in conjunction with the  function to count the frequency difference between two signals. For example, to count the difference between a modulated carrier and its upper sideband:



Set the Marker to the peak of the carrier response with  .



Select the Manual mode by pressing  or activating .

Activate  to count the carrier frequency.

Activate  and then press .

(This stores the counted carrier frequency in the Offset Register.)

Activate  and set the Marker to the peak (or skirt) of the upper side frequency. The "OFS CNTR" (Offset Counter) reading indicates that the difference frequency is 1.2345 kHz.

A close examination of the swept display (above) reveals the presence of what appears to be a harmonic response at about 1.2 kHz above the upper side frequency. It may be a harmonic or it may be a noise spike. One way to tell for sure is to narrow the RBW and VBW and measure it in the Manual mode. This could be done by setting the Marker to the peak of the apparent harmonic, narrowing the Bandwidth and fine tuning with  and . However, this would be a rather tedious process especially if the "response" turns out to be a noise spike. A faster, more accurate way to tune to the harmonic frequency is to set the Step Size equal to the modulating frequency indicated by the "OFS CNTR" reading and increment the Manual frequency to the second harmonic. The procedure is as follows:

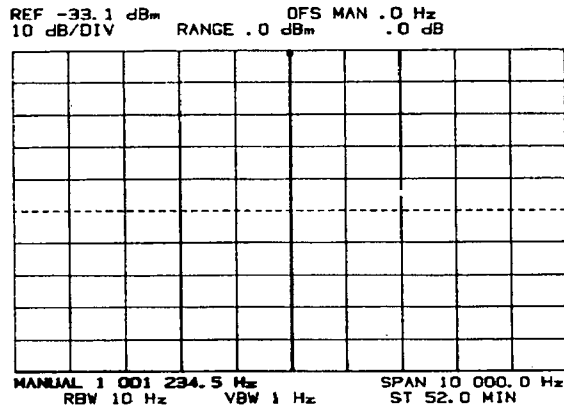

- a. With the Marker still at the peak of the upper side frequency, set the CF Step Size equal to the difference frequency by pressing .

(This sets the Step Size equal to the "OFS CNTR" reading.)

Press .

(This sets the Center Frequency and Manual frequency equal to the absolute Counter frequency; i.e., the upper side frequency.)

Clear the trace by pressing .

Narrow the RBW and VBW to the desired settings.

Move the response to the top of the screen by pressing .

Deactivate .

(The Counter is no longer needed and the harmonic is too low in level to be measured with the Counter.)

Press .

(This allows the harmonic to be measured in "dB" relative to the upper side frequency rather than the carrier.)

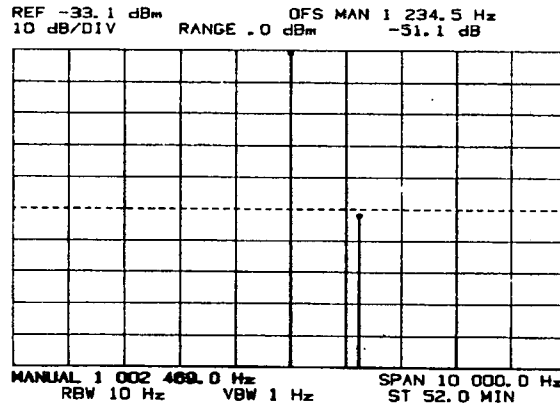



- b. Step to the second harmonic by pressing .

(The harmonic is definitely present and is 51.1 dB below the fundamental.)

Using The Noise Level Function

In the Manual mode with the  function activated, noise readings are repetitively calculated and updated at a rate proportional to the Noise measurement time. Noise measurement times range from approximately 0.3 seconds (30 kHz RBW) to 33 seconds (3 Hz RBW). While a noise reading is being calculated, the suffix of the current amplitude or noise level reading is displayed brighter than normal. At the end of each noise calculation, there is a time delay of approximately 0.5 seconds during which the readout is updated and the suffix returns to normal brightness to indicate that a valid noise reading is available. The CRT trace at the Manual measurement point is also updated during this 0.5 second period. The trace is not updated during a noise calculation.



Noise level readings are displayed in place of the Manual or Marker amplitude in the upper right-hand corner of the CRT screen. They are displayed in the same units as the Reference Level; i.e., “dBm (Hz)”, “dBV(Hz)” or “V $\sqrt{\text{Hz}}$ ”. Offset noise level readings are displayed in “dB (Hz)”. The noise level readings indicate the absolute (or relative) rms random noise spectral density at the Manual or Marker frequency, normalized to a 1 Hz noise power bandwidth.

The  function operates in much the same manner as the  function. It can be used with the Marker at the Manual measurement point or with the Marker tuned away from the Manual measurement point:



- a. When the Marker is at the Manual measurement point, noise readings are calculated according to the real-time input-signal amplitude at the *Manual* frequency.
- b. When the Marker is not at the Manual measurement point, noise readings are based on the real-time signal amplitude at the *Marker* frequency. At the end of each noise calculation, the CRT trace is updated at the Manual measurement point; but the trace is *not updated* at the Marker frequency. In the absence of a noise reading, the Marker readout will indicate the Marker's amplitude on the CRT trace which may be totally unrelated to the real-time signal amplitude from which the noise readings are calculated.

Noise Measurement Techniques

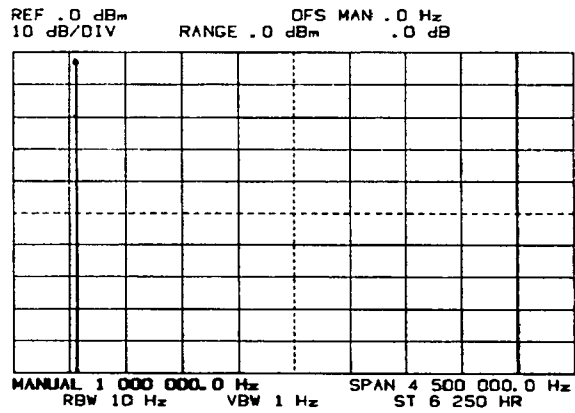

Absolute noise-level measurements can be performed by simply setting the Manual frequency or Marker to the frequency of interest and activating the  function.

The  function can be used in conjunction with the  function to measure signal-to-noise ratio. Here is an example:



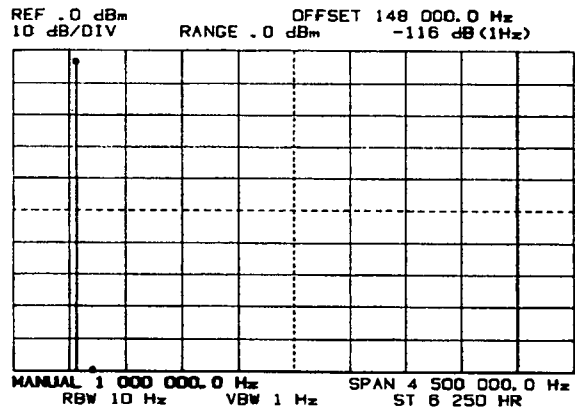

- a. Tune to the peak of the signal. Activate  and then press .







- b. Activate  and set the Marker to the noise measurement frequency with .
- Activate  and allow time for the "dB" (1 Hz)" reading to appear.



(The "OFFSET" frequency readout indicates the difference between the current Manual frequency stored in the Offset Register and the Marker frequency. The "dB (1 Hz)" reading indicates the rms random noise spectral density (at the Marker) in a 1 Hz bandwidth *relative* to the signal amplitude in the Offset Register.)

Step The Manual Frequency To Measure Equally Spaced Signals

Pressing   OR  changes the Manual frequency in steps equal to the Center Frequency Step Size. The Center Frequency Step Size is settable within the range of 0 Hz to 40.1 MHz with 0.1 Hz resolution. It can be changed by Marker/Offset Entry, Step Entry or Numeric Entry:

Marker/Offset:  Sets CF Step Size equal to current Manual, Marker, Counter or Offset frequency (whichever is being displayed).

Step Entry:    Changes CF Step Size to next value in a 1, 2, 5, 10 sequence.

Numeric Entry:   Selects specific step size; 0 Hz to 40.1 MHz, 0.1 Hz resolution.

The ability to step the Manual frequency makes it possible to quickly measure equally spaced signals within a specific frequency span. This is especially useful for individually measuring the harmonic components of a complex signal over a wide frequency span or for measuring low-level harmonic distortion products in a narrow bandwidth to maximize the noise-free dynamic range. Here are some examples:

Measuring Equally-Spaced Signals Over A Wide Frequency Span

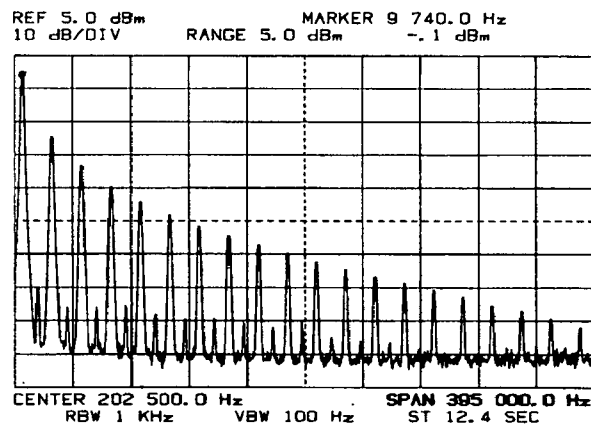

A single sweep over a 395 kHz Span displays the harmonic components of a 10 kHz triangle waveform. With the Resolution Bandwidth set to 1 kHz, many of the low-level even harmonics are too near the noise floor to be measured accurately. In the Manual mode, the harmonics can be individually measured using a narrow bandwidth.

STEP MANUAL FREQUENCY

Measuring Equally-Spaced Signals

To individually measure the harmonics in the Manual mode, proceed as follows:

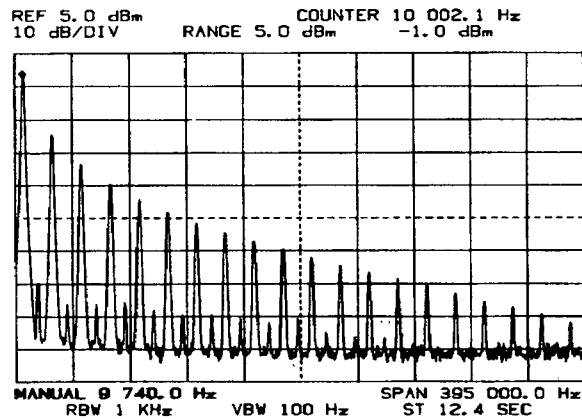

- a. Set the Marker to the peak of the fundamental with .
- Select the Manual mode by pressing or activating .
- Activate to precisely measure the fundamental frequency.

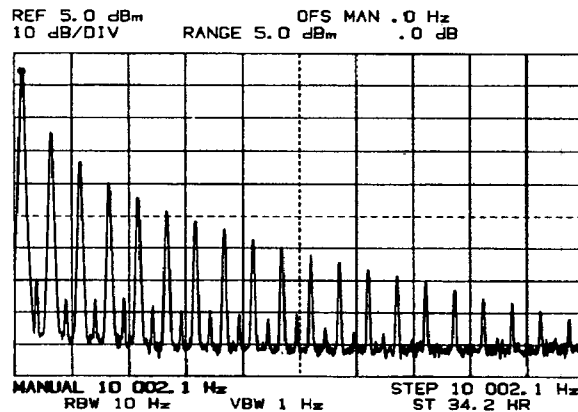

- b. Set the Manual frequency exactly equal to the Counter frequency by Numeric Entry.

Set the CF Step Size equal to the Counter frequency by pressing or by Numeric Entry.

Deactivate .

Narrow the RBW to reduce the internal noise level. For good video averaging, set the VBW to 10% (or narrower) of the RBW.

(Narrowing the RBW one step reduces the internal noise level by about 4.5 dB.)

To measure the succeeding harmonics in "dB" relative to the fundamental, activate and press .

STEP MANUAL FREQUENCY Measuring Equally-Spaced Signals

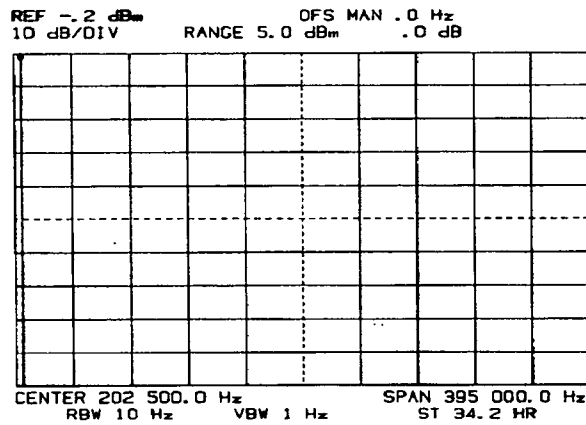

c. Clear the trace by pressing  .

Move the fundamental to the top of the screen by pressing  .

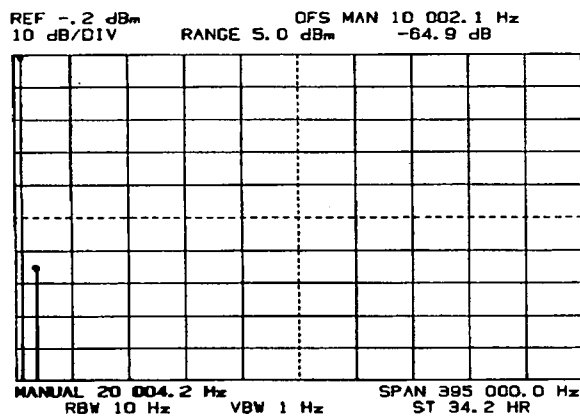

(The trace is no longer needed so it is best to clear it from the screen. If you wish to retain the trace on the screen, you may omit the clear operation. If the trace is needed for future reference, store it in "B" by pressing  .)

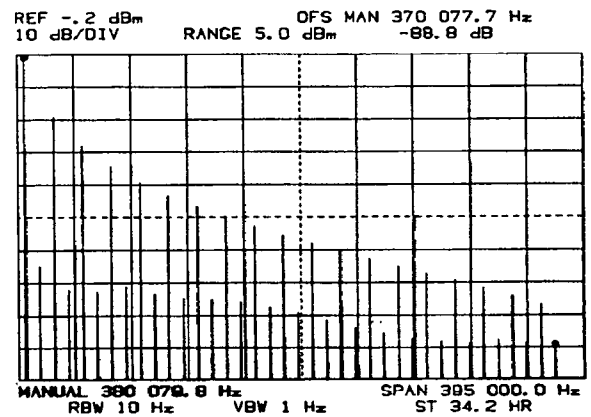

Second Harmonic



.....38th Harmonic

d. Press   to display and measure succeeding harmonics.

STEP MANUAL FREQUENCY

Measuring Harmonic Distortion

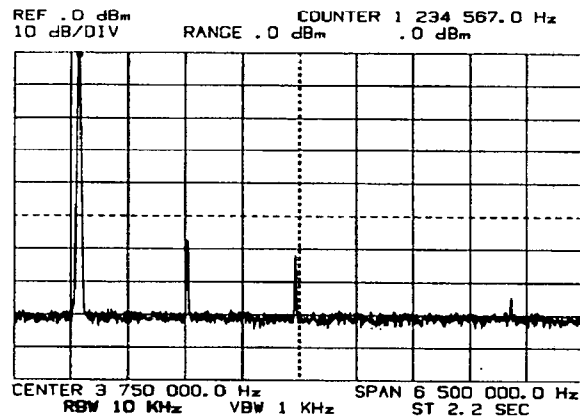

Measuring Low-Level Harmonic Distortion



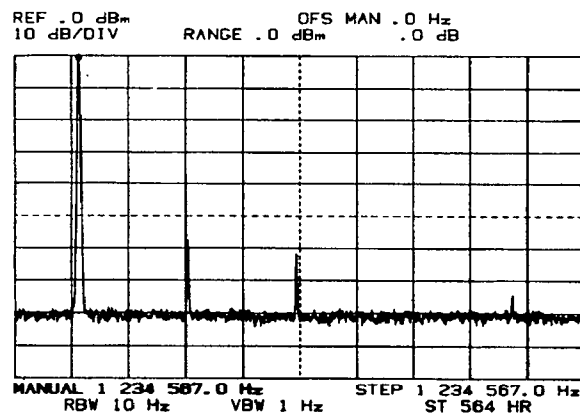

A single sweep with a 10 kHz RBW clearly shows the second and third harmonics of a 1.2 MHz signal. The fifth harmonic is visible but near the noise floor and the fourth harmonic is well below the noise. Narrowing the RBW to 10 Hz will reduce the noise by about 30 dB, enabling the fourth harmonic to be measured. All five harmonics can be quickly measured with a 10 Hz RBW by stepping the Manual frequency.

Here is the procedure:



- a. Set the Marker to the peak of the fundamental with  .



Select the Manual mode by pressing  or activating .

Activate  to precisely measure the fundamental frequency.

Set the Manual frequency equal to the Counter frequency by Numeric Entry.

Set the CF Step Size equal to the Counter frequency by pressing  or by Numeric Entry; then, deactivate .

Narrow the RBW to 10 Hz and the VBW to 1 Hz.



Activate  and press .

NOTE

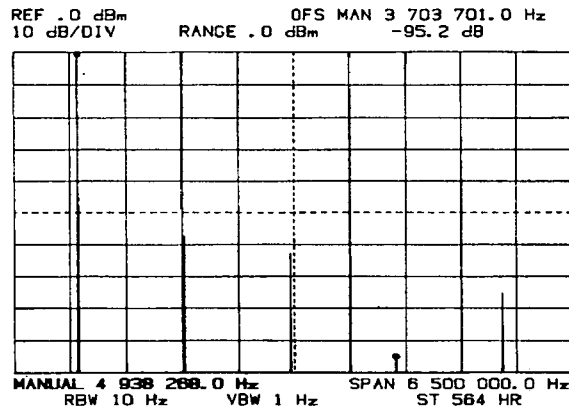
When measuring second and third harmonic distortion products that are more than 80 dB below the fundamental; or IM distortion products that are more than 70 dB below the larger of the two driving signals, increment the RANGE to optimize the distortion-free dynamic range (see Chapter 2, Page 31). In this particular example, the second and third harmonics are well above the analyzer's internal distortion level.



- b. Clear the trace by pressing .





Step the Manual frequency to measure individual harmonics by pressing  .

(The fourth harmonic is 95.2 dB below the fundamental.)

STEP MANUAL FREQUENCY

Measuring Harmonic Distortion

After measuring a signal in the Manual mode, it is sometimes desirable to “zoom-in” on that signal and observe it with a frequency sweep. To accomplish this:

- Step the Manual frequency to the signal of interest.
- Move the signal to the center of the screen by pressing  .
- Narrow the Frequency Span about the Center Frequency to obtain the desired frequency display range (and a reasonable Sweep Time).
- If necessary, lower the Reference Level to display the signal and noise on the upper portion of the CRTscreen (or press  to move the signal to the top of the screen).
- Activate the  or  SWEEP function.

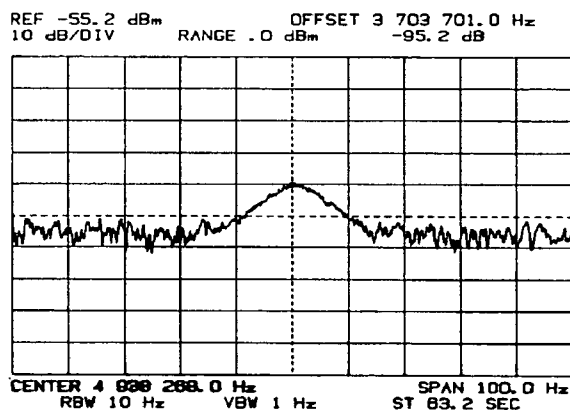

Fourth harmonic of 1.2 MHz signal measured in Manual mode (preceding example) moved to center of screen and displayed with 100 Hz Span. Reference Level lowered to -55.2 dBm to display the signal and noise on the CRT screen. (With the Reference Level at its original setting of 0 dBm, the noise is below the bottom graticule line and is not displayed.)

Other harmonics can be moved to the center of the screen and displayed in the same span by simply incrementing or decrementing the Center Frequency. The Center Frequency steps are equal to the Manual frequency steps.

For example:

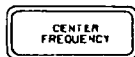
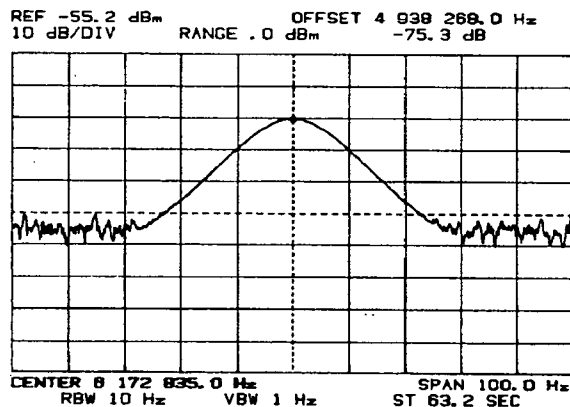

displays the fifth harmonic-after a 63.2-second frequency sweep.

Step The Manual Frequency By Stepping The Center Frequency

A change in the Center Frequency produces a corresponding change in the Manual frequency. Therefore, if the Center Frequency is changed, the absolute Manual frequency will also change; but the difference between the Manual frequency and the Center frequency will remain the same. For instance, if the Manual frequency is initially set equal to the Center Frequency and the Center Frequency is changed by 1 kHz, the Manual frequency will also change by 1 kHz and will remain in the center of the screen.



The Manual frequency can be stepped within the limits of the selected Frequency Span; but the Center Frequency can be stepped within the range of 0 Hz to 40.1 MHz regardless of the Frequency Span. By setting the Manual frequency equal to the Center Frequency (or vice-versa) and stepping the Center Frequency, you can measure equally spaced signals over the entire frequency range of the instrument with any arbitrary Frequency Span.

To illustrate the concept of stepping the Center Frequency to measure equally spaced signals in the Manual mode, we will give two examples. The first is a repeat of the harmonic distortion measurement previously made by stepping the Manual frequency. The second example shows a very rapid technique for measuring the intermodulation (IM) distortion products of two closely spaced signals.

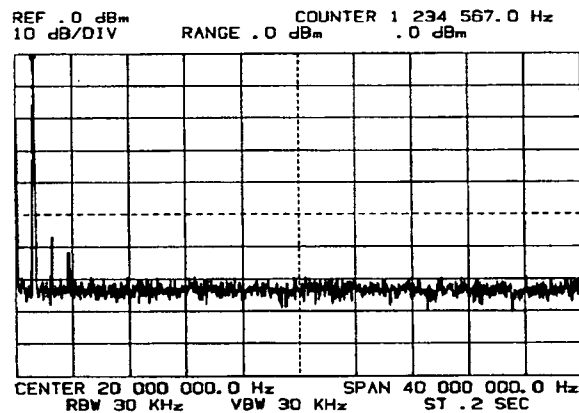
Measuring Harmonic Distortion By Stepping The Center Frequency



- a. Start with a full Span by pressing  .

Set the Marker to the peak of the fundamental with   .

(If the fundamental is masked by the zero response, decrement the Stop Frequency until the fundamental response is distinguishable.)

Activate  to precisely measure the fundamental frequency.

STEP CF
Measuring Harmonic Distortion

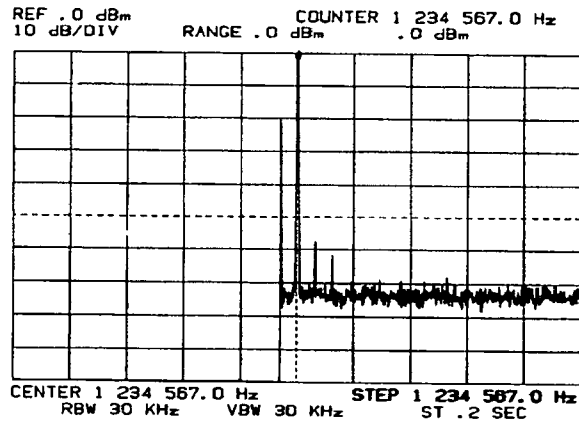

- b. Set the Center Frequency equal to the Counter frequency by pressing .

Set the CF Step Size equal to the Counter frequency by pressing .

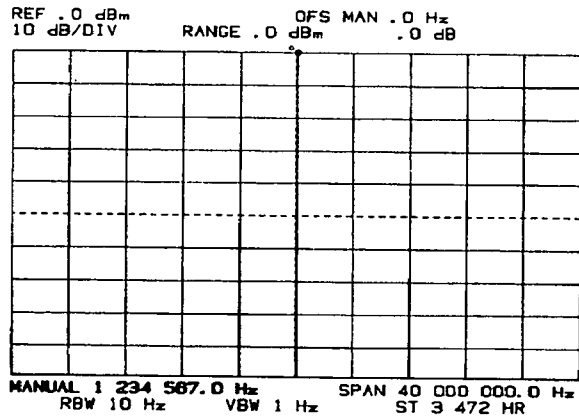

- c. Select the Manual mode by pressing or activating .

(This sets the Manual frequency equal to the Marker frequency which, after is equal to the Center Frequency.)

Clear the Trace by pressing .

Narrow the RBW to 10 Hz and the VBW to 1 Hz.

(The 3 Hz RBW would provide a lower noise level than the 10 Hz RBW. In this case, however, the 10 Hz RBW provides adequate sensitivity and further allows a 10:1 RBW/VBW ratio. This gives better noise averaging than the 3:1 ratio that would be obtained with a 3 Hz RBW.)

Deactivate .

To measure the harmonics in "dB" relative to the fundamental, activate and then press .

STEP CF
Measuring Harmonic Distortion

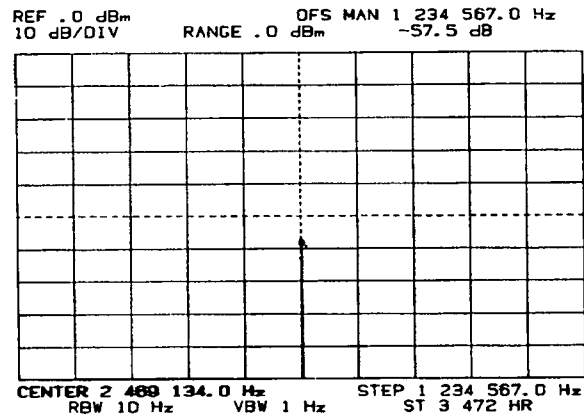

d. Press   to measure the second harmonic.

(The "OFS MAN" (Offset Manual) frequency readout indicates the difference between the fundamental frequency stored in the Offset Register with  and the current Manual frequency.)

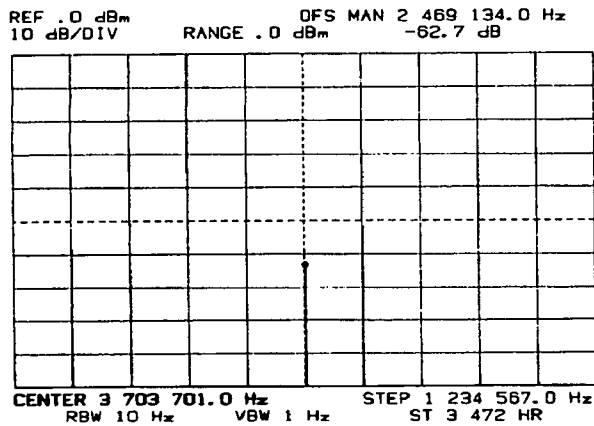

Third Harmonic

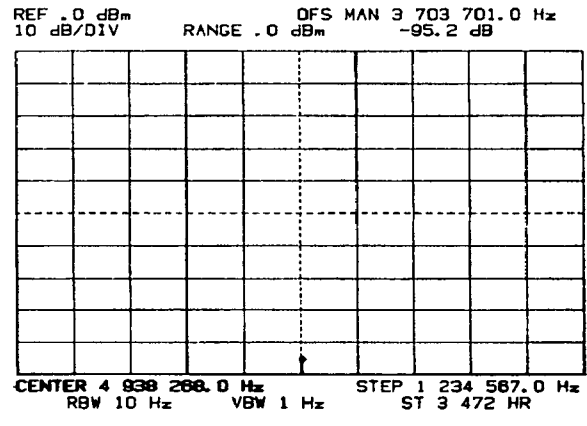

Fourth Harmonic

e. Press  to measure succeeding harmonics.

(Starting with , an experienced operator can measure all five harmonics in less than one minute using this procedure.)

STEP CF
Measuring IM Distortion

Stepping The Center Frequency To Measure IM Distortion Products.

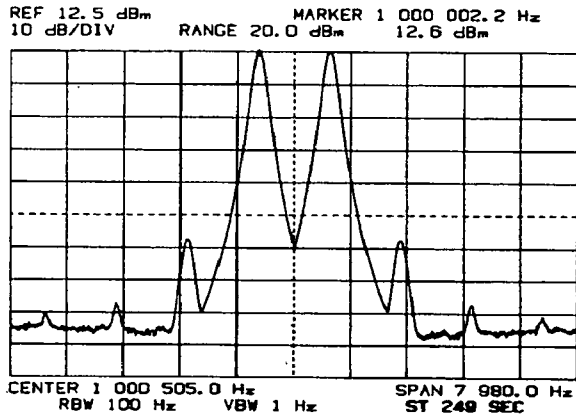

Driving Signals and Odd-Order IM Distortion Products.

Figure A

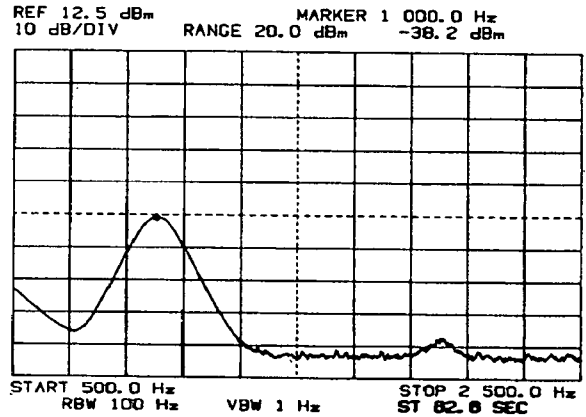

Second and Fourth-Order IM Distortion Products.

Figure B

A 249-second sweep (Figure A) displays the odd-order (i.e., 3rd, 5th and 7th) IM distortion products generated by a high-frequency amplifier that is driven by two 12.6 dBm signals. The signals are about 1 kHz apart; the lower driving frequency is 1 MHz and the upper driving frequency is about 1.001 MHz.

Another frequency sweep (Figure B) displays the even-order (i.e., 2nd and 4th) IM products which appear at 1 kHz and 2 kHz, respectively.

The total time required to complete the IM distortion measurement with two frequency sweeps (counting setup time, etc) is about seven minutes. In the Manual mode, however, the IM distortion products can be individually measured in about 2.5 minutes starting from full Span. Here is the procedure:

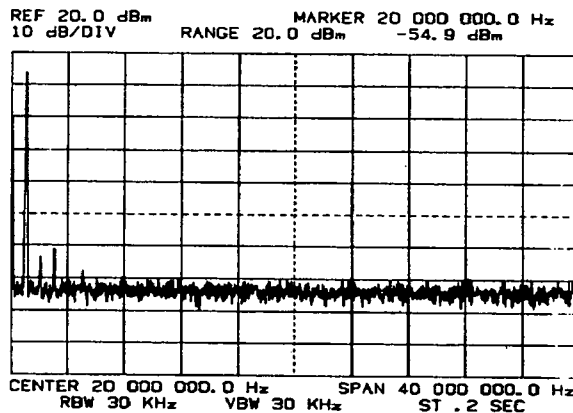



- a. Start with a full Span by pressing  .

(The full span and 30 kHz RBW does not provide the resolution needed to separate the two closely spaced signals; so they appear as one response.)

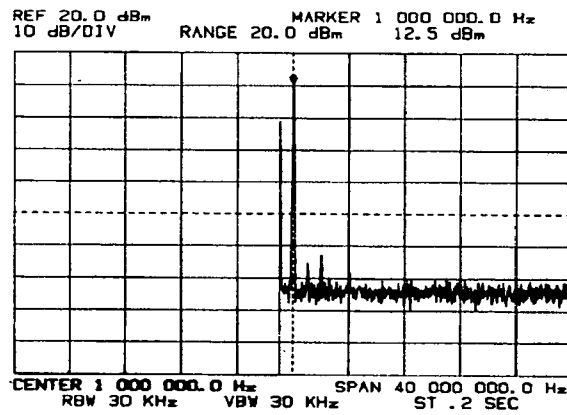
STEP CF
Measuring IM Distortion



b. Set the Marker to the peak of the large response with  .

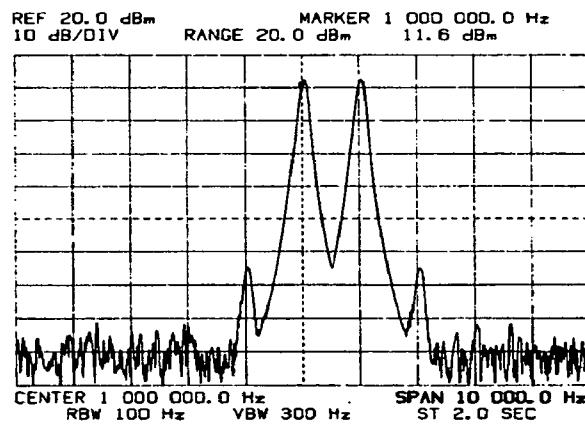

Move the response to the center of the screen by pressing  .



c. Narrow the Frequency Span (with  ) just enough to resolve the two driving signals.

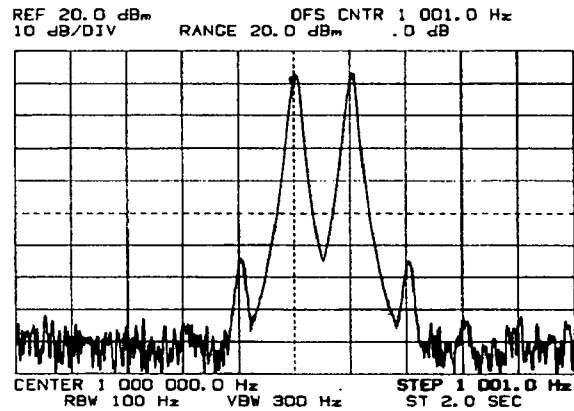

STEP CF
Measuring IM Distortion





- d. Select the Manual mode by pressing  or activating .

(This sets the Manual frequency equal to the Marker frequency which is near the peak of the 1 MHz driving signal.)

Activate  to precisely measure the frequency of the lower driving signal on which the Marker is positioned.

Activate  and then press .

(This stores the counted frequency of the lower driving signal in the Offset Register.)

Activate  and set the Marker to the peak of the upper driving signal with .

(The "OFS CNTR" (Offset Counter) reading indicates the difference between the frequency of the lower driving signal in the Offset Register and the counted frequency of the upper driving signal.)

Set the CF Step Size equal to the difference frequency (i.e., "OFS CNTR" frequency) by pressing .

STEP CF
Measuring IM Distortion

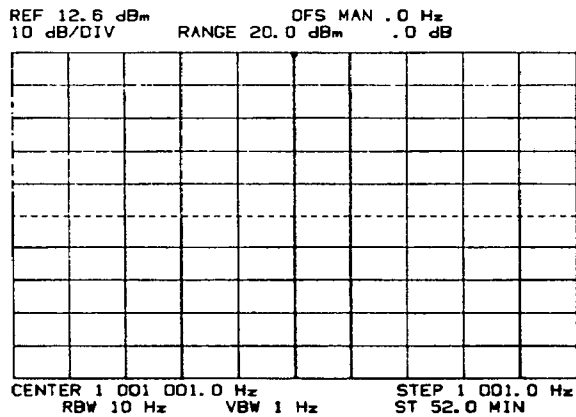

e. Press .

(This sets the Center Frequency and Manual frequency equal to the absolute Counter frequency which is the frequency of the upper driving signal.)

Clear the trace by pressing .

Narrow the RBW and VBW to the desired settings.

Move the response to the top of the screen by pressing .

Deactivate .

To insure an accurate offset reference, press .

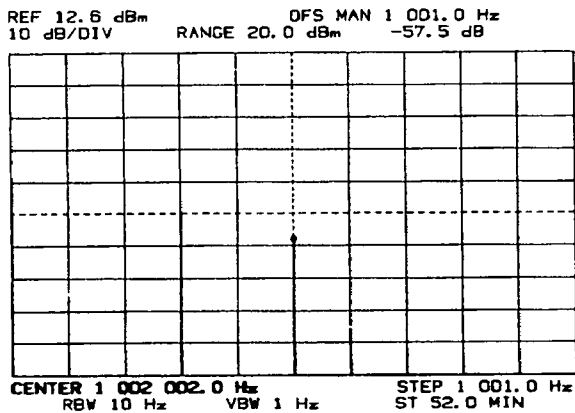

Third Order

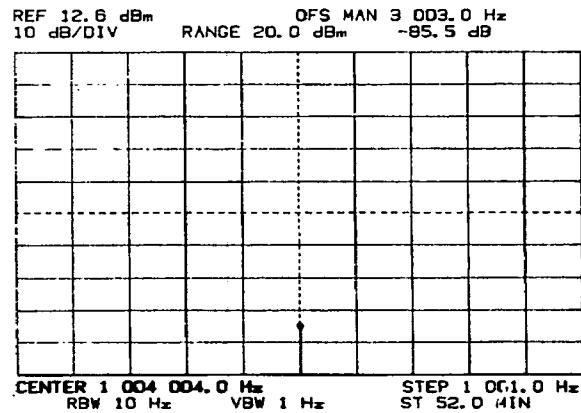

...Seventh Order

f. Increment the Center Frequency () to individually measure the odd-order IM products in the region above the upper driving signal.

(Since the IM distortion products are the same on both sides of the driving signals, it is not normally necessary to measure both sides. If desired, however, the distortion products below the lower driving signal can be measured by decrementing the Center Frequency.)

STEP CF
Measuring IM Distortion

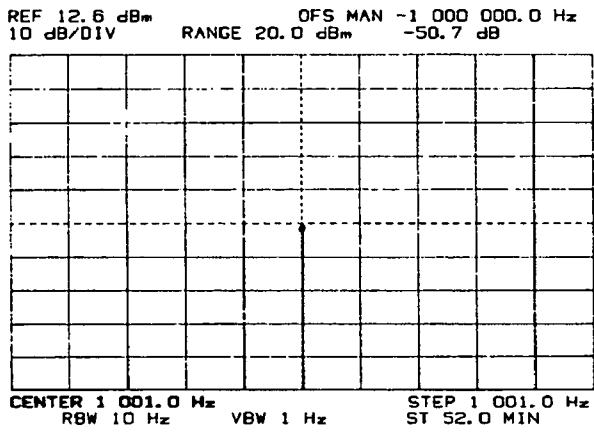

Second Order

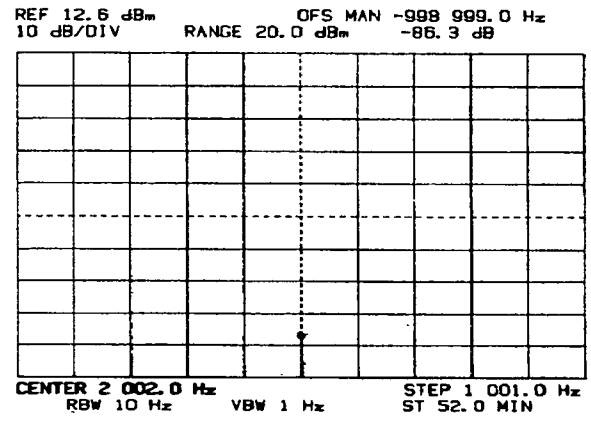

Fourth Order

- g. Set the Center Frequency to 0 Hz by Numeric Entry.

Press   to measure the even-order IM products.

CHAPTER 4

INPUT AND RANGE FUNCTIONS

This chapter describes the 3585A's two input channels and the Impedance, Range and Reference-Level Track functions located in the INPUT control block.

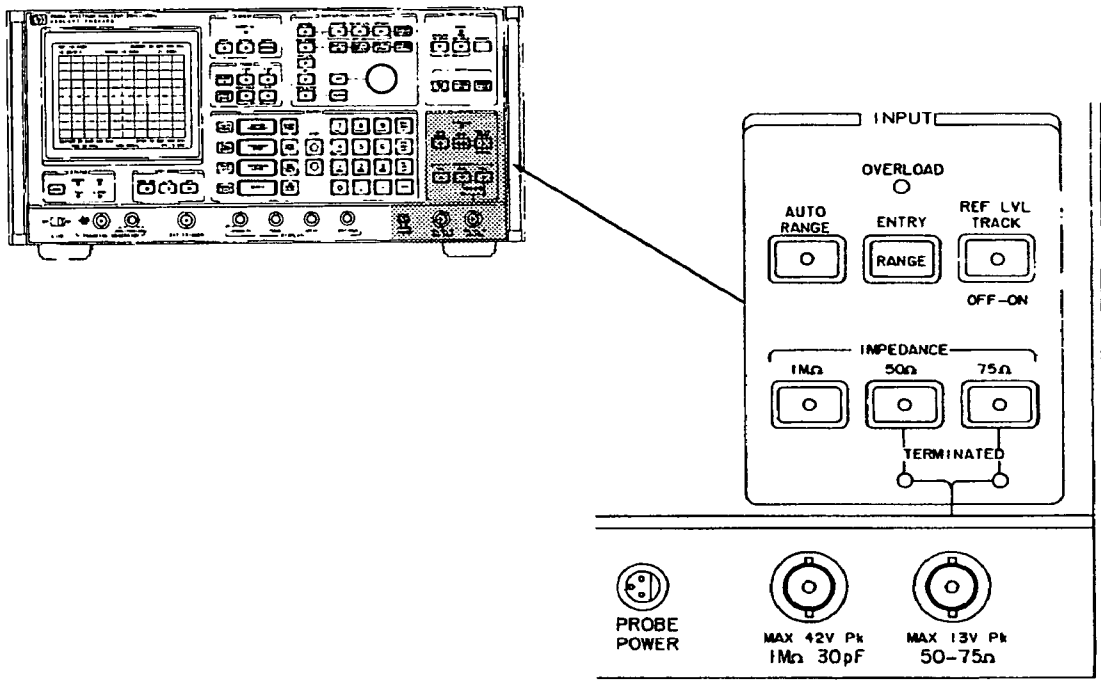

INPUTS

INPUTS

The 3585A has two input channels:

Terminated ($50\ \Omega$ or $75\ \Omega$)
High Impedance ($1\ \text{M}\Omega < 30\ \text{pF}$)

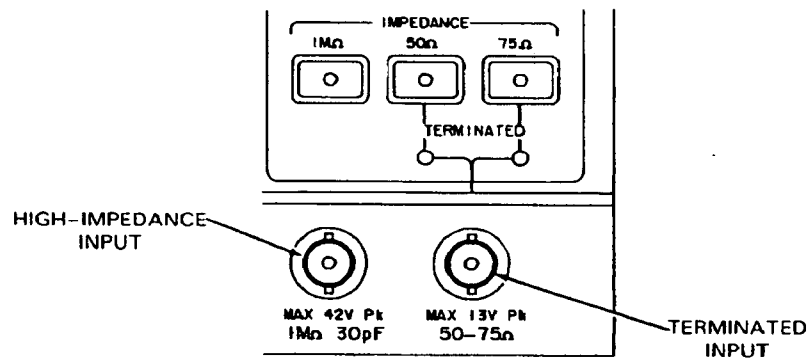

The inputs are mutually exclusive and, therefore, cannot be used simultaneously.

NOTE

To avoid crosstalk interference between input channels, it is good practice to disconnect the signal source from the input that is not being used; i.e., if you are using the Terminated input leave the High-Impedance input disconnected and vice-versa. (Interchannel isolation typically ranges from about 104 dB at 20 Hz to 85 dB at 40.1 MHz.)

Both inputs are single ended (unbalanced) and, to minimize ground-loop problems, the outer shells of the female BNC input connectors are connected to a special measurement ground which is isolated at low frequencies. The isolation is provided by a low-resistance saturable-core inductor connected between measurement ground and chassis ground.

Do not, under any circumstances, attempt to float the outer shells of the input connectors above chassis ground.

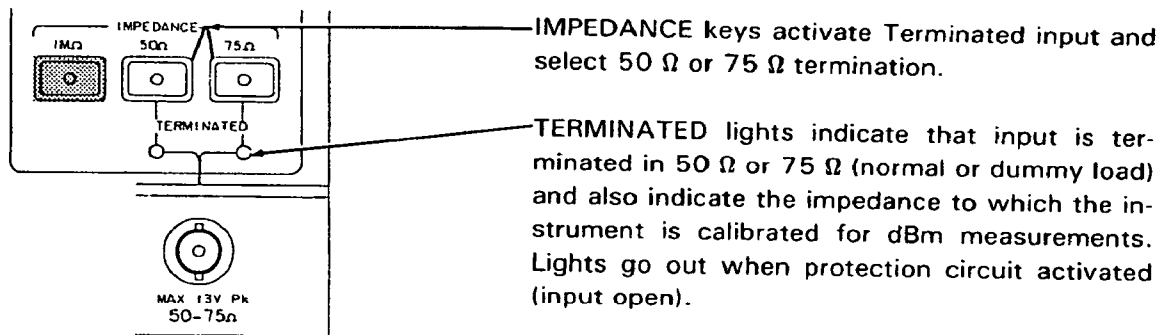

Terminated Input



The Terminated input provides a 50-ohm or 75-ohm (± 1 ohm) resistive termination. The dc-coupled terminating resistance is rated at one watt; specified return loss is > 26 dB.*

CAUTION

The Terminated input is dc coupled. Peak (combined ac/dc) input levels exceeding ± 13 volts will activate the protection circuit but may still damage the input circuitry.

To use the Terminated input simply press  OR .

The IMPEDANCE key will light to indicate that the Terminated input is activated; the TERMINATED light, located directly below the IMPEDANCE key, will light to indicate that the input is terminated. The TERMINATED light that is on indicates the impedance to which the instrument is automatically calibrated for dBm measurements; i.e., dBm/50 Ω or dBm/75 Ω .

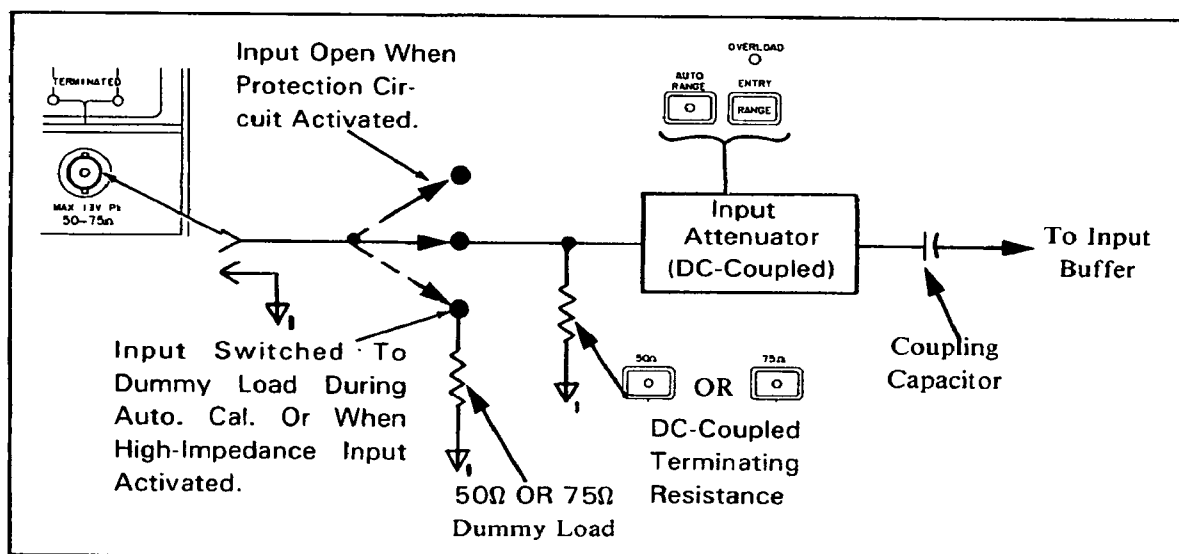

Terminated Input Channel

*When the input is terminated in a dummy load, the return loss is typically > 20 dB.

TERMINATED INPUT

Overvoltage Protection

The Terminated input channel is equipped with an over-voltage protection circuit which automatically opens the input when the peak (combined ac/dc) input level exceeds ± 13 volts.* When the protection circuit activates, the yellow 50 Ω or 75 Ω TERMINATED light goes out, indicating that the input is no longer terminated. (The IMPEDANCE key light stays on.) With the Terminated input open, the instrument cannot respond to the input signal. Consequently, the OVERLOAD light will go out and with the AUTO RANGE function on, the instrument will automatically downrange to -25 dBm.

To reset the protection circuit:

- a. Remove the overload by disconnecting the signal source or reducing the input level.
- b. Press any of the IMPEDANCE keys (including the one currently activated) or press  .

Things To Note Or Observe

- a. The terminating impedance is not displayed on the CRT.
- b. When the dc input voltage is greater than ten times the RANGE setting, the first two amplitude readings after an Automatic Calibration cycle will be incorrect.
- c. When the dc input voltage is greater than 100 times the RANGE setting, the 3585A will not calibrate properly. ("CALIBRATION ERROR 03" will appear on the CRT screen.)
- d. When the 3585A automatically calibrates, the Terminated input is internally switched to a 50 Ω or 75 Ω dummy load. This switching operation, occurring at the beginning and end of each calibration cycle, opens the input for an instant in time causing the input level to increase. The resulting transients do not normally affect the 3585A but they may affect other instruments connected to the signal source in parallel with the 3585A. (With a large input-signal level, the transients could potentially activate the protection circuit; but this does not normally occur.)
- e. The 3585A Automatic Calibration system operates through the Terminated input channel regardless of which input is being used. The Terminated input, therefore, provides much higher amplitude accuracy than the High-Impedance input. The Terminated input channel also has lower noise and distortion than the High-Impedance input; so it should be used whenever optimum accuracy and dynamic range is required. Signal sources having output impedances other than 50 Ω or 75 Ω can be connected to the Terminated input through an impedance matching network or high-impedance probe.

* 13 volts peak = 9.19 V rms = +19.27 dBV = +32.28 dBm/50 Ω = +30.52 dBm/75 Ω

High Impedance Input

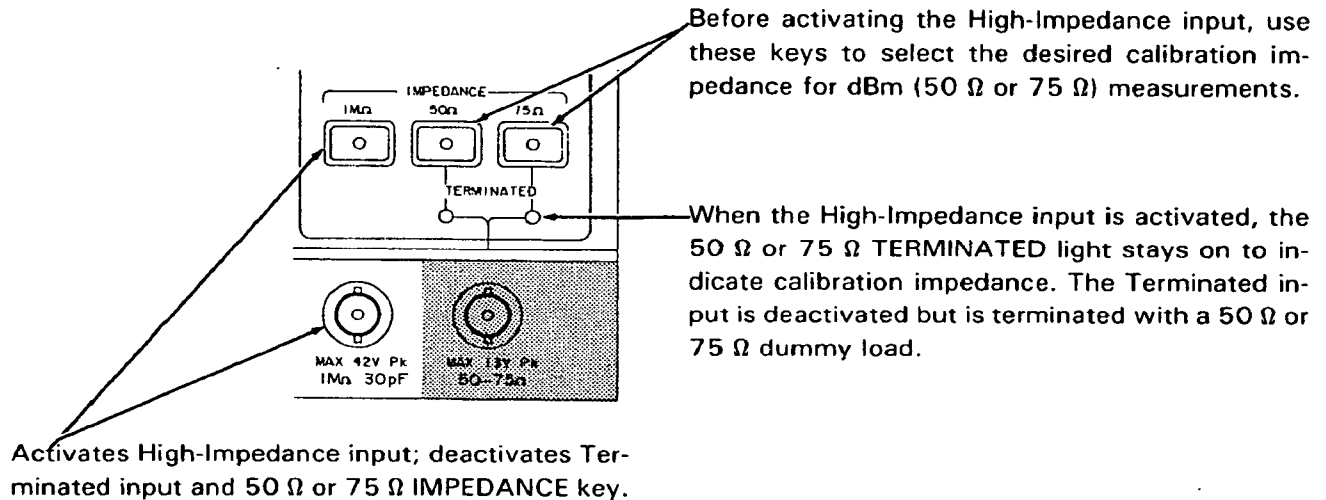







The High-Impedance input is ac coupled and has an input impedance of 1 megohm ($\pm 3\%$) shunted by less than 30 pF. It is intended for general-purpose measurements where optimum amplitude accuracy and dynamic range is not required. The input can be used directly for in-circuit probing of low-frequency devices; it can be bridged across a terminated transmission line or it can be externally terminated to match the output impedance of a specific signal source. The 1 megohm 30 pF input impedance is compatible with several high-impedance 'scope probes such as the -hp- Model 10040A.

CAUTION

RF input levels exceeding those listed in Table 1 may damage the input circuitry. The peak (combined ac/dc) input level applied to the high-Impedance input must not exceed ± 42 volts.

To use the High-Impedance input:

- a. Select the desired calibration impedance by pressing  OR . (The calibration impedance is the impedance to which the instrument is automatically calibrated for dBm measurements; i.e., dBm/50 Ω or dBm/75 Ω. For measurements in dBV or volts, the IMPEDANCE setting is arbitrary.)
- b. Activate the High-Impedance input by pressing .

The  key will light to indicate that the High-Impedance input is activated. The  or  key will go out but the 50 Ω or 75 Ω TERMINATED light will stay on to indicate the calibration impedance and also to indicate that the Terminated input is terminated with a 50 Ω or 75 Ω dummy load.

HIGH IMPEDANCE INPUT

Overvoltage Protection

The High-Impedance input channel is protected by passive circuitry which does not require resetting. As indicated on the 3585A front panel, the High-Impedance input will withstand peak (combined ac/dc) input levels up to ± 42 volts.* However, high-level, high-frequency signals applied over a long period of time may damage the input circuitry. To avoid this possibility, the RF signal level applied to the High-Impedance input must not exceed the maximum ac input levels listed in Table 1. The dc input level must be such that the peak input level does not exceed ± 42 volts.

Table 1. Maximum ac Input Levels (High-Impedance Input).

Frequency Range	Maximum ac Input Level
dc to 5 MHz	± 42 V peak
5 MHz to 10 MHz	± 21 V peak
10 MHz to 20 MHz	± 10.5 V peak
20 MHz to 50 MHz	± 5.25 V peak

CAUTION: Input levels exceeding those listed in this table may damage the input circuitry.

NOTE

When the dc input voltage is greater than ten times the RANGE setting, the first two amplitude readings after an Automatic Calibration cycle will be incorrect.

PROBE POWER JACK

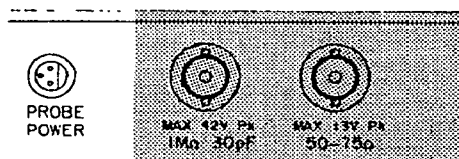

The PROBE POWER jack supplies power for high-impedance 1:1 active probes such as the -hp-Model 1120A 500 MHz AC Probe, which is recommended for use with the 3585A. The voltage outputs are +15 V dc and -12.6 V dc, with a maximum current of 150 mA. To preserve the ground isolation feature when an active probe is used, the ground terminal of the PROBE POWER jack is connected to the same isolated measurement ground as the outer shells of the BNC input connectors.

* 42 volts peak = 29.69 V rms = 29.45 dBV = 42.46 dBm/50 Ω = 40.70 dBm/75 Ω .

RANGE

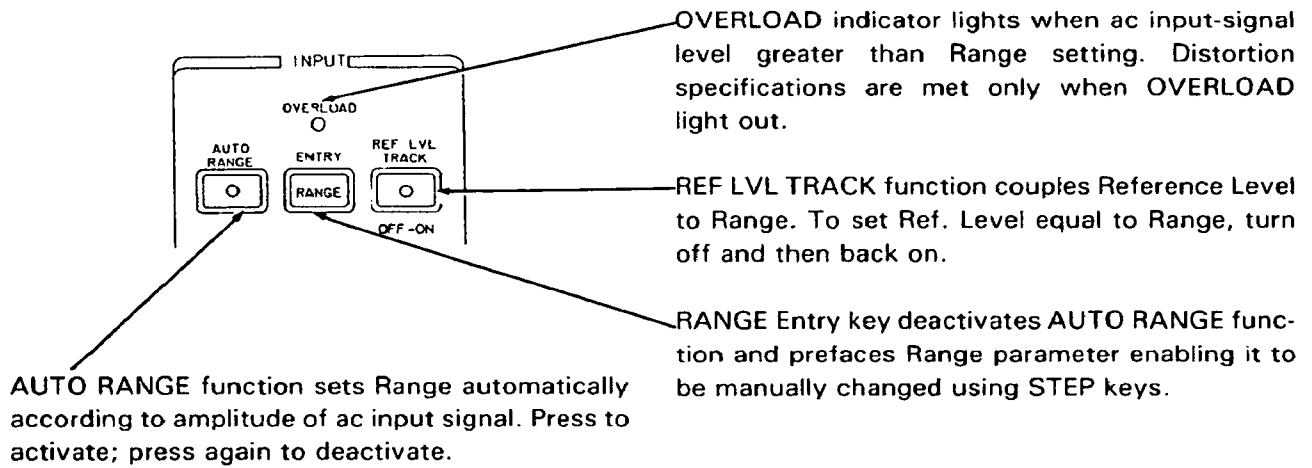

The Range setting determines the maximum ac signal level that can be applied to the Input (i.e., the input currently activated) without overdriving the input circuitry.

The 3585A has a total of twelve Range settings; -25 dBm to +30 dBm, selectable in 5 dB increments.

The Range can be set automatically using the AUTO RANGE feature or it can be manually incremented or decremented (in 5 dB steps) using the STEP keys. *The Range cannot be set by Numeric Entry.*

Range Readout

The selected RANGE setting appears in the top middle portion of the CRT screen. It is displayed in dBm (50 Ω or 75 Ω), dBV or rms volts, corresponding to the units in which the Reference Level (REF) is displayed. Even though the Range setting is displayed on the CRT screen, Range information is not normally needed to make measurements with the 3585A.

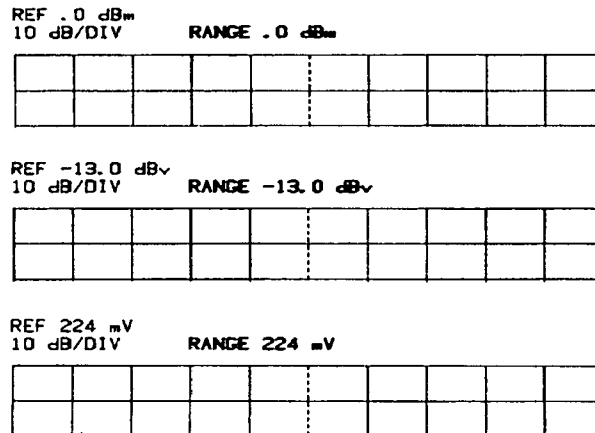

RANGE

Range Settings For Terminated Input

When the Terminated input is activated, the Range settings are defined in dBm/50 ohms or dBm/75 ohms, depending on the terminating impedance:

RANGE (dBm)	50-OHM OVERLOAD LEVEL			75-OHM OVERLOAD LEVEL		
	(dBV)*	(RMS VOLTS)	(PK VOLTS)	(dBV)*	(RMS VOLTS)	(PK VOLTS)
+30.0	+16.99	7.08 V	10.01 V	+18.75	8.68 V	12.27 V
+25.0	+11.99	3.98 V	5.63 V	+13.75	4.86 V	6.87 V
+20.0	+6.99	2.24 V	3.17 V	+8.75	2.74 V	3.87 V
+15.0	+1.99	1.25 V	1.77 V	+3.75	1.54 V	2.18 V
+10.0	-3.01	708 mV	1.00 V	-1.25	868 mV	1.23 V
+5.0	-8.01	398 mV	563 mV	-6.25	486 mV	687 mV
+0.0	-13.01	224 mV	317 mV	-11.25	274 mV	387 mV
-5.0	-18.01	125 mV	177 mV	-16.25	154 mV	218 mV
-10.0	-23.01	70.8 mV	100 mV	-21.25	86.8 mV	123 mV
-15.0	-28.01	39.8 mV	56.3 mV	-26.25	48.6 mV	68.7 mV
-20.0	-33.01	22.4 mV	31.7 mV	-31.25	27.4 mV	38.7 mV
-25.0	-38.01	12.5 mV	17.7 mV	-36.25	15.4 mV	21.8 mV

*On the CRT display, the "dBV" Range settings are rounded off to the nearest 0.1 dB; e.g., +16.99 dBV = +17.0 dBV

Range and Overload Levels (Terminated Input)

Range Settings For High-Impedance Input





When the High-Impedance input is activated, the Range settings are defined in dBV (1 V rms = 0 dBV), corresponding to cardinal points on the dBm/50-ohm scale:

RANGE (dBV)*	OVERLOAD LEVEL			
	(dBm/50 OHMS)	(dBm/75 OHMS)*	(RMS VOLTS)	(PK VOLTS)
+16.99	+30.0	+28.24	7.08 V	10.01 V
+11.99	+25.0	+23.24	3.98 V	5.63 V
+6.99	+20.0	+18.24	2.24 V	3.17 V
+1.99	+15.0	+13.24	1.25 V	1.77 V
-3.01	+10.0	+8.24	708 mV	1.00 V
-8.01	+5.0	+3.24	398 mV	563 mV
-13.01	+0.0	-1.76	224 mV	317 mV
-18.01	-5.0	-6.76	125 mV	177 mV
-23.01	-10.0	-11.76	70.8 mV	100 mV
-28.01	-15.0	-16.76	39.8 mV	56.3 mV
-33.01	-20.0	-21.76	22.4 mV	31.7 mV
-38.01	-25.0	-26.76	12.5 mV	17.7 mV

*On the CRT display, the Range settings in dBV and dBm/75 Ω are rounded off to the nearest 0.1 dB.



Range and Overload Levels (High-Impedance Input)

Auto Range Operation

Pressing  OR  activates the Auto Range function. Unless you specifically override the Auto Range function by pressing  or deactivating , the 3585A will automatically select the proper Range according to the amplitude of the ac input signal. (The Auto Range circuitry is ac coupled and, therefore, will not respond to a dc input.) The Range that is selected automatically is typically the lowest Range that can be used without overdriving the input circuitry and is referred to as the “optimum” Range setting. For single-tone measurements at the Terminated input, the optimum Range setting will provide at least 80 dB of distortion-free dynamic range. Since the Range is set automatically and Range information is not needed to make measurements, the Range setting can generally be ignored.

Manual Ranging

To manually change the Range setting:

Press  then  OR 

Pressing  deactivates the Auto Range function and prefaces the Range parameter. An “UP” step increases the Range by 5 dB; a “DOWN” step decreases the Range by 5 dB. Step entries do not terminate the entry sequence; so the Range can be stepped any number of times without being reprefaced. Attempts to step above the highest Range or below the lowest Range will cause the beeper to sound and the error message, “OUT OF RANGE” to appear on the CRT screen.

QUESTION:

Since the Range can be set automatically, why have the manual Range capability?

ANSWER:

Two reasons:

1. While the Auto. Range feature is very convenient and certainly a rare commodity on a spectrum analyzer, it is not practical for all measurement applications. For example, auto-ranging cannot be used when measuring intermittent signals or signals that are slowly varying about the Auto. Range threshold. Also, for in-circuit probing applications, it is generally preferable to set the Range manually rather than wait for the instrument to auto. range each time the probe is moved to a different node.
2. The ability to manually change the Range setting makes it possible to optimize the dynamic range according to the type of measurement being performed. When measuring the low-level spurious components or noise of an external source, it is often beneficial to decrement the Range one or two steps below the optimum setting. This overdrives the input and increases the internal distortion; but it also improves the signal-to-noise ratio, making it possible to measure low-level signals that would otherwise be buried in noise. Up-ranging from the optimum setting increases the internal noise level but decreases the internal distortion. By up-ranging and then narrowing the Resolution Bandwidth to reduce the noise, the operator can optimize the distortion-free dynamic range for low-level distortion measurements.

Overload Indicator

Whenever the ac input-signal level is greater than the Range setting, the instrument will uprange (AUTO RANGE on, Range < +30 dBm) or the OVERLOAD indicator will light. An Overload indication simply means that the input circuitry is being overdriven and the internal distortion levels may be higher than specified. As long as the input-signal level does not exceed the maximum input levels listed on the front panel, the inputs may be overdriven up to 12.3 dB above the Range setting. Overdriving improves the signal-to-noise ratio (at the cost of higher distortion) and is a very effective way to optimize the noise-free dynamic range for low-level measurements that are not affected by internal distortion.

Things To Note Or Observe

- a. The Auto Range function cannot be used in cases where the amplitude of the input signal varies slowly above and below the Auto-Range threshold. This commonly occurs during swept frequency response measurements with the 3585A Tracking Generator.
- b. It is normal for the OVERLOAD indicator to flash on and off as the 3585A upranges and downranges in search of the proper Range setting.
- c. The OVERLOAD indicator (and Auto Range function) is controlled by a broadband ac-coupled detector which responds to the composite ac input-signal level. (It does not respond to a dc input.) The OVERLOAD indicator lights (and/or the instrument upranges) when the input-signal level exceeds the Range setting by approximately +0.2 dB. When the input signal is in this +0.2 dB region, the input circuitry is slightly overdriven and, for this reason, the instrument may not meet its distortion specifications- even though the OVERLOAD light is off. When making distortion measurements that could be affected by the analyzer's internal distortion, be sure that the composite ac input-signal level is equal to or lower than the Range setting indicated by the "RANGE" readout. Do not rely on the OVERLOAD light as an indication that the distortion specifications are met.
- d. The 3585A has an internal limiting system which prevents the Reference Level from being set lower than 100 dB below Range or higher than 10 dB above Range. When the Reference Level is not coupled to the Range (REF LVL TRACK deactivated), this system will operate in reverse to prevent the Range from being set lower than 10 dB below the Reference Level or higher than 100 dB above the Reference Level. Attempts to exceed these limits (either manually or automatically) will cause the beeper to sound and an error message to appear on the CRT screen.

REFERENCE LEVEL TRACK FUNCTION





The Reference Level is the absolute amplitude represented by the top horizontal line of the CRT graticule. The 3585A Reference Level is settable from 100 dB below RANGE to 10 dB above RANGE with 0.1 dB resolution. By adjusting the Reference Level, any response within the 110 dB range can be moved to the top of the screen for measurement. *



The  function couples the Reference Level to RANGE. Thus, as the Range is changed (either automatically or manually), the Reference Level changes in corresponding 5 dB increments. The coupling does not operate in reverse; i.e., changing the Reference Level does not affect the Range.



When the REF LVL TRACK function is activated, the Reference Level changes in 5 dB steps along with the Range, no matter what the current Reference Level setting happens to be. However, the primary purpose of the coupling system is to initially set the Reference Level equal to the Range so that the vertical display range is compatible with the input-signal level.



The  and  functions are automatically activated when the  key is pressed at the beginning of a measurement. Range and Reference Level are both preset to +30 dBm; but with no input signal, the instrument automatically downranges to -25 dBm. With the REF LVL TRACK function activated, the Reference Level changes along with the Range; so it also drops to -25 dBm. When the signal source is initially connected to the Input, the instrument either remains on the -25 dBm Range or automatically upranges, depending on the input-signal amplitude. In either case, the Reference Level remains equal to the Range. With Range and Reference Level both set according to the input-signal amplitude, the vertical display range is automatically tailored to display the input-signal responses; and, in most cases, the largest response is at or near the top of the screen ready for measurement. In some cases, the noise level will be so low that the noise floor is entirely off screen. The Reference Level coupling does not compensate for this effect; but it does insure that the largest input-signal responses are on the CRT screen. Low-level signals that are below the display range can be moved onto the screen by lowering the Reference Level.

Once you have adjusted the frequency parameters to display the signals of interest, you may independently adjust the Reference Level to move individual responses to the top of the screen for measurement and/or vertical expansion. It is *not necessary* to deactivate the REF LVL TRACK function when adjusting the Reference Level. The REF LVL TRACK function will not affect the Range setting; nor will it interfere with the adjustment of the Reference Level. As long as the Range setting remains constant, the REF LVL TRACK function will not change the Reference Level.

After adjusting the Reference Level to measure one signal, it is often convenient to reset the Reference Level equal to the Range so that another signal can be quickly located and moved to the top of the screen for measurement. The Reference Level can be set equal to the Range at any time by simply turning the  function off and then back on.

For certain types of measurements, it is desirable to manually uprange or downrange without changing the Reference Level. For example, if you are measuring the low-level spurious components of a large signal, you may wish to leave the signal at the top of the screen and downrange one or two steps to improve the signal-to-noise ratio. To accomplish this, first deactivate  and then decrement the Range with  .

*The various Reference Level entry methods are outlined in Chapter 5 and are also described in the Basic Operating Procedure given in Chapter 2.

CHAPTER 5

MAJOR OPERATING PARAMETERS AND ENTRY FUNCTIONS

This chapter is intended to familiarize you with the 3585A's major operating parameters, their entry functions and the basic sequences for changing parameter values using the Step keys and the Number/Units keyboard.

THE MAJOR PARAMETERS

The 3585A has twelve major operating parameters:











Amplitude	<div style="display: inline-block; vertical-align: middle;"> <div style="font-size: 2em; vertical-align: middle;">[</div> <div style="display: inline-block; vertical-align: middle;"> Range Reference Level (REF) Vertical Scale (dB/DIV) </div> </div>	<div style="display: inline-block; vertical-align: middle;"> overload level top line of CRT graticule amplitude display range </div>
Frequency	<div style="display: inline-block; vertical-align: middle;"> <div style="font-size: 2em; vertical-align: middle;">[</div> <div style="display: inline-block; vertical-align: middle;"> Frequency Span (SPAN) Center Frequency (CENTER or CF) Start Frequency (START) Stop Frequency (STOP) Manual Frequency (MANUAL) Center-Frequency Step Size (STEP) </div> </div>	<div style="display: inline-block; vertical-align: middle;"> displayed frequency range center frequency of span lowest frequency of span highest frequency of span manual frequency tuning frequency increment for Center and Manual frequency steps </div>
Bandwidth	<div style="display: inline-block; vertical-align: middle;"> <div style="font-size: 2em; vertical-align: middle;">[</div> <div style="display: inline-block; vertical-align: middle;"> Resolution Bandwidth (RBW) Video Bandwidth (VBW) </div> </div>	<div style="display: inline-block; vertical-align: middle;"> frequency selectivity and sensitivity noise averaging or "smoothing" </div>
	Sweep Time (S.T.)	sweep rate

To efficiently operate the 3585A, the operator must have a basic understanding of these operating parameters and the various entry methods that can be used to change their values.

OVERVIEW OF ENTRY METHODS

Overview Of Entry Methods

More than 60 percent of the keys on the 3585A front panel are dedicated to entering and controlling the major operating parameters. There are six different methods through which the parameters can be entered or adjusted:

Entry Method	Description	Parameters
Automatic/Coupled	<p>With  activated, Range is set automatically.</p> <p>With  activated, Reference Level is coupled to Range and, therefore, changes automatically along with Range.</p> <p>With  activated, RBW and VBW are set automatically as a function of Frequency Span; Sweep Time is automatically adjusted to maintain calibration.</p>	<p>Range</p> <p>Reference Level</p> <p>RBW, VBW, ST</p>
Step Entry	Change in steps using STEP keys:  OR 	All Parameters
Numeric Entry	Set value exactly using Number/Units keyboard: 	All Parameters except Range
Continuous Entry	Adjust using Continuous Entry control: 	Reference Level Center Frequency Manual Frequency
Marker Entry:	Single key (e.g., ) sets parameter equal to current Marker amplitude or Marker/Counter frequency.	Reference Level Center Frequency CF Step Size
Offset Entry	Single key (e.g., ) sets parameter equal to Offset frequency; i.e., the difference between the current Marker/Counter frequency and Marker/Counter frequency at which  pressed.	Frequency Span Start and Stop CF Step Size

The Automatic/Coupled functions are automatically activated when the  key is pressed at the beginning of a measurement. With these functions activated, the operator simply selects the desired input and impedance, connects the signal source and then adjusts the frequency parameters to display the signals of interest. During this process, the Range, Reference Level, RBW, VBW and Sweep Time parameters are set automatically. The settings that are selected automatically are not necessarily the best settings for your particular measurement; but they always provide a convenient starting point from which the parameters can be individually adjusted to obtain the required result.

Parameter Definitions

The remainder of this chapter is devoted to defining the major operating parameters and describing the general Step Entry and Numeric Entry sequences. The Automatic/Coupled functions are described in Chapters 4 and 7; the Continuous, Marker and Offset entry functions are described in Chapter 8.

Amplitude Parameters

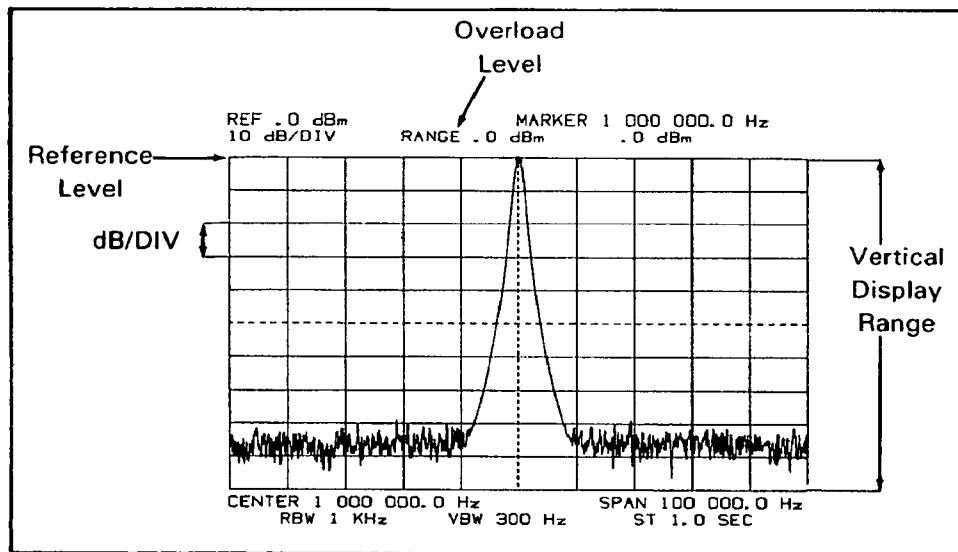

Amplitude Parameters

Range. The Range setting determines the maximum ac signal level that can be applied to the input without overdriving the input circuitry.

Settability: twelve settings; -25 dBm to +30 dBm, 5 dB steps

Entry Methods:

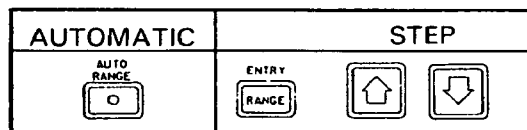



PARAMETER DEFINITIONS

Reference Level (REF). The Reference Level, represented by the top horizontal line of the CRT graticule, is the calibrated absolute amplitude to which the Marker amplitude readings are referenced and is also the amplitude value about which the vertical scale is expanded. The amplitude display range extends from approximately 0.23 divisions above the Reference Level to 10 divisions below the Reference Level.

For operating purposes, the Reference Level can be thought of as the absolute amplitude to which the top line of the CRT graticule is calibrated. It is important to note, however, that the CRT graticule is not internally generated; so there is absolutely no way for the 3585A to actually calibrate to the top graticule line. The correlation between the Reference Level amplitude and the trace amplitude at the top graticule line depends entirely on the CRT trace alignment which is *not specified*. To obtain the specified amplitude accuracy, you must make your measurements using the instrument's tunable Marker, rather than the CRT graticule. The Marker amplitude accuracy is relative to the Reference Level accuracy: When the Marker amplitude reading is equal to the Reference Level, the Marker accuracy is equal to the Reference Level accuracy. When the Marker amplitude is not equal to the Reference Level, the Marker accuracy is determined by the Reference Level Accuracy *and* Amplitude Linearity specifications.

The Reference Level is settable from 100 dB below RANGE to 10 dB above RANGE with 0.1 dB resolution. It can be entered and displayed in dBm, dBV or rms volts. The ability to adjust the Reference Level allows you to move the signals of interest to the top of the screen where they can be measured with Reference Level accuracy and/or expanded vertically by reducing the Vertical Scale (dB/DIV) setting. Low-level signals that are below the display range can be moved onto the screen by lowering the Reference Level. This is an important capability because it allows you to utilize the analyzer's full dynamic range which may easily exceed 100 dB when a narrow Resolution Bandwidth is used.

Settability: 100 dB below RANGE to 10 dB above RANGE; 0.1 dB resolution.
Entry Methods:

COUPLED TO RANGE	STEP	NUMERIC	CONTINUOUS	MARKER	
		STEP 	OR 		
		STEP 	OR 		

Vertical Scale (dB/DIV). The vertical axis of the CRT graticule has ten major divisions and is calibrated in "dB" relative to the Reference Level. (The 3585A does not have a linear scale.) Each major division represents 10 dB, 5 dB, 2 dB or 1 dB, depending on the Vertical Scale (dB/DIV) setting. The 10 dB/DIV setting provides a display range of 100 dB, enabling both large and small signals (within the analyzer's dynamic range) to be observed simultaneously. The 5 dB, 2 dB and 1 dB settings expand the vertical scale downward from the Reference Level. This improves the amplitude resolution (the 2 dB and 1 dB settings also improve accuracy) but limits the display range to 50 dB, 20 dB or 10 dB, respectively. Signals that are above the Reference Level will overdrive the display; but this will not damage the instrument or degrade its performance. Signals that are below the display range can be moved onto the screen by lowering the Reference Level.

Settability: four settings; 10 dB, 5 dB, 2 dB or 1 dB per division

Entry Methods:

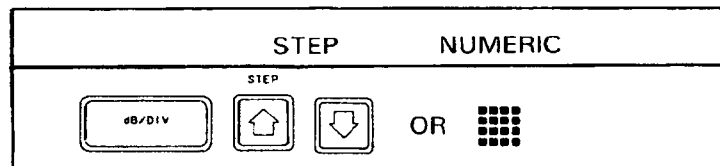

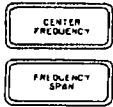

PARAMETER DEFINITIONS

Frequency Parameters

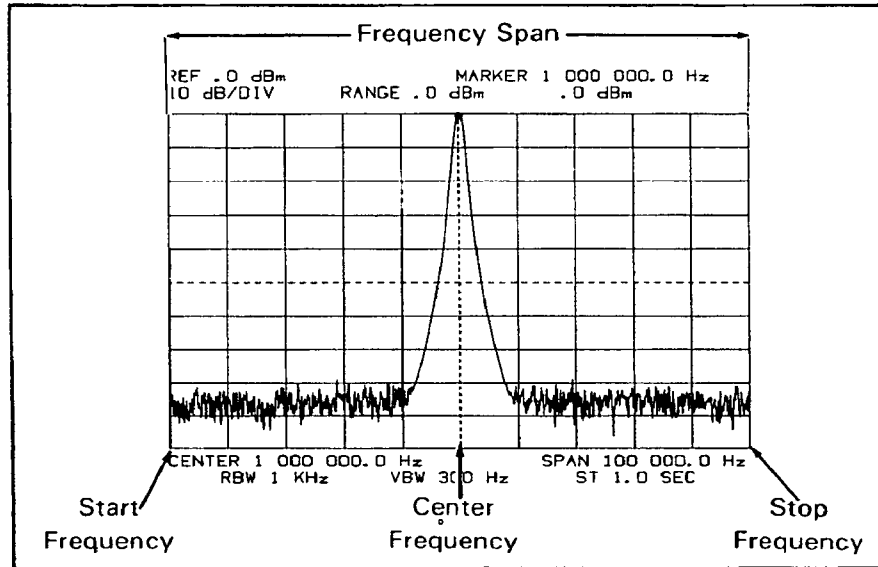

Frequency Parameters

Frequency Span (SPAN). Frequency Span (sometimes called “scan width”) is the portion of the analyzer’s frequency range that is displayed on the horizontal axis of the CRT and is the frequency range over which the instrument can be swept or manually tuned.

Settability: 0 Hz to 40.1 MHz; 0.1 Hz resolution

Entry Methods:

STEP		NUMERIC	OFFSET
		OR	

Center Frequency (CENTER or CF). The Center Frequency, represented by the middle vertical line of the CRT graticule, is the frequency at which the Frequency Span is centered and the frequency about which the horizontal axis is expanded.

Settability: 0 Hz to 40.1 MHz; 0.1 Hz resolution

Entry Methods:

STEP	NUMERIC	CONTINUOUS	MARKER
	OR		



Start Frequency (START). The Start Frequency, represented by the first vertical line on the left-hand side of the CRT graticule, is the lower frequency limit of the Frequency Span and the frequency at which the sweep begins.

Stop Frequency (STOP). The Stop Frequency, represented by the right-most vertical line of the CRT graticule, is the upper frequency limit on the CRT trace. (The 3585A sweeps 0.1% of the Frequency Span *past* the Stop Frequency. The positive peak video amplitude in that 0.1% region is displayed at the Stop Frequency point on the CRT.)

Settability (Start and Stop): 0 Hz to 40.1 MHz; 0.1 Hz resolution

Entry Methods:

STEP		NUMERIC	OFFSET
START FREQ	OR	STOP FREQ	STEP ↑ ↓
START FREQ	OR	STOP FREQ	
		OR	CF STEP SIZE

Manual Frequency (MANUAL). The 3585A has a “Manual” mode in which the electronic frequency sweep is disabled and the 3585A functions as a tunable receiver or “tunable voltmeter” which can be set to any frequency within the selected Frequency Span. The frequency to which the analyzer is tuned in the Manual mode is referred to as the “Manual” frequency. The Manual mode provides a convenient way to make real-time amplitude measurements at the specific frequencies of interest without waiting for a frequency sweep.

Settability: any frequency within the Frequency Span; 0.1 Hz resolution.

Entry Methods:

STEP		NUMERIC	CONTINUOUS
ENTRY MANUAL	STEP ↑ ↓	OR	MAN SWEEP ○
ENTRY MANUAL	STEP ↑ ↓	OR	

Center Frequency Step Size (STEP). The Center Frequency and Manual frequency can be incremented or decremented using the STEP keys. The Center-Frequency Step Size parameter sets the Center-Frequency *and* Manual-Frequency step size.

Settability: 0 Hz to 40.1 MHz; 0.1 Hz resolution

Entry Methods:

STEP		NUMERIC	MARKER/OFFSET
CF STEP SIZE	STEP ↑ ↓	OR	MFR CF S ← →
CF STEP SIZE	STEP ↑ ↓	OR	

RES BW PARAMETER DEFINITIONS

Bandwidth And Sweep Time Parameters

ENTRY METHODS (RBW, VBW and ST)

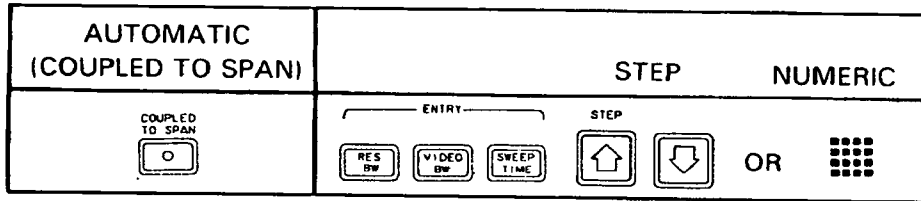

Resolution Bandwidth (RBW). The Resolution Bandwidth setting determines the 3 dB bandwidth of the final IF filter which, in turn, establishes the frequency selectivity of the instrument. Narrowing the Resolution Bandwidth improves the analyzer's ability to separate or "resolve" signals that are closely spaced in frequency; and it also lowers the noise level which improves the sensitivity and noise-free dynamic range. Narrow bandwidths increase the analyzer's response time and, therefore, require slow sweep rates.

Wide Resolution Bandwidths are generally used with wide frequency spans for spectrum surveillance and fast, broadband signal analysis. Narrow bandwidths and narrow spans are used for detailed examination of individual responses, distortion products, modulation sidebands, noise sidebands, close-in spurious responses, etc. The 3585A's nine Resolution Bandwidth settings make it easy to separate and measure signals regardless of their frequency spacing.

Settability: nine settings; 3 Hz to 30 kHz; 1, 3, 10 sequence

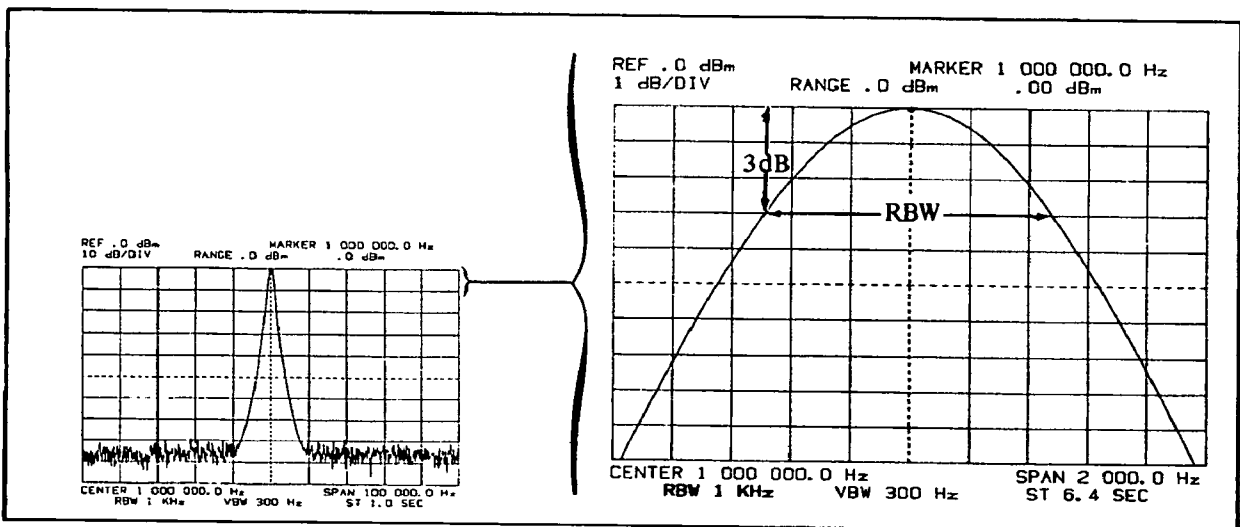

Resolution Bandwidth

Video Bandwidth (VBW). The Video Bandwidth setting determines the 3 dB bandwidth of the instrument's post-detection video filter which averages or "smooths out" the noise appearing on the CRT. Narrowing the Video Bandwidth reduces the peak noise variations on the CRT display, making it easier to discern low-level responses that are near the noise floor. The video filtering is the most effective when the Video Bandwidth is 10% to 1% of the Resolution Bandwidth. Narrowing the Video Bandwidth increases the analyzer's response time, making it necessary to sweep at a slower rate to maintain amplitude calibration.

Settability: ten settings; 1 Hz to 30 kHz; 1, 3, 10 sequence

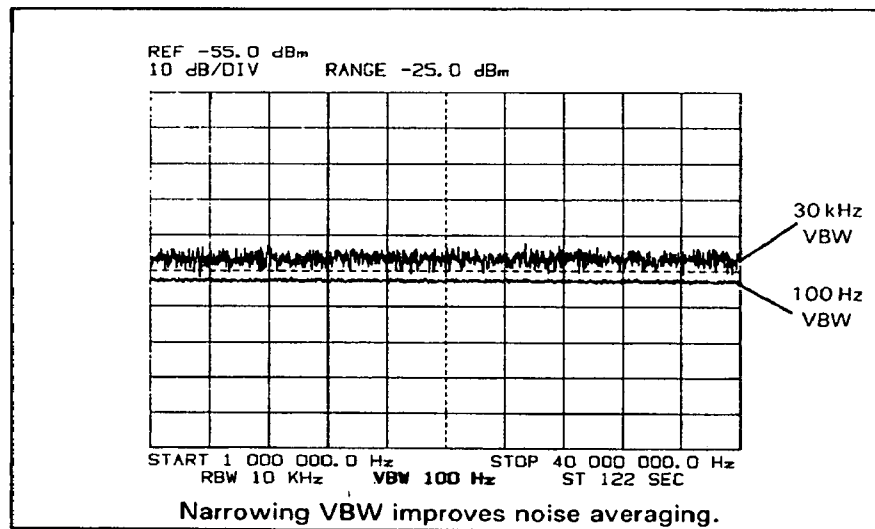

Video Bandwidth

Sweep Time (ST). The Sweep Time setting determines the *sweep rate* in Hertz per second:

$$\text{Sweep Rate (Hz/sec)} = \frac{\text{Frequency Span (Hz)}}{\text{Sweep Time (seconds)}}$$

Due to internal processing requirements, a frequency sweep may be interrupted (i.e., stopped and restarted) more than 40 times before it finally reaches the Stop Frequency. Because of these interruptions, the total time required to sweep across the Span may be noticeably longer than the Sweep Time setting. The Sweep Time setting determines the time that is actually spent sweeping; it does not include time delays caused by sweep interruptions.

Settability: 0.2 sec to 99,999.8 sec with 0.2-sec resolution;
100,000 sec to 999,999 sec with 1-sec resolution

(Minimum sweep-rate limit is 0.1 Hz/sec for 30 kHz and 10 kHz RBW; 0.005 Hz/sec for all other RBW settings. Sweep Time can be stepped up to 59,652 hours; i.e., 6.81 years.)

ENTRY KEYS

ENTRY KEYS

Each of the twelve major parameters has a dark brown ENTRY key which, when pressed, activates or "prefaces" that parameter, enabling it to be changed using the STEP keys or the Numeric Entry keys. Only one parameter can be prefaced at a time and the parameter that is prefaced (if any) is displayed brighter than the other parameters on the CRT.

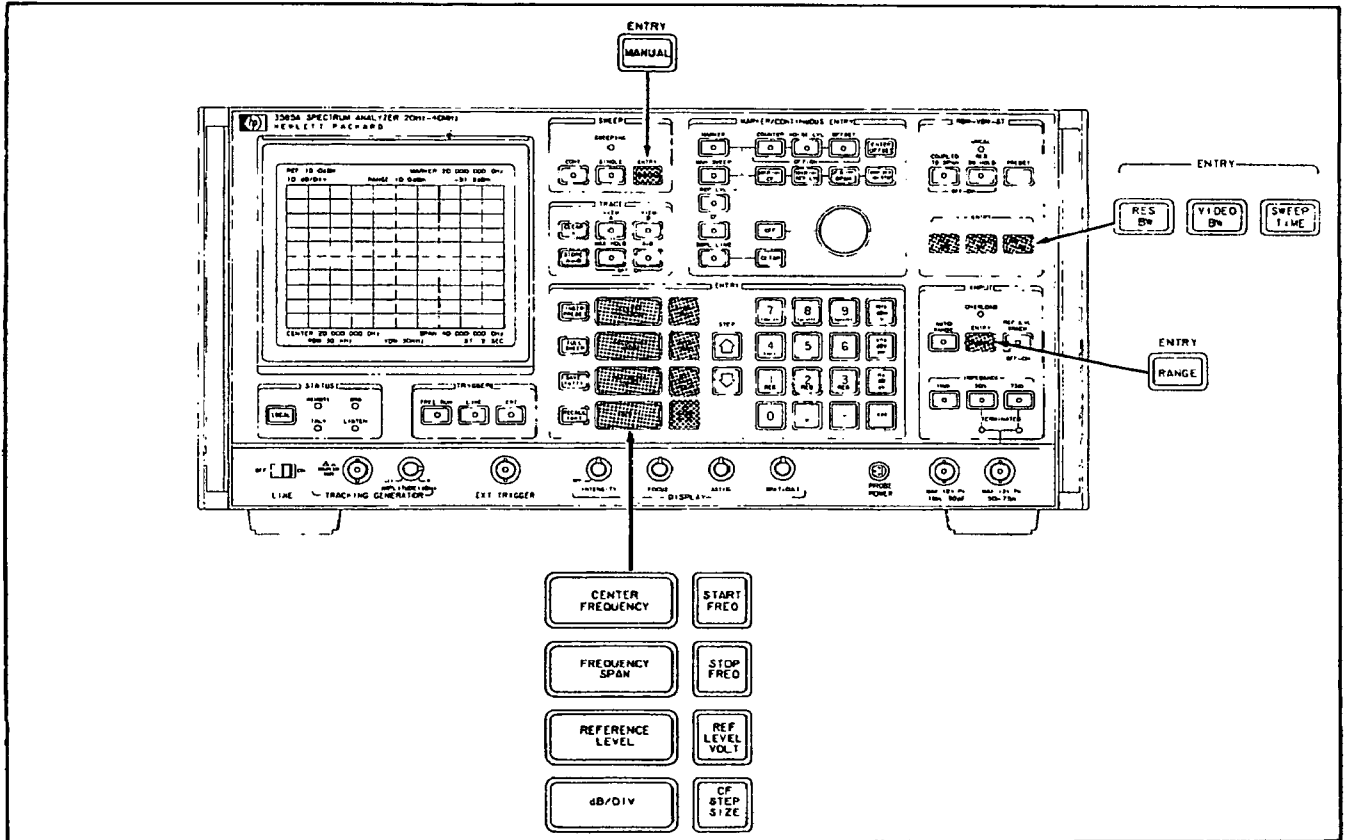

ENTRY Key Locations

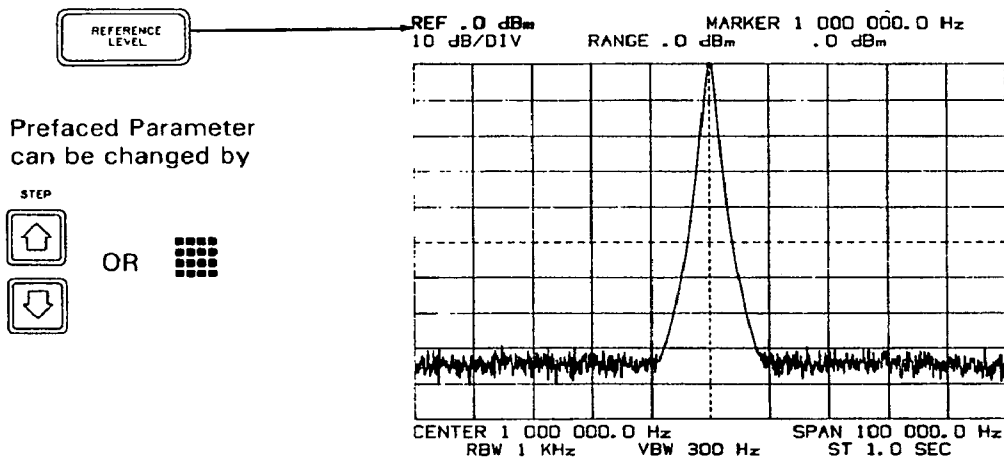

NOTES

1. The Range setting can be changed using the STEP keys; but it cannot be entered numerically. The "RANGE", REF and amplitude readouts can be converted from "dBm" to "dBV" (or vice-versa) by entering

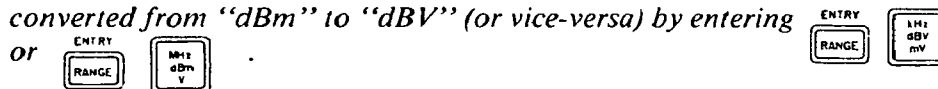

2. The Reference Level parameter has two Entry keys:

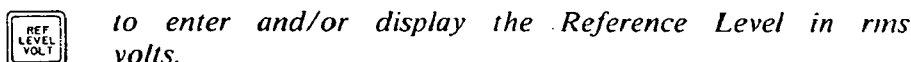
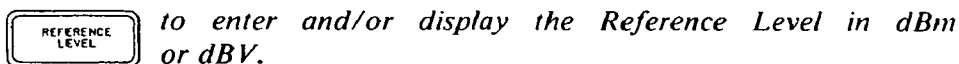





The "RANGE" and amplitude readouts are displayed in the same units as the Reference Level.





Unprefacing .

The parameter that is currently prefaced can be unprefaced by:

a. Prefacing a different parameter.

b. Pressing an *appropriate* Suffix key. (e.g.,  will unpreface Sweep Time but will not unpreface a frequency, amplitude or bandwidth parameter.)

c. Pressing a Marker/Offset Entry key:    

d. Pressing  OR  OR  OR  OR 

e. Activating  will unpreface "RANGE".

PARAMETER READOUTS

PARAMETER READOUTS

The parameter readouts display the current values of the operating parameters and also, the digits that are entered during a Numeric Entry sequence. Any of the twelve major parameters can be displayed on the CRT; but only eight can be displayed simultaneously:

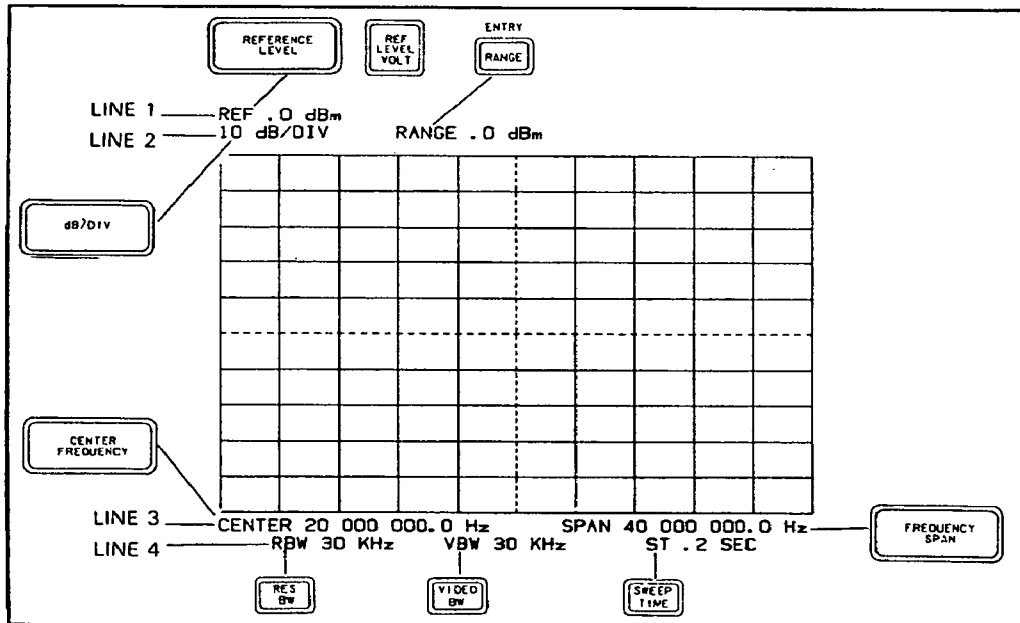

Parameter Readout Locations

The parameters appearing in Lines 1, 2 and 4 are always displayed. Line 3 displays the pertinent frequency parameters defined by the operator's entry:

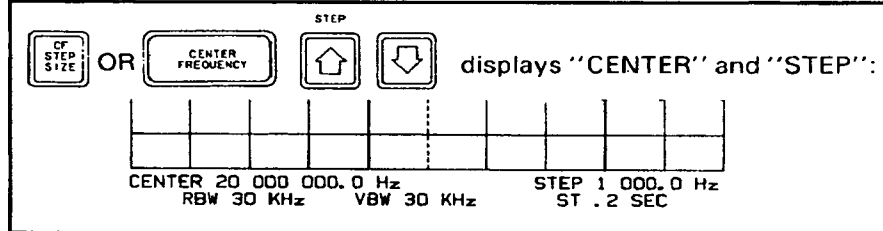
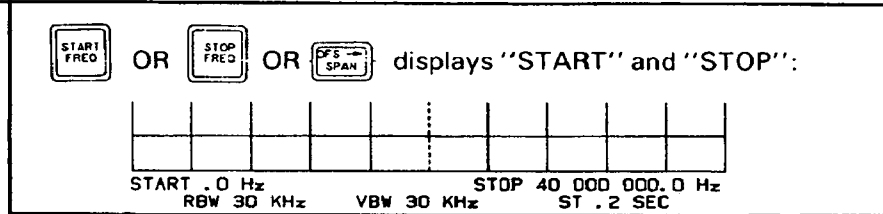
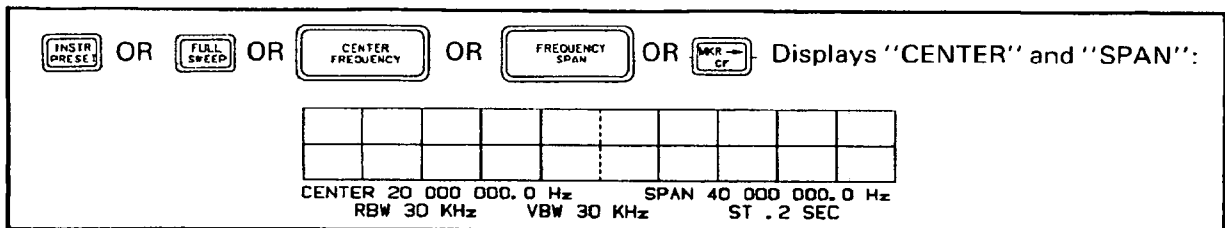

PARAMETER READOUTS

When the Manual frequency is *prefaced*, the “MANUAL” frequency is displayed in place of “CENTER” or “START”:*

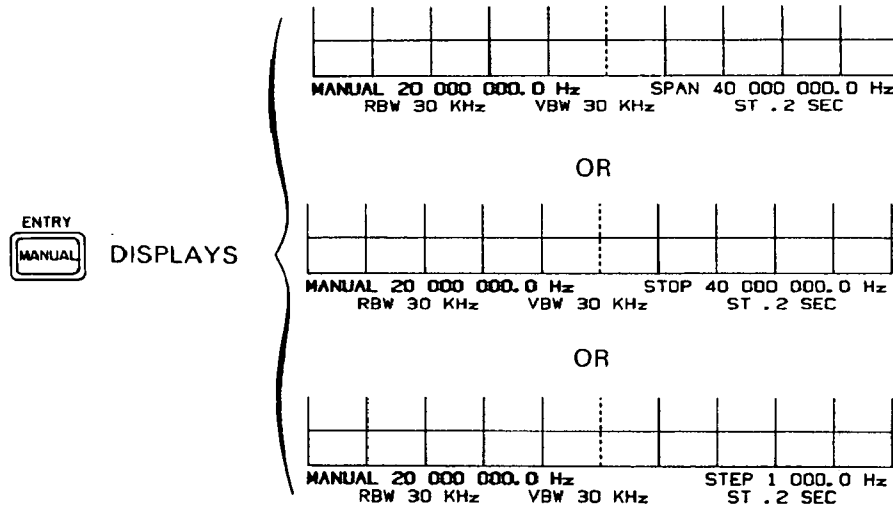

When the “MANUAL” entry is terminated, the display reverts to “CENTER” and “SPAN”:

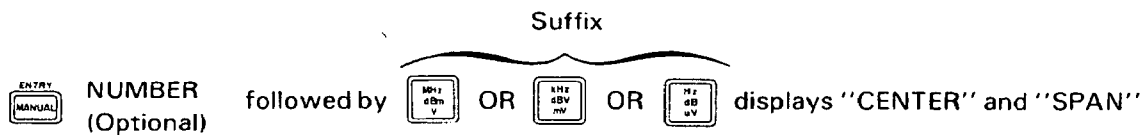



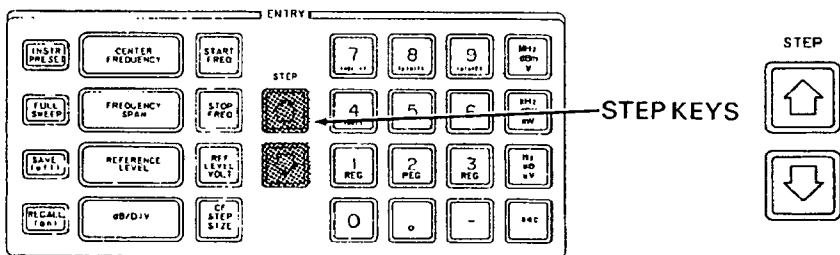

* When the Marker is at the Manual frequency point on the CRT trace and the COUNTER, OFFSET and DISPL LINE functions are deactivated, the Manual frequency is also displayed in the upper right-hand corner of the screen (whether or not it is prefaced).

STEP ENTRIES

STEP ENTRIES



The STEP keys increment  or decrement  the value of the parameter that is prefaced. Step sizes are as follows:

Range Vertical Scale (dB/DIV) Resolution Bandwidth (RBW) Video Bandwidth (VBW)	Steps select next available setting. Example:   selects next narrower RBW setting
Reference Level (REF)	Steps change Reference Level by 5% of amplitude display range; i.e., 5 dB, 2.5 dB, 1 dB or 0.5 dB, depending on Vertical Scale setting
Frequency Span (SPAN) CF Step Size (STEP)	Steps change SPAN or STEP to next internally-defined cardinal setting; 22 settings; 0 Hz to 40 MHz, 1, 2, 5, 10 sequence
Start Frequency (START) Stop Frequency (STOP)	Steps change START or STOP such that Frequency Span is at next cardinal setting
Center Frequency (CF) Manual Frequency (MANUAL)	Steps change CF or MANUAL frequency by amount equal to CF Step Size
Sweep Time (S.T.)	 doubles Sweep Time  divides Sweep Time by two

Each press of a STEP key produces a single step. Step entries do not terminate the entry sequence. Therefore, once a parameter has been prefaced it can be stepped up or down any number of times without being prefaced.

Steps that would cause a parameter to go out of limits will not be accepted; i.e., the parameter will not change, the beeper will sound and an error message (typically "OUT OF RANGE") will appear on the CRT screen.

NUMERIC ENTRIES

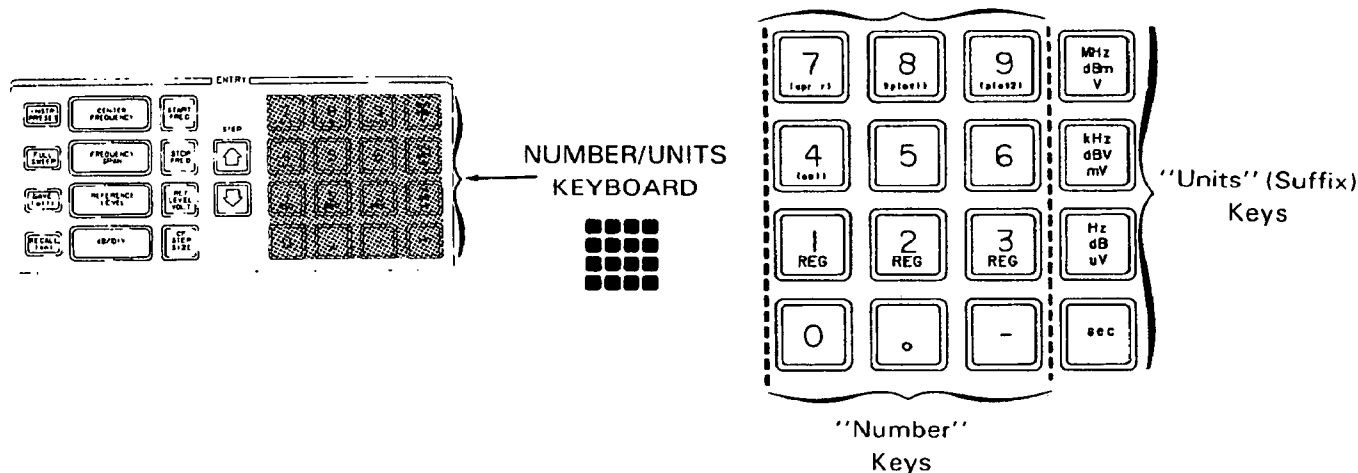

Numeric entries permit the operator to set the parameters to the exact values that are needed to make a specific measurement. While all of the major operating parameters (except Range) can be entered numerically, Numeric entries are used primarily to set the frequency parameters such as Center Frequency and Frequency Span or Start and Stop.

Numeric Entry Sequence.

Numeric entries require three steps:

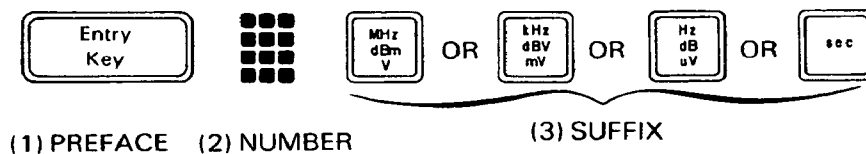

Example:



NUMERIC ENTRIES

Entry Sequence

Decimal Point And Leading Zeros

The NUMBER portion of the entry may contain a decimal point . If it does not, the decimal is understood at the end of the number. Leading zeros (if entered) are ignored.

Corrections

The only way to correct the NUMBER portion of a Numeric Entry is to reface the parameter by again pressing the ENTRY key. Pressing the ENTRY key at any time during the entry sequence erases the digits that have been entered and returns the current value to the screen.

Multiple Changes

Numeric entries (unlike Step entries) *terminate* the entry sequence. You must, therefore, reface the parameter each time a Numeric Entry is required.

Negative Entries



Reference Level (dBm or dBV) is the only parameter (except Range) that has negative values. The “minus” sign  is ignored for all other parameters.

The Number/Units keyboard does not have a “plus” (+) sign. Therefore, if a minus sign is not entered, positive polarity is assumed. The minus sign is usually entered at the beginning of the number; but it can be entered between numeric digits or at the end of the number. (No matter where the minus sign is entered, it is automatically placed at the beginning of the number.)

The polarity of a Reference Level entry can be reversed (i.e., positive to negative OR negative to positive) at any time during the entry sequence by pressing the  key.

Free Entry Format

The 3585A uses a "free-entry" format which allows you to make Numeric entries in the units that are most convenient:

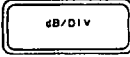



<p>Frequency and Bandwidth entries can be made in "Hz", "kHz" or "MHz"</p> <p>Example:</p> <p>A Frequency of 10 MHz can be entered as 10,000,000.0 Hz, 10,000 kHz or 10 MHz.</p> <p>A Bandwidth of 30 kHz can be entered as 30,000 Hz, 30 kHz or 0.03(000) MHz.</p>
<p> entries can be made in "V", "mV" or μV</p> <p>Example:</p> <p>A Reference Level of one millivolt can be entered as 0.001 V, 1.00 mV or 999 μV (3-digits maximum; 999 μV is rounded to 1 mV.)</p>
<p> entries can be made in "dBm" (50 Ω or 75 Ω) or "dBV" (1 V rms = 0 dBV)</p>
<p> entries can be made in "dB", "dBm" or "dBV". (Vertical Scale is defined in "dB" per division; the suffix is arbitrary.)</p>

NUMERIC ENTRIES

Display Units

Display Units

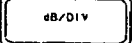
During the Numeric Entry sequence, the digits that are entered are displayed on the CRT. However, when the suffix key is pressed, the entry is displayed in standard, internally-defined units which may differ from the units in which the entry was made:

	settings are displayed in "dBm" or "dBV" (as entered) with 0.1 dB resolution. Entries containing two fractional digits (0.0X dB) are rounded off to 0.1 dB. If an entry contains more than two fractional digits, only the first two fractional digits are accepted; the remaining fractional digits are ignored.
	settings are displayed in "V", "mV", "μV" or "nV" (Table 1).*
	settings are displayed in "dB" with 1 dB resolution.
All frequency parameters are displayed in "Hz" with 0.1 Hz resolution. "Hz" entries containing more than one fractional digit are automatically <i>truncated</i> to 0.1 Hz resolution (maximum frequency resolution is 0.1 Hz).	
 and 	settings 300 Hz and narrower are displayed in "Hz"; settings 1 kHz and wider are displayed in "kHz".
Sweep Time is displayed in seconds (SEC), minutes (MIN) or hours (HRS) as outlined in Table 2. (Sweep Time is entered in seconds; the <i>display</i> conversion to minutes or hours does not affect the entry; e.g., a Sweep Time of 2000.0 sec [3.33 minutes] is displayed as 3.3 minutes but the actual Sweep Time is 2,000.0 sec.)	

*Reference Level voltage settability is limited to 0.1 dB (approximately 1%). When a Reference Level voltage is entered, the 3585A converts that entry to "dBV", sets the Reference level accordingly and then reconverts the "dBV" setting to volts and displays the result. Because of this settability limitation and the rounding-off process that is used in the conversion routine, the Reference level voltage that is finally displayed may differ slightly from the voltage that you entered.

Table 1. Reference Level Volts Display.

REF LEVEL	DISPLAY
0.125 μ V to 1.00 μ V*	125 nV to 1,000 nV
1.00 μ V to 1.00 mV*	1.00 μ V to 1,000 μ V
1.00 mV to 1.00 V*	1.00 mV to 1,000 mV
1.00 V to 27.3 V	1.00 V to 27.3 V

* These transition points are not well defined; e.g., 1.00 V will sometimes be displayed as 1,000 mV and other times as 1.00 V, depending on how it is processed internally.

Table 2. Sweep Time Display.

Sweep Time	Disp. Units	Disp. Resolution
0.2 sec to 99.8 sec	SEC	0.2 SEC
100.0 sec to 999.8 sec	SEC	1 SEC
1,000.0 sec to 5,999.8 sec	MIN	0.1 MIN
6,000.0 sec to 359,999 sec	HR	0.1 HR
360,000 sec to 214,748,160 sec*	HR	1 HR

*Maximum Numeric Entry is 999,999 seconds but Sweep Time can be incremented to maximum value shown using STEP keys.

NUMERIC ENTRY CONSTRAINTS

Numeric Entry Constraints

General

Entries that exceed the upper or lower limit of a parameter are not accepted; i.e., the parameter does not change, the beeper sounds and an error message (typically "OUT OF RANGE") appears on the CRT screen. If the "out of range" entry is the result of pressing the wrong suffix key (e.g., "MHz" instead of "kHz"), the entry can be completed by simply pressing the correct suffix key. If the NUMBER portion of the entry is unacceptable, you must either reface the parameter and enter a valid number or, if the number is too small, add digits to the entry. (Digits may be added without refaceing.)

There is also a limit to the number of digits that can be entered for a given parameter (leading zeros, decimal point and minus sign are not counted as digits). Attempts to enter more than the maximum number of digits cause the beeper to sound and the error message, "TOO MANY DIGITS" to appear on the CRT screen. This occurs before the suffix key is pressed and, therefore, does not affect or terminate the entry. The digit entry that produces the error message is not accepted; but preceding digits are retained, and if they constitute a valid entry, they are accepted when the suffix key is pressed.

Limits are as follows:

PARAMETER	LOWER LIMIT	UPPER LIMIT	MAX. DIGITS
Reference Level (dBm/dBV) *	100 dB below Range	10 dB above Range	5
Reference Level Volt *	100 dB below Range	10 dB above Range	3
Vertical Scale	1 dB	10 dB	2
Frequency Span **	0 Hz	40.1 MHz	9
Center Frequency **	0 Hz	40.1 MHz	9
Start Frequency ***	0 Hz	40.1 MHz	9
Stop Frequency ***	0 Hz	40.1 MHz	9
Manual Frequency	Start Frequency	Stop Frequency	9
CF Step Size	0 Hz	40.1 MHz	9
Res. Bandwidth	3 Hz	30 kHz	5
Video Bandwidth	1 Hz	30 kHz	5
Sweep Time	0.2 sec	see following text	6
<p>* Reference Level entries that exceed the lower limit produce the error message, "REF < 100 dB BELOW RNG"; entries that exceed the upper limit produce the error message; "REF > 10 dB OVER RANGE".</p> <p>** Whenever the Center Frequency and Frequency Span settings are such that the Start Frequency is below 0 Hz or the Stop Frequency is above 40.1 MHz, the "out of range" portion of the CRT Trace is blanked and the message, "SWEEP SPAN LIMITED" appears on the screen.</p> <p>*** If the Start Frequency entry is higher than the current Stop Frequency, the Stop Frequency is automatically set equal to the Start Frequency. Conversely, if the Stop frequency entry is lower than the current Start Frequency, the Start Frequency is set equal to the Stop Frequency.</p>			

Vertical Scale, RBW and VBW

The Vertical Scale (dB/DIV), RBW and VBW parameters have a limited number of discrete settings. To numerically set the value of these parameters, you must enter a specific setting that is available:

dB/DIV	RBW	VBW
10 dB	30 kHz	30 kHz
5 dB	10 kHz	10 kHz
2 dB	3 kHz	3 kHz
1 dB	1 kHz	1 kHz
	300 Hz	300 Hz
	100 Hz	100 Hz
	30 Hz	30 Hz
	10 Hz	10 Hz
	3 Hz	3 Hz
		1 Hz

Vertical Scale entries other than those listed or entries containing a decimal point will not be accepted; i.e., the setting will not change, the beeper will sound and the message, “/DIV = 1;2;5;10 ONLY” will appear. Attempts to enter more than two digits will cause the beeper to sound and the “TOO MANY DIGITS” message to appear. The first two digits will be accepted if they constitute a valid entry.

The RBW and VBW settings listed can be entered with up to five digits using the free-entry format. Attempts to enter more than five digits will cause the beeper to sound and the “TOO MANY DIGITS” message to appear. Entries other than those listed will not be accepted; i.e., the setting will not change, the beeper will sound and the error message, “1;3;10 STEPS ONLY” will appear.

Sweep Time

The maximum Sweep Time that can be entered (Numeric or Step) is determined by the Resolution Bandwidth and Frequency Span settings:

Resolution Bandwidth	Minimum Sweep Rate	Maximum Sweep Time(sec)
30 kHz or 10 kHz	0.1 Hz/sec	10 × Freq. Span (Hz)
3 kHz thru 3 Hz	0.005 Hz/sec	200 × Freq. Span (Hz)

Entries exceeding the maximum Sweep Time limit will not be accepted; i.e., the Sweep Time will not change, the beeper will sound and the error message, “SWEEP RATE TOO SMALL” will appear on the CRT.

Sweep Time is settable from 0.1 seconds to 99,999.8 seconds with 0.2-second resolution and from 100,000 seconds to 999,999 seconds with 1-second resolution. Attempts to enter more than six digits will cause the beeper to sound and the “TOO MANY DIGITS” message to appear on the CRT. The first six digits will be accepted if they constitute a valid entry.

Fractional entries can be made only in 0.2-second steps; i.e., 0.2, 0.4, 0.6 or 0.8 seconds. Fractional entries that are not in 0.2-second steps will be accepted; but when the suffix key is pressed, the fractional digit will automatically be incremented by 0.1 second and the error message, “S.T. IN .2 SEC STEPS” will appear on the CRT.

CHAPTER 6

CRT DISPLAY AND TRACE FUNCTIONS

This chapter describes the 3585A's CRT display, the DISPLAY adjustments, the graphic traces and TRACE functions and the alphanumeric readouts.

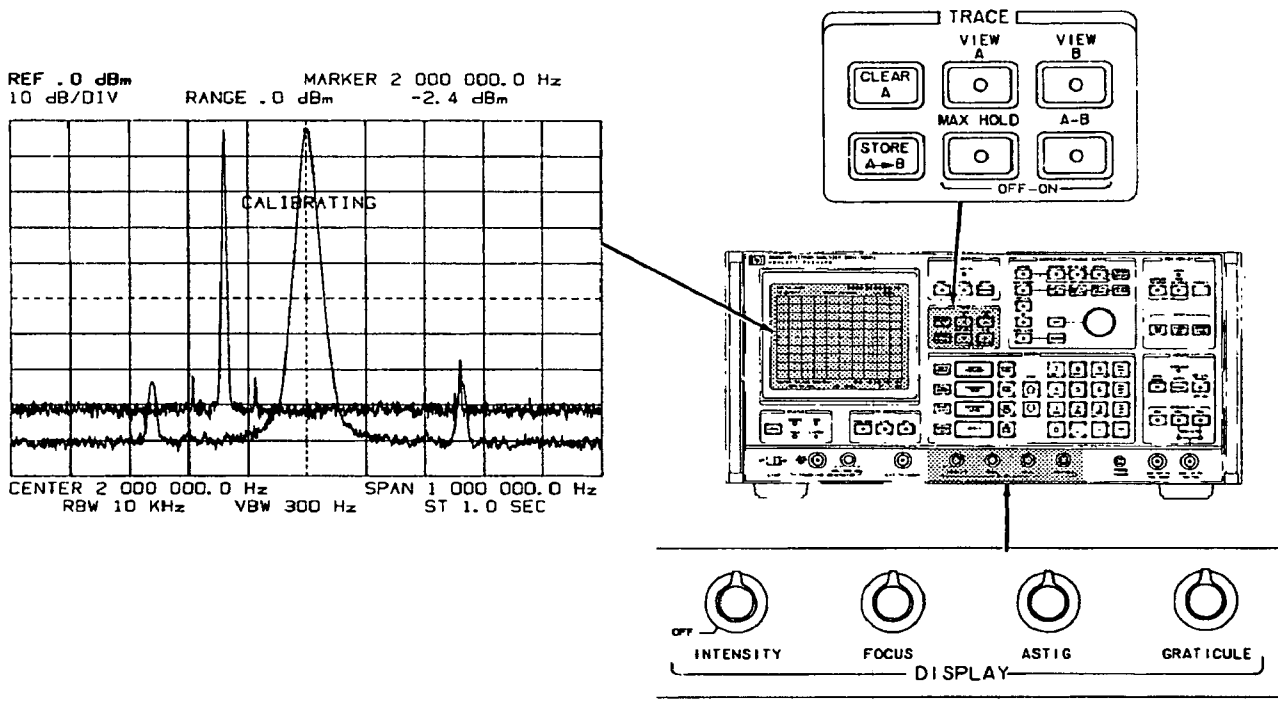

INTRODUCTION AND OVERVIEWS

The 3585A's CRT (Cathode Ray Tube) displays two digitally-stored graphic traces of amplitude versus frequency; plus Marker and Display-Line information, measurement data, alphanumeric readouts of all pertinent operating parameters and a variety of useful operating messages to indicate instrument status, calibration failures and operator errors.

All of the information appearing on the CRT screen can be simultaneously displayed on an auxiliary CRT monitor connected to the rear-panel DISPLAY outputs; and the graphic traces can be plotted with an external X-Y recorder connected to the PLOTTER outputs. (See Chapter 1 for information concerning the DISPLAY and PLOTTER outputs.)

Remote Capabilities

The graphic traces and alphanumeric readouts appearing on the CRT screen can be remotely transmitted to an external device via the HP-IB. As an added feature, the CRT can be used to display externally-generated graphics and alphanumeric messages that are input from the HP-IB. Details concerning these remote display capabilities are included in Part Two of Section III.

OVERVIEW

Display Controls

The DISPLAY controls, aligned horizontally along the bottom recess of the front panel, affect both the graphic and alphanumeric display presentations:



Controls the brightness of the graphic traces and alphanumeric readouts. The display is blanked when the control is in the OFF (full CCW) position. The intensity is internally limited; so you may select any comfortable setting without danger of burning the CRT face. The INTENSITY control does not affect the graticule illumination.

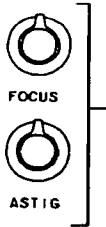



Set the FOCUS control to midrange. Adjust the ASTIG (Astigmatism) control for the sharpest trace possible and then adjust the FOCUS control for the sharpest trace possible. Iterate between the ASTIG and FOCUS controls until optimum adjustment is obtained.





Adjusts the background illumination provided by a flood gun within the CRT. Background illumination improves the contrast making it easier to see the CRT graticule. (This control can also be used to help establish the desired contrast when taking CRT photographs.)

Overview of Traces and Trace Functions



The 3585A's graphic traces are digitally-stored, point-by-point plots consisting of 1,001 equally spaced points. The points are difficult to see because they are interconnected by straight lines generated by the instrument's Display Processor. There are two trace memories, "A" and "B", in which two complete 1,001-point traces can be stored. The traces can be viewed separately or simultaneously using the

 and  keys:

a. The Current ("A" or "A-B") Trace:



As the analyzer's frequency is swept, digitized video samples are stored in Trace Memory "A". With the  function activated, the contents of Trace Memory "A" are written onto the CRT screen at a rapid, flicker-free rate to produce the Current Trace. The Current Trace is the *only* trace that is updated by the frequency sweep or in the Manual mode. When the  function is activated, the "B" Trace is subtracted from the current "A" Trace to produce the "A-B" Trace which is used for trace comparisons.

b. The "B" Trace:

If the Current Trace is needed for future reference, it can be transferred to Trace Memory "B" () where it can be retained until a different trace is stored or the instrument is turned off. The "B" Trace can be displayed at any time by activating the  function.



Displays Current ("A" or "A-B") Trace that is stored in Trace Memory "A".

(Automatically activated by  or by deactivating ; press to deactivate, press again to activate.)





Erases Trace Memory "A" and clears Current Trace from CRT screen. Resets and rearms continuous sweep; terminates single sweep.



Non-destructively transfers Current Trace to Trace Memory "B". Automatically activates .



Displays trace that is stored in Trace Memory "B".

(Automatically activated by  or deactivating ; press to deactivate, press again to activate.)

OVERVIEW



Instantly subtracts "B" Trace from current "A" Trace and writes the difference into Trace Memory "A", to produce the "A-B" Trace. The "A-B" Trace, referenced to the *middle* graticule line, represents the amplitude of Trace "A" in dB relative to Trace "B".

(Press to activate; press again to deactivate.)





Updates the amplitude at each point in the "A" Trace Memory only if the current video sample is higher in amplitude (more positive) than the sample that is already stored. As a result, the Current Trace retains the maximum positive video amplitude that occurs over successive frequency sweeps or at the Manual measurement point.

(Press to activate; press again to deactivate.)

Marker Overview

Markers are simply intensified dots that appear at discrete points on the CRT traces. There are three markers that can be displayed:

a. Tunable Marker:

The tunable Marker can be moved along the trace with   , to directly measure the absolute frequency and amplitude of on-screen responses. The Marker's frequency and amplitude is displayed in the upper right-hand corner of the CRT screen. The tunable Marker can also be used in conjunction with the Marker functions in the Marker/Continuous Entry block to perform Offset measurements, Counter and Noise Level measurements and change parameter values. In the Manual mode, the Marker automatically tracks the Manual frequency to provide a direct reading of the Manual frequency and real-time signal amplitude.

b. Stationary (Offset) Marker:

When the OFFSET function is activated, a stationary marker dot appears at the point on the CRT trace that represents the Offset reference frequency; i.e., the frequency that is stored in the Offset Register with  .

c. Sweep Marker:

When the instrument is sweeping and the Sweep Time is *one second or longer*, a sweep marker appears on the Current Trace to indicate the position of the frequency sweep. The sweep marker jumps from point-to-point along the trace; but the actual frequency sweep is continuous rather than incremental.

MAKE MULTICOLORED CRT PLOTS USING THE -hp- 9872A DIGITAL PLOTTER:

If this manual were printed in multiple colors, the "CRT" photographs" would be surprisingly colorful because they are actually reduced line photographs of multicolored plots generated by the -hp- 9872A Digital Plotter and 9825A Calculator, linked to the 3585A via the HP-IB.

To make a CRT plot, we simply load the program into the calculator, place an ordinary sheet of drafting paper on the Plotter and press the Calculator's RUN key. The Plotter then comes to life:

First, it zips over to its pen compartment, selects the blue pen and very quickly draws the graticule lines (including the dashed center axes). It then puts the blue pen away and selects the red pen. At that point, there is a short time delay while the 3585A dumps the "A" Trace data into the Calculator. Once the transfer operation is complete, the Plotter proceeds to draw the "A" Trace exactly as it appears on the CRT screen (albeit bright red). After completing the "A" Trace and replacing the red pen, the Plotter selects the black pen and draws the alphanumeric readouts with remarkable speed and dexterity. It then, of course, puts the black pen away. Finally, the Calculator readout displays the question, "PLOT B TRACE?". If we give an affirmative answer by pressing "1" CONTINUE, the Plotter again goes into action to plot the "B" Trace in emerald green.

While the cost of using multicolored CRT plots in the manual was officially declared, "Out of Range" at the onset of operations, we made the original plots using the aforementioned color scheme to provide a slight amount of contrast in the line photographs. The time required to make a full-screen plot with the 9872A/9825A system is about three minutes, as opposed to 30 seconds with a 'scope camera. However, the reproduced quality of the 9872A plots far surpasses that of ordinary CRT photographs, making it well worth the extra time. (Any "skips", "runs" or ambiguities are the fault of the reproduction process, not the Plotter.)

While writing this manual, we made literally hundreds of plots and wore out several sets of disposable pens. But the 9872A, showing absolutely no signs of wear and tear or even writer's cramp, proved to be extremely reliable. In fact, we're so impressed with the results that we have included a 9872A program listing (for the 9825A) in Part 2 of Section III. The program that is listed differs somewhat from the program that we used; but it will provide a good source to which you can make your own modifications to obtain any special effects that may be required.

If you are looking for an excellent plotting system to go along with your 3585A and haven't as yet seen the 9872A in operation, be sure to contact your -hp- Sales Representative for a demonstration.

THE GRAPHIC PRESENTATION

Display Graticule

The graphic traces are displayed on a standard CRT graticule, having ten horizontal divisions and ten vertical divisions. The dashed graticule lines are the center axes. The horizontal axis represents absolute frequency; the vertical axis represents the absolute amplitude of the "A" or "B" Trace or, on the "A-B" Trace, the amplitude of Trace "A" relative to Trace "B".

The graticule aspect ratio (Y/X) = 1:1.56

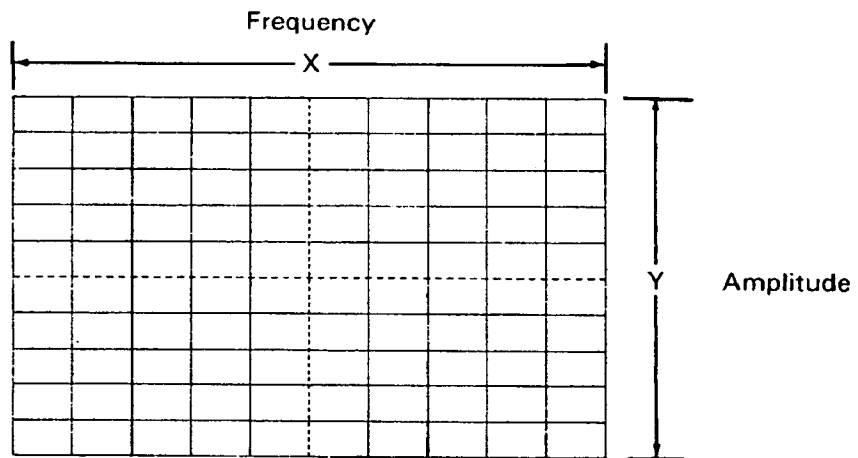

CRT Graticule

Horizontal Axis

As the analyzer's frequency is swept, the Current Trace is plotted from left-to-right across the CRT screen. The first vertical line on the left-hand side of the display graticule represents the Start Frequency, the middle vertical line represents the Center frequency and the right-most vertical line represents the Stop Frequency.

The frequency range between the Start Frequency and the Stop Frequency is the Frequency Span. The Start Frequency Stop Frequency, Center Frequency and Frequency span parameters are all settable within the range of 0 Hz to 40.1 MHz with 0.1 Hz resolution. Whenever the Center Frequency and Frequency Span settings are such that the Start Frequency is lower than 0 Hz or the Stop Frequency is higher than 40.1 MHz, the sweep span is automatically limited and the out-of-range portion of the Current Trace is blanked. This causes the "SWEEP SPAN LIMITED" message to appear on the CRT screen.*

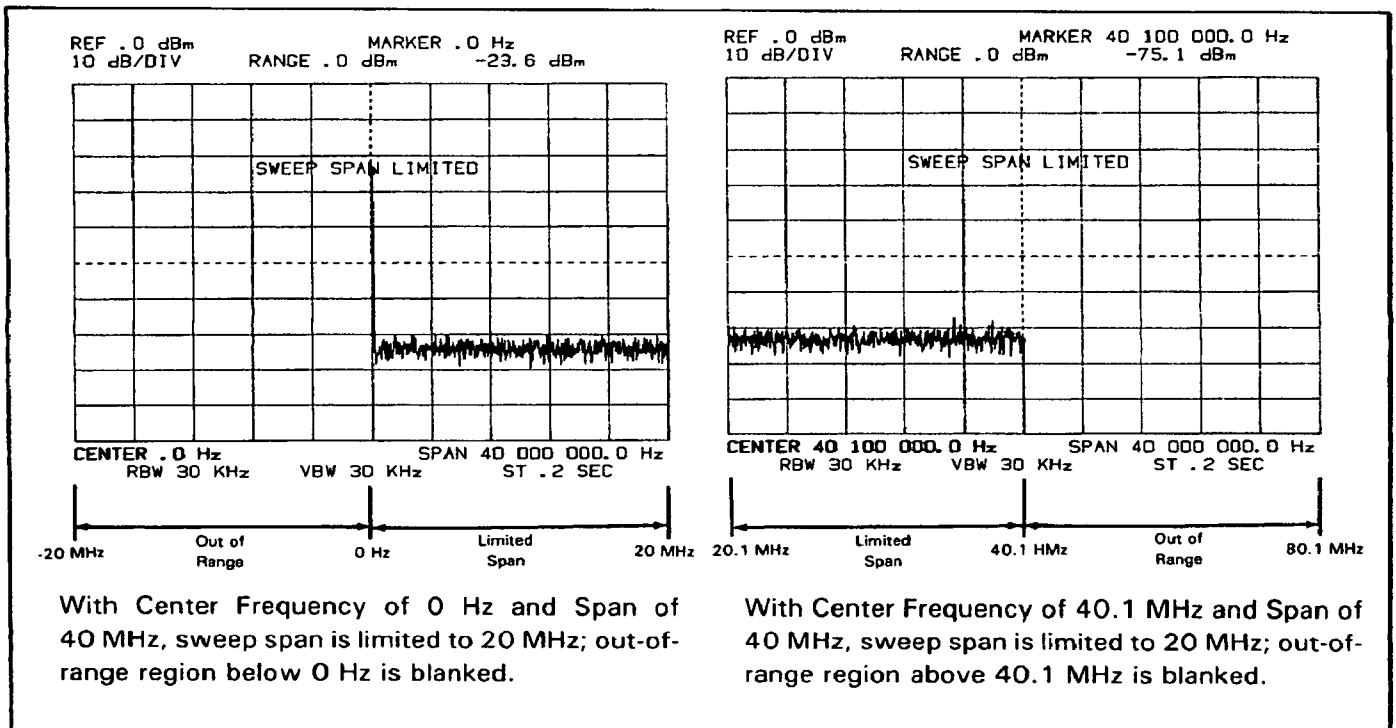

Limited Sweep Span

*The "SWEEP SPAN LIMITED" message remains on screen for about 5 to 10 seconds and then disappears.

A limited sweep span condition will *erase* the "out of range" portion of a Current Trace that is retained on screen after a single sweep has terminated.

GRAPHICS

Vertical

Vertical Axis

The vertical axis is calibrated in logarithmic units of “dB” relative to the Reference Level which is represented by the top graticule line. The vertical display range extends from approximately 0.23 divisions above the top graticule line to 10 divisions below the top graticule line. Amplitude accuracy is *not specified* in the region above the Reference Level. However, the accuracy in that region is *typically* ± 0.5 dB with respect to the Reference Level accuracy.

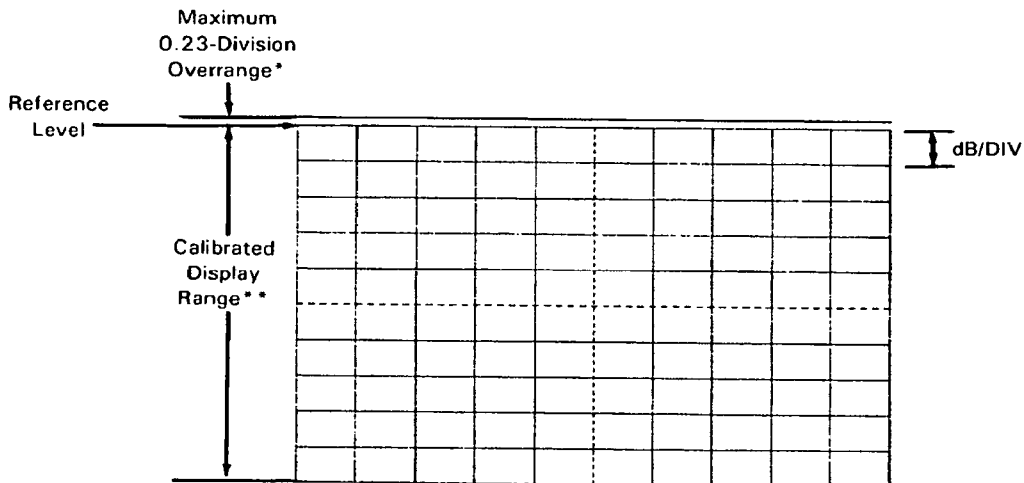

*0.23 divisions = 2.3 dB, 1.15 dB, 0.46 dB or 0.23 dB; depending on the Vertical Scale (dB/DIV) setting. Amplitude accuracy is unspecified in this overrange region.

**The CRT graticule is not actually calibrated. "Calibrated" display range refers to the display range in which the *Marker* amplitude accuracy is specified.

Vertical Display Range

Vertical Scale

The 3585A has four Vertical Scale (dB/DIV) settings: 10 dB, 5 dB, 2 dB and 1 dB per division. The 10 dB/DIV setting provides a vertical display range of 100 dB; however, the Marker amplitude accuracy is specified only in the top 90 dB portion of that range. The 5 dB, 2 dB and 1 dB per-division settings expand the vertical scale downward from the Reference Level. This improves the amplitude resolution, but limits the display range to 50 dB, 20 dB or 10 dB, respectively. The 1 dB and 2 dB per-division settings provide a 0.1 dB improvement in the Reference Level (and Marker) accuracy.

Signals that are higher than 0.23 divisions above the Reference Level will overdrive the display, but will not damage the instrument or affect the amplitude accuracy within the calibrated display range.

Introduction To Digital Storage

Spectrum analyzers require some form of display storage to retain the slowly scanned graphic trace information on the CRT. In traditional spectrum analyzers, this is accomplished by the use of a "storage CRT" in which the trace is retained by the phosphor or a storage mesh located behind the CRT face. Nevertheless, modern spectrum analyzers such as the 3585A use a digital storage technique in which discrete samples of the analyzer's detected video output are converted to binary numbers and stored in a digital memory. The digital memory containing the stored trace is then scanned at a fixed rate and its contents (after being reconverted to analog) are written onto the CRT. The major advantages of digital storage are:

- a. Digital storage permits the use of a standard oscilloscope CRT. Standard CRT's are rugged and relatively inexpensive to replace.
- b. Display adjustments are not required when the frequency and sweep parameters are changed. The digitally stored trace is displayed at a fixed rate independent of Sweep Time.
- c. The INTENSITY and FOCUS controls have the same effect as those on a regular oscilloscope. Once they are set they do not need to be readjusted. Also, the trace intensity can be set to any level with out danger of burning the CRT face. Digital storage provides a bright, crisp, flicker-free presentation; there is no blooming or display ambiguity.
- d. A trace that is stored in a digital memory can be retained and displayed indefinitely...as long as the instrument is turned on.
- e. In a microprocessor-based system such as the 3585A, traces that are digitally stored can also be digitally processed to perform trace arithmetic and provide special trace functions that would not otherwise be available.

The Digital Storage Concept

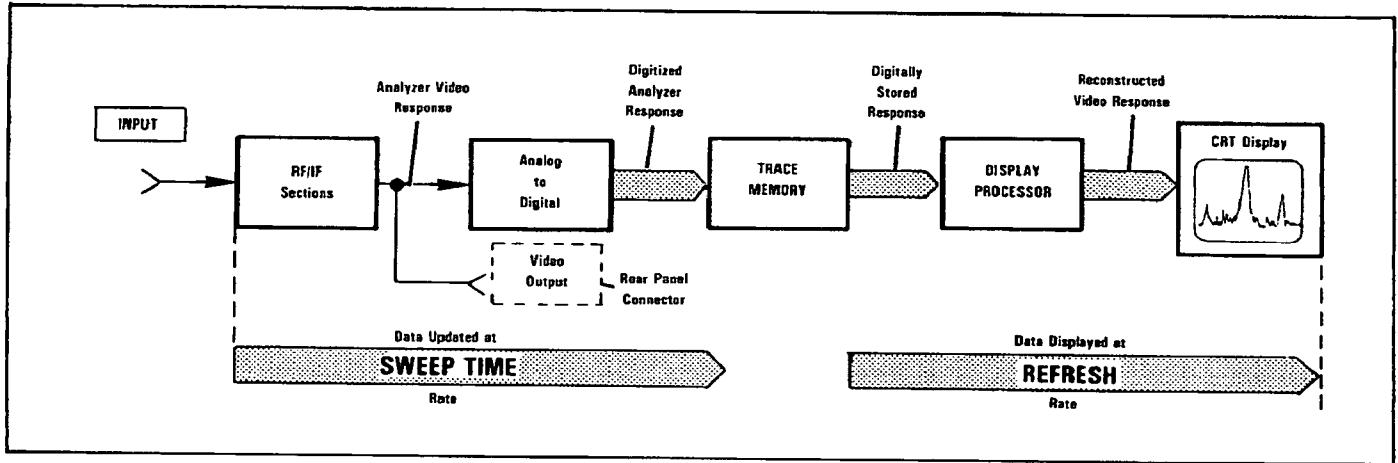



The above figure is a simplified block diagram showing the main signal path from the Input connector to the CRT display. The RF and IF sections of the analyzer comprise a swept superhetrodyne receiver whose output is a dc voltage that is logarithmically proportional to the input-signal amplitude. This dc voltage or "video response" is applied to the Analog-to-Digital (A/D) Converter where it is peak detected, sampled and transferred to the Trace Memory at a rate proportional to the Sweep Time.

The Trace Memory, in which the digitized video samples are stored, has 1,001 storage locations or "addresses". After a frequency sweep has been made, each address contains a 10-bit binary number representing the video amplitude at a specific frequency point on the CRT trace. Since each address represents a specific frequency point and the binary number in a given address represents the video amplitude at that point, the Trace Memory, in effect, contains a point-by-point plot of the amplitude-vs.-frequency display.

The entire CRT display (including alphanumeric) is typically updated or "refreshed" every 17 milliseconds or approximately 60 times each second. This provides a flicker-free presentation that is totally independent of Sweep Time.

At some point during each CRT refresh period, the Trace Memory is cycled through its 1,001 addresses in synchronism with a horizontal sweep generated by the Display Processor. During this sequence, the binary numbers that are read out of the Trace Memory are converted to dc voltages. If these dc voltages were applied directly to the vertical deflection system, the graphic trace would appear as a series of dots on the CRT screen. To avoid this situation, the Display Processor, which contains a variable-slope line generator, draws lines between the dots to provide a fully reconstructed display. As a result, the trace that is written onto the CRT screen consists of 1,001 discrete points, connected by 1,000 straight-line vectors.

Frequency Resolution

One inherent drawback associated with a point-by-point spectral display is that its frequency resolution is limited according to the number of points on the trace and the frequency spacing between them. This effect is particularly noticeable when using the 3585A's tunable Marker: As the Marker frequency is varied with   , the Marker dot jumps from point-to-point along the trace and the "MARKER" readout indicates the frequency and amplitude at each point. Since the Marker cannot be set between two points, its frequency resolution is limited by the resolution of the point-by-point display.

With 1,001 equally-spaced points, the frequency spacing between points is equal to the Frequency Span divided by 1,000 or 0.1% of the Frequency Span. Two signals whose frequency spacing is less than 0.1% of the Frequency Span cannot be separated on the CRT trace even when a narrow Resolution Bandwidth is used:

In Figure A, for example, the Frequency Span is 40 MHz and the frequency spacing between points is $40 \text{ MHz} / 1,000 = 40 \text{ kHz}$. Although there is only one response appearing on the trace, there are actually two input signals. One is -6.00 dBm at 10.00 MHz and the other is 0.00 dBm at 10.035 MHz. The Resolution Bandwidth is set to 1 kHz which is narrow enough to fully resolve both signals. Because of the limited display resolution, however, the two signals appear as one response. Also, because of the positive peak detection described in later paragraphs, the amplitude of the response is equal to the larger of the two signals (0 dBm, 10.035 MHz); but is displayed at the 10.00 MHz point.

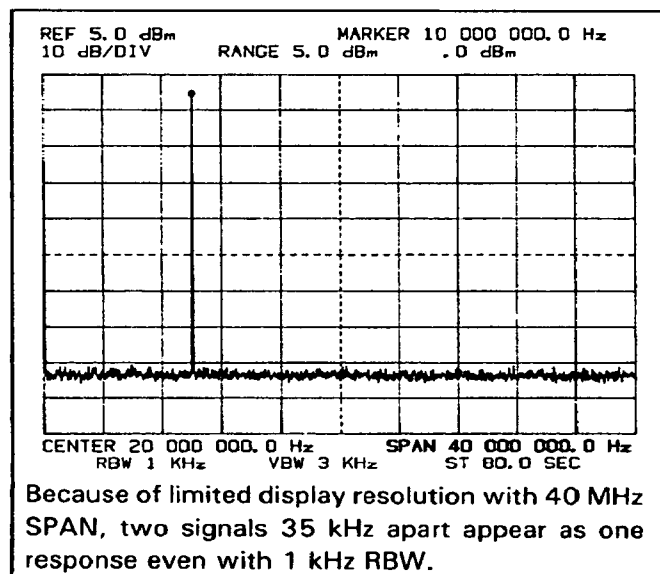

Figure A.

GRAPHICS

Amplitude Resolution

Narrowing the Frequency Span decreases the frequency spacing between points on the CRT trace and, therefore, improves the frequency resolution. As shown in Figure B, a 1 MHz Span provides the resolution needed to completely separate the two signals.

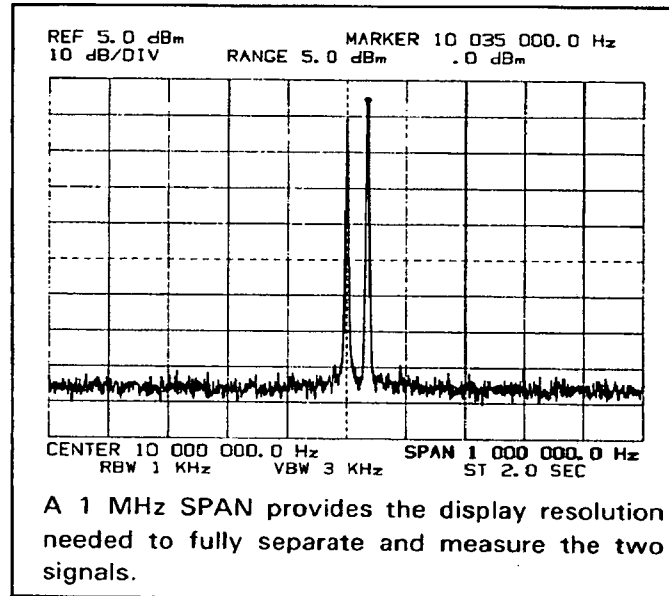

Figure B.

Amplitude Resolution

The video amplitude at each point on the CRT trace is represented by a 10-bit binary number. This means that the total vertical display range is represented by 2^{10} or 1,024 discrete amplitude values, referred to as "display units". The display range within the top and bottom graticule lines contains 1,001 display units; while the overrange region above the top graticule line contains an additional 23 display units.

With 1,001 display units in ten vertical divisions, each major division represents 100 display units. The amplitude resolution is, therefore, equal to the dB/DIV Vertical Scale setting divided by 100. For instance, if the Vertical Scale is 10 dB/DIV, the amplitude resolution is $10 \text{ dB}/100 = 0.1 \text{ dB}$. Similarly, if the Vertical Scale is 1 dB/DIV, the amplitude resolution is $1 \text{ dB}/100 = 0.01 \text{ dB}$.

Peak Detection

The 3585A must be able to display and accurately measure the peak amplitude of any response that can be resolved on the CRT screen. This presents a problem because the CRT trace is a point-by-point plot in which the points appear at fixed frequencies that do not necessarily correspond to the frequencies of the responses whose peaks must be displayed. For example, if the Frequency Span is 40 MHz and the Start Frequency is 0 Hz, there will be points at 0 Hz, 40 kHz, 80 kHz, 120 kHz, 160 kHz, 200 kHz, etc. However, the peaks of the responses that the operator wishes to measure could be between any of these points:

For instance, a 70 kHz input signal containing odd and even harmonics would produce responses at 70 kHz, 140 kHz, 210 kHz, 280 kHz, 350 kHz, etc. But with a 40 MHz Span, only one of these responses (280 kHz) would peak at a discrete point on the CRT trace. The peaks of the remaining responses would be clipped by the straight lines that are drawn between points. Moreover, a very narrow response occurring between two points would be missed entirely and would not appear on the trace.

To eliminate this potential problem, the 3585A uses a technique called “positive peak detection”. With positive peak detection, the digitized video samples that are stored in the Trace Memory represent the positive peak video amplitude that occurs during each segment of the frequency sweep. This means that *each point on the CRT trace represents the positive peak video amplitude in the region between it and the following point*:

For example, if the points are 40 kHz apart, the 40 kHz point represents the positive peak video amplitude in the region between 40 kHz and 80 kHz; the 80 kHz point represents the positive peak video amplitude in the region between 80 kHz and 120 kHz, etc.*

With this technique, any resolved response that even raises its head above the noise is retained and displayed at a discrete point on the CRT trace, regardless of the frequency spacing between points. If there are points at 40 kHz and 80 kHz, a response that peaks at 70 kHz will not be missed but it will appear at the 40 kHz point. If the instrument’s tunable Marker is then set to the peak of that response, the amplitude readout will accurately indicate the peak amplitude, although the frequency readout will indicate 40 kHz.

The negative frequency offset caused by peak detection is of little consequence since the frequency of a response can be precisely measured using the 3585A COUNTER function. Also, the frequency resolution and accuracy of the CRT trace and Marker can be improved by narrowing the Frequency Span. For instance, if the Span were narrowed from 40 MHz to 20 MHz, the points would be 20 kHz apart and the peak of a 70 kHz response would appear at the 60 kHz point rather than the 40 kHz point.

*Only 1,000 of the 1,001 Trace Memory addresses are filled by the time the frequency sweep reaches the Stop Frequency. To obtain a sample for Trace Memory address 1,001 (i.e., the Stop Frequency point on the trace), the 3585A sweeps 0.1% of the Frequency Span *past* the Stop Frequency. Thus, the amplitude of the Stop Frequency point on the CRT trace represents the positive peak video amplitude in the 0.1% region above the Stop Frequency.

GRAPHICS

Peak Detection/Sweep Dynamics

Peak Detection And Sweep Dynamics

Peak detection introduces a negative frequency offset on the CRT trace, but this effect is often counteracted by the positive frequency skew caused by sweep dynamics:

When the 3585A is sweeping rapidly, the response of the IF filter delays the arrival of the responses that are applied to the A/D Converter. Positive responses that arrive too late to be displayed at one point are retained by the peak detection circuit and displayed at the following point. Consequently, they appear at a higher frequency on the CRT trace.

When the analyzer is sweeping at the maximum-calibrated rate, the positive frequency skew is approximately 33% of the Resolution Bandwidth setting. The frequency skew is inversely proportional to Sweep Time; e.g., a factor of four (two step) increase in Sweep Time will reduce the frequency skew by a factor of four.

In some cases, the positive frequency skew caused by sweep dynamics is just enough to override the negative frequency offset caused by peak detection:

In the following figure, the instrument is sweeping at the maximum calibrated rate and the Marker is set to the peak of a response whose true frequency is 20.035 MHz. This response would ordinarily peak at the 20.00 MHz point; but because of the positive frequency skew, the peak is displayed at the 20.04 MHz point as indicated by the "MARKER" frequency readout. Since 20.04 MHz is closer to 20.035 MHz than 20.00 MHz, the frequency skew in this particular case is improving the frequency accuracy:

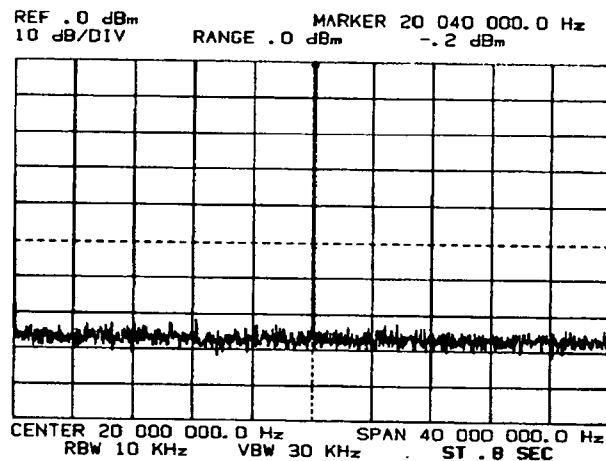

With optimum Sweep Time, 20.035 MHz response is skewed to the right and displayed at the 20.04 MHz point on the CRT trace.

In the next figure, the Sweep Time has been increased by a factor of four to minimize the frequency skew. As a result, the peak of the 20.035 MHz response is displayed at the 20.00 MHz point. From an accuracy standpoint, this effect could also work in reverse. For instance, a 19.065 MHz response could be skewed over to the 20.00 MHz point during a fast sweep and then move back to the 19.06 MHz point when the Sweep Time is increased.

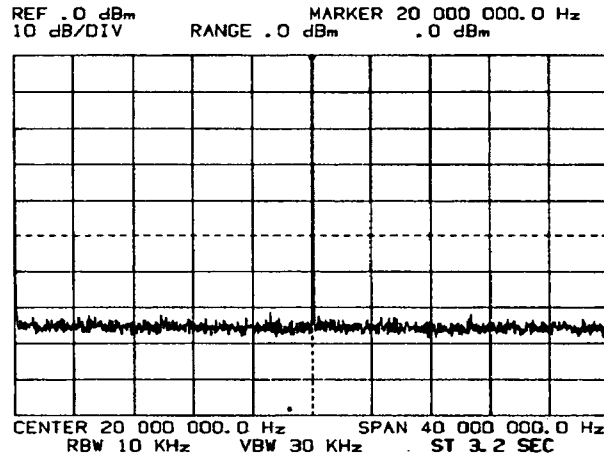

Sweep Time increased two steps to minimize frequency skew. Because of peak detection, 20.035 MHz response is now displayed at the 20.00 MHz point.

(Increasing the Sweep Time also minimized the amplitude compression, causing the signal amplitude to increase by 0.2 dB.)

Sweep dynamics also cause amplitude compression:

When the analyzer is sweeping rapidly, the IF and video filters do not have enough time to fully respond to the rapid changes in amplitude that occur as the sweep passes through a signal. This compresses the signal's response, causing it to appear at a slightly lower level on the CRT screen. When the instrument is sweeping at the maximum-calibrated rate, the worst-case amplitude compression is about 0.2 dB. Amplitude compression can be minimized by increasing the Sweep Time; or it can be completely eliminated by using the Manual mode.

NOTE

The effects of peak detection are negligible in the Manual mode. During Manual mode operation, the Trace Memory address that represents the Manual measurement point is updated every 200 microseconds; but the Manual measurement point is only updated every 17 milliseconds (i.e., the CRT refresh rate). While the peak detector is not disabled in the Manual mode, it is reset after each 200-microsecond sample and does not have the opportunity to accumulate the maximum positive amplitude that occurs over a significant time interval.

GRAPHICS

Peak Detection/Time Interval

Effects Of Peak Detection And Time Interval

Each point on the CRT trace represents the positive peak video amplitude in a region that is equal to 0.1% of the Frequency Span. Similarly, each point also represents the positive peak video amplitude for a *time interval* that is equal to 0.1% of the Sweep Time. When the analyzer is sweeping over a response whose amplitude is stable, the amplitude of the video signal changes according to the slope of the response which, in turn, is strictly a function of frequency. Thus, the trace that is plotted is independent of the time interval. Because of the positive peak detection, however, any positive excursions that occur as a function of *time*, such as transients and noise spikes, are *retained* on the CRT trace. Increasing the Sweep Time increases the time interval for each point on the trace and, therefore, increases the probability that a transient will appear on the trace. For instance, a trace that is plotted over as ten-hour period is more susceptible to transients than a trace that is plotted over a 0.2-second period.

Peak Detection And Noise

The effects of peak detection and time interval are particularly noticeable when the analyzer is sweeping over random noise:

- a. Because of the positive peak detection, only the positive noise peaks are displayed. In the absence of negative peaks, the average value of a random noise signal on the CRT screen *appears* to be significantly higher than it actually is. To illustrate this, the following figure shows a side-by-side comparison of the same noise level plotted with and without peak detection. As indicated by the "DISPLAY LINE" amplitude, the average value of the peak-detected noise appears to be about 4.6 dB higher than that of the non peak-detected noise:

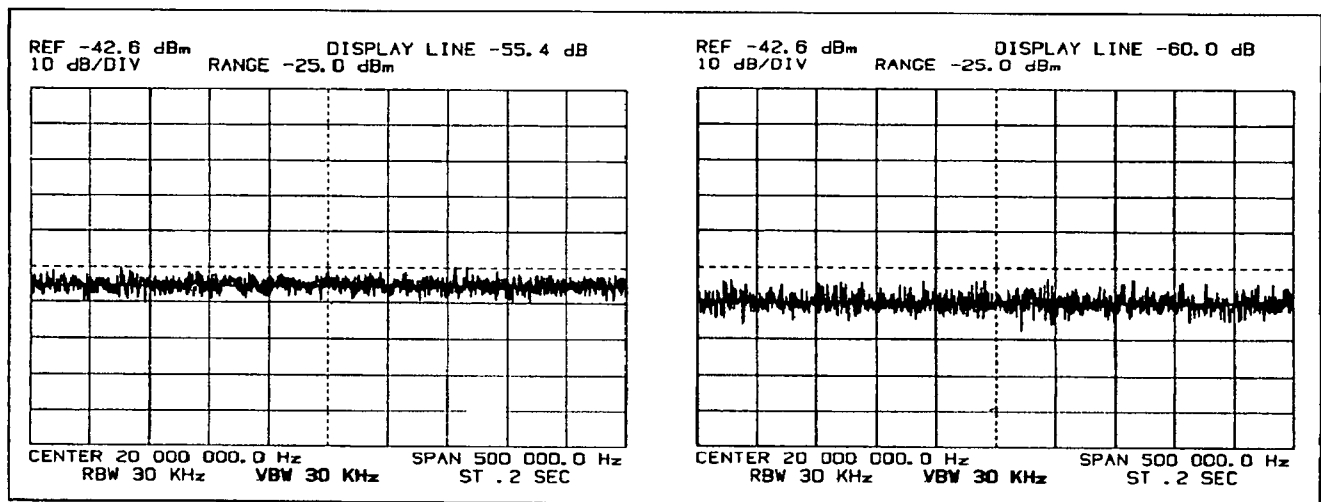

Noise With Peak Detection

Noise Without Peak Detection

- b. Narrowing the Video Bandwidth averages the noise *before* it reaches the peak detector and, therefore, minimizes the effects of peak detection. In the following figure, the VBW has been narrowed to 1% of the RBW to obtain good noise averaging. The true average values of the peak-detected and non peak-detected noise signals are approximately the same:

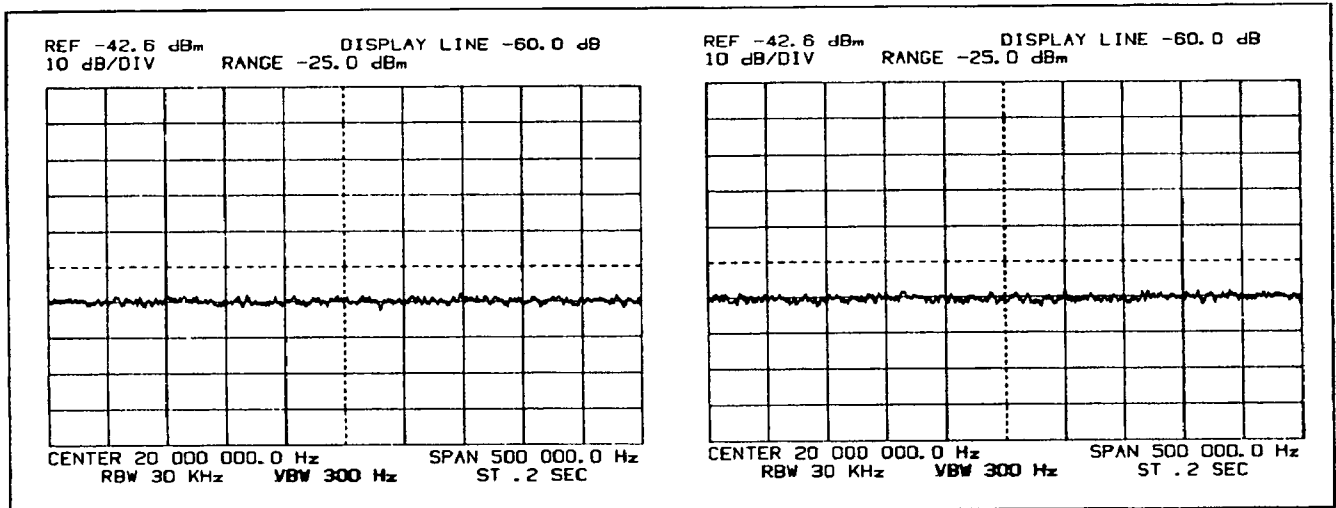

Average Peak-Detected Noise

Average Non Peak-Detected Noise

- c. Increasing the Sweep Time increases the time interval which, in turn, gives the random noise a greater opportunity to reach a maximum positive value at each point on the CRT trace. For this reason, the level of a noise signal that is plotted with insufficient video filtering will *appear* to increase as a function of Sweep Time:

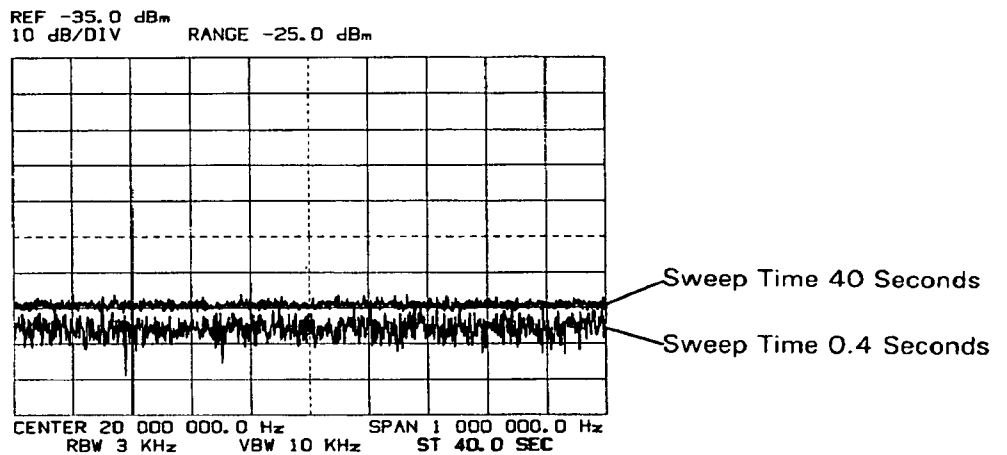

GRAPHICS

Peak Detection/Time Interval

- d. The effects of Sweep Time can be minimized by narrowing the Video Bandwidth to 1% of the Resolution Bandwidth (or narrower). In the following figure, the *both* traces were plotted with a 40-second Sweep Time. The upper trace, showing the effects of peak detection, was plotted with a VBW of 10 kHz. The lower trace, showing an apparent 10 dB decrease in the noise level, was plotted with a VBW of 30 Hz:

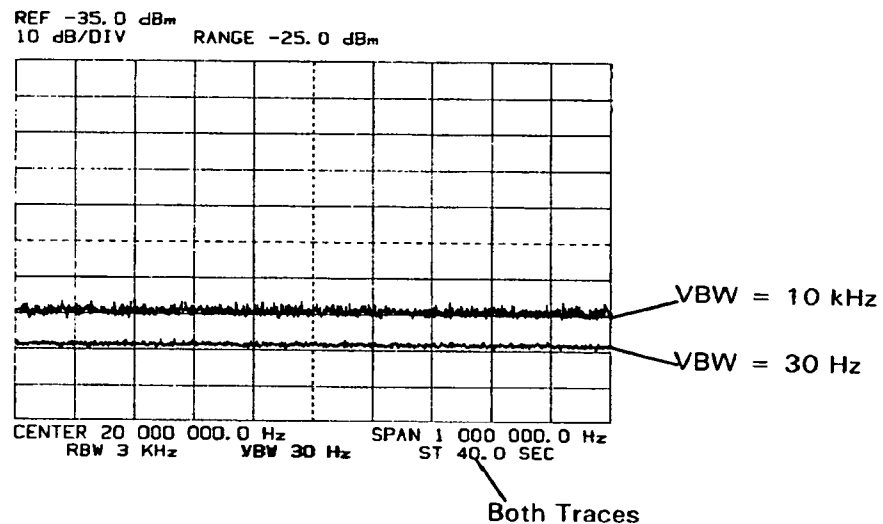

Measuring Noise

Random noise can best be measured using the 3585A NOISE LVL function described in Chapter 8, or by using the Manual mode to minimize the effects of peak detection. To measure the rms average noise level in the Manual mode, set the VBW to 1% of the RBW for good video averaging and add +2.5 dB to the "MANUAL" amplitude readout. (This +2.5 dB includes a 1 dB correction for the instrument's average responding detector and a 1.5 dB correction for the log converter.)

Where necessary, the approximate average noise level can be measured from the CRT trace using the following procedure:

- Set the Video Bandwidth to 1% of the Resolution Bandwidth or narrower. (Narrow the Frequency Span to minimize Sweep Time.)
- Ignoring the UNCAL indicator, decrement the Sweep Time until the displayed noise level no longer decreases. (The spectrum shape of the noise should be gradually changing, not abrupt, allowing the analyzer to follow it well.)
- Set the Marker to the point of interest on the noise floor.
- Add +2.5 dB to the "MARKER" amplitude reading to determine the rms value of the average noise.

TRACE FUNCTIONS

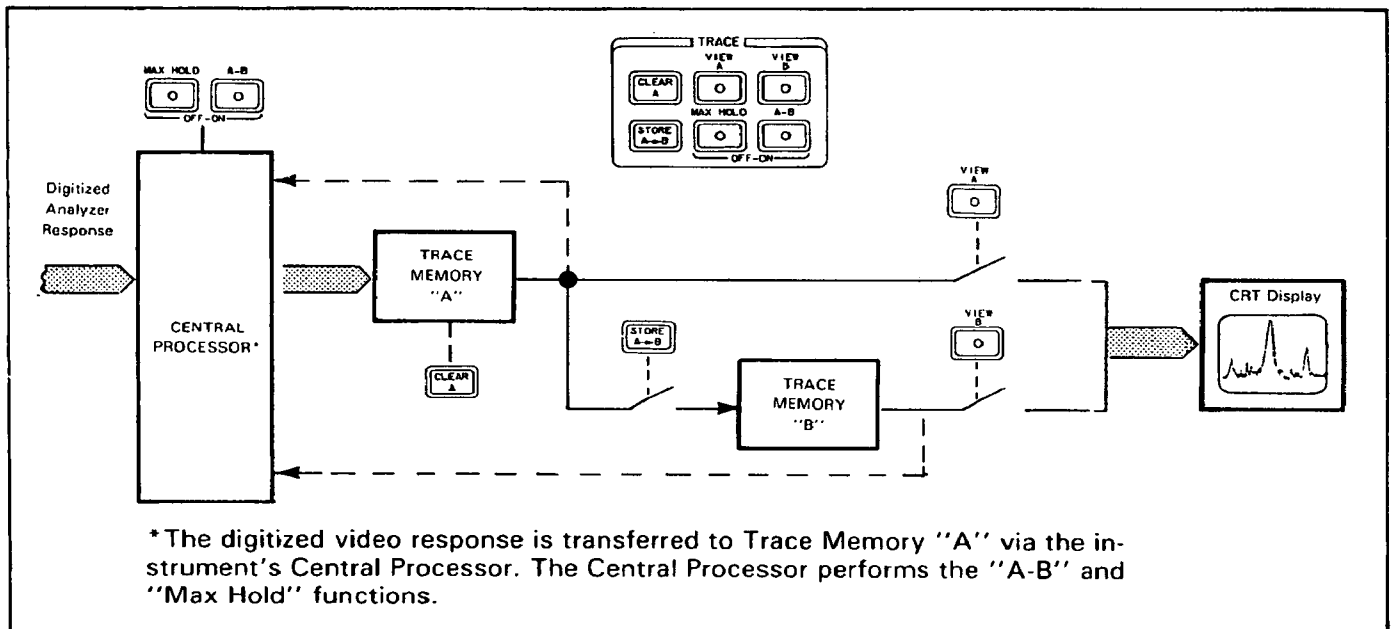

Functional Overview of Trace Memories and Trace Functions

The "A" Trace And Function

As the analyzer's frequency is swept, the trace that is generated is digitized and stored in Trace Memory "A" and is, therefore, referred to as the "A" Trace. The "A" Trace is also called the "Current Trace" because it is the trace that is currently being generated and is the *only* trace that is updated by the frequency sweep or in the Manual mode.

When the VIEW A function is activated, the contents of Trace Memory "A" are written onto the CRT screen at the CRT refresh rate. When the VIEW A function is deactivated, the "A" Trace is not displayed; but it is still generated, retained in memory and updated by the frequency sweep.

TRACE FUNCTIONS

Clear A Function





The CLEAR A function erases Trace Memory "A", causing the Current Trace to appear as a straight line at the bottom of the CRT screen. It does not affect Trace Memory "B". Pressing the CLEAR A key will reset and rearm a continuous sweep and will *terminate* a single sweep.



Store A → B And View B Functions



If the "A" Trace is needed for future reference, it can be instantly transferred to Trace Memory "B" by pressing the  key. This transfer operation is nondestructive and, therefore, does not affect the "A" Trace.

When the  key is pressed, the VIEW B function is *automatically* activated and the "B" Trace (initially a duplication of the "A" Trace) appears on the CRT screen. The "B" Trace is retained in memory until a different trace is stored or until the instrument is turned off. It can be cleared from the screen or recalled at any time by simply pressing the  key.

NOTES

1. The  and  functions can be activated individually or simultaneously to display either or both traces. Deactivating the VIEW A function automatically activates the VIEW B function and vice-versa. Therefore, one of these two functions will always be activated.
2. Whenever the Center Frequency and Frequency Span settings are such that the Start Frequency is lower than 0 Hz or the Stop Frequency is higher than 40.1 MHz, the sweep span is limited and the "out of range" portion of the Current Trace is blanked. The blanking operation is performed by erasing the appropriate portion of Trace Memory "A"; and the erasure takes place whether or not the instrument is sweeping. Consequently, if an "A" Trace is retained on screen after a single sweep and the frequency parameters are changed to produce a limited span condition, the "out of range" portion of the trace will be erased. To avoid the possibility of accidentally destroying a trace that you wish to retain, store the trace in "B".
3. To make measurements on a stored trace (i.e., the "B" Trace or a Current Trace that is retained on screen), the Start Frequency, Stop Frequency, Reference Level and Vertical Scale settings must be the same as they were when the trace was originally plotted.

Trace Identification

The two traces are displayed at the same intensity; so it is sometimes difficult to determine which one is "A" and which one is "B". When in doubt, the operator can, of course, turn off the "B" Trace, identify the "A" Trace and then turn the "B" Trace back on. There are, however, some other distinguishing features that should be noted:

- When the analyzer is sweeping and the Sweep Time is one second or longer, a sweep marker dot appears on the Current ("A" or "A-B") Trace to indicate the position of the frequency sweep. When the Sweep Time is less than one second, the sweep marker is not displayed; but the Current Trace will normally exhibit amplitude variations as it is updated by the frequency sweep. The "B" Trace, *totally unaffected* by the frequency sweep, will not change.
- When both traces are being displayed, the instrument's tunable Marker will appear on the Current Trace rather than the "B" Trace.
- When the analyzer is sweeping or in the Manual mode, the Current Trace will respond to a change in operating parameters as it is updated by the frequency sweep or at the Manual measurement point. The "B" Trace is *not affected* by the operating parameters.

The Maximum Hold Function



When the MAX HOLD function is activated, the Current Trace retains the maximum positive video amplitude that occurs during successive frequency sweeps or at the Manual measurement point. This function is useful for observing maximum peak noise or for plotting the frequency drift or positive amplitude drift of a signal over a period of time. In the following figure, for example, the "A" Trace with MAX HOLD displays the frequency drift of a signal during the warmup period of the signal source.

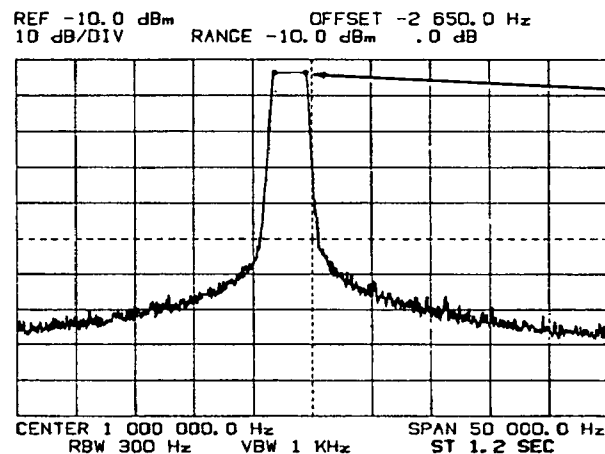

Trace plotted with MAX HOLD shows frequency drift of signal source during its 5-minute warmup.

As indicated by the "OFFSET" readout, the signal source has a negative frequency drift of 2,650 Hz.

TRACE FUNCTIONS

The "A-B" Function



When the  function is activated, the 3585A initially subtracts the contents of Trace Memory "B" from Trace Memory "A" and writes the difference into Trace Memory "A". As a result, the "A" Trace is instantly transformed into "A-B". This subtraction process continues as Trace Memory "A" is updated by the frequency sweep or by the video samples that are taken at the Manual frequency. The "A-B" Trace, therefore, becomes the Current Trace whose amplitude is equal to the "dB difference" between the "A" Trace that would ordinarily be displayed and the stored "B" Trace.

The "A-B" Trace is referenced to "0 dB" which is represented by the *middle* horizontal line on the CRT graticule. If the "A" and "B" Traces are identical, the "A-B" Trace will appear as a straight line at the 0 dB level. Positive variations from the 0 dB reference indicate that Trace "A" is higher in amplitude than Trace "B" and vice-versa. The amplitude of the "A-B" Trace, in dB relative to the 0 dB reference, can be read directly from the "MARKER" amplitude readout or from the CRT graticule. The Vertical Scale for the "A-B" Trace is 10 dB, 5 dB, 2 dB or 1 dB per-division, depending on the dB/DIV setting.

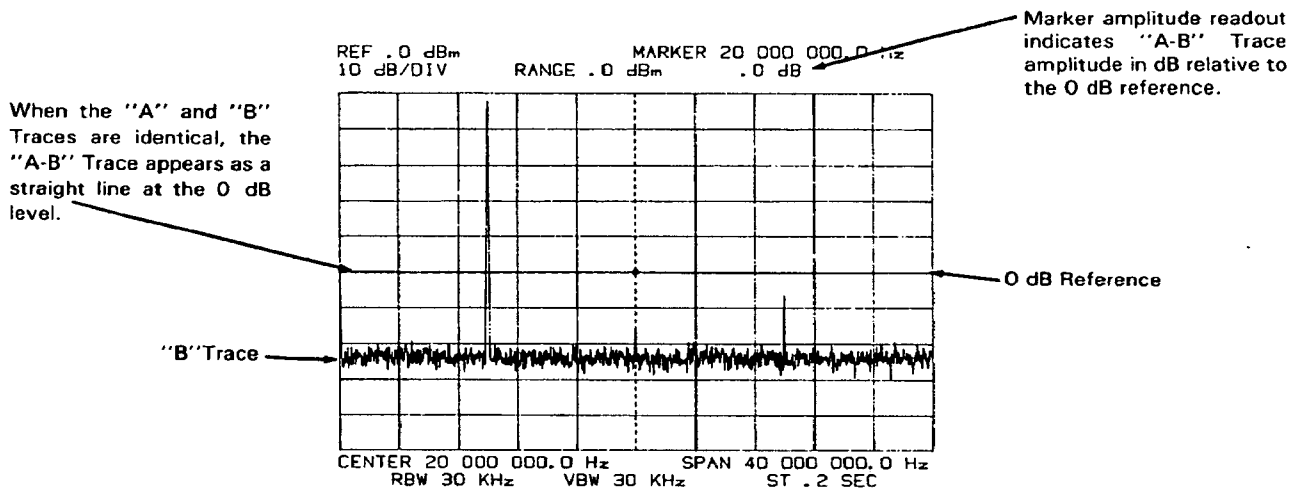

The "A-B" Trace

The "A-B" function will operate whether or not the VIEW A function is activated. However, the VIEW A function *must be activated* to *display* the "A-B" Trace. Since the "A-B" Trace is stored in Trace Memory "A" and there is no other Trace Memory in which to store the "A" Trace, the "A" and "A-B" Traces cannot be displayed simultaneously. The "B" Trace is independent of the "A-B" function, and can be turned on or off using the VIEW B key.

When the operator deactivates the "A-B" function, the 3585A adds the "B" Trace to the "A-B" Trace and stores the sum ($B + A - B = A$) in Trace Memory "A". Thus, the "A" Trace is instantly returned to the screen.

NOTES

1. To maintain proper display correlation when the "A-B" function is used, the Start Frequency, Stop Frequency, Reference Level and Vertical Scale settings must be the same for the "A", "B" and "A-B" Traces.

2. An "A-B" Trace that exceeds the vertical display range will cause Trace Memory "A" to overflow. If an overflow condition exists when the "A-B" function is deactivated, the "A" Trace that returns to the screen (i.e., $B + (A-B)$) will be distorted. This effect is of little consequence when the analyzer is sweeping rapidly since the "A" Trace will be fully restored after a sweep has been made. However, if the analyzer is sweeping slowly or is not sweeping, the distorted "A" Trace will remain on the screen until it is finally updated by the frequency sweep or cleared from memory.

Applications For "A-B"

The "A-B" function is useful for any application requiring trace comparison. The two most common applications are:

- a. To correct for the frequency response (flatness) variations of the 3585A and its Tracking Generator when measuring the amplitude frequency-response of an external device.

For this application, the 3585A Tracking Generator output is connected directly to the Input that is to be used for measurements. The 3585A is then swept across the spectrum of interest and the resulting plot, showing the flatness variations of the 3585A, is stored in "B". Next, the device to be characterized is inserted between the Tracking Generator output and 3585A Input and its response is plotted using the "A-B" function so that the analyzer's response in "B" is subtracted from the measurement. (Procedures for making flatness measurements are given in Chapter 2.)

- b. To simplify the comparison of a test response to a standard response that is stored in "B".

This is particularly useful for production-line applications where a number of networks (e.g., filters) are to be adjusted for identical frequency-response characteristics. For this application, the response of a "production standard" network is plotted and stored in "B". The response of the network under test is then plotted with "A-B" and the network is adjusted so that the "A-B" Trace is a straight line.

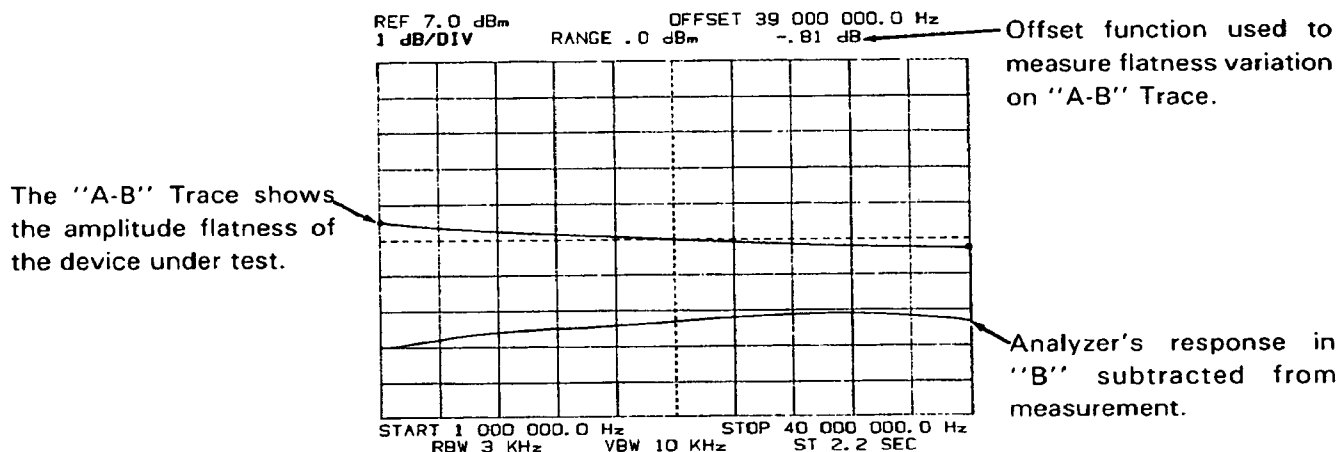



Flatness Measurement With A-B

TRACE FUNCTIONS

Functions That Interact With "A-B"

Note the following:

- a . The  and  functions have the same effect on the "A-B" Trace as they do on the "A" Trace.
- b . An "A-B" Trace can be stored in "B" by pressing  ; but the result may be confusing:
 - 1 . If the "A-B" Trace is stored in "B" while the instrument is sweeping, the "B" Trace will be a duplication of the current "A-B" Trace; and the "A-B" Trace, when updated by the frequency sweep, will become $A - (A-B) = A - A + B$. Thus, the "A-B" Trace will be a reproduction of the original "B" Trace that changes according to the difference between the current "A" Trace and the previous "A" Trace.
 - 2 . If the analyzer is not sweeping, the "B" Trace will be a duplication of the "A-B" Trace and the "A-B" Trace will not be affected.

It is important to note that an "A-B" Trace that has been stored in "B" cannot be measured directly with the Marker because the amplitude readout will indicate the Marker's *absolute* amplitude on the "B" Trace. This can be counteracted by setting the Marker to the 0 dB reference point on the "B" (i.e. stored "A-B") Trace, activating the OFFSET function and pressing the ENTER OFFSET key.
- c . When the analyzer is sweeping or in the Manual mode, the COUNTER function will operate with the "A-B" Trace. The "COUNTER" frequency reading, however, applies *only* to the current "A" Trace which is not displayed.
- d . The 3585A NOISE LVL function will *not* operate when the "A-B" function is activated.
- e . The DISPL LINE function will operate with the "A-B" Trace; but the Display-Line amplitude is displayed in dB relative to the *top* graticule line rather than the middle graticule line to which the "A-B" Trace is referenced.
- f . The OFFSET function can be used to make relative measurements on the "A-B" Trace; but it must be used with care: The 3585A is designed to inhibit Offset measurements between the "A-B" Trace and the "A" or "B" Trace. Valid Offset measurements can be performed on the "A-B" Trace *only* when the Offset is *entered and measured* on that trace.
- g . All other instrument functions will operate in the normal manner; but remember that a change in operating parameters will affect the current "A" Trace but will not affect the stored "B" Trace and will, therefore, change the definition of the "A-B" Trace.

ALPHANUMERIC READOUTS

The alphanumeric readouts that appear on the CRT screen can be divided into three main categories:

a . Parameter Readouts:

Current values of pertinent operating parameters.

b . Frequency and Amplitude Readout:

1 . Marker, Counter or Manual frequency; Marker or Manual amplitude; Offset frequency and amplitude.

2 . Display-Line amplitude.

c . Operating Messages:

- 1 . Status messages
- 2 . Entry requests
- 3 . Operator error messages
- 4 . Calibration error codes

Parameter Readouts

The 3585A has eight parameter readouts which are used to display the current values of the pertinent operating parameters. The parameter that is prefaced is displayed brighter than the other parameters:

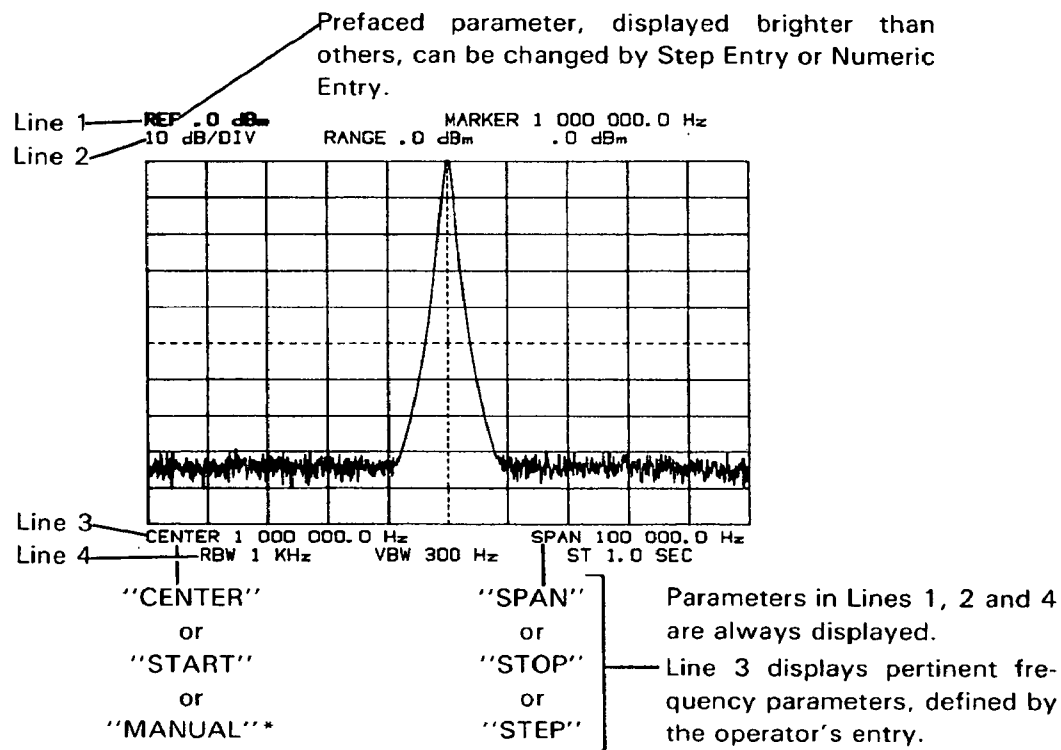

* The Manual frequency is displayed here *only* when it is prefaced. The Manual frequency may also be displayed on the frequency readout in the upper right-hand corner of the screen.

READOUTS

Frequency And Amplitude Readout

The frequency and amplitude readout, located in the top-right corner of the CRT screen, displays *measurement data* obtained using the Marker, Counter, Manual, Offset and Display-Line functions:

- a. All frequency readings (absolute and relative) are displayed in “Hz” with 0.1 Hz resolution.
- b. Absolute amplitude readings are displayed in dBm (50Ω or 75Ω), dBV or rms volts, corresponding to the units in which the Reference Level (and Range) is displayed.
 1. Absolute noise level readings are displayed in dBm (1 Hz), dBV (1 Hz) or $V \sqrt{\text{Hz}}$.
 2. The resolution for dBm and dBV amplitude readings is 0.1 dB, 0.05 dB, 0.02 dB or 0.01 dB, depending on the Vertical-Scale setting; i.e., 10 dB, 5 dB, 2 dB or 1 dB per-division, respectively.
 3. The resolution for voltage readings is limited to approximately 0.1 dB or 1%.
- c. Relative (Offset, “A-B” or Display-Line) amplitude readings are displayed in dB. Resolution is 0.1 dB, 0.05 dB, 0.02 dB or 0.01 dB, depending on the Vertical Scale setting.

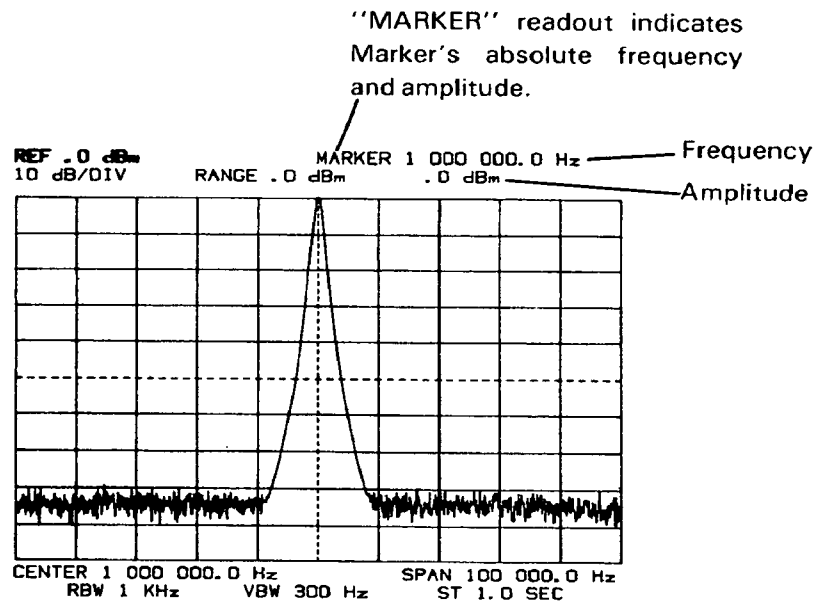







Readouts and Readout Priority

Any one of seven different readouts can be displayed in the top-right corner of the screen. The various readouts and their priorities are as follows:

a. Display Line Amplitude:





Whenever the  function is activated, the "DISPLAY LINE" amplitude (in dB relative to the Reference Level) is displayed in place of all other readouts.



b. Frequency/Amplitude Readouts:

Priority	Readout  deactivated)	Readout  activated)	Displayed When:
1	"COUNTER"	"OFS CNTR" (Offset Counter)	 and  activated, Counter triggered by frequency sweep or in Manual mode, Marker or Manual frequency not being changed*
2	"MANUAL"	"OFS MAN" (Offset Manual)	 and/or  deactivated, instrument in Manual mode and Marker at Manual measurement point on CRT trace; or whenever Manual frequency is being changed.
3	"MARKER"	"OFFSET"	requirements for "Counter or "Manual" readout are not met.

NOTES

1. Once the  function has been activated, the Display Line will remain on the CRT screen until the Display Line CLEAR key is pressed or the instrument is preset.

2. The  function can be deactivated by pressing the OFF key or by activating any of the other Continuous Entry functions. When  or  is activated, the Display Line remains on the screen; but the "DISPLAY LINE" readout is replaced by the Frequency/Amplitude readout. Once the "DISPLAY LINE" readout has been overridden, it will not reappear until the  function is reactivated.

3. Pressing the Display Line CLEAR key deactivates the  function (if activated) and clears the Display Line and its readout from the screen. If the "DISPLAY LINE" readout is being displayed when the CLEAR key is pressed, the readout will go blank and will remain blank until  or  is activated or until the instrument is preset.

* Counter readings are momentarily inhibited when operating parameters are changed and also during Automatic Calibrations. During these periods, the readout reverts to the next lower priority.

READOUTS

Frequency/Amplitude Readout Definitions

a. "MARKER"

Frequency:

Absolute Marker frequency on CRT trace; i.e., the frequency of the point on which the Marker is positioned.

Amplitude:

On "A" or "B" Trace: Marker's absolute amplitude

On "A-B" Trace: Amplitude of "A" in dB relative to "B" at Marker setting.

b. "MANUAL"

Frequency: Current Manual frequency.

Amplitude:

On "A" Trace: Real-time absolute amplitude at Manual frequency.

On "B" Trace: Marker's absolute amplitude on "B" Trace.

On "A-B" Trace: Real-time amplitude at Manual frequency in dB relative to corresponding point on "B" Trace.

c. "COUNTER"

1. Instrument Sweeping:

Frequency:

Absolute frequency of the signal causing the response on which the Marker is positioned. (Counter readings apply only to the "A" Trace which is *not displayed* when "A-B" is activated.)

Amplitude:

On "A" Trace: Absolute amplitude at *Marker* setting.

On "A-B" Trace: Amplitude of "A" in dB relative to "B" at *Marker* setting.

2. In Manual Mode:

Marker At Manual Frequency:

Frequency: Absolute frequency of signal detected at Manual frequency.

Amplitude:

On "A" Trace: Real-time absolute amplitude at Manual frequency.

On "A-B" Trace: Real-time amplitude at Manual frequency in dB relative to corresponding point on "B" Trace.

Marker Not At Manual Frequency:

Frequency: Absolute frequency of input-signal response detected at *Marker* frequency.

Amplitude:

On "A" Trace: Marker's absolute amplitude on the CRT trace.

On "A-B" Trace: Amplitude of "A" relative to "B" at *Marker* setting.

d. "OFFSET"

Current "MARKER" frequency and amplitude relative to frequency and amplitude in Offset Register.

e. "OFS MAN" (Offset Manual)

Current "MANUAL" frequency and amplitude relative to frequency and amplitude in Offset Register.

f. "OFS CNTR" (Offset Counter)

Current "COUNTER" frequency and amplitude relative to frequency and amplitude in Offset Register.

READOUTS

Operating Messages

Operating messages are internally-generated, single-line messages that appear in the upper middle portion of the CRT screen. These messages, indicating instrument status, entry requests, operator errors and calibration error codes, provide a valuable “human interface” between the 3585A and the operator.

Status Messages

“CALIBRATING”

Displayed for the duration of each Automatic Calibration cycle to let the operator know that a calibration is taking place.

“CALIBRATION DISABLED”

Displayed in place of “CALIBRATING” message when Automatic Calibration is disabled.



“BEEPER DISABLED”

Displayed for about 10 seconds after operator initially disables beeper.

“SWEEP SPAN LIMITED”

Appears for 5 to 10 seconds when Center Frequency and Frequency Span parameters are set so that the Start Frequency is lower than 0 Hz or the Stop Frequency is higher than 40.1 MHz. The “out of range” portion of the Current Trace is blanked.



“HP-IB REMOTE SET”

Displayed when the instrument is in Remote and any of the front panel keys except  or  is pressed or the Continuous Entry control is rotated. (The  key is completely ignored when the instrument is in Remote.)

“HP-IB LOCAL LOCKOUT”

Displayed when  key pressed and instrument is in HP-IB Local Lockout mode.

“INSTR. TEST MODE XX”

Displayed continuously (except during Auto. Cal.) when instrument is in a Test Mode. Test Modes 01 through 09 can be activated from the front panel and deactivated by pressing . These Test Modes and all other Test Modes can also be selected with internal switches. If pressing  does not clear a “Test Mode” readout, have a qualified service technician check to be sure that the internal Test Mode switches are in the off position.

“LOCAL OSC. UNLOCKED”

Displayed when any of the instrument’s main phase-locked loops becomes unlocked. It is *normal* for this message to be displayed momentarily when the instrument is first turned on; and also when the internal Oven Reference is enabled about ten minutes after turn on or when an external frequency reference is initially connected. Outside of these three normal conditions, the appearance of this message usually indicates an internal failure. However, before sending your instrument in for repair, check to be sure that the BNC-to-BNC jumper is *securely* connected between the rear-panel OVEN REF OUT and EXT REF IN connectors; or, if you are using an external frequency reference, be sure that your reference source is properly connected and is supplying the correct frequency and amplitude (i.e., 10 MHz or any subharmonic down to 1 MHz; 0 dBm to + 15 dBm/50 ohms).



The local oscillator loops will lock with *no signal* applied to the EXT REF IN connector. However, if the applied signal is *intermittent* or out of tolerance, the loops will not operate properly.

“COUNTER FAILURE”

Displayed when  activated and internal Counter failure is detected.



Entry Requests

“ENTER REG. NUMBER”

This message appears when the operator presses the  or  key. It remains on the screen until a Register Number (1 through 9) is entered, the Continuous Entry control () is rotated or any front-panel key is pressed.

(Entries other than  or digits 1 through 9 terminate the entry sequence and cause the “REGISTER UNDEFINED” message to appear.)

“ENTER TST #??”

Displayed when operator initiates instrument Test Mode entry sequence by pressing  . To select a Test Mode, the operator then enters a two-digit number (i.e., 01 through 09). Upon receipt of the Test Mode number, the readout displays “ENTER TST#XX *PRESET*”. The operator then presses  to activate the Test Mode. (Test Mode entries other than 01 through 09 are ignored.)

NOTE

The Instrument Test Modes, used primarily for adjustments and troubleshooting, are fully defined in the 3585A Service Manual.

Test Modes 06 and 07 can sometimes be used when making swept frequency response measurements with the 3585A Tracking Generator. Procedures for using these Test Modes are outlined in Chapter 2.

READOUTS







Operator Error Messages

If the operator attempts to make an "illegal" entry or initiate a sequence that the 3585A is incapable of executing, the beeper will sound and one of the following error messages will appear on the CRT screen:

ERROR MESSAGE	CAUSED BY:
"OUT OF RANGE"	Entries that exceed the upper or lower limit of a parameter. (Applies to all parameters except Reference Level and minimum sweep rate limit.)
"TOO MANY DIGITS"	Attempts to enter more than the maximum number of digits for a given parameter. The digit that produces the error message is not accepted; but preceding digits are retained and will be accepted if they constitute a valid entry.
"REF < 100 dB BELOW RANGE"	Attempts to set the Reference Level lower than 100 dB below the RANGE setting; or attempts to set the RANGE higher than 100 dB above the Reference Level.
"REF > 10 dB OVER RANGE"	Attempts to set the Reference Level higher than 10 dB above the RANGE setting; or attempts to set the RANGE lower than 10 dB below the Reference Level.
"1;3;10 STEPS ONLY"	Numeric entries that attempt to select unavailable RBW or VBW settings; RBW settings are 3 Hz thru 30 kHz; VBW settings are 1 Hz thru 30 kHz - 1, 3, 10 sequence.
" /DIV = 1;2;5;10 ONLY"	Numeric Vertical Scale (dB/DIV) entries other than 1 dB, 2 dB, 5 dB or 10 dB.
"S.T. IN .2 SEC STEPS"	Numeric Sweep Time entries containing a fractional digit other than 0.2, 0.4, 0.6 or 0.8. (Sweep Time is settable in 0.2 second steps. Illegal fractional digits are accepted; but, when the suffix key is pressed, the fractional digit is automatically incremented by 0.1 second and the error message appears on the screen. The beeper does not sound.)

ERROR MESSAGE

CAUSED BY:

"SWEEP RATE TOO SMALL"	Sweep Time entries that produce a sweep rate slower than 0.1 Hz/sec (30 kHz and 10 kHz RBW) or 0.005 Hz/sec.
"USE STEP KEYS ONLY"	Attempts to set RANGE by Numeric Entry.
"ENTRY MODE UNDEFINED"	Pressing a STEP key or Number/Units key without first prefacing a parameter.
"REGISTER UNDEFINED"	Pressing  or  followed by any key other than  or digits  through  .
"COUNTER OUT OF LIMIT"	Pressing  when "COUNTER" frequency reading is higher than 40.1 MHz.

Calibration Error Codes

During each Automatic Calibration cycle, the 3585A performs a comprehensive algorithm in which frequency and amplitude offsets are measured and corrected and many of the instrument's functional capabilities are verified. If, for any reason, the 3585A is unable to successfully complete an Automatic Calibration, the beeper will sound and a Calibration Error Code (e.g., "CALIBRATION ERROR 03") will appear on the CRT screen. There are 33 Calibration Error Codes, all of which are fully defined in the 3585A Service Manual. The calibration errors are quite explicit and will often lead the service technician directly to the source of trouble.

CHAPTER 7

BANDWIDTH AND SWEEP TIME COUPLING

This chapter describes the operation of the Bandwidth and Sweep-Time coupling system, controlled by the keys located in the RBW-VBW-ST control block.

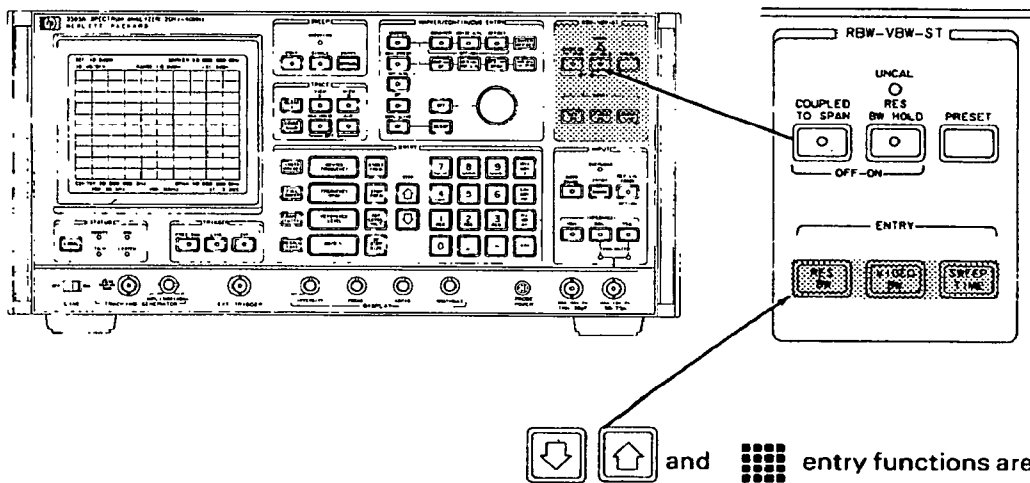



OVERVIEW

 Couples RBW to Frequency Span; couples VBW to RBW; automatically adjusts Sweep Time according to RBW, VBW and Frequency Span.

(Automatically activated by  ; press to deactivate, press again to reactivate.)

 Prevents RBW *and* VBW from changing as a function of Frequency Span.

(Press to activate; press again to deactivate.)

 Restores “optimum” RBW, VBW and Sweep Time settings. If  activated, restores optimum VBW and Sweep Time; but does not affect RBW.

 Lights when manually-selected sweep rate is too fast to maintain calibration.

INTRODUCTION TO COUPLING

INTRODUCTION TO COUPLING

Mechanical coupling is commonly used in spectrum analyzers to permit two or more parameters to be simultaneously adjusted with one control knob. For those who are unfamiliar with the concept of coupling, a typical coupled control is described in Figure 1.

The 3585A Bandwidth and Sweep Time coupling system is electronic rather than mechanical. As such, it performs the same basic function as a mechanical system, but it provides greater flexibility and more precise control.

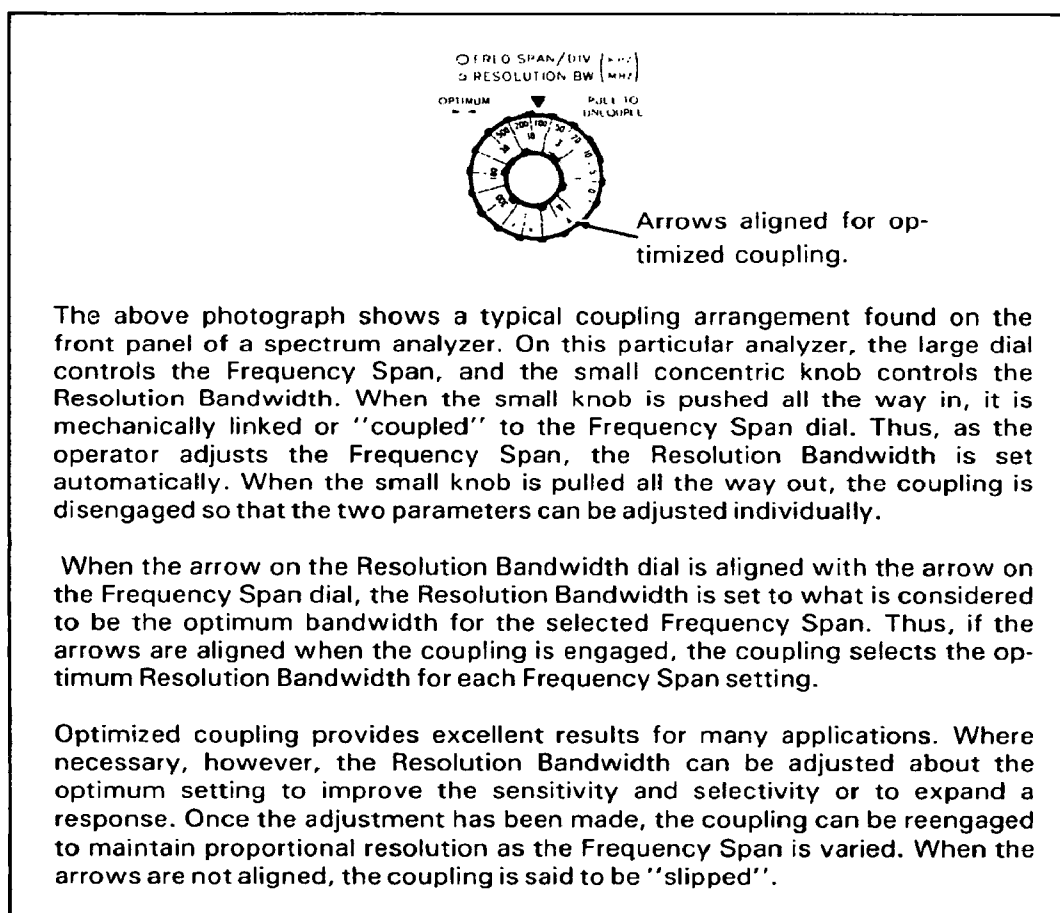







Figure 1. Mechanical Coupling.

OPERATION WITH OPTIMIZED COUPLING



To begin a measurement, the operator normally presses . This activates , deactivates  and sets the Frequency Span to 40 MHz. It also presets the Resolution Bandwidth (RBW) and Video Bandwidth (VBW) to 30 kHz and the Sweep Time to 0.2 seconds. These Bandwidth and Sweep Time settings are the preferred or “optimum” settings for the full 40 MHz Span. Once these settings are established, the Bandwidth and Sweep Time coupling is considered to be “optimized”. With optimized coupling, the  function automatically selects the optimum RBW and VBW settings as a function of Frequency Span; and automatically adjusts the Sweep Time to maintain the maximum-calibrated sweep rate. The “optimum” RBW, VBW and Sweep Time settings are not necessarily the best settings for your particular measurement. They are, however, suitable for many general-purpose measurements and they always provide an excellent starting point from which the parameters can be individually adjusted to obtain the required results.

Changing Parameter Values

As described in Chapter 5, the RBW, VBW and Sweep Time settings can be changed by Step Entry or Numeric Entry. It is *not necessary* (or desirable) to deactivate the  function when adjusting the RBW, VBW or Sweep Time settings. The coupling system will allow you to select any available RBW, VBW, ST combination. It will then (if possible) maintain the relationships that you have established. With optimized Sweep Time coupling, the operator can freely select the desired RBW and VBW settings; the Sweep Time is automatically adjusted to maintain the optimum sweep rate.

Preset Key

The PRESET key automatically restores the optimum RBW, VBW and Sweep Time settings. This provides a convenient way to reoptimize the coupling without presetting the entire instrument or individually adjusting the Bandwidth and Sweep Time parameters. Operation is as follows:

- a. The PRESET key is operative whether or not the  function is activated.
- b. If the  function is activated, the PRESET key will restore the optimum Video Bandwidth (relative to RBW) and Sweep Time; but it will not change the RBW setting.

DETAILED ASPECTS OF OPERATION

The  function controls two independent but interactive coupling systems:

- a. Bandwidth Coupling
- b. Sweep Time Coupling

BANDWIDTH COUPLING

Bandwidth Coupling

With the  function activated, the Video Bandwidth (VBW) is coupled to Resolution Bandwidth (RBW); and Resolution Bandwidth is coupled to Frequency Span. Operation is as follows:

- a. Changing the RBW automatically changes the VBW.* (Changing the VBW does not change the RBW.)
- b. The RBW is set automatically as a function of Frequency Span; i.e., narrowing the Span narrows the RBW. Since the VBW is coupled to RBW, it also changes as a function of Frequency Span. (Again, the coupling does not operate in reverse; changing the RBW and/or VBW does not change the Frequency Span.)

The optimum RBW and VBW settings are listed in Table 1.

The optimum RBW settings maintain a good aspect ratio and generally provide adequate resolution and sensitivity. However, the most suitable RBW setting must ultimately be selected by the operator.

The optimum VBW settings are the narrowest settings that can be used without increasing the Sweep Time. For good video filtering, the VBW should be narrowed to at least 10% of the RBW setting.

Slipped Bandwidth Coupling

Changing the RBW and/or VBW, in effect, “slips” the Bandwidth coupling. Operation with slipped coupling is as follows:

- a. The Resolution Bandwidth changes according to the Frequency Span as outlined in Table 1. The relationship between the operator’s RBW setting and the optimum RBW setting is automatically maintained. For example, if the operator narrows the RBW two steps from the optimum setting, the coupling system (where possible) automatically sets the RBW two steps below optimum when the Frequency Span is changed. The coupling system will not attempt to force the RBW to go below 3 Hz or above 30 kHz. Therefore, if the Frequency Span is narrowed to the point where the RBW would go below 3 Hz, the RBW will remain 3 Hz. This does not alter or reoptimize the coupling. The coupling system will *remember* that the RBW should be a given number of steps below optimum and will automatically restore that relationship when the Frequency Span is widened.
- b. The Video Bandwidth changes according to the RBW as shown in Table 1. (Note that the VBW does *not* change when the RBW is changed from 30 kHz to 10 kHz or vice-versa.) The relationship between the operator’s VBW setting and the optimum VBW setting is automatically maintained. Again, the coupling system will not attempt to force the VBW to go below 1 Hz or above 30 kHz; but it will remember the number of steps above or below the optimum setting and restore that relationship when the limit is no longer exceeded.



*Except when RBW is changed from 30 kHz to 10 kHz and vice-versa.

Table 1. Optimum RBW/VBW Settings.

Frequency Span	Optimum RBW	Optimum VBW
0 Hz to 199.9 Hz	3 Hz	10 Hz
200.0 Hz to 999.9 Hz	10 Hz	30 Hz
1,000.0 Hz to 4,999.9 Hz	30 Hz	100 Hz
5,000.0 Hz to 19,999.9 Hz	100 Hz	300 Hz
20,000.0 Hz to 99,999.9 Hz	300 Hz	1 kHz
100,000.0 Hz to 499,999.9 Hz	1 kHz	3 kHz
500,000.0 Hz to 1,999,999.9 Hz	3 kHz	10 kHz
2,000,000.0 Hz to 9,999,999.9 Hz	10 kHz	30 kHz
10,000,000.0 Hz to 40,100,000.0 Hz	30 kHz	30 kHz

Resolution Bandwidth Hold Function.



The  function inhibits the RBW coupling and, therefore, prevents the RBW (and VBW) from changing as a function of Frequency Span. (As long as  is activated, VBW remains coupled to RBW.) When the RBW HOLD function is activated, the RBW and VBW settings can still be changed by Step Entry or Numeric Entry; but they will not change automatically and the RBW will not change when the PRESET key is pressed.

Sweep Time Coupling

With the  function activated, the optimum Sweep Time is mathematically calculated according to the Frequency Span, RBW and VBW settings:

Widening the Frequency Span or narrowing the RBW and/or VBW increases the Sweep Time.

(The coupling does not operate in reverse; changing the Sweep time does not affect the Frequency Span, RBW or VBW.)

With optimized Sweep Time coupling, the Sweep Time is (where possible) automatically adjusted to maintain the maximum-calibrated sweep rate. The minimum Sweep Time is 0.2 seconds. If the maximum-calibrated sweep rate is such that the Sweep Time would be less than 0.2 seconds, the Sweep Time is automatically set to 0.2 seconds.

When the instrument is sweeping at the maximum-calibrated rate, the amplitude compression is approximately 0.2 dB and the Frequency skew is about 33 percent of the RBW setting. This dynamic error can be reduced by a factor of four by increasing the Sweep Time two steps from the optimum setting. If the Sweep Time is decreased below the optimum setting, the UNCAL indicator will light to indicate that the instrument is sweeping too fast to maintain calibration.

SWEEP TIME COUPLING

Slipped Sweep Time Coupling

Changing the Sweep Time by Step or Numeric Entry “slips” the Sweep Time coupling. Operation with slipped coupling is as follows:

- a. When the Sweep Time is changed by Step Entry, the coupling system simply remembers the operator’s setting in steps above or below the optimum setting and automatically maintains that relationship.
- b. When the Sweep Time is changed by Numeric Entry:
 1. The operator’s Sweep Time setting is retained until the Frequency Span, RBW or VBW setting is changed.
 2. When the Frequency Span, RBW or VBW setting is changed, the coupling system converts the operator’s Sweep Time to an integral number of steps above or below the optimum setting and maintains that relationship.

Since each Sweep Time step (as in a Step Entry) either multiplies or divides the Sweep Time by 2, the Sweep Time selected by the coupling system will always be 2^N times the optimum setting.

The following formula is used to convert the operator’s Sweep Time setting to an integral number of steps above or below the optimum setting:

$$N = \log_2 S$$

Where:

$$N(\text{rounded off}) = \text{integral number of steps above or below optimum Sweep Time}$$

$$S = \frac{\text{Operator's Sweep Time}}{\text{Optimum Sweep Time}}$$

Peculiarities of Slipped Sweep Time Coupling (Numeric Entry)

If the operator’s numeric Sweep Time entry is such that “S” is not an integral power of 2, the number “N” will be a decimal or mixed number and will, therefore, be rounded off to the nearest whole number of steps. As a result, the following peculiarities may be observed:

- a. If the operator’s Sweep Time entry is less than one half step above or below the optimum setting, the optimum Sweep Time will be restored when the Frequency Span, RBW or VBW is changed.

- b. If the operator's Sweep Time is not an integral number of steps above or below the optimum Sweep Time, a change in Frequency Span, RBW or VBW may not produce a proportional change in Sweep Time:

Example:

Decreasing the RBW by a factor of 10 normally increases the Sweep Time by a factor of 100. However, if the optimum Sweep Time is 0.8 seconds and the operator enters a Sweep Time of 2 seconds and then decrements the RBW by a factor of 10, the Sweep Time will change to 160 seconds rather than 200 seconds. Since 2 seconds is not an integral number of steps above 0.8 seconds, the coupling system, in this case, converts the operator's entry to 1.6 seconds (0.8×2) which, when multiplied by 100, yields a Sweep Time of 160 seconds.*

- c. If the operator enters a Sweep Time, changes the Frequency Span, RBW or VBW and then returns to the original settings, the Sweep Time selected by the coupling system may differ from the operator's original entry.

Example:

Continuing with the preceding example—if the Sweep Time is 160 seconds and the RBW is returned to its original setting, the Sweep Time will change to 1.6 seconds rather than the operator's entry of 2 seconds.

- d. When the Frequency Span, RBW or VBW setting is changed, the operator's Sweep Time will be converted to an integral number of steps above or below the optimum setting *even if the optimum setting does not change*. Consequently, the Sweep Time may increase when it would be expected to decrease.

Example 1:

If the optimum Sweep Time is 2 seconds and the operator enters a Sweep Time of 3 seconds and increments the VBW, the Sweep Time will increase to 4 seconds. With optimized bandwidth coupling, increasing the VBW does not change the optimum Sweep Time. In this case, the optimum Sweep Time remained 2 seconds but, in response to the VBW change, the operator's Sweep Time was converted to one step above optimum.

Example 2:

If the optimum Sweep Time is 0.2 seconds and the operator enters a Sweep Time of 10 seconds, holds the bandwidth and narrows the Frequency Span, the Sweep Time will *increase* to 12.8 seconds. Narrowing the Frequency Span (with bandwidth constant) normally decreases the Sweep Time. In this case, however, the optimum Sweep Time cannot go below 0.2 seconds (minimum 3585A Sweep Time) so the coupling system converted the operator's Sweep Time to an integral number of steps above 0.2 seconds. Due to the rounding off process, a Sweep Time of 10 seconds converts to six steps above 0.2 seconds which is 12.8 seconds. A Sweep Time of 8 seconds, however, would be converted to 5 steps above 0.2 seconds and the Sweep Time would decrease to 6.4 seconds.

* To demonstrate this, press  and decrement the RBW one step to obtain a Sweep Time of 0.8 seconds. Then, enter a Sweep Time of 2 seconds and decrement the RBW two steps.

CHAPTER 8

MARKER/CONTINUOUS-ENTRY FUNCTIONS

The MARKER/CONTINUOUS ENTRY control block contains the Continuous Entry control (knob) and the control keys for thirteen special operating functions. While these special functions are not essential for basic instrument operation, they allow you to make measurements faster and with greater accuracy. Once you become familiar with them, you will find them extremely useful and virtually indispensable.

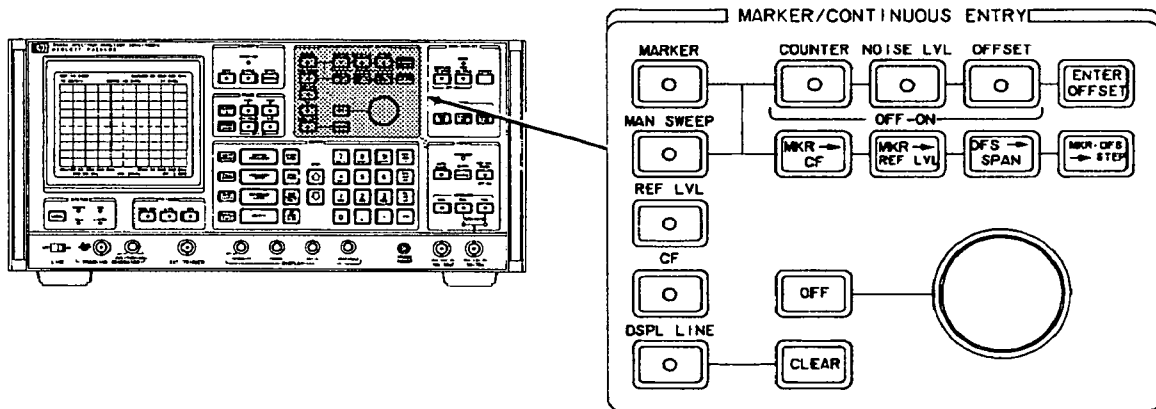

OVERVIEW

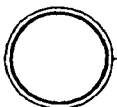

Continuous Entry control: continuous adjustment of Marker frequency, Manual frequency, Reference Level, Center Frequency or Display Line; depending on which Continuous Entry function is activated.



Deactivates Continuous Entry function that is currently activated.



Couples Continuous Entry control to the instrument's tunable Marker to permit the Marker to be moved from point-to-point along the CRT trace.



Selects Manual mode; sets Manual frequency equal to current Marker frequency; couples Continuous Entry control to Manual frequency to permit manual frequency tuning.



Couples Continuous Entry control to Reference Level for continuous Reference Level adjustment. Resolution is 0.1 dB.



Couples Continuous Entry control to Center Frequency to permit Center Frequency tuning. Resolution is 0.1% of Frequency Span or 0.1 Hz.

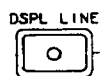

Places horizontal Display Line on CRT screen; couples Continuous Entry control to Display Line for adjustment of Display-Line amplitude. Display Line readout indicates Display-Line amplitude in "dB" relative to the Reference Level.



Deactivates  function (if activated); clears Display Line from CRT screen, but does not reset Display Line or change its amplitude.



Precisely measures the frequency of the response on which the marker is positioned. Marker must be at least 20 dB above noise and 20 dB above any unresolved signal that is inside the IF filter skirts.

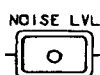

Provides direct readout of rms random noise spectral density (at the Marker or Manual frequency) normalized to a 1 Hz noise power bandwidth. All correction factors are included in the internal noise-measurement routine.



Displays difference between frequency in Offset Register and current Marker, Counter or Manual frequency; and "dB" difference between amplitude in Offset Register and current Marker amplitude.



Stores current (absolute) Marker, Counter or Manual frequency and Marker amplitude in Offset Register. (Operative only when  activated.)



Sets Center Frequency equal to current (absolute) Marker, Counter or Manual frequency (whichever is being displayed); and sets Marker to Center-Frequency point on CRT trace.



Sets Reference Level equal to current (absolute) Marker amplitude, indicated by "MARKER" or "MANUAL" readout.



Sets Frequency Span equal to displayed Offset frequency; i.e., the difference between the frequency in the Offset Register and the current Marker, Counter or Manual frequency. (Operative only when  function activated.)



Sets Center Frequency Step Size (also Manual frequency step size) equal to current Marker, Counter, Manual or Offset frequency (whichever is being displayed).

DETAILED ASPECTS OF OPERATION

The following discussion is divided into two parts:

- a. Continuous Entry Functions
- b. Marker Functions

The Continuous-Entry functions are described first to provide background information for the various Marker functions.

CONTINUOUS ENTRY FUNCTIONS

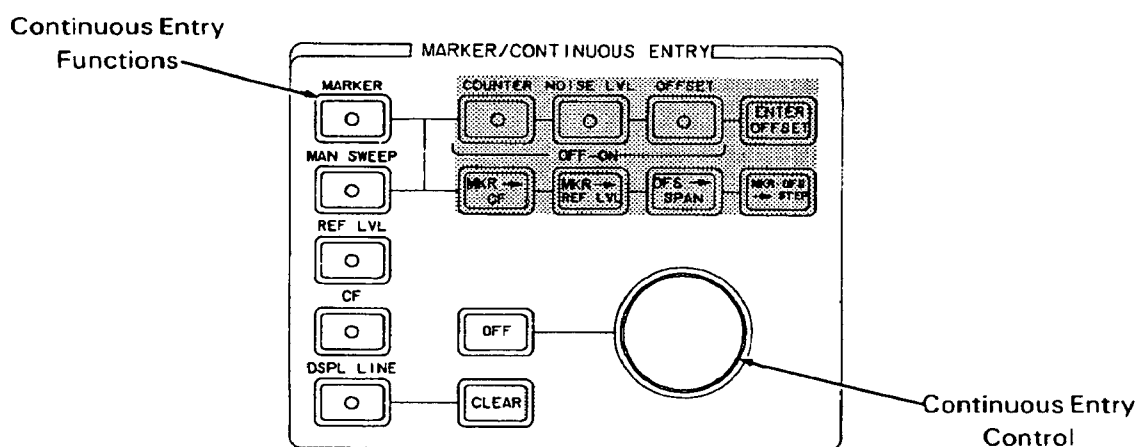

Continuous Entry Control

The Continuous Entry control has the physical appearance and “feel” of an ordinary analog potentiometer. Nevertheless, it is actually a digital device called a “Rotary Pulse Generator” or “RPG”. As the Continuous Entry knob is rotated, the RPG generates electrical impulses which, depending on the direction of rotation, either increment (CW) or decrement (CCW) the value of the function or parameter that is under Continuous Entry control. The increment size is internally regulated to maintain comfortable sensitivity and adequate resolution for the parameter being adjusted.

Continuous Entry Function Keys

The Continuous Entry function keys are aligned vertically along the left-hand edge of the MARKER/CONTINUOUS ENTRY control block. Only one of these keys can be activated at a time, and the key that is activated determines the parameter or function to which the Continuous Entry control is coupled. The OFF key, located to the left of the Continuous Entry control, deactivates the Continuous Entry function that is currently activated. This, in effect, turns off the Continuous Entry control.

When a Continuous Entry function is initially activated, the parameter or function that is selected does not change until the Continuous Entry control is rotated. Also, a parameter or function that is under Continuous Entry control can still be changed (where applicable) by Step Entry, Numeric Entry or Marker Entry.



Marker Function



With the MARKER function activated, the Continuous Entry control is coupled to the instrument's tunable Marker. The tunable Marker, whose frequency and amplitude appears in the upper right-hand corner of the CRT screen, can be used to directly measure the absolute frequency and amplitude of any point on a displayed trace. The Marker can also be used in conjunction with the various Marker/Manual functions to perform relative (Offset) measurements, Counter and Noise Level measurements and change parameter values.

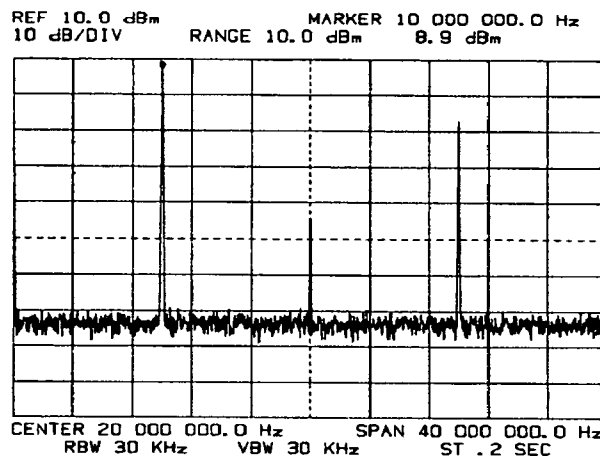



Measure absolute frequency and amplitude of on-screen responses with



The tunable Marker is simply an intensified dot which appears on the CRT trace. As long as the DISPL LINE function is deactivated, the Marker dot is displayed whether or not the MARKER function is activated.

Marker Trace Priority and Amplitude Display Units

The Marker appears on the trace that is selected by the TRACE function keys:

- With  activated, the Marker is displayed on the Current ("A" or "A-B") Trace.
- With  activated and  deactivated, the Marker appears on the "B" Trace.

When the Marker is on the "A" or "B" Trace, its absolute amplitude is displayed in the same units as the Reference Level; i.e., dBm, dBV or rms volts. When the Marker is on the "A-B" Trace, its amplitude, displayed *only* in dB, indicates the amplitude of Trace "A" *relative* to Trace "B".

NOTE

When using the Marker to measure the frequency and amplitude of a stored trace (i.e., the "B" Trace or an "A" or "A-B" Trace that is retained on the CRT screen), the Start Frequency, Stop Frequency, Reference Level and Vertical Scale settings must be the same as they were when the trace was originally plotted. If different settings are used, the Marker's frequency and amplitude will not correspond to the true frequency and amplitude of the points on the stored trace.



Marker Amplitude Resolution and Accuracy

When the Marker amplitude is displayed in dBm, dBV or dB, the amplitude resolution is 0.1 dB, 0.05 dB, 0.02 dB or 0.01 dB, corresponding to the Vertical Scale setting (i.e., 10 dB, 5 dB, 2 dB or 1 dB per-division, respectively).

When the Marker amplitude is displayed in volts, the amplitude resolution is limited to approximately 0.1 dB or 1%. This limitation is the result of the rounding off process that is used in the mathematical conversion from dBV to volts.

The Marker amplitude accuracy is determined by the Reference Level Accuracy and Amplitude Linearity specifications listed in Table 1-1. When the Marker amplitude reading is equal to the Reference Level, the Marker amplitude accuracy is equal to the Reference Level accuracy which includes frequency response, Range and scale errors. When the Marker amplitude is not equal to the Reference Level, the Amplitude Linearity specification must be added to the Reference Level Accuracy specification to determine the Marker accuracy.

Marker Frequency Resolution and Accuracy

The Marker frequency resolution is limited to 0.1% of the Frequency Span (Frequency Span divided by 1,000). This is equal to the frequency spacing between the points on the CRT trace. As the Marker frequency is tuned, the Marker dot jumps from point-to-point along the trace and the Marker readout indicates the frequency and amplitude at each point.

The peak detection system that is used in the 3585A insures that the peak of any response is displayed at a point on the CRT trace. However, the frequency of the point at which the peak is displayed, may differ from the true peak frequency. This limitation can be overcome by:

- a. Using the COUNTER function.
- b. Narrowing the Frequency Span to improve the Marker's frequency resolution and accuracy.
- c. Using the Manual mode to improve the frequency resolution.

The Marker frequency accuracy is:

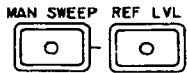

$$\pm 0.2\% \text{ of Span} + \text{RBW}$$

This worst-case specification reflects the maximum error that will be encountered when using the Marker to measure the frequency of a signal. The specification includes a potential Marker error of $\pm 0.2\%$ of the Frequency Span (i.e., 2 points on the CRT trace) plus a dynamic error equal to the Resolution Bandwidth (RBW) setting. The Marker error accounts for any frequency drift within the instrument and frequency errors caused by the limited Marker resolution and the effects of peak detection. The dynamic error accounts for frequency offsets caused by sweeping. This specification is somewhat conservative: When the instrument is sweeping at the optimum (maximum-calibrated) rate, the frequency offset or "skew" is *typically* about 33 percent of the RBW setting. This frequency skew, directly proportional to sweep rate, can be reduced by a factor of four by *increasing* the Sweep Time two steps from the optimum setting.



Manual Sweep Function



The MAN SWEEP function can be activated by pressing the  key *or* the  key (located in SWEEP block). Pressing either key deactivates the Continuous Entry function that is currently activated; and also deactivates the CONT or SINGLE Sweep function, selects the Manual mode and sets the Manual frequency equal to the current Marker frequency. The MANUAL Entry key prefaces the Manual frequency, enabling it to be changed by Step Entry or Numeric Entry. The MAN SWEEP key couples the Continuous Entry control to the instrument's frequency control system to permit manual frequency tuning.

Once the Manual mode has been selected, the instrument remains in that mode until the CONT or SINGLE Sweep function is reactivated. Reactivating the CONT or SINGLE Sweep function deactivates the MAN SWEEP function and automatically activates the MARKER function.

When operating in the Manual mode, you may deactivate the MAN SWEEP function by pressing the OFF key or by activating a different Continuous Entry function. (Any of the Continuous Entry functions can be used in the Manual mode.) However, the MAN SWEEP function will automatically be reactivated when you preface the Manual Frequency.

Manual Sweep Resolution

The Manual frequency tuning is incremental; but, unlike the normal Marker tuning, the Manual frequency resolution is not limited by the resolution of the point-by-point display. The frequency resolution for the MAN SWEEP function is approximately 3 percent of the Resolution Bandwidth (Table 1) or 0.1% of the Frequency Span (whichever is smaller). Maximum frequency resolution is 0.1 Hz.

Table 1. Manual Tuning Increments (as determined by RBW setting)

Resolution Bandwidth	Increment Size
30 kHz	1 kHz
10 kHz	300 Hz
3 kHz	100 Hz
1 kHz	30 Hz
300 Hz	10 Hz
100 Hz	3 Hz
30 Hz	1 Hz
10 Hz	0.3 Hz
3 Hz	0.1 Hz

As the Manual frequency is tuned by Continuous Entry, the Marker dot jumps from point-to-point on the horizontal axis and deflects vertically to indicate the real-time signal amplitude at the Manual frequency. The resulting trace is plotted (and retained) on the CRT screen. The Manual frequency and amplitude can be read directly from the "MANUAL" readout which appears in place of the Marker readout in the upper right-hand corner of the CRT screen. Manual frequency tuning does not initiate an Automatic Calibration cycle.

Reference Level Function



With the REF LVL function activated, the Reference Level can be manually adjusted from 100 dB below RANGE to 10 dB above RANGE using the Continuous Entry control. Continuous Entry resolution is 0.1 dB for all Vertical Scale (dB/DIV) settings.

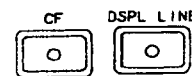

Center Frequency Function

The CF function couples the Continuous Entry control to the Center Frequency, enabling the Center Frequency to be manually tuned within the range of 0 Hz to 40.1 MHz. The tuning increments are internally set to 0.1% of the Frequency Span; maximum Center-Frequency resolution is 0.1 Hz. When the Center Frequency is changed by Continuous Entry, the instrument automatically calibrates approximately two seconds after the change is made.

Display-Line Functions

When the DISPL LINE function is initially activated, a horizontal Display Line appears at the bottom of the CRT screen; and the Display-Line amplitude, in dB relative to the Reference Level, is displayed in place of the "MARKER" or other readout in the upper right-hand corner of the screen. With the DISPL LINE function activated, the Display Line can be positioned anywhere on the vertical scale using the Continuous Entry control. The adjustment range and amplitude resolution is determined by the Vertical Scale setting:

VERTICAL SCALE SETTING	DISPL LINE RANGE	DISPL LINE RESOLUTION
10 dB/DIV	100 dB	0.1 dB
5 dB/DIV	50 dB	0.05 dB
2 dB/DIV	20 dB	0.02 dB
1 dB/DIV	10 dB	0.01 dB

The Display-Line function is particularly useful for harmonic distortion measurements where the fundamental is first moved to the top of the screen and the Display Line is then used to measure the harmonics in dB relative to the fundamental. This application is illustrated and described in Chapter 2.



NOTE

None of the Marker functions will operate when DISPL LINE is activated.

Display Line Retained On Screen

Once the Display Line has been positioned, it will remain on the screen until the CLEAR key is pressed or the instrument is preset. You may, therefore, deactivate the DISPL LINE function and freely use any of the other Continuous Entry functions without disturbing the Display-Line setting.

When the Display Line is retained on screen, the Display-Line amplitude will either continue to be displayed or will be replaced by other information, depending on the selected Continuous Entry function:

- If the DISPL LINE function is deactivated by pressing  ;  ; or  , the Display-Line amplitude will continue to be displayed until the CLEAR key is pressed or the MARKER or MAN SWEEP function is activated.
- When the MARKER or MAN SWEEP function is activated, the Marker or Manual information is displayed in place of the Display-Line amplitude. The Display-Line amplitude does not reappear until the DISPL LINE function is reactivated.

DISPL LINE



Changing the Vertical Scale setting will not change the Display-Line position; but it will redefine the Vertical scale and change the Display-Line amplitude reading. For instance if the Vertical Scale is set to 10 dB/DIV and the Display Line is seven divisions below the Reference Level, the Display-Line amplitude will be -70.0 dB. If the Vertical Scale is then changed to 1 dB/DIV, the Display-Line amplitude will become -7.00 dB.

The Display Line is strictly a display function and is totally unaffected by a change in the Reference Level or TRACE functions.

NOTE

When the "A-B" Trace is displayed, the Display-Line amplitude is still referenced to the top graticule line. The "A-B" Trace, however, is referenced to the middle graticule line.

Clearing The Display Line

When the Display-Line CLEAR key is pressed, the Display Line is cleared from the CRT screen; but its *amplitude setting is automatically retained* until the instrument is preset or turned off. Thus, when the DISPL LINE function is reactivated, the Display Line reappears at the same amplitude as when the CLEAR key was pressed.

Clearing the Display Line does not reactivate MARKER or any of the other Continuous Entry functions. The Marker and its readout will not reappear on the CRT screen until the MARKER or MAN SWEEP function is activated or the instrument is preset.

MARKER FUNCTIONS

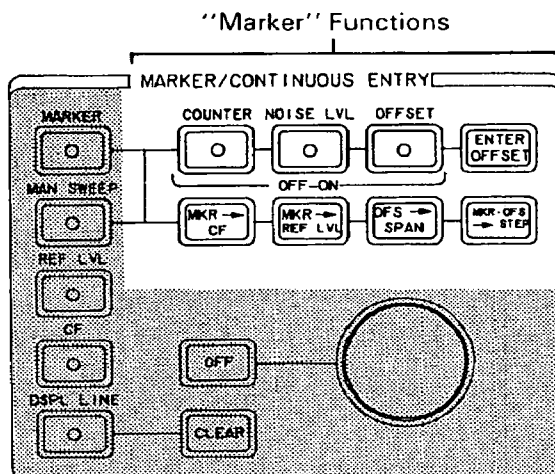
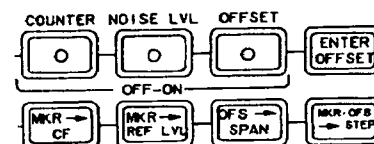

NOTES

- As indicated by the lines between the ; and "Marker" function keys, the "Marker" functions operate in conjunction with the tunable Marker and in the Manual mode. However, the "Marker" functions are operative whether or not the or function is activated.
- None of the "Marker" functions will operate when the function is activated.
- The and functions operate only when the instrument is sweeping or in the Manual mode. They will not operate after a single sweep has terminated. (All other functions remain operative after a single sweep.)
- The and functions are operative only when the function is activated.

Marker Function Keys

The "Marker" function keys are aligned horizontally in two rows along top of the MARKER/CONTINUOUS ENTRY control block. The ; ; and keys are "OFF-ON" functions; i.e., press once to activate, press again to deactivate. None of these functions are activated by . The remaining keys are momentary-contact functions; e.g., pressing sets the Reference Level equal to the Marker amplitude.



Counter Function

The Marker frequency accuracy is limited by the display resolution and sweep dynamics. To overcome this limitation, the COUNTER function can be used to precisely measure the frequency of the signal that is producing the response on which the Marker is positioned.

To use the COUNTER function, the operator simply sets the Marker at least 20 dB above the noise on the skirt or peak of the response to be measured. The "COUNTER" frequency, displayed in place of the Marker frequency, very accurately indicates the true signal frequency.

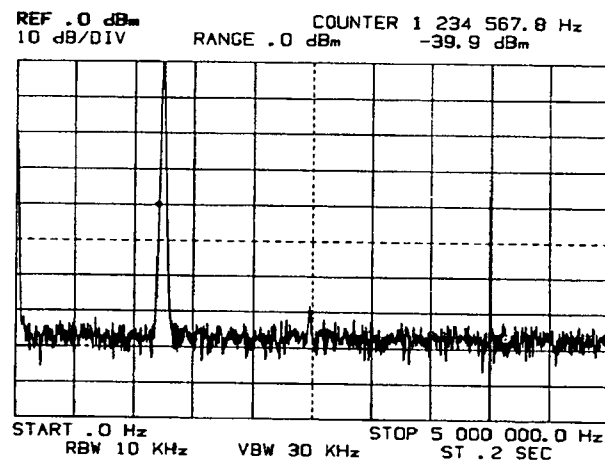

The "COUNTER" readout indicates the true signal frequency which applies to the peak of the response on which the Marker is positioned. (Note that the amplitude readout indicates the *Marker* amplitude rather than the peak amplitude.)

Counter Accuracy

The specified frequency accuracy of the Counter is:

$$\pm 0.3 \text{ Hz} \pm 1 \times 10^{-7} \text{ per month of counted frequency.}$$

This specification applies only when the Marker is at least 20 dB above the noise and 20 dB above any unresolved signal that is inside the IF filter skirts. When an external frequency reference is used, the frequency accuracy of the external reference can be substituted for the internal Oven Reference time coefficient (i.e., $\pm 1 \times 10^{-7}$ per month) in the Counter accuracy specification.



Requirements For Use

To properly use the COUNTER function, the following conditions must exist:

- a. The COUNTER function must be activated.
- b. The DISPL LINE function must be deactivated.
- c. The instrument must either be sweeping or be in the Manual mode.

(The Counter will not operate after a single sweep has terminated.)

- d. The VIEW A Trace function must be activated.

(The Counter reading applies only to the Current ("A" or "A-B") Trace. A counter reading cannot be obtained when the "B" Trace is displayed by itself and Counter measurements cannot be performed on the "B" Trace.)

- c. To obtain an accurate, stable Counter reading, the Marker must be at least 20 dB above the noise and 20 dB above any unresolved response.

(If the Marker is between responses or too near the noise, the Counter reading will be unstable and, in some cases, completely erroneous.)

NOTES

1. When the instrument is sweeping, the counting operation that is performed during each sweep will sometimes produce dynamic "glitching" on the response being measured. This effect is normal and it does not degrade the accuracy of the frequency or amplitude readout.

2. Unstable Counter readings may be encountered in cases where a small response is masked by the skirt of a large response. With the Marker positioned on what appears to be the skirt of a single response, the Counter reading fluctuates as it tries to capture the average frequency of the two responses. If the small response is well hidden, this effect may appear as a Counter malfunction; but it is actually a benefit since it can reveal the presence of a response that might not otherwise be detected. (The responses can be separated and measured individually by narrowing the Resolution Bandwidth.)

Measurement Techniques

The COUNTER function can be used three ways:

- a. With the instrument sweeping.
- b. In the Manual mode with the Marker at the Manual frequency point on the CRT trace.
- c. In the Manual mode with the Marker independently tuned away from the Manual frequency.



Instrument Sweeping

When the instrument is sweeping, the Counter is triggered each time the sweep passes through the Marker frequency. When the sweep reaches the Marker frequency, the sweep stops (for 0.25 to 0.6 seconds) to permit the frequency to be counted. At the end of the counter period, the sweep resumes and the "COUNTER" frequency is displayed in place of the Marker frequency.

The "COUNTER" frequency continues to be displayed and updated by each frequency sweep until the Marker is moved. While the Marker is being tuned, the readout indicates the "MARKER" frequency to assist the operator in locating the response to be measured. When the Marker becomes stationary, the Marker frequency continues to be displayed until the sweep again passes through the Marker frequency and a new "COUNTER" reading is generated.

During a single sweep, the Counter reading is generated or updated when the sweep passes through the Marker frequency. The "COUNTER" reading continues to be displayed after the sweep has terminated. However, once the Marker is moved, the display reverts to "MARKER" and a Counter reading cannot be obtained until another sweep is made.

During swept measurements, the time required to obtain a Counter reading depends largely on the Sweep Time setting. Once the Counter has been triggered by the frequency sweep, the actual counting operation takes anywhere from 0.25 seconds to 0.6 seconds, depending on the frequency difference between the Marker and the peak of the response being measured. The counting time can be minimized by setting the Marker at or near the peak of the response. When the Marker is on the noise floor where accurate readings cannot be obtained, the sweep is delayed by approximately 0.5 seconds while the Counter tries to capture the frequency of the random noise.

Manual Mode*

In the Manual mode, Counter measurements can be performed at the Manual frequency or at the Marker frequency with the Marker independently tuned away from the Manual frequency point. One major advantage of the Manual mode is that Counter measurements can be made in "real-time" without waiting for a frequency sweep. The Counter is triggered continuously at a rate proportional to the Counter period. Again, the Counter period varies from approximately 0.25 seconds to 0.6 seconds, depending on the frequency difference between the Marker and the peak of the response being measured.

*See Chapter 3 for details concerning the use of the Counter in the Manual mode.



Marker To Center-Frequency Function

Pressing the  key sets the Center Frequency equal to the current *absolute* Marker, Counter or Manual frequency; and automatically moves the Marker dot to the Center-Frequency point on the CRT trace. This function provides a quick and easy way to move a signal of interest to the center of the screen where it can be measured more accurately and/or expanded horizontally (by narrowing the Span) to observe close-in spurious responses, noise sidebands, etc.

NOTES

1. The  function remains operative when the *OFFSET* function is activated; but the Center frequency is always set equal to the absolute Marker, Counter or Manual frequency:

<i>Offset Readout</i>	<i>CF Set Equal to</i>
"OFFSET"	<i>absolute Marker frequency</i>
"OFS CNTR"	<i>absolute Counter frequency</i>
"OFS MAN"	<i>absolute Manual frequency</i>



2. In the Manual mode, the  function sets the Center Frequency and Manual frequency equal to the "COUNTER" frequency (if COUNTER activated); or the "MARKER" frequency if the Marker is not at the Manual measurement point.

3. Pressing  when the "COUNTER" frequency reading is higher than 40.1 MHz will cause the beeper to sound and the message, "COUNTER OUT OF LIMIT" to appear on the CRT screen. This error message simply indicates that the Center-Frequency entry cannot be accepted because it is higher than 40.1 MHz; it does not indicate a Counter malfunction.

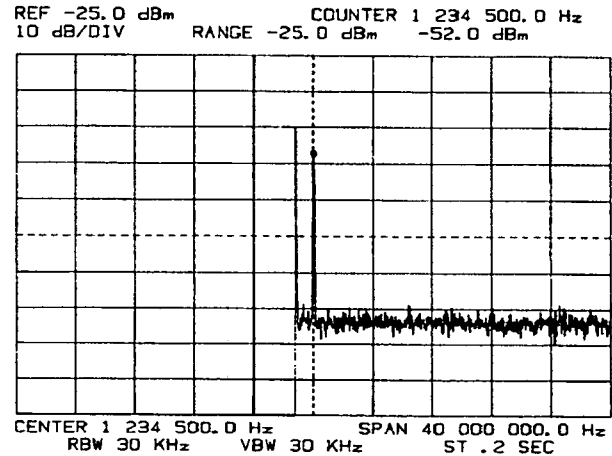
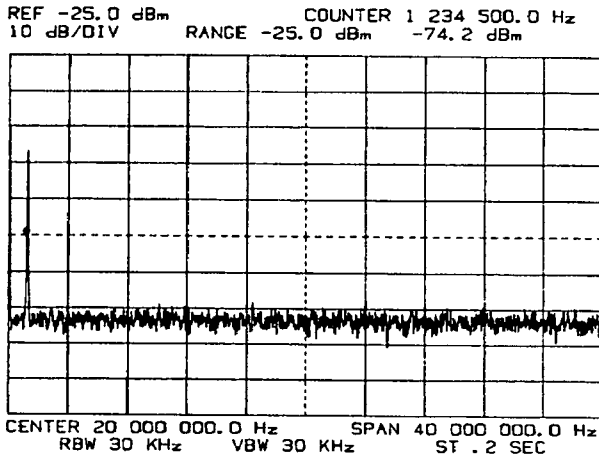

USE  AND  TO QUICKLY ZOOM-IN ON A SIGNAL OF INTEREST:



a. With  and  activated, set Marker on skirt or peak of response; allow time for "COUNTER" reading to appear.

b. Move response to center of screen by pressing .

(This sets Center Frequency equal to "COUNTER", and automatically places Marker at Center-Frequency point.)

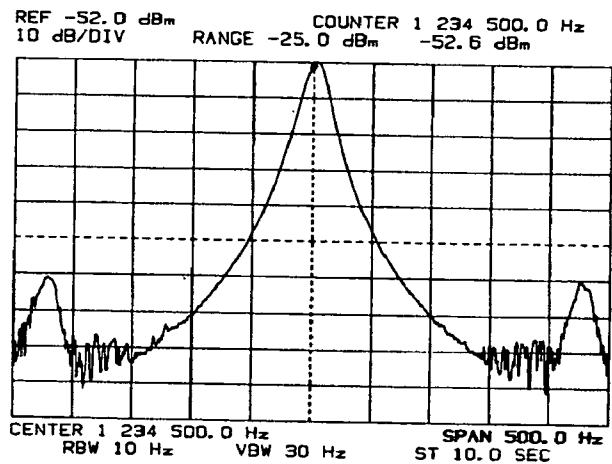
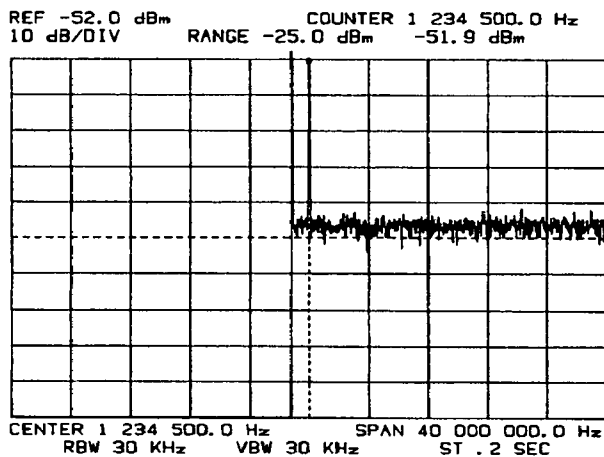



c. Move response to top of screen by pressing .



d. Narrow Frequency Span to obtain required resolution.

(The response is skewed slightly off center due to sweep dynamics.)



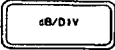

Marker To Reference Level Function

Pressing the  key sets the Reference Level (top graticule line) equal to the current absolute Marker amplitude on the CRT trace. This function allows you to very rapidly move a response to the top of the screen where it can be measured with higher amplitude accuracy and/or expanded vertically by reducing the Vertical Scale (dB/DIV) setting. The procedure for using the  function is as follows:



- a. Set the Marker to the desired Reference Level amplitude on the CRT trace or to the peak of a response that is to be moved to the top of the screen.
- b. Press  .
- c. If desired, expand the response vertically with   .

Effect Of Scale Errors

When a low-level response is moved to the top of the screen using the  function, the peak of the response may arrive at a point slightly above or below the top graticule line. This effect is caused by non-linearity in the vertical scale:



For example, if the Reference Level is set to 0 dBm, a response whose peak amplitude is -65.0 dBm could, under worst-case conditions, measure -64.0 dBm. Pressing  (with the Marker set to the peak of the response) would set the Reference Level to -64.0 dBm, causing the response to move to the top of the screen. At that point, however, the worst-case scale error is only ± 0.5 dB; so the peak of the -65.0 dBm response would appear somewhere between -64.5 dBm and -65.5 dBm, which is *below* the 64.0 dBm Reference Level. Because of this potential error, the amplitude of a full-scale response should always be read from the *Marker* readout, *not* the Reference Level readout.

Functional Capabilities

The  function will operate with the instrument sweeping, in the Manual mode or after a single sweep has terminated. No matter which trace the Marker is on, the  function sets the Reference Level equal to the absolute Marker amplitude. Keep in mind, however, that a stored trace is totally unaffected by the Reference Level or any other parameter. A response that is on a stored trace cannot be moved to the top of the screen. When the instrument is sweeping, points on the CRT trace will reflect a change in the Reference Level *only* as they are updated by the frequency sweep. In the Manual mode, the Manual measurement point is the only point on the trace that is updated and is, therefore, the only point that will reflect a change in the Reference Level.



A response whose peak is above the Reference Level can be moved down to the top graticule line using the  function; but this capability is limited:

The Marker's amplitude range extends approximately 0.2 divisions above the Reference Level.* If the peak of a response is within the Marker's amplitude range, that peak can be moved down to the top graticule line by pressing  one time. On the other hand, if the peak is above the Marker's amplitude range, pressing  will merely increment the Reference Level in 0.2-division steps. Since it may take dozens of steps to finally move the peak of a high-level response onto the screen, it is generally preferable to increment the Reference Level using the STEP keys or adjust it with the Continuous Entry control.

*0.2 divisions = 2 dB, 1 dB, 0.4 dB or 0.2 dB; depending on the Vertical Scale setting.

Offset Function

The OFFSET function can be used to measure the relative frequency and amplitude between any two points within the measurement range of the instrument. It can also be used with the function for making signal-to-noise ratio measurements and with the and functions to set the Frequency Span and Center-Frequency Step Size.

Basic Offset Measurements

The primary purpose of the OFFSET function is to provide an easy way to measure the relative frequency and amplitude between two points on a given trace. The procedure for making this basic Offset measurement is as follows:

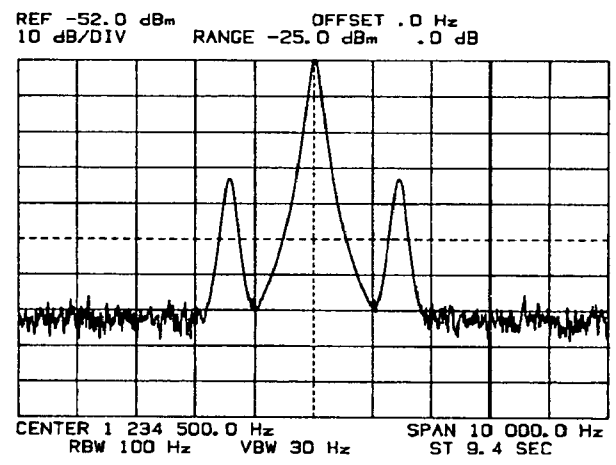

- a. Set the Marker to the desired reference point with . Activate and then press .

(This stores the "MARKER" frequency and amplitude in the Offset Register.)

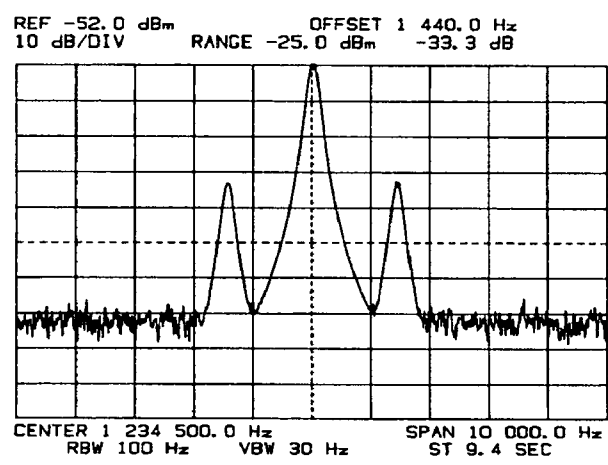

- b. Set the Marker to the point of interest on the trace and observe the "OFFSET" reading.



Offset Readings

When the  key is pressed, the Marker's frequency and amplitude is stored in the instrument's Offset Register. The frequency and amplitude in the Offset Register is then algebraically subtracted from the current Marker reading to produce the "OFFSET" reading. The "OFFSET" reading, therefore, indicates the Marker's current frequency and amplitude *relative* to the frequency and amplitude in the Offset Register.

Offset readings are displayed in place of the normal Marker readings in the upper right-hand corner of the CRT screen. The Offset frequency is displayed in "Hz" with 0.1 Hz resolution; the Offset amplitude is displayed in "dB" (it cannot be displayed in volts). Offset amplitude resolution is 0.1 dB, 0.05 dB, 0.02 dB or 0.01 dB, corresponding to the Vertical Scale setting.

The Stationary Marker

When the tunable Marker is moved away from the reference point (i.e., the point where  pressed), a stationary marker dot remains at that point. The stationary marker normally provides a convenient visual indication of the Offset reference, but it can be deceiving:

- a. The stationary marker appears at the point on the CRT trace that represents the frequency in the Offset Register. However, the amplitude of the stationary marker is determined entirely by the amplitude of the *trace* on which it is displayed. As long as the trace amplitude does not change, the stationary marker will provide an accurate indication of the reference amplitude. If the amplitude of the trace changes, however, the amplitude of the stationary marker will also change and will no longer represent the reference amplitude.

Offset amplitude readings are calculated according to the amplitude that is in the *Offset Register* and are totally unaffected by the amplitude of the stationary marker dot.

- b. When the tunable Marker is on the skirt of a response and the COUNTER function is activated, the "COUNTER" frequency readout indicates the frequency at the peak of the response. When the ENTER OFFSET key is pressed, the "COUNTER" frequency is stored in the Offset Register and the stationary marker appears at the *peak* of the response. However, the amplitude that is stored in the Offset Register is the amplitude of the *tunable Marker*, rather than the peak amplitude indicated by the stationary Marker.

When entering Offsets using the COUNTER function, always set the tunable Marker to the peak of the response; unless you are making special measurements where it is necessary to store a specific Marker amplitude.

Stationary Marker Not Needed To Make Offset Measurements

Since Offset readings are calculated according to the reference parameters that are stored in the Offset Register, valid Offset readings can be obtained whether or not the stationary marker is on the screen. For example, the display in Figure A shows the spectral components of a 10 MHz square wave. With the Offset reference set to the peak of the fundamental and the tunable Marker set to the peak of the third harmonic, the "OFFSET" reading indicates the frequency and amplitude of the third harmonic relative to the fundamental.

In Figure B, the Center Frequency and Span have been changed so that only the third harmonic is being displayed. Even though the stationary marker is no longer on the screen, the "OFFSET" reading still indicates the frequency and amplitude of the harmonic relative to the fundamental frequency and amplitude in the Offset Register.

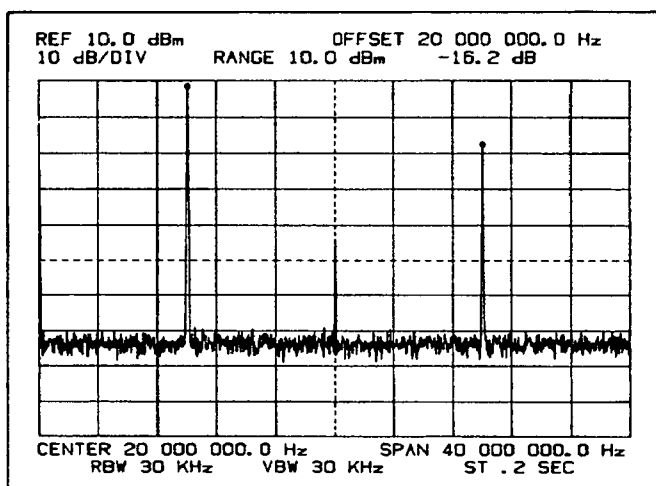

"OFFSET" reading indicates frequency and amplitude of third harmonic relative to 10 MHz fundamental.

Figure A.

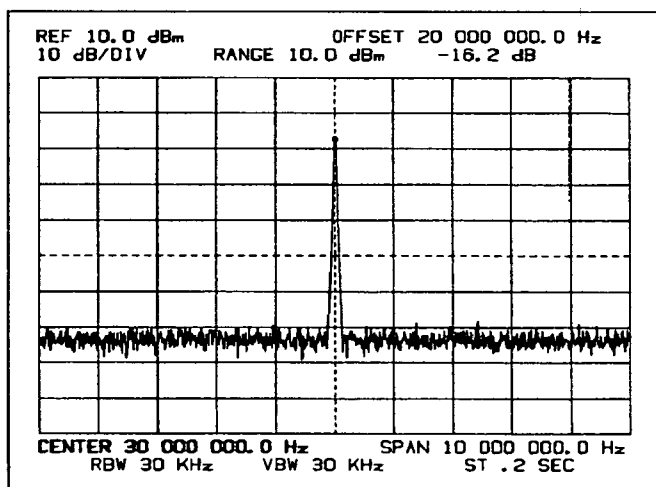



Stationary Marker no longer displayed; but "OFFSET" reading still indicates frequency and amplitude of third harmonic relative to fundamental frequency and amplitude in Offset Register.

Figure B.



Offset Entry Techniques

When the instrument is first turned on or  is pressed, the Offset Register is automatically set to 0 Hz and 0 dBV. Offsets can be entered *only* when the OFFSET function is activated. Once an Offset has been entered, it is retained in the Offset Register until a different Offset is entered or until the instrument is preset or turned off.

When the  key is pressed, the *amplitude* that is stored in the Offset Register is one of the following:

- a. The *absolute* Marker amplitude on the CRT trace.
- b. The absolute real-time amplitude at the Manual frequency.

(When the instrument is in the Manual mode and the Marker is at the Manual measurement point on the CRT trace.)

- c. When the  TRACE function is activated, *two* amplitude values are stored in the Offset Register:

1. The “dB” amplitude of the “A-B” Trace at the Marker or Manual frequency (whether or not the “A-B” Trace is being displayed).
2. The absolute amplitude of the “B” Trace at the Marker setting.

The “A-B” amplitude is used as the Offset reference only when the “A-B” Trace is displayed. If the Marker is on the “B” Trace (i.e., the “B” Trace is displayed by itself) or, if the A-B function is deactivated after the Offset is entered and the Marker appears on the “A” Trace, the “B” Trace amplitude automatically becomes the Offset reference. For this reason, you cannot enter an Offset on the “A-B” Trace and make an Offset measurement between “A-B” and “B” or “A-B” and “A”.

Once an Offset has been entered with the A-B function activated, the instrument will (until it is preset) continue to store two amplitude values each time the ENTER OFFSET key is pressed:

When the Marker is on the “A” Trace, the “A” and “A-B” amplitude values are stored in the Offset Register.





When the Marker is on the “B” Trace, the “B” and “A-B” amplitude values are stored in the Offset Register.

Offset measurements on the “A-B” Trace are relative to the “A-B” Offset reference and Offset measurements on the “A” or “B” Trace are relative to the absolute “A” or “B” Offset Reference. This completely inhibits Offset amplitude measurements between the “A” or “B” Trace and the “A-B” Trace.





The frequency that is stored in the Offset Register is the absolute “MARKER”, “COUNTER” or “MANUAL” frequency, depending on which functions are currently activated. Entry techniques are as follows:

a. With COUNTER *deactivated*:



1. Set the Marker to the desired reference frequency with   ; activate  and then press .

(This sets the Offset Reference equal to the “MARKER” frequency and amplitude. This technique can be used with the instrument sweeping, in the Manual mode or after a single sweep has terminated.)

2. Set the Manual frequency to the desired reference point, activate  and then press .

(The Marker automatically tracks the Manual frequency tuning. Pressing  sets the Offset Register equal to the current “MANUAL” frequency and amplitude.)

b. With COUNTER activated:

1. Set the tunable Marker or Manual frequency so that the Marker is at the *peak* of the response that is to become the reference. Activate  and then press .

(When  is pressed, the “COUNTER” frequency is stored in the Offset Register and the stationary marker appears at the peak of the response. However, it is the amplitude of the *tunable Marker* that is stored in the Offset Register.)



Offset Measurement Techniques

When the instrument calculates an Offset reading, it doesn't care how the offset was entered. It simply subtracts the frequency and appropriate amplitude value in the Offset Register from the current Marker, Manual or Counter reading. You may, therefore, enter an offset using any one of the techniques previously described and then make your offset measurement using the same technique or a different technique:

a. With COUNTER *deactivated*:

1. Set the Marker to the point of interest on the displayed trace with  and observe the "OFFSET" reading.

(The "OFFSET" readout indicates the current *Marker* frequency and amplitude relative to the frequency and amplitude in the Offset Register. This technique can be used when the instrument is sweeping, in the Manual mode or after a single sweep has terminated. It can also be used to measure offsets on the "B" Trace.)

2. Set the Manual frequency to the point of interest and observe the "OFS MAN" (Offset Manual) reading.

(The "OFS MAN" readout indicates the current *Manual* frequency and amplitude relative to the frequency and amplitude in the Offset Register.)

b. With COUNTER activated:

1. Set the Marker or Manual frequency so that the Marker is at the *peak* of the response to be measured. Observe the "OFS CNTR" (Offset Counter) reading.



(The "OFS CNTR" readout indicates the *Counter* frequency and *Marker* amplitude relative to the frequency and amplitude in the Offset Register. If the Marker is not at the *peak* of the response, the frequency reading will apply to the peak; but the amplitude reading will apply to the *Marker* setting.)

REMINDER

The Counter will operate only when the instrument is sweeping or in the Manual mode. To obtain accurate, stable counter readings, the Marker (or real-time amplitude at Marker frequency) must be at least 20 dB above the noise and 20 dB above any unresolved response. The Counter cannot be used to enter or measure offsets on a stored trace.

Offset Trace Priority and Offsets Between Traces

Offset measurements can be performed on the Current (“A” or “A-B”) Trace, the “B” Trace or between the “A” Trace and the “B” Trace. As previously described, Offset amplitude measurements *cannot* be performed between the “A-B” Trace and the “A” or “B” Trace:

- a. With  activated, the Marker appears on the “A” or “A-B” Trace, thus enabling offsets to be entered and/or measured on that trace.
- b. With  activated and  deactivated, the Marker appears on the “B” Trace, allowing offsets to be entered and/or measured on that trace.

NOTES

1. When entering or measuring offsets on a stored trace (i.e., the “B” Trace or a Current Trace that has been retained on the CRT), be sure that the Start Frequency, Stop Frequency Reference Level and Vertical Scale settings are the same as they were when the trace was originally plotted.

(If the frequency or amplitude parameters differ from the ones that were used when the trace was plotted, the Marker’s absolute frequency and amplitude will not correspond to the displayed trace and, in most cases, errors will be encountered in the Offset measurement.)

2. Do not store an “A-B” Trace in “B” and attempt to measure offsets between the stored “A-B” Trace and a different trace.

(When the “A-B” Trace is displayed in “B”, the Marker amplitude reading, from which the Offset reading is calculated, is the absolute Marker amplitude on the “B” Trace; not the relative amplitude between “A” and “B”. Measurements between a stored “A-B” Trace and a different trace are normally meaningless. Valid offset measurements can be performed on a Current or stored “A-B” trace as long as the Offset is entered and measured on that trace.)

OFFSET

Offsets can be measured between traces “A” and “B”; but *only* when both traces represent absolute frequency and amplitude. While relative amplitude measurements can be made between Traces “A” and “B” using the “A-B” TRACE function, the “A-B” function is applicable only when the frequencies of the two traces correspond. The OFFSET function can be used to measure the relative frequency and amplitude between any two points on the two traces, regardless of their frequency relationship. General procedures for measuring offsets between Traces “A” and “B” are as follows:

- a. To measure a point on “A” relative to a point on “B” (i.e., “A” - “B”):
 1. With VIEW B activated and VIEW A deactivated, set the Marker to the desired reference point on Trace “B”, activate OFFSET and then press ENTER OFFSET.
 2. With the VIEW A function activated (A-B function deactivated), set the Marker to the point of interest on the “A” Trace and observe the offset reading.





REMINDER

When entering or measuring offsets on the “B” Trace, be sure the Start Frequency, Stop Frequency, Reference Level and Vertical Scale settings are the same as they were when the trace was originally plotted.

- b. To measure a point on “B” relative to a point on “A” (i.e., “B” - “A”):
 1. With VIEW A activated (A-B deactivated), set the Marker to the desired reference point on Trace “A”, activate OFFSET and then press ENTER OFFSET .
 2. With VIEW B activated and VIEW A deactivated, set the Marker to the point of interest on Trace “B” and observe the offset reading.

Offset To Span Function

The Offset to Span function permits the operator to set the Start and Stop frequencies of the Span using the Marker, Counter or Manual function . This feature is particularly useful for narrowing the Span to magnify portions of the spectrum or for “zooming-in” on a particular response. The basic procedure for using the Offset to Span function is as follows:

- a. Set the Marker to the desired Start (or Stop) Frequency with   .
- b. Activate  and then press  .
- c. Set the Marker to the desired Stop (or Start) Frequency and press  .

The Offset to Span function is operative only when the OFFSET function is activated. Pressing the  key sets the Frequency Span equal to the “OFFSET”, “OFS MAN” or “OFS CNTR” frequency, whichever is currently being displayed. The Start and Stop frequencies are set equal to:

Readout	Start/Stop
“OFFSET”	frequency in Offset Register and current <i>Marker</i> frequency.
“OFS MAN”	frequency in Offset Register and current <i>Manual</i> frequency.
“OFS CNTR”	frequency in Offset Register and current <i>Counter</i> frequency.

The Start Frequency is automatically set equal to the lower of the two frequencies.



Operation In Manual Mode And With Counter

General procedures for using the Offset to Span function in the Manual mode and with the Counter are as follows:

a. In the Manual mode:

1. Set the Manual frequency to the desired Start Frequency (or Stop Frequency).
2. Activate the OFFSET function and press the ENTER OFFSET key.
3. Set the Manual frequency to the desired Stop Frequency (or Start Frequency).
4. Press .

b. With the Counter:

1. With the COUNTER function activated, set the tunable Marker or Manual frequency so that the marker dot is at least 20 dB above the noise floor on the skirt of the response whose peak is to become the Start (or Stop) Frequency.
2. Allow time for the Counter reading to be updated. Activate the OFFSET function and press the ENTER OFFSET key.
3. If the Stop (or Start) Frequency is at the peak of a response, leave the COUNTER function activated; if not, deactivate the COUNTER function.
4. If the COUNTER function is activated: Set the tunable Marker or Manual frequency so that the marker dot is at least 20 dB above the noise floor on the skirt of the response whose peak is to become the Stop (or Start) Frequency. Allow time for the Counter reading to be updated and press .

If the COUNTER function is deactivated: Set the tunable Marker or Manual frequency to the desired Stop (or Start) Frequency and press .



Marker-Offset To Step Function

Pressing the  key sets the Center Frequency Step Size equal to the frequency that is currently being displayed in the upper right-hand corner of the CRT screen:

Readout	Center Frequency Step Size
“MARKER”	current absolute Marker frequency.
“COUNTER”	absolute frequency at peak of response on which the Marker is positioned.
“MANUAL”	the frequency to which the analyzer is tuned in the Manual mode.
“OFFSET”	difference between current <i>Marker</i> frequency and frequency in Offset Register.
“OFS CNTR”	difference between current <i>Counter</i> frequency and frequency in Offset Register.
“OFS MAN”	difference between current <i>Manual</i> frequency and frequency in Offset Register.

The Center Frequency or Manual frequency can be incremented or decremented in steps equal to the Center-Frequency Step Size using the STEP keys. The ability to step the Center or Manual frequency allows you to quickly and easily measure signals that are equally spaced in frequency; and the Marker-Offset to Step function provides a very convenient way to enter the step size. Procedures for using the Marker-Offset to Step function are included in Chapters 2 and 3.



Noise Level Function



Random noise spectral density measurements can be performed with almost any analyzer having good sensitivity, a well-defined selectivity characteristic and a narrow-band video filter. However, the normal procedures for making these measurements require time-consuming calculations and a considerable amount of painstaking effort on the part of the operator. With the 3585A NOISE LVL function, all of the work is done automatically. The operator simply sets the tunable Marker to the point of interest on the noise to be measured, activates the NOISE LVL function and observes the noise density reading which appears in place of the Marker amplitude in the upper right-hand corner of the CRT screen:

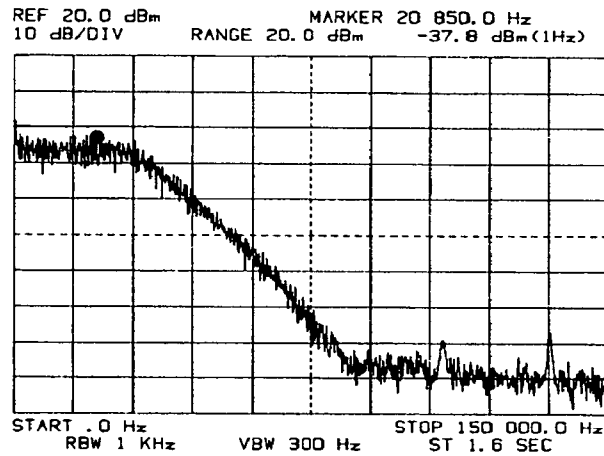

Noise level "dBm (1 Hz)" reading in top-right corner of screen indicates rms random noise spectral density at Marker, normalized to a 1 Hz noise power bandwidth.



To avoid damaging the instrument, the noise power applied to the Terminated input must not exceed 1 watt; and the broadband noise level applied to the High-Impedance input must not exceed 3.7V rms.



WHAT RANDOM NOISE SPECTRAL DENSITY IS:

A complex random noise signal theoretically consists of an infinite number of frequency components, each contributing an infinitesimal amount to the total power. This implies that if random noise were to be measured with an analyzer having an infinitesimal bandwidth, the noise reading would be zero at all frequencies. Going to the other extreme, a signal having an infinite number of components would have an infinite bandwidth and, therefore, infinite power. Since all physical systems have finite bandwidths, these two extremes are never encountered. However, the theory does reveal something about the nature of noise and permits one to conclude that it is possible to measure a finite quantity of random noise that is directly proportional to the measurement bandwidth.

In physics, the term "density" is used to describe quantity per unit volume, unit area or unit length. In exactly the same way, the term is applied to noise theory to describe the quantity of noise (i.e. power) per unit of bandwidth.

We know that we cannot truly measure the noise power at a specific frequency; but we can, using a narrow band spectrum analyzer, measure the average value of the total noise power quantized within its bandwidth. If we choose a Resolution Bandwidth setting that is narrow enough to resolve a flat portion of the noise power spectrum, we can safely assume that the average noise power (in watts) is directly proportional to the analyzer's noise power bandwidth.* We can, therefore, divide the total noise power by the analyzer's noise power bandwidth to determine the noise *density* per unit of bandwidth. By repeating this measurement at various points throughout the spectrum of interest, we can plot the noise power density as a function of frequency to graphically show the *power density spectrum*.

* *The analyzer's noise power bandwidth* is the ideal rectangular filter bandwidth having the same power response as the actual gaussian-shaped filter. In the 3585A, this is approximately 1.2 times the true 3 dB bandwidth established by the Resolution Bandwidth setting.



Requirements For Use

To properly use the NOISE LVL function, the following conditions must exist:

- a. The  function must be activated.
- b. The DISPL LINE function must be *deactivated*.
- c. The VIEW A Trace function must be activated, and the A-B function must be *deactivated*.
(Noise measurements can be performed *only* on the “A” Trace.)
- d. The instrument must either be sweeping or be in the Manual mode.
(Noise readings cannot be obtained after a single sweep has terminated.)
- e. The noise being measured must be *random* noise.
- f. The Resolution Bandwidth must be narrow enough to resolve a relatively flat portion of the noise spectrum.
- g. The external noise being measured must be equal to or greater than the analyzer’s internal noise.

(A practical limit of sensitivity is about 10 dB above the analyzer’s noise level.)

The 3585A Noise Readout

The 3585A NOISE LVL function provides a direct reading of the rms random noise spectral density (at the Marker), normalized to a 1 Hz bandwidth. Absolute noise level readings are displayed in the same units as the Reference Level; i.e., dBm, dBV or rms volts. Readings in “dBm (1 Hz)” indicate the noise power density in dB relative to one milliwatt across the 50-ohm or 75-ohm terminating impedance. Readings in “dBV (1 Hz)” indicate the random noise magnitude in dB relative to one volt rms i.e., 1V rms = 0 dBV (1 Hz). Readings in “volts $\sqrt{\text{Hz}}$ ” simply indicate the rms noise voltage in a 1 Hz bandwidth.

Relative (Offset) noise-level readings are always displayed in “dB (1 Hz)” relative to the amplitude in the Offset Register.

Random noise power (in watts) is equal to the voltage squared divided by the resistance. When working with arbitrary impedances, however, it is common practice to assume a resistance of one ohm and use voltage squared as the unit of power. Random noise spectral density is usually specified in terms of power or voltage squared per unit of bandwidth. Readings in “dBV” (and dBm) are proportional to voltage squared and can, therefore, be correctly expressed as “dBV per hertz” and written “dBV/1 Hz” or, as on the 3585A readout, “dBV (1 Hz)”. In practice, it is also common to work with the rms noise voltage. Given the noise power density in V^2/Hz , we can take the square root of the quantity to obtain “volts per root Hz” which is commonly written “V $\sqrt{\text{Hz}}$ ”. This again is simply a way of expressing the quantity of random noise voltage in a 1 Hz bandwidth.

How Noise Readings Are Calculated

To calculate a random noise spectral density reading, the 3585A first takes one hundred independent, real-time amplitude readings at the Marker frequency. It then computes the average of the one hundred readings, adds correction factors to compensate for the response of the instrument's average-responding detector and log converter, and finally normalizes the result to a 1 Hz noise power bandwidth.

Noise Measurement Time

To obtain one hundred statistically independent amplitude readings, the instrument must allow adequate settling time between each reading. Settling time is determined primarily by the Resolution Bandwidth setting.* Narrowing the Resolution Bandwidth increases the instrument's response time and, therefore, increases the time required to obtain a noise reading. Approximate noise measurement times are as follows:

Resolution Bandwidth	Noise Measurement Time
30kHz	0.3 sec.
10kHz	0.3 sec.
3kHz	0.3 sec.
1kHz	0.3 sec.
300Hz	0.3 sec.
100Hz	1.1 sec.
30Hz	3.3 sec.
10Hz	11 sec.
3Hz	33 sec.

*The time between samples must be equal to or greater than the reciprocal of the equivalent bandwidth established by the RBW and VBW settings. During a noise measurement, the 3585A internally selects the 100 Hz VBW; so the measurement time is unaffected by the VBW that is selected by the operator.



Noise Measurement Accuracy

A noise reading is a *statistical estimate* of the random noise spectral density, based on the average of one hundred independent samples. A precise measurement of the true random noise density would theoretically require an infinite number of samples and thus, an infinite averaging period. Fortunately, however, the average of a reasonable number of samples yields results that are sufficiently accurate for practical purposes. Statistical theory indicates that the confidence level in an average is proportional to the square root of the number of samples. Thus, the average of one hundred samples is ten times better than a single sample.

The result obtained with a finite number of samples differs from the true value and the error itself is a random variable. For this reason, we cannot specify an exact amount of error; but we can, knowing its probability distribution, determine the probability of it being within certain limits. Based on the normal gaussian probability distribution, we can state (with 95% confidence) that the *composite* noise measurement accuracy is equal to the specified Marker amplitude accuracy ± 1.3 dB. It is important to note that the *composite* noise level includes both the external noise to be measured and the analyzer's own internal noise.

Noise Measurement Techniques

Noise level measurements can be performed three ways:

- a. With the instrument sweeping and the Marker set to the point of interest on the noise floor.
- b. In the Manual mode with the Marker at the Manual measurement point on the CRT trace.
- c. In the Manual mode with the Marker independently tuned away from the Manual frequency.

Instrument Sweeping

When the instrument is sweeping, a noise reading is calculated each time the frequency sweep passes through the Marker frequency. When the sweep reaches the Marker frequency, the sweep stops for a period of 0.3 seconds to 33 seconds while the *real-time* noise reading is calculated. During this period, the *suffix* of the amplitude or noise reading currently appearing in the top-right corner of the CRT screen is displayed brighter than normal to indicate that a noise reading is being taken. (The SWEEP-ING light, located in the Sweep control block, goes out to indicate that the sweep has been interrupted.) At the end of the noise calculation, the sweep resumes, the initial or updated noise level reading appears on the readout and the suffix returns to normal brightness to indicate that a valid noise reading is available.

NOTES

1. *The 3585A automatically calibrates at two-minute intervals, but the Auto.Cal. will not interrupt a noise calculation. If an Auto. Cal. cycle is initiated during a noise calculation, the calibration is held-off until the calculation is complete.*
2. *Changing the Marker frequency or any of the frequency or amplitude parameters will abort the noise calculation (if any) currently in progress. If the change in parameters initiates an Automatic Calibration, the new noise calculation does not begin until the end of the calibration cycle.*



Manual Mode

When the instrument is in the Manual mode, noise readings are repetitively calculated and updated at a rate proportional to the noise measurement time. During a noise calculation, the suffix of the current amplitude or noise reading is displayed brighter than normal. At the end of each calculation, there is a delay of approximately 0.5 seconds during which the noise level readout is updated and the suffix returns to normal brightness to indicate that a new noise reading is available. Also, during this 0.5-second period, the CRT trace is updated at the Manual measurement point. The trace is *not updated* during a noise calculation.

In the Manual mode, noise-level measurements can be performed at the Manual frequency (i.e., with the Marker at the Manual measurement point) or at the *Marker* frequency with the Marker independently tuned away from the Manual measurement point:

- a. When the Marker is at the Manual measurement point, noise-level readings are calculated according to the real-time signal amplitude at the *Manual* frequency.

Changing the Manual frequency aborts the noise calculation that is currently in progress and causes the "MANUAL" readout to display the normal amplitude reading.. The normal amplitude reading then continues to be displayed until a new noise reading is calculated. When the Manual frequency is changed by Continuous Entry, a new noise calculation begins immediately after the change is made. When the Manual frequency is changed by Step Entry or Numeric Entry, the instrument automatically calibrates immediately after the change takes place and the noise calculation is held-off until the end of the calibration cycle.

- b. In the Manual mode, the Marker can be independently tuned with   . While the Marker is being tuned, the noise calculation is held-off and the readout indicates the "MARKER" frequency and amplitude. When the Marker becomes stationary, a real-time noise measurement is performed at the *Marker* frequency and, at the end of the noise calculation, the noise level reading appears on the readout.

In this mode of operation, the instrument's frequency tuning internally alternates between the Marker frequency and the Manual frequency. This alternation takes place at the end of each noise calculation. At the Manual frequency, the Manual measurement point on the CRT trace is updated to reflect the real-time input-signal amplitude. At the Marker frequency, the CRT trace is *not updated*, but the instrument does actually sample the input signal to obtain a real-time noise-level reading.

(When using this mode of operation, keep in mind that the Marker dot will appear on any trace that happens to be retained on the CRT and, in the absence of a noise-level reading, the readout will indicate the Marker's amplitude on the CRT trace. Since the CRT trace is not updated at the Marker frequency, noise-level readings are calculated according to the *undisplayed* real-time signal amplitude at the Marker frequency and are, therefore, totally unrelated to the Marker's amplitude on the CRT trace.)



Measuring Signal-to-Noise Ratio

The NOISE LVL function can be used in conjunction with the OFFSET function to measure signal-to-noise ratio. The recommended procedure is as follows:

- a. With the instrument sweeping or in the Manual mode, set the tunable Marker to the peak of the signal.
- b. Activate OFFSET and then press ENTER OFFSET.
- c. Set the Marker to the point of interest on the noise and then activate the NOISE LVL function. Allow time for the noise reading to be calculated and observe the result.

(Do not measure the signal with NOISE LVL activated.)

With the signal amplitude in the Offset Register, the “OFFSET” reading actually indicates the “noise-to-signal” ratio rather than the “signal-to-noise” ratio. This minor technicality can be corrected by mentally changing the polarity of the “OFFSET” reading. The polarity could be reversed by storing the noise level in the Offset Register and measuring the signal, but it is generally preferable to store the signal because it is more stable than the noise.

Noise Measurement Capabilities

It is important to note that the 3585A NOISE LVL function is intended only for measuring *random* noise. It cannot be used to accurately measure impulse noise or other signals containing discrete, phase-coherent frequency components. The main types of random noise that can be measured with the NOISE LVL function are:

a. Thermal Noise (“Johnson” or “white” noise):

Generated by thermally-excited random movement of electrons in a conductor. Characterized by uniform distribution of energy over the spectrum, and a gaussian distribution of levels. Present in virtually every electrical system (at temperatures above absolute zero) and is the most common type of noise that is measured.

b. Shot (“pink”) Noise:

A noise mechanism caused by random current pulsations in tubes, transistors and diodes. It is actually a form of white noise, having constant power per Hertz of bandwidth.

c. Low Frequency (1/f) Noise:

Surface noise observed in tubes, transistors, diodes and various resistive elements, theoretically having infinite power at 0 Hz. Typically exhibits 3 dB per octave roll-off.

d. Phase Noise and Residual A.M.:

Phase noise (random phase modulation or “phase jitter”) and residual A.M. (“amplitude jitter”) measurements are commonly used to characterize the stability of oscillators and frequency synthesizers. Phase noise is a primary concern in the design of transmitting and receiving systems, particularly those used in guidance and detection applications. It is also a major concern in spectrum-analyzer design because it creates noise sidebands which degrade sensitivity.

e. Channel Noise:

This is a telecommunications term used to describe the composite background noise in a communications channel. It includes thermal noise, intermodulation noise (from multiplex pilot tones) and, in some cases, random cross-talk.

Further information concerning random noise measurements can be found in -hp- Application Notes 150-4 and 207. These application notes can be ordered from the nearest -hp- Sales Office.



Bandwidth Considerations

Noise level measurements can generally be performed using any convenient Resolution Bandwidth setting. No matter which RBW setting is used, the noise level reading is normalized to a 1 Hz bandwidth. There are, however, two important things to consider when selecting a RBW setting for noise measurements:

- a. Discrete signals (including spurious components and zero response) that are in the analyzer's passband during a noise level measurement can cause significant errors to appear in the noise reading. The RBW setting must, therefore, be narrow enough to resolve only the noise and reject any discrete components about the noise measurement frequency.

Before making noise-level measurements in a congested region, it is good practice to narrow the Frequency Span and Resolution Bandwidth to verify that there are no hidden discrete components near the noise measurement frequency. An elevated point on the trace can be checked to determine whether it is discrete or random by narrowing the RBW. The amplitude of a discrete component will remain essentially constant when the RBW is narrowed; but the noise amplitude on the CRT trace will decrease. This test must be performed with the instrument sweeping, or else in the Manual mode with the suspected component in the center of the passband.

- b. The amplitude of the noise signal must be reasonably flat within the analyzer's passband. When measuring low-frequency noise or phase noise where the noise amplitude rolls off, it is important to use a RBW that is narrow enough to resolve a flat portion of the noise curve.

Video Bandwidth

The 3585A internally selects the 100 Hz VBW setting during its noise measurement routine. (This does not appear on the VBW readout.) For this reason, the VBW that is selected by the operator does not affect the noise averaging process or the measurement time.

EFFECTS OF RESOLUTION BANDWIDTH ON NOISE MEASUREMENT SENSITIVITY:

Since random noise power is directly proportional to the measurement bandwidth, narrowing the Resolution Bandwidth by a factor of ten would theoretically reduce the internal noise level by a factor of ten or 10 dB. As a result, the internal random noise spectral density would be the same for all RBW settings and the noise measurement sensitivity would be unaffected.

Due to noise mechanisms in the instrument's IF section, however, the internal noise level does not always decrease in direct proportion to the Resolution Bandwidth. For this reason, there are cases where narrowing the Resolution Bandwidth increases the internal noise spectral density and, consequently, decreases the noise measurement sensitivity. This effect is particularly noticeable when switching from the 1 kHz RBW to the 300 Hz RBW.

The following table lists the *typical* internal noise spectral density for each RBW setting *relative* to the 30 kHz RBW. This information can be used as an aid in selecting a Resolution Bandwidth that will provide the best compromise between sensitivity and resolution for your particular measurement.

RBW	Internal Noise Density (Relative to 30 kHz RBW)
30 kHz	0 dB (1 Hz)
10 kHz	+ 0.2 dB (1 Hz)
3 kHz	+ 0.8 dB (1 Hz)
1 kHz	+ 0.8 dB (1 Hz)
300 Hz	+ 4.0 dB (1 Hz)
100 Hz	+ 2.0 dB (1 Hz)
30 Hz	+ 1.0 dB (1 Hz)
10 Hz	+ 1.0 dB (1 Hz)
3 Hz	+ 1.0 dB (1 Hz)



Noise Measurement Sensitivity

The lower limit of sensitivity for noise-level measurements is determined by the analyzer's own internally generated noise. During a noise calculation, the 3585A samples the composite noise signal within its passband, which includes its own internal noise as well as the external noise that the operator is interested in measuring. The total noise power in the analyzer's passband is the sum of the powers of the individual noise signals. Thus, if the external noise power is equal to the internal noise power, the total noise power (and the noise-level reading) will be 3 dB above the internal noise level. For practical purposes, an external noise signal that produces a 3 dB increase in the noise-level reading is considered to be the minimum discernable signal.

In the measurement of a minimum-discernable signal, the error contributed by the analyzer's internal noise is about 3 dB. Since this amount of error is unacceptable for most applications, it is necessary to either increase the limit of sensitivity or measure the analyzer's internal noise and subtract it from the noise-level reading.

In keeping with the accuracy requirements for most noise measurement applications, a reasonable limit of sensitivity is 10 dB above the analyzer's internal noise level. When the external noise is 10 dB above the internal noise, the error contributed by the internal noise is about 0.41 dB. From that point, the error (in dB) is inversely proportional to the external noise power. Thus, if the external noise is increased to 20 dB above the internal noise (a factor of ten), the error is reduced to 0.04 dB.

Internal Noise Measurement

The analyzer's internal noise spectrum consists of broadband thermal noise, shot noise, low-frequency (1/f) noise and phase noise. With the exception of phase noise, the internal noise spectral density can be measured (with no input signal) and subtracted from the composite noise-level reading using the procedure given in Figure C. Internal phase noise, which appears only in the presence of a large input-signal response, is difficult to measure and must, therefore, be treated separately.

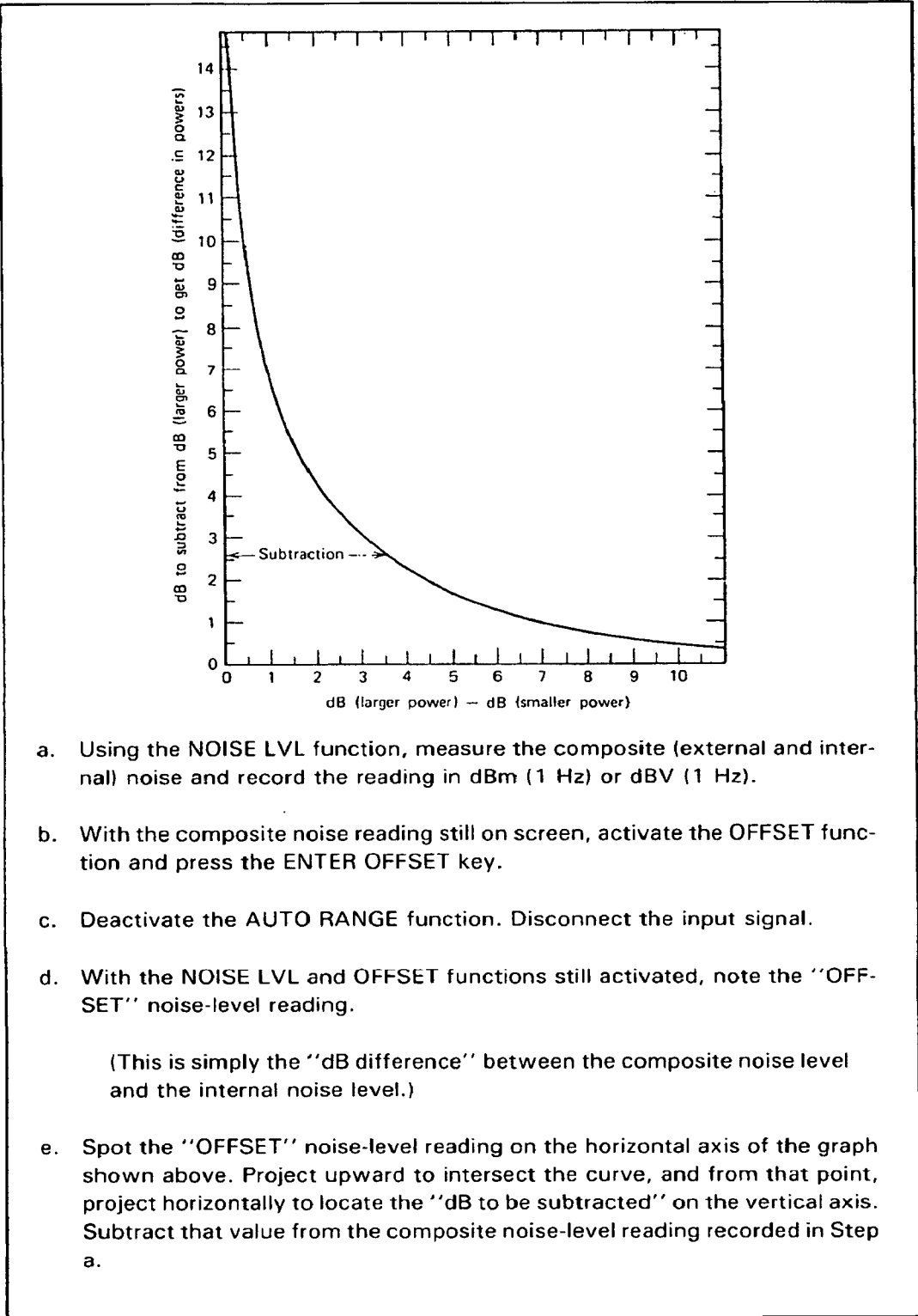

Figure C. Subtracting the Analyzer's Internal Noise



Internal Phase Noise

As a general rule, the 3585A's internal phase noise does not need to be considered unless you are measuring the phase noise of an external source or are otherwise measuring low-level noise near the skirt of a large response. As shown in Figure D, the internal phase-noise sidebands form a pedestal which extends approximately 150 kHz on each side of the signal (i.e., "carrier") frequency. The amplitude of the phase-noise pedestal (and the phase-noise spectral density) is proportional to the carrier amplitude. When the peak of the carrier's response is less than 80 dB above the broadband noise floor, the phase-noise pedestal is well below the broadband noise and cannot be seen or measured.

The phase noise *spectral density* is unaffected by the Resolution Bandwidth setting. However, as the Resolution Bandwidth is increased, the filter skirts become wider and, therefore, cover a wider portion of the phase-noise spectrum. With the Resolution Bandwidth set to 30 kHz, the entire phase-noise pedestal is masked by the filter skirts. When the RBW is set to 10 kHz, the worst-case phase noise, appearing at approximately ± 35 kHz away from the carrier, is typically more than 118 dB (1 Hz) below the peak of the carrier. When the RBW is 3 kHz or narrower, the phase noise is typically more than 115 dB (1 Hz) below the peak of the carrier at frequencies ± 15 times the RBW away from the carrier.

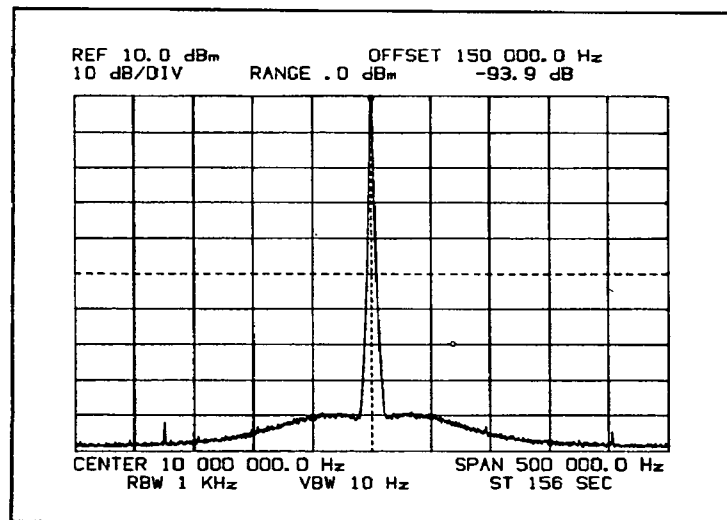

Figure D. Internal Phase-Noise Pedestal

SECTION III PART TWO REMOTE OPERATION

3-2-1. HP-IB OPERATION.

3-2-2. The Model 3585A is remotely controlled by means of the Hewlett-Packard Interface Bus (HP-IB). The following information gives a general description of the HP-IB and defines the terms, concepts, and messages used in an HP-IB system. It also lists the capabilities and requirements for programming the 3585A. Program examples using a specific Hewlett-Packard calculator as the system controller may be found in the Supplemental Programming Information, Appendix 3-A at the end of this section.

NOTE

HP-IB is Hewlett-Packard Co.'s implementation of IEEE Standard 488-1975, "Standard Digital Interface for Programmable Instrumentation."

3-2-3. General HP-IB Description.

3-2-4. The HP-IB is a parallel bus of 16 active signal lines grouped into three sets according to function, to interconnect up to 15 instruments. Figure 3-2-1 is a diagram of the interface connections and bus structure. A complete description of the HP-IB lines, commands, internal operation, etc., may be found in the HP-IB Abbreviated Description, -hp- Part No. 5955-2903. A copy may be obtained through your nearest -hp- Sales and Service Office.

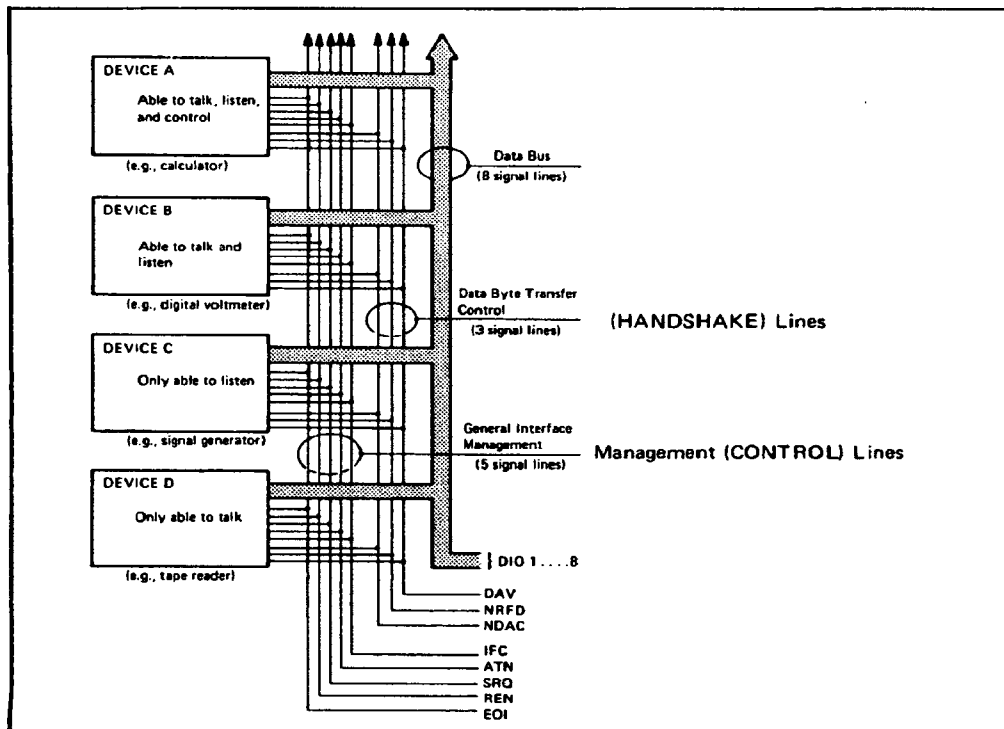

Figure 3-2-1. Interface Connections and Bus Structure.

3-2-5. Eight signal lines form the first set and are termed “data” lines. The data lines carry coded messages which represent addresses, program data, measurements, and status bytes. The same data lines are used for input and output messages in bit-parallel, byte-serial form. Normally, a seven-bit ASCII code represents each piece (byte) of data, leaving the eighth bit available for parity checking.

3-2-6. Data transfer is controlled by means of an interlocked “handshake” technique which permits data transfer (asynchronously) at the rate of the slowest device participating in that particular conversation. The three data byte transfer control lines which implement the handshake form the second set of lines.

3-2-7. The remaining five general interface management lines form the third set, and are used in such ways as activating all the connected devices at once, clearing the interface, etc. Table 3-2-1 defines each of the management lines.

Table 3-2-1. General Interface Management Lines.

Name	Mnemonic	Description
Attention	ATN	Enables a device to interpret data on the bus as a controller command (command mode) or data transfer (data mode).
Interface Clear	IFC	Initializes the HP-IB system to an idle state (no activity on the bus).
Service Request	SRQ	Alerts the controller to a need for communication.
Remote Enable	REN	Places instruments under remote program control.
End or Identify	EOI	Indicates last data transmission during a data transfer sequence; used with ATN to poll devices for their status.

3-2-8. Definition of HP-IB Terms and Concepts.

Byte—A unit of information consisting of eight binary digits (bits).

Device—Any unit that is compatible with the IEEE Standard 488-1975.

Device Dependent—(1) An action a device performs in response to information sent on the HP-IB. The action is characteristic of an individual device and may vary from device to device. (2) The data required to communicate with a particular device.

Operator—The person that operates either the system or any device in the system.

Address—The characters sent by a controller to specify which device will receive information. A device may also have its address fixed so that it may only receive information (listen only) or only send information (talk only).

Polling—Polling is a means by which a controller can identify a device that needs interaction with it. The controller may poll devices for their operational condition one at a time, which is termed a serial poll, or as groups of devices simultaneously, which is termed a parallel poll.

3-2-9. Basic Device Communication Capability.

3-2-10. Devices which communicate along the interface bus fall into three basic categories.

Talkers—Devices which send information on the bus when they have been addressed.

Listeners—Devices which receive information sent on the bus when they have been addressed.

Controllers—Devices that can specify the talker and listener(s) for an information transfer. The controller can be an active controller or a system controller. The active controller is defined as the current controlling device on the bus. The system controller can take control of the bus even if it is not the active controller. Each system can have only one system controller, even if several controllers have system control capability.

3-2-11. Message Definitions.

3-2-12. Information is transferred on the HP-IB from one device to one or more other devices in quantities called “messages.” Some of the messages consist of two basic parts, the address portion and the information portion. Others are general messages to all devices. Messages can be classified into twelve types, which are referred to as “meta messages.” These are defined in Table 3-2-2. A block diagram presentation of meta messages and their implementation will be found in Appendix 3-B at the end of this section.

Table 3-2-2. Definition of Meta Messages.

Message	Definition
DATA	The actual information (binary bytes) which is sent from a talker to one or more listeners. The information or data can be in a numeric form or a string of characters.
TRIGGER	The trigger message causes the listening device(s) to perform a device-dependent action.
CLEAR	A clear message will cause a device(s) to return to a pre-defined device-dependent state.
REMOTE	The remote message causes the listening device(s) to switch from local front panel control, to remote program control. This message remains in effect so that devices subsequently addressed to listen will go into remote operation.
LOCAL	This message clears the remote message from the listening device(s) and returns the device(s) to local front panel control.
LOCAL LOCKOUT	The local lockout message is implemented to prevent the device operator from manually inhibiting remote program control.
CLEAR LOCKOUT AND SET LOCAL	This message causes all devices to be removed from the local lockout mode and revert to local. It will also clear the remote message for all devices.
REQUIRE SERVICE	A device can send this message at any time to signify that it needs some type of interaction with the controller. The message is cleared by the device's status byte message if it no longer requires service.
STATUS BYTE	A byte that represents the status of a single device. One bit indicates whether the device sent the required service message and the remaining 7 bits indicate operational conditions defined by the device. This byte is sent from the talking device in response to a "Serial Poll" operation performed by a controller.
STATUS BIT	<p>A byte that represents the operational conditions of a group of devices on the bus. Each device responds on a particular bit of the byte thus identifying a device dependent condition. This bit is typically sent by devices in response to a parallel poll operation.</p> <p>The status bit message can also be used by a controller to specify the particular bit and logic level that a device will respond with when a parallel poll operation is performed. Thus more than one device may respond on the same bit.</p>
PASS CONTROL	This message transfers the bus management responsibilities from the active controller to another controller.
ABORT	The system controller sends the abort message to unconditionally assume control of the bus from the active controller. The message will terminate all bus communications but does not implement the clear message.

3-2-13. 3585A Response to Messages.

3-2-14. The 3585A is capable of implementing only those messages indicated in Table 3-2-3. In order for those messages to be implemented, certain bus actions are required, which are shown in the Interface Functions column.

Table 3-2-3. 3585A Implementation of Messages.

Message	Implementation*	Interface Functions**		3585A Response
		Sender	Receiver	
Data	SR	T, SH	L ⁿ , AH	Will send or receive as instructed.
Trigger	R	T, SH	L ⁿ , AH	Rearms sweep. Will start next sweep when next trigger (Free Run, Line or Ext) occurs.
Clear	R	C, SH C, SH	DC ⁿ , L, AH DC ⁿ , AH	Device Clear sets 3585A to initial turn-on conditions. See Para. 2-26.
Remote	R	C _s SH ⁿ	RL ⁿ , L, AH RL ⁿ , AH	Goes to Remote. Can be set to Local by LOCAL key.
Local	R	C, SH	RL ⁿ , L, AH	Goes to Local.
Local Lockout	R	C, SH	RL ⁿ , AH	Goes to Remote. Cannot be set to Local by LOCAL key.
Clear Lockout and Set Local	R	C _s	RL ⁿ	Goes to Local from Local Lockout.
Require Service	S	SR ⁿ	C	Sets SRQ True.
Status Byte	S	SR, T, SH	L ⁿ , AH	Sends byte which indicates if service required and reason.
Status Bit	NA	PP ⁿ	C	None
Pass Control	NA	C _A , SH	C _B , T, AH	None
Abort	R	C _s		Unaddress

*S = Send Only
R = Receive Only
SR = Send and Receive
NA = Not Applicable

**SH = Source Handshake
AH = Acceptor Handshake
T = Talker (includes TE = Extended Talker)
L = Listener (includes LE = Extended Listener)
SR = Service Request
RL = Remote/Local
PP = Parallel Poll
DC = Device Clear
DT = Device Trigger
C = Any Controller
C_N = A specific controller (for example, C_A, C_B)
C_s = The System Controller
Xⁿ = Indicates message can be sent by/to one or more devices simultaneously.

3-2-15. HP-IB Work Sheet.

3-2-16. A work sheet is provided at the end of Appendix 3-B for listing the address and message capabilities of each instrument in your HP-IB system. When this sheet is filled out, it will provide a summary of the system capabilities.

3-2-17. HP-IB Addressing.

3-2-18. Certain messages require that a specific talker and listener be designated. Each instrument on the bus has its own distinctive listen and/or talk address which distinguishes it from other devices. The 3585A receives programming instructions or binary information when addressed to listen. When addressed to talk, it will respond to the instructions it received prior to being addressed to talk, such as output mode or serial poll.

3-2-19. Addressing usually takes the form of "universal unlisten, device talk, device(s) listen." The universal unlisten command removes all listeners from the bus, allowing only the listener(s) designated by the device(s) listen parameter to receive information. The information is sent by the talker designated by the device talk parameter. The system controller may designate itself as either talker or listener.

3-2-20. 3585A REMOTE PROGRAMMING.**3-2-21. 3585A HP-IB Capabilities.**

3-2-22. Table 3-2-4 lists the HP-IB capabilities of the 3585A which are compatible with IEEE Standard 488-1975.

Table 3-2-4. Interface Functions.

Code	Function
SH1	Source handshake capability
AH1	Acceptor handshake capability
T6	Basic talker; Serial Poll; Unaddressed to talk if addressed to listen
L4	Basic listener; Unaddressed to listen if addressed to talk
SR1	Service request capability
RL1	Remote/Local capability
PP0	No Parallel poll capability
DC1	Device clear capability
DT1	Device trigger capability
C0	No controller capability

3-2-23. Developing an HP-IB Program.

3-2-24. Basically, the 3585A is programmed remotely in the same manner as it is programmed from the front panel. The following exceptions apply:

- a. The Instrument Preset key requires a device clear or selected device clear from the bus. This message will be effective even if the 3585A processor has become lost.
- b. Key codes which cause an internal calibration will execute the calibration as a part of the key code processing.

3-2-25. The order in which key code programming occurs is just as important as when entering key codes from the front panel. Hints on how to program the 3585A in the fastest manner may be found in Paragraph 3-2-72. Other important factors to keep in mind when programming from the bus are:

- a. ASCII characters for space, plus, comma and carriage return are ignored.
- b. The ASCII character for line feed terminates the entry of a string of key codes.
- c. The SRQ line will be set when an input code is received that is not understood. When a serial poll of the instrument is made, Status Byte bit 0 will be set to a "1".
- d. A device trigger will rearm the sweep in either single or continuous sweep mode.
- e. The 3585A will not read data from or write data to the bus while it is calibrating.
- f. The data accepted line (NDAC) is set when the 3585A has received the data which has been sent. The ready for data line (NRFD) will also be set at this time; however, new data will not be accepted until the processing of the previous code is completed.

NOTE

To insure that the previous data sent to the 3585A has been processed, terminate each ASCII key code string with an ASCII line feed. This is done since a device clear can over-ride the processing of the last command if it is sent before processing of the previous command is completed.

3-2-26. Several steps are needed to develop an HP-IB program.

- a. Completely define the operation(s) the system is required to perform.
- b. Write the program in flow chart or algorithm form. (An algorithm may be defined as a fixed step-by-step procedure for finding a solution to a problem.) Use the key words for meta messages shown in Table 3-2-2 in developing the program. The twelve key words are repeated here for reference.

Data	Clear Lockout and Set Local
Trigger	Require Service
Clear	Status Byte
Remote	*Status Bit
Local	*Pass Control
Local Lockout	Abort

NOTE

The meta message in itself is not a program code or an HP-IB command. It is only intended as a tool to translate a program written as an algorithm into the controller's code.

*Not implemented by the 3585A.

c. Define the operation in program codes that the instrument can use. Each instrument has its own set of program codes which are ASCII characters. The 3585A program codes are shown in Table 3-2-6 and Table 3-2-10.

d. Convert the program into the controller's language. The conversion information is supplied with each controller. For example, the -hp- 9825A Calculator Extended I/O Manual provides a chart for program code conversion.

NOTE

Examples for controlling the 3585A with a specific Hewlett-Packard calculator are provided in the Supplemental Programming Information, Appendix 3-A at the end of this section.

3-2-27. Block diagrams and explanations of the meta messages that apply to the 3585A are shown in Appendix 3-B at the end of this section.

3-2-28. Universal and Addressed Commands.

3-2-29. The 3585A will respond to the following commands sent in the command mode (ATN true).

Universal Commands

Mnemonic	Command	ASCII Code
DCL	Device Clear	DC4
LLO	Local Lockout	DC1
MLA	My Listen Address	(selectable)
MTA	My Talk Address	(selectable)
SPD	Serial Poll Disable	EM
SPE	Serial Poll Enable	CAN
UNL	Unlisten	?
UNT	Untalk	—

Addressed Commands

GTL	Go To Local	SOH
SDC	Selected Device Clear	EOT
GET	Group Execute Trigger	BS

3-2-30. Placing The 3585A In Remote.

3-2-31. The 3585A will go to Remote when ATN is true, REN is true, and it receives its listen address.

3-2-32. The 3585A address is normally set at the factory to:

	ASCII	5-Bit Octal	(5-Bit Octal Equivalent)	
			Decimal	Hexadecimal
Listen	+	13	11	B
Talk	K	13	11	B

NOTE

1. All programming is shown in ASCII code.
2. Table 3-2-6 is a summary of the 3585A program data messages and programming times. Table 3-2-7 lists program codes in octal, decimal, and hexadecimal.
3. The 3585A must be set to REMOTE and addressed to LISTEN before it will accept device dependent data messages.
4. When the 3585A is addressed to listen while in local, it will handshake the data message and then ignore the data.

3-2-33. 3585A Data Message Formats.

3-2-34. The following list shows the valid programming strings (data messages) for the 3585A. In Table 3-2-6 the valid programming strings are referred to, by type, in the column labeled "Message Format".

- 1) Mnemonic, Data, Delimiter, EOS.
- 2) Mnemonic, Data, EOS.
- 3) Mnemonic, EOS.

Where EOS is the end-of-string character. The Valid EOS character is:

LF = Line Feed = octal 12

All spaces (octal 40), carriage returns (octal 15), pluses (octal 53) and commas (octal 54) are ignored by the 3585A.

3-2-35. Settling Time.

3-2-36. Table 3-2-5 shows the time required after a manual frequency change for the Local Oscillator section to settle to within .01 dB of its final value. The times shown do not include any auto-calibration time which might be present.

Table 3-2-5. Settling Times.

RBW	VBW=3RBW	VBW=RBW	VBW	VBW=1/3RBW	VBW < 1/3RBW
3	.692 sec	.795 sec	1	1.53 sec	2.34 sec
10	.225	.256	3	.525	.795
30	91.7 msec	.102	10	.175	.256
100	45.0	48.1 msec	30	75.0 msec	.102
300	31.7	32.7	100	40.0	48.1 msec
1K	27.0	27.3	300	30.0	32.7
3K	25.7	25.8	1K	26.5	27.3
10K	25.2	25.2	3K	25.5	25.8
30K	25.1	25.1	10K	25.1	----
			30K	----	----

Table 3-2-6. Summary of 3585A Programming Mnemonics, Delimiters and Times.

Mnemonics	(ASCII)	Data	Delimiters	Message Format	Approximate Programming Time
ENTRY					
Center Freq.	CF	≤ 9 digits plus decimal 0 to 40.1 MHz Up or Down	HZ KZ MZ	1, 2	50 - 250 ms
Freq. Span	FS	"	HZ KZ MZ	"	65 - 230 ms
Start Freq.	FA	"	HZ KZ MZ	"	65 - 230 ms
Stop Freq.	FB	"	HZ KZ MZ	"	65 - 230 ms
Center Freq. Step Size	CS	"	HZ KZ MZ	"	35 - 200 ms
Reference Level	RL	≤ 3 digits plus decimal, from 10 dB above range to -100 dB below range, Up or Down	DM DV	"	70 - 210 ms
dB/DIV	DD	1,2,5 or 10 Up or Down	DB	"	65 - 170 ms
Reference Level Volt	RV	≤ 3 digits plus decimal from range times 3.14 to range times 1 x 10 ⁻⁵ Up or Down	V mV μV	"	60 - 170 ms
Full Sweep	FL	NA	NA	3	60 - 80 ms
Save Register	SV	numeric entry from 1 to 9	NA	2	28 - 100 ms
Recall Register	RC	numeric entries from 1-5, 7-9, 601 - 609	NA	2	28 - 100 ms

Table 3-2-6. Summary of 3585A Programming Mnemonics, Delimiter and Times (Cont'd).

Mnemonics	(ASCII)	Data	Delimiters	Message Format	Approximate Programming Time
INPUT					
1 M ohm	I1	NA	NA	3	40 - 45 ms
50 ohm	I2	NA	NA		
75 ohm	I3	NA	NA		
Auto range	AR	0 (off)	NA	3	6 - 18 ms
	AR	1 (on)	"	3	6 - 25 ms
Range	RA	UP or DN	NA	2	45 - 280 ms
	R	01 thru 12	NA	2	45 - 225 ms
Ref Lvl Track	AL	0 (off)	NA	3	3 - 13 ms
	AL	1 (on)	NA	3	3 - 25 ms
RBW • VBW • ST					
BW Coupled to Span	CP	0 (off)	NA	3	5 - 15 ms
	CP	1 (on)			
Res. BW Hold	BH	0 (off)	NA	3	5 - 15 ms
	BH	1 (on)			
Preset	PR	NA	NA	3	50 - 65 ms
Res. BW	RB	3, 10, 30 . . . 30,000	HZ	1, 2	25 - 55 ms
		Up or Down	KZ		
Video BW	VB	1, 3, 10 . . . 30,000	HZ	1, 2	25 - 55 ms
		Up or Down	KZ		
Sweep Time	ST	.2 to 999,999 Up or Down	SC	1, 2	65 - 75 ms
SWEEP					
Continuous	S1	NA	NA	3	50 - 60 ms
Single	S2	NA	NA	3	50 - 60 ms
Manual Entry	S3	Any numeric entry from 0 to 40,100,000 that falls within the frequency span limits, up or down.	HZ KZ MZ	1, 2	60 - 90 ms

Table 3-2-6. Summary of 3585A Programming Mnemonics, Delimiter and Times (Cont'd).

Mnemonic	(ASCII)	Data	Delimiters	Message Format	Approximate Programming Time
TRACE					
Clear A	CA	NA	NA	3	45 - 175 ms
View Trace A	TA	0 (off)	NA	3	4 - 13 ms
	TA	1 (on)			5 - 25 ms
View Trace B	TB	0 (off)	NA	3	4 - 13 ms
	TB	1 (on)			5 - 27 ms
Store A - B	SA	NA	NA	3	45 - 220 ms
Max Hold	MH	0 (off)	NA	3	5 - 15 ms
	MH	1 (on)			5 - 25 ms
A - B	AB	0 (off)	NA	3	5 - 25 ms
	AB	1 (on)			6 - 32 ms
MARKER/CONTINUOUS ENTRY					
Marker	C1	IL or IR	NA	3	35 - 190 ms
Manual	C2	IL or IR	NA	2,3	130 - 240 ms
Ref. Level	C3	IL or IR	NA	3	20 - 130 ms
Center Freq.	C4	IL or IR	NA	3	22 - 140 ms
Dsp. Line	C5	IL or IR	NA	3	10 - 45 ms
Off	C6	NA	NA	3	5 - 25 ms
Clear Dsp. Line	CL	NA	NA	3	5 - 25 ms
Counter	CN	0 (off)	NA	3	5 - 25 ms
	CN	1 (on)	NA	3	5 - 10 ms
Noise Level	NL	0 (off)	NA	3	5 - 10 ms
	NL	1 (on)	NA	3	5 - 10 ms
Offset	OF	0 (off)	NA	3	5 - 20 ms
	OF	1 (on)	NA	3	5 - 27 ms
Enter Offset	MO	NA	NA	3	65 - 350 ms
Mkr - Center Freq.	MC	NA	NA	3	60 - 65 ms
Mkr - Ref. Level	MR	NA	NA	3	35 - 190 ms
Offset -> Span	OS	NA	NA	3	4 - 25 ms
Mkr/Ofs -> Step	MS	NA	NA	3	15 - 35 ms
Knob					
increment left	IL	NA	NA	3	40 - 300 ms
increment right	IR	NA	NA	3	40 - 300 ms
TRIGGER					
Free Run	T1	NA	NA	3	45 - 60 ms
Line	T2	NA	NA	3	45 - 60 ms
Ext	T3	NA	NA	3	45 - 60 ms

Table 3-2-6. Summary of 3585A Programming Mnemonics, Delimiter and Times (Cont'd).

Mnemonics(ASCII)	Data	Delimiters	Message Format	Approximate Programming Time	
				Mnemonic	Function Execution
HP-IB INSTRUCTIONS					
Trigger					
T4	NA	NA	3	6-30 msec	
T5	NA	NA	3	45-55 msec	
T6	NA	NA	3	45-55 msec	
Dump Modes					
D1	NA	NA	3	4-25 ms	22-100 ms
D2	NA	NA	3	4-25 ms	26-110 ms
D3	NA	NA	3	5-25 ms	0.7-5 sec
D4	NA	NA	3	5-25 ms	0.7-5 sec
D5	NA	NA	3	5-27 ms	24-590 ms
D6	NA	NA	3	7-30 ms	12-40 ms
D7	NA	NA	3	7-30 ms	115-600 ms
D8	NA	NA	3	7-30 ms	22-115 ms
D9	NA	NA	3	7-30 ms	22-115 ms
Display Modes					
DG	NA	NA	3	5-25 ms	
DA	NA	NA	3	5-30 ms	
DS	NA	NA	3	4-10 ms	
ES	NA	NA	3	4-10 ms	
DC	NA	NA	3	8-15 ms	
LA	50 ASCII characters with codes from octal 40 to octal 135 excepting octal 44, 100, 134	NA	2	5-25 ms	.5 ms - 1.8 ms per character
L1, L2, L3, L4, L5 and L6	50 ASCII characters with codes from octal 40 to octal 135 excepting octal 44, 100, 134	NA	2	5-30 ms	.43 ms - .5 ms per character
Special Function Modes					
EE	NA	NA	3	3-15 ms	
EQ	NA	NA	3	3-15 ms	
EC	NA	NA	3	3-15 ms	
Binary Modes					
LI	100 binary words	NA	3	3-15 ms	.036-1 sec
LO	100 binary words	NA	3	3-15 ms	.036-1.27 sec
BI	2004 binary words	NA	3	3-15 ms	0.5-35 sec
BO	2004 binary words	NA	3	3-15 ms	0.5-25 sec
AI	2004 binary words	NA	3	3-15 ms	0.5-35 sec

Table 3-2-7. Programming Codes.

Command Name	Mnemonic Entry	Decimal	Octal	Hexadecimal
ENTRY				
Center Freq.	C	67	103	43
	F	70	106	46
Freq. Span	F	70	106	46
	S	83	123	53
Start Freq.	F	70	106	46
	A	65	101	41
Stop Freq.	F	70	106	46
	B	66	102	42
Center Freq. Step Size	C	67	103	43
	S	83	123	53
Reference Level	R	82	122	52
	L	76	114	4C
dB/DIV	D	68	104	44
	D	68	104	44
Reference Level Volt	R	82	122	52
	V	86	126	56
Up	U	85	125	55
	P	80	120	50
Down	D	68	104	44
	N	78	116	4E
Volts	V	86	126	56
	L	76	114	4C
MHz	M	77	115	4D
	Z	90	132	5A
dBm	D	68	104	44
	M	77	115	4D
Millivolts	M	77	115	4D
	V	86	126	56
kHz	K	75	113	4B
	Z	90	132	5A
dBV	D	68	104	44
	V	86	126	56
Microvolts	U	85	125	55
	V	86	126	56

Table 3-2-7. Programming Codes (Cont'd).

Command Name	Mnemonic Entry	Decimal	Octal	Hexadecimal
Hz	H	72	110	48
	Z	90	132	5A
dB	D	68	104	44
	B	66	102	42
Seconds	S	83	123	53
	C	67	103	43
Full Sweep	F	70	106	46
	L	76	114	4C
Save	S	83	123	53
	V	86	126	56
Recall	R	82	122	52
	C	67	103	43
	0	48	60	30
	1	49	61	31
	2	50	62	32
	3	51	63	33
	4	52	64	34
	5	53	65	35
	6	54	66	36
	7	55	67	37
	8	56	70	38
	9	57	71	39
	-	45	55	2D
		46	56	2E
SWEEP				
Continuous	S	83	123	53
	1	49	61	31
Single	S	83	123	53
	2	50	62	32
Manual Entry	S	83	123	53
	3	51	63	33

Table 3-2-7. Programming Codes (Cont'd).

Command Name	Mnemonic Entry	Decimal	Octal	Hexadecimal
SWEEP TRIGGER				
Free Run	T	84	124	54
	1	49	61	31
Line	T	84	124	54
	2	50	62	32
Ext	T	84	124	54
	3	51	63	33
RBW/VBW/ST				
BW Coupled to Span (off)	C	67	103	43
	P	80	120	50
	0	48	60	30
BW Coupled to Span (on)	C	67	103	43
	P	80	120	50
	1	49	61	31
Preset	P	80	120	50
	R	82	122	52
Res. BW Hold (off)	B	66	102	42
	H	72	110	48
	0	48	60	30
Res. BW Hold (on)	B	66	102	42
	H	72	110	48
	1	49	61	31
Res. BW	R	82	122	52
	B	66	102	42
Video BW	V	86	126	56
	B	66	102	42
Sweep Time	S	83	123	53
	T	84	124	54
INPUT				
1 M ohm	I	73	111	49
	1	49	61	31
50 ohm	I	73	111	49
	2	50	62	32
75 ohm	I	73	111	49
	3	51	63	33

Table 3-2-7. Programming Codes (Cont'd).

Command Name	Mnemonic Entry	Decimal	Octal	Hexadecimal	
RANGE					
Auto Range (off)	A	65	101	41	
	R	82	122	52	
	O	48	60	30	
Auto Range (on)	A	65	101	41	
	R	82	122	52	
	1	49	61	31	
Range (UP or DN)	R	82	122	52	
	A	65	101	41	
Ranges	- 25 dBm	R	82	122	52
		O	48	60	30
		1	49	61	31
- 20 dBm	R	82	122	52	
	O	48	60	30	
	2	50	62	32	
- 15 dBm	R	82	122	52	
	O	48	60	30	
	3	51	63	33	
- 10 dBm	R	82	122	52	
	O	48	60	30	
	4	52	64	34	
- 5 dBm	R	82	122	52	
	O	48	60	30	
	5	53	65	35	
0 dBm	R	82	122	52	
	O	48	60	30	
	6	54	66	36	
5 dBm	R	82	122	52	
	O	48	60	30	
	7	55	67	37	
10 dBm	R	82	122	52	
	O	48	60	30	
	8	56	70	38	
15 dBm	R	82	122	52	
	O	48	60	30	
	9	57	71	39	
20 dBm	R	82	122	52	
	1	49	61	31	
	O	48	60	30	

Table 3-2-7. Programming Codes (Cont'd).

Command Name	Mnemonic Entry	Decimal	Octal	Hexadecimal
RANGE (Cont'd)				
25 dBm	R	82	122	52
	1	49	61	31
	1	49	61	31
30 dBm	R	82	122	52
	1	49	61	31
	2	50	62	32
Ref Lvl Track (off)	A	65	101	41
	L	76	114	4C
	O	48	60	30
Ref Lvl Track (on)	A	65	101	41
	L	76	114	4C
	1	49	61	31
DISPLAY				
Clear A	C	67	103	43
	A	65	101	41
Store A → B	S	83	123	53
	A	65	101	41
View Trace A (off)	T	84	124	54
	A	65	101	41
	O	48	60	30
View Trace A (on)	T	84	124	54
	A	65	101	41
	1	49	61	31
View Trace B (off)	T	84	124	54
	B	66	102	42
	O	48	60	30
View Trace B (on)	T	84	124	54
	B	66	102	42
	1	49	61	31
Max Hold (off)	M	77	115	4D
	H	72	110	48
	O	48	60	30
Max Hold (on)	M	77	115	4D
	H	72	110	48
	1	49	61	31
A - B (off)	A	65	101	41
	B	66	102	42
	O	48	60	30
A - B (on)	A	65	101	41
	B	66	102	42
	1	49	61	31

Table 3-2-7. Programming Codes (Cont'd).

Command Name	Mnemonic Entry	Decimal	Octal	Hexadecimal
CONTINUOUS				
Marker	C	67	103	43
	1	49	61	31
Manual Sweep	C	67	103	43
	2	50	62	32
Ref Level	C	67	103	43
	3	51	63	33
Center Freq	C	67	103	43
	4	52	64	34
Dsp Line	C	67	103	43
	5	53	65	35
Off	C	67	103	43
	6	54	66	36
Clear Dsp Line	C	67	103	43
	L	76	114	4C
Noise Level (off)	N	78	116	4E
	L	76	114	4C
	O	48	60	30
Noise Level (on)	N	78	116	4E
	L	76	114	4C
	1	49	61	31
Counter (off)	C	67	103	43
	N	78	116	4E
	O	48	60	30
Counter (on)	C	67	103	43
	N	78	116	4E
	1	49	61	31
Offset -- Span	O	79	117	4F
	S	83	123	53
Mkr -- Center Freq	M	77	115	4D
	C	67	103	43
Mkr -- Ref Level	M	77	115	4D
	R	82	122	52
Enter Offset	M	77	115	4D
	O	79	117	4F
Mkr/Ofs -- Step	M	77	115	4D
	S	83	123	53

Table 3-2-7. Programming Codes (Cont'd).

Command Name	Mnemonic Entry	Decimal	Octal	Hexadecimal
CONTINUOUS (Cont'd)				
Knob (increment left)	I	73	111	49
	L	76	114	4C
Knob (increment right)	I	73	111	49
	R	82	122	52
Offset (off)	O	79	117	4F
	F	70	106	46
	0	48	60	30
Offset (on)	O	79	117	4F
	F	70	106	46
	1	49	61	31
DUMP MODES				
Dump Marker Amp only	D	68	104	44
	1	49	61	31
Dump Marker Amp & Freq.	D	68	104	44
	2	50	62	32
Dump A Trace	D	68	104	44
	3	51	63	33
Dump B Trace	D	68	104	44
	4	52	64	34
Dump Cal Reg.	D	68	104	44
	5	53	65	35
Dump Status	D	68	104	44
	6	54	66	36
Dump Alphanumerics	D	68	104	44
	7	55	67	37
Dump Marker Amp Continuous	D	68	104	44
	8	56	70	38
Dump Marker Amp & Freq. Continuous	D	68	104	44
	9	57	71	39
TRIGGER MODES				
Immediate Trigger	T	84	124	54
	4	52	64	34
Delayed Trigger	T	84	124	54
	5	53	65	35
Delay Trigger without SRQ	T	84	124	54
	6	54	66	36

Table 3-2-7. Programming Codes (Cont'd).

Command Name	Mnemonic Entry	Decimal	Octal	Hexadecimal
SPECIAL DISPLAY MODES				
Display Graphics	D	68	104	44
	G	71	107	47
Display Annotation	D	68	104	44
	A	65	101	41
Display Script	D	68	104	44
	S	83	123	53
Erase Script	E	69	105	45
	S	83	123	53
Enter Annotation	L	76	114	4C
	A	65	101	41
Enter Script Line 1	L	76	114	4C
	1	49	61	31
Enter Script Line 2	L	76	114	4C
	2	50	62	32
Enter Script Line 3	L	76	114	4C
	3	51	63	33
Enter Script Line 4	L	76	114	4C
	4	52	64	34
Enter Script Line 5	L	76	114	4C
	5	53	65	35
Enter Script Line 6	L	76	114	4C
	6	54	66	36
SPECIAL FUNCTION MODES				
Enable key entry	E	69	105	45
	E	69	105	45
Enable key entry with SRQ	E	69	105	45
	Q	81	121	51
Clear enable entry	E	69	105	45
	C	67	103	43

Table 3-2-7. Programming Codes (Cont'd).

Command Name	Mnemonic Entry	Decimal	Octal	Hexadecimal
BINARY DATA MODE				
Learn mode in from HP-IB	L	76	114	4C
	I	73	111	49
Learn mode out to HP-IB	L	76	114	4C
	O	79	117	4F
B Trace in (binary) from HP-IB	B	66	102	42
	I	73	111	49
B Trace out (binary) to HP-IB	B	66	102	42
	O	79	117	4F
A Trace in (binary) from HP-IB	A	65	101	41
	1	49	61	31

3-2-37. HP-IB INSTRUCTION DEFINITIONS.**3-2-38. Programming Output Functions.****3-2-39. Output Function Operating Conditions.**

- a. Each dump type (D1 to D9) and each trigger (T4, T5 or T6) is mutually exclusive and is in effect until changed.
- b. The output functions are not stored by the save and recall functions and are not output in the learn mode.
- c. The conditions after a power up or Instrument Preset are D1 with no trigger.
- d. Amplitude output format:
 - 1 . 11 characters with leading zero's set to blanks.
 - 2 . \pm XXXX.XXE-X.
 - 3 . E-X (power of ten) = E-0 for measurements of dB.
- e. Frequency output format:
 - 1 . 12 characters with leading zero's set to blanks.
 - 2 . \pm XXXXXXXXX.X.
 - 3 . Output is always in .1 Hz units.
- f. Each output must be preceded by a trigger except for D8 and D9.
- g. To insure maximum output speed, normal instrument operation is held up during an output string (such as D3 – D7). This is not true if the instrument is in Manual Sweep due to the 3585A's internal priority structure.

3-2-40. Data Dump Modes.**3-2-41. Programming Dump Modes.** The dump modes function as follows:

D1—Dump Marker amplitude. This is the default mode taken by the 3585A when the power is applied or Instrument Preset is activated.

D2—Dump Marker frequency and amplitude.

D3—Dump the write trace. This mode outputs the 1001 amplitude readings of the A trace. It works in the same manner as reading each of the 1001 points on the A trace in the D1 mode with the Noise Level key off.

D4—Dump the stored trace. Same operation as D3 except that the operations occur on the B trace.

D5—Dump the Calibration Registers. The output for this mode consists of the offset frequency and offset amplitude used as correction factors in each bandwidth (9 pairs total). The output starts with the 3 Hz bandwidth pair. The frequency output is in 0.1 Hz resolution and the amplitude output is in dB to 0.01 dB resolution.

D6—Dump the Status registers. This output consists of two binary words. The first word contains the status bits as shown in Figure 3-2-2. The second status word, shown in Table 3-2-8, contains the code for the last error message that was displayed. Bits 4, 5 and 6 of the first word and the entire second word will be cleared with an Instrument Preset or a device clear. The appropriate bit of the status word will be set to a “1” if the condition is true. Bit 7 of the first status word is set by a S1, S2, T5 or T6 command. It is cleared when the sweep started by the sweep or trigger command is completed.

D7—Dump CRT Alphanumerics. The alphanumerics will be output as displayed on the CRT in the following order:

- Reference Level
- Top Right Frequency
- dB per Division
- Range
- Marker Amplitude
- Start or Center Frequency
- Stop or Span Frequency
- Resolution Bandwidth
- Video Bandwidth
- Sweep Time

D8—Performs the same function as a D1 dump, except that the trigger is automatically reapplied after the output is completed.

D9—Performs the same function as a D2 dump, except that the trigger is automatically reapplied after the output is completed.

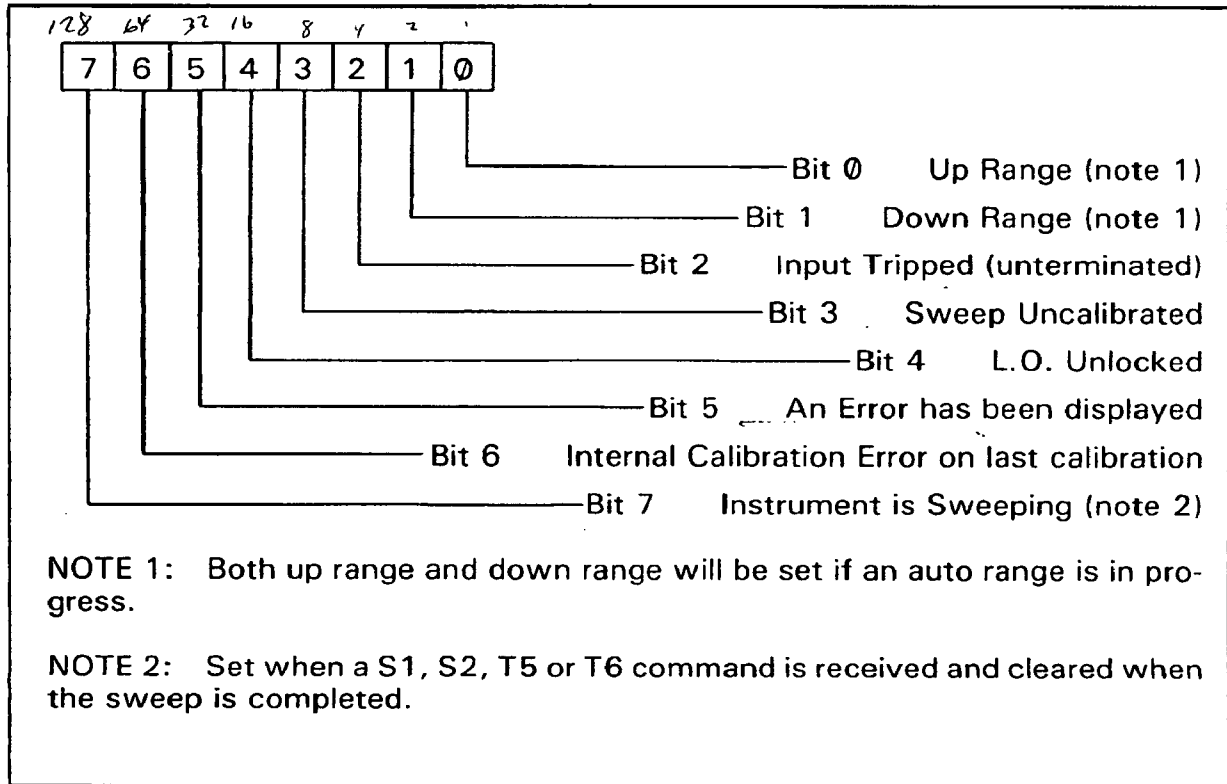

Figure 3-2-2. First Status Word For Dump Mode 6.

Table 3-2-8. Second Status Word For Dump Mode 6.

Hex	Code	Octal	Message
	Decimal		
1	1	01	OUT OF RANGE
2	2	02	REF < 100 DB BELOW RNG
3	3	03	1, 3, 10 STEPS ONLY
4	4	04	TOO MANY DIGITS
5	5	05	ENTRY MODE UNDEFINED
6	6	06	CALIBRATING
7	7	07	USE STEP KEYS ONLY
8	8	10	HP-IB REMOTE SET
9	9	11	/DIV = 1, 2, 5, 10 ONLY
A	10	12	REF > 10 DB OVER RANGE
B	11	13	SWEEP SPAN LIMITED
C	12	14	SWEEP RATE TOO SMALL
D	13	15	HP-IB LOCAL LOCKOUT
E	14	16	S.T. IN .2 SEC STEPS
F	15	17	ENTER REG. NUMBER
10	16	20	REGISTER UNDEFINED
11	17	21	CALIBRATION ERROR XX
12	18	22	LOCAL OSC. UNLOCKED
13	19	23	CALIBRATION DISABLED
14	20	24	INSTR. TEST MODE XX
15	21	25	COUNTER FAILURE
16	22	26	BEEPER DISABLED
17	23	27	COUNTER OUT OF LIMIT
18	24	30	ENTER TST#?? PRESET
19	25	31	HP-IB FLAG LINE ERROR

3-2-42. Dump Mode Output Formats. All the symbols shown are ASCII symbols unless otherwise noted (this includes commas). The dump modes are output in the following formats:

D1—Marker amplitude CR LF

D2—Marker frequency, marker amplitude CR LF

D3—Marker amplitude (position 1),
 Marker amplitude (position 2),

•
 •
 •

 Marker amplitude (position 1001) CR LF

D4—Same as D3.

D5—Cal offset frequency 3 Hz BW, Cal offset amplitude 3 Hz BW,
 Cal offset frequency 10 Hz BW, Cal offset amplitude 10 Hz, BW,

•
 •
 •

•
 •
 •

 Cal offset frequency 30 kHz BW, Cal offset amplitude 30 kHz BW CR LF

D6—Status word 1 (binary), Status word 2 (binary).

D7—Note—unused characters are sent as blanks.

a. Reference Level

1 . 14 characters + CR and LF.

2 . Form; preface number suffix CR LF.

b. Top Right Frequency

1 . 25 characters + CR and LF.

2 . Form; see a(2).

c. dB Per Division

1 . 9 characters + CR and LF.

2 . Form; number suffix CR LF

d. Range

1 . 15 characters + CR and LF.

2 . Form; see a(2).

e. Marker Amplitude

- 1 . 14 characters + CR and LF.
- 2 . Form; see c(2).

f. Start, Center Frequency Display.

- 1 . 22 characters + CR and LF.
- 2 . Form; see a(2).

g. Stop, Span Frequency Display.

- 1 . 20 characters + CR and LF.
- 2 . Form; see a(2).

h. Resolution Bandwidth

- 1 . 11 characters + CR and LF.
- 2 . Form; see a(2).

i. Video Bandwidth.

- 1 . 11 characters + CR and LF.
- 2 . Form; see a(2).

j. Sweep Time.

- 1 . 12 characters + CR and LF.
- 2 . Form; see a(2).

D8—Marker amplitude CR LF.

D9—Marker frequency, marker amplitude CR LF.

3-2-43. Programming Trigger Modes.

3-2-44. There are three types of programmable trigger modes in the 3585A. They are as follows:

T4—Immediate Trigger. The output data specified by the dump mode is immediately transferred to the output buffer (D3 and D4 not included). If the marker is not displayed (i.e. when the display line is on) the last marker reading will be transferred to the output buffer.

T5—Delayed Trigger. A T5 trigger performs exactly like a T4 trigger for dump modes D3, D4, D5, D6 and D7. In the other dump modes a T5 trigger functions as follows:

a. The marker data is transferred to the output buffer when the sweep is equal to the marker in continuous or single sweep mode.

b. The sweep is re-armed in continuous and single sweep mode.

c. In manual sweep mode the marker data is not transferred until the RBW and VBW settling times are completed.

d. The marker data transfer is delayed until after a counter reading is made and/or a noise reading is made if these functions are active.

e. SRQ will be set when the output is ready. Bit 1 in the serial poll response will be set. SRQ will be cleared automatically after the first output word is sent.

f. Output will be delayed until the trigger conditions are met.

g. If the marker is not displayed a T5 trigger will be treated as a T4 trigger.

NOTE

“T5” should be the last command of a command string.

T6—Delayed Trigger without SRQ. This trigger mode functions in the same manner as a T5 trigger. The difference is that SRQ is not used to indicate an output ready condition.

3-2-45. Programming Range.

3-2-46. When programming range the auto-range key is automatically turned off. The codes for programming range are as follows:

Programming Code	Range in 50 Ω Termination		
	dBm	dBV	Volts
R01	- 25	- 38	12.6 mV
R02	- 20	- 33	22.4 mV
R03	- 15	- 28	39.8 mV
R04	- 10	- 23	70.8 mV
R05	- 5	- 18	126 mV
R06	+ 0	- 13	224 mV
R07	+ 5	- 8	398 mV
R08	+ 10	- 3	708 mV
R09	+ 15	+ 2	1.26 V
R10	+ 20	+ 7	2.24 V
R11	+ 25	+ 12	3.98 V
R12	+ 30	+ 17	7.08 V

3-2-47. Programming Marker Position.

3-2-48. The marker may be positioned to any of its 1001 positions on the A or B trace by using an MK command with the appropriate position number. This command will also turn on the Marker key in the Marker/Continuous Entry section. When using an MK command the following conditions apply:

- a. Valid MK commands are MK 1 thru MK 1001.
- b. The next input character other than an ignored code or a number will act as the delimiter.
- c. Only four numbers will be accepted, the rest will be ignored.
- d. Leading zeros will be suppressed.
- e. "MK" with no numbers is assumed to be "MK0".
- f. MK 1002 thru MK 9999 = MK 1001.
- g. MK0 = MK 1.
- h. The ASCII characters for minus and decimal point are treated as delimiting characters.

3-2-49. Programming Special Display Modes.

3-2-50. Several special alphanumeric display modes are available with the HP-IB interface. The allowable characters for all special display modes are the ASCII codes 40 (octal) thru 137 (octal), with the following exceptions:

- a. Code 44 (\$) = blank.
- b. Code 100 (@) = blank.
- c. Code 134 (/) = square root.
- d. Code 136 () = blank.
- e. Code 137 (-) = blank.

3-2-51. Annotation Display Mode. A 50 character alphanumeric display line may be placed on the CRT between the first and second horizontal graticule lines in this mode. To control the annotation display line use the following ASCII commands:

DA—turns the annotation line on.

DG—turns the annotation line off.

LA—enter annotation alphanumerics.

After an “LA” command ASCII characters may be entered according to the following conditions:

- a. The LA command erases the present line.
- b. Characters following an LA command are entered from the left.
- c. Any number of characters greater than 50 are ignored.
- d. An entry string is terminated by a line feed.
- e. ASCII character codes out of the range given above are ignored.
- f. The annotation line is cleared by turning the power off. It is not cleared by an instrument preset or a device clear; however, it is turned off.
- g. The annotation line is only displayed when the A trace is on.

3-2-52. One example of how this display mode might be used would be for on screen titles. An example procedure using 9825A language would be as follows:

```
wrt711,“DALA HARMONIC DISTORTION TEST”
```

This command sequence will put the words “HARMONIC DISTORTION TEST” in the upper left hand corner of the CRT graticule. To turn off the annotation display line this command can be used:

```
wrt711,“DG”
```

Another way to turn off the annotation line is to turn the B trace on and the A trace off or to turn the script display on. By using any of these methods the annotation display is not erased and may be turned on again at a later time.

3-2-53. Script Display Mode. The script mode allows you to put a set of six alphanumeric lines of 50 characters each on the CRT. In this mode the normal graphic display is turned off and only the six lines of script are displayed. The script mode is controlled in the following manner:

DS—Turns the script display on.

ES—Erases all six lines of script.

DG—Turns the script display off and the graphics display on.

DC—allows the script display and the B trace to be simultaneously displayed.

Data may be entered using the command L1, L2, L3, L4, L5 or L6 for desired line according to the following conditions:

- a. The L# (L1-L6) command erases the present line.
- b. Characters following an L# command are entered from the left.
- c. Any number of characters greater than 50 are ignored.
- d. An entry string is terminated by a line feed.
- e. ASCII character codes out of the range given above are ignored.
- f. The Script display is cleared by turning the power off. It is not cleared by an instrument preset or a device clear; however, it is turned off.

3-2-54. An example of the script mode using the 9825A calculator might be as follows:

```
wrt711, "ESDSL1HELLO"
```

In this command string the script display will be erased (ES), turned on (DS) and the word "HELLO" displayed on line one (L1). To put the words "SPECTRUM ANALYZER" on the second line (L2) the command sequence would be:

```
wrt711, "L2SPECTRUM ANALYZER"
```

Lines 3 thru 6 may be programmed in this manner also. The alphanumerics of Lines 1 thru 6 may be individually changed at anytime without changing the contents of the other lines by using a command similar to the one above. This can be done even if the script display is off.

3-2-55. Another way of using the script mode is to have the script and the B trace displayed simultaneously. In other words, the script display becomes a part of the B trace. This is accomplished with a "DC" command. This command can change a normal script display to a script display on the B trace or it can be used in place of a "DS" command to enter a script display directly onto the B trace. Data entry for the individual lines in the "DC" mode must follow the same rules as those used in the "DS" mode outlined previously.

3-2-56. Special Function Modes.

3-2-57. The Special Function modes allow you to output the binary code for each front panel key, shown in Table 3-2-9, to the HP-IB. In this mode, normal operation of the keyboard is suspended. The keyboard will output the binary codes for the individual keys until this mode is disabled. The codes for the individual keys are listed in Table 3-2-9. The ASCII codes for this mode of operation are as follows:

EE—Enable Entry. After this code is received, the 3585A will output the binary code for any key which is pressed. Normal key operation is disabled.

EQ—Enable Entry with SRQ. This command acts the same as the “EE” command except that SRQ is also set when a key is pressed. The serial poll response will be bit 2 set.

EC—Enable Entry Clear. This command disables the “EE” or “EQ” mode. Normal keyboard operation is resumed.

3-2-58. Some of the uses for the “EE” and “EQ” modes are for checking key operation and entering numbers or decisions into a controller. An example of the “EE” mode’s key checking ability would be this 9825A program:

```
wrt711,“EE”

rdb(711)→ A

dsp A

jmp -3
```

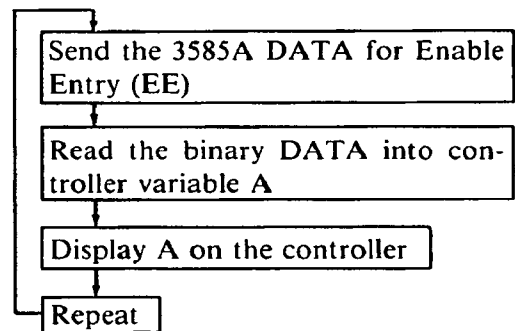

This program will display the decimal code for any key that is pressed. If a key is bad, the code displayed will not change when that key is pressed. If a key is stuck, only that key’s code will be displayed.

3-2-59. The “EE” mode can also be used for entering decisions. For example, the following information could be displayed on the 3585A CRT in the script mode:

I.F. FILTER ADJUSTMENT. ENTER THE NUMBER FOR THE DESIRED TEST ON THE 3585 KEYBOARD.

- I.F. FILTERS 1 AND 2.....1
- I.F. FILTERS 3.....2
- I.F. FILTERS 4 AND 5.....3

Using the “EE” mode the user enters either 1, 2 or 3 on the 3585A keyboard, the instrument will output the code for the key as listed in Table 3-2-9. This key code can then be decoded and used for a subroutine decision which will execute the selected test. This is feasible since each key on the 3585A has a known, unique code which can be decoded and used.

Table 3-2-9. Key codes for Special Function modes "EE" and "EQ".

NOTE			Decimal Code	Octal Code	
<i>Instrument Preset does not have a key code.</i>					INPUT
			21	025	1 MΩ
			19	023	50 Ω
			20	024	75 Ω
					RANGE
			22	026	Autorange
			11	013	Range
			23	027	Ref Lvl Track
					DISPLAY
Decimal Code	Octal Code	ENTRY			
0	000	Center Freq.			
1	001	Freq. Span			
2	002	Start Freq.			
3	003	Stop Freq.	32	040	Clear A
4	004	Center Freq. Step Size	33	041	Store A
5	005	Ref Level	34	042	View Trace A
6	006	dB/DIV	35	043	View Trace B
7	007	Ref Level Volt	36	044	Max Hold
41	051	Up	26	032	A - B
40	050	Down			CONTINUOUS
12	014	MHz/dBm/V	25	031	Marker
13	015	kHz/dBV/mV	68	104	Manual
14	016	Hz/dB/μV	27	033	Ref Level
15	017	sec	67	103	Center Freq.
44	054	Full Sweep	28	034	Dsp. Line
42	052	Save Register	29	035	Off
43	053	Recall Register	37	045	Dsp. Line
		SWEEP	31	037	Noise Level
58	072	Cont	65	101	Counter
59	073	Single	38	046	Offset → Span
60	074	Manual	39	047	MRK → Center
		SWEEP TRIGGER	30	036	MRK → Ref Level
61	075	Free Run	66	102	Enter Offset
62	076	Line	64	100	MRK/Ofs→ Step
63	077	Ext	70, 69	106, 105	Knob
		RBW/VBW/ST	24	030	Offset
					ENTRY
16	020	Coupled to Span	48	60	0
17	021	Preset	49	61	1
18	022	RBW Hold	50	62	2
8	010	RBW	51	63	3
9	011	Video	52	64	4
10	012	Sweep Time	53	65	5
47	057	Local	54	66	6
			55	67	7
			56	70	8
			57	71	9
			45	55	-
			46	56	-

3-2-60. Test Modes.

3-2-61. Another special mode of the 3585A consists of 9 internal test modes. These test modes allow you to connect internal sources, disable calibration or reconfigure particular circuit boards so that tests can be made on the 3585A. The tests are defined as follows:

Entry Code	Switch Code (Octal)	Function
00	000	Test Modes off.
01	001	Normal instrument operation but with calibration disabled and no calibration offsets.
02	002	Internal 10 MHz switched into input otherwise normal instrument operation.
03	003	Internal 10 MHz switched into input and calibration disabled and no calibration offsets.
04	004	Tracking generator switched into input, otherwise normal operation.
05	005	Tracking generator switched into input; no calibration; no calibration offsets.
06	006	Local oscillator will perform in its single loop mode for all BW's.
07	007	Takes Center Frequency Step Size as a tracking generator offset upon a calibration. Tracking generator frequency is set positive with respect to analyzer tuned frequency. Maximum offset is 1.5 kHz.
08	010	Displays the Tracking Generator 10.35 MHz VCXO tuning curve on screen with the vertical scale = CF Step Size. The counter reads frequency deviation above and below 10.35 MHz. A CF Step Size > 500 Hz exercises the course VCXO tuning DAC, while CF Step Sizes \leq 499 Hz exercise the fine DAC with the course DAC held at its current position. This mode is activated when the counter is turned on and the RES BW being used is calibrated.
09	011	Calibration disabled and no calibration offsets. If CF Step Size is any number other than 1.1 Hz, 1.2 Hz, or 1.3 Hz this mode is the same as Test Mode .1. If CF Step Size is one of the above numbers the P.C. Board corresponding to that number will be programmed to the chosen BW while the other two boards will be programmed to 30 kHz BW. This mode is accessed when the RBW is changed. This Test mode is used for adjusting the IF BW's.

3-2-62. The test modes are chosen by entering a Recall 6 (RC6) and the entry code for the desired test. The test mode is then put into effect by executing a device clear. The following command sequence shows how this is accomplished using 9825A language:

```
wrt711 "RC6XX";           clr711
                        desired test #       device clear
```

An Instrument Preset or device clear command must be issued after the test number command string for the test mode to become active. The test mode will then continue in effect until the next Instrument Preset or device clear command is issued.

3-2-63. Binary Data Mode.

3-2-64. The 3585A has a group of commands which handle binary data. These commands are used to send or receive binary data describing the traces or present control settings.

3-2-65. Binary Data Input. When an ASCII command is received that indicates a binary input to the 3585A, the information following the command is treated as binary data. If a carriage return or line feed is sent after the ASCII command to enter a binary mode, it will be ignored. Enough binary data must be sent to the 3585A to satisfy the given command conditions. After receiving the last binary word, the 3585A will return to receiving information in ASCII.

3-2-66. Binary Data Output. For a binary output from the 3585A, a set of binary words which will satisfy the binary command conditions is output when the 3585A is addressed to talk. None of the binary output commands require a trigger to start their operation. Any previous trigger or dump is terminated by a binary operation; however, the previous dump mode is remembered and can be triggered to output data as soon as the binary operation is completed.

3-2-67. Binary Commands. The binary operations are as follows:

LO—Learn mode out. When this command is received the state of the instrument is captured, as in the Save key function, and is output as a set of 100 binary words.

LI—Learn mode in. When this command is received the instrument will accept the binary data obtained by a "LO" command as the new state of the instrument. After the command is received, the next 100 binary words will be input to the instrument. After the last word is received by the 3585A, the new state of the instrument will become active. It is important that the order of the binary words not change from those received with a "LO".

BI—B trace in. This command allows the B trace to be generated from the HP-IB. The B trace consists of 1002, 16 bit data words which represent the Y-axis magnitude for each X-axis location. The display is generated by connecting each Y-axis magnitude in adjacent X-axis locations with a straight line. Each of the 16 bit data words are generated from the HP-IB by combining 8 bit binary bus words in pairs. These pairs are received and combined as shown in Figure 3-2-3.

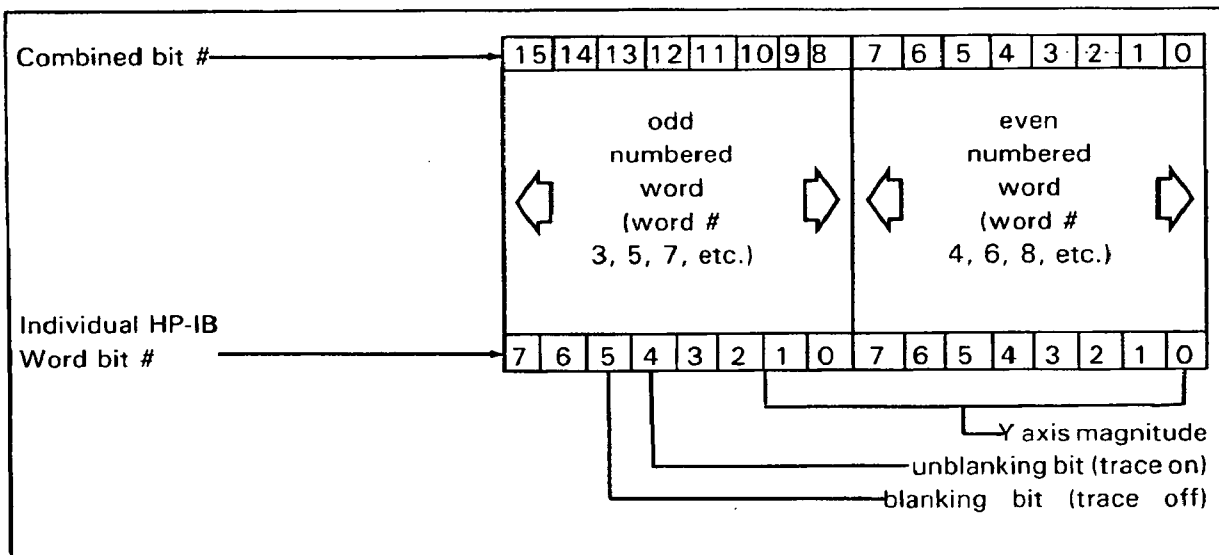

Figure 3-2-3. CRT Trace Word In Binary Mode.

In this mode the first two HP-IB words must be sent with all bits set to one. These first two words are not used in the display. Therefore, 1002, 16 bit words or 2004 HP-IB words must be sent in order to define one complete display.

After each HP-IB word pair is received and combined, it is stored in consecutive X-axis locations starting from the left of the CRT. After the HP-IB word is combined, the binary code may be interpreted as follows:

Bits 0 to 9.

The binary magnitude of the Y-axis deflection with the bottom of the screen equal to 0 and the top of the screen equal to octal 1777 (decimal 1023). the reference level is equal to octal 1750 (decimal 1000).

Bits 10, 11, 14, 15.

Ignored.

Bits 12 and 13.

These bits serve to blank (bit 13) and unblank (bit 12) the trace. In other words, they serve to turn the trace on and off. When bit 12 is received set, all the line segments following will be turned on. Once bit 12 is received set, the 3585A ignores bit 12 until bit 13 is set. When bit 13 is received set, all the line segments following will be turned off. The blanking or unblanking starts at the Y-axis magnitude contained in the same word as the blank or unblank bit. Care must be taken not to have bits 12 and 13 set at the same time.

BO—B trace out. This command outputs 2004 binary words which are the present B trace data. The bit and word interpretation are the same as for “BI”. These binary words may be directly output with a “BI” command in the same order as they were received to regenerate a stored trace.

AI—A trace in. This is the same as “BI” except that it acts on trace A.

NOTE

If the instrument is sweeping or a calibration occurs, a trace loaded in the “AI” mode could be disturbed or lost. Care must be taken to insure that these conditions do not occur while the trace is being loaded or during the time that you wish to retain this trace. Also, an Instrument Preset may be needed to reactivate normal A trace operation.

3-2-68. Instrument Status Messages.

3-2-69. Service Requests. The 3585A will set the SRQ line true for any of the following reasons:

- a. A command has been sent which was not understood.
- b. A T5 trigger has completed the Bandwidth settling requirements and is ready to output data.
- c. A key has been pressed while the “EQ” mode is in effect.

3-2-70. Serial Poll. When the system controller determines that the SRQ line is true, it may conduct either a Serial Poll or a Parallel Poll to determine which device(s) initiated the Service Request, and the reason(s) for the Service Request. The 3585A responds to a Serial Poll, which is conducted in the following manner:

Controller places ATN true (command mode)
 Controller sends Serial Poll Enable (SPE) on lines DIO 1-8 (ASCII CAN, binary code x0011000)
 Controller sends 3585A Talk address
 Controller places ATN false (data mode)
 3585A responds by sending status byte on DIO 1-8
 Controller places ATN true
 Controller sends Serial Poll Disable (SPD) (ASCII EM, binary code x0011001)
 Controller places ATN false

Serial Poll Disable clears the SRQ message originated by the 3585A, resetting bits 0 through 2 and bit 6 in the status byte.

3-2-71. Status Byte. A Status Byte consists of one 8-bit byte on the data lines DIO 0-7. A "1" in bit 6 indicates that the 3585A did request service (placed SRQ true), and a "0" in bit 6 indicates that it did not request service. A "1" in bits 1 through 6 indicate the following (bit 7 conveys no information) conditions as shown in Figure 3-2-4.

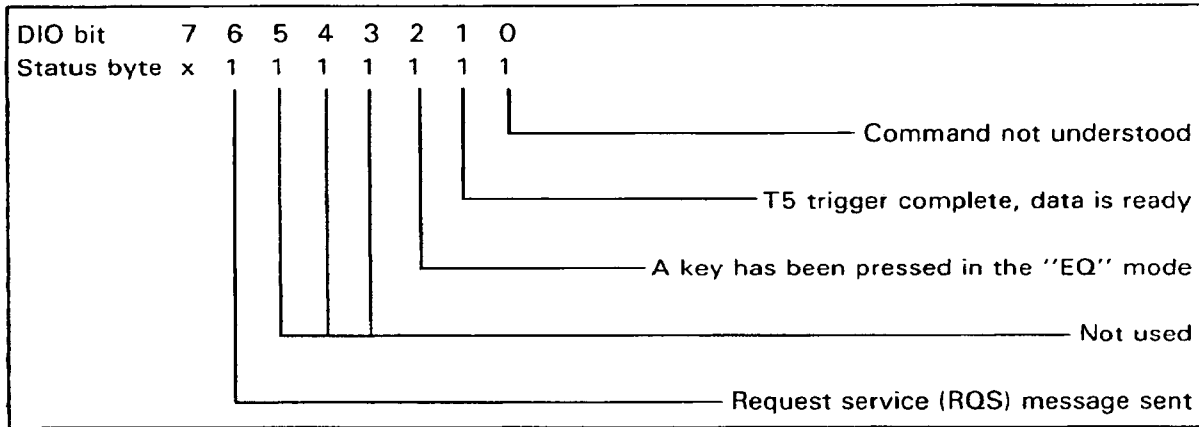
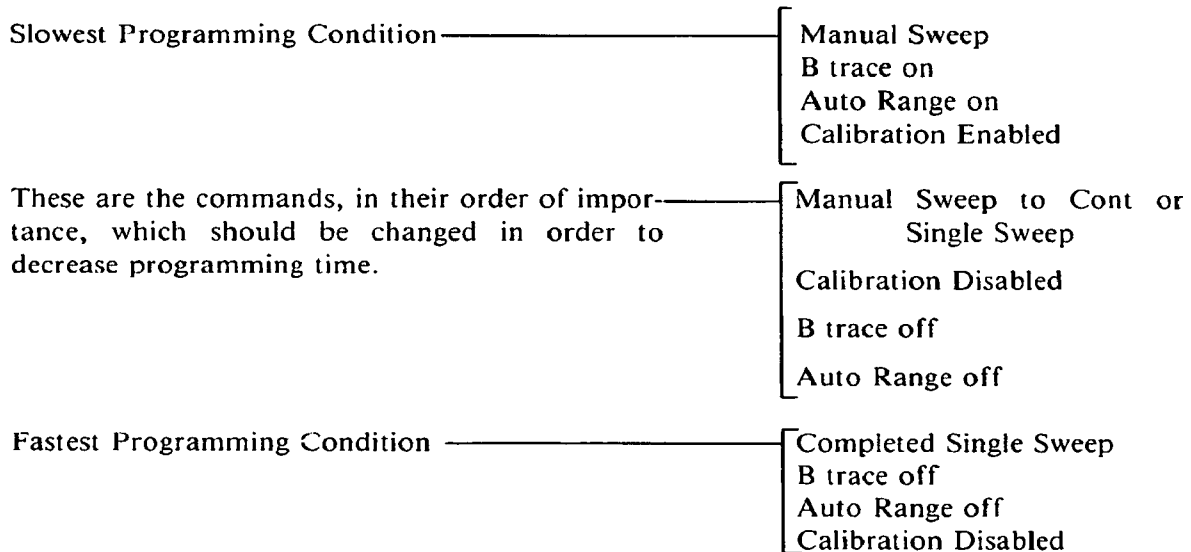

Figure 3-2-4. Status Byte.

3-2-72. Programming The 3585A For Maximum Speed.

3-2-73. The 3585A can be programmed in an infinite variety of ways. However, the actual programming time depends upon the state of the instrument before programming begins. The list of commands that follows shows the fastest and slowest programming states of the instrument. Also shown is a list of parameters which can be changed to decrease programming time. These commands are listed in the order in which they effect programming time. For instance, Manual Sweep is the parameter which will cause the greatest change in programming time. Therefore, it should be the first parameter changed (to Single Sweep if possible) since it will cause the greatest decrease in programming time. The closer the instrument is to the fastest programming condition when programming begins, the quicker the instrument will be programmed.



3-2-74. Due to Bandwidth and Center Frequency definitions, a calibration will occur two or more times for some programming conditions. This only serves to slow down the programming process. To avoid any unnecessary calibrations, disable the calibration system (SV4) at the beginning of a command string and force a calibration (RC4) after all conditions which will cause a calibration have been programmed.

Table 3-2-10. Summary of Programming Mnemonics.

ENTRY	ASCII DATA CODES	RANGE	ASCII DATA CODES
Center Freq.	- CF	Autorange	- ARO, AR1
Freq. Span	- FS	Range	- RA UP or DN
Start Freq.	- FA	- 25 dBm	- R01
Stop Freq.	- FB	- 20 dBm	- R02
Cen Freq. Step Size	- CS	- 15 dBm	- R03
Ref Level	- RL	- 10 dBm	- R04
dB/DIV	- DD	- 5 dBm	- R05
Ref Level Volt	- RV	0 dBm	- R06
		5 dBm	- R07
Up	- UP	10 dBm	- R08
Down	- DN	15 dBm	- R09
		20 dBm	- R10
V/MHz/dBm	- VL, MZ, DM	25 dBm	- R11
mV/kHz/dBV	- MV, KZ, DV	30 dBm	- R12
μV/Hz/dB	- UV, HZ, DB	Ref Level Track	- ALO, AL1
sec	- SC		
Full Sweep	- FL	DISPLAY	
Save Register	- SV	Clear A	- CA
Recall Register	- RC	Store A	- SA
0	- 0	View Trace A	- TA0, TA1
1	- 1	View Trace B	- TB0, TB1
2	- 2	Max Hold	- MH0, MH1
3	- 3	A-B	- ABO, AB1
4	- 4		
5	- 5	MARKER/CONTINUOUS ENTRY	
6	- 6	Marker	- C1
7	- 7	Manual	- C2
8	- 8	Ref Level	- C3
9	- 9	Center Freq.	- C4
.	- .	Display Line	- C5
		Off	- C6
		Clear Display Line	- CL
SWEEP		Noise Level	- NLO; NL1
Cont	- S1	Counter	- CNO, CN1
Single	- S2	Offset - Span	- OS
Manual	- S3	MRK - CF	- MC
		MRK - Ref Level	- MR
SWEEP TRIGGER		Enter Offset	- MO
Free Run	- T1	MRK . OFS - Step	- MS
Line	- T2	Knob (increment left, increment right).	- IL, IR
Ext	- T3	Offset	- OF0, OF1
		DUMP MODES	
RBW/VBW/ST		Dump Marker Amp only	- D1 (default)
Coupled to Span	- CPO, CP1	Dump Marker Amp & Freq.	- D2
Preset	- PR	Dump A Trace	- D3
RBW Hold	- BHO, BH1	Dump B Trace	- D4
Res. BW	- RB	Dump Cal Reg.	- D5
Video BW	- VB	Dump Status	- D6
Sweep Time	- ST	Dump Alphanumerics	- D7
		Dump D1 Continuous	- D8
INPUT		Dump D2 Continuous	- D9
Impedance		TRIGGER MODES	
1 MΩ	- I1	Immediate Trigger	- T4
50 Ω	- I2	Delayed Trigger	- T5
75 Ω	- I3	Delay Trigger without SRQ	- T6

Table 3-2-10. Summary of Programming Mnemonics (Cont'd).

<p>MARKER</p> <p>Set Marker Location — MK1 to MK1001</p> <p>SPECIAL DISPLAY MODES</p> <p>Display Graphics — DG Display Annotation — DA Display Script — DS Display Script combined with B Trace — DC Erase Script — ES Enter Annotation — LA Enter Script Line 1 — L1 Enter Script Line 2 — L2 Enter Script Line 3 — L3 Enter Script Line 4 — L4 Enter Script Line 5 — L5 Enter Script Line 6 — L6</p>	<p>SPECIAL FUNCTION MODES</p> <p>Enable key entry — EE Enable key entry with SRQ — EQ Clear enable entry — EC</p> <p>BINARY DATA MODE</p> <p>Learn mode in from HP-IB — LI Learn mode out to HP-IB — LO B Trace in (binary) from HP-IB — BI B Trace out (binary) to HP-IB — BO A Tract in (binary) from HP-IB — AI</p>
---	--

APPENDIX 3-A

PROGRAMMING EXAMPLES USING THE -hp- 9825A CALCULATOR

Programming Notes

Here are a few helpful hints for programming the 3585A that should keep the number of programming headaches to a minimum.

If format statements are being used to enter data to the 3585A, the following number of decimal places are allowable:

Two decimal places are allowed with the commands:

Reference Level
Reference Level Volt

One decimal place is allowed with the commands:

All those above
Center Frequency
Frequency Span
Start Frequency
Stop Frequency
CF Step Size
Sweep Time
Manual Entries

No decimal places are allowed with the commands:

All those above
dB/DIV
Marker
Save
Recall
Input
Sweep
Trigger
Res. BW
Video BW
Range
Dump modes
Script Line Numbers

The 3585A will not accept a small “e” for a power of ten indication. Data must be entered using the appropriate data and delimiter.

invalid command
(entered as 4 Hz)

“CF4e7HZ”

valid command
(entered as 40 MHz)

“CF40MZ”

Finding Programming Errors

If there is an error in the 3585A programming string the beeper will sound. If this occurs, the following procedure should help you locate the problem.

a. Stop the program as soon as the beeper sounds. This should indicate roughly where the programming error occurred.

b. Begin to execute individual lines that contain 3585A programming codes. Start where the program was stopped and back up until the line causing the beep is found.

c. When the program line that causes the 3585A to beep is found, try one of the following methods to isolate the erroneous command:

1. Observe the error message. This will often point out the programming error. Some error messages disappear so quickly that they are hard to read, several executions of the suspected line may be necessary to read the message.

2. If the error message is displayed too quickly to observe, begin eliminating 3585A commands from the end of the string until the error is eliminated. This process should point out which command is in error.

Programming Examples

The following examples are provided to assist you in developing programs for the 3585A when the -hp- 9825A Calculator is used as the system controller.

Example 1: This is a basic programming statement which will accomplish the following:

Address the 3585A to listen
Send program DATA for:

Center Frequency	10 MHz	(CF10MZ)
Frequency Span	5 kHz	(FS5KZ)
Resolution BW	30 Hz	(RB30HZ)
Continuous Sweep		(S1)

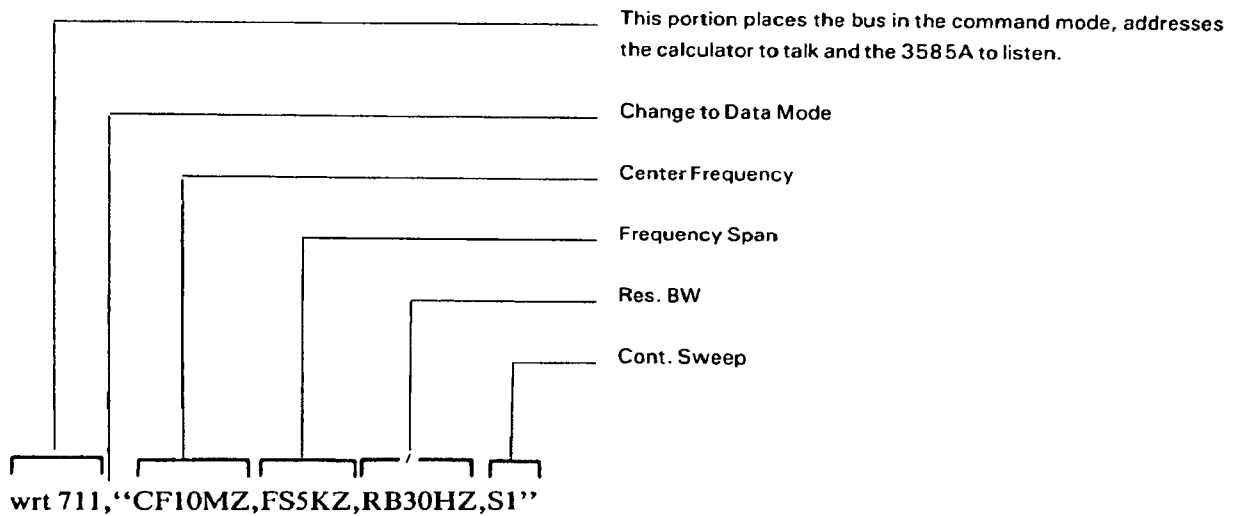

Example 2: This programming statement executes the same commands as the statement in Example 1; however, in this example the command string is written in accordance with the maximum programming speed guidelines of Paragraph 3.2.72. Try both Example 1 and 2 and note the difference in programming time.

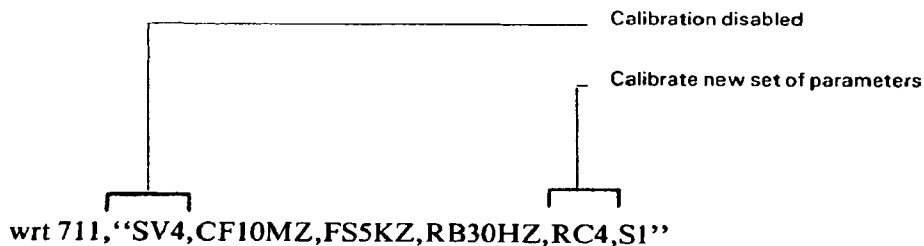

Example 3: Harmonic Distortion measurement using the Manual Mode.

The power and speed of the 3585A Manual Mode can be demonstrated with this program. When looking for Harmonic Distortion products reduction of the Resolution Bandwidth is often necessary to separate the signals from the noise floor. With the Manual Mode, the Resolution Bandwidth can be reduced as necessary while keeping the full 40 MHz span. The 3585A may now be programmed to the discrete frequencies of interest with the chosen resolution. Note that the sweep time is irrelevant, the time required to make the measurement is entirely determined by the IF settling and Calibration time.

```

0: dev "3585",711 _____ Device "3585" assigned Listen Address 711
1: wrt "3585","RB30Hz" _____ set 3585 for a Res. BW of 30 Hz
2: for I=1 to 5
3: wrt "3585","S3",2*I,"MZ,D1,T5" _____ Set 3585 Manual freq. for harmonics of 2 MHz
4: red "3585",A _____ Read 3585 marker amplitude
5: prt "Harmonic #",I,A _____ Print results
6: next I
7: end
*8263
    
```

Sample of Printed Results

Harmonic	#	1.00	—Harmonic number
		-0.10	—Harmonic amplitude
Harmonic	#	2.00	
		-65.80	
Harmonic	#	3.00	
		-69.10	
Harmonic	#	4.00	
		-90.80	
Harmonic	#	5.00	
		-90.40	

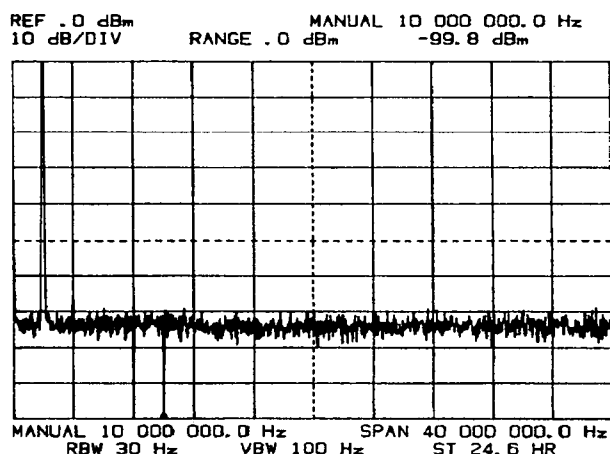

Harmonic Distortion - Manual Mode

Example 4: Measuring Power Line Sidebands with the Manual Mode.

Another example of using the Manual Mode with the full 40 MHz span is the measurement of power line sidebands. By using the 3 Hz Resolution Bandwidth we are able to resolve these sidebands. This program measures the 60 Hz sidebands around a 34 MHz signal by stepping the Manual frequency by the CF Step Size. After the measurement conditions have been programmed and calibrated, the calibration is turned off. This action helps save time and does not radically effect the 3585A's measurement accuracy since such a narrow band of frequencies are being measured.

```

0: dev "3585",711 _____ Device "3585" assigned Listen Address 711
1: wrt "3585","SV4,S334MZ,CS60HZ,_____ Set 3585 Manual freq. at 34 MHz, CF Step Size 60 Hz
   RB3HZ,VB1HZ,RC4,SV4,T5" Res. BW 3Hz, Video BW 1Hz, Calibrate, disable Cal, trigger
2: red "3585",B_____ Read the amplitude of the 34 MHz signal into B
3: for I=1 to 3
4: wrt "3585","S3,UP,T5"_____ Increment the Manual freq. 60 Hz, trigger the 3585
5: red "3585",A_____ Read the sideband amplitude into A
6: prt "Sideband Freq",I*60,A-B_____ Print the sideband freq. and relative sideband amplitude
7: next I
8: end
*6819
  
```

Sample of Printed Results

```

Sideband Freq
60.00
-96.90
Sideband Freq
120.00
-88.90
Sideband Freq
180.00
-90.10
  
```

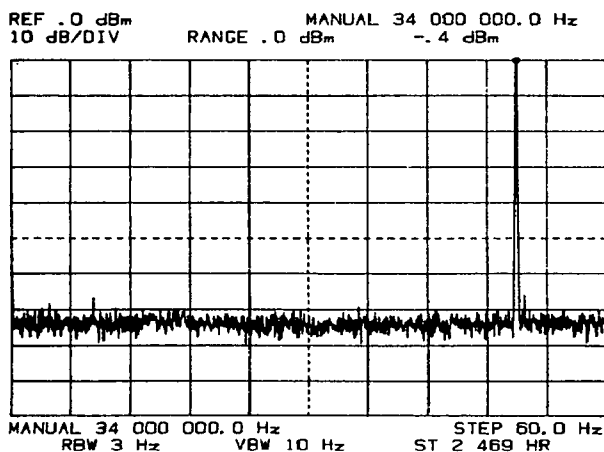

34 MHz Input Signal

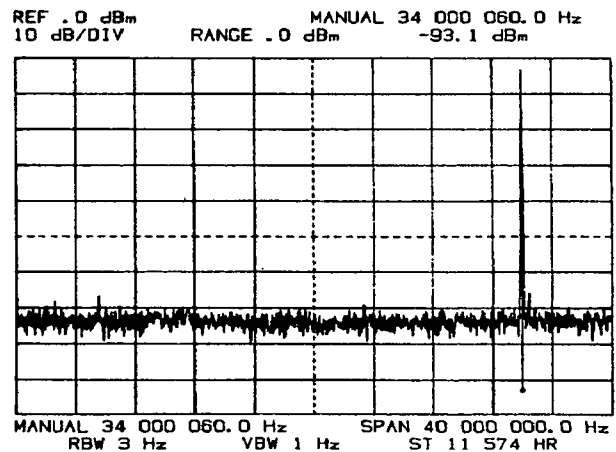

Upper 60 Hz Sideband

Example 5: Peak Search

This program will determine the largest displayed response (independent of span), count it and enter the counted frequency as the Center Frequency. Note the manner in which the Counter reading is made. The Counter must be triggered before reading it's value or entering it as the Center Frequency (Mkr - CF). Programming the sequence, Counter on, Mrk - CF will result in the Marker reading being entered as the Center Frequency instead of the Counter reading. A Noise Level reading is accomplished in much the same way. The Noise Level key is turned on, a "T5" trigger issued and the Noise Level read. Also note the format used to enter the marker position; four digits with no decimal place.

```

0: dev "3585",711_____ Device "3585" assigned Listen Address 711
1: -200→B→C_____ Initialize variables
2: wrt "3585","D3,T4"_____ Instruct 3585 to dump A trace
3: for I=1 to 1001
4: red "3585",A_____ Read each displayed point
5: if I>4;if A>B;A→B;I→C_____ Place maximum point in B, loop number (I) in C
6: next I
7: fmt 1,"MK",f4.0;wrt "3585.1",C_____ Place marker on maximum amplitude point
8: wrt "3585","CN1,D2,T5"_____ Turn on Counter, dump freq. and amplitude
9: red "3585",A_____ Read Counter frequency into A
10: wrt "3585","CN0,MC"_____ Enter Counter freq. as Center freq., Counter off
11: prt "Freq. =",A_____ Print Counted frequency
12: end
*3451

```

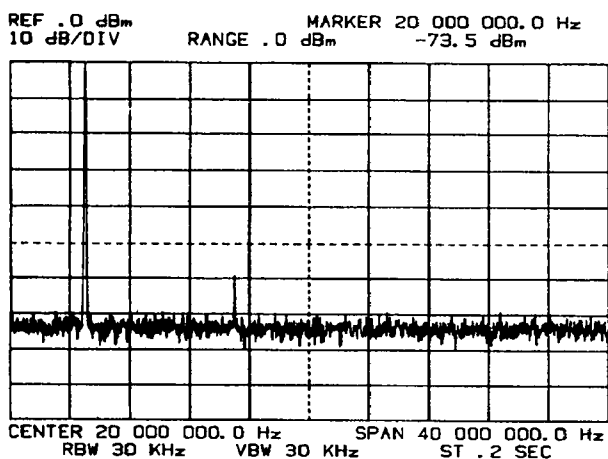

Display Before Program Begins

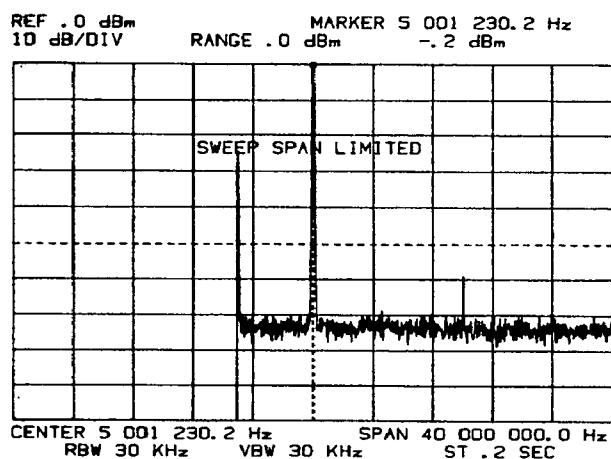

Peak Search Completed and Signal Centered.

Example 6: Harmonic Levels and Total Harmonic Distortion

The program shown below will allow you to measure the harmonic levels of any input signal from 250 Hz to 20 MHz. This example demonstrates the script mode on B trace, script mode, D1, D2 and T5.

The program works as follows: Press RUN. The program will instruct you to place the marker on the peak of the signal you wish to analyze. During this time, Entry parameters may be changed so that the signal may be easily viewed. When ready, press CONTINUE on the calculator. The results, which include the fundamental frequency and amplitude and the amplitude below the fundamental for harmonics 2 thru 5 and, the Total Harmonic Distortion will be displayed on the 3585A CRT.

```

0: "2/15/78; Harmonic Distortion M
  easurement":
1: wrt 711,"TB1ESDCL1PUT THE MARKE
  R ON THE PEAK OF THE FUNDAMENTAL"
2: wrt 711,"L2FREQUENCY. PRESS CON
  TINUE WHEN READY";lcl 711;sto
3: wrt 711,"SV1S3CN1T5";red 711,B
4: wrt 711,"MCMSCN0D2T5"
5: red 711,F,A
6: wrt 711,"RB30HZ"
7: for I=1 to 8
8: if F*(I+1)>4e7;gto "B"
9: wrt 711,"CFUPD1T5"
10: red 711,rI
11: "B":next I
12: for I=1 to 8
13: 10^(rI/20)->r(I+10)
14: r(I+10)^2+D->D;next I
15: sqrt(D/10^(A/20))->D;20*log(D)-A->D
16: wrt 711,"ESDSL1HARMONIC D1STOR
  TION RESULTS IN DB BELOW SIGNAL"
17: fmt 1,"L2FUNDAMENTAL =",f11.1,
  f14.1,"HZ";wrt 711.1,A,F
18: for I=1 to 4
19: fmt 2,"L",f1.0," HARMONIC ",
  f1.0,f11.1
20: fmt 3,"L",f1.0," HARMONIC ",
  f1.0,f11.1," THD=",f8.2,"DB"
21: if F*(I+1)>4e7;gto "C"
22: if I=4;wrt 711.3,I+2,I+1,rI+ab
  s(A),D;jmp 2
23: wrt 711.2,I+2,I+1,rI+abs(A)
24: "C":next I
25: lcl 711;end
*23715
  
```

Write message onto B trace

Count frequency to be analyzed

Move counted frequency to center

Read freq. and amp. of counted freq.

For harmonics 2-5

Out of limits check

Next harmonic

Calculate Total Harmonic Distortion (THD)

Script mode title

Fundamental amplitude and frequency

Out of limits check

Display each harmonics amplitude value

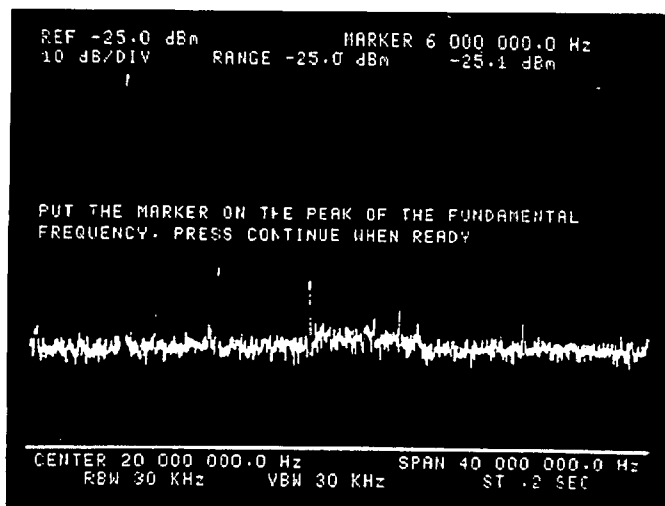

How the CRT looks after pressing RUN w/6MHz input.

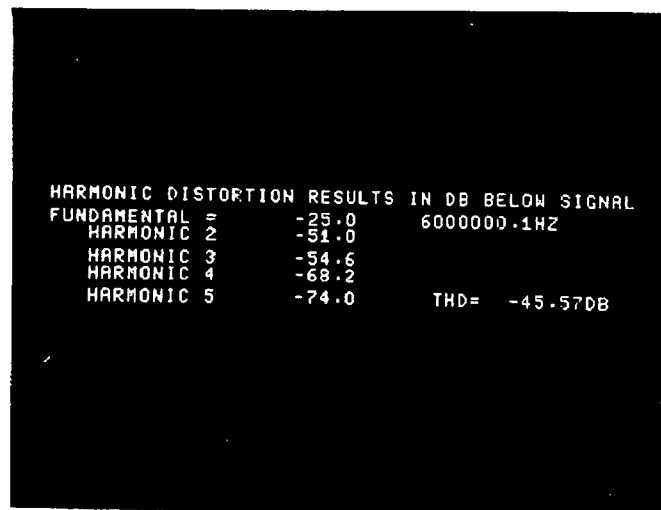

Picture of script display results.

Example 7: Plotting the 3585A "A" trace on the -hp- 9871A Printer

This program will print the presently displayed parameters and plot the A trace on the -hp- 9871A printer. This program demonstrates the D7, D3 and T4 modes. In order to execute this program, file 40 track 0 of the 9825A General Utility Routine tape (P.N. 09825-10004) must be loaded from Line 1 thru 110 as indicated by the space in the line numbers.

```

0: "Plot 3585A trace 11/08/77" :gto "Start 2"
1:
thru 110: File 40 from 9825A General Utility Routines tape

111: "Start 2":
112: dim A[1001],A$[30],B$[70];701+r0
113: ent "Comments for Plot header?",B$ _____ Enter Title for plot on calculator keyboard
114: fmt 1,4/;wrt 701.1
115: wrt 711,"D7T4"
116: for I=1 to 10
117: red 711,A$;wrt 701,A$;next I } Read and print the parameters displayed on the CRT
118: wrt 701;wrt 701,B$;wrt 701 _____ Print the previously entered plot title
119: wrt 711,"T4";for I=1 to 10
120: if I=1;red 711,A _____ Read the Ref. level into A
121: if I=3;red 711,B _____ Read the dB/DIV into B
122: red 711,A$;next I;wrt 701
123: cll 'form'(13.2,5,5)
124: cll 'psiz'(5,7.5,0,1)
125: cll 'scl'(0,100,A-B*10,A+.24*B)

```

```

126: cll 'xaxis'(A-B*5,10)
127: cll 'yaxis'(100,B)
128: cll 'move'(1,A-B*10);fmt 2,f6.1,"dBm
",z;wrt 701.2,A-B*10;0→M
129: cll 'yaxis'(0,B)
130: cll 'move'(1,A);fmt 2,f6.1,"dBm";wrt
701.2,A
131: "PT1":wrt 711,"S2OF0D3T4"
132: for I=1 to 1001;red 711,A[I];next I
133: for I=2 to 1001;M+1→M
134: if M=3;cll 'plt'(I/10,A[I]);0→M
135: next I
136: ent "Do another plot? 0=yes,1=no",D
137: if D=0;goto "PT1"
138: cll 'move'(0,A-B*10)
139: end
*28274

```

Print axes for the plot

Store 1001 points from trace

Plot trace using 1000/M points

Plot another trace on the same axes?

Move to lower left of plot

```

REF -20.0 DBM
MARKER 500.0 HZ
10 DB/DIV
RANGE -20.0 DBM
-119.7 DBM
START .0 HZ
STOP 1 000.0 HZ
RBW 10 HZ
VBW 30 HZ
ST 20.0 SEC

```

Triangle wave input at 200Hz

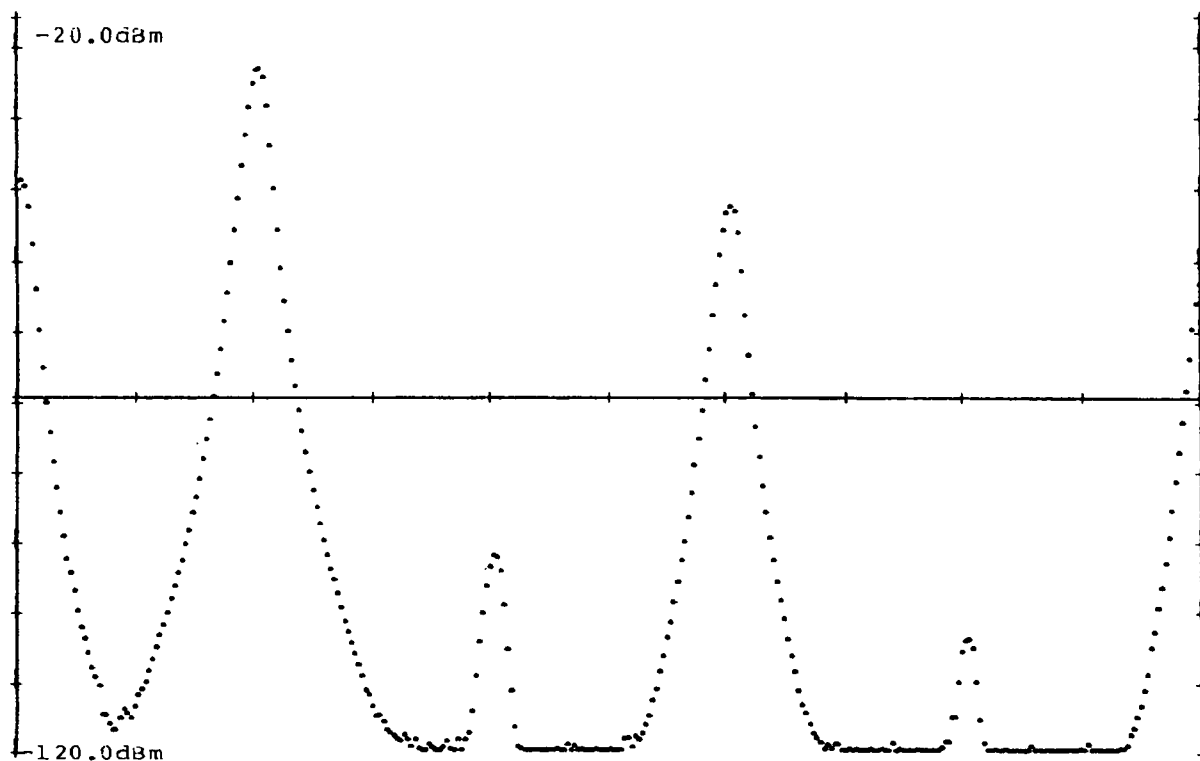

Sample of -hp- 9871A Printer Output

Example 8: Entering Arbitrary Frequency and Amplitude Offsets

A capability that is not available on the front panel is the entry of arbitrary frequency and amplitude Offsets. Under HP-IB control this function becomes possible. The program works as follows: The Offset Frequency value is entered into variable X and the dBm Offset Amplitude value is entered into variable Y. The X value is programmed as a Manual Entry on the 3585A and entered as an Offset. The Reference Level is programmed with the Y value. Next, the 3585A's memory is accessed and the Reference Level value read into variable A. The complement of variable A is then placed in A. This new value for A is then read into the 3585A's Amplitude Offset location in memory. When the Offset key is activated the new Offset values will become active. Remember that the Manual Frequency, Reference Level and Sweep parameters have been changed.

When using this program, the Offset Amplitude value entered into Y must follow the rules for Reference Level. This allows essentially any Amplitude Offset value to be entered if the correct Range is chosen, Do Not try to change the values in lines 6 and 11. Any attempt to do so may result in the processor becoming lost in such a way that the power will have to be cycled to regain instrument control.

```
0: dev "3585", 711
1: ent "Offset Freq? (in Hz)", X
2: ent "Offset Amp? (in dBm)", Y
3: wrt "3585", "S3", X, "HZ, OF1, MO, OF0"
4: wrt "3585", "RL", Y, "DM"
5: moct
6: wtb "3585", "MD", 377, 377, 176, 36, 0, 1
7: rdb("3585") → A; rdb("3585") → B
8: shf(A, -8) → A
9: ior(A, B) → A
10: cmpA → A
11: wtb "3585", "ML", 377, 377, 176, 44, 0, 1
12: shf(A, 8) → B
13: wtb "3585", B
14: wtb "3585", A
15: wrt "3585", "OF1, AL0, AL1, AR1"
16: mdec; end
*24386
```

Example 9: This program stores the 3585A B Trace and the present front panel key settings on 9825A cassette tapes. The program can be stored on track 0 and the B Trace and key settings information on track 1. Before using the program, the 9825A cassette tape must have 32 files of 4300 bytes marked on track 1. This allows you to record up to 32 different traces on the tape.

This program demonstrates the use of the script, EE, EC and DG modes. It initially displays instructions for loading or recording the B trace and key settings. This choice is made on the 3585 keyboard. The desired file is chosen and the data is either read, packed and recorded or read from tape, unpacked and loaded depending on the choice made earlier. Control of the 3585 is returned to the operator after the program is completed.

```

0: "Trace & Keyboard Saver 05/24/7
8":
1: fxd 0
2: wrt 711,"ESDSL1CHOOSE THE DESIR
ED ACTION AND ENTER YOUR CHOICE ON
"
3: wrt 711,"L2THE 3585 ENTRY KEYS"
4: wrt 711,"L4RECORD B TRACE AND P
RESENT KEY SETTINGS.....1"
5: wrt 711,"L5LOAD B TRACE AND KEY
SETTINGS"
6: wrt 711,"L6ON TAPE BACK INTO 35
85.....2"
7: "Rpt":gsb "Keyscn"
8: if F=49;gto "Record"
9: if F=50;gto "Dump"
10: gto "Rpt"
11:
12: "Record":
13: dim A$(1002,2),B$(50,2),C$(35)
14: gsb "File#"
15: wrt "3585","L5ENTER TITLE FOR
TRACE ON CALCULATOR, CONT."
16: ent "Title for trace",C$
17: wrt 711,"B0"
18: for I=1 to 1002
19: char(rdb(711))&char(rdb(711))>
A$(I)
20: next I
21: wrt 711,"LOSV4"
22: for I=1 to 50
23: char(rdb(711))&char(rdb(711))>
B$(I)
24: next I
25: trk 1;rcf Z,A$,B$,C$;trk 0
26: beep;dsp "DONE"
27: wrt 711,"DG";lcl 711;end

```

Display instructions for program use

If "1", go to "Record"

If "2", go to "Load"

Dimension strings

Trace title entered into C\$

Read and pack data for "B" trace into A\$

Read and pack data for present keyboard settings into B\$

Record information in specified file

Return to local, end

```

28:
29: "Dump":
30: gsb "File#"
31: dim A$(1002,2),B$(50,2),C$(35) _____ Dimension strings

32: trk 1;ldf 2,A$,B$,C$;trk 0 _____ Load data from tape to memory
33: wrt 711,"S2SV4BI"
34: for I=1 to 1002
35: num(A$[I,1,1])>B;wtb 711,B
36: num(A$[I,2,2])>B;wtb 711,B
37: next I
38: wrt 711,"LI"
39: for I=1 to 50
40: num(B$[I,1,1])>B;wtb 711,B
41: num(B$[I,2,2])>B;wtb 711,B
42: next I
43: wrt 711,"TA0TB1DG";lcl 711 _____ Return to local
44: dsp C$ _____ Display stored trace title
45: end
46:
47: "Keyscn":
48: wrt 711,"EE" _____ Enable key entry mode
49: rdb(711)>F _____ Read key value into F
50: if F<40;gto "Keyscn"
51: wrt 711,"EC" _____ Disable key entry mode
52: ret
53:
54: "File#":
55: wrt 711,"ESDSL1ENTER FILE NUMB]
ER DESIRED (01 - 32)" _____ Instructions
56: wrt 711,"L2ON THE 3585 KEYBOAR]
D"
57: gsb "Keyscn"
58: (F-48)*10>Z _____ Enter 10's digit into Z
59: gsb "Keyscn"
60: F+(Z-48)>Z _____ Enter 1's digit into Z
61: wrt 711,"L4 FILE #",Z _____ Display Z as file #
62: wrt 711,"L6 LOADING"
63: ret
*23510

```

Example 10: This program plots a replica of the 3585 CRT display on the -hp- 9872A Plotter. The plot will include the grid, trace and alphanumeric. The program sets P1 and P2 so that the plot will be proportional to the 3585 CRT. If a different size or proportioned plot is desired, the "ip" command in line two can be modified or deleted. The plot is designed to work on standard size 8½ by 11 paper. A full size version of a typical plot is shown after the program listing. This program gives an excellent alternative to CRT photographs, giving a large, convenient, clear, reproducible copy of the display. Many of the CRT pictures used in this manual were reproduced in this manner.

```

0: "Plot 3585 CRT on 9872 version
2: 3/13/78":
1: dim C$(30)
2: wrt 705,"VS20";wrt 705,"ip0,0,1_____ Set the pen velocity slower for the grid. Set P1 and P2.
0739,6911"
3: psc 705;line_____ Set the printer address
4: wrt 711,"D7T4"
5: for I=1 to 10
6: if I=1;red 711,A
7: if I=3;red 711,B
8: red 711,C$;next I
9: A+2*B+C
10: A-B*10-2*B+D
11:
12: "Grid":
13: scl -200,1200,D,C
14: pen# 1
15: for I=0 to 10 by 2
16: xax I*B+(A-B*10),0,0,1000
17: if I+1=5;line 2,1.2
18: if I=10;gto +2
19: xax (I+1)*B+(A-B*10),0,1000,0
20: line ;next I
21: for I=0 to 10 by 2
22: yax I*100,0,A-B*10,A
23: if I+1=5;line 2,.85
24: if I=10;gto +2
25: yax (I+1)*100,0,A,A-B*10
26: line ;next I;wrt 705,"VS36"
27:
28: "Trace Plot":
29: pen# 4
30: wrt 711,"D3T4"
31: for I=1 to 1001;red 711,H;plt
I,H;next I
32:

```

Read 3585 Ref. Level and dB/DIV

Calculate scaling factors

Plot horizontal grid

Plot vertical grid and set pen velocity to normal

Plot the A trace from the 3585

```

33: "Label":0→E
34: csiz 2.2,2. _____ Set character size
35: iplt 0,0,1;pen# 2
36: wrt 711,"D7T4"
37: plt 0,A+B,1
38: gsb "S"
39: plt 500,A+B,1
40: gsb "S"
41: plt 0,A+B/2,1
42: gsb "S" _____ Position pen for upper five alphanumeric labels
43: plt 300,A+B/2,1
44: gsb "S"
45: plt 680,A+B/2,1
46: gsb "S"
47: A-B*10-B/2→C;C-B/2→D _____ Calculate vertical position for lower alphanumerics
48: plt 0,C,1;gsb "S"
49: gsb "L"
50: plt Z-20,C,1;gsb "S1"
51: plt 90,D,1;gsb "S" _____ Position pen for lower five alphanumeric labels
52: plt 380,D,1;gsb "S"
53: gsb "L"
54: plt Z-100,D,1;gsb "S1"
55: pen# ;lcl 711;gto "B" _____ Store pen
56:
57: "S":
58: red 711,C$ _____ Read alphanumeric string from 3585
59: "S1":lcl C$;ret _____ Plot string variable as a label
60: "L":
61: red 711,C$ _____ Read alphanumeric string from 3585
62: len(C$)→Z;1000-Z*20→Z _____ Calculate string length and place in Z
63: ret
64:
65: "B":
66: ent "Plot B Trace?",G
67: if G=0;gto "END"
68: pen# 3
69: wrt 711,"D4T4"
70: for I=1 to 1001;red 711,H;plt I,H;next I _____ Plot the B trace from the 3585
71: pen# ;lcl 711
72: "END":end
73:
*296

```

REF 20.0 DBM
10 DB/DIV

MARKER 1 006 946.4 HZ
RANGE 20.0 DBM 18.3 DBM

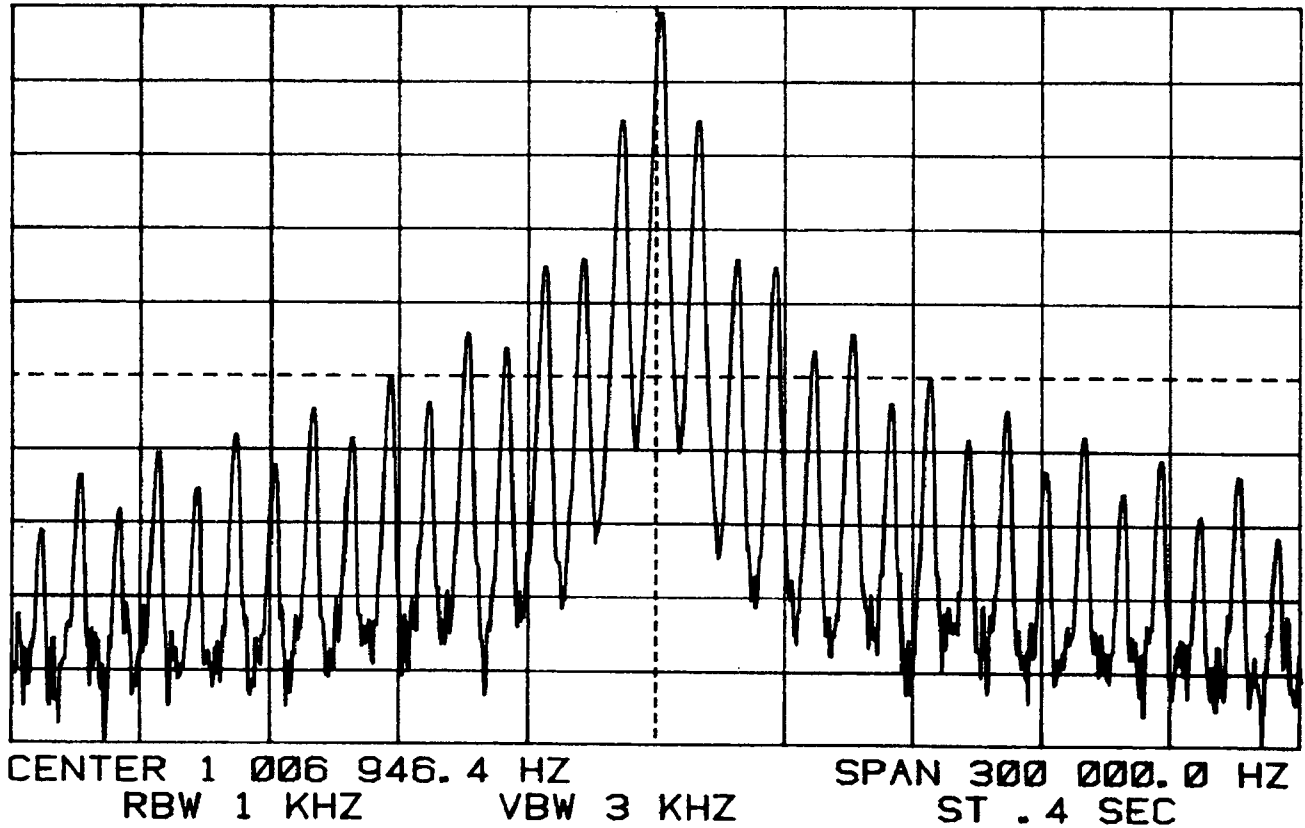

Sample of -hp- 9872A Plotter Output

APPENDIX 3-B META MESSAGES BLOCK DIAGRAMMED

DATA MESSAGES. The Data message is the actual information that is sent from a talker to one or more listeners. This action requires the controller to first enter the command mode to set up the talker and listener(s) for the transfer of data. The information is then transferred in the data mode.

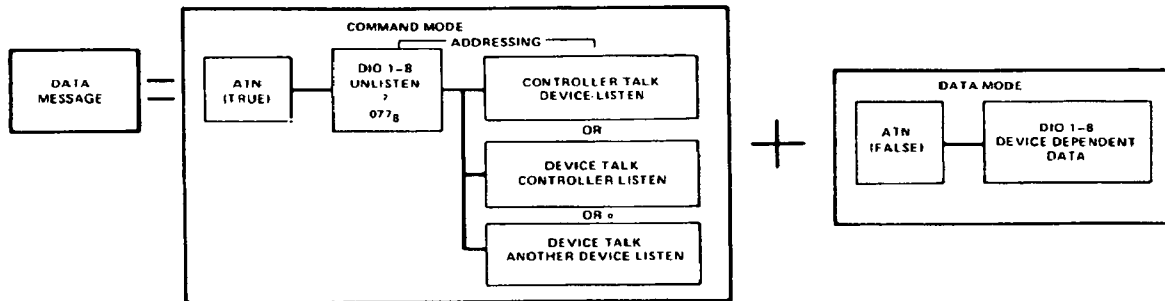

TRIGGER. The Trigger message causes all addressed instruments with this capability to execute some predefined function simultaneously.

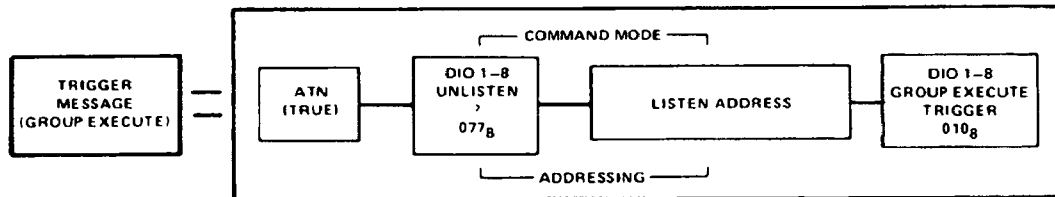

REN MUST BE TRUE BEFORE EXECUTING THE TRIGGER MESSAGE

CLEAR. The Clear message may be implemented for addressed devices or for all devices on the bus capable of responding. In both cases the controller places the bus in the command mode to execute the message.

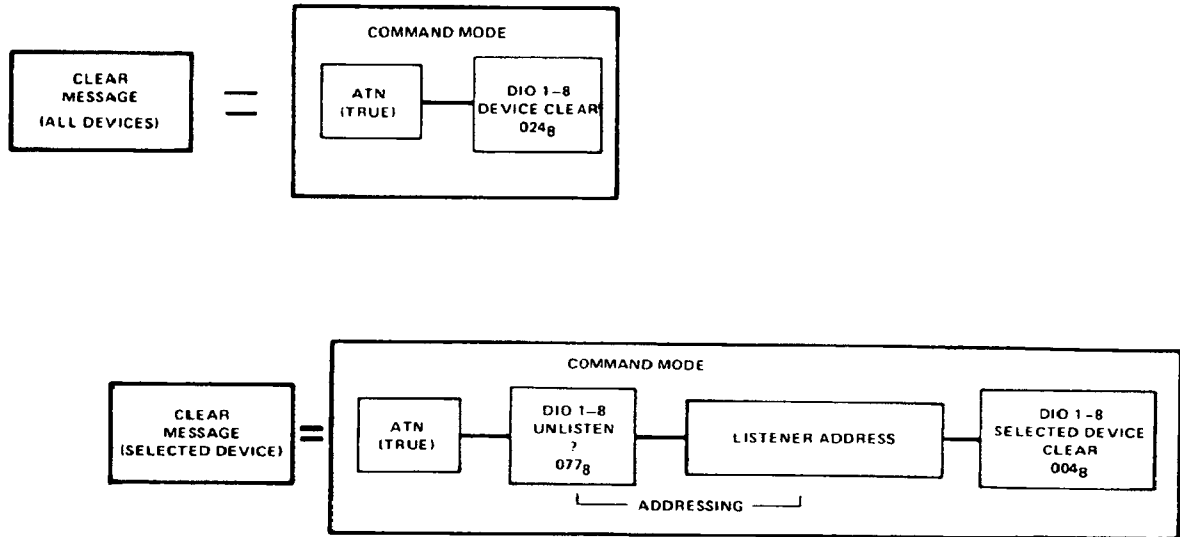

REMOTE. Only the system controller can place the device into the Remote operating condition. To implement the Remote operating message, the controller must set the REN line true. The HP-IB is then in the Remote Enable mode. The controller then sends the listen addresses of those devices that are to be placed in the Remote operating condition. Some instruments have been designed to enter the Remote mode as soon as REN is true.

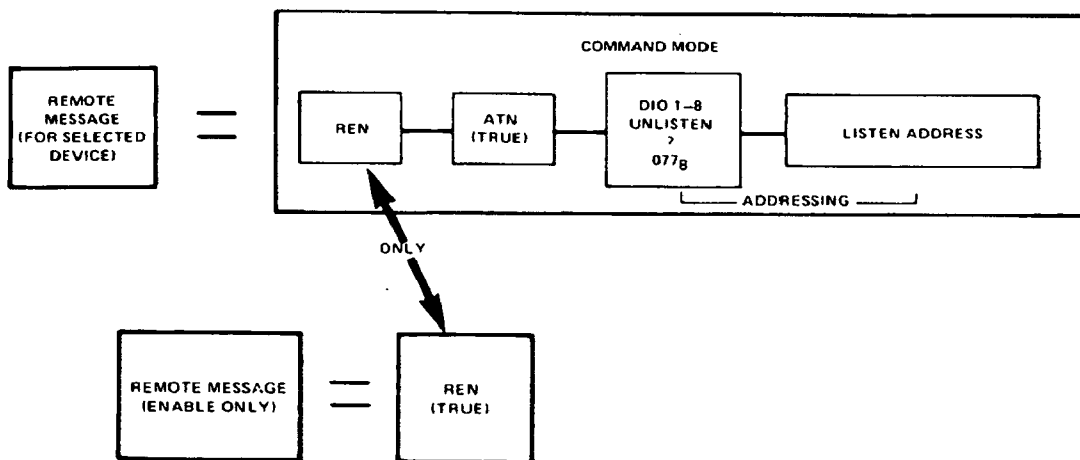

LOCAL. The Local message will remove addressed devices from the Remote operating mode to local (front panel) control. The controller must place the HP-IB into the command mode and address to listen all devices that are to be returned to local. The Local message does not remove the HP-IB from the Remote mode, only the listening devices.

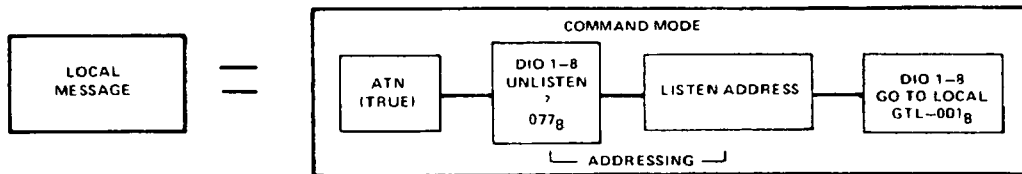

LOCAL LOCKOUT. The Local Lockout message prevents the operator from placing the instrument into local control from the front panel. The controller must be in the command mode to send the Local Lockout message.

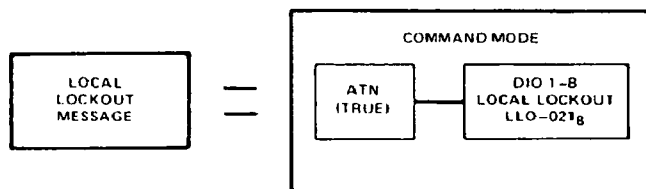

REN MUST BE TRUE BEFORE EXECUTING THE LOCAL LOCKOUT MESSAGE

CLEAR LOCKOUT AND SET LOCAL. This message removes all devices from the Local Lockout mode and causes them to revert to local control. Because the REN line is set false, the HP-IB is in the local mode.

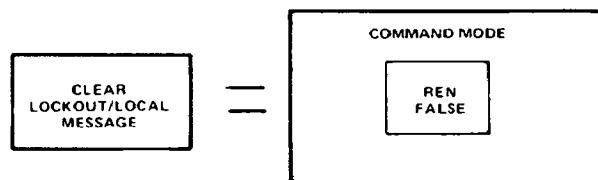

REQUIRE SERVICE. The Require Service message is implemented by a device by setting the SRQ line true. The Require Service message and, therefore, the SRQ line is held true until a poll is conducted by the controller to determine the cause of the request for service, or until the device no longer needs service.

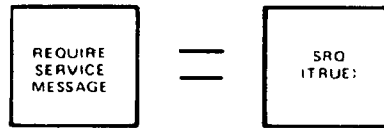

*REFER TO THE STATUS BYTE MESSAGE FOR THE SPECIFICATIONS REQUIRED TO FORCE SRQ FALSE

STATUS BYTE. The Status Byte message represents the operational status of a single instrument during a Serial Poll. A controller usually Serial Polls devices in response to a Request Service message. The controller requests device status from one device at a time. The status information byte (8 bits) sent by the device will tell whether that device needed service and why. A device will stop requesting service upon being Serial Polled, or if it no longer needs service. The controller initiates the message by placing the bus into the command mode, sending the Serial Poll Enable command, and addressing the specific devices to be polled, one at a time. The device then sends its Status Byte and clears the SRQ line provided the cause for the Require Service message is no longer present. The controller then places the bus in the command mode to terminate the message with a Serial Poll Disable command.

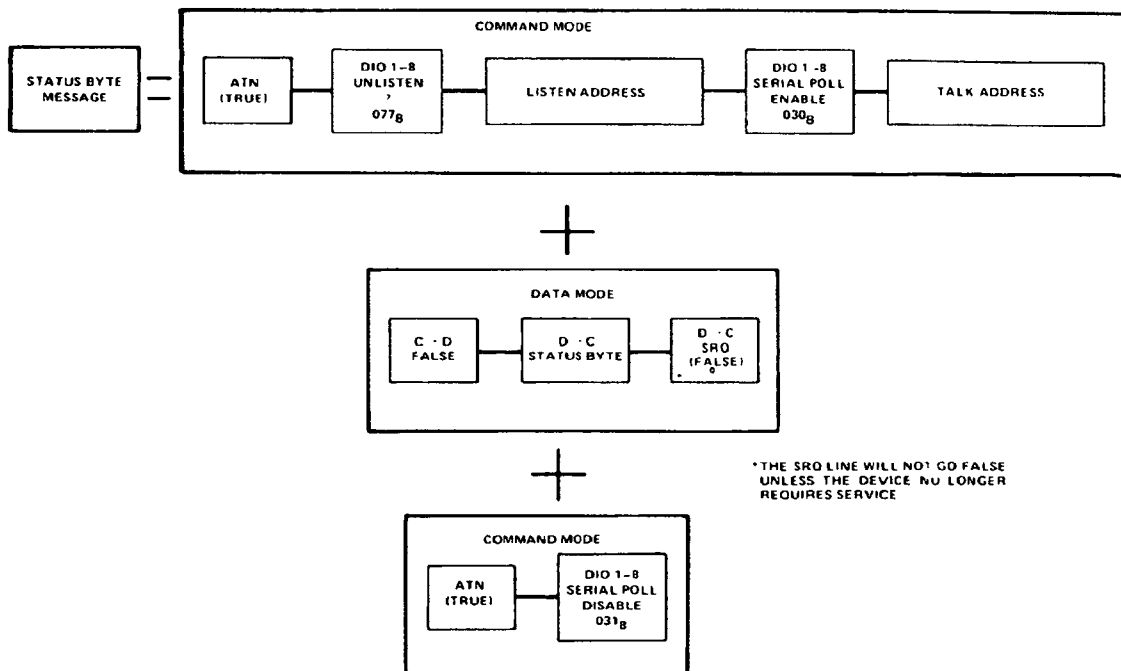

STATUS BIT. The Status Bit message is sent by a device to the controller to indicate its operational status in response to a Parallel Poll. Parallel Polling consists of the controller requesting one bit of status from each device simultaneously. The Parallel Poll may consist of three types of operations: Configuring, Polling, and Unconfiguring. In Configuring, the controller assigns each device a logic level and bit (on the bus data lines) for a poll response. During polling, each device responds on its assigned data line with the appropriate logic level. In Unconfiguring, the controller negates the bit and level assignments for all or selected devices. Several devices may be assigned to the same bit and level, causing their response bits to be logically ORed or ANDED.

NOTE

The 3585A does not respond to Parallel Poll.

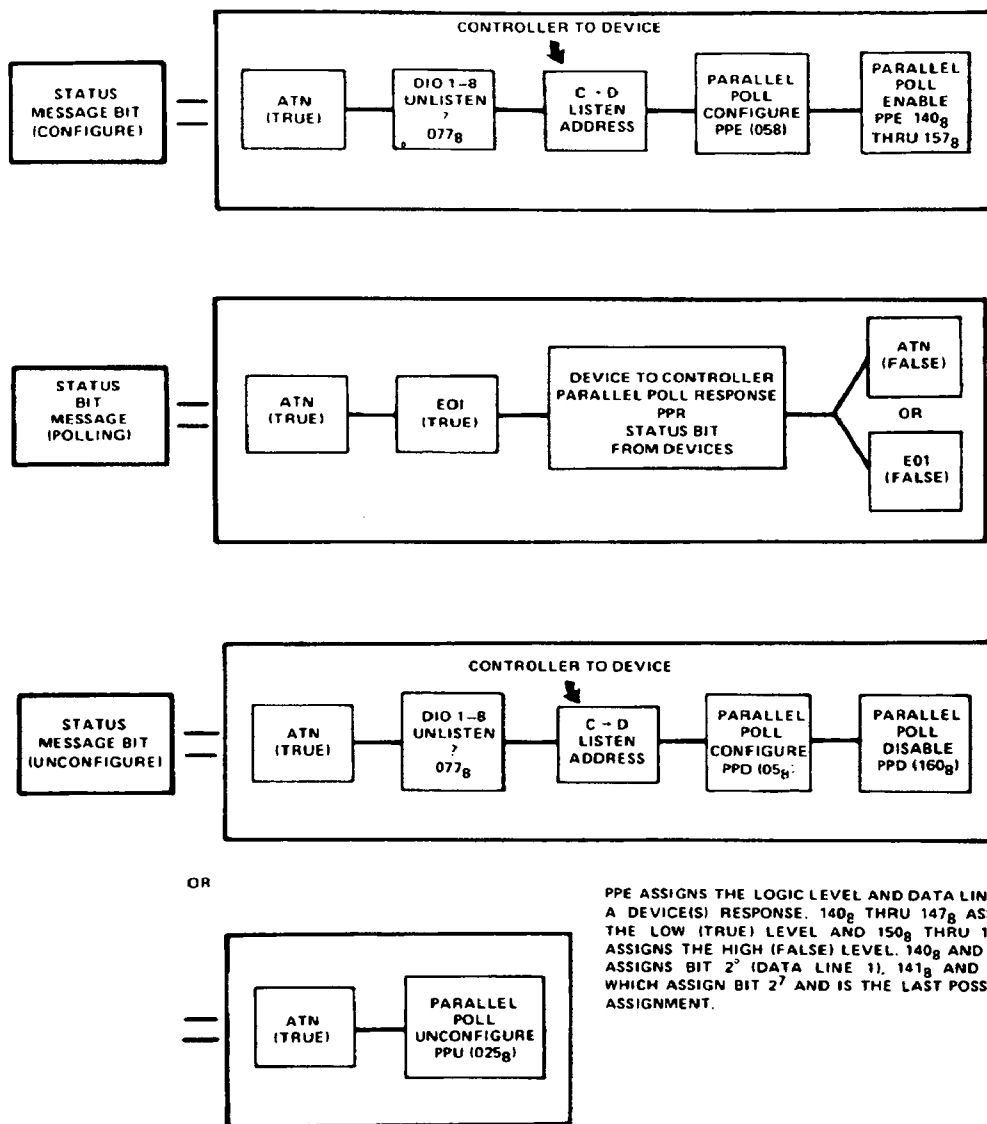

PASS CONTROL. The Pass Control message transfers bus management responsibilities from the active controller to another controller. In order to pass control, the active controller must enter the command mode, send the talk address, and the HP-IB characters for talk control.

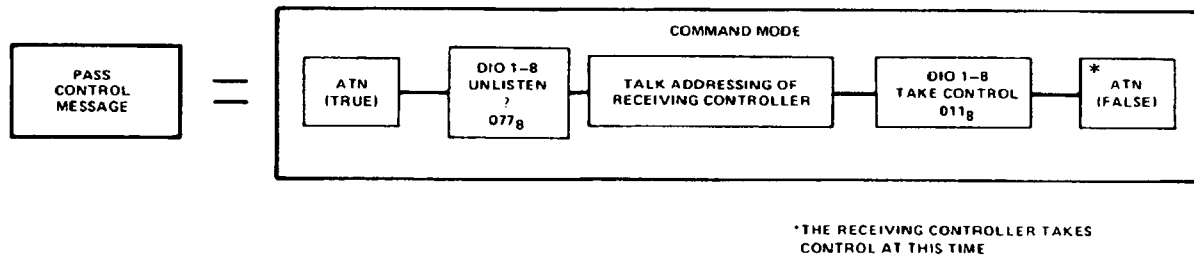

ABORT. The system Controller implements the Abort Message to regain control of the HP-IB from the active controller.



HP-IB IMPLEMENTATION WORKSHEET

Device Identification																		
Address	Listen																	
	Talk																	
	Decimal																	
Message	Device Implementation*																	
Data																		
Trigger																		
Clear																		
Local																		
Remote																		
Local Lockout																		
Clear Lockout and Set Local																		
Require Service																		
Status Byte																		
Status Bit																		
Pass Control																		
Abort																		

*S = Send Only

R = Receive Only

SR = Send and Receive

N = Not Implemented

SECTION IV

PERFORMANCE TESTS

4-1. INTRODUCTION.

4-2. This section contains the procedures for the performance tests which verify that the 3585A will meet its published specifications as listed in Table 1-1. Access to the interior of the instrument is not needed to perform any of the tests. Two different types of tests are included in this section: Semi-Automatic Performance Tests and Operational Verification Tests. The Semi-Automatic Performance Tests are used to verify that the 3585A meets its published specifications. The Operational Verification Tests will give you a good indication that the 3585A is working as specified; however, they do not verify that the 3585A meets *all* its specifications.

4-3. RECOMMENDED TEST EQUIPMENT.

4-4. The equipment that is recommended for testing the 3585A is listed in Table 4-1. If the recommended model is not available, use a substitute that meets the "Required Characteristics" given in the table. When using the Semi-Automatic Performance Tests, see Paragraph 4-14 for further instructions.

Table 4-1. Recommended Test Equipment.

Instrument	Required Characteristics	Usage		Recommended Model
		Semi-Automatic Performance Test	Operational Verification Tests	
Audio Oscillator	Frequency: 1kHz Distortion: ≤ -90 dB Amplitude: 0.1Vrms	x	x	-hp- 339 or -hp- 239
Attenuator: Variable 10dB/Step Variable 1dB/Step See Note 1	Range: 0 - 120dB Range: 0 - 12dB	x x	x x	-hp- 355D -hp- 355C
Bridge: Directional 50 Ω 75 Ω See Note 2, 3	Frequency: 0.1 - 40 MHz Return Loss > 30dB Directivity > 40dB	x x	x x	-hp- 8721A -hp- 8721A Option 008
Calculator	Compatible with -hp- 9825A Software and I/O	x		-hp- 9825
Calculator ROM's	HP-IB* and -hp- 9825A Compatible	x		-hp- 98210A and -hp- 98213A
Filter: 9MHz Low Pass	See Figure 4-14	x	x	
Frequency Counter	Range: 5 to 10 MHz Resolution: 0.1 Hz Accuracy: ± 1 count, $\pm 5 \times 10^{-10}$ /day	x	x	-hp- 5328A Option 010
Frequency Synthesizer	Freq. Range: 200 Hz to 40.1 MHz Amp. Range: + 10 to -85 dBm Amplitude Accuracy: ± 0.25 dBm	x	x	-hp- 3335A
Frequency Synthesizer	Freq. Range: 1 kHz to 33 MHz Amplitude Range: -25 dBm Amplitude Accuracy: ± 0.4 dB	x	x	-hp- 3330B
Function Generator See Note 3	Frequency: 1.2kHz Square Wave: 100ns rise time dc Offset: ± 1 V	x		-hp- 3311A
HP-IB* Interconnection Cables		x		-hp- 10631
HP-IB* Interface Cable	-hp- 9825A Compatible	x		-hp- 98034A
Impedance Matching Network (50 Ω to 75 Ω Minimum Loss Pad)	Frequency: 0.1 to 40 MHz VSWR < 1.05	x	x	-hp- 8542B
Mixer: Double Balanced See Note 3	Frequency: 0.1 - 40MHz	x		-hp- 10534
Oscilloscope See Note 2	Vertical Scale: ≥ 5 mV/Div. Horizontal Scale: ≥ 50 nsec/Div.		x	-hp- 1740A
Power Supply: DC See Note 4	Voltage range: 0 - 10 V DC	x		-hp- 6213A
Printer: Impact Summer	Plotter Capability See Figure 4-15	x x	x	-hp- 9871A
Termination: Feedthrough 50 Ω 75 Ω	± 0.1 ohm, 1 Watt	x x	x x	-hp- 11048C -hp- 11094C
Thermal Voltage Converter: 50 Ω , 0.5 V See Note 4	Frequency: 0.1 - 60MHz Calibration Data	x		-hp- 11051A Option 01
Voltage Divider: 10 to 1 Terminated in 50 Ω See Note 4	See Figure 4-7	x		
Voltmeter: Digital See Note 4	Full Scale Range: 1Vdc Accuracy: ± 0.004 % Resolution: 6 Digits Input Resistance: > 1 M Ω	x		-hp- 3455A

NOTES

1. Attenuator must be calibrated by standards lab. Correction factors are required for the Operational Verification Tests.
2. Required for the Operation Verification Return Loss Test.
3. Required for the Semi-Automatic Performance Test Return Loss procedure.
4. Required to run the calibrator accuracy program.

* Hewlett-Packard Interface Bus.

4-5. SEMI-AUTOMATIC PERFORMANCE TESTS OVERVIEW.

4-6. Due to the vast number of features incorporated in the 3585A, Semi-Automatic Performance testing is a highly desirable alternative to the Operational Verification tests. The function of Semi-Automatic Performance testing is to free the operator from the time consuming data gathering and documentation normally associated with Performance Tests. Semi-Automatic Performance Tests will check all of the specifications and do so in a much more detailed manner than the Operational Verification Tests. The Semi-Automatic Performance Tests give you a confidence level of 99% and take approximately 2 1/4 hours to complete.

4-7. The Semi-automatic Performance Tests and associated instructions are contained on the cassette tape (Part Number 03585-10001) included with the 3585A. In order to run the Performance Tests automatically, the program contained on the cassette tape is loaded into the -hp- 9825A calculator memory and run. Once the program is started, instructions for running the Performance Tests are printed by the calculator or displayed on the 3585A CRT. After the instructions have been completed, the calculator will proceed to execute the present test and document the data. This process gives the operator a neatly typed summary of the performance of the 3585A in a minimum amount of time.

4-8. OPERATIONAL VERIFICATION TESTS OVERVIEW.

4-9. The Operational Verification Tests are done manually for the 3585A and are designed to be run with a minimum amount of equipment. A comparison of the required test equipment is presented in Table 4-1. These tests give the user a good indication of the overall condition of the 3585A. Using this method of testing a 90% level of confidence that the 3585A meets all its specifications is obtained. The Operational Verification tests take about 3 hours to run (as compared to 2 1/4 hours for a complete semi-automatic characterization).

4-10. PERFORMANCE TEST CARD.

4-11. A Performance Test Card is provided at the end of this section for your convenience, to record the performance of the 3585A during the Operational Verification Tests. This card can be removed from the manual and used as a permanent record of the incoming inspection or of a routine Performance Test. The Performance Test Card may be reproduced without the written permission of Hewlett-Packard. The Performance Test Card is not used for the Semi-Automatic Performance Tests. The printer documents the tests results for you in a form similar to that of the Performance Test Card.

4-12. CALIBRATION CYCLE.

4-13. The 3585A requires verification of its specified performance every 12 months. The Performance Tests can also be used as a part of incoming inspection or after a repair is made to the instrument. The filter screen on the fan should be cleaned each time the instrument's performance is checked.

4-14. SEMI-AUTOMATIC PERFORMANCE TESTS.

4-15. Program Summary.

4-16. Table 4-2 is a list of the programs used during the Semi-Automatic Performance Tests. The Performance Test cassette tape file numbers are also contained in this table so that any program may be run individually.

Table 4-2. Summary of Programs Used For Semi-Automatic Performance Testing.

Size	Maximum Size	Track	File	Test Title
3440	5000	0	0	"10/14/77 GRIND":
4910	5000	0	1	"03/03/78; instrument interconnect test & Header"
4988	5000	0	2	"06/10/78": "Turn on/Cal Offset"
4954	5000	0	3	"06/10/78": "Source Accuracy"
2016	5000	0	4	"02/07/78": "Calibrator Accuracy" (Optional)
1574	5000	0	5	"02/13/78 Range Calibration":
2928	5000	0	6	"6/10/78": "Amplitude Linearity"
3264	5000	0	7	"6/14/78": "Ref Level Set Accuracy"
3720	5000	0	8	"6/10/78": "Flatness, 50 ohm, no cal, 10 Hz to 40 M"
3630	5000	0	9	"06/10/78": "Flatness, 1 M, 20 Hz to 40 MHz"
3372	5000	0	10	"06/13/78": "RETURN LOSS"
1978	5000	0	11	"6/14/78": "Noise vs. BANDWIDTH"
1610	5000	0	12	"06/10/78": "1 M Input Noise, open circuit"
1234	5000	0	13	"10/21/77 Marker Accuracy":
4340	5000	0	14	"4/14/78": "Low Freq. Response/LO sidebands"
1084	5000	0	15	"4/18/78": "Residual Spurs"
2160	5000	0	16	"04/13/78": "Conv/Input Spurs and Image"
2014	5000	0	17	"06/07/78": "IF Harmonic Distortion"
3224	5000	0	18	"6/10/78": "Harmonic Distortion"
4018	5000	0	19	"6/13/78": "IM Distortion"
3648	5000	0	20	"BW MEAS 5/31/78":
2324	5000	0	21	"10/24/77": "Tracking Generator Flatness"
1710	5000	0	22	"04/18/78": "Step IF, Fraction N Spurs"
1820	5000	0	23	"10/24/77": "API Spurs in Multiple Loop"
346	5000	0	24	"10/24/77 End of Perf. Test message":
4998	5000	0	25	"Dynamic Range Chart 1/20/78":
1014	5000	0	26	"HP-IB Test for Op. Verification 3/08/78":

4-17. Semi-Automatic Performance Test Equipment.

4-18. The Semi-Automatic Performance Test software is designed to be run with a particular set of HP-IB compatible instruments. These instruments are denoted by an asterisk (*) in Table 4-3. Critical specifications for this equipment may be found in Table 4-1. For usage of equipment other than that listed in Table 4-3, refer to Paragraph 4-19.

Table 4-3. Semi-Automatic Performance Test Equipment List

1-hp- 03585-10001	Semi-Automatic Performance Test Cartridge	
*-hp- 9825A	Programmable Calculator	
*-hp- 9871A	Character Impact Printer	
*-hp- 3335A	Frequency Synthesizer	
*-hp- 3330B	Frequency Synthesizer	
*-hp- 3455A	Digital Voltmeter	
*-hp- 98034A	HP-IB Interface	
Frequency Counter		-hp- 5328A
Function Generator		-hp- 3311A
Audio Oscillator		-hp- 339A
50Ω Return Loss Bridge		-hp- 8721A
75Ω Return Loss Bridge		-hp- 8721A Option 008
50Ω Feed Thru Termination		-hp- 11048C
75Ω Feed Thru Termination		-hp- 11094B
10dB/Step Attenuator		-hp- 355D
1dB/Step Attenuator		-hp- 355C
0.5V Thermal Voltage Converter		-hp- 11051A Option 01
Double Balanced Mixer		-hp- 10534A
HP-IB Cables		-hp- 10631
10:1 Voltage Divider Terminated in 50Ω	(See Figure 4-7)	
Frequency Summer	(See Figure 4-15)	
9MHz Low Pass Filter	(See Figure 4-14)	
DC Power Supply		-hp- 6213A
50/75Ω Minimum Loss Pad		-hp- 85428B

4-19. Test Equipment Substitutions.

4-20. The included Semi-Automatic Performance Test software is designed to be used with the calculator, printer and frequency synthesizers listed under Recommended Test Equipment, Table 4-3. Other HP-IB compatible controllers and instruments may be used for the tests; however, the user must write his own software to be compatible with his particular equipment. To facilitate this, flow charts of the Semi-Automatic Performance Tests are included in Appendix 4-A. Substitute test equipment must meet the critical specifications listed in Table 4-1.

NOTE

HP-IB is Hewlett-Packard's implementation of IEEE std 488-1975, "standard digital interface for programmable instrumentation".

4-25. HP-IB Address Switch Settings.

4-26. The HP-IB Address switch settings for the instruments used in the Semi-Automatic Performance Tests are listed in Table 4-4. If the Addresses for the 3585A, 3330B or 9871A are incorrectly set, a qualified service technician must set them correctly. The procedure for changing the 3585A HP-IB address can be found in Paragraph 2-32. For instructions on changing the other instruments HP-IB addresses, refer to each instruments individual manual. The -hp- 3335A and -hp- 3455A HP-IB Instrument Listen Address switches are located on their respective rear panels and may be changed for these tests.

Table 4-4. HP-IB Address Switch Settings

Instrument	HP-IB Listen Address (5-Bit Decimal Code)
-hp- 3585A Spectrum Analyzer	11
-hp- 9871A Impact Printer	1
-ho- 3335A Frequency Synthesizer	5
-hp- 3330B Frequency Synthesizer	4
-hp- 3455A Digital Voltmeter	22



HP-IB Address switches which require access to the interior of the instrument should be changed only by qualified service personal.

3585A Switch Settings

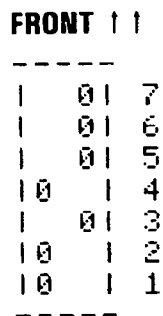

3335A Switch Settings

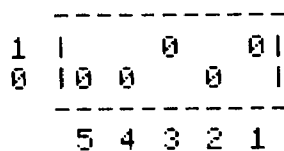

9871A Switch Settings

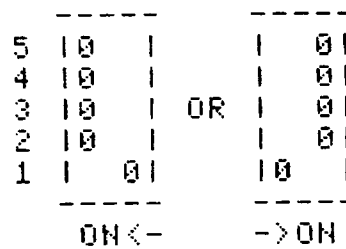

3330B Switch Settings

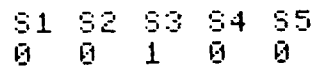

3455A Switch Settings

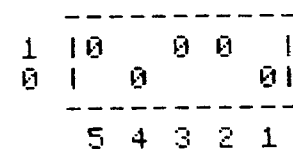

4-27. Manual Tests

4-28. Before proceeding with the calculator controlled portion of the Semi-Automatic Performance Tests, two manual tests must be performed. The first of these tests is for frequency accuracy, and the second test checks the 1 M ohm input impedance and capacitance.

4-29. Frequency Accuracy

4-30. This test verifies the frequency accuracy of the 3585A by using an external counter to check the internal frequency reference. It is important that the frequency counter used to do this test has a reference which is more accurate than that of the 3585A.

Specification: Counter Accuracy, $\pm 0.3\text{Hz} \pm 1 \times 10^{-7}/\text{month}$

Procedure:

a. Allow the instruments used in this test to warm up for 15 to 20 minutes before beginning this test.

b. Set the synthesizer controls for:

FREQUENCY.....9 MHz
 AMPLITUDE.....0 dBm

c. Set the 3585A controls for:

INSTRUMENT PRESET
 MANUAL SWEEP.....9 MHz
 COUNTER.....on

d. Using a BNC "T" connector, connect the synthesizer's 50 ohm output to the frequency counter and the 3585A 50 ohm input.

NOTE

Be sure that the synthesizer and the 3585A are operating on their own internal references. disconnect any reference connection common to both instruments.

e. Record the frequency difference between the frequency counter and the 3585A counter reading. Difference frequency equals _____ Hz.

f. The 3585A frequency accuracy is specified in terms of frequency drift; therefore, if the frequency accuracy derived from this test is not in accordance with your requirements, turn to Section 5 of this manual for the Reference Oscillator Adjustment procedure.

g. This completes the Frequency Accuracy Test, reconnect any necessary references.

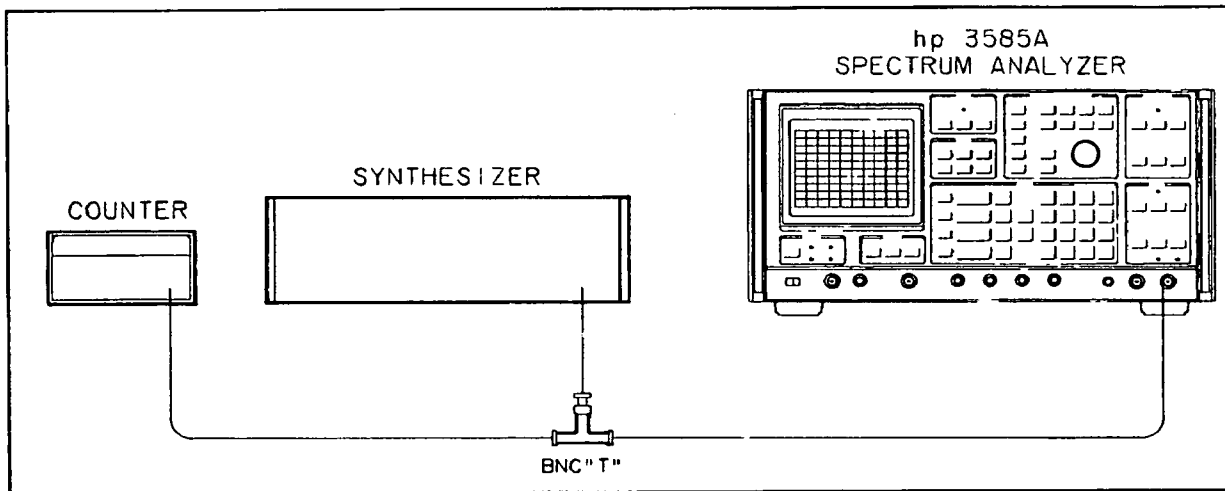

Figure 4-1. Frequency Accuracy Test

4-31. 1 M Ohm Input Impedance Test.

4-32. These tests verify that the 3585A meets the Input Impedance specifications for the 1 MΩ, 30 pf Input Impedance setting.

Equipment Required:

- Resistor: 1MΩ ± 1%, 1/8W film.....-hp- Part No. 0757-0344
- 50Ω Feed Thru Termination.....-hp- 11048C
- Synthesizer.....-hp- 3335A

Specification: 1MΩ ± 3%, < 30 pf

Procedure:

a. Set the 3585A controls as follows:

```

INSTRUMENT PRESET
CENTER FREQUENCY.....1 kHz
MANUAL SWEEP.....on
RES. BW.....100 Hz
dB/DIV.....2 dB
RANGE.....0 dBm
INPUT IMPEDANCE.....1 MΩ
    
```

b. Connect the 50Ω termination to the 3585A 1 MΩ input. Connect the synthesizer output to the termination input.

c. Set the synthesizer controls for:

```

FREQUENCY.....1 kHz
AMPLITUDE.....0 dBm
    
```

- d. Set the 3585A controls for OFFSET on. Allow time for the marker reading to stabilize and press the ENTER OFFSET button.
- e. Using short clip leads, insert the 1 M Ω resistor between the output of the termination and the 3585A 1 M Ω input as shown in Figure 4-2.
- f. The 3585A marker amplitude reading should be $-6.0 \text{ dB} \pm 0.44 \text{ dB}$, verifying that the input resistance is $1 \text{ M}\Omega \pm 5\%$.
- g. Press the 3585A ENTER OFFSET button.
- h. Set the synthesizer frequency to 10 kHz.
- i. Set the 3585A for a CENTER FREQUENCY of 10 kHz.
- j. The 3585A marker reading should be between -2 dB and -3 dB , verifying that the shunt capacitance is less than 30 pf.

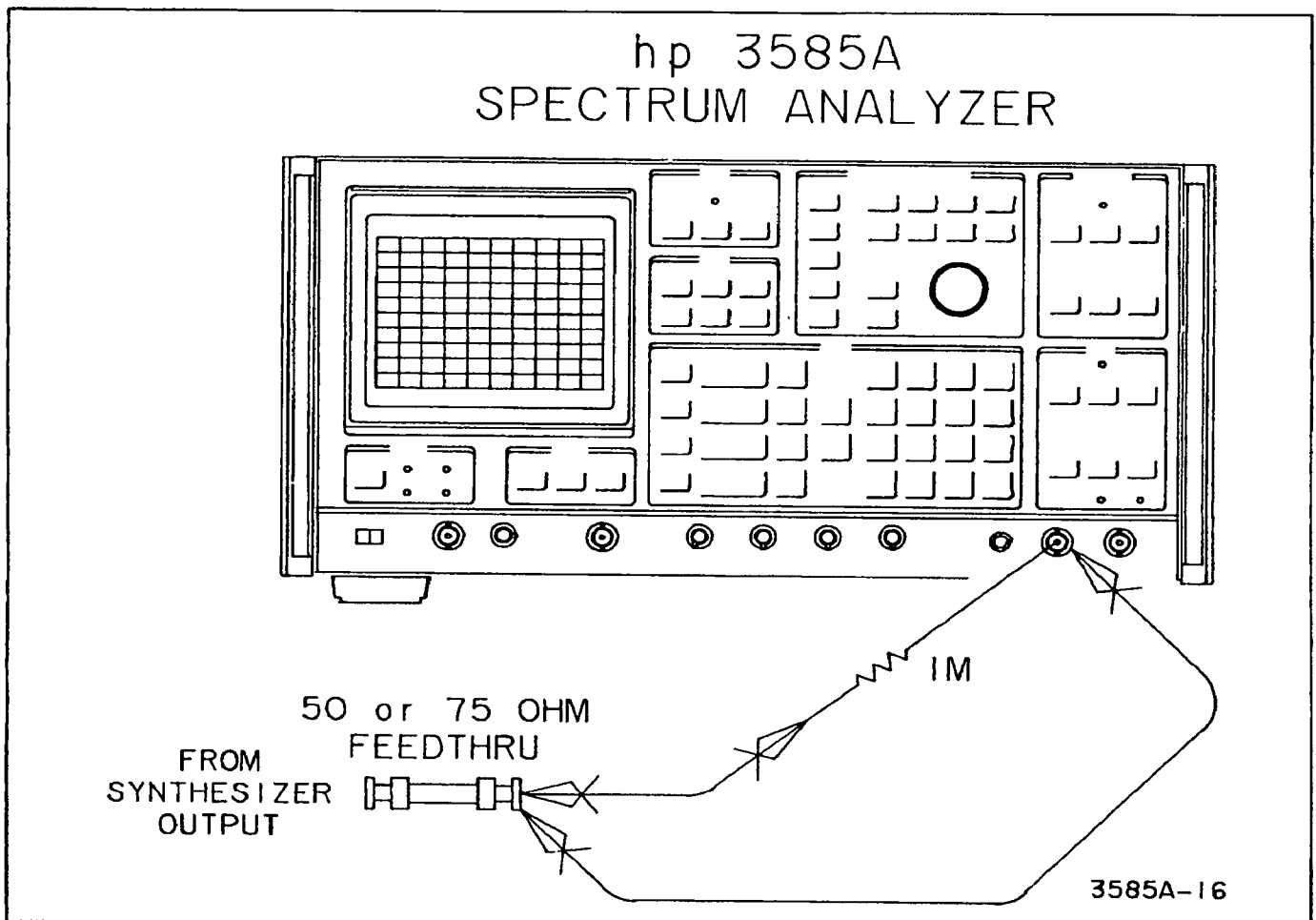

Figure 4-2. 1 M Ohm Input Impedance Test.

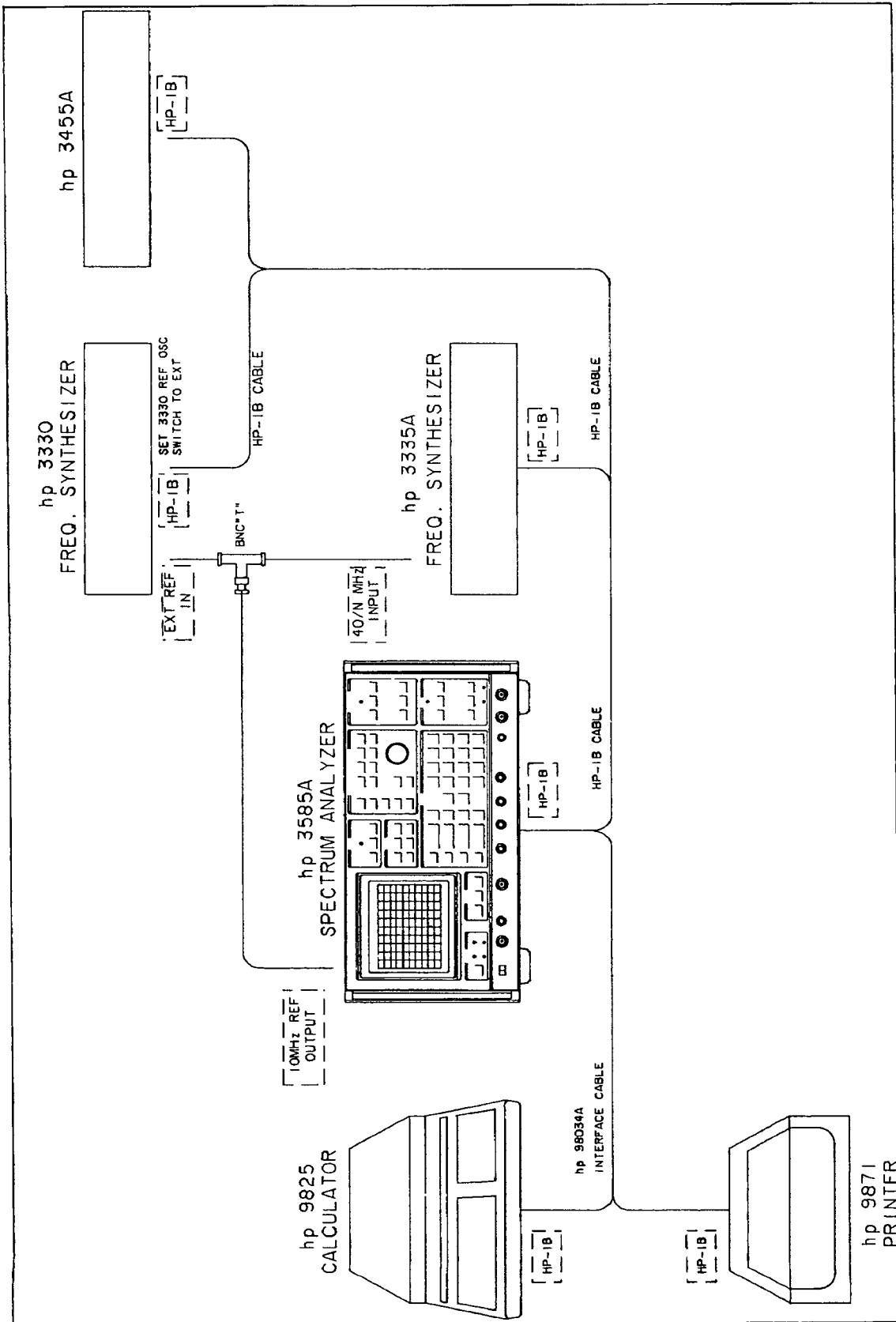

Figure 4-3. Semi-Automatic Performance Test Equipment Set-up.

4-33. Semi-Automatic Performance Test Equipment Set-up.

4-34. To run the Semi-Automatic Performance Tests, the -hp- 9825A Calculator, -hp- 9871 Printer, -hp- 3335A Frequency Synthesizer, -hp- 3330 Frequency Synthesizer and -hp- 3585A Spectrum Analyzer must be connected together as shown in Figure 4-3 and remain so for all of the performance tests unless otherwise noted.

4-35. Semi-Automatic Performance Test Procedure.

- a. Turn the calculator power off.
- b. Insert the calculator ROM's described in the Recommended Test Equipment list, Table 4-1, and into the slots under the calculator keyboard (see Figure 4-4).
- c. Check the rotary switch setting (Figure 4-5) on the HP-IB interface cable. The pointer should be on "7". If the pointer is at some other setting, use a small screwdriver to set it on "7".
- d. Turn the calculator, printer, synthesizer and spectrum analyzer power on.
- e. Load the supplied performance test cassette tape (Part Number 03585-10001) into the cassette tape slot.
- f. Press **LOAD** **0** on the calculator keyboard.
- g. Press **EXECUTE**
- h. After the run light has gone out, press **RUN** on the calculator keyboard.
- i. From this point on, the calculator will give instructions for what to do next. The manual does contain equipment set-ups for some of the tests. As these tests are encountered, the calculator will refer you to the equipment set-up diagram in the manual.

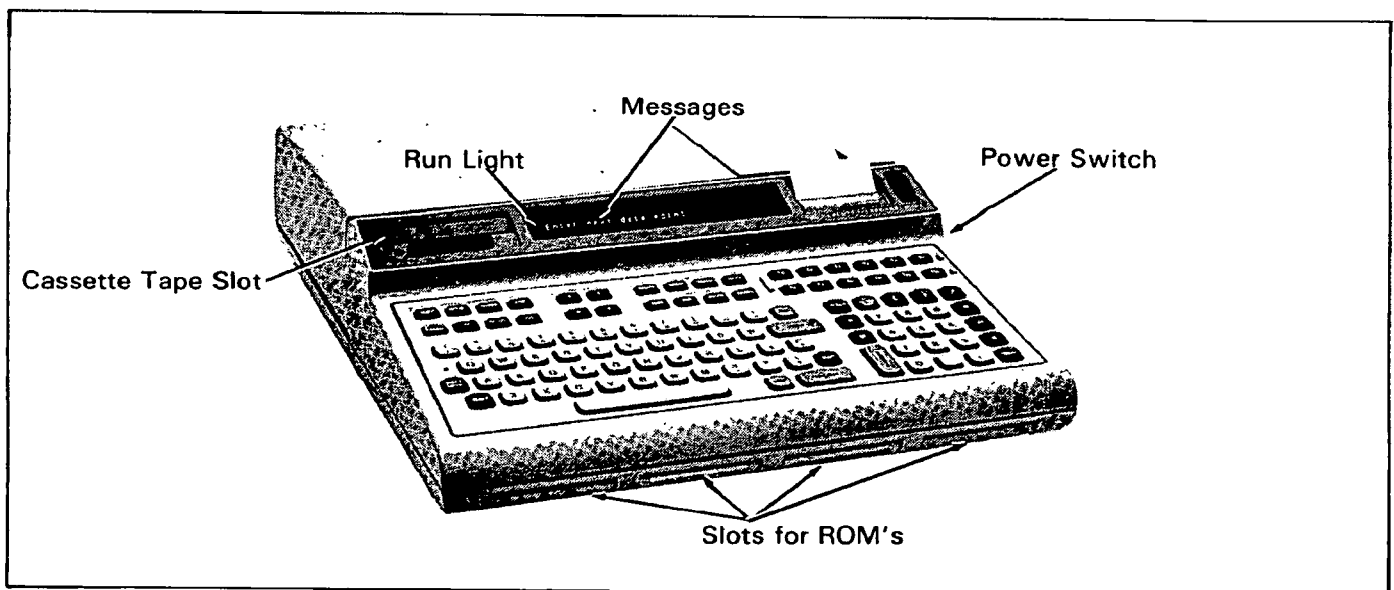

Figure 4-4. HP 9825A Calculator

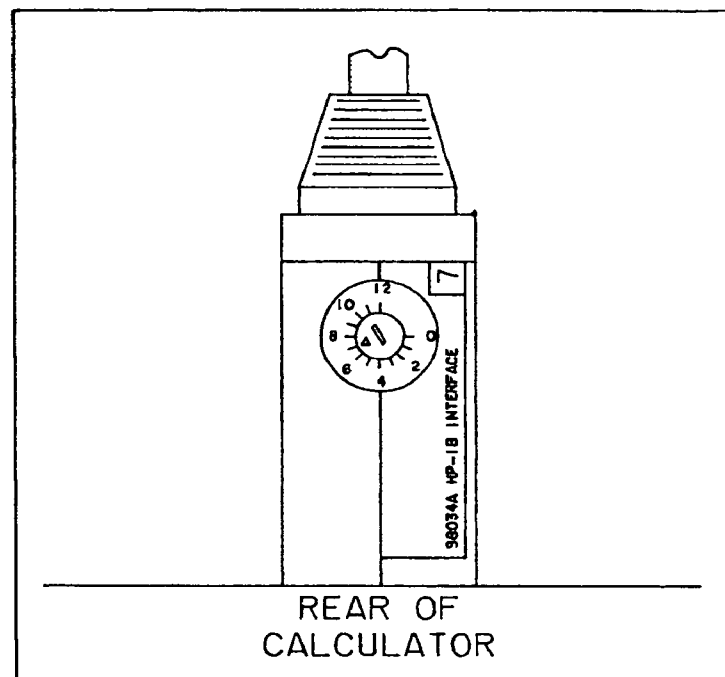

Figure 4-5. HP-IB Interface Cable Switch Setting.

4-36. Source Accuracy Program.

4-37. The purpose of the source accuracy program is to calibrate the amplitude flatness of the synthesizer. This is done so that the synthesizer's corrected amplitude will be perfectly flat for the Calibrator Flatness and Range Calibration tests. The results of the Calibrator Flatness test will show how accurately the 3585A is being calibrated with respect to frequency.

4-38. To begin the Source Accuracy program, the calibration data for the N.B.S.*-Certified Thermal Converter is entered into the calculator memory (this information can be obtained by ordering Option 01 with your -hp- 11051A Thermal Converter). After entering the frequency-related calibration data, a reference output voltage is obtained for a known input voltage. This is accomplished by a DC to DC transfer measurement. This measurement involves inputting a DC signal to the Thermal Converter that is equivalent to a 6 dBm signal into 50Ω. Next, the output of the synthesizer is applied to the N.B.S.*-Certified Thermal Converter. The output of the Thermal Converter is monitored using a high accuracy, high resolution digital voltmeter. The program will adjust the output of the synthesizer until the previously measured Thermal converter output voltage is read by the digital voltmeter. The output level and frequency of the synthesizer are then stored in the calculator memory. Thirty-three frequencies are calibrated in this manner across the 40 MHz range. Once the 40 MHz range has been calibrated, the correction factors stored in the calculator's memory are recorded onto the performance test tape for use in later programs.

*U.S. National Bureau of Standards.

NOTE

It is very important that the synthesizer and output cable used to perform the source accuracy program are the same ones used to perform the calibrator flatness and range calibration tests.

4-39. The data that is recorded on the tape for the source calibration test is only valid for one particular synthesizer-cable combination. Anytime the synthesizer or output cable is changed, a new set of source calibration data must be taken. For this reason, a space is provided at the beginning of the source calibration program to enter any pertinent information about the synthesizer, output cables or conditions.

4-40. Using the Source Accuracy Program.

4-41. The Source Accuracy program is structured in such a way so that maximum flexibility is available to the user. Because of this flexibility, guidelines are needed to help you understand the workings of this test. The flow chart of Figure 4-6 outlines the workings of this program. As you can see, the program centers around the menu which will appear as follows:

```
YOUR MENU IS:
ENTER THERMAL CONVERTER CALIBRATION DATA.....0
MEASURE THE THERMAL CONVERTER OUTPUT.....1
MEASURE THE SOURCE FOR CORRECTION DATA.....2
MANIPULATE DATA..(Print, Load, Record).....3
ENTER ONE OPTION # ON THE CALCULATOR KEYBOARD, CONT.
```

From the menu any of the four paths are available. When each path is completed a message will be displayed like this one:

```
GO BACK TO THE MENU.....CONTINUE
END.....1, CONTINUE
```

This message allows you to continue working in the Source Accuracy program for as long as you desire.

4-42. From the "List of Operations" (Table 4-5), a typical usage of the Source Accuracy program can be derived. This is the normal way in which the Source Accuracy program should be run. This typical usage would involve entering the Thermal Converter calibration data, measuring the Thermal Converter output, measuring the synthesizer for calibration data and recording the data. This sequence of events may be accomplished by performing operations a, b, c and d of Table 4-5. Another possibility is that the recorded Thermal Converter calibration data is correct, but a new set of synthesizer correction data needs to be taken. This may be accomplished by completing operations g and d. Data on the tape may be checked at any time by using operations e and f. Operation e may also be used during the running of the Source Accuracy program to check the data presently in memory.

NOTE

Unless the source accuracy program has been run within the last 30 days, it should be run again. This will assure that the data used to check the 3585A calibrator is valid.

Table 4-5. List of Operations.

<p>a. To enter the Thermal Converter calibration data.</p>	<ol style="list-style-type: none"> 1. go to the menu 2. choose path #0
<p>b. To measure the Thermal Converter output voltage.</p>	<ol style="list-style-type: none"> 1. go to the menu 2. choose path #1 3. answer "no" to the question 4. take the measurement as directed
<p>c. To measure the synthesizer for correction data.</p>	<ol style="list-style-type: none"> 1. go to the menu 2. choose path #2 3. connect the equipment as directed 4. wait for the completion of the test
<p>d. To record the correction data onto the Performance Test tape.</p>	<ol style="list-style-type: none"> 1. go to the menu 2. choose path #3 3. choose option #3 4. follow the instructions for recording the data
<p>e. To print the correction and Thermal Converter calibration data contained in memory.</p>	<ol style="list-style-type: none"> 1. go to the menu 2. choose path #3 3. choose option #1
<p>f. To load the correction data from the Performance Test tape into memory</p>	<ol style="list-style-type: none"> 1. go to the menu 2. choose path #3 3. choose option #2
<p>g. To use the Thermal Converter calibration data and take a new set of synthesizer correction data.</p>	<ol style="list-style-type: none"> 1. go to the menu 2. choose path #3 3. choose option #2 4. go to the menu 5. choose path #1 6. go to the menu 7. choose path #2

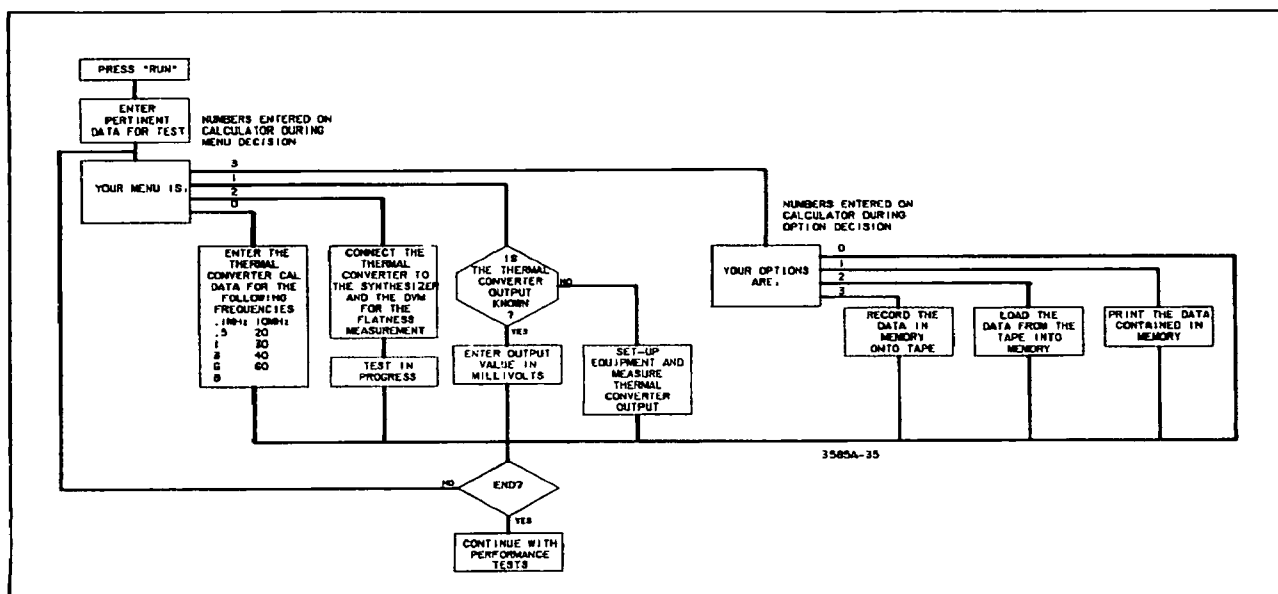

Figure 4-6. Source Accuracy Program Flowchart.

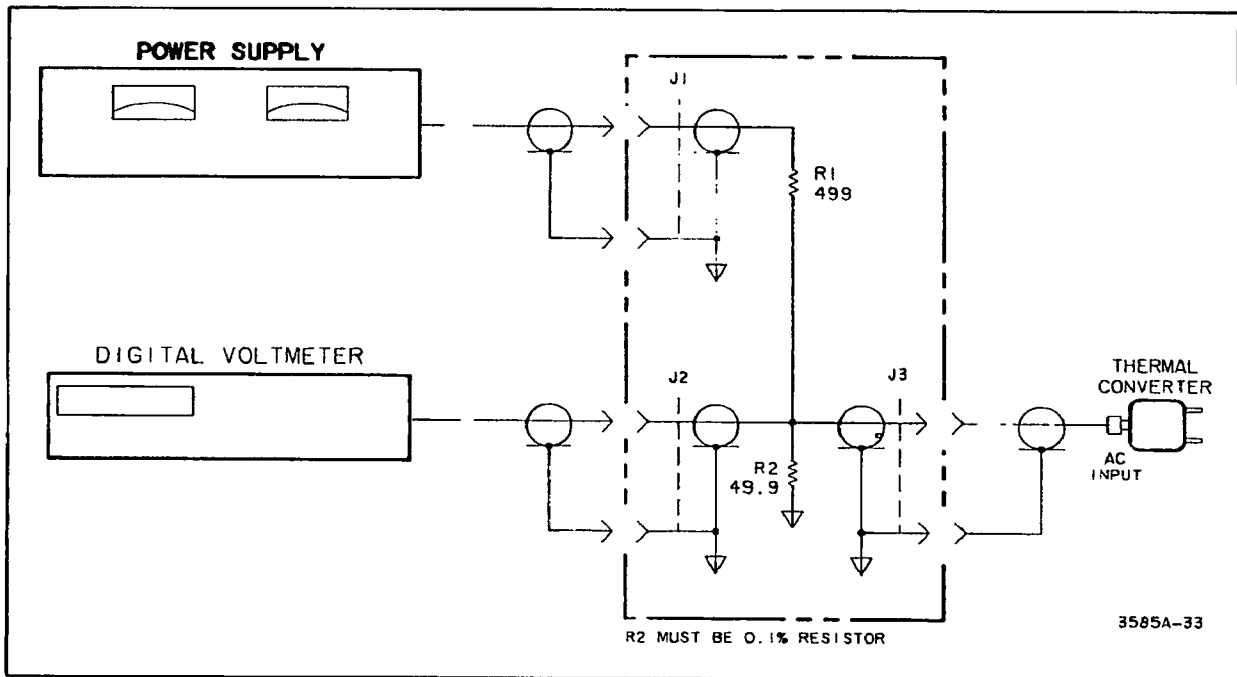

Figure 4-7. Thermal Converter Output Calibration.

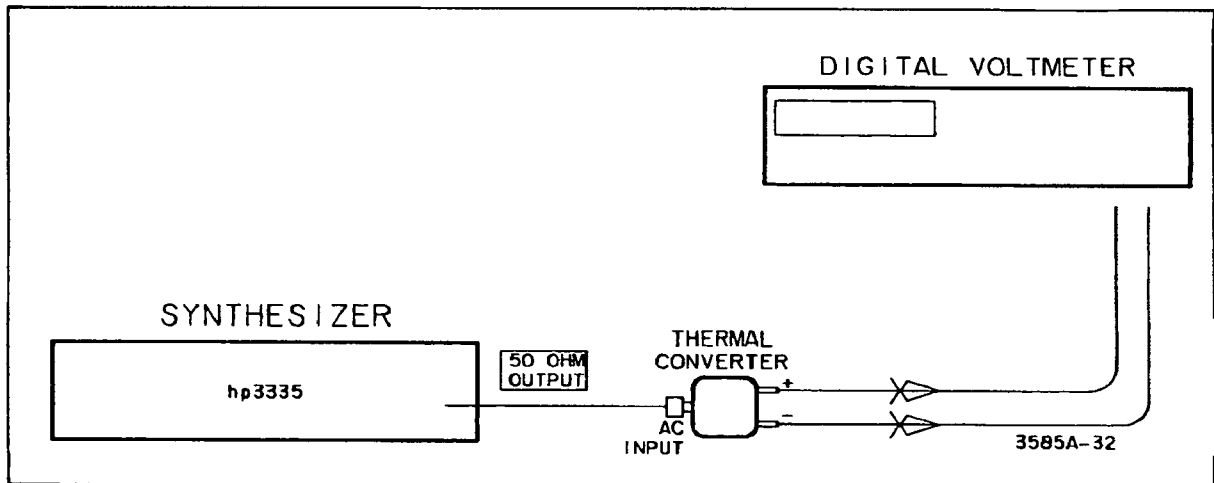

Figure 4-8. Measurement of Frequency Synthesizer For Calibration Data.

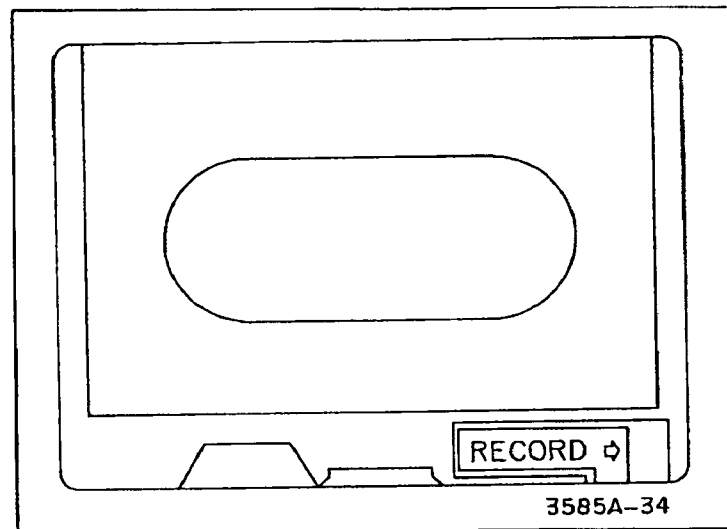

Figure 4-9. 9825A Cassette Tape.

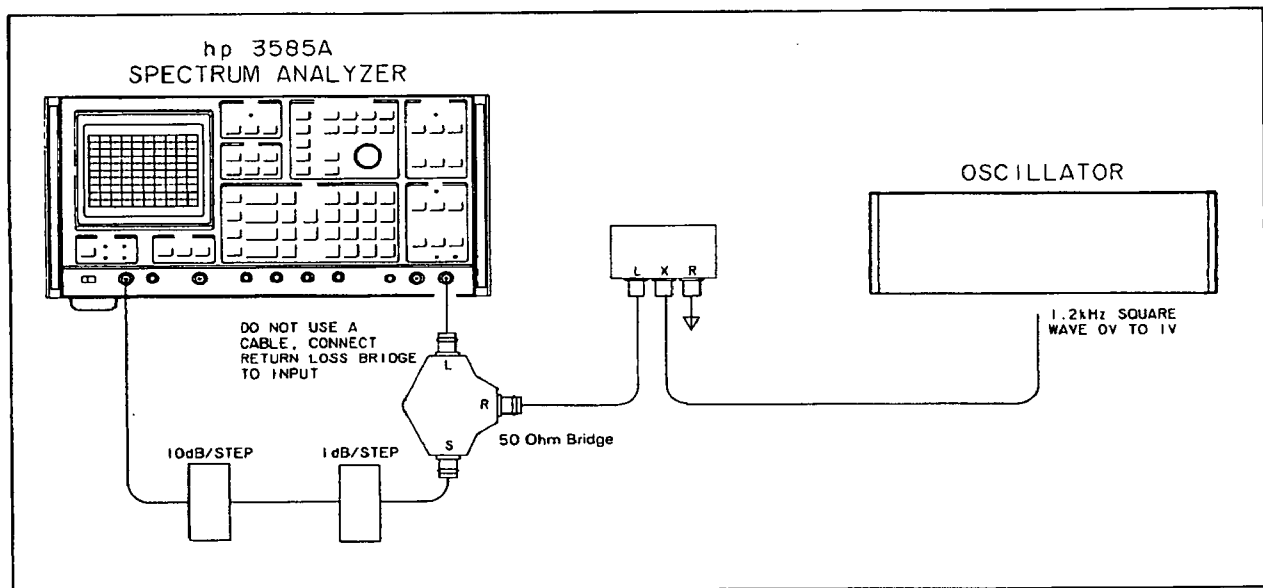

Figure 4-10. 50 ohm Return Loss Test (Automatic Tests).

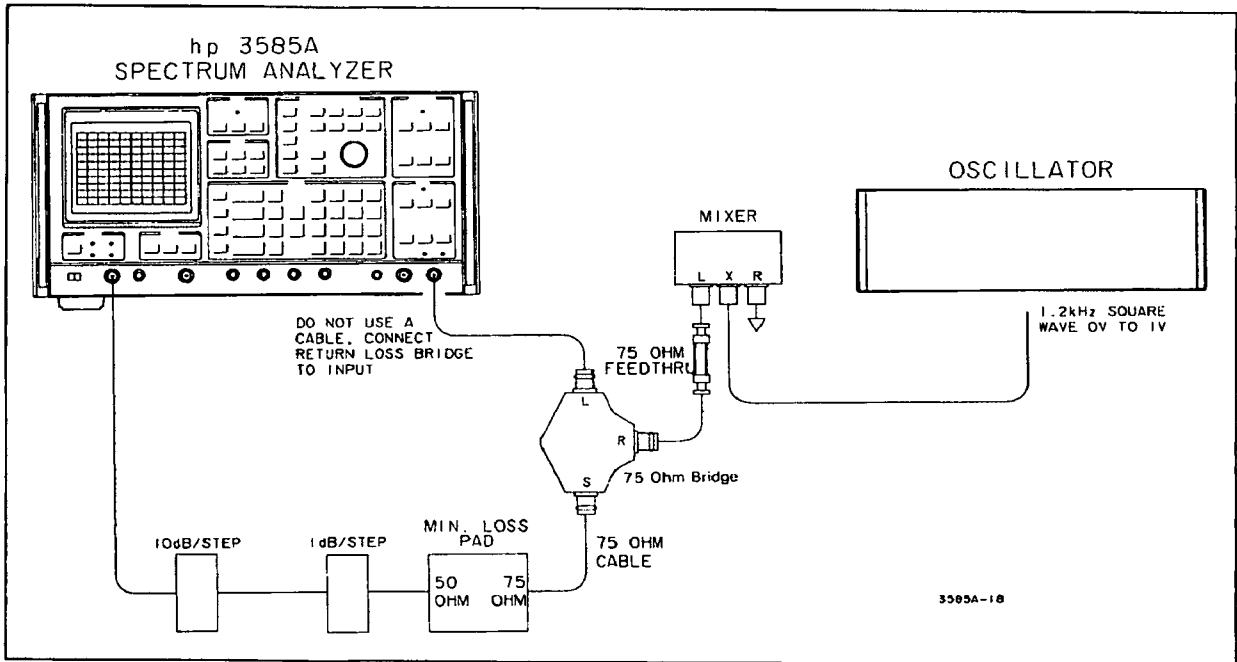

Figure 4-11. 75 ohm Return Loss Test (Automatic Tests).

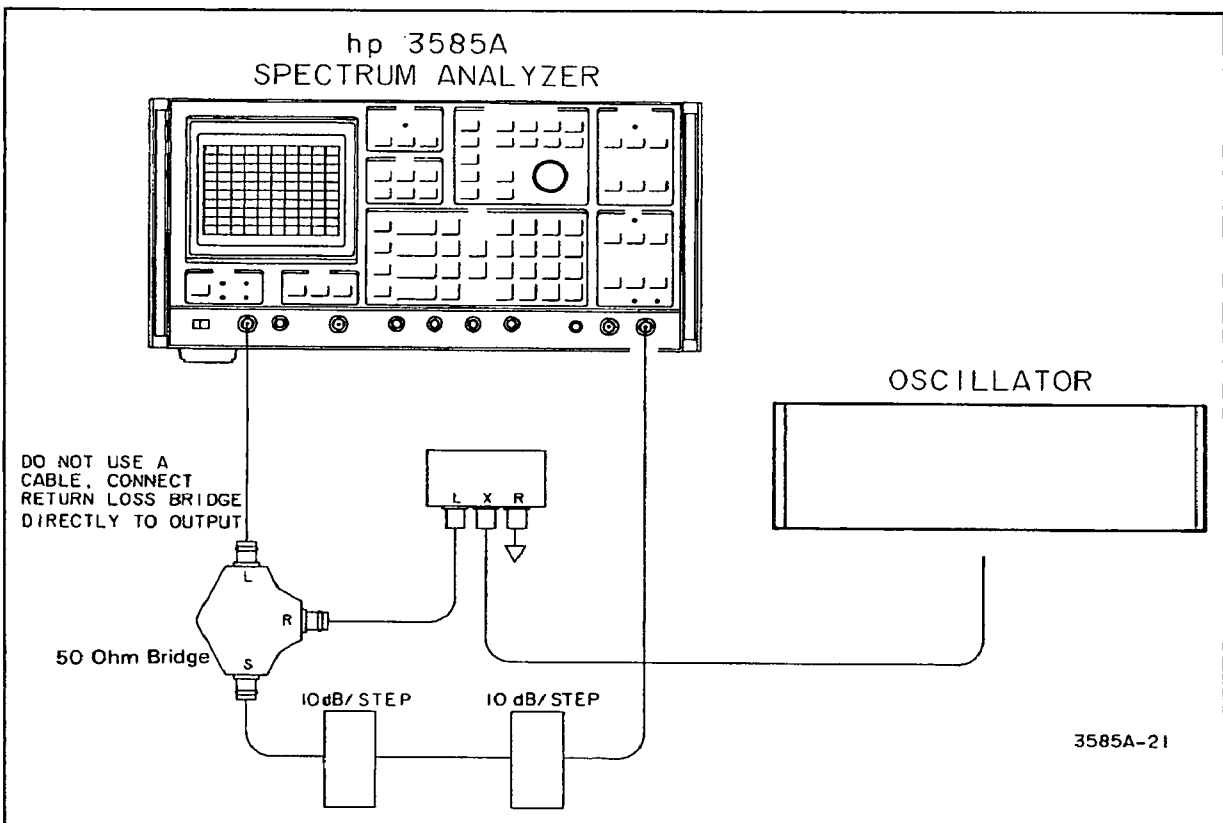

Figure 4-12. Tracking Generator Return Loss Test (Automatic Tests).

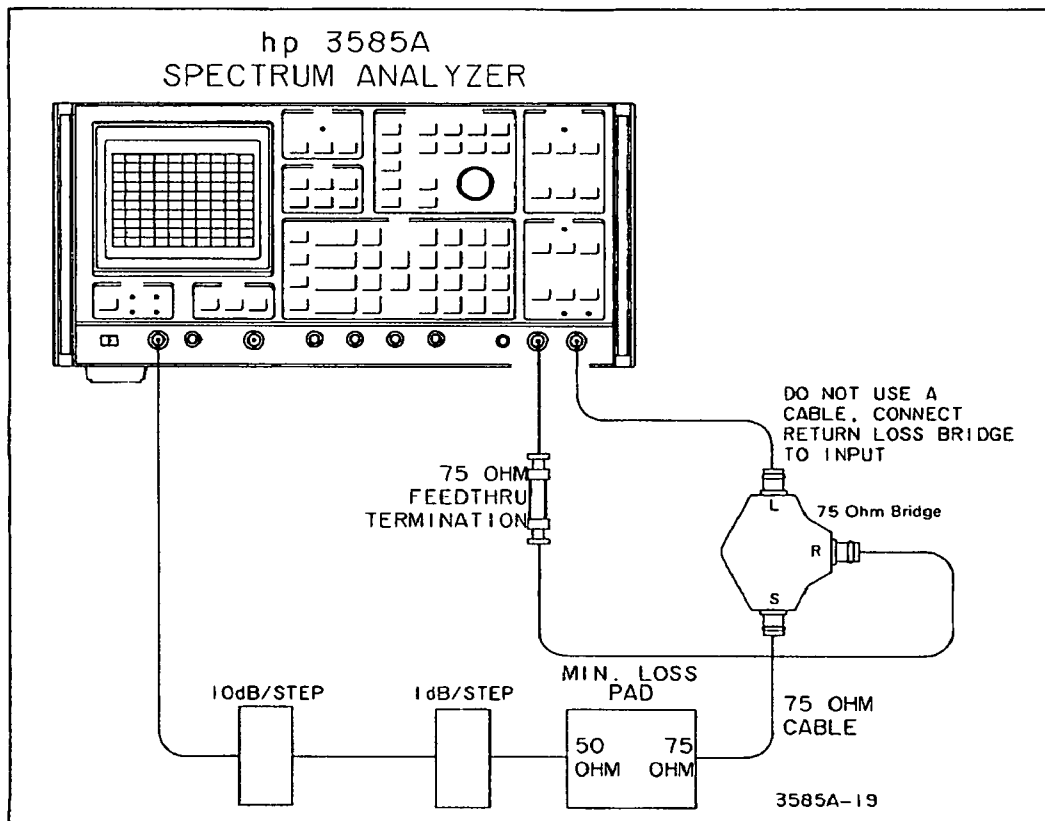
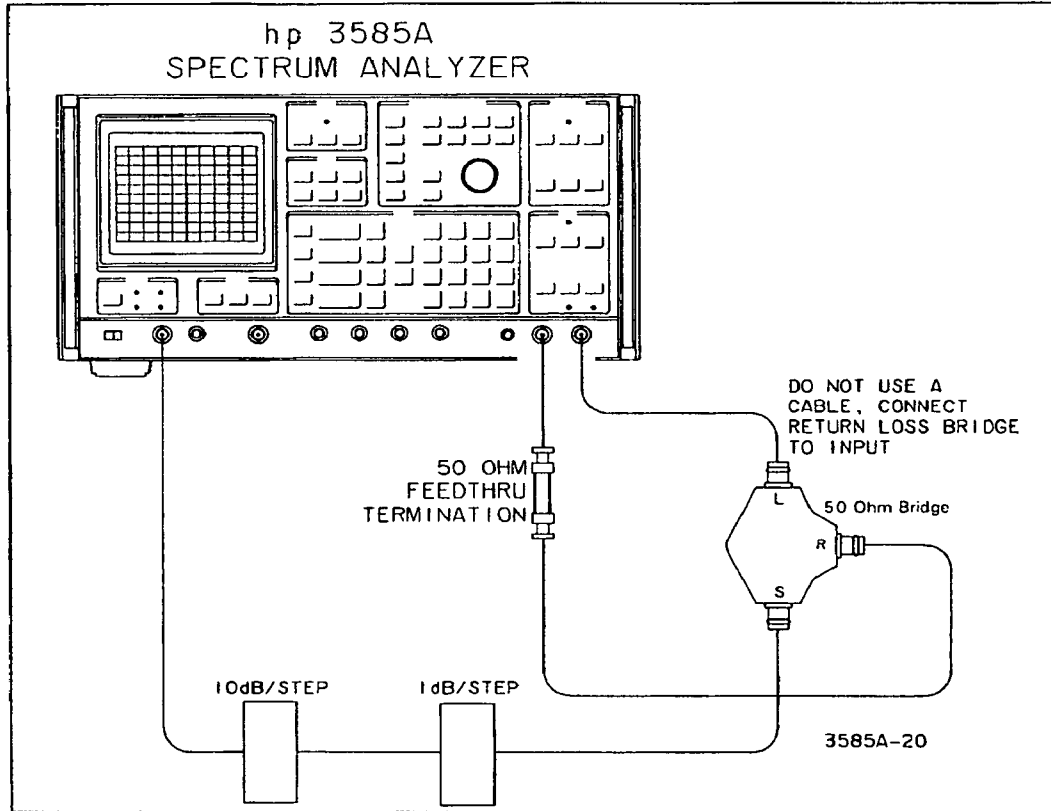

Figure 4-13. Terminated Input Return Loss Test (Automatic Tests).

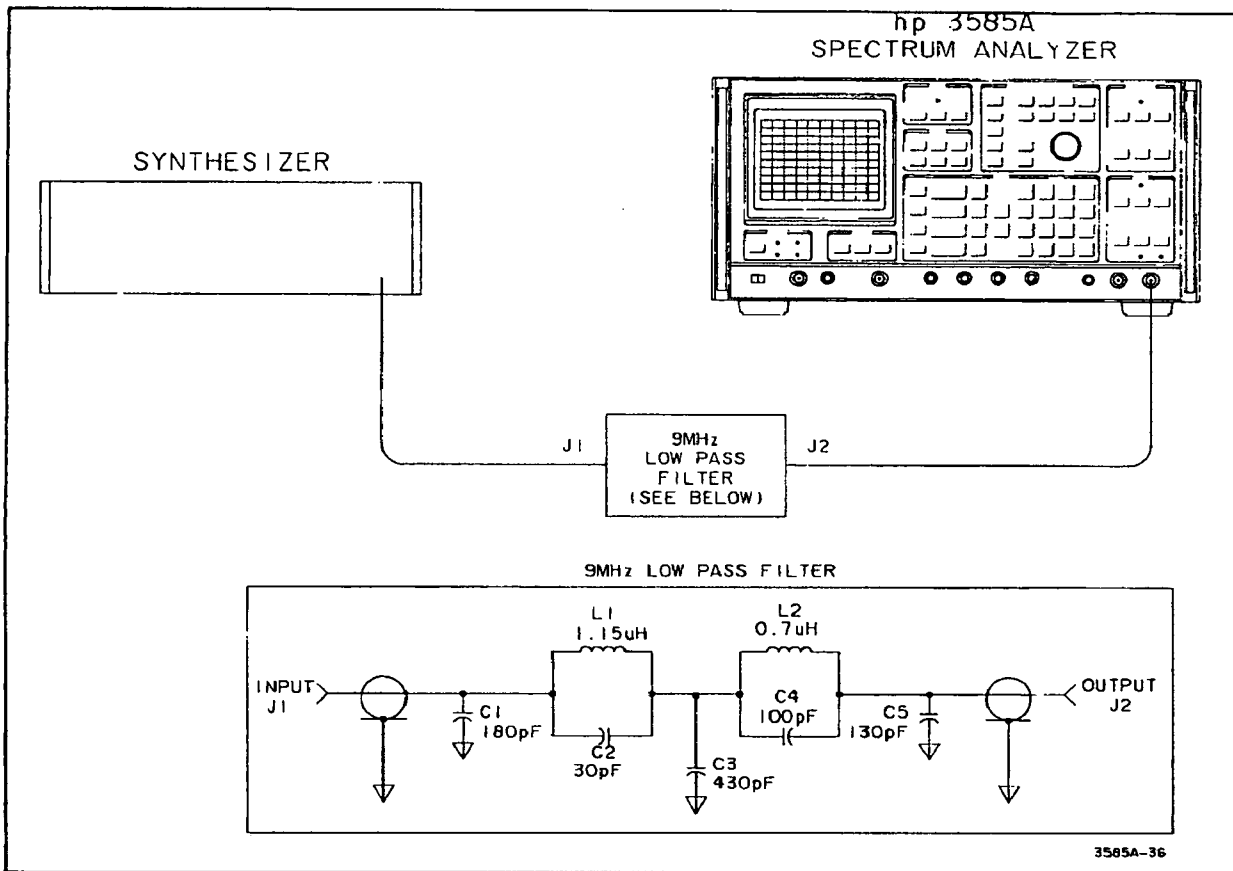

Figure 4-14. Harmonic Distortion Test

		-hp- Part No.
C1	180pf 5%, 300V	0140-0197
C2	30pf 5%, 300V	0162-2199
C3	430pf 5%, 300V	0160-0939
C4	100pf 5%, 300V	0162-0939
C5	130pf 5%, 300V	0140-0195
L1,2	1 μ H adjustable, 10%	9100-3312
	Adjust as shown in Figure 4-20	

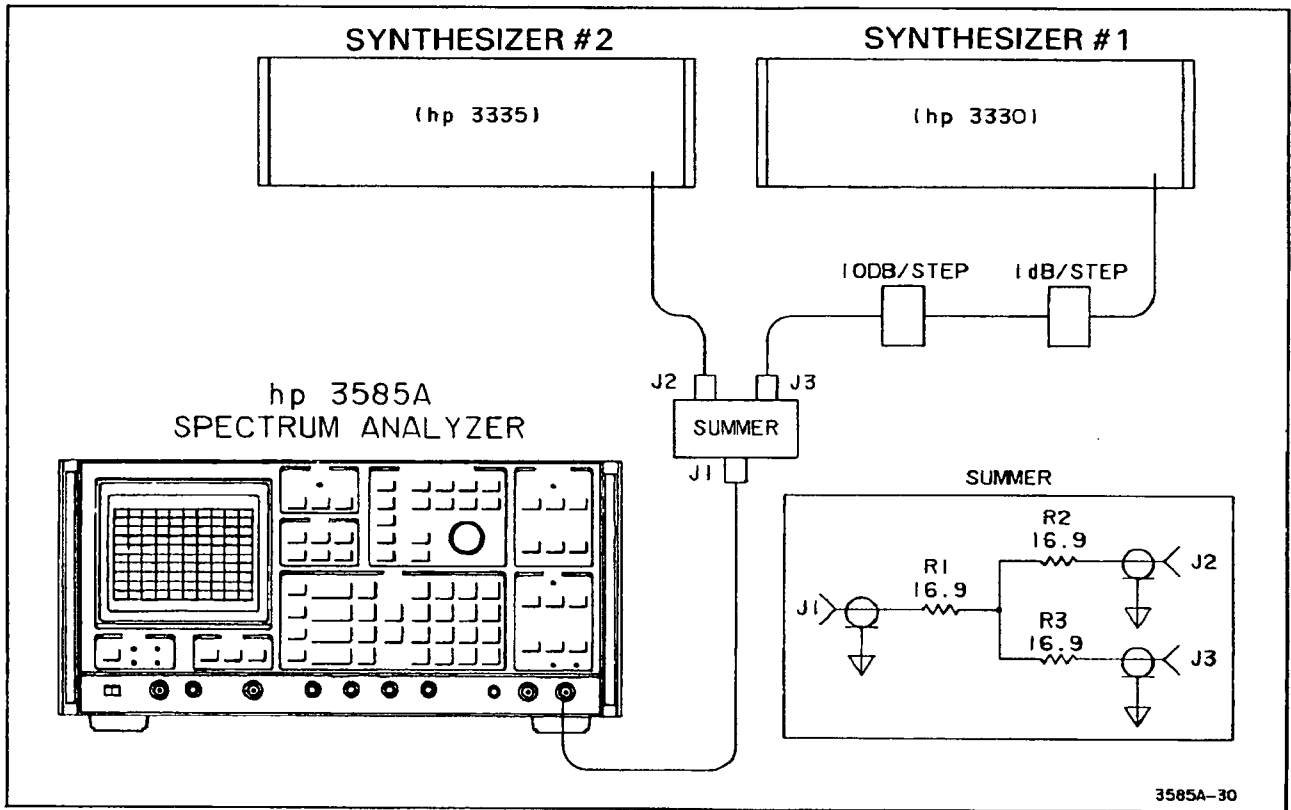

Figure 4-15. Intermodulation Distortion Test.

4-43. OPERATIONAL VERIFICATION TESTS

4.44. This portion of Section IV contains the following Operational Verification Tests:

Test Name	Paragraph
Frequency Accuracy.....	4-47
Calibrator Test (Optional).....	4-49
Cal Offset Test (Optional).....	4-51
Range Calibration Test.....	4-53
Amplitude Linearity Test.....	4-55
Reference Level Accuracy Test.....	4-57
50/75Ω Frequency Response Test.....	4-59
1 MΩ Frequency Response Test.....	4-61
Return Loss Tests.....	4-63
1 MΩ Input Impedance Test.....	4-65
Marker Accuracy Test.....	4-67
Noise Test.....	4-69
Zero Response Test.....	4-71
Low Frequency Responses Test.....	4-73
Local Oscillator Sidebands Test.....	4-75
Residual Spurs Test.....	4-77
Harmonic Distortion Test.....	4-79
Intermodulation Distortion Test.....	4-81
Bandwidth Tests.....	4-83
Fractional N API Spur Test.....	4-85
Tracking Generator Flatness Test.....	4-87
HP-IB Check (Optional).....	4-89

4-45. Synthesizer Reference Connections.

4-46. Unless otherwise specified the synthesizer reference oscillator input (40/N MHz input for the 3335A) should be connected to the 3585A 10 MHz REF OUTPUT. This will assure accurate frequency measurements during the Operational Verification Tests.

4-47. Frequency Accuracy.

4-48. This test verifies the frequency accuracy of the 3585A by using an external counter to check the internal frequency reference. It is important that the frequency counter used to do this test has a reference which is more accurate than that of the 3585A.

Specification: Counter Accuracy, $\pm 0.3\text{Hz} \pm 1 \times 10^{-7}/\text{month}$

Equipment Required:

Frequency Counter.....-hp- 5328A
Frequency Synthesizer.....-hp- 3335A

Procedure:

a. Allow the instruments used in this test to warm up for 15 to 20 minutes before beginning this test.

b. Set the synthesizer controls for:

FREQUENCY.....9 MHz
AMPLITUDE.....0 dBm

c. Set the 3585A controls for:

INSTRUMENT PRESET
MANUAL ENTRY.....9 HMz
COUNTER.....on

d. Using a BNC "T" connector, connect the synthesizer's 50 ohm output to the frequency counter and the 3585A 50 ohm input.

NOTE

Be sure that the synthesizer and the 3585A are operating on their own internal references. Disconnect any reference connection common to both instruments.

e. Record the frequency difference between the frequency counter and the 3585A counter reading. Difference frequency equals _____ Hz.

f. If the frequency accuracy derived from this test is not in accordance with your requirements, turn to Section 5 of this manual for the Reference Oscillator Adjustment procedure.

g. This completes the Frequency Accuracy Test, reconnect the references as outlined in Paragraph 4-45.

4-49. Calibrator Test. (Optional)

4-50. This test makes a two point test of the calibrator flatness to check for any high frequency roll-off.

Equipment Required:

Frequency Synthesizer.....-hp- 3335A

Specification: At 100kHz, -25dBm \pm 0.25dB
At 40MHz, the 100kHz reading \pm 0.25dB

Procedure:

- a. Set the synthesizer for:

FREQUENCY.....100 kHz
AMPLITUDE.....-25 dBm

- b. Set the 3585A controls for:

dB/DIV.....1 dB
CENTER FREQUENCY.....100 kHz
MANUAL SWEEP.....on

- c. Connect the 3585A 50 Ω input to the synthesizer 50 Ω output.

d. The marker amplitude reading should be -25 dBm \pm 0.25 dB to verify proper operation of the calibrator.

- e. Set the 3585A controls for:

OFFSET.....on
ENTER OFFSET
CENTER FREQUENCY.....40 MHz

- f. Set the synthesizer controls for:

FREQUENCY.....40 MHz

g. The marker amplitude reading should be less than \pm 0.25 dB verifying that the high frequency roll-off of the calibrator is not excessive.

4-51. Cal Offset Test. (Optional)

4-52. This test is a check of the amplitude and frequency offsets within the 3585A when the calibration system is turned off. It's purpose is to check the adjustment of the 3585A IF section for large errors which the calibration system may mask. A failure in this test indicates a need to adjust the IF section.

Equipment Required:

Frequency Synthesizer.....-hp- 3335A

Specification: See Table 4-6.

Procedure:

- a. Set the synthesizer controls for:

FREQUENCY.....10 MHz
 AMPLITUDE.....-25 dBm

- b. Connect the 50Ω output of the synthesizer to the 50Ω input of the 3585A.

- c. Set the 3585A controls for:

RECALL 602
 INSTRUMENT PRESET
 RES. BW HOLD.....on
 CENTER FREQUENCY.....10 MHz
 FREQUENCY SPAN.....50 kHz
 REFERENCE LEVEL.....-22 dBm
 dB/DIV.....1 dB
 SWEEP TIME.....0.8 sec
 OFFSET.....on
 ENTER OFFSET
 SAVE 1
 RECALL 601
 INSTRUMENT PRESET
 RECALL 1

Table 4-6. Cal Offset Settings.

Res. BW	Freq. Span	Freq. Test Limit	Amplitude Test Limit
30 kHz	50 kHz	± 3.5 kHz	± 3.5 dB
10 kHz	20 kHz	± 3.5 kHz	± 3.5 dB
3 kHz	5 kHz	± 3.5 kHz	± 3.5 dB
1 kHz	2 kHz	± 3 kHz	± 3.5 dB
300 Hz	500 Hz	± 900 Hz	± 3.5 dB
100 Hz	200 Hz	± 300 Hz	± 3.5 dB
30 Hz	50 Hz	± 90 Hz	± 3.5 dB
10 Hz	20 Hz	30 Hz	± 3.5 dB
3 Hz	7 Hz	± 9 Hz	± 3.5 dB

- d. Place the marker on the most positive point of the CRT trace. The marker reading in the upper right of the CRT will assist you in finding this point.
- e. Enter the Offset and Marker reading on the Performance Test Card.
- f. Repeat Steps d and e for each of the Resolution Bandwidths in Table 4-6.

4-53. Range Calibration.

4-54. This test verifies that the Range Calibration system is working as specified.

Equipment Required:

Frequency Synthesizer-hp- 3335A

Specification:

± 0.7 dB (Equals the Reference Level Accuracy (± 0.4 dB) for a -25 dBm signal plus the Amplitude Linearity spec (0.3 dB) for a signal 5 dB below the Reference Level)

Procedure:

- a. Connect the 50 Ω output of the synthesizer to the 3585A 50 Ω input.
- b. Set the synthesizer controls for:

FREQUENCY150 kHz
 AMPLITUDE-25 dBm

- c. Set the 3585A controls for:

INSTRUMENT PRESET
 CENTER FREQUENCY150 kHz
 REFERENCE LEVEL-20 dBm
 1 dB/DIV
 RES BW10 Hz
 MANUAL SWEEPon
 REF LEVEL TRACKoff
 OFFSETon
 ENTER OFFSET

- d. Set the 3585A controls for:

RANGE UP

- e. Check the marker reading, it should be less than ± 0.7 dB to verify that the RANGE shown is within spec.
- f. Repeat steps d and e until all ranges have been checked.

4-55. Amplitude Linearity Test.

4-56. This test confirms that the 3585A will read the amplitude of the input signal correctly within the limits of the specification. A frequency synthesizer with a very accurate, calibrated output is used as the source.

Equipment Required:

10dB/step Attenuator.....-hp-355D
 Frequency Synthesizer.....-hp-3335A

Specification:

Amplitude Linearity	0dB	-20dB	-50dB	-80dB	-100dB
	± 0.3dB	± 0.6dB	± 1 dB	± 2 dB	

Procedures:

a. Connect the 3585A Tracking Generator output to the input of the attenuator. Connect the output of the attenuator to the 50Ω input of the 3585A.

b. Set the attenuator to 0 dB of attenuation.

c. Set the 3585A controls for:

INSTRUMENT PRESET
 CENTER FREQUENCY.....1 MHz
 RES. BW.....3 Hz
 VIDEO BW.....3 Hz
 RANGE.....0 dBm
 MANUAL SWEEP.....on

d. Adjust the AMPLITUDE of the 3585A Tracking Generator so that the marker amplitude reads .0 dBm.

e. Set the Variable Attenuator for one of the settings listed in Column A, Table 4-7.

f. Add the Correction Factor (Column B) to the Ideal reading (Column C) and enter this value in Column D.

g. Record the 3585A Marker Reading in Column E.

h. Subtraction of Column D from Column E should yield a value within the Test Tolerance of Column F, thereby verifying the Amplitude Linearity specification.

i. Repeat Steps e thru h until all the Variable Attenuator settings have been checked.

Table 4-7. Amplitude Linearity Test.

(A) Variable Attenuator	(B) Correction Factor*	(C) Ideal Reading	(D) Correct Reading (B+C)	(E) 3585A Marker Reading**	(F) Test Tolerance
0 dB	-----	00.0 dB	00.0 dB	00.0 dB	-----
-10 dB	_____	-10.0 dB	_____ dB	_____ dB	± 0.3 dB
-20 dB	_____	-20.0 dB	_____ dB	_____ dB	± 0.3 dB
-30 dB	_____	-30.0 dB	_____ dB	_____ dB	± 0.6 dB
-40 dB	_____	-40.0 dB	_____ dB	_____ dB	± 0.6 dB
-50 dB	_____	-50.0 dB	_____ dB	_____ dB	± 0.6 dB
-60 dB	_____	-60.0 dB	_____ dB	_____ dB	± 1.0 dB
-70 dB	_____	-70.0 dB	_____ dB	_____ dB	± 1.0 dB
-80 dB	_____	-80.0 dB	_____ dB	_____ dB	± 1.0 dB
-90 dB	_____	-90.0 dB	_____ dB	_____ dB	± 2.0 dB

4-57. Reference Level Accuracy.

4-58. This test verifies that the 3585A meets the specification for Reference Level Accuracy.

Equipment Required:

Frequency Synthesizer.....-hp- 3335A

Specifications: Reference Level Accuracy, Terminated Input

+ 10dB	-50dB	-70dB	-100dB
± 0.4dB	± 0.7dB	± 1.5dB	

Procedure:

- a. Connect the 50Ω output of the synthesizer to the 50Ω input of the 3585A.
- b. Set the synthesizer controls for:

FREQUENCY.....20 MHz
 AMPLITUDE.....10 dBm
 AMPLITUDE INCR.....10 dBm

- c. Set the 3585A controls for:

INSTRUMENT PRESET
 RANGE.....0 dBm
 REFERENCE LEVEL.....10 dBm
 REF LVL TRACK.....off
 1 dB/DIV
 RES BW.....100 Hz
 VIDEO BW.....1 Hz
 MANUAL SWEEP.....on

*Correction factor must be obtained from attenuator calibration data.

**If noise jitter is present, use average marker reading.

d. Enter the marker amplitude reading in Column (C). Subtract the value in Column (C) from that in Column (A) and enter this value in Column (D). The value in Column (D) should not exceed the Test Tolerance of Column (E). This will confirm that the 3585A meets its Reference Level Accuracy spec.

e. Set the Synthesizer Level to the next value in Column (A) and the 3585A REFERENCE LEVEL for the next value in Column (B) as shown in Table 4-8.

f. Repeat Steps d and e until all values in Table 4-8 have been checked.

Table 4-8. Reference Level Accuracy Tests.

(A)	(B)	(C)	(D)	(E)
Synthesizer Level	3585A Reference Level	3585A Marker Reading	Synthesizer Level Minus The 3585A Marker Reading (A-C)	Test Tolerance
+ 10 dBm	+ 10 dBm	_____	_____	± 0.4 dB
0 dBm	0 dBm	_____	_____	± 0.4 dB
- 10 dBm	- 10 dBm	_____	_____	± 0.4 dB
- 20 dBm	- 20 dBm	_____	_____	± 0.4 dB
- 30 dBm	- 30 dBm	_____	_____	± 0.4 dB
- 40 dBm	- 40 dBm	_____	_____	± 0.4 dB
- 50 dBm	- 50 dBm	_____	_____	± 0.7 dB
- 60 dBm	- 60 dBm	_____	_____	± 0.7 dB
- 70 dBm	- 70 dBm	_____	_____	± 1.5 dB
- 80 dBm	- 80 dBm	_____	_____	± 1.5 dB

4-59. 50/75Ω Frequency Response Test.

4-60. In this test the 50Ω and 75Ω flatness of the instrument is checked against the output of the internal calibrator. The display shows the Tracking Generator switched through the internal calibrator, which is assumed to be flat, sweeping across the frequency range of the instrument. The maximum and minimum points of the sweep are measured. This gives the total deviation of the 3585A 50 or 75Ω input relative to the flatness of the calibrator.

Specification:

Frequency Response, Terminated Input: ±0.5 dB referenced to 20.1 MHz

Procedure:

a. Set the 3585A controls for:

```

RECALL 604
INSTRUMENT PRESET
START FREQUENCY.....0.1 MHz
STOP FREQUENCY.....40.1 MHz
REFERENCE LEVEL.....-20 dBm
dB/DIV.....1 dB
REF LVL TRACK.....off
RANGE.....-25 dBm
    
```

- b. Press the SINGLE SWEEP button on the 3585A.
- c. Wait until the sweep is completed. The trace you now see is the flatness of the 50Ω input.
- d. Move the marker to the center of the trace. The marker amplitude reading in the upper right-hand corner of the display will help you find this point.
- e. Set the 3585A controls for OFFSET on and ENTER OFFSET.
- f. Using the marker, find the point on the trace which gives the greatest positive or negative deviation as shown by the marker amplitude reading.
- g. The marker amplitude reading displayed is the greatest deviation from the calibrator flatness for the range shown. Record this value under Maximum Amplitude Deviation on the Performance Test Card.
- h. Set the 3585A controls for RANGE.....STEP UP.
- i. Repeat Steps b thru h until all ranges have been tested.
- j. Set the 3585A controls for:

RANGE.....-25 dBm
 INPUT IMPEDANCE.....75Ω
 SINGLE SWEEP

- k. Wait until the sweep is completed. The trace you now see is the flatness of the 75Ω input.
- l. Repeat Steps d thru f and enter the results on the Performance Test Card.

4-61. 1 M Ohm Frequency Response Test.

4-62. This test checks the frequency response of the 1 MΩ input relative to the flatness of the 50Ω input. Ideally the difference between the two signals would be zero.

Equipment Required:

50Ω Feed Thru Termination.....-hp- 11048C

Specification:

High Impedance Frequency Response

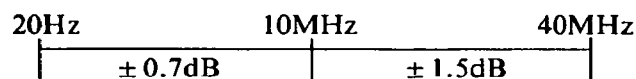

Procedure:

- a. Set the 3585A controls for:

```

INSTRUMENT PRESET
STOP FREQUENCY.....10 MHz
dB/DIV.....1 dB
RANGE.....0 dBm
RES. BW.....3 kHz
RES. BW HOLD.....on
RECALL.....4

```

- b. Connect the 3585A Tracking Generator output to the 3585A 50Ω input.
- c. Adjust the Tracking Generator Amplitude control for the center of its range.
- d. Allow one complete sweep to occur. Press the STORE A → B key of the 3585A.
- e. Connect a 50Ω termination to the 1 MΩ input of the 3585A. Connect the output of the Tracking Generator to the input of this termination.

- f. Set the 3585A controls for:

```

INPUT.....1 MΩ
B TRACE.....off
A-B.....on

```

- g. Move the marker to the most negative point on the displayed trace. (Ignore the LO feedthrough point at 0 Hz)

- h. Set the 3585A controls for:

```

OFFSET.....on
ENTER OFFSET

```

- i. Move the marker to the most positive point on the displayed trace. (Ignore the LO feedthrough point at 0 Hz)
- j. Record the marker amplitude on the Performance Test Card as the 1 MΩ unflatness for the 0 to 10 MHz band. The marker amplitude should be less than ± 0.7 dB to verify the specification.

- k. Set the 3585A controls for:

```

START FREQUENCY.....10 MHz
STOP FREQUENCY.....40 MHz
INPUT.....50Ω
A-B.....off

```

- l. Repeat Steps b thru i.

m. Record the marker amplitude on the Performance Test Card as the 1 M Ω unflatness for the 10 MHz to 40 MHz band. The marker amplitude reading should be less than ± 1.5 dB to verify the specification.

4-63. Return Loss Tests.

4-64. These tests verify that the 3585A meets the Return Loss specification for the 50 Ω , 75 Ω and Terminated inputs.

Equipment Required:

100 MHz Oscilloscope.....	-hp- 1740A
50 Ω Return Loss Bridge.....	-hp- 8721A
75 Ω Return Loss Bridge.....	-hp- 8721 Option 008
50 Ω Feed Thru Termination.....	-hp- 11048C
75 Ω Feed Thru Termination.....	-hp- 11094B
50/75 Ω Min. Loss Pad.....	-hp-85428B
(2) 12' 75 Ω Cables.....	-hp- 11170E
Male BNC/BNC Adapter.....	-hp- Part No. 1250-0216
Frequency Synthesizer.....	-hp-3335A

Specification:

Return Loss, 50 Ω or 75 Ω Terminated Input.....	> 26 dB
50 Ω or 75 Ω Dummy Load.....	> 14 dB (Optional)

Procedure:

a. Set the 3585A controls for:

INSTRUMENT PRESET
 MANUAL SWEEP.....40 MHz
 RANGE.....5 dBm

b. Set the synthesizer controls for:

FREQUENCY.....40 MHz
 AMPLITUDE.....10.5 dBm

c. Set the oscilloscope controls for:

VERTICAL SCALE.....0.1 V/DIV (ac coupled)
 HORIZONTAL SCALE.....0.05 μ sec/DIV

d. Connect the equipment as shown in Figure 4-16.

e. Check the waveform amplitude displayed on the scope. The amplitude displayed should equal 0.35 V p-p. Adjust the synthesizer as necessary to obtain this amplitude.

f. Remove the shorting connection from the Load port of the Return Loss Bridge.

- g. Connect the Return Loss Bridge Load port to the 50 Ω input of the 3585A.
- h. Read the amplitude of the waveform on the scope display. It should be less than 0.0175 V p-p. This confirms that the 50 Ω (75 Ω) Return Loss of the 3585A is greater than 26 dB.
- i. Press the 1 M Ω input impedance key on the 3585A.
- j. Again check the amplitude of the scope waveform. It should be less than 0.07 V p-p. This will confirm that the Return Loss of the Terminated input is greater than 14 dB.
- k. Connect the equipment as shown in Figure 4-17 for the 75 Ω Return Loss tests.
- l. Press the 75 Ω input impedance key on the 3585A.
- m. Repeat Steps d thru i for the values in parenthesis.
- n. Change the synthesizer frequency to 15 MHz.
- o. Set the 3585A controls for MANUAL SWEEP 15 MHz.
- p. Repeat Steps c thru m.
- q. This completes the Return Loss Tests. Disconnect the test equipment.

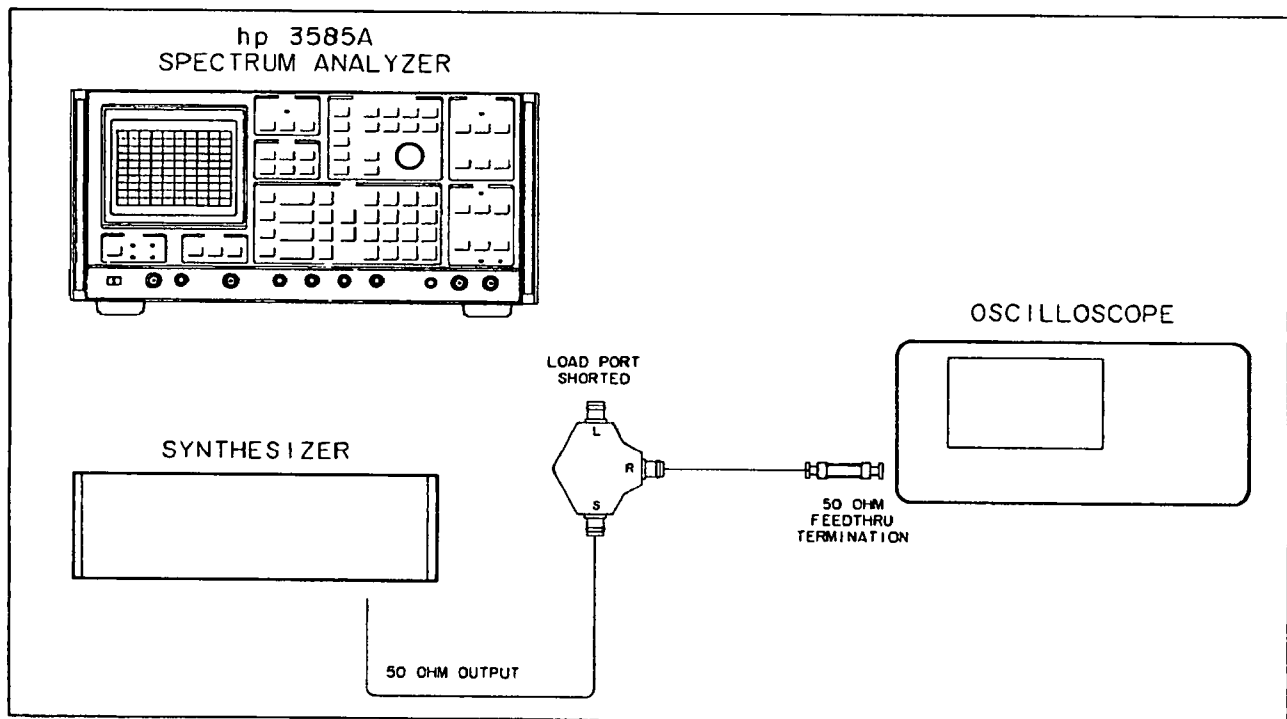

Figure 4-16. 50 Ω Return Loss Test (Operational Verification).

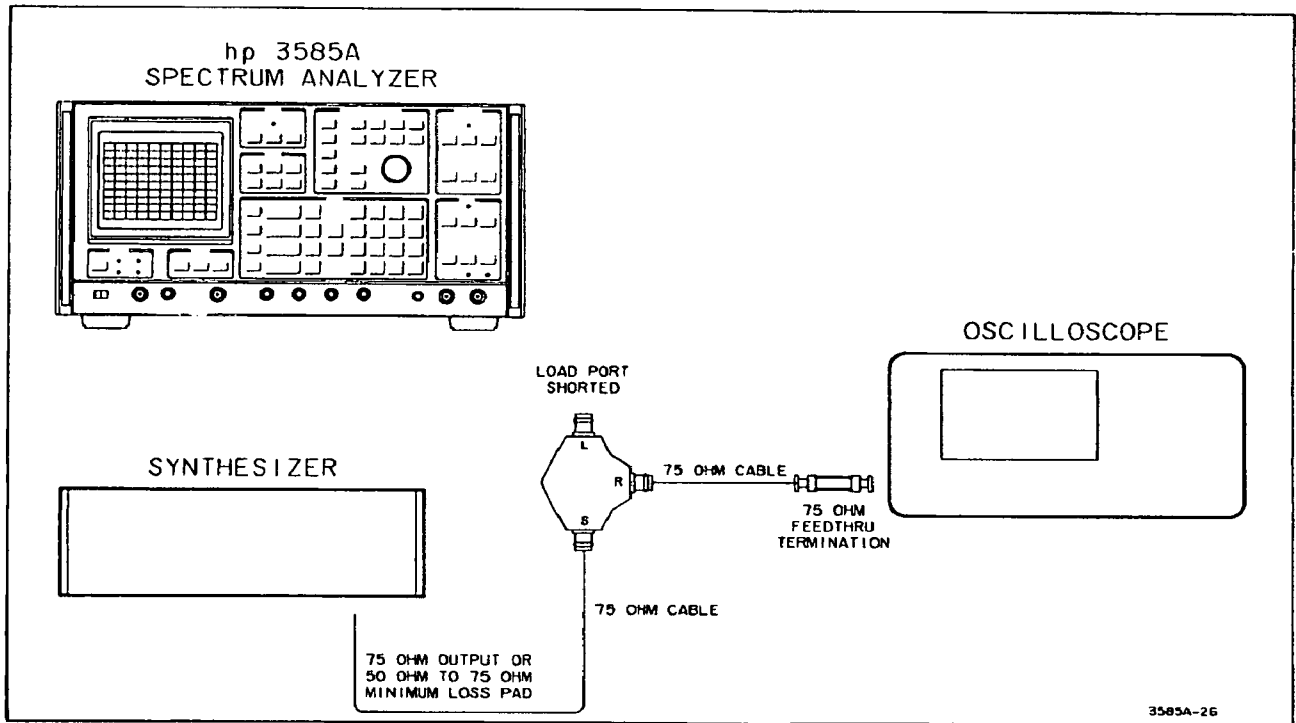

Figure 4-17. 75Ω Return Loss Test (Operational Verification).

4-65. 1 M ohm Input Impedance Test.

4-66. These tests verify that the 3585A meets the Input Impedance specifications for the 1 MΩ, 30 pf Input Impedance setting.

Equipment Required:

Resistor:

- 1 MΩ ± 1%, 1/8W Film.....-hp- Part No. 0757-0344
- 50Ω Feed Thru Termination.....-hp- 11048C
- Synthesizer.....-hp- 3335A

Specification:

1MΩ ± 3%, <30 pf

Procedure:

- a. Set the 3585A controls as follows:

INSTRUMENT PRESET
 CENTER FREQUENCY.....1 kHz
 MANUAL SWEEP.....on
 RES. BW.....100 Hz
 RANGE.....0 dBm
 INPUT IMPEDANCE.....1 MΩ

b. Connect the 50Ω termination to the 3585A 1 MΩ input. Connect the synthesizer output to the termination input.

c. Set the synthesizer controls for:

FREQUENCY.....1 kHz
AMPLITUDE.....0 dBm

d. Set the 3585A controls for OFFSET on. Allow time for the marker reading to stabilize, then press the ENTER OFFSET button.

e. Using short clip leads, insert the 1 MΩ resistor between the output of the termination and the 3585A 1 MΩ input as shown in Figure 4-18.

f. The 3585A marker amplitude reading should be -6.0 dB ± 0.44 dB, verifying that the input resistance is 1 MΩ ± 5%.

g. Press the 3585A ENTER OFFSET button.

h. Set the synthesizer frequency to 10 kHz.

i. Set the 3585A for a CENTER FREQUENCY of 10 kHz.

j. The 3585A marker reading should be between -2 dB and -3 dB, verifying that the shunt capacitance is less than 30 pf.

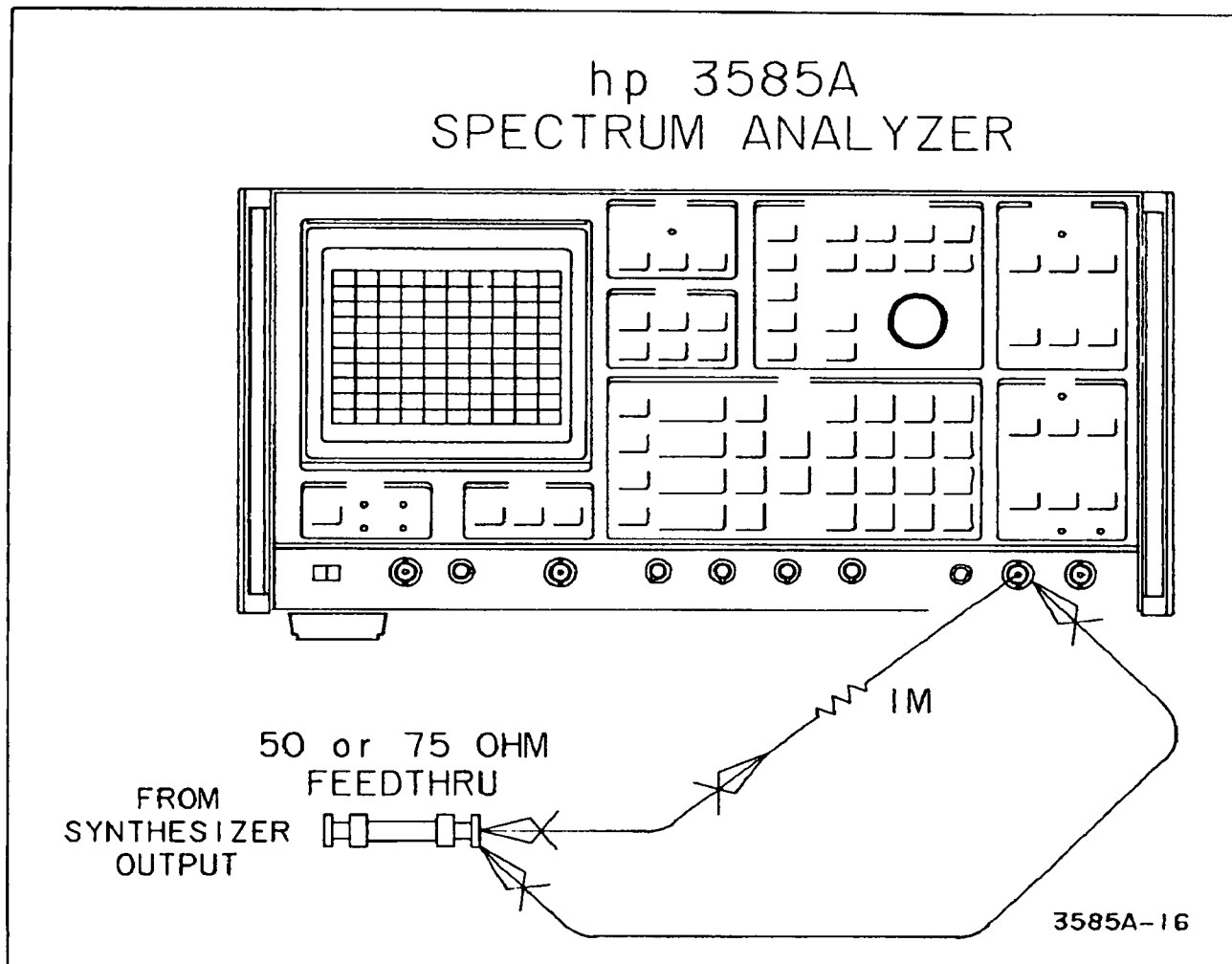

Figure 4-18. 1 M ohm Input Impedance Test.

4-67. Marker Accuracy.

4-68. This test verifies that the 3585A meets its marker accuracy specification.

Specification:

$$\pm 0.2\% \text{ of frequency span} \pm \text{Resolution Bandwidth setting}$$

Procedure:

- a. Set the 3585A controls for:

INSTRUMENT PRESET

- b. Connect the 50 Ω output of the synthesizer to the 50 Ω input of the 3585A.

- c. Set the synthesizer controls for:

FREQUENCY.....20.08 MHz
 AMPLITUDE.....-25 dBm

- d. Put the marker at the peak of the response shown on the 3585A CRT.

e. The marker frequency should read between 20.00 MHz and 20.16 MHz thereby verifying that the 3585A marker reads within $\pm 0.2\%$ of the input frequency.

4-69. Noise.

4-70. This test is used to determine the average noise level in each of the resolution bandwidths.

Specification: 50/75Ω input, -25 dBm Range

Res. BW	Specification
30 kHz	-100 dBm
10 kHz	-104 dBm
3 kHz	-108 dBm
1 kHz	-111 dBm
300 Hz	-115 dBm
100 Hz	-122 dBm
30 Hz	-127 dBm
10 Hz	-132 dBm
3 Hz	-137 dBm

Procedure:

- a. Disconnect all inputs to the 3585A.
- b. Set the 3585A controls for:

INSTRUMENT PRESET
 CENTER FREQUENCY.....9.35 MHz
 REFERENCE LEVEL.....-75 dBm
 RES. BW.....30 kHz
 VIDEO BW.....30 Hz
 MANUAL SWEEP.....on

c. Read the marker amplitude. Take an average of the readings displayed. This average value should be below the test tolerance shown in Table 4-9.

d. Record the average noise reading, across from the BW displayed, on the Performance Test Card.

- e. Set the 3585A controls for RES. BW STEP DOWN.

f. Repeat Steps c thru e until all Resolution Bandwidths have been measured for their average noise level.

Table 4-9. Noise Test.

(A) 3585A Res BW	(B) Average Noise Reading	(C) Test Tolerance
30 kHz	_____	-100
10 kHz	_____	-104
3 kHz	_____	-108
1 kHz	_____	-111
300 Hz	_____	-115
100 Hz	_____	-122
30 Hz	_____	-127
10 Hz	_____	-132
3 Hz	_____	-137

4-71. Zero Response.

4-72. This test measures the amplitude of the local oscillator feedthrough. This response occurs at 0 Hz due to the local oscillator passing directly through the IF section.

Specification:

LO Feed Through < -15 dB below range

Procedure:

- a. Disconnect all inputs to the 3585A.
- b. Set the 3585A controls for:

INSTRUMENT PRESET
RANGE.....0 dBm

- c. Using the MANUAL ENTRY key set the manual frequency to 0 Hz.
- d. Read the marker amplitude. The reading should be less than -15 dB.
- e. Record the marker amplitude reading under zero response on the Performance Test Card.

4-73. Low Frequency Responses.

4-74. Within the 3585A there are several frequencies which may be picked up by the sensitive analog circuits. These frequencies include:

- 60 Hz* Power Line
- 5 kHz A/D clock
- 20 KHz (approx) Power Supply Switching Oscillator
- 30 kHz (approx) CRT High Voltage Oscillator
- 100 kHz Fractional N Clock
- 1 MHz Fractional N Step Loop Clock
- 10 MHz Internal Reference

*or other power line frequency.

These frequencies and their harmonics will be used to verify that all Low Frequency Responses are less than -120 dBm.

Specification:

Residual Responses < -120 dBm

Procedure:

- a. Disconnect all inputs to the 3585A.
- b. Set the 3585A controls for:

```

INSTRUMENT PRESET
REFERENCE LEVEL.....-75 dBm
RES. BW.....3 Hz
VIDEO BW.....1 Hz
MANUAL SWEEP.....on
    
```

- c. Set the 3585A controls for:

```

CENTER FREQUENCY.....] One of the frequencies
CF STEP SIZE.....] in Table 4-10.
    
```

d. The marker is now displaying the amplitude of the frequency chosen in Step c. Record the marker reading across from the frequency chosen in Step c on the Performance Test Card.

e. Set the 3585A controls for CENTER FREQUENCY....STEP UP. This will increment the marker to the next harmonic component of the frequency chosen in Step c.

f. Take an average reading of the marker amplitude. Record the reading across from the frequency chosen in Step c and under the harmonic presently being measured.

g. Repeat Steps e and f until the fifth harmonic of the frequency entered in Step c has been measured.

- h. Repeat Steps c thru g until all frequencies in Table 4-10 have been checked.

- i. Set the 3585A controls for:

```

INSTRUMENT PRESET
CENTER FREQUENCY.....20 kHz
FREQUENCY SPAN.....2 kHz
AUTO RANGE.....off
RANGE.....-25 dBm
INPUT IMPEDANCE.....1 MΩ
    
```

j. Connect a coaxial cable between the EXT TRIGGER input and the 1 MΩ input of the 3585A. You are now looking at the Power Supply Switching frequency and possibly the fourth harmonic of the 5 kHz A/D clock.

k. Set the marker on the most positive point of the largest response. this will be at 20 kHz \pm 20 Hz.

l. Set the 3585A controls for COUNTER on. Wait for the counter reading to stabilize before proceeding.

m. Set the 3585A controls for:

```

MKR — CF
COUNTER.....off
REFERENCE LEVEL.....-75 dBm
FREQUENCY SPAN.....1 MHz
RES. BW.....10 Hz
VIDEO BW.....3 Hz
INPUT IMPEDANCE.....50 $\Omega$ 
MANUAL SWEEP.....on
  
```

n. Enter the displayed CENTER FREQUENCY value as a CF STEP SIZE.

o. Enter the CENTER FREQUENCY reading under the correct frequency heading (Power Supply or CRT Oscillator) on the Performance Test Card.

p. Read the 3585A marker amplitude and enter the value as the first harmonic on the Performance Test Card.

q. Set the 3585A controls for CENTER FREQUENCY - STEP UP. This increments the marker to the next harmonic of the original CENTER FREQUENCY reading.

r. Read the marker amplitude. Record the reading under the correct harmonic on the Performance Test Card.

s. Repeat Steps q and r up through the fifth harmonic of the original CENTER FREQUENCY.

t. Set the 3585A controls for:

```

INSTRUMENT PRESET
CENTER FREQUENCY.....28 kHz
FREQUENCY SPAN.....15 kHz
AUTO RANGE.....off
RANGE.....-25 dBm
INPUT IMPEDANCE.....1 M $\Omega$ 
  
```

u. Disconnect the cable from the EXT TRIGGER input and hold the end of the cable on the CRT display. You are now observing the CRT High Voltage Oscillator Frequency.

v. Set the marker on the most positive point of the response.

w. Repeat Steps l thru s.

Table 4-10. Low Frequency Responses.

Description	Frequency	Harmonics				
		*1	*2	*3	*4	*5
Line Frequency	60 Hz*	_____	_____	_____	_____	_____
A/D Clock	5 kHz	_____	_____	_____	_____	_____
Fractional N Clock	100 kHz	_____	_____	_____	_____	_____
Step Loop Clock	1 MHz	_____	_____	_____	_____	_____
Internal Reference	10 MHz	_____	_____	_____	_____	_____
Power Supply	_____	_____	_____	_____	_____	_____
CRT Oscillator	_____	_____	_____	_____	_____	_____

4-75. Local Oscillator Sidebands.

4-76. The OVEN REF output on the rear panel of the 3585A is a source relatively free of Local Oscillator Sidebands. The OVEN REF output is used as the input for this test. This test checks to what extent internal frequencies are mixing with the input signal in the Local Oscillator and appearing on the output.

Specification:

Spurious Responses < -80 dB below signal

Procedure:

- a. In this test use the frequencies from Table 4-10 (omitting 10 MHz).
- b. Disconnect the OVEN REF OUT from the EXT REF IN. Both of these connectors are found on the rear panel of the 3585A.
- c. Connect the OVEN REF OUT to the front panel 50Ω input.
- d. Set the 3585A controls for:

```

INSTRUMENT PRESET
CENTER FREQUENCY.....10 MHz
COUNTER.....on
    
```

- e. When the counter reading is stable, set the 3585A controls for:

```

MARKER → CF
COUNTER.....off
OFFSET.....on
ENTER OFFSET
REFERENCE LEVEL.....-50 dBm
RES. BW.....3 Hz
VIDEOBW.....3 Hz
MANUAL SWEEP.....on
SAVE 1
    
```

- f. Set the 3585A controls for a CF STEP SIZE equal to one of the frequencies for the Low Frequency Responses test, Table 4-10.

- g. Set the 3585A controls for MANUAL ENTRY - STEP DOWN. this puts the marker one CF STEP SIZE lower in frequency.
- h. Take an average reading of the marker amplitude. Enter this number on the Performance Test Card under the correct sideband frequency.
- i. Repeat Steps f and g two more times.
- j. Press the STEP UP key four times. This puts the marker on the first upper sideband frequency (+ 1).
- k. Take an average reading of the marker amplitude. Enter this number on the Performance Test Card under the correct sideband harmonic frequency.
- l. Press the STEP UP key on the 3585A. This puts the marker one CF STEP SIZE higher in frequency.
- m. Repeat Steps k and l two more times.
- n. Set the 3585A controls for RECALL 1. This returns you to the original Center Frequency.
- o. Repeat Steps f thru n until all the frequencies in the Low Frequency Response Test Table have been tested.
- p. Reconnect the OVEN REF OUT and the EXT REF IN on the rear panel. This completes the Local Oscillator Sideband Test.

4-77. Residual spurs.

4-78. This test checks for mixing product harmonics of the 90 MHz and 10 MHz internal reference frequencies. Due to frequency offsets in the IF the exact frequency of these mixing products is not known; therefore, a 1 kHz span is used to account for any frequency offsets.

Specification:

Residual Responses < -120 dBm

Procedure:

- a. Disconnect all inputs to the 3585A.
- b. Set the 3585A controls for:

```

INSTRUMENT PRESET
REFERENCE LEVEL.....-75 dBm
RES. BW.....30 Hz
VIDEO BW.....1 Hz
RANGE.....-25 dBm
MANUAL SWEEP.....on

```

c. Set the 3585A CENTER FREQUENCY for each of the frequencies listed in Table 4-11. The average value of the marker reading, when placed on the most positive point, should be less than -120 dBm verifying that the 3585A meets its Residual Spur specification..

Table 4-11. Residual Spur Test Frequencies.

39.825 MHz
29.475 MHz
23.1 MHz
16.2 MHz
14.7375 MHz
9.5625 MHz
37.2375 MHz
32.0625 MHz
9.72 MHz
5.58 MHz
27.72 MHz

4-79. Harmonic Distortion.

4-80. This test verifies that the harmonic distortion produced by the 3585A is less than -80 dB below signal. The filter shown for this test removes the harmonic distortion of the sources. This leaves only the distortion of the 3585A.

Equipment Required:

- 9MHz Low Pass Filter (see Figure 4-19)
- Frequency Synthesizer -hp- 3335A

Specification:

Spurious Responses < -80 dB below signal

Procedure:

- a. Connect the output of the 3585A Tracking Generator to the input of the filter shown in Figure 4-18. Connect the output of the filter to the 3585A 50Ω input.
- b. Compare the displayed trace with that of Figure 4-20. This will confirm that the filter is operating properly.
- c. Disconnect the filter.
- d. Set the 3585A controls for:

```

INSTRUMENT PRESET
CENTER FREQUENCY.....9 MHz
CENTER FREQUENCY STEP.....9 MHz
RES. BW.....10 Hz
RANGE.....-25 dBm
MANUAL SWEEP.....on
    
```

- e. Set the synthesizer frequency at 9 MHz, -25 dBm.

f. Connect the 50Ω output of the synthesizer to the input of the filter. Connect the output of the filter to the 50Ω input of the 3585A (see Figure 4-21).

g. Set the 3585A controls for:

OFFSET.....on
 ENTER OFFSET
 REFERENCE LEVEL.....-50 dBm

h. Set the 3585A for CENTER FREQUENCY UP. Read the marker amplitude and record it on the Performance Test Card.

i. Repeat Step h until the fourth harmonic has been checked. All values should be less than -80 dB verifying that the instrument meets its Harmonic Distortion specification.

j. Disconnect the synthesizer and filter from the 3585A.

k. Connect the low distortion Audio Oscillator to the 50Ω input of the 3585A.

l. Set the Audio Oscillator for:

FREQUENCY.....1 kHz
 OUTPUT LEVEL.....0.1 V

m. Set the 3585A controls for:

OFFSET..... off
 RANGE.....-20 dBm
 REFERENCE LEVEL.....-20 dBm
 CENTER FREQUENCY.....1 kHz
 COUNTER..... on

n. When the counter reading is stable, enter these commands on the 3585A:

MARKER → CF
 COUNTER.....off

o. Enter the CENTER FREQUENCY reading as the CF STEP SIZE.

p. Repeat Steps g thru i.

q. Disconnect the Audio Oscillator. This completes the Harmonic Distortion Test.

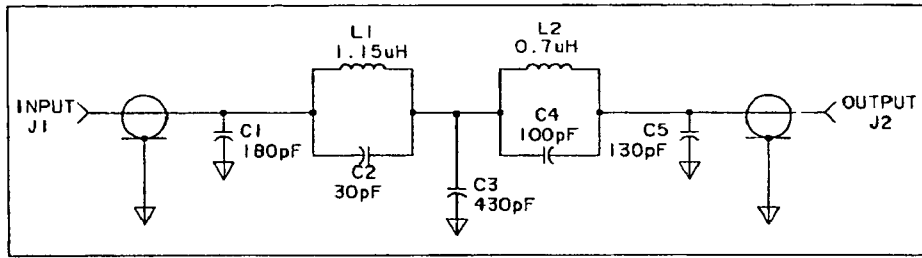

3585A-36

Figure 4-19. 9 MHz Low Pass Filter.

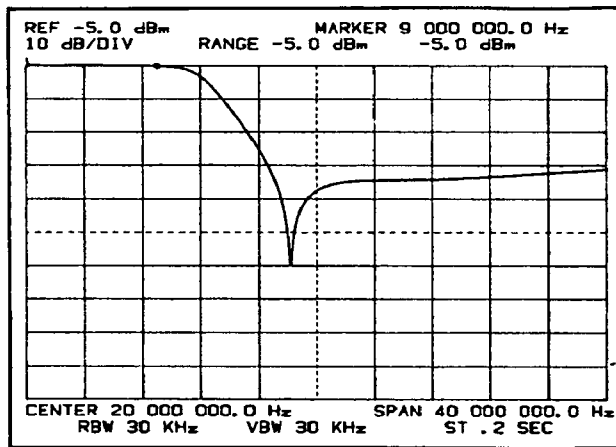

Figure 4-20. Approximate Filter Response.

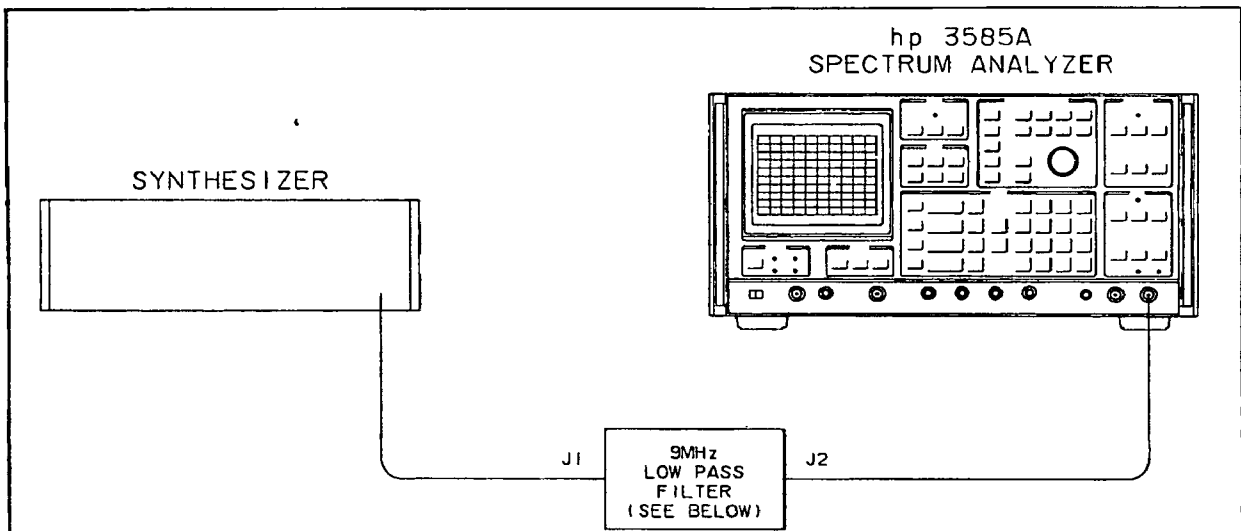

Figure 4-21. Harmonic Distortion Test.

4-81. Intermodulation Distortion Test.

4-82. This test places two signals 100 Hz apart at the input of the 3585A. The second and third order IM products are then checked against the specification.

Equipment Required:

- Frequency Synthesizer-hp-3335A
- Frequency Synthesizer-hp- 3330B
- 10 dB/Step Attenuator-hp-355D
- 1 dB/Step Attenuator-hp- 355C
- Frequency Summer(See Figure 4-22)

Specification:

Intermodulation Distortion:

For two signals, each at least 6 dB below the RANGE setting and separated in frequency by at least 100 Hz, referred to the larger of the two signals.

< -80 dB; except 2nd order IM with one or both of the input signals within the range of 10 MHz to 40 MHz, < -70 dB

Procedure:

- a. Set the 3585A controls for:

- INSTRUMENT PRESET
- CENTER FREQUENCY1.65 kHz
- FREQUENCY SPAN350 Hz
- OFFSETon

- b. Connect synthesizer #1 and #2 to the summer as shown in Figure 4-23. Connect the output of the summer to the 50Ω input of the 3585A. Set the attenuators for 0 dB of attenuation.

- c. Set the controls of synthesizer #1 for:

- FREQUENCY1.6 kHz
- AMPLITUDE-25 dBm

- d. Set the controls of synthesizer #2 for:

- FREQUENCY1.7 kHz
- AMPLITUDE-25 dBm

- e. All one complete sweep to occur on the 3585A.

- f. Move the marker to the maximum point on the 1.6 kHz (33 MHz) response.
- g. Press ENTER OFFSET on the 3585A.
- h. Watching the offset frequency in the upper right-hand corner of the 3585A display, move the marker until the frequency reads -100 Hz \pm 1 Hz (see Figure 4-24).
- i. The marker amplitude reading should be less than -80 dB to verify that the 3585A meets its Intermodulation Distortion specification.
- j. Move the marker until the offset frequency reads 200 Hz \pm 1 Hz.
- k. The marker amplitude reading should be less than -80 dB to verify that the 3585A meets its Intermodulation Distortion specification.

l. Set the 3585A controls for:

```

MARKER – CF
MANUAL SWEEP
CLEAR A
CENTER FREQUENCY..... 100 Hz
    
```

m. The marker reading is the second order IM distortion product and should be less than -80 dB (-70 dB) verifying that the 3585A meets its IM Distortion specification.

n. Set the controls of synthesizer #1 for:

```

FREQUENCY..... 33 MHz
                (13 MHz for the -hp- 3330B)
AMPLITUDE..... -25 dBm
For the 3330B this requires using the rear panel
output and an attenuator to get the required fre-
quency and level.
    
```

o. Set the controls of synthesizer #2 for:

```

FREQUENCY..... 33.0001 MHz
AMPLITUDE..... -25 dBm
    
```

p. Set the 3585A controls for:

```

CENTER FREQUENCY..... 33.00005 MHz
CONT. SWEEP
    
```

q. Repeat Steps e thru m using the values in parenthesis.

r. This completes the test, disconnect all inputs to the 3585A.

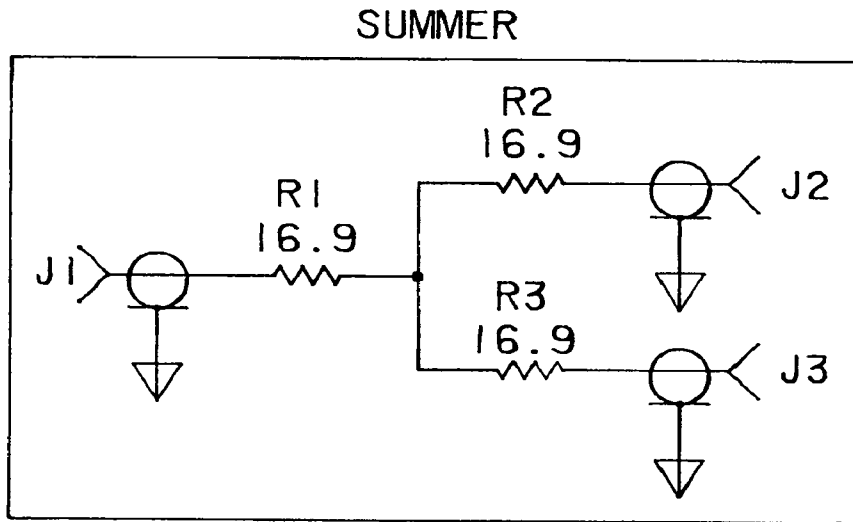

Figure 4-22. Frequency Summer.

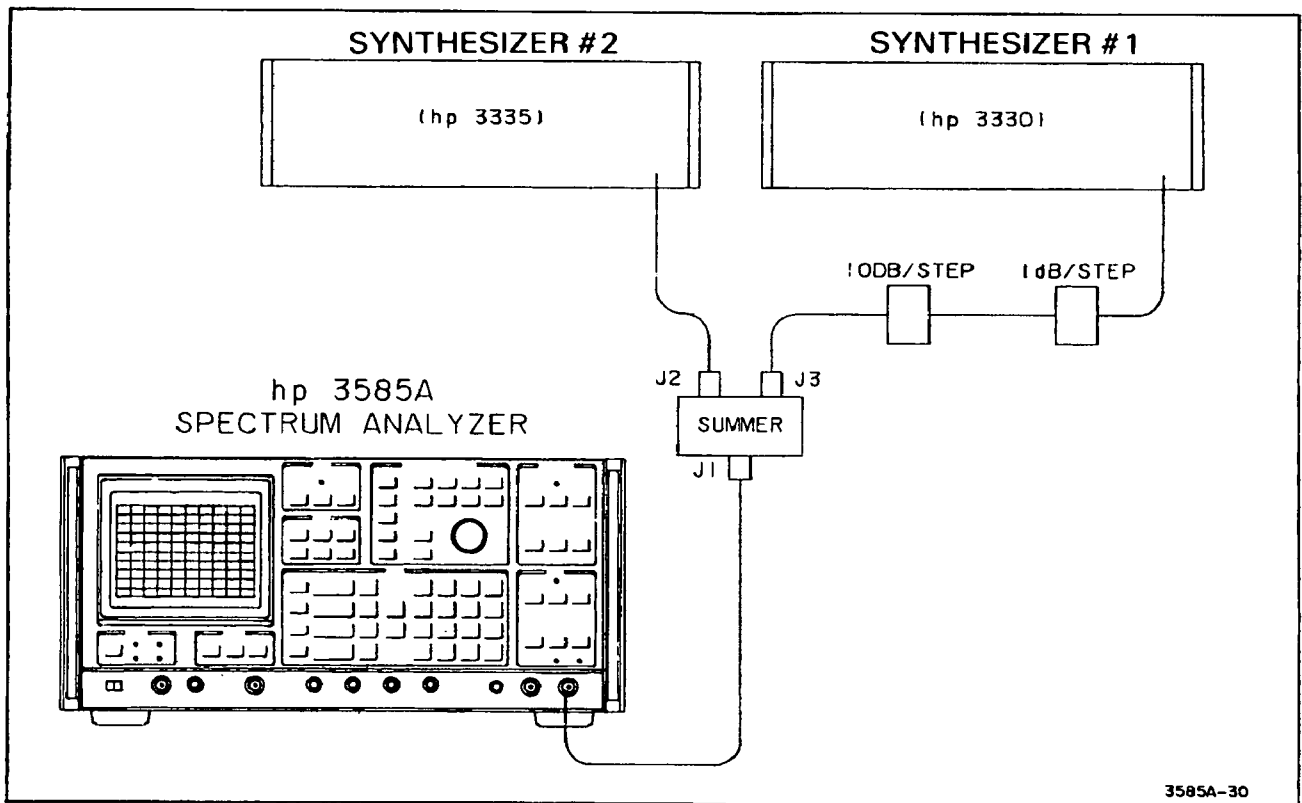

Figure 4-23. Intermodulation Distortion Test.

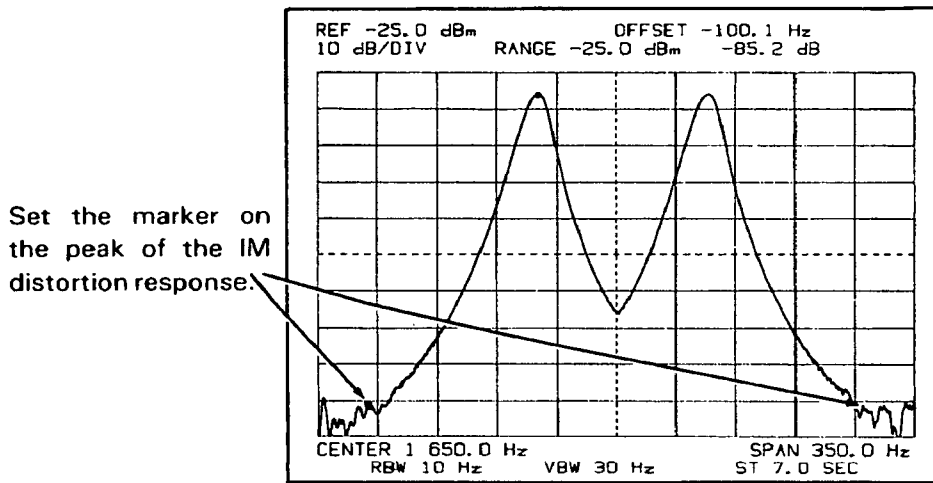

Figure 4-24. IM Distortion Response.

4-83. Bandwidth Tests.

These tests will verify that the 3585A meets its 3 dB, Bandwidth and Shape Factor specifications.

Specification:

Resolution Bandwidth Accuracy
 3 dB Bandwidth..... ± 20% of BW setting at the 3 dB points
 Selectivity (Shape Factor)..... < 11:1

Procedure:

- a. Set the 3585A controls for:

```

RECALL 602
INSTRUMENT PRESET
CENTER FREQUENCY..... 10 MHz
FREQUENCY SPAN..... 10 Hz
REFERENCE LEVEL..... -24.5 dBm
dB/DIV..... 1 dB
RES. BW..... 3 Hz
RES. BW HOLD..... on
    
```

- b. Initially this test checks the 3 dB points of each Resolution Bandwidth; therefore, ignore the values in parenthesis until instructed otherwise.

- c. Allow one complete sweep to occur. Now put the marker on the most positive point of the trace, using the marker amplitude reading as your guide.

- d. Set the 3585A controls for:

```

OFFSET..... on
ENTER OFFSET
    
```

Table 4-12. Bandwidth Control Settings.

RES. BW	Frequency Span	
	3 dB	60 dB
3 Hz	10 Hz	100 Hz
10 Hz	30 Hz	200 Hz
30 Hz	100 Hz	500 Hz
100 Hz	200 Hz	2 kHz
300 Hz	1 kHz	5 kHz
1 kHz	2 kHz	20 kHz
3 kHz	10 kHz	50 kHz
10 kHz	20 kHz	100 kHz
30 kHz	100 kHz	500 kHz

4-85. Fractional N API Spur Test.

4-86. This test checks that the Fractional N API circuitry is operating properly by checking the spurious response level.

Specification:

Spurious Responses < -80 dB below signal

Procedure:

- a. Set the synthesizer controls for:

FREQUENCY.....37,648,955 Hz
 AMPLITUDE..... + 10dBm

- b. Connect the 50Ω output of the synthesizer to the 50Ω input of the 3585A.

- c. Set the 3585A controls for:

INSTRUMENT PRESET
 CENTER FREQUENCY.....37,650,055 Hz
 FREQUENCY SPAN.....200 Hz
 REFERENCE LEVEL.....-30 dBm
 RANGE.....0 dBm
 VIDEO BW.....10Hz

- d. Allow one complete sweep to occur.

e. All points on the display should read less than -80 dB, verifying that the 3585A passes this Fractional N API Spur test.

4-87. Tracking Generator Flatness Test.

4-88. This test compares the output of the calibrator to the output of the Tracking Generator. Any unflatness contributed by the input section is subtracted out.

Specification:

Tracking Generator Frequency Response ± 0.7 dB

Procedure:

- a. Set the 3585A controls for:

```

RECALL 604
INSTRUMENT PRESET
dB/DIV.....1 dB
REFERENCE LEVEL.....-20 dBm

```

- b. Allow a complete sweep to occur, then enter these commands:

```

STORE A - B
INSTRUMENT PRESET
dB/DIV.....1 dB
RANGE.....0 dBm

```

- c. Connect the Tracking Generator output to the 3585A 50 Ω input.

d. Adjust the Tracking Generator Amplitude control so that the displayed trace is in the middle of the CRT display.

- e. Turn the A-B function on.

- f. Move the marker to the most negative point on the trace.

- g. Set the 3585A controls for:

```

OFFSET.....on
ENTER OFFSET

```

h. Move the marker to the most positive point on the trace. The marker amplitude should read less than 1.5 dB thereby verifying that the 3585A Tracking Generator meets its flatness specification.

4-89. HP-IB Check (Optional).

4-90. Up to this point the 3585A has been checked only as a bench operated instrument. If the instrument is to be used with a controller, the HP-IB interface should be checked. The program shown in Figure 4-23 will check the HP-IB operation of the instrument to a high level of confidence. This program is flow charted using controller independent language (meta message) so that it may be adapted to your controller. If you have a -hp- 9825A calculator, a listing of this program appears in Table 4-14. The program is also contained on File 26, Trace 0 of the Semi-Automatic Performance Test tape (P.N. 0]3585-10001). If an error is detected in the HP-IB interface of the 3585A, an error number will be printed out. The error definitions are contained in Table 4-13 and may be used to help locate problems on the 3585A HP-IB board.

4-91. To run the HP-IB check with the -hp- 9825A calculator, insert the Semi-Automatic Performance Test tape in the calculator tape slot and press the following keys:

LOAD **2** **6** **EXECUTE**

When the lazy "T" () has reappeared on the 9825A display, press the **RUN** key. To complete the test, follow the instructions on the calculator display. If no HP-IB errors are found by the test, "HP-IB OK" will be printed by the calculator. This ends the HP-IB check program.

Table 4-13. HP-IB Error Definitions.

Error #	Explanation
1	} Large HP-IB Problem; DSA Required
2	
3	
4	} Data Line Problem
5	
6	
7	
8	} Front Panel Light or Interface Problem; otherwise use DSA
9	
10	
11	

Table 4-14. HP-IB Check Program Listing For The 9825A Calculator.

```
0: "HP-IB Test for Op. Verification 3/08/78":
1: spc 2;prt "HPIB Test";spc 2;0→Q
2: clr 711
3: rem 7
4: wrt 711,"D2T4"
5: red 711,A,B
6: if A#2e7;1→S;gsb "ERR"
7: wrt 711,"IRT4"
8: red 711,A,B
9: if A#2.004e7;2→S;gsb "ERR"
10: clr 711
11: wrt 711,"D2T4"
12: red 711,A,B
13: if A#2e7;3→S;gsb "ERR"
14: wrt 711,"ML"
15: wtb 731,255,255,112,1,0,2,85,170,170,85
16: wrt 711,"MD"
17: wtb 731,255,255,112,1,0,2
18: rdb(711)→A;rdb(711)→B;rdb(711)→C;rdb(711)→D
19: if A#85;4→S;gsb "ERR"
20: if B#170;5→S;gsb "ERR"
21: if C#170;6→S;gsb "ERR"
22: if D#85;7→S;gsb "ERR"
23: wtb 711,85,170
24: cli 7
25: lcl 7;8→S
26: 0→R;beep;ent "SRQ Light on=cont;off=1,cont",R;if R=1;gsb "ERR"
27: rds(711)→A
28: red 711;9→S
29: 0→R;beep;ent "Talk Light on=cont;off=1,cont",R;if R=1;gsb "ERR"
30: wrt 711
31: lcl 7;10→S
32: 0→R;beep;ent "Listen Light on=cont;off=1,cont",R;if R=1;gsb "ERR"
33: rem 7
34: wrt 711
35: cli 7;11→S
36: 0→R;beep;ent "Remote Light on=cont;off=1,cont",R;if R=1;gsb "ERR"
37: if Q=0;prt "HPIB OK";spc 2
38: end
39: "ERR":prt "HPIB Failure      Test #",S;spc 2;1→Q
40: ret
*6082
```

PERFORMANCE TEST CARD

Hewlett-Packard Model 3585A

Spectrum Analyzer

Serial No. _____

Tests Performed By _____

Date _____

FREQUENCY ACCURACY TEST

Frequency difference from reference _____ Hz

CALIBRATOR TEST

Frequency	3585A Marker Reading
100 kHz	_____ dBm
40 MHz	_____ dB

CAL OFFSET TEST

Res. BW	3585A Offset Frequency Reading	Frequency Test Limit	3585A Amplitude Reading	Amplitude Test Limit
300 Hz	_____ Hz	± 3.5 kHz	_____ dB	± 3.5 dB
10 kHz	_____ Hz	± 3.5 kHz	_____ dB	± 3.5 dB
3 kHz	_____ Hz	± 3.5 kHz	_____ dB	± 3.5 dB
1 kHz	_____ Hz	± 3 kHz	_____ dB	± 3.5 dB
300 Hz	_____ Hz	± 900 Hz	_____ dB	± 3.5 dB
100 Hz	_____ Hz	± 300 Hz	_____ dB	± 3.5 dB
30 Hz	_____ Hz	± 90 Hz	_____ dB	± 3.5 dB
10 Hz	_____ Hz	± 30 Hz	_____ dB	± 3.5 dB
3 Hz	_____ Hz	± 9 Hz	_____ dB	± 3.5 dB

RANGE CALIBRATION TEST

Test Limit ± .7 dB

Range	Marker Reading
-25 dBm	_____ 0 dB
-20 dBm	_____ dB
-15 dBm	_____ dB
-10 dBm	_____ dB
- 5 dBm	_____ dB
0 dBm	_____ dB
5 dBm	_____ dB
10 dBm	_____ dB
15 dBm	_____ dB
20 dBm	_____ dB
25 dBm	_____ dB
30 dBm	_____ dB

PERFORMANCE TEST CARD (Cont'd)

AMPLITUDE LINEARITY TEST

(A) Variable Attenuator	(B) Correction Factor*	(C) Ideal Reading	(D) Correct Reading	(E) 3585A Marker Reading**	(F) Test Tolerance
0 dB	- - - -	00.0 dB	00.0 dB	00.0 dB	----
-10 dB	_____	-10.0 dB	_____ dB	_____ dB	± 0.3 dB
-20 dB	_____	-20.0 dB	_____ dB	_____ dB	± 0.3 dB
-30 dB	_____	-30.0 dB	_____ dB	_____ dB	± 0.6 dB
-40 dB	_____	-40.0 dB	_____ dB	_____ dB	± 0.6 dB
-50 dB	_____	-50.0 dB	_____ dB	_____ dB	± 1.0 dB
-60 dB	_____	-60.0 dB	_____ dB	_____ dB	± 1.0 dB
-70 dB	_____	-70.0 dB	_____ dB	_____ dB	± 1.0 dB
-80 dB	_____	-80.0 dB	_____ dB	_____ dB	± 2.0 dB
-90 dB	_____	-90.0 dB	_____ dB	_____ dB	± 2.0 dB

* Correction factor must be obtained from attenuator calibration data.

** If noise jitter is present, use average marker reading.

REFERENCE LEVEL ACCURACY TESTS

(A) Synthesizer Level	(B) 3585A Reference Level	(C) 3585A Marker Reading	(D) Synthesizer Level Minus The 3585A Marker Reading	(E) Test Tolerance
+ 10 dBm	+ 10 dBm	_____ dBm	_____ dB	± 0.4 dB
0 dBm	0 dBm	_____ dBm	_____ dB	± 0.4 dB
- 10 dBm	- 10 dBm	_____ dBm	_____ dB	± 0.4 dB
- 20 dBm	- 20 dBm	_____ dBm	_____ dB	± 0.4 dB
- 30 dBm	- 30 dBm	_____ dBm	_____ dB	± 0.4 dB
- 40 dBm	- 40 dBm	_____ dBm	_____ dB	± 0.4 dB
- 50 dBm	- 50 dBm	_____ dBm	_____ dB	± 0.7 dB
- 60 dBm	- 60 dBm	_____ dBm	_____ dB	± 0.7 dB
- 70 dBm	- 70 dBm	_____ dBm	_____ dB	± 1.5 dB
- 80 dBm	- 80 dBm	_____ dBm	_____ dB	± 1.5 dB

50Ω FREQUENCY RESPONSE TEST

Test Limit ± .5 dB

Range	Maximum Amplitude Deviation
- 25 dBm	_____ dB
- 20 dBm	_____ dB
- 15 dBm	_____ dB
- 10 dBm	_____ dB
- 5 dBm	_____ dB
0 dBm	_____ dB
5 dBm	_____ dB
10 dBm	_____ dB
15 dBm	_____ dB
20 dBm	_____ dB
25 dBm	_____ dB
30 dBm	_____ dB

PERFORMANCE TEST CARD (Cont'd)

75Ω FREQUENCY RESPONSE TEST

Test Limit $\pm .5$ dB

Range	Maximum Unflatness
- 25 dBm	_____ dB

1 MΩ FREQUENCY RESPONSE TEST

Frequency	Maximum Unflatness	Test Limit
0 to 10 MHz	_____ dB	± 0.7 dB
10 MHz to 40 MHz	_____ dB	± 1.5 dB

RETURN LOSS TESTS

Input	Test Limit < 17.5 mV p-p		Test Limit
	40 MHz	15 MHz	
50Ω	_____	_____	17.5 mV
Terminated (50Ω)	_____	_____	70 mV
75Ω	_____	_____	17.5 mV
Terminated (75Ω)	_____	_____	70 mV

1 MΩ INPUT IMPEDANCE TEST

Frequency	3585A Reading	Test Limit
0 kHz	_____ dB	-5.56 to -6.44 dB
10 kHz	_____ dB	-2 to -3 dB

MARKER ACCURACY TEST

Test Limit < $\pm 0.2\%$ Of Span

Ideal Reading	3585A Reading	Test Limit
20.08 MHz	_____ MHz	20-20.16 MHz

PERFORMANCE TEST CARD (Cont'd)

DYNAMIC RANGE TESTS

NOISE

3585A Res. BW	9.36 MHz Average Noise Reading	Test Limit
30 kHz	_____ dBm	-100
10 kHz	_____ dBm	-104
3 kHz	_____ dBm	-108
1 kHz	_____ dBm	-111
300 Hz	_____ dBm	-115
100 Hz	_____ dBm	-122
30 Hz	_____ dBm	-127
10 Hz	_____ dBm	-132
3 Hz	_____ dBm	-137

ZERO RESPONSE TEST

Test Limit < -15 dB Below Range

3585A reading = _____ dB

LOW FREQUENCY RESPONSES

Description	Frequency	*1	*2	Harmonics *3	*4	*5
Line Frequency	60 Hz	_____	_____	_____	_____	_____
A/D Clock	5 kHz	_____	_____	_____	_____	_____
Fractional N Clock	100 kHz	_____	_____	_____	_____	_____
Step Loop Clock	1 MHz	_____	_____	_____	_____	_____
Internal Reference	10 MHz	_____	_____	_____	_____	_____
Power Supply	_____	_____	_____	_____	_____	_____
CRT Oscillator	_____	_____	_____	_____	_____	_____

PERFORMANCE TEST CARD (Cont'd)
LOCAL OSCILLATOR SIDEBANDS

Test Limit > -80 dB Down From Signal

Frequency	Sideband Harmonics					
	-3	-2	-1	+1	+2	+3
60 Hz	_____	_____	_____	_____	_____	_____
5 kHz	_____	_____	_____	_____	_____	_____
100 kHz	_____	_____	_____	_____	_____	_____
1 MHz	_____	_____	_____	_____	_____	_____
Power Supply _____ Hz	_____	_____	_____	_____	_____	_____
CRT Oscillator _____ Hz	_____	_____	_____	_____	_____	_____

RESIDUAL SPURS

Test Limit < -120 dBm

Frequency	3585A Reading
39.825 MHz	_____ dBm
29.475 MHz	_____ dBm
23.1 MHz	_____ dBm
16.2 MHz	_____ dBm
14.7375 MHz	_____ dBm
9.5625 MHz	_____ dBm
37.2375 MHz	_____ dBm
32.0625 MHz	_____ dBm
9.72 MHz	_____ dBm
5.58 MHz	_____ dBm
27.72 MHz	_____ dBm

HARMONIC DISTORTION TEST

Test Limit < -80 dB Down From Signal

Fundamental Frequency	Harmonics		
	2	3	4
1 kHz	_____ dB	_____ dB	_____ dB
9 MHz	_____ dB	_____ dB	_____ dB

INTERMODULATION DISTORTION TEST

Synthesizer #1 Frequency	100 Hz Below Frequency Shown ($2F_1 - F_2$)	200 Hz Above Frequency Shown ($2F_2 - F_1$)	100 Hz ($F_2 - F_1$)
	1 kHz	_____ dB	_____ dB
33 MHz	_____ dB	_____ dB	_____ dB

PERFORMANCE TEST CARD (Cont'd)

BANDWIDTH TESTS

3585A Res. BW	3 dB Bandwidth Test Limit $\pm 20\%$ of BW	60 dB Bandwidth	Shape Factor Test Limit < 11:1
30 kHz	_____ Hz	_____ Hz	_____
10 kHz	_____ Hz	_____ Hz	_____
3 kHz	_____ Hz	_____ Hz	_____
1 kHz	_____ Hz	_____ Hz	_____
300 Hz	_____ Hz	_____ Hz	_____
100 Hz	_____ Hz	_____ Hz	_____
30 Hz	_____ Hz	_____ Hz	_____
10 Hz	_____ Hz	_____ Hz	_____
3 Hz	_____ Hz	_____ Hz	_____

FRACTIONAL N API SPUR TEST

Maximum Point On Displayed Trace _____ dB

TRACKING GENERATOR FLATNESS TEST

Test Limit < ± 0.7 dB

3585A Maximum Unflatness Reading _____ dB