

Errata

Title & Document Type: 3561A Dynamic Signal Analyzer Service Manual, Volume 1

Manual Part Number: 03561-90010

Revision Date: March 1, 1990

HP References in this Manual

This manual may contain references to HP or Hewlett-Packard. Please note that Hewlett-Packard's former test and measurement, semiconductor products and chemical analysis businesses are now part of Agilent Technologies. We have made no changes to this manual copy. The HP XXXX referred to in this document is now the Agilent XXXX. For example, model number HP8648A is now model number Agilent 8648A.

About this Manual

We've added this manual to the Agilent website in an effort to help you support your product. This manual provides the best information we could find. It may be incomplete or contain dated information, and the scan quality may not be ideal. If we find a better copy in the future, we will add it to the Agilent website.

Support for Your Product

Agilent no longer sells or supports this product. You will find any other available product information on the Agilent Test & Measurement website:

www.tm.agilent.com

Search for the model number of this product, and the resulting product page will guide you to any available information. Our service centers may be able to perform calibration if no repair parts are needed, but no other support from Agilent is available.



Model HP 3561A
Dynamic Signal Analyzer
Service Manual
Volume 1

ATZU

Service Manual
MODEL HP 3561A
Dynamic Signal Analyzer

Volume I

Serial Prefix
2338A

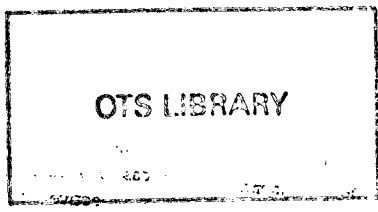

HP Part Number 03561-90010
Microfiche Part No. 03561-90060
Printed in U.S.A.

Print Date: March 1990

©Hewlett-Packard Company, 1983, 1990. All rights reserved.
8600 Soper Hill Road, Everett, WA 98205-1298



Warning



To prevent potential fire or shock hazard, do not expose equipment to rain or moisture.

001
6/27/10
11:11:11
2010/06/27





SAFETY SUMMARY

The following general safety precautions must be observed during all phases of operation, service, and repair of this instrument. Failure to comply with these precautions or with specific warnings elsewhere in this manual violates safety standards of design, manufacture, and intended use of the instrument. Hewlett-Packard Company assumes no liability for the customer's failure to comply with these requirements. This is a Safety Class 1 instrument.

GROUND THE INSTRUMENT

To minimize shock hazard, the instrument chassis and cabinet must be connected to an electrical ground. The instrument is equipped with a three-conductor ac power cable. The power cable must either be plugged into an approved three-contact electrical outlet or used with a three-contact to two-contact adapter with the grounding wire (green) firmly connected to an electrical ground (safety ground) at the power outlet. The power jack and mating plug of the power cable meet International Electrotechnical Commission (IEC) safety standards.

DO NOT OPERATE IN AN EXPLOSIVE ATMOSPHERE

Do not operate the instrument in the presence of flammable gases or fumes. Operation of any electrical instrument in such an environment constitutes a definite safety hazard.

KEEP AWAY FROM LIVE CIRCUITS

Operating personnel must not remove instrument covers. Component replacement and internal adjustments must be made by qualified maintenance personnel. Do not replace components with power cable connected. Under certain conditions, dangerous voltages may exist even with the power cable removed. To avoid injuries, always disconnect power and discharge circuits before touching them.

DO NOT SERVICE OR ADJUST ALONE

Do not attempt internal service or adjustment unless another person, capable of rendering first aid and resuscitation, is present.

USE CAUTION WHEN EXPOSING OR HANDLING THE CRT

Breakage of the Cathode-ray Tube (CRT) causes a high-velocity scattering of glass fragments (implosion). To prevent CRT implosion, avoid rough handling or jarring of the instrument. Handling of the CRT shall be done only by qualified maintenance personnel using approved safety mask and gloves.

DO NOT SUBSTITUTE PARTS OR MODIFY INSTRUMENT

Because of the danger of introducing additional hazards, do not install substitute parts or perform any unauthorized modification to the instrument. Return the instrument to a Hewlett-Packard Sales and Service Office for service and repair to ensure that safety features are maintained.

DANGEROUS PROCEDURE WARNINGS

Warnings, such as the example below, precede potentially dangerous procedures throughout this manual. Instructions contained in the warnings must be followed.

WARNING

Dangerous voltages, capable of causing death, are present in this instrument. Use extreme caution when handling, testing, and adjusting.

TABLE OF CONTENTS

SECTION I GENERAL INFORMATION

Paragraph	Title	Page
1-1	INTRODUCTION	1-1
1-2	MANUAL/INSTRUMENT IDENTIFICATION	1-2
1-3	INSTRUMENT DESCRIPTION	1-3
1-4	OPTIONS	1-3
1-5	SAFETY CONSIDERATIONS	1-3
1-6	OPERATOR MAINTENANCE	1-4
1-7	POWER REQUIREMENTS	1-4
1-8	AVAILABLE SERVICE KIT	1-6
1-9	PERFORMANCE SPECIFICATIONS	1-6
1-10	RECOMMENDED TEST EQUIPMENT	1-9
1-11	STORAGE AND SHIPMENT	1-11

SECTION II PERFORMANCE TEST

Paragraph	Title	Page
2-1	INTRODUCTION	2-1
2-2	CALIBRATION CYCLE	2-1
2-3	REQUIRED TEST EQUIPMENT	2-2
2-4	PERFORMANCE TEST SUMMARY	2-3
2-5	OPERATIONAL VERIFICATION SUMMARY	2-4
2-6	dc Offset	2-4
2-7	Amplitude Accuracy/Flatness	2-5
2-8	Amplitude Linearity	2-8
2-9	Noise Level/Spurious Signal Level	2-11
2-10	Frequency Accuracy	2-13
2-11	Input Coupling Insertion Loss	2-15
2-12	Anti Alias Filter Response	2-17
2-13	A-Weight Filter Response	2-19
2-14	Phase Accuracy	2-21
2-15	Input Impedance	2-24
2-16	Floating Ground Capacitance	2-27
2-17	Harmonic Distortion	2-29
2-18	Two Tone Intermodulation Distortion	2-32
2-19	Noise Source Output Impedance	2-36
2-20	Noise Source Amplitude Accuracy/Flatness	2-38
2-21	External Sample	2-42
2-22	Internal Self Test	2-44

SECTION III ADJUSTMENTS

Paragraph	Title	Page
3-1	INTRODUCTION	3-1
3-2	SAFETY CONSIDERATIONS	3-1
3-3	EQUIPMENT REQUIRED	3-2
3-4	ADJUSTMENT LOCATIONS	3-2
3-5	ADJUSTMENT SUMMARY	3-2
3-6	A71 POWER SUPPLY LOW LINE DETECT ADJUSTMENT PROCEDURE	3-3
3-7	A90 CRT DISPLAY ADJUSTMENT PROCEDURE	3-4
3-8	A40 REFERENCE OSCILLATOR ADJUSTMENT PROCEDURE	3-8
3-9	A15 DIGITIZER ASSEMBLY ADJUSTMENT PROCEDURE	3-10
3-10	A10 INPUT ASSEMBLY ADJUSTMENT PROCEDURE	3-16
3-11	A50 NOISE SOURCE ADJUSTMENT PROCEDURE	3-22

SECTION IV REPLACEABLE PARTS

Paragraph	Title	Page
4-1	INTRODUCTION	4-1
4-2	STANDARD ABBREVIATIONS	4-1
4-3	ORDERING INFORMATION	4-2
4-4	MANUFACTURER'S CODE LIST	4-2
4-5	REPLACEABLE PARTS LIST	4-2
4-6	DIRECT MAIL ORDER SYSTEM	4-4

SECTION V BACKDATING

Paragraph	Title	Page
5-1	INTRODUCTION	5-1
5-2	MANUAL CHANGES	5-1
5-3	A10 Input Amplifier Assembly Backdating	5-2
5-4	A15 Digitizer Assembly Backdating	5-3
5-5	A20 Digital Filter Assembly Backdating	5-4
5-6	A30 FFT/RAM Assembly Backdating	5-4
5-7	A40 Processor/ROM Assembly Backdating	5-4
5-8	A50 Local Oscillator/Noise Source Assembly Backdating	5-7/5-8
5-9	A82 Rear Panel Assembly Backdating	5-13
5-10	A99 Motherboard Assembly Backdating	5-14

SECTION VI FAULT ISOLATION

Paragraph	Title	Page
6-1	INTRODUCTION	6-1
6-2	SAFETY CONSIDERATIONS	6-3
6-3	RECOMMENDED TEST EQUIPMENT: FAULT ISOLATION	6-4
6-4	SELF CALIBRATION	6-4
6-5	Calibration Procedure	6-4
6-6	Calibration Failures	6-5
6-7	TROUBLESHOOTING GUIDELINES	6-6

Paragraph	Title	Page
6-8	FAULT ISOLATION PROCEDURE	6-11
6-9	Using the Fault Isolation Procedure	6-11
6-10	TEST A: Bias Power Supply A71, A99	6-12
6-11	TEST B: Main Power Supply A70, A71, A72, A99	6-14
6-12	TEST C: Display Driver A60, A90, A99	6-19
6-13	TEST D: Processor/ROM A40	6-23
6-14	TEST E: FFT/RAM A30	6-29
6-15	TEST F: Digital Filter A20	6-35
6-16	TEST G: Input Amplifier/Digitizer A10, A15	6-39
6-17	TEST H: Local Oscillator/Noise Source A50	6-45
6-18	TEST I: CMOS/Bubble Memory A66, A65	6-49
6-19	DIAGNOSTIC/SELF TEST DESCRIPTIONS	6-50
6-20	Introduction	6-50
6-21	Test Menu Explanation	6-52
6-22	General Error Code Format	6-54
6-23	Test 0: Power-On Test	6-55
6-24	Test 1 Quick Functional Test	6-61
6-25	Test 12 A30 FFT Test	6-63
6-26	Test 13 A20 Timing Counter Test	6-64
6-27	Test 14 A20 Digital Filter/DMA Channel R Test	6-65
6-28	Test 18 A20 DMA Channel G And Trigger Test	6-67
6-29	Test 19 A65/A66 CMOS Memory Test	6-69
6-30	Test 20 A65 Bubble Memory Test	6-69
6-31	Test 50 Display Pattern Test	6-71
6-32	Test 52 A10 Calibrator Adjustment	6-71
6-33	Test 53 A10 20dB Flatness Adjustment	6-72
6-34	Test 54 A10 40dB Flatness Adjustment	6-74
6-35	Test 110 A10 Front End Control Register Test	6-75
6-36	Test 111 - 116 A15 Timing and Control Circuit Setups	6-76
6-37	Test 118 Display Calibration Constants	6-76
6-38	Test 119 Clear Calibration Constant	6-77
6-39	Test 120 A20 Digital Filter DSA	6-77
6-40	Test 121 A20 Timing Counter DSA	6-77
6-41	Test 122 A20 DMA Channel G DSA	6-78
6-42	Test 123 A20 DMA Channel R DSA	6-78
6-43	Test 150 A50 Local Oscillator DSA	6-78
6-44	Test 151 A50 Analog Source Test	6-79
6-45	Test 152 A50 Noise Source DSA Setup 1	6-79
6-46	Test 153 A50 Noise Source DSA Setup 2	6-80
6-47	Test 154 A50 HP-IB I/O Verification Test Routine	6-80
6-48	Test 167 A65 Bubble Memory Read DSA	6-83
6-49	Test 168 A65 Bubble Memory Bootloop Routine	6-84
6-50	Test 169 A65 Bubble Memory Reseed Routine	6-92
6-51	Test 170 A65 Format Nonvolatile Memory Routine	6-93
6-52	OVERALL INSTRUMENT THEORY OF OPERATION	6-94
6-53	Introduction to Theory of Operation	6-94
6-54	Control Circuits and Bus Structure	6-94
6-55	Measurement Data Flow	6-95

**SECTION VII
SCHEMATICS/SERVICE**

Paragraph	Title	Page
7-1	INTRODUCTION	7-1
7-2	SAFETY CONSIDERATIONS	7-2
7-3	SCHEMATIC NOTES	7-3
7-4	A10 INPUT AMPLIFIER ASSEMBLY	7-7
7-5	Input Amplifier Circuit Description	7-7
7-6	Troubleshooting the Input Amplifier	7-12
7-7	A15 DIGITIZER ASSEMBLY	7-23
7-8	Digitizer Circuit Description	7-23
7-9	Troubleshooting the Digitizer	7-27
7-10	A20 DIGITAL FILTER ASSEMBLY	7-39
7-11	Digital Filter Circuit Description	7-39
7-12	Troubleshooting the A20 Assembly	7-44
7-13	A30 FFT/RAM ASSEMBLY	7-71
7-14	FFT/RAM Circuit Description	7-71
7-15	Troubleshooting the A30 Assembly	7-74
7-16	A40 PROCESSOR/ROM ASSEMBLY	7-95
7-17	Processor/ROM Circuit Description	7-95
7-18	Troubleshooting the Processor/ROM	7-100
7-19	A50 LOCAL OSCILLATOR/NOISE SOURCE ASSEMBLY	7-123
7-20	Local Oscillator/Noise Source Circuit Description	7-123
7-21	Troubleshooting the Local Oscillator/Noise Source	7-128
7-22	A60 DIGITAL DISPLAY DRIVER ASSEMBLY	7-153
7-23	Digital Display Driver Circuit Description	7-153
7-24	Troubleshooting the Digital Display Driver	7-157
7-25	A65/A66 CMOS/BUBBLE MEMORY ASSEMBLY	7-181
7-26	CMOS/Bubble Memory Circuit Description	7-181
7-27	Troubleshooting The A65/66 Assemblies	7-183
7-28	A70, A71, A72 POWER SUPPLY ASSEMBLIES AND PART OF A99 MOTHERBOARD ASSEMBLY	7-203
7-29	Power Supply Circuit Description	7-203
7-30	Troubleshooting the Power Supply	7-207
7-31	A80 AND A81 KEYBOARD ASSEMBLIES	7-221
7-32	Keyboard Driver Circuit Description	7-221
7-33	Removing the Front Panel	7-222
7-34	Troubleshooting the Keyboard Assemblies	7-224
7-35	A82 ASSEMBLY: REAR PANEL	7-226
7-36	A90 ANALOG DISPLAY DRIVER ASSEMBLY AND PART OF A99 MOTHERBOARD ASSEMBLY	7-235
7-37	Analog Display Driver Circuit Description	7-235
7-38	Troubleshooting the Analog Display Driver	7-238
7-39	A99 MOTHERBOARD ASSEMBLY	7-251
7-40	Motherboard Circuit Descriptions	7-251

LIST OF TABLES

Table	Title	Page
1-1	Manual Section Descriptions	1-2
1-2	-hp-3561A Options	1-3
1-3	-hp-3561A Service Kit Contents	1-6
1-4	-hp-3561A Performance Specifications	1-7
1-5	Recommended Test Equipment	1-12
2-1	Performance Test Summary	2-3
2-2	Operational Verification Summary	2-4
2-3	Amplitude Accuracy/Flatness Measurement	2-5
2-4	Amplitude Linearity Measurement	2-8
2-5	Noise Level/Spurious Signal Measurement	2-11
2-6	Anti Alias Filter Response Measurement	2-17
2-7	A-Weight Filter Response Measurement	2-19
2-8	Phase Accuracy Measurement	2-21
2-9	Harmonic Frequencies Measurement One	2-29
2-10	Harmonic Frequencies Measurement Two	2-29
2-11	Intermodulation Products Measurement One	2-32
2-12	Intermodulation Products Measurement Two	2-32
2-13	Noise Source Flatness Measurement	2-38
3-1	-hp-3561A List of Adjustments	3-2
4-1	Reference Designations and Abbreviations	4-1
4-2	Manufactures Code List	4-2
4-3	Replaceable Parts	4-5
5-1	Revision A Assemblies Versus Revision B Assemblies	5-1
6-1	Recommended Test Equipment for Fault Isolation	6-4
6-2	Cal Failures	6-6
6-3	Failure Symptom Table	6-7
6-4	Fault Isolation Procedure Summary	6-4
6-12	-hp-3561A Diagnostic/Self Tests	6-51
7-1	Schematic Diagrams	7-1
7-2	Attenuator Settings vs. Range Settings	7-8
7-3	A-Weight Filter Characteristics	7-10
7-4	A10 Assembly Signal Descriptions	7-11
7-5	Signal Amplitudes vs. Range Setting	7-12
7-6	A10 Assembly Signal Connections	7-17
7-7	ADC Input Switch Control	7-25
7-8	A15 Assembly Signal Descriptions	7-26
7-9	A15 Assembly Signal Connections	7-33
7-10	Digital Filter Operation	7-40
7-11	A20 Assembly Signal Descriptions	7-42
7-12	A20 Troubleshooting Order	7-44
7-13	A20 Failure Symptoms	7-44
7-14	A20 Diagnostic Test Return Code Descriptions	7-45
7-15	A20 Processor Interface Signatures	7-47
7-16	Test 123 Channel R Address Bus Latch Signatures	7-54
7-17	Test 120 Digital Filter Signatures	7-55
7-18	Test 122 Channel G Address Bus Latch Signatures	7-57
7-19	A20 Assembly Signal Connections	7-58
7-20	A30 Assembly Signal Descriptions	7-74
7-21	A30 Circuit Troubleshooting Order	7-76
7-22	RAM Bus Arbitrator Signals with DF3BR Grounded	7-79
7-23	RAM Address and Data Bus Signatures	7-83
7-24	FFT/Processor Interface Signatures	7-83
7-25	Power on Test RAM Failures	7-85

Table	Title	Page
7-26	FFT Processor and ROM Signatures	7-86
7-27	A30 Assembly Signal Connections	7-87
7-28	A40 Assembly Signal Descriptions	7-98
7-29	A40 Circuit Troubleshooting Order	7-100
7-30	Processor Loop Test Input Signals	7-104
7-31	A40W2 Test Signatures	7-107
7-32	Power-on Test ROM Return Codes	7-109
7-33	Processor I/O and Address Bus Signatures	7-110
7-34	Processor Data Bus and RAM Address Bus Signatures	7-111
7-35	A40 Assembly Signal Connections	7-112
7-36	A50 Assembly Signal Descriptions	7-127
7-37	A50 Circuit Troubleshooting Order	7-128
7-38	Local Oscillator Signatures For Functional Circuits A, C, D, and F	7-131
7-39	Local Oscillator Signatures For Functional Circuit G	7-133
7-40	Local Oscillator Signatures For Functional Circuits H, I, J, and L	7-134
7-41	Local Oscillator Interface Signatures For Functional Circuit X	7-135
7-42	Noise Source Signatures for Functional Circuits O, P, R, and T	7-137
7-43	Noise Source Signatures For Functional Circuits Q, Y, and EE	7-138
7-44	Noise Source Signatures For Functional Circuits W and AA	7-139
7-45	A50 Assembly Signal Connections	7-144
7-46	A60 Assembly Signal Descriptions	7-156
7-47	A60 Circuit Troubleshooting Order	7-157
7-48	RAM Byte Address and Bit Address Signatures	7-164
7-49	RAM Address Signatures	7-167
7-50	Power On Test Return Codes for the Display RAM	7-167
7-51	A60 Processor Interface Signatures	7-170
7-52	A60 Assembly Signal Connections	7-170
7-53	A65 Assembly Signal Descriptions	7-183
7-54	A66 Circuit Troubleshooting Order	7-184
7-55	Test 20 RETURN CODE Descriptions	7-189
7-56	A65 Circuit Troubleshooting Order	7-1
7-57	A66/65 Assembly Signal Connections	7-197
7-58	Keyboard Failure Symptoms	7-224
7-59	Keyboard DSA Troubleshooting Information	7-227
7-60	A90 Assembly Signal Descriptions	7-237
7-61	Possible Values for A99 C5, C6, C7, C8	7-246
7-62	Optimum Values for A99 C5, C6, C7, C8	7-246
7-63	A90 Assembly Signal Connections	7-247
7-64	Signal Interconnect	7-251

LIST OF ILLUSTRATIONS

Figure	Title	Page
1-1	-hp-3561A With Accessories Supplied	1-1
1-2	Line Voltage Ranges	1-7
1-3	Switch Position and Fuse Selection vs. Voltage Range	1-7
1-4	BNC Resistor Connector	1-12
2-1	Amplitude Accuracy/Flatness Test Setup	2-6
2-2	Amplitude Linearity Test Setup	2-9
2-3	Noise Level/Spurious Signal Test Setup	2-12
2-4	Frequency Accuracy Test Setup	2-14
2-5	Input Coupling Insertion Loss Test Setup	2-16
2-6	Anti-Alias Filter Response Test Setup	2-18
2-7	A-Weight Filter Response Test Setup	2-20
2-8	Phase Accuracy Test Setup	2-22
2-9	Input Resistance Test Setup	2-25
2-10	Input Capacitance Test Setup	2-26
2-11	Floating Ground Capacitance Test Setup	2-28
2-12	Harmonic Distortion Test Setup	2-30
2-13	Intermodulation Distortion Test Setup	2-33
2-14	Noise Source Impedance Test Setup	2-36
2-15	Noise Source Amplitude Accuracy Test Setup	2-39
2-16	External Sample Test	2-42
2-17	Cal Signal In External Sample Mode	2-43
3-1	100 Volt Input Voltage Selection Switch Setting	3-3
3-2	A71R1 Adjustment Location	3-4
3-3	A90 Adjustment and TP Locations	3-4
3-4	A60J100 Jumper Position	3-4
3-5	A99L101 Adjustment Reference	3-6
3-6	Display Alignment Pattern	3-7
3-7	A40 Adjustment Locator	3-8
3-8	Correctly and Incorrectly Adjusted A40C201	3-9
3-9	Digitizer Adjustment Setup	3-10
3-10	A15 Adjustment Locator	3-11
3-11	Correctly and Incorrectly Adjusted A15R115	3-13
3-12	Correctly and Incorrectly Adjusted A15R201	3-14
3-13	Correctly and Incorrectly Adjusted A15R200	3-14
3-14	A15R202 DC Offset Adjustment	3-15
3-15	A10 Assembly Adjustment Locations	3-16
3-16	Response of A10 ZERO Adjustment	3-18
3-17	Response of A10 A-Weight Filter Adjustment	3-21
3-18	A50R400 Adjustment Location	3-22
3-19	A50R400 Adjustment Reference	3-23
4-1	Mechanical Exploded View	4-49
5-1	A10 Assembly Revision A Component Locator	5-2
5-2	A40 Assembly Revision A Component Locator	5-5/5-6
5-3	A50 Assembly Revision A Component Locator	5-7/5-8
5-4	A50 Assembly RC Filter Deletion	5-9
5-5	A50 GCLOCK GENERATOR K Revision A Modification	5-11
5-6	A82 Assembly Revision A Component Locator	5-13
5-7	A99 Assembly Revision A Component Locator	5-14
6-1	Fault Isolation Procedure Flow Chart	6-2
6-2	A71 Component Locator	6-13
6-31	-hp-3561A Test Menu	6-53
6-32	Front Panel LED Error Indicators For Test 0	6-57
6-33	HP-IB Connector Pinout Configuration	6-81

Figure	Title	Page
6-34	Reseed Module Installed Properly	6-92
6-36	-hp-3561A Simplified Block Diagram	6-94
6-37	Assembly and Cable Locations (Top View of Instrument)	6-98
6-38	-hp-3561A Detailed Block Diagram	6-99/6-100
7-1	Cal Signal Waveform	7-13
7-2	A-Weight Filter Response	7-15
7-3	Front End Control Register Waveforms	7-16
7-4	A/D Converter Signal Timing	7-24
7-5	A15 Assembly Clock Waveforms	7-27
7-6	A15 Assembly Analog Waveforms in Test 115	7-28
7-7	Second Pass ADC Input Waveforms in Test 115	7-29
7-8	Track and Hold Waveforms	7-30
7-9	Test Pattern Output in Test 112	7-31
7-10	-hp-3561A Display in Test 113	7-32
7-11	A15 Status Output	7-33
7-12	A20 Clock Waveforms	7-46
7-13	A20 Counter Clock Waveforms	7-48
7-14	Test 121 Counter Input Waveforms	7-50
7-15	A20 Counter Output Waveforms	7-51
7-16	Test 123 RAM Bus Interface Waveforms	7-52
7-17	Test 123 Channel R DMA Counter Waveforms	7-53
7-18	Test 122 Channel G DMA Counter Waveforms	7-56
7-19	"DONEG" Waveforms	7-57
7-20	Convert/Sync2 Waveforms in Test 122	7-58
7-21	RAM Access State Machine Timing	7-72
7-22	RAM State Machine Waveforms	7-76
7-23	RAM Bus Arbitrator Waveforms	7-79
7-24	DF3BG With DF3BR Grounded	7-80
7-25	RAM Refresh Counter Waveforms	7-81
7-26	A40 Clock Waveforms	7-101
7-27	Clock Divider and Interrupt Waveforms	7-102
7-28	Processor Loop Test Waveforms	7-105
7-29	Correct Waveform at A50TP"DAC OUT"	7-140
7-30	Correct Waveform at A50U401(6)	7-141
7-31	Correct Waveform at A50U404(6)	7-141
7-32	Correct Waveform at A50U901(4)	7-141
7-33	Clock and Timing Waveforms	7-158
7-34	Position Address Waveforms	7-162
7-35	Row and Column Address Counter Waveforms	7-165
7-36	RAM Data Reader Waveforms	7-168
7-37	Beeper Timing Waveforms	7-169
7-38	Correct Waveforms at A66U100(4,5)	7-185
7-39	Correct Waveforms at A66 TP103	7-186
7-40	A65 Failure Isolation Chart	7-187/7-188
7-41	Correct Waveforms at A65 TP301 and TP302	7-190
7-42	Correct Waveform at A65 U302(6)	7-191
7-43	Correct Waveform at A65 U300(5)	7-192
7-44	Correct Waveforms at A65 U201(8,11)	7-192
7-45	Correct Waveform at A65 TP304	7-193
7-46	Correct Output Waveform at A65 U200	7-193
7-47	Correct Waveforms at A65 U2	7-196
7-48	Correct Waveform at A65 U1, U100, TP1, TP2, TP4, TP104	7-196

Figure	Title	Page
7-49	A70 Assembly Troubleshooting Waveforms	7-210
7-50	Correct Waveform at A71CR100	7-212
7-51	Front Panel Disassembly Screw Locations	7-223
7-52	Correct Power-up CRT Display	7-225
7-53	"S" Ramp	7-236
7-54	PLANE2 Video Drive Waveforms	7-240
7-55	PLANE1 Video Drive Waveforms	7-240
7-56	Slow Sweep Horizontal Drive Waveforms	7-241
7-57	Fast Sweep Waveforms In Open Loop Mode	7-242
7-58	Fast Sweep Waveforms In Closed Loop Mode	7-243
7-59	High Voltage Waveforms	7-244
7-60	Measuring The CRT Anode Voltage	7-245
7-61	Retrace Pulse Width Measurement	7-246

SECTION I
GENERAL INFORMATION

Paragraph	Title	Page
1-1	INTRODUCTION	1-1
1-2	MANUAL/INSTRUMENT IDENTIFICATION	1-2
1-3	INSTRUMENT DESCRIPTION	1-3
1-4	OPTIONS	1-3
1-5	SAFETY CONSIDERATIONS	1-3
1-6	OPERATOR MAINTENANCE	1-4
1-7	POWER REQUIREMENTS	1-4
1-8	AVAILABLE SERVICE KIT	1-6
1-9	PERFORMANCE SPECIFICATIONS	1-6
1-10	RECOMMENDED TEST EQUIPMENT	1-9
1-11	STORAGE AND SHIPMENT	1-11

SAFETY SYMBOLS

General Definitions of Safety Symbols Used On Equipment or In Manuals.



Instruction manual symbol: the product will be marked with this symbol when it is necessary for the user to refer to the instruction manual in order to protect against damage to the instrument.



Indicates dangerous voltage (terminals fed from the interior by voltage exceeding 1000 volts must be so marked).

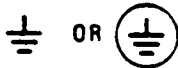

Protective conductor terminal. For protection against electrical shock in case of a fault. Used with field wiring terminals to indicate the terminal which must be connected to ground before operating equipment.



Low-noise or noiseless, clean ground (earth) terminal. Used for a signal common, as well as providing protection against electrical shock in case of a fault. A terminal marked with this symbol must be connected to ground in the manner described in the installation (operating) manual, and before operating the equipment.

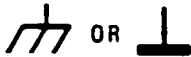

Frame or chassis terminal. A connection to the frame (chassis) of the equipment which normally includes all exposed metal structures.



Alternating current (power line).



Direct current (power line).



Alternating or direct current (power line).

WARNING

The **WARNING** sign denotes a hazard. It calls attention to a procedure, practice, condition or the like, which, if not correctly performed or adhered to, could result in injury or death to personnel.

CAUTION

The **CAUTION** sign denotes a hazard. It calls attention to an operating procedure, practice, condition or the like, which, if not correctly performed or adhered to, could result in damage to or destruction of part or all of the product.

NOTE :

The **NOTE** sign denotes important information. It calls attention to procedure, practice, condition or the like, which is essential to highlight.

Figure 5-1a A10 Assembly Revision A Component Locator

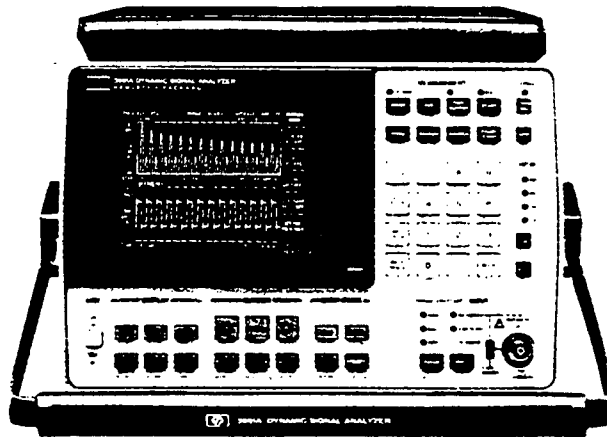

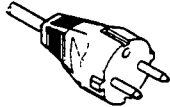
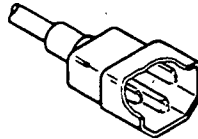
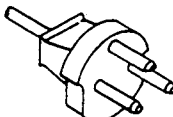
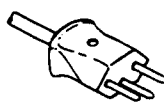
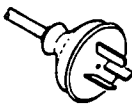
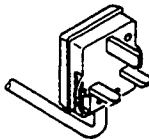
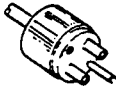
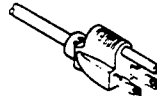
<p style="text-align: center;">250 V OPERATION</p>  <p>PLUG*: CEE7-V11 CABLE*: HP 8120-1882</p>	<p style="text-align: center;">250 V OPERATION</p>  <p>PLUG*: CEE22-V1 CABLE*: HP 8120-1880</p>	<p style="text-align: center;">250 V OPERATION</p>  <p>PLUG*: DHCR 107 CABLE*: HP 8120-2856</p>	<p style="text-align: center;">250 V OPERATION</p>  <p>PLUG*: SEV 1011.1958-24507 TYPE 12 CABLE*: HP 8120-2104</p>
<p style="text-align: center;">250 V OPERATION</p>  <p>PLUG*: NZSS 188/AS C112 CABLE*: HP 8120-0698</p>	<p style="text-align: center;">250 V OPERATION</p>  <p>PLUG*: BS 1363A CABLE*: HP 8120-1703</p>	<p style="text-align: center;">250 V - 6A**</p>  <p>PLUG*: NEMA G-15P CABLE*: HP 8120-0698</p>	<p style="text-align: center;">125 V - 6A**</p>  <p>PLUG*: NEMA 5-15P CABLE*: HP 8120-1521</p>
<p>STD-S-1186 (Rev.)</p> <p>*The number shown for the plug is the industry identifier for the plug only. The number shown for the cable is an HP part number for a complete cable including the plug. **UL listed for use in the United States of America</p>			

SECTION I

GENERAL INFORMATION

1-1 INTRODUCTION

This service manual provides all the information required by service personnel to test, adjust, and service the -hp-3561A Dynamic Signal Analyzer. Figure 1-1 shows the -hp-3561A with the accessories supplied.

The Service Manual is divided into seven sections, each covering a particular topic for the servicing of the -hp-3561A. A brief description of each section is given in Table 1-1.

This service manual is designed for troubleshooting the -hp-3561A in a two step process. In step one, the information given in Section 6 is used to isolate the failure to the circuit board level. Once the failure is isolated to a circuit board, the information given in Section 7 is used to further isolate the failure to the component level. The troubleshooting procedure given below describes the standard troubleshooting process.

HOW TO USE THE TROUBLESHOOTING PROCEDURES

Troubleshooting Procedure:

1. Observe the failure symptoms.
 - Does the failure affect any front panel keys?
 - Does the failure result in a Cal Failure message?
 - Does the power up test fail with an Error Return Code?
2. Check paragraph 6-7, Troubleshooting Guidelines, for the failure symptom.
If the symptom is listed, start the fault isolation procedure with the indicated test.
3. If the failure results in a Cal Failure message, refer to paragraph 6-6, Calibration Failures. Start the fault isolation procedure with the indicated test.
4. If the power up test fails with an Error Return Code, start the fault isolation test with TEST B.
5. When in doubt, start the fault isolation test with TEST A.
6. Proceed with the fault isolation test until the failure is isolated to a circuit board.
 - If the failure is not detected by the fault isolation procedure, the performance test (Section 2) can be used to further test the -hp-3561A operation.
7. Once the Failure is isolated to a circuit board, proceed to isolate the failure to a component using the information given in Section 7.
 - If the circuit board is out of adjustment, refer to the adjustment procedures given in Section 3.

Table 1-1 Manual Section Descriptions

Section	Title	Description
I	GENERAL INFORMATION	This section contains information on how to use this manual. Also included are Safety Considerations, Recommended Test Equipment, and the -hp-3561A performance specifications.
II	PERFORMANCE TEST	The Performance Test section contains the procedure used to verify the instrument's performance specifications which are listed in Table 1-4. Also included is the Operational Verification procedure, which can be used for post repair verification or incoming inspection.
III	ADJUSTMENTS	This section describes the adjustment procedures which will return the instrument to peak operating condition after repairs are completed or for periodic preventative maintenance.
IV	REPLACEABLE PARTS	In this section, the replaceable parts are listed in order of their reference designation. This section also contains the information on how to order these parts.
V	BACKDATING	The Backdating section has the modification information necessary to adapt this service manual to -hp-3561As which were manufactured before the printing of this manual.
VI	FAULT ISOLATION	The Fault Isolation section contains the information needed to isolate failures to the circuit board level. Also included is an explanation of the Cal Failure messages, a description of the various internal diagnostic test routines, and an overall instrument theory of operation.
VII	SERVICE	This section contains the schematic diagrams, assembly level theory of operation, component level troubleshooting and component locators. They are organized in assembly reference designation order from A10 through A99.

1-2 MANUAL/INSTRUMENT IDENTIFICATION

The instrument identification serial number is located on the rear panel of the instrument. Hewlett-Packard uses a two-section serial number consisting of a four digit prefix and a five digit suffix separated by a letter designating the country in which the instrument was manufactured (A = U.S.A.; G = West Germany; J = Japan; U = United Kingdom). The prefix is the same for all identical instruments and changes only when a major instrument change is made. The suffix, however, is assigned sequentially and is unique to each instrument. The contents of this manual apply directly to instruments having the same serial number prefix as listed on the title page of this manual.

Instruments manufactured after the printing of this manual may have a serial prefix that is not listed on the title page. This unlisted prefix indicates that the instrument is different from those documented in this manual. The manual for this instrument is supplied with a yellow Manual Changes supplement which contains change information that documents the differences.

In addition to change information, the supplement may contain information for correcting errors in the manual. To keep this manual as accurate and current as possible, Hewlett-Packard recommends that you periodically request the latest Manual Changes supplement.

Listed on the title page of this manual is a manual part number and a microfiche part number. The manual part number can be used to order extra copies of this service manuals. The microfiche part number can be used to order 4 by 6 inch microfilm transparencies of this service manual.

1-3 INSTRUMENT DESCRIPTION

The -hp-3561A is a high performance, single channel Dynamic Signal Analyzer designed for portable or bench use. Its frequency coverage of 0 to 100kHz with a dynamic range of 80dB makes it suitable for vibration and rotational machinery analysis, as well as audio and general purpose electronic measurements.

Fast Fourier Transform (FFT) and Digital Filter technology is used in the -hp-3561A as well as a raster scan CRT and a line switching power supply. HP-IB is standard with the ability to plot directly to an HP-GL plotter with its own built-in software eliminating the need for a controller.

1-4 OPTIONS

There are four options available to the -hp-3561A. They are available either when the instrument is ordered or for later installation. These options are listed in Table 1-2.

Table 1-2 -hp-3561A Options

Option	Description
001	Bubble Memory
908	Rack Mounting Kit
910	Extra Operating Manual
910	Extra Service Manual

1-5 SAFETY CONSIDERATIONS

The -hp-3561A is a Safety Class 1 instrument (provided with a protective earth terminal). Although this instrument has been designed in accordance with international safety standards, this manual contains information, cautions and warnings which must be followed to ensure safe operation and to retain the -hp-3561A in safe operating condition. Service and adjustments should be performed only by qualified personnel who are aware of the hazards involved.

1-6 OPERATOR MAINTENANCE

Operator maintenance is limited to replacing the line fuse and cleaning the fan filter. There are no operator controls or user serviceable parts inside the -hp-3561A. Only trained service personnel should perform instrument repairs.

WARNING

To avoid serious injury, disconnect the ac line power cord before removing or installing the ac line fuse.

WARNING

Only fuses with the required rated current and specified type should be used for replacement. The use of repaired fuses and short circuiting of fuse holders is not permitted. Whenever it is likely that the protection offered by the fuse has been impaired, the -hp-3561A must be made inoperative and secured against any unintended operation.

WARNING

Under no circumstances should an operator remove any covers, screws, or in any other way enter the -hp-3561A. There are no operator controls inside the -hp-3561A.

1-7 POWER REQUIREMENTS

CAUTION

Before applying ac line power to the -hp-3561A, ensure that the voltage selection switches on the bottom of the instrument are set for the proper line voltage and that the correct line fuse is installed in the rear panel fuse holder.

The -hp-3561A can be operated from any single phase ac power source supplying 100V, 120V, 220V, or 240V (-10% to +5%). For 100/120V power, the -hp-3561A can be operated in the frequency range of 48-440 Hz. For 220/240V power, the -hp-3561A can be operated in the frequency range of 48-66 Hz. Power consumption is less than 120VA. Refer to Figure 1-2 for the line voltage ranges and Figure 1-3 for the switch positions and fuse selection verses voltage range.

Figure 1-2 Line Voltage Ranges

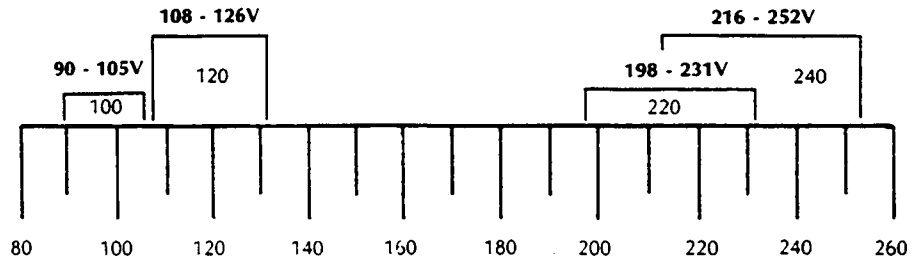
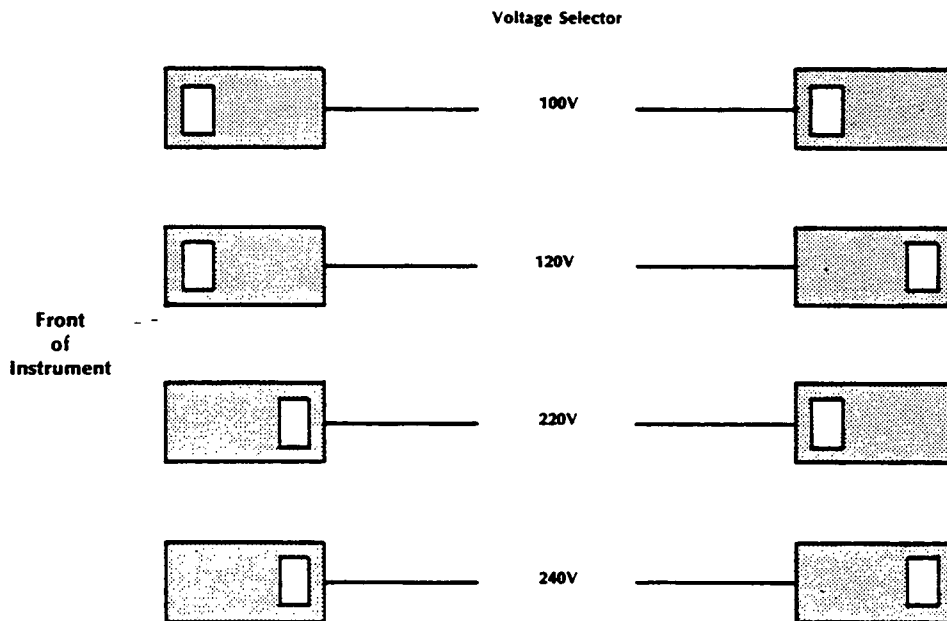

Figure 1-3 Switch Position and Fuse Selection versus Voltage Range

Line Setting	Fuse Type	hp- Part No.
110 V/120 V	3 A 250 V Normal Blow	2110-0003
220 V/240 V	1.5 A TD 250 V Time Delay	2110-0304



1-8 AVAILABLE SERVICE KIT

A Service Kit, HP part number 03561-84401, is needed to repair the -hp-3561A. This service kit can be ordered through your local HP sales office. Refer to Section 5, Replaceable Parts, for ordering instructions. Included in the kit are special adapter cables, extender boards and a circuit module for servicing the Bubble Memory option. Table 1-3 lists the contents of the -hp-3561A Service Kit.

Table 1-3 -hp-3561A Service Kit Contents

Description	Qty.	-hp- Part Number
BNC-J Cable Adapter	1	03585-61616
J Male-Male Adapter	1	1250-0669
Bubble Memory Reseed Module	1	1818-3304
PC Extender Board 25 Dual Pin	1	03561-66595
PC Extender Board 22 Dual Pin	1	03561-66596
Adjustment Tool .1 inch Hex	1	8710-1388

1-9 PERFORMANCE SPECIFICATIONS

The -hp-3561A performance specifications are listed in Table 1-4. These specifications are the performance standards or limits against which the -hp-3561A is to be tested.

Table 1-4 -hp-3561A Performance Specifications

3561A SPECIFICATIONS

Specifications describe the instrument's warranted performance. Supplemental characteristics are intended to provide information useful in applying the instrument by giving typical, but non-warranted, performance specifications. Supplemental characteristics are denoted as 'typical,' 'nominal,' or 'approximately.'

Frequency and Time

MEASUREMENT MODES:
Narrowband: 125 μ Hz to 100,000 Hz frequency range. Resolution is frequency span/400. All window, trigger and averaging types are available.
Phase: Phase spectrum is available with or without triggering. When triggered, phase is referenced to the trigger.
% Octave: 0.8 Hz to 80 kHz - see separate Octave section.
Full Octave: 1 Hz to 63 kHz - see separate Octave section.
Time Capture: Time record can be extended from 1k to 40k samples of continuous input data. Up to 40x zoom expansion factor can be applied to this data.
External Sampling: Input sample rate can be externally controlled up to 256 kHz TTL compatible sample rate input on rear panel. (Note: Some specs may be degraded in external sample mode).

FREQUENCY SELECTION:
0 to 100 kHz: Measurement is made over the full frequency range of the analyzer with 250 Hz resolution.
Define Start or Center: Measurement is made over the selected frequency span. Start or center frequency can be set anywhere in the 0 to 100 kHz range with resolution of 0.25 Hz.
Define Span: Measurement frequency spans are provided in a 1, 2, 2.5, 5, 10 sequence. (Other spans exist between these intervals, but are too numerous to list in the space available.)
Define Time Length: Measurement time can be set from 0.004 seconds to 651 minutes per time record. Time setting is rounded up to agree with next available span.

ACCURACY: **Frequency Accuracy:** $\pm 0.003\%$ of frequency reading

RESOLUTION: **Frequency Resolution:** Span/400

SPANS:	Zoom		Baseband
	# spans available	min span	max span
	43	0.25 Hz	52
		100 kHz	0.01 Hz
		400/span	100 kHz
		span/400	400/span
			span/400

MEASUREMENT WINDOWS: Windows are weighting functions which are applied to input data to reduce measurement errors due to leakage.

Flat Top: Provides optimum amplitude accuracy.
Hann: Provides an amplitude accuracy/frequency resolution compromise. Useful for general purpose and measurements using random noise.
Uniform: Equal weighting of the time record for measuring transients, or response measurements using the internal periodic noise source.
Exponential: Variable exponential decay weighting is applied to the time record. Useful for transients which have a duration greater than the time record.
Window Parameters:

	Flat Top	Hann	Uniform
Noise Equiv. BW (% of span)	0.955	0.375	0.25
3dB BW (% of span)	0.90	0.37	0.25
Shape factor (60dB BW/3dB BW)	2.6	9.1	7.16

TYPICAL REAL TIME BANDWIDTH:	Operating mode	Real time bandwidth	Spectra-sec
	HP-IB transfer	750 Hz	1.9
	Single display	3 kHz	7.5
	Fast Averaging	7.5 kHz	20

Amplitude and Input

AMPLITUDE:
Input Range: The calibrated input range is 27 dBV (+22.4 V) to -51 dBV (3 mV) maximum input level (single tone RMS). Range is adjustable in 1 dB (10%) increments.
Autorange: The optimum input range is automatically selected prior to processing. This feature can be deactivated.
Amplitude Overload/Underload: Overload occurs when the input level exceeds input range by nominally 1.0 dB or 10%. Overload measurements can be automatically rejected during averaging. The HALF range indicator lights when input signal is within 6 dB of full scale.
Dynamic Range: Distortion, spurious and alias products ≥ 80 dB below input range.
DC Response: (With Auto-Cal on)
 -27 dBV to -35 dBV: > 30 dB below input range
 -36 dBV to -51 dBV: > 20 dB below input range
Amplitude Marker Resolution:
 Log: 0.01 dB
 Linear: 4 digits
Amplitude Accuracy:
 Full Scale Accuracy at calculated frequency points
 Overall accuracy is the sum of absolute accuracy, window flatness and noise level.
Absolute Accuracy:
 ± 0.15 dB $\pm 0.015\%$ of input range
 +27 dBV to -40 dBV
 ± 0.25 dB $\pm 0.025\%$ of input range.
 -41 dBV to -51 dBV
Window flatness:
 Flat top: +0, -0.01 dB
 Hanning: +0, -1.5 dB
 Uniform: +0, -4.0 dB
Noise Level: Flat top filter, 50 Ω source impedance, 20 Hz to 1 kHz (1 kHz span) < -131 dBV (-141 dBV/ $\sqrt{\text{Hz}}$)
 2 kHz to 100 kHz (100 kHz span) < -120 dBV (-150 dBV/ $\sqrt{\text{Hz}}$)
Phase Marker Resolution: 0.1 degree
Phase Accuracy: $\pm 2^\circ$, dc-10 kHz. $\pm 10^\circ$ 10 kHz - 100 kHz referenced to the trigger point.

INPUT:
Input Impedance: 1M Ω $\pm 5\%$ shunted by 95 pF maximum
 Floating Ground to Case Capacitance: < 0.25 μ F
DC Isolation: Input low may be connected to chassis ground or floated up to 30 volts RMS (42 Vpk).
Input Coupling: The input signal may be ac or dc coupled. Low frequency 3 dB roll off < 1.0 Hz for ac.
Anti-Alias Filter Roll-Off: Analog and digital anti-aliasing filters roll off at a nominal rate of 130 dB/octave with a cut-off frequency at 105 kHz nominally.
A-Weight Filter: The hardware A-weight input filter conforms to ANSI Standard S1.4-1971.(R1976)
ICP Current: Nominal 4 mA current source provided on input BNC connector. Compatible with Integrated Circuit Piezoelectric accelerometers. Open circuit voltage is 24 volts nominal.

Table 1-4 -hp-3561A Performance Specifications (Cont'd)

Octave Analysis

The measurement is made in synthesized 1/3 or full (1/1) octave bands. Filter bandwidth, center frequency, and bandshape meet ANSI Class III (Class II for full octave) specifications.

	# Bands Available	# Bands Displayed
1/3	51	33
1/1	17	11

1/3 and 1/1 Octave Analysis Parameters:

	Band center Frequency Range	Data Collection Time	Band #'s Displayed
1/3 Octave	50 Hz to 80 kHz	0.4 sec	17 to 49
	25 Hz to 40 kHz	0.8 sec	14 to 46
	12.5 Hz to 20 kHz	1.6 sec	11 to 43
	6.3 Hz to 10 kHz	3.2 sec	8 to 40
	3.15 Hz to 5 kHz	6.4 sec	5 to 37
1/1 Octave	1.6 Hz to 2.2 kHz	12.8 sec	2 to 34
	0.8 Hz to 1.25 kHz	25.6 sec	-1 to 31
	63 Hz to 63 kHz	0.4 sec	18 to 48
	31.5 Hz to 31.5 kHz	0.8 sec	15 to 45
	16 Hz to 16 kHz	1.6 sec	12 to 42
	8 Hz to 8 kHz	3.2 sec	9 to 39
	4 Hz to 4 kHz	6.4 sec	6 to 36
2 Hz to 2 kHz	12.8 sec	3 to 33	
	1 Hz to 1 kHz	25.6 sec	0 to 30

Computation Time: 1/3 octave and 1/1 octave computation is made in less than 0.80 seconds

Trigger

TRIGGER MODES:

Free Run: A new measurement is initiated by completion of the previous measurement.
External: A new measurement is initiated by a TTL pulse applied to the rear panel external trigger input.
Internal: Allows measurements to be initiated by pressing manual arm.
Input: A new measurement is initiated when the input signal meets the defined trigger level conditions.
Source: New measurements are synchronized with the internal source.
HP-IB: A new measurement is initiated by sending a group execute trigger from an external controller over the HP-IB.

TRIGGER ARM:

Auto Arm: Measurements are initiated automatically when trigger conditions are met.
Manual Arm: Enables a single measurement when the trigger conditions are met.

TRIGGER LEVEL:

Triggering can be set to occur when the input reaches a user definable input level. Definable from 0 to 110% of full range setting. Positive and negative levels and slopes can be set.

TRIGGER DELAY:

Pre-Trigger: The measurement can be based on input data from 1/1024 to 8 time records before trigger conditions have been met, with resolution of 1/1024 of a record. Time capture mode can be used for pre-trigger delays of up to 40 records.
Post-Trigger: The measurement is initiated from 1/1024 to 1023 time records after trigger conditions have been met. Resolution is 1/1024 of a record.

Measurement Averaging

AVERAGING TYPES:

RMS: For each calculated frequency point the displayed amplitude is averaged in a root mean square fashion.

Peak Hold: Same as RMS except the maximum amplitude value is stored for each frequency bin. Phase is not available.

RMS Exponential Weighting: After each spectrum measurement the average is updated by weighting the new spectrum and the previous average as follows, where k is a user defined factor.

$$A_i = (1-k)A_{i-1} + (k)A_{new}$$

Time: For each calculated frequency point the displayed amplitude and phase are averaged linearly. In this mode, a trigger signal is required, and signals that are not synchronous with the trigger will average toward zero.

Number of Averages: 1 to 16,383.

AVERAGE CONTROL:

Start: Starts a new average or measurement.

Pause/Cont.: Pauses the average, or continues a paused average.

Overload Reject: Automatically detects and rejects overloaded blocks from the average.

Fast Display: Provides maximum averaging rate by not displaying intermediate results.

Normal Display: The average is computed and displayed for each new spectrum.

Repeat Display: The Repeat Display function inhibits the display of intermediate average results. Only the final computed average is displayed, and then the measurement is restarted. Available in RMS and time average modes only.

Source

Band limited, band translated pseudo random, random, impulse or TTL "sync" signals are available on the rear panel. Impulse produces nominal 2 V peak into 50 Ω, with no attenuation.

Impedance: 50 ± 5 ohms.

LEVEL AND ACCURACY:

	Baseband	All spans*	0.7 V rms ± 10%
	Zoom	All spans	0.5 V rms ± 15%

* Random Source in 0-100 kHz span has level accuracy of ±20%.

FLATNESS:

	Baseband	0-50 kHz	Periodic ±0.7 dB	Random** ±0.7 dB
		0-100 kHz	±0.8 dB	±1.6 dB
	zoom	all spans	±2.0 dB	±2.0 dB

** Random Source flatness approaches these specs as number of RMS Averages increases.

Note: All zoom flatness specs are valid if center frequency > 0.7 × span

ATTENUATION:

	(nominal 1.5 dB steps)	max attenuation
	pseudo random, random	40.5 dB
	impulse	30 dB

Table 1-4 -hp-3561A Performance Specifications (Cont'd)

Display

Magnitude, Phase, Time and Math traces may be selected. Units available are: Horizontal: Hz, Seconds, RPM, and Orders with linear or logarithmic spacing. Vertical: Volts, dBV, dBm (selectable R), and user defined units.

MAGNITUDE: **Log:** 0.5 to 40 dB/division. Units of dBV, dB relative, dBm (user defined impedance) and dBEU are provided.
Linear: Constant volts/division, milliwatts/division, or user defined units/division.

PHASE: **Resolution:** 0.1 degree with marker
Display Range: ±240 degrees about user definable center reference. (±320 degrees)

TIME: **Resolution** = Time Record Length (sec)/400
Display Range: ±110% of input range.

MATH: Arithmetic operations can be performed on new and recalled traces. Addition, subtraction, multiplication, division, single and double integration, differentiation and user definable constants are provided. 1/BW is provided for PSD computations.

FORMAT: **Single:** Selected data is displayed on full CRT trace height.
Front-Back: Two selected traces are displayed simultaneously, full CRT height. Back trace has no marker and is displayed at "half bright" intensity.
Upper-Lower: Two one-half height traces can be displayed.
Map: 1 to 60 amplitude spectra may be displayed simultaneously in a "spectral map" display. These may be consecutive measurement spectra, stored traces, or transformed from time capture records.

SCALE: Linear or Log magnitude scales may be selected. Full scale, dB/div, and degrees/div are user definable. Center scale definable in time or phase traces.
Autoscale: Provides a one time automatic scaling of data to optimize display scale and units per division for best view.

Internal Memory

	Traces + States (non-volatile)	Time Buffer (volatile)
Standard	2 traces + 6 states	40 time records
Option 001	traces + states + (1+2 × time capture records) = 127	40 time records

Marker

Single: Provides precision readout of X and Y axis values of currently displayed units. MKR — Peak, MKR — Center Frequency, MKR — Full Scale and Peak-track are provided. Relative marker provides measurements relative to a reference which can be set with the single marker or user-defined X and Y axis unit settings.

Band Power: Two independently controllable markers may be used to calculate power in a given band.

Harmonic: Up to 20 harmonics of the selected fundamental are marked. T.H.D. is calculated and displayed.

Sideband: Up to 10 modulation sidebands can be marked. Carrier frequency is user definable. The ratio of sideband to carrier power is displayed.

Amplitude Marker Resolution: log: 0.01 dB
linear: 4 digits

Plot

Controls HP-GL compatible digital plotters and raster graphics printers directly. Replicates display contents. "MARKER plot" allows marker position and amplitude to be annotated on plots at user defined locations.

General

Specifications apply when:
Warm-up time: None with AUTO-CAL enabled, or 30 minutes without AUTO-CAL enabled.
Within 5°C and 2 hrs of last internal calibration.
Ambient temperature: 0° to 55° C.
Relative Humidity: < 95% at 40° C.
Altitude: < 4570m (15,000 ft.)
Storage: Temperature: -40° to +75° C.
Altitude: < 15,240m (50,000 ft.)
Power: 100/120 VAC +5% -10%, 48-440 Hz
220/240 VAC +5% -10%, 48-66 Hz
150 VA maximum
Weight: 15 kg (33 lbs) net
21.6 kg (47.5 lbs) shipping
Dimensions: Without handle: 197mm (7.8") high
335mm (13.2") wide
595mm (23.4") deep

HP-IB: Implementation of IEEE Std 488-1978 SH1 AH1 T5 TE0 L4 LEO SR1 RL1 PPO DC1 DT1 CO

Accessories Included: Front (bail) handle, pouch, front cover, Operating and Service manuals.

Accessories:
Transit case for 3561A: HP # 9211-2459
Rack Adapter for 3561A: HP #10491B, also requires fixed slides (1490-0714) or pivot slides (1490-0768).

1-10 RECOMMENDED TEST EQUIPMENT

The equipment required to maintain the -hp-3561A is listed in Table 1-5, Recommended Test Equipment. If the recommended model number is not available, a substitute can be used if it meets or exceeds the listed critical specifications. When substitutes are used, the user may have to modify the performance and adjustment procedures to accommodate the different operating characteristics of the substitute.

Figure 1-4 Series Resistor BNC Case

Resistance	Tolerance	Power	-hp- Part Number
1 k Ω	1%	.25 W	0757-0280
100 k Ω	1%	.25 W	0757-0465

Assembly

1. Cut resistor leads to 12mm on each end.
2. Solder one resistor lead to the center conductor of the BNC FEMALE connector.
3. Solder the CONDUCTOR CENTER PIN to the other lead of the resistor.
4. Screw the SLEEVE and the BNC MALE connector into place. Tighten securely.

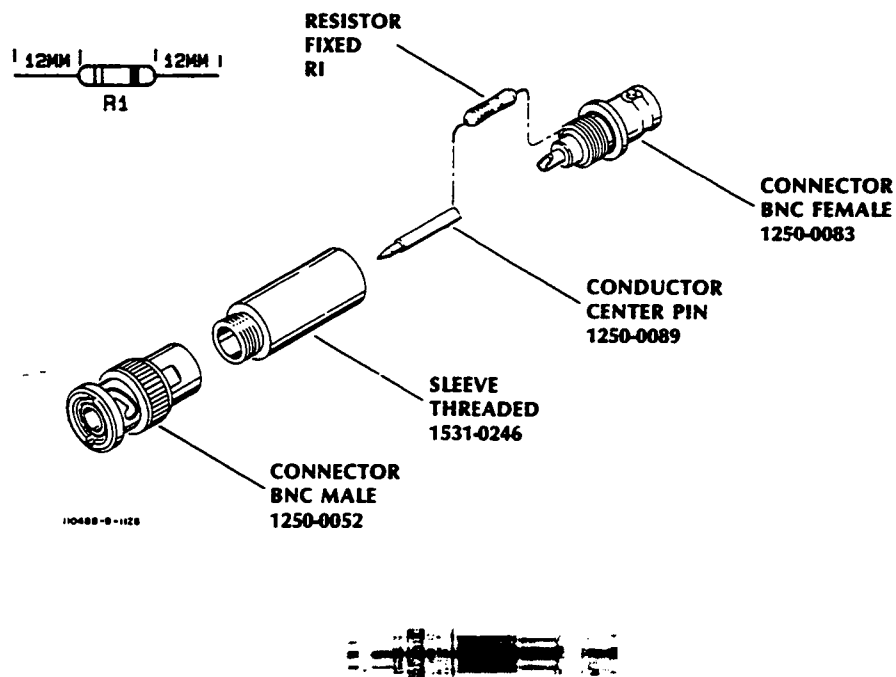

1-11 STORAGE AND SHIPMENT

Environment

The -hp-3561A should be stored in a clean, dry environment. The following are environmental limitations that apply to both storage and shipment:

Temperature	-40°C to +75°C
Humidity	Up to 95%
Altitude	Up to 15,300 meters (50,000 feet)

The instrument should also be protected from temperature extremes which cause condensation within the instrument.

Original Packaging

Containers and materials equivalent to those used in factory packaging are available through Hewlett-Packard offices. If the instrument is being returned to Hewlett-Packard for service, attach a tag indicating the type of service required, return address, model and full serial number.

Other Packaging

The following general instructions should be used for repackaging with commercially available materials:

1. Wrap the instrument with heavy paper or plastic.
2. Use a strong shipping container. A doublewall carton made of 350 pound test material is adequate.
3. Use a layer of shock absorbing material 70 to 100 mm (3 to 4 inches) thick around all sides of the instrument to provide firm cushioning and prevent movement inside of the container. Protect the control panel with cardboard.

CAUTION

Styrene pellets in any shape should never be used as packing material. The pellets do not adequately cushion or prevent the instrument from shifting in the carton. The pellets also create static electricity which can damage electronic components.

4. Seal the shipping container securely.
5. Mark the shipping container FRAGILE to ensure careful handling.
6. In any correspondence, refer to the instrument by model and full serial number.

Table 1-5 Recommended Test Equipment

Description	Qty	Critical Specifications	Recommended Model	Use *
AC Calibrator	1	Frequency Range: 10 Hz - 100 kHz Amplitude Range: 3 - .003 Vrms Amplitude Accuracy: .02 dB Phase Locking Capability	FLUKE 5200A Alternatives: -hp-745	P,O A
Frequency Synthesizer	1	Frequency Range: 1 Hz - 1 MHz Frequency Accuracy: 5 ppm Amplitude Range: +8 - -50 dBV Amplitude Accuracy: 0.2 dB 1 Hz - 100 kHz 1.0 dB 100 kHz - 1 MHz Harmonic Distortion: All harmonics < -60 dB below carrier.	-hp-3325A Option 001 Alternatives: -hp-3336C -hp-3320B -hp-3330B	P,O A,T F
Digital Voltmeter	1	5 Digit Input Impedance: > 1 MΩ AC Voltage- Frequency Range: 30 Hz - 1 MHz Amplitude Range: 0.1 - 500 Vrms Amplitude Accuracy: .05% DC Voltage- Amplitude Accuracy: .05%	-hp-3455A	P,O A,T F
Oscilloscope	1	Bandwidth: > 50 MHz Two Channel External Trigger	-hp-1980 A,T Alternatives: -hp-1740	P,O F
High Voltage Probe	1	Division Ratio: 1000:1 Maximum Voltage: > 8000 Vrms Impedance 1000 MΩ	-hp-34111A	T,A
Signature Analyzer	1	Maximum Clock: > 25 MHz Clock Set-up Time: < 20 nSec	-hp-5006A Alternatives: -hp-5005A -hp-5005B -hp-3466A	T T
Digital Multimeter	1	Volts AC Volts DC Ohms	Alternatives: -hp-3438A -hp-3468A -hp-3478A	T
-hp-3561A Service Kit	1	No Substitute (See Table 1-2 for individual part numbers)	03561-84401	T,A F

- * P = Performance Test
- O = Operational Verification
- A = Adjustment
- T = Troubleshooting
- F = Fault Isolation

Table 1-5 Recommended Test Equipment (cont)

Description	Qty	Critical Specifications	Recommended Model	Use *
Low Distortion Oscillator	1	Frequency Range: 1 Hz - 1 MHz Amplitude Range: 2 Vrms Distortion: < -80 dB (.01%)THD	-hp-339	P,A T,F
Resistor	2	Accuracy: 1% Power: .25 W Value: 100 kΩ	See Figure 1-4	P
Resistor	1	Accuracy: 1% Power: .25 W Value: 1 kΩ		P
Probe, Oscilloscope	1	Impedance: 10 MΩ Division Ratio: 10:1 Maximum Voltage: 500 Vdc	-hp-10014A Alternatives: -hp-10016B -hp-10004A -hp-10005D	T,A
Termination	1	50 ohm Feedthrough	-hp-10100C	P,O,A, T,F
Termination	1	600 ohm Feedthrough	-hp-11095A	P,O,A, T,F
Variable AC Power Supply		Voltage Range: 80 - 120VAC Frequency Range: 50 Hz or 60 Hz Voltage Accuracy: ±2 %	**	A
Controller	1	HP Series 200 Computer	-hp-9836	T***
Boot Loop Program	1	Runs on HP Series 200 Computer	03561-19400	T***

- * P = Performance Test
- O = Operational Verification
- A = Adjustment
- T = Troubleshooting
- F = Fault Isolation

** No specific model number is recommended, any Variable AC Power Supply which meets the listed critical specifications may be used.

*** Required for -hp-3561A Option 001 only

SECTION II
PERFORMANCE TEST

Paragraph	Title	Page
2-1	INTRODUCTION	2-1
2-2	CALIBRATION CYCLE	2-1
2-3	REQUIRED TEST EQUIPMENT	2-2
2-4	PERFORMANCE TEST SUMMARY	2-3
2-5	OPERATIONAL VERIFICATION SUMMARY	2-4
2-6	dc Offset	2-4
2-7	Amplitude Accuracy/Flatness	2-5
2-8	Amplitude Linearity	2-8
2-9	Noise Level/Spurious Signal Level	2-11
2-10	Frequency Accuracy	2-13
2-11	Input Coupling Insertion Loss	2-15
2-12	Anti Alias Filter Response	2-17
2-13	A-Weight Filter Response	2-19
2-14	Phase Accuracy	2-21
2-15	Input Impedance	2-24
2-16	Floating Ground Capacitance	2-27
2-17	Harmonic Distortion	2-29
2-18	Two Tone Intermodulation Distortion	2-32
2-19	Noise Source Output Impedance	2-36
2-20	Noise Source Amplitude Accuracy/Flatness	2-38
2-21	External Sample	2-42
2-22	Internal Self Test	2-44

SECTION II

PERFORMANCE TEST

2-1 INTRODUCTION

This section contains the procedures for the performance tests which will verify the 3561A's conformance to its published specifications listed in Table 1-4. A complete performance test consists of running the tests listed in paragraph 2-4, PERFORMANCE TEST SUMMARY, and requires approximately five hours to complete. If complete performance testing is not required, an operational verification can be performed. The operational verification does not verify conformance to published specifications, however, it does provide a high level of confidence regarding correct instrument operation. An operational verification consists of running all of the tests listed in paragraph 2-5, OPERATIONAL VERIFICATION SUMMARY, and requires approximately one hour to complete.

For your convenience, a Performance Test Record card is provided at the end of this section to record the 3561A's performance test, or operational verification test results. This card can be removed from the manual and used as a permanent record of the test results. The Performance Test Record may be reproduced without the written permission of Hewlett-Packard.

2-2 CALIBRATION CYCLE

The -hp-3561A Dynamic Signal Analyzer requires a complete Performance Test every twelve months to verify conformance to its published specifications. The operational verification can be used as part of installation, incoming inspection, or after a repair to verify general operation.

2-3 REQUIRED TEST EQUIPMENT

The equipment required to test the -hp-3561A is listed in Table 1-5. If the recommended equipment is not available, a substitute, which meets or exceeds the "Required Characteristics" given in the table, may be used. When substitutions are made the user may have to modify the performance test procedures to accommodate the different operating characteristics of the substitute. The equipment required for each test is listed at the beginning of each individual test section.

When the recommended test equipment of Table 1-5 is used to complete the performance tests, the instruments listed below must be set to the preset conditions listed before beginning the tests. If any equipment parameters are not specified in the individual test, the unspecified parameter should be set to the condition listed below.

-hp-3325A Frequency Synthesizer

FUNCTION SINEWAVE (~)
 FREQUENCY 1 kHz
 AMPLITUDE 1 mVrms
 PHASE 0 degrees
 dc OFFSET 0 V
 MODULATION OFF
 SWEEP OFF

-hp-3455A Digital Voltmeter

FUNCTION AC V (~ V)
 RANGE AUTO
 TRIGGER INTERNAL
 SAMPLE RATE MAXIMUM
 HIGH RESOLUTION ON
 AUTO CAL ON

Fluke 5200 AC Calibrator

FREQUENCY 1 kHz
 AMPLITUDE . . .01 Vrms (equivalent to -40 dBV)
 VOLTAGE ERROR-% OFF
 VERNIER 0
 MODE OPER
 CONTROL LOCAL
 PHASE LOCK OFF
 SENSE INTERNAL

2-4 PERFORMANCE TEST SUMMARY

The tests listed in Table 2-1 must be completed to verify that the -hp-3561A meets its published specifications. Because some tests depend on previous test results, the tests must be performed in the order listed. No warm up time is required. If any of the tests fail, the -hp-3561A must be either repaired or adjusted. The "What if the Test Fails" column of Table 2-1 indicates the troubleshooting procedures or adjustments most likely to correct the failure.

Table 2-1 Performance Test Summary

Paragraph Number	Test Name	What if the Test Fails			
		Adjustments		Troubleshooting	
		Assembly	Paragraph	Assembly	Paragraph
2-6	dc Offset	A10	3-17	A10	7-4
		A15	3-12	A15	7-7
2-7	Amplitude Accuracy/ Flatness	A10	3-13	A10	7-4
		A15	3-9	A15	7-7
2-8	Amplitude Linearity	A15	3-9	A10	7-4
				A15	7-7
2-9	Noise Level/ Spurious Signal Level	A15	3-9	A10	7-4
				A15	7-7
				A20	7-10
2-10	Frequency Accuracy	A40	3-8	A40	7-16
2-11	Input Coupling Insertion Loss			A10	7-4
2-12	Anti-Alias Filter Response			A15	7-7
2-13	A-Weight Filter Response	A10	3-18	A10	7-4
2-14	Phase Accuracy			A15	7-7
				A20	7-10
2-15	Input Impedance			A10	7-4
2-16	Floating Ground Capacitance			A10	7-4
2-17	Harmonic Distortion	A15	3-9	A10	7-4
				A15	7-7
2-18	Two-Tone Intermodulation Distortion	A15	3-9	A10	7-4
				A15	7-7
2-19	Noise Source Output Impedance			A50	7-19
				A82	7-35
2-20	Noise Source Amplitude Accuracy/Flatness	A50	3-19	A50	7-19
		A50	3-19	A82	7-35

2-5 OPERATIONAL VERIFICATION SUMMARY †

The tests listed in Table 2-2 comprise the operational verification. To minimize the time required to change instrument configurations between tests, run the tests in the order shown. No warm up time is required.

† All tests marked with a † next to the paragraph title are part of the operational verification. The operational verification is a subset of the performance test. When performing an operational verification, complete only the measurements and procedure steps marked with a †. The Performance Test Record can be used to record the operational verification results. All measurements required for the operational verification are marked with a † on the Performance Test Record.

Table 2-2 Operational Verification Summary

Paragraph Number	Test Name
2-6	dc Offset
2-7	Amplitude Accuracy/Flatness
2-9	Noise Level/Spurious Signal Level
2-10	Frequency Accuracy
2-14	Phase Accuracy
2-20	Noise Source Amplitude Accuracy/Flatness
2-22	Internal Self Test

2-6 dc Offset †

This test measures the level of the dc offset generated within the -hp-3561A when the auto-zero circuit is enabled.

SPECIFICATION

For range settings between +27 dBV and -35 dBV, the dc offset will be greater than 30 dB below the range setting; for range setting less than -35 dBV, the dc offset will be greater than 20 dB below the range setting.

REQUIRED TEST EQUIPMENT

none

PROCEDURE

† 1. Set the -hp-3561A controls as follows:

```

PRESET
RANGE ..... DEFINE RANGE ..... 0 dBV
FORMAT ..... SINGLE
AVerage ..... DEFINE NUM
                AVGS ..... 4 ENTER
                RMS
INPUT ..... SINGLE CAL
    
```

† 2. When the calibration is complete, press the -hp-3561A START key to initiate a measurement.

† 3. When the average is complete, move the marker to 0 Hz and record the the marker amplitude (Y:) reading on the Performance Test Record.

† 4. Set the -hp-3561A controls as follows:

RANGE DEFINE RANGE-25 dBV

† 5. Repeat steps 2 and 3.

† 6. Set the -hp-3561A controls as follows:

RANGE DEFINE RANGE-51 dBV

† 7. Repeat steps 2 and 3.

2-7 Amplitude Accuracy/Flatness †

This test measures the amplitude accuracy of the -hp-3561A against the amplitude reference of the ac calibrator. To insure that the ac calibrator output is set to the center of an -hp-3561A measurement bin, the ac calibrator is frequency locked to the frequency synthesizer. The amplitude accuracy is measured at each of the points listed in Table 2-3.

Table 2-3 Amplitude Accuracy/Flatness Measurement

Signal Frequency	Range Setting	ac Calibrator Amplitude	Tolerance
† 1 kHz	8 dBV	(2.5119 Vrms)	± .15 dB
† 99 kHz	8 dBV	(2.5119 Vrms)	± .15 dB
† 1 kHz	-11 dBV	(.28184 Vrms)	± .15 dB
† 99 kHz	-11 dBV	(.28184 Vrms)	± .15 dB
1 kHz	-22 dBV	(79.433 mVrms)	± .15 dB
50 kHz	-22 dBV	(79.433 mVrms)	± .15 dB
90 kHz	-22 dBV	(79.433 mVrms)	± .15 dB
100 kHz	-22 dBV	(79.433 mVrms)	± .15 dB
1 kHz	-51 dBV	(2.8184 mVrms)	± .25 dB
1 kHz	-49 dBV	(3.5481 mVrms)	± .25 dB
1 kHz	-47 dBV	(4.4668 mVrms)	± .25 dB
1 kHz	-45 dBV	(5.6234 mVrms)	± .25 dB
1 kHz	-43 dBV	(7.0795 mVrms)	± .25 dB
1 kHz	-41 dBV	(8.9125 mVrms)	± .25 dB
1 kHz	-39 dBV	(11.220 mVrms)	± .15 dB
1 kHz	-29 dBV	(35.481 mVrms)	± .15 dB
1 kHz	-27 dBV	(44.668 mVrms)	± .15 dB
1 kHz	-25 dBV	(56.234 mVrms)	± .15 dB

† When performing an operational verification rather than a full performance test, complete these measurements only.

Specification

For an input sine wave with an amplitude equal to the range setting, the marker amplitude reading will not deviate from the actual signal amplitude by more than:

Range Setting	Accuracy
+23 dBV to -39 dBV	.15 dB (1.74%)
-40 dBV to -51 dBV	.25 dB (2.92%)

REQUIRED TEST EQUIPMENT

Frequency Synthesizer	hp-3325A
AC Calibrator	FLUKE 5200A

INITIAL TEST SETUP

Figure 2-1 Amplitude Accuracy/Flatness Test Setup

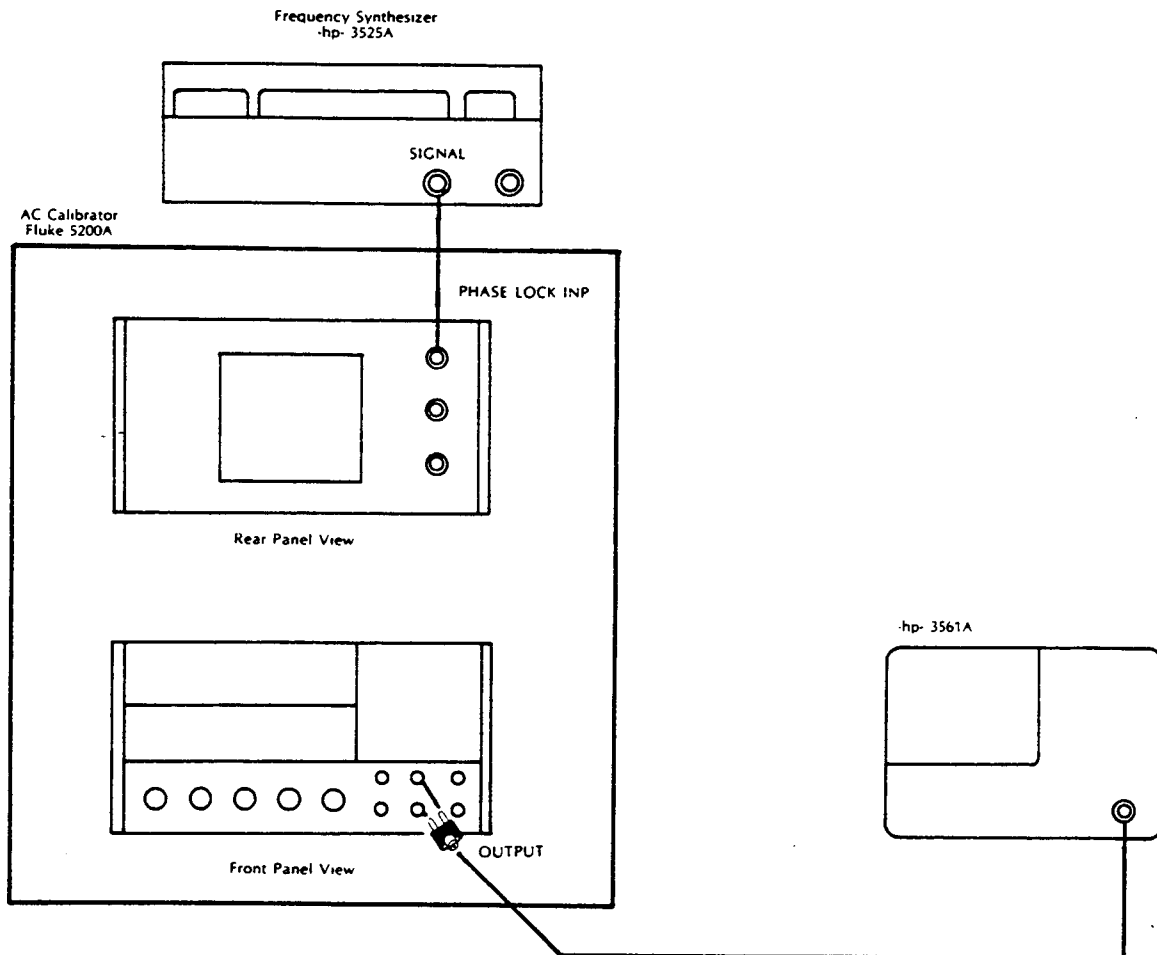

PROCEDURE

- † 1. Connect the test instruments as shown in Figure 2-1 and set the instrument controls as follows:

Frequency Synthesizer

Function Square Wave
 Frequency 1 kHz
 Amplitude 1 Vrms

AC Calibrator

Frequency 1 kHz
 Amplitude 2.5119 Vrms (8 dBV)
 Phase Lock ON
 Sense INTERNAL
 Mode OPER

-hp-3561A

PRESET
 RANGE DEFINE RANGE 8 dBV
 FORMAT SINGLE
 AVeraGe RMS
 DEFINE NUM
 AVGS 4 ENTER
 INPUT SINGLE CAL

- † 2. When the calibration is complete, press the -hp-3561A START key to initiate measurement.
- † 3. When the average is complete, move the marker to 1 kHz and record the marker amplitude (Y:) reading on the Performance Test Record.
- † 4. Set the ac calibrator controls as follows:
 Frequency 99 kHz

- † 5. Set the frequency synthesizer controls as follows:
 Frequency 99 kHz

- † 6. Press the -hp-3561A START key to initiate a measurement.
- † 7. When the average is complete, move the marker to 99 kHz and record the marker amplitude (Y:) reading on the Performance Test Record.

- † 8. Set the ac calibrator controls as follows:
 Frequency 1 kHz
 Amplitude 2 8184 Vrms (-11 dBV)

† 9. Set the frequency synthesizer controls as follows:

Frequency 1 kHz

† 10. Set the -hp-3561A controls as follows:

RANGE DEFINE RANGE -11 dBV

† 11. Press the -hp-3561A START key to initiate a measurement.

† 12. When the average is complete, move the marker to 1 kHz and record the marker amplitude (Y:) reading on the Performance Test Record.

† 13. Repeat steps 8 through 12 for each of the remaining measurements listed in Table 2-3. For each measurement, set the ac calibrator and the frequency synthesizer to the signal frequency listed in the Table. Set the -hp-3561A range setting and the ac calibrator amplitude to the corresponding values listed. Record the marker amplitude (Y:) reading on the Performance Test Record for each measurement.

2-8 Amplitude Linearity

This test measures the amplitude linearity of the -hp-3561A against the amplitude reference of the ac calibrator. The ac calibrator is used to input a signal to the -hp-3561A at each of the amplitudes listed in Table 2-4. All values of Table 2-4 are measured at frequencies of 1 kHz and 99 kHz.

Table 2-4 Amplitude Linearity Measurement

Amplitude	
Vrms	(dBV)
10.0 Vrms	(+20 dBV)
1.00 Vrms	(+0 dBV)
100.0 mVrms	(-20 dBV)
10.0 mVrms	(-40 dBV)
3.1623 mVrms	(-50 dBV)
1.00 mVrms	(-60 dBV)

SPECIFICATION

The marker amplitude reading will not deviate from the actual signal amplitude by more than:

Range Setting	Accuracy
+23 dBV to -40 dBV	.15 dB ± .015 % of Range Setting
-41 dBV to -51 dBV	.25 dB ± .025 % of Range Setting

REQUIRED TEST EQUIPMENT

Frequency Synthesizer-hp-3325A
 AC Calibrator FLUKE 5200A

INITIAL TEST SETUP

Figure 2-2 Amplitude Linearity Test Setup

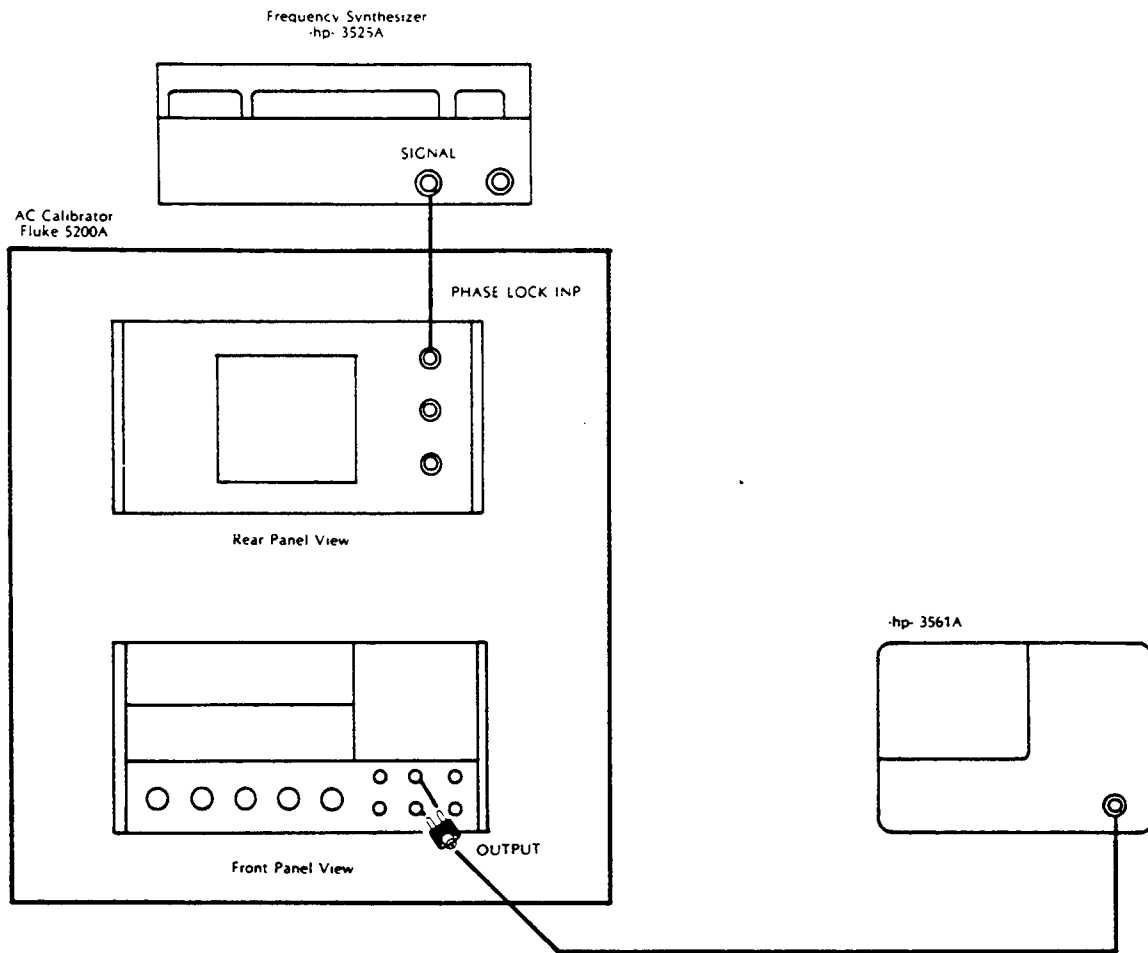

PROCEDURE

1. Connect the test instruments as shown in Figure 2-2 and set the instrument controls as follows:

Frequency Synthesizer

Function	Square Wave
Frequency	1 kHz
Amplitude	1 Vrms

AC Calibrator

Frequency 1 kHz
 Amplitude 10 Vrms
 Phase Lock ON
 Sense INTERNAL
 Mode OPER

-hp-3561A

PRESET

RANGE DEFINE RANGE 10 Vrms
 FREQuency DEFINE SPAN 10 kHz
 FORMAT SINGLE
 VERTical SCALE .. DEFINE dB/DIV 20 dB
 AVeraGe RMS
 DEFINE NUM
 AVGS 10 ENTER
 INPUT SINGLE CAL

2. When the calibration is complete, press the -hp-3561A START key to initiate a measurement.
3. When the average is complete, move the marker to 1 kHz and record the marker amplitude (Y:) reading on the Performance Test Record.
4. Set the ac calibrator controls as follows:

Amplitude 1.00 Vrms
5. Press the -hp-3561A START key to initiate a measurement.
6. When the average is complete, record the marker amplitude (Y:) reading on the Performance Test Record.
7. Repeat steps 4 through 6, for the remaining ac calibrator amplitudes listed in Table 2-4. Record the marker amplitude (Y:) reading for each of the amplitude settings in the corresponding position of the Performance Test Record.
8. Set the ac calibrator controls as follows:

Frequency 99 kHz
 Amplitude 10 Vrms
9. Set the frequency synthesizer controls as follows:

Frequency 99 kHz

10. Set the -hp-3561A controls as follows:
 FREQUENCY DEFINE SPAN 100 kHz
11. Set the ac calibrator controls as follows:
 Amplitude 10 Vrms
12. Press the -hp-3561A START key to initiate a measurement.
13. When the average is complete, move the marker to 99 kHz, and record the marker amplitude (Y:) reading on the Performance Test Record.
14. Repeat steps 11 through 13, for the remaining ac calibrator amplitudes listed in Table 2-4. Record the marker amplitude (Y:) reading for each of the amplitude settings in the corresponding position of the Performance Test Record.

2-9 Noise Level/Spurious Signal Level †

This test measures the level of the noise floor and any spurious signals generated within the -hp-3561A. The input is terminated with a 50 Ω load, and the noise level or spurious signal level is read from the display marker in each of the measurements listed in Table 2-5. In all measurements both the noise level and discrete signals should be below the value given on the Performance Test Record.

Table 2-5 Noise Level/Spurious Signal Measurement

Start Frequency	Frequency Span	Window / Bandwidth	Noise Level
20 Hz	2 kHz	Uniform / 5.0 Hz	≤ -131 dBV
2 kHz	25 kHz	Uniform / 62.5 Hz	≤ -131 dBV
25 kHz	25 kHz	Uniform / 62.5 Hz	≤ -131 dBV
50 kHz	25 kHz	Uniform / 62.5 Hz	≤ -131 dBV
75 kHz	25 kHz	Uniform / 62.5 Hz	≤ -131 dBV
† 20 Hz	1 kHz	Flat Top / 9.5475 Hz	≤ -131 dBV
† 2 kHz	100 kHz	Flat Top / 954.75 Hz	≤ -120 dBV

† When performing an operational verification rather than a full performance test, complete these measurements only.

SPECIFICATION

When the input is terminated with a 50 Ω load, the amplitude of all spurious signals will be greater than 80 dB below the range setting and the average noise level will be less than:

Frequency	Noise Level	
2 kHz to 100 kHz	-150 dBV/√Hz	(-120 dBV for a 955 Hz Bandwidth)
20 Hz to 1 kHz	-141 dBV/√Hz	(-131 dBV for a 9.55 Hz Bandwidth)

REQUIRED TEST EQUIPMENT

50 Ω Termination-hp-11048C

INITIAL TEST SETUP

Figure 2-3 Noise Level/Spurious Signal Test Setup

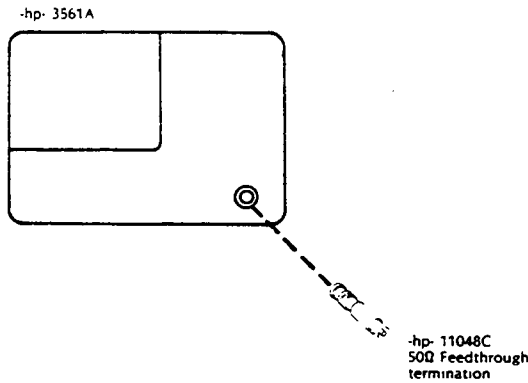

PROCEDURE

† 1. Connect the test instruments as shown in Figure 2-3 and set the instrument controls as follows:

-hp-3561A

PRESET	
RANGE	DEFINE RANGE-51 dBV
FORMAT	SINGLE
VERTical SCALE ..	DEFINE FULL SCL-71 dBV
FREQuency	DEFINE START 20 Hz
	DEFINE SPAN 2 kHz
WINDOW	UNIFORM
AVerage	RMS
	DEFINE NUM
	AVGS 20 ENTER
INPUT.....	SINGLE CAL

2. When the calibration is complete, press the -hp-3561A START key to initiate a measurement.
3. When the average is complete, set the -hp-3561A controls as follows:
 MarKeR MKR —> PEAK
4. Record the marker amplitude (Y:) reading on the Performance Test Record.
5. Set the -hp-3561A controls as follows:
 FREQuency DEFINE SPAN25 kHz
 DEFINE START2 kHz
6. Repeat steps 2 through 4.
7. Set the -hp-3561A start frequency to 25 kHz, 50 kHz, and 75 kHz. For each start frequency, repeat steps 2 through 4 to measure the peak signal level. For each measurement, record the marker amplitude (Y:) reading in the corresponding position of the Performance Test Record.
8. Set the -hp-3561A controls as follows:
 FREQuency DEFINE SPAN1 kHz
 DEFINE START20 Hz
 WINDOW FLAT TOP
9. Repeat steps 2 through 4.
10. Set the -hp-3561A controls as follows:
 FREQuency DEFINE SPAN100 kHz
 DEFINE START2 kHz
11. Repeat steps 2 through 4.

2-10 Frequency Accuracy †

This test measures the frequency accuracy of the -hp-3561A against the frequency reference of the frequency synthesizer. Complete the entire test for both a performance test and an operational verification.

SPECIFICATION

The frequency reading will not deviate from the actual signal frequency by more than .003 % (equivalent to ± 3 Hz at 100 kHz).

REQUIRED TEST EQUIPMENT

Frequency Synthesizer-hp-3325A
 50 Ω Termination.....-hp-11048C

INITIAL TEST SETUP

Figure 2-4 Frequency Accuracy Test Setup

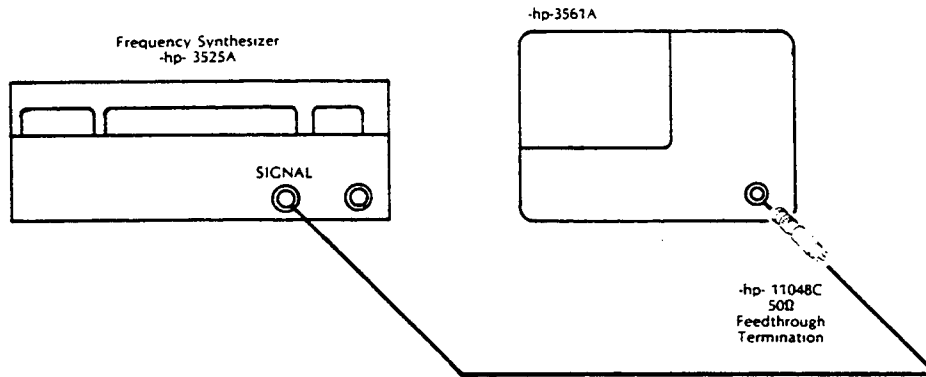

PROCEDURE

† 1. Connect the test instruments as shown in Figure 2-4 and set the instrument controls as follows:

Frequency Synthesizer

Frequency 99.99 kHz
 Amplitude 1 Vrms (0 dBV)

-hp-3561A

PRESET
 RANGE DEFINE RANGE 0 dBV
 FORMAT SINGLE
 FREQUENCY DEFINE SPAN 100 Hz
 DEFINE CENTER..... 99.99 kHz
 WINDOW UNIFORM
 INPUT..... SINGLE CAL

† 2. When the calibration is complete, set the -hp-3561A controls as follows:

MarKeR MKR —> PEAK

† 3. Record the marker frequency (X:) reading on the Performance Test Record.

2-11 Input Coupling Insertion Loss

This test measures the insertion loss at 1 Hz due to the ac coupling capacitor. The amplitude of a 1 Hz signal from the frequency synthesizer is measured in both the ac and dc coupled modes. The insertion loss is then calculated as:

$$\text{dc Coupled Amplitude} - \text{ac Coupled Amplitude} = \text{Insertion Loss}$$

SPECIFICATION

The insertion loss at 1 Hz due to the ac coupling capacitor will be less than 3 dB.

REQUIRED TEST EQUIPMENT

Frequency Synthesizer	-hp-3325A
50 Ω Termination	-hp-11048C

INITIAL TEST SETUP

Figure 2-5 Input Coupling Insertion Loss Test Setup

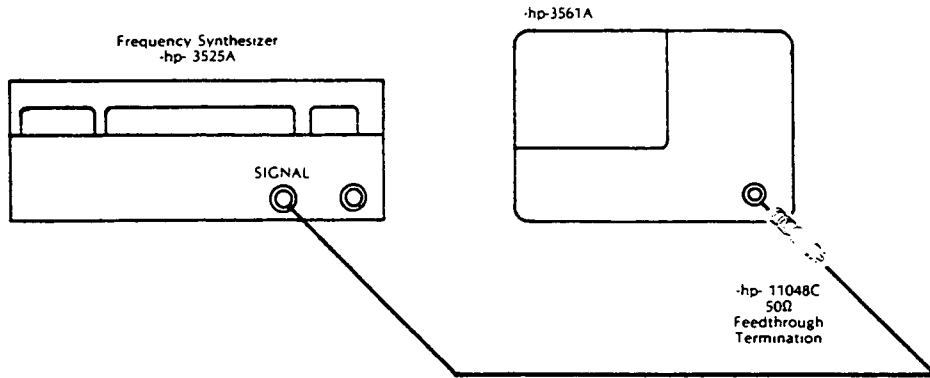

PROCEDURE

1. Connect the test instruments as shown in Figure 2-5 and set the instrument controls as follows:

Frequency Synthesizer

Frequency 1 Hz
 Amplitude 1 Vrms (0 dBV)

-hp-3561A

PRESET

FORMAT SINGLE
 RANGE DEFINE RANGE 0 dBV
 FREQUENCY DEFINE SPAN 100 Hz
 INPUT SINGLE CAL

2. When the calibration is complete, move the marker to 1 Hz and set the -hp-3561A controls as follows:

RELATIVE MarKeR . REL MKR ON
 MKR —> REF
 INPUT COUPLE AC

3. When the measurement is complete, record the marker relative amplitude (Yr:) reading as the insertion loss value on the Performance Test Record.

2-12 Anti-Alias filter Response

This test measures the response of the 100 kHz low pass anti-alias filter. All measurements are made relative to the filter attenuation of a signal with a 100 kHz actual frequency. Due to internal sampling at a 256 kHz rate, signals with frequencies greater than 156 kHz may be shifted down (aliased) into the 100 kHz frequency range of the -hp-3561A. The signal frequencies listed in Table 2-6 will be shifted to the corresponding alias frequencies listed in the table.

NOTE

Some spurious signals due to the -hp-3325A may show up in the 0 - 100 kHz span of the -hp-3561A. Ignore signals at frequencies other than those listed in Table 2-6 when performing this test.

Table 2-6 Anti-Alias Filter Response Measurement

Signal Frequency	Alias Frequency
156 kHz	100 kHz
185 kHz	71 kHz
206 kHz	50 kHz
267 kHz	11 kHz
924 kHz	100 kHz

SPECIFICATION

All signals aliased into the 0 - 100 kHz frequency span will be attenuated to more than 80 dB below the range setting.

REQUIRED TEST EQUIPMENT

- Frequency Synthesizer-hp-3325A
- 50 Ω Termination.....-hp-11048C

4. Set the frequency synthesizer controls as follows:
 Frequency 156 kHz
5. Press the -hp-3561A START key to initiate a measurement.
6. When the average is complete, move the marker to 100 kHz and record the marker relative amplitude (Yr:) on the Performance Test Record.
7. Repeat steps 4 through 6, setting the frequency synthesizer to each of the frequencies listed in the signal frequency column of Table 2-6. For each frequency setting, move the marker to the corresponding frequency listed in the alias frequency column of Table 2-6. Record the marker relative amplitude (Yr:) reading in the corresponding position of the Performance Test Record for each measurement.

2-13 A-Weight Filter Response

This test measures the filter shape of the -hp-3561A's internal A-Weight Filter. The frequency synthesizer is used to input a sine wave at each of the frequencies listed in Table 2-7. The A-Weight filter is switched into the main signal path to compensate for the frequency response of the human ear when making acoustic measurements.

Table 2-7 A-Weight Filter Response Measurement

Frequency	Amplitude	Tolerance
10 Hz	-70.4 dB	± 4 dB
80 Hz	-22.5 dB	± 1 dB
400 Hz	-4.8 dB	± 1 dB
1000 Hz	0 dB	± 1 dB
2500 Hz	1.3 dB	± 1 dB
5000 Hz	0.5 dB	+1, -2 dB
20000 Hz	-9.3 dB	+3, -∞ dB

SPECIFICATIONS

The A-Weight filter will conform to ANSI Standard SI.4-1971 (1976) for Type 1 A-Weight Filter.

REQUIRED TEST EQUIPMENT

Frequency Synthesizer-hp-3325A
 50 Ω Termination-hp-11048C

INITIAL TEST SETUP

Figure 2-7 A-Weight Filter Response Test Setup

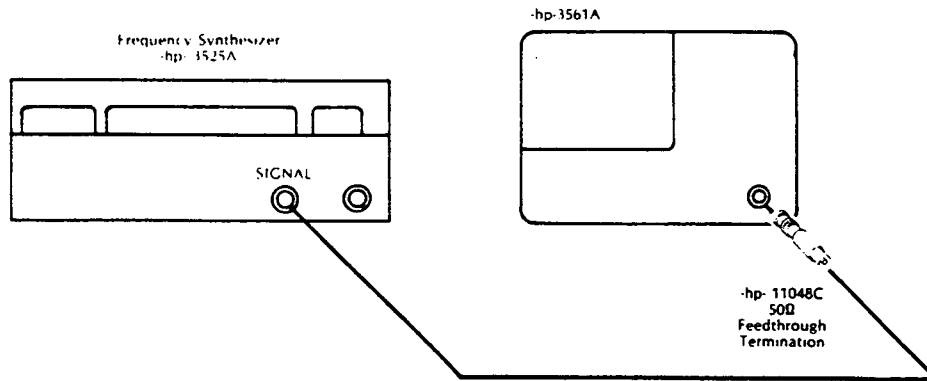

PROCEDURE

1. Connect the test instruments as shown in Figure 2-7 and set the instrument controls as follows:

Frequency Synthesizer

Frequency 1 kHz
 Amplitude 1 Vrms (0 dBV)

-hp-3561A

PRESET
 RANGE DEFINE RANGE 5 dBV
 FORMAT SINGLE
 FREQUENCY DEFINE SPAN 2 kHz
 AVERAGE RMS
 DEFINE NUM
 AVGS 4 ENTER
 INPUT SINGLE CAL

2. When the calibration is complete, press the -hp-3561A START key to initiate a measurement.

- When the average is complete, move the marker to 1 kHz and set the -hp-3561A controls as follows:

```

RELative MarKeR . REL MKR ON
                  DEFINE MAG REF .....MKR VALUE
INPUT..... A WT FLT ON
FREQuency ..... DEFINE SPAN .....400 Hz
    
```

- Set the frequency synthesizer controls as follows:

```

Frequency ..... 10 Hz
    
```

- Press the -hp-3561A START key to initiate a measurement.

- When the average is complete, move the marker to 10 Hz and record the marker relative amplitude (Yr:) reading on the Performance Test Record.

- Repeat steps 4 through 6, setting the frequency synthesizer and and the marker to 80 Hz and 400 Hz. Record the marker relative amplitude (Yr:) reading for each frequency in the corresponding Position of the Performance Test Record

- Set the -hp-3561A controls as follows:

```

FREQuency ..... DEFINE SPAN .....50 kHz
    
```

- Repeat steps 4 through 6, setting the frequency synthesizer and and the marker to each of the remaining frequencies listed in Table 2-7. Record the marker relative amplitude (Yr:) reading for each frequency in the corresponding position of the Performance Test Record.

2-14 Phase Accuracy †

This test measures the phase accuracy of the -hp-3561A. The frequency synthesizer is used to input a square wave to the -hp-3561A signal input and external trigger input. All phase measurements are made relative to the phase of the trigger signal.

Table 2-8 Phase Accuracy Measurement

	Frequency	Slope	Trigger Type
†	99 kHz	POS	INPUT
†	99 kHz	POS	EXTERNAL
	99 kHz	NEG	INPUT
	99 kHz	NEG	EXTERNAL
	9 kHz	POS	INPUT
	9 kHz	POS	EXTERNAL

† When performing an operational verification rather than a full performance test, complete these measurements only.

SPECIFICATION

The marker phase reading will not deviate from the actual phase of the signal relative to the trigger by more than:

Frequency Range	Phase Deviation
0 - 10 kHz	≤ 2 deg
10 kHz - 100 kHz	≤ 10 deg

REQUIRED TEST EQUIPMENT

Frequency Synthesizer-hp-3325A
 50 Ω Termination.....-hp-11048C

INITIAL TEST SETUP

Figure 2-8 Phase Accuracy Test Setup

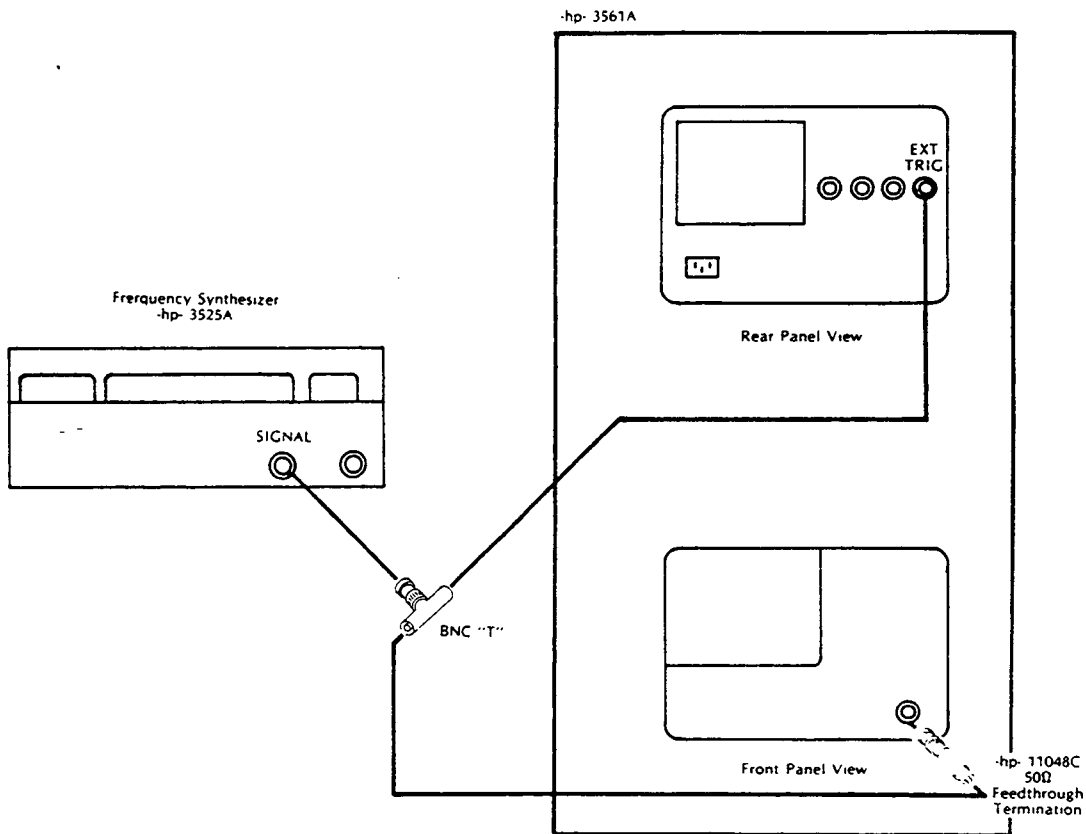

PROCEDURE

- † 1. Connect the test instruments as shown in Figure 2-8 and set the instrument controls as follows:

Frequency Synthesizer

Frequency 99 kHz
 Amplitude 5 Vp-p
 dc Offset 2.5 Vdc
 Function SQUARE WAVE

-hp-3561A

PRESET
 RANGE DEFINE RANGE 15 dBV
 FORMAT SINGLE
 DEFINE TRACE ... PHASE
 WINDOW UNIFORM
 AVerAge TIME
 DEFINE NUM
 AVGS 4 ENTER
 TRIGger SElect... TRIGGER
 SETUP SELECT ... DEFINE % OF RNG 10%
 SLOPE POS
 INPUT..... SINGLE CAL

- † 2. When the calibration is complete, set the -hp-3561A controls as follows:

TRIGger SElect... INPUT TRIGGER

- † 3. Press the -hp-3561A START key to initiate a measurement.
- † 4. When the average is complete, move the marker to 99 kHz and record the marker phase (Y:) reading on the Performance Test Record.
- † 5. Set the -hp-3561A controls as follows:

TRIGger SElect... EXTERNAL
 TRIGGER

- † 6. Press the -hp-3561A START key to initiate a measurement.
- † 7. When the average is complete, move the marker to 99 kHz and record the marker phase (Y:) reading on the Performance Test Record.
- 8. Set the -hp-3561A controls as follows:

TRIGger SElect... SETUP SELECT ... SLOPE NEG

- 9. Repeat Steps 2 through 7.

- 10. Set the frequency synthesizer controls as follows:

Frequency 9 kHz

- 11. Set the -hp-3561A controls as follows:

TRIGger SElect . . . SETUP SELECT . . . SLOPE POS

- 12. Repeat steps 2 through 7, setting the marker to 9 kHz. Record the marker phase (Y:) reading in the corresponding 9 kHz position of the Performance Test Record.

2-15 Input Impedance

This test measures the input impedance of the -hp-3561A as a parallel resistance (R) and capacitance (C). The digital voltmeter is used to measure the input resistance directly. The input capacitance is then measured by inputting a 100 kHz signal from the frequency synthesizer. The equations used to calculate the capacitance are given on the Performance Test Record.

SPECIFICATION

Input Resistance (R) = $1\text{ M}\Omega \pm 50\text{ k}\Omega$ (5%)

Input Capacitance (C) $\leq 95\text{ pf}$

REQUIRED TEST EQUIPMENT

Frequency Synthesizer-hp-3325A
 Digital Voltmeter-hp-3455A
 100 k Ω Resistor 1%see Figure 1-4

INITIAL EQUIPMENT SETUP

Figure 2-9 Input Resistance Test Setup

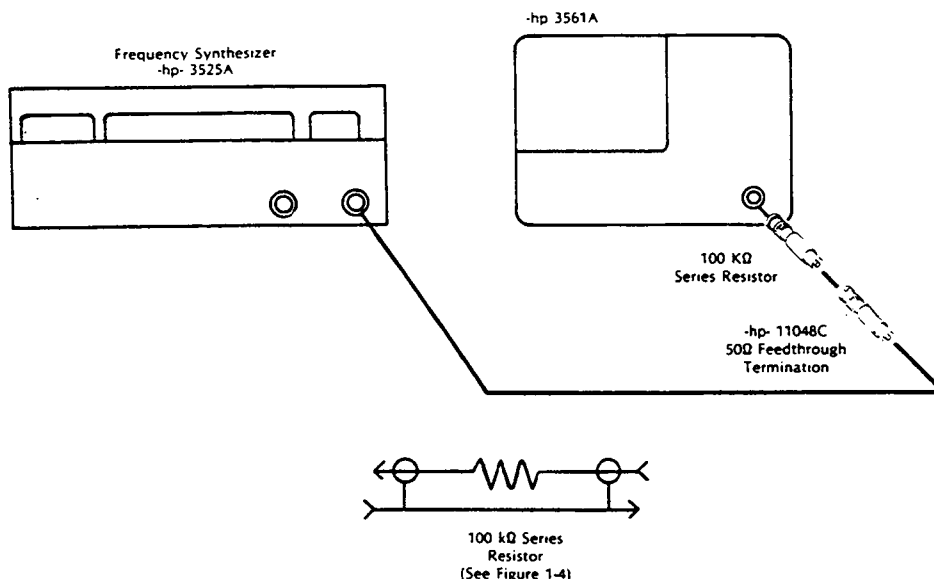

PROCEDURE

1. Connect the test instruments as shown in Figure 2-9 and set the instrument controls as follows:

Digital Voltmeter

FUNCTION 2WIRE kΩ
 RANGE AUTO
 TRIGGER INTERNAL

-hp-3561A

PRESET
 RANGE DEFINE RANGE 20 dBV
 Ground Switch ... CHASSIS

2. Record the digital voltmeter reading on the Performance Test Record.
3. Set the -hp-3561A controls as follows:

RANGE DEFINE RANGE 0 dBV

4. Record the digital voltmeter reading on the Performance Test Record.
5. Set the -hp-3561A controls as follows:
 RANGE DEFINE RANGE-13 dBV
6. Record the digital voltmeter reading on the Performance Test Record.
7. Connect the test instruments as shown in Figure 2-10.

Figure 2-10 Input Capacitance Test Setup

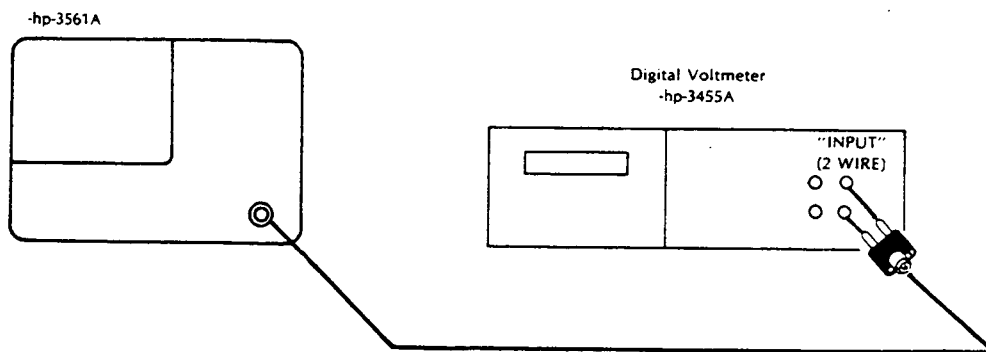

8. Set the frequency synthesizer controls as follows:
 Frequency 100 kHz
 Amplitude 1 Vrms (0 dBV)
9. Set the -hp-3561A controls as follows:
 PRESET
 RANGE DEFINE RANGE1 Vrms
 FORMAT SINGLE
 INPUT..... SINGLE CAL
10. When the calibration is complete, move the marker to 100 kHz and record the marker amplitude (Y:) reading in the V1 position of the Performance Test Record.
11. Remove the 100 kΩ resistor from the signal path and connect the BNC cable with the 50 Ω termination directly to -hp-3561A input connector.
12. Record the marker amplitude (Y:) reading in the V2 position of the Performance Test Record.

- 13. Use the equations given on the Performance Test Record to calculate the capacitance.

2-16 Floating Ground Capacitance

This test measures the capacitance between the floating ground and the chassis ground when the front panel ground switch is in the FLOAT position. The equations used to calculate the capacitance are given on the Performance Test Record.

SPECIFICATION

The capacitance between the floating ground and the chassis ground will be less than or equal to .25 μ f.

REQUIRED TEST EQUIPMENT

Frequency Synthesizer	-hp-3325A
50 Ω Termination	-hp-11048C
600 Ω Termination	-hp-11095A

INITIAL TEST SETUP

Figure 2-11 Floating Ground Capacitance Test Setup

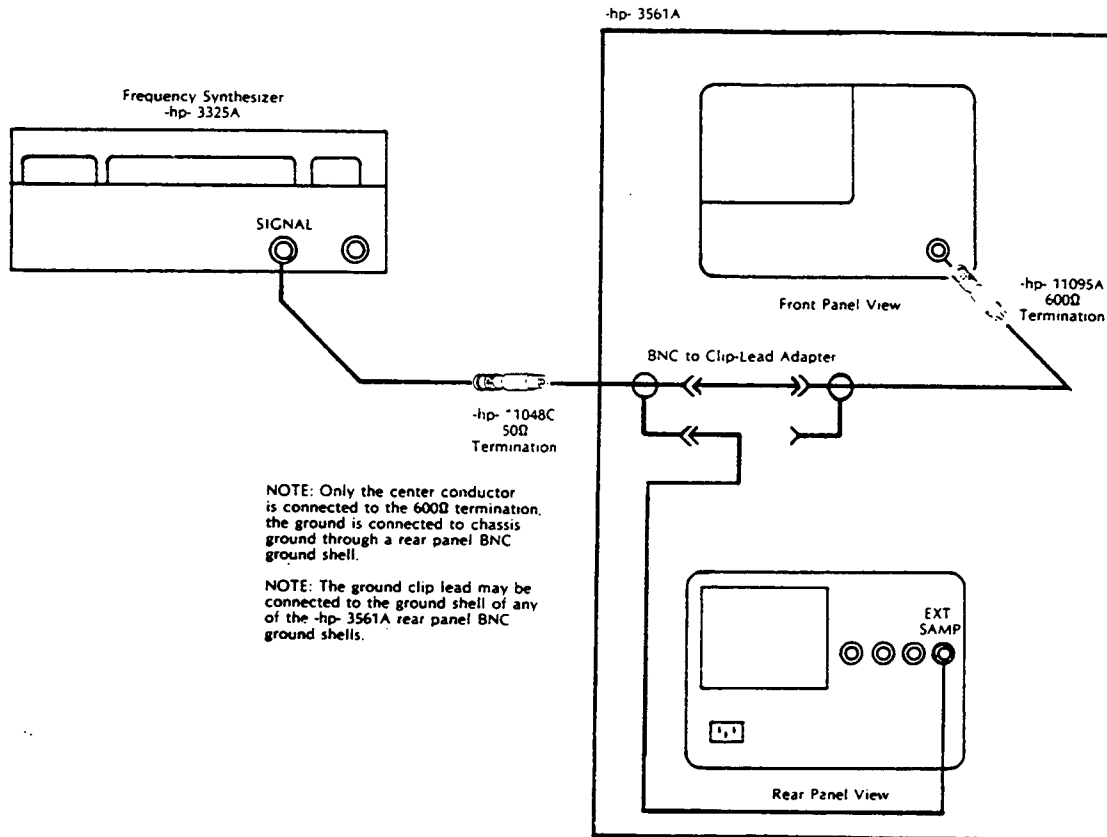

PROCEDURE

1. Connect the test instruments as shown in Figure 2-11 and set the instrument controls as follows:

Frequency Synthesizer

Frequency 1 kHz
Amplitude 1 Vrms (0 dBV)

-hp-3561A

PRESET

RANGE DEFINE RANGE 1 Vrms
FREQUENCY DEFINE SPAN 10 kHz
FORMAT SINGLE
Ground Switch ... CHASSIS
INPUT SINGLE CAL

2. When the calibration is complete, move the marker to 1 kHz. Record the marker amplitude (Y:) reading in the V1 position of the Performance Test Record.
3. Set the -hp-3561A controls as follows:
 Ground Switch FLOAT
4. Record the marker amplitude (Y:) reading in the V2 position of the Performance Test Record.
5. Use the equations given on the Performance Test Record to calculate the capacitance.

2-17 Harmonic Distortion

This test measures the harmonic distortion generated in the -hp-3561A. In the first measurement, a low noise oscillator is used to input a sinewave at a frequency of 99 kHz ÷ N (for N equal to 2, 3, 4, and 5). The amplitude of the Nth harmonic is measured at 99 kHz on the -hp-3561A display. In the second measurement, the low noise oscillator is used to input a sinewave at 1 kHz. The first five harmonics generated within the -hp-3561A are then measured on the -hp-3561A display.

Table 2-9 Harmonic Frequencies Measurement One

Signal Frequency	Harmonic Number	Harmonic Frequency
49500 Hz	2nd	99 kHz
33000 Hz	3rd	99 kHz
24750 Hz	4th	99 kHz
19800 Hz	5th	99 kHz

Table 2-10 Harmonic Frequencies Measurement Two

Signal Frequency	Harmonic Number	Harmonic Frequency
1 kHz	2nd	2 kHz
1 kHz	3rd	3 kHz
1 kHz	4th	4 kHz
1 kHz	5th	5 kHz
1 kHz	6th	6 kHz

SPECIFICATION

The relative amplitude of all harmonics will be greater than 80 dB below the amplitude of the fundamental.

REQUIRED TEST EQUIPMENT

- Low Distortion Oscillator-hp-339A
 600 Ω Termination-hp-11095A

INITIAL TEST SETUP

Figure 2-12 Harmonic Distortion Test Setup

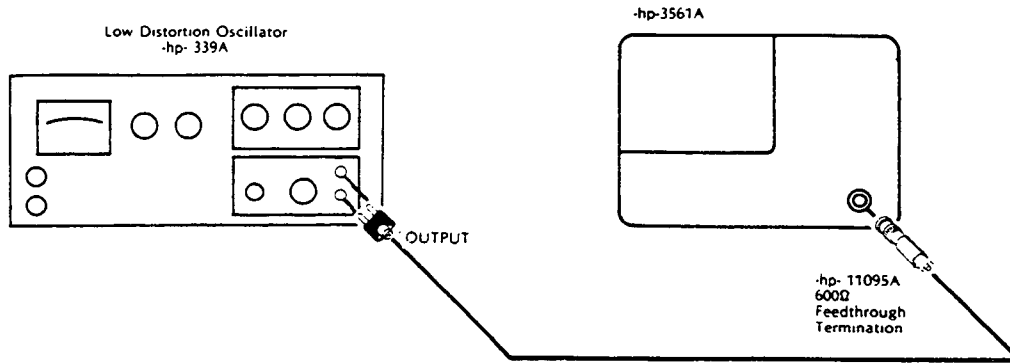

PROCEDURE

1. Connect the test instruments as shown in Figure 2-12 and set the instrument controls as follows:

Low Noise Oscillator

Frequency 49 kHz
 Amplitude 1 Vrms

-hp-3561A

PRESET
 FORMAT SINGLE
 RANGE DEFINE RANGE 0 dBV
 FREQUENCY DEFINE CENTER... 49.5 kHz
 DEFINE SPAN 10 kHz
 INPUT SINGLE CAL

2. When the calibration is complete, move the marker to 49.5 kHz. Adjust the low noise oscillator frequency vernier for a 49.5 kHz sine wave output. Adjust the low noise oscillator amplitude vernier for a marker amplitude reading of between -2 dBV and 0 dBV.
3. Set the -hp-3561A controls as follows:

RELative MarKeR . REL MKR ON
 DEFINE MAG REF MKR VALUE
 FREQUENCY DEFINE CENTER... 99 kHz
 VERTICAL SCALE .. DEFINE FULL SCL -20 dBV
 AVerAge DEFINE NUM
 AVGS 20 ENTER
 RMS

4. Press the -hp-3561A START key to initiate a measurement.
5. When the average is complete, move the marker to 99 kHz and record the marker relative amplitude (Yr:) reading on the Performance Test Record.
6. Set the -hp-3561A controls as follows:
 AVeraGe OFF
7. Set the low noise oscillator controls as follows:
 Frequency 32 kHz
8. Set the -hp-3561A controls as follows:
 FREQUENCY DEFINE CENTER...33 kHz
 VERTICAL SCALE .. DEFINE FULL SCL0 dBV
9. Move the marker to 33 kHz. Adjust the low noise oscillator frequency vernier for a frequency of 33 kHz.
10. Repeat steps 3 through 6.
11. Set the low noise oscillator controls as follows:
 Frequency 24 kHz
12. Set the -hp-3561A controls as follows:
 FREQUENCY DEFINE CENTER...24.75 kHz
 VERTICAL SCALE .. DEFINE FULL SCL0 dBV
13. Move the marker to 24.75 kHz. Adjust the low noise oscillator frequency vernier for a frequency of 24.75 kHz.
14. Repeat steps 3 through 6.
15. Set the low noise oscillator controls as follows:
 FREQUENCY 19 kHz
16. Set the -hp-3561A controls as follows:
 FREQUENCY DEFINE CENTER...19.8 kHz
 VERTICAL SCALE .. DEFINE FULL SCL0 dBV
17. Move the marker to 19.8 kHz. Adjust the low noise oscillator frequency vernier for a frequency of 19.8 kHz.
18. Repeat steps 3 through 6. 19. Set the low noise oscillator as follows:
 Frequency 990 Hz
20. Set the -hp-3561A as follows:
 FREQUENCY DEFINE SPAN10 kHz
 DÉFINE START 0 Hz
 VERTICAL SCALE .. DEFINE FULL SCL0 dBV

21. Move the marker to 1 kHz. Adjust the low noise oscillator frequency vernier for a frequency of 1 kHz.
22. Set the -hp-3561A controls as follows:
 - RELative MarKeR . REL MKR ON
 - DEFINE MAG REF MKR VALUE
 - VERTical SCALE . . . DEFINE FULL SCL -20 dBV
 - AVerAge DEFINE NUM
 - AVGS 20 ENTER
 - RMS
23. Press the -hp-3561A START key to initiate a measurement.
24. When the average is complete, move the marker to each of the harmonic frequencies listed in Table 2-10. Record the marker relative amplitude (Yr:) reading for each harmonic on the Performance Test Record.

2-18 Two-Tone Intermodulation Distortion

This test measures the level of the intermodulation distortion products generated within the -hp-3561A out to the 4th order. The outputs of the frequency synthesizer and the low noise oscillator are summed together through two 1 kΩ resistors.

Table 2-11 Intermodulation Products Measurement One

Fundamental Frequencies		Intermodulation Distortion	
F1	F2	Order	Frequency
25 kHz	30 kHz	F2 - F1	5 kHz
25 kHz	30 kHz	2F1 - F2	20 kHz
25 kHz	30 kHz	2F2 - 2F1	10 kHz
25 kHz	30 kHz	3F1 - 2F2	15 kHz

Table 2-12 Intermodulation Products Measurement Two

Fundamental Frequencies		Intermodulation Distortion	
F1	F2	Order	Frequency
95 kHz	100 kHz	F2 - F1	5 kHz
95 kHz	100 kHz	2F1 - F2	90 kHz
95 kHz	100 kHz	2F2 - 2F1	10 kHz
95 kHz	100 kHz	3F1 - 2F2	85 kHz

SPECIFICATION

The amplitude of all intermodulation products will be greater than 80 dB below the fundamental amplitude.

REQUIRED TEST EQUIPMENT

- Frequency Synthesizer-hp-3325A
- Low Noise Oscillator-hp-339A
- (2) 50 Ω Terminations-hp-11048C
- (2) 1 k Ω Series Resistorssee Figure 1-6

INITIAL TEST SETUP

Figure 2-13 Intermodulation Distortion Test Setup

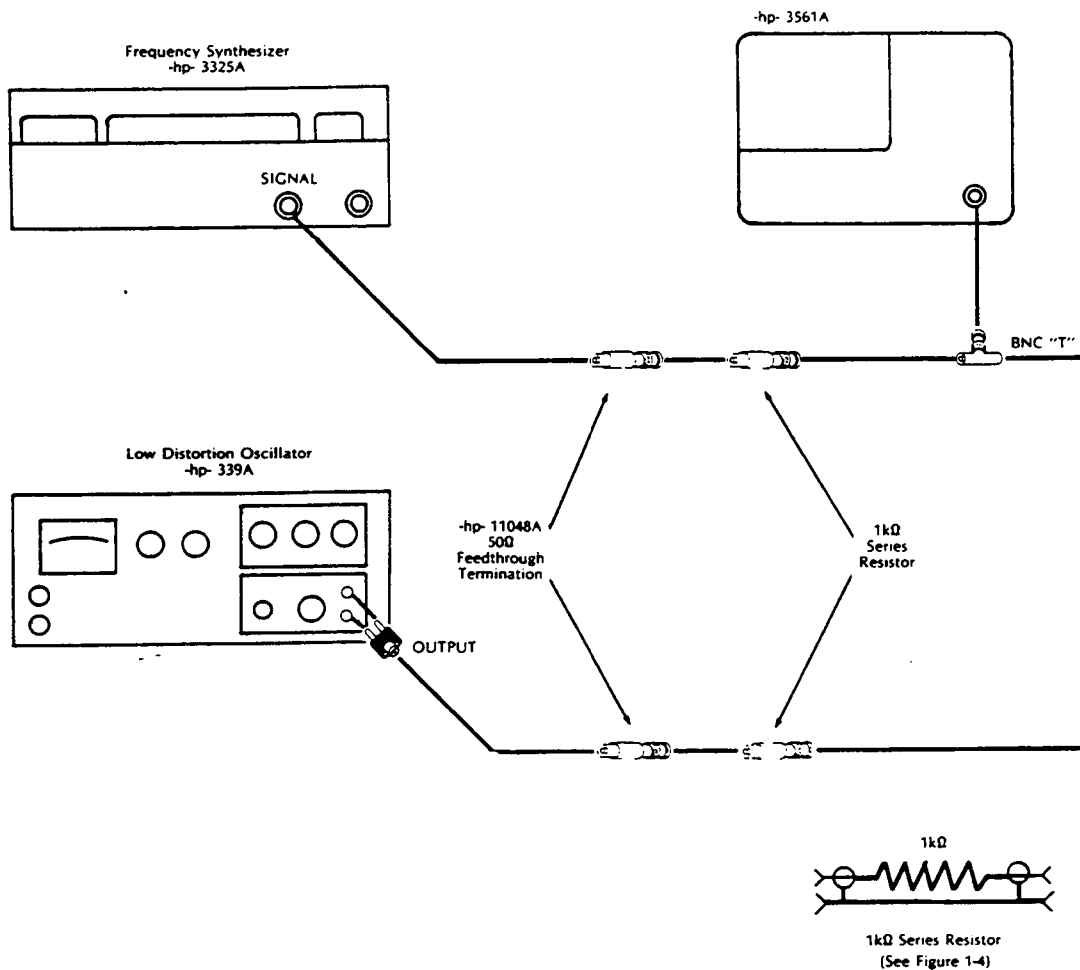

8. Repeat steps 5 through 7 for each of the remaining intermodulation distortion frequencies listed in Table 2-11. For each frequency record the marker relative amplitude (Yr:) reading on the corresponding position of the Performance Test Record.

9. Set the frequency synthesizer controls as follows:

Frequency 100 kHz

10. Set the low noise oscillator controls as follows:

Frequency 94 kHz

11. Set the -hp-3561A controls as follows:

AVerAge OFF
 FREQuency DEFINE CENTER.....100 kHz
 VERTical SCALE .. DEFINE FULL SCL-19 dBV

12. Move the marker to 100 kHz and set the -hp-3561A as follows:

RELative MarKeR . REL MKR ON
 DEFINE MAG REF MKR VALUE
 FREQuency DEFINE CENTER.....95 kHz

13. Adjust the low noise oscillator frequency vernier for a frequency of 95 kHz. Adjust the low noise oscillator amplitude until the marker amplitude offset is 0 dB ± .5 dB at 95 kHz.

14. Set the -hp-3561A controls as follows:

VERTical SCALE .. DEFINE FULL SCL-40 dBV
 AVerAge RMS
 DEFINE NUM
 AVGS20 ENTER

15. Set the -hp-3561A controls as follows:

FREQuency DEFINE CENTER.....5 kHz

16. Press the -hp-3561A START key to initiate a measurement.

17. When the average is complete, move the marker to 5 kHz. Record the marker relative amplitude (Yr:) reading on the Performance Test Record.

18. Repeat steps 15 through 17 for each of the remaining intermodulation distortion frequencies listed in Table 2-12. For each frequency record the marker relative amplitude (Yr:) reading on the corresponding position of the Performance Test Record.

2-19 Noise Source Output Impedance

This test uses the -hp-3561A input channel to measure the output level of the noise source with and without a 50 Ω termination on the source output. From these two measurements the noise source output impedance is calculated.

SPECIFICATION

The noise source output impedance will be 50 $\Omega \pm 5 \Omega$ (10%)

REQUIRED TEST EQUIPMENT

50 Ω Termination-hp-11048C

INITIAL TEST SETUP

Figure 2-14 Noise Source Impedance Test Setup

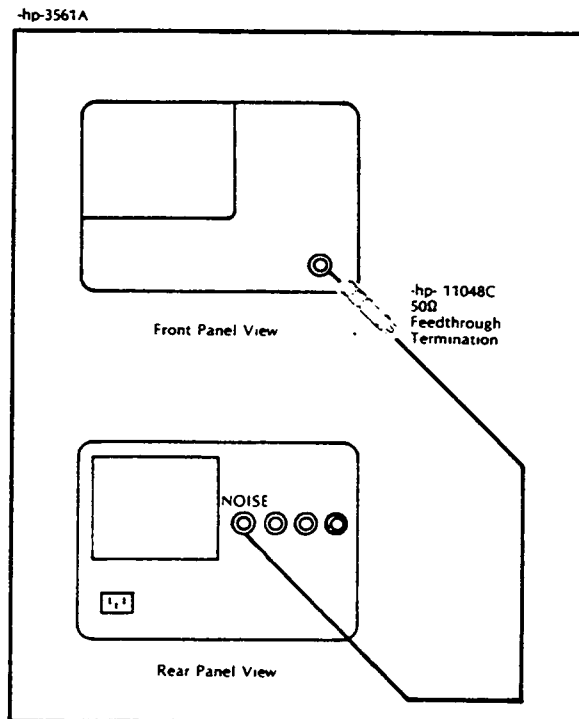

PROCEDURE

1. Connect the test instruments as shown in Figure 2-14 and set the instrument controls as follows:

-hp-3561A

PRESET

RANGE DEFINE RANGE 3.5 Vrms

FORMAT SINGLE

WINDOW UNIFORM

AVERaGe DEFINE NUM

AVGS 10 ENTER

RMS

SOURCE PERIODIC NOISE

DEFINE ATTEN 0 dB

INPUT SINGLE CAL

Ground Switch ... CHASSIS

2. When the calibration is complete, press the -hp-3561A START key to initiate a measurement.
3. When the average is complete, move the marker to 10 kHz and record the marker amplitude (Y:) reading in the V1 position of the Performance Test Record.
4. Remove the 50 Ω termination from the -hp-3561A input connector. Connect the noise source directly to the -hp-3561A input connector.
5. Press the -hp-3561A START key to initiate a measurement.
6. When the average is complete, move the marker to 10 kHz and record the marker amplitude (Y:) reading in the V2 position of the Performance Test Record.
7. Calculate the noise source output resistance on the Performance Test Record.

2-20 Noise Source Amplitude Accuracy/Flatness †

This test uses the -hp-3561A input channel to measure the flatness of the noise source over frequency and the RMS amplitude accuracy. The noise source level accuracy is measured using the Band Power special marker. The flatness specification is then calculated by dividing the band power reading by 20 to obtain the noise per bin on the -hp-3561A display and then multiplying by the flatness specification to obtain the acceptable deviation.

Table 2-13 Noise Source Flatness Measurement

Noise Source	Baseband/ Zoom	Start Frequency	Frequency Span
† Periodic	Baseband	0 Hz	100 kHz
Periodic	Baseband	0 Hz	10 kHz
Periodic	Zoom	21 kHz	10 kHz
† Random	Baseband	0 Hz	100 kHz
Random	Baseband	0 Hz	20 kHz
Random	Zoom	50 kHz	50 kHz

† When performing an operational verification rather than a full performance test, complete these measurements only.

SPECIFICATION

RMS Amplitude Accuracy

The maximum in-band power output into a 50 Ω termination is specified in the Amplitude Accuracy column, and the Amplitude flatness over the specified frequency span is listed in the Amplitude Flatness Column.

NOTE

Random source flatness can only be measured with long term averaging (16000), for shorter averages, add .4 dB \times (1000/number of averages) to the Amplitude Flatness specification. This value has already been factored into the tolerances listed on the Performance Test Record.

Table 2-14 Noise Source Amplitude Accuracy Specification

Noise Source Selected	Frequency Span	Baseband/ Zoom	Amplitude Accuracy	Amplitude Flatness
Periodic	100 kHz	Baseband	0.7 Vrms \pm .07 Vrms	\pm 0.8 dB
Periodic	\leq 50 kHz	Baseband	0.7 Vrms \pm .07 Vrms	\pm 0.7 dB
Periodic	all	Zoom	0.5 Vrms \pm .075 Vrms	\pm 1.0 dB
Random	100 kHz	Baseband	0.7 Vrms \pm .14 Vrms	\pm 1.6 dB
Random	\leq 50 kHz	Baseband	0.7 Vrms \pm .07 Vrms	\pm 0.7 dB
Random	all	Zoom	0.5 Vrms \pm .075 Vrms	\pm 2.0 dB

Figure 2-15 Noise Source Amplitude Accuracy Test Setup

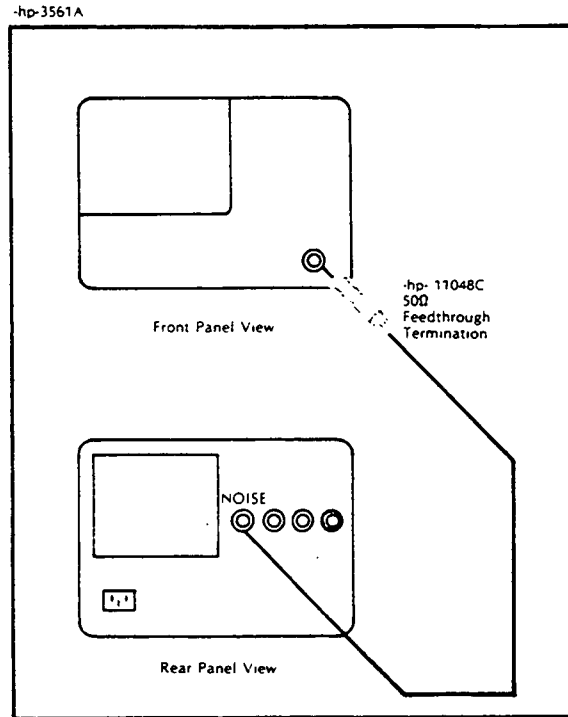

Procedure

- † 1. Connect the test instruments as shown in Figure 2-15 and set the instrument controls as follows:

-hp-3561A

PRESET		
RANGE	DEFINE RANGE	3.5 Vrms
FORMAT	SINGLE	
WINDOW	UNIFORM	
AVerage	DEFINE NUM	
	AVGS	4 ENTER
	RMS	
SOURCE	PERIODIC NOISE	
	DEFINE ATTEN	0 dB
SPeCiaL MarKeR	BAND POWER ...	DEFINE LEFT FRQ ... 0 Hz
		DEFINE RGHT FRQ ... 100 kHz
INPUT	SINGLE CAL	

† 11. Set up the -hp-3561A controls as follows:

```

VERTical SCALE .  DEFINE FULL SCL ..... 3.5 Vrms
                   DEFINE dB/DIV ..... 10 dB
FREQuency ..... 0 - 100 kHz
SOURCE .....     RANDOM
                   DEFINE ATTEN ..... 0 dB
AVeraGe .....   DEFINE NUM
                   AVGS ..... 1000 ENTER
                   SETUP SELECT ... FAST DISPLAY
SPeCiaL MarKeR . BAND POWER ... DEFINE LEFT FRQ .. 0 Hz
                   DEFINE RGHT FRQ . 100 kHz
    
```

† 12. Repeat steps 2 through 6. Record the marker readings for random noise, 100 kHz baseband.

13. Set up the -hp-3561A controls as follows:

```

VERTical SCALE   DEFINE FULL SCL ..... 3.5 Vrms
                   DEFINE dB/DIV ..... 10 dB
FREQuency ..... DEFINE SPAN ..... 20 kHz
SPeCiaL MarKeR . BAND POWER ... DEFINE LEFT FRQ .. 0 Hz
                   DEFINE RGHT FRQ . 20 kHz
    
```

14. Repeat steps 2 through 6, record the marker readings for random noise, 20 kHz baseband.

15. Set up the -hp-3561A controls as follows:

```

VERTical SCALE .  DEFINE FULL SCL ..... 3.5 Vrms
                   DEFINE dB/DIV ..... 10 dB
FREQuency .....  DEFINE SPAN ..... 50 kHz
                   DEFINE START ..... 50 kHz
SPeCiaL MarKeR . BAND POWER ... DEFINE LEFT FRQ .. 50 kHz
                   DEFINE RGHT FRQ . 100 kHz
    
```

16. Repeat steps 2 through 6. Record the marker readings for random noise, 50 kHz zoom.

† 17. Calculate the maximum and minimum noise level specifications for each measurement using the equations given under the specification column of each table.

2-21 External Sample

This test checks the external sample rear panel to insure TTL compatibility. The frequency synthesizer is used as an external sample input, while the internal CAL signal is viewed on the display.

SPECIFICATION

TTL compatible.

REQUIRED TEST EQUIPMENT

Frequency Synthesizer-hp-3325A

INITIAL TEST SETUP

Figure 2-16 External Sample Test

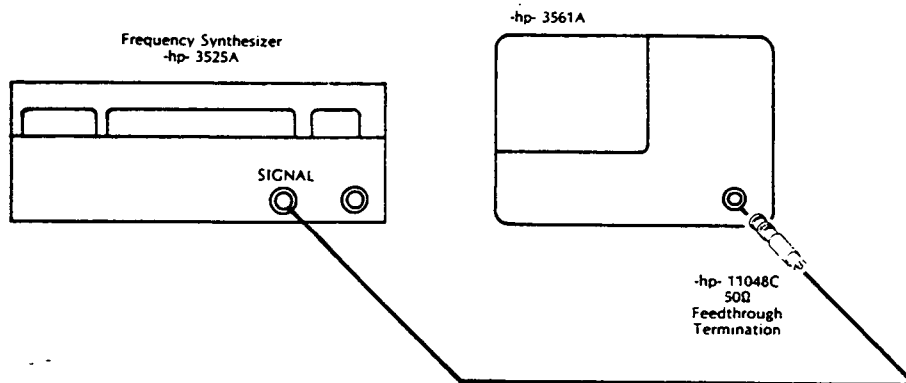

PROCEDURE

1. Connect the test instruments as shown in Figure 2-16 and set the instrument controls as follows:

Frequency Synthesizer

Frequency 128 kHz
 Amplitude 5.0 Vp-p
 dc Offset 2.5 Vdc
 Function SQUARE WAVE

-hp-3561A

PRESET

RANGE DEFINE RANGE -12 dBV
 INPUT CAL SIG ON
 MODE EXT SAMP ON

2. Verify that the CAL signal appears on the -hp-3561 CRT screen as shown in Figure 2-17, and that the "EXTERNAL SAMPLE TO FAST" message does not appear on the screen.

Figure 2-17 Cal Signal In External Sample Mode

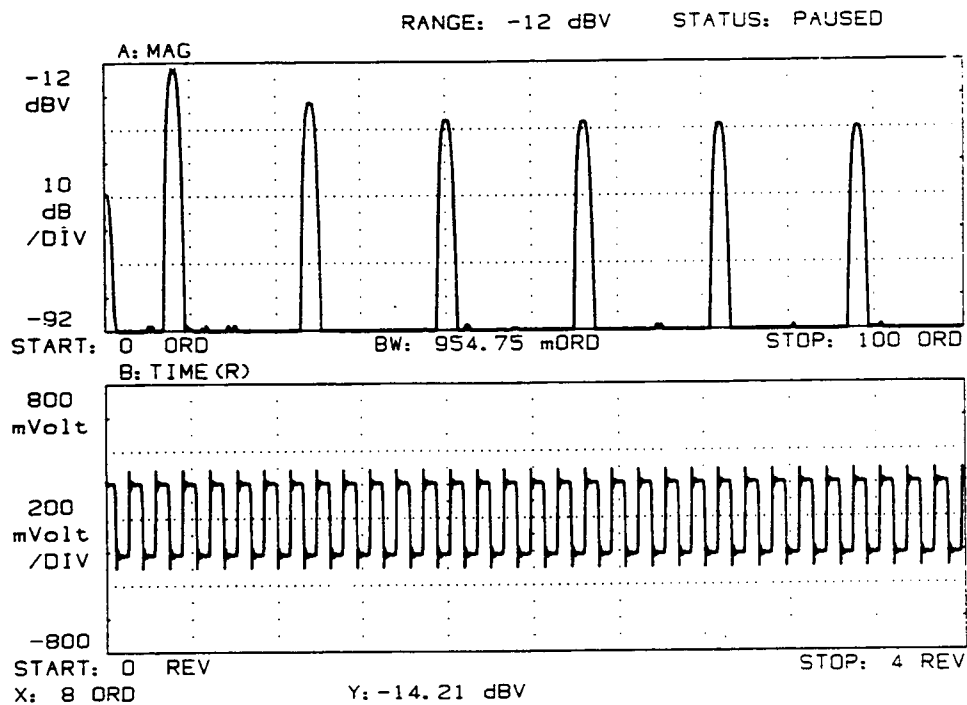

2-22 Internal Self Test †

This test runs three internal circuit verification routines. Each test passes if no return codes are displayed on the -hp-3561A CRT screen when the test is complete. These tests are run only for an operational verification and do not guarantee performance to specifications.

REQUIRED TEST EQUIPMENT

None

PROCEDURE

- † 1. Set the -hp-3561A controls as follows:

```
PRESET  
MODE ..... TEST SELECT.....DEFINE TEST NUM   1 ENTER  
                                START SINGLE TEST
```

- † 2. When the "TEST #1 IS COMPLETE" message is displayed, set the -hp-3561A controls as follows:

```
                                DEFINE TEST NUM   14 ENTER  
                                START SINGLE TEST
```

- † 3. When the "TEST #14 IS COMPLETE" message is displayed, set the -hp-3561A controls as follows:

```
                                DEFINE TEST NUM   19 ENTER  
                                START SINGLE TEST
```

- † 4. When the "TEST #19 IS COMPLETE" message is displayed, press PRESET to exit the test mode.

**Performance Test Record
-hp-3561A Spectrum Analyzer**

Serial Number: _____

Test Performed by: _____

Date: _____

dc Offset †

Range Setting	Specification	Measured Value
		Marker Y: reading
0 dBV	≤ -30 dBV	_____dBV †
-25 dBV	≤ -55 dBV	_____dBV †
-51 dBV	≤ -71 dBV	_____dBV †

Amplitude Accuracy/Flatness †

Signal Frequency	Range Setting	ac Calibrator Amplitude	Specification		Measured Value
			Lower Limit dBV	Upper Limit dBV	Marker Y: reading
1 kHz	8 dBV	(2.5119 Vrms)	7.85	8.15	_____dBV †
99 kHz	8 dBV	(2.5119 Vrms)	7.85	8.15	_____dBV †
1 kHz	-11 dBV	(.28184 Vrms)	-11.15	-10.85	_____dBV †
99 kHz	-11 dBV	(.28184 Vrms)	-11.15	-10.85	_____dBV †
1 kHz	-22 dBV	(79.433 mVrms)	-22.15	-21.85	_____dBV
50 kHz	-22 dBV	(79.433 mVrms)	-22.15	-21.85	_____dBV
90 kHz	-22 dBV	(79.433 mVrms)	-22.15	-21.85	_____dBV
100 kHz	-22 dBV	(79.433 mVrms)	-22.15	-21.85	_____dBV
1 kHz	-51 dBV	(2.8184 mVrms)	-51.25	-50.75	_____dBV
1 kHz	-49 dBV	(3.5481 mVrms)	-49.25	-48.75	_____dBV
1 kHz	-47 dBV	(4.4668 mVrms)	-47.25	-46.75	_____dBV
1 kHz	-45 dBV	(5.6234 mVrms)	-45.25	-44.75	_____dBV
1 kHz	-43 dBV	(7.0795 mVrms)	-43.25	-42.75	_____dBV
1 kHz	-41 dBV	(8.9125 mVrms)	-41.25	-40.75	_____dBV
1 kHz	-39 dBV	(11.220 mVrms)	-39.15	-38.85	_____dBV
1 kHz	-29 dBV	(35.481 mVrms)	-29.15	-28.85	_____dBV
1 kHz	-27 dBV	(44.668 mVrms)	-27.15	-26.85	_____dBV
1 kHz	-25 dBV	(56.234 mVrms)	-25.15	-24.85	_____dBV

Amplitude Linearity

Signal Frequency = 1 kHz

Amplitude		Specification		Measured Value
Vrms	(dBV)	Upper Limit	Lower Limit	
10.0 Vrms	(+ 20 dBV)	10.17 Vrms	9.827 Vrms	_____ Vrms
1.00 Vrms	(+ 0 dBV)	1.019 Vrms	981.4 mVrms	_____ Vrms
100.0 mVrms	(-20 dBV)	103.2 mVrms	96.79 mVrms	_____ Vrms
10.0 mVrms	(-40 dBV)	11.67 mVrms	8.329 mVrms	_____ Vrms
3.1623 mVrms	(-50 dBV)	4.717 mVrms	1.608 mVrms	_____ Vrms
1.00 mVrms	(-60 dBV)	2.517 mVrms	0.000 mVrms	_____ Vrms

Signal Frequency = 99 kHz

Amplitude		Specification		Measured Value
Vrms	(dBV)	Upper Limit	Lower Limit	
10.0 Vrms	(+ 20 dBV)	10.17 Vrms	9.827 Vrms	_____ Vrms
1.00 Vrms	(+ 0 dBV)	1.019 Vrms	981.4 mVrms	_____ Vrms
100.0 mVrms	(-20 dBV)	103.2 mVrms	96.79 mVrms	_____ Vrms
10.0 mVrms	(-40 dBV)	11.67 mVrms	8.329 mVrms	_____ Vrms
3.1623 mVrms	(-50 dBV)	4.717 mVrms	1.608 mVrms	_____ Vrms
1.00 mVrms	(-60 dBV)	2.517 mVrms	0.000 mVrms	_____ Vrms

Noise Level/Spurious Signal Level †

Start Frequency	Frequency Span	Window / Bandwidth	Noise Level Specification	Measured Value
				Marker Y: reading
20 Hz	2 kHz	Uniform / 2.5 Hz	≤ -131 dBV	_____ dBV
2 kHz	25 kHz	Uniform / 62.5 Hz	≤ -131 dBV	_____ dBV
25 kHz	25 kHz	Uniform / 62.5 Hz	≤ -131 dBV	_____ dBV
50 kHz	25 kHz	Uniform / 62.5 Hz	≤ -131 dBV	_____ dBV
75 kHz	25 kHz	Uniform / 62.5 Hz	≤ -131 dBV	_____ dBV
20 Hz	1 kHz	Flat Top / 9.5475 Hz	≤ -131 dBV	_____ dBV †
2 kHz	100 kHz	Flat Top / 954.75 Hz	≤ -120 dBV	_____ dBV †

Frequency Accuracy †

Signal Frequency	Specification		Measured Value
	Lower limit	Upper Limit	Marker X: reading
99,990 Hz	99,987 Hz	99,993 Hz	_____ Hz †

Input Coupling Insertion Loss

Specification	Measured Value
	Marker Yr: reading
Insertion loss \leq 3 dB	_____ dB

Anti-Allas Filter Response

Frequency Synthesizer Frequency	Alias Frequency	Specification	Measured Value
			Marker Yr: reading
100 kHz			_____ 0.0 dB
156 kHz	100 kHz	\leq -80 dB	_____ dB
185 kHz	71 kHz	\leq -80 dB	_____ dB
206 kHz	50 kHz	\leq -80 dB	_____ dB
267 kHz	11 kHz	\leq -80 dB	_____ dB
924 kHz	100 kHz	\leq -80 dB	_____ dB

A-Weight Filter Response
Signal Amplitude = 0 dBV

Frequency	Amplitude	Specification		Measured Value Marker Yr: reading
		Upper Limit dBV	Lower Limit dBV	
10 Hz	-70.4 dBV	-66.4	-74.4	_____ dBV
80 Hz	-22.5 dBV	-21.5	-23.5	_____ dBV
400 Hz	-4.8 dBV	-3.8	-5.8	_____ dBV
1000 Hz	0.0 dBV	1.0	-1.0	_____ dBV
2500 Hz	1.3 dBV	2.3	0.3	_____ dBV
5000 Hz	0.5 dBV	1.5	-1.5	_____ dBV
20000 Hz	-9.3 dBV	-6.3	$-\infty$	_____ dBV

Phase Accuracy †

Frequency	Trigger Slope	Trigger Type	Specification		Measured Value Marker Y: reading
			Lower Limit	Upper Limit	
99 kHz	POS	INPUT	-100 °	-80 °	_____ ° †
99 kHz	POS	EXTERNAL	-100 °	-80 °	_____ ° †
99 kHz	NEG	INPUT	80 °	100 °	_____ °
99 kHz	NEG	EXTERNAL	80 °	100 °	_____ °
9 kHz	POS	INPUT	-92 °	-88 °	_____ °
9 kHz	POS	EXTERNAL	-92 °	-88 °	_____ °

**Input Impedance
Resistance Measurement**

Range Setting	Specification		Measured Value Digital Voltmeter reading
	Lower limit	Upper Limit	
20 dBV	950 kΩ	1050 kΩ	_____ Ω (R1)
0 dBV	950 kΩ	1050 kΩ	_____ Ω (R2)
-13 dBV	950 kΩ	1050 kΩ	_____ Ω (R3)

Capacitance Measurement

$V1 = \text{_____} V_{rms}$ $V2 = \text{_____} V_{rms}$	
$C = \left(\frac{V2}{V1} - 1 \right) 16 \text{ pf} - 1.6 \text{ pf}$	
Specification $\leq 95 \text{ pf}$	Measured Value _____ pf

Floating Ground Capacitance

Ground Switch	Measured Value Marker Y: reading
CHASSIS FLOAT	$V1 = \text{_____} V_{rms}$ $V2 = \text{_____} V_{rms}$
$C = \left(\frac{V2}{V1 - V2} \right) .254 \mu F$	
Specification $C \leq .25 \mu F$	Measured Value $C = \text{_____} \mu F$

Harmonic Distortion

Signal Frequency	Harmonic Number	Harmonic Frequency	Specification	Measured Value Marker Yr: reading
49500 Hz	2nd	99 kHz	≤ -80 dB	_____dB
33000 Hz	3rd	99 kHz	≤ -80 dB	_____dB
24750 Hz	4th	99 kHz	≤ -80 dB	_____dB
19800 Hz	5th	99 kHz	≤ -80 dB	_____dB

Signal Frequency	Harmonic Number	Harmonic Frequency	Specification	Measured Value Marker Yr: reading
1 kHz	2nd	2 kHz	≤ -80 dB	_____dB
1 kHz	3rd	3 kHz	≤ -80 dB	_____dB
1 kHz	4th	4 kHz	≤ -80 dB	_____dB
1 kHz	5th	5 kHz	≤ -80 dB	_____dB
1 kHz	6th	6 kHz	≤ -80 dB	_____dB

Two-Tone Intermodulation Distortion

Fundamental Frequencies F1 F2	Intermodulation Distortion		Specification	Measured Value
	Order	Frequency		Marker Yr: reading
25 kHz 30 kHz	F2 - F1	5 kHz	≤ -80 dB	_____dB
25 kHz 30 kHz	2F1 - F2	20 kHz	≤ -80 dB	_____dB
25 kHz 30 kHz	2F2 - 2F1	10 kHz	≤ -80 dB	_____dB
25 kHz 30 kHz	3F1 - 2F2	15 kHz	≤ -80 dB	_____dB

Fundamental Frequencies F1 F2	Intermodulation Distortion		Specification	Measured Value
	Order	Frequency		Marker Yr: reading
95 kHz 100 kHz	F2 - F1	5 kHz	≤ -80 dB	_____dB
95 kHz 100 kHz	2F1 - F2	90 kHz	≤ -80 dB	_____dB
95 kHz 100 kHz	2F2 - 2F1	10 kHz	≤ -80 dB	_____dB
95 kHz 100 kHz	3F1 - 2F2	85 kHz	≤ -80 dB	_____dB

Noise Source Output Impedance

50 Ω Termination	Measured Value
	Marker Y: reading
Connected Disconnected	V1 = _____Vrms V2 = _____Vrms
Measured Resistance = $50 \Omega \left(\frac{V2 - V1}{V1} \right)$	
Specification 50 Ω ± 5 Ω	Measured Value _____Ω

**Source Amplitude Accuracy/Flatness †
Noise Source Amplitude Accuracy**

Noise Source Selected	Frequency Span	Baseband/ Zoom	Specification Level Accuracy		Measured Value
			Upper Limit	Lower Limit	Band Power(BND:) Marker Reading
Periodic	100 kHz	Baseband	770 mVrms	630 mVrms	_____mVrms†
Periodic	20 kHz	Baseband	770 mVrms	630 mVrms	_____mVrms
Periodic	10 kHz	Zoom	575 mVrms	425 mVrms	_____mVrms
Random	100 kHz	Baseband	840 mVrms	560 mVrms	_____mVrms†
Random	20 kHz	Baseband	770 mVrms	630 mVrms	_____mVrms
Random	50 kHz	Zoom	575 mVrms	425 mVrms	_____mVrms

Noise Source Flatness: Maximum Noise Level

The maximum noise level specification for each noise source/frequency span combination is calculated from the band power marker value as shown in the equation below. Division by 20 in this equation converts band power to power per bin.

Specification = Band Power Value × (1 + percent tolerance)/20

Noise Source Selected	Frequency Span	Baseband/ Zoom	Specification Maximum Noise Level		Measured Value
			Band Power (BND:) Marker Value	Calculated Value	Marker Y: reading
Periodic	100 kHz	Baseband	_____mVrms × (1.096/20) =	_____mVrms	_____mVrms†
Periodic	20 kHz	Baseband	_____mVrms × (1.084/20) =	_____mVrms	_____mVrms
Periodic	10 kHz	Zoom	_____mVrms × (1.259/20) =	_____mVrms	_____mVrms
Random	100 kHz	Baseband	_____mVrms × (1.259/20) =	_____mVrms	_____mVrms†
Random	20 kHz	Baseband	_____mVrms × (1.135/20) =	_____mVrms	_____mVrms
Random	50 kHz	Zoom	_____mVrms × (1.318/20) =	_____mVrms	_____mVrms

Noise Source Flatness: Minimum Noise Level

The minimum noise level specification for each noise source/frequency span combination is calculated from the band power marker value as shown in the equation below. Division by 20 in this equation converts band power to power per bin.

$$\text{Specification} = \text{Band Power Value} \times (1 - \text{percent tolerance})/20$$

Noise Source Selected	Frequency Span	Baseband/ Zoom	Specification Minimum Noise Level		Measured Value Marker Yr: reading
			Band Power(BND:) Marker Value	Calculated Value	
Periodic	100 kHz	Baseband	_____mVrms × (.9120/20) =	_____mVrms	_____mVrmst
Periodic	20 kHz	Baseband	_____mVrms × (.9226/20) =	_____mVrms	_____mVrms
Periodic	10 kHz	Zoom	_____mVrms × (.7943/20) =	_____mVrms	_____mVrms
Random	100 kHz	Baseband	_____mVrms × (.7943/20) =	_____mVrms	_____mVrmst
Random	20 kHz	Baseband	_____mVrms × (.8810/20) =	_____mVrms	_____mVrmst
Random	50 kHz	Zoom	_____mVrms × (.7586/20) =	_____mVrms	_____mVrmst

SECTION III
ADJUSTMENTS

Paragraph	Title	Page
3-1	INTRODUCTION.....	3-1
3-2	SAFETY CONSIDERATIONS	3-1
3-3	EQUIPMENT REQUIRED.....	3-2
3-4	ADJUSTMENT LOCATIONS	3-2
3-5	ADJUSTMENT SUMMARY.....	3-2
3-6	A71 POWER SUPPLY LOW LINE DETECT ADJUSTMENT PROCEDURE	3-3
3-7	A90 CRT DISPLAY ADJUSTMENT PROCEDURE	3-4
3-8	A40 REFERENCE OSCILLATOR ADJUSTMENT PROCEDURE.....	3-8
3-9	A15 DIGITIZER ASSEMBLY ADJUSTMENT PROCEDURE	3-10
3-10	A10 INPUT ASSEMBLY ADJUSTMENT PROCEDURE	3-16
3-11	A50 NOISE SOURCE ADJUSTMENT PROCEDURE.....	3-22



SECTION III ADJUSTMENTS

3-1 INTRODUCTION

This section describes the adjustments which will return the -hp-3561A to specified operating accuracy after repairs are completed or for periodic maintenance. Before adjustments are made, the -hp-3561A must have a 15 minute warm-up and the line voltage should be $\pm 5\%$ -10% of nominal. The adjustment procedures are listed in the order in which they should be performed. This order must be followed since certain adjustment results are measured by the -hp-3561A itself.

3-2 SAFETY CONSIDERATIONS

Although the -hp-3561A has been designed in accordance with international safety standards, this manual contains information, cautions, and warnings which must be followed to ensure safe operation and to keep the unit in safe condition. Service and adjustments should be performed only by qualified personnel who are aware of the hazards involved.

WARNING

Any interruption of the protective (grounding) conductor inside or outside the unit, or disconnection of the protective earth terminal is likely to make the unit hazardous. Capacitors inside the -hp-3561A may still be charged even though the -hp-3561A has been removed from the mains supply.

Only fuses with the required rated current and specified type should be used for replacement. The use of repaired fuses and short circuiting of fuse holders is not permitted. Whenever it is likely that the protection offered by the fuse has been impaired, the -hp-3561A must be made inoperative and secured against any unintended operation.

Adjustments described in this section are performed with the protective covers removed and the power applied. Energy available at many points can, if contacted, result in serious personal injury.

3-3 EQUIPMENT REQUIRED

The test equipment required to adjust the -hp-3561A is listed in Table 1-5, Recommended Test Equipment. The test equipment needed for the adjustment of each particular assembly is also listed at the beginning of the adjustment procedure for that assembly. If the recommended equipment is not available, a substitute which meets or exceeds the "Required Characteristics" given in Table 1-5 may be used.

3-4 ADJUSTMENT LOCATIONS

As an adjustment aid, locators for each assembly are given at the beginning of each of the assembly adjustment procedures. These locators are simplified illustrations of the assembly showing the location of the test points and adjustable components.

3-5 ADJUSTMENT SUMMARY



The -hp-3561A contains components which may be damaged as a result of static discharge. Remove circuit assemblies only at a static protected workstation.

The adjustments are listed in the order in which they should be performed. Any deviation from this order is not recommended. However, after an assembly repair, it is only necessary to adjust the repaired assembly.

Refer to Table 3-1 for the list of the adjustments. If any of the adjustment results are unattainable, refer to the troubleshooting section for that assembly.

Table 3-1 -hp-3561A List of Adjustments

Paragraph Number	Test Name
3-6	A71 Power Supply Low Line Detect Adjustment
3-7	A90 CRT Display Adjustment
3-8	A40 Reference Oscillator Adjustment
3-9	A15 Digitizer Assembly Adjustment
3-10	A10 Input Assembly Adjustment
3-11	A50 Local Oscillator/Noise Source Adjustment

3-6 A71 Power Supply Low Line Detect Adjustment Procedure

This adjustment sets the Low-Line sense trip point.

EQUIPMENT NEEDED

Variable ac Source

SETUP PROCEDURE

1. With the power removed, remove the top cover of the -hp-3561A.
2. Remove PC cover plate (cover plate behind the CRT) over the power supply assemblies by removing the four screws in the plate's corners.
3. Set the -hp-3561A input voltage selection switches located on the bottom side of the motherboard to the 100V position as shown in Figure 3-1.

Figure 3-1 100V Input Voltage Selection Switch Setting

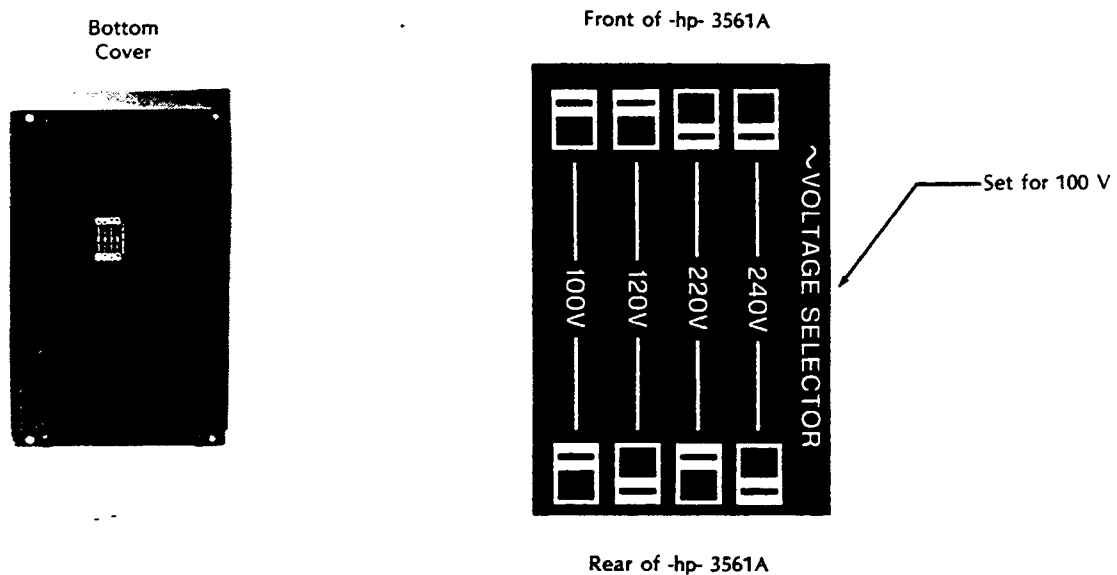

ADJUSTMENT PROCEDURE

1. Set the variable ac source to $100V \pm 4V$ and turn on the -hp-3561A.
2. Adjust A71R1 fully CCW. (See Figure 3-2)
3. Adjust the variable ac source down to $82V \pm 1V$.
4. Adjust A71R1 slowly CW just to the point where the -hp-3561A goes into its power-up reset routine.
5. Turn the power off and reset the -hp-3561A line voltage switches to the proper position.

This completes the A71 Power Supply adjustment.

ADJUSTMENT PROCEDURE

NOTE

Refer to Figure 3-3 for adjustment and test point locations.

WARNING

The following adjustments expose hazardous voltages!

1. With the power cord removed from the instrument, remove the top cover of the -hp-3561A by turning the four screws on the top cover one-quarter turn CCW. Also remove the long aluminum PC cover located on the right side of the instrument opposite the CRT.
2. Apply power to the -hp-3561A and move the A60J100 jumper from the Normal position to the FB (Full Bright) position as shown in the diagram in Figure 3-4. The CRT should now display a bright checkerboard pattern.

Figure 3-4 A60J100 Jumper Position

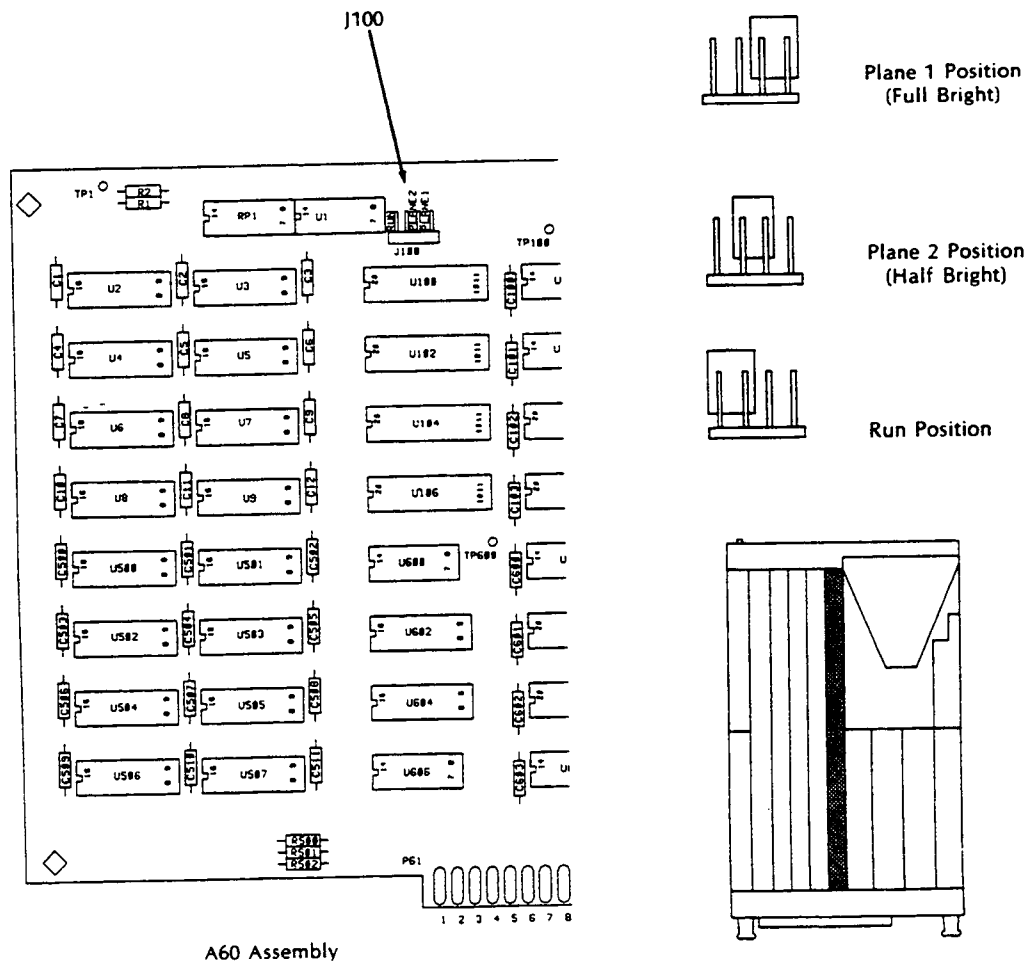

3. Adjust A90R200 "G1" until the CRT pattern is no longer visible.
4. Connect the HV Probe ground clip to A90 TP "GND" located directly above A90U1.
5. Using the HV Probe, measure the voltage at TP300 (or J300(10)). Adjust A90R300 "BRIGHT" for a reading of 400Vdc \pm 10V.
6. Readjust A90R200 "G1" fully CW and then CCW until the background raster just disappears. The checkerboard pattern should now be at its brightest level without "blooming" or fuzz at the edges.
7. Adjust A90R201 "FOCUS" for the best overall screen focus.
8. Move the A60J100 jumper back to the normal position (see Figure 3-4) and then press the front panel PRESET key.
9. Adjust A99L101 "VERTICAL SIZE" to align the soft key separator lines as shown in Figure 3-5. (Note: A99L101 is located on the A99 Assembly next to the flyback transformer.)

Figure 3-5 A99L101 Adjustment Reference (soft key separator alignment)

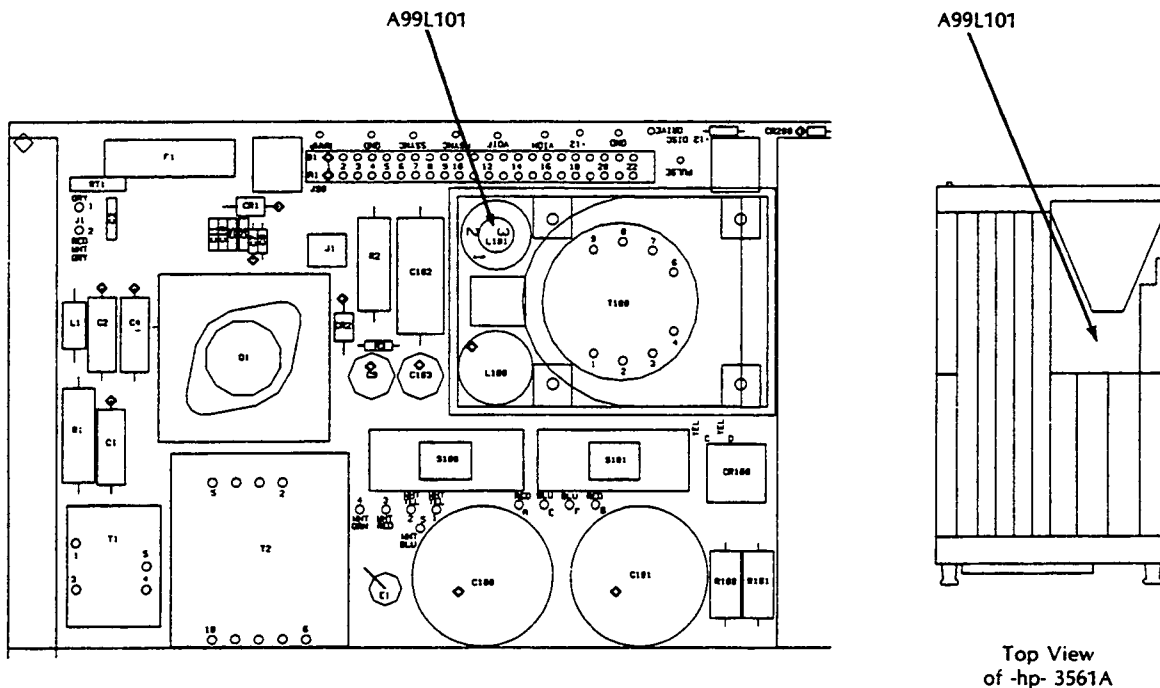

10. Place the -hp-3561A in test mode 50 by pressing the following keys:

```
MODE ..... TEST SELECT ..... 50 ENTER
                START SNGL TST
```

The CRT should now show the display alignment pattern shown in Figure 3-6.

11. Adjust A90R2 "WIDTH" until the width of the alignment pattern is approximately 3.8 inches (97mm). Refer to Figure 3-6 for the alignment example.

Figure 3-6 Display Alignment Pattern

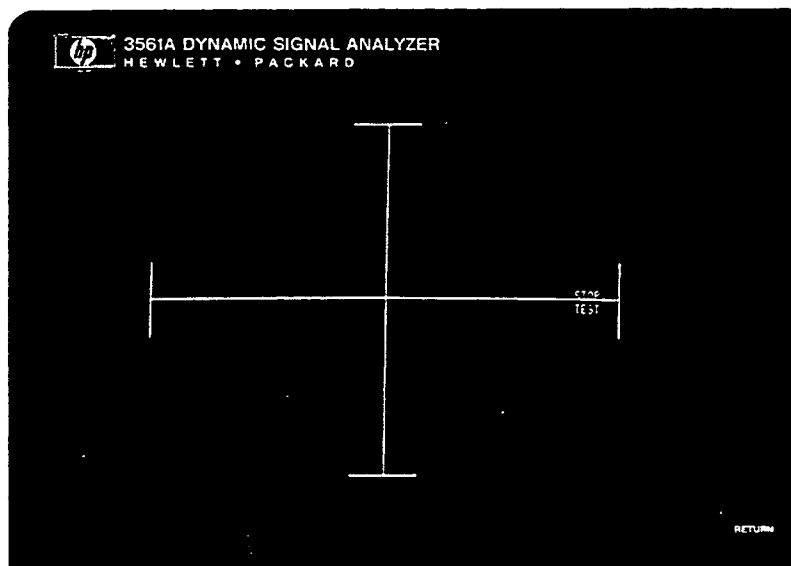

12. Adjust A90R1 "LEFT EDGE" to center the alignment pattern in the CRTK display. Refer to Figure 3-6 for the alignment example.
13. Press the soft key STOP TEST.
14. Press the front panel PRESET key.
15. Adjust A90R100 "HALF BRIGHT" for a comfortable viewing contrast between half bright and full bright characters on the display.
16. Readjust A90R201 "FOCUS" if necessary.
17. Repeat steps 7 through 16 to "fine tune" the display alignment.
This completes the adjustments for the CRT display.

3-8 A40 Reference Oscillator Adjustment Procedure

This adjustment sets the frequency of the -hp-3561A's reference oscillator.

EQUIPMENT NEEDED

Frequency Synthesizer-hp-3325A

Figure 3-7 A40 Adjustment Locator

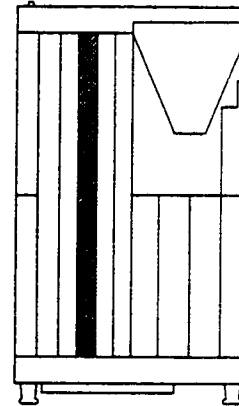
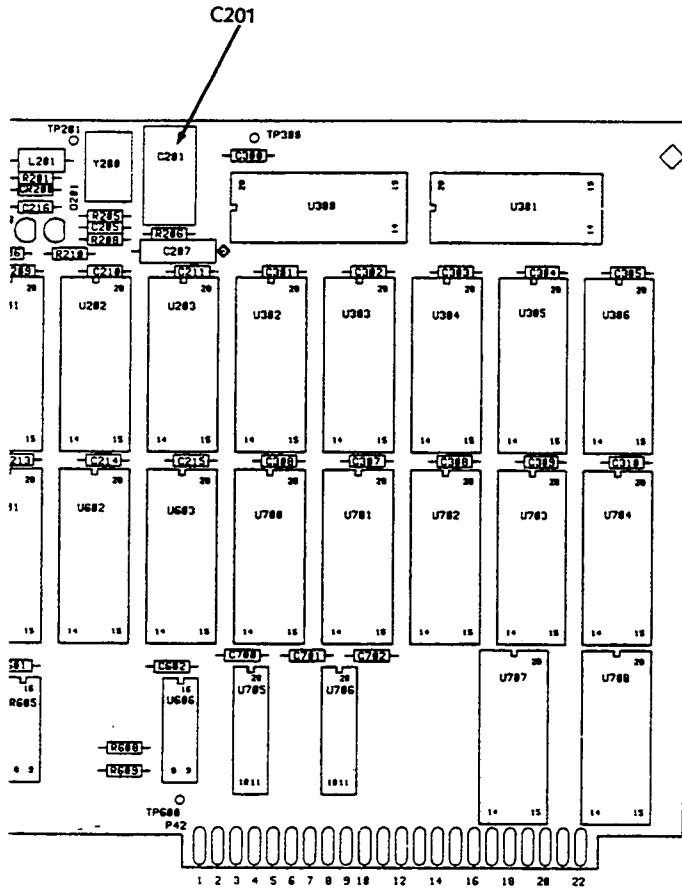

ADJUSTMENT PROCEDURE

1. Set the frequency synthesizer to 99 kHz at an amplitude of 1Vrms.
2. Connect the output of the frequency synthesizer to the front panel input of the -hp-3561A.
3. Press the following -hp-3561A front panel keys:

```

FORMAT ..... SINGLE
FREquency ..... DEFINE CENTER..... 99 kHz
                   DEFINE SPAN ..... 5 kHz
WINDOW ..... UNIFORM
  
```

4. A measurement will be made and displayed on the CRT.
5. Adjust A40C201 for minimum skirt width as shown in Figure 3-8.

Figure 3-8 Correctly and Incorrectly Adjusted A40C201

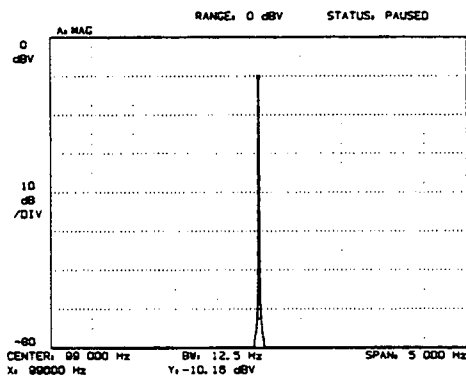

**A40C201
Correctly Adjusted
for a minimum
width skirt**

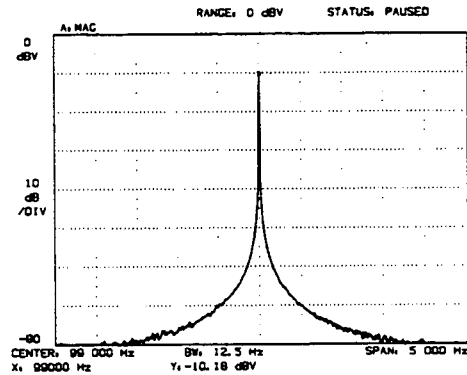

**A40C201
Incorrectly
Adjusted**

3-9 A15 Digitizer Assembly Adjustment Procedure

Figure 3-9 Digitizer Adjustment Setup

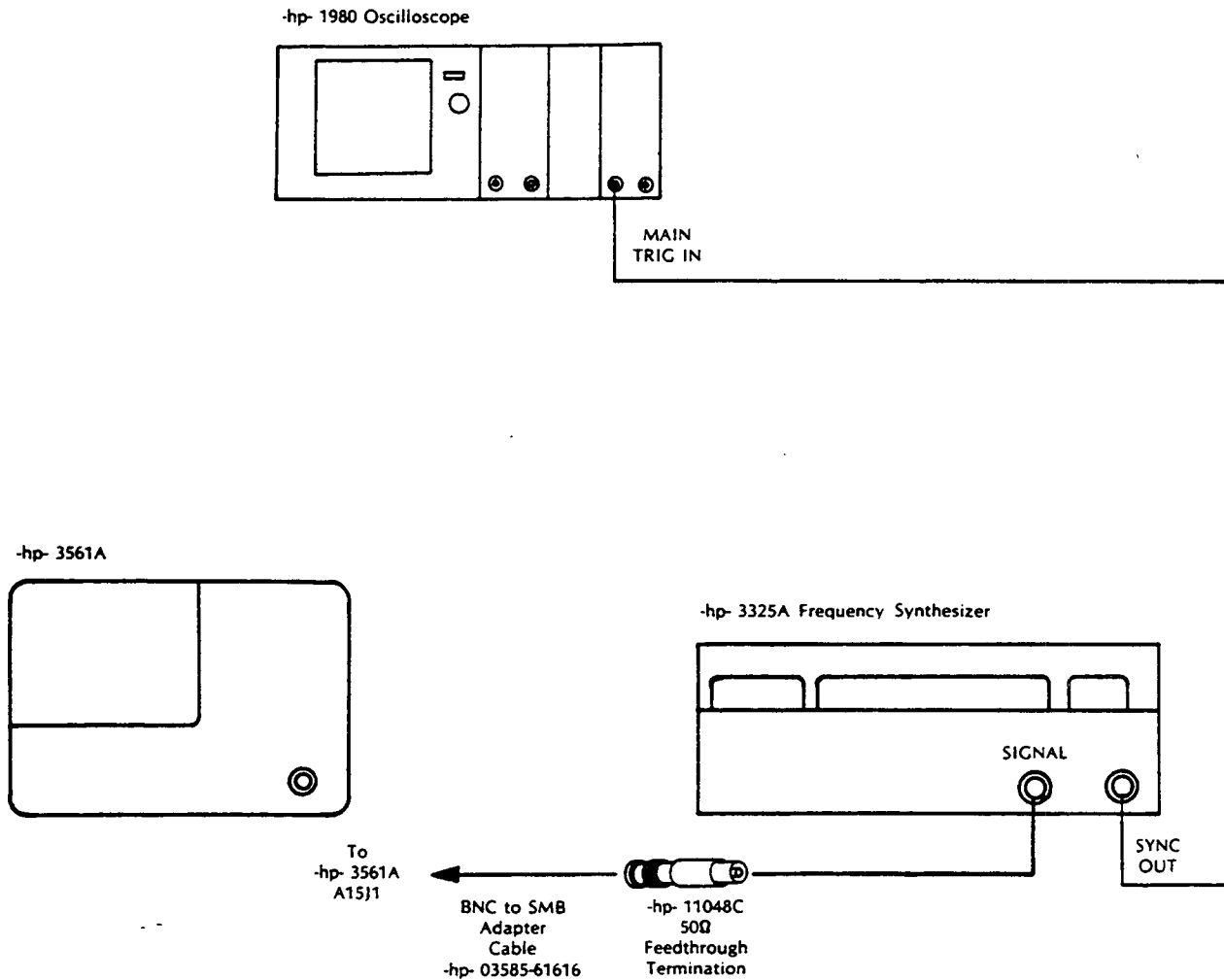

The A15 adjustment procedure assumes all the -hp-3561A assemblies are installed and functional. To perform the adjustments, the top cover of the -hp-3561A must be removed. The long cover plate over the PC assemblies in the right side of the instrument (opposite the CRT) must also be removed by unscrewing the four pan-head screws (two on each end of the plate).

SECOND GAIN ADJUSTMENT

Refer to the test setup shown in Figure 3-9 and follow the directions below.

1. Connect the "SYNC OUT" of the frequency synthesizer to the "MAIN TRIG IN" input of the oscilloscope and set the oscilloscope to the External Trigger mode.
2. Remove the coax cable (W15) from A15J1.
3. Connect the SIGNAL output of the frequency synthesizer to A15J1 using the adapter cable -hp- PN 03585-61616 and a 50 Ω load.
4. Set the frequency synthesizer output waveform to triangle with a frequency of 200 Hz and an amplitude of 10mVrms.
5. Program the -hp-3561A for an input RANGE of 0 dBV and the AUTO-RANGE function to OFF.
6. Place the -hp-3561A into test mode 114 by pressing the following keys in the following order:

```
MODE ..... TEST SELECT ..... 114 ENTER
                START SNGL TST
```

The display of the -hp-3561A should indicate that test 114 is complete. At this time, the -hp-3561A is programmed properly and the rest of the adjustment may be performed. If the display does not indicate that test 114 is complete, repeat step 6.

7. Set the oscilloscope sensitivity to 5.0mV/Div. and the time base to 1.0mS/Div.
8. Connect the oscilloscope probe to A15 TP "2ND GAIN" which is located next to resistor R105. Connect the probe ground clip to the A15 "1 GND" TP which is located in the upper-right corner of the A15 assembly next to regulator U201. Refer to Figure 3-10 for TP and adjustment locations.
9. Adjust A15R115 2ND GAIN for a flat waveform on the oscilloscope as seen in the left photo of Figure 3-11.

Figure 3-11 Correctly and Incorrectly Adjusted R115

Correctly adjusted R115

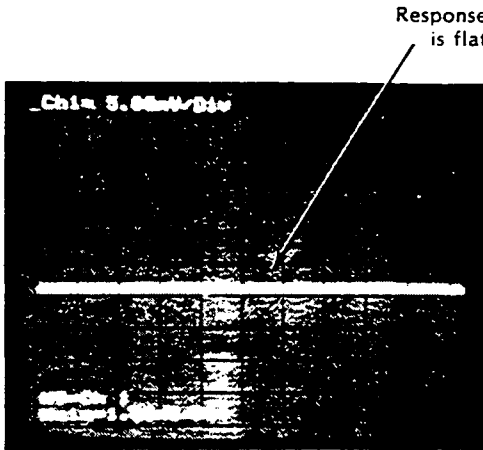

Incorrectly adjusted R115

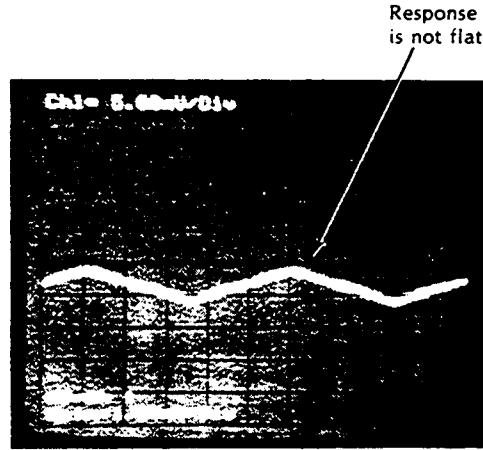

Probe: 10:1
 Ch1: Connection - A15 TP "2ND GAIN"
 Coupling - dc
 Ground - Center Graticule

Trigger: Internal - Ch1
 Slope - Positive

Bandwidth Limit: OFF

FIRST PASS ADJUSTMENT PROCEDURE

Use the test equipment interconnect setup as shown in Figure 3-9 and follow steps 1 and 2 of the Second Gain Adjustment procedure when connecting the equipment.

1. Set the frequency synthesizer output waveform to triangle with a frequency of 200 Hz and an amplitude of 200mVrms.
2. Connect the oscilloscope probe to A15 TP"ADC IN" located below IC U204. Connect the ground clip to the A15 "I GND" TP located in the upper-right corner of the A15 assembly near regulator U201.
3. Program the -hp-3561A for an input RANGE of 0dBV with the Auto-Range function to OFF.
4. Program the -hp-3561A for the INPUT AUTO-CAL off.
5. Place the 3561A into Test Mode 111 by pressing the following keys in the following order:

MODE TEST SELECT 111 ENTER
 START SNGL TST

6. Set the oscilloscope sensitivity to 10mV/Div and the time base to 1.0mS/Div.
7. Adjust R201 "REF" for a flat response as shown in the left photo of Figure 3-12.

Figure 3-12 Correctly and Incorrectly Adjusted R201 "REF"

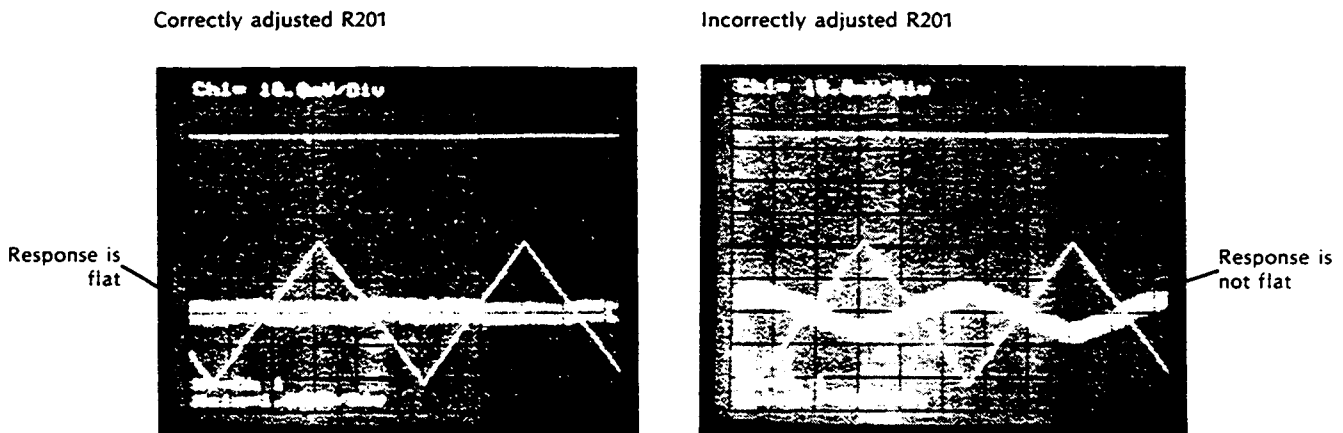

Probe: 10:1
 CH1: Connection - TP ADC IN
 Coupling - dc
 Ground - Center Graticule
 Trigger: Internal - Ch1
 Slope - Positive
 Bandwidth Limit: OFF

8. Adjust R200 "FP ZERO" to center the flat response waveform within the triangle wave as shown in the left photo of Figure 3-13.

Figure 3-13 Correctly and Incorrectly Adjusted R200

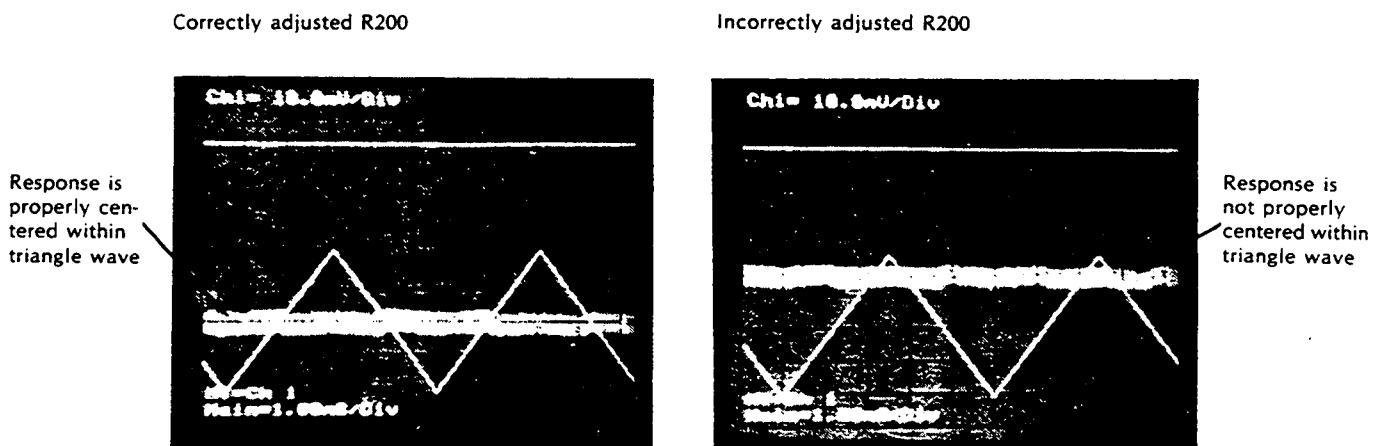

Probe: 10:1
 CH1: Connection - TP ADC IN
 Coupling - dc
 Ground - Center Graticule
 Trigger: Internal - Ch1
 Slope - Positive
 Bandwidth Limit: OFF

DC OFFSET ADJUSTMENT

The DC Offset Adjustment does not require the use of any test equipment. Adjustment is made using the -hp-3561A CRT in the PRESET state.

1. Remove the coax cable (W15) from A15J1.
Short A15J1 using a test lead or shorting connector.
2. Press the PRESET key on the front panel of the -hp-3561A.
3. Press the following keys on the -hp-3561A front panel:

FORMAT SINGLE
4. Adjust A15 R202 for a minimum peak at the dc (left-most) point of the -hp-3561A CRT display. Refer to the left waveform in Figure 3-14 for the properly adjusted response.
5. Remove the short from A15J1 and replace the coax cable coming from the A10 Assembly.

Figure 3-14 A15 R202 DC Offset Adjustment

Correctly adjusted R202

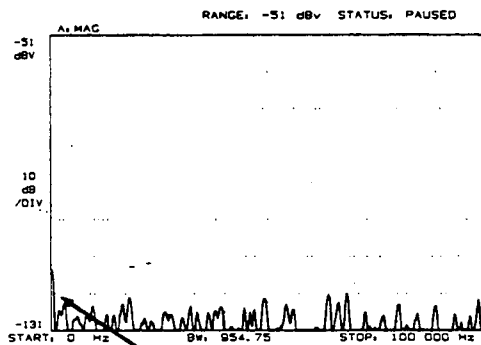

Minimum DC response

Incorrectly adjusted R202

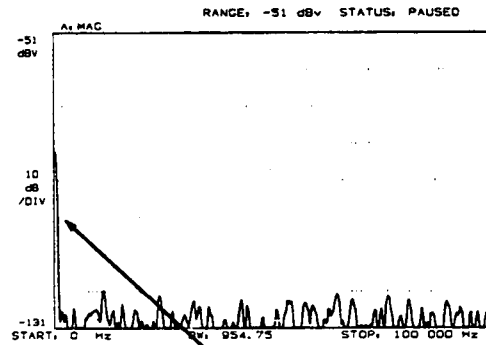

DC response out of adjustment

3-10 A10 Input Assembly Adjustment Procedure

There are five adjustments on the A10 Input Assembly: Zero, Amplitude, 20dB Attenuator flatness, 40dB Attenuator flatness and A-Weight Filter.

EQUIPMENT NEEDED

AC Calibrator	Fluke 5200A
Frequency Synthesizer	-hp- 3325A
Extender Board	-hp- 03561-66595
Adjustment Tool 0.1in hex	-hp- 8710-1388
BNC to J cable adapter	-hp- 03585-61616

Figure 3-15 A10 Assembly Adjustment Locations

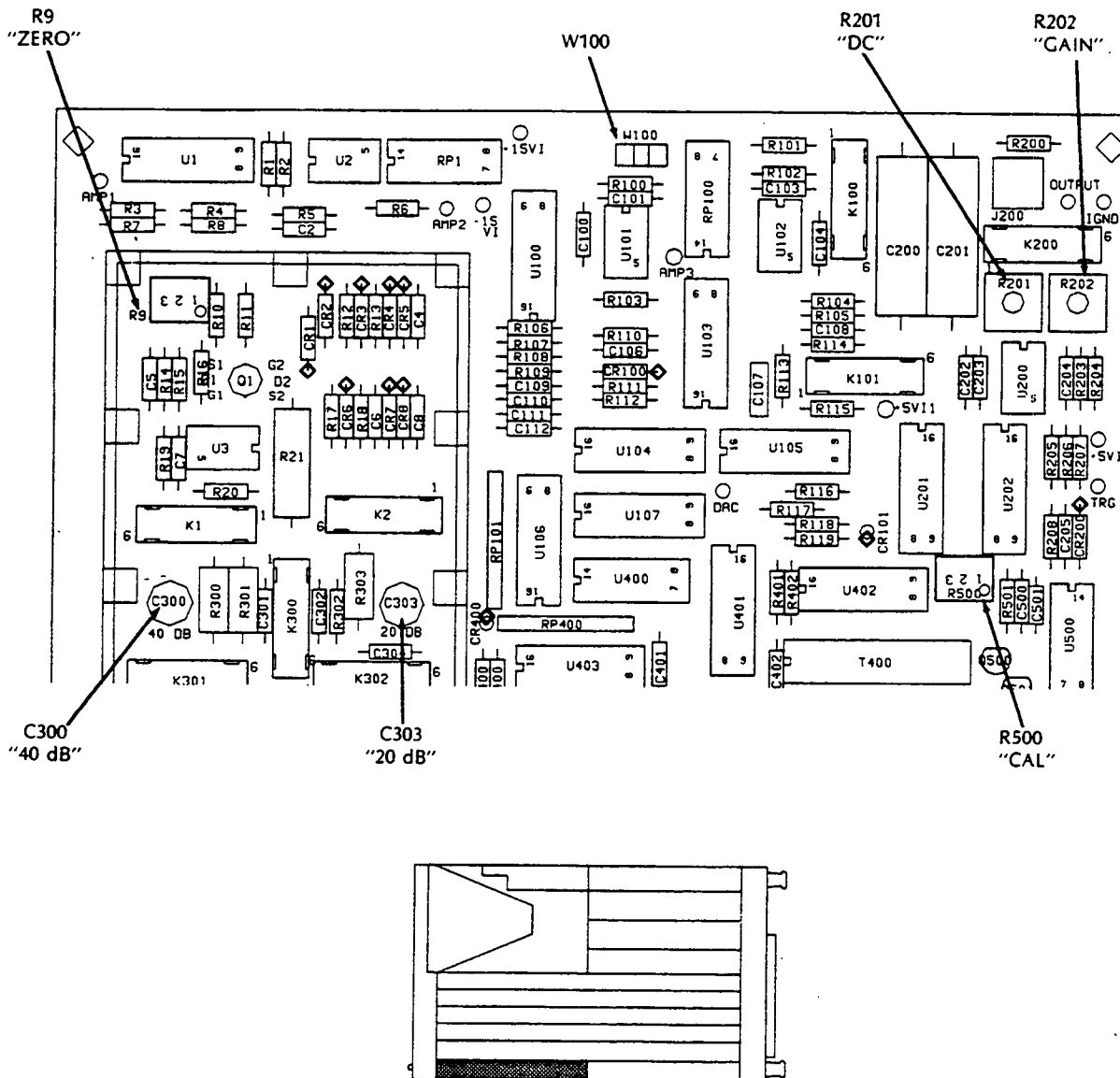

SETUP PROCEDURE

1. With the power cord removed from the instrument, remove the top and bottom covers from the -hp-3561A by turning the four screws of each cover CCW.
2. Carefully remove the input cable coming in at the lower left of the A10 Input Assembly by pulling it straight out toward the front of the instrument.
3. Remove the A10 assembly and reinsert into the instrument on an extender board.
4. Connect the BNC to J cable to A10J300 (located in the lower-left corner of the A10 assembly).

ZERO ADJUSTMENT PROCEDURE

This adjustment does not require the use of external equipment.

1. Disconnect any signal going into the A10 assembly.
2. Move the A10W100 jumper from the N (normal) position to the T (test) position. This jumper is located in the top center of the A10 assembly. (Refer to Figure 3-15)
3. Press the -hp-3561A PRESET key. The CRT will show both a MAG and TIME display. The 0Hz (dc) portion of the MAG display should be greater than 35dB down from full scale as shown in the left diagram of Figure 3-16.
4. Adjust A10R9 "ZERO" for the minimum response at 0 Hz (dc).
5. Move the Jumper A10W100 back to the N position.

Figure 3-16 Response Of A10 ZERO Adjustment

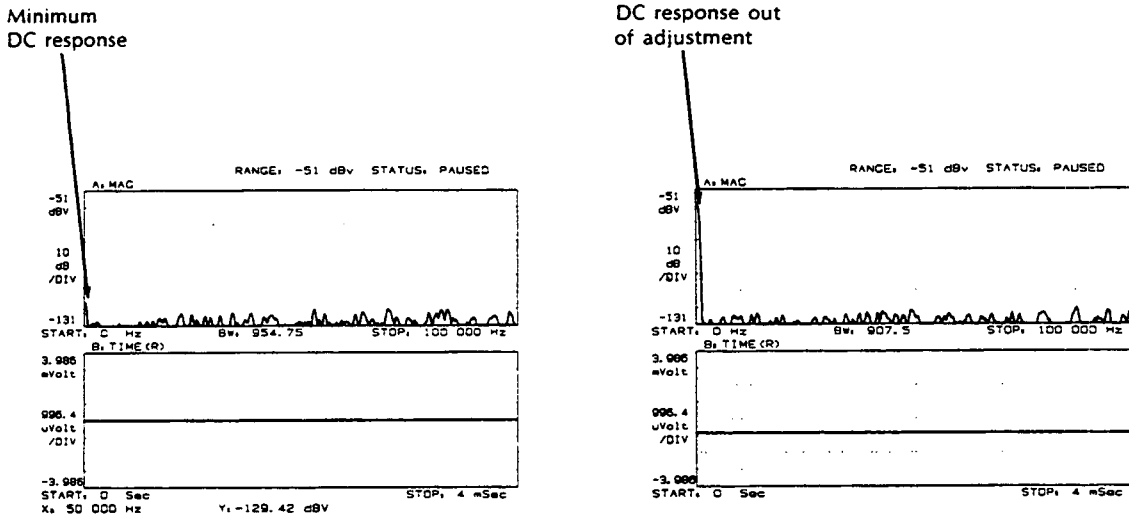

AMPLITUDE ADJUSTMENT PROCEDURE

1. Connect the frequency synthesizer signal output to the Fluke 5200A PHASE LOCK (located on the rear panel).
2. Connect the Fluke 5200A front panel output to the BNC adapter cable going to A10J300.
3. Set the output of the synthesizer to 1 kHz at 2.0Vrms.
4. Set the Fluke 5200A AC Calibrator front panel controls as follows:

VOLTAGE RANGE	1.0V
VOLTAGE ERROR	OFF
FREQUENCY RANGE	10k
VOLTAGE	200mV
FREQUENCY	1.000kHz
CONTROL	LOCAL
PHASE LOCK	ON
SENSE	INT
MODE	OPERate

5. Press the following front panel keys:

```

PRESET
MODE ..... TEST SELECT ..... 52 ENTER
                START CONT TST
    
```

The CRT will display the instructions to input a sinewave signal of 1 kHz at 200mVrms.

6. Input the 1 kHz signal to the A10 assembly and press the menu key "CONTINUE".
The CRT will display "Calibration deviation = value" where value is the numerical amount of error in the amplitude adjustment.
7. Adjust A10R500 "CAL" until the value of the error is equal to $0.00 \pm .05$.
When the adjustment is finished, press the menu key STOP TEST.

20dB ATTENUATOR FLATNESS ADJUSTMENT PROCEDURE

This adjustment does not require the use of external equipment.

1. Press the following keys on the -hp-3561A front panel:

```

PRESET
MODE ..... TEST SELECT ..... 53 ENTER
                START CONT TST
    
```

The -hp-3561A CRT should display "TEST # 53 IN PROGRESS" and "Calibration deviation = value" where value is the numerical amount of error in the adjustment of the 20dB attenuator circuit.

2. Adjust A10C303 until the value of the error is equal to $0.00 \pm .05$.
When the adjustment is finished, press the menu key STOP TEST.

40dB ATTENUATOR FLATNESS ADJUSTMENT PROCEDURE

This adjustment procedure does not require the use of external equipment.

1. Press the following keys on the -hp-3561A front panel:

```

PRESET
MODE ..... TEST SELECT ..... 54 ENTER
                START CONT TST
    
```

The -hp-3561A CRT should display "TEST # 54 IN PROGRESS" and "Calibration deviation = value" where value is the numerical amount of error in the adjustment of the 40dB attenuator circuit.

- Adjust A10C300 until the value of the error is equal to $0.00 \pm .05$.
When the adjustment is finished, press the menu key STOP TEST.

A-WEIGHT FILTER ADJUSTMENT PROCEDURE

EQUIPMENT NEEDED

Frequency Synthesizer-hp-3325A

ADJUSTMENT PROCEDURE

- Press the following keys on the -hp-3561A front panel:

```
PRESET
INPUT..... A WT FLT
                ON OFF
```

This should turn the A-Weight Filter on.

- Connect a 50Ω load to the A10 input cable and adjust A10R201 for a minimum 0Hz response as shown in the left diagram of Figure 3-16.
- Connect the frequency synthesizer to the input cable of the A10 Assembly and set as follows:

```
FREQUENCY ..... 2.5 kHz
FUNCTION ..... SINE
AMPLITUDE ..... 1.0Vrms
```

- Press the following keys on the -hp-3561A front panel:

```
PRESET
MKR ..... DEFINE MKR POS ..... 2.5 kHz
INPUT..... A WT FLT
                ON OFF
```

The -hp-3561A should now be making baseband measurements of the 2.5 kHz input signal with the Y-MARKER and the A-Weight Filter turned on.

- Adjust A10R202 "GAIN" for a Y-MARKER reading of $+1.3\text{dBV} \pm .02\text{dB}$ as indicated by the left diagram in Figure 3-17.

Figure 3-17 Response Of A10 A-Weight Filter Adjustment

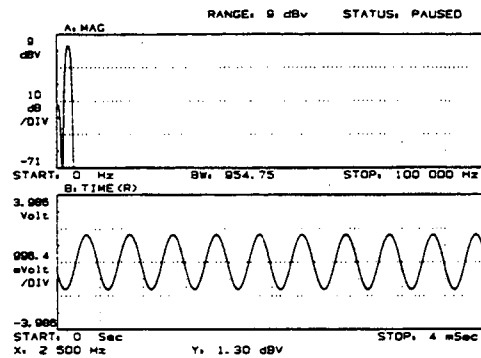

Y-MARKER properly
adjusted to +1.30 dBV

3-11 A50 Local Oscillator/Noise Source Adjustment Procedure

This adjustment does not require the use of external equipment.

SETUP PROCEDURE

Connect the -hp-3561A rear panel noise source output to the front panel input BNC using a 50Ω load.

ADJUSTMENT PROCEDURE

1. Press the following -hp-3561A front panel keys:

```

PRESET
WINDOW ..... UNIFORM
FREQuency ..... DEFINE SPAN ..... 25 kHz
MarKeR ..... DEFINE MKR POS ..... 12.5 kHz
SOURCE ..... PERIODIC NOISE
                DEFINE ATTN ..... 0 dB
    
```

2. Adjust A50R400 until the Y-MARKER reads -28.9dBV \pm .04dBV as shown in Figure 3-19.

Figure 3-19 A50R400 Adjustment Reference

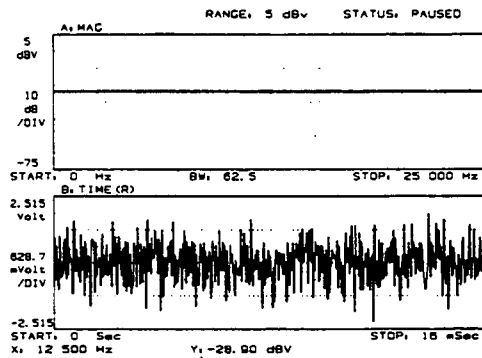

Y-MARKER properly
adjusted to -28.90 dBV

SECTION IV
REPLACEABLE PARTS

Paragraph	Title	Page
4-1	INTRODUCTION	4-1
4-2	STANDARD ABBREVIATIONS	4-1
4-3	ORDERING INFORMATION	4-2
4-4	MANUFACTURER'S CODE LIST	4-2
4-5	REPLACEABLE PARTS LIST	4-2
4-6	DIRECT MAIL ORDER SYSTEM	4-4

SECTION IV REPLACEABLE PARTS

4-1 INTRODUCTION

This section of the manual contains information for ordering replaceable parts for the -hp-3561A. Table 4-1 lists standard abbreviations used in the parts list. Table 4-2 is a listing of all the replaceable parts in order of reference designator. Table 4-3 lists the names and addresses which correspond to the manufacturer's code numbers.

4-2 STANDARD ABBREVIATIONS

The standard abbreviations used in the parts list and throughout the manual are listed in Table 4-1. In some cases, two forms of an abbreviation are used, one in all CAPITAL letters and one in partial or no capital letters. Abbreviations in the parts list are given in all capital letters, on the schematics and in other parts of the manual abbreviations may be given in either lower case or capital letters.

Table 4-1 Reference Designations and Abbreviations

		ABBREVIATIONS					
Ag	silver	Hz	hertz (cycles) per second)	NPO	negative positive zero (zero temperature coefficient)	sl	slide
Al	aluminum	ID	inside diameter	ns	nanosecond(s) = 10 ⁻⁹ seconds	SPDT	single-pole double-throw
A	ampere(s)	img	impregnated	nsr	not separately replaceable	SPST	single-pole single-throw
Au	gold	incd	incandescent	Ω	ohm(s)	Ta	tantalum
C	capacitor	ins	insulation(s)	Ω	order by description	TC	temperature coefficient
car	ceramic	kΩ	kiloohm(s) = 10 ⁻³ ohms	obd	outside diameter	TiO ₂	titanium dioxide
coef	coefficient	kMHz	kiloherzt = 10 ⁻³ hertz	OD	outside diameter	tol	tolerance
com	common	L	inductor	p	peak	tol	tolerance
conn	connection	ln	linear taper	pA	picoampere(s)	trim	trimmer
dep	deposited	log	logarithmic taper	PC	printed circuit	TSTR	transistor
DPDT	double-pole double-throw	mA	milliampere(s) = 10 ⁻³ amperes	pF	picofarad(s) 10 ⁻¹² farads	V	volt(s)
DPST	double-pole single-throw	MHZ	megahertz = 10 ⁻⁶ hertz	pV	peak inverse voltage	vacw	alternating current working voltage
elect	electrolytic	MΩ	megohm(s) = 10 ⁻⁶ ohms	p/p	part of	var	variable
encap	encapsulated	met fm	metal film	pos	position(s)	vdcw	direct current working voltage
F	farad(s)	mfr	manufacturer	pot	potentiometer	W	watt(s)
FET	field effect transistor	ms	millisecond	p-p	peak-to-peak	w/	with
fsd	fixed	mg	mounting	ppm	parts per million	ww	working reverse voltage
GeAs	gallium arsenide	mV	millivolt(s) = 10 ⁻³ volts	prec	precision (temperature coefficient, long term stability and/or tolerance)	w/o	without
GHz	gigahertz = 10 ⁻⁹ hertz	μF	microfarad(s)	R	resistor	ww	wirewound
gd	guarded	as	microsecond(s)	Rh	rhodium		
Ge	germanium	μV	microvolt(s) = 10 ⁻⁶ volts	rms	root-mean-square		
gnd	grounded	mv	millivolt(s)	rot	rotary		
H	henry(ies)	nA	nanoampere(s) = 10 ⁻⁹ amperes	Se	selenium		
Mg	mercury	NC	normally closed	sect	section(s)		
		Ne	neon	sec	section(s)		
		NO	normally open	Si	silicon		
							Ⓢ optimum value selected at factory, average value shown (part may be omitted) no standard type number assigned selected or special type
							Ⓢ Dupont de Nemours
		OPERATORS					
A	assembly	FL	filter	Q	transistor	TS	terminal strip
B	motor	HR	heater	QCR	transistor/diode	U	microcircuit
BT	battery	IC	integrated circuit	R(p)	resistor(pack)	V	vacuum tube, neon bulb, photocell, etc
C	capacitor	J	jack	RT	thermistor	W	wire
CR	diode or thyristor	K	relay	S	switch	X	socket
DL	delay line	L	inductor	T	transformer	XDS	lampholder
DS	lamp	M	meter	TB	terminal board	XF	fuseholder
E	misc electronic part	MP	mechanical part	TC	thermocouple	Y	crystal
F	fuse	P	plug	TP	test point	Z	network

4-3 ORDERING INFORMATION

To order a part listed in Table 4-3, quote the Hewlett-Packard part number (with the check digit) and indicate the quantity required. To order a part not listed in Table 4-3, include the instrument Model Number (-hp-3561A), the instrument serial number, a description and function of the part, and the quantity of the part required. Address the order to the nearest Hewlett-Packard office (office locations are listed at the back of this manual).

4-4 MANUFACTURER'S CODE LIST

The information given in the parts list includes the manufacturer's code and part number. Table 4-2 contains the names and addresses which correspond with the manufacturer's code number.

Table 4-2 Manufacturer's Code List

Mfr No.	Manufacturer Name	Address
01121	Allen-Bradley Co	Milwaukee WI 53204
01295	Texas Instr Inc Semicond Cmpnt Div	Dallas TX 75222
0192B	RCA Corp Solid State Div	Somerville NJ 08876
03888	KDI Pyrofilm Corp	Whippany NJ 07981
04713	Motorola Semiconductor Products	Phoenix AZ 85062
07263	Fairchild Semiconductor Div	Mountain View CA 94042
13606	Sprague Elect Co Semiconductor Div	Concord NH 03301
17856	Siliconix Inc	Santa Clara CA 95054
18324	Signetics Corp	Sunnyvale CA 94086
19701	Mepco/Electra Corp	Mineral Wells TX 76067
20932	Emcon Div Itw	San Diego CA 92129
24546	Corning Glass Works (Bradford)	Bradford PA 16701
27014	National Semiconductor Corp	Santa Clara CA 95051
28480	Hewlett-Packard Co Corporate Hq	Palo Alto CA 94304
51642	Centre Engineering Inc	State College PA 16801
56289	Sprague Electric Co	North Adams MA 02147
72136	Electro Motive Corp Sub IEC	Willimantic CT 06226
80103	Lambda Electronics Corp	Melville NY 11746

4-5 REPLACEABLE PARTS LIST

Table 4-3 is the list of replaceable parts in the -hp-3561A and is organized as follows:

- a. Electrical assemblies and their components are listed in numerical order.
- b. Chassis-mounted parts are listed in order of their reference designation.
- c. Miscellaneous parts.

The parts list contains seven columns. The descriptions for these columns are given below:

Column 1: Reference Designation

This is the reference designation of the part. It is a two part number. The first part identifies the assembly on which the component is located. The second part identifies the component type and location as it is mounted on the PC assembly. For example: component A10R101 is on the A10 Assembly, it is a resistor, and it is the upper-left resistor located in quadrant 100.

Column 2: HP Part Number

This is the Hewlett-Packard part number for the component.

Column 3: CD

This is the Check Digit for the Hewlett-Packard part number. It is an internal number used by Hewlett-Packard to verify the validity of the part number.

Column 4: Qty

This is the total quantity of that part used on the assembly. The total quantity for each part is given only once per assembly at the first appearance of the part number in the assembly parts list.

Column 5: Description

This is a description of the part sometimes including color, power rating, value, etc.

Column 6: Mfr Code

This is a Hewlett-Packard internal code number assigned to the various manufacturing vendors. Table 4-3 lists the name and address of the manufacturers along with their Mfr. Code number.

Column 7: Mfr Part Number

This is the part number assigned to the part by the manufacturer.

4-6 DIRECT MAIL ORDER SYSTEM

Within the USA, Hewlett-Packard can supply parts through a direct mail order system. Advantages of using the system are:

- a. Direct ordering and shipment from the HP Parts Center in Mountain View, California.
- b. No maximum or minimum on any mail order (there is a minimum order amount for parts ordered through a local HP office when the order requires billing and invoicing).
- c. Prepaid transportation (there is a small handling charge for each order).
- d. No invoices — to provide these advantages, a check or money order must accompany each order.

Mail order forms and specific ordering information are available through your local HP office. The addresses and phone numbers of the offices are located at the back of this manual.

Table 4-3 Replaceable Parts

Reference Designation	HP Part Number	C D	Qty	Description	Mfr Code	Mfr Part Number
A10	03561-66510	5	1	INPUT AMPLIFIER ASSEMBLY (REVISION B)	28480	03561-66510
A10C002	0160-4571	B	21	CAPACITOR-FXD .1UF +80-20% 50VDC CER	28480	0160-4571
A10C004	0160-4571	B		CAPACITOR-FXD .1UF +80-20% 50VDC CER	28480	0160-4571
A10C005	0160-4532	1	1	CAPACITOR-FXD 1000PF +-20% 50VDC CER	28480	0160-4532
A10C006	0160-4571	B		CAPACITOR-FXD .1UF +80-20% 50VDC CER	28480	0160-4571
A10C007	0160-4792	B		CAPACITOR-FXD 8.2pf	28480	0160-4792
A10C008	0160-4811	B		CAPACITOR-FXD 270pf	28480	0160-4811
A10C100	0160-4571	B		CAPACITOR-FXD .1UF +80-20% 50VDC CER	28480	0160-4571
A10C101	0160-4571	B		CAPACITOR-FXD .1UF +80-20% 50VDC CER	28480	0160-4571
A10C103	0160-4571	B		CAPACITOR-FXD .1UF +80-20% 50VDC CER	28480	0160-4571
A10C104	0160-4571	B		CAPACITOR-FXD .1UF +80-20% 50VDC CER	28480	0160-4571
A10C106	0160-4571	B	1	CAPACITOR-FXD .1UF +80-20% 50VDC CER	28480	0160-4571
A10C107	0160-4953	B		CAPACITOR-FXD .027UF +-5% 50VDC CER	28480	0160-4953
A10C108	0160-4089	3	1	CAPACITOR-FXD 2200PF +-1% 500VDC MICA	28480	0160-4089
A10C109	0160-4571	B		CAPACITOR-FXD .1UF +80-20% 50VDC CER	28480	0160-4571
A10C110	0160-4571	B		CAPACITOR-FXD .1UF +80-20% 50VDC CER	28480	0160-4571
A10C111	0160-4571	B		CAPACITOR-FXD .1UF +80-20% 50VDC CER	28480	0160-4571
A10C112	0160-4801	7	2	CAPACITOR-FXD 100PF +-5% 100VDC CER	28480	0160-4801
A10C200	0170-0042	1	3	CAPACITOR-FXD .33UF +-5% 100VDC POLYE	99515	E1-3340
A10C201	0170-0042	1		CAPACITOR-FXD .33UF +-5% 100VDC POLYE	99515	E1-3340
A10C202	0160-4571	B		CAPACITOR-FXD .1UF +80-20% 50VDC CER	28480	0160-4571
A10C203	0160-4801	7		CAPACITOR-FXD 100PF +-5% 100VDC CER	28480	0160-4801
A10C204	0160-4571	B		CAPACITOR-FXD .1UF +80-20% 50VDC CER	28480	0160-4571
A10C205	0160-4571	B		CAPACITOR-FXD .1UF +80-20% 50VDC CER	28480	0160-4571
A10C300	0121-0536	5	2	CAPACITOR-V TRMR-PSTN 1-5.5PF 250V	28480	0121-0536
A10C301	0160-2207	3	1	CAPACITOR-FXD 300PF +-5% 300VDC MICA	28480	0160-2207
A10C302	0160-4796	9	2	CAPACITOR-FXD 3.9PF +-25PF 100VDC CER	28480	0160-4796
A10C303	0121-0536	5		CAPACITOR-V TRMR-PSTN 1-5.5PF 250V	28480	0121-0536
A10C304	0160-4796	9		CAPACITOR-FXD 3.9PF +-25PF 100VDC CER	28480	0160-4796
A10C305	0160-4798	1	1	CAPACITOR-FXD 2.7PF +-25PF 100VDC CER	28480	0160-4798
A10C306	0160-4571	B		CAPACITOR-FXD .1UF +80-20% 50VDC CER	28480	0160-4571
A10C307	0170-0042	1		CAPACITOR-FXD .33UF +-5% 100VDC POLYE	99515	E1-3340
A10C308	0180-0116	1	1	CAPACITOR-FXD 6.8UF+-10% 35VDC TA	56289	150D685X9035R2
A10C400	0160-3847	9	12	CAPACITOR-FXD .01UF +100-0% 50VDC CER	28480	0160-3847
A10C401	0160-4571	B		CAPACITOR-FXD .1UF +80-20% 50VDC CER	28480	0160-4571
A10C402	0160-4571	B		CAPACITOR-FXD .1UF +80-20% 50VDC CER	28480	0160-4571
A10C404	0160-3847	9		CAPACITOR-FXD .01UF +100-0% 50VDC CER	28480	0160-3847
A10C405	0160-4571	B		CAPACITOR-FXD .1UF +80-20% 50VDC CER	28480	0160-4571
A10C406	0160-4811	9	4	CAPACITOR-FXD 270PF +-5% 100VDC CER	28480	0160-4811
A10C407	0160-4571	B		CAPACITOR-FXD .1UF +80-20% 50VDC CER	28480	0160-4571
A10C408	0160-4811	9		CAPACITOR-FXD 270PF +-5% 100VDC CER	28480	0160-4811
A10C409	0160-4571	B		CAPACITOR-FXD .1UF +80-20% 50VDC CER	28480	0160-4571
A10C410	0160-4811	9		CAPACITOR-FXD 270PF +-5% 100VDC CER	28480	0160-4811
A10C411	0160-4571	B		CAPACITOR-FXD .1UF +80-20% 50VDC CER	28480	0160-4571
A10C412	0160-4811	9		CAPACITOR-FXD 270PF +-5% 100VDC CER	28480	0160-4811
A10C413	0160-3847	9		CAPACITOR-FXD .01UF +100-0% 50VDC CER	28480	0160-3847
A10C414	0180-0228	6	1	CAPACITOR-FXD 22UF+-10% 35VDC TA	56209	150D226X9015R2
A10C415	0180-1794	3	2	CAPACITOR-FXD 22UF+-10% 35VDC TA	56289	150D226X9035R2
A10C416	0160-3847	9		CAPACITOR-FXD .01UF +100-0% 50VDC CER	28480	0160-3847
A10C417	0160-3847	9		CAPACITOR-FXD .01UF +100-0% 50VDC CER	28480	0160-3847
A10C418	0180-1794	3		CAPACITOR-FXD 22UF+-10% 35VDC TA	56289	150D226X9035R2
A10C500	0160-3847	9		CAPACITOR-FXD .01UF +100-0% 50VDC CER	28480	0160-3847
A10C501	0160-0127	2	3	CAPACITOR-FXD 1UF +-20% 25VDC CER	28480	0160-0127
A10C503	0160-0127	2		CAPACITOR-FXD 1UF +-20% 25VDC CER	28480	0160-0127
A10C505	0160-3847	9		CAPACITOR-FXD .01UF +100-0% 50VDC CER	28480	0160-3847
A10C506	0160-3847	9		CAPACITOR-FXD .01UF +100-0% 50VDC CER	28480	0160-3847
A10C507	0160-3847	9		CAPACITOR-FXD .01UF +100-0% 50VDC CER	28480	0160-3847
A10C508	0160-0127	2		CAPACITOR-FXD 1UF +-20% 25VDC CER	28480	0160-0127
A10C509	0180-2208	6	1	CAPACITOR-FXD 220UF+-10% 10VDC TA	56289	150D227X9010S2
A10C510	0160-0128	3	1	CAPACITOR-FXD 2.2UF +-20% 50VDC CER	28480	0160-0128
A10C511	0160-3847	9		CAPACITOR-FXD .01UF +100-0% 50VDC CER	28480	0160-3847
A10C512	0160-3847	9		CAPACITOR-FXD .01UF +100-0% 50VDC CER	28480	0160-3847
A10C513	0160-3847	9		CAPACITOR-FXD .01UF +100-0% 50VDC CER	28480	0160-3847
A10CR001	1901-0579	1	2	DIODE-SWITCHING 40V 20MA 300NS DO-7	28480	1901-0579
A10CR002	1901-0579	1		DIODE-SWITCHING 40V 20MA 300NS DO-7	28480	1901-0579
A10CR003	1901-0040	1	2	DIODE-SWITCHING 30V 50MA 2NS DO-35	28480	1901-0040
A10CR004	1902-0049	2	4	DIODE-ZNR 6.19V 5% DO-35 PD=.4W	28480	1902-0049
A10CR005	1902-0049	2		DIODE-ZNR 6.19V 5% DO-35 PD=.4W	28480	1902-0049
A10CR006	1901-0040	1		DIODE-SWITCHING 30V 50MA 2NS DO-35	28480	1901-0040
A10CR007	1902-0049	2		DIODE-ZNR 6.19V 5% DO-35 PD=.4W	28480	1902-0049
A10CR008	1902-0049	2		DIODE-ZNR 6.19V 5% DO-35 PD=.4W	28480	1902-0049
A10CR100	1902-0686	3	3	DIODE-ZNR 6.2V 2% DO-7 PD=.4W TC=+.002%	04713	1N825
A10CR101	1990-0486	6	2	LED-LAMP LUM-INT=1MCD IF=20MA-MAX RVR=5V	28480	5082-4684
A10CR200	1902-0686	3		DIODE-ZNR 6.2V 2% DO-7 PD=.4W TC=+.002%	04713	1N825
A10CR300	1902-0627	2	1	DIODE-CUR RGLTR 1N5312 100V DO-7	04713	1N5312
A10CR301	1901-0743	1	1	DIODE-PWR RECT 1N4004 400V 1A DO-41	01295	1N4004
A10CR400	1990-0486	6		LED-LAMP LUM-INT=1MCD IF=20MA-MAX RVR=5V	28480	5082-4684
A10CR401	1901-0050	3	2	DIODE-SWITCHING 80V 200MA 2NS DO-35	28480	1901-0050

See introduction to this section for ordering information
 *Indicates factory selected value

Table 4-3 Replaceable Parts (Cont'd)

Reference Designation	HP Part Number	C D	Qty	Description	Mfr Code	Mfr Part Number
A10CR500	1902-0686	3		DIODE-ZNR 6.2V 2% DO-7 PD=.4W TC=+.002%	04713	1NR25
A10CR501	1901-0050	3		DIODE-SWITCHING 80V 200MA 2NS DO-35	28480	1901-0050
A10K001	0490-1403	8	14	RELAY-REED 1A 500MA 200VDC 5VDC-COIL	28480	0490-1403
A10K002	0490-1403	8		RELAY-REED 1A 500MA 200VDC 5VDC-COIL	28480	0490-1403
A10K100	0490-1403	8		RELAY-REED 1A 500MA 200VDC 5VDC-COIL	28480	0490-1403
A10K101	0490-1403	8		RELAY-REED 1A 500MA 200VDC 5VDC-COIL	28480	0490-1403
A10K200	0490-1403	8		RELAY-REED 1A 500MA 200VDC 5VDC-COIL	28480	0490-1403
A10K300	0490-1403	8		RELAY-REED 1A 500MA 200VDC 5VDC-COIL	28480	0490-1403
A10K301	0490-1403	8		RELAY-REED 1A 500MA 200VDC 5VDC-COIL	28480	0490-1403
A10K302	0490-1403	8		RELAY-REED 1A 500MA 200VDC 5VDC-COIL	28480	0490-1403
A10K303	0490-1403	8		RELAY-REED 1A 500MA 200VDC 5VDC-COIL	28480	0490-1403
A10K304	0490-1403	8		RELAY-REED 1A 500MA 200VDC 5VDC-COIL	28480	0490-1403
A10K305	0490-1403	8		RELAY-REED 1A 500MA 200VDC 5VDC-COIL	28480	0490-1403
A10K306	0490-1403	8		RELAY-REED 1A 500MA 200VDC 5VDC-COIL	28480	0490-1403
A10K307	0490-1403	8		RELAY-REED 1A 500MA 200VDC 5VDC-COIL	28480	0490-1403
A10K308	0490-1403	8		RELAY-REED 1A 500MA 200VDC 5VDC-COIL	28480	0490-1403
A10L300	9140-0748	0	2	INDUCTOR 250UH 25% .25DX.5LG Q=3	28480	9140-0748
A10L400	9140-0740	0		INDUCTOR 250UH 25% .25DX.5LG Q=3	28480	9140-0748
A10L401	9140-0029	0	2	INDUCTOR RF-CH-MLD 100UH 10% .25DX.313LG	28480	9140-0029
A10L402	9140-0029	0		INDUCTOR RF-CH-MLD 100UH 10% .25DX.313LG	28480	9140-0029
A10L403	03561-60305	0		INDUCTOR 2 mH	28480	03561-60305
A10Q001	1855-0460	0	1	TRANSISTOR J-FET N-CHAN	28480	1855-0460
A10Q500	1854-0215	1	3	TRANSISTOR NPN SI PD=350MW FT=300MHZ	04713	2N3904
A10Q501	1854-0215	1		TRANSISTOR NPN SI PD=350MW FT=300MHZ	04713	2N3904
A10Q502	1854-0215	1		TRANSISTOR NPN SI PD=350MW FT=300MHZ	04713	2N3904
A10R001	0698-6634	1	2	RESISTOR 1.05K 1% .125W F TC=0+-25	28480	0698-6634
A10R002	0698-6624	5	5	RESISTOR 2K 1% .125W F TC=0+-25	28480	0698-6634
A10R003	0757-0416	7	1	RESISTOR 511 1% .125W F TC=0+-100	24546	C4-1/8-T0-511R-F
A10R004	0698-6362	0	1	RESISTOR 3K 1% .125W F TC=0+-25	28480	0698-6362
A10R005	0698-6362	8	5	RESISTOR 1K 1% .125W F TC=0+-25	28480	0698-6362
A10R006	0757-0280	3	3	RESISTOR 1K 1% .125W F TC=0+-100	24546	C4-1/8-T0-1001-F
A10R007	0698-3178	8	1	RESISTOR 487 1% .125W F TC=0+-100	24546	C4-1/8-T0-487R-F
A10R008	0698-6699	4	1	RESISTOR 127 .25% .125W F TC=0+-50	28480	0698-6699
A10R009	2100-3874	8	1	RESISTOR-TRMR 5K 10% C TOP-ADJ 17-TRN	28480	2100-3874
A10R010	0757-0457	6	2	RESISTOR 47.5K 1% .125W F TC=0+-100	24546	C4-1/8-T0-4752-F
A10R011	0757-0457	6		RESISTOR 47.5K 1% .125W F TC=0+-100	24546	C4-1/8-T0-4752-F
A10R012	0757-0427	0	3	RESISTOR 1.5K 1% .125W F TC=0+-100	24546	C4-1/8-T0-1501-F
A10R013	0757-0279	0	4	RESISTOR 3.16K 1% .125W F TC=0+-100	24546	C4-1/8-T0-3161-F
A10R014	0698-6362	8		RESISTOR 1K 1% .125W F TC=0+-25	28480	0698-6362
A10R015	0757-0273	4	2	RESISTOR 3.01K 1% .125W F TC=0+-100	24546	C4-1/8-T0-3011-F
A10R016	0757-0273	4		RESISTOR 3.01K 1% .125W F TC=0+-100	24546	C4-1/8-T0-3011-F
A10R017	0757-0427	0	1	RESISTOR 1.5K 1% .125W F TC=0+-100	24546	C4-1/8-T0-1501-F
A10R018	0757-0279	0	1	RESISTOR 3.16K 1% .125W F TC=0+-100	24546	C4-1/8-T0-3161-F
A10R019	0698-6624	5	0	RESISTOR 2K 1% .125W F TC=0+-25	28480	0698-6624
A10R020	0698-7332	4	1	RESISTOR 1M 1% .125W F TC=0+-100	28480	0698-7332
A10R021	0757-0833	2	1	RESISTOR 5.11K 1% .5W F TC=0+-100	28480	0757-0833
A10R100	0698-6362	8		RESISTOR 1K 1% .125W F TC=0+-25	28480	0698-6362
A10R101	0698-6362	8		RESISTOR 1K 1% .125W F TC=0+-25	28480	0698-6362
A10R102	0698-6624	5	5	RESISTOR 2K 1% .125W F TC=0+-25	28480	0698-6624
A10R103	0698-6624	5		RESISTOR 2K 1% .125W F TC=0+-25	28480	0698-6624
A10R104	0757-0426	9	1	RESISTOR 1.3K 1% .125W F TC=0+-100	24546	C4-1/8-T0-1311-F
A10R105	0698-4479	4	1	RESISTOR 14K 1% .125W F TC=0+-100	24546	C4-1/8-T0-1402-F
A10R106	0698-6616	5	1	RESISTOR 750 1% .125W F TC=0+-25	28480	0698-6616
A10R107	0698-8611	4	1	RESISTOR 254.34 1% .125W F TC=0+-25	28480	0698-8611
A10R108	0698-8858	1	1	RESISTOR 12.4K 1% .125W F TC=0+-25	28480	0698-8858
A10R109	0757-0427	0		RESISTOR 1.5K 1% .125W F TC=0+-100	24546	C4-1/8-T0-1501-F
A10R110	0757-0280	3		RESISTOR 1K 1% .125W F TC=0+-100	24546	C4-1/8-T0-1001-F
A10R111	0757-0290	5	2	RESISTOR 6.19K 1% .125W F TC=0+-100	19701	MF4C1/8-T0-6191-F
A10R112	0757-0290	5		RESISTOR 6.19K 1% .125W F TC=0+-100	19701	MF4C1/8-T0-6191-F
A10R113	0698-4508	0	1	RESISTOR 78.7K 1% .125W F TC=0+-100	24546	C4-1/8-T0-7872-F
A10R114	0698-4440	9	1	RESISTOR 3.4K 1% .125W F TC=0+-100	24546	C4-1/8-T0-3401-F
A10R115	0757-0401	0	5	RESISTOR 100 1% .125W F TC=0+-100	24546	C4-1/8-T0-101-F
A10R116	0683-5125	8	6	RESISTOR 5.1K 5% .25W FC TC=-400/+700	01121	CR5125
A10R117	0683-5125	8		RESISTOR 5.1K 5% .25W FC TC=-400/+700	01121	CR5125
A10R118	0683-1025	9	4	RESISTOR 1K 5% .25W FC TC=-400/+600	01121	CR1025
A10R119	0683-5125	8		RESISTOR 5.1K 5% .25W FC TC=-400/+700	01121	CR5125
A10R200	0683-1525	4	2	RESISTOR 1.5K 5% .25W FC TC=-400/+700	01121	CR1525
A10R201	2100-0558	9	1	RESISTOR-TRMR 20K 10% C TOP-ADJ 1-TRN	28480	2100-0558
A10R202	2100-0567	0	1	RESISTOR-TRMR 2K 10% C TOP-ADJ 1-TRN	28480	2100-0567
A10R203	0698-7343	7	1	RESISTOR 78.7K .5% .125W F TC=0+-50	19701	MF4C1/8-T0-7872-D
A10F204	0698-6519	7	1	RESISTOR 26.7K 1% .125W F TC=0+-25	28480	0698-6519
A10K205	0757-0279	0		RESISTOR 3.16K 1% .125W F TC=0+-100	24546	C4-1/8-T0-3161-F
A10R206	0757-0279	0		RESISTOR 3.16K 1% .125W F TC=0+-100	24546	C4-1/8-T0-3161-F
A10R207	0698-3226	7	1	RESISTOR 6.49K 1% .125W F TC=0+-100	24546	C4-1/8-T0-6491-F
A10R208	0683-1525	4		RESISTOR 1.5K 5% .25W FC TC=-400/+700	01121	CR1525

See introduction to this section for ordering information
 *Indicates factory selected value

Table 4-3 Replaceable Parts (Cont'd)

Reference Designation	HP Part Number	C D	Qty	Description	Mfr Code	Mfr Part Number
A10R300	0698-6306	0	1	RESISTOR 990K .1% .25W F TC=0+-25	28480	0698-6306
A10R301	0698-6975	9	1	RESISTOR 10.1K .1% .125W F TC=0+-25	28480	0698-6975
A10R302	0698-6977	3	1	RESISTOR 111.1K .1% .125W F TC=0+-25	28480	0698-6977
A10R303	0698-6305	9	1	RESISTOR 900K .1% .25W F TC=0+-25	28480	0698-6305
A10R304	0757-0401	0		RESISTOR 100 1% .125W F TC=0+-100	24546	C4-1/8-T0-101-F
A10R400	0683-1025	9		RESISTOR 1K 5% .25W FC TC=-400/+600	01121	CR1025
A10R401	0698-4456	7	1	RESISTOR 549 1% .125W F TC=0+-100	24546	C4-1/8-T0-549R-F
A10R402	0698-3510	2	1	RESISTOR 453 1% .125W F TC=0+-100	24546	C4-1/8-T0-453R-F
A10R403	0698-6362	8		RESISTOR 1K .1% .125W F TC=0+-25	28480	0698-6362
A10R404	0698-6624	5		RESISTOR 2K .1% .125W F TC=0+-25	28480	0698-6624
A10R405	0698-4123	5	4	RESISTOR 499 1% .125W F TC=0+-100	24546	C4-1/8-T0-499R-F
A10R406	0683-1025	9		RESISTOR 1K 5% .25W FC TC=-400/+600	01121	CR1025
A10R407	0698-4123	5		RESISTOR 499 1% .125W F TC=0+-100	24546	C4-1/8-T0-499R-F
A10R408	0698-4123	5		RESISTOR 499 1% .125W F TC=0+-100	24546	C4-1/8-T0-499R-F
A10R409	0698-4123	5		RESISTOR 499 1% .125W F TC=0+-100	24546	C4-1/8-T0-499R-F
A10R410	0698-4376	0	1	RESISTOR 32.4 1% .125W F TC=0+-100	24546	C4-1/8-T0-32R4-F
A10R500	2100-3020	6	1	RESISTOR-TMR 10 20% C TOP-ADJ 17-TRN	32997	3292W-1-100
A10R501	0698-7161	7	1	RESISTOR 139.17 .1% .125W F TC=0+-25	28480	0698-7161
A10R502	0683-4705	8	2	RESISTOR 47 5% .25W FC TC=-400/+500	01121	CR4705
A10R503	0683-5125	8		RESISTOR 5.1K 5% .25W FC TC=-400/+700	01121	CR5125
A10R504	0698-3404	9	1	RESISTOR 6.65K 1% .125W F TC=0+-100	24546	C4-1/8-T0-6651-F
A10R505	0683-5125	8		RESISTOR 5.1K 5% .25W FC TC=-400/+700	01121	CR5125
A10R506	0757-0442	9	2	RESISTOR 10K 1% .125W F TC=0+-100	24546	C4-1/8-T0-1002-F
A10R507	0683-4705	8		RESISTOR 47 5% .25W FC TC=-400/+500	01121	CR4705
A10R508	0698-6625	6	2	RESISTOR 6K .1% .125W F TC=0+-25	28480	0698-6625
A10R509	0683-1025	9		RESISTOR 1K 5% .25W FC TC=-400/+600	01121	CR1025
A10R510	0757-0401	0		RESISTOR 100 1% .125W F TC=0+-100	24546	C4-1/8-T0-101-F
A10R511	0757-0442	9		RESISTOR 10K 1% .125W F TC=0+-100	24546	C4-1/8-T0-1002-F
A10R512	0698-4438	5	1	RESISTOR 3.09K 1% .125W F TC=0+-100	24546	C4-1/8-T0-3091-F
A10R513	0757-0401	0		RESISTOR 100 1% .125W F TC=0+-100	24546	C4-1/8-T0-101-F
A10R514	0757-0260	3		RESISTOR 1K 1% .125W F TC=0+-100	24546	C4-1/8-T0-1001-F
A10R515	0698-6625	6		RESISTOR 6K .1% .125W F TC=0+-25	28480	0698-6625
A10R516	0698-6377	5	1	RESISTOR 200 .1% .125W F TC=0+-25	28480	0698-6377
A10R517	0757-0401	0		RESISTOR 100 1% .125W F TC=0+-100	24546	C4-1/8-T0-101-F
A10R518	0757-0462	3	2	RESISTOR 75K 1% .125W F TC=0+-100	24546	C4-1/8-T0-7502-F
A10R519	0757-0462	3		RESISTOR 75K 1% .125W F TC=0+-100	24546	C4-1/8-T0-7502-F
A10R520	0698-4492	1	1	RESISTOR 32.4K 1% .125W F TC=0+-100	24546	C4-1/8-T0-32R4-F
A10RP001	1810-0523	2	2	NETWORK-RES 14-DIP MULTI-VALUE	28480	1810-0523
A10RP100	1810-0523	2		NETWORK-RES 14-DIP MULTI-VALUE	28480	1810-0523
A10RP101	1810-0231	9	2	NETWORK-RES 8-SIP2.2K OHM X 7	01121	288A222
A10RP400	1810-0231	9		NETWORK-RES 8-SIP2.2K OHM X 7	01121	288A222
A10T400	9100-0468	7	1	TRANSFORMER-PULSE PRI OCL: 30UH; TURNS	28480	9100-0468
A10U001	1826-0581	5	3	IC SWITCH ANLG 16-DIP-C PKG	27014	LF13508D
A10U002	1826-0715	7	5	IC OP AMP LOW-NOISE 8-DIP-P PKG	18324	NF5334AN
A10U003	1826-0715	7		IC OP AMP LOW-NOISE 8-DIP-P PKG	18324	NF5334AN
A10U100	1826-0581	5		IC SWITCH ANLG 16-DIP-C PKG	27014	LF13508D
A10U101	1826-0715	7		IC OP AMP LOW-NOISE 8-DIP-P PKG	18324	NF5334AN
A10U102	1826-0715	7		IC OP AMP LOW-NOISE 8-DIP-P PKG	18324	NF5334AN
A10U103	1826-0581	5		IC SWITCH ANLG 16-DIP-C PKG	27014	LF13508D
A10U104	1820-1934	2	2	IC CONV 8-B-D/A 16-DIP-C PKG	06665	DAC-080E
A10U105	1820-1662	3	4	IC SHF-RCTR CMOS SERIAL-IN PRL-OUT 8-BIT	3L585	CD4094BE
A10U106	1820-0047	5	2	TRANSISTOR ARRAY 16-PIN PLSTC DIP	13686	ULN-2003A
A10U107	1820-1662	3		IC SHF-RCTR CMOS SERIAL-IN PRL-OUT 8-BIT	3L585	CD4094BE
A10U200	1826-0319	7	1	IC OP AMP LOW-BIAS-H-IMPD TO-99 PKG	04713	LF356G
A10U201	1820-1662	3		IC SHF-RCTR CMOS SERIAL-IN PRL-OUT 8-BIT	3L585	CD4094BE
A10U202	1820-1934	2		IC CONV 8-B-D/A 16-DIP-C PKG	06665	DAC-080E
A10U400	1820-1273	2	1	IC RFR TTL LS NOR QUAD 2-INP	01295	SN74LS28N
A10U401	1820-1662	3		IC SHF-RCTR CMOS SERIAL-IN PRL-OUT 8-BIT	3L585	CD4094BE
A10U402	1820-1440	5	1	IC LCH TTL LS QUAD	01295	SN74LS279N
A10U403	1858-0047	5		TRANSISTOR ARRAY 16-PIN PLSTC DIP	17606	ULN-2003A
A10U404	1820-2634	1	1	IC INV TTL ALS HEX	01295	SN74ALS04N
A10U405	1820-1074	1	1	IC DRVR TTL NOR QUAD 2-INP	01295	SN74128N
A10U500	1820-2488	3	1	IC FF TTL ALS D-TYPE POS-EDGE-TRIG	01295	SN74ALS74N
A10U501	1826-0715	7		IC OP AMP LOW-NOISE 8-DIP-P PKG	18324	NF5334AN
A10U502	1826-0043	4	1	IC OP AMP GP TO-99 PKG	3L585	CA302T
				A10 MISCELLANEOUS PARTS		
	03561-23702	7	1	SHIELD, COMP SIDE	28480	03561-23702
	03561-01227	5	1	CVR, SHLD CAN	28480	03561-01227
	03577-20601	7	1	SHLD-CIRC SIDE	28480	03577-20601
	1250-1339	2	1	CONNECTOR-RF SH-SLD M PC 50-OHM	28480	1250-1339
	1250-1512	3	1	CONNECTOR-RF SH M PC 50-OHM	28480	1250-1512
	1251-5033	3	1	CONNECTOR 3-PIN M POST TYPE	28480	1251-5033
	5040-6843	2	1	BOARD EXTRACTOR	28480	5040-6843
	5000-9043	6	1	BOARD EXTRACTOR PIN	28480	5000-9043
	0515-0158	2	6	SCREW-MACH M3 X 0.5 20MM-LC	00000	ORDER BY DESCRIPTION

See introduction to this section for ordering information
 *Indicates factory selected value

Table 4-3 Replaceable Parts (Cont'd)

Reference Designation	HP Part Number	C D	Qty	Description	Mfr Code	Mfr Part Number
A15	03561-66515	0	1	DIGITIZER ASSEMBLY (REVISION B)	28400	03561-66515
A15C001	0160-5862	2	1	CAPACITOR-FXD 240PF +-1% 100VDC CER	28480	0160-5862
A15C002	0160-5872	4	1	CAPACITOR-FXD 750PF +-1% 100VDC CER	28480	0160-5872
A15C003	0160-5861	1	1	CAPACITOR-FXD 100PF +-1% 100VDC CER	28480	0160-5861
A15C004	0160-5874	6	2	CAPACITOR-FXD 2000PF +-1% 50VDC CER	28480	0160-5874
A15C005	0160-5870	2	1	CAPACITOR-FXD 430PF +-1% 100VDC CER	28480	0160-5870
A15C006	0160-5874	6		CAPACITOR-FXD 2000PF +-1% 50VDC CER	28480	0160-5874
A15C007	0160-5871	3	1	CAPACITOR-FXD 510PF +-1% 100VDC CER	28480	0160-5871
A15C008	0160-5880	4	1	CAPACITOR-FXD 2200PF +-1% 50VDC CER	28480	0160-5880
A15C009	0160-5873	5	1	CAPACITOR-FXD 1500PF +-1% 50VDC CER	28480	0160-5873
A15C010	0180-0291	3	9	CAPACITOR-FXD 1UF+-10% 35VDC TA	56289	150D105X9035A2
A15C011	0160-4571	8	33	CAPACITOR-FXD .1UF +80-20% 50VDC CER	28480	0160-4571
A15C012	0160-4571	8		CAPACITOR-FXD .1UF +80-20% 50VDC CER	28480	0160-4571
A15C013	0180-1794	3	2	CAPACITOR-FXD 22UF+-10% 35VDC TA	56289	150D226X9035R2
A15C014	0180-1794	3		CAPACITOR-FXD 22UF+-10% 35VDC TA	56289	150D226X9035R2
A15C015	0160-4801	7	5	CAPACITOR-FXD 100PF +-5% 100VDC CER	28480	0160-4801
A15C016	0160-4788	9	1	CAPACITOR-FXD 18PF +-5% 100VDC CER 0+-30	28480	0160-4788
A15C017	0160-4801	7		CAPACITOR-FXD 100PF +-5% 100VDC CER	28480	0160-4801
A15C018	0160-4807	3	1	CAPACITOR-FXD 33PF +-5% 100VDC CER 0+-30	28480	0160-4807
A15C019	0160-5865	5	1	CAPACITOR-FXD 36PF +-5% 200VDC CER 0+-30	28480	0160-5865
A15C100	0160-4571	8		CAPACITOR-FXD .1UF +80-20% 50VDC CER	28480	0160-4571
A15C101	0160-4571	8		CAPACITOR-FXD .1UF +80-20% 50VDC CER	28480	0160-4571
A15C102	0160-5863	3	1	CAPACITOR-FXD 330PF +-1% 100VDC CER	28480	0160-5863
A15C103	0160-4793	6	3	CAPACITOR-FXD 6.8PF +-5PF 100VDC CER	28480	0160-4793
A15C104	0160-4571	8		CAPACITOR-FXD .1UF +80-20% 50VDC CER	28480	0160-4571
A15C105	0180-0291	3		CAPACITOR-FXD 1UF+-10% 35VDC TA	56289	150D105X9035A2
A15C106	0180-0291	3		CAPACITOR-FXD 1UF+-10% 35VDC TA	56289	150D105X9035A2
A15C107	0160-4447	7	2	CAPACITOR-FXD 220PF +-10% 50VDC POLYP	28480	0160-4447
A15C108	0160-4447	7		CAPACITOR-FXD 220PF +-10% 50VDC POLYP	28480	0160-4447
A15C109	0160-4571	8		CAPACITOR-FXD .1UF +80-20% 50VDC CER	28480	0160-4571
A15C110	0160-4571	8		CAPACITOR-FXD .1UF +80-20% 50VDC CER	28480	0160-4571
A15C111	0180-0291	3		CAPACITOR-FXD 1UF+-10% 35VDC TA	56289	150D105X9035A2
A15C112	0180-0291	3		CAPACITOR-FXD 1UF+-10% 35VDC TA	56289	150D105X9035A2
A15C113	0160-4571	8		CAPACITOR-FXD .1UF +80-20% 50VDC CER	28480	0160-4571
A15C114	0180-4793	6		CAPACITOR-FXD 6.3PF +-5PF 100VDC CER	28480	0160-4793
A15C115	0160-4571	8		CAPACITOR-FXD .1UF +80-20% 50VDC CER	28480	0160-4571
A15C116	0180-0291	3		CAPACITOR-FXD 1UF+-10% 35VDC TA	56289	150D105X9035A2
A15C117	0160-4571	8		CAPACITOR-FXD .1UF +80-20% 50VDC CER	28480	0160-4571
A15C118	0160-4571	8		CAPACITOR-FXD .1UF +80-20% 50VDC CER	28480	0160-4571
A15C119	0160-4571	8		CAPACITOR-FXD .1UF +80-20% 50VDC CER	28480	0160-4571
A15C120	0160-4793	6		CAPACITOR-FXD 6.3PF +-5PF 100VDC CER	28480	0160-4793
A15C121	0180-0291	3		CAPACITOR-FXD 1UF+-10% 35VDC TA	56289	150D105X9035A2
A15C122	0180-0291	3		CAPACITOR-FXD 1UF+-10% 35VDC TA	56289	150D105X9035A2
A15C123	0180-0309	4	3	CAPACITOR-FXD 4.7UF+-20% 10VDC TA	56289	150D475X0010A2
A15C124	0160-4571	8		CAPACITOR-FXD .1UF +80-20% 50VDC CER	28480	0160-4571
A15C200	0160-4789	0	3	CAPACITOR-FXD 15PF +-5% 100VDC CER 0+-30	28480	0160-4789
A15C201	0160-4571	8		CAPACITOR-FXD .1UF +80-20% 50VDC CER	28480	0160-4571
A15C202	0160-4787	8	1	CAPACITOR-FXD 22PF +-5% 100VDC CER 0+-30	28480	0160-4787
A15C203	0160-4571	8		CAPACITOR-FXD .1UF +80-20% 50VDC CER	28480	0160-4571
A15C204	0180-0291	3		CAPACITOR-FXD 1UF+-10% 35VDC TA	56289	150D105X9035A2
A15C205	0180-0309	4		CAPACITOR-FXD 4.7UF+-20% 10VDC TA	56289	150D475X0010A2
A15C206	0160-4571	8		CAPACITOR-FXD .1UF +80-20% 50VDC CER	28480	0160-4571
A15C207	0160-4825	5	1	CAPACITOR-FXD 560PF +-5% 100VDC CER	28480	0160-4825
A15C208	0160-4571	8		CAPACITOR-FXD .1UF +80-20% 50VDC CER	28480	0160-4571
A15C209	0160-4571	8		CAPACITOR-FXD .1UF +80-20% 50VDC CER	28480	0160-4571
A15C210	0160-4571	8		CAPACITOR-FXD .1UF +80-20% 50VDC CER	28480	0160-4571
A15C211	0160-4571	8		CAPACITOR-FXD .1UF +80-20% 50VDC CER	28480	0160-4571
A15C212	0180-0197	8	1	CAPACITOR-FXD 2.2UF+-10% 20VDC TA	56289	150D225X9020A2
A15C213	0160-4571	8		CAPACITOR-FXD .1UF +80-20% 50VDC CER	28480	0160-4571
A15C300	0160-4571	8		CAPACITOR-FXD .1UF +80-20% 50VDC CER	28480	0160-4571
A15C301	0160-4571	8		CAPACITOR-FXD .1UF +80-20% 50VDC CER	28480	0160-4571
A15C302	0160-4822	2	1	CAPACITOR-FXD 1000PF +-5% 100VDC CER	28480	0160-4822
A15C303	0160-4801	7		CAPACITOR-FXD 100PF +-5% 100VDC CER	28480	0160-4801
A15C304	0160-4789	0		CAPACITOR-FXD 15PF +-5% 100VDC CER 0+-30	28480	0160-4789
A15C305	0160-4571	8		CAPACITOR-FXD .1UF +80-20% 50VDC CER	28480	0160-4571
A15C306	0160-4814	0		CAPACITOR-FXD 150PF +-5% 10VDC CER 0+-30	28480	0160-4814
A15C307	0160-4571	8		CAPACITOR-FXD .1UF +80-20% 50VDC CER	28480	0160-4571
A15C308	0180-0228	6	1	CAPACITOR-FXD 22UF+-10% 15VDC TA	56289	150D226X9015E2
A15C309	0160-4571	8		CAPACITOR-FXD .1UF +80-20% 50VDC CER	28480	0160-4571
A15C400	0160-4571	8		CAPACITOR-FXD .1UF +80-20% 50VDC CER	28480	0160-4571
A15C401	0160-4571	8		CAPACITOR-FXD .1UF +80-20% 50VDC CER	28480	0160-4571

See introduction to this section for ordering information
 *Indicates factory selected value

Table 4-3 Replaceable Parts (Cont'd)

Reference Designation	HP Part Number	C D	Qty	Description	Mfr Code	Mfr Part Number
A15C402	0160-4801	7		CAPACITOR-FXD 100PF +-5% 100VDC CER	28480	0160-4801
A15C403	0160-4801	7		CAPACITOR-FXD 100PF +-5% 100VDC CER	28480	0160-4801
A15C404	0160-3847	9	2	CAPACITOR-FXD .01UF +100-0% 50VDC CER	28480	0160-3847
A15C405	0160-4571	8		CAPACITOR-FXD .1UF +80-20% 50VDC CER	28480	0160-4571
A15C406	0180-0307	4		CAPACITOR-FXD 4.7UF+-20% 10VDC TA	56289	150D475X0010A2
A15C407	0160-4571	8		CAPACITOR-FXD .1UF +80-20% 50VDC CER	28480	0160-4571
A15C500	0160-4571	8		CAPACITOR-FXD .1UF +80-20% 50VDC CER	28480	0160-4571
A15C501	0160-4808	8		CAPACITOR-FXD 470PF	28480	0160-4808
A15C502	0160-4794	7	1	CAPACITOR-FXD 5.6PF +- .5PF 100VDC CER	28480	0160-4794
A15C503	0160-4571	8		CAPACITOR-FXD .1UF +80-20% 50VDC CER	28480	0160-4571
A15C504	0160-3847	9		CAPACITOR-FXD .01UF +100-0% 50VDC CER	28480	0160-3847
A15C505	0160-4571	8		CAPACITOR-FXD .1UF +80-20% 50VDC CER	28480	0160-4571
A15CR100	1901-0040	1	12	DIODE-SWITCHING 30V 50MA 2NS DO-35	28480	1901-0040
A15CR101	1902-0952	6	1	DIODE-ZNR 5.6V 5% DO-35 PD=.4W TC=-.046%	28480	1902-0952
A15CR102	1901-0518	8	2	DIODE-SM SIG SCHOTTKY	28480	1901-0518
A15CR103	1901-0518	8		DIODE-SM SIG SCHOTTKY	28480	1901-0518
A15CR104	1901-0040	1		DIODE-SWITCHING 30V 50MA 2NS DO-35	28480	1901-0040
A15CR105	1901-0040	1		DIODE-SWITCHING 30V 50MA 2NS DO-35	28480	1901-0040
A15CR201	1901-0040	1		DIODE-SWITCHING 30V 50MA 2NS DO-35	28480	1901-0040
A15CR300	1901-0376	6	2	DIODE-GEN PRP 35V 50MA DO-35	28480	1901-0376
A15CR301	1901-0376	6		DIODE-GEN PRP 35V 50MA DO-35	28480	1901-0376
A15CR400	1902-0948	0	2	DIODE-ZNR 3.9V 5% DO-35 PD=.4W TC=-.012%	28480	1902-0948
A15CR401	1902-0945	7	2	DIODE-ZNR 3V 5% DO-35 PD=.4W TC=-.043%	28480	1902-0945
A15CR402	1901-0040	1		DIODE-SWITCHING 30V 50MA 2NS DO-35	28480	1901-0040
A15CR403	1901-0040	1		DIODE-SWITCHING 30V 50MA 2NS DO-35	28480	1901-0040
A15CR500	1901-0040	1		DIODE-SWITCHING 30V 50MA 2NS DO-35	28480	1901-0040
A15CR501	1901-0040	1		DIODE-SWITCHING 30V 50MA 2NS DO-35	28480	1901-0040
A15CR502	1901-0040	1		DIODE-SWITCHING 30V 50MA 2NS DO-35	28480	1901-0040
A15CR503	1902-0945	7		DIODE-ZNR 3V 5% DO-35 PD=.4W TC=-.043%	28480	1902-0945
A15CR504	1901-0040	1		DIODE-SWITCHING 30V 50MA 2NS DO-35	28480	1901-0040
A15CR505	1901-0040	1		DIODE-SWITCHING 30V 50MA 2NS DO-35	28480	1901-0040
A15CR506	1902-0948	0		DIODE-ZNR 3.9V 5% DO-35 PD=.4W TC=-.012%	28480	1902-0948
A15J001	1250-1339	2	1	CONNECTOR-RF SM-GLD M PC 50-OHM	28480	1250-1339
A15J100	1251-4822	6	1	CONNECTOR 3-PIN M POST TYPE	28480	1251-4822
A15J300	1251-4778	1	1	CONNECTOR 10-PIN M POST TYPE	22526	65547-110
A15L001	03561-60302	1	1	L-2304UH 1% .125W F TC=0+-25	28480	03561-60302
A15L002	03561-60303	2	1	L-1834UH 1%	28480	03561-60303
A15L003	03561-60301	0	2	L-2035UH 1%	28480	03561-60301
A15L004	03561-60301	0		L-2035UH 1%	28480	03561-60301
A15L500	9100-2265	6	1	INDUCTOR RF-CH-MLD 10UH 10% .105DX.26LG	28480	9100-2265
A15L501	9140-0748	0	3	INDUCTOR 250UH 25% .25DX.5LG Q=3	28480	9140-0748
A15L502	9140-0748	0		INDUCTOR 250UH 25% .25DX.5LG Q=3	28480	9140-0748
A15L503	9140-0748	0		INDUCTOR 250UH 25% .25DX.5LG Q=3	28480	9140-0748
A15P100	1258-0141	8	1	JUMPER-REM	28480	1258-0141
A15Q100	1855-0267	7	1	TRANSISTOR MOSFET N-CHAN E-MODC T0-72 SI	18324	SD214
A15R001	0698-7847	6	1	RESISTOR 1.111K 1% .125W F TC=0+-25	19701	MF4C1/8-T9-1111R-B
A15R002	0698-6360	6	1	RESISTOR 10K 1% .125W F TC=0+-25	28480	0698-6360
A15R003	8150-3375	5	1	RESISTOR-ZERO OHMS 22 AWG LEAD DIA	20480	8150-3375
A15R004	0698-4500	2	1	RESISTOR 57.6K 1% .125W F TC=0+-100	24546	C4-1/8-T0-57.6-F
A15R005	0698-8629	4	1	RESISTOR 1.67K 1% .125W F TC=0+-25	28480	0698-8629
A15R006	0698-6362	8	4	RESISTOR 1K 1% .125W F TC=0+-25	28480	0698-6362
A15R007	0698-6624	5	5	RESISTOR 2K 1% .125W F TC=0+-25	28480	0698-6624
A15R008	0698-3454	3	2	RESISTOR 215K 1% .125W F TC=0+-100	24546	C4-1/8-T0-215K-F
A15R009	0757-0280	3	9	RESISTOR 1K 1% .125W F TC=0+-100	24546	C4-1/8-T0-1001-F
A15R010	0698-4471	6	1	RESISTOR 7.15K 1% .125W F TC=0+-100	24546	C4-1/8-T0-7151-F
A15R011	0698-4429	4	1	RESISTOR 1.87K 1% .125W F TC=0+-100	24546	C4-1/8-T0-1871-F
A15R012	0757-0482	7	1	RESISTOR 511K 1% .125W F TC=0+-100	28480	0757-0482
A15R013	0757-0280	3	1	RESISTOR 1K 1% .125W F TC=0+-100	24546	C4-1/8-T0-1001-F
A15R014	0757-0280	3	1	RESISTOR 1K 1% .125W F TC=0+-100	24546	C4-1/8-T0-1001-F
A15R015	0757-0280	3	1	RESISTOR 1K 1% .125W F TC=0+-100	24546	C4-1/8-T0-1001-F
A15R016	0757-0280	3		RESISTOR 1K 1% .125W F TC=0+-100	24546	C4-1/8-T0-1001-F
A15R100	0698-6362	8		RESISTOR 1K 1% .125W F TC=0+-25	28480	0698-6362
A15R101	0698-6624	5		RESISTOR 2K 1% .125W F TC=0+-25	28480	0698-6624
A15R102	0698-6362	8		RESISTOR 1K 1% .125W F TC=0+-25	28480	0698-6362
A15R103	0757-0274	5	3	RESISTOR 1.21K 1% .125W F TC=0+-100	24546	C4-1/8-T0-1211-F
A15R104	0698-6320	8	1	RESISTOR 5K 1% .125W F TC=0+-25	03088	PME55-1/8-T9-5001-B
A15R105	0698-6627	8	1	RESISTOR 25K 1% .125W F TC=0+-25	28480	0698-6627
A15R106	0757-0346	2	8	RESISTOR 10 1% .125W F TC=0+-100	24546	C4-1/8-T0-10R0-F
A15R107	0757-0346	2	2	RESISTOR 10 1% .125W F TC=0+-100	24546	C4-1/8-T0-10R0-F
A15R108	0698-4412	5	1	RESISTOR 143 1% .125W F TC=0+-100	24546	C4-1/8-T0-143R-F
A15R109	0698-3161	9	2	RESISTOR 30.3K 1% .125W F TC=0+-100	24546	C4-1/8-T0-3832-F
A15R110	0757-0346	2	2	RESISTOR 10 1% .125W F TC=0+-100	24546	C4-1/8-T0-10R0-F
A15R111	0757-0346	2	2	RESISTOR 10 1% .125W F TC=0+-100	24546	C4-1/8-T0-10R0-F
A15R112	0757-0403	2	1	RESISTOR 121 1% .125W F TC=0+-100	24546	C4-1/8-T0-121R-F
A15R113	0757-0457	8	1	RESISTOR 56.2K 1% .125W F TC=0+-100	24546	C4-1/8-T0-5622-F

See introduction to this section for ordering information
 *Indicates factory selected value

Table 4-3 Replaceable Parts (Cont'd)

Reference Designation	HP Part Number	C D	Qty	Description	Mfr Code	Mfr Part Number
A15R114	0698-3156	2	1	RESISTOR 14.7K 1% .125W F TC=0+-100	24546	C4-1/8-T0-1472-F
A15R115	2100-3296	8	1	RESISTOR-TRMR 1K 10% C TOP-ADJ 17-TRN	20480	2100-3296
A15R116	0757-0346	2		RESISTOR 10 1% .125W F TC=0+-100	24546	C4-1/8-T0-10R0-F
A15R117	0757-0346	2		RESISTOR 10 1% .125W F TC=0+-100	24546	C4-1/8-T0-10R0-F
A15R118	0757-0346	2		RESISTOR 10 1% .125W F TC=0+-100	24546	C4-1/8-T0-10R0-F
A15R119	0757-0346	2		RESISTOR 10 1% .125W F TC=0+-100	24546	C4-1/8-T0-10R0-F
A15R120	0757-1094	9	2	RESISTOR 1.47K 1% .125W F TC=0+-100	24546	C4-1/8-T0-1471-F
A15R121	0698-3161	9		RESISTOR 30.3K 1% .125W F TC=0+-100	24546	C4-1/8-T0-3032-F
A15R122	0757-0472	5	1	RESISTOR 200K 1% .125W F TC=0+-100	24546	C4-1/8-T0-2003-F
A15R123	0698-6347	9	1	RESISTOR 1.5K 1% .125W F TC=0+-25	20480	0698-6347
A15R124	0757-0274	5		RESISTOR 1.21K 1% .125W F TC=0+-100	24546	C4-1/8-T0-1211-F
A15R125	0683-0475	1	1	RESISTOR 4.7 5% .25W FC TC=-400/+500	01121	CR4705
A15R200	2100-3354	9	1	RESISTOR-TRMR 50K 10% C SIDE-ADJ 1 TRN	20480	2100-3354
A15R201	2100-3207	1	1	RESISTOR-TRMR 5K 10% C SIDE-ADJ 1 TRN	20480	2100-3207
A15R202	2100-3354	6	1	RESISTOR-TRMR 50K 10% C SIDE-ADJ 17-TRN	02111	43P503
A15R203	0698-6624	5		RESISTOR 2K 1% .125W F TC=0+-25	20480	0698-6624
A15R204	0698-3162	0	1	RESISTOR 46.4K 1% .125W F TC=0+-100	24546	C4-1/8-T0-4642-F
A15R205	0757-1094	9		RESISTOR 1.47K 1% .125W F TC=0+-100	24546	C4-1/8-T0-1471-F
A15R206	0698-6624	5		RESISTOR 2K 1% .125W F TC=0+-25	20480	0698-6624
A15R207	0757-0467	8	1	RESISTOR 121K 1% .125W F TC=0+-100	24546	C4-1/8-T0-1213-F
A15R208	0757-0442	9		RESISTOR 10K 1% .125W F TC=0+-100	24546	C4-1/8-T0-1002-F
A15R209	0698-3445	2	1	RESISTOR 348 1% .125W F TC=0+-100	24546	C4-1/8-T0-348R-F
A15R210	0698-6361	7	3	RESISTOR 8K 1% .125W F TC=0+-25	20480	0698-6361
A15R211	0698-6361	7		RESISTOR 8K 1% .125W F TC=0+-25	20480	0698-6361
A15R212	0757-0270	5	1	RESISTOR 6.19K 1% .125W F TC=0+-100	19701	MF4C1/8-T0-6191-F
A15R213	0698-3444	1	1	RESISTOR 316 1% .125W F TC=0+-100	24546	C4-1/8-T0-316R-F
A15R214	0670-4503	5	1	RESISTOR 66.5K 1% .125W F TC=0+-100	24546	C4-1/8-T0-6652-F
A15R215	0698-6624	5	1	RESISTOR 302 1% .125W F TC=0+-25	20480	0698-6624
A15R216	0757-0428	1	1	RESISTOR 1.62K 1% .125W F TC=0+-100	24546	C4-1/8-T0-1621-F
A15R217	0698-6624	5		RESISTOR 2K 1% .125W F TC=0+-25	20480	0698-6624
A15R218	0757-0462	3	1	RESISTOR 75K 1% .125W F TC=0+-100	24546	C4-1/8-T0-7502-F
A15R219	0698-3445	9	1	RESISTOR 348 1% .125W F TC=0+-100	24546	C4-1/8-T0-348R-F
A15R220	0757-0401	0	1	RESISTOR 100 1% .125W F TC=0+-100	24546	C4-1/8-T0-101-F
A15R221	0757-0280	3		RESISTOR 1K 1% .125W F TC=0+-100	24546	C4-1/8-T0-1001-F
A15R222	0698-7394	8	1	RESISTOR 698 1% .125W F TC=0+-25	19701	MF4C1/8-T0-698R-F
A15R223	0698-6361	7		RESISTOR 8K 1% .125W F TC=0+-25	20480	0698-6361
A15R224	0698-6366	2	1	RESISTOR 800 1% .125W F TC=0+-25	20480	0698-6366
A15R225	0698-6377	5	1	RESISTOR 200 1% .125W F TC=0+-25	20480	0698-6377
A15R226	0757-0484			RESISTOR 619K 1% .125W	20480	0757-0484
A15R300	0698-3454	3		RESISTOR 215K 1% .125W F TC=0+-100	24546	C4-1/8-T0-2153-F
A15R301	0698-3202	9	1	RESISTOR 1.74K 1% .125W F TC=0+-100	24546	C4-1/8-T0-1741-F
A15R302	0757-0280	3		RESISTOR 1K 1% .125W F TC=0+-100	24546	C4-1/8-T0-1001-F
A15R303	0698-3266	5	1	RESISTOR 237K 1% .125W F TC=0+-100	24546	C4-1/8-T0-2373-F
A15R304	0757-0280	3		RESISTOR 1K 1% .125W F TC=0+-100	24546	C4-1/8-T0-1001-F
A15R305	0757-0439	4	1	RESISTOR 6.81K 1% .125W F TC=0+-100	24546	C4-1/8-T0-6811-F
A15R306	0698-0085	0	1	RESISTOR 2.61K 1% .125W F TC=0+-100	24546	C4-1/8-T0-2611-F
A15R307	0698-4439	6	1	RESISTOR 3.24K 1% .125W F TC=0+-100	24546	C4-1/8-T0-3241-F
A15R308	0757-0416	7	1	RESISTOR 511 1% .125W F TC=0+-100	24546	C4-1/8-T0-511R-F
A15R309	0698-6362	8		RESISTOR 1K 1% .125W F TC=0+-25	20480	0698-6362
A15R310	0698-6348	0	1	RESISTOR 3K 1% .125W F TC=0+-25	20480	0698-6348
A15R311	0698-4211	2	1	RESISTOR 158K 1% .125W F TC=0+-100	24546	C4-1/8-T0-1583-F
A15R403	0698-3402	1	1	RESISTOR 316 1% .5W F TC=0+-100	20480	0698-3402
A15R401	0757-0280	3		RESISTOR 1K 1% .125W F TC=0+-100	24546	C4-1/8-T0-1001-F
A15R402	0698-0384	9	1	RESISTOR 2.15K 1% .125W F TC=0+-100	24546	C4-1/8-T0-2151-F
A15R403	0757-1060	9	1	RESISTOR 196 1% .5W F TC=0+-100	20480	0757-1060
A15R500	0698-3437	4	1	RESISTOR 178 1% .125W F TC=0+-100	24546	C4-1/8-T0-178R-F
A15R501	0757-0274	5		RESISTOR 1.21K 1% .125W F TC=0+-100	24546	C4-1/8-T0-1211-F
A15R502	0757-0418	9	1	RESISTOR 619 1% .125W F TC=0+-100	24546	C4-1/8-T0-619R-F
A15R503	0757-0443			RESISTOR 11K 1% .125W	20480	0757-0443
A15RP400	1810-0037	3	2	NETWORK-RES 16-DIP 1.0K OHM X 8	11236	761-3-R1K
A15RP500	1810-0037	3	2	NETWORK-RES 16-DIP 1.0K OHM X 8	11236	761-3-R1K
A15T001	9100-2616	1	1	TRANSFORMER-PULSE BIFILAR WOUND; 10.0 MM	20480	9100-2616
A15T400	9100-4336	6	2	PE8304	20480	9100-4336
A15T500	9100-4336	6		PE8304	20480	9100-4336
A15U001	1826-0715	7	2	IC OP AMP LOW-NOISE 3-DIP-P PKG	18324	NE5534AN
A15U002	1826-0175	3	3	IC COMPARATOR GP DUAL 14-DIP-P PKG	27014	LM319N
A15U100	1826-0715	7		IC OP AMP LOW-NOISE 8-DIP-P PKG	18324	NE5534AN
A15U101	1826-0109	3	3	IC OP AMP WB TO-99 PKG	34371	HA2-2625-B0593
A15U102	1826-1110	8	1	D/A 16-BIT 24-DIP-C BPLR	20480	1826-1110
A15U200	1826-0109	3		IC OP AMP WB TO-99 PKG	34371	HA2-2625-B0593
A15U201	1826-0445	0	1	IC 7905 V RGLTR TO-220	07263	UA7905UC
A15U202	1826-1127	7	1	IC PRCN DUAL 8-T0-99 PKG	20480	1026-1127
A15U203	1826-0528	0	1	IC OP AMP LOW-BIAS H-IMP D TO-99 PKG	27014	LF356RH
A15U204	1826-0501	9	1	IC MULTIPLXR 2-CHAN-ANLG TRIPLE 16-DIP-P	04713	MC14653BCP
A15U205	1826-0109	3		IC OP AMP WB TO-99 PKG	34371	HA2-2625-B0593
A15U206	1826-1112	0	1	A/D 8-1/2-BIT 18-DIP-C BPLR	20480	1826-1112
A15U300	1826-0175	3		IC COMPARATOR GP DUAL 14-DIP-P PKG	27014	LM319N
A15U301	1826-0488	1	1	IC OP AMP WB TO-99 PKG	27014	LM218H
A15U302	1826-0175	3		IC COMPARATOR GP DUAL 14-DIP-P PKG	27014	LM319N

See introduction to this section for ordering information
 *Indicates factory selected value

Table 4-3 Replaceable Parts (Cont'd)

Reference Designation	HP Part Number	C D	Qty	Description	Mfr Code	Mfr Part Number
A15U303	1820-1922	8	1	IC SHF-RGTR TTL LS PRL IN SERIAL-OUT	01295	SN74LS166N
A15U304	1820-2634	1	2	IC INV TTL ALS HEX	01295	SN74ALS04N
A15U305	1820-1440	5	1	IC LCH TTL LS QUAD	01295	SN74LS277N
A15U306	1820-2656	7	2	IC GATE TTL ALS NAND QUAD 2-IMP	01295	SN74ALS00N
A15U400	1820-1175	7	1	IC FF TTL LS D-TYPE POS-EDGE-TRIG COM	01295	SN74LS175N
A15U401	1820-1492	7	1	IC BFR TTL LS INV HEX 1-IMP	01295	SN74LS368AN
A15U402	1820-3441	0	1	IC GATE-ARY CMOS	20400	1820-3441
A15U403	1820-1662	3	1	IC SHF-RGTR CMOS SERIAL-TN PRL-OUT 8-BIT	3L585	CD4094BC
A15U404	1820-0471	0	2	IC INV TTL HEX 1-IMP	01295	SN7406N
A15U405	1820-0693	8	1	IC FF TTL S D-TYPE POS-EDGE-TRIG	01295	SN74S74N
A15U406	1820-2656	7		IC GATE TTL ALS NAND QUAD 2 IMP	01295	SN74ALS00N
A15U500	1820-2634	1		IC INV TTL ALS HEX	01295	SN74ALS04N
A15U501	1820-0471	0		IC INV TTL HEX 1-IMP	01295	SN7406N
A15 MISCELLANEOUS PARTS						
	0340-0564	3	1	INSULATOR-XSTR THRM-CNDCT	20480	0340-0564
	1251-0600	0	1	CONNECTOR-SGL CONT PIN 1.14-MM-RSC S7 S0	20480	1251-0600
	1480-0116	8	1	PIN-GRV .032-IN DIA .25-IN-LG STL	20480	1480-0116
	2190-0004	9	1	WASHER-LK INTL T NO. 4 .115-IN-ID	20480	2190-0004
	2200-0105	4	1	SCREW-MACH 4-40 .312-IN-LG PAN-HD-POZI	00000	ORDER BY DESCRIPTION
	2760-0001	5	1	NUT-HEX-DBL-CHAM 4-40-THD .094-IN-THK	20480	2760-0001
	3050-0440	2	1	WASHER SHLDR NO. 4 .115-IN-ID .2-IN-OD	20480	3050-0440
	3050-0863	3	3	WASHER-FL NM 9/32 IN .295-IN ID	20480	3050-0863
	4040-0711	0	1	EXTR-PC RD BRN POLYC .07 RD-THKNS	20480	4040-0711
	4040-0753	0	1	EXTR-PC BD GRN POLYC .062-BD-THKNS	20480	4040-0753

See introduction to this section for ordering information
 *Indicates factory selected value

Table 4-3 Replaceable Parts (Cont'd)

Reference Designation	HP Part Number	C D	Qty	Description	Mfr Code	Mfr Part Number
A20	03561-66520	7	1	DIGITAL FILTER ASSEMBLY (REVISION B)	28480	03561-66520
A20C001	0160-4571	8	36	CAPACITOR-FXD .1UF +80-20% 50VDC CER	28480	0160-4571
A20C002	0160-4571	8		CAPACITOR-FXD .1UF +80-20% 50VDC CER	28480	0160-4571
A20C003	0180-0374	3	5	CAPACITOR-FXD 10UF+-10% 20VDC TA	56209	150D106X9020R2
A20C004	0160-4571	8		CAPACITOR-FXD .1UF +80-20% 50VDC CER	28480	0160-4571
A20C005	0180-0374	3		CAPACITOR-FXD 10UF+-10% 20VDC TA	56209	150D106X9020R2
A20C006	0160-4571	8		CAPACITOR-FXD .1UF +80-20% 50VDC CER	28480	0160-4571
A20C007	0160-4571	8		CAPACITOR-FXD .1UF +80-20% 50VDC CER	28480	0160-4571
A20C008	0160-4810	8	2	CAPACITOR-FXD 330PF +-5% 100VDC CER	28480	0160-4810
A20C009	0160-4810	8		CAPACITOR-FXD 330PF +-5% 100VDC CER	28480	0160-4810
A20C010	0160-4571	8		CAPACITOR-FXD .1UF +80-20% 50VDC CER	28480	0160-4571
A20C011	0160-4571	8		CAPACITOR-FXD .1UF +80-20% 50VDC CER	28480	0160-4571
A20C012	0160-4571	8		CAPACITOR-FXD .1UF +80-20% 50VDC CER	28480	0160-4571
A20C013	0160-4571	8		CAPACITOR-FXD .1UF +80-20% 50VDC CER	28480	0160-4571
A20C014	0160-4571	8		CAPACITOR-FXD .1UF +80-20% 50VDC CER	28480	0160-4571
A20C015	0160-4571	8		CAPACITOR-FXD .1UF +80-20% 50VDC CER	28480	0160-4571
A20C016	0160-4571	8		CAPACITOR-FXD .1UF +80-20% 50VDC CER	28480	0160-4571
A20C017	0160-4571	8		CAPACITOR-FXD .1UF +80-20% 50VDC CER	28480	0160-4571
A20C018	0160-4571	8		CAPACITOR-FXD .1UF +80-20% 50VDC CER	28480	0160-4571
A20C019	0160-4571	8		CAPACITOR-FXD .1UF +80-20% 50VDC CER	28480	0160-4571
A20C020	0160-4571	8		CAPACITOR-FXD .1UF +80-20% 50VDC CER	28480	0160-4571
A20C021	0160-4571	8		CAPACITOR-FXD .1UF +80-20% 50VDC CER	28480	0160-4571
A20C022	0160-4571	8		CAPACITOR-FXD .1UF +80-20% 50VDC CER	28480	0160-4571
A20C023	0160-4571	8		CAPACITOR-FXD .1UF +80-20% 50VDC CER	28480	0160-4571
A20C024	0160-4571	8		CAPACITOR-FXD .1UF +80-20% 50VDC CER	28480	0160-4571
A20C025	0160-4571	8		CAPACITOR-FXD .1UF +80-20% 50VDC CER	28480	0160-4571
A20C026	0160-4571	8		CAPACITOR-FXD .1UF +80-20% 50VDC CER	28480	0160-4571
A20C027	0160-4571	8		CAPACITOR-FXD .1UF +80-20% 50VDC CER	28480	0160-4571
A20C028	0160-4571	8		CAPACITOR-FXD .1UF +80-20% 50VDC CER	28480	0160-4571
A20C029	0160-4571	8		CAPACITOR-FXD .1UF +80-20% 50VDC CER	28480	0160-4571
A20C030	0160-4571	8		CAPACITOR-FXD .1UF +80-20% 50VDC CER	28480	0160-4571
A20C031	0160-4571	8		CAPACITOR-FXD .1UF +80-20% 50VDC CER	28480	0160-4571
A20C032	0160-4571	8		CAPACITOR-FXD .1UF +80-20% 50VDC CER	28480	0160-4571
A20C033	0160-4571	8		CAPACITOR-FXD .1UF +80-20% 50VDC CER	28480	0160-4571
A20C034	0160-4571	8		CAPACITOR-FXD .1UF +80-20% 50VDC CER	28480	0160-4571
A20C035	0160-4571	8		CAPACITOR-FXD .1UF +80-20% 50VDC CER	28480	0160-4571
A20C036	0160-4571	8		CAPACITOR-FXD .1UF +80-20% 50VDC CER	28480	0160-4571
A20C037	0160-4571	8		CAPACITOR-FXD .1UF +80-20% 50VDC CER	28480	0160-4571
A20C038	0160-4571	8		CAPACITOR-FXD .1UF +80-20% 50VDC CER	28480	0160-4571
A20C039	0160-4571	8		CAPACITOR-FXD .1UF +80-20% 50VDC CER	28480	0160-4571
A20C040	0160-4571	8		CAPACITOR-FXD .1UF +80-20% 50VDC CER	28480	0160-4571
A20C041	0160-4571	8		CAPACITOR-FXD .1UF +80-20% 50VDC CER	28480	0160-4571
A20C042	0160-4571	8		CAPACITOR-FXD .1UF +80-20% 50VDC CER	28480	0160-4571
A20C043	0160-4571	8		CAPACITOR-FXD .1UF +80-20% 50VDC CER	28480	0160-4571
A20C044	0160-4571	8		CAPACITOR-FXD .1UF +80-20% 50VDC CER	28480	0160-4571
A20C045	0160-4571	8		CAPACITOR-FXD .1UF +80-20% 50VDC CER	28480	0160-4571
A20C046	0160-4571	8		CAPACITOR-FXD .1UF +80-20% 50VDC CER	28480	0160-4571
A20C047	0160-4571	8		CAPACITOR-FXD .1UF +80-20% 50VDC CER	28480	0160-4571
A20C048	0160-4571	8		CAPACITOR-FXD .1UF +80-20% 50VDC CER	28480	0160-4571
A20C049	0160-4571	8		CAPACITOR-FXD .1UF +80-20% 50VDC CER	28480	0160-4571
A20C050	0160-4571	8		CAPACITOR-FXD .1UF +80-20% 50VDC CER	28480	0160-4571
A20C051	0160-4571	8		CAPACITOR-FXD .1UF +80-20% 50VDC CER	28480	0160-4571
A20C052	0160-4571	8		CAPACITOR-FXD .1UF +80-20% 50VDC CER	28480	0160-4571
A20C053	0160-4571	8		CAPACITOR-FXD .1UF +80-20% 50VDC CER	28480	0160-4571
A20C054	0160-4571	8		CAPACITOR-FXD .1UF +80-20% 50VDC CER	28480	0160-4571
A20C055	0160-4571	8		CAPACITOR-FXD .1UF +80-20% 50VDC CER	28480	0160-4571
A20C056	0160-4571	8		CAPACITOR-FXD .1UF +80-20% 50VDC CER	28480	0160-4571
A20C057	0160-4571	8		CAPACITOR-FXD .1UF +80-20% 50VDC CER	28480	0160-4571
A20C058	0160-4571	8		CAPACITOR-FXD .1UF +80-20% 50VDC CER	28480	0160-4571
A20C059	0160-4571	8		CAPACITOR-FXD .1UF +80-20% 50VDC CER	28480	0160-4571
A20C060	0160-4571	8		CAPACITOR-FXD .1UF +80-20% 50VDC CER	28480	0160-4571
A20C061	0160-4571	8		CAPACITOR-FXD .1UF +80-20% 50VDC CER	28480	0160-4571
A20C062	0160-4571	8		CAPACITOR-FXD .1UF +80-20% 50VDC CER	28480	0160-4571
A20C063	0160-4571	8		CAPACITOR-FXD .1UF +80-20% 50VDC CER	28480	0160-4571
A20C064	0160-4571	8		CAPACITOR-FXD .1UF +80-20% 50VDC CER	28480	0160-4571
A20C065	0160-4571	8		CAPACITOR-FXD .1UF +80-20% 50VDC CER	28480	0160-4571
A20C066	0160-4571	8		CAPACITOR-FXD .1UF +80-20% 50VDC CER	28480	0160-4571
A20C067	0160-4571	8		CAPACITOR-FXD .1UF +80-20% 50VDC CER	28480	0160-4571
A20C068	0160-4571	8		CAPACITOR-FXD .1UF +80-20% 50VDC CER	28480	0160-4571
A20C069	0160-4571	8		CAPACITOR-FXD .1UF +80-20% 50VDC CER	28480	0160-4571
A20C070	0160-4571	8		CAPACITOR-FXD .1UF +80-20% 50VDC CER	28480	0160-4571
A20C071	0160-4571	8		CAPACITOR-FXD .1UF +80-20% 50VDC CER	28480	0160-4571
A20C072	0160-4571	8		CAPACITOR-FXD .1UF +80-20% 50VDC CER	28480	0160-4571
A20C073	0160-4571	8		CAPACITOR-FXD .1UF +80-20% 50VDC CER	28480	0160-4571
A20C074	0160-4571	8		CAPACITOR-FXD .1UF +80-20% 50VDC CER	28480	0160-4571
A20J100	1251-5202	8	2	CONNECTOR 5-PIN M POST TYPE	28480	1251-5202
A20J200	1251-5202	8		CONNECTOR 5-PIN M POST TYPE	28480	1251-5202
A20R001	0150-3375	5	2	RESISTOR-ZERO OHMS 22 AWG LEAD DIA	28480	0150-3375
A20R002	0683-1005	5	4	RESISTOR 10 5% .25W FC TC=-400/+500	01121	CB1005
A20R003	0683-1005	5		RESISTOR 10 5% .25W FC TC=-400/+500	01121	CB1005
A20R004	0603-2415	3	2	RESISTOR 240 5% .25W FC TC=-400/+600	01121	CB2415
A20R005	0683-1025	9	11	RESISTOR 1K 5% .25W FC TC=-400/+600	01121	CB1025
A20R006	0683-1025	9		RESISTOR 1K 5% .25W FC TC=-400/+600	01121	CB1025
A20R007	0150-3375	5		RESISTOR-ZERO OHMS 22 AWG LEAD DIA	28480	0150-3375
A20R008	0683-1005	5		RESISTOR 10 5% .25W FC TC=-400/+500	01121	CB1005
A20R009	0683-1005	5		RESISTOR 10 5% .25W FC TC=-400/+500	01121	CB1005
A20R010	0683-1025	9		RESISTOR 1K 5% .25W FC TC=-400/+600	01121	CB1025
A20R011	0683-2415	3		RESISTOR 240 5% .25W FC TC=-400/+600	01121	CB2415
A20R012	0603-1025	7		RESISTOR 1K 5% .25W FC TC=-400/+600	01121	CB1025
A20R013	0683-4715	0	2	RESISTOR 470 5% .25W FC TC=-400/+600	01121	CB4715
A20R014	0683-4715	0		RESISTOR 470 5% .25W FC TC=-400/+600	01121	CB4715
A20R015	0683-1025	9		RESISTOR 1K 5% .25W FC TC=-400/+600	01121	CB1025
A20R016	0683-1025	9		RESISTOR 1K 5% .25W FC TC=-400/+600	01121	CB1025
A20R100	0683-1025	9		RESISTOR 1K 5% .25W FC TC=-400/+600	01121	CB1025
A20R200	0683-4725	2	2	RESISTOR 4.7K 5% .25W FC TC=-400/+700	01121	CB4725
A20R300	0683-1025	9		RESISTOR 1K 5% .25W FC TC=-400/+600	01121	CB1025
A20R400	0683-6815	5	1	RESISTOR 680 5% .25W FC TC=-400/+600	01121	CB6815
A20R401	0757-0430	5	1	RESISTOR 2.2K 1% .125W F TC=0+-100	24546	C4-1/8-T0-2211-F
A20R402	0757-0442	9	1	RESISTOR 10K 1% .125W F TC=0+-100	24546	C4-1/8-T0-1002-F
A20R500	0683-1025	9		RESISTOR 1K 5% .25W FC TC=-400/+600	01121	CB1025
A20R501	0683-4725	2		RESISTOR 4.7K 5% .25W FC TC=-400/+700	01121	CB4725
A20R700	0683-1025	9		RESISTOR 1K 5% .25W FC TC=-400/+600	01121	CB1025

See introduction to this section for ordering information
 *Indicates factory selected value

Table 4-3 Replaceable Parts (Cont'd)

Reference Designation	HP Part Number	C D	Qty	Description	Mfr Code	Mfr Part Number
A20R701	0683-1025	9		RESISTOR 1K 5% .25W FC TC=-400/+600	01121	CR1025
A20RP200	1810-0280	8	3	NETWORK-RES 10-SIP10.0K OHM X 9	01121	210A103
A20RP400	1310-0280	8		NETWORK-RES 10-SIP10.0K OHM X 9	01121	210A103
A20RP500	1810-0280	8		NETWORK-RES 10-SIP10.0K OHM X 9	01121	210A103
A20TP001	1251-0600	0	16	CONNECTOR-SGL CONT PIN 1.14-MM-BSC-SZ SQ	28480	1251-0600
A20TP100	1251-0600	0		CONNECTOR-SGL CONT PIN 1.14-MM-BSC-SZ SQ	28480	1251-0600
A20TP101	1251-0600	0		CONNECTOR-SGL CONT PIN 1.14-MM-BSC-SZ SQ	28480	1251-0600
A20TP102	1251-0600	0		CONNECTOR-SGL CONT PIN 1.14-MM-BSC-SZ SQ	28480	1251-0600
A20TP200	1251-0600	0		CONNECTOR-SGL CONT PIN 1.14-MM-BSC-SZ SQ	28480	1251-0600
A20TP201	1251-0600	0		CONNECTOR-SGL CONT PIN 1.14-MM-BSC-SZ SQ	28480	1251-0600
A20TP300	1251-0600	0		CONNECTOR-SGL CONT PIN 1.14-MM-BSC-SZ SQ	28480	1251-0600
A20TP301	1251-0600	0		CONNECTOR-SGL CONT PIN 1.14-MM-BSC-SZ SQ	28480	1251-0600
A20TP302	1251-0600	0		CONNECTOR-SGL CONT PIN 1.14-MM-BSC-SZ SQ	28480	1251-0600
A20TP500	1251-0600	0		CONNECTOR-SGL CONT PIN 1.14-MM-BSC-SZ SQ	28480	1251-0600
A20TP501	1251-0600	0		CONNECTOR-SGL CONT PIN 1.14-MM-BSC-SZ SQ	28480	1251-0600
A20TP502	1251-0600	0		CONNECTOR-SGL CONT PIN 1.14-MM-BSC-SZ SQ	28480	1251-0600
A20TP700	1251-0600	0		CONNECTOR-SGL CONT PIN 1.14-MM-BSC-SZ SQ	28480	1251-0600
A20TP701	1251-0600	0		CONNECTOR-SGL CONT PIN 1.14-MM-BSC-SZ SQ	28480	1251-0600
A20TP702	1251-0600	0		CONNECTOR-SGL CONT PIN 1.14-MM-BSC-SZ SQ	28480	1251-0600
A20TP703	1251-0600	0		CONNECTOR-SGL CONT PIN 1.14-MM-BSC-SZ SQ	28480	1251-0600
A20U001	15C3-0033	5	2	DECIMATION FLTR	28480	15C3-0033
A20U002	1820-2103	9	2	IC DRVR TTL CLOCK DRVR DUAL	27014	D59056CJ-8
A20U003	1820-2103	9		IC DRVR TTL CLOCK DRVR DUAL	27014	D59056CJ-8
A20U004	15C4-0034	8	1	FLTR CONTROLLER	28400	15C4-0034
A20U005	1320-2656	7		IC GATE TTL ALS NAND QUAD 2-INP	01295	SN74ALS00A
A20U100	1820-0681	4	1	IC GATE TTL S NAND QUAD 2-INP	01295	SN74S00N
A20U101	1020-2634	1	2	IC INV TTL ALS HEX	01295	SN74ALS04N
A20U102	1020-0629	0	1	IC FF TTL S J-K NEG-EDGE-TRIG	01295	SN74S112N
A20U103	1020-1205	0	2	IC GATE TTL LS AND DUAL 4-INP	01295	SN74LS21N
A20U104	1820-1196	8	1	IC FF TTL LS D-TYPE POS-EDGE-TRIG COM	01295	SN74LS174N
A20U105	1320-1433	6	2	IC SHF-RGTR TTL LS R-S SERIAL-IN PRL-OUT	01295	SN74LS164N
A20U106	1820-2635	2	2	IC GATE TTL ALS AND QUAD 2-INP	01295	SN74ALS08N
A20U107	1820-3237	4	5	IC DRVR TTL ALS BUS OCTL	28480	1320-3237
A20U108	1820-1205	8		IC GATE TTL LS AND DUAL 4-INP	01295	SN74LS21N
A20U109	1020-1281	2	1	IC DCDR TTL LS 2-TO-4-LINE DUAL 2-INP	01295	SN74LS139N
A20U110	1820-2046	9	2	IC MUXR/DATA-SEL TTL LS 4-TO-1-LINE DUAL	01295	SN74LS353N
A20U111	1820-2046	9		IC MUXR/DATA-SEL TTL LS 4-TO-1-LINE DUAL	01295	SN74LS353N
A20U200	1820-2691	0	6	IC FF TTL F D-TYPE POS-EDGE-TRIG	07263	74F74PC
A20U201	1020-2691	0		IC FF TTL F D-TYPE POS-EDGE-TRIG	07263	74F74PC
A20U202	1820-2705	7	1	IC-8-BIT/16-BIT SYSTEM TIMING CONTROLLER	28480	1020-2705
A20U203	1820-2691	0		IC FF TTL F D-TYPE POS-EDGE-TRIG	07263	74F74PC
A20U300	1820-2635	2		IC GATE TTL ALS AND QUAD 2-INP	01295	SN74ALS08N
A20U301	1020-2691	0		IC FF TTL F D-TYPE POS-EDGE-TRIG	07263	74F74PC
A20U302	1820-2691	0		IC FF TTL F D-TYPE POS-EDGE-TRIG	07263	74F74PC
A20U303	1020-2691	0		IC FF TTL F D-TYPE POS-EDGE-TRIG	07263	74F74PC
A20U304	1820-2772	8	1	IC FF TTL ALS J-K NEG-EDGE-TRIG	01295	SN74ALS112N
A20U305	1820-2488	3	2	IC FF TTL ALS D-TYPE POS-EDGE-TRIG	01295	SN74ALS74N
A20U306	1820-3100	8	2	IC DCDR TTL ALS BIN 3-TO-8-LINE 3-INP	28480	1820-3100
A20U307	1020-3100	8		IC DCDR TTL ALS BIN 3-TO-8-LINE 3-INP	28480	1820-3100
A20U308	1820-1211	8	2	IC GATE TTL LS EXCL-OR QUAD 2-INP	01295	SN74LS86N
A20U309	1820-1211	8		IC GATE TTL LS EXCL-OR QUAD 2-INP	01295	SN74LS86N
A20U400	1820-3238	3	3	IC TRANSCIEVER TTL ALS BUS OCTL	28480	1820-3238
A20U401	15C3-0033	5		DECIMATION FLTR	28480	15C3-0033
A20U402	1820-3238	3		IC TRANSCIEVER TTL ALS BUS OCTL	28480	1820-3238
A20U500	1820-1730	6	3	IC FF TTL LS D-TYPE POS-EDGE-TRIG COM	01295	SN74LS273N
A20U501	1820-1730	6		IC FF TTL LS D-TYPE POS-EDGE-TRIG COM	01295	SN74LS273N
A20U502	1820-1195	7	2	IC FF TTL LS D-TYPE POS-EDGE-TRIG COM	01295	SN74LS175N
A20U503	1820-2773	9	2	IC GATE TTL ALS NAND 8-INP	01295	SN74ALS30N
A20U504	1820-2739	7	1	IC GATE TTL ALS NOR QUAD 2-INP	01295	SN74ALS02N
A20U505	1820-1244	7	2	IC MUXR/DATA-SEL TTL LS 4-TO-1-LINE DUAL	01295	SN74LS153N
A20U506	1820-1730	6		IC FF TTL LS D-TYPE POS-EDGE-TRIG COM	01295	SN74LS273N
A20U507	1820-1244	7		IC MUXR/DATA-SEL TTL LS 4-TO-1-LINE DUAL	01295	SN74LS153N
A20U508	1820-1430	3	1	IC CNTR TTL LS BIN SYNCHRO POS-EDGE-TRIG	01295	SN74LS161AN
A20U509	1820-1195	7		IC FF TTL LS D-TYPE POS-EDGE-TRIG COM	01295	SN74LS175N
A20U510	1820-1997	7	5	IC FF TTL LS D-TYPE POS-EDGE-TRIG PRL-IN	01295	SN74LS374N
A20U600	1820-3238	3		IC TRANSCIEVER TTL ALS BUS OCTL	28480	1820-3238
A20U601	1020-3239	4		IC DRVR TTL ALS BUS OCTL	28480	1820-3239
A20U602	1820-1997	7		IC FF TTL LS D-TYPE POS-EDGE-TRIG PRL-IN	01295	SN74LS374N
A20U603	1820-1997	7		IC FF TTL LS D-TYPE POS-EDGE-TRIG PRL-IN	01295	SN74LS374N
A20U604	1820-3239	4		IC DRVR TTL ALS BUS OCTL	28480	1820-3239
A20U605	1820-3239	4		IC DRVR TTL ALS BUS OCTL	28480	1320-3239
A20U606	1820-1997	7		IC FF TTL LS D-TYPE POS-EDGE-TRIG PRL-IN	01295	SN74LS374N
A20U607	1820-1997	7		IC FF TTL LS D-TYPE POS-EDGE-TRIG PRL-IN	01295	SN74LS374N
A20U700	1820-2096	9	3	IC CNTR TTL LS BIN DUAL 4 BIT	01295	SN74LS393N
A20U701	1320-2657	8	1	IC GATE TTL ALS OR QUAD 2-INP	01295	SN74ALS32N

See introduction to this section for ordering information
 *Indicates factory selected value

Table 4-3 Replaceable Parts (Cont'd)

Reference Designation	HP Part Number	C D	Qty	Description	Mfr Code	Mfr Part Number
A20U702	1020-0683	6	1	IC INV TTL S HEX 1-INP	01295	SN74S04N
A20U703	1020-2634	1		IC INV TTL ALS HEX	01295	SN74ALS04N
A20U704	1020-2773	9		IC GATE TTL ALS NAND 8-INP	01295	SN74ALS30N
A20U705	1020-2096	9		IC CNTR TTL LS BIN DUAL 4-BIT	01295	SN74LS393N
A20U706	1020-2396	9		IC CNTR TTL LS BIN DUAL 4-BIT	01295	SN74LS393N
A20U707	1020-3239	4		IC DRVR TTL ALS BUS OCTL	20480	1020-3239
A20U708	1020-2408	3		IC FF TTL ALS D-TYPE POG-EDGE-TRIG	01295	SN74ALS74N
A20U709	1020-1991	7	1	IC	01295	SN74LS390PC
A20U710	1020-1433	6		IC SHF-RGTR TTL LS R-S SERIAL-IN PRL-OUT	01295	SN74LS164N
A20X708	1200-0638	7	1	SOCKET-IC 14-CONT DIP DIP-SLDR	20480	1200-0638
A20X709	1200-0607	0	1	SOCKET-IC 16-CONT DIP DIP-SLDR	20480	1200-0607
				A20 MISCELLANEOUS PARTS		
	03561-41101	8	3	HEAT SINK	20480	03561-41101
	0300-0411	3	12	SPACER-RND .5-IN-LG .114-IN-ID	20480	0300-0411
	0515-0064	9	12	SCREW-MACH M3 X 0.5 16MM-LS PAN-HD	20480	0515-0064
	0590-1095	6	1	THREADED INSERT-NUT M3 X 0.5 .059-IN-LG	20480	0590-1095
	1200-1011	2	1	SOCKET-IC 64-CONT SQUARE DIP-SLDR	20480	1200-1011
	1260-0989	7	2	SEMICONDUCTOR PKG PART CERAMIC PLUG-IN	20480	1260-0989
	1460-1007	2	12	SPRING-CYRSN .24-IN-OD .375-IN-OA-LG MW	20480	1460-1007
	1480-0116	8	1	PIN-GRV .062-IN-DIA .25-IN-LG STL	20480	1480-0116
	3980-0621	2	2	LID-ALMNA .6-WD .6-LG .071-THK	20480	3980-0621
	4040-0748	3	1	EXTR-PC BD BLK POLYC .062-BD-THKNS	20480	4040-0748
	4040-0750	7	1	EXTR-PC BD RED POLYC .062-BD-THKNS	20480	4040-0750

See introduction to this section for ordering information
 *Indicates factory selected value

Table 4-3 Replaceable Parts (Cont'd)

Reference Designation	HP Part Number	C D	Qty	Description	Mfr Code	Mfr Part Number
A30	03561-66530	?	1	FFT/RAM ASSEMBLY (REVISION B)	28400	03561-66530
A30C001	0160-4571	8	55	CAPACITOR-FXD .1UF +80-20% 50VDC CER	28480	0160-4571
A30C002	0160-4571	8		CAPACITOR-FXD .1UF +80-20% 50VDC CER	28480	0160-4571
A30C003	0160-4571	8		CAPACITOR-FXD .1UF +80-20% 50VDC CER	28480	0160-4571
A30C004	0160-4571	8		CAPACITOR-FXD .1UF +80-20% 50VDC CER	28480	0160-4571
A30C005	0160-4571	8		CAPACITOR-FXD .1UF +80-20% 50VDC CER	28480	0160-4571
A30C006	0160-4571	8		CAPACITOR-FXD .1UF +80-20% 50VDC CER	28480	0160-4571
A30C100	0160-4791	4	2	CAPACITOR-FXD 10PF +-5% 100VDC CER 0+-30	28480	0160-4791
A30C131	0160-4791	4		CAPACITOR-FXD 10PF +-5% 100VDC CER 0+-30	28480	0160-4791
A30C102	0160-4571	8		CAPACITOR-FXD .1UF +80-20% 50VDC CER	28480	0160-4571
A30C133	0160-4571	8		CAPACITOR-FXD .1UF +80-20% 50VDC CER	28480	0160-4571
A30C104	0160-4571	8		CAPACITOR-FXD .1UF +80-20% 50VDC CER	28480	0160-4571
A30C135	0160-4571	8		CAPACITOR-FXD .1UF +80-20% 50VDC CER	28480	0160-4571
A30C200	0160-4571	8		CAPACITOR-FXD .1UF +80-20% 50VDC CER	28480	0160-4571
A30C201	0160-4571	8		CAPACITOR-FXD .1UF +80-20% 50VDC CER	28480	0160-4571
A30C202	0160-4571	8		CAPACITOR-FXD .1UF +80-20% 50VDC CER	28480	0160-4571
A30C203	0160-4571	8		CAPACITOR-FXD .1UF +80-20% 50VDC CER	28480	0160-4571
A30C204	0160-4571	8		CAPACITOR-FXD .1UF +80-20% 50VDC CER	28480	0160-4571
A30C205	0160-4571	8		CAPACITOR-FXD .1UF +80-20% 50VDC CER	28480	0160-4571
A30C206	0160-4571	8		CAPACITOR-FXD .1UF +80-20% 50VDC CER	28480	0160-4571
A30C207	0160-4571	8		CAPACITOR-FXD .1UF +80-20% 50VDC CER	28480	0160-4571
A30C208	0160-4571	8		CAPACITOR-FXD .1UF +80-20% 50VDC CER	28480	0160-4571
A30C209	0160-4571	8		CAPACITOR-FXD .1UF +80-20% 50VDC CER	28480	0160-4571
A30C210	0160-4571	8		CAPACITOR-FXD .1UF +80-20% 50VDC CER	28480	0160-4571
A30C211	0160-4571	8		CAPACITOR-FXD .1UF +80-20% 50VDC CER	28480	0160-4571
A30C300	0160-4571	8		CAPACITOR-FXD .1UF +80-20% 50VDC CER	28480	0160-4571
A30C301	0160-4571	8		CAPACITOR-FXD .1UF +80-20% 50VDC CER	28480	0160-4571
A30C302	0160-4571	8		CAPACITOR-FXD .1UF +80-20% 50VDC CER	28480	0160-4571
A30C303	0160-4571	8		CAPACITOR-FXD .1UF +80-20% 50VDC CER	28480	0160-4571
A30C304	0160-4571	8		CAPACITOR-FXD .1UF +80-20% 50VDC CER	28480	0160-4571
A30C305	0160-4571	8		CAPACITOR-FXD .1UF +80-20% 50VDC CER	28480	0160-4571
A30C306	0160-4571	8		CAPACITOR-FXD .1UF +80-20% 50VDC CER	28480	0160-4571
A30C307	0160-4571	8		CAPACITOR-FXD .1UF +80-20% 50VDC CER	28480	0160-4571
A30C308	0160-4571	8		CAPACITOR-FXD .1UF +80-20% 50VDC CER	28480	0160-4571
A30C309	0160-4571	8		CAPACITOR-FXD .1UF +80-20% 50VDC CER	28480	0160-4571
A30C310	0160-4571	8		CAPACITOR-FXD .1UF +80-20% 50VDC CER	28480	0160-4571
A30C400	0160-4571	8		CAPACITOR-FXD .1UF +80-20% 50VDC CER	28480	0160-4571
A30C500	0160-4571	8		CAPACITOR-FXD .1UF +80-20% 50VDC CER	28480	0160-4571
A30C501	0160-4571	8		CAPACITOR-FXD .1UF +80-20% 50VDC CER	28480	0160-4571
A30C502	0160-4571	8		CAPACITOR-FXD .1UF +80-20% 50VDC CER	28480	0160-4571
A30C503	0160-4571	8		CAPACITOR-FXD .1UF +80-20% 50VDC CER	28480	0160-4571
A30C504	0160-4571	8		CAPACITOR-FXD .1UF +80-20% 50VDC CER	28480	0160-4571
A30C505	0160-4571	8		CAPACITOR-FXD .1UF +80-20% 50VDC CER	28480	0160-4571
A30C600	0160-4571	8		CAPACITOR-FXD .1UF +80-20% 50VDC CER	28480	0160-4571
A30C601	0160-4571	8		CAPACITOR-FXD .1UF +80-20% 50VDC CER	28480	0160-4571
A30C602	0160-4571	8		CAPACITOR-FXD .1UF +80-20% 50VDC CER	28480	0160-4571
A30C603	0160-4571	8		CAPACITOR-FXD .1UF +80-20% 50VDC CER	28480	0160-4571
A30C604	0160-4571	8		CAPACITOR-FXD .1UF +80-20% 50VDC CER	28480	0160-4571
A30C605	0160-4571	8		CAPACITOR-FXD .1UF +80-20% 50VDC CER	28480	0160-4571
A30C606	0160-4571	8		CAPACITOR-FXD .1UF +80-20% 50VDC CER	28480	0160-4571
A30C607	0160-4571	8		CAPACITOR-FXD .1UF +80-20% 50VDC CER	28480	0160-4571
A30C700	0160-4571	8		CAPACITOR-FXD .1UF +80-20% 50VDC CER	28480	0160-4571
A30C701	0160-4571	8		CAPACITOR-FXD .1UF +80-20% 50VDC CER	28480	0160-4571
A30C702	0160-4571	8		CAPACITOR-FXD .1UF +80-20% 50VDC CER	28480	0160-4571
A30C703	0160-4571	8		CAPACITOR-FXD .1UF +80-20% 50VDC CER	28480	0160-4571
A30C704	0160-4571	8		CAPACITOR-FXD .1UF +80-20% 50VDC CER	28480	0160-4571
A30C705	0160-4571	8		CAPACITOR-FXD .1UF +80-20% 50VDC CER	28480	0160-4571
A30C706	0160-4571	8		CAPACITOR-FXD .1UF +80-20% 50VDC CER	28480	0160-4571
A30CR001	1990-0485	5	1	LED-LAMP LHM-INT=800UCD 1F=30MA-MAX	28480	5332-4984
A30J001	1251-5202	8	2	CONNECTOR 5-PIN H POST TYPE	28480	1251-5202
A30J200	1251-5202	8		CONNECTOR 5-PIN H POST TYPE	28480	1251-5202
A30R001	0683-2715	6	1	RESISTOR 270 5% .25W FC TC=-400/+600	01121	CB0715
A30R002	0683-1025	9	8	RESISTOR 1K 5% .25W FC TC=-400/+600	01121	CB1025
A30R003	0683-1025	9		RESISTOR 1K 5% .25W FC TC=-400/+600	01121	CB1025
A30R004	0683-1025	9		RESISTOR 1K 5% .25W FC TC=-400/+600	01121	CB1025
A30R300	0683-4705	8	4	RESISTOR 47 5% .25W FC TC=-400/+500	01121	CB4705
A30R301	0683-4705	8		RESISTOR 47 5% .25W FC TC=-400/+500	01121	CB4705
A30R302	0683-4705	8		RESISTOR 47 5% .25W FC TC=-400/+500	01121	CB4705
A30R401	0683-1025	5		RESISTOR 1K 5% .25W FC TC=-400/+600	01121	CB1025
A30R403	8150-3375	9	4	RESISTOR-ZERO OHMS 22 AWG LEAD DIA	28480	8150-3375
A30R406	0683-1025	9		RESISTOR 1K 5% .25W FC TC=-400/+600	01121	CB1025

See introduction to this section for ordering information
 *Indicates factory selected value

Table 4-3 Replaceable Parts (Cont'd)

Reference Designation	HP Part Number	C D	Qty	Description	Mfr Code	Mfr Part Number
A30R407	3150-3375	5		RESISTOR-ZERO OHMS 22 AWG LEAD DIA	20480	8150-3375
A30R409	0150-3375	5		RESISTOR-ZERO OHMS 22 AWG LEAD DIA	20480	8150-3375
A3JR411	3150-3375	5		RESISTOR-ZERO OHMS 22 AWG LEAD DIA	20480	3150-3375
A30R500	0683-1025	9		RESISTOR 1K 5% .25W FC TC=-400/+600	01121	CB1025
A3JR501	0683-1025	9		RESISTOR 1K 5% .25W FC TC=-400/+600	01121	CB1025
A30R600	0683-4705	8		RESISTOR 47 5% .25W FC TC=-400/+500	01121	CB4705
A3JR700	0683-1025	9		RESISTOR 1K 5% .25W FC TC=-400/+600	01121	CB1025
A30RP200	1810-0533	4	1	NETWORK-RES 16-DIP33.0 OHM X 8	20480	1810-0533
A30RP500	1810-0280	8	5	NETWORK-RES 10-SIP10.0K OHM X 7	01121	210A103
A30RP501	1810-0280	8		NETWORK-RES 10-SIP10.0K OHM X 9	01121	210A103
A30RP600	1810-0280	8		NETWORK-RES 10-SIP10.0K OHM X 9	01121	210A103
A30RP601	1810-0280	8		NETWORK-RES 10-SIP10.0K OHM X 9	01121	210A103
A30RP700	1810-0280	8		NETWORK-RES 10-SIP10.0K OHM X 7	01121	210A103
A30TP001	1251-0600	0	10	CONNECTOR-SGL CONT PIN 1.14-MM-BSC-SZ SQ	20480	1251-0600
A30TP002	1251-0600	0		CONNECTOR-SGL CONT PIN 1.14-MM-BSC-GZ SQ	20480	1251-0600
A30TP003	1251-0600	0		CONNECTOR-SGL CONT PIN 1.14-MM-BSC-SZ SQ	20480	1251-0600
A30TP004	1251-0600	0		CONNECTOR-SGL CONT PIN 1.14-MM-BSC-GZ SQ	20480	1251-0600
A30TP100	1251-0600	0		CONNECTOR-SGL CONT PIN 1.14-MM-BSC-SZ SQ	20480	1251-0600
A30TP101	1251-0600	0		CONNECTOR-SGL CONT PIN 1.14-MM-BSC-GZ SQ	20480	1251-0600
A30TP102	1251-0600	0		CONNECTOR-SGL CONT PIN 1.14-MM-BSC-SZ SQ	20480	1251-0600
A30TP200	1251-0600	0		CONNECTOR-SGL CONT PIN 1.14-MM-BSC-GZ SQ	20480	1251-0600
A30TP300	1251-0600	0		CONNECTOR-SGL CONT PIN 1.14-MM-BSC-SZ SQ	20480	1251-0600
A30TP301	1251-0600	0		CONNECTOR-SGL CONT PIN 1.14-MM-BSC-GZ SQ	20480	1251-0600
A30U001	1820-2488	3	3	IC FF TTL ALS D-TYPE POS-EDGE-TRIG	01295	SN74ALS74N
A30U002	1020-2081	3	1	IC-SN74ALS27	20480	1020-2081
A30U003	1820-0683	6	1	IC INV TTL S HEX 1-INP	01295	SN74S04N
A30U004	1820-2565	7	2	IC BFR TTL S LINE DRVR OCTL	34335	AM74S244N
A30U005	1820-2488	3		IC FF TTL ALS D-TYPE POS-EDGE-TRIG	01295	SN74ALS74N
A30U006	1820-2635	2	3	IC GATE TTL ALS AND QUAD 2-INP	01295	SN74ALS08N
A30U007	1820-2565	7		IC BFR TTL S LINE DRVR OCTL	34335	AM74S244N
A30U100	T-55272	0	1	TMS320	20480	T-55272
A30U101	1820-1997	7	8	IC FF TTL LS D-TYPE POS-EDGE-TRIG PRL-IN	01295	SN74LS374N
A30U102	1820-1997	7		IC FF TTL LS D-TYPE POS-EDGE-TRIG PRL-IN	01295	SN74LS374N
A30U103	1820-1997	7		IC FF TTL LS D-TYPE POS-EDGE-TRIG PRL-IN	01295	SN74LS374N
A30U104	1820-1997	7		IC FF TTL LS D-TYPE POS-EDGE-TRIG PRL-IN	01295	SN74LS374N
A30U105	1820-1997	7		IC FF TTL LS D-TYPE POS-EDGE-TRIG PRL-IN	01295	SN74LS374N
A30U106	1820-1997	7		IC FF TTL LS D-TYPE POS-EDGE-TRIG PRL-IN	01295	SN74LS374N
A30U200	1820-1428	9	2	IC MUXR/DATA-SEL TTL LS 2-TO-1-LINE QUAD	01295	SN74LS150N
A30U201	1818-3006	8	16	IC NMOS 65536 (64K) DYN RAM 200-NS 3-S	20480	1818-3006
A30U202	1818-3006	8		IC NMOS 65536 (64K) DYN RAM 200-NS 3-S	20480	1818-3006
A30U203	1818-3006	8		IC NMOS 65536 (64K) DYN RAM 200-NS 3-S	20480	1818-3006
A30U204	1818-3006	8		IC NMOS 65536 (64K) DYN RAM 200-NS 3-S	20480	1818-3006
A30U205	1820-1428	9		IC MUXR/DATA-SEL TTL LS 2-TO-1-LINE QUAD	01295	SN74LS150N
A30U206	1820-3239	4	3	IC DRVR TTL ALS BUS OCTL	20480	1820-3239
A30U207	1818-3006	8		IC NMOS 65536 (64K) DYN RAM 200-NS 3-S	20480	1818-3006
A30U208	1818-3006	8		IC NMOS 65536 (64K) DYN RAM 200-NS 3-S	20480	1818-3006
A30U209	1818-3006	8		IC NMOS 65536 (64K) DYN RAM 200-NS 3-S	20480	1818-3006
A30U210	1818-3006	8		IC NMOS 65536 (64K) DYN RAM 200-NS 3-S	20480	1818-3006
A30U300	1818-3006	8		IC NMOS 65536 (64K) DYN RAM 200-NS 3-S	20480	1818-3006
A30U301	1818-3006	8		IC NMOS 65536 (64K) DYN RAM 200-NS 3-S	20480	1818-3006
A30U302	1818-3006	8		IC NMOS 65536 (64K) DYN RAM 200-NS 3-S	20480	1818-3006
A30U303	1818-3006	8		IC NMOS 65536 (64K) DYN RAM 200-NS 3-S	20480	1818-3006
A30U304	1820-2775	1	3	IC GATE TTL ALS NAND TPL 3-INP	01295	SN74ALS10N
A30U305	1820-2656	7	3	IC GATE TTL ALS NAND QUAD 2-INP	01295	SN74ALS00N
A30U306	1818-3006	8		IC NMOS 65536 (64K) DYN RAM 200-NS 3-S	20480	1818-3006
A30U307	1818-3006	8		IC NMOS 65536 (64K) DYN RAM 200-NS 3-S	20480	1818-3006
A30U308	1818-3006	8		IC NMOS 65536 (64K) DYN RAM 200-NS 3-S	20480	1818-3006
A30U309	1818-3006	8		IC NMOS 65536 (64K) DYN RAM 200-NS 3-S	20480	1818-3006
A30U310	1820-2635	2		IC GATE TTL ALS AND QUAD 2-INP	01295	SN74ALS08N
A30U311	1820-2635	2		IC GATE TTL ALS AND QUAD 2-INP	01295	SN74ALS08N
A30U400	03561-60315	6	1	PROGRAMMED PROM	20480	03561-60315
A30U401	1820-2656	7		IC GATE TTL ALS NAND QUAD 2-INP	01295	SN74ALS00N
A30U402	03561-60316	7	1	PROGRAMMED PROM	20480	03561-60316
A30U501	1820-1997	7		IC FF TTL LS D-TYPE POS-EDGE-TRIG PRL-IN	01295	SN74LS374N
A30U502	1820-3239	4		IC DRVR TTL ALS BUS OCTL	20480	1820-3239
A30U503	1820-1997	7		IC FF TTL LS D-TYPE POS-EDGE-TRIG PRL-IN	01295	SN74LS374N
A30U504	1820-3239	4		IC DRVR TTL ALS BUS OCTL	20480	1820-3239
A30U600	1820-1195	7	1	IC FF TTL LS D-TYPE POS-EDGE-TRIG COM	01295	SN74LS175N
A30U601	1820-2096	9	1	IC CNTR TTL LS BIN DUAL 4-BIT	01295	SN74LS393N
A30U602	1820-2634	1	1	IC INV TTL ALS HEX	01295	SN74ALS04N
A30U603	1820-3238	3	2	IC TRANSCEIVER TTL ALS BUS OCTL	20480	1820-3238
A30U605	1820-2657	8	1	IC GATE TTL ALS OR QUAD 2-INP	01295	SN74ALS32N
A30U606	1820-3100	8	1	IC DCDR TTL ALS BIN 3-TO-8-LINE 3-INP	20480	1820-3100

See introduction to this section for ordering information
 *Indicates factory selected value

Table 4-3 Replaceable Parts (Cont'd)

Reference Designation	HP Part Number	C D	Qty	Description	Mfr Code	Mfr Part Number
A30U607	1020-2656	7		IC GATE TTL ALS NAND QUAD 2-INP	31295	SN74ALS00N
A30U608	1820-2488	3		IC FF TTL ALS D-TYPE POS-EDGE-TRIG	01295	SN74ALS74N
A30U609	1820-2775	1		IC GATE TTL ALS NAND TPL 3-INP	31295	SN74ALS13N
A30U700	1820-3239	3		IC TRANSCEIVER TTL ALS BUS OCTL	28480	1026-3238
A30U701	1320-1730	6	2	IC FF TTL LS D-TYPE POS-EDGE-TRIG COM	01295	SN74LS273N
A30U702	1820-2739	7	1	IC GATE TTL ALS NOR QUAD 2 INP	01295	SN74ALS02N
A30U703	1320-0629	0	3	IC FF TTL S J-K NEG-EDGE-TRIG	01295	SN74S112N
A30U704	1820-0629	0		IC FF TTL S J-K NEG-EDGE-TRIG	01295	SN74S112N
A30U705	1820-2775	1		IC GATE TTL ALS NAND TPL 3-INP	31295	SN74ALS10N
A30U706	1820-1729	3	1	IC LCH TTL LS COM CLEAR 8-BIT	01295	SN74LS259N
A30U707	1320-1730	6		IC FF TTL LS D-TYPE POS-EDGE-TRIG COM	01295	SN74LS273N
A30U708	1820-1051	2	1	IC ENCDR TTL LS	01295	SN74LS148N
A30U709	1820-0629	0		IC FF TTL S J-K NEG-EDGE-TRIG	01295	SN74S112N
A30W100	1251-5285	7	1	CONNECTOR 2-PIN M POST TYPE	28480	1251-5285
A30W101	T-55274	2	2	8X2 JUMPER	28480	T-55274
A30W102	T-55274	2		8X2 JUMPER	28480	T-55274
A30Y001	3110-1501	9	1	CRYSTAL-QUARTZ 20 MHZ HC-18/U-HLDR	28480	3110-1501
				A30 MISCELLANEOUS PARTS		
	1251-5376	7	1	CONNECTOR 8-PIN M POST TYPE	28480	1251-5376
	1480-0116	8	1	PIN-GRV .062-IN-DIA .25-IN-LG STL	28480	1480-0116
	4040-0748	3	1	EXTR-PC BD BLK POLYC .062-BD-THKNS	28480	4040-0748
	4040-0751	8	1	EXTR-PC BD DRN POLYC .062-BD-THKNS	28480	4040-0751

See introduction to this section for ordering information
 *Indicates factory selected value

Table 4-3 Replaceable Parts (Cont'd)

Reference Designation	HP Part Number	C D	Qty	Description	Mfr Code	Mfr Part Number
A40	3351-66540	1	1	PROCESSOR/ROM ASSEMBLY (REVISION B)	20480	0351-66540
A40C001	0160-4571	8	60	CAPACITOR-FXD .1UF +80-20% 50VDC CER	20480	0160-4571
A40C002	3160-3847	9	3	CAPACITOR-FXD .01UF +100-0% 50VDC CER	20480	0160-3847
A40C003	0180-0229	7	1	CAPACITOR-FXD 33UF+-10% 10VDC TA	56289	150D336X901CR2
A40C004	3160-4571	8		CAPACITOR-FXD .1UF +80-20% 50VDC CER	20480	0160-4571
A40C005	0160-4571	8		CAPACITOR-FXD .1UF +80-20% 50VDC CER	20480	0160-4571
A40C006	0160-4571	8		CAPACITOR-FXD .1UF +80-20% 50VDC CER	20480	0160-4571
A40C007	0160-4571	8		CAPACITOR-FXD .1UF +86-20% 50VDC CER	20480	0160-4571
A40C008	0160-4571	8		CAPACITOR-FXD .1UF +80-20% 50VDC CER	20480	0160-4571
A40C009	0160-4571	8		CAPACITOR-FXD .1UF +86-20% 50VDC CER	20480	0160-4571
A40C010	0160-4571	8		CAPACITOR-FXD .1UF +80-20% 50VDC CER	20480	0160-4571
A40C011	0160-4571	8		CAPACITOR-FXD .1UF +86-20% 50VDC CER	20480	0160-4571
A40C010	0100-0228	6	1	CAPACITOR-FXD 22UF+-10% 15VDC TA	56289	150D226X9015CR2
A40C011	0160-4571	8		CAPACITOR-FXD .1UF +80-20% 50VDC CER	20480	0160-4571
A40C012	0160-4571	8		CAPACITOR-FXD .1UF +80-20% 50VDC CER	20480	0160-4571
A40C013	0160-4571	8		CAPACITOR-FXD .1UF +86-20% 50VDC CER	20480	0160-4571
A40C014	0160-4571	8		CAPACITOR-FXD .1UF +80-20% 50VDC CER	20480	0160-4571
A40C015	0160-4571	8		CAPACITOR-FXD .1UF +80-20% 50VDC CER	20480	0160-4571
A40C016	0160-4571	8		CAPACITOR-FXD .1UF +88-20% 50VDC CER	20480	0160-4571
A40C017	0160-4571	8		CAPACITOR-FXD .1UF +86-20% 50VDC CER	20480	0160-4571
A40C018	0160-4571	8		CAPACITOR-FXD .1UF +80-20% 50VDC CER	20480	0160-4571
A40C019	0160-4571	8		CAPACITOR-FXD .1UF +80-20% 50VDC CER	20480	0160-4571
A40C110	3160-3047	9		CAPACITOR-FXD .01UF +100-0% 50VDC CER	20480	0160-3047
A40C200	0160-4571	8		CAPACITOR-FXD .1UF +80-20% 50VDC CER	20480	0160-4571
A40C201	0121-3432	8	1	CAPACITOR-V TRMR AIR 2.1-13.3PF 350V	74970	189-3505-125
A40C202	0160-4571	8		CAPACITOR-FXD .1UF +80-20% 50VDC CER	20480	0160-4571
A40C203	0160-4821	1	1	CAPACITOR-FXD 1200PF +-5% 100VDC CER	20480	0160-4821
A40C204	0180-0374	3	1	CAPACITOR-FXD 18UF+-10% 20VDC TA	56289	150D186X9020CR2
A40C205	3160-4790	3	1	CAPACITOR-FXD 12PF +-5% 100VDC CER 3+-30	20480	0160-4790
A40C206	0160-3847	9		CAPACITOR-FXD .01UF +100-0% 50VDC CER	20480	0160-3847
A40C207	3130-0116	1	1	CAPACITOR-FXD 6.5UF+-10% 35VDC TA	56289	150D635X9035CR2
A40C208	0160-4571	8		CAPACITOR-FXD .1UF +80-20% 50VDC CER	20480	0160-4571
A40C209	0160-4571	8		CAPACITOR-FXD .1UF +82-20% 50VDC CER	20480	0160-4571
A40C210	0160-4571	8		CAPACITOR-FXD .1UF +80-20% 50VDC CER	20480	0160-4571
A40C211	3130-4571	8		CAPACITOR-FXD .1UF +80-20% 50VDC CER	20480	0160-4571
A40C212	0160-4571	8		CAPACITOR-FXD .1UF +80-20% 50VDC CER	20480	0160-4571
A40C213	0160-4571	8		CAPACITOR-FXD .1UF +80-20% 50VDC CER	20480	0160-4571
A40C214	0160-4571	8		CAPACITOR-FXD .1UF +80-20% 50VDC CER	20480	0160-4571
A40C215	3130-4571	8		CAPACITOR-FXD .1UF +80-20% 50VDC CER	20480	0160-4571
A40C216	0160-2328	9	1	CAPACITOR-FXD 200PF +-1% 360VDC MICA	20480	0160-2328
A40C300	0160-4571	9		CAPACITOR-FXD .1UF +80-20% 50VDC CER	20480	0160-4571
A40C301	0160-4571	8		CAPACITOR-FXD .1UF +80-20% 50VDC CER	20480	0160-4571
A40C302	3160-4571	8		CAPACITOR-FXD .1UF +80-20% 50VDC CER	20480	0160-4571
A40C303	0160-4571	8		CAPACITOR-FXD .1UF +80-20% 50VDC CER	20480	0160-4571
A40C304	3160-4571	8		CAPACITOR-FXD .1UF +80-20% 50VDC CER	20480	0160-4571
A40C305	0160-4571	8		CAPACITOR-FXD .1UF +86-20% 50VDC CER	20480	0160-4571
A40C306	0160-4571	8		CAPACITOR-FXD .1UF +80-20% 50VDC CER	20480	0160-4571
A40C307	0160-4571	8		CAPACITOR-FXD .1UF +86-20% 50VDC CER	20480	0160-4571
A40C308	0160-4571	8		CAPACITOR-FXD .1UF +80-20% 50VDC CER	20480	0160-4571
A40C309	0160-4571	8		CAPACITOR-FXD .1UF +86-20% 50VDC CER	20480	0160-4571
A40C310	3130-4571	8		CAPACITOR-FXD .1UF +80-20% 50VDC CER	20480	0160-4571
A40C400	0160-4571	8		CAPACITOR-FXD .1UF +80-20% 50VDC CER	20480	0160-4571
A40C401	0160-4571	8		CAPACITOR-FXD .1UF +80-20% 50VDC CER	20480	0160-4571
A40C402	0160-4571	8		CAPACITOR-FXD .1UF +86-20% 50VDC CER	20480	0160-4571
A40C403	0160-4571	8		CAPACITOR-FXD .1UF +80-20% 50VDC CER	20480	0160-4571
A40C404	0160-4571	8		CAPACITOR-FXD .1UF +80-20% 50VDC CER	20480	0160-4571
A40C405	3160-4571	8		CAPACITOR-FXD .1UF +80-20% 50VDC CER	20480	0160-4571
A40C406	0160-4571	8		CAPACITOR-FXD .1UF +80-20% 50VDC CER	20480	0160-4571
A40C407	0160-4571	8		CAPACITOR-FXD .1UF +80-20% 50VDC CER	20480	0160-4571
A40C408	0160-4571	8		CAPACITOR-FXD .1UF +86-20% 50VDC CER	20480	0160-4571
A40C409	0160-4571	8		CAPACITOR-FXD .1UF +80-20% 50VDC CER	20480	0160-4571
A40C500	0160-4571	8		CAPACITOR-FXD .1UF +86-20% 50VDC CER	20480	0160-4571
A40C501	3160-4571	8		CAPACITOR-FXD .1UF +80-20% 50VDC CER	20480	0160-4571
A40C502	0160-4571	8		CAPACITOR-FXD .1UF +80-20% 50VDC CER	20480	0160-4571
A40C503	3160-4571	8		CAPACITOR-FXD .1UF +80-20% 50VDC CER	20480	0160-4571
A40C504	0160-4571	8		CAPACITOR-FXD .1UF +86-20% 50VDC CER	20480	0160-4571
A40C600	0160-4571	8		CAPACITOR-FXD .1UF +80-20% 50VDC CER	20480	0160-4571
A40C601	0160-4571	8		CAPACITOR-FXD .1UF +80-20% 50VDC CER	20480	0160-4571
A40C602	3160-4571	8		CAPACITOR-FXD .1UF +80-20% 50VDC CER	20480	0160-4571
A40C700	0160-4571	8		CAPACITOR-FXD .1UF +80-20% 50VDC CER	20480	0160-4571
A40C701	3160-4571	8		CAPACITOR-FXD .1UF +80-20% 50VDC CER	20480	0160-4571

See introduction to this section for ordering information
 *Indicates factory selected value

Table 4-3 Replaceable Parts (Cont'd)

Reference Designation	HP Part Number	C D	Qty	Description	Mfr Code	Mfr Part Number
A40C732	3160-4571	8		CAPACITOR-FXD .1UF +80-20% 50VDC CER	28480	0160-4571
A40CR001	1990-0485	5	1	LED-LAMP LUM-INT=800UCD IF=30MA-MAX	28480	5082-4984
A40CR002	1793-0486	6	1	LED-LAMP LUM-INT=1MCD IF=20MA-MAX BUR=5V	28480	5082-4684
A40CR003	1902-0943	5	1	DIODE-ZNR 2.4V 5% DO-35 PD=.4W TC=-.037%	28480	1902-0943
A40CR200	1931-0025	2	1	DIODE-GEN PRP 100V 200MA DO-7	28480	1931-0025
A40J100	1251-5202	8	1	CONNECTOR 5-PIN M POST TYPE	28480	1251-5202
A40L100	9140-0748	0	1	INDUCTOR 250UH 25% .25DX.5LG Q=3	28480	9140-0748
A40L101	9100-3313	7	1	INDUCTOR RF-CH-MLD 22UH 5% .166DX.385LG	28480	9100-3313
A40L201	9140-0253	2	1	INDUCTOR RF-CH-MLD 300NH 1% .166DX.385LG	28480	9140-0253
A40Q100	1854-0019	3	1	TRANSISTOR NPN SI TO-18 PD=360MW	28480	1854-0019
A40Q200	1054-0215	1	2	TRANSISTOR NPN SI PD=350MW FT=300MHZ	04713	2N3904
A40Q201	1854-0215	1	1	TRANSISTOR NPN SI PD=350MW FT=300MHZ	04713	2N3904
A40R001	3757-0415	6	3	RESISTOR 475 1% .125W F TC=0+/-100	24546	C4-1/8-T0-475R-F
A40R002	0683-2215	1	1	RESISTOR 220 5% .25W FC TC=-400/+600	01121	CR2215
A40R003	0698-3279	0	6	RESISTOR 4.99K 1% .125W F TC=0+/-100	24546	C4-1/8-T0-4991-F
A40R004	0683-1015	7	1	RESISTOR 100 5% .25W FC TC=-400/+500	01121	CR1015
A40R005	0603-9135	8	1	RESISTOR 91K 5% .25W FC TC=-400/+800	01121	CR9135
A40R006	0683-1035	1	3	RESISTOR 10K 5% .25W FC TC=-400/+700	01121	CR1035
A40R007	3683-1035	1	1	RESISTOR 10K 5% .25W FC TC=-400/+700	01121	CR1035
A40R008	0683-1535	6	1	RESISTOR 15K 5% .25W FC TC=-400/+800	01121	CR1535
A40R009	3678-3279	3	1	RESISTOR 4.99K 1% .125W F TC=0+/-100	24546	C4-1/8-T0-4991-F
A40R100	0698-3279	0	1	RESISTOR 4.99K 1% .125W F TC=0+/-100	24546	C4-1/8-T0-4991-F
A40R101	0683-1025	7	4	RESISTOR 1K 5% .25W FC TC=-400/+600	01121	CR1025
A40R102	0683-2715	6	2	RESISTOR 270 5% .25W FC TC=-400/+600	01121	CR2715
A40R103	3683-2715	6	1	RESISTOR 270 5% .25W FC TC=-400/+600	01121	CR2715
A40R104	0683-1025	9	1	RESISTOR 1K 5% .25W FC TC=-400/+600	01121	CR1025
A40R105	3683-1025	9	1	RESISTOR 1K 5% .25W FC TC=-400/+600	01121	CR1025
A40R200	0683-4705	8	4	RESISTOR 47 5% .25W FC TC=-400/+500	01121	CR4705
A40R201	0633-5115	6	1	RESISTOR 510 5% .25W FC TC=-400/+600	01121	CR5115
A40R203	0698-3279	0	1	RESISTOR 4.99K 1% .125W F TC=0+/-100	24546	C4-1/8-T0-4991-F
A40R204	0683-4705	8	1	RESISTOR 47 5% .25W FC TC=-400/+500	01121	CR4705
A40R205	0757-0415	6	1	RESISTOR 475 1% .125W F TC=0+/-100	24546	C4-1/8-T0-475R-F
A40R206	3683-4705	8	1	RESISTOR 47 5% .25W FC TC=-400/+500	01121	CR4705
A40R207	0683-1035	1	1	RESISTOR 10K 5% .25W FC TC=-400/+700	01121	CR1035
A40R208	0757-0415	6	1	RESISTOR 475 1% .125W F TC=0+/-100	24546	C4-1/8-T0-475R-F
A40R209	0698-3279	0	1	RESISTOR 4.99K 1% .125W F TC=0+/-100	24546	C4-1/8-T0-4991-F
A40R210	0683-4705	8	1	RESISTOR 47 5% .25W FC TC=-400/+500	01121	CR4705
A40R400	0683-1025	9	1	RESISTOR 1K 5% .25W FC TC=-400/+600	01121	CR1025
A40R401	0603-3305	2	1	RESISTOR 33 5% .25W FC TC=-400/+500	01121	CR3305
A40R402	0698-3279	0	1	RESISTOR 4.99K 1% .125W F TC=0+/-100	24546	C4-1/8-T0-4991-F
A40R503	3150-3375	5	0	RESISTOR-ZERO OHMS 22 AWG LEAD DIA	28480	8150-3375
A40R504	8150-3375	5	0	RESISTOR-ZERO OHMS 22 AWG LEAD DIA	28480	8150-3375
A40R505	0150-3375	5	0	RESISTOR-ZERO OHMS 22 AWG LEAD DIA	28480	8150-3375
A40R600	8150-3375	5	0	RESISTOR-ZERO OHMS 22 AWG LEAD DIA	28480	8150-3375
A40R601	8150-3375	5	0	RESISTOR-ZERO OHMS 22 AWG LEAD DIA	28480	8150-3375
A40R603	8150-3375	5	0	RESISTOR-ZERO OHMS 22 AWG LEAD DIA	28480	8150-3375
A40R604	8150-3375	5	0	RESISTOR-ZERO OHMS 22 AWG LEAD DIA	28480	8150-3375
A40R609	8150-3375	5	0	RESISTOR-ZERO OHMS 22 AWG LEAD DIA	28480	8150-3375
A40RP001	1810-0280	8	6	NETWORK-RES 10-SIP10.0K OHM X 9	01121	210A103
A40RP100	1010-0280	8	1	NETWORK-RES 10-SIP10.0K OHM X 9	01121	210A103
A40RP101	1810-0280	8	1	NETWORK-RES 10-SIP10.0K OHM X 9	01121	210A103
A40RP102	1810-0286	8	1	NETWORK-RES 10-SIP10.0K OHM X 9	01121	210A103
A40RP103	1810-0280	8	1	NETWORK-RES 10-SIP10.0K OHM X 9	01121	210A103
A40RP104	1810-0286	8	1	NETWORK-RES 10-SIP10.0K OHM X 9	01121	210A103
A40RP400	1810-0279	5	1	NETWORK-RES 10-SIP4.7K OHM X 9	01121	210A472
A40TP001	1251-0600	0	21	CONNECTOR-SGL CONT PIN 1.14-MM-BSC-SZ SQ	28480	1251-0600
A40TP002	1251-0600	0	0	CONNECTOR-SGL CONT PIN 1.14-MM-BSC-SZ SQ	28480	1251-0600
A40TP003	1251-0600	0	0	CONNECTOR-SGL CONT PIN 1.14-MM-BSC-SZ SQ	28480	1251-0600
A40TP004	1251-0600	0	0	CONNECTOR-SGL CONT PIN 1.14-MM-BSC-SZ SQ	28480	1251-0600
A40TP100	1251-0600	0	0	CONNECTOR-SGL CONT PIN 1.14-MM-BSC-SZ SQ	28480	1251-0600
A40TP101	1251-0600	0	0	CONNECTOR-SGL CONT PIN 1.14-MM-BSC-SZ SQ	28480	1251-0600
A40TP102	1251-0600	0	0	CONNECTOR-SGL CONT PIN 1.14-MM-BSC-SZ SQ	28480	1251-0600
A40TP200	1251-0600	0	0	CONNECTOR-SGL CONT PIN 1.14-MM-BSC-SZ SQ	28480	1251-0600
A40TP201	1251-0600	0	0	CONNECTOR-SGL CONT PIN 1.14-MM-BSC-SZ SQ	28480	1251-0600
A40TP202	1251-0600	0	0	CONNECTOR-SGL CONT PIN 1.14-MM-BSC-SZ SQ	28480	1251-0600
A40TP300	1251-0600	0	0	CONNECTOR-SGL CONT PIN 1.14-MM-BSC-SZ SQ	28480	1251-0600
A40TP400	1251-0600	0	0	CONNECTOR-SGL CONT PIN 1.14-MM-BSC-SZ SQ	28480	1251-0600
A40TP401	1251-0600	0	0	CONNECTOR-SGL CONT PIN 1.14-MM-BSC-SZ SQ	28480	1251-0600
A40TP402	1251-0600	0	0	CONNECTOR-SGL CONT PIN 1.14-MM-BSC-SZ SQ	28480	1251-0600
A40TP403	1251-0600	0	0	CONNECTOR-SGL CONT PIN 1.14-MM-BSC-SZ SQ	28480	1251-0600
A40TP404	1251-0600	0	0	CONNECTOR-SGL CONT PIN 1.14-MM-BSC-SZ SQ	28480	1251-0600
A40TP405	1251-0600	0	0	CONNECTOR-SGL CONT PIN 1.14-MM-BSC-SZ SQ	28480	1251-0600
A40TP500	1251-0600	0	0	CONNECTOR-SGL CONT PIN 1.14-MM-BSC-SZ SQ	28480	1251-0600
A40TP501	1251-0600	0	0	CONNECTOR-SGL CONT PIN 1.14-MM-BSC-SZ SQ	28480	1251-0600
A40TP502	1251-0600	0	0	CONNECTOR-SGL CONT PIN 1.14-MM-BSC-SZ SQ	28480	1251-0600

See introduction to this section for ordering information
 *Indicates factory selected value

Table 4-3 Replaceable Parts (Cont'd)

Reference Designation	HP Part Number	C D	Qty	Description	Mfr Code	Mfr Part Number
A40TP600	1251-0600	0		CONNECTOR-SGL CNT PIN 1.14-MM BSC-5Z SQ	28480	1251-0600
A40U001	1826-0138	8	1	IC COMPARTOP GP QUAD 14-DIP-P PKG	01295	LK339N
A40U002	1813-0130	3	1	IC OCC HYBRID	34344	K114BA-16.0MHZ
A40U003	1820-2488	3	2	IC FF TTL ALS D-TYPE POS-EDGE-TRIG	01295	SN74ALS74N
A40U004	1820-2096	9	1	IC CNTR TTL LS 3-IN DUAL 4 BIT	01295	SN74LS373N
A40U005	1820-0668	7	1	IC BFR TTL NON-INV HEX 1-INP	01295	SN7407N
A40U006	1820-2505	5	1	IC	28480	1820-2505
A40U007	1820-2772	8	1	IC FF TTL ALS J-K NEG-EDGE-TRIG	01295	SN74ALS112N
A40U008	1820-1433	6	1	IC SHF-RGTR TTL LS R-S SERIAL-IN PRL-OUT	01295	SN74LS164N
A40U009	1820-2634	1	1	IC INV TTL ALS HEX	01295	SN74ALS04N
A40U010	1820-3237	4	6	IC DRVR TTL ALS BUS OCTL	28480	1820-3237
A40U100	1820-3238	3	4	IC TRANSCEIVER TTL ALS BUS OCTL	28480	1820-3238
A40U101	1820-1997	7	3	IC FF TTL LS D-TYPE POS-EDGE-TRIG PRL-IN	01295	SN74ALS374N
A40U102	1820-3238	3		IC TRANSCEIVER TTL ALS BUS OCTL	28480	1820-3238
A40U103	1820-1492	7	1	IC BFR TTL LS INV HEX 1-INP	01295	SN74LS368AN
A40U104	1820-3238	3		IC TRANSCEIVER TTL ALS BUS OCTL	28480	1820-3238
A40U105	1820-3238	3		IC TRANSCEIVER TTL ALS BUS OCTL	28480	1820-3238
A40U106	03561-60320			IC PROGRAMMED PROM	28480	03561-60320
A40U200	03561-60321			IC PROGRAMMED PROM	28480	03561-60321
A40U201	03561-60322			IC PROGRAMMED PROM	28480	03561-60322
A40U202	03561-60323			IC PROGRAMMED PROM	28480	03561-60323
A40U203	03561-60324			IC PROGRAMMED PROM	28480	03561-60324
A40U300	03561-60325			IC PROGRAMMED PROM	28480	03561-60325
A40U301	03561-60326			IC PROGRAMMED PROM	28480	03561-60326
A40U302	03561-60327			IC PROGRAMMED PROM	28480	03561-60327
A40U303	03561-60328			IC PROGRAMMED PROM	28480	03561-60328
A40U304	03561-60329			IC PROGRAMMED PROM	28480	03561-60329
A40U305	03561-60330			IC PROGRAMMED PROM	28480	03561-60330
A40U306	03561-60331			IC PROGRAMMED PROM	28480	03561-60331
A40U400	1820-2488	3		IC FF TTL ALS D-TYPE POS-EDGE-TRIG	01295	SN74ALS74N
A40U401	1820-2657	8	2	IC GATE TTL ALS OR QUAD 2-INP	01295	SN74ALS32N
A40U402	1820-2774	0	1	IC GATE TTL ALS NAND DUAL 4-INP	01295	SN74ALS20N
A40U403	1820-2656	7	1	IC GATE TTL ALS NAND QUAD 2-INP	01295	SN74ALS00N
A40U404	1820-1217	4	2	IC MUXR/DATA-SEL TTL LS 8-TO-1-LINE	01295	SN74LS151N
A40U405	1820-1217	4		IC MUXR/DATA-SEL TTL LS 8-TO-1-LINE	01295	SN74LS151N
A40U406	1820-2739	7	1	IC GATE TTL ALS NOR QUAD 2-INP	01295	SN74ALS02N
A40U407	1820-2657	8		IC GATE TTL ALS OR QUAD 2-INP	01295	SN74ALS32N
A40U408	1820-1851	2	1	IC ENCDP TTL LS	01295	SN74LS148N
A40U409	1820-2635	2	1	IC GATE TTL ALS AND QUAD 2-INP	01295	SN74ALS08N
A40U500	1820-3239	4		IC DRVR TTL ALS BUS OCTL	28480	1820-3239
A40U501	1820-3239	4		IC DRVR TTL ALS BUS OCTL	28480	1820-3239
A40U502	03561-60332			IC PROGRAMMED PROM	28480	03561-60332
A40U503	1820-3239	4		IC DRVR TTL ALS BUS OCTL	28480	1820-3239
A40U504	1820-3100	8	3	IC DCDR TTL ALS BIN 3-TO-8-LINE 3-INP	28480	1820-3100
A40U505	1820-1991			IC TTL LS	01295	SN74LS390PC
A40U600	03561-60333			IC PROGRAMMED PROM	28480	03561-60333
A40U601	03561-60334			IC PROGRAMMED PROM	28480	03561-60334
A40U602	03561-60335			IC PROGRAMMED PROM	28480	03561-60335
A40U603	03561-60336			IC PROGRAMMED PROM	28480	03561-60336
A40U604	1820-1991			IC TTL LS	01295	SN74LS390PC
A40U605	1820-3100	8		IC DCDR TTL ALS BIN 3-TO-8-LINE 3-INP	28480	1820-3100
A40U606	1820-3100	8		IC DCDR TTL ALS BIN 3-TO-8-LINE 3-INP	28480	1820-3100
A40U700	03561-60337			IC PROGRAMMED PROM	28480	03561-60337
A40U701	03561-60338			IC PROGRAMMED PROM	28480	03561-60338
A40U702	03561-60339			IC PROGRAMMED PROM	28480	03561-60339
A40U703	03561-60340			IC PROGRAMMED PROM	28480	03561-60340
A40U704	03561-60341			IC PROGRAMMED PROM	28480	03561-60341
A40U705	1820-3239	4		IC DRVR TTL ALS BUS OCTL	28480	1820-3239
A40U706	1820-3239	4		IC DRVR TTL ALS BUS OCTL	28480	1820-3239
A40U707	03561-60342			IC PROGRAMMED PROM	28480	03561-60342
A40U708	03561-60343			IC PROGRAMMED PROM	28480	03561-60343
A40W001	1251-4700	9	3	CONNECTOR 3-PIN M POST TYPE	28480	1251-4700
A40W002	1251-4700	9		CONNECTOR 3-PIN M POST TYPE	28480	1251-4700
A40W003	1251-4700	9		CONNECTOR 3-PIN M POST TYPE	28480	1251-4700
A40X003	1200-0638	7	1	SOCKET-IC 14-CENT DIP DIP SLDR	28480	1200-0638
A40Y200	0410-1503	1	1	CRYSTAL-QUARTZ 20.48 MHZ HC-18/U-HLDR	28480	0410-1503
A40 MISCELLANEOUS PARTS						
	0340-0944	3	1	INSULATOR-IC NYLON BLACK	28480	0340-0944
	1258-0141	8	1	JUMPER-REM	28480	1258-0141
	1480-0116	8	1	PIN-GRV .062-IN-DIA .25-IN-LG STL	28480	1480-0116
	4040-0748	3	1	EXTR-PC BD BLK POLYC .062-BD-THKNS	28480	4040-0748
	4040-0752	9	1	EXTR-PC BD YEL POLYC .062-BD-THKNS	28480	4040-0752

See introduction to this section for ordering information
 *Indicates factory selected value

Table 4-3 Replaceable Parts (Cont'd)

Reference Designation	HP Part Number	C D	Qty	Description	Mfr Code	Mfr Part Number
A50	33561-66553	3	1	LOCAL OSCILLATOR/NOISE SOURCE ASSEMBLY (REV B)	28480	33561-66553
A50C001	0160-3847	9	47	CAPACITOR-FXD .01UF +100-0% 50VDC CER	28480	0160-3847
A50C002	0160-3847	9		CAPACITOR-FXD .01UF +100-0% 50VDC CER	28480	0160-3847
A50C003	0160-3847	9		CAPACITOR-FXD .01UF +100-0% 50VDC CER	28480	0160-3847
A50C004	0160-3847	9		CAPACITOR-FXD .01UF +100-0% 50VDC CER	28480	0160-3847
A50C100	0160-3847	9		CAPACITOR-FXD .01UF +100-0% 50VDC CER	28480	0160-3847
A50C101	0160-3847	9		CAPACITOR-FXD .01UF +100-0% 50VDC CER	28480	0160-3847
A50C102	0160-3847	9		CAPACITOR-FXD .01UF +100-0% 50VDC CER	28480	0160-3847
A50C103	0160-3847	9		CAPACITOR-FXD .01UF +100-0% 50VDC CER	28480	0160-3847
A50C104	0160-3847	9		CAPACITOR-FXD .01UF +100-0% 50VDC CER	28480	0160-3847
A50C105	0160-3847	9		CAPACITOR-FXD .01UF +100-0% 50VDC CER	28480	0160-3847
A50C106	0160-3847	9		CAPACITOR-FXD .01UF +100-0% 50VDC CER	28480	0160-3847
A50C200	0160-3847	9		CAPACITOR-FXD .01UF +100-0% 50VDC CER	28480	0160-3847
A50C203	0160-3847	9		CAPACITOR-FXD .01UF +100-0% 50VDC CER	28480	0160-3847
A50C204	0160-3847	9		CAPACITOR-FXD .01UF +100-0% 50VDC CER	28480	0160-3847
A50C205	0160-3847	9		CAPACITOR-FXD .01UF +100-0% 50VDC CER	28480	0160-3847
A50C206	0160-3847	9		CAPACITOR-FXD .01UF +100-0% 50VDC CER	28480	0160-3847
A50C207	0160-3847	9		CAPACITOR-FXD .01UF +100-0% 50VDC CER	28480	0160-3847
A50C208	0160-3847	9		CAPACITOR-FXD .01UF +100-0% 50VDC CER	28480	0160-3847
A50C300	0160-3847	9		CAPACITOR-FXD .01UF +100-0% 50VDC CER	28480	0160-3847
A50C301	0160-3847	9		CAPACITOR-FXD .01UF +100-0% 50VDC CER	28480	0160-3847
A50C302	0160-3847	9		CAPACITOR-FXD .01UF +100-0% 50VDC CER	28480	0160-3847
A50C303	0160-3847	9		CAPACITOR-FXD .01UF +100-0% 50VDC CER	28480	0160-3847
A50C304	0160-3847	9		CAPACITOR-FXD .01UF +100-0% 50VDC CER	28480	0160-3847
A50C305	0160-3847	9		CAPACITOR-FXD .01UF +100-0% 50VDC CER	28480	0160-3847
A50C306	0160-3847	9		CAPACITOR-FXD .01UF +100-0% 50VDC CER	28480	0160-3847
A50C307	0160-3847	9		CAPACITOR-FXD .01UF +100-0% 50VDC CER	28480	0160-3847
A50C308	0160-3847	9		CAPACITOR-FXD .01UF +100-0% 50VDC CER	28480	0160-3847
A50C309	0160-3847	9		CAPACITOR-FXD .01UF +100-0% 50VDC CER	28480	0160-3847
A50C310	0160-3847	9		CAPACITOR-FXD .01UF +100-0% 50VDC CER	28480	0160-3847
A50C400	0160-4786	7	1	CAPACITOR-FXD 27PF +-5% 130VDC CER 0+-30	28480	0160-4786
A50C401	0160-4786	1	1	CAPACITOR-FXD 27PF +-5% 130VDC CER	28480	0160-4786
A50C402	0160-5878	0	1	CAPACITOR-FXD 3600PF +-1% 50VDC CER	28480	0160-5878
A50C403	0160-5876	8	1	CAPACITOR-FXD 1300PF +-1% 50VDC CER	28480	0160-5876
A50C404	0160-4571	8	3	CAPACITOR-FXD .1UF +80-20% 50VDC CER	28480	0160-4571
A50C405	0160-5890	6	1	CAPACITOR-FXD 9100PF +-1% 50VDC CER	28480	0160-5890
A50C406	0160-4571	8		CAPACITOR-FXD .1UF +80-20% 50VDC CER	28480	0160-4571
A50C407	0160-5877	9	1	CAPACITOR-FXD 2400PF +-1% 50VDC CER	28480	0160-5877
A50C408	0160-5889	3	1	CAPACITOR-FXD 5600PF +-1% 50VDC CER	28480	0160-5889
A50C409	0160-4571	8		CAPACITOR-FXD .1UF +80-20% 50VDC CER	28480	0160-4571
A50C410	0160-4571			CAPACITOR-FXD .1 UF	28480	0160-4571
A50C411	0160-4571			CAPACITOR-FXD .1 UF	28480	0160-4571
A50C413	0160-4571			CAPACITOR-FXD .1 UF	28480	0160-4571
A50C414	0160-4571			CAPACITOR-FXD .1 UF	28480	0160-4571
A50C415	0160-4571			CAPACITOR-FXD .1 UF	28480	0160-4571
A50C416	0160-4571			CAPACITOR-FXD .1 UF	28480	0160-4571
A50C417	0160-4571			CAPACITOR-FXD .1 UF	28480	0160-4571
A50C418	0160-4571			CAPACITOR-FXD .1 UF	28480	0160-4571
A50C500	0160-3847	9		CAPACITOR-FXD .01UF +100-0% 50VDC CER	28480	0160-3847
A50C501	0160-3847	9		CAPACITOR-FXD .01UF +100-0% 50VDC CER	28480	0160-3847
A50C502	0160-3847	9		CAPACITOR-FXD .01UF +100-0% 50VDC CER	28480	0160-3847
A50C503	0160-3847	9		CAPACITOR-FXD .01UF +100-0% 50VDC CER	28480	0160-3847
A50C504	0160-3847	9		CAPACITOR-FXD .01UF +100-0% 50VDC CER	28480	0160-3847
A50C600	0160-3847	9		CAPACITOR-FXD .01UF +100-0% 50VDC CER	28480	0160-3847
A50C601	0160-3847	9		CAPACITOR-FXD .01UF +100-0% 50VDC CER	28480	0160-3847
A50C602	0160-3847	9		CAPACITOR-FXD .01UF +100-0% 50VDC CER	28480	0160-3847
A50C603	0160-3847	9		CAPACITOR-FXD .01UF +100-0% 50VDC CER	28480	0160-3847
A50C700	0160-3847	9		CAPACITOR-FXD .01UF +100-0% 50VDC CER	28480	0160-3847
A50C800	0160-3847	9		CAPACITOR-FXD .01UF +100-0% 50VDC CER	28480	0160-3847
A50C801	0160-3847	9		CAPACITOR-FXD .01UF +100-0% 50VDC CER	28480	0160-3847
A50C802	0160-3847	9		CAPACITOR-FXD .01UF +100-0% 50VDC CER	28480	0160-3847
A50C803	0160-3847	9		CAPACITOR-FXD .01UF +100-0% 50VDC CER	28480	0160-3847
A50C804	0160-3847	9		CAPACITOR-FXD .01UF +100-0% 50VDC CER	28480	0160-3847
A50C805	0160-3847	9		CAPACITOR-FXD .01UF +100-0% 50VDC CER	28480	0160-3847
A50C806	0160-3847	9		CAPACITOR-FXD .01UF +100-0% 50VDC CER	28480	0160-3847
A50C807	0160-2249	5	3	CAPACITOR-FXD 47UF+-10% 20VDC TA	56289	150D476X9020R2
A50C900	0160-3847	9		CAPACITOR-FXD .01UF +100-0% 50VDC CER	28480	0160-3847
A50C902	0160-2249	5		CAPACITOR-FXD 47UF+-10% 20VDC TA	56289	150D476X9020R2
A50C903	0160-2249	5		CAPACITOR-FXD 47UF+-10% 20VDC TA	56289	150D476X9020R2
A50C904	0160-4571			CAPACITOR-FXD .1 UF	28480	0160-4571
A50C905	0160-4571			CAPACITOR-FXD .1 UF	28480	0160-4571
A50C906	0160-4801			CAPACITOR-FXD 100 PF	28480	0160-4801
A50C907	0160-4791			CAPACITOR-FXD 10 PF	28480	00160-4791
A50C908	0160-4571			CAPACITOR-FXD .1 UF	28480	0160-4571
A50C909	0160-4571			CAPACITOR-FXD .1 UF	28480	0160-4571

See introduction to this section for ordering information
 *Indicates factory selected value

Table 4-3 Replaceable Parts (Cont'd)

Reference Designation	HP Part Number	C D	Qty	Description	Mfr Code	Mfr Part Number
A50C990	0160-5439	9	1	CAPACITOR-FXD 510PF +-5% 100VDC CER	20480	0160-5439
A50C991	0160-5405	7	1	CAPACITOR-FXD 130PF +-5% 100VDC CER	20480	0160-5405
A50C992	0160-5404	8	1	CAPACITOR-FXD 36.0PF +-5% 100VDC CER	20480	0160-5404
A50C993	0160-4811	9	1	CAPACITOR-FXD 270PF +-5% 100VDC CER	20480	0160-4811
A50CR400	1902-0951	5	1	DIODE-ZNR 5.1V 5% DO-35 PD=.4W TC=+.035%	20480	1902-0951
A50CR401	1902-0777	3	1	DIODE-ZNR 1N825 6.2V 5% DO-7 PD=.4W	04713	1N825
A50CR960	1901-0040	1	2	DIODE-SWITCHING 30V 50MA 2NS DO-35	20480	1901-0040
A50CR931	1901-0040	1	1	DIODE-SWITCHING 30V 50MA 2NS DO-35	20480	1901-0040
A50J001	1251-5285	7	1	CONNECTOR 2-PIN M POST TYPE	20480	1251-5285
A50J100	1251-5202	8	2	CONNECTOR 5-PIN M POST TYPE	20480	1251-5202
A50J200	1251-5202	8	1	CONNECTOR 5-PIN M POST TYPE	20480	1251-5202

See introduction to this section for ordering information
 *Indicates factory selected value

Table 4-3 Replaceable Parts (Cont'd)

Reference Designation	HP Part Number	C D	Qty	Description	Mfr Code	Mfr Part Number
AS0L400	03561-60304	3	1	FILTER IND 1	28480	03561-60304
AS0L401	03561-60300	9	1	FILTER IND 2	28480	03561-60300
AS0L402	9140-0748	0	4	INDUCTOR 250UH 25% .25DX .5LG Q=3	28480	9140-0748
AS0L800	9140-0748	0		INDUCTOR 250UH 25% .25DX .5LG Q=3	28480	9140-0748
AS0L900	9140-0748	0		INDUCTOR 250UH 25% .25DX .5LG Q=3	28480	9140-0748
AS0L902	9100-3551			INDUCTOR 1uH	28480	9100-3551
AS0L901	9140-0748	0		INDUCTOR 250UH 25% .25DX .5LG Q=3	28480	9140-0748
AS0R301	0683-4725	2	10	RESISTOR 4.7K 5% .25W FC TC=-400/+700	01121	CR4725
AS0R002	0683-4725	2		RESISTOR 4.7K 5% .25W FC TC=-400/+700	01121	CR4725
AS0R200	0683-4725	2		RESISTOR 4.7K 5% .25W FC TC=-400/+700	01121	CR4725
AS0R201	0698-6362	8	2	RESISTOR 1K .1% .125W F TC=0+-25	28480	0698-6362
AS0R300	0603-4725	2		RESISTOR 4.7K 5% .25W FC TC=-400/+700	01121	CR4725
AS0R301	0683-4725	2		RESISTOR 4.7K 5% .25W FC TC=-400/+700	01121	CR4725
AS0R400	2100-3123	0	1	RESISTOR-TRMR 500 10% C SIDE-ADJ 17-1RN	02111	43P501
AS0R401	0757-0421	4	1	RESISTOR 825 1% .125W F TC=0+-100	24546	C4-1/8-T0-805R-F
AS0R402	0698-6377	5	1	RESISTOR 200 .1% .125W F TC=0+-25	28480	0698-6377
AS0R403	0683-6815	5	1	RESISTOR 680 5% .25W FC TC=-400/+600	01121	CR6815
AS0R404	0658-6360	6	1	RESISTOR 10K .1% .125W F TC=0+-25	28480	0658-6360
AS0R405	0698-6320	8	1	RESISTOR 5K .1% .125W F TC=0+-25	03888	PHF55-1/P-T0 5001-B
AS0R406	3757-3283	6	1	RESISTOR 2K 1% .125W F TC=0+-100	24546	C4-1/8-T0-2001-F
AS0R407	0698-6624	5	1	RESISTOR 2K .1% .125W F TC=0+-25	28480	0698-6624
AS0R408	0698-6362	8		RESISTOR 1K .1% .125W F TC=0+-25	28480	0698-6362
AS0R409	0698-4381			RESISTOR-FXD 48.70	28480	0698-4381
AS0R410	0698-4381			RESISTOR-FXD 48.70	28480	0698-4381
AS0R411	0698-4381			RESISTOR-FXD 48.70	28480	0698-4381
AS0R412	0698-4381			RESISTOR-FXD 48.70	28480	0698-4381
AS0R413	0698-4381			RESISTOR-FXD 48.70	28480	0698-4381
AS0R414	0698-4381			RESISTOR-FXD 48.70	28480	0698-4381
AS0R600	0683-4725	2		RESISTOR 4.7K 5% .25W FC TC=-400/+700	01121	CR4725
AS0R700	0683-4725	2		RESISTOR 4.7K 5% .25W FC TC=-400/+700	01121	CR4725
AS0R800	0683-4725	2		RESISTOR 4.7K 5% .25W FC TC=-400/+700	01121	CR4725
AS0R901	0683-4725	2		RESISTOR 4.7K 5% .25W FC TC=-400/+700	01121	CR4725
AS0R902	0683-4725	2		RESISTOR 4.7K 5% .25W FC TC=-400/+700	01121	CR4725
AS0R900	0811-3657	0	2	RESISTOR 5.94K .1% .25W PWV TC=0+-10	28480	0811-3657
AS0R901	0699-0123	9	1	RESISTOR 6.75K .1% .125W F TC=0+-25	28480	0699-0123
AS0R902	0757-0280			RESISTOR 1K 1% .125W F TC=0+-25+-100	28480	0757-0280 0-101-F
AS0R903	0811-3657	0		RESISTOR 5.94K .1% .25W PWV TC=0+-10	28480	0811-3657
AS0R904	0757-0346			RESISTOR-100	18480	0747-0346
AS0R905	0757-0401			RESISTOR-FXD 1000	28480	0757-0401
AS0R906	0698-4381			RESISTOR-FXD 48.70	28480	0698-4381
AS0R907	0698-4381			RESISTOR-FXD 48.70	28480	0698-4381
AS0RP400	1E10-0279	5	1	NETWORK-RES 10-SIP4.7K OHM X 9	01121	21CA472
AS0TP001	1251-0600	0	16	CONNECTOR-CGL CONT PIN 1.14-MM-BSC-SZ SQ	28480	1251-0600
AS0TP002	1251-0600	0		CONNECTOR-SGL CONT PIN 1.14-MM-BSC-SZ SQ	28480	1251-0600
AS0TP003	1251-0600	0		CONNECTOR-CGL CONT PIN 1.14-MM-BSC-SZ SQ	28480	1251-0600
AS0TP004	1251-0600	0		CONNECTOR-SGL CONT PIN 1.14-MM-BSC-SZ SQ	28480	1251-0600
AS0TP005	1251-0600	0		CONNECTOR-CGL CONT PIN 1.14-MM-BSC-SZ SQ	28480	1251-0600
AS0TP006	1251-0600	0		CONNECTOR-SGL CONT PIN 1.14-MM-BSC-SZ SQ	28480	1251-0600
AS0TP007	1251-0600	0		CONNECTOR-CGL CONT PIN 1.14-MM-BSC-SZ SQ	28480	1251-0600
AS0TP008	1251-0600	0		CONNECTOR-SGL CONT PIN 1.14-MM-BSC-SZ SQ	28480	1251-0600
AS0TP009	1251-0600	0		CONNECTOR-CGL CONT PIN 1.14-MM-BSC-SZ SQ	28480	1251-0600
AS0TP010	1251-0600	0		CONNECTOR-SGL CONT PIN 1.14-MM-BSC-SZ SQ	28480	1251-0600
AS0TP011	1251-0600	0		CONNECTOR-CGL CONT PIN 1.14-MM-BSC-SZ SQ	28480	1251-0600
AS0TP012	1251-0600	0		CONNECTOR-SGL CONT PIN 1.14-MM-BSC-SZ SQ	28480	1251-0600
AS0TP013	1251-0600	0		CONNECTOR-CGL CONT PIN 1.14-MM-BSC-SZ SQ	28480	1251-0600
AS0TP014	1251-0600	0		CONNECTOR-SGL CONT PIN 1.14-MM-BSC-SZ SQ	28480	1251-0600
AS0TP015	1251-0600	0		CONNECTOR-CGL CONT PIN 1.14-MM-BSC-SZ SQ	28480	1251-0600
AS0TP016	1251-0600	0		CONNECTOR-SGL CONT PIN 1.14-MM-BSC-SZ SQ	28480	1251-0600
AS0U001	1820-1196	8	2	IC FF TTL LS D-TYPE POS-EDGE-TRIG COM	01295	SN74LS174N
AS0U002	1820-1230	9	3	IC MUXR/DATA-SEL TTL LS 4-TO-1-LINE DUAL	01295	SN74LS253N
AS0U003	1820-2720	6	1	IC ADDR TTL LS QUAD	01295	SN74LS385N
AS0U004	1820-1445	0	1	IC LCH TTL LS 4-BIT	01295	SN74LS375N
AS0U005	1820-1441	6	6	IC ADDR TTL LS BIN FULL ADDR 4-BIT	01295	SN74LS283N
AS0U006	1820-1441	6		IC ADDR TTL LS BIN FULL ADDR 4-BIT	01295	SN74LS283N
AS0U007	1820-2201	8	2	IC SHF-REG TTL LS COM CLEAR SERIAL-OUT	01295	SN74LS322AN
AS0U008	1820-1441	6		IC ADDR TTL LS BIN FULL ADDR 4-BIT	01295	SN74LS283N
AS0U009	1820-1441	6		IC ADDR TTL LS BIN FULL ADDR 4-BIT	01295	SN74LS283N
AS0U010	1820-1470	1	2	IC MUXR/DATA-SEL TTL LS 2-TO-1-LINE QUAD	01295	SN74LS157N
AS0U011	1820-2120	0	2	IC MULTR TTL LS 8-BIT	34335	AM25LS14DC
AS0U012	1820-1730	6	2	IC FF TTL LS D-TYPE POS-EDGE-TRIG COM	01295	SN74LS273N
AS0U013	03561-60310	1	1	PROGRAMMED PROM	28480	03561-60310
AS0U014	1020-2657	8		IC GATE TTL ALS OR QUAD 2-INP	01295	SN74ALS32N
AS0U015	1020-1196	8		IC FF TTL LS D-TYPE POS-EDGE-TRIG COM	01295	SN74LS174N
AS0U016	1820-1441	6		IC ADDR TTL LS BIN FULL ADDR 4-BIT	01295	SN74LS283N
AS0U017	1820-1441	6		IC ADDR TTL LS BIN FULL ADDR 4-BIT	01295	SN74LS283N
AS0U018	1820-2657	8	2	IC GATE TTL ALS OR QUAD 2-INP	01295	SN74ALS32N

See introduction to this section for ordering information
 *Indicates factory selected value

Table 4-3 Replaceable Parts (Cont'd)

Reference Designation	HP Part Number	C D	Qty	Description	Mfr Code	Mfr Part Number
A50U200	1820-2313	3	1	IC SHF-RGTR TTL LS SERIAL-IN SERIAL-OUT	01295	SN74ALS673N
A50U201	1820-2201	8		IC SHF-RGTR TTL LS COM CLEAR SERIAL-OUT	01295	SN74ALS323AN
A50U202	1820-1433	6	4	IC SHF-RGTR TTL LS R-S SERIAL-IN PRL-OUT	01295	SN74LS164N
A50U203	1820-1433	6		IC SHF-RGTR TTL LS R-S SERIAL-IN PRL-OUT	01295	SN74LS164N
A50U204	1820-1432	5	3	IC CNTR TTL LS BIN SYNCHRD POS-EDGE-TRIG	01295	SN74LS163AN
A50U205	1820-1432	5		IC CNTR TTL LS BIN SYNCHRD POS-EDGE-TRIG	01295	SN74LS163AN
A50U206	1820-1432	5		IC CNTR TTL LS BIN SYNCHRD POS-EDGE-TRIG	01295	SN74LS163AN
A50U207	1820-2635	2	2	IC GATE TTL ALS AND QUAD 2-INP	01295	SN74ALS08N
A50U300	1820-1433	6		IC SHF-RGTR TTL LS R-S SERIAL-IN PRL-OUT	01295	SN74LS164N
A50U301	1820-1470	1		IC MUXR/DATA-SCL TTL LS 2-TO-1-LINE QUAD	01295	SN74LS157N
A50U302	1820-1211	8	1	IC GATE TTL LS EXCL-OR QUAD 2-INP	01295	SN74LS86N
A50U303	1820-1977	7	8	IC FF TTL LS D-TYPE POS-EDGE-TRIG PRL-IN	01295	SN74LS374N
A50U304	1820-1238	9		IC MUXR/DATA-SCL TTL LS 4-TO-1-LINE DUAL	01295	SN74LS253N
A50U305	1820-2488	3	4	IC FF TTL ALS D-TYPE POS-EDGE-TRIG	01295	SN74ALS74N
A50U306	1820-1433	6		IC SHF-RGTR TTL LS R-S SERIAL-IN PRL-OUT	01295	SN74LS164N
A50U307	1820-1977	7		IC FF TTL LS D-TYPE POS-EDGE-TRIG PRL-IN	01295	SN74LS374N
A50U308	1820-3238	3	2	IC TRANSCEIVER TTL ALS BUS OCTL	28480	1820-3238
A50U400	1826-1111	9	1	D/A 6-BIT 14-DIP-C CMOS	28480	1826-1111
A50U401	1826-1125	5	4	IC OP AMP PRCN 8-TO-99 PKG	28480	1826-1125
A50U402	1820-1934	2	1	IC CONV 8-B-D/A 16-DIP-C PKG	06665	DAC-08EQ
A50U403	1826-1125	5		IC OP AMP PRCN 8-TO-99 PKG	28480	1826-1125
A50U404	1826-1125	5		IC OP AMP PRCN 8-TO-99 PKG	28480	1826-1125
A50U500	1820-2488	3		IC FF TTL ALS D-TYPE POS-EDGE-TRIG	01295	SN74ALS74N
A50U501	1820-3100	8	1	IC DCDR TTL ALS BIN 3-TO-8-LINE 3-INP	28480	1820-3100
A50U502	1820-1922	8	2	IC SHF-RGTR TTL LS PRL-IN SERIAL-OUT	01295	SN74LS166N
A50U503	1820-1922	8		IC SHF-RGTR TTL LS PRL-IN SERIAL-OUT	01295	SN74LS166N
A50U504	1820-1977	7		IC FF TTL LS D-TYPE POS-EDGE-TRIG PRL-IN	01295	SN74LS374N
A50U505	1820-0681	4	1	IC GATE TTL S NAND QUAD 2-INP	01295	SN74S00N
A50U506	03561-60312	3	1	PROGRAMMED PROM	28480	03561-60312
A50U507	03561-60311	2	1	PROGRAMMED PROM	28480	03561-60311
A50U600	1820-1977	7		IC FF TTL LS D-TYPE POS-EDGE-TRIG PRL-IN	01295	SN74LS374N
A50U601	1820-1977	7		IC FF TTL LS D-TYPE POS-EDGE-TRIG PRL-IN	01295	SN74LS374N
A50U602	1820-1977	7		IC FF TTL LS D-TYPE POS-EDGE-TRIG PRL-IN	01295	SN74LS374N
A50U603	1820-2405	4	3	IC FF TTL LS D-TYPE POS-EDGE-TRIG COM	34335	AM25LS2520DC
A50U604	1820-2405	4		IC FF TTL LS D-TYPE POS-EDGE-TRIG COM	34335	AM25LS2520DC
A50U605	1820-2405	4		IC FF TTL LS D-TYPE POS-EDGE-TRIG COM	34335	AM25LS2520DC
A50U606	T-55280	0	1	IC-PAL168BA	28480	T-55280
A50U700	03561-60313	4	1	PROGRAMMED PROM	28480	03561-60313
A50U701	03561-60314	5	1	PROGRAMMED PROM	28480	03561-60314
A50U702	1820-1730	6		IC FF TTL LS D-TYPE POS-EDGE-TRIG COM	01295	SN74LS273N
A50U703	1820-1431	4	1	IC CNTR TTL LS DECD SYNCHRD	01295	SN74LS162AN
A50U704	1820-2120	0		IC MULTR TTL LS 8-BIT	34335	AM25LS14DC
A50U705	1820-1977	7		IC FF TTL LS D-TYPE POS-EDGE-TRIG PRL-IN	01295	SN74LS374N
A50U706	1820-1977	7		IC FF TTL LS D-TYPE POS-EDGE-TRIG PRL-IN	01295	SN74LS374N
A50U800	1820-2488	3		IC FF TTL ALS D-TYPE POS-EDGE-TRIG	01295	SN74ALS74N
A50U801	1820-2634	1	1	IC INV TTL ALS HEX	01295	SN74ALS04N
A50U802	1820-2488	3		IC FF TTL ALS D-TYPE POS-EDGE-TRIG	01295	SN74ALS74N
A50U803	1820-0697	2	1	IC DRVR TTL S NAND LINE DUAL 4-INP	01295	SN74S140N
A50U804	1820-3238	3		IC TRANSCEIVER TTL ALS BUS OCTL	28480	1820-3238
A50U805	1820-2548	6	1	IC-TMS 9914	28480	1820-2548
A50U806	1820-2635	2		IC GATE TTL ALS AND QUAD 2-INP	01295	SN74ALS08N
A50U807	1820-1416	5	1	IC SCHMITT-TRIG TTL LS INV HEX 1-INP	01295	SN74LS14N
A50U808	1820-1238	9		IC MUXR/DATA-SCL TTL LS 4-TO-1-LINE DUAL	01295	SN74LS253N
A50U900	1820-2485	0	1	IC RCVR TTL LS BUS OCTL	01295	SN75160N
A50U901	1820-0224	1	1	IC OP AMP SPCL TO-99 PKG	27914	LH0002CH
A50U902	1826-1125	5		IC OP AMP PRCN 8-TO-99 PKG	28480	1826-1125
A50U903	1820-2483	8	1	IC RCVR TTL LS BUS OCTL	01295	SN75161N
A50X001	4040-0740	3	1	EXTR-PC BD BLK POLYC .062-RD-THKNS	28480	4040-0740
A50X002	4040-0753	0	1	EXTR-PC BD GRN POLYC .062-BD-THKNS	28480	4040-0753
A50X002	1200-0638	7	1	SOCKET-IC 14-CONT DIP DIP-SLDR	28480	1200-0638
A50 MISCELLANEOUS PARTS						
	0515-0055	8	4	SCREW-MACH M3 X 0.5 6MM-LG PAN-HD	28480	0515-0055
	0590-1230	1	1	THREADED INSERT-STDF M3 X 0.5 12-PM-LG	28480	0590-1230
	1205-0011	0	1	HEAT SINK TO-5/TO-39-CS	28480	1205-0011
	2190-0004	9	4	WASHER-LK INTL T NO. 4 .115-IN-ID	28480	2190-0004
	03561-01226	4	1	SHLD, 50 RD SRCE	28480	03561-01226
	1480-0116	8	2	PIN-GRV .062-1N-DIA .25-1N-LG STL	28480	1480-0116

See introduction to this section for ordering information
 *Indicates factory selected value

Table 4-3 Replaceable Parts (Cont'd)

Reference Designation	HP Part Number	C D	Qty	Description	Mfr Code	Mfr Part Number
A60	03561-66560	5	1	DIGITAL DISPLAY DRIVER ASSEMBLY (REVISION B)	28480	03561-66560
A60C001	0160-4571	8	56	CAPACITOR-FXD .1UF +80-20% 50VDC CER	28480	0160-4571
A60C002	0160-4571	8		CAPACITOR-FXD .1UF +80-20% 50VDC CER	28480	0160-4571
A60C003	0160-4571	8		CAPACITOR-FXD .1UF +80-20% 50VDC CER	28480	0160-4571
A60C004	0160-4571	8		CAPACITOR-FXD .1UF +80-20% 50VDC CER	28480	0160-4571
A60C005	0160-4571	8		CAPACITOR-FXD .1UF +80-20% 50VDC CER	28480	0160-4571
A60C006	0160-4571	8		CAPACITOR-FXD .1UF +80-20% 50VDC CER	28480	0160-4571
A60C007	0160-4571	8		CAPACITOR-FXD .1UF +80-20% 50VDC CER	28480	0160-4571
A60C008	0160-4571	8		CAPACITOR-FXD .1UF +80-20% 50VDC CER	28480	0160-4571
A60C009	0160-4571	8		CAPACITOR-FXD .1UF +80-20% 50VDC CER	28480	0160-4571
A60C010	0160-4571	8		CAPACITOR-FXD .1UF +80-20% 50VDC CER	28480	0160-4571
A60C011	0160-4571	8		CAPACITOR-FXD .1UF +80-20% 50VDC CER	28480	0160-4571
A60C012	0160-4571	8		CAPACITOR-FXD .1UF +80-20% 50VDC CER	28480	0160-4571
A60C100	0160-4571	8		CAPACITOR-FXD .1UF +80-20% 50VDC CER	28480	0160-4571
A60C101	0160-4571	8		CAPACITOR-FXD .1UF +80-20% 50VDC CER	28480	0160-4571
A60C102	0160-4571	8		CAPACITOR-FXD .1UF +80-20% 50VDC CER	28480	0160-4571
A60C103	0160-4571	8		CAPACITOR-FXD .1UF +80-20% 50VDC CER	28480	0160-4571
A60C200	0160-4571	8		CAPACITOR-FXD .1UF +80-20% 50VDC CER	28480	0160-4571
A60C201	0160-4571	8		CAPACITOR-FXD .1UF +80-20% 50VDC CER	28480	0160-4571
A60C202	0160-4571	8		CAPACITOR-FXD .1UF +80-20% 50VDC CER	28480	0160-4571
A60C203	0160-4571	8		CAPACITOR-FXD .1UF +80-20% 50VDC CER	28480	0160-4571
A60C204	0160-4571	8		CAPACITOR-FXD .1UF +80-20% 50VDC CER	28480	0160-4571
A60C300	0160-4571	8		CAPACITOR-FXD .1UF +80-20% 50VDC CER	28480	0160-4571
A60C301	0160-3847	9	5	CAPACITOR-FXD .01UF +100-0% 50VDC CER	28480	0160-3847
A60C302	0160-4571	8		CAPACITOR-FXD .1UF +80-20% 50VDC CER	28480	0160-4571
A60C303	0160-4571	8		CAPACITOR-FXD .1UF +80-20% 50VDC CER	28480	0160-4571
A60C304	0160-4571	8		CAPACITOR-FXD .1UF +80-20% 50VDC CER	28480	0160-4571
A60C400	0160-4571	8		CAPACITOR-FXD .1UF +80-20% 50VDC CER	28480	0160-4571
A60C401	0160-3847	9		CAPACITOR-FXD .01UF +80-20% 50VDC CER	28480	0160-3847
A60C402	0160-4571	8		CAPACITOR-FXD .1UF +80-20% 50VDC CER	28480	0160-4571
A60C406	0160-4571	8		CAPACITOR-FXD .1UF +80-20% 50VDC CER	28480	0160-4571
A60C407	0160-4571	8		CAPACITOR-FXD .1UF +80-20% 50VDC CER	28480	0160-4571
A60C500	0160-4571	8		CAPACITOR-FXD .1UF +80-20% 50VDC CER	28480	0160-4571
A60C501	0160-4571	8		CAPACITOR-FXD .1UF +80-20% 50VDC CER	28480	0160-4571
A60C502	0160-4571	8		CAPACITOR-FXD .1UF +80-20% 50VDC CER	28480	0160-4571
A60C503	0160-4571	8		CAPACITOR-FXD .1UF +80-20% 50VDC CER	28480	0160-4571
A60C504	0160-4571	8		CAPACITOR-FXD .1UF +80-20% 50VDC CER	28480	0160-4571
A60C505	0160-4571	8		CAPACITOR-FXD .1UF +80-20% 50VDC CER	28480	0160-4571
A60C506	0160-4571	8		CAPACITOR-FXD .1UF +80-20% 50VDC CER	28480	0160-4571
A60C507	0160-4571	8		CAPACITOR-FXD .1UF +80-20% 50VDC CER	28480	0160-4571
A60C508	0160-4571	8		CAPACITOR-FXD .1UF +80-20% 50VDC CER	28480	0160-4571
A60C509	0160-4571	8		CAPACITOR-FXD .1UF +80-20% 50VDC CER	28480	0160-4571
A60C510	0160-4571	8		CAPACITOR-FXD .1UF +80-20% 50VDC CER	28480	0160-4571
A60C511	0160-4571	8		CAPACITOR-FXD .1UF +80-20% 50VDC CER	28480	0160-4571
A60C600	0160-4571	8		CAPACITOR-FXD .1UF +80-20% 50VDC CER	28480	0160-4571
A60C601	0160-4571	8		CAPACITOR-FXD .1UF +80-20% 50VDC CER	28480	0160-4571
A60C602	0160-4571	8		CAPACITOR-FXD .1UF +80-20% 50VDC CER	28480	0160-4571
A60C603	0160-4571	8		CAPACITOR-FXD .1UF +80-20% 50VDC CER	28480	0160-4571
A60C700	0160-4571	8		CAPACITOR-FXD .1UF +80-20% 50VDC CER	28480	0160-4571
A60C701	0160-4571	8		CAPACITOR-FXD .1UF +80-20% 50VDC CER	28480	0160-4571
A60C702	0160-4571	8		CAPACITOR-FXD .1UF +80-20% 50VDC CER	28480	0160-4571
A60C703	0160-4571	8		CAPACITOR-FXD .1UF +80-20% 50VDC CER	28480	0160-4571
A60C800	0160-4571	8		CAPACITOR-FXD .1UF +80-20% 50VDC CER	28480	0160-4571
A60C801	0160-4571	8		CAPACITOR-FXD .1UF +80-20% 50VDC CER	28480	0160-4571
A60C802	0160-4571	8		CAPACITOR-FXD .1UF +80-20% 50VDC CER	28480	0160-4571
A60C803	0160-4571	8		CAPACITOR-FXD .1UF +80-20% 50VDC CER	28480	0160-4571
A60C901	0160-4571	8		CAPACITOR-FXD .1UF +80-20% 50VDC CER	28480	0160-4571
A60C903	0160-4571	8		CAPACITOR-FXD .1UF +80-20% 50VDC CER	28480	0160-4571
A60C904	0160-4571	8		CAPACITOR-FXD .1UF +80-20% 50VDC CER	28480	0160-4571
A60C907	0160-3847	9		CAPACITOR-FXD .01UF +100-0% 50VDC CER	28480	0160-3847
A60C908	0160-3847	9		CAPACITOR-FXD .01UF +100-0% 50VDC CER	28480	0160-3847
A60C909	0160-3847	9		CAPACITOR-FXD .01UF +100-0% 50VDC CER	28480	0160-3847
A60C910	0180-0391	3	1	CAPACITOR-FXD .1UF +10% 35VDC TA	56289	15301J5X9035A2
A60C911	0180-0309	4	1	CAPACITOR-FXD 4.7UF +20% 10VDC TA	56289	150D475X0010A2
A60C912	0180-0374	3	1	CAPACITOR-FXD .10UF +10% 20VDC TA	56289	1530106X9020E2
A60CR800	1901-0025	2	1	DIODE-GEN PRP 100V 200MA DO-7	28480	1901-0025
A60J100	1251-5286	8	1	CONNECTOR 4-PIN M POST TYPE	28480	1251-5286
A60J300	1251-4700	9	1	CONNECTOR 3-PIN M POST TYPE	28480	1251-4700
A60R001	0683-4725	2	2	RESISTOR 4.7K 5% .25W FC TC=-400/+700	01121	CB4725
A60R002	0683-4725	2		RESISTOR 4.7K 5% .25W FC TC=-400/+700	01121	CB4725
A60R300	0683-1025	9	2	RESISTOR 1K 5% .25W FC TC=-400/+600	01121	CB1025
A60R500	0683-4705	8	3	RESISTOR 47 5% .25W FC TC=-400/+500	01121	CB4705
A60R501	0683-4705	8		RESISTOR 47 5% .25W FC TC=-400/+500	01121	CB4705

See introduction to this section for ordering information
 *Indicates factory selected value

Table 4-3 Replaceable Parts (Cont'd)

Reference Designation	HP Part Number	C D	Qty	Description	Mfr Code	Mfr Part Number
A60R532	0703-4705	8		RESISTOR 47 5% .25W FC TC=-400/+500	31121	C84705
A60R900	0683-1025	9		RESISTOR 1K 5% .25W FC TC=-400/+600	31121	CD1025
A60R901	3603-8225	5	1	RESISTOR 8.2K 5% .25W FC TC=-400/+700	31121	C88225
A60F902	0683-2435	7	1	RESISTOR 24K 5% .25W FC TC=-400/+800	31121	CE7435
A60R903	3683-1535	6	1	RESISTOR 15K 5% .25W FC TC=-400/+800	31121	CE1535
A60RF001	1810-0450	4	1	NETWORK-RES 14-DIP47.0 OHM X 7	11236	760-3-R47
A60U001	1820-2656	7	4	IC GATE TTL ALS NAND QUAD 2-INP	31295	SN74ALS00N
A60U002	1818-1775	4	16	IC NMOS 16384 (16K) DYN RAM 120-NS 3-S	S4013	HM4816AP-4(SELECTED)
A60U003	1818-1775	4		IC NMOS 16384 (16K) DYN RAM 120-NS 3-S	S4013	HM4816AP-4(SELECTED)
A60U004	1818-1775	4		IC NMOS 16384 (16K) DYN RAM 120-NS 3-S	S4013	HM4816AP-4(SELECTED)
A60U005	1818-1775	4		IC NMOS 16384 (16K) DYN RAM 120-NS 3-S	S4013	HM4816AP-4(SELECTED)
A60U006	1818-1775	4		IC NMOS 16384 (16K) DYN RAM 120-NS 3-S	S4013	HM4816AP-4(SELECTED)
A60U007	1818-1775	4		IC NMOS 16384 (16K) DYN RAM 120-NS 3-S	S4013	HM4816AP-4(SELECTED)
A60U008	1818-1775	4		IC NMOS 16384 (16K) DYN RAM 120-NS 3-S	S4013	HM4816AP-4(SELECTED)
A60U009	1818-1775	4		IC NMOS 16384 (16K) DYN RAM 120-NS 3-S	S4013	HM4816AP-4(SELECTED)
A60U010	1820-1794	2	5	IC RFP TTL LS NON-INV OCTL	27014	DM01LS95N
A60U101	1820-2096	9	3	IC CNTR TTL LS BIN DUAL 4-BIT	31295	SN74LS393N
A60U102	1820-1794	2		IC RFR TTL LS NON-INV OCTL	27014	DM01LS95N
A60U103	1820-2096	9		IC CNTR TTL LS BIN DUAL 4-BIT	31295	SN74LS393N
A60U104	1820-1794	2		IC RFR TTL LS NON-INV OCTL	27014	DM01LS95N
A60U105	1820-1730	6	5	IC FF TTL LS D-TYPE POS-EDGE-TRIG COM	31295	SN74LS273N
A60U106	1820-1794	2		IC RFR TTL LS NON-INV OCTL	27014	DM01LS95N
A60U107	1820-1730	6		IC FF TTL LS D-TYPE POS-EDGE-TRIG COM	31295	SN74LS273N
A60U200	1820-2096	9		IC CNTR TTL LS BIN DUAL 4-BIT	31295	SN74LS393N
A60U201	1820-2488	3	4	IC FF TTL ALS D-TYPE POS-EDGE-TRIG	31295	SN74ALS74N
A60U202	1820-2488	3		IC FF TTL ALS D-TYPE POS-EDGE-TRIG	31295	SN74ALS74N
A60U203	1820-2408	3		IC FF TTL ALS D-TYPE POS-EDGE-TRIG	31295	SN74ALS74N
A60U204	1820-2775	1	1	IC GATE TTL ALS NAND TPL 3-INP	31295	SN74ALS10N
A60U205	1820-2739	7	1	IC GATE TTL ALS NOR QUAD 2-INP	31295	SN74ALS02N
A60U206	1820-1441	6	4	IC ADDR TTL LS BIN FULL ADDR 4-BIT	31295	SN74LS283N
A60U207	1820-1441	6		IC ADDR TTL LS BIN FULL ADDR 4-BIT	31295	SN74LS283N
A60U208	1820-1441	6		IC ADDR TTL LS BIN FULL ADDR 4-BIT	31295	SN74LS283N
A60U209	1820-1730	6		IC FF TTL LS D-TYPE POS-EDGE-TRIG COM	31295	SN74LS273N
A60U300	1820-1211	8	1	IC GATE TTL LS EXCL-OR QUAD 2-INP	31295	SN74LS86N
A60U301	1820-1416	5	1	IC SCHMITT-TRIG TTL LS INV HEX 1-INP	31295	SN74LS14N
A60U302	1820-2488	3		IC FF TTL ALS D-TYPE POS-EDGE-TRIG	31295	SN74ALS74N
A60U303	1820-2635	2	4	IC GATE TTL ALS AND QUAD 2-INP	31295	SN74ALS08N
A60U304	1820-2657	8	2	IC GATE TTL ALS OR QUAD 2-INP	31295	SN74ALS32N
A60U305	1820-0693	8	1	IC FF TTL S D-TYPE POS-EDGE-TRIG	31295	SN74C74N
A60U400	1820-2777	3	1	IC CNTR TTL ALS BIN SYNCHRO	31295	SN74ALS161N
A60U401	1820-2506	6	1	IC INV TTL F HEX	07263	74F04PC
A60U500	1818-1775	4		IC NMOS 16384 (16K) DYN RAM 120-NS 3-S	S4013	HM4816AP-4(SELECTED)
A60U501	1818-1775	4		IC NMOS 16384 (16K) DYN RAM 120-NS 3-S	S4013	HM4816AP-4(SELECTED)
A60U502	1818-1775	4		IC NMOS 16384 (16K) DYN RAM 120-NS 3-S	S4013	HM4816AP-4(SELECTED)
A60U503	1818-1775	4		IC NMOS 16384 (16K) DYN RAM 120-NS 3-S	S4013	HM4816AP-4(SELECTED)
A60U504	1818-1775	4		IC NMOS 16384 (16K) DYN RAM 120-NS 3-S	S4013	HM4816AP-4(SELECTED)
A60U505	1818-1775	4		IC NMOS 16384 (16K) DYN RAM 120-NS 3-S	S4013	HM4816AP-4(SELECTED)
A60U506	1818-1775	4		IC NMOS 16384 (16K) DYN RAM 120-NS 3-S	S4013	HM4816AP-4(SELECTED)
A60U507	1818-1775	4		IC NMOS 16384 (16K) DYN RAM 120-NS 3-S	S4013	HM4816AP-4(SELECTED)
A60U600	1820-2635	2		IC GATE TTL ALS AND QUAD 2-INP	31295	SN74ALS08N
A60U601	1820-2635	2		IC GATE TTL ALS AND QUAD 2-INP	31295	SN74ALS08N
A60U602	1820-1922	8	2	IC SHF-RCTR TTL LS PRL-IN SERIAL-OUT	31295	SN74LS166N
A60U603	1820-1997	7	2	IC FF TTL LS D-TYPE POS-EDGE-TRIG PRL-IN	31295	SN74LS374N
A60U604	1820-1922	8		IC SHF-RCTR TTL LS PRL-IN SERIAL-OUT	31295	SN74LS166N
A60U605	1820-1997	7		IC FF TTL LS D-TYPE POS-EDGE-TRIG PRL-IN	31295	SN74LS374N
A60U606	1820-2655	7		IC GATE TTL ALS NAND QUAD 2-INP	31295	SN74ALS00N
A60U607	1820-2634	1	1	IC INV TTL ALS HEX	31295	SN74ALS04N
A60U700	1820-1441	6		IC ADDR TTL LS BIN FULL ADDR 4-BIT	31295	SN74LS283N
A60U701	1820-1730	6		IC FF TTL LS D-TYPE POS-EDGE-TRIG COM	31295	SN74LS273N
A60U702	1820-3100	8	2	IC DCDR TTL ALS BIN 3-TO-8-LINE 3-INP	28480	1820-3100
A60U703	1820-3375	9	3	IC CNTR TTL ALS BIN UP/DOWN SYNCHRO	28480	1820-3375
A60U704	1820-1217	4	2	IC MUXR/DATA-SEL TTL LS 8-TO-1-LINE	31295	SN74LS151N
A60U705	1820-3375	9		IC CNTR TTL ALS BIN UP/DOWN SYNCHRO	28480	1820-3375
A60U706	1820-1794	2		IC RFR TTL LS NON-INV OCTL	27014	DM01LS95N
A60U707	1820-1975	1	1	IC SHF-RCTR TTL LS NEG-EDGE-TRIG PRL-IN	31295	SN74LS165N
A60U800	1820-1730	6		IC FF TTL LS D-TYPE POS-EDGE-TRIG COM	31295	SN74LS273N
A60U801	1820-2656	7		IC GATE TTL ALS NAND QUAD 2-INP	31295	SN74ALS00N
A60U802	1820-3375	9		IC CNTR TTL ALS BIN UP/DOWN SYNCHRO	28480	1820-3375
A60U803	1820-1433	6	1	IC SHF-RCTR TTL LS R-S SERIAL-IN PRL-OUT	31295	SN74LS164N
A60U804	1820-1217	4		IC MUXR/DATA-SEL TTL LS 8-TO-1-LINE	31295	SN74LS151N
A60U805	1820-2657	8		IC GATE TTL ALS OR QUAD 2-INP	31295	SN74ALS32N
A60U806	1820-3100	8		IC DCDR TTL ALS BIN 3-TO-8-LINE 3-INP	28480	1820-3100
A60U807	1820-2635	2		IC GATE TTL ALS AND QUAD 2-INP	31295	SN74ALS08N
A60U900	1820-3772	8	1	IC FF TTL ALS J-K NEG-EDGE-TRIG	31295	SN74ALS112N
A60U901	1820-2669	8	1	IC GATE TTL ALS AND TPL 3-INP	28480	1820-2669
A60U902	1820-2656	7		IC GATE TTL ALS NAND QUAD 2-INP	31295	SN74ALS00N

See introduction to this section for ordering information
 *Indicates factory selected value

Table 4-3 Replaceable Parts (Cont'd)

Reference Designation	HP Part Number	C D	Qty	Description	Mfr Code	Mfr Part Number
A60U933	1826-0205	0	1	IC TIMER TTL	10324	NE555A
A60Y400	1813-0393	0	1	XTAL-CLK-0CC	28400	1813 0393

See introduction to this section for ordering information
 *Indicates factory selected value

Table 4-3 Replaceable Parts (Cont'd)

Reference Designation	HP Part Number	C D	Qty	Description	Mfr Code	Mfr Part Number
A65	33561-66565	0	1	CMOS/BUBBLE MEMORY ASSEMBLY (REVISION B) OPT 001	28480	03561-66565
A65BT100	1420-0278	7	1	BATTERY 3V .72A-HR LI/S-DIOX W-FLEX	28480	1420-0278
A65C001	0180-2765	0	6	CAPACITOR-FXD .15UF+-20% 20VDC TA	28480	0180-2765
A65C002	0180-2765	0		CAPACITOR-FXD .15UF+-20% 20VDC TA	28480	0180-2765
A65C003	0160-3443	1	7	CAPACITOR-FXD .1UF +80-20% 50VDC CER	28480	0160-3443
A65C004	0160-3443	1		CAPACITOR-FXD .1UF +80-20% 50VDC CER	28480	0160-3443
A65C005	0160-2205	1	2	CAPACITOR-FXD 120PF +-5% 300VDC MICA	28480	0160-2205
A65C006	0160-2205	1		CAPACITOR-FXD 120PF +-5% 300VDC MICA	28480	0160-2205
A65C007	0160-3443	1		CAPACITOR-FXD .1UF +80-20% 50VDC CER	28480	0160-3443
A65C008	0180-2765	0		CAPACITOR-FXD .15UF+-20% 20VDC TA	28480	0180-2765
A65C009	0160-3443	1		CAPACITOR-FXD .1UF +80-20% 50VDC CER	28480	0160-3443
A65C100	0180-2765	0		CAPACITOR-FXD .15UF+-20% 20VDC TA	28480	0180-2765
A65C101	0160-3443	1		CAPACITOR-FXD .1UF +80-20% 50VDC CER	28480	0160-3443
A65C102	0160-3443	1		CAPACITOR-FXD .1UF +80-20% 50VDC CER	28480	0160-3443
A65C103	0180-0197	8	1	CAPACITOR-FXD 2.2UF+-10% 20VDC TA	56289	150D225X9020A2
A65C104	0160-3947	9	10	CAPACITOR-FXD .01UF +100-0% 50VDC CER	28480	0160-3947
A65C105	0180-0499	3	1	CAPACITOR-FXD 10UF+-20% 20VDC TA	28480	0180-0499
A65C200	0180-2765	0		CAPACITOR-FXD .15UF+-20% 20VDC TA	28480	0180-2765
A65C201	0160-3443	1		CAPACITOR-FXD .1UF +80-20% 50VDC CER	28480	0160-3443
A65C202	0180-2249	5	2	CAPACITOR-FXD 47UF+-10% 20VDC TA	56289	150D476X9020R2
A65C203	0180-2249	5		CAPACITOR-FXD 47UF+-10% 20VDC TA	56289	150D476X9020R2
A65C204	0180-2765	0		CAPACITOR-FXD .15UF+-20% 20VDC TA	28480	0180-2765
A65C205	0160-3847	9		CAPACITOR-FXD .01UF +100-0% 50VDC CER	28480	0160-3847
A65C206	0160-3847	9		CAPACITOR-FXD .01UF +100-0% 50VDC CER	28480	0160-3847
A65C300	0160-3847	9		CAPACITOR-FXD .01UF +100-0% 50VDC CER	28480	0160-3847
A65C301	0160-3847	9		CAPACITOR-FXD .01UF +100-0% 50VDC CER	28480	0160-3847
A65C302	0160-3847	9		CAPACITOR-FXD .01UF +100-0% 50VDC CER	28480	0160-3847
A65C303	0160-3847	9		CAPACITOR-FXD .01UF +100-0% 50VDC CER	28480	0160-3847
A65C304	0160-3847	9		CAPACITOR-FXD .01UF +100-0% 50VDC CER	28480	0160-3847
A65C305	0160-3847	9		CAPACITOR-FXD .01UF +100-0% 50VDC CER	28480	0160-3847
A65C306	0160-3847	9		CAPACITOR-FXD .01UF +100-0% 50VDC CER	28480	0160-3847
A65CR100	1901-0539	3	1	DIODE-SH SIG SCHOTTKY	28480	1901-0539
A65CR101	1902-3059	0	1	DIODE-ZNR 3.83V 5% DO-35 PD=.4W	28480	1902-3059
A65CR102	1901-0050	3	2	DIODE-SWITCHING 80V 200MA 2NS DO-35	28480	1901-0050
A65CR300	1901-0050	3		DIODE-SWITCHING 80V 200MA 2NS DO-35	28480	1901-0050
A65Q100	1853-0281	9	1	TRANSISTOR PNP 2N2907A SI TO-18 PD=400MW	04713	2N2907A
A65Q101	1854-0215	1	1	TRANSISTOR NPN SI PD=350MW FT=300MHZ	04713	2N3704
A65Q102	1855-0269	7	2	TRANSISTOR MOSFET N-CHAN E-MODE TO-72 SI	18324	SD214
A65Q300	1855-0423	5	1	TRANSISTOR MOSFET N-CHAN E-MODE	17856	5D13KM
A65Q301	1855-0269	7		TRANSISTOR MOSFET N-CHAN E-MODE TO-72 SI	18324	SD214
A65R003	0698-7521	3	2	RESISTOR 5.1 5% .25W F TC=0+-100	11532	TF07-1/4-T0-5R1-J
A65R004	0698-7521	3		RESISTOR 5.1 5% .25W F TC=0+-100	11532	TF07-1/4-T0-5R1-J
A65R005	0757-0438	3	4	RESISTOR 5.11K 1% .125W F TC=0+-100	24546	C4-1/8-T0-5111-F
A65R100	0683-4725	2	3	RESISTOR 4.7K 5% .25W FC TC=-400/+700	01121	CR4725
A65R102	0698-5652	9	1	RESISTOR 500 1% .125W F TC=0+-100	24546	C4-1/8-T0-500R-F
A65R103	0698-3155	1	2	RESISTOR 4.64K 1% .125W F TC=0+-100	24546	C4-1/8-T0-4641-F
A65R104	0603-4705	8	1	RESISTOR 47 5% .25W FC TC=-400/+500	01121	CR4705
A65R105	0757-0397	3	1	RESISTOR 68.1 1% .125W F TC=0+-100	24546	C4-1/8-T0-68R1-F
A65R106	0757-0417	8	1	RESISTOR 562 1% .125W F TC=0+-100	24546	C4-1/8-T0-562R-F
A65R107	0683-3335	8	1	RESISTOR 33K 5% .25W FC TC=-400/+800	01121	CR3335
A65R108	0603-5625	3	1	RESISTOR 5.6K 5% .25W FC TC=-400/+700	01121	CR5625
A65R109	0683-3925	2	1	RESISTOR 3.9K 5% .25W FC TC=-400/+700	01121	CR3925
A65R200	0757-0438	3		RESISTOR 5.11K 1% .125W F TC=0+-100	24546	C4-1/8-T0-5111-F
A65R201	0683-1005	5	1	RESISTOR 10 5% .25W FC TC=-400/+500	01121	CR1005
A65R202	0757-0438	3		RESISTOR 5.11K 1% .125W F TC=0+-100	24546	C4-1/8-T0-5111-F
A65R203	0757-0438	3		RESISTOR 5.11K 1% .125W F TC=0+-100	24546	C4-1/8-T0-5111-F
A65R204	0683-1025	9	3	RESISTOR 1K 5% .25W FC TC=-400/+600	01121	CR1025
A65R205	0683-4725	2		RESISTOR 4.7K 5% .25W FC TC=-400/+700	01121	CR4725
A65R300	0603-1025	9		RESISTOR 1K 5% .25W FC TC=-400/+600	01121	CR1025
A65R301	0698-3152	8	1	RESISTOR 3.48K 1% .125W F TC=0+-100	24546	C4-1/8-T0-3481-F
A65R302	0698-3155	1		RESISTOR 4.64K 1% .125W F TC=0+-100	24546	C4-1/8-T0-4641-F
A65R303	0683-4725	2		RESISTOR 4.7K 5% .25W FC TC=-400/+700	01121	CR4725
A65R304	0603-1025	9		RESISTOR 1K 5% .25W FC TC=-400/+600	01121	CR1025
A65RP001	1810-0374	1	1	NETWORK-RES 8-SIP1.0K DIM X 4	01121	200B102
A65U001	1050-0081	7	2	TRANSISTOR ARRAY 14-PIN CER DIP	28480	1050-0081
A65U002	1820-2816	1	1	IC MISC CMOS	28480	1820-2816
A65U003	1820-2817	2	1	IC-INS 803PLN-11	28480	1820-2817
A65U004	1820-2807	0	1	IC BUBMEM 1048576 BRL-MEM	28480	1820-2807
A65U100	1858-0031	7		TRANSISTOR ARRAY 14-PIN CER DIP	28480	1858-0031

See introduction to this section for ordering information
 *Indicates factory selected value

Table 4-3 Replaceable Parts (Cont'd)

Reference Designation	HP Part Number	C D	Qty	Description	Mfr Code	Mfr Part Number
A65U102	1020-2818	3	1	IC MISC TTL S	28480	1820-2818
A65U103	1018-3183	2	1	ICM 6264L155 C28	28480	1018-3183
A65U200	1020-2806	9	1	IC-BUBBLE MEMORY CONTROLLER	28480	1820-2806
A65U201	1820-2657	8	2	IC GATE TTL ALS OR QUAD 2-INP	01295	SN74ALS32N
A65U202	1020-3230	3	1	IC TRANSCEIVER TTL ALS BUS CCTL	28480	1620-3238
A65U203	1820-2757	9	1	IC FF TTL ALS D-TYPE POS-EDGE-TRIG OCTL	01295	SN74ALS574N
A65U300	1020-2520	4	1	IC DRVR TTL DUAL	01295	SN75463N
A65U301	1820-2657	8	1	IC GATE TTL ALS OR QUAD 2-INP	01295	SN74ALS32N
A65U302	1020-1246	9	1	IC GATE TTL LS AND QUAD 2-INP	01295	SN74ALS09N
A65U303	1020-2634	1	1	IC INV TTL ALS HEX	01295	SN74ALS04N
A65U304	1020-2488	3	1	IC FF TTL ALS D-TYPE POS-EDGE-TRIG	01295	SN74ALS74N
A65U305	1820-1641	8	2	IC DRVR TTL LS BUS DRVR HEX 1-INP	01295	SN74LS365AN
A65U306	1020-1641	8	1	IC DRVR TTL LS BUS DRVR HEX 1-INP	01295	SN74LS365AN
A65X004	1200-1106	6	1	BUBBLE SOCKET	28480	1200-1106
A65X102	1200-1096	3	1	22 PIN DIP	28480	1200-1096
A65 MISCELLANEOUS PARTS						
	1480-0116	0	1	PIN-GRV .362-IN DIA .25-IN-LG STL	28480	1480-0116
	4040-0753	0	1	EXTR-PC RD GPN POLYC .062-BD-THKNS	28480	4040-0753
	4040-0754	1	1	EXTR-PC RD BLU POLYC .062-BD-THKNS	28480	4040-0754

See introduction to this section for ordering information
 *Indicates factory selected value

Table 4-3 Replaceable Parts (Cont'd)

Reference Designation	HP Part Number	C D	Qty	Description	Mfr Code	Mfr Part Number
A66	03561-66566	1	1	CMOS MEMORY ASSEMBLY (REVISION B)	29480	03561-66566
A66BT100	1420-0278	7	1	BATTERY 3V .72A-HR LI/S-DIOX W-FLEX	28400	1420-0278
A66C134	0160-3847	9	3	CAPACITOR-FXD .01UF +100-0% 50VDC CER	28480	0160-3847
A66C202	0180-2249	5	1	CAPACITOR-FXD 47UF+-10% 20VDC TA	50789	1500476X9020R2
A66C235	0160-3847	9	9	CAPACITOR-FXD .01UF +100-3% 50VDC CER	28400	0160-3847
A66C206	0160-3847	9	9	CAPACITOR-FXD .01UF +100-0% 50VDC CER	28400	0160-3847
A66CR100	1901-0539	3	1	DIODE-SM SIG SCHOTTKY	20480	1901-0539
A66CR101	1902-3057	0	1	DIODE-ZNR 3.83V 5% DO-35 PD=.4W	28480	1902-3057
A66Q130	1053-0281	7	1	TRANSISTOR PNP 2N2907A SI TO-18 PD=400MW	04713	2N2907A
A66Q101	1854-0215	1	1	TRANSISTOR NPN SI PD=350MW FT=300MHZ	04713	2N3904
A66Q102	1055-0269	7	2	TRANSISTOR MOSFET N-CHAN E-MODE TO-72 SI	10324	SD214
A66Q301	1055-0269	7	7	TRANSISTOR MOSFET N-CHAN E-MODE TO-72 SI	10324	SD214
A66R100	0683-4725	2	2	RESISTOR 4.7K 5% .125W FC TC=-400/+700	01121	CB4725
A66R102	0698-5052	9	1	RESISTOR 500 1% .125W F TC=0+-100	24546	C4-1/8-T0-500R-F
A66R103	0698-3155	1	2	RESISTOR 4.64K 1% .125W F TC=0+-100	24546	C4-1/8-T0-4641-F
A66R105	0757-0397	3	1	RESISTOR 68.1 1% .125W F TC=0+-100	24546	C4-1/8-T0-68R1-F
A66R106	0757-0417	8	1	RESISTOR 562 1% .125W F TC=0+-100	24546	C4-1/8-T0-562R-F
A66R302	0698-3155	1	2	RESISTOR 4.64K 1% .125W F TC=0+-100	24546	C4-1/8-T0-4641-F
A66R303	0693-4725	2	1	RESISTOR 4.7K 5% .125W FC TC=-400/+700	01121	CB4725
A66U100	1820-1281	2	1	IC DCDR TTL LS 2-TO-4-LINE DUAL 2-INP	01295	SN74LS139H
A66U101	1820-3239	4	1	IC DRVR TTL ALS BUS OCTL	28480	1820-3239
A66U103	1818-3183	2	1	ICM 6264L155 C2B	28480	1818-3183
A66U202	1820-3238	3	1	IC TRANSCEIVER TTL ALS BUS OCTL	29480	1820-3238
A66U203	1820-2757	9	1	IC FF TTL ALS D-TYPE POS-EDGE-TRIG OCTL	01295	SN74ALS574N
				A66 MISCELLANEOUS PARTS		
	1480-0116	8	1	PIN-GRV .062-IN-DIA .25-IN-LG STL	28480	1480-0116
	4040-0753	0	1	EXTR-PC BD GRN POLYC .062-3D-THKMS	28480	4040-0753
	4040-0754	1	1	EXTR-PC BD BLU POLYC .062-RD-THKMS	29480	4040-0754

See introduction to this section for ordering information
 *Indicates factory selected value

Table 4-3 Replaceable Parts (Cont'd)

Reference Designation	HP Part Number	C D	Qty	Description	Mfr Code	Mfr Part Number
A70	33561-66570	7	1	POWER SUPPLY PWM ASSEMBLY (REVISION B)	20480	33561-66570
A70C001	0160-4791	4	3	CAPACITOR-FXD 10PF +-5% 100VDC CER 0+-30	20480	0160-4791
A70C002	0160-2228	8	2	CAPACITOR-FXD 2700PF +-5% 300VDC MICA	20480	0160-2228
A70C003	0160-4682	2	1	CAPACITOR-FXD 1000PF +-2.5% 160VDC POLYP	20480	0160-4682
A70C004	0160-2220	8	8	CAPACITOR-FXD 2700PF +-5% 300VDC MICA	20480	0160-2228
A70C005	0160-0159	0	1	CAPACITOR-FXD 6000PF +-10% 200VDC POLYE	20480	0160-0159
A70C006	0160-4812	0	1	CAPACITOR-FXD 220PF +-5% 100VDC CER	20480	0160-4812
A70C007	0160-0127	2	1	CAPACITOR-FXD 1UF +-20% 250VDC CER	20480	0160-0127
A70C101	0160-4571	8	8	CAPACITOR-FXD .1UF +80-20% 50VDC CER	20480	0160-4571
A70C102	0100-0180	3	1	CAPACITOR-FXD 4.7UF +-10% 35VDC TA	50209	1500475X9030R2
A70C103	0160-4571	8	8	CAPACITOR-FXD .1UF +80-20% 50VDC CER	20480	0160-4571
A70C104	0160-4571	8	8	CAPACITOR-FXD .1UF +80-20% 50VDC CER	20480	0160-4571
A70C200	0160-4571	8	8	CAPACITOR-FXD .1UF +80-20% 50VDC CER	20480	0160-4571
A70C201	0160-4571	8	8	CAPACITOR-FXD .1UF +80-20% 50VDC CER	20480	0160-4571
A70C400	0160-0194	3	2	CAPACITOR-FXD .015UF +-10% 200VDC POLYE	20480	0160-0194
A70C401	0160-0194	3	3	CAPACITOR-FXD .015UF +-10% 200VDC POLYE	20480	0160-0194
A70C402	0160-4535	4	1	CAPACITOR-FXD 1UF +-10% 50VDC CER	20480	0160-4535
A70C500	0160-4791	4	4	CAPACITOR-FXD 10PF +-5% 100VDC CER 0+-30	20480	0160-4791
A70C501	0160-4791	4	4	CAPACITOR-FXD 10PF +-5% 100VDC CER 0+-30	20480	0160-4791
A70C502	0160-4571	8	8	CAPACITOR-FXD .1UF +80-20% 50VDC CER	20480	0160-4571
A70C503	0160-4571	8	8	CAPACITOR-FXD .1UF +80-20% 50VDC CER	20480	0160-4571
A70C504	0160-4571	8	8	CAPACITOR-FXD .1UF +80-20% 50VDC CER	20480	0160-4571
A70C600	0140-0200	0	2	CAPACITOR-FXD 390PF + 5% 300VDC MICA	72136	DM15F391J03000V1CR
A70C601	0140-0200	0	0	CAPACITOR-FXD 390PF +-5% 300VDC MICA	72136	DM15F391J03000V1CR
A70C602	0160-4281	7	1	CAPACITOR-FXD 2200PF +-20% 250VAC(RMS)	C0633	PNE271Y422
A70C700	0160-4702	7	2	CAPACITOR-FXD 1UF +-10% 400VDC MET-POLYP	20480	0160-4702
A70C701	0160-4702	7	7	CAPACITOR-FXD 1UF +-10% 400VDC MET-POLYP	20480	0160-4702
A70CR001	1990-0486	6	4	LED-LAMP LUM-INT=1MCD IF=20MA-MAX BUR=5V	20480	5082-4684
A70CR002	1990-0486	6	6	LED-LAMP LUM-INT=1MCD IF=20MA-MAX BUR=5V	20480	5082-4684
A70CR003	1990-0486	6	6	LED-LAMP LUM-INT=1MCD IF=20MA-MAX BUR=5V	20480	5082-4684
A70CR004	1990-0486	6	6	LED-LAMP LUM-INT=1MCD IF=20MA-MAX BUR=5V	20480	5082-4684
A70CR005	1901-0050	3	22	DIODE-SWITCHING 80V 200MA 2NS DO-35	20480	1901-0050
A70CR006	1901-0050	3	3	DIODE-SWITCHING 80V 200MA 2NS DO-35	20480	1901-0050
A70CR100	1901-0050	3	3	DIODE-SWITCHING 80V 200MA 2NS DO-35	20480	1901-0050
A70CR101	1901-0050	3	3	DIODE-SWITCHING 80V 200MA 2NS DO-35	20480	1901-0050
A70CR103	1901-0050	3	3	DIODE-SWITCHING 80V 200MA 2NS DO-35	20480	1901-0050
A70CR201	1901-0050	3	3	DIODE-SWITCHING 80V 200MA 2NS DO-35	20480	1901-0050
A70CR202	1901-0050	3	3	DIODE-SWITCHING 80V 200MA 2NS DO-35	20480	1901-0050
A70CR203	1901-0050	3	3	DIODE-SWITCHING 80V 200MA 2NS DO-35	20480	1901-0050
A70CR204	1901-0050	3	3	DIODE-SWITCHING 80V 200MA 2NS DO-35	20480	1901-0050
A70CR206	1901-0050	3	3	DIODE-SWITCHING 80V 200MA 2NS DO-35	20480	1901-0050
A70CR207	1901-0050	3	3	DIODE-SWITCHING 80V 200MA 2NS DO-35	20480	1901-0050
A70CR208	1901-0050	3	3	DIODE-SWITCHING 80V 200MA 2NS DO-35	20480	1901-0050
A70CR209	1901-0050	3	3	DIODE-SWITCHING 80V 200MA 2NS DO-35	20480	1901-0050
A70CR400	1901-0050	3	3	DIODE-SWITCHING 80V 200MA 2NS DO-35	20480	1901-0050
A70CR401	1901-0050	3	3	DIODE-SWITCHING 80V 200MA 2NS DO-35	20480	1901-0050
A70CR402	1901-0050	3	3	DIODE-SWITCHING 80V 200MA 2NS DO-35	20480	1901-0050
A70CR403	1901-0050	3	3	DIODE-SWITCHING 80V 200MA 2NS DO-35	20480	1901-0050
A70CR404	1901-0050	3	3	DIODE-SWITCHING 80V 200MA 2NS DO-35	20480	1901-0050
A70CR405	1901-0050	3	3	DIODE-SWITCHING 80V 200MA 2NS DO-35	20480	1901-0050
A70CR406	1901-0050	3	3	DIODE-SWITCHING 80V 200MA 2NS DO-35	20480	1901-0050
A70CR500	1901-0050	3	3	DIODE-SWITCHING 80V 200MA 2NS DO-35	20480	1901-0050
A70CR501	1901-0050	3	3	DIODE-SWITCHING 80V 200MA 2NS DO-35	20480	1901-0050
A70J300	1251-5347	2	1	CONNECTOR 5-PIN M POST TYPE	20480	1251-5347
A70J700	1251-4348	1	1	CONNECTOR 6-PIN M POST TYPE	20480	1251-4348
A70L100	0140-0748	0	1	INDUCTOR 250UH 25% .25DX.5LG Q=3	20480	0140-0748
A70Q001	1853-0036	2	6	TRANSISTOR PNP SI PD=310MW FT=250MHZ	20480	1853-0036
A70Q002	1853-0036	2	2	TRANSISTOR PNP SI PD=310MW FT=250MHZ	20480	1853-0036
A70Q003	1853-0036	2	2	TRANSISTOR PNP SI PD=310MW FT=250MHZ	20480	1853-0036
A70Q101	1853-0036	2	2	TRANSISTOR PNP SI PD=310MW FT=250MHZ	20480	1853-0036
A70Q102	1854-0215	1	3	TRANSISTOR NPN SI PD=350MW FT=300MHZ	04713	2N3904
A70Q300	1855-0536	1	2	TRANSISTOR	20480	1855-0536
A70Q400	1853-0036	2	2	TRANSISTOR PNP SI PD=310MW FT=250MHZ	20480	1853-0036
A70Q500	1854-0215	1	2	TRANSISTOR NPN SI PD=350MW FT=300MHZ	04713	2N3904
A70Q501	1853-0036	2	1	TRANSISTOR PNP SI PD=310MW FT=250MHZ	20480	1853-0036
A70Q502	1854-0215	1	1	TRANSISTOR NPN SI PD=350MW FT=300MHZ	04713	2N3904
A70Q700	1855-0536	1	1	TRANSISTOR	20480	1855-0536
A70R001	0683-1225	1	4	RESISTOR 1.2K 5% .25W FC TC=-400/+700	01121	CR1225
A70R002	0683-1225	1	1	RESISTOR 1.2K 5% .25W FC TC=-400/+700	01121	CR1225
A70R003	0603-1225	1	1	RESISTOR 1.2K 5% .25W FC TC=-400/+700	01121	CR1225
A70R004	0683-1225	1	1	RESISTOR 1.2K 5% .25W FC TC=-400/+700	01121	CR1225
A70R005	0603-1045	3	3	RESISTOR 100K 5% .25W FC TC=-400/+800	01121	CR1045

See introduction to this section for ordering information
 *Indicates factory selected value

Table 4-3 Replaceable Parts (Cont'd)

Reference Designation	HP Part Number	C D	Qty	Description	Mfr Code	Mfr Part Number
A70R006	0698-3279	0	2	RESISTOR 4.59K 1% .125W F TC=0+-100	24546	C4-1/8-T0-4991-F
A70R007	0698-4501	3	1	RESISTOR 57K 1% .125W F TC=0+-100	24546	C4-1/8-T0-5702-F
A70R038	0698-3161	9	1	RESISTOR 30.2K 1% .125W F TC=0+-100	24546	C4-1/8-T0-3832-F
A70R009	0757-0445	2	1	RESISTOR 13K 1% .125W F TC=0+-100	24546	C4-1/8-T0-1302-F
A70R010	0698-4477	2	1	RESISTOR 10.5K 1% .125W F TC=0+-100	24546	C4-1/8-T0-1052-F
A70R011	0698-4488	5	1	RESISTOR 26.7K 1% .125W F TC=0+-100	24546	C4-1/8-T0-2672-F
A70R012	0698-3515	7	1	RESISTOR 5.9K 1% .125W F TC=0+-100	24546	C4-1/8-T0-5901-F
A70R013	8150-3375	5	3	RESISTOR-ZERO OHMS 22 AWG LEAD DIA	20480	8150-3375
A70R014	0683-5625	3	3	RESISTOR 5.6K 5% .25W FC TC=-400/+700	01121	CB5625
A70R015	0757-0401	0	3	RESISTOR 100 1% .125W F TC=0+-100	24546	C4-1/8-T0-101-F
A70R016	0757-0433	8	2	RESISTOR 3.32K 1% .125W F TC=0+-100	24546	C4-1/8-T0-3321-F
A70R017	0757-0442	9	3	RESISTOR 10K 1% .125W F TC=0+-100	24546	C4-1/8-T0-1002-F
A70R018	0683-1045	3	1	RESISTOR 100K 5% .25W FC TC=-400/+800	01121	CB1045
A70R019	0683-5135	0	1	RESISTOR 51K 5% .25W FC TC=-400/+800	01121	CB5135
A70R020	0757-0433	3	6	RESISTOR 5.11K 1% .125W F TC=0+-100	24546	C4-1/8-T0-5111-F
A70R103	0757-0290	5	2	RESISTOR 6.19K 1% .125W F TC=0+-100	19701	MF4C1/8-T0-6121-F
A70R104	0757-0453	2	1	RESISTOR 30.1K 1% .125W F TC=0+-100	24546	C4-1/8-T0-3012-F
A70R105	0757-0200	7	2	RESISTOR 5.62K 1% .125W F TC=0+-100	24546	C4-1/8-T0-5621-F
A70R106	0683-2035	3	1	RESISTOR 20K 5% .25W FC TC=-400/+800	01121	CB2035
A70R107	0757-0444	1	1	RESISTOR 12.1K 1% .125W F TC=0+-100	24546	C4-1/8-T0-1212-F
A70R108	0757-0442	9	1	RESISTOR 10K 1% .125W F TC=0+-100	24546	C4-1/8-T0-1002-F
A70R109	0683-3325	6	1	RESISTOR 3.3K 5% .25W FC TC=-400/+700	01121	CB3325
A70R110	0683-1345	3	1	RESISTOR 100K 5% .25W FC TC=-400/+800	01121	CB1045
A70R111	0683-1035	1	2	RESISTOR 10K 5% .25W FC TC=-400/+700	01121	CB1035
A70R112	0683-1025	9	3	RESISTOR 1K 5% .25W FC TC=-400/+600	01121	CB1025
A70R113	8150-3375	5	3	RESISTOR-ZERO OHMS 22 AWG LEAD DIA	20480	8150-3375
A70R114	0698-3157	3	2	RESISTOR 19.6K 1% .125W F TC=0+-100	24546	C4-1/8-T0-1962-F
A70R115	0698-0280	3	1	RESISTOR 1K 1% .125W F TC=0+-100	24546	C4-1/8-T0-1001-F
A70R116	0698-3279	0	3	RESISTOR 4.59K 1% .125W F TC=0+-100	24546	C4-1/8-T0-4991-F
A70R117	0683-1035	1	1	RESISTOR 10K 5% .25W FC TC=-400/+700	01121	CB1035
A70R118	0698-4467	0	1	RESISTOR 1.05K 1% .125W F TC=0+-100	24546	C4-1/8-T0-1051-F
A70R200	0699-1167	3	2	RESISTOR	28480	0699-1167
A70R201	0699-1168	4	2	RESISTOR	28480	0699-1168
A70R202	0699-1167	3	3	RESISTOR	28480	0699-1167
A70R203	0699-1168	4	4	RESISTOR	28480	0699-1168
A70R400	0683-5625	3	1	RESISTOR 5.6K 5% .25W FC TC=-400/+700	01121	CB5625
A70R401	0757-0450	7	2	RESISTOR 51.1K 1% .125W F TC=0+-100	24546	C4-1/8-T0-5112-F
A70R402	8150-3375	5	3	RESISTOR-ZERO OHMS 22 AWG LEAD DIA	20480	8150-3375
A70R403	0757-0290	5	5	RESISTOR 6.19K 1% .125W F TC=0+-100	19701	MF4C1/8-T0-6121-F
A70R404	0757-0442	9	9	RESISTOR 10K 1% .125W F TC=0+-100	24546	C4-1/8-T0-1002-F
A70R405	0757-0200	7	1	RESISTOR 5.62K 1% .125W F TC=0+-100	24546	C4-1/8-T0-5621-F
A70R406	0683-5125	8	3	RESISTOR 5.1K 5% .25W FC TC=-400/+700	01121	CB5125
A70R407	0757-0451	0	1	RESISTOR 24.3K 1% .125W F TC=0+-100	24546	C4-1/8-T0-2432-F
A70R408	0698-0082	7	2	RESISTOR 464 1% .125W F TC=0+-100	24546	C4-1/8-T0-4640-F
A70R409	0757-0440	7	1	RESISTOR 7.5K 1% .125W F TC=0+-100	24546	C4-1/8-T0-7501-F
A70R410	0757-0401	0	1	RESISTOR 100 1% .125W F TC=0+-100	24546	C4-1/8-T0-101-F
A70R411	0698-3572	6	1	RESISTOR 68.4K 1% .125W F TC=0+-100	24546	C4-1/8-T0-6842-F
A70R412	0757-0401	0	1	RESISTOR 100 1% .125W F TC=0+-100	24546	C4-1/8-T0-101-F
A70R413	0698-3271	2	1	RESISTOR 115K 1% .125W F TC=0+-100	24546	C4-1/8-T0-1153-F
A70R414	0698-0082	7	1	RESISTOR 464 1% .125W F TC=0+-100	24546	C4-1/8-T0-4640-F
A70R415	0757-0458	7	1	RESISTOR 51.1K 1% .125W F TC=0+-100	24546	C4-1/8-T0-5112-F
A70R416	0683-1025	9	1	RESISTOR 1K 5% .25W FC TC=-400/+600	01121	CB1025
A70R417	0683-1025	9	1	RESISTOR 1K 5% .25W FC TC=-400/+600	01121	CB1025
A70R418	0683-5645	7	1	RESISTOR 560K 5% .25W FC TC=-800/+900	01121	CB5645
A70R419	0757-0438	3	1	RESISTOR 5.11K 1% .125W F TC=0+-100	24546	C4-1/8-T0-5111-F
A70R420	0757-0438	3	1	RESISTOR 5.11K 1% .125W F TC=0+-100	24546	C4-1/8-T0-5111-F
A70R421	0757-0471	4	1	RESISTOR 182K 1% .125W F TC=0+-100	24546	C4-1/8-T0-1823-F
A70R422	0698-3558	8	1	RESISTOR 4.02K 1% .125W F TC=0+-100	24546	C4-1/8-T0-4021-F
A70R423	0757-0283	6	6	RESISTOR 2K 1% .125W F TC=0+-100	24546	C4-1/8-T0-2001-F
A70R424	0698-3157	3	1	RESISTOR 19.6K 1% .125W F TC=0+-100	24546	C4-1/8-T0-1962-F
A70R425	0757-0279	0	1	RESISTOR 3.16K 1% .125W F TC=0+-100	24546	C4-1/8-T0-3161-F
A70R426	0698-4431	8	2	RESISTOR 2.05K 1% .125W F TC=0+-100	24546	C4-1/8-T0-2051-F
A70R427	0698-3519	1	1	RESISTOR 12.4K 1% .125W F TC=0+-100	24546	C4-1/8-T0-1242-F
A70R428	0698-0084	9	1	RESISTOR 2.15K 1% .125W F TC=0+-100	24546	C4-1/8-T0-2151-F
A70R429	0698-4431	8	1	RESISTOR 2.05K 1% .125W F TC=0+-100	24546	C4-1/8-T0-2051-F
A70R430	0757-0438	3	1	RESISTOR 5.11K 1% .125W F TC=0+-100	24546	C4-1/8-T0-5111-F
A70R431	0698-4493	2	1	RESISTOR 34K 1% .125W F TC=0+-100	24546	C4-1/8-T0-3402-F
A70R432	0683-2725	8	1	RESISTOR 2.7K 5% .25W FC TC=-400/+700	01121	CB2725
A70R433	0757-0438	3	1	RESISTOR 5.11K 1% .125W F TC=0+-100	24546	C4-1/8-T0-5111-F
A70R430	0683-5125	8	3	RESISTOR 5.1K 5% .25W FC TC=-400/+700	01121	CB5125
A70R501	0757-0403	2	1	RESISTOR 121 1% .125W F TC=0+-100	24546	C4-1/8-T0-121R-F
A70R502	0757-0433	8	1	RESISTOR 3.32K 1% .125W F TC=0+-100	24546	C4-1/8-T0-3321-F
A70R503	0698-4445	4	1	RESISTOR 5.76K 1% .125W F TC=0+-100	24546	C4-1/8-T0-5761-F
A70R504	0683-5625	3	1	RESISTOR 5.6K 5% .25W FC TC=-400/+700	01121	CB5625
A70R505	0698-4510	4	1	RESISTOR 84.5K 1% .125W F TC=0+-100	24546	C4-1/8-T0-8452-F

See introduction to this section for ordering information
 *Indicates factory selected value

Table 4-3 Replaceable Parts (Cont'd)

Reference Designation	HP Part Number	C D	Qty	Description	Mfr Code	Mfr Part Number
A7CR506	0698-4202	1	2	RESISTOR 0.07K 1% .125W F TC=0+-100	24546	C4-1/8-T0-8871-F
A7CR507	0757-0283	6		RESISTOR 2K 1% .125W F TC=0+-100	24546	C4-1/8-T0-2001-F
A7CR508	0698-0063	4	1	RESISTOR 5.23K 1% .125W F TC=0+-100	21637	CMF-1/8-T1-5231-F
A7OR509	0757-0283	6		RESISTOR 2K 1% .125W F TC=0+-100	24546	C4-1/8-T0-2001-F
A7OR510	0757-0283	6		RESISTOR 2K 1% .125W F TC=0+-100	24546	C4-1/8-T0-2001-F
A7OR511	0698-4202	1		RESISTOR 8.07K 1% .125W F TC=0+-100	24546	C4-1/8-T0-8871-F
A7OR512	0757-0438	3		RESISTOR 5.11K 1% .125W F TC=0+-100	24546	C4-1/8-T0-5111-F
A7CR513	0757-0454	3	1	RESISTOR 33.2K 1% .125W F TC=0+-100	24546	C4-1/8-T0-3322-F
A7OR514	0757-0203	6		RESISTOR 2K 1% .125W F TC=0+-100	24546	C4-1/8-T0-2001-F
A7OR515	0698-4432	9	1	RESISTOR 2.1K 1% .125W F TC=0+-100	24546	C4-1/8-T0-2101-F
A7OR516	0757-0283	6		RESISTOR 2K 1% .125W F TC=0+-100	24546	C4-1/8-T0-2001-F
A7OR517	0683-5125	8		RESISTOR 5.1K 5% .25W FC TC=-400/+70C	01121	C85125
A7OR600	0698-3613	6	2	RESISTOR 39 5% 2W MO TC=0+-200	27167	FP42-2-T00-39R0-J
A7OR601	0698-3613	6		RESISTOR 39 5% 2W MO TC=0+-200	27167	FP42-2-T00-39R0-J
A7OT200	9140-3828	7	1	GATE DRIVE TFR	28480	9140-3828
A7OT600	9100-4348	0	1	CURR. SENSE INDC	28480	9100-4348
A7OTP100	1251-0600	0	9	CONNECTOR-SGL CNT PIN 1.14-MM-BSC-SZ SQ	28480	1251-0600
A7OTP101	1251-0600	0		CONNECTOR-SGL CNT PIN 1.14-MM-BSC-SZ SQ	28480	1251-0600
A7OTP102	1251-0600	0		CONNECTOR-SGL CNT PIN 1.14-MM-BSC-SZ SQ	28480	1251-0600
A7OTP103	1251-0600	0		CONNECTOR-SGL CNT PIN 1.14-MM-BSC-SZ SQ	28480	1251-0600
A7OTP104	1251-0600	0		CONNECTOR-SGL CNT PIN 1.14-MM-BSC-SZ SQ	28480	1251-0600
A7OTP400	1251-0600	0		CONNECTOR-SGL CNT PIN 1.14-MM-BSC-SZ SQ	28480	1251-0600
A7OTP401	1251-0600	0		CONNECTOR-SGL CNT PIN 1.14-MM-BSC-SZ SQ	28480	1251-0600
A7OTP500	1251-0600	0		CONNECTOR-SGL CNT PIN 1.14-MM-BSC-SZ SQ	28480	1251-0600
A7OTP501	1251-0600	0		CONNECTOR-SGL CNT PIN 1.14-MM-BSC-SZ SQ	28480	1251-0600
A7OU001	1826-1040	3	1	IC V RCLTR-SWG 4.85/5.15V 10-DIP-C PKG	28480	1826-1040
A7OU002	1826-0340	4	2	IC OP AMP LOW-BIAS-H-IMPD TO-99 PKG	28480	1826-0340
A7OU003	1826-0340	4		IC OP AMP LOW-BIAS-H-IMPD TO-99 PKG	28480	1826-0340
A7OU100	1820-1288	9	1	IC DRVR TTL CLOCK DRVR TTL-TO-MOS 1-IMP	04713	MMH002CL
A7OU101	1826-0065	0	1	IC COMPARATOR PRCN 8-DIP-P PKG	50545	UPC311C
A7OU102	1826-0138	8	3	IC COMPARATOR GP QUAD 14-DIP-P PKG	01295	LM339N
A7OU400	1820-1145	7	1	IC BFP CMOS INV HEX 1-IMP	31585	CD4049UBE
A7OU401	1826-0601	0	1	IC OP AMP PRCN TO-99 PKG	06665	OP-16FJ
A7OU402	1826-0138	8		IC COMPARATOR GP QUAD 14-DIP-P PKG	01295	LM339N
A7OU500	1820-2228	9	1	IC LCU CMOS NAND R-S QUAD	34713	MC14044BCP
A7OU501	1850-0054	4	1	TRANSISTOR ARRAY 16-PIN PLSTC DIP	28480	1050-0054
A7OU502	1826-0138	8		IC COMPARATOR GP QUAD 14-DIP-P PKG	01295	LM339N
A7OU503	1990-0545	8	1	OPTO-ISOLATOR LED-PDIO/XSTR IF=40MA-MAX	28480	5082-4371
A70 MISCELLANEOUS PARTS						
	0535-0004	9	4	NUT-HEX DDL-CHAM M3 X 0.5 2.4MM-THK	00000	ORDER BY DESCRIPTION
	0590-0875	8	1	THREADED INSERT-STDF 4-40 .25-IN-LG SST	28480	0590-0875
	2190-0004	9	4	WASHER-LK INTL T NO. 4 .115-IN-ID	28480	2190-0004
	2190-0008	3	1	WASHER-LK EXT T NO. 6 .141-IN-ID	28480	2190-0008
	2200-0704	9	1	SCREW-MACH 4-40 .375-IN-LG RDG-HD-SLT	00000	ORDER BY DESCRIPTION
	3050-0004	4	1	WASHER-SHLDR NO. 4 .12-IN-ID .312-IN-OD	28480	3050-0004
	3050-0054	4	1	WASHER-FL MTLC NO. 6 .166-IN-ID	28480	3050-0054
	4040-0748	3	1	EXTR-PC BD BLK POLYC .062-RD-THKNS	28480	4040-0748
	4040-0755	2	1	EXTR-PC BD VID POLYC .062-RD-THKNS	28480	4040-0755
	1205-0495	4	2	HEAT SINK SCL TO-3-CS	28480	1205-0495
	1480-0116	2	2	PN-GRV	28480	1480-0116

See introduction to this section for ordering information
 *Indicates factory selected value

Table 4-3 Replaceable Parts (Cont'd)

Reference Designation	HP Part Number	C D	Qty	Description	Mfr Code	Mfr Part Number
A71	03561-66571	8	1	POWER SUPPLY TRANSFORMER ASSEMBLY (REVISION B)	28480	03561-66571
A71C001	0160-4571	8	2	CAPACITOR-FXD .1UF +80-20% 50VDC CER	28480	0160-4571
A71C002	0180-2803	7	2	CAPACITOR-FXD 100UF+50-10% 50VDC AL	28480	0180-2803
A71C003	0160-0576	5	2	CAPACITOR-FXD .1UF +-20% 50VDC CER	28480	0160-0576
A71C004	0160-4571	8	2	CAPACITOR-FXD .1UF +80-20% 50VDC CER	28480	0160-4571
A71C005	0160-4325	0	1	CAPACITOR-FXD .33UF +-5% 50VDC MET-POLYC	28480	0160-4325
A71C006	0160-4832	4	6	CAPACITOR-FXD .01UF +-10% 100VDC CER	28480	0160-4832
A71C007	0180-1846	6	2	CAPACITOR-FXD 2.2UF+-10% 35VDC TA	56289	150D225X9035D2
A71C100	0180-2803	7	2	CAPACITOR-FXD 100UF+50-10% 50VDC AL	28480	0180-2803
A71C101	0160-0576	5	2	CAPACITOR-FXD .1UF +-20% 50VDC CER	28480	0160-0576
A71C102	0180-2351	0	1	CAPACITOR-FXD 2000UF+75-10% 50VDC AL	28480	0180-2351
A71C200	0160-4832	4	4	CAPACITOR-FXD .01UF +-10% 100VDC CER	28480	0160-4832
A71C201	0180-1046	6	2	CAPACITOR-FXD 2.2UF+-10% 35VDC TA	56289	150D225X9035D2
A71C202	0160-3455	5	2	CAPACITOR-FXD 470PF +-10% 1KVDC CER	28480	0160-3455
A71C203	0160-4832	4	4	CAPACITOR-FXD .01UF +-10% 100VDC CER	28480	0160-4832
A71C204	0160-4832	4	4	CAPACITOR-FXD .01UF +-10% 100VDC CER	28480	0160-4832
A71C205	0160-4832	4	4	CAPACITOR-FXD .01UF +-10% 100VDC CER	28480	0160-4832
A71C300	0160-4832	4	4	CAPACITOR-FXD .01UF +-10% 100VDC CER	28480	0160-4832
A71C301	0160-3455	5	2	CAPACITOR-FXD 470PF +-10% 1KVDC CER	28480	0160-3455
A71CR001	1901-0743	1	2	DIODE-PWR RECT 1N4004 400V 1A DO-41	01295	1N4004
A71CR002	1901-0364	2	1	DIODE-FW BRD 200V 1A	28480	1901-0364
A71CR003	1901-0743	1	1	DIODE-PWR RECT 1N4004 400V 1A DO-41	01295	1N4004
A71CR100	1906-0278	7	1	DIODES	28480	1906-0278
A71CR200	0837-0193	7	1	SUPPRESSOR-VOLTAGE AXIAL LEAD; PEAK	28480	0837-0193
A71CP201	1901-0050	3	3	DIODE-SWITCHING 80V 200MA 2NS DO-35	28480	1901-0050
A71CR202	1901-1110	8	0	DIODE-SWITCHING 300V 1A 50NS	28480	1901-1110
A71CR203	1901-0050	3	2	DIODE-SWITCHING 80V 200MA 2NS DO-35	28480	1901-0050
A71CR204	1901-1108	4	2	DIODE-SWITCHING 300V 3A 50NS	28480	1901-1108
A71CR205	1901-0050	3	2	DIODE-SWITCHING 80V 200MA 2NS DO-35	28480	1901-0050
A71CR206	1901-1110	8	2	DIODE-SWITCHING 300V 1A 50NS	28480	1901-1110
A71CR207	1901-1110	8	2	DIODE-SWITCHING 300V 1A 50NS	28480	1901-1110
A71CR208	1901-1108	4	2	DIODE-SWITCHING 300V 3A 50NS	28480	1901-1108
A71CR209	1901-1110	8	2	DIODE-SWITCHING 300V 1A 50NS	28480	1901-1110
A71CR300	1901-1110	8	2	DIODE-SWITCHING 300V 1A 50NS	28480	1901-1110
A71CR301	1901-1110	8	2	DIODE-SWITCHING 300V 1A 50NS	28480	1901-1110
A71CR302	1901-1109	9	2	DIODE-PWR RECT 150V 6A 30NS	28480	1901-1109
A71CR303	1901-1109	5	2	DIODE-SWITCHING 400V 3A 50NS	28480	1901-1109
A71CR304	1901-1111	9	2	DIODE-PWR RECT 150V 6A 30NS	28480	1901-1111
A71CR305	1901-1109	5	2	DIODE-SWITCHING 400V 3A 50NS	28480	1901-1109
A71CR306	1901-1110	8	2	DIODE-SWITCHING 300V 1A 50NS	28480	1901-1110
A71CR307	1901-1110	8	2	DIODE-SWITCHING 300V 1A 50NS	28480	1901-1110
A71L001	9140-0829	8	1	40UH TOROID	28480	9140-0829
A71L300A	9170-0847	3	1	CORE-SHIELDING BEAD	02114	56-590-65/38 PARYLENE COATED
A71L300	9170-0847	3	1	CORE-SHIELDING BEAD	02114	56-590-65/38 PARYLENE COATED
A71L301	9170-0847	3	1	CORE-SHIELDING BEAD	02114	56-590-65/38 PARYLENE COATED
A71L301A	9170-0847	3	4	CORE-SHIELDING BEAD	02114	56-590-65/38 PARYLENE COATED
A71Q001	1853-0036	2	1	TRANSISTOR PNP SI PD=310MW FT=250MHZ	28480	1853-0036
A71R001	2100-3273	1	1	RESISTOR-TRMR 2K 10% C SIDE-ADJ 1-TRM	28480	2100-3273
A71R002	0757-0290	5	1	RESISTOR 6.19K 1% .125W F TC=0+-100	19701	MF4C1/8-T0-6191-F
A71R003	0698-4408	9	2	RESISTOR 124 1% .125W F TC=0+-100	24546	C4-1/8-T0-124R-F
A71R004	0698-4408	9	2	RESISTOR 124 1% .125W F TC=0+-100	24546	C4-1/8-T0-124R-F
A71R005	0698-4196	2	2	RESISTOR 1.07K 1% .125W F TC=0+-100	24546	C4-1/8-T0-1071-F
A71R006	0757-0420	3	1	RESISTOR 750 1% .125W F TC=0+-100	24546	C4-1/8-T0-751-F
A71R007	0698-3156	2	1	RESISTOR 14.7K 1% .125W F TC=0+-100	24546	C4-1/8-T0-1472-F
A71R008	0683-4725	2	1	RESISTOR 4.7K 5% .25W FC TC=-400/+700	01121	CR4725
A71R009	0698-4477	2	1	RESISTOR 10.5K 1% .125W F TC=0+-100	24546	C4-1/8-T0-1052-F
A71R010	0683-4735	8	1	RESISTOR 47 5% .25W FC TC=-400/+500	01121	CR4735
A71R011	0757-0458	7	1	RESISTOR 51.1K 1% .125W F TC=0+-100	24546	C4-1/8-T0-5112-F
A71R100	0698-4196	2	2	RESISTOR 1.07K 1% .125W F TC=0+-100	24546	C4-1/8-T0-1071-F
A71R101	8150-3375	5	2	RESISTOR-ZERO OHMS 22 AWG LEAD DIA R:F .005	28480	8150-3375
A71R200	63312-80001	4	1	RESISTOR-ZERO OHMS 22 AWG LEAD DIA R:F .005	28480	63312-80001
A71R201	0757-0289	2	1	RESISTOR 13.3K 1% .125W F TC=0+-100	19701	MF4C1/8-T0-1332-F
A71R202	0757-0273	4	1	RESISTOR 3.01K 1% .125W F TC=0+-100	24546	C4-1/8-T0-3011-F
A71R203	0698-3609	0	1	RESISTOR 22 5% 2W MO TC=0+-200	27167	FP42-2-T00-22R0-J
A71R204	0683-4735	4	2	RESISTOR 47K 5% .25W FC TC=-400/+800	01121	CR4735
A71R205	0757-0286	3	1	RESISTOR 1K 1% .125W F TC=0+-100	24546	C4-1/8-T0-1001-F
A71R206	0683-4735	4	2	RESISTOR 47K 5% .25W FC TC=-400/+800	01121	CR4735
A71R207	8150-3375	5	2	RESISTOR-ZERO OHMS 22 AWG LEAD DIA	28480	8150-3375
A71R208	0698-3631	8	2	RESISTOR 330 5% 2W MO TC=0+-200	28480	0698-3631
A71R300	0698-3631	8	2	RESISTOR 330 5% 2W MO TC=0+-200	28480	0698-3631

See introduction to this section for ordering information
 *Indicates factory selected value

Table 4-3 Replaceable Parts (Cont'd)

Reference Designation	HP Part Number	C D	Qty	Description	Mfr Code	Mfr Part Number
A71S100	3103-0114	0	1	SWITCH-THRM FXD 4R.C 3A CL-CN-RISE	28480	3103-0114
A71T300	9100-4340	2	1	TRANSFORMER-PWR (MISC ITEM)	28480	9100-4340
A71U031	1826-0393	7	1	IC V RGLTR TC-220	27314	LH317T
A71U100	1826-0527	9	1	IC 337 V RGLTR TC-220	27614	LH337T
A71U200	1826-0138	8	1	IC COMPARATOR GP QUAD 14-DIP-P PKG	01275	LH337N
A71W071	03561-61604	8	1	CABLE ASSY 70/71	28480	03561-61604
				A71 MISCELLANEOUS PARTS		
	0515-0055	8	2	SCREW-MACH M3 X 0.5 6MM-LG PAN-HD	28480	0515-0055
	0535-0034	9	4	NUT-HEX DEL-CHAM M3 X 0.5 2.4MM-THK	33300	ORDER BY DESCRIPTION
	1205-0560	4	1	HEATSINK	28480	1205-0560
	1480-0116	8	1	PIN-GRV .062-IN DIA .05-IN-LG STL	28480	1480-0116
	2190-0004	9	5	WASHER-LK INTL T NO. 4 .115-IN-ID	28480	2190-0004
	2190-0005	0	1	WASHER-LK EXT T NO. 4 .116-IN-ID	28480	2190-0005
	2190-0008	3	1	WASHER-LK EXT T NO. 6 .141-IN-ID	28480	2190-0008
	2420-0003	7	1	NUT-HEX DEL-CHAM 6-32-11D .094-IN-THK	28480	2420-0003
	4040-0749	4	1	EXTR-PC BD BRN POLYC .062-8D-THKNS	28480	4040-0749
	4040-0755	2	1	EXTR-PC BD VIO POLYC .062-8D-THKNS	28480	4040-0755
	1205-0495	4	1	HEAT SINK	28480	1205-0495

See introduction to this section for ordering information
 *Indicates factory selected value

Table 4-3 Replaceable Parts (Cont'd)

Reference Designation	HP Part Number	C D	Qty	Description	Mfr Code	Mfr Part Number
A72	03561-66572	9	1	POWER SUPPLY FILTER ASSEMBLY (REVISION A)	28480	03561-66572
A72C025	0180-3382	9	8	CAPACITOR-FXD 440UF+100-10% 50VDC AL	28480	0180-3382
A72C026	0180-3382	9		CAPACITOR-FXD 440UF+100-10% 50VDC AL	28480	0180-3382
A72C027	0180-3382	9		CAPACITOR-FXD 440UF+100-10% 50VDC AL	28480	0180-3382
A72C028	0180-3382	9		CAPACITOR-FXD 440UF+100-10% 50VDC AL	28480	0180-3382
A72C029	0180-3382	9		CAPACITOR-FXD 440UF+100-10% 50VDC AL	28480	0100-3382
A72C030	0180-3382	9		CAPACITOR-FXD 440UF+100-10% 50VDC AL	28480	0180-3382
A72C031	0180-3382	9		CAPACITOR-FXD 440UF+100-10% 50VDC AL	28480	0180-3382
A72C032	0180-3382	9		CAPACITOR-FXD 440UF+100-10% 50VDC AL	28480	0180-3382
A72CR040	1902-0679	4	2	DIODE-ZNR 17.4V 5% DO-15 PD=1W TC=+.068%	28480	1902-0679
A72CR041	1902-0679	4		DIODE-ZNR 17.4V 5% DO-15 PD=1W TC=+.068%	28480	1902-0679
A72CR043	1902-0555	5	1	DIODE-ZNR 13V 5% PD=1W IR=5UA	28480	1902-0555
A72CR045	1902-0654	5	1	DIODE-ZNR 33V 5% PD=1W IR=5UA	28480	1902-0654
A72CR047	1902-0556	6	2	DIODE-ZNR 20V 5% PD=1W IR=5UA	28480	1902-0556
A72CR049	1902-0556	6		DIODE-ZNR 20V 5% PD=1W IR=5UA	28480	1902-0556
A72CR051	1902-0652	3	1	DIODE-ZNR 11V 5% PD=1W IP=5UA	28480	1902-0652
A72L003	9140-0830	1	3	1040UH -12	28480	9140-0830
A72L004	9140-0830	1		1040UH -12	28480	9140-0830
A72L005	9140-0832	3	1	765UH +8	28480	9140-0832
A72L006	9140-0831	2	1	4240UH I+24	28480	9140-0831
A72L007	9140-0833	4	2	INDUCTOR	28480	9140-0833
A72L008	9140-0833	4		INDUCTOR	28480	9140-0833
A72L009	9140-0830	1		1040UH I+24	28480	9140-0830
A72LS001	0960-0483	9	1	ALARM-AUDIBLE RATED INPUT: 0.05W	28480	0960-0483
				A72 MISCELLANEOUS PARTS		
	1480-0116	8	1	PIN-GRV .062-IN-DIA .25-IN-LG STL	28480	1480-0116
	3050-0696	2	1	WASHER-FL NH 1/4 IN .3-IN-ID .535-IN-OD	28480	3050-0696
	3050-1082	0	1	WASHER-FL NH NO. 6 .159-IN-ID .29-IN-OD	28480	3050-1082
	4040-0750	7	1	EXTR-PC BD RED POLYC .362-BD-THKNS	28480	4040-0750
	4040-0755	2	1	EXTR-PC BD VIO POLYC .062-RD-THKNS	28480	4040-0755
	5020-8387	1	1	MYLAR DISC	28480	5020-8387
	9170-1237	7	1	MOUNTING CLIP	28480	9170-1237

See introduction to this section for ordering information
 *Indicates factory selected value

Table 4-3 Replaceable Parts (Cont'd)

Reference Designation	HP Part Number	C D	Qty	Description	Mfr Code	Mfr Part Number
A30	03561-66580	9	1	KEYBOARD ASSEMBLY (REVISION A)	28480	03561-66580
AC0DS001	1990-0487	7	14	LED-LAMP LUM-INT=1MCD IF=20MA-MAX RVR=5V	28480	5082-4584
AC0DS002	1990-0487	7		LED-LAMP LUM-INT=1MCD IF=20MA-MAX RVR=5V	28480	5082-4584
AC0DS003	1990-0487	7		LED-LAMP LUM-INT=1MCD IF=20MA-MAX RVR=5V	28480	5082-4584
AC0DS004	1990-0487	7		LED-LAMP LUM-INT=1MCD IF=20MA-MAX RVR=5V	28480	5082-4584
AC0DS005	1990-0487	7		LED-LAMP LUM-INT=1MCD IF=20MA-MAX RVR=5V	28480	5082-4584
AC0DS006	1990-0487	7		LED-LAMP LUM-INT=1MCD IF=20MA-MAX RVR=5V	28480	5082-4584
AC0DS007	1990-0487	7		LED-LAMP LUM-INT=1MCD IF=20MA-MAX RVR=5V	28480	5082-4584
AC0DS008	1990-0487	7		LED-LAMP LUM-INT=1MCD IF=20MA-MAX RVR=5V	28480	5082-4584
AC0DS009	1990-0487	7		LED-LAMP LUM-INT=1MCD IF=20MA-MAX RVR=5V	28480	5082-4584
AC0DS010	1990-0487	7		LED-LAMP LUM-INT=1MCD IF=20MA-MAX RVR=5V	28480	5082-4584
AC0DS011	1990-0486	6	1	LED-LAMP LUM-INT=1MCD IF=20MA-MAX RVR=5V	28480	5082-4684
AC0DS012	1990-0485	5	1	LED-LAMP LUM-INT=800UCD IF=30MA-MAX	28480	5082-4584
AC0DS013	1990-0487	7		LED-LAMP LUM-INT=1MCD IF=20MA-MAX RVR=5V	28480	5082-4584
AC0DS014	1990-0487	7		LED-LAMP LUM-INT=1MCD IF=20MA-MAX RVR=5V	28480	5082-4584
AC0DS015	1990-0487	7		LED-LAMP LUM-INT=1MCD IF=20MA-MAX RVR=5V	28480	5082-4584
AC0DS016	1990-0487	7		LED-LAMP LUM-INT=1MCD IF=20MA-MAX RVR=5V	28480	5082-4584

See introduction to this section for ordering information
 *Indicates factory selected value

Table 4-3 Replaceable Parts (Cont'd)

Reference Designation	HP Part Number	C D	Qty	Description	Mfr Code	Mfr Part Number
A81	03561-66581	0	1	KEYBOARD DRIVER ASSEMBLY (REVISION A)	20400	03561-66581
A81C001	0160-4571	8	7	CAPACITOR-FXD .1UF +80-20% 50VDC CER	28480	0160-4571
A81C002	0160-4571	8		CAPACITOR-FXD .1UF +80-20% 50VDC CER	28480	0160-4571
A81C003	0160-4571	8		CAPACITOR-FXD .1UF +80-20% 50VDC CER	28480	0160-4571
A81C004	0160-4571	8		CAPACITOR-FXD .1UF +80-20% 50VDC CER	28480	0160-4571
A81C005	0160-4571	8		CAPACITOR-FXD .1UF +80-20% 50VDC CER	28480	0160-4571
A81C006	0160-4571	8		CAPACITOR-FXD .1UF +80-20% 50VDC CER	28480	0160-4571
A81C007	0160-4571	8		CAPACITOR-FXD .1UF +80-20% 50VDC CER	28480	0160-4571
A81RP001	1810-3280	0	1	NETWORK-RES 10-SIP10.0K OHM X 9	01121	313A103
A81RP002	1810-3325	2	2	NETWORK-RES 16-DIP150.0 OHM X 8	01121	3168151
A81RP003	1810-3325	2		NETWORK-RES 16-DIP150.0 OHM X 8	01121	3168151
A81U001	1820-2951	5	1	IC DRVR TTL ALS BUS OCTL	28480	1820-2951
A81U002	1820-1997	7	3	IC FF TTL LS D-TYPE POS-EDGE-TRIG PRL-IN	01295	SN74LS374N
A81U003	1820-1997	7		IC FF TTL LS D-TYPE POS-EDGE-TRIG PRL-IN	01295	SN74LS374N
A81U004	1820-1997	7		IC FF TTL LS D-TYPE POS-EDGE-TRIG PRL-IN	01295	SN74LS374N
A81U005	1820-3238	3	1	IC TRANSCEIVER TTL ALS BUS OCTL	28480	1820-3238
A81U006	1820-3376	0	2	IC INV TTL ALS HEX	28480	1820-3376
A81U007	1820-3100	0	1	IC DCDR TTL ALS BIN 3-TO-8-LINE 3-INP	28480	1820-3100
A81U008	1820-3376	0		IC INV TTL ALS HEX	28480	1820-3376
A81W081	03561-61605	9	1	CABLE ASSY	28480	03561-61605

See introduction to this section for ordering information
 *Indicates factory selected value

Table 4-3 Replaceable Parts (Cont'd)

Reference Designation	HP Part Number	C D	Qty	Description	Mfr Code	Mfr Part Number
A02	03561-66502	1	1	REAR PANEL ASSEMBLY (REVISION B)	28480	03561-66502
A02C001	0160-4571	8	6	CAPACITOR-FXD .1UF +80-20% 50VDC CER	28480	0160-4571
A02C002	0160-4571	8		CAPACITOR-FXD .1UF +80-20% 50VDC CER	28480	0160-4571
A02C003	0160-4571	8		CAPACITOR-FXD .1UF +80-20% 50VDC CER	28480	0160-4571
A02C004	0160-4571	8		CAPACITOR-FXD .1UF +80-20% 50VDC CER	28480	0160-4571
A02C005	0160-4571	8		CAPACITOR-FXD .1UF +80-20% 50VDC CER	28480	0160-4571
A02C006	0160-4571	8		CAPACITOR-FXD .1UF +80-20% 50VDC CER	28480	0160-4571
A02CR011	1902-1291	8	3	DIODE-ZNR 1N5330R 5.1V 5% PD=5W IR=1UA	04713	1N5330R
A02CR002	1901-0050	3	10	DIODE-SWITCHING 80V 200MA 2NS DO-35	28480	1901-0050
A02CR003	1901-0050	3		DIODE-SWITCHING 80V 200MA 2NS DO-35	28480	1901-0050
A02CR004	1901-0050	3		DIODE-SWITCHING 80V 200MA 2NS DO-35	28480	1901-0050
A02CR005	1901-0050	3		DIODE-SWITCHING 80V 200MA 2NS DO-35	28480	1901-0050
A02CR006	1901-0704	4	0	DIODE-PWR RECT 1N4002 100V 1A DO-41	01295	1N4002
A02CR007	1901-0050	3		DIODE-SWITCHING 80V 200MA 2NS DO-35	28480	1901-0050
A02CR008	1901-0050	3		DIODE-SWITCHING 80V 200MA 2NS DO-35	28480	1901-0050
A02CR009	1901-0050	3		DIODE-SWITCHING 80V 200MA 2NS DO-35	28480	1901-0050
A02CR010	1901-0050	3		DIODE-SWITCHING 80V 200MA 2NS DO-35	28480	1901-0050
A02CR011	1901-0704	4		DIODE-PWR RECT 1N4002 100V 1A DO-41	01295	1N4002
A02CR012	1901-0050	3		DIODE-SWITCHING 80V 200MA 2NS DO-35	28480	1901-0050
A02CR013	1901-0050	3		DIODE-SWITCHING 80V 200MA 2NS DO-35	28480	1901-0050
A02CR014	1901-0050	3		DIODE-SWITCHING 80V 200MA 2NS DO-35	28480	1901-0050
A02CR015	1901-0050	3		DIODE-SWITCHING 80V 200MA 2NS DO-35	28480	1901-0050
A02CR016	1901-0704	4		DIODE-PWR RECT 1N4002 100V 1A DO-41	01295	1N4002
A02CR017	1901-0050	3		DIODE-SWITCHING 80V 200MA 2NS DO-35	28480	1901-0050
A02CR018	1901-0704	4		DIODE-PWR RECT 1N4002 100V 1A DO-41	01295	1N4002
A02CR019	1901-0050	3		DIODE-SWITCHING 80V 200MA 2NS DO-35	28480	1901-0050
A02CR020	1901-0050	3		DIODE-SWITCHING 80V 200MA 2NS DO-35	28480	1901-0050
A02CR021	1901-0704	4		DIODE-PWR RECT 1N4002 100V 1A DO-41	01295	1N4002
A02CR022	1901-0050	3		DIODE-SWITCHING 80V 200MA 2NS DO-35	28480	1901-0050
A02CR023	1902-1291	8		DIODE-ZNR 1N5330R 5.1V 5% PD=5W IR=1UA	04713	1N5330R
A02CR024	1901-0704	4		DIODE-PWR RECT 1N4002 100V 1A DO-41	01295	1N4002
A02CR025	1901-0704	4		DIODE-PWR RECT 1N4002 100V 1A DO-41	01295	1N4002
A02CR026	1901-0704	4		DIODE-PWR RECT 1N4002 100V 1A DO-41	01295	1N4002
A02CR027	1902-1291	8		DIODE-ZNR 1N5330R 5.1V 5% PD=5W IR=1UA	04713	1N5330R
A02J002	1250-1687	3	4	CONNECTOR-RF BNC FEM SGL-HOLE-RR 50-OHM	28480	1250-1687
A02J003	1250-1687	3		CONNECTOR-RF BNC FEM SGL-HOLE-RR 50-OHM	28480	1250-1687
A02J004	1250-1687	3		CONNECTOR-RF BNC FEM SGL-HOLE-RR 50-OHM	28480	1250-1687
A02J005	1250-1687	3		CONNECTOR-RF BNC FEM SGL-HOLE-RR 50-OHM	28480	1250-1687
A02J006	1250-1512	3	1	CONNECTOR-RF SMD M PC 50-OHM	28480	1250-1512
A02J007	1251-4040	0	1	CONNECTOR 24-PIN F MICRO RIBBON	28480	1251-4040
A02R001	0683-5105	4	2	RESISTOR 51 5% .25W FC TC=-400/+500	01121	C85105
A02R002	0757-1040	5	1	RESISTOR 50 1% .25W F TC=0/+100	24546	C5-1/4-T0-50R-F
A02R003	0683-7515	4	1	RESISTOR 750 5% .25W FC TC=-400/+600	01121	C87515
A02R004	0603-5105	4		RESISTOR 51 5% .25W FC TC=-400/+500	01121	C85105
A02R005	0837-0275	6	3	THERMISTOR DISC 50-OHM TC=+2.35%/C-DEG	28480	0837-0275
A02R006	0837-0275	6		THERMISTOR DISC 50-OHM TC=+2.35%/C-DEG	28480	0837-0275
A02R007	0837-0275	6		THERMISTOR DISC 50-OHM TC=+2.35%/C-DEG	28480	0837-0275
A02U001	1820-2024			IC 74LS244	28480	1820-2024
A02W002	03561-61605	9	1	CABLE ASSEMBLY	28480	03561-61605
				A02 MISCELLANEOUS PARTS		
	0380-0741	2	2	STANDOFF-RVT-ON .107-IN-LG 6-3211D	00000	ORDER BY DESCRIPTION

See introduction to this section for ordering information
 *Indicates factory selected value

Table 4-3 Replaceable Parts (Cont'd)

Reference Designation	HP Part Number	C D	Qty	Description	Mfr Code	Mfr Part Number
A90	03561-66590	1	1	ANALOG DISPLAY DRIVER ASSEMBLY (REVISION A)	28480	03561-66590
A90C001	0160-4571	8	5	CAPACITOR-FXD .10UF +80-20% 50VDC CER	28480	0160-4571
A90C002	0160-4808	4	1	CAPACITOR-FXD 470PF +-5% 100VDC CER	28480	0160-4808
A90C003	0180-0224	2	6	CAPACITOR-FXD 10UF+75-10% 16VDC AL	56289	30D106G016EA2
A90C004	0180-0061	5	1	CAPACITOR-FXD 100UF+75-10% 16VDC AL	56289	30D107G016FC2
A90C005	0180-0224	2	2	CAPACITOR-FXD 10UF+75-10% 16VDC AL	56289	30D106G016EA2
A90C100	0100-3224	2	2	CAPACITOR-FXD 10UF+75-10% 16VDC AL	56289	30D106G016EA2
A90C101	0160-5271	7	1	CAPACITOR-FXD 30PF +-5% 100VDC CER 0+-30	28480	0160-5271
A90C102	0180-3224	2	2	CAPACITOR-FXD 10UF+75-10% 16VDC AL	56289	30D106G016EA2
A90C200	0160-4571	8	8	CAPACITOR-FXD .10UF +80-20% 50VDC CER	28480	0160-4571
A90C201	0160-4571	8	8	CAPACITOR-FXD .10UF +80-20% 50VDC CER	28480	0160-4571
A90C300	0160-4230	6	3	CAPACITOR-FXD .01UF +80-20% 1KVDC CER	71570	CAP-103
A90C301	0160-4230	6	6	CAPACITOR-FXD .01UF +80-20% 1KVDC CER	71570	CAP-103
A90C302	0160-4230	6	6	CAPACITOR-FXD .01UF +80-20% 1KVDC CER	71570	CAP-103
A90C303	0150-3012	3	1	CAPACITOR-FXD .01UF +-20% 1KVDC CER	56289	C323A102J103MS38
A90C304	0180-0089	7	1	CAPACITOR-FXD 10UF+50-10% 150VDC AL	56289	30D106F150DD2
A90C400	0160-0168	1	1	CAPACITOR-FXD .10UF +-10% 200VDC POLY	28480	0160-0168
A90C401	0160-4571	8	8	CAPACITOR-FXD .10UF +80-20% 50VDC CER	28480	0160-4571
A90C402	0180-0224	2	2	CAPACITOR-FXD 10UF+75-10% 16VDC AL	56289	30D106G016EA2
A90C403	0180-0224	2	2	CAPACITOR-FXD 10UF+75-10% 16VDC AL	56289	30D106G016EA2
A90C404	0160-5404	8	1	CAPACITOR-FXD 360PF +-5% 100VDC CER	28480	0160-5404
A90C405	0160-4811	9	1	CAPACITOR-FXD 270PF +-5% 100VDC CER	28480	0160-4811
A90C406	0160-5349	3	1	CAPACITOR-FXD 200PF +-5% 100VDC CER	28480	0160-5349
A90C500	0160-4571	8	8	CAPACITOR-FXD .10UF +80-20% 50VDC CER	28480	0160-4571
A90C501	0160-4823	3	1	CAPACITOR-FXD 620PF +-5% 100VDC CER	28480	0160-4823
A90C502	0160-3847	9	1	CAPACITOR-FXD .01UF +100-0% 50VDC CER	28480	0160-3847
A90C503	0160-0161	4	1	CAPACITOR-FXD .01UF +-10% 200VDC POLY	28480	0160-0161
A90CR001	1901-0050	3	9	DIODE-SWITCHING 80V 200MA 2NS DO-35	28480	1901-0050
A90CR002	1901-0050	3	3	DIODE-SWITCHING 80V 200MA 2NS DO-35	28480	1901-0050
A90CR003	1901-0050	3	3	DIODE-SWITCHING 80V 200MA 2NS DO-35	28480	1901-0050
A90CR004	1902-0777	3	2	DIODE-ZNR 1N825 6.2V 5% DO-7 PD=.4W	28480	1N825
A90CR005	1902-0777	3	3	DIODE-ZNR 1N825 6.2V 5% DO-7 PD=.4W	28480	1N825
A90CR100	1901-0350	3	3	DIODE-SWITCHING 80V 200MA 2NS DO-35	28480	1901-0350
A90CR102	1901-0050	3	3	DIODE-SWITCHING 80V 200MA 2NS DO-35	28480	1901-0050
A90CR103	1901-0350	3	3	DIODE-SWITCHING 80V 200MA 2NS DO-35	28480	1901-0350
A90CR201	1901-0050	3	3	DIODE-SWITCHING 80V 200MA 2NS DO-35	28480	1901-0050
A90CR202	1901-0350	3	3	DIODE-SWITCHING 80V 200MA 2NS DO-35	28480	1901-0350
A90CR300	1901-0732	8	1	DIODE-PWR RECT 1KV 1A	28480	1901-0732
A90CR400	1902-0952	6	1	DIODE-ZNR 5.6V 5% DO-35 PD=.4W TC=+.046%	28480	1902-0952
A90CR500	1901-0050	3	3	DIODE-SWITCHING 80V 200MA 2NS DO-35	28480	1901-0050
A90CR900	1901-0328	5	1	DIODE-PWR RECT 400V 750MA DO-29	28480	1901-0328
A90DS300	2140-0028	2	1	LAMP-NEON	28480	2140-0028
A90J001	1251-5393	8	1	CONNECTOR 3-PIN M POST TYPE	28480	1251-5393
A90J300	1251-5346	1	1	CONNECTOR 10-PIN M POST TYPE	28480	1251-5346
A90J400	1251-5639	5	1	CONNECTOR 2-PIN M POST TYPE	28480	1251-5639
A90L100	9140-0748	0	2	INDUCTOR 250UH 25% .25DX.5LG Q=3	28480	9140-0748
A90L101	9140-0210	1	2	INDUCTOR RF-CH-HLD 100UH 5% .166DX.365LG	28480	9140-0210
A90L102	9140-0748	0	2	INDUCTOR 250UH 25% .25DX.5LG Q=3	28480	9140-0748
A90L200	9100-0539	3	1	INDUCTOR (MISC ITEM)	28480	9100-0539
A90L400	9140-0210	1	1	INDUCTOR RF-CH-HLD 100UH 5% .166DX.365LG	28480	9140-0210
A90Q001	1854-0215	1	7	TRANSISTOR NPN SI PD=350MW FT=300MHZ	04713	2N3904
A90Q002	1853-0036	2	4	TRANSISTOR PNP SI PD=310MW FT=250MHZ	28480	1853-0036
A90Q003	1853-0036	2	2	TRANSISTOR PNP SI PD=310MW FT=250MHZ	28480	1853-0036
A90Q004	1853-0413	9	1	TRANSISTOR PNP 2N6049 SI TO-66 PD=75W	28480	1853-0413
A90Q005	1854-0072	8	1	TRANSISTOR NPN 2N3054 SI TO-66 PD=25W	3L565	2N3054
A90Q006	1854-0215	1	1	TRANSISTOR NPN SI PD=350MW FT=300MHZ	04713	2N3904
A90Q007	1854-0215	1	1	TRANSISTOR NPN SI PD=350MW FT=300MHZ	04713	2N3904
A90Q008	1853-0036	2	2	TRANSISTOR PNP SI PD=310MW FT=250MHZ	28480	1853-0036
A90Q009	1854-0215	1	1	TRANSISTOR NPN SI PD=350MW FT=300MHZ	04713	2N3904
A90Q010	1853-0036	2	2	TRANSISTOR PNP SI PD=310MW FT=250MHZ	28480	1853-0036
A90Q011	1854-0215	1	1	TRANSISTOR NPN SI PD=350MW FT=300MHZ	04713	2N3904
A90Q012	1854-0215	1	1	TRANSISTOR NPN SI PD=350MW FT=300MHZ	04713	2N3904
A90Q013	1854-0477	7	1	TRANSISTOR NPN 2N2222A SI TO-18 PD=500MW	04713	2N2222A
A90Q014	1854-0215	1	1	TRANSISTOR NPN SI PD=350MW FT=300MHZ	04713	2N3904
A90R001	2100-3274	2	1	RESISTOR-TRMR 10K 10% C SIDE-ADJ 1-TRN	28480	2100-3274
A90R002	2100-3352	7	1	RESISTOR-TRMR 1K 10% C SIDE-ADJ 1-TRN	28480	2100-3352
A90R003	3757-0446	3	1	RESISTOR 15K 1% .125W F TC=0+-100	24546	C4-1/8-TO-1502-F
A90R004	0683-1035	1	2	RESISTOR 10K 5% .25W FC TC=-400/+700	61121	CR1035
A90R005	0683-2415	3	1	RESISTOR 240 5% .25W FC TC=-400/+600	31121	CR2415

See introduction to this section for ordering information
 *Indicates factory selected value

Table 4-3 Replaceable Parts (Cont'd)

Reference Designation	HP Part Number	C D	Qty	Description	Mfr Code	Mfr Part Number
A93R306	0683-5125	0	1	RESISTOR 5.1K 5% .25W FC TC=-400/+700	01121	CR5125
A90R007	0698-4510	4	1	RESISTOR 84.5K 1% .125W F TC=0+-100	24546	C4-1/8-T0-0452-F
A90R008	0683-5135	0	2	RESISTOR 51K 5% .25W F TC=-400/+800	01121	CR5135
A90R009	0683-1045	3	5	RESISTOR 100K 5% .25W FC TC=-400/+800	01121	CR1045
A93R310	0683-1045	3	3	RESISTOR 100K 5% .25W FC TC=-400/+800	01121	CR1045
A90R011	0698-4530	8	1	RESISTOR 232K 1% .125W F TC=0+-100	24546	C4-1/8-T0-2323-F
A93R312	0757-0465	6	1	RESISTOR 100K 1% .125W F TC=0+-100	24546	C4-1/8-T0-1003-F
A70R013	0698-4496	5	1	RESISTOR 45.3K 1% .125W F TC=0+-100	24546	C4-1/8-T0-4533-F
A93R314	0690-4462	5	2	RESISTOR 760 1% .125W F TC=0+-100	24546	C4-1/8-T0-768R-F
A90R015	0698-4462	5	5	RESISTOR 760 1% .125W F TC=0+-100	24546	C4-1/8-T0-768R-F
A90R016	0757-0124	4	1	RESISTOR 39.2K 1% .125W F TC=0+-100	20480	0757-0124
A90R100	2100-3273	1	1	RESISTOR-TRMP 2K 10% C SIDE-ADJ 1-TRN	20480	2100-3273
A93R131	0698-4431	0	1	RESISTOR 2.05K 1% .125W F TC=0+-100	24546	C4-1/8-T0-2051-F
A90R102	0693-1515	2	2	RESISTOR 150 5% .25W FC TC=-400/+600	01121	CR1515
A90R103	0683-1045	3	3	RESISTOR 100K 5% .25W FC TC=-400/+800	01121	CR1045
A90R104	0683-1035	1	1	RESISTOR 10K 5% .25W FC TC=-400/+700	01121	CR1035
A90R105	0811-3329	3	2	RESISTOR 2.7 5% 3W PW TC=0+-50	20480	0811-3329
A90R106	0693-5605	9	2	RESISTOR 50 5% .25W FC TC=-400/+500	01121	CR5605
A90R107	0603-3935	4	2	RESISTOR 39K 5% .25W FC TC= 400/+800	01121	CR3935
A90R108	0683-1015	7	6	RESISTOR 100 5% .25W FC TC=-400/+500	01121	CR1015
A90R109	0683-8215	3	3	RESISTOR 820 5% .25W FC TC=-400/+600	01121	CR8215
A90R110	0683-4715	0	2	RESISTOR 470 5% .25W FC TC=-400/+600	01121	CR4715
A93R111	0011-0070	5	1	RESISTOR 1.3K 1% 3W PW TC=0+-20	20480	0011-0070
A90R112	0683-3025	3	1	RESISTOR 3K 5% .25W FC TC=-400/+700	01121	CR3025
A93R113	0683-4715	0	3	RESISTOR 470 5% .25W FC TC=-400/+600	01121	CR4715
A90R114	0683-8215	3	3	RESISTOR 820 5% .25W FC TC=-400/+600	01121	CR8215
A93R115	0683-1015	7	7	RESISTOR 100 5% .25W FC TC=-400/+500	01121	CR1015
A90R116	0683-3935	4	4	RESISTOR 39K 5% .25W FC TC=-400/+800	01121	CR3935
A93R117	0683-5625	9	9	RESISTOR 56 5% .25W FC TC=-400/+500	01121	CR5625
A90R118	0811-3329	3	2	RESISTOR 2.7 5% 3W PW TC=0+-50	20480	0811-3329
A90R200	2100-3355	0	1	RESISTOR-TRMR 100K 10% C SIDE-ADJ 1-TRN	20480	2100-3355
A90R201	2100-3358	3	2	RESISTOR-TPMR 1M 20% C SIDE-ADJ 1-TRN	20480	2100-3358
A93R202	0683-2735	0	1	RESISTOR 27K 5% .25W FC TC=-400/+800	01121	CR2735
A90R203	0683-2715	6	2	RESISTOR 270 5% .25W FC TC=-400/+600	01121	CR2715
A90R204	0683-1015	7	7	RESISTOR 100 5% .25W FC TC=-400/+500	01121	CR1015
A90R205	0683-2715	6	6	RESISTOR 270 5% .25W FC TC=-400/+600	01121	CR2715
A90R206	0683-1015	7	7	RESISTOR 100 5% .25W FC TC=-400/+500	01121	CR1015
A90R207	0683-5615	1	2	RESISTOR 560 5% .25W FC TC=-400/+600	01121	CR5615
A90R208	0683-5615	1	1	RESISTOR 560 5% .25W FC TC=-400/+600	01121	CR5615
A90R300	2100-3358	3	3	RESISTOR-TRMP 1M 20% C SIDE-ADJ 1-TRN	20480	2100-3358
A90R301	0683-1055	5	3	RESISTOR 1M 5% .25W FC TC=-800/+900	01121	CR1055
A90R302	0683-1055	5	5	RESISTOR 1M 5% .25W FC TC=-800/+900	01121	CR1055
A93R303	0683-1045	3	3	RESISTOR 100K 5% .25W FC TC=-400/+800	01121	CR1045
A90R304	0683-1015	7	7	RESISTOR 100 5% .25W FC TC=-400/+500	01121	CR1015
A93R305	0764-0016	8	1	RESISTOR 1K 5% 2W MO TC=0+-200	20480	0764-0016
A90R306	0698-3640	9	1	RESISTOR 1.8K 5% 2W MO TC=0+-200	27167	FP42-2-T00 1001-J
A90R307	0683-2745	2	1	RESISTOR 27K 5% .25W FC TC=-800/+900	01121	CR2745
A90R308	0683-1055	5	5	RESISTOR 1M 5% .25W FC TC=-800/+900	01121	CR1055
A93R400	0683-1025	9	4	RESISTOR 1K 5% .25W FC TC=-400/+600	01121	CR1025
A90R401	0683-1025	9	9	RESISTOR 1K 5% .25W FC TC=-400/+600	01121	CR1025
A93R402	0683-2015	9	1	RESISTOR 200 5% .25W FC TC=-400/+600	01121	CR2015
A90R403	0683-2025	1	2	RESISTOR 2K 5% .25W FC TC=-400/+700	01121	CR2025
A93R404	0683-3015	1	2	RESISTOR 300 5% .25W FC TC=-400/+600	01121	CR3015
A90R405	0683-8215	3	3	RESISTOR 820 5% .25W FC TC=-400/+600	01121	CR8215
A90R406	0683-2025	1	1	RESISTOR 2K 5% .25W FC TC=-400/+700	01121	CR2025
A90R407	0683-1525	4	3	RESISTOR 1.5K 5% .25W FC TC=-400/+700	01121	CR1525
A90R500	0683-1525	4	1	RESISTOR 1.5K 5% .25W FC TC=-400/+700	01121	CR1525
A90R501	0698-4482	9	1	RESISTOR 17.4K 1% .125W F TC=0+-100	03099	PME55-1/8-T0 1742-F
A90R502	0683-3015	1	7	RESISTOR 300 5% .25W FC TC=-400/+600	01121	CR3015
A90R503	0683-1015	7	1	RESISTOR 100 5% .25W FC TC=-400/+500	01121	CR1015
A93R504	0683-5135	3	3	RESISTOR 51K 5% .25W FC TC=-400/+800	01121	CR5135
A90R505	0683-1045	3	3	RESISTOR 100K 5% .25W FC TC=-400/+800	01121	CR1045
A90R506	0683-1025	9	9	RESISTOR 1K 5% .25W FC TC=-400/+600	01121	CR1025
A90R507	0683-1525	4	4	RESISTOR 1.5K 5% .25W FC TC=-400/+700	01121	CR1525
A90R508	0150-3375	5	1	RESISTOR-ZERO OHMS 22 AWG LEAD DIA	20480	0150-3375
A90R509	0683-1515	2	9	RESISTOR 150 5% .25W FC TC=-400/+600	01121	CR1515
A90R600	0683-1025	9	2	RESISTOR 1K 5% .25W FC TC=-400/+600	01121	CR1025
A90TP001	1251-0600	0	22	CONNECTOR-SGL CNT PIN 1.14-MM-RSC-SZ SQ	20480	1251-0600
A90TP100	1251-0600	0	0	CONNECTOR-SGL CNT PIN 1.14-MM-RSC-SZ SQ	20480	1251-0600
A90TP101	1251-0600	0	0	CONNECTOR-SGL CNT PIN 1.14-MM-RSC-SZ SQ	20480	1251-0600
A90TP102	1251-0600	0	0	CONNECTOR-SGL CNT PIN 1.14-MM-RSC-SZ SQ	20480	1251-0600
A90TP132	1251-0600	0	0	CONNECTOR-SGL CNT PIN 1.14-MM-RSC-SZ SQ	20480	1251-0600
A90TP133	1251-0600	0	0	CONNECTOR-SGL CNT PIN 1.14-MM-RSC-SZ SQ	20480	1251-0600
A90TP200	1251-0600	0	0	CONNECTOR-SGL CNT PIN 1.14-MM-RSC-SZ SQ	20480	1251-0600
A90TP300	1251-0600	0	0	CONNECTOR-SGL CNT PIN 1.14-MM-RSC-SZ SQ	20480	1251-0600
A90TP301	1251-0600	0	0	CONNECTOR-SGL CNT PIN 1.14-MM-RSC-SZ SQ	20480	1251-0600
A90TP302	1251-0600	0	0	CONNECTOR-SGL CNT PIN 1.14-MM-RSC-SZ SQ	20480	1251-0600
A90TP303	1251-0600	0	0	CONNECTOR-SGL CNT PIN 1.14-MM-RSC-SZ SQ	20480	1251-0600

See introduction to this section for ordering information
 *Indicates factory selected value

Table 4-3 Replaceable Parts (Cont'd)

Reference Designation	HP Part Number	C D	Qty	Description	Mfr Code	Mfr Part Number
A90TP334	1251-0600	3		CONNECTOR-SGL CONT PIN 1.14-MM-BSC-SZ SQ	28480	1251-0600
A90TP400	1251-0600	0		CONNECTOR-SGL CONT PIN 1.14-MM-BSC-SZ SQ	28480	1251-0600
A90TP503	1251-0600	3		CONNECTOR-SGL CONT PIN 1.14-MM-BSC-SZ SQ	28480	1251-0600
A90TP501	1251-0600	0		CONNECTOR-SGL CONT PIN 1.14-MM-BSC-SZ SQ	28480	1251-0600
A90TP502	1251-0600	3		CONNECTOR-SGL CONT PIN 1.14-MM-BSC-SZ SQ	28480	1251-0600
A90TP503	1251-0600	0		CONNECTOR-SGL CONT PIN 1.14-MM-BSC-SZ SQ	28480	1251-0600
A90TP504	1251-0600	3		CONNECTOR-SGL CONT PIN 1.14-MM-BSC-SZ SQ	28480	1251-0600
A90TP505	1251-0600	0		CONNECTOR-SGL CONT PIN 1.14-MM-BSC-SZ SQ	28480	1251-0600
A90TP506	1251-0600	3		CONNECTOR-SGL CONT PIN 1.14-MM-BSC-SZ SQ	28480	1251-0600
A90TP507	1251-0600	0		CONNECTOR-SGL CONT PIN 1.14-MM-BSC-SZ SQ	28480	1251-0600
A90TP900	1251-0600	0		CONNECTOR-SGL CONT PIN 1.14-MM-BSC-SZ SQ	28480	1251-0600
A90TP901	1251-0600	0		CONNECTOR-SGL CONT PIN 1.14-MM-BSC-SZ SQ	28480	1251-0600
A90U001	1826-0312	0	1	IC OP AMP GP QUAD 14-DIP-P PKG	04713	HC3403P
A90U500	1826-0119	5	1	IC TIMER TTL MONO/ASTBL	18324	NE555T
A90U501	1820-1322	2	1	IC GATE TTL S NCR QUAD 2-1NP	01295	SN74S02N
A90U600	1820-0471	0	1	IC INV TTL HEX 1-1NP	01295	SN7406N
				A90 MISCELLANEOUS PARTS		
	2190-0007	2	4	WASHER-LK INTL T NO. 6 .141-IN-ID	28480	2190-0007
	2420-0003	7	4	NUT-HEX-DCL-CHAM 6-32-THD .094-IN-TXK	28480	2420-0003
	1205-0419	2	2	HEAT SINK	28480	1205-0419
	4040-0756	3	1	EXTR-WHITE PC BD	28480	4040-0756
	4040-0748	3	1	EXTR-BLACK PC BD	28480	4040-0748
	1483-0116	8	2	PIN-GRV .062-IN-DIA .25-IN-LG STL	28480	1483-0116

See introduction to this section for ordering information
 *Indicates factory selected value

Table 4-3 Replaceable Parts (Cont'd)

Reference Designation	HP Part Number	C D	Qty	Description	Mfr Code	Mfr Part Number
A99	02561-66599	3	1	MOTHERBOARD ASSEMBLY (REVISION B)	23430	03561-66599
A99C001	0180-0059	1	3	CAPACITOR-FXD 10UF+75-10% 25VDC AL	56289	30D106G025B10
A99C002	0180-0059	1	3	CAPACITOR-FXD 10UF+75-10% 25VDC AL	56289	30D106G025B10
A99C003	0150-0012	3	1	CAPACITOR-FXD .01UF +-20% 1KVDC CER	56289	C023A102J103M038
A99C004	0100-0059	1	1	CAPACITOR-FXD 10UF+75-10% 25VDC AL	56259	30D106G025B10
A99C5*	0160-3454	4	1	C-F 220 pF, 10% 1000 Vdc Max Voltage, Ceramic	28480	0160-3454
	0160-3455	5	1	C-F 470 pF, 10% 1000 Vdc Max Voltage, Ceramic	28480	0160-3455
	0160-3466	8	1	C-F 1000 pF, 10% 1000 Vdc Max Voltage, Ceramic	28480	0160-3466
A99C6* Same as A99C5			1			
A99C7* Same as A99C5			1			
A99C8* Same as A99C5			1			
A99C009	0180-2803	7	2	CAPACITOR-FXD 100UF+50-10% 50VDC AL	28480	0180-2803
A99C010	0160-3456	6	2	CAPACITOR-FXD 1000PF +-10% 1KVDC CER	28480	0160-3456
A99C011	0160-3455	5	2	CAPACITOR-FXD 470PF +-10% 1KVDC CER	28480	0160-3455
A99C013	0180-3307	4	2	CAPACITOR-FXD 1300UF+50-10% 250VDC AL	28480	0180-3307
A99C01	0180-3387	4	1	CAPACITOR-FXD 1300UF+50-10% 250VDC AL	28480	0180-3387
A99C102	0160-3830	0	1	CAPACITOR-FXD 50UF +-10% 50VDC MET-POLY	28480	0160-3830
A99C103	0180-2803	7	1	CAPACITOR-FXD 100UF+50-10% 50VDC AL	28480	0180-2803
A99C104	0160-3455	5	1	CAPACITOR-FXD 470PF +-10% 1KVDC CER	28480	0160-3455
A99C200	0180-0100	3	9	CAPACITOR-FXD 4.7UF+-10% 35VDC TA	56289	150D475X903502
A99C201	0180-0100	3	7	CAPACITOR-FXD 4.7UF+-10% 35VDC TA	56289	150D475X903502
A99C202	0160-3622	8	7	CAPACITOR-FXD .1UF +80-20% 100VDC CER	26654	2130Y5V100R104Z
A99C203	0180-0100	3	3	CAPACITOR-FXD 4.7UF+-10% 35VDC TA	56289	150D475X903502
A99C204	0160-3622	8	3	CAPACITOR-FXD .1UF +80-20% 100VDC CER	26654	2130Y5V100R104Z
A99C205	0180-0100	3	3	CAPACITOR-FXD 4.7UF+-10% 35VDC TA	56289	150D475X903502
A99C206	0160-3622	8	1	CAPACITOR-FXD .1UF +80-20% 100VDC CER	26654	2130Y5V100R104Z
A99C207	0180-0100	3	1	CAPACITOR-FXD 4.7UF+-10% 35VDC TA	56289	150D475X903502
A99C208	0160-3622	8	1	CAPACITOR-FXD .1UF +80-20% 100VDC CER	26654	2130Y5V100R104Z
A99C209	0180-0100	3	1	CAPACITOR-FXD 4.7UF+-10% 35VDC TA	56289	150D475X903502
A99C210	0180-3368	1	1	CAPACITOR-FXD 3300UF 25V AL	28480	0180-3368
A99C300	0160-3622	8	3	CAPACITOR-FXD .1UF +80-20% 100VDC CER	26654	2130Y5V100R104Z
A99C301	0180-0100	3	3	CAPACITOR-FXD 4.7UF+-10% 35VDC TA	56289	150D475X903502
A99C302	0160-3622	8	3	CAPACITOR-FXD .1UF +80-20% 100VDC CER	26654	2130Y5V100R104Z
A99C303	0180-0100	3	3	CAPACITOR-FXD 4.7UF+-10% 35VDC TA	56289	150D475X903502
A99C304	0160-3622	8	3	CAPACITOR-FXD .1UF +80-20% 100VDC CER	26654	2130Y5V100R104Z
A99C305	0180-0100	3	3	CAPACITOR-FXD 4.7UF+-10% 35VDC TA	56289	150D475X903502
A99CR001	1901-0848	7	2	DIODE-PWR RECT 400V 3A 200NS	34713	MR054
A99CR002	1901-0848	7	2	DIODE-PWR RECT 400V 3A 200NS	34713	MR054
A99CR100	1906-0080	9	1	DIODE-FW ERDG 600V 10A	28480	1906-0080
A99CR200	1901-0743	1	18	DIODE-PWR RECT 1N4004 400V 1A DO-41	01295	1N4004
A99CR201	1901-0743	1	18	DIODE-PWR RECT 1N4004 400V 1A DO-41	01295	1N4004
A99CR202	1901-0743	1	1	DIODE-PWR RECT 1N4004 400V 1A DO-41	01295	1N4004
A99CR203	1901-0743	1	1	DIODE-PWR RECT 1N4004 400V 1A DO-41	01295	1N4004
A99CR204	1901-0743	1	1	DIODE-PWR RECT 1N4004 400V 1A DO-41	01295	1N4004
A99CR205	1901-0743	1	1	DIODE-PWR RECT 1N4004 400V 1A DO-41	01295	1N4004
A99CR206	1901-0743	1	1	DIODE-PWR RECT 1N4004 400V 1A DO-41	01295	1N4004
A99CR207	1901-0743	1	1	DIODE-PWR RECT 1N4004 400V 1A DO-41	01295	1N4004
A99CR208	1901-0743	1	1	DIODE-PWR RECT 1N4004 400V 1A DO-41	01295	1N4004
A99CR209	1901-0743	1	1	DIODE-PWR RECT 1N4004 400V 1A DO-41	01295	1N4004
A99CR300	1901-0743	1	1	DIODE-PWR RECT 1N4004 400V 1A DO-41	01295	1N4004
A99CR301	1901-0743	1	1	DIODE-PWR RECT 1N4004 400V 1A DO-41	01295	1N4004
A99CR302	1901-0743	1	1	DIODE-PWR RECT 1N4004 400V 1A DO-41	01295	1N4004
A99CR303	1901-0743	1	1	DIODE-PWR RECT 1N4004 400V 1A DO-41	01295	1N4004
A99CR304	1901-0743	1	1	DIODE-PWR RECT 1N4004 400V 1A DO-41	01295	1N4004
A99CR305	1901-0743	1	1	DIODE-PWR RECT 1N4004 400V 1A DO-41	01295	1N4004
A99CR306	1901-0743	1	1	DIODE-PWR RECT 1N4004 400V 1A DO-41	01295	1N4004
A99CR307	1901-0743	1	1	DIODE-PWR RECT 1N4004 400V 1A DO-41	01295	1N4004
A99E001	1970-0094	0	1	250V SPARK GAP	28480	1970-0094
A99F001	2110-0004	1	1	FUSE .25A 250V NTD 1.25X.25 UL	28480	2110-0004
A99J001	1251-6173	4	1	CONNECTOR 2-PIN M POST TYPE	28480	1251-6173
A99J010	1251-2915	4	9	CONNECTOR-PC EDGE 25-CONT/ROW 2-ROWS	28480	1251-2915
A99J015	1251-1365	6	8	CONNECTOR-PC EDGE 22-CONT/ROW 2-ROWS	28480	1251-1365
A99J021	1251-2915	4	4	CONNECTOR-PC EDGE 25-CONT/ROW 2-ROWS	28480	1251-2915
A99J022	1251-1365	6	4	CONNECTOR-PC EDGE 22-CONT/ROW 2-ROWS	28480	1251-1365
A99J031	1251-2915	4	4	CONNECTOR-PC EDGE 25-CONT/ROW 2-ROWS	28480	1251-2915
A99J032	1251-1365	6	4	CONNECTOR-PC EDGE 22-CONT/ROW 2-ROWS	28480	1251-1365
A99J041	1251-2915	4	4	CONNECTOR-PC EDGE 25-CONT/ROW 2-ROWS	28480	1251-2915
A99J042	1251-1365	6	4	CONNECTOR-PC EDGE 22-CONT/ROW 2-ROWS	28480	1251-1365
A99J051	1251-2915	4	4	CONNECTOR-PC EDGE 25-CONT/ROW 2-ROWS	28480	1251-2915
A99J052	1251-1365	6	4	CONNECTOR-PC EDGE 22-CONT/ROW 2-ROWS	28480	1251-1365
A99J061	1251-2915	4	4	CONNECTOR-PC EDGE 25-CONT/ROW 2-ROWS	28480	1251-2915
A99J062	1251-1365	6	4	CONNECTOR-PC EDGE 22-CONT/ROW 2-ROWS	28480	1251-1365
A99J065	1251-1365	6	4	CONNECTOR-PC EDGE 22-CONT/ROW 2-ROWS	28480	1251-1365
A99J070	1251-2915	4	4	CONNECTOR-PC EDGE 25-CONT/ROW 2-ROWS	28480	1251-2915

* Whenever T100 is replaced, C5, C6, C7, and C8 must be reselected using the procedure given in Paragraph 7-30. C5, C6, C7, and C8 are factory selected components, and must be reselected whenever A99100 is replaced.

See introduction to this section for ordering information
 *Indicates factory selected value

Table 4-3 Replaceable Parts (Cont'd)

Reference Designation	HP Part Number	C D	Qty	Description	Mfr Code	Mfr Part Number
A99J071	1251-2915	4		CONNECTOR-PC EDGE 25-CONT/ROW 2-ROWS	28480	1251-2915
A99J072	1251-2915	4		CONNECTOR-PC EDGE 25-CONT/ROW 2-ROWS	28480	1251-2915
A99J081	1251-5721	6	2	CONNECTOR 40-PIN M POST TYPE	28480	1251-5721
A99J082	1251-5721	6		CONNECTOR 40-PIN M POST TYPE	28480	1251-5721
A99J093	1251-1365	6		CONNECTOR-PC EDGE 22-CONT/ROW 2-ROWS	28480	1251-1365
A99J300	1250-1339	2	1	CONNECTOR-RF SM-SLD M PC 50-OHM	28480	1250-1339
A99L001	9140-0748	0	1	INDUCTOR 250UH 25% .25DX .5LG Q=3	28480	9140-0748
A99L101	9140-0822	1	1	COIL-VAR 30UH-140UH Q=3? PC-MTC	20480	9140-0822
A99Q001	1054-0780	5	1	TRANSISTOR NPN CI TO-3 PD=60W FT=4MHZ	02540	IUX83
A99R001	0811-1854	5	1	RESISTOR 50 5% 5W PW TC=0+-20	28480	0811-1854
A99R002	0811-3478	3	1	RESISTOR .1 1% 5W PW TC=0+-20	28480	0811-3478
A99R003	0683-1045	3	1	RESISTOR 100K 5% .25W FC TC=-400/+300	01121	CD1045
A99R103	0764-0040	8	2	RESISTOR 39K 5% 2W MO TC=0+-200	28480	0764-0040
A99R101	0764-0040	8		RESISTOR 39K 5% 2W MO TC=0+-200	28480	0764-0040
A99R102	0757-0159		1	RESISTOR 1K 5% 1/2W MO TC=0+-200	28480	0757-0159
A99R300	0698-3608	9	1	RESISTOR 20 5% 2W MO TC=0+-200	27167	FP42-2-T00-2CR0-J
A99R113	0837-0135	7	1	THERMISTOR DISC 5-OHM TC=-3.3%/C-DEG	15454	SDASR0-220-SIL-Z
A99S100	3101-2298	1	2	SWITCH-SL DPDT STD 5A 250VAC SLDR-LUG	28480	3101-2298
A99S101	3101-2298	1		SWITCH-SL DPDT STD 5A 250VAC SLDR-LUG	28480	3101-2298
A99T001	9100-4344	1	1	TRANSFORMER PRI IND: 9.4 MH NOM; SEC	28480	9100-4344
A99T032	T-106196	9	1	BIAS XFMR	28480	T-106196
A99T100	9100-4341	3	1	TRANSFORMER-FLYBACK FREQUENCY: 36.2KHZ	28480	9100-4341
A99W001	DS-JUMP-BLU	9	2	JUMPER, 22 AWG	28480	DS-JUMP-BLU
A99W002	DS-JUMP-BLU	9		JUMPER, 22 AWG	28480	DS-JUMP-BLU
A99W003	DS-JUMP-RED	2	2	JUMPER, 22 AWG	28480	DS-JUMP-RED
A99W004	DS-JUMP-WHL	4	1	JUMPER, 22 AWG	28480	DS-JUMP-WHL
A99W005	DS-JUMP-LGR	0	1	JUMPER, 22 AWG	28480	DS-JUMP-LGR
A99W006	DS-JUMP-WRE	6	2	JUMPER, 22 AWG	28480	DS-JUMP-WRE
A99W007	DS-JUMP-WYE	6	1	JUMPER, 22 AWG	28480	DS-JUMP-WYE
A99W008	DS-JUMP-YEL	2	2	JUMPER, 22 AWG	28480	DS-JUMP-YEL
A99W009	DS-JUMP-RED	2		JUMPER, 22 AWG	28480	DS-JUMP-RED
A99W010	DS-JUMP-WRE	6		JUMPER, 22 AWG	28480	DS-JUMP-WRE
A99W011	DS-JUMP-YEL	2		JUMPER, 22 AWG	28480	DS-JUMP-YEL
A99U200	1826-0147	9	2	IC 7812 V RGLTR TO-220	04713	MC7812CP
A99U231	1826-0147	9		IC 7812 V RGLTR TO-220	04713	MC7812CP
A99U202	1826-0221	0	1	IC V RGLTR TO-220	04713	MC7912CT
A99U203	1826-0146	8	1	IC 7808 V RGLTR TO-220	04713	MC7808CP
A99U204	1826-0122	0	2	IC 7805 V RGLTR TO-220	07263	7805UC
A99U205	1826-0122	0		IC 7805 V RGLTR TO-220	07263	7805UC
A99U300	1826-0214	1	1	IC V RGLTR TO-220	04713	MC7915CT
A99U301	1826-0136	0	1	IC 7815 V RGLTR TO-220	04713	MC7815CP
A99U302	1826-0150	4	1	IC 340T-24 V RGLTR TO-220	07263	7824UC
A99W070	03561-61607	1	1	CABLE ASSY 70/99	20480	03561-61607
A99 MISCELLANEOUS PARTS						
	0340-0564	3	1	INSULATOR-XSTR THRM-CONDCT	28480	0340-0564
	03561-01231	1	1	FLYBK SHLD, RIGHT	28480	03561-01231
	03561-01232	2	1	FLYBK SHLD, LEFT	28480	03561-01232
	0515-0054	7	1	SCREW-MACH M3 X 0.5 10MM-LG PAN-HD	20480	0515-0054
	0515-0055	8	7	SCREW-MACH M3 X 0.5 6MM-LG PAN-HD	28480	0515-0055
	0515-0104	8	13	SCREW-MACH M3 X 0.5 8MM-LG PAN-HD	28480	0515-0104
	0535-0034	9	2	NUT-HEX DBL-CHAM M3 X 0.5 2.4MM-THK	00000	ORDER BY DESCRIPTION
	0590-1088	7	1	THREADED INSERT-NUT M3 X 0.5 CARB-STL	28480	0590-1088
	0590-1220	9	2	THREADED INSERT-NUT M3 X 0.5 1.5-MM-LG	28480	0590-1220
	1205-0495	4	1	HEAT SINK	28480	1205-0495
	2110-0643	4	1	FUSEHOLDER-CLIP TYPE 15A 250 V	28480	2110-0643
	03561-01222	0	1	REG HEAT SINK	28480	03561-01222
	1251-0600	0	1	CONNECTOR-SGL CFMT PIN 1.14-MM-BSC-SZ 50	28480	1251-0600
	03561-60601	3	1	FLYBK SHLD ASSY	28480	03561-60601
	2190-0004	9	15	WASHER-LK INTL T NO. 4 .115-IN-ID	28480	2190-0004
	2260-0009	3	2	NUT-HEX-W/LKWR 4-40-THD .094-IN-THK	00000	ORDER BY DESCRIPTION
	3050-0066	8	2	WASHER-FL HTLC NO. 6 .147-IN-ID	28480	3050-0066
	3050-0440	2	1	WASHER-SHLDR NO. 4 .115-IN-ID .2-IN-OD	28480	3050-0440

See introduction to this section for ordering information
 *Indicates factory selected value

Table 4-3 Replaceable Parts (Cont'd)

Reference Designation	HP Part Number	C D	Qty	Description	Mfr Code	Mfr Part Number
B1	3160-0439	2	1	FAN	28480	3160-0439
C1	0160-3622	8	1	CAPACITOR-FXD .1UF +80-20% 100VDC CER	26654	2130Y5V100R104Z
C2	3150-0312	3	1	CAPACITOR-FXD .01UF +-20% 1KVDC CER	56209	C023A102J103H030
DS1	2140-0024	8	1	NEON LAMP	28480	2140-0024
F2 (110/120V)	2110-0003			FUSE 3A 250V NORMAL BLOW	28480	2110-0003
F2 (220/240V)	2110-0304			FUSE 1.5A	28480	2110-0304
MP001	03561-04101	0	1	TOP COVER	28480	03561-04101
MP002	03561-04102	1	1	BOTTOM COVER	28480	03561-04102
MP003	03561-01210	6	1	DIGITAL ASSEMBLY HOLDDOWN COVER	28480	03561-01210
MP004	03561-01211	7	1	POWER SUPPLY HOLDDOWN COVER	28480	03561-01211
MP005	03561-01205	9	1	A90 ASSEMBLY HOLDDOWN COVER	28480	03561-01205
MP006	03561-00601	7	1	CRT TUBE SHIELD	28480	03561-00601
MP007	03561-60605	7	1	MOTHERBOARD CAPACITOR HOLDDOWN BRACKET	28480	03561-60605
MP008	03561-41202	0	1	DIGITAL COVER NYLON SEPARATOR (SHORT)	28480	03561-41202
MP009	03561-41201	9	1	DIGITAL COVER NYLON SEPARATOR (LONG)	28480	03561-41201
MP010	03561-41203	1	1	POWER SUPPLY COVER NYLON SEPARATOR	28480	03561-41203
MP011	5040-0516	4	1	FRONT PANEL HELMET	28480	5040-0516
MP012	03561-01212	5	1	A10 ASSEMBLY COVER PLATE	28480	03561-01212
MP013	03561-01220	8	1	A10 ASSEMBLY SIDE SHIELD	28480	03561-01220
MP014	03561-23701	6	1	RIGHT SIDE RAIL	28480	03561-23701
MP015	03561-04304	5	1	LABEL, LINE SELECTION SWITCH	28480	03561-04304
MP016	03561-01216	2	1	A90 ASSEMBLY SIDE SHIELD	28480	03561-01216
MP017	03561-01225	3	1	FUSE SHIELD, PLASTIC	28480	03561-01225
MP018	03561-01202	0	1	PS REGULATOR HEAT SINK	28480	03561-01202
MP019	03561-23703	8	1	LEFT SIDE RAIL	28480	03561-23703
MP020	1540-0292	9	1	TOP COVER VINYL POUCH	20480	1540-0292
MP021	4324-0395	5	1	DIGITAL PC COVER FOAM PAD	28480	4324-0395
MP022	03561-44302	7	1	MAIN KEYPAD	28480	03561-44302
MP023	03561-44301	6	1	SOFTKEY KEYPAD	28480	03561-44301
MP024	3150-0218	4	1	FAN AIR FILTER	28480	3150-0218
MP025	03561-20002	4	1	REAR PANEL CASTING	28480	03561-20002
MP026	3160-0092	3	1	FAN GRILL	28480	3160-0092
MP027	03561-01217	3	1	FAN HOUSING	28480	03561-01217
MP028	03561-01209	3	1	REAR SUBPANEL	28480	03561-01209
MP029	03561-01206	0	1	FAN AIR DEFLECTOR	28480	03561-01206
MP030	03561-60603	5	1	REAR SHEET METAL ASSEMBLY GUIDE	28480	03561-60603
MP031	5041-2625	2	1	CARRYING HANDLE	28480	5041-2625
MP032	1460-0604	7	2	HANDLE COMPRESSION SPRING	28480	1460-0604
MP033	0380-1661	7	2	CRT MOUNTING STANDOFF	28480	0380-1661
MP034	5020-0735	3	2	HANDLE HUB GEAR	28480	5020-0735
MP035	1390-0084	8		1/4 TURN CLIP-ON NUT	28480	1390-0084
MP036	5020-0780	6	2	HANDLE RING GEAR	28480	5020-0780
MP037	0160-0467	1	4	RFI STRIP FINGERS	28480	0160-0467
MP038	5040-0511	9	2	HANDLE RING TRIM CAP	28480	5040-0511
MP039	0340-0564	3	9	REGULATOR INSULATORS	28480	0340-0564
MP040	03561-01230	0	1	CRT WIRE RING RETAINER	28480	03561-01230
MP041	03561-21201	7	1	CRT RUBBER GASKET	28480	03561-21201
MP042	03561-20601	3	1	FRONT PANEL CASTING	28480	03561-20601
MP043	0355-0013	0		FAN FILTER THumbnUT	00000	ORDER BY DESCRIPTION
MP044	2950-0035	8		MP-ID BNC NUTS	00000	ORDER BY DESCRIPTION
MP045	9135-0212	2	1	LINE FILTER ASSEMBLY	28480	9135-0212
MP046	03561-01218	4	1	MOTHERBOARD SHIELD, PLASTIC	28480	03561-01218
MP047	03561-01203	2	1	A15 ASSEMBLY SIDE SHIELD	28480	03561-01203
MP048	1390-0532	1	3	A10 SHIELD PLASTIC NUT	94222	F1-10-106-12
MP049	03561-01213	9	1	REAR SHIELD INSULATOR, PLASTIC	28480	03561-01213
MP050	03561-01212	8	1	FRONT SHIELD INSULATOR, PLASTIC	28480	03561-01212
MP051	0403-0132	5	5	REAR PLASTIC ASSEMBLY GUIDES	28480	0403-0132
MP052	03561-60602	4	1	DIGITAL ASSEMBLY GUIDE, FRONT	28480	03561-60602
MP053	03561-60604	6	1	DIGITAL ASSEMBLY GUIDE, CENTER	28480	03561-60604
MP054	5040-5062	3	4	REAR FOOT BODY	28480	5040-5062
MP055	5041-0201	6	1	POWER SWITCH KEY CAP	28480	5041-0201
MP056	03561-60601	3	1	FLYBACK TRANSFORMER SHIELD	28480	03561-60601
MP057	1205-0495	4	1	A99 HEATSINK	28480	1205-0495
MP058	5040-5061	2	4	REAR FOOT CAP	28480	5040-5061
MP059	03561-01226	4	1	A50 ASSEMBLY ANALOG SHIELD	28480	03561-01226
MP060	03561-41101	8	3	A20 IC HEATSINK	28480	03561-41101
MP061	03561-41101	8		A20 IC HEATSINK	28480	03561-41101
MP062	03561-41101	8		A20 IC HEATSINK	28480	03561-41101
MP063	03561-23702	7	1	A10 SHIELD, COMPONENT SIDE	28480	03561-23702
MP064	03561-01227	5	1	A10 ATTENUATOR RING STANDOFF	28480	03561-01227
MP065	03561-20601	9	1	A10 SHIELD, CIRCUIT SIDE	28480	03561-20601
MP066	03561-01215	1	1	MEMORY SHIELD	28480	03561-01215
MP067	2110-0569	3	1	FUSEHOLDER COMPONENT NUT, THREAD M12.7	28480	2110-0569
MP068	1400-0090	9	1	FUSEHOLDER COMPONENT FOR USE ON	28480	1400-0090
MP069	2110-0564	0	1	FUSEHOLDER BODY 12A MAX FOR UL	119027	031.1657
MP070	2110-0565	9	1	FUSEHOLDER CAP 12A MAX FOR UL	28480	2110-0565

See introduction to this section for ordering information
 *Indicates factory selected value

Table 4-3 Replaceable Parts (Cont'd)

Reference Designation	HP Part Number	C D	Qty	Description	Mfr Code	Mfr Part Number
MP071	03561-01229	7	1	PLASTIC INSULATOR, SIDE	28480	03561-01229
MP072	03561-04301	2	1	SIDE TRIM, FRONT (SHORT)	28480	03561-04301
MP073	03561-04302	3	1	SIDE TRIM, REAR (LONG)	28480	03561-04302
MP074	03561-64301	8	1	DRESS PANEL, FRONT	28480	03561-64301
MP075	03561-64302	9	1	DRESS PANEL, REAR	28480	03561-64302
MP076	1390-0532	1	1	PLASTIC NUT (A10 ISOLATION)	94222	F1-10-106-12
MP077	0400-0163	6	4	PLASTIC STRIP	28480	0400-0163
MP078	8160-0466	0	4	SIDE RAIL RFI STRIP	28480	8160-0466
S1	3101-2216	3	1	POWER SWITCH, LINE	28480	3101-2216
S2	3101-0199	7	1	SLIDE SWITCH	28480	3101-0199
V1	03561-62501	6	1	CRT/YOKE ASSEMBLY	28480	03561-62501
W10	03561-61602	6	1	INPUT CABLE ASSEMBLY	28480	03561-61602
W15	03586-61677	4	2	COAX CABLE 13"	28480	03586-61677
W50	03586-61677	4	1	COAX CABLE 10"	28480	03586-61677
W80	1251-8598	1	1	FOAM CABLE, KEYBOARD ASSEMBLY	28480	1251-8598
W90	03561-61608	2	1	CRT CONNECTOR ASSEMBLY	28480	03561-61608
MP079	03561-01223			LEFT REAR SIDE RAIL SPACER	28480	03561-01223
MP080	03561-01224			REGULATOR HEAT SINK BRACKET	28480	03561-01224

See introduction to this section for ordering information
 *Indicates factory selected value

Table 4-3 Replaceable Parts (Cont'd)

PART NUMBER	DESCRIPTION	WHERE USED	QTY:
1390-0088	1/4 Turn Fastener	Top & Bottom Covers (MP1, MP2)	8
1390-0211	1/4 Turn Retainer	Top & Bottom Covers (MP1, MP2)	8
1390-0084	1/4 Turn Clip On Nut	Front & Rear Panel Castings (MP42, 25)	8
2360-0117	6-32 Screw	Bail Handle To Ratchet (MP31)	4
0515-0072	Panhead Screw	Bail Handle To Siderail (MP31)	2
2190-0073	Lockwasher	Bail Handle To Siderail (MP31)	2
0515-0055	Panhead Screw	PC Assembly Holddown Covers (MP3, MP4)	8
0515-0076	Countersunk Screw	Nylon PC Holddown Retainers (MP8, MP9, MP10)	8
0515-0055	Panhead Screw	A90 Assembly Holddown Plate (MP5)	2
0515-0074	Panhead Screw	Motherboard Capacitor Bracket (MP7)	2
0535-0008	M2.5 Nut	Motherboard Capacitor Bracket (MP7)	2
2190-0004	Lockwasher	Motherboard Capacitor Bracket (MP7)	2
0515-0076	Countersunk Screw	Dress Panel To Frame (MP74)	4
2510-0107	8 x 32 Screw	Fnt & Rear Frame To Siderail (MP25, MP42)	8
2190-0009	Lockwasher	Fnt & Rear Frame To Siderail (MP25, MP42)	8
0515-0074	M2.5 Screw	Line Switch Mounting (S1)	2
0515-0104	Panhead Screw	Reg. Heat Sink To Siderail (MP19)	3
0515-0104	Panhead Screw	A90 Shield To Siderail	3
0515-0053	Panhead Screw	A10 and A15 Shields to Siderail (MP13, MP47)	9
0515-0104	Panhead Screw	A10 and A15 Shields to Siderail (MP13, MP47)	4
3050-0004	Insulated Washer	A10 and A15 Shields to Siderail (MP13, MP47)	4
0515-0077	Countersunk Screw	Motherboard Shield (MP46)	5
0515-0055	Panhead Screw	Motherboard To All Shields (A99)	17
2190-0004	Lockwasher	Motherboard To All Shields (A99)	17
0515-0231	Panhead Screw	Rear Feet To Casting (MP58, MP54)	4
2190-0003	Lockwasher	Rear Feet To Casting (MP58, MP54)	4
3050-0066	Flatwasher	Rear Feet To Casting (MP58, MP54)	4
2360-0115	Screw	Line Filter To Casting (by plug) (MP45)	2
0515-0067	Screw	Line Filter To Casting (by A82) (MP45)	1
0535-0007	M3.5 Nut	Line Filter To Casting (by A82) (MP45)	1
3050-0066	Flatwasher	Line Filter To Casting (by A82) (MP45)	1
0515-0147	Screw	Fan Mounting (MP27, B1)	4
2190-0007	Flatwasher	Fan Mounting (MP27, B1)	4
0535-0007	M3.5 Nut	Fan Mounting (MP27, B1)	4
0535-0013	Thumbnut	Fan Mounting (MP27, B1)	4
0380-0643	Stud	HP-1B Mounting	2
2190-0073	Lockwasher	HP-1B Mounting	2
2950-0035	BNC Nut	Rear Panel Output BNCs	4
0520-0128	2 x 56 Screw	Front Panel Isolation Switch (S2)	2
0610-0001	2 x 56 Nut	Front Panel Isolation Switch (S2)	2
0515-0937	M3.5 Screw	A80 To Front Casting (Hex)	23
2360-0316	6 x 23 Screw	CRT Standoff To Front Casting (MP33)	4
0380-1661	Standoff	CRT Mounting Standoffs (MP33)	4
2360-0121	6 x 32 Screw	CRT Retainer To Standoff (MP33)	4
3050-0066	Flatwasher	CRT Retainer To Standoff (MP33)	4
0515-0076	Screw	CRT Shield To Front Casting (MP6)	4
2950-0054	BNC Nut	Front Panel Input BNC (W10)	1
3050-0313	Insulating Washer	Front Panel Input BNC (W10)	1

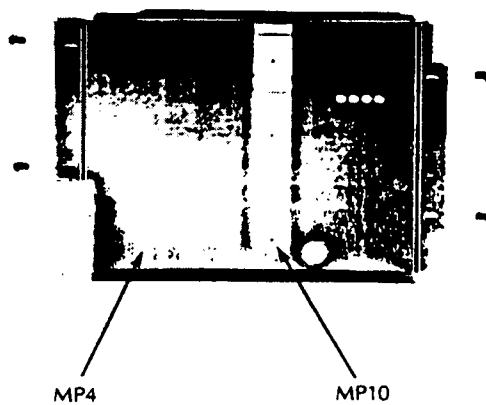
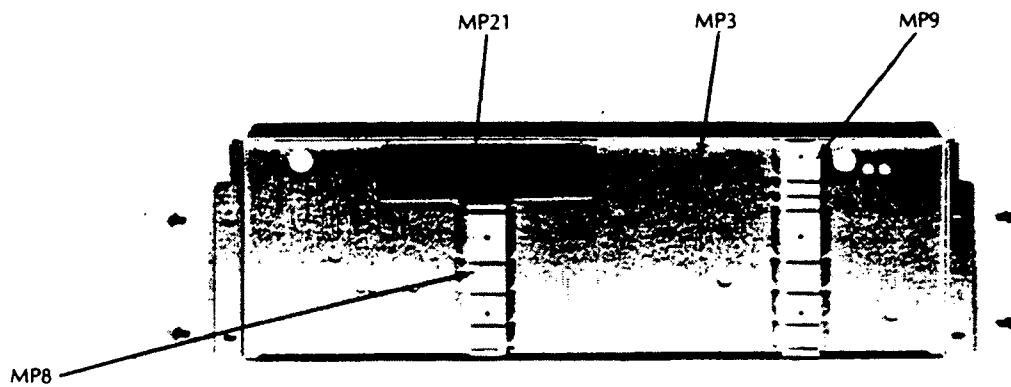
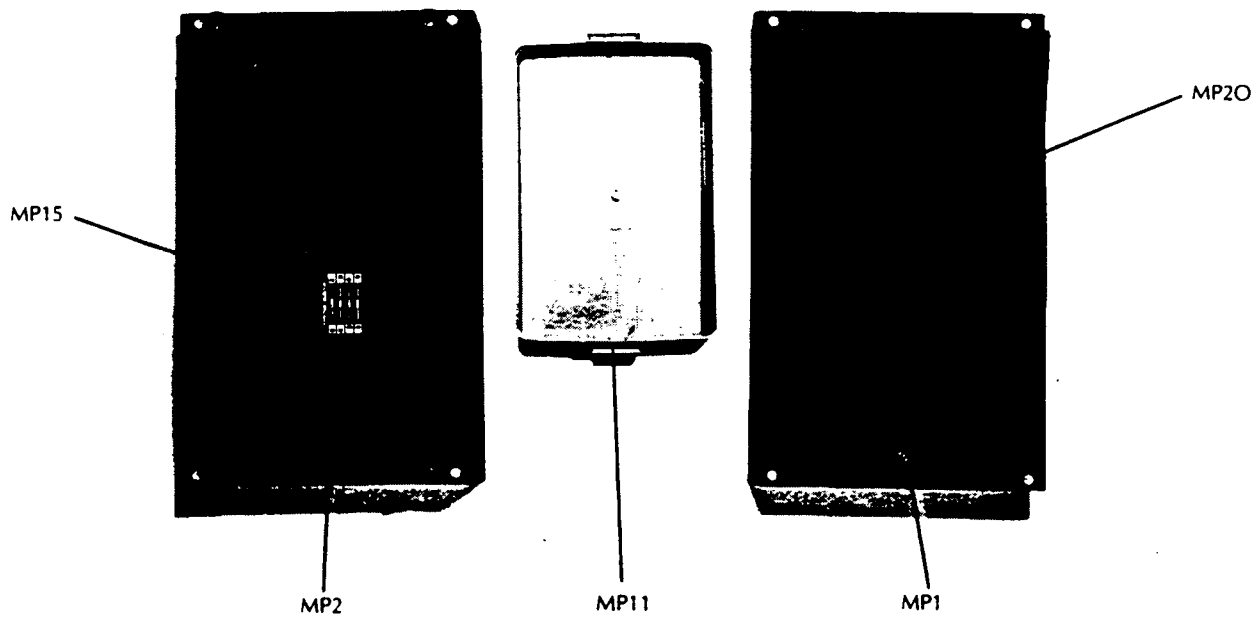

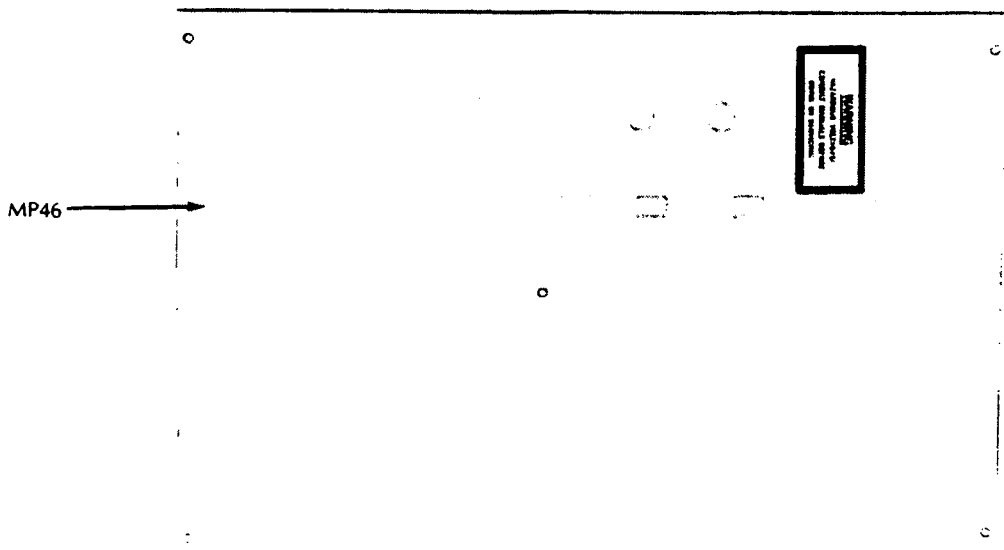
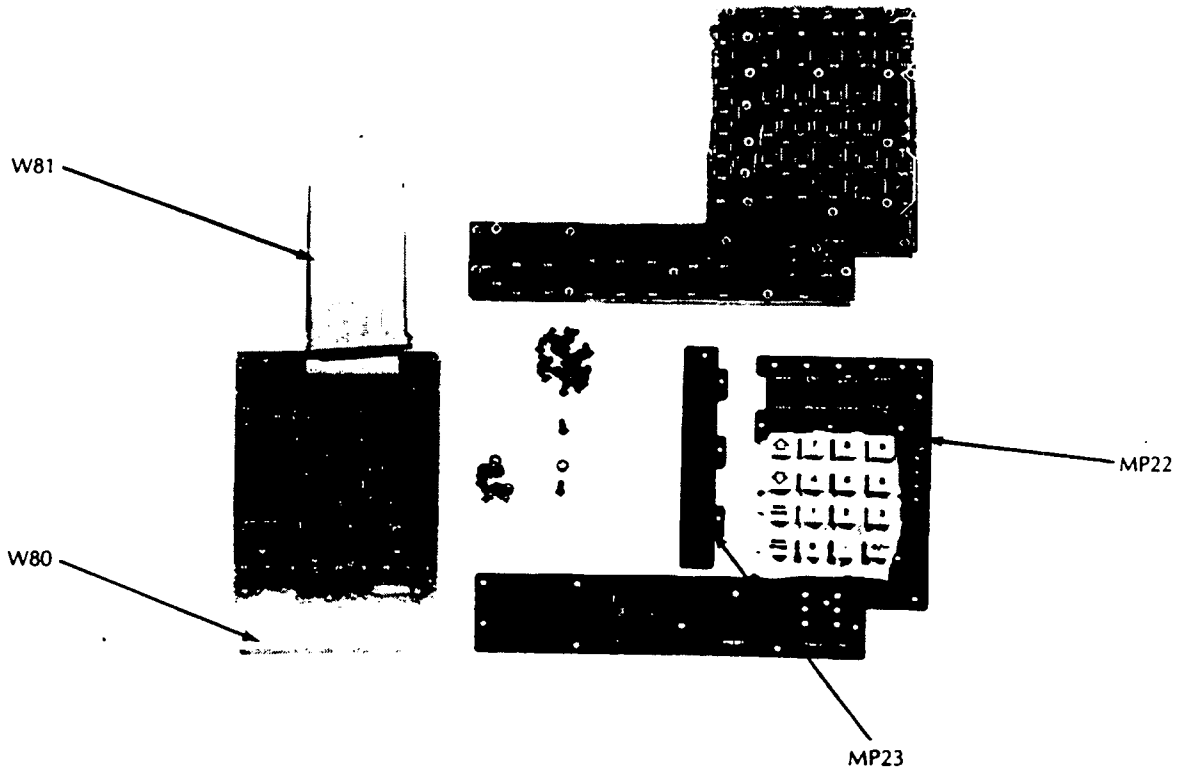

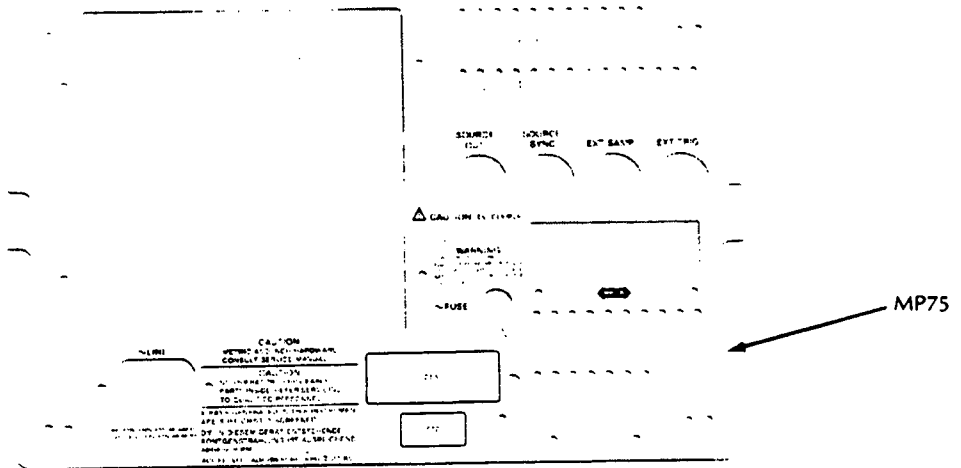
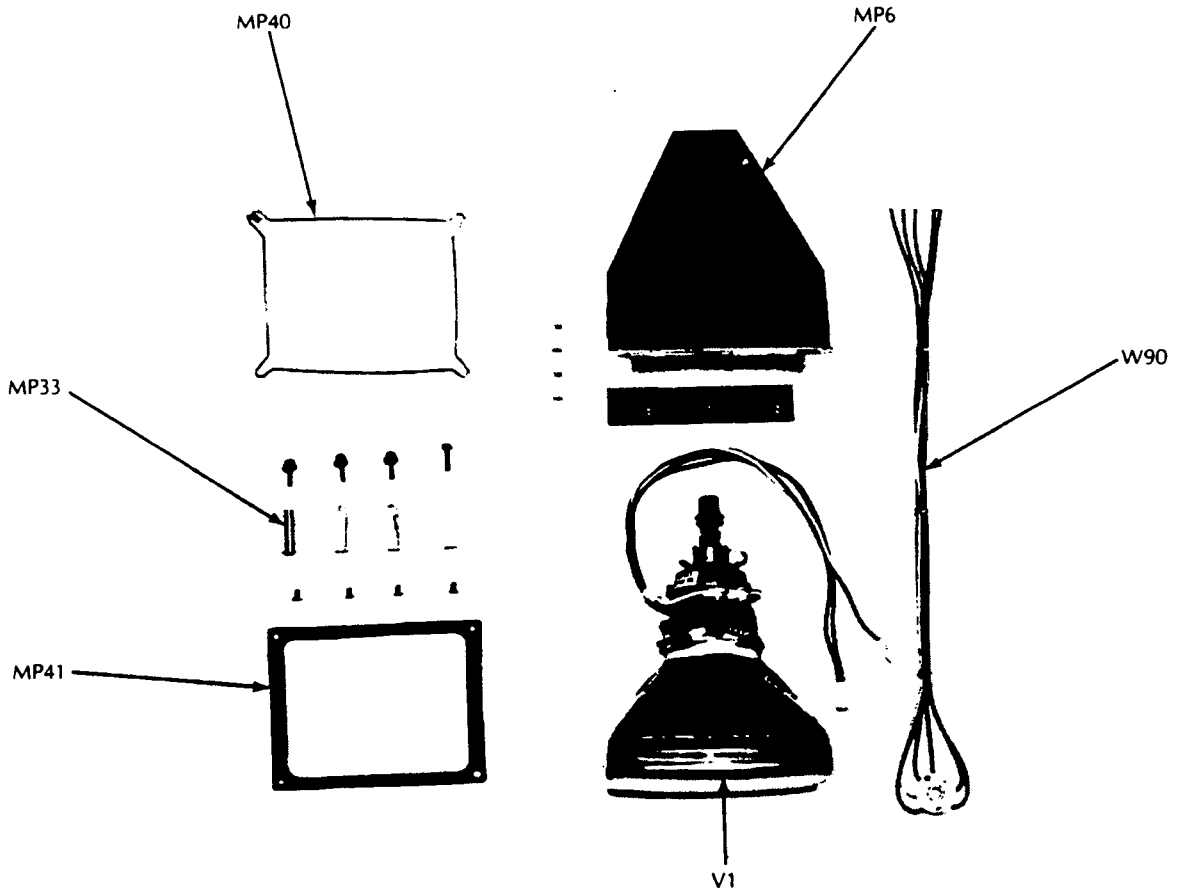

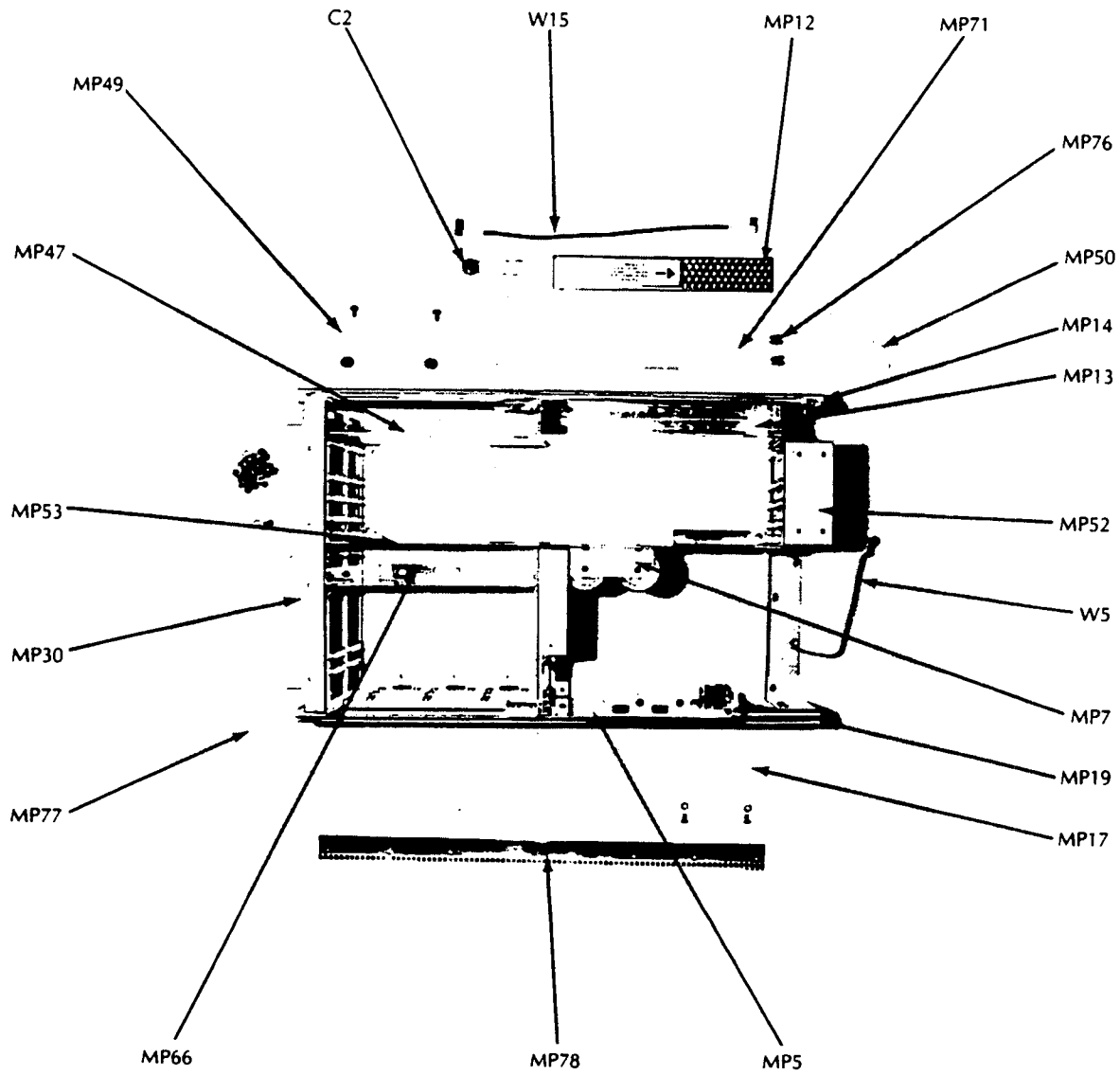

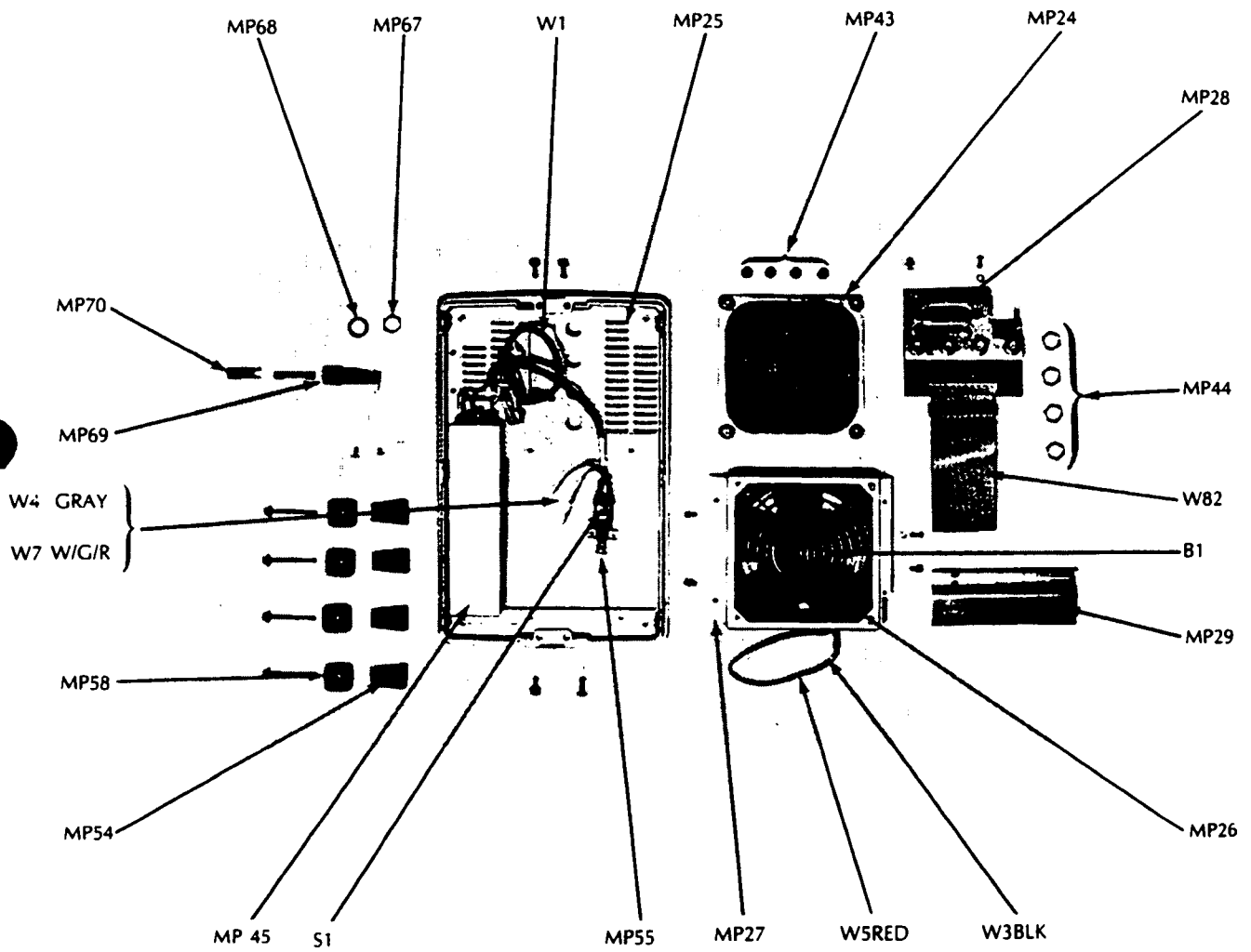

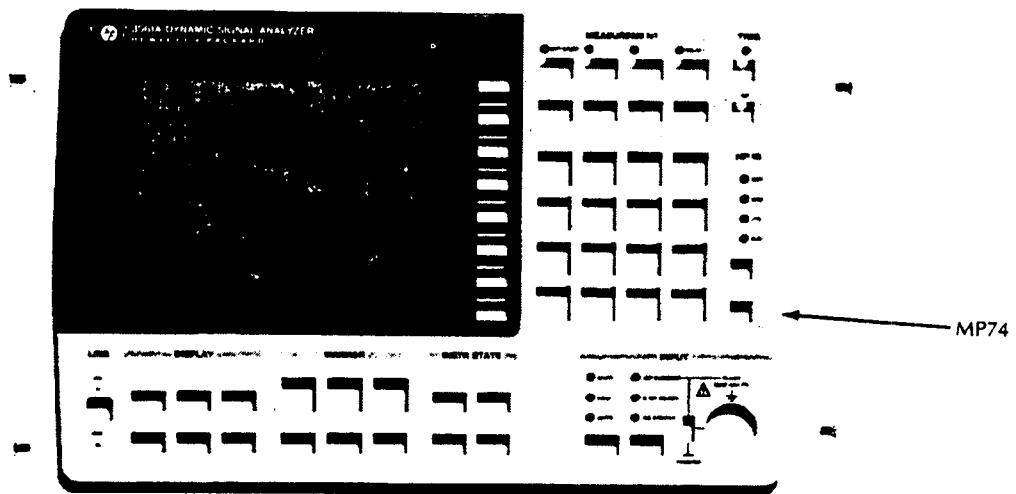
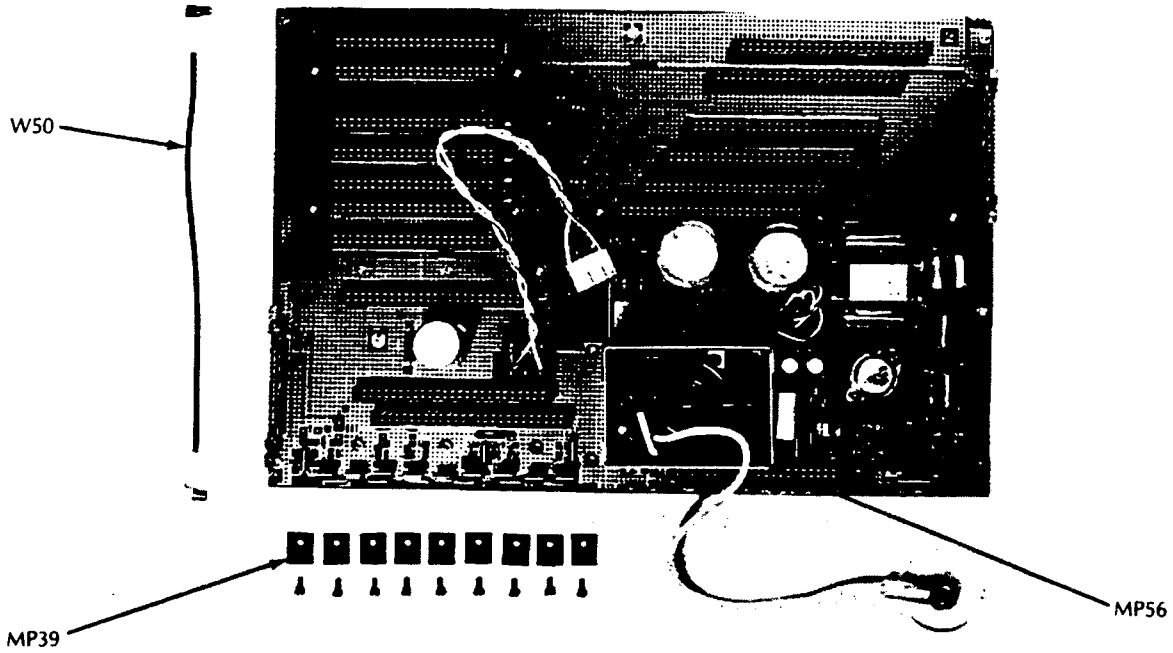

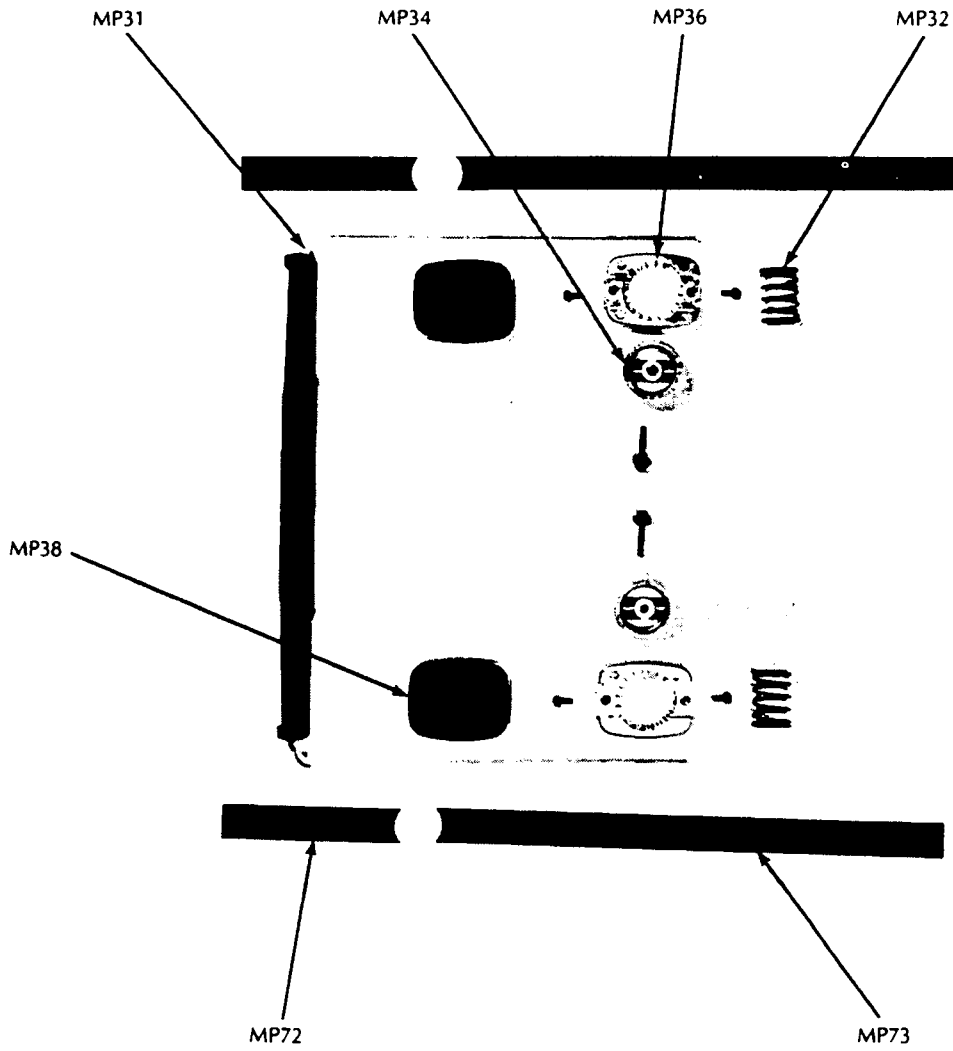

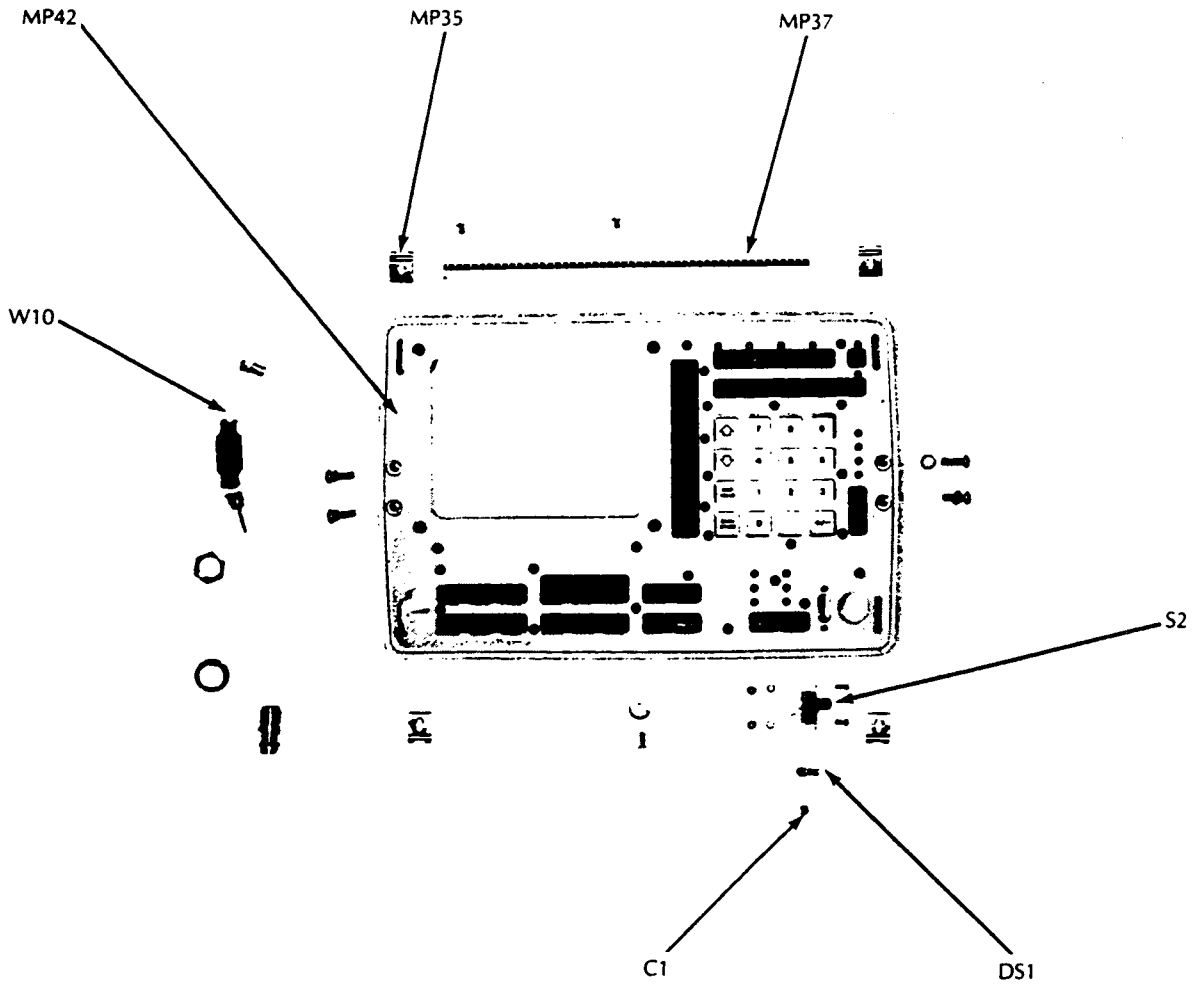

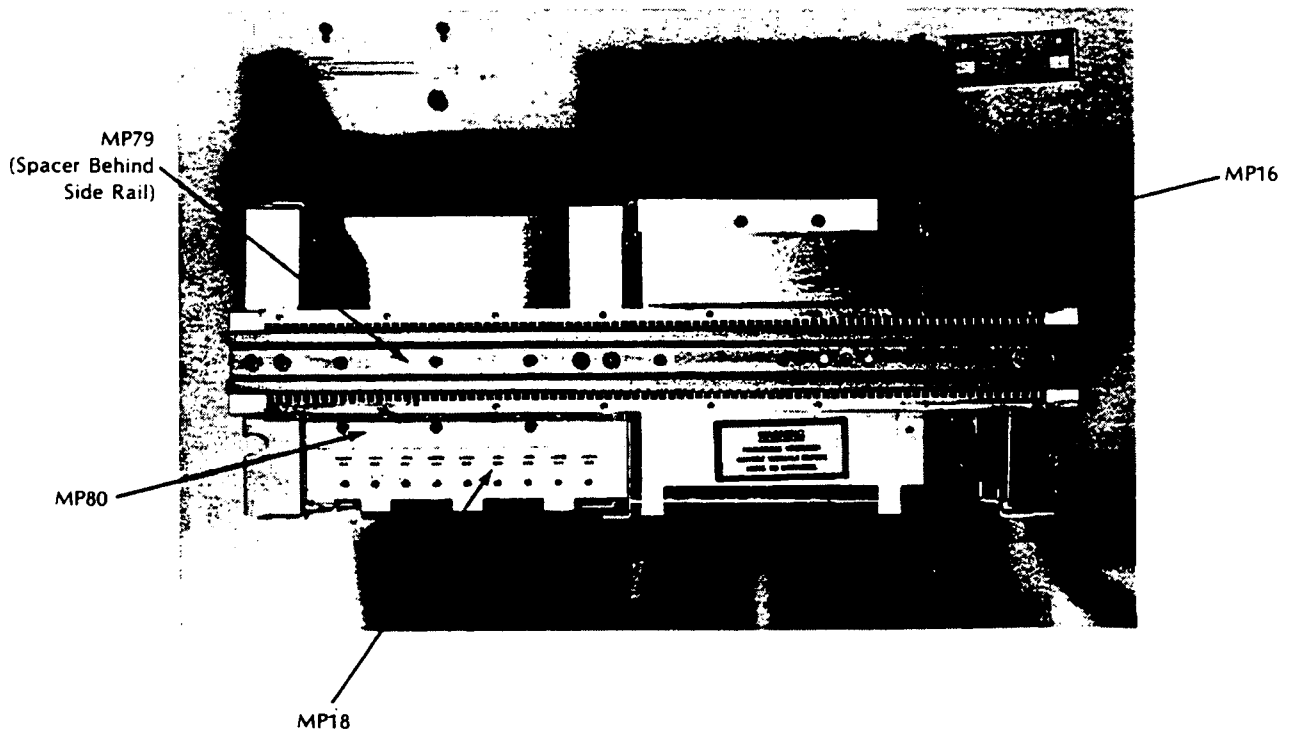

**SECTION V
BACKDATING**

Paragraph	Title	Page
5-1	INTRODUCTION	5-1
5-2	MANUAL CHANGES	5-1
5-3	A10 Input Amplifier Assembly Backdating	5-2
5-4	A15 Digitizer Assembly Backdating	5-3
5-5	A20 Digital Filter Assembly Backdating	5-4
5-6	A30 FFT/RAM Assembly Backdating	5-4
5-7	A40 Processor/ROM Assembly Backdating	5-4
5-8	A50 Local Oscillator/Noise Source Assembly Backdating	5-7/5-8
5-9	A82 Rear Panel Assembly Backdating	5-13
5-10	A99 Motherboard Assembly Backdating	5-14

SECTION V BACKDATING

5-1 INTRODUCTION

The purpose of this section is to provide the information necessary to modify this manual to apply to instruments which have revision A PC Assemblies only. Note that some of the circuit assemblies are revised for ease of manufacturing and do not necessarily incorporate circuit changes. For this reason, some revision A assemblies are identical to revision B assemblies.

5-2 MANUAL CHANGES

Table 5-1 lists the current revision letter for each PC Assembly. Refer to the assembly headings following Table 5-1 for the actual manual changes.

Table 5-1 Revision A Assemblies Versus Revision B Assemblies

The following assemblies are currently revision A:
A72 Power Supply Filter Assembly A80 Keyboard Assembly A81 Keyboard Driver Assembly A90 Analog Display Assembly
The following assemblies are currently revision B:
A10 Input Amplifier Assembly A15 Digitizer Assembly A20 Digital Filter Assembly A30 FFT/RAM Assembly A40 Processor/ROM Assembly A50 Local Oscillator/Noise Source Assembly *A60 Digital Display Driver Assembly *A65 CMOS/Bubble Memory Assembly (Option 001) *A66 CMOS Memory Assembly *A70 Power Supply PWM Assembly *A71 Power Supply Transformer Assembly A82 Rear Panel Assembly A99 Motherboard Assembly

*These assemblies are revised for ease of manufacturing and do not incorporate circuit changes. For this reason, no backdating information is necessary.

5-3 A10 Input Amplifier Assembly Backdating

Do the following to modify the A10 Assembly information to reflect revision A:

1. Replace the A10 component locator in Section VII with the revision A component locator in Figure 5-1a.
2. Delete capacitor C7 (0160-4792 8.2pf) from the A10 schematic (Circuit E) and replaceable parts list.
3. Delete capacitor C8 (0160-4811 270pf) from the A10 schematic (Circuit D) and replaceable parts list.

Figure 5-1a A10 Assembly Revision A Component Locator

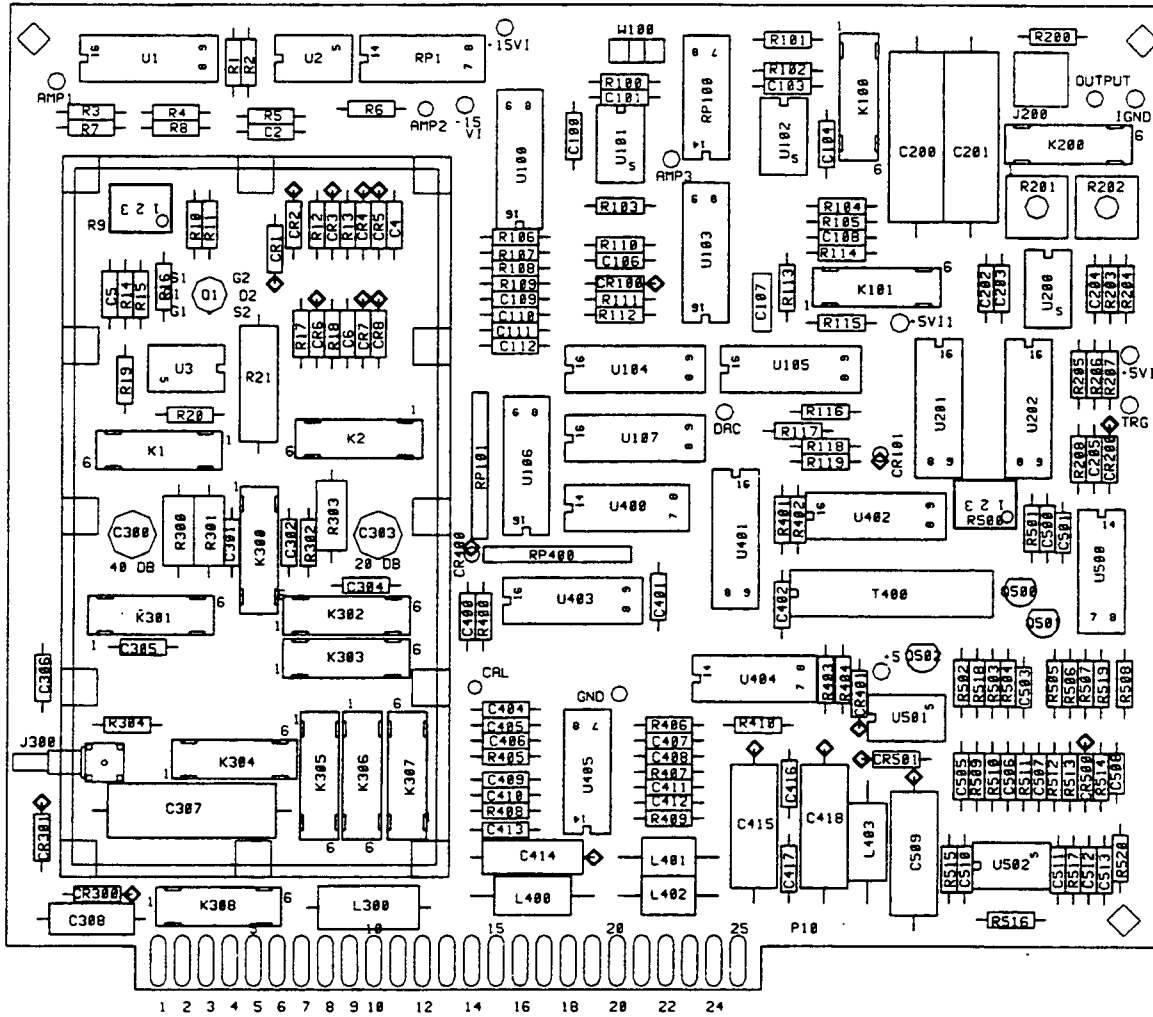

5-4 A15 Digitizer Assembly Backdating

Do the following to modify the A15 Assembly information to reflect revision A:

1. Delete Test Point "SOUT" from the A15 schematic (Circuit L).
2. Delete capacitor C501 (0160-4808 470PF) from the A15 schematic (Circuit L) and replaceable parts list.
3. Delete resistor R226 (0757-0484 619K) from the A15 schematic (Circuit L) and replaceable parts list.
4. Delete resistor R503 (0757-0443 11K) from the A15 schematic (Circuit L) and replaceable parts list.
5. Replace the A15 component locator in Section VII with the revision A component locator in Figure 5-1b.

Figure 5-1b A15 Revision A Component Locator

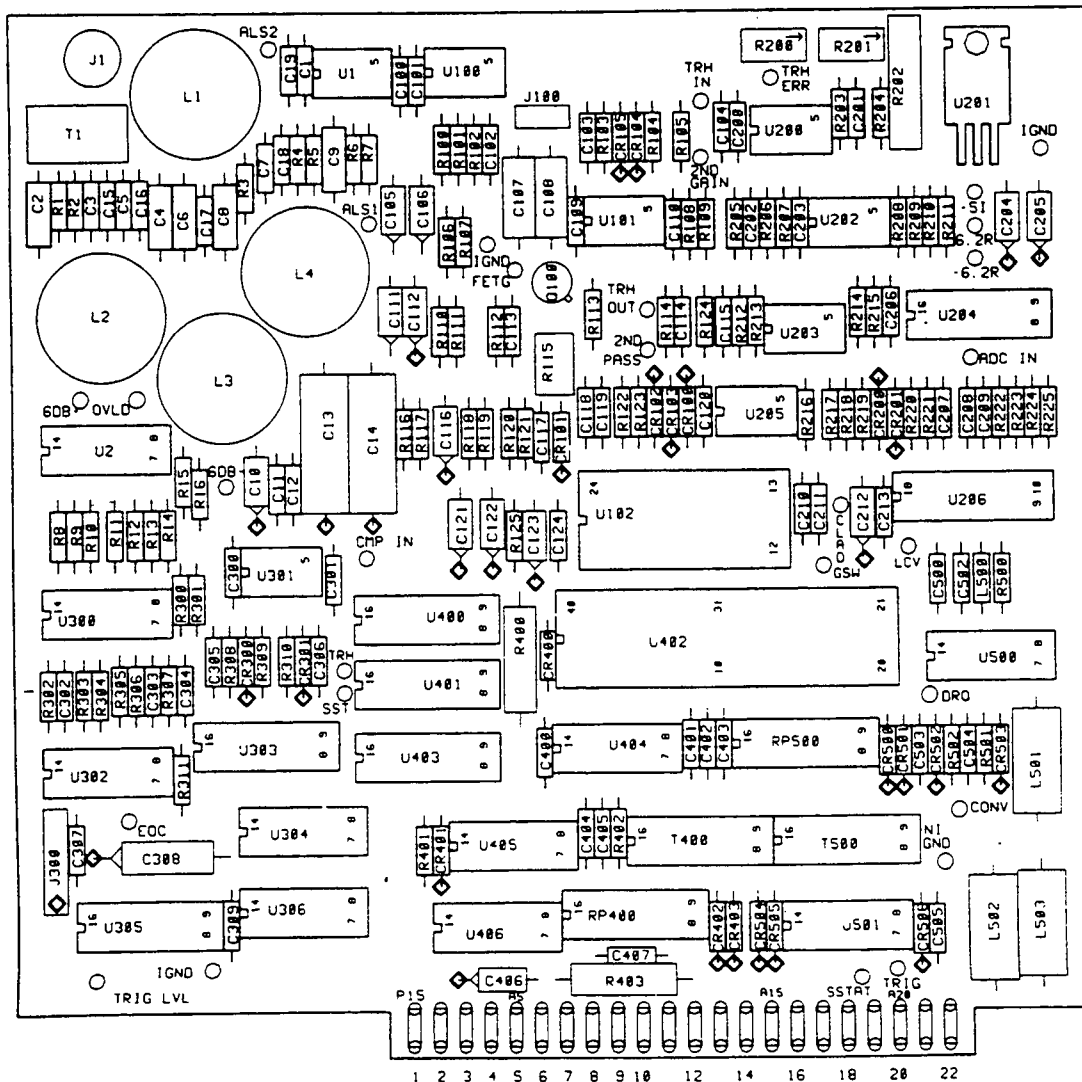

5-5 A20 Digital Filter Assembly Backdating

Do the following to modify the A20 Assembly information to reflect revision A:

1. Delete Test Point TP503 from the A20 schematic (Circuit U).
2. Delete Test Point TP504 from the A20 schematic (Circuit U).

5-6 A30 FFT/RAM Assembly Backdating

Do the following to modify the A30 Assembly information to reflect revision A:

1. Delete Test Point TP704 from the A30 schematic (Circuit H).
2. Delete Test Point TP705 from the A30 schematic (Circuit H).

5-7 A40 Processor/ROM Assembly Backdating

Do the following to modify the A40 Assembly information to reflect revision A:

1. Replace the A40 component locator in Section VII with the revision A component locator in Figure 5-2.

Figure 5-2 A40 Assembly Revision A Component Locator

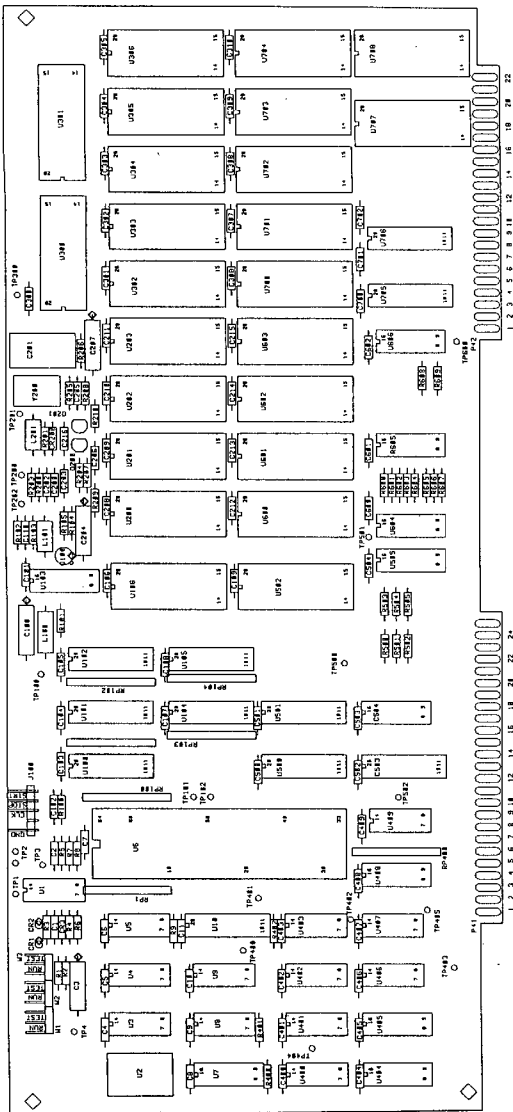

5-8 A50 Local Oscillator/Noise Source Assembly Backdating

Do the following to modify the A50 Assembly information to reflect revision A:

- 1. Replace the A50 component locator in Section VII with the revision A component locator in Figure 5-3.

Figure 5-3 A50 Assembly Revision A Component Locator

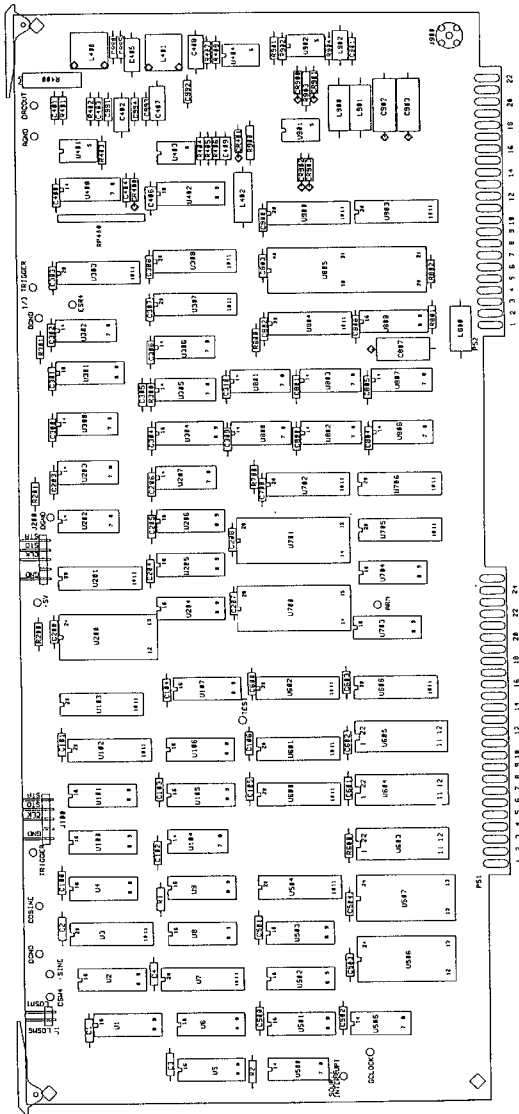

2. Delete the power supply RC filter circuits going to pins 4 and 7 of U401 (Circuit FF), U403 (Circuit CC), U404 (Circuit HH) and U902 (Circuit II) as shown in Figure 5-4.

Figure 5-4 A50 Assembly RC Filter Deletion

From this:

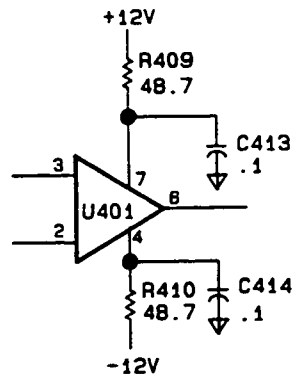

To this:

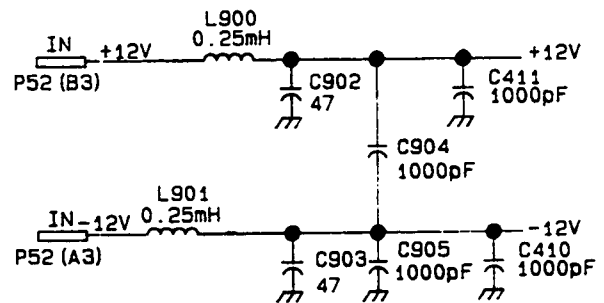

3. Delete the four $\pm 12V$.1uF filter capacitors C410, C411, C904 and C905 connected to L900 and L901 from the A50 schematic.
4. Delete the 10pF capacitor C907 connected between pins U404(2,6) from the A50 schematic (Circuit HH).
5. Delete the 100pF capacitor C906 connected between pins U902(2,6) from the A50 schematic (Circuit II).
6. Delete the 100 Ω resistor R905 connected between U902(2) and the cathode of CR900 (Circuit II) and replace with a short circuit. U902(2) should now connect directly to the cathode of CR900.
7. Change the Functional Circuit GCLOCK GENERATOR K as shown in Figure 5-5.

8. Change capacitor C401 from .1uF to 27pF on the A50 schematic (Circuit CC).
9. Delete inductor L902 from the A50 schematic (Circuit II).
10. Change resistor R902 from 10k Ω to 1k Ω on the A50 schematic (Circuit II).
11. Delete the following twelve .1uF capacitors (0160-4571) from the A50 replaceable parts list: C410, C411, C413, C414, C415, C416, C417, C418, C904, C905, C908 and C909.
12. Delete the following eight 48.7 Ω resistors from (0698-4381) the A50 replaceable parts list: R409, R410, R411, R412, R413, R414, R906 and R907.
13. Delete 10pF capacitor C907 (0160-4791) from the A50 replaceable parts list.
14. Delete 100pF capacitor C906 (0160-4801) from the A50 replaceable parts list.
15. Delete 100 Ω resistor R905 (0757-0401) from the A50 replaceable parts list.
16. Delete U010 (1820-2657) from the A50 replaceable parts list.
17. Change capacitor C401 from 0160-4786 (27pf) to 0160-4795 (4.7pf) in the A50 replaceable parts list.
18. Change resistor R902 from 0757-0280 (1K) to 0757-0401 (10K) in the A50 replaceable parts list.
19. Delete inductor L902 (9100-3551 1uH) from the A50 replaceable parts list.

5-9 A82 Rear Panel Assembly Backdating

Do the following to modify the A82 Assembly information to reflect revision A:

1. Replace the A82 component locator in Section VII with the revision A component locator in Figure 5-6.

Figure 5-6 A82 Assembly Revision A Component Locator

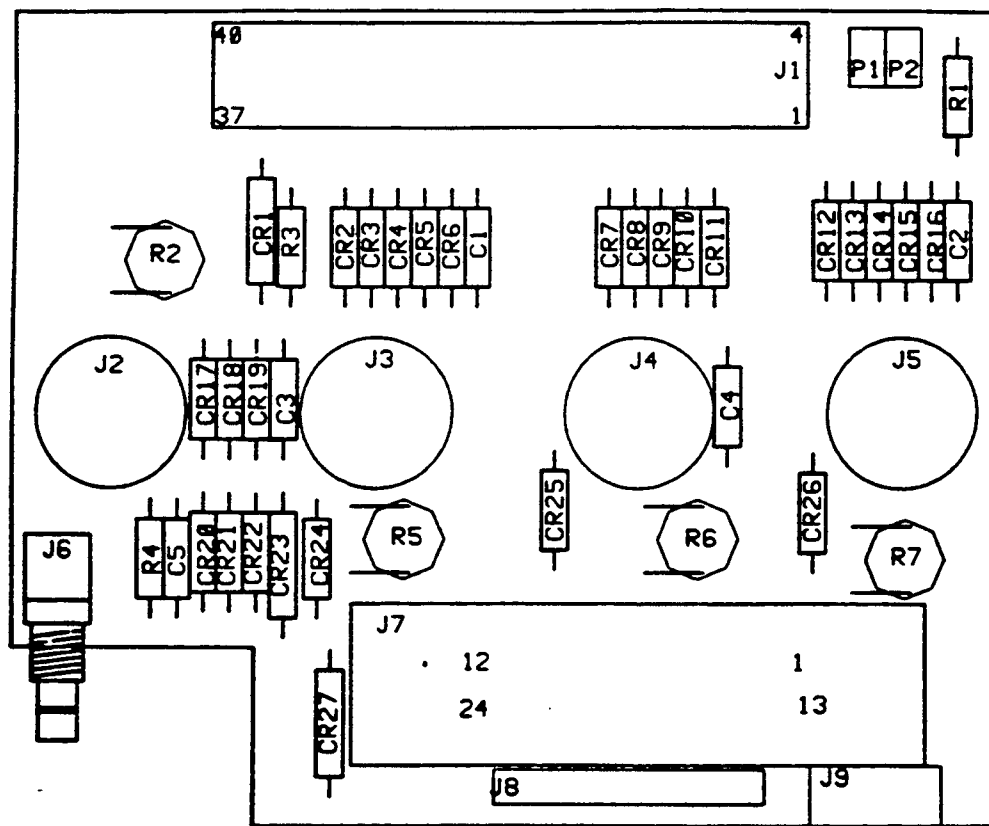

2. Delete U1 and C6 from the A82 schematic.
3. Delete U1 (1820-2024) from the A82 replaceable parts list.
4. Delete C6 (0160-4571) from the A82 replaceable parts list.

5-10 A99 Motherboard Assembly Backdating

Do the following to modify the A99 Assembly information to reflect revision A:

1. Replace the A99 component locator in Section VII with the revision A component locator in Figure 5-7.
2. Delete C104 from the A99 schematic and connect R102 directly across L101.
3. Delete capacitor C104 (0160-3455) from the A99 replaceable parts list.
4. Change resistor R102 from 0757-0159 (1k 1/2W) to 0764-0016 (1k 2W) in the A99 replaceable parts list.

Figure 5-7 A99 Assembly Revision A Component Locator

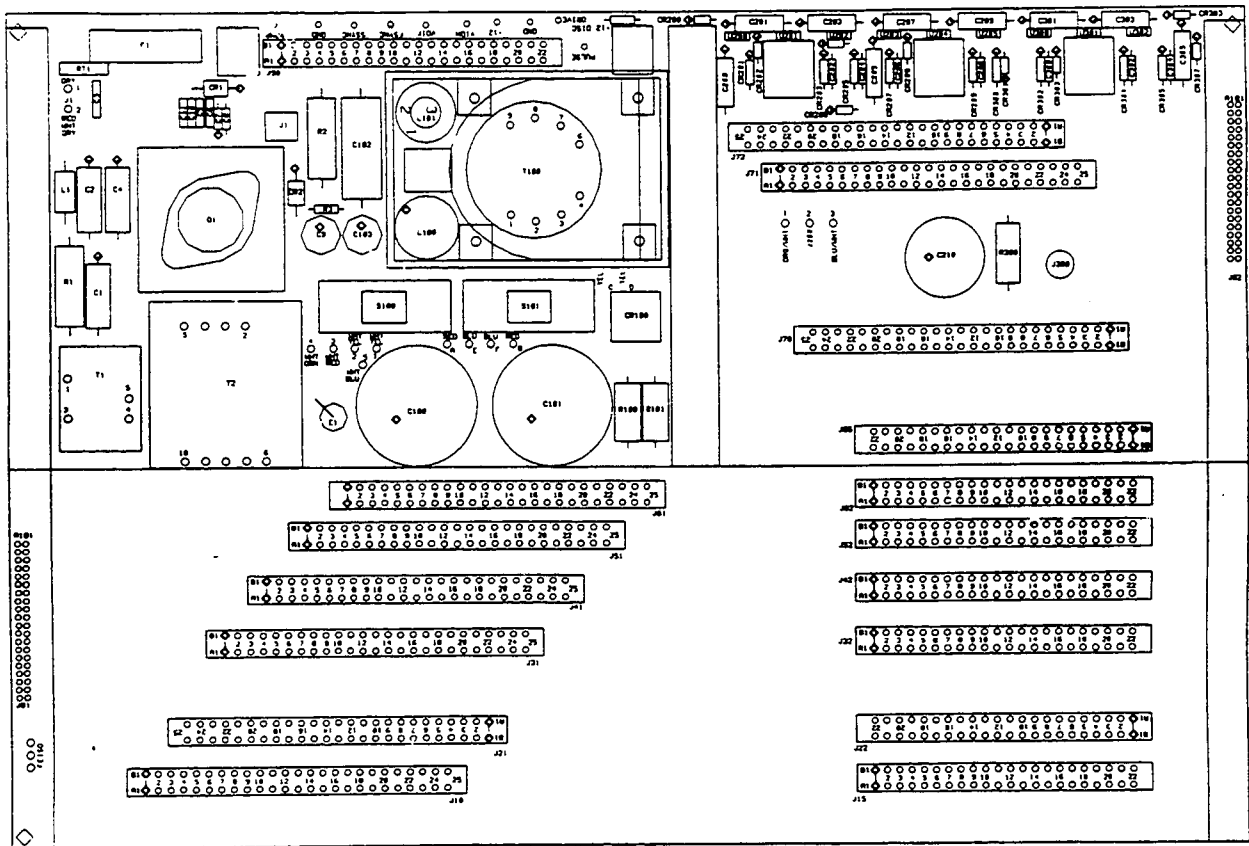

SECTION VI
FAULT ISOLATION

Paragraph	Title	Page
6-1	INTRODUCTION	6-1
6-2	SAFETY CONSIDERATIONS	6-3
6-3	RECOMMENDED TEST EQUIPMENT: FAULT ISOLATION	6-4
6-4	SELF CALIBRATION	6-4
6-5	Calibration Procedure	6-4
6-6	Calibration Failures	6-5
6-7	TROUBLESHOOTING GUIDELINES	6-6
6-8	FAULT ISOLATION PROCEDURE	6-11
6-9	Using the Fault Isolation Procedure	6-11
6-10	TEST A: Bias Power Supply A71, A99	6-12
6-11	TEST B: Main Power Supply A70, A71, A72, A99	6-14
6-12	TEST C: Display Driver A60, A90, A99	6-19
6-13	TEST D: Processor/ROM A40	6-23
6-14	TEST E: FFT/RAM A30	6-29
6-15	TEST F: Digital Filter A20	6-35
6-16	TEST G: Input Amplifier/Digitizer A10, A15	6-39
6-17	TEST H: Local Oscillator/Noise Source A50	6-45
6-18	TEST I: CMOS/Bubble Memory A66, A65	6-49
6-19	DIAGNOSTIC/SELF TEST DESCRIPTIONS	6-50
6-20	Introduction	6-50
6-21	Test Menu Explanation	6-52
6-22	General Error Code Format	6-54
6-23	Test 0: Power-On Test	6-55
6-24	Test 1 Quick Functional Test	6-61
6-25	Test 12 A30 FFT Test	6-63
6-26	Test 13 A20 Timing Counter Test	6-64
6-27	Test 14 A20 Digital Filter/DMA Channel R Test	6-65
6-28	Test 18 A20 DMA Channel G And Trigger Test	6-67
6-29	Test 19 A65/A66 CMOS Memory Test	6-69
6-30	Test 20 A65 Bubble Memory Test	6-69
6-31	Test 50 Display Pattern Test	6-71
6-32	Test 52 A10 Calibrator Adjustment	6-71
6-33	Test 53 A10 20dB Flatness Adjustment	6-72
6-34	Test 54 A10 40dB Flatness Adjustment	6-74
6-35	Test 110 A10 Front End Control Register Test	6-75
6-36	Test 111 - 116 A15 Timing and Control Circuit Setups	6-76
6-37	Test 118 Display Calibration Constants	6-76
6-38	Test 119 Clear Calibration Constant	6-77
6-39	Test 120 A20 Digital Filter DSA	6-77
6-40	Test 121 A20 Timing Counter DSA	6-77
6-41	Test 122 A20 DMA Channel G DSA	6-78
6-42	Test 123 A20 DMA Channel R DSA	6-78
6-43	Test 150 A50 Local Oscillator DSA	6-78
6-44	Test 151 A50 Analog Source Test	6-79
6-45	Test 152 A50 Noise Source DSA Setup 1	6-79
6-46	Test 153 A50 Noise Source DSA Setup 2	6-80
6-47	Test 154 A50 HP-IB I/O Verification Test Routine	6-80
6-48	Test 167 A65 Bubble Memory Read DSA	6-83
6-49	Test 168 A65 Bubble Memory Bootloop Routine	6-84
6-50	Test 169 A65 Bubble Memory Reseed Routine	6-92
6-51	Test 170 A65 Format Nonvolatile Memory Routine	6-93
6-52	OVERALL INSTRUMENT THEORY OF OPERATION	6-94
6-53	Introduction to Theory of Operation	6-94
6-54	Control Circuits and Bus Structure	6-94
6-55	Measurement Data Flow	6-95

SECTION VI

FAULT ISOLATION

6-1 INTRODUCTION

The information given in this section is used to isolate failures to a circuit board. Once the failure is isolated to a circuit board, the information given in Section 7 is used to further isolate the failure to a component. Figure 6-1 illustrates the use of the information given in this section. The fault isolation procedure is the primary tool for isolating a failure to the circuit board level. To isolate a failure, start the fault isolation procedure with TEST A, and continue with each test in alphabetical order until one of the test fails. The failed test will indicate the circuit board which most likely caused the failure. Troubleshooting to the component level on the failed circuit board can then be continued in Section 7.

The self calibration paragraph describes the 3561A's self calibration procedure and lists the calibration failure messages.

The troubleshooting guidelines paragraph gives a list of failure symptoms and the corresponding circuit boards which most likely caused the failure. A recommended starting point in the fault isolation procedure is listed for each failure symptom.

The diagnostic/self-tests paragraph contains a description of each of the internal diagnostic routines. For each test, a description of how the test works and a list of return codes is given.

The overall instrument theory of operation paragraph gives a description of the interaction of the circuit boards in the -hp-3561A.

Figure 6-1 Fault Isolation Procedure Flow Chart

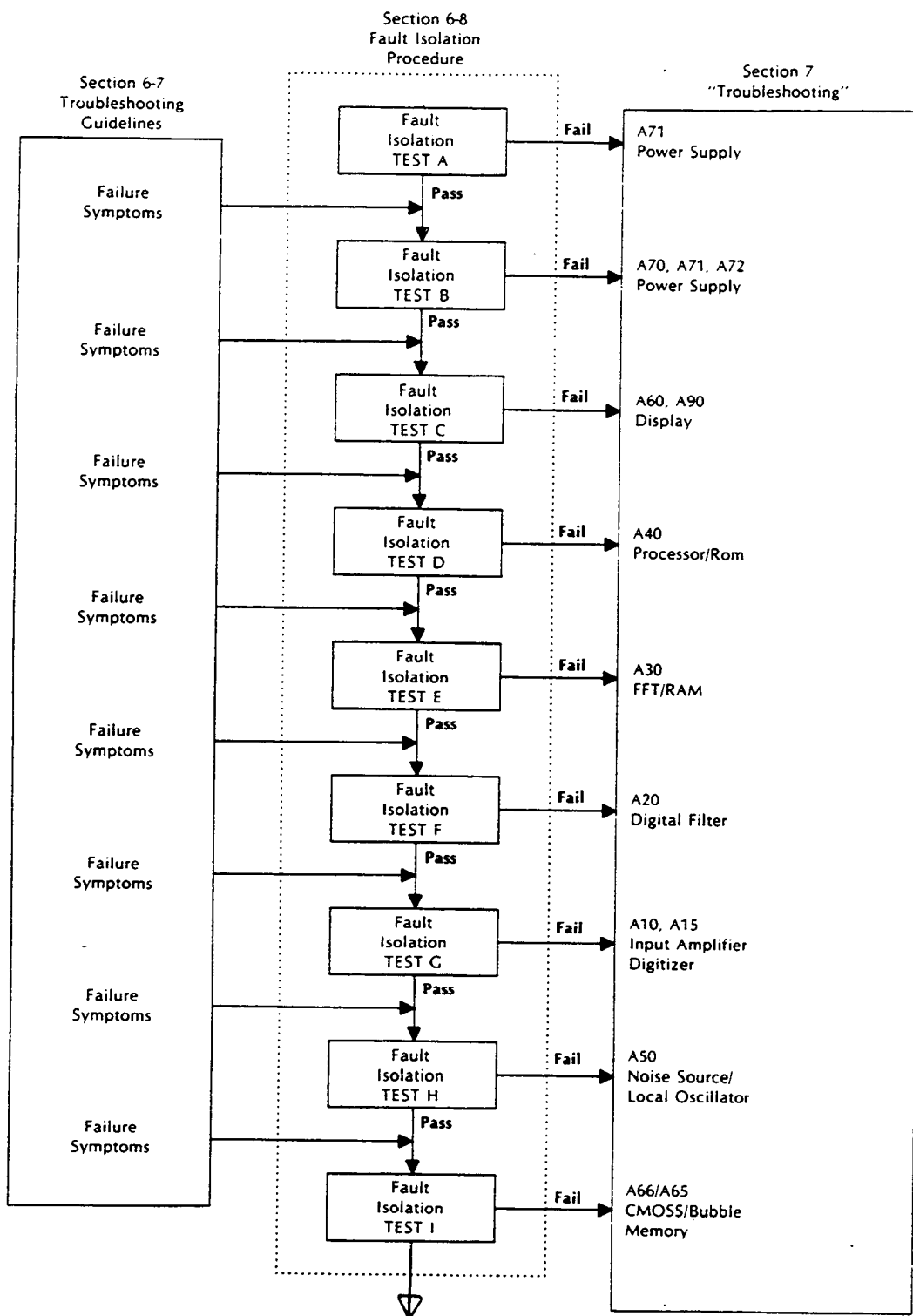

6-2 SAFETY CONSIDERATIONS

WARNING

Maintenance described herein is performed with power supplied to the instrument and with the protective covers removed. Such maintenance should be performed only by service-trained personnel who are aware of the hazards involved (for example, electrical shock and fire).

Any interruption of the protective grounding conductor inside or outside the instrument, or disconnection of the protective earth terminal, is likely to make the instrument hazardous.

WARNING

± 170 Volts are present on the A70 and A71 Assemblies. ± 170 Volts are present on the heat sinks on the A70 Assembly. This voltage is exposed whenever the protective power supply cover is removed. Be extremely careful when working in proximity to this area. The high voltage can cause serious personal injury if contacted.

WARNING

Capacitors in the power supply will remain charged to ± 170 Volts dc for at least three(3) minutes after power is removed from the instrument. Do not remove the power supply assemblies (A70, A71, A72) for at least three(3) minutes after power is removed from the -hp-3561A.

WARNING

Only fuses with the required current rating and of the specified type should be used for replacement. The use of repaired fuses or short circuiting the fuse holder is not permitted. Whenever it is likely that the protection offered by the fuse has been impaired, the instrument must be made inoperative, and secured against any unintended operation.

WARNING

+ 8000 Volts are present in the CRT AT ALL TIMES, EVEN WHEN POWER IS REMOVED FROM THE INSTRUMENT. Be extremely careful when working in proximity to this area. The high voltage can cause serious personal injury if contacted.

6-3 RECOMMENDED TEST EQUIPMENT: FAULT ISOLATION

The test equipment required to perform the fault isolation procedure is listed in Table 1-5 and in Table 6-1. If the recommended equipment is not available, a substitute which meets or exceeds the required characteristics given in Table 1-5 may be used.

Table 6-1 Recommended Test Equipment for Fault Isolation

Description	Recommended Model Number
Frequency Synthesizer	-hp-3325A
Oscilloscope	-hp-1980A
Digital Voltmeter	-hp-3455A
Extender Card (44 pin)	-hp-03561-66595
Extender Card (50 pin)	-hp-03561-66596

6-4 SELF CALIBRATION

6-5 Calibration Procedure

The -hp-3561A is equipped with a self calibration circuit which is used to determine measurement correction factors. A full calibration consists of three steps: 1) Auto Zero, 2) PRN Magnitude and Phase Calibration, and 3) Harmonic Calibration.

A full calibration is performed whenever the SINGLE CAL softkey is pressed and every 30 minutes after instrument warm up. During warm up, full calibrations are performed as follows:

- At turn on
- 5 minutes after turn on
- 15 minutes after turn on
- 35 minutes after turn on
- Every 30 minutes

In addition, auto zero is performed whenever the instrument range function is changed.

AUTO ZERO

The auto zero digital to analog converter on the A10 Assembly is programmed for a minimum DC response.

PRN MAGNITUDE AND PHASE CALIBRATION

The PRN CAL signal which is generated on the A20 Assembly is selected as the input to the A10 cal level generator. A spectrum is taken and the results are used to calculate a set of magnitude and phase correction factors. These correction factors are stored by the processor and used to correct measurement data. Self test 118 may be used to read the correction factors and self test 119 may be used to clear the correction factors to zero. A complete description of these self tests is given in the diagnostics/self-test section of this manual.

HARMONIC CALIBRATION

A 2 kHz square wave is selected as the input to the cal level generator on the A10 Assembly. A spectrum is measured and the results used to calculate a time delay correction factor used for triggered measurements. This correction factor is added to the magnitude and phase correction factors and may be read and cleared in the same way.

6-6 Calibration Failures

When the calibration procedure encounters a failure, a failure message is immediately displayed on the CRT screen and the calibration procedure is stopped. Failure messages are listed below in the order in which they occur in the calibration procedure. For each cal failure, the assemblies which most likely caused the failure, the recommended starting point in the fault isolation procedure, and possible adjustments to correct the failure are listed.

NOTE

Calibration error messages remain on the CRT screen for ten seconds unless a second error is detected. A second failure message occurring less than one second after the original failure is not displayed. A second failure message occurring more than one second after the original failure replaces the original failure message.

Table 6-2 Cal Failures

Error Message and Description	Assemblies	Fault Isolation	Adjustments
CAL FAILURE: DMA TIME OUT The Digital Filter or DMA counter on the A20 assembly is not responding to the micro-processor.	A20	TEST E	
CAL FAILURE: A/D COUNTER MISMATCH The timing and control counter on the A20 Assembly is giving inconsistent readings on consecutive measurements of the cal signal.	A15, A20	TEST F	
CAL FAILURE: FFT TIME OUT The FFT processor on the A30 assembly is not responding to the microprocessor.	A30	TEST E	
CAL FAILURE: PRN PHASE BAD AT 2 KHZ The phase of the PRN calibration signal is too far off to be corrected. Large amplitude errors or a DC offset error will also result in a phase error and this error message.	A10, A15 A20	TEST F	A10, A15
CAL FAILURE: CORRECTION TOO LARGE The Amplitude of the PRN calibration signal is too far off to be corrected.	A10, A15	TEST F	A10, A15
CAL FAILURE: NO TRIGGER No input trigger has been sent from the A15 Assembly trigger comparator.	A10, A15 A20	TEST F	
CAL FAILURE: 64 KHZ PHASE UNDEFINED Unable to calculate the phase of the A20 64 kHz harmonic.	A10, A15 A20	TEST F	

6-7 TROUBLESHOOTING GUIDELINES

Table 6-3 lists several failure symptoms, the assembly which most likely caused the failure, and the suggested starting point in the Fault Isolation Procedure. If a fault isolation test is not listed, proceed with troubleshooting in Section 7 with the first assembly listed in the table. These failure symptoms are guidelines to shorten the repair time but do not contain all possible failures. When in doubt about a particular failure, start the fault isolation procedure at TEST A. Failure symptoms listed in Table 6-3 are organized as either general symptoms or as a symptom associated with a particular front panel key operation.

OPERATING DIAGNOSTIC MESSAGES

Diagnostic messages will be displayed during normal operation. Many of the messages indicate the status of the -hp-3561A such as the message "AVG COMPLETE," or an incorrect key sequence such as the message "COMMAND INVALID FOR TIME TRACE." The messages listed below may indicate a hardware failure.

Table 6-3 Failure Symptom Table

OPERATING DIAGNOSTIC MESSAGES

Symptom of Failure (Diagnostic Message):	Troubleshooting	
	Assemblies	Fault Isolation
BUBBLE MEMORY ERROR: CANNOT INITIALIZE	A65	
BUBBLE MEMORY ERROR: RECALL FAILED	A65	
BUBBLE MEMORY ERROR: STORE FAILED	A65	
CANNOT PERFORM RECALL: FILE DATA INVALID	A66/65	
CHECKSUM ERROR DETECTED	A50	
CMOS MEMORY ERROR: RECALL FAILED	A66/65	
DMA ERROR DETECTED	A20, A30	TEST E
DMA ERROR DURING AUTO RANGE	A20, A30	TEST E
ESR PHASE COUNTER OVERFLOW	A20	
EXTERNAL SAMPLE CLOCK < 5HZ OR INCOMPATIBLE	A20	
EXTERNAL SAMPLE TOO FAST OR INCOMPATIBLE	A15, A20	TEST F
FFT ERROR DETECTED	A30	TEST E
FRONTEND PROGRAMMING ERROR DETECTED	A10, A15	TEST G
	A20	
NO INTERNAL CLOCK	A40, A20	TEST D
NONVOLATILE MEMORY ERROR: FORMAT REQUIRED	A65	
Indicates a hardware error only if the format routine (self test 170) fails to correct the failure.		

GENERAL SYMPTOMS

Symptom of Failure:	Troubleshooting	
	Assemblies	Fault Isolation
Harmonic distortion failure.	A10, A15 A20	
Instrument completely dead, no front panel LEDs turned on, and no display.	A70, A71 A72	TEST A
Instrument locks during the power on test.	A70, A71 A72, A40	TEST A
Keyboard responds properly but display is incorrect.	A60, A90	TEST C
Input signal amplitude varies with frequency.	A15, A10	
Input signal amplitude is incorrect.	A15, A10 A20	TEST F
Noise Level is too high.	A10, A15 A20	TEST F
Power on Test Failure - RETURN CODE (0 X XX)	A40, A30 A20, A50 A60, A65	TEST B

FRONT PANEL KEY - MODE

GENERAL HEADINGS - EXTERNAL SAMPLE, THIRD OCTAVE , FULL OCTAVE, TIME CAPTURE

Symptom of Failure:	Troubleshooting	
	Assemblies	Fault Isolation
Instrument works properly in all modes except external sample mode.	A20, A82	TEST E
Instrument works properly in external sample mode but not in internal sample mode (external sample off).	A20	
Instrument works properly in all modes except third octave and full octave.	A30, A20	
Instrument works properly in third octave and full octave modes but not in narrow band mode.	A20, A30	

FRONT PANEL KEY - TRIG SEL, ARM

GENERAL HEADINGS - INPUT TRIGGER, EXTERNAL TRIGGER, SOURCE TRIGGER, HP-IB TRIGGER

Symptom of Failure	Troubleshooting	
	Assemblies	Fault Isolation
Instrument works properly with input trigger but not with external trigger.	A20, A82 W82	TEST F
Instrument works properly with external trigger but not with input trigger.	A15, A10 A20	
Instrument works properly with all triggers except HP-IB trigger or source trigger.	A50 W82	

FRONT PANEL KEY - SOURCE

GENERAL HEADINGS - PERIODIC SOURCE, IMPULSE SOURCE, RANDOM SOURCE, SOURCE SYNC

Symptom of Failure	Troubleshooting	
	Assemblies	Fault Isolation
Rear panel noise source output ("SOURCE OUT") is incorrect. Amplitude incorrect, flatness incorrect, etc.	A50, A82 W50	
Random noise source works properly but impulse or periodic source do not.	A50	
Impulse and periodic source work properly but random source does not.	A50	
Noise source output works properly, but the "SOURCE SYNC" output does not.	A50	

**FRONT PANEL KEY - DEFINE TRACE
GENERAL HEADINGS - MAGNITUDE, PHASE, TIME**

Symptom of Failure	Troubleshooting	
	Assemblies	Fault Isolation
Magnitude trace works properly, but phase trace does not work properly.	A20	TEST F
All traces work properly except input time and input magnitude.	A20	TEST F
Input time and input magnitude are the only traces that work properly.	A20	TEST F

FRONT PANEL KEY - STORE/RECALL, SAVE, RECALL

Symptom of Failure	Troubleshooting	
	Assemblies	Fault Isolation
Invalid data stored in M1 or M2, or in the six instrument states S1 -S6.	A30, A65	TEST D
Cannot store or recall a catalog file.	A65	TEST I
File catalog lost.	A65	TEST I

FRONT PANEL KEY - RANGE

Symptom of Failure	Troubleshooting	
	Assemblies	Fault Isolation
Instrument works properly in some range settings and improperly in other range settings.	A10, A15 A20	TEST G
Instrument does not auto-range.	A10, A15 A20	TEST G
Over-range LED or half-range LED is constantly on.	A10, A15 A20	TEST G

**FRONT PANEL KEY - INPUT
GENERAL HEADINGS - CALIBRATION/CAL SIGNAL, AD/DC COUPLING, A WEIGHT FILTER, ICP CURRENT SOURCE**

Symptom of Failure	Troubleshooting	
	Assemblies	Fault Isolation
Instrument fails in ac coupling only or in dc coupling only.	A10	TEST G
Instrument fails only when the A-Weight filter is enabled.	A10	
ICP current source fails.	A10	
Cal signal appears incorrect.	A10, A15	

**FRONT PANEL KEY - LCL, HP-IB BUS OPERATION
FAULT SYMPTOM OF FAILURE ASSEMBLIES ISOLATION**

Symptom of Failure	Troubleshooting	
	Assemblies	Fault Isolation
Instrument works properly from the front panel but does not respond to HP-IB commands.	A50, A82 W82	
Instrument works properly with INPUT TRIGGER and EXTERNAL TRIGGER but does not respond to HP-IB TRIGGER.	A50, A82 W82	
Instrument will not drive plotter.	A50, A82 W82	
Noise source output works correctly in Baseband mode, but not in zoom mode.	A50	

**FRONT PANEL KEY - FREQ
GENERAL HEADINGS - BASEBAND OPERATION, ZOOM OPERATION, FREQUENCY SPAN**

Symptom of Failure	Troubleshooting	
	Assemblies	Fault Isolation
Instrument works properly with a 100 kHz frequency span but not with a frequency span of less than 100 kHz.	A20	TEST F
Instrument works properly in baseband mode (start frequency = 0 Hz) but not in zoom mode (start frequency > 0 Hz or set center).	A50, A20	TEST F
Frequency readings are incorrect.	A40, A20 A15	TEST D

6-8 FAULT ISOLATION PROCEDURE

WARNING

Maintenance described herein is performed with power supplied to the instrument and with the protective covers removed. Review Paragraph 6-2, "SAFETY CONSIDERATIONS" before performing the Fault Isolation Procedures.

CAUTION

Do not remove circuit assemblies when the -hp-3561A LINE power switch is ON.

CAUTION

The -hp-3561A contains components which may be damaged as a result of static discharge. Remove circuit assemblies from the -hp-3561A only at a static protected work station.

6-9 Using the Fault Isolation Procedure

The fault isolation procedure uses the internal diagnostic test routines and waveform comparison to isolate a failure to the circuit board level. The fault isolation procedure should be started with TEST A unless the symptoms of the failure indicate otherwise (see Paragraph 6-7, "Troubleshooting Guidelines"). Once the fault isolation procedure is started, the remaining tests should be run in sequence. When a fault isolation test fails, the test will indicate the assembly which most likely caused the failure, and the paragraph in Section 7 where troubleshooting can be continued to the component level. The experienced technician will be able to skip certain tests if the circuits are obviously working correctly (eg., the display driver tests may be skipped if the display is operational).

The fault isolation procedure does not detect every possible failure. If a failure is not detected, the performance test (Section 2) can be used to further test the -hp-3561A.

NOTE

Except where otherwise noted, oscilloscope waveforms shown in this manual are measured with a 10:1 oscilloscope probe. To obtain the actual signal levels, multiply the volts per division value by ten(10).

NOTE

Some power supply failures may appear to be processor or RAM bus failures. In addition, some of the power supplies provide power to selected components (eg, the + 8 Volt supply powers the digital filter only). A failure in one of these supplies may be mistaken for a component failure.

Table 6-4 Fault Isolation Procedure Summary

Test Number	Description	Assemblies Tested
TEST A	Bias Power Supply	A71, A99
TEST B	Main Power Supply	A70, A71, A72, A99
TEST C	Display Driver	A60, A90, A99
TEST D	Processor/ROM	A40, A81
TEST E	FFT/RAM	A30
TEST F	Digital Filter	A20
TEST G	Digitizer/Input Amplifier	A15, A10
TEST H	Local Oscillator/Noise Source	A50
TEST I	CMOS/Bubble Memory	A65, A66

6-10 TEST A: Bias Power Supply A71, A99

The bias power supply provides power to the main power supply components.

WARNING

±170 Volts are present on the A70 and A71 Assemblies. ±170 Volts are present on the heat sinks on the A70 Assembly. Be extremely careful when working in proximity to this area. The high voltage can cause serious personal injury if contacted.

1. Turn the -hp-3561A LINE power switch ON.
2. Check for +12 ± 0.6 Vdc at test point A71 TP''+12BIAS'', and for -12 ± 0.6 Vdc at test point A71 TP''-12BIAS'' as shown in Figure 6-2.
3. If the bias supply voltages are incorrect, proceed with troubleshooting the A71 Assembly (Section 7: "Power Supply").

Continue with **TEST B** on Page 6-14 .

Figure 6-2 A71 Component Locator

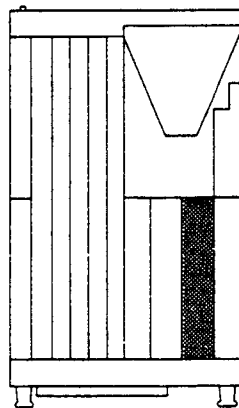
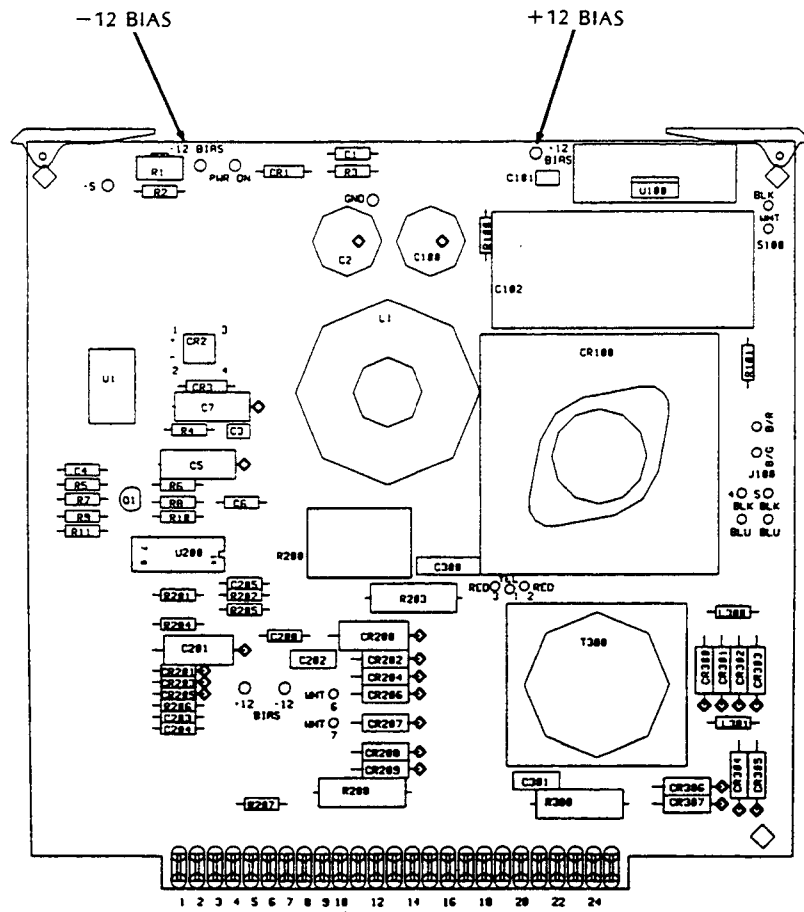

6-11 TEST B: Main Power Supply A70, A71, A72, A99**WARNING**

±170 Volts are present on the A70 and A71 Assemblies. ±170 Volts are present on the heat sinks on the A70 Assembly. Be extremely careful when working in proximity to this area. The high voltage could cause serious personal injury if contacted.

The main power supply is a switching-regulated, +5V logic supply. Several other linear-regulated supply voltages are derived from this "master" +5 Volt supply. Thus, a failure in the +5 Volt logic supply will affect all other power supply voltages. A shut-down protection circuit monitors all of the power supply outputs for an over-voltage, or a primary over-current condition. If a failure is detected, the protection circuit will shut down the power supply and light an LED to indicate the cause of the failure.

Power supplies in the -hp-3561A are divided into two categories: power supplies referenced to the chassis ground, and power supplies referenced to the isolated (or floating) ground. The isolated ground is a completely separate ground derived from the power transformer. All voltages referenced to the isolated ground are marked with an "I" (eg. +15 V_I). Voltages referenced to the isolated ground cannot be measured in with respect to the chassis ground unless the front panel ground switch is in the CHASSIS position.

Model 3561A

TEST B: Main Power Supply

Protection Circuit Test

1. Move the hp-3561A front panel ground switch to the CHASSIS position.
2. Turn the hp-3561A LINE power switch ON.
3. Check the protection circuit LEDs shown in Figure 6-3 for the pass/fail conditions listed.

Fail: One or more of the protection circuit LEDs is on.

A72 Power Supply Test

This test determines whether the linear-regulated power supplies are loading down the master +5 V supply.

1. Turn the hp-3561A LINE power switch OFF.
2. By removing the A72 Assembly, disconnect the linear-regulated power supplies on the A72 Assembly from the power transformer on the hp-3561A LINE power switch ON.
3. Turn the hp-3561A LINE power switch ON.
4. Check the protection circuit LEDs shown in Figure 6-3 for the pass/fail conditions listed.
5. Turn the hp-3561A LINE power switch OFF and reinsert the A72 Assembly.

Pass: All of the protection circuit LEDs are off.

Troubleshoot the A70, A71, A72 Assemblies (Section 7: Power Supply).

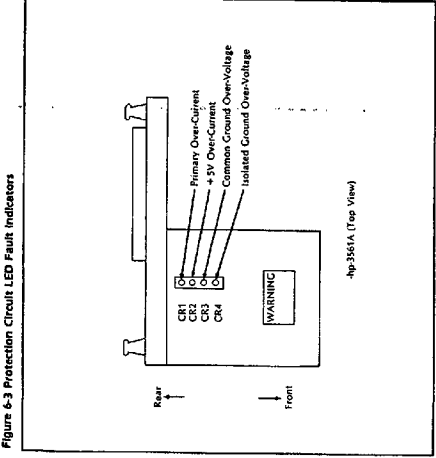

Figure 6-3 Protection Circuit LED Fault Indicators

Power Supply Switching Clock Test

The master switching power supply receives its clock from the A20 Assembly. When the A20 Assembly is removed, the power supply will generate its own clock. This test determines whether or not the A20 clock is causing the failure.

1. Turn the hp-3561A LINE power switch OFF.
2. Remove the A20 Assembly.
3. Turn the hp-3561A LINE power switch ON.
4. Check the protection circuit LEDs shown in Figure 6-3 for the pass/fail conditions listed.
5. Turn the hp-3561A LINE power switch OFF and reinsert the A20 Assembly.

Fail: One or more of the protection circuit LEDs is on.

Pass: All of the protection circuit LEDs are off.

Troubleshoot the A20 Assembly (Section 7: Digital Filter).

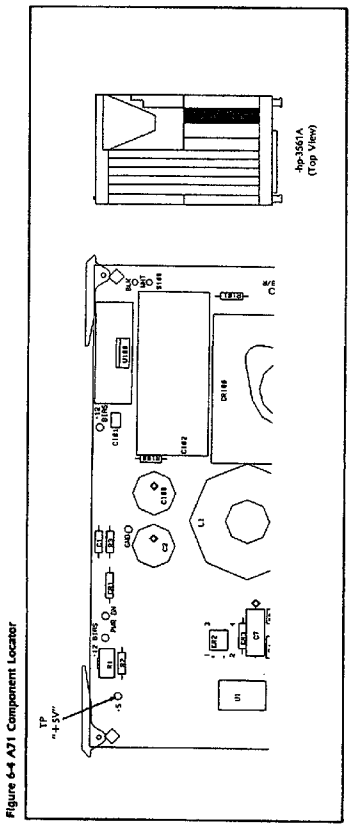

Figure 6-4 A71 Component Locator

Power Supply Loading Test

A destination assembly may be loading down the supply or the supply itself may have a failure. Starting with the A10 Assembly, this test isolates the failure to one of the destination assemblies, or to the power supply.

1. Turn the hp-3561A LINE power switch OFF.
2. Remove the A10 Assembly.

CAUTION

Before removing the A10 Assembly, remove the bottom cover and disconnect the input cable (VPI).

3. Turn the hp-3561A LINE power switch ON.
4. Check the protection circuit LEDs shown in Figure 6-3 for the pass/fail conditions.
5. If all the LEDs are on, the A10 Assembly is removed, troubleshoot the A10 Assembly (Section 7: Input Amplifier).
6. If any of the protection circuit LEDs are on, proceed with step 5.
7. Turn the hp-3561A LINE power switch OFF and reinsert the A10 Assembly.
8. Repeat steps 1 through 5 for the assemblies listed in Table 6-5.
9. If the failure is not corrected, turn the power off before removing each assembly and repeat the assembly steps preceding with the next assembly.

Table 6-5 Power Supply Destination Assemblies

Assembly	Process With Troubleshooting at:
A15	Section 7: "Digitalizer"
A20	Section 7: "Digital Filter"
A30	Section 7: "PTMAM"
A40	Section 7: "PTMAM"
A50	Section 7: "Local Oscillator/Noise Source"
A60	Section 7: "Digital Display Driver"
A65	Section 7: "Digital Display Driver"
A70	Section 7: "Timing Display Driver"

NOTE

The A20 Assembly must be removed whenever the A40 Assembly is removed. If the A20 Assembly is not removed, the primary protection circuit may turn the power supply off with a primary over-current failure. This occurs because the power supply clock is generated on the A20 Assembly by dividing down the A40 Assembly 20.48 MHz clock.

NOTE

The failure may also exist on the Foreboard Assembly (AF) or the Rear Panel Assembly (RP). If the failure persists after the two assemblies have been removed, the failure may exist in the power supply itself and because failure may exist in the power supply, the test should be completed on the power supply in Section 7 before testing these two assemblies. Refer to Section 7 for instructions on removing the rear panel.

Pass: Removing one of the destination assemblies causes the protection circuit LEDs to all turn off.

Troubleshoot the assembly which, when removed, eliminates the failure.

Fail: After all of the destination assemblies have been tested one or more of the protection circuit LEDs remains on.

Troubleshoot the A70, A71, A72 Assemblies (Section 7: Power Supply).

TEST B Continued on next page

Model 3561A

Fault Isolation

Figure 4-5 Voltage Regulator Locations and Pinouts

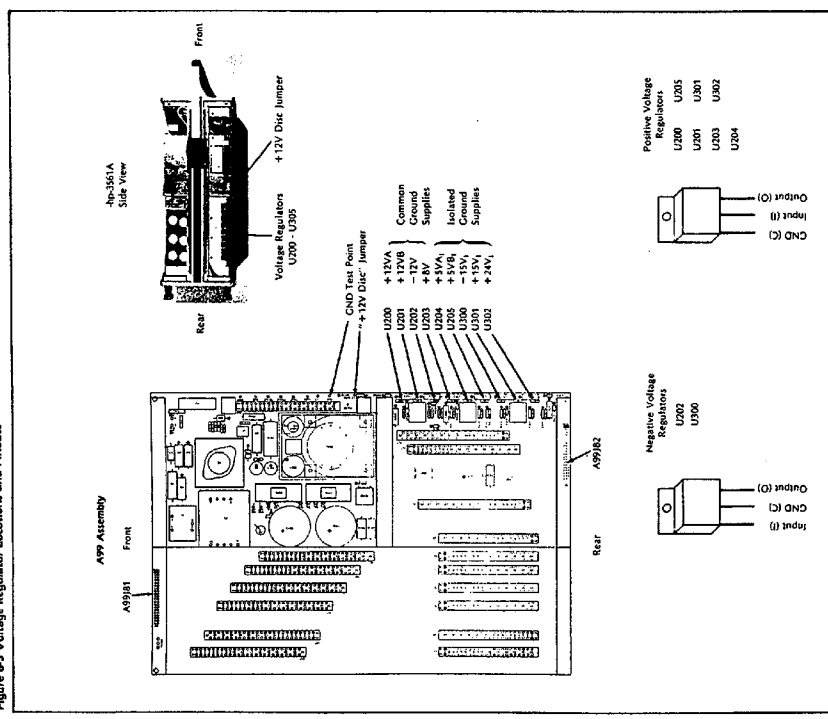

+12 V₁ Power Supply Test
 The +12 V₁ supply provides power to circuits on the A08 and A09 Assemblies only.
 1. Turn the hp-3561A LINE power switch ON.
 2. Use a voltmeter to check the +12 V₁ supply for +12 ± 0.6 V at the +12 DDC₁ jumper as shown in Figure 6-5.

Pass: +11.4 Volts ≤ +12 V₁ ≤ +12.6 Volts
 Fail: The +12 V₁ supply is incorrect.

+12 V₁ Supply Loading Test
 The destination assemblies (A09, A59) may be loading down the supply itself may have a failure. Starting with the A09 Assembly, this test isolates the failure to one of the destination assemblies, or to the power supply.
 1. Turn the hp-3561A LINE power switch OFF.
 2. Turn the hp-3561A LINE power switch ON.
 3. Check the +12 V₁ supply for +12 ± 0.6 V.
 4. Turn the hp-3561A LINE power switch OFF and reinsert the +12 DDC₁ jumper into the A09 Assembly.
 5. Repeat steps 1 through 4 for the remaining destination assemblies.

Pass: +11.4 Volts ≤ +12 V₁ ≤ +12.6 Volts
 Fail: +12 V₁ supply is incorrect.

Troubleshoot the A08, A09 Assemblies (Section 7: "Power Supply")

Chassis Ground Power Supply Test
 1. Move the front panel ground switch to the CHASSIS position.
 2. Turn the hp-3561A LINE power switch ON.
 3. Use a voltmeter to check all of the chassis ground power supply voltages listed in Table 6-6. The test point for each voltage is shown in Figure 6-5.

Table 6-6 Chassis Ground Power Supply Voltages

Voltage	Test Location	Destination Assemblies
+12 ± 0.6 V	A09 U200(Output)	A15, A20, A40, A48, A64/A45
+8 ± 0.4 V	A09 U200(Output)	A20, A50, A52, A90
-12 ± 0.6 V	A09 U200(Output)	A20, A50, A52, A90

Pass: All of the voltages are correct.
 Fail: One or more of the voltages is incorrect.

Chassis Ground Power Supply Loading Test
 A destination assembly may be loading down the supply or the supply itself may have a failure. Starting with the A20 Assembly, this test isolates the failure to one of the destination assemblies, or to the power supply.
 1. Turn the hp-3561A LINE power switch OFF.
 2. Turn the hp-3561A LINE power switch ON.
 3. Check the chassis ground power supply voltages listed in Table 6-6.
 4. If the voltages are correct, troubleshoot the A20 Assembly (Section 7: "Digital Filter").
 5. If one or more of the voltages is incorrect, proceed with step 5.
 6. Repeat steps 1 through 5 for the remaining destination assemblies.

Pass: Removing one of the destination assemblies corrects the voltage.
 Troubleshoot the destination assembly, which, when removed, corrects the voltage.

Troubleshoot the A20, A71, A72 Assemblies (Section 7: "Power Supply")

Isolated Ground Power Supply Test
 1. Move the front panel ground switch to the CHASSIS position.
 2. Turn the hp-3561A LINE power switch ON.
 3. Use a voltmeter to check the isolated ground power supply voltages listed in Table 6-8. The test point for each voltage is shown in Figure 6-5.

Table 6-8 Isolated Ground Power Supply Voltages

Voltage	Test Location	Destination Assemblies
+24 ± 0.12 V	A09 U300(Output)	A10
+15 ± 0.75 V	A09 U300(Output)	A10, A15
+5 ± 0.25 V	A09 U300(Output)	A10, A15
-15 ± 0.75 V	A09 U300(Output)	A10, A15

Pass: All of the voltages are correct.
 Fail: One or more of the voltages is incorrect.

Isolated Ground Power Supply Loading Test
 A destination assembly may be loading down the supply or the supply itself may have a failure. Starting with the A10 Assembly, this test isolates the failure to one of the destination assemblies, or to the power supply.
 1. Turn the hp-3561A LINE power switch OFF.
 2. Turn the hp-3561A LINE power switch ON.
 3. Check the isolated ground power supply voltages listed in Table 6-8.
 4. If the voltages are correct, troubleshoot the A10 Assembly (Section 7: "Input Amplifier").
 5. If one or more of the voltages is incorrect, proceed with step 5.
 6. Repeat steps 1 through 5 for the A15 Assembly. If the voltage is correct when the A15 Assembly is removed, troubleshoot the A15 Assembly (Section 7: "Digitizer").

Pass: Removing one of the destination assemblies corrects the voltage.
 Troubleshoot the destination assembly, which, when removed, corrects the voltage.

Troubleshoot the A10, A71, A72 Assemblies (Section 7: "Power Supply")

6-12 TEST C: Display Driver A60, A90, A99**WARNING**

+450 Volts and -150 Volts are present on the A90 and A99 Assemblies. Be extremely careful when working in proximity to this area. The high voltage could cause serious personal injury if contacted.

The -hp-3561A display driver is divided into two circuit assemblies, the digital display driver (A60), and the analog display driver (A90). The digital display driver receives display data directly from the central processor. It then reformats the data into the CRT video drive, horizontal sweep, and vertical sweep signals. The analog display driver converts these signals into the actual analog CRT drive signals.

Figure 6-6 -hp-3561A CRT Test Pattern

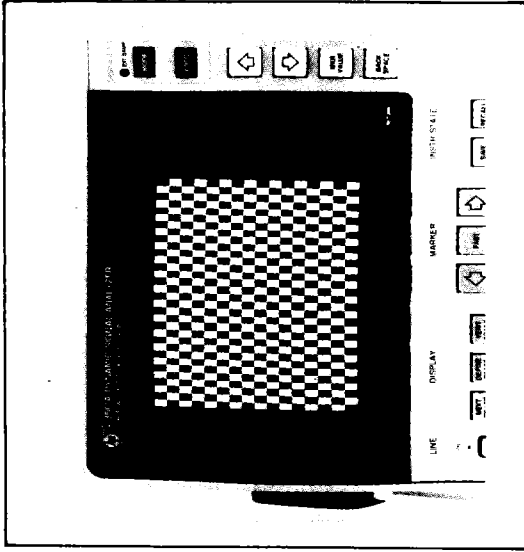

TEST C: Display Driver

Display Test

1. Turn the -hp-3561A LINE power switch ON.
2. Move the A60 Assembly test jumper J100 to the PLANE2 (half bright) position as shown in Figure 6-7.
3. Check the -hp-3561A CRT screen for the display shown in Figure 6-6. Check for brightness, alignment, size, focus, and vibration of the pattern.
4. Move the A60 Assembly test jumper J100 to the PLANE1 (full bright) position as shown in Figure 6-7.
5. Check the -hp-3561A CRT screen for the display shown in Figure 6-6. The pattern should be brighter than the PLANE2 pattern. Check for brightness, alignment, size, focus, and vibration of the pattern.
6. If both display patterns are correct, move test jumper A60 J100 back to the RUN position, and press the -hp-3561A front panel PRESET key.

Pass: Both CRT patterns are correct.

TEST C Complete.
Continue with
TEST D

Fail: One or both CRT patterns are incorrect.

Digital Display Driver

1. Move the A60 Assembly test jumper J100 to the PLANE2 (half bright) position as shown in Figure 6-7, and use an oscilloscope to check for the waveforms shown in Figure 6-8.
2. Move the A60 Assembly test jumper J100 to the PLANE1 (full bright) position as shown in Figure 6-7, and use an oscilloscope to check for the waveforms shown in Figure 6-9.
3. Move the A60 Assembly test jumper J100 back to the RUN position and press the front panel PRESET key.

Fail: One or more of the waveforms is incorrect.

Troubleshoot the A60 Assembly (Section 7: "Digital Display Driver")

Pass: All of the waveforms are correct.

Troubleshoot the A90, A99 Assemblies (Section 7: "Analog Display Driver")

6-13 TEST D: Processor/ROM A40

The A40 Assembly contains the central processor, ROM, and the master 20.48 MHz clock. Failures on the A40 Assembly will usually result in the instrument not completing its power up routine, or in a power on test return code. This test gives a high probability of isolating the failure, but does not exhaust all possible failures. If a bus failure is suspected which is not isolated by this routine, a more complete bus test using signature analysis is given in the "Processor/ROM" paragraph of Section 7.

When the power is turned on, the main processor will perform diagnostic self tests 0 and 1. For more information on these tests, refer to Paragraph 6-18 "Diagnostic/Self-Test Descriptions."

DISPLAY ACTIVITY DURING POWER ON TEST

When power is first applied, the message "POWER ON TEST IN PROGRESS" is displayed at the top of the CRT screen for approximately three seconds (for approximately one second when the A30 Assembly is removed). A test pattern is then displayed and erased, which requires approximately three seconds. When the display pattern is completely erased, the "POWER ON TEST IN PROGRESS" message is again displayed at the top of the CRT screen for approximately two seconds. The power on test is then complete and initiates the measurement display if no failures are encountered, or displays a return code for each failure encountered.

FRONT PANEL LED ACTIVITY DURING POWER ON TEST

When power is first applied, all of the front panel LEDs turn on for approximately three seconds (for approximately one second when the A30 Assembly is removed). The LEDs then turn off for approximately three seconds while the test pattern is being displayed and erased on the CRT. The LEDs then turn on for approximately two more seconds. The power on test is then complete and initiates normal measurement operation if no failures are encountered or displays a return code on the LEDs for the failures encountered. The front panel LED return code descriptions are given in Figure 6-10.

SUMMARY OF TEST 0 RETURN CODES

Processor Failures (A40)
 0 3 25
 0 8 01 through 0 8 24

RAM Failures (A30)
 0 7 26
 0 3 27
 0 7 31

Interrupt Failure (A40)
 0 2 30

Display Failures (A60)
 0 7 28
 0 3 29

Figure 6-10 Front Panel LED Return Codes

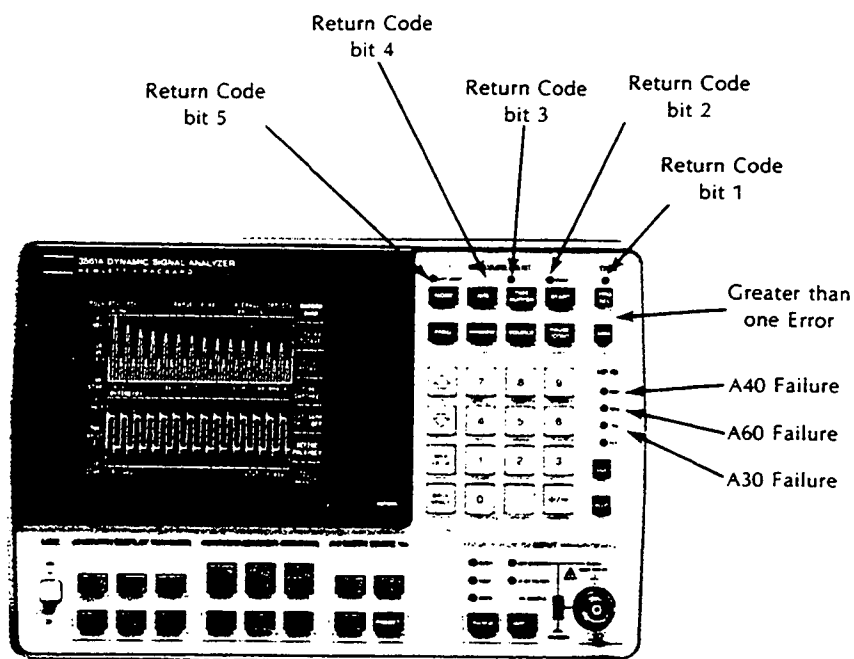

Example:

EXT SAMP	-ON	16
AVG	-OFF	0
TIME BUFFER	-OFF	0
MEAS	-ON	2
TRIG	-OFF	0
		Return Code = 18

LED	Description
EXT SAMP	Has a value of 16 in the return code when turned on.
AVG	Has a value of 8 in the return code when turned on.
TIME BUFFER	Has a value of 4 in the return code when turned on.
MEAS	Has a value of 2 in the return code when turned on.
TRIG	Has a value of 1 in the return code when turned on.
ARM	More than one failure occurred during the power on test.
RMT	An A40 Assembly failure occurred during the power on test.
SRQ	An A60 Assembly failure occurred during the power on test.
LTN	An A30 Assembly failure occurred during the power on test.

Fault Isolation

TEST D: Processor/DMA **Power On Test**
 Turn the hp-3551A LINE power switch ON. Check the result of the power on test for the fault/return conditions listed.

TEST D Calibrated on next page (Power On Test Card)

Fail: The power on test does not complete, or the power on test completes and indicates a failure on more than one assembly.

Fail: The power on test completes and indicates a display failure (0 7 26, or 0 3 29), but no DMA failure or processor failure.

Fail: The power on test completes and indicates a processor failure (0 8 01 through 0 8 24, or 0 2 20), but no DMA failure or display failure.

Troubleshoot the A40 Assembly (Section 7: "Processor/DMA").

General Bus Fault Test

These failures can be caused by an assembly loading down the processor address or data bus. Starting with the A66A5 Assembly, this test isolates the failure to an assembly loading down the processor address or data bus, or to the A40 Assembly.

1. Turn the hp-3551A LINE power switch OFF.
2. Remove the A66A5 Assembly.
3. Turn the hp-3551A LINE power switch ON and check for the following conditions:

If the power on test completes with no test 0 return codes, troubleshoot the A66A5 Assembly (Section 7: "CMOS/Random Access Memory").

If the power on test fails with return code (0 3 28), continue with step 4.

If the power on test does not complete, or completes and indicates a failure on more than one assembly, continue with step 4.

NOTE
 The following LEDs are on for return code (0 3 28): 17N, TIME BUFFER, AYC, Z11, SAMP. All other LEDs should be off.

NOTE
 This procedure is for the A66A5 Assembly. Do not load down the processor address or data bus. Because access to the A40 Assembly is difficult, and because failures are rare, it is recommended that troubleshooting be completed on the A40 Assembly in Section 7 before testing the A66A5 Assembly. Refer to Section 7 for instructions on removing the front panel.

Assembly	Fail Condition	Proceed With Troubleshooting At:
A20	no test 0 return codes	Section 7: "Digital Filter"
A30	no test 0 return codes	Section 7: "Local Oscillator/Noise Source"
A40	no test 0 return codes (0 3 28 only)	Section 7: "Digital Display Driver"

Interrupt Test

Starting with the A66A5 Assembly, this test checks for assemblies interrupting the processor:

1. Turn the hp-3551A LINE power switch OFF.
2. Remove the A66A5 Assembly.
3. Turn the hp-3551A LINE power switch ON and check for the following conditions:

If the power on test completes with no test 0 return codes, troubleshoot the A66A5 Assembly (Section 7: "CMOS/Random Access Memory").

If the power on test fails with return code (0 2 30), continue with step 4.

If the power on test does not complete, or completes and indicates a failure on more than one assembly, continue with step 4.

NOTE
 When the A30 Assembly is removed, only return code (0 3 27) should occur.

Assembly	Fail Condition	Proceed With Troubleshooting At:
A20	no test 0 return codes	Section 7: "Digital Filter"
A30	no test 0 return codes	Section 7: "Local Oscillator/Noise Source"
A40	no test 0 return codes	Section 7: "Digital Display Driver"

Display Handshake Test

1. Turn the hp-3551A LINE power switch OFF.
2. Place the A40 Assembly on an extended board and remove the A60 Assembly.
3. Turn the hp-3551A LINE power switch ON and check for the following conditions:

If the power on test completes with no test 0 return codes, troubleshoot the A40 Assembly (Section 7: "Digital Display Driver").

If the power on test fails with return code (0 2 30), continue with step 4.

If the power on test does not complete, or completes and indicates a failure on more than one assembly, continue with step 4.

NOTE
 When the A30 Assembly is removed, only return code (0 3 27) should occur.

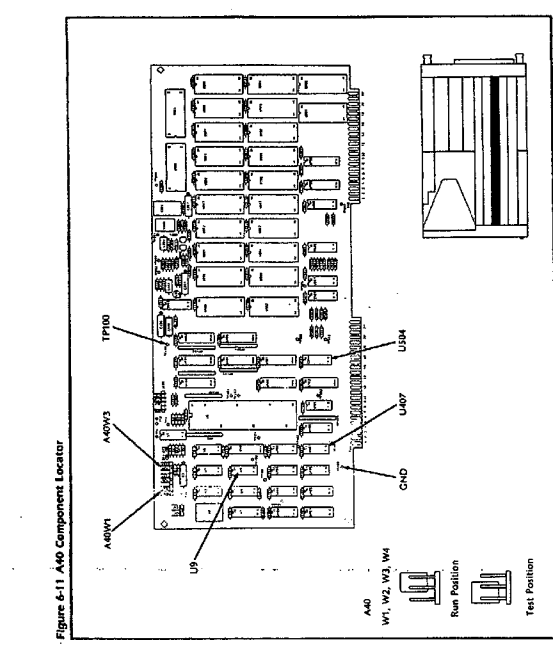

Figure 6-11 A40 Component Locator

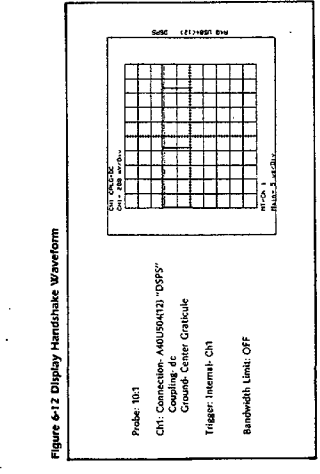

Figure 6-12 Display Handshake Waveform

Pass: The power on test completes with no test 0 return codes when one of the assemblies is removed.

Troubleshoot the assembly, which, when removed, eliminates the return code.

Pass: The power on test completes with no test 0 return codes when one of the assemblies is removed.

Troubleshoot the assembly, which, when removed, eliminates the return code.

Pass: The power on test completes with no test 0 return codes when one of the assemblies is removed.

Troubleshoot the assembly, which, when removed, eliminates the return code.

Pass: The power on test completes with no test 0 return codes when one of the assemblies is removed.

Troubleshoot the assembly, which, when removed, eliminates the return code.

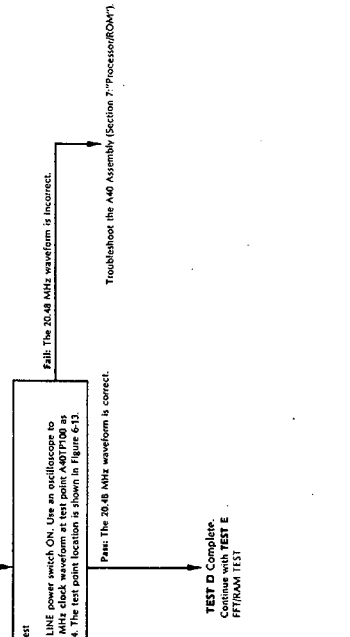
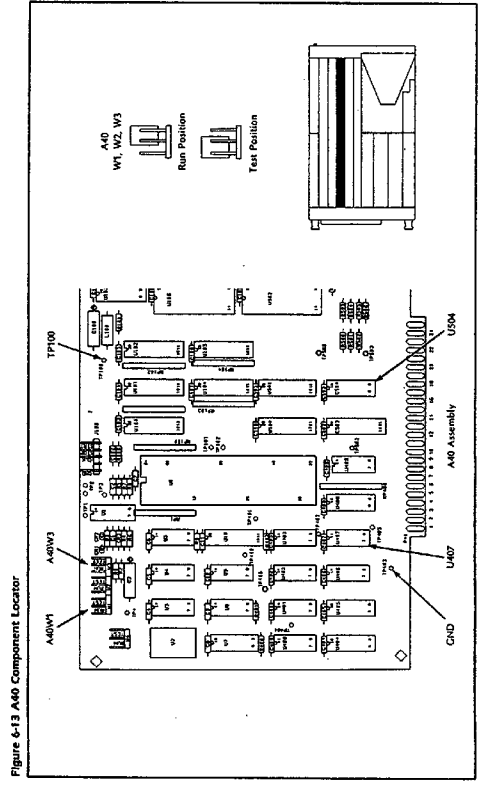
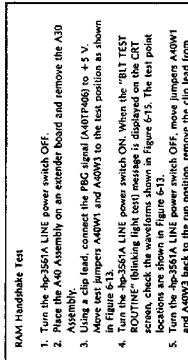
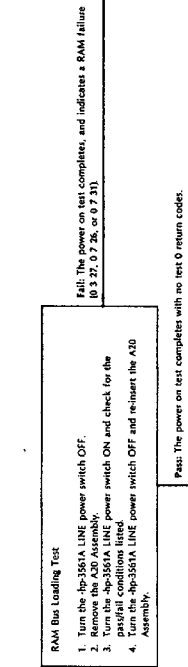
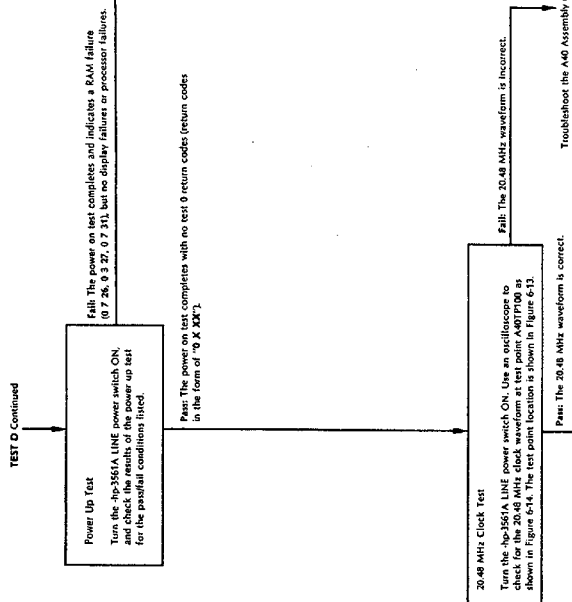
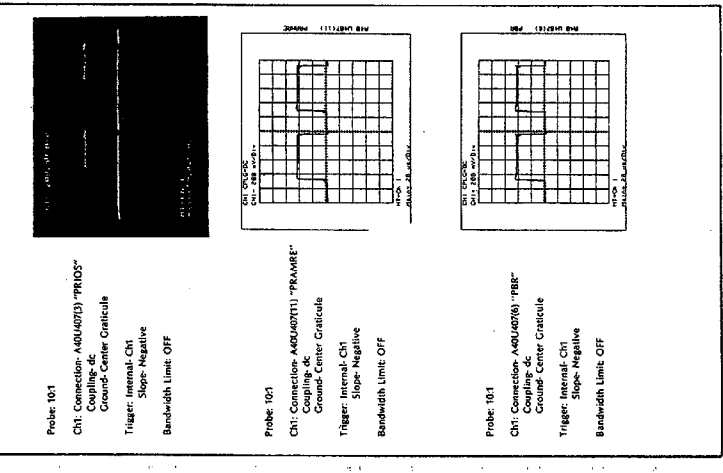

Figure 6-15 RAM Handshake Waveforms



6-14 TEST E: FFT/RAM A30

The A30 Assembly contains the instrument RAM and the FFT Processor. The FFT processor is a separate microprocessor with its own ROM and an asynchronous clock. This test uses the power up test and self test 12 to verify proper operation of the A30 Assembly.

Model 3561A

Fault Isolation

TEST E: FT/IRAM

Power On Test
Turn the 4p-3561A LINE power switch ON. Check the results of the power on test for the pass/fail conditions listed.

Pass: The power on test completes with no return codes.
Fail: The power on test does not complete or completes with one or more test 0 return codes (return codes of the format 0 X XXX).

Proceed with fault isolation TEST D: "ProcessorROM" on page 6-356-26.

Pass: The power on test completes with a digital filter or input section return code (1 00, 1 01, 1 20, 1 21, 1 22, or 1 300).

Fail: The power on test completes with an FFT return code (1 200, or 1 301).

Troubleshoot the A30 Assembly (Section 7: "FT/IRAM").

Pass: The power on test completes with a measurement data return code (1 6 00 through 1 6 99).

Fail: The power on test completes with no return codes.

These return codes generally indicate a failure on the A10, A15, or A20 Assemblies. Continue with TEST E.

TEST E Continued on next page

RAM Bus Arbitrator Test

These return codes usually indicate a failure on the A10, A15, or A20 Assemblies but may be caused by the RAM bus arbitrator.

- Turn the 4p-3561A LINE power switch OFF.
- Remove the A20 Assembly and place the A30 Assembly on an extender board. Short the two pins of jumper A30W100 together.
- Move the A40 Assembly test jumpers A40W1 and A40W3 to the test position.
- Turn the 4p-3561A LINE power switch ON.
- When the "BIT TEST ROUTINE" (blinking light test) message is displayed on the CRT screen, check the signals listed in Table 6-11. The signal test points are shown in Figure 6-17.

Signal Name	Test Point	State
DF58B	U750(3)	TTL High
DF58C	U704	TTL High
DF58D	U705	TTL High
DF58E	U706	TTL High
DF58F	U707	TTL High
DF58G	U708	TTL High
DF58H	U709	TTL High
DF58I	U710	TTL High

- If all of the signals show in Table 6-11, no connect, use a clip lead to short DF58B (A30T700) to ground. Check the DF58C signal at A30T700 for the waveform shown in Figure 6-18. The test point location is shown in Figure 6-17.
- If DF58C is correct, remove the short from DF58B and short DF58B (A30T700) to ground. Check the DF58C signal at A30T701 for the waveform shown in Figure 6-18. The test point locations are shown in Figure 6-17.
- If DF58C is correct, remove the short from DF58B and short DF58B (A30T702) to ground. Check the DF58C signal at A30T702 for the waveform shown in Figure 6-18. The test point locations are shown in Figure 6-17.
- Turn the 4p-3561A LINE power switch OFF. Remove the clip lead from DF58B and move jumper A40W1 and A40W3 back to the Run position as shown in Figure 6-16. Remove the clip lead from the test point locations shown in Figure 6-17.
- Turn the 4p-3561A LINE power switch ON. When the power-on test is complete, set the controls as follows: TEST NAME: 121 ENTER PRESET: TEST SELECT: START COUNT TEST MODE:
- Check the RDS signal at A30T601 for the waveform shown in Figure 6-19. The test point location is shown in Figure 6-17.
- Turn the 4p-3561A LINE power switch OFF and retest the A20 and A30 Assemblies.

Fail: One or more of the signals is incorrect.

Troubleshoot the A30 Assembly (Section 7: "FT/IRAM").

Pass: All of the signals are correct.

Figure 6-16. A40 Component Locator

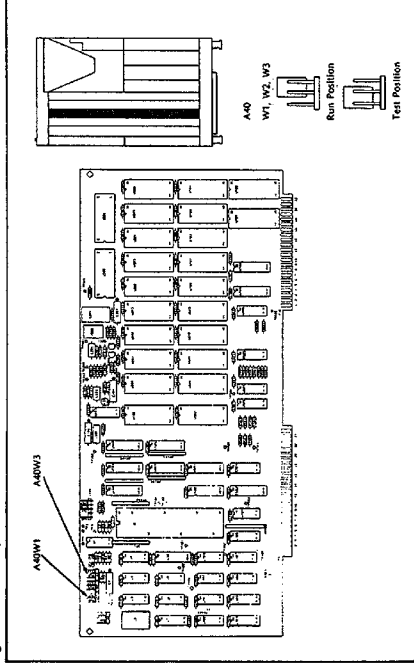

Figure 6-17. A30 Component Locator

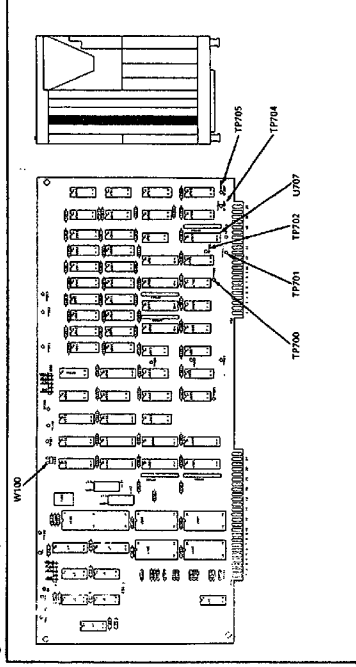
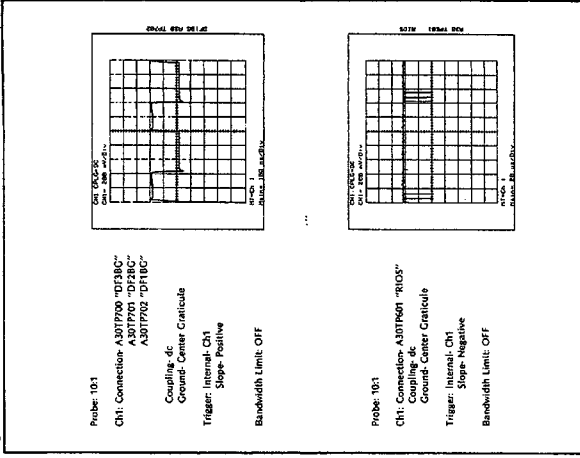

Figure 6-18. RAM Bus Arbitrator Waveforms



TEST E (Continued)

Self Test 12

1. Set the -hp-3561A controls as follows:

PRESET MODE . . . TEST SELECT . . . DEFINE TEST NUM . . . 12 ENTER START SNGL TST

2. When the "TEST #12 IS COMPLETE" message is displayed, check for the pass/fail conditions listed.

3. Press the -hp-3561A PRESET key.

Pass: Self test 12 completes with no return codes.

TEST E Complete.
Continue with TEST F

Fail: Self test 12 completes with one or more return codes.

RAM Bus Loading Test

1. Turn the -hp-3561A LINE power switch OFF.

2. Remove the A20 Assembly.

3. Turn the -hp-3561A LINE power switch ON and set the -hp-3561A controls as follows:

PRESET MODE . . . TEST SELECT . . . DEFINE TEST NUM . . . 12 ENTER START SNGL TST

5. When the "TEST #12 IS COMPLETE" message is displayed, check for the pass/fail conditions listed.

6. Turn the -hp-3561A LINE power switch OFF, and re-insert the A20 Assembly.

Pass: Self test 12 completes with no return codes.

Troubleshoot the A20 Assembly (Section 7: "Digital Filter")

Fail: Self test 12 completes with one or more return codes.

Troubleshoot the A30 Assembly (Section 7: "FFRAM")

6-15 TEST F: Digital Filter A20

The A20 Assembly contains the digital filters, DMA address counters, main trigger counter, and phase counter. The digital filters receive data from the A15 Assembly and the A50 Assembly. The processed data is then transferred to the main RAM on the A30 Assembly. This test uses self tests 13, 14, and 18 to verify correct operation of the A20 Assembly and assumes proper operation of the A30 Assembly.

TEST F: DIGITAL FILTER

Self Tests #13, #14, and #18

1. Set the -hp-3561A controls as follows:
PRESET
MODE TEST SELECT DEFINE TEST NUM 13 ENTER
START SNGL TST
2. When the "TEST #13 IS COMPLETE" message is displayed, check for
3. Set the -hp-3561A controls as follows:
DEFINE TEST NUM 14 ENTER
START SNGL TST
4. When the "TEST #14 IS COMPLETE" message is displayed, check for return codes
5. Set the -hp-3561A controls as follows:
DEFINE TEST NUM 18 ENTER
START SNGL TST
6. When the "TEST #18 IS COMPLETE" message is displayed, check for return codes.

Fail: Self tests #13, #14, or #18 complete with one or more return codes.

Troubleshoot the A20 Assembly (Section 7: "Digital Filter")

A20 I/O Signal Test

1. Turn the -hp-3561A LINE power switch OFF.
2. Place the A20 Assembly on an extender board and remove the A50 and A15 Assemblies.
3. Turn the -hp-3561A LINE power switch ON.
4. Set the -hp-3561A controls as follows:
PRESET
MODE TEST SELECT DEFINE TEST NUM 122 ENTER
START CONT TEST
5. Check the following signals as shown in Figure 6-20. The signal test point locations are shown in Figure 6-19.
Signal Name Test Point
10 MHz A20TP302
CONVERT A20TP100
DATAREQ A20TP501
SYNCZ A20TP101
6. Set the -hp-3561A controls as follows:
PRESET
INPUT CAL SIG ON
FREQUENCY DEFINE CENTER 50 kHz
7. Check the following signals as shown in Figure 6-20. The signal test point locations are shown in Figure 6-19.
Signal Name Test Point
ESR*4 A20TP701
FE CAL A20TP502
ZPHTRIG A20U702(2)
8. Turn the -hp-3561A LINE power switch OFF and re-insert the A15, A20, and A50 Assemblies

Pass: All A20 I/O signals are correct

TEST F Complete
Continue with TEST G.

Fail: One or more of the A20 I/O signals is incorrect.

Troubleshoot the A20 Assembly (Section 7: "Digital Filter").

Figure 6-19 A20 Component Locator

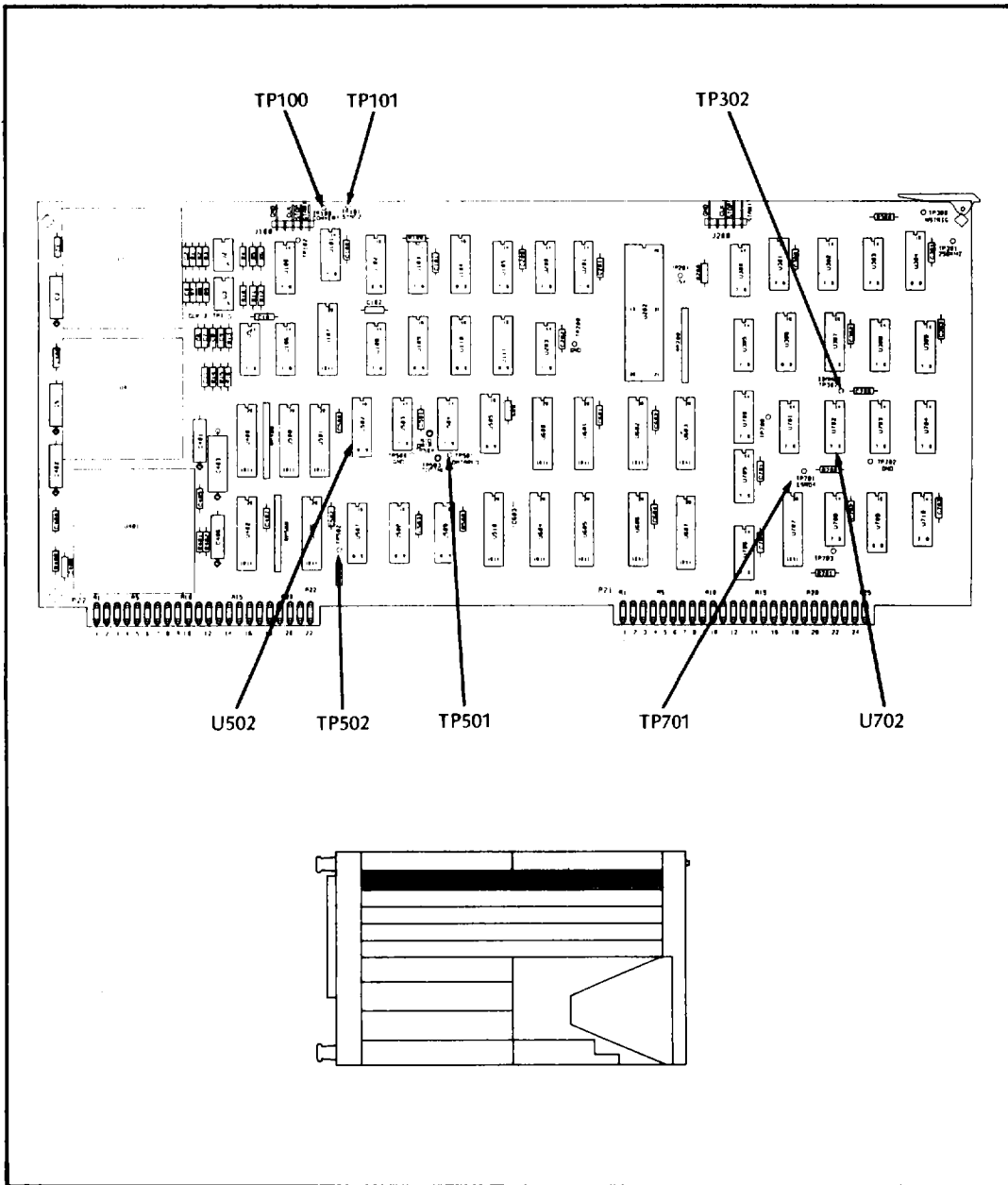

Figure 6-20 A20 I/O Signal Waveforms

Probe: 10:1

Ch1: Connection- A20TP302 "10 MHz"
Coupling- dc
Ground- Center Graticule

Trigger: Internal- Ch1
Slope- Positive

Bandwidth Limit: OFF

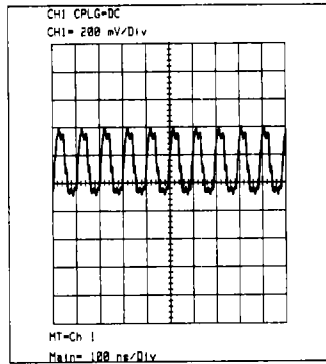

Probe: 10:1

Ch1: Connection- A20TP101 "SYNC2"
Coupling- dc
Ground- Center Graticule

Trigger: Internal- Ch1
Slope- Positive

Bandwidth Limit: OFF

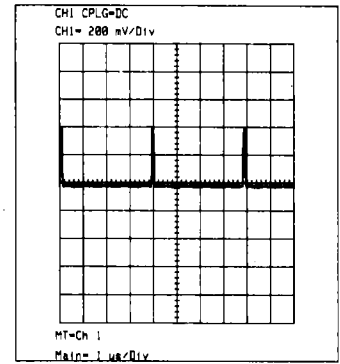

Probe: 10:1

Ch1: Connection- A20TP100 "CONVERT"
Coupling- dc
Ground- Center Graticule

Trigger: Internal- Ch1
Slope- Positive

Bandwidth Limit: OFF

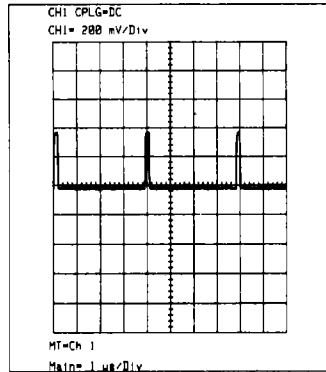

Probe: 10:1

Ch1: Connection- A20TP501 "DATAREQ"
Coupling- dc
Ground- Center Graticule

Trigger: Internal- Ch1
Slope- Positive

Bandwidth Limit: OFF

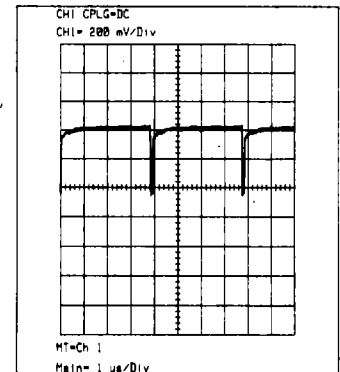

Probe: 10:1

Ch1: Connection- A20 U702(2) "ZPHTRIG"
Coupling- dc
Ground- Center Graticule

Trigger: Internal- Ch1
Slope- Positive

Bandwidth Limit: OFF

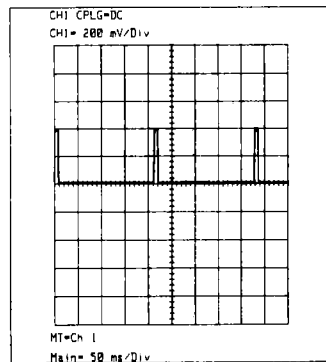

Probe: 10:1

Ch1: Connection- A20TP701 "ESR*4"
Coupling- dc
Ground- Center Graticule

Trigger: Internal- Ch1
Slope- Positive

Bandwidth Limit: OFF

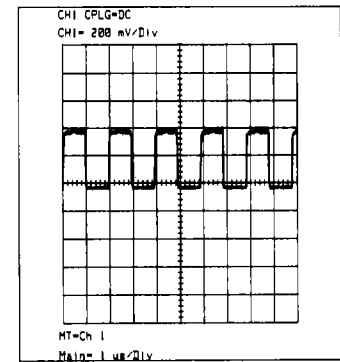

Probe: 10:1

Ch1: Connection- A20TP502 "FE CAL"
Coupling- dc
Ground- Center Graticule

Trigger: Internal- Ch1
Slope- Positive

Bandwidth Limit: OFF

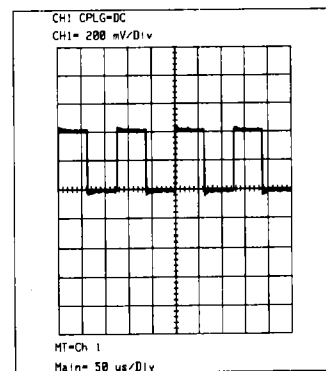

6-16 TEST G: Input Amplifier/Digitizer A10, A15

The A10 Assembly contains the input amplifiers and attenuators used to set the instrument range. The A15 Assembly contains the 100 kHz low pass anti-alias filter, the A/D converter, the trigger level comparators, and the overload/underload comparators.

The central processor controls the A10 and A15 Assemblies through the front end control latch on the A20 Assembly. Programming data is passed first through the A10 Assembly, and then to the A15 Assembly. Thus, the A10 Assembly must be installed for the A15 Assembly to operate.

Test G does not check for distortion failures. To isolate known distortion failures between the A10 Assembly and the A15 Assembly, refer to the A10 Assembly troubleshooting information given in Section 7 (Section 7: "Input Amplifier").

6-17 TEST H: Local Oscillator/Noise Source A50

The A50 Assembly contains the noise source, the HP-IB interface, and the local oscillator circuits.

The noise source provides three types of noise outputs; random, periodic, and impulse. When the periodic source is selected, the "SOURCE SYNC" rear panel output provides a trigger pulse. If problems are encountered with the noise source, and the A20 I/O signal test passed, the failure is most likely on the A50 Assembly. Troubleshoot the A50 Assembly noise source circuit (Section 7:"Local Oscillator/Noise Source").

The HP-IB circuit provides an interface between the central processor and the rear panel HP-IB connector. If problems are encountered during HP-IB operation only, troubleshoot the A50 Assembly HP-IB circuit (Section 7:"Local Oscillator/Noise Source").

The local oscillator provides a digital sine wave to both the digital filter and the noise source. The local oscillator frequency is set equal to the center frequency when the -hp-3561A is operated in "zoom" mode (when the start frequency is set to greater than 0 Hz or the "SET CENTER" softkey is used). For a more complete test of the local oscillator refer to the "Local Oscillator/Noise Source" paragraph in Section 7.

NOTE

If the -hp-3561A passes the local oscillator test but does not operate correctly in "zoom" mode, the most likely cause of the failure is the data latch or the digital filters on the A20 Assembly (Section 7:"Digital Filter")

TEST G: Input Amplifier/Digitizer

Input Signal Test

NOTE
This test can be repeated at any 100 Hz range setting. The waveforms shown in Figure 6-23 are valid as long as the amplitude of the input sine wave is equal to the hp-3551A range setting.

1. Connect the frequency synthesizer output to the hp-3551A front panel input through a 50 Ω length through termination as shown in Figure 6-21.
2. Set the frequency synthesizer controls as follows:
 Frequency 8 kHz
 Amplitude 1 Vrms (0 dBV)
 Function Sine Wave
3. Set the hp-3551A controls as follows:
 PRESET
 DEFINE RANGE 0 dBV
 TRIGGER SELECT TRIGGER
 SETUP SELECT DEFINE % OF RING 50 %
 SLOPE POS
 MARKER DEFINE MRK POS 8 kHz
4. The hp-3551A CRT screen should appear as shown in Figure 6-22. The front panel "CHRG" LED should be off, the "TRIG" and "AMP" LEDs should be lighting, and the "70Hz" and "400Hz" LEDs should be on.

Pass: The hp-3551A display and front panel LEDs are correct. TEST G Complete. Continue with TEST H

Fail: The hp-3551A display or front panel LEDs are incorrect.

A10 Output Signal Test

1. Do not change the frequency synthesizer or the hp-3551A controls.
2. Use an oscilloscope to check the waveforms shown in Figure 6-23.
3. Check the voltage at the A15 Assembly test point TP"TRIG LV1" for $50V \pm 0.8Vdc$.

Pass: Both of the signals and the trigger level voltage are correct.

Fail: One of the signals or the trigger level voltage is incorrect.

Troubleshoot the A10 Assembly (Section 7: "Input Amplifier").

TEST C Continued on next page.

Figure 6-21 Input Signal Test Equipment Setup

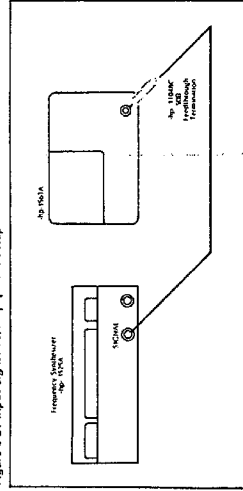

Figure 6-22 8 kHz Sine Wave

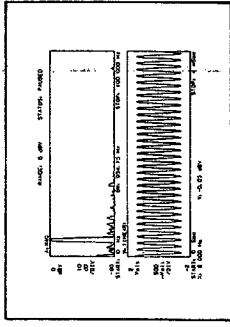

Figure 6-23 A10 Assembly Output Waveforms

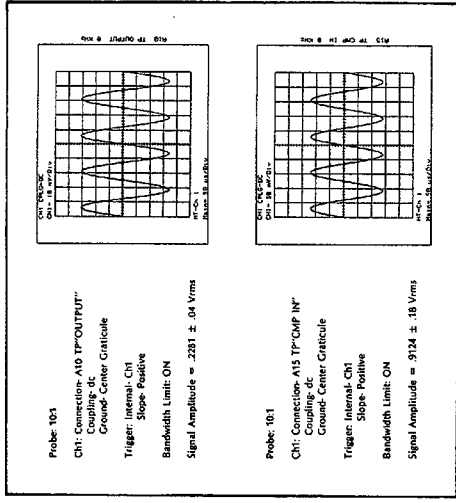
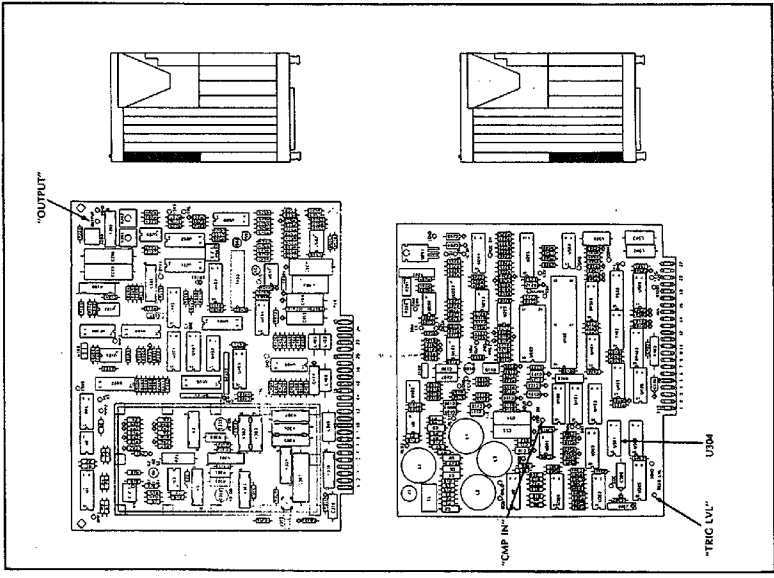

Figure 6-24 A10/A15 Component Locators



TEST G (Continued)

A15 Programming Test

1. Set the -hp-3561A controls as follows:

PRESET
MODE TEST SELECT DEFINE TEST NUM .110 ENTER
START CONT TST
2. Use an oscilloscope to check the waveforms given in Figure 6-27.
The test point locations are given in Figure 6-26.
3. Press the -hp-3561A PRESET key.

Pass: All of the A20 programming signals are correct.

Troubleshoot the A15 Assembly (Section 7: "Digitizer").

Fail: One or more of the A15 programming signals is incorrect.

A20 Programming Test

1. Turn the -hp-3561A LINE power switch OFF.
2. Place the A20 Assembly on an extender board, and remove the A10 Assembly.

CAUTION

Before removing the A10 Assembly, remove the bottom cover and disconnect the the input cable (W10).

3. Turn the -hp-3561A LINE power switch ON and set the controls as follows:

PRESET
MODE TEST SELECT DEFINE TEST NUM .110 ENTER
START CONT TST
4. Use an oscilloscope to check the waveforms given in Figure 6-28.
The test point locations are given in Figure 6-25.
5. Press the -hp-3561A PRESET key.

Fail: One or more of the A20 programming signals is incorrect.

Troubleshoot the A20 Assembly (Section 7: "Digital Filter").

Pass: All of the A15 programming signals are correct.

Troubleshoot the A10 Assembly (Section 7: "Input Amplifier").

Figure 6-25 A20 Component Locator

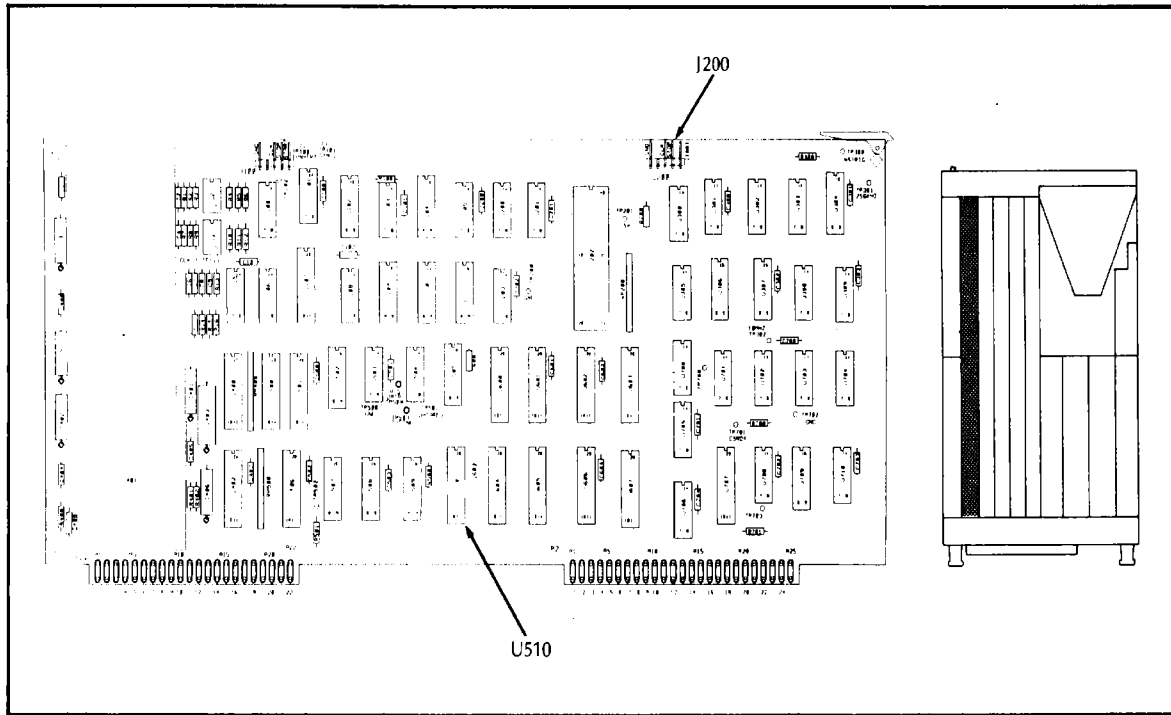

Figure 6-26 A15 Component Locator

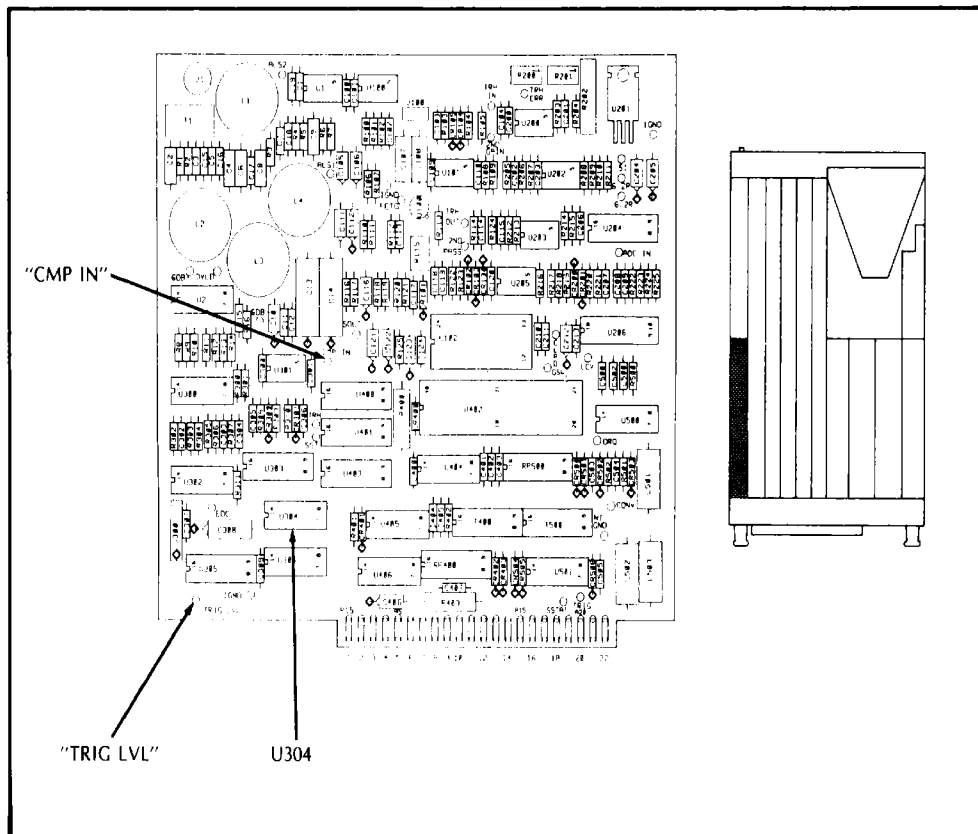

Figure 6-28 A20 Programming Waveforms

Probe: 10:1

Ch1: Connection- A20 U510(12) "FELATCH"
Coupling- dc
Ground- Center Graticule

Trigger: External- A20 J200(5)
Slope- Negative

Bandwidth Limit: ON

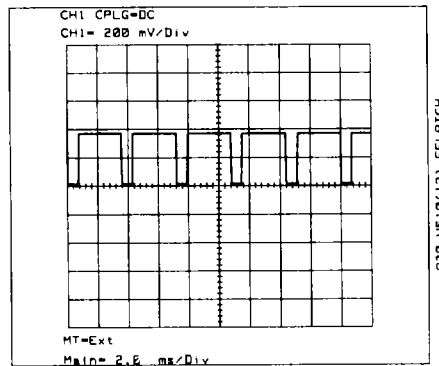

Probe: 10:1

Ch1: Connection- A20 U510(15) "FECLK"
Coupling- dc
Ground- Center Graticule

Trigger: External- A20 J200(5)
Slope- Positive

Bandwidth Limit: ON

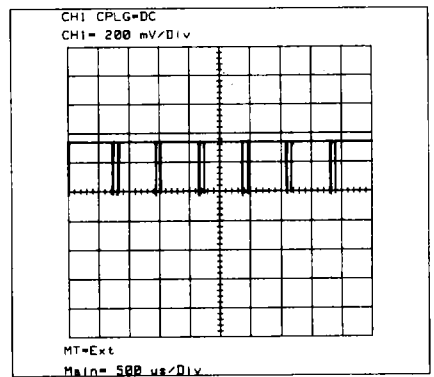

Probe: 10:1

Ch1: Connection- A20 U510(16) "FEDATA"
Coupling- dc
Ground- Center Graticule

Trigger: External- A20 J200(5)
Slope- Positive

Bandwidth Limit: ON

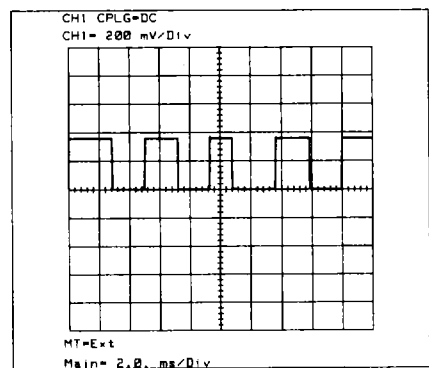

Figure 6-27 A15 Programming Waveforms

Probe: 10:1

Ch1: Connection- A15 U304(1) "FELATCHI"
Coupling- dc
Ground- Center Graticule

Trigger: External- A20 J200(5)
Slope- Negative

Bandwidth Limit: ON

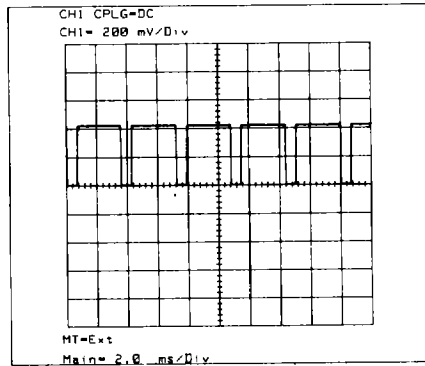

Probe: 10:1

Ch1: Connection- A15 U304(3) "FECLKI"
Coupling- dc
Ground- Center Graticule

Trigger: External- A20 J200(5)
Slope- Positive

Bandwidth Limit: ON

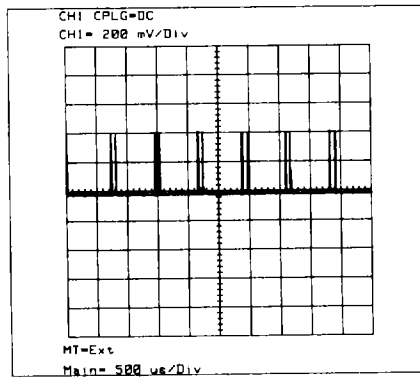

Probe: 10:1

Ch1: Connection- A15 U304(5) "FEDATAIC"
Coupling- dc
Ground- Center Graticule

Trigger: External- A20 J200(5)
Slope- Positive

Bandwidth Limit: ON

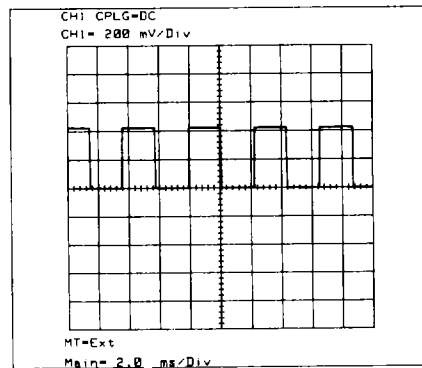

Fault Isolation

0 programming signals are correct.

Troubleshoot the A15 Assembly (Section 7: "Digitizer").

rect.

of the A20 programming signals is incorrect.

Troubleshoot the A20 Assembly (Section 7: "Digital F...")

TEST H: Local Oscillator/Noise Source

Local Oscillator Test

In this test, the noise source circuitry is used to output the local oscillator signal. The noise source output is checked first to verify the signal path, then self test 151 is used output the local oscillator signal.

1. Connect the -hp-3561A rear panel "SOURCE OUT" output to the 3561's front panel BNC connector.
2. Set the -hp-3561A controls as follows:

```

PRESET
WINDOW ..... UNIFORM
SOURCE ..... PERIODIC NOISE
          ..... DEFINE ATTEN ..... 0 dB
TRIGGER SELECT TRIGGER
          SOURCE TRIGGER
    
```

3. The -hp-3561A display should appear as shown in Figure 6-29. This verifies that the noise source signal path is operational. The marker should read -23 dBV ± 1.5 dB at 50 KHZ.
4. Set the -hp-3561A controls as follows:

```

PRESET
MODE ..... TEST SELECT ..... DEFINE TEST NUM 151 ENTER
          START CONT 151
    
```

5. Use an oscilloscope to check the local oscillator signal at the "SOURCE OUT" rear panel connector. The sine wave should appear as shown in Figure 6-30.

Pass: The local oscillator sine wave is correct.

TEST H Complete.
Continue with
TEST I

Fail: The local oscillator sine wave is incorrect.

Troubleshoot the A50 Assembly (Section 7: "Local Oscillator/Noise Source").

Figure 6-29 Periodic Noise Source Display

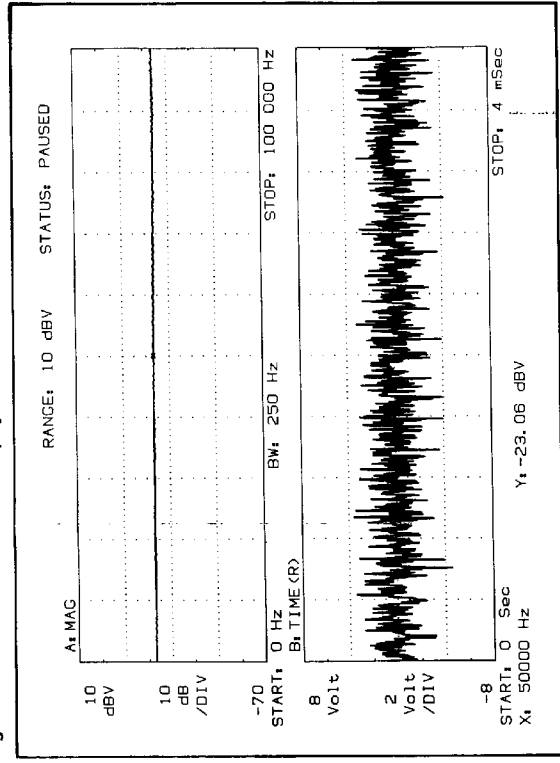
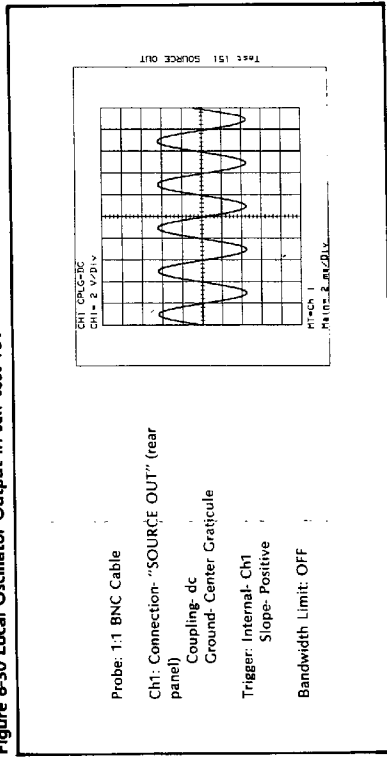

Figure 6-30 Local Oscillator Output in self test 151



6-18 TEST 1 CMOS/Bubble Memory A65, A66

Every instrument is equipped with either an A65 or an A66 Assembly. The A65 Assembly contains CMOS and bubble memory; the A66 Assembly contains only CMOS memory. Use the bubble memory test only if the instrument under test is equipped with an A65 Assembly.



Removing power, or turning the LINE power switch OFF while self test 20 is running, could result in permanent damage to the bubble memory.

CMOS Memory Test

- 1. Set the -hp-3561A controls as follows:

PRESET
MODE.....TEST SELECT.....DEFINE TEST NUM ...19 ENTER
START SNGL TST

- 2. The test should complete with no return codes. If any return codes are given, troubleshoot the CMOS memory on the A66/65 Assembly (Section 7: "CMOS/Bubble Memory").

Bubble Memory Test

- 1. Set the -hp-3561A controls as follows:

PRESET
MODE.....TEST SELECT.....DEFINE TEST NUM ...20 ENTER
START SNGL TST

- 2. The test should complete with no return codes. If any return codes are given, troubleshoot the bubble memory on the A65 Assembly (Section 7: "CMOS/Bubble Memory").

6-19 DIAGNOSTIC/SELF-TEST DESCRIPTIONS

6-20 Introduction

NOTE

The following information documents the meaning of the diagnostics and their Error Return Codes. If the -hp-3561A displays an Error Return Code during power-on or operation, refer to the Fault Isolation information in the front of this section for failure identification.

The -hp-3561A has many built-in diagnostic routines. These diagnostic routines are used during instrument power-up, adjustments and troubleshooting. There are four types of test routines which are identified by their test number as follows:

Power-On Routine Number 0

This routine is only performed on power-on or if the 68000 CPU IC reset line is activated (manually by the technician or automatically by the Low-Line monitor circuit in the Power Supply). Test 1 is also executed as part of the power-on routine.

Functional Routines Numbers 1 through 49

In these test routines, the processor tests and verifies the results of the tests. Test failures will be indicated on the CRT.

Adjustment Routines Numbers 50 through 99

In these test routines, the instrument is programmed to make a measurement and display the resultant data on the CRT.

Service Tests Numbers 100 and up

In these test routines, specific instrument circuits are set to defined conditions which are then verified by external equipment. For example, a circuit can be stimulated or set-up so that digital signature analysis or oscilloscope timing waveforms can be observed. The processor does not verify the results of the setups.

All of the test routines depend on the proper operation of the Processor/ROM (A40), Power Supply (A70,A71,A72 and A99), the Display (A60 and A90) and the Front Panel Keyboard (A80 and A81) except for the power up routine Test #0. The power up routine depends on proper operation of the power Supply, Processor/ROM and either the Display or the Front Panel.

Note that even though there are tests with numbers greater than 100, there are only 34 test routines in the instrument. These 34 test routines and their names are listed in Table 6-12 and described in paragraphs 6-23 through 6-51.

Table 6-12 -hp-3561A Diagnostic/Self Tests

Test Number	Description
0	Power-On Test: Only run at power-on or when the microprocessor reset input is activated. This test checks the processor and its support circuitry. The routine cannot be initiated from the front panel.
1	Quick Functional Test: causes the -hp-3561A to make one measurement and verify the result. Test 1 is automatically run after Test 0 as part of the power-on routine.
12	Test 12 tests the FFT circuitry on the A30 FFT/RAM Assembly. The processor initiates the FFT circuits to perform a transform on fixed data and then checks the result.
13	A20 Timing Counter Test: Checks the operation of the Timing Counter IC and its support circuitry. Both circuits are located on the A20 Assembly.
14	Digital Filter/DMA Channel R Test: Used to test the Digital Filter and Channel R DMA Address Counter circuits on the A20 Digital Filter Assembly.
18	DMA Channel G/ Trigger Test: Used to test the Channel G DMA Address Counter and Trigger circuits on the A20 Digital Filter Assembly.
19	CMOS Memory Test: Writes and reads a known pattern to the A66 CMOS Memory Assembly to check the CMOS memory IC. This test is also used to check the CMOS memory IC on the optional A65 CMOS/Bubble Memory Assembly
20	Bubble Memory Test: Writes and reads a known pattern to the A65 CMOS/Bubble Memory Assembly to check the Bubble Memory module. Note: Bubble Memory is an option for the -hp-3561A.
50	Display Pattern Test: Used for the alignment of the CRT display.
52	Calibrator Adjust Test: Used in the adjustment procedure to properly set the Calibrator Signal.
53	20dB Attenuator Adjustment Test: Places the -hp-3561A in a mode of operation used to adjust the A10 Input Assembly 20dB attenuator flatness.
54	40dB Attenuator Adjustment Test: Places the -hp-3561A in a mode of operation used to adjust the A10 Input Assembly 40dB attenuator flatness.
110	Front End Control Register Test: Used in troubleshooting to check the A10 Input Assembly Front End Control Register.
111 through 116	Digitizer Test Register Setups: Used in troubleshooting the A15 Digitizer Assembly. These tests program various circuits on the A15 assembly enabling waveform verification using an oscilloscope.
118	Display Calibration Correction: Prints the Calibration constant on the CRT.
119	Clear Calibration Correction: Resets the Calibration Constant.
120	Digital Filter DSA Test: Programs the A20 Digital Filter Assembly for digital signature analysis. Test Description Number.
121	Timing Counter DSA Test: Programs the Timing Counter IC on the A20 Digital Filter Assembly for troubleshooting.

Table 6-12 (Cont'd)

122	DMA Channel G DSA Test: Used to troubleshoot the A20 DMA Channel G address counter circuit using Digital Signature Analysis.
123	DMA Channel R DSA Test: Used to troubleshoot the A20 DMA Channel R address counter circuit using Digital Signature Analysis.
150	Local Oscillator DSA Test: Programs the A50 Assembly for Digital Signature Analysis.
151	Analog Source DSA Test: Used to test the analog portion of the source output. The processor programs the source to output a sinewave of approximately 250Hz at 8Vp-p.
152	Noise Source DSA Setup 1: Programs the A50 Assembly for Digital Signature Analysis.
153	Noise Source DSA Setup 2: Programs the A50 Assembly for Digital Signature Analysis.
154	HP-IB Interface Test: Programs the -hp-3561A to continually read the HP-IB I/O lines and display their state on the CRT.
167	Bubble Memory Read DSA Test: Used to troubleshoot the A65 Bubble Memory Assembly in its Read mode using Digital Signature Analysis.
168	Bubble Memory Bootloop Routine: Rewrites the bootloop in the Bubble Memory. This test can only be accessed and executed through HP-IB. All stored data is destroyed by this test routine.
169	Bubble Memory Reseed Routine: Used to Reseed the Bubble Memory module. This routine requires the use of the Reseed module -hp- Part Number 1818-3304. This module is part of the -hp-3561A Service Kit P/N 03561-80004. Note: This routine causes all data in the Bubble Memory module to be lost.
170	Bubble Memory Format Routine: Used to format the A65 CMOS with Bubble information. This test routine is necessary to run only if the A65 CMOS IC or the battery were replaced. When executed, the instructions will be displayed on the front panel CRT.

6-21 Test Menu Explanation

The Test Menu is the CRT display which defines the softkeys used to access and control the built-in -hp-3561A test routines. The Test Menu is displayed by pressing the following -hp-3561A front panel keys:

PRESET
 MODE TEST SELECT

This will cause the CRT to display the Test Menu shown in Figure 6-31.

Figure 6-31 -hp-3561A Test Menu

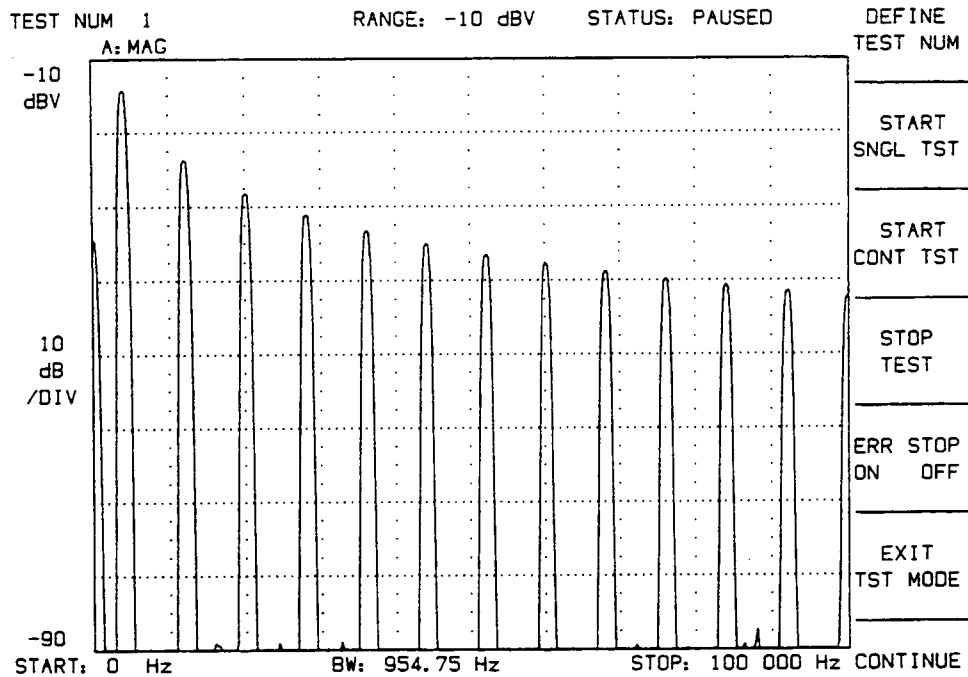

The following text describes the meaning and uses of each of the Softkey functions.

DEFINE TEST NUMBER: Pressing this key allows the operator to enter the test routine number to be executed. When pressed, the CRT will change the softkey definitions to ENTER and CANCEL. At this point, press the front panel numeric keys to define the test routine number. When entering the test routine number from the front panel keyboard, the entries are displayed in the upper left-hand portion of the CRT. If an incorrect number is entered, use the BACK SPACE key or press the CANCEL softkey. Pressing the CANCEL softkey will cause the CRT to display the Test Menu. Press the ENTER menu key to store the number into the instrument and redisplay the test menu.

START SINGLE TEST: Press this key to execute the test routine once. When pressed, the CRT will indicate that the test is in progress and then complete. Some tests are very short and the "test in progress" may not be seen. Any errors will also be displayed.

- START CONTInuous TeST:** Press this key to loop continuously on a test routine. When pressed, the CRT will indicate that the test is in progress. Also listed on the CRT will be any detected errors or continually updated test results.
- STOP TEST:** Pressing this key will halt a test routine which is running.
- ERRor STOP ON OFF:** Pressing this key toggles the "stop on error" function. When on, the test stops on the first error detected and displays the error return code on the CRT. When off, the test will display any error return code on the CRT and continue executing the test routine.
- EXIT TeST MODE:** Pressing this key will cause the instrument to terminate the test mode, execute a PRESET, and display the MODE menu on the CRT. This key is not active while a test is in progress.
- CONTINUE:** This key is used by some of the tests which pause to display a message. Pressing this key will cause the test routine to continue its operation.

6-22 General Error Code Format

The general error code format is a CRT displayed message with a three section number. The message is "RETURN CODE =" and the three section number defines the error. The three sections identify the test routine number, the class of error and the error type, in that order. The test routine section can be a one, two or three digit number depending on the test routine number. The class section is always a single digit number from one to nine. The error type is always a two digit number.

For example: RETURN CODE = 1 2 00

In the above example, the error detected is in test routine #1 as indicated by the first section number 1.

The second section is a 2 which indicates a timeout/no trigger problem. The explanation of the second section, error class, is given in Error Class Description following the next paragraph.

The third section is a 00 which indicates a DMA timeout problem. All third section error numbers are unique to the individual test routines. Their meaning is covered in the individual test descriptions in paragraphs 6-23 through 6-51.

ERROR CLASS DESCRIPTION

The second section of the error code indicates the class of error. It is a single digit number from 1 to 9. The classes are explained as follows:

- Class 1 = Programming error which is the case when the processor performs a setup on a circuit and then cannot read or reads back an incorrect setup.
- Class 2 = Timeout error which occurs when a function is triggered or initiated and does not return a "finished" signal within the correct time.
- Class 3 = DTACK error where DTACK is the DaTa ACKnowledge signal used during the handshaking of data. An error results if the DTACK signal does not occur within a time period determined by the particular data transfer.
- Class 4 = Undefined
- Class 5 = Overload error.
- Class 6 = Random/Undefined data error.
- Class 7 = RAM data error.
- Class 8 = ROM checksum error.
- Class 9 = DMA address counter contains incorrect data.

6-23 Test 0 Power-On Test

TEST DESCRIPTION

Test number 0 is automatically run during the initial power-on of the instrument (Test 1 is also run as part of the power-on routine). The power-on test checks the circuit block operations of the A30 FFT/RAM, A40 Main Processor and A60 Digital Display Driver Assemblies. These are the assemblies required to run the operating system. A failure during this test will result in an error message on the CRT display and an error pattern on the -hp-3561A front panel LEDs. Figure 6-32 shows the front panel LEDs used for error detection. The error numbers and their meaning are listed after the explanation of the test. Note that when more than one error is detected, only the first occurring error is indicated by the LEDs and the greater-than-one LED is illuminated. Also indicated by the LEDs is the assembly causing the error. The failing assembly would be the A30 FFT/RAM, A40 Processor or the A60 Digital Display Assemblies. However, all the errors detected are displayed on the CRT.

The circuits of the A30, A40 and A60 Assemblies are tested in the following order:

1. Turn on the front panel LEDs.
2. Check the main RAM on the A30 Assembly by writing and reading a known pattern.
3. Turn off the front panel LEDs.
4. Check the display RAM on the A60 Assembly by writing and reading a known pattern.
5. Turn on the front panel LEDs.
6. Check main ROM on the A40 Assembly by verifying their checksums.
7. Check the DaTACKnowledge signal for proper operation.
8. Turn off the front panel LEDs.
9. Display any errors and initiate the instrument's operating system.
10. Perform Test 1.

DEPENDENCY

Test 0 depends on the proper operation of the following assemblies:

1. A70,A71,A72,A99 Power Supply Assemblies
2. A80 and A81 Front Panel Assemblies or A60,A90 Display Assemblies

Figure 6-32 Front Panel LED Error Indicators For Test 0

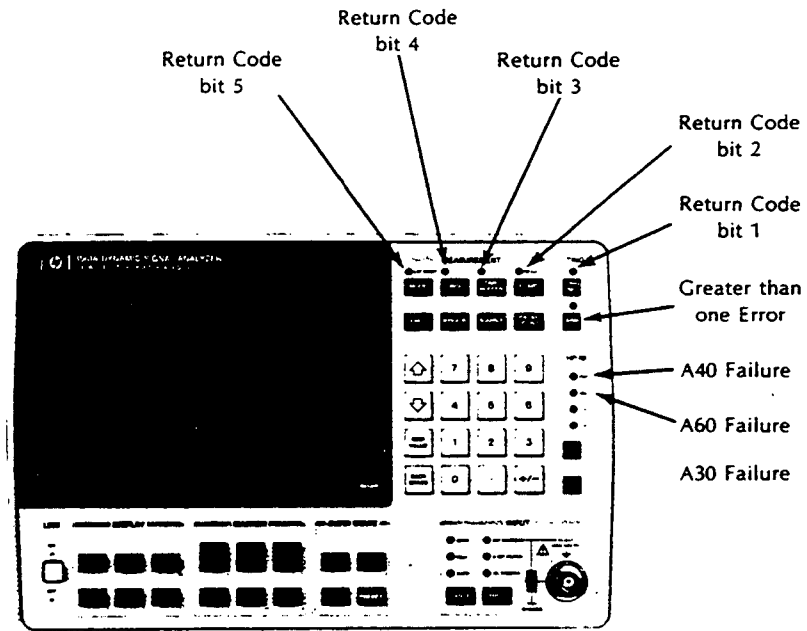

Example:

```

EXT SAMP - ON      16
AVG      - OFF     0
TIME BUFFER- OFF  0
MEAS     - ON      2
TRIG     - OFF     0
Return Code =    18
    
```

LED	Description
EXT SAMP	Has a value of 16 in the return code when turned on.
AVG	Has a value of 8 in the return code when turned on.
TIME BUFFER	Has a value of 4 in the return code when turned on.
MEAS	Has a value of 2 in the return code when turned on.
TRIG	Has a value of 1 in the return code when turned on.
ARM	More than one failure occurred during the power on test.
RMT	An A40 Assembly failure occurred during the power on test.
SRQ	An A60 Assembly failure occurred during the power on test.
LTN	An A30 Assembly failure occurred during the power on test.

TEST 0 ERROR CODE DESCRIPTION

The following is a list of all the error RETURN CODES which could be displayed during the power-on test 0. Included with the list of error RETURN CODES are their meaning.

RETURN CODE DESCRIPTION

0 8 01 through 0 8 24
 ROM Checksum Error where the defective ROM is identified by the two digit number of the return code. For example, return code 0 3 18 indicates a ROM checksum error in ROM U305 on the A40 Processor Assembly as indicated in the drawing below.

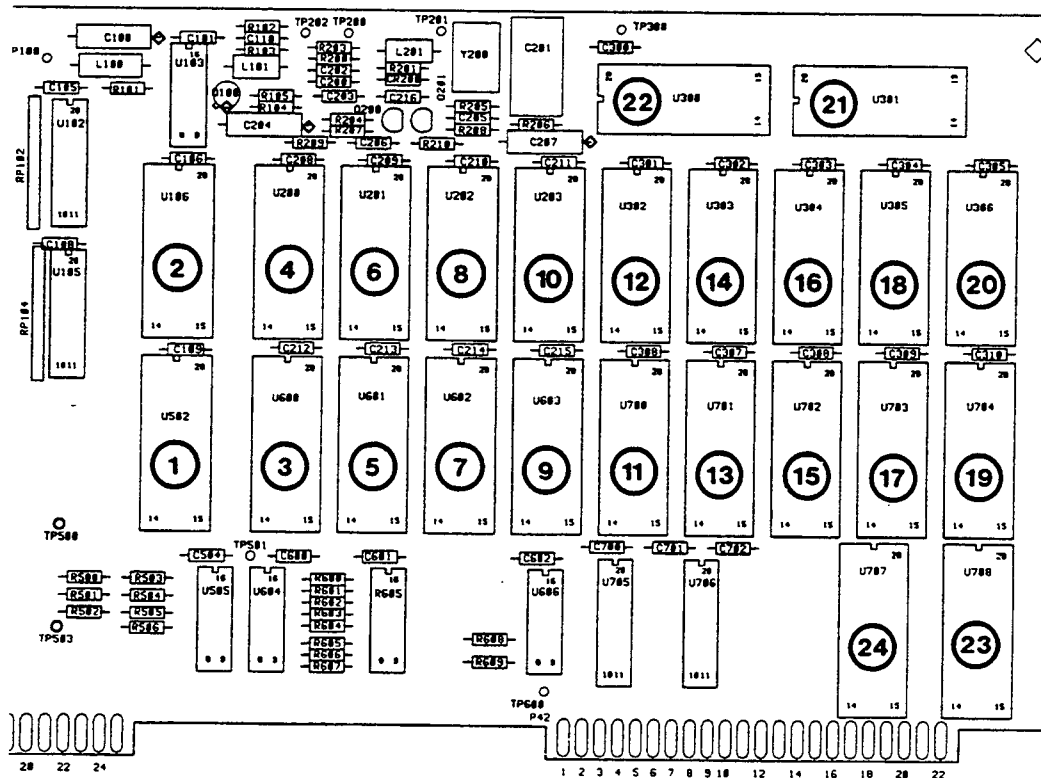

RETURN CODE	DESCRIPTION
0 3 25	DTACK error indicating that the Data handshake signal DaTaACKnowledge is not functioning properly.
0 7 26	Main RAM Error determined by writing to and reading from RAM and comparing the actual with the expected value. Also indicated with this error is a Chip Code which is displayed at the bottom of the CRT screen. The Chip Code will be a single hexadecimal number from 0 through F for each failure, indicating which RAM chip is defective. For example, if the Chip Code is B, then RAM U210 on the A30 FFT/RAM Assembly is defective as indicated in the drawing below.

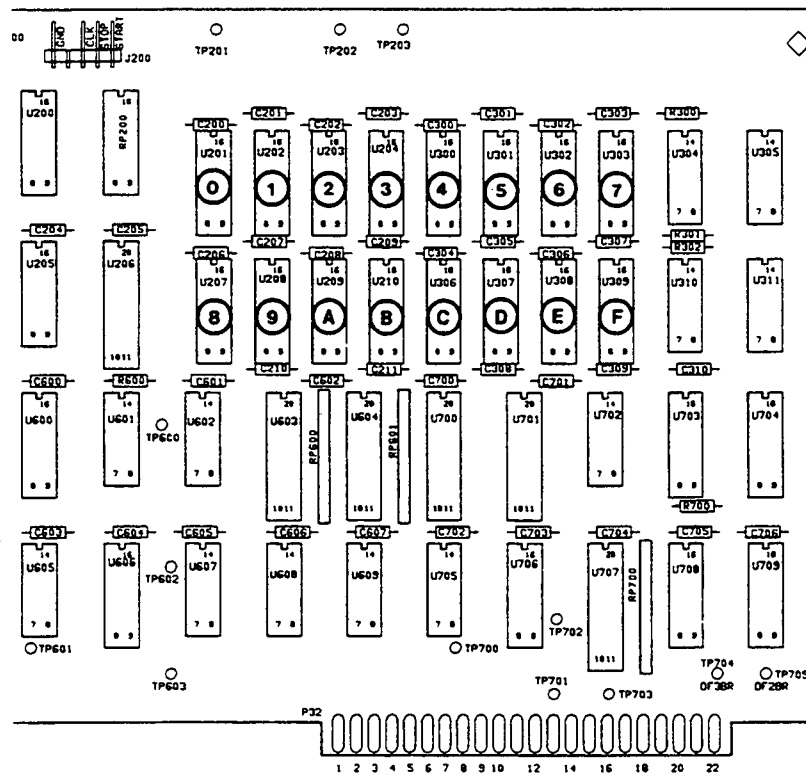

RETURN CODE DESCRIPTION

- 0 3 27 Main RAM DTACK Error indicates that the Main RAM DaTaACKnowledge handshake signal is not functioning properly.

- 0 7 28 Display RAM Error determined by writing to and reading from the Display RAM and comparing the actual with the expected value. Also indicated with this error is a Chip Code which is displayed at the bottom of the CRT screen. The Chip Code will be a single alpha character between G and Z for each failure, which will indicate the defective RAM. Use the following Plane Bit Vs. Chip table to determine which Display Ram is defective.

Plane 1 bit: 0 1 2 3 4 5 6 7
 Chip Code : G H J K L M N P

Plane 2 bit: 0 1 2 3 4 5 6 7
 Chip Code : R T U V W X Y Z

For example, if the RETURN CODE was 0 7 28 with a chip code of N, this indicates a Display RAM IC error in bit 6 of Plane 1 which is A60U5. See the diagram below to cross-reference the chip codes with the actual IC.

- 0 3 29 Display DTACK Error indicates that the Display RAM DaTaACKnowledge handshake signal is not functioning properly.

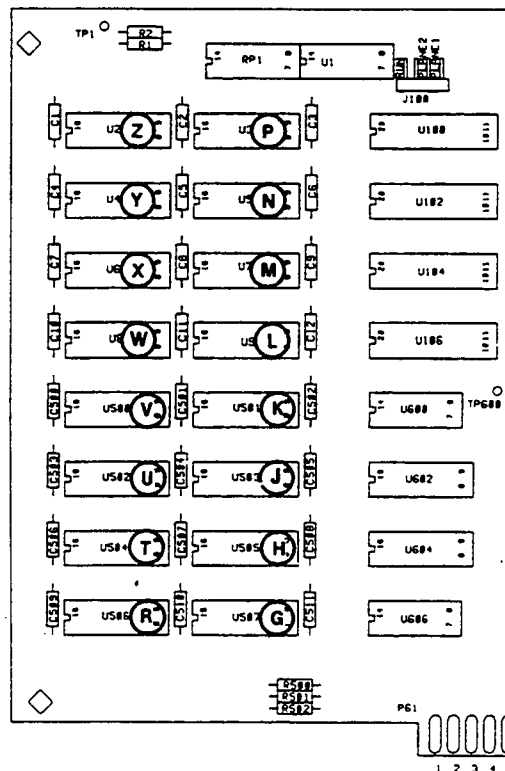

RETURN CODE	DESCRIPTIONS
0 2 30	Unexpected Interrupt indicates that an interrupt was generated out of sequence.
0 7 31	RAM Refresh Test Error

6-24 Test 1 Quick Functional Test

TEST DESCRIPTION

The Quick Functional Test takes a zoom measurement on the built in 4kHz cal signal and checks for a correct spectrum. This test is meant to be a global confidence test. The cal signal is input to the A10 Input Assembly and processed through the entire signal path. This test is run automatically after the Power-On Test 0. If any errors are detected, their RETURN CODE is displayed on the CRT.

In Test 1, the following takes place:

1. Initialize I/O Ports on the A10 Front End Register, A50 Local Oscillator, A20 DMA, A50 Source, and A20 Trigger and Calibrate circuits.
2. Start the A20 Channel G in triggered mode.
3. Initiate and start the A20 FFT.
4. Compare the actual spectrum with the expected.

DEPENDENCY

Test 1 is meant to be a global confidence test. As such, all boards are tested and must be functionally operational.

TEST 1 ERROR CODE DESCRIPTIONS

The following is a list of all of the error RETURN CODES which could be displayed during the quick functional test. Included with the list of error RETURN CODES are their meaning.

RETURN CODE	DESCRIPTION
1 1 00	Front End Programming error occurs when the Front End Control Register circuit setup is read by the processor and is found to be incorrectly set.
1 1 01	Timing Counter Programming error indicates that the A20 Timing Counter setup is incorrect.
1 2 00	DMA Timeout error can occur if DMA does not request a data transfer when expected.
1 2 01	Trigger Timeout error indicates the trigger did not occur when expected.
1 2 02	FFT Timeout error indicates that the FFT circuitry did not request a data transfer when expected.
1 2 03	Autozero DMA Timeout error.
1 5 00	Front End/Digital Filter Overload occurs if the Front End Control Register or the Digital Filter circuits overload or if they did not overload when expected.
1 5 01	FFT Overload error indicates the A20 FFT circuitry overloaded or did not overload when expected.
1 6 00	Fundamental incorrect.
1 6 01	Even Harmonic incorrect.
1 6 02	Odd Harmonic incorrect.
1 6 03	DC bin error.
1 6 04	Noise Floor error.

6-25 Test 12 A30 FFT Test**TEST DESCRIPTION**

In Test 12, the processor uses the FFT circuitry on the A30 Assembly to perform an FFT on fixed data. The processor then compares the actual results with the expected results.

DEPENDENCY

Test 12 depends on the proper operation of all the assemblies with the exception of the following:

1. A10 Input Assembly
2. A15 Digitizer Assembly
3. A50 Local Oscillator Noise Source Assembly
4. A20 Digital Filter Assembly

TEST 12 ERROR CODE DESCRIPTIONS

RETURN CODE	DESCRIPTION
12 2 00	FFT Timeout error indicating that the A20 FFT circuitry did not request a data transfer when expected.
12 5 00	FFT Overload error indicates that the A20 FFT circuitry overloaded or did not overload when expected.
12 6 00	FFT Auto Scaling error.
12 6 02	Time Buffer Corrupted error.
12 6 05	FFT Output Bad error.
12 6 06	Both errors 02 and 05 occurred.
12 6 07	No FFT Output error.
12 6 08	Both errors 02 and 07 occurred.
12 6 98	Twiddle buffer error.
12 6 99	Window Buffer error.

6-26 Test 13 A20 Timing Counter Test

TEST DESCRIPTION

In this test, the processor uses the Timing Counter on the A20 Assembly to read a fixed clock which tests the operation of the Timing Counter, the processor interface to it and the fixed clock, all of which are on the A20 Digital Filter Assembly. The Timing Counter is tested with two signal frequencies; 2.048 MHz and 5.12 MHz. At each of those frequencies, the Timing Counter's outputs are read by the processor and the data is compared with the expected result. The tested circuits of the A20 Assembly are checked in the following order:

1. The Timing Counter is initialized and verified by the processor through the Timing Counter I/O.
2. The Timing Counter Clock is preset to 2.048 MHz and enabled.
3. The Timing Counter Clock is disabled after 100 mS and the processor reads the output states of the Timing Counter through the Timing Counter I/O.
4. The processor compares the actual data with the expected data and displays any errors on the CRT.

Steps 1 through 3 are repeated with step 2 setting the Timing Counter Clock to 5.12MHz. These two tests are repeated 6 times using a different Timing Counter Circuit setup each time, thereby checking all operating combinations of the Timing Counter IC.

DEPENDENCY

This test depends on the proper operation of the following circuits:

1. A20 Digital Filter Assembly
2. A30 FFT/RAM Assembly

TEST 13 ERROR CODE DESCRIPTIONS

The following is a list of all of the error RETURN CODES which could be displayed during the A20 Timing Counter Test. Included with the list of error RETURN CODES are their meaning.

RETURN CODE	DESCRIPTION
13 1 00 through 13 1 05	Timing Counter Programming error is displayed if the processor reads the Timing Counter after the setup and the result is incorrect. The third section number 00 through 05 indicates which of the six Timing Counter Setups failed.
13 6 00 and 13 6 01	Timing Counter error determined by reading the Timing Counter outputs and verifying that the actual data does not match the expected data.

6-27 Test 14 A20 Digital Filter/DMA Channel R Test**TEST DESCRIPTION**

In Test 14, the processor writes data to the A20 Digital Filter Assembly. The Digital Filter then processes the data and transfers the result to RAM. The RAM address is established by the DMA Channel R counters. This test exercises the A20 Digital Filters, the DMA Channel R counters, the RAM BUS Arbitrator and the Channel Select circuits.

DEPENDENCY

This test depends on the proper operation of the following assemblies:

1. A20 Digital Filter Assembly
2. A30 FFT/RAM Assembly

TEST 14 ERROR CODE DESCRIPTIONS

The following is a list of all of the error RETURN CODES which could be displayed during the Digital Filter/DMA test. Included with the list is a description of each of the codes.

RETURN CODE	DESCRIPTION
14 2 00 through 14 2 11	DMA Timeout occurs if the DMA Channel R does not request a DMA transfer when expected. This error can also occur if the Digital Filter IC's do not request a DMA transfer. There are twelve subtests where the DMA transfer request is monitored and a problem in any one can cause a unique RETURN CODE as indicated by the last two-digit number 00 to 11. The twelve subtests are listed following the Test 14 RETURN CODE descriptions.
14 2 20	FFT Timeout error indicates that the A20 FFT circuitry did not request a data transfer when expected.
14 5 00 through 14 5 11	Digital Filter Overload occurs if after the subtest routine, the Digital Filter IC indicates an overload when not expected or does not indicate an overload when expected. There are twelve subtests where an overload can occur as indicated by the last two-digit number (00 to 11) in the RETURN CODE. Those subtests are listed following the Test 14 RETURN CODE descriptions.
14 5 20	FFT Overload error indicates the A20 FFT circuitry overloaded or did not overload when expected.
14 6 00 through 14 6 11	Digital Filter Data Error occurs when the data transferred from the Digital Filter IC to memory is not as expected. There are twelve subtests where a data error can occur as indicated by the last two-digit number of the RETURN CODE. Those twelve subtests are listed next.

TEST 14 SUBTESTS

00 The instrument is programmed to the Local Oscillator and Digitizer test mode. The test then verifies this setup.

The following 11 subtests alternately check the Real and Imaginary Digital Filter IC's with the various Decimation Amounts as indicated.

Subtest	Real/Imaginary	Decimation Amount
01	R	0
02	I	0
03	R	/5
04	I	/5
05	R	/10
06	I	/10
07	R	/20
08	I	/20
09	R	/2/10
10	I	/2/10
11	R	/2/5 (Zoom mode)

6-28 Test 18 A20 DMA Channel G and Trigger Test

TEST DESCRIPTION

In this test, the processor checks the Trigger and DMA Channel G counters on the A20 Digital Filter Assembly by presetting the A20 Trigger circuits and verifying the setup. It then checks the Channel G DMA counters and their ability to DMA data by starting a transfer into memory. The data transferred is written to the processor input port of the Digital Filter ICs and then to memory. The data in memory is then checked for validity.

DEPENDENCY

This test depends on the proper operation of the following assemblies:

1. A20 Digital Filter Assembly
2. A30 FFT/RAM Assembly

TEST 18 ERROR CODE DESCRIPTIONS

The following is a list of all the error RETURN CODEs which could be displayed during Test 18. Included with the list of error codes are their meaning.

RETURN CODE	DESCRIPTION
18 1 01 through 18 1 06	Timing Counter programming error is displayed if the processor reads the Timing Counter after the setup and the setup is incorrect. The third section number 01 through 06 indicates which of the Timing Counter setups failed.
18 3 01	Unexpected Trigger occurred when the Timing Counter was forced clear.
18 3 02	Unexpected Trigger occurred when the Timing Counter was armed.
18 3 03	Unexpected Trigger occurred when the Timing Counter was forced clear.
18 3 04	Unexpected Trigger occurred when the Timing Counter was forced clear.
18 3 05	Missing Trigger when triggered.
18 3 06	Missing Trigger when forced set.
18 3 07	DMA Channel G not done.
18 5 01	Digital Filter Overload error.
18 6 01	RAM changed during DMA off test.
18 6 02	Digital Filter data bad.
18 8 00 through 18 8 15	DMA Channel G address incorrect when testing block numbers 0 through 15.
18 9 01	DMA Address changed when DMA was off.
18 9 02	DMA Address was incorrect when DMA was enabled.
18 9 03	DMA Address was incorrect when DMA was finished.
18 9 04	DMA Address changed after DMA was completed.

6-29 Test 19 A65/A66 CMOS Memory Test**TEST DESCRIPTION**

In this test, the processor checks the operation of the CMOS IC on the A65/A66 Assemblies. The first step in the test is to read all data which is stored in CMOS and place it in main RAM. This is done so the data in CMOS is not destroyed. After the test, the data is written back into CMOS. During the test, the processor writes data into the CMOS memory and then reads it out again. The processor then compares the data and displays any error codes on the CRT display. This test checks the CMOS memory, the processor interface and the CMOS paging circuit.

DEPENDENCY

This test depends on the proper operation of all the assemblies with the exception of the following:

1. A10 Input Assembly
2. A15 Digitizer Assembly
3. A20 FFT/RAM Assembly
4. A50 Local Oscillator/Noise Source Assembly

TEST 19 ERROR CODE DESCRIPTIONS

There is only one error RETURN CODE in the CMOS Test 19. This error code indicates the actual data does not match the expected data. The problem could exist in the CMOS memory IC, the processor interface or the CMOS paging circuit.

The RETURN CODE is 19 6 00.

6-30 Test 20 A65 Bubble Memory Test**TEST DESCRIPTION**

In this test, the processor writes data to the A65 Bubble memory module and then reads it back again. The processor then compares the actual data with the expected data. If a mismatch is detected, an error condition exists and an ERROR CODE is displayed on the CRT. This test checks all of the Bubble Memory control circuits, the processor interface and the Bubble Memory module.

DEPENDENCY

This test depends on the proper operation of all the assemblies with the exception of the following:

1. A10 Input Assembly
2. A15 Digitizer Assembly
3. A20 Digital Filter Assembly
4. A50 Local Oscillator/Source Assembly

TEST 20 ERROR CODE DESCRIPTIONS

The following is a list of all the error RETURN CODES which could be displayed during the A65 Bubble Memory Test. Included with the list of error RETURN CODES are their meaning.

RETURN CODE	DESCRIPTION
20 1 00	No bubble is present or bad communication between the A40 Processor and A65 Bubble Controller.
20 2 00	The Bubble circuitry failed during a read operation.
20 2 01	The Bubble circuitry failed during a write operation.
20 2 02	RETURN CODEs 20 2 00 and 20 6 03 both occurred.
20 2 03	RETURN CODEs 20 2 01 and 20 6 03 both occurred.
20 6 00	The FIFO in the A65 Bubble Controller is not functioning properly.
20 6 01	The A65 Bootloop Register in the Sense Amplifier is not communicating with the Bubble Controller.
20 6 02	The Bubble cannot be initialized.
20 6 03	Data read from the Bubble memory at initialization does not match the fixed pattern. The first time this test is performed, this failure will occur since the stored pattern will not yet be in place. However, Test 20 checks and writes the fixed pattern twice, and if it fails the second time also, the next RETURN CODE 20 6 04 will be displayed.
20 6 04	Data read from the Bubble memory does not match the fixed pattern. See also RETURN CODE 20 6 03.
20 6 05	RETURN CODEs 20 2 00 and 20 2 01 both occurred.

6-31 Test 50 Display Pattern Test**TEST DESCRIPTION**

In this test, the processor writes to the A60 Digital Display Assembly causing a defined pattern to be displayed on the CRT. This pattern is used in the adjustments to align the CRT display. There are no error codes in this test.

DEPENDENCY

This test depends on the proper operation of the following circuits:

1. A40 Processor Assembly
2. A60 Digital Display Assembly
3. A70,A71,A72,A99 Power Supply Assemblies
4. A90 Analog Display Assembly

TEST 50 ERROR CODE DESCRIPTIONS

There are no error RETURN CODEs in Test 50.

6-32 Test 52 A10 Calibrator Adjustment**TEST DESCRIPTION**

In this test, the processor compares the internally generated Calibration signal with an external reference signal. Test 52 programs the -hp-3561A to make a measurement on an external reference with a frequency of 1 kHz and an amplitude of 200 mVrms, and then measure the internal calibrator signal. The difference between the two signals is then calculated and displayed on the CRT display. The adjustment is made to yield a difference of zero. The measurement and display routines are continuous. This allows the real-time adjustment of the internal Calibration signal.

DEPENDENCY

This test depends on the proper operation of all the assemblies with the exception of the A50 Local Oscillator/Noise Source and A65/66 CMOS Bubble Memory Assemblies.

TEST 52 ERROR CODE DESCRIPTIONS

The following is a list of all the error RETURN CODES which could be displayed during Test 52. Also included is description of the error.

RETURN CODE	DESCRIPTION
52 1 00	Front End Programming error occurs when the Front End Control Register circuit setup is read by the processor and is found to be incorrect.
52 1 01	Timing Counter programming error is displayed if the processor reads the A20 Timing Counter after the setup and the setup is incorrect.
52 2 00	DMA/Trigger Timeout error which can occur if DMA does not request a transfer when expected.
52 2 01	Trigger Timeout error indicates the trigger did not occur when expected.
52 2 02	FFT Timeout error indicates that the A20 FFT circuitry did not request a data transfer when expected.
52 2 03	Autozero DMA Timeout error. 52 5 00 Front End/Digital Filter Overload occurs if the Front End Control Register or the Digital Filter circuits overloaded or they did not overload when expected.
52 5 01	FFT Overload error indicates the A20 FFT circuitry overloaded or did not overload when expected.
52 6 00	Input Signal Out-Of-Range.

6-33 Test 53 A10 20dB Flatness Adjustment**TEST DESCRIPTION**

In this test, the processor programs the -hp-3561A to make a measurement on the internal Calibration Signal which is programmed to go through the 20dB attenuator on the A10 Assembly. This signal passes through the 20dB attenuator on the A10 Assembly. The measurement is made twice, once at each of two frequencies. Those frequencies are 1 kHz and 64 kHz. The processor then compares the magnitude of the two measurements. The difference in the magnitudes is then displayed on the CRT. This test is run continuously and the CRT is updated approximately every 100 ms.

DEPENDENCY

This test depends on the proper operation of all the assemblies with the exception of the A50 Local Oscillator/Noise Source and A65/66 CMOS Bubble Memory Assemblies.

TEST 53 ERROR CODE DESCRIPTIONS

The following is a list of all the error RETURN CODES which could be displayed during Test 53. Also included is the description of the error.

RETURN CODE	DESCRIPTION
53 1 00	Front End Programming error which occurs when the front end control circuit setup is read by the processor and is found to be incorrect.
53 1 01	Timing Counter programming error is displayed if the processor reads the A20 Timing Counter after the setup and the setup is incorrect.
53 2 00	Dma/Trigger Timeout error which can occur if DMA does not request a transfer when expected.
53 2 01	Trigger Timeout error indicates the trigger did not occur when expected.
53 2 02	FFT Timeout error indicates that the A20 FFT circuitry did not request a data transfer when expected.
53 2 03	Autozero DMA Timeout error.
53 5 00	Front End/Digital Filter Overload occurs if the Front End Control Register or the Digital Filter circuits overloaded or they did not overload when expected.
53 5 01	FFT Overload error indicates the A20 FFT circuitry overloaded or did not overload when expected.

6-34 Test 54 A10 40dB Flatness Adjustment**TEST DESCRIPTION**

In this test, the processor programs the -hp-3561A to make a measurement on the internal Calibrator Signal which is programmed to go through the 40dB attenuator on the A10 Assembly. The calibrate signal passes through the 40dB attenuator on the A10 Assembly. The measurement is made twice, once at each of two frequencies. Those frequencies are 1 kHz and 64 kHz. The processor then compares the magnitude of the two measurements. The difference in the magnitudes is then displayed on the CRT. This test is run continuously and the CRT is updated approximately every 100 mS.

DEPENDENCY

This test depends on the proper operation of all the assemblies with the exception of the A50 Local Oscillator/Noise Source and A65/66 CMOS Bubble Memory Assemblies.

TEST 54 ERROR CODE DESCRIPTIONS

The following is a list of all the error RETURN CODES which could be displayed during Test 54. Also included is the description of the error.

RETURN CODE	DESCRIPTION
54 1 00	Front End Programming error which occurs when the front end control circuit setup is read by the processor and is found to be incorrect.
54 1 01	Timing Counter programming error is displayed if the processor reads the A20 Timing Counter after the setup and the setup is incorrect.
54 2 00	Dma/Trigger Timeout error which can occur if DMA does not request a transfer when expected.
54 2 01	Trigger Timeout error indicates that the trigger did not occur when expected.
54 2 02	FFT Timeout error indicates that the A20 FFT circuitry did not request a data transfer when expected.

RETURN CODE	DESCRIPTION
54 2 03	Autozero DMA Timeout error.
54 5 00	Front End/Digital Filter Overload occurs if the Front End Control Register or the Digital Filter circuits overloaded or if they did not overload when expected.
54 5 01	FFT Overload error indicates that the A20 FFT circuitry overloaded or did not overload when expected.

6-35 Test 110 A10 Front End Control Register Test

TEST DESCRIPTION

Test 110 is used for troubleshooting the Front End Control Register on the A10 Input Assembly and the Test Control Register circuitry on the A15 Assembly. The processor sends a clock which is latched by the Front End Register. This is repeated for as long as Test 110 is allowed to run. This process generates defined states on the outputs of the Registers which enable Digital Signature Analysis or oscilloscope waveform analysis to be performed.

CAUTION

This test routine should not be used for periods longer than 30 minutes or the A10 relays may be damaged.

There are no error RETURN CODEs in Test 110.

DEPENDENCY

This test depends on the proper operation of all the assemblies with the exception of the A50 Local Oscillator/Noise Source and A65/66 CMOS Bubble Memory Assemblies.

6-36 Test 111 Through 116 A15 Timing And Control Circuit Setups

TEST DESCRIPTION

These tests are used to setup the A15 Timing And Control circuitry for troubleshooting. There are six setups which completely test the A15 Timing and Control circuitry.

NOTE

These setup tests cannot be changed by the operating system. It is important to exit these test modes by pressing the softkey EXIT TEST or by pressing the front panel PRESET key when you are finished with troubleshooting.

There are no error RETURN CODEs in Tests 111 through 116.

DEPENDENCY

These tests depend on the proper operation of all the assemblies with the exception of the A50 Local Oscillator/Noise Source and A65/66 CMOS Bubble Memory Assemblies.

6-37 Test 118 Display Calibration Constants

TEST DESCRIPTION

Test routine 118 causes the Calibrate Correction Constants to be displayed on the CRT. This test disrupts normal instrument operation if PRESET or EXIT TEST mode keys are not pressed to exit Test 118. After initiating the test routine, press the MODE key to display the normal measurement screen. Use the MARKER to display the desired Calibrate Correction. In the Frequency display, the MARKER value X indicates the frequency and Y indicates the Calibrate Correction. In the Phase display, the MARKER value X indicates degrees and Y indicates the Calibration Correction.

There are no error RETURN CODEs in Test 118.

6-38 Test 119 Clear Calibration Constant**TEST DESCRIPTION**

Test routine 119 resets the Calibrate Constant to zero. This test disrupts normal instrument operation if PRESET or EXIT TEST mode keys are not pressed to exit Test 119.

There are no error RETURN CODEs in Test 119. *SEC* 6-39 Test 120 A20 Digital Filter DSA

6-39 Test 120 A20 Digital Filter DSA**TEST DESCRIPTION**

Test 120 is used to troubleshoot the A20 Digital Filter circuits. The processor continually writes to the Digital Filter allowing Digital Signature Analysis.

There are no error RETURN CODEs in Test 120.

DEPENDENCY

Test 120 depends on the proper operation of all the assemblies with the exception of the following:

1. A10 Input Assembly
2. A15 Digitizer Assembly
3. A50 Local Oscillator/Noise Source Assembly
4. A65/66 CMOS Bubble Memory Assemblies

6-40 Test 121 A20 Timing Counter DSA**TEST DESCRIPTION**

Test 121 is used to troubleshoot the Timing Counter and associated circuitry on the A20 Digital Filter Assembly using Digital Signature Analysis. There are no error RETURN CODEs in Test 121.

DEPENDENCY

Test 121 depends on the proper operation of the following assemblies:

1. A20 Digital Filter Assembly
2. A30 FFT/RAM Assembly

6-41 Test 122 A20 DMA Channel G DSA**TEST DESCRIPTION**

Test 122 is used to set up the A20 Digital Filter Assembly for troubleshooting the DMA Channel G circuitry using an oscilloscope to check the output timing waveforms.

There are no error RETURN CODEs in Test 122.

DEPENDENCY

Test 122 depends on the proper operation if the following assemblies:

1. A20 Digital Filter Assembly
2. A30 FFT/RAM Assembly

6-42 Test 123 A20 DMA Channel R DSA**TEST DESCRIPTION**

Test 123 is used to set up the A20 Digital Filter Assembly for troubleshooting the DMA Channel R circuitry using an oscilloscope to check the output timing waveforms.

There are no error RETURN CODEs in Test 123.

DEPENDENCY

Test 123 depends on the proper operation of the following assemblies:

1. A20 Digital Filter Assembly
2. A30 FFT/RAM Assembly

6-43 Test 150 A50 Local Oscillator DSA**TEST DESCRIPTION**

This test sets up the A50 PRN circuitry for troubleshooting using Digital Signature Analysis.

There are no error RETURN CODEs in Test 150.

DEPENDENCY

Test 150 depends on the proper operation of all the assemblies with the exception of the following:

1. A10 Input Assembly
2. A15 Digitizer Assembly
3. A65/66 CMOS Bubble Memory Assembly

6-44 Test 151 A50 Analog Source Test**TEST DESCRIPTION**

Test 151 programs the -hp-3561A to output an 8Vp-p 250Hz sinewave signal out the rear panel SOURCE BNC connector. This test is used to verify proper operation of the built-in source signal. It checks both the digital and the analog circuitry.

There are no error RETURN CODEs in Test 151.

DEPENDENCY

Test 151 depends on the proper operation of all the assemblies with the exception of the following:

1. A10 Input Assembly
2. A15 Digitizer Assembly
3. A65/66 CMOS Bubble Memory Assembly

6-45 Test 152 A50 Noise Source DSA Setup 1**TEST DESCRIPTION**

Test 152 is used to troubleshoot the Noise Source circuitry on the A50 Assembly using Digital Signature Analysis and oscilloscope waveform analysis.

There are no error RETURN CODEs in Test 152.

DEPENDENCY

Test 152 depends on the proper operation of all the assemblies with the exception of the following:

1. A10 Input Assembly
2. A15 Digitizer Assembly
3. A65/66 CMOS Bubble Memory Assembly

6-46 Test 153 A50 Noise Source DSA Setup 2**TEST DESCRIPTION**

Test 153 is used to troubleshoot the PRN ROM using Digital Signature Analysis and oscilloscope waveform analysis.

There are no error RETURN CODEs in Test 153.

DEPENDENCY

Test 153 depends on the proper operation of all the assemblies with the the exception of the following:

1. A10 Input Assembly
2. A15 Digitizer Assembly
3. A65/66 CMOS Bubble Memory Assembly

6-47 Test 154 A50 HP-IB I/O Verification Test Routine**TEST DESCRIPTION**

In this test, the HP-IB I/O circuitry is checked for proper operation. Test 154 is a user interactive test. While the test is running, the HP-IB connector pins must be shorted to ground, one pin at a time. When this is done, the CRT will so indicate. The HP-IB connector is located on the rear panel of of the -hp-3561A. See Figure 6-33 for the pinout configuration.

There are no error RETURN CODEs in Test 154.

Note: Test 154 can only be accessed through the front panel.

Figure 6-33 HP-IB Connector Pinout Configuration

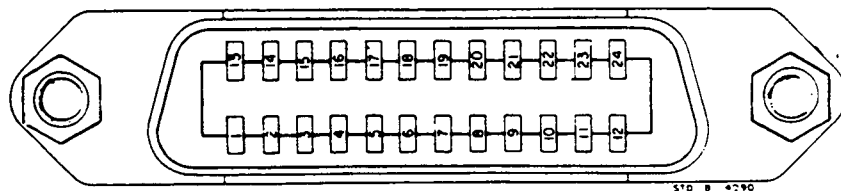

CAUTION

The -hp-3561 contains metric threaded HP-IB cable mounting studs as opposed to English threads. Metric threaded -hp-10833A, B, C or D HP-IB cable lockscrews must be used to secure the cable to the instrument. Identification of the two types of mounting studs and lockscrews is made by their color. English threaded fasteners are colored silver and metric threaded fasteners are colored black. DO NOT Mate silver and black fasteners to each other or the threads of either or both will be destroyed. Metric threaded HP-IB cable hardware illustrations and part numbers follow.

Pin	Line
1	D101
2	D102
3	D103
4	D104
13	D105
14	D106
15	D107
16	D108
5	EOI
17	REN
6	DAV
7	NRFD
8	NDAC
9	IFC
10	SRQ
11	ATN
12	SHIELD - CHASSIS GROUND
18	P/O TWISTED PAIR WITH PIN 6
19	P/O TWISTED PAIR WITH PIN 7
20	P/O TWISTED PAIR WITH PIN 8
21	P/O TWISTED PAIR WITH PIN 9
22	P/O TWISTED PAIR WITH PIN 10
23	P/O TWISTED PAIR WITH PIN 11
24	ISOLATED DIGITAL GROUND

NOTE
The HP-IB is Hewlett-Packard implementation of IEEE std 488-1978, "Standard Digital Interface for Programmable Instrumentation."

THESE PINS ARE INTERNALLY GROUNDED

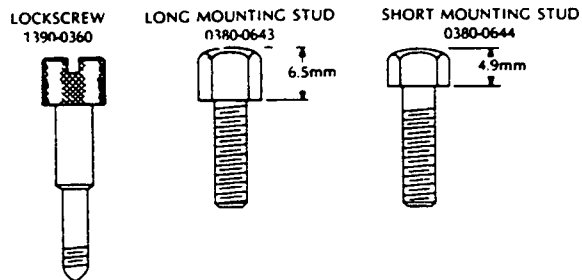

HP-IB Interconnect Cables

Part Number	Length
10833A	1 m (3.3 ft)
10833B	2 m (6.6 ft)
10833C	4 m (13.2 ft)
10833D	0.5 m (1.6 ft)

TEST OPERATING PROCEDURE

Use the following procedure to initiate and operate the HP-IB I/O Verification Routine:

1. Program the -hp-3561A to run Test 154 by pressing the following front panel keys:

```
PRESET
MODE ..... TEST SELECT .....154 ENTER
START CONT..... TeST
```

The CRT should indicate that Test 154 is in progress and to press the STOP TEST key to ABORT the test. The STOP TEST key must be pressed to exit this test! Failure to do this will result in -hp-3561A operating errors! The CRT should also display the HP-IB I/O connector signal names, pin numbers and pin-state in six columns as shown next:

DIO1	1	O	O	13	DIO5
DIO2	2	O	O	14	DIO6
DIO3	3	O	O	15	DIO7
DIO4	4	O	O	16	DIO8
EOI	5	O	O	17	REN
DAV	6	O	O	18	GND
NRFD	7	O	O	19	GND
NDAC	8	O	O	20	GND
IFC	9	O	O	21	GND
SRQ	10	O	O	22	GND
ATN	11	O	O	23	GND
SHLD	12	O	O	24	IGND

where columns one and six identify the signal names, columns two and five identify the connector pin numbers and columns three and four identify the state of the pins (O indicates a high state).

2. Short the I/O pins to chassis (ground) one at a time. The shorted pin will cause the CRT to display a # instead of an O next to the corresponding pin number.

For example: Short pin number 1 of the HP-IB connector to ground. This will cause the CRT to display

```
DIO1  1  #  instead of  DIO1  1  O
```

No other pins should be affected. If any other pins are affected, troubleshoot the HP-IB circuitry.

Only pin 11, ATN, will cause changes to other pins. When pin 11 is grounded, the CRT will display the following:

DIO1	1	?	?	13	DIO5
DIO2	2	?	?	14	DIO6
DIO3	3	?	?	15	DIO7
DIO4	4	?	?	16	DIO8
EOI	5	?	?	17	REN
DAV	6	?	O	18	GND
NRFD	7	?	O	19	GND
NDAC	8	?	O	20	GND
IFC	9	?	O	21	GND
SRQ	10	?	O	22	GND
ATN	11	#	O	23	GND
SHLD	12	O	O	24	IGND

Note that the SHLD and GND pins will never change. Their state will always display a O.

Remember, press the STOP TEST key before changing test modes or exiting Test 154.

DEPENDENCY

Test 154 depends on the proper operation of the following circuits:

1. A30 FFT/RAM Assembly

6-48 Test 167 A65 Bubble Memory Read DSA

TEST DESCRIPTION

Test 167 is used to troubleshoot the A65 Bubble Memory Assembly using Digital Signature Analysis. In this test, the processor continually reads a fixed pattern from record 128 of the Bubble Memory module. Note that this test does not destroy any data stored in the Bubble Memory module.

DEPENDENCY

Test 167 depends on the proper operation of all the assemblies with the exception of the following:

1. A10 Input Assembly
2. A15 Digitizer Assembly
3. A20 Digital Filter Assembly
4. A50 Local Oscillator/Noise Source Assembly

TEST 167 ERROR CODE DESCRIPTIONS

There is only one error RETURN CODE in Test 167. It is 167 1 00. This error indicates that the A65 Assembly is not installed or that the communication between the A65 Assembly and the A40 Processor is not functioning properly.

6-49 Test 168 A65 Bubble Memory Bootloop Routine

TEST DESCRIPTION

Test Routine 168 is used to rewrite the Bootloop into the Bubble Memory module. The purpose of the Bootloop is to provide a map that shows which storage loops are good and which are defective. This map is stored internally to the Bubble Memory module. It is also copied on a label on the outside of the Bubble Memory module (A65 U4) which is used by this routine. The Bootloop also contains a synchronization code which is used in positioning the data storage loops to provide a physical address reference.

The Bootloop will normally never need to be rewritten during the useful life of the Bubble Memory module. However, when the Bootloop is rewritten, all data stored in the Bubble Memory module is lost.

Note: This test routine can only be accessed through HP-IB!

BOOTLOOP ROUTINE OPERATING PROCEDURE

The Bootloop Routine requires an -hp-9836 HP-IB controller. The program listed in the following pages must first be loaded into the controller. To run the program, answer the prompts which will be displayed on the controller CRT. The prompts are explained following the error code descriptions.

TEST 168 ERROR CODE DESCRIPTIONS

There is only one error RETURN CODE in Test 168. It is 168 1 00. This error indicates that the A65 Bubble Memory Assembly is not installed or that the communication between the A40 Processor and the A65 Bubble Memory Assemblies is not functioning properly.

BOOTLOOP PROGRAM PROMPT EXPLANATIONS



Turn power off before removing or installing the A65 Assembly.

There are two methods to load the Bootloop program into the controller. The first method is to type the program listed in the following pages into the controller and pressing RUN. The second method is to load the program from the 5¼ inch floppy disk P/N 03561-69400 and pressing RUN. If the 5¼ inch floppy disk is available, use the following procedure to load and run the Bootloop program:

1. Insert the floppy disk P/N 03561-69400 into the right drive of the -hp-98364 Controller.
2. Type "LOAD BOOTLOOP" and press the RUN key.

All operating instructions are displayed on the controller CRT and explained in the following paragraphs.

After loading the basic program into the controller, type RUN to begin. The first screen will say to remove the A65 Bubble Memory assembly and copy the bootloop. The bootloop is located on the Bubble Memory module label. The following is an example:

7110-1	Part number
PYI03 8251	Date code
FFDBDFFBBFBFF9F	
BBFFF8FF77FFF8FF	
FFFFFF9FFDFFEFF	Bootloop (hexadecimal characters)
FFFFBFDD7DEFFFD	
FDF5FFCF8C9D9BF9	

Carefully copy the bootloop onto a piece of paper. It will be entered into the controller later. It is important to copy the bootloop accurately since entering the incorrect bootloop will harm the Bubble Memory module necessitating its replacement.

After replacing the A65 Assembly and powering the instrument, set the HP-IB address to 11. Do this by pressing:

LCL DEFINE ADDRESS11 ENTER

After the address has been programmed and the -hp-3561A and controller have been cabled together, press the CONTINUE key on the controller.

The current bootloop in the Bubble Memory module will be read and displayed on the controller's CRT. Also displayed will be selections to:

1. Edit the bootloop displayed on the controller's CRT
2. Rewrite the displayed bootloop to the Bubble Memory module
3. Exit the bootloop routine and return the -hp-3561A to local control

EDIT mode allows the displayed bootloop to be modified using the cursor arrows, backspace key or space bar. Move the cursor over the incorrect bootloop element and type the correct hexadecimal character. To exit the edit mode, press the ENTER key on the controller and the three selection functions will again be displayed on the CRT.

REWRITE mode causes the CRT displayed bootloop to be written to the -hp-3561A Bubble Memory module. When this is performed, the display will ask if the bootloop is correct. If N, you will be allowed to re-edit. If Y, the bootloop will be written. After writing, the controller reads the new bootloop and compares it to the bootloop just written. If they match, the program is completed. If there is a mismatch, the controller will display the message:

AN ERROR WAS DETECTED IN SENDING THE BOOTLOOP, TRY AGAIN

and display the three selection functions on the CRT. Type 2 to rewrite the bootloop. If the above message is again displayed, perform Test Routine 169 "A65 Bubble Memory Reseed Routine." After which, again try to write the bootloop. If the failure is still present, troubleshoot the HP-IB or Bubble Memory assemblies.

EXIT mode aborts the program in an orderly fashion and returns the -hp-3561A to local control.

```

10 ! THIS PROGRAM IS A SERVICE ROUTINE USED WHEN SERVICING
20 ! THE ATLAS BUBBLE MEMORY BOOTLOOP. WHEN RUN, THE PROGRAM WILL
30 ! DISPLAY THE CURRENT BOOTLOOP STORED IN THE BUBBLE MEMORY. IF IT
40 ! APPEARS TO BE CORRECT, THE USER MAY THEN EXIT THE TEST. IF THERE
50 ! IS AN ERROR IN THE BOOTLOOP THE USER MAY CALL UP A SCREEN EDITOR.
60 ! EDIT THE BOOTLOOP AND THEN WRITE THE NEW BOOTLOOP TO THE BUBBLE
70 ! MEMORY. IF THERE IS A MISMATCH OF THE BOOTLOOP SENT AND THE
80 ! BOOTLOOP READ, THE USER IS NOTIFIED TO TRY AGAIN.
90 !
100 DIM Bootloop_ready$(1),Current_chr$(1)
110 DIM Key$(160)
120 INTEGER Bl_col,Bl_row
130 COM New_bootloop$(5)[16],Old_bootloop$(5)[16],INTEGER Bootloop(40)
140 CALL Scr_clr
150 PRINT "BUBBLE BOOTLOOP SERVICE PROGRAM"
160 PRINT ""
170 PRINT "THE BUBBLE BOOTLOOP IS PRINTED ON THE LABEL OVER THE BUBBLE CHIP."
180 PRINT "TURN OFF THE POWER AND PULL THE A65 BUBBLE MEMORY ASSEMBLY AND "
190 PRINT "COPY THE BOOTLOOP CAREFULLY."
200 PRINT ""
210 PRINT "EXTREME CARE IS NEEDED WHEN COPYING THE BOOTLOOP, SINCE WRITING"
220 PRINT "TO A BAD LOOP WILL HARM THE BUBBLE MEMORY."
230 PRINT ""
240 PRINT "WHEN FINISHED COPYING THE BOOTLOOP, REPLACE THE A65 BUBBLE MEMORY"
250 PRINT "ASSEMBLY. POWER UP THE INSTRUMENT, SET THE 3561A HP-IB ADDRESS TO"-
260 PRINT "11 AND PRESS THE CONTINUE KEY."
270 PAUSE
280 !
290 ! START TEST AND GET THE CURRENT BUBBLE BOOTLOOP
300 !
310 CALL Scr_clr
320 CALL Start_bub_tst
330 CALL Get_old_bl
340 FOR I=1 TO 5
350 PRINT Old_bootloop$(I)
360 NEXT I
370 PRINT ""
380 PRINT " CURRENT BUBBLE BOOTLOOP"
390 !
400 ! DISPLAY MENU
410 !
420 Menu_up: !
430 INPUT "ENTER(1.EDIT BOOTLOOP, 2.REWRITE BOOTLOOP, 3.EXIT):",Opt_num
440 IF Opt_num=1 THEN GOSUB Edit_bootloop
450 IF Opt_num=2 THEN GOSUB Rewrite_bl
460 IF Opt_num=3 THEN GOTO Test_done
470 GOTO Menu_up
480 !
490 ! REWRITE BOOTLOOP WILL SEND OUT THE NEW BUBBLE BOOTLOOP THEN READ
500 ! IT BACK AND VERIFY IT WAS PROPERLY SENT AND RECEIVED
510 !
520 Rewrite_bl: !
530 INPUT "ARE YOU SURE THE BOOTLOOP IS CORRECT? (Y OR N)",Bootloop_ready$
540 IF Bootloop_ready$<>"Y" THEN GOTO Menu_up
550 CALL Read_crt
560 CALL Setup_new_bl
570 OUTPUT 711;"CTTS"
580 CALL Send_bootloop
590 OUTPUT 711;"SPTS;"
600 A=SPOLL(711)

```

```

610 IF BIT(A,4)=0 THEN GOTO 600
620 OUTPUT 711:"SSTS:"
630 CALL Get_olb_b1
640 Cmp=FNCompare(New_bootloop$(*),Old_bootloop$(*))
650 IF Cmp=1 THEN GOTO Test_done2
660 CONTROL 1.1:6
670 CONTROL 1.0:1
680 PRINT " "
690 PRINT "AN ERROR WAS DETECTED IN SENDING THE BOOTLOOP. TRY AGAIN"
700 GOTO Menu_up
710 RETURN
720 !
730 ! EDIT BOOTLOOP IS A SIMPLE SCREEN EDITOR
740 !
750 Edit_bootloop: !
760 CONTROL 1.1:6
770 CONTROL 1.0:1
780 PRINT " "
790 PRINT "BOOTLOOP EDITOR"
800 PRINT ""
810 PRINT " THE ARROW KEYS, SPACE AND BACKSPACE CAN BE USED TO MOVE THE CURSOR
"
820 PRINT " WHEN A HEXADECIMAL DIGIT IS ENTERED ON THE KEYBOARD, IT WILL UPDAT
E"
830 PRINT " THE CURRENT CURSOR POSITION WITH THAT DIGIT AND ADVANCE THE CURSOR
"
840 PRINT ""
850 PRINT "HIT ENTER WHEN YOU ARE SATISFIED WITH THE BOOTLOOP"
860 B1_row=1
870 B1_col=1
880 CALL Intensify(B1_col,B1_row)
890 ON KBD GOSUB Process_keys
900 B1_entered=0
910 REPEAT
920 UNTIL B1_entered>0
930 OFF KBD
940 RETURN
950 !
960 ! PROCESS KEYS FROM THE KEYBOARD
970 !
980 Process_keys: Key$=KBDS
990 REPEAT
1000 DISP ""
1010 Key_code=NUM(Key${1,1})
1020 SELECT Key_code
1030 CASE 65 TO 70,48 TO 57 ! A TO F,0 TO 9
1040 CALL Print_new_chr(B1_col,B1_row,Key${1,1})
1050 B1_col=(B1_col MOD 16)+1
1060 IF B1_col=1 THEN B1_row=(B1_row MOD 5)+1
1070 Intensify(B1_col,B1_row)
1080 CASE 97 TO 102
1090 Key${1,1}=CHR$(Key_code-32)
1100 CALL Print_new_chr(B1_col,B1_row,Key${1,1})
1110 B1_col=(B1_col MOD 16)+1
1120 IF B1_col=1 THEN B1_row=(B1_row MOD 5)+1
1130 Intensify(B1_col,B1_row)
1140 CASE 32
1150 GOSUB Forward
1160 CASE 255
1170 Key$=Key${2}

```

```

1180     Key_code=NUM(Key${1,1})
1190     IF Key_code=66 THEN GOSUB Backup
1200     IF Key_code=60 THEN GOSUB Backup
1210     IF Key_code=62 THEN GOSUB Forward
1220     IF Key_code=94 THEN GOSUB Moveup
1230     IF Key_code=86 THEN GOSUB Movedown
1240     IF Key_code=69 THEN GOSUB Bl_enter
1250     CASE ELSE
1260     BEEP
1270     DISP "INPUT ERROR, LAST KEY IGNORED"
1280     END SELECT
1290     Key$=Key${2}
1300     UNTIL LEN(Key$)=0
1310     RETURN
1320 Forward: !
1330     Detensify(Bl_col,Bl_row)
1340     Bl_col=(Bl_col MOD 16)+1
1350     IF Bl_col=1 THEN Bl_row=(Bl_row MOD 5)+1
1360     Intensify(Bl_col,Bl_row)
1370     RETURN
1380 Backup: !
1390     Detensify(Bl_col,Bl_row)
1400     Bl_col=((Bl_col+14) MOD 16)+1
1410     IF Bl_col=16 THEN Bl_row=((Bl_row+3) MOD 5)+1
1420     Intensify(Bl_col,Bl_row)
1430     RETURN
1440 Moveup: !
1450     Detensify(Bl_col,Bl_row)
1460     Bl_row=((Bl_row+3) MOD 5)+1
1470     Intensify(Bl_col,Bl_row)
1480     RETURN
1490 Movedown: !
1500     Detensify(Bl_col,Bl_row)
1510     Bl_row=(Bl_row MOD 5)+1
1520     Intensify(Bl_col,Bl_row)
1530     RETURN
1540 Bl_enter: !
1550     Bl_entered=1
1560     Detensify(Bl_col,Bl_row)
1570     CONTROL 1,1;6
1580     CONTROL 1,0;1
1590     RETURN
1600 Test_done2: !
1610     CALL Scr_clr
1620     PRINT "BOOTLOOP WAS SUCCESSFULLY WRITTEN"
1630     GOTO Test_finished
1640 Test_done: !
1650     CALL Scr_clr
1660 Test_finished: !
1670     OUTPUT 711;"SPTS;RST;"
1680     LOCAL 711
1690     SEND 7;UNL
1700     PRINT "BOOTLOOP SERVICE ROUTINE FINISHED"
1710     END
1720 SUB Intensify(INTEGER Col,Row)
1730 DIM Intensify_chr${1}
1740 CONTROL 1,1;Row
1750 CONTROL 1,0;Col
1760 ENTER 1;Intensify_chr$
1770 PRINT CHR$(129)

```

```

1780 CONTROL 1,1;Row
1790 CONTROL 1,0;Col
1800 OUTPUT 1;Intensify_chr$
1810 PRINT CHR$(128)
1820 SUBEND
1830 SUB Detensify(INTEGER Col,Row)
1840 DIM Detensify_chr$[1]
1850 CONTROL 1,1;Row
1860 CONTROL 1,0;Col
1870 ENTER 1;Detensify_chr$
1880 CONTROL 1,1;Row
1890 CONTROL 1,0;Col
1900 OUTPUT 1;Detensify_chr$
1910 SUBEND
1920 SUB Print_new_chr(INTEGER Col,Row,New_chr$)
1930 CONTROL 1,1;Row
1940 CONTROL 1,0;Col
1950 OUTPUT 1;New_chr$
1960 SUBEND
1970 SUB Scr_clr
1980 OUTPUT 2;CHR$(255)&"K";
1990 WAIT .2
2000 SUBEND
2010 SUB Start_bub_tst
2020 OUTPUT 711;"TNUM 168;SSTS:"
2030 SUBEND
2040 SUB Get_oid_bl
2050 COM New_bootloop$(5)[16],Old_bootloop$(5)[16],INTEGER Bootloop(40)
2060 FOR I=1 TO 40
2070 ENTER 711 USING "#,B";Bootloop(I)
2080 NEXT I
2090 FOR I=1 TO 5
2100 Old_bootloop$(I)=" "
2110 FOR J=1 TO 8
2120 Old_bootloop$(I)=Old_bootloop$(I)&FNDechex$(Bootloop(J+(8*(I-1))))
2130 NEXT J
2140 NEXT I
2150 SUBEND
2160 DEF FNDechex$(INTEGER Dec_val)
2170 Hexstr$="0123456789ABCDEF"
2180 High=(Dec_val DIV 16)+1
2190 Low=(Dec_val MOD 16)+1
2200 RETURN Hexstr$[High,High]&Hexstr$[Low,Low]
2210 FNEND
2220 DEF FNHexdec(Hex_val$)
2230 Hexstr$="123456789ABCDEF"
2240 RETURN POS(Hexstr$,Hex_val$[1,1])*16+POS(Hexstr$,Hex_val$[2,2])
2250 FNEND
2260 SUB Read_crt
2270 COM New_bootloop$(5)[16],Old_bootloop$(5)[16],INTEGER Bootloop(40)
2280 CONTROL 1;1,1
2290 FOR I=1 TO 5
2300 ENTER 1 USING "16A";New_bootloop$(I)
2310 NEXT I
2320 SUBEND
2330 SUB Setup_new_bl
2340 COM New_bootloop$(5)[16],Old_bootloop$(5)[16],INTEGER Bootloop(40)
2350 FOR I=1 TO 5
2360 FOR J=1 TO 8
2370 Bootloop((I-1)*8+J)=FNHexdec(New_bootloop$(I)[(2*J-1),(2*J)])

```

```
2380     NEXT J
2390     NEXT I
2400     SUBEND
2410     SUB Send_bootloop
2420     COM New_bootloop$(5)[16],Old_bootloop$(5)[16],INTEGER Bootloop(40)
2430     FOR I=1 TO 40
2440         OUTPUT 711 USING "#,B":Bootloop(I)
2450     NEXT I
2460     SUBEND
2470     DEF FNCompare(S1$(*),S2$(*))
2480     FOR I=1 TO 5
2490         IF S1$(I)<>S2$(I) THEN RETURN 0
2500     NEXT I
2510     RETURN 1
2520     FNEND
```

6-50 Test 169 A65 Bubble Memory Reseed Routine

TEST DESCRIPTION

Test Routine 169 is used to Reseed the Bubble Memory module. This Routine requires a special electronic Reseed module which plugs into the IC socket of U102 on the A65 Bubble Memory Assembly. This Reseed module is -hp- part number 1818-3304 and is part of the -hp-3561A Service Accessory Kit -hp- part number 03561-84401.

A bubble is generated in the Bubble Memory module by replicating a seed bubble that is always present at the GEN element which is inside the module. If this seed is lost or destroyed, it will be necessary to run this routine.

RESEED ROUTINE OPERATING PROCEDURE

1. With the line power switch OFF, remove the A65 Bubble Memory Assembly.
2. Remove U102 and install the Reseed module 1818-3304 into U102's socket being careful to orient pin 1 properly as shown in Figure 6-34.

Figure 6-34 Reseed Module Installed Properly.

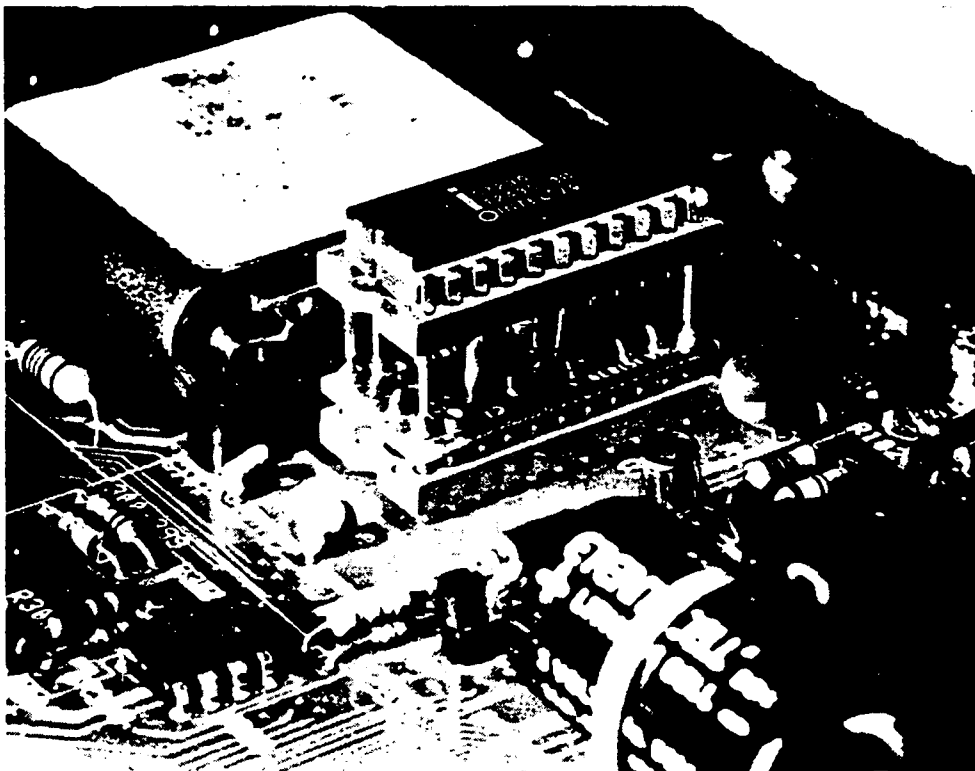

3. Install U102 into the Reseed module being careful to orient pin 1 properly.
4. Place a clip lead across 47 Ω resistor R104 effectively connecting U4(1,6) directly to +12V.
5. Install the A65 Assembly into the -hp-3561A using an extender board -hp- part number 03561-66596. An extender board must be used because the Reseed module and U102 IC combination will not have enough clearance to be installed in the instrument.
6. Turn the -hp-3561A power ON.
7. After the power-on routine, program the instrument to run Test 169 by pressing the following front panel keys:

MODE TEST SELECT 169 ENTER NTER

8. Begin the routine by pressing the softkey START SINGLE TEST.
9. The CRT will ask if the Reseed Module is in place and to press CONTINUE if it is. Press CONTINUE.

The Reseed routine will take less than one second.

10. When the Reseed routine is finished, turn the line power switch off and remove the clip lead and Reseed module, and reinsert U102 into the A65 Assembly.

Although it is not necessary, it is good practice to check the Bootloop of the Bubble Memory whenever it is necessary to Reseed. Do this by running Test 168. *SEC* 6-51 Test 170 Format Nonvolatile Memory Routine

6-51 Test 170 Format NonVolatile Memory Routine

TEST DESCRIPTION

Test Routine 170 is used to format the optional A65 Assembly. The format routine will initialize the CMOS IC with the Bubble Memory information. This test routine will normally only be necessary to run if the A65 CMOS IC or the battery were replaced.

TEST 170 OPERATING INSTRUCTIONS

Use the -hp-3561A Test Menu to initialize Test 170. Press the softkey START SINGLE TeST to execute. The instructions will be displayed on the CRT display.

TEST 170 ERROR CODE DESCRIPTIONS

There are two error RETURN CODEs in Test 170. They are listed and explained below.

RETURN CODE	DESCRIPTION
170 2 00	Bubble Initialize Timeout error occurs if the A65 bubble controller does not respond to the processor.
170 6 00	Bubble Bootloop Data error occurs when the processor cannot read data from the bootloop register

6-52 Overall Instrument Theory of Operation

6-53 Introduction to Theory of Operation

An overview of the -hp-3561A operation is given here to illustrate some of the primary interactions between the individual circuit boards. The 3561A's control circuits and bus structure are described first, followed by a description of the measurement data flow. A detailed circuit description for each circuit board is given in Section Seven. A simplified instrument block diagram is given in Figure 6-34, the assembly locations are given in Figure 6-35, and a detailed block diagram is given in Figure 6-36.

Figure 6-34 -hp-3561A Simplified Block Diagram

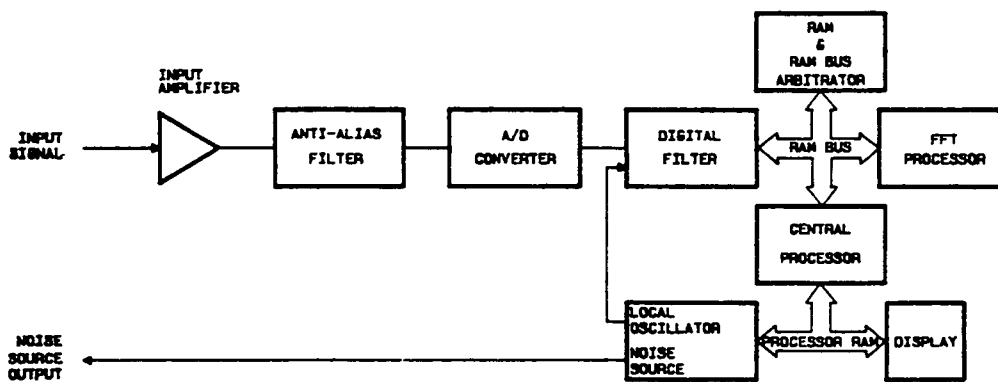

6-54 Control Circuits and Bus structure

INSTRUMENT CONTROL

The -hp-3561A is controlled by a 68000 microprocessor on the A40 Assembly. The microprocessor, ROM and other circuits on the A40 assembly are referred to here as the central processor. The central processor directs all activity required for the -hp-3561A to accept, process, and display measurement data. When power is initially applied to the the -hp-3561A, the central processor runs a self test and then configures the -hp-3561A circuits to preset conditions. The central processor then moni-

tors the front panel for new instructions. When a front panel key is pressed, the central processor programs the -hp-3561A circuits to implement the keyed instruction.

The -hp-3561A uses the processor bus and the RAM bus for instrument control and data transfer. The processor bus and RAM bus both consists of a 16 bit address bus and a 16 bit data bus. The processor bus is controlled by the central processor, and the RAM bus is controlled by the RAM bus arbitrator on the A30 Assembly. Because the -hp-3561A uses a two bus structure, two activities can take place at the same time (e.g., The processor can access the display over the processor bus at the same time as the digital filter is accessing RAM over the RAM bus).

PROCESSOR BUS

The processor address bus and data bus are used by the central processor to send instructions to the various -hp-3561A circuits and to transfer data to display. The processor address bus is a 16 bit single direction bus which is partially decoded on the A40 Assembly to generate select lines. Select lines are used to address a particular functional block. The functional block then decodes the remaining address lines to determine the exact circuit addressed. The processor data bus is a 16 bit bi-directional bus. Over this bus, the processor writes data to, or reads data from the addressed circuit.

RAM BUS

The RAM bus is used by three circuits to transfer data to and from the instrument RAM. The three circuits are the FFT processor, the central processor, and the digital filter. To prevent a bus contention, the RAM bus arbitrator uses a priority decoder to control access to both the RAM address bus and data bus. The FFT processor has top priority, the digital filter second, and the central processor third. To access the RAM bus, a circuit issues a RAM bus request. The RAM bus arbitrator compares the priority of the bus request to the priority of any other bus requests it has received and issues a bus grant to the highest priority requester. The circuit receiving the bus grant has access to the RAM bus until a higher priority bus request is received.

6-55 Measurement Data Flow

FFT MEASUREMENTS

The -hp-3561A uses the Fast Fourier Transform (FFT) to convert time domain data into frequency domain data. The FFT is a mathematical algorithm which is implemented in a microprocessor on the A30 Assembly called the FFT processor. The FFT processor is the heart of the -hp-3561A. Most other circuits in the -hp-3561A are provided to support the FFT processor by either preparing the input data to be transformed, or by transferring the FFT results to the CRT display.

The FFT processor operates on blocks of 1024 time domain data samples resulting in 512 frequency and 512 phase values.

INPUT AMPLIFIER (A10 ASSEMBLY)

The first step in processing the input signal is to scale its amplitude to the correct value for the A/D converter. This scaling is accomplished in the input amplifier circuits on the A10 Assembly. The gain of the input amplifier is set by the front panel range setting. An input sine wave with an amplitude equal to the range setting will be scaled to an amplitude of .228 Vrms at the input to the A15 Assembly.

ANTI-ALIAS FILTER AND A/D CONVERTER (A15 ASSEMBLY)

After it is scaled by the input amplifier, the input signal is passed through the 100 kHz low pass anti-alias filter. This filter prevents aliasing which occurs as part of the sampling process in the A/D converter.

At the output of the anti-alias filter, the input signal has been fully conditioned to be digitized. The analog-to-digital converter always samples the input signal at a 256 kHz rate (except in external sample mode). For each sample, the A/D converter outputs a 13 bit digital value to the digital filter.

DIGITAL FILTER (A20 ASSEMBLY)

The digital filter is a low-pass filter with a pass-band frequency span equal to the selected display frequency span. The digital filter processes data serially, that is the digital filter inputs only one data sample at a time and produces one output value for each input value. The digital filter outputs are stored directly into RAM. The RAM address where the data is stored is determined by the direct memory access (DMA) circuit. Because the FFT processor operates on blocks of 1024 data samples, the DMA circuit stores the digital filter output values in blocks of 1024 outputs each. Each block of 1024 values is called a time record. The first data sample of a time record is determined by one of five possible triggers: input trigger, internal trigger, external trigger, source trigger, or HP-IB trigger. When a trigger is received, the DMA circuit stores the next 1024 digital filter output values into a time record. When the time record has been filled, the DMA circuit issues a DMA interrupt signal to the central processor to indicate that the time record is ready for processing by the FFT processor.

FFT PROCESSOR (A30 ASSEMBLY)

On receipt of a DMA interrupt, the central processor performs a window function on the data if a window is selected, and then issues an FFT RESET signal to the FFT processor. The FFT RESET signal indicates to the FFT processor that a complete time record is stored in RAM and is ready for processing. The FFT processor then performs a fast fourier transform on the time record, resulting in 512 frequency and 512 phase values. The FFT results are then stored into the frequency buffer location of

the instrument RAM. When the FFT processor completes a transform, it issues an FFT interrupt signal to the central processor to indicate that the data is ready to be displayed.

POST PROCESSING AND DISPLAY

When the central processor receives an FFT interrupt signal, it determines whether the data should be directly transferred to the display or whether some post processing is required such as a math function or third octave display. The processor performs any post processing required while the data is stored in the instrument RAM. When the post processing is complete, the processor transfers the data to the appropriate location in the display memory depending on the display type chosen.

MEASUREMENTS WHEN THE FREQUENCY SPAN IS LESS THAN 100 kHz

To obtain maximum frequency resolution when the frequency span is less than 100 kHz, the input data is resampled after it has been digitally filtered. The new sample rate can be calculated by multiplying 256 kHz by 100 and then dividing by the selected frequency span. Thus if a frequency span of 20 kHz is selected, the new sample rate is 51.2 kHz. To obtain a sample rate of 51.2 kHz, four out of every five digital filter outputs are discarded, and only one out of five are stored in RAM.

ZOOM MODE OPERATION

Because the digital filter and the FFT processor can only process signals in a frequency span centered at 0 Hz, the -hp-3561A is equipped with a digital local oscillator. The purpose of the local oscillator is to mix the the signals in the selected frequency span down to an equivalent span centered at 0 Hz. The signals can then be digitally filtered, and transformed by the FFT processor. The local oscillator output signal is set to a frequency equal to the center frequency of the selected span (e.g., for a 20 kHz span centered at 50 kHz, the local oscillator will have a frequency of 50 kHz). This signal is then multiplied with the sampled input signal. The multiplication occurs inside the digital filter, but before the the digital filtering takes place.

Figure 6-35 Assembly and Cable Locations (Top View of Instrument)

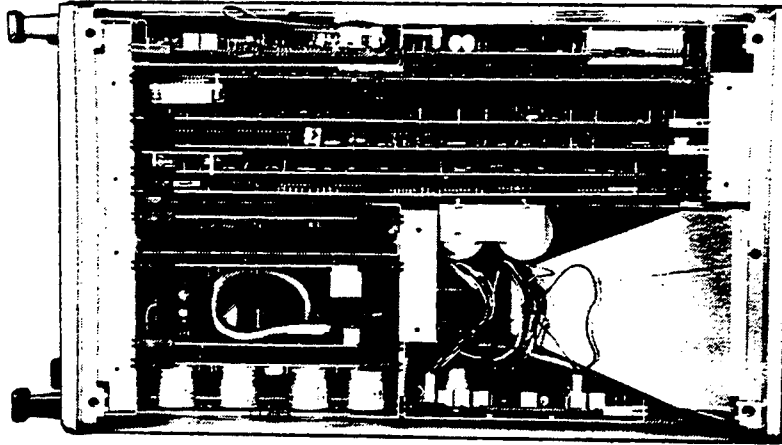
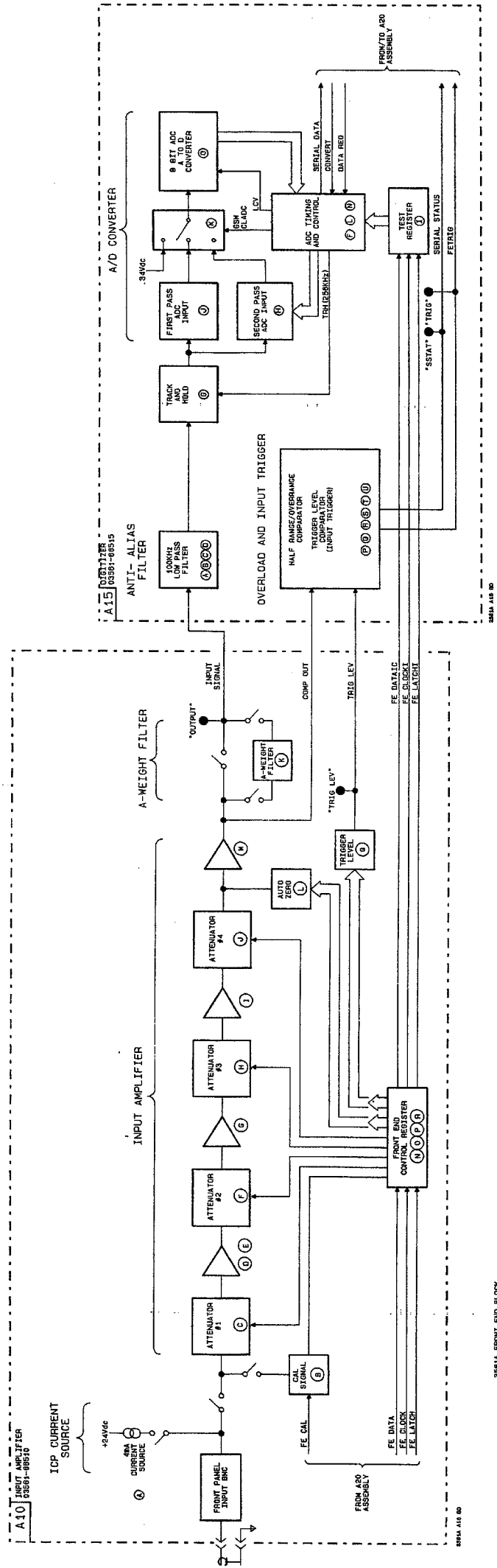
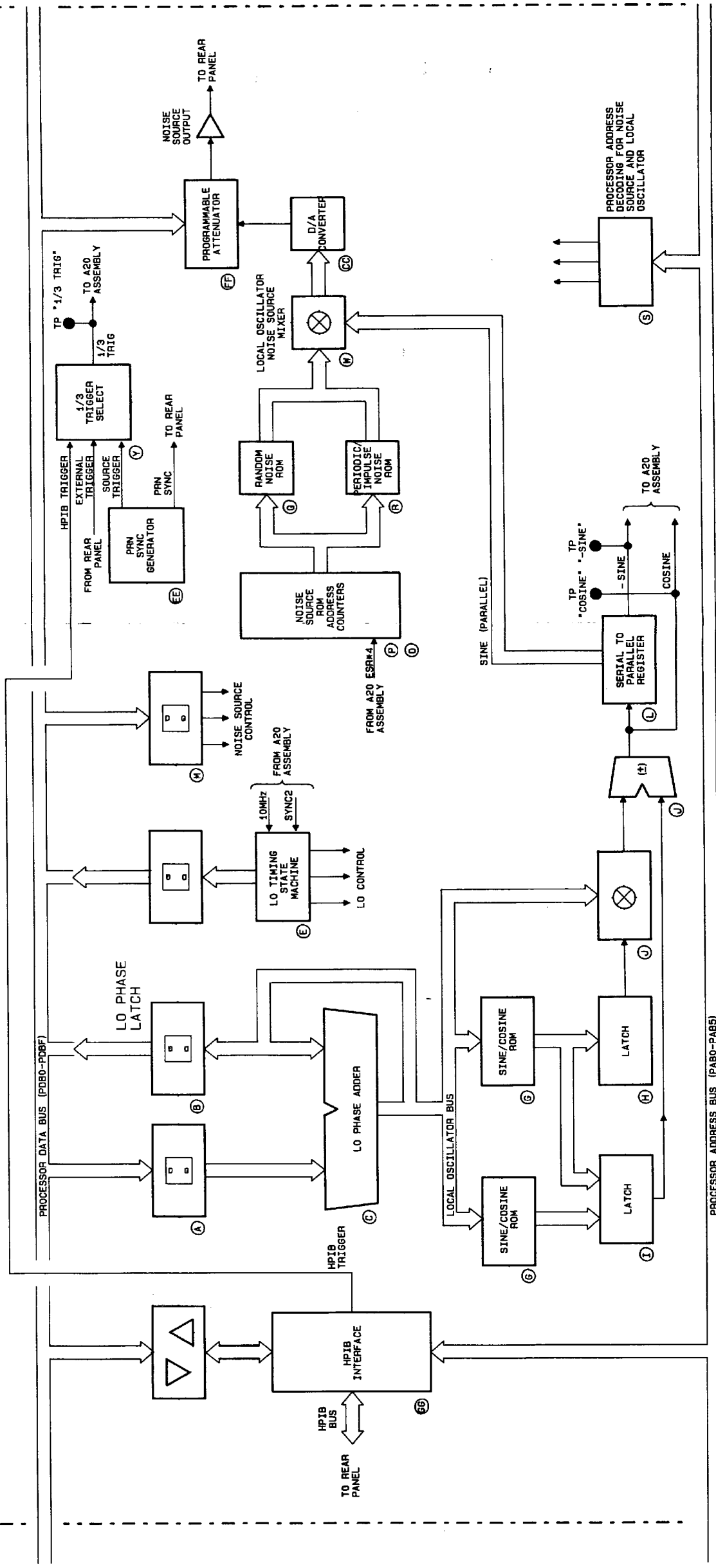

Figure 6-36 Detailed Block Diagram of the -hp-3561A



3561A FRONT END BLOCK

A50 LOCAL OSCILLATOR/NOISE SOURCE ASSEMBLY
03561-66550



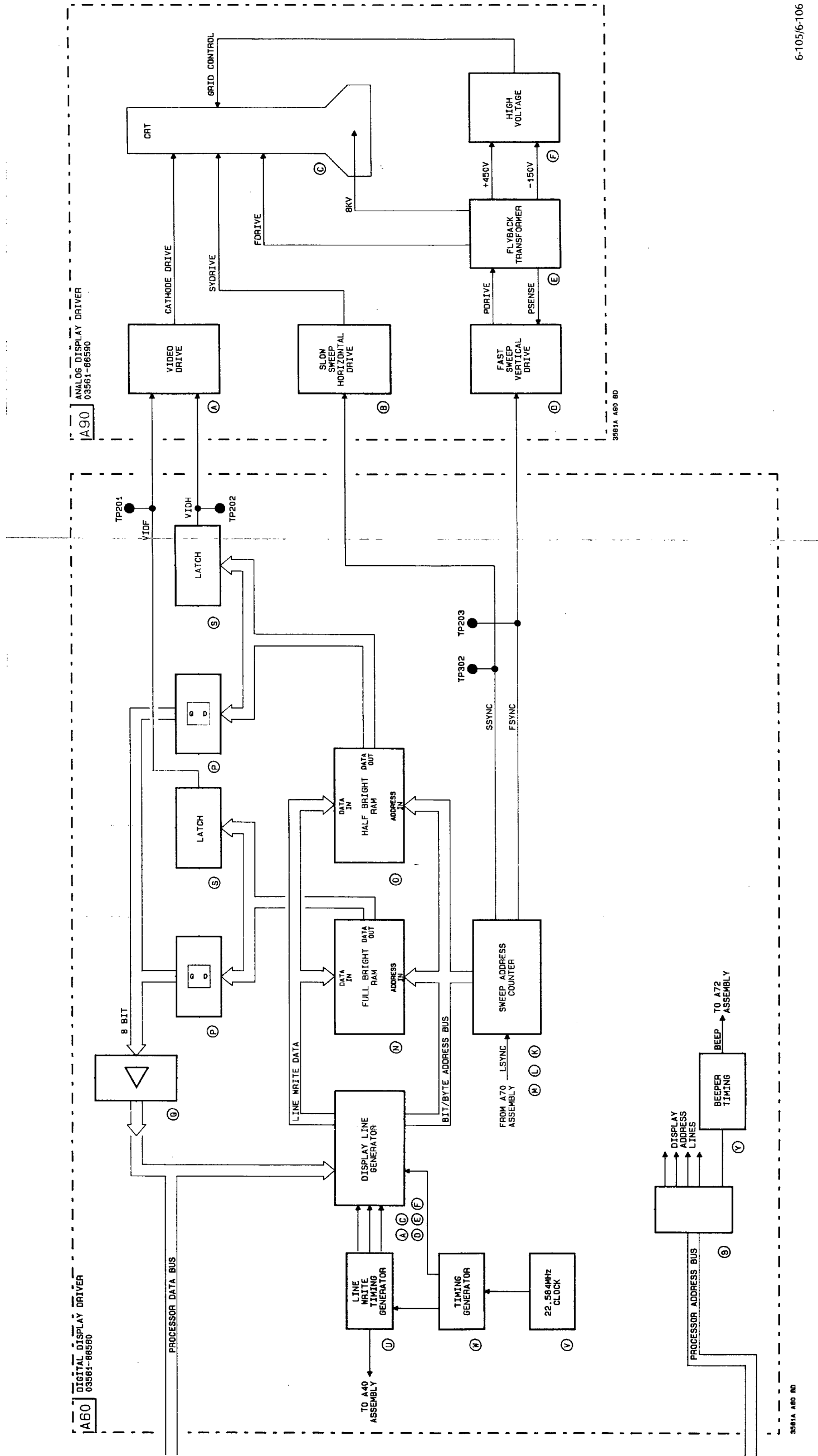

A65 CMOS/BUBBLE MEMORY
03561-66565

A80/A81 KEYBOARD/KEYBOARD DRIVER
03561-66580/03561-66581

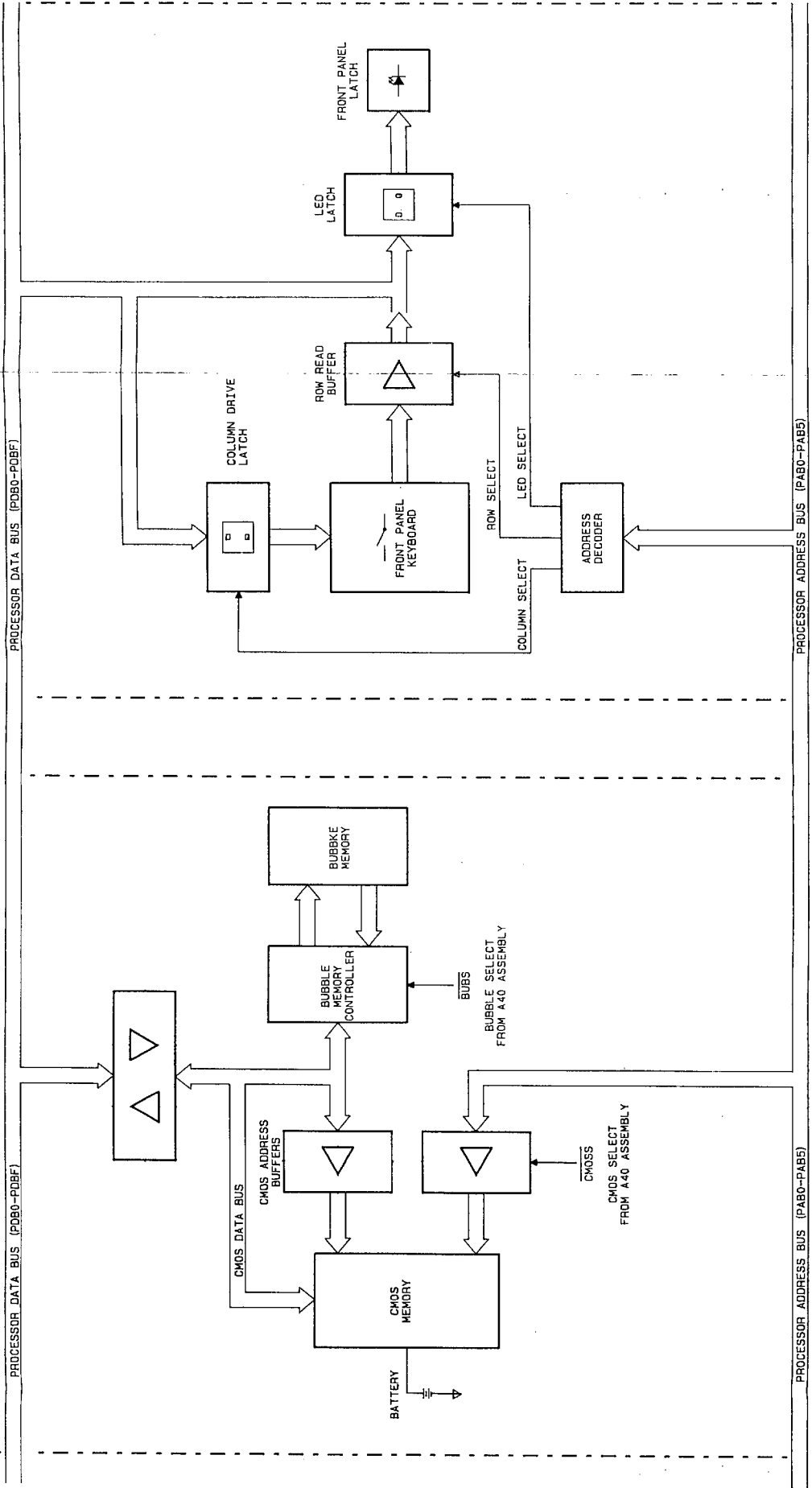

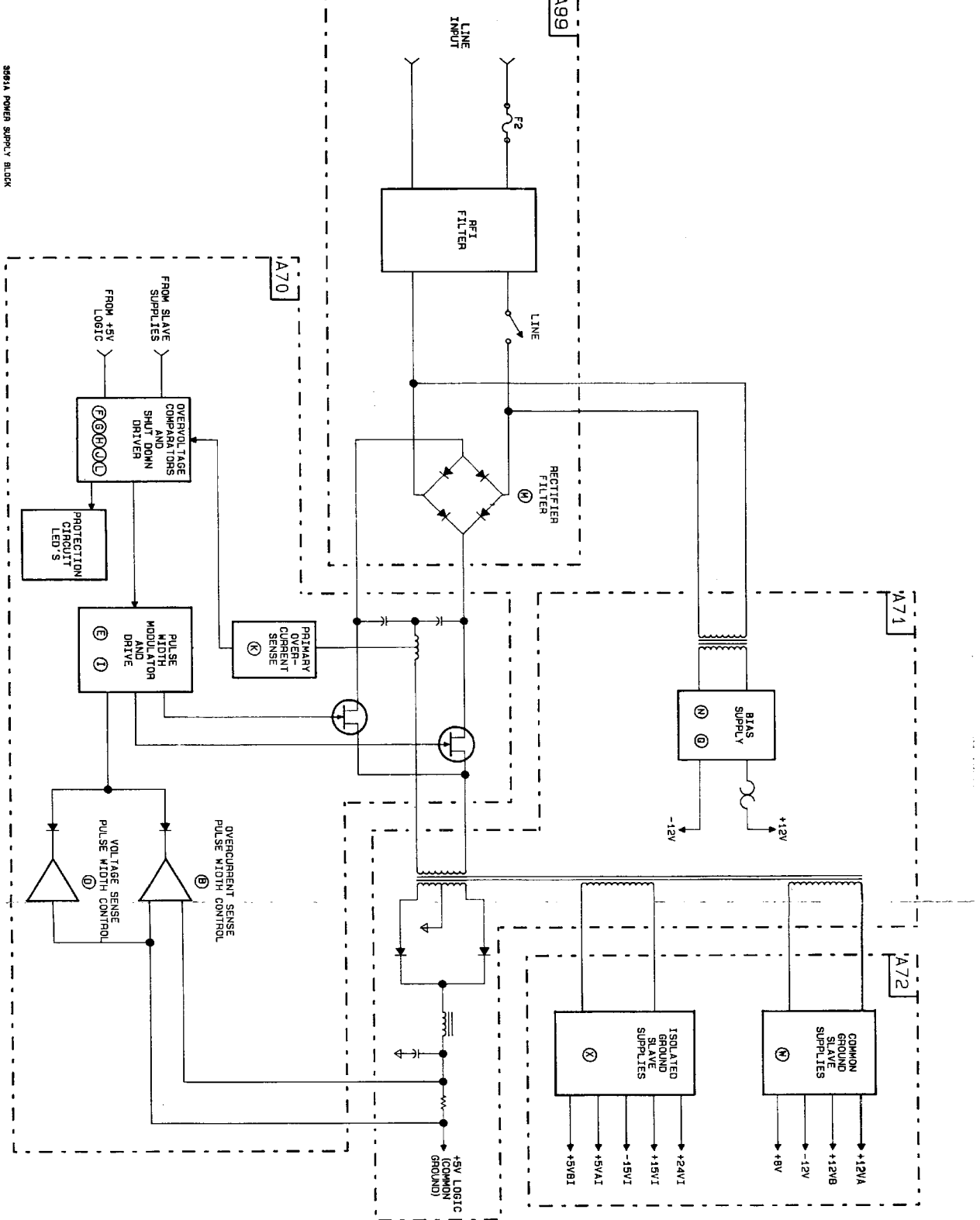

**Manual Part No.
03561-90010**