



Agilent E8257D PSG Analog Signal Generator

Data Sheet



The Agilent E8257D is a fully synthesized signal generator with high output power, low phase noise, and optional ramp sweep capability.

Specifications apply over a 0 to 55 °C range, unless otherwise stated, and apply after a 45 minute warm-up time. Supplemental characteristics, denoted as typical, nominal, or measured, provide additional (non-warranted) information at 25 °C, which may be useful in the application of the product.

Definitions

Specifications (spec): Represents warranted performance for instruments with a current calibration.

Typical (typ): Represents characteristic performance which is non-warranted. Describes performance that will be met by a minimum of 80% of all products.

Nominal (nom): Represents characteristic performance which is non-warranted. Represents the value of a parameter that is most likely to occur; the mean and/or mode of all measurements of a parameter.

Measured: Represents characteristic performance which is non-warranted. Represents the value of a parameter measured on an instrument during design verification.



Agilent Technologies

Table of Contents

Specifications	3
Frequency	3
Step (digital) sweep	4
Ramp (analog) sweep	4
Output	5
Spectral purity	8
Frequency modulation	13
Phase modulation	13
Amplitude modulation	14
External modulation inputs	15
Internal modulation source	15
Pulse modulation	16
Narrow pulse modulation	16
Internal pulse generator	17
Simultaneous modulation	17
Remote programming	18
General specifications	19
Input/Output Descriptions	20
Front panel connectors	20
Rear panel connectors	20
Options, Accessories, and Related Products	22
Web Resources	23
Related Agilent Literature	23

Specifications

Frequency

Range ¹		
Option 520	250 kHz to 20 GHz	
Option 532	250 kHz to 31.8 GHz	
Option 540	250 kHz to 40 GHz	
Option 550	250 kHz to 50 GHz	
Option 567	250 kHz to 67 GHz (operational up to 70 GHz)	
Resolution		
CW	0.001 Hz	
All sweep modes	0.01 Hz ²	
CW switching speed ^{3,4}		
	< 11 ms (typ)	
	7 ms (nom)	
Phase offset		
	Adjustable in nominal 0.1 ° increments	
Frequency bands		
Band	Frequency range	N ⁵
1	250 kHz to 250 MHz	1/8
2	> 250 to 500 MHz	1/16
3	> 500 MHz to 1 GHz	1/8
4	> 1 to 2 GHz	1/4
5	> 2 to 3.2 GHz	1/2
6	> 3.2 to 10 GHz	1
7	> 10 to 20 GHz	2
8	> 20 to 40 GHz	4
9	> 40 GHz	8
Accuracy		
	± aging rate ± temperature effects	
	± line voltage effects (nom) ± calibration accuracy	
Internal timebase reference oscillator		
Aging rate	Standard ⁷ < ±3 × 10 ⁻⁸ /year or < ±2.5 × 10 ⁻¹⁰ /day after 30 days	Option UNR/UNX < ±3 × 10 ⁻⁸ /year or < ±2.5 × 10 ⁻¹⁰ /day after 30 days
Temperature effects (typ)	< ±4.5 × 10 ⁻⁹ 0 to 55 °C	< ±4.5 × 10 ⁻⁹ 0 to 55 °C
Line voltage effects (typ)	< ±2 × 10 ⁻¹⁰ for ±10% change	< ±2 × 10 ⁻¹⁰ for ±10% change
External reference frequency		
Lock range	10 MHz only ±1.0 ppm	10 MHz only ±1.0 ppm
Reference output		
Frequency	10 MHz	
Amplitude	> +4 dBm into 50 Ω load (typ)	
External reference input		
Amplitude	5 dBm ±5 dB	
Option UNR/UNX	5 dBm ±5 dB ⁶	
Input impedance	50 Ω (nom)	

1. Operational, but unspecified, down to 100 kHz.

2. In ramp sweep mode (Option 007), resolution is limited with narrow spans and slow sweep speeds. Refer to ramp sweep specifications for more information.

3. Time from GPIB trigger to frequency within 0.1 ppm of final frequency above 250 MHz or within 100 Hz below 250 MHz.

4. Add 12 ms (typical) when switching from greater than 3.2 GHz to less than 3.2 GHz.

5. N is a factor used to help define certain specifications within the document.

6. To optimize phase noise use 5 dBm ± 2 dB.

7. Standard performance applies to units with serial numbers ending with 48050000 or greater. For units with lower serial numbers, refer to the data sheet shipped with the unit or the version of this document dated November 5, 2007.

Step (digital) sweep

Operating modes	<ul style="list-style-type: none"> • Step sweep of frequency or amplitude or both (start to stop) • List sweep of frequency or amplitude or both (arbitrary list)
Sweep range	
Frequency sweep	Within instrument frequency range
Amplitude sweep	Within attenuator hold range (see "Output" section)
Dwell time	1 ms to 60 s
Number of points	2 to 65535 (step sweep) 2 to 1601 per table (list sweep)
Triggering	Auto, external, single, or GPIB
Settling time	
Frequency	< 8 ms (typ) ¹
Amplitude	< 5 ms (typ)

Ramp (analog) sweep (Option 007)²

Operating modes	<ul style="list-style-type: none"> • Synthesized frequency sweep (start/stop), (center/span), (swept CW) • Power (amplitude) sweep (start/stop) • Manual sweep RPG control between start and stop frequencies • Alternate sweep Alternates successive sweeps between current and stored states 		
Sweep span range	Settable from minimum ³ to full range		
Maximum sweep rate	Start frequency	Maximum sweep rate	Max span for 100 ms sweep
	250 kHz to < 0.5 GHz	25 MHz/ms	2.5 GHz
	0.5 to < 1 GHz	50 MHz/ms	5 GHz
	1 to < 2 GHz	100 MHz/ms	10 GHz
	2 to < 3.2 GHz	200 MHz/ms	20 GHz
	≥ 3.2 GHz	400 MHz/ms	40 GHz
Frequency accuracy	± 0.05% of span ± timebase (at 100 ms sweep time, for sweep spans less than maximum values given above) Accuracy improves proportionally as sweep time increases ⁴		
Sweep time intervals)			
Manual mode settable	10 ms to 200 seconds		
Resolution	1 ms		
Auto mode	Set to minimum value determined by maximum sweep rate and 8757D setting		
Triggering	Auto, external, single, or GPIB		
Markers			
Display	10 independent continuously variable frequency markers		
Functions	Z-axis intensity or RF amplitude pulse M1 to center, M1/M2 to start/stop, marker delta		
Two-tone (master/slave) measurements⁵	Two PSG's can synchronously track each other, with independent control of start/stop frequencies		
Network analyzer compatibility	Fully compatible with Agilent 8757D scalar network analyzer ⁶ Also useable with Agilent 8757A/C/E scalar network analyzers for making basic swept measurements. ⁷		

1. 19 ms (typ) when stepping from greater than 3.2 GHz to less than 3.2 GHz.

2. During ramp sweep operation, AM, FM, phase modulation, and pulse modulation are useable but performance is not guaranteed.

3. Minimum settable sweep span is proportional to carrier frequency and sweep time. Actual sweep span may be slightly different than desired setting for spans less than $[0.00004\% \text{ of carrier frequency or } 140 \text{ Hz}] \times [\text{sweep time in seconds}]$. Actual span will always be displayed correctly.

4. Typical accuracy for sweep times > 100 ms can be calculated from the equation: $[(0.005\% \text{ of span}) / (\text{sweep time in seconds})] \pm \text{timebase}$. Accuracy is not specified for sweep times < 100 ms.

5. For master/slave operation use Agilent part #8120-8806 master/slave interface cable.

6. When measuring low-pass devices in AC mode, dynamic range may be reduced up to 10 dB below 3.2 GHz. An external highpass filter may be required to remove 27 kHz pulse source feed-through (For instruments operating from 10 MHz to 20 GHz with 3.5 mm connectors, use Bias Tee part number 5086-7322. For instruments operating from 10 MHz to 50 GHz with 2.4 mm connectors, use Bias Tee part number 5086-7484.)

7. GPIB system interface is not supported with 8757A/C/E, only with 8757D. As a result, some features of 8757A/C/E, such as frequency display, pass-through mode, and alternate sweep, do not function with PSG signal generators.

Output

Power ¹ (dBm)	Standard	Option 1EA spec. (typ)
Frequency range		
Option 520:		
250 kHz to 3.2 GHz	-20 to +15 ⁵	-20 to +16 (+19)
250 kHz to 3.2 GHz with Option UNW	-20 to +11	-20 to +11 (+14)
250 kHz to 3.2 GHz with Option 1EH	-20 to +13 ²	-20 to +13 (+16) ²
250 kHz to 3.2 GHz with Options UNW and 1EH	-20 to +10 ²	-20 to +10 (+13) ²
> 3.2 GHz to 5.2 GHz	-20 to +15 ⁵	-20 to +22 (+23) ⁴
> 5.2 GHz to 12 GHz	-20 to +15 ⁵	-20 to +23 (+24) ⁴
> 12 GHz to 20 GHz	-20 to +15 ⁵	-20 to +21 (+23) ⁴
Options 532 and 540:		
250 kHz to 3.2 GHz	-20 to +11 ⁵	-20 to +15 (+18)
250 kHz to 3.2 GHz with Option UNW	-20 to +9	-20 to +10 (+13)
250 kHz to 3.2 GHz with Option 1EH	-20 to +9	-20 to +12 (+15) ²
250 kHz to 3.2 GHz with Options UNW and 1EH	-20 to +9 ²	-20 to +9 (+12) ²
> 3.2 to 17 GHz	-20 to +11 ⁵	-20 to +19 (+21) ⁴
> 17 to 37 GHz	-20 to +11 ⁵	-20 to +16 (+19) ⁴
> 37 to 40 GHz	-20 to +11 ⁵	-20 to +14 (+17)
Options 550 and 567:		
250 kHz to 3.2 GHz	-20 to +5	-20 to +14 (+17)
250 kHz to 3.2 GHz with Option UNW	-20 to +5	-20 to +9 (+12)
250 kHz to 3.2 GHz with Option 1EH	-20 to +5	-20 to +11 (+14) ²
250 kHz to 3.2 GHz with Options UNW and 1EH	-20 to +5	-20 to +8 (+11) ²
> 3.2 to 10 GHz	-20 to +5	-20 to +14 (+21)
> 10 to 20 GHz	-20 to +5	-20 to +14 (+17)
> 20 to 30 GHz	-20 to +5	-20 to +11 (+17)
> 30 to 65 GHz	-20 to +5	-20 to +11 (+14)
> 65 to 67 GHz	-20 to +5	-20 to +10 (+14)
> 67 to 70 GHz	-20 to +5 (typ)	-20 to +8 (typ)
Option 520 with step attenuator (Option 1E1):		
250 kHz to 3.2 GHz	-135 to +13 ⁵	-135 to +15 (+18)
250 kHz to 3.2 GHz with Option UNW	-135 to +10	-135 to +10 (+13)
250 kHz to 3.2 GHz with Option 1EH	-135 to +11 ³	-135 to +12 (+15) ²
250 kHz to 3.2 GHz with Options UNW and 1EH	-135 to +9 ²	-135 to +9 (+12) ²
> 3.2 GHz to 10 GHz	-135 to +13 ⁵	-135 to +21 (+22) ⁴
> 10 GHz to 20 GHz	-135 to +13 ⁵	-135 to +19 (+20) ⁴
Options 532 and 540 with step attenuator (Option 1E1):		
250 kHz to 3.2 GHz	-135 to +9 ⁵	-135 to +14 (+17)
250 kHz to 3.2 GHz with Option UNW	-135 to +7	-135 to +9 (+12)
250 kHz to 3.2 GHz with Option 1EH	-135 to +7	-135 to +11 (+14) ²
250 kHz to 3.2 GHz with Options UNW and 1EH	-135 to +7 ³	-135 to +8 (+11) ²
> 3.2 to 17 GHz	-135 to +9 ⁵	-135 to +17 (+20) ⁴
> 17 to 37 GHz	-135 to +9 ⁵	-135 to +14 (+17) ⁴
> 37 to 40 GHz	-135 to +9 ⁵	-135 to +12 (+16)
Options 550 and 567 with step attenuator (Option 1E1):		
250 kHz to 3.2 GHz	-110 to +3	-110 to +13 (+16)
250 kHz to 3.2 GHz with Option UNW	-110 to +3	-110 to +8 (+11)
250 kHz to 3.2 GHz with Option 1EH	-110 to +3	-110 to +10 (+13) ²
250 kHz to 3.2 GHz with Options UNW and 1EH	-110 to +3	-110 to +7 (+10) ²
> 3.2 to 10 GHz	-110 to +3	-110 to +13 (+20)
> 10 to 20 GHz	-110 to +3	-110 to +13 (+16)
> 20 to 30 GHz	-110 to +3	-110 to +9 (+16)
> 30 to 65 GHz	-110 to +3	-110 to +9 (+12)
> 65 to 67 GHz	-110 to +3	-110 to +8 (+12)
> 67 to 70 GHz	-110 to +3 (typ)	-110 to +6 (typ)

1. Maximum power specifications are warranted from 15 to 35 °C, and is typical from 0 to 15 °C. Maximum power over the 35 to 55 °C range typically degrades less than 2 dB.
2. With harmonic filters switched off. With filters on, maximum output power is reduced 3 dB for frequencies below 2 GHz.
3. With harmonic filters switched off. With filters on, maximum output power is reduced 2 dB for frequencies below 2 GHz.
4. Specification applies to units with serial numbers ending with 45470000 or greater. For units with lower serial numbers, refer to the data sheet shipped with the unit or the version of this document dated December 16, 2004.
5. Standard performance applies to units with serial numbers ending with 48050000 or greater. For units with lower serial numbers, refer to the data sheet shipped with the unit or the version of this document dated November 5, 2007.

Step attenuator¹ (Option 1E1)

Options 520, 532, and 540

0 dB and 5 dB to 115 dB in 10 dB steps

Options 550 and 567

0 dB to 90 dB in 10 dB steps

Maximum available power (measured)

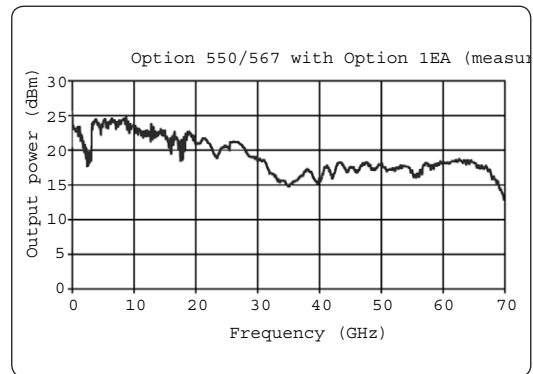
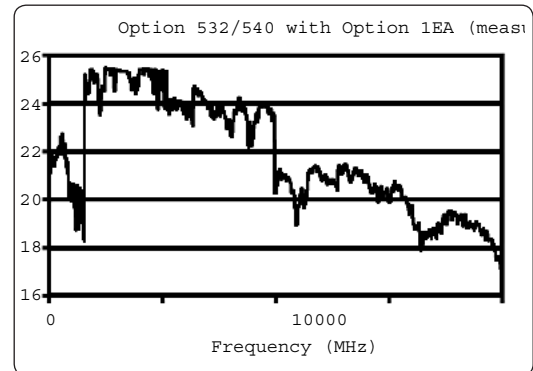
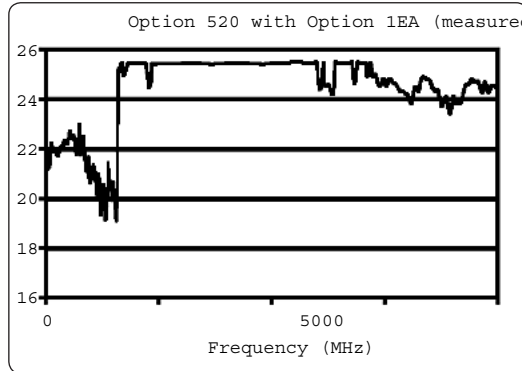

Attenuator hold range**Minimum**

From -20 dBm to maximum specified output power with step attenuator in 0 dB position. Can be offset using Option 1E1 attenuator.

Amplitude switching speed²

ALC on or off

< 3 ms (typ)

(without power search)

Level accuracy³ (dB)

Frequency	> +10 dBm	+10 to 0 dBm	0 to -10 dBm	-10 to -20 dBm
250 kHz to 2 GHz	±0.6	±0.6	±0.6	±1.4
> 2 GHz to 20 GHz	±0.8	±0.8	±0.8	±1.2
> 20 to 40 GHz	±1.0	±0.9	±0.9	±1.3
> 40 to 50 GHz	---	±1.3	±0.9	±1.2
> 50 to 67 GHz	---	±1.5	±1.0	±1.2 (typ)

1. The step attenuator provides coarse power attenuation to achieve low power levels. Fine power level adjustment is provided by the ALC (Automatic Level Control) within the attenuator hold range.

2. To within 0.1 dB of final amplitude within one attenuator range. Add 10 to 50 ms when using power search.

3. Specifications apply in CW and list/step sweep modes over the 15 to 35 °C temperature range with the ALC on. Degradation outside this range, for power levels > -10 dBm, is typically < 0.3 dB. In ramp sweep mode (with Option 007), specifications are typical. For instruments with Type-N connectors (Option 1ED), specifications are degraded typically 0.2 dB above 18 GHz. Specifications do not apply above the maximum specified power.

Level accuracy with step attenuator (Option 1E1)¹ (dB)

Frequency	> +10 dBm	+10 to 0 dBm	0 to -10 dBm	-10 to -70 dBm	-70 to -90 dBm
250 kHz to 2 GHz	±0.6	±0.6	±0.6	±0.7	±0.8
> 2 to 20 GHz	±0.8	±0.8	±0.8	±0.9	±1.0
> 20 to 40 GHz	±1.0	±0.9	±0.9	±1.0	±2.0
> 40 to 50 GHz	---	±1.3	±0.9	±1.5	±2.5
> 50 to 67 GHz	---	±1.5	±1.0	±1.5 (typ)	±2.5 (typ)

Level accuracy (measured)

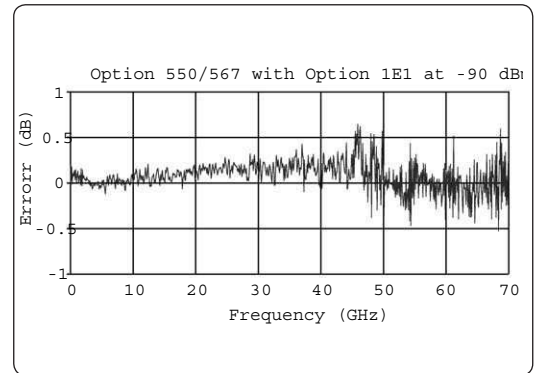
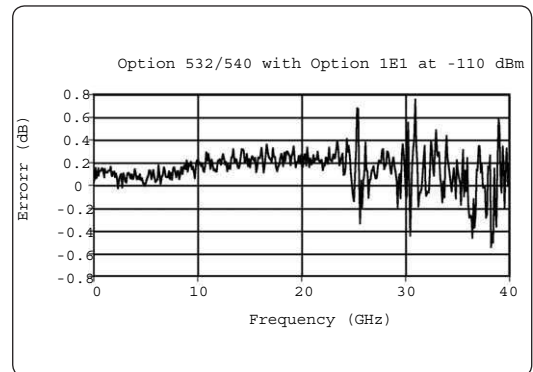
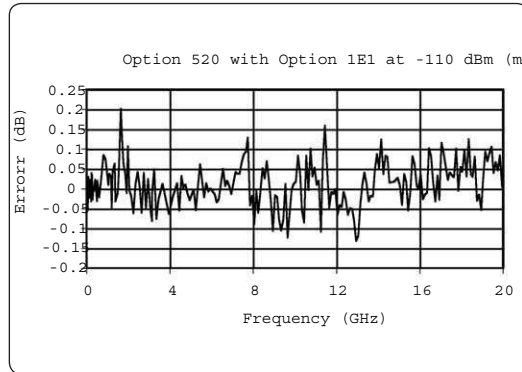

Resolution	0.01 dB
Temperature stability	0.01 dB/°C (typ) ²
User flatness correction	
Number of points	2 to 1601 points/table
Number of tables	Up to 10,000, memory limited
Path loss	Arbitrary, within attenuator range
Entry modes	Remote power meter ³ , remote bus, manual (user edit/view)

1. Specifications apply in CW and list/step sweep modes over the 15 to 35 °C temperature range, with attenuator hold off (normal operating mode). Degradation outside this range, for ALC power levels > -10 dBm, is typically < 0.3 dB. In ramp sweep mode (with Option 007), specifications are typical. For instruments with type-N connectors (Option 1ED), specifications are degraded typically 0.2 dB above 18 GHz. Specifications do not apply above the maximum specified power.

2. Options 550 and 567: 0.03dB/°C (typ) above 2 GHz.

3. Compatible with Agilent EPM Series (E4418B and E4419B) power meters.

Output impedance	50 Ω (nom)
SWR (internally leveled)	
250 kHz to 2 GHz	< 1.4:1 (typ)
> 2 GHz to 20 GHz	< 1.6:1 (typ)
> 20 GHz to 40 GHz	< 1.8:1 (typ)
> 40 GHz to 67 GHz	< 2.0:1 (typ)
Leveling modes	Internal leveling, external detector leveling, millimeter source module, ALC off
External detector leveling	
Range	-0.2 mV to -0.5 V (nom) (-36 dBm to +4 dBm using Agilent 33330D/E detector)
Bandwidth	Selectable 0.1 to 100 kHz (nom) (Note: not intended for pulsed operation)
Maximum reverse power	1/2 Watt, 0 V _{DC}

Spectral purity

Harmonics¹	(dBc at +10 dBm or maximum specified output power, whichever is lower)
< 10 MHz	-28 dBc (typical below 1 MHz)
10 MHz to 2 GHz	-30 dBc ^{2,3}
10 MHz to 2 GHz (with Option 1EH filters on)	-55 dBc ⁴
> 2 GHz to 20 GHz	-55 dBc
> 20 GHz to 67 GHz (Option 532, 540, 550 & 567)	-50 dBc (typical)
Harmonics (measured)	

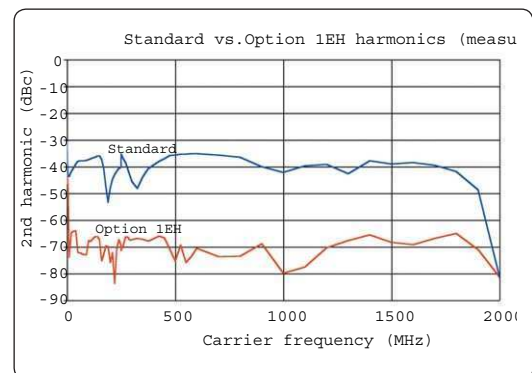
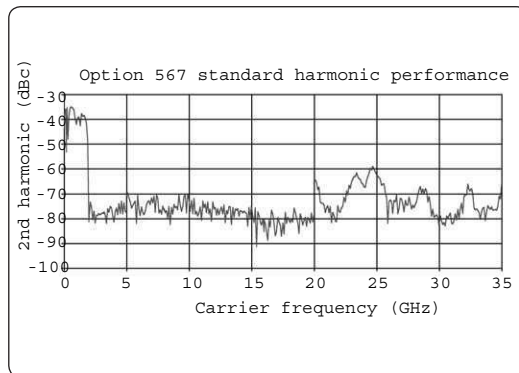
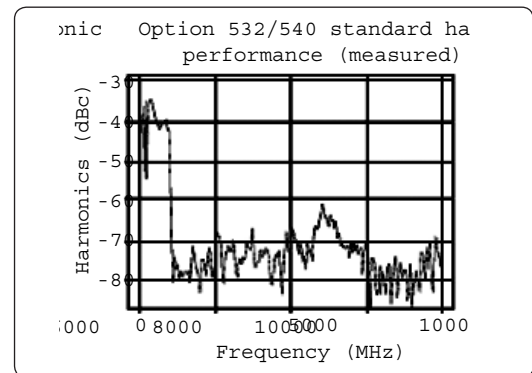
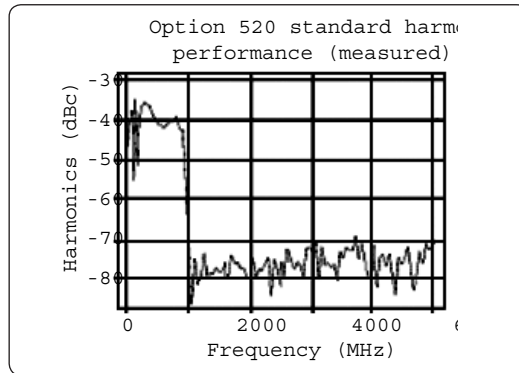

1. Specifications are typical for harmonics beyond specified frequency range (beyond 50 GHz for Option 567).
2. Specification applies to units with serial numbers ending with 45130000 or greater. For units with lower serial numbers, the specification is -28 dBc.
3. Typical below 250 MHz if Option 1EH is installed and the filters are off.
4. In ramp sweep mode (Option 007), harmonics are -30 dBc below 250 MHz.

Sub-harmonics¹		(dBc at +10 dBm or maximum specified output power, whichever is lower)		
250 kHz to 10 GHz		None		
> 10 GHz to 20 GHz		< -60 dBc		
> 20 GHz		< -50 dBc		
Non-harmonics²		(dBc at +10 dBm or maximum specified output power, whichever is lower, for offsets > 3 kHz [> 300 Hz with Option UNX or UNR])		
Frequency	Spec	Typical		
250 kHz to 250 MHz	-65	-72 for > 10 kHz offsets		
> 250 MHz to 1 GHz	-80	-88		
> 1 to 2 GHz	-74	-82		
> 2 to 3.2 GHz	-68	-76		
> 3.2 to 10 GHz	-62	-70		
> 10 to 20 GHz	-56	-64		
> 20 to 40 GHz	-50	-58		
> 40 GHz	-44	-52		
SSB phase noise (CW)³		Offset from carrier (dBc/Hz)		
Frequency	20 kHz	20 kHz (typical)		
250 kHz to 250 MHz ⁴	-130	-134		
> 250 to 500 MHz ⁴	-134	-138		
> 500 MHz to 1 GHz ⁴	-130	-134		
> 1 to 2 GHz ⁴	-124	-128		
> 2 to 3.2 GHz	-120	-124		
> 3.2 to 10 GHz	-110	-113		
> 10 to 20 GHz	-104	-108		
> 20 to 40 GHz	-98	-102		
> 40 to 67 GHz	-92	-96		
Option UNR: Enhanced SSB phase noise (CW)³		Offset from carrier (dBc/Hz)		
Frequency	100 Hz spec (typ)	1 kHz spec (typ)	10 kHz spec (typ)	100 kHz spec (typ)
250 kHz to 250 MHz ⁴	-94 (-115)	-110 (-123)	-128 (-132)	-130 (-133)
> 250 to 500 MHz ⁴	-100 (-110)	-124 (-130)	-132 (-136)	-136 (-141)
> 500 MHz to 1 GHz ⁴	-94 (-104)	-118 (-126)	-130 (-135)	-130 (-135)
> 1 to 2 GHz ⁴	-88 (-98)	-112 (-120)	-124 (-129)	-124 (-129)
> 2 to 3.2 GHz	-84 (-94)	-108 (-116)	-120 (-125)	-120 (-125)
> 3.2 to 10 GHz	-74 (-84)	-98 (-106)	-110 (-115)	-110 (-115)
> 10 to 20 GHz	-68 (-78)	-92 (-100)	-104 (-107)	-104 (-109)
> 20 to 40 GHz	-62 (-72)	-86 (-94)	-98 (-101)	-98 (-103)
> 40 to 67 GHz	-56 (-66)	-80 (-88)	-92 (-95)	-92 (-97)

1. Sub-harmonics are defined as Carrier Freq / N). Specifications are typical for sub-harmonics beyond specified frequency range (beyond 50 GHz for Option 567).
2. Specifications are typical for spurs beyond specified frequency range (beyond 50 GHz for Option 567). Specifications apply for CW mode, without modulation. In ramp sweep mode (Option 007), performance is typical for offsets > 1 MHz.
3. Phase noise specifications are warranted from 15 to 35 °C.
4. Measurement at +10 dBm or maximum specified output power, whichever is less.

Option UNX: Absolute SSB phase noise (dBc/Hz) (CW)¹

Frequency	Offset from carrier					
	1 Hz	10 Hz	100 Hz	1 kHz	10 kHz	100 kHz
	Spec (typ)	Spec (typ)	Spec (typ)	Spec (typ)	Spec (typ)	Spec (typ)
250 kHz to 250 MHz ²	-58 (-66)	-87 (-94)	-104 (-120)	-121 (-128)	-128 (-132)	-130 (-133)
> 250 to 500 MHz ²	-61 (-72)	-88 (-98)	-108 (-118)	-126 (-132)	-132 (-136)	-136 (-141)
> 500 MHz to 1 GHz ²	-57 (-65)	-84 (-93)	-101 (-111)	-121 (-130)	-130 (-134)	-130 (-135)
> 1 to 2 GHz ²	-51 (-58)	-79 (-86)	-96 (-106)	-115 (-124)	-124 (-129)	-124 (-129)
> 2 to 3.2 GHz	-46 (-54)	-74 (-82)	-92 (-102)	-111 (-120)	-120 (-124)	-120 (-124)
> 3.2 to 10 GHz	-37 (-44)	-65 (-72)	-81 (-92)	-101 (-109)	-110 (-114)	-110 (-115)
> 10 to 20 GHz	-31 (-38)	-59 (-66)	-75 (-87)	-95 (-106)	-104 (-107)	-104 (-109)
> 20 to 40 GHz	-25 (-32)	-53 (-60)	-69 (-79)	-89 (-99)	-98 (-101)	-98 (-103)
> 40 to 67 GHz	-20 (-26)	-47 (-56)	-64 (-73)	-84 (-90)	-92 (-95)	-92 (-97)

Option UNX: Residual SSB phase noise (dBc/Hz) (CW)¹

Frequency	Offset from carrier					
	1 Hz	10 Hz	100 Hz	1 kHz	10 kHz	100 kHz
	Spec (typ)	Spec (typ)	Spec (typ)	Spec (typ)	Spec (typ)	Spec (typ)
250 kHz to 250 MHz ²	(-94)	-100 (-107)	-110 (-118)	-120 (-126)	-128 (-132)	-130 (-133)
> 250 to 500 MHz ²	(-101)	-105 (-112)	-115 (-122)	-124 (-131)	-132 (-136)	-136 (-141)
> 500 MHz to 1 GHz ²	(-94)	-100 (-107)	-110 (-118)	-120 (-126)	-130 (-134)	-130 (-134)
> 1 to 2 GHz ²	(-89)	-96 (-101)	-104 (-112)	-114 (-120)	-124 (-129)	-124 (-129)
> 2 to 3.2 GHz	(-85)	-92 (-97)	-100 (-108)	-110 (-116)	-120 (-124)	-120 (-124)
> 3.2 to 10 GHz	(-74)	(-87)	(-98)	(-106)	(-114)	(-115)

1. Phase noise specifications are warranted from 15 to 35 °C.

2. Measured at +10 dBm or maximum specified power, whichever is less.

Measured phase noise with E5500 and plotted without spurs

Standard phase noise

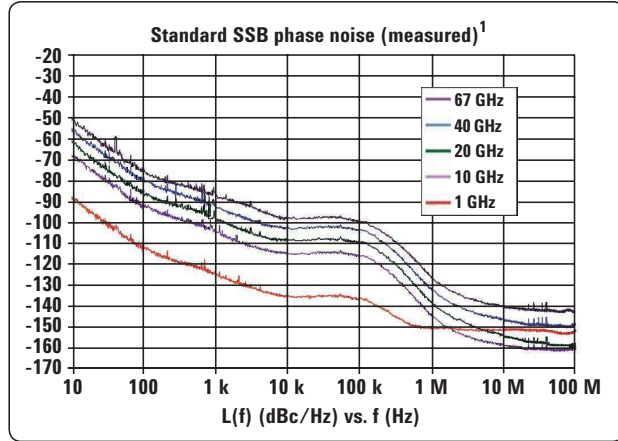

Option UNX phase noise

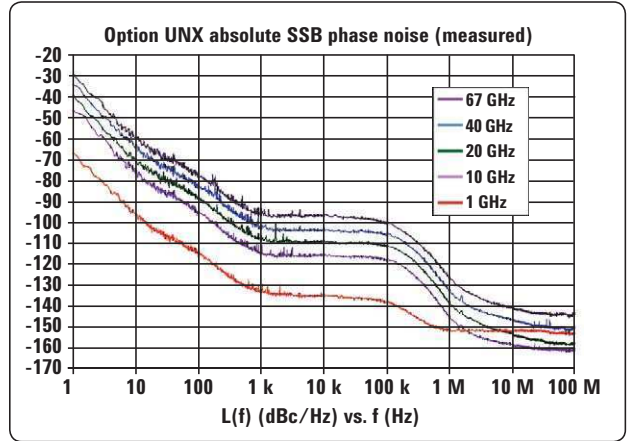

Residual phase noise

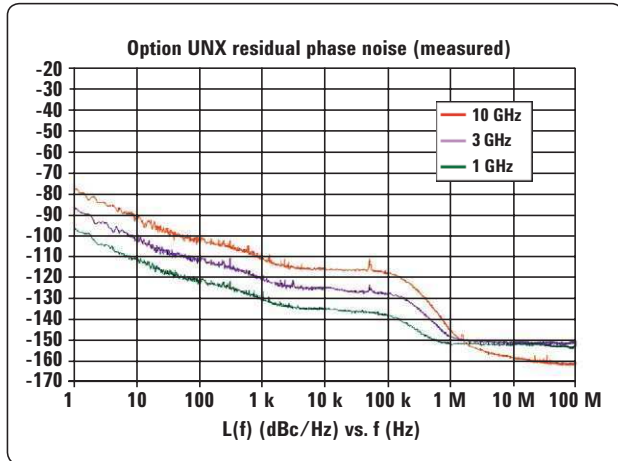

AM noise at 10 GHz

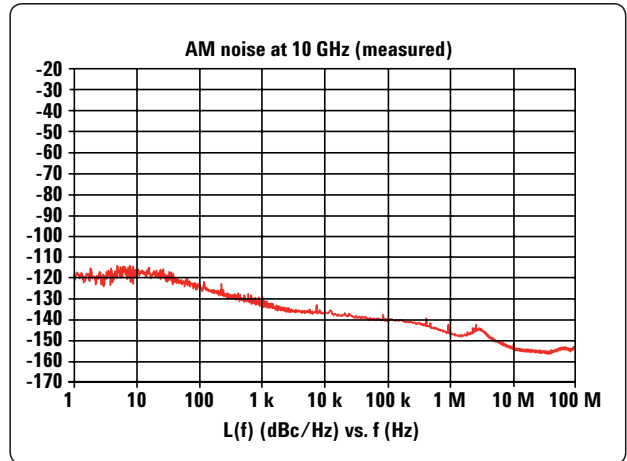

1. Measured standard performance applies to units with serial numbers ending with 48050000 or greater. For units with lower serial numbers, refer to the data sheet shipped with the unit or the version of this document dated November 5, 2007.

Residual FM	
(RMS, 50 Hz to 15 kHz bandwidth)	
CW mode	< N x 6 Hz (typ)
Option UNX/UNR	< N x 4 Hz (typ)
Ramp sweep mode	< N x 1 kHz (typ)
Broadband noise	
(CW mode at +10 dBm or maximum specified output power, whichever is lower, for offsets > 10 MHz)	
> 2.4 to 20 GHz	< -148 dBc/Hz (typ)
> 20 to 40 GHz	< -141 dBc/Hz (typ)
> 40 GHz	< -135 dBc/Hz (typ)

Measured RMS jitter¹

Standard

Carrier frequency	SONET/SDH data rates	RMS jitter bandwidth	Unit intervals (μ UI)	Time (fs)
155 MHz	155 MB/s	100 Hz to 1.5 MHz	25	158
622 MHz	622 MB/s	1 kHz to 5 MHz	21	34
2.488 GHz	2488 MB/s	5 kHz to 20 MHz	57	23
9.953 GHz	9953 MB/s	10 kHz to 80 MHz	152	15
39.812 GHz	39812 MB/s	40 kHz to 320 MHz	627	16

Option UNX

Carrier frequency	SONET/SDH data rates	RMS jitter bandwidth	Unit intervals (μ UI)	Time (fs)
155 MHz	155 MB/s	100 Hz to 1.5 MHz	23	151
622 MHz	622 MB/s	1 kHz to 5 MHz	19	30
2.488 GHz	2488 MB/s	5 kHz to 20 MHz	56	22
9.953 GHz	9953 MB/s	10 kHz to 80 MHz	152	15
39.812 GHz	39812 MB/s	40 kHz to 320 MHz	626	16

1. Calculated from phase noise performance in CW mode only at +10 dBm. For other frequencies, data rate, or bandwidths, please contact your sales representative.

Frequency modulation¹ (Option UNT)

Maximum deviation²	Frequency	Maximum deviation
	250 kHz to 250 MHz	2 MHz
	> 250 to 500 MHz	1 MHz
	> 500 MHz to 1 GHz	2 MHz
	> 1 GHz to 2 GHz	4 MHz
	> 2 GHz to 3.2 GHz	8 MHz
	> 3.2 GHz to 10 GHz	16 MHz
	> 10 GHz to 20 GHz	32 MHz
	> 20 GHz to 40 GHz	64 MHz
> 40 GHz to 67 GHz	128 MHz	
Resolution	0.1% of deviation or 1 Hz, whichever is greater	
Deviation accuracy	< ± 3.5% of FM deviation + 20 Hz (1 kHz rate, deviations < N x 800 kHz)	
Modulation frequency response³	(at 100 kHz deviation)	
Path [coupling]	1 dB bandwidth	3 dB bandwidth (typ)
FM path 1 [DC]	DC to 100 kHz	DC to 10 MHz
FM path 2 [DC]	DC to 100 kHz	DC to 1 MHz
FM path 1 [AC]	20 Hz to 100 kHz	5 Hz to 10 MHz
FM path 2 [AC]	20 Hz to 100 kHz	5 Hz to 1 MHz
DC FM⁴ carrier offset	±0.1% of set deviation + (N x 8 Hz)	
Distortion	< 1% (1 kHz rate, deviations < N x 800 kHz)	
Sensitivity	±1 V _{peak} for indicated deviation	
Paths	FM1 and FM2 are summed internally for composite modulation. Either path may be switched to any one of the modulation sources: Ext1, Ext2, internal1, internal2. The FM2 path is limited to a maximum rate of 1 MHz. The FM2 path must be set to a deviation less than FM1.	

Phase modulation⁵ (Option UNT)

Maximum deviation⁶	Frequency	Normal BW mode	High BW mode
	250 kHz to 250 MHz	20 rad	2 rad
	> 250 to 500 MHz	10 rad	1 rad
	> 500 MHz to 1 GHz	20 rad	2 rad
	> 1 GHz to 2 GHz	40 rad	4 rad
	> 2 GHz to 3.2 GHz	80 rad	8 rad
	> 3.2 GHz to 10 GHz	160 rad	16 rad
	> 10 GHz to 20 GHz	320 rad	32 rad
	> 20 GHz to 40 GHz	640 rad	64 rad
> 40 GHz to 67 GHz	1280 rad	128 rad	
Resolution	0.1% of set deviation		
Deviation accuracy	< ±5% of deviation + 0.01 radians (1 kHz rate, normal BW mode)		
Modulation frequency response⁷	Normal BW mode	High BW mode	
Rates (3 dB BW)	DC to 100 kHz	DC to 1 MHz (typ) ⁸	
Distortion	< 1% (1 kHz rate, Total Harmonic Distortion (THD), dev < N x 80 rad, normal BW mode)		
Sensitivity	±1 V _{peak} for indicated deviation		
Paths	ΦM1 and ΦM2 are summed internally for composite modulation. Either path may be switched to any one of the modulation sources: Ext1, Ext2, internal1, internal2. The ΦM2 path must be set to a deviation less than ΦM1.		

- Above 50 GHz, FM is useable; however performance is not warranted.
- Through any combination of path1, path2, or path1 + path2.
- Specifications apply in CW and list/step sweep modes. During ramp sweep operation (Option 007), 3 dB bandwidth is typically 50 kHz to 10 MHz (FM1 path), and 50 kHz to 1 MHz (FM2 path).
- At the calibrated deviation and carrier frequency, within 5 °C of ambient temperature at time of user calibration.
- Above 50 GHz, phase modulation is useable; however performance is not warranted.
- Through any combination of path1, path2, or path1 + path2.
- Specifications apply in CW and list/step sweep modes. During ramp sweep operation (Option 007), 3 dB bandwidth is typically 50 kHz to 1 MHz (high BW mode).
- Path 1 is useable to 4 MHz for external inputs less than 0.3 V peak.

Amplitude modulation¹
(part of Option UNT)
(typical)

Depth	Linear mode	Exponential (log) mode (downward modulation only)
Maximum:	ALC On: > 90%	> 20 dB
	ALC Off with Power Search ² or ALC On with Deep AM ³ : > 95 %	> 40 dB
Settable:	0 to 100 % (0 to 100 %/volt sensitivity)	0 to 40 dB (0 to 40 dB/volt sensitivity)
Resolution:	0.1%	0.01 dB
Accuracy (ALC On, 1kHz rate): < ± (2% of setting +0.2dB)		< ±(6% of setting + 1%)
Ext sensitivity	± 1 V _{peak} for indicated depth –1 V for indicated depth	
Rates (3 dB bandwidth, 30% depth)		
DC Coupled	0 to 100 kHz	
AC coupled	10 Hz to 100 kHz (useable to 1 MHz)	
Distortion (1 kHz rate, ALC On, linear mode, Total Harmonic Distortion)		
30% AM	< 1.5%	
60% AM	< 2%	
Paths	AM1 and AM2 are summed internally for composite modulation. Either path may be switched to any one of the modulation sources: Ext1, Ext2, Internal1, Internal2.	

1. AM specifications are typical. For carrier frequencies below 2 MHz or above 50 GHz, AM is useable but not specified. Unless otherwise stated, specifications apply with ALC on and envelope peaks within ALC operating range (–20 dBm to maximum specified power, excluding step-attenuator setting).
2. ALC Off is used for narrow pulse modulation and/or high AM depths, with envelope peaks below ALC operating range. Carrier power level will be accurate after a Power Search is executed.
3. ALC On with Deep AM provides high AM depths together with closed-loop internal leveling. This mode can be used with a repetitive AM waveform (frequency > 10 Hz) with peaks > –5 dBm (nominal, excluding step-attenuator setting).

External modulation inputs
(Ext1 & Ext2)
(Option UNT)

Modulation types	AM, FM, and Φ M
Input impedance	50 or 600 (nom) switched
High/low indicator (100 Hz to 10 MHz BW, ac coupled inputs only)	Activated when input level error exceeds 3% (nom)

Internal modulation source
(Option UNT)

Dual function generators provides two independent signals (internal1 and internal2) for use with AM, FM, Φ M, or LF Out.	
Waveforms	Sine, square, positive ramp, negative ramp, triangle, Gaussian noise, uniform noise, swept sine, dual sine ¹
Rate range	
Sine	0.5 Hz to 1 MHz
Square, ramp, triangle	0.5 Hz to 100 kHz
Resolution	0.5 Hz
Accuracy	Same as timebase
LF Out	
Output	Internal1 or internal2. Also provides monitoring of internal1 or internal2 when used for AM, FM, or Φ M.
Amplitude	0 to 3 V _{peak} , (nom) into 50 Ω
Output impedance	50 Ω (nom)
Swept sine mode: (frequency, phase continuous)	
Operating modes	Triggered or continuous sweeps
Frequency range	1 Hz to 1 MHz
Sweep rate	0.5 Hz to 100 kHz sweeps/s, equivalent to sweep times 10 μ s to 2 s
Resolution	0.5 Hz (0.5 sweep/s)

1. Internal2 is not available when using swept sine or dual sine modes.

Pulse modulation^{1, 2} (Option UNU)

	500 MHz to 3.2 GHz	Above 3.2 GHz
On/Off ratio	80 dB (typ)	80 dB
Rise/Fall times (Tr, Tf)	100 ns (typ)	6 ns (typ)
Minimum pulse width		
Internally leveled	2 us	1 us
Level hold (ALC off with power search)	0.5 us	0.15 us
Repetition frequency		
Internally leveled	10 Hz to 250 kHz	10 Hz to 500 kHz
Level hold (ALC off with power search)	dc to 1 MHz	dc to 3 MHz
Level accuracy (relative to CW)		
Internally leveled	±0.5 dB	±0.5 dB
Level hold (ALC off with power search)	±0.5 dB (typ)	±0.5 dB (typ)
Width compression (RF width relative to video out)	±50 ns (typ)	±5 ns (typ)
Video feed-through ³	< 200 mv (typ)	< 2 mv (typ)
Video delay (ext input to video)	50 ns (nom)	50 ns (nom)
RF delay (video to RF output)	270 ns (nom)	35 ns (nom)
Pulse overshoot	< 10% (typ)	< 10% (typ)
Input level	+1 V _{peak} = RF On	+1 V _{peak} = RF On
Input impedance	50 Ω (nom)	50 Ω (nom)

Narrow pulse modulation^{1, 2} (Option UNW)

	10 MHz to 3.2 GHz	Above 3.2 GHz
On/Off ratio	80 dB	80 dB
Rise/Fall times (Tr, Tf)	10 ns (8 ns typical)	10 ns (6 ns typical)
Minimum pulse width		
Internally leveled	1 us	1 us
Level hold (ALC off with power search)	20 ns	20 ns
Repetition frequency		
Internally leveled	10 Hz to 500 kHz	10 Hz to 500 kHz
Level hold (ALC off with power search)	dc to 5 MHz	dc to 10 MHz
Level accuracy (relative to CW)		
Internally leveled	±0.5 dB	±0.5 dB (0.15 dB typical)
Level hold (ALC off with power search)	±1.3 dB (typ)	±0.5 dB (typ)

1. With ALC off, specs apply after the execution of power search. Specifications apply with Atten Hold Off (default mode for instruments with attenuator), or ALC level between -5 and +10 dBm or maximum specific power, whichever is lower. Above 50 GHz, pulse modulation is useable; however performance is not warranted.
2. Power search is a calibration routine that improves level accuracy with ALC off. The instrument microprocessor momentarily closes the ALC loop to find the modulator drive setting necessary to make the quiescent RF level equal to an entered value, then opens the ALC loop while maintaining that modulator drive setting. When executing power search, RF power will be present for typically 10 to 50 ms; the step attenuator (Option 1E1) can be set to automatically switch to maximum attenuation to protect sensitive devices. Power search can be configured to operate either automatically or manually at the carrier frequency, or over a user-definable frequency range.
3. With attenuator in 0 dB position. Video feed-through decreases with attenuator setting.

	10 MHz to 3.2 GHz	Above 3.2 GHz
Width compression (RF width relative to video out)	±5 ns (typ)	±5 ns (typ)
Video feed-through¹	< 125 mv (typ)	< 2 mv (typ)
Video delay (ext input to video)	50 ns (nom)	50 ns (nom)
RF delay (video to RF output)	45 ns (nom)	35 ns (nom)
Pulse overshoot	< 15% (typ)	< 10% (typ)
Input level	+1 V _{peak} = RF On	+1 V _{peak} = RF On
Input impedance	50 Ω (nom)	50 Ω (nom)

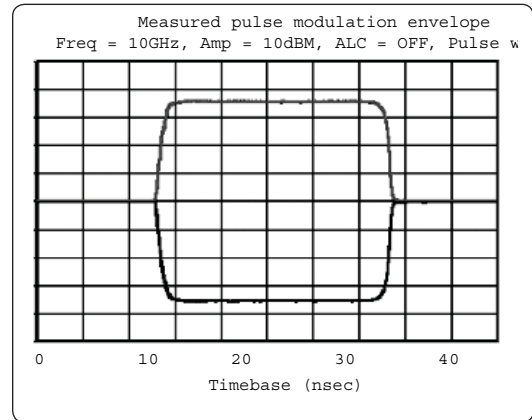

Internal pulse generator (Option UNU or UNW)

Modes	Free-run, triggered, triggered with delay, doublet, and gated. Triggered with delay, doublet, and gated require external trigger source.
Period (PRI) (Tp)	70 ns to 42 s (Repetition frequency: 0.024 Hz to 14.28 MHz)
Pulse width (Tw)	10 ns to 42 s
Delay (Td)	Free-run mode: 0 to ±42 s Triggered with delay and doublet modes: 75 ns to 42s with ±10 ns jitter
Resolution	10 ns (width, delay, and PRI)

Td Video delay (variable)
Tw Video pulse width (variable)
Tp Pulse period (variable)
Tm RF delay
Trf RF pulse width
Tf RF pulse fall time
Tr RF pulse rise time
Vor Pulse overshoot
Vf Video feedthrough

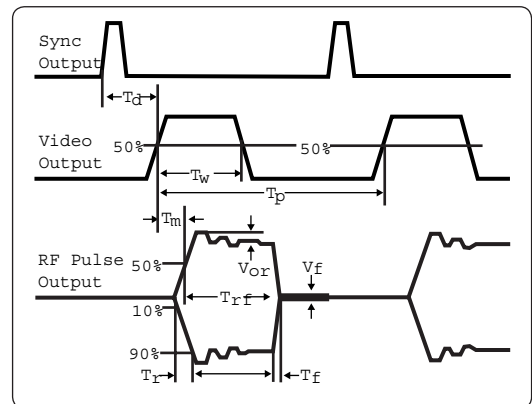

Simultaneous modulation

All modulation types (FM, AM, ΦM, and pulse modulations) may be simultaneously enabled except: FM with ΦM, and linear AM with exponential AM. AM, FM, and ΦM can sum simultaneous inputs from any two sources (Ext1, Ext2, internal1, or internal2). Any given source (Ext1, Ext2, internal1, or internal2) may be routed to only one activated modulation type.

1. With attenuator in 0 dB position. Video feed-through decreases with attenuator setting.

Remote programming

Interfaces	GPIB (IEEE-488.2,1987) with listen and talk, RS-232, and 10BaseT LAN interface.
Control languages	SCPI version 1997.0. Completely code compatible with previous PSG signal generator models: <ul style="list-style-type: none">• E8241A• E8244A• E8251A• E8254A• E8247C• E8257C <p>The E8257D will emulate the applicable commands for the following Agilent signal generators, providing general compatibility with ATE systems:</p> <ul style="list-style-type: none">• 8340-series (8340/41B)• 8360-series (836xxB/L)• 83700-series (837xxB)• 8662A/63A
IEEE-488 functions	SH1, AH1, T6, TE0, L4, LE0, SR1, RL1, PP0, DC1, DT0, C0, E2.
ISO compliant	This family of signal generators is manufactured in an ISO-9001 registered facility in concurrence with Agilent commitment to quality.
Agilent IO Libraries	Agilent's IO Library Suite ships with the E8257D to help you quickly establish an error-free connection between your PC and instruments – regardless of the vendor. It provides robust instrument control and works with the software development environment you choose.

General specifications

Power requirements	90 to 132 VAC 47 to 64 Hz or 365 to 435 Hz; or 195 to 267 VAC 47 to 64 Hz, (automatically selected); < 250 W typical, 300 W maximum.
Operating temperature range	0 to 55 °C
Storage temperature range¹	–40 to 70 °C
Altitude	< 4,572 m (15,000 ft.)
Environmental testing	Samples of this product have been tested in accordance with the Agilent Environmental Test Manual and verified to be robust against the environmental stresses of storage, transportation, and end-use; those stresses include but are not limited to temperature, humidity, shock, vibration, altitude, and power line conditions. Test methods are aligned with IEC 60068-2 and levels are similar to MIL-PRF-28800F Class 3. ²
EMC	Meets the conducted and radiated interference and immunity requirements of IEC/EN 61326-1. Meets radiated emission requirements of CISPR Pub 11/1997 Group 1 class A.
Storage registers	Memory is shared by instrument states and sweep list files. There is 14 MB of flash memory available in the E8257D PSG. Depending on how the memory is used, a maximum of 1000 instrument states can be saved.
Security	Display blanking Memory clearing functions (see Application Note <i>Security of Agilent Signal Generators Issues and Solutions</i> , literature number 5989-1091EN)
Compatibility	Agilent 83550 Series Millimeter Heads and OML millimeter source modules. Agilent 8757D scalar network analyzers. Agilent EPM Series power meters.
Self-test	Internal diagnostic routine tests most modules (including microcircuits) in a preset condition. For each module, if its node voltages are within acceptable limits, then the module “passes” the test.
Weight	< 22 kg (48 lb.) net, < 30 kg (68 lb.) shipping
Dimensions	178 mm H x 426 mm W x 515 mm D (7” H x 16.8” W x 20.3” D in.)
Recommended calibration cycle	24 months

1. Storage below –20 °C instrument states may be lost.

2. As is the case with all signal generation equipment, phase noise specifications are not warranted in a vibrating environment.

Input/Output Descriptions

Front panel connectors

(All connectors are BNC female unless otherwise noted.)¹

RF output	Output impedance 50 Ω (nom)
Option 520	Precision APC-3.5 male, or Type-N with Option 1ED
Options 532, 540 and 550	Precision 2.4 mm male; plus 2.4 – 2.4 mm and 2.4 – 2.9 mm female adapters
Option 567	Precision 1.85 mm male; plus 1.85 – 1.85 mm and 2.4 – 2.9 mm female adapters
ALC input	Used for negative external detector leveling. Nominal input impedance 120 kΩ, damage level ±15 V.
LF output	Outputs the internally generated LF source. Nominal output impedance 50 Ω.
External input 1	Drives either AM, FM, or ΦM. Nominal input impedance 50 or 600 Ω, damage levels are 5 V _{rms} and 10 V _{peak} .
External input 2	Drives either AM, FM, or ΦM. Nominal input impedance 50 or 600 Ω, damage levels are 5 V _{rms} and 10 V _{peak} .
Pulse/trigger gate input	Accepts input signal for external fast pulse modulation. Also accepts external trigger pulse input for internal pulse modulation. Nominal impedance 50 Ω. Damage levels are 5 V _{rms} and 10 V _{peak} .
Pulse video out	Outputs a signal that follows the RF output in all pulse modes. TTL-level compatible, nominal source impedance 50 Ω.
Pulse sync out	Outputs a synchronizing pulse, nominally 50 ns width, during internal and triggered pulse modulation. TTL-level compatible, nominal source impedance 50 Ω.

Rear panel connectors

(all connectors are BNC female unless otherwise noted.)¹

Auxiliary interface (dual mode)	Used for RS-232 serial communication and for master/slave source synchronization. (9-pin subminiature female connector).
GPIB	Allows communication with compatible devices
LAN	Allows 10BaseT LAN communication
10 MHz input	Accepts an external reference (timebase) input (at 1, 2, 2.5, 5, 10 MHz for standard and 10 MHz only for Option UNX and UNR) Nominal input impedance 50 Ω Damage levels > +10 dBm
10 MHz output	Outputs internal or external reference signal. Nominal output impedance 50 Ω. Nominal output power +8 dBm.
Sweep output (dual mode)	Supplies a voltage proportional to the RF power or frequency sweep ranging from 0 volts at the start of sweep to +10 volts (nom) at the end of sweep, regardless of sweep width. During CW operation, supplies a voltage proportional to the output frequency, +10 volts (nom) corresponding to the maximum specified frequency. When connected to an Agilent 8757D scalar network analyzer (Option 007), generates a selectable number of equally spaced 1 us pulses (nom) across a ramp (analog) sweep. Number of pulses can be set from 101 to 1601 by remote control from the 8757D. Output impedance: < 1 Ω (nom), can drive 2000 Ω.

1. Digital inputs and output are 3.3 V CMOS unless indicated otherwise. Inputs will accept 5 V CMOS, 3 V CMOS, or TTL voltage levels.

Stop sweep In/Out ramp	Open-collector, TTL-compatible input/output. In sweep operation, provides low level (nominally 0 V) during sweep retrace and bandcross intervals, and high level during the forward portion of the sweep. Sweep will stop when grounded externally, sweep will resume when allowed to go high.
Trigger output (dual mode) vides	Outputs a TTL signal. High at start of dwell, or when waiting for point trigger; low when dwell is over or point trigger is received. In ramp sweep mode, provides 1601 equally-spaced 1us pulses (nom) across a ramp sweep. When using LF Out, provides 2 us pulse at start of LF sweep.
Trigger input	Accepts 3.3V CMOS signal for triggering point-to-point in manual sweep mode, or to trigger start of LF sweep. Damage levels $\geq +10$ V or ≤ -4 V.
Source module interface	Provides power and leveling connections to the millimeter source modules.
Source settled	Provides an output trigger that indicates when the signal generator has settled to a new frequency or power level. High indicates source not settled, Low indicates source settled.
Z-axis Blank/Markers	During ramp sweep, supplies +5 V (nom) level during retrace and bandswitch intervals. Supplies -5 V (nom) level when the RF frequency is at a marker frequency.
10 MHz EFC	(Option UNR/UNX only) Accepts an external DC voltage, ranging from -5 V to +5 V, for electronic frequency control (EFC) of the internal 10 MHz reference oscillator. This voltage inversely tunes the oscillator about its center frequency approximately -0.07 ppm/V. The nominal input impedance is greater than 1 M Ω .
1 GHz Out	(Option UNX only) Low noise 1 GHz reference output signal, approximately +5 dBm (nom).

Options, Accessories, and Related Products

Model/option	Description
E8257D-520	Frequency range from 250 kHz to 20 GHz
E8257D-532	Frequency range from 250 kHz to 31.8 GHz
E8257D-540	Frequency range from 250 kHz to 40 GHz
E8257D-550	Frequency range from 250 kHz to 50 GHz
E8257D-567	Frequency range from 250 kHz to 67 GHz
E8257D-007	Analog ramp sweep
E8257D-UNX	Ultra low phase noise
E8257D-UNT	AM, FM, phase modulation, and LF output
E8257D-UNU	Pulse modulation
E8257D-UNW¹	Narrow pulse modulation
E8257D-1EA	High output power
E8257D-1E1	Step attenuator
E8257D-1ED	Type-N (f) RF output connector (Option 520 only)
E8257D-1EH	Improved harmonics below 2 GHz
E8257D-1EM	Moves all front panel connectors to the rear panel
E8257D-1CN	Front handle kit
E8257D-1CM	Rackmount flange kit
E8257D-1CP	Rackmount flange and front handle kit
E8257D-C09	Move all front panel connectors to the rear panel except for the RF output connector
E8257D-HSM²	Scan modulation (20 GHz model only)
E8257D-HAR⁴	Optimize phase noise < 500 MHz carrier
E8257D-H1S	1 GHz external frequency reference input and output
E8257D-HCC	Connections for phase coherency > 250 MHz
E8257D-H30¹	Internal mixer for up conversion capability in the 20, 31.8, and 40 GHz models
E8257D-H60¹	Internal mixer for up conversion capability in the 50 and 67 GHz models
E8257D-UK6	Commercial calibration certificate and test data
E8257D-CD1	CD-ROM containing the English documentation set
E8257D-ABA	Printed copy of the English documentation set
E8257D-0BW	Printed copy of the assembly-level service guide
8120-8806	Master/slave interface cable
9211-2656	Transit case
9211-7481	Transit case with wheels
E8257DS15³	OML Inc. Millimeter source module, 50 GHz to 75 GHz at +8 dBm
E8257DS12³	OML Inc. Millimeter source module, 60 GHz to 90 GHz at +6 dBm
E8257DS10³	OML Inc. Millimeter source module, 75 GHz to 110 GHz at +5 dBm
E8257DS08³	OML Inc. Millimeter source module, 90 GHz to 140 GHz at -2 dBm
E8257DS06³	OML Inc. Millimeter source module, 110 GHz to 170 GHz at -6 dBm
E8257DS05³	OML Inc. Millimeter source module, 140 GHz to 220 GHz at -12 dBm
E8257DS03³	OML Inc. Millimeter source module, 220 GHz to 325 GHz at -25 dBm

1. Must be ordered with Option 1E1.

2. Must be ordered with Option UNT and not available with Option UNU.

3. Millimeter source module a product of Oleson Microwave Labs, Inc. and must be ordered with Option 1EA.

4. Must be ordered with Options UNX and 1EH.

Web Resources

For additional information, visit:

www.agilent.com/find/psg

For more information about renting, leasing or financing Agilent's latest technology, visit:

www.agilent.com/find/buy/alternatives

For more accessory information, visit:

www.agilent.com/find/accessories

For additional description of Agilent's IO Libraries Suite features and installation requirements, please go to:

www.agilent.com/find/iosuite/database

Related Agilent Literature

Agilent PSG Signal Generators

Brochure, Literature number 5989-1324EN

E8257D PSG Signal Generators

Configuration Guide, Literature number 5989-1325EN

E8267D PSG Vector Signal Generator

Data Sheet, Literature number 5989-0697EN

E8267D PSG Vector Signal Generator

Configuration Guide, Literature number 5989-1326EN

Millimeter Wave Source Modules from OML, Inc. for the Agilent PSG Signal Generators

Technical Overview, Literature number 5989-2923EN

Security of Agilent Signal Generators

Issues and Solutions, Literature number 5989-1091EN



Agilent Email Updates

www.agilent.com/find/emailupdates
Get the latest information on the products and applications you select.



Agilent Direct

www.agilent.com/find/agilentdirect
Quickly choose and use your test equipment solutions with confidence.



www.agilent.com/find/open
Agilent Open simplifies the process of connecting and programming test systems to help engineers design, validate and manufacture electronic products. Agilent offers open connectivity for a broad range of system-ready instruments, open industry software, PC-standard I/O and global support, which are combined to more easily integrate test system development.

Remove all doubt

Our repair and calibration services will get your equipment back to you, performing like new, when promised. You will get full value out of your Agilent equipment throughout its lifetime. Your equipment will be serviced by Agilent-trained technicians using the latest factory calibration procedures, automated repair diagnostics and genuine parts. You will always have the utmost confidence in your measurements.

Agilent offers a wide range of additional expert test and measurement services for your equipment, including initial start-up assistance onsite education and training, as well as design, system integration, and project management.

For more information on repair and calibration services, go to:

www.agilent.com/find/removealldoubt

www.agilent.com

For more information on Agilent Technologies' products, applications or services, please contact your local Agilent office. The complete list is available at:

www.agilent.com/find/contactus

Americas

Canada	(877) 894-4414
Latin America	305 269 7500
United States	(800) 829-4444

Asia Pacific

Australia	1 800 629 485
China	800 810 0189
Hong Kong	800 938 693
India	1 800 112 929
Japan	0120 (421) 345
Korea	080 769 0800
Malaysia	1 800 888 848
Singapore	1 800 375 8100
Taiwan	0800 047 866
Thailand	1 800 226 008

Europe & Middle East

Austria	0820 87 44 11
Belgium	32 (0) 2 404 93 40
Denmark	45 70 13 15 15
Finland	358 (0) 10 855 2100
France	0825 010 700*
	*0.125 €/minute
Germany	01805 24 6333**
	**0.14 €/minute
Ireland	1890 924 204
Israel	972-3-9288-504/544
Italy	39 02 92 60 8484
Netherlands	31 (0) 20 547 2111
Spain	34 (91) 631 3300
Sweden	0200-88 22 55
Switzerland	0800 80 53 53
United Kingdom	44 (0) 118 9276201

Other European Countries:

www.agilent.com/find/contactus

Revised: March 27, 2008

Product specifications and descriptions in this document subject to change without notice.

© Agilent Technologies, Inc. 2008
Printed in USA, June 23, 2008
5989-0698EN



Agilent Technologies