

Agilent E5070B/E5071B ENA Series RF Network Analyzers

Programmer's Guide

Ninth Edition

FIRMWARE REVISIONS

This manual applies directly to instruments that have the firmware revision A.08.10.

For additional information about firmware revisions, see Appendix A.



Manufacturing No. E5070-90412

June 2007

Notices

The information contained in this document is subject to change without notice.

This document contains proprietary information that is protected by copyright. All rights are reserved. No part of this document may be photocopied, reproduced, or translated to another language without the prior written consent of Agilent Technologies.

Microsoft®, MS-DOS®, Windows®, Visual C++®, Visual Basic®, VBA® and Excel® are registered

UNIX is a registered trademark in U.S. and other countries, licensed exclusively through X/Open Company Limited.

Portions ©Copyright 1996, Microsoft Corporation. All rights reserved.

© Copyright 2002, 2003, 2004, 2005, 2006, 2007 Agilent Technologies

Manual Printing History

The manual's printing date and part number indicate its current edition. The printing date changes when a new edition is printed. (Minor corrections and updates that are incorporated at reprint do not cause the date to change.) The manual part number changes when extensive technical changes are incorporated.

August 2002	First Edition (part number: E5070-90032)
March 2003	Second Edition (part number: E5070-90042, changes for firmware version A.03.50)
January 2004	Third Edition (part number: E5070-90052, changes for firmware version A.03.60)
August 2004	Fourth Edition (part number: E5070-90062, changes for firmware version A.04.00)
May 2005	Fifth Edition (part number: E5070-90072, changes for firmware version A.05.00)
November 2005	Sixth Edition (part number: E5070-90082, changes for firmware version A.06.00)
May 2006	Seventh Edition (part number: E5070-90092, changes for firmware version A.06.50)
February 2007	Eighth Edition (part number: E5070-90402, changes for firmware version A.08.00)
June 2007	Ninth Edition (part number: E5070-90412, changes for firmware version A.08.10)

Typeface Conventions

Bold	Boldface type is used when a term is defined. For example: icons are symbols.
<i>Italic</i>	Italic type is used for emphasis and for titles of manuals and other publications.
[Key]	Indicates the hardkey whose key label is Key.
[Key] - Item	Indicates a series of key operations in which you press the [Key] key, select (highlight) the item called Item on the displayed menu using the [↓] key and so on, and then press the [Enter] key.

Sample Program Disk

A sample program disk (Agilent part number: E5070-180x0) is furnished with this manual. The disk contains the sample programs used in this manual.

The customer shall have the personal, non-transferable rights to use, copy, or modify SAMPLE PROGRAMS in this manual for the customer's internal operations. The customer shall use the SAMPLE PROGRAMS solely and exclusively for their own purposes and shall not license, lease, market, or distribute the SAMPLE PROGRAMS or modification of any part thereof.

Agilent Technologies shall not be liable for the quality, performance, or behavior of the SAMPLE PROGRAMS. Agilent Technologies especially disclaims any responsibility for the operation of the SAMPLE PROGRAMS to be uninterrupted or error-free. The SAMPLE PROGRAMS are provided AS IS.

AGILENT TECHNOLOGIES DISCLAIMS ANY IMPLIED WARRANTY OF MERCHANTABILITY AND FITNESS FOR A PARTICULAR PURPOSE.

Agilent Technologies shall not be liable for any infringement of any patent, trademark, copyright, or other proprietary right by the SAMPLE PROGRAMS or their use. Agilent Technologies does not warrant that the SAMPLE PROGRAMS are free from infringements of such rights of third parties. However, Agilent Technologies will not knowingly infringe or deliver software that infringes the patent, trademark, copyright, or other proprietary right of a third party.

E5070B/E5071B Documentation Map

The following manuals are available for the E5070B/E5071B.

- ***User's Guide (Part Number: E5070-904x0, attached to optional ABA)***

This manual describes most of the basic information necessary to use the E5070B/E5071B. It provides a function overview, detailed operation procedure for each function (from preparation for measurement to analysis of measurement results), measurement examples, specifications, and supplemental information. For programming guidance on performing automatic measurement with the E5070B/E5071B, please see the *Programming Manual*.
- ***Installation and Quick Start Guide (Part Number: E5070-900x1, attached to optional ABA)***

This manual describes installation after it is delivered and the basic operation procedures for applications and analysis. Refer to this manual when you use the E5070B/E5071B for the first time.
- ***Programmer's Guide (Part Number: E5070-900x2, attached to optional ABA)***

This manual provides programming information for performing automatic measurement with the E5070B/E5071B. It includes an outline of remote control, procedures for detecting measurement start (trigger) and end (sweep end), application programming examples, command reference, and related information.
- ***VBA Programmer's Guide (Part Number: E5070-900x3, attached to optional ABA)***

This manual describes programming information for performing automatic measurement with internal controller. It includes an outline of VBA programming, some sample programming examples, a COM object reference, and related information.

NOTE

The number position shown by "x" in the part numbers above indicates the edition number. This convention is applied to each manual, CD-ROM (for manuals), and sample programs disk issued.

1. Making Effective Use of This Manual	
Contents of This Manual	24
How To Use This Manual	26
Looking up SCPI commands	26
Using sample programs	27
2. Overview of Remote Control	
Types of remote control system	30
GPIB remote control system	31
What is GPIB?	31
System configuration	31
Device selector	32
LAN remote control system	33
System configuration	33
Control over SICL-LAN server	34
Control over telnet server	39
USB Remote Control System	42
System configuration	42
Sending SCPI command messages	48
Types and structure of commands	48
Grammar of messages	49
Remote mode	50
3. Setting Up the Analyzer	
Selecting the Active Channel/Trace	52
Configuring Measurement Conditions	53
Setting the number of traces	53
Selecting measurement parameters	53
Setting the sweep condition (Stimulus)	53
Configuring Averaging Settings	55
Setting the System Z0	56
Configuring Display Settings	57
Setting the layout of windows and graphs	57
Configuring trace display settings	60
Printing a message in the echo window	63
Turning On/Off display update	63
Showing/hiding frequencies	63
Showing or hiding the title	63
Configuring date/time display	63
Turning On/Off the LCD backlight	63
Setting display colors	64
Saving and Loading the Settings	65
Sample Program	66
4. Performing Calibration	
Calibration	74
Performing calibration (obtaining calibration coefficients)	74
Defining calibration kits	81

Saving and loading calibration coefficients	84
Reading/Writing Calibration Coefficient Only	84
Clearing calibration data and calibration coefficients	86
Power Calibration	87
Preparation for power calibration	87
Loss compensation	88
Measuring power calibration data	89
Turning ON/OFF power-level error correction	89
Reading/writing power calibration data array	89
Receiver Calibration	91
Measurement of receiver calibration data and calculation of calibration coefficient	91
Turning ON/OFF receiver error correction	91
Scalar-Mixer Calibration	92
Measurement of scalar-mixer calibration data	92
Calculation of scalar-mixer calibration coefficient	93
Turning ON/OFF scalar-mixer error correction	93
Implementing scalar-mixer calibration with ECal	93
Partial overwrite	95
Executing calculation of calibration coefficients using partial overwrite	95
Sample Program	96
Calibration	96
ECal	104
Power Calibration	108
Reading/Writing Error Coefficient	113
5. Making a Measurement	
Trigger System	128
System-wide states and transitions	129
Channel-wide states and transitions	130
Trigger only to the specified channel	130
Starting a Measurement Cycle (triggering the instrument)	131
Configuring the instrument to automatically perform continuous measurement	131
Starting Measurement on Demand	131
Waiting for the End of Measurement	132
Using the status register	132
Using the :TRIG:SING Command	135
Using wait time	136
Point Trigger Function	137
Point trigger	137
Switching over modes	137
Averaging Trigger Function	138
Averaging trigger	138
Toggling the mode	138
6. Analyzing Data	
Retrieving Measurement Results at Specified Points	140
Showing/hiding markers	140
Turning On or Off reference marker mode	140

Setting (changing) and retrieving stimulus value at marker positions	140
Retrieving measurement results at marker positions.	140
Searching for Positions That Match Specified Criteria	141
Using marker search	141
Using the Analysis Commands	143
Sample Program	145
Bandwidth Search	147
Setting the bandwidth definition value	147
Retrieving bandwidth search results	147
Sample Program	147
Statistical Analysis	149
Analysis Using the Fixture Simulator	150
Matching Circuit Embedding	150
Port Impedance Conversion	151
Network De-embedding	151
4-Port Network Embedding/De-embedding	152
Balance-Unbalance Conversion	153
Differential Matching Circuit Embedding	154
Differential Port Impedance Conversion.	155
Sample Program	156
Analysis in Time Domain (time domain function)	158
Transforming measurement data to data in time domain	158
Deleting unnecessary measurement data in the time domain	159
Sample Program	160
Analyzing impedance	162
7. Reading/Writing Measurement Data	
Data Transfer Format	164
ASCII Transfer Format	165
Binary Transfer Format	166
Internal data processing	168
Data flow	168
Internal data arrays	168
Retrieving Measurement Results	171
Retrieving Internal Data Arrays	171
Entering Data into a Trace	175
8. Limit Test	
Performing a Limit Test	180
Configuring limit lines	180
Showing/hiding limit lines	180
Turning ON or OFF the Limit Test Feature	180
Showing/hiding “Fail”.	180
Obtaining Test Results	181
Test results at each measurement point	181
Test results for each trace	181
Test results for each channel	182
Overall test results.	184

Sample Program	186
9. Saving and Recalling (File Management)	
Saving and Recalling File	194
Specifying file	194
Saving and recalling instrument status	194
Saving measurement data	195
Saving measurement data in touchstone format	195
Saving the images on the LCD screen	196
Saving and recalling the segment sweep table	197
Saving and recalling the limit table	197
Saving/recalling Power Sensor Calibration Factor Table	197
Saving/recalling Loss Compensation Table	198
Saving/loading (importing) the VBA program	198
Sample program	199
Managing Files	202
Creating directory (folder)	202
Deleting file (directory)	202
Copying file	202
Transferring files	202
Retrieving data from storage	202
Sample program	203
10. Communication with External Instruments Using Handler I/O Port	
Handler I/O Port Overview	210
I/O Signal Pin Layout and Description	211
Inputting/Outputting Data	215
Specifying signal direction of port	215
Reading data input to port	216
Data output to port	216
Preset states at power-on	217
Timing Chart	218
Electrical Characteristics	222
Input signal	222
Output signal	223
Power supply (+5 V)	223
Sample Program	224
11. Working with Automatic Test Systems	
Preventing Erroneous Key Operation on the Front Panel (key lock feature)	226
Improving Command Processing Speed	227
Measurement results (trace) do not need to be updated	227
Measurement results (trace) need to be updated	227
Sample program	228
Detecting Occurrence of an Error	230
Using the status reporting system	230
Using the error queue	230
Sample program	231

12. Controlling E5091A	
Controlling E5091A	234
Selecting Test Set	234
Turning control ON/OFF	234
Selecting ports assigned to Port 1 to Port n	234
Setting control line	235
Sample program	236
13. Sample Application Programs	
Basic Measurement (measuring a band pass filter)	240
Measurement with Automatic Test Systems	246
Measurement using E5091A (measuring FEM)	256
Control Using SICL-LAN Server	265
Using VBA macro	265
Description of operation in VBA macro	266
Controlling Using Telnet Server	273
Using VBA macro	273
Description of operation in VBA macro	274
14. SCPI Command Reference	
Notational conventions in this command reference	284
Syntax	284
Description	284
Parameters	285
Query response	285
Related commands	285
Equivalent key	285
IEEE Common Commands	286
*CLS	286
*ESE	287
*ESR?	287
*IDN?	288
*OPC	288
*OPC?	288
*OPT?	289
*RST	289
*SRE	290
*STB?	291
*TRG	291
*WAI	291
E5070B/E5071B commands	292
:ABOR	292
:CALC{1-16}:BLIM	293
:CALC{1-16}:BLIM:DB	294
:CALC{1-16}:BLIM:DISP:MARK	295
:CALC{1-16}:BLIM:DISP:VAL	296
:CALC{1-16}:BLIM:FAIL?	297
:CALC{1-16}:BLIM:MAX	298

:CALC{1-16}:BLIM:MIN	299
:CALC{1-16}:BLIM:REP?	300
:CALC{1-16}:CONV	301
:CALC{1-16}:CONV:FUNC	302
:CALC{1-16}:CORR:EDEL:MED	303
:CALC{1-16}:CORR:EDEL:TIME	304
:CALC{1-16}:CORR:EDEL:WGC	305
:CALC{1-16}:CORR:OFFS:PHAS	306
:CALC{1-16}:DATA:FDAT	307
:CALC{1-16}:DATA:FMEM	308
:CALC{1-16}:DATA:SDAT	309
:CALC{1-16}:DATA:SMEM	310
:CALC{1-16}:EQU:STAT	311
:CALC{1-16}:EQU:TEXT	312
:CALC{1-16}:EQU:VAL?	313
:CALC{1-16}:FILT:TIME	314
:CALC{1-16}:FILT:TIME:CENT	315
:CALC{1-16}:FILT:TIME:SHAP	316
:CALC{1-16}:FILT:TIME:SPAN	317
:CALC{1-16}:FILT:TIME:STAR	318
:CALC{1-16}:FILT:TIME:STAT	319
:CALC{1-16}:FILT:TIME:STOP	320
:CALC{1-16}:FORM	321
:CALC{1-16}:FSIM:BAL:CZC:BPOR{1-2}:IMAG	323
:CALC{1-16}:FSIM:BAL:CZC:BPOR{1-2}:REAL	324
:CALC{1-16}:FSIM:BAL:CZC:BPOR{1-2}:Z0	325
:CALC{1-16}:FSIM:BAL:CZC:STAT	326
:CALC{1-16}:FSIM:BAL:DEV	327
:CALC{1-16}:FSIM:BAL:DMC:BPOR{1-2}	328
:CALC{1-16}:FSIM:BAL:DMC:BPOR{1-2}:PAR:C	329
:CALC{1-16}:FSIM:BAL:DMC:BPOR{1-2}:PAR:G	330
:CALC{1-16}:FSIM:BAL:DMC:BPOR{1-2}:PAR:L	331
:CALC{1-16}:FSIM:BAL:DMC:BPOR{1-2}:PAR:R	332
:CALC{1-16}:FSIM:BAL:DMC:BPOR{1-2}:USER:FIL	333
:CALC{1-16}:FSIM:BAL:DMC:STAT	334
:CALC{1-16}:FSIM:BAL:DZC:BPOR{1-2}:IMAG	335
:CALC{1-16}:FSIM:BAL:DZC:BPOR{1-2}:REAL	336
:CALC{1-16}:FSIM:BAL:DZC:BPOR{1-2}:Z0	337
:CALC{1-16}:FSIM:BAL:DZC:STAT	338
:CALC{1-16}:FSIM:BAL:PAR{1-16}:BBAL	339
:CALC{1-16}:FSIM:BAL:PAR{1-16}:SBAL	340
:CALC{1-16}:FSIM:BAL:PAR{1-16}:SSB	341
:CALC{1-16}:FSIM:BAL:PAR{1-16}:STAT	342
:CALC{1-16}:FSIM:BAL:TOP:BBAL	343
:CALC{1-16}:FSIM:BAL:TOP:PROP:STAT	344
:CALC{1-16}:FSIM:BAL:TOP:SBAL	345
:CALC{1-16}:FSIM:BAL:TOP:SSB	346
:CALC{1-16}:FSIM:EMB:NETW{1-2}:FIL	347
:CALC{1-16}:FSIM:EMB:NETW{1-2}:TYPE	348

:CALC{1-16}:FSIM:EMB:STAT	349
:CALC{1-16}:FSIM:EMB:TOP:A:PORT	350
:CALC{1-16}:FSIM:EMB:TOP:B:PORT	351
:CALC{1-16}:FSIM:EMB:TOP:C:PORT	352
:CALC{1-16}:FSIM:EMB:TYPE.	353
:CALC{1-16}:FSIM:SEND:DEEM:PORT{1-4}	354
:CALC{1-16}:FSIM:SEND:DEEM:PORT{1-4}:USER:FIL.	355
:CALC{1-16}:FSIM:SEND:DEEM:STAT	356
:CALC{1-16}:FSIM:SEND:PMC:PORT{1-4}	357
:CALC{1-16}:FSIM:SEND:PMC:PORT{1-4}:PAR:C	358
:CALC{1-16}:FSIM:SEND:PMC:PORT{1-4}:PAR:G	359
:CALC{1-16}:FSIM:SEND:PMC:PORT{1-4}:PAR:L	360
:CALC{1-16}:FSIM:SEND:PMC:PORT{1-4}:PAR:R	361
:CALC{1-16}:FSIM:SEND:PMC:PORT{1-4}:USER:FIL	362
:CALC{1-16}:FSIM:SEND:PMC:STAT	363
:CALC{1-16}:FSIM:SEND:ZCON:PORT{1-4}:IMAG	364
:CALC{1-16}:FSIM:SEND:ZCON:PORT{1-4}:REAL	365
:CALC{1-16}:FSIM:SEND:ZCON:PORT{1-4}:ZO	366
:CALC{1-16}:FSIM:SEND:ZCON:STAT	367
:CALC{1-16}:FSIM:STAT	368
:CALC{1-16}:FUNC:DATA?	369
:CALC{1-16}:FUNC:DOM	370
:CALC{1-16}:FUNC:DOM:COUP	371
:CALC{1-16}:FUNC:DOM:STAR.	372
:CALC{1-16}:FUNC:DOM:STOP.	373
:CALC{1-16}:FUNC:EXEC.	373
:CALC{1-16}:FUNC:PEXC.	374
:CALC{1-16}:FUNC:POIN?	375
:CALC{1-16}:FUNC:PPOL	376
:CALC{1-16}:FUNC:TARG	377
:CALC{1-16}:FUNC:TTR	378
:CALC{1-16}:FUNC:TYPE.	379
:CALC{1-16}:LIM	380
:CALC{1-16}:LIM:DATA	381
:CALC{1-16}:LIM:DISP	382
:CALC{1-16}:LIM:FAIL?	383
:CALC{1-16}:LIM:OFFS:AMPL.	384
:CALC{1-16}:LIM:OFFS:MARK	385
:CALC{1-16}:LIM:OFFS:STIM	386
:CALC{1-16}:LIM:REP?	387
:CALC{1-16}:LIM:REP:ALL?	388
:CALC{1-16}:LIM:REP:POIN?	389
:CALC{1-16}:MARK:BWID	390
:CALC{1-16}:MARK:COUP	391
:CALC{1-16}:MARK:FUNC:DOM.	392
:CALC{1-16}:MARK:FUNC:DOM:COUP.	393
:CALC{1-16}:MARK:FUNC:DOM:STAR	394
:CALC{1-16}:MARK:FUNC:DOM:STOP	395
:CALC{1-16}:MARK:NOTC.	396

:CALC{1-16}:MARK:REF	397
:CALC{1-16}:MARK{1-10}	398
:CALC{1-16}:MARK{1-10}:ACT	399
:CALC{1-16}:MARK{1-10}:BWID:DATA?	400
:CALC{1-16}:MARK{1-10}:BWID:THR	401
:CALC{1-16}:MARK{1-10}:DISC	402
:CALC{1-16}:MARK{1-10}:FUNC:EXEC	403
:CALC{1-16}:MARK{1-10}:FUNC:PEXC	404
:CALC{1-16}:MARK{1-10}:FUNC:PPOL	405
:CALC{1-16}:MARK{1-10}:FUNC:TARG	406
:CALC{1-16}:MARK{1-10}:FUNC:TRAC	407
:CALC{1-16}:MARK{1-10}:FUNC:TTR	408
:CALC{1-16}:MARK{1-10}:FUNC:TYPE	409
:CALC{1-16}:MARK{1-10}:NOTC:DATA?	410
:CALC{1-16}:MARK{1-10}:NOTC:THR	411
:CALC{1-16}:MARK{1-10}:SET	412
:CALC{1-16}:MARK{1-10}:X	413
:CALC{1-16}:MARK{1-10}:Y?	414
:CALC{1-16}:MATH:FUNC	415
:CALC{1-16}:MATH:MEM	416
:CALC{1-16}:MIX:XAX	417
:CALC{1-16}:MST	418
:CALC{1-16}:MST:DATA?	419
:CALC{1-16}:OFFS:XAX	420
:CALC{1-16}:PAR:COUN	421
:CALC{1-16}:PAR{1-16}:DEF	422
:CALC{1-16}:PAR{1-16}:SEL	424
:CALC{1-16}:PAR{1-16}:SPOR	425
:CALC{1-16}:RLIM	426
:CALC{1-16}:RLIM:DATA	427
:CALC{1-16}:RLIM:DISP:LINE	428
:CALC{1-16}:RLIM:DISP:SEL	429
:CALC{1-16}:RLIM:DISP:VAL	430
:CALC{1-16}:RLIM:FAIL?	431
:CALC{1-16}:RLIM:REP?	432
:CALC{1-16}:SMO	433
:CALC{1-16}:SMO:APER	434
:CALC{1-16}:TRAN:TIME	435
:CALC{1-16}:TRAN:TIME:CENT	436
:CALC{1-16}:TRAN:TIME:IMP:WIDT	437
:CALC{1-16}:TRAN:TIME:KBES	438
:CALC{1-16}:TRAN:TIME:LPFR	439
:CALC{1-16}:TRAN:TIME:SPAN	439
:CALC{1-16}:TRAN:TIME:STAR	440
:CALC{1-16}:TRAN:TIME:STAT	441
:CALC{1-16}:TRAN:TIME:STEP:RTIM	442
:CALC{1-16}:TRAN:TIME:STIM	443
:CALC{1-16}:TRAN:TIME:STOP	444
:CONT:HAND:A	445

:CONT:HAND:B	445
:CONT:HAND:C	446
:CONT:HAND:C:MODE	447
:CONT:HAND:D	448
:CONT:HAND:D:MODE	449
:CONT:HAND:E	450
:CONT:HAND:F	451
:CONT:HAND:IND:STAT	452
:CONT:HAND:OUTP{1-2}	452
:CONT:HAND:RTR:STAT	453
:DISP:ANN:FREQ	454
:DISP:CCL	454
:DISP:CLOC	455
:DISP:COL{1-2}:BACK	456
:DISP:COL{1-2}:GRAT{1-2}	457
:DISP:COL{1-2}:LIM{1-2}	458
:DISP:COL{1-2}:RES	458
:DISP:COL{1-2}:TRAC{1-16}:DATA	459
:DISP:COL{1-2}:TRAC{1-16}:MEM	460
:DISP:ECHO	461
:DISP:ECHO:CLE	461
:DISP:ENAB	462
:DISP:FSIG	463
:DISP:IMAG	464
:DISP:MAX	465
:DISP:SKEY	465
:DISP:SPL	466
:DISP:TABL	468
:DISP:TABL:TYPE	469
:DISP:UPD	470
:DISP:WIND{1-16}:ACT	470
:DISP:WIND{1-16}:ANN:MARK:ALIG	471
:DISP:WIND{1-16}:ANN:MARK:SING	472
:DISP:WIND{1-16}:LAB	473
:DISP:WIND{1-16}:MAX	474
:DISP:WIND{1-16}:SPL	475
:DISP:WIND{1-16}:TITL	476
:DISP:WIND{1-16}:TITL:DATA	477
:DISP:WIND{1-16}:TRAC{1-16}:ANN:MARK:POS:X	478
:DISP:WIND{1-16}:TRAC{1-16}:ANN:MARK:POS:Y	479
:DISP:WIND{1-16}:TRAC{1-16}:MEM	480
:DISP:WIND{1-16}:TRAC{1-16}:STAT	481
:DISP:WIND{1-16}:TRAC{1-16}:Y:AUTO	481
:DISP:WIND{1-16}:TRAC{1-16}:Y:PDIV	482
:DISP:WIND{1-16}:TRAC{1-16}:Y:RLEV	483
:DISP:WIND{1-16}:TRAC{1-16}:Y:RPOS	484
:DISP:WIND{1-16}:X:SPAC	485
:DISP:WIND{1-16}:Y:DIV	486
:FORM:BORD	487

:FORM:DATA	488
:HCOP	489
:HCOP:ABOR	489
:HCOP:IMAG	490
:INIT{1-16}	490
:INIT{1-16}:CONT	491
:MMEM:CAT?	492
:MMEM:COPY	493
:MMEM:DEL	494
:MMEM:LOAD	495
:MMEM:LOAD:ASCF	496
:MMEM:LOAD:BSCF	497
:MMEM:LOAD:CHAN	498
:MMEM:LOAD:CKIT{1-20}	499
:MMEM:LOAD:LIM	500
:MMEM:LOAD:PLOS{1-4}	501
:MMEM:LOAD:PROG	502
:MMEM:LOAD:RLIM	503
:MMEM:LOAD:SEGM	504
:MMEM:MDIR	505
:MMEM:STOR	506
:MMEM:STOR:ASCF	507
:MMEM:STOR:BSCF	508
:MMEM:STOR:CHAN	509
:MMEM:STOR:CHAN:CLE	509
:MMEM:STOR:CKIT{1-20}	510
:MMEM:STOR:FDAT	511
:MMEM:STOR:IMAG	512
:MMEM:STOR:LIM	513
:MMEM:STOR:PLOS{1-4}	514
:MMEM:STOR:PROG	515
:MMEM:STOR:RLIM	516
:MMEM:STOR:SALL	517
:MMEM:STOR:SEGM	518
:MMEM:STOR:SNP	519
:MMEM:STOR:SNP:FORM	520
:MMEM:STOR:SNP:TYPE:S1P	521
:MMEM:STOR:SNP:TYPE:S2P	522
:MMEM:STOR:SNP:TYPE:S3P	523
:MMEM:STOR:SNP:TYPE:S4P	524
.	525
:MMEM:TRAN	526
:OUTP	527
:PROG:CAT?	527
:PROG:NAME	528
:PROG:STAT	529
:PROG:VAR:ARR{1-10}	530
:PROG:VAR:ARR{1-10}:SIZE	531
:PROG:VAR:DOUB{1-10}	532

:PROG:VAR:LONG{1-10}	533
:PROG:VAR:STR{1-10}	534
:SENS:CORR:COLL:ECAL:ORI	535
:SENS:CORR:COLL:ECAL:PATH	536
:SENS:CORR:IMP	537
:SENS:MULT:CAT?	538
:SENS:MULT{1-2}:COUN?	539
:SENS:MULT{1-2}:DISP	539
:SENS:MULT{1-2}:INC?	540
:SENS:MULT{1-2}:NAME	541
:SENS:MULT{1-2}:STAT	542
:SENS{1-16}:AVER:CLE	543
:SENS{1-16}:AVER	543
:SENS{1-16}:AVER:COUN	544
:SENS{1-16}:BAND	545
:SENS{1-16}:BWID	546
:SENS{1-16}:CORR:CLE	547
:SENS{1-16}:CORR:COEF	548
:SENS{1-16}:CORR:COEF:METH:ERES	550
:SENS{1-16}:CORR:COEF:METH:OPEN	551
:SENS{1-16}:CORR:COEF:METH:SHOR	552
:SENS{1-16}:CORR:COEF:METH:SOLT1	553
:SENS{1-16}:CORR:COEF:METH:SOLT2	554
:SENS{1-16}:CORR:COEF:METH:SOLT3	555
:SENS{1-16}:CORR:COEF:METH:SOLT4	556
:SENS{1-16}:CORR:COEF:METH:THRU	557
:SENS{1-16}:CORR:COEF:SAVE	558
:SENS{1-16}:CORR:COLL:ADAP{1-4}:LENG	559
:SENS{1-16}:CORR:COLL:CKIT	560
:SENS{1-16}:CORR:COLL:CKIT:LAB	561
:SENS{1-16}:CORR:COLL:CKIT:ORD	562
:SENS{1-16}:CORR:COLL:CKIT:ORD:LOAD	563
:SENS{1-16}:CORR:COLL:CKIT:ORD:OPEN	564
:SENS{1-16}:CORR:COLL:CKIT:ORD:SHOR	565
:SENS{1-16}:CORR:COLL:CKIT:ORD:THRU	566
:SENS{1-16}:CORR:COLL:CKIT:ORD:TRLL	567
:SENS{1-16}:CORR:COLL:CKIT:ORD:TRLR	568
:SENS{1-16}:CORR:COLL:CKIT:ORD:TRLT	569
:SENS{1-16}:CORR:COLL:CKIT:RES	570
:SENS{1-16}:CORR:COLL:CKIT:STAN{1-21}:ARB	571
:SENS{1-16}:CORR:COLL:CKIT:STAN{1-21}:C0	572
:SENS{1-16}:CORR:COLL:CKIT:STAN{1-21}:C1	573
:SENS{1-16}:CORR:COLL:CKIT:STAN{1-21}:C2	574
:SENS{1-16}:CORR:COLL:CKIT:STAN{1-21}:C3	575
:SENS{1-16}:CORR:COLL:CKIT:STAN{1-21}:CHAR	576
:SENS{1-16}:CORR:COLL:CKIT:STAN{1-21}:DEL	577
:SENS{1-16}:CORR:COLL:CKIT:STAN{1-21}:FMAX	578
:SENS{1-16}:CORR:COLL:CKIT:STAN{1-21}:FMIN	579
:SENS{1-16}:CORR:COLL:CKIT:STAN{1-21}:L0	580

Contents

:SENS{1-16}:CORR:COLL:CKIT:STAN{1-21};L1	581
:SENS{1-16}:CORR:COLL:CKIT:STAN{1-21};L2	582
:SENS{1-16}:CORR:COLL:CKIT:STAN{1-21};L3	583
:SENS{1-16}:CORR:COLL:CKIT:STAN{1-21};LAB	584
:SENS{1-16}:CORR:COLL:CKIT:STAN{1-21};LOSS	585
:SENS{1-16}:CORR:COLL:CKIT:STAN{1-21};TYPE	586
:SENS{1-16}:CORR:COLL:CKIT:STAN{1-21};Z0	587
:SENS{1-16}:CORR:COLL:CKIT:TRL:IMP	588
:SENS{1-16}:CORR:COLL:CKIT:TRL:RPL	589
:SENS{1-16}:CORR:COLL:CLE	590
:SENS{1-16}:CORR:COLL:ECAL:CCH	591
:SENS{1-16}:CORR:COLL:ECAL:ERES	592
:SENS{1-16}:CORR:COLL:ECAL:ISOL	593
:SENS{1-16}:CORR:COLL:ECAL:SOLT1	594
:SENS{1-16}:CORR:COLL:ECAL:SOLT2	594
:SENS{1-16}:CORR:COLL:ECAL:SOLT3	595
:SENS{1-16}:CORR:COLL:ECAL:SOLT4	595
:SENS{1-16}:CORR:COLL:ECAL:THRU	596
:SENS{1-16}:CORR:COLL:ECAL:UCH	597
:SENS{1-16}:CORR:COLL:ECAL:UTHR	598
:SENS{1-16}:CORR:COLL:ISOL	599
:SENS{1-16}:CORR:COLL:LOAD	600
:SENS{1-16}:CORR:COLL:METH:ADAP:REM	601
:SENS{1-16}:CORR:COLL:METH:ERES	602
:SENS{1-16}:CORR:COLL:METH:OPEN	603
:SENS{1-16}:CORR:COLL:METH:SHOR	603
:SENS{1-16}:CORR:COLL:METH:SOLT1	604
:SENS{1-16}:CORR:COLL:METH:SOLT2	604
:SENS{1-16}:CORR:COLL:METH:SOLT3	605
:SENS{1-16}:CORR:COLL:METH:SOLT4	605
:SENS{1-16}:CORR:COLL:METH:THRU	606
:SENS{1-16}:CORR:COLL:METH:TRL2	607
:SENS{1-16}:CORR:COLL:METH:TRL3	608
:SENS{1-16}:CORR:COLL:METH:TRL4	609
:SENS{1-16}:CORR:COLL:METH:TYPE?	610
:SENS{1-16}:CORR:COLL:OPEN	611
:SENS{1-16}:CORR:COLL:PART:SAVE	612
:SENS{1-16}:CORR:COLL:SAVE	613
:SENS{1-16}:CORR:COLL:SHOR	613
:SENS{1-16}:CORR:COLL:SIMP:SAVE	614
:SENS{1-16}:CORR:COLL:SUBC	615
:SENS{1-16}:CORR:COLL:THRU	616
:SENS{1-16}:CORR:COLL:TRLL	617
:SENS{1-16}:CORR:COLL:TRLR	618
:SENS{1-16}:CORR:COLL:TRLT	619
:SENS{1-16}:CORR:EXT	620
:SENS{1-16}:CORR:EXT:AUTO:CONF	621
:SENS{1-16}:CORR:EXT:AUTO:DCOF	622
:SENS{1-16}:CORR:EXT:AUTO:LOSS	623

:SENS{1-16}:CORR:EXT:AUTO:MEAS	624
:SENS{1-16}:CORR:EXT:AUTO:PORT{1-4}	625
:SENS{1-16}:CORR:EXT:AUTO:RESet.	626
:SENS{1-16}:CORR:EXT:AUTO:STAR.	627
:SENS{1-16}:CORR:EXT:AUTO:STOP.	628
:SENS{1-16}:CORR:EXT:PORT{1-4}	629
:SENS{1-16}:CORR:EXT:PORT{1-4}:FREQ{1-2}	630
:SENS{1-16}:CORR:EXT:PORT{1-4}:INCL{1-2}	631
:SENS{1-16}:CORR:EXT:PORT{1-4}:LDC.	632
:SENS{1-16}:CORR:EXT:PORT{1-4}:LOSS{1-2}	633
:SENS{1-16}:CORR:OFFS:CLE	634
:SENS{1-16}:CORR:OFFS:COLL:CLE	635
:SENS{1-16}:CORR:OFFS:COLL:ECAL:SMIX2	636
:SENS{1-16}:CORR:OFFS:COLL:ECAL:SOLT1	637
:SENS{1-16}:CORR:OFFS:COLL:LOAD	638
:SENS{1-16}:CORR:OFFS:COLL:METH:SMIX2.	639
:SENS{1-16}:CORR:OFFS:COLL:METH:SOLT1	640
:SENS{1-16}:CORR:OFFS:COLL:OPEN	641
:SENS{1-16}:CORR:OFFS:COLL:PMET.	642
:SENS{1-16}:CORR:OFFS:COLL:SAVE	643
:SENS{1-16}:CORR:OFFS:COLL:SHOR.	644
:SENS{1-16}:CORR:OFFS:COLL:THRU.	645
:SENS{1-16}:CORR:PROP	646
:SENS{1-16}:CORR:REC{1-4}.	647
:SENS{1-16}:CORR:REC{1-4}:COLL:ACQ	648
:SENS{1-16}:CORR:RVEL:COAX.	649
:SENS{1-16}:CORR:STAT	650
:SENS{1-16}:CORR:TRIG:FREE	651
:SENS{1-16}:CORR:TYPE{1-16}?.	652
:SENS{1-16}:FREQ	653
:SENS{1-16}:FREQ:CENT	654
:SENS{1-16}:FREQ:DATA?	655
:SENS{1-16}:FREQ:SPAN.	656
:SENS{1-16}:FREQ:STAR	657
:SENS{1-16}:FREQ:STOP.	658
:SENS{1-16}:MULT{1-2}:OUTP	659
:SENS{1-16}:MULT{1-2}:PORT{1-20}	660
:SENS{1-16}:MULT{1-2}:PORT{1-20}:CAT?.	662
:SENS{1-16}:MULT{1-2}:TSET9:OUTP	663
:SENS{1-16}:MULT{1-2}:TSET9:PORT1	664
:SENS{1-16}:MULT{1-2}:TSET9:PORT2	665
:SENS{1-16}:MULT{1-2}:TSET9:PORT3	666
:SENS{1-16}:MULT{1-2}:TSET9:PORT4	667
:SENS{1-16}:OFFS	668
:SENS{1-16}:OFFS:ASP	669
:SENS{1-16}:OFFS:LOC:CONT.	670
:SENS{1-16}:OFFS:LOC:DATA?	671
:SENS{1-16}:OFFS:LOC:DIV	672
:SENS{1-16}:OFFS:LOC:MULT.	673

:SENS{1-16}:OFFS:LOC:OFFS	674
:SENS{1-16}:OFFS:LOC:STAR	675
:SENS{1-16}:OFFS:LOC:STOP	676
:SENS{1-16}:OFFS:LOC:POW	677
:SENS{1-16}:OFFS:LOC:POW:SLOP	678
:SENS{1-16}:OFFS:LOC:POW:SLOP:STAT	679
:SENS{1-16}:OFFS:LOC:STAT	680
:SENS{1-16}:OFFS:PORT{1-4}:DATA?	681
:SENS{1-16}:OFFS:PORT{1-4}:DIV	682
:SENS{1-16}:OFFS:PORT{1-4}:MULT	683
:SENS{1-16}:OFFS:PORT{1-4}:OFFS	684
:SENS{1-16}:OFFS:PORT{1-4}:STAR	685
:SENS{1-16}:OFFS:PORT{1-4}:STOP	686
:SENS{1-16}:ROSC:SOUR?	687
:SENS{1-16}:SEGM:DATA	688
:SENS{1-16}:SEGM:SWE:POIN?	690
:SENS{1-16}:SEGM:SWE:TIME?	690
:SENS{1-16}:SWE:ASP	691
:SENS{1-16}:SWE:DEL	691
:SENS{1-16}:SWE:GEN	692
:SENS{1-16}:SWE:POIN	693
:SENS{1-16}:SWE:TIME	694
:SENS{1-16}:SWE:TIME:AUTO	695
:SENS{1-16}:SWE:TYPE	696
:SERV:CHAN:ACT?	696
:SERV:CHAN:COUN?	697
:SERV:CHAN{1-16}:TRAC:ACT?	697
:SERV:CHAN:TRAC:COUN?	697
:SERV:PORT:COUN?	698
:SERV:SREV?	698
:SERV:SWE:FREQ:MAX?	699
:SERV:SWE:FREQ:MIN?	699
:SERV:SWE:POIN?	699
:SOUR:POW:PORT:CORR:COLL:ASEN:RCF	700
:SOUR:POW:PORT:CORR:COLL:BSEN:RCF	701
:SOUR:POW:PORT:CORR:COLL:TABL:ASEN:DATA	702
:SOUR:POW:PORT:CORR:COLL:TABL:BSEN:DATA	703
:SOUR{1-16}:POW	704
:SOUR{1-16}:POW:ATT	705
:SOUR{1-16}:POW:ATT:AUTO	706
:SOUR{1-16}:POW:CENT	708
:SOUR{1-16}:POW:PORT:COUP	709
:SOUR{1-16}:POW:PORT{1-4}	710
:SOUR{1-16}:POW:PORT{1-4}:CORR	711
:SOUR{1-16}:POW:PORT{1-4}:CORR:COLL	711
:SOUR{1-16}:POW:PORT{1-4}:CORR:COLL:AVER	712
:SOUR{1-16}:POW:PORT{1-4}:CORR:COLL:NTOL	713
:SOUR{1-16}:POW:PORT{1-4}:CORR:COLL:TABL:LOSS	714
:SOUR{1-16}:POW:PORT{1-4}:CORR:COLL:TABL:LOSS:DATA	715

:SOUR{1-16}:POW:PORT{1-4}:CORR:DATA	716
:SOUR{1-16}:POW:SLOP	717
:SOUR{1-16}:POW:SLOP:STAT	718
:SOUR{1-16}:POW:SPAN	719
:SOUR{1-16}:POW:STAR	720
:SOUR{1-16}:POW:STOP	721
:STAT:OPER?	722
:STAT:OPER:COND?	722
:STAT:OPER:ENAB	723
:STAT:OPER:NTR	724
:STAT:OPER:PTR	725
:STAT:PRES	726
:STAT:QUES?	726
:STAT:QUES:BLIM?	727
:STAT:QUES:BLIM:CHAN{1-16}?	727
:STAT:QUES:BLIM:CHAN{1-16}:COND?	727
:STAT:QUES:BLIM:CHAN{1-16}:ECH?	729
:STAT:QUES:BLIM:CHAN{1-16}:ECH:COND?	729
:STAT:QUES:BLIM:CHAN{1-16}:ECH:ENAB	730
:STAT:QUES:BLIM:CHAN{1-16}:ECH:NTR	731
:STAT:QUES:BLIM:CHAN{1-16}:ECH:PTR	732
:STAT:QUES:BLIM:CHAN{1-16}:ENAB	733
:STAT:QUES:BLIM:CHAN{1-16}:NTR	734
:STAT:QUES:BLIM:CHAN{1-16}:PTR	735
:STAT:QUES:BLIM:COND?	735
:STAT:QUES:BLIM:ELIM?	736
:STAT:QUES:BLIM:ELIM:COND?	736
:STAT:QUES:BLIM:ELIM:ENAB	737
:STAT:QUES:BLIM:ELIM:NTR	738
:STAT:QUES:BLIM:ELIM:PTR	739
:STAT:QUES:BLIM:ENAB	740
:STAT:QUES:BLIM:NTR	741
:STAT:QUES:BLIM:PTR	742
:STAT:QUES:COND?	743
:STAT:QUES:ENAB	744
:STAT:QUES:LIM?	745
:STAT:QUES:LIM:CHAN{1-16}?	745
:STAT:QUES:LIM:CHAN{1-16}:COND?	745
:STAT:QUES:LIM:CHAN{1-16}:ECH?	747
:STAT:QUES:LIM:CHAN{1-16}:ECH:COND?	747
:STAT:QUES:LIM:CHAN{1-16}:ECH:ENAB	748
:STAT:QUES:LIM:CHAN{1-16}:ECH:NTR	749
:STAT:QUES:LIM:CHAN{1-16}:ECH:PTR	750
:STAT:QUES:LIM:CHAN{1-16}:ENAB	751
:STAT:QUES:LIM:CHAN{1-16}:NTR	752
:STAT:QUES:LIM:CHAN{1-16}:PTR	753
:STAT:QUES:LIM:COND?	754
:STAT:QUES:LIM:ELIM?	754
:STAT:QUES:LIM:ELIM:COND?	755

:STAT:QUES:LIM:ELIM:ENAB	755
:STAT:QUES:LIM:ELIM:NTR	756
:STAT:QUES:LIM:ELIM:PTR	757
:STAT:QUES:LIM:ENAB	758
:STAT:QUES:LIM:NTR	759
:STAT:QUES:LIM:PTR	760
:STAT:QUES:NTR	761
:STAT:QUES:PTR	762
:STAT:QUES:RLIM?	763
:STAT:QUES:RLIM:CHAN{1-16}?	763
:STAT:QUES:RLIM:CHAN{1-16}:COND?	763
:STAT:QUES:RLIM:CHAN{1-16}:ECH?	765
:STAT:QUES:RLIM:CHAN{1-16}:ECH:COND?	765
:STAT:QUES:RLIM:CHAN{1-16}:ECH:ENAB	766
:STAT:QUES:RLIM:CHAN{1-16}:ECH:NTR	767
:STAT:QUES:RLIM:CHAN{1-16}:ECH:PTR	768
:STAT:QUES:RLIM:CHAN{1-16}:ENAB	769
:STAT:QUES:RLIM:CHAN{1-16}:NTR	770
:STAT:QUES:RLIM:CHAN{1-16}:PTR	771
:STAT:QUES:RLIM:COND?	771
:STAT:QUES:RLIM:ELIM?	772
:STAT:QUES:RLIM:ELIM:COND?	772
:STAT:QUES:RLIM:ELIM:ENAB	773
:STAT:QUES:RLIM:ELIM:NTR	774
:STAT:QUES:RLIM:ELIM:PTR	775
:STAT:QUES:RLIM:ENAB	776
:STAT:QUES:RLIM:NTR	777
:STAT:QUES:RLIM:PTR	778
:SYST:BACK	779
:SYST:BEEP:COMP:IMM	780
:SYST:BEEP:COMP:STAT	780
:SYST:BEEP:WARN:IMM	781
:SYST:BEEP:WARN:STAT	781
:SYST:COMM:GPIB:PMET:ADDR	782
:SYST:COMM:GPIB:SGEN:ADDR	783
:SYST:COMM:GPIB:SGEN:CCOM:FREQ	784
:SYST:COMM:GPIB:SGEN:CCOM:POW	785
:SYST:COMM:GPIB:SGEN:CCOM:PRES	786
:SYST:COMM:GPIB:SGEN:CCOM:RFON	787
:SYST:COMM:GPIB:SGEN:DWEL	788
:SYST:COMM:GPIB:SGEN:TYPE	789
:SYST:CORR	790
:SYST:DATE	790
:SYST:ERR?	791
:SYST:ISPC:PORT	792
:SYST:ISPC:STAT	793
:SYST:KLOC:KBD	794
:SYST:KLOC:MOUS	795
:SYST:POFF	796

:SYST:PRES	796
:SYST:SEC:LEV	797
:SYST:SERV?	798
:SYST:TEMP	799
:SYST:TEMP:HIGH	799
:SYST:TIME	800
:SYST:UPR	801
:TRIG	802
:TRIG:AVER	803
:TRIG:EXT:DEL	804
:TRIG:EXT:LLAT	805
:TRIG:POIN	806
:TRIG:SCOP	807
:TRIG:SING	808
:TRIG:SOUR	809
Command list	810
List by front panel key	810
Command tree	828

A. Manual Changes

Manual Changes	852
Change 10	853
Change 9	853
Change 8	854
Change 7	854
Change 6	857
Change 5	857
Change 4	859
Change 3	861
Change 2	862
Change 1	862

B. Status Reporting System

General Status Register Model	864
Event Register	865
Enable Register	865
Status Byte Register	865
Condition Register and Transition Filter	866
Status Register Structure	867
Using the Status Reporting System	894

C. Comparing Commands on the 8753ES and E5070B/E5071B

8753ES vs. E5070B/E5071B Command Correspondence (by function)	898
8753ES vs. E5070B/E5071B Command Comparison (8753ES-only commands excluded)	929

1 Making Effective Use of This Manual

This chapter describes the contents of this guide. Using this chapter with the table of contents helps you to retrieve description of a subject you wish to understand as well as to obtain an overview of this guide. Also see the latter part of this chapter for brief description of usage of this guide, focusing on searching commands.

Contents of This Manual

This is a programming guide with Agilent E5070B/E5071B.

This guide describes programming method mainly aiming at learning how to write a program that remotely controls the E5070B/E5071B using SCPI commands, focusing on sample usage with the HTBasic.

Controlling the E5070B/E5071B using the built-in VBA is not covered by this guide; it is described in *VBA Programmer's Guide*. For using the E5070B/E5071B VBA, see *VBA Programmer's Guide*.

Description in this guide assumes that the reader has learned manual operation of the E5070B/E5071B. Thus, this guide does not describe each feature of the E5070B/E5071B in detail. For detailed information on each feature, see *User's Guide*.

The chapter-by-chapter contents of this manual are as follows.

Chapter 1, "Making Effective Use of This Manual."

This chapter describes the contents of this guide. Using this chapter with the table of contents helps you to retrieve description of a subject you wish to understand as well as to obtain an overview of this guide. Also see the latter part of this chapter for brief description of usage of this guide, focusing on searching commands.

Chapter 2, "Overview of Remote Control."

This chapter provides an overview of the remote control system and the SCPI commands.

Chapter 3, "Setting Up the Analyzer."

This chapter describes how to configure measurement conditions and how to configure the way the instrument displays measurement results on the LCD.

Chapter 4, "Performing Calibration."

This chapter explains how to obtain calibration coefficients and perform error correction as well as how to define the calibration kit required to obtain the calibration coefficients. It also shows how to perform power calibration.

Chapter 5, "Making a Measurement."

This chapter explains how to trigger the instrument to start a new measurement cycle and how to detect the end of a measurement cycle.

Chapter 6, "Analyzing Data."

This chapter describes how to use markers, analysis commands, and fixture simulator features.

Chapter 7, "Reading/Writing Measurement Data."

This chapter provides an overview of the Agilent E5070B/E5071B's internal data processing flow and describes how to read and write measurement results (internal data array).

Chapter 8, “Limit Test.”

This chapter explains how to use the Limit Test feature to perform a limit test and determine the pass/fail status of the measured data.

Chapter 9, “Saving and Recalling (File Management).”

This chapter describes how to save and recall instrument status and measurement results onto/from the files. Here also covered is managing files.

Chapter 10, “Communication with External Instruments Using Handler I/O Port.”

This chapter provides necessary information for communicating with external instruments (for example, a handler in a production line) using the handler I/O port equipped with the Agilent E5070B/E5071B.

Chapter 11, “Working with Automatic Test Systems.”

This chapter describes useful features when the Agilent E5070B/E5071B is integrated with an automatic test system.

Chapter 12, “Controlling E5091A.”

This chapter explains how to control the E5091A.

Chapter 13, “Sample Application Programs.”

This chapter introduces several sample programs for basic measurement, measurement with a system using the handler I/O, and controlling the instrument over a LAN.

Chapter 14, “SCPI Command Reference.”

This chapter provides the SCPI command reference for the Agilent E5070B/E5071B. It describes the commands using their abbreviated format in alphabetical order. If you want to look up commands using their fully specified format, refer to the index for the desired SCPI command. If you want to look up commands by their function, refer to the SCPI command list ordered by function.

Appendix A, “Manual Changes.”

This appendix contains the information required to adapt this manual to earlier versions or configurations of the Agilent E5070B/E5071B than that indicated by the current printing date of this manual. The information in this manual applies directly to the E5070B/E5071B model that has the serial number prefix listed on the title page of this manual.

Appendix B, “Status Reporting System.”

This appendix describes the status reporting system of the Agilent E5070B/E5071B.

Appendix C, “Comparing Commands on the 8753ES and E5070B/E5071B.”

The following table presents a comparison of commands on the Agilent 8753ES and Agilent E5070B/E5071B, listed alphabetically by function.

How To Use This Manual

Chapters 3 to 9 provide task-based descriptions of SCPI commands that are useful for programming and explain how you can use them. These chapters contain explanations and sample program listings that you can use to develop your custom programs. For more information on individual commands, see Chapter 14, “SCPI Command Reference.”

Looking up SCPI commands

Chapter 14 “SCPI Command Reference” contains a complete reference of SCPI commands. You can look up a particular SCPI command in any of the following ways:

Lookup by Abbreviated Command Name

The command reference is organized alphabetically according to the abbreviated name used as the title for each command’s description.

Lookup by Full Command Name

You can use the index at the end of the manual to find full command names along with the page numbers where they appear.

Lookup by Command Function

Table 14-1 on page 811 provides a complete list of commands by function and indicates the page numbers where the commands appear in the command reference.

Lookup by Front panel key

Table 14-1 on page 811 provides a complete list of commands that correspond to the front panel key tree and indicates the page numbers where the commands appear in the command reference.

NOTE

Some SCPI commands supported by the E5070B/E5071B have optional syntax elements. In the command reference conventions, these elements are enclosed between square brackets ([]) or printed in lowercase letters. See “Syntax” on page 284 for more information.

Using sample programs

This manual comes with a sample program disk, which contains the source files of the sample programs used in the manual. The disk is DOS-formatted and the files are saved in ASCII format.

Loading a sample program

To load a sample program into the HTBasic interpreter, use the GET command. For example, you can load setup.bas, one of the sample programs, by the following procedure:

In the HTBasic screen, type the following command and press the Return key.

```
GET "setup.bas"
```

Looking up a sample program

To look up the description of a sample program, see the listings under "Sample program" in the index.

Making Effective Use of This Manual
How To Use This Manual

2 Overview of Remote Control

This chapter provides an overview of the remote control system and the SCPI commands.

Types of remote control system

Depending on the system controller and the interface, you can configure 4 types of remote control system as shown in the table below.

System controller	Interface	Overview
External controller (external computer such as PC and workstation)	GPIB (talker/listener mode)	System to control the E5070B/E5071B and other devices connected via GPIB from the external controller. For more information, refer to “GPIB remote control system” on page 31.
	LAN	System to control the E5070B/E5071B and other devices connected via LAN from the external controller. For more information, refer to “LAN remote control system” on page 33.
	USB	System to control the E5070B/E5071B and other devices connected via USB from the external controller. For more information, refer to “USB Remote Control System” on page 42.
E5070B/E5071B	—	System to control the E5070B/E5071B itself using built-in E5070B/E5071B VBA. For more information, refer to <i>VBA Programmers Guide</i> .
	GPIB (system controller mode)	System to control the E5070B/E5071B itself and external devices connected via GPIB using built-in E5070B/E5071B VBA. For more information, refer to <i>VBA Programmers Guide</i> .

GPIB remote control system

What is GPIB?

GPIB (General Purpose Interface Bus) is an interface standard for connecting computers and peripherals, which supports the following international standards: IEEE 488.1, IEC-625, IEEE 488.2, and JIS-C1901. The GPIB interface allows you to control the Agilent E5070B/E5071B from an external computer. The computer sends commands and instructions to the E5070B/E5071B and receives data sent from the E5070B/E5071B via GPIB.

System configuration

Use GPIB cables to connect between the E5070B/E5071B, the external controller (computer), and peripherals. Figure 2-1 shows the overview of the system configuration of the GPIB remote control system.

Figure 2-1 Configuration of the GPIB remote control system

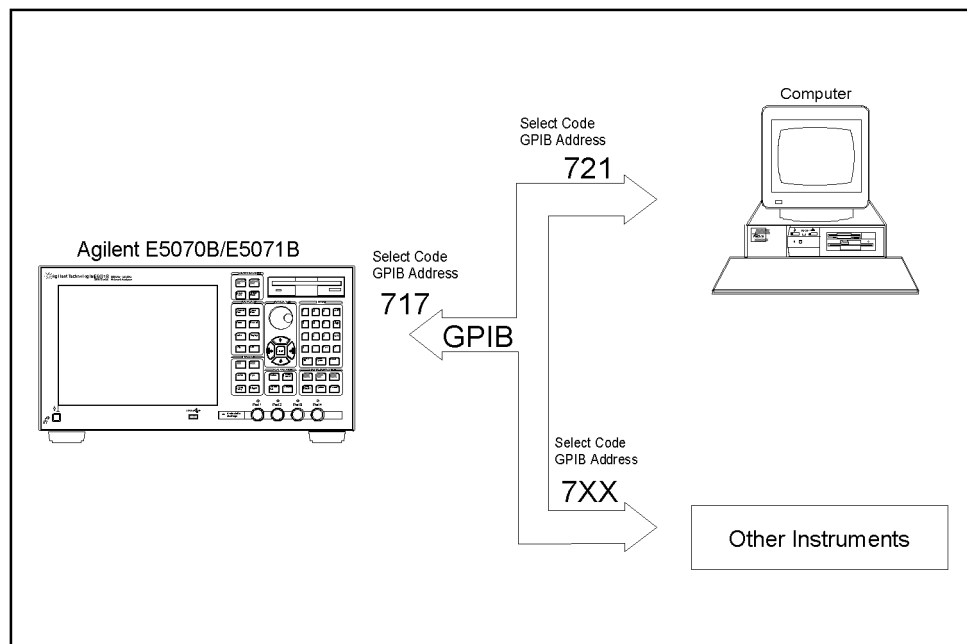

e5070bpe013

NOTE

While the E5070B/E5071B is turned off, the SRQ status of the E5070B/E5071B is active. To prevent an incorrect operation on the SRQ of the GPIB remote control system, disconnect the E5070B/E5071B from the system when the E5070B/E5071B is turned off.

Overview of Remote Control GPIB remote control system

Required Equipment

1. E5070B/E5071B
2. External controller (computer)
Use a personal computer or workstation equipped with the GPIB interface. You need to install software to control this instrument via GPIB into the external controller (for example, HTBasic and Agilent VEE) and set the GPIB mode to talker/listener mode (**[System] - Misc Setup - GPIB Setup - Talker/Listener Address**).
3. Other devices (other instruments and/or peripherals that serve your purpose)
4. GPIB cables for connecting the E5070B/E5071B, the external controller, and other devices

Scale of system you can construct

- You can connect up to 15 devices in a single GPIB system.
- The length of cables to connect between devices must be 4 m or less. The total length of connecting cables in a single GPIB system must be $2 \text{ m} \times$ the number of connected devices (including the controller) or less. You cannot construct the system in which the total cable length exceeds 20 m.
- The number of connectors connected to an individual device must be 4 or less. If you connect 5 or more connectors, excessive force is applied to the connector part, which may result in failure.
- You can choose the device connection topology from star, linear, and combined. Loop connection is not supported.

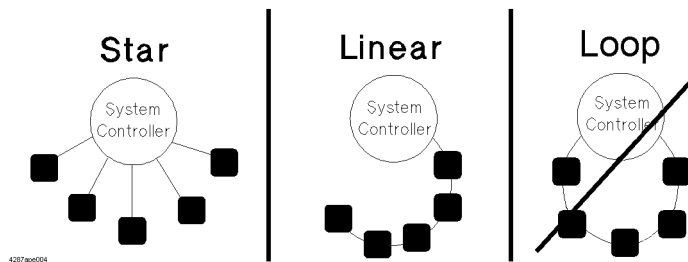

Device selector

The device selector is a unique value assigned to each device that is used by the controller to select the control target (to send/receive messages) among devices connected on the GPIB remote control system.

The device selector consists of a select code (usually, 7) and a GPIB address. For example, when the select code is 7 and the GPIB address is 17, the device selector is 717. The select code must be set for each system. The GPIB address must be set to a unique value for each device, which is used to identify devices on the same system. In the description and sample programs in this manual, it is assumed that the device selector is set to 717.

Setting the GPIB address of the E5070B/E5071B

[System] - GPIB Setup - Talker/Listener Address

LAN remote control system

The LAN (Local Area Network) remote control system provides two methods: controlling the E5070B/E5071B using the SICL-LAN server and controlling the E5070B/E5071B using the telnet server.

System configuration

Use a LAN cable to connect between the E5070B/E5071B and the external controller (computer). Figure 2-2 shows the overview of the system configuration of the LAN remote control system.

Figure 2-2

Configuration of the LAN remote control system

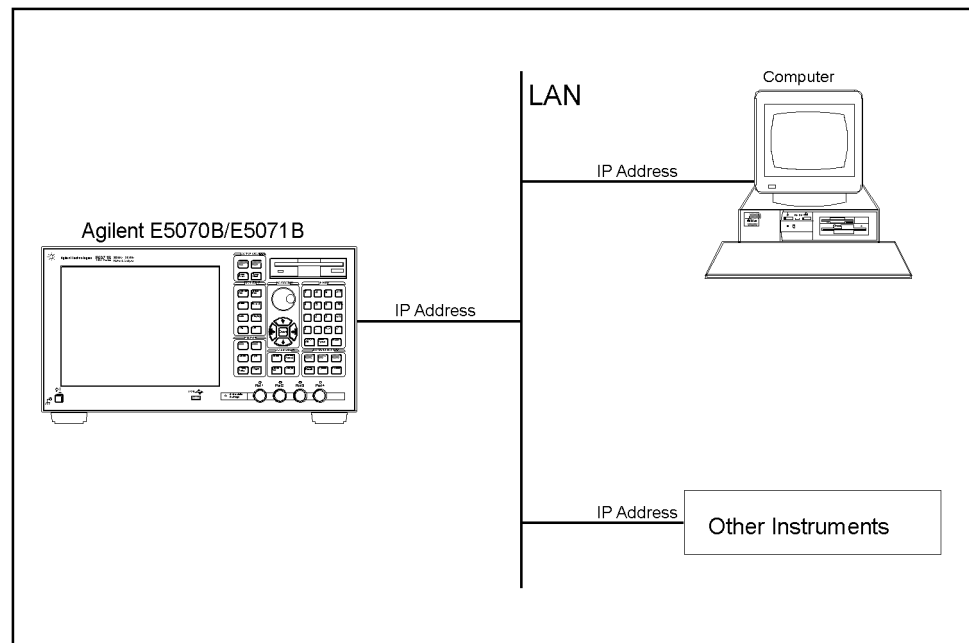

e5070bpe015

Required Equipment

1. E5070B/E5071B
2. External controller (personal computer or workstation that can be connected to LAN and Agilent I/O Library is installed into)
3. Other devices (other instruments and/or peripherals that serve your purpose)
4. LAN cable for connecting the E5070B/E5071B with the external controller

Preparing the E5070B/E5071B

Before controlling the E5070B/E5071B via LAN, you need to configure the network function. For detailed information on the procedure, refer to *User's Guide*.

Control over SICL-LAN server

In the control system using the SICL-LAN server, communication between the external controller (client) and the E5070B/E5071B (server) is performed using the SICL-LAN protocol. Communication is performed using SICL (Standard Instrument Control Library). You can control the E5070B/E5071B by programming using SICL or VISA with the C language in the UNIX environment, or Visual C++, Visual Basic, or VEE in the Windows environment.

Preparing the E5070B/E5071B

To communicate with the external controller, follow these steps to turn on the SICL-LAN server of the E5070B/E5071B in advance.

Step 1. Turn on the SICL-LAN server of the E5070B/E5071B.

[System] - Misc Setup - Network Setup - SICL-LAN Server [ON]

Step 2. Set the GPIB address of the E5070B/E5071B for control with the SICL-LAN server. “XX” represents an address number.

[System] - Misc Setup - Network Setup - SICL-LAN Address [XX]

NOTE

You need to restart the E5070B/E5071B firmware after changing the on/off setting or address setting of the SICL-LAN server.

Preparing the external controller

In order to establish communication to the E5070B/E5071B using the TCP/IP protocol, you need to set the I/O interface of the external controller in advance. This section shows the setting procedure when using the external controller in the Windows environment.

NOTE

You must install the Agilent I/O Libraries in advance.

Use Agilent I/O Libraries M.01.01 or Agilent I/O Libraries Suite 14 or later.

For further information on the I/O Libraries, see the Agilent I/O Libraries Manual.

The Agilent I/O Libraries may not be available for certain external controllers or OS versions. For further details, refer to the Help guidance for the Agilent I/O Libraries.

Step 1. From your PC's Start menu, click Program - Agilent I/O Libraries Suite - Agilent Connection Expert to open the Agilent Connection Expert setting screen.

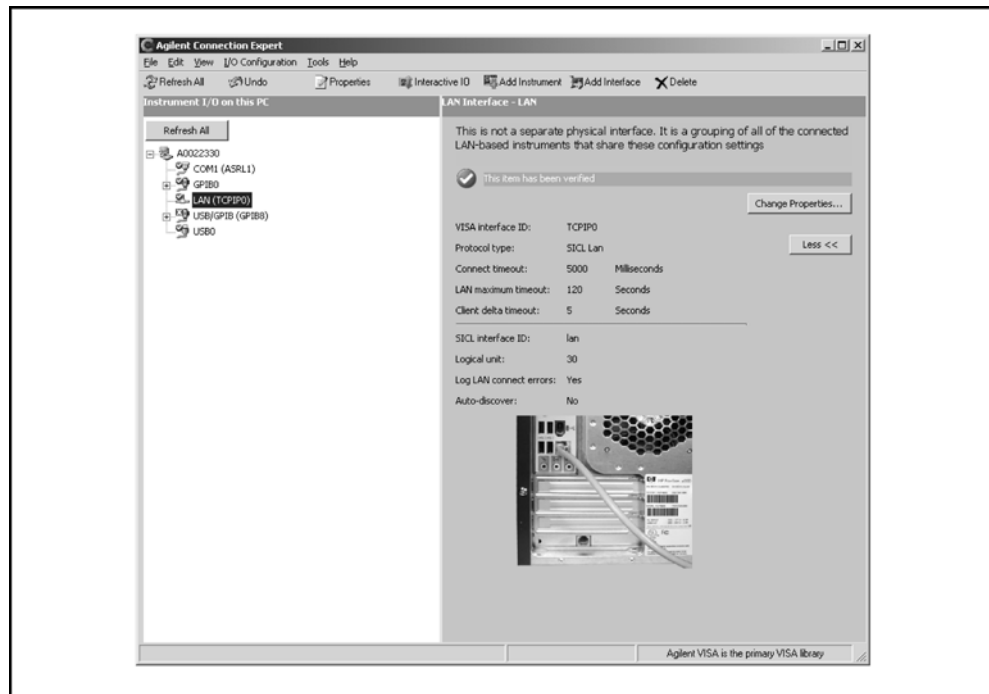

e5070bpj7002

Step 2. In the Agilent Connection Expert setting screen, select **LAN(TCPIP0) in the Instrument I/O on this PC** frame, and then select **I/O Configuration - Add Instrument** on the menu.

Step 3. In the Add Instrument screen, press **OK** as LAN has been selected.

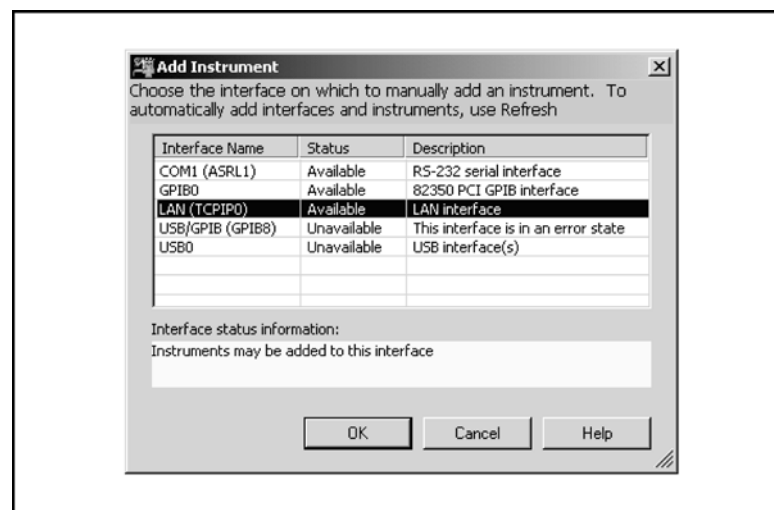

e5070bpj7003

Overview of Remote Control LAN remote control system

Step 4. In the LAN Instrument Properties screen, set up the IP address of the E5070B/E5071B and click **OK**. You can change settings as necessary. For details, refer to the Agilent I/O Libraries Suite manual.

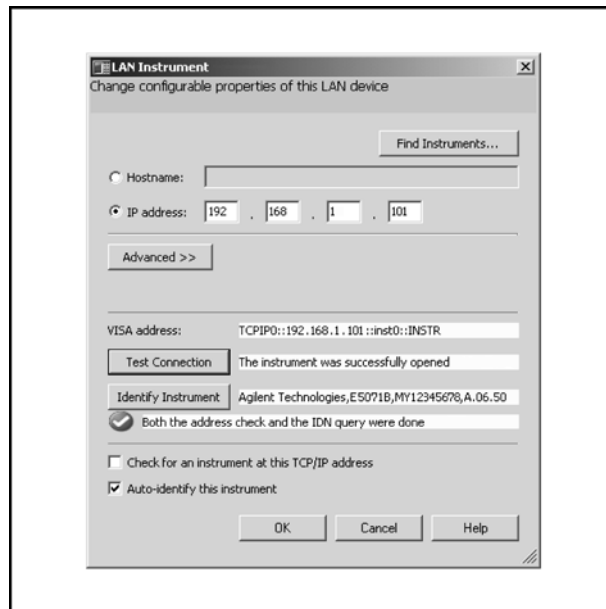

e5070bpj7004

Step 5. In the Agilent Connection Expert screen, check that the E5070B/E5071B has been added under **LAN(TCPIP0)** in the **Instrument I/O on this PC** frame.

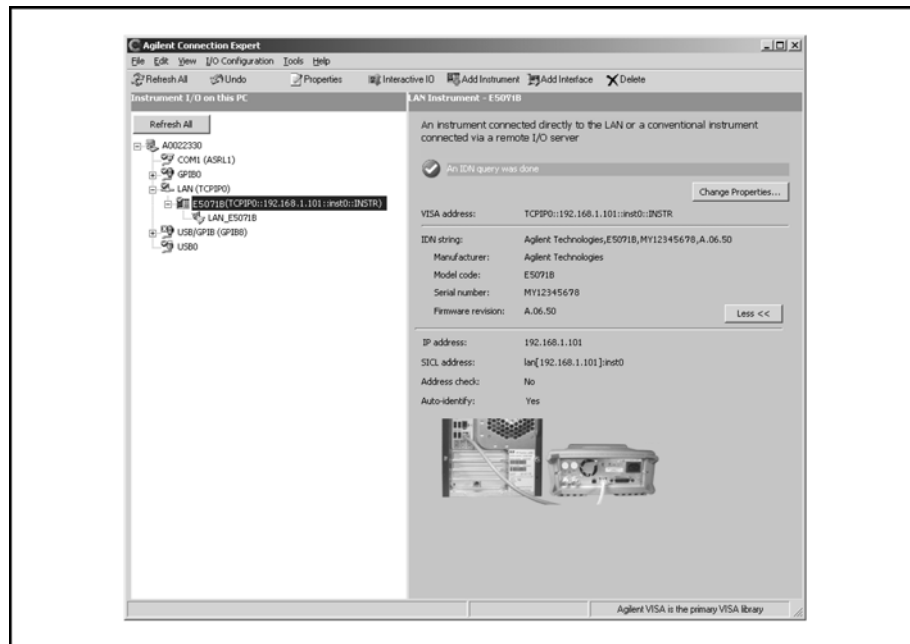

e5070bpj7005

Control using C or Visual Basic

You can control the E5070B/E5071B by programming using SICL with the C language in the UNIX environment, or Visual C++ or Visual Basic in the Windows environment.

For more information on the control method, see a sample program using the VBA macro of Microsoft Excel described in “Control Using SICL-LAN Server” on page 265.

Control using Agilent VEE

Agilent VEE allows you to control the E5070B/E5071B via the I/O interface. The following example shows how to control the E5070B/E5071B that is set as follows: the address of the SICL-LAN server is 17 and the IP address is 192.168.0.1.

NOTE

When using Agilent VEE for PC, use Agilent VEE Pro 6 for Windows or later.

Step 1. On the Agilent EVE’s I/O menu, click **Instrument Manager...**

Step 2. In the Instrument Manager setting screen, click **Add...**

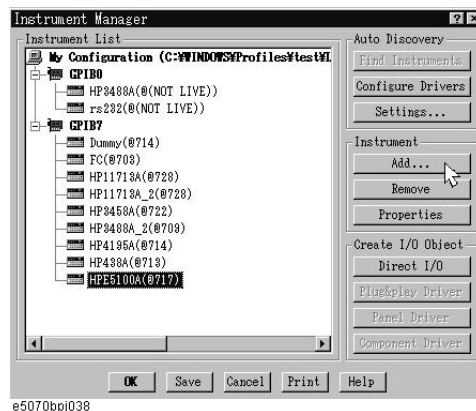

Step 3. The Instrument Properties setting screen appear. Make the settings as follows: Name (1 in the figure below): **SICL_LAN** (you can specify any name), Interface (2 in the figure below): **GPIB**, and Address (3 in the figure below): **917** (for the E5070B/E5071B, fixed to 9. 17 is the address of the SICL-LAN server). Then, click Gateway: **This host**. The Select or Enter Gateway setting screen appears. Enter the IP address or host name of the E5070B/E5071B (4 in the figure below).

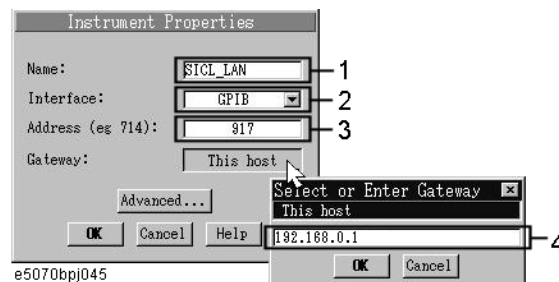
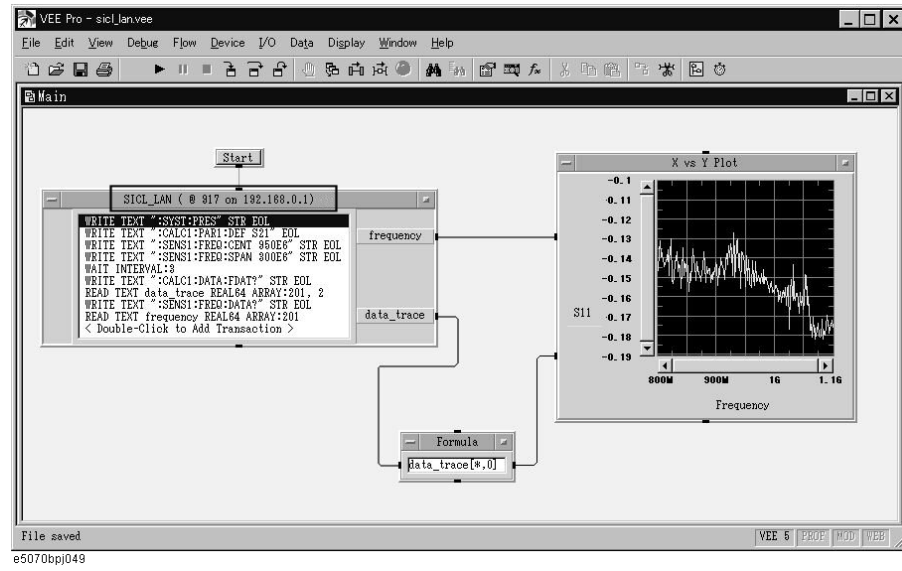

Figure 2-3 shows an example of control using the I/O interface that has been set in the above procedure.

Figure 2-3

Example of control using Agilent VEE



Control over telnet server

In the control system over telnet server, communications are performed through connection between the sockets provided by the processes of the external controller and the E5070B/E5071B to establish a network path between them.

A socket is an endpoint for network connection; port 23 and port 5025 are provided for the sockets for the E5070B/E5071B. Port 23 is provided for conversational control using telnet (user interface program for the TELNET protocol) and port 5025 for control from a program.

Preparing the E5070B/E5071B

To communicate with the external controller, follow these steps to turn on the telnet server of the E5070B/E5071B in advance.

[System] - Misc Setup - Network Setup - Telnet Server [ON]

Conversational control using telnet (using port 23)

You can use telnet to perform conversational control by sending SCPI commands to the E5070B/E5071B on a message-by-message basis. For telnet, the socket of port 23 is used for communications.

In this example, in order to show you the control procedure using telnet, you control the E5070B/E5071B (IP address: 192.168.0.1 and host name: e5070a) from the external controller in the Windows environment.

- Step 1.** Open the MS-DOS command prompt screen.
- Step 2.** At the MS-DOS prompt, type telnet 192.168.0.1 or telnet e5070a and press the return key.
- Step 3.** The telnet screen opens.
- Step 4.** Type a command and press the return key; it is sent to the E5070B/E5071B and executed. If you enter a command that queries some data, the query response is displayed below the line you have entered the command.

Figure 2-4 shows the screen after using the :SYST:PRES command on page 796 to reset, the :SENS{1-16}:FREQ:STAR command on page 657 and :SENS{1-16}:FREQ:STOP command on page 658 commands to set the sweep start value and stop value to 1 GHz and 2 GHz respectively, and checking the settings.

Figure 2-4

Example of control using telnet

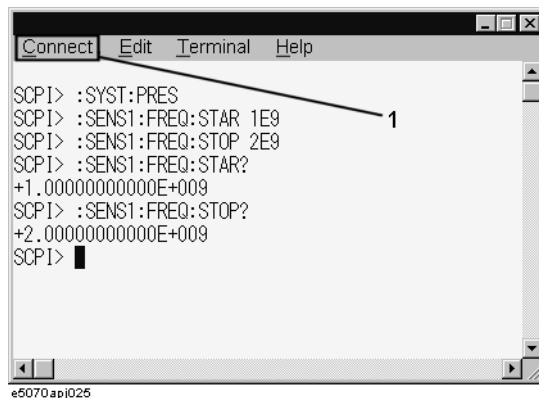

The screenshot shows a telnet window with a menu bar (Connect, Edit, Terminal, Help) and a command prompt. The text in the window is as follows:

```
SCPI> :SYST:PRES
SCPI> :SENS1:FREQ:STAR 1E9
SCPI> :SENS1:FREQ:STOP 2E9
SCPI> :SENS1:FREQ:STAR?
+1.0000000000E+009
SCPI> :SENS1:FREQ:STOP?
+2.0000000000E+009
SCPI> █
```

A line with the number '1' points to the 'Connect' menu item in the window's title bar.

- Step 5.** Select Disconnect from the Connect menu in the telnet screen (1 in Figure 2-4) to break the connection to the E5070B/E5071B and select Exit from the Edit menu to exit the telnet. (In other environment such as the UNIX environment, press] while holding down the control key. The telnet prompt appears. At the telnet prompt, type quit and press the return key. The connection to the E5070B/E5071B breaks and telnet finishes.)

Control from a program (using port 5025)

When controlling the E5070B/E5071B from a program on the external controller, use the socket of port 5025 for connection.

NOTE

Some functions such as service requests that are available in the GPIB remote control system are not available in control over telnet server.

Control using C or Visual Basic

You can control the E5070B/E5071B by socket programming using the C language in the UNIX environment, or Visual C++ or Visual Basic in the Windows environment.

For socket programming, the library for network connection on the TCP/IP protocol is required. For the UNIX environment, BSD (Berkeley Software Distribution) Sockets API is available; for the Windows environment, WinSock (WinSock1.1 and WinSock2.0) created by porting BSD Sockets to Windows and expanding it is available.

For more information on the control method, see a sample program for control using WinSock described in “Controlling Using Telnet Server” on page 273.

Agilent Control using VEE

Agilent VEE allows you to control the E5070B/E5071B through the connection to the socket of port 5025 using To/From Socket. Figure 2-5 shows an example (when the IP address of the E5070B/E5071B is 192.168.0.1). Enter 5025 in the field to specify the port for connection (1 in Figure 2-5) and enter the IP address or host name of the E5070B/E5071B in the field to specify the host name (2 in Figure 2-5).

Figure 2-5

Example of control using Agilent VEE

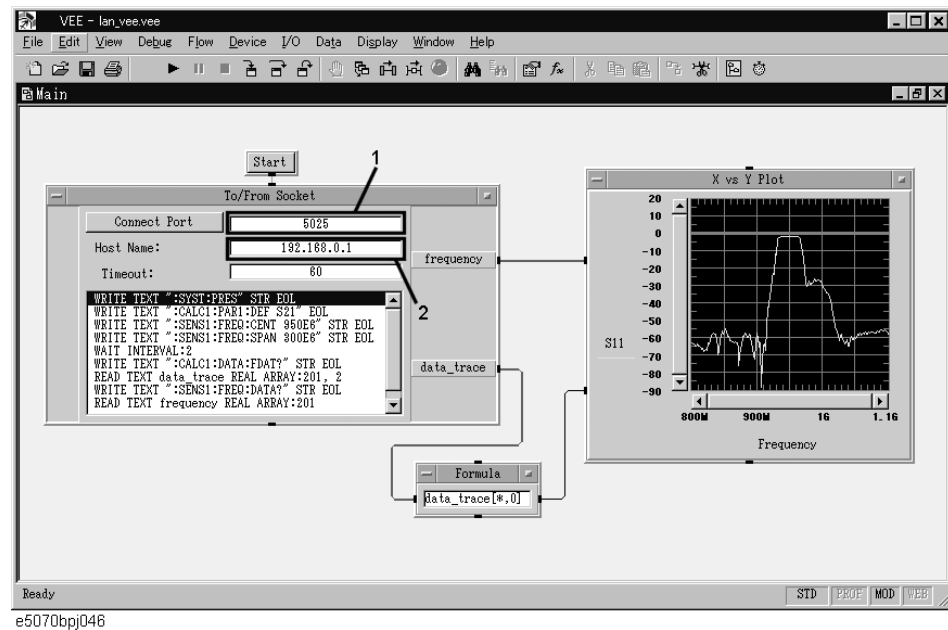

USB Remote Control System

The USB (Universal Serial Bus) remote control system provides device control via USB that is equivalent to control via GRIP. Connection is made through an interface in compliance with USBTMC-USB488 and USB 2.0.

System configuration

The USB remote control system controls instruments that use the name “alias.” There is no such address for GPIB connections.

Use a LAN cable to connect the E5070B/E5071B to an external controller (personal computer). Figure 2-6 shows an overview of the system configuration for the USB remote control system.

Figure 2-6

USB Remote Control System Configuration

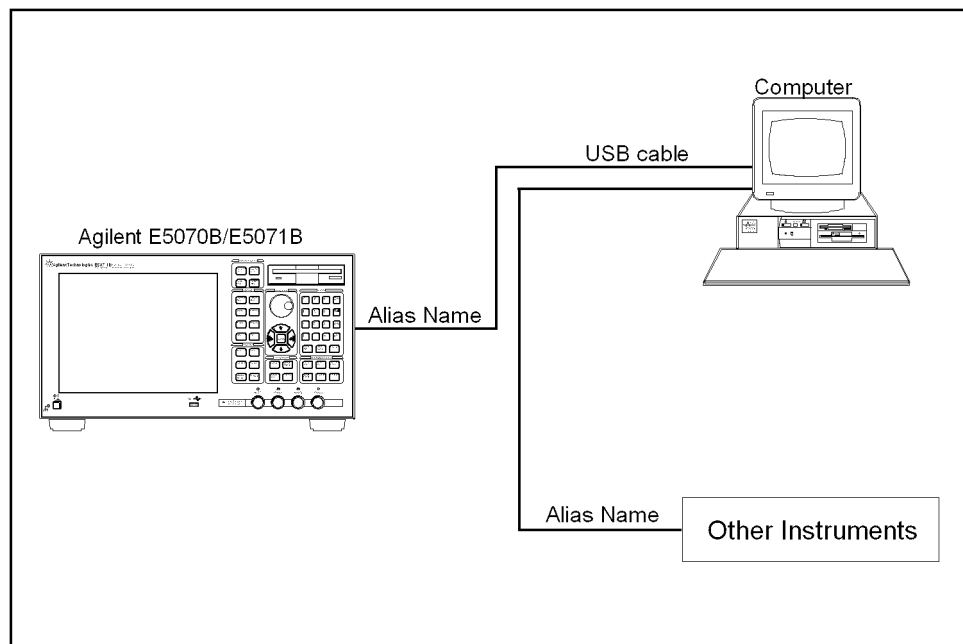

e5070bpe5008



Required Equipment

1. E5070B/E5071B (models with USB (USBTMC) interface port (type B)).
2. External controller (personal computer with installed Agilent I/O Libraries and USB host port (type A)).
3. Other USB compatible devices (instruments and/or peripherals for specific purposes).
4. USB cable connecting E5070B/E5071B and external controller (with type A/4-prong male or type B/4-prong male connectors depending on device used).

USB Port Types

There are two standard types of USB ports. The external controller (PC) must be connected

via the USB host port (type A), while the E5070B/E5071B and other USB compatible devices must be connected via the USB interface port (type B).

	Type A: USB host port
	Type B: USB (USBTMC) interface port

Preparing E5070B/E5071B

You do not have to configure any softkey or command of the E5070B/E5071B in order to control the E5070B/E5071B from an external controller. Simply connect a USB cable to the USB interface port.

Preparing External Controller

In order to establish communication with the E5070B/E5071B via USB, you must set up the I/O interface of the external controller in advance. The USB can identify devices automatically, so once you connect a USB cable to a target device, a dialog box will appear for USB device registration.

NOTE The E5070B/E5071B will be identified as new device if its serial number has been changed.

NOTE You must install the Agilent I/O Libraries in advance. Use Agilent I/O Libraries M.01.01 or Agilent I/O Libraries Suite 14 or later.

For further information on the I/O Libraries, see the Agilent I/O Libraries Manual.

The Agilent I/O Libraries may not be available for certain external controllers or OS versions. For further details, refer to the Help guidance for the Agilent I/O Libraries.

1. Registering Alias When USB Cable Is Connected

When new device is connected via USB cable, the following dialog box will appear automatically. Follow the steps below to register alias, when you use the Agilent I/O Libraries Suite 14.

Step 1. In the Assign USB device alias dialog box, enter an alias and then click the **OK** button.

Figure 2-7

Registering Alias



NOTE

For alias, use the ASCII format less than 127 digits. Alias is upper/lower case insensitive.

If "Never show this dialog" is selected in the "Show this dialog" frame, the dialog box does not appear even if a new device is connected.

NOTE

Once new device is identified, the "New Hardware Search Wizard" will start. Follow the instruction to implement the processing.

2. Changing Alias on Setting Screen

The following are steps using the Agilent I/O Libraries Suite 14.

- Step 1.** Step 1: From the Start menu of your PC, click Program - Agilent IO Libraries Suite -Agilent Connection Expert to open the Config setting screen.
- Step 2.** In the Config setting screen, select the alias names from **USB0** onward in the **Instrument I/O on this PC** frame, and then use the **Change Properties** from **I/O Configuration** on the menu bar.

Figure 2-8 Changing Alias

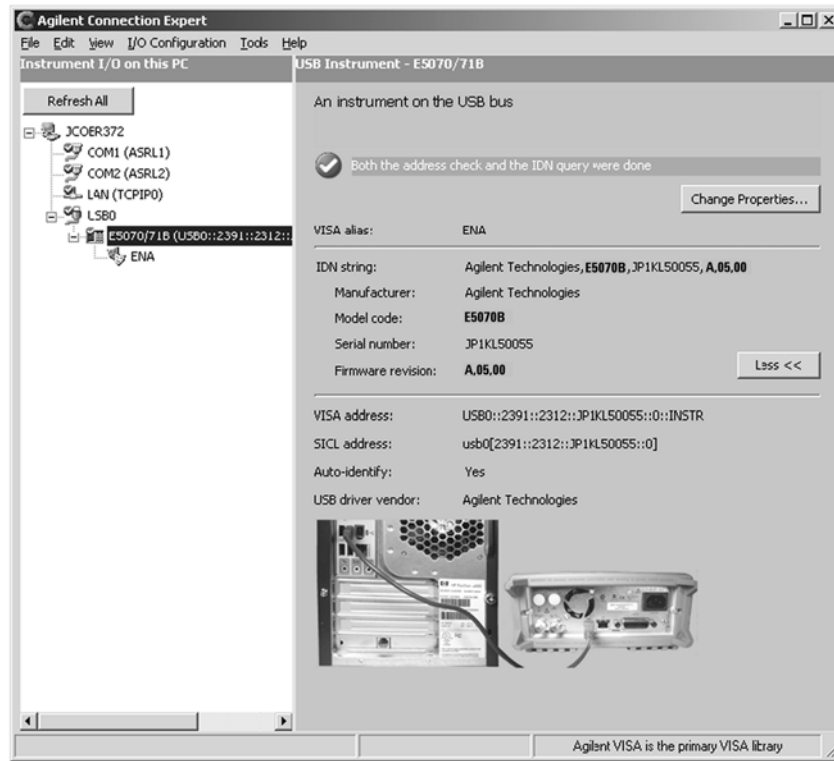

e5070bpj5005

2. Overview of Remote Control

Control using C or Visual Basic

You can control the E5070B/E5071B by programming using Visual C++ or Visual Basic in the Windows environment as well as SICL/VISA. For further information on controlling the E5070B/E5071B, see the manual of SICL or VISA. For Agilent I/O Libraries, use Agilent I/O Libraries M.01.01 or Agilent I/O Libraries Suite 14.

You may use alias in the programming using SICL/VISA.

The following example shows an OPEN command to control the E5070B/E5071B to which alias is given as ENA_USBIF.

SICL	id = iopen("ENA_USBIF")
VISA	viOpen(...,"ENA_USBIF",...)

NOTE

For further details of the programming using SICL/VISA, see the SICL Users Guide or the VISA Users Guide.

Overview of Remote Control USB Remote Control System

Control using Agilent VEE

Agilent VEE allows you to control the E5070B/E5071B via the direct I/O interface. The following example shows how to control the E5070B/E5071B to which alias is given as ENA_USBIF.

NOTE When using Agilent VEE for PC, use Agilent VEE Pro 7 for Windows or later version.

Step 1. On the Agilent VEE's I/O menu, click **Instrument Manager...**

Step 2. In the Instrument Manager setting screen, click **Add...**

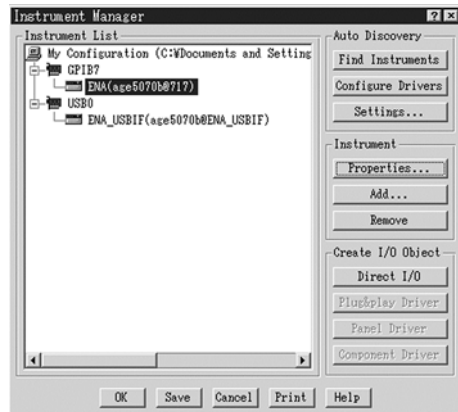

e5070bpj5001

Step 3. The Instrument Properties dialog box appears. Specify Name: **ENA_USBIF** (1 shown below, any other name acceptable), Interface: **USB** (2 shown below), Board Number: **0** (3 shown below, USB port number), and Alias: **ENA_USBIF** (4 shown below which is registered in the IO Config setting screen), then click **OK**.

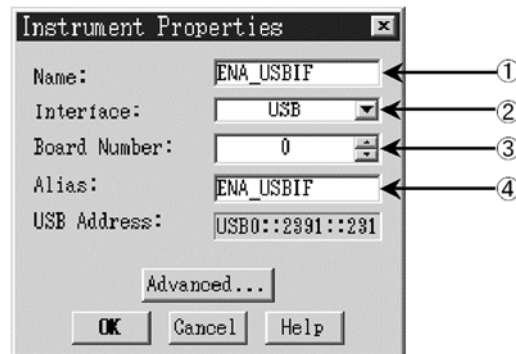

e5070bpj5003

Figure 2-9 shows an example of control using the direct I/O interface that has been set in the above procedures.

Figure 2-9 Sample Control Using Agilent VEE (USB)

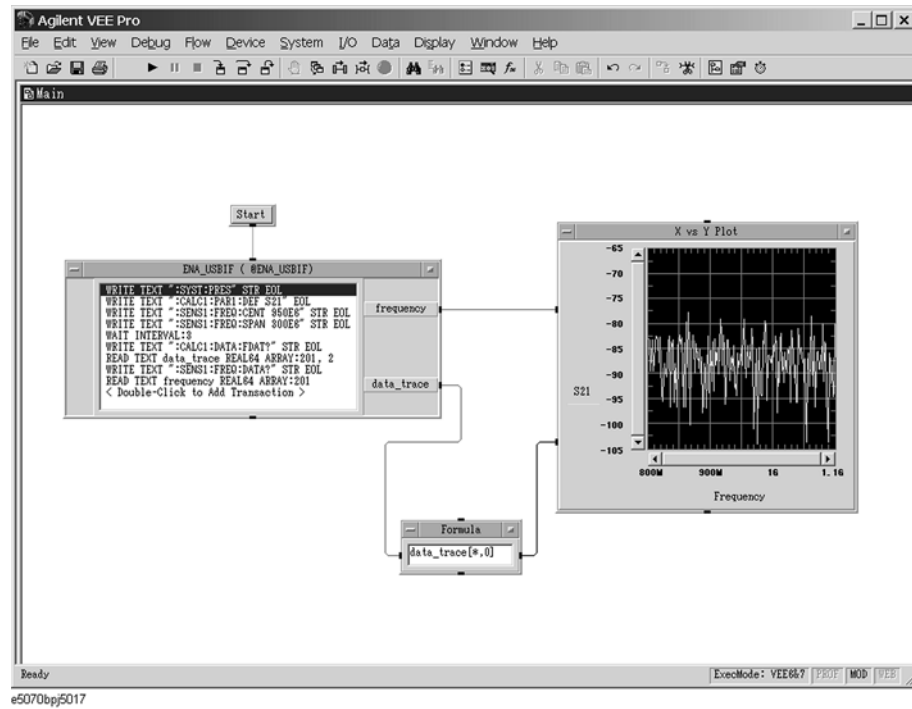

2. Overview of Remote Control

Sending SCPI command messages

Types and structure of commands

The SCPI commands available for the E5070B/E5071B are classified into 2 groups as follows.

E5070B/E5071B commands

Commands specific to the E5070B/E5071B. They cover all measurement functions that the E5070B/E5071B has and some general-purpose functions. The commands in this group are arranged in a hierarchical structure called the command tree (see “Command tree” on page 828). Each command consists of character strings (mnemonics) indicating each hierarchical level and colon (:) separators between hierarchical levels.

IEEE common commands

Commands to cover general-purpose functions defined in IEEE488.2 that are available commonly to instruments that support this standard. The commands in this group have an asterisk (*) at the beginning. For the commands in this group, there is no hierarchical structure.

Concepts of the command tree

The commands at the top of the command tree are called “root command” or simply “root.” To access lower level commands in the tree, you need to specify a specific path like a directory path in the DOS file system. After power-on or reset, the current path is set to the root. Special characters in messages change the path setting as described below.

- Message terminator A message terminator such as the
<new line> character sets the current path to the root.
- Colon (:) A colon between 2 command mnemonics lowers the level of the current path in the command tree. A colon used as the first character of a command specifies the command mnemonic that follows as the root-level command.
- Semicolon (;) A semicolon does not change the current path and separates 2 commands in the same message.

Figure 2-10 shows an example of how to use colons and semicolons to efficiently access commands in the command tree.

Figure 2-10

Using colons and semicolons

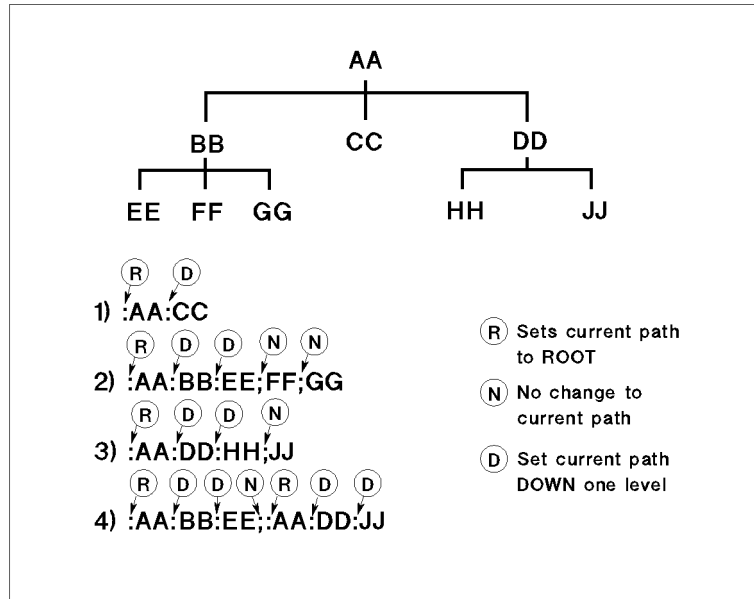

Grammar of messages

This section describes the grammar to send program messages via GPIB. Program messages are messages that the user sends to the instrument from the external controller to control the instrument. A program message consists of 1 or more commands and their necessary parameters.

Upper/lower case sensitivity

Upper/lower case insensitive.

Program message terminator

A program message must be terminated with one of the 3 program message terminators: <new line>, <^END>, or <new line><^END>. <^END> indicates that EOI on the GPIB interface becomes active at the instant when the immediately previous data byte is sent. For example, the OUTPUT command of HTBasic automatically sends the message terminator after the last data byte.

Parameters

A space (ASCII code: 32) is required between a command and its first parameter. When sending several parameters in a single command, separate each parameter with a comma (,).

Message including several commands

When sending 2 or more commands in a single message, separate each command with a semicolon (;). The following example shows how to send the *CLS command and the :STAT:PRES command in a single message using HTBasic.

```
OUTPUT 717; "*CLS; :STAT:PRES"
```

Remote mode

The E5070B/E5071B does not provide remote mode. Therefore, even if you send a GPIB command, it never enters into remote mode automatically. There is no local key to release remote mode.

If you need to prevent misoperation during remote control due to entry from the front panel or mouse, lock the input devices using the following commands.

- :SYST:KLOC:KBD command on page 794
- :SYST:KLOC:MOUS command on page 795

3

Setting Up the Analyzer

This chapter describes how to configure measurement conditions and how to configure the way the instrument displays measurement results on the LCD.

Selecting the Active Channel/Trace

You can configure the E5070B/E5071B by using various commands. Some commands require you to specify and work with a particular channel or trace, while other commands do not have this restriction.

Those commands that do not require you to specify a particular channel or trace apply to the currently active channels and traces. Before issuing such a command, therefore, you must make the appropriate channels and traces active.

To make a channel active, use the following command:

- `:DISP:WIND{1-16}:ACT` on page 470

NOTE

Only the currently displayed channels can be active channels. Therefore, you must display the desired channels by using the `:DISP:SPL` command on page 466 before making them active.

To make a trace active, use the following command:

- `:CALC{1-16}:PAR{1-16}:SEL` on page 424

NOTE

Only the currently displayed traces can be active traces. Therefore, you must display the desired traces by using the `:CALC{1-16}:PAR:COUN` command on page 421 before making them active.

Configuring Measurement Conditions

Setting the number of traces

When you set the number of traces, that setting determines the upper limit trace number; for example, if the setting is 3, traces 1 through 3 will be displayed. To set the number of traces, use the following command:

- :CALC{1-16}:PAR:COUN on page 421

NOTE

Only the currently displayed traces can be active traces. Therefore, you must set the number of traces appropriately before making them active.

Selecting measurement parameters

To select the measurement parameter (S parameter) for each trace, use the following command:

- :CALC{1-16}:PAR{1-16}:DEF on page 422

When you use the Balance-Unbalance Conversion feature, you can select the mixed mode S parameter as well. For more information, refer to “Analysis Using the Fixture Simulator” on page 150.

Setting the sweep condition (Stimulus)

How you can set the sweep condition depends on the sweep type. You can choose between the following four sweep types:

- Linear sweep
- Log sweep
- Segment sweep
- Power sweep

To select one of the above sweep types, use the following command:

- :SENS{1-16}:SWE:TYPE on page 696

To select the sweep mode (stepped/fast stepped/swept/fast swept), use the following command:

- :SENS{1-16}:SWE:GEN on page 692

Turning On/Off stimulus signal output

To turn on/off the stimulus signal output, use the following commands. For example, if the power output is automatically turned off due to the power trip feature, remove the cause of the over-input and turn on the stimulus signal output by executing the following command. You cannot perform measurement until you turn on the stimulus signal output.

- :OUTP on page 527

Setting Up the Analyzer

Configuring Measurement Conditions

Configuring linear sweep settings

To set the sweep range, use the following commands:

Start value	:SENS{1-16}:FREQ:STAR on page 657
Stop value	:SENS{1-16}:FREQ:STOP on page 658
Center value	:SENS{1-16}:FREQ:CENT on page 654
Span value	:SENS{1-16}:FREQ:SPAN on page 656

To set the number of measurement points, use the following command:

- :SENS{1-16}:SWE:POIN on page 693

To set the measurement time, use the following commands:

Measurement time	:SENS{1-16}:SWE:TIME on page 694
Turning on/off auto setting	:SENS{1-16}:SWE:TIME:AUTO on page 695

To set the sweep delay time, use the following command:

- :SENS{1-16}:SWE:DEL on page 691

To set the IF bandwidth, use the one of the following commands (both provide the same function):

- :SENS{1-16}:BAND on page 545
- :SENS{1-16}:BWID on page 546

Setting power level

When the instrument is equipped with the power range expansion function (Option 214, 314, or 414), you can select the power range by using the following command:

- :SOUR{1-16}:POW:ATT on page 705

To set the power level, use the following command:

- :SOUR{1-16}:POW on page 704

To select whether to output the same power level (the set value for port 1) or a different power level for each port, use the following command:

- :SOUR{1-16}:POW:PORT:COUP on page 709
- :SOUR{1-16}:POW:PORT{1-4} on page 710

To set the correction of power-level attenuation so that it's proportional to the frequency (power slope feature), use the following command:

- :SOUR{1-16}:POW:SLOP:STAT on page 718
- :SOUR{1-16}:POW:SLOP on page 717

NOTE

If you turn on the power slope feature, the sweep mode is changed to the step mode.

Configuring segment sweep settings

When you opt to use segment sweep, you can set all items (in the segment sweep table) by using a single command:

- :SENS{1-16}:SEGM:DATA on page 688

Alternatively, you can configure the segment sweep settings based on the data contained in a CSV file by issuing the following command:

- :MMEM:LOAD:SEGM on page 504

Also, you can save the contents of the current segment sweep table to a file by issuing the following command:

- :MMEM:STOR:SEGM on page 518

For more information on how to save and load the segment sweep table, refer to “Saving and recalling the segment sweep table.”

Configuring power sweep settings

To set the sweep range, use the following commands:

Start value	:SOUR{1-16}:POW:STAR on page 720
Stop value	:SOUR{1-16}:POW:STOP on page 721
Center value	:SOUR{1-16}:POW:CENT on page 708
Span value	:SOUR{1-16}:POW:SPAN on page 719

To set the fixed frequency (CW frequency), use the following command:

- :SENS{1-16}:FREQ on page 653

To set the number of points, the sweep time, the sweep delay time, and the IF bandwidth, use the same commands as for the linear/log sweep.

Configuring Averaging Settings

To configure the smoothing settings, use the following commands:

On/off	:SENS{1-16}:AVER on page 543
Averaging factor	:SENS{1-16}:AVER:COUN on page 544
Clear (Restart)	:SENS{1-16}:AVER:CLE on page 543

For averaging, normally, the instrument must be triggered according to the number of averaging; however, when the averaging trigger is turned on, sweeps for the number of averaging can be executed by a single trigger. For details on the averaging trigger, refer to “Averaging Trigger Function” on page 138 of Chapter 5, “Making a Measurement,”

Setting the System Z0

NOTE

This function is available with the firmware version 3.01 or greater.

To set the system characteristic impedance (Z_0), use the following command:

- :SENS:CORR:IMP on page 537

Configuring Display Settings

Setting the layout of windows and graphs

You can split the E5070B/E5071B's LCD screen into multiple windows that display channel-specific result information, and the window layout can be selected from a number of variations. In addition, you can place on screen a segment sweep table or echo window, which you can use to display messages from your custom program.

Selecting the window layout (Channel Display Mode)

One window displays the results for a single channel. You cannot have a single window display the results from more than one channel. This means that setting the window layout determines the number of channels displayed on screen.

To select one of the 19 different window layouts shown in Figure 3-1, use the following command:

- `:DISP:SPL` on page 466

Selecting the graph layout (Trace Display Mode)

You can place a number of trace graphs in each window by selecting one of the pre-defined graph layouts. The number of graphs differs depending on your selected graph layout. If the number of graphs is equal to or larger than the number of traces (set by the `:CALC{1-16}:PAR:COUN` command on page 421), each graph always displays one trace. On the other hand, if the number of graphs is smaller than the number of traces, some of the graphs display two or more traces. Graph 1 is populated with trace 1, graph 2 with trace 2, and so on. Traces whose numbers exceed the last graph's number will populate graph 1, graph 2, and so on.

To select one of the 19 different graph layouts shown in Figure 3-1, use the following command:

- `:DISP:WIND{1-16}:SPL` on page 475

Maximizing a window or a trace graph

When you have multiple windows displayed, you can maximize the active channel window so that it covers the entire screen area. To maximize a window, use the following command:

- `:DISP:MAX` on page 465

Similarly, when you have multiple traces displayed, you can maximize the active trace so that it extends throughout the entire window. To maximize a trace, use the following command:

- `:DISP:WIND{1-16}:MAX` on page 474

Setting Up the Analyzer Configuring Display Settings

Figure 3-1

Window/graph layouts and command parameters

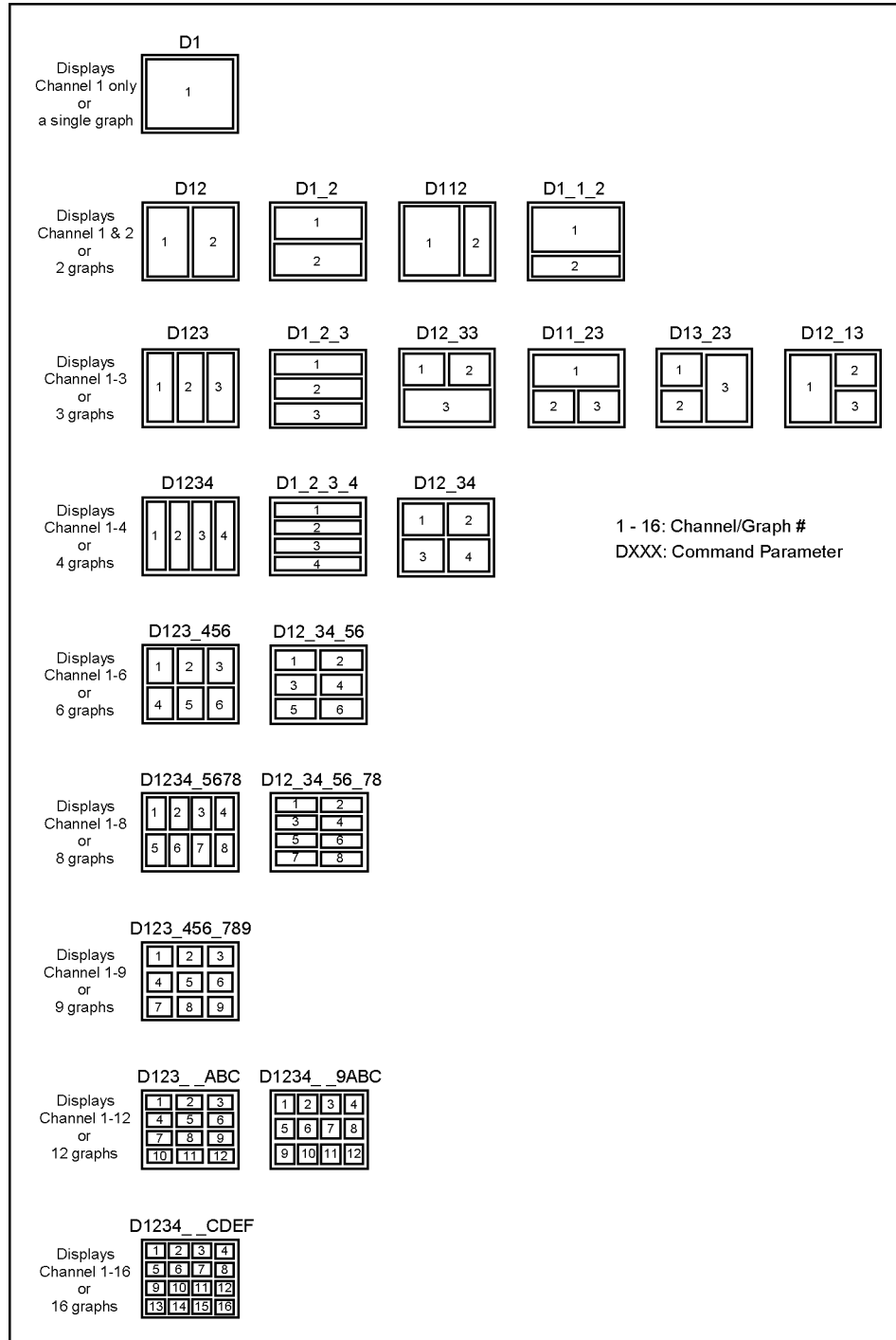

e5070bpe030

Showing/hiding a table or echo window

You can display the following items at the bottom of the LCD screen:

- Segment sweep table
- Limit table
- Marker list table
- Echo window (a window that displays messages from a custom program)
- Loss compensation table
- Power sensor's calibration factor table

To show or hide each of the above items, use the following command:

- :DISP:TABL on page 468

You can have two or more of the above items displayed at a time. The screen displays only the selected item by using the following command:

- :DISP:TABL:TYPE on page 469

Showing/hiding softkey labels

You can show or hide the softkey labels placed alongside the right-hand edge of the LCD screen. To show or hide the softkey labels, use the following command:

- :DISP:SKEY on page 465

Configuring trace display settings

Selecting which traces to display

Each trace has two different representations: data and memory traces. You can show or hide the data and memory traces independently of each other. To show or hide the data or memory traces, use the following commands:

Data trace	:DISP:WIND{1-16}:TRAC{1-16}:STAT on page 481
Memory trace	:DISP:WIND{1-16}:TRAC{1-16}:ANN:MARK:POS:X on page 478

To copy the data trace to the memory trace, use the following command:

- :CALC{1-16}:MATH:MEM on page 416

Configuring cross-trace math operations

You can perform math operations between the data and memory traces and have the results displayed as the data trace. To perform cross-trace math operations, use the following command:

- :CALC{1-16}:MATH:FUNC on page 415

Configuring smoothing settings

To turn on/off smoothing, use the following command:

- :CALC{1-16}:SMO on page 433

The smoothing aperture is expressed as a percentage with respect to the sweep range. To set the smoothing aperture, use the following command:

- :CALC{1-16}:SMO:APER on page 434

Selecting the data format

You can select the following data formats:

- Rectangular display formats
 - Log magnitude format
 - Phase format
 - Group delay format
 - Linear magnitude format
 - SWR format
 - Real format
 - Imaginary format
 - Expanded phase format
 - Positive phase format
- Imaginary format
- Expanded phase format

To select the measurement parameter data format, use the following command:

- :CALC{1-16}:FORM on page 321

Setting Up the Analyzer

Configuring Display Settings

Configuring the display scale

Depending on the measurement parameter data format, you can configure the display scale in one of the following two ways:

Rectangular display formats:

When you use one of rectangular display formats (Logarithmic magnitude/Phase/ Group delay/Linear magnitude/SWR/Real/Imaginary/Expanded phase/Positive phase), you can configure the display scale by setting the following four items:

Number of divisions	:DISP:WIND{1-16}:Y:DIV on page 486
Scale per division	:DISP:WIND{1-16}:TRAC{1-16}:Y:PDIV on page 482
Reference graticule line	:DISP:WIND{1-16}:TRAC{1-16}:Y:RPOS on page 484
Reference graticule line value	:DISP:WIND{1-16}:TRAC{1-16}:Y:RLEV on page 483

NOTE

The number of divisions is a channel-wide setting (shared among all traces), while the remaining three settings are trace-specific.

You can show or hide graticule label (the label on the left-hand side of the graticule lines) by issuing the following command:

- :DISP:WIND{1-16}:LAB on page 473

Smith chart/Polar formats:

When you are using one of Smith chart/Polar formats, you can only set the full scale value (the outermost circle's value) using the following command:

- :DISP:WIND{1-16}:TRAC{1-16}:Y:PDIV on page 482

Auto Scale

You can use Auto Scale to automatically set the display scale. This feature works by automatically adjusting the reference division line value and the scale value per division when you are using one of the rectangular display formats or the full scale value when you are using one of Smith chart/Polar formats.

To perform Auto Scale, use the following command:

- :DISP:WIND{1-16}:TRAC{1-16}:Y:AUTO on page 481

Printing a message in the echo window

You can print a message in the echo window by issuing the following command:

- :DISP:ECHO on page 461

You can clear any message displayed in the echo window by issuing the following command:

- :DISP:ECHO:CLE on page 461

Turning On/Off display update

To turn on/off the update of the LCD screen, use the following command:

- :DISP:ENAB on page 462

Showing/hiding frequencies

To show or hide frequencies on the LCD screen, use the following command:

- :DISP:ANN:FREQ on page 454

Showing or hiding the title

To show or hide the title, use the following command:

- :DISP:WIND{1-16}:TITL on page 476

To define the title string that appears in the title display area, use the following command:

- :DISP:WIND{1-16}:TITL:DATA on page 477

Configuring date/time display

To show or hide the current date and time on the left-hand side of the instrument status bar, use the following command:

- :DISP:CLOC on page 455

To set the date and time, use the following command:

- :SYST:DATE on page 790
- :SYST:UPR on page 801

Turning On/Off the LCD backlight

To turn on/off the LCD backlight, use the following command (note that turning off the backlight makes the screen unreadable):

- :SYST:BACK on page 779

Setting display colors

Selecting display mode

You can select the one of two LCD display modes: normal display (black background) or inverted display (white background).

To select the display mode, use the following command:

- :DISP:IMAG on page 464

Setting display color for each item

To set the display colors, use the following commands:

Data trace	:DISP:COL{1-2}:TRAC{1-16}:DATA on page 459
Memory trace	:DISP:COL{1-2}:TRAC{1-16}:MEM on page 460
Graph	:DISP:COL{1-2}:GRAT{1-2} on page 457
Limit test	:DISP:COL{1-2}:LIM{1-2} on page 458
Background	:DISP:COL{1-2}:BACK on page 456

Resetting display colors to factory state

You can reset the display colors in normal display and inverted display to the preset factory state.

To reset the display colors, use the following command:

- :DISP:COL{1-2}:RES on page 458

Saving and Loading the Settings

You can save the settings for measurement conditions and screen display to a file along with other instrument settings, and these settings can later be loaded from the file.

Once you have saved the measurement condition and screen display settings to a file, you can later load them whenever necessary; therefore, you can quickly modify the settings loaded from a file to create new settings without having to issue many commands.

To save the current settings to a file, use the following command:

- :MMEM:STOR on page 506

To load the settings from a file, use the following command:

- :MMEM:LOAD on page 495

For more information on how to save and load the settings, refer to “Saving and recalling instrument status.”

Sample Program

Example 3-1 is a sample program that demonstrates how to configure measurement conditions. You can find the source file of this program, named setup.htb, on the sample program disk.

The sample program puts the instrument into the preset state, configures it as shown in Table 3-1, and saves the settings to a file named “Ex_3_1.sta”.

Table 3-1

Target settings in Example 3-1

Item		Setting	
Window Layout		Channel 1 in the upper window (2/3 of the screen height) and channel 2 in the lower window (1/3 of the screen height)	
Channel 1	Sweep type	Segment	
	Sweep range	See Table 3-2.	
	Number of measurement points		
	IF bandwidth		
	Power		
	Number of traces	4	
	Graph Layout		Four graphs at upper left, upper right, lower left, and lower right.
	Trace 1	Measurement parameter	S11
		Data format	Smith chart (Lin)
		Full-scale value	2
	Trace 2	Measurement parameter	S21
		Data format	Log magnitude
		Reference division line number	9
		Reference division line value	2
	Trace 3	Scale per division	10 dBm
		Measurement parameter	S12
		Data format	Log magnitude
		Reference division line number	9
		Reference division line value	2
	Trace 4	Scale per division	10 dBm
Measurement parameter		S22	
Data format		Smith chart (Lin)	
	Full-scale value	2	

Table 3-1 Target settings in Example 3-1

Item		Setting	
Channel 2	Sweep type	Linear	
	Sweep range	Center value	1.9 GHz
		Span value	500 MHz
	Number of measurement points	101	
	IF bandwidth	70 kHz	
	Power	0 dBm	
	Number of traces	4	
	Graph Layout	Two graphs at left and right	
	Trace 1	Measurement parameter	S21
		Data format	Log magnitude
		Reference division line number	9
		Reference division line value	2
		Scale per division	10 dBm
	Trace 2	Measurement parameter	S22
Data format		Smith chart (Lin)	
Full-scale value		2	

Table 3-2 Segment table for channel 1

Segment Number	Start value	Stop value	Number of measurement points	IF bandwidth	Power
1	1.7 GHz	1.9 GHz	21	50 kHz	0 dBm
2	1.9 GHz	2 GHz	101	10 kHz	-10 dBm
3	2 GHz	2.2 GHz	21	50 kHz	0 dBm

Setting Up the Analyzer Sample Program

The program is described in detail below:

Line 70	Assigns a GPIB address to the I/O pass.
Line 90	Stores the number of channel 1's sweep segments into the Segm variable.
Lines 100 to 150	These lines store the start and stop values for channel 1's segments 1 through 3 into the Star1(*) and Stop1(*) variables, respectively.
Lines 160 to 170	These lines store channel 2's center and span values into the Star2 and Stop2 variables, respectively.
Lines 180 to 210	These lines store the number of points for channel 1's segments 1 through 3 into the Nop1(*) variable and the number of measurement points for channel 2 into the Nop2 variable.
Lines 220 to 250	These lines store the IF bandwidth for channel 1's segments 1 through 3 into the If_bw1(*) variable and the IF bandwidth for channel 2 into the If_bw2 variable.
Lines 260 to 290	These lines store the power for channel 1's segments 1 through 3 into the Pow1(*) variable and the power for channel 2 into the Pow2 variable.
Lines 300 to 310	These lines store the number of channel 1's traces into the Num_of_tr1 variable and the number of channel 2's traces into the Num_of_tr2 variable.
Lines 320 to 330	These lines store channel 1's graph layout into the Allocate1\$ variable and channel 2's graph layout into the Allocate2\$ variable.
Lines 340 to 390	These lines store the measurement parameters for channel 1's traces 1 through 4 into the Para1\$(*) variable and the measurement parameters for channel 2's traces 1 through 2 into the Para2\$(*) variable.
Lines 400 to 450	These lines store the data formats for channel 1's traces 1 through 4 into the Fmt1\$(*) variable and the data formats for channel 2's traces 1 through 2 into the Fmt2\$(*) variable.
Lines 460 to 480	These lines store the reference division line numbers for channel 1's traces 2 through 3 into the Ref_pos1(*) variable and the reference division line numbers for channel 2's trace 1 into the Ref_pos2(*) variable.
Lines 490 to 510	These lines store the reference division line values for channel 1's traces 2 through 3 into the Ref_lev1(*) variable and the reference division line values for channel 2's trace 1 into the Ref_lev2(*) variable.
Lines 520 to 570	These lines store the data formats for channel 1's traces 1 through 4 into the Fmt1\$(*) variable and the data formats for channel 2's traces 1 through 2 into the Fmt2\$(*) variable.
Line 580	Stores the name of the file into the File\$ variable.
Line 600	Puts the instrument into preset state.
Line 620	Places the window for channel 1 in the upper part of the LCD screen and the window for channel 2 in the lower part.
Lines 630 to 640	These lines turn on Continuous Activation mode for channels 1 and 2.

Line 680	Sets channel 1's sweep type to "segment".
Lines 690 to 730	<p>These lines set up the segment table for channel 1.</p> <p>Line 600: Sends the command that sets up the segment table along with the parameter header ("5,0,1,1,0,0" causes the IF bandwidth and power to be set on a segment-by-segment basis; Segm represents the number of segments).</p> <p>Lines 700 to 730: Send the data for the start and stop values, number of points, IF bandwidth, and power (Star1, Stop1, Nop1, If_bw1, Pow1) on a segment-by-segment basis.</p>
Lines 750 to 760	For channel 1, these lines set the number of traces to Num_of_tr1 and the graph layout to Allocate1\$.
Lines 770 to 890	<p>For channel 1, the program iterates the following loop while incrementing i from 1 to Num_of_tr1 for each trace.</p> <p>Line 780: Sets the measurement parameter to Para1\$(i).</p> <p>Line 790: Makes trace(i) active.</p> <p>Line 800: Sets the data format to Fmt1\$(i).</p> <p>Line 830: If the data format is Smith chart or polar, this line sets the full-scale value to Scale1(i).</p> <p>Lines 850 to 870: If the data format is neither Smith chart nor polar, these lines set the reference division line number to Ref_pos1(i), the reference division line value to Ref_lev1(i), and the scale per division to Scale1(i).</p>
Line 930	Sets channel 2's sweep type to "linear".
Lines 940 to 980	For channel 2, these lines set the center value to Cent2, the span value to Span2, the number of measurement points to Nop2, the IF bandwidth to If_bw2, and the power to Pow2.
Lines 1000 to 1010	For channel 2, these lines set the number of traces to Num_of_tr2 and the graph layout to Allocate2\$.
Lines 1020 to 1140	<p>For channel 2, the program iterates the following loop while incrementing i from 1 to Num_of_tr2 for each trace.</p> <p>Line 1030: Sets the measurement parameter to Para2\$(i).</p> <p>Line 1040: Makes trace(i) active.</p> <p>Line 1050: Sets the data format to Fmt2\$(i).</p> <p>Line 1080: If the data format is Smith chart or polar, this line sets the full-scale value to Scale2(i).</p> <p>Lines 1100 to 1120: If the data format is neither Smith chart nor polar, these lines set the reference division line number to Ref_pos2(i), the reference division line value to Ref_lev2(i), and the scale per division to Scale2(i).</p>
Line 1160	Saves the settings of the E5070B/E5071B under the file name File\$.

Setting Up the Analyzer Sample Program

Example 3-1

Configuring measurement conditions (setup.htb)

```
10 DIM Allocate1$(9),Allocate2$(9),File$(20)
20 DIM Para1$(1:4)(9),Para2$(1:2)(9),Fmt1$(1:4)(9),Fmt2$(1:2)(9)
30 REAL Star1(1:3),Stop1(1:3),Pow1(1:3),Cent2,Span2,Pow2
40 REAL Ref_rev1(1:4),Ref_rev2(1:2),Scale1(1:4),Scale2(1:2)
50 INTEGER Segm,Nop1(1:3),Nop2,Num_of_tr1,Num_of_tr2
60 INTEGER Ref_pos1(1:4),Ref_pos2(1:2),I
70 ASSIGN @Agte507x TO 717
80 !
90 Segm=3 ! Number of Segment Ch.1 : 3
100 Star1(1)=1.7E+9 ! Start Frequency Ch.1 Segm.1: 1.7 GHz
110 Star1(2)=1.9E+9 ! Segm.2: 1.9 GHz
120 Star1(3)=2.E+9 ! Segm.3: 2 GHz
130 Stop1(1)=1.9E+9 ! Stop Frequency Ch.1 Segm.1: 1.9 GHz
140 Stop1(2)=2.E+9 ! Segm.2: 2 GHz
150 Stop1(3)=2.2E+9 ! Segm.3: 2.2 GHz
160 Cent2=1.9E+9 ! Center Frequency Ch.2 : 1.9 GHz
170 Span2=5.00E+8 ! Span Ch.2 : 500 MHz
180 Nop1(1)=21 ! Number Ch.1 Segm.1: 21
190 Nop1(2)=101 ! of Points Segm.2: 101
200 Nop1(3)=21 ! Segm.3: 21
210 Nop2=101 ! Ch.2 : 101
220 If_bw1(1)=5.0E+4 ! IF Bandwidth Ch.1 Segm.1: 50 kHz
230 If_bw1(2)=1.0E+4 ! Segm.2: 10 kHz
240 If_bw1(3)=5.0E+4 ! Segm.3: 50 kHz
250 If_bw2=7.0E+4 ! Ch.2 : 70 kHz
260 Pow1(1)=0 ! Power Ch.1 Segm.1: 0 dBm
270 Pow1(2)=-10 ! Segm.2: -10 dBm
280 Pow1(3)=0 ! Segm.3: 0 dBm
290 Pow2=0 ! Ch.2 : 0 dBm
300 Num_of_tr1=4 ! Number Ch.1 : 4
310 Num_of_tr2=2 ! of Traces Ch.2 : 2
320 Allocate1$="D12_34" ! Allocate Traces Ch.1 : D12_34
330 Allocate2$="D12" ! Ch.2 : D12
340 Para1$(1)="S11" ! Measurement Ch.1 Trace1: S11
350 Para1$(2)="S21" ! Parameter Trace2: S21
360 Para1$(3)="S12" ! Trace3: S12
370 Para1$(4)="S22" ! Trace4: S22
380 Para2$(1)="S31" ! Ch.2 Trace1: S31
390 Para2$(2)="S33" ! Trace2: S33
400 Fmt1$(1)="SLIN" ! Data Format Ch.1 Trace1: Smith(Lin/Phase)
410 Fmt1$(2)="MLOG" ! Trace2: Log Mag
420 Fmt1$(3)="MLOG" ! Trace3: Log Mag
430 Fmt1$(4)="SLIN" ! Trace4: Smith(Lin/Phase)
440 Fmt2$(1)="MLOG" ! Ch.2 Trace1: Log Mag
450 Fmt2$(2)="SLIN" ! Trace2: Smith(Lin/Phase)
460 Ref_pos1(2)=9 ! Reference Ch.1 Trace2: 9
470 Ref_pos1(3)=9 ! Position Trace3: 9
480 Ref_pos2(1)=9 ! Ch.2 Trace1: 9
490 Ref_lev1(2)=0 ! Reference Level Ch.1 Trace2: 0 dBm
500 Ref_lev1(3)=0 ! Trace3: 0 dBm
510 Ref_lev2(1)=0 ! Ch.2 Trace1: 0 dBm
520 Scale1(1)=2 ! Scale Ch.1 Trace1: 2
530 Scale1(2)=10 ! Trace2: 10 dBm
540 Scale1(3)=10 ! Trace3: 10 dBm
550 Scale1(4)=2 ! Trace4: 2
560 Scale2(1)=10 ! Ch.2 Trace1: 10 dBm
570 Scale2(2)=2 ! Trace2: 2
580 File$="Ex_3_1.sta" ! Save File Name : Ex_3_1.sta
590 !
600 OUTPUT @Agte507x;":SYST:PRES"
610 !
620 OUTPUT @Agte507x;":DISP:SPL D1_1_2"
630 OUTPUT @Agte507x;":INIT1:CONT ON"
640 OUTPUT @Agte507x;":INIT2:CONT ON"
```

```

650      !
660      ! Channel 1
670      !
680      OUTPUT @Agte507x;":SENS1:SWE:TYPE SEGM"
690      OUTPUT @Agte507x;":SENS1:SEGM:DATA 5,0,1,1,0,0,";Segm;" ";
700      FOR I=1 TO Segm-1
710          OUTPUT @Agte507x;Star1(I);",";Stop1(I);",";Nop1(I);",";If_bw1
(I);",";Pow1(I);",";
720      NEXT I
730      OUTPUT @Agte507x;Star1(Segm);",";Stop1(Segm);",";Nop1(Segm);","
;If_bw1(Segm);",";Pow(Segm)
740      !
750      OUTPUT @Agte507x;":CALC1:PAR:COUN ";Num_of_tr1
760      OUTPUT @Agte507x;":DISP:WIND1:SPL "&Allocate1$
770      FOR I=1 TO Num_of_tr1
780          OUTPUT @Agte507x;":CALC1:PAR"&VAL$(I)&":DEF "&Para1$(I)
790          OUTPUT @Agte507x;":CALC1:PAR"&VAL$(I)&":SEL"
800          OUTPUT @Agte507x;":CALC1:FORM "&Fmt1$(I)
810          SELECT Fmt1$(I)
820              CASE "SLIN","SLOG","SCOM","SMIT","SADM","PLIN","PLOG","POL"
830                  OUTPUT @Agte507x;":DISP:WIND1:TRAC"&VAL$(I)&":Y:PDIV ";
Scale1(I)
840              CASE ELSE
850                  OUTPUT @Agte507x;":DISP:WIND1:TRAC"&VAL$(I)&":Y:RPOS ";
Ref_pos1(I)
860                  OUTPUT @Agte507x;":DISP:WIND1:TRAC"&VAL$(I)&":Y:RLEV ";
Ref_rev1(I)
870                  OUTPUT @Agte507x;":DISP:WIND1:TRAC"&VAL$(I)&":Y:PDIV ";
Scale1(I)
880              END SELECT
890      NEXT I
900      !
910      ! Channel 2
920      !
930      OUTPUT @Agte507x;":SENS2:SWE:TYPE LIN"
940      OUTPUT @Agte507x;":SENS2:FREQ:CENT ";Cent2
950      OUTPUT @Agte507x;":SENS2:FREQ:SPAN ";Span2
960      OUTPUT @Agte507x;":SENS2:SWE:POIN ";Nop2
970      OUTPUT @Agte507x;":SENS2:BAND ";If_bw2
980      OUTPUT @Agte507x;":SOUR2:POW ";Pow2
990      !
1000     OUTPUT @Agte507x;":CALC2:PAR:COUN ";Num_of_tr2
1010     OUTPUT @Agte507x;":DISP:WIND2:SPL "&Allocate2$
1020     FOR I=1 TO Num_of_tr2
1030         OUTPUT @Agte507x;":CALC2:PAR"&VAL$(I)&":DEF "&Para2$(I)
1040         OUTPUT @Agte507x;":CALC2:PAR"&VAL$(I)&":SEL"
1050         OUTPUT @Agte507x;":CALC2:FORM "&Fmt2$(I)
1060         SELECT Fmt2$(I)
1070             CASE "SLIN","SLOG","SCOM","SMIT","SADM","PLIN","PLOG","POL"
1080                 OUTPUT @Agte507x;":DISP:WIND2:TRAC"&VAL$(I)&":Y:PDIV ";
Scale2(I)
1090             CASE ELSE
1100                 OUTPUT @Agte507x;":DISP:WIND2:TRAC"&VAL$(I)&":Y:RPOS ";
Ref_pos2(I)
1110                 OUTPUT @Agte507x;":DISP:WIND2:TRAC"&VAL$(I)&":Y:RLEV ";
Ref_rev2(I)
1120                 OUTPUT @Agte507x;":DISP:WIND2:TRAC"&VAL$(I)&":Y:PDIV ";
Scale2(I)
1130             END SELECT
1140     NEXT I
1150     !
1160     OUTPUT @Agte507x;":MMEM:STOR ""&File$&""
1170     END

```

Setting Up the Analyzer
Sample Program

4

Performing Calibration

This chapter explains how to obtain calibration coefficients and perform error correction as well as how to define the calibration kit required to obtain the calibration coefficients. It also shows how to perform power calibration.

Calibration

You need to execute calibration to eliminate error elements related to measurement, thus allowing you to perform accurate measurement.

Performing calibration (obtaining calibration coefficients)

Selecting a Calibration Kit

To select a calibration kit, use the following command:

- `:SENS{1-16}:CORR:COLL:CKIT` on page 560

Selecting a Calibration Type

The calibration coefficients are calculated based on the selected calibration type. Therefore, before you can calculate the calibration coefficients, you must select the appropriate calibration type by using one of the following commands.

Calibration type		Command
Response	OPEN	<code>:SENS{1-16}:CORR:COLL:METH:OPEN</code> on page 603
	SHORT	<code>:SENS{1-16}:CORR:COLL:METH:SHOR</code> on page 603
	THRU	<code>:SENS{1-16}:CORR:COLL:METH:THRU</code> on page 606
Enhanced Response		<code>:SENS{1-16}:CORR:COLL:METH:ERES</code> on page 602
1-Port		<code>:SENS{1-16}:CORR:COLL:METH:SOLT1</code> on page 604
Full 2-Port		<code>:SENS{1-16}:CORR:COLL:METH:SOLT2</code> on page 604
Full 3-Port		<code>:SENS{1-16}:CORR:COLL:METH:SOLT3</code> on page 605
Full 4-Port		<code>:SENS{1-16}:CORR:COLL:METH:SOLT4</code> on page 605
2-Port TRL		<code>:SENS{1-16}:CORR:COLL:METH:TRL2</code> on page 607
3-Port TRL		<code>:SENS{1-16}:CORR:COLL:METH:TRL3</code> on page 608
4-Port TRL		<code>:SENS{1-16}:CORR:COLL:METH:TRL4</code> on page 609

NOTE

To calculate the calibration coefficients for the simplified full 3-port and simplified full 4-port calibrations, select the full 3-port and full-4 port commands, respectively. To calculate the calibration coefficient for the simplified 3-port TRL calibration and the simplified 4-port TRL calibration, select the 3-port TRL and the 4-port TRL commands, respectively.

To check the currently selected calibration type, use the following command:

- `:SENS{1-16}:CORR:COLL:METH:TYPE?` on page 610

Setting the trigger source for calibration

To set the trigger source for calibration, use the following command. By setting the trigger source for calibration to “System,” setting the trigger source for measurement to “External,” and turning on the point trigger function, it becomes possible to use “calibration for each measurement point using the external trigger.”

- :SENS{1-16}:CORR:TRIG:FREE on page 651

NOTE

The trigger source for calibration does not function for the calibrations of E-Cal, power, receiver, and scalar mixer.

Measuring Calibration Data

To measure the calibration data, use one of the following commands:

Calibration data items	Command
OPEN	:SENS{1-16}:CORR:COLL:OPEN on page 611
SHORT	:SENS{1-16}:CORR:COLL:SHOR on page 613
LOAD	:SENS{1-16}:CORR:COLL:LOAD on page 600
THRU	:SENS{1-16}:CORR:COLL:THRU on page 616
Isolation	:SENS{1-16}:CORR:COLL:ISOL on page 599
TRL Thru	:SENS{1-16}:CORR:COLL:TRLT on page 619
TRL Reflection	:SENS{1-16}:CORR:COLL:TRLR on page 618
TRL Line/Match	:SENS{1-16}:CORR:COLL:TRLL on page 617

NOTE

You cannot run more than one of the commands listed above at a time; if you issue another command before the currently running command completes successfully, the current command will be aborted. Therefore, when you write a program that issues multiple calibration commands in series, you should use the *OPC? command on page 288 or some other means to ensure that no command is executed before the preceding command completes itself.

As shown in Table 4-1, the data required to calculate the calibration coefficients differ depending on the selected calibration type.

Table 4-1

Calibration Types and Required Data

Calibration type (Selected ports are enclosed in parentheses)		Data				
		OPEN	SHORT	LOAD	THRU	Isolation
Response	OPEN (a)	a	Not required	[a]	Not required	Not required
	SHORT (a)	Not required	a	[a]	Not required	Not required
	THRU (a-b)	Not required	Not required	Not required	a-b	[a-b]
Enhanced Response (a-b)		b	b	b	a-b	[a-b]
1-Port (a)		a	a	a	Not required	Not required
Full 2-Port (a-b)		a, b	a, b	a, b	a-b, b-a	[a-b], [b-a]

Table 4-1

Calibration Types and Required Data

Calibration type (Selected ports are enclosed in parentheses)	Data				
	OPEN	SHORT	LOAD	THRU	Isolation
Full 3-Port (a-b-c)	a, b, c	a, b, c	a, b, c	a-b, b-a a-c, c-a b-c, c-b	[a-b], [b-a] [a-c], [c-a] [b-c], [c-b]
Simplified Full 3-Port					
(1-2-3)	1, 2, 3	1, 2, 3	1, 2, 3	1-2, 2-1 1-3, 3-1 [2-3], [3-2]	[1-2], [2-1] [1-3], [3-1] [2-3], [3-2]
(1-2-4)	1, 2, 4	1, 2, 4	1, 2, 4	1-2, 2-1 1-4, 4-1 [2-4], [4-2]	[1-2], [2-1] [1-4], [4-1] [2-4], [4-2]
(1-3-4)	1, 3, 4	1, 3, 4	1, 3, 4	1-3, 3-1 [1-4], [4-1] 3-4, 4-3	[1-3], [3-1] [1-4], [4-1] [3-4], [4-3]
(2-3-4)	2, 3, 4	2, 3, 4	2, 3, 4	2-3, 3-2 [2-4], [4-2] 3-4, 4-3	[2-3], [3-2] [2-4], [4-2] [3-4], [4-3]
Full 4-Port	1, 2, 3, 4	1, 2, 3, 4	1, 2, 3, 4	1-2, 2-1 1-3, 3-1 1-4, 4-1 2-3, 3-2 2-4, 4-2 3-4, 4-3	[1-2], [2-1] [1-3], [3-1] [1-4], [4-1] [2-3], [3-2] [2-4], [4-2] [3-4], [4-3]
Simplified Full 4-Port	1, 2, 3, 4	1, 2, 3, 4	1, 2, 3, 4	1-2, 2-1 1-3, 3-1 [1-4], [4-1] [2-3], [3-2] [2-4], [4-2] 3-4, 4-3	[1-2], [2-1] [1-3], [3-1] [1-4], [4-1] [2-3], [3-2] [2-4], [4-2] [3-4], [4-3]

In the data section in the table, the letter m (for example, 1, a) represents the measurement data at port m; m-n (for example, 1-2, a-b) represents the measurement data between response port m and stimulus port n. You can omit data enclosed in brackets.

Calculating Calibration Coefficients

To calculate the calibration coefficients, use one of the following commands:

Calibration type	Command
Response, 1/2/3/4 port	:SENS{1-16}:CORR:COLL:SAVE on page 613
Simplified full 3/4 port Simplified 3/4-port TRL	:SENS{1-16}:CORR:COLL:SIMP:SAVE on page 614

Before issuing the above commands, you must measure all required calibration data items according to your selected calibration type (see Table 4-1). Calculating the calibration coefficients clears all calibration data regardless of whether they are used for the calculation. The calibration type selection is also cleared, which results in a state where no calibration type is selected.

Simplified full 3-/4-port calibration

NOTE

This function is available with firmware version 3.50 or greater. Note that you can execute this function from the front panel only for firmware version A.06.50 or greater.

The simplified full 3-/4-port calibration acquires the calibration coefficients while omitting a part of the thru measurement.

NOTE

Notes on the simplified full 3-/4-port calibration

Compared to the normal full 3-/4-port calibration, the simplified full 3-/4-port calibration is more sensitive to the error that may arise when acquiring calibration data. This because the calibration coefficients are calculated without a part of the thru measurement data. Therefore, the following should be considered when measuring data for the simplified full 3-/4-port calibration.

- The standard used for measurement must match its definition value.
 - Use a standard that provides good repeatability (stability).
 - Do not omit the length of the thru when defining the standard.
 - When using a user-created standard, verify the definition value.
 - For the N connector, remember that it has two different types: male and female.
- Assure high reliability and repeatability for measurement.
 - Reduce the difference in external environment (such as temperature difference) between the time when measuring calibration data and when measuring actual data.
 - Set the power level of the stimulus signal sufficiently small so that compression does not occur.
 - Narrow the IF bandwidth.
 - Increase the averaging factor.
 - Use a cable that has robust amplitude/phase characteristics against bending.
 - Use high-precision connectors.

Simplified 3/4-port TRL calibration

NOTE

This function is available with firmware version A.06.50 or greater.

The simplified 3/4-port TRL calibration calculates the calibration coefficient by skipping part of the thru/line measurement (or line/match measurement) that is necessary for normal 3/4-port TRL calibration.

NOTE

You need to give consideration to the same conditions for the simplified 3/4-port TRL calibration as those for the simplified full 3/4-port calibration listed above.

Turning ON/OFF Error Correction

To turn ON/OFF error correction, use the following command:

- `:SENS{1-16}:CORR:STAT` on page 650

Also, once you have calculated the calibration coefficient using the `:SENS{1-16}:CORR:COLL:SAVE` or `:SENS{1-16}:CORR:COLL:SIMP:SAVE` command, error correction is automatically turned on.

Using ECal

An ECal (Electronic Calibration) module allows you to perform 1-/2-/3-/4-port calibration and response (THRU) calibration without having to replace the standard device.

ECal works by using the calibration kit data contained in the ECal module instead of the calibration kit data selected for the E5070B/E5071B. This means that you do not have to define or select a calibration kit when using ECal.

NOTE

When two or more ECal modules are connected through the USB port, the system uses the calibration kit data of the first ECal module.

To perform ECal, use one of the following commands:

Calibration type	Command
1-Port Calibration	:SENS{1-16}:CORR:COLL:ECAL:SOLT1 on page 594
Full 2-Port Calibration	:SENS{1-16}:CORR:COLL:ECAL:SOLT2 on page 594
Full 3-Port Calibration	:SENS{1-16}:CORR:COLL:ECAL:SOLT3 on page 595
Full 4-Port Calibration	:SENS{1-16}:CORR:COLL:ECAL:SOLT4 on page 595
Enhanced Response Calibration	:SENS{1-16}:CORR:COLL:ECAL:ERES on page 592
Response Calibration (THRU)	:SENS{1-16}:CORR:COLL:ECAL:THRU on page 596

Simply issuing one of the above commands completes all of the tasks necessary for error correction, including measuring the calibration data, calculating the calibration coefficients, and running the error correction feature.

NOTE

Once you have initiated ECal, you cannot cancel the operation.

No command entered following the initiation of ECal will be processed until ECal completes successfully. Accordingly, if you issue a command that queries some data, the system will not respond to the query until ECal is complete.

You can control whether to perform isolation measurement during ECal. To turn ON/OFF isolation measurement, use the following command:

- :SENS{1-16}:CORR:COLL:ECAL:ISOL on page 593

You can control whether to perform unknown thru calibration during ECal. To turn ON/OFF unknown thru calibration, use the following command:

- :SENS{1-16}:CORR:COLL:ECAL:UTHR on page 598

NOTE

If the ECal module does not support isolation measurement, the system will not perform it.

To select the ECal characteristic for a user-characterized ECal, use the following command:

- :SENS{1-16}:CORR:COLL:ECAL:UCH on page 597

Performing Calibration Calibration

ECal Auto-detect Function

The ECal module can automatically detect which port of the ECal module is connected to the E5070B/E5071B test port. Turn off the auto-detect function to specify a port manually.

To turn OFF the auto-detect function, use the following command.

- `:SENS:CORR:COLL:ECAL:ORI` on page 535

To turn OFF the auto-detect function and set a port manually, use the following command.

- `:SENS:CORR:COLL:ECAL:PATH` on page 536

Checking the Applied Calibration Type

When you turn on error correction, you can check the calibration type actually applied to each trace. To check the calibration type, use the following command:

- `:SENS{1-16}:CORR:TYPE{1-16}?` on page 652

NOTE

The above command reads out the same parameter (SOLT3) for both the full 3-port and simplified full 3-port calibrations, and thus they cannot be discriminated. For the same reason, the following calibrations cannot be discriminated: full 4-port and simplified full 4-port, 3-port TRL and simplified 3-port TRL, and 4-port TRL and simplified 4-port TRL.

Defining calibration kits

Selecting a Calibration Kit

To select a calibration kit, use the following command:

- `:SENS{1-16}:CORR:COLL:CKIT` on page 560

Setting the Calibration Kit Name

To set the name of a calibration kit, use the following command:

- `:SENS{1-16}:CORR:COLL:CKIT:LAB` on page 561

Standard definitions

Selecting a Standard Type

To select a standard type, use the following command:

- `:SENS{1-16}:CORR:COLL:CKIT:STAN{1-21}:TYPE` on page 586

Setting the Standard Name To set the standard name, use the following command:

- `:SENS{1-16}:CORR:COLL:CKIT:STAN{1-21}:LAB` on page 584

Setting the Standard Value To set the standard value, use one of the following commands:

Item	Command
C0	<code>:SENS{1-16}:CORR:COLL:CKIT:STAN{1-21}:C0</code> on page 572
C1	<code>:SENS{1-16}:CORR:COLL:CKIT:STAN{1-21}:C1</code> on page 573
C2	<code>:SENS{1-16}:CORR:COLL:CKIT:STAN{1-21}:C2</code> on page 574
C3	<code>:SENS{1-16}:CORR:COLL:CKIT:STAN{1-21}:C3</code> on page 575
L0	<code>:SENS{1-16}:CORR:COLL:CKIT:STAN{1-21}:L0</code> on page 580
L1	<code>:SENS{1-16}:CORR:COLL:CKIT:STAN{1-21}:L1</code> on page 581
L2	<code>:SENS{1-16}:CORR:COLL:CKIT:STAN{1-21}:L2</code> on page 582
L3	<code>:SENS{1-16}:CORR:COLL:CKIT:STAN{1-21}:L3</code> on page 583
Offset Delay	<code>:SENS{1-16}:CORR:COLL:CKIT:STAN{1-21}:DEL</code> on page 577
Offset Loss	<code>:SENS{1-16}:CORR:COLL:CKIT:STAN{1-21}:LOSS</code> on page 585
Offset Z0	<code>:SENS{1-16}:CORR:COLL:CKIT:STAN{1-21}:Z0</code> on page 587
Arbitrary Impedance	<code>:SENS{1-16}:CORR:COLL:CKIT:STAN{1-21}:ARB</code> on page 571
Start Frequency	<code>:SENS{1-16}:CORR:COLL:CKIT:STAN{1-21}:FMIN</code> on page 579
Stop Frequency	<code>:SENS{1-16}:CORR:COLL:CKIT:STAN{1-21}:FMAX</code> on page 578
Media Type	<code>:SENS{1-16}:CORR:COLL:CKIT:STAN{1-21}:CHAR</code> on page 576

Performing Calibration Calibration

As shown in Table 4-2, you need to set different items depending on the standard type.

Table 4-2 Settings Specific to Each Standard Type

Standard Types	C0 to C3	L0 to L3	Offset Delay	Offset Loss	Offset Z0	Arbitrary Impedance	Min. Frequency	Max. Frequency	Connector Type
OPEN	√		√	√	√		√	√	√
SHORT		√	√	√	√		√	√	√
LOAD			√	√	√		√	√	√
THRU			√	√	√		√	√	√
Arbitrary Impedance			√	√	√	√	√	√	√

You need to set the items identified by √ marks in the table above.

Saving/Recalling the Definition File

To save the definition of the selected calibration kit to a file, use the following command.

- :MMEM:STOR:CKIT{1-20} on page 510

To recall the definition of the calibration kit from a file and set, use the following command.

- :MMEM:LOAD:CKIT{1-20} on page 499

Defining a Subclass of the Standard

To set the standard type that varies with the frequency range, use the following command to specify the subclass.

- :SENS{1-16}:CORR:COLL:SUBC on page 615

To select the subclass, use the following command.

- :SENS{1-16}:CORR:COLL:CKIT:ORD on page 562

To set the start frequency of a specified subclass, use the following command.

- :SENS{1-16}:CORR:COLL:CKIT:STAN{1-21}:FMIN on page 579

To set the stop frequency of a specified subclass, use the following command.

- :SENS{1-16}:CORR:COLL:CKIT:STAN{1-21}:FMAX on page 578

Defining a Standard Class Assignment

To select the standard to be applied to the OPEN measurement for each port, use the following command:

- :SENS{1-16}:CORR:COLL:CKIT:ORD:OPEN on page 564

To select the standard to be applied to the SHORT measurement for each port, use the following command:

- :SENS{1-16}:CORR:COLL:CKIT:ORD:SHOR on page 565

To select the standard to be applied to the LOAD measurement for each port, use the following command:

- :SENS{1-16}:CORR:COLL:CKIT:ORD:LOAD on page 563

To select the standard to be applied to the THRU measurement between each pair of ports, use the following command:

- :SENS{1-16}:CORR:COLL:CKIT:ORD:THRU on page 566

To select the standard to be applied to the THRU measurement for the TRL calibration between each pair of ports, use the following command.

- :SENS{1-16}:CORR:COLL:CKIT:ORD:TRLT on page 569

To select the standard to be applied to the Reflection measurement for the TRL calibration between each pair of ports, use the following command.

- :SENS{1-16}:CORR:COLL:CKIT:ORD:TRLR on page 568

To select the standard to be applied to the Line/Match measurement for the TRL calibration between each pair of ports, use the following command.

- :SENS{1-16}:CORR:COLL:CKIT:ORD:TRLL on page 567

Setting the Standard Media Type

To select the media type of the standard to be used, use the following command.

- :SENS{1-16}:CORR:COLL:CKIT:STAN{1-21}:CHAR on page 576

Saving and loading calibration coefficients

You can save calibration coefficients to a file along with other instrument settings and then later load them from the file.

By default, the system does not save calibration coefficients when it saves instrument settings. Therefore, to save calibration coefficients, you must explicitly configure the system to save them by issuing the following command:

- on page 525

To save calibration coefficients to a file, use the following command:

- :MMEM:STOR on page 506

To load calibration coefficients from a file, use the following command:

- :MMEM:LOAD on page 495

For more information on how to save and load calibration coefficients, refer to “Saving and recalling instrument status.”

Reading/Writing Calibration Coefficient Only

The calibration coefficient alone can be read from and written to the E5070B/E5071B by using the following command:

- :SENS{1-16}:CORR:COEF on page 548

To write a positive calibration coefficient, use one of the following commands to declare the calibration type:

- :SENS{1-16}:CORR:COEF:METH:ERES on page 550
- :SENS{1-16}:CORR:COEF:METH:OPEN on page 551
- :SENS{1-16}:CORR:COEF:METH:SHOR on page 552
- :SENS{1-16}:CORR:COEF:METH:SOLT1 on page 553
- :SENS{1-16}:CORR:COEF:METH:SOLT2 on page 554
- :SENS{1-16}:CORR:COEF:METH:SOLT3 on page 555
- :SENS{1-16}:CORR:COEF:METH:SOLT4 on page 556
- :SENS{1-16}:CORR:COEF:METH:THRU on page 557

To validate the written calibration coefficient, use the following command:

- :SENS{1-16}:CORR:COEF:SAVE on page 558

About Calibration Types and Coefficients

The following table shows the required calibration coefficients for each calibration type.

Table 4-3 Calibration Type and Valid Calibration Coefficient

Calibration Type	Calibration Coefficient					
	ES	ER	ED	EL	ET	EX
Response calibration (OPEN)		*	*			
Response calibration (SHORT)		*	*			
Response calibration (THRU)					*	*
Enhanced response calibration	*	*	*		*	*
1-port calibration	*	*	*			
Full 2-port calibration	*	*	*	*	*	*
Full 3-port calibration	*	*	*	*	*	*
Full 4-port calibration	*	*	*	*	*	*
2-Port TRL calibration	*	*	*	*	*	
3-Port TRL calibration	*	*	*	*	*	
4-Port TRL calibration	*	*	*	*	*	

NOTE

If either an invalid calibration coefficient is specified for the writing command or a nonexistent calibration coefficient is specified for its reading command, the following error will occur:

23, Specified error term does not exist

Procedures for Writing Calibration Coefficient

You must follow the steps below to write the calibration coefficient.

1. Declare the calibration type to write.
Execute `:SENS{1-16}:CORR:COEF:METH:xxxx` command
2. Write any calibration coefficient.
Execute `:SENS{1-16}:CORR:COEF` command as needed for the written calibration coefficients
3. Validate the calibration coefficients.
Execute `:SENS{1-16}:CORR:COEF:SAVE` command

NOTE

Do not execute any other command while writing the calibration coefficients. This may cause the system to function incorrectly.

If the fixture simulator is turned on, the calibration coefficient writing will not function correctly. Make sure to turn off the fixture simulator before execution.

Clearing calibration data and calibration coefficients

Clearing Calibration Data

You can use the following command to clear the measurement values of calibration data executed with `:SENS{1-16}:CORR:OFFS:COLL:OPEN` on page 641 command, etc. when the frequency offset function has been enabled.

- `:SENS{1-16}:CORR:OFFS:COLL:CLE` on page 635

By implementing the measurement of calibration data, the temporarily changed settings are recovered to the original state, including trace number and measurement parameters.

Clearing Calibration Coefficients

You can use the following command to clear the calibration coefficients used when the frequency offset function is enabled.

- `:SENS{1-16}:CORR:OFFS:CLE` on page 634

This command does not clear calibration coefficients related to normal calibration.

Power Calibration

The E5070B/E5071B lets you perform power calibration by using a power meter to output a more accurate power level.

Preparation for power calibration

Connecting Power Meter and Power Sensor

The E5070B/E5071B performs power calibration by controlling the power meter via GPIB. Therefore, you need to connect the E5070B/E5071B and the power meter by using the USB/GPIB interface. For details on this as well as information on available power meters and power sensors, refer to the *User's Guide*.

Setting GPIB Address of Power Meter

Use the following command to set the GPIB address of the power meter to the E5070B/E5071B.

- :SYST:COMM:GPIB:PMET:ADDR on page 782

Setting Power Sensor Calibration Factor Table

Before performing power calibration, set the reference calibration factor (the calibration factor at 50 MHz) and the calibration factor for each frequency depending on the power sensor you use.

NOTE

Depending on the combination of power meter and power sensor that you use, the power sensor calibration factor table may be set automatically by the power meter. In this case, do not set the calibration factor table with the E5070B/E5071B. For details, refer to the *User's Guide*.

To set the reference calibration factor of the power sensor, use the following commands:

Channel A	:SOUR:POW:PORT:CORR:COLL:ASEN:RCF on page 700
Channel B	:SOUR:POW:PORT:CORR:COLL:BSEN:RCF on page 701

To set the calibration factor table of the power sensor for each frequency, use the following commands:

Channel A	:SOUR:POW:PORT:CORR:COLL:TABL:ASEN:DATA on page 702
Channel B	:SOUR:POW:PORT:CORR:COLL:TABL:BSEN:DATA on page 703

Performing Calibration

Power Calibration

Alternatively, you can configure the power sensor calibration factor table based on the data contained in a CSV file by issuing the following commands:

Channel A	:MMEM:LOAD:ASCF on page 496
Channel B	:MMEM:LOAD:BSCF on page 497

Also, you can save the contents of the current power sensor calibration factor table to a file by issuing the following commands:

Channel A	:MMEM:STOR:ASCF on page 507
Channel B	:MMEM:STOR:BSCF on page 508

For more information on saving/recalling the power sensor calibration factor table, refer to “Saving/recalling Power Sensor Calibration Factor Table” on page 197.

Loss compensation

You can perform loss compensation by setting in advance the power loss due to the difference in connections (cables, adapters, etc.) between the when the power calibration data are measured and when the actual DUTs are measured.

Setting Loss Compensation Table

To set the loss compensation table for each frequency, use the following command:

- :SOUR{1-16}:POW:PORT{1-4}:CORR:COLL:TABL:LOSS:DATA on page 715

Alternatively, you can configure the loss compensation table based on the data contained in a CSV file by issuing the following command:

- :MMEM:LOAD:PLOS{1-4} on page 501

Also, you can save the contents of the current loss compensation table to a file by issuing the following command:

- :MMEM:STOR:PLOS{1-4} on page 514

Turning ON/OFF Loss Compensation

To turn on or off the loss compensation, use the following command:

- :SOUR{1-16}:POW:PORT{1-4}:CORR:COLL:TABL:LOSS on page 714

Measuring power calibration data

NOTE

Before measuring power calibration data, you need to execute zero adjustment and calibration of the power sensor. For information on how to perform these procedures, refer to the operation manual of the power meter you are using.

When using the power sensor calibration factor table of the E5070B/E5071B, set the reference calibration factor of the power meter to 100% when calibrating the power sensor.

To set the number of power calibration data measurements at one measurement point (averaging factor), use the following command:

- `:SOUR{1-16}:POW:PORT{1-4}:CORR:COLL:AVER` on page 712

To set a tolerance for power calibration, use the following command:

- `:SOUR{1-16}:POW:PORT{1-4}:CORR:COLL:NTOL` on page 713

NOTE

When a tolerance for power calibration is set, if the measured value does not fall within the tolerance, even after measurement is performed during power calibration the number of times specified by the averaging factor, an error message is displayed and the power calibration is aborted. In this case, the power correction is not turned on.

To measure the power calibration data, use the following command. When the measurement is complete, the power calibration is automatically turned on.

- `:SOUR{1-16}:POW:PORT{1-4}:CORR:COLL` on page 711

NOTE

If you issue another command during the measurement of the power calibration data by the above command, the measurement may be aborted. Therefore, when you write a program that issues multiple calibration commands in series, you should use the `*OPC?` command on page 288 or some other means to ensure that no command is executed before the preceding command completes itself.

Turning ON/OFF power-level error correction

To turn on or off the power-level error correction, use the following command:

- `:SOUR{1-16}:POW:PORT{1-4}:CORR` on page 711

NOTE

When the power calibration data measurement initiated with the `:SOUR{1-16}:POW:PORT{1-4}:CORR:COLL` command is complete, the power calibration is automatically turned on.

Reading/writing power calibration data array

The power calibration data array contains data used to perform error correction for the power level at each measurement point (values obtained by subtracting the value actually measured with the power meter from the set power level value when measuring power calibration data at each measurement point).

The number of power calibration data arrays that are assigned to individual ports of individual channels can be up to 64 (16×4). To read/write one of the power calibration data arrays, use the following command:

Performing Calibration
Power Calibration

- :SOUR{1-16}:POW:PORT{1-4}:CORR:DATA on page 716

Receiver Calibration

The E5070B/E5071B has a receiver calibration capability to calibrate the gain for each receiver in an absolute measurement.

Measurement of receiver calibration data and calculation of calibration coefficient

NOTE

Before starting a measurement of receiver calibration data, you must connect a THRU between the source port at which power calibration was applied and the receiver port on which you want to implement receiver calibration.

Use the following command for the measurement of receiver calibration data and calculation of calibration coefficient. The value following REC signifies a receiver port number, and the value given as an argument is a source port number. Specifying the same port to both the receiver port and source port will cause an error.

- `:SENS{1-16}:CORR:REC{1-4}:COLL:ACQ` on page 648

Once the measurement is completed, calculation of the calibration coefficient takes place automatically, turning on receiver error correction automatically.

NOTE

The power calibration information on both the receiver port and source port is used to calculate calibration coefficients. The accuracy of receiver calibration will increase if power calibration is implemented for both the receiver port and the source port before starting receiver calibration. For information on power calibration, refer to “Power Calibration” on page 87.

NOTE

Verify the frequency of each port before starting a frequency offset sweep. Since this command does not change the frequency setting, you cannot expect a correct measurement result unless the frequency is the same for both the receiver port and the source port.

When using power calibration in combination with receiver calibration, you must implement it so that it sufficiently covers the frequencies of both ports or implement it twice, before and after the receiver calibration.

Turning ON/OFF receiver error correction

To turn on or off the receiver error correction, use the following command:

- `:SENS{1-16}:CORR:REC{1-4}` on page 647

NOTE

Once the measurement of receiver calibration data is completed with the `:SENS{1-16}:CORR:REC{1-4}:COLL:ACQ` command, receiver error correction is automatically turned on.

Scalar-Mixer Calibration

The E5070B/E5071B's frequency offset function allows you to measure any device that has different input and output frequencies. To correct such measurements, you must determine the transmission frequency characteristics at different frequencies.

Scalar-mixer calibration is a method to calculate the transmission frequency characteristics at different frequencies by using a power meter.

Measurement of scalar-mixer calibration data

Setting Frequency Offset Function

You can use the following command to enable the frequency offset function before starting a measurement of scalar-mixer calibration data.

- `:SENS{1-16}:OFFS` on page 668

NOTE

To use scalar-mixer calibration, the frequency offset function must be enabled.

Selecting Calibration Port and Type

You can use the following commands to set the port on which a measurement of scalar-mixer calibration data is implemented and the type of calibration.

- `:SENS{1-16}:CORR:OFFS:COLL:METH:SMIX2` on page 639
- `:SENS{1-16}:CORR:OFFS:COLL:METH:SOLT1` on page 640

“SMIX2” will set a scalar-mixer calibration for 2-port forward, reverse and both directions. “SOLT1” will set 1-port calibration.

NOTE

The two ports specified by “SMIX2” must be different from each other.

The setting of forward, reverse and both directions is not dependent on the order of the two specified ports but determined by specifying an appropriate command for calibration data measurement, such as `:SENS{1-16}:CORR:OFFS:COLL:OPEN` on page 641.

Measuring the Calibration Data

You can use the following command to measure the scalar-mixer calibration data.

- `:SENS{1-16}:CORR:OFFS:COLL:OPEN` on page 641
- `:SENS{1-16}:CORR:OFFS:COLL:SHOR` on page 644
- `:SENS{1-16}:CORR:OFFS:COLL:LOAD` on page 638
- `:SENS{1-16}:CORR:OFFS:COLL:THRU` on page 645

Measuring Power

You can use the following command to measure power.

- :SENS{1-16}:CORR:OFFS:COLL:PMET on page 642

NOTE

Power measurement is required for scalar-mixer calibration, but it is not required for 1-port calibration. The setting for power measurement is the same as for the normal power calibration. For information on power calibration, refer to “Power Calibration” on page 87.

Calculation of scalar-mixer calibration coefficient

If the needed measurement is completed for the calibration port and type you have selected, use the following command to start calculation of calibration coefficients.

- :SENS{1-16}:CORR:OFFS:COLL:SAVE on page 643

NOTE

If the necessary measurement is not completed, an error will occur. Once the calculation of calibration coefficients is completed, the measurement values are cleared despite whether they were used and error correction is turned on automatically.

Turning ON/OFF scalar-mixer error correction

To turn on or off scalar-mixer error correction, use the following command. This command is commonly used for the normal calibration; scalar-mixer calibration data are enabled while the frequency offset is turned on, and the normal calibration data are enabled while it is turned off.

- :SENS{1-16}:CORR:STAT on page 650

NOTE

Once the scalar-mixer calibration coefficient has been calculated, scalar-mixer correction is automatically turned on.

Implementing scalar-mixer calibration with ECal

An ECal (Electronic Calibration) module allows you to perform scalar-mixer calibration and 1-port calibration without needing to replace the standard device.

To perform ECal, use one of the following commands:

Calibration type	Command
1-Port Calibration	:SENS{1-16}:CORR:OFFS:COLL:ECAL:SOLT1 on page 637
Scalar-Mixer Calibration	:SENS{1-16}:CORR:OFFS:COLL:ECAL:SMIX2 on page 636

Simply issuing one of the above commands completes some of the tasks necessary for error correction, including measuring the calibration data, calculating the calibration coefficients, and running the error correction feature. To implement scalar-mixer calibration, you must measure the power in advance. For 1-port calibration, you do not need to do this.

Performing Calibration
Scalar-Mixer Calibration

NOTE

Once ECal has started, you cannot interrupt the operation.

Any command received after ECal has started will not be executed until ECal is completed. In other words, even if you issue a command with a Query, you cannot get the Query response until ECal is finished.

Partial overwrite

The E5070B/E5071B has the following calibration coefficients for full N-port calibration: Er, Es, Ed (reflection), Et (transmission), and Ex (isolation). The partial overwrite function is used to measure some of these calibration coefficients after completion of the initial calibration and then to overwrite them.

The conditions under which the calibration coefficients can be calculated by the partial overwrite are as follows:

- Calibration is completed once and valid (status other than C? or C!)
- One or more measurements for re-calculation are performed.

NOTE

The isolation calibration coefficient, Ex, cannot be returned to the initial value, 0, once it is calculated.

If calculation of the calibration coefficients is attempted without the measurements required to execute the partial overwrite, an error message (20: Additional Standard Needed) is displayed.

Executing calculation of calibration coefficients using partial overwrite

To calculate the calibration coefficients using partial overwrite, use the following command:

- `:SENS{1-16}:CORR:COLL:PART:SAVE` on page 612

NOTE

Before you can calculate the calibration coefficients with the partial overwrite, you must select the appropriate calibration type in the same way used for normal calibration. If calculation of the calibration coefficients is attempted without selecting the calibration type, an error message (28: Invalid Calibration Method) is displayed.

Sample Program

Calibration

Example 4-1 shows a sample program that demonstrates how to calibrate the instrument. You can find the source file of this program, named `cal.htb`, on the sample program disk.

The sample program performs calibration with the specified calibration type and saves the results to a file named “`Ex_4_1.sta`.”

The program is described in detail below:

Line 40	Assigns a GPIB address to the I/O pass.
Line 50	Stores the name of the file (<code>Ex_4_1.sta</code>) into the <code>File\$</code> variable.
Line 60	Stores the channel number (1) into the <code>Ch\$</code> variable.
Line 80	Calls a subprogram named <code>Select_cal_kit</code> to select the calibration kit.
Line 110	Allows the user to return to the entry start line and re-enter the data if an error (such as an invalid entry) occurs while selecting the calibration type number.
Lines 130 to 230	These lines display the list of supported calibration types and prompt the user to choose one of the items by typing in the appropriate number.
Line 240	Converts the entered value into an integer and stores it into the <code>Cal_type</code> variable.
Line 250	Returns to the entry start line if an invalid value is contained in <code>Cal_type</code> .
Lines 280 to 500	These lines call a subprogram named <code>Select_port</code> to select the appropriate port based on the value of <code>Cal_type</code> and then perform calibration. Lines 300 to 310: If <code>Cal_type = 1</code> , the program calls a subprogram named <code>Cal_resp</code> to perform response calibration (OPEN) after selecting the port. Lines 330 to 340: If <code>Cal_type = 2</code> , the program calls the subprogram <code>Cal_resp</code> to perform response calibration (SHORT) after selecting the port. Lines 360 to 370: If <code>Cal_type = 3</code> , the program calls a subprogram named <code>Cal_resp_thru</code> to perform response calibration (THRU) after selecting the port. Lines 390 to 400: If <code>Cal_type = 4</code> , the program calls a subprogram named <code>Cal_solt</code> to perform 1-port calibration after selecting the port. Lines 420 to 430: If <code>Cal_type = 5</code> , the program calls the subprogram <code>Cal_solt</code> to perform full 2-port calibration after selecting the port. Lines 450 to 460: If <code>Cal_type = 6</code> , the program calls the

subprogram Cal_solt to perform full 3-port calibration after selecting the port.

Lines 480 to 490: If Cal_type = 7, the program calls the subprogram Cal_solt to perform full 4-port calibration after selecting the port.

Lines 520 to 530 These lines configure the system to save calibration coefficients along with instrument settings and then save the instrument settings under the file name contained in the File\$ variable.

The Select_cal_kit subprogram in lines 580 to 820, which selects the calibration kit, is described below.

Lines 630 to 670 These lines retrieve the names of all the calibration kits and store them into the Cal_kit_lbl\$(*) variable.

Line 680 Allows the user to return to the entry start line and re-enter the data if an error (such as an invalid entry) occurs while entering the number that identifies the calibration kit.

Lines 700 to 760 These lines display the list of supported calibration kits and prompt the user to choose one of the items by typing in the appropriate number.

Line 770 Converts the entered value into an integer and stores it into the Cal_kit variable.

Line 780 Returns to the entry start line if an invalid value is contained in Cal_kit.

Line 810 Selects the calibration kit that matches the number contained in the Cal_kit variable.

The Select_port subprogram in lines 860 to 1090, which allows the user to select a port, is described below.

Lines 910 to 940 If the value of Num_of_ports is 4 (4-port), the subprogram determines the port numbers (1, 2, 3, 4) without prompting the user to enter port numbers and then stores the port numbers into the Port(*) variable.

Lines 960 to 1090 If the value of Num_of_ports is not 4, the subprogram prompts the user to select the number of ports indicated by Num_of_ports.

Line 970: Allows the user to return to the entry start line and re-enter the data if an error (such as an invalid entry) occurs while entering the port number.

Lines 990 to 1010: These lines print the index of the current port and prompt the user to enter the port number.

Lines 1020: Converts the entered value into an integer and stores it into the Port(*) variable.

Lines 1040 to 1060: These lines return to the entry start line if the port number is beyond the range of 1 to 4 or conflicts with an already selected number.

Performing Calibration

Sample Program

The Cal_resp subprogram in lines 1150 to 1260, which performs response calibration (OPEN/SHORT), is described below.

- Line 1180 Displays the calibration type.
- Line 1190 Configures the instrument to perform response calibration (Type\$) on the port identified by the Port variable.
- Lines 1200 to 1210 These lines prompt the user to connect a Type\$ to port Port, and wait for a press of the [Enter] key after the connection.
- Lines 1220 to 1240 These lines execute the calibration data measurement command identified by Type\$ on port Port and wait until the measurement completes successfully.
- Line 1250 Calculates the calibration coefficients and turns on error correction.
- Line 1260 Displays a closing message.

The Cal_resp_thru subprogram in lines 1310 to 1430, which performs response calibration (THRU), is described below.

- Line 1340 Displays the calibration type.
- Line 1350 Configures the instrument to perform response calibration (THRU) on response port Port 1 and stimulus port Port 2.
- Lines 1360 to 1370 These lines prompt the user to connect a THRU standard between the ports identified by Port 1 and Port 2 and wait for a press of the [Enter] key after the connection.
- Lines 1380 to 1400 These lines execute the THRU calibration data measurement command on response port Port1 and stimulus port 2 and wait until the measurement completes successfully.
- Line 1410 Calculates the calibration coefficients and turns on error correction.
- Line 1420 Displays a closing message.

The Cal_solt subprogram in lines 1470 to 2000, which performs full n-port calibration, is described below.

Line 1510 Displays the calibration type.

Lines 1550 to 1590 These lines configure the instrument to perform full Num_of_ports port calibration on the ports identified by Port(1) through Port(Num_of_ports).

Lines 1630 to 1790 These lines make up a loop that iterates while incrementing i from 1 to Num_of_ports.

Lines 1640 to 1650: Prompt the user to connect an OPEN standard to port Port(i) and wait for a press of the [Enter] key after the connection.

Lines 1660 to 1680: Execute the OPEN calibration data measurement command on port Port(i) and wait until the measurement completes successfully.

Lines 1690 to 1700: Prompt the user to connect a SHORT standard to port Port(i) and wait for a press of the [Enter] key after the connection.

Lines 1710 to 1730: Execute the SHORT calibration data measurement command on port Port(i) and wait until the measurement completes successfully.

Lines 1740 to 1750: Prompt the user to connect a LOAD standard to port Port(i) and wait for a press of the [Enter] key after the connection.

Lines 1760 to 1780: Execute the LOAD calibration data measurement command on port Port(i) and wait until the measurement completes successfully.

Lines 1830 to 1940 These lines make up a loop that iterates while incrementing i from 1 to Num_of_ports-1 and j from i+1 to Num_of_ports.

Lines 1850 to 1860: Prompt the user to connect a THRU standard between port Port(i) and port Port(j) and wait for a press of the [Enter] key after the connection.

Lines 1660 to 1680: Execute the THRU calibration data measurement command on response port Port(i) and stimulus port Port(j) and wait until the measurement completes successfully.

Lines 1690 to 1700: Execute the THRU calibration data measurement command on response port Port(j) and stimulus port Port(i) and wait until the measurement completes successfully.

Line 1980 Calculates the calibration coefficients and turns on error correction.

Line 1990 Displays a closing message.

Performing Calibration Sample Program

Example 4-1

Calibration (cal.htb)

```
10   DIM File$[20],Ch$[9],Inp_char$[9]
20   INTEGER Cal_kit,Cal_type,Port(1:4)
30   !
40   ASSIGN @Agte507x TO 717
50   File$="Ex_4_1.sta"
60   Ch$="1"
70   !
80   Select_cal_kit(@Agte507x,Ch$)
90   !
100  CLEAR SCREEN
110  ON ERROR GOTO Type_select
120  Type_select: !
130  PRINT "## Calibration Type Selection ##"
140  PRINT " 1: Response (Open) "
150  PRINT " 2: Response (Short) "
160  PRINT " 3: Response (Thru) "
170  PRINT " 4: Full 1 Port "
180  PRINT " 5: Full 2 Port "
190  PRINT " 6: Full 3 Port "
200  PRINT " 7: Full 4 Port "
210  PRINT ""
220  PRINT "Input 1 to 7"
230  INPUT "Input number? (1 to 7)",Inp_char$
240  Cal_type=IVAL(Inp_char$,10)
250  IF Cal_type<1 OR Cal_type>7 THEN Type_select
260  OFF ERROR
270  !
280  SELECT Cal_type
290  CASE 1
300    Select_port(1,Port(*))
310    Cal_resp(@Agte507x,Ch$,"OPEN",Port(1))
320  CASE 2
330    Select_port(1,Port(*))
340    Cal_resp(@Agte507x,Ch$,"SHOR",Port(1))
350  CASE 3
360    Select_port(2,Port(*))
370    Cal_resp_thru(@Agte507x,Ch$,Port(1),Port(2))
380  CASE 4
390    Select_port(1,Port(*))
400    Cal_solt(@Agte507x,Ch$,1,Port(*))
410  CASE 5
420    Select_port(2,Port(*))
430    Cal_solt(@Agte507x,Ch$,2,Port(*))
440  CASE 6
450    Select_port(3,Port(*))
460    Cal_solt(@Agte507x,Ch$,3,Port(*))
470  CASE 7
480    Select_port(4,Port(*))
490    Cal_solt(@Agte507x,Ch$,4,Port(*))
500  END SELECT
510  !
520  OUTPUT @Agte507x;":MMEM:STOR:STYP CST"
530  OUTPUT @Agte507x;":MMEM:STOR """"&File$&""""
540  END
550  !=====
560  ! Calibration Kit Selection Function
570  !=====
580  SUB Select_cal_kit(@Agte507x,Ch$)
590  DIM Cal_kit_lbl$(1:10)[20],Inp_char$[9]
600  INTEGER Cal_kit,I
610  CLEAR SCREEN
```

```

620 !
630 FOR I=1 TO 10
640   OUTPUT @Agte507x;":SENS1:CORR:COLL:CKIT ";I
650   OUTPUT @Agte507x;":SENS1:CORR:COLL:CKIT:LAB?"
660   ENTER @Agte507x;Cal_kit_lbl$(I)
670 NEXT I
680 ON ERROR GOTO Kit_select
690 Kit_select: !
700 PRINT "## Calibration Kit Selection ##"
710 FOR I=1 TO 10
720   PRINT USING "X,2D,A,X,20A";I,":",Cal_kit_lbl$(I)
730 NEXT I
740 PRINT ""
750 PRINT "Input 1 to 10"
760 INPUT "Input number? (1 to 10)",Inp_char$
770 Cal_kit=IVAL(Inp_char$,10)
780 IF Cal_kit<1 OR Cal_kit>10 THEN Kit_select
790 OFF ERROR
800 !
810 OUTPUT @Agte507x;":SENS"&Ch$&":CORR:COLL:CKIT ";Cal_kit
820 SUBEND
830 !=====
840 ! Port Selection Function
850 !=====
860 SUB Select_port(INTEGER Num_of_ports,INTEGER Port(*))
870 DIM Inp_char$(9)
880 !
890 CLEAR SCREEN
900 IF Num_of_ports=4 THEN
910   Port(1)=1
920   Port(2)=2
930   Port(3)=3
940   Port(4)=4
950 ELSE
960   PRINT "## Test Ports Selection ##"
970   ON ERROR GOTO Port_select
980   FOR I=1 TO Num_of_ports
990     PRINT "Port("&VAL$(I)&"):";
1000 Port_select: !
1010   INPUT "Number?",Inp_char$
1020   Port(I)=IVAL(Inp_char$,10)
1030   IF Port(I)<1 OR Port(I)>4 THEN Port_select
1040   FOR J=1 TO I-1
1050     IF Port(I)=Port(J) THEN Port_select
1060   NEXT J
1070   PRINT Port(I)
1080 NEXT I
1090 OFF ERROR
1100 END IF
1110 SUBEND
1120 !=====
1130 ! Response (Open/Short) Calibration Function
1140 !=====
1150 SUB Cal_resp(@Agte507x,Ch$,Type$,INTEGER Port)
1160 DIM Buff$(9)
1170 !
1180 PRINT "## Response("&Type$&") Calibration ##"
1190 OUTPUT @Agte507x;":SENS"&Ch$&":CORR:COLL:METH:"&Type$& " ;Port
1200 PRINT "Set "&Type$& " to Port "&VAL$(Port)& ". Then push [Enter]
key."
1210 INPUT "",Buff$
1220 OUTPUT @Agte507x;":SENS"&Ch$&":CORR:COLL:"&Type$& " ;Port
1230 OUTPUT @Agte507x;"*OPC?"
1240 ENTER @Agte507x;Buff$

```

Performing Calibration Sample Program

```
1250 OUTPUT @Agte507x;":SENS"&Ch$&":CORR:COLL:SAVE"
1260 PRINT "Done"
1270 SUBEND
1280 !=====
1290 ! Response (Thru) Calibration Function
1300 !=====
1310 SUB Cal_resp_thru(@Agte507x,Ch$,INTEGER Port1,Port2)
1320 DIM Buff$(9)
1330 !
1340 PRINT "## Response (Thru) Calibration ##"
1350 OUTPUT @Agte507x;":SENS"&Ch$&":CORR:COLL:METH:THRU ";Port1;",";
Port2
1360 PRINT "Set THRU between Port "&VAL$(Port1)&" and Port "&VAL$(Port2
)&". Then push [Enter] key."
1370 INPUT "",Buff$
1380 OUTPUT @Agte507x;":SENS"&Ch$&":CORR:COLL:THRU ";Port1;",";Port2
1390 OUTPUT @Agte507x;"*OPC?"
1400 ENTER @Agte507x;Buff$
1410 OUTPUT @Agte507x;":SENS"&Ch$&":CORR:COLL:SAVE"
1420 PRINT "Done"
1430 SUBEND
1440 !=====
1450 ! Full n Port Calibration Function
1460 !=====
1470 SUB Cal_solt(@Agte507x,Ch$,INTEGER Num_of_ports,INTEGER Port(*))
1480 DIM Buff$(9)
1490 INTEGER I,J
1500 !
1510 PRINT "## Full "&VAL$(Num_of_ports)&" Port Calibration ##"
1520 !
1530 ! Calibration Type Selection
1540 !
1550 OUTPUT @Agte507x;":SENS"&Ch$&":CORR:COLL:METH:SOLT"&VAL$(Num_of_
ports)&" ";
1560 FOR I=1 TO Num_of_ports-1
1570 OUTPUT @Agte507x;Port (I);",";
1580 NEXT I
1590 OUTPUT @Agte507x;Port (Num_of_ports)
1600 !
1610 ! Reflection Measurement
1620 !
1630 FOR I=1 TO Num_of_ports
1640 PRINT "Set OPEN to Port "&VAL$(Port(I))&". Then push [Enter]
key."
1650 INPUT "",Buff$
1660 OUTPUT @Agte507x;":SENS"&Ch$&":CORR:COLL:OPEN ";Port (I)
1670 OUTPUT @Agte507x;"*OPC?"
1680 ENTER @Agte507x;Buff$
1690 PRINT "Set SHORT to Port "&VAL$(Port(I))&". Then push [Enter]
key."
1700 INPUT "",Buff$
1710 OUTPUT @Agte507x;":SENS"&Ch$&":CORR:COLL:SHOR ";Port (I)
1720 OUTPUT @Agte507x;"*OPC?"
1730 ENTER @Agte507x;Buff$
1740 PRINT "Set LOAD to Port "&VAL$(Port(I))&". Then push [Enter]
key."
1750 INPUT "",Buff$
1760 OUTPUT @Agte507x;":SENS"&Ch$&":CORR:COLL:LOAD ";Port (I)
1770 OUTPUT @Agte507x;"*OPC?"
1780 ENTER @Agte507x;Buff$
1790 NEXT I
1800 !
1810 ! Transmission Measurement
1820 !
```

```
1830  FOR I=1 TO Num_of_ports-1
1840    FOR J=I+1 TO Num_of_ports
1850      PRINT "Set THRU between Port "&VAL$(Port(I))&" and Port "&
VAL$(Port(J))&". Then push [Enter] key."
1860      INPUT "",Buff$
1870      OUTPUT @Agte507x;":SENS"&Ch$&":CORR:COLL:THRU ";Port(I);", "
;Port(J)
1880      OUTPUT @Agte507x;"*OPC?"
1890      ENTER @Agte507x;Buff$
1900      OUTPUT @Agte507x;":SENS"&Ch$&":CORR:COLL:THRU ";Port(J);", "
;Port(I)
1910      OUTPUT @Agte507x;"*OPC?"
1920      ENTER @Agte507x;Buff$
1930    NEXT J
1940  NEXT I
1950  !
1960  ! Done
1970  !
1980  OUTPUT @Agte507x;":SENS"&Ch$&":CORR:COLL:SAVE"
1990  PRINT "Done"
2000 SUBEND
```

Performing Calibration

Sample Program

ECal

Example 4-2 shows a sample program that demonstrates how to use ECal. You can find the source file of this program, named ecal.htb, on the sample program disk.

The sample program performs 1-port or 2-port calibration using ECal and saves the results to a file named “Ex_4_2.sta.”

The program is described in detail below:

Line 40	Assigns a GPIB address to the I/O pass.
Line 50	Stores the name of the file (Ex_4_2.sta) into the File\$ variable.
Line 60	Stores the channel number (1) into the Ch\$ variable.
Line 90	Allows the user to return to the entry start line and re-enter the data if an error (such as an invalid entry) occurs while selecting the calibration type number.
Lines 110 to 160	These lines display the list of supported calibration types and prompt the user to choose one of the items by typing in the appropriate number.
Line 170	Converts the entered value into an integer and stores it into the Cal_type variable.
Line 180	Returns to the entry start line if an invalid value is contained in Cal_type.
Lines 230 to 240	These lines call a subprogram named Select_port to select the appropriate port based on the value of Cal_type and then perform ECal.
Lines 260 to 270	These lines configure the system to save calibration coefficients along with instrument settings and then save the instrument settings under the file name contained in the File\$ variable.

For more information on the Select_port subprogram (lines 320 to lines 570), refer to the description in Example 4-1.

The Ecal subprogram in lines 610 to 1030, which performs ECal, is described below.

Line 650	Displays the calibration type.
Line 670	Clears the error queue.
Lines 700 to 720	If Num_of_ports = 1, the subprogram prompts the user to connect the E5070B/E5071B's port Port(1) with the ECal module and waits for a press of the [Enter] key after the connection.
Line 730	If Num_of_ports = 1, the subprogram executes the ECal command that performs 1-port calibration on port Port(1).
Lines 750 to 780	If Num_of_ports = 2, the subprogram prompts the user to connect the E5070B/E5071B's ports Port(1) and Port(2) with the ECal module and waits for a press of the [Enter] key after the connection.
Line 790	If Num_of_ports = 2, the subprogram executes the ECal command that performs full 2-port calibration on ports Port(1) and Port(2).
Lines 810 to 850	If Num_of_ports = 3, the subprogram prompts the user to connect the E5070B/E5071B's ports Port(1), Port(2) and Port(3) with the ECal module and waits for a press of the [Enter] key after the connection.
Line 860	If Num_of_ports = 3, the subprogram executes the ECal command that performs full 3-port calibration on ports Port(1), Port(2) and Port(3).
Lines 880 to 900	If Num_of_ports = 4, the subprogram prompts the user to connect the E5070B/E5071B's ports 1, 2, 3 and 4 with the ECal module and waits for a press of the [Enter] key after the connection.
Line 910	If Num_of_ports = 4, the subprogram executes the ECal command that performs full 4-port calibration.
Lines 940 to 950	These lines retrieve the error number and error message from the error queue and then store them into the variables Err_no and Err_msg\$, respectively.

NOTE

Unlike calibration data measurement commands such as **:SENS{1-16}:CORR:COLL:OPEN**, the ECal command cannot be combined with the ***OPC?** command to make the program wait until the measurement completes successfully. However, since the system accepts no command during ECal, you can suspend the program until ECal is complete by following the ECal command with a command that queries some data. The sample program executes **:SYST:ERR?** in order to wait for the completion of ECal and check for any error.

Lines 970 to 990	If Err_no returns a non-zero value (an error value), the program displays the corresponding error message.
Line 1010	If Err_no returns 0 (no error), the program displays a closing message.

Performing Calibration Sample Program

Example 4-2

ECal (ecal.htb)

```
10   DIM File$[20],Ch$[9],Inp_char$[9]
20   INTEGER Cal_kit,Cal_type,Port(1:4)
30   !
40   ASSIGN @Agte507x TO 717
50   File$="Ex_4_2.sta"
60   Ch$="1"
70   !
80   CLEAR SCREEN
90   ON ERROR GOTO Type_select
100  Type_select: !
110  PRINT "## Calibration Type Selection ##"
120  PRINT " 1: Full 1 Port"
130  PRINT " 2: Full 2 Port"
140  PRINT " 3: Full 3 Port"
150  PRINT " 4: Full 4 Port"
160  PRINT ""
170  PRINT "Input 1 to 4"
180  INPUT "Input number? (1 to 4)",Inp_char$
190  Cal_type=IVAL(Inp_char$,10)
200  IF Cal_type<1 OR Cal_type>4 THEN Type_select
210  OFF ERROR
220  !
230  Select_port(Cal_type,Port(*))
240  Ecal(@Agte507x,Ch$,Cal_type,Port(*))
250  !
260  OUTPUT @Agte507x;":MMEM:STOR:STYP CST"
270  OUTPUT @Agte507x;":MMEM:STOR ""&File$&""
280  END
290  !=====
300  ! Port Selection Function
310  !=====
320  SUB Select_port(INTEGER Num_of_ports,INTEGER Port(*))
330  DIM Inp_char$[9]
340  !
350  CLEAR SCREEN
360  IF Num_of_ports=4 THEN
370    Port(1)=1
380    Port(2)=2
390    Port(3)=3
400    Port(4)=4
410  ELSE
420    PRINT "## Test Ports Selection ##"
430    ON ERROR GOTO Port_select
440    FOR I=1 TO Num_of_ports
450      PRINT "Port("&VAL$(I)&"):";
460  Port_select: !
470    INPUT "Number?",Inp_char$
480    Port(I)=IVAL(Inp_char$,10)
490    IF Port(I)<1 OR Port(I)>4 THEN Port_select
500    FOR J=1 TO I-1
510      IF Port(I)=Port(J) THEN Port_select
520    NEXT J
530    PRINT Port(I)
540  NEXT I
550  OFF ERROR
560  END IF
570  SUBEND
580  !=====
590  ! Electronic Calibration Function
600  !=====
610  SUB Ecal(@Agte507x,Ch$,INTEGER Num_of_ports,INTEGER Port(*))
```

```

620 DIM Buff$(9),Err_msg$(100)
630 INTEGER Err_no,Port1
640 !
650 PRINT "## Full "&VAL$(Num_of_ports)&" Port ECal ##"
660 !
670 OUTPUT @Agte507x;"*CLS"
680 SELECT Num_of_ports
690 CASE 1
700 PRINT "Connect Port "&VAL$(Port(1))&" to ECal Module."
710 PRINT "Then push [Enter] key."
720 INPUT "",Buff$
730 OUTPUT @Agte507x;":SENS"&Ch$&":CORR:COLL:ECAL:SOLT1 ";Port(1)
740 CASE 2
750 PRINT "Connect Port "&VAL$(Port(1));
760 PRINT " and Port "&VAL$(Port(2))&" to ECal Module."
770 PRINT "Then push [Enter] key."
780 INPUT "",Buff$
790 OUTPUT @Agte507x;":SENS"&Ch$&":CORR:COLL:ECAL:SOLT2 ";Port(1);
",";Port(2)
800 CASE 3
810 PRINT "Connect Port "&VAL$(Port(1));
820 PRINT ", Port "&VAL$(Port(2));
830 PRINT " and Port "&VAL$(Port(3))&" to ECal Module."
840 PRINT "Then push [Enter] key."
850 INPUT "",Buff$
860 OUTPUT @Agte507x;":SENS"&Ch$&":CORR:COLL:ECAL:SOLT3 ";Port(1);
",";Port(2);",";Port(3)
870 CASE 4
880 PRINT "Connect Port 1, Port 2, Port 3 and Port 4 to to ECal Mod
ule."
890 PRINT "Then push [Enter] key."
900 INPUT "",Buff$
910 OUTPUT @Agte507x;":SENS"&Ch$&":CORR:COLL:ECAL:SOLT4 1,2,3,4"
920 END SELECT
930 PRINT "Executing ..."
940 OUTPUT @Agte507x;":SYST:ERR?"
950 ENTER @Agte507x;Err_no,Err_msg$
960 IF Err_no<>0 THEN
970 PRINT "Error occurred!!"
980 PRINT " No: ";Err_no,"Description: "&Err_msg$
990 PRINT "ECAL INTERRUPT!!"
1000 ELSE
1010 PRINT "Done"
1020 END IF
1030 SUBEND

```

Power Calibration

Example 4-3 shows a sample program that demonstrates how to perform power calibration. You can find the source file of this program, named `pow_cal.htb`, on the sample program disk.

This program, as shown in Figure 4-1, is run by making connections between the E5070B/E5071B and the power meter (E4418B) through the USB/GPIB interface and between the E5070B/E5071B and the external controller through the GPIB cable. Then the program executes the power calibration of the E5070B/E5071B by using the power sensor (E4412A). The obtained power calibration data array is saved into a file.

Figure 4-1

Connecting E5070B/E5071B, power meter, and external controller

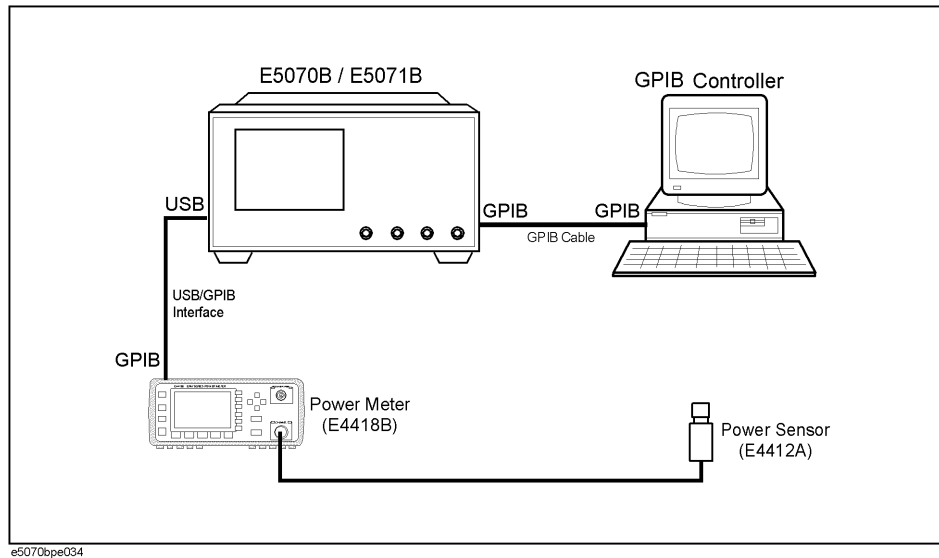

The program is described in detail below:

- | | |
|------------------|--|
| Line 70 | Assigns a GPIB address to the I/O path. |
| Lines 90 to 140 | Set the sweep type (power sweep), the number of points (41), the power range (-20 to +12 dBm), the sweep start value (-20 dBm), the sweep stop value (-10 dBm), and the fixed frequency (1 GHz) to the <code>Swp_type</code> , <code>Nop</code> , <code>Pow_rang</code> , <code>Start_p</code> , <code>Stop_p</code> , and <code>Cw_freq</code> variables, respectively. |
| Lines 150 to 160 | Set the number of power calibration data measurements for each measurement point (4) and the limit value of the power calibration data array (10 dBm) into the <code>Num_avg</code> and <code>Limit</code> variables, respectively. |
| Line 200 | Returns the E5070B/E5071B to the preset state. |
| Line 240 | Sets the power meter's GPIB address (13) in the E5070B/E5071B. |
| Lines 280 to 330 | For channel 1, set the sweep type to the <code>Swp_type</code> variable, the number of points to the <code>Nop</code> variable, the power range to the <code>Pow_rang</code> variable, the sweep start value to the <code>Start_p</code> variable, the sweep stop value to the <code>Stop_p</code> variable, and the fixed frequency to the <code>Cw_freq</code> variable. |

Lines 350 to 420 Display a message asking whether to execute the zero adjustment and calibration of the power sensor connected to channel A of the power meter. When the **[Y]** key and the **[Enter]** key are pressed, the subprogram prompts for the zero adjustment and calibration of the power sensor using the power meter and waits for a pressing of the **[Enter]** key after that operation.

NOTE

Because a GPIB connection is not available between the power meter and the external controller, you need to execute the zero adjustment and calibration of the power sensor manually.

Lines 480 to 510 These lines clear the error queue and then prompt you to connect the power sensor to port 1 of the E5070B/E5071B and wait for a pressing of the **[Enter]** key after the connection.

Lines 550 to 580 For port 1 of channel 1, these lines set the number of power calibration data measurements for each measurement point to the Num_avg variable and then start the measurement of the power calibration data and wait for the completion of the measurement.

Lines 620 to 630 These lines read out an error that has occurred in the E5070B/E5071B during the measurement of the power calibration data and set this error in the Err_no and Err_mes\$ variables.

Lines 650 to 780 If no error has occurred, these lines use the value of the Nop variable (the number of points) to set the range of the array variable for reading out the power calibration data array again and read out the power calibration data array. In addition, the subprogram uses the FNLim function program to check whether the read out power calibration data array exceeds the specified limit value. If the limit value is exceeded, the return value of the FNLim function program, -1, is returned. Then, a message is displayed asking whether to perform the power calibration again. Pressing the **[Y]** key and then the **[Enter]** key returns to the start of the power calibration data measurement. If another key is pressed, the program is terminated. For information on the FNLim function program (Lines 1190 to 1360), see the description later.

Lines 800 to 880 If an error occurs, these lines display an error message and a message asking whether to execute the power calibration again. Pressing the **[Y]** key and then the **[Enter]** key returns to the start of the power calibration data measurement. If another key is pressed, the program is terminated.

Lines 920 to 1060 These lines write the read out power calibration data array into a file named "CORR_DATA." Then, a message is displayed confirming that saving into a file has successfully completed.

The FNLim program in lines 1190 to 1360 is described below.

Lines 1230 to 1320 If the absolute value of the read out power calibration data array exceeds the specified limit value, these lines turn off the power calibration function and return the value of -1. Otherwise, the subprogram returns the value of 0.

Performing Calibration Sample Program

Example 4-3

Power calibration (pow_cal.htb)

```
10 DIM Swp_type$[11], Inp_char$[9], Buff$[9], Err_mes$[50], File$[20]
20 DIM Corr_data(1:1601)
30 REAL Start_p, Stop_p, Cw_freq, Limit
40 INTEGER Nop, Pow_rang, Num_avg, Err_no, Verifier, Data_size, I
50 CLEAR SCREEN
60 !
70 ASSIGN @Agte507x TO 717
80 !
90 Swp_type$="POW"           !Sweep type           : POWER
100 Nop=41                  !Number of points      : 41
110 Pow_rang=0              !Power Range           : -20 to +12 dBm
120 Start_p=-2.0E+1        !Start Power           : -20 dBm
130 Stop_p=-1.0E+1         !Stop Power            : -10 dBm
140 Cw_freq=1.0E+9         !CW frequency          : 1 GHz
150 Num_avg=4              !Number of averaging   : 4
160 Limit=10               !limit for corrected data : 10 dBm
170 !
180 ! Presetting the analyzer
190 !
200 OUTPUT @Agte507x;":SYST:PRES"
210 !
220 ! Setting GPIB address of the power meter to E5070B/E5071B
230 !
240 OUTPUT @Agte507x;":SYST:COMM:GPIB:PMET:ADDR 13"
250 !
260 ! Setting measurement conditions
270 !
280 OUTPUT @Agte507x;":SENS1:SWE:TYPE "&Swp_type$
290 OUTPUT @Agte507x;":SENS1:SWE:POIN ";Nop
300 OUTPUT @Agte507x;":SOUR1:POW:ATT ";Pow_rang
310 OUTPUT @Agte507x;":SOUR1:POW:STAR ";Start_p
320 OUTPUT @Agte507x;":SOUR1:POW:STOP ";Stop_p
330 OUTPUT @Agte507x;":SENS1:FREQ ";Cw_freq
340 !
350 PRINT "Do you perform zeroing and calibrating the power sensor?"
360 PRINT
370 INPUT "[Y/N]", Inp_char$
380 IF UPC$(Inp_char$)="Y" THEN
390     PRINT "Zero and calibrate the power sensor by using the power
meter, then press [Enter] key."
400     PRINT
410     INPUT "", Inp_char$
420 END IF
430 !
440 Meas_start: !
450 !
460 ! Connecting the power sensor to the port 1 in the E5070/71B
470 !
480 OUTPUT @Agte507x;"*CLS"
490 PRINT "Set the power sensor connected to the port 1 in the
E5070/71B, then press [Enter] key."
500 PRINT
510 INPUT "", Inp_char$
520 !
530 ! Performing power calibration measurement
540 !
550 OUTPUT @Agte507x;":SOUR1:POW:PORT1:CORR:COLL:AVER ";Num_avg
560 OUTPUT @Agte507x;":SOUR1:POW:PORT1:CORR:COLL:ASEN"
570 OUTPUT @Agte507x;"*OPC?"
580 ENTER @Agte507x;Buff$
590 !
```

```

600 ! Error handling at power meter measurement
610 !
620 OUTPUT @Agte507x;":SYST:ERR?"
630 ENTER @Agte507x;Err_no,Err_mes$
640 !
650 IF Err_no=0 THEN
660     REDIM Corr_data(1:Nop)
670     OUTPUT @Agte507x;":FORM:DATA ASC"
680     OUTPUT @Agte507x;":SOUR1:POW:PORT1:CORR:DATA?"
690     ENTER @Agte507x;Corr_data(*)
700     Verifier=FNLim(@Agte507x,Nop,Limit,Corr_data(*))
710     IF Verifier=-1 THEN
720         PRINT "Do you perform the power meter calibration measurement
again?"
730         PRINT
740         INPUT "[Y/N]",Inp_char$
750         IF UPC$(Inp_char$)="Y" THEN GOTO Meas_start
760         IF UPC$(Inp_char$)<>"Y" THEN GOTO Prog_stop
770         END IF
780         PRINT "Power meter calibration measurement is complete."
790         PRINT
800     ELSE
810         PRINT "Error: "&Err_mes$
820         PRINT
830         PRINT "Do you perform the power meter calibration measurement
again?"
840         PRINT
850         INPUT "[Y/N]",Inp_char$
860         IF UPC$(Inp_char$)="Y" THEN GOTO Meas_start
870         IF UPC$(Inp_char$)<>"Y" THEN GOTO Prog_stop
880     END IF
890 !
900 ! Installing the corrected data to a file
910 !
920 File$="CORR_DATA"
930 Data_size=Nop*8
940 ON ERROR GOTO Skip_purge
950 PURGE File$
960 Skip_purge: OFF ERROR
970 PRINT "The file installing power correction data: "&File$
980 PRINT
990 CREATE File$,Data_size
1000 ASSIGN @File TO File$;FORMAT ON
1010 FOR I=1 TO Nop
1020     OUTPUT @File USING "3D,3X,MD.4DE";I,Corr_data(I)
1030 NEXT I
1040 ASSIGN @File TO *
1050 !
1060 PRINT "Installing the corrected data to the file is DONE."
1070 !
1080 GOTO Prog_end
1090 !
1100 Prog_stop: !
1110 PRINT "Program Interruption"
1120 !
1130 Prog_end: !
1140 !
1150 END
1160 !
1170 ! Limit Test Function for the Corrected Data
1180 !
1190 DEF FNLim(@Agte507x,INTEGER Nop,REAL Limit,REAL Corr_data(*))
1200     INTEGER I
1210     !

```

Performing Calibration

Sample Program

```
1220   FOR I=1 TO Nop
1230       IF ABS(Corr_data(I))>Limit THEN
1240           OUTPUT @Agte507x;"SOUR1:POW:PORT1:CORR OFF"
1250           PRINT "The corrected data is out of limit!"
1260           PRINT
1270           RETURN -1
1280           GOTO Fn_exit
1290       END IF
1300   NEXT I
1310   !
1320   RETURN 0
1330   !
1340 Fn_exit:  !
1350   !
1360 FNEND
```

Reading/Writing Error Coefficient

Example 4-4 shows a sample program to read/write the error coefficient. You can find the source file of this program, named ErrTerm.htb, in the sample program disk.

This program will set measurement conditions and perform full 2-port calibration, preset the E5070B/E5071B with the read error coefficient to be written, and then again read the error coefficient.

NOTE

The error coefficient read from the E5070B/E5071B will be displayed in a graph.

The program is described in detail below:

Line 2100 - 2120: Clears PC screen and initializes the graphics.

Line 2150: Assigns the address (717) of the E5070B/E5071B to the Agte507x variable.

Line 2170: Assigns the channel number (1) to the Ch\$ variable.

Line 2220: Configures for the timeout (15 seconds) and interrupt service for the timeout while communicating with the E5070B/E5071B.

Line 2220: Configures for the timeout (15 seconds) and interrupt service for the timeout while communicating with the E5070B/E5071B.

Line 2250 - 2260: Assigns in Port(*) the port number to be used.

Line 2290: Configures the segment table using the subprogram Set_sgm_tbl.

Line 2320: Selects the calibration kit using the subprogram Select_cal_kit.

Line 2350: Executes full 2-port calibration using the subprogram Cal_solt.

Line 2380: Acquires the total number of measurement points of all segments in the segment sweep table using the subprogram Get_nop.

Line 2400 - 2420: Defines the stock variables for the error coefficient as needed for NOP.

Line 2440: Reads the error coefficient for ES with a value 1 for the response port and 1 for the stimulus port.

Stores the read error coefficient into the stock variable.

Line 2450: Reads the error coefficient for ES with a value 2 for the response port and 2 for the stimulus port.

Stores the read error coefficient into the stock variable.

Line 2460: Reads the error coefficient for ER with a value 1 for the response port and 1 for the stimulus port.

Stores the read error coefficient into the stock variable.

Line 2470: Reads the error coefficient for ER with a value 2 for the response port and 2 for the stimulus port.

Stores the read error coefficient into the stock variable.

Line 2480: Reads the error coefficient for ED with a value 1 for the response port and 1 for the stimulus port.

Stores the read error coefficient into the stock variable.

Performing Calibration

Sample Program

Line 2490: Reads the error coefficient for ED with a value 2 for the response port and 2 for the stimulus port.
Stores the read error coefficient into the stock variable.

Line 2510: Reads the error coefficient for EL with a value 1 for the response port and 2 for the stimulus port.
Stores the read error coefficient into the stock variable.

Line 2520: Reads the error coefficient for EL with a value 2 for the response port and 1 for the stimulus port.
Stores the read error coefficient into the stock variable.

Line 2530: Reads the error coefficient for ET with a value 1 for the response port and 2 for the stimulus port.
Stores the read error coefficient into the stock variable.

Line 2540: Reads the error coefficient for ET with a value 2 for the response port and 1 for the stimulus port.
Stores the read error coefficient into the stock variable.

Line 2560 - 2580: Clears the PC screen.
Displays the request message to preset the E5070B/E5071B. Waits for the PC's [Enter] key to be pressed after the E5070B/E5071B is preset.

Line 2600: Configures the segment table.

Line: 2620: Sets the calibration coefficient with the type specified and full 2-port calibration between two ports.

Line 2640: Writes the stored data of line 2440 as the error coefficient for ES, with the response port 1 and the stimulus port 1.

Line 2650: Writes the stored data of line 2450 as the error coefficient for ES, with the response port 2 and the stimulus port 2.

Line 2660: Writes the stored data of line 2460 as the error coefficient for ER, with the response port 1 and the stimulus port 1.

Line 2670: Writes the stored data of line 2470 as the error coefficient for ER, with the response port 2 and the stimulus port 2.

Line 2680: Writes the stored data of line 2480 as the error coefficient for ED, with the response port 1 and the stimulus port 1.

Line 2690: Writes the stored data of line 2490 as the error coefficient for ED, with the response port 2 and the stimulus port 2.

Line 2710: Writes the stored data of line 2510 as the error coefficient for EL, with the response port 1 and the stimulus port 2.

Line 2720: Writes the stored data of line 2520 as the error coefficient for EL, with the response port 2 and the stimulus port 1.

Line 2730: Writes the stored data of line 2530 as the error coefficient for ET, with the response port 1 and the stimulus port 2.

Line 2740: Writes the stored data of line 2540 as the error coefficient for ET, with the response port 2 and the stimulus port 1.

Line 2760: Validates the written error coefficient.

Line 2780: Reads the error coefficient for ES with a value 1 for the response port and 1 for the stimulus port.
Stores the read error coefficient into the stock variable.

Line 2790: Reads the error coefficient for ES with a value 2 for the response port and 2 for the stimulus port.
Stores the read error coefficient into the stock variable.

Line 2800: Reads the error coefficient for ER with a value 1 for the response port and 1 for the stimulus port.
Stores the read error coefficient into the stock variable.

Line 2810: Reads the error coefficient for ER with a value 2 for the response port and 2 for the stimulus port.
Stores the read error coefficient into the stock variable.

Line 2820: Reads the error coefficient for ED with a value 1 for the response port and 1 for the stimulus port.
Stores the read error coefficient into the stock variable.

Line 2830: Reads the error coefficient for ED with a value 2 for the response port and 2 for the stimulus port.
Stores the read error coefficient into the stock variable.

Line 2850: Reads the error coefficient for EL with a value 1 for the response port and 2 for the stimulus port.
Stores the read error coefficient into the stock variable.

Line 2860: Reads the error coefficient for EL with a value 2 for the response port and 1 for the stimulus port.
Stores the read error coefficient into the stock variable.

Line 2870: Reads the error coefficient for ET with a value 1 for the response port and 2 for the stimulus port.
Stores the read error coefficient into the stock variable.

Line 2880: Reads the error coefficient for ET with a value 2 for the response port and 1 for the stimulus port.
Stores the read error coefficient into the stock variable.

Line 2900 - 2920: Executes processing after the program has ended successfully. Clears the GPIB address to the I/O pass.
Displays a program closing message (Done)

Line 2950 - 2990: Executes processing after the E5070B/E5071B has encountered a timeout.
Clears the interrupt setting for the timeout.
Clears the GPIB address to the I/O pass.
Displays a message indicating a time out has occurred for the E5070B/E5071B (ENA Timeout)

Performing Calibration

Sample Program

The following is a description of the Set_sgm_tbl subprogram in lines 3020 to 3390 used to configure the segment table.

- Line 3100: Assigns the number of channel 1's sweep segments into the Segm variable.
- Line 3110 - 3140: Assigns the start and stop values for channel 1's segments 1 through 2 into the Start1(*) and Stop1(*) variables, respectively.
- Line 3150 - 3160: Assigns the number of points in channel 1's segments 1 through 2 into the Nop1(*) variables, respectively.
- Line 3170 - 3180: Assigns the IF bandwidths in channel 1's segments 1 through 2 into the if_bw1(*) variable, respectively.
- Line 3190 - 3200: Assigns the powers in channel 1's segments 1 through 2 into the Pow1(*) variable, respectively.
- Line 3220 - 3240: Presets the E5070B/E5071B. Wait 5 seconds for the E5070B/E5071B to complete the preset.
- Line 3280: Sets channel 1's sweep type to segment.
- Line 3290 - 3330: Sets the segment table for channel 1.

Line 3290: Sends the command that sets up the segment table along with the parameter header ("5, 0, 1, 1, 0, 0" causing the IF bandwidth and power to be set on a segment-by-segment basis, with Segm representing the number of segments).

Line 3300: Sends the data for the start and stop values, number of points, IF bandwidth, and power (Star1, Stop1, Nop1, If_bw1, Pow1) on a segment-by-segment basis.

The following is a description of the Select_cal_kit subprogram in lines 3020 to 3390 to select a calibration kit.

- Line 3540: Assigns the number of registered valid calibration kits.
- Line 3560 - 3600: Retrieve the names of all the calibration kits and assigns them into the Cal_kit_lbl\$(*) variable.
- Line 3610: Configures to generate a beep to allow for reentry when an error occurred by entering an invalid value for the calibration kit numbers.
- Line 3630 - 3700: Displays a list for the calibration kits.
- Line 3730 - 3740: Prompts to enter the number of the list.
- Line 3750: Converts the entered value into an integer and stores it into the Cal_kit variable.
- Line 3760: Repeats entering the numbers of the list so that the value of Cal_kit may become appropriate.
- Line 3810 - 3830: Changes the display color into green for the selected calibration kit in order to prompt to verify the calibration kit.
- Line 3850: Repeats verifying the numbers of the list and the calibration kits so that the value of Wk\$ become "Y."
- Line 3860 - 3890: Turns the display color for the selected calibration kit back into white.
- Line 3930: Selects the calibration kit that matches the number contained in the Cal_kit variable.

Performing Calibration

Sample Program

The following is a description of the Cal_solt subprogram in lines 3960 to 4560 to perform full n-port calibration.

- Line 4070: Displays the calibration type.
- Line 4110 - 4150: Configures the instrument to perform full Num_of_ports port calibration on the ports identified by Port(1) through Port(Num_of_ports).
- Line 4190 - 4350: Makes up a loop that iterates while incrementing i from 1 to Num_of_ports.
- Line 4200 - 4210: Prompts the user to connect an OPEN standard to port Port(i) and waits for a press of the Enter key after the connection.
 - Line 4220 - 4240: Executes the OPEN calibration data measurement command on port Port(i) and waits until the measurement completes successfully.
 - Line 4250 - 4270: Prompts the user to connect a SHORT standard to port Port(i) and waits for a press of the Enter key after the connection.
 - Line 4270 - 4290: Executes the SHORT calibration data measurement command on port Port(i) and waits until the measurement completes successfully.
 - Line 4300 - 4310: Prompts the user to connect a LOAD standard to port Port(i) and waits for a press of the Enter key after the connection.
 - Line 4320 - 4340: Executes the LOAD calibration data measurement command on port Port(i) and waits until the measurement completes successfully.
- Line 4390 - 4500: Makes up a loop that iterates while incrementing i from 1 to Num_of_ports-1 and j from i+1 to Num_of_ports.
- Line 4410 - 4420: Prompts the user to connect a THRU standard between the ports identified by Port(i) and Port(j) and waits for a press of the Enter key after the connection.
 - Line 4430 - 4450: Executes the THRU calibration data measurement command on response port Port(i) and stimulus port Port(j) and waits until the measurement completes successfully.
 - Line 4460 - 4480: Executes the THRU calibration data measurement command on response port Port(j) and stimulus port Port(i) and waits until the measurement completes successfully.
- Line 4540: Calculates the calibration coefficients and turns on error correction.
- Line 4550: Displays a program-closing message.

The following is a description of the Get_nop subprogram in lines 4580 to 4620 to acquire the total number of measurement points of all segments in the segment sweep table.

Line 4600 - 4610: Acquires the total number of measurement points of all segments in the segment sweep table.

The following is a description of the Exec_error_term subprogram in lines 4630 to 4970.

- Line 4690: Defines the data area for "real" and "image" as needed for NOP.
- Line 4730 - 4760: Assigns the stocked data into the writing variable.
- Line 4780: Writes the data in the error coefficient items for the specified response port and stimulus port.
- Line 4810 - 4840: Initializes the retrieving variable for the error coefficient with -999.
- Line 4860 - 4870: Retrieves the data from the error coefficient items for the specified response port and stimulus port.
- Line 4890: Graphs the retrieved error coefficients.
- Line 4910 - 4760: Assigns the retrieved error coefficients into the stocking variable.

The following is a description of the Data_plot subprogram in lines 4990 to 5950.

- Line 5080 - 5090: Specifies the waveform color.
 - Pen (1): Yellow (Real)
 - Pen (2): Green (Imaginary)
- Line 5120 - 5130: Acquires the minimum and maximum values from all data.
- Line 5150 - 5180: Executes the processing when both the minimum and maximum values are zero.
- Line 5200 - 5230: Executes the processing when the minimum and maximum values are the same.
- Line 5260 - 5280: Displays the graph area.
- Line 5300 - 5460: Displays the legend.
- Line 5480 - 5560: Displays the header.
- Line 5580 - 5670: Displays the minimum and maximum values for the y-axis.
- Line 5690 - 5760: Displays the minimum and maximum values for the x-axis.
- Line 5780 - 5900: Displays the waveform in the graph area.
 - Line 5820 - 5840: Plots the Real value in yellow.
 - Line 5870 - 5890: Plots the Imaginary value in green.

Performing Calibration Sample Program

Example 4-4

Reading/Writing Error Coefficient (ErrTerm.htb)

```
2000 Main:!  
2010 INTEGER Agte507x,Ii,Nop  
2020 INTEGER Respons,Stimulas  
2030 INTEGER Port(1:2)  
2040 REAL Stok(12,1:5000)  
2050 REAL Stok2(12,1:5000)  
2060 REAL Stok3(12,1:5000)  
2070 DIM Ch$[10],Wk$[128]  
2080 !  
2090 ! PC's Monitor Clear  
2100 CLEAR SCREEN  
2110 GINIT  
2130 !  
2140 ! Set ENA++'s Addr  
2150 Agte507x=717  
2160 !  
2170 Ch$="1"  
2180 !  
2190 ! Set ENA++'s I/O Path  
2200 ASSIGN @Agte507x TO Agte507x  
2210 !  
2220 ON TIMEOUT SC(@Agte507x),15 RECOVER Tout  
2230 !  
2240 ! Set Start Port and End Port  
2250 Port(1)=1  
2260 Port(2)=2  
2270 !  
2280 ! Setup Segment Table  
2290 CALL Set_sgm_tbl(@Agte507x)  
2300 !  
2310 ! Select Cal Kit  
2320 CALL Select_cal_kit(@Agte507x,Ch$)  
2330 !  
2340 ! Execute Full-2Port Calibration  
2350 CALL Cal_solt(@Agte507x,Ch$,2,Port(*))  
2360 !  
2370 ! Get All Segment's Points  
2380 CALL Get_nop(@Agte507x,Nop,Ch$)  
2390 !  
2400 REDIM Stok(12,1:Nop*2)  
2410 REDIM Stok2(12,1:Nop*2)  
2420 REDIM Stok3(12,1:Nop*2)  
2430 !  
2440 CALL Exec_error_term(@Agte507x,"READ","ES",Ch$,1,Nop,1,1,Stok(*))  
2450 CALL Exec_error_term(@Agte507x,"READ","ES",Ch$,2,Nop,2,2,Stok(*))  
2460 CALL Exec_error_term(@Agte507x,"READ","ER",Ch$,3,Nop,1,1,Stok(*))  
2470 CALL Exec_error_term(@Agte507x,"READ","ER",Ch$,4,Nop,2,2,Stok(*))  
2480 CALL Exec_error_term(@Agte507x,"READ","ED",Ch$,5,Nop,1,1,Stok(*))  
2490 CALL Exec_error_term(@Agte507x,"READ","ED",Ch$,6,Nop,2,2,Stok(*))  
2500 !  
2510 CALL Exec_error_term(@Agte507x,"READ","EL",Ch$,7,Nop,1,2,Stok(*))  
2520 CALL Exec_error_term(@Agte507x,"READ","EL",Ch$,8,Nop,2,1,Stok(*))  
2530 CALL Exec_error_term(@Agte507x,"READ","ET",Ch$,9,Nop,1,2,Stok(*))  
2540 CALL Exec_error_term(@Agte507x,"READ","ET",Ch$,10,Nop,2,1,Stok(*))  
2550 !  
2560 CLEAR SCREEN  
2570 PRINT "Push [Preset] - OK of ENA. Then push [Enter] key."  
2580 INPUT "",Wk$  
2590 !  
2600 CALL Set_sgm_tbl(@Agte507x)  
2610 !
```



```

2620 OUTPUT @Agte507x;":SENS"&Ch$&":CORR:COEF:METH:SOLT2
";Port (1);",";Port (2)
2630 !
2640 CALL Exec_error_term(@Agte507x,"WRITE","ES",Ch$,1,Nop,1,1,Stok(*))
2650 CALL Exec_error_term(@Agte507x,"WRITE","ES",Ch$,2,Nop,2,2,Stok(*))
2660 CALL Exec_error_term(@Agte507x,"WRITE","ER",Ch$,3,Nop,1,1,Stok(*))
2670 CALL Exec_error_term(@Agte507x,"WRITE","ER",Ch$,4,Nop,2,2,Stok(*))
2680 CALL Exec_error_term(@Agte507x,"WRITE","ED",Ch$,5,Nop,1,1,Stok(*))
2690 CALL Exec_error_term(@Agte507x,"WRITE","ED",Ch$,6,Nop,2,2,Stok(*))
2700 !
2710 CALL Exec_error_term(@Agte507x,"WRITE","EL",Ch$,7,Nop,1,2,Stok(*))
2720 CALL Exec_error_term(@Agte507x,"WRITE","EL",Ch$,8,Nop,2,1,Stok(*))
2730 CALL Exec_error_term(@Agte507x,"WRITE","ET",Ch$,9,Nop,1,2,Stok(*))
2740 CALL
Exec_error_term(@Agte507x,"WRITE","ET",Ch$,10,Nop,2,1,Stok(*))
2750 !
2760 OUTPUT @Agte507x;":SENS"&Ch$&":CORR:COEF:SAVE"
2770 !
2780 CALL Exec_error_term(@Agte507x,"READ","ES",Ch$,1,Nop,1,1,Stok2(*))
2790 CALL Exec_error_term(@Agte507x,"READ","ES",Ch$,2,Nop,2,2,Stok2(*))
2800 CALL Exec_error_term(@Agte507x,"READ","ER",Ch$,3,Nop,1,1,Stok2(*))
2810 CALL Exec_error_term(@Agte507x,"READ","ER",Ch$,4,Nop,2,2,Stok2(*))
2820 CALL Exec_error_term(@Agte507x,"READ","ED",Ch$,5,Nop,1,1,Stok2(*))
2830 CALL Exec_error_term(@Agte507x,"READ","ED",Ch$,6,Nop,2,2,Stok2(*))
2840 !
2850 CALL Exec_error_term(@Agte507x,"READ","EL",Ch$,7,Nop,1,2,Stok2(*))
2860 CALL Exec_error_term(@Agte507x,"READ","EL",Ch$,8,Nop,2,1,Stok2(*))
2870 CALL Exec_error_term(@Agte507x,"READ","ET",Ch$,9,Nop,1,2,Stok2(*))
2880 CALL
Exec_error_term(@Agte507x,"READ","ET",Ch$,10,Nop,2,1,Stok2(*))
2890 !
2900 ASSIGN @Agte507x TO *
2910 !
2920 DISP CHR$(139)&" Done ..."&CHR$(136)
2930 STOP
2940 !
2950 Tout: OFF TIMEOUT SC(@Agte507x)
2960 !
2970 ASSIGN @Agte507x TO *
2980 !
2990 PRINT CHR$(137)&" ENA Timeout ..."&CHR$(136)
3000 END
3010!
3020 Set_sgm_tbl: SUB Set_sgm_tbl(@Agte507x)
3030 REAL Star1(1:2),Stop1(1:2),Pow1(1:2)
3040 INTEGER Segm,Nop1(1:2),Num_of_tr1
3050 INTEGER I
3060 !
3070 CLEAR SCREEN
3080 DISP CHR$(138)&" Wait ..."&CHR$(136)
3090 !
3100 Segm=2 ! Number of Segment Ch.1 : 2
3110 Star1(1)=3.E+6 ! Start Frequency Ch.1 Segm.1: 3.0 MHz
3120 Star1(2)=5.0E+7 ! Segm.2: 50.0 MHz
3130 Stop1(1)=1.0E+7 ! Stop Frequency Ch.1 Segm.1: 10.0 MHz
3140 Stop1(2)=8.E+9 ! Segm.2: 8.0 GHz
3150 Nop1(1)=2 ! Number Ch.1 Segm.1: 2
3160 Nop1(2)=170 ! of Points Segm.2: 170
3170 If_bw1(1)=7.0E+4 ! IF Bandwidth Ch.1 Segm.1: 70 kHz
3180 If_bw1(2)=7.0E+4 ! Segm.2: 70 kHz
3190 Pow1(1)=0 ! Power Ch.1 Segm.1: 0 dBm
3200 Pow1(2)=0 ! Segm.2: 0 dBm
3210 !
3220 OUTPUT @Agte507x;":SYST:PRES"

```

Performing Calibration Sample Program

```
3230      !
3240      WAIT 5
3250      !
3260      ! Channel 1
3270      !
3280      OUTPUT @Agte507x;":SENS1:SWE:TYPE SEGM"
3290      OUTPUT @Agte507x;":SENS1:SEGM:DATA 5,0,1,1,0,0,";Segm;",";
3300      FOR I=1 TO Segm-1
3310          OUTPUT
@Agte507x;Star1(I);",";Stop1(I);",";Nop1(I);",";If_bwl(I);",";Pow1(I);",
";
3320      NEXT I
3330      OUTPUT
@Agte507x;Star1(Segm);",";Stop1(Segm);",";Nop1(Segm);",";If_bwl(Segm);",
";Pow1(Segm)
3340      !
3350      OUTPUT @Agte507x;":CALC1:PAR:COUN ";Num_of_tr1
3360      FOR I=1 TO Num_of_tr1
3370          OUTPUT @Agte507x;":CALC1:PAR"&VAL$(I)&":SEL"
3380      NEXT I
3390      SUBEND
3400!
3410 Select_cal_kit: SUB Select_cal_kit(@Agte507x,Ch$)
3420      !=====
3430      ! Calibration Kit Selection Function
3440      !=====
3450      !
3460      DIM Cal_kit_lbl$(1:10)[20],Inp_char$(9)
3470      DIM Msg$(80),Wk$(10)
3480      INTEGER Cal_kit,I,Noc
3490      !
3500      ! PC's Monitor Clear
3510      CLEAR SCREEN
3520      !
3530      ! Number of Cal Kid
3540      Noc=10
3550      !
3560      FOR I=1 TO Noc
3570          OUTPUT @Agte507x;":SENS1:CORR:COLL:CKIT ";I
3580          OUTPUT @Agte507x;":SENS1:CORR:COLL:CKIT:LAB?"
3590          ENTER @Agte507x;Cal_kit_lbl$(I)
3600      NEXT I
3610      ON ERROR GOTO Kit_select
3620      !
3630      PRINT "## Calibration Kit Selection ##"
3640      FOR I=1 TO Noc
3650          PRINT USING "X,2D,A,X,20A";I,";",Cal_kit_lbl$(I)
3660      NEXT I
3670      PRINT ""
3680      PRINT "Input 1 to "&VAL$(Noc)
3690      !
3700      Msg$="Input number? (1 to "&VAL$(Noc)&") "
3710      LOOP
3720          LOOP
3730              DISP Msg$;
3740              INPUT Inp_char$
3750              Cal_kit=IVAL(Inp_char$,10)
3760              EXIT IF 1<=Cal_kit AND Cal_kit<=Noc
3770 Kit_select: !
3780              BEEP
3790              END LOOP
3800              !
3810              Wk$=""
3820              PRINT TABXY(1,Cal_kit+1);
```

```

3830     PRINT USING
"X,B,2D,A,X,20A,B";139,Cal_kit,":",Cal_kit_lbl$(Cal_kit),136
3840     INPUT "Sure ? [Y/N]",Wk$
3850     EXIT IF (UPC$(Wk$)="Y")
3860     PRINT TABXY(1,Cal_kit+1);
3870     PRINT USING "X,2D,A,X,20A";Cal_kit,":",Cal_kit_lbl$(Cal_kit)
3880     BEEP
3890     BEEP
3900     END LOOP
3910     OFF ERROR
3920     !
3930     OUTPUT @Agte507x;":SENS"&Ch$&":CORR:COLL:CKIT ";Cal_kit
3940     SUBEND
3950!
3960 Cal_solt: SUB Cal_solt(@Agte507x,Ch$,INTEGER Num_of_ports,INTEGER
Port(*))
3970     !=====
3980     ! Full n Port Calibration Function
3990     !=====
4000     !
4010     DIM Buff$(9)
4020     INTEGER I,J
4030     !
4040     ! PC's Monitor Clear
4050     CLEAR SCREEN
4060     !
4070     PRINT "## Full "&VAL$(Num_of_ports)&" Port Calibration ##"
4080     !
4090     ! Calibration Type Selection
4100     !
4110     OUTPUT
@Agte507x;":SENS"&Ch$&":CORR:COLL:METH:SOLT"&VAL$(Num_of_ports)&" ";
4120     FOR I=1 TO Num_of_ports-1
4130         OUTPUT @Agte507x;Port(I);", ";
4140     NEXT I
4150     OUTPUT @Agte507x;Port(Num_of_ports)
4160     !
4170     ! Reflection Measurement
4180     !
4190     FOR I=1 TO Num_of_ports
4200         PRINT "Set OPEN to Port "&VAL$(Port(I))&". Then push [Enter]
key."
4210         INPUT "",Buff$
4220         OUTPUT @Agte507x;":SENS"&Ch$&":CORR:COLL:OPEN ";Port(I)
4230         OUTPUT @Agte507x;"*OPC?"
4240         ENTER @Agte507x;Buff$
4250         PRINT "Set SHORT to Port "&VAL$(Port(I))&". Then push [Enter]
key."
4260         INPUT "",Buff$
4270         OUTPUT @Agte507x;":SENS"&Ch$&":CORR:COLL:SHOR ";Port(I)
4280         OUTPUT @Agte507x;"*OPC?"
4290         ENTER @Agte507x;Buff$
4300         PRINT "Set LOAD to Port "&VAL$(Port(I))&". Then push [Enter]
key."
4310         INPUT "",Buff$
4320         OUTPUT @Agte507x;":SENS"&Ch$&":CORR:COLL:LOAD ";Port(I)
4330         OUTPUT @Agte507x;"*OPC?"
4340         ENTER @Agte507x;Buff$
4350     NEXT I
4360     !
4370     ! Transmission Measurement
4380     !
4390     FOR I=1 TO Num_of_ports-1
4400         FOR J=I+1 TO Num_of_ports

```

Performing Calibration Sample Program

```
4410      PRINT "Set THRU between Port "&VAL$(Port(I))&" and Port
"&VAL$(Port(J))&". Then push [Enter] key."
4420      INPUT "",Buff$
4430      OUTPUT @Agte507x;":SENS"&Ch$&":CORR:COLL:THRU
";Port(I);",";Port(J)
4440      OUTPUT @Agte507x;"*OPC?"
4450      ENTER @Agte507x;Buff$
4460      OUTPUT @Agte507x;":SENS"&Ch$&":CORR:COLL:THRU
";Port(J);",";Port(I)
4470      OUTPUT @Agte507x;"*OPC?"
4480      ENTER @Agte507x;Buff$
4490      NEXT J
4500      NEXT I
4510      !
4520      ! Done
4530      !
4540      OUTPUT @Agte507x;":SENS"&Ch$&":CORR:COLL:SAVE"
4550      PRINT "Done"
4560      SUBEND
4570!
4580 Get_nop: SUB Get_nop(@Agte507x,INTEGER Nop,Ch$)
4590      ! Get All Segment's Points
4600      OUTPUT @Agte507x;":SENS"&Ch$&":SEGM:SWE:POIN?"
4610      ENTER @Agte507x;Nop
4620      SUBEND
4630 Exec_error_term: SUB Exec_error_term(@Agte507x,Rw$,Id$,Ch$,INTEGER
Idx,Nop,Respons,Stimulas,REAL Stok(*))
4640      INTEGER Ii
4650      REAL Error_term_data(1:5000)
4660      !
4670      DISP CHR$(138)&" Wait ..."&CHR$(136)
4680      !
4690      REDIM Error_term_data(1:Nop*2)
4700      !
4710      SELECT Rw$
4720      CASE "WRITE"
4730          FOR Ii=1 TO Nop
4740              Error_term_data(2*Ii-1)=Stok(Idx,2*Ii-1)
4750              Error_term_data(2*Ii)=Stok(Idx,2*Ii)
4760          NEXT Ii
4770          !
4780          OUTPUT @Agte507x;":SENS"&Ch$&":CORR:COEF
"&Id$&",";Respons;",";Stimulas;",";Error_term_data(*)
4790          !
4800          CASE "READ"
4810              FOR Ii=1 TO Nop
4820                  Error_term_data(2*Ii-1)=-999
4830                  Error_term_data(2*Ii)=-999
4840              NEXT Ii
4850              !
4860              OUTPUT @Agte507x;":SENS"&Ch$&":CORR:COEF?
"&Id$&",";Respons;",";Stimulas
4870              ENTER @Agte507x;Error_term_data(*)
4880              !
4890              CALL Data_plot(Id$,Respons,Stimulas,Nop,Error_term_data(*))
4900              !
4910              FOR Ii=1 TO Nop
4920                  Stok(Idx,2*Ii-1)=Error_term_data(2*Ii-1)
4930                  Stok(Idx,2*Ii)=Error_term_data(2*Ii)
4940              NEXT Ii
4950              !
4960          END SELECT
4970      SUBEND
4980!
```

```

4990 Data_plot: SUB Data_plot(Error_term$,INTEGER
Respons,Stimulus,Nop,REAL Error_term_data(*)
5000   INTEGER Ii,Pen(1:2)
5010   REAL Y_minmax(1:2)
5020   DIM Wk$[20]
5030   !
5040   CLEAR SCREEN
5050   GINIT
5060   GCLEAR
5070   !
5080   Pen(1)=3
5090   Pen(2)=4
5100   !
5110   ! Get Min Value and Max Value from all data
5120   Y_minmax(1)=MIN(Error_term_data(*)
5130   Y_minmax(2)=MAX(Error_term_data(*)
5150   !
5160   IF (Y_minmax(1)=Y_minmax(2)) AND (Y_minmax(1)=0) THEN
5170     Y_minmax(1)=1
5180     Y_minmax(2)=-1
5190   ELSE
5200     IF (Y_minmax(1)=Y_minmax(2)) THEN
5210       Y_minmax(1)=Y_minmax(1)*.5
5220       Y_minmax(2)=Y_minmax(2)*1.5
5230     END IF
5240   END IF
5250   !
5260   VIEWPORT 25*RATIO,80*RATIO,40,90
5270   WINDOW 1,Nop,Y_minmax(1),Y_minmax(2)
5280   FRAME
5290   !
5300   VIEWPORT 80*RATIO,100*RATIO,40,90
5310   WINDOW 0,2,0,2
5320   PEN Pen(1)
5330   CSIZE 2.5
5340   LOG 2
5350   MOVE .2,1.5
5360   DRAW .4,1.5
5370   MOVE .5,1.5
5380   PEN 1
5390   LABEL ":Real Value"
5400   !
5410   PEN Pen(2)
5420   MOVE .2,1
5430   DRAW .4,1
5440   MOVE .5,1
5450   PEN 1
5460   LABEL ":Image Value"
5470   !
5480   VIEWPORT 25*RATIO,80*RATIO,90,100
5490   WINDOW 0,2,0,2
5500   CSIZE 3
5510   LOG 5
5520   MOVE 1,1.2
5530   LABEL "Error Term:"&Error_term$
5540   !
5550   MOVE 1,.5
5560   LABEL "Respons Port:"&VAL$(Respons)&" Stimulus
Port:"&VAL$(Stimulus)
5570   !
5580   VIEWPORT 0,25*RATIO,40,90
5590   WINDOW 0,2,0,2
5600   CLIP -10,10,-10,10
5610   LOG 8

```

Performing Calibration

Sample Program

```
5620     CSIZE 3
5630     !
5640     MOVE 1.9,0
5650     LABEL VAL$(Y_minmax(1))
5660     MOVE 1.9,2
5670     LABEL VAL$(Y_minmax(2))
5680     !
5690     VIEWPORT 25*RATIO,80*RATIO,30,40
5700     WINDOW 0,2,0,2
5710     CLIP -10,10,-10,10
5720     LORG 5
5730     MOVE 0,1.5
5740     LABEL VAL$(1)
5750     MOVE 2,1.5
5760     LABEL VAL$(Nop)
5770     !
5780     VIEWPORT 25*RATIO,80*RATIO,40,90
5790     WINDOW 1,Nop,Y_minmax(1),Y_minmax(2)
5800     FOR Ii=2 TO Nop
5820         PEN Pen(1)
5830         MOVE Ii-1,Error_term_data(2*(Ii-1)-1)
5840         DRAW Ii,Error_term_data(2*Ii-1)
5860         !
5870         PEN Pen(2)
5880         MOVE Ii-1,Error_term_data(2*(Ii-1))
5890         DRAW Ii,Error_term_data(2*Ii)
5900     NEXT Ii
5910     !
5920     PEN 1
5930     BEEP
5940     INPUT "Cont:push [Enter] key",Wk$
5950     SUBEND
5960!
```

5

Making a Measurement

This chapter explains how to trigger the instrument to start a new measurement cycle and how to detect the end of a measurement cycle.

Trigger System

The trigger system is responsible for such tasks as detecting the start of a measurement cycle (triggering) and enabling/disabling measurement on each channel. As shown in Figure 5-1, the trigger system has two types of states: system-wide and channel-wide. The system-wide state can be “Hold”, “Waiting for Trigger”, or “Measurement”, while the channel-wide state can be “Idle” or “Initiate”.

Figure 5-1 Trigger system

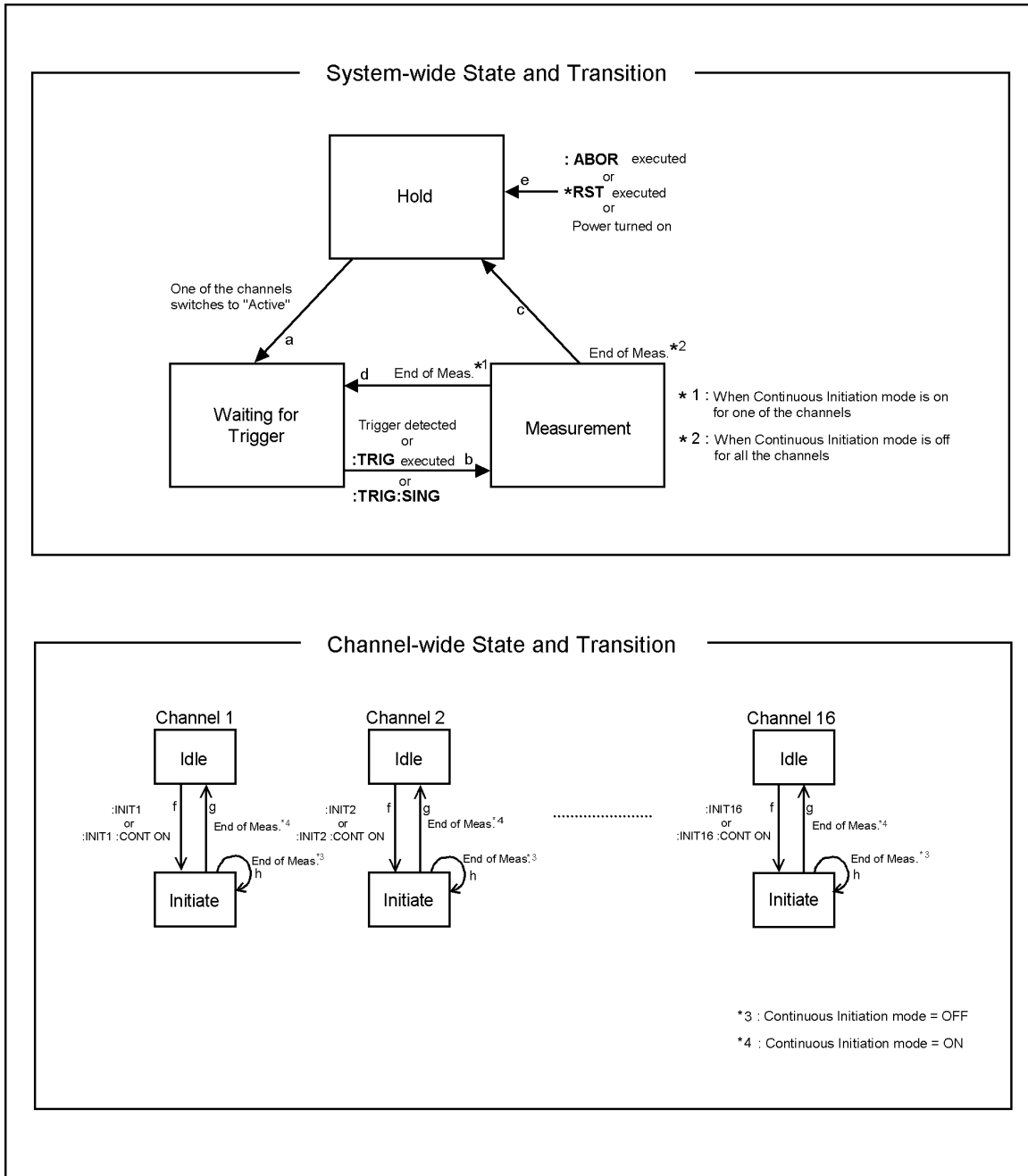

e5070bpe014

The following subsections describe each state and explains how the trigger system switches among the states.

System-wide states and transitions

“Hold” State

The trigger system switches to “Hold” state when one of the following commands has been executed (arrow “e” in Figure 5-1). Also, turning on the power to the instrument puts the trigger system into “Hold” state. When the power is turned on, however, continuous initiation mode is on for channel 1 and the trigger source is set to “Internal”; accordingly, the trigger system immediately switches to “Waiting for Trigger” state and subsequently repeats transitions between “Measurement” and “Waiting for Trigger” states.

- :ABOR on page 292
- *RST on page 289

When the trigger system is in “Hold” state and one of the channels switches to “Initiate” state (arrow “f” in Figure 5-1), the trigger system switches to “Waiting for Trigger” state (arrow “a” in Figure 5-1).

“Waiting for Trigger” State

When the trigger system is in “Waiting for Trigger” state and either the instrument is triggered (i.e., a trigger is detected) or one of the following commands is executed, the trigger system switches to “Measurement” state (arrow “B” in Figure 5-1).

- :TRIG on page 802
- :TRIG:SING on page 808

As shown in the table below, the instrument is triggered differently depending on which trigger source is specified. To specify the trigger source, use the :TRIG:SOUR command on page 809.

Trigger Source	How instrument is triggered
Internal trigger	The instrument is automatically triggered within itself.
External trigger	The instrument is triggered when a trigger signal is input through the Ext Trig terminal or the handler interface.
Bus trigger	The instrument is triggered when the *TRG command on page 291 is issued.
Manual trigger	The instrument is triggered when you press [Trigger] - Trigger on the front panel.

Making a Measurement Trigger System

“Measurement” State

In “Measurement” state, the instrument waits for the elapse of the sweep delay time (set by the :SENS{1-16}:SWE:DEL command on page 691) and then starts a measurement cycle; this process is performed sequentially on each of those channels that were in “Initiate” state immediately before the transition to this state, in ascending order of channel number.

When the instrument has finished measuring all of the active channels, the trigger system behaves in one of the following ways depending on the setting of the continuous initiation mode.

If continuous initiation mode is off for all channels:

The trigger system switches to “Hold” state (arrow “c” in Figure 5-1).

If continuous initiation mode is on for one of the channels:

The trigger system switches to “Waiting for Trigger” state (arrow “d” in Figure 5-1).

Channel-wide states and transitions

“Idle” State

A channel switches to “Initiate” state when one of the following commands has been executed (arrow “f” in Figure 5-1).

- :INIT{1-16} on page 490
- :INIT{1-16}:CONT on page 491 (“ON” specified)

“Initiate” State

A channel in this state is measured just before the entire system switches to “Measurement” state.

When the instrument has finished measuring a channel, the channel behaves in one of the following ways depending on the setting of the continuous initiation mode (set by the :INIT{1-16}:CONT command on page 491).

If continuous initiation mode is off: The channel switches to “Idle” state (arrow “g” in Figure 5-1).

If continuous initiation mode is on: The channel remains in “Initiate” state (arrow “h” in Figure 5-1).

Trigger only to the specified channel

Only the active channel is triggered when the following command has been executed.

- :TRIG:SCOP on page 807

When you set the effective range of a trigger scope to “Active Channel” when the trigger mode is continuous sweep mode (INIT:CONT:ON), the channel to be triggered is changed only by switching channels.

Starting a Measurement Cycle (triggering the instrument)

Configuring the instrument to automatically perform continuous measurement

- Step 1.** Use the `:INIT{1-16}:CONT` command on page 491 to turn on continuous initiation mode for the channels you want to measure and turn the mode off for any other channel.
- Step 2.** Issue the `:TRIG:SOUR` command on page 809 to set the trigger source to Internal trigger.

Starting Measurement on Demand

- Step 1.** Use the `:INIT{1-16}:CONT` command to turn on continuous initiation mode for the channels you want to measure and turn the mode off for any other channel.
- Step 2.** Issue the `:TRIG:SOUR` command to set the trigger source to “Bus Trigger”.
- Step 3.** Trigger the instrument whenever you want to perform measurement. An external controller can trigger the instrument by using one of the following three commands:

Command	Can <code>*OPC?</code> command on page 288 be used to wait for end of sweep?	Applicable trigger source
<code>*TRG</code> on page 291	No	Bus trigger only
<code>:TRIG</code> on page 802		External trigger Bus trigger
<code>:TRIG:SING</code> on page 808	Yes	Manual trigger

- Step 4.** Repeat step 3 to start the next measurement cycle.

Waiting for the End of Measurement

Using the status register

The status of the E5070B/E5071B can be detected through the status registers. This section explains how to detect the end of measurement by using the status registers. For a complete description of the status report mechanism, including the specifications of each bit, see Appendix B, “Status Reporting System.”

Measurement status is reported by the operation status condition register (see Table B-3 on page 880). An SRQ (service request) is useful when creating a program that uses the information reported by this register to detect the end of measurement.

To detect the end of measurement via an SRQ, use one of the following commands:

- *SRE on page 290
- :STAT:OPER:ENAB on page 723
- :STAT:OPER:PTR on page 725
- :STAT:OPER:NTR on page 724

Follow these steps to utilize an SRQ:

- Step 1.** Configure the E5070B/E5071B so that it generates an SRQ when the operation status condition register’s bit 4 (a bit that is set to 1 during measurement) is changed from 1 to 0.
- Step 2.** Trigger the instrument to start a measurement cycle.
- Step 3.** When an SRQ is generated, the program interrupts the measurement cycle.

Figure 5-2

SRQ generation sequence (at end of measurement)

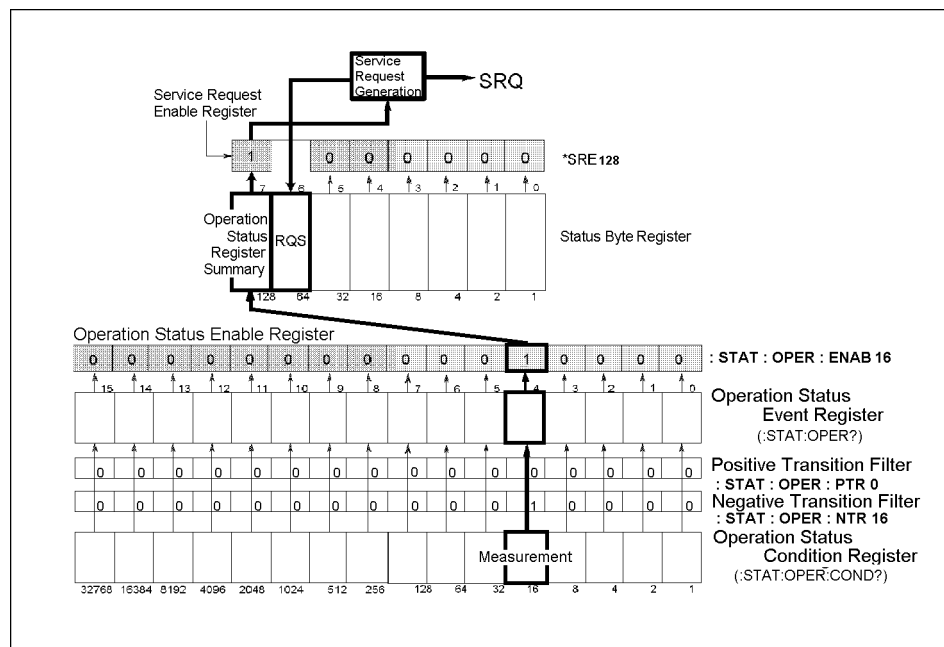

4287ape007

Sample Program

Example 5-2 is a sample program that demonstrates how to use an SRQ to detect the end of measurement. You can find the source file of this program, named `srq_meas.htb`, on the sample program disk.

NOTE

This sample program correctly runs when the maximum number of channels/traces is set to 9 channels/9 traces.

The sample program sets up the trigger system, configures the instrument to properly generate an SRQ, and then triggers the instrument. When the instrument has generated an SRQ that indicates the end of measurement, the program exits after printing a measurement completion message.

The program is described in detail below:

- Line 40 Assigns a GPIB address to the I/O pass.
- Lines 60 to 140 These lines store the settings of continuous initiation mode for each channel (on for channels 1 and 2; off for channels 3 through 9) into the array variable `Cont_mode$(*)`.
- Lines 160 to 180 These lines turn on or off continuous initiation mode for each channel depending on the value of `Cont_mode$(*)`.
- Line 190 Sets the trigger source to “Bus Trigger”.
- Lines 210 to 220 These lines configure the instrument so that operation status event register’s bit 4 is set to 1 only when the operation status condition register’s bit 4 is changed from 1 to 0 (negative transition).
- Lines 230 to 240 These lines enable the operation status event register’s bit 4 and status byte register’s bit 7.
- Lines 250 to 270 These lines clear the status byte register and operation status event register.
- Lines 290 to 300 These lines set the branch target for an SRQ interrupt to enable SRQ interruptions.
- Lines 310 to 320 These lines trigger the instrument and wait until the measurement cycle finishes.
- Line 350 Displays a measurement completion message.

Making a Measurement

Waiting for the End of Measurement

Example 5-1

Using an SRQ to detect the end of measurement (srq_meas.htb)

```
10     DIM Cont_mode$(1:9) [9], Buff$ [9]
20     INTEGER I
30     !
40     ASSIGN @Agte507x TO 717
50     !
60     Cont_mode$(1) = "ON"
70     Cont_mode$(2) = "ON"
80     Cont_mode$(3) = "OFF"
90     Cont_mode$(4) = "OFF"
100    Cont_mode$(5) = "OFF"
110    Cont_mode$(6) = "OFF"
120    Cont_mode$(7) = "OFF"
130    Cont_mode$(8) = "OFF"
140    Cont_mode$(9) = "OFF"
150    !
160    FOR I=1 TO 9
170        OUTPUT @Agte507x; ":INIT"&VAL$(I) & ":CONT "&Cont_mode$(I)
180    NEXT I
190    OUTPUT @Agte507x; ":TRIG:SOUR BUS"
200    !
210    OUTPUT @Agte507x; ":STAT:OPER:PTR 0"
220    OUTPUT @Agte507x; ":STAT:OPER:NTR 16"
230    OUTPUT @Agte507x; ":STAT:OPER:ENAB 16"
240    OUTPUT @Agte507x; "*SRE 128"
250    OUTPUT @Agte507x; "*CLS"
260    OUTPUT @Agte507x; "*OPC?"
270    ENTER @Agte507x; Buff$
280    !
290    ON INTR 7 GOTO Meas_end
300    ENABLE INTR 7;2
310    OUTPUT @Agte507x; "*TRG"
320    PRINT "Waiting..."
330 Meas_wait: GOTO Meas_wait
340 Meas_end: OFF INTR 7
350     PRINT "Measurement Complete"
360     END
```

Using the :TRIG:SING Command

When you trigger the instrument by issuing the :TRIG:SING command on page 808, you can use the *OPC? command to wait until the measurement cycle is completed.

Sample Program

Example 5-2 is a sample program that demonstrates how to use the :TRIG:SING command to wait until the measurement cycle is completed. You can find the source file of this program, named trg_sing.htb, on the sample program disk.

NOTE

This sample program correctly runs when the maximum number of channels/traces is set to 9 channels/9 traces.

The sample program uses the :TRIG:SING command to start a sweep (measurement) cycle, uses the *OPC? command to wait until the measurement cycle is completed, then prints a message and exits.

The program is described in detail below:

Line 40	Assigns a GPIB address to the I/O pass.
Lines 60 to 140	These lines store the settings of continuous initiation mode for each channel (on for channels 1 and 2; off for channels 3 through 9) into the array variable Cont_mode\$(*).
Lines 160 to 180	These lines turn on or off continuous initiation mode for each channel depending on the value of Cont_mode\$(*).
Line 190	Sets the trigger source to “Bus Trigger”.
Line 210	Triggers the instrument to start a sweep cycle.
Lines 220 to 230	These lines execute the *OPC? command and wait until the command returns 1 (i.e., the measurement cycle is completed).
Line 250	Displays a measurement completion message.

Making a Measurement

Waiting for the End of Measurement

Example 5-2

Using the :TRIG:SING command to wait until the end of measurement (trg_sing.htb)

```
10     DIM Cont_mode$(1:9) [9], Buff$ [9]
20     INTEGER I
30     !
40     ASSIGN @Agte507x TO 717
50     !
60     Cont_mode$(1) = "ON"
70     Cont_mode$(2) = "ON"
80     Cont_mode$(3) = "OFF"
90     Cont_mode$(4) = "OFF"
100    Cont_mode$(5) = "OFF"
110    Cont_mode$(6) = "OFF"
120    Cont_mode$(7) = "OFF"
130    Cont_mode$(8) = "OFF"
140    Cont_mode$(9) = "OFF"
150    !
160    FOR I=1 TO 9
170        OUTPUT @Agte507x; ":INIT"&VAL$(I) & ":CONT "&Cont_mode$(I)
180    NEXT I
190    OUTPUT @Agte507x; ":TRIG:SOUR BUS"
200    !
210    OUTPUT @Agte507x; ":TRIG:SING"
220    OUTPUT @Agte507x; "*OPC?"
230    ENTER @Agte507x; Buff$
240    !
250    PRINT "Measurement complete"
260    END
```

Using wait time

Before creating your program, actually measure the time between the start and end of the measurement cycle. Then code your program so that the controller waits for the actually measured time by using the appropriate command (for example, the WAIT command for HTBasic). This is a straightforward method, but care must be taken: an incorrect wait time could result in an unexpected error.

Point Trigger Function

Point trigger

Point trigger is a method used to measure a single point each time the instrument is triggered. You can perform this type of measurement by turning ON/OFF the point trigger function.

Switching over modes

You can use the following command to toggle between the point trigger's ON/OFF status.

- :TRIG:POIN on page 806

NOTE

If the trigger source is internal, the point trigger function does not work if it is specified to ON.

Low-latency external trigger

When the trigger source is an external trigger and the point trigger function is on, the low-latency external trigger function is available. The low-latency external trigger function is used to set the external trigger delay time each time a trigger for a measurement point is given.

The setting of the low-latency external trigger function is valid for all channels.

Setting the low-latency external trigger

To toggle ON/OFF the low-latency external trigger function, use the following command:

- :TRIG:EXT:LLAT on page 805

NOTE

If the trigger source is not an external trigger, the low-latency external trigger function does not work if it is specified to ON, nor does it work when the point trigger function is off.

To set the external trigger delay time, use the following command:

- :TRIG:EXT:DEL on page 804

Averaging Trigger Function

Averaging trigger

The averaging trigger function is used to execute the number of sweeps specified as the averaging factor with a single trigger when the sweep averaging function is used. When a trigger is given, the sweep count is cleared, the sweep is executed the number of times specified by the averaging count, and then the instrument goes into Hold status.

The setting of the averaging trigger function is valid for all channels. Note that you can set the sweep averaging function for each channel.

Toggling the mode

To toggle ON/OFF the averaging trigger function, use the following command:

- :TRIG:AVER on page 803

NOTE

When the point trigger function is on, its setting has priority and the setting of the averaging trigger is ignored. More specifically, the required number of triggers is: number of measurement points in a single sweep \times averaging factor.

When the averaging function is off for the active channel, the averaging trigger function does not work for the channel. When a trigger is given, the sweep is executed only once, and then the instrument goes into Hold status.

6 Analyzing Data

This chapter describes how to use markers, analysis commands, and fixture simulator features.

Retrieving Measurement Results at Specified Points

Markers allow you to retrieve measurement results at specified points. You can use up to eight markers for each trace, and you can move them to any point on the trace. In addition to the regular markers, you can use a reference marker.

Showing/hiding markers

To show or hide markers, including the reference marker, use the following command:

- :CALC{1-16}:MARK{1-10} on page 398

NOTE You can move markers or retrieve the data at a marker even when the markers are hidden.

NOTE The display of the reference marker is turned on or off when you turn On or Off Reference Marker mode.

Turning On or Off reference marker mode

Turning on Reference Marker mode provides relative marker values with respect to the reference marker (by subtracting the value at the reference marker from the value at a particular marker).

To turn On or Off Reference Marker mode, use the following command:

- :CALC{1-16}:MARK:REF on page 397

Setting (changing) and retrieving stimulus value at marker positions

To set (or change along the frequency axis) the stimulus value at a particular marker or the reference maker or to retrieve the current stimulus value, use the following command:

- :CALC{1-16}:MARK{1-10}:X on page 413

When Reference Marker mode is on, the stimulus value at a regular marker is a relative stimulus value obtained by subtracting the stimulus value at the reference marker from the actual stimulus value at that particular marker.

Retrieving measurement results at marker positions

To retrieve the measurement results (response values) at a particular marker or the reference marker, use the following command:

- :CALC{1-16}:MARK{1-10}:Y? on page 414

When Reference Marker mode is on, the response value at a regular marker is a relative value obtained by subtracting the response value at the reference marker from the actual response value at that particular marker.

Searching for Positions That Match Specified Criteria

You can search for a position that matches specified criteria by using the Marker Search feature or analysis commands.

Using marker search

NOTE

Marker Search is available whether the markers are shown or hidden.

Setting the Search Range

You can use either the entire sweep range or a user-defined range for the marker search range by using the following command:

- `:CALC{1-16}:MARK:FUNC:DOM` on page 392

When you opt to use a user-defined range, use the following commands to set the range:

Start value (lower limit value)	<code>:CALC{1-16}:MARK:FUNC:DOM:STAR</code> on page 394
Stop value (upper limit value)	<code>:CALC{1-16}:MARK:FUNC:DOM:STOP</code> on page 395

You can also select whether to specify the marker search range independently for each trace by using the following command.

- `:CALC{1-16}:MARK:FUNC:DOM:COUP` on page 393

Selecting a Search Type

Marker Search allows you to choose from the following eight search types:

- Maximum value
- Minimum value
- Peak (3 types)
 - Maximum peak (for a positive peak), minimum peak (for a negative peak)
 - Peak nearest to the marker position on its left-hand side
 - Peak nearest to the marker position on its right-hand side
- Target (3 types)
 - Peak nearest to the marker position
 - Target nearest to the marker position on its left-hand side
 - Target nearest to the marker position on its right-hand side

To select a search type, use the following command:

- `:CALC{1-16}:MARK{1-10}:FUNC:TYPE` on page 409

Analyzing Data

Searching for Positions That Match Specified Criteria

Defining a Peak

You can define a peak by specifying the lower limit for the peak excursion value and polarity (positive or negative peak). The peak excursion value is the difference between the positive peak and the minimum value on either side of it (or between the negative peak and the maximum value on either side of it). For more information on the peak excursion value, see *User's Guide*.

To define a peak, use the following commands:

Lower limit for the peak excursion value	:CALC{1-16}:MARK{1-10}:FUNC:PEXC on page 404
Polarity	:CALC{1-16}:MARK{1-10}:FUNC:PPOL on page 405

Defining a Target

You can define a target by specifying the target value (response value) and transitional direction (positive or negative value change).

To define a target, use the following commands:

Target value	:CALC{1-16}:MARK{1-10}:FUNC:TARG on page 406
Transitional direction	:CALC{1-16}:MARK{1-10}:FUNC:TTR on page 408

Performing Marker Search

To perform Marker Search, use the following command:

- :CALC{1-16}:MARK{1-10}:FUNC:EXEC on page 403

To turn On or Off the Search Tracking feature, which performs Marker Search every time the trace is updated, use the following command:

- :CALC{1-16}:MARK{1-10}:FUNC:TRAC on page 407

Retrieving Search Results

Performing Marker Search moves the marker to the points that matches the search criteria, so you can obtain the search results by retrieving the marker value. For information on how to retrieve marker values, refer to “Setting (changing) and retrieving stimulus value at marker positions” on page 140 and “Retrieving measurement results at marker positions” on page 140.

Using the Analysis Commands

You can use the analysis Commands to perform search and analysis.

Setting the Search (Analysis) Range

You can use either the entire sweep range or a user-defined range as the search (analysis) range by using the following command:

- :CALC{1-16}:FUNC:DOM on page 370

When you opt to use a user-defined range, use the following commands to set the range:

Start value (lower limit value)	:CALC{1-16}:FUNC:DOM:STAR on page 372
Stop value (upper limit value)	:CALC{1-16}:FUNC:DOM:STOP on page 373

You can also select whether to specify the marker search (analysis) range independently for each trace by using the following command:

- :CALC{1-16}:FUNC:DOM:COUP on page 371

Selecting the Search (Analysis) Type

The analysis commands allows you to choose from the following five search types:

- Maximum value
- Minimum value
- Maximum peak (for a positive peak), minimum peak (for a negative peak)
- All peaks
- All targets

In addition, you can choose from the following three analysis types:

- Difference between the maximum and minimum values
- Standard deviation
- Average

To select the search (analysis) type, use the following command:

- :CALC{1-16}:FUNC:TYPE on page 379

Defining a Peak

You can define a peak by specifying the lower limit for the peak excursion value and polarity (positive or negative peak). The peak excursion value is the difference between the positive peak and the minimum value on either side of it (or between the negative peak and the maximum value on either side of it). For more information on the peak excursion value, see *User's Guide*.

To define a peak, use the following commands:

Lower limit for the peak excursion value	:CALC{1-16}:FUNC:PEXC on page 374
Polarity	:CALC{1-16}:FUNC:PPOL on page 376

Defining a Target

You can define a target by specifying the target value (response value) and transitional direction (positive or negative value change).

To define a target, use the following commands:

Target value	:CALC{1-16}:FUNC:TARG on page 377
Transitional direction	:CALC{1-16}:FUNC:TTR on page 378

Performing Search (Analysis)

To perform search (analysis), use the following command:

- :CALC{1-16}:FUNC:EXEC on page 373

Retrieving Search (Analysis) Results

To retrieve search (analysis) results, use the following command:

- :CALC{1-16}:FUNC:DATA? on page 369

The number of data items contained in search (analysis) results differ depending on the search (analysis) type and the number of points found by the search operation. To retrieve the number of data items, use the following command:

- :CALC{1-16}:FUNC:POIN? on page 375

Sample Program

Example 6-2 is a sample program that demonstrates how to search for peaks using the Marker Search feature and analysis commands. You can find the source file of this program, named `search.htb`, on the sample program disk.

This program works in two steps: first, it uses Marker Search to search for the maximum positive peak and displays the results; second, it uses analysis commands to search for all positive peaks and displays the results.

The program is described in detail below:

Line 50	Assigns a GPIB address to the I/O pass.
Line 60	Stores a peak excursion value of 0.5 into the Excursion variable.
Lines 80 to 120	These lines configure the system to generate an SRQ when it cannot perform Bandwidth Search due to an error.
Lines 130 to 140	These lines set the branch target for an SRQ interrupt to enable SRQ interruptions.
Line 180	Sets the active trace to trace 1.
Line 190	Sets the search type for marker 1 to Peak.
Lines 200 to 210	These lines set the Excursion variable to the peak excursion value for the peak search of marker 1 and set the polarity to Positive Peak.
Line 220	Performs Peak Search and moves marker 1 to the maximum positive peak.
Lines 230 to 240	These lines retrieve the frequency at marker 1.
Lines 250 to 260	These lines retrieve the response value at marker 1.
Lines 270 to 290	These lines display the results of searching for the maximum positive peak.
Line 330	Sets the analysis range to the entire sweep range.
Line 340	Sets the search type of the analysis command to All Peaks.
Lines 350 to 360	These lines set the Excursion variable to the peak excursion value for the analysis command's peak search and set the polarity to Positive Peak.
Line 370	Searches for all peaks.
Lines 380 to 390	These lines retrieve the number of data pairs contained in the search results and store that number into the Point variable.
Line 400	Resizes the Result array based on the value of the Point variable.
Lines 380 to 390	These lines retrieve the response values and frequencies for all peaks.
Lines 430 to 470	These lines display the results of searching for all peaks.
Lines 490 to 530	These lines define an error handler that retrieves and displays the number and message of an error that has occurred.

Analyzing Data

Searching for Positions That Match Specified Criteria

Example 6-1

Peak Search (search.htb)

```
10 DIM Buff$[9],Img$[50],Err_msg$[100]
20 REAL Excursion,Freq,Resp,Result(1:100,1:2)
30 INTEGER Poin,Err_no
40 !
50 ASSIGN @Agte507x TO 717
60 Excursion=.5
70 !
80 OUTPUT @Agte507x;"*ESE 60"
90 OUTPUT @Agte507x;"*SRE 32"
100 OUTPUT @Agte507x;"*CLS"
110 OUTPUT @Agte507x;"*OPC?"
120 ENTER @Agte507x;Buff$
130 ON INTR 7 GOTO Err
140 ENABLE INTR 7;2
150 !
160 PRINT "Maximum Peak Search using Marker 1"
170 !
180 OUTPUT @Agte507x;":CALC1:PAR1:SEL"
190 OUTPUT @Agte507x;":CALC1:MARK1:FUNC:TYPE PEAK"
200 OUTPUT @Agte507x;":CALC1:MARK1:FUNC:PEXC ";Excursion
210 OUTPUT @Agte507x;":CALC1:MARK1:FUNC:PPOL POS"
220 OUTPUT @Agte507x;":CALC1:MARK1:FUNC:EXEC"
230 OUTPUT @Agte507x;":CALC1:MARK1:X?"
240 ENTER @Agte507x;Freq
250 OUTPUT @Agte507x;":CALC1:MARK1:Y?"
260 ENTER @Agte507x;Resp
270 Img$="8A,MD.4DE,2X,MD.6DE"
280 PRINT "          Frequency          Response"
290 PRINT USING Img$;"Peak:   ",Freq,Resp
300 !
310 PRINT "All Peaks Search using Command"
320 !
330 OUTPUT @Agte507x;":CALC1:FUNC:DOM OFF"
340 OUTPUT @Agte507x;":CALC1:FUNC:TYPE APE"
350 OUTPUT @Agte507x;":CALC1:FUNC:PEXC ";Excursion
360 OUTPUT @Agte507x;":CALC1:FUNC:PPOL POS"
370 OUTPUT @Agte507x;":CALC1:FUNC:EXEC"
380 OUTPUT @Agte507x;":CALC1:FUNC:POIN?"
390 ENTER @Agte507x;Poin
400 REDIM Result(1:Poin,1:2)
410 OUTPUT @Agte507x;":CALC1:FUNC:DATA?"
420 ENTER @Agte507x;Result(*)
430 Img$="4A,2D,2A,MD.4DE,2X,MD.6DE"
440 PRINT "          Frequency          Response"
450 FOR I=1 TO Poin
460     PRINT USING Img$;"Peak",I," : ",Result(I,2),Result(I,1)
470 NEXT I
480 GOTO No_err
490 Err: OFF INTR 7
500 OUTPUT @Agte507x;";:SYST:ERR?"
510 ENTER @Agte507x;Err_no,Err_msg$
520 PRINT "Error occurred!!"
530 PRINT " No: ";Err_no,"Description: "&Err_msg$
540 No_err: OFF INTR 7
550 END
```

Bandwidth Search

The E5070B/E5071B has a feature called Bandwidth Search. This feature searches for the cutoff points on both right- and left-hand sides of the marker position on the trace.

- Bandwidth ($BW = high - low$)
- Center frequency ($cent = \frac{high + low}{2}$)
- Q value ($Q = \frac{cent}{BW}$)
- Loss (response value at the marker position)

Where *high* is the right-hand cutoff point frequency; *low* is the left-hand cutoff point frequency.

Setting the bandwidth definition value

Bandwidth Search finds a point whose response value is different, by the amount defined as the bandwidth definition value, from the response value at the marker position, and identifies that point as the cutoff point.

To set the bandwidth definition value, use the following command:

- `:CALC{1-16}:MARK{1-10}:BWID:THR` on page 401

Retrieving bandwidth search results

Once you have moved the marker to the appropriate position using Marker Search or some other feature, you can retrieve the results of Bandwidth Search by using the following command:

- `:CALC{1-16}:MARK{1-10}:BWID:DATA?` on page 400

Also, you can use the following command to control whether to display the results of Bandwidth Search on the LCD:

- `:CALC{1-16}:MARK:BWID` on page 390

NOTE

You can retrieve the results of Bandwidth Search even after you have turned off the display of markers or the results of Bandwidth Search.

Sample Program

Example 6-2 shows a sample program that demonstrates how to perform Bandwidth Search. You can find the source file of this program, named `bandwid.htb`, on the sample program disk.

The sample program moves the marker to the maximum value position and then retrieves and displays the results of Bandwidth Search.

The program is described in detail below:

- Line 50 Assigns a GPIB address to the I/O pass.
- Line 60 Stores a bandwidth definition value of 3 into the Threshold variable.

Analyzing Data

Bandwidth Search

Lines 80 to 120	These lines configure the system to generate an SRQ when it cannot perform Bandwidth Search due to an error.
Lines 130 to 140	These lines set the branch target for an SRQ interrupt to enable SRQ interruptions.
Line 160	Sets the search type for marker 1 to Peak.
Lines 170 to 180	These lines use the Marker Search feature to move the marker to the maximum value position.
Line 190	Sets the bandwidth definition value to Threshold.
Lines 200	Sends the command to retrieve the results of Bandwidth Search.
Lines 210	Waits 0.5 seconds to prevent retrieval before an SRQ is generated if an error occurs on Bandwidth Search.
Lines 220	Retrieves the results of Bandwidth Search.
Lines 240 to 280	These lines display the results of Bandwidth Search.
Lines 310 to 350	These lines define an error handler that retrieves and displays the number and message of an error that has occurred.

Example 6-2

Bandwidth Search (bandwid.htb)

```
10 DIM Buff$(9),Err_msg$(100)
20 REAL Threshold,Bwid,Cent,Q, Loss
30 INTEGER Err_no
40 !
50 ASSIGN @Agte507x TO 717
60 Threshold=-3
70 !
80 OUTPUT @Agte507x;"*ESE 60"
90 OUTPUT @Agte507x;"*SRE 32"
100 OUTPUT @Agte507x;"*CLS"
110 OUTPUT @Agte507x;"*OPC?"
120 ENTER @Agte507x;Buff$
130 ON INTR 7 GOTO Err
140 ENABLE INTR 7;2
150 !
160 OUTPUT @Agte507x;":CALC1:PAR1:SEL"
170 OUTPUT @Agte507x;":CALC1:MARK1:FUNC:TYPE MAX"
180 OUTPUT @Agte507x;":CALC1:MARK1:FUNC:EXEC"
190 OUTPUT @Agte507x;":CALC1:MARK1:BWID:THR ";Threshold
200 OUTPUT @Agte507x;":CALC1:MARK1:BWID:DATA?"
210 WAIT .5
220 ENTER @Agte507x;Bwid,Cent,Q, Loss
230 !
240 PRINT "## Bandwidth Search ##"
250 PRINT "Bandwidth : ",Bwid
260 PRINT "Center Frequency: ",Cent
270 PRINT "Q : ",Q
280 PRINT "Loss : ",Loss
290 !
300 GOTO No_err
310 Err: OFF INTR 7
320 OUTPUT @Agte507x;";:SYST:ERR?"
330 ENTER @Agte507x;Err_no,Err_msg$
340 PRINT "Error occurred!!"
350 PRINT " No: ";Err_no,"Description: "&Err_msg$
360 No_err: OFF INTR 7
370 END
```

Statistical Analysis

The E5070B/E5071B provides a mechanism that analyzes trace statistics. You can analyze the following statistics:

- Average
- Standard deviation
- Difference between the maximum and minimum values

To retrieve the results of statistical analysis, use the following command:

- :CALC{1-16}:MST:DATA? on page 419

Also, you can use the following command to control whether to display the results of statistical analysis on the LCD:

- :CALC{1-16}:MST on page 418

NOTE

You can retrieve the results of statistical analysis even after you have turned off the display showing these results.

Alternatively, you can use the analysis commands to analyze the trace statistics. When you use the analysis commands, you can analyze the trace data in a specific range as well as the trace data throughout the entire sweep range. For information on how to use the analysis commands, refer to “Using the Analysis Commands” on page 143.

Analysis Using the Fixture Simulator

The Fixture Simulator provides the following functions:

- Matching Circuit Embedding
- Port Impedance Conversion
- Network De-embedding
- 4-Port Network Embedding/De-embedding
- Balance-Unbalance Conversion (only 3-port/4-port models)
- Differential Matching Circuit Embedding (only 3-port/4-port models)
- Differential Port Impedance Conversion (only 3-port/4-port models)

Before you can use any of the features listed above, you must turn on the desired feature individually and issue the following command to turn on the Fixture Simulator:

- `:CALC{1-16}:FSIM:STAT` on page 368

Matching Circuit Embedding

The Matching Circuit feature simulates the characteristics that the DUT would exhibit when connected to a matching circuit.

On/Off

To turn on or off the Matching Circuit, use the following command:

- `:CALC{1-16}:FSIM:SEND:PMC:STAT` on page 363

You can only turn on or off Matching Circuit for all the ports, not for each port individually. However, any port whose circuit type is set to “None” behaves as if this feature were permanently off.

Configuring the Matching Circuit Settings

To select a circuit type, use the following command:

- `:CALC{1-16}:FSIM:SEND:PMC:PORT{1-4}` on page 357

To set the circuit constant, use the following commands:

Circuit constant	Command
C	<code>:CALC{1-16}:FSIM:SEND:PMC:PORT{1-4}:PAR:C</code> on page 358
G	<code>:CALC{1-16}:FSIM:SEND:PMC:PORT{1-4}:PAR:G</code> on page 359
L	<code>:CALC{1-16}:FSIM:SEND:PMC:PORT{1-4}:PAR:L</code> on page 360
R	<code>:CALC{1-16}:FSIM:SEND:PMC:PORT{1-4}:PAR:R</code> on page 361

When you want to use a user file to define the circuit type, specify the file by using the following command:

- `:CALC{1-16}:FSIM:SEND:PMC:PORT{1-4}:USER:FIL` on page 362

Port Impedance Conversion

The Port Impedance Conversion feature converts the measurement results with a port impedance of 50 Ω to the characteristics of a different port impedance.

On/Off

To turn on or off Port Impedance Conversion, use the following command:

- `:CALC{1-16}:FSIM:SEND:ZCON:STAT` on page 367

You can only turn on or off Port Impedance Conversion for all of the ports, not for each port individually. However, any port with Z0 set to 50 Ω behaves as if this feature were permanently off.

Setting the Z0 Value

To set the target port impedance, use the following command:

- `:CALC{1-16}:FSIM:SEND:ZCON:PORT{1-4}:Z0` on page 366
- `:CALC{1-16}:FSIM:SEND:ZCON:PORT{1-4}:REAL` on page 365
- `:CALC{1-16}:FSIM:SEND:ZCON:PORT{1-4}:IMAG` on page 364

Network De-embedding

The Network De-embedding feature eliminates any network that can cause error between the calibration level and the DUT.

On/Off

To turn on or off Network De-embedding, use the following command:

- `:CALC{1-16}:FSIM:SEND:DEEM:STAT` on page 356

You can only turn on or off Network De-embedding for all of the ports, not for each port individually. However, any port whose Network De-embedding type is set to “None” behaves as if this feature were permanently off.

Selecting a Type

To select a Network De-embedding type, use the following command:

- `:CALC{1-16}:FSIM:SEND:DEEM:PORT{1-4}` on page 354

Specifying the File

To specify the file that defines the criteria for Network De-embedding, use the following command:

- `:CALC{1-16}:FSIM:SEND:DEEM:PORT{1-4}:USER:FIL` on page 355

4-Port Network Embedding/De-embedding

The 4-port Network Embedding/De-embedding feature is provided to embed or de-embed a network (defined in a 4-port touchstone file) between the calibration surface and the DUT.

On/Off

To turn on or off the 4-port network embedding/de-embedding feature, use the following command:

- :CALC{1-16}:FSIM:EMB:STAT on page 349

Setting Topology (connection method between analyzer and DUT)

To select a connection type, use the following command:

- :CALC{1-16}:FSIM:EMB:TYPE on page 353

Figure 6-1

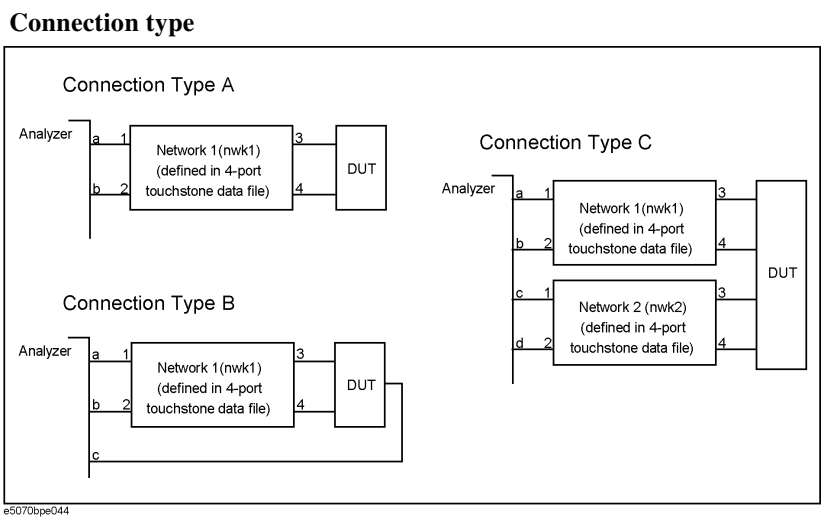

To assign the ports (ports a through d in Figure 6-1), use the appropriate command that matches your selected connection type, as identified in the following table:

Connection type	Command
A	:CALC{1-16}:FSIM:EMB:TOP:A:PORT on page 350
B	:CALC{1-16}:FSIM:EMB:TOP:B:PORT on page 351
C	:CALC{1-16}:FSIM:EMB:TOP:C:PORT on page 352

Selecting Processing Type (embedding/de-embedding)

To select a network processing type, use the following command:

- :CALC{1-16}:FSIM:EMB:NETW{1-2}:TYPE on page 348

Specifying File

To select a file that defines the criteria for network embedding/de-embedding, use the following command:

- :CALC{1-16}:FSIM:EMB:NETW{1-2}:FIL on page 347

Balance-Unbalance Conversion

The Balance-Unbalance Conversion feature converts the measurement results obtained in an unbalanced state to the characteristics of a balanced state. You can select mixed mode S parameter, balance and CMRR as the measurement parameter when you turn on Balance-Unbalance Conversion.

On/Off

You can turn on or off Balance-Unbalance Conversion for each trace individually. To turn on or off Balance-Unbalance Conversion, use the following command:

- :CALC{1-16}:FSIM:BAL:PAR{1-16}:STAT on page 342

Setting the Topology

To select a balance device type, use the following command:

- :CALC{1-16}:FSIM:BAL:DEV on page 327

Figure 6-2

Balance device type

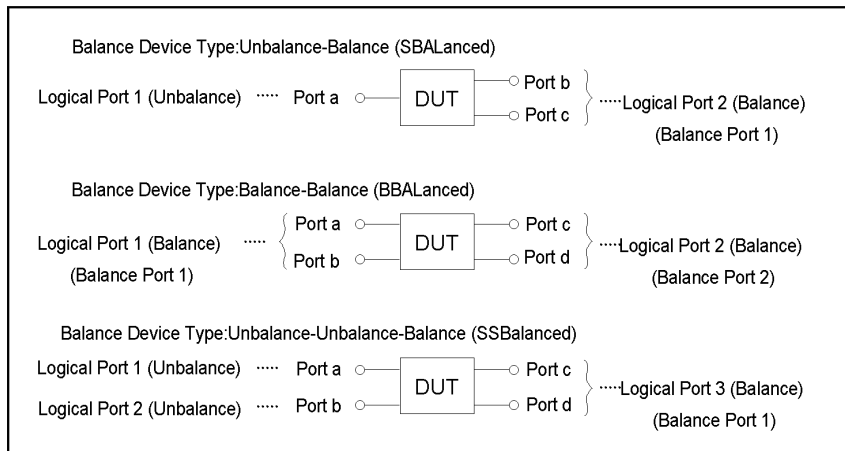

e5070ape019

To assign the ports (ports a through d in Figure 6-2), use the command that matches your selected device type, as identified in the following table:

Device type	Command
Unbalance-balance (SBALanced)	:CALC{1-16}:FSIM:BAL:TOP:SBAL on page 345
Balance-balance (BBALanced)	:CALC{1-16}:FSIM:BAL:TOP:BBAL on page 343
Unbalance-unbalance-balance (SSBALanced)	:CALC{1-16}:FSIM:BAL:TOP:SSB on page 346

Selecting the Measurement Parameter

To select the measurement parameter, use the command that matches your selected device type, as identified in the following table:

Device type	Command
Unbalance-balance	:CALC{1-16}:FSIM:BAL:PAR{1-16}:SBAL on page 340

Device type	Command
Balance-balance	:CALC{1-16}:FSIM:BAL:PAR{1-16}:BBAL on page 339
Unbalance-unbalance-balance	:CALC{1-16}:FSIM:BAL:PAR{1-16}:SSB on page 341

Differential Matching Circuit Embedding

The Differential Matching Circuit Embedding feature simulates the characteristics the DUT would exhibit if a balance-unbalance converted differential port were connected to a matching circuit after being subjected to balance-unbalance conversion.

On/Off

To turn on or off Differential Matching Circuit Embedding, use the following command:

- :CALC{1-16}:FSIM:BAL:DMC:STAT on page 334

You can only turn on or off Differential Matching Circuit Embedding for all of the ports, not for each balance port individually. However, any balance port whose circuit type is set to “None” behaves as if this feature were permanently off.

Configuring the Matching Circuit Settings

To select a circuit type, use the following command:

- :CALC{1-16}:FSIM:BAL:DMC:BPOR{1-2} on page 328

To set the circuit constant, use the following commands:

Circuit constant	Command
C	:CALC{1-16}:FSIM:BAL:DMC:BPOR{1-2}:PAR:C on page 329
G	:CALC{1-16}:FSIM:BAL:DMC:BPOR{1-2}:PAR:G on page 330
L	:CALC{1-16}:FSIM:BAL:DMC:BPOR{1-2}:PAR:L on page 331
R	:CALC{1-16}:FSIM:BAL:DMC:BPOR{1-2}:PAR:R on page 332

When you want to use a user file to define the circuit type, specify the file using the following command:

- :CALC{1-16}:FSIM:BAL:DMC:BPOR{1-2}:USER:FIL on page 333

Differential Port Impedance Conversion

The Differential Port Impedance Conversion feature converts the measurement results for a balance-unbalance converted differential port to the characteristics of a different port impedance.

On/Off

To turn on or off Differential Port Impedance Conversion, use the following command:

- `:CALC{1-16}:FSIM:BAL:DZC:STAT` on page 338

You can only turn on or off Differential Port Impedance Conversion for all of the balance ports, not for each port individually.

Setting the Z0 Value

To set the target differential port impedance, use the following command:

- `:CALC{1-16}:FSIM:BAL:DZC:BPOR{1-2}:Z0` on page 337
- `:CALC{1-16}:FSIM:BAL:DZC:BPOR{1-2}:REAL` on page 336
- `:CALC{1-16}:FSIM:BAL:DZC:BPOR{1-2}:IMAG` on page 335

Sample Program

Example 6-2 shows a sample program that demonstrates how to use the Fixture Simulator. You can find the source file of this program, named `fixture.htb`, on the sample program disk.

The program configures the Balance-Unbalance Conversion, Differential Matching Circuit Embedding, Port Impedance Conversion, and Differential Port Impedance Conversion features so that the instrument can correctly deal with an unbalance-balance (3-port) DUT.

The program is described in detail below:

Line 50	Assigns a GPIB address to the I/O pass.
Lines 70 to 100	These lines store the balance device type (unbalance-balance), port assignments (logical port 1 = port 1, logical port 2 = port 2 and port 3), and measurement parameter (Sds21) into the variables <code>Dev_type\$</code> , <code>Port(*)</code> , and <code>Para\$</code> , respectively.
Lines 120 to 150	These lines store the balance matching circuit constants (C:1 pF, G:2 mS, L:30 nH, R:4 m Ω) into the variables <code>Dmc_c</code> , <code>Dmc_g</code> , <code>Dmc_l</code> , and <code>Dmc_r</code> , respectively.
Lines 160 to 170	These lines store the port impedance (100 Ω) and the differential port impedance (210 Ω) into the variables <code>Z0_se</code> and <code>Z0_diff</code> , respectively.
Lines 210 to 230	These lines set the balance device type to <code>Dev_type\$</code> , the port assignment to <code>Port(*)</code> , and the measurement parameter of port 1 (Sds21) to <code>Para\$</code> .
Line 240	Turns on Balance-Unbalance Conversion.
Line 280	Specifies the type of differential matching circuit to be a circuit composed of an L and a shunt C.
Lines 290 to 320	These lines set the differential matching circuit constants (C, G, L, R) to <code>Dmc_c</code> , <code>Dmc_g</code> , <code>Dmc_l</code> , and <code>Dmc_r</code> , respectively.
Line 330	Turns on Differential Matching Circuit Embedding.
Lines 370 to 380	Sets the port impedance of port 2 and port 3 to <code>Z0_se</code> .
Line 390	Turns on Port Impedance Conversion.
Line 430	Sets the differential port impedance of balance port 1 to <code>Z0_diff</code> .
Line 440	Turns on Differential Port Impedance Conversion.
Line 480	Turns on the Fixture Simulator.

Example 6-3

Fixture Simulator (fixture.htb)

```

10     DIM Dev_type$[9],Para$[9]
20     REAL Dmc_c,Dmc_g,Dmc_l,Dmc_r,Z0_se,Z0_diff
30     INTEGER Port (1:3)
40     !
50     ASSIGN @Agte507x TO 717
60     !
70     Dev_type$="SBAL"      ! Device Type      : SE-Bal
80     Port (1)=1           ! Port1(SE)       : 1
90     Port (2)=2           ! Port2(Bal)      : 2,3
100    Port (3)=3           !
110    Para$="SDS21"        ! Meas. Parameter : Sds21
120    Dmc_c=1.E-12         ! Diff.           C: 1 pF
130    Dmc_g=2.E-3         ! Matching        G: 2 mS
140    Dmc_l=3.E-8         ! Circuit         L: 30 nH
150    Dmc_r=4.E-3         !                 R: 4 mohm
160    Z0_se=100           ! Z Conversion    Z0: 100 ohm
170    Z0_diff=210         ! Diff. Z Conv.  Z0: 210 ohm
180    !
190    ! Balance-Unbalance Conversion Setting
200    !
210    OUTPUT @Agte507x;":CALC1:FSIM:BAL:DEV "&Dev_type$
220    OUTPUT @Agte507x;":CALC1:FSIM:BAL:TOP:"&Dev_type$&" ";Port (*)
230    OUTPUT @Agte507x;":CALC1:FSIM:BAL:PAR1:"&Dev_type$&" "&Para$
240    OUTPUT @Agte507x;":CALC1:FSIM:BAL:PAR1:STAT ON"
250    !
260    ! Diff. Matching Circuit Setting
270    !
280    OUTPUT @Agte507x;":CALC1:FSIM:BAL:DMC:BPOR1 PLPC"
290    OUTPUT @Agte507x;":CALC1:FSIM:BAL:DMC:BPOR1:PAR:C ";Dmc_c
300    OUTPUT @Agte507x;":CALC1:FSIM:BAL:DMC:BPOR1:PAR:G ";Dmc_g
310    OUTPUT @Agte507x;":CALC1:FSIM:BAL:DMC:BPOR1:PAR:L ";Dmc_l
320    OUTPUT @Agte507x;":CALC1:FSIM:BAL:DMC:BPOR1:PAR:R ";Dmc_r
330    OUTPUT @Agte507x;":CALC1:FSIM:BAL:DMC:STAT ON"
340    !
350    ! Z Conversion Setting
360    !
370    OUTPUT @Agte507x;":CALC1:FSIM:SEND:ZCON:PORT2:Z0 ";Z0_se
380    OUTPUT @Agte507x;":CALC1:FSIM:SEND:ZCON:PORT3:Z0 ";Z0_se
390    OUTPUT @Agte507x;":CALC1:FSIM:SEND:ZCON:STAT ON"
400    !
410    ! Diff. Z Conversion Setting
420    !
430    OUTPUT @Agte507x;":CALC1:FSIM:BAL:DZC:BPOR1:Z0 ";Z0_diff
440    OUTPUT @Agte507x;":CALC1:FSIM:BAL:DZC:STAT ON"
450    !
460    ! Fixture Simulator On/Off
470    !
480    OUTPUT @Agte507x;":CALC1:FSIM:STAT ON"
490    !
500    END

```

Analysis in Time Domain (time domain function)

The time domain function provides the following functions:

- Transforming measurement data to data in the time domain (Transformation Function)
- Deleting unnecessary measurement data in the time domain (Gating Function)

Transforming measurement data to data in time domain

By using the Transformation Function, you can convert the results measured in the frequency domain to data in the time domain and analyze it.

On/Off

To turn on or off the transformation function, use the following command:

- :CALC{1-16}:TRAN:TIME:STAT on page 441

Selecting Transformation Type

To select the transformation type (band pass/low pass), use the following command:

- :CALC{1-16}:TRAN:TIME on page 435

To select the stimulus type (impulse/step) when the transformation type is low pass, use the following command:

- :CALC{1-16}:TRAN:TIME:STIM on page 443

When the transformation type is low pass, you need to execute the following command because each measurement point must be a multiple of the start frequency.

- :CALC{1-16}:TRAN:TIME:LPFR on page 439

Setting Window Shape

To set the window shape, use one of the following items.

Item	Command
β	:CALC{1-16}:TRAN:TIME:KBES on page 438
Impulse width	:CALC{1-16}:TRAN:TIME:IMP:WIDT on page 437
Rise time of step signal	:CALC{1-16}:TRAN:TIME:STEP:RTIM on page 442

The above three items are dependent on each other. When the value of one of them is changed, the values of the other two are automatically changed to corresponding values.

Unlike manual operation, you cannot set the window shape by selecting the window type (maximum/normal/minimum). However, you can set the same shape as each window type by setting β as follows:

	Maximum	Normal	Minimum
Value of β .	13	6	0

Setting Display Range

To set the display range after time domain transformation, use the following commands:

Start value	:CALC{1-16}:TRAN:TIME:STAR on page 440
Stop value	:CALC{1-16}:TRAN:TIME:STOP on page 444
Center value	:CALC{1-16}:TRAN:TIME:CENT on page 436
Span value	:CALC{1-16}:TRAN:TIME:SPAN on page 439

Deleting unnecessary measurement data in the time domain

You can use the Gating Function to delete unnecessary time domain data.

On/Off

To turn on or off the gating function, use the following command:

- :CALC{1-16}:FILT:TIME:STAT on page 319

Selecting Gate Type

To select the gate type, use the following command:

- :CALC{1-16}:FILT:TIME on page 314

Setting Gate Shape

To select the gate shape, use the following command:

- :CALC{1-16}:FILT:TIME:SHAP on page 316

Setting Gate Range

To set the gate range, use the following commands:

Start value	:CALC{1-16}:FILT:TIME:STAR on page 318
Stop value	:CALC{1-16}:FILT:TIME:STOP on page 320
Center value	:CALC{1-16}:FILT:TIME:CENT on page 315
Span value	:CALC{1-16}:FILT:TIME:SPAN on page 317

Sample Program

Example 6-2 shows a sample program that demonstrates how to use the transformation function of the time domain function. You can find the source file of this program, named `time_dom.htb`, on the sample program disk.

The sample program executes calibration (ECal), performs measurement once, converts the results to data in the time domain, and displays this data.

The program is described in detail below:

Line 50	Assigns a GPIB address to the I/O path.
Lines 70 to 90	These lines set the sweep stop frequency (3 GHz), the number of points (201), and the measurement parameter (S11) to the <code>Stop_freq</code> , <code>Nop</code> , and <code>Para\$</code> variables, respectively.
Lines 110 to 150	These lines set the transformation type (low pass), the stimulus type (impulse), the β value of the window (13), the start value of the display range (0 s), and the stop value of the display range (10 ns) into the <code>Tran_type\$</code> , <code>Stim_type\$</code> , <code>Win_beta</code> , <code>Star_time</code> , and <code>Stop_time</code> variables, respectively.
Lines 170 to 190	After preset, These lines set the sweep stop frequency to <code>Stop_freq</code> and the number of points to <code>Nop</code> .
Line 210	Sets a measurement point that is appropriate when the transformation type is low pass.
Lines 230 to 240	These lines set the measurement parameter to <code>Para\$</code> and the trigger source to <code>BUS</code> .
Lines 280 to 320	These lines use the ECal module to execute 1-port calibration on port 1.
Lines 360 to 410	These lines perform measurement once after the DUT is connected.
Lines 430 to 450	These lines execute auto scale and suspend progress to the next process (transformation to data in the time domain) until any key is pressed.
Lines 490 to 530	These lines set the transformation type to <code>Tran_type\$</code> , the stimulus type to <code>Stim_type\$</code> , the β value of the window to <code>Win_beta</code> , the start value of the display range to <code>Star_time</code> , and the stop value of the display range to <code>Stop_time</code> .
Line 540	Turns on the transformation function of the time domain function.
Lines 560 to 580	These lines set the data format to the real format and execute auto scale.

Example 6-4

Time Domain Transformation (`time_dom.htb`)

```
10    DIM Para$[9],Tran_type$[9],Stim_type$[9],Buff$[9],Inp_ch
ar$[9]
20    REAL Stop_freq,Win_beta,Star_time,Stop_time
30    INTEGER Nop
40    !
50    ASSIGN @Agte507x TO 717
60    !
70    Stop_freq=3.E+9      ! Stop Frequency   : 3 GHz
```



```

80      Nop=201                ! Nop                : 201
90      Para$="S11"           ! Meas. Parameter : S11
100     !
110     Tran_type$="LPAS"     ! Transform Type  : Lowpass
120     Stim_type$="IMP"      ! Stimulus Type   : Impulse
130     Win_beta=13           ! Window Beta     : 13 (Maximum Type)
140     Star_time=0           ! Start time      : 0 s
150     Stop_time=1.E-8       ! Stop time       : 10 ns
160     !
170     OUTPUT @Agte507x;" :SYST:PRES"
180     OUTPUT @Agte507x;" :SENS1:FREQ:STOP ";Stop_freq
190     OUTPUT @Agte507x;" :SENS1:SWE:POIN ";Nop
200     !
210     OUTPUT @Agte507x;" :CALC1:TRAN:TIME:LPFR"
220     !
230     OUTPUT @Agte507x;" :CALC1:PAR1:DEF "&Para$
240     OUTPUT @Agte507x;" :TRIG:SOUR BUS"
250     !
260     ! 1 Port Full Calibration (ECal)
270     !
280     PRINT "Connect Port 1 to ECal Module. Then push [Enter] key."
290     INPUT "",Buff$
300     OUTPUT @Agte507x;" :SENS1:CORR:COLL:ECAL:SOLT1 1"
310     OUTPUT @Agte507x;" :SYST:ERR?"
320     ENTER @Agte507x;Buff$
330     !
340     ! Measurement
350     !
360     PRINT "Set DUT. Then Push [Enter] key."
370     INPUT "",Inp_char$
380     !
390     OUTPUT @Agte507x;" :TRIG:SING"
400     OUTPUT @Agte507x;" *OPC?"
410     ENTER @Agte507x;Buff$
420     !
430     OUTPUT @Agte507x;" :DISP:WIND1:TRAC1:Y:AUTO"
440     PRINT "Push [Enter] key. -> [Time Domain Transform]"
450     INPUT "",Inp_char$
460     !
470     ! Time Domain Transform
480     !
490     OUTPUT @Agte507x;" :CALC1:TRAN:TIME "&Tran_type$
500     OUTPUT @Agte507x;" :CALC1:TRAN:TIME:STIM "&Stim_type$
510     OUTPUT @Agte507x;" :CALC1:TRAN:TIME:KBES ";Win_beta
520     OUTPUT @Agte507x;" :CALC1:TRAN:TIME:STAR ";Star_time
530     OUTPUT @Agte507x;" :CALC1:TRAN:TIME:STOP ";Stop_time
540     OUTPUT @Agte507x;" :CALC1:TRAN:TIME:STAT ON"
550     !
560     OUTPUT @Agte507x;" :CALC1:PAR1:SEL"
570     OUTPUT @Agte507x;" :CALC1:FORM REAL"
580     OUTPUT @Agte507x;" :DISP:WIND1:TRAC1:Y:AUTO"
590     END

```

Analyzing impedance

By turning on the parameter conversion function, you can convert the measurement result of the S parameter to the following parameters.

- Equivalent impedance in reflection measurement
- Equivalent impedance in transmission measurement
- Equivalent admittance in reflection measurement
- Equivalent admittance in transmission measurement
- Inverse of S-parameter (1/S)

To turn On/Off the parameter conversion function, use the following command:

- :CALC{1-16}:CONV on page 301

To select the parameter to which you want to convert the measurement result, use the following command:

- :CALC{1-16}:CONV:FUNC on page 302

7**Reading/Writing Measurement Data**

This chapter provides an overview of the Agilent E5070B/E5071B's internal data processing flow and describes how to read and write measurement results (internal data array).

Data Transfer Format

When you transfer data using the one of the following commands, you can choose among ASCII transfer format, IEEE 64-bit floating point binary transfer format and IEEE 32-bit floating point binary transfer format.

NOTE

The instrument always uses the ASCII transfer format when you transfer data without using any of the following commands.

- :CALC{1-16}:BLIM:REP? on page 300
- :CALC{1-16}:DATA:FDAT on page 307
- :CALC{1-16}:DATA:FMEM on page 308
- :CALC{1-16}:DATA:SDAT on page 309
- :CALC{1-16}:DATA:SMEM on page 310
- :CALC{1-16}:FUNC:DATA? on page 369
- :CALC{1-16}:LIM:DATA on page 381
- :CALC{1-16}:LIM:REP? on page 387
- :CALC{1-16}:LIM:REP:ALL? on page 388
- :CALC{1-16}:RLIM:DATA on page 427
- :CALC{1-16}:RLIM:REP? on page 432
- :SENS{1-16}:FREQ:DATA? on page 655
- :SENS{1-16}:SEGM:DATA on page 688
- :SOUR:POW:PORT:CORR:COLL:TABL:ASEN:DATA on page 702
- :SOUR:POW:PORT:CORR:COLL:TABL:BSSEN:DATA on page 703
- :SOUR{1-16}:POW:PORT{1-4}:CORR:COLL:TABL:LOSS on page 714
- :SOUR{1-16}:POW:PORT{1-4}:CORR:DATA on page 716

To set the data transfer format, use the following command:

- :FORM:DATA on page 488

NOTE

Executing the :SYST:PRES command on page 796 or *RST command on page 289 does not affect the current setting of the data transfer format.

ASCII Transfer Format

When you select the ASCII transfer format as the data transfer format, numbers are transferred as ASCII bytes, each of which corresponds to one of the formats shown below. Note that numbers are separated from one another with a comma (,) in accordance with the IEEE 488.2 specification.

NOTE

Numeric data strings vary in length. Keep this in mind when you extract some data from retrieved numeric data strings in your program.

- Integer format

Figure 7-1 shows this format. Numbers are expressed as integers. For example, 201 is expressed as “+201” or “201.”

Figure 7-1

Integer format

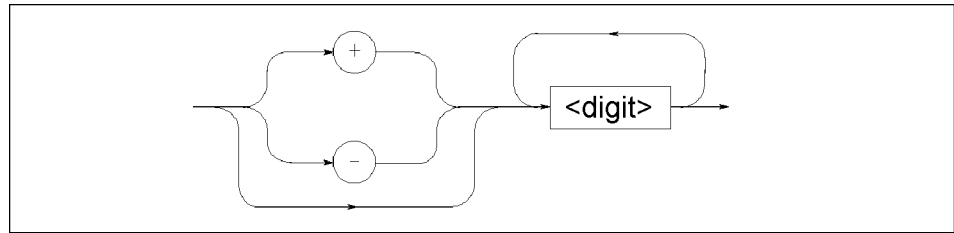

- Floating-point number format

Figure 7-2 shows this format. Numbers are expressed with floating points. For example, 1000 is expressed as “+201” or “201.”

Figure 7-2

Floating-point number format

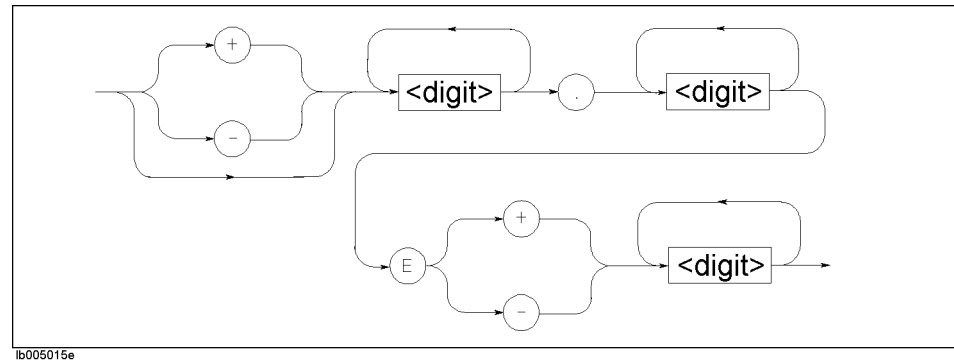

Binary Transfer Format

You can select the binary transfer format from the IEEE 64-bit floating point format or the IEEE 32-bit floating point format depending on the controller you use.

IEEE 64-bit floating point format

When you select the IEEE 64-bit floating point binary transfer format as the data transfer format, numbers are transferred in the format shown in Figure 7-3.

Figure 7-3

Binary transfer format

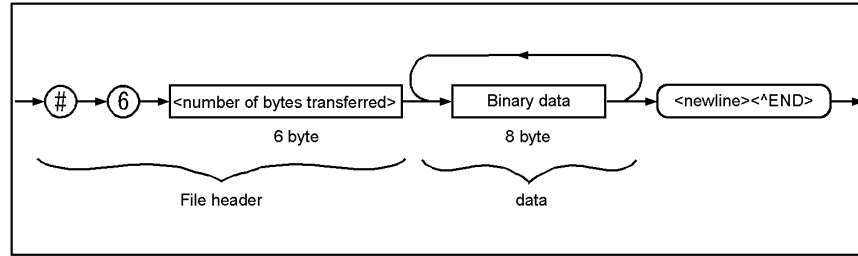

4287ape024

This data transfer format uses a header that consists of a sharp character (#), a number of 6 (which indicates the byte size of the <number of bytes transferred> part), and the <number of bytes transferred> part in this order. The header is followed by the binary data (each number consists of 8 bytes and the total is the byte size indicated by <number of bytes transferred>) and the message terminator <new line>^END.

The binary data is expressed in the IEEE 754 64-bit floating-point number format shown in Figure 7-4.

Figure 7-4

64-bit floating point format

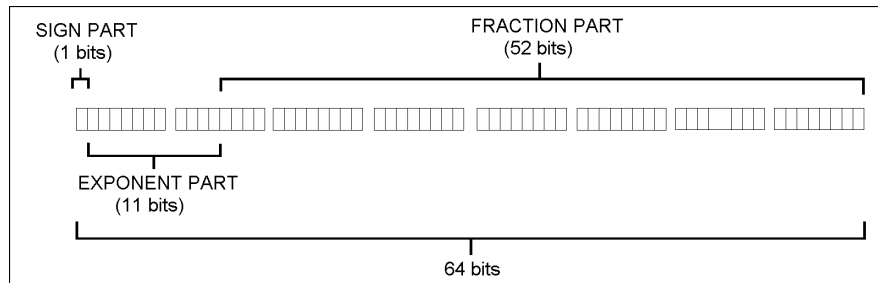

4287ape025

IEEE 32-bit floating point format

When you select the IEEE 32-bit floating point binary transfer format as the data transfer format, numbers are transferred in the format shown in Figure 7-5.

Figure 7-5

IEEE 32-bit floating point binary transfer format

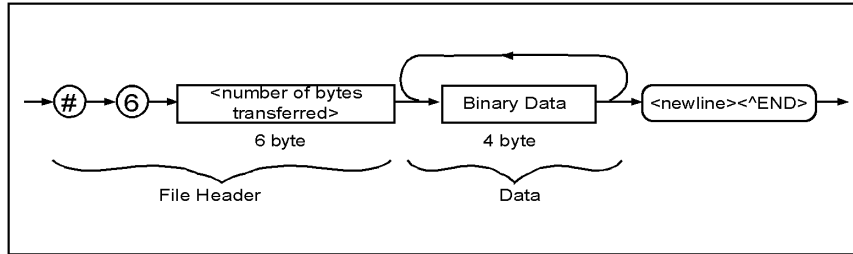

e5070bpe032

This data transfer format uses a header that consists of a sharp character (#), a number of 6 (which indicates the byte size of the <number of bytes transferred> part), and the <number of bytes transferred> part in this order. The header is followed by the binary data (each number consists of 4 bytes and the total is the byte size indicated by <number of bytes transferred>) and the message terminator <new line>^END.

The binary data is expressed in the IEEE 754 32-bit floating-point number format shown in Figure 7-6.

Figure 7-6

32-bit floating point data

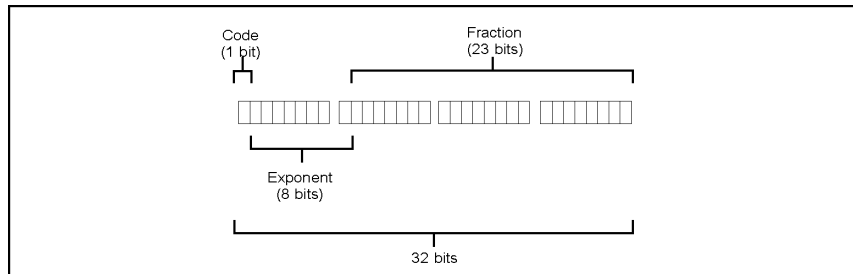

e5070bpe033

Byte order

When you opt to perform binary transfer, you can configure the instrument to transfer the bytes of the data in one of the following two byte orders:

- NORMAL Transfer begins with the byte that contains the MSB (most significant bit); that is, the leftmost byte in Figure 7-4 and Figure 7-6.
- SWAPped Transfer begins with the byte that contains the LSB (least significant bit); that is, the rightmost byte in Figure 7-4 and Figure 7-6.

To set the byte order, use the following command:

- :FORM:BORD on page 487

NOTE

Executing the :SYST:PRES command on page 796 or *RST command on page 289 does not affect the current setting of the byte order.

Internal data processing

Data flow

Figure 7-7 provides an overview of the E5070B/E5071B's internal data processing flow. For more information on the data processing flow, refer to “*User's Guide.*”

Figure 7-7 E5070B/E5071B's data processing flow

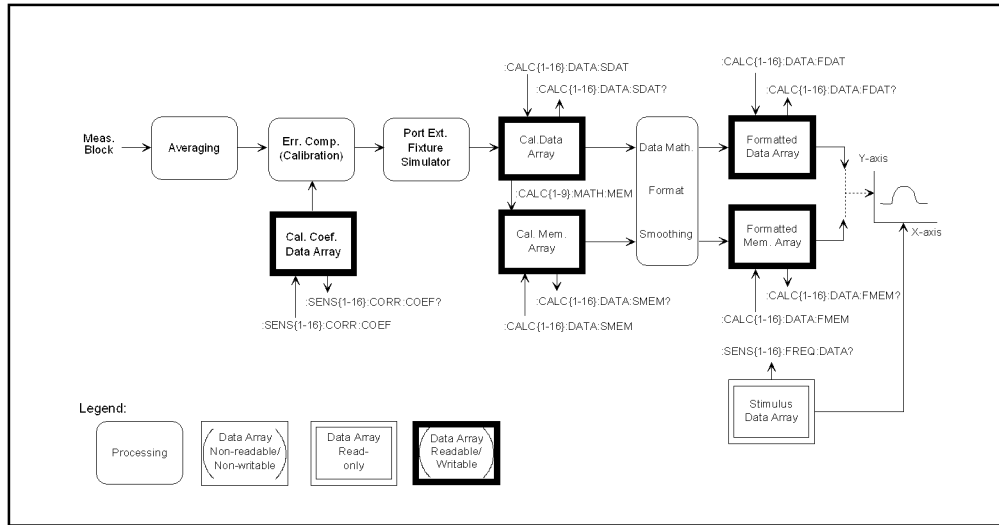

e5070bpe5018

Internal data arrays

Corrected data arrays

A corrected data array contains the corrected data obtained by performing error correction, port extension compensation (calibration), Fixture Simulator operations on the raw measured data of S parameter specified for each trace of each channel. Each data element is stored as a complex number (Re/Im).

The instrument retains 81 corrected data arrays at maximum, each of which is associated with one of the 9 traces contained in one of the 9 channels $9 \times 9 = 81$). To read/write one of the corrected data arrays, use the following command:

- :CALC{1-16}:DATA:SDAT on page 309

Corrected memory arrays

When the :CALC{1-16}:MATH:MEM command on page 416 command is executed on a particular corrected data array, its copy is stored into the corrected memory array corresponding to that corrected data array.

The instrument retains 81 corrected memory arrays at maximum, each of which is associated with one of the 9 traces contained in one of the 9 channels $9 \times 9 = 81$). To read/write one of the corrected data arrays, use the following command:

- :CALC{1-16}:DATA:SMEM on page 310

Formatted data array

A formatted data array contains the formatted data (values to be displayed) obtained by performing data math operations, measurement parameter conversion, and smoothing on a particular corrected data array. Regardless of the data format, it contains two data elements per measurement point as shown in the following table:

Table 7-1

Data elements and data formats

Data format* ¹	Data element (primary value)	Data element (secondary value)
log magnitude	log magnitude	Always 0
Phase	Phase	Always 0
Group delay	Group delay	Always 0
Smith chart (Lin)	Liner magnitude	Phase
Smith chart (Log)	log magnitude	Phase
Smith chart (Re/Im)	Real part of a complex number	Imaginary part of a complex number
Smith chart (R+jX)	Resistance	Reactance
Smith chart (G+jB)	Conductance	Susceptance
Polar (Lin)	Liner magnitude	Phase
Polar (Log)	log magnitude	Phase
Polar (Re/Im)	Real part of a complex number	Imaginary part of a complex number
Liner magnitude	Liner magnitude	Always 0
SWR	SWR	Always 0
Real number	Real part of a complex number	Always 0
Imaginary number	Imaginary part of a complex number	Always 0
Expanded phase	Expanded phase	Always 0

*1. To set this, use the :CALC{1-16}:FORM command on page 321 command.

The instrument retains 81 formatted data arrays at maximum, each of which is associated with one of the 9 traces contained in one of the 9 channels (9×9 = 81). To read/write one of the formatted data arrays, use the following command:

- :CALC{1-16}:DATA:FDAT on page 307

Formatted memory arrays

A formatted memory array contains the formatted data (values to be displayed) obtained by performing data math operations, measurement parameter conversion, and smoothing on a particular corrected memory array.

The instrument retains 81 formatted memory arrays at maximum, each of which is associated with one of the 9 traces contained in one of the 9 channels $9 \times 9 = 81$). To read/write one of the formatted memory arrays, use the following command:

- `:CALC{1-16}:DATA:FMEM` on page 308

Stimulus data arrays

A stimulus data array contains the stimulus values for all measurement points.

The instrument retains 16 stimulus data arrays at maximum, each of which is associated with one of the 16 channels. Stimulus data arrays are read-only. To retrieve one of the stimulus data arrays, use the following command:

- `:SENS{1-16}:FREQ:DATA?` on page 655

Calibration Coefficient Data Arrays

A calibration coefficient data array contains the calibration coefficients calculated based on the results of measurement performed with standard devices.

The instrument retains 16 calibration coefficient data arrays at maximum, each of which is associated with each channel. Commands are available for reading or writing calibration coefficient data arrays. To read or write, first use the following command:

- `:SENS{1-16}:CORR:COEF` on page 548

NOTE

If any calibration coefficient is stored, the stored calibration coefficient data array will be retrieved. Once a calibration coefficient data array has been written, execute the command to validate it (`:SENS{1-16}:CORR:COEF:SAVE`).

Retrieving Measurement Results

“Internal data arrays” on page 168 allow you to retrieve all measurement results throughout a particular trace. Alternatively, markers allow you to retrieve measurement results at your specified points. For information on how to retrieve marker values, refer to “Retrieving measurement results at marker positions” on page 140.

Retrieving Internal Data Arrays

You can choose between the ASCII and binary data transfer formats when you retrieve internal data arrays. For more information, refer to “Data Transfer Format” on page 164.

Example 7-1 and Example 7-2 show sample programs that demonstrate how to retrieve formatted data arrays. The sample program in Example 7-1 uses the ASCII transfer format while the sample in Example 7-2 uses the binary transfer format. You can find the source files of these programs, named `read_asc.htb` and `read_bin.htb`, on the sample program disk.

Each of the sample programs holds the sweep on channel 1, then retrieves and displays the stimulus array for channel 1 and the formatted data array for trace 1.

The program in Example 7-1 is described in detail below:

Line 50	Assigns a GPIB address to the I/O pass.
Lines 70 to 90	These lines set channel 1's active trace to trace 1 and hold the sweep.
Lines 100 to 110	These lines retrieve the number of points in channel 1 and stores that number into the Nop variable.
Line 120	Resizes the Fdata and Freq arrays based on the value of the Nop variable (the number of points).
Line 160	Sets the data transfer format to ASCII.
Lines 180 to 190	These lines retrieve the formatted data array for the active trace (trace 1) in channel 1, and store the data into the Fdata array.
Lines 200 to 210	These lines retrieve the stimulus array for channel 1 and stores the data into the Freq variable.
Lines 250 to 260	These lines retrieve the data format for the active trace (trace 1) in channel 1, and store it into the Fmt\$ array.
Lines 270 to 400	The lines display each point along with one measured value and a frequency if the Fmt\$ is “MLOG”, “PHAS”, “GDEL”, “MLIN”, “SWR”, “REAL”, “IMAG”, or “UPH”; or along with two measured values and a frequency if Fmt\$ returns any other string.

Example 7-1

Using the ASCII Transfer Format to Retrieve Internal Data Arrays (read_asc.htb)

```
10 REAL Fdata(1:1601,1:2),Freq(1:1601)
20 DIM Img$(30)
30 INTEGER Nop,I
40 !
50 ASSIGN @Agte507x TO 717
60 !
70 OUTPUT @Agte507x;":CALC1:PAR1:SEL"
80 OUTPUT @Agte507x;":INIT1:CONT OFF"
90 OUTPUT @Agte507x;":ABOR"
100 OUTPUT @Agte507x;":SENS1:SWE:POIN?"
110 ENTER @Agte507x;Nop
120 REDIM Fdata(1:Nop,1:2),Freq(1:Nop)
130 !
140 ! Reading out in ASCII transfer format
150 !
160 OUTPUT @Agte507x;":FORM:DATA ASC"
170 !
180 OUTPUT @Agte507x;":CALC1:DATA:FDAT?"
190 ENTER @Agte507x;Fdata(*)
200 OUTPUT @Agte507x;":SENS1:FREQ:DATA?"
210 ENTER @Agte507x;Freq(*)
220 !
230 ! Displaying
240 !
250 OUTPUT @Agte507x;":CALC1:FORM?"
260 ENTER @Agte507x;Fmt$
270 SELECT Fmt$
280     CASE "MLOG","PHAS","GDEL","MLIN","SWR","REAL","IMAG","UPH"
290         Img$="MD.4DE,2X,MD.6DE"
300         PRINT " Frequency          Data"
310         FOR I=1 TO Nop
320             PRINT USING Img$;Freq(I),Fdata(I,1)
330         NEXT I
340     CASE ELSE
350         Img$="MD.4DE,2X,MD.6DE,2X,MD.6DE"
360         PRINT " Frequency          Data1          Data2"
370         FOR I=1 TO Nop
380             PRINT USING Img$;Freq(I),Fdata(I,1),Fdata(I,2)
390         NEXT I
400     END SELECT
410 !
420 END
```

The program in Example 7-2 is described in detail below:

Lines 50 to 60	Assigns a GPIB address to the I/O pass.
Lines 80 to 100	These lines set channel 1's active trace to trace 1 and hold the sweep.
Lines 110 to 120	These lines retrieve the number of points in channel 1 and store that number into the Nop variable.
Line 130	Resizes the Fdata and Freq arrays based on the value of the Nop variable (the number of points).
Line 170	Sets the data transfer format to binary.
Lines 190 to 200	These lines retrieve the data header.
Line 210	Retrieves the formatted data array for the active trace (trace 1) in channel 1, and stores the data into the Fdata array.

NOTE

Because binary data must be read without being formatted, the program uses an I/O path (@Binary) that is configured to support the retrieval of unformatted data. This applies to line 250 as well.

Line 220	Reads the message terminator at the end of the data.
Lines 230 to 240	These lines retrieve the data header.
Line 250	Retrieves the stimulus array for channel 1 and stores the data into the Freq variable.
Line 260	Reads the message terminator at the end of the data.
Lines 300 to 310	These lines retrieve the data format for the active trace (trace 1) in channel 1, and store it into the Fmt\$ array.
Lines 320 to 450	The lines display each point along with one measured value and a frequency if the Fmt\$ is "MLOG", "PHAS", "GDEL", "MLIN", "SWR", "REAL", "IMAG", or "UPH"; or along with two measured values and a frequency if Fmt\$ returns any other string.

Example 7-2

Using the Binary Transfer Format to Retrieve Internal Data Arrays (read_bin.htb)

```
10 REAL Fdata(1:1601,1:2),Freq(1:1601)
20 DIM Buff$(9),Img$(30)
30 INTEGER Nop,I
40 !
50 ASSIGN @Agte507x TO 717
60 ASSIGN @Binary TO 717;FORMAT OFF
70 !
80 OUTPUT @Agte507x;":CALC1:PAR1:SEL"
90 OUTPUT @Agte507x;":INIT1:CONT OFF"
100 OUTPUT @Agte507x;":ABOR"
110 OUTPUT @Agte507x;":SENS1:SWE:POIN?"
120 ENTER @Agte507x;Nop
130 REDIM Fdata(1:Nop,1:2),Freq(1:Nop)
140 !
150 ! Reading out in binary transfer format
160 !
170 OUTPUT @Agte507x;":FORM:DATA REAL"
180 !
190 OUTPUT @Agte507x;":CALC1:DATA:FDAT?"
200 ENTER @Agte507x USING "#,8A";Buff$
210 ENTER @Binary;Fdata(*)
220 ENTER @Agte507x USING "#,1A";Buff$
230 OUTPUT @Agte507x;":SENS1:FREQ:DATA?"
240 ENTER @Agte507x USING "#,8A";Buff$
250 ENTER @Binary;Freq(*)
260 ENTER @Agte507x USING "#,1A";Buff$
270 !
280 ! Displaying
290 !
300 OUTPUT @Agte507x;":CALC1:FORM?"
310 ENTER @Agte507x;Fmt$
320 SELECT Fmt$
330 CASE "MLOG","PHAS","GDEL","MLIN","SWR","REAL","IMAG","UPH"
340     Img$="MD.4DE,2X,MD.6DE"
350     PRINT " Frequency          Data"
360     FOR I=1 TO Nop
370         PRINT USING Img$;Freq(I),Fdata(I,1)
380     NEXT I
390 CASE ELSE
400     Img$="MD.4DE,2X,MD.6DE,2X,MD.6DE"
410     PRINT " Frequency          Data1          Data2"
420     FOR I=1 TO Nop
430         PRINT USING Img$;Freq(I),Fdata(I,1),Fdata(I,2)
440     NEXT I
450 END SELECT
460 !
470 END
```

Entering Data into a Trace

You can change the data/memory trace on the LCD by writing the new data into the “Formatted data array” on page 169/“Formatted memory arrays” on page 170.

When you write data into formatted data/memory array, you can choose either the ASCII or binary transfer format (see “Data Transfer Format” on page 164).

Example 7-3 and Example 7-4 show sample programs that demonstrate how to write data into formatted data arrays. The sample program in Example 7-3 uses the ASCII transfer format while the sample in Example 7-4 uses the binary transfer format. You can find the source files of these programs, named write_a.htb and write_b.htb, on the sample program disk.

Each of the sample programs holds the sweep on channel 1, retrieves the data from a specified file (a file saved measurement data using the :MMEM:STOR:FDAT command on page 511 command), and populates trace 1 for channel 1 with the retrieved data.

The program in Example 7-3 is described in detail below:

- Line 50 Assigns a GPIB address to the I/O pass.
- Line 70 Passes control to a subprogram named Inp_file_name, which lets the user input a file name, and then stores the returned file name into the File\$ variable. For more information on the Inp_file_name subprogram, refer to the description in Example 7-4.
- Lines 90 to 110 These lines set channel 1's active trace to trace 1 and hold the sweep.
- Lines 130 to 140 These lines retrieve the number of points in channel 1 and stores that number into the Nop variable.
- Line 150 Resizes the Fdata array based on the value of the Nop variable (the number of points).
- Line 170 This line points to the statement block to be executed if an error occurs in retrieving data from the file (for example, if no file matches File\$).
- Lines 180 to 260 These lines retrieve the formatted data from the file identified by File\$, and store the data into the Fdata array.
- Line 280 Sets the data transfer format to ASCII.
- Line 300 Writes Fdata into the formatted data array for the active trace (trace 1) in channel 1.
- Lines 340 to 380 This statement block is executed if an error occurs in retrieving data from the file.

Reading/Writing Measurement Data
Entering Data into a Trace

Example 7-3

Using the ASCII Transfer Format to Write Formatted Data Arrays (write_a.htb)

```
10 REAL Freq,Fdata(1:1601,1:2)
20 DIM File$(300)
30 INTEGER Nop
40 !
50 ASSIGN @Agte507x TO 717
60 !
70 CALL Inp_file_name(File$)
80 !
90 OUTPUT @Agte507x;":CALC1:PAR1:SEL"
100 OUTPUT @Agte507x;":INIT1:CONT OFF"
110 OUTPUT @Agte507x;":ABOR"
120 !
130 OUTPUT @Agte507x;":SENS1:SWE:POIN?"
140 ENTER @Agte507x;Nop
150 REDIM Fdata(1:Nop,1:2)
160 !
170 ON ERROR GOTO File_error
180 ASSIGN @File TO File$
190 ENTER @File USING "K";Buff$
200 ENTER @File USING "K";Buff$
210 ENTER @File USING "K";Buff$
220 FOR I=1 TO Nop
230 ENTER @File USING "19D,2X,19D,2X,19D";Freq,Fdata(I,1),Fdata
(I,2)
240 NEXT I
250 ASSIGN @File TO *
260 OFF ERROR
270 !
280 OUTPUT @Agte507x;":FORM:DATA ASC"
290 !
300 OUTPUT @Agte507x;":CALC1:DATA:FDAT ";Fdata(*)
310 !
320 GOTO Prog_end
330 !
340 File_error: OFF ERROR
350 PRINT "##### ERROR #####"
360 PRINT File$&" is NOT exist."
370 PRINT " or"
380 PRINT File$&" has UNSUITABLE data."
390 !
400 Prog_end: END
410 !=====
420 ! File Name Input Function
430 !=====
440 SUB Inp_file_name(Inp_name$)
450 DIM Inp_char$(9)
460 ON ERROR GOTO Inp_start
470 Inp_start: !
480 PRINT "Input File Name!"
490 INPUT "Name?",Inp_name$
500 PRINT "Input Name: "&Inp_name$
510 INPUT "OK? [Y/N]",Inp_char$
520 IF UPC$(Inp_char$)<>"Y" THEN Inp_start
530 OFF ERROR
540 SUBEND
```

The program in Example 7-4 is described in detail below:

Lines 50 to 60	Assigns a GPIB address to the I/O pass.
Line 70	Passes control to a subprogram named <code>Inp_file_name</code> , which lets the user input a file name, and then stores the returned file name into the <code>File\$</code> variable.
Lines 90 to 110	These lines set channel 1's active trace to trace 1 and hold the sweep.
Lines 130 to 140	These lines retrieve the number of points in channel 1 and stores that number into the <code>Nop</code> variable.
Line 150	Resizes the <code>Fdata</code> array based on the value of the <code>Nop</code> variable (the number of points).
Line 170	This line points to the statement block to be executed if an error occurs in retrieving data from the file (for example, if no file matches <code>File\$</code>).
Lines 180 to 260	These lines retrieve the formatted data from the file identified by <code>File\$</code> , and store the data into the <code>Fdata</code> array.
Line 280	Sets the data transfer format to binary.
Line 290	Creates the data header and stores it into the <code>Header\$</code> variable.
Line 300	Sends the command that writes data into the formatted data array for the active trace (trace 1) in channel 1, following it with the data header (<code>Header\$</code>).
Line 310	Sends the data itself (<code>Fdata</code>), following it with a message terminator.

NOTE

Because binary data must be written without being formatted, the program uses an I/O path (`@Binary`) that is configured to support writing unformatted data.

Lines 340 to 380 This statement block is executed if an error occurs in retrieving data from the file.

The `Inp_file_name` subprogram in lines 440 to 540, which is used to enter a save filename, is described below.

Line 460	Allows the user to return to the entry start line and re-enter the data if an error (such as an invalid entry) occurs while entering the target file name.
Lines 480 to 490	These lines prompt the user to enter the target file name. The program does not continue till the user actually enters the file name.
Lines 500 to 510	These lines display the entered file name and waits for a confirmation entry (y/n key).
Line 520	Returns to the entry start line if the key the user pressed in line 870 is not the y key.

Reading/Writing Measurement Data Entering Data into a Trace

Example 7-4

Using the Binary Transfer Format to Write Formatted Data Arrays (write_b.htb)

```
10 REAL Freq,Fdata(1:1601,1:2)
20 DIM File$(300),Header$(10)
30 INTEGER Nop
40 !
50 ASSIGN @Agte507x TO 717
60 ASSIGN @Binary TO 717;FORMAT OFF
70 CALL Inp_file_name(File$)
80 !
90 OUTPUT @Agte507x;":CALC1:PAR1:SEL"
100 OUTPUT @Agte507x;":INIT1:CONT OFF"
110 OUTPUT @Agte507x;":ABOR"
120 !
130 OUTPUT @Agte507x;":SENS1:SWE:POIN?"
140 ENTER @Agte507x;Nop
150 REDIM Fdata(1:Nop,1:2)
160 !
170 ON ERROR GOTO File_error
180 ASSIGN @File TO File$
190 ENTER @File USING "K";Buff$
200 ENTER @File USING "K";Buff$
210 ENTER @File USING "K";Buff$
220 FOR I=1 TO Nop
230 ENTER @File USING "19D,2X,19D,2X,19D";Freq,Fdata(I,1),Fdata
(I,2)
240 NEXT I
250 ASSIGN @File TO *
260 OFF ERROR
270 !
280 OUTPUT @Agte507x;":FORM:DATA REAL"
290 Header$="#6"&IVAL$(8*2*Nop,10)
300 OUTPUT @Agte507x;":CALC1:DATA:FDAT ";Header$;
310 OUTPUT @Binary;Fdata(*),END
320 GOTO Prog_end
330 !
340 File_error: OFF ERROR
350 PRINT "##### ERROR #####"
360 PRINT File$&" is NOT exist."
370 PRINT " or"
380 PRINT File$&" has UNSUITABLE data."
390 !
400 Prog_end: END
410 !=====
420 ! File Name Input Function
430 !=====
440 SUB Inp_file_name(Inp_name$)
450 DIM Inp_char$(9)
460 ON ERROR GOTO Inp_start
470 Inp_start: !
480 PRINT "Input File Name!"
490 INPUT "Name?",Inp_name$
500 PRINT "Input Name: "&Inp_name$
510 INPUT "OK? [Y/N]",Inp_char$
520 IF UPC$(Inp_char$)<>"Y" THEN Inp_start
530 OFF ERROR
540 SUBEND
```

8 Limit Test

This chapter explains how to use the Limit Test feature to perform a limit test and determine the pass/fail status of the measured data.

Performing a Limit Test

Configuring limit lines

The Limit Test feature of the E5070B/E5071B allows you to create up to 100 upper/lower limit lines on each trace and then determine the pass/fail status of the measured data.

When you manually configure limit lines, you must add each segment (limit line) to the limit table and define various conditions that apply to the specific segment. On the other hand, when you use an external controller to configure limit lines, you can use the following command to define all of the segment conditions (all limit lines) in the active table trace at once.

- `:CALC{1-16}:LIM:DATA` on page 381

Alternatively, you can configure limit lines based on the data contained in a CSV file by issuing the following command:

- `:MMEM:LOAD:LIM` on page 500

Also, you can save the contents of the current limit table to a file by issuing the following command:

- `:MMEM:STOR:LIM` on page 513

Showing/hiding limit lines

To turn ON or OFF limit lines, use the following command:

- `:CALC{1-16}:LIM:DISP` on page 382

Even when limit lines are hidden, the system performs a limit test if the Limit Test feature is on.

Turning ON or OFF the Limit Test Feature

To turn ON or OFF the Limit Test feature, use the following command:

- `:CALC{1-16}:LIM` on page 380

Showing/hiding “Fail”

To turn ON or OFF the “Fail” indicator that is displayed at the center of the window when the test result for the channel is “fail,” use the following command:

- `:DISP:FSIG` on page 463

Obtaining Test Results

You can obtain test results by issuing a result retrieval command or through the status register. For detailed information on the status register, see Appendix B, “Status Reporting System.”

Test results at each measurement point

Using commands that retrieve test results

You can obtain the test results at each measurement point by retrieving the stimulus value at failed measurement points. To retrieve failed measurement points, use the following command:

Stimulus value	:CALC{1-16}:LIM:REP? on page 387
Number of measurement points	:CALC{1-16}:LIM:REP:POIN? on page 389

Using the status register

You cannot use the status register to obtain the test results at each measurement point.

Test results for each trace

Using commands that retrieve test results

You can retrieve the test result for each trace (i.e., the trace-wide result that combines the results for all measurement points in a particular trace) by issuing the following command:

- :CALC{1-16}:LIM:FAIL? on page 383

Using the status register

The condition register and event register under the questionable limit channel {1-16} status register provide 14 bits that correspond to traces 1 to 14 and contain the test results (0: Pass, 1: Fail) for the respective traces; for example, you can obtain the test result for trace 1 from bit 1 and that for trace 14 from bit 14. The condition register and event register under the questionable limit channel {1-16} extra status register provide two bits that correspond to traces 15 to 16 and contain the test results (0: Pass, 1: Fail) for the respective traces; for example, you can obtain the test result for trace 15 from bit 1 and that for trace 16 from bit 2.

Every bit of the condition register is set to 0 when a measurement cycle is started. Upon completion of measurement, those bits that correspond to failed traces are set to 1.

If the corresponding bit of the positive transition filter is set to 1 (preset value), each bit of the event register is set to 1 when the corresponding bit of the condition register changes from 0 to 1 (indicating that the corresponding trace failed the test).

Limit Test

Obtaining Test Results

To retrieve the registers, use the following commands:

Questionable limit channel {1-16} status register	
Condition register	:STAT:QUES:LIM:CHAN{1-16}:COND? on page 745
Event register	:STAT:QUES:LIM:CHAN{1-16}? on page 745
Questionable limit channel {1-16} extra status register	
Condition register	:STAT:QUES:LIM:CHAN{1-16}:ECH:COND? on page 747
Event register	:STAT:QUES:LIM:CHAN{1-16}:ECH? on page 747

Test results for each channel

Using commands that retrieve test results

No command is available that allows you to directly retrieve the test result for each channel (i.e., the channel-wide result that combines the results for all traces in a particular channel).

Using the status register

The questionable limit status event register provides 14 bits that correspond to channels 1 to 14 and contain the test results (0: Pass, 1: Fail) for the respective channels; for example, you can obtain the test result for channel 1 from bit 1 and that for channel 14 from bit 14. The questionable limit extra status event register provides nine bits that correspond to channels 1 to 2 and contain the test results (0: Pass, 1: Fail) for the respective channels; for example, you can obtain the test result for channel 14 from bit 1 and that for channel 15 from bit 2.

Every bit of the condition register is set to 0 after the event registers are cleared by the *CLS command on page 286. Upon completion of measurement, if the channel-wide test result that combines the results for all traces^{*1} in a channel is “fail,” the corresponding bit of the condition register is set to 1.

If the corresponding bit of the positive transition filter is set to 1 (preset value), every bit of the event register is set to 1 when the corresponding bit of the condition register changes from 0 to 1.

To retrieve the registers, use the following commands:

Questionable limit status register	
Condition register	:STAT:QUES:LIM:COND? on page 754
Event register	:STAT:QUES:LIM? on page 745
Questionable limit extra status register	
Condition register	:STAT:QUES:LIM:ELIM:COND? on page 755
Event register	:STAT:QUES:LIM:ELIM? on page 754

*1. This is when the registers are set as preset values. You can configure the enable registers and transition filters under the questionable limit channel {1-16} status register and the questionable limit channel {1-16} extra status register so that the condition register’s bits reflect the result that combines the results for a limited set of traces rather than for all the traces.

Figure 8-1

Obtaining test results for a channel (channel 1 in this example) using the status register

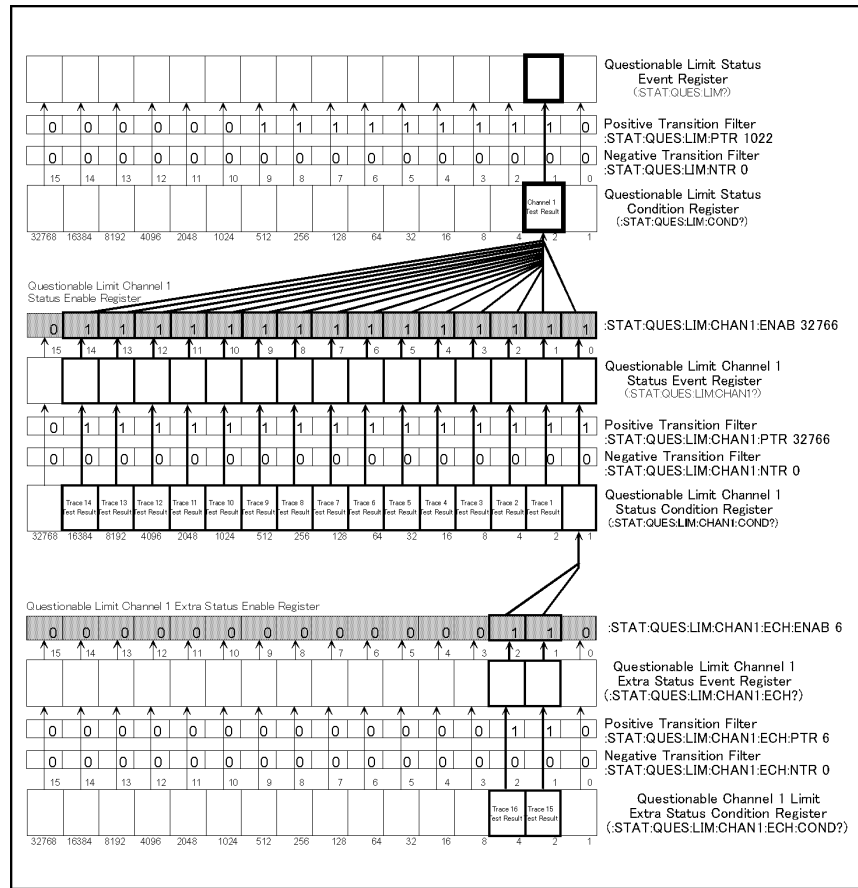

e5070bpe022

Overall test results

Using commands that retrieve test results

No command is available that allows you to directly retrieve the overall test results that combine the test results for all channels.

Using the status register

The condition register and event register under the questionable status event register each provides bit 10, from which you can obtain the overall test result (0: Pass, 1: Fail).

The condition register's bit 10 is set to 0 after the event registers are cleared by the *CLS command on page 286. Upon completion of measurement, this bit is set to 1 if the overall test result that combines the results for all channels^{*1} is "fail."

If the positive transition filter's bit 10 is set to 1 (preset value), the event register's bit 10 is set to 1 when the condition register's bit 10 changes from 0 to 1.

To retrieve the condition register and event register under the questionable status register, use the following commands:

Condition register	:STAT:QUES:COND? on page 743
Event register	:STAT:QUES? on page 726

*1. This is when the registers are set as preset values. You can configure the enable registers and transition filters under the questionable limit status register and the questionable limit extra status register so that the condition register's bit 10 reflects the result that combines the results for a limited set of channels rather than for all of the channels.

Figure 8-2

Obtaining overall test results using the status register

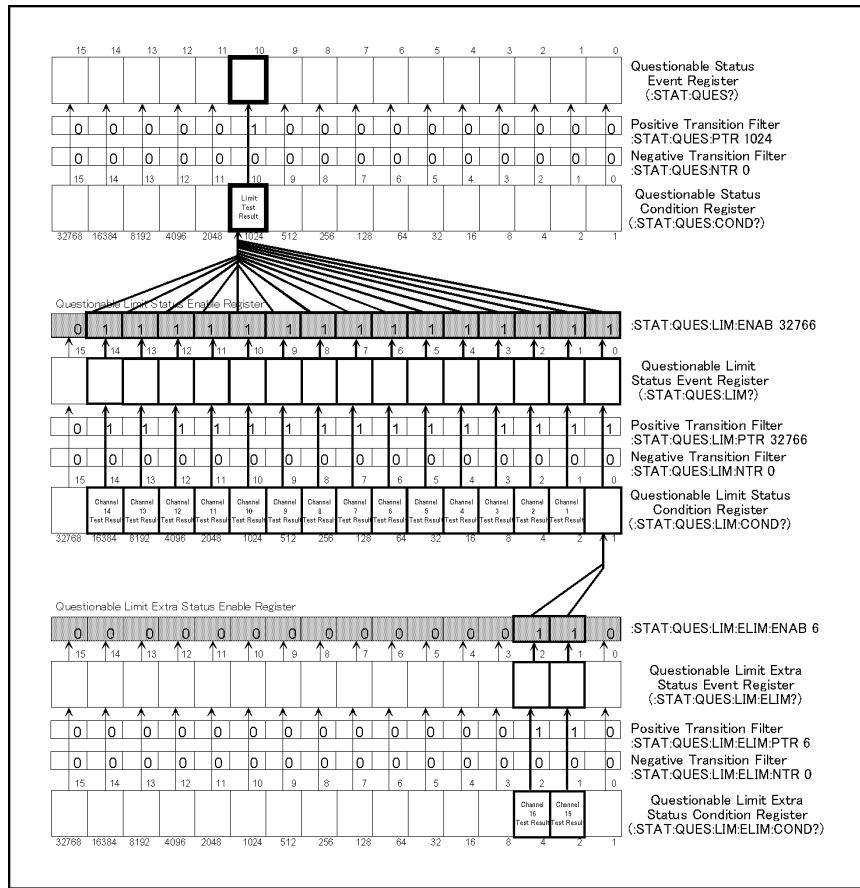

e5070bpe023

Sample Program

Example 8-1 shows a sample program that demonstrates how to perform limit tests. You can find the source file of this program, named `lim_test.htb`, on the sample program disk.

The sample program creates a limit table as shown in Table 8-1 and Table 8-2, turns on the Limit Test feature, performs one cycle of measurement, and then displays the test results.

Table 8-1

Limit table for trace 1

No.	Type	Begin Stimulus	End Stimulus	Begin Response	End Response
1	MAX	847.5 MHz	905.0 MHz	-55.0 dBm	-55.0 dBm
2	MIN	935.0 MHz	960.0 MHz	-3.5 dBm	-3.5 dBm
3	MAX	935.0 MHz	960.0 MHz	0 dBm	0 dBm
4	MAX	980.0 MHz	1047.5 MHz	-25.0 dBm	-25.0 dBm

Table 8-2

Limit table for trace 2

No.	Type	Begin Stimulus	End Stimulus	Begin Response	End Response
1	MAX	847.5 MHz	925.0 MHz	0 dBm	0 dBm
2	MIN	935.0 MHz	960.0 MHz	-9.5 dBm	-9.5 dBm
3	MAX	970.0 MHz	1047.5 MHz	0 dBm	0 dBm

The program is described in detail below:

- Line 50 Assigns a GPIB address to the I/O pass.
- Lines 70 to 120 These lines store the sweep center value, sweep span value, trace 1 measurement parameter, trace 2 measurement parameter, trace 1 data format, and trace 2 data format into the variables `Cent`, `Span`, `Param1$`, `Param2$`, `Fmt1$`, and `Fmt2$`, respectively.
- Line 150 Stores the number of segments in trace 1 limit table into the `Num_of_seg1` variable.
- Lines 160 to 390 These lines store the settings in trace 1 limit table into the `Lim1(*)` variable.
- Line 410 Stores the number of segments in trace 2 limit table into the `Num_of_seg2` variable.
- Lines 420 to 590 These lines store the settings in trace 2 limit table into the `Lim2(*)` variable.
- Lines 610 to 620 These lines configure the sweep range for channel 1's sweep range using the center and span values contained in the `Cent` and `Span` values.
- Lines 630 to 660 These lines configure channel 1 so that it contains 2 traces, displays graphs in two windows tiled horizontally (i.e., with the screen split into upper and lower halves), uses a bus trigger source, and works in continuous activation mode.

Line 700	Sets channel 1's active trace to trace 1.
Lines 720 to 730	These lines store trace 1's measurement parameter and data format into the variables Param1\$ and Fmt1\$, respectively.
Lines 750 to 810	These lines set up the limit table for trace 1. Line 750: Sends the command that sets up a limit table along with the Num_of_seg1 variable that contains the number of segments. Lines 770 to 790: Sends five data items (type, start point stimulus value, end point stimulus value, start point response value, and end point response value) for each segment.
Lines 820 to 830	These lines turn on the display of limit lines and the Limit Test feature for trace 1.
Line 870	Sets channel 1's active trace to trace 2.
Lines 890 to 900	These lines set trace 2's measurement parameter and data format to Param2\$ and Fmt2\$, respectively.
Lines 920 to 980	These lines set up the limit table for trace 2.
Lines 990 to 1000	These lines turn on the display of limit lines and the Limit Test feature for trace 2.
Lines 1040 to 1060	These lines set, under the questionable limit channel 1 status register, the enable register and positive transition filter to 6 (000000000000110 in binary notation) while setting the negative transition filter to 0 so that the questionable limit status condition register's bit 1 is set to 1 when the test result that combines the results for trace 1 and trace 2 is "fail."

NOTE

The sample program provides an example of explicitly configuring the register bits so that they reflect the test results that only cover trace 1 and trace 2. However, because the results for traces 3 to 9 will never be "fail" as long as the Limit Test feature is disabled for those traces, the register bits would reflect the test result that is limited to traces 1 and 2, even if the default setting is not changed.

Lines 1070 to 1080	These lines set transition filters so that the questionable limit status event register's bit 1 is set to 1 when the questionable limit status condition register's bit 1 changes from 0 to 1.
Line 1090	Clears the questionable limit status event register and questionable limit channel 1 status event register.
Lines 1110 to 1130	These lines trigger the instrument and wait until the sweep cycle is completed.
Lines 1170 to 1190	These lines retrieve the value of the questionable limit status event register and store the setting of bit 1 of the value into Ch1_judge.
Lines 1200 to 1230	These lines retrieve the value of the questionable limit channel 1 status event register and store the settings of bit 1 and bit 2 of the value into Tr1_judge and Tr2_judge, respectively.
Line 1280	Displays a message indicating that the DUT has passed the limit test if the test result for channel 1 is "Pass" (i.e., if Ch1_judge returns 0).
Lines 1300 to 1660	These lines are executed if the test result for channel 1 is "Fail" (i.e., if

Limit Test Sample Program

Ch1_judge returns 1).

Line 1300: Notifies the user that the limit test result is “Fail”.

Line 1320: Displays a message indicating that trace 1 has passed the limit test if the test result for trace 1 is “Pass” (i.e., if Tr1_judge returns 0).

Lines 1340 to 1470: These lines are executed if the test result for trace 1 is “Fail” (i.e., if Tr1_judge returns 1). The lines notify the user that the test result for trace 1 is “Fail” and then retrieve and display the frequencies at the failed measurement points on trace 1.

Line 1340: Notifies the user that the limit test result for trace 1 is “Pass.”

Line 1380: Sets channel 1’s active trace to trace 2.

Lines 1390 to 1410: These lines retrieve the number of failed measurement points on trace 1 and, based on that number, resize the array that contains retrieved frequencies.

Lines 1420 to 1470: These lines retrieve and display the frequencies at the failed measurement points on trace 1.

Line 1500: Displays a message indicating that trace 2 has passed the limit test if the test result for trace 2 is “Pass” (i.e., if Tr2_judge returns 0).

Lines 1520 to 1650: If the test result for trace 2 is “Fail” (i.e., if Tr2_judge returns 1), these lines notify the user that trace 2 has failed to pass the limit test and then retrieve and display the frequencies at the failed measurement points on trace 2.

Example 8-1

Limit Test (lim_test.htb)

```

10 DIM Param1$(9),Param2$(9),Fmt1$(9),Fmt2$(9),Buff$(9)
20 REAL Cent,Span,Lim1(1:4,1:5),Lim2(1:3,1:5),Fail_data(1:1601)
30 INTEGER Num_of_seg1,Num_of_seg2,Segment,Column,Fail_point
40 !
50 ASSIGN @Agte507x TO 717
60 !
70 Cent=9.475E+8
80 Span=2.00E+8
90 Param1$="S21"
100 Param2$="S11"
110 Fmt1$="MLOG"
120 Fmt2$="MLOG"
130 !
140 ! == Trace 1 Limit Line ==
150 Num_of_seg1=4 ! Number of segments: 4
160 ! -- Segment 1 --
170 Lim1(1,1)=1 ! Type : Maximum
180 Lim1(1,2)=8.475E+8 ! Frequency Start: 847.5 MHz
190 Lim1(1,3)=9.050E+8 ! Stop : 905.0 MHz
200 Lim1(1,4)=-55 ! Response Start: -55 dBm
210 Lim1(1,5)=-55 ! Stop : -55 dBm
220 ! -- Segment 2 --
230 Lim1(2,1)=2 ! Type : Minimum
240 Lim1(2,2)=9.350E+8 ! Frequency Start: 935.0 MHz
250 Lim1(2,3)=9.600E+8 ! Stop : 960.0 MHz
260 Lim1(2,4)=-3.5 ! Response Start: -3.5 dBm
270 Lim1(2,5)=-3.5 ! Stop : -3.5 dBm
280 ! -- Segment 3 --
290 Lim1(3,1)=1 ! Type : Maximum
300 Lim1(3,2)=9.350E+8 ! Frequency Start: 935.0 MHz
310 Lim1(3,3)=9.600E+8 ! Stop : 960.0 MHz
320 Lim1(3,4)=0 ! Response Start: 0 dBm
330 Lim1(3,5)=0 ! Stop : 0 dBm
340 ! -- Segment 4 --
350 Lim1(4,1)=1 ! Type : Maximum
360 Lim1(4,2)=9.800E+8 ! Frequency Start: 980.0 MHz
370 Lim1(4,3)=1.0475E+9 ! Stop : 1047.5 MHz
380 Lim1(4,4)=-25 ! Response Start: -25 dBm
390 Lim1(4,5)=-25 ! Stop : -25 dBm
400 ! == Trace 2 Limit Line ==
410 Num_of_seg2=3 ! Number of segments: 3
420 ! -- Segment 1 --
430 Lim2(1,1)=1 ! Type : Maximum
440 Lim2(1,2)=8.475E+8 ! Frequency Start: 847.5 MHz
450 Lim2(1,3)=9.250E+8 ! Stop : 925.0 MHz
460 Lim2(1,4)=0 ! Response Start: 0 dBm
470 Lim2(1,5)=0 ! Stop : 0 dBm
480 ! -- Segment 2 --
490 Lim2(2,1)=1 ! Type : Maximum
500 Lim2(2,2)=9.350E+8 ! Frequency Start: 935.0 MHz
510 Lim2(2,3)=9.600E+8 ! Stop : 960.0 MHz
520 Lim2(2,4)=-9.5 ! Response Start: -9.5 dBm
530 Lim2(2,5)=-9.5 ! Stop : -9.5 dBm
540 ! -- Segment 3 --
550 Lim2(3,1)=1 ! Type : Maximum

```

Limit Test Sample Program

```
560 Lim2(3,2)=9.700E+8      ! Frequency Start: 970.0 MHz
570 Lim2(3,3)=1.0475E+9    !                      Stop : 1047.5 MHz
580 Lim2(3,4)=0            ! Response Start: 0 dBm
590 Lim2(3,5)=0           !                      Stop : 0 dBm
600 !
610 OUTPUT @Agte507x;":SENS1:FREQ:CENT ";Cent
620 OUTPUT @Agte507x;":SENS1:FREQ:SPAN ";Span
630 OUTPUT @Agte507x;":CALC1:PAR1:COUN 2"
640 OUTPUT @Agte507x;":DISP:WIND1:SPL D1_2"
650 OUTPUT @Agte507x;":TRIG:SOUR BUS"
660 OUTPUT @Agte507x;":INIT1:CONT ON"
670 !
680 ! Trace 1
690 !
700 OUTPUT @Agte507x;":CALC1:PAR1:SEL"
710 !
720 OUTPUT @Agte507x;":CALC1:PAR1:DEF "&Param1$
730 OUTPUT @Agte507x;":CALC1:FORM "&Fmt1$
740 !
750 OUTPUT @Agte507x;":CALC1:LIM:DATA ";Num_of_seg1;
760 FOR Segment=1 TO Num_of_seg1
770   FOR Column=1 TO 5
780     OUTPUT @Agte507x;",";Lim1(Segment,Column);
790   NEXT Column
800 NEXT Segment
810 OUTPUT @Agte507x;" "
820 OUTPUT @Agte507x;":CALC1:LIM:DISP ON"
830 OUTPUT @Agte507x;":CALC1:LIM ON"
840 !
850 ! Trace 2
860 !
870 OUTPUT @Agte507x;":CALC1:PAR2:SEL"
880 !
890 OUTPUT @Agte507x;":CALC1:PAR2:DEF "&Param2$
900 OUTPUT @Agte507x;":CALC1:FORM "&Fmt2$
910 !
920 OUTPUT @Agte507x;":CALC1:LIM:DATA ";Num_of_seg2;
930 FOR Segment=1 TO Num_of_seg2
940   FOR Column=1 TO 5
950     OUTPUT @Agte507x;",";Lim2(Segment,Column);
960   NEXT Column
970 NEXT Segment
980 OUTPUT @Agte507x;" "
990 OUTPUT @Agte507x;":CALC1:LIM:DISP ON"
1000 OUTPUT @Agte507x;":CALC1:LIM ON"
1010 !
1020 ! Setting status registers
1030 !
1040 OUTPUT @Agte507x;":STAT:QUES:LIM:CHAN1:ENAB 6"
1050 OUTPUT @Agte507x;":STAT:QUES:LIM:CHAN1:PTR 6"
1060 OUTPUT @Agte507x;":STAT:QUES:LIM:CHAN1:NTR 0"
1070 OUTPUT @Agte507x;":STAT:QUES:LIM:PTR 2"
1080 OUTPUT @Agte507x;":STAT:QUES:LIM:NTR 0"
1090 OUTPUT @Agte507x;"*CLS"
1100 !
1110 OUTPUT @Agte507x;":TRIG:SING"
1120 OUTPUT @Agte507x;"*OPC?"
1130 ENTER @Agte507x;Buff$
```

```

1140 !
1150 ! Checking test results
1160 !
1170 OUTPUT @Agte507x;":STAT:QUES:LIM?"
1180 ENTER @Agte507x;Reg_val
1190 Ch1_judge=BIT(Reg_val,1)
1200 OUTPUT @Agte507x;":STAT:QUES:LIM:CHAN1?"
1210 ENTER @Agte507x;Reg_val
1220 Tr1_judge=BIT(Reg_val,1)
1230 Tr2_judge=BIT(Reg_val,2)
1240 !
1250 ! Displaying test results
1260 !
1270 IF Ch1_judge=0 THEN
1280     PRINT "## PASS! ##"
1290 ELSE
1300     PRINT "## FAIL! ##"
1310     IF Tr1_judge=0 THEN
1320         PRINT " Trace1(S21): PASS"
1330     ELSE
1340         PRINT " Trace1(S21): FAIL"
1350         !
1360         ! Reading and displaying frequency at failed points
1370         !
1380         OUTPUT @Agte507x;":CALC1:PAR1:SEL"
1390         OUTPUT @Agte507x;":CALC1:LIM:REP:POIN?"
1400         ENTER @Agte507x;Fail_point
1410         REDIM Fail_data(1:Fail_point)
1420         OUTPUT @Agte507x;":CALC1:LIM:REP?"
1430         ENTER @Agte507x;Fail_data(*)
1440         PRINT "   Frequency:"
1450         FOR I=1 TO Fail_point
1460             PRINT USING "3X,MD.4DE";Fail_data(I)
1470         NEXT I
1480     END IF
1490     IF Tr2_judge=0 THEN
1500         PRINT " Trace2(S11): PASS"
1510     ELSE
1520         PRINT " Trace2(S11): FAIL"
1530         !
1540         ! Reading and displaying frequency at failed points
1550         !
1560         OUTPUT @Agte507x;":CALC1:PAR2:SEL"
1570         OUTPUT @Agte507x;":CALC1:LIM:REP:POIN?"
1580         ENTER @Agte507x;Fail_point
1590         REDIM Fail_data(1:Fail_point)
1600         OUTPUT @Agte507x;":CALC1:LIM:REP?"
1610         ENTER @Agte507x;Fail_data(*)
1620         PRINT "   Frequency:"
1630         FOR I=1 TO Fail_point
1640             PRINT USING "3X,MD.4DE";Fail_data(I)
1650         NEXT I
1660     END IF
1670 END IF
1680 END

```

Limit Test
Sample Program

9 Saving and Recalling (File Management)

This chapter describes how to save and recall instrument status and measurement results onto/from the files. Here also covered is managing files.

Saving and Recalling File

Specifying file

When running a command for saving, recalling, and managing files, use a filename with extension to specify a particular file. Specify “A:” in the beginning of the file name, when specifying a file on the flexible disk. Also, when specifying a file name with directory, use “/” (slash) or “\” (backslash) as a delimiter.

Saving and recalling instrument status

You can save the instrument state using one of the following 2 methods:

- Saving the entire instrument state into a file
- Saving the state for each channel into registers A to D (volatile memory)

Selecting content to be saved

When saving the instrument status into a file or register, the content to be saved can be selected among the following 4 options:

- Instrument status only (see *Users Guide* for setting items to be saved)
- Instrument status and calibration coefficient array.
- Instrument status, corrected data/memory array (measurement data)
- Instrument status, calibration coefficient array, and corrected data/memory array (measurement data)

To select a content to be saved, use the following command:

- on page 525

Selecting Content to be Saved

To select whether to save the setting of all channels/traces or that of the displayed channels/traces, use the following command:

- :MMEM:STOR:SALL on page 517

Saving and recalling entire instrument status

To save the entire instrument status into a file, use the following command:

- :MMEM:STOR on page 506

Recalling a file saved with the above command can reproduce the status when it was saved. To recall the settings from a file, use the following command:

- :MMEM:LOAD on page 495

Auto recall

The file saved with the name autorec.sta or A:autorec.sta will be automatically recalled the E5070B/E5071B is powered ON.

Saving the state for each channel into a register

For the active channel, when you want to save the instrument state specific to that channel into only one of the registers A to D, use the following command:

- `:MMEM:STOR:CHAN` on page 509

Recalling an instrument state saved in a register can reproduce it as the state of the active channel. To recall a register, use the following command:

- `:MMEM:LOAD:CHAN` on page 498

NOTE

It is possible to recall a file from a different channel where it was saved.

The contents in the registers are lost when you turn OFF the power. You can delete (clear) the contents of all registers using the following command.

- `:MMEM:STOR:CHAN:CLE` on page 509

Saving measurement data

Measurement data (in a formatted data array) can be saved to a file in CSV (Comma Separated Value) format.

To save measurement data in a file, use the following command:

- `:MMEM:STOR:FDAT` on page 511

Executing the above command will save the measurement data of the active trace. Note that the data saved using the above command cannot be recalled from the E5070B/E5071B.

Saving measurement data in touchstone format

Measurement data for the active channel can be saved to a file in touchstone format.

To determine a file type in touchstone file format and specify a port, use one of the following commands according to the number of ports used:

- `:MMEM:STOR:SNP:TYPE:S1P` on page 521
- `:MMEM:STOR:SNP:TYPE:S2P` on page 522
- `:MMEM:STOR:SNP:TYPE:S3P` on page 523
- `:MMEM:STOR:SNP:TYPE:S4P` on page 524

To set a data type for files saved in touchstone format, use the following command:

- `:MMEM:STOR:SNP:FORM` on page 520

To save measurement data in touchstone format, use the following command:

- `:MMEM:STOR:SNP` on page 519

NOTE

Only trace data of frequency sweep can be saved in touchstone format files. Trace data of frequency offset measurement and power sweep measurement cannot be saved.

Saving the images on the LCD screen

Images displayed on the LCD screen can be saved to a file in the bitmap (.bmp) or portable network graphics (.png) format.

To save the screen image to a file, use the following command:

- :MMEM:STOR:IMAG on page 512

Executing the above command will save the screen image when the command is invoked.

NOTE

Note that this gives different screen image results from those obtained by pressing the **[Capture]** key on the front panel.

Saving and recalling the segment sweep table

Segment sweep table can be saved in the file with CSV (Comma Separated Value) format.

To save segment sweep table on a file, use the following command:

- :MMEM:STOR:SEGM on page 518

Executing the above command will save the segment sweep table for the active channel.

Recalling the file saved using the above command can reproduce the segment sweep table on the active channel.

To recall the settings from a file, use the following command:

- :MMEM:LOAD:SEGM on page 504

NOTE

It is possible to recall a file from a different channel where it was saved. Note that recalling operation is not guaranteed for the file that might have been modified with editor.

Saving and recalling the limit table

Limit table can be saved in the file with CSV (Comma Separated Value) format. To save limit table on a file, use the following command:

- :MMEM:STOR:LIM on page 513

Executing the above command will save the limit table for the active trace of the active channel.

Recalling the file saved using the above command can reproduce the limit table on the active trace of the active channel. To recall the settings from a file, use the following command:

- :MMEM:LOAD:LIM on page 500

NOTE

It is possible to recall a file from a different channel or trace where it was saved. Note that recalling operation is not guaranteed for the file that might have been modified with editor.

Saving/recalling Power Sensor Calibration Factor Table

The power sensor calibration table can be saved in the file with CSV (Comma Separated Value) format. To save the power sensor calibration factor table that is set specifically to the E5070B/E5071B into a file, use the following commands:

- :MMEM:STOR:ASCF on page 507
- :MMEM:STOR:BSCF on page 508

Recalling a file saved with the above command can reproduce the power sensor calibration factor table when it was saved. To recall the settings from a file, use the following command:

- :MMEM:LOAD:ASCF on page 496
- :MMEM:LOAD:BSCF on page 497

NOTE

Recalling operation is not guaranteed for the file that might have been modified with editor.

Saving/recalling Loss Compensation Table

The loss compensation table can be saved in the file with CSV (Comma Separated Value) format. To save the loss compensation table that is set for each port into a file, use the following command:

- :MMEM:STOR:PLOS{1-4} on page 514

Executing the above command will save the loss compensation table for the active channel.

Recalling the file saved using the above command can reproduce the loss compensation table on the active channel. To recall the settings from a file, use the following command:

- :MMEM:LOAD:PLOS{1-4} on page 501

NOTE

It is possible to recall a file from a different channel or port where it was saved. Note that recalling operation is not guaranteed for the file that might have been modified with editor.

Saving/loading (importing) the VBA program

Saving

Only the VBA project file can be saved using command.

To save the VBA project that is opened on the VBA editor on the file, use the following command.

- :MMEM:STOR:PROG on page 515

Loading (importing)

To load the VBA project to the VBA editor, or to import the module/form file, use the following command.

- :MMEM:LOAD:PROG on page 502

Executing above command will load/import the file according to its extension as follows:

Extension	File type
vba	VBA Project
bas	Standard module
frm	User Forms
cls	Class Modules

Sample program

Example 9-1 shows a sample program that demonstrates how to save a file. You can find the source file of this program, named `file_sav.bas`, on the sample program disk.

This program saves selected content on a file with a specified name.

The program is described in detail below:

Line 40	Assigns a GPIB address to the I/O pass.
Line 60	Allows the user to return to the entry start line and re-enter the data if an error (such as an invalid entry) occurs while entering the number that identifies the content to be saved.
Lines 80 to 180	These lines display the list of options for content to be saved, and prompt the user to choose one of the items by typing in the appropriate number.
Line 190	Converts the entered value into an integer and stores it into the Content variable.
Line 200	Returns to the entry start line if an invalid value is contained in Content.
Line 230	Passes control to a subprogram named <code>Inp_file_name</code> , which lets the user input a file name for saving, and then stores the returned file name into the <code>File\$</code> variable.
Lines 270 to 280	If Content is equal to 1, these lines set the content to be saved as the instrument status to “instrument status only”, and store the state with the file name which is combined the <code>File\$</code> variable with the extension “.sta”.
Lines 300 to 310	If Content is equal to 2, these lines set the content to be saved as the instrument status to “instrument status and calibration coefficient”, and store the state with the file name which is combined the <code>File\$</code> variable with the extension “.sta”.
Lines 330 to 340	If Content is equal to 3, these lines set the content to be saved as the instrument status to “instrument status and measurement data”, and store the state with the file name which is combined the <code>File\$</code> variable with the extension “.sta”.
Lines 360 to 370	If Content is equal to 4, these lines set the content to be saved as the instrument status to “instrument status, calibration coefficient, and measurement data”, and store the state with the file name which is combined the <code>File\$</code> variable with the extension “.sta”.
Line 390	If Content is equal to 5, and store the state with the file name which is combined the <code>File\$</code> variable with the extension “.csv”.
Line 410	If Content is equal to 6, and store the image data of the LCD screen with the file name which is combined the <code>File\$</code> variable with the extension “.bmp”.

Saving and Recalling (File Management)

Saving and Recalling File

The `Inp_file_name` subprogram in lines 480 to 590, which is used to enter a save filename, is described below.

- Line 500 Allows the user to return to the entry start line and re-enter the data if an error (such as an invalid entry) occurs while entering the target file name.
- Lines 520 to 540 These lines prompt the user to enter the target file name. The program does not continue till the user actually enters the file name.
- Lines 550 to 560 These lines display the entered file name and waits for a confirmation entry (y/n key).
- Line 570 Returns to the entry start line if the key the user pressed in line 560 is not the y key.

Example 9-1

Saving file (`file_sav.htb`)

```
10   DIM File$(300),Inp_char$(30)
20   INTEGER Content
30   CLEAR SCREEN
40   ASSIGN @Agte507x TO 717
50   !
60   ON ERROR GOTO Content_select
70 Content_select: !
80   PRINT "## Save Content Selection ##"
90   PRINT "Select Content"
100  PRINT " 1: State (State only) "
110  PRINT " 2: State (State & Cal) "
120  PRINT " 3: State (State & Trace) "
130  PRINT " 4: State (State & Cal & Trace) "
140  PRINT " 5: Trace Data (CSV) "
150  PRINT " 6: Screen"
160  PRINT ""
170  PRINT "Input 1 to 6"
180  INPUT "Number?",Inp_char$
190  Content=IVAL(Inp_char$,10)
200  IF Content<1 OR Content>6 THEN Content_select
210  OFF ERROR
220  !
230  CALL Inp_file_name(File$)
240  !
250  SELECT Content
260  CASE 1
270      OUTPUT @Agte507x;":MMEM:STOR:STYP STAT"
280      OUTPUT @Agte507x;":MMEM:STOR ""&File$&".sta""
290  CASE 2
300      OUTPUT @Agte507x;":MMEM:STOR:STYP CST"
310      OUTPUT @Agte507x;":MMEM:STOR ""&File$&".sta""
320  CASE 3
330      OUTPUT @Agte507x;":MMEM:STOR:STYP DST"
340      OUTPUT @Agte507x;":MMEM:STOR ""&File$&".sta""
350  CASE 4
360      OUTPUT @Agte507x;":MMEM:STOR:STYP CDST"
370      OUTPUT @Agte507x;":MMEM:STOR ""&File$&".sta""
380  CASE 5
390      OUTPUT @Agte507x;":MMEM:STOR:FDAT ""&File$&".csv""
400  CASE 6
```



```
410     OUTPUT @Agte507x;":MMEM:STOR:IMAG ""&File$&".bmp""
420 END SELECT
430 !
440 END
450 !=====
460 ! File Name Input Function
470 !=====
480 SUB Inp_file_name(Inp_name$)
490   DIM Inp_char$(9)
500   ON ERROR GOTO Inp_start
510 Inp_start: !
520   PRINT "## File Name Input ##"
530   PRINT "Input Save File Name (without Extension)"
540   INPUT "Name?",Inp_name$
550   PRINT "Input Name: "&Inp_name$
560   INPUT "OK? [Y/N] ",Inp_char$
570   IF UPC$(Inp_char$)<>"Y" THEN Inp_start
580   OFF ERROR
590 SUBEND
```

Managing Files

Creating directory (folder)

To create a directory (folder), use the following command:

- :MMEM:MDIR on page 505

Deleting file (directory)

To delete a file or a directory, use the following command:

- :MMEM:DEL on page 494

Copying file

To copy a file, use the following command:

- :MMEM:COPY on page 493

Transferring files

File transfer from the external controller to the E5070B/E5071B can be possible by reading data from a file on the controller and then writing them to the file on the E5070B/E5071B.

- :MMEM:TRAN on page 526

Also, file transfer from the E5070B/E5071B to the external controller can be possible by reading data from a file on the E5070B/E5071B using the commands as query and then writing them to the file on the controller.

Retrieving data from storage

To retrieve information for the storage that is built in the E5070B/E5071B (usage, property of file located in a specified directory), use the following command;

- :MMEM:CAT? on page 492

Sample program

Example 9-1 shows a sample program for transferring files between the external controller and the E5070B/E5071B. You can find the source file of this program, named file_xfr.bas, on the sample program disk.

This program reads out data from a specified file on the external controller (or the E5070B/E5071B), then write them to a specified file on the E5070B/E5071B(or the external controller).

The program is described in detail below:

- | | |
|------------------|---|
| Line 40 | Assigns a GPIB address to the I/O pass. |
| Lines 60 to 130 | These line allow the user to return to the entry start line and re-enter the data if an error (such as an invalid entry) occurs while entering the number that indicates the transfer direction. Then, these line display the list of transfer directions and prompt the user to input a selected number. |
| Lines 80 to 130 | These lines display the list of transfer directions, and prompt the user to choose one of the items by typing in the appropriate number. |
| Lines 140 to 150 | Converts the entered value into an integer and stores it into the Direction variable. Returns to the entry start line if an invalid value is contained in Direction. |
| Lines 180 to 210 | These lines obtain the name of the source file for copying from the user input, store it into the Src_file\$ variable, and display the value of Src_file\$. |
| Lines 180 to 210 | These lines obtain the name of the source file for copying from the user input, store it into the Src_file\$ variable, and display the value of Src_file\$. |
| Lines 230 to 270 | If Direction is equal to 2 (from the external controller to the E5070B/E5071B), these lines obtain the size of the source file for copying, store it into the Src_size_char\$, and display the value of Src_size_char\$. |
| Lines 290 to 320 | These lines obtain the name of the destination file for copying from the user input, store it into the Dst_file\$ variable, and display the value of Dst_file\$. |
| Line 350 | If Direction is equal to 1 (from the E5070B/E5071B to the external controller), these lines use the subprogram Copy_to_contr to transfer (copy) a file with the name Src_file\$ on the E5070B/E5071B to a file with the name Dst_file\$ on the external controller. |
| Line 370 | If Direction is equal to 2, these lines use the subprogram Copy_to_e507x to transfer (copy) a file with the name Src_file\$ on the external controller to a file with the name Dst_file\$ on the E5070B/E5071B. |
- Copy_to_contr, a subprogram for transferring files from the E5070B/E5071B to the external controller that appears in lines 440 to 1000, is described below.
- | | |
|------------------|--|
| Lines 490 to 520 | If any file with the name File\$ already exists, these lines delete the file and newly create a file with the name File\$. |
| Line 530 | Assigns a destination file for copying to the I/O pass. |

Saving and Recalling (File Management)

Managing Files

- Line 540 This line stores a maximum number of transferred data (in bytes) per one transfer, that is 24 KByte to meet the size limitation of string arrays in the HTBasic, into Max_bsize variable.
- Lines 560 to 600 These lines configure the system to generate an SRQ when it cannot find a source file for copying due to an error.
- Lines 620 to 630 These lines set the branch target for an SRQ interrupt to enable SRQ interrupts.
- Lines 640 to 650 These lines display a message showing that the transfer has started, and execute commands for reading data from a file on the E5070B/E5071B.
- Lines 670 to 680 These lines read the header symbol (#) in a block data, read number of digits (characters) indicating the size of data in bytes, then store it into Digit\$ variable.
- Line 690 This line creates a format for reading characters in Digit\$.
- Line 700 This line reads the data size in byte and stores it into Src_size_char\$ variable.
- Line 720 This line converts Src_size_char\$ to a real number and stores it into Src_size variable.
- Lines 730 to 870 These lines repeat the procedures below until Src_size reaches 0.
- Lines 740 to 780: If Src_size is greater than Max_bsize, these lines assign the value of the Max_bsize to Block_size variable (transferred data in bytes). If Src_size is equal or less than Max_bsize, assign the value of Src_size to Block_size.
- Line 800 This line defines Dat\$ string variable with the size as large as Block_size and reserves memory area.
- Line 810 This line creates a format for reading characters as many as Block_size characters.
- Line 820 This line reads data from the file on the E5070B/E5071B, then stores them into Dat\$.
- Line 830 This line writes the contents of Dat\$ to the file on the external controller.
- Lines 840 to 860 These lines free the memory area for Dat\$ and subtract Block_size from Src_size.
- Lines 890 to 900 These lines display a message showing the completion of transfer, then read a message terminator at the end of the data.
- Lines 940 to 980 These lines define an error handler that retrieves and displays the number and message of an error that has occurred.
- Copy_to_e507x, a subprogram for transferring files from the external controller to the E5070B/E5071B that appears in lines 1040 to 1540, is described below.
- Lines 1090 to 1110 Assigns a destination file for copying to the I/O pass.
- Line 1120 This line stores a maximum number of transferred data (in bytes) per one transfer, that is 24 KByte, into Max_bsize variable.
- Lines 1140 to 1160 Clears the error queue.

- Line 1180 Displays a measurement start message.
- Lines 1190 to 1200 These lines create the header part indicating that data will be sent as many as Src_size_char\$ bytes, then send the header part of the command and its parameters for writing the data to the file on the E5070B/E5071B.
- Line 1220 This line converts Src_size_char\$ to a real number and stores it into Src_size variable.
- Lines 1230 to 1370 These lines repeat the procedures below until Src_size reaches 0.
- Lines 1240 to 1280: If Src_size is greater than Max_bsize, these lines assign the value of the Max_bsize to Block_size variable (transferred data in bytes). If Src_size is equal or less than Max_bsize, assign the value of Src_size to Block_size.
- Line 1300 This line defines Dat\$ string variable with the size as large as Block_size and reserves memory area.
- Line 1310 This line creates a format for reading characters as many as Block_size characters.
- Line 1320 This line reads data from the file on the external controller, then stores them into Dat\$.
- Line 1330 This line writes the contents of Dat\$ to the file on the E5070B/E5071B.
- Lines 1340 to 1360 These lines free the memory area for Dat\$ and subtract Block_size from Src_size.
- Line 1390 This line sends a message terminator at the end of data.
- Lines 1420 to 1430 These lines retrieve the error number and error message from the error queue, and then store them into the variables Err_no and Err_msg\$, respectively.
- Lines 1440 to 1490 If Err_no is equal to 0 (no error occurred), these lines display the message indicating completion of transfer, and if Err_no is not equal to 0 (an error occurred), display Err_no along with Err_msg\$.
- Lines 1510 to 1520 These lines handle the case with no source file for copying is found.

Saving and Recalling (File Management)

Managing Files

Example 9-2

File transfer (file_xfr.htb)

```
10   DIM Src_file$(50),Dst_file$(50),Src_size_char$(50),Inp_char$(30)
20   INTEGER Direction
30   ASSIGN @Agte507x TO 717
40   !
50   CLEAR SCREEN
60   ON ERROR GOTO Direct_select
70 Direct_select: !
80   PRINT "#### File Transfer ####"
90   PRINT " 1: E507x -> Controller"
100  PRINT " 2: Controller -> E507x"
110  PRINT ""
120  PRINT "Input 1 or 2"
130  INPUT "Number?",Inp_char$
140  Direction=IVAL(Inp_char$,10)
150  IF Direction<1 OR Direction>2 THEN Direct_select
160  OFF ERROR
170  !
180  PRINT ""
190  PRINT " Input source file name.          ";
200  INPUT "Name?",Src_file$
210  PRINT ": "&Src_file$
220  !
230  IF Direction=2 THEN
240    PRINT " Input source file size.          ";
250    INPUT "Size[Byte]?",Src_size_char$
260    PRINT ": "&Src_size_char&"[Byte]"
270  END IF
280  !
290  PRINT " Input destination file name.    ";
300  INPUT "Name?",Dst_file$
310  PRINT ": "&Dst_file$
320  PRINT ""
330  !
340  IF Direction=1 THEN
350    Copy_to_contr(@Agte507x,Src_file$,Dst_file$)
360  ELSE
370    Copy_to_e507x(@Agte507x,Src_file$,Src_size_char$,Dst_file$)
380  END IF
390  !
400  END
410  !=====
420  ! File Transfer Function (E507x -> Controller)
430  !=====
440  SUB Copy_to_contr(@Agte507x,Src_file$,Dst_file$)
450  DIM Img$(32),Src_size_char$(10),Buff$(9),Err_msg$(100)
460  INTEGER Max_bsize,Block_size,Err_no
470  REAL Src_size
480  !
490  ON ERROR GOTO Skip_purge
500  PURGE Dst_file$
510 Skip_purge: OFF ERROR
520  CREATE Dst_file$,1
530  ASSIGN @Dst_file TO Dst_file$
540  Max_bsize=24576 ! 24KByte
550  !
560  OUTPUT @Agte507x;"*ESE 60"
570  OUTPUT @Agte507x;"*SRE 32"
580  OUTPUT @Agte507x;"*CLS"
590  OUTPUT @Agte507x;"*OPC?"
600  ENTER @Agte507x;Buff$
610  !
```

```

620   ON INTR 7 GOTO Err
630   ENABLE INTR 7;2
640   PRINT "Now Copying: "&Src_file$&"(@E507x) -> "&Dst_file$&"(@Contro
      ller)"
650   OUTPUT @Agte507x;":MMEM:TRAN? ""&Src_file$&""
660   WAIT .1
670   ENTER @Agte507x USING "#,A";Buff$
680   ENTER @Agte507x USING "#,A";Digit$
690   Img$="#,&Digit$&"A"
700   ENTER @Agte507x USING Img$;Src_size_char$
710   !
720   Src_size=VAL(Src_size_char$)
730   WHILE Src_size>0
740     IF Src_size>Max_bsize THEN
750       Block_size=Max_bsize
760     ELSE
770       Block_size=Src_size
780     END IF
790     !
800     ALLOCATE Dat$[Block_size]
810     Img$="#,&VAL$(Block_size)&"A"
820     ENTER @Agte507x USING Img$;Dat$
830     OUTPUT @Dst_file USING Img$;Dat$
840     DEALLOCATE Dat$
850     !
860     Src_size=Src_size-Block_size
870   END WHILE
880   !
890   PRINT "Done"
900   ENTER @Agte507x USING "#,A";Buff$
910   ASSIGN @Dst_file TO *
920   !
930   GOTO Skip_error
940 Err: OFF INTR 7
950   OUTPUT @Agte507x;";:SYST:ERR?"
960   ENTER @Agte507x;Err_no,Err_msg$
970   PRINT "Error occurred!!"
980   PRINT " No.:";Err_no,"Description: "&Err_msg$
990 Skip_error: OFF INTR 7
1000 SUBEND
1010 !=====
1020 ! File Transfer Function (Controller -> E507x)
1030 !=====
1040 SUB Copy_to_e507x(@Agte507x,Src_file$,Src_size_char$,Dst_file$)
1050 DIM Img$[32],Header$[10],Buff$[9],Err_msg$[100]
1060 INTEGER Max_bsize,Block_size,Err_no
1070 REAL Src_size
1080 !
1090 ON ERROR GOTO File_error
1100 ASSIGN @Src_file TO Src_file$
1110 OFF ERROR
1120 Max_bsize=24576 ! 24KByte
1130 !
1140 OUTPUT @Agte507x;"*CLS"
1150 OUTPUT @Agte507x;"*OPC?"
1160 ENTER @Agte507x;Buff$
1170 !
1180 PRINT "Now Copying: "&Src_file$&"(@Controller) -> "&Dst_file$&"(@
      E507x)"
1190 Header$="#&VAL$(LEN(Src_size_char$))&Src_size_char$
1200 OUTPUT @Agte507x;":MMEM:TRAN ""&Dst_file$&""",&Header$;
1210 !
1220 Src_size=VAL(Src_size_char$)
1230 WHILE Src_size>0

```

Saving and Recalling (File Management)

Managing Files

```
1240     IF Src_size>Max_bsize THEN
1250         Block_size=Max_bsize
1260     ELSE
1270         Block_size=Src_size
1280     END IF
1290     !
1300     ALLOCATE Dat$(Block_size)
1310     Img$="#,&VAL$(Block_size)&"A"
1320     ENTER @Src_file USING Img$;Dat$
1330     OUTPUT @Agte507x USING Img$;Dat$
1340     DEALLOCATE Dat$
1350     !
1360     Src_size=Src_size-Block_size
1370 END WHILE
1380 !
1390 OUTPUT @Agte507x;"",END
1400 ASSIGN @Src_file TO *
1410 !
1420 OUTPUT @Agte507x;"":SYST:ERR?"
1430 ENTER @Agte507x;Err_no,Err_msg$
1440 IF Err_no=0 THEN
1450     PRINT "Done"
1460 ELSE
1470     PRINT "Error occurred!!"
1480     PRINT "  No:";Err_no,"Description: "&Err_msg$
1490 END IF
1500 GOTO Skip_error
1510 File_error:OFF ERROR
1520 PRINT "File name NOT found!"
1530 Skip_error:~
1540 SUBEND
```

10

Communication with External Instruments Using Handler I/O Port

This chapter provides necessary information for communicating with external instruments (for example, a handler in a production line) using the handler I/O port equipped with the Agilent E5070B/E5071B.

Handler I/O Port Overview

The E5070B/E5071B handler I/O port provides four independent parallel ports for data I/O associated with several control signal lines and the power line. All signals operate in TTL logic.

The data I/O ports are configured with 2 pairs of 8 bit output port and 2 pairs of 4 bit bi-directional port. Also those ports can cooperate to provide a maximum 16-bit-width output port or a maximum 8-bit-width input port.

The I/O signals operate on the negative logic basis, which can be altered. The control signal lines consist of various control output data, including completion of measurement or control signal for handshaking. Figure 10-1 outlines the I/O ports and control signal lines.

Figure 10-1

Handler I/O port overview

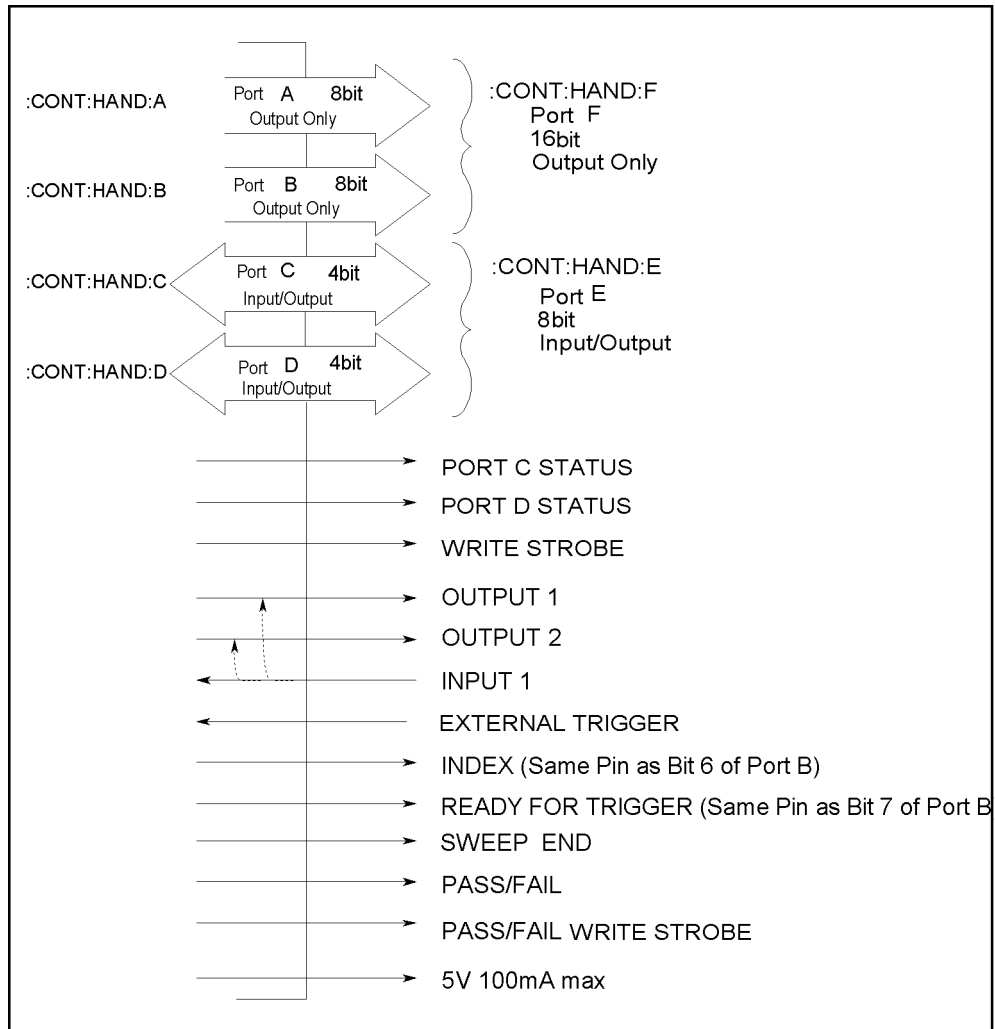

e5070ape001

I/O Signal Pin Layout and Description

Figure 10-2 illustrates the layout of the I/O signal pins on the handler interface connector while Table 10-1 on page 212 briefly describes those signals.

Figure 10-2

Handler interface connector pin layout

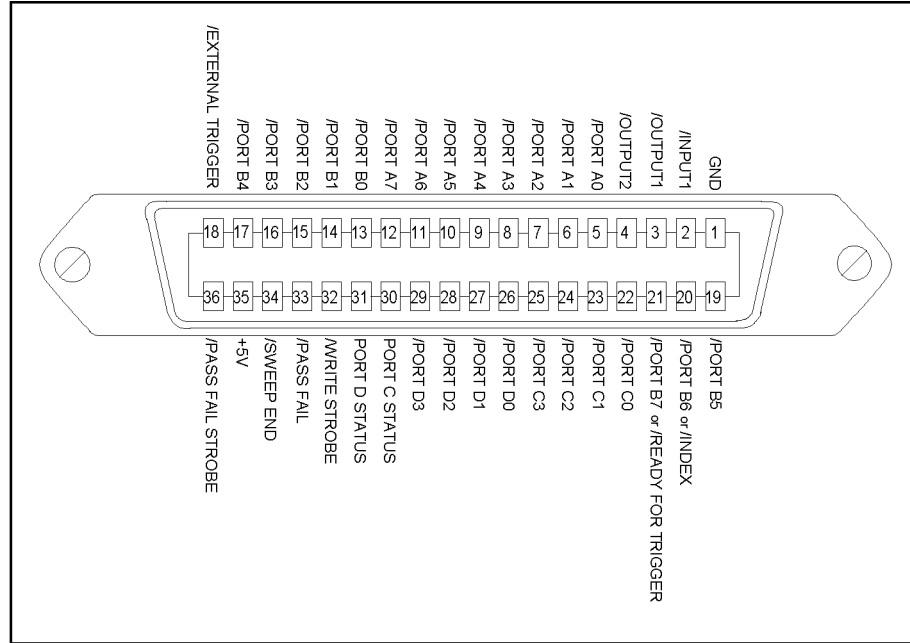

e5070ape002

NOTE A slash (/) symbol preceding signal names means that they are negative logic (active low).

Table 10-1

Description of the handler interface I/O signals

Pin number	Signal name	Input/Output	Description
1	GND	—	Ground.
2	/INPUT1	Input	When this port receives a negative pulse, /OUTPUT1 and /OUTPUT2 are changed to the Low level.
3	/OUTPUT1	Output	Changes to the Low level when /INPUT1 receives a negative pulse. A command can be available for altering the Low/High level logic.
4	/OUTPUT2	Output	Changes to the Low level when /INPUT1 receives a negative pulse. A command can be available for altering the Low/High level logic.
5	/PORT A0	Output	Bit 0 of port A (8 bit parallel output port)
6	/PORT A1	Output	Bit 1 of port A.
7	/PORT A2	Output	Bit 2 of port A.
8	/PORT A3	Output	Bit 3 of port A.
9	/PORT A4	Output	Bit 4 of port A.
10	/PORT A5	Output	Bit 5 of port A.
11	/PORT A6	Output	Bit 6 of port A.
12	/PORT A7	Output	Bit 7 of port A.
13	/PORT B0	Output	Bit 0 of port B (8 bit parallel output port)
14	/PORT B1	Output	Bit 1 of port B.
15	/PORT B2	Output	Bit 2 of port B.
16	/PORT B3	Output	Bit 3 of port B.
17	/PORT B4	Output	Bit 4 of port B.
18	/EXTERNAL TRIGGER	Input	An external trigger signal. When the trigger source is set to the “External,” this port generates a trigger in respond to the trailing edge of a negative pulse.
19	/PORT B5	Output	Bit 5 of port B.
20*1	/PORT B6	Output	Bit 6 of port B.
	/INDEX		Indicates that analog measurement is complete. The /INDEX signal changes to the Low level when analog measurement (all sweeps of all channels) is complete. When the handler receives the signal, it assumes that it is ready to connect the next DUT. However, no measurement data are available until data calculation is completed. When the point trigger function is on, it goes to the High level before starting measurement of the first measurement point and returns to the Low level after completing measurement of all measurement points.

Table 10-1

Description of the handler interface I/O signals

Pin number	Signal name	Input/Output	Description
21* ²	/PORT B7	Output	Bit 7 of port B.
	/READY FOR TRIGGER		Indicates that the instrument is ready for triggering. This signal is changed to the Low level when the instrument is ready for receiving a trigger signal. With the point trigger function on, it goes to the Low level when the instrument is ready to accept the trigger signal for the first point and goes to the High level when the trigger signal for the first point is received. When measurement of all measurement points is completed and the instrument is ready to receive the trigger signal for the first point of the next sweep, this signal goes to the Low level again.
22	/PORT C0	Input/Output	Bit 0 of port C (4 bit parallel I/O port)
23	/PORT C1	Input/Output	Bit 1 of port C.
24	/PORT C2	Input/Output	Bit 2 of port C.
25	/PORT C3	Input/Output	Bit 3 of port C.
26	/PORT D0	Input/Output	Bit 0 of port D (4 bit parallel I/O port)
27	/PORT D1	Input/Output	Bit 1 of port D.
28	/PORT D2	Input/Output	Bit 2 of port D.
29	/PORT D3	Input/Output	Bit 3 of port D.
30	PORT C STATUS	Output	Port C status signal. This signal is changed to the High level when the port C is configured to output port. It is changed to the Low level when the port is configured to input port.
31	PORT D STATUS	Output	Port D status signal. This signal is changed to the High level when the port D is configured to output port. It is changed to the Low level when the port is configured to input port.
32	/WRITE STROBE	Output	A output port write strobe signal. When data is present (that is, output level changes) on any of the output ports, this signal provides a negative pulse.
33	/PASS FAIL	Output	Each limit test's results* ³ signal. This signal changes to the High level when limit test, bandwidth test, or ripple test results return FAIL. It changes to the Low level when all limit test results return PASS.
34	/SWEEP END	Output	A sweep completion signal. When measurement (all sweeps of all channels) and data calculation are completed, this signal provides this signal provides a negative pulse.
35	+5V	Output	Provides +5V DC power supply for external instruments.

Table 10-1

Description of the handler interface I/O signals

Pin number	Signal name	Input/Output	Description
36	/PASS FAIL STROBE	Output	Each limit test's results write a strobe signal. When limit test result is present on /PASS FAIL, this signal provides a negative pulse.

*1. This signal provides various functions depending upon the setting of :CONT:HAND:IND:STAT command on page 452.



*2. This signal provides various functions depending upon the setting of :CONT:HAND:RTR:STAT command on page 453.

*3. The overall test result that combine the test results for all traces in all channels.

Inputting/Outputting Data

The E5070B/E5071B handler I/O port provides the ports for data I/O shown in Table 10-2.

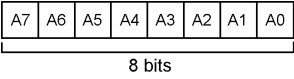
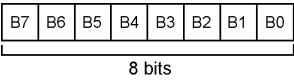
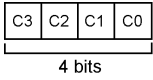
Table 10-2 I/O port

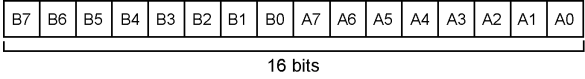
Port Name	Usage	Data Structure
Port A	Output	 <p>A7 A6 A5 A4 A3 A2 A1 A0 8 bits</p>
Port B	Output	 <p>B7 B6 B5 B4 B3 B2 B1 B0 8 bits</p>
Port C	Input/Output	 <p>C3 C2 C1 C0 4 bits</p>
Port D	Input/Output	 <p>D3 D2 D1 D0 4 bits</p>
Port E	Input/Output	 <p>D3 D2 D1 D0 C3 C2 C1 C0 8 bits</p>
Port F	Output	 <p>B7 B6 B5 B4 B3 B2 B1 B0 A7 A6 A5 A4 A3 A2 A1 A0 16 bits</p>

Specifying signal direction of port

Signal direction (input/output) can be changed for the ports C, D, and E as shown in Table 10-2. Thus, before the ports are used, the directions should be determined according to their usage.

To specify the signal direction for the ports C and D, use the following command. Direction for the port E depends on the setting for the ports C and D.

Port Name	Command
Port C	:CONT:HAND:C:MODE on page 447
Port D	:CONT:HAND:D:MODE on page 449

Reading data input to port

When the ports C, D, or E is configured to input ports, binary data represented with High(0)/Low(1) of each bit of the port will be read as decimal data.

To retrieve the data, use the following command as query:

Port Name	Command
Port C	:CONT:HAND:C on page 446
Port D	:CONT:HAND:D on page 448
Port E	:CONT:HAND:E on page 450

Data output to port

To the ports A through F (the ports C, D, and E should be configured to output ports), binary data (decimal data when output data is specified with a command) represented with High(0)/Low(1) of each bit of the port can be output.

To output data, use the following command.

Port Name	Command
Port A	:CONT:HAND:A on page 445
Port B	:CONT:HAND:B on page 445
Port C	:CONT:HAND:C on page 446
Port D	:CONT:HAND:D on page 448
Port E	:CONT:HAND:E on page 450
Port F	:CONT:HAND:F on page 451

NOTE

The bit 6 of the data outputted by **:CONT:HAND:B** command (the bit 14 of the data outputted by **:CONT:HAND:F** command) is ignored when outputting the /INDEX signal is turned on.

The bit 7 of the data outputted by **:CONT:HAND:B** command (the bit 15 of the data outputted by **:CONT:HAND:F** command) is ignored when outputting the /READY FOR TRIGGER signal is turned on.

Preset states at power-on

The handler I/O port is set at power-on as follows (not affected at reset).

Port A	High (All Bits)
Port B	High (All Bits)
Port C	Input
Port D	Input
PORT C STATUS	Low
PORT D STATUS	Low
/OUTPUT1	High
/OUTPUT2	High
/SWEEP END	High
/PASS FAIL	High

Timing Chart

Figure 10-3 shows the timing chart for each timing signal output, from the start of measurement (pulse input to /EXTERNAL TRIGGER) until the end of measurement when the point trigger function is off.

Table 10-3 Values of T1 through T2 in Figure 10-3 (typical)

		Minimum value	Typical Value	Maximum value
T1	Pulse width of /EXTERNAL TRIGGER	1 μs *1	—	—
T2	Pulse width of /SWEEP END	10 μs	12 μs	—

*1. When a trigger signal is input from the handler I/O port.

Figure 10-3 Timing chart of /EXTERNAL TRIGGER, /INDEX, /SWEEP END, and /READY FOR TRIGGER (when point trigger function is off)

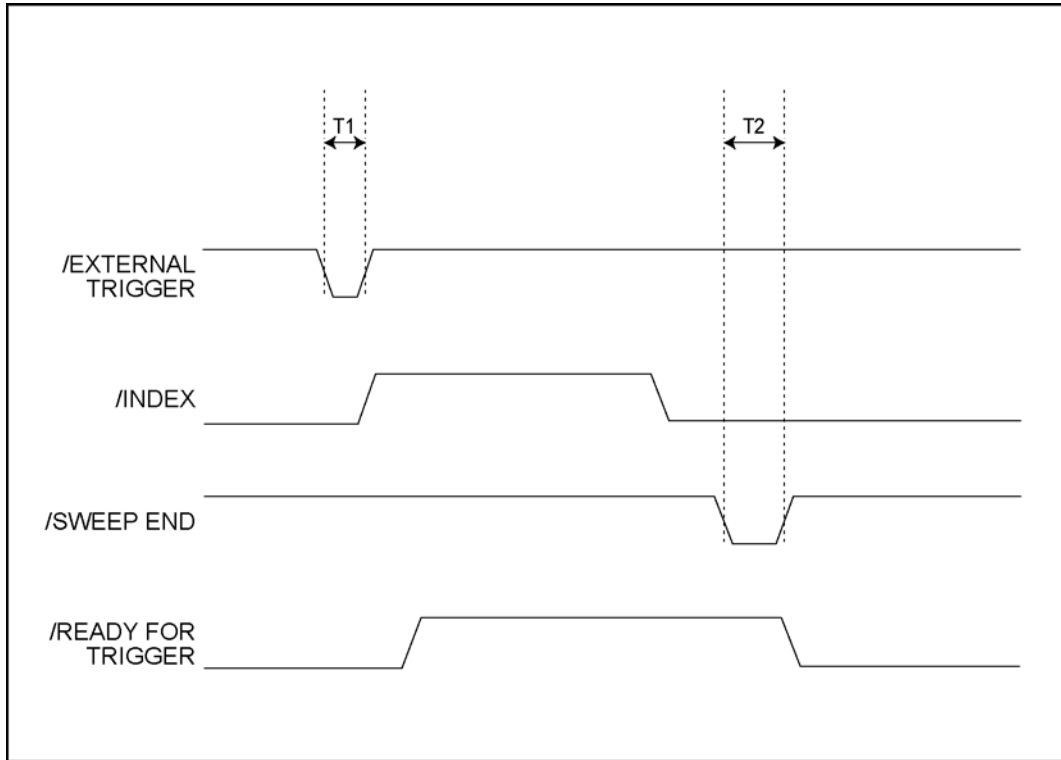

e5070apj009

/INDEX and /READY FOR TRIGGER signals can be outputted by using the following commands.

/INDEX	:CONT:HAND:C:MODE on page 447
/READY FOR TRIGGER	:CONT:HAND:D:MODE on page 449

Figure 10-4 shows the timing chart of the timing signal outputs, from the start of measurement (pulse input to /EXTERNAL TRIGGER) to the end of measurement, when the point trigger function is on and the low-latency external trigger mode is on.

Figure 10-4 Timing chart of /EXTERNAL TRIGGER, /INDEX, /SWEEP END, and /READY FOR TRIGGER (when point trigger function is on and low-latency external trigger mode is on)

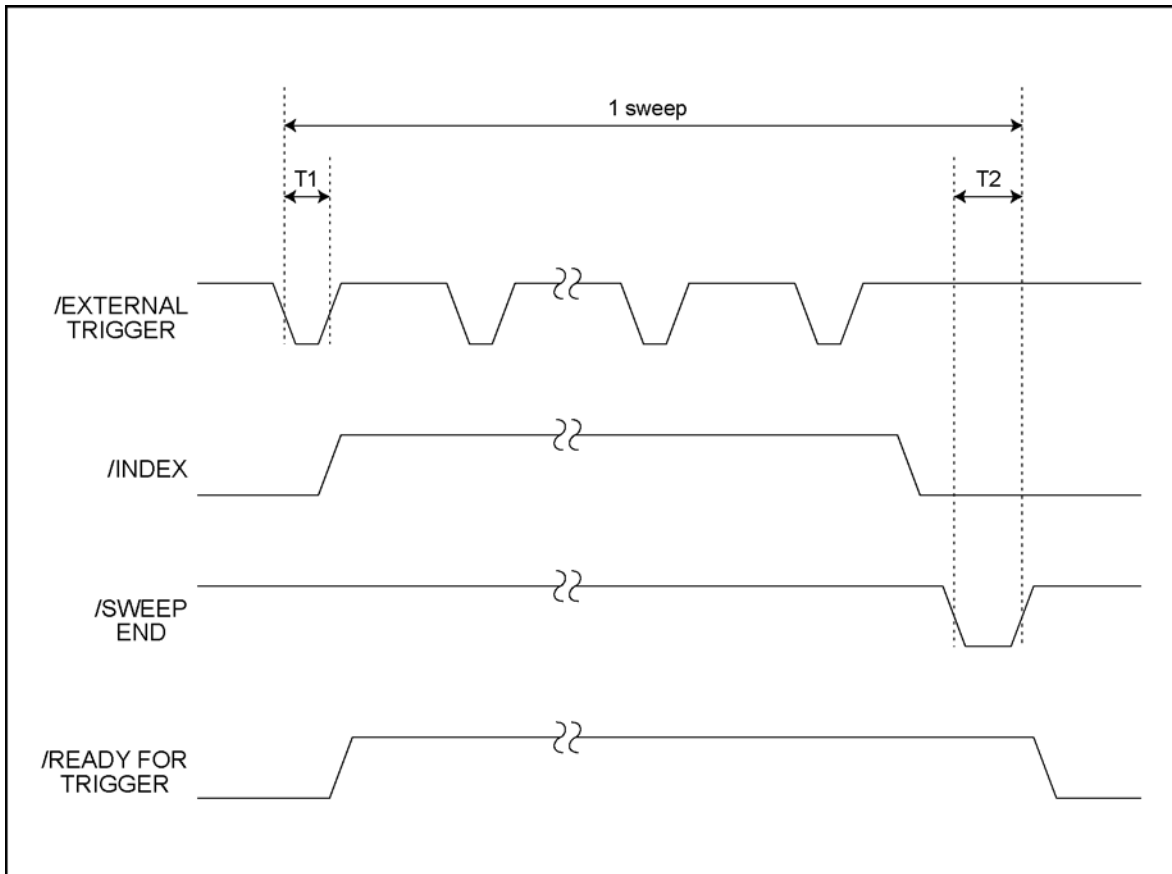

e5070bpj7001

NOTE

When both the point trigger function and the low-latency external trigger mode are on, the /EXTERNAL TRIGGER signal must be inputted for each measurement point during a single sweep. The /INDEX signal goes to the High level before starting measurement of the first measurement point and returns to the Low level after the completing measurement of all measurement points. The /READY FOR TRIGGER signal goes to the Low level when the instrument is ready to accept the trigger signal for the first point and then goes to the High level when the trigger signal for the first point is received. When measurement of all measurement points is completed and the instrument is ready to receive the trigger signal for the first point of the next sweep, this signal goes to the Low level again.

When the point trigger function is on and the low-latency external trigger mode is off, the /READY FOR TRIGGER signal goes High each time a trigger signal is received and goes Low when measurement of each measurement point is completed and the instrument is ready to accept a trigger for the next measurement point.

The times of T1 and T2 are the same as those when the point trigger function is off. For

more information, see Table 10-3 on page 218.

Figure 10-5 shows the timing chart for data output and write strobe signal output to ports A through F.

Table 10-4 Values of T1 through T2 in Figure 10-5 (typical)

T1	Response time of write strobe signal	1 μ s
T2	Pulse width of write strobe signal	1 μ s

Figure 10-5 Timing chart of data output and write strobe signal

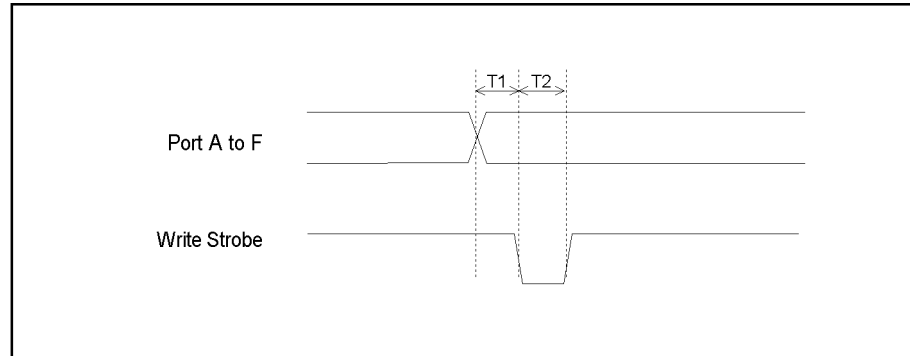

e5070ape010

Figure 10-6 shows the timing chart of limit test result output (/PASS FAIL signal output) and /PASS FAIL write strobe signal output.

The timing chart of the limit test result contains a ripple test and a bandwidth test.

Table 10-5 Values of T1 through T2 in Figure 10-6 (typical)

T1	Response time of /PASS FAIL write strobe	1 μ s
T2	Pulse width of /PASS FAIL write strobe	1 μ s

Figure 10-6 Timing chart of limit test result output and write strobe signal

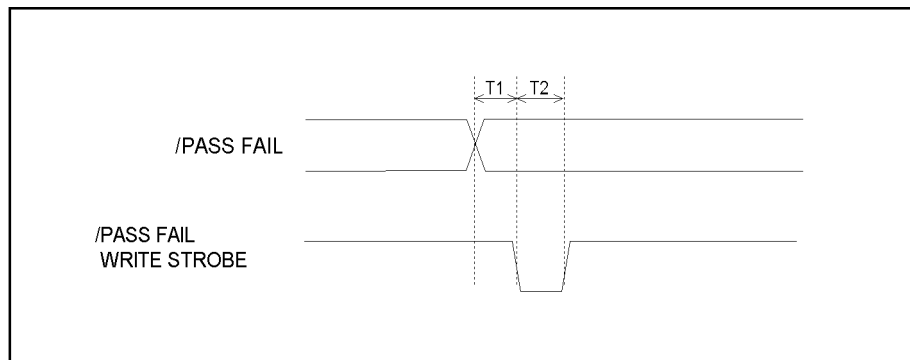

e5070ape011

NOTE

When the average trigger function is activated, the fail and write strobe signals are outputted at the time that the average test result shows “failed” on a certain channel.

Figure 10-7 shows the timing chart of a pulse input to /INPUT1, /OUTPUT1 signal output, and /OUTPUT2 signal output.

Table 10-6

Values of T1 through T2 in Figure 10-7 (typical)

		Minimum value	Maximum value
T1	Pulse width of /INPUT1	1 μ s	—
T2	Response time of /OUTPUT1, /OUTPUT2	0.4 μ s	0.6 μ s

Figure 10-7

Timing chart of /INPUT1 and /OUTPUT1, /OUTPUT2

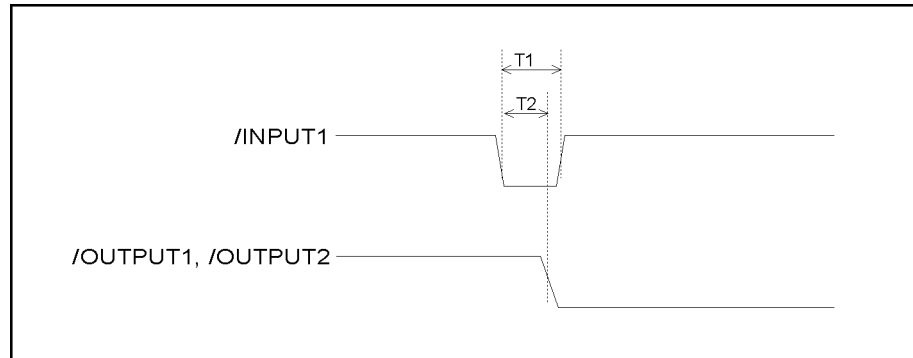

e5070apj012

Electrical Characteristics

Input signal

All input signals are TTL compatible. Table 10-7 shows the electrical characteristics of input signals. Figure 10-8 shows the circuit diagram of input signals.

Table 10-7

Electrical characteristics of input signals (typical)

Maximum rate input voltage		-0.5 V to 5.5 V
Input voltage	High level	2.0 V to 5.0 V
	Low level	0 V to 0.5 V

Figure 10-8

Circuit diagram of input signals

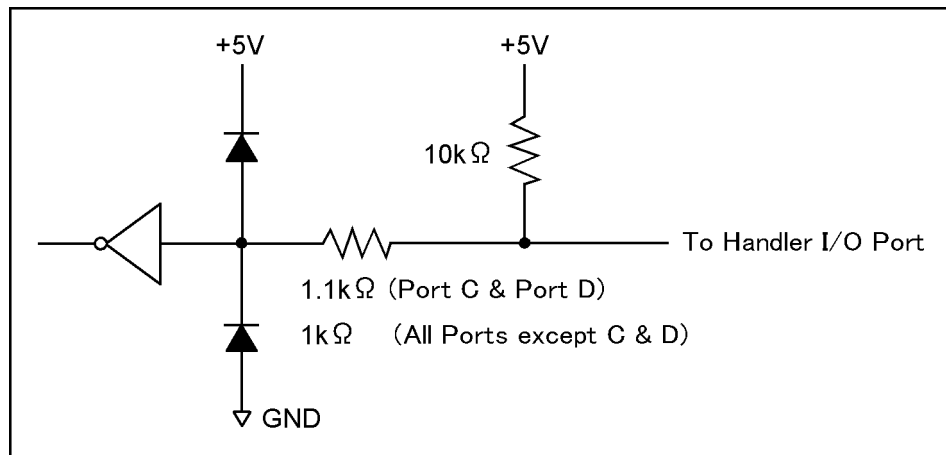

e5070ape027

Output signal

All output signals are TTL compatible. Table 10-8 shows the electrical characteristics of output signals. Figure 10-9 shows the circuit diagram of output signals.

Table 10-8 Electrical characteristics of output signals (typical)

Maximum rate output current		-10 mA to 10 mA
Output current	High level	-5 mA
	Low level	3 mA
Output voltage	High level	2.0 V to 3.3 V (when output current is from -5 mA to 0 mA) 3.20 V (when output current is -1 mA) 2.75 V (when output current is -5 mA)
	Low level	0 V to 0.8 V (when output current is from 0 mA to 3 mA) 0.25 V*1 (when output current is 1 mA) 0.55 V (when output current is 3 mA)

*1. Notice that, in case of C0 to C3 (port C) and D0 to D3 (port D), output voltage is 0.30 V.

Figure 10-9 Circuit diagram of output signals

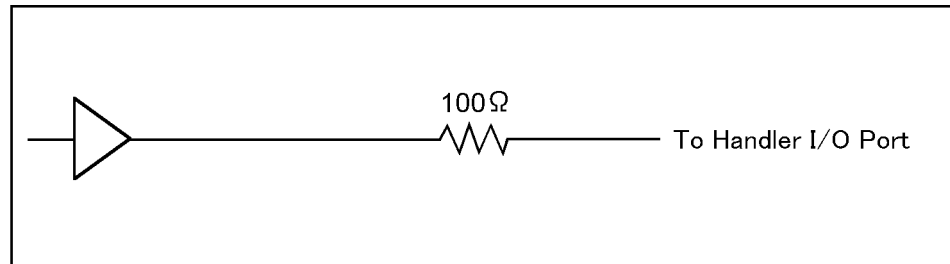

e5070ape028

Power supply (+5 V)

Table 10-9 shows electrical characteristics of +5 V power supply for external instruments.

Table 10-9 Electrical characteristics of +5 V power supply (typical)

Output voltage	4.5 V to 5.5 V
Maximum output current	100 mA

Sample Program

Example 10-1 provides a sample program that communicates with an external instrument through the handler I/O port. You can find the source file of this program, named `handler.htb`, on the sample program disk.

This program outputs 5 (sets bit 2 and bit 0 to Low, and the other bits to High) to the port A of the handler I/O port, then waits until the bit 3 of the port C is set to Low.

The program is described in detail below:

Line 40	Assigns a GPIB address to the I/O pass.
Lines 60 to 70	These lines store the output data on the port A (binary) and bit location (bit 3) into <code>Out_data_bin\$</code> and <code>Flag_bit</code> variables, respectively.
Line 90	This line configures the port C to input port.
Lines 100 to 110	These lines enable <code>/INDEX</code> and <code>/READY FOR TRIGGER</code> signals.
Lines 130 to 140	These lines convert <code>Out_data_bin\$</code> to a decimal value and set it to the port A.
Lines 160 to 200	These lines repeat reading data from the port C until <code>Flag_bit</code> becomes <code>TRUE</code> .

Example 10-1

Communicating with external instruments (handler.htb)

```
10    INTEGER Out_data, In_data, Bit_stat
20    DIM Out_data_bin$ [9]
30    !
40    ASSIGN @Agte507x TO 717
50    !
60    Out_data_bin$="00000101"
70    Flag_bit=3
80    !
90    OUTPUT @Agte507x; ":CONT:HAND:C:MODE INP"
100   OUTPUT @Agte507x; ":CONT:HAND:IND:STAT ON"
110   OUTPUT @Agte507x; ":CONT:HAND:RTR:STAT ON"
120   !
130   Out_data=IVAL(Out_data_bin$, 2)
140   OUTPUT @Agte507x; ":CONT:HAND:A "; Out_data
150   !
160   REPEAT
170     OUTPUT @Agte507x; ":CONT:HAND:C?"
180     ENTER @Agte507x; In_data
190     Bit_stat=BIT(In_data, Flag_bit)
200   UNTIL Bit_stat=1
210   END
```

11 Working with Automatic Test Systems

This chapter describes useful features when the Agilent E5070B/E5071B is integrated with an automatic test system.

Preventing Erroneous Key Operation on the Front Panel (key lock feature)

When no operation is required from the front panel controls, the mouse, or the keyboard, disabling these input devices can prevent any erroneous operation that might be caused by accidentally touching the devices.

To turn on or off Key Locking, use the following commands:

Locking the front panel controls and the keyboard	:SYST:KLOC:KBD on page 794
Locking the mouse and the touch screen	:SYST:KLOC:MOUS on page 795

Improving Command Processing Speed

SCPI commands should be processed quickly to improve throughput when such commands are frequently executed (for example, reading out traces for each measurement).

With the E5070B/E5071B, the processing time for SCPI commands can be improved by decreasing the refresh rate of the LCD display.

Measurement results (trace) do not need to be updated

When the measurement trace does not need to be updated, turn off the updating of the LCD display. This improves the processing speed of SCPI commands and eliminates the time used for updating the screen.

To turn off the updating of the LCD display, use the following command:

- :DISP:ENAB command on page 462

Measurement results (trace) need to be updated

When the measurement trace needs to be updated, the processing speed of SCPI commands can still be improved by controlling the update timing of the LCD display:

- Step 1.** Execute all SCPI commands that are required before measurement, including commands setting conditions.
- Step 2.** Turn OFF the update of the LCD display.
- Step 3.** Perform the measurement.
- Step 4.** Execute the commands for reading out measurement result or analyzing the result. Note that reading out the result in binary format will accelerate data transfer.
- Step 5.** Execute the following command to update the LCD display once.
 - :DISP:UPD command on page 470
- Step 6.** Return to Step 3.

Sample program

Example 11-2 shows a sample program where the command processing time is improved by controlling the update timing of the LCD display. You can find the source file of this program, named `cont_upd.htb`, on the sample program disk.

NOTE

This sample program correctly runs when the maximum number of channels/traces is set to 9 channels/9 traces.

This program sets the necessary measurement conditions and then turns off the updating of the LCD display. Next, it performs measurement, reads out the result, and updates the screen once. This program repeats this measurement procedure ten times.

The program is described in detail below:

Lines 50 to 60	Assigns a GPIB address to the I/O pass.
Lines 80 to 110	These lines set the sweep type to linear sweep, the sweep center value to 950 MHz, the sweep span value to 100 MHz, and the number of measurement points to 201.
Lines 120 to 160	These lines set the trigger source to bus trigger, turn on Continuous Activation mode for channel 1, and turn the mode off for channels 2 through 9.
Lines 180 to 190	These lines display the window for channel 1 only and arrange two graphs tiled horizontally.
Lines 210 to 270	These lines set the number of traces for channel 1 to 2, the measurement parameter and its data format for trace 1 to S21 and Log Mag, respectively, and those for trace 2 to S11 and Log Mag, respectively.
Line 290	This line turns Off the updating of the LCD screen.
Line 300	This line sets the data transfer format to binary.
Lines 320 to 540	These lines repeat the following procedure ten times. <ol style="list-style-type: none">1. Lines 340 to 360: These lines trigger the instrument and wait until the measurement cycle finishes.2. Lines 400 to 440: Reads out the formatted data array of trace 1 in channel 1.3. Lines 460 to 500: Reads out the formatted data array of trace 2 in channel 1.4. Line 540: This line updates the LCD screen once.

Example 11-1

Controlling the update timing of LCD display (cont_upd.htb)

```

10     REAL Trace1(1:201,1:2),Trace2(1:201,1:2)
20     DIM Buff$(9),Img$(30)
30     INTEGER Nop,I
40     !
50     ASSIGN @Agte507x TO 717
60     ASSIGN @Binary TO 717;FORMAT OFF
70     !
80     OUTPUT @Agte507x;":SENS1:SWE:TYPE LIN"
90     OUTPUT @Agte507x;":SENS1:FREQ:CENT 950E6"
100    OUTPUT @Agte507x;":SENS1:FREQ:SPAN 100E6"
110    OUTPUT @Agte507x;":SENS1:SWE:POIN 201"
120    OUTPUT @Agte507x;":TRIG:SOUR BUS"
130    OUTPUT @Agte507x;":INIT1:CONT ON"
140    FOR I=2 TO 9
150        OUTPUT @Agte507x;":INIT"&VAL$(I)&":CONT OFF"
160    NEXT I
170    !
180    OUTPUT @Agte507x;":DISP:SPL D1"
190    OUTPUT @Agte507x;":DISP:WIND1:SPL D1_2"
200    !
210    OUTPUT @Agte507x;":CALC1:PAR:COUN 2"
220    OUTPUT @Agte507x;":CALC1:PAR1:DEF S21"
230    OUTPUT @Agte507x;":CALC1:PAR1:SEL"
240    OUTPUT @Agte507x;":CALC1:FORM MLOG"
250    OUTPUT @Agte507x;":CALC1:PAR2:DEF S11"
260    OUTPUT @Agte507x;":CALC1:PAR2:SEL"
270    OUTPUT @Agte507x;":CALC1:FORM MLOG"
280    !
290    OUTPUT @Agte507x;":DISP:ENAB OFF"
300    OUTPUT @Agte507x;":FORM:DATA REAL"
310    !
320    FOR I=1 TO 10
330        OUTPUT @Agte507x;":TRIG:SING"
340        OUTPUT @Agte507x;"*OPC?"
350        ENTER @Agte507x;Buff$
360        !
370        ! Read Trace Data
380        !
390        OUTPUT @Agte507x;":CALC1:PAR1:SEL"
400        OUTPUT @Agte507x;":CALC1:DATA:FDAT?"
410        ENTER @Agte507x USING "#,8A";Buff$
420        ENTER @Binary;Trace1(*)
430        ENTER @Agte507x USING "#,1A";Buff$
440        !
450        OUTPUT @Agte507x;":CALC1:PAR2:SEL"
460        OUTPUT @Agte507x;":CALC1:DATA:FDAT?"
470        ENTER @Agte507x USING "#,8A";Buff$
480        ENTER @Binary;Trace2(*)
490        ENTER @Agte507x USING "#,1A";Buff$
500        !
510        ! Update Display
520        !
530        OUTPUT @Agte507x;":DISP:UPD"
540    NEXT I
550    END

```

Detecting Occurrence of an Error

Using the status reporting system

The status of the E5070B/E5071B can be detected through the status registers. This section describes how to detect the end of measurement by using the status registers. For a complete description of the status report mechanism, including the specifications of each bit, see Appendix B, “Status Reporting System.”

The occurrence of an error will be present in the standard event status register. An SRQ (service request) is useful when you create a program that uses the information reported by this register to detect the occurrence of an error.

To detect the end of sweep via an SRQ, use one of the following commands:

- *SRE on page 290
- *ESE on page 287

Follow these steps:

Step 1. Set the E5070B/E5071B so that it generates an SRQ when any of the error occurrence bits is set to 1 in the standard event status register.

Step 2. When an SRQ is generated, the program interrupts the measurement cycle.

Figure 11-1

SRQ generation sequence (when an error occurs)

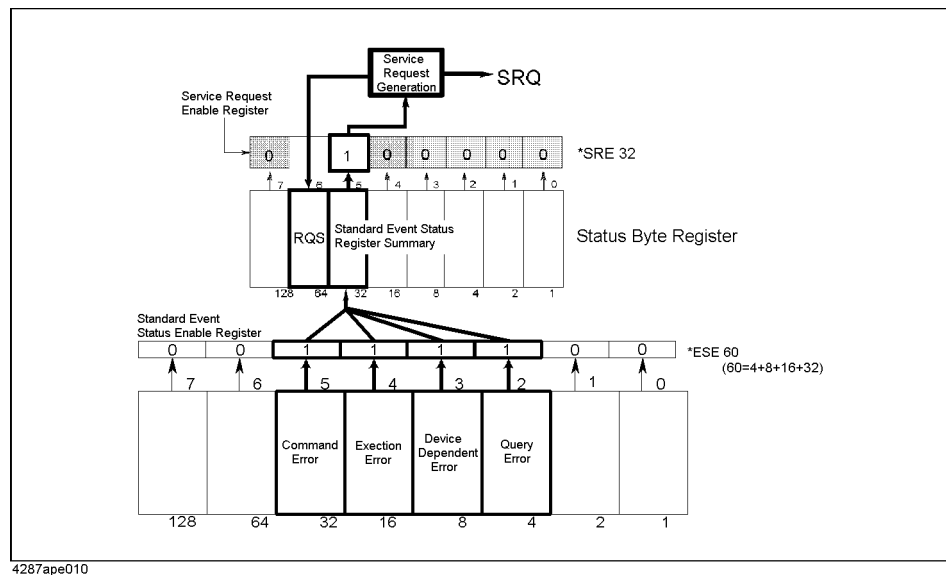

Using the error queue

An error queue holds the number for the error and the error message. Reading the error queue allows the user to verify the error that has occurred. To retrieve the content of an error queue, use the following command:

- :SYST:ERR? on page 791

The error queue can be used in the following ways:

1. It is used as a branch for error handling. When an error queue is retrieved, it returns 0 as the error number and “No error” as the error message if no error is detected. This can be used for detecting of an error and for branching the flow of a program. This is also useful when you wish to handle a specific error(s). Note that this method will not allow the user to perform any processing during the occurrence of an error.
2. When an error is detected using SRQ, the error queue is used to examine the error. Refer to the example in Example 11-2.

Sample program

Example 11-2 is a sample program that demonstrates how to use an SRQ to detect the occurrence of an error. You can find the source file of this program, named `srq_err.htb`, on the sample program disk.

This program sets SRQs and then intentionally sends an invalid parameter to generate an error to be handled by this program. In the error handling part, this program examines the error, displays the error number and error message, and then displays the message indicating the suspension of the program.

- | | |
|------------------|---|
| Line 40 | Assigns a GPIB address to the I/O pass. |
| Lines 60 to 70 | These lines enable bits 2, 3, 4 and 5 in the standard event status register and set bit 5 to 1 in the service request enable register. |
| Lines 80 to 100 | These lines clear the status byte register, the standard event status register, and the error queue. |
| Lines 120 to 130 | These lines set the branch target for an SRQ interrupt to enable SRQ interruptions. |
| Lines 140 to 260 | These lines set the measurement parameters and their data formats for traces 1 and 2. An invalid parameter is given to the data format setting for trace 2, causing an error. |
| Lines 280 to 330 | These lines define an error handler in the following way.

Lines 290 to 300: These lines retrieve the error number and error messages for the error from the error queue.

Lines 310 to 330 These lines display the message indicating the occurrence of the error, the error number, the error message, and the message showing that the program is suspended. |
| Line 350 | Displays a closing message. Note that this message will not display unless this program is re-executed after setting a corrected parameter to the data format setting for trace 2. |

Example 11-2 **Error detection using an SRQ (srq_err.bas)**

```
10     DIM Buff$(9),Err_mes$(50)
20     INTEGER Err_no
30     !
40     ASSIGN @Agte507x TO 717
50     !
60     OUTPUT @Agte507x;"*ESE 60"
70     OUTPUT @Agte507x;"*SRE 32"
80     OUTPUT @Agte507x;"*CLS"
90     OUTPUT @Agte507x;"*OPC?"
100    ENTER @Agte507x;Buff$
110    !
120    ON INTR 7 GOTO Err_proc
130    ENABLE INTR 7;2
140    OUTPUT @Agte507x;":CALC1:PAR:COUN 2"
150    PRINT "Trace 1 Meas.Para: S21"
160    PRINT "Trace 1 Format   : Log Mag"
170    OUTPUT @Agte507x;":CALC1:PAR1:DEF S21"
180    OUTPUT @Agte507x;":CALC1:PAR1:SEL"
190    OUTPUT @Agte507x;":CALC1:FORM MLOG"
200    PRINT "Trace 2 Meas.Para: S11"
210    PRINT "Trace 2 Format   : Log Mag"
220    OUTPUT @Agte507x;":CALC1:PAR2:DEF S11"
230    OUTPUT @Agte507x;":CALC1:PAR2:SEL"
240    OUTPUT @Agte507x;":CALC1:FORM LOG"
250    OUTPUT @Agte507x;"*OPC?"
260    ENTER @Agte507x;Buff$
270    GOTO Skip_err_proc
280 Err_proc: OFF INTR 7
290    OUTPUT @Agte507x;";:SYST:ERR?"
300    ENTER @Agte507x;Err_no,Err_mes$
310    PRINT "Error occurred!!"
320    PRINT "  No: ";Err_no,"Description: "&Err_mes$
330    PRINT "PROGRAM INTERRUPT!!"
340    GOTO Prog_end
350 Skip_err_proc: PRINT "PROGRAM DONE."
360 Prog_end: END
```

12 **Controlling E5091A**

This chapter explains how to control the E5091A.

Controlling E5091A

Selecting Test Set

The E5091A test set provides test set 1 and test set 2. To select the test set, use the following command:

- :SENS:MULT{1-2}:NAME on page 541

The following models are available for the test set.

E5091A_009	Option 009
E5091A_013	Option 016 (13-port measurement)
E5091A_016	Option 016 (16-port measurement)

Checking the name of available test set

To check the name of the available test set of the E5091A, use the following command:

- :SENS:MULT:CAT? on page 538

Turning control ON/OFF

To turn ON/OFF the control of the E5091A, use the following command:

- :SENS:MULT{1-2}:STAT on page 542

If you turn OFF the control of the E5091A, it does not affect the operation of the E5070B/E5071B, even if it is connected. You can control test set 1 and test set 2 separately.

Selecting ports assigned to Port 1 to Port n

Selecting the connection ports

You can select the ports assigned to Port 1 to Port n for each channel. To select the ports, use the following commands:

- :SENS{1-16}:MULT{1-2}:PORT{1-20} on page 660

NOTE

The connection between the assigned ports and Port 1 to Port 4 inside the E5091A is not changed when one of the above commands is executed but it is changed immediately before a sweep for each channel.

Turning ON/OFF state display of connection ports (properties display)

You can display the state of the ports assigned to Port 1 to Port n (E5091 properties) in the lower right part in the window for each channel. To turn ON/OFF the properties display, use the following command:

- :SENS:MULT{1-2}:DISP on page 539

Checking number of ports

To check the number of the E5091A's connected ports, use the following command:

- `:SENS:MULT{1-2}:COUN?` on page 539

Checking the available port name.

To check the name of the E5091A's connected ports, use the following command:

- `:SENS{1-16}:MULT{1-2}:PORT{1-20}:CAT?` on page 662

Checking number of input ports.

To check the number of the E5091A's input ports, use the following command:

- `:SENS:MULT{1-2}:INC?` on page 540

Setting control line

You can set the HIGH/LOW state of each line of the control line for each channel. To set the HIGH/LOW of each line, use the following command:

- `:SENS{1-16}:MULT{1-2}:TSET9:OUTP` on page 663

NOTE

The HIGH/LOW state of each line of the E5091A is not changed when the above command is executed but it is changed immediately before a sweep for each channel.

Sample program

Example 12-1 shows a sample program that demonstrates how to control the E5091A. You can find the source file of this program, named e5091ctr.htb, on the sample program disk.

This program assigns Port 1 of the E5091A to A, Port 2 to T2, Port 3 to R2+, and Port 4 to R2- and sets Line 1 and Line 3 of the control line to HIGH.

The program is described in detail below:

Line 70	Assigns a GPIB address to the I/O path.
Line 90	Assigns the name of the test set, E5091A-009 (Option009) to the variables Model\$.
Lines 110 to 140	Sets the port assigned to Port 1 (A), the port assigned to Port 2 (T2), the port assigned to Port 3 (R2+), and the port assigned to Port 4 (R2-) to the Port1\$, Port2\$, Port3\$, and Port4\$ variables.
Lines 160 to 230	Sets the states of Line 1 to Line 8 of the control line (1 and 3: HIGH, 4 to 8: LOW) to Line1\$ through Line8\$ variables, respectively.
Lines 250	Specifies the test set name.
Lines 270 to 300	Sets the port assigned to Port 1 to Port1\$, the port assigned to Port 2 to Port2\$, the port assigned to Port 3 to Port3\$, and the port assigned to Port 4 to Port4\$.
Lines 270 to 290	Creates a decimal setting value from Line1\$ to Line8\$ and uses it to set the control line.
Line 360	Turns ON the E5091A property display.
Line 370	Turns ON the control of the E5091A.

Example 12-1 Controlling E5091A (e5091ctr_2.htb)

```

10     DIM Port1${3},Port2${3},Port3${3},Port4${3},Data_bin${9]
20     DIM Line1${3},Line2${3},Line3${3},Line4${3]
30     DIM Line5${3},Line6${3},Line7${3},Line8${3]
40     DIM Model${8]
50     INTEGER Data_dec
60     !
70     ASSIGN @Agte507x TO 717
80     !
90     Model$="E5091_9"      ! Model:E5091A-009
100    !
110    Port1$="A"           ! Port1: A
120    Port2$="T2"         ! Port2: T2
130    Port3$="R2"         ! Port3: R2+
140    Port4$="R2"         ! Port4: R2-
150    !
160    Line1$="1"          ! Line1: HIGH
170    Line2$="0"          ! Line2: Low
180    Line3$="1"          ! Line3: HIGH
190    Line4$="0"          ! Line4: Low
200    Line5$="0"          ! Line5: Low
210    Line6$="0"          ! Line6: Low
220    Line7$="0"          ! Line7: Low
230    Line8$="0"          ! Line8: Low
240    !
250    OUTPUT @Agte507x;":SENS1:MULT1:NAME "&Model$
260    !
270    OUTPUT @Agte507x;":SENS1:MULT1:PORT1 "&Port1$
280    OUTPUT @Agte507x;":SENS1:MULT1:PORT2 "&Port2$
290    OUTPUT @Agte507x;":SENS1:MULT1:PORT3 "&Port3$
300    OUTPUT @Agte507x;":SENS1:MULT1:PORT4 "&Port4$
310    !
320
Data_bin$=Line8$&Line7$&Line6$&Line5$&Line4$&Line3$&Line2$&Line1$
330    Data_dec=IVAL(Data_bin$,2)
340    OUTPUT @Agte507x;":SENS1:MULT1:OUTP ";Data_dec
350    !
360    OUTPUT @Agte507x;":SENS:MULT1:DISP ON"
370    OUTPUT @Agte507x;":SENS:MULT1:STAT ON"
380    !
390    END

```

Controlling E5091A
Sample program

13 Sample Application Programs

This chapter introduces several sample programs for basic measurement, measurement with a system using the handler I/O, and controlling the instrument over a LAN.

Basic Measurement (measuring a band pass filter)

Example 13-1 is a sample program that measures a band pass filter. You can find the source file of this program, named `meas_bpf.htb`, on the sample program disk.

The sample program performs full 2-port calibration using the 85032F calibration kit, measures a band-pass filter (center frequency: 947.5 MHz), and calculates and displays its bandwidth, insertion loss, and so on. This measurement is the same as “Measuring a band pass filter” in *Installation and Quick Start Guide* of the E5070B/E5071B. Therefore, for information on the flow of the measurement, the connection of the standard, and so on, refer to the description in *Installation and Quick Start Guide*.

When started, the program displays the message “Set OPEN to Port 1. Then push [Enter] key.” Connect the OPEN standard to port 1 and press **[Enter]** to measure the OPEN calibration data. Likewise, connect the SHORT and the LOAD standards and measure their calibration data.

Next, the program displays the message “Set OPEN to Port 2. Then push [Enter] key.” Connect the OPEN standard to port 2 and press **[Enter]** to measure the OPEN calibration data. Likewise, connect the SHORT and the LOAD standards and measure their calibration data.

Then, the program displays the message “Set THRU between Port 1 and Port 2. Then push [Enter] key.” Connect the THRU standard between ports 1 and 2 and press **[Enter]** to measure the THRU calibration data.

When the calibration is finished, the program displays the message “Set DUT. Then Push [Enter] key.” Connect the DUT and press **[Enter]**. This initiates the measurement and display the result as shown in Figure 13-1.

Figure 13-2 shows a sample display of the LCD screen after the program exits execution.

Figure 13-1

Sample execution result of the program in Example 13-1

```
## Measurement Result ##  
  BW:      3.63757249908E+7  
 cent:     9.4836227902E+8  
  low:     9.30174417035E+8  
  high:    9.66550142015E+8  
   Q:      26.0712980976  
 loss:    -2.2447956671
```

Figure 13-2

Sample screen display after program in Example 13-1 exits execution

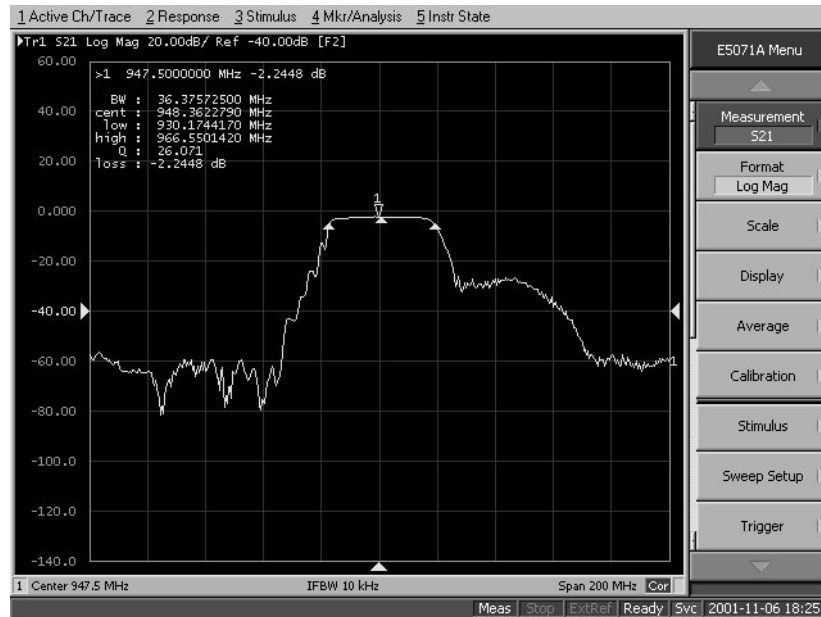

The program is described in detail below:

- Line 50 Assigns a GPIB address to the I/O pass.
- Lines 70 to 110 Stores the sweep center value (947.5 MHz), the sweep span value (200 MHz), the number of measurement points (401), the IF bandwidth (10 kHz), and the power level (-10 dBm) into the variables Center, Span, Nop, If_Bw, and Pow, respectively.
- Lines 120 to 160 Stores the number of traces (1), the measurement parameter (S21), the data format (log Mag), the calibration kit number (4: 85032F), and the save file name (State08.sta) into the variables Num_of_tr, Para\$, Fmt\$, CalKit, and File\$, respectively.
- Line 200 Puts the instrument into the preset state.
- Lines 220 to 260 These lines assign the sweep center value for channel 1 to Center, sweep span value to Span, number of measurement points to Nop, IF bandwidth to If_bw, and power level to Pow, respectively.
- Lines 280 to 310 These lines assign the number of traces for channel 1 to Num_of_tr, measurement parameters to Para\$, and data format to Fmt\$, respectively.
- Line 350 Stores the calibration kit number for channel 1 to the CalKit variable.
- Lines 360 to 380 These lines specify ports 1 and 2 to be used and call the sub-program Cal_solt to perform full 2-port calibration for channel 1. For more information on the Cal_solt sub-program, refer to the description in Example 4-1 on page 100.
- Lines 420 to 430 Saves the settings of the E5070B/E5071B and the calibration coefficients under the file name File\$.
- Lines 480 to 490 These lines set the trigger source to the bus trigger and turn on the continuous initiation mode for channel 1.

13. Sample Application Programs

Sample Application Programs

Basic Measurement (measuring a band pass filter)

- Lines 510 to 520 These lines prompt the user to connect the DUT and wait for **[Enter]** to be pressed after the DUT is connected.
- Lines 540 to 560 These lines trigger the instrument and wait until the measurement cycle finishes.
- Line 580 This line executes auto scale for trace 1 of channel 1.
- Lines 620 to 650 These lines turn on the display of marker 1, move the marker to the position where the stimulus value is equal to Center, read out the response value at the marker, and assign the value to the Resp variable.
- Lines 670 to 710 These lines configure the system to generate an SRQ when it cannot perform Bandwidth Search due to an error.
- Lines 730 to 740 These lines set the branch target for an SRQ interrupt to enable SRQ interruptions.
- Lines 750 to 790 Sets the bandwidth definition value to -3 dB and the bandwidth search result display to on, reads out the bandwidth search results (bandwidth, center frequency, Q value, and insertion loss), and stores them into the variables Bwid, Cent, Q, and Loss, respectively.
- Lines 830 to 900 These lines define an error handler that retrieves the error number and error messages for the error and then assign 0 to Bwid, Cent and Q, Resp (response value at marker 1) to Loss.
- Lines 930 to 940 These lines calculate the two (higher and lower) cutoff frequencies from the values in the Bw and Cent variables and stores them into the Cut_l and Cut_h variables.
- Lines 980 to 1040 These lines display the measurement results (values of Bwid, Cent, Q, Loss, Cut_l, and Cut_h).
- Lines 1060 to 1070 These lines prompt the user to decide whether to perform another measurement. When **[y]** is pressed followed by the **[Enter]** key, the program will return to the part where the DUT is connected and continue measurement.

Example 13-1 Measurement of band pass filter (meas_bpf.htb)

```

10 DIM Para$[9],Fmt$[9],File$[20],Buff$[9],Inp_char$[9],Err_msg$[20]
20 REAL Center,Span,If_bw,Pow,Resp,Bwid,Cent,Q,Loss,Cut_l,Cut_h
30 INTEGER Nop,Num_of_tr,Cal_kit,Port(1:4),Err_no
40 !
50 ASSIGN @Agte507x TO 717
60 !
70 Center=9.475E+8 ! Center Freq. : 947.5 MHz
80 Span=2.00E+8 ! Span : 200 MHz
90 Nop=401 ! Number of Points : 401
100 If_bw=1.0E+4 ! IF Bandwidth : 10 kHz
110 Pow=-10 ! Power Level : -10 dBm
120 Num_of_tr=1 ! Number of Traces : 1
130 Para$="S21" ! Meas. Parameter : S21
140 Fmt$="MLOG" ! Data Format : Log Mag
150 Cal_kit=4 ! Calibration Kit : 85032F
160 File$="State08.sta" ! Save File Name : State08.sta
170 !
180 ! Measurement Condition
190 !
200 OUTPUT @Agte507x;":SYST:PRES"
210 !
220 OUTPUT @Agte507x;":SENS1:FREQ:CENT ";Center
230 OUTPUT @Agte507x;":SENS1:FREQ:SPAN ";Span
240 OUTPUT @Agte507x;":SENS1:SWE:POIN ";Nop
250 OUTPUT @Agte507x;":SENS1:BAND ";If_bw
260 OUTPUT @Agte507x;":SOUR1:POW ";Pow
270 !
280 OUTPUT @Agte507x;":CALC1:PAR:COUN ";Num_of_tr
290 OUTPUT @Agte507x;":CALC1:PAR1:DEF "&Para$"
300 OUTPUT @Agte507x;":CALC1:PAR1:SEL"
310 OUTPUT @Agte507x;":CALC1:FORM "&Fmt$"
320 !
330 ! Full 2 Port Calibration (@ Port 1 & Port 2)
340 !
350 OUTPUT @Agte507x;":SENS1:CORR:COLL:CKIT ";Cal_kit
360 Port(1)=1
370 Port(2)=2
380 Cal_solt(@Agte507x,"1",2,Port(*))
390 !
400 ! Save State & Cal
410 !
420 OUTPUT @Agte507x;":MMEM:STOR:STYP CST"
430 OUTPUT @Agte507x;":MMEM:STOR ""&File$&""
440 !
450 ! Measurement
460 !
470 CLEAR SCREEN
480 OUTPUT @Agte507x;":TRIG:SOUR BUS"
490 OUTPUT @Agte507x;":INIT1:CONT ON"
500 Meas_start:!  

510 PRINT "Set DUT, then Push [Enter] key"
520 INPUT "",Inp_char$
530 !
540 OUTPUT @Agte507x;":TRIG:SING"
550 OUTPUT @Agte507x;":*OPC?"
560 ENTER @Agte507x;Buff$
570 !
580 OUTPUT @Agte507x;":DISP:WIND1:TRAC1:Y:AUTO"
590 !
600 ! Analysis
610 !

```

Sample Application Programs

Basic Measurement (measuring a band pass filter)

```
620 OUTPUT @Agte507x; ":CALC1:MARK1 ON"
630 OUTPUT @Agte507x; ":CALC1:MARK1:X ";Center
640 OUTPUT @Agte507x; ":CALC1:MARK1:Y?"
650 ENTER @Agte507x;Resp
660 !
670 OUTPUT @Agte507x; "*ESE 60"
680 OUTPUT @Agte507x; "*SRE 32"
690 OUTPUT @Agte507x; "*CLS"
700 OUTPUT @Agte507x; "*OPC?"
710 ENTER @Agte507x;Buff$
720 !
730 ON INTR 7 GOTO Bw_err
740 ENABLE INTR 7;2
750 OUTPUT @Agte507x; ":CALC1:MARK1:BWID:THR -3"
760 OUTPUT @Agte507x; ":CALC1:MARK1:BWID ON"
770 OUTPUT @Agte507x; ":CALC1:MARK1:BWID:DATA?"
780 WAIT .5
790 ENTER @Agte507x;Bwid,Cent,Q, Loss
800 GOTO Skip_bw_err
810 !
820 Bw_err: OFF INTR 7
830 OUTPUT @Agte507x; " :SYST:ERR?"
840 ENTER @Agte507x;Err_no,Err_msg$
850 PRINT "Error occurred!!"
860 PRINT " No: ";Err_no, "Description: "&Err_msg$
870 Bwid=0
880 Cent=0
890 Q=0
900 Loss=Resp
910 !
920 Skip_bw_err: OFF INTR 7
930 Cut_l=Cent-(Bwid/2)
940 Cut_h=Cent+(Bwid/2)
950 !
960 ! Display
970 !
980 PRINT "## Measurement Result ##"
990 PRINT " BW:",Bwid
1000 PRINT " cent:",Cent
1010 PRINT " low:",Cut_l
1020 PRINT " high:",Cut_h
1030 PRINT " Q:",Q
1040 PRINT " loss:",Loss
1050 !
1060 INPUT "Once more? [Y]es/[N]o",Inp_char$
1070 IF UPC$(Inp_char$)="Y" OR UPC$(Inp_char$)="YES" THEN Meas_start
1080 !
1090 END
1100 !=====
1110 ! Full n Port Calibration Function
1120 !=====
1130 SUB Cal_solt (@Agte507x,Ch$,INTEGER Num_of_ports,INTEGER Port (*))
1140 DIM Buff$[9]
1150 INTEGER I,J
1160 !
1170 PRINT "## Full "&VAL$(Num_of_ports)&" Port Calibration ##"
1180 !
1190 ! Calibration Type Selection
1200 !
1210 OUTPUT @Agte507x; ":SENS"&Ch$& ":CORR:COLL:METH:SOLT"&VAL$(Num_of_
ports)&" ";
1220 FOR I=1 TO Num_of_ports-1
1230 OUTPUT @Agte507x;Port (I); ", ";
1240 NEXT I
```

```
1250 OUTPUT @Agte507x;Port (Num_of_ports)
1260 !
1270 ! Reflection Measurement
1280 !
1290 FOR I=1 TO Num_of_ports
1300 PRINT "Set OPEN to Port "&VAL$(Port(I))&". Then push [Enter]
key."
1310 INPUT "",Buff$
1320 OUTPUT @Agte507x;":SENS"&Ch$&":CORR:COLL:OPEN ";Port(I)
1330 OUTPUT @Agte507x;"*OPC?"
1340 ENTER @Agte507x;Buff$
1350 PRINT "Set SHORT to Port "&VAL$(Port(I))&". Then push [Enter]
key."
1360 INPUT "",Buff$
1370 OUTPUT @Agte507x;":SENS"&Ch$&":CORR:COLL:SHOR ";Port(I)
1380 OUTPUT @Agte507x;"*OPC?"
1390 ENTER @Agte507x;Buff$
1400 PRINT "Set LOAD to Port "&VAL$(Port(I))&". Then push [Enter]
key."
1410 INPUT "",Buff$
1420 OUTPUT @Agte507x;":SENS"&Ch$&":CORR:COLL:LOAD ";Port(I)
1430 OUTPUT @Agte507x;"*OPC?"
1440 ENTER @Agte507x;Buff$
1450 NEXT I
1460 !
1470 ! Transmission Measurement
1480 !
1490 FOR I=1 TO Num_of_ports-1
1500 FOR J=I+1 TO Num_of_ports
1510 PRINT "Set THRU between Port "&VAL$(Port(I))&" and Port "&
VAL$(Port(J))&". Then push [Enter] key."
1520 INPUT "",Buff$
1530 OUTPUT @Agte507x;":SENS"&Ch$&":CORR:COLL:THRU ";Port(I);", "
;Port(J)
1540 OUTPUT @Agte507x;"*OPC?"
1550 ENTER @Agte507x;Buff$
1560 OUTPUT @Agte507x;":SENS"&Ch$&":CORR:COLL:THRU ";Port(J);", "
;Port(I)
1570 OUTPUT @Agte507x;"*OPC?"
1580 ENTER @Agte507x;Buff$
1590 NEXT J
1600 NEXT I
1610 !
1620 ! Done
1630 !
1640 OUTPUT @Agte507x;":SENS"&Ch$&":CORR:COLL:SAVE"
1650 PRINT "Done"
1660 SUBEND
```

Measurement with Automatic Test Systems

Example 13-2 is a sample program that performs duplexer measurement by making use of the limit test function and the handler I/O port (trigger input and test result output), assuming use with an automated test system using the handler. You can find the source file of this program, named meas_sys.htb, on the sample program disk.

When started, the program displays the screen where the user can select the calibration kit. Enter a number corresponding the desired kit and press **[Enter]**. Next, the program displays the message “Set OPEN to Port 1. Then push [Enter] key.” Connect the OPEN standard to port 1 and press **[Enter]** to measure the OPEN calibration data. Likewise, connect the SHORT and the LOAD standards and measure their calibration data. Follow instructions on the screen to measure OPEN/SHORT/LOAD calibration data for ports 2 and 3 as well as for port 1.

When the measurement of OPEN/SHORT/LOAD calibration data is completed, the program displays the message “Set THRU between Port 1 and Port 2. Then push [Enter] key.” Connect the THRU standard between ports 1 and 2 and press **[Enter]** to measure the THRU calibration data. Likewise, measure THRU calibration data for ports 1 and 3 as well as 2 and 3.

When the calibration is done, the program displays the message “Set DUT. Then input external trigger.” Connect the DUT and supply an external trigger signal through the handler I/O port. When the measurement is finished, the program displays the measurement result, the insertion loss for Tx and Rx, and the pass band ripple. After this operation is repeated ten times, the program terminates.

The program is described in detail below:

- Line 70 Assigns a GPIB address to the I/O pass.
- Lines 90 to 110 These lines assign the measurement times (10), the upper limit of ripple for Tx (2 dBm), and that for Rx (2 dBm) to the variables Max_meas, Tx_rpl_lim, and Rx_rpl_lim, respectively.
- Lines 130 to 190 These lines assign the IF bandwidth (70 kHz), the power level (0 dBm), the number of traces (2), the measurement parameters for trace 1 (S13), those for trace 2 (S21), the data format for trace 1 (Log Mag), and that for trace 2 (Log Mag) to the variables If_bw, Pow, Num_of_tr, Param1\$, Param2\$, Fmt1\$, and Fmt2\$, respectively.
- Lines 210 to 420 These lines assign the necessary settings to the corresponding variables to create the segment sweep table shown in Table 13-1.

Table 13-1

Segment sweep table

No.	Start	Stop	Points
1	1730 MHz	1830 MHz	50
2	1830 MHz	2030 MHz	400
3	2030 MHz	2130 MHz	50
4	3650 MHz	4030 MHz	38
5	5500 MHz	6020 MHz	52

Lines 440 to 1010 These lines assign the necessary settings to the corresponding variables to create the limit tables shown in Table 13-2, Table 13-3.

Table 13-2

Limit table for trace 1

No.	Type	Begin Stimulus	End Stimulus	Begin Response	End Response
1	MAX	1730 MHz	1930 MHz	0 dBm	0 dBm
2	MIN	1850 MHz	1910 MHz	-4 dBm	-4 dBm
3	MAX	1930 MHz	1990 MHz	-35 dBm	-35 dBm
4	MAX	1990 MHz	2130 MHz	-40 dBm	-40 dBm
5	MAX	2130 MHz	6020 MHz	-25 dBm	-25 dBm

Table 13-3

Limit table for trace 2

No.	Type	Begin Stimulus	End Stimulus	Begin Response	End Response
1	MAX	1730 MHz	1850 MHz	-40 dBm	-40 dBm
2	MAX	1850 MHz	1910 MHz	-45 dBm	-45 dBm
3	MAX	1910 MHz	6020 MHz	0 dBm	0 dBm
4	MIN	1930 MHz	1990 MHz	-5 dBm	-5 dBm

Lines 1050 to 1070 These lines execute presetting and then assign the IF bandwidth for channel 1 to If_bw and the power level to Pow, respectively.

Lines 1080 to 1140 These lines set the sweep type for channel 1 to segment sweep and create a segment sweep table.

Lines 1150 to 1240 These lines assign the number of traces for channel 1 to Num_of_tr, the measurement parameters and data format for channel 1 to Para1\$ and Fmt1\$, those for channel 2 to Para2\$ and Fmt2\$, arrange two graphs tiled horizontally, and configure the display of the horizontal axis to order basis.

Lines 1280 to 1320 These lines call the sub-program Select_cal_kit to select a calibration kit for channel 1, set the ports to be used to 1, 2, and 3, and then call another sub-program Cal_solt to perform full 3-port calibration. For more information on the subprograms Select_cal_kit and Cal_solt, refer to the description in Example 4-1 on page 100.

Lines 1360 to 1370 These lines set the trigger source to the external trigger and turn on the continuous initiation mode for channel 1.

Lines 1410 to 1500 These lines create the limit table for trace 1 of channel 1 and then turn on the limit line display and limit test.

Lines 1540 to 1630 These lines create the limit table for trace 2 of channel 1 and then turn on the limit line display and limit test.

Lines 1670 to 1700 These lines set each bit in the operation status register and the service request enable register so that an SRQ is generated upon completion of the measurement.

Lines 1720 to 1740 These lines set each bit in the questionable limit channel 1 status register so that the combined test results of trace 1 and 2 are set to bit 1 in the questionable limit status event register.

Sample Application Programs

Measurement with Automatic Test Systems

Lines 1780 to 1790 These lines lock out any operation from the front panel, keyboard, or mouse.

Line 1830 This line turns OFF the updating of the LCD screen.

Lines 1870 to 2470 These lines repeat the following procedure Meas_max times.

1. Lines 1880 to 1910: Waits until the trigger system switches to “Waiting for Trigger” state.
2. Lines 1920 to 1940: Clears the status byte register, the operation status event register, the questionable limit status event register, and the questionable limit channel 1 status register.
3. Lines 1950 to 1960: These lines set the branch target for an SRQ interrupt to enable SRQ interruptions.
4. Lines 1970 to 1980: Displays a message prompting the user to connect the DUT and input an external trigger and then waits until the program terminates upon the external trigger input.

NOTE

This example employs the status reporting system to synchronize the trigger input and the termination of the program. It is also possible to use /READY FOR TRIG, /INDEX, or /SWEEP END output signals from the handler I/O port for synchronizing.

5. Lines 2030 to 2050: Retrieves the combined limit test results of traces 1 and 2.

NOTE

It is also possible to obtain the limit test result using the /PASS_FAIL output signal from the handler I/O port.

6. Lines 2090 to 2100: Calls the sub-program Select_cal_kit to obtain insertion loss for Tx and Rx and the value of pass band ripple.
7. Lines 2140 to 2230: Determines the ripple test results for Tx and Rx based on the ripple values for Tx and Rx.
8. Lines 2240 to 2300: Determines the overall result of all tests based on the limit test result and the ripple test results for Tx and Rx.
9. Line 2340: Output the overall result of entire test (Pass:0, Fail:1) to the bit 1 of the port A in the handler I/O port.
10. Line 2380: Updates the display on the LCD screen once.
11. Lines 2420 to 2460: Displays the measurement result.

The sub-program Analysis, which resides from line 3380 to 3560, analyzes the minimum value and the difference between maximum and minimum values. Details are as follows.

Line 3410 Sets the trace with trace number Tr\$ in channel 1 active.

Lines 3430 to 3450 Sets the analysis range for the analysis command from Start to Stop.

Lines 3470 to 3500 Uses the analysis command to search for the minimum value, retrieve the value, and assign it to the Min variable.

Lines 3520 to 3550 Uses the analysis command to search for the difference between maximum and minimum values, retrieve the value, and assign it to the Ptp variable.

Example 13-2

Measurement with Automatic Test Systems (meas_sys.htb)

```

10     DIM Param1$(9),Param2$(9),Fmt1$(9),Fmt2$(9),Buff$(9),Judge$(9),
Handler$(9)
20     REAL If_bw,Pow,Swp(1:5,1:3),Lim1(1:5,1:5),Lim2(1:4,1:5)
30     REAL Tx_loss,Rx_loss,Tx_rpl,Rx_rpl,Tx_rpl_lim,Rx_rpl_lim
40     INTEGER Max_meas,Segm_swp,Segm_lim1,Segm_lim2,Segment,Column
50     INTEGER Port(1:4),Cond_reg,Lim_judge,Tx_rpl_judge,Rx_rpl_judge,I
60     !
70     ASSIGN @Agte507x TO 717
80     !
90     Max_meas=10      !
100    Tx_rpl_lim=2     ! Pass Band      Tx: 2 dBm
110    Rx_rpl_lim=2     ! Ripple Limit Rx: 2 dBm
120    !
130    If_bw=7.0E+4     ! IF Bandwidth   : 70 kHz
140    Pow=0            ! Power level    : 0 dBm
150    Num_of_tr=2     ! Number of Traces: 2
160    Param1$="S13"   ! Meas.         Trace1: S13
170    Param2$="S21"   ! Param.        Trace2: S21
180    Fmt1$="MLOG"    ! Data          Trace1:
190    Fmt2$="MLOG"    ! Format        Trace2:
200    !
210    ! == Segment Sweep Table ==
220    Segm_swp=5      ! Segments      : 5
230    ! -- Segment 1 --
240    Swp(1,1)=1.73E+9 ! Start         : 1730 MHz
250    Swp(1,2)=1.83E+9 ! Stop          : 1830 MHz
260    Swp(1,3)=50     ! Nop           : 50
270    ! -- Segment 2 --
280    Swp(2,1)=1.83E+9 ! Start         : 1830 MHz
290    Swp(2,2)=2.03E+9 ! Stop          : 2030 MHz
300    Swp(2,3)=400    ! Nop           : 400
310    ! -- Segment 3 --
320    Swp(3,1)=2.03E+9 ! Start         : 2030 MHz
330    Swp(3,2)=2.13E+9 ! Stop          : 2130 MHz
340    Swp(3,3)=50     ! Nop           : 50
350    ! -- Segment 4 --
360    Swp(4,1)=3.65E+9 ! Start         : 3650 MHz
370    Swp(4,2)=4.03E+9 ! Stop          : 4030 MHz
380    Swp(4,3)=38     ! Nop           : 38
390    ! -- Segment 5 --
400    Swp(5,1)=5.5E+9 ! Start         : 5500 MHz
410    Swp(5,2)=6.02E+9 ! Stop          : 6020 MHz
420    Swp(5,3)=52     ! Nop           : 52
430    !
440    ! == Trace 1 (S13) Limit Line ==
450    Segm_lim1=5     ! Segments      : 5

```

Sample Application Programs

Measurement with Automatic Test Systems

```

460      ! -- Segment 1 --
470      Lim1(1,1)=1                ! Type           : Maximum
480      Lim1(1,2)=1.73E+9         ! Freq. Start: 1730 MHz
490      Lim1(1,3)=1.93E+9         !                Stop : 1930 MHz
500      Lim1(1,4)=0                ! Resp. Start: 0 dBm
510      Lim1(1,5)=0                !                Stop : 0 dBm
520      ! -- Segment 2 --
530      Lim1(2,1)=2                ! Type           : Minimum
540      Lim1(2,2)=1.85E+9         ! Freq. Start: 1850 MHz
550      Lim1(2,3)=1.91E+9         !                Stop : 1910 MHz
560      Lim1(2,4)=-4               ! Resp. Start: -4 dBm
570      Lim1(2,5)=-4               !                Stop : -4 dBm
580      ! -- Segment 3 --
590      Lim1(3,1)=1                ! Type           : Maximum
600      Lim1(3,2)=1.93E+9         ! Freq. Start: 1930 MHz
610      Lim1(3,3)=1.99E+9         !                Stop : 1990 MHz
620      Lim1(3,4)=-35              ! Resp. Start: -35 dBm
630      Lim1(3,5)=-35              !                Stop : -35 dBm
640      ! -- Segment 4 --
650      Lim1(4,1)=1                ! Type           : Maximum
660      Lim1(4,2)=1.99E+9         ! Freq. Start: 1990 MHz
670      Lim1(4,3)=2.13E+9         !                Stop : 2130 MHz
680      Lim1(4,4)=-40              ! Resp. Start: -40 dBm
690      Lim1(4,5)=-40              !                Stop : -40 dBm
700      ! -- Segment 5 --
710      Lim1(5,1)=1                ! Type           : Maximum
720      Lim1(5,2)=2.13E+9         ! Freq. Start: 2130 MHz
730      Lim1(5,3)=6.02E+9         !                Stop : 6020 MHz
740      Lim1(5,4)=-25              ! Resp. Start: -25 dBm
750      Lim1(5,5)=-25              !                Stop : -25 dBm
760      ! == Trace 2 (S21) Limit Line ==
770      Segm_lim2=4                ! Segments      : 4
780      ! -- Segment 1 --
790      Lim2(1,1)=1                ! Type           : Maximum
800      Lim2(1,2)=1.73E+9         ! Freq. Start: 1730 MHz
810      Lim2(1,3)=1.85E+9         !                Stop : 1850 MHz
820      Lim2(1,4)=-40              ! Resp. Start: -40 dBm
830      Lim2(1,5)=-40              !                Stop : -40 dBm
840      ! -- Segment 2 --
850      Lim2(2,1)=1                ! Type           : Maximum
860      Lim2(2,2)=1.85E+9         ! Freq. Start: 1850 MHz
870      Lim2(2,3)=1.91E+9         !                Stop : 1910 MHz
880      Lim2(2,4)=-45              ! Resp. Start: -45 dBm
890      Lim2(2,5)=-45              !                Stop : -45 dBm
900      ! -- Segment 3 --
910      Lim2(3,1)=1                ! Type           : Maximum
920      Lim2(3,2)=1.91E+9         ! Freq. Start: 1910 MHz
930      Lim2(3,3)=6.20E+9         !                Stop : 6020 MHz
940      Lim2(3,4)=0                ! Resp. Start: 0 dBm
950      Lim2(3,5)=0                !                Stop : 0 dBm
960      ! -- Segment 4 --
970      Lim2(4,1)=2                ! Type           : Minimum
980      Lim2(4,2)=1.93E+9         ! Freq. Start: 1930 MHz
990      Lim2(4,3)=1.99E+9         !                Stop : 1990 MHz
1000     Lim2(4,4)=-5                ! Resp. Start: -5 dBm
1010     Lim2(4,5)=-5                !                Stop : -5 dBm
1020     !
1030     ! Measurement Conditions
1040     !
1050     OUTPUT @Agte507x;":SYST:PRES"
1060     OUTPUT @Agte507x;":SENS1:BWID ";If_bw
1070     OUTPUT @Agte507x;":SOUR1:POW ";Pow

```

Sample Application Programs

Measurement with Automatic Test Systems

```
1710 !
1720 OUTPUT @Agte507x;":STAT:QUES:LIM:CHAN1:ENAB 6"
1730 OUTPUT @Agte507x;":STAT:QUES:LIM:CHAN1:PTR 6"
1740 OUTPUT @Agte507x;":STAT:QUES:LIM:CHAN1:NTR 0"
1750 !
1760 ! Key Lock: ON
1770 !
1780 OUTPUT @Agte507x;":SYST:KLOC:KBD ON"
1790 OUTPUT @Agte507x;":SYST:KLOC:MOUS ON"
1800 !
1810 ! Display Update: OFF
1820 !
1830 OUTPUT @Agte507x;":DISP:ENAB OFF"
1840 !
1850 ! Measurement
1860 !
1870 FOR I=1 TO Max_meas
1880 REPEAT
1890     OUTPUT @Agte507x;":STAT:OPER:COND?"
1900     ENTER @Agte507x;Cond_reg
1910     UNTIL BIT(Cond_reg,5)
1920     OUTPUT @Agte507x;"*CLS"
1930     OUTPUT @Agte507x;"*OPC?"
1940     ENTER @Agte507x;Buff$
1950     ON INTR 7 GOTO Meas_end
1960     ENABLE INTR 7;2
1970     PRINT "Set DUT, then input external trigger!"
1980 Meas_wait: GOTO Meas_wait
1990 Meas_end: OFF INTR 7
2000 !
2010 ! Limit Test Result
2020 !
2030 OUTPUT @Agte507x;":STAT:QUES:LIM?"
2040 ENTER @Agte507x;Reg_val
2050 Lim_judge=BIT(Reg_val,1)    ! Fail:1, Pass:0
2060 !
2070 ! Insertion Loss & Ripple
2080 !
2090 Analysis(@Agte507x,"1",1.85E+9,1.91E+9,Tx_loss,Tx_rpl)
2100 Analysis(@Agte507x,"2",1.93E+9,1.99E+9,Rx_loss,Rx_rpl)
2110 !
2120 ! Pass/Fail Judgement
2130 !
2140 IF Tx_rpl>Tx_rpl_lim THEN
2150     Tx_rpl_judge=1
2160 ELSE
2170     Tx_rpl_judge=0
2180 END IF
2190 IF Rx_rpl>Rx_rpl_lim THEN
2200     Rx_rpl_judge=1
2210 ELSE
2220     Rx_rpl_judge=0
2230 END IF
2240 IF Lim_judge=0 AND Tx_rpl_judge=0 AND Rx_rpl_judge=0 THEN
2250     Judge$="PASS"
2260     Handler$="00000000"
2270 ELSE
2280     Judge$="FAIL"
2290     Handler$="00000001"
2300 END IF
```

```

2310      !
2320      ! Set Data to Handler I/O Port A
2330      !
2340      OUTPUT @Agte507x;":CONT:HAND:A ";IVAL(Handler$,2)
2350      !
2360      ! Update E507XA Display
2370      !
2380      OUTPUT @Agte507x;":DISP:UPD"
2390      !
2400      ! Display Results
2410      !
2420      PRINT "## "&Judge$&"! ##"
2430      PRINT USING "X,15A,X,SD.5DE";"[Tx] Ins. Loss:",Tx_loss
2440      PRINT USING "X,15A,X,SD.5DE";" Ripple :",Tx_rpl
2450      PRINT USING "X,15A,X,SD.5DE";"[Rx] Ins. Loss:",Rx_loss
2460      PRINT USING "X,15A,X,SD.5DE";" Ripple :",Rx_rpl
2470      NEXT I
2480      !
2490      END
2500      !=====
2510      ! Calibration Kit Selection Function
2520      !=====
2530      SUB Select_cal_kit(@Agte507x,Ch$)
2540          DIM Cal_kit_lbl$(1:10)[20],Inp_char$(9)
2550          INTEGER Cal_kit,I
2560          CLEAR SCREEN
2570          !
2580          FOR I=1 TO 10
2590              OUTPUT @Agte507x;":SENS1:CORR:COLL:CKIT ";I
2600              OUTPUT @Agte507x;":SENS1:CORR:COLL:CKIT:LAB?"
2610              ENTER @Agte507x;Cal_kit_lbl$(I)
2620          NEXT I
2630          ON ERROR GOTO Kit_select
2640      Kit_select: !
2650          PRINT "## Calibration Kit Selection ##"
2660          FOR I=1 TO 10
2670              PRINT USING "X,2D,A,X,20A";I,":",Cal_kit_lbl$(I)
2680          NEXT I
2690          PRINT ""
2700          PRINT "Input 1 to 10"
2710          INPUT "Input number? (1 to 10)",Inp_char$
2720          Cal_kit=IVAL(Inp_char$,10)
2730          IF Cal_kit<1 OR Cal_kit>10 THEN Kit_select
2740          OFF ERROR
2750          !
2760          OUTPUT @Agte507x;":SENS"&Ch$&":CORR:COLL:CKIT ";Cal_kit
2770      SUBEND
2780      !=====
2790      ! Full n Port Calibration Function
2800      !=====
2810      SUB Cal_solt(@Agte507x,Ch$,INTEGER Num_of_ports,INTEGER Port(*))
2820          DIM Buff$(9)
2830          INTEGER I,J
2840          !
2850          PRINT "## Full "&VAL$(Num_of_ports)&" Port Calibration ##"
2860          !
2870          ! Calibration Type Selection
2880          !
2890          OUTPUT @Agte507x;":SENS"&Ch$&":CORR:COLL:METH:SOLT"&VAL$(Num_of_
ports)&" ";
2900          FOR I=1 TO Num_of_ports-1
2910              OUTPUT @Agte507x;Port(I);", ";
2920          NEXT I

```

Sample Application Programs

Measurement with Automatic Test Systems

```
2930 OUTPUT @Agte507x;Port (Num_of_ports)
2940 !
2950 ! Reflection Measurement
2960 !
2970 FOR I=1 TO Num_of_ports
2980 PRINT "Set OPEN to Port "&VAL$(Port(I))&". Then push [Enter]
key."
2990 INPUT "",Buff$
3000 OUTPUT @Agte507x;":SENS"&Ch$&":CORR:COLL:OPEN ";Port (I)
3010 OUTPUT @Agte507x;"*OPC?"
3020 ENTER @Agte507x;Buff$
3030 PRINT "Set SHORT to Port "&VAL$(Port(I))&". Then push [Enter]
key."
3040 INPUT "",Buff$
3050 OUTPUT @Agte507x;":SENS"&Ch$&":CORR:COLL:SHOR ";Port (I)
3060 OUTPUT @Agte507x;"*OPC?"
3070 ENTER @Agte507x;Buff$
3080 PRINT "Set LOAD to Port "&VAL$(Port(I))&". Then push [Enter]
key."
3090 INPUT "",Buff$
3100 OUTPUT @Agte507x;":SENS"&Ch$&":CORR:COLL:LOAD ";Port (I)
3110 OUTPUT @Agte507x;"*OPC?"
3120 ENTER @Agte507x;Buff$
3130 NEXT I
3140 !
3150 ! Transmission Measurement
3160 !
3170 FOR I=1 TO Num_of_ports-1
3180 FOR J=I+1 TO Num_of_ports
3190 PRINT "Set THRU between Port "&VAL$(Port(I))&" and Port "&
VAL$(Port (J
))&". Then push [Enter] key."
3200 INPUT "",Buff$
3210 OUTPUT @Agte507x;":SENS"&Ch$&":CORR:COLL:THRU ";Port (I);","
;Port (J)
3220 OUTPUT @Agte507x;"*OPC?"
3230 ENTER @Agte507x;Buff$
3240 OUTPUT @Agte507x;":SENS"&Ch$&":CORR:COLL:THRU ";Port (J);","
;Port (I)
3250 OUTPUT @Agte507x;"*OPC?"
3260 ENTER @Agte507x;Buff$
3270 NEXT J
3280 NEXT I
3290 !
3300 ! Done
3310 !
3320 OUTPUT @Agte507x;":SENS"&Ch$&":CORR:COLL:SAVE"
3330 PRINT "Done"
3340 SUBEND
3350 !=====
3360 ! Min. Value & Peak to Peak Analysis Function
3370 !=====
3380 SUB Analysis(@Agte507x,Tr$,REAL Star,REAL Stop,REAL Min,REAL Ptp)
3390 REAL Dummy
3400 !
3410 OUTPUT @Agte507x;":CALC1:PAR"&Tr$&":SEL"
3420 !
3430 OUTPUT @Agte507x;":CALC1:FUNC:DOM ON"
3440 OUTPUT @Agte507x;":CALC1:FUNC:DOM:STAR ";Star
3450 OUTPUT @Agte507x;":CALC1:FUNC:DOM:STOP ";Stop
3460 !
```

```
3470 OUTPUT @Agte507x;":CALC1:FUNC:TYPE MIN"  
3480 OUTPUT @Agte507x;":CALC1:FUNC:EXEC"  
3490 OUTPUT @Agte507x;":CALC1:FUNC:DATA?"  
3500 ENTER @Agte507x;Min,Dummy  
3510 !  
3520 OUTPUT @Agte507x;":CALC1:FUNC:TYPE PTP"  
3530 OUTPUT @Agte507x;":CALC1:FUNC:EXEC"  
3540 OUTPUT @Agte507x;":CALC1:FUNC:DATA?"  
3550 ENTER @Agte507x;Ptp,Dummy  
3560 SUBEND
```

Measurement using E5091A (measuring FEM)

Example 13-3 shows a sample program of front end module (FEM) measurement as a sample program of measurement using the E5091A. You can find the source file of this program, named meas_fem.htb, on the sample program disk.

This program calibrates each channel using the ECal module and then measures the transmission characteristics EGSM:Tx-Antenna (channel 1), EGSM:Antenna-Rx (channel 2), GSM1800:Tx-Antenna (channel 3), and GSM1800:Antenna-Rx (channel 4) of the 6-port dual-band FEM as shown in the below figure.

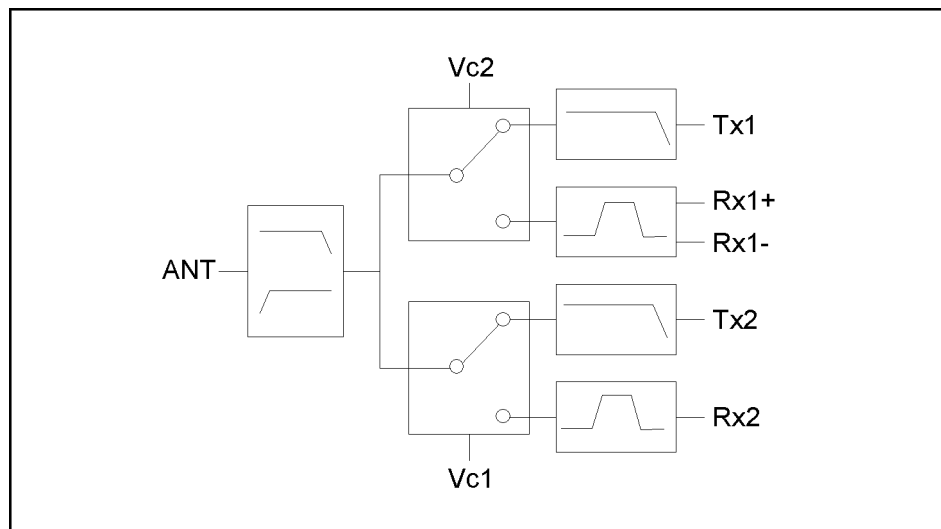

e5070buj073

When you start the program, “Connect A and T1 to ECal Module.” is displayed. Connect the cables connected to A and T1 of the E5091A to the ECal module and press the **[Enter]** key to calibrate channel 1. If an error occurs due to a problem in the connection to the ECal module, an error message appears and “Re-try? [Y]es/[N]o” appears. You can execute calibration again by pressing the **[y]** key and then the **[Enter]** key. If you want to abort the program, press the **[n]** key and then the **[Enter]** key. For channels 2 to 4, execute the calibration in the same way.

When the calibration is complete, “Set DUT. Then Push [Enter] key.” is displayed. Connect the DUT (FEM) and the E5091A as shown below and press the **[Enter]** key to start the measurement.

FEM		E5091A
Antenna		A
EGSM	Tx	T1
	Rx+	R1+
	Rx-	R1-
GSM1800	Tx	T2
	Rx	R2+
Vc1		Control Line 1
Vc2		Control Line 2

Figure 13-3 shows a sample display of the LCD screen after the program exits execution.

Figure 13-3

Example of display after executing program in Example 13-3

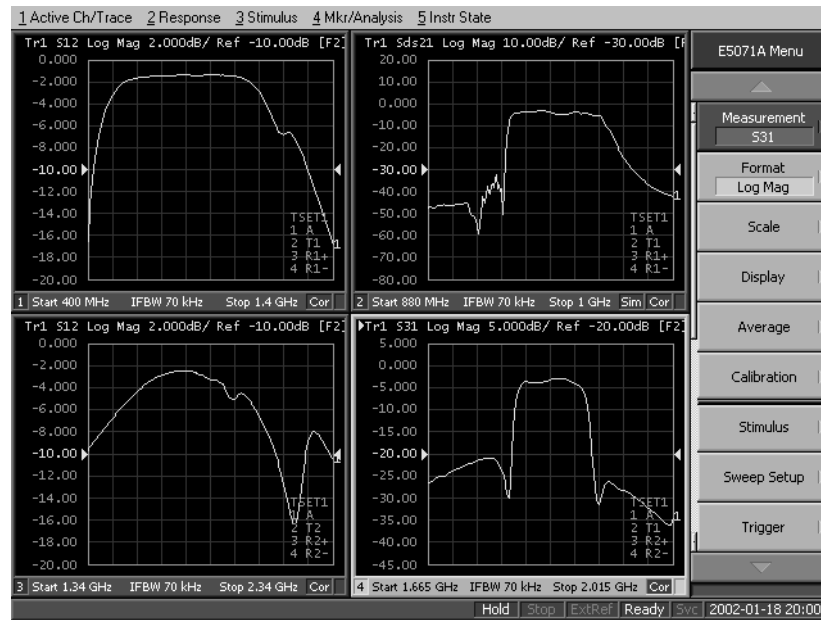

The program is described in detail below:

- Line 80 Assigns a GPIB address to the I/O path.
- Line 120 Assigns the name of the test set, E5091A-009 (Option009) to the variables Model\$.
- Lines 140 to 330 Sets the ports assigned to port 1 to port 4 of the E5091A and the control line setting (table below) into the Port1\$(*), Port2\$(*), Port3\$(*), Port4\$(*), and C_lines\$(*) variables.

Channel number	Port 1	Port 2	Port 3	Port 4	Control Lines
1	A	T1	R1+	R1-	0 (00000000)
2	A	T1	R1+	R1-	2 (00000010)
3	A	T2	R2+	R2-	0 (00000000)
4	A	T2	R2+	R2-	1 (00000001)

- Lines 370 to 690 Sets the settings required for the measurement conditions in the tables below to the appropriate variables.

Channel number	Sweep range		Number of points	Number of traces	Measurement parameter
	Start	Stop			
1	400 MHz	1.4 GHz	51	1	S12
2	880 MHz	1 GHz	101	1	Sds21
3	1.34 GHz	2.34 GHz	201	1	S12
4	1.665 GHz	2.015 GHz	101	1	S31

Sample Application Programs
Measurement using E5091A (measuring FEM)

Channel number	Fixture simulator		Title
	ON/OFF	Topology	
1	Off	—	[EGSM] Tx-Antenna
2	On	SE:1, Bal:3,4	[EGSM] Antenna-Rx
3	Off	—	[GSM1800] Antenna-Rx
4	Off	—	[GSM1800] Tx-Antenna

- Line 720 Puts the instrument into the preset state.
- Line 730 Allocates the windows to the upper left, upper right, lower left, and lower right.
- Line 750 Sets the test set name.
- Lines 770 to 1050 Repeats the following for channels 1 to 4, where i is the channel number.
- Lines 810 to 850: For the E5091A whose ID is 1, sets the port assigned to port 1 to Port1\$(i), the port assigned to port 2 to Port2\$(i), the port assigned to port 3 to Port3\$(i), and the port assigned to port 4 to Port4\$(i).
- Line 850: Sets the control line of the E5091A whose ID is 1 to C_lines(i).
- Lines 890 to 920: Sets the sweep start value to Star(i), the sweep stop value to Stop(i), the number of points to Nop(i), and the number of traces to N_tr(i).
- Lines 940 to 980: If the fixture simulator function is ON (Fsim\$(i) is “ON”), sets the fixture simulator function to ON, the device type to Dev\$(i), the port assignment to Top\$(i), the balance-unbalance conversion to ON, and the measurement parameter (mix mode S-parameter) to Trc\$(i).
- Line 1000: If the fixture simulator function is OFF (Fsim\$(i) is “OFF”), sets the measurement parameter (S-parameter) to Trc\$.
- Lines 1020 to 1040: Sets the title label to Ttl\$(i), the title display to ON, and the continuous startup mode to ON, respectively.
- Line 1070 Sets the trigger source to “Bus.”
- Lines 1080 to 1090 For the E5091A whose ID is 1, sets the properties display to ON and the control to ON.
- Lines 1130 to 1140 Uses the subprogram FNCal_solt_tset to execute the calibration of channel 1 with the ECal module (full 2-port calibration of ports A and T1). If the calibration is not completed correctly, aborts the program.
- Lines 1150 to 1200 Executes the calibration of channels 2 to 4 in the same way.
- Lines 1250 to 1260 Prompts the user to connect the DUT and waits for **[Enter]** to be pressed after the DUT is connected.
- Lines 1280 to 1300 Triggers the instrument and waits until the measurement cycle finishes.
- Lines 1320 to 1340 Executes auto scale for trace 1 of channels 1 to 4.

Lines 1360 to 1370 Prompts the user to decide whether to perform another measurement. When **[y]** is pressed followed by the **[Enter]** key, the program will return to the part where the DUT is connected and continue measurement.

Sample Application Programs

Measurement using E5091A (measuring FEM)

The FNCal_solt_tset subprogram in lines 1430 to 1680, which performs ECal, is described below.

- Line 1470 Displays the calibration type.
- Line 1500 Clears the error queue.
- Lines 1510 to 1530 Prompts the user to connect the Tset_Port\$ of the E5091A to the ECal module and waits for the **[Enter]** key to be pressed after the connection.
- Line 1540 Executes the ECal command for the full solt\$-port calibration for the port Ana_port\$ of the channel Ch\$.
- Lines 1560 to 1570 Retrieves the error number and error message from the error queue and then stores them into the variables Err_no and Err_msg\$, respectively.
- Lines 1590 to 1600 If Err_no returns a non-zero value (an error value), the program displays the corresponding error message.
- Lines 1610 to 1630 If Err_no is other than 0 (occurrence of an error), prompts the user to decide whether to execute ECal again. When **[y]** is pressed followed by the **[Enter]** key, the program will return to the point of the connection and repeat ECal. When a key other than the **[y]** key is pressed followed by the **[Enter]** key, the program will return Err_no as the return value of the sub-program.
- Lines 1650 to 1660 If Err_no is 0 (no error occurrence), displays the ECal completion message and returns Err_no (0) as the return value of the sub-program.

Example 13-3 Measurement of FEM (meas_fem_2.htb)

```

10     DIM
Port1$(1:4) [9],Port2$(1:4) [9],Port3$(1:4) [9],Port4$(1:4) [9]
20     DIM Fsim$(1:4) [9],Tpl$(1:4) [9],Trc$(1:4) [9],Ttl$(1:4) [30]
30     DIM Buff$(9),Inp_char$(9)
40     DIM Model$(8)
50     REAL Star(1:4),Stop(1:4)
60     INTEGER C_lines(1:4),Nop(1:4),N_tr(1:4),Ch,Res
70     !
80     ASSIGN @Agte507x TO 717
90     !
100    ! E5091A Setup
110    !
120    Model$="E5091_9"    ! Model:E5091A-009
130    !
140    Port1$(1)="A"      ![Ch1]      Port1: A
150    Port2$(1)="T1"    !           Port2: T1
160    Port3$(1)="R1"    !           Port3: R1+
170    Port4$(1)="R1"    !           Port4: R1-
180    C_lines(1)=0      !           Ctrl Lines: 0
190    Port1$(2)="A"      ![Ch2]      Port1: A
200    Port2$(2)="T1"    !           Port2: T1
210    Port3$(2)="R1"    !           Port3: R1+
220    Port4$(2)="R1"    !           Port4: R1-
230    C_lines(2)=2      !           Ctrl Lines: 2 (Line2:HIGH)
240    Port1$(3)="A"      ![Ch3]      Port1: A
250    Port2$(3)="T2"    !           Port2: T2
260    Port3$(3)="R2"    !           Port3: R2+
270    Port4$(3)="R2"    !           Port4: R2- (Dummy)
280    C_lines(3)=0      !           Ctrl Lines: 0
290    Port1$(4)="A"      ![Ch4]      Port1: A
300    Port2$(4)="T2"    !           Port2: T2
310    Port3$(4)="R2"    !           Port3: R2+
320    Port4$(4)="R2"    !           Port4: R2- (Dummy)
330    C_lines(4)=1      !           Ctrl Lines: 1 (Line1:HIGH)
340    !
350    ! Measurement Condition
360    !           [Ch1]
370    Star(1)=4.E+8      ! Start Frequency   : 400 MHz
380    Stop(1)=1.4E+9    ! Stop Frequency    : 1.4 GHz
390    Nop(1)=51         ! Number of Points  : 51
400    N_tr(1)=1         ! Number of Traces  : 1
410    Fsim$(1)="OFF"    ! Fixture Simulator : OFF
420    Trc$(1)="S12"     ! Meas. Param.     : S12
430    Ttl$(1)=" [EGSM] Tx-Antenna"
440    !           [Ch2]
450    Star(2)=8.8E+8    ! Start Frequency   : 880 MHz
460    Stop(2)=1.E+9     ! Stop Frequency    : 1 GHz
470    Nop(2)=101        ! Number of Points  : 101
480    N_tr(2)=1         ! Number of Traces  : 1
490    Fsim$(2)="ON"     ! Fixture Simulator : ON
500    Dev$(2)="SBAL"    ! Bal. Device Type  : SE-Bal
510    Tpl$(2)="1,3,4"   ! Topology          : SE:1,Bal:3-4
520    Trc$(2)="SDS21"   ! Meas. Param.     : Sds21
530    Ttl$(2)=" [EGSM] Antenna-Rx"
540    !           [Ch3]

```

Sample Application Programs

Measurement using E5091A (measuring FEM)

```
550 Star(3)=1.34E+9 ! Start Frequency : 1.34 GHz
560 Stop(3)=2.34E+9 ! Stop Frequency : 2.34 GHz
570 Nop(3)=201 ! Number of Points : 201
580 N_tr(3)=1 ! Number of Traces : 1
590 Fsim$(3)="OFF" ! Fixture Simulator : OFF
600 Trc$(3)="S12" ! Meas. Param. : S12
610 Ttl$(3)=" [GSM1800] Tx-Antenna"
620 ! [Ch4]
630 Star(4)=1.665E+9 ! Start Frequency : 1.665 GHz
640 Stop(4)=2.015E+9 ! Stop Frequency : 2.015 GHz
650 Nop(4)=101 ! Number of Points : 101
660 N_tr(4)=1 ! Number of Traces : 1
670 Fsim$(4)="OFF" ! Fixture Simulator : OFF
680 Trc$(4)="S31" ! Meas. Param. : S31
690 Ttl$(4)=" [GSM1800] Antenna-Rx"
700 !
710 CLEAR SCREEN
720 OUTPUT @Agte507x;":SYST:PRES"
730 OUTPUT @Agte507x;":DISP:SPL D12_34"
740 !
750 OUTPUT @Agte507x;":SENS1:MULT1:NAME "&Model$
760 !
770 FOR Ch=1 TO 4
780 !
790 ! E5091A Setup
800 !
810 OUTPUT @Agte507x;":SENS"&VAL$(Ch) & ":MULT1:PORT1
"&Port1$(Ch)
820 OUTPUT @Agte507x;":SENS"&VAL$(Ch) & ":MULT1:PORT2
"&Port2$(Ch)
830 OUTPUT @Agte507x;":SENS"&VAL$(Ch) & ":MULT1:PORT3
"&Port3$(Ch)
840 OUTPUT @Agte507x;":SENS"&VAL$(Ch) & ":MULT1:PORT4
"&Port4$(Ch)
850 OUTPUT @Agte507x;":SENS"&VAL$(Ch) & ":MULT1:OUTP
";C_lines(Ch)
860 !
870 ! Measurement Condition
880 !
890 OUTPUT @Agte507x;":SENS"&VAL$(Ch) & ":FREQ:STAR ";Star(Ch)
900 OUTPUT @Agte507x;":SENS"&VAL$(Ch) & ":FREQ:STOP ";Stop(Ch)
910 OUTPUT @Agte507x;":SENS"&VAL$(Ch) & ":SWE:POIN ";Nop(Ch)
920 OUTPUT @Agte507x;":CALC"&VAL$(Ch) & ":PAR:COUN ";N_tr(Ch)
930 IF Fsim$(Ch)="ON" THEN
940 OUTPUT @Agte507x;":CALC"&VAL$(Ch) & ":FSIM:STAT ON"
950 OUTPUT @Agte507x;":CALC"&VAL$(Ch) & ":FSIM:BAL:DEV
"&Dev$(Ch)
960 OUTPUT
@Agte507x;":CALC"&VAL$(Ch) & ":FSIM:BAL:TOP:"&Dev$(Ch) & " "&Tpl$(Ch)
970 OUTPUT @Agte507x;":CALC"&VAL$(Ch) & ":FSIM:BAL:PAR1:STAT
ON"
980 OUTPUT
@Agte507x;":CALC"&VAL$(Ch) & ":FSIM:BAL:PAR1:"&Dev$(Ch) & " "&Trc$(Ch)
990 ELSE
1000 OUTPUT @Agte507x;":CALC"&VAL$(Ch) & ":PAR1:DEF "&Trc$(Ch)
1010 END IF
1020 OUTPUT @Agte507x;":DISP:WIND"&VAL$(Ch) & ":TITL:DATA
""&Ttl$(Ch) & "" ""
```

```

1030     OUTPUT @Agte507x;":DISP:WIND"&VAL$(Ch)&":TITL ON"
1040     OUTPUT @Agte507x;":INIT"&VAL$(Ch)&":CONT ON"
1050 NEXT Ch
1060     !
1070     OUTPUT @Agte507x;":TRIG:SOUR BUS"
1080     OUTPUT @Agte507x;":SENS:MULT1:DISP ON"
1090     OUTPUT @Agte507x;":SENS:MULT1:STAT ON"
1100     !
1110     ! Calibration
1120     !
1130     Res=FNEcal_solt_tset(@Agte507x,"1","2","1,2","A and T1")
1140     IF Res<>0 THEN Prg_end
1150     Res=FNEcal_solt_tset(@Agte507x,"2","3","1,3,4","A, R1+ and
R1-")
1160     IF Res<>0 THEN Prg_end
1170     Res=FNEcal_solt_tset(@Agte507x,"3","2","1,2","A and T2")
1180     IF Res<>0 THEN Prg_end
1190     Res=FNEcal_solt_tset(@Agte507x,"4","2","1,3","A and R2+")
1200     IF Res<>0 THEN Prg_end
1210     !
1220     ! Measurement
1230     !
1240 Meas_start:!
1250     PRINT "Set DUT. Then Push [Enter] key."
1260     INPUT "",Inp_char$
1270     !
1280     OUTPUT @Agte507x;":TRIG:SING"
1290     OUTPUT @Agte507x;"*OPC?"
1300     ENTER @Agte507x;Buff$
1310     !
1320     FOR Ch=1 TO 4
1330         OUTPUT @Agte507x;":DISP:WIND"&VAL$(Ch)&":TRAC1:Y:AUTO"
1340     NEXT Ch
1350     !
1360     INPUT "Once more? [Y]es/[N]o",Inp_char$
1370     IF UPC$(Inp_char$)="Y" OR UPC$(Inp_char$)="YES" THEN
Meas_start
1380 Prg_end:!
1390     END
1400     !=====
1410     ! Electronic Full n Port Calibration Function for E5091A
1420     !=====
1430 DEF FNEcal_solt_tset(@Agte507x,Ch$,Solt$,Ana_port$,Tset_port$)
1440     DIM Buff$[9],Err_msg$[100]
1450     INTEGER Err_no
1460     !
1470     PRINT "## [Ch "&Ch$&"] Full "&Solt$&" Port Calibration (Ecal)
##"
1480     !
1490 Ecal_start:!
1500     OUTPUT @Agte507x;"*CLS"
1510     PRINT "Connect "&Tset_port$&" to ECal Module."
1520     PRINT "Then push [Enter] key."
1530     INPUT "",Buff$
1540     OUTPUT @Agte507x;":SENS"&Ch$&":CORR:COLL:ECAL:SOLT"&Solt$&"
"&Ana_port$
1550     PRINT "Executing ..."
1560     OUTPUT @Agte507x;":SYST:ERR?"

```

Sample Application Programs

Measurement using E5091A (measuring FEM)

```
1570  ENTER @Agte507x;Err_no,Err_msg$
1580  IF Err_no<>0 THEN
1590      PRINT "Error occurred!!"
1600      PRINT "  No: ";Err_no,"Description: "&Err_msg$
1610      INPUT "Re-try? [Y]es/[N]o",Inp_char$
1620      IF UPC$(Inp_char$)="Y" OR UPC$(Inp_char$)="YES" THEN
Ecal_start
1630          RETURN Err_no
1640      ELSE
1650          PRINT "Done"
1660          RETURN Err_no
1670      END IF
1680  FNEND
```

Control Using SICL-LAN Server

This section explains how to control the E5070B/E5071B by using SICL in the Windows environment. Here, the sample program (a VBA macro for Microsoft Excel) is written in Visual Basic. The source file of this program, ctrl_lansicl.xls, is available on the sample program disk.

NOTE

To control the E5070B/E5071B using the SICL-LAN server, you need to make the preparations described in “Control over SICL-LAN server” on page 34.

Using VBA macro

Opening ctrl_lansicl.xls in Microsoft Excel displays a screen as shown in Figure 13-4.

Figure 13-4

ctrl_lansicl.xls

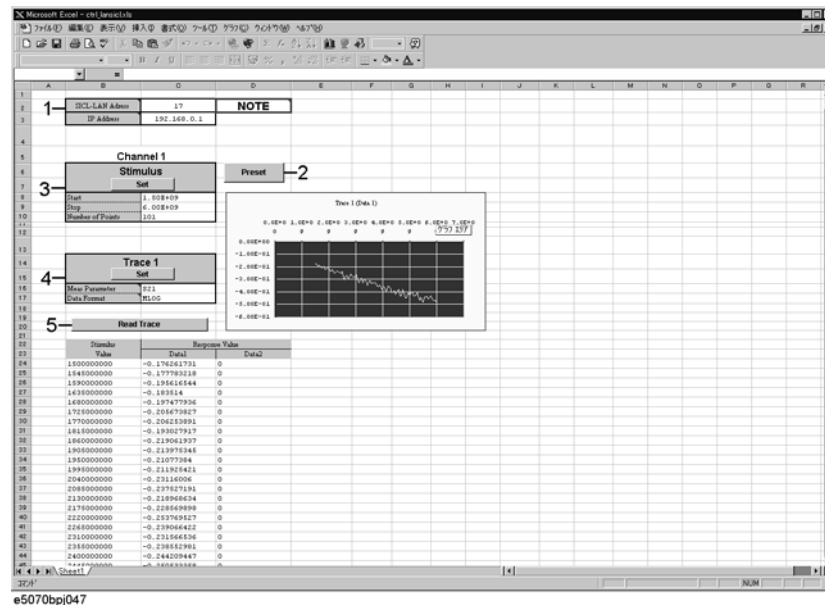

13. Sample Application Programs

For how to use each element in Figure 13-4, refer to the following description.

We begin by describing part 1. In the cell to the right of the SICL-LAN Address, enter the address of the E5070B/E5071B for control with the SICL-LAN server. This address is **xx**, which has been set with the command **[System] - Misc Setup - Network Setup - SICL-LAN Address [xx]**. Enter the IP address of the E5070B/E5071B in the cell to the right of the IP Address. This VBA macro will not work properly without the correct values in these two cells.

Clicking the button labeled Preset in part 2 executes the presetting operation.

In part 3, the sweep range (start and stop points) and the number of measurement points for channel 1 are set. Clicking the button labeled Set executes the setting as shown in the setting table.

Part 4 sets the measurement parameters and data format for trace 1 in channel 1. Clicking the button labeled Set executes the setting as shown in the setting table.

Sample Application Programs

Control Using SICL-LAN Server

Clicking the button labeled Read Trace in part 5 retrieves the formatted data array of trace 1 in channel 1 and displays it in tabular and graphical formats.

Description of operation in VBA macro

This section describes the operation of the VBA macro, focusing on the part related to control with SICL.

In order to use SICL in your VBA macro, you must declare functions and define variables with a SICL definition file (for VB). In the VBA macro, ctrl_sicllan.xls, the standard module whose object name is "SICL," is the definition file.

The basic control flow with SICL is shown in Figure 13-5.

NOTE

In this sample program, the **ivprintf** function, the **ivscanf** function, and the **iread** function are used in its communication part; you can use other SICL functions as well. For details, refer to sicl.hlp (the online help of SICL).

Figure 13-5

Flow of control using SICL

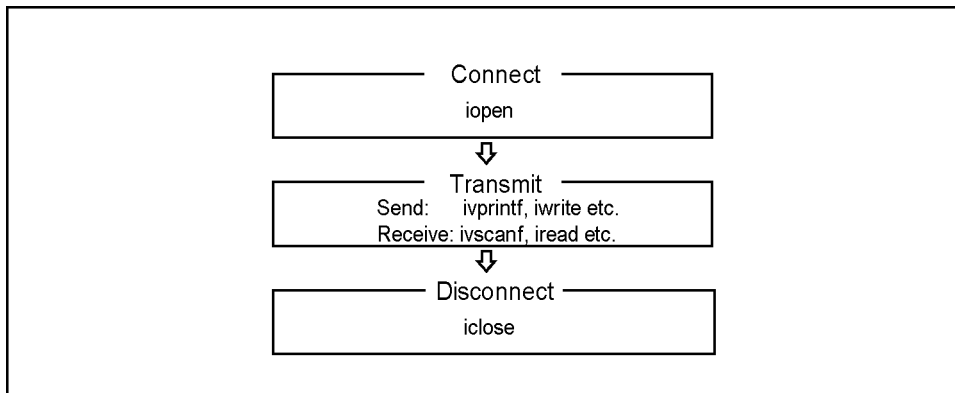

e5070bpe041

NOTE

For more information on how to use each function of SICL, refer to the SICL manual.

The procedures of each step in Figure 13-5 are described below.

Connection

The procedure corresponding to connection is `OpenSession` (Example 13-4). `OpenSession` establishes a connection to the E5070B/E5071B with the `iopen` function of SICL, using the SICL-LAN Address and IP Address entered in part 1 in Figure 13-4. The `iopen` function takes the address information of the E5070B/E5071B you specify as its parameters.

Syntax

`addr = iopen(dev)`

Variable

	<i>addr</i>
Description	Session information (output)
Data type	Integer type

	<i>dev</i>
Description	Address information of the instrument you specify (input)
Data type	Character string type
Grammar	<i>sicl-name</i> *1 [<i>ip-address</i> *2]: <i>interface</i> *3, <i>sicl-lan-address</i> *4

- *1. The SICL interface name you set with the Agilent I/O Libraries in external control.
- *2. The IP address of the E5070B/E5071B.
- *3. For the E5070B/E5071B, specify `hpib9`.
- *4. The address of the E5070B/E5071B for control with the SICL-LAN server.

For example, if the parameter (*dev*) is “lan[192.168.0.1]:hpib9,17,” connection is made to the address of **17** of the interface of **hpib9** with the E5070B/E5071B whose IP address is **192.168.0.1** by using the external controller whose SICL interface name is **lan**.

Example 13-4

OpenSession

Function `OpenSession()` As Integer

```

Dim ServAddr As String
Dim IpAddr As String

On Error GoTo ErrHandler

'''Get Sicl-Lan Address
Sheets("Sheet1").Select
Range("C2").Select
ServAddr = ActiveCell.FormulaR1C1

'''Get Ip Address
Sheets("Sheet1").Select
Range("C3").Select
IpAddr = ActiveCell.FormulaR1C1

OpenSession = iopen("lan[" & IpAddr & "]:hpib9," & ServAddr)
Call itimeout(OpenSession, 10000)
Exit Function

```

Sample Application Programs

Control Using SICL-LAN Server

```

ErrorHandler:
  MsgBox "*** Error : " & Error$
  Call siclcleanup
  End

End Function

```

Sending

The procedure corresponding to sending in communication is OutputSiclLan (Example 13-5). OutputSiclLan uses the **ivprintf** function of SICL to send messages (SCPI commands). The **ivprintf** function takes the session information outputted from the **iopen** function and a program message as its parameters.

Syntax

Status = ivprintf(*addr*,*mes*)

Variable

Table 13-4

Variable (*Status*)

	<i>Status</i>
Description	Return value of the function (output)
Data type	Integer type

Table 13-5

Variable (*addr*)

	<i>addr</i>
Description	Session information (input)
Data type	Integer type

	<i>mes</i>
Description	Program message (input)*1
Data type	Character string type

*1. When sending a program message of a SCPI command, add the message terminator at the end of the message (in Example 13-5, Chr\$(10)).

Example 13-5

OutputSiclLan

```

Sub OutputSiclLan(addr As Integer, message As String)

  Dim Status As Integer
  Dim actualcnt As Long
  Dim length As Long

  On Error GoTo ErrorHandler

  length = Len(message)

  Status = ivprintf(addr, message & Chr$(10))
  Exit Sub

```

```

ErrorHandler:
  MsgBox "*** Error : " & Error$
  Call siclcleanup
  End
End Sub

```

Receiving

The procedure corresponding to receiving ASCII format messages in communication is EnterSicLan (Example 13-6). EnterSicLan uses the **ivscanf** function of SICL to receive a message in ASCII format and store it into the output variable. The **ivscanf** function takes the session information outputted from the **iopen** function, the format for output, and the data to be outputted as its parameters.

Syntax

Status = ivscanf(*addr*,*fmt*,*ap*)

Variable

	<i>fmt</i>
Description	Format for output (input)
Data type	Character string type

	<i>ap</i>
Description	Data to be outputted (output)
Data type	Character string type

For information on the variable (*Status*) and the variable (*addr*), refer to Table 13-4, “Variable (Status),” on page 268 and Table 13-5, “Variable (addr),” on page 268, respectively.

NOTE

In Visual Basic, variables must be declared as a fixed-length string when receiving string data using the **ivscanf** function.

Example 13-6

EnterSicLan

```

Sub EnterSicLan(addr As Integer, Query As String)

  Dim Status As Integer
  Dim actualcnt As Long
  Dim res As String * 256

  On Error GoTo ErrorHandler

  Status = ivscanf(addr, "%t", res)
  Query = Trim(res)
  Exit Sub

ErrorHandler:
  MsgBox "*** Error : " & Error$
  Call siclcleanup

```

Sample Application Programs
Control Using SICL-LAN Server

End

End Sub

The procedure corresponding to receiving array data in communication is EnterSicLanArrayReal64 (Example 13-7), which uses the **iread** function of SICL to receive array data in the IEEE 64-bit floating point binary transfer format and store it into the output variable. The **iread** function takes the session information outputted from the **ioopen** function, the data to be outputted, the number of data bytes, the condition to finish reading data, and the number of data bytes actually read out as its parameters.

Syntax

Status = iread(*addr*,*buf*,*bufsize*,*reason*,*actual*)

Variable

	<i>buf</i>
Description	Data to be outputted (output)
Data type	Character string type

	<i>bufsize</i>
Description	The number of data bytes (input)
Data type	Long integer type

	<i>reason</i>
Description	The condition to finish reading out data (input)
Data type	Integer type

	<i>actual</i>
Description	The number of data bytes actually read out (output)
Data type	Long integer type

For information on the variable (*Status*) and the variable (*addr*), refer to Table 13-4, “Variable (*Status*),” on page 268 and Table 13-5, “Variable (*addr*),” on page 268, respectively.

Each functional part of EnterSicLanArrayReal64 is described below.

- (1) Retrieves the data header.
- (2) Stores the number of data bytes into the size variable in the header part.
- (3) Retrieves the formatted data array for trace 1 in channel 1 and stores it into the databuf variable.
- (4) Retrieves the message terminator at the end of the data.

Example 13-7

EnterSicLanArrayReal64

```

Function EnterSicLanArrayReal64(addr As Integer, databuf() As Double)
As Long

    Dim Status As Integer
    Dim actualcnt As Long
    Dim buf As String * 8
    Dim size As Long

    On Error GoTo ErrHandler

    '''Read header info of "#6NNNNNN"
    Status = iread(addr, buf, 8, I_TERM_MAXCNT, actualcnt)
'.....(1)

    size = Val(Mid$(buf, 3, 6))
'.....(2)

    '''Read data
    Status = iread(addr, databuf, size, I_TERM_MAXCNT, actualcnt)
'.....(3)

    '''Read ending LF
    Status = iread(addr, buf, 1, I_TERM_MAXCNT, actualcnt)
'.....(4)

    EnterSicLanArrayReal64 = size / 8
    Exit Function

ErrHandler:
    MsgBox "*** Error : " & Error$
    Call siclcleanup
    End

End Function

```

Disconnection

The **iclose** function of SICL is used to disconnect communication. The **iclose** function takes the session information outputted from the **iopen** function as its parameter.

Syntax

Status = iclose(*addr*)

For information on the variable (*Status*) and the variable (*addr*), refer to Table 13-4, “Variable (Status),” on page 268 and Table 13-5, “Variable (addr),” on page 268, respectively.

Sample Application Programs

Control Using SICL-LAN Server

Sample control

The E5070B/E5071B can be controlled by executing the above procedures in order, following the control flow in Figure 13-5. This is demonstrated by the Preset procedure (a procedure that is executed when the Preset button is clicked) as described in Example 13-8.

Example 13-8

Preset

```
Sub Preset ()  
  
    ''' Open Session  
    E507x = OpenSession  
  
    '''Presetting the analyzer  
    Call OutputSiclLan(E507x, ":SYST:PRES")  
  
    '''Close Session  
    Call iclose(E507x)  
  
End Sub
```

Controlling Using Telnet Server

This section explains how to control the E5070B/E5071B by using WinSock API in the Windows environment, using a sample program written in Visual Basic (VBA macro). You can find the source file of this program, named ctrl_lan.xls (Microsoft Excel file), on the sample program disk.

Using VBA macro

Opening ctrl_lan.xls in Microsoft Excel displays the screen shown in Figure 13-6.

Figure 13-6

ctrl_lan.xls

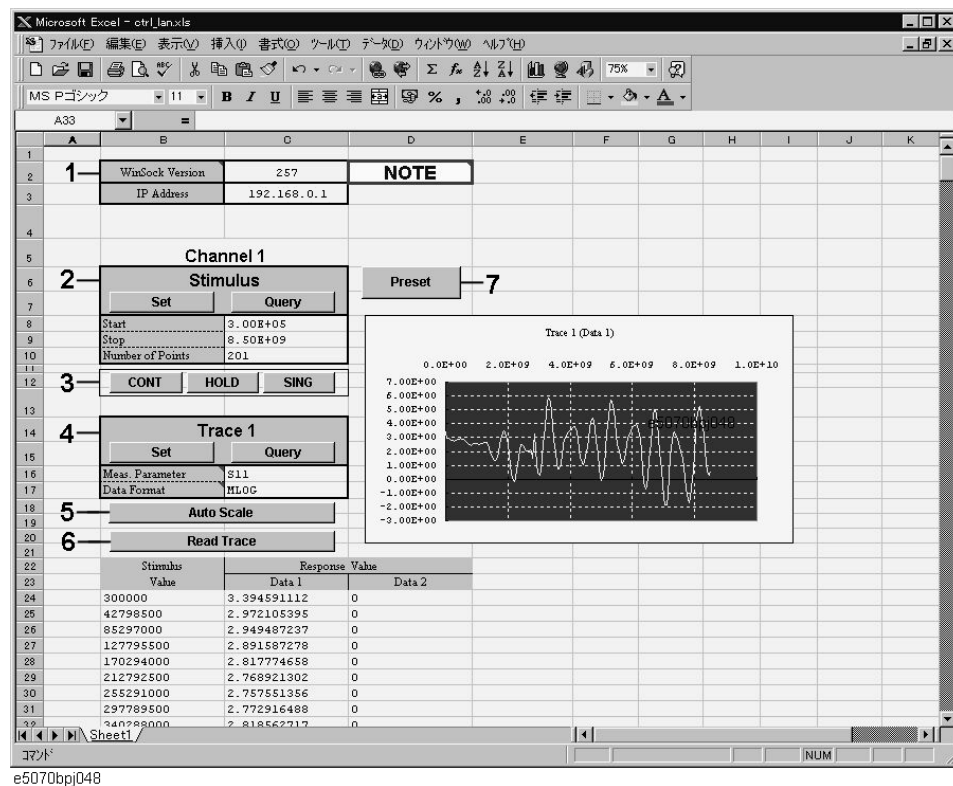

For how to use each element in Figure 13-6, refer to the following description.

We begin by describing part 1. Enter the version number of WinSock API in the cell to the right side of “Winsock Version.” The version number is obtained by multiplying 256 by the major version and then adding the minor version. For example, when the version of your Winsock API is 1.1, the version number is obtained as follows: $256 \times 1 + 1 = 257$. Enter the IP address of the E5070B/E5071B in the cell to the right side of “IP Address.” This VBA macro will not work properly without the correct values in these two cells.

In part 2, the sweep range (start and stop points) and the number of measurement points are set. Clicking the button labeled “Set” executes the setting operation as specified with the setting table, while clicking the button labeled “Query” retrieves the current settings of the E5070B/E5071B.

Sample Application Programs

Controlling Using Telnet Server

Part 3 is dedicated to setting the trigger mode.

Part 4 sets the measurement parameters and data format for trace 1 in channel 1. Clicking the button labeled “Set” executes the setting operation as specified with the setting table, while clicking the button labeled “Query” retrieves the current settings of the E5070B/E5071B.

In part 5, clicking the button labeled “Auto Scale” executes auto scaling for trace 1 in channel 1.

Clicking the button labeled “Read Trace” in part 6 retrieves the formatted data of trace 1 in channel 1 and displays it in tabular and graphical formats.

Clicking the button labeled “Preset” executes the presetting operation.

Description of operation in VBA macro

This section describes the operation of the VBA macro, focusing on the part related to control with WinSock API.

In order to use WinSock API, you must declare functions and define variables with a definition file of WinSock API, as shown in Example 13-9.

Example 13-9

Definition file of WinSock API

```
'This is the Winsock API definition file for Visual Basic

'Setup the variable type 'hostent' for the WSStartup command
Type Hostent
    h_name As Long
    h_aliases As Long
    h_addrtype As String * 2
    h_length As String * 2
    h_addr_list As Long
End Type
Public Const SZHOSTENT = 16

'Set the Internet address type to a long integer (32-bit)
Type in_addr
    s_addr As Long
End Type

'A note to those familiar with the C header file for Winsock
'Visual Basic does not permit a user-defined variable type
'to be used as a return structure. In the case of the
'variable definition below, sin_addr must
'be declared as a long integer rather than the user-defined
'variable type of in_addr.
Type sockaddr_in
    sin_family As Integer
    sin_port As Integer
    sin_addr As Long
    sin_zero As String * 8
End Type

Public Const WSADESCRIPTION_LEN = 256
Public Const WSASYS_STATUS_LEN = 128
Public Const WSA_DescriptionSize = WSADESCRIPTION_LEN + 1
Public Const WSA_SysStatusSize = WSASYS_STATUS_LEN + 1
```

```
'Setup the structure for the information returned from
'the WSASStartup() function.
Type WSADATA
    wVersion As Integer
    wHighVersion As Integer
    szDescription As String * WSA_DescriptionSize
    szSystemStatus As String * WSA_SysStatusSize
    iMaxSockets As Integer
    iMaxUdpDg As Integer
    lpVendorInfo As String * 200
End Type

'Define socket return codes
Public Const INVALID_SOCKET = &HFFFF
Public Const SOCKET_ERROR = -1

'Define socket types
Public Const SOCK_STREAM = 1           'Stream socket
Public Const SOCK_DGRAM = 2           'Datagram socket
Public Const SOCK_RAW = 3             'Raw data socket
Public Const SOCK_RDM = 4             'Reliable Delivery socket
Public Const SOCK_SEQPACKET = 5       'Sequenced Packet socket

'Define address families
Public Const AF_UNSPEC = 0             'unspecified
Public Const AF_UNIX = 1              'local to host (pipes, portals)
Public Const AF_INET = 2              'internetwork: UDP, TCP, etc.
Public Const AF_IMPLINK = 3           'arpanet imp addresses
Public Const AF_PUP = 4               'pup protocols: e.g. BSP
Public Const AF_CHAOS = 5             'mit CHAOS protocols
Public Const AF_NS = 6                'XEROX NS protocols
Public Const AF_ISO = 7               'ISO protocols
Public Const AF_OSI = AF_ISO           'OSI is ISO
Public Const AF_ECMA = 8              'european computer manufacturers
Public Const AF_DATAKIT = 9           'datakit protocols
Public Const AF_CCITT = 10            'CCITT protocols, X.25 etc
Public Const AF_SNA = 11              'IBM SNA
Public Const AF_DECnet = 12           'DECnet
Public Const AF_DLI = 13              'Direct data link interface
Public Const AF_LAT = 14              'LAT
Public Const AF_HYLINK = 15          'NSC Hyperchannel
Public Const AF_APPLETALK = 16        'AppleTalk
Public Const AF_NETBIOS = 17          'NetBios-style addresses
Public Const AF_MAX = 18              'Maximum # of address families

'Setup sockaddr data type to store Internet addresses
Type sockaddr
    sa_family As Integer
    sa_data As String * 14
End Type
Public Const SADDRLEN = 16

'Declare Socket functions

Public Declare Function closesocket Lib "wsock32.dll" (ByVal s As Long)
As Long

Public Declare Function connect Lib "wsock32.dll" (ByVal s As Long, addr
As sockaddr_in, ByVal namelen As Long) As Long

Public Declare Function htons Lib "wsock32.dll" (ByVal hostshort As Long)
```

Sample Application Programs

Controlling Using Telnet Server

As Integer

```
Public Declare Function inet_addr Lib "wsock32.dll" (ByVal cp As String) As Long
```

```
Public Declare Function recv Lib "wsock32.dll" (ByVal s As Long, ByVal buf As Any, ByVal buflen As Long, ByVal flags As Long) As Long
```

```
Public Declare Function recvB Lib "wsock32.dll" Alias "recv" (ByVal s As Long, buf As Any, ByVal buflen As Long, ByVal flags As Long) As Long
```

```
Public Declare Function send Lib "wsock32.dll" (ByVal s As Long, buf As Any, ByVal buflen As Long, ByVal flags As Long) As Long
```

```
Public Declare Function socket Lib "wsock32.dll" (ByVal af As Long, ByVal socktype As Long, ByVal protocol As Long) As Long
```

```
Public Declare Function WSASStartup Lib "wsock32.dll" (ByVal wVersionRequired As Long, lpWSAData As WSAData) As Long
```

```
Public Declare Function WSACleanup Lib "wsock32.dll" () As Long
```

```
Public Declare Function WSAUnhookBlockingHook Lib "wsock32.dll" () As Long
```

```
Public Declare Sub CopyMemory Lib "kernel32" Alias "RtlMoveMemory" (hpvDest As Any, hpvSource As Any, ByVal cbCopy As Long)
```

The basic control flow with WinSock API is shown in Figure 13-7.

Figure 13-7

Control flow with WinSock API

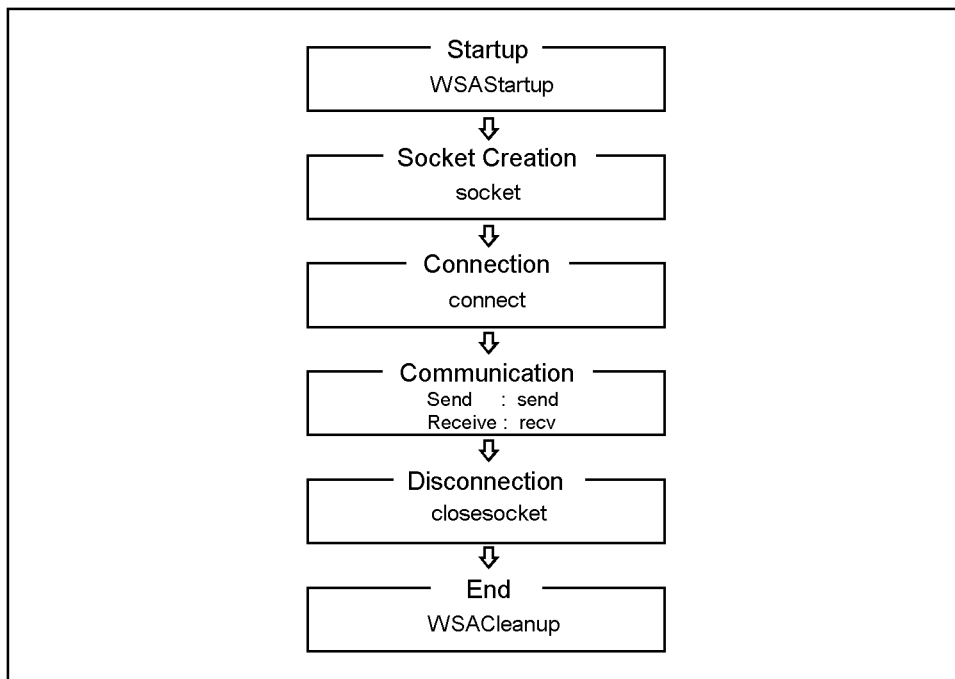

e5070ape029

The procedures of each step in Figure 13-7 are described below.

Startup

The procedure corresponding to Startup is StartIt (Example 13-10). StartIt launches and initializes WinSock API with **WSAStartup**, whose version is shown in part 1 of Figure 13-6. The function WSAStartup should always be used when initiating WinSock. This function takes the version number (input) and launching information (output) as its parameters.

Example 13-10

StartIt

```
Sub StartIt ()

    Dim StartUpInfo As WSADATA

    'Version 1.1 (1*256 + 1) = 257
    'version 2.0 (2*256 + 0) = 512

    'Get WinSock version
    Sheets("Sheet1").Select
    Range("C2").Select
    version = ActiveCell.FormulaR1C1

    'Initialize Winsock DLL
    x = WSAStartup(version, StartUpInfo)

End Sub
```

Socket Creation and Connection

The procedure for Socket Creation and Connection is OpenSocket (Example 13-11). OpenSocket makes a connection to an instrument associated with the IP address specified with the input parameter Hostname. It uses a socket of the port specified with the input parameter PortNumber. Each functional part of OpenSocket is described below.

In (1), the `inet_addr` function of WinSock API is used to convert an IP address delimited by “.” to an Internet address.

In (2), a new socket is created with the **socket** function of WinSock API and its socket descriptor is obtained. If an error occurs, the control returns to the main program with a message. The socket function takes an address family (input), a socket type (input), and a protocol number (input) as its parameters.

In (3), the socket address is specified. Note that `htons`, which is used for specifying the port number, is a function of WinSock API. This function converts a 2-byte integer from the Windows byte order (little endian) to the network byte order (big endian).

In (4), a connection to the E5070B/E5071B is made by using the **connect** function of WinSock API. If an error occurs, the control returns to the main program with a message. The connect function takes a socket descriptor (input), a socket address (input), and the size of the socket address (input) as its parameters.

Example 13-11 OpenSocket

Function OpenSocket(ByVal Hostname As String, ByVal PortNumber As Integer) As Integer

```
Dim I_SocketAddress As sockaddr_in
Dim ipAddress As Long

ipAddress = inet_addr(Hostname) '.....(1)

'Create a new socket
socketId = socket(AF_INET, SOCK_STREAM, 0) '
If socketId = SOCKET_ERROR Then '
    MsgBox ("ERROR: socket = " + Str$(socketId)) '.....(2)
    OpenSocket = COMMAND_ERROR '
    Exit Function '
End If '

'Open a connection to a server

I_SocketAddress.sin_family = AF_INET '
I_SocketAddress.sin_port = htons(PortNumber) '.....(3)
I_SocketAddress.sin_addr = ipAddress '
I_SocketAddress.sin_zero = String$(8, 0) '

x = connect(socketId, I_SocketAddress, Len(I_SocketAddress)) '
If socketId = SOCKET_ERROR Then '
    MsgBox ("ERROR: connect = " + Str$(x)) '...(4)
    OpenSocket = COMMAND_ERROR '
    Exit Function '
End If '

OpenSocket = socketId

End Function
```

Communication

The procedure corresponding to Communication is SendCommand (Example 13-12). SendCommand transmits a message (SCPI command) specified with the input parameter “command” to the E5070B/E5071B using the **send** function of WinSock API. The send function takes a socket descriptor (input), a message to be transmitted (input), message length (input) and a flag (input) as its parameters.

Example 13-12 SendCommand

Function SendCommand(ByVal command As String) As Integer

```
Dim strSend As String

strSend = command + vbCrLf

count = send(socketId, ByVal strSend, Len(strSend), 0)

If count = SOCKET_ERROR Then
    MsgBox ("ERROR: send = " + Str$(count))
    SendCommand = COMMAND_ERROR
    Exit Function
End If

SendCommand = NO_ERROR

End Function
```

The procedure corresponding to the Receiving part of communication is RecvAscii (Example 13-13) and other functions. RecvAscii receives a message in ASCII format and stores it in the dataBuf output parameter. Maximum length of the message is specified with the maxLength input parameter. Each functional part of RecvAscii is described below.

In (1), a message (a response to a query for a SCPI command) is received from the E5070B/E5071B as a series of characters using the **recv** function of WinSock API. If an error occurs, the control returns to the main program with a message. The recv function takes a socket descriptor (input), a message to be received (input), message length (input) and a flag (input) as its parameters.

In (2), it is determined whether each received character is LF (ASCII code: 10). When it is LF, receiving is terminated by adding NULL (ASCII code: 0) to the end of the dataBuf string and the control returns to the main program.

In (3), the number of the last characters that were read out is added to the count value for checking the number of received characters, and the characters are appended to the end of the dataBuf string.

Example 13-13

RecvAscii

Function RecvAscii(dataBuf As String, ByVal maxLength As Integer) As Integer

```

    Dim c As String * 1
    Dim length As Integer

    dataBuf = ""
    While length < maxLength
        DoEvents
        count = recv(socketId, c, 1, 0)
        If count < 1 Then
            RecvAscii = RECV_ERROR ..... (1)
            dataBuf = Chr$(0)
            Exit Function
        End If

        If c = Chr$(10) Then
            dataBuf = dataBuf + Chr$(0) ..... (2)
            RecvAscii = NO_ERROR
            Exit Function
        End If

        length = length + count ..... (3)
        dataBuf = dataBuf + c
    Wend

    RecvAscii = RECV_ERROR

End Function

```

13. Sample Application Programs

Disconnection

The procedure corresponding to Disconnection is CloseConnection (Example 13-14). CloseConnection disconnects communication and removes a socket using the **closesocket** function of WinSock API. The closesocket function takes a socket descriptor (input) as its parameter.

Example 13-14

CloseConnection

```
Sub CloseConnection()  
  
    x = closesocket(socketId)  
  
    If x = SOCKET_ERROR Then  
        MsgBox ("ERROR: closesocket = " + Str$(x))  
        Exit Sub  
    End If  
  
End Sub
```

End

The procedure corresponding to End is EndIt (Example 13-15). EndIt disconnects WinSock API using the **WSACleanup** function of WinSock API. The function WSACleanup should always be used when terminating WinSock.

Example 13-15

EndIt

```
Sub EndIt()  
  
    'Shutdown Winsock DLL  
    x = WSACleanup()  
  
End Sub
```

Example of control

The E5070B/E5071B can be controlled by executing the above procedures in order, following the control flow in Figure 13-7. This is demonstrated by the procedure autoscale (a procedure that is executed when the Auto Scale button is clicked) as described in Example 13-16.

Example 13-16 autoscale

```
Sub autoscale()  
'  
' auto scaling  
'  
    Call StartIt  
    Call get_hostname  
    x = OpenSocket (Hostname$, ScpiPort)  
  
    x = SendCommand (":DISP:WIND1:TRAC1:Y:AUTO")  
  
    Call CloseConnection  
    Call EndIt  
  
End Sub
```

NOTE

When you execute more than one command by connecting and disconnecting a socket for every command, the sequence of execution may change.

- ❑ Connection → Command 1 → Command 2 → Disconnection
Commands 1 and 2 are always executed in this sequence.
- ❑ Connection → Command 1 → Disconnection → Connection → Command 2 → Disconnection
These commands may also be in the sequence of Command 2 → command 1.

14**SCPI Command Reference**

This chapter provides the SCPI command reference for the Agilent E5070B/E5071B. It describes the commands using their abbreviated format in alphabetical order. If you want to look up commands using their fully specified format, refer to the index for the desired SCPI command. If you want to look up commands by their function, refer to the SCPI command list ordered by function.

Notational conventions in this command reference

This section explains the rules for reading the descriptions of commands in this chapter.

Syntax

The part with heading “Syntax” describes the syntax used to send a command from the external controller to the E5070B/E5071B. A syntax consists of a command part and a parameter part. The separator between these parts is a space.

If there are several parameters, the separator between adjacent parameters is a comma (.). Ellipsis (...) between commas indicates that parameters in that part are omitted. For example, <numeric 1>, ..., <numeric 4> indicates that 4 parameters, <numeric 1>, <numeric 2>, <numeric 3>, <numeric 4>, are required.

String-type parameters, <string>, <string 1>, and so on, must be enclosed in double quotation marks ("). <block> shows block format data.

You can omit the lowercase letters in syntax. For example, ":CALibration:CABLe" can be shortened as ":CAL:CABL."

The definition of symbols used in the syntax is as follows:

<>	Characters enclosed in this pair of symbols are necessary parameters when sending the command.
[]	Part enclosed in this parenthesis pair can be omitted.
{}	Part enclosed in this parenthesis pair indicates that you must select one of the items in this part. Individual items are separated by a vertical bar ().

For example, ":CALC:CORR:EDEL:TIME 0.1,"
":CALCULATE1:SELECTED:CORR:EDEL:TIME 25E-3," and so on are valid for the syntax given below.

Syntax

:CALCulate{[1]|2|3|4|5|6|7|8|9}[:SElected]:CORRection:EDELay:TIME <numeric>

Description

Part with heading “Description” describes how to use the command or the operation when executed.

Parameters

Part with heading “Parameters” describes necessary parameters when sending the command. When a parameter is a value type or a string type enclosed with <>, its description, allowable setup range, preset (factory-set) value, and so on are given; when a parameter is a selection type enclosed with {}, the description of each selection item is given.

Query response

Part with heading “Query response” describes the data format read out when query (reading out data) is available with the command.

Each readout parameter is enclosed with {}. If there are several items within {} separated by the pipe (|), only one of them is read out.

When several parameters are read out, they are separated with a comma (.). Note that, 3 points (...) between commas indicate that the data of that part is omitted. For example, {numeric 1},...,{numeric 4} indicates that 4 data items, {numeric 1}, {numeric 2}, {numeric 3}, and {numeric 4}, are read out.

<newline><^END> after the parameters is the program message terminator.

Related commands

Part with heading “Related commands” describes the commands related to this command.

Equivalent key

Part with heading “Equivalent key” shows the operational procedure of the front panel keys that has the same effect as this command.

[Key] Indicates that you press the key named Key.

[Key] - Item Indicates a series of key operation in which you press the **[Key]** key, select (highlight) the item called **Item** on the displayed menu using the [↓] key and so on, and then press the **[Enter]** key.

IEEE Common Commands

This section describes the IEEE common commands.

*CLS

Syntax

*CLS

Description

Clears the followings. (No query)

- Error Queue
- Status Byte Register
- Standard Event Status Register
- Operation Status Event Register
- Questionable Status Event Register
- Questionable Limit Status Event Register
- Questionable Limit Extra Status Event Register
- Questionable Limit Channel{1-16} Status Event Register
- Questionable Limit Channel{1-16} Extra Status Event Register
- Questionable Bandwidth Limit Status Event Register
- Questionable Bandwidth Limit Extra Status Event Register
- Questionable Bandwidth Limit Channel{1-16} Status Event Register
- Questionable Bandwidth Limit Channel{1-16} Extra Status Event Register
- Questionable Ripple Limit Status Event Register
- Questionable Ripple Limit Extra Status Event Register
- Questionable Ripple Limit Channel{1-16} Status Event Register
- Questionable Ripple Limit Channel{1-16} Extra Status Event Register

Example of use

```
10 OUTPUT 717; "*CLS"
```

Equivalent key

No equivalent key is available on the front panel.

***ESE**

Syntax *ESE <numeric>
*ESE?

Description Sets the value of the Standard Event Status Enable Register.

Parameters

	<numeric>
Description	Setup value of the register
Range	0 to 255
Preset value	0
Resolution	1

If the specified parameter is out of the allowable setup range, the result of bitwise AND with 255 (0xff) is set.

Query response {numeric}<newline><^END>

Example of use
10 OUTPUT 717;"*ESE 16"
20 OUTPUT 717;"*ESE?"
30 ENTER 717;A

Related commands *SRE on page 290

Equivalent key No equivalent key is available on the front panel.

***ESR?**

Syntax *ESR?

Description Reads out the value of the Standard Event Status Register. Executing this command clears the register value. (Query only)

Query response {numeric}<newline><^END>

Example of use
10 OUTPUT 717;"*ESR?"
20 ENTER 717;A

Equivalent key No equivalent key is available on the front panel.

***IDN?**

Syntax	*IDN?
Description	Reads out the product information (manufacturer, model number, serial number, and firmware version number) of the E5070B/E5071B. (Query only)
Query response	{string 1},{string 2},{string 3},{string 4}<newline><^END> Readout data is as follows: {string 1} Manufacturer. Agilent Technologies is always read out. {string 2} Model number (example: E5070B). {string 3} Serial number (example: JP1KI00101). {string 4} Firmware version number (example: 03.00).
Example of use	10 OUTPUT 717; "*IDN?" 20 ENTER 717;A\$
Equivalent key	[System] - Firmware Revision [System] - Service Menu - Enable Options - Serial Number

***OPC**

Syntax	*OPC
Description	Sets the OPC bit (bit 0) of the Standard Event Status Register at the completion of all pending operations. (No query)
Example of use	10 OUTPUT 717; "*OPC"
Equivalent key	No equivalent key is available on the front panel.

***OPC?**

Syntax	*OPC?
Description	1 is read out at the completion of all pending operations. (Query only)
Query response	{1}<newline><^END>
Example of use	10 OUTPUT 717; "*OPC?" 20 ENTER 717;A
Equivalent key	No equivalent key is available on the front panel.

***OPT?**

Syntax	*OPT?
Description	Reads out the identification number of an option installed in the E5070B/E5071B. (Query only)
Query response	{numeric}<newline><^END> If there is no installed option, 0 is read out.
Example of use	10 OUTPUT 717;"*OPT?" 20 ENTER 717;A\$
Equivalent key	No equivalent key is available on the front panel.

***RST**

Syntax	*RST
Description	Performs preset. There is the following difference from the setting state preset with the :SYST:PRES command. (No query) <ul style="list-style-type: none"> The continuous initiation mode of channel 1 is set to OFF.
Example of use	10 OUTPUT 717;"*RST"
Related commands	:SYST:PRES on page 796 :SYST:UPR on page 801 :INIT{1-16}:CONT on page 491
Equivalent key	No equivalent key is available on the front panel.

***SRE**

Syntax *SRE <numeric>
 *SRE?

Description Sets the value of the Service Request Enable Register.

Parameters

	<numeric>
Description	Setup value of the register
Range	0 to 255
Preset value	0
Resolution	1

If the specified parameter is out of the allowable setup range, the result of bitwise AND with 255 (0xff) is set. Note that bit 6 cannot be set to 1.

Query response {numeric}<newline><^END>

Example of use 10 OUTPUT 717; "*SRE 128"
 20 OUTPUT 717; "*SRE?"
 30 ENTER 717;A

Related commands *ESE on page 287
 :STAT:OPER:ENAB on page 723
 :STAT:QUES:ENAB on page 744

Equivalent key No equivalent key is available on the front panel.

***STB?**

Syntax	*STB?
Description	Reads out the value of the Status Byte Register. (Query only)
Query response	{numeric}<newline><^END>
Example of use	10 OUTPUT 717; "*STB?" 20 ENTER 717;A
Equivalent key	No equivalent key is available on the front panel.

***TRG**

Syntax	*TRG
Description	If the trigger source is set to GPIB/LAN (set to BUS with the :TRIG:SOUR command), triggers the E5070B/E5071B waiting for a trigger. (No query)
Example of use	10 OUTPUT 717; "*TRG"
Related commands	:TRIG:SOUR on page 809
Equivalent key	No equivalent key is available on the front panel.

***WAI**

Syntax	*WAI
Description	Waits for the execution of all commands sent before this command to be completed. (No query)
Example of use	10 OUTPUT 717; "*WAI"
Equivalent key	No equivalent key is available on the front panel.

E5070B/E5071B commands

This section describes the commands specific to the E5070B/E5071B.

:ABOR

Syntax	:ABORt
Description	<p>Aborts the measurement and changes the trigger sequence for all channels to idle state. (No query)</p> <p>After the change to the idle state, the channels for which the continuous initiation mode is set to ON (set to ON with the :INIT{1-16}:CONT command) change into the initiate state.</p> <p>For details about the trigger system, refer to “Trigger System” on page 128. (No query)</p>
Example of use	10 OUTPUT 717; ":ABOR"
Related commands	:INIT{1-16} on page 490 :INIT{1-16}:CONT on page 491
Equivalent key	[Trigger] - Restart

:CALC{1-16}:BLIM

Syntax :CALCulate{[1]|2|3|4|5|6|7|8|9|10|11|12|13|14|15|16}[:SELEcted]:BLIMit[:STATe] {ON|OFF|1|0}
:CALCulate{[1]|2|3|4|5|6|7|8|9|10|11|12|13|14|15|16}[:SELEcted]:BLIMit[:STATe]?

Description For the active trace of channel 1 (:CALC1) to channel 16 (:CALC16) (specified with the :CALC{1-16}:PAR{1-16}:SEL command), turns ON/OFF the bandwidth test function.

Parameters

	Description
ON or 1	Turns ON the bandwidth test function.
OFF or 0 (preset value)	Turns OFF the bandwidth test function.

Query response {1|0}<newline><^END>

Example of use
10 OUTPUT 717; ":CALC1:BLIM ON"
20 OUTPUT 717; ":CALC1:BLIM?"
30 ENTER 717;A

Related commands
:CALC{1-16}:PAR{1-16}:SEL on page 424
:CALC{1-16}:BLIM:DB on page 294
:CALC{1-16}:BLIM:DISP:MARK on page 295
:CALC{1-16}:BLIM:DISP:VAL on page 296
:CALC{1-16}:BLIM:FAIL? on page 297
:CALC{1-16}:BLIM:MAX on page 298
:CALC{1-16}:BLIM:MIN on page 299
:CALC{1-16}:BLIM:REP? on page 300

Equivalent key [Analysis] - Bandwidth Limit - BW Test

:CALC{1-16}:BLIM:DB

Syntax :CALCulate{[1]|2|3|4|5|6|7|8|9|10|11|12|13|14|15|16}{[:SElected]:BLIMit:DB <numeric>
:CALCulate{[1]|2|3|4|5|6|7|8|9|10|11|12|13|14|15|16}{[:SElected]:BLIMit:DB?

Description For channel 1 (:CALC1) to channel 16 (:CALC16) (specified with the :CALC{1-16}:PAR{1-16}:SEL command), sets the bandwidth threshold value (attenuation from the peak) of the bandwidth test.

Parameters

	<numeric>
Description	Bandwidth N dB points
Range	0 to 5E8
Preset value	0
Unit	dB

Query response {numeric}<newline><^END>

Example of use
10 OUTPUT 717; ":CALC1:BLIM:DB 3"
20 OUTPUT 717; ":CALC1:BLIM:DB?"
30 ENTER 717;A

Related commands :CALC{1-16}:PAR{1-16}:SEL on page 424
:CALC{1-16}:BLIM on page 293

Equivalent key [Analysis] - Bandwidth Limit - N dB Points

:CALC{1-16}:BLIM:DISP:MARK

Syntax :CALCulate{[1]|2|3|4|5|6|7|8|9|10|11|12|13|14|15|16}[:SELEcted]:BLIMit:DISPlay:MARKer
{ON|OFF|1|0}
:CALCulate{[1]|2|3|4|5|6|7|8|9|10|11|12|13|14|15|16}[:SELEcted]:BLIMit:DISPlay:MARKer?

Description For the active trace of channel 1 (:CALC1) to channel 16 (:CALC16) (specified with the :CALC{1-16}:PAR{1-16}:SEL command), turns ON/OFF the marker display of the bandwidth test.

Parameters

	Description
ON or 1	Turns ON the bandwidth marker.
OFF or 0 (preset value)	Turns OFF the bandwidth marker.

Query response {1|0}<newline><^END>

Example of use
10 OUTPUT 717;":CALC1:BLIM:DISP:MARK ON"
20 OUTPUT 717;":CALC1:BLIM:DISP:MARK?"
30 ENTER 717;A

Related commands
:CALC{1-16}:PAR{1-16}:SEL on page 424
:CALC{1-16}:BLIM on page 293
:CALC{1-16}:BLIM:DISP:VAL on page 296

Equivalent key [Analysis] - Bandwidth Limit - BW Marker

:CALC{1-16}:BLIM:DISP:VAL

Syntax :CALCulate{[1|2|3|4|5|6|7|8|9|10|11|12|13|14|15|16]}[:SElected]:BLIMit:DISPlay:VALue
{ON|OFF|1|0}
:CALCulate{[1|2|3|4|5|6|7|8|9|10|11|12|13|14|15|16]}[:SElected]:BLIMit:DISPlay:VALue?

Description For the active trace of channel 1 (:CALC1) to channel 16 (:CALC16) (specified with the :CALC{1-16}:PAR{1-16}:SEL command), turns ON/OFF the bandwidth value display of the bandwidth test.

Parameters

	Description
ON or 1	Turns ON the bandwidth display.
OFF or 0 (preset value)	Turns OFF the bandwidth display.

Query response {1|0}<newline><^END>

Example of use
10 OUTPUT 717; ":CALC1:BLIM:DISP:VAL ON"
20 OUTPUT 717; ":CALC1:BLIM:DISP:VAL?"
30 ENTER 717;A

Related commands
:CALC{1-16}:PAR{1-16}:SEL on page 424
:CALC{1-16}:BLIM on page 293
:CALC{1-16}:BLIM:DISP:MARK on page 295

Equivalent key [Analysis] - Bandwidth Limit - BW Display

:CALC{1-16}:BLIM:FAIL?

Syntax :CALCulate{[1]|2|3|4|5|6|7|8|9|10|11|12|13|14|15|16}[:SElected]:BLIMit:FAIL?

Description For the active trace of channel 1 (:CALC1) to channel 16 (:CALC16) (specified with the :CALC{1-16}:PAR{1-16}:SEL command), reads out the bandwidth test result. (Query only)

Query response {1|0}<newline><^END>

	Description
1	The bandwidth test result is FAIL.
0	The bandwidth test result is PASS.

When the bandwidth limit test is set to OFF, 0 is always read out.

Example of use

```
10 OUTPUT 717; ":CALC1:BLIM:FAIL?"
20 ENTER 717;A
```

Related commands :CALC{1-16}:PAR{1-16}:SEL on page 424
:CALC{1-16}:BLIM on page 293

Equivalent key No equivalent key is available on the front panel.

:CALC{1-16}:BLIM:MAX

Syntax :CALCulate{[1]|2|3|4|5|6|7|8|9|10|11|12|13|14|15|16}{[:SElected]:BLIMit:MAXimum <numeric>
:CALCulate{[1]|2|3|4|5|6|7|8|9|10|11|12|13|14|15|16}{[:SElected]:BLIMit:MAXimum?

Description For channel 1 (:CALC1) to channel 16 (:CALC16) (specified with the :CALC{1-16}:PAR{1-16}:SEL command), sets the upper limit value of the bandwidth test.

Parameters

	<numeric>
Description	Maximum bandwidth.
Range	0 to 1E12
Preset value	0
Unit	Hz (hertz), dBm or second

Query response {numeric}<newline><^END>

Example of use
10 OUTPUT 717; ":CALC1:BLIM:MAX 3E5"
20 OUTPUT 717; ":CALC1:BLIM:MAX?"
30 ENTER 717;A

Related commands
:CALC{1-16}:PAR{1-16}:SEL on page 424
:CALC{1-16}:BLIM on page 293
:CALC{1-16}:BLIM:MIN on page 299

Equivalent key [Analysis] - Bandwidth Limit - Max Bandwidth

:CALC{1-16}:BLIM:MIN

Syntax :CALCulate{[1]|2|3|4|5|6|7|8|9|10|11|12|13|14|15|16}[:SELEcted]:BLIMit:MINimum <numeric>
:CALCulate{[1]|2|3|4|5|6|7|8|9|10|11|12|13|14|15|16}[:SELEcted]:BLIMit:MINimum?

Description For channel 1 (:CALC1) to channel 16 (:CALC16) (specified with the :CALC{1-16}:PAR{1-16}:SEL command), sets the lower limit value of the bandwidth test.

Parameters

	<numeric>
Description	Minimum bandwidth.
Range	0 to 1E12
Preset value	0
Unit	Hz (hertz), dBm or second

Query response {numeric}<newline><^END>

Example of use
10 OUTPUT 717; ":CALC1:BLIM:MIN 1E4"
20 OUTPUT 717; ":CALC1:BLIM:MIN?"
30 ENTER 717;A

Related commands
:CALC{1-16}:PAR{1-16}:SEL on page 424
:CALC{1-16}:BLIM on page 293
:CALC{1-16}:BLIM:MAX on page 298

Equivalent key [Analysis] - Bandwidth Limit - Min Bandwidth

:CALC{1-16}:BLIM:REP?

Syntax	:CALCulate{[1] 2 3 4 5 6 7 8 9 10 11 12 13 14 15 16}{[:SElected]:BLIMit:REPort[:DATA]?
Description	<p>For the active trace of channel 1 (:CALC1) to channel 16 (:CALC16) (specified with the :CALC{1-16}:PAR{1-16}:SEL command), reads out the bandwidth value of the bandwidth test.</p> <p>The data transfer format when this command is executed depends on the setting with the :FORM:DATA command. (Query only)</p>
Query response	{numeric}<newline><^END>
Example of use	10 OUTPUT 717; ":CALC1:BLIM:REP?" 20 ENTER 717;A
Related commands	:CALC{1-16}:PAR{1-16}:SEL on page 424 :FORM:DATA on page 488 :CALC{1-16}:BLIM on page 293
Equivalent key	No equivalent key is available on the front panel.

:CALC{1-16}:CONV

Syntax :CALCulate{[1]|2|3|4|5|6|7|8|9|10|11|12|13|14|15|16}[:SELEcted]:CONVersion[:STATe] {ON|OFF|1|0}
:CALCulate{[1]|2|3|4|5|6|7|8|9|10|11|12|13|14|15|16}[:SELEcted]:CONVersion[:STATe]?

Description For the active trace of channel 1 (:CALC1) to channel 16 (:CALC16) (specified with the :CALC{1-16}:PAR{1-16}:SEL command), turns ON/OFF the parameter conversion function.

Parameters

	Description
ON or 1	Turns ON the parameter conversion function.
OFF or 0 (preset value)	Turns OFF the parameter conversion function.

Query response {1|0}<newline><^END>

Example of use
10 OUTPUT 717; ":CALC1:CONV ON"
20 OUTPUT 717; ":CALC1:CONV?"
30 ENTER 717;A

Related commands
:CALC{1-16}:CONV:FUNC on page 302
:CALC{1-16}:PAR{1-16}:SEL on page 424

Equivalent key [Analysis] - Conversion - Conversion

:CALC{1-16}:CONV:FUNC

Syntax

```
:CALCulate{[1]|2|3|4|5|6|7|8|9|10|11|12|13|14|15|16}[:SElected]:CONVersion:FUNCtion {ZREFlection|
ZTRansmit|YREFlection|YTRansmit|INVersion|ZTSHunt|YTSHunt|CONJugation}

:CALCulate{[1]|2|3|4|5|6|7|8|9|10|11|12|13|14|15|16}[:SElected]:CONVersion:FUNCtion?
```

Description

For the active trace of channel 1 (:CALC1) to channel 16 (:CALC16) (specified with the :CALC{1-16}:PAR{1-16}:SEL command), select the parameter after conversion using the parameter conversion function.

Parameters

	Description
ZREFlection (preset value)	Specifies the equivalent impedance in reflection measurement.
ZTRansmit	Specifies the equivalent impedance (series) in transmission measurement.
YREFlection	Specifies the equivalent admittance in reflection measurement.
YTRansmit	Specifies the equivalent admittance (series) in transmission measurement.
INVersion	Specifies the inverse S-parameter.
ZTSHunt	Specifies the equivalent impedance (shunt) in transmission measurement.
YTSHunt	Specifies the equivalent admittance (shunt) in transmission measurement.
CONJugation	Specifies the conjugate.

Query response

```
{ZREF|ZTR|YREF|YTR|INV|ZTSH|YTSH|CONJ}<newline><^END>
```

Example of use

```
10 OUTPUT 717; ":CALC1:CONV:FUNC ZTR"
20 OUTPUT 717; ":CALC1:CONV:FUNC?"
30 ENTER 717;A$
```

Related commands

:CALC{1-16}:CONV on page 301
:CALC{1-16}:PAR{1-16}:SEL on page 424

Equivalent key

[Analysis] - Conversion - Z:Reflection|Z:Transmission|Y:Reflection|Y:Transmission|1/S|Z:Trans-Shunt|Y:Trans-Shunt|Conjugation

:CALC{1-16}:CORR:EDEL:MED

Syntax :CALCulate{[1]|2|3|4|5|6|7|8|9|10|11|12|13|14|15|16}{[:SElected]:CORRection:EDELay:MEdium
{COAXial|WAVeguide}
:CALCulate{[1]|2|3|4|5|6|7|8|9|10|11|12|13|14|15|16}{[:SElected]:CORRection:EDELay:MEdium?

Description To calculate the electrical delay time of channel 1 (:CALC1) to channel 16 (:CALC16), select the media type.

Parameters

	Description
COAXial (preset value)	Selects coaxial as a media type.
WAVeguide	Selects waveguide as a media type.

Query response {COAXial|WAVeguide}<newline><^END>

Example of use
10 OUTPUT 717; ":CALC1:CORR:EDEL:MED WAV"
20 OUTPUT 717; ":CALC1:CORR:EDEL:MED?"
30 ENTER 717;A\$

Related commands
:CALC{1-16}:CORR:EDEL:TIME on page 304
:CALC{1-16}:CORR:EDEL:WGC on page 305

Equivalent key [Scale] - Electrical Delay - Media

:CALC{1-16}:CORR:EDEL:TIME

Syntax :CALCulate{[1]|2|3|4|5|6|7|8|9|10|11|12|13|14|15|16}[:SELEcted]:CORRection:EDELay:TIME <numeric>
:CALCulate{[1]|2|3|4|5|6|7|8|9|10|11|12|13|14|15|16}[:SELEcted]:CORRection:EDELay:TIME?

Description Sets the electrical delay time of the active trace of channel 1 (:CALC1) to channel 16 (:CALC16) (specified with the :CALC{1-16}:PAR{1-16}:SEL command).

Parameters

	<numeric>
Description	Electrical delay time
Range	-10 to 10
Preset value	0
Unit	s (second)

If the specified parameter is out of the allowable setup range, the minimum value (if the lower limit of the range is not reached) or the maximum value (if the upper limit of the range is exceeded) is set.

Query response {numeric}<newline><^END>

Example of use
10 OUTPUT 717; ":CALC1:CORR:EDEL:TIME 0.2"
20 OUTPUT 717; ":CALC1:CORR:EDEL:TIME?"
30 ENTER 717;A

Related commands
:CALC{1-16}:CORR:EDEL:MED on page 303
:CALC{1-16}:CORR:EDEL:WGC on page 305
:CALC{1-16}:PAR{1-16}:SEL on page 424

Equivalent key [Scale] - Electrical Delay

:CALC{1-16}:CORR:EDEL:WGC

Syntax :CALCulate{[1]|2|3|4|5|6|7|8|9|10|11|12|13|14|15|16}[:SElected]:CORRection:EDELay:WGCutoff <numeric>
:CALCulate{[1]|2|3|4|5|6|7|8|9|10|11|12|13|14|15|16}[:SElected]:CORRection:EDELay:WGCutoff?

Description For channel 1(:CALC1) to channel 16 (:CALC16), sets the cut-off frequency when the media type of the electrical delay is set to “Waveguide.”

Parameters

	<numeric>
Description	Cut-off frequency
Range	3E5 to 3.0E9 (for E5070B) 3E5 to 8.5E9 (for E5071B)
Preset value	3E5
Unit	Hz (Hertz)

If the specified parameter is out of the allowable setup range, the minimum value (if the lower limit of the range is not reached) or the maximum value (if the upper limit of the range is exceeded) is set.

Query response {numeric}<newline><^END>

Example of use
10 OUTPUT 717;":CALC1:CORR:EDEL:WGC 1E9"
20 OUTPUT 717;":CALC1:CORR:EDEL:WGC?"
30 ENTER 717;A

Related commands
:CALC{1-16}:CORR:EDEL:MED on page 303
:CALC{1-16}:CORR:EDEL:TIME on page 304

Equivalent key [Scale] - Electrical Delay - Cutoff Frequency

:CALC{1-16}:CORR:OFFS:PHAS

Syntax :CALCulate{[1]|2|3|4|5|6|7|8|9|10|11|12|13|14|15|16}[:SElected]:CORRection:OFFSet:PHASe <numeric>
:CALCulate{[1]|2|3|4|5|6|7|8|9|10|11|12|13|14|15|16}[:SElected]:CORRection:OFFSet:PHASe?

Description Sets the phase offset of the active trace of channel 1 (:CALC1) to channel 16 (:CALC16) (specified with the :CALC{1-16}:PAR{1-16}:SEL command).

Parameters

	<numeric>
Description	Phase offset
Range	-360 to 360
Preset value	0
Unit	° (degree)

If the specified parameter is out of the allowable setup range, the minimum value (if the lower limit of the range is not reached) or the maximum value (if the upper limit of the range is exceeded) is set.

Query response {numeric}<newline><^END>

Example of use
10 OUTPUT 717; ":CALC1:CORR:OFFS:PHAS 2.5"
20 OUTPUT 717; ":CALC1:CORR:OFFS:PHAS?"
30 ENTER 717;A

Related commands :CALC{1-16}:PAR{1-16}:SEL on page 424

Equivalent key [Scale] - Phase Offset

:CALC{1-16}:DATA:FDAT

Syntax

```
:CALCulate{[1]|2|3|4|5|6|7|8|9|10|11|12|13|14|15|16}[:SElected]:DATA:FDATa <numeric 1>,...,<numeric NOP×2>
:CALCulate{[1]|2|3|4|5|6|7|8|9|10|11|12|13|14|15|16}[:SElected]:DATA:FDATa?
```

Description

For the active trace of channel 1 (:CALC1) to channel 16 (:CALC16) (specified with the :CALC{1-16}:PAR{1-16}:SEL command), sets/reads out the formatted data array. (It is the data array for which processing such as format has been performed for corrected data array. For details, refer to “Formatted data array” on page 169.)

The data transfer format when this command is executed depends on the setting with the :FORM:DATA command.

Parameters

	Description
<numeric n×2-1>	Data (primary value) at the n-th measurement point.
<numeric n×2>	Data (secondary value) at the n-th measurement point. Always 0 when the data format is not the Smith chart format or the polar format.

Where NOP is the number of measurement points and n is an integer between 1 and NOP.

Query response

```
{numeric 1},...,{numeric NOP×2}<newline><^END>
```

Example of use

```
10 DIM A(1:201,1:2)
20 OUTPUT 717;" :CALC1:DATA:FDAT?"
30 ENTER 717;A(*)
```

Related commands

:CALC{1-16}:PAR{1-16}:SEL on page 424
:CALC{1-16}:DATA:FMEM on page 308
:CALC{1-16}:DATA:SDAT on page 309
:FORM:DATA on page 488

Equivalent key

No equivalent key is available on the front panel.

:CALC{1-16}:DATA:FMEM

Syntax :CALCulate{[1]|2|3|4|5|6|7|8|9|10|11|12|13|14|15|16}[:SElected]:DATA:FMEMemory <numeric 1>,...,<numeric NOP×2>
 :CALCulate{[1]|2|3|4|5|6|7|8|9|10|11|12|13|14|15|16}[:SElected]:DATA:FMEMemory?

Description For the active trace of channel 1 (:CALC1) to channel 16 (:CALC16) (specified with the :CALC{1-16}:PAR{1-16}:SEL command), sets/reads out the formatted memory array. (It is the data array for which processing such as format has been performed for corrected memory array. For details, refer to “Formatted memory arrays” on page 170.)

The data transfer format when this command is executed depends on the setting with the :FORM:DATA command.

Parameters

	Description
<numeric n×2-1>	Data (primary value) at the n-th measurement point.
<numeric n×2>	Data (secondary value) at the n-th measurement point. Always 0 when the data format is not the Smith chart format or the polar format.

Where NOP is the number of measurement points and n is an integer between 1 and NOP.

Query response {numeric 1},...,{numeric NOP×2}<newline><^END>

Example of use
 10 DIM A(1:201,1:2)
 20 OUTPUT 717;":CALC1:DATA:FMEM?"
 30 ENTER 717;A(*)

Related commands
 :CALC{1-16}:PAR{1-16}:SEL on page 424
 :CALC{1-16}:DATA:FDAT on page 307
 :CALC{1-16}:DATA:SMEM on page 310
 :FORM:DATA on page 488

Equivalent key No equivalent key is available on the front panel.

:CALC{1-16}:DATA:SDAT

Syntax

```
:CALCulate{[1]|2|3|4|5|6|7|8|9|10|11|12|13|14|15|16}[:SElected]:DATA:SDATa <numeric 1>,...,<numeric NOPx2>
:CALCulate{[1]|2|3|4|5|6|7|8|9|10|11|12|13|14|15|16}[:SElected]:DATA:SDATa?
```

Description

For the active trace of channel 1 (:CALC1) to channel 16 (:CALC16) (specified with the :CALC{1-16}:PAR{1-16}:SEL command), sets/reads out the corrected data array. (It is the data array for which processing such as error correction to measured raw data has been performed. For details, refer to “Corrected data arrays” on page 168.)

The data transfer format when this command is executed depends on the setting with the :FORM:DATA command.

Query response

```
{numeric 1},...,{numeric NOPx2}<newline><^END>
```

	Description
{numeric n×2-1}	Real part of the data (complex number) at the n-th measurement point.
{numeric n×2}	Imaginary part of the data (complex number) at the n-th measurement point.

Where NOP is the number of measurement points and n is an integer between 1 and NOP.

Example of use

```
10 DIM A(1:201,1:2)
20 OUTPUT 717;" :CALC1:DATA:SDAT?"
30 ENTER 717;A(*)
```

Related commands

:CALC{1-16}:DATA:SMEM on page 310
:CALC{1-16}:DATA:FDAT on page 307
:FORM:DATA on page 488

Equivalent key

No equivalent key is available on the front panel.

:CALC{1-16}:DATA:SMEM

Syntax :CALCulate{[1]|2|3|4|5|6|7|8|9|10|11|12|13|14|15|16}{[:SElected]:DATA:SMEMory <numeric 1>,...,<numeric NOP×2>
:CALCulate{[1]|2|3|4|5|6|7|8|9|10|11|12|13|14|15|16}{[:SElected]:DATA:SMEMory?

Description For the active trace of channel 1 (:CALC1) to channel 16 (:CALC16) (specified with the :CALC{1-16}:PAR{1-16}:SEL command), sets/reads out the corrected memory array. (It is the copy of the corrected data array when the :CALC{1-16}:MATH:MEM command is executed. For details, refer to “Corrected memory arrays” on page 168.)

The data transfer format when this command is executed depends on the setting with the :FORM:DATA command. (Query only)

Query response {numeric 1},...,{numeric NOP×2}<newline><^END>

	Description
{numeric n×2-1}	Real part of the data (complex number) at the n-th measurement point.
{numeric n×2}	Imaginary part of the data (complex number) at the n-th measurement point.

Where NOP is the number of measurement points and n is an integer between 1 and NOP.

Example of use

```
10 DIM A(1:201,1:2)
20 OUTPUT 717; ":CALC1:DATA:SMEM?"
30 ENTER 717;A(*)
```

Related commands

- :CALC{1-16}:MATH:MEM on page 416
- :CALC{1-16}:DATA:SDAT on page 309
- :CALC{1-16}:DATA:FMEM on page 308
- :FORM:DATA on page 488

Equivalent key No equivalent key is available on the front panel.

:CALC{1-16}:EQU:STAT

Syntax :CALCulate{[1]|2|3|4|5|6|7|8|9|10|11|12|13|14|15|16}[:SELEcted]:EQUation:STATe {ON|OFF|1|0}
:CALCulate{[1]|2|3|4|5|6|7|8|9|10|11|12|13|14|15|16}[:SELEcted]:EQUation:STATe?

Description For the active trace of channel 1 (:CALC1) to channel 16 (:CALC16) (specified with the :CALC{1-16}:PAR{1-16}:SEL command), turns ON/OFF the calculation function of the equation editor.

Parameters

	Description
ON or 1	Turns ON the calculation function of the equation editor.
OFF or 0 (preset value)	Turns OFF the calculation function of the equation editor.

Query response {1|0}<newline><^END>

Example of use
10 OUTPUT 717;":CALC1:EQU:STAT ON"
20 OUTPUT 717;":CALC1:EQU:STAT?"
30 ENTER 717;A

Related commands :CALC{1-16}:EQU:TEXT on page 312
:CALC{1-16}:EQU:VAL? on page 313

Equivalent key [Display] - Equation

:CALC{1-16}:EQU:TEXT

Syntax :CALCulate{[1]|2|3|4|5|6|7|8|9|10|11|12|13|14|15|16}{[:SElected]:EQUation:TEXT <string>
:CALCulate{[1]|2|3|4|5|6|7|8|9|10|11|12|13|14|15|16}{[:SElected]:EQUation:TEXT?

Description For the active trace of channel 1 (:CALC1) to channel 16 (:CALC16) (specified with the :CALC{1-16}:PAR{1-16}:SEL command), specifies the equation and equation label used in the equation editor. The equation label can be omitted.

Parameters

	<string>
Description	Specifies the equation and equation label in the equation editor.
Range	254 characters or less
Preset value	""

Example of use
10 OUTPUT 717; ":CALC1:EQU:TEXT "MyTr=S21/(1-S11) "" "
20 OUTPUT 717; ":CALC1:EQU:TEXT?"
30 ENTER 717;A

Related commands :CALC{1-16}:EQU:STAT on page 311
:CALC{1-16}:EQU:VAL? on page 313

Equivalent key [Display] - Equation Editor...

:CALC{1-16}:EQU:VAL?

Syntax :CALCulate{[1]|2|3|4|5|6|7|8|9|10|11|12|13|14|15|16}[:SElected]:EQUation:VALid?

Description For the active trace of channel 1 (:CALC1) to channel 16 (:CALC16) (specified with the :CALC{1-16}:PAR{1-16}:SEL command), reads out whether data specified by the equation in the equation editor is valid or invalid.

Measurement data refers to “Meas Data:” in the equation editor. If you specify data that does not exist, that data is invalid.

NOTE This command cannot read out errors of the equation and equation label.

Query response {1|0}<newline><^END>

	Description
1	Data specified by the equation is valid.
0	Data specified by the equation is invalid.

Example of use

```
10 OUTPUT 717; ":CALC1:EQU:VAL?"
20 ENTER 717;A
```

Related commands

:CALC{1-16}:EQU:STAT on page 311

:CALC{1-16}:EQU:TEXT on page 312

Equivalent key No equivalent key is available on the front panel.

:CALC{1-16}:FILT:TIME

Syntax

```
:CALCulate{[1]|2|3|4|5|6|7|8|9|10|11|12|13|14|15|16}{[:SElected]:FILTer[:GATE]:TIME[:TYPE] {BPASs|NOTCh}
:CAlCuLate{[1]|2|3|4|5|6|7|8|9|10|11|12|13|14|15|16}{[:SElected]:FILTer[:GATE]:TIME[:TYPE]?
```

Description

For the active trace of channel 1 (:CALC1) to channel 16 (:CALC16) (specified with the :CALC{1-16}:PAR{1-16}:SEL command), selects the gate type used for the gating function of the time domain function.

Parameters

	Description
BPASs (preset value)	Specifies the band-pass type.
NOTCh	Specifies the notch type.

Query response

```
{BPAS|NOTC}<newline><^END>
```

Example of use

```
10 OUTPUT 717; ":CALC1:FILT:TIME NOTC"
20 OUTPUT 717; ":CALC1:FILT:TIME?"
30 ENTER 717;A$
```

Related commands

```
:CALC{1-16}:FILT:TIME:SHAP on page 316
:CAlCuLate{[1]|2|3|4|5|6|7|8|9|10|11|12|13|14|15|16}{[:SElected]:FILTer[:GATE]:TIME[:TYPE] on page 319
:CAlCuLate{[1]|2|3|4|5|6|7|8|9|10|11|12|13|14|15|16}{[:SElected]:FILTer[:GATE]:TIME[:TYPE]? on page 424
```

Equivalent key

[Analysis] - Gating - Type

:CALC{1-16}:FILT:TIME:CENT

Syntax :CALCulate{[1]|2|3|4|5|6|7|8|9|10|11|12|13|14|15|16}[:SELEcted]:FILTer[:GATE]:TIME:CENTer <numeric>
:CALCulate{[1]|2|3|4|5|6|7|8|9|10|11|12|13|14|15|16}[:SELEcted]:FILTer[:GATE]:TIME:CENTer?

Description For the active trace of channel 1 (:CALC1) to channel 16 (:CALC16) (specified with the :CALC{1-16}:PAR{1-16}:SEL command), sets the center value of the gate used for the gating function of the time domain function.

Parameters

	<numeric>
Description	The center value of the gate.
Range	Varies depending on the frequency span and the number of points.
Preset value	0
Unit	s (second)

If the specified parameter is out of the allowable setup range, the minimum value (if the lower limit of the range is not reached) or the maximum value (if the upper limit of the range is exceeded) is set.

Query response {numeric}<newline><^END>

Example of use
10 OUTPUT 717; ":CALC1:FILT:TIME:CENT 1E-8"
20 OUTPUT 717; ":CALC1:FILT:TIME:CENT?"
30 ENTER 717;A

Related commands
:CALC{1-16}:FILT:TIME:SPAN on page 317
:CALC{1-16}:FILT:TIME:STAT on page 319
:CALC{1-16}:PAR{1-16}:SEL on page 424

Equivalent key [Analysis] - Gating - Center

:CALC{1-16}:FILT:TIME:SHAP

Syntax :CALCulate{[1]|2|3|4|5|6|7|8|9|10|11|12|13|14|15|16}[:SELEcted]:FILTer[:GATE]:TIME:SHAPE {MAXimum|WIDE|NORMal|MINimum}

:CALCulate{[1]|2|3|4|5|6|7|8|9|10|11|12|13|14|15|16}[:SELEcted]:FILTer[:GATE]:TIME:SHAPE?

Description For the active trace of channel 1 (:CALC1) to channel 16 (:CALC16) (specified with the :CALC{1-16}:PAR{1-16}:SEL command), selects the shape of the gate used for the gating function of the time domain function.

Parameters

	Description
MAXimum	Specifies the maximum shape.
WIDE	Specifies the wide shape.
NORMal (preset value)	Specifies the normal shape.
MINimum	Specifies the minimum shape.

Query response {MAX|WIDE|NORM|MIN}<newline><^END>

Example of use

```
10 OUTPUT 717; ":CALC1:FILT:TIME:SHAP WIDE"
20 OUTPUT 717; ":CALC1:FILT:TIME:SHAP?"
30 ENTER 717;A$
```

Related commands

- :CALC{1-16}:FILT:TIME on page 314
- :CALC{1-16}:FILT:TIME:STAT on page 319
- :CALC{1-16}:PAR{1-16}:SEL on page 424

Equivalent key [Analysis] - Gating - Shape - Maximum|Wide|Normal|Minimum

:CALC{1-16}:FILT:TIME:SPAN

Syntax :CALCulate{[1]|2|3|4|5|6|7|8|9|10|11|12|13|14|15|16}[:SELEcted]:FILTer[:GATE]:TIME:SPAN <numeric>
:CALCulate{[1]|2|3|4|5|6|7|8|9|10|11|12|13|14|15|16}[:SELEcted]:FILTer[:GATE]:TIME:SPAN?

Description For the active trace of channel 1 (:CALC1) to channel 16 (:CALC16) (specified with the :CALC{1-16}:PAR{1-16}:SEL command), sets the span value of the gate used for the gating function of the time domain function.

Parameters

	<numeric>
Description	The span value of the gate.
Range	Varies depending on the frequency span and the number of points.
Preset value	2E-8
Unit	s (second)

If the specified parameter is out of the allowable setup range, the minimum value (if the lower limit of the range is not reached) or the maximum value (if the upper limit of the range is exceeded) is set.

Query response {numeric}<newline><^END>

Example of use
10 OUTPUT 717; ":CALC1:FILT:TIME:SPAN 1E-8"
20 OUTPUT 717; ":CALC1:FILT:TIME:SPAN?"
30 ENTER 717;A

Related commands
:CALC{1-16}:FILT:TIME:CENT on page 315
:CALC{1-16}:FILT:TIME:STAT on page 319
:CALC{1-16}:PAR{1-16}:SEL on page 424

Equivalent key [Analysis] - Gating - Span

:CALC{1-16}:FILT:TIME:STAR

Syntax :CALCulate{[1]|2|3|4|5|6|7|8|9|10|11|12|13|14|15|16}[:SELEcted]:FILTer[:GATE]:TIME:STARt <numeric>
:CALCulate{[1]|2|3|4|5|6|7|8|9|10|11|12|13|14|15|16}[:SELEcted]:FILTer[:GATE]:TIME:STARt?

Description For the active trace of channel 1 (:CALC1) to channel 16 (:CALC16) (specified with the :CALC{1-16}:PAR{1-16}:SEL command), sets the start value of the gate used for the gating function of the time domain function.

Parameters

	<numeric>
Description	The start value of the gate.
Range	Varies depending on the frequency span and the number of points.
Preset value	-1E-8
Unit	s (second)

If the specified parameter is out of the allowable setup range, the minimum value (if the lower limit of the range is not reached) or the maximum value (if the upper limit of the range is exceeded) is set.

Query response {numeric}<newline><^END>

Example of use
10 OUTPUT 717; ":CALC1:FILT:TIME:STAR 0"
20 OUTPUT 717; ":CALC1:FILT:TIME:STAR?"
30 ENTER 717;A

Related commands
:CALC{1-16}:FILT:TIME:STOP on page 320
:CALC{1-16}:FILT:TIME:STAT on page 319
:CALC{1-16}:PAR{1-16}:SEL on page 424

Equivalent key [Analysis] - Gating - Start

:CALC{1-16}:FILT:TIME:STAT

Syntax	:CALCulate{[1] 2 3 4 5 6 7 8 9 10 11 12 13 14 15 16}[:SELEcted]:FILTer[:GATE]:TIME:STATe {ON OFF 1 0} :CALCulate{[1] 2 3 4 5 6 7 8 9 10 11 12 13 14 15 16}[:SELEcted]:FILTer[:GATE]:TIME:STATe?						
Description	<p>For the active trace of channel 1 (:CALC1) to channel 16 (:CALC16) (specified with the :CALC{1-16}:PAR{1-16}:SEL command), turns ON/OFF the gating function of the time domain function.</p> <p>You can turn ON the gating function only when the sweep type is the linear sweep and the number of points is 3 or more. If you execute this command to try to turn ON the gating function when the sweep type is other than the linear sweep or the number of points is less than 3, an error occurs and the command is ignored.</p> <p>When the sweep type is the power sweep, you cannot turn on the gating function. If you execute this command trying to turn on the gating function during the power sweep, an error occurs and the command is ignored.</p>						
Parameters	<table border="1" style="width: 100%; border-collapse: collapse;"> <thead> <tr> <th style="width: 50%;"></th> <th style="width: 50%; text-align: center;">Description</th> </tr> </thead> <tbody> <tr> <td>ON or 1</td> <td>Turns ON the gating function.</td> </tr> <tr> <td>OFF or 0 (preset value)</td> <td>Turns OFF the gating function.</td> </tr> </tbody> </table>		Description	ON or 1	Turns ON the gating function.	OFF or 0 (preset value)	Turns OFF the gating function.
	Description						
ON or 1	Turns ON the gating function.						
OFF or 0 (preset value)	Turns OFF the gating function.						
Query response	{1 0}<newline><^END>						
Example of use	<pre>10 OUTPUT 717; ":CALC1:FILT:TIME:STAT ON" 20 OUTPUT 717; ":CALC1:FILT:TIME:STAT?" 30 ENTER 717;A</pre>						
Related commands	:CALC{1-16}:PAR{1-16}:SEL on page 424 :SENS{1-16}:SWE:TYPE on page 696 :SENS{1-16}:SWE:POIN on page 693						
Equivalent key	[Analysis] - Gating - Gating						

:CALC{1-16}:FILT:TIME:STOP

Syntax :CALCulate{[1]|2|3|4|5|6|7|8|9|10|11|12|13|14|15|16}[:SElected]:FILTer[:GATE]:TIME:STOP <numeric>
:CALCulate{[1]|2|3|4|5|6|7|8|9|10|11|12|13|14|15|16}[:SElected]:FILTer[:GATE]:TIME:STOP?

Description For the active trace of channel 1 (:CALC1) to channel 16 (:CALC16) (specified with the :CALC{1-16}:PAR{1-16}:SEL command), sets the stop value of the gate used for the gating function of the time domain function.

Parameters

	<numeric>
Description	The stop value of the gate.
Range	Varies depending on the frequency span and the number of points.
Preset value	1E-8
Unit	s (second)

If the specified parameter is out of the allowable setup range, the minimum value (if the lower limit of the range is not reached) or the maximum value (if the upper limit of the range is exceeded) is set.

Query response {numeric}<newline><^END>

Example of use
10 OUTPUT 717; ":CALC1:FILT:TIME:STOP 2E-8"
20 OUTPUT 717; ":CALC1:FILT:TIME:STOP?"
30 ENTER 717;A

Related commands
:CALC{1-16}:FILT:TIME:STAR on page 318
:CALC{1-16}:FILT:TIME:STAT on page 319
:CALC{1-16}:PAR{1-16}:SEL on page 424

Equivalent key [Analysis] - Gating - Stop

:CALC{1-16}:FORM

Syntax

```
:CALCulate{[1]|2|3|4|5|6|7|8|9|10|11|12|13|14|15|16}[:SElected]:FORMat {MLOGarithmic|PHASe|GDELay|
SLINear|SLOGarithmic|SCOMplex|SMITH|SADMittance|PLINear|PLOGarithmic|POLar|MLINear|SWR|REAL|
IMAGinary|UPHase|PPHase}
:CALCulate{[1]|2|3|4|5|6|7|8|9|10|11|12|13|14|15|16}[:SElected]:FORMat?
```

Description

Selects the data format of the active trace of channel 1 (:CALC1) to channel 16 (:CALC16) (specified with the :CALC{1-16}:PAR{1-16}:SEL command).

Parameters

	Description
MLOGarithmic (preset value)	Specifies the logarithmic magnitude format.
PHASe	Specifies the phase format.
GDELay	Specifies the group delay format.
SLINear	Specifies the Smith chart format (Lin/Phase).
SLOGarithmic	Specifies the Smith chart format (Log/Phase).
SCOMplex	Specifies the Smith chart format (Real/Imag).
SMITH	Specifies the Smith chart format (R+jX).
SADMittance	Specifies the Smith chart format (G+jB).
PLINear	Specifies the polar format (Lin).
PLOGarithmic	Specifies the polar format (Log).
POLar	Specifies the polar format (Re/Im).
MLINear	Specifies the linear magnitude format.
SWR	Specifies the SWR format.
REAL	Specifies the real format.
IMAGinary	Specifies the imaginary format.
UPHase	Specifies the expanded phase format.
PPHase	Specifies the positive phase format.

Query response

```
{MLOG|PHAS|GDEL|SLIN|SLOG|SCOM|SMIT|SADM|PLIN|PLOG|POL|MLIN|SWR|
REAL|IMAG|UPH|PPH}<newline><^END>
```

Example of use

```
10 OUTPUT 717;":CALC1:FORM SLIN"
20 OUTPUT 717;":CALC1:FORM?"
30 ENTER 717;A$
```

Related commands

:CALC{1-16}:PAR{1-16}:SEL on page 424

Equivalent key

[Format] - Log Mag|Phase|Group Delay|Lin Mag|SWR|Real|Imaginary|Expand Phase|Positive Phase
[Format] - Smith - Lin/Phase|Log/Phase|Real/Imag|R+jX|G+jB

[Format] - Polar - Lin/Phase|Log/Phase|Real/Imag

:CALC{1-16}:FSIM:BAL:CZC:BPOR{1-2}:IMAG

Syntax

```
:CALCulate{[1|2|3|4|5|6|7|8|9|10|11|12|13|14|15|16]}:FSIMulator:BALun:CZConversion:BPORt{[1|2]}:IMAGinary <numeric>  
:CALCulate{[1|2|3|4|5|6|7|8|9|10|11|12|13|14|15|16]}:FSIMulator:BALun:CZConversion:BPORt{[1|2]}:IMAGinary?
```

Description

For balance port 1 (:BPOR1) or balance port 2 (:BPOR2) of channel 1 (:CALC1) to channel 16 (:CALC16), sets the impedance value (imaginary part) for the common port impedance conversion function.

For details about the balance port number, see Figure 6-2 on page 153.

Parameters

	<numeric>
Description	Impedance value (imaginary part)
Range	-1E+18 to 1E+18
Preset value	0
Unit	Ω (ohm)

If the specified parameter is out of the allowable setup range, the minimum value (if the lower limit of the range is not reached) or the maximum value (if the upper limit of the range is exceeded) is set.

Query response

```
{numeric}<newline><^END>
```

Example of use

```
10 OUTPUT 717; ":CALC1:FSIM:BAL:CZC:BPOR1:IMAG 30E6"  
20 OUTPUT 717; ":CALC1:FSIM:BAL:CZC:BPOR1:IMAG?"  
30 ENTER 717;A
```

Related commands

:CALC{1-16}:FSIM:BAL:CZC:BPOR{1-2}:REAL on page 324

:CALC{1-16}:FSIM:BAL:CZC:BPOR{1-2}:Z0 on page 325

:CALC{1-16}:FSIM:BAL:CZC:STAT on page 326

Equivalent key

[Analysis] - Fixture Simulator - Cmn ZConversion - Port1(bal) Imag|Port2(bal) Imag|Port3(bal) Imag

:CALC{1-16}:FSIM:BAL:CZC:BPOR{1-2}:REAL

Syntax

```
:CALCulate{[1]2|3|4|5|6|7|8|9|10|11|12|13|14|15|16}:FSIMulator:BALun:CZConversion:BPORt{[1]2}:REAL <numeric>  
:CALCulate{[1]2|3|4|5|6|7|8|9|10|11|12|13|14|15|16}:FSIMulator:BALun:CZConversion:BPORt{[1]2}:REAL?
```

Description

For balance port 1 (:BPOR1) or balance port 2 (:BPOR2) of channel 1 (:CALC1) to channel 16 (:CALC16), sets the impedance value (real part) for the common port impedance conversion function.

For details about the balance port number, see Figure 6-2 on page 153.

NOTE

This command functions in the same way as
:CALC{1-16}:FSIM:BAL:CZC:BPOR{1-2}:Z0 on page 325

Parameters

	<numeric>
Description	Impedance value (real part)
Range	1E-3 to 1E7
Preset value	25
Unit	Ω (ohm)
Resolution	0.001

If the specified parameter is out of the allowable setup range, the minimum value (if the lower limit of the range is not reached) or the maximum value (if the upper limit of the range is exceeded) is set.

Query response

```
{numeric}<newline><^END>
```

Example of use

```
10 OUTPUT 717; ":CALC1:FSIM:BAL:CZC:BPOR1:REAL 30E6"  
20 OUTPUT 717; ":CALC1:FSIM:BAL:CZC:BPOR1:REAL?"  
30 ENTER 717;A
```

Related commands

:CALC{1-16}:FSIM:BAL:CZC:BPOR{1-2}:IMAG on page 323

:CALC{1-16}:FSIM:BAL:CZC:BPOR{1-2}:Z0 on page 325

:CALC{1-16}:FSIM:BAL:CZC:STAT on page 326

Equivalent key

[Analysis] - Fixture Simulator - Cmn ZConversion - Port1(bal) Real|Port2(bal) Real|Port3(bal) Real

:CALC{1-16}:FSIM:BAL:CZC:BPOR{1-2}:Z0

Syntax

```
:CALCulate{[1]2[3]4[5]6[7]8[9]10[11]12[13]14[15]16}:FSIMulator:BALun:CZConversion:BPORt{[1]2}:Z0[:R] <numeric>
:CALCulate{[1]2[3]4[5]6[7]8[9]10[11]12[13]14[15]16}:FSIMulator:BALun:CZConversion:BPORt{[1]2}:Z0[:R]?
```

Description

For balance port 1 (:BPOR1) or balance port 2 (:BPOR2) of channel 1 (:CALC1) to channel 16 (:CALC16), sets the impedance value for the common port impedance conversion function.

For details about the balance port number, see Figure 6-2 on page 153.

Parameters

	<numeric>
Description	Impedance value
Range	1E-3 to 1E7
Preset value	25
Unit	Ω (ohm)
Resolution	0.001

If the specified parameter is out of the allowable setup range, the minimum value (if the lower limit of the range is not reached) or the maximum value (if the upper limit of the range is exceeded) is set.

CAUTION

This command clears setting value of “:CALC{1-16}:FSIM:BAL:CZC:BPOR{1-2}:IMAG” on page 323

Query response

```
{numeric}<newline><^END>
```

Example of use

```
10 OUTPUT 717; ":CALC1:FSIM:BAL:CZC:BPOR1:Z0 30"
20 OUTPUT 717; ":CALC1:FSIM:BAL:CZC:BPOR1:Z0?"
30 ENTER 717;A
```

Related commands

:CALC{1-16}:FSIM:BAL:CZC:BPOR{1-2}:IMAG on page 323
:CALC{1-16}:FSIM:BAL:CZC:BPOR{1-2}:REAL on page 324
:CALC{1-16}:FSIM:BAL:CZC:STAT on page 326

Equivalent key

[Analysis] - Fixture Simulator - Cmn ZConversion - Port1(bal) Real|Port2(bal) Real|Port3(bal) Real

:CALC{1-16}:FSIM:BAL:CZC:STAT

Syntax :CALCulate{[1][2][3][4][5][6][7][8][9][10][11][12][13][14][15][16]}:FSIMulator:BALun:CZConversion:STATe {ON|OFF|1|0}
:CALCulate{[1][2][3][4][5][6][7][8][9][10][11][12][13][14][15][16]}:FSIMulator:BALun:CZConversion:STATe?

Description For all the balance ports of channel 1 (:CALC1) to channel 16 (:CALC16), turns ON/OFF the common port impedance conversion function when the fixture simulator function is ON (ON is specified with the :CALC{1-16}:FSIM:STAT command).

Parameters

	Description
ON or 1	Turns ON the common impedance conversion function.
OFF or 0 (preset value)	Turns OFF the common impedance conversion function.

Query response {1|0}<newline><^END>

Example of use
10 OUTPUT 717; ":CALC1:FSIM:BAL:CZC:STAT ON"
20 OUTPUT 717; ":CALC1:FSIM:BAL:CZC:STAT?"
30 ENTER 717;A

Related commands
:CALC{1-16}:FSIM:STAT on page 368
:CALC{1-16}:FSIM:BAL:CZC:BPOR{1-2}:IMAG on page 323
:CALC{1-16}:FSIM:BAL:CZC:BPOR{1-2}:REAL on page 324
:CALC{1-16}:FSIM:BAL:CZC:BPOR{1-2}:Z0 on page 325

Equivalent key [Analysis] - Fixture Simulator - Cmn ZConversion - Cmn ZConversion

:CALC{1-16}:FSIM:BAL:DEV

Syntax

```
:CALCulate{[1]|2|3|4|5|6|7|8|9|10|11|12|13|14|15|16}:FSIMulator:BALun:DEvice {SBALanced|BBALanced|SSBalanced}
:CALCulate{[1]|2|3|4|5|6|7|8|9|10|11|12|13|14|15|16}:FSIMulator:BALun:DEvice?
```

Description

For channel 1 (:CALC1) to channel 16 (:CALC16), selects the balance device type of the fixture simulator function.

For details about the balance device type, see Figure 6-2 on page 153.

Parameters

	Description
SBALanced (preset value)	Specifies the unbalance-balance (3 ports).
BBALanced	Specifies the balance-balance (4 ports).
SSBalanced	Specifies the unbalance-unbalance-balance (4 ports).

Query response

```
{SBAL|BBAL|SSB}<newline><^END>
```

Example of use

```
10 OUTPUT 717;":CALC1:FSIM:BAL:DEV BBAL"
20 OUTPUT 717;":CALC1:FSIM:BAL:DEV?"
30 ENTER 717;A$
```

Related commands

:CALC{1-16}:FSIM:BAL:TOP:SBAL on page 345

:CALC{1-16}:FSIM:BAL:TOP:BBAL on page 343

:CALC{1-16}:FSIM:BAL:TOP:SSB on page 346

Equivalent key

[Analysis] - Fixture Simulator - Topology - Device

:CALC{1-16}:FSIM:BAL:DMC:BPOR{1-2}

Syntax :CALCulate{[1]|2|3|4|5|6|7|8|9|10|11|12|13|14|15|16}:FSIMulator:BALun:DMCircuit:BPORt{[1]|2}[:TYPE] {NONE|PLPC|USER}
:CALCulate{[1]|2|3|4|5|6|7|8|9|10|11|12|13|14|15|16}:FSIMulator:BALun:DMCircuit:BPORt{[1]|2}[:TYPE]?

Description For balance port 1 (:BPOR1) or balance port 2 (:BPOR2) of channel 1 (:CALC1) to channel 16 (:CALC16), selects the type of the differential matching circuit.

If you want to select the user-defined circuit, you must specify the 2-port touchstone file in which the proper information on the user-defined circuit is saved in advance. If you do not specify the appropriate file and you select the user-defined circuit, an error occurs and NONE is automatically selected.

For details about the balance port number, see figure Figure 6-2 on page 153.

Parameters

	Description
NONE (preset value)	Specifies no-circuit.
PLPC	Specifies the circuit that consists of shunt L and shunt C.
USER	Specifies the user-defined circuit *1.

*1. The information on the circuit is read out from the 2-port touchstone file specified with the :CALC{1-16}:FSIM:BAL:DMC:BPOR{1-2}:USER:FIL command.

For more information on the circuits, refer to “User’s Guide.”

Query response {NONE|PLPC|USER}<newline><^END>

Example of use
10 OUTPUT 717; ":CALC1:FSIM:BAL:DMC:BPOR1 PLPC"
20 OUTPUT 717; ":CALC1:FSIM:BAL:DMC:BPOR1?"
30 ENTER 717;A\$

Related commands
:CALC{1-16}:FSIM:BAL:DMC:STAT on page 334
:CALC{1-16}:FSIM:BAL:DMC:BPOR{1-2}:PAR:C on page 329
:CALC{1-16}:FSIM:BAL:DMC:BPOR{1-2}:PAR:G on page 330
:CALC{1-16}:FSIM:BAL:DMC:BPOR{1-2}:PAR:L on page 331
:CALC{1-16}:FSIM:BAL:DMC:BPOR{1-2}:PAR:R on page 332
:CALC{1-16}:FSIM:BAL:DMC:BPOR{1-2}:USER:FIL on page 333

Equivalent key [Analysis] - Fixture Simulator - Diff Matching - Select Circuit

:CALC{1-16}:FSIM:BAL:DMC:BPOR{1-2}:PAR:C

Syntax :CALCulate{[1]|2|3|4|5|6|7|8|9|10|11|12|13|14|15|16}:FSIMulator:BALun:DMCircuit:BPORt{[1]|2}:PARAmeters:C <numeric>
:CALCulate{[1]|2|3|4|5|6|7|8|9|10|11|12|13|14|15|16}:FSIMulator:BALun:DMCircuit:BPORt{[1]|2}:PARAmeters:C?

Description For balance port 1 (:BPOR1) or balance port 2 (:BPOR2) of channel 1 (:CALC1) to channel 16 (:CALC16), sets the C value of the differential matching circuit.
For details about the balance port number, see figure Figure 6-2 on page 153.

Parameters

	<numeric>
Description	C value of the differential matching circuit
Range	-1E18 to 1E18
Preset value	0
Unit	F (farad)

If the specified parameter is out of the allowable setup range, the minimum value (if the lower limit of the range is not reached) or the maximum value (if the upper limit of the range is exceeded) is set.

Query response {numeric}<newline><^END>

Example of use
10 OUTPUT 717;":CALC1:FSIM:BAL:DMC:BPOR1:PAR:C 12.3"
20 OUTPUT 717;":CALC1:FSIM:BAL:DMC:BPOR1:PAR:C?"
30 ENTER 717;A

Related commands
:CALC{1-16}:FSIM:BAL:DMC:STAT on page 334
:CALC{1-16}:FSIM:BAL:DMC:BPOR{1-2} on page 328
:CALC{1-16}:FSIM:BAL:DMC:BPOR{1-2}:PAR:G on page 330
:CALC{1-16}:FSIM:BAL:DMC:BPOR{1-2}:PAR:L on page 331
:CALC{1-16}:FSIM:BAL:DMC:BPOR{1-2}:PAR:R on page 332

Equivalent key [Analysis] - Fixture Simulator - Diff Matching - C

:CALC{1-16}:FSIM:BAL:DMC:BPOR{1-2}:PAR:G

Syntax :CALCulate{[1]|2|3|4|5|6|7|8|9|10|11|12|13|14|15|16}:FSIMulator:BALun:DMCircuit:BPORt{[1]|2}
:PARameters:G <numeric>
:CALCulate{[1]|2|3|4|5|6|7|8|9|10|11|12|13|14|15|16}:FSIMulator:BALun:DMCircuit:BPORt{[1]|2}
:PARameters:G?

Description For balance port 1 (:BPOR1) or balance port 2 (:BPOR2) of channel 1 (:CALC1) to channel 16 (:CALC16), sets the G value of the differential matching circuit.

For details about the balance port number, see Figure 6-2 on page 153.

Parameters

	<numeric>
Description	G value of the differential matching circuit
Range	-1E18 to 1E18
Preset value	0
Unit	S (siemens)

If the specified parameter is out of the allowable setup range, the minimum value (if the lower limit of the range is not reached) or the maximum value (if the upper limit of the range is exceeded) is set.

Query response {numeric}<newline><^END>

Example of use
10 OUTPUT 717; ":CALC1:FSIM:BAL:DMC:BPOR1:PAR:G 12.3"
20 OUTPUT 717; ":CALC1:FSIM:BAL:DMC:BPOR1:PAR:G?"
30 ENTER 717;A

Related commands
:CALC{1-16}:FSIM:BAL:DMC:STAT on page 334
:CALC{1-16}:FSIM:BAL:DMC:BPOR{1-2} on page 328
:CALC{1-16}:FSIM:BAL:DMC:BPOR{1-2}:PAR:C on page 329
:CALC{1-16}:FSIM:BAL:DMC:BPOR{1-2}:PAR:L on page 331
:CALC{1-16}:FSIM:BAL:DMC:BPOR{1-2}:PAR:R on page 332

Equivalent key [Analysis] - Fixture Simulator - Diff Matching - G

:CALC{1-16}:FSIM:BAL:DMC:BPOR{1-2}:PAR:L

Syntax :CALCulate{[1]|2|3|4|5|6|7|8|9|10|11|12|13|14|15|16}:FSIMulator:BALun:DMCircuit:BPORt{[1]|2}:PARAmeters:L <numeric>
:CALCulate{[1]|2|3|4|5|6|7|8|9|10|11|12|13|14|15|16}:FSIMulator:BALun:DMCircuit:BPORt{[1]|2}:PARAmeters:L?

Description For balance port 1 (:BPOR1) or balance port 2 (:BPOR2) of channel 1 (:CALC1) to channel 16 (:CALC16), sets the L value of the differential matching circuit.
For details about the balance port number, see Figure 6-2 on page 153.

Parameters

	<numeric>
Description	L value of the differential matching circuit
Range	-1E18 to 1E18
Preset value	0
Unit	H (henry)

If the specified parameter is out of the allowable setup range, the minimum value (if the lower limit of the range is not reached) or the maximum value (if the upper limit of the range is exceeded) is set.

Query response {numeric}<newline><^END>

Example of use
10 OUTPUT 717; ":CALC1:FSIM:BAL:DMC:BPOR1:PAR:L 12.3"
20 OUTPUT 717; ":CALC1:FSIM:BAL:DMC:BPOR1:PAR:L?"
30 ENTER 717;A

Related commands
:CALC{1-16}:FSIM:BAL:DMC:STAT on page 334
:CALC{1-16}:FSIM:BAL:DMC:BPOR{1-2} on page 328
:CALC{1-16}:FSIM:BAL:DMC:BPOR{1-2}:PAR:C on page 329
:CALC{1-16}:FSIM:BAL:DMC:BPOR{1-2}:PAR:G on page 330
:CALC{1-16}:FSIM:BAL:DMC:BPOR{1-2}:PAR:R on page 332

Equivalent key [Analysis] - Fixture Simulator - Diff Matching - L

:CALC{1-16}:FSIM:BAL:DMC:BPOR{1-2}:PAR:R

Syntax :CALCulate{[1]|2|3|4|5|6|7|8|9|10|11|12|13|14|15|16}:FSIMulator:BALun:DMCircuit:BPORt{[1]|2}
:PARameters:R <numeric>
:CALCulate{[1]|2|3|4|5|6|7|8|9|10|11|12|13|14|15|16}:FSIMulator:BALun:DMCircuit:BPORt{[1]|2}
:PARameters:R?

Description For balance port 1 (:BPOR1) or balance port 2 (:BPOR2) of channel 1 (:CALC1) to channel 16 (:CALC16), sets the R value of the differential matching circuit.

For details about the balance port number, see Figure 6-2 on page 153.

Parameters

	<numeric>
Description	R value of the differential matching circuit
Range	-1E18 to 1E18
Preset value	0
Unit	Ω (ohm)

If the specified parameter is out of the allowable setup range, the minimum value (if the lower limit of the range is not reached) or the maximum value (if the upper limit of the range is exceeded) is set.

Query response {numeric}<newline><^END>

Example of use
10 OUTPUT 717; ":CALC1:FSIM:BAL:DMC:BPOR1:PAR:R 12.3"
20 OUTPUT 717; ":CALC1:FSIM:BAL:DMC:BPOR1:PAR:R?"
30 ENTER 717;A

Related commands
:CALC{1-16}:FSIM:BAL:DMC:STAT on page 334
:CALC{1-16}:FSIM:BAL:DMC:BPOR{1-2} on page 328
:CALC{1-16}:FSIM:BAL:DMC:BPOR{1-2}:PAR:C on page 329
:CALC{1-16}:FSIM:BAL:DMC:BPOR{1-2}:PAR:G on page 330
:CALC{1-16}:FSIM:BAL:DMC:BPOR{1-2}:PAR:L on page 331

Equivalent key [Analysis] - Fixture Simulator - Diff Matching - R

:CALC{1-16}:FSIM:BAL:DMC:BPOR{1-2}:USER:FIL

Syntax :CALCulate{[1]|2|3|4|5|6|7|8|9|10|11|12|13|14|15|16}:FSIMulator:BALun:DMCircuit:BPORt{[1]|2}:USER:FILEname <string>

:CALCulate{[1]|2|3|4|5|6|7|8|9|10|11|12|13|14|15|16}:FSIMulator:BALun:DMCircuit:BPORt{[1]|2}:USER:FILEname?

Description For balance port 1 (:BPOR1) or balance port 2 (:BPOR2) of channel 1 (:CALC1) to channel 16 (:CALC16), specifies the file in which the information on the user-defined differential matching circuit is saved (2-port touchstone file).

Specify the file name with the .s2p extension. If you want to specify a file on the floppy disk drive, you need to add "A:" at the beginning of the file name. When you use directory names and file name, separate them with "/" (slash) or "\" (backslash).

Even if the specified file does not exist, no error occurs when you execute this command*1. However, when you set the type of the differential matching circuit to the user-defined circuit with the :CALC{1-16}:FSIM:BAL:DMC:BPOR{1-2} command, an error occurs.

For details about the balance port number, see Figure 6-2 on page 153.

Parameters

	<string>
Description	2-port touchstone file name
Range	254 characters or less
Preset value	""

Query response {string}<newline><^END>

Example of use

```
10 OUTPUT 717;":CALC1:FSIM:BAL:DMC:BPOR1:USER:FIL ""Match_d.s2p""
20 OUTPUT 717;":CALC1:FSIM:BAL:DMC:BPOR1:USER:FIL?"
30 ENTER 717;A$
```

Related commands :CALC{1-16}:FSIM:BAL:DMC:STAT on page 334

:CALC{1-16}:FSIM:BAL:DMC:BPOR{1-2} on page 328

Equivalent key [Analysis] - Fixture Simulator - Diff Matching - User File

*1.If you set the type of the differential matching circuit to the user-defined circuit before you execute this command, an error occurs and the command is ignored when you execute this command.

:CALC{1-16}:FSIM:BAL:DMC:STAT

Syntax :CALCulate{[1]|2|3|4|5|6|7|8|9|10|11|12|13|14|15|16}:FSIMulator:BALun:DMCircuit:STATe {ON|OFF|1|0}
:CALCulate{[1]|2|3|4|5|6|7|8|9|10|11|12|13|14|15|16}:FSIMulator:BALun:DMCircuit:STATe?

Description For all the balance ports of channel 1 (:CALC1) to channel 16 (:CALC16), turns ON/OFF the differential matching circuit embedding function when the fixture simulator function is ON (ON is specified with the :CALC{1-16}:FSIM:STAT command).

Parameters

	Description
ON or 1	Turns ON the differential matching circuit embedding function.
OFF or 0 (preset value)	Turns OFF the differential matching circuit embedding function.

Query response {1|0}<newline><^END>

Example of use
10 OUTPUT 717; ":CALC1:FSIM:BAL:DMC:STAT ON"
20 OUTPUT 717; ":CALC1:FSIM:BAL:DMC:STAT?"
30 ENTER 717;A

Related commands
:CALC{1-16}:FSIM:STAT on page 368
:CALC{1-16}:FSIM:BAL:DMC:BPOR{1-2} on page 328
:CALC{1-16}:FSIM:BAL:DMC:BPOR{1-2}:PAR:C on page 329
:CALC{1-16}:FSIM:BAL:DMC:BPOR{1-2}:PAR:G on page 330
:CALC{1-16}:FSIM:BAL:DMC:BPOR{1-2}:PAR:L on page 331
:CALC{1-16}:FSIM:BAL:DMC:BPOR{1-2}:PAR:R on page 332
:CALC{1-16}:FSIM:BAL:DMC:BPOR{1-2}:USER:FIL on page 333

Equivalent key [Analysis] - Fixture Simulator - Diff Matching - Diff Matching

:CALC{1-16}:FSIM:BAL:DZC:BPOR{1-2}:IMAG

Syntax :CALCulate{[1]|2|3|4|5|6|7|8|9|10|11|12|13|14|15|16}:FSIMulator:BALun:DZConversion:BPORt{[1]|2}:IMAGinary <numeric>
:CALCulate{[1]|2|3|4|5|6|7|8|9|10|11|12|13|14|15|16}:FSIMulator:BALun:DZConversion:BPORt{[1]|2}:IMAGinary?

Description For balance port 1 (:BPOR1) or balance port 2 (:BPOR2) of channel 1 (:CALC1) to channel 16 (:CALC16), sets the impedance value (imaginary part) for the differential port impedance conversion function.

For details about the balance port number, see Figure 6-2 on page 153.

Parameters

	<numeric>
Description	Impedance value (imaginary part)
Range	-1E+18 to 1E+18
Preset value	0
Unit	Ω (ohm)

If the specified parameter is out of the allowable setup range, the minimum value (if the lower limit of the range is not reached) or the maximum value (if the upper limit of the range is exceeded) is set.

Query response {numeric}<newline><^END>

Example of use
10 OUTPUT 717; ":CALC1:FSIM:BAL:DZC:BPOR1:IMAG 300"
20 OUTPUT 717; ":CALC1:FSIM:BAL:DZC:BPOR1:IMAG?"
30 ENTER 717;A

Related commands :CALC{1-16}:FSIM:BAL:DZC:BPOR{1-2}:Z0 on page 337
:CALC{1-16}:FSIM:BAL:DZC:STAT on page 338

Equivalent key [Analysis] - Fixture Simulator - Diff ZConversion - Port1(bal) Imag|Port2(bal) Imag|Port3(bal) Imag

:CALC{1-16}:FSIM:BAL:DZC:BPOR{1-2}:REAL

Syntax :CALCulate{[1]|2|3|4|5|6|7|8|9|10|11|12|13|14|15|16}:FSIMulator:BALun:DZConversion:BPORt{[1]|2}:REAL <numeric>
:CALCulate{[1]|2|3|4|5|6|7|8|9|10|11|12|13|14|15|16}:FSIMulator:BALun:DZConversion:BPORt{[1]|2}:REAL?

Description For balance port 1 (:BPOR1) or balance port 2 (:BPOR2) of channel 1 (:CALC1) to channel 16 (:CALC16), sets the impedance value (real part) for the differential port impedance conversion function.

For details about the balance port number, see Figure 6-2 on page 153.

NOTE This command performs in the same way as :CALC{1-16}:FSIM:BAL:DZC:BPOR{1-2}:Z0 on page 337

Parameters

	<numeric>
Description	Impedance value (real part)
Range	1E-3 to 1E7
Preset value	100
Unit	Ω (ohm)
Resolution	0.001

If the specified parameter is out of the allowable setup range, the minimum value (if the lower limit of the range is not reached) or the maximum value (if the upper limit of the range is exceeded) is set.

Query response {numeric}<newline><^END>

Example of use
10 OUTPUT 717; ":CALC1:FSIM:BAL:DZC:BPOR1:REAL 300"
20 OUTPUT 717; ":CALC1:FSIM:BAL:DZC:BPOR1:REAL?"
30 ENTER 717;A

Related commands :CALC{1-16}:FSIM:BAL:DZC:BPOR{1-2}:IMAG on page 335
:CALC{1-16}:FSIM:BAL:DZC:BPOR{1-2}:Z0 on page 337
:CALC{1-16}:FSIM:BAL:DZC:STAT on page 338

Equivalent key [Analysis] - Fixture Simulator - Diff ZConversion - Port1(bal) Real|Port2(bal) Real|Port3(bal) Real

:CALC{1-16}:FSIM:BAL:DZC:BPOR{1-2}:Z0

Syntax :CALCulate{[1]|2|3|4|5|6|7|8|9|10|11|12|13|14|15|16}:FSIMulator:BALun:DZConversion:BPORt{[1]|2}:Z0[:R] <numeric>
:CALCulate{[1]|2|3|4|5|6|7|8|9|10|11|12|13|14|15|16}:FSIMulator:BALun:DZConversion:BPORt{[1]|2}:Z0[:R]?

Description For balance port 1 (:BPOR1) or balance port 2 (:BPOR2) of channel 1 (:CALC1) to channel 16 (:CALC16), sets the impedance value for the differential port impedance conversion function.

For details about the balance port number, see Figure 6-2 on page 153.

Parameters

	<numeric>
Description	Impedance value
Range	1E-3 to 1E7
Preset value	100
Unit	Ω (ohm)
Resolution	0.001

If the specified parameter is out of the allowable setup range, the minimum value (if the lower limit of the range is not reached) or the maximum value (if the upper limit of the range is exceeded) is set.

CAUTION This command clears setting value of “:CALC{1-16}:FSIM:BAL:DZC:BPOR{1-2}:IMAG” on page 335

Query response {numeric}<newline><^END>

Example of use
10 OUTPUT 717; ":CALC1:FSIM:BAL:DZC:BPOR1:Z0 300"
20 OUTPUT 717; ":CALC1:FSIM:BAL:DZC:BPOR1:Z0?"
30 ENTER 717;A

Related commands
:CALC{1-16}:FSIM:BAL:DZC:BPOR{1-2}:IMAG on page 335
:CALC{1-16}:FSIM:BAL:DZC:BPOR{1-2}:REAL on page 336
:CALC{1-16}:FSIM:BAL:DZC:STAT on page 338

Equivalent key [Analysis] - Fixture Simulator - Diff ZConversion - Port1(bal) Real|Port2(bal) Real|Port3(bal) Real

:CALC{1-16}:FSIM:BAL:DZC:STAT

Syntax :CALCulate{[1]|2|3|4|5|6|7|8|9|10|11|12|13|14|15|16}:FSIMulator:BALun:DZConversion:STATe {ON|OFF|1|0}
:CALCulate{[1]|2|3|4|5|6|7|8|9|10|11|12|13|14|15|16}:FSIMulator:BALun:DZConversion:STATe?

Description For all the balance ports of channel 1 (:CALC1) to channel 16 (:CALC16), turns ON/OFF the differential port impedance conversion function when the fixture simulator function is ON (ON is specified with the :CALC{1-16}:FSIM:STAT command).

Parameters

	Description
ON or 1	Turns ON the differential impedance conversion function.
OFF or 0 (preset value)	Turns OFF the differential impedance conversion function.

Query response {1|0}<newline><^END>

Example of use
10 OUTPUT 717; ":CALC1:FSIM:BAL:DZC:STAT ON"
20 OUTPUT 717; ":CALC1:FSIM:BAL:DZC:STAT?"
30 ENTER 717;A

Related commands
:CALC{1-16}:FSIM:BAL:DZC:BPOR{1-2}:IMAG on page 335
:CALC{1-16}:FSIM:BAL:DZC:BPOR{1-2}:REAL on page 336
:CALC{1-16}:FSIM:BAL:DZC:BPOR{1-2}:Z0 on page 337
:CALC{1-16}:FSIM:STAT on page 368

Equivalent key [Analysis] - Fixture Simulator - Diff ZConversion - Diff ZConversion

:CALC{1-16}:FSIM:BAL:PAR{1-16}:BBAL

Syntax

```
:CALCulate{[1][2][3][4][5][6][7][8][9][10][11][12][13][14][15][16]}:FSIMulator:BALun:PARAmeter{[1][2][3][4][5][6][7][8][9][10][11][12][13][14][15][16]}:BBALanced[:DEFine] {SDD11|SDD21|SDD12|SDD22|SCD11|SCD21|SCD12|SCD22|SDC11|SDC21|SDC12|SDC22|SCC11|SCC21|SCC12|SCC22|IMB1|IMB2|CMRR}
:CALCulate{[1][2][3][4][5][6][7][8][9][10][11][12][13][14][15][16]}:FSIMulator:BALun:PARAmeter{[1][2][3][4][5][6][7][8][9][10][11][12][13][14][15][16]}:BBALanced[:DEFine]?
```

Description

For channel 1 (:CALC1) to channel 16 (:CALC16), sets the measurement parameters of trace 1 (:PAR1) to trace 16 (:PAR16) when the balance device type is set to “balance-balance” (BBAL is specified with the :CALC{1-16}:FSIM:BAL:DEV command).

Parameters

	Description
SDD11 (preset value)	Specifies Sdd11.
SDD21	Specifies Sdd21.
SDD12	Specifies Sdd12.
SDD22	Specifies Sdd22.
SCD11	Specifies Scd11.
SCD21	Specifies Scd21.
SCD12	Specifies Scd12.
SCD22	Specifies Scd22.
SDC11	Specifies Sdc11.
SDC21	Specifies Sdc21.
SDC12	Specifies Sdc12.
SDC22	Specifies Sdc22.
SCC11	Specifies Scc11.
SCC21	Specifies Scc21.
SCC12	Specifies Scc12.
SCC22	Specifies Scc22.
IMB1	Specifies Imbalance1.
IMB2	Specifies Imbalance2.
CMRR	Specifies CMRR (Sdd21/Scc21).

Query response

```
{SDD11|SDD21|SDD12|SDD22|SCD11|SCD21|SCD12|SCD22|SDC11|SDC21|SDC12|SDC22|SCC11|SCC21|SCC12|SCC22|IMB1|IMB2|CMRR}<newline><<^END>
```

Example of use

```
10 OUTPUT 717; ":CALC1:FSIM:BAL:PAR1:BBAL SDD21"
20 OUTPUT 717; ":CALC1:FSIM:BAL:PAR1:BBAL?"
30 ENTER 717;A$
```

Related commands

:CALC{1-16}:FSIM:BAL:DEV on page 327
:CALC{1-16}:FSIM:BAL:PAR{1-16}:SBAL on page 340
:CALC{1-16}:FSIM:BAL:PAR{1-16}:SSB on page 341

Equivalent key

[Analysis] - Fixture Simulator[Meas] - Sdd11|Sdd21|Sdd12|Sdd22|Scd11|Scd21|Scd12|Scd22|Sdc11|Sdc21|Sdc12|Sdc22|Scc11|Scc21|Scc12|Scc22|Imbalance1|Imbalance2|Sdd21/Scc21

:CALC{1-16}:FSIM:BAL:PAR{1-16}:SBAL

Syntax

```
:CALCulate{[1]|2|3|4|5|6|7|8|9|10|11|12|13|14|15|16}:FSIMulator:BALun:PARameter{[1]|2|3|4|5|6|7|8|9|10|11|12|13|14|15|16}
:SBALanced[:DEFine] {SSS11|SDS21|SSD12|SCS21|SSC12|SDD22|SCD22|SDC22|SCC22|IMB|CMRR|CMRR2}
:CALCulate{[1]|2|3|4|5|6|7|8|9|10|11|12|13|14|15|16}:FSIMulator:BALun:PARameter{[1]|2|3|4|5|6|7|8|9|10|11|12|13|14|15|16}
:SBALanced[:DEFine]?
```

Description

For channel 1 (:CALC1) to channel 16 (:CALC16), sets the measurement parameters of trace 1 (:PAR1) to trace 16 (:PAR16) when the balance device type is set to “unbalance-balance” (SBAL is specified with the :CALC{1-16}:FSIM:BAL:DEV command).

Parameters

	Description
SSS11 (preset value)	Specifies Sss11.
SDS21	Specifies Sds21.
SSD12	Specifies Ssd12.
SCS21	Specifies Scs21.
SSC12	Specifies Ssc12.
SDD22	Specifies Sdd22.
SCD22	Specifies Scd22.
SDC22	Specifies Sdc22.
SCC22	Specifies Scc22.
IMB	Specifies Imbalance.
CMRR	Specifies CMRR (Sds21/Scs21).
CMRR2	Specifies CMRR (Ssd12/Ssc12).

Query response

```
{SSS11|SDS21|SSD12|SCS21|SSC12|SDD22|SCD22|SDC22|SCC22|IMB|CMRR|CMRR2}<newline>
e> <^END>
```

Example of use

```
10 OUTPUT 717; ":CALC1:FSIM:BAL:PAR1:SBAL SDS21"
20 OUTPUT 717; ":CALC1:FSIM:BAL:PAR1:SBAL?"
30 ENTER 717;A$
```

Related commands

:CALC{1-16}:FSIM:BAL:DEV on page 327
:CALC{1-16}:FSIM:BAL:PAR{1-16}:BBAL on page 339
:CALC{1-16}:FSIM:BAL:PAR{1-16}:SSB on page 341

Equivalent key

[Analysis] - Fixture Simulator|[Meas] - Sss11|Sds21|Ssd12|Scs21|Ssc12|Sdd22|Scd22|Sdc22|Scc22|Imbalance|Sds21/Scs21|Ssd12/Ssc12

:CALC{1-16}:FSIM:BAL:PAR{1-16}:SSB

Syntax

```
:CALCulate{[1]|2|3|4|5|6|7|8|9|10|11|12|13|14|15|16}:FSIMulator:BALun:PARAmeter{[1]|2|3|4|5|6|7|8|9|10|11|12|13|14|15|16}
:SSBalanced[:DEFine] {SSS11|SSS21|SSS12|SSS22|SDS31|SDS32|SSD13|SSD23|SCS31|SCS32|SSC13|SSC23|SDD33|SCD33|
SDC33|SCC33|IMB1|IMB2|IMB3|IMB4|CMRR1|CMRR2}
:CALCulate{[1]|2|3|4|5|6|7|8|9|10|11|12|13|14|15|16}:FSIMulator:BALun:PARAmeter{[1]|2|3|4|5|6|7|8|9|10|11|12|13|14|15|16}
:SSBalanced[:DEFine]?
```

Description

For channel 1 (:CALC1) to channel 16 (:CALC16), sets the measurement parameters of trace 1 (:PAR1) to trace 16 (:PAR16) when the balance device type is set to “unbalance-unbalance-balance” (SSB is specified with the :CALC{1-16}:FSIM:BAL:DEV command).

Parameters

	Description
SSS11 (preset value)	Specifies Sss11.
SSS21	Specifies Sss21.
SSS12	Specifies Sss12.
SSS22	Specifies Sss22.
SDS31	Specifies Sds31.
SDS32	Specifies Sds32.
SSD13	Specifies Ssd13.
SSD23	Specifies Ssd23.
SCS31	Specifies Scs31.
SCS32	Specifies Scs32.
SSC13	Specifies Ssc13.
SSC23	Specifies Ssc23.
SDD33	Specifies Sdd33.
SCD33	Specifies Scd33.
SDC33	Specifies Sdc33.
SCC33	Specifies Scc33.
IMB1	Specifies Imbalance1.
IMB2	Specifies Imbalance2.
IMB3	Specifies Imbalance3.
IMB4	Specifies Imbalance4.
CMRR1	Specifies CMRR (Sds31/Scs31).
CMRR2	Specifies CMRR (Sds32/Scs32).

Query response

```
{SSS11|SSS21|SSS12|SSS22|SDS31|SDS32|SSD13|SSD23|SCS31|SCS32|SSC13|SSC23|
SDD33|SCD33|SDC33|SCC33|IMB1|IMB2|IMB3|IMB4|CMRR1|CMRR2}<newline><<^
END>
```

Example of use

```
10 OUTPUT 717; ":CALC1:FSIM:BAL:PAR1:SSB SDS31"
20 OUTPUT 717; ":CALC1:FSIM:BAL:PAR1:SSB?"
30 ENTER 717;A$
```

Related commands

:CALC{1-16}:FSIM:BAL:DEV on page 327
:CALC{1-16}:FSIM:BAL:PAR{1-16}:BBAL on page 339
:CALC{1-16}:FSIM:BAL:PAR{1-16}:SBAL on page 340

Equivalent key

[Analysis] - Fixture Simulator|[Meas] - Sss11|Sss21|Sss12|Sss22|Sds31|Sds32|Ssd13|Ssd23|Scs31|Scs32|Ssc13|Ssc23|Sdd33|Scd33|Sdc33|Scc33|Imbalance1|Imbalance2|Imbalance3|Imbalance4|Sds31|Scs31|Sds32|Scs32

:CALC{1-16}:FSIM:BAL:PAR{1-16}:STAT

Syntax

```
:CALCulate{[1]|2|3|4|5|6|7|8|9|10|11|12|13|14|15|16}:FSIMulator:BALun:PARAmeter{[1]|2|3|4|5|6|7|8|9|10|11|12|13|14|15|16}:STATe {ON|OFF|1|0}  
:CALCulate{[1]|2|3|4|5|6|7|8|9|10|11|12|13|14|15|16}:FSIMulator:BALun:PARAmeter{[1]|2|3|4|5|6|7|8|9|10|11|12|13|14|15|16}:STATe?
```

Description

For channel 1 (:CALC1) to channel 16 (:CALC16), turns ON/OFF the balance-unbalance conversion function for trace 1 (:PAR1) to trace 16 (:PAR16) when the fixture simulator function is ON (ON is specified with the :CALC{1-16}:FSIM:STAT command).

Parameters

	Description
ON or 1	Sets the balance-unbalance conversion function to ON.
OFF or 0 (preset value)	Turns OFF the balance-unbalance conversion function.

Query response

```
{1|0}<newline><^END>
```

Example of use

```
10  OUTPUT 717; ":CALC1:FSIM:BAL:PAR1:STAT ON"  
20  OUTPUT 717; ":CALC1:FSIM:BAL:PAR1:STAT?"  
30  ENTER 717;A
```

Related commands

:CALC{1-16}:FSIM:STAT on page 368

Equivalent key

[Analysis] - Fixture Simulator - BalUn

:CALC{1-16}:FSIM:BAL:TOP:BBAL

Syntax :CALCulate{[1]|2|3|4|5|6|7|8|9|10|11|12|13|14|15|16}:FSIMulator:BALun:TOPology:BBALanced[:PPORts] <numeric 1>, <numeric 2>,<numeric 3>,<numeric 4>

:CALCulate{[1]|2|3|4|5|6|7|8|9|10|11|12|13|14|15|16}:FSIMulator:BALun:TOPology:BBALanced[:PPORts]?

Description For channel 1 (:CALC1) to channel 16 (:CALC16), sets the port assignment when the balance device type is set to “balance-balance” (BBAL is specified with the :CALC{1-16}:FSIM:BAL:DEV command).

For details about the balance device type, see Figure 6-2 on page 153.

Parameters

	<numeric 1>	<numeric 2>	<numeric 3>	<numeric 4>
Description	Port numbers assigned to logical port 1 (balance).		Port numbers assigned to logical port 2 (balance).	
	a in Figure 6-2	b in Figure 6-2	c in Figure 6-2	d in Figure 6-2
Range	1 to 4	1 to 4	1 to 4	1 to 4
Preset value	1	2	3	4
Resolution	1	1	1	1

For each parameter, you must specify a different port number. If you specify the same port number for 2 or more parameters, an error occurs and the command is ignored.

Query response {numeric 1},{numeric 2},{numeric 3},{numeric 4}<newline><^END>

Example of use

```
10 OUTPUT 717; ":CALC1:FSIM:BAL:TOP:BBAL 1,2,3,4"
20 OUTPUT 717; ":CALC1:FSIM:BAL:TOP:BBAL?"
30 ENTER 717;A,B,C,D
```

Related commands :CALC{1-16}:FSIM:BAL:DEV on page 327

Equivalent key [Analysis] - Fixture Simulator - Topology - Port1(bal)
[Analysis] - Fixture Simulator - Topology - Port2(bal)

NOTE When performing the operation from the front panel, set each logical port separately.

:CALC{1-16}:FSIM:BAL:TOP:PROP:STAT

Syntax :CALCulate{[1]|2|3|4|5|6|7|8|9|10|11|12|13|14|15|16}:FSIMulator:BALun:TOPology
:PROPerty:STATe {ON|OFF|1|0}
:CALCulate{[1]|2|3|4|5|6|7|8|9|10|11|12|13|14|15|16}:FSIMulator:BALun:TOPology
:PROPerty:STATe?

Description For channel 1 (:CALC1) to channel 16 (:CALC16), turns on/off the property display for the topology setting when using the balance-unbalance conversion.

Parameters

	Description
ON or 1	Turns on the property display of the topology setting.
OFF or 0 (preset value)	Turns off the property display of the topology setting.

Query response {1|0}<newline><^END>

Example of use
10 OUTPUT 717; ":CALC1:FSIM:BAL:TOP:PROP:STAT ON"
20 OUTPUT 717; ":CALC1:FSIM:BAL:TOP:PROP:STAT?"
30 ENTER 717;A

Equivalent key **[Analysis] - Fixture Simulator - Topology - Property**

:CALC{1-16}:FSIM:BAL:TOP:SBAL

Syntax :CALCulate{[1]|2|3|4|5|6|7|8|9|10|11|12|13|14|15|16}:FSIMulator:BALun:TOPology:SBALanced[:PPORts] <numeric 1>, <numeric 2>,<numeric 3>
:CALCulate{[1]|2|3|4|5|6|7|8|9|10|11|12|13|14|15|16}:FSIMulator:BALun:TOPology:SBALanced[:PPORts]?

Description For channel 1 (:CALC1) to channel 16 (:CALC16), sets the port assignment when the balance device type is set to “unbalance-balance” (SBAL is specified with the :CALC{1-16}:FSIM:BAL:DEV command).

For details about the balance device type, see Figure 6-2 on page 153.

Parameters

	<numeric 1>	<numeric 2>	<numeric 3>
Description	Port number assigned to logical port 1 (unbalance). (a in Figure 6-2)	Port numbers assigned to logical port 2 (balance).	
		b in Figure 6-2	c in Figure 6-2
Range	1 to 4	1 to 4	1 to 4
Preset value	1	2	3
Resolution	1	1	1

For each parameter, you must specify a different port number. If you specify the same port number for 2 or more parameters, an error occurs and the command is ignored.

Query response {numeric 1},{numeric 2},{numeric 3}<newline><^END>

Example of use
10 OUTPUT 717; ":CALC1:FSIM:BAL:TOP:SBAL 1,2,3"
20 OUTPUT 717; ":CALC1:FSIM:BAL:TOP:SBAL?"
30 ENTER 717;A,B,C

Related commands :CALC{1-16}:FSIM:BAL:DEV on page 327

Equivalent key [Analysis] - Fixture Simulator - Topology - Port1(se)
[Analysis] - Fixture Simulator - Topology - Port2(bal)

NOTE When performing the operation from the front panel, set each logical port separately.

:CALC{1-16}:FSIM:BAL:TOP:SSB

Syntax :CALCulate{[1][2][3][4][5][6][7][8][9][10][11][12][13][14][15][16]}:FSIMulator:BALun:TOPology:SSBalanced[:PPORts] <numeric 1>, <numeric 2>,<numeric 3>,<numeric 4>
:CALCulate{[1][2][3][4][5][6][7][8][9][10][11][12][13][14][15][16]}:FSIMulator:BALun:TOPology:SSBalanced[:PPORts]?

Description For channel 1 (:CALC1) to channel 16 (:CALC16), sets the port assignment when the balance device type is set to “unbalance-unbalance-balance” (SSB is specified with the :CALC{1-16}:FSIM:BAL:DEV command).

For details about the balance device type, see Figure 6-2 on page 153.

Parameters

	<numeric 1>	<numeric 2>	<numeric 3>	<numeric 4>
Description	Port number assigned to logical port 1 (unbalance). (a in Figure 6-2)	Port number assigned to logical port 2 (unbalance). (b in Figure 6-2)	Port numbers assigned to logical port 3 (balance). c in Figure 6-2 d in Figure 6-2	
Range	1 to 4	1 to 4	1 to 4	1 to 4
Preset value	1	2	3	4
Resolution	1	1	1	1

For each parameter, you must specify a different port number. If you specify the same port number for 2 or more parameters, an error occurs and the command is ignored.

Query response {numeric 1},{numeric 2},{numeric 3},{numeric 4}<newline><^END>

Example of use
10 OUTPUT 717; ":CALC1:FSIM:BAL:TOP:SSB 1,2,3,4"
20 OUTPUT 717; ":CALC1:FSIM:BAL:TOP:SSB?"
30 ENTER 717;A,B,C,D

Related commands :CALC{1-16}:FSIM:BAL:DEV on page 327

Equivalent key [Analysis] - Fixture Simulator - Topology - Port1(se)
[Analysis] - Fixture Simulator - Topology - Port2(se)
[Analysis] - Fixture Simulator - Topology - Port3(bal)

NOTE When performing the operation from the front panel, set each logical port separately.

:CALC{1-16}:FSIM:EMB:NETW{1-2}:FIL

Syntax

```
:CALCulate{[1]|2|3|4|5|6|7|8|9|10|11|12|13|14|15|16}:FSIMulator:EMBed:NETWork{[1]|2}:
FILename <string>

:CALCulate{[1]|2|3|4|5|6|7|8|9|10|11|12|13|14|15|16}:FSIMulator:EMBed:NETWork{[1]|2}:
FILename?
```

Description

For channel 1 (:CALC1) to channel 16 (:CALC16), specifies a file in which the information of network 1 (:NETW1) or network 2 (:NETW2) you want to embed/de-embed using the 4-port network embedding/de-embedding feature is saved (4-port touchstone file).

Specify a file name with the extension ".s4p." If you want to specify a file on the floppy disk drive, you need to add "A:" at the beginning of the file name. When you use directory names and file name, separate them with "/" (slash) or "\" (backslash).

Even if the specified file does not exist, no error occurs when you execute this command.^{*1} However, when you set a network processing type to embedding/de-embedding with the :CALC{1-16}:FSIM:EMB:NETW{1-2}:TYPE command, an error occurs.

For information on network numbers, refer to Figure 6-1 on page 152.

NOTE This function is available with the firmware version 3.50 or greater.

Parameters

	<string>
Description	4-port touchstone file name
Range	254 characters or less
Preset value	""

Query response {string}<newline><^END>

Example of use

```
10 OUTPUT 717;":CALC1:FSIM:EMB:NETW1:FIL ""Network.s4p""
20 OUTPUT 717;":CALC1:FSIM:EMB:NETW1:FIL?"
30 ENTER 717;A$
```

Related commands

:CALC{1-16}:FSIM:EMB:STAT on page 349
:CALC{1-16}:FSIM:EMB:NETW{1-2}:TYPE on page 348

Equivalent key [Analysis] - Fixture Simulator - De-Embedding S4P - Topology - User File (nwk1)|User File (nwk2)

*1. If the network processing type has been set to embedding/de-embedding, an error occurs when this command is executed and the command is ignored.

:CALC{1-16}:FSIM:EMB:NETW{1-2}:TYPE

Syntax :CALCulate{[1]|2|3|4|5|6|7|8|9|10|11|12|13|14|15|16}:FSIMulator:EMBed:NETWork{[1]|2}:TYPE {NONE|EMBed|DEEMbed}
:CALCulate{[1]|2|3|4|5|6|7|8|9|10|11|12|13|14|15|16}:FSIMulator:EMBed:NETWork{[1]|2}:TYPE?

Description For the 4-port network embedding/de-embedding feature for channel 1 (:CALC1) to channel 16 (:CALC16), selects a network processing type for network 1 (:NETW1) or network 2 (:NETW2).

Before selecting embedding/de-embedding, execute the :CALC{1-16}:FSIM:EMB:NETW{1-2}:FIL command to specify the 4-port touchstone file in which the information on the network is saved. If you do not specify any appropriate file and you select network embedding/de-embedding, an error occurs and NONE is automatically selected.

NOTE This function is available with the firmware version 3.50 or greater.

Parameters

	Description
NONE (preset value)	Specifies no-processing.
EMBed	Specifies embedding.
DEEMbed	Specifies de-embedding.

Query response {NONE|EMB|DEEM}<newline><^END>

Example of use
10 OUTPUT 717; ":CALC1:FSIM:EMB:NETW1:TYPE DEEM"
20 OUTPUT 717; ":CALC1:FSIM:EMB:NETW1:TYPE?"
30 ENTER 717;A\$

Related commands :CALC{1-16}:FSIM:EMB:STAT on page 349
:CALC{1-16}:FSIM:EMB:NETW{1-2}:FIL on page 347

Equivalent key [Analysis] - Fixture Simulator - De-Embedding S4P - Topology - Type (nwk1)|Type (nwk2) - None|Embed|De-Embed

:CALC{1-16}:FSIM:EMB:STAT

Syntax :CALCulate{[1]|2|3|4|5|6|7|8|9|10|11|12|13|14|15|16}:FSIMulator:EMBed:STATe {ON|OFF|1|0}
:CALCulate{[1]|2|3|4|5|6|7|8|9|10|11|12|13|14|15|16}:FSIMulator:EMBed:STATe?

Description For channel 1 (:CALC1) to channel 16 (:CALC16), turns ON/OFF the 4-port network embedding/de-embedding feature when the fixture simulator feature is ON (ON is specified with the :CALC{1-16}:FSIM:STAT command).

NOTE This function is available with the firmware version 3.50 or greater.

Parameters

	Description
ON or 1	Turns ON the 4-port network embedding/de-embedding feature.
OFF or 0 (Preset value)	Turns OFF the 4-port network embedding/de-embedding feature.

Query response {1|0}<newline><^END>

Example of use
10 OUTPUT 717; ":CALC1:FSIM:EMB:STAT ON"
20 OUTPUT 717; ":CALC1:FSIM:EMB:STAT?"
30 ENTER 717;A

Related commands
:CALC{1-16}:FSIM:STAT on page 368
:CALC{1-16}:FSIM:EMB:NETW{1-2}:TYPE on page 348
:CALC{1-16}:FSIM:EMB:NETW{1-2}:FIL on page 347

Equivalent key [Analysis] - Fixture Simulator - De-Embedding S4P - De-Embedding S4P

:CALC{1-16}:FSIM:EMB:TOP:A:PORT

Syntax :CALCulate{[1]|2|3|4|5|6|7|8|9|10|11|12|13|14|15|16}:FSIMulator:EMBed:TOPology:A:PORTs
<value 1>,<value 2>
:CALCulate{[1]|2|3|4|5|6|7|8|9|10|11|12|13|14|15|16}:FSIMulator:EMBed:TOPology:A:PORTs?

Description For the 4-port network embedding/de-embedding feature of channel 1 (:CALC1) to channel 16 (:CALC16), sets the test port assignment when the connection type (Topology) is set to A (A is specified with the :CALC{1-16}:FSIM:EMB:TYPE command).

For information on the connection type, refer to Figure 6-1 on page 152.

NOTE This function is available with the firmware version 3.50 or greater.

Parameters

	<value 1>	<value 2>
Description	Port number assigned to a in Figure 6-1.	Port number assigned to b in Figure 6-1.
Range	1 to 4	1 to 4
Preset value	1	2
Resolution	1	1

For each parameter, you must specify a different port number. If you specify an identical port number for multiple parameters, an error occurs and the command is ignored.

Query response {value 1},{value 2}<newline><^END>

Example of use
10 OUTPUT 717; ":CALC1:FSIM:EMB:TOP:A:PORT 1,2"
20 OUTPUT 717; ":CALC1:FSIM:EMB:TOP:A:PORT?"
30 ENTER 717;A,B

Related commands :CALC{1-16}:FSIM:EMB:TYPE on page 353

Equivalent key [Analysis] - Fixture Simulator - De-Embedding S4P - Topology - Ports - 1-2|1-3|1-4|2-1|2-3|2-4|3-1|3-2|3-4|4-1|4-2|4-3

:CALC{1-16}:FSIM:EMB:TOP:B:PORT

Syntax :CALCulate{[1]|2|3|4|5|6|7|8|9|10|11|12|13|14|15|16}:FSIMulator:EMBed:TOPology:B:PORTs
<value 1>,<value 2>,<value 3>
:CALCulate{[1]|2|3|4|5|6|7|8|9|10|11|12|13|14|15|16}:FSIMulator:EMBed:TOPology:B:PORTs?

Description For the 4-port network embedding/de-embedding feature of channel 1 (:CALC1) to channel 16 (:CALC16), sets the test port assignment when the connection type (Topology) is set to B (B is specified with the :CALC{1-16}:FSIM:EMB:TYPE command).

For information on the connection type, refer to Figure 6-1 on page 152.

NOTE This function is available with the firmware version 3.50 or greater.

Parameters

	<value 1>	<value 2>	<value 3>
Description	Port number assigned to a in Figure 6-1.	Port number assigned to b in Figure 6-1.	Port number assigned to c in Figure 6-1.
Range	1 to 4	1 to 4	1 to 4
Preset value	1	2	3
Resolution	1	1	1

For each parameter, you must specify a different port number. If you specify an identical port number for multiple parameters, an error occurs and the command is ignored.

Query response {value 1},{value 2},{value 3}<newline><^END>

Example of use
10 OUTPUT 717;":CALC1:FSIM:EMB:TOP:B:PORT 1,2,3"
20 OUTPUT 717;":CALC1:FSIM:EMB:TOP:B:PORT?"
30 ENTER 717;A,B,C

Related commands :CALC{1-16}:FSIM:EMB:TYPE on page 353

Equivalent key [Analysis] - Fixture Simulator - De-Embedding S4P - Topology - Ports -
1-2-3|1-2-4|1-3-2|1-3-4|1-4-2|1-4-3|2-1-3|2-1-4|2-3-1|2-3-4|2-4-1|2-4-3|
3-1-2|3-1-4|3-2-1|3-2-4|3-4-1|3-4-2|4-1-2|4-1-3|4-2-1|4-2-3|4-3-1|4-3-2

:CALC{1-16}:FSIM:EMB:TOP:C:PORT

Syntax :CALCulate{[1][2][3][4][5][6][7][8][9][10][11][12][13][14][15][16]}:FSIMulator:EMBed:TOPology:C:PORTs
<value 1>,<value 2>,<value 3>,<value 4>
:CALCulate{[1][2][3][4][5][6][7][8][9][10][11][12][13][14][15][16]}:FSIMulator:EMBed:TOPology:C:PORTs?

Description For the 4-port network embedding/de-embedding feature of channel 1 (:CALC1) to channel 16 (:CALC16), sets the test port assignment when the connection type (Topology) is set to C (C is specified with the :CALC{1-16}:FSIM:EMB:TYPE command).

For information on the connection type, refer to Figure 6-1 on page 152.

NOTE This function is available with the firmware version 3.50 or greater.

Parameters

	<value 1>	<value 2>	<value 3>	<value 4>
Description	Port number assigned to a in Figure 6-1.	Port number assigned to b in Figure 6-1.	Port number assigned to c in Figure 6-1.	Port number assigned to d in Figure 6-1.
Range	1 to 4	1 to 4	1 to 4	1 to 4
Preset value	1	2	3	4
Resolution	1	1	1	1

For each parameter, you must specify a different port number. If you specify an identical port number for multiple parameters, an error occurs and the command is ignored.

Query response {value 1},{value 2},{value 3},{value 4}<newline><^END>

Example of use
10 OUTPUT 717; ":CALC1:FSIM:EMB:TOP:C:PORT 1,2,3,4"
20 OUTPUT 717; ":CALC1:FSIM:EMB:TOP:C:PORT?"
30 ENTER 717;A,B,C,D

Related commands :CALC{1-16}:FSIM:EMB:TYPE on page 353

Equivalent key [Analysis] - Fixture Simulator - De-Embedding S4P - Topology - Ports -
1-2-3-4|1-2-4-3|1-3-2-4|1-3-4-2|1-4-2-3|1-4-3-2|2-1-3-4|2-1-4-3|2-3-1-4|2-3-4-1|
2-4-1-3|2-4-3-1|3-1-2-4|3-1-4-2|3-2-1-4|3-2-4-1|3-4-1-2|3-4-2-1|4-1-2-3|4-1-3-2|
4-2-1-3|4-2-3-1|4-3-1-2|4-3-2-1

:CALC{1-16}:FSIM:EMB:TYPE

Syntax :CALCulate{[1]|2|3|4|5|6|7|8|9|10|11|12|13|14|15|16}:FSIMulator:EMBed:TYPE {A|B|C}
:CALCulate{[1]|2|3|4|5|6|7|8|9|10|11|12|13|14|15|16}:FSIMulator:EMBed:TYPE?

Description For the 4-port network embedding/de-embedding feature for channel 1 (:CALC1) to channel 16 (:CALC16), selects a connection type.
For information on the connection type, refer to Figure 6-1 on page 152.

NOTE This function is available with the firmware version 3.50 or greater.

Parameters

	Description
A (preset value)	Specifies the type (Topology A) to connect between the 2 ports of the analyzer and the DUT.
B	Specifies the type (Topology B) to connect between the 3 ports of the analyzer and the DUT.
C	Specifies the type (Topology C) to connect between the 3 ports of the analyzer and the DUT.

Query response {A|B|C}<newline><^END>

Example of use
10 OUTPUT 717; ":CALC1:FSIM:EMB:TYPE A"
20 OUTPUT 717; ":CALC1:FSIM:EMB:TYPE?"
30 ENTER 717;A\$

Related commands
:CALC{1-16}:FSIM:EMB:TOP:A:PORT on page 350
:CALC{1-16}:FSIM:EMB:TOP:B:PORT on page 351
:CALC{1-16}:FSIM:EMB:TOP:C:PORT on page 352

Equivalent key [Analysis] - Fixture Simulator - De-Embedding S4P - Topology - Select Topology - A|B|C

:CALC{1-16}:FSIM:SEND:DEEM:PORT{1-4}

Syntax :CALCulate{[1]|2|3|4|5|6|7|8|9|10|11|12|13|14|15|16}:FSIMulator:SENDEd:DEEMbed:PORT{[1]|2|3|4}[:TYPE] {NONE|USER}
:CALCulate{[1]|2|3|4|5|6|7|8|9|10|11|12|13|14|15|16}:FSIMulator:SENDEd:DEEMbed:PORT{[1]|2|3|4}[:TYPE]?

Description For port 1 (:PORT1) to port 4 (:PORT4) of channel 1 (:CALC1) to channel 16 (:CALC16), selects the type of the network de-embedding.

If you want to select the user-defined network de-embedding, you must specify the 2-port touchstone file in which the information on the user-defined network is saved in advance. If you do not specify the appropriate file and you select the user-defined network de-embedding, an error occurs and NONE is automatically selected.

Parameters

	Description
NONE (preset value)	Specifies no-de-embedding.
USER	Specifies the user-defined network de-embedding*1.

*1. The information on the network is read out from the 2-port touchstone file specified with the :CALC{1-16}:FSIM:SEND:DEEM:PORT{1-4}:USER:FIL command.

Query response {NONE|USER}<newline><^END>

Example of use
10 OUTPUT 717; ":CALC1:FSIM:SEND:DEEM:PORT1 USER"
20 OUTPUT 717; ":CALC1:FSIM:SEND:DEEM:PORT1?"
30 ENTER 717;A\$

Related commands :CALC{1-16}:FSIM:SEND:DEEM:STAT on page 356
:CALC{1-16}:FSIM:SEND:DEEM:PORT{1-4}:USER:FIL on page 355

Equivalent key [Analysis] - Fixture Simulator - De-Embedding - Select Type

:CALC{1-16}:FSIM:SEND:DEEM:PORT{1-4}:USER:FIL

Syntax :CALCulate{[1]|2|3|4|5|6|7|8|9|10|11|12|13|14|15|16}:FSIMulator:SENDEd:DEEMbed:PORT{[1]|2|3|4}:USER:FILEname <string>
:CALCulate{[1]|2|3|4|5|6|7|8|9|10|11|12|13|14|15|16}:FSIMulator:SENDEd:DEEMbed:PORT{[1]|2|3|4}:USER:FILEname?

Description For port 1 (:PORT1) to port 4 (:PORT4) of channel 1 (:CALC1) to channel 16 (:CALC16), specifies the file in which the information on the user-defined network for the network de-embedding function is saved (2-port touchstone file).

Specify the file name with the .s2p extension. If you want to specify a file on the floppy disk drive, you need to add "A:" at the beginning of the file name. When you use directory names and file name, separate them with "/" (slash) or "\" (backslash).

Even if the specified file does not exist, no error occurs when you execute this command.*1 However, when you set the type of the network de-embedding to the user-defined network with the :CALC{1-16}:FSIM:SEND:DEEM:PORT{1-4} command, an error occurs.

Parameters

	<string>
Description	2-port touchstone file name
Range	254 characters or less
Preset value	""

Query response {string}<newline><^END>

Example of use
10 OUTPUT 717;" :CALC1:FSIM:SEND:DEEM:PORT1:USER:FIL ""Network.s2p""
20 OUTPUT 717;" :CALC1:FSIM:SEND:DEEM:PORT1:USER:FIL?"
30 ENTER 717;A\$

Related commands :CALC{1-16}:FSIM:SEND:DEEM:STAT on page 356
:CALC{1-16}:FSIM:SEND:DEEM:PORT{1-4} on page 354

Equivalent key [Analysis] - Fixture Simulator - De-Embedding - User File

*1. If you set the type of the network de-embedding to the user-defined network before you execute this command, an error occurs and the command is ignored when you execute this command.

:CALC{1-16}:FSIM:SEND:DEEM:STAT

Syntax :CALCulate{[1]|2|3|4|5|6|7|8|9|10|11|12|13|14|15|16}:FSIMulator:SENDEd:DEEMbed:STATe {ON|OFF|1|0}
:CALCulate{[1]|2|3|4|5|6|7|8|9|10|11|12|13|14|15|16}:FSIMulator:SENDEd:DEEMbed:STATe?

Description For all the ports of channel 1 (:CALC1) to channel 16 (:CALC16), turns ON/OFF the network de-embedding function when the fixture simulator function is ON (ON is specified with the :CALC{1-16}:FSIM:STAT command).

Parameters

	Description
ON or 1	Turns ON the network de-embedding function.
OFF or 0 (preset value)	Turns OFF the network de-embedding function.

Query response {1|0}<newline><^END>

Example of use
10 OUTPUT 717; ":CALC1:FSIM:SEND:DEEM:STAT ON"
20 OUTPUT 717; ":CALC1:FSIM:SEND:DEEM:STAT?"
30 ENTER 717;A

Related commands
:CALC{1-16}:FSIM:STAT on page 368
:CALC{1-16}:FSIM:SEND:DEEM:PORT{1-4} on page 354
:CALC{1-16}:FSIM:SEND:DEEM:PORT{1-4}:USER:FIL on page 355

Equivalent key [Analysis] - Fixture Simulator - De-Embedding - De-Embedding

:CALC{1-16}:FSIM:SEND:PMC:PORT{1-4}

Syntax

```
:CALCulate{[1]|2|3|4|5|6|7|8|9|10|11|12|13|14|15|16}:FSIMulator:SENDEd:PMCircuit:PORT{[1]|2|3|4}[:TYPE] {NONE|SLPC|PCSL|PLSC|SCPL|PLPC|USER}
:CALCulate{[1]|2|3|4|5|6|7|8|9|10|11|12|13|14|15|16}:FSIMulator:SENDEd:PMCircuit:PORT{[1]|2|3|4}[:TYPE]?
```

Description

For port 1 (:PORT1) to port 4 (:PORT4) of channel 1 (:CALC1) to channel 16 (:CALC16), selects the type of the matching circuit.

If you want to select the user-defined circuit, you must specify the 2-port touchstone file in which the proper information on the user-defined circuit is saved in advance. If you do not specify the appropriate file and you select the user-defined circuit, an error occurs and NONE is automatically selected.

Parameters

	Description
NONE (preset value)	Specifies no-circuit.
SLPC	Specifies the circuit that consists of series L and shunt C.
PCSL	Specifies the circuit that consists of shunt C and series L.
PLSC	Specifies the circuit that consists of shunt L and series C.
SCPL	Specifies the circuit that consists of series C and shunt L.
PLPC	Specifies the circuit that consists of shunt L and shunt C.
USER	Specifies the user-defined circuit ^{*1} .

*1. The information on the circuit is read out from the 2-port touchstone file specified with the :CALC{1-16}:FSIM:SEND:PMC:PORT{1-4}:USER:FIL command.

For more information on the circuits, refer to “*User's Guide*.”

Query response

```
{NONE|SLPC|PCSL|PLSC|SCPL|PLPC|USER}<newline><<^END>
```

Example of use

```
10 OUTPUT 717;":CALC1:FSIM:SEND:PMC:PORT1 SLPC"
20 OUTPUT 717;":CALC1:FSIM:SEND:PMC:PORT1?"
30 ENTER 717;A$
```

Related commands

```
:CALC{1-16}:FSIM:SEND:PMC:STAT on page 363
:CALC{1-16}:FSIM:SEND:PMC:PORT{1-4}:PAR:C on page 358
:CALC{1-16}:FSIM:SEND:PMC:PORT{1-4}:PAR:G on page 359
:CALC{1-16}:FSIM:SEND:PMC:PORT{1-4}:PAR:L on page 360
:CALC{1-16}:FSIM:SEND:PMC:PORT{1-4}:PAR:R on page 361
:CALC{1-16}:FSIM:SEND:PMC:PORT{1-4}:USER:FIL on page 362
```

Equivalent key

[Analysis] - Fixture Simulator - Port Matching - Select Circuit

:CALC{1-16}:FSIM:SEND:PMC:PORT{1-4}:PAR:C

Syntax :CALCulate{[1][2][3][4][5][6][7][8][9][10][11][12][13][14][15][16]}:FSIMulator:SENDEd:PMCircuit:PORT{[1][2][3][4]}:PARameters:C <numeric>
:CALCulate{[1][2][3][4][5][6][7][8][9][10][11][12][13][14][15][16]}:FSIMulator:SENDEd:PMCircuit:PORT{[1][2][3][4]}:PARameters:C?

Description For port 1 (:PORT1) to port 4 (:PORT4) of channel 1 (:CALC1) to channel 16 (:CALC16), sets the C value of the matching circuit.

Parameters

	<numeric>
Description	C value of the matching circuit
Range	-1E18 to 1E18
Preset value	0
Unit	F (farad)

If the specified parameter is out of the allowable setup range, the minimum value (if the lower limit of the range is not reached) or the maximum value (if the upper limit of the range is exceeded) is set.

Query response {numeric}<newline><^END>

Example of use
10 OUTPUT 717; ":CALC1:FSIM:SEND:PMC:PORT1:PAR:C 12.3"
20 OUTPUT 717; ":CALC1:FSIM:SEND:PMC:PORT1:PAR:C?"
30 ENTER 717;A

Related commands
:CALC{1-16}:FSIM:SEND:PMC:STAT on page 363
:CALC{1-16}:FSIM:SEND:PMC:PORT{1-4} on page 357
:CALC{1-16}:FSIM:SEND:PMC:PORT{1-4}:PAR:G on page 359
:CALC{1-16}:FSIM:SEND:PMC:PORT{1-4}:PAR:L on page 360
:CALC{1-16}:FSIM:SEND:PMC:PORT{1-4}:PAR:R on page 361

Equivalent key [Analysis] - Fixture Simulator - Port Matching - C

:CALC{1-16}:FSIM:SEND:PMC:PORT{1-4}:PAR:G

Syntax :CALCulate{[1]|2|3|4|5|6|7|8|9|10|11|12|13|14|15|16}:FSIMulator:SENDEd:PMCircuit:PORT{[1]|2|3|4}:PARameters:G <numeric>

:CALCulate{[1]|2|3|4|5|6|7|8|9|10|11|12|13|14|15|16}:FSIMulator:SENDEd:PMCircuit:PORT{[1]|2|3|4}:PARameters:G?

Description For port 1 (:PORT1) to port 4 (:PORT4) of channel 1 (:CALC1) to channel 16 (:CALC16), sets the G value of the matching circuit.

Parameters

	<numeric>
Description	G value of the matching circuit
Range	-1E18 to 1E18
Preset value	0
Unit	S (siemens)

If the specified parameter is out of the allowable setup range, the minimum value (if the lower limit of the range is not reached) or the maximum value (if the upper limit of the range is exceeded) is set.

Query response {numeric}<newline><^END>

Example of use

```
10  OUTPUT 717; ":CALC1:FSIM:SEND:PMC:PORT1:PAR:G 12.3"
20  OUTPUT 717; ":CALC1:FSIM:SEND:PMC:PORT1:PAR:G?"
30  ENTER 717;A
```

Related commands

- :CALC{1-16}:FSIM:SEND:PMC:STAT on page 363
- :CALC{1-16}:FSIM:SEND:PMC:PORT{1-4} on page 357
- :CALC{1-16}:FSIM:SEND:PMC:PORT{1-4}:PAR:C on page 358
- :CALC{1-16}:FSIM:SEND:PMC:PORT{1-4}:PAR:L on page 360
- :CALC{1-16}:FSIM:SEND:PMC:PORT{1-4}:PAR:R on page 361

Equivalent key [Analysis] - Fixture Simulator - Port Matching - G

:CALC{1-16}:FSIM:SEND:PMC:PORT{1-4}:PAR:L

Syntax :CALCulate{[1][2][3][4][5][6][7][8][9][10][11][12][13][14][15][16]}:FSIMulator:SENDEd:PMCircuit:PORT{[1][2][3][4]}:PARAmeters:L <numeric>

:CALCulate{[1][2][3][4][5][6][7][8][9][10][11][12][13][14][15][16]}:FSIMulator:SENDEd:PMCircuit:PORT{[1][2][3][4]}:PARAmeters:L?

Description For port 1 (:PORT1) to port 4 (:PORT4) of channel 1 (:CALC1) to channel 16 (:CALC16), sets the L value of the matching circuit.

Parameters

	<numeric>
Description	L value of the matching circuit
Range	-1E18 to 1E18
Preset value	0
Unit	H (henry)

If the specified parameter is out of the allowable setup range, the minimum value (if the lower limit of the range is not reached) or the maximum value (if the upper limit of the range is exceeded) is set.

Query response {numeric}<newline><^END>

Example of use
 10 OUTPUT 717; ":CALC1:FSIM:SEND:PMC:PORT1:PAR:L 12.3"
 20 OUTPUT 717; ":CALC1:FSIM:SEND:PMC:PORT1:PAR:L?"
 30 ENTER 717;A

Related commands
 :CALC{1-16}:FSIM:SEND:PMC:STAT on page 363
 :CALC{1-16}:FSIM:SEND:PMC:PORT{1-4} on page 357
 :CALC{1-16}:FSIM:SEND:PMC:PORT{1-4}:PAR:C on page 358
 :CALC{1-16}:FSIM:SEND:PMC:PORT{1-4}:PAR:G on page 359
 :CALC{1-16}:FSIM:SEND:PMC:PORT{1-4}:PAR:R on page 361

Equivalent key [Analysis] - Fixture Simulator - Port Matching - L

:CALC{1-16}:FSIM:SEND:PMC:PORT{1-4}:PAR:R

Syntax :CALCulate{[1]|2|3|4|5|6|7|8|9|10|11|12|13|14|15|16}:FSIMulator:SENDEd:PMCircuit:PORT{[1]|2|3|4}:PARameters:R <numeric>

:CALCulate{[1]|2|3|4|5|6|7|8|9|10|11|12|13|14|15|16}:FSIMulator:SENDEd:PMCircuit:PORT{[1]|2|3|4}:PARameters:R?

Description For port 1 (:PORT1) to port 4 (:PORT4) of channel 1 (:CALC1) to channel 16 (:CALC16), sets the R value of the matching circuit.

Parameters

	<numeric>
Description	R value of the matching circuit
Range	-1E18 to 1E18
Preset value	0
Unit	Ω (ohm)

If the specified parameter is out of the allowable setup range, the minimum value (if the lower limit of the range is not reached) or the maximum value (if the upper limit of the range is exceeded) is set.

Query response {numeric}<newline><^END>

Example of use

```
10 OUTPUT 717; ":CALC1:FSIM:SEND:PMC:PORT1:PAR:R 12.3"
20 OUTPUT 717; ":CALC1:FSIM:SEND:PMC:PORT1:PAR:R?"
30 ENTER 717;A
```

Related commands

- :CALC{1-16}:FSIM:SEND:PMC:STAT on page 363
- :CALC{1-16}:FSIM:SEND:PMC:PORT{1-4} on page 357
- :CALC{1-16}:FSIM:SEND:PMC:PORT{1-4}:PAR:C on page 358
- :CALC{1-16}:FSIM:SEND:PMC:PORT{1-4}:PAR:G on page 359
- :CALC{1-16}:FSIM:SEND:PMC:PORT{1-4}:PAR:L on page 360

Equivalent key [Analysis] - Fixture Simulator - Port Matching - R

:CALC{1-16}:FSIM:SEND:PMC:PORT{1-4}:USER:FIL

Syntax :CALCulate{[1]|2|3|4|5|6|7|8|9|10|11|12|13|14|15|16}:FSIMulator:SENDEd:PMCCircuit:PORT{[1]|2|3|4}:USER:FILEname <string>
:CALCulate{[1]|2|3|4|5|6|7|8|9|10|11|12|13|14|15|16}:FSIMulator:SENDEd:PMCCircuit:PORT{[1]|2|3|4}:USER:FILEname?

Description For port 1 (:PORT1) to port 4 (:PORT4) of channel 1 (:CALC1) to channel 16 (:CALC16), specifies the file in which the information on the user-defined matching circuit is saved (2-port touchstone file).

Specify the file name with the .s2p extension. If you want to specify a file on the floppy disk drive, you need to add "A:" at the beginning of the file name. When you use directory names and file name, separate them with "/" (slash) or "\" (backslash).

Even if the specified file does not exist, no error occurs when you execute this command.*1 However, when you set the type of the matching circuit to the user-defined circuit with the :CALC{1-16}:FSIM:SEND:PMC:PORT{1-4} command, an error occurs.

Parameters

	<string>
Description	2-port touchstone file name
Range	254 characters or less
Preset value	""

Query response {string}<newline><^END>

Example of use
10 OUTPUT 717; ":CALC1:FSIM:SEND:PMC:PORT1:USER:FIL "Match.s2p""
20 OUTPUT 717; ":CALC1:FSIM:SEND:PMC:PORT1:USER:FIL?"
30 ENTER 717;A\$

Related commands :CALC{1-16}:FSIM:SEND:PMC:STAT on page 363
:CALC{1-16}:FSIM:SEND:PMC:PORT{1-4} on page 357

Equivalent key [Analysis] - Fixture Simulator - Port Matching - User File

*1.If you set the type of the matching circuit to the user-defined circuit before you execute this command, an error occurs and the command is ignored when you execute this command.

:CALC{1-16}:FSIM:SEND:PMC:STAT

Syntax

```
:CALCulate{[1]|2|3|4|5|6|7|8|9|10|11|12|13|14|15|16}:FSIMulator:SENDEd:PMCircuit:STATe {ON|OFF|1|0}
:CALCulate{[1]|2|3|4|5|6|7|8|9|10|11|12|13|14|15|16}:FSIMulator:SENDEd:PMCircuit:STATe?
```

Description

For all the ports of channel 1 (:CALC1) to channel 16 (:CALC16), turns ON/OFF the matching circuit embedding function when the fixture simulator function is ON (ON is specified with the :CALC{1-16}:FSIM:STAT command).

Parameters

	Description
ON or 1	Turns ON the matching circuit embedding function.
OFF or 0 (preset value)	Turns OFF the matching circuit embedding function.

Query response

```
{1|0}<newline><^END>
```

Example of use

```
10 OUTPUT 717; ":CALC1:FSIM:SEND:PMC:STAT ON"
20 OUTPUT 717; ":CALC1:FSIM:SEND:PMC:STAT?"
30 ENTER 717;A
```

Related commands

:CALC{1-16}:FSIM:STAT on page 368
 :CALC{1-16}:FSIM:SEND:PMC:PORT{1-4} on page 357
 :CALC{1-16}:FSIM:SEND:PMC:PORT{1-4}:PAR:C on page 358
 :CALC{1-16}:FSIM:SEND:PMC:PORT{1-4}:PAR:G on page 359
 :CALC{1-16}:FSIM:SEND:PMC:PORT{1-4}:PAR:L on page 360
 :CALC{1-16}:FSIM:SEND:PMC:PORT{1-4}:PAR:R on page 361
 :CALC{1-16}:FSIM:SEND:PMC:PORT{1-4}:USER:FIL on page 362

Equivalent key

[Analysis] - Fixture Simulator - Port Matching - Port Matching

:CALC{1-16}:FSIM:SEND:ZCON:PORT{1-4}:IMAG

Syntax :CALCulate{[1]|2|3|4|5|6|7|8|9|10|11|12|13|14|15|16}:FSIMulator:SENDEd:ZCONversion:PORT{[1]|2|3|4}:IMAGinary <numeric>
:CALCulate{[1]|2|3|4|5|6|7|8|9|10|11|12|13|14|15|16}:FSIMulator:SENDEd:ZCONversion:PORT{[1]|2|3|4}:IMAGinary?

Description For port 1 (:PORT1) to port 4 (:PORT4) of channel 1 (:CALC1) to channel 16 (:CALC16), sets the impedance value (imaginary part) for the port impedance conversion function.

Parameters

	<numeric>
Description	Impedance value (imaginary part)
Range	-1E+18 to 1E+18
Preset value	0
Unit	Ω (ohm)

If the specified parameter is out of the allowable setup range, the minimum value (if the lower limit of the range is not reached) or the maximum value (if the upper limit of the range is exceeded) is set.

Query response {numeric}<newline><^END>

Example of use
10 OUTPUT 717; ":CALC1:FSIM:SEND:ZCON:PORT1:IMAG 75"
20 OUTPUT 717; ":CALC1:FSIM:SEND:ZCON:PORT1:IMAG?"
30 ENTER 717;A

Related commands
:CALC{1-16}:FSIM:SEND:ZCON:PORT{1-4}:REAL on page 365
:CALC{1-16}:FSIM:SEND:ZCON:PORT{1-4}:Z0 on page 366
:CALC{1-16}:FSIM:SEND:ZCON:STAT on page 367

Equivalent key [Analysis] - Fixture Simulator - Port ZConversion - Port1 Z0 Imag|Port2 Z0 Imag|Port3 Z0 Imag|Port4 Z0 Imag

:CALC{1-16}:FSIM:SEND:ZCON:PORT{1-4}:REAL

Syntax :CALCulate{[1]|2|3|4|5|6|7|8|9|10|11|12|13|14|15|16}:FSIMulator:SENDEd:ZCONversion:PORT{[1]|2|3|4}:REAL <numeric>
:CALCulate{[1]|2|3|4|5|6|7|8|9|10|11|12|13|14|15|16}:FSIMulator:SENDEd:ZCONversion:PORT{[1]|2|3|4}:REAL?

Description For port 1 (:PORT1) to port 4 (:PORT4) of channel 1 (:CALC1) to channel 16 (:CALC16), sets the impedance value (real part) for the port impedance conversion function.

NOTE This command performs in the same way of :CALC{1-16}:FSIM:SEND:ZCON:PORT{1-4}:Z0 on page 366

Parameters

	<numeric>
Description	Impedance value (real part)
Range	1E-3 to 1E7
Preset value	50
Unit	Ω (ohm)
Resolution	0.001

If the specified parameter is out of the allowable setup range, the minimum value (if the lower limit of the range is not reached) or the maximum value (if the upper limit of the range is exceeded) is set.

Query response {numeric}<newline><^END>

Example of use
10 OUTPUT 717; ":CALC1:FSIM:SEND:ZCON:PORT1:REAL 75"
20 OUTPUT 717; ":CALC1:FSIM:SEND:ZCON:PORT1:REAL?"
30 ENTER 717;A

Related commands
:CALC{1-16}:FSIM:SEND:ZCON:PORT{1-4}:IMAG on page 364
:CALC{1-16}:FSIM:SEND:ZCON:PORT{1-4}:Z0 on page 366
:CALC{1-16}:FSIM:SEND:ZCON:STAT on page 367

Equivalent key [Analysis] - Fixture Simulator - Port ZConversion - Port1 Z0 Real|Port2 Z0 Real|Port3 Z0 Real|Port4 Z0 Real

:CALC{1-16}:FSIM:SEND:ZCON:PORT{1-4}:Z0

Syntax :CALCulate{[1]|2|3|4|5|6|7|8|9|10|11|12|13|14|15|16}:FSIMulator:SENDEd:ZCONversion:PORT{[1]|2|3|4}:Z0[:R] <numeric>
:CALCulate{[1]|2|3|4|5|6|7|8|9|10|11|12|13|14|15|16}:FSIMulator:SENDEd:ZCONversion:PORT{[1]|2|3|4}:Z0[:R]?

Description For port 1 (:PORT1) to port 4 (:PORT4) of channel 1 (:CALC1) to channel 16 (:CALC16), sets the impedance value for the port impedance conversion function.

Parameters

	<numeric>
Description	Impedance value
Range	1E-3 to 1E7
Preset value	50
Unit	Ω (ohm)
Resolution	0.001

If the specified parameter is out of the allowable setup range, the minimum value (if the lower limit of the range is not reached) or the maximum value (if the upper limit of the range is exceeded) is set.

CAUTION This command clears setting value of “:CALC{1-16}:FSIM:SEND:ZCON:PORT{1-4}:IMAG” on page 364

Query response {numeric}<newline><^END>

Example of use
10 OUTPUT 717; ":CALC1:FSIM:SEND:ZCON:PORT1:Z0 75"
20 OUTPUT 717; ":CALC1:FSIM:SEND:ZCON:PORT1:Z0?"
30 ENTER 717;A

Related commands
:CALC{1-16}:FSIM:SEND:ZCON:PORT{1-4}:IMAG on page 364
:CALC{1-16}:FSIM:SEND:ZCON:PORT{1-4}:REAL on page 365
:CALC{1-16}:FSIM:SEND:ZCON:STAT on page 367

Equivalent key [Analysis] - Fixture Simulator - Port ZConversion - Port1 Z0 Real|Port2 Z0 Real|Port3 Z0 Real|Port4 Z0 Real

:CALC{1-16}:FSIM:SEND:ZCON:STAT

Syntax :CALCulate{[1]|2|3|4|5|6|7|8|9|10|11|12|13|14|15|16}:FSIMulator:SENDEd:ZCONversion:STATe {ON|OFF|1|0}
:CALCulate{[1]|2|3|4|5|6|7|8|9|10|11|12|13|14|15|16}:FSIMulator:SENDEd:ZCONversion:STATe?

Description For all the ports of channel 1 (:CALC1) to channel 16 (:CALC16), turns ON/OFF the port impedance conversion function when the fixture simulator function is ON (ON is specified with the :CALC{1-16}:FSIM:STAT command).

Parameters

	Description
ON or 1	Turns ON the port impedance conversion function.
OFF or 0 (preset value)	Turns OFF the port impedance conversion function.

Query response {1|0}<newline><^END>

Example of use
10 OUTPUT 717; ":CALC1:FSIM:SEND:ZCON:STAT ON"
20 OUTPUT 717; ":CALC1:FSIM:SEND:ZCON:STAT?"
30 ENTER 717;A

Related commands
:CALC{1-16}:FSIM:STAT on page 368
:CALC{1-16}:FSIM:SEND:ZCON:PORT{1-4}:REAL on page 365
:CALC{1-16}:FSIM:SEND:ZCON:PORT{1-4}:IMAG on page 364

Equivalent key [Analysis] - Fixture Simulator - Port ZConversion - Port ZConversion

:CALC{1-16}:FSIM:STAT

Syntax :CALCulate{[1]|2|3|4|5|6|7|8|9|10|11|12|13|14|15|16}:FSIMulator:STATe {ON|OFF|1|0}
:CALCulate{[1]|2|3|4|5|6|7|8|9|10|11|12|13|14|15|16}:FSIMulator:STATe?

Description Turns ON/OFF the fixture simulator function of channel 1 (:CALC1) to channel 16 (:CALC16).

Parameters

	Description
ON or 1	Turns ON the fixture simulator function.
OFF or 0 (preset value)	Turns OFF the fixture simulator function.

Query response {1|0}<newline><^END>

Example of use
10 OUTPUT 717; ":CALC1:FSIM:STAT ON"
20 OUTPUT 717; ":CALC1:FSIM:STAT?"
30 ENTER 717;A

Equivalent key [Analysis] - Fixture Simulator - Fixture Simulator

:CALC{1-16}:FUNC:DATA?

Syntax :CALCulate{[1]|2|3|4|5|6|7|8|9|10|11|12|13|14|15|16}[:SELEcted]:FUNCtion:DATA?

Description For the active trace of channel 1 (:CALC1) to channel 16 (:CALC16) (specified with the :CALC{1-16}:PAR{1-16}:SEL command), reads out the analysis result of the :CALC{1-16}:FUNC:EXEC command.

The data transfer format when this command is executed depends on the setting with the :FORM:DATA command. (Query only)

Query response {numeric 1},...,{numeric N×2}<newline><^END>

	Description
{numeric n×2-1}	Response value or analysis result of the searched n-th measurement point.
{numeric n×2}	Stimulus value of the searched n-th measurement point. Always set to 0 for the analysis of maximum and minimum values/standard deviation/mean value.

Where N is the number of data pairs (can be read out with :CALC{1-16}:FUNC:POIN? command) and n is an integer between 1 and N.

Example of use

```

10  OUTPUT 717;":CALC1:FUNC:POIN?"
20  ENTER 717;A
30  REDIM B(1:2*A)
40  OUTPUT 717;":CALC1:FUNC:DATA?"
50  ENTER 717;B(*)

```

Related commands

- :CALC{1-16}:FUNC:EXEC on page 373
- :CALC{1-16}:FUNC:POIN? on page 375
- :CALC{1-16}:PAR{1-16}:SEL on page 424
- :FORM:DATA on page 488

Equivalent key No equivalent key is available on the front panel.

:CALC{1-16}:FUNC:DOM

Syntax :CALCulate{[1]|2|3|4|5|6|7|8|9|10|11|12|13|14|15|16}[:SELEcted]:FUNCTion:DOMain[:STATe] {ON|OFF|1|0}
:CALCulate{[1]|2|3|4|5|6|7|8|9|10|11|12|13|14|15|16}[:SELEcted]:FUNCTion:DOMain[:STATe]?

Description For channel 1 (:CALC1) to channel 16 (:CALC16), sets whether to use an arbitrary range when executing the analysis with the :CALC{1-16}:FUNC:EXEC command.

When the trace coupling is off, the active trace is the target to be set.

Parameters

	Description
ON or 1	Specifies an arbitrary range*1.
OFF or 0 (preset value)	Specifies the entire sweep range.

*1. Use the :CALC{1-16}:FUNC:DOM:STAR command and the :CALC{1-16}:FUNC:DOM:STOP command to specify a range.

Query response {1|0}<newline><^END>

Example of use
10 OUTPUT 717; ":CALC1:FUNC:DOM ON"
20 OUTPUT 717; ":CALC1:FUNC:DOM?"
30 ENTER 717;A

Related commands
:CALC{1-16}:FUNC:EXEC on page 373
:CALC{1-16}:FUNC:DOM:COUP on page 371
:CALC{1-16}:FUNC:DOM:STAR on page 372
:CALC{1-16}:FUNC:DOM:STOP on page 373

Equivalent key No equivalent key is available on the front panel.

:CALC{1-16}:FUNC:DOM:COUP

Syntax :CALCulate{[1]|2|3|4|5|6|7|8|9|10|11|12|13|14|15|16}[:SElected]:FUNction:DOMain:COUPle {ON|OFF|1|0}
:CALCulate{[1]|2|3|4|5|6|7|8|9|10|11|12|13|14|15|16}[:SElected]:FUNction:DOMain:COUPle?

Description For channel 1 (:CALC1) to channel 16 (:CALC16), specifies whether to set the coupling of the analysis range of the :CALC{1-16}:FUNC:EXEC command for all traces.

Parameters

	Description
ON or 1 (preset value)	Specifies the analysis range with the trace coupling.
OFF or 0	Specifies the analysis range for each trace.

Query response {1|0}<newline><^END>

Example of use
10 OUTPUT 717;":CALC1:FUNC:DOM:COUP OFF"
20 OUTPUT 717;":CALC1:FUNC:DOM:COUP?"
30 ENTER 717;A

Related commands :CALC{1-16}:FUNC:EXEC on page 373

Equivalent key No equivalent key is available on the front panel.

:CALC{1-16}:FUNC:DOM:STAR

Syntax :CALCulate{[1]|2|3|4|5|6|7|8|9|10|11|12|13|14|15|16}[:SELEcted]:FUNCTion:DOMain:STARt <numeric>
:CALCulate{[1]|2|3|4|5|6|7|8|9|10|11|12|13|14|15|16}[:SELEcted]:FUNCTion:DOMain:STARt?

Description For channel 1 (:CALC1) to channel 16 (:CALC16), sets the start value of the analysis range of the :CALC{1-16}:FUNC:EXEC command.

When the trace coupling is off, the active trace is the target to be set.

Parameters

	<numeric>
Description	Start value of the analysis range
Preset value	0
Unit	Hz (hertz), dBm or second

Query response {numeric}<newline><^END>

Example of use
10 OUTPUT 717; ":CALC1:FUNC:DOM:STAR 1.7E9"
20 OUTPUT 717; ":CALC1:FUNC:DOM:STAR?"
30 ENTER 717;A

Related commands
:CALC{1-16}:FUNC:EXEC on page 373
:CALC{1-16}:FUNC:DOM on page 370
:CALC{1-16}:FUNC:DOM:COUP on page 371
:CALC{1-16}:FUNC:DOM:STOP on page 373

Equivalent key No equivalent key is available on the front panel.

:CALC{1-16}:FUNC:DOM:STOP

- Syntax** :CALCulate{[1]|2|3|4|5|6|7|8|9|10|11|12|13|14|15|16}[:SELEcted]:FUNction:DOMain:STOP <numeric>
:CALCulate{[1]|2|3|4|5|6|7|8|9|10|11|12|13|14|15|16}[:SELEcted]:FUNction:DOMain:STOP?
- Description** For channel 1 (:CALC1) to channel 16 (:CALC16), sets the stop value of the analysis range of the :CALC{1-16}:FUNC:EXEC command.
- When the trace coupling is off, the active trace is the target to be set.

Parameters

	<numeric>
Description	Stop value of the analysis range
Preset value	0
Unit	Hz (hertz), dBm or second

- Query response** {numeric}<newline><^END>
- Example of use**
- ```
10 OUTPUT 717; ":CALC1:FUNC:DOM:STOP 1.8E9"
20 OUTPUT 717; ":CALC1:FUNC:DOM:STOP?"
30 ENTER 717;A
```

- Related commands**
- :CALC{1-16}:FUNC:EXEC on page 373
  - :CALC{1-16}:FUNC:DOM on page 370
  - :CALC{1-16}:FUNC:DOM:COUP on page 371
  - :CALC{1-16}:FUNC:DOM:STAR on page 372

- Equivalent key** No equivalent key is available on the front panel.

## :CALC{1-16}:FUNC:EXEC

- Syntax** :CALCulate{[1]|2|3|4|5|6|7|8|9|10|11|12|13|14|15|16}[:SELEcted]:FUNction:EXECute
- Description** For the active trace of channel 1 (:CALC1) to channel 16 (:CALC16) (specified with the :CALC{1-16}:PAR{1-16}:SEL command), executes the analysis specified with the :CALC{1-16}:FUNC:TYPE command. (No query)
- Example of use**
- ```
10 OUTPUT 717; ":CALC1:FUNC:EXEC"
```
- Related commands**
- :CALC{1-16}:FUNC:TYPE on page 379
 - :CALC{1-16}:FUNC:DOM on page 370
 - :CALC{1-16}:PAR{1-16}:SEL on page 424
- Equivalent key** No equivalent key is available on the front panel.

:CALC{1-16}:FUNC:PEXC

Syntax :CALCulate{[1]|2|3|4|5|6|7|8|9|10|11|12|13|14|15|16}{[:SElected]:FUNCtion:PEXCursion <numeric>
:CALCulate{[1]|2|3|4|5|6|7|8|9|10|11|12|13|14|15|16}{[:SElected]:FUNCtion:PEXCursion?

Description For the active trace of channel 1 (:CALC1) to channel 16 (:CALC16) (specified with the :CALC{1-16}:PAR{1-16}:SEL command), sets the lower limit for the peak excursion value when executing the peak search with the :CALC{1-16}:FUNC:EXEC command.

Parameters

	<numeric>
Description	Lower limit for the peak excursion value
Range	0 to 5e8
Preset value	3
Unit	Varies depending on the data format as follows: Logarithmic Magnitude: dB (decibel) Phase, Expand Phase, Positive Phase: ° (degree) Group Delay: s (second) Others: No unit

If the specified parameter is out of the allowable setup range, the minimum value (if the lower limit of the range is not reached) or the maximum value (if the upper limit of the range is exceeded) is set.

Query response {numeric}<newline><^END>

Example of use
10 OUTPUT 717; ":CALC1:FUNC:PEXC 0.2"
20 OUTPUT 717; ":CALC1:FUNC:PEXC?"
30 ENTER 717;A

Related commands
:CALC{1-16}:FUNC:EXEC on page 373
:CALC{1-16}:FUNC:PPOL on page 376
:CALC{1-16}:FUNC:TYPE on page 379
:CALC{1-16}:PAR{1-16}:SEL on page 424

Equivalent key No equivalent key is available on the front panel.

:CALC{1-16}:FUNC:POIN?

Syntax	:CALCulate{[1] 2 3 4 5 6 7 8 9 10 11 12 13 14 15 16}{[:SElected]:FUNCtion:POINts?}
Description	<p>For the active trace of channel 1 (:CALC1) to channel 16 (:CALC16) (specified with the :CALC{1-16}:PAR{1-16}:SEL command), reads out the number of data pairs of the analysis result of the :CALC{1-16}:FUNC:EXEC command.</p> <p>For the analysis of the mean value or the search of the maximum value, 1 is always read out; for the search of all peaks or the search of all targets, the total number of searched measurement points is read out. (Query only)</p>
Query response	{numeric}<newline><^END>
Example of use	10 OUTPUT 717; ":CALC1:FUNC:POIN?" 20 ENTER 717;A
Related commands	:CALC{1-16}:FUNC:EXEC on page 373 :CALC{1-16}:FUNC:DATA? on page 369 :CALC{1-16}:PAR{1-16}:SEL on page 424
Equivalent key	No equivalent key is available on the front panel.

:CALC{1-16}:FUNC:PPOL

Syntax :CALCulate{[1]|2|3|4|5|6|7|8|9|10|11|12|13|14|15|16}{[:SElected]:FUNCtion:PPOLarity {POSitive|NEGative|BOTH}}
:CALCulate{[1]|2|3|4|5|6|7|8|9|10|11|12|13|14|15|16}{[:SElected]:FUNCtion:PPOLarity?}

Description For the active trace of channel 1 (:CALC1) to channel 16 (:CALC16) (specified with the :CALC{1-16}:PAR{1-16}:SEL command), selects the polarity when performing the peak search with the :CALC{1-16}:FUNC:EXEC command.

Parameters

	Description
POSitive (preset value)	Specifies the positive peak.
NEGative	Specifies the negative peak.
BOTH	Specifies both the positive peak and the negative peak.

Query response {POS|NEG|BOTH}<newline><^END>

Example of use
10 OUTPUT 717; ":CALC1:FUNC:PPOL BOTH"
20 OUTPUT 717; ":CALC1:FUNC:PPOL?"
30 ENTER 717;A\$

Related commands
:CALC{1-16}:FUNC:EXEC on page 373
:CALC{1-16}:FUNC:PEXC on page 374
:CALC{1-16}:FUNC:TYPE on page 379
:CALC{1-16}:PAR{1-16}:SEL on page 424

Equivalent key No equivalent key is available on the front panel.

:CALC{1-16}:FUNC:TARG

Syntax :CALCulate{[1]|2|3|4|5|6|7|8|9|10|11|12|13|14|15|16}[:SELEcted]:FUNCtion:TARGet <numeric>
:CALCulate{[1]|2|3|4|5|6|7|8|9|10|11|12|13|14|15|16}[:SELEcted]:FUNCtion:TARGet?

Description For the active trace of channel 1 (:CALC1) to channel 16 (:CALC16) (specified with the :CALC{1-16}:PAR{1-16}:SEL command), selects the target value when performing the target search with the :CALC{1-16}:FUNC:EXEC command.

Parameters

	<numeric>
Description	Target value
Range	-5E8 to 5E8
Preset value	0
Unit	Varies depending on the data format as follows: Logarithmic Magnitude: dB (decibel) Phase, Expand Phase, Positive Phase: ° (degree) Group Delay: s (second) Others: No unit

If the specified parameter is out of the allowable setup range, the minimum value (if the lower limit of the range is not reached) or the maximum value (if the upper limit of the range is exceeded) is set.

Query response {numeric}<newline><^END>

Example of use
10 OUTPUT 717;":CALC1:FUNC:TARG -12.5"
20 OUTPUT 717;":CALC1:FUNC:TARG?"
30 ENTER 717;A

Related commands
:CALC{1-16}:FUNC:EXEC on page 373
:CALC{1-16}:FUNC:TTR on page 378
:CALC{1-16}:FUNC:TYPE on page 379
:CALC{1-16}:PAR{1-16}:SEL on page 424

Equivalent key No equivalent key is available on the front panel.

:CALC{1-16}:FUNC:TTR

Syntax :CALCulate{[1]|2|3|4|5|6|7|8|9|10|11|12|13|14|15|16}{[:SElected]:FUNction:TTRansition {POSitive|NEGative|BOTH}}

:CALCulate{[1]|2|3|4|5|6|7|8|9|10|11|12|13|14|15|16}{[:SElected]:FUNction:TTRansition?}

Description For the active trace of channel 1 (:CALC1) to channel 16 (:CALC16) (specified with the :CALC{1-16}:PAR{1-16}:SEL command), selects the transition type when performing the target search with the :CALC{1-16}:FUNC:EXEC command.

Parameters

	Description
POSitive	Specifies positive.
NEGative	Specifies negative.
BOTH (preset value)	Specifies both positive and negative.

Query response {POS|NEG|BOTH}<newline><^END>

Example of use

```
10  OUTPUT 717; ":CALC1:FUNC:TTR NEG"
20  OUTPUT 717; ":CALC1:FUNC:TTR?"
30  ENTER 717;A$
```

Related commands

- :CALC{1-16}:FUNC:EXEC on page 373
- :CALC{1-16}:FUNC:TARG on page 377
- :CALC{1-16}:FUNC:TYPE on page 379
- :CALC{1-16}:PAR{1-16}:SEL on page 424

Equivalent key No equivalent key is available on the front panel.

:CALC{1-16}:FUNC:TYPE

Syntax :CALCulate{[1]|2|3|4|5|6|7|8|9|10|11|12|13|14|15|16}[:SELEcted]:FUNCtion:TYPE {PTPeak|STDEV|MEAN|MAXimum|MINimum|PEAK|APEak|ATARget}
:CALCulate{[1]|2|3|4|5|6|7|8|9|10|11|12|13|14|15|16}[:SELEcted]:FUNCtion:TYPE?

Description For the active trace of channel 1 (:CALC1) to channel 16 (:CALC16) (specified with the :CALC{1-16}:PAR{1-16}:SEL command), selects the type of analysis.

Parameters

	Description
PTPeak (preset value)	Specifies the analysis of the difference between the maximum value and the minimum value (Peak to Peak).
STDEV	Specifies the analysis of the standard deviation.
MEAN	Specifies the analysis of the mean value.
MAXimum	Specifies the search for the maximum value.
MINimum	Specifies the search for the minimum value.
PEAK	Specifies the search for the maximum positive (minimum negative) peak ^{*1} .
APEak	Specifies the search for all peaks ^{*1} .
ATARget	Specifies the search for all targets ^{*2} .

*1. To specify the conditions of the peak, use the :CALC{1-16}:FUNC:PEXC command and the :CALC{1-16}:FUNC:PPOL command.

*2. To specify the conditions of the target, use the :CALC{1-16}:FUNC:TARG command and the :CALC{1-16}:FUNC:TTR command.

Query response {PTP|STDEV|MEAN|MAX|MIN|PEAK|APE|ATAR}<newline><^END>

Example of use
10 OUTPUT 717; ":CALC1:FUNC:TYPE PEAK"
20 OUTPUT 717; ":CALC1:FUNC:TYPE?"
30 ENTER 717;A\$

Related commands
:CALC{1-16}:FUNC:EXEC on page 373
:CALC{1-16}:FUNC:PEXC on page 374
:CALC{1-16}:FUNC:PPOL on page 376
:CALC{1-16}:FUNC:TARG on page 377
:CALC{1-16}:FUNC:TTR on page 378
:CALC{1-16}:PAR{1-16}:SEL on page 424

Equivalent key No equivalent key is available on the front panel.

:CALC{1-16}:LIM

Syntax :CALCulate{[1]|2|3|4|5|6|7|8|9|10|11|12|13|14|15|16}{[:SElected]:LIMit[:STATe] {ON|OFF|1|0}}
:CALCulate{[1]|2|3|4|5|6|7|8|9|10|11|12|13|14|15|16}{[:SElected]:LIMit[:STATe]?

Description For the active trace of channel 1 (:CALC1) to channel 16 (:CALC16) (specified with the :CALC{1-16}:PAR{1-16}:SEL command), turns ON/OFF the limit test function.

Parameters

	Description
ON or 1	Turns ON the limit test.
OFF or 0 (preset value)	Turns OFF the limit test.

Query response {1|0}<newline><^END>

Example of use
10 OUTPUT 717; ":CALC1:LIM ON"
20 OUTPUT 717; ":CALC1:LIM?"
30 ENTER 717;A

Related commands
:CALC{1-16}:PAR{1-16}:SEL on page 424
:CALC{1-16}:LIM:DISP on page 382
:DISP:FSIG on page 463

Equivalent key [Analysis] - Limit Test - Limit Test

:CALC{1-16}:LIM:DATA

Syntax

```
:CALCulate{[1]|2|3|4|5|6|7|8|9|10|11|12|13|14|15|16}[:SELected]:LIMit:DATA <numeric 1>,...,<numeric 1+(N×5)>
:CALCulate{[1]|2|3|4|5|6|7|8|9|10|11|12|13|14|15|16}[:SELected]:LIMit:DATA?
```

Description

For the active trace of channel 1 (:CALC1) to channel 16 (:CALC16) (specified with the :CALC{1-16}:PAR{1-16}:SEL command), sets the limit table.

The data transfer format when this command is executed depends on the setting with the :FORM:DATA command.

Parameters

	Description
<numeric 1>	The number of lines. (0 to 100)
<numeric 1+(n×5)-4>	The type of the n-th line. Specify an integer 0 to 2: 0: Off 1: Upper limit line 2: Lower limit line
<numeric 1+(n×5)-3>	The value on the horizontal axis (frequency/power/time) of the start point of the n-th line.
<numeric 1+(n×5)-2>	The value on the horizontal axis (frequency/power/time) of the end point of the n-th line.
<numeric 1+(n×5)-1>	The value on the vertical axis of the start point of the n-th line.
<numeric 1+(n×5)>	The value on the vertical axis of the end point of the n-th line.

Where N is the number of lines (specified with <numeric 1>) and n is an integer between 1 and N.

If you set the number of lines to 0 (clear the limit table), this command needs only <numeric 1> as the parameter.

Query response

```
{numeric 1},...,{numeric 1+(N×5)}<newline><^END>
```

Example of use

```
10 DIM B(1:2,1:5)
20 OUTPUT 717;":CALC1:LIM:DATA 2,1,1E9,3E9,0,0,2,1E9,3E9,-3,-3"
30 OUTPUT 717;":CALC1:LIM:DATA?"
40 ENTER 717;A,B(*)

10 OUTPUT 717;":CALC1:LIM:DATA 0" ! Clear Limit Table
```

Related commands

:CALC{1-16}:PAR{1-16}:SEL on page 424

:CALC{1-16}:LIM on page 380

:CALC{1-16}:LIM:DISP on page 382

:FORM:DATA on page 488

Equivalent key

[Analysis] - Limit Test - Edit Limit Line

:CALC{1-16}:LIM:DISP

Syntax

```
:CALCulate{[1]|2|3|4|5|6|7|8|9|10|11|12|13|14|15|16}[:SElected]:LIMit:DISPlay[:STATe] {ON|OFF|1|0}  
:CALCulate{[1]|2|3|4|5|6|7|8|9|10|11|12|13|14|15|16}[:SElected]:LIMit:DISPlay[:STATe]?
```

Description

For the active trace of channel 1 (:CALC1) to channel 16 (:CALC16) (specified with the :CALC{1-16}:PAR{1-16}:SEL command), turns ON/OFF the limit line display.

Parameters

	Description
ON or 1	Turns ON the limit line display.
OFF or 0 (preset value)	Turns OFF the limit line display.

Query response

```
{1|0}<newline><^END>
```

Example of use

```
10 OUTPUT 717; ":CALC1:LIM:DISP ON"  
20 OUTPUT 717; ":CALC1:LIM:DISP?"  
30 ENTER 717;A
```

Related commands

:CALC{1-16}:LIM on page 380
:CALC{1-16}:PAR{1-16}:SEL on page 424

Equivalent key

[Analysis] - Limit Test - Limit Line

:CALC{1-16}:LIM:FAIL?

Syntax :CALCulate{[1]|2|3|4|5|6|7|8|9|10|11|12|13|14|15|16}{[:SElected]:LIMit:FAIL?

Description For the active trace of channel 1 (:CALC1) to channel 16 (:CALC16) (specified with the :CALC{1-16}:PAR{1-16}:SEL command), reads out the limit test result. (Query only)

Query response {1|0}<newline><^END>

	Description
1	The limit test result is FAIL.
0	The limit test result is PASS.

When the limit test is set to OFF, 0 is always read out.

Example of use

```
10 OUTPUT 717; ":CALC1:LIM:FAIL?"
20 ENTER 717;A
```

Related commands :CALC{1-16}:LIM on page 380
:CALC{1-16}:PAR{1-16}:SEL on page 424

Equivalent key No equivalent key is available on the front panel.

:CALC{1-16}:LIM:OFFS:AMPL

Syntax

```
:CALCulate{[1]|2|3|4|5|6|7|8|9|10|11|12|13|14|15|16}[:SElected]:LIMit:OFFSet:AMPLitude <numeric>  
:CALCulate{[1]|2|3|4|5|6|7|8|9|10|11|12|13|14|15|16}[:SElected]:LIMit:OFFSet:AMPLitude?
```

Description

For channel 1 (:CALC1) to channel 16 (:CALC16) (specified with the :CALC{1-16}:PAR{1-16}:SEL command), sets the limit line amplitude offset.

The setting of the limit line doesn't change even if the offset value is changed.

Parameters

	<numeric>
Description	The limit line amplitude offset value for the limit test.
Range	-5E8 to 5E8
Preset value	0
Unit	dB

Query response

```
{numeric}<newline><^END>
```

Example of use

```
10 OUTPUT 717; ":CALC1:LIM:OFFS:AMPL -10"  
20 OUTPUT 717; ":CALC1:LIM:OFFS:AMPL?"  
30 ENTER 717;A
```

Related commands

:CALC{1-16}:LIM on page 380

:CALC{1-16}:LIM:OFFS:MARK on page 385

:CALC{1-16}:LIM:OFFS:STIM on page 386

Equivalent key

[Analysis] - Limit Test - Limit Line Offsets - Amplitude Offset

:CALC{1-16}:LIM:OFFS:MARK

Syntax	<code>:CALCulate{[1] 2 3 4 5 6 7 8 9 10 11 12 13 14 15 16}[:SElected]:LIMit:OFFSet:MARKer</code>
Description	<p>For channel 1 (:CALC1) to channel 16 (:CALC16) (specified with the :CALC{1-16}:PAR{1-16}:SEL command), sets the active marker value to amplitude offset using the limit line.</p> <p>The setting of the limit line does not change even if the offset value is changed.</p> <p>When the markers are not displayed, this command does not operate.</p>
Example of use	<pre>10 OUTPUT 717; ":CALC1:LIM:OFFS:MARK"</pre>
Related commands	<p>:CALC{1-16}:LIM on page 380</p> <p>:CALC{1-16}:LIM:OFFS:AMPL on page 384</p> <p>:CALC{1-16}:LIM:OFFS:STIM on page 386</p>
Equivalent key	[Analysis] - Limit Test - Limit Line Offsets - Marker -> Amplitude Offset

:CALC{1-16}:LIM:OFFS:STIM

Syntax :CALCulate{[1]|2|3|4|5|6|7|8|9|10|11|12|13|14|15|16}[:SElected]:LIMit:OFFSet:STIMulus <numeric>
:CALCulate{[1]|2|3|4|5|6|7|8|9|10|11|12|13|14|15|16}[:SElected]:LIMit:OFFSet:STIMulus?

Description For channel 1 (:CALC1) to channel 16 (:CALC16) (specified with the :CALC{1-16}:PAR{1-16}:SEL command), sets the stimulus offset of the limit line. The setting of the limit line doesn't change even if the offset value is changed.

Parameters

	<numeric>
Description	The stimulus offset value of the limit line.
Range	-1E12 to 1E12
Preset value	0
Unit	Hz (hertz), dBm or second

Query response {numeric}<newline><^END>

Example of use

```
10 OUTPUT 717; ":CALC1:LIM:OFFS:STIM 5E3"
20 OUTPUT 717; ":CALC1:LIM:OFFS:STIM?"
30 ENTER 717;A
```

Related commands :CALC{1-16}:LIM on page 380
:CALC{1-16}:LIM:OFFS:AMPL on page 384
:CALC{1-16}:LIM:OFFS:MARK on page 385

Equivalent key [Analysis] - Limit Test - Limit Line Offsets - Stimulus Offset

:CALC{1-16}:LIM:REP?

Syntax	:CALCulate{[1] 2 3 4 5 6 7 8 9 10 11 12 13 14 15 16}{[:SElected]:LIMit:REPort[:DATA]}?
Description	<p>For the active trace of channel 1 (:CALC1) to channel 16 (:CALC16) (specified with the :CALC{1-16}:PAR{1-16}:SEL command), reads out the stimulus values (frequency, power level or time) at all the measurement point that failed the limit test.</p> <p>The data transfer format when this command is executed depends on the setting with the :FORM:DATA command.(Query only)</p>
Query response	<p>{numeric 1},..., {numeric N}<newline><<^END></p> <p>Where N is the number of the measurement points that failed (can be read out with the :CALC{1-16}:LIM:REP:POIN? command).</p>
Example of use	<pre>10 OUTPUT 717; ":CALC1:LIM:REP:POIN?" 20 ENTER 717;A 30 REDIM B(1:A) 40 OUTPUT 717; ":CALC1:LIM:REP?" 50 ENTER 717;B(*)</pre>
Related commands	<p>:CALC{1-16}:PAR{1-16}:SEL on page 424</p> <p>:FORM:DATA on page 488</p> <p>:CALC{1-16}:LIM:REP:POIN? on page 389</p> <p>:CALC{1-16}:LIM on page 380</p>
Equivalent key	No equivalent key is available on the front panel.

:CALC{1-16}:LIM:REP:ALL?

Syntax :CALCulate{[1]|2|3|4|5|6|7|8|9|10|11|12|13|14|15|16}{[:SElected]:LIMit:REPort:ALL?

Description For the active trace of channel 1 (:CALC1) to channel 16 (:CALC16) (specified with the :CALC{1-16}:PAR{1-16}:SEL command), reads out the bandwidth test results (stimulus value, limit test result, upper limit value, lower limit value of all measurement points).

The data transfer format when this command is executed depends on the setting with the :FORM:DATA command. (Query only)

Query Response {numeric 1},...,{numeric N×4}<newline><^END>

	Description
<numeric n×4-3>	The stimulus value for the measurement point.
<numeric n×4-2>	The limit test result. Specify an integer -1 to 1: 0: Fail 1: Pass -1: No limit
<numeric n×4-1>	The upper limit value at the measurement point. (If there is no limit at this point, reads out 0.)
<numeric n×4>	The lower limit value at the measurement point. (If there is no limit at this point, reads out 0.)

Where N is the number of measurement points (specified with the :SENS{1-16}:SWE:POIN command) and n is an integer between 1 and N.

Example of use

```

10 OUTPUT 717; ":SENS1:SWE:POIN?"
20 ENTER 717;A
30 REDIM B(1:4*A)
40 OUTPUT 717; ":CALC1:LIM:REP:ALL?"
50 ENTER 717;B(*)

```

Related commands

- :CALC{1-16}:PAR{1-16}:SEL on page 424
- :CALC{1-16}:LIM on page 380
- :CALC{1-16}:LIM:REP? on page 387
- :CALC{1-16}:LIM:REP:POIN? on page 389

Equivalent key No equivalent key is available on the front panel.

:CALC{1-16}:LIM:REP:POIN?

Syntax	<code>:CALCulate{[1] 2 3 4 5 6 7 8 9 10 11 12 13 14 15 16}{[:SElected]:LIMit:REPort:POINts?</code>
Description	For the active trace of channel 1 (:CALC1) to channel 16 (:CALC16) (specified with the :CALC{1-16}:PAR{1-16}:SEL command), reads out the number of the measurement points that failed the limit test. (Query only)
Query response	{numeric}<newline><^END>
Example of use	10 OUTPUT 717; ":CALC1:LIM:REP:POIN?" 20 ENTER 717;A
Related commands	:CALC{1-16}:PAR{1-16}:SEL on page 424 :CALC{1-16}:LIM on page 380
Equivalent key	No equivalent key is available on the front panel.

:CALC{1-16}:MARK:BWID

Syntax :CALCulate{[1]|2|3|4|5|6|7|8|9|10|11|12|13|14|15|16}[:SElected]:MARKer:BWIDth[:STATe] {ON|OFF|1|0}
:CALCulate{[1]|2|3|4|5|6|7|8|9|10|11|12|13|14|15|16}[:SElected]:MARKer:BWIDth[:STATe]?

Description For the active trace of channel 1 (:CALC1) to channel 16 (:CALC16) (specified with the :CALC{1-16}:PAR{1-16}:SEL command), turns ON/OFF the bandwidth search result display.

Parameters

	Description
ON or 1	Turns ON the bandwidth search result display.
OFF or 0 (preset value)	Turns OFF the bandwidth search result display.

Query response {1|0}<newline><^END>

Example of use
10 OUTPUT 717; ":CALC1:MARK:BWID ON"
20 OUTPUT 717; ":CALC1:MARK:BWID?"
30 ENTER 717;A

Related commands
:CALC{1-16}:MARK{1-10}:BWID:DATA? on page 400
:CALC{1-16}:MARK{1-10}:BWID:THR on page 401
:CALC{1-16}:PAR{1-16}:SEL on page 424

Equivalent key [Marker Search] - Bandwidth

:CALC{1-16}:MARK:COUP

Syntax :CALCulate{[1|2|3|4|5|6|7|8|9|10|11|12|13|14|15|16][:SElected]:MARKer:COUPle {ON|OFF|1|0}
:CALCulate{[1|2|3|4|5|6|7|8|9|10|11|12|13|14|15|16][:SElected]:MARKer:COUPe?

Description For channel 1 (:CALC1) to channel 16 (:CALC16), turns ON/OFF the marker coupling between traces.

Parameters

	Description
ON or 1 (preset value)	Turns ON the marker coupling.
OFF or 0	Turns OFF the marker coupling.

Query response {1|0}<newline><^END>

Example of use
10 OUTPUT 717; ":CALC1:MARK:COUP OFF"
20 OUTPUT 717; ":CALC1:MARK:COUP?"
30 ENTER 717;A

Equivalent key [Marker Fctn] - Couple

:CALC{1-16}:MARK:FUNC:DOM

Syntax

```
:CALCulate{[1]|2|3|4|5|6|7|8|9|10|11|12|13|14|15|16}{[:SElected]:MARKer:FUNcTion:DOMain[:STATe]} {ON|OFF|1|0}
:CALCulate{[1]|2|3|4|5|6|7|8|9|10|11|12|13|14|15|16}{[:SElected]:MARKer:FUNcTion:DOMain[:STATe]}?
```

Description

For channel 1 (:CALC1) to channel 16 (:CALC16), sets whether to use an arbitrary range when executing the marker search.

When the trace coupling is off, the active trace is the target to be set.

Parameters

	Description
ON or 1	Specifies an arbitrary range ^{*1} .
OFF or 0 (preset value)	Specifies the entire sweep range.

*1. Use the :CALC{1-16}:MARK:FUNC:DOM:STAR command and the :CALC{1-16}:MARK:FUNC:DOM:STOP command to specify a range.

Query response

```
{1|0}<newline><^END>
```

Example of use

```
10 OUTPUT 717; ":CALC1:MARK:FUNC:DOM ON"
20 OUTPUT 717; ":CALC1:MARK:FUNC:DOM?"
30 ENTER 717;A
```

Related commands

:CALC{1-16}:MARK{1-10}:FUNC:EXEC on page 403
:CALC{1-16}:MARK:FUNC:DOM:COUP on page 393
:CALC{1-16}:MARK:FUNC:DOM:STAR on page 394
:CALC{1-16}:MARK:FUNC:DOM:STOP on page 395

Equivalent key

[Marker Search] - Search Range - Search Range [ON/OFF]

:CALC{1-16}:MARK:FUNC:DOM:COUP

Syntax

```
:CALCulate{[1]|2|3|4|5|6|7|8|9|10|11|12|13|14|15|16}[:SElected]:MARKer:FUNcTION:DOMain:COUPle {ON|OFF|1|0}
:CALCulate{[1]|2|3|4|5|6|7|8|9|10|11|12|13|14|15|16}[:SElected]:MARKer:FUNcTION:DOMain:COUPle?
```

Description

For channel 1 (:CALC1) to channel 16 (:CALC16), specifies whether to set the coupling of the marker search range for all traces.

Parameters

	Description
ON or 1 (preset value)	Specifies the search range with the trace coupling.
OFF or 0	Specifies the search range for each trace.

Query response

```
{1|0}<newline><^END>
```

Example of use

```
10 OUTPUT 717; ":CALC1:MARK:FUNC:DOM:COUP OFF"
20 OUTPUT 717; ":CALC1:MARK:FUNC:DOM:COUP?"
30 ENTER 717;A
```

Related commands

:CALC{1-16}:MARK:FUNC:DOM on page 392
:CALC{1-16}:PAR{1-16}:SEL on page 424

Equivalent key

[Marker Search] - Search Range - Couple

:CALC{1-16}:MARK:FUNC:DOM:STAR

Syntax

```
:CALCulate{[1]|2|3|4|5|6|7|8|9|10|11|12|13|14|15|16}{[:SElected]:MARKer:FUNcTion:DOMain:STARt <numeric>  
:CALCulate{[1]|2|3|4|5|6|7|8|9|10|11|12|13|14|15|16}{[:SElected]:MARKer:FUNcTion:DOMain:STARt?
```

Description

For channel 1 (:CALC1) to channel 16 (:CALC16), sets the start value of the marker search range.

When the trace coupling is off, the active trace is the target to be set.

Parameters

	<numeric>
Description	The start value of the search range
Preset value	0
Unit	Hz (hertz), dBm or second

Query response

```
{numeric}<newline><^END>
```

Example of use

```
10 OUTPUT 717; ":CALC1:MARK:FUNC:DOM:STAR 1.7E9"  
20 OUTPUT 717; ":CALC1:MARK:FUNC:DOM:STAR?"  
30 ENTER 717;A
```

Related commands

:CALC{1-16}:MARK{1-10}:FUNC:EXEC on page 403

:CALC{1-16}:MARK:FUNC:DOM on page 392

:CALC{1-16}:MARK:FUNC:DOM:STOP on page 395

Equivalent key

[Marker Search] - Search Range - Start

:CALC{1-16}:MARK:FUNC:DOM:STOP

Syntax

```
:CALCulate{[1]|2|3|4|5|6|7|8|9|10|11|12|13|14|15|16}[:SElected]:MARKer:FUNCtion:DOMain:STOP <numeric>  
:CALCulate{[1]|2|3|4|5|6|7|8|9|10|11|12|13|14|15|16}[:SElected]:MARKer:FUNCtion:DOMain:STOP?
```

Description

For channel 1 (:CALC1) to channel 16 (:CALC16), sets the stop value of the marker search range.

When the trace coupling is off, the active trace is the target to be set.

Parameters

	<numeric>
Description	The stop value of the search range
Preset value	0
Unit	Hz (hertz), dBm or second

Query response

```
{numeric}<newline><^END>
```

Example of use

```
10 OUTPUT 717; ":CALC1:MARK:FUNC:DOM:STOP 1.8E9"  
20 OUTPUT 717; ":CALC1:MARK:FUNC:DOM:STOP?"  
30 ENTER 717;A
```

Related commands

:CALC{1-16}:MARK{1-10}:FUNC:EXEC on page 403

:CALC{1-16}:MARK:FUNC:DOM on page 392

:CALC{1-16}:MARK:FUNC:DOM:STAR on page 394

Equivalent key

[Marker Search] - Search Range - Stop

:CALC{1-16}:MARK:NOTC

Syntax

```
:CALCulate{[1]|2|3|4|5|6|7|8|9|10|11|12|13|14|15|16}[:SElected]:MARKer:NOTCh[:STATe] {ON|OFF|1|0}  
:CALCulate{[1]|2|3|4|5|6|7|8|9|10|11|12|13|14|15|16}[:SElected]:MARKer:NOTCh[:STATe]?
```

Description

For the active trace of channel 1 (:CALC1) to channel 16 (:CALC16) (specified with the :CALC{1-16}:PAR{1-16}:SEL command), turns ON/OFF the notch search result display.

Parameters

	Description
ON or 1	Turns ON the notch search result display.
OFF or 0 (preset value)	Turns OFF the notch search result display.

Query response

```
{1|0}<newline><^END>
```

Example of use

```
10  OUTPUT 717; ":CALC1:MARK:NOTC ON"  
20  OUTPUT 717; ":CALC1:MARK:NOTC?"  
30  ENTER 717;A
```

Related commands

:CALC{1-16}:PAR{1-16}:SEL on page 424
:CALC{1-16}:MARK{1-10}:NOTC:DATA? on page 410
:CALC{1-16}:MARK{1-10}:NOTC:THR on page 411

Equivalent key

[Marker Search] - Notch

:CALC{1-16}:MARK:REF

Syntax :CALCulate{[1]|2|3|4|5|6|7|8|9|10|11|12|13|14|15|16}[:SELEcted]:MARKer:REFerence[:STATe] {ON|OFF|1|0}
:CALCulate{[1]|2|3|4|5|6|7|8|9|10|11|12|13|14|15|16}[:SELEcted]:MARKer:REFerence[:STATe]?

Description For the active trace of channel 1 (:CALC1) to channel 16 (:CALC16) (specified with the :CALC{1-16}:PAR{1-16}:SEL command), turns ON/OFF the reference marker mode.
The reference marker mode is turned on or off when you turn on or off the display of the reference marker.

Parameters

	Description
ON or 1	Turns ON the reference marker mode.
OFF or 0 (preset value)	Turns OFF the reference marker mode.

Query response {1|0}<newline><^END>

Example of use
10 OUTPUT 717; ":CALC1:MARK:REF ON"
20 OUTPUT 717; ":CALC1:MARK:REF?"
30 ENTER 717;A

Related commands :CALC{1-16}:PAR{1-16}:SEL on page 424
:CALC{1-16}:MARK{1-10} on page 398

Equivalent key [Marker] - Ref Maker Mode

:CALC{1-16}:MARK{1-10}

Syntax

```
:CALCulate{[1][2][3][4][5][6][7][8][9][10][11][12][13][14][15][16]}[:SElected]:MARKer{[1][2][3][4][5][6][7][8][9][10]}[:STATe] {ON|OFF|1|0}
:CALCulate{[1][2][3][4][5][6][7][8][9][10][11][12][13][14][15][16]}[:SElected]:MARKer{[1][2][3][4][5][6][7][8][9][10]}[:STATe]?
```

Description

For the active trace of channel 1 (:CALC1) to channel 16 (:CALC16) (specified with the :CALC{1-16}:PAR{1-16}:SEL command), turns ON/OFF the display of marker 1 (:MARK1) to marker 9 (:MARK9) and reference marker (:MARK10).

The display of the reference marker is turned on or off when you turn on or off the reference marker mode.

Parameters

	Description
ON or 1	Turns ON the display of the marker.
OFF or 0 (preset value)	Turns OFF the display of the marker.

Query response

```
{1|0}<newline><^END>
```

Example of use

```
10 OUTPUT 717; ":CALC1:MARK1 ON"
20 OUTPUT 717; ":CALC1:MARK1?"
30 ENTER 717;A
```

Related commands

:CALC{1-16}:PAR{1-16}:SEL on page 424

:CALC{1-16}:MARK:REF on page 397

Equivalent key

When turning ON the display of the marker

[Marker] - Marker 1|Marker 2|Marker 3|Marker 4|Ref Marker

[Marker] - More Markers - Marker 5|Marker 6|Marker 7|Marker 8|Marker 9

NOTE

When performing the operation from the front panel, a marker set to ON is automatically set to the active marker.

When turning OFF the display of the marker

[Marker] - Clear Marker Menu - Marker 1|Marker 2|Marker 3|Marker 4|Marker 5|Marker 6|Marker 7|Marker 8|Marker 9|Ref Marker

:CALC{1-16}:MARK{1-10}:ACT

Syntax	:CALCulate{[1] 2 3 4 5 6 7 8 9 10 11 12 13 14 15 16}[:SELEcted]:MARKer{[1] 2 3 4 5 6 7 8 9 10}:ACTivate
Description	For the active trace of channel 1 (:CALC1) to channel 16 (:CALC16) (specified with the :CALC{1-16}:PAR{1-16}:SEL command), sets marker 1 (:MARK1) to marker 9 (:MARK9) and reference marker (:MARK10) to the active marker. (No query)
NOTE	If you set a marker set to OFF to the active marker, it is automatically set to ON.
Example of use	10 OUTPUT 717; ":CALC1:MARK1:ACT"
Related commands	:DISP:WIND{1-16}:ACT on page 470 :CALC{1-16}:PAR{1-16}:SEL on page 424
Equivalent key	[Marker] - Marker 1 Marker 2 Marker 3 Marker 4 Ref Marker [Marker] - More Markers - Marker 5 Marker 6 Marker 7 Marker 8 Marker 9

:CALC{1-16}:MARK{1-10}:BWID:DATA?

Syntax

:CALCulate{[1][2][3][4][5][6][7][8][9][10][11][12][13][14][15][16]}[:SELected]:MARKer{[1][2][3][4][5][6][7][8][9][10]}:BWIDth:DATA?

Description

For the active trace of channel 1 (:CALC1) to channel 16 (:CALC16) (specified with the :CALC{1-16}:PAR{1-16}:SEL command), reads out the bandwidth search result of marker 1 (:MARK1) to marker 9 (:MARK9) and reference marker (:MARK10).

If the bandwidth search is impossible, an error occurs and the command is ignored. In this case, no query response is obtained. (Query only)

Query response

{numeric 1},{numeric 2},{numeric 3},{numeric 4}<newline><^END>

	Description
{numeric 1}	The bandwidth.
{numeric 2}	The center frequency.
{numeric 3}	The Q value.
{numeric 4}	The loss.

Example of use

```
10 OUTPUT 717; ":CALC1:MARK1:BWID:DATA?"
20 ENTER 717;A,B,C,D
```

Related commands

:CALC{1-16}:MARK:BWID on page 390

:CALC{1-16}:MARK{1-10}:BWID:THR on page 401

:CALC{1-16}:PAR{1-16}:SEL on page 424

Equivalent key

No equivalent key is available on the front panel.

:CALC{1-16}:MARK{1-10}:BWID:THR

Syntax :CALCulate{[1]|2|3|4|5|6|7|8|9|10|11|12|13|14|15|16}[:SELEcted]:MARKer{[1]|2|3|4|5|6|7|8|9|10}:BWIDth:THReshold <numeric>
:CALCulate{[1]|2|3|4|5|6|7|8|9|10|11|12|13|14|15|16}[:SELEcted]:MARKer{[1]|2|3|4|5|6|7|8|9|10}:BWIDth:THReshold?

Description For the active trace of channel 1 (:CALC1) to channel 16 (:CALC16) (specified with the :CALC{1-16}:PAR{1-16}:SEL command), sets the bandwidth definition value of marker 1 (:MARK1) to marker 9 (:MARK9) and reference marker (:MARK10).

Parameters

	<numeric>
Description	Bandwidth definition value
Range	-5E8 to 5E8
Preset value	-3
Unit	Varies depending on the data format as follows: Logarithmic Magnitude: dB (decibel) Phase, Expand Phase, Positive Phase: ° (degree) Group Delay: s (second) Others: No unit

If the specified parameter is out of the allowable setup range, the minimum value (if the lower limit of the range is not reached) or the maximum value (if the upper limit of the range is exceeded) is set.

Query response {numeric}<newline><^END>

Example of use
10 OUTPUT 717; ":CALC1:MARK1:BWID:THR 6"
20 OUTPUT 717; ":CALC1:MARK1:BWID:THR?"
30 ENTER 717;A

Related commands
:CALC{1-16}:MARK:BWID on page 390
:CALC{1-16}:PAR{1-16}:SEL on page 424

Equivalent key [Marker Search] - Bandwidth Value

:CALC{1-16}:MARK{1-10}:DISC

Syntax

```
:CALCulate{[1][2][3][4][5][6][7][8][9][10][11][12][13][14][15][16]}[:SELEcted]:MARKer{[1][2][3][4][5][6][7][8][9][10]}:DISCrete {ON|OFF|1|0}  
:CALCulate{[1][2][3][4][5][6][7][8][9][10][11][12][13][14][15][16]}[:SELEcted]:MARKer{[1][2][3][4][5][6][7][8][9][10]}:DISCrete?
```

Description

For the active trace of channel 1 (:CALC1) to channel 16 (:CALC16) (specified with the :CALC{1-16}:PAR{1-16}:SEL command), turns ON/OFF the discrete mode (mode in which the marker moves only at the measurement points) with marker 1 (:MARK1) to marker 9 (:MARK9) and reference marker (:MARK10).

Parameters

	Description
ON or 1	Turn OFF the discrete mode.
OFF or 0 (preset value)	Turns OFF the discrete mode.

Query response

```
{1|0}<newline><^END>
```

Example of use

```
10 OUTPUT 717; ":CALC1:MARK1:DISC OFF "  
20 OUTPUT 717; ":CALC1:MARK1:DISC?"  
30 ENTER 717;A
```

Equivalent key

[Marker Fctn] - Discrete

:CALC{1-16}:MARK{1-10}:FUNC:EXEC

Syntax	:CALCulate{[1] 2 3 4 5 6 7 8 9 10 11 12 13 14 15 16}[:SELected]:MARKer{[1] 2 3 4 5 6 7 8 9 10}:FUNCtion:EXECute
Description	<p>For the active trace of channel 1 (:CALC1) to channel 16 (:CALC16) (specified with the :CALC{1-16}:PAR{1-16}:SEL command), executes the search with marker 1 (:MARK1) to marker 9 (:MARK9) and reference marker (:MARK10).</p> <p>To specify the type of the search, use the :CALC{1-16}:MARK{1-10}:FUNC:TYPE command. (No query)</p>
Example of use	10 OUTPUT 717; ":CALC1:MARK1:FUNC:EXEC"
Related commands	<p>:CALC{1-16}:MARK{1-10}:FUNC:TYPE on page 409</p> <p>:CALC{1-16}:PAR{1-16}:SEL on page 424</p> <p>:CALC{1-16}:MARK:FUNC:DOM on page 392</p>
Equivalent key	<p>[Marker Search] - Max Min</p> <p>[Marker Search] - Peak - Search Peak Search Left Search Right</p> <p>[Marker Search] - Target - Search Target Search Left Search Right</p>
NOTE	When performing the operation from the front panel, you select the search type and execute the search at the same time.

:CALC{1-16}:MARK{1-10}:FUNC:PEXC

Syntax :CALCulate{[1]|2|3|4|5|6|7|8|9|10|11|12|13|14|15|16}[:SElected]:MARKer{[1]|2|3|4|5|6|7|8|9|10}:FUNctio:n:PEXCursion <numeric>
:CALCulate{[1]|2|3|4|5|6|7|8|9|10|11|12|13|14|15|16}[:SElected]:MARKer{[1]|2|3|4|5|6|7|8|9|10}:FUNctio:n:PEXCursion?

Description For the active trace of channel 1 (:CALC1) to channel 16 (:CALC16) (specified with the :CALC{1-16}:PAR{1-16}:SEL command), sets the lower limit for the peak excursion value of marker 1 (:MARK1) to marker 9 (:MARK9) and reference marker (:MARK10).

Parameters

	<numeric>
Description	Lower limit for the peak excursion value
Range	0 to 5E8
Preset value	3
Unit	Varies depending on the data format as follows: Logarithmic Magnitude: dB (decibel) Phase, Expand Phase, Positive Phase: ° (degree) Group Delay: s (second) Others: No unit

If the specified parameter is out of the allowable setup range, the minimum value (if the lower limit of the range is not reached) or the maximum value (if the upper limit of the range is exceeded) is set.

Query response {numeric}<newline><^END>

Example of use
10 OUTPUT 717; ":CALC1:MARK1:FUNC:PEXC 0.2"
20 OUTPUT 717; ":CALC1:MARK1:FUNC:PEXC?"
30 ENTER 717;A

Related commands
:CALC{1-16}:MARK{1-10}:FUNC:PPOL on page 405
:CALC{1-16}:MARK{1-10}:FUNC:TYPE on page 409
:CALC{1-16}:PAR{1-16}:SEL on page 424

Equivalent key [Marker Search] - Peak - Peak Excursion

:CALC{1-16}:MARK{1-10}:FUNC:PPOL

Syntax :CALCulate{[1]|2|3|4|5|6|7|8|9|10|11|12|13|14|15|16}[:SElected]:MARKer{[1]|2|3|4|5|6|7|8|9|10}:FUNCtion:PPOLarity {POSitive|NEGative|BOTH}
:CALCulate{[1]|2|3|4|5|6|7|8|9|10|11|12|13|14|15|16}[:SElected]:MARKer{[1]|2|3|4|5|6|7|8|9|10}:FUNCtion:PPOLarity?

Description For the active trace of channel 1 (:CALC1) to channel 16 (:CALC16) (specified with the :CALC{1-16}:PAR{1-16}:SEL command), selects the polarity of the peak to be searched with marker 1 (:MARK1) to marker 9 (:MARK9) and reference marker (:MARK10).

Parameters

	Description
POSitive (preset value)	Specifies the positive peak.
NEGative	Specifies the negative peak.
BOTH	Specifies both the positive peak and the negative peak.

Query response {POS|NEG|BOTH}<newline><^END>

Example of use
10 OUTPUT 717; ":CALC1:MARK1:FUNC:PPOL NEG"
20 OUTPUT 717; ":CALC1:MARK1:FUNC:PPOL?"
30 ENTER 717;A\$

Related commands
:CALC{1-16}:MARK{1-10}:FUNC:PEXC on page 404
:CALC{1-16}:MARK{1-10}:FUNC:TYPE on page 409
:CALC{1-16}:PAR{1-16}:SEL on page 424

Equivalent key [Marker Search] - Peak - Peak Polarity

:CALC{1-16}:MARK{1-10}:FUNC:TARG

Syntax :CALCulate{[1][2][3][4][5][6][7][8][9][10][11][12][13][14][15][16]}[:SElected]:MARKer{[1][2][3][4][5][6][7][8][9][10]}:FUNCtion:TARGet <numeric>
:CALCulate{[1][2][3][4][5][6][7][8][9][10][11][12][13][14][15][16]}[:SElected]:MARKer{[1][2][3][4][5][6][7][8][9][10]}:FUNCtion:TARGet?

Description For the active trace of channel 1 (:CALC1) to channel 16 (:CALC16) (specified with the :CALC{1-16}:PAR{1-16}:SEL command), sets the target value to be searched with marker 1 (:MARK1) to marker 9 (:MARK9) and reference marker (:MARK10).

Parameters

	<numeric>
Description	Target value for target search
Range	-5E8 to 5E8
Preset value	0
Unit	Varies depending on the data format as follows: Logarithmic Magnitude: dB (decibel) Phase, Expand Phase, Positive Phase: ° (degree) Group Delay: s (second) Others: No unit

If the specified parameter is out of the allowable setup range, the minimum value (if the lower limit of the range is not reached) or the maximum value (if the upper limit of the range is exceeded) is set.

Query response {numeric}<newline><^END>

Example of use
10 OUTPUT 717; ":CALC1:MARK1:FUNC:TARG -12.5"
20 OUTPUT 717; ":CALC1:MARK1:FUNC:TARG?"
30 ENTER 717;A

Related commands
:CALC{1-16}:MARK{1-10}:FUNC:TTR on page 408
:CALC{1-16}:MARK{1-10}:FUNC:TYPE on page 409
:CALC{1-16}:PAR{1-16}:SEL on page 424

Equivalent key [Marker Search] - Target - Target Value

:CALC{1-16}:MARK{1-10}:FUNC:TRAC

Syntax :CALCulate{[1]|2|3|4|5|6|7|8|9|10|11|12|13|14|15|16}[:SElected]:MARKer{[1]|2|3|4|5|6|7|8|9|10}:FUNCtion:TRACking {ON|OFF|1|0}
:CALCulate{[1]|2|3|4|5|6|7|8|9|10|11|12|13|14|15|16}[:SElected]:MARKer{[1]|2|3|4|5|6|7|8|9|10}:FUNCtion:TRACking?

Description For the active trace of channel 1 (:CALC1) to channel 16 (:CALC16) (specified with the :CALC{1-16}:PAR{1-16}:SEL command), turns ON/OFF the search tracking (function to repeat the search for each sweep) of marker 1 (:MARK1) to marker 9 (:MARK9) and reference marker (:MARK10).

Parameters

	Description
ON or 1	Turns ON the search tracking.
OFF or 0 (preset value)	Turns OFF the search tracking.

Query response {1|0}<newline><<^END>

Example of use
10 OUTPUT 717; ":CALC1:MARK1:FUNC:TRAC ON"
20 OUTPUT 717; ":CALC1:MARK1:FUNC:TRAC?"
30 ENTER 717;A

Related commands
:CALC{1-16}:MARK{1-10}:FUNC:EXEC on page 403
:CALC{1-16}:MARK{1-10}:FUNC:TYPE on page 409
:CALC{1-16}:PAR{1-16}:SEL on page 424

Equivalent key [Marker Search] - Tracking

:CALC{1-16}:MARK{1-10}:FUNC:TTR

Syntax :CALCulate{[1][2][3][4][5][6][7][8][9][10][11][12][13][14][15][16]}[:SElected]:MARKer{[1][2][3][4][5][6][7][8][9][10]}:FUNction:
TTRansition {POSitive|NEGative|BOTH}
:CALCulate{[1][2][3][4][5][6][7][8][9][10][11][12][13][14][15][16]}[:SElected]:MARKer{[1][2][3][4][5][6][7][8][9][10]}:FUNction:
TTRansition?

Description For the active trace of channel 1 (:CALC1) to channel 16 (:CALC16) (specified with the :CALC{1-16}:PAR{1-16}:SEL command), selects the transition type when performing the target search with marker 1 (:MARK1) to marker 9 (:MARK9) and reference marker (:MARK10).

Parameters

	Description
POSitive	Specifies positive.
NEGative	Specifies negative.
BOTH (preset value)	Specifies both positive and negative.

Query response {POS|NEG|BOTH}<newline><^END>

Example of use
10 OUTPUT 717; ":CALC1:MARK1:FUNC:TTR NEG"
20 OUTPUT 717; ":CALC1:MARK1:FUNC:TTR?"
30 ENTER 717;A\$

Related commands
:CALC{1-16}:MARK{1-10}:FUNC:TARG on page 406
:CALC{1-16}:MARK{1-10}:FUNC:TYPE on page 409
:CALC{1-16}:PAR{1-16}:SEL on page 424

Equivalent key [Marker Search] - Target - Target Transition

:CALC{1-16}:MARK{1-10}:FUNC:TYPE

Syntax
:CALCulate{[1]|2|3|4|5|6|7|8|9|10|11|12|13|14|15|16}[:SElected]:MARKer{[1]|2|3|4|5|6|7|8|9|10}:FUNCtion
:TYPE {MAXimum|MINimum|PEAK|LPEak|RPEak|TARGet|LTARget|RTARget}
:CALCulate{[1]|2|3|4|5|6|7|8|9|10|11|12|13|14|15|16}[:SElected]:MARKer{[1]|2|3|4|5|6|7|8|9|10}:FUNCtion
:TYPE?

Description
For the active trace of channel 1 (:CALC1) to channel 16 (:CALC16) (specified with the :CALC{1-16}:PAR{1-16}:SEL command), selects the search type of marker 1 (:MARK1) to marker 9 (:MARK9) and reference marker (:MARK10).

Parameters

	Description
MAXimum (preset value)	Specifies the maximum value search.
MINimum	Specifies the minimum value search.
PEAK	Specifies the maximum positive (minimum negative) peak ^{*1} search.
LPEak	Specifies the peak ^{*1} search to the left from the marker position.
RPEak	Specifies the peak ^{*1} search to the right from the marker position.
TARGet	Specifies the search for the target ^{*2} closest to the current marker position.
LTARget	Specifies the target ^{*2} search to the left from the marker position.
RTARget	Specifies the target ^{*2} search to the right from the marker position.

- *1. To specify the conditions of the peak, use the :CALC{1-16}:MARK{1-10}:FUNC:PEXC command and the :CALC{1-16}:MARK{1-10}:FUNC:PPOL command.
- *2. To specify the conditions of the target, use the :CALC{1-16}:MARK{1-10}:FUNC:TARG command and the :CALC{1-16}:MARK{1-10}:FUNC:TTR command.

Query response {MAX|MIN|PEAK|LPE|RPE|TARG|LTAR|RTAR}<newline><^END>

Example of use
10 OUTPUT 717; ":CALC1:MARK1:FUNC:TYPE PEAK"
20 OUTPUT 717; ":CALC1:MARK1:FUNC:TYPE?"
30 ENTER 717;A\$

Related commands
:CALC{1-16}:MARK{1-10}:FUNC:EXEC on page 403
:CALC{1-16}:MARK{1-10}:FUNC:PEXC on page 404
:CALC{1-16}:MARK{1-10}:FUNC:PPOL on page 405
:CALC{1-16}:MARK{1-10}:FUNC:TARG on page 406
:CALC{1-16}:MARK{1-10}:FUNC:TTR on page 408
:CALC{1-16}:PAR{1-16}:SEL on page 424

Equivalent key
[Marker Search] - Max|Min
[Marker Search] - Peak - Search Peak|Search Left|Search Right
[Marker Search] - Target - Search Target|Search Left|Search Right

NOTE
When performing the operation from the front panel, you select the search type and execute the search at the same time.

:CALC{1-16}:MARK{1-10}:NOTC:DATA?

Syntax

:CALCulate{[1]|2|3|4|5|6|7|8|9|10|11|12|13|14|15|16}[:SElected]:MARKer{[1]|2|3|4|5|6|7|8|9|10}:NOTCh:DATA?

Description

For the active trace of channel 1 (:CALC1) to channel 16 (:CALC16) (specified with the :CALC{1-16}:PAR{1-16}:SEL command), reads out the notch search result of marker 1 (:MARK1) to marker 9 (:MARK9) and reference marker (:MARK10).

If the notch search is impossible, an error occurs and the command is ignored.

In this case, no query response is obtained. (Query only)

Query response

{value 1},{value 2},{value 3},{value 4}<newline><<^END>

	Description
{value 1}	Bandwidth.
{value 2}	Center frequency.
{value 3}	Q value.
{value 4}	Loss.

Example of use

```
10 OUTPUT 717; ":CALC1:MARK1:NOTC:DATA?"  
20 ENTER 717;A,B,C,D
```

Related commands

:CALC{1-16}:PAR{1-16}:SEL on page 424

:CALC{1-16}:MARK:NOTC on page 396

:CALC{1-16}:MARK{1-10}:NOTC:THR on page 411

Equivalent key

No equivalent key is available on the front panel.

:CALC{1-16}:MARK{1-10}:NOTC:THR

Syntax

```
:CALCulate{[1]|2|3|4|5|6|7|8|9|10|11|12|13|14|15|16}[:SElected]:MARKer{[1]|2|3|4|5|6|7|8|9|10}:NOTCh:THReshold <value>
:CALCulate{[1]|2|3|4|5|6|7|8|9|10|11|12|13|14|15|16}[:SElected]:MARKer{[1]|2|3|4|5|6|7|8|9|10}:NOTCh:THReshold?
```

Description

For the active trace of channel 1 (:CALC1) to channel 16 (:CALC16) (specified with the :CALC{1-16}:PAR{1-16}:SEL command), sets the notch definition value of marker 1 (:MARK1) to marker 9 (:MARK9) and reference marker (:MARK10).

Parameters

	<value>
Description	Notch definition value
Range	-5E8 to 5E8
Preset value	-3
Unit	Varies depending on the data format as follows: Amplitude (MLOG): dB (decibel) Phase (PHAS), expanded phase (UPH), positive phase (PPH): ° (degree) Group delay (GDEL): s (second) Others: No unit

If the specified parameter is out of the allowable setup range, the minimum value (if the lower limit of the range is not reached) or the maximum value (if the upper limit of the range is exceeded) is set.

Query response

```
{value}<newline><^END>
```

Example of use

```
10 OUTPUT 717; ":CALC1:MARK1:NOTC:THR 5"
20 OUTPUT 717; ":CALC1:MARK1:NOTC:THR?"
30 ENTER 717;A
```

Related commands

```
:CALC{1-16}:PAR{1-16}:SEL on page 424
:CALC{1-16}:MARK:NOTC on page 396
:CALC{1-16}:MARK{1-10}:NOTC:DATA? on page 410
```

Equivalent key

[Marker Search] - Notch Value

:CALC{1-16}:MARK{1-10}:SET

Syntax

:CALCulate{[1]|2|3|4|5|6|7|8|9|10|11|12|13|14|15|16}[:SELEcted]:MARKer{[1]|2|3|4|5|6|7|8|9|10}:SET {START|STOP|CENTer|RLEVel|DELay}

Description

For the active trace of channel 1 (:CALC1) to channel 16 (:CALC16) (specified with the :CALC{1-16}:PAR{1-16}:SEL command), sets the value of the specified item to the value of the position of marker 1 (:MARK1) to marker 9 (:MARK9) and reference marker (:MARK10).

Regardless of the ON/OFF of the reference marker mode (specified with the :CALC{1-16}:MARK:REF command), the value when the reference marker mode is OFF is always set. (No query)

Parameters

	Description
START	Sets the sweep start value to the stimulus value at the marker position.
STOP	Sets the sweep stop value to the stimulus value at the marker position.
CENTER	Sets the sweep center value to the stimulus value at the marker position.
RLEVEL	Sets the reference line value to the response value at the marker position.
DELAY	Sets the electrical delay time value to the group delay value at the marker position.

Example of use

```
10 OUTPUT 717; ":CALC1:MARK1:SET CENT"
```

Related commands

:CALC{1-16}:PAR{1-16}:SEL on page 424

:CALC{1-16}:MARK:REF on page 397

Equivalent key

[Marker Fctn] - Marker -> Start|Marker -> Stop|Marker -> Center|Marker -> Reference|Marker -> Delay

:CALC{1-16}:MARK{1-10}:X

Syntax

```
:CALCulate{[1]|2|3|4|5|6|7|8|9|10|11|12|13|14|15|16}[:SElected]:MARKer{[1]|2|3|4|5|6|7|8|9|10}:X <numeric>
:CALCulate{[1]|2|3|4|5|6|7|8|9|10|11|12|13|14|15|16}[:SElected]:MARKer{[1]|2|3|4|5|6|7|8|9|10}:X?
```

Description

For the active trace of channel 1 (:CALC1) to channel 16 (:CALC16) (specified with the :CALC{1-16}:PAR{1-16}:SEL command), sets the stimulus value of marker 1 (:MARK1) to marker 9 (:MARK9) and reference marker (:MARK10).

Parameters

	<numeric>
Description	Stimulus value *1
Range	Sweep start value to sweep stop value *2
Preset value	Sweep start value *3
Unit	Hz (hertz), dBm or second

- *1. When the reference marker mode is ON (ON is specified with the :CALC{1-16}:MARK:REF command), it is the value relative to the reference marker.
- *2. When the span value of the sweep range is 0, the range is from 0 to sweep time value.
- *3. When the span value of the sweep range is 0, the unit is 0.

If the specified parameter is out of the allowable setup range, the minimum value (if the lower limit of the range is not reached) or the maximum value (if the upper limit of the range is exceeded) is set.

Query response

```
{numeric}<newline><^END>
```

Example of use

```
10 OUTPUT 717; ":CALC1:MARK1:X 1E9"
20 OUTPUT 717; ":CALC1:MARK1:X?"
30 ENTER 717;A
```

Related commands

```
:CALC{1-16}:MARK{1-10}:Y? on page 414
:CALC{1-16}:PAR{1-16}:SEL on page 424
:CALC{1-16}:MARK:REF on page 397
```

Equivalent key

```
[Marker] - Marker 1|Marker 2|Marker 3|Marker 4|Ref Marker
[Marker] - More Markers - Marker 5|Marker 6|Marker 7|Marker 8|Marker 9
```

NOTE

When performing the operation from the front panel, you turn ON the marker and set the stimulus value at the same time.

:CALC{1-16}:MARK{1-10}:Y?

Syntax :CALCulate{[1]|2|3|4|5|6|7|8|9|10|11|12|13|14|15|16}{[:SElected]:MARKer{[1]|2|3|4|5|6|7|8|9|10}:Y?

Description For the active trace of channel 1 (:CALC1) to channel 16 (:CALC16) (specified with the :CALC{1-16}:PAR{1-16}:SEL command), reads out the response value of marker 1 (:MARK1) to marker 9 (:MARK9) and reference marker (:MARK10).

When the reference marker mode is ON (ON is specified with the :CALC{1-16}:MARK:REF command), the readout value is the value relative to the reference marker. (Query only)

Query response {numeric 1},{numeric 2}<newline><^END>

	Description
{numeric 1}	Response value (primary value) at the marker position.
{numeric 2}	Response value (secondary value) at the marker position. Always 0 when the data format is not the Smith chart format or the polar format.

Example of use
10 OUTPUT 717;":CALC1:MARK1:Y?"
30 ENTER 717;A,B

Related commands
:CALC{1-16}:MARK{1-10}:X on page 413
:CALC{1-16}:PAR{1-16}:SEL on page 424
:CALC{1-16}:MARK:REF on page 397

Equivalent key No equivalent key is available on the front panel.

:CALC{1-16}:MATH:FUNC

Syntax :CALCulate{[1]|2|3|4|5|6|7|8|9|10|11|12|13|14|15|16}[:SELEcted]:MATH:FUNCtion {NORMal|SUBTract|DIVide|ADD|MULTiply}

:CALCulate{[1]|2|3|4|5|6|7|8|9|10|11|12|13|14|15|16}[:SELEcted]:MATH:FUNCtion?

Description For the active trace of channel 1 (:CALC1) to channel 16 (:CALC16) (specified with the :CALC{1-16}:PAR{1-16}:SEL command), selects the data trace display method (math method between measurement data and memory trace data).

The math result according to this setting is displayed on the data trace.

Parameters

	Description
NORMal (preset value)	Specifies <i>Data</i> (no math).
DIVide	Specifies <i>Data / Mem</i> .
MULTiply	Specifies <i>Data × Mem</i> .
SUBTract	Specifies <i>Data - Mem</i> .
ADD	Specifies <i>Data + Mem</i> .

Where *Data* is the measurement data and *Mem* is the data stored in the memory trace.

Query response {NORM|DIV|MULT|SUBT|ADD}<newline><^END>

Example of use

```
10 OUTPUT 717; ":CALC1:MATH:FUNC DIV"
20 OUTPUT 717; ":CALC1:MATH:FUNC?"
30 ENTER 717;A$
```

Related commands :CALC{1-16}:PAR{1-16}:SEL on page 424

Equivalent key [Display] - Data Math - OFF|Data / Mem|Data * Mem|Data – Mem|Data + Mem

:CALC{1-16}:MATH:MEM

Syntax	:CALCulate{[1] 2 3 4 5 6 7 8 9 10 11 12 13 14 15 16}[[:SElected]:MATH:MEMorize
Description	For the active trace of channel 1 (:CALC1) to channel 16 (:CALC16) (specified with the :CALC{1-16}:PAR{1-16}:SEL command), copies the measurement data at the execution of the command to the memory trace. (No query)
Example of use	10 OUTPUT 717; ":CALC1:MATH:MEM"
Related commands	:CALC{1-16}:PAR{1-16}:SEL on page 424
Equivalent key	[Display] - Data → Mem

:CALC{1-16}:MIX:XAX

Syntax :CALCulate{[1]|2|3|4|5|6|7|8|9|10|11|12|13|14|15|16}[:SELEcted]:MIXer:XAXis {NORMal|RFPLo|RFMLo|LOMRf}

:CALCulate{[1]|2|3|4|5|6|7|8|9|10|11|12|13|14|15|16}[:SELEcted]:MIXer:XAXis?

Description Sets the X-axis frequency for the active trace of channel 1 (:CALC1) to channel 16 (:CALC16).

When using this command, set the frequency offset mode to off (refer to :SENS{1-16}:OFFS command on page 668).

Parameters

	Description
NORMal (Preset value)	Sets the normal frequency.
RFPLo	Sets RF + LO. *1
RFMLo	Sets RF - LO. *1
LOMRf	Sets LO - RF. *1

*1. RF is the normal frequency and LO is the frequency of the external signal source.

Query response {NORM|RFPL|RFML|LOMR}<newline><^END>

Example of use

```
10 OUTPUT 717; ":CALC1:MIX:XAX RFPL"
20 OUTPUT 717; ":CALC1:MIX:XAX?"
30 ENTER 717;A$
```

Related commands :SENS{1-16}:OFFS on page 668
:CALC{1-16}:OFFS:XAX on page 420

Equivalent key [Sweep Setup] - Frequency Offset - X-Axis - Normal|RF+LO|RF-LO|LO-RF

:CALC{1-16}:MST

Syntax :CALCulate{[1]|2|3|4|5|6|7|8|9|10|11|12|13|14|15|16}[:SElected]:MSTatistics[:STATe] {ON|OFF|1|0}
:CALCulate{[1]|2|3|4|5|6|7|8|9|10|11|12|13|14|15|16}[:SElected]:MSTatistics[:STATe]?

Description For the active trace of channel 1 (:CALC1) to channel 16 (:CALC16) (specified with the :CALC{1-16}:PAR{1-16}:SEL command), turns ON/OFF the statistics value display (the mean value, the standard deviation, and the difference between the maximum value and the minimum value).

Parameters

	Description
ON or 1	Turns ON the statistics value display.
OFF or 0 (preset value)	Turns OFF the statistics value display.

Query response {1|0}<newline><^END>

Example of use
10 OUTPUT 717; ":CALC1:MST ON"
20 OUTPUT 717; ":CALC1:MST?"
30 ENTER 717;A

Related commands :CALC{1-16}:MST:DATA? on page 419
:CALC{1-16}:PAR{1-16}:SEL on page 424

Equivalent key [Marker Fctn] - Statistics

:CALC{1-16}:MST:DATA?

Syntax :CALCulate{[1]|2|3|4|5|6|7|8|9|10|11|12|13|14|15|16}{[:SElected]:MStatistics:DATA?

Description For the active trace of channel 1 (:CALC1) to channel 16 (:CALC16) (specified with the :CALC{1-16}:PAR{1-16}:SEL command), reads out the statistics values (the mean value, the standard deviation, and the difference between the maximum value and the minimum value) display. (Query only)

Query response {numeric 1},{numeric 2},{numeric 3}<newline><^END>

	Description
{numeric 1}	Mean value
{numeric 2}	Standard deviation
{numeric 3}	Difference between the maximum value and the minimum value (Peak to Peak)

Example of use
10 OUTPUT 717; ":CALC1:MST:DATA?"
20 ENTER 717;A,B,C

Related commands
:CALC{1-16}:MST on page 418
:CALC{1-16}:PAR{1-16}:SEL on page 424

Equivalent key No equivalent key is available on the front panel.

:CALC{1-16}:OFFS:XAX

Syntax :CALCulate{[1]|2|3|4|5|6|7|8|9|10|11|12|13|14|15|16}[:SElected]:OFFSet:XAXis {BASE|STIMulus|RESPonse}
:CALCulate{[1]|2|3|4|5|6|7|8|9|10|11|12|13|14|15|16}[:SElected]:OFFSet:XAXis?

Description Sets the X-axis frequency for the active trace of channel 1 (:CALC1) to channel 16 (:CALC16).

When using this command, set the frequency offset mode to on (refer to :SENS{1-16}:OFFS command on page 668).

Parameters

	Description
BASE	Sets the normal frequency.
STIMulus	Sets the frequency for the source port for the specified measurement parameter.
RESPonse (Preset value)	Sets the frequency for the receiver port for the specified measurement parameter.

Query response {BASE|STIMulus|RESPonse}<newline><^END>

Example of use
10 OUTPUT 717; ":CALC1:OFFS:XAX RESP"
20 OUTPUT 717; ":CALC1:OFFS:XAX?"
30 ENTER 717;A\$

Related commands :SENS{1-16}:OFFS on page 668
:CALC{1-16}:MIX:XAX on page 417

Equivalent key [Sweep Setup] - Frequency Offset - X-Axis - BASE|STIMulus|RESPonse

:CALC{1-16}:PAR:COUN

Syntax :CALCulate{[1]|2|3|4|5|6|7|8|9|10|11|12|13|14|15|16}:PARAmeter:COUNt <numeric>
:CALCulate{[1]|2|3|4|5|6|7|8|9|10|11|12|13|14|15|16}:PARAmeter:COUNt?

Description Sets the number of traces of channel 1 (:CALC1) to channel 16 (:CALC16).

Parameters

	<numeric>
Description	Number of traces
Range	Varies depending on the upper limit setting for channel/trace number.
Preset value	1
Resolution	1

If the specified parameter is out of the allowable setup range, the minimum value (if the lower limit of the range is not reached) or the maximum value (if the upper limit of the range is exceeded) is set.

Query response {numeric}<newline><^END>

Example of use
10 OUTPUT 717;":CALC1:PAR:COUN 4"
20 OUTPUT 717;":CALC1:PAR:COUN?"
30 ENTER 717;A

Equivalent key [Display] - Num of Traces

:CALC{1-16}:PAR{1-16}:DEF

Syntax

```
:CALCulate{[1]|2|3|4|5|6|7|8|9|10|11|12|13|14|15|16}:PARmeter{[1]|2|3|4|5|6|7|8|9|10|11|12|13|14|15|16}:DEFine  

{S11|S21|S31|S41|S12|S22|S32|S42|S13|S23|S33|S43|S14|S24|S34|S44|A|B|C|D|R1|R2|R3|R4}  

:CALCulate{[1]|2|3|4|5|6|7|8|9|10|11|12|13|14|15|16}:PARmeter{[1]|2|3|4|5|6|7|8|9|10|11|12|13|14|15|16}:DEFine?
```

Description

Sets the measurement parameter of trace 1 (:PAR1) to trace 16 (:PAR16) of channel 1 (:CALC1) to channel 16 (:CALC16).

Parameters

	Description
S11 (preset value)	Specifies S11.
S21	Specifies S21.
S31	Specifies S31.
S41	Specifies S41.
S12	Specifies S12.
S22	Specifies S22.
S32	Specifies S32.
S42	Specifies S42.
S13	Specifies S13.
S23	Specifies S23.
S33	Specifies S33.
S43	Specifies S43.
S14	Specifies S14.
S24	Specifies S24.
S34	Specifies S34.
S44	Specifies S44.
A	Specifies A. (when the absolute measurement is executed.)
B	Specifies B. (when the absolute measurement is executed.)
C	Specifies C. (when the absolute measurement is executed.)
D	Specifies D. (when the absolute measurement is executed.)
R1	Specifies R1. (when the absolute measurement is executed.)
R2	Specifies R2. (when the absolute measurement is executed.)

	Description
R3	Specifies R3. (when the absolute measurement is executed.)
R4	Specifies R4. (when the absolute measurement is executed.)

When the absolute measurement parameter above is selected, selects the source port specified with the :CALC{1-16}:PAR{1-16}:SPOR on page 425 command.

Query response {S11|S21|S31|S41|S12|S22|S32|S42|S13|S23|S33|S43|S14|S24|S34|S44|A|B|C|D|R1|R2|R3|R4}<newline><^END>

Example of use

```
10 OUTPUT 717;":CALC1:PAR1:DEF S21"
20 OUTPUT 717;":CALC1:PAR1:DEF?"
30 ENTER 717;A$
```

Related commands :CALC{1-16}:PAR{1-16}:SPOR on page 425

Equivalent key [Meas] - S11|S21|S31|S41|S12|S22|S32|S42|S13|S23|S33|S43|S14|S24|S34|S44
[Meas] - Absolute - A(1)|A(2)|A(3)|A(4)|---|R4(1)|R4(2)|R4(3)|R4(4)

:CALC{1-16}:PAR{1-16}:SEL

Syntax	:CALCulate{[1][2][3][4][5][6][7][8][9][10][11][12][13][14][15][16]}:PARameter{[1][2][3][4][5][6][7][8][9][10][11][12][13][14][15][16]}:SELect
Description	<p>Sets trace 1 (:PAR1) to trace 16 (:PAR16) of channel 1 (:CALC1) to channel 16 (:CALC16) to the active trace.</p> <p>You can set only the displayed trace to the active trace. If you execute this command trying to set a not displayed trace to the active trace, an error occurs and the command is ignored. (No query)</p>
Example of use	10 OUTPUT 717; ":CALC1:PAR1:SEL"
Related commands	:DISP:WIND{1-16}:ACT on page 470
Equivalent key	[Trace Prev] / [Trace Next]

:CALC{1-16}:PAR{1-16}:SPOR

Syntax :CALCulate{[1]|2|3|4|5|6|7|8|9|10|11|12|13|14|15|16}:PARAmeter{[1]|2|3|4|5|6|7|8|9|10|11|12|13|14|15|16}:SPORt <numeric>
:CALCulate{[1]|2|3|4|5|6|7|8|9|10|11|12|13|14|15|16}:PARAmeter{[1]|2|3|4|5|6|7|8|9|10|11|12|13|14|15|16}:SPORt?

Description Sets the output port for absolute measurement.

Parameters

	<value>
Description	Output port number
Range	Depends on the number of ports.
Preset value	1
Resolution	1

When setting the output port with this command, specify the measurement parameter for absolute measurement with the :CALC{1-16}:PAR{1-16}:DEF on page 422 command.

Query response {value}<newline><^END>

Example of use

```
10 OUTPUT 717;":CALC1:PAR1:DEF B"
20 OUTPUT 717;":CALC1:PAR1:SPOR 4"
30 OUTPUT 717;":CALC1:PAR1:SPOR?"
30 ENTER 717;A
```

Related commands :CALC{1-16}:PAR{1-16}:DEF on page 422

Equivalent key [Meas] - Absolute - A(1)~A(4) ... D(1)~D(4) ... R1(1)~R1(4) ... R4(1)~R4(4)

:CALC{1-16}:RLIM

Syntax :CALCulate{[1][2][3][4][5][6][7][8][9][10][11][12][13][14][15][16]}[:SElected]:RLIMit[:STATe] {ON|OFF|1|0}
 :CALCulate{[1][2][3][4][5][6][7][8][9][10][11][12][13][14][15][16]}[:SElected]:RLIMit[:STATe]?

Description For the active trace of channel 1 (:CALC1) to channel 16 (:CALC16) (specified with the :CALC{1-16}:PAR{1-16}:SEL command), turns ON/OFF the ripple test function.

Parameters

	Description
ON or 1	Turns ON the ripple test function.
OFF or 0 (preset value)	Turns OFF the ripple test function.

Query response {1|0}<newline><^END>

Example of use
 10 OUTPUT 717; ":CALC1:RLIM ON"
 20 OUTPUT 717; ":CALC1:RLIM?"
 30 ENTER 717;A

Related commands
 :CALC{1-16}:PAR{1-16}:SEL on page 424
 :CALC{1-16}:RLIM:DATA on page 427
 :CALC{1-16}:RLIM:DISP:LINE on page 428
 :CALC{1-16}:RLIM:DISP:SEL on page 429
 :CALC{1-16}:RLIM:DISP:VAL on page 430
 :CALC{1-16}:RLIM:FAIL? on page 431
 :CALC{1-16}:RLIM:REP? on page 432

Equivalent key [Analysis] - Ripple Limit - Ripple Limit Test

:CALC{1-16}:RLIM:DATA

Syntax

```
:CALCulate{[1]|2|3|4|5|6|7|8|9|10|11|12|13|14|15|16}[:SELected]:RLIMit:DATA <numeric 1>,...,<numeric 1+(N×4)>
:CALCulate{[1]|2|3|4|5|6|7|8|9|10|11|12|13|14|15|16}[:SELected]:RLIMit:DATA?
```

Description

For the active trace of channel 1 (:CALC1) to channel 16 (:CALC16) (specified with the :CALC{1-16}:PAR{1-16}:SEL command), sets the ripple limit table.

The data transfer format when this command is executed depends on the setting with the :FORM:DATA command.

Parameters

	Description
<numeric 1>	The number of ripple limit bands. (0 to 12)
<numeric 1+(n×4)-3>	The type of the n-th ripple limit band. Specify an integer 0 to 1: 0: Off 1: On
<numeric 1+(n×4)-2>	The value on the horizontal axis (frequency/power/time) of the start point of the n-th line.
<numeric 1+(n×4)-1>	The value on the horizontal axis (frequency/power/time) of the end point of the n-th line.
<numeric 1+(n×4)>	The value of maximum ripple (dB) range.

Where N is the number of lines (specified with <numeric 1>) and n is an integer between 1 and N.

If you set the number of lines to 0 (clear the limit table), this command needs only <numeric 1> as the parameter.

Query response

```
{numeric 1},...,{numeric 1+(N×4)}<newline><^END>
```

Example of use

```
10 DIM B(1:2,1:4)
20 OUTPUT 717;":CALC1:RLIM:DATA 2,1,1E9,3E9,3,1,5E9,7E9,3"
30 OUTPUT 717;":CALC1:RLIM:DATA?"
40 ENTER 717;A,B(*)

10 OUTPUT 717;":CALC1:RLIM:DATA 0" ! Clear Ripple Limit Table
```

Related commands

:CALC{1-16}:PAR{1-16}:SEL on page 424
:CALC{1-16}:RLIM on page 426

Equivalent key

[Analysis] - Ripple Limit - Edit Ripple Limit - Add

:CALC{1-16}:RLIM:DISP:LINE

Syntax :CALCulate{[1]|2|3|4|5|6|7|8|9|10|11|12|13|14|15|16}[:SElected]:RLIMit:DISPlay:LINE {ON|OFF|1|0}
:CALCulate{[1]|2|3|4|5|6|7|8|9|10|11|12|13|14|15|16}[:SElected]:RLIMit:DISPlay:LINE?

Description For the active trace of channel 1 (:CALC1) to channel 16 (:CALC16) (specified with the :CALC{1-16}:PAR{1-16}:SEL command), turns ON/OFF the ripple limit line display.

Parameters

	Description
ON or 1	Turns ON the ripple limit line display.
OFF or 0 (preset value)	Turns OFF the ripple limit line display.

Query response {1|0}<newline><^END>

Example of use
10 OUTPUT 717; ":CALC1:RLIM:DISP:LINE ON"
20 OUTPUT 717; ":CALC1:RLIM:DISP:LINE?"
30 ENTER 717;A

Related commands
:CALC{1-16}:PAR{1-16}:SEL on page 424
:CALC{1-16}:RLIM on page 426
:CALC{1-16}:RLIM:DISP:SEL on page 429
:CALC{1-16}:RLIM:DISP:VAL on page 430

Equivalent key [Analysis] - Ripple Limit - Ripple Limit

:CALC{1-16}:RLIM:DISP:SEL

Syntax :CALCulate{[1]|2|3|4|5|6|7|8|9|10|11|12|13|14|15|16}{[:SELEcted]:RLIMit:DISPlay:SELEct <numeric>
:CALCulate{[1]|2|3|4|5|6|7|8|9|10|11|12|13|14|15|16}{[:SELEcted]:RLIMit:DISPlay:SELEct?

Description For channel 1 (:CALC1) to channel 16 (:CALC16) (specified with the :CALC{1-16}:PAR{1-16}:SEL command), sets the ripple limit band for ripple value display.

Parameters

	<numeric>
Description	The ripple limit band.
Range	1 to 12
Preset value	1

Query response {numeric}<newline><^END>

Example of use
10 OUTPUT 717;":CALC1:RLIM:DISP:SEL 5"
20 OUTPUT 717;":CALC1:RLIM:DISP:SEL?"
30 ENTER 717;A

Related commands
:CALC{1-16}:PAR{1-16}:SEL on page 424
:CALC{1-16}:RLIM on page 426
:CALC{1-16}:RLIM:DISP:LINE on page 428
:CALC{1-16}:RLIM:DISP:VAL on page 430

Equivalent key [Analysis] - Ripple Limit - Ripple Band

:CALC{1-16}:RLIM:DISP:VAL

Syntax :CALCulate{[1]|2|3|4|5|6|7|8|9|10|11|12|13|14|15|16}[:SELEcted]:RLIMit:DISPlay:VALue {OFF|ABS|MAR}
:CALCulate{[1]|2|3|4|5|6|7|8|9|10|11|12|13|14|15|16}[:SELEcted]:RLIMit:DISPlay:VALue?

Description For the active trace of channel 1 (:CALC1) to channel 16 (:CALC16) (specified with the :CALC{1-16}:PAR{1-16}:SEL command), selects the display type for the ripple value.

Parameters

	Description
OFF (preset value)	Specifies the display off.
ABS	Specifies the absolute value for display type.
MAR	Specifies the margin for display type.

Query response {OFF|ABS|MAR}<newline><^END>

Example of use
10 OUTPUT 717; ":CALC1:RLIM:DISP:VAL ABS"
20 OUTPUT 717; ":CALC1:RLIM:DISP:VAL?"
30 ENTER 717;A\$

Related commands
:CALC{1-16}:PAR{1-16}:SEL on page 424
:CALC{1-16}:RLIM on page 426
:CALC{1-16}:RLIM:DISP:LINE on page 428
:CALC{1-16}:RLIM:DISP:SEL on page 429

Equivalent key [Analysis] - Ripple Limit - Ripple Value - OFF | Absolute | Margin

:CALC{1-16}:RLIM:FAIL?

Syntax :CALCulate{[1|2|3|4|5|6|7|8|9|10|11|12|13|14|15|16]}[:SElected]:RLIMit:FAIL?

Description For the active trace of channel 1 (:CALC1) to channel 16 (:CALC16) (specified with the :CALC{1-16}:PAR{1-16}:SEL command), reads out the ripple test result. (Query only)

Query response {1|0}<newline><^END>

	Description
1	The ripple test result is FAIL.
0	The ripple test result is PASS.

When the ripple test is set to OFF, 0 is always read out.

Example of use

```
10 OUTPUT 717; ":CALC1:RLIM:FAIL?"
20 ENTER 717;A
```

Related commands :CALC{1-16}:PAR{1-16}:SEL on page 424
:CALC{1-16}:RLIM on page 426

Equivalent key No equivalent key is available on the front panel.

:CALC{1-16}:RLIM:REP?

Syntax :CALCulate{[1]|2|3|4|5|6|7|8|9|10|11|12|13|14|15|16}{[:SElected]:RLIMit:REPort[:DATA]?

Description For the active trace of channel 1 (:CALC1) to channel 16 (:CALC16) (specified with the :CALC{1-16}:PAR{1-16}:SEL command), reads out the ripple value of the ripple test.
The data transfer format when this command is executed depends on the setting with the :FORM:DATA command. (Query only)

Query response {numeric 1},...,{numeric 1+N×3}<newline><^END>

	Description
<numeric 1>	Number of ripple limit line (1 to 12)
<numeric 1+(n×3)-2>	Number of ripple limit bands
<numeric 1+(n×3)-1>	Ripple value
<numeric 1+(n×3)>	Results of ripple test 0: Pass 1: Fail

Where N is the number of lines (specified with <numeric 1>) and n is an integer between 1 and 12.

Example of use

```
10 DIM B(1:2,1:3)
20 OUTPUT 717;":CALC1:RLIM:REP?"
30 ENTER 717;A,B(*)
```

Related commands :CALC{1-16}:PAR{1-16}:SEL on page 424
:CALC{1-16}:RLIM on page 426

Equivalent key No equivalent key is available on the front panel.

:CALC{1-16}:SMO

Syntax :CALCulate{[1]|2|3|4|5|6|7|8|9|10|11|12|13|14|15|16}[:SELEcted]:SMOothing[:STATe] {ON|OFF|1|0}
:CALCulate{[1]|2|3|4|5|6|7|8|9|10|11|12|13|14|15|16}[:SELEcted]:SMOothing[:STATe]?

Description For the active trace of channel 1 (:CALC1) to channel 16 (:CALC16) (specified with the :CALC{1-16}:PAR{1-16}:SEL command), turns ON/OFF the smoothing.

Parameters

	Description
ON or 1	Turns ON the smoothing.
OFF or 0 (preset value)	Turns OFF the smoothing.

Query response {1|0}<newline><^END>

Example of use
10 OUTPUT 717; ":CALC1:SMO:STAT ON"
20 OUTPUT 717; ":CALC1:SMO:STAT?"
30 ENTER 717;A

Related commands
:CALC{1-16}:PAR{1-16}:SEL on page 424
:CALC{1-16}:SMO:APER on page 434

Equivalent key [Avg] - Smoothing

:CALC{1-16}:SMO:APER

Syntax :CALCulate{[1]|2|3|4|5|6|7|8|9|10|11|12|13|14|15|16}{[:SElected];SMOothing:APERture <numeric>
:CALCulate{[1]|2|3|4|5|6|7|8|9|10|11|12|13|14|15|16}{[:SElected];SMOothing:APERture?

Description Sets the smoothing aperture for channel 1 (:CALC1) to channel 16 (:CALC16) (specified with the :CALC{1-16}:PAR{1-16}:SEL command).

Parameters

	<numeric>
Description	Percentage relative to the sweep span value
Range	0.05 to 25
Preset value	1.5
Unit	% (percent)
Resolution	1E-14

If the specified parameter is out of the allowable setup range, the minimum value (if the lower limit of the range is not reached) or the maximum value (if the upper limit of the range is exceeded) is set.

Query response {numeric}<newline><^END>

Example of use
10 OUTPUT 717; ":CALC1:SMO:APER 2.5"
20 OUTPUT 717; ":CALC1:SMO:APER?"
30 ENTER 717;A

Related commands :CALC{1-16}:PAR{1-16}:SEL on page 424
:CALC{1-16}:SMO on page 433

Equivalent key [Avg] - Smo Aperture

:CALC{1-16}:TRAN:TIME

Syntax :CALCulate{[1]|2|3|4|5|6|7|8|9|10|11|12|13|14|15|16}[:SELEcted]:TRANsform:TIME[:TYPE] {BPASs|LPASs}
:CALCulate{[1]|2|3|4|5|6|7|8|9|10|11|12|13|14|15|16}[:SELEcted]:TRANsform:TIME[:TYPE]?

Description For the active trace of channel 1 (:CALC1) to channel 16 (:CALC16) (specified with the :CALC{1-16}:PAR{1-16}:SEL command), selects the transformation type used for the transformation function of the time domain function.

Parameters

	Description
BPASs (preset value)	Specifies the band-pass ^{*1} .
LPASs	Specifies the low-pass ^{*2} .

*1. You do not need to select the stimulus type. Impulse is selected automatically.

*2. You need to select the stimulus type (impulse or step) with the :CALC{1-16}:TRAN:TIME:STIM command.

Query response {BPAS|LPAS}<newline><^END>

Example of use

```
10 OUTPUT 717; ":CALC1:TRAN:TIME LPAS"
20 OUTPUT 717; ":CALC1:TRAN:TIME?"
30 ENTER 717;A$
```

Related commands

:CALC{1-16}:TRAN:TIME:STIM on page 443
:CALC{1-16}:TRAN:TIME:STAT on page 441
:CALC{1-16}:PAR{1-16}:SEL on page 424

Equivalent key [Analysis] - Transform - Type - Bandpass|Lowpass Step|Lowpass Imp.

NOTE When performing this operation from the front panel, you select the stimulus type at the same time.

:CALC{1-16}:TRAN:TIME:CENT

Syntax :CALCulate{[1]|2|3|4|5|6|7|8|9|10|11|12|13|14|15|16}[:SElected]:TRANsform:TIME:CENTer <numeric>
:CALCulate{[1]|2|3|4|5|6|7|8|9|10|11|12|13|14|15|16}[:SElected]:TRANsform:TIME:CENTer?

Description For the active trace of channel 1 (:CALC1) to channel 16 (:CALC16) (specified with the :CALC{1-16}:PAR{1-16}:SEL command), selects the center value used for the transformation function of the time domain function.

Parameters

	<numeric>
Description	Center value
Range	Varies depending on the frequency span and the number of points.
Preset value	0
Unit	s (second)

If the specified parameter is out of the allowable setup range, the minimum value (if the lower limit of the range is not reached) or the maximum value (if the upper limit of the range is exceeded) is set.

Query response {numeric}<newline><^END>

Example of use
10 OUTPUT 717; ":CALC1:TRAN:TIME:CENT 1E-8"
20 OUTPUT 717; ":CALC1:TRAN:TIME:CENT?"
30 ENTER 717;A

Related commands
:CALC{1-16}:TRAN:TIME:SPAN on page 439
:CALC{1-16}:TRAN:TIME:STAT on page 441
:CALC{1-16}:PAR{1-16}:SEL on page 424

Equivalent key [Analysis] - Transform - Center

:CALC{1-16}:TRAN:TIME:IMP:WIDT

Syntax

```
:CALCulate{[1]|2|3|4|5|6|7|8|9|10|11|12|13|14|15|16}[:SElected]:TRANsform:TIME:IMPulse:WIDTh <numeric>  
:CALCulate{[1]|2|3|4|5|6|7|8|9|10|11|12|13|14|15|16}[:SElected]:TRANsform:TIME:IMPulse:WIDTh?
```

Description

For the active trace of channel 1 (:CALC1) to channel 16 (:CALC16) (specified with the :CALC{1-16}:PAR{1-16}:SEL command), sets the shape of the Kayser Bessel window using the impulse width used for the transformation function of the time domain function.

Parameters

	<numeric>
Description	Impulse width
Range	Varies depending on the frequency span and the transformation type.
Preset value	Varies depending on the frequency span and the transformation type.
Unit	s (second)

If the specified parameter is out of the allowable setup range, the minimum value (if the lower limit of the range is not reached) or the maximum value (if the upper limit of the range is exceeded) is set.

Query response

```
{numeric}<newline><^END>
```

Example of use

```
10 OUTPUT 717; ":CALC1:TRAN:TIME:IMP:WIDT 1E-10"  
20 OUTPUT 717; ":CALC1:TRAN:TIME:IMP:WIDT?"  
30 ENTER 717;A
```

Related commands

```
:CALC{1-16}:TRAN:TIME:KBES on page 438  
:CALC{1-16}:TRAN:TIME:STEP:RTIM on page 442  
:CALC{1-16}:TRAN:TIME:STAT on page 441  
:CALC{1-16}:PAR{1-16}:SEL on page 424
```

Equivalent key

[Analysis] - Transform - Window - User - Impulse Width

:CALC{1-16}:TRAN:TIME:KBES

Syntax :CALCulate{[1]|2|3|4|5|6|7|8|9|10|11|12|13|14|15|16}[:SElected]:TRANsform:TIME:KBESsel <numeric>
:CALCulate{[1]|2|3|4|5|6|7|8|9|10|11|12|13|14|15|16}[:SElected]:TRANsform:TIME:KBESsel?

Description For the active trace of channel 1 (:CALC1) to channel 16 (:CALC16) (specified with the :CALC{1-16}:PAR{1-16}:SEL command), sets the shape of the Kayser Bessel window using β used for the transformation function of the time domain function.

Parameters

	<numeric>
Description	The value of β .
Range	0 to 13
Preset value	6

If the specified parameter is out of the allowable setup range, the minimum value (if the lower limit of the range is not reached) or the maximum value (if the upper limit of the range is exceeded) is set.

Query response {numeric}<newline><^END>

Example of use
10 OUTPUT 717; ":CALC1:TRAN:TIME:KBES 3"
20 OUTPUT 717; ":CALC1:TRAN:TIME:KBES?"
30 ENTER 717;A

Related commands
:CALC{1-16}:TRAN:TIME:IMP:WIDT on page 437
:CALC{1-16}:TRAN:TIME:STEP:RTIM on page 442
:CALC{1-16}:TRAN:TIME:STAT on page 441
:CALC{1-16}:PAR{1-16}:SEL on page 424

Equivalent key [Analysis] - Transform - Window - User - Kaiser Beta

:CALC{1-16}:TRAN:TIME:LPFR

Syntax :CALCulate{[1]|2|3|4|5|6|7|8|9|10|11|12|13|14|15|16}[:SElected]:TRANsform:TIME:LPFRequency

Description For the active trace of channel 1 (:CALC1) to channel 16 (:CALC16) (specified with the :CALC{1-16}:PAR{1-16}:SEL command), changes the frequency range to match with the low-pass type transformation of the transformation function of the time domain function. (No query)

Related commands :CALC{1-16}:TRAN:TIME on page 435
:CALC{1-16}:TRAN:TIME:STAT on page 441
:CALC{1-16}:PAR{1-16}:SEL on page 424

Equivalent key [Analysis] - Transform - Set Freq Low pass

:CALC{1-16}:TRAN:TIME:SPAN

Syntax :CALCulate{[1]|2|3|4|5|6|7|8|9|10|11|12|13|14|15|16}[:SElected]:TRANsform:TIME:SPAN <numeric>
:CALCulate{[1]|2|3|4|5|6|7|8|9|10|11|12|13|14|15|16}[:SElected]:TRANsform:TIME:SPAN?

Description For the active trace of channel 1 (:CALC1) to channel 16 (:CALC16) (specified with the :CALC{1-16}:PAR{1-16}:SEL command), selects the span value used for the transformation function of the time domain function.

Parameters

	<numeric>
Description	Span value
Range	Varies depending on the frequency span and the number of points.
Preset value	2E-8
Unit	s (second)

If the specified parameter is out of the allowable setup range, the minimum value (if the lower limit of the range is not reached) or the maximum value (if the upper limit of the range is exceeded) is set.

Query response {numeric}<newline><^END>

Example of use
10 OUTPUT 717; ":CALC1:TRAN:TIME:SPAN 1E-8"
20 OUTPUT 717; ":CALC1:TRAN:TIME:SPAN?"
30 ENTER 717;A

Related commands :CALC{1-16}:TRAN:TIME:CENT on page 436
:CALC{1-16}:TRAN:TIME:STAT on page 441
:CALC{1-16}:PAR{1-16}:SEL on page 424

Equivalent key [Analysis] - Transform - Span

:CALC{1-16}:TRAN:TIME:STAR

Syntax :CALCulate{[1]|2|3|4|5|6|7|8|9|10|11|12|13|14|15|16}[:SElected]:TRANSform:TIME:STARt <numeric>
:CALCulate{[1]|2|3|4|5|6|7|8|9|10|11|12|13|14|15|16}[:SElected]:TRANSform:TIME:STARt?

Description For the active trace of channel 1 (:CALC1) to channel 16 (:CALC16) (specified with the :CALC{1-16}:PAR{1-16}:SEL command), selects the start value used for the transformation function of the time domain function.

Parameters

	<numeric>
Description	Start value
Range	Varies depending on the frequency span and the number of points.
Preset value	-1E-8
Unit	s (second)

If the specified parameter is out of the allowable setup range, the minimum value (if the lower limit of the range is not reached) or the maximum value (if the upper limit of the range is exceeded) is set.

Query response {numeric}<newline><^END>

Example of use
10 OUTPUT 717; ":CALC1:TRAN:TIME:STAR 0"
20 OUTPUT 717; ":CALC1:TRAN:TIME:STAR?"
30 ENTER 717;A

Related commands
:CALC{1-16}:TRAN:TIME:STOP on page 444
:CALC{1-16}:TRAN:TIME:STAT on page 441
:CALC{1-16}:PAR{1-16}:SEL on page 424

Equivalent key [Analysis] - Transform - Start

:CALC{1-16}:TRAN:TIME:STAT

Syntax :CALCulate{[1]|2|3|4|5|6|7|8|9|10|11|12|13|14|15|16}{[:SELEcted]:TRANsform:TIME:STATe {ON|OFF|1|0}}
:CALCulate{[1]|2|3|4|5|6|7|8|9|10|11|12|13|14|15|16}{[:SELEcted]:TRANsform:TIME:STATe?}

Description For the active trace of channel 1 (:CALC1) to channel 16 (:CALC16) (specified with the :CALC{1-16}:PAR{1-16}:SEL command), turns ON/OFF the transformation function of the time domain function.

You can enable the transformation function only when the sweep type is the linear sweep and the number of points is 3 or more. If you execute this command to try to enable the transformation function when the sweep type is other than the linear sweep or the number of points is less than 3, an error occurs and the command is ignored.

When the sweep type is the power sweep, you cannot turn on the transformation function. If you execute this command trying to turn on the transformation function during the power sweep, an error occurs and the command is ignored.

Parameters

	Description
ON or 1	Turns ON the transformation function.
OFF or 0 (preset value)	Turns OFF the transformation function.

Query response {1|0}<newline><^END>

Example of use
10 OUTPUT 717;":CALC1:TRAN:TIME:STAT ON"
20 OUTPUT 717;":CALC1:TRAN:TIME:STAT?"
30 ENTER 717;A

Related commands
:CALC{1-16}:PAR{1-16}:SEL on page 424
:SENS{1-16}:SWE:TYPE on page 696
:SENS{1-16}:SWE:POIN on page 693

Equivalent key [Analysis] - Transform - Transform

:CALC{1-16}:TRAN:TIME:STEP:RTIM

Syntax :CALCulate{[1]|2|3|4|5|6|7|8|9|10|11|12|13|14|15|16}[:SElected]:TRANsform:TIME:STEP:RTIME <numeric>
:CALCulate{[1]|2|3|4|5|6|7|8|9|10|11|12|13|14|15|16}[:SElected]:TRANsform:TIME:STEP:RTIME?

Description For the active trace of channel 1 (:CALC1) to channel 16 (:CALC16) (specified with the :CALC{1-16}:PAR{1-16}:SEL command), sets the shape of the Kayser Bessel window using the rise time of step signal used for the transformation function of the time domain function.

Parameters

	<numeric>
Description	The rise time of step signal
Range	Varies depending on the frequency span.
Preset value	Varies depending on the frequency span.
Unit	s (second)

If the specified parameter is out of the allowable setup range, the minimum value (if the lower limit of the range is not reached) or the maximum value (if the upper limit of the range is exceeded) is set.

Query response {numeric}<newline><^END>

Example of use
10 OUTPUT 717; ":CALC1:TRAN:TIME:STEP:RTIM 1E-10"
20 OUTPUT 717; ":CALC1:TRAN:TIME:STEP:RTIM?"
30 ENTER 717;A

Related commands
:CALC{1-16}:TRAN:TIME:IMP:WIDT on page 437
:CALC{1-16}:TRAN:TIME:KBES on page 438
:CALC{1-16}:TRAN:TIME:STAT on page 441
:CALC{1-16}:PAR{1-16}:SEL on page 424

Equivalent key [Analysis] - Transform - Window - User - Rise Time

:CALC{1-16}:TRAN:TIME:STIM

Syntax :CALCulate{[1]|2|3|4|5|6|7|8|9|10|11|12|13|14|15|16}[:SELEcted]:TRANsform:TIME:STIMulus {IMPulse|STEP}
:CALCulate{[1]|2|3|4|5|6|7|8|9|10|11|12|13|14|15|16}[:SELEcted]:TRANsform:TIME:STIMulus?

Description For the active trace of channel 1 (:CALC1) to channel 16 (:CALC16) (specified with the :CALC{1-16}:PAR{1-16}:SEL command), selects the stimulus type used for the transformation function of the time domain function.

Parameters

	Description
IMPulse (preset value)	Specifies the impulse ^{*1} .
STEP	Specifies the step ^{*2} .

*1. You need to select the transformation type (band-pass or low-pass) with the :CALC{1-16}:TRAN:TIME command.

*2. You do not need to select the transformation type. Low-pass is selected automatically.

Query response {IMP|STEP}<newline><<^END>

Example of use

```
10 OUTPUT 717; ":CALC1:TRAN:TIME LPAS"
20 OUTPUT 717; ":CALC1:TRAN:TIME:STIM STEP"
30 OUTPUT 717; ":CALC1:TRAN:TIME:STIM?"
40 ENTER 717;A$
```

Related commands

:CALC{1-16}:TRAN:TIME on page 435
:CALC{1-16}:TRAN:TIME:STAT on page 441
:CALC{1-16}:PAR{1-16}:SEL on page 424

Equivalent key [Analysis] - Transform - Type - Bandpass|Lowpass Step|Lowpass Imp.

NOTE When performing this operation from the front panel, you select the transformation type at the same time.

:CALC{1-16}:TRAN:TIME:STOP

Syntax

```
:CALCulate{[1]|2|3|4|5|6|7|8|9|10|11|12|13|14|15|16}[:SElected]:TRANsform:TIME:STOP <numeric>  
:CALCulate{[1]|2|3|4|5|6|7|8|9|10|11|12|13|14|15|16}[:SElected]:TRANsform:TIME:STOP?
```

Description

For the active trace of channel 1 (:CALC1) to channel 16 (:CALC16) (specified with the :CALC{1-16}:PAR{1-16}:SEL command), selects the stop value used for the transformation function of the time domain function.

Parameters

	<numeric>
Description	Stop value
Range	Varies depending on the frequency span and the number of points.
Preset value	1E-8
Unit	s (second)

If the specified parameter is out of the allowable setup range, the minimum value (if the lower limit of the range is not reached) or the maximum value (if the upper limit of the range is exceeded) is set.

Query response

```
{numeric}<newline><^END>
```

Example of use

```
10  OUTPUT 717; ":CALC1:TRAN:TIME:STOP 2E-8"  
20  OUTPUT 717; ":CALC1:TRAN:TIME:STOP?"  
30  ENTER 717;A
```

Related commands

:CALC{1-16}:TRAN:TIME:STAR on page 440
:CALC{1-16}:TRAN:TIME:STAT on page 441
:CALC{1-16}:PAR{1-16}:SEL on page 424

Equivalent key

[Analysis] - Transform - Stop

:CONT:HAND:A

Syntax :CONTrol:HANDler:A[:DATA] <numeric>

Description Outputs data to output port A (A0 to A7) of the handler I/O. Data is outputted as 8-bit binary using A0 as LSB and A7 as MSB. (No query)

For details about the handler I/O, see Chapter 10.

Parameters

	<numeric>
Description	Output data
Range	0 to 255
Resolution	1

If the specified parameter is out of the allowable setup range, the minimum value (if the lower limit of the range is not reached) or the maximum value (if the upper limit of the range is exceeded) is set.

Example of use 10 OUTPUT 717; ":CONT:HAND:A 15"

Equivalent key No equivalent key is available on the front panel.

:CONT:HAND:B

Syntax :CONTrol:HANDler:B[:DATA] <numeric>

Description Outputs data to output port B (B0 to B7) of the handler I/O. Data is outputted as 8-bit binary using B0 as LSB and B7 as MSB. (No query)

For details about the handler I/O, see Chapter 10.

Parameters

	<numeric>
Description	Output data
Range	0 to 255
Resolution	1

If the specified parameter is out of the allowable setup range, the minimum value (if the lower limit of the range is not reached) or the maximum value (if the upper limit of the range is exceeded) is set.

Example of use 10 OUTPUT 717; ":CONT:HAND:B 15"

Equivalent key No equivalent key is available on the front panel.

:CONT:HAND:C

Syntax :CONTrol:HANDler:C[:DATA] <numeric>
:CONTrol:HANDler:C[:DATA]?

Description When input/output port C of the handler I/O is set to the output port, outputs data to output port C (C0 to C3).
When input/output port C is set to the input port, reads out data inputted to port C (C0 to C3).
Data is outputted as 4-bit binary using C0 as LSB and C3 as MSB.
For details about the handler I/O, see Chapter 10.

Parameters

	<numeric>
Description	Output data/input data
Range	0 to 15
Resolution	1

If the specified parameter is out of the allowable setup range, the minimum value (if the lower limit of the range is not reached) or the maximum value (if the upper limit of the range is exceeded) is set.

Query response {numeric}<newline><^END>

Example of use

```
10 OUTPUT 717; ":CONT:HAND:C:MODE OUTP "  
20 OUTPUT 717; ":CONT:HAND:C 15 "  
  
10 OUTPUT 717; ":CONT:HAND:C:MODE INP "  
20 OUTPUT 717; ":CONT:HAND:C? "  
30 ENTER 717;A
```

Related commands :CONT:HAND:C:MODE on page 447

Equivalent key No equivalent key is available on the front panel.

:CONT:HAND:C:MODE

Syntax :CONTRol:HANDler:C:MODE {INPut|OUTPut}
:CONTRol:HANDler:C:MODE?

Description Sets the input/output direction of port C of the handler I/O.
For details about the handler I/O, see Chapter 10.

Parameters

	Description
INPut (preset value)	Specifies input.
OUTPut	Specifies output.

Query response {INP|OUTP}<newline><^END>

Example of use

```
10 OUTPUT 717; ":CONT:HAND:C:MODE OUTP"
20 OUTPUT 717; ":CONT:HAND:C:MODE?"
30 ENTER 717;A$
```

Related commands :CONT:HAND:C on page 446

Equivalent key No equivalent key is available on the front panel.

:CONT:HAND:D

Syntax :CONTrol:HANDler:D[:DATA] <numeric>
:CONTrol:HANDler:D[:DATA]?

Description When input/output port D of the handler I/O is set to the output port, outputs data to output port D (D0 to D3).
When input/output port D is set to the input port, reads out data inputted to port D (D0 to D3).
Data is outputted as 4-bit binary using D0 as LSB and D3 as MSB.
For details about the handler I/O, see Chapter 10.

Parameters

	<numeric>
Description	Output data/input data
Range	0 to 15
Resolution	1

If the specified parameter is out of the allowable setup range, the minimum value (if the lower limit of the range is not reached) or the maximum value (if the upper limit of the range is exceeded) is set.

Query response {numeric}<newline><^END>

Example of use
10 OUTPUT 717; ":CONT:HAND:D:MODE OUTP "
20 OUTPUT 717; ":CONT:HAND:D 15 "

10 OUTPUT 717; ":CONT:HAND:D:MODE INP "
20 OUTPUT 717; ":CONT:HAND:D?"
30 ENTER 717;A

Related commands :CONT:HAND:D:MODE on page 449

Equivalent key No equivalent key is available on the front panel.

:CONT:HAND:D:MODE

Syntax :CONTrol:HANDler:C:MODE {INPut|OUTPut}
:CONTrol:HANDler:C:MODE?

Description Sets the input/output direction of port D of the handler I/O.
For details about the handler I/O, see Chapter 10.

Parameters

	Description
INPut (preset value)	Specifies input.
OUTPut	Specifies output.

Query response {INP|OUTP}<newline><^END>

Example of use

```
10 OUTPUT 717; ":CONT:HAND:D:MODE OUTP"
20 OUTPUT 717; ":CONT:HAND:D:MODE?"
30 ENTER 717;A$
```

Related commands :CONT:HAND:D on page 448

Equivalent key No equivalent key is available on the front panel.

:CONT:HAND:E

Syntax :CONTrol:HANDler:E[:DATA] <numeric>
 :CONTrol:HANDler:E[:DATA]?

Description When input/output port E (port C + port D) of the handler I/O is set to the output port, outputs data to output port E.
 When input/output port E is set to the input port, reads out data inputted to port E.
 Data is outputted as 8-bit binary using C0 as LSB and D3 as MSB.
 For details about the handler I/O, see Chapter 10.

Parameters

	<numeric>
Description	Output data/input data
Range	0 to 255
Resolution	1

If the specified parameter is out of the allowable setup range, the minimum value (if the lower limit of the range is not reached) or the maximum value (if the upper limit of the range is exceeded) is set.

Query response {numeric}<newline><^END>

Example of use

```

10 OUTPUT 717; ":CONT:HAND:C:MODE OUTP "
20 OUTPUT 717; ":CONT:HAND:D:MODE OUTP "
30 OUTPUT 717; ":CONT:HAND:E 128 "

10 OUTPUT 717; ":CONT:HAND:C:MODE INP "
20 OUTPUT 717; ":CONT:HAND:D:MODE INP "
30 OUTPUT 717; ":CONT:HAND:E?"
40 ENTER 717;A
  
```

Related commands

- :CONT:HAND:C:MODE on page 447
- :CONT:HAND:D:MODE on page 449
- :CONT:HAND:C on page 446
- :CONT:HAND:D on page 448

Equivalent key No equivalent key is available on the front panel.

:CONT:HAND:F

Syntax :CONTrol:HANDler:F[:DATA] <numeric>

Description Outputs data to output port F (port A + port B) of the handler I/O. Data is outputted as 16-bit binary using A0 as LSB and B7 as MSB. (No query)

For details about the handler I/O, see Chapter 10.

Parameters

	<numeric>
Description	Output data
Range	0 to 65535
Resolution	1

If the specified parameter is out of the allowable setup range, the minimum value (if the lower limit of the range is not reached) or the maximum value (if the upper limit of the range is exceeded) is set.

Example of use 10 OUTPUT 717; ":CONT:HAND:F 511 "

Related commands :CONT:HAND:A on page 445

:CONT:HAND:B on page 445

Equivalent key No equivalent key is available on the front panel.

:CONT:HAND:IND:STAT

Syntax :CONTrol:HANDler[:EXTension]:INDex:STATe {ON|OFF|1|0}
:CONTrol:HANDler[:EXTension]:INDex:STATe?

Description Turns ON/OFF outputting the INDEX signal to B6 of the handler I/O.
For details about the handler I/O, see Chapter 10.

Parameters

	Description
ON or 1	Turns ON the INDEX signal output.
OFF or 0 (preset value)	Turns OFF the INDEX signal output.

Query response {1|0}<newline><^END>

Example of use
10 OUTPUT 717; ":CONT:HAND:IND:STAT ON"
20 OUTPUT 717; ":CONT:HAND:IND:STAT?"
30 ENTER 717;A

Related commands :CONT:HAND:RTR:STAT on page 453

Equivalent key No equivalent key is available on the front panel.

:CONT:HAND:OUTP{1-2}

Syntax :CONTrol:HANDler:OUTPut{[1]|2}[:DATA] {1|0}
:CONTrol:HANDler:OUTPut{[1]|2}[:DATA]?

Description Sets HIGH/LOW of OUTPUT1 (:OUTP1) or OUTPUT2 (:OUTP2) of the handler I/O.
For details about the handler I/O, see Chapter 10.

Parameters

	Description
1	Specifies LOW.
0	Specifies HIGH.

Query response {1|0}<newline><^END>

Example of use
10 OUTPUT 717; ":CONT:HAND:OUTP1 1"
20 OUTPUT 717; ":CONT:HAND:OUTP1?"
30 ENTER 717;A

Equivalent key No equivalent key is available on the front panel.

:CONT:HAND:RTR:STAT

Syntax :CONTRol:HANDler[:EXTension]:RTRigger:STATe {ON|OFF|1|0}
:CONTRol:HANDler[:EXTension]:RTRigger:STATe?

Description Turns ON/OFF outputting the READY FOR TRIGGER signal to B7 of the handler I/O.
For details about the handler I/O, see Chapter 10.

Parameters

	Description
ON or 1	Turns ON the READY FOR TRIGGER signal output.
OFF or 0 (preset value)	Turns OFF the READY FOR TRIGGER signal output.

Query response {1|0}<newline><^END>

Example of use

```
10 OUTPUT 717; ":CONT:HAND:RTR:STAT ON"
20 OUTPUT 717; ":CONT:HAND:RTR:STAT?"
30 ENTER 717;A
```

Related commands :CONT:HAND:IND:STAT on page 452

Equivalent key No equivalent key is available on the front panel.

:DISP:ANN:FREQ

Syntax :DISPlay:ANNotation:FREQuency[:STATe] {ON|OFF|1|0}
:DISPlay:ANNotation:FREQuency[:STATe]?

Description Turns ON/OFF the frequency display on the LCD display.

Parameters

	Description
ON or 1 (preset value)	Turns ON the frequency display.
OFF or 0	Turns OFF the frequency display.

Query response {1|0}<newline><^END>

Example of use
10 OUTPUT 717; ":DISP:ANN:FREQ OFF"
20 OUTPUT 717; ":DISP:ANN:FREQ?"
30 ENTER 717;A

Equivalent key [Display] - Frequency

:DISP:CCL

Syntax :DISPlay:CCLear

Description Clears the error message display on the instrument status bar (at the bottom of the LCD display). (No query)

Example of use 10 OUTPUT 717; ":DISP:CCL"

Equivalent key All front panel keys.

:DISP:CLOC

Syntax :DISPlay:CLOCK {ON|OFF|1|0}
 :DISPlay:CLOCK?

Description Turns ON/OFF the clock display at the right edge of the instrument status bar (at the bottom of the LCD display).

Parameters

	Description
ON or 1 (preset value)	Turns ON the clock display.
OFF or 0	Turns OFF the clock display.

Query response {1|0}<newline><^END>

Example of use

```
10  OUTPUT 717; ":DISP:CLOC OFF"
20  OUTPUT 717; ":DISP:CLOC?"
30  ENTER 717;A
```

Equivalent key [System] - Misc Setup - Clock Setup - Show Clock

:DISP:COL{1-2}:BACK

Syntax :DISPlay:COLor{[1]2}:BACK <numeric 1>,<numeric 2>,<numeric 3>
:DISPlay:COLor{[1]2}:BACK?

Description Sets the background color for normal display (:COL1) and inverted display (:COL2).

Parameters

	<numeric 1>	<numeric 2>	<numeric 3>
Description	Amount of red	Amount of green	Amount of blue
Range	0 to 5	0 to 5	0 to 5
Resolution	1	1	1

If the specified parameter is out of the allowable setup range, the minimum value (if the lower limit of the range is not reached) or the maximum value (if the upper limit of the range is exceeded) is set.

Query response {numeric 1},{numeric 2},{numeric 3}<newline><^END>

Example of use
10 OUTPUT 717; ":DISP:COL:BACK 1,2,3"
20 OUTPUT 717; ":DISP:COL:BACK?"
30 ENTER 717;A,B,C

Related commands :DISP:COL{1-2}:RES on page 458

Equivalent key [System] - Misc Setup - Color Setup - Normal|Invert - Background

:DISP:COL{1-2}:GRAT{1-2}

Syntax :DISPlay:COLor{[1]2}:GRATicule{[1]2} <numeric 1>,<numeric 2>,<numeric 3>
:DISPlay:COLor{[1]2}:GRATicule{[1]2}?

Description Sets the color of the graticule label and the outer frame line of the graph (:GRAT1) and the color of the grid line of the graph (:GRAT2) for normal display (:COL1) and inverted display (:COL2).

Parameters

	<numeric 1>	<numeric 2>	<numeric 3>
Description	Amount of red	Amount of green	Amount of blue
Range	0 to 5	0 to 5	0 to 5
Resolution	1	1	1

If the specified parameter is out of the allowable setup range, the minimum value (if the lower limit of the range is not reached) or the maximum value (if the upper limit of the range is exceeded) is set.

Query response {numeric 1},{numeric 2},{numeric 3}<newline><^END>

Example of use
10 OUTPUT 717;":DISP:COL1:GRAT1 1,2,3"
20 OUTPUT 717;":DISP:COL1:GRAT1?"
30 ENTER 717;A,B,C

Related commands :DISP:COL{1-2}:RES on page 458

Equivalent key [System] - Misc Setup - Color Setup - Normal|Invert - Graticule Main|Graticule Sub

:DISP:COL{1-2}:LIM{1-2}

Syntax :DISPlay:COLor{[1]|2}:LIMit{[1]|2} <numeric 1>,<numeric 2>,<numeric 3>
:DISPlay:COLor{[1]|2}:LIMit{[1]|2}?

Description Sets the fail display color used for the limit test result, bandwidth test result, and ripple test result (:LIM1) and the color of the limit line (:LIM2) for normal display (:COL1) and inverted display (:COL2).

Parameters

	<numeric 1>	<numeric 2>	<numeric 3>
Description	Amount of red	Amount of green	Amount of blue
Range	0 to 5	0 to 5	0 to 5
Resolution	1	1	1

If the specified parameter is out of the allowable setup range, the minimum value (if the lower limit of the range is not reached) or the maximum value (if the upper limit of the range is exceeded) is set.

Query response {numeric 1},{numeric 2},{numeric 3}<newline><^END>

Example of use
10 OUTPUT 717; ":DISP:COL1:LIM1 1,2,3"
20 OUTPUT 717; ":DISP:COL1:LIM1?"
30 ENTER 717;A,B,C

Related commands :DISP:COL{1-2}:RES on page 458

Equivalent key [System] - Misc Setup - Color Setup - Normal|Invert - Limit Fail|Limit Line

:DISP:COL{1-2}:RES

Syntax :DISPlay:COLor{[1]|2}:RESet

Description Resets the display color settings for all the items to the factory preset state for normal display (:COL1) and inverted display (:COL2). (No query)

Example of use 10 OUTPUT 717; ":DISP:COL1:RES"

Related commands
:DISP:COL{1-2}:BACK on page 456
:DISP:COL{1-2}:GRAT{1-2} on page 457
:DISP:COL{1-2}:LIM{1-2} on page 458
:DISP:COL{1-2}:BACK on page 456
:DISP:COL{1-2}:BACK on page 456

Equivalent key [System] - Misc Setup - Color Setup - Normal|Invert - Reset Color - OK

:DISP:COL{1-2}:TRAC{1-16}:DATA

Syntax

```
:DISPlay:COLor{[1]|2}:TRAC{[1]|2|3|4|5|6|7|8|9|10|11|12|13|14|15|16}:DATA <numeric 1>,<numeric 2>,<numeric 3>
:DISPlay:COLor{[1]|2}:TRAC{[1]|2|3|4|5|6|7|8|9|10|11|12|13|14|15|16}:DATA?
```

Description

Sets the color of the data trace of trace 1 (:TRAC1) to trace 16 (:TRAC16) for normal display (:COL1) and inverted display (:COL2).

Parameters

	<numeric 1>	<numeric 2>	<numeric 3>
Description	Amount of red	Amount of green	Amount of blue
Range	0 to 5	0 to 5	0 to 5
Resolution	1	1	1

If the specified parameter is out of the allowable setup range, the minimum value (if the lower limit of the range is not reached) or the maximum value (if the upper limit of the range is exceeded) is set.

Query response

```
{numeric 1},{numeric 2},{numeric 3}<newline><^END>
```

Example of use

```
10 OUTPUT 717; ":DISP:COL1:TRAC1:DATA 1,2,3"
20 OUTPUT 717; ":DISP:COL1:TRAC1:DATA?"
30 ENTER 717;A,B,C
```

Related commands

:DISP:COL{1-2}:RES on page 458

Equivalent key

[System] - Misc Setup - Color Setup - Normal|Invert - Data Trace 1|Data Trace 2|Data Trace 3|Data Trace 4|Data Trace 5|Data Trace 6|Data Trace 7|Data Trace 8|Data Trace 9

:DISP:COL{1-2}:TRAC{1-16}:MEM

Syntax

:DISPlay:COLor{[1]|2}:TRAC{[1]|2|3|4|5|6|7|8|9|10|11|12|13|14|15|16}:MEMory <numeric 1>,<numeric 2>,<numeric 3>
:DISPlay:COLor{[1]|2}:TRAC{[1]|2|3|4|5|6|7|8|9|10|11|12|13|14|15|16}:MEMory?

Description

Sets the color of the memory trace of trace 1 (:TRAC1) to trace 16 (:TRAC16) for normal display (:COL1) and inverted display (:COL2).

Parameters

	<numeric 1>	<numeric 2>	<numeric 3>
Description	Amount of red	Amount of green	Amount of blue
Range	0 to 5	0 to 5	0 to 5
Resolution	1	1	1

If the specified parameter is out of the allowable setup range, the minimum value (if the lower limit of the range is not reached) or the maximum value (if the upper limit of the range is exceeded) is set.

Query response

{numeric 1},{numeric 2},{numeric 3}<newline><^END>

Example of use

```
10 OUTPUT 717; ":DISP:COL1:TRAC1:MEM 1,2,3"  
20 OUTPUT 717; ":DISP:COL1:TRAC1:MEM?"  
30 ENTER 717;A,B,C
```

Related commands

:DISP:COL{1-2}:RES on page 458

Equivalent key

[System] - Misc Setup - Color Setup - Normal|Invert - Mem Trace 1|Mem Trace 2|
Mem Trace 3|Mem Trace 4|Mem Trace 5|Mem Trace 6|Mem Trace 7|Mem Trace 8|Mem Trace 9

:DISP:ECHO

Syntax :DISPlay:ECHO[:DATA] <string>

Description Displays a character string in the echo window. (No query)

Parameters

	<string>
Description	Character string you want to display
Range	254 characters or less

Example of use 10 OUTPUT 717; ":DISP:ECHO "TEST RESULT""

Related commands :DISP:ECHO:CLE on page 461
:DISP:TABL on page 468
:DISP:TABL:TYPE on page 469

Equivalent key No equivalent key is available on the front panel.

:DISP:ECHO:CLE

Syntax :DISPlay:ECHO:CLEar

Description Clears all character strings displayed in the echo window. (No query)

Example of use 10 OUTPUT 717; ":DISP:ECHO:CLE"

Related commands :DISP:ECHO on page 461

Equivalent key [Macro Setup] - Clear Echo

:DISP:ENAB

Syntax :DISPlay:ENABle {ON|OFF|1|0}
:DISPlay:ENABle?

Description Turns ON/OFF the update of the LCD display.
When the update of the LCD display is OFF, You can update the LCD display once using :DISP:UPD command.

Parameters

	Description
ON or 1 (preset value)	Turns ON the update.
OFF or 0	Turns OFF the update.

Query response {1|0}<newline><^END>

Example of use
10 OUTPUT 717; ":DISP:ENAB OFF"
20 OUTPUT 717; ":DISP:ENAB?"
30 ENTER 717;A

Related commands :DISP:UPD on page 470

Equivalent key [Display] - Update

:DISP:FSIG

Syntax :DISPlay:FSIGn {ON|OFF|1|0}
:DISPlay:FSIGn?

Description Turns on or off the Fail display when the limit test or bandwidth test or ripple test fails.

Parameters

	Description
ON or 1 (preset value)	Turns on the Fail display.
OFF or 0	Turns off the Fail display.

On/off of the Fail display cannot be set at each test. When the Fail display of either of test is turned on, the Fail display of other tests turns on, too.

Query response {1|0}<newline><^END>

Example of use
10 OUTPUT 717;":DISP:FSIG OFF"
20 OUTPUT 717;":DISP:FSIG?"
30 ENTER 717;A

Related commands
:CALC{1-16}:LIM on page 380
:CALC{1-16}:RLIM on page 426
:CALC{1-16}:BLIM on page 293

Equivalent key
[Analysis] - Limit Test - Fail Sign
[Analysis] - Ripple Limit - Fail Sign
[Analysis] - Bandwidth Limit - Fail Sign

:DISP:IMAG

Syntax :DISPlay:IMAGe {NORMal|INVert}
:DISPlay:IMAGe?

Description Selects the display type of the LCD display.

Parameters

	Description
NORMal (preset value)	Specifies the normal display (background color: black).
INVert	Specifies the display in which the color of the normal display is inverted (background color: white).

Query response {NORM|INV}<newline><^END>

Example of use
10 OUTPUT 717; ":DISP:IMAG INV"
20 OUTPUT 717; ":DISP:IMAG?"
30 ENTER 717;A\$

Equivalent key [Display] - Invert Color

:DISP:MAX

Syntax :DISPlay:MAXimize {ON|OFF|1|0}
:DISPlay:MAXimize?

Description Turns ON/OFF the window maximization of the active channel (specified with the :DISP:WIND{1-16}:ACT command).
If you turned ON the maximization, only the window of the active channel is maximized on the LCD display and the windows of the other channels are not displayed.

Parameters

	Description
ON or 1	Turns ON the maximization.
OFF or 0 (preset value)	Turns OFF the maximization.

Query response {1|0}<newline><^END>

Example of use
10 OUTPUT 717;":DISP:MAX ON"
20 OUTPUT 717;":DISP:MAX?"
30 ENTER 717;A

Related commands :DISP:WIND{1-16}:ACT on page 470

Equivalent key [Channel Max]

:DISP:SKEY

Syntax :DISPlay:SKEY[:STATe] {ON|OFF|1|0}
:DISPlay:SKEY[:STATe]?

Description Turns ON/OFF the display of the softkey labels.

Parameters

	Description
ON or 1 (preset value)	Specifies ON.
OFF or 0	Specifies OFF.

Query response {1|0}<newline><^END>

Example of use
10 OUTPUT 717;":DISP:MAX ON"
20 OUTPUT 717;":DISP:MAX?"
30 ENTER 717;A

Equivalent key [Entry Off] ([Softkey On/Off])

:DISP:SPL

Syntax

```
:DISPlay:SPLit {D1|D12|D1_2|D112|D1_1_2|D123|D1_2_3|D12_33|D11_23|D13_23|D12_13|
D1234|D1_2_3_4|D12_34|D123_456|D12_34_56|D1234_5678|D12_34_56_78|D123_456_789|
D123__ABC|D1234__9ABC|D1234__DEFG}
:DISPlay:SPLit?
```

Description

Sets the layout of the windows on the LCD display. For details about the window layout, refer to Figure 3-1 on page 58.

Parameters

	Description
D1 (preset value)	Specifies the layout in which the window for channel 1 only is displayed on the entire display.
D12	Specifies the layout in which the window for channel 1 is displayed on the left side of the display area and the window for channel 2 on the right side.
D1_2	Specifies the layout in which the window for channel 1 is displayed in the upper part and the window for channel 2 in the lower part.
D112	Specifies the layout in which the window for channel 1 is displayed on the left side of 2/3 and the window for channel 2 on the right side of 1/3.
D1_1_2	Specifies the layout in which the window for channel 1 is displayed in the upper part of 2/3 and the window for channel 2 in the lower part of 1/3.
D123	Specifies the layout in which the windows for channel 1, 2, and 3 are displayed in the left side, middle part, and right side, respectively.
D1_2_3	Specifies the layout in which the windows for channel 1, 2, and 3 are displayed in the upper part, middle part, and the lower part, respectively.
D12_33	Specifies the layout in which the windows for channel 1, 2, and 3 are displayed in the upper left, upper right, and lower part, respectively.
D11_23	Specifies the layout in which the windows for channel 1, 2, and 3 are displayed in the upper part, lower left, and lower right, respectively.
D13_23	Specifies the layout in which the windows for channel 1, 2, and 3 are displayed in the upper left, lower left, and right side, respectively.
D12_13	Specifies the layout in which the windows for channel 1, 2, and 3 are displayed in the left side, upper right, and lower right, respectively.
D1234	Specifies the layout in which the windows for channel 1, 2, 3 and 4 are displayed by splitting the screen horizontally into four equal parts.
D1_2_3_4	Specifies the layout in which the windows for channel 1, 2, 3 and 4 are displayed by splitting the screen vertically into four equal parts.
D12_34	Specifies the layout in which the windows for channel 1, 2, 3, and 4 are displayed in the upper left, upper right, lower left, and lower right, respectively.
D123_456	Specifies the layout in which the windows for channel 1, 2, 3, 4, 5 and 6 are displayed in the upper left, upper middle, upper right, lower left, lower middle, and lower right, respectively.
D12_34_56	Specifies the layout in which the windows for channel 1, 2, 3, 4, 5 and 6 are displayed in the upper left, upper right, middle left, middle right, lower left, and lower right, respectively.
D1234_5678	Specifies the layout in which the windows for channel 1, 2, 3 and 4 are displayed in the upper part and the windows for channel 5, 6, 7 and 8 are displayed in the lower part of the window.
D12_34_56_78	Specifies the layout in which the windows for channel 1, 3, 5 and 7 are displayed on the left side and the windows for channel 2, 4, 6 and 8 are displayed on the right side of the window.

	Description
D123_456_789	Specifies the layout in which the windows for channel 1, 2, 3, 4, 5, 6, 7, 8 and 9 are displayed in the left, middle, and right of the upper part of the window, in the left, middle, and right of the middle part, and in the left, middle, and right of the lower part, respectively.
D123__ABC	Specifies the window layout as follows: windows for channels 1, 4, 7, and 10 from the top of the 1st column, windows for channels 2, 5, 8, and 11 from the top of the 2nd column, and windows for channels 3, 6, 9, and 12 from the top of the 3rd column.
D1234_9ABC	Specifies the window layout as follows: windows for channels 1, 2, 3, and 4 from the left of the upper part, windows for channels 5, 6, 7, and 8 from the left of the middle part, and the windows for channels 9, 10, 11, and 12 from the left of the lower part.
D1234__DEFG	Specifies the window layout as follows: windows for channels 1, 5, 9, and 13 from the top of the 1st column, windows for channels 2, 6, 10, and 14 from the top of the 2nd column, windows for channels 3, 7, 11, and 15 from the top of the 3rd column, and windows for channels 4, 8, 12, and 16 from the top of the 4th column.

Query response {D1|D12|D1_2|D112|D1_1_2|D123|D1_2_3|D12_33|D11_23|D13_23|D12_13|D1234|D1_2_3_4|D12_34|D123_456|D12_34_56|D1234_5678|D12_34_56_78|D123_456_789|D123__ABC|D1234_9ABC|D1234__DEFG}<newline><^END>

Example of use

```
10 OUTPUT 717;" :DISP:SPL D1_2"
20 OUTPUT 717;" :DISP:SPL?"
30 ENTER 717;A$
```

Related commands :DISP:WIND{1-16}:SPL on page 475

Equivalent key [Display] - Allocate Channels

:DISP:TABL

Syntax :DISPlay:TABLE[:STATe] {ON|OFF|1|0}
:DISPlay:TABLE[:STATe]?

Description Turns ON/OFF the display of the window selected with the :DISP:TABL:TYPE command.

Parameters

	Description
ON or 1	Turns ON the display.
OFF or 0 (preset value)	Turns OFF the display.

Query response {1|0}<newline><^END>

Example of use
10 OUTPUT 717; ":DISP:TABL ON"
20 OUTPUT 717; ":DISP:TABL?"
30 ENTER 717;A

Related commands :DISP:TABL:TYPE on page 469

Equivalent key [Sweep Setup] - Edit Segment Table
[Marker] - Marker Table
[Analysis] - Limit Test - Edit Limit Line
[Analysis] - Ripple Limit - Edit Ripple Limit
[Macro Setup] - Echo Window
[Cal] - Power Calibration - Loss Compen
[Cal] - Power Calibration - Sensor A Settings|Sensor B Settings

NOTE When performing the operation from the front panel, you select the window and turn ON/OFF the display at the same time.

:DISP:TABL:TYPE

Syntax :DISPlay:TABLE:TYPE { MARKer|LIMit|SEGMent|ECHO|PLOSs|SCFactor|RLIMit}
:DISPlay:TABLE:TYPE?

Description Selects the window whose display is turned ON/OFF with the :DISP:TABL command.

Parameters

	Description
MARKer (preset value)	Specifies the marker table window.
LIMit	Specifies the limit test table window.
SEGMent	Specifies the segment table window.
ECHO	Specifies the echo window.
PLOSs	Specifies the loss compensation table window.
SCFactor	Specifies the power sensor's calibration factor table window.
RLIMit	Specifies the ripple test table window.

Query response {MARK|LIM|SEGM|ECHO|PLOS|SCF|RLIM}<newline><^END>

Example of use

```
10 OUTPUT 717; ":DISP:TABL:TYPE SEGM"
20 OUTPUT 717; ":DISP:TABL:TYPE?"
30 ENTER 717;A$
```

Related commands :DISP:TABL on page 468

Equivalent key

- [Sweep Setup] - Edit Segment Table
- [Marker] - Marker Table
- [Analysis] - Limit Test - Edit Limit Line
- [Macro Setup] - Echo Window
- [Cal] - Power Calibration - Loss Compen
- [Cal] - Power Calibration - Sensor A Settings|Sensor B Settings
- [Analysis] - Ripple Limit - Edit Ripple Limit

NOTE When performing the operation from the front panel, you select the window and turn ON/OFF the display at the same time.

:DISP:UPD

Syntax	:DISPlay:UPDate[:IMMEdiate]
Description	Updates the LCD display once when the update of the LCD display is OFF (OFF is specified with the :DISP:ENAB command). (No query)
Example of use	10 OUTPUT 717; ":DISP:UPD"
Related commands	:DISP:ENAB on page 462
Equivalent key	No equivalent key is available on the front panel.

:DISP:WIND{1-16}:ACT

Syntax	:DISPlay:WINDow{[1] 2 3 4 5 6 7 8 9 10 11 12 13 14 15 16}:ACTivate
Description	Sets one of channel 1 (:WIND1) to channel 16 (:WIND16) to the active channel. You can set only the displayed channel to the active channel. If you execute this command trying to set a not displayed channel to the active channel, an error occurs and the command is ignored. (No query)
Example of use	10 OUTPUT 717; ":DISP:WIND1:ACT"
Related commands	:CALC{1-16}:PAR{1-16}:SEL on page 424
Equivalent key	[Channel Prev] / [Channel Next]

:DISP:WIND{1-16}:ANN:MARK:ALIG

Syntax :DISPlay:WINDow{[1]|2|3|4|5|6|7|8|9|10|11|12|13|14|15|16}:ANNotation:MARKer:ALIG
n[:STATe] {ON|OFF|1|0}

:DISPlay:WINDow{[1]|2|3|4|5|6|7|8|9|10|11|12|13|14|15|16}:ANNotation:MARKer:ALIG
n[:STATe]?

Description For channel 1 (:WIND1) to channel 16 (:WIND16), turn ON/OFF the mode that align the
marker display position of each trace based on trace 1.

Parameters

	Description
ON or 1 (preset value)	Turns ON the mode that align marker display position based on trace 1.
OFF or 0	Turns OFF the alignment.

Query response {1|0}<newline><^END>

Example of use

```
10  OUTPUT 717; ":DISP:WIND1:ANN:MARK:ALIG OFF"
20  OUTPUT 717; ":DISP:WIND1:ANN:MARK:ALIG?"
30  ENTER 717;A
```

Related commands :DISP:WIND{1-16}:ANN:MARK:SING on page 472
:DISP:WIND{1-16}:TRAC{1-16}:ANN:MARK:POS:X on page 478
:DISP:WIND{1-16}:TRAC{1-16}:ANN:MARK:POS:Y on page 479

Equivalent key **[Marker Fctn] - Annotation Options - Align**

:DISP:WIND{1-16}:ANN:MARK:SING

Syntax :DISPlay:WINDow{[1]|2|3|4|5|6|7|8|9|10|11|12|13|14|15|16}:ANNotation:MARKer:SINGl
e[:STATe] {ON|OFF|1|0}

:DISPlay:WINDow{[1]|2|3|4|5|6|7|8|9|10|11|12|13|14|15|16}:ANNotation:MARKer:SINGl
e[:STATe]?

Description For channel 1 (:WIND1) to channel 16 (:Wind16), turns ON/OFF the display of the marker value of only active traces.

If you turn off the function, marker values of all traces (markers) will be displayed.

Parameters

	Description
ON or 1 (preset value)	Displays the marker values of only active traces.(ON)
OFF or 0	Displays the marker values of all traces. (OFF)

Query response {1|0}<newline><^END>

Example of use
10 OUTPUT 717; ":DISP:WIND1:ANN:MARK:SING OFF"
20 OUTPUT 717; ":DISP:WIND1:ANN:MARK:SING?"
30 ENTER 717;A

Related commands
:DISP:WIND{1-16}:ANN:MARK:ALIG on page 471
:DISP:WIND{1-16}:TRAC{1-16}:ANN:MARK:POS:X on page 478
:DISP:WIND{1-16}:TRAC{1-16}:ANN:MARK:POS:Y on page 479

Equivalent key [Marker Fctn] - Annotation Options - Active Only

:DISP:WIND{1-16}:LAB

Syntax :DISPlay:WINDow{[1]|2|3|4|5|6|7|8|9|10|11|12|13|14|15|16}:LABel {ON|OFF|1|0}
:DISPlay:WINDow{[1]|2|3|4|5|6|7|8|9|10|11|12|13|14|15|16}:LABel?

Description Turns ON/OFF the display of the graticule label of channel 1 (:WIND1) to channel 16 (:WIND16).

Parameters

	Description
ON or 1 (preset value)	Turns ON the graticule label display.
OFF or 0	Turns OFF the graticule label display.

Query response {1|0}<newline><^END>

Example of use

```
10  OUTPUT 717; ":DISP:WIND1:LAB ON"
20  OUTPUT 717; ":DISP:WIND1:LAB?"
30  ENTER 717;A
```

Equivalent key **[Display] - Graticule Label**

:DISP:WIND{1-16}:MAX

Syntax :DISPlay:WINDow{[1]|2|3|4|5|6|7|8|9|10|11|12|13|14|15|16}:MAXimize {ON|OFF|1|0}
:DISPlay:WINDow{[1]|2|3|4|5|6|7|8|9|10|11|12|13|14|15|16}:MAXimize?

Description Turns ON/OFF the maximization of the active trace of channel 1 (:WIND1) to channel 16 (:WIND16) (specified with the :CALC{1-16}:PAR{1-16}:SEL command).
If you turned ON the maximization, only the maximized active trace is displayed in the window and the other traces are not displayed.

Parameters

	Description
ON or 1	Turns ON the maximization.
OFF or 0 (preset value)	Turns OFF the maximization.

Query response {1|0}<newline><^END>

Example of use
10 OUTPUT 717; ":DISP:WIND1:MAX ON"
20 OUTPUT 717; ":DISP:WIND1:MAX?"
30 ENTER 717;A

Related commands :CALC{1-16}:PAR{1-16}:SEL on page 424
:DISP:MAX on page 465

Equivalent key [Trace Max]

:DISP:WIND{1-16}:SPL

Syntax

```
:DISPlay:WINDow{[1]|2|3|4|5|6|7|8|9|10|11|12|13|14|15|16}:SPLit {D1|D12|D1_2|D112|D1_1_2|
D123|D1_2_3|D12_33|D11_23|D13_23|D12_13|D1234|D1_2_3_4|D12_34|D123_456|D12_34_56|
D1234_5678|D12_34_56_78|D123_456_789|D123__ABC|D1234__9ABC|D1234__DEFG}
:DISPlay:WINDow{[1]|2|3|4|5|6|7|8|9|10|11|12|13|14|15|16}:SPLit?
```

Description

Sets the graph layout of channel 1 (:WIND1) to channel 16 (:WIND16). For details about the graph layout, refer to Figure 3-1 on page 58.

Parameters

	Description
D1 (preset value)	Specifies the layout in which one graph is displayed in the entire window.
D12	Specifies the layout in which 2 graphs in total are displayed on the left side and right side of the window.
D1_2	Specifies the layout in which 2 graphs in total are displayed in the upper part and lower part of the window.
D112	Specifies the layout in which 2 graphs in total are displayed on the left side of 2/3 and right side of 1/3 of the window.
D1_1_2	Specifies the layout in which 2 graphs in total are displayed in the upper part of 2/3 and lower part of 1/3 of the window.
D123	Specifies the layout in which 3 graphs in total are displayed on the left side, middle part, and right side of the window.
D1_2_3	Specifies the layout in which 3 graphs in total are displayed in the upper part, middle part, and lower part of the window.
D12_33	Specifies the layout in which 3 graphs in total are displayed in the upper left, upper right, and lower part of the window.
D11_23	Specifies the layout in which 3 graphs in total are displayed in the upper part, lower left, and lower right of the window.
D13_23	Specifies the layout in which 3 graphs in total are displayed in the upper left, lower left, and right side of the window.
D12_13	Specifies the layout in which 3 graphs in total are displayed in the left side, upper right, and lower right of the window.
D1234	Specifies the layout in which 4 graphs in total are displayed by splitting the window horizontally into four equal parts.
D1_2_3_4	Specifies the layout in which 4 graphs in total are displayed by splitting the window vertically into four equal parts.
D12_34	Specifies the layout in which 4 graphs in total are displayed in the upper left, upper right, lower left, and lower right of the window.
D123_456	Specifies the layout in which 6 graphs in total are displayed in the upper left, upper middle, upper right, lower left, lower middle, and lower right of the window.
D12_34_56	Specifies the layout in which 6 graphs in total are displayed in the upper left, upper right, middle left, middle right, lower left, and lower right of the window.
D1234_5678	Specifies the layout in which 8 graphs in total (4 in the upper part and 4 in the lower part of the window) are displayed.
D12_34_56_78	Specifies the layout in which 8 graphs in total (4 on the left side and 4 on the right side of the window) are displayed.
D123_456_789	Specifies the layout in which 9 graphs in total (in the left, middle, and right of the upper part of the window, in the left, middle, and right of the middle part, and in the left, middle, and right of the lower part) are displayed.

	Description
D123__ABC	Specifies the layout in which 12 graphs in total are displayed: 4 graphs in the 1st column, 4 in the 2nd column, and 4 in the 3rd column from the left of the window.
D1234__9ABC	Specifies the layout in which 12 graphs in total (4 in the upper part, 4 in the middle part, and 4 in the lower part of the window) are displayed.
D1234__DEFG	Specifies the layout in which 16 graphs in total are displayed: 4 graphs in the 1st column, 4 in the 2nd column, 4 in the 3rd column, and 4 in the 4th column from the left of the window.

Query response {D1|D12|D1_2|D112|D1_1_2|D123|D1_2_3|D12_33|D11_23|D13_23|D12_13|D1234|D1_2_3_4|D12_34|D123_456|D12_34_56|D1234_5678|D12_34_56_78|D123_456_789|D123__ABC|D1234__9ABC|D1234__DEFG}<newline><<^END>

Example of use
 10 OUTPUT 717; ":DISP:WIND:SPL D1_2"
 20 OUTPUT 717; ":DISP:WIND:SPL?"
 30 ENTER 717;A\$

Related commands :DISP:SPL on page 466

Equivalent key [Display] - Allocate Traces

:DISP:WIND{1-16}:TITL

Syntax :DISPlay:WINDow{[1]|2|3|4|5|6|7|8|9|10|11|12|13|14|15|16}:TITLe[:STATe] {ON|OFF|1|0}
 :DISPlay:WINDow{[1]|2|3|4|5|6|7|8|9|10|11|12|13|14|15|16}:TITLe[:STATe]?

Description Turns ON/OFF the display of the title label of channel 1 (:WIND1) to channel 16 (:WIND16) in the title area.

Parameters

	Description
ON or 1	Turns ON the title label display.
OFF or 0 (preset value)	Turns OFF the title label display.

Query response
 10 OUTPUT 717; ":DISP:WIND1:TITL ON"
 20 OUTPUT 717; ":DISP:WIND1:TITL?"
 30 ENTER 717;A

Related commands :DISP:WIND{1-16}:TITL:DATA on page 477

Equivalent key [Display] - Title Label

:DISP:WIND{1-16}:TITL:DATA

Syntax :DISPlay:WINDow{[1]|2|3|4|5|6|7|8|9|10|11|12|13|14|15|16}:TITLe:DATA <string>
:DISPlay:WINDow{[1]|2|3|4|5|6|7|8|9|10|11|12|13|14|15|16}:TITLe:DATA?

Description Sets the title label displayed in the title area of channel 1 (:WIND1) to channel 16 (:WIND16).

Parameters

	<string>
Description	Title label
Range	254 characters or less
Preset value	""

Query response {string}<newline><^END>

Example of use

```
10  OUTPUT 717;":DISP:WIND1:TITL:DATA "Title""
20  OUTPUT 717;":DISP:WIND1:TITL?"
30  ENTER 717;A$
```

Related commands :DISP:WIND{1-16}:TITL on page 476

Equivalent key [Display] - Edit Title Label

:DISP:WIND{1-16}:TRAC{1-16}:ANN:MARK:POS:X

Syntax :DISPlay:WINDow{[1]|2|3|4|5|6|7|8|9|10|11|12|13|14|15|16}:TRACe{[1]|2|3|4|5|6|7|8|9|10|11|12|13|14|15|16}:ANNotation:MARKer:POSition:X <numeric>
:DISPlay:WINDow{[1]|2|3|4|5|6|7|8|9|10|11|12|13|14|15|16}:TRACe{[1]|2|3|4|5|6|7|8|9|10|11|12|13|14|15|16}:ANNotation:MARKer:POSition:X?

Description For trace 1 (:TRAC1) to trace 16 (:TRAC16) of channel 1 (:WIND1) to channel 16 (:WIND16), sets the display position of the marker value on the X-axis by a percentage of the width of the display span.

Parameters

	<numeric>
Description	Display position of the marker value on the X-axis.
Range	-15 to 100
Preset value	1
Unit	% (percent)
Resolution	1

Query response {numeric}<newline><^END>

Example of use
10 OUTPUT 717; ":DISP:WIND1:TRAC1:ANN:MARK:POS:X 33"
20 OUTPUT 717; ":DISP:WIND1:TRAC1:ANN:MARK:POS:X?"
30 ENTER 717;A

Related commands
:DISP:WIND{1-16}:ANN:MARK:ALIG on page 471
:DISP:WIND{1-16}:ANN:MARK:SING on page 472
:DISP:WIND{1-16}:TRAC{1-16}:ANN:MARK:POS:Y on page 479

Equivalent key [Marker Fctn] - Annotation Options - Marker Info X Pos

:DISP:WIND{1-16}:TRAC{1-16}:ANN:MARK:POS:Y

Syntax

:DISPlay:WINDow{[1]|2|3|4|5|6|7|8|9|10|11|12|13|14|15|16}:TRACe{[1]|2|3|4|5|6|7|8|9|10|11|12|13|14|15|16}:ANNotation:MARKer:POSition:Y <numeric>
:DISPlay:WINDow{[1]|2|3|4|5|6|7|8|9|10|11|12|13|14|15|16}:TRACe{[1]|2|3|4|5|6|7|8|9|10|11|12|13|14|15|16}:ANNotation:MARKer:POSition:Y?

Description

For trace 1 (:TRAC1) to trace 16 (:TRAC16) of channel 1 (:WIND1) to channel 16 (:WIND16), sets the display position of the marker value on the Y-axis by a percentage of the height of the display span.

Parameters

	<numeric>
Description	Display position of the marker value on the Y-axis.
Range	-15 to 100
Preset value	1
Unit	% (percent)
Resolution	1

Query response

{numeric}<newline><^END>

Example of use

```
10 OUTPUT 717; ":DISP:WIND1:TRAC1:ANN:MARK:POS:Y 33"
20 OUTPUT 717; ":DISP:WIND1:TRAC1:ANN:MARK:POS:Y?"
30 ENTER 717;A
```

Related commands

:DISP:WIND{1-16}:ANN:MARK:ALIG on page 471
:DISP:WIND{1-16}:ANN:MARK:SING on page 472
:DISP:WIND{1-16}:TRAC{1-16}:ANN:MARK:POS:X on page 478

Equivalent key

[Marker Fctn] - Annotation Options - Marker Info Y Pos

:DISP:WIND{1-16}:TRAC{1-16}:MEM

Syntax

```
:DISPlay:WINDow{[1]|2|3|4|5|6|7|8|9|10|11|12|13|14|15|16}:TRACe{[1]|2|3|4|5|6|7|8|9|10|11|12|13|14|15|16}  
:MEMory[:STATe] {ON|OFF|1|0}  
  
:DISPlay:WINDow{[1]|2|3|4|5|6|7|8|9|10|11|12|13|14|15|16}:TRACe{[1]|2|3|4|5|6|7|8|9|10|11|12|13|14|15|16}  
:MEMory[:STATe]?
```

Description

For trace 1 (:TRAC1) to trace 16 (:TRAC16) of channel 1 (:WIND1) to channel 16 (:WIND16), turns ON/OFF the display of the memory trace.

Parameters

	Description
ON or 1	Turns ON the memory trace display.
OFF or 0 (preset value)	Turns OFF the memory trace display.

Query response

```
{1|0}<newline><^END>
```

Example of use

```
10 OUTPUT 717; ":DISP:WIND1:TRAC1:MEM ON"  
20 OUTPUT 717; ":DISP:WIND1:TRAC1:MEM?"  
30 ENTER 717;A
```

Related commands

:DISP:WIND{1-16}:TRAC{1-16}:STAT on page 481
:CALC{1-16}:MATH:MEM on page 416

Equivalent key

[Display] - Display - Mem (when the data trace display is OFF)
[Display] - Display - Data & Mem (when the data trace display is ON)

:DISP:WIND{1-16}:TRAC{1-16}:STAT

Syntax :DISPlay:WINDow{[1]|2|3|4|5|6|7|8|9|10|11|12|13|14|15|16}:TRACe{[1]|2|3|4|5|6|7|8|9|10|11|12|13|14|15|16}:STATe {ON|OFF|1|0}
:DISPlay:WINDow{[1]|2|3|4|5|6|7|8|9|10|11|12|13|14|15|16}:TRACe{[1]|2|3|4|5|6|7|8|9|10|11|12|13|14|15|16}:STATe?

Description For trace 1 (:TRAC1) to trace 16 (:TRAC16) of channel 1 (:WIND1) to channel 16 (:WIND16), turns ON/OFF the display of the data trace.

Parameters

	Description
ON or 1 (preset value)	Turns ON the data trace display.
OFF or 0	Turns OFF the data trace display.

Query response {1|0}<newline><^END>

Example of use
10 OUTPUT 717; ":DISP:WIND1:TRAC1:STAT ON"
20 OUTPUT 717; ":DISP:WIND1:TRAC1:STAT?"
30 ENTER 717;A

Related commands :DISP:WIND{1-16}:TRAC{1-16}:ANN:MARK:POS:X on page 478

Equivalent key [Display] - Display - Data (when the memory trace display is OFF)
[Display] - Display - Data & Mem (when the memory trace display is ON)

:DISP:WIND{1-16}:TRAC{1-16}:Y:AUTO

Syntax :DISPlay:WINDow{[1]|2|3|4|5|6|7|8|9|10|11|12|13|14|15|16}:TRACe{[1]|2|3|4|5|6|7|8|9|10|11|12|13|14|15|16}:Y[:SCALE]:AUTO

Description For trace 1 (:TRAC1) to trace 16 (:TRAC16) of channel 1 (:WIND1) to channel 16 (:WIND16), executes the auto scale (function to automatically adjust the value of the reference graticule line and the scale per division to display the trace appropriately). (No query)

Example of use 10 OUTPUT 717; ":DISP:WIND1:TRAC1:Y:AUTO"

Related commands :DISP:WIND{1-16}:TRAC{1-16}:Y:PDIV on page 482
:DISP:WIND{1-16}:TRAC{1-16}:Y:RLEV on page 483

Equivalent key [Scale] - Auto Scale

:DISP:WIND{1-16}:TRAC{1-16}:Y:PDIV

Syntax :DISPlay:WINDow{[1]|2|3|4|5|6|7|8|9|10|11|12|13|14|15|16}:TRACe{[1]|2|3|4|5|6|7|8|9|10|11|12|13|14|15|16}
:Y[:SCALe]:PDIVision <numeric>
:DISPlay:WINDow{[1]|2|3|4|5|6|7|8|9|10|11|12|13|14|15|16}:TRACe{[1]|2|3|4|5|6|7|8|9|10|11|12|13|14|15|16}
:Y[:SCALe]:PDIVision?

Description For trace 1 (:TRAC1) to trace 16 (:TRAC16) of channel 1 (:WIND1) to channel 16 (:WIND16): when the data format is not the Smith chart format or the polar format, sets the scale per division; when the data format is the Smith chart format or the polar format, sets the full scale value (the value of the outermost circle).

Parameters

	<numeric>
Description	Scale value
Range	1E-18 to 1E8
Preset value	Varies depending on the data format as follows: Logarithmic Magnitude: 10 Phase, Expand Phase, Positive Phase: 90 Group Delay: 1E-8 Smith, Polar, SWR: 1 Linear Magnitude: 0.1 Real, Imaginary: 0.2
Unit	Varies depending on the data format as follows: Logarithmic Magnitude: dB (decibel) Phase, Expand Phase, Positive Phase: ° (degree) Group Delay: s (second) Others: No unit

If the specified parameter is out of the allowable setup range, the minimum value (if the lower limit of the range is not reached) or the maximum value (if the upper limit of the range is exceeded) is set.

Query response {numeric}<newline><^END>

Example of use
10 OUTPUT 717; ":DISP:WIND1:TRAC1:Y:PDIV 2.5"
20 OUTPUT 717; ":DISP:WIND1:TRAC1:Y:PDIV?"
30 ENTER 717;A

Related commands
:DISP:WIND{1-16}:Y:DIV on page 486
:DISP:WIND{1-16}:TRAC{1-16}:Y:RLEV on page 483
:DISP:WIND{1-16}:TRAC{1-16}:Y:RPOS on page 484

Equivalent key [Scale] - Scale/Div

:DISP:WIND{1-16}:TRAC{1-16}:Y:RLEV

Syntax

```
:DISPlay:WINDow{[1]|2|3|4|5|6|7|8|9|10|11|12|13|14|15|16}:TRACe{[1]|2|3|4|5|6|7|8|9|10|11|12|13|14|15|16}
:Y[:SCALe]:RLEVel <numeric>

:DISPlay:WINDow{[1]|2|3|4|5|6|7|8|9|10|11|12|13|14|15|16}:TRACe{[1]|2|3|4|5|6|7|8|9|10|11|12|13|14|15|16}
:Y[:SCALe]:RLEVel?
```

Description

For trace 1 (:TRAC1) to trace 16 (:TRAC16) of channel 1 (:WIND1) to channel 16 (:WIND16), sets the value of the reference graticule line.

Parameters

	<numeric>
Description	Value of reference graticule line
Range	-5E8 to 5E8
Preset value	0*1
Unit	Varies depending on the data format as follows: Logarithmic Magnitude: dB (decibel) Phase, Expand Phase, Positive Phase: ° (degree) Group Delay: s (second) Others: No unit

*1. When the data format is "SWR," the preset value is 1.

If the specified parameter is out of the allowable setup range, the minimum value (if the lower limit of the range is not reached) or the maximum value (if the upper limit of the range is exceeded) is set.

Query response

```
{numeric}<newline><^END>
```

Example of use

```
10 OUTPUT 717; ":DISP:WIND1:TRAC1:Y:RLEV 1E2"
20 OUTPUT 717; ":DISP:WIND1:TRAC1:Y:RLEV?"
30 ENTER 717;A
```

Related commands

```
:DISP:WIND{1-16}:Y:DIV on page 486
:DISP:WIND{1-16}:TRAC{1-16}:Y:PDIV on page 482
:DISP:WIND{1-16}:TRAC{1-16}:Y:RPOS on page 484
```

Equivalent key

[Scale] - Reference Value

:DISP:WIND{1-16}:TRAC{1-16}:Y:RPOS

Syntax :DISPlay:WINDow{[1][2][3][4][5][6][7][8][9][10][11][12][13][14][15][16]}:TRACe{[1][2][3][4][5][6][7][8][9][10][11][12][13][14][15][16]}:Y[:SCALe]:RPOSition <numeric>
:DISPlay:WINDow{[1][2][3][4][5][6][7][8][9][10][11][12][13][14][15][16]}:TRACe{[1][2][3][4][5][6][7][8][9][10][11][12][13][14][15][16]}:Y[:SCALe]:RPOSition?

Description For trace 1 (:TRAC1) to trace 16 (:TRAC16) of channel 1 (:WIND1) to channel 16 (:WIND16), specifies a reference graticule line with its number (an integer assigned starting from 0 from the lowest division).

Parameters

	<numeric>
Description	Number of graticule line
Range	0 to the number of divisions *1
Preset value	5*2
Resolution	1

*1. Set with the :DISP:WIND{1-16}:Y:DIV commands.

*2. When the data format is "Linear Magnitude" or "SWR," the preset value is 1.

If the specified parameter is out of the allowable setup range, the minimum value (if the lower limit of the range is not reached) or the maximum value (if the upper limit of the range is exceeded) is set.

Query response {numeric}<newline><^END>

Example of use
10 OUTPUT 717; ":DISP:WIND1:TRAC1:Y:RPOS 6"
20 OUTPUT 717; ":DISP:WIND1:TRAC1:Y:RPOS?"
30 ENTER 717;A

Related commands
:DISP:WIND{1-16}:Y:DIV on page 486
:DISP:WIND{1-16}:TRAC{1-16}:Y:PDIV on page 482
:DISP:WIND{1-16}:TRAC{1-16}:Y:RLEV on page 483

Equivalent key [Scale] - Reference Position

:DISP:WIND{1-16}:X:SPAC

Syntax :DISPlay:WINDow{[1]|2|3|4|5|6|7|8|9|10|11|12|13|14|15|16}:X:SPACing {LINear|OBASe}
:DISPlay:WINDow{[1]|2|3|4|5|6|7|8|9|10|11|12|13|14|15|16}:X:SPACing?

Description Selects the display method of the graph horizontal axis of channel 1 (:WIND1) to channel 16 (:WIND16) for segment sweep.

Parameters

	Description
LINear	Specifies the frequency base (linear frequency axis with the minimum frequency at the left edge and the maximum frequency at the right edge).
OBASe (preset value)	Specifies the order base (axis in which the measurement point numbers are positioned evenly in the order of measurement).

Query response {LIN|OBAS}<newline><^END>

Example of use

```
10  OUTPUT 717; ":DISP:WIND1:X:SPAC OBAS"
20  OUTPUT 717; ":DISP:WIND1:X:SPAC?"
30  ENTER 717;A$
```

Related commands :SENS{1-16}:SWE:TYPE on page 696

Equivalent key [Sweep Setup] - Segment Display

:DISP:WIND{1-16}:Y:DIV

Syntax :DISPlay:WINDow{[1]|2|3|4|5|6|7|8|9|10|11|12|13|14|15|16}:Y[:SCALe]:DIVisions <numeric>
:DISPlay:WINDow{[1]|2|3|4|5|6|7|8|9|10|11|12|13|14|15|16}:Y[:SCALe]:DIVisions?

Description Sets the number of divisions of all the graphs of channel 1 (:WIND1) to channel 16 (:WIND16).

The number of graticule line (specified with the :DISP:WIND{1-16}:TRAC{1-16}:Y:RPOS command) depends on this setting.

Parameters

	<numeric>
Description	Divisions
Range	4 to 30
Preset value	10
Resolution	2

If the specified parameter is out of the allowable setup range, the minimum value (if the lower limit of the range is not reached) or the maximum value (if the upper limit of the range is exceeded) is set.

Query response {numeric}<newline><^END>

Example of use
10 OUTPUT 717; ":DISP:WIND1:Y:DIV 12"
20 OUTPUT 717; ":DISP:WIND1:Y:DIV?"
30 ENTER 717;A

Related commands
:DISP:WIND{1-16}:TRAC{1-16}:Y:PDIV on page 482
:DISP:WIND{1-16}:TRAC{1-16}:Y:RLEV on page 483
:DISP:WIND{1-16}:TRAC{1-16}:Y:RPOS on page 484

Equivalent key [Scale] - Divisions

:FORM:BORD

Syntax :FORMat:BORDer {NORMal|SWAPped}
:FORMat:BORDer?

Description When the data transfer format is set to the binary transfer format, sets the transfer order of each byte in data (byte order).
For details about the data transfer format, refer to “Data Transfer Format” on page 164.

Parameters

	Description
NORMal (preset value)	Specifies the byte order in which transfer starts from the byte including MSB (Most Significant Bit).
SWAPped	Specifies the byte order in which transfer starts from the byte including LSB (Least Significant Bit).

Query response {NORM|SWAP}<newline><^END>

Example of use

```
10 OUTPUT 717; ":FORM:BORD SWAP "
20 OUTPUT 717; ":FORM:BORD?"
30 ENTER 717;A$
```

Related commands :FORM:DATA on page 488

Equivalent key No equivalent key is available on the front panel.

:FORM:DATA

Syntax :FORMat:DATA { ASCii|REAL|REAL32}
:FORMat:DATA?

Description Use the following commands to set the format to transfer data.

- :CALC{1-16}:DATA:FDAT on page 307
- :CALC{1-16}:DATA:FMEM on page 308
- :CALC{1-16}:DATA:SDAT on page 309
- :CALC{1-16}:DATA:SMEM on page 310
- :CALC{1-16}:FUNC:DATA? on page 369
- :CALC{1-16}:LIM:DATA on page 381
- :CALC{1-16}:LIM:REP? on page 387
- :CALC{1-16}:LIM:REP:ALL? on page 388
- :CALC{1-16}:BLIM:REP? on page 300
- :CALC{1-16}:RLIM:DATA on page 427
- :CALC{1-16}:RLIM:REP? on page 432
- :SENS{1-16}:FREQ:DATA? on page 655
- :SENS{1-16}:SEGM:DATA on page 688
- :SOUR:POW:PORT:CORR:COLL:TABL:ASEN:DATA on page 702
- :SOUR:POW:PORT:CORR:COLL:TABL:BSSEN:DATA on page 703
- :SOUR{1-16}:POW:PORT{1-4}:CORR:COLL:TABL:LOSS:DATA on page 715
- :SOUR{1-16}:POW:PORT{1-4}:CORR:DATA on page 716

For details about the data transfer format, refer to “Data Transfer Format” on page 164.

Parameters

	Description
ASCii (preset value)	Specifies the ASCII transfer format.
REAL	Specifies the IEEE 64-bit floating point binary transfer format.
REAL32	Specifies the IEEE 32-bit floating point binary transfer format.

Query response {ASC|REAL|REAL32}<newline><^END>

Example of use

```

10  OUTPUT 717; ":FORM:DATA REAL"
20  OUTPUT 717; ":FORM:DATA?"
30  ENTER 717;A$

```

Related commands :FORM:BORD on page 487

Equivalent key No equivalent key is available on the front panel.

:HCOP

Syntax :HCOPy[:IMMediate]

Description Outputs the display image on the LCD display to the printer connected to the E5070B/E5071B. (No query)

Example of use 10 OUTPUT 717; ":HCOP "

Related commands :HCOP:ABOR on page 489
:HCOP:IMAG on page 490

Equivalent key **[System] - Print**

:HCOP:ABOR

Syntax :HCOPy:ABORt

Description Aborts the print output. (No query)

Example of use 10 OUTPUT 717; ":HCOP:ABOR "

Related commands :HCOP on page 489

Equivalent key **[System] - Abort Printing**

:HCOP:IMAG

Syntax :HCOPy:IMAGe {NORMal|INVert}
:HCOPy:IMAGe?

Description Selects the print color for output to the printer.

Parameters

	Description
NORMal	Specifies printing in close color to the display color.
INVert (preset value)	Specifies printing in the inverted color of the display color.

Query response {NORM|INV}<newline><^END>

Example of use
10 OUTPUT 717; ":HCOP:IMAG NORM"
20 OUTPUT 717; ":HCOP:IMAG?"
30 ENTER 717;A\$

Related commands :HCOP on page 489

Equivalent key [System] - Invert Image

:INIT{1-16}

Syntax :INITiate{[1]|2|3|4|5|6|7|8|9|10|11|12|13|14|15|16}[:IMMediate]

Description Changes the state of each channel of channel 1 (:INIT1) to channel 16 (:INIT16) to the startup state in the trigger system.

When this command is executed for a channel in the idle state, it goes into the initiate state immediately. Then, after measurement is executed once, it goes back to the idle state.

If this command is executed for a channel that is not in the idle state or for which the continuous initiation mode is set to ON (ON is specified with the :INIT{1-16}:CONT command), an error occurs and the command is ignored.

For details about the trigger system, refer to "Trigger System" on page 128. (No query)

Example of use 10 OUTPUT 717; ":INIT1"

Related commands :INIT{1-16}:CONT on page 491

Equivalent key [Trigger] - Single

:INIT{1-16}:CONT

Syntax :INITiate{[1]|2|3|4|5|6|7|8|9|10|11|12|13|14|15|16}:CONTinuous {ON|OFF|1|0}
:INITiate{[1]|2|3|4|5|6|7|8|9|10|11|12|13|14|15|16}:CONTinuous?

Description Turns ON/OFF of the continuous initiation mode of channel 1 (:INIT1) to channel 16 (:INIT16) in the trigger system.

For details about the trigger system, refer to “Trigger System” on page 128.

Parameters

	Description
ON or 1	Turns ON the continuous initiation mode.
OFF or 0	Turns OFF the continuous initiation mode.

Regarding to this setting, only channel 1 is initialized to ON with the :SYST:PRES command; all the channels are initialized to OFF with the *RST command.

Query response {1|0}<newline><^END>

Example of use

```
10 OUTPUT 717; ":INIT1:CONT OFF"
20 OUTPUT 717; ":INIT1:CONT?"
30 ENTER 717;A
```

Related commands :INIT{1-16} on page 490

Equivalent key **[Trigger] - Continuous** (continuous initiation mode ON)
[Trigger] - Hold (continuous initiation mode OFF)

:MMEM:CAT?

Syntax :MMEMory:CATalog? <string 1>

Description Reads out the following information on the built-in storage device of the E5070B/E5071B.

To read out the information in the root directory (folder), specify “\” (backslash). If you want to specify a directory on the floppy disk drive, you need to add “A:” at the beginning of the file name. Separate directory names with “/” (slash) or “\” (backslash). (Query only)

- Space in use
- Available space
- Name and size of all files (including directories) in the specified directory.

Parameters

	<string 1>
Description	Directory name whose information you want to read out
Range	254 characters or less

Query response {string 2}<newline><^END>

The format of the readout character string is as follows:

"{used_size},{free_size},{name 1},{size 1},...,{name N},{size N}"

Where N is the number of all files in the specified directory and n is an integer between 1 and N.

{used_size}: Space in use of the built-in storage device (byte)^{*1}.

{free_size}: Available space of the built-in storage device (byte)^{*1}.

{name n}: Name of the n-th file (directory).

{size n}: Size (byte) of the n-th file (directory). Always 0 for directories.

Example of use

```
10 DIM A$[1000]
20 OUTPUT 717; ":MMEM:CAT? "\"\"""
30 ENTER 717;A$
```

Equivalent key No equivalent key is available on the front panel.

^{*1}. If you specify a directory on the floppy disk drive, it is the capacity of the floppy disk in the drive.

:MMEM:COPY

Syntax :MMEMory:COPY <string 1>,<string 2>

Description Copies a file.

Specify the file name with the extension. If you want to specify a file on the floppy disk drive, you need to add "A:" at the beginning of the file name. When you use directory (folder) names and file name, separate them with "/" (slash) or "\" (backslash).

If the specified copy source file does not exist, an error occurs and the command is ignored. Notice that, if a file with the same name as the specified copy destination file name exists, its contents are overwritten. (No query)

Parameters

	<string 1>	<string 2>
Description	Copy source file name	Copy destination file name
Range	254 characters or less	254 characters or less

Example of use 10 OUTPUT 717;":MMEM:COPY "Test1/State01.sta","A:Test1_01.sta""

Equivalent key [Save/Recall] - Save State - File Dialog...

:MMEM:DEL

Syntax :MMEMory:DELeTe <string>

Description Deletes an existing file or directory (folder).

When you delete a directory, all the files and directories in it are deleted.

Specify the file name with the extension. If you want to specify a file or directory on the floppy disk drive, you need to add "A:" at the beginning of its name. When you specify a file (directory) under an existing directory, separate them with "/" (slash) or "\" (backslash).

If the specified file or directory does not exist, an error occurs and the command is ignored. (No query)

Parameters

	<string>
Description	File name or directory name you want to delete
Range	254 characters or less

Example of use

```
10 OUTPUT 717; ":MMEM:DEL "Test1/State01.sta""
10 OUTPUT 717; ":MMEM:DEL "A:State01.sta""
```

Equivalent key [Save/Recall] - Save State - File Dialog...

:MMEM:LOAD

Syntax :MMEMory:LOAD[:STATe] <string>

Description Recalls the specified instrument state file (file with the .sta extension saved with the :MMEM:STOR command).

Specify the file name with the extension. If you want to specify a file on the floppy disk drive, you need to add "A:" at the beginning of the file name. When you use directory names and file name, separate them with "/" (slash) or "\" (backslash).

If the specified file does not exist, an error occurs and the command is ignored. (No query)

Parameters

	<string>
Description	Instrument state file name
Range	254 characters or less

Example of use

```
10 OUTPUT 717;":MMEM:LOAD ""Test1/State01.sta""
10 OUTPUT 717;":MMEM:LOAD ""A:State01.sta""
```

Related commands :MMEM:STOR on page 506

Equivalent key [Save/Recall] - Recall State

:MMEM:LOAD:ASCF

Syntax :MMEMory:LOAD:ASCFactor <string>

Description Recalls the file (file with the .csv extension saved with the :MMEM:STOR:ASCF command) you want to specify as the table for the reference calibration coefficient and the calibration coefficient table for power sensor A.

Specify the file name with the extension. If you want to specify a file on the floppy disk drive, you need to add "A:" at the beginning of the file name. When you use directory names and file name, separate them with "/" (slash) or "\" (backslash).

If the specified file does not exist, an error occurs and the command is ignored. (No query)

Parameters

	<string>
Description	A file name of the reference calibration coefficient and the calibration coefficient table for power sensor A.
Range	254 characters or less

Example of use

```
10 OUTPUT 717; ":MMEM:LOAD:ASCF "Test1/Sensor01.csv""
10 OUTPUT 717; ":MMEM:LOAD:ASCF "A:Sensor01.csv""
```

Related commands :MMEM:STOR:ASCF on page 507

Equivalent key [Cal] - Power Calibration - Sensor A Settings - Import from CSV File

:MMEM:LOAD:BSCF

Syntax :MMEMory:LOAD:BSCFactor <string>

Description Recalls the file (file with the .csv extension saved with the :MMEM:STOR:BSCF command) you want to specify as the table for the reference calibration coefficient and the calibration coefficient table for power sensor B.

Specify the file name with the extension. If you want to specify a file on the floppy disk drive, you need to add "A:" at the beginning of the file name. When you use directory names and file name, separate them with "/" (slash) or "\" (backslash).

If the specified file does not exist, an error occurs and the command is ignored. (No query)

Parameters

	<string>
Description	A file name of the reference calibration coefficient and the calibration coefficient table for power sensor B.
Range	254 characters or less

Example of use

```
10 OUTPUT 717;":MMEM:LOAD:BSCF ""Test1/Sensor01.csv""
10 OUTPUT 717;":MMEM:LOAD:BSCF ""A:Sensor01.csv""
```

Related commands :MMEM:STOR:BSCF on page 508

Equivalent key [Cal] - Power Calibration - Sensor B Settings - Import from CSV File

:MMEM:LOAD:CHAN

Syntax :MMEMory:LOAD:CHANnel[:STATe] {A|B|C|D}

Description Recalls the instrument state for an individual channel (saved with the :MMEM:STOR:CHAN command) from the specified register as the setting of the active channel (specified with the :DISP:WIND{1-16}:ACT command).

It is possible to recall the register from a different channel where it was saved.

If no instrument state has been saved in the specified register, an error occurs and the command is ignored. (No query)

Parameters

	Description
A	Specifies register A.
B	Specifies register B.
C	Specifies register C.
D	Specifies register D.

Example of use 10 OUTPUT 717; ":MMEM:LOAD:CHAN A"

Related commands :MMEM:STOR:CHAN on page 509
:DISP:WIND{1-16}:ACT on page 470

Equivalent key [Save/Recall] - Recall Channel - A|B|C|D

:MMEM:LOAD:CKIT{1-20}

Syntax :MMEMory:LOAD:CKIT{[1]|2|3|4|5|6|7|8|9|10|11|12|13|14|15|16|17|18|19|20} <string>

Description Recall a definition file of the calibration kit (saved with the :MMEM:STOR:CHAN command with the extension .ckx) you want to specify.

Specifies the file name with the extension. If you want to specify a file on the floppy disk drive, you need to add "A:" at the beginning of the file name. When you use a directory name and file name, separate them with a "/" (slash), or a "\" (backslash).

If the specified file does not exist, an error occurs and the command is ignored. (No query)

Parameters

	<string>
Description	File name of the definition table of a calibration kit
Range	254 characters or less

Example of use

```
10 OUTPUT 717;":MMEM:LOAD:CKIT1 "Test1/Ckit01.ckx""
10 OUTPUT 717;":MMEM:LOAD:LIM "A:Ckit01.ckx""
```

Related commands :MMEM:STOR:CKIT{1-20} on page 510

Equivalent key [Cal] - Modify Cal Kit - Import Cal Kit...

:MMEM:LOAD:LIM

Syntax :MMEMory:LOAD:LIMit <string>

Description As the limit table for the active trace (specified with the :CALC{1-16}:PAR{1-16}:SEL command) of the active channel (specified with the :DISP:WIND{1-16}:ACT command), recalls the specified limit table file (file with the .csv extension saved with the :MMEM:STOR:LIM command).

Specify the file name with the extension. If you want to specify a file on the floppy disk drive, you need to add "A:" at the beginning of the file name. When you use directory names and file name, separate them with "/" (slash) or "\" (backslash).

If the specified file does not exist, an error occurs and the command is ignored. (No query)

Parameters

	<string>
Description	File name of limit table
Range	254 characters or less

Example of use

```
10 OUTPUT 717; ":MMEM:LOAD:LIM "Test1/Limit01.csv""
10 OUTPUT 717; ":MMEM:LOAD:LIM "A:Limit01.csv""
```

Related commands :MMEM:STOR:LIM on page 513
:DISP:WIND{1-16}:ACT on page 470

Equivalent key [Analysis] - Limit Test - Edit Limit Line - Import from CSV File

:MMEM:LOAD:PLOS{1-4}

Syntax :MMEMory:LOAD:PLOSs{[1]|2|3|4} <string>

Description For port 1 (:PLOS1) to port 4(:PLOS4), as the loss compensation table for the active channel (specified with the :DISP:WIND{1-16}:ACT command), recalls the specified loss compensation table file (a file with the .csv extension saved with the :MMEM:STOR:PLOS{1-4} command).

Specify the file name with the extension. If you want to specify a file on the floppy disk drive, you need to add "A:" at the beginning of the file name. When you use directory names and file name, separate them with "/" (slash) or "\" (backslash).

If the specified file does not exist, an error occurs and the command is ignored. (No query)

Parameters

	<string>
Description	A file name of the loss compensation table
Range	254 characters or less

Example of use

```
10 OUTPUT 717; ":MMEM:LOAD:PLOS1 " "Test1/Loss01.csv" ""
10 OUTPUT 717; ":MMEM:LOAD:PLOS1 " "A:Loss01.csv" ""
```

Related commands :MMEM:STOR:PLOS{1-4} on page 514
:DISP:WIND{1-16}:ACT on page 470

Equivalent key [Cal] - Power Calibration - Loss Compn - Import from CSV File

:MMEM:LOAD:PROG

Syntax :MMEMory:LOAD:PROGram <string>

Description Loads (or imports) a VBA project (a file with the .vba extension), a module (a file with the .bas extension), a user form (a file with the .frm extension) or a class module (a file with the .cls extension).

Specify the file name with the extension. If you want to specify a file on the floppy disk drive, you need to add "A:" at the beginning of the file name. When you use directory names and file name, separate them with "/" (slash) or "\" (backslash).

If the specified file does not exist, an error occurs and the command is ignored. (No query)

Parameters

	<string>
Description	File name
Range	254 characters or less

Example of use

```
10 OUTPUT 717; ":MMEM:LOAD:PROG "Test1/Test1_01.vba""
10 OUTPUT 717; ":MMEM:LOAD:PROG "A:Test1_01.vba""
```

Related commands :MMEM:STOR:PROG on page 515

Equivalent key [Macro Setup] - Load VBA Project

:MMEM:LOAD:RLIM

Syntax :MMEMory:LOAD:RLIMit <string>

Description As the ripple limit table for the active trace (specified with the :CALC{1-16}:PAR{1-16}:SEL command) of the active channel (specified with the :DISP:WIND{1-16}:ACT command), recalls the specified ripple limit table file (file with the .csv extension saved with the :MMEM:STOR:RLIM command).

Specify the file name with the extension. If you want to specify a file on the floppy disk drive, you need to add "A:" at the beginning of the file name. When you write directory names and the file name, separate them with a "/" (slash) or "\" (backslash).

If the specified file does not exist, an error occurs and the command is ignored. (No query)

Parameters

	<string>
Description	File name of the ripple limit table.
Range	254 characters or less

Example of use

```
10 OUTPUT 717;":MMEM:LOAD:RLIM "RTest1/Rlim01.csv""
10 OUTPUT 717;":MMEM:LOAD:RLIM "A:Rlim01.csv""
```

Related commands

- :MMEM:STOR:RLIM on page 516
- :DISP:WIND{1-16}:ACT on page 470
- :CALC{1-16}:PAR{1-16}:SEL on page 424

Equivalent key [Analysis] - Ripple Limit - Edit Ripple Limit - Import from CSV File

:MMEM:LOAD:SEGM

Syntax :MMEMory:LOAD:SEGMent <string>

Description As the segment sweep table for the active channel (specified with the :DISP:WIND{1-16}:ACT command), recalls the specified segment sweep table file (a file with the .csv extension saved with the :MMEM:STOR:SEGM command).

Specify the file name with the extension. If you want to specify a file on the floppy disk drive, you need to add "A:" at the beginning of the file name. When you use directory names and file name, separate them with "/" (slash) or "\" (backslash).

If the specified file does not exist, an error occurs and the command is ignored. (No query)

Parameters

	<string>
Description	File name of segment sweep table
Range	254 characters or less

Example of use

```
10 OUTPUT 717; ":MMEM:LOAD:SEGM "Test1/Segm01.csv""
10 OUTPUT 717; ":MMEM:LOAD:SEGM "A:Segm01.csv""
```

Related commands :MMEM:STOR:SEGM on page 518
:DISP:WIND{1-16}:ACT on page 470

Equivalent key [Sweep Setup] - Edit Segment Table - Import from CSV File

:MMEM:MDIR

Syntax :MMEMory:MDIRectory <string>

Description Creates a new directory (folder).

If you want to create a directory on the floppy disk drive, you need to add "A:" at the beginning of the directory name. When you create a directory under an existing directory, separate between the directory names with "/" (slash) or "\" (backslash).

If a directory with the same name as the specified directory name exists, an error occurs and the command is ignored. (No query)

Parameters

	<string>
Description	Directory name you want to create
Range	254 characters or less

Example of use

```
10 OUTPUT 717;":MMEM:MDIR ""Test1""
10 OUTPUT 717;":MMEM:MDIR ""A:Test1""
```

Equivalent key [Save/Recall] - Save State - File Dialog...

:MMEM:STOR

Syntax :MMEMory:STORe[:STATe] <string>

Description Saves the instrument state (data to be saved specified with the command) into a file. Specify the file name with the .sta extension. If you want to specify a file on the floppy disk drive, you need to add "A:" at the beginning of the file name. When you use directory names and file name, separate them with "/" (slash) or "\" (backslash). Notice that, if a file with the specified file name exists, its contents are overwritten. (No query)

NOTE The instrument setting file saved with the autorec.sta (or A:autorec.sta) file name is automatically recalled when turning on the E5070B/E5071B.

Parameters

	<string>
Description	File name in which you want to save the instrument state
Range	254 characters or less

Example of use
10 OUTPUT 717; ":MMEM:STOR "Test1/State01.sta""
10 OUTPUT 717; ":MMEM:STOR "A:State01.sta""

Related commands :MMEM:LOAD on page 495
on page 525

Equivalent key [Save/Recall] - Save State|Re-Save State

:MMEM:STOR:ASCF

Syntax :MMEMory:STORe:ASCFactor <string>

Description Saves the reference calibration coefficient and the calibration coefficient table for power sensor A into a CSV file.

Specify the file name with the .sta extension. If you want to specify a file on the floppy disk drive, you need to add "A:" at the beginning of the file name. When you use directory names and file name, separate them with "/" (slash) or "\" (backslash).

Notice that, if a file with the specified file name exists, its contents are overwritten. (No query)

Parameters

	<string>
Description	A file name used to save the reference calibration coefficient and the calibration coefficient table for power sensor A.
Range	254 characters or less

Example of use

```
10 OUTPUT 717;":MMEM:STOR:ASCF "Test1/Sensor01.csv""
10 OUTPUT 717;":MMEM:STOR:ASCF "A:Sensor01.csv""
```

Related commands :MMEM:LOAD:ASCF on page 496

Equivalent key [Cal] - Power Calibration - Sensor A Settings - Export to CSV File

:MMEM:STOR:BSCF

Syntax :MMEMory:STORe:BSCFactor <string>

Description Saves the reference calibration coefficient and the calibration coefficient table for power sensor B into a CSV file.

Specify the file name with the .sta extension. If you want to specify a file on the floppy disk drive, you need to add "A:" at the beginning of the file name. When you use directory names and file name, separate them with "/" (slash) or "\" (backslash).

Notice that, if a file with the specified file name exists, its contents are overwritten. (No query)

Parameters

	<string>
Description	A file name used to save the reference calibration coefficient and the calibration coefficient table for power sensor B.
Range	254 characters or less

Example of use

```
10 OUTPUT 717; ":MMEM:STOR:BSCF "Test1/Sensor01.csv""
10 OUTPUT 717; ":MMEM:STOR:BSCF "A:Sensor01.csv""
```

Related commands :MMEM:LOAD:BSCF on page 497

Equivalent key [Cal] - Power Calibration - Sensor B Settings - Export to CSV File

:MMEM:STOR:CHAN

Syntax :MMEMory:STORe:CHANnel[:STATe] { A|B|C|D }

Description Saves the instrument state of the items set for the active channel (specified with the :DISP:WIND{1-16}:ACT command) specific to that channel only into the specified register (volatile memory).

Notice that, if an instrument state has been saved already in the specified register, its contents are overwritten. (No query)

Parameters

	Description
A	Specifies register A.
B	Specifies register B.
C	Specifies register C.
D	Specifies register D.

Example of use 10 OUTPUT 717; ":MMEM:STOR:CHAN A"

Related commands :MMEM:LOAD:CHAN on page 498
:DISP:WIND{1-16}:ACT on page 470

Equivalent key [Save/Recall] - Save Channel - A|B|C|D

:MMEM:STOR:CHAN:CLE

Syntax :MMEMory:STORe:CHANnel:CLEar

Description Deletes the instrument state for each channel (saved with the :MMEM:STOR:CHAN command) in all the registers. (No query)

Example of use 10 OUTPUT 717; ":MMEM:STOR:CHAN:CLE"

Related commands :MMEM:STOR:CHAN on page 509

Equivalent key [Save/Recall] - Save Channel - Clear States - OK

:MMEM:STOR:CKIT{1-20}

Syntax :MMEMory:STORe:CKIT{[1]|2|3|4|5|6|7|8|9|10|11|12|13|14|15|16|17|18|19|20} <string>

Description Saves the definition table of the calibration kit to a file.
Specify the file name with the .ckx extension. If you want to specify a file on the floppy disk drive, you need to add "A:" at the beginning of the file name. When you use a directory name and file name, separate them with "/" (slash) or "\" (backslash).
Notice that, if a file with the specified file name exists, its contents are overwritten. (No query)

Parameters

	<string>
Description	A file name used to save the definition of the calibration kit.
Range	254 characters or less

Example of use
10 OUTPUT 717; ":MMEM:STOR:CKITÅ@" "Test1/Ckit01.ckx" ""
10 OUTPUT 717; ":MMEM:STOR:CKITÅ@" "a:Ckit01.ckx" ""

Related commands :MMEM:LOAD:CKIT{1-20} on page 499

Equivalent key [Cal] - Modify Cal Kit - Export Cal Kit...

:MMEM:STOR:FDAT

Syntax :MMEMory:STORe:FDATa <string>

Description Saves the formatted data array of the active trace (specified with the :CALC{1-16}:PAR{1-16}:SEL command) of the active channel (specified with the :DISP:WIND{1-16}:ACT command) into a file in the CSV format.

Specify the file name with the .csv extension. If you want to specify a file on the floppy disk drive, you need to add "A:" at the beginning of the file name. When you use directory names and file name, separate them with "/" (slash) or "\" (backslash).

Notice that, if a file with the specified file name exists, its contents are overwritten. (No query)

Parameters

	<string>
Description	File name in which you want to save the formatted data array
Range	254 characters or less

Example of use

```
10 OUTPUT 717;":MMEM:STOR:FDAT "Result/Trace01.csv""
10 OUTPUT 717;":MMEM:STOR:FDAT "A:Trace01.csv""
```

Related commands :DISP:WIND{1-16}:ACT on page 470
:CALC{1-16}:PAR{1-16}:SEL on page 424

Equivalent key [Save/Recall] - Save Trace Data

:MME:STOR:IMAG

Syntax :MME:STOR:IMAG <string>

Description Saves the display image on the LCD display at the execution of the command into a file in the bitmap (.bmp) or portable network graphics (.png) format.

Specify the file name with the .bmp or .png extension. If you want to specify a file on the floppy disk drive, you need to add "A:" at the beginning of the file name. When you use directory names and file name, separate them with "/" (slash) or "\" (backslash).

Notice that, if a file with the specified file name exists, its contents are overwritten. (No query)

Parameters

	<string>
Description	File name in which you want to save the display image on the LCD display
Range	254 characters or less

Example of use

```
10 OUTPUT 717; ":MME:STOR:IMAG "Result/Image01.bmp""
10 OUTPUT 717; ":MME:STOR:IMAG "A:Image01.png""
```

Equivalent key **[System] - Dump Screen Image**

When performing the operation from the front panel, the image on the LCD display memorized in the volatile memory (clipboard) (the image on the LCD display when the **[Capture]** key is pressed) is saved. Notice that, if no image is memorized in the clipboard, in the same way as the command, the image on the LCD display at the execution is memorized in the clipboard and then it is saved.

:MMEM:STOR:LIM

Syntax :MMEMory:STORe:LIMit <string>

Description Saves the limit table for the active trace (specified with the :CALC{1-16}:PAR{1-16}:SEL command) of the active channel (specified with the :DISP:WIND{1-16}:ACT command) into a file in the CSV format.

Specify the file name with the .csv extension. If you want to specify a file on the floppy disk drive, you need to add "A:" at the beginning of the file name. When you use directory names and file name, separate them with "/" (slash) or "\" (backslash).

Notice that, if a file with the specified file name exists, its contents are overwritten. (No query)

Parameters

	<string>
Description	File name in which you want to save the limit table
Range	254 characters or less

Example of use

```
10 OUTPUT 717;":MMEM:STOR:LIM "Test1/Limit01.csv""
10 OUTPUT 717;":MMEM:STOR:LIM "A:Limit01.csv""
```

Related commands :DISP:WIND{1-16}:ACT on page 470
:CALC{1-16}:PAR{1-16}:SEL on page 424

Equivalent key [Analysis] - Limit Test - Edit Limit Line - Export to CSV File

:MMEM:STOR:PLOS{1-4}

Syntax :MMEMory:STORe:PLOSs{[1]|2|3|4} <string>

Description For port 1 (:PLOS1) to port 4 (:PLOS4), saves the loss compensation table for the active channel (specified with the :DISP:WIND{1-16}:ACT command) into a file in the CSV format.

Specify the file name with the .csv extension. If you want to specify a file on the floppy disk drive, you need to add "A:" at the beginning of the file name. When you use directory names and file name, separate them with "/" (slash) or "\" (backslash).

Notice that, if a file with the specified file name exists, its contents are overwritten. (No query)

Parameters

	<string>
Description	A file name in which you want to save the loss compensation table
Range	254 characters or less

Example of use

```
10 OUTPUT 717; ":MMEM:STOR:PLOS1 "Test1/Loss01.csv""
10 OUTPUT 717; ":MMEM:STOR:PLOS1 "A:Loss01.csv""
```

Related commands :MMEM:LOAD:PLOS{1-4} on page 501
:DISP:WIND{1-16}:ACT on page 470

Equivalent key [Cal] - Power Calibration - Loss Compen - Export to CSV File

:MMEM:STOR:PROG

Syntax :MMEMory:STORe:PROGram <string>

Description Saves a VBA project opened on the VBA editor into a file.
Specify the file name with the .vba extension. If you want to specify a file on the floppy disk drive, you need to add "A:" at the beginning of the file name. When you use directory names and file name, separate them with "/" (slash) or "\" (backslash).
Notice that, if a file with the specified file name exists, its contents are overwritten. (No query)

Parameters

	<string>
Description	File name in which you want to save the VBA project
Range	254 characters or less

Example of use

```
10 OUTPUT 717;":MMEM:STOR:PROG "Test1/Test1_01.vba""
10 OUTPUT 717;":MMEM:STOR:PROG "A:Test1_01.vba""
```

Related commands :MMEM:LOAD:PROG on page 502

Equivalent key [Macro Setup] - Save VBA Project

:MMEM:STOR:RLIM

Syntax :MMEMory:STORe:RLIMit <string>

Description Saves the ripple limit table of the active trace (specified with the :CALC{1-16}:PAR{1-16}:SEL command) of the active channel (specified with the :DISP:WIND{1-16}:ACT command) into a file in the CSV format.

Specify the file name with the .sta extension. If you want to specify a file on the floppy disk drive, you need to add "A:" at the beginning of the file name. When you write directory names and the file name, separate them with a "/" (slash) or "\" (backslash).

Note that if a file with the specified file name already exists, its contents will be overwritten. (No query)

Parameters

	<string>
Description	File name used to save the ripple limit table.
Range	254 characters or less

Example of use

```
10 OUTPUT 717; ":MMEM:STOR:RLIM "RTest1/Rlim01.csv""
10 OUTPUT 717; ":MMEM:STOR:RLIM "A:Rlim01.csv""
```

Related commands

:MMEM:LOAD:RLIM on page 503
:DISP:WIND{1-16}:ACT on page 470
:CALC{1-16}:PAR{1-16}:SEL on page 424

Equivalent key [Analysis] - Ripple Limit - Edit Ripple Limit - Export to CSV File

:MMEM:STOR:SALL

Syntax :MMEMory:STORe:SALL {ON|OFF|1|0}
:MMEMory:STORe:SALL?

Description Selects whether to save the setting of all channels/traces or that of the displayed channels/traces only as the instrument state to be saved.

Parameters

	Description
ON or 1	Specifies the setting of all channels/traces as the target to be saved.
OFF or 0 (preset value)	Specifies the setting of displayed channels/traces only as the target to be saved.

Query response {1|0}<newline><^END>

Example of use
10 OUTPUT 717; ":MMEM:STOR:SALL ON"
20 OUTPUT 717; ":MMEM:STOR:SALL?"
30 ENTER 717;A

Related commands :MMEM:STOR on page 506

Equivalent key [Save/Recall] - Channel/Trace

:MMEM:STOR:SEGM

Syntax :MMEMory:STORe:SEGMent <string>

Description Saves the segment sweep table for the active channel (specified with the :DISP:WIND{1-16}:ACT command) into a file in the CSV format.

Specify the file name with the .csv extension. If you want to specify a file on the floppy disk drive, you need to add "A:" at the beginning of the file name. When you use directory names and file name, separate them with "/" (slash) or "\" (backslash).

Notice that, if a file with the specified file name exists, its contents are overwritten. (No query)

Parameters

	<string>
Description	File name in which you want to save the segment sweep table
Range	254 characters or less

Example of use

```
10 OUTPUT 717; ":MMEM:STOR:SEGM "Test1/Segm01.csv""
10 OUTPUT 717; ":MMEM:STOR:SEGM "A:Segm01.csv""
```

Related commands :MMEM:LOAD:SEGM on page 504
:DISP:WIND{1-16}:ACT on page 470

Equivalent key [Sweep Setup] - Edit Segment Table - Export to CSV File

:MMEM:STOR:SNP

Syntax :MMEMory:STORe:SNP[:DATA] <string>

Description Saves the measurement data for the active channel (specified with the :DISP:WIND{1-16}:ACT command) to a file in the touchstone format.

You need to specify a file format and file type before saving a file. The extension differs depending on the file type.

<file type>	<extension>
When specifying one port	s1p
When specifying two ports	s2p
When specifying three ports	s3p
When specifying four ports	s4p

If you want to specify a file on a floppy disk, you need to add "A:" at the beginning of the file name. When you use directory names and file name, separate them with "/" (slash) or "\" (back slash).

Note that if a file with the specified file name exists, its contents are overwritten. (No query)

Parameters

	<string>
Description	File name you want to use when saving the file in touchstone format
Range	254 characters or less

NOTE When an invalid extension is specified, an error message appears and the command is ignored.

Example of use

```

10 OUTPUT 717; "DISP:WIND1:ACT"
20 OUTPUT 717; ":MMEM:STOR:SNP:FORM RI"
30 OUTPUT 717; ":MMEM:STOR:SNP:TYPE:S3P 1,2,4"
40 OUTPUT 717; ":MMEM:STOR:SNP " "SNP01.s3p" "
```

Related commands

- :DISP:WIND{1-16}:ACT on page 470
- :MMEM:STOR:SNP:FORM on page 520
- :MMEM:STOR:SNP:TYPE:S1P on page 521
- :MMEM:STOR:SNP:TYPE:S2P on page 522
- :MMEM:STOR:SNP:TYPE:S3P on page 523
- :MMEM:STOR:SNP:TYPE:S4P on page 524

Equivalent key After a file type is specified, a dialog box will appear.

:MMEM:STOR:SNP:FORM

Syntax :MMEMory:STORe:SNP:FORMat { AUTO|MA|DB|RI}
:MMEMory:STORe:SNP:FORMat?

Description Specifies data format for saving measurement data for the active channel (specified with :DISP:WIND{1-16}:ACT command) to a file in the touchstone format.

Parameters

	Description
AUTO	Specifies data format automatically according to the display format of the active trace. *1
MA	Specifies data format "log magnitude - angle."
DB	Specifies data format "linear magnitude - angle."
RI	Specifies data format "real part - imaginary part."

*1. When the display format of the active trace is set to one other than log magnitude format (LogMag), linear magnitude format (LinMag), or real-imaginary number format (Real/Imag), the data format is automatically set to "real part -imaginary part."

Query response { AUTO|MA|DB|RI}<newline><^END>

Example of use
10 OUTPUT 717; ":MMEM:STOR:SNP:FORM MA"
20 OUTPUT 717; ":MMEM:STOR:SNP:FORM?"
30 ENTER 717;A\$

Related commands :DISP:WIND{1-16}:ACT on page 470
:MMEM:STOR:SNP on page 519

Equivalent key [Save/Recall] - Save Snp - Snp Format -
AUTO|LogMag/Angle|LinMag/Angle|Real/Imaginary

:MMEM:STOR:SNP:TYPE:S1P

Syntax :MMEMory:STORe:SNP:TYPE:S1P <numeric>
:MMEMory:STORe:SNP:TYPE:S1P?

Description Sets specified port to the file type (1 port) when saving measurement data for the active channel (specified with :DISP:WIND{1-16}:ACT command) to a file in the touchstone format.

Parameters

	<numeric>
Description	Port number
Range	1 to 4
Resolution	1

Example of use

```
10 OUTPUT 717;":MMEM:STOR:SNP:TYPE:S1P 2"
20 OUTPUT 717;":MMEM:STOR:SNP:TYPE:S1P?"
30 ENTER 717;A$
```

Related commands

- :DISP:WIND{1-16}:ACT on page 470
- :MMEM:STOR:SNP on page 519
- :MMEM:STOR:SNP:FORM on page 520

Equivalent key [Save/Recall] - Save Snp - S1p - 1|2|3|4

:MMEM:STOR:SNP:TYPE:S2P

Syntax :MMEMory:STORe:SNP:TYPE:S2P <numeric 1>, <numeric 2>
 :MMEMory:STORe:SNP:TYPE:S2P?

Description Sets specified port to the file type (2 ports) when saving measurement data for the active channel (specified with :DISP:WIND{1-16}:ACT command) to a file in the touchstone format.

Parameters

	<numeric 1>	<numeric 2>
Description	Port number	Port number
Range	1 to 4	1 to 4
Resolution	1	1

For each parameter, you must specify a different port number. If you specify the same port number for two or more parameters, an error occurs and the command is ignored.

Example of use

```

10 OUTPUT 717; ":MMEM:STOR:SNP:TYPE:S2P 2,3"
20 OUTPUT 717; ":MMEM:STOR:SNP:TYPE:S2P?"
30 ENTER 717;A$
  
```

Related commands

- :DISP:WIND{1-16}:ACT on page 470
- :MMEM:STOR:SNP on page 519
- :MMEM:STOR:SNP:FORM on page 520

Equivalent key [Save/Recall] - Save Snp - S2p - 1-2|1-3|1-4|2-3|2-4|3-4

:MMEM:STOR:SNP:TYPE:S3P

Syntax :MMEMory:STORe:SNP:TYPE:S3P <numeric 1>, <numeric 2>, <numeric 3>
:MMEMory:STORe:SNP:TYPE:S3P?

Description Sets specified port to the file type (3 ports) when saving measurement data for the active channel (specified with :DISP:WIND{1-16}:ACT command) to a file in the touchstone format.

Parameters

	<numeric 1>	<numeric 2>	<numeric 3>
Description	Port number	Port number	Port number
Range	1 to 4	1 to 4	1 to 4
Resolution	1	1	1

For each parameter, you must specify a different port number. If you specify the same port number for two or more parameters, an error occurs and the command is ignored.

Example of use

```
10 OUTPUT 717; ":MMEM:STOR:SNP:TYPE:S3P 2,3,4"
20 OUTPUT 717; ":MMEM:STOR:SNP:TYPE:S3P?"
30 ENTER 717;A$
```

Related commands

- :DISP:WIND{1-16}:ACT on page 470
- :MMEM:STOR:SNP on page 519
- :MMEM:STOR:SNP:FORM on page 520

Equivalent key [Save/Recall] - Save Snp - S3p - 1-2-3|1-2-4|1-3-4|2-3-4

:MMEM:STOR:SNP:TYPE:S4P

Syntax	:MMEMory:STORe:SNP:TYPE:S4P 1, 2, 3, 4 :MMEMory:STORe:SNP:TYPE:S4P?
Description	Sets specified port to the file type (4 ports) when saving measurement data for the active channel (specified with :DISP:WIND{1-16}:ACT command) to a file in the touchstone format.
Example of use	10 OUTPUT 717; ":MMEM:STOR:SNP:TYPE:S4P 1,2,3,4" 20 OUTPUT 717; ":MMEM:STOR:SNP:TYPE:S3P?" 30 ENTER 717;A\$
Related commands	:DISP:WIND{1-16}:ACT on page 470 :MMEM:STOR:SNP on page 519 :MMEM:STOR:SNP:FORM on page 520
Equivalent key	[Save/Recall] - Save Snp - S4p - 1-2-3-4

:MMEM:STOR:STYP

Syntax :MMEMory:STORe:STYPe {STATe|CSTate|DSTate|CDSTate}
:MMEMory:STORe:STYPe?

Description Selects the contents saved when saving the instrument state into a file with the :MMEM:STOR command.

Parameters

	Description
STATe	Specifies the save of the measurement conditions *1 only.
CSTate (preset value)	Specifies the save of the measurement conditions *1 and the calibration state.
DSTate	Specifies the save of the measurement conditions *1 and the formatted data array.
CDSTate	Specifies the save of the measurement conditions *1, the calibration state, and the formatted data array.

*1.For details about the measurement conditions that can be saved, refer to the *User's Guide*.

Query response {STAT|CST|DST|CDST}<newline><^END>

Example of use
10 OUTPUT 717;":MMEM:STOR:STYP CDST"
20 OUTPUT 717;":MMEM:STOR:STYP?"
30 ENTER 717;A\$

Related commands :MMEM:STOR on page 506

Equivalent key [Save/Recall] - Save Type - State Only|State & Cal|State & Trace|All

:MMEM:TRAN

Syntax :MMEMory:TRANsfer <string>,<block>
 :MMEMory:TRANsfer? <string>

Description Writes/reads data to/from a file on the built-in storage device of the E5070B/E5071B.

By reading out data with this command and writing it to a file on the external controller, file transfer from the E5070B/E5071B to the external controller can be realized. On the other hand, by reading out data from the external controller and writing it to a file on the E5070B/E5071B with this command, file transfer from the external controller to the E5070B/E5071B can be realized.

Specify the file name with the extension. If you want to specify a file on the floppy disk drive, you need to add "A:" at the beginning of the file name. When you use directory names and file name, separate them with "/" (slash) or "\" (backslash).

If a file with the specified file name already exists for writing or if the specified file does not exist for reading out (Query), an error occurs and the command is ignored.

Parameters

	<string>	<block>
Description	File name on the E5070B/E5071B	Data written on/read out from the file.
Range	254 characters or less	GPIB: 20 Mbytes or less LAN: 100 Kbytes or less

Query response {block}<newline><^END>

Example of use

```

10 OUTPUT 717; ":MMEM:TRAN "Trace01.csv",#6012345";Dat$
10 OUTPUT 717; ":MMEM:TRAN? "Trace01.csv"
20 ENTER 717 USING "#,A";A$
30 ENTER 717 USING "#,A";Digit$
40 Img$="#,"&Digit$&"A"
50 ENTER 717 USING Img$;Byte$
60 Img$=Byte$&"A"
70 ALLOCATE Dat$[VAL(Byte$)]
80 ENTER 717 USING Img$;Dat$
  
```

Equivalent key No equivalent key is available on the front panel.

:OUTP

Syntax :OUTPut[:STATe] {ON|OFF|1|0}
:OUTPut[:STATe]?

Description Turns on/off of the stimulus signal output. You cannot perform measurement until you turn on the stimulus signal output.

Parameters

	Description
ON or 1 (preset value)	Turns on the stimulus signal output.
OFF or 0	Turns off the stimulus signal output.

Query response {1|0}<newline><^END>

Example of use
10 OUTPUT 717; ":OUTP ON"
20 OUTPUT 717; ":OUTP?"
30 ENTER 717;A

Equivalent key [Sweep Setup] - Power - RF Out

:PROG:CAT?

Syntax :PROG:CATalog?

Description Reads out the list of all executable VBA macros (procedures defined by Public including the VBA project loaded on the VBA editor). (Query only)

Query response {string}<newline><^END>

The character string in the following format, in which each macro is separated by a comma (.), is read out.

"{macro 1},{macro 2},...,{macro N}"

Where N is the total number of VBA macros.

{macro n}: VBA macro name (module name.procedure name)

Example of use
10 DIM A\$[1000]
20 OUTPUT 717; ":PROG:CAT?"
30 ENTER 717;A\$

Equivalent key [Macro Setup] - Select Macro

:PROG:NAME

Syntax :PROG:NAME[:SElected]:NAME <string>
:PROG:NAME[:SElected]:NAME?

Description Selects the VBA macro controlled with the :PROG:STAT command.
Selectable VBA macro names can be read out with the :PROG:CAT? command.

Parameters

	<string>
Description	VBA macro name (module name.procedure name)
Range	254 characters or less
Preset value	""

Query response {string}<newline><^END>

Example of use
10 OUTPUT 717; ":PROG:NAME " "Module1.main" ""
20 OUTPUT 717; ":PROG:NAME?"
30 ENTER 717;A\$

Related commands :PROG:CAT? on page 527
:PROG:STAT on page 529

Equivalent key [Macro Setup] - Select Macro

NOTE When performing the operation from the front panel, you select the VBA macro and execute it at the same time.

:PROG:STAT

Syntax :PROG:STAT[:SELection]:STATe {STOP|RUN}
:PROG:STAT[:SELection]:STATe?

Description Reads out the control/state of the VBA macro selected with the :PROG:STAT command.

Parameters

	Description
STOP (preset value)	Specifies stop.
RUN	Specifies run.

Query response {STOP|RUN}<newline><^END>

Example of use
10 OUTPUT 717; ":PROG:STAT RUN"
20 OUTPUT 717; ":PROG:STAT?"
30 ENTER 717;A\$

Related commands :PROG:NAME on page 528

Equivalent key [Macro Break] (to stop)
[Macro Setup] - Select Macro (to run)

NOTE When performing the operation from the front panel, you select the VBA macro and execute it at the same time.

:PROG:VAR:ARR{1-10}

- Syntax** :PROG:VAR:ARRy{[1][2][3][4][5][6][7][8][9][10][:DATA] <numeric 1>,...,<numeric n>
:PROG:VAR:ARRy{[1][2][3][4][5][6][7][8][9][10][:DATA]?
- Description** Specifies the array type user defined variable. Up to ten (1-10) areas can be used for the user defined variables.
You need to specify the size of an array of data (:PROG:VAR:ARR{1-10}:SIZE command) when you execute this command.

NOTE Turning off the power of the instrument initializes the user defined variables, while executing the preset command does not initialize them.

	Description
{numeric 1}	The first array data.
{numeric n}	The n-th array data.

“n” is the value specified by the :PROG:VAR:ARR{1-10}:SIZE.

Query response {numeric 1},...,{numeric n}<newline><^END>

Example of use

```
10 OUTPUT 717; ":PROG:VAR:ARR2:SIZE 4"
20 OUTPUT 717; ":PROG:VAR:ARR2 1.0,2.0,3.0,4.0"
30 OUTPUT 717; ":PROG:VAR:ARR2?"
40 ENTER 717;A(*)
```

Related commands :PROG:VAR:ARR{1-10}:SIZE on page 531
:PROG:VAR:DOUB{1-10} on page 532
:PROG:VAR:LONG{1-10} on page 533
:PROG:VAR:STR{1-10} on page 534

Equivalent key No equivalent key is available on the front panel.

:PROG:VAR:ARR{1-10}:SIZE

Syntax :PROG:VAR:ARR{[1]2|3|4|5|6|7|8|9|10}:SIZE <numeric>
:PROG:VAR:ARR{[1]2|3|4|5|6|7|8|9|10}:SIZE?

Description Specifies the data size of the array type user defined variable. Up to ten (1-10) areas can be used for the user defined variables.

NOTE Turning off the power of the instrument initializes the user defined variables, while executing the preset command does not initialize them.

	<numeric>
Description	The value of data size
Range	1 to 40002
Preset value	402
Resolution	1

Query response {numeric}<newline><^END>

Example of use
10 OUTPUT 717; ":PROG:VAR:ARR:SIZE 32 "
20 OUTPUT 717; ":PROG:VAR:ARR?"
30 ENTER 717;A

Related commands :PROG:VAR:ARR{1-10} on page 530

Equivalent key No equivalent key is available on the front panel.

:PROG:VAR:DOUB{1-10}

Syntax :PROG:VAR:DOUB{[1|2|3|4|5|6|7|8|9|10][:DATA] <numeric>
:PROG:VAR:DOUB{[1|2|3|4|5|6|7|8|9|10][:DATA]}?

Description Specifies the double precision floating point type user defined variable. Up to ten (1-10) areas can be used for the user defined variables.

NOTE Turning off the power of the instrument initializes the user defined variables, while executing the preset command does not initialize them.

	<numeric>
Description	The value of the double precision floating point type
Range	Compliant with the double precision floating point type
Preset value	0

Query response {numeric}<newline><^END>

Example of use
10 OUTPUT 717; ":PROG:VAR:DOUB 1500.23"
20 OUTPUT 717; ":PROG:VAR:DOUB?"
30 ENTER 717;A

Related commands
:PROG:VAR:ARR{1-10} on page 530
:PROG:VAR:LONG{1-10} on page 533
:PROG:VAR:STR{1-10} on page 534

Equivalent key No equivalent key is available on the front panel.

:PROG:VAR:LONG{1-10}

Syntax :PROG:VAR:LONG{[1|2|3|4|5|6|7|8|9|10][:DATA] <numeric>
:PROG:VAR:LONG{[1|2|3|4|5|6|7|8|9|10][:DATA]?

Description Specifies the user defined long integer variable. Up to ten (1-10) areas can be used for the user defined variables.

NOTE Turning off the power of the instrument initializes the user defined variables, while executing the preset command does not initialize them.

	<numeric>
Description	The value of the long integer type
Range	Compliant with the long integer type
Preset value	0

Query response {numeric}<newline><^END>

Example of use
10 OUTPUT 717; ":PROG:VAR:LONG 250"
20 OUTPUT 717; ":PROG:VAR:LONG?"
30 ENTER 717;A

Related commands
:PROG:VAR:ARR{1-10} on page 530
:PROG:VAR:DOUB{1-10} on page 532
:PROG:VAR:STR{1-10} on page 534

Equivalent key No equivalent key is available on the front panel.

:PROG:VAR:STR{1-10}

Syntax :PROG:VAR:STRing{[1]|2|3|4|5|6|7|8|9|10}[[:DATA] <string>
:PROG:VAR:STRing{[1]|2|3|4|5|6|7|8|9|10}[[:DATA]?

Description Specifies the user defined character string type variable. Up to ten (1-10) areas can be used for the user defined variables.

NOTE Turning off the power of the instrument initializes the user defined variables, while executing the preset command does not initialize them.

	<numeric>
Description	The value of the character string type
Range	Compliant with the value of the character string type
Preset value	""

Query response {string}<newline><^END>

Example of use
10 OUTPUT 717; ":PROG:VAR:STR ""TEST DATA""
20 OUTPUT 717; ":PROG:VAR:STR?"
30 ENTER 717;A\$

Related commands
:PROG:VAR:ARR{1-10} on page 530
:PROG:VAR:DOUB{1-10} on page 532
:PROG:VAR:LONG{1-10} on page 533

Equivalent key No equivalent key is available on the front panel.

:SENS:CORR:COLL:ECAL:ORI

Syntax :SENSe:CORRection:COLLect:ECAL:ORientation[:STATe] {ON|OFF|1|0}
:SENSe:CORRection:COLLect:ECAL:ORientation[:STATe]?

Description Turns ON/OFF the ECal auto detect funcion.

Parameters

	Description
ON or 1 (preset value)	Turns ON the auto detect function.
OFF or 0	Turns OFF the auto detect function.

Query response {0|1}<newline><<^END>

	Description
0	Nothing is connected.
1	Port A is connected.
2	Port B is connected.
3	Port C is connected.
4	Port D is connected.

Example of use
10 OUTPUT 717; ":SENS:CORR:COLL:ECAL:ORI ON"
20 OUTPUT 717; ":SENS:CORR:COLL:ECAL:ORI?"
30 ENTER 717;A

Related commands :SENS:CORR:COLL:ECAL:PATH on page 536

Equivalent key [Cal] - ECal - Orientation

:SENS:CORR:COLL:ECAL:PATH

Syntax :SENSe:CORRection:COLLect:ECAL:PATH <numeric 1>,<numeric 2>
:SENSe:CORRection:COLLect:ECAL:PATH? <numeric 1>

Description Specify the ECal module n port number which is connected to a specified port.

Parameters

	<numeric 1>	<numeric 2>
Description	ENA port number	ECal module port number
Range	1 to 4	0 to 4
Resolution	1	1

CAUTION If you specify 0 for <numeric 2>, the ECal module port will not be connected to the ENA port.

ECal module port number

	Description
0	Nothing is connected.
1	Port A is connected.
2	Port B is connected.
3	Port C is connected.
4	Port D is connected.

Example of use 10 OUTPUT 717; ":SENS1:CORR:COLL:ECAL:PATH 1,2"

Related commands :SENS:CORR:COLL:ECAL:ORI on page 535

Equivalent key [Cal] - ECal - Orientation - Port n - Port n

:SENS:CORR:IMP

Syntax :SENSe:CORRection:IMPedance[:INPut][:MAGNitude] <numeric>
:SENSe:CORRection:IMPedance[:INPut][:MAGNitude]?

Description Sets the system characteristic impedance (Z0) value.

NOTE This command is available with the firmware version 3.01 or greater.

Parameters

	<numeric>
Description	System Z0 value
Range	1E-3 to 1000
Preset value	50
Unit	Ω (ohm)
Resolution	0.001

If the specified parameter is out of the allowable setup range, the minimum value (if the lower limit of the range is not reached) or the maximum value (if the upper limit of the range is exceeded) is set.

Query response {numeric}<newline><^END>

Example of use

```
10 OUTPUT 717; ":SENS:CORR:IMP 75"
20 OUTPUT 717; ":SENS:CORR:IMP?"
30 ENTER 717;A
```

Equivalent key [Cal] - Set Z0

:SENS:MULT:CAT?

Syntax	:SENSe:MULTiplexer{[1] 2}:CATalog?
Description	Reads the name (E5091_9 or E5091_13 or E5091_16) of the E5091A test set. (Query only)
Query response	{string}<newline><^END>
Example of use	10 OUTPUT 717; ":SENS:MULT:CAT?" 20 ENTER 717;A\$
Related commands	:SENS:MULT{1-2}:NAME on page 541
Equivalent key	No equivalent key is available on the front panel.

:SENS:MULT{1-2}:COUN?

- Syntax** :SENSe:MULTiplexer{[1]|2}:COUNt?
- Description** Reads the number of ports (7 or 9) of the E5091A whose ID is 1 (:MULT1) or 2 (:MULT2). (Query only)
- Query response** {numeric}<newline><^END>
0 is read when the E5091A is not connected.
- Example of use**
- ```
10 OUTPUT 717; ":SENS:MULT1:COUN?"
20 ENTER 717;A
```
- Equivalent key** No equivalent key is available on the front panel.

### :SENS:MULT{1-2}:DISP

- Syntax** :SENSe:MULTiplexer{[1]|2}:DISPlay[:STATe] {ON|OFF|1|0}  
:SENSe:MULTiplexer{[1]|2}:DISPlay[:STATe]?
- Description** Turns ON/OFF the property display (the state of the port assignment) of the E5091A whose ID is 1 (:MULT1) or 2 (:MULT2).

**Parameters**

|                         | Description                     |
|-------------------------|---------------------------------|
| ON or 1                 | Turns ON the property display.  |
| OFF or 0 (preset value) | Turns OFF the property display. |

- Query response** {1|0}<newline><^END>
- Example of use**
- ```
10 OUTPUT 717; ":SENS:MULT1:DISP ON"
20 OUTPUT 717; ":SENS:MULT1:DISP?"
30 ENTER 717;A
```
- Related commands**
- :SENS{1-16}:MULT{1-2}:TSET9:PORT1 on page 664
 - :SENS{1-16}:MULT{1-2}:TSET9:PORT2 on page 665
 - :SENS{1-16}:MULT{1-2}:TSET9:PORT3 on page 666
 - :SENS{1-16}:MULT{1-2}:TSET9:PORT4 on page 667
 - :SENS{1-16}:MULT{1-2}:PORT{1-20} on page 660
 - :SENS{1-16}:MULT{1-2}:PORT{1-20}:CAT? on page 662
- Equivalent key** [System] - Multiport Test Set Setup - Test Set 1|Test Set 2 - Property

:SENS:MULT{1-2}:INC?

Syntax	:SENSe:MULTiplexer{[1] 2}:INCount?
Description	<p>The E5091A returns the number of input ports of ID 1 (:MULT1) or ID 2 (:MULT2) (Query only)</p> <p>When model name is E5091_9 or E5091_13, the return value is 4.</p> <p>When model name is E5091_16, the return value is 7.</p>
Query response	{numeric}<newline><^END>
Example of use	<pre>10 OUTPUT 717; ":SENS:MULT1:INC?" 20 ENTER 717;A</pre>
Related commands	:SENS:MULT{1-2}:NAME on page 541
Equivalent key	No equivalent key is available on the front panel.

:SENS:MULT{1-2}:NAME

Syntax :SENSe:MULTiplexer{[1]|2}:NAME {E5091_9|E5091_13|E5091_16}
:SENSe:MULTiplexer{[1]|2}:NAME?

Description Specifies the name of the E5091A test set.
There is no distinction between upper and lower cases.

Parameters

	Description
E5091_9	Select the E5091A option 009.
E5091_13	Select the E5091A option 016 for the 13-port device function.
E5091_16	Select the E5091A option 016 for the 16-port device function.

Query response {E5091_9|E5091_13|E5091_16}<newline><^END>

Example of use
10 OUTPUT 717; ":SENS:MULT1:NAME E5091_9"
20 OUTPUT 717; ":SENS:MULT1:NAME?"
30 ENTER 717;A\$

Related commands :SENS:MULT:CAT? on page 538
:SENS:MULT{1-2}:INC? on page 540

Equivalent key [System] - Multiport Test Set Setup - Test Set 1|Test Set 2 - Select Test Set - E5091_9|E5091_13|E5091_16

:SENS:MULT{1-2}:STAT

Syntax :SENSe:MULTiplexer{[1]|2}:STATe {ON|OFF|1|0}
 :SENSe:MULTiplexer{[1]|2}:STATe?

Description Turns ON/OFF the control (switching the internal switch that connects between the ports and changing control line output) of the E5091A whose ID is 1 (:MULT1) or 2 (:MULT2).

Parameters

	Description
ON or 1	Turns ON the control.
OFF or 0 (preset value)	Turns OFF the control.

Query response {1|0}<newline><^END>

Example of use
 10 OUTPUT 717; ":SENS:MULT1:STAT ON"
 20 OUTPUT 717; ":SENS:MULT1:STAT?"
 30 ENTER 717;A

Related commands
 :SENS{1-16}:MULT{1-2}:OUTP on page 659
 :SENS{1-16}:MULT{1-2}:PORT{1-20} on page 660
 :SENS{1-16}:MULT{1-2}:TSET9:OUTP on page 663
 :SENS{1-16}:MULT{1-2}:TSET9:PORT1 on page 664
 :SENS{1-16}:MULT{1-2}:TSET9:PORT2 on page 665
 :SENS{1-16}:MULT{1-2}:TSET9:PORT3 on page 666
 :SENS{1-16}:MULT{1-2}:TSET9:PORT4 on page 667

Equivalent key [System] - Multiport Test Set Setup - Test Set 1|Test Set 2 - Control

:SENS{1-16}:AVER:CLE

- Syntax** :SENSe{[1]|2|3|4|5|6|7|8|9|10|11|12|13|14|15|16}:AVERage:CLEar
- Description** Clears the measurement data used for averaging of channel 1 (:SENS1) to channel 16 (:SENS16). Measurement data before the execution of this command is not used for averaging. (No query)
- Example of use** 10 OUTPUT 717; ":SENS1:AVER:CLE"
- Related commands** :SENS{1-16}:AVER on page 543
:SENS{1-16}:AVER:COUN on page 544
- Equivalent key** [Avg] - Averaging Restart

:SENS{1-16}:AVER

- Syntax** :SENSe{[1]|2|3|4|5|6|7|8|9|10|11|12|13|14|15|16}:AVERage[:STATe] {ON|OFF|1|0}
:SENSe{[1]|2|3|4|5|6|7|8|9|10|11|12|13|14|15|16}:AVERage[:STATe]?
- Description** Turns ON/OFF the averaging function of channel 1 (:SENS1) to channel 16 (:SENS16).

Parameters

	Description
ON or 1	Turns ON the averaging function.
OFF or 0 (preset value)	Turns OFF the averaging function.

- Query response** {1|0}<newline><<^END>
- Example of use** 10 OUTPUT 717; ":SENS1:AVER ON"
20 OUTPUT 717; ":SENS1:AVER?"
30 ENTER 717;A
- Related commands** :SENS{1-16}:AVER:CLE on page 543
:SENS{1-16}:AVER:COUN on page 544
- Equivalent key** [Avg] - Averaging

:SENS{1-16}:AVER:COUN

Syntax :SENSe{[1]|2|3|4|5|6|7|8|9|10|11|12|13|14|15|16}:AVERage:COUNt <numeric>
:SENSe{[1]|2|3|4|5|6|7|8|9|10|11|12|13|14|15|16}:AVERage:COUNt?

Description Sets the averaging factor of channel 1 (:SENS1) to channel 16 (:SENS16).

Parameters

	<numeric>
Description	Averaging factor
Range	1 to 999
Preset value	16
Resolution	1

If the specified parameter is out of the allowable setup range, the minimum value (if the lower limit of the range is not reached) or the maximum value (if the upper limit of the range is exceeded) is set.

Query response {numeric}<newline><^END>

Example of use
10 OUTPUT 717; ":SENS1:AVER:COUN 4"
20 OUTPUT 717; ":SENS1:AVER:COUN?"
30 ENTER 717;A

Related commands
:SENS{1-16}:AVER on page 543
:SENS{1-16}:AVER:CLE on page 543

Equivalent key [Avg] - Avg Factor

:SENS{1-16}:BAND

Syntax :SENSe{[1]|2|3|4|5|6|7|8|9|10|11|12|13|14|15|16}:BANDwidth[:RESolution] <numeric>
:SENSe{[1]|2|3|4|5|6|7|8|9|10|11|12|13|14|15|16}:BANDwidth[:RESolution]?

Description Sets the IF bandwidth of channel 1 (:SENS1) to channel 16 (:SENS16).
This command provides the same function as the :SENS{1-16}:BWID command.

Parameters

	<numeric>
Description	IF bandwidth
Range	10 to 100000
Preset value	100000
Unit	Hz (hertz)
Resolution	In steps of 1, 1.5, 2, 3, 4, 5, or 7

If the specified parameter is out of the allowable setup range, the minimum value (if the lower limit of the range is not reached) or the maximum value (if the upper limit of the range is exceeded) is set.

Query response {numeric}<newline><^END>

Example of use

```
10 OUTPUT 717; ":SENS1:BAND 1.5E3"
20 OUTPUT 717; ":SENS1:BAND?"
30 ENTER 717;A
```

Related commands :SENS{1-16}:BWID on page 546

Equivalent key [Avg] - IF Bandwidth

:SENS{1-16}:BWID

Syntax :SENSe{[1]|2|3|4|5|6|7|8|9|10|11|12|13|14|15|16}:BWIDth[:RESolution] <numeric>
:SENSe{[1]|2|3|4|5|6|7|8|9|10|11|12|13|14|15|16}:BWIDth[:RESolution]?

Description Sets the IF bandwidth of channel 1 (:SENS1) to channel 16 (:SENS16).
This command provides the same function as the :SENS{1-16}:BAND command.

Parameters

	<numeric>
Description	IF bandwidth
Range	10 to 100000
Preset value	70000
Unit	Hz (hertz)
Resolution	In steps of 1, 1.5, 2, 3, 4, 5, or 7

If the specified parameter is out of the allowable setup range, the minimum value (if the lower limit of the range is not reached) or the maximum value (if the upper limit of the range is exceeded) is set.

Query response {numeric}<newline><^END>

Example of use
10 OUTPUT 717; ":SENS1:BWID 1.5E3"
20 OUTPUT 717; ":SENS1:BWID?"
30 ENTER 717;A

Related commands :SENS{1-16}:BAND on page 545

Equivalent key [Avg] - IF Bandwidth

:SENS{1-16}:CORR:CLE

Syntax	<code>:SENSe{[1] 2 3 4 5 6 7 8 9 10 11 12 13 14 15 16}:CORRection:CLEar</code>
Description	<p>Clears the error coefficient for calibration when the frequency offset mode is off for channel 1 (:SENS1) to channel 16 (:SENS16). (No query)</p> <p>To toggle the frequency offset mode, use :SENS{1-16}:OFFS command on page 668.</p>
Example of use	<code>10 OUTPUT 717; ":SENS1:CORR:CLE"</code>
Related commands	<p>:SENS{1-16}:OFFS on page 668</p> <p>:SENS{1-16}:CORR:OFFS:CLE on page 634</p>
Equivalent key	[Cal] - Clear - OK

:SENS{1-16}:CORR:COEF

Syntax

```
:SENSe{[1]|2|3|4|5|6|7|8|9|10|11|12|13|14|15|16}:CORRection:COEFFicient[:DATA]
{ES|ER|ED|EL|ET|EX},<numeric 1>, <numeric 2>, <numeric 3>,..., <numeric 3 n×2>

:SENSe{[1]|2|3|4|5|6|7|8|9|10|11|12|13|14|15|16}:CORRection:COEFFicient[:DATA]?
{ES|ER|ED|EL|ET|EX},<numeric 1>, <numeric 2>
```

Description

Reads out/write the calibration coefficient data for specified channel.

When the calibration factor is interpolated, the interpolated calibration coefficient array is read. Similarly, when the calibration factor is not interpolated, a non-interpolated calibration coefficient array is read.

After writing the calibration coefficient array, the written value becomes effective only after the :SENS{1-16}:CORR:COEF:SAVE command is executed.

Parameters

	<numeric>
ES	Source match
ER	Reflection tracking
ED	Directivity
EL	Load match
ET	Transmission tracking
EX	Isolation
numeric 1	Response port
numeric 2	Stimulus port
numeric 3 ... numeric 3 n×2	Calibration coefficient array for measurement point. (The values of the real part and the imaginary part are necessary for each measurement point.)

If ES, ER, or ED is used, the response port and the stimulus port must be the same, while EL, ET, or EX is used, the response port and the stimulus port must be different.

Query response

```
{numeric 1},...,{numeric NOP×2}<newline><^END>
```

	Description
{numeric n×2-1}	Real part of data (complex number) at the n-th measurement point.
{numeric n×2}	Imaginary part of data (complex number) at the n-th measurement point.

Because the calibration coefficient array is expressed by a complex number, the real part and the imaginary part of one measurement point are returned and obtained as a value. Here, NOP is the number of measurement points and n is an integer between 1 and NOP.

Example of use	<pre>10 DIM A(1:201) 20 OUTPUT 717;" :SENS1:CORR:COEF? EL,1,2" 30 ENTER 717;A(*)</pre>
Related commands	<p>:SENS{1-16}:CORR:COEF:METH:ERES on page 550</p> <p>:SENS{1-16}:CORR:COEF:METH:OPEN on page 551</p> <p>:SENS{1-16}:CORR:COEF:METH:SHOR on page 552</p> <p>:SENS{1-16}:CORR:COEF:METH:SOLT1 on page 553</p> <p>:SENS{1-16}:CORR:COEF:METH:SOLT2 on page 554</p> <p>:SENS{1-16}:CORR:COEF:METH:SOLT3 on page 555</p> <p>:SENS{1-16}:CORR:COEF:METH:SOLT4 on page 556</p> <p>:SENS{1-16}:CORR:COEF:METH:THRU on page 557</p> <p>:SENS{1-16}:CORR:COEF:SAVE on page 558</p> <p>:SENS{1-16}:CORR:COLL:METH:TRL2 on page 607</p> <p>:SENS{1-16}:CORR:COLL:METH:TRL3 on page 608</p> <p>:SENS{1-16}:CORR:COLL:METH:TRL4 on page 609</p>
Equivalent key	No equivalent key is available on the front panel.

:SENS{1-16}:CORR:COEF:METH:ERES

Syntax :SENSe{[1|2|3|4|5|6|7|8|9|10|11|12|13|14|15|16]}:CORRection:COEFFicient:METhod:ERESponse
<numeric 1>,<numeric 2>

Description For channel 1 (:SENS1) to channel 16 (:SENS16), sets the calibration type to the enhanced response calibration between the two specified ports when the calibration coefficient data array is written with the :SENS{1-16}:CORR:COEF command. (No query)

Parameters

	<numeric 1>	<numeric 2>
Description	Response port number	Stimulus port number
Range	1 to 4	1 to 4
Resolution	1	1

For each parameter, you must specify a different port number. If you specify the same port number for 2 or more parameters, an error occurs and the command is ignored.

Example of use 10 OUTPUT 717; ":SENS1:CORR:COEF:METH:ERES 1,2"

Related commands :SENS{1-16}:CORR:COEF on page 548
:SENS{1-16}:CORR:COEF:SAVE on page 558

Equivalent key No equivalent key is available on the front panel.

:SENS{1-16}:CORR:COEF:METH:OPEN

Syntax :SENSe{[1]|2|3|4|5|6|7|8|9|10|11|12|13|14|15|16}:CORRection:COEFFicient:METhod[:RESponse]:OPEN
<numeric>

Description For channel 1 (:SENS1) to channel 16 (:SENS16), sets the calibration type to the response calibration (open) of the specified port when the calibration coefficient data array is written with the :SENS{1-16}:CORR:COEF command. (No query)

Parameters

	<numeric>
Description	Port number
Range	1 to 4
Resolution	1

Example of use 10 OUTPUT 717; ":SENS1:CORR:COEF:METH:OPEN 1"

Related commands :SENS{1-16}:CORR:COEF on page 548
:SENS{1-16}:CORR:COEF:SAVE on page 558

Equivalent key No equivalent key is available on the front panel.

:SENS{1-16}:CORR:COEF:METH:SHOR

Syntax

:SENSe{[1|2|3|4|5|6|7|8|9|10|11|12|13|14|15|16]}:CORRection:COEFficient:METhod[:RESPonse]:SHORt
<numeric>

Description

For channel 1 (:SENS1) to channel 16 (:SENS16), sets the calibration type to the response calibration (short) of the specified port when the calibration coefficient data array is written with the :SENS{1-16}:CORR:COEF command. (No query)

Parameters

	<numeric>
Description	Port number
Range	1 to 4
Resolution	1

Example of use

```
10 OUTPUT 717; ":SENS1:CORR:COEF:METH:SHOR 1"
```

Related commands

:SENS{1-16}:CORR:COEF on page 548
:SENS{1-16}:CORR:COEF:SAVE on page 558

Equivalent key

No equivalent key is available on the front panel.

:SENS{1-16}:CORR:COEF:METH:SOLT1

Syntax :SENSe{[1|2|3|4|5|6|7|8|9|10|11|12|13|14|15|16]}:CORRection:COEFficient:METhod:SOLT1
<numeric>

Description For channel 1 (:SENS1) to channel 16 (:SENS16), sets the calibration type to the 1-port calibration of the specified port when the calibration coefficient data array is written with the :SENS{1-16}:CORR:COEF command. (No query)

Parameters

	<numeric>
Description	Port number
Range	1 to 4
Resolution	1

Example of use 10 OUTPUT 717; ":SENS1:CORR:COEF:METH:SOLT1 1"

Related commands :SENS{1-16}:CORR:COEF on page 548
:SENS{1-16}:CORR:COEF:SAVE on page 558

Equivalent key No equivalent key is available on the front panel.

:SENS{1-16}:CORR:COEF:METH:SOLT2

Syntax :SENSe{[1]|2|3|4|5|6|7|8|9|10|11|12|13|14|15|16}:CORRection:COEFFicient:METHod:SOLT2
<numeric 1>,<numeric 2>

Description For channel 1 (:SENS1) to channel 16 (:SENS16), sets the calibration type to full 2-port calibration between the two specified ports when the calibration coefficient data array is written with the :SENS{1-16}:CORR:COEF command. (No query)

Parameters

	<numeric 1>	<numeric 2>
Description	Port number	Port number
Range	1 to 4	1 to 4
Resolution	1	1

For each parameter, you must specify a different port number. If you specify the same port number for 2 or more parameters, an error occurs and the command is ignored.

Example of use 10 OUTPUT 717; ":SENS1:CORR:COEF:METH:SOLT2 1,2"

Related commands :SENS{1-16}:CORR:COEF on page 548
:SENS{1-16}:CORR:COEF:SAVE on page 558

Equivalent key No equivalent key is available on the front panel.

:SENS{1-16}:CORR:COEF:METH:SOLT3

Syntax :SENSe{[1|2|3|4|5|6|7|8|9|10|11|12|13|14|15|16]}:CORRection:COEFficient:METhod:SOLT3
<numeric 1>,<numeric 2>, <numeric 3>

Description For channel 1 (:SENS1) to channel 16 (:SENS16), sets the calibration type to full 3-port calibration between the three specified ports when the calibration coefficient data array is written with the :SENS{1-16}:CORR:COEF command. (No query)

Parameters

	<numeric 1>	<numeric 2>	<numeric 3>
Description	Port number	Port number	Port number
Range	1 to 4	1 to 4	1 to 4
Resolution	1	1	1

For each parameter, you must specify a different port number. If you specify the same port number for 2 or more parameters, an error occurs and the command is ignored.

Example of use 10 OUTPUT 717; ":SENS1:CORR:COEF:METH:SOLT3 1,2,3"

Related commands :SENS{1-16}:CORR:COEF on page 548
:SENS{1-16}:CORR:COEF:SAVE on page 558

Equivalent key No equivalent key is available on the front panel.

:SENS{1-16}:CORR:COEF:METH:SOLT4

Syntax :SENSe{[1]|2|3|4|5|6|7|8|9|10|11|12|13|14|15|16}:CORRection:COEFFicient:METhod:SOLT4
<numeric 1>, <numeric 2>, <numeric 3>, <numeric 4>

Description For channel 1 (:SENS1) to channel 16 (:SENS16), sets the calibration type to full 4-port calibration when the calibration coefficient data array is written with the :SENS{1-16}:CORR:COEF command. (No query)

Parameters

	<numeric 1>	<numeric 2>	<numeric 3>	<numeric 4>
Description	Port number	Port number	Port number	Port number
Range	1 to 4	1 to 4	1 to 4	1 to 4
Resolution	1	1	1	1

For each parameter, you must specify a different port number. If you specify the same port number for 2 or more parameters, an error occurs and the command is ignored.

Example of use 10 OUTPUT 717; ":SENS1:CORR:COEF:METH:SOLT4 1,2,3,4"

Related commands :SENS{1-16}:CORR:COEF on page 548
:SENS{1-16}:CORR:COEF:SAVE on page 558

Equivalent key No equivalent key is available on the front panel.

:SENS{1-16}:CORR:COEF:METH:THRU

Syntax

:SENSe{[1]|2|3|4|5|6|7|8|9|10|11|12|13|14|15|16}:CORRection:COEFFicient:METHod[:RESponse]:THRU
<numeric 1>,<numeric 2>

Description

For channel 1 (:SENS1) to channel 16 (:SENS16), sets the calibration type to the response calibration (open) between the two specified ports when the calibration coefficient data array is written with the :SENS{1-16}:CORR:COEF command. (No query)

Parameters

	<numeric 1>	<numeric 2>
Description	Response port number	Stimulus port number
Range	1 to 4	1 to 4
Resolution	1	1

For each parameter, you must specify a different port number. If you specify the same port number for two or more parameters, an error occurs and the command is ignored.

Example of use

```
10 OUTPUT 717; ":SENS1:CORR:COEF:METH:THRU 2,1"
```

Related commands

:SENS{1-16}:CORR:COEF on page 548

:SENS{1-16}:CORR:COEF:SAVE on page 558

Equivalent key

No equivalent key is available on the front panel.

:SENS{1-16}:CORR:COEF:SAVE

Syntax	:SENSe{[1] 2 3 4 5 6 7 8 9 10 11 12 13 14 15 16}:CORRection:COEFficient:SAVE
Description	<p>From the writing calibration data, enables the calibration coefficients depending on the selected calibration type.</p> <p>Enabling the calibration coefficients clears all calibration data regardless of whether the data are used for the calculation and also clears the calibration type selections.</p> <p>If you execute this command before all calibration data needed for calculating the calibration coefficients are written, an error occurs and the command is ignored. (No query)</p>
Example of use	10 OUTPUT 717; ":SENS1:CORR:COEF:SAVE"
Related commands	<p>:SENS{1-16}:CORR:COEF on page 548</p> <p>:SENS{1-16}:CORR:COEF:METH:ERES on page 550</p> <p>:SENS{1-16}:CORR:COEF:METH:OPEN on page 551</p> <p>:SENS{1-16}:CORR:COEF:METH:SHOR on page 552</p> <p>:SENS{1-16}:CORR:COEF:METH:SOLT1 on page 553</p> <p>:SENS{1-16}:CORR:COEF:METH:SOLT2 on page 554</p> <p>:SENS{1-16}:CORR:COEF:METH:SOLT3 on page 555</p> <p>:SENS{1-16}:CORR:COEF:METH:SOLT4 on page 556</p> <p>:SENS{1-16}:CORR:COEF:METH:THRU on page 557</p> <p>:SENS{1-16}:CORR:COLL:METH:TRL2 on page 607</p> <p>:SENS{1-16}:CORR:COLL:METH:TRL3 on page 608</p> <p>:SENS{1-16}:CORR:COLL:METH:TRL4 on page 609</p>
Equivalent key	No equivalent key is available on the front panel.

:SENS{1-16}:CORR:COLL:ADAP{1-4}:LENG

Syntax :SENSe{[1]|2|3|4|5|6|7|8|9|10|11|12|13|14|15|16}:CORRection:COLLect:ADAPter{[1]|2|3|4}:LENGth <numeric>
:SENSe{[1]|2|3|4|5|6|7|8|9|10|11|12|13|14|15|16}:CORRection:COLLect:ADAPter{[1]|2|3|4}:LENGth?

Description Sets the approximate length of the adapter, for the selected channel 1 (:SENS1) to channel 16 (:SENS16) and for the selected port 1 to port 4.

NOTE Adapter length is positive for adapter removal and negative for adapter insertion.

Parameters

	<numeric>
Description	Adapter length
Range	-10 to 10
Preset value	0 (AUTO)
Unit	s (second)

Query response {numeric}<newline><^END>

Example of use
10 OUTPUT 717;":SENS1:CORR:COLL:ADAP:LENG 0.01"
20 OUTPUT 717;":SENS1:CORR:COLL:ADAP:LENG?"
30 ENTER 717;A

Related commands :SENS{1-16}:CORR:COLL:METH:ADAP:REM on page 601

Equivalent key [Cal] - Calibrate - Adapter Removal - Adapter Length

:SENS{1-16}:CORR:COLL:CKIT

Syntax :SENSe{[1]|2|3|4|5|6|7|8|9|10|11|12|13|14|15|16}:CORRection:COLLect:CKIT[:SElect] <numeric>
:SENSe{[1]|2|3|4|5|6|7|8|9|10|11|12|13|14|15|16}:CORRection:COLLect:CKIT[:SElect]?

Description Selects the calibration kit of channel 1 (:SENS1) to channel 16 (:SENS16).

Parameters

	<numeric>
Description	Number of calibration kit *1
Range	1 to 20
Preset value	1
Resolution	1

*1. The numbers of 1 to 20 assigned from the top to the calibration kit names displayed on the softkey labels when performing **[Cal] - Cal Kit**.

If the specified parameter is out of the allowable setup range, an error occurs and the command is ignored.

Query response {numeric}<newline><^END>

Example of use
10 OUTPUT 717; ":SENS1:CORR:COLL:CKIT 3"
20 OUTPUT 717; ":SENS1:CORR:COLL:CKIT?"
30 ENTER 717;A

Equivalent key **[Cal] - Cal Kit**

:SENS{1-16}:CORR:COLL:CKIT:LAB

Syntax :SENSe{[1]|2|3|4|5|6|7|8|9|10|11|12|13|14|15|16}:CORRection:COLLect:CKIT:LABel <string>
:SENSe{[1]|2|3|4|5|6|7|8|9|10|11|12|13|14|15|16}:CORRection:COLLect:CKIT:LABel?

Description Sets a calibration kit name for the calibration kit selected for channel 1 (:SENS1) to channel 16 (:SENS16).

Parameters

	<string>
Description	Calibration kit name
Range	254 characters or less
Preset value	Varies depending on the calibration kit number as follows: 1: "85033E" 2: "85033D" 3: "85052D" 4: "85032F" 5: "85032B" 6: "85036B/E" 7: "85031B" 8: "85050C/D" 9: "85052C" 10 to 20: "User"

Query response {string}<newline><^END>

Example of use
10 OUTPUT 717;":SENS1:CORR:COLL:CKIT:LAB "MY_KIT"
20 OUTPUT 717;":SENS1:CORR:COLL:CKIT:LAB?"
30 ENTER 717;A\$

Related commands :SENS{1-16}:CORR:COLL:CKIT on page 560

Equivalent key [Cal] - Modify Cal Kit - Label Kit

:SENS{1-16}:CORR:COLL:CKIT:ORD

Syntax :SENSe{[1]|2|3|4|5|6|7|8|9|10|11|12|13|14|15|16}:CORRection:COLLect:CKIT:ORDeR[:SE
Lect] <numeric>

:SENSe{[1]|2|3|4|5|6|7|8|9|10|11|12|13|14|15|16}:CORRection:COLLect:CKIT:ORDeR[:SE
Lect]?

Description Sets a subclass of the standard for calibrating channel 1 (:SENS1) to channel 16 (:SENS16).

Parameters

	<numeric>
Description	The number of the standard subclass for the calibration.
Range	1 to 8
Resolution	1

If the specified parameter is out of the allowable setup range, an error occurs and the command is ignored.

Query response {numeric}<newline><^END>

Example of use
 10 OUTPUT 717; ":SENS1:CORR:COLL:CKIT:ORD 1"
 20 OUTPUT 717; ":SENS1:CORR:COLL:CKIT:ORD?"
 30 ENTER 717;A

Related commands
 :SENS{1-16}:CORR:COLL:CKIT on page 560
 :SENS{1-16}:CORR:COLL:CKIT:ORD:LOAD on page 563
 :SENS{1-16}:CORR:COLL:CKIT:ORD:OPEN on page 564
 :SENS{1-16}:CORR:COLL:CKIT:ORD:SHOR on page 565
 :SENS{1-16}:CORR:COLL:CKIT:ORD:THRU on page 566
 :SENS{1-16}:CORR:COLL:CKIT:ORD:TRLL on page 567
 :SENS{1-16}:CORR:COLL:CKIT:ORD:TRLR on page 568
 :SENS{1-16}:CORR:COLL:CKIT:ORD:TRLT on page 569

Equivalent key [Cal] - Modify Cal Kit - Specify CLSs - Sub Class - Sub Class 1|...|Sub Class 8

:SENS{1-16}:CORR:COLL:CKIT:ORD:LOAD

Syntax

```
:SENSe{[1|2|3|4|5|6|7|8|9|10|11|12|13|14|15|16]}:CORRection:COLLect:CKIT:ORDer:LOAD <numeric 1>,<numeric 2>
:SENSe{[1|2|3|4|5|6|7|8|9|10|11|12|13|14|15|16]}:CORRection:COLLect:CKIT:ORDer:LOAD? <numeric 1>
```

Description

For the calibration kit selected for channel 1 (:SENS1) to channel 16 (:SENS16), selects the standard used for the load measurement of the specified port.

If the standard number is 0, the standard is invalid for that subclass.

Parameters

	<numeric 1>	<numeric 2>
Description	Port number	Standard number
Range	1 to 4	0 to 21
Resolution	1	1

If the specified parameter is out of the allowable setup range, an error occurs and the command is ignored.

Query response

```
{numeric 2}<newline><^END>
```

Example of use

```
10 OUTPUT 717; ":SENS1:CORR:COLL:CKIT:ORD:LOAD 1,9"
20 OUTPUT 717; ":SENS1:CORR:COLL:CKIT:ORD:LOAD? 1"
30 ENTER 717;A
```

Related commands

```
:SENS{1-16}:CORR:COLL:CKIT on page 560
:SENS{1-16}:CORR:COLL:CKIT:ORD on page 562
:SENS{1-16}:CORR:COLL:CKIT:ORD:OPEN on page 564
:SENS{1-16}:CORR:COLL:CKIT:ORD:SHOR on page 565
:SENS{1-16}:CORR:COLL:CKIT:ORD:THRU on page 566
:SENS{1-16}:CORR:COLL:CKIT:ORD:TRLL on page 567
:SENS{1-16}:CORR:COLL:CKIT:ORD:TRLR on page 568
:SENS{1-16}:CORR:COLL:CKIT:ORD:TRLT on page 569
```

Equivalent key

```
[Cal] - Modify Cal Kit - Specify CLSs - Load - Port 1|Port 2|Port 3|Port 4
```

:SENS{1-16}:CORR:COLL:CKIT:ORD:OPEN

Syntax

```
:SENSe{[1]|2|3|4|5|6|7|8|9|10|11|12|13|14|15|16}:CORRection:COLLect:CKIT:ORDer:OPEN <numeric 1>,<numeric 2>  
:SENSe{[1]|2|3|4|5|6|7|8|9|10|11|12|13|14|15|16}:CORRection:COLLect:CKIT:ORDer:OPEN? <numeric 1>
```

Description

For the calibration kit selected for channel 1 (:SENS1) to channel 16 (:SENS16), selects the standard used for the open measurement of the specified port.

If the standard number is 0, the standard is invalid for that subclass.

Parameters

	<numeric 1>	<numeric 2>
Description	Port number	Standard number
Range	1 to 4	0 to 21
Resolution	1	1

If the specified parameter is out of the allowable setup range, an error occurs and the command is ignored.

Query response

```
{numeric 2}<newline><<^END>
```

Example of use

```
10  OUTPUT 717; ":SENS1:CORR:COLL:CKIT:ORD:OPEN 1,2"  
20  OUTPUT 717; ":SENS1:CORR:COLL:CKIT:ORD:OPEN? 1"  
30  ENTER 717;A
```

Related commands

:SENS{1-16}:CORR:COLL:CKIT on page 560
:SENS{1-16}:CORR:COLL:CKIT:ORD on page 562
:SENS{1-16}:CORR:COLL:CKIT:ORD:LOAD on page 563
:SENS{1-16}:CORR:COLL:CKIT:ORD:SHOR on page 565
:SENS{1-16}:CORR:COLL:CKIT:ORD:THRU on page 566
:SENS{1-16}:CORR:COLL:CKIT:ORD:TRLL on page 567
:SENS{1-16}:CORR:COLL:CKIT:ORD:TRLR on page 568
:SENS{1-16}:CORR:COLL:CKIT:ORD:TRLT on page 569

Equivalent key

[Cal] - Modify Cal Kit - Specify CLSs - Open - Port 1|Port 2|Port 3|Port 4

:SENS{1-16}:CORR:COLL:CKIT:ORD:SHOR

Syntax

```
:SENSe{[1|2|3|4|5|6|7|8|9|10|11|12|13|14|15|16]}:CORRection:COLLect:CKIT:ORDer:SHORt <numeric 1>,<numeric 2>
:SENSe{[1|2|3|4|5|6|7|8|9|10|11|12|13|14|15|16]}:CORRection:COLLect:CKIT:ORDer:SHORt? <numeric 1>
```

Description

For the calibration kit selected for channel 1 (:SENS1) to channel 16 (:SENS16), selects the standard used for the short measurement of the specified port.

If the standard number is 0, the standard is invalid for that subclass.

Parameters

	<numeric 1>	<numeric 2>
Description	Port number	Standard number
Range	1 to 4	0 to 21
Resolution	1	1

If the specified parameter is out of the allowable setup range, an error occurs and the command is ignored.

Query response

```
{numeric 2}<newline><^END>
```

Example of use

```
10 OUTPUT 717; ":SENS1:CORR:COLL:CKIT:ORD:SHOR 1,1"
20 OUTPUT 717; ":SENS1:CORR:COLL:CKIT:ORD:SHOR? 1"
30 ENTER 717;A
```

Related commands

```
:SENS{1-16}:CORR:COLL:CKIT on page 560
:SENS{1-16}:CORR:COLL:CKIT:ORD on page 562
:SENS{1-16}:CORR:COLL:CKIT:ORD:LOAD on page 563
:SENS{1-16}:CORR:COLL:CKIT:ORD:OPEN on page 564
:SENS{1-16}:CORR:COLL:CKIT:ORD:THRU on page 566
:SENS{1-16}:CORR:COLL:CKIT:ORD:TRLL on page 567
:SENS{1-16}:CORR:COLL:CKIT:ORD:TRLR on page 568
:SENS{1-16}:CORR:COLL:CKIT:ORD:TRLT on page 569
```

Equivalent key

```
[Cal] - Modify Cal Kit - Specify CLSs - Short - Port 1|Port 2|Port 3|Port 4
```

:SENS{1-16}:CORR:COLL:CKIT:ORD:THRU

Syntax

```
:SENSe{[1]|2|3|4|5|6|7|8|9|10|11|12|13|14|15|16}:CORRection:COLLect:CKIT:ORDer:THRU <numeric 1>,<numeric 2>,<numeric 3>
:SENSe{[1]|2|3|4|5|6|7|8|9|10|11|12|13|14|15|16}:CORRection:COLLect:CKIT:ORDer:THRU? <numeric 1>,<numeric 2>
```

Description

For the calibration kit selected for channel 1 (:SENS1) to channel 16 (:SENS16), selects the standard used for the thru measurement between the specified 2 ports. the standard is invalid for that subclass 0, the standard is invalid for that subclass.

Parameters

	<numeric 1>	<numeric 2>	<numeric 3>
Description	Port number 1	Port number 2	Standard number
Range	1 to 4	1 to 4	0 to 21
Resolution	1	1	1

For <numeric 1> and <numeric 2>, you must specify a different port number. If you specify the same port number, an error occurs and the command is ignored.

If the specified parameter is out of the allowable setup range, an error occurs and the command is ignored.

Query response

```
{numeric 3}<newline><^END>
```

Example of use

```
10 OUTPUT 717; ":SENS1:CORR:COLL:CKIT:ORD:THRU 1,2,11"
20 OUTPUT 717; ":SENS1:CORR:COLL:CKIT:ORD:THRU? 1,2"
30 ENTER 717;A
```

Related commands

- :SENS{1-16}:CORR:COLL:CKIT on page 560
- :SENS{1-16}:CORR:COLL:CKIT:ORD on page 562
- :SENS{1-16}:CORR:COLL:CKIT:ORD:LOAD on page 563
- :SENS{1-16}:CORR:COLL:CKIT:ORD:OPEN on page 564
- :SENS{1-16}:CORR:COLL:CKIT:ORD:SHOR on page 565
- :SENS{1-16}:CORR:COLL:CKIT:ORD:TRLL on page 567
- :SENS{1-16}:CORR:COLL:CKIT:ORD:TRLR on page 568
- :SENS{1-16}:CORR:COLL:CKIT:ORD:TRLT on page 569

Equivalent key

[Cal] - Modify Cal Kit - Specify CLSs - Thru - Port 1-2|Port 1-3|Port 1-4|Port 2-3|Port 2-4|Port 3-4

:SENS{1-16}:CORR:COLL:CKIT:ORD:TRLL

Syntax

```
:SENSe{[1|2|3|4|5|6|7|8|9|10|11|12|13|14|15|16]}:CORRection:COLLect:CKIT:ORDer:TRLLine <numeric 1>,<numeric 2>,<numeric 3>
:SENSe{[1|2|3|4|5|6|7|8|9|10|11|12|13|14|15|16]}:CORRection:COLLect:CKIT:ORDer:TRLLine? <numeric 1>,<numeric 2>
```

Description

For the calibration kit selected for channel 1 (:SENS1) to channel 16 (:SENS16), selects the standard used for the line measurement of the TRL calibration between the two specified ports.

If the standard number is 0, the standard is invalid for that subclass.

Parameters

	<numeric 1>	<numeric 2>	<numeric 3>
Description	Port number 1	Port number 2	Standard number
Range	1 to 4	1 to 4	0 to 21
Resolution	1	1	1

For <numeric 1> and <numeric 2>, you must specify a different port number. If you specify the same port number, an error occurs and the command is ignored.

If the specified parameter is out of the allowable setup range, an error occurs and the command is ignored.

Query response

```
{numeric 3}<newline><^END>
```

Example of use

```
10 OUTPUT 717; ":SENS1:CORR:COLL:CKIT:ORD:TRLL 1,2,11"
20 OUTPUT 717; ":SENS1:CORR:COLL:CKIT:ORD:TRLL? 1,2"
30 ENTER 717;A
```

Related commands

:SENS{1-16}:CORR:COLL:CKIT on page 560
 :SENS{1-16}:CORR:COLL:CKIT:ORD on page 562
 :SENS{1-16}:CORR:COLL:CKIT:ORD:LOAD on page 563
 :SENS{1-16}:CORR:COLL:CKIT:ORD:OPEN on page 564
 :SENS{1-16}:CORR:COLL:CKIT:ORD:SHOR on page 565
 :SENS{1-16}:CORR:COLL:CKIT:ORD:THRU on page 566
 :SENS{1-16}:CORR:COLL:CKIT:ORD:TRLR on page 568
 :SENS{1-16}:CORR:COLL:CKIT:ORD:TRLT on page 569

Equivalent key

[Cal] - Modify Cal Kit - Specify CLSs - TRL Line/Match - Set All|Port 1-2|Port 1-3|Port 1-4|Port 2-3|Port 2-4|Port 3-4

:SENS{1-16}:CORR:COLL:CKIT:ORD:TRLR

Syntax

```
:SENSe{[1]|2|3|4|5|6|7|8|9|10|11|12|13|14|15|16}:CORRection:COLLect:CKIT:ORDer:TRLRefect <numeric>  
:SENSe{[1]|2|3|4|5|6|7|8|9|10|11|12|13|14|15|16}:CORRection:COLLect:CKIT:ORDer:TRLRefect?
```

Description

For the calibration kit selected for channel 1 (:SENS1) to channel 16 (:SENS16), selects the standard used for the reflection measurement of the TRL calibration between the two specified ports.

If the standard number is 0, the standard is invalid for that subclass.

Parameters

	<numeric>
Description	Setup value of the standard number
Range	0 to 21
Resolution	1

If the specified parameter is out of the allowable setup range, the minimum value (if the lower limit of the range is not reached) or the maximum value (if the upper limit of the range is exceeded) is set.

Query response

```
{numeric}<newline><^END>
```

Example of use

```
10 OUTPUT 717; ":SENS1:CORR:COLL:CKIT:ORD:TRLR 11"  
20 OUTPUT 717; ":SENS1:CORR:COLL:CKIT:ORD:TRLR?"  
30 ENTER 717;A
```

Related commands

```
:SENS{1-16}:CORR:COLL:CKIT on page 560  
:SENS{1-16}:CORR:COLL:CKIT:ORD on page 562  
:SENS{1-16}:CORR:COLL:CKIT:ORD:LOAD on page 563  
:SENS{1-16}:CORR:COLL:CKIT:ORD:OPEN on page 564  
:SENS{1-16}:CORR:COLL:CKIT:ORD:SHOR on page 565  
:SENS{1-16}:CORR:COLL:CKIT:ORD:THRU on page 566  
:SENS{1-16}:CORR:COLL:CKIT:ORD:TRLL on page 567  
:SENS{1-16}:CORR:COLL:CKIT:ORD:TRLT on page 569
```

Equivalent key

[Cal] - Modify Cal Kit - Specify CLSs - TRL Reflect

:SENS{1-16}:CORR:COLL:CKIT:ORD:TRLT

Syntax

```
:SENSe{[1]|2|3|4|5|6|7|8|9|10|11|12|13|14|15|16}:CORRection:COLLect:CKIT:ORDer:TRLThru <numeric 1>, <numeric 2>, <numeric 3>
:SENSe{[1]|2|3|4|5|6|7|8|9|10|11|12|13|14|15|16}:CORRection:COLLect:CKIT:ORDer:TRLThru? <numeric 1>,<numeric 2>
```

Description

For the calibration kit selected for channel 1 (:SENS1) to channel 16 (:SENS16), selects the standard used for the THRU measurement of the TRL calibration between the two specified ports.

If the standard number is 0, the standard is invalid for that subclass.

Parameters

	<numeric 1>	<numeric 2>	<numeric 3>
Description	Port number 1	Port number 2	Standard number
Range	1 to 4	1 to 4	0 to 21
Resolution	1	1	1

For <numeric 1> and <numeric 2>, you must specify a different port number. If you specify the same port number, an error occurs and the command is ignored.

If the specified parameter is out of the allowable setup range, an error occurs and the command is ignored.

Query response

```
{numeric 3}<newline><^END>
```

Example of use

```
10 OUTPUT 717; ":SENS1:CORR:COLL:CKIT:ORD:TRLT 1,2,5"
20 OUTPUT 717; ":SENS1:CORR:COLL:CKIT:ORD:TRLT? 1,2"
30 ENTER 717;A
```

Related commands

:SENS{1-16}:CORR:COLL:CKIT on page 560
 :SENS{1-16}:CORR:COLL:CKIT:ORD on page 562
 :SENS{1-16}:CORR:COLL:CKIT:ORD:LOAD on page 563
 :SENS{1-16}:CORR:COLL:CKIT:ORD:OPEN on page 564
 :SENS{1-16}:CORR:COLL:CKIT:ORD:SHOR on page 565
 :SENS{1-16}:CORR:COLL:CKIT:ORD:THRU on page 566
 :SENS{1-16}:CORR:COLL:CKIT:ORD:TRLL on page 567
 :SENS{1-16}:CORR:COLL:CKIT:ORD:TRLR on page 568

Equivalent key

[Cal] - Modify Cal Kit - Specify CLSs - TRL Thru - Set All|Port 1-2|Port 1-3|Port 1-4|Port 2-3|Port 2-4|Port 3-4

:SENS{1-16}:CORR:COLL:CKIT:RES

Syntax	:SENSe{[1] 2 3 4 5 6 7 8 9 10 11 12 13 14 15 16}:CORRection:COLLect:CKIT:RESet
Description	Resets the calibration kit selected for channel 1 (:SENS1) to channel 16 (:SENS16) to the factory setting state. (No query)
Example of use	10 OUTPUT 717; ":SENS1:CORR:COLL:CKIT:RES"
Related commands	:SENS{1-16}:CORR:COLL:CKIT on page 560
Equivalent key	[Cal] - Modify Cal Kit - Restore Cal Kit

:SENS{1-16}:CORR:COLL:CKIT:STAN{1-21}:ARB

Syntax :SENSe{[1]|2|3|4|5|6|7|8|9|10|11|12|13|14|15|16}:CORRection:COLLect:CKIT:STAN{[1]|2|3|4|5|6|7|8|9|10|11|12|13|14|15|16|17|18|19|20|21}:ARBitrary <numeric>
:SENSe{[1]|2|3|4|5|6|7|8|9|10|11|12|13|14|15|16}:CORRection:COLLect:CKIT:STAN{[1]|2|3|4|5|6|7|8|9|10|11|12|13|14|15|16|17|18|19|20|21}:ARBitrary?

Description For the calibration kit selected for channel 1 (:SENS1) to channel 16 (:SENS16), sets the value of the arbitrary impedance of the standard1 (:STAN1) to standard 21 (:STAN21).

Parameters

	<numeric>
Description	Arbitrary impedance
Range	-1E18 to 1E18
Preset value	Varies depending on the calibration kit and the standard.
Unit	Ω (ohm)

If the specified parameter is out of the allowable setup range, the minimum value (if the lower limit of the range is not reached) or the maximum value (if the upper limit of the range is exceeded) is set.

Query response {numeric}<newline><^END>

Example of use
10 OUTPUT 717; ":SENS1:CORR:COLL:CKIT:STAN1:ARB 50.5"
20 OUTPUT 717; ":SENS1:CORR:COLL:CKIT:STAN1:ARB?"
30 ENTER 717;A

Equivalent key [Cal] - Modify Cal Kit - Define STDs - no. name^{*1} - Arb. Impedance

*1.no: standard number (1 to 21), name: standard name (variable)

:SENS{1-16}:CORR:COLL:CKIT:STAN{1-21}:C0

Syntax

```
:SENSe{[1]|2|3|4|5|6|7|8|9|10|11|12|13|14|15|16}:CORRection:COLLect:CKIT:STAN{[1]|2|3|4|5|6|7|8|9|10|11|12|13|14|15|16|17|18|19|20|21}:C0 <numeric>
:SENSe{[1]|2|3|4|5|6|7|8|9|10|11|12|13|14|15|16}:CORRection:COLLect:CKIT:STAN{[1]|2|3|4|5|6|7|8|9|10|11|12|13|14|15|16|17|18|19|20|21}:C0?
```

Description

For the calibration kit selected for channel 1 (:SENS1) to channel 16 (:SENS16), sets the value of the C0 of the standard1 (:STAN1) to standard 21 (:STAN21).

Parameters

	<numeric>
Description	C0
Range	-1E18 to 1E18
Preset value	Varies depending on the calibration kit and the standard.
Unit	fF (femtofarad)

If the specified parameter is out of the allowable setup range, the minimum value (if the lower limit of the range is not reached) or the maximum value (if the upper limit of the range is exceeded) is set.

Query response

{numeric}<newline><^END>

Example of use

```
10 OUTPUT 717; ":SENS1:CORR:COLL:CKIT:STAN1:C0 12.3"
20 OUTPUT 717; ":SENS1:CORR:COLL:CKIT:STAN1:C0?"
30 ENTER 717;A
```

Equivalent key

[Cal] - Modify Cal Kit - Define STDs - no. name^{*1} - C0

*1.no: standard number (1 to 21), name: standard name (variable)

:SENS{1-16}:CORR:COLL:CKIT:STAN{1-21}:C1

Syntax

```
:SENSe{[1]|2|3|4|5|6|7|8|9|10|11|12|13|14|15|16}:CORRection:COLLect:CKIT:STAN{[1]|2|3|4|5|6|7|8|9|10|11|12|13|14|15|16|17|18|19|20|21}:C1 <numeric>
:SENSe{[1]|2|3|4|5|6|7|8|9|10|11|12|13|14|15|16}:CORRection:COLLect:CKIT:STAN{[1]|2|3|4|5|6|7|8|9|10|11|12|13|14|15|16|17|18|19|20|21}:C1?
```

Description

For the calibration kit selected for channel 1 (:SENS1) to channel 16 (:SENS16), sets the value of the C1 of the standard1 (:STAN1) to standard 21 (:STAN21).

Parameters

	<numeric>
Description	C1
Range	-1E18 to 1E18
Preset value	Varies depending on the calibration kit and the standard.
Unit	1E-27 F/Hz (1E-27 farad/hertz)

If the specified parameter is out of the allowable setup range, the minimum value (if the lower limit of the range is not reached) or the maximum value (if the upper limit of the range is exceeded) is set.

Query response

```
{numeric}<newline><^END>
```

Example of use

```
10 OUTPUT 717; ":SENS1:CORR:COLL:CKIT:STAN1:C1 12.3"
20 OUTPUT 717; ":SENS1:CORR:COLL:CKIT:STAN1:C1?"
30 ENTER 717;A
```

Equivalent key

[Cal] - Modify Cal Kit - Define STDs - no. name^{*1} - C1

*1.no: standard number (1 to 21), name: standard name (variable)

:SENS{1-16}:CORR:COLL:CKIT:STAN{1-21}:C2

Syntax

```
:SENSe{[1]|2|3|4|5|6|7|8|9|10|11|12|13|14|15|16}:CORRection:COLLect:CKIT:STAN{[1]|2|3|4|5|6|7|8|9|10|11|12|13|14|15|16|17|18|19|20|21}:C2 <numeric>
:SENSe{[1]|2|3|4|5|6|7|8|9|10|11|12|13|14|15|16}:CORRection:COLLect:CKIT:STAN{[1]|2|3|4|5|6|7|8|9|10|11|12|13|14|15|16|17|18|19|20|21}:C2?
```

Description

For the calibration kit selected for channel 1 (:SENS1) to channel 16 (:SENS16), sets the value of the C2 of the standard1 (:STAN1) to standard 21 (:STAN21).

Parameters

	<numeric>
Description	C2
Range	-1E18 to 1E18
Preset value	Varies depending on the calibration kit and the standard.
Unit	1E-36 F/Hz ² (1E-36 farad/hertz ²)

If the specified parameter is out of the allowable setup range, the minimum value (if the lower limit of the range is not reached) or the maximum value (if the upper limit of the range is exceeded) is set.

Query response

{numeric}<newline><^END>

Example of use

```
10 OUTPUT 717; ":SENS1:CORR:COLL:CKIT:STAN1:C2 12.3"
20 OUTPUT 717; ":SENS1:CORR:COLL:CKIT:STAN1:C2?"
30 ENTER 717;A
```

Equivalent key

[Cal] - Modify Cal Kit - Define STDs - no. name^{*1} - C2

*1.no: standard number (1 to 21), name: standard name (variable)

:SENS{1-16}:CORR:COLL:CKIT:STAN{1-21}:C3

Syntax

```
:SENSe{[1]|2|3|4|5|6|7|8|9|10|11|12|13|14|15|16}:CORRection:COLLect:CKIT:STAN{[1]|2|3|4|5|6|7|8|9|10|11|12|13|14|15|16|17|18|19|20|21}:C3 <numeric>
:SENSe{[1]|2|3|4|5|6|7|8|9|10|11|12|13|14|15|16}:CORRection:COLLect:CKIT:STAN{[1]|2|3|4|5|6|7|8|9|10|11|12|13|14|15|16|17|18|19|20|21}:C3?
```

Description

For the calibration kit selected for channel 1 (:SENS1) to channel 16 (:SENS16), sets the value of the C3 of the standard1 (:STAN1) to standard 21 (:STAN21).

Parameters

	<numeric>
Description	C3
Range	-1E18 to 1E18
Preset value	Varies depending on the calibration kit and the standard.
Unit	1E-45 F/Hz ³ (1E-45 farad/hertz ³)

If the specified parameter is out of the allowable setup range, the minimum value (if the lower limit of the range is not reached) or the maximum value (if the upper limit of the range is exceeded) is set.

Query response

```
{numeric}<newline><^END>
```

Example of use

```
10 OUTPUT 717;":SENS1:CORR:COLL:CKIT:STAN1:C3 12.3"
20 OUTPUT 717;":SENS1:CORR:COLL:CKIT:STAN1:C3?"
30 ENTER 717;A
```

Equivalent key

[Cal] - Modify Cal Kit - Define STDs - no. name^{*1} - C3

*1.no: standard number (1 to 21), name: standard name (variable)

:SENS{1-16}:CORR:COLL:CKIT:STAN{1-21}:CHAR

Syntax

```
:SENSe{[1]|2|3|4|5|6|7|8|9|10|11|12|13|14|15|16}:CORRection:COLLect:CKIT:STAN{[1]|2|3|4|5|6|7|8|9|10|11|12|13|14|15|16|17|18|19|20|21}:CHARacter {COAXial|WAVeguide}
:SENSe{[1]|2|3|4|5|6|7|8|9|10|11|12|13|14|15|16}:CORRection:COLLect:CKIT:STAN{[1]|2|3|4|5|6|7|8|9|10|11|12|13|14|15|16|17|18|19|20|21}:CHARacter?
```

Description

For the standard 1 (:STAN1) to standard 21 (:STAN21) selected for the channel 1 (:SENS1) to channel 16 (:SENS16), set the media type.

Parameters

	Description
COAXial (preset value)	Selects the coaxial as the media type.
WAVeguide	Selects the waveguide as the media type.

Query response

```
{COAXial|WAVeguide}<newline><<^END>
```

Example of use

```
10 OUTPUT 717; ":SENS1:CORR:COLL:CKIT:STAN1:CHAR WAV"
20 OUTPUT 717; ":SENS1:CORR:COLL:CKIT:STAN1:CHAR?"
30 ENTER 717;A$
```

Related commands

:SENS{1-16}:CORR:COLL:CKIT:STAN{1-21}:DEL on page 577

Equivalent key

[Cal] - Modify Cal Kit - Define STDs - no. name*¹ - Media

*1.no: standard number (1 to 21), name: standard name (variable)

:SENS{1-16}:CORR:COLL:CKIT:STAN{1-21}:DEL

Syntax :SENSe{[1]|2|3|4|5|6|7|8|9|10|11|12|13|14|15|16}:CORRection:COLLect:CKIT:STAN{[1]|2|3|4|5|6|7|8|9|10|11|12|13|14|15|16|17|18|19|20|21}:DELay <numeric>
:SENSe{[1]|2|3|4|5|6|7|8|9|10|11|12|13|14|15|16}:CORRection:COLLect:CKIT:STAN{[1]|2|3|4|5|6|7|8|9|10|11|12|13|14|15|16|17|18|19|20|21}:DELay?

Description For the calibration kit selected for channel 1 (:SENS1) to channel 16 (:SENS16), sets the value of the offset delay of the standard1 (:STAN1) to standard 21 (:STAN21).

Parameters

	<numeric>
Description	Offset delay
Range	-1E18 to 1E18
Preset value	Varies depending on the calibration kit and the standard.
Unit	s (second)

If the specified parameter is out of the allowable setup range, the minimum value (if the lower limit of the range is not reached) or the maximum value (if the upper limit of the range is exceeded) is set.

Query response {numeric}<newline><^END>

Example of use 10 OUTPUT 717; ":SENS1:CORR:COLL:CKIT:STAN1:DEL 12.3"
20 OUTPUT 717; ":SENS1:CORR:COLL:CKIT:STAN1:DEL?"
30 ENTER 717;A

Related commands :SENS{1-16}:CORR:COLL:CKIT:STAN{1-21}:CHAR on page 576

Equivalent key [Cal] - Modify Cal Kit - Define STDs - no. name *1 - Offset Delay

*1.no: standard number (1 to 21), name: standard name (variable)

:SENS{1-16}:CORR:COLL:CKIT:STAN{1-21}:FMAX

Syntax

```
:SENSe{[1]|2|3|4|5|6|7|8|9|10|11|12|13|14|15|16}:CORRection:COLLect:CKIT:STAN{[1]|2|3|4|5|6|7|8|9|10|11|12|13|14|15|16|17|18|19|20|21}:FMAXimum <numeric>
:SENSe{[1]|2|3|4|5|6|7|8|9|10|11|12|13|14|15|16}:CORRection:COLLect:CKIT:STAN{[1]|2|3|4|5|6|7|8|9|10|11|12|13|14|15|16|17|18|19|20|21}:FMAXimum?
```

Description

For the calibration kit selected for channel 1 (:SENS1) to channel 16 (:SENS16), sets the value of the stop frequency of the standard1 (:STAN1) to standard 21 (:STAN21).

Parameters

	<numeric>
Description	Stop frequency of the selected standard.
Range	0 to 999E9
Preset value	Varies depending on the calibration kit and the standard.
Unit	Hz (hertz)

If the specified parameter is out of the allowable setup range, the minimum value (if the lower limit of the range is not reached) or the maximum value (if the upper limit of the range is exceeded) is set.

Query response

{numeric}<newline><^END>

Example of use

```
10 OUTPUT 717; ":SENS1:CORR:COLL:CKIT:STAN1:FMAX 5E9"
20 OUTPUT 717; ":SENS1:CORR:COLL:CKIT:STAN1:FMAX?"
30 ENTER 717;A
```

Related commands

:SENS{1-16}:CORR:COLL:CKIT:STAN{1-21}:FMIN on page 579

Equivalent key

[Cal] - Modify Cal Kit - Define STDs - no. name^{*1} - Max. Frequency

*1.no: standard number (1 to 21), name: standard name (variable)

:SENS{1-16}:CORR:COLL:CKIT:STAN{1-21}:FMIN

Syntax :SENSe{[1]|2|3|4|5|6|7|8|9|10|11|12|13|14|15|16}:CORRection:COLLect:CKIT:STAN{[1]|2|3|4|5|6|7|8|9|10|11|12|13|14|15|16|17|18|19|20|21}:FMINimum <numeric>
:SENSe{[1]|2|3|4|5|6|7|8|9|10|11|12|13|14|15|16}:CORRection:COLLect:CKIT:STAN{[1]|2|3|4|5|6|7|8|9|10|11|12|13|14|15|16|17|18|19|20|21}:FMINimum?

Description For the standard1 (:STAN1) to standard 21 (:STAN21) selected for channel 1 (:SENS1) to channel 16 (:SENS16), sets the value of the start frequency.

NOTE When the media type defined by the standard is “Waveguide,” sets the start frequency of the cut-off frequency.

Parameters

	<numeric>
Description	Start frequency of the selected standard.
Range	0 to 999E9
Preset value	Varies depending on the calibration kit and the standard.
Unit	Hz (hertz)

If the specified parameter is out of the allowable setup range, the minimum value (if the lower limit of the range is not reached) or the maximum value (if the upper limit of the range is exceeded) is set.

Query response {numeric}<newline><^END>

Example of use
10 OUTPUT 717;":SENS1:CORR:COLL:CKIT:STAN1:FMIN 1E9"
20 OUTPUT 717;":SENS1:CORR:COLL:CKIT:STAN1:FMIN?"
30 ENTER 717;A

Related commands :SENS{1-16}:CORR:COLL:CKIT:STAN{1-21}:FMAX on page 578

Equivalent key [Cal] - Modify Cal Kit - Define STDs - no. name^{*1} - Min. Frequency

*1.no: standard number (1 to 21), name: standard name (variable)

:SENS{1-16}:CORR:COLL:CKIT:STAN{1-21}:L0

Syntax

```
:SENSe{[1]|2|3|4|5|6|7|8|9|10|11|12|13|14|15|16}:CORRection:COLLect:CKIT:STAN{[1]|2|3|4|5|6|7|8|9|10|11|12|13|14|15|16|17|18|19|20|21}:L0 <numeric>
:SENSe{[1]|2|3|4|5|6|7|8|9|10|11|12|13|14|15|16}:CORRection:COLLect:CKIT:STAN{[1]|2|3|4|5|6|7|8|9|10|11|12|13|14|15|16|17|18|19|20|21}:L0?
```

Description

For the calibration kit selected for channel 1 (:SENS1) to channel 16 (:SENS16), sets the value of the L0 of the standard1 (:STAN1) to standard 21 (:STAN21).

Parameters

	<numeric>
Description	L0
Range	-1E18 to 1E18
Preset value	Varies depending on the calibration kit and the standard.
Unit	pH (picohenry)

If the specified parameter is out of the allowable setup range, the minimum value (if the lower limit of the range is not reached) or the maximum value (if the upper limit of the range is exceeded) is set.

Query response

{numeric}<newline><^END>

Example of use

```
10 OUTPUT 717; ":SENS1:CORR:COLL:CKIT:STAN1:L0 12.3"
20 OUTPUT 717; ":SENS1:CORR:COLL:CKIT:STAN1:L0?"
30 ENTER 717;A
```

Equivalent key

[Cal] - Modify Cal Kit - Define STDs - no. name*1 - L0

*1.no: standard number (1 to 21), name: standard name (variable)

:SENS{1-16}:CORR:COLL:CKIT:STAN{1-21}:L1

Syntax

```
:SENSe{[1]|2|3|4|5|6|7|8|9|10|11|12|13|14|15|16}:CORRection:COLLect:CKIT:STAN{[1]|2|3|4|5|6|7|8|9|10|11|12|13|14|15|16|17|18|19|20|21}:L1 <numeric>
```

```
:SENSe{[1]|2|3|4|5|6|7|8|9|10|11|12|13|14|15|16}:CORRection:COLLect:CKIT:STAN{[1]|2|3|4|5|6|7|8|9|10|11|12|13|14|15|16|17|18|19|20|21}:L1?
```

Description

For the calibration kit selected for channel 1 (:SENS1) to channel 16 (:SENS16), sets the value of the L1 of the standard1 (:STAN1) to standard 21 (:STAN21).

Parameters

	<numeric>
Description	L1
Range	-1E18 to 1E18
Preset value	Varies depending on the calibration kit and the standard.
Unit	1E-24 H/Hz (1E-24 henry/hertz)

If the specified parameter is out of the allowable setup range, the minimum value (if the lower limit of the range is not reached) or the maximum value (if the upper limit of the range is exceeded) is set.

Query response

```
{numeric}<newline><^END>
```

Example of use

```
10 OUTPUT 717; ":SENS1:CORR:COLL:CKIT:STAN1:L1 12.3"
20 OUTPUT 717; ":SENS1:CORR:COLL:CKIT:STAN1:L1?"
30 ENTER 717;A
```

Equivalent key

[Cal] - Modify Cal Kit - Define STDs - no. name^{*1} - L1

*1.no: standard number (1 to 21), name: standard name (variable)

:SENS{1-16}:CORR:COLL:CKIT:STAN{1-21}:L2

Syntax

```
:SENSe{[1]|2|3|4|5|6|7|8|9|10|11|12|13|14|15|16}:CORRection:COLLect:CKIT:STAN{[1]|2|3|4|5|6|7|8|9|10|11|12|13|14|15|16|17|18|19|20|21}:L2 <numeric>
:SENSe{[1]|2|3|4|5|6|7|8|9|10|11|12|13|14|15|16}:CORRection:COLLect:CKIT:STAN{[1]|2|3|4|5|6|7|8|9|10|11|12|13|14|15|16|17|18|19|20|21}:L2?
```

Description

For the calibration kit selected for channel 1 (:SENS1) to channel 16 (:SENS16), sets the value of the L2 of the standard1 (:STAN1) to standard 21 (:STAN21).

Parameters

	<numeric>
Description	L2
Range	-1E18 to 1E18
Preset value	Varies depending on the calibration kit and the standard.
Unit	1E-33 H/Hz ² (1E-33 henry/hertz ²)

If the specified parameter is out of the allowable setup range, the minimum value (if the lower limit of the range is not reached) or the maximum value (if the upper limit of the range is exceeded) is set.

Query response

{numeric}<newline><^END>

Example of use

```
10 OUTPUT 717; ":SENS1:CORR:COLL:CKIT:STAN1:L2 12.3"
20 OUTPUT 717; ":SENS1:CORR:COLL:CKIT:STAN1:L2?"
30 ENTER 717;A
```

Equivalent key

[Cal] - Modify Cal Kit - Define STDs - no. name^{*1} - L2

*1.no: standard number (1 to 21), name: standard name (variable)

:SENS{1-16}:CORR:COLL:CKIT:STAN{1-21}:L3

Syntax :SENSe{[1]|2|3|4|5|6|7|8|9|10|11|12|13|14|15|16}:CORRection:COLLect:CKIT:STAN{[1]|2|3|4|5|6|7|8|9|10|11|12|13|14|15|16|17|18|19|20|21}:L3 <numeric>
:SENSe{[1]|2|3|4|5|6|7|8|9|10|11|12|13|14|15|16}:CORRection:COLLect:CKIT:STAN{[1]|2|3|4|5|6|7|8|9|10|11|12|13|14|15|16|17|18|19|20|21}:L3?

Description For the calibration kit selected for channel 1 (:SENS1) to channel 16 (:SENS16), sets the value of the L3 of the standard1 (:STAN1) to standard 21 (:STAN21).

Parameters

	<numeric>
Description	L3
Range	-1E18 to 1E18
Preset value	Varies depending on the calibration kit and the standard.
Unit	1E-42 H/Hz ³ (1E-42 henry/hertz ³)

If the specified parameter is out of the allowable setup range, the minimum value (if the lower limit of the range is not reached) or the maximum value (if the upper limit of the range is exceeded) is set.

Query response {numeric}<newline><^END>

Example of use 10 OUTPUT 717;":SENS1:CORR:COLL:CKIT:STAN1:L3 12.3"
20 OUTPUT 717;":SENS1:CORR:COLL:CKIT:STAN1:L3?"
30 ENTER 717;A

Equivalent key [Cal] - Modify Cal Kit - Define STDs - no. name^{*1} - L3

*1.no: standard number (1 to 21), name: standard name (variable)

:SENS{1-16}:CORR:COLL:CKIT:STAN{1-21}:LAB

Syntax

:SENSe{[1]|2|3|4|5|6|7|8|9|10|11|12|13|14|15|16}:CORRection:COLLect:CKIT:STAN{[1]|2|3|4|5|6|7|8|9|10|11|12|13|14|15|16|17|18|19|20|21}:LABel <string>

:SENSe{[1]|2|3|4|5|6|7|8|9|10|11|12|13|14|15|16}:CORRection:COLLect:CKIT:STAN{[1]|2|3|4|5|6|7|8|9|10|11|12|13|14|15|16|17|18|19|20|21}:LABel?

Description

For the calibration kit selected for channel 1 (:SENS1) to channel 16 (:SENS16), sets the name of the standard1 (:STAN1) to standard 21 (:STAN21).

Parameters

	<string>
Description	Standard name
Range	254 characters or less
Preset value	Varies depending on the calibration kit and the standard.

Query response

{string}<newline><^END>

Example of use

```
10 OUTPUT 717; ":SENS1:CORR:COLL:CKIT:STAN1:LAB "OPEN" ""
20 OUTPUT 717; ":SENS1:CORR:COLL:CKIT:STAN1:LAB?"
30 ENTER 717;A$
```

Equivalent key

[Cal] - Modify Cal Kit - Define STDs - no. name^{*1} - Label

*1.no: standard number (1 to 21), name: standard name (variable)

:SENS{1-16}:CORR:COLL:CKIT:STAN{1-21}:LOSS

Syntax

```
:SENSe{[1]|2|3|4|5|6|7|8|9|10|11|12|13|14|15|16}:CORRection:COLLect:CKIT:STAN{[1]|2|3|4|5|6|7|8|9|10|11|12|13|14|15|16|17|18|19|20|21}:LOSS <numeric>
```

```
:SENSe{[1]|2|3|4|5|6|7|8|9|10|11|12|13|14|15|16}:CORRection:COLLect:CKIT:STAN{[1]|2|3|4|5|6|7|8|9|10|11|12|13|14|15|16|17|18|19|20|21}:LOSS?
```

Description For the calibration kit selected for channel 1 (:SENS1) to channel 16 (:SENS16), sets the value of the offset loss of the standard1 (:STAN1) to standard 21 (:STAN21).

Parameters

	<numeric>
Description	Offset Loss
Range	-1E18 to 1E18
Preset value	Varies depending on the calibration kit and the standard.
Unit	Ω /s (ohm/second)

If the specified parameter is out of the allowable setup range, the minimum value (if the lower limit of the range is not reached) or the maximum value (if the upper limit of the range is exceeded) is set.

Query response {numeric}<newline><^END>

Example of use

```
10 OUTPUT 717; ":SENS1:CORR:COLL:CKIT:STAN1:LOSS 12.3"
```

```
20 OUTPUT 717; ":SENS1:CORR:COLL:CKIT:STAN1:LOSS?"
```

```
30 ENTER 717;A
```

Equivalent key [Cal] - Modify Cal Kit - Define STDs - no. name^{*1} - Offset Loss

*1.no: standard number (1 to 21), name: standard name (variable)

:SENS{1-16}:CORR:COLL:CKIT:STAN{1-21}:TYPE

Syntax

```
:SENSe{[1]|2|3|4|5|6|7|8|9|10|11|12|13|14|15|16}:CORRection:COLLect:CKIT:STAN{[1]|2|3|4|5|6|7|8|9|10|11|12|13|14|15|16|17|18|19|20|21}:TYPE {OPEN|SHORt|LOAD|THRU|UTHRu|ARBI|NONE}
:SENSe{[1]|2|3|4|5|6|7|8|9|10|11|12|13|14|15|16}:CORRection:COLLect:CKIT:STAN{[1]|2|3|4|5|6|7|8|9|10|11|12|13|14|15|16|17|18|19|20|21}:TYPE?
```

Description

For the calibration kit selected for channel 1 (:SENS1) to channel 16 (:SENS16), sets the standard type of the standard1 (:STAN1) to standard 21 (:STAN21).

Parameters

	Description
OPEN	Specifies open.
SHORt	Specifies short.
LOAD	Specifies load.
THRU	Specifies thru.
UTHRu	Specifies unknown thru.
ARBI	Specify arbitrary impedance.
NONE	Specifies DUT of which theoretical values are 0.

Query response

{OPEN|SHORt|LOAD|THRU|UTHRu|ARBI|NONE}<newline><^END>

Example of use

```
10 OUTPUT 717; ":SENS1:CORR:COLL:CKIT:STAN1:TYPE OPEN"
20 OUTPUT 717; ":SENS1:CORR:COLL:CKIT:STAN1:TYPE?"
30 ENTER 717;A$
```

Equivalent key

[Cal] - Modify Cal Kit - Define STDs - no. name*1 - STD Type

*1.no: standard number (1 to 21), name: standard name (variable)

:SENS{1-16}:CORR:COLL:CKIT:STAN{1-21}:Z0

Syntax

```
:SENSe{[1]|2|3|4|5|6|7|8|9|10|11|12|13|14|15|16}:CORRection:COLLect:CKIT:STAN{[1]|2|3|4|5|6|7|8|9|10|11|12|13|14|15|16|17|18|19|20|21}:Z0 <numeric>
:SENSe{[1]|2|3|4|5|6|7|8|9|10|11|12|13|14|15|16}:CORRection:COLLect:CKIT:STAN{[1]|2|3|4|5|6|7|8|9|10|11|12|13|14|15|16|17|18|19|20|21}:Z0?
```

Description

For the calibration kit selected for channel 1 (:SENS1) to channel 16 (:SENS16), sets the value of the Offset Z0 of the standard 1 (:STAN1) to standard 21 (:STAN21).

Parameters

	<numeric>
Description	Offset Z0
Range	-1E18 to 1E18
Preset value	Varies depending on the calibration kit and the standard.
Unit	Ω (ohm)

If the specified parameter is out of the allowable setup range, the minimum value (if the lower limit of the range is not reached) or the maximum value (if the upper limit of the range is exceeded) is set.

Query response

```
{numeric}<newline><^END>
```

Example of use

```
10 OUTPUT 717; ":SENS1:CORR:COLL:CKIT:STAN1:Z0 50"
20 OUTPUT 717; ":SENS1:CORR:COLL:CKIT:STAN1:Z0?"
30 ENTER 717;A
```

Equivalent key

[Cal] - Modify Cal Kit - Define STDs - no. name^{*1} - Offset Z0

*1.no: standard number (1 to 21), name: standard name (variable)

:SENS{1-16}:CORR:COLL:CKIT:TRL:IMP

Syntax :SENSe{[1]|2|3|4|5|6|7|8|9|10|11|12|13|14|15|16}:CORRection:COLLect:CKIT:TRLoption:IMPedance {LINE|SYSTem}
:SENSe{[1]|2|3|4|5|6|7|8|9|10|11|12|13|14|15|16}:CORRection:COLLect:CKIT:TRLoption:IMPedance?

Description For channel 1 (:SENS1) to channel 16 (:SENS16). selects the reference impedance during the TRL calibration.

Parameters

	Description
SYSTem (preset value)	Calculates the error coefficients by setting the system impedance to the reference impedance.
LINE	Calculates the error coefficients by setting the characteristic impedance of the line standard to the reference impedance.

Query response {LINE|SYST}<newline><^END>

Example of use
10 OUTPUT 717; ":SENS1:CORR:COLL:CKIT:TRL:IMP LINE"
20 OUTPUT 717; ":SENS1:CORR:COLL:CKIT:TRL:IMP?"
30 ENTER 717;A\$

Related commands :SENS{1-16}:CORR:COLL:CKIT:TRL:RPL on page 589

Equivalent key [Cal] - Modify Cal Kit - TRL Option - Impedance

:SENS{1-16}:CORR:COLL:CKIT:TRL:RPL

Syntax :SENSe{[1]|2|3|4|5|6|7|8|9|10|11|12|13|14|15|16}:CORRection:COLLect:CKIT:TRLOption:RPLane {THRU|REFLect}

:SENSe{[1]|2|3|4|5|6|7|8|9|10|11|12|13|14|15|16}:CORRection:COLLect:CKIT:TRLOption:RPLANE?

Description For channel 1 (:SENS1) to channel 16 (:SENS16), selects the calculation method of the calibration plane.

Parameters

	Description
THRU (preset value)	Uses the length of the THRU and LINE standard to calculate the calibration plane.
REFLect	Uses the reflection coefficient of the reflection standard to calculate the calibration plane.

Query response {THRU|REFL}<newline><^END>

Example of use

```
10 OUTPUT 717; ":SENS1:CORR:COLL:CKIT:TRL:RPL REFL"
20 OUTPUT 717; ":SENS1:CORR:COLL:CKIT:TRL:RPL?"
30 ENTER 717;A$
```

Related commands :SENS{1-16}:CORR:COLL:CKIT:TRL:IMP on page 588

Equivalent key [Cal] - Modify Cal Kit - TRL Option - Reference Plane

:SENS{1-16}:CORR:COLL:CLE

Syntax	<code>:SENSe{[1] 2 3 4 5 6 7 8 9 10 11 12 13 14 15 16}:CORRection:COLLect:CLEar</code>
Description	<p>Clears the measurement value of the Mechanical Cal kit for calibration when the frequency offset mode is off for channel 1 (:SENS1) to channel 16 (:SENS16). (No query)</p> <p>To toggle the frequency offset mode, use :SENS{1-16}:OFFS command on page 668.</p> <p>Settings that have been temporarily changed due to measurement for each standard (number of traces, measurement parameter, and so on) return to their original values.</p>
Example of use	<pre>10 OUTPUT 717; ":SENS1:CORR:COLL:CLE"</pre>
Related commands	:SENS{1-16}:OFFS on page 668
Equivalent key	<p>[Cal] - Calibrate - Response(Open) - Cancel - OK</p> <p>[Cal] - Calibrate - Response(Short) - Cancel - OK</p> <p>[Cal] - Calibrate - Response(Thru) - Cancel - OK</p> <p>[Cal] - Calibrate - 1-Port Cal - Cancel - OK</p> <p>[Cal] - Calibrate - 2-Port Cal - Cancel - OK</p> <p>[Cal] - Calibrate - 3-Port Cal - Cancel - OK</p> <p>[Cal] - Calibrate - 4-Port Cal - Cancel - OK</p>

:SENS{1-16}:CORR:COLL:ECAL:CCH

Syntax :SENSe{[1]|2|3|4|5|6|7|8|9|10|11|12|13|14|15|16}:CORRection:COLLect:ECAL:CCHeck[:ACQuire]

Description Using ECal (Electronic Calibration), executes the confidence check of the calibration coefficients for channel 1 (:SENS1) to channel 16 (:SENS16) (sets the data measured with the analyzer and the data stored in ECal so that they can be compared).

If you execute this command when the ECal module is not connected or when ports are not properly connected with each other, an error occurs and the command is ignored. (No query)

NOTE This function is available with the firmware version 3.50 or greater.

Example of use

```
10  OUTPUT 717; ":SENS1:CORR:COLL:ECAL:CCH"  
20  OUTPUT 717; "*OPC?"  
30  ENTER 717;A
```

Equivalent key **[Cal] - ECal - Confidence Check**

:SENS{1-16}:CORR:COLL:ECAL:ERES

Syntax :SENSe{[1]|2|3|4|5|6|7|8|9|10|11|12|13|14|15|16}:CORRection:COLLect:ECAL:ERESponse
<numeric 1>,<numeric 2>

Description Executes enhanced response calibration between the two specified ports of channel 1 (:SENS1) to channel 16 (:SENS16) using the ECal (Electrical Calibration) module.
If you execute this command when the ECal module is not connected, an error occurs and the command is ignored. (No query)

Parameters

	<numeric 1>	<numeric 2>
Description	Response port number	Stimulus port number
Range	1 to 4	1 to 4
Resolution	1	1

For each parameter, you must specify a different port number. If you specify the same port number for 2 or more parameters, an error occurs and the command is ignored.

Example of use

```
10 OUTPUT 717; ":SENS1:CORR:COLL:ECAL:ERES 1,2"  
20 OUTPUT 717; "*OPC?"  
30 ENTER 717;A
```

Equivalent key [Cal] - ECal - Enhanced Response - 2-1 (S21 S11)|3-1 (S31 S11)|...|3-4 (S34 S44)

:SENS{1-16}:CORR:COLL:ECAL:ISOL

Syntax

```
:SENSe{[1|2|3|4|5|6|7|8|9|10|11|12|13|14|15|16]}:CORRection:COLLect:ECAL:ISOLation[:STATe] {ON|OFF|1|0}
:SENSe{[1|2|3|4|5|6|7|8|9|10|11|12|13|14|15|16]}:CORRection:COLLect:ECAL:ISOLation[:STATe]?
```

Description

For channel 1 (:SENS1) to channel 16 (:SENS16), turns ON/OFF the isolation measurement when executing Ecal (Electrical Calibration).

Parameters

	Description
ON or 1	Turns ON the isolation measurement.
OFF or 0 (preset value)	Turns OFF the isolation measurement.

Query response

```
{1|0}<newline><^END>
```

Example of use

```
10 OUTPUT 717; ":SENS1:CORR:COLL:ECAL:ISOL ON"
20 OUTPUT 717; ":SENS1:CORR:COLL:ECAL:ISOL?"
30 ENTER 717;A
```

Related commands

```
:SENS{1-16}:CORR:COLL:ECAL:SOLT1 on page 594
:SENS{1-16}:CORR:COLL:ECAL:SOLT2 on page 594
:SENS{1-16}:CORR:COLL:ECAL:SOLT3 on page 595
:SENS{1-16}:CORR:COLL:ECAL:SOLT4 on page 595
:SENS{1-16}:CORR:COLL:ECAL:THRU on page 596
```

Equivalent key

[Cal] - ECal - Isolation

:SENS{1-16}:CORR:COLL:ECAL:SOLT1

Syntax :SENSe{[1]|2|3|4|5|6|7|8|9|10|11|12|13|14|15|16}:CORRection:COLLect:ECAL:SOLT1 <numeric>

Description Executes 1-port calibration of the specified port of channel 1 (:SENS1) to channel 16 (:SENS16) using the ECal (Electrical Calibration) module.

If you execute this command when the ECal module is not connected, an error occurs and the command is ignored. (No query)

Parameters

	<numeric>
Description	Port number
Range	1 to 4
Resolution	1

Example of use

```
10 OUTPUT 717; ":SENS1:CORR:COLL:ECAL:SOLT1 1"
20 OUTPUT 717; "*OPC?"
30 ENTER 717;A
```

Equivalent key **[Cal] - ECal - 1-Port Cal - Port 1|Port 2|Port 3|Port 4**

:SENS{1-16}:CORR:COLL:ECAL:SOLT2

Syntax :SENSe{[1]|2|3|4|5|6|7|8|9|10|11|12|13|14|15|16}:CORRection:COLLect:ECAL:SOLT2 <numeric 1>,<numeric 2>

Description Executes full 2-port calibration between the 2 specified ports of channel 1 (:SENS1) to channel 16 (:SENS16) using the ECal (Electrical Calibration) module.

If you execute this command when the ECal module is not connected, an error occurs and the command is ignored. (No query)

Parameters

	<numeric 1>	<numeric 2>
Description	Port number	Port number
Range	1 to 4	1 to 4
Resolution	1	1

For each parameter, you must specify a different port number. If you specify the same port number for 2 or more parameters, an error occurs and the command is ignored.

Example of use

```
10 OUTPUT 717; ":SENS1:CORR:COLL:ECAL:SOLT2 1,2"
20 OUTPUT 717; "*OPC?"
30 ENTER 717;A
```

Equivalent key **[Cal] - ECal - 2-Port Cal - Port 1-2|Port 1-3|Port 1-4|Port 2-3|Port 2-4|Port 3-4**

:SENS{1-16}:CORR:COLL:ECAL:SOLT3

Syntax

:SENSe{[1]|2|3|4|5|6|7|8|9|10|11|12|13|14|15|16}:CORRection:COLLect:ECAL:SOLT3 <numeric 1>,<numeric 2>,<numeric 3>

Description

Executes full 3-port calibration between the 3 specified ports of channel 1 (:SENS1) to channel 16 (:SENS16) using the ECal (Electrical Calibration) module.

If you execute this command when the 4 ports ECal module is not connected, an error occurs and the command is ignored. (No query)

Parameters

	<numeric 1>	<numeric 2>	<numeric 3>
Description	Port number	Port number	Port number
Range	1 to 4	1 to 4	1 to 4
Resolution	1	1	1

For each parameter, you must specify a different port number. If you specify the same port number for 2 or more parameters, an error occurs and the command is ignored.

Example of use

```
10 OUTPUT 717; ":SENS1:CORR:COLL:ECAL:SOLT3 1,2,3"
20 OUTPUT 717; "*OPC?"
30 ENTER 717;A
```

Equivalent key

[Cal] - ECal - 3-Port Cal - Port 1-2-3|Port 1-2-4|Port 1-3-4|Port 2-3-4

:SENS{1-16}:CORR:COLL:ECAL:SOLT4

Syntax

:SENSe{[1]|2|3|4|5|6|7|8|9|10|11|12|13|14|15|16}:CORRection:COLLect:ECAL:SOLT4 1,2,3,4

Description

Executes full 4-port calibration of channel 1 (:SENS1) to channel 16 (:SENS16) using the ECal (Electrical Calibration) module.

If you execute this command when the 4 ports ECal module is not connected, an error occurs and the command is ignored. (No query)

Example of use

```
10 OUTPUT 717; ":SENS1:CORR:COLL:ECAL:SOLT4 1,2,3,4"
20 OUTPUT 717; "*OPC?"
30 ENTER 717;A
```

Equivalent key

[Cal] - ECal - 4-Port Cal

:SENS{1-16}:CORR:COLL:ECAL:THRU

Syntax

:SENSe{[1]|2|3|4|5|6|7|8|9|10|11|12|13|14|15|16}:CORRection:COLLect:ECAL:THRU <numeric 1>,<numeric 2>

Description

Executes response calibration (thru) between the 2 specified ports of channel 1 (:SENS1) to channel 16 (:SENS16) using the ECal (Electrical Calibration) module.

If you execute this command when the ECal module is not connected, an error occurs and the command is ignored. (No query)

Parameters

	<numeric 1>	<numeric 2>
Description	Response port number	Stimulus port number
Range	1 to 4	1 to 4
Resolution	1	1

For each parameter, you must specify a different port number. If you specify the same port number for 2 or more parameters, an error occurs and the command is ignored.

Example of use

```
10 OUTPUT 717; ":SENS1:CORR:COLL:ECAL:SOLT2 1,2"
20 OUTPUT 717; "*OPC?"
30 ENTER 717;A
```

Equivalent key

[Cal] - ECal - Thru Cal - 2-1 (S21)|3-1 (S31)|4-1 (S41)|1-2 (S12)|3-2 (S32)|4-2 (S42)|
 1-3 (S13)|2-3 (S23)|4-3 (S43)|1-4 (S14)|2-4 (S24)|3-4 (S34)

:SENS{1-16}:CORR:COLL:ECAL:UCH

Syntax :SENSe{[1]|2|3|4|5|6|7|8|9|10|11|12|13|14|15|16}:CORRection:COLLect:ECAL:UCHar {CHAR0|CHAR1|CHAR2|CHAR3|CHAR4|CHAR5}
:SENSe{[1]|2|3|4|5|6|7|8|9|10|11|12|13|14|15|16}:CORRection:COLLect:ECAL:UCHar?

Description For channel 1 (:SENS1) to channel 16 (:SENS16), selects the ECal characteristic used when executing the user-defined ECal.

The user-defined ECal is a type of ECal that is executed using the characteristic stored in the ECal's flash memory that has been acquired by the user. For more information, refer to *User's Guide*.

When the ECal module is not connected or the characteristic is not stored at the specified location number, executing this command will cause an error and the execution will be ignored.

NOTE This function is available with the firmware version 3.50 or greater.

Parameters

	Description
CHAR0 (preset value)	Specifies the factory-default characteristic. (Normal ECal)
CHAR1	Specifies the characteristic stored at location number 1 in the ECal's flash memory.
CHAR2	Specifies the characteristic stored at location number 2 in the ECal's flash memory.
CHAR3	Specifies the characteristic stored at location number 3 in the ECal's flash memory.
CHAR4	Specifies the characteristic stored at location number 4 in the ECal's flash memory.
CHAR5	Specifies the characteristic stored at location number 5 in the ECal's flash memory.

Query response {CHAR0|CHAR1|CHAR2|CHAR3|CHAR4|CHAR5}<newline><^END>

Example of use

```
10 OUTPUT 717; ":SENS1:CORR:COLL:ECAL:UCH CHAR1"
20 OUTPUT 717; ":SENS1:CORR:COLL:ECAL:UCH?"
30 ENTER 717;A$
```

Equivalent key [Cal] - ECal - Characterization - Factory|User1|User2|User3|User4|User5

:SENS{1-16}:CORR:COLL:ECAL:UTHR

Syntax

```
:SENSe{[1]|2|3|4|5|6|7|8|9|10|11|12|13|14|15|16}:CORRection:COLLect:ECAL:UTHRu[:STATe] {ON|OFF|1|0}  
:SENSe{[1]|2|3|4|5|6|7|8|9|10|11|12|13|14|15|16}:CORRection:COLLect:ECAL:UTHRu[:STATe]?
```

Description

For channel 1 (:SENS1) to channel 16 (:SENS16), turns ON/OFF the unknown thru calibration when executing Ecal (Electrical Calibration).

Parameters

	Description
ON or 1	Turns ON the unknown thru calibration.
OFF or 0 (preset value)	Turns OFF the unknown thru calibration.

Query response

```
{1|0}<newline><^END>
```

Example of use

```
10  OUTPUT 717; ":SENS1:CORR:COLL:ECAL:UTHR ON"  
20  OUTPUT 717; ":SENS1:CORR:COLL:ECAL:UTHR?"  
30  ENTER 717;A
```

Equivalent key

[Cal] - ECal - Unknown Thru

:SENS{1-16}:CORR:COLL:ISOL

Syntax

:SENSe{[1]|2|3|4|5|6|7|8|9|10|11|12|13|14|15|16}:CORRection:COLLect[:ACQuire]:ISOLation <numeric 1>,<numeric 2>

Description

For channel 1 (:SENS1) to channel 16 (:SENS16), measure the calibration data of the isolation from the stimulus port to the response port. (No query)

Parameters

	<numeric 1>	<numeric 2>
Description	Response port number	Stimulus port number
Range	1 to 4	1 to 4
Resolution	1	1

For each parameter, you must specify a different port number. If you specify the same port number for 2 or more parameters, an error occurs and the command is ignored.

Example of use

```
10 OUTPUT 717; ":SENS1:CORR:COLL:ISOL 1,2"
20 OUTPUT 717; "*OPC?"
30 ENTER 717;A
```

Equivalent key

[Cal] - Calibrate - Response (Thru) - Isolation (Optional)

[Cal] - Calibrate - n-Port Cal - Isolation (Optional) - Port m-n Isol

:SENS{1-16}:CORR:COLL:LOAD

Syntax

:SENSe{[1]|2|3|4|5|6|7|8|9|10|11|12|13|14|15|16}:CORRection:COLLect[:ACQuire]:LOAD <numeric>

Description

For channel 1 (:SENS1) to channel 16 (:SENS16), measures the calibration data of the load standard of the specified port. (No query)

Parameters

	<numeric>
Description	Port number
Range	1 to 4
Resolution	1

Example of use

```
10 OUTPUT 717; ":SENS1:CORR:COLL:LOAD 1"  
20 OUTPUT 717; "*OPC?"  
30 ENTER 717;A
```

Equivalent key

[Cal] - Calibrate - Response (Open)|Response (Short) - Load (Optional)

[Cal] - Calibrate - 1-Port Cal - Load

[Cal] - Calibrate - n-Port Cal - Reflection - Port m Load

:SENS{1-16}:CORR:COLL:METH:ADAP:REM

Syntax

:SENSe{[1]|2|3|4|5|6|7|8|9|10|11|12|13|14|15|16}:CORRection:COLLect:METhod:ADAPter:REMOval
<numeric>

Description

For channel 1 (:SENS1) to channel 16 (:SENS16), sets the specified port of the adapter removal. (No query)

Parameters

	<numeric>
Description	Port number
Range	1 to 4
Resolution	1

Example of use

```
10 OUTPUT 717; ":SENS1:CORR:COLL:METH:ADAP:REM 1"
20 OUTPUT 717; "*OPC?"
30 ENTER 717;A
```

Related commands

:SENS{1-16}:CORR:COLL:ADAP{1-4}:LENG on page 559

Equivalent key

[Cal] - Calibrate - Adapter Removal - Select Port

:SENS{1-16}:CORR:COLL:METH:ERES

Syntax

:SENSe{[1]|2|3|4|5|6|7|8|9|10|11|12|13|14|15|16}:CORRection:COLLect:METHod:ERESponse
<numeric 1>,<numeric 2>

Description

For channel 1 (:SENS1) to channel 16 (:SENS16), sets the calibration type to the enhanced response calibration between the two specified ports. (No query)

Parameters

	<numeric 1>	<numeric 2>
Description	Response port number	Stimulus port number
Range	1 to 4	1 to 4
Resolution	1	1

For each parameter, you must specify a different port number. If you specify the same port number for 2 or more parameters, an error occurs and the command is ignored.

Example of use

```
10 OUTPUT 717; ":SENS1:CORR:COLL:METH:ERES 1,2"
```

Related commands

:SENS{1-16}:CORR:COLL:METH:TYPE? on page 610

Equivalent key

[Cal] - Calibrate - Enhanced Response - Select Ports - 2-1 (S21 S11)|3-1 (S31 S11)|...|3-4 (S34 S44)

:SENS{1-16}:CORR:COLL:METH:OPEN

Syntax :SENSe{[1]|2|3|4|5|6|7|8|9|10|11|12|13|14|15|16}:CORRection:COLLect:METhod[:RESPOse]:OPEN <numeric>

Description For channel 1 (:SENS1) to channel 16 (:SENS16), sets the calibration type to the response calibration (open) of the specified port. (No query)

Parameters

	<numeric>
Description	Port number
Range	1 to 4
Resolution	1

Example of use 10 OUTPUT 717; ":SENS1:CORR:COLL:METH:OPEN 1"

Related commands :SENS{1-16}:CORR:COLL:METH:TYPE? on page 610

Equivalent key [Cal] - Calibrate - Response (Open) - Select Port

:SENS{1-16}:CORR:COLL:METH:SHOR

Syntax :SENSe{[1]|2|3|4|5|6|7|8|9|10|11|12|13|14|15|16}:CORRection:COLLect:METhod[:RESPOse]:SHORt <numeric>

Description For channel 1 (:SENS1) to channel 16 (:SENS16), sets the calibration type to the response calibration (short) of the specified port. (No query)

Parameters

	<numeric>
Description	Port number
Range	1 to 4
Resolution	1

Example of use 10 OUTPUT 717; ":SENS1:CORR:COLL:METH:SHOR 1"

Related commands :SENS{1-16}:CORR:COLL:METH:TYPE? on page 610

Equivalent key [Cal] - Calibrate - Response (Short) - Select Port

:SENS{1-16}:CORR:COLL:METH:SOLT1

Syntax

:SENSe{[1]|2|3|4|5|6|7|8|9|10|11|12|13|14|15|16}:CORRection:COLLect:METhod:SOLT1 <numeric>

Description

For channel 1 (:SENS1) to channel 16 (:SENS16), sets the calibration type to the 1-port calibration of the specified port. (No query)

Parameters

	<numeric>
Description	Port number
Range	1 to 4
Resolution	1

Example of use

10 OUTPUT 717; ":SENS1:CORR:COLL:METH:SOLT1 1"

Related commands

:SENS{1-16}:CORR:COLL:METH:TYPE? on page 610

Equivalent key

[Cal] - Calibrate - 1-Port Cal - Select Port

:SENS{1-16}:CORR:COLL:METH:SOLT2

Syntax

:SENSe{[1]|2|3|4|5|6|7|8|9|10|11|12|13|14|15|16}:CORRection:COLLect:METhod:SOLT2 <numeric 1>,<numeric 2>

Description

For channel 1 (:SENS1) to channel 16 (:SENS16), sets the calibration type to the full 2-port calibration between the 2 specified ports. (No query)

Parameters

	<numeric 1>	<numeric 2>
Description	Port number	Port number
Range	1 to 4	1 to 4
Resolution	1	1

For each parameter, you must specify a different port number. If you specify the same port number for 2 or more parameters, an error occurs and the command is ignored.

Example of use

10 OUTPUT 717; ":SENS1:CORR:COLL:METH:SOLT2 1,2"

Related commands

:SENS{1-16}:CORR:COLL:METH:TYPE? on page 610

Equivalent key

[Cal] - Calibrate - 2-Port Cal - Select Ports

:SENS{1-16}:CORR:COLL:METH:SOLT3

Syntax :SENSe{[1]|2|3|4|5|6|7|8|9|10|11|12|13|14|15|16}:CORRection:COLLect:METhod:SOLT3 <numeric 1>, <numeric 2>,<numeric 3>

Description For channel 1 (:SENS1) to channel 16 (:SENS16), sets the calibration type to the full 3-port calibration between the 3 specified ports. (No query)

Parameters

	<numeric 1>	<numeric 2>	<numeric 3>
Description	Port number	Port number	Port number
Range	1 to 4	1 to 4	1 to 4
Resolution	1	1	1

For each parameter, you must specify a different port number. If you specify the same port number for 2 or more parameters, an error occurs and the command is ignored.

Example of use 10 OUTPUT 717; ":SENS1:CORR:COLL:METH:SOLT3 1,2,3"

Related commands :SENS{1-16}:CORR:COLL:METH:TYPE? on page 610

Equivalent key [Cal] - Calibrate - 3-Port Cal - Select Ports

:SENS{1-16}:CORR:COLL:METH:SOLT4

Syntax :SENSe{[1]|2|3|4|5|6|7|8|9|10|11|12|13|14|15|16}:CORRection:COLLect:METhod:SOLT4 1,2,3,4

Description For channel 1 (:SENS1) to channel 16 (:SENS16), sets the calibration type to the full 4-port calibration. (No query)

Example of use 10 OUTPUT 717; ":SENS1:CORR:COLL:METH:SOLT3 1,2,3,4"

Related commands :SENS{1-16}:CORR:COLL:METH:TYPE? on page 610

Equivalent key [Cal] - Calibrate - 4-Port Cal

:SENS{1-16}:CORR:COLL:METH:THRU

Syntax

:SENSe{[1]|2|3|4|5|6|7|8|9|10|11|12|13|14|15|16}:CORRection:COLLect:METhod[:RESPOse]:THRU <numeric 1>,<numeric 2>

Description

For channel 1 (:SENS1) to channel 16 (:SENS16), sets the calibration type to the response calibration (thru) between the 2 specified ports. (No query)

Parameters

	<numeric 1>	<numeric 2>
Description	Port number	Port number
Range	1 to 4	1 to 4
Resolution	1	1

For each parameter, you must specify a different port number. If you specify the same port number for 2 or more parameters, an error occurs and the command is ignored.

Example of use

```
10 OUTPUT 717; ":SENS1:CORR:COLL:METH:THRU 1,2"
```

Related commands

:SENS{1-16}:CORR:COLL:METH:TYPE? on page 610

Equivalent key

[Cal] - Calibrate - Response (Thru) - Select Ports

:SENS{1-16}:CORR:COLL:METH:TRL2

Syntax

```
:SENSe{[1]|2|3|4|5|6|7|8|9|10|11|12|13|14|15|16}:CORRection:COLLect  
:METHod:TRL2 <numeric 1>,<numeric 2>
```

Description

For channel 1 (:SENS1) to channel 16 (:SENS16), sets the calibration type to the TRL calibration between the two specified ports. (No query)

Parameters

	<numeric 1>	<numeric 2>
Description	Port number	Port number
Range	1 to 4	1 to 4
Resolution	1	1

For each parameter, you must specify a different port number. If you specify the same port number for 2 or more parameters, an error occurs and the command is ignored.

Example of use

```
10 OUTPUT 717; ":SENS1:CORR:COLL:METH:TRL2 1,2"
```

Related commands

:SENS{1-16}:CORR:COEF on page 548

:SENS{1-16}:CORR:COEF:SAVE on page 558

Equivalent key

[Cal] - Calibrate - 2-Port TRL Cal - Select Ports - 1-2|1-3*1|1-4*2|2-3*1|2-4*2|3-4*2

*1. Only with Options 313, 314, 413, and 414.

*2. Only with Options 413 and 414.

:SENS{1-16}:CORR:COLL:METH:TRL3

Syntax

:SENSe{[1]|2|3|4|5|6|7|8|9|10|11|12|13|14|15|16}:CORRection:COLLect
 :METHod:TRL3 <numeric 1>,<numeric 2>,<numeric 3>

Description

For channel 1 (:SENS1) to channel 16 (:SENS16), sets the calibration type to the TRL calibration between the 3 specified ports. (No query)

Parameters

	<numeric 1>	<numeric 2>	<numeric 3>
Description	Port number	Port number	Port number
Range	1 to 4	1 to 4	1 to 4
Resolution	1	1	1

For each parameter, you must specify a different port number. If you specify the same port number for 2 or more parameters, an error occurs and the command is ignored.

Example of use

10 OUTPUT 717; ":SENS1:CORR:COLL:METH:TRL3 1,2,3"

Related commands

:SENS{1-16}:CORR:COEF on page 548
 :SENS{1-16}:CORR:COEF:SAVE on page 558

Equivalent key

[Cal] - Calibrate - 3-Port TRL Cal*1 - Select Ports - 1-2-3|1-2-4*2|1-3-4*2|2-3-4*2

*1. Only with Options 313, 314, 413, and 414.
 *2. Only with Options 413 and 414.

:SENS{1-16}:CORR:COLL:METH:TRL4

Syntax

```
:SENSe{[1]|2|3|4|5|6|7|8|9|10|11|12|13|14|15|16}:CORRection:COLLect  
:METHod:TRL4 <numeric 1>,<numeric 2>,<numeric 3>,<numeric 4>
```

Description

For channel 1 (:SENS1) to channel 16 (:SENS16), sets the calibration type to the TRL calibration between the 4 specified ports. (No query)

Parameters

	<numeric 1>	<numeric 2>	<numeric 3>	<numeric 4>
Description	Port number	Port number	Port number	Port number
Range	1 to 4	1 to 4	1 to 4	1 to 4
Resolution	1	1	1	1

For each parameter, you must specify a different port number. If you specify the same port number for 2 or more parameters, an error occurs and the command is ignored.

Example of use

```
10 OUTPUT 717; ":SENS1:CORR:COLL:METH:TRL4 1,2,3,4"
```

Related commands

:SENS{1-16}:CORR:COEF on page 548

:SENS{1-16}:CORR:COEF:SAVE on page 558

Equivalent key

[Cal] - Calibrate - 4-Port TRL Cal^{*1}

^{*1}. Only with Options 413 and 414.

:SENS{1-16}:CORR:COLL:METH:TYPE?

Syntax :SENSe{[1]|2|3|4|5|6|7|8|9|10|11|12|13|14|15|16}:CORRection:COLLect:METHod:TYPE?

Description For channel 1 (:SENS1) to channel 16 (:SENS16), reads out the calibration type selected for calculation of the calibration coefficients. (Query only)

Query response {ERES|NONE|RESPO|RESPS|RESPT|SOLT1|SOLT2|SOLT3|SOLT4|TRL2|TRL3|TRL4}
<newline><<^END>

	Description
ERES	The calibration type is the enhanced response calibration.
NONE	The calibration type is set to nothing.
RESPO	The calibration type is the response calibration (open).
RESPS	The calibration type is the response calibration (short).
RESPT	The calibration type is the response calibration (thru).
SOLT1	The calibration type is the 1-port calibration.
SOLT2	The calibration type is the full 2-port calibration.
SOLT3	The calibration type is the full 3-port calibration.
SOLT4	The calibration type is the full 4-port calibration.
TRL2	The calibration type is the TRL 2-port calibration.
TRL3	The calibration type is the TRL 3-port calibration.
TRL4	The calibration type is the TRL 4-port calibration.

Example of use
10 OUTPUT 717; ":SENS1:CORR:COLL:METH:TYPE?"
20 ENTER 717;A\$

Equivalent key No equivalent key is available on the front panel.

:SENS{1-16}:CORR:COLL:OPEN

Syntax :SENSe{[1]|2|3|4|5|6|7|8|9|10|11|12|13|14|15|16}:CORRection:COLLect[:ACQuire]:OPEN <numeric>

Description For channel 1 (:SENS1) to channel 16 (:SENS16), measures the calibration data of the open standard of the specified port. (No query)

Parameters

	<numeric>
Description	Port number
Range	1 to 4
Resolution	1

Example of use

```
10 OUTPUT 717;":SENS1:CORR:COLL:OPEN 1"
20 OUTPUT 717;"*OPC?"
30 ENTER 717;A
```

Equivalent key **[Cal] - Calibrate - Response (Open)|1-Port Cal - Open**
[Cal] - Calibrate - n-Port Cal - Reflection - Port m Open

:SENS{1-16}:CORR:COLL:PART:SAVE

Syntax

:SENSe{[1]|2|3|4|5|6|7|8|9|10|11|12|13|14|15|16}:CORRection:COLLect:PARTial:SAVE

Description

For partial overwrite, recalculates the calibration coefficients from the measured calibration data depending on the selected calibration type.

Calculating the calibration coefficients clears all calibration data, regardless of whether the data are used for the calculation, and also clears the calibration type selections.

If you execute partial overwrite before selecting the calibration type, an error occurs and the command is ignored. (No query)

Example of use

```
10 OUTPUT 717; ":SENS1:CORR:COLL:PART:SAVE"
```

Equivalent key

[Cal] - Calibrate - n-Port Cal - Overwrite

:SENS{1-16}:CORR:COLL:SAVE

Syntax :SENSe{[1]|2|3|4|5|6|7|8|9|10|11|12|13|14|15|16}:CORRection:COLLect:SAVE

Description From the measured calibration data, calculates the calibration coefficients depending on the selected calibration type.

Calculating the calibration coefficients clears all calibration data whether or not used for the calculation and also clears the calibration type selections.

If you execute this command before all necessary calibration data for calculating the calibration coefficients is measured, an error occurs and the command is ignored. (No query)

Example of use 10 OUTPUT 717; ":SENS1:CORR:COLL:SAVE"

Related commands

- :SENS{1-16}:CORR:COLL:METH:OPEN on page 603
- :SENS{1-16}:CORR:COLL:METH:SHOR on page 603
- :SENS{1-16}:CORR:COLL:METH:THRU on page 606
- :SENS{1-16}:CORR:COLL:METH:SOLT1 on page 604
- :SENS{1-16}:CORR:COLL:METH:SOLT2 on page 604
- :SENS{1-16}:CORR:COLL:METH:SOLT3 on page 605
- :SENS{1-16}:CORR:COLL:METH:SOLT4 on page 605

Equivalent key [Cal] - Calibrate - Response|n-Port Cal - Done

:SENS{1-16}:CORR:COLL:SHOR

Syntax :SENSe{[1]|2|3|4|5|6|7|8|9|10|11|12|13|14|15|16}:CORRection:COLLect[:ACQuire]:SHORt <numeric>

Description For channel 1 (:SENS1) to channel 16 (:SENS16), measures the calibration data of the short standard of the specified port. (No query)

Parameters

	<numeric>
Description	Port number
Range	1 to 4
Resolution	1

Example of use

```
10 OUTPUT 717; ":SENS1:CORR:COLL:SHOR 1"
20 OUTPUT 717; "*OPC?"
30 ENTER 717;A
```

Equivalent key [Cal] - Calibrate - Response (Short)|1-Port Cal - Short
[Cal] - Calibrate - n-Port Cal - Reflection - Port m Short

:SENS{1-16}:CORR:COLL:SIMP:SAVE

Syntax	:SENSe{[1] 2 3 4 5 6 7 8 9 10 11 12 13 14 15 16}:CORRection:COLLect:SIMPlified:SAVE
Description	<p>When the full 3/4 port calibration is selected as the calibration type, calculates the calibration coefficients for the simplified full 3 port calibration or the simplified full 4 port calibration from the measured calibration data.</p> <p>If the response calibration or the 1/2 port calibration is selected as the calibration type, this command provides the same function as the :SENS{1-16}:CORR:COLL:SAVE command.</p> <p>After the calibration coefficients are calculated, the measured data and the calibration type setting are cleared.</p> <p>If you execute this command before all the necessary calibration data for calculating the calibration coefficients for the simplified full 3 port calibration or the simplified full 4 port calibration is measured, an error occurs and the command is ignored. (No query)</p>
<hr/> NOTE	<hr/> This function is available with the firmware version 3.50 or greater.
<hr/> NOTE	<hr/> With the firmware version 6.50 or greater, when the 3/4 port TRL calibration is selected as the calibration type, calculates the calibration coefficients for simplified 3 port TRL calibration and simplified 4 port TRL calibration from the measured calibration data.
Example of use	10 OUTPUT 717; ":SENS1:CORR:COLL:SIMP:SAVE"
Related commands	:SENS{1-16}:CORR:COLL:METH:SOLT3 on page 605 :SENS{1-16}:CORR:COLL:METH:SOLT4 on page 605 :SENS{1-16}:CORR:COLL:METH:TRL3 on page 608 :SENS{1-16}:CORR:COLL:METH:TRL4 on page 609
Equivalent key	No equivalent key is available on the front panel.

:SENS{1-16}:CORR:COLL:SUBC

Syntax :SENSe{[1]|2|3|4|5|6|7|8|9|10|11|12|13|14|15|16}:CORRection:COLLect[:ACQuire]:SUBClass
<numeric>
:SENSe{[1]|2|3|4|5|6|7|8|9|10|11|12|13|14|15|16}:CORRection:COLLect[:ACQuire]:SUBClass?

Description For channel 1 (:SENS1) to channel 16 (:SENS16), sets the standard subclass for the calibration.

Parameters

	<numeric>
Description	The setting number of the standard subclass for the calibration.
Range	1 to 8
Resolution	1

Query response {numeric}<newline><^END>

Example of use 10 OUTPUT 717; ":SENS1:CORR:COLL:SUBC 1"

Equivalent key No equivalent key is available on the front panel.

:SENS{1-16}:CORR:COLL:THRU

Syntax

:SENSe{[1]|2|3|4|5|6|7|8|9|10|11|12|13|14|15|16}:CORRection:COLLect[:ACQuire]:THRU <numeric 1>,<numeric 2>

Description

For channel 1 (:SENS1) to channel 16 (:SENS16), measure the calibration data of the thru standard from the stimulus port to the response port. (No query)

Parameters

	<numeric 1>	<numeric 2>
Description	Response port number	Stimulus port number
Range	1 to 4	1 to 4
Resolution	1	1

For each parameter, you must specify a different port number. If you specify the same port number for 2 or more parameters, an error occurs and the command is ignored.

Example of use

```
10  OUTPUT 717; ":SENS1:CORR:COLL:THRU 1,2"  
20  OUTPUT 717; "*OPC?"  
30  ENTER 717;A
```

Equivalent key

[Cal] - Calibrate - Response (Thru) - Thru

[Cal] - Calibrate - n-Port Cal - Transmission - Port m-n Thru

:SENS{1-16}:CORR:COLL:TRLL

Syntax :SENSe{[1]|2|3|4|5|6|7|8|9|10|11|12|13|14|15|16}:CORRection:COLLect[:ACQuire]:TRLLine
<numeric 1>,<numeric 2>

Description For channel 1 (:SENS1) to channel 16 (:SENS16), executes LINE or MATCH measurement of the TRL calibration for the selected calibration kit.

(No Query)

Parameters

	<numeric 1>	<numeric 2>
Description	Response port number	Stimulus port number
Range	1 to 4	1 to 4
Resolution	1	1

For each parameter, you must specify a different port number. If you specify the same port number for 2 or more parameters, an error occurs and the command is ignored.

Example of use

```
10 OUTPUT 717;":SENS1:CORR:COLL:TRLL 1,2"
20 OUTPUT 717;"*OPC?"
30 ENTER 717;A
```

Related commands :SENS{1-16}:CORR:COLL:TRLR on page 618
:SENS{1-16}:CORR:COLL:TRLT on page 619

Equivalent key [Cal] - Calibrate - 2-Port TRL Cal - Line/Match - x-y Line/Match|x-y Fwd (Syx)|x-y Rvs (Sxy)

[Cal] - Calibrate - 3-Port TRL Cal - Line/Match - x-y Line/Match|x-y Fwd (Syx)|x-y Rvs (Sxy)|x-z Line/Match|x-z Fwd (Szx)|x-z Rvs (Sxz)|y-z Line/Match|y-z Fwd (Szy)|y-z Rvs (Syz)

[Cal] - Calibrate - 4-Port TRL Cal - Line/Match - x-y Line/Match|x-y Fwd (Syx)|x-y Rvs (Sxy) - x-z Line/Match|x-z Fwd (Szx)|x-z Rvs (Sxz) - x-w Line/Match|x-w Fwd (Swx)|x-w Rvs (Sxw) - y-z Line/Match|y-z Fwd (Szy)|y-z Rvs (Syz) - y-w Line/Match|y-w Fwd (Swy)|y-w Rvs (Syw) - z-w Line/Match|z-w Fwd (Swz)|z-w Rvs (Szw)

:SENS{1-16}:CORR:COLL:TRLR

Syntax :SENSe{[1]|2|3|4|5|6|7|8|9|10|11|12|13|14|15|16}:CORRection:COLLect[:ACQuire]:TRLReflect
 <numeric>

Description For channel 1 (:SENS1) to channel 16 (:SENS16), executes the reflection measurement of the TRL calibration for the selected calibration kit.(No Query)

Parameters

	<numeric>
Description	Port number
Range	1 to 4
Resolution	1

For each parameter, you must specify a different port number. If you specify the same port number for 2 or more parameters, an error occurs and the command is ignored.

Example of use

```

10  OUTPUT 717; ":SENS1:CORR:COLL:TRLR 1"
20  OUTPUT 717; "*OPC?"
30  ENTER 717;A
    
```

Related commands :SENS{1-16}:CORR:COLL:TRLL on page 617
 :SENS{1-16}:CORR:COLL:TRLT on page 619

Equivalent key [Cal] - Calibrate - 2-Port TRL Cal - Reflect - Portx Reflect|Porty Reflect
 [Cal] - Calibrate - 3-Port TRL Cal - Reflect - Portx Reflect|Porty Reflect|Portz Reflect
 [Cal] - Calibrate - 4-Port TRL Cal - Reflect - Portx Reflect|Porty Reflect|Portz Reflect|Portw Reflect

:SENS{1-16}:CORR:COLL:TRLT

Syntax :SENSe{[1]|2|3|4|5|6|7|8|9|10|11|12|13|14|15|16}:CORRection:COLLect[:ACQuire]:TRLThru
<numeric 1>,<numeric 2>

Description For channel 1 (:SENS1) to channel 16 (:SENS16), executes the THRU measurement of the TRL calibration for the selected calibration kit. (No Query)

Parameters

	<numeric 1>	<numeric 2>
Description	Response port number	Stimulus port number
Range	1 to 4	1 to 4
Resolution	1	1

For each parameter, you must specify a different port number. If you specify the same port number for 2 or more parameters, an error occurs and the command is ignored.

Example of use

```
10 OUTPUT 717;":SENS1:CORR:COLL:TRLT 1,2"
20 OUTPUT 717;"*OPC?"
30 ENTER 717;A
```

Related commands :SENS{1-16}:CORR:COLL:TRLL on page 617
:SENS{1-16}:CORR:COLL:TRLR on page 618

Equivalent key [Cal] - Calibrate - 2-Port TRL Cal - Thru/Line - Port x-y Thru
[Cal] - Calibrate - 3-Port TRL Cal - Thru/Line - Port x-y Thru|Port x-z Thru|Port y-z Thru
[Cal] - Calibrate - 4-Port TRL Cal - Thru/Line - Port x-y Thru|Port x-z Thru|Port x-w Thru|Port y-z Thru|Port y-w Thru|Port z-w Thru

:SENS{1-16}:CORR:EXT

Syntax :SENSe{[1]|2|3|4|5|6|7|8|9|10|11|12|13|14|15|16}:CORRection:EXTension[:STATe] {ON|OFF|1|0}
:SENSe{[1]|2|3|4|5|6|7|8|9|10|11|12|13|14|15|16}:CORRection:EXTension[:STATe]?

Description For channel 1 (:SENS1) to channel 16 (:SENS16), turns ON/OFF the port extension.

Parameters

	Description
ON or 1	Turns ON the port extension.
OFF or 0 (preset value)	Turns OFF the port extension.

Query response {1|0}<newline><^END>

Example of use
10 OUTPUT 717; ":SENS1:CORR:EXT ON"
20 OUTPUT 717; ":SENS1:CORR:EXT?"
30 ENTER 717;A

Related commands
:SENS{1-16}:CORR:EXT:AUTO:PORT{1-4} on page 625
:SENS{1-16}:CORR:EXT:AUTO:PORT{1-4} on page 625
:SENS{1-16}:CORR:EXT:PORT{1-4}:INCL{1-2} on page 631
:SENS{1-16}:CORR:EXT:PORT{1-4}:LDC on page 632
:SENS{1-16}:CORR:EXT:PORT{1-4}:LOSS{1-2} on page 633

Equivalent key [Cal] - Port Extensions - Extensions

:SENS{1-16}:CORR:EXT:AUTO:CONF

Syntax :SENSe{[1]|2|3|4|5|6|7|8|9|10|11|12|13|14|15|16}:CORRection:EXTension:AUTO:CONFig
{CSPN|AMKR|USPN}
:SENSe{[1]|2|3|4|5|6|7|8|9|10|11|12|13|14|15|16}:CORRection:EXTension:AUTO:CONFig?

Description For channel 1 (:SENS1) to channel 16 (:SENS16), sets the frequency point to calculate the loss value of the auto port extension.

Parameters

	Description
CSPN (preset value)	Uses the frequency of the current sweep range.
AMKR	Use the frequency of the active marker.* ¹ This is applied to Loss 1 and Loss 2 is ignored.
USPN	This action is executed with the arbitrarily specified start frequency and stop frequency.

*1. Even if active marker is set to OFF, it turns on automatically.

Query response {CSPN|AMKR|USPN}<newline><^END>

Example of use
10 OUTPUT 717; ":SENS1:CORR:EXT:AUTO:CONF CSPN"
20 OUTPUT 717; ":SENS1:CORR:EXT:AUTO:CONF?"
30 ENTER 717;A\$

Related commands
:SENS{1-16}:CORR:EXT:AUTO:STAR on page 627
:SENS{1-16}:CORR:EXT:AUTO:STOP on page 628

Equivalent key [Cal] - Port Extensions - Auto Port Extension - Method - Current Span|Active Marker|User Span

:SENS{1-16}:CORR:EXT:AUTO:DCOF

Syntax :SENSe{[1]|2|3|4|5|6|7|8|9|10|11|12|13|14|15|16}:CORRection:EXTension:AUTO:DCOFfs
et {ON|OFF|1|0}

:SENSe{[1]|2|3|4|5|6|7|8|9|10|11|12|13|14|15|16}:CORRection:EXTension:AUTO:DCOFfs
et?

Description For channel 1 (:SENS1) to channel 16 (:SENS16),enables or disables the usage of DC loss value for the results of the auto port extension.

Parameters

	Description
ON or 1	Uses the DC loss value for the results.
OFF or 0 (preset value)	Does not use the DC loss value for the results.

Query response {1|0}<newline><^END>

Example of use
10 OUTPUT 717; ":SENS1:CORR:EXT:AUTO:DCOF ON"
20 OUTPUT 717; ":SENS1:CORR:EXT:AUTO:DCOF?"
30 ENTER 717;A

Related commands
:SENS{1-16}:CORR:EXT on page 620
:SENS{1-16}:CORR:EXT:AUTO:LOSS on page 623
:SENS{1-16}:CORR:EXT:AUTO:MEAS on page 624
:SENS{1-16}:CORR:EXT:AUTO:PORT{1-4} on page 625

Equivalent key [Cal] - Port Extensions - Auto Port Extension - Adjust Mismatch

:SENS{1-16}:CORR:EXT:AUTO:LOSS

Syntax :SENSe{[1]|2|3|4|5|6|7|8|9|10|11|12|13|14|15|16}:CORRection:EXTension:AUTO:LOSS
{ON|OFF|1|0}
:SENSe{[1]|2|3|4|5|6|7|8|9|10|11|12|13|14|15|16}:CORRection:EXTension:AUTO:LOSS?

Description For channel 1 (:SENS1) to channel 16 (:SENS16), enables or disables the loss correction for the auto port extension results.

Parameters

	Description
ON or 1	Turns on the loss compensation
OFF or 0 (preset value)	Turns off the loss compensation

Query response {1|0}<newline><^END>

Example of use
10 OUTPUT 717; ":SENS1:CORR:EXT:AUTO:LOSS ON"
20 OUTPUT 717; ":SENS1:CORR:EXT:AUTO:LOSS?"
30 ENTER 717;A

Related commands
:SENS{1-16}:CORR:EXT on page 620
:SENS{1-16}:CORR:EXT:AUTO:DCOF on page 622
:SENS{1-16}:CORR:EXT:AUTO:MEAS on page 624
:SENS{1-16}:CORR:EXT:AUTO:PORT{1-4} on page 625

Equivalent key [Cal] - Port Extensions - Auto Port Extension - Include Loss

:SENS{1-16}:CORR:EXT:AUTO:MEAS

Syntax :SENSe{[1]|2|3|4|5|6|7|8|9|10|11|12|13|14|15|16}:CORRection:EXTension:AUTO:MEASu
re {OPEN|SHORT}

:SENSe{[1]|2|3|4|5|6|7|8|9|10|11|12|13|14|15|16}:CORRection:EXTension:AUTO:MEASu
re?

Description For channel 1 (:SENS1) to channel 16 (:SENS16), measures the calibration data of the OPEN standard or SHORT standard of the auto port extension.

Parameters

	Description
OPEN	Measures the calibration data of the OPEN standard
SHORt (preset value)	Measures the calibration data of the SHORT standard

Query response {OPEN|SHOR}<newline><^END>

Example of use
10 OUTPUT 717; ":SENS1:CORR:EXT:AUTO:MEAS OPEN"
20 OUTPUT 717; ":SENS1:CORR:EXT:AUTO:MEAS?"
30 ENTER 717;A\$

Related commands
:SENS{1-16}:CORR:EXT on page 620
:SENS{1-16}:CORR:EXT:AUTO:DCOF on page 622
:SENS{1-16}:CORR:EXT:AUTO:LOSS on page 623
:SENS{1-16}:CORR:EXT:AUTO:PORT{1-4} on page 625

Equivalent key [Cal] - Port Extensions - Auto Port Extension - Measure OPEN|Measure Short-
All|Port 1|Port 2|Port 3|Port 4

:SENS{1-16}:CORR:EXT:AUTO:PORT{1-4}

Syntax :SENSe{[1]|2|3|4|5|6|7|8|9|10|11|12|13|14|15|16}:CORRection:EXTension:AUTO:PORT{[1]|2|3|4} {ON|OFF|1|0}
:SENSe{[1]|2|3|4|5|6|7|8|9|10|11|12|13|14|15|16}:CORRection:EXTension:AUTO:PORT{[1]|2|3|4}?

Description For channel 1 (:SENS1) to channel 16 (:SENS16), turns ON/OFF the auto port extension.

Parameters

	Description
ON or 1 (preset value)	Turns ON the auto port extension
OFF or 0	Turns OFF the auto port extension

Query response {1|0}<newline><^END>

Example of use
10 OUTPUT 717; ":SENS1:CORR:EXT:AUTO:PORT1 ON"
20 OUTPUT 717; ":SENS1:CORR:EXT:AUTO:PORT1?"
30 ENTER 717;A\$

Related commands
:SENS{1-16}:CORR:EXT on page 620
:SENS{1-16}:CORR:EXT:AUTO:DCOF on page 622
:SENS{1-16}:CORR:EXT:AUTO:LOSS on page 623
:SENS{1-16}:CORR:EXT:AUTO:MEAS on page 624

Equivalent key [Cal] - Port Extensions - Auto Port Extension - Select Ports - Port 1|Port 2|Port 3|Port 4

:SENS{1-16}:CORR:EXT:AUTO:RESet

Syntax	:SENSe{[1] 2 3 4 5 6 7 8 9 10 11 12 13 14 15 16}:CORRection:EXTension:AUTO:RESet
Description	For channel 1 (:SENS1) to channel 16 (:SENS16), deletes the finished measurement data (OPEN and SHORT). (No Query)
Example of use	10 OUTPUT 717; ":SENS1:CORR:EXT:AUTO:RESet "
Related commands	:SENS{1-16}:CORR:EXT on page 620 :SENS{1-16}:CORR:EXT:AUTO:CONF on page 621 :SENS{1-16}:CORR:EXT:AUTO:DCOF on page 622 :SENS{1-16}:CORR:EXT:AUTO:LOSS on page 623 :SENS{1-16}:CORR:EXT:AUTO:MEAS on page 624 :SENS{1-16}:CORR:EXT:AUTO:PORT{1-4} on page 625 :SENS{1-16}:CORR:EXT:AUTO:STAR on page 627 :SENS{1-16}:CORR:EXT:AUTO:STOP on page 628
Equivalent key	No equivalent key is available on the front panel.

:SENS{1-16}:CORR:EXT:AUTO:STAR

Syntax :SENSe{[1]|2|3|4|5|6|7|8|9|10|11|12|13|14|15|16}:CORRection:EXTension:AUTO:STARt
<numeric>
:SENSe{[1]|2|3|4|5|6|7|8|9|10|11|12|13|14|15|16}:CORRection:EXTension:AUTO:STARt?

Description For channel 1 (:SENS1) to channel 16 (:SENS16), sets the start frequency within the frequency range of the user specified auto port extension.

Parameters

	<numeric>
Description	Start frequency
Range	3E5 to 3.0E9 (for E5070B) 3E5 to 8.5E9 (for E5071B)
Preset value	3E5
Unit	Hz (hertz)

Query response {numeric}<newline><^END>

Example of use
10 OUTPUT 717; ":SENS1:CORR:EXT:AUTO:STAR 1.2E9"
20 OUTPUT 717; ":SENS1:CORR:EXT:AUTO:STAR?"
30 ENTER 717;A

Related commands
:SENS{1-16}:CORR:EXT on page 620
:SENS{1-16}:CORR:EXT:AUTO:CONF on page 621
:SENS{1-16}:CORR:EXT:AUTO:PORT{1-4} on page 625
:SENS{1-16}:CORR:EXT:AUTO:STOP on page 628

Equivalent key [Cal] - Port Extensions - Auto Port Extension - Method - User Span Start

:SENS{1-16}:CORR:EXT:AUTO:STOP

Syntax :SENSe{[1]|2|3|4|5|6|7|8|9|10|11|12|13|14|15|16}:CORRection:EXTension:AUTO:STOP
<numeric>
:SENSe{[1]|2|3|4|5|6|7|8|9|10|11|12|13|14|15|16}:CORRection:EXTension:AUTO:STOP?

Description For channel 1 (:SENS1) to channel 16 (:SENS16), sets the stop frequency within the frequency range of the user specified auto port extension.

Parameters

	<numeric>
Description	Stop frequency
Range	3E5 to 3.0E9 (for E5070B) 3E5 to 8.5E9 (for E5071B)
Preset value	3.0E9 (for E5070B) 8.5E9 (for E5071B)
Unit	Hz (hertz)

Query response {numeric}<newline><^END>

Example of use
10 OUTPUT 717; ":SENS1:CORR:EXT:AUTO:STOP 1.5E9"
20 OUTPUT 717; ":SENS1:CORR:EXT:AUTO:STOP?"
30 ENTER 717;A

Related commands
:SENS{1-16}:CORR:EXT on page 620
:SENS{1-16}:CORR:EXT:AUTO:CONF on page 621
:SENS{1-16}:CORR:EXT:AUTO:PORT{1-4} on page 625
:SENS{1-16}:CORR:EXT:AUTO:STAR on page 627

Equivalent key [Cal] - Port Extensions - Auto Port Extension - Method - User Span Start

:SENS{1-16}:CORR:EXT:PORT{1-4}

Syntax

```
:SENSe{[1]|2|3|4|5|6|7|8|9|10|11|12|13|14|15|16}:CORRection:EXTension:PORT{[1]|2|3|4} <numeric>  
:SENSe{[1]|2|3|4|5|6|7|8|9|10|11|12|13|14|15|16}:CORRection:EXTension:PORT{[1]|2|3|4}?
```

Description

For channel 1 (:SENS1) to channel 16 (:SENS16), sets the correction amount for the port extension of port 1 (:PORT1) to port 4 (:PORT4) as the delay time.

Parameters

	<numeric>
Description	Delay time
Range	-10 to 10
Preset value	0
Unit	s (second)

If the specified parameter is out of the allowable setup range, the minimum value (if the lower limit of the range is not reached) or the maximum value (if the upper limit of the range is exceeded) is set.

Query response

```
{numeric}<newline><^END>
```

Example of use

```
10 OUTPUT 717;":SENS1:CORR:EXT:PORT1 1E-3"  
20 OUTPUT 717;":SENS1:CORR:EXT?"  
30 ENTER 717;A
```

Related commands

```
:SENS{1-16}:CORR:EXT on page 620  
:SENS{1-16}:CORR:EXT:PORT{1-4}:FREQ{1-2} on page 630  
:SENS{1-16}:CORR:EXT:PORT{1-4}:INCL{1-2} on page 631  
:SENS{1-16}:CORR:EXT:PORT{1-4}:LDC on page 632  
:SENS{1-16}:CORR:EXT:PORT{1-4}:LOSS{1-2} on page 633
```

Equivalent key

```
[Cal] - Port Extensions - Extension Port 1|Extension Port 2|Extension Port 3|  
Extension Port 4
```

:SENS{1-16}:CORR:EXT:PORT{1-4}:FREQ{1-2}

Syntax :SENSe{[1]|2|3|4|5|6|7|8|9|10|11|12|13|14|15|16}:CORRection:EXTension:PORT{[1]|2|3|4}:FREQUency{[1]|2} <numeric>
 :SENSe{[1]|2|3|4|5|6|7|8|9|10|11|12|13|14|15|16}:CORRection:EXTension:PORT{[1]|2|3|4}:FREQUency{[1]|2}?

Description For channel 1 (:SENS1) to channel 16 (:SENS16), sets the frequency used for the loss calculation of frequency 1 (:FREQ1) or frequency 2(FREQ2) of port 1 (:PORT1) to port 4 (:PORT4).

Parameters

	<numeric>
Description	Frequency
Range	3E5 to 3.0E9 (for E5070B) 3E5 to 8.5E9 (for E5071B)
Preset value	1E9
Unit	Hz (hertz)

If the specified parameter is out of the allowable setup range, the minimum value (if the lower limit of the range is not reached) or the maximum value (if the upper limit of the range is exceeded) is set.

Example of use

```
10 OUTPUT 717; ":SENS1:CORR:EXT:PORT1:FREQ1 10E6"
20 OUTPUT 717; ":SENS1:CORR:EXT:PORT1:FREQ1?"
30 ENTER 717;A
```

Related commands

- :SENS{1-16}:CORR:EXT on page 620
- :SENS{1-16}:CORR:EXT:PORT{1-4} on page 629
- :SENS{1-16}:CORR:EXT:PORT{1-4}:INCL{1-2} on page 631
- :SENS{1-16}:CORR:EXT:PORT{1-4}:LDC on page 632
- :SENS{1-16}:CORR:EXT:PORT{1-4}:LOSS{1-2} on page 633

Equivalent key [Cal] - Port Extensions - Loss - Freq1|Freq2

:SENS{1-16}:CORR:EXT:PORT{1-4}:INCL{1-2}

Syntax :SENSe{[1]|2|3|4|5|6|7|8|9|10|11|12|13|14|15|16}:CORRection:EXTension:PORT{[1]|2|3|4}:INCLude{[1]|2}[:STATe] {ON|OFF|1|0}
:SENSe{[1]|2|3|4|5|6|7|8|9|10|11|12|13|14|15|16}:CORRection:EXTension:PORT{[1]|2|3|4}:INCLude{[1]|2}[:STATe]?

Description For channel 1 (:SENS1) to channel 16 (:SENS16), turns ON/OFF the set of loss value and frequency value of include 1 (: INCL1) and include 2 (: INCL2) of port 1 (:PORT1) to port 4 (:PORT4).

Parameters

	Description
ON or 1	Turns ON the loss value and frequency value.
OFF or 0 (preset value)	Turns OFF the loss value and frequency value.

Query response {1|0}<newline><^END>

Example of use
10 OUTPUT 717; ":SENS1:CORR:EXT:PORT1:INCL1 ON"
20 OUTPUT 717; ":SENS1:CORR:EXT:PORT1:INCL1?"
30 ENTER 717;A

Related commands
:SENS{1-16}:CORR:EXT on page 620
:SENS{1-16}:CORR:EXT:PORT{1-4} on page 629
:SENS{1-16}:CORR:EXT:PORT{1-4}:FREQ{1-2} on page 630
:SENS{1-16}:CORR:EXT:PORT{1-4}:LDC on page 632
:SENS{1-16}:CORR:EXT:PORT{1-4}:LOSS{1-2} on page 633

Equivalent key [Cal] - Port Extensions - Loss - Loss1|Loss2

:SENS{1-16}:CORR:EXT:PORT{1-4}:LDC

Syntax :SENSe{[1]|2|3|4|5|6|7|8|9|10|11|12|13|14|15|16}:CORRection:EXTension:PORT{[1]|2|3|4}:LDC <numeric>
:SENSe{[1]|2|3|4|5|6|7|8|9|10|11|12|13|14|15|16}:CORRection:EXTension:PORT{[1]|2|3|4}:LDC?

Description For channel 1 (:SENS1) to channel 16 (:SENS16), sets the DC loss value of the port 1 (:PORT1) to port 4 (:PORT4).

Parameters

	<numeric>
Description	The loss value of DC.
Range	-90 to 90
Preset value	0
Unit	dBm

If the specified parameter is out of the allowable setup range, the minimum value (if the lower limit of the range is not reached) or the maximum value (if the upper limit of the range is exceeded) is set.

Query response {1|0}<newline><^END>

Example of use
10 OUTPUT 717; ":SENS1:CORR:EXT:PORT1:LDC 1.2"
20 OUTPUT 717; ":SENS1:CORR:EXT:PORT1:LDC?"
30 ENTER 717;A

Related commands
:SENS{1-16}:CORR:EXT on page 620
:SENS{1-16}:CORR:EXT:PORT{1-4} on page 629
:SENS{1-16}:CORR:EXT:PORT{1-4}:FREQ{1-2} on page 630
:SENS{1-16}:CORR:EXT:PORT{1-4}:INCL{1-2} on page 631
:SENS{1-16}:CORR:EXT:PORT{1-4}:LOSS{1-2} on page 633

Equivalent key [Cal] - Port Extensions - Loss - Loss at DC

:SENS{1-16}:CORR:EXT:PORT{1-4}:LOSS{1-2}

Syntax :SENSe{[1]|2|3|4|5|6|7|8|9|10|11|12|13|14|15|16}:CORRection:EXTension:PORT{[1]|2|3|4}:LOSS{[1]|2} <numeric>
:SENSe{[1]|2|3|4|5|6|7|8|9|10|11|12|13|14|15|16}:CORRection:EXTension:PORT{[1]|2|3|4}:LOSS{[1]|2}?

Description For channel 1 (:SENS1) to channel 16 (:SENS16), sets the loss value of the loss 1 (:LOSS1) or loss 2 (:LOSS2) of the port 1 (:PORT1) to port 4 (:PORT4).

Parameters

	<numeric>
Description	The loss value
Range	-90 to 90
Preset value	0
Unit	dBm

If the specified parameter is out of the allowable setup range, the minimum value (if the lower limit of the range is not reached) or the maximum value (if the upper limit of the range is exceeded) is set.

Query response {1|0}<newline><^END>

Example of use
10 OUTPUT 717; ":SENS1:CORR:EXT:PORT1:LOSS1 0.8"
20 OUTPUT 717; ":SENS1:CORR:EXT:PORT1:LOSS1?"
30 ENTER 717;A

Related commands
:SENS{1-16}:CORR:EXT on page 620
:SENS{1-16}:CORR:EXT:PORT{1-4} on page 629
:SENS{1-16}:CORR:EXT:PORT{1-4}:FREQ{1-2} on page 630
:SENS{1-16}:CORR:EXT:PORT{1-4}:INCL{1-2} on page 631
:SENS{1-16}:CORR:EXT:PORT{1-4}:LDC on page 632

Equivalent key [Cal] - Port Extensions - Loss - Loss1|Loss2

:SENS{1-16}:CORR:OFFS:CLE

Syntax	<code>:SENSe{[1] 2 3 4 5 6 7 8 9 10 11 12 13 14 15 16}:CORRection:OFFSet:CLEar</code>
Description	<p>Clears the error coefficient for calibration when the frequency offset mode is on for channel 1 (:SENS1) to channel 16 (:SENS16). (No query)</p> <p>To toggle the frequency offset mode, use :SENS{1-16}:OFFS command on page 668.</p> <p>This command does not clear the error coefficient when the frequency offset mode is off.</p>
Example of use	<pre>10 OUTPUT 717; ":SENS1:CORR:OFFS:CLE"</pre>
Related commands	<p>:SENS{1-16}:OFFS on page 668</p> <p>:SENS{1-16}:CORR:CLE on page 547</p>
Equivalent key	[Cal] - Mixer/Converter Calibration - Clear - OK

:SENS{1-16}:CORR:OFFS:COLL:CLE

Syntax	<code>:SENSe{[1] 2 3 4 5 6 7 8 9 10 11 12 13 14 15 16}:CORRection:OFFSet:COLLect:CLEar</code>
Description	<p>Clears the measurement value of the Mechanical Cal kit for calibration when the frequency offset mode is on for channel 1 (:SENS1) to channel 16 (:SENS16). This command also clears the measurement value of the power meter. (No query)</p> <p>To toggle the frequency offset mode, use :SENS{1-16}:OFFS command on page 668.</p> <p>Settings that have been temporarily changed due to measurement for each standard (number of traces, measurement parameter, and so on) return to their original values.</p>
Example of use	<code>10 OUTPUT 717; ":SENS1:CORR:OFFS:COLL:CLE"</code>
Related commands	<p>:SENS{1-16}:OFFS on page 668</p> <p>:SENS{1-16}:CORR:OFFS:CLE on page 634</p>
Equivalent key	[Cal] - Mixer/Converter Calibration - Scalar Cal (Manual) - Cancel - OK

:SENS{1-16}:CORR:OFFS:COLL:ECAL:SMIX2

Syntax :SENSe{[1]|2|3|4|5|6|7|8|9|10|11|12|13|14|15|16}:CORRection:OFFSet:COLLect:ECAL:SMIX2
<numeric 1>,<numeric 2>

Description For channel 1 (:SENS1) to channel 16 (:SENS16), performs 2-port ECal module measurement and error coefficient calculation (scalar-mixer calibration) when the frequency offset mode is on. (No query)

Note that power meter measurement with :SENS{1-16}:CORR:OFFS:COLL:PMET command on page 642 must be complete to execute this command.

Parameters

	<value 1>	<value 2>
Description	Port number 1 *1	Port number 2 *1
Range	1 to 4	1 to 4
Resolution	1	1

*1. The direction (forward or reverse) is determined by the presence/absence of power meter measurement data instead of port number 1 or port number 2 specified here.

Example of use

```
10 OUTPUT 717; ":SENS1:CORR:OFFS:COLL:ECAL:SMIX2 1,2"
20 OUTPUT 717; "*OPC?"
30 ENTER 717;A
```

Related commands

:SENS{1-16}:OFFS on page 668
:SENS{1-16}:CORR:OFFS:COLL:PMET on page 642
:SENS{1-16}:CORR:OFFS:COLL:ECAL:SOLT1 on page 637

Equivalent key [Cal] - Mixer/Converter Calibration - Scalar Cal (ECal) - ECal & Done

:SENS{1-16}:CORR:OFFS:COLL:ECAL:SOLT1

Syntax :SENSe{[1]|2|3|4|5|6|7|8|9|10|11|12|13|14|15|16}:CORRection:OFFSet:COLLect:ECAL:SOLT1
<numeric>

Description For channel 1 (:SENS1) to channel 16 (:SENS16), performs 1-port ECal module measurement and error coefficient calculation (scalar-mixer calibration) when the frequency offset mode is on. (No query)

Parameters

	<value>
Description	Port number
Range	1 to 4
Resolution	1

Example of use

```

10 OUTPUT 717;":SENS1:CORR:OFFS:COLL:ECAL:SOLT1 2"
20 OUTPUT 717;"*OPC?"
30 ENTER 717;A

```

Related commands :SENS{1-16}:OFFS on page 668
:SENS{1-16}:CORR:OFFS:COLL:ECAL:SMIX2 on page 636

Equivalent key [Cal] - Mixer/Converter Calibration - Scalar Cal (ECal) - ECal & Done

:SENS{1-16}:CORR:OFFS:COLL:LOAD

Syntax :SENSe{[1]|2|3|4|5|6|7|8|9|10|11|12|13|14|15|16}:CORRection:OFFSet:COLLect[:ACQuire]:LOAD
<numeric 1>,<numeric 2>

Description For channel 1 (:SENS1) to channel 16 (:SENS16), measures the calibration data of the load standard of the specified port when the frequency offset mode is on. (No query)

Parameters

	<value 1>	<value 2>
Description	Port number for measurement	Port number for which the frequency is specified ^{*1}
Range	1 to 4	1 to 4
Resolution	1	1

*1. The specified frequency is used for the specified port. For information on how to set the frequency for the port, refer to the desired command in the related commands list.

Example of use

```
10 OUTPUT 717; ":SENS1:CORR:OFFS:COLL:LOAD 1,4"
20 OUTPUT 717; "*OPC?"
30 ENTER 717;A
```

Related commands

:SENS{1-16}:OFFS on page 668
 :SENS{1-16}:CORR:OFFS:COLL:OPEN on page 641
 :SENS{1-16}:CORR:OFFS:COLL:SHOR on page 644
 :SENS{1-16}:OFFS:PORT{1-4}:DIV on page 682
 :SENS{1-16}:OFFS:PORT{1-4}:MULT on page 683
 :SENS{1-16}:OFFS:PORT{1-4}:OFFS on page 684
 :SENS{1-16}:OFFS:PORT{1-4}:STAR on page 685
 :SENS{1-16}:OFFS:PORT{1-4}:STOP on page 686

Equivalent key [Cal] - Mixer/Converter Calibration - Scalar Cal (Manual) - Reflection - PortX@FreqY
[Broadband]

NOTE The softkey, PortX and FreqY, changes depending on the selected Cal method and port.

:SENS{1-16}:CORR:OFFS:COLL:METH:SMIX2

Syntax :SENSe{[1]|2|3|4|5|6|7|8|9|10|11|12|13|14|15|16}:CORRection:OFFSet:COLLect:METhod:SMIX2
<numeric 1>,<numeric 2>

Description For channel 1 (:SENS1) to channel 16 (:SENS16), specifies the port used for the execution of 2-port scalar-mixer calibration when the frequency offset mode is on. (No query)

Different values must be specified for 2 ports. The order of port number 1 and port number 2 is arbitrary.

Parameters

	<value 1>	<value 2>
Description	Port number 1 ^{*1}	Port number 2 ^{*1}
Range	1 to 4	1 to 4
Resolution	1	1

*1. The direction (forward, reverse, or both) is determined by appropriately calling one of the :SENS{1-16}:CORR:OFFS:COLL:LOAD command on page 638, :SENS{1-16}:CORR:OFFS:COLL:OPEN command on page 641, :SENS{1-16}:CORR:OFFS:COLL:SHOR command on page 644, and :SENS{1-16}:CORR:OFFS:COLL:THRU command on page 645 commands, instead of port number 1 or port number 2 specified here.

Example of use 10 OUTPUT 717; ":SENS1:CORR:OFFS:COLL:METH:SMIX2 1,2"

Related commands :SENS{1-16}:OFFS on page 668
:SENS{1-16}:CORR:OFFS:COLL:LOAD on page 638
:SENS{1-16}:CORR:OFFS:COLL:OPEN on page 641
:SENS{1-16}:CORR:OFFS:COLL:SHOR on page 644
:SENS{1-16}:CORR:OFFS:COLL:THRU on page 645
:SENS{1-16}:CORR:OFFS:COLL:METH:SOLT1 on page 640

Equivalent key [Cal] - Mixer/Converter Calibration - Scalar Cal (Manual) - Select Ports - 2-1(fwd) | 1-2(rev) | 1,2(both) ...

:SENS{1-16}:CORR:OFFS:COLL:METH:SOLT1

Syntax :SENSe{[1]|2|3|4|5|6|7|8|9|10|11|12|13|14|15|16}:CORRection:OFFSet:COLLect:MEtHod:SOLT1
<numeric>

Description For channel 1 (:SENS1) to channel 16 (:SENS16), specifies the port used for the execution of 1-port scalar-mixer calibration when the frequency offset mode is on. (No query)

Parameters

	<value 1>
Description	Port number
Range	1 to 4
Resolution	1

Example of use 10 OUTPUT 717; ":SENS1:CORR:OFFS:COLL:METH:SOLT1 2"

Related commands :SENS{1-16}:OFFS on page 668
:SENS{1-16}:CORR:OFFS:COLL:METH:SMIX2 on page 639

Equivalent key [Cal] - Mixer/Converter Calibration - Scalar Cal (Manual) - Select Ports - Port 1 |Port 2 | Port 3 ...

:SENS{1-16}:CORR:OFFS:COLL:OPEN

Syntax :SENSe{[1]|2|3|4|5|6|7|8|9|10|11|12|13|14|15|16}:CORRection:OFFSet:COLLect[:ACQuire]:OPEN
<numeric 1>,<numeric 2>

Description For channel 1 (:SENS1) to channel 16 (:SENS16), measures the calibration data of the open standard of the specified port when the frequency offset mode is on. (No query)

Parameters

	<value 1>	<value 2>
Description	Port number for measurement	Port number for which the frequency is specified*1
Range	1 to 4	1 to 4
Resolution	1	1

*1. The specified frequency is used for the specified port. For information on how to set the frequency for the port, refer to the desired command in the related commands list.

Example of use

```

10 OUTPUT 717;" :SENS1:CORR:OFFS:COLL:OPEN 1,4"
20 OUTPUT 717;"*OPC?"
30 ENTER 717;A

```

Related commands

- :SENS{1-16}:OFFS on page 668
- :SENS{1-16}:CORR:OFFS:COLL:LOAD on page 638
- :SENS{1-16}:CORR:OFFS:COLL:SHOR on page 644
- :SENS{1-16}:OFFS:PORT{1-4}:DIV on page 682
- :SENS{1-16}:OFFS:PORT{1-4}:MULT on page 683
- :SENS{1-16}:OFFS:PORT{1-4}:OFFS on page 684
- :SENS{1-16}:OFFS:PORT{1-4}:STAR on page 685
- :SENS{1-16}:OFFS:PORT{1-4}:STOP on page 686

Equivalent key [Cal] - Mixer/Converter Calibration - Scalar Cal (Manual) - Reflection - PortX@FreqY
[Open]

NOTE The softkey, PortX and FreqY, changes depending on the selected Cal method and port.

:SENS{1-16}:CORR:OFFS:COLL:PMET

Syntax :SENSe{[1]|2|3|4|5|6|7|8|9|10|11|12|13|14|15|16}:CORRection:OFFSet:COLLect[:ACQuire]:PMETer <numeric 1>,<numeric 2>,{ASENSor|BSENSor}

Description For channel 1 (:SENS1) to channel 16 (:SENS16), performs measurement with the power meter for the specified port when the frequency offset mode is on. (No query)

Parameters

	<value 1>	<value 2>
Description	Port number for measurement	Port number for which the frequency is specified*1
Range	1 to 4	1 to 4
Resolution	1	1

*1. The specified frequency is used for the specified port. For information on how to set the frequency for the port, refer to the desired command in the related commands list.

	Description
ASENSor	Specifies the power sensor registered as A sensor.
BSENSor	Specifies the power sensor registered as B sensor.

NOTE The setting of the power sensor is common to that for power meter calibration. Make the settings on the menu under **[Cal] - Power Calibration - Sensor A/B Settings**.

Example of use

```
10 OUTPUT 717; ":SENS1:CORR:OFFS:COLL:PMET 1,4,ASEN"
20 OUTPUT 717; "*OPC?"
30 ENTER 717;A
```

Related commands

- :SENS{1-16}:OFFS on page 668
- :SENS{1-16}:CORR:OFFS:COLL:LOAD on page 638
- :SENS{1-16}:CORR:OFFS:COLL:OPEN on page 641
- :SENS{1-16}:CORR:OFFS:COLL:SHOR on page 644

Equivalent key **[Cal] - Mixer/Converter Calibration - Scalar Cal (Manual) - Power Meter - PortX@FreqY**

NOTE The softkey, PortX and FreqY, changes depending on the selected Cal method and port.

:SENS{1-16}:CORR:OFFS:COLL:SAVE

Syntax	<code>:SENSe{[1] 2 3 4 5 6 7 8 9 10 11 12 13 14 15 16}:CORRection:OFFSet:COLLect:SAVE</code>
Description	<p>From the measured calibration data, calculates the error coefficient for the calibration type selected with <code>:SENS{1-16}:CORR:OFFS:COLL:METH:SMIX2</code> command on page 639 or <code>:SENS{1-16}:CORR:OFFS:COLL:METH:SOLT1</code> command on page 640. (No query)</p> <p>After the error coefficient is calculated, the measured data and the calibration type setting are cleared.</p> <p>If you execute this command before all necessary calibration data for calculating the calibration coefficient is measured, an error occurs and the command is ignored.</p>
Example of use	<pre>10 OUTPUT 717; ":SENS1:CORR:OFFS:COLL:SAVE"</pre>
Related commands	<p><code>:SENS{1-16}:CORR:OFFS:COLL:METH:SMIX2</code> on page 639</p> <p><code>:SENS{1-16}:CORR:OFFS:COLL:METH:SOLT1</code> on page 640</p> <p><code>:SENS{1-16}:CORR:OFFS:COLL:LOAD</code> on page 638</p> <p><code>:SENS{1-16}:CORR:OFFS:COLL:OPEN</code> on page 641</p> <p><code>:SENS{1-16}:CORR:OFFS:COLL:SHOR</code> on page 644</p> <p><code>:SENS{1-16}:CORR:OFFS:COLL:THRU</code> on page 645</p>
Equivalent key	[Cal] - Mixer/Converter Calibration - Scalar Cal (Manual) - Done

:SENS{1-16}:CORR:OFFS:COLL:SHOR

Syntax :SENSe{[1]|2|3|4|5|6|7|8|9|10|11|12|13|14|15|16}:CORRection:OFFSet:COLLect[:ACQuire]:SHORT <numeric 1>,<numeric 2>

Description For channel 1 (:SENS1) to channel 16 (:SENS16), measures the calibration data of the short standard of the specified port when the frequency offset mode is on. (No query)

Parameters

	<value 1>	<value 2>
Description	Port number for measurement	Port number for which the frequency is specified ^{*1}
Range	1 to 4	1 to 4
Resolution	1	1

*1. The specified frequency is used for the specified port. For information on how to set the frequency for the port, refer to the desired command in the related commands list.

Example of use

```
10 OUTPUT 717; ":SENS1:CORR:OFFS:COLL:SHOR 1,4"
20 OUTPUT 717; "*OPC?"
30 ENTER 717;A
```

Related commands

- :SENS{1-16}:OFFS on page 668
- :SENS{1-16}:CORR:OFFS:COLL:LOAD on page 638
- :SENS{1-16}:CORR:OFFS:COLL:OPEN on page 641
- :SENS{1-16}:OFFS:PORT{1-4}:DIV on page 682
- :SENS{1-16}:OFFS:PORT{1-4}:MULT on page 683
- :SENS{1-16}:OFFS:PORT{1-4}:OFFS on page 684
- :SENS{1-16}:OFFS:PORT{1-4}:STAR on page 685
- :SENS{1-16}:OFFS:PORT{1-4}:STOP on page 686

Equivalent key [Cal] - Mixer/Converter Calibration - Scalar Cal (Manual) - Reflection - PortX@FreqY [Short]

NOTE The softkey, PortX and FreqY, changes depending on the selected Cal method and port.

:SENS{1-16}:CORR:OFFS:COLL:THRU

Syntax :SENSe{[1]|2|3|4|5|6|7|8|9|10|11|12|13|14|15|16}:CORRection:OFFSet:COLLect[:ACQuire]:THRU
<numeric 1>,<numeric 2>

Description For channel 1 (:SENS1) to channel 16 (:SENS16), measures the calibration data of the thru standard from the stimulus port to the response port when the frequency offset mode is on. (No query)

Parameters

	<value 1>	<value 2>
Description	Response port number	Stimulus port number
Range	1 to 4	1 to 4
Resolution	1	1

NOTE If the same port number is specified for the response port number and the stimulus port number, an error occurs.

Example of use

```
10 OUTPUT 717;":SENS1:CORR:OFFS:COLL:THRU 1,4"
20 OUTPUT 717;"*OPC?"
30 ENTER 717;A
```

Related commands

- :SENS{1-16}:OFFS on page 668
- :SENS{1-16}:CORR:OFFS:COLL:LOAD on page 638
- :SENS{1-16}:CORR:OFFS:COLL:OPEN on page 641
- :SENS{1-16}:CORR:OFFS:COLL:SHOR on page 644

Equivalent key [Cal] - Mixer/Converter Calibration - Scalar Cal (Manual) - Transmission - ThruX-Y@FreqZ [Thru]

NOTE The softkey, ThruX-Y and FreqZ, changes depending on the selected Cal method and port.

:SENS{1-16}:CORR:PROP

Syntax :SENSe{[1]|2|3|4|5|6|7|8|9|10|11|12|13|14|15|16}:CORRection:PROPerTy {ON|OFF|1|0}
:SENSe{[1]|2|3|4|5|6|7|8|9|10|11|12|13|14|15|16}:CORRection:PROPerTy?

Description Turns ON/OFF the display of the calibration property of channel 1 (:SENS1) to channel 16 (:SENS16).

Parameters

	Description
ON or 1	Turns ON the calibration property display.
OFF or 0 (preset value)	Turns OFF the calibration property display.

Query response {1|0}<newline><^END>

Example of use
10 OUTPUT 717; ":SENS1:CORR:PROP ON"
20 OUTPUT 717; ":SENS1:CORR:PROP?"
30 ENTER 717;A

Equivalent key [Cal] - Property

:SENS{1-16}:CORR:REC{1-4}

Syntax :SENSe{[1]|2|3|4|5|6|7|8|9|10|11|12|13|14|15|16}:CORRection:RECEiver{[1]|2|3|4}[:STATe]
{ON|OFF|1|0}
:SENSe{[1]|2|3|4|5|6|7|8|9|10|11|12|13|14|15|16}:CORRection:RECEiver{[1]|2|3|4}[:STATe]?

Description For channel 1 (:SENS1) to channel 16 (:SENS16), turns on/off the receiver correction.

Parameters

	Description
ON or 1	Turns on the receiver correction.
OFF or 0 (preset value)	Turns off the receiver correction.

Query response {1|0}<newline><^END>

Example of use
10 OUTPUT 717;":SENS1:CORR:REC1 ON"
20 OUTPUT 717;":SENS1:CORR:REC1?"
30 ENTER 717;A

Related commands :SENS{1-16}:CORR:REC{1-4}:COLL:ACQ on page 648

Equivalent key [Cal] - Receiver Calibration - Correction

:SENS{1-16}:CORR:REC{1-4}:COLL:ACQ

Syntax

:SENSe{[1]|2|3|4|5|6|7|8|9|10|11|12|13|14|15|16}:CORRection:RECeiver{[1]|2|3|4}:COLLect:ACQui
re <numeric>

Description

For channel 1 (:SENS1) to channel 16 (:SENS16), calculates the receiver calibration error coefficient for the specified port (executes receiver calibration). (No query)

The measurement port and the source port are THRU-connected for execution. Therefore, if the same port number is specified for the measurement port and the source port, an error occurs.

Because information of power calibration for both the measurement port and the source port is used for error coefficient calculation, the precision of receiver calibration is improved by executing power calibration for the both ports before executing receiver calibration.

Parameters

	<value 1>
Description	Source port number
Range	1 to 4
Resolution	1

Example of use

```
10 OUTPUT 717; ":SENS1:CORR:REC1:COLL:ACQ 2"  
20 OUTPUT 717; "*OPC?"  
30 ENTER 717;A
```

Related commands

:SOUR{1-16}:POW:PORT{1-4}:CORR:COLL on page 711

:SENS{1-16}:CORR:REC{1-4} on page 647

Equivalent key

[Cal] - Receiver Calibration - Take Cal Sweep

:SENS{1-16}:CORR:RVEL:COAX

Syntax :SENSe{[1]|2|3|4|5|6|7|8|9|10|11|12|13|14|15|16}:CORRection:RVELocity:COAX <numeric>
:SENSe{[1]|2|3|4|5|6|7|8|9|10|11|12|13|14|15|16}:CORRection:RVELocity:COAX?

Description For channel 1 (:SENS1) to channel 16 (:SENS16), sets the velocity factor.

Parameters

	<numeric>
Description	Velocity factor
Range	0 to 10
Preset value	1

If the specified parameter is out of the allowable setup range, the minimum value (if the lower limit of the range is not reached) or the maximum value (if the upper limit of the range is exceeded) is set.

Query response {numeric}<newline><^END>

Example of use

```
10  OUTPUT 717; ":SENS1:CORR:RVEL:COAX 0.7"
20  OUTPUT 717; ":SENS1:CORR:RVEL:COAX?"
30  ENTER 717;A
```

Equivalent key **[Cal] - Velocity Factor**

:SENS{1-16}:CORR:STAT

Syntax :SENSe{[1]|2|3|4|5|6|7|8|9|10|11|12|13|14|15|16}:CORRection:STATe {ON|OFF|1|0}
:SENSe{[1]|2|3|4|5|6|7|8|9|10|11|12|13|14|15|16}:CORRection:STATe?

Description For channel 1 (:SENS1) to channel 16 (:SENS16), turns ON/OFF the error correction.

Parameters

	Description
ON or 1	Turns ON the error correction.
OFF or 0 (preset value)	Turns OFF the error correction.

Query response {1|0}<newline><^END>

Example of use
10 OUTPUT 717; ":SENS1:CORR:STAT ON"
20 OUTPUT 717; ":SENS1:CORR:STAT?"
30 ENTER 717;A

Equivalent key [Cal] - Correction

:SENS{1-16}:CORR:TRIG:FREE

Syntax :SENSe{[1]|2|3|4|5|6|7|8|9|10|11|12|13|14|15|16}:CORRection:TRIGger:FREE[:STATe]
{ON|OFF|1|0}
:SENSe{[1]|2|3|4|5|6|7|8|9|10|11|12|13|14|15|16}:CORRection:TRIGger:FREE[:STATe]?

Description Sets the trigger source for calibration to internal (ON) or to the state of the trigger source (:TRIG:SOUR) when measurement is made (OFF).

When you change the trigger source during sweep, the sweep is canceled.

Parameters

	Description
0 or 1 (preset value)	Specifies internal for the trigger source for calibration. It corresponds to the softkey "Internal".
OFF or 0	Matches the state of the trigger source when measurement is made. It corresponds to the softkey "System".

Query response {1|0}<newline><^END>

Example of use
10 OUTPUT 717; ":SENS1:CORR:TRIG:FREE OFF"
20 OUTPUT 717; ":SENS1:CORR:TRIG:FREE?"
30 ENTER 717;A

Equivalent key [Cal] - Cal Trigger Source - Internal|System

:SENS{1-16}:CORR:TYPE{1-16}?

Syntax :SENSe{[1]|2|3|4|5|6|7|8|9|10|11|12|13|14|15|16}:CORRection:TYPE{[1]|2|3|4|5|6|7|8|9|10|11|12|13|14|15|16}?

Description For trace 1 (:TYPE1) to trace 16 (:TYPE16) of channel 1 (:SENS1) to channel 16 (:SENS16), reads out the information (calibration type, port numbers) of the applied calibration coefficients for the actual error correction.

Query response {ERES|NONE|RESPO|RESPS|RESPT|SOLT1|SOLT2|SOLT3|SOLT4|SMIX2},{numeric 1},{numeric 2},{numeric 3},{numeric 4}<newline><^END>
{ERES|NONE|RESPO|RESPS|RESPT|SOLT1|SOLT2|SOLT3|SOLT4|SMIX2}:

	Description
ERES	The enhanced response calibration is applied.
NONE	Any calibration is not applied.
RESPO	The response calibration (open) is applied.
RESPS	The response calibration (short) is applied.
RESPT	The response calibration (thru) is applied.
SMIX2	The scalar-mixer calibration is applied.
SOLT1	The 1-port calibration is applied.
SOLT2	The full 2-port calibration is applied.
SOLT3	The full 3-port calibration is applied.
SOLT4	The full 4-port calibration is applied.

{numeric 1}: the calibration port number
(This parameter is 0 when the first parameter is NONE.)
the response port number when the SMIX2 is selected.

{numeric 2}: the calibration port number
(This parameter is 0 when the first parameter is not ERES, RESPT, SOLT2, SOLT3, SOLT4 and SMIX2.)
the stimulus port number when the SMIX2 is selected.

{numeric 3}: the calibration port number
(This parameter is 0 when the first parameter is not SOLT3 and SOLT4.)

{numeric 4}: the calibration port number
(This parameter is 0 when the first parameter is not SOLT4.)

Example of use
10 OUTPUT 717; ":SENS1:CORR:TYPE1?"
20 ENTER 717;A\$

Equivalent key No equivalent key is available on the front panel.

:SENS{1-16}:FREQ

Syntax :SENSe{[1]|2|3|4|5|6|7|8|9|10|11|12|13|14|15|16}:FREQuency[:CW|FIXed] <numeric>
:SENSe{[1]|2|3|4|5|6|7|8|9|10|11|12|13|14|15|16}:FREQuency[:CW|FIXed]?

Description Sets the fixed frequency (CW frequency) for the power sweep for channel 1 (:SENS1) to channel 16 (:SENS16).

Parameters

	<numeric>
Description	Fixed frequency
Range	3E5 to 8.5E9
Preset value	3E5
Unit	Hz (hertz)
Resolution	1

If the specified parameter is out of the allowable setup range, the minimum value (if the lower limit of the range is not reached) or the maximum value (if the upper limit of the range is exceeded) is set.

Query response {numeric}<newline><^END>

Example of use
10 OUTPUT 717; ":SENS1:FREQ 1E9"
20 OUTPUT 717; ":SENS1:FREQ?"
30 ENTER 717;A

Related commands :SENS{1-16}:SWE:TYPE on page 696

Equivalent key [Sweep Setup] - Power - CW Freq

:SENS{1-16}:FREQ:CENT

Syntax :SENSe{[1]|2|3|4|5|6|7|8|9|10|11|12|13|14|15|16}:FREQuency:CENTer <numeric>
:SENSe{[1]|2|3|4|5|6|7|8|9|10|11|12|13|14|15|16}:FREQuency:CENTer?

Description Sets the center value of the sweep range of channel 1 (:SENS1) to channel 16 (:SENS16).

Parameters

	<numeric>
Description	Center value
Range	3E5 to 8.5E9
Preset value	4.25015E9
Unit	Hz (hertz)
Resolution	0.5 or 1

If the specified parameter is out of the allowable setup range, the minimum value (if the lower limit of the range is not reached) or the maximum value (if the upper limit of the range is exceeded) is set.

Query response {numeric}<newline><^END>

Example of use
10 OUTPUT 717; ":SENS1:FREQ:CENT 2E9"
20 OUTPUT 717; ":SENS1:FREQ:CENT?"
30 ENTER 717;A

Related commands :SENS{1-16}:FREQ:SPAN on page 656

Equivalent key [Center]

:SENS{1-16}:FREQ:DATA?

Syntax :SENSe{[1|2|3|4|5|6|7|8|9|10|11|12|13|14|15|16]}:FREQuency:DATA?

Description For channel 1 (:SENS1) to channel 16 (:SENS16), reads out the frequencies of all measurement point.

The data transfer format when this command is executed depends on the setting with the :FORM:DATA command. (Query only)

Query response {numeric 1},...,{numeric NOP}<newline><^END>

	Description
{numeric n}	Frequency at the n-th measurement point

Where NOP is the number of measurement points and n is an integer between 1 and NOP.

Example of use

```
10 DIM A(1:201)
20 OUTPUT 717; ":SENS1:FREQ:DATA?"
30 ENTER 717;A(*)
```

Related commands :FORM:DATA on page 488

Equivalent key No equivalent key is available on the front panel.

:SENS{1-16}:FREQ:SPAN

Syntax :SENSe{[1]|2|3|4|5|6|7|8|9|10|11|12|13|14|15|16}:FREQuency:SPAN <numeric>
:SENSe{[1]|2|3|4|5|6|7|8|9|10|11|12|13|14|15|16}:FREQuency:SPAN?

Description Sets the span value of the sweep range of channel 1 (:SENS1) to channel 16 (:SENS16).

Parameters

	<numeric>
Description	Span value
Range	0 to 8.4997E9
Preset value	8.4997E9
Unit	Hz (hertz)
Resolution	1

If the specified parameter is out of the allowable setup range, the minimum value (if the lower limit of the range is not reached) or the maximum value (if the upper limit of the range is exceeded) is set.

Query response {numeric}<newline><^END>

Example of use
10 OUTPUT 717; ":SENS1:FREQ:SPAN 1E9"
20 OUTPUT 717; ":SENS1:FREQ:SPAN?"
30 ENTER 717;A

Related commands :SENS{1-16}:FREQ:CENT on page 654

Equivalent key [Span]

:SENS{1-16}:FREQ:STAR

Syntax :SENSe{[1]|2|3|4|5|6|7|8|9|10|11|12|13|14|15|16}:FREQuency:STARt <numeric>
:SENSe{[1]|2|3|4|5|6|7|8|9|10|11|12|13|14|15|16}:FREQuency:STARt?

Description Sets the start value of the sweep range of channel 1 (:SENS1) to channel 16 (:SENS16).

Parameters

	<numeric>
Description	Start value
Range	3E5 to 8.5E9
Preset value	3E5
Unit	Hz (hertz)
Resolution	1

If the specified parameter is out of the allowable setup range, the minimum value (if the lower limit of the range is not reached) or the maximum value (if the upper limit of the range is exceeded) is set.

Query response {numeric}<newline><^END>

Example of use
10 OUTPUT 717; ":SENS1:FREQ:STAR 100E6"
20 OUTPUT 717; ":SENS1:FREQ:STAR?"
30 ENTER 717;A

Related commands :SENS{1-16}:FREQ:STOP on page 658

Equivalent key [Start]

:SENS{1-16}:FREQ:STOP

Syntax

```
:SENSe{[1]|2|3|4|5|6|7|8|9|10|11|12|13|14|15|16}:FREQuency:STOP <numeric>  
:SENSe{[1]|2|3|4|5|6|7|8|9|10|11|12|13|14|15|16}:FREQuency:STOP?
```

Description

Sets the stop value of the sweep range of channel 1 (:SENS1) to channel 16 (:SENS16).

Parameters

	<numeric>
Description	Stop value
Range	3E5 to 8.5E9
Preset value	8.5E9
Unit	Hz (hertz)
Resolution	1

If the specified parameter is out of the allowable setup range, the minimum value (if the lower limit of the range is not reached) or the maximum value (if the upper limit of the range is exceeded) is set.

Query response

```
{numeric}<newline><^END>
```

Example of use

```
10 OUTPUT 717; ":SENS1:FREQ:STOP 100E6"  
20 OUTPUT 717; ":SENS1:FREQ:STOP?"  
30 ENTER 717;A
```

Related commands

:SENS{1-16}:FREQ:STAR on page 657

Equivalent key

[Stop]

:SENS{1-16}:MULT{1-2}:OUTP

Syntax :SENSe{[1]|2|3|4|5|6|7|8|9|10|11|12|13|14|15|16}:MULTiplexer{[1]|2}:OUTPut[:DATA]
<numeric>

:SENSe{[1]|2|3|4|5|6|7|8|9|10|11|12|13|14|15|16}:MULTiplexer{[1]|2}:OUTPut[:DATA]?

Description Sets HIGH/LOW for all the control lines of the E5091A whose ID is 1 (:MULT1) or 2 (:MULT2) when measuring channel 1 (:SENS1) to channel 16 (:SENS16) in measurements using the E5091A.

To set the control lines, use the values obtained by converting 8-bit binary values expressed HIGH (1) / LOW (0) of individual lines as decimal values, assuming line 1 as LSB and line 8 as MSB.

Parameters

	<numeric>
Description	Sets/gets control line value
Range	0 to 255
Preset value	0
Unit	Hz (hertz), dBm or second

If the specified parameter is out of the allowable setup range, the minimum value (if the lower limit of the range is not reached) or the maximum value (if the upper limit of the range is exceeded) is set.

Query response {numeric}<newline><^END>

Example of use
10 OUTPUT 717; ":SENS1:MULT1:OUTP 5"
20 OUTPUT 717; ":SENS1:MULT1:OUTP?"
30 ENTER 717;A

Related commands :SENS:MULT{1-2}:STAT on page 542

Equivalent key [System] - Multiport Test Set Setup - Test Set 1|Test Set 2 - Control Lines

:SENS{1-16}:MULT{1-2}:PORT{1-20}

Syntax :SENSe{[1]|2|3|4|5|6|7|8|9|10|11|12|13|14|15|16}:MULTiplexer{[1]|2}:PORT{[1]|2|3|4|5|6|7|8|9|10|11|12|13|14|15|16|17|18|19|20}[:SELEct] <string>
 :SENSe{[1]|2|3|4|5|6|7|8|9|10|11|12|13|14|15|16}:MULTiplexer{[1]|2}:PORT{[1]|2|3|4|5|6|7|8|9|10|11|12|13|14|15|16|17|18|19|20}[:SELEct]?

Description Selects a port assigned to Port 1 (:PORT1) to Port 20 (:PORT20) of the E5091A whose ID is 1 (:MULT1) or 2 (MULT2) when measuring channel 1 (:SENS1) to channel 16 (:SENS16) in the measurement using the E5091A.

The upper case and lower case are not distinguished.

Parameters **When the E5091A-009 is Connected**

Port name	Description
Port1	Selects a port between A or T1* ¹
Port2	Selects a port between T1* ¹ or T2
Port3	Selects a port among R1+, R2+ or R3+
Port4	Selects a port among R1-, R2- or R3-

*1.If port T1 has already been assigned to port 2 when you try to assign port T1 to port 1, port T2 is automatically assigned to port 2. If port T1 has already been assigned to port 1 when you try to assign port T1 to port 2, port A is automatically assigned to port 1.

When the E5091A-013 is Connected

Port name	Description
Port1	Selects a port among A1,T1,T2, or T3
Port2	Selects a port among T1,T2,T3 or T4
Port3	Selects a port among R1+, R2+,R3+ or R4+
Port4	Selects a port among R1-, R2-, or R3-

When the E5091A-016 is Connected

Port name	Description
Port1	Selects among A1(A), A2, A3, A4, T1, T2 or T3.
Port2	Selects among B1(T4), B2, B3, B4, T1, T2, or T3.
Port3	Selects among R1+, R2+, R3+ or R4+
Port4	Selects among R1-, R2-, R3- or R4-
Port5	Selects between X1 or X2.
Port6	Selects between Y1 or Y2
Port7	Selects between Z1 or Z2.

Query response {string}<newline><^END>

Example of use
 10 OUTPUT 717;":SENS1:MULT1:PORT1 A"
 20 OUTPUT 717;":SENS1:MULT1:PORT1?"
 30 ENTER 717;A\$

Related commands
 :SENS:MULT{1-2}:DISP on page 539
 :SENS{1-16}:MULT{1-2}:PORT{1-20}:CAT? on page 662
 :SENS{1-16}:MULT{1-2}:TSET9:PORT1 on page 664
 :SENS{1-16}:MULT{1-2}:TSET9:PORT2 on page 665
 :SENS{1-16}:MULT{1-2}:TSET9:PORT3 on page 666
 :SENS{1-16}:MULT{1-2}:TSET9:PORT4 on page 667

Equivalent key [System] - Multiport Test Set Setup - Test Set 1|Test Set 2 - Port 1|Port 2|Port 3|Port 4|Port 5|Port 6|Port 7

:SENS{1-16}:MULT{1-2}:PORT{1-20}:CAT?

Syntax	:SENSe{[1] 2 3 4 5 6 7 8 9 10 11 12 13 14 15 16}:MULTiplexer{[1] 2}:PORT{[1] 2 3 4 5 6 7 8 9 10 11 12 13 14 15 16 17 18 19 20}:CATalog?
Description	Selects a port assigned to Port 1 (:PORT1) to Port 20 (:PORT20) of the E5091A whose ID is 1 (:MULT1) or 2 (MULT2) when measuring channel 1 (:SENS1) to channel 16 (:SENS16) in the measurement using the E5091A. (Query only)
Query response	{string}<newline><^END>
Example of use	10 OUTPUT 717; ":SENS1:MULT1:PORT1:CAT?" 20 ENTER 717;A\$
Related commands	:SENS:MULT{1-2}:DISP on page 539 :SENS{1-16}:MULT{1-2}:PORT{1-20} on page 660 :SENS{1-16}:MULT{1-2}:TSET9:PORT1 on page 664 :SENS{1-16}:MULT{1-2}:TSET9:PORT2 on page 665 :SENS{1-16}:MULT{1-2}:TSET9:PORT3 on page 666 :SENS{1-16}:MULT{1-2}:TSET9:PORT4 on page 667
Equivalent key	No equivalent key is available on the front panel.

:SENS{1-16}:MULT{1-2}:TSET9:OUTP

Syntax :SENSe{[1]|2|3|4|5|6|7|8|9|10|11|12|13|14|15|16}:MULTiplexer{[1]|2}:TSET9:OUTPut[:DATA] <numeric>
:SENSe{[1]|2|3|4|5|6|7|8|9|10|11|12|13|14|15|16}:MULTiplexer{[1]|2}:TSET9:OUTPut[:DATA]?

Description Sets the HIGH/LOW of all the control line of the E5091A whose ID is 1 (:MULT1) or 2 (:MULT2) when measuring channel 1 (:SENS1) to channel 16 (:SENS16) in the measurement using the E5091A.

To set the control lines, use values obtained by converting 8-bit binary values expressed by HIGH (1)/LOW (0) of individual lines to decimal values, assuming line 1 as LSB and line 8 as MSB.

Parameters

	<numeric>
Description	Setting value the control line
Range	0 to 255
Preset value	0
Resolution	1

If the specified parameter is out of the allowable setup range, the minimum value (if the lower limit of the range is not reached) or the maximum value (if the upper limit of the range is exceeded) is set.

Query response {numeric}<newline><^END>

Example of use
10 OUTPUT 717;":SENS1:MULT1:TSET9:OUTP 5"
20 OUTPUT 717;":SENS1:MULT1:TSET9:OUTP?"
30 ENTER 717;A

Related commands :SENS:MULT{1-2}:STAT on page 542

Equivalent key [System] - Multiport Test Set Setup - Test Set 1|Test Set 2 - Control Lines

:SENS{1-16}:MULT{1-2}:TSET9:PORT1

Syntax

```
:SENSe{[1]|2|3|4|5|6|7|8|9|10|11|12|13|14|15|16}:MULTiplexer{[1]|2}:TSET9:PORT1 {A|T1}  
:SENSe{[1]|2|3|4|5|6|7|8|9|10|11|12|13|14|15|16}:MULTiplexer{[1]|2}:TSET9:PORT1?
```

Description

Selects a port assigned to Port 1 of the E5091A whose ID is 1 (:MULT1) or 2 (:MULT2) when measuring channel 1 (:SENS1) to channel 16 (:SENS16) in the measurement using the E5091A.

If the port assigned to Port 2 is T1 and you select T1 as the port assigned to Port 1, the port assigned to Port 2 is changed to T2 automatically.

Parameters

	Description
A (preset value)	Specifies A.
T1	Specifies T1.

Query response

```
{A|T1}<newline><^END>
```

Example of use

```
10 OUTPUT 717; ":SENS1:MULT1:TSET9:PORT1 T1"  
20 OUTPUT 717; ":SENS1:MULT1:TSET9:PORT1?"  
30 ENTER 717;A$
```

Related commands

```
:SENS:MULT{1-2}:DISP on page 539  
:SENS:MULT{1-2}:STAT on page 542  
:SENS{1-16}:MULT{1-2}:PORT{1-20}:CAT? on page 662  
:SENS{1-16}:MULT{1-2}:TSET9:PORT2 on page 665  
:SENS{1-16}:MULT{1-2}:TSET9:PORT3 on page 666  
:SENS{1-16}:MULT{1-2}:TSET9:PORT4 on page 667
```

Equivalent key

```
[System] - Multiport Test Set Setup - Test Set 1|Test Set 2 - Port1 - A|T1
```

:SENS{1-16}:MULT{1-2}:TSET9:PORT2

Syntax :SENSe{[1]|2|3|4|5|6|7|8|9|10|11|12|13|14|15|16}:MULTiplexer{[1]|2}:TSET9:PORT2 {T1|T2}
:SENSe{[1]|2|3|4|5|6|7|8|9|10|11|12|13|14|15|16}:MULTiplexer{[1]|2}:TSET9:PORT2?

Description Selects a port assigned to Port 2 of the E5091A whose ID is 1 (:MULT1) or 2 (:MULT2) when measuring channel 1 (:SENS1) to channel 16 (:SENS16) in the measurement using the E5091A.

If the port assigned to Port 1 is T1 and you select T1 as the port assigned to Port 2, the port assigned to Port 1 is changed to A automatically.

Parameters

	Description
T1 (preset value)	Specifies T1.
T2	Specifies T2.

Query response {A|T1}<newline><^END>

Example of use

```
10  OUTPUT 717; ":SENS1:MULT1:TSET9:PORT2 T2"
20  OUTPUT 717; ":SENS1:MULT1:TSET9:PORT2?"
30  ENTER 717;A$
```

Related commands

- :SENS:MULT{1-2}:DISP on page 539
- :SENS:MULT{1-2}:STAT on page 542
- :SENS{1-16}:MULT{1-2}:PORT{1-20}:CAT? on page 662
- :SENS{1-16}:MULT{1-2}:TSET9:PORT1 on page 664
- :SENS{1-16}:MULT{1-2}:TSET9:PORT3 on page 666
- :SENS{1-16}:MULT{1-2}:TSET9:PORT4 on page 667

Equivalent key [System] - Multiport Test Set Setup - Test Set 1|Test Set 2 - Port2 - T1|T2

:SENS{1-16}:MULT{1-2}:TSET9:PORT3

Syntax :SENSe{[1]|2|3|4|5|6|7|8|9|10|11|12|13|14|15|16}:MULTiplexer{[1]|2}:TSET9:PORT3 {R1|R2|R3}
 :SENSe{[1]|2|3|4|5|6|7|8|9|10|11|12|13|14|15|16}:MULTiplexer{[1]|2}:TSET9:PORT3?

Description Selects a port assigned to Port 3 of the E5091A whose ID is 1 (:MULT1) or 2 (:MULT2) when measuring channel 1 (:SENS1) to channel 16 (:SENS16) in the measurement using the E5091A.

Parameters

	Description
R1 (preset value)	Specifies R1+.
R2	Specifies R2+.
R3	Specifies R3+ *1.

*1. For Option 007 (7 ports), R2+.

Query response {R1|R2|R3}<newline><^END>

Example of use
 10 OUTPUT 717; ":SENS1:MULT1:TSET9:PORT3 R2"
 20 OUTPUT 717; ":SENS1:MULT1:TSET9:PORT3?"
 30 ENTER 717;A\$

Related commands
 :SENS:MULT{1-2}:DISP on page 539
 :SENS:MULT{1-2}:STAT on page 542
 :SENS{1-16}:MULT{1-2}:PORT{1-20}:CAT? on page 662
 :SENS{1-16}:MULT{1-2}:TSET9:PORT1 on page 664
 :SENS{1-16}:MULT{1-2}:TSET9:PORT2 on page 665
 :SENS{1-16}:MULT{1-2}:TSET9:PORT4 on page 667

Equivalent key [System] - Multiport Test Set Setup - Test Set 1|Test Set 2 - Port3 - R1+|R2+|R3+

:SENS{1-16}:MULT{1-2}:TSET9:PORT4

Syntax :SENSe{[1]|2|3|4|5|6|7|8|9|10|11|12|13|14|15|16}:MULTiplexer{[1]|2}:TSET9:PORT4 {R1|R2|R3}
:SENSe{[1]|2|3|4|5|6|7|8|9|10|11|12|13|14|15|16}:MULTiplexer{[1]|2}:TSET9:PORT4?

Description Selects a port assigned to Port 4 of the E5091A whose ID is 1 (:MULT1) or 2 (:MULT2) when measuring channel 1 (:SENS1) to channel 16 (:SENS16) in the measurement using the E5091A.

Parameters

	Description
R1 (preset value)	Specifies R1-.
R2	Specifies R2-.
R3	Specifies R3- *1.

*1. For Option 007 (7 ports), R2-.

Query response {R1|R2|R3}<newline><^END>

Example of use
10 OUTPUT 717; ":SENS1:MULT1:TSET9:PORT4 R2"
20 OUTPUT 717; ":SENS1:MULT1:TSET9:PORT4?"
30 ENTER 717;A\$

Related commands
:SENS:MULT{1-2}:DISP on page 539
:SENS:MULT{1-2}:STAT on page 542
:SENS{1-16}:MULT{1-2}:PORT{1-20}:CAT? on page 662
:SENS{1-16}:MULT{1-2}:TSET9:PORT1 on page 664
:SENS{1-16}:MULT{1-2}:TSET9:PORT2 on page 665
:SENS{1-16}:MULT{1-2}:TSET9:PORT3 on page 666

Equivalent key [System] - Multiport Test Set Setup - Test Set 1|Test Set 2 - Port4 - R1-|R2-|R3-

:SENS{1-16}:OFFS

Syntax :SENSe{[1]|2|3|4|5|6|7|8|9|10|11|12|13|14|15|16}:OFFSet[:STATe] {ON|OFF|1|0}
:SENSe{[1]|2|3|4|5|6|7|8|9|10|11|12|13|14|15|16}:OFFSet[:STATe]?

Description Turns on/off the frequency offset for channel 1 (:SENS1) to channel 16 (:SENS16).
When the frequency offset mode is on, different frequencies can be used for measurement for each port. Frequencies set for each port are used regardless of whether the port is on the stimulus side or response side.

Parameters

	Description
ON or 1	Turns on the frequency offset mode.
OFF or 0 (preset value)	Turns off the frequency offset mode.

Query response {1|0}<newline><^END>

Example of use
10 OUTPUT 717; ":SENS1:OFFS ON"
20 OUTPUT 717; ":SENS1:OFFS?"
30 ENTER 717;A

Equivalent key [Sweep Setup] - Frequency Offset - Frequency Offset

:SENS{1-16}:OFFS:ASP

Syntax :SENSe{[1]|2|3|4|5|6|7|8|9|10|11|12|13|14|15|16}:OFFSet:ASPurious {ON|OFF|1|0}
:SENSe{[1]|2|3|4|5|6|7|8|9|10|11|12|13|14|15|16}:OFFSet:ASPurious?

Description Turns on/off the spurious avoidance for channel 1 (:SENS1) to channel 16 (:SENS16).
When the spurious avoidance is on, measurement is performed avoiding spurious that occurs due to the following signals.

- Source signal and its harmonics
- When the frequency setting for the external signal source is enabled, the set signal and its harmonics.

Parameters

	Description
ON or 1	Turns on the spurious avoidance.
OFF or 0 (preset value)	Turns off the spurious avoidance.

Query response {1|0}<newline><^END>

Example of use
10 OUTPUT 717; ":SENS1:OFFS:ASP ON"
20 OUTPUT 717; ":SENS1:OFFS:ASP?"
30 ENTER 717;A

Equivalent key [Sweep Setup] - Frequency Offset - Avoid Spurious

:SENS{1-16}:OFFS:LOC:CONT

Syntax :SENSe{[1]|2|3|4|5|6|7|8|9|10|11|12|13|14|15|16}:OFFSet:LOCAl:CONTRol[:STATe] {ON|OFF|1|0}
:SENSe{[1]|2|3|4|5|6|7|8|9|10|11|12|13|14|15|16}:OFFSet:LOCAl:CONTRol[:STATe]?

Description Turns on/off the external signal source control for channel 1 (:SENS1) to channel 16 (:SENS16).

Parameters

	Description
ON or 1	Turns on the external signal source control.
OFF or 0 (preset value)	Turns off the external signal source control.

Query response {1|0}<newline><^END>

Example of use
10 OUTPUT 717; ":SENS1:OFFS:LOC:CONT ON"
20 OUTPUT 717; ":SENS1:OFFS:LOC:CONT?"
30 ENTER 717;A

Equivalent key **[Sweep Setup] - Frequency Offset - External Source - Control**

:SENS{1-16}:OFFS:LOC:DATA?

Syntax	:SENSe{[1 2 3 4 5 6 7 8 9 10 11 12 13 14 15 16]}:OFFSet:LOCal[:FREQuency]:DATA?
Description	<p>Reads out the frequency data of the external signal source for channel 1 (:SENS1) to channel 16 (:SENS16). (Query only)</p> <p>This command reads out the frequencies of all measurement points as an array.</p>
Query response	{value 1},...,{value NOP}<newline><<^END>
NOTE	Where, NOP is the number of points.
Example of use	<pre>10 DIM A(1:201) 20 OUTPUT 717;" :SENS1:OFFS:LOC:DATA?" 30 ENTER 717;A(*)</pre>
Related commands	<p>:SENS{1-16}:OFFS:LOC:DIV on page 672</p> <p>:SENS{1-16}:OFFS:LOC:MULT on page 673</p> <p>:SENS{1-16}:OFFS:LOC:OFFS on page 674</p> <p>:SENS{1-16}:OFFS:LOC:STAR on page 675</p> <p>:SENS{1-16}:OFFS:LOC:STOP on page 676</p>
Equivalent key	No equivalent key is available on the front panel.

:SENS{1-16}:OFFS:LOC:DIV

Syntax :SENSe{[1]|2|3|4|5|6|7|8|9|10|11|12|13|14|15|16}:OFFSet:LOCal[:FREQuency]:DIVisor <numeric>
:SENSe{[1]|2|3|4|5|6|7|8|9|10|11|12|13|14|15|16}:OFFSet:LOCal[:FREQuency]:DIVisor?

Description Sets a divisor when making the frequency setting of the external signal source as a multiplier, divisor, or offset for channel 1 (:SENS1) to channel 16 (:SENS16).

NOTE There are two methods to set the frequency range of the external signal source: using a multiplier, divisor, or offset for the normal frequency setting (:SENS[<chan>]:FREQ Node or segment list setting) and using the start frequency and the stop frequency.

Parameters

	<value>
Description	Divisor
Range	1 to 100
Preset value	1
Unit	N/A

If the specified parameter is out of the allowable setup range, the minimum value (if the lower limit of the range is not reached) or the maximum value (if the upper limit of the range is exceeded) is set.

Query response {value}<newline><^END>

Example of use
10 OUTPUT 717; ":SENS1:OFFS:LOC:DIV 1E1"
20 OUTPUT 717; ":SENS1:OFFS:LOC:DIV?"
30 ENTER 717;A

Related commands
:SENS{1-16}:OFFS:LOC:MULT on page 673
:SENS{1-16}:OFFS:LOC:OFFS on page 674
:SENS{1-16}:OFFS:LOC:STAR on page 675
:SENS{1-16}:OFFS:LOC:STOP on page 676

Equivalent key [Sweep Setup] - Frequency Offset - External Source - Divisor

:SENS{1-16}:OFFS:LOC:MULT

Syntax :SENSe{[1]|2|3|4|5|6|7|8|9|10|11|12|13|14|15|16}:OFFSet:LOCal[:FREQuency]:MULTiplier
<numeric>
:SENSe{[1]|2|3|4|5|6|7|8|9|10|11|12|13|14|15|16}:OFFSet:LOCal[:FREQuency]:MULTiplier?

Description Sets a multiplier when making the frequency setting of the external signal source as a multiplier, divisor, or offset for channel 1 (:SENS1) to channel 16 (:SENS16).

NOTE There are two methods to set the frequency range of the external signal source: using a multiplier, divisor, or offset for the normal frequency setting (:SENS[<chan>]:FREQ Node or segment list setting) and using the start frequency and the stop frequency.

Parameters

	<value>
Description	Multiplier
Range	-100 to 100
Preset value	0
Unit	N/A

If the specified parameter is out of the allowable setup range, the minimum value (if the lower limit of the range is not reached) or the maximum value (if the upper limit of the range is exceeded) is set.

Query response {value}<newline><^END>

Example of use

```
10 OUTPUT 717; ":SENS1:OFFS:LOC:MULT -1E1"
20 OUTPUT 717; ":SENS1:OFFS:LOC:MULT?"
30 ENTER 717;A
```

Related commands

- :SENS{1-16}:OFFS:LOC:DIV on page 672
- :SENS{1-16}:OFFS:LOC:OFFS on page 674
- :SENS{1-16}:OFFS:LOC:STAR on page 675
- :SENS{1-16}:OFFS:LOC:STOP on page 676

Equivalent key [Sweep Setup] - Frequency Offset - External Source - Multiplier

:SENS{1-16}:OFFS:LOC:OFFS

Syntax :SENSe{[1]|2|3|4|5|6|7|8|9|10|11|12|13|14|15|16}:OFFSet:LOCa[:FREQuency]:OFFSet <numeric>
:SENSe{[1]|2|3|4|5|6|7|8|9|10|11|12|13|14|15|16}:OFFSet:LOCa[:FREQuency]:OFFSet?

Description Sets an offset when making the frequency setting of the external signal source as a multiplier, divisor, or offset for channel 1 (:SENS1) to channel 16 (:SENS16).

NOTE There are two methods to set the frequency range of the external signal source: using a multiplier, divisor, or offset for the normal frequency setting (:SENS[<chan>]:FREQ Node or segment list setting) and using the start frequency and the stop frequency.

Parameters

	<value>
Description	Offset
Range	-1e+012 to 1e+012
Preset value	0
Unit	Hz

If the specified parameter is out of the allowable setup range, the minimum value (if the lower limit of the range is not reached) or the maximum value (if the upper limit of the range is exceeded) is set.

Query response {value}<newline><^END>

Example of use
10 OUTPUT 717; ":SENS1:OFFS:LOC:OFFS 5E9"
20 OUTPUT 717; ":SENS1:OFFS:LOC:OFFS?"
30 ENTER 717;A

Related commands
:SENS{1-16}:OFFS:LOC:DIV on page 672
:SENS{1-16}:OFFS:LOC:MULT on page 673
:SENS{1-16}:OFFS:LOC:STAR on page 675
:SENS{1-16}:OFFS:LOC:STOP on page 676

Equivalent key [Sweep Setup] - Frequency Offset - External Source - Offset

:SENS{1-16}:OFFS:LOC:STAR

Syntax :SENSe{[1]|2|3|4|5|6|7|8|9|10|11|12|13|14|15|16}:OFFSet:LOCal[:FREQuency]:STARt <numeric>
:SENSe{[1]|2|3|4|5|6|7|8|9|10|11|12|13|14|15|16}:OFFSet:LOCal[:FREQuency]:STARt?

Description Sets a start frequency when making the frequency setting of the external signal source as a start frequency and the stop frequency for channel 1 (:SENS1) to channel 16 (:SENS16).

NOTE There are two methods to set the frequency range of the external signal source: using a multiplier, divisor, or offset for the normal frequency setting (:SENS[<chan>]:FREQ Node or segment list setting) and using the start frequency and the stop frequency.

Parameters

	<value>
Description	Start frequency
Range	0 to 1e+012
Preset value	0
Unit	Hz

If the specified parameter is out of the allowable setup range, the minimum value (if the lower limit of the range is not reached) or the maximum value (if the upper limit of the range is exceeded) is set.

Query response {value}<newline><^END>

Example of use
10 OUTPUT 717;":SENS1:OFFS:LOC:STAR 5E9"
20 OUTPUT 717;":SENS1:OFFS:LOC:STAR?"
30 ENTER 717;A

Related commands
:SENS{1-16}:OFFS:LOC:DIV on page 672
:SENS{1-16}:OFFS:LOC:MULT on page 673
:SENS{1-16}:OFFS:LOC:OFFS on page 674
:SENS{1-16}:OFFS:LOC:STOP on page 676

Equivalent key [Sweep Setup] - Frequency Offset - External Source - Start

:SENS{1-16}:OFFS:LOC:STOP

Syntax :SENSe{[1]|2|3|4|5|6|7|8|9|10|11|12|13|14|15|16}:OFFSet:LOCa[:FREQuency]:STOP <numeric>
:SENSe{[1]|2|3|4|5|6|7|8|9|10|11|12|13|14|15|16}:OFFSet:LOCa[:FREQuency]:STOP?

Description Sets a stop frequency when making the frequency setting of the external signal source as a start frequency and the stop frequency for channel 1 (:SENS1) to channel 16 (:SENS16).

NOTE There are two methods to set the frequency range of the external signal source: using a multiplier, divisor, or offset for the normal frequency setting (:SENS[<chan>]:FREQ Node or segment list setting) and using the start frequency and the stop frequency.

Parameters

	<value>
Description	Stop frequency
Range	0 to 1e+012
Preset value	0
Unit	Hz

If the specified parameter is out of the allowable setup range, the minimum value (if the lower limit of the range is not reached) or the maximum value (if the upper limit of the range is exceeded) is set.

Query response {value}<newline><^END>

Example of use
10 OUTPUT 717; ":SENS1:OFFS:LOC:STOP 5E9"
20 OUTPUT 717; ":SENS1:OFFS:LOC:STOP?"
30 ENTER 717;A

Related commands
:SENS{1-16}:OFFS:LOC:DIV on page 672
:SENS{1-16}:OFFS:LOC:MULT on page 673
:SENS{1-16}:OFFS:LOC:OFFS on page 674
:SENS{1-16}:OFFS:LOC:STAR on page 675

Equivalent key [Sweep Setup] - Frequency Offset - External Source - Stop

:SENS{1-16}:OFFS:LOC:POW

Syntax :SENSe{[1]|2|3|4|5|6|7|8|9|10|11|12|13|14|15|16}:OFFSet:LOCal:POWer[:LEVel][:IMMediate]
[:AMPLitude] <numeric>
:SENSe{[1]|2|3|4|5|6|7|8|9|10|11|12|13|14|15|16}:OFFSet:LOCal:POWer[:LEVel][:IMMediate]
[:AMPLitude]?

Description Sets the power level of the external signal source for channel 1 (:SENS1) to channel 16 (:SENS16).

Parameters

	<value>
Description	Power level
Range	-150 to 30
Preset value	-10
Unit	dBm
Resolution	0.01

If the specified parameter is out of the allowable setup range, the minimum value (if the lower limit of the range is not reached) or the maximum value (if the upper limit of the range is exceeded) is set.

Query response {value}<newline><^END>

Example of use

```
10  OUTPUT 717; ":SENS1:OFFS:LOC:POW -12.5"
20  OUTPUT 717; ":SENS1:OFFS:LOC:POW?"
30  ENTER 717;A
```

Related commands :SENS{1-16}:OFFS:LOC:POW:SLOP on page 678
:SENS{1-16}:OFFS:LOC:POW:SLOP:STAT on page 679

Equivalent key [Sweep Setup] - Frequency Offset - External Source - Power

:SENS{1-16}:OFFS:LOC:POW:SLOP

Syntax :SENSe{[1]|2|3|4|5|6|7|8|9|10|11|12|13|14|15|16}:OFFSet:LOCal:POWer[:LEVel]:SLOPe[:DATA]
 <numeric>
 :SENSe{[1]|2|3|4|5|6|7|8|9|10|11|12|13|14|15|16}:OFFSet:LOCal:POWer[:LEVel]:SLOPe[:DATA]?

Description Sets the power slope value of the external signal source for channel 1 (:SENS1) to channel 16 (:SENS16).

Parameters

	<value>
Description	Power slope value
Range	-2 to 2
Preset value	0
Unit	dB/GHz
Resolution	0.01

If the specified parameter is out of the allowable setup range, the minimum value (if the lower limit of the range is not reached) or the maximum value (if the upper limit of the range is exceeded) is set.

Query response {value}<newline><^END>

Example of use
 10 OUTPUT 717; ":SENS1:OFFS:LOC:POW:SLOP 1.0"
 20 OUTPUT 717; ":SENS1:OFFS:LOC:POW:SLOP?"
 30 ENTER 717;A

Related commands
 :SENS{1-16}:OFFS:LOC:POW on page 677
 :SENS{1-16}:OFFS:LOC:POW:SLOP:STAT on page 679

Equivalent key [Sweep Setup] - Frequency Offset - External Source - Slope

:SENS{1-16}:OFFS:LOC:POW:SLOP:STAT

Syntax :SENSe{[1]|2|3|4|5|6|7|8|9|10|11|12|13|14|15|16}:OFFSet:LOCal:POWer[:LEVel]:SLOPe:STATe
{ON|OFF|1|0}
:SENSe{[1]|2|3|4|5|6|7|8|9|10|11|12|13|14|15|16}:OFFSet:LOCal:POWer[:LEVel]:SLOPe:STATe?

Description Turns on/off the power slope setting of the external signal source for channel 1 (:SENS1) to channel 16 (:SENS16).

Parameters

	Description
ON or 1	Turns on the power slope of the external signal source.
OFF or 0 (preset value)	Turns off the power slope of the external signal source.

Query response {1|0}<newline><^END>

Example of use
10 OUTPUT 717;":SENS1:OFFS:LOC:POW:SLOP:STAT ON"
20 OUTPUT 717;":SENS1:OFFS:LOC:POW:SLOP:STAT?"
30 ENTER 717;A

Related commands :SENS{1-16}:OFFS:LOC:POW on page 677
:SENS{1-16}:OFFS:LOC:POW:SLOP on page 678

Equivalent key [Sweep Setup] - Frequency Offset - External Source - Slope

:SENS{1-16}:OFFS:LOC:STAT

Syntax :SENSe{[1]|2|3|4|5|6|7|8|9|10|11|12|13|14|15|16}:OFFSet:LOCAl:STATe {ON|OFF|1|0}
 :SENSe{[1]|2|3|4|5|6|7|8|9|10|11|12|13|14|15|16}:OFFSet:LOCAl:STATe?

Description Turns on/off the frequency setting of the external signal source for measurement regardless of on/off of the frequency offset mode for channel 1 (:SENS1) to channel 16 (:SENS16).

Parameters

	Description
ON or 1	Uses the frequency setting of the external signal source.
OFF or 0 (preset value)	Does not use the frequency setting of the external signal source.

Query response {1|0}<newline><^END>

Example of use
 10 OUTPUT 717; ":SENS1:OFFS:LOC:STAT ON"
 20 OUTPUT 717; ":SENS1:OFFS:LOC:STAT?"
 30 ENTER 717;A

Related commands
 :SENS{1-16}:OFFS:LOC:DIV on page 672
 :SENS{1-16}:OFFS:LOC:MULT on page 673
 :SENS{1-16}:OFFS:LOC:OFFS on page 674
 :SENS{1-16}:OFFS:LOC:STAR on page 675
 :SENS{1-16}:OFFS:LOC:STOP on page 676

Equivalent key [Sweep Setup] - Frequency Offset - External Source - LO Frequency

:SENS{1-16}:OFFS:PORT{1-4}:DATA?

Syntax	:SENSe{[1] 2 3 4 5 6 7 8 9 10 11 12 13 14 15 16}:OFFSet:PORT{[1] 2 3 4}[:FREQuency]:DATA?
Description	<p>Reads out the frequency data of the specified port when the frequency offset mode is on for channel 1 (:SENS1) to channel 16 (:SENS16). (Query only)</p> <p>This command reads out the frequencies of all measurement points as an array.</p>
Query response	{value 1},...,{value NOP}<newline><^END>
NOTE	Where, NOP is the number of points.
Example of use	<pre>10 DIM A(1:201) 20 OUTPUT 717;" :SENS1:OFFS:PORT2:DATA?" 30 ENTER 717;A(*)</pre>
Related commands	<p>:SENS{1-16}:OFFS:PORT{1-4}:DIV on page 682</p> <p>:SENS{1-16}:OFFS:PORT{1-4}:MULT on page 683</p> <p>:SENS{1-16}:OFFS:PORT{1-4}:OFFS on page 684</p> <p>:SENS{1-16}:OFFS:PORT{1-4}:STAR on page 685</p> <p>:SENS{1-16}:OFFS:PORT{1-4}:STOP on page 686</p>
Equivalent key	No equivalent key is available on the front panel.

:SENS{1-16}:OFFS:PORT{1-4}:DIV

Syntax :SENSe{[1]|2|3|4|5|6|7|8|9|10|11|12|13|14|15|16}:OFFSet:PORT{[1]|2|3|4}[:FREQUency]:DIVisor
<numeric>
:SENSe{[1]|2|3|4|5|6|7|8|9|10|11|12|13|14|15|16}:OFFSet:PORT{[1]|2|3|4}[:FREQUency]:DIVisor?

Description Sets a divisor when the setting method for the frequency setting for the specified port is a multiplier, divisor, or offset when the frequency offset mode is on for channel 1 (:SENS1) to channel 16 (:SENS16).

NOTE There are two methods to set the frequency when the frequency offset mode is on: using a multiplier, divisor, or offset for the normal frequency setting (:SENS[<chan>]:FREQ Node or segment list setting) and using the start frequency and the stop frequency.

Parameters

	<value>
Description	Divisor
Range	1 to 100
Preset value	1
Unit	N/A

If the specified parameter is out of the allowable setup range, the minimum value (if the lower limit of the range is not reached) or the maximum value (if the upper limit of the range is exceeded) is set.

Query response {value}<newline><^END>

Example of use
10 OUTPUT 717; ":SENS1:OFFS:PORT2:DIV 1E1"
20 OUTPUT 717; ":SENS1:OFFS:PORT2:DIV?"
30 ENTER 717;A

Related commands
:SENS{1-16}:OFFS:PORT{1-4}:MULT on page 683
:SENS{1-16}:OFFS:PORT{1-4}:OFFS on page 684
:SENS{1-16}:OFFS:PORT{1-4}:STAR on page 685
:SENS{1-16}:OFFS:PORT{1-4}:STOP on page 686

Equivalent key [Sweep Setup] - Frequency Offset - Port X - Divisor

NOTE Choose the softkey of the port number you want to set as Port X.

:SENS{1-16}:OFFS:PORT{1-4}:MULT

Syntax

```
:SENSe{[1]|2|3|4|5|6|7|8|9|10|11|12|13|14|15|16}:OFFSet:PORT{[1]|2|3|4}[:FREQuency]
:MULTiplier <numeric>

:SENSe{[1]|2|3|4|5|6|7|8|9|10|11|12|13|14|15|16}:OFFSet:PORT{[1]|2|3|4}[:FREQuency]
:MULTiplier?
```

Description Sets a multiplier when the setting method for the frequency setting for the specified port is a multiplier, divisor, or offset when the frequency offset mode is on for channel 1 (:SENS1) to channel 16 (:SENS16).

NOTE There are two methods to set the frequency when the frequency offset mode is on: using a multiplier, divisor, or offset for the normal frequency setting (:SENS[<chan>]:FREQ Node or segment list setting) and using the start frequency and the stop frequency.

Parameters

	<value>
Description	Multiplier
Range	-100 to 100
Preset value	1
Unit	N/A

If the specified parameter is out of the allowable setup range, the minimum value (if the lower limit of the range is not reached) or the maximum value (if the upper limit of the range is exceeded) is set.

Query response {value}<newline><^END>

Example of use

```
10 OUTPUT 717; ":SENS1:OFFS:PORT2:MULT 1E1"
20 OUTPUT 717; ":SENS1:OFFS:PORT2:MULT?"
30 ENTER 717;A
```

Related commands

- :SENS{1-16}:OFFS:PORT{1-4}:DIV on page 682
- :SENS{1-16}:OFFS:PORT{1-4}:OFFS on page 684
- :SENS{1-16}:OFFS:PORT{1-4}:STAR on page 685
- :SENS{1-16}:OFFS:PORT{1-4}:STOP on page 686

Equivalent key [Sweep Setup] - Frequency Offset - Port X - Multiplier

NOTE Choose the softkey of the port number you want to set as Port X.

:SENS{1-16}:OFFS:PORT{1-4}:OFFS

Syntax :SENSe{[1]|2|3|4|5|6|7|8|9|10|11|12|13|14|15|16}:OFFSet:PORT{[1]|2|3|4}[:FREQUency]:OFFSet
<numeric>
:SENSe{[1]|2|3|4|5|6|7|8|9|10|11|12|13|14|15|16}:OFFSet:PORT{[1]|2|3|4}[:FREQUency]:OFFSet?

Description Sets an offset when the setting method for the frequency setting for the specified port is a multiplier, divisor, or offset when the frequency offset mode is on for channel 1 (:SENS1) to channel 16 (:SENS16).

NOTE There are two methods to set the frequency when the frequency offset mode is on: using a multiplier, divisor, or offset for the normal frequency setting (:SENS[<chan>]:FREQ Node or segment list setting) and using the start frequency and the stop frequency.

Parameters

	<value>
Description	Offset
Range	-1e+012 to 1e+012
Preset value	0
Unit	Hz

If the specified parameter is out of the allowable setup range, the minimum value (if the lower limit of the range is not reached) or the maximum value (if the upper limit of the range is exceeded) is set.

Query response {value}<newline><^END>

Example of use
10 OUTPUT 717; ":SENS1:OFFS:PORT2:OFFS 1E9"
20 OUTPUT 717; ":SENS1:OFFS:PORT2:OFFS?"
30 ENTER 717;A

Related commands
:SENS{1-16}:OFFS:PORT{1-4}:DIV on page 682
:SENS{1-16}:OFFS:PORT{1-4}:MULT on page 683
:SENS{1-16}:OFFS:PORT{1-4}:STAR on page 685
:SENS{1-16}:OFFS:PORT{1-4}:STOP on page 686

Equivalent key [Sweep Setup] - Frequency Offset - Port X - Offset

NOTE Choose the softkey of the port number you want to set as Port X.

:SENS{1-16}:OFFS:PORT{1-4}:STAR

Syntax :SENSe{[1]|2|3|4|5|6|7|8|9|10|11|12|13|14|15|16}:OFFSet:PORT{[1]|2|3|4}[:FREQuency]:STARt
<numeric>

:SENSe{[1]|2|3|4|5|6|7|8|9|10|11|12|13|14|15|16}:OFFSet:PORT{[1]|2|3|4}[:FREQuency]:STARt?

Description Sets a start frequency when the setting method for the frequency setting for the specified port is the start frequency and the stop frequency when the frequency offset mode is on for channel 1 (:SENS1) to channel 16 (:SENS16).

NOTE There are two methods to set the frequency when the frequency offset mode is on: using a multiplier, divisor, or offset for the normal frequency setting (:SENS[<chan>]:FREQ Node or segment list setting) and using the start frequency and the stop frequency.

Parameters

	<value>
Description	Start frequency
Range	300000 to 3.0e+009 or 8.5e+009
Preset value	300000
Unit	Hz

If the specified parameter is out of the allowable setup range, the minimum value (if the lower limit of the range is not reached) or the maximum value (if the upper limit of the range is exceeded) is set.

Query response {value}<newline><^END>

Example of use

```
10 OUTPUT 717; ":SENS1:OFFS:PORT2:STAR 300000"
20 OUTPUT 717; ":SENS1:OFFS:PORT2:STAR?"
30 ENTER 717;A
```

Related commands

- :SENS{1-16}:OFFS:PORT{1-4}:DIV on page 682
- :SENS{1-16}:OFFS:PORT{1-4}:MULT on page 683
- :SENS{1-16}:OFFS:PORT{1-4}:OFFS on page 684
- :SENS{1-16}:OFFS:PORT{1-4}:STOP on page 686

Equivalent key [Sweep Setup] - Frequency Offset - Port X - Start

NOTE Choose the softkey of the port number you want to set as Port X.

:SENS{1-16}:OFFS:PORT{1-4}:STOP

Syntax :SENSe{[1]|2|3|4|5|6|7|8|9|10|11|12|13|14|15|16}:OFFSet:PORT{[1]|2|3|4}[:FREQuency]:STOP
<numeric>
:SENSe{[1]|2|3|4|5|6|7|8|9|10|11|12|13|14|15|16}:OFFSet:PORT{[1]|2|3|4}[:FREQuency]:STOP?

Description Sets a stop frequency when the setting method for the frequency setting for the specified port is the start frequency and the stop frequency when the frequency offset mode is on for channel 1 (:SENS1) to channel 16 (:SENS16).

NOTE There are two methods to set the frequency when the frequency offset mode is on: using a multiplier, divisor, or offset for the normal frequency setting (:SENS[<chan>]:FREQ Node or segment list setting) and using the start frequency and the stop frequency.

Parameters

	<value>
Description	Stop frequency
Range	300000 to 3.0e+009 or 8.5e+009
Preset value	8500000000
Unit	Hz

If the specified parameter is out of the allowable setup range, the minimum value (if the lower limit of the range is not reached) or the maximum value (if the upper limit of the range is exceeded) is set.

Query response {value}<newline><^END>

Example of use
10 OUTPUT 717; ":SENS1:OFFS:PORT2:STOP 1e+009"
20 OUTPUT 717; ":SENS1:OFFS:PORT2:STOP?"
30 ENTER 717;A

Related commands
:SENS{1-16}:OFFS:PORT{1-4}:DIV on page 682
:SENS{1-16}:OFFS:PORT{1-4}:MULT on page 683
:SENS{1-16}:OFFS:PORT{1-4}:OFFS on page 684
:SENS{1-16}:OFFS:PORT{1-4}:STAR on page 685

Equivalent key [Sweep Setup] - Frequency Offset - Port X - Stop

NOTE Choose the softkey of the port number you want to set as Port X.

:SENS{1-16}:ROSC:SOUR?

Syntax :SENSe{[1]|2|3|4|5|6|7|8|9|10|11|12|13|14|15|16}:ROSCillator:SOURce?

Description Reads out whether the external reference signal is inputted to the Ref In connector on the rear panel. (Query only)

Query response {INTernal|EXTernal}<newline><^END>

	Description
INTernal	The external reference signal is not inputted.
EXTernal	The external reference signal is inputted.

Example of use

```
10 OUTPUT 717; ":SENS1:ROSC:SOUR?"
20 ENTER 717;A$
```

Equivalent key Displayed on the instrument status bar (at the bottom of the LCD display).

:SENS{1-16}:SEGM:DATA

Syntax

```
:SENSe{[1]|2|3|4|5|6|7|8|9|10|11|12|13|14|15|16}:SEGMent:DATA
5,<mode>,<ifbw>,<pow>,<del>,<time>,<segm>,
<star 1>,<stop 1>,<nop 1>,<ifbw 1>,<pow 1>,<del 1>,<time 1>,...,
<star n>,<stop n>,<nop n>,<ifbw n>,<pow n>,<del n>,<time n>,...,
<star N>,<stop N>,<nop N>,<ifbw N>,<pow N>,<del N>,<time N>

:SENSe{[1]|2|3|4|5|6|7|8|9|10|11|12|13|14|15|16}:SEGMent:DATA
6,<mode>,<ifbw>,<pow>,<del>,<swp>,<time>,<segm>,
<star 1>,<stop 1>,<nop 1>,<ifbw 1>,<pow 1>,<del 1>,<swp 1>,<time 1>,...,
<star n>,<stop n>,<nop n>,<ifbw n>,<pow n>,<del n>,<swp n>,<time n>,...,
<star N>,<stop N>,<nop N>,<ifbw N>,<pow N>,<del N>,<swp N>,<time N>

:SENSe{[1]|2|3|4|5|6|7|8|9|10|11|12|13|14|15|16}:SEGMent:DATA?
```

Where N is the number of segments (specified with <segm>) and n is an integer between 1 and N.

Description

Creates the segment sweep table for channel 1 (:SENS1) to channel 16 (:SENS16).

The data transfer format when this command is executed depends on the setting with the :FORM:DATA command.

Parameters

The first value is 5 or 6 and the parameters listed below follow.

	Description
<mode>	Stimulus setting mode 0: Specifies with start/stop values 1: Specifies with center/span values
<ifbw>	ON/OFF of the IF bandwidth setting for each segment 0: Off, 1: On
<pow>	ON/OFF of the power setting for each segment 0: Off, 1: On
	ON/OFF of the sweep delay time setting for each segment 0: Off, 1: On
<swp>	ON/OFF of the sweep mode setting for each segment 0: Off, 1: On Not required when the first value is 5
<time>	ON/OFF of the sweep time setting for each segment 0: Off, 1: On
<segm>	Number of segments (1 to 201)
<star n>	Start value/center value of the n-th segment
<stop n>	Stop value/span value of the n-th segment
<nop n>	Number of measurement points of the n-th segment
<ifbw n>	IF bandwidth of the n-th segment Not required when the IF bandwidth setting for each segment is OFF (<ifbw> = 0)

	Description
<pow n>	Power of the n-th segment Not required when the power setting for each segment is OFF (<pow> = 0)
<del n>	Sweep delay time of the n-th segment Not required when the sweep delay time setting for each segment is OFF (= 0)
<swp n>	Sweep mode of the n-th segment 0: Stepped mode 1: Swept mode 2: Fast stepped mode 3: Fast swept mode Not required when the first value is 5 or the sweep mode setting for each segment is OFF (<swp> = 0)
<time n>	Sweep time of the n-th segment (specify 0 If you want to set "auto setting") Not required when the sweep time setting for each segment is OFF (<time> = 0)

Query response

When the sweep mode setting for each segment is OFF:

```
5,{mode},{ifbw},{pow},{del},{time},{segm},
{star 1},{stop 1},{nop 1},{pow 1},{del 1},{time 1},...,
{star n},{stop n},{nop n},{pow n},{del n},{time n},...,
{star N},{stop N},{nop N},{pow N},{del N},{time N}<newline><^END>
```

When the sweep mode setting for each segment is ON:

```
6,{mode},{ifbw},{pow},{del},{swp},{time},{segm},
{star 1},{stop 1},{nop 1},{pow 1},{del 1},{swp 1},{time 1},...,
{star n},{stop n},{nop n},{pow n},{del n},{swp n},{time n},...,
{star N},{stop N},{nop N},{pow N},{del N},{swp N},{time N}<newline><^END>
```

Example of use

```
10 DIM H(1:3,1:4)
20 OUTPUT 717;" :SENS1:SEGM:DATA 5,0,1,0,0,0,3,";
30 OUTPUT 717;"1E9,3E9,11,70e3,";
40 OUTPUT 717;"3E9,4E9,51,7e3,";
50 OUTPUT 717;"4E9,6E9,11,70e3"
60 OUTPUT 717;" :SENS1:SEGM:DATA?"
70 ENTER 717;A,B,C,D,E,F,G,H(*)

10 DIM H(1:3,1:5)
20 OUTPUT 717;" :SENS1:SEGM:DATA 6,0,1,0,0,1,0,3,";
30 OUTPUT 717;"1E9,3E9,11,70e3,3,";
40 OUTPUT 717;"3E9,4E9,51,7e3,2,";
50 OUTPUT 717;"4E9,6E9,11,70e3,3"
60 OUTPUT 717;" :SENS1:SEGM:DATA?"
70 ENTER 717;A,B,C,D,E,F,G,H(*)
```

Related commands

:SENS{1-16}:SWE:TYPE on page 696
:FORM:DATA on page 488

Equivalent key

[Sweep Setup] - Edit Segment Table

:SENS{1-16}:SEGM:SWE:POIN?

Syntax	:SENSe{[1] 2 3 4 5 6 7 8 9 10 11 12 13 14 15 16}:SEGMENT:SWEep:POINTs?
Description	For the segment sweep table of channel 1 (:SENS1) to channel 16 (:SENS16), reads out the total number of the measurement points of all segments. (Query only)
Query response	{numeric}<newline><^END>
Example of use	10 OUTPUT 717; ":SENS1:SEGM:SWE:POIN?" 20 ENTER 717;A
Related commands	:SENS{1-16}:SEGM:DATA on page 688
Equivalent key	No equivalent key is available on the front panel.

:SENS{1-16}:SEGM:SWE:TIME?

Syntax	:SENSe{[1] 2 3 4 5 6 7 8 9 10 11 12 13 14 15 16}:SEGMENT:SWEep:TIME?
Description	For the segment sweep table of channel 1 (:SENS1) to channel 16 (:SENS16), reads out the total sweep time of all segments. (Query only)
Query response	{numeric}<newline><^END>
Example of use	10 OUTPUT 717; ":SENS1:SEGM:SWE:TIME?" 20 ENTER 717;A
Related commands	:SENS{1-16}:SEGM:DATA on page 688
Equivalent key	No equivalent key is available on the front panel.

:SENS{1-16}:SWE:ASP

Syntax :SENSe{[1]|2|3|4|5|6|7|8|9|10|11|12|13|14|15|16}:SWEep:ASPurious {ON|OFF|1|0}
:SENSe{[1]|2|3|4|5|6|7|8|9|10|11|12|13|14|15|16}:SWEep:ASPurious?

Description For channel 1 (:SENS1) to channel 16 (:SENS16), turns ON/OFF the spurious avoidance mode.

Parameters

	Description
ON or 1 (preset value)	Turns ON the spurious avoidance mode.
OFF or 0	Turns OFF the spurious avoidance mode.

Query response {1|0}<newline><^END>

Example of use
10 OUTPUT 717; ":SENS1:SWE:ASP OFF"
20 OUTPUT 717; ":SENS1:SWE:ASP?"
30 ENTER 717;A

Equivalent key [System] - Service Menu - Avoid Spurious

:SENS{1-16}:SWE:DEL

Syntax :SENSe{[1]|2|3|4|5|6|7|8|9|10|11|12|13|14|15|16}:SWEep:DELAy <numeric>
:SENSe{[1]|2|3|4|5|6|7|8|9|10|11|12|13|14|15|16}:SWEep:DELAy?

Description Sets the sweep delay time of channel 1 (:SENS1) to channel 16 (:SENS16).

Parameters

	<numeric>
Description	Sweep delay time
Range	0 to 1
Preset value	0
Unit	s (second)
Resolution	0.001

If the specified parameter is out of the allowable setup range, the minimum value (if the lower limit of the range is not reached) or the maximum value (if the upper limit of the range is exceeded) is set.

Query response {numeric}<newline><^END>

Example of use
10 OUTPUT 717; ":SENS1:SWE:DEL 0.05"
20 OUTPUT 717; ":SENS1:SWE:DEL?"
30 ENTER 717;A

Equivalent key [Sweep Setup] - Sweep Delay

:SENS{1-16}:SWE:GEN

Syntax :SENSe{[1]|2|3|4|5|6|7|8|9|10|11|12|13|14|15|16}:SWEep:GENeration {STEPped|ANALog|FSTepped|FANalog}
:SENSe{[1]|2|3|4|5|6|7|8|9|10|11|12|13|14|15|16}:SWEep:GENeration?

Description Selects the sweep mode of channel 1 (:SENS1) to channel 16 (:SENS16).
When the sweep type is the power sweep (POW specified with the :SENS{1-16}:SWE:TYPE command), when the power calibration is on (ON specified with the :SOUR{1-16}:POW:PORT{1-4}:CORR command), or the power slope value is other than 0 and the power slope function is on (ON specified with the :SOUR{1-16}:POW:SLOP:STAT command), if you execute this command to try to set the sweep mode to the swept mode or the fast swept mode, an error occurs and the sweep mode is automatically set to the step mode or the fast step mode, respectively.

Parameters

	Description
STEPped (preset value)	Specifies stepped mode.
ANALog	Specifies swept mode.
FSTepped	Specifies fast stepped mode.
FANalog	Specifies fast swept mode.

Query response {STEP|ANAL|FST|FAN}<newline><^END>

Example of use
10 OUTPUT 717; ":SENS1:SWE:GEN ANAL"
20 OUTPUT 717; ":SENS1:SWE:GEN?"
30 ENTER 717;A\$

Related commands
:SENS{1-16}:SWE:TYPE on page 696
:SOUR{1-16}:POW:PORT{1-4}:CORR on page 711
:SOUR{1-16}:POW:SLOP:STAT on page 718

Equivalent key [Sweep Setup] - Sweep Mode - Std Stepped|Std Swept|Fast Stepped|Fast Swept

:SENS{1-16}:SWE:POIN

Syntax :SENSe{[1]|2|3|4|5|6|7|8|9|10|11|12|13|14|15|16}:SWEp:POINts <numeric>
:SENSe{[1]|2|3|4|5|6|7|8|9|10|11|12|13|14|15|16}:SWEp:POINts?

Description Sets the number of measurement points of channel 1 (:SENS1) to channel 16 (:SENS16).

Parameters

	<numeric>
Description	Number of measurement points
Range	2 to 1601
Preset value	201
Resolution	1

If the specified parameter is out of the allowable setup range, the minimum value (if the lower limit of the range is not reached) or the maximum value (if the upper limit of the range is exceeded) is set.

Query response {numeric}<newline><^END>

Example of use

```
10  OUTPUT 717;":SENS1:SWE:POIN 801"
20  OUTPUT 717;":SENS1:SWE:POIN?"
30  ENTER 717;A
```

Equivalent key **[Sweep Setup] - Points**

:SENS{1-16}:SWE:TIME

Syntax :SENSe{[1]|2|3|4|5|6|7|8|9|10|11|12|13|14|15|16}:SWEp:TIME[:DATA] <numeric>
 :SENSe{[1]|2|3|4|5|6|7|8|9|10|11|12|13|14|15|16}:SWEp:TIME[:DATA]?

Description Sets the sweep time of channel 1 (:SENS1) to channel 16 (:SENS16).
 When the auto setting of the sweep time is ON, even if you try to set the sweep time to any value with this command, it automatically returns to the value defined by the E5070B/E5071B. Before using this command, turns OFF the auto setting of the sweep time (specify OFF with the :SENS{1-16}:SWE:TIME:AUTO command).

Parameters

	<numeric>
Description	Sweep time
Range	Varies depending on the measurement conditions.
Preset value	Varies depending on the measurement conditions.
Unit	s (second)

If the specified parameter is out of the allowable setup range, the minimum value (if the lower limit of the range is not reached) or the maximum value (if the upper limit of the range is exceeded) is set.

Query response {numeric}<newline><^END>

Example of use
 10 OUTPUT 717; ":SENS1:SWE:TIME 1.5"
 20 OUTPUT 717; ":SENS1:SWE:TIME?"
 30 ENTER 717;A

Related commands :SENS{1-16}:SWE:TIME:AUTO on page 695

Equivalent key [Sweep Setup] - Sweep Time

:SENS{1-16}:SWE:TIME:AUTO

Syntax :SENSe{[1]|2|3|4|5|6|7|8|9|10|11|12|13|14|15|16}:SWEp:TIME:AUTO {ON|OFF|1|0}
:SENSe{[1]|2|3|4|5|6|7|8|9|10|11|12|13|14|15|16}:SWEp:TIME:AUTO?

Description Sets whether to automatically set the sweep time of channel 1 (:SENS1) to channel 16 (:SENS16).

Parameters

	Description
ON or 1 (preset value)	Turns ON the auto setting.
OFF or 0	Turns OFF the auto setting.

Query response {1|0}<newline><^END>

Example of use
10 OUTPUT 717; ":SENS1:SWE:TIME:AUTO ON"
20 OUTPUT 717; ":SENS1:SWE:TIME:AUTO?"
30 ENTER 717;A

Related commands :SENS{1-16}:SWE:TIME on page 694

Equivalent key [Sweep Setup] - Sweep Time

:SENS{1-16}:SWE:TYPE

Syntax

```
:SENSe{[1]|2|3|4|5|6|7|8|9|10|11|12|13|14|15|16}:SWEep:TYPE {LINear|LOGarithmic|SEGment|POWer}
:SENSe{[1]|2|3|4|5|6|7|8|9|10|11|12|13|14|15|16}:SWEep:TYPE?
```

Description

Sets the sweep type of channel 1 (:SENS1) to channel 16 (:SENS16).

Parameters

	Description
LINear (preset value)	Specifies the linear sweep.
LOGarithmic	Specifies the logarithmic sweep. *1
SEGment	Specifies the segment sweep.
POWer	Specifies the power sweep.

*1. If you execute this command to try to specify the log sweep when the frequency span condition necessary for the log sweep is not satisfied (the stop frequency is about 4 times or more the start frequency), an error occurs and the command is ignored.

Query response

```
{LIN|LOG|SEG|POW}<newline><^END>
```

Example of use

```
10 OUTPUT 717; ":SENS1:SWE:TYPE SEGM"
20 OUTPUT 717; ":SENS1:SWE:TYPE?"
30 ENTER 717;A$
```

Equivalent key

[Sweep Setup] - Sweep Type - Lin Freq|Log Freq|Segment

:SERV:CHAN:ACT?

Syntax

```
:SERVice:CHANnel:ACTive?
```

Description

Reads out the active channel number. (Query only)

Query response

```
{numeric}<newline><^END>
```

Example of use

```
10 OUTPUT 717; ":SERV:CHAN:ACT?"
20 ENTER 717;A
```

Related commands

:DISP:WIND{1-16}:ACT on page 470

Equivalent key

No equivalent key is available on the front panel.

:SERV:CHAN:COUN?

Syntax	:SERVice:CHANnel:COUNT?
Description	Reads out the upper limit of the number of channels of the E5070B/E5071B. (Query only)
Query response	{numeric}<newline><^END>
Example of use	10 OUTPUT 717; ":SERV:CHAN:COUN?" 20 ENTER 717;A
Equivalent key	No equivalent key is available on the front panel.

:SERV:CHAN{1-16}:TRAC:ACT?

Syntax	:SERVice:CHANnel{[1] 2 3 4 5 6 7 8 9 10 11 12 13 14 15 16}:TRACe:ACTive?
Description	Reads out the active trace number of channel 1 (:CHAN1) to channel 16 (:CHAN16). (Query only)
Query response	{numeric}<newline><^END>
Example of use	10 OUTPUT 717; ":SERV:CHAN1:TRAC:ACT?" 20 ENTER 717;A
Related commands	:CALC{1-16}:PAR{1-16}:SEL on page 424
Equivalent key	No equivalent key is available on the front panel.

:SERV:CHAN:TRAC:COUN?

Syntax	:SERVice:CHANnel:TRACe:COUNt?
Description	Reads out the upper limit of the number of traces per channel. (Query only)
Query response	{numeric}<newline><^END>
Example of use	10 OUTPUT 717; ":SERV:CHAN:TRAC:COUN?" 20 ENTER 717;A
Equivalent key	No equivalent key is available on the front panel.

:SERV:PORT:COUN?

Syntax	:SERVice:PORT:COUNT?
Description	Reads out the number of ports of the E5070B/E5071B. (Query only)
Query response	{numeric}<newline><^END>
Example of use	10 OUTPUT 717; ":SERV:PORT:COUN?" 20 ENTER 717;A
Equivalent key	No equivalent key is available on the front panel.

:SERV:SREV?

Syntax	:SERVice:SREVersion?
Description	Reads out the system spec version of the E5070B/E5071B. (Query only) 1 means applying new system specifications. 0 means applying old system specifications.
Query response	{1 0}<newline><^END>
Example of use	10 OUTPUT 717; ":SERV:SREV?" 20 ENTER 717;A
Equivalent key	No equivalent key is available on the front panel.

:SERV:SWE:FREQ:MAX?

Syntax	:SERVice:SWEep:FREQuency:MAXimum?
Description	Reads out the upper limit of the measurement frequency of the E5070B/E5071B. (Query only)
Query response	{numeric}<newline><^END>
Example of use	10 OUTPUT 717;":SERV:SWE:FREQ:MAX?" 20 ENTER 717;A
Equivalent key	No equivalent key is available on the front panel.

:SERV:SWE:FREQ:MIN?

Syntax	:SERVice:SWEep:FREQuency:MINimum?
Description	Reads out the lower limit of the measurement frequency of the E5070B/E5071B. (Query only)
Query response	{numeric}<newline><^END>
Example of use	10 OUTPUT 717;":SERV:SWE:FREQ:MIN?" 20 ENTER 717;A
Equivalent key	No equivalent key is available on the front panel.

:SERV:SWE:POIN?

Syntax	:SERVice:SWEep:FREQuency:MINimum?
Description	Reads out the upper limit of the number of measurement points of the E5070B/E5071B. (Query only)
NOTE	This command depends on the set of channel and trace.
Query response	{numeric}<newline><^END>
Example of use	10 OUTPUT 717;":SERV:SWE:POIN?" 20 ENTER 717;A
Equivalent key	No equivalent key is available on the front panel.

:SOUR:POW:PORT:CORR:COLL:ASEN:RCF

Syntax :SOURce:POWer:PORT:CORRection:COLLect:ASENsor:RCFactor <numeric>
:SOURce:POWer:PORT:CORRection:COLLect:ASENsor:RCFactor?

Description Sets the reference calibration factor (the calibration factor at 50 MHz) for power sensor A.

Parameters

	<numeric>
Description	Reference calibration factor
Range	1 to 150
Preset value	100
Unit	% (percent)
Resolution	0.01

If the specified parameter is out of the allowable setup range, the minimum value (if the lower limit of the range is not reached) or the maximum value (if the upper limit of the range is exceeded) is set.

Query response {numeric}<newline><^END>

Example of use
10 OUTPUT 717; ":SOUR:POW:PORT:CORR:COLL:ASEN:RCF 99.5"
20 OUTPUT 717; ":SOUR:POW:PORT:CORR:COLL:ASEN:RCF?"
30 ENTER 717;A

Related commands :SOUR:POW:PORT:CORR:COLL:BSEN:RCF on page 701

Equivalent key [Cal] - Power Calibration - Sensor A Settings - Ref Cal Factor

:SOUR:POW:PORT:CORR:COLL:BSEN:RCF

Syntax :SOURce:POWer:PORT:CORRection:COLLect:BSEnSor:RCFactor <numeric>
:SOURce:POWer:PORT:CORRection:COLLect:BSEnSor:RCFactor?

Description Sets the reference calibration factor (the calibration factor at 50 MHz) for power sensor B.

Parameters

	<numeric>
Description	Reference calibration factor
Range	1 to 150
Preset value	100
Unit	% (percent)
Resolution	0.01

If the specified parameter is out of the allowable setup range, the minimum value (if the lower limit of the range is not reached) or the maximum value (if the upper limit of the range is exceeded) is set.

Query response {numeric}<newline><^END>

Example of use
10 OUTPUT 717; ":SOUR:POW:PORT:CORR:COLL:BSEN:RCF 99.5"
20 OUTPUT 717; ":SOUR:POW:PORT:CORR:COLL:BSEN:RCF?"
30 ENTER 717;A

Related commands :SOUR:POW:PORT:CORR:COLL:ASEN:RCF on page 700

Equivalent key [Cal] - Power Calibration - Sensor B Settings - Ref Cal Factor

:SOUR:POW:PORT:CORR:COLL:TABL:ASEN:DATA

Syntax :SOURce:POWer:PORT:CORRection:COLLect:TABL:ASENsor:DATA <numeric 1>,...,<numeric 1+(N×2)>
:SOURce:POWer:PORT:CORRection:COLLect:TABL:ASENsor:DATA?

Description Sets the calibration factor table for power sensor A.
The data transfer format when this command is executed depends on the setting with the :FORM:DATA command.

Parameters

	Description
<numeric 1>	The number of data items (0 to 100).
<numeric 1+(n×2)-1>	The frequency of the n-th data item (1 kHz to 500 GHz).
<numeric 1+(n×2)>	The calibration factor of the n-th data item (1% to 150%).

Where N is the number of data items (specified with <numeric 1>) and n is an integer between 1 and N.

When the number of data items is 0 (to clear the calibration coefficient table), you specify only the <numeric 1> parameter.

Query response {numeric 1},...,{numeric 1+(N×2)}<newline><<^END>

Example of use
10 DIM B(1:3,1:2)
20 OUTPUT 717;" :SOUR:POW:PORT:CORR:COLL:TABL:ASEN:DATA 3, ";
30 OUTPUT 717;"1E6,98.5,1E7,99,1E8,99.5"
40 OUTPUT 717;" :SOUR:POW:PORT:CORR:COLL:TABL:ASEN:DATA?"
50 ENTER 717;A,B(*)

10 OUTPUT 717;" :SOUR:POW:PORT:CORR:COLL:TABL:ASEN:DATA 0" !Clear Table

Related commands :SOUR:POW:PORT:CORR:COLL:TABL:BSEN:DATA on page 703
:FORM:DATA on page 488

Equivalent key [Cal] - Power Calibration - Sensor A Settings - Delete|Add|Clear Cal Factor Table

:SOUR:POW:PORT:CORR:COLL:TABL:BSEN:DATA

Syntax :SOURce:POWer:PORT:CORRection:COLLect:TABLe:BSEnSor:DATA <numeric 1>,...,<numeric 1+(N×2)>
:SOURce:POWer:PORT:CORRection:COLLect:TABLe:BSEnSor:DATA?

Description Sets the calibration factor table for power sensor B.
The data transfer format when this command is executed depends on the setting with the :FORM:DATA command.

Parameters

	Description
<numeric 1>	The number of data items (0 to 100).
<numeric 1+(n×2)-1>	The frequency of the n-th data item (1 kHz to 500 GHz).
<numeric 1+(n×2)>	The calibration factor of the n-th data item (1% to 150%).

Where N is the number of data items (specified with <numeric 1>) and n is an integer between 1 and N.

When the number of data items is 0 (to clear the calibration coefficient table), you specify only the <numeric 1> parameter.

Query response {numeric 1},...,{numeric 1+(N×2)}<newline><^END>

Example of use
10 DIM B(1:3,1:2)
20 OUTPUT 717;":SOUR:POW:PORT:CORR:COLL:TABL:BSEN:DATA 3, ";
30 OUTPUT 717;"1E6,98.5,1E7,99,1E8,99.5"
40 OUTPUT 717;":SOUR:POW:PORT:CORR:COLL:TABL:BSEN:DATA?"
50 ENTER 717;A,B(*)
10 OUTPUT 717;":SOUR:POW:PORT:CORR:COLL:TABL:BSEN:DATA 0" !Clear Table

Related commands :SOUR:POW:PORT:CORR:COLL:TABL:ASEN:DATA on page 702
:FORM:DATA on page 488

Equivalent key [Cal] - Power Calibration - Sensor B Settings - Delete|Add|Clear Cal Factor Table

:SOUR{1-16}:POW

Syntax :SOURce{[1]|2|3|4|5|6|7|8|9|10|11|12|13|14|15|16}:POWer[:LEVel][:IMMediate]
[:AMPLitude] <numeric>

:SOURce{[1]|2|3|4|5|6|7|8|9|10|11|12|13|14|15|16}:POWer[:LEVel][:IMMediate]
[:AMPLitude]?

Description Sets the power level of channel 1 (:SOUR1) to channel 16 (:SOUR16).

Parameters

	<numeric>
Description	Power level
Range	Varies depending on the power range.
Preset value	0
Unit	dBm
Resolution	0.05

If the specified parameter is out of the allowable setup range, the minimum value (if the lower limit of the range is not reached) or the maximum value (if the upper limit of the range is exceeded) is set.

Query response {numeric}<newline><^END>

Example of use
10 OUTPUT 717; ":SOUR1:POW -12.5"
20 OUTPUT 717; ":SOUR1:POW?"
30 ENTER 717;A

Related commands :SOUR{1-16}:POW:ATT on page 705
:SOUR{1-16}:POW:ATT:AUTO on page 706

Equivalent key [Sweep Setup] - Power

:SOUR{1-16}:POW:ATT

Syntax :SOURce{[1]|2|3|4|5|6|7|8|9|10|11|12|13|14|15|16}:POWer:ATTenuation[:DATA] <numeric>
:SOURce{[1]|2|3|4|5|6|7|8|9|10|11|12|13|14|15|16}:POWer:ATTenuation[:DATA]?

Description Sets the power range of channel 1 (:SOUR1) to channel 16 (:SOUR16).
The power range is selected depending on the setting of the attenuator. The following table shows the relationship between the attenuator value and the power range.

When Auto Power Range set function is effective, this command is ignored and an attenuator level and a power range are selected automatically according to a maximum frequency and a maximum setting power.

Attenuator	Power range	Attenuator	Power range
0 dB	-20 to +12 dBm	5 dB	-25 to +7 dBm
10 dB	-30 to +2 dBm	15 dB	-35 to -3 dBm
20 dB	-40 to -8 dBm	25 dB	-45 to -13 dBm
30 dB	-50 to -18 dBm	35 dB	-55 to -23 dBm

If you execute this command when the power range extension function is not installed, an error occurs and the command is ignored.

Parameters

	<numeric>
Description	Attenuator value
Range	0 to 35
Preset value	0
Unit	dB
Resolution	5

If the specified parameter is out of the allowable setup range, the minimum value (if the lower limit of the range is not reached) or the maximum value (if the upper limit of the range is exceeded) is set.

Query response {numeric}<newline><^END>

Example of use
10 OUTPUT 717;":SOUR1:POW:ATT 15"
20 OUTPUT 717;":SOUR1:POW:ATT?"
30 ENTER 717;A

Related commands :SOUR{1-16}:POW on page 704
:SOUR{1-16}:POW:ATT:AUTO on page 706

Equivalent key [Sweep Setup] - Power - Power Ranges

Parameters

	Description
ON or 1 (preset value)	Turn ON the Auto Power Range set function.
OFF or 0	Turn OFF the Auto Power Range set function.

Query response {1|0}<newline><<^END>

Example of use

```
10 OUTPUT 717;":SOUR1:POW:ATT:AUTO ON"
20 OUTPUT 717;":SOUR1:POW:ATT:AUTO?"
30 ENTER 717;A
```

Related commands

:SOUR{1-16}:POW on page 704
:SOUR{1-16}:POW:ATT on page 705

Equivalent key [Sweep Setup] - Power - Auto Range

:SOUR{1-16}:POW:CENT

Syntax :SOURce{[1]|2|3|4|5|6|7|8|9|10|11|12|13|14|15|16}:POWer:CENTer <numeric>
:SOURce{[1]|2|3|4|5|6|7|8|9|10|11|12|13|14|15|16}:POWer:CENTer?

Description Sets the center value of the sweep range for the power sweep for channel 1 (:SOUR1) to channel 16 (:SOUR16).

Parameters

	<numeric>
Description	Center value
Range	Varies depending on the power range.
Preset value	-7.5
Unit	dBm
Resolution	0.05 or 0.025

If the specified parameter is out of the allowable setup range, the minimum value (if the lower limit of the range is not reached) or the maximum value (if the upper limit of the range is exceeded) is set.

Query response {numeric}<newline><^END>

Example of use
10 OUTPUT 717; ":SOUR1:POW:CENT 0"
20 OUTPUT 717; ":SOUR1:POW:CENT?"
30 ENTER 717;A

Related commands
:SENS{1-16}:SWE:TYPE on page 696
:SOUR{1-16}:POW:ATT on page 705
:SOUR{1-16}:POW:SPAN on page 719

Equivalent key [Center]

:SOUR{1-16}:POW:PORT:COUP

Syntax :SOURce{[1]|2|3|4|5|6|7|8|9|10|11|12|13|14|15|16}:POWer:PORT:COUPle {ON|OFF|1|0}
:SOURce{[1]|2|3|4|5|6|7|8|9|10|11|12|13|14|15|16}:POWer:PORT:COUPle?

Description Sets whether to output the same power level for each port of channel 1 (:SOUR1) to channel 16 (:SOUR16). When the power slope feature is on (ON specified with the :SOUR{1-16}:POW:SLOP:STAT command), the same power level is always outputted to all ports regardless of this setting because different power levels cannot be outputted for each port.

Parameters

	Description
ON or 1 (preset value)	Outputs the same power level to individual ports.
OFF or 0	Outputs different power levels to individual ports.

Query response {1|0}<newline><^END>

Example of use
10 OUTPUT 717;":SOUR1:POW:PORT:COUP OFF"
20 OUTPUT 717;":SOUR1:POW:PORT:COUP?"
30 ENTER 717;A

Related commands :SOUR{1-16}:POW:PORT{1-4} on page 710

Equivalent key [Sweep Setup] - Power - Port Couple

:SOUR{1-16}:POW:PORT{1-4}

Syntax

```
:SOURce{[1]2[3]4[5]6[7]8[9]10[11]12[13]14[15]16}:POWer:PORT{[1]2[3]4}[:LEVel][:IMMediate][:AMPLitude] <numeric>
:SOURce{[1]2[3]4[5]6[7]8[9]10[11]12[13]14[15]16}:POWer:PORT{[1]2[3]4}[:LEVel][:IMMediate][:AMPLitude]?
```

Description

Sets the power level of port 1 (:PORT1) to port 4 (:PORT4) of channel 1 (:SOUR1) to channel 16 (:SOUR16).

Parameters

	<numeric>
Description	The power level at the specified port.
Range	Varies depending on the power range.
Preset value	0
Unit	dBm
Resolution	0.05

If the specified parameter is out of the allowable setup range, the minimum value (if the lower limit of the range is not reached) or the maximum value (if the upper limit of the range is exceeded) is set.

Query response

```
{numeric}<newline><^END>
```

Example of use

```
10 OUTPUT 717; ":SOUR1:POW:PORT1 -12.5"
20 OUTPUT 717; ":SOUR1:POW:PORT1?"
30 ENTER 717;A
```

Related commands

:SOUR{1-16}:POW:PORT:COUP on page 709

:SOUR{1-16}:POW:ATT on page 705

Equivalent key

[Sweep Setup] - Power - Port Power - Port 1 Power|Port 2 Power|Port 3 Power|Port 4 Power

:SOUR{1-16}:POW:PORT{1-4}:CORR

Syntax

```
:SOURce{[1]|2|3|4|5|6|7|8|9|10|11|12|13|14|15|16}:POWer:PORT{[1]|2|3|4}:CORRection[:STATe] {ON|OFF|1|0}
:SOURce{[1]|2|3|4|5|6|7|8|9|10|11|12|13|14|15|16}:POWer:PORT{[1]|2|3|4}:CORRection[:STATe]?
```

Description

For port 1 (:PORT1) to port 4 (:PORT4) of channel 1 (:SOUR1) to channel 16 (:SOUR16), turn on/off the error correction of the power level.

Parameters

	Description
ON or 1	Turns on the power level error correction.
OFF or 0 (preset value)	Turns off the power level error correction.

Query response

```
{1|0}<newline><<^END>
```

Example of use

```
10 OUTPUT 717; ":SOUR1:POW:PORT1:CORR ON"
20 OUTPUT 717; ":SOUR1:POW:PORT1:CORR?"
30 ENTER 717;A
```

Equivalent key

[Cal] - Power Calibration - Correction

:SOUR{1-16}:POW:PORT{1-4}:CORR:COLL

Syntax

```
:SOURce{[1]|2|3|4|5|6|7|8|9|10|11|12|13|14|15|16}:POWer:PORT{[1]|2|3|4}:CORRection:COLLect[:ACQuire] {ASENsor|BSEnSor}
```

Description

For port 1 (:PORT1) to port 4 (:PORT4) of channel 1 (:SOUR1) to channel 16 (:SOUR16), measure the power calibration data using the specified power sensor. When the measurement is complete successfully, the power level error correction is automatically turned on.

If the power sensor is not connected, an error occurs and the command is ignored. (No query)

Parameters

	Description
ASENsor	Specifies power sensor A.
BSEnSor	Specifies power sensor B.

Example of use

```
10 OUTPUT 717; ":SOUR1:POW:PORT1:CORR:COLL ASEN"
20 OUTPUT 717; "*OPC?"
30 ENTER 717;A
```

Related commands

:SOUR{1-16}:POW:PORT{1-4}:CORR:COLL:AVER on page 712

Equivalent key

[Cal] - Power Calibration - Take Cal Sweep

:SOUR{1-16}:POW:PORT{1-4}:CORR:COLL:AVER

Syntax :SOURce{[1]|2|3|4|5|6|7|8|9|10|11|12|13|14|15|16}:POWer:PORT{[1]|2|3|4}:CORRection:COLLect :AVERAge[:COUNT] <numeric>
:SOURce{[1]|2|3|4|5|6|7|8|9|10|11|12|13|14|15|16}:POWer:PORT{[1]|2|3|4}:CORRection:COLLect :AVERAge[:COUNT]?

Description For port 1 (:PORT1) to port 4 (:PORT4) of channel 1 (:SOUR1) to channel 16 (:SOUR16), sets the number of power calibration data measurements per measurement point (averaging factor).

Parameters

	<numeric>
Description	Averaging factor
Range	1 to 100
Preset value	1
Resolution	1

If the specified parameter is out of the allowable setup range, the minimum value (if the lower limit of the range is not reached) or the maximum value (if the upper limit of the range is exceeded) is set.

Query response {numeric}<newline><^END>

Example of use
10 OUTPUT 717; ":SOUR1:POW:PORT1:CORR:COLL:AVER 6"
20 OUTPUT 717; ":SOUR1:POW:PORT1:CORR:COLL:AVER?"
30 ENTER 717;A

Related commands :SOUR{1-16}:POW:PORT{1-4}:CORR:COLL on page 711

Equivalent key [Cal] - Power Calibration - Num of Readings

:SOUR{1-16}:POW:PORT{1-4}:CORR:COLL:NTOL

Syntax :SOURce{[1]|2|3|4|5|6|7|8|9|10|11|12|13|14|15|16}:POWer:PORT{[1]|2|3|4}
:CORRection:COLLect:NTOLerance <numeric>

:SOURce{[1]|2|3|4|5|6|7|8|9|10|11|12|13|14|15|16}:POWer:PORT{[1]|2|3|4}
:CORRection:COLLect:NTOLerance?

Description For port 1 (:PORT1) to port 4 (:PORT4) of channel 1 (:SOUR1) to channel 16 (:SOUR16), sets the tolerance of power calibration data for each measurement point.

Parameters

	<numeric>
Description	Tolerance of power calibration
Range	0 to 100
Preset value	5
Unit	dB
Resolution	0.001

When the measurement result is outside the tolerance, an error message appears and the power-correction function is not turned on.

Query response {numeric}<newline><^END>

Example of use
10 OUTPUT 717;":SOUR1:POW:PORT1:CORR:COLL:NTOL 6"
20 OUTPUT 717;":SOUR1:POW:PORT1:CORR:COLL:NTOL?"
30 ENTER 717;A

Related commands :SOUR{1-16}:POW:PORT{1-4}:CORR:COLL on page 711

Equivalent key [Cal] - Power Calibration - Tolerance

:SOUR{1-16}:POW:PORT{1-4}:CORR:COLL:TABL:LOSS

Syntax :SOURce{[1]|2|3|4|5|6|7|8|9|10|11|12|13|14|15|16}:POWer:PORT{[1]|2|3|4}:CORRection:COLLect
:TABLe:LOSS[:STATe] {ON|OFF|1|0}
:SOURce{[1]|2|3|4|5|6|7|8|9|10|11|12|13|14|15|16}:POWer:PORT{[1]|2|3|4}:CORRection:COLLect
:TABLe:LOSS[:STATe]?

Description For port 1 (:PORT1) to port 4 (:PORT4) of channel 1 (:SOUR1) to channel 16 (:SOUR16), turn on/off the loss compensation.

Parameters

	Description
ON or 1	Turns on the loss compensation.
OFF or 0 (preset value)	Turns off the loss compensation.

Query response {1|0}<newline><^END>

Example of use
10 OUTPUT 717; ":SOUR1:POW:PORT1:CORR:COLL:TABL:LOSS ON"
20 OUTPUT 717; ":SOUR1:POW:PORT1:CORR:COLL:TABL:LOSS?"
30 ENTER 717;A

Equivalent key [Cal] - Power Calibration - Loss Compen - Compensation

:SOUR{1-16}:POW:PORT{1-4}:CORR:COLL:TABL:LOSS:DATA

Syntax :SOURce{[1][2][3][4][5][6][7][8][9][10][11][12][13][14][15][16]}:POWer:PORT{[1][2][3][4]}:CORRection:COLLect
:TABLe:LOSS:DATA <numeric 1>,...,<numeric 1+(N×2)>

:SOURce{[1][2][3][4][5][6][7][8][9][10][11][12][13][14][15][16]}:POWer:PORT{[1][2][3][4]}:CORRection:COLLect
:TABLe:LOSS:DATA?

Description For port 1 (:PORT1) to port 4 (:PORT4) of channel 1 (:SOUR1) to channel 16 (:SOUR16), sets the loss compensation table.

The data transfer format when this command is executed depends on the setting with the :FORM:DATA command.

Parameters

	Description
<numeric 1>	The number of data items (0 to 100).
<numeric 1+(n×2)-1>	The frequency of the n-th data item (1 kHz to 500 GHz).
<numeric 1+(n×2)>	The loss of the n-th data item (-100 dB to 100 dB).

Where N is the number of data items (specified with <numeric 1>) and n is an integer between 1 and N.

When the number of data items is 0 (to clear the loss coefficient table), you specify only the <numeric 1> parameter.

Query response {numeric 1},...,{numeric 1+(N×2)}<newline><^END>

Example of use

```
10 DIM B(1:2,1:2)
20 OUTPUT 717; ":SOUR:POW:PORT:CORR:COLL:TABL:LOSS:DATA 2, ";
30 OUTPUT 717; "1E8,0.5,1E9,0.8"
40 OUTPUT 717; ":SOUR:POW:PORT:CORR:COLL:TABL:LOSS:DATA?"
50 ENTER 717;A,B(*)

10 OUTPUT 717; ":SOUR:POW:PORT:CORR:COLL:TABL:LOSS:DATA 0" ! Clear Table
```

Related commands :SOUR{1-16}:POW:PORT{1-4}:CORR:COLL:TABL:LOSS on page 714
:FORM:DATA on page 488

Equivalent key [Cal] - Power Calibration - Loss Comp - Delete|Add|Clear Loss Table

:SOUR{1-16}:POW:PORT{1-4}:CORR:DATA

Syntax :SOURce{[1]|2|3|4|5|6|7|8|9|10|11|12|13|14|15|16}:POWER:PORT{[1]|2|3|4}:CORRection:DATA <numeric 1>, ...,<numeric NOP>
:SOURce{[1]|2|3|4|5|6|7|8|9|10|11|12|13|14|15|16}:POWER:PORT{[1]|2|3|4}:CORRection:DATA?

Description For port 1 (:PORT1) to port 4 (:PORT4) of channel 1 (:SOUR1) to channel 16 (:SOUR16), sets/reads out the power calibration data array.

The data transfer format when this command is executed depends on the setting with the :FORM:DATA command.

Parameters

	Description
<numeric n>	Data at the n-th measurement point

Where NOP is the number of points and n is an integer between 1 and NOP.

Query response {numeric 1},...,{numeric NOP}<newline><^END>

Example of use
10 DIM A(1:201)
20 OUTPUT 717; ":SOUR1:POW:PORT1:CORR:DATA?"
30 ENTER 717;A(*)

Related commands :SOUR{1-16}:POW:PORT{1-4}:CORR on page 711
:FORM:DATA on page 488

Equivalent key No equivalent key is available on the front panel.

:SOUR{1-16}:POW:SLOP

Syntax :SOURce{[1]|2|3|4|5|6|7|8|9|10|11|12|13|14|15|16}:POWer[:LEVel]:SLOPe[:DATA] <numeric>
:SOURce{[1]|2|3|4|5|6|7|8|9|10|11|12|13|14|15|16}:POWer[:LEVel]:SLOPe[:DATA]?

Description Sets the correction value of the power slope feature of channel 1 (:SOUR1) to channel 16 (:SOUR16).

Parameters

	<numeric>
Description	The correction value of the power slope feature
Range	-2 to 2
Preset value	0
Unit	dB/GHz
Resolution	0.01

If the specified parameter is out of the allowable setup range, the minimum value (if the lower limit of the range is not reached) or the maximum value (if the upper limit of the range is exceeded) is set.

Query response {numeric}<newline><^END>

Example of use

```
10 OUTPUT 717;":SOUR1:POW:SLOP 0.1"
20 OUTPUT 717;":SOUR1:POW:SLOP?"
30 ENTER 717;A
```

Related commands :SOUR{1-16}:POW:SLOP:STAT on page 718

Equivalent key [Sweep Setup] - Power - Slope [xxx dB/GHz]

:SOUR{1-16}:POW:SLOP:STAT

Syntax :SOURce{[1]|2|3|4|5|6|7|8|9|10|11|12|13|14|15|16}:POWer[:LEVel]:SLOPe:STATe {ON|OFF|1|0}
:SOURce{[1]|2|3|4|5|6|7|8|9|10|11|12|13|14|15|16}:POWer[:LEVel]:SLOPe:STATe?

Description Turns on/off the power slope feature of channel 1 (:SOUR1) to channel 16 (:SOUR16). This function is a function to correct the attenuation of simple power level proportional to the frequency (attenuation due to cables and so on).

Parameters

	Description
ON or 1	Turns on the power slope feature.
OFF or 0 (preset value)	Turns off the power slope feature.

Query response {1|0}<newline><^END>

Example of use
10 OUTPUT 717; ":SOUR1:POW:SLOP:STAT ON"
20 OUTPUT 717; ":SOUR1:POW:SLOP:STAT?"
30 ENTER 717;A

Related commands :SOUR{1-16}:POW:SLOP on page 717

Equivalent key [Sweep Setup] - Power - Slop [ON/OFF]

:SOUR{1-16}:POW:SPAN

Syntax :SOURce{[1]|2|3|4|5|6|7|8|9|10|11|12|13|14|15|16}:POWer:SPAN <numeric>
:SOURce{[1]|2|3|4|5|6|7|8|9|10|11|12|13|14|15|16}:POWer:SPAN?

Description Sets the span value of the sweep range for the power sweep for channel 1 (:SOUR1) to channel 16 (:SOUR16).

Parameters

	<numeric>
Description	Span value
Range	Varies depending on the power range.
Preset value	15
Unit	dBm
Resolution	0.05

If the specified parameter is out of the allowable setup range, the minimum value (if the lower limit of the range is not reached) or the maximum value (if the upper limit of the range is exceeded) is set.

Query response {numeric}<newline><^END>

Example of use
10 OUTPUT 717;":SOUR1:POW:SPAN 10"
20 OUTPUT 717;":SOUR1:POW:SPAN?"
30 ENTER 717;A

Related commands
:SENS{1-16}:SWE:TYPE on page 696
:SOUR{1-16}:POW:ATT on page 705
:SOUR{1-16}:POW:CENT on page 708

Equivalent key [Span]

:SOUR{1-16}:POW:STAR

Syntax :SOURce{[1]|2|3|4|5|6|7|8|9|10|11|12|13|14|15|16}:POWer:STARt <numeric>
:SOURce{[1]|2|3|4|5|6|7|8|9|10|11|12|13|14|15|16}:POWer:STARt?

Description Sets the start value of the sweep range for the power sweep for channel 1 (:SOUR1) to channel 16 (:SOUR16).

Parameters

	<numeric>
Description	Start value
Range	Varies depending on the power range.
Preset value	-15
Unit	dBm
Resolution	0.05

If the specified parameter is out of the allowable setup range, the minimum value (if the lower limit of the range is not reached) or the maximum value (if the upper limit of the range is exceeded) is set.

Query response {numeric}<newline><^END>

Example of use
10 OUTPUT 717; ":SOUR1:POW:STAR -10"
20 OUTPUT 717; ":SOUR1:POW:STAR?"
30 ENTER 717;A

Related commands
:SENS{1-16}:SWE:TYPE on page 696
:SOUR{1-16}:POW:ATT on page 705
:SOUR{1-16}:POW:STOP on page 721

Equivalent key [Start]

:SOUR{1-16}:POW:STOP

Syntax :SOURce{[1]|2|3|4|5|6|7|8|9|10|11|12|13|14|15|16}:POWer:STOP <numeric>
:SOURce{[1]|2|3|4|5|6|7|8|9|10|11|12|13|14|15|16}:POWer:STOP?

Description Sets the stop value of the sweep range for the power sweep for channel 1 (:SOUR1) to channel 16 (:SOUR16).

Parameters

	<numeric>
Description	Stop value
Range	Varies depending on the power range.
Preset value	0
Unit	dBm
Resolution	0.05

If the specified parameter is out of the allowable setup range, the minimum value (if the lower limit of the range is not reached) or the maximum value (if the upper limit of the range is exceeded) is set.

Query response {numeric}<newline><^END>

Example of use
10 OUTPUT 717;":SOUR1:POW:STOP 10"
20 OUTPUT 717;":SOUR1:POW:STOP?"
30 ENTER 717;A

Related commands
:SENS{1-16}:SWE:TYPE on page 696
:SOUR{1-16}:POW:ATT on page 705
:SOUR{1-16}:POW:STAR on page 720

Equivalent key [Stop]

:STAT:OPER?

Syntax	:STATus:OPERation[:EVENT]?
Description	Reads out the value of the Operation Status Event Register. (Query only)
Query response	{numeric}<newline><^END>
Example of use	10 OUTPUT 717; ":STAT:OPER?" 20 ENTER 717;A
Related commands	*CLS on page 286
Equivalent key	No equivalent key is available on the front panel.

:STAT:OPER:COND?

Syntax	:STATus:OPERation:CONDition?
Description	Reads out the value of the Operation Status Condition Register. (Query only)
Query response	{numeric}<newline><^END>
Example of use	10 OUTPUT 717; ":STAT:OPER:COND?" 20 ENTER 717;A
Related commands	:STAT:OPER:NTR on page 724 :STAT:OPER:PTR on page 725
Equivalent key	No equivalent key is available on the front panel.

:STAT:OPER:ENAB

Syntax :STATus:OPERation:ENABle <numeric>
:STATus:OPERation:ENABle?

Description Sets the value of the Operation Status Enable Register.

Parameters

	<numeric>
Description	Value of the enable register
Range	0 to 65535
Preset value	0
Resolution	1

Note that bit 0 to bit 3, bit 6 to bit 13 and bit 15 cannot be set to 1.

Query response {numeric}<newline><^END>

Example of use

```
10  OUTPUT 717;":STAT:OPER:ENAB 16"
20  OUTPUT 717;":STAT:OPER:ENAB?"
30  ENTER 717;A
```

Related commands *SRE on page 290

Equivalent key No equivalent key is available on the front panel.

:STAT:OPER:NTR

Syntax :STATus:OPERation:NTRansition <numeric>
:STATus:OPERation:NTRansition?

Description Sets the value of negative transition filter of the Operation Status Register.

Parameters

	<numeric>
Description	Value of the negative transition filter
Range	0 to 65535
Preset value	0
Resolution	1

Note that bit 0 to bit 3, bit 6 to bit 13 and bit 15 cannot be set to 1.

Query response {numeric}<newline><^END>

Example of use
10 OUTPUT 717; ":STAT:OPER:NTR 16"
20 OUTPUT 717; ":STAT:OPER:NTR?"
30 ENTER 717;A

Related commands :STAT:OPER? on page 722
:STAT:OPER:PTR on page 725

Equivalent key No equivalent key is available on the front panel.

:STAT:OPER:PTR

Syntax :STATus:OPERation:PTRansition <numeric>
:STATus:OPERation:PTRansition?

Description Sets the value of positive transition filter of the Operation Status Register.

Parameters

	<numeric>
Description	Value of the positive transition filter
Range	0 to 65535
Preset value	16432
Resolution	1

Note that bit 0 to bit 3, bit 6 to bit 13 and bit 15 cannot be set to 1.

Query response {numeric}<newline><^END>

Example of use

```
10 OUTPUT 717;":STAT:OPER:PTR 16"
20 OUTPUT 717;":STAT:OPER:PTR?"
30 ENTER 717;A
```

Related commands :STAT:OPER? on page 722
:STAT:OPER:NTR on page 724

Equivalent key No equivalent key is available on the front panel.

:STAT:PRES

Syntax	:STATus:PRESet
Description	Initialize the Operation Status Register, Questionable Status Register, Questionable Limit Status Register, Questionable Limit Extra Status Register, Questionable Limit Channel Status Register, and Questionable Limit Channel Extra Status Register. (No query)
Equivalent key	No equivalent key is available on the front panel.

:STAT:QUES?

Syntax	:STATus:QUEStionable[:EVENT]?
Description	Reads out the value of the Questionable Status Event Register. (Query only)
Query response	{numeric}<newline><^END>
Example of use	10 OUTPUT 717; ":STAT:QUES?" 20 ENTER 717;A
Related commands	*CLS on page 286
Equivalent key	No equivalent key is available on the front panel.

:STAT:QUES:BLIM?

Syntax	:STATus:QUEStionable:BLIMit[:EVENT]?
Description	Reads out the value of the Questionable Bandwidth Limit Status Event Register. (Query only)
Query response	{numeric}<newline><^END>
Example of use	10 OUTPUT 717; ":STAT:QUES:BLIM?" 20 ENTER 717;A
Related commands	*CLS on page 286
Equivalent key	No equivalent key is available on the front panel.

:STAT:QUES:BLIM:CHAN{1-16}?

Syntax	:STATus:QUEStionable:BLIMit:CHANnel{[1] 2 3 4 5 6 7 8 9 10 11 12 13 14 15 16}[:EVENT]?
Description	Reads out the value of the Questionable Bandwidth Limit Channel Status Event Register of channel 1 (:CHAN1) to channel 16 (:CHAN16). (Query only)
Query response	{numeric}<newline><^END>
Example of use	10 OUTPUT 717; ":STAT:QUES:BLIM:CHAN1?" 20 ENTER 717;A
Related commands	*CLS on page 286
Equivalent key	No equivalent key is available on the front panel.

:STAT:QUES:BLIM:CHAN{1-16}:COND?

Syntax	:STATus:QUEStionable:BLIMit:CHANnel{[1] 2 3 4 5 6 7 8 9 10 11 12 13 14 15 16}:CONDition?
Description	Reads out the value of the Questionable Bandwidth Limit Channel Status Condition Register of channel 1 (:CHAN1) to channel 16 (:CHAN16). (Query only)
Query response	{numeric}<newline><^END>
Example of use	10 OUTPUT 717; ":STAT:QUES:BLIM:CHAN1:COND?" 20 ENTER 717;A
Related commands	:STAT:QUES:BLIM:CHAN{1-16}:NTR on page 734 :STAT:QUES:BLIM:CHAN{1-16}:PTR on page 735

Equivalent key No equivalent key is available on the front panel.

:STAT:QUES:BLIM:CHAN{1-16}:ECH?

Syntax	:STATus:QUEStionable:BLIMit:CHANnel{[1] 2 3 4 5 6 7 8 9 10 11 12 13 14 15 16}:ECHannel[:EVENT]?
Description	Reads out the value of the Questionable Bandwidth Limit Channel Extra Status Event Register of channel 1 (:CHAN1) to channel 16 (:CHAN16). (Query only)
Query response	{numeric}<newline><^END>
Example of use	10 OUTPUT 717; ":STAT:QUES:BLIM:CHAN1:ECH?" 20 ENTER 717;A
Related commands	*CLS on page 286
Equivalent key	No equivalent key is available on the front panel.

:STAT:QUES:BLIM:CHAN{1-16}:ECH:COND?

Syntax	:STATus:QUEStionable:BLIMit:CHANnel{[1] 2 3 4 5 6 7 8 9 10 11 12 13 14 15 16}:ECHannel:CONDition?
Description	Reads out the value of the Questionable Bandwidth Limit Channel Extra Status Condition Register of channel 1 (:CHAN1) to channel 16 (:CHAN16). (Query only)
Query response	{numeric}<newline><^END>
Example of use	10 OUTPUT 717; ":STAT:QUES:BLIM:CHAN1:ECH:COND?" 20 ENTER 717;A
Related commands	:STAT:QUES:BLIM:CHAN{1-16}:ECH:NTR on page 731 :STAT:QUES:BLIM:CHAN{1-16}:ECH:PTR on page 732
Equivalent key	No equivalent key is available on the front panel.

:STAT:QUES:BLIM:CHAN{1-16}:ECH:ENAB

Syntax

```
:STATus:QUEStionable:BLIMit:CHANnel{[1]|2|3|4|5|6|7|8|9|10|11|12|13|14|15|16}:ECHannel:ENABle  
<numeric>  
:STATus:QUEStionable:BLIMit:CHANnel{[1]|2|3|4|5|6|7|8|9|10|11|12|13|14|15|16}:ECHannel:ENABle?
```

Description

Sets the value of the Questionable Bandwidth Limit Channel Extra Status Enable Register of channel 1 (:CHAN1) to channel 16 (:CHAN16).

Parameters

	<numeric>
Description	Value of the enable register
Range	0 to 65535
Preset value	Varies depending on the upper limit setting for channel/trace number.
Resolution	1

Bits 0 and 3 to 15 cannot be set to 1.

Query response

```
{numeric}<newline><^END>
```

Example of use

```
10 OUTPUT 717; ":STAT:QUES:BLIM:CHAN1:ECH:ENAB 6"  
20 OUTPUT 717; ":STAT:QUES:BLIM:CHAN1:ECH:ENAB?"  
30 ENTER 717;A
```

Related commands

:STAT:QUES:BLIM:CHAN{1-16}:ENAB on page 733

Equivalent key

No equivalent key is available on the front panel.

:STAT:QUES:BLIM:CHAN{1-16}:ECH:NTR

Syntax

```
:STATus:QUEStionable:BLIMit:CHANnel{[1]|2|3|4|5|6|7|8|9|10|11|12|13|14|15|16}:ECHannel:NTRansition
<numeric>
:STATus:QUEStionable:BLIMit:CHANnel{[1]|2|3|4|5|6|7|8|9|10|11|12|13|14|15|16}:ECHannel:NTRansition?
```

Description

Sets the value of the negative transition filter of the Questionable Bandwidth Limit Channel Extra Status Register of channel 1 (:CHAN1) to channel 16 (:CHAN16).

Parameters

	<numeric>
Description	Value of the negative transition filter
Range	0 to 65535
Preset value	0
Resolution	1

Bits 0 and 3 to 15 cannot be set to 1.

Query response

```
{numeric}<newline><^END>
```

Example of use

```
10 OUTPUT 717;":STAT:QUES:BLIM:CHAN1:ECH:NTR 6"
20 OUTPUT 717;":STAT:QUES:BLIM:CHAN1:ECH:NTR?"
30 ENTER 717;A
```

Related commands

:STAT:QUES:BLIM:CHAN{1-16}:ECH? on page 729

:STAT:QUES:BLIM:CHAN{1-16}:ECH:PTR on page 732

Equivalent key

No equivalent key is available on the front panel.

:STAT:QUES:BLIM:CHAN{1-16}:ECH:PTR

Syntax

```
:STATus:QUEStionable:BLIMit:CHANnel{[1]|2|3|4|5|6|7|8|9|10|11|12|13|14|15|16}:ECHannel:PTRansition  
<numeric>  
:STATus:QUEStionable:BLIMit:CHANnel{[1]|2|3|4|5|6|7|8|9|10|11|12|13|14|15|16}:ECHannel:PTRansition?
```

Description

Sets the value of the positive transition filter of the Questionable Bandwidth Limit Channel Extra Status Register of channel 1 (:CHAN1) to channel 16 (:CHAN16).

Parameters

	<numeric>
Description	Value of the positive transition filter
Range	0 to 65535
Preset value	Varies depending on the upper limit setting for channel/trace number.
Resolution	1

Bits 0 and 3 to 15 cannot be set to 1.

Query response

{numeric}<newline><^END>

Example of use

```
10  OUTPUT 717; ":STAT:QUES:BLIM:CHAN1:ECH:PTR 6"  
20  OUTPUT 717; ":STAT:QUES:BLIM:CHAN1:ECH:PTR?"  
30  ENTER 717;A
```

Related commands

:STAT:QUES:BLIM:CHAN{1-16}:ECH? on page 729
:STAT:QUES:BLIM:CHAN{1-16}:ECH:NTR on page 731

Equivalent key

No equivalent key is available on the front panel.

:STAT:QUES:BLIM:CHAN{1-16}:ENAB

Syntax :STATus:QUEStionable:BLIMit:CHANnel{[1]|2|3|4|5|6|7|8|9|10|11|12|13|14|15|16}:ENABle
<numeric>
:STATus:QUEStionable:BLIMit:CHANnel{[1]|2|3|4|5|6|7|8|9|10|11|12|13|14|15|16}:ENABle?

Description Sets the value of the Questionable Bandwidth Limit Channel Status Enable Register of channel 1 (:CHAN1) to channel 16 (:CHAN16).

Parameters

	<numeric>
Description	Value of the enable register
Range	0 to 65535
Preset value	Varies depending on the upper limit setting for channel/trace number.
Resolution	1

Note that bit 15 cannot be set to 1.

Query response {numeric}<newline><^END>

Example of use
10 OUTPUT 717; ":STAT:QUES:BLIM:CHAN1:ENAB 16"
20 OUTPUT 717; ":STAT:QUES:BLIM:CHAN1:ENAB?"
30 ENTER 717;A

Related commands :STAT:QUES:BLIM:ENAB on page 740

Equivalent key No equivalent key is available on the front panel.

:STAT:QUES:BLIM:CHAN{1-16}:NTR

Syntax :STATus:QUEStionable:BLIMit:CHANnel{[1]|2|3|4|5|6|7|8|9|10|11|12|13|14|15|16}:NTRansition
<numeric>
:STATus:QUEStionable:BLIMit:CHANnel{[1]|2|3|4|5|6|7|8|9|10|11|12|13|14|15|16}:NTRansition?

Description Sets the value of the negative transition filter of the Questionable Bandwidth Limit Channel Status Register of channel 1 (:CHAN1) to channel 16 (:CHAN16).

Parameters

	<numeric>
Description	Value of the negative transition filter
Range	0 to 65535
Preset value	0
Resolution	1

Note that bit 15 cannot be set to 1.

Query response {numeric}<newline><^END>

Example of use
10 OUTPUT 717; ":STAT:QUES:BLIM:CHAN1:NTR 16"
20 OUTPUT 717; ":STAT:QUES:BLIM:CHAN1:NTR?"
30 ENTER 717;A

Related commands :STAT:QUES:BLIM:CHAN{1-16}? on page 727
:STAT:QUES:BLIM:CHAN{1-16}:PTR on page 735

Equivalent key No equivalent key is available on the front panel.

:STAT:QUES:BLIM:CHAN{1-16}:PTR

Syntax :STATus:QUEStionable:BLIMit:CHANnel{[1]|2|3|4|5|6|7|8|9|10|11|12|13|14|15|16}:PTRansition
<numeric>
:STATus:QUEStionable:BLIMit:CHANnel{[1]|2|3|4|5|6|7|8|9|10|11|12|13|14|15|16}:PTRansition?

Description Sets the value of the positive transition filter of the Questionable Bandwidth Limit Channel Status Register of channel 1 (:CHAN1) to channel 16 (:CHAN16).

Parameters

	<numeric>
Description	Value of the positive transition filter
Range	0 to 65535
Preset value	Varies depending on the upper limit setting for channel/trace number.
Resolution	1

Note that bit 15 cannot be set to 1.

Query response {numeric}<newline><^END>

Example of use
10 OUTPUT 717; ":STAT:QUES:BLIM:CHAN1:PTR 16"
20 OUTPUT 717; ":STAT:QUES:BLIM:CHAN1:PTR?"
30 ENTER 717;A

Related commands :STAT:QUES:BLIM:CHAN{1-16}? on page 727
:STAT:QUES:BLIM:CHAN{1-16}:NTR on page 734

Equivalent key No equivalent key is available on the front panel.

:STAT:QUES:BLIM:COND?

Syntax :STATus:QUEStionable:BLIMit:CONDition?

Description Reads out the value of the Questionable Bandwidth Limit Status Condition Register. (Query only)

Query response {numeric}<newline><^END>

Example of use
10 OUTPUT 717; ":STAT:QUES:BLIM:COND?"
20 ENTER 717;A

Related commands :STAT:QUES:BLIM:NTR on page 741
:STAT:QUES:BLIM:PTR on page 742

Equivalent key No equivalent key is available on the front panel.

:STAT:QUES:BLIM:ELIM?

Syntax	:STATus:QUEStionable:BLIMit:ELIMit[:EVENT]?
Description	Reads out the value of the Questionable Bandwidth Limit Extra Status Event Register. (Query only)
Query response	{numeric}<newline><^END>
Example of use	10 OUTPUT 717; ":STAT:QUES:BLIM:ELIM?" 20 ENTER 717;A
Related commands	*CLS on page 286
Equivalent key	No equivalent key is available on the front panel.

:STAT:QUES:BLIM:ELIM:COND?

Syntax	:STATus:QUEStionable:BLIMit:ELIMit:CONDition?
Description	Reads out the value of the Questionable Bandwidth Limit Extra Status Condition Register. (Query only)
Query response	{numeric}<newline><^END>
Example of use	10 OUTPUT 717; ":STAT:QUES:BLIM:ELIM:COND?" 20 ENTER 717;A
Related commands	:STAT:QUES:BLIM:ELIM:NTR on page 738 :STAT:QUES:BLIM:ELIM:PTR on page 739
Equivalent key	No equivalent key is available on the front panel.

:STAT:QUES:BLIM:ELIM:ENAB

Syntax :STATus:QUEStionable:BLIMit:ELIMit:ENABle <numeric>
:STATus:QUEStionable:BLIMit:ELIMit:ENABle?

Description Sets the value of the Questionable Bandwidth Limit Extra Status Enable Register.

Parameters

	<numeric>
Description	Value of the enable register
Range	0 to 65535
Preset value	Varies depending on the upper limit setting for channel/trace number.
Resolution	1

Bits 0 and 3 to 15 cannot be set to 1.

Query response {numeric}<newline><^END>

Example of use
10 OUTPUT 717;":STAT:QUES:BLIM:ELIM:ENAB 6"
20 OUTPUT 717;":STAT:QUES:BLIM:ELIM:ENAB?"
30 ENTER 717;A

Related commands :STAT:QUES:BLIM:ENAB on page 740

Equivalent key No equivalent key is available on the front panel.

:STAT:QUES:BLIM:ELIM:NTR

Syntax :STATus:QUEStionable:BLIMit:ELIMit:NTRansition <numeric>
:STATus:QUEStionable:BLIMit:ELIMit:NTRansition?

Description Sets the value of the negative transition filter of the Questionable Bandwidth Limit Extra Status Register.

Parameters

	<numeric>
Description	Value of the negative transition filter
Range	0 to 65535
Preset value	0
Resolution	1

Bits 0 and 3 to 15 cannot be set to 1.

Query response {numeric}<newline><^END>

Example of use
10 OUTPUT 717; ":STAT:QUES:BLIM:ELIM:NTR 6"
20 OUTPUT 717; ":STAT:QUES:BLIM:ELIM:NTR?"
30 ENTER 717;A

Related commands :STAT:QUES:BLIM:ELIM? on page 736

:STAT:QUES:BLIM:ELIM:PTR on page 739

Equivalent key No equivalent key is available on the front panel.

:STAT:QUES:BLIM:ELIM:PTR

Syntax :STATus:QUEStionable:BLIMit:ELIMit:PTRansition <numeric>
:STATus:QUEStionable:BLIMit:ELIMit:PTRansition?

Description Sets the value of the positive transition filter of the Questionable Bandwidth Limit Extra Status Register.

Parameters

	<numeric>
Description	Value of the positive transition filter
Range	0 to 65535
Preset value	Varies depending on the upper limit setting for channel/trace number.
Resolution	1

Bits 0 and 3 to 15 cannot be set to 1.

Query response {numeric}<newline><^END>

Example of use
10 OUTPUT 717;":STAT:QUES:BLIM:ELIM:PTR 6"
20 OUTPUT 717;":STAT:QUES:BLIM:ELIM:PTR?"
30 ENTER 717;A

Related commands :STAT:QUES:BLIM:ELIM? on page 736
:STAT:QUES:BLIM:ELIM:NTR on page 738

Equivalent key No equivalent key is available on the front panel.

:STAT:QUES:BLIM:ENAB

Syntax :STATus:QUEStionable:BLIMit:ENABle <numeric>
:STATus:QUEStionable:BLIMit:ENABle?

Description Sets the value of the Questionable Bandwidth Limit Status Enable Register.

Parameters

	<numeric>
Description	Value of the enable register
Range	0 to 65535
Preset value	Varies depending on the upper limit setting for channel/trace number.
Resolution	1

Note that bit 15 cannot be set to 1.

Query response {numeric}<newline><^END>

Example of use
10 OUTPUT 717; ":STAT:QUES:BLIM:ENAB 16"
20 OUTPUT 717; ":STAT:QUES:BLIM:ENAB?"
30 ENTER 717;A

Related commands :STAT:QUES:ENAB on page 744

Equivalent key No equivalent key is available on the front panel.

:STAT:QUES:BLIM:NTR

Syntax :STATus:QUEStionable:BLIMit:NTRansition <numeric>
:STATus:QUEStionable:BLIMit:NTRansition?

Description Sets the value of the negative transition filter of the Questionable Bandwidth Limit Status Register.

Parameters

	<numeric>
Description	Value of the negative transition filter
Range	0 to 65535
Preset value	0
Resolution	1

Note that bit 15 cannot be set to 1.

Query response {numeric}<newline><^END>

Example of use

```
10 OUTPUT 717;":STAT:QUES:BLIM:NTR 16"
20 OUTPUT 717;":STAT:QUES:BLIM:NTR?"
30 ENTER 717;A
```

Related commands :STAT:QUES:BLIM? on page 727
:STAT:QUES:BLIM:PTR on page 742

Equivalent key No equivalent key is available on the front panel.

:STAT:QUES:BLIM:PTR

Syntax :STATus:QUEStionable:BLIMit:PTRansition <numeric>
:STATus:QUEStionable:BLIMit:PTRansition?

Description Sets the value of the positive transition filter of the Questionable Bandwidth Limit Status Register.

Parameters

	<numeric>
Description	Value of the positive transition filter
Range	0 to 65535
Preset value	Varies depending on the upper limit setting for channel/trace number.
Resolution	1

Note that bit 15 cannot be set to 1.

Query response {numeric}<newline><^END>

Example of use
10 OUTPUT 717; ":STAT:QUES:BLIM:PTR 16"
20 OUTPUT 717; ":STAT:QUES:BLIM:PTR?"
30 ENTER 717;A

Related commands :STAT:QUES:BLIM? on page 727
:STAT:QUES:BLIM:NTR on page 741

Equivalent key No equivalent key is available on the front panel.

:STAT:QUES:COND?

Syntax	:STATus:QUEStionable:CONDition?
Description	Reads out the value of the Questionable Status Condition Register. (Query only)
Query response	{numeric}<newline><^END>
Example of use	10 OUTPUT 717; ":STAT:QUES:COND?" 20 ENTER 717;A
Related commands	:STAT:QUES:NTR on page 761 :STAT:QUES:PTR on page 762
Equivalent key	No equivalent key is available on the front panel.

:STAT:QUES:ENAB

Syntax :STATus:QUEStionable:ENABle <numeric>
:STATus:QUEStionable:ENABle?

Description Sets the value of the Questionable Status Enable Register.

Parameters

	<numeric>
Description	Value of the enable register
Range	0 to 65535
Preset value	0
Resolution	1

Note that bit 0 to bit 9 and bit 12 to bit 15 cannot be set to 1.

Query response {numeric}<newline><^END>

Example of use
10 OUTPUT 717; ":STAT:QUES:ENAB 16"
20 OUTPUT 717; ":STAT:QUES:ENAB?"
30 ENTER 717;A

Related commands *SRE on page 290

Equivalent key No equivalent key is available on the front panel.

:STAT:QUES:LIM?

Syntax	:STATus:QUEStionable:LIMit[:EVENT]?
Description	Reads out the value of the Questionable Limit Status Event Register. (Query only)
Query response	{numeric}<newline><^END>
Example of use	10 OUTPUT 717; ":STAT:QUES:LIM?" 20 ENTER 717;A
Related commands	*CLS on page 286
Equivalent key	No equivalent key is available on the front panel.

:STAT:QUES:LIM:CHAN{1-16}?

Syntax	:STATus:QUEStionable:LIMit:CHANnel{[1] 2 3 4 5 6 7 8 9 10 11 12 13 14 15 16}[:EVENT]?
Description	Reads out the value of the Questionable Limit Channel Status Event Register of channel 1 (:CHAN1) to channel 16 (:CHAN16). (Query only)
Query response	{numeric}<newline><^END>
Example of use	10 OUTPUT 717; ":STAT:QUES:LIM:CHAN1?" 20 ENTER 717;A
Related commands	*CLS on page 286
Equivalent key	No equivalent key is available on the front panel.

:STAT:QUES:LIM:CHAN{1-16}:COND?

Syntax	:STATus:QUEStionable:LIMit:CHANnel{[1] 2 3 4 5 6 7 8 9 10 11 12 13 14 15 16}:CONDition?
Description	Reads out the value of the Questionable Limit Channel Status Condition Register of channel 1 (:CHAN1) to channel 16 (:CHAN16). (Query only)
Query response	{numeric}<newline><^END>
Example of use	10 OUTPUT 717; ":STAT:QUES:LIM:CHAN1:COND?" 20 ENTER 717;A
Related commands	:STAT:QUES:LIM:CHAN{1-16}:NTR on page 752 :STAT:QUES:LIM:CHAN{1-16}:PTR on page 753

Equivalent key No equivalent key is available on the front panel.

:STAT:QUES:LIM:CHAN{1-16}:ECH?

Syntax	:STATus:QUEStionable:LIMit:CHANnel{[1] 2 3 4 5 6 7 8 9 10 11 12 13 14 15 16}:ECHannel[:EVENT]?
Description	Reads out the value of the Questionable Limit Channel Extra Status Event Register of channel 1 (:CHAN1) to channel 16 (:CHAN16). (Query only)
Query response	{numeric}<newline><^END>
Example of use	10 OUTPUT 717; ":STAT:QUES:LIM:CHAN1:ECH?" 20 ENTER 717;A
Related commands	*CLS on page 286
Equivalent key	No equivalent key is available on the front panel.

:STAT:QUES:LIM:CHAN{1-16}:ECH:COND?

Syntax	:STATus:QUEStionable:LIMit:CHANnel{[1] 2 3 4 5 6 7 8 9 10 11 12 13 14 15 16}:ECHannel:CONDition?
Description	Reads out the value of the Questionable Limit Channel Extra Status Condition Register of channel 1 (:CHAN1) to channel 16 (:CHAN16). (Query only)
Query response	{numeric}<newline><^END>
Example of use	10 OUTPUT 717; ":STAT:QUES:LIM:CHAN1:ECH:COND?" 20 ENTER 717;A
Related commands	:STAT:QUES:LIM:CHAN{1-16}:ECH:NTR on page 749 :STAT:QUES:LIM:CHAN{1-16}:ECH:PTR on page 750
Equivalent key	No equivalent key is available on the front panel.

:STAT:QUES:LIM:CHAN{1-16}:ECH:ENAB

Syntax

:STATus:QUEStionable:LIMit:CHANnel{[1]|2|3|4|5|6|7|8|9|10|11|12|13|14|15|16}:ECHannel:ENABle <numeric>
:STATus:QUEStionable:LIMit:CHANnel{[1]|2|3|4|5|6|7|8|9|10|11|12|13|14|15|16}:ECHannel:ENABle?

Description

Sets the value of the Questionable Limit Channel Extra Status Enable Register of channel 1 (:CHAN1) to channel 16 (:CHAN16).

Parameters

	<numeric>
Description	Value of the enable register
Range	0 to 65535
Preset value	Varies depending on the upper limit setting for channel/trace number.
Resolution	1

Bits 0 and 3 to 15 cannot be set to 1.

Query response

{numeric}<newline><^END>

Example of use

```
10 OUTPUT 717; ":STAT:QUES:LIM:CHAN1:ECH:ENAB 6"  
20 OUTPUT 717; ":STAT:QUES:LIM:CHAN1:ECH:ENAB?"  
30 ENTER 717;A
```

Related commands

:STAT:QUES:LIM:CHAN{1-16}:ENAB on page 751

Equivalent key

No equivalent key is available on the front panel.

:STAT:QUES:LIM:CHAN{1-16}:ECH:NTR

Syntax

```
:STATus:QUEStionable:LIMit:CHANnel{[1]|2|3|4|5|6|7|8|9|10|11|12|13|14|15|16}:ECHannel:NTRansition <numeric>
:STATus:QUEStionable:LIMit:CHANnel{[1]|2|3|4|5|6|7|8|9|10|11|12|13|14|15|16}:ECHannel:NTRansition?
```

Description

Sets the value of the negative transition filter of the Questionable Limit Channel Extra Status Register of channel 1 (:CHAN1) to channel 16 (:CHAN16).

Parameters

	<numeric>
Description	Value of the negative transition filter
Range	0 to 65535
Preset value	0
Resolution	1

Bits 0 and 3 to 15 cannot be set to 1.

Query response

```
{numeric}<newline><^END>
```

Example of use

```
10 OUTPUT 717; ":STAT:QUES:LIM:CHAN1:ECH:NTR 6"
20 OUTPUT 717; ":STAT:QUES:LIM:CHAN1:ECH:NTR?"
30 ENTER 717;A
```

Related commands

:STAT:QUES:LIM:CHAN{1-16}:ECH? on page 747

:STAT:QUES:LIM:CHAN{1-16}:ECH:PTR on page 750

Equivalent key

No equivalent key is available on the front panel.

:STAT:QUES:LIM:CHAN{1-16}:ECH:PTR

Syntax

```
:STATus:QUEStionable:LIMit:CHANnel{[1]|2|3|4|5|6|7|8|9|10|11|12|13|14|15|16}:ECHannel:PTRansition <numeric>  
:STATus:QUEStionable:LIMit:CHANnel{[1]|2|3|4|5|6|7|8|9|10|11|12|13|14|15|16}:ECHannel:PTRansition?
```

Description

Sets the value of the positive transition filter of the Questionable Limit Channel Extra Status Register of channel 1 (:CHAN1) to channel 16 (:CHAN16).

Parameters

	<numeric>
Description	Value of the positive transition filter
Range	0 to 65535
Preset value	Varies depending on the upper limit setting for channel/trace number.
Resolution	1

Bits 0 and 3 to 15 cannot be set to 1.

Query response

```
{numeric}<newline><^END>
```

Example of use

```
10  OUTPUT 717; ":STAT:QUES:LIM:CHAN1:ECH:PTR 6"  
20  OUTPUT 717; ":STAT:QUES:LIM:CHAN1:ECH:PTR?"  
30  ENTER 717;A
```

Related commands

:STAT:QUES:LIM:CHAN{1-16}:ECH? on page 747
:STAT:QUES:LIM:CHAN{1-16}:ECH:NTR on page 749

Equivalent key

No equivalent key is available on the front panel.

:STAT:QUES:LIM:CHAN{1-16}:ENAB

Syntax

```
:STATus:QUEStionable:LIMit:CHANnel{[1]|2|3|4|5|6|7|8|9|10|11|12|13|14|15|16}:ENABle <numeric>
:STATus:QUEStionable:LIMit:CHANnel{[1]|2|3|4|5|6|7|8|9|10|11|12|13|14|15|16}:ENABle?
```

Description

Sets the value of the Questionable Limit Channel Status Enable Register of channel 1 (:CHAN1) to channel 16 (:CHAN16).

Parameters

	<numeric>
Description	Value of the enable register
Range	0 to 65535
Preset value	Varies depending on the upper limit setting for channel/trace number.
Resolution	1

Note that bit 15 cannot be set to 1.

Query response

```
{numeric}<newline><^END>
```

Example of use

```
10 OUTPUT 717; ":STAT:QUES:LIM:CHAN1:ENAB 16"
20 OUTPUT 717; ":STAT:QUES:LIM:CHAN1:ENAB?"
30 ENTER 717;A
```

Related commands

:STAT:QUES:LIM:ENAB on page 758

Equivalent key

No equivalent key is available on the front panel.

:STAT:QUES:LIM:CHAN{1-16}:NTR

Syntax :STATus:QUEStionable:LIMit:CHANnel{[1]|2|3|4|5|6|7|8|9|10|11|12|13|14|15|16}:NTRansition <numeric>
:STATus:QUEStionable:LIMit:CHANnel{[1]|2|3|4|5|6|7|8|9|10|11|12|13|14|15|16}:NTRansition?

Description Sets the value of the negative transition filter of the Questionable Limit Channel Status Register of channel 1 (:CHAN1) to channel 16 (:CHAN16).

Parameters

	<numeric>
Description	Value of the negative transition filter
Range	0 to 65535
Preset value	0
Resolution	1

Note that bit 15 cannot be set to 1.

Query response {numeric}<newline><^END>

Example of use
10 OUTPUT 717; ":STAT:QUES:LIM:CHAN1:NTR 16"
20 OUTPUT 717; ":STAT:QUES:LIM:CHAN1:NTR?"
30 ENTER 717;A

Related commands :STAT:QUES:LIM:CHAN{1-16}? on page 745
:STAT:QUES:LIM:CHAN{1-16}:PTR on page 753

Equivalent key No equivalent key is available on the front panel.

:STAT:QUES:LIM:CHAN{1-16}:PTR

Syntax

```
:STATus:QUEStionable:LIMit:CHANnel{[1]|2|3|4|5|6|7|8|9|10|11|12|13|14|15|16}:PTRansition <numeric>  
:STATus:QUEStionable:LIMit:CHANnel{[1]|2|3|4|5|6|7|8|9|10|11|12|13|14|15|16}:PTRansition?
```

Description

Sets the value of the positive transition filter of the Questionable Limit Channel Status Register of channel 1 (:CHAN1) to channel 16 (:CHAN16).

Parameters

	<numeric>
Description	Value of the positive transition filter
Range	0 to 65535
Preset value	Varies depending on the upper limit setting for channel/trace number.
Resolution	1

Note that bit 15 cannot be set to 1.

Query response

```
{numeric}<newline><^END>
```

Example of use

```
10 OUTPUT 717; ":STAT:QUES:LIM:CHAN1:PTR 16"  
20 OUTPUT 717; ":STAT:QUES:LIM:CHAN1:PTR?"  
30 ENTER 717;A
```

Related commands

:STAT:QUES:LIM:CHAN{1-16}? on page 745
:STAT:QUES:LIM:CHAN{1-16}:NTR on page 752

Equivalent key

No equivalent key is available on the front panel.

:STAT:QUES:LIM:COND?

Syntax	:STATus:QUEStionable:LIMit:CONDition?
Description	Reads out the value of the Questionable Limit Status Condition Register. (Query only)
Query response	{numeric}<newline><<^END>
Example of use	10 OUTPUT 717; ":STAT:QUES:LIM:COND?" 20 ENTER 717;A
Related commands	:STAT:QUES:LIM:NTR on page 759 :STAT:QUES:LIM:PTR on page 760
Equivalent key	No equivalent key is available on the front panel.

:STAT:QUES:LIM:ELIM?

Syntax	:STATus:QUEStionable:LIMit:ELIMit[:EVENT]?
Description	Reads out the value of the Questionable Limit Extra Status Event Register. (Query only)
Query response	{numeric}<newline><<^END>
Example of use	10 OUTPUT 717; ":STAT:QUES:LIM:ELIM?" 20 ENTER 717;A
Related commands	*CLS on page 286
Equivalent key	No equivalent key is available on the front panel.

:STAT:QUES:LIM:ELIM:COND?

Syntax	:STATus:QUEStionable:LIMit:ELIMit:CONDition?
Description	Reads out the value of the Questionable Limit Extra Status Condition Register. (Query only)
Query response	{numeric}<newline><^END>
Example of use	10 OUTPUT 717; ":STAT:QUES:LIM:ELIM:COND?" 20 ENTER 717;A
Related commands	:STAT:QUES:LIM:ELIM:NTR on page 756 :STAT:QUES:LIM:ELIM:PTR on page 757
Equivalent key	No equivalent key is available on the front panel.

:STAT:QUES:LIM:ELIM:ENAB

Syntax	:STATus:QUEStionable:LIMit:ELIMit:ENABLE <numeric> :STATus:QUEStionable:LIMit:ELIMit:ENABle?
Description	Sets the value of the Questionable Limit Extra Status Enable Register.
Parameters	

	<numeric>
Description	Value of the enable register
Range	0 to 65535
Preset value	Varies depending on the upper limit setting for channel/trace number.
Resolution	1

Bits 0 and 3 to 15 cannot be set to 1.

Query response	{numeric}<newline><^END>
Example of use	10 OUTPUT 717; ":STAT:QUES:LIM:ELIM:ENAB 6" 20 OUTPUT 717; ":STAT:QUES:LIM:ELIM:ENAB?" 30 ENTER 717;A
Related commands	:STAT:QUES:LIM:ENAB on page 758
Equivalent key	No equivalent key is available on the front panel.

:STAT:QUES:LIM:ELIM:NTR

Syntax :STATus:QUEStionable:LIMit:ELIMit:NTRansition <numeric>
:STATus:QUEStionable:LIMit:ELIMit:NTRansition?

Description Sets the value of the negative transition filter of the Questionable Limit Extra Status Register.

Parameters

	<numeric>
Description	Value of the negative transition filter
Range	0 to 65535
Preset value	0
Resolution	1

Bits 0 and 3 to 15 cannot be set to 1.

Query response {numeric}<newline><^END>

Example of use
10 OUTPUT 717; ":STAT:QUES:LIM:ELIM:NTR 6"
20 OUTPUT 717; ":STAT:QUES:LIM:ELIM:NTR?"
30 ENTER 717;A

Related commands :STAT:QUES:LIM:ELIM? on page 754
:STAT:QUES:LIM:ELIM:PTR on page 757

Equivalent key No equivalent key is available on the front panel.

:STAT:QUES:LIM:ELIM:PTR

Syntax :STATus:QUEStionable:LIMit:ELIMit:PTRansition <numeric>
:STATus:QUEStionable:LIMit:ELIMit:PTRansition?

Description Sets the value of the positive transition filter of the Questionable Limit Extra Status Register.

Parameters

	<numeric>
Description	Value of the positive transition filter
Range	0 to 65535
Preset value	Varies depending on the upper limit setting for channel/trace number.
Resolution	1

Bits 0 and 3 to 15 cannot be set to 1.

Query response {numeric}<newline><^END>

Example of use

```
10 OUTPUT 717;":STAT:QUES:LIM:ELIM:PTR 6"
20 OUTPUT 717;":STAT:QUES:LIM:ELIM:PTR?"
30 ENTER 717;A
```

Related commands :STAT:QUES:LIM:ELIM? on page 754
:STAT:QUES:LIM:ELIM:NTR on page 756

Equivalent key No equivalent key is available on the front panel.

:STAT:QUES:LIM:ENAB

Syntax :STATus:QUEStionable:LIMit:ENABle <numeric>
:STATus:QUEStionable:LIMit:ENABle?

Description Sets the value of the Questionable Limit Status Enable Register.

Parameters

	<numeric>
Description	Value of the enable register
Range	0 to 65535
Preset value	Varies depending on the upper limit setting for channel/trace number.
Resolution	1

Note that bit 15 cannot be set to 1.

Query response {numeric}<newline><^END>

Example of use
10 OUTPUT 717; ":STAT:QUES:LIM:ENAB 16"
20 OUTPUT 717; ":STAT:QUES:LIM:ENAB?"
30 ENTER 717;A

Related commands :STAT:QUES:ENAB on page 744

Equivalent key No equivalent key is available on the front panel.

:STAT:QUES:LIM:NTR

Syntax :STATus:QUEStionable:LIMit:NTRansition <numeric>
:STATus:QUEStionable:LIMit:NTRansition?

Description Sets the value of the negative transition filter of the Questionable Limit Status Register.

Parameters

	<numeric>
Description	Value of the negative transition filter
Range	0 to 65535
Preset value	0
Resolution	1

Note that bit 15 cannot be set to 1.

Query response {numeric}<newline><^END>

Example of use

```
10 OUTPUT 717;":STAT:QUES:LIM:CHAN1:NTR 16"
20 OUTPUT 717;":STAT:QUES:LIM:CHAN1:NTR?"
30 ENTER 717;A
```

Related commands :STAT:QUES:LIM? on page 745
:STAT:QUES:LIM:PTR on page 760

Equivalent key No equivalent key is available on the front panel.

:STAT:QUES:LIM:PTR

Syntax :STATus:QUEStionable:LIMit:PTRansition <numeric>
:STATus:QUEStionable:LIMit:PTRansition?

Description Sets the value of the positive transition filter of the Questionable Limit Status Register.

Parameters

	<numeric>
Description	Value of the positive transition filter
Range	0 to 65535
Preset value	Varies depending on the upper limit setting for channel/trace number.
Resolution	1

Note that bit 15 cannot be set to 1.

Query response {numeric}<newline><^END>

Example of use
10 OUTPUT 717; ":STAT:QUES:LIM:CHAN1:PTR 16"
20 OUTPUT 717; ":STAT:QUES:LIM:CHAN1:PTR?"
30 ENTER 717;A

Related commands :STAT:QUES:LIM? on page 745
:STAT:QUES:LIM:NTR on page 759

Equivalent key No equivalent key is available on the front panel.

:STAT:QUES:NTR

Syntax :STATus:QUEStionable:NTRansition <numeric>
:STATus:QUEStionable:NTRansition?

Description Sets the value of negative transition filter of the Questionable Status Register.

Parameters

	<numeric>
Description	Value of the negative transition filter
Range	0 to 65535
Preset value	0
Resolution	1

Note that bit 0 to bit 9 and bit 12 to bit 15 cannot be set to 1.

Query response {numeric}<newline><^END>

Example of use

```
10 OUTPUT 717;":STAT:QUES:NTR 16"
20 OUTPUT 717;":STAT:QUES:NTR?"
30 ENTER 717;A
```

Related commands :STAT:QUES? on page 726
:STAT:QUES:PTR on page 762

Equivalent key No equivalent key is available on the front panel.

:STAT:QUES:PTR

Syntax :STATus:QUEStionable:PTRansition <numeric>
:STATus:QUEStionable:PTRansition?

Description Sets the value of positive transition filter of the Questionable Status Register.

Parameters

	<numeric>
Description	Value of the positive transition filter
Range	0 to 65535
Preset value	3072
Resolution	1

Note that bit 0 to bit 9 and bit 12 to bit 15 cannot be set to 1.

Query response {numeric}<newline><^END>

Example of use
10 OUTPUT 717; ":STAT:QUES:PTR 16"
20 OUTPUT 717; ":STAT:QUES:PTR?"
30 ENTER 717;A

Related commands :STAT:QUES? on page 726
:STAT:QUES:NTR on page 761

Equivalent key No equivalent key is available on the front panel.

:STAT:QUES:RLIM?

Syntax	:STATus:QUEStionable:RLIMit[:EVENT]?
Description	Reads out the value of the Questionable Ripple Limit Status Event Register. (Query only)
Query response	{numeric}<newline><^END>
Example of use	10 OUTPUT 717; ":STAT:QUES:RLIM?" 20 ENTER 717;A
Related commands	*CLS on page 286
Equivalent key	No equivalent key is available on the front panel.

:STAT:QUES:RLIM:CHAN{1-16}?

Syntax	:STATus:QUEStionable:RLIMit:CHANnel{[1] 2 3 4 5 6 7 8 9 10 11 12 13 14 15 16}[:EVENT]?
Description	Reads out the value of the Questionable Ripple Limit Channel Status Event Register of channel 1 (:CHAN1) to channel 16 (:CHAN16). (Query only)
Query response	{numeric}<newline><^END>
Example of use	10 OUTPUT 717; ":STAT:QUES:RLIM:CHAN1?" 20 ENTER 717;A
Related commands	*CLS on page 286
Equivalent key	No equivalent key is available on the front panel.

:STAT:QUES:RLIM:CHAN{1-16}:COND?

Syntax	:STATus:QUEStionable:RLIMit:CHANnel{[1] 2 3 4 5 6 7 8 9 10 11 12 13 14 15 16}:CONDition?
Description	Reads out the value of the Questionable Ripple Limit Channel Status Condition Register of channel 1 (:CHAN1) to channel 16 (:CHAN16). (Query only)
Query response	{numeric}<newline><^END>
Example of use	10 OUTPUT 717; ":STAT:QUES:RLIM:CHAN1:COND?" 20 ENTER 717;A
Related commands	:STAT:QUES:RLIM:CHAN{1-16}:NTR on page 770 :STAT:QUES:RLIM:CHAN{1-16}:PTR on page 771

Equivalent key No equivalent key is available on the front panel.

:STAT:QUES:RLIM:CHAN{1-16}:ECH?

Syntax	:STATus:QUEStionable:RLIMit:CHANnel{[1] 2 3 4 5 6 7 8 9 10 11 12 13 14 15 16}:ECHannel[:EVENT]?
Description	Reads out the value of the Questionable Ripple Limit Channel Extra Status Event Register of channel 1 (:CHAN1) to channel 16 (:CHAN16). (Query only)
Query response	{numeric}<newline><^END>
Example of use	10 OUTPUT 717; ":STAT:QUES:RLIM:CHAN1:ECH?" 20 ENTER 717;A
Related commands	*CLS on page 286
Equivalent key	No equivalent key is available on the front panel.

:STAT:QUES:RLIM:CHAN{1-16}:ECH:COND?

Syntax	:STATus:QUEStionable:RLIMit:CHANnel{[1] 2 3 4 5 6 7 8 9 10 11 12 13 14 15 16}:ECHannel:CONDition?
Description	Reads out the value of the Questionable Ripple Limit Channel Extra Status Condition Register of channel 1 (:CHAN1) to channel 16 (:CHAN16). (Query only)
Query response	{numeric}<newline><^END>
Example of use	10 OUTPUT 717; ":STAT:QUES:RLIM:CHAN1:ECH:COND?" 20 ENTER 717;A
Related commands	:STAT:QUES:RLIM:CHAN{1-16}:ECH:NTR on page 767 :STAT:QUES:RLIM:CHAN{1-16}:ECH:PTR on page 768
Equivalent key	No equivalent key is available on the front panel.

:STAT:QUES:RLIM:CHAN{1-16}:ECH:ENAB

Syntax

:STATus:QUEStionable:RLIMit:CHANnel{[1]|2|3|4|5|6|7|8|9|10|11|12|13|14|15|16}:ECHannel:ENABle
<numeric>
:STATus:QUEStionable:RLIMit:CHANnel{[1]|2|3|4|5|6|7|8|9|10|11|12|13|14|15|16}:ECHannel:ENABle?

Description

Sets the value of the Questionable Ripple Limit Channel Extra Status Enable Register of channel 1 (:CHAN1) to channel 16 (:CHAN16).

Parameters

	<numeric>
Description	Value of the enable register
Range	0 to 65535
Preset value	Varies depending on the upper limit setting for channel/trace number.
Resolution	1

Bits 0 and 3 to 15 cannot be set to 1.

Query response

{numeric}<newline><^END>

Example of use

```
10 OUTPUT 717; ":STAT:QUES:RLIM:CHAN1:ECH:ENAB 6"  
20 OUTPUT 717; ":STAT:QUES:RLIM:CHAN1:ECH:ENAB?"  
30 ENTER 717;A
```

Related commands

:STAT:QUES:RLIM:CHAN{1-16}:ENAB on page 769

Equivalent key

No equivalent key is available on the front panel.

:STAT:QUES:RLIM:CHAN{1-16}:ECH:NTR

Syntax

```
:STATus:QUEStionable:RLIMit:CHANnel{[1]|2|3|4|5|6|7|8|9|10|11|12|13|14|15|16}:ECHannel:NTRansition
<numeric>
:STATus:QUEStionable:RLIMit:CHANnel{[1]|2|3|4|5|6|7|8|9|10|11|12|13|14|15|16}:ECHannel:NTRansition?
```

Description

Sets the value of the negative transition filter of the Questionable Ripple Limit Channel Extra Status Register of channel 1 (:CHAN1) to channel 16 (:CHAN16).

Parameters

	<numeric>
Description	Value of the negative transition filter
Range	0 to 65535
Preset value	0
Resolution	1

Bits 0 and 3 to 15 cannot be set to 1.

Query response

```
{numeric}<newline><^END>
```

Example of use

```
10 OUTPUT 717; ":STAT:QUES:RLIM:CHAN1:ECH:NTR 6"
20 OUTPUT 717; ":STAT:QUES:RLIM:CHAN1:ECH:NTR?"
30 ENTER 717;A
```

Related commands

```
:STAT:QUES:RLIM:CHAN{1-16}:ECH? on page 765
:STAT:QUES:RLIM:CHAN{1-16}:ECH:PTR on page 768
```

Equivalent key

No equivalent key is available on the front panel.

:STAT:QUES:RLIM:CHAN{1-16}:ECH:PTR

Syntax

:STATus:QUEStionable:RLIMit:CHANnel{[1]|2|3|4|5|6|7|8|9|10|11|12|13|14|15|16}:ECHannel:PTRansition
<numeric>
:STATus:QUEStionable:RLIMit:CHANnel{[1]|2|3|4|5|6|7|8|9|10|11|12|13|14|15|16}:ECHannel:PTRansition?

Description

Sets the value of the positive transition filter of the Questionable Ripple Limit Channel Extra Status Register of channel 1 (:CHAN1) to channel 16 (:CHAN16).

Parameters

	<numeric>
Description	Value of the positive transition filter
Range	0 to 65535
Preset value	Varies depending on the upper limit setting for channel/trace number.
Resolution	1

Bits 0 and 3 to 15 cannot be set to 1.

Query response

{numeric}<newline><^END>

Example of use

```
10 OUTPUT 717; ":STAT:QUES:RLIM:CHAN1:ECH:PTR 6"  
20 OUTPUT 717; ":STAT:QUES:RLIM:CHAN1:ECH:PTR?"  
30 ENTER 717;A
```

Related commands

:STAT:QUES:RLIM:CHAN{1-16}:ECH? on page 765

:STAT:QUES:RLIM:CHAN{1-16}:ECH:NTR on page 767

Equivalent key

No equivalent key is available on the front panel.

:STAT:QUES:RLIM:CHAN{1-16}:ENAB

Syntax :STATus:QUEStionable:RLIMit:CHANnel{[1]|2|3|4|5|6|7|8|9|10|11|12|13|14|15|16}:ENABle
<numeric>
:STATus:QUEStionable:RLIMit:CHANnel{[1]|2|3|4|5|6|7|8|9|10|11|12|13|14|15|16}:ENABle?

Description Sets the value of the Questionable Ripple Limit Channel Status Enable Register of channel 1 (:CHAN1) to channel 16 (:CHAN16).

Parameters

	<numeric>
Description	Value of the enable register
Range	0 to 65535
Preset value	Varies depending on the upper limit setting for channel/trace number.
Resolution	1

Note that bit 15 cannot be set to 1.

Query response {numeric}<newline><^END>

Example of use
10 OUTPUT 717; ":STAT:QUES:RLIM:CHAN1:ENAB 16"
20 OUTPUT 717; ":STAT:QUES:RLIM:CHAN1:ENAB?"
30 ENTER 717;A

Related commands :STAT:QUES:RLIM:ENAB on page 776

Equivalent key No equivalent key is available on the front panel.

:STAT:QUES:RLIM:CHAN{1-16}:NTR

Syntax :STATus:QUEStionable:RLIMit:CHANnel{[1]|2|3|4|5|6|7|8|9|10|11|12|13|14|15|16}:NTRansition
<numeric>
:STATus:QUEStionable:RLIMit:CHANnel{[1]|2|3|4|5|6|7|8|9|10|11|12|13|14|15|16}:NTRansition?

Description Sets the value of the negative transition filter of the Questionable Ripple Limit Channel Status Register of channel 1 (:CHAN1) to channel 16 (:CHAN16).

Parameters

	<numeric>
Description	Value of the negative transition filter
Range	0 to 65535
Preset value	0
Resolution	1

Note that bit 15 cannot be set to 1.

Query response {numeric}<newline><^END>

Example of use
10 OUTPUT 717; ":STAT:QUES:RLIM:CHAN1:NTR 16"
20 OUTPUT 717; ":STAT:QUES:RLIM:CHAN1:NTR?"
30 ENTER 717;A

Related commands :STAT:QUES:RLIM:CHAN{1-16}? on page 763
:STAT:QUES:RLIM:CHAN{1-16}:PTR on page 771

Equivalent key No equivalent key is available on the front panel.

:STAT:QUES:RLIM:CHAN{1-16}:PTR

Syntax :STATus:QUEStionable:RLIMit:CHANnel{[1]|2|3|4|5|6|7|8|9|10|11|12|13|14|15|16}:PTRansition
<numeric>
:STATus:QUEStionable:RLIMit:CHANnel{[1]|2|3|4|5|6|7|8|9|10|11|12|13|14|15|16}:PTRansition?

Description Sets the value of the positive transition filter of the Questionable Ripple Limit Channel Status Register of channel 1 (:CHAN1) to channel 16 (:CHAN16).

Parameters

	<numeric>
Description	Value of the positive transition filter
Range	0 to 65535
Preset value	Varies depending on the upper limit setting for channel/trace number.
Resolution	1

Note that bit 15 cannot be set to 1.

Query response {numeric}<newline><^END>

Example of use
10 OUTPUT 717; ":STAT:QUES:RLIM:CHAN1:PTR 16"
20 OUTPUT 717; ":STAT:QUES:RLIM:CHAN1:PTR?"
30 ENTER 717;A

Related commands :STAT:QUES:RLIM:CHAN{1-16}? on page 763
:STAT:QUES:RLIM:CHAN{1-16}:NTR on page 770

Equivalent key No equivalent key is available on the front panel.

:STAT:QUES:RLIM:COND?

Syntax :STATus:QUEStionable:RLIMit:CONDition?

Description Reads out the value of the Questionable Ripple Limit Status Condition Register. (Query only)

Query response {numeric}<newline><^END>

Example of use
10 OUTPUT 717; ":STAT:QUES:RLIM:COND?"
20 ENTER 717;A

Related commands :STAT:QUES:RLIM:NTR on page 777
:STAT:QUES:RLIM:PTR on page 778

Equivalent key No equivalent key is available on the front panel.

:STAT:QUES:RLIM:ELIM?

Syntax	:STATus:QUEStionable:RLIMit:ELIMit[:EVENT]?
Description	Reads out the value of the Questionable Ripple Limit Extra Status Event Register. (Query only)
Query response	{numeric}<newline><^END>
Example of use	10 OUTPUT 717; ":STAT:QUES:RLIM:ELIM?" 20 ENTER 717;A
Related commands	*CLS on page 286
Equivalent key	No equivalent key is available on the front panel.

:STAT:QUES:RLIM:ELIM:COND?

Syntax	:STATus:QUEStionable:RLIMit:ELIMit:CONDition?
Description	Reads out the value of the Questionable Ripple Limit Extra Status Condition Register. (Query only)
Query response	{numeric}<newline><^END>
Example of use	10 OUTPUT 717; ":STAT:QUES:RLIM:ELIM:COND?" 20 ENTER 717;A
Related commands	:STAT:QUES:RLIM:ELIM:NTR on page 774 :STAT:QUES:RLIM:ELIM:PTR on page 775
Equivalent key	No equivalent key is available on the front panel.

:STAT:QUES:RLIM:ELIM:ENAB

Syntax :STATus:QUEStionable:RLIMit:ELIMit:ENABle <numeric>
:STATus:QUEStionable:RLIMit:ELIMit:ENABle?

Description Sets the value of the Questionable Ripple Limit Extra Status Enable Register.

Parameters

	<numeric>
Description	Value of the enable register
Range	0 to 65535
Preset value	Varies depending on the upper limit setting for channel/trace number.
Resolution	1

Bits 0 and 3 to 15 cannot be set to 1.

Query response {numeric}<newline><^END>

Example of use
10 OUTPUT 717;":STAT:QUES:RLIM:ELIM:ENAB 6"
20 OUTPUT 717;":STAT:QUES:RLIM:ELIM:ENAB?"
30 ENTER 717;A

Related commands :STAT:QUES:RLIM:ENAB on page 776

Equivalent key No equivalent key is available on the front panel.

:STAT:QUES:RLIM:ELIM:NTR

Syntax :STATus:QUEStionable:RLIMit:ELIMit:NTRansition <numeric>
:STATus:QUEStionable:RLIMit:ELIMit:NTRansition?

Description Sets the value of the negative transition filter of the Questionable Ripple Limit Extra Status Register.

Parameters

	<numeric>
Description	Value of the negative transition filter
Range	0 to 65535
Preset value	0
Resolution	1

Bits 0 and 3 to 15 cannot be set to 1.

Query response {numeric}<newline><<^END>

Example of use
10 OUTPUT 717; ":STAT:QUES:RLIM:ELIM:NTR 6"
20 OUTPUT 717; ":STAT:QUES:RLIM:ELIM:NTR?"
30 ENTER 717;A

Related commands :STAT:QUES:RLIM:ELIM? on page 772
:STAT:QUES:RLIM:ELIM:PTR on page 775

Equivalent key No equivalent key is available on the front panel.

:STAT:QUES:RLIM:ELIM:PTR

Syntax :STATus:QUEStionable:RLIMit:ELIMit:PTRansition <numeric>
:STATus:QUEStionable:RLIMit:ELIMit:PTRansition?

Description Sets the value of the positive transition filter of the Questionable Ripple Limit Extra Status Register.

Parameters

	<numeric>
Description	Value of the positive transition filter
Range	0 to 65535
Preset value	Varies depending on the upper limit setting for channel/trace number.
Resolution	1

Bits 0 and 3 to 15 cannot be set to 1.

Query response {numeric}<newline><^END>

Example of use

```
10 OUTPUT 717;":STAT:QUES:RLIM:ELIM:PTR 6"
20 OUTPUT 717;":STAT:QUES:RLIM:ELIM:PTR?"
30 ENTER 717;A
```

Related commands :STAT:QUES:RLIM:ELIM? on page 772
:STAT:QUES:RLIM:ELIM:NTR on page 774

Equivalent key No equivalent key is available on the front panel.

:STAT:QUES:RLIM:ENAB

Syntax :STATus:QUEStionable:RLIMit:ENABle <numeric>
:STATus:QUEStionable:RLIMit:ENABle?

Description Sets the value of the Questionable Ripple Limit Status Enable Register.

Parameters

	<numeric>
Description	Value of the enable register
Range	0 to 65535
Preset value	Varies depending on the upper limit setting for channel/trace number.
Resolution	1

Note that bit 15 cannot be set to 1.

Query response {numeric}<newline><^END>

Example of use
10 OUTPUT 717; ":STAT:QUES:RLIM:ENAB 16"
20 OUTPUT 717; ":STAT:QUES:RLIM:ENAB?"
30 ENTER 717;A

Related commands :STAT:QUES:ENAB on page 744

Equivalent key No equivalent key is available on the front panel.

:STAT:QUES:RLIM:NTR

Syntax :STATus:QUEStionable:RLIMit:NTRansition <numeric>
:STATus:QUEStionable:RLIMit:NTRansition?

Description Sets the value of the negative transition filter of the Questionable Ripple Limit Status Register.

Parameters

	<numeric>
Description	Value of the negative transition filter
Range	0 to 65535
Preset value	0
Resolution	1

Note that bit 15 cannot be set to 1.

Query response {numeric}<newline><^END>

Example of use
10 OUTPUT 717;":STAT:QUES:RLIM:NTR 16"
20 OUTPUT 717;":STAT:QUES:RLIM:NTR?"
30 ENTER 717;A

Related commands :STAT:QUES:RLIM? on page 763
:STAT:QUES:RLIM:PTR on page 778

Equivalent key No equivalent key is available on the front panel.

:STAT:QUES:RLIM:PTR

Syntax :STATus:QUEStionable:RLIMit:PTRansition <numeric>
:STATus:QUEStionable:RLIMit:PTRansition?

Description Sets the value of the positive transition filter of the Questionable Ripple Limit Status Register.

Parameters

	<numeric>
Description	Value of the positive transition filter
Range	0 to 65535
Preset value	Varies depending on the upper limit setting for channel/trace number.
Resolution	1

Note that bit 15 cannot be set to 1.

Query response {numeric}<newline><^END>

Example of use
10 OUTPUT 717; ":STAT:QUES:RLIM:PTR 16"
20 OUTPUT 717; ":STAT:QUES:RLIM:PTR?"
30 ENTER 717;A

Related commands :STAT:QUES:RLIM? on page 763

:STAT:QUES:RLIM:NTR on page 777

Equivalent key No equivalent key is available on the front panel.

:SYST:BACK

Syntax :SYSTem:BACKlight {ON|OFF|1|0}
:SYSTem:BACKlight?

Description Turns ON/OFF the backlight of the LCD display.
When the backlight is OFF, you cannot read the information on the display.

Parameters

	Description
ON or 1 (preset value)	Turns ON the backlight.
OFF or 0	Turns OFF the backlight.

Query response {1|0}<newline><^END>

Example of use

```
10 OUTPUT 717; ":SYST:BACK OFF"
20 OUTPUT 717; ":SYST:BACK?"
30 ENTER 717;A
```

Equivalent key **[System] - Backlight**
To turn it ON, press any key on the front panel.

:SYST:BEEP:COMP:IMM

- Syntax** :SYSTem:BEEPer:COMPLete:IMMEDIATE
- Description** Generates a beep for the notification of the completion of the operation. (No query)
- Example of use** 10 OUTPUT 717; ":SYST:BEEP:COMP:IMM"
- Related commands** :SYST:BEEP:COMP:STAT on page 780
:SYST:BEEP:WARN:IMM on page 781
- Equivalent key** [System] - Misc Setup - Beeper - Test Beep Complete

:SYST:BEEP:COMP:STAT

- Syntax** :SYSTem:BEEPer:COMPLete:STATe {ON|OFF|1|0}
:SYSTem:BEEPer:COMPLete:STATe?
- Description** Turns ON/OFF the beeper for the notification of the completion of the operation.
- Parameters**

	Description
ON or 1 (preset value)	Turns ON the beeper.
OFF or 0	Turns OFF the beeper.

- Query response** {1|0}<newline><^END>
- Example of use** 10 OUTPUT 717; ":SYST:BEEP:COMP:STAT OFF"
20 OUTPUT 717; ":SYST:BEEP:COMP:STAT?"
30 ENTER 717;A
- Related commands** :SYST:BEEP:COMP:IMM on page 780
:SYST:BEEP:WARN:STAT on page 781
- Equivalent key** [System] - Misc Setup - Beeper - Beep Complete

:SYST:BEEP:WARN:IMM

- Syntax** :SYSTem:BEEPer:WARNing:IMMEDIATE
- Description** Generates a beep for the notification of warning/limit test result. (No query)
- Example of use** 10 OUTPUT 717; ":SYST:BEEP:WARN:IMM"
- Related commands** :SYST:BEEP:WARN:STAT on page 781
:SYST:BEEP:COMP:IMM on page 780
- Equivalent key** [System] - Misc Setup - Beeper - Test Beep Warning

:SYST:BEEP:WARN:STAT

- Syntax** :SYSTem:BEEPer:WARNing:STATe {ON|OFF|1|0}
:SYSTem:BEEPer:WARNing:STATe?
- Description** Turns ON/OFF the beeper for the notification of warning/limit test result.

Parameters

	Description
ON or 1 (preset value)	Turns ON the beeper.
OFF or 0	Turns OFF the beeper.

- Query response** {1|0}<newline><^END>
- Example of use** 10 OUTPUT 717; ":SYST:BEEP:WARN:STAT OFF"
20 OUTPUT 717; ":SYST:BEEP:WARN:STAT?"
30 ENTER 717;A
- Related commands** :SYST:BEEP:WARN:IMM on page 781
:SYST:BEEP:COMP:STAT on page 780
- Equivalent key** [System] - Misc Setup - Beeper - Beep Warning

:SYST:COMM:GPIB:PMET:ADDR

Syntax :SYSTem:COMMunicate:GPIB:PMETer:ADDRess <numeric>
:SYSTem:COMMunicate:GPIB:PMETer:ADDRess?

Description Sets/reads out the GPIB address of the power meter in use.

Parameters

	<numeric>
Description	The GPIB address of the power meter
Range	0 to 30
Preset value	13
Resolution	1

If the specified parameter is out of the valid setting range, an error occurs and the command is ignored.

Query response {numeric}<newline><^END>

Example of use
10 OUTPUT 717; ":SYST:COMM:GPIB:PMET:ADDR 10"
20 OUTPUT 717; ":SYST:COMM:GPIB:PMET:ADDR?"
30 ENTER 717;A

Equivalent key [System] - Misc Setup - GPIB Setup - Power Meter Address

:SYST:COMM:GPIB:SGEN:ADDR

Syntax :SYSTem:COMMunicate:GPIB:SGENerator:ADDRess <numeric>
:SYSTem:COMMunicate:GPIB:SGENerator:ADDRess?

Description Sets/reads out the GPIB address of the external signal source.

Parameters

	<value>
Description	The GPIB address of the external signal source
Range	0 to 30
Preset value	19
Resolution	1

If the specified parameter is out of the valid setting range, an error occurs and the command is ignored.

Query response {value}<newline><^END>

Example of use 10 OUTPUT 717; ":SYST:COMM:GPIB:SGEN:ADDR 19"
20 OUTPUT 717; ":SYST:COMM:GPIB:SGEN:ADDR?"
30 ENTER 717;A

Equivalent key **[System] - Misc Setup - GPIB Setup - Signal Generator Address - Address**

:SYST:COMM:GPIB:SGEN:CCOM:FREQ

Syntax :SYSTem:COMMunicate:GPIB:SGENerator:CCOMmand:FREQuency <string>
:SYSTem:COMMunicate:GPIB:SGENerator:CCOMmand:FREQuency?

Description Sets/reads out the command string of the output frequency setting of the external signal source.

This command is available when 1: User-defined is selected as the type of the external signal source. To select the type of the external signal source, use :SYST:COMM:GPIB:SGEN:TYPE command on page 789. If another type of external signal source is selected, the selected external signal source command is used and this command is ignored.

Parameters

	<string>
Description	Output frequency setting command for the external signal source
Range	254 characters or less
Preset value	"FR %f% HZ"

NOTE Writes a variable as "%f%" in the command string to be set. The E5070B/E5071B sends the command string to the external signal source with the frequency setting value of the external signal source that may be changed for each measurement point set in the variable.

Query response {string}<newline><^END>

Example of use

```
10 OUTPUT 717; ":SYST:COMM:GPIB:SGEN:CCOM:FREQ ""FREQ %f%HZ""
20 OUTPUT 717; ":SYST:COMM:GPIB:SGEN:CCOM:FREQ?"
30 ENTER 717;A$
```

Related commands

- :SYST:COMM:GPIB:SGEN:TYPE on page 789
- :SYST:COMM:GPIB:SGEN:CCOM:POW on page 785
- :SYST:COMM:GPIB:SGEN:CCOM:PRES on page 786
- :SYST:COMM:GPIB:SGEN:CCOM:RFON on page 787
- :SYST:COMM:GPIB:SGEN:DWEL on page 788

Equivalent key [System] - Misc Setup - GPIB Setup - Signal Generator Address - Custom Commands - Set Frequency

:SYST:COMM:GPIB:SGEN:CCOM:POW

Syntax :SYSTem:COMMunicate:GPIB:SGENerator:CCOMmand:POWer <string>
:SYSTem:COMMunicate:GPIB:SGENerator:CCOMmand:POWer?

Description Sets/reads out the command string of the power level setting of the external signal source.
This command is available when 1: User-defined is selected as the type of the external signal source. To select the type of the external signal source, use :SYST:COMM:GPIB:SGEN:TYPE command on page 789. If another type of external signal source is selected, the selected external signal source command is used and this command is ignored.

Parameters

	<string>
Description	Power level setting command for the external signal source
Range	254 characters or less
Preset value	"AP %p% DM"

NOTE Writes a variable as "%p%" in the command string to be set. The E5070B/E5071B sends the command string to the external signal source with the setting value of the power level of the external signal source that may be changed for each measurement point set in the variable.

Query response {string}<newline><^END>

Example of use
10 OUTPUT 717; ":SYST:COMM:GPIB:SGEN:CCOM:POW " "AMPL %p%DBM" "
20 OUTPUT 717; ":SYST:COMM:GPIB:SGEN:CCOM:POW?"
30 ENTER 717;A\$

Related commands
:SYST:COMM:GPIB:SGEN:TYPE on page 789
:SYST:COMM:GPIB:SGEN:CCOM:FREQ on page 784
:SYST:COMM:GPIB:SGEN:CCOM:PRES on page 786
:SYST:COMM:GPIB:SGEN:CCOM:RFON on page 787
:SYST:COMM:GPIB:SGEN:DWEL on page 788

Equivalent key [System] - Misc Setup - GPIB Setup - Signal Generator Address - Custom Commands - Set Power Level

:SYST:COMM:GPIB:SGEN:CCOM:PRES

Syntax :SYSTem:COMMunicate:GPIB:SGENerator:CCOMmand:PRESet <string>
:SYSTem:COMMunicate:GPIB:SGENerator:CCOMmand:PRESet?

Description Sets/reads out the preset command string for the external signal source.

This command is available when 1: User-defined is selected as the type of the external signal source. To select the type of the external signal source, use :SYST:COMM:GPIB:SGEN:TYPE command on page 789. If another type of external signal source is selected, the selected external signal source command is used and this command is ignored.

Parameters

	<string>
Description	Preset command for the external signal source
Range	254 characters or less
Preset value	"" (not defined)

Query response {string}<newline><^END>

Example of use

```
10 OUTPUT 717; ":SYST:COMM:GPIB:SGEN:CCOM:PRES ""*RST""
20 OUTPUT 717; ":SYST:COMM:GPIB:SGEN:CCOM:PRES?"
30 ENTER 717;A$
```

Related commands

- :SYST:COMM:GPIB:SGEN:TYPE on page 789
- :SYST:COMM:GPIB:SGEN:CCOM:FREQ on page 784
- :SYST:COMM:GPIB:SGEN:CCOM:POW on page 785
- :SYST:COMM:GPIB:SGEN:CCOM:RFON on page 787
- :SYST:COMM:GPIB:SGEN:DWEL on page 788

Equivalent key [System] - Misc Setup - GPIB Setup - Signal Generator Address - Custom Commands - Preset

:SYST:COMM:GPIB:SGEN:CCOM:RFON

Syntax :SYSTem:COMMunicate:GPIB:SGENerator:CCOMmand:RFON <string>
:SYSTem:COMMunicate:GPIB:SGENerator:CCOMmand:RFON?

Description Sets/reads out the command string of the RF output on of the external signal source.
This command is available when 1: User-defined is selected as the type of the external signal source. To select the type of the external signal source, use :SYST:COMM:GPIB:SGEN:TYPE command on page 789. If another type of external signal source is selected, the selected external signal source command is used and this command is ignored.

Parameters

	<string>
Description	RF output on command for the external signal source
Range	254 characters or less
Preset value	"R3"

Query response {string}<newline><^END>

Example of use
10 OUTPUT 717; ":SYST:COMM:GPIB:SGEN:CCOM:RFON ""AMPL:STATE ON"""
20 OUTPUT 717; ":SYST:COMM:GPIB:SGEN:CCOM:RFON?"
30 ENTER 717;A\$

Related commands
:SYST:COMM:GPIB:SGEN:TYPE on page 789
:SYST:COMM:GPIB:SGEN:CCOM:FREQ on page 784
:SYST:COMM:GPIB:SGEN:CCOM:POW on page 785
:SYST:COMM:GPIB:SGEN:CCOM:PRES on page 786
:SYST:COMM:GPIB:SGEN:DWEL on page 788

Equivalent key [System] - Misc Setup - GPIB Setup - Signal Generator Address - Custom Commands - Turn RF Out On

:SYST:COMM:GPIB:SGEN:DWEL

Syntax :SYSTem:COMMunicate:GPIB:SGENerator:DWEL <numeric>
:SYSTem:COMMunicate:GPIB:SGENerator:DWEL?

Description Sets/reads out a wait time after setting the output frequency and the power level of the external signal source.

Parameters

	<value>
Description	Wait time after setting the output frequency and the power level of the external signal source
Range	0 to 1
Preset value	0.1
Unit	Sec.
Resolution	0.001

Query response {value}<newline><^END>

Example of use
10 OUTPUT 717; ":SYST:COMM:GPIB:SGEN:DWEL 0.2"
20 OUTPUT 717; ":SYST:COMM:GPIB:SGEN:DWEL?"
30 ENTER 717;A

Related commands :SYST:COMM:GPIB:SGEN:CCOM:FREQ on page 784
:SYST:COMM:GPIB:SGEN:CCOM:POW on page 785

Equivalent key [System] - Misc Setup - GPIB Setup - Signal Generator Address - Switching Time

:SYST:COMM:GPIB:SGEN:TYPE

Syntax :SYSTem:COMMunicate:GPIB:SGENerator:TYPE <numeric>
:SYSTem:COMMunicate:GPIB:SGENerator:TYPE?

Description Sets/reads out the type of the external signal source.

Parameters

	<value>
Description	Type of the external signal source
Range	1 to 3
Preset value	3
Resolution	1

	Description of types
1	Controls the external signal source with the user-defined command.*1
2	8643A, 8644B, 8664A, 8665A/B
3 (preset value)	8648A/B/C/D, ESG Series, PSG Series

*1. When 1: User-defined is specified as the type, the output frequency setting (:SYST:COMM:GPIB:SGEN:CCOM:FREQ command on page 784) and the power level setting (:SYST:COMM:GPIB:SGEN:CCOM:POW command on page 785) are necessary.

Query response {value}<newline><^END>

Example of use
10 OUTPUT 717;":SYST:COMM:GPIB:SGEN:TYPE 2"
20 OUTPUT 717;":SYST:COMM:GPIB:SGEN:TYPE?"
30 ENTER 717;A

Related commands
:SENS{1-16}:OFFS:LOC:CONT on page 670
:SYST:COMM:GPIB:SGEN:CCOM:FREQ on page 784
:SYST:COMM:GPIB:SGEN:CCOM:POW on page 785

Equivalent key [System] - Misc Setup - GPIB Setup - Signal Generator Address - Custom Commands|8643A,8644B,8664A,8665A/B|8648A/B/C/D,ESG Series,PSG Series

:SYST:CORR

Syntax :SYSTem:CORRection[:STATe] {ON|OFF|1|0}
:SYSTem:CORRection[:STATe]?

Description Turns ON/OFF the system error correction. Changing this state clears the calibration coefficients.

Parameters

	Description
ON or 1 (preset value)	Turns ON the system error correction.
OFF or 0	Turns OFF the system error correction.

Query response {1|0}<newline><^END>

Example of use
10 OUTPUT 717; ":SYST:CORR OFF"
20 OUTPUT 717; ":SYST:CORR?"
30 ENTER 717;A

Equivalent key [System] - Service Menu - System Correction

:SYST:DATE

Syntax :SYSTem:DATE <numeric 1>,<numeric 2>,<numeric 3>
:SYSTem:DATE?

Description Sets the date of the clock built in the E5070B/E5071B.

Parameters

	<numeric 1>	<numeric 2>	<numeric 3>
Description	Year	Month	Day
Range	1980 to 2099	1 to 12	1 to 31
Resolution	1	1	1

If the specified parameter is out of the allowable setup range, the minimum value (if the lower limit of the range is not reached) or the maximum value (if the upper limit of the range is exceeded) is set.

Query response {numeric 1},{numeric 2},{numeric 3}<newline><^END>

Example of use
10 OUTPUT 717; ":SYST:DATE 2002,1,1"
20 OUTPUT 717; ":SYST:DATE?"
30 ENTER 717;A,B,C

Related commands :SYST:UPR on page 801
:DISP:CLOC on page 455

Equivalent key [System] - Misc Setup - Clock Setup - Set Date and Time

:SYST:ERR?

Syntax	:SYSTem:ERRor?
Description	<p>Reads out the oldest error of the errors stored in the error queue of the E5070B/E5071B. The read-out error is deleted from the error queue. The size of the error queue is 100.</p> <p>Executing the *CLS command clears the errors stored in the error queue. (Query only)</p>
NOTE	<p>This command can not return an error that occurs by the manual operation or the COM object used in controlling the E5070B/E5071B from the VBA Macro.</p>
Query response	<p>{numeric},{string}<newline><^END></p> <p>{numeric}: Error number</p> <p>{string}: Error message (a character string with double quotation marks ("))</p> <p>If no error is stored in the error queue, 0 and "No error" are read out as the error number and the error message.</p>
Example of use	<pre>10 OUTPUT 717;":SYST:ERR?" 20 ENTER 717;A,B\$</pre>
Related commands	*CLS on page 286
Equivalent key	No equivalent key is available on the front panel.

:SYST:ISPC:PORT

Syntax :SYSTem:ISPControl:PORT <numeric>

:SYSTem:ISPControl:PORT?

Description Specifies a test port to be selected for stimulus destination when the Initial Source Port Control feature is on.

Parameters

	<numeric>
Description	(preset value: 1) Specifies a test port for stimulus destination.
Range	1 to 4

Query response {1-4}<newline><^END>

Example of use
10 :INIT:CONT OFF
20 :SYSTem:ISPControl[:STATe] ON
30 :SYSTem:ISPControl:PORT 1

Related commands :SYST:ISPC:STAT on page 793

Equivalent key [System] - Service - Init Src Port [1|2|3|4]

:SYST:ISPC:STAT

Syntax :SYSTem:ISPControl [:STATe] {ON|OFF|1|0}
:SYSTem:ISPControl [:STATe] ?

Description Turns on/off the Initial Source Port Control feature (to switch the stimulus output in the trigger hold state to a test port).

Parameters

	Description
ON or 1 (preset value)	Turns on the Initial Source Port Control feature.
OFF or 0	Turns off the Initial Source Port Control feature.

Query response {1|0}<newline><^END>

Example of use
10 :INIT:CONT OFF
20 :SYSTem:ISPControl[:STATe] ON
30 :SYSTem:ISPControl:PORT 1

Related commands :SYST:ISPC:PORT on page 792

Equivalent key [System] - Service - Init Src Ctrl [ON]

:SYST:KLOC:KBD

Syntax :SYSTem:KLOCK:KBD {ON|OFF|1|0}
:SYSTem:KLOCK:KBD?

Description Sets whether to lock the operation of the front panel (key and rotary knob) and keyboard.

Parameters

	Description
ON or 1	Specifies lock.
OFF or 0 (preset value)	Specifies unlock.

Query response {1|0}<newline><^END>

Example of use
10 OUTPUT 717; ":SYST:KLOC:KBD ON"
20 OUTPUT 717; ":SYST:KLOC:KBD?"
30 ENTER 717;A

Related commands :SYST:KLOC:MOUS on page 795

Equivalent key [System] - Misc Setup - Key Lock - Front Panel & Keyboard Lock

:SYST:KLOC:MOUS

Syntax :SYSTem:KLOCK:MOUSe {ON|OFF|1|0}
:SYSTem:KLOCK:MOUSe?

Description Sets whether to lock the operation of the mouse and touch screen.

Parameters

	Description
ON or 1	Specifies lock.
OFF or 0 (preset value)	Specifies unlock.

Query response {1|0}<newline><^END>

Example of use
10 OUTPUT 717; ":SYST:KLOC:MOUS ON"
20 OUTPUT 717; ":SYST:KLOC:MOUS?"
30 ENTER 717;A

Related commands :SYST:KLOC:KBD on page 794

Equivalent key [System] - Misc Setup - Key Lock - Mouse Lock

:SYST:POFF

Syntax	:SYSTem:POFF
Description	Turns OFF the E5070B/E5071B. (No query)
Example of use	10 OUTPUT 717; ":SYST:POFF"
Equivalent key	Standby switch

:SYST:PRES

Syntax	:SYSTem:PRESet
Description	Performs preset. There is the following difference from the setting state preset with the *RST command. (No query) <ul style="list-style-type: none">• The continuous initiation mode of channel 1 is set to ON.
Example of use	10 OUTPUT 717; ":SYST:PRES"
Related commands	*RST on page 289
Equivalent key	[Preset] - OK

:SYST:SEC:LEV

Syntax :SYSTem:SECurity:LEVel {NON|LOW|HIGH}
:SYSTem:SECurity:LEVel?

Description Sets/Reads the security level.

Parameters

	Description
NON (preset value)	Turns OFF the security level.
LOW	Turns ON and specifies LOW level to the security level.
HIGH	Turns ON and specifies HIGH level to the security level.

When the setting of security level is LOW, it is able to change to NON or HIGH. But when this setting is HIGH, it is not able to change NON or LOW.

The setting of security level can be turned NON by executing the preset or recalling when the setting of security level is HIGH.

Even if the setting of security level is ON, the command that reads out the frequency is not influenced.

Query response {NON|LOW|HIGH}<newline><^END>

Example of use
10 OUTPUT 717; ":SYST:SEC:LEV LOW"
20 OUTPUT 717; ":SYST:SEC:LEV?"
30 ENTER 717;A\$

Equivalent key [System] - Service Menu - Security Level - None|Low|High

:SYST:SERV?

Syntax :SYSTem:SERVice?

Description Reads out whether to be in the service mode. (Query only)

Query response {1|0}<newline><^END>

	Description
1	In the service mode.
0	Not in the service mode.

Example of use
10 OUTPUT 717; ":SYST:SERV?"
30 ENTER 717;A

Equivalent key Displayed on the instrument status bar (at the bottom of the LCD display).

:SYST:TEMP

Syntax :SYSTem:TEMPerature[:STATe]?

Description Reads out whether warm-up to satisfy the specifications of the E5070B/E5071B is enough. (Query only)

Query response {1|0}<newline><^END>

	Description
1	Enough warm-up.
0	Not enough warm-up.

Example of use
10 OUTPUT 717; ":SYST:TEMP?"
30 ENTER 717;A

Equivalent key Displayed on the instrument status bar (at the bottom of the LCD display).

:SYST:TEMP:HIGH

Syntax :SYSTem:TEMPerature:HIGH {ON|OFF|1|0}
:SYSTem:TEMPerature:HIGH?

Description Turns ON/OFF the high temperature measurement mode.

Parameters

	Description
ON or 1	Turns ON the high temperature measurement mode.
OFF or 0 (preset value)	Turns OFF the high temperature measurement mode.

Query response {1|0}<newline><^END>

Example of use
10 OUTPUT 717; ":SYST:TEMP:HIGH ON"
20 OUTPUT 717; ":SYST:TEMP:HIGH?"
30 ENTER 717;A

Equivalent key [System] - Service Menu - High Temperature

:SYST:TIME

Syntax :SYSTem:TIME <numeric 1>,<numeric 2>,<numeric 3>
:SYSTem:TIME?

Description Sets the time of the clock built in the E5070B/E5071B.

Parameters

	<numeric 1>	<numeric 2>	<numeric 3>
Description	Hour (24-hour basis)	Minute	Second
Range	0 to 23	0 to 59	0 to 59
Resolution	1	1	1

If the specified parameter is out of the allowable setup range, the minimum value (if the lower limit of the range is not reached) or the maximum value (if the upper limit of the range is exceeded) is set.

Query response {numeric 1},{numeric 2},{numeric 3}<newline><^END>

Example of use
10 OUTPUT 717; ":SYST:TIME 17,30,0"
20 OUTPUT 717; ":SYST:TIME?"
30 ENTER 717;A,B,C

Related commands
:SYST:DATE on page 790
:DISP:CLOC on page 455

Equivalent key [System] - Misc Setup - Clock Setup - Set Date and Time

:SYST:UPR

Syntax	:SYSTem:UPReset
Description	<p>Performs presets with the user settings.</p> <p>The command is executed regardless of the operation mode in preset state.</p> <p>(No query)</p> <p>If you try to specify a file for a preset (D:\UserPreset.sta) that does not exist, a warning message is displayed and SYST:PRES will be executed.</p>
Sample of use	10 OUTPUT 717; ":SYST:UPR"
Related commands	*RST on page 289 :SYST:PRES on page 796
Equivalent key	[Preset] - OK

:TRIG

Syntax	:TRIGger[:SEQuence][:IMMediate]
Description	<p>Regardless of the setting of the trigger mode, generates a trigger immediately and executes a measurement.</p> <p>There is the following difference from the trigger with the :TRIG:SING command.</p> <ul style="list-style-type: none">• The execution of the command finishes at the time of a trigger. <p>If you execute this command when the trigger system is not in the trigger wait state (trigger event detection state), an error occurs and the command is ignored.</p> <p>For details about the trigger system, refer to “Trigger System” on page 128. (No query)</p>
Example of use	<pre>10 OUTPUT 717; ":TRIG"</pre>
Related commands	:TRIG:SING on page 808
Equivalent key	No equivalent key is available on the front panel.

:TRIG:AVER

Syntax :TRIGger[:SEQuence]:AVERage {ON|OFF|1|0}
:TRIGger[:SEQuence]:AVERage?

Description Turns ON/OFF the averaging trigger feature.
The sweep averaging feature must be set to on when turning on the averaging trigger feature.

Parameters

	Description
ON or 1	Turns on the averaging trigger feature.
OFF or 0 (preset value)	Turns off the averaging trigger feature.

Query response {1|0}<newline><^END>

Example of use
10 OUTPUT 717; ":TRIG:AVER ON"
20 OUTPUT 717; ":TRIG:AVER?"
30 ENTER 717;A

Related commands :SENS{1-16}:AVER on page 543

Equivalent key [Ave] - Ave Trigger

:TRIG:EXT:DEL

Syntax :TRIGger[:SEQuence]:EXTernal:DELay <numeric>
:TRIGger[:SEQuence]:EXTernal:DELay?

Description When the trigger source is external, sets the time that it takes from receiving the trigger to starting measurement.

Parameter

	<numeric>
Description	External trigger delay time
Range	0 to 1
Preset value	0
Unit	s (second)
Resolution	10 μ

Query response {numeric}<newline><^END>

Example of use
10 OUTPUT 717; ":TRIG:EXT:DEL 0.05"
20 OUTPUT 717; ":TRIG:EXT:DEL?"
30 ENTER 717;A

Related commands :TRIG:EXT:LLAT on page 805
:TRIG:POIN on page 806

Equivalent key [Trigger] - Ext Trig Delay

:TRIG:EXT:LLAT

Syntax :TRIGger[:SEQuence]:EXTernal:LLATency[:STATe] {ON|OFF|1|0}
:TRIGger[:SEQuence]:EXTernal:LLATency[:STATe]?

Description Turns ON/OFF the low-latency external trigger feature.
When turning on the low-latency external trigger feature, the point trigger feature must be set to on and the trigger source must be set to external trigger.

NOTE When the point trigger feature is set to off, or the trigger source is set to one other than the external trigger, the change is ignored.

Parameter

	Description
ON or 1	Turns on the low-latency external trigger feature.
OFF or 0 (preset value)	Turns off the low-latency external trigger feature.

Query response {1|0}<newline><^END>

Example of use
10 OUTPUT 717;":TRIG:EXT:LLAT ON"
20 OUTPUT 717;":TRIG:EXT:LLAT?"
30 ENTER 717;A

Related commands
:TRIG:EXT:DEL on page 804
:TRIG:POIN on page 806
:TRIG:SOUR on page 809

Equivalent key [Trigger] - Low Latency

:TRIG:POIN

Syntax :TRIGger[:SEQuence]:POINt {ON|OFF|1|0}
:TRIGger[:SEQuence]:POINt?

Description Turns on/off of the point trigger feature.
The sweep mode is changed to "Stepped" when the point trigger feature is turned on.

NOTE When the trigger source is set to the internal trigger (Internal), the change is ignored.

Parameters

	Description
ON or 1	Turns on the point trigger feature.
OFF or 0 (preset value)	Turns off the point trigger feature.

Query response {1|0}<newline><^END>

Example of use
10 OUTPUT 717; ":TRIG:POIN ON"
20 OUTPUT 717; ":TRIG:POIN?"
30 ENTER 717;A

Related commands :TRIG:SOUR on page 809

Equivalent key [Trigger] - Trigger Event

:TRIG:SCOP

Syntax :TRIGger[:SEQuence]:SCOPE {ALL|ACTive}
:TRIGger[:SEQuence]:SCOPE?

Description Selects the channel to be triggered.

Parameters

	Description
ALL (preset value)	Selects all channels.
ACTive	Selects the active channel.

Query response {ALL|ACTive}<newline><^END>

Example of use
10 OUTPUT 717; ":TRIG:SCOP ACT"
20 OUTPUT 717; ":TRIG:SCOP?"
30 ENTER 717;A\$

Related commands :INIT{1-16}:CONT on page 491

Equivalent key [Trigger] - Trigger Scope - All Channel|Active Channel

:TRIG:SING

Syntax	:TRIGger[:SEQuence]:SINGle
Description	<p>Regardless of the setting of the trigger mode, generates a trigger immediately and executes a measurement.</p> <p>There is the following difference from the trigger with the :TRIG command.</p> <ul style="list-style-type: none">• The execution of the command finishes when the measurement (all sweeps) initiated with this command finishes. In other words, you can wait for the end of the measurement using the *OPC? command. <p>If you execute this command when the trigger system is not in the trigger wait state (trigger event detection state), an error occurs and the command is ignored.</p> <p>For details about the trigger system, refer to “Trigger System” on page 128. (No query)</p>
Example of use	<pre>10 OUTPUT 717; ":TRIG:SING" 20 OUTPUT 717; "*OPC?" 30 ENTER 717;A</pre>
Related commands	:TRIG on page 802 *OPC? on page 288
Equivalent key	No equivalent key is available on the front panel.

:TRIG:SOUR

Syntax :TRIGger[:SEQuence]:SOURce {INTernal|EXTernal|MANual|BUS}
:TRIGger[:SEQuence]:SOURce?

Description Selects the trigger source from the following 4 types.

Internal	Uses the internal trigger to generate continuous triggers automatically.
External	Generates a trigger when the trigger signal is inputted externally via the Ext Trig connector or the handler interface.
Manual	Generates a trigger when the key operation of [Trigger] - Trigger is executed from the front panel.
Bus	Generates a trigger when the *TRG command is executed.

When you change the trigger source during sweep, the sweep is canceled.

Parameters

	Description
INTernal (preset value)	Specifies internal.
EXTernal	Specifies external.
MANual	Specifies manual.
BUS	Specifies bus.

Query response {BUS|EXT|INT|MAN}<newline><^END>

Example of use

```
10 OUTPUT 717; ":TRIG:SOUR BUS"
20 OUTPUT 717; ":TRIG:SOUR?"
30 ENTER 717;A$
```

Related commands *TRG on page 291

Equivalent key **[Trigger] - Trigger Source - Internal|External|Manual|Bus**

Command list

List by front panel key

Table 14-1 shows the SCPI commands that correspond to the front panel keys (in alphabetical order).

Table 14-1 Front panel key tree vs. SCPI commands correspondence table

Key (operation)		Corresponding GPIB command			
[Analysis]	Bandwidth Limit	BW Display	:CALC{1-16}:BLIM:DISP:VAL on page 296		
		BW Marker	:CALC{1-16}:BLIM:DISP:MARK on page 295		
		BW Test	:CALC{1-16}:BLIM on page 293		
		Fail Sign	:DISP:FSIG on page 463		
		Max Bandwidth	:CALC{1-16}:BLIM:MAX on page 298		
		Min Bandwidth	:CALC{1-16}:BLIM:MIN on page 299		
		N dB Points	:CALC{1-16}:BLIM:DB on page 294		
	Conversion	Conversion	:CALC{1-16}:CONV on page 301		
		Function	:CALC{1-16}:CONV:FUNC on page 302		
	Fixture Simulator	BalUn	BalUn	:CALC{1-16}:FSIM:BAL:PAR{1-16}:STAT on page 342	
			Balun OFF All Traces	N/A	
			Balun ON All Traces	N/A	
		Cmn ZConversion	Cmn ZConversion	:CALC{1-16}:FSIM:BAL:CZC:STAT on page 326	
			Port n (bal) Imag	:CALC{1-16}:FSIM:BAL:CZC:BPOR{1-2}:IMAG on page 323	
			Port n (bal) Real	:CALC{1-16}:FSIM:BAL:CZC:BPOR{1-2}:REAL on page 324 :CALC{1-16}:FSIM:BAL:CZC:BPOR{1-2}:Z0 on page 325	
		De-Embedding	De- Embedding	:CALC{1-16}:FSIM:SEND:DEEM:STAT on page 356	
			Select Port	:CALC{1-16}:FSIM:SEND:DEEM:PORT{1-4} on page 354	
			Select Type		
			User File	:CALC{1-16}:FSIM:SEND:DEEM:PORT{1-4}:USER:FIL on page 355	
		De-Embedding S4P	De-Embedding S4P		:CALC{1-16}:FSIM:EMB:STAT on page 349
			Topology	Ports	:CALC{1-16}:FSIM:EMB:TOP:A:PORT on page 350 :CALC{1-16}:FSIM:EMB:TOP:B:PORT on page 351 :CALC{1-16}:FSIM:EMB:TOP:C:PORT on page 352
				Select Topology	:CALC{1-16}:FSIM:EMB:TYPE on page 353
				Type (nwk1)	:CALC{1-16}:FSIM:EMB:NETW{1-2}:TYPE on page 348
				Type (nwk2)	
				User File (nwk1)	:CALC{1-16}:FSIM:EMB:NETW{1-2}:FIL on page 347
				User File (nwk2)	
		Diff Matching	C	:CALC{1-16}:FSIM:BAL:DMC:BPOR{1-2}:PAR:C on page 329	
			Diff Matching	:CALC{1-16}:FSIM:BAL:DMC:STAT on page 334	
	G		:CALC{1-16}:FSIM:BAL:DMC:BPOR{1-2}:PAR:G on page 330		
	L		:CALC{1-16}:FSIM:BAL:DMC:BPOR{1-2}:PAR:L on page 331		
	R		:CALC{1-16}:FSIM:BAL:DMC:BPOR{1-2}:PAR:R on page 332		
	Select Bal Port		:CALC{1-16}:FSIM:BAL:DMC:BPOR{1-2} on page 328		
	Select Circuit				
	User File		:CALC{1-16}:FSIM:BAL:DMC:BPOR{1-2}:USER:FIL on page 333		

Table 14-1 Front panel key tree vs. SCPI commands correspondence table

		Key (operation)		Corresponding GPIB command	
[Analysis] (Continued)	Fixture Simulator (Continued)	Diff ZConversion	Diff ZConversion	:CALC{1-16}:FSIM:BAL:DZC:STAT on page 338	
			Port n (bal) Imag	:CALC{1-16}:FSIM:BAL:DZC:BPOR{1-2}:IMAG on page 335	
			Port n (bal) Real	:CALC{1-16}:FSIM:BAL:DZC:BPOR{1-2}:REAL on page 336	
				:CALC{1-16}:FSIM:BAL:DZC:BPOR{1-2}:Z0 on page 337	
		Measurement		:CALC{1-16}:PAR{1-16}:DEF on page 422	
				:CALC{1-16}:FSIM:BAL:PAR{1-16}:SBAL on page 340	
				:CALC{1-16}:FSIM:BAL:PAR{1-16}:BBAL on page 339	
				:CALC{1-16}:FSIM:BAL:PAR{1-16}:SSB on page 341	
		Fixture Simulator		:CALC{1-16}:FSIM:STAT on page 368	
		Port Matching	C	C	:CALC{1-16}:FSIM:SEND:PMC:PORT{1-4}:PAR:C on page 358
				G	:CALC{1-16}:FSIM:SEND:PMC:PORT{1-4}:PAR:G on page 359
			L	:CALC{1-16}:FSIM:SEND:PMC:PORT{1-4}:PAR:L on page 360	
			Port Matching		:CALC{1-16}:FSIM:SEND:PMC:STAT on page 363
			R	:CALC{1-16}:FSIM:SEND:PMC:PORT{1-4}:PAR:R on page 361	
			Select Port		:CALC{1-16}:FSIM:SEND:PMC:PORT{1-4} on page 357
			Select Circuit		
			User File		:CALC{1-16}:FSIM:SEND:PMC:PORT{1-4}:USER:FIL on page 362
	Port ZConversion	Port ZConversion		:CALC{1-16}:FSIM:SEND:ZCON:STAT on page 367	
		Port n Z0 Imag		:CALC{1-16}:FSIM:SEND:ZCON:PORT{1-4}:IMAG on page 364	
		Port n Z0 Real		:CALC{1-16}:FSIM:SEND:ZCON:PORT{1-4}:REAL on page 365	
				:CALC{1-16}:FSIM:SEND:ZCON:PORT{1-4}:Z0 on page 366	
	Topology	Device		:CALC{1-16}:FSIM:BAL:DEV on page 327	
		Port n (se)		:CALC{1-16}:FSIM:BAL:TOP:SSB on page 346	
		Port n (bal)		:CALC{1-16}:FSIM:BAL:TOP:SBAL on page 345	
				:CALC{1-16}:FSIM:BAL:TOP:BBAL on page 343	
		Property		:CALC{1-16}:FSIM:BAL:TOP:PROP:STAT on page 344	
	Gating	Center		:CALC{1-16}:FILT:TIME:CENT on page 315	
		Gating		:CALC{1-16}:FILT:TIME:STAT on page 319	
		Shape		:CALC{1-16}:FILT:TIME:SHAP on page 316	
		Span		:CALC{1-16}:FILT:TIME:SPAN on page 317	
		Start		:CALC{1-16}:FILT:TIME:STAR on page 318	
		Stop		:CALC{1-16}:FILT:TIME:STOP on page 320	
		Type		:CALC{1-16}:FILT:TIME on page 314	

Table 14-1 Front panel key tree vs. SCPI commands correspondence table

		Key (operation)		Corresponding GPIB command			
[Analysis] (Continued)	Limit Test	Edit Limit Line	Add / Delete / Clear Limit Table	:CALC{1-16}:LIM:DATA on page 381			
			Export to CSV File	:MMEM:STOR:LIM on page 513			
			Import from CSV File	:MMEM:LOAD:LIM on page 500			
		Fail Sign			:DISP:FSIG on page 463		
		Limit Line			:CALC{1-16}:LIM:DISP on page 382		
		Limit Line Offsets	Amplitude Offset			:CALC{1-16}:LIM:OFFS:AMPL on page 384	
			Marker -> Amplitude Offset			:CALC{1-16}:LIM:OFFS:MARK on page 385	
			Stimulus Offset			:CALC{1-16}:LIM:OFFS:STIM on page 386	
		Limit Test			:CALC{1-16}:LIM on page 380		
		Ripple Limit	Edit Ripple Limit	Add / Delete / Clear Ripple Limit Table			:CALC{1-16}:RLIM:DATA on page 427
	Export to CSV File					:MMEM:STOR:RLIM on page 516	
	Import from CSV File					:MMEM:LOAD:RLIM on page 503	
	Fail Sign				:DISP:FSIG on page 463		
	Ripple Limit				:CALC{1-16}:RLIM:DISP:LINE on page 428		
	Ripple Limit Test				:CALC{1-16}:RLIM on page 426		
	Ripple Value				:CALC{1-16}:RLIM:DISP:VAL on page 430		
	Ripple Band				:CALC{1-16}:RLIM:DISP:SEL on page 429		
	Transform	Center				:CALC{1-16}:TRAN:TIME:CENT on page 436	
		Set Freq Low Pass				:CALC{1-16}:TRAN:TIME:LPFR on page 439	
		Span				:CALC{1-16}:TRAN:TIME:SPAN on page 439	
		Start				:CALC{1-16}:TRAN:TIME:STAR on page 440	
		Stop				:CALC{1-16}:TRAN:TIME:STOP on page 444	
		Transform				:CALC{1-16}:TRAN:TIME:STAT on page 441	
		Type				:CALC{1-16}:TRAN:TIME on page 435 :CALC{1-16}:TRAN:TIME:STIM on page 443	
		Window	Impulse Width				:CALC{1-16}:TRAN:TIME:IMP:WIDT on page 437
			Kaiser Beta				:CALC{1-16}:TRAN:TIME:KBES on page 438
			Maximum				
	Minimum						
Normal							
	Step Rise				:CALC{1-16}:TRAN:TIME:STEP:RTIM on page 442		
[Avg]	Ave Trigger				:TRIG:AVER on page 803		
	Averaging				:SENS{1-16}:AVER on page 543		
	Averaging Restart				:SENS{1-16}:AVER:CLE on page 543		
	Avg Factor				:SENS{1-16}:AVER:COUN on page 544		
	Smo Aperture				:CALC{1-16}:SMO:APER on page 434		
	Smoothing				:CALC{1-16}:SMO on page 433		
	IF Bandwidth				:SENS{1-16}:BAND on page 545 :SENS{1-16}:BWID on page 546		

Table 14-1 Front panel key tree vs. SCPI commands correspondence table

Key (operation)				Corresponding GPIB command		
[Cal]	Cal Kit			:SENS{1-16}:CORR:COLL:CKIT on page 560		
	Cal Trigger Source			:SENS{1-16}:CORR:TRIG:FREE on page 651		
	Calibrate	1-Port Cal	Cancel	OK	:SENS{1-16}:CORR:COLL:CLE on page 590	
			Done		:SENS{1-16}:CORR:COLL:SAVE on page 613	
			Load		:SENS{1-16}:CORR:COLL:LOAD on page 600	
			Open		:SENS{1-16}:CORR:COLL:OPEN on page 611	
			Select Port		:SENS{1-16}:CORR:COLL:METH:SOLT1 on page 604	
			Short		:SENS{1-16}:CORR:COLL:SHOR on page 613	
	2-Port Cal 3-Port Cal 4-Port Cal	2-Port Cal	Cancel	OK	:SENS{1-16}:CORR:COLL:CLE on page 590	
			Done		:SENS{1-16}:CORR:COLL:SAVE on page 613	
		3-Port Cal	Isolation (Optional)		:SENS{1-16}:CORR:COLL:ISOL on page 599	
			Overwrite		:SENS{1-16}:CORR:COLL:PART:SAVE on page 612	
			Reflection	Port n Load		:SENS{1-16}:CORR:COLL:LOAD on page 600
		Port n Open		:SENS{1-16}:CORR:COLL:OPEN on page 611		
		Port n Short		:SENS{1-16}:CORR:COLL:SHOR on page 613		
		Select Ports	(2-Port Cal)		:SENS{1-16}:CORR:COLL:METH:SOLT2 on page 604	
			(3-Port Cal)		:SENS{1-16}:CORR:COLL:METH:SOLT3 on page 605	
			(4-Port Cal)		:SENS{1-16}:CORR:COLL:METH:SOLT4 on page 605	
	Transmission			:SENS{1-16}:CORR:COLL:THRU on page 616		
	2-Port TRL 3-Port TRL 4-Port TRL	2-Port TRL	Cancel	OK	:SENS{1-16}:CORR:COLL:CLE on page 590	
			Done		:SENS{1-16}:CORR:COLL:SAVE on page 613	
		3-Port TRL	Line/Match		:SENS{1-16}:CORR:COLL:TRLL on page 617	
			Reflect	Port x Reflect		:SENS{1-16}:CORR:COLL:TRLR on page 618
		4-Port TRL	Select Ports	(2-Port TRL)		:SENS{1-16}:CORR:COLL:METH:TRL2 on page 607
				(3-Port TRL)		:SENS{1-16}:CORR:COLL:METH:TRL3 on page 608
	(4-Port TRL)			:SENS{1-16}:CORR:COLL:METH:TRL4 on page 609		
	Thru/Line			:SENS{1-16}:CORR:COLL:TRLT on page 619		
	Adapter Removal	Adapter Length			:SENS{1-16}:CORR:COLL:ADAP{1-4}:LENG on page 559	
		Cal Kit			:SENS{1-16}:CORR:COLL:CKIT on page 560	
		Cancel	OK		:SENS{1-16}:CORR:COLL:CLE on page 590	
		Done			:SENS{1-16}:CORR:COLL:SAVE on page 613	
		Isolation (Optional)			:SENS{1-16}:CORR:COLL:ISOL on page 599	
		Load			:SENS{1-16}:CORR:COLL:LOAD on page 600	
		Open			:SENS{1-16}:CORR:COLL:OPEN on page 611	
		Select Port			:SENS{1-16}:CORR:COLL:METH:ERES on page 602	
		Short			:SENS{1-16}:CORR:COLL:SHOR on page 613	

Table 14-1 Front panel key tree vs. SCPI commands correspondence table

Key (operation)			Corresponding GPIB command		
[Cal] (Continued)	Calibrate (Continued)	Enhanced Response	Cancel	OK	:SENS{1-16}:CORR:COLL:CLE on page 590
			Done		:SENS{1-16}:CORR:COLL:SAVE on page 613
			Isolation (Optional)		:SENS{1-16}:CORR:COLL:ISOL on page 599
			Load		:SENS{1-16}:CORR:COLL:LOAD on page 600
			Open		:SENS{1-16}:CORR:COLL:OPEN on page 611
			Select Port		:SENS{1-16}:CORR:COLL:METH:ERES on page 602
			Short		:SENS{1-16}:CORR:COLL:SHOR on page 613
			Thru		:SENS{1-16}:CORR:COLL:THRU on page 616
		Response (Open)	Cancel	OK	:SENS{1-16}:CORR:COLL:CLE on page 590
			Done		:SENS{1-16}:CORR:COLL:SAVE on page 613
			Load (Optional)		:SENS{1-16}:CORR:COLL:LOAD on page 600
			Open		:SENS{1-16}:CORR:COLL:OPEN on page 611
			Select Port		:SENS{1-16}:CORR:COLL:METH:OPEN on page 603
		Response (Short)	Cancel	OK	:SENS{1-16}:CORR:COLL:CLE on page 590
			Done		:SENS{1-16}:CORR:COLL:SAVE on page 613
			Load (Optional)		:SENS{1-16}:CORR:COLL:LOAD on page 600
			Select Port		:SENS{1-16}:CORR:COLL:METH:SHOR on page 603
			Short		:SENS{1-16}:CORR:COLL:SHOR on page 613
		Response (Thru)	Cancel	OK	:SENS{1-16}:CORR:COLL:CLE on page 590
			Done		:SENS{1-16}:CORR:COLL:SAVE on page 613
			Isolation (Optional)		:SENS{1-16}:CORR:COLL:ISOL on page 599
			Select Ports		:SENS{1-16}:CORR:COLL:METH:THRU on page 606
			Thru		:SENS{1-16}:CORR:COLL:THRU on page 616
		Clear	OK		:SENS{1-16}:CORR:CLE on page 547
		Correction			:SENS{1-16}:CORR:STAT on page 650
		ECal	1-Port Cal		:SENS{1-16}:CORR:COLL:ECAL:SOLT1 on page 594
			2-Port Cal		:SENS{1-16}:CORR:COLL:ECAL:SOLT2 on page 594
			3-Port Cal		:SENS{1-16}:CORR:COLL:ECAL:SOLT3 on page 595
			4-Port Cal		:SENS{1-16}:CORR:COLL:ECAL:SOLT4 on page 595
			Characterization		:SENS{1-16}:CORR:COLL:ECAL:UCH on page 597
			Characterization Info		N/A
			Confidence Check		:SENS{1-16}:CORR:COLL:ECAL:CCH on page 591
			Enhanced Response		:SENS{1-16}:CORR:COLL:ECAL:ERES on page 592
			Isolation		:SENS{1-16}:CORR:COLL:ECAL:ISOL on page 593
			Orientation		:SENS:CORR:COLL:ECAL:ORI on page 535
				Port n	Port n
	Thru Cal		:SENS{1-16}:CORR:COLL:ECAL:THRU on page 596		
	Unknown Thru		:SENS{1-16}:CORR:COLL:ECAL:UTHR on page 598		

Table 14-1 Front panel key tree vs. SCPI commands correspondence table

Key (operation)			Corresponding GPIB command			
[Cal] (Continued)	Mixer / Converter Calibration	Clear	OK	:SENS{1-16}:CORR:OFFS:CLE on page 634		
		Scalar Cal (Manual)	Cancel	OK	:SENS{1-16}:CORR:OFFS:COLL:CLE on page 635	
			Done		:SENS{1-16}:CORR:OFFS:COLL:SAVE on page 643	
			Power Meter	Port x1 @ Freq y1 to Port x2 @ Freq y2		:SENS{1-16}:CORR:OFFS:COLL:PMET on page 642
				:		
			Reflection	Port x @ Freq y (Broadband)		:SENS{1-16}:CORR:OFFS:COLL:LOAD on page 638
				:		
				Port x @ Freq y (Open)		:SENS{1-16}:CORR:OFFS:COLL:OPEN on page 641
				:		
			Port x @ Freq y (Short)			:SENS{1-16}:CORR:OFFS:COLL:SHOR on page 644
				:		
				:		
			Select Ports	2-1 (fwd)		:SENS{1-16}:CORR:OFFS:COLL:METH:SMIX2 on page 639
		:				
		Port 1			:SENS{1-16}:CORR:OFFS:COLL:METH:SOLT1 on page 640	
		Transmiss ion	Thru x-y @ Freq z (Thru)		:SENS{1-16}:CORR:OFFS:COLL:THRU on page 645	
			:			
		Scalar Cal (ECal)	Cancel	OK	:SENS{1-16}:CORR:OFFS:COLL:CLE on page 635	
			ECal & Done		:SENS{1-16}:CORR:OFFS:COLL:ECAL:SMIX2 on page 636 :SENS{1-16}:CORR:OFFS:COLL:ECAL:SOLT1 on page 637	
			Power Meter	Port x1 @ Freq y1 to Port x2 @ Freq y2		N/A
:						
Select Ports	2-1 (fwd)			N/A		
	:					
	Port 1			N/A		
:						

Table 14-1 Front panel key tree vs. SCPI commands correspondence table

Key (operation)				Corresponding GPIB command			
[Cal] (Continued)	Modify Cal Kit	Define STDs	1. XXXX to 21. XXXX	Label	:SENS{1-16}:CORR:COLL:CKIT:STAN{1-21}:LAB on page 584		
				STD Type	:SENS{1-16}:CORR:COLL:CKIT:STAN{1-21}:TYPE on page 586		
				C0	:SENS{1-16}:CORR:COLL:CKIT:STAN{1-21}:C0 on page 572		
				C1	:SENS{1-16}:CORR:COLL:CKIT:STAN{1-21}:C1 on page 573		
				C2	:SENS{1-16}:CORR:COLL:CKIT:STAN{1-21}:C2 on page 574		
				C3	:SENS{1-16}:CORR:COLL:CKIT:STAN{1-21}:C3 on page 575		
				L0	:SENS{1-16}:CORR:COLL:CKIT:STAN{1-21}:L0 on page 580		
				L1	:SENS{1-16}:CORR:COLL:CKIT:STAN{1-21}:L1 on page 581		
				L2	:SENS{1-16}:CORR:COLL:CKIT:STAN{1-21}:L2 on page 582		
				L3	:SENS{1-16}:CORR:COLL:CKIT:STAN{1-21}:L3 on page 583		
				Offset Delay	:SENS{1-16}:CORR:COLL:CKIT:STAN{1-21}:DEL on page 577		
				Offset Z0	:SENS{1-16}:CORR:COLL:CKIT:STAN{1-21}:Z0 on page 587		
				Offset Loss	:SENS{1-16}:CORR:COLL:CKIT:STAN{1-21}:LOSS on page 585		
				Arb. Impedance	:SENS{1-16}:CORR:COLL:CKIT:STAN{1-21}:ARB on page 571		
				Min. Frequency	:SENS{1-16}:CORR:COLL:CKIT:STAN{1-21}:FMIN on page 579		
		Max. Frequency	:SENS{1-16}:CORR:COLL:CKIT:STAN{1-21}:FMAX on page 578				
		Media	:SENS{1-16}:CORR:COLL:CKIT:STAN{1-21}:CHAR on page 576				
		Export Cal Kit...				:MMEM:STOR:CKIT{1-20} on page 510	
		Import Cal Kit...				:MMEM:LOAD:CKIT{1-20} on page 499	
		Label Kit				:SENS{1-16}:CORR:COLL:CKIT:LAB on page 561	
		Specify CLSs	Load			:SENS{1-16}:CORR:COLL:CKIT:ORD:LOAD on page 563	
			Open			:SENS{1-16}:CORR:COLL:CKIT:ORD:OPEN on page 564	
			Short			:SENS{1-16}:CORR:COLL:CKIT:ORD:SHOR on page 565	
			Sub Class			:SENS{1-16}:CORR:COLL:CKIT:ORD on page 562	
			Thru			:SENS{1-16}:CORR:COLL:CKIT:ORD:THRU on page 566	
			TRL Line/Match			:SENS{1-16}:CORR:COLL:CKIT:ORD:TRLL on page 567	
			TRL Reflect			:SENS{1-16}:CORR:COLL:CKIT:ORD:TRLR on page 568	
TRL Thru			:SENS{1-16}:CORR:COLL:CKIT:ORD:TRLT on page 569				

Table 14-1 Front panel key tree vs. SCPI commands correspondence table

Key (operation)			Corresponding GPIB command		
[Cal] (Continued)	Modify Cal Kit (Continued)	Auto Port Extension	Adjust Mismatch	:SENS{1-16}:CORR:EXT:AUTO:DCOF on page 622	
			Include Loss	:SENS{1-16}:CORR:EXT:AUTO:LOSS on page 623	
			Measure OPEN	All	:SENS{1-16}:CORR:EXT:AUTO:MEAS on page 624
				Port 1	
				Port 2	
				Port 3	
				Port 4	
			Measure Short	All	:SENS{1-16}:CORR:EXT:AUTO:MEAS on page 624
				Port 1	
				Port 2	
				Port 3	
				Port 4	
			Method	Active Marker	:SENS{1-16}:CORR:EXT:AUTO:CONF on page 621
				Current Span	
				User Span	
	User Span Start				
	User Span Stop				
	Select Ports	Port 1	:SENS{1-16}:CORR:EXT:AUTO:PORT{1-4} on page 625		
		Port 2			
		Port 3			
Port 4					
Port Extensions	Extension Port 1		:SENS{1-16}:CORR:EXT:AUTO:PORT{1-4} on page 625		
	Extension Port 2				
	Extension Port 3				
	Extension Port 4				
	Extensions			:SENS{1-16}:CORR:EXT on page 620	
	Loss	Freq1		:SENS{1-16}:CORR:EXT:PORT{1-4}:FREQ{1-2} on page 630	
		Freq2			
		Loss at DC			:SENS{1-16}:CORR:EXT:PORT{1-4}:LDC on page 632
		Loss1			:SENS{1-16}:CORR:EXT:PORT{1-4}:LOSS{1-2} on page 633
		Loss2			
		Select Port	Port 1	N/A	
			Port 2		
	Port 3				
	Port 4				

Table 14-1 Front panel key tree vs. SCPI commands correspondence table

Key (operation)		Corresponding GPIB command		
[Cal] (Continued)	Power Calibration	Abort	:ABOR on page 292	
		Correction	:SOUR{1-16}:POW:PORT{1-4}:CORR on page 711	
		Loss Compen	Add / Delete / Clear Loss Table	:SOUR{1-16}:POW:PORT{1-4}:CORR:COLL:TABL:LOSS:DATA on page 715
			Compensation	:SOUR{1-16}:POW:PORT{1-4}:CORR:COLL:TABL:LOSS on page 714
			Export to CSV File	:MMEM:STOR:PLOS{1-4} on page 514
			Import from CSV File	:MMEM:LOAD:PLOS{1-4} on page 501
		Num of Readings	:SOUR{1-16}:POW:PORT{1-4}:CORR:COLL:AVER on page 712	
		Select Port	N/A	
		Sensor A Settings	Add / Delete / Clear Factor Table	:SOUR:POW:PORT:CORR:COLL:TABL:ASEN:DATA on page 702
			Export to CSV File	:MMEM:STOR:ASCF on page 507
			Import from CSV File	:MMEM:LOAD:ASCF on page 496
			Ref Cal Factor	:SOUR:POW:PORT:CORR:COLL:ASEN:RCF on page 700
		Sensor B Settings	Add / Delete / Clear Factor Table	:SOUR:POW:PORT:CORR:COLL:TABL:BSEN:DATA on page 703
			Export to CSV File	:MMEM:STOR:BSCF on page 508
			Import from CSV File	:MMEM:LOAD:BSCF on page 497
	Ref Cal Factor		:SOUR:POW:PORT:CORR:COLL:BSEN:RCF on page 701	
	Take Cal Sweep	:SOUR{1-16}:POW:PORT{1-4}:CORR:COLL on page 711		
	Tolerance	:SOUR{1-16}:POW:PORT{1-4}:CORR:COLL:NTOL on page 713		
	Use Sensor	N/A		
	Property	:SENS{1-16}:CORR:PROP on page 646		
	Receiver Calibration	Correction	:SENS{1-16}:CORR:REC{1-4} on page 647	
		Take Cal Sweep	:SENS{1-16}:CORR:REC{1-4}:COLL:ACQ on page 648	
	Set Z0	:SENS:CORR:IMP on page 537		
Velocity Factor	:SENS{1-16}:CORR:RVEL:COAX on page 649			
[Center]	:SENS{1-16}:FREQ:CENT on page 654 :SOUR{1-16}:POW:CENT on page 708			
[Channel Prev]	:DISP:WIND{1-16}:ACT on page 470			
[Channel Max]	:DISP:MAX on page 465			
[Channel Next]	:DISP:WIND{1-16}:ACT on page 470			

Table 14-1 Front panel key tree vs. SCPI commands correspondence table

Key (operation)		Corresponding GPIB command
[Display]	Allocate Channels	:DISP:SPL on page 466
	Allocate Traces	:DISP:WIND{1-16}:SPL on page 475
	Data - > Mem	:CALC{1-16}:MATH:MEM on page 416
	Data Math	:CALC{1-16}:MATH:FUNC on page 415
	Display	:DISP:WIND{1-16}:TRAC{1-16}:STAT on page 481 :DISP:WIND{1-16}:TRAC{1-16}:ANN:MARK:POS:X on page 478
	Edit Title Label	:DISP:WIND{1-16}:TITL:DATA on page 477
	Equation	:CALC{1-16}:EQU:STAT on page 311
	Equation Editor...	:CALC{1-16}:EQU:TEXT on page 312
	Frequency	:DISP:ANN:FREQ on page 454
	Graticule Label	:DISP:WIND{1-16}:LAB on page 473
	Invert Color	:DISP:IMAG on page 464
	Num of Traces	:CALC{1-16}:PAR:COUN on page 421
	Title Label	:DISP:WIND{1-16}:TITL on page 476
Update	:DISP:ENAB on page 462	
[Format]		:CALC{1-16}:FORM on page 321
[Macro Break]		:PROG:STAT on page 529
[Macro Run]		N/A
[Macro Setup]	Clear Echo	:DISP:ECHO:CLE on page 461
	Close Editor	N/A
	Continue	N/A
	Echo Window	:DISP:TABL on page 468 :DISP:TABL:TYPE on page 469
	Load & Run	N/A
	Load Project	:MMEM:LOAD:PROG on page 502
	New Project	N/A
	Preset User Menu	N/A
	Save Project	:MMEM:STOR:PROG on page 515
	Select Macro	:PROG:NAME on page 528 :PROG:STAT on page 529
	Stop	:PROG:STAT on page 529
	User Menu	N/A
	VBA Editor	N/A

Table 14-1 Front panel key tree vs. SCPI commands correspondence table

Key (operation)		Corresponding GPIB command	
[Marker]	Clear Marker Menu	:CALC{1-16}:MARK{1-10} on page 398	
	Marker 1 to Marker 4	:CALC{1-16}:MARK{1-10} on page 398 :CALC{1-16}:MARK{1-10}:ACT on page 399 :CALC{1-16}:MARK{1-10}:X on page 413	
	Marker - > Ref Marker	N/A	
	More Markers	Marker 5 to Marker 9	:CALC{1-16}:MARK{1-10} on page 398 :CALC{1-16}:MARK{1-10}:ACT on page 399 :CALC{1-16}:MARK{1-10}:X on page 413
	Ref Marker	:CALC{1-16}:MARK{1-10} on page 398 :CALC{1-16}:MARK{1-10}:ACT on page 399 :CALC{1-16}:MARK{1-10}:X on page 413 :CALC{1-16}:MARK:REF on page 397	
	Ref Marker Mode	:CALC{1-16}:MARK:REF on page 397	
[Marker Func]	Annotation Options	Active Only	:DISP:WIND{1-16}:ANN:MARK:SING on page 472
		Align	:DISP:WIND{1-16}:ANN:MARK:ALIG on page 471
		Marker Info X Pos	:DISP:WIND{1-16}:TRAC{1-16}:ANN:MARK:POS:X on page 478
		Marker Info Y Pos	:DISP:WIND{1-16}:TRAC{1-16}:ANN:MARK:POS:Y on page 479
	Couple	:CALC{1-16}:MARK:COUP on page 391	
	Discrete	:CALC{1-16}:MARK{1-10}:DISC on page 402	
	Marker Table	:DISP:TABL on page 468 :DISP:TABL:TYPE on page 469	
	Marker - > Center	:CALC{1-16}:MARK{1-10}:SET on page 412	
	Marker - > Delay		
	Marker - > Reference		
	Marker - > Start		
	Marker - > Stop		
	Statistics	:CALC{1-16}:MST on page 418 :CALC{1-16}:MST:DATA? on page 419	

Table 14-1 Front panel key tree vs. SCPI commands correspondence table

Key (operation)		Corresponding GPIB command	
[Marker Search]	Bandwidth	:CALC{1-16}:MARK:BWID on page 390 :CALC{1-16}:MARK{1-10}:BWID:DATA? on page 400	
	Bandwidth Value	:CALC{1-16}:MARK{1-10}:BWID:THR on page 401	
	Max	:CALC{1-16}:MARK{1-10}:FUNC:TYPE on page 409	
	Min	:CALC{1-16}:MARK{1-10}:FUNC:EXEC on page 403	
	Notch	:CALC{1-16}:MARK:NOTC on page 396 :CALC{1-16}:MARK{1-10}:NOTC:DATA? on page 410	
	Notch Value	:CALC{1-16}:MARK{1-10}:NOTC:THR on page 411	
	Peak	Peak Excursion	:CALC{1-16}:MARK{1-10}:FUNC:PEXC on page 404
		Peak Polarity	:CALC{1-16}:MARK{1-10}:FUNC:PPOL on page 405
		Search Left	:CALC{1-16}:MARK{1-10}:FUNC:TYPE on page 409
		Search Peak	:CALC{1-16}:MARK{1-10}:FUNC:EXEC on page 403
		Search Right	
	Search Range	Couple	:CALC{1-16}:MARK:FUNC:DOM:COUP on page 393
		Search Range	:CALC{1-16}:MARK:FUNC:DOM on page 392
		Start	:CALC{1-16}:MARK:FUNC:DOM:STAR on page 394
		Stop	:CALC{1-16}:MARK:FUNC:DOM:STOP on page 395
	Target	Search Left	:CALC{1-16}:MARK{1-10}:FUNC:TYPE on page 409
		Search Right	:CALC{1-16}:MARK{1-10}:FUNC:EXEC on page 403
		Search Target	
		Target Transition	:CALC{1-16}:MARK{1-10}:FUNC:TTR on page 408
		Target Value	:CALC{1-16}:MARK{1-10}:FUNC:TARG on page 406
Tracking	:CALC{1-16}:MARK{1-10}:FUNC:TRAC on page 407		
[Meas]	S11 to S44	:CALC{1-16}:PAR{1-16}:DEF on page 422	
	SSS11 to CMRR2	:CALC{1-16}:FSIM:BAL:PAR{1-16}:SBAL on page 340 :CALC{1-16}:FSIM:BAL:PAR{1-16}:BBAL on page 339 :CALC{1-16}:FSIM:BAL:PAR{1-16}:SSB on page 341	
	Absolute	A(1)	:CALC{1-16}:PAR{1-16}:SPOR on page 425
		A(2)	:CALC{1-16}:PAR{1-16}:DEF on page 422
		:	
		R4(3)	
		R4(4)	
[Preset]	OK	:SYST:PRES on page 796 :SYST:UPR on page 801	

Table 14-1 Front panel key tree vs. SCPI commands correspondence table

Key (operation)		Corresponding GPIB command	
[Save/ Recall]	Channel/Trace	:MMEM:STOR:SALL on page 517	
	Explorer	N/A	
	Recall by File Name	:MMEM:LOAD on page 495	
	Recall Channel	:MMEM:LOAD:CHAN on page 498	
	Recall State	:MMEM:LOAD on page 495	
	Save Channel	Clear States	:MMEM:STOR:CHAN:CLE on page 509
		State A - State D	:MMEM:STOR:CHAN on page 509
	Save Snp	Snp Format	:MMEM:STOR:SNP:FORM on page 520
		S1p	:MMEM:STOR:SNP:TYPE:S1P on page 521 :MMEM:STOR:SNP on page 519
		S2p	:MMEM:STOR:SNP:TYPE:S2P on page 522 :MMEM:STOR:SNP on page 519
		S3p	:MMEM:STOR:SNP:TYPE:S3P on page 523 :MMEM:STOR:SNP on page 519
		S4p	:MMEM:STOR:SNP:TYPE:S4P on page 524 :MMEM:STOR:SNP on page 519
	Save State	:MMEM:STOR on page 506	
	Save Trace Data	:MMEM:STOR:FDAT on page 511	
Save Type	on page 525		
[Scale]	Auto Scale	:DISP:WIND{1-16}:TRAC{1-16}:Y:AUTO on page 481	
	Auto Scale All	N/A	
	Divisions	:DISP:WIND{1-16}:Y:DIV on page 486	
	Electrical Delay	Electrical Delay	:CALC{1-16}:CORR:EDEL:TIME on page 304
		Cutoff	:CALC{1-16}:CORR:EDEL:WGC on page 305
		Media	:CALC{1-16}:CORR:EDEL:MED on page 303
	Marker - > Reference	:CALC{1-16}:MARK{1-10}:SET on page 412	
	Phase Offset	:CALC{1-16}:CORR:OFFS:PHAS on page 306	
	Reference Position	:DISP:WIND{1-16}:TRAC{1-16}:Y:RPOS on page 484	
	Reference Value	:DISP:WIND{1-16}:TRAC{1-16}:Y:RLEV on page 483	
Scale/Div	:DISP:WIND{1-16}:TRAC{1-16}:Y:PDIV on page 482		
[Softkey On/Off]	:DISP:SKEY on page 465		
[Span]	:SENS{1-16}:FREQ:SPAN on page 656 :SOUR{1-16}:POW:SPAN on page 719		
[Start]	:SENS{1-16}:FREQ:STAR on page 657 :SOUR{1-16}:POW:STAR on page 720		
[Stop]	:SENS{1-16}:FREQ:STOP on page 658 :SOUR{1-16}:POW:STOP on page 721		

Table 14-1 Front panel key tree vs. SCPI commands correspondence table

Key (operation)		Corresponding GPIB command		
[Sweep Setup]	Edit Segment Table		:SENS{1-16}:SEGM:DATA on page 688	
	Edit Segment Table	Export to CSV File	:MMEM:STOR:SEGM on page 518	
		Import from CSV File	:MMEM:LOAD:SEGM on page 504	
	Frequency Offset	Avoid Spurious		:SENS{1-16}:OFFS:ASP on page 669
		External Source	Control	:SENS{1-16}:OFFS:LOC:CONT on page 670
			Divisor	:SENS{1-16}:OFFS:LOC:DIV on page 672
			LO Frequency	:SENS{1-16}:OFFS:LOC:STAT on page 680
			Multiplier	:SENS{1-16}:OFFS:LOC:MULT on page 673
			Offset	:SENS{1-16}:OFFS:LOC:OFFS on page 674
			Start	:SENS{1-16}:OFFS:LOC:STAR on page 675
			Stop	:SENS{1-16}:OFFS:LOC:STOP on page 676
			Power	:SENS{1-16}:OFFS:LOC:POW on page 677
			Slope [x dB/GHz]	:SENS{1-16}:OFFS:LOC:POW:SLOP on page 678
			Slope [ON/OFF]	:SENS{1-16}:OFFS:LOC:POW:SLOP:STAT on page 679
		Frequency Offset		:SENS{1-16}:OFFS on page 668
		Port 1	Divisor	:SENS{1-16}:OFFS:PORT{1-4}:DIV on page 682
			Multiplier	:SENS{1-16}:OFFS:PORT{1-4}:MULT on page 683
	Offset		:SENS{1-16}:OFFS:PORT{1-4}:OFFS on page 684	
	Start		:SENS{1-16}:OFFS:PORT{1-4}:STAR on page 685	
	Stop		:SENS{1-16}:OFFS:PORT{1-4}:STOP on page 686	
	:			
	X-Axis	Base / Stimulus / Response / Normal / RF+LO / RF-LO / LO-RF	:CALC{1-16}:OFFS:XAX on page 420 :CALC{1-16}:MIX:XAX on page 417	
		Points		:SENS{1-16}:SWE:POIN on page 693
	Power	Auto Range	:SOUR{1-16}:POW:ATT:AUTO on page 706	
		CW Freq	:SENS{1-16}:FREQ on page 653	
		Port Couple	:SOUR{1-16}:POW:PORT:COUP on page 709	
		Port Power	:SOUR{1-16}:POW:PORT{1-4} on page 710	
		Power	:SOUR{1-16}:POW on page 704	
		Power Ranges	:SOUR{1-16}:POW:ATT on page 705	
		RF Out	:OUTP on page 527	
Slope [ON/OFF]		:SOUR{1-16}:POW:SLOP:STAT on page 718		
Slope [xx dB/GHz]		:SOUR{1-16}:POW:SLOP on page 717		
Segment Display		:DISP:WIND{1-16}:X:SPAC on page 485		
Sweep Delay		:SENS{1-16}:SWE:DEL on page 691		
Sweep Mode		:SENS{1-16}:SWE:GEN on page 692		
Sweep Time		:SENS{1-16}:SWE:TIME on page 694 :SENS{1-16}:SWE:TIME:AUTO on page 695		
Sweep Type		:SENS{1-16}:SWE:TYPE on page 696		

Table 14-1 Front panel key tree vs. SCPI commands correspondence table

Key (operation)			Corresponding GPIB command		
[System]	Abort Printing		:HCOP:ABOR on page 489		
	Backlight		:SYST:BACK on page 779		
	Dump Screen Image		:MMEM:STOR:IMAG on page 512		
	Firmware Revision		*IDN? on page 288		
	Invert Image		:HCOP:IMAG on page 490		
	Misc Setup	Beeper	Beep Complete	:SYST:BEEP:COMP:STAT on page 780	
			Beep Warning	:SYST:BEEP:WARN:STAT on page 781	
			Test Beep Complete	:SYST:BEEP:COMP:IMM on page 780	
			Test Beep Warning	:SYST:BEEP:WARN:IMM on page 781	
	Channel/Trace Setup		N/A		
	Clock Setup	Set Date and Time		:SYST:DATE on page 790 :SYST:UPR on page 801	
		Show Clock		:DISP:CLOC on page 455	
	Color Setup		:DISP:COL{1-2}:TRAC{1-16}:DATA on page 459 :DISP:COL{1-2}:TRAC{1-16}:MEM on page 460 :DISP:COL{1-2}:GRAT{1-2} on page 457 :DISP:COL{1-2}:LIM{1-2} on page 458 :DISP:COL{1-2}:BACK on page 456 :DISP:COL{1-2}:RES on page 458		
	Control Panel...		N/A		
	GPIB Setup	Power Meter Address		:SYST:COMM:GPIB:PMET:ADDR on page 782	
		Signal Generator Address	Address		:SYST:COMM:GPIB:SGEN:ADDR on page 783
			Custom Command	Set Frequency	:SYST:COMM:GPIB:SGEN:CCOM:FREQ on page 784
				Preset	:SYST:COMM:GPIB:SGEN:CCOM:PRES on page 786
				Set Power Level	:SYST:COMM:GPIB:SGEN:CCOM:POW on page 785
				Turn RF Out On	:SYST:COMM:GPIB:SGEN:CCOM:RFON on page 787
8643A, 8644B, 8664A, 8665A/B			:SYST:COMM:GPIB:SGEN:TYPE on page 789		
8648A/B/C/D, ESG Series, PSG Series					
Switching Time		:SYST:COMM:GPIB:SGEN:DWEL on page 788			
System Controller Configuration		N/A			
Talker/Listener Address		N/A			

Table 14-1 Front panel key tree vs. SCPI commands correspondence table

Key (operation)			Corresponding GPIB command		
[System] (Continued)	Misc Setup (Continued)	Key Lock	Front Panel & Keyboard Lock	:SYST:KLOC:KBD on page 794	
			Touch Screen & Mouse Lock	:SYST:KLOC:MOUS on page 795	
		Network Setup		N/A	
		Preset Setup	Confirm		N/A
			State	Factory	N/A
				User	
	Multiport Test Set Setup	Test Set 1	Control		:SENS:MULT{1-2}:STAT on page 542
			Control Lines		:SENS{1-16}:MULT{1-2}:OUTP on page 659 :SENS{1-16}:MULT{1-2}:TSET9:OUTP on page 663
			Port 1		:SENS{1-16}:MULT{1-2}:PORT{1-20} on page 660
			Port 2		
			Port 3		
			Port 4		
			Port 5 ^{*1}		
			Port 6 ^{*1}		
			Port 7 ^{*1}		
		Property		:SENS:MULT{1-2}:DISP on page 539	
	Select Test Set		:SENS:MULT{1-2}:NAME on page 541		
	Test Set 2		Displays the model selected for test set 2.		
	Print			:HCOP on page 489	
	Printer Setup			N/A	
	Service Menu	Avoid Spurious		:SENS{1-16}:SWE:ASP on page 691	
		Channel/Trace Setup		N/A	
		Enable Options		N/A	
		High Temperature		:SYST:TEMP:HIGH on page 799	
		Init Src Port		:SYST:ISPC:PORT on page 792	
		Init Src Ctrl		:SYST:ISPC:STAT on page 793	
		Security Level		:SYST:SEC:LEV on page 797	
		System Correction		:SYST:CORR on page 790	
		Test Menu	Adjust Touch Screen		N/A
			Display		N/A
			Front Panel		N/A
			Power On Test		N/A
		Restart Firmware		N/A	
Service Functions		N/A			
Update Firmware		N/A			
[Trace Prev]			:CALC{1-16}:PAR{1-16}:SEL on page 424		
[Trace Max]			:DISP:WIND{1-16}:MAX on page 474		
[Trace Next]			:CALC{1-16}:PAR{1-16}:SEL on page 424		

Table 14-1 Front panel key tree vs. SCPI commands correspondence table

	Key (operation)	Corresponding GPIB command
[Trigger]	Continuous	:INIT{1-16}:CONT on page 491
	Continuous Disp Channels	N/A
	Ext Trig Delay	:TRIG:EXT:DEL on page 804
	Hold	:ABOR on page 292 :INIT{1-16}:CONT on page 491
	Hold All Channels	N/A
	Low Latency	:TRIG:EXT:LLAT on page 805
	Restart	:ABOR on page 292
	Single	:ABOR on page 292 :INIT{1-16}:CONT on page 491 :INIT{1-16} on page 490
	Trigger Event	:TRIG:POIN on page 806
	Trigger Scope	:TRIG:SCOP on page 807
	Trigger Source	:TRIG:SOUR on page 809
	Trigger	:TRIG on page 802

*1. E5091A-016 only

Command tree

Table 14-2 shows the SCPI command tree of the E5070B/E5071B.

Table 14-2 E5070B/E5071B SCPI command tree

Command	Parameters	Note
ABORt		[No query]
CALCulate{[1] 2 3 4 5 6 7 8 9 10 11 12 13 14 15 16}		
:FSIMulator		
:BALun		
:CZConversion		
:BPORT{[1] 2}		
:IMAGinary	<numeric>	
:REAL	<numeric>	
:ZO		
[:R]	<numeric>	
:STATe	{ON OFF 1 0}	
:DEVIce	{SBALanced BBALanced SSBalanced}	
:DMCircuit		
:BPORT{[1] 2}		
:PARAMeters		
:C	<numeric>	
:G	<numeric>	
:L	<numeric>	
:R	<numeric>	
[:TYPE]	{NONE PLPC USER}	
:USER		
:FILENAME	<string>	
:STATe	{ON OFF 1 0}	
:DZConversion		
:BPORT{[1] 2}		
:IMAGinary	<numeric>	
:REAL	<numeric>	
:ZO		
[:R]	<numeric>	
:STATe	{ON OFF 1 0}	
:PARAMeter{[1] 2 3 4 5 6 7 8 9 10 11 12 13 14 15 16}		
:BBALanced		
[:DEFine]	{SCC11 SCC21 SCC12 SCC22 SDC11 SDC21 SDC12 SDC22 SCD11 SCD21 SCD12 SCD22 SDD11 SDD21 SDD12 SDD22 IMB1 IMB2 CMRR}	
:SBALanced		
[:DEFine]	{SSS11 SCS21 SSC12 SDS21 SSD12 SCC22 SDC22 SCD22 SDD22 IMB CMRR CMRR2}	
:SSBalanced		
[:DEFine]	{SSS11 SSS21 SSS12 SSS22 SCS31 SCS32 SSC13 SSC23 SDS31 SDS32 SSD13 SSD23 SCC33 SDC33 SCD33 SDD33 IMB1 IMB2 IMB3 IMB4 CMRR1 CMRR2}	
:STATe	{ON OFF 1 0}	

Table 14-2 E5070B/E5071B SCPI command tree

Command	Parameters	Note
CALCulate{[1] 2 3 4 5 6 7 8 9 10 11 12 13 14 15 16}		
:FSIMulator		
:BALun		
:TOPology		
:BBALanced		
[:PPORts]	<numeric>,<numeric>,<numeric>,<numeric>	
:PROPerTy		
:STATe	{ON OFF 1 0}	
:SBALanced		
[:PPORts]	<numeric>,<numeric>,<numeric>	
:SSBalanced		
[:PPORts]	<numeric>,<numeric>,<numeric>,<numeric>	
:EMBed		
:NETWork{[1] 2}		
:FILEname	<string>	
:TYPE	{NONE ENBed DEEMbed}	
:STATe	{ON OFF 1 0}	
:TOPology		
:A		
:PORTs	<numeric>,<numeric>	
:B		
:PORTs	<numeric>,<numeric>,<numeric>	
:C		
:PORTs	<numeric>,<numeric>,<numeric>,<numeric>	
:TYPE	{A B C}	
:SENDEd		
:DEEMbed		
:PORT{[1] 2 3 4}		
[:TYPE]	{NONE USER}	
:USER		
:FILEname	<string>	
:STATe	{ON OFF 1 0}	
:PMCircuit		
:PORT{[1] 2 3 4}		
:PARAmeters		
:C	<numeric>	
:G	<numeric>	
:L	<numeric>	
:R	<numeric>	
[:TYPE]	{NONE SLPC PCSL PLSC SCPL PLPC USER}	
:USER		
:FILEname	<string>	
:STATe	{ON OFF 1 0}	

Table 14-2 E5070B/E5071B SCPI command tree

Command	Parameters	Note
CALCulate{[1] 2 3 4 5 6 7 8 9 10 11 12 13 14 15 16}		
:FSIMulator		
:SENDEd		
:ZCONversion		
:PORT{[1] 2 3 4}		
:IMAGinary	<numeric>	
:REAL	<numeric>	
:Z0		
[:R]	<numeric>	
:STATe	{ON OFF 1 0}	
:STATe	{ON OFF 1 0}	
:PARAmeter		
:COUNT	<numeric>	
:PARAmeter{[1] 2 3 4 5 6 7 8 9 10 11 12 13 14 15 16}		
:DEFine	{S11 S21 S31 S41 S12 S22 S32 S42 S13 S23 S33 S43 S14 S24 S34 S44 A B C D R1 R2 R3 R4}	
:SELEct		[No query]
:SPORt	<numeric>	
[:SELEcted]		
:BLIMit		
:DB	<numeric>	
:DISPlay		
:MARKer	{ON OFF 1 0}	
:VALue	{ON OFF 1 0}	
:FAIL?		[Query only]
:MAXimum	<numeric>	
:MINimum	<numeric>	
:REPORt		
[:DATA]?		[Query only]
[:STATe]	{ON OFF 1 0}	
:CONVersion		
:FUNCTion	{ZREFlection ZTRansmit YREFlection YTRansmit INVersion ZTSHunt YTSHunt CONJugation}	
[:STATe]	{ON OFF 1 0}	
:CORRection		
:EDELay		
:MEDIum	{COAXial WAVEguide}	
:TIME	<numeric>	
:WGCutoff	<numeric>	
:OFFSet		
:PHASe	<numeric>	

Table 14-2 E5070B/E5071B SCPI command tree

Command	Parameters	Note
CALCulate{[1] 2 3 4 5 6 7 8 9 10 11 12 13 14 15 16}		
[:SElected]		
:LIMit		
:REPort		
:ALL?		[Query only]
[:DATA]?		[Query only]
:POINts?		[Query only]
[:STATe]	{ON OFF 1 0}	
:MARKer		
:BWIDth		
[:STATe]	{ON OFF 1 0}	
:COUple	{ON OFF 1 0}	
:DISCcrete	{ON OFF 1 0}	
:FUNcTion		
:DOMain		
:COUple	{ON OFF 1 0}	
:STARt	<numeric>	
[:STATe]	{ON OFF 1 0}	
:STOP	<numeric>	
:NOTCh		
[:STATe]	{ON OFF 1 0}	
:REFerence		
[:STATe]	{ON OFF 1 0}	
:MARKer{[1] 2 3 4 5 6 7 8 9 10}		
:ACTivate		[No query]
:BWIDth		
:DATA?		[Query only]
:THReshold	<numeric>	
:FUNcTion		
:EXECute		[No query]
:PEXCursion	<numeric>	
:PPOLarity	{POSitive NEGative BOTH}	
:TARGet	<numeric>	
:TRACking	{ON OFF 1 0}	
:TTRansition	{POSitive NEGative BOTH}	
:TYPE	{MAXimum MINimum PEAK LPEak RPEak TARGet LTARget RTARget}	
:NOTCh		
:DATA?		[Query only]
:THReshold	<numeric>	
:SET	{STARt STOP CENTer RLEVel DELay}	[No query]
[:STATe]	{ON OFF 1 0}	
:X	<numeric>	
:Y?		[Query only]
:MATH		
:FUNcTion	{NORMal SUBTract DIVide ADD MULTIply}	
:MEMorize		[No query]

Table 14-2 E5070B/E5071B SCPI command tree

Command	Parameters	Note
CALCulate{[1] 2 3 4 5 6 7 8 9 10 11 12 13 14 15 16}		
[:SELEcted]		
:MIXer		
:XAXis	{NORMal RFPLo RFMLo LOMRf}	
:MSTatistics		
:DATA?		[Query only]
[:STATe]	{ON OFF 1 0}	
:OFFSet		
:XAXis	{BASE STIMulus RESPonse}	
:RLIMit		
:DATA	<numeric>,...,<numeric> (1 + number of lines × 4 parameters)	
:DISPlay		
:LINE	{ON OFF 1 0}	
:SELEct	<numeric>	
:VALue	{OFF ABSolute MARGin}	
:FAIL?		[Query only]
:REPort		
[:DATA]?		[Query only]
[:STATe]	{ON OFF 1 0}	
:SMOothing		
:APERture	<numeric>	
[:STATe]	{ON OFF 1 0}	
:TRANsform		
:TIME		
:CENTer	<numeric>	
:IMPulse		
:WIDTh	<numeric>	
:KBESsel	<numeric>	
:LPFREquency		[No query]
:SPAN	<numeric>	
:STARt	<numeric>	
:STATe	{ON OFF 1 0}	
:STEP		
:RTIME	<numeric>	
:STIMulus	{IMPulse STEP}	
:STOP	<numeric>	
[:TYPE]	{BPASs LPASs}	
CONTRol		
:HANDler		
:A		
[:DATA]	<numeric>	[No query]
:B		
[:DATA]	<numeric>	[No query]

Table 14-2 E5070B/E5071B SCPI command tree

Command	Parameters	Note
CONTrol		
:HANDler		
:C	[:DATA]	<numeric>
:MODE		{INPut OUTPut}
:D	[:DATA]	<numeric>
:MODE		{INPut OUTPut}
:E	[:DATA]	<numeric>
[:EXTension]		
:INdex		
:STATe		{ON OFF 1 0}
:RTRigger		
:STATe		{ON OFF 1 0}
:F	[:DATA]	<numeric>
:OUTPut{[1] 2}		[No query]
[:DATA]		<numeric>
DISPlay		
:ANNotation		
:FREQuency	[:STATe]	{ON OFF 1 0}
:CLOCK		{ON OFF 1 0}
:COLor{[1] 2}		
:BACK		<numeric>,<numeric>,<numeric>
:GRATicule{[1] 2}		<numeric>,<numeric>,<numeric>
:LIMit{[1] 2}		<numeric>,<numeric>,<numeric>
:RESet		[No query]
:TRACe{[1] 2 3 4 5 6 7 8 9 10 11 12 13 14 15 16}		
:DATA		<numeric>,<numeric>,<numeric>
:MEMory		<numeric>,<numeric>,<numeric>
:ECHO		
:CLEar		[No query]
[:DATA]		<string>
:ENABle		{ON OFF 1 0}
:FSIGn		{ON OFF 1 0}
:IMAGe		{NORMal INVert}
:MAXimize		{ON OFF 1 0}
:SKEY		
[:STATe]		{ON OFF 1 0}
:SPLit		{D1 D12 D1_2 D112 D1_1_2 D123 D1_2_3 D12_33 D11_23 D13_23 D12_13 D1234 D1_2_3_4 D12_34 D123_456 D12_34_56 D1234_5678 D12_34_56_78 D123_456_789 D1234_9ABC D123__ABC D1234__DEFG}

Table 14-2 E5070B/E5071B SCPI command tree

Command	Parameters	Note
DISPlay		
:TABLE		
[:STATe]	{ON OFF 1 0}	
:TYPE	{MARKer LIMit SEGment ECHO PLOSs SCFactor RLIMit}	
:UPDate		
[:IMMediate]		[No query]
:WINDow{[1] 2 3 4 5 6 7 8 9 10 11 12 13 14 15 16}		
:ACTivate		[No query]
:AFANNotation		
:MARKer		
:ALIGn		
[:STATe]	{ON OFF 1 0}	
:SINGle		
[:STATe]	{ON OFF 1 0}	
:LABel	{ON OFF 1 0}	
:MAXimize	{ON OFF 1 0}	
:SPLit	{D1 D12 D1_2 D112 D1_1_2 D123 D1_2_3 D12_33 D11_23 D13_23 D12_13 D1234 D1_2_3_4 D12_34 D123_456 D12_34_56 D1234_5678 D12_34_56_78 D123_456_789 D1234_9ABC D123__ABC D1234__DEFG}	
:TITLe		
:DATA	<string>	
[:STATe]	{ON OFF 1 0}	
:TRACe{[1] 2 3 4 5 6 7 8 9 10 11 12 13 14 15 16}		
:ANNotation		
:MARKer		
:POSition		
:X	<numeric>	
:Y	<numeric>	
:MEMory		
[:STATe]	{ON OFF 1 0}	
:STATe	{ON OFF 1 0}	
:Y		
[:SCALe]		
:AUTO		[No query]
:PDIVision	<numeric>	
:RLEVel	<numeric>	
:RPOSition	<numeric>	
:X		
:SPACing	{LINear OBASe}	
:Y		
[:SCALe]		
:DIVisions	<numeric>	

Table 14-2 E5070B/E5071B SCPI command tree

Command	Parameters	Note
FORMat		
:BORDER	{NORMAL SWAPPED}	
:DATA	{ASCII REAL REAL32}	
HCOpy		
:ABORt		[No query]
:IMAGe	{NORMAL INVERT}	
[:IMMediate]		[No query]
INITiate{[1] 2 3 4 5 6 7 8 9 10 11 12 13 14 15 16}		
:CONTinuous	{ON OFF 1 0}	
[:IMMediate]		[No query]
MMEMory		
:CATalog?	<string>	[Query only]
:COPY	<string>,<string>	[No query]
:DELete	<string>	[No query]
:LOAD		
:ASCFactor	<string>	[No query]
:BSCFactor	<string>	[No query]
:CHANnel		
[:STATe]	{A B C D}	[No query]
:CKIT{[1] 2 3 4 5 6 7 8 9 10 11 12 13 14 15 16 17 18 19 20}	<string>	[No query]
:LIMit	<string>	[No query]
:PROSS	<string>	[No query]
:PROGram	<string>	[No query]
:RLIMit	<string>	[No query]
:SEGment	<string>	[No query]
[:STATe]	<string>	[No query]
:MDIRectory	<string>	[No query]
:STORe		
:ASCFactor	<string>	[No query]
:BSCFactor	<string>	[No query]
:CHANnel		
:CLEar		[No query]
[:STATe]	{A B C D}	[No query]
:CKIT{[1] 2 3 4 5 6 7 8 9 10 11 12 13 14 15 16 17 18 19 20}	<string>	[No query]
:FDATa	<string>	[No query]
:IMAGe	<string>	[No query]
:LIMit	<string>	[No query]
:PLOSS	<string>	[No query]
:PROGram	<string>	[No query]
:RLIMit	<string>	[No query]
:SALL	{ON OFF 1 0}	
:SEGment	<string>	[No query]

Table 14-2 E5070B/E5071B SCPI command tree

Command	Parameters	Note
MMEMory		
:STORe		
:SNP		
[:DATA]	<string>	[No query]
:FORMat	{AUTO MA DB RI}	
:TYPE		
:S1P	<numeric>	
:S2P	<numeric>,<numeric>	
:S3P	<numeric>,<numeric>,<numeric>	
:S4P	<numeric>,<numeric>,<numeric>,<numeric>	
[:STATe]	<string>	[No query]
:STYPe	{STATe CSTate DSTate CDSTate}	
:TRANsfer	<string>,<block>	[No query]
OUTPut		
[:STATe]	{ON OFF 1 0}	
PROGram		
:CATalog?		[Query only]
[:SELected]		
:NAME	<string>	
:STATe	{STOP RUN}	
:VARIable		
:ARRay{[1] 2 3 4 5 6 7 8 9 10}		
[:DATA]	<numeric>,...,<numeric>	
:SIZE	<numeric>	
:DOUBle{[1] 2 3 4 5 6 7 8 9 10}		
[:DATA]	<numeric>	
:LONG{[1] 2 3 4 5 6 7 8 9 10}		
[:DATA]	<numeric>	
:STRing{[1] 2 3 4 5 6 7 8 9 10}		
[:DATA]	<string>	

Table 14-2 E5070B/E5071B SCPI command tree

Command	Parameters	Note
SENSE		
:CORRection		
:COLLect		
:ECAL		
:ORientation		
[:STATe]	{ON OFF 1 0}	
:PATH	<numeric>,<numeric>	[No query]
:PATH?		[Query only]
:IMP		
:MULTiplexer		
:CATalog?		[Query only]
:MULTiplexer{[1] 2}		
:COUNT?		[Query only]
:DISPlay		
[:STATe]	{ON OFF 1 0}	
:INCount?	<numeric>	[Query only]
:NAME	{E5091_9 E5091_16}	
:STATe	{ON OFF 1 0}	
SENSe{[1] 2 3 4 5 6 7 8 9 10 11 12 13 14 15 16}		
:AVERage		
:CLEar		[No query]
:COUNT	<numeric>	
[:STATe]	{ON OFF 1 0}	
:BANDwidth		
[:RESolution]	<numeric>	
:BWIDth		
[:RESolution]	<numeric>	
:CORRection		
:CLEar		[No query]
:COEFFicient		
[:DATA]	{ES ER ED EL ET EX},<numeric>,<numeric>,<real 1>,<imag 1>,...,<real n>,<imag n> (n is number of points)	
:METHOD		
:ERESponse	<numeric>,<numeric>	[No query]
[:RESPonse]		
:OPEN	<numeric>	[No query]
:SHORT	<numeric>	[No query]
:THRU	<numeric>,<numeric>	[No query]
:SOLT1	<numeric>	[No query]
:SOLT2	<numeric>,<numeric>	[No query]
:SOLT3	<numeric>,<numeric>,<numeric>	[No query]
:SOLT4	<numeric>,<numeric>,<numeric>,<numeric>	[No query]
:SAVE		[No query]
:COLLect		
[:ACQuire]		

Table 14-2 E5070B/E5071B SCPI command tree

Command	Parameters	Note
SENSe{[1] 2 3 4 5 6 7 8 9 10 11 12 13 14 15 16}		
:CORRection		
:COLLect		
[:ACQuire]		
:ISOLation	<numeric>,<numeric>	[No query]
:LOAD	<numeric>	[No query]
:OPEN	<numeric>	[No query]
:SHORt	<numeric>	[No query]
:SUBClass	<numeric>	
:THRU	<numeric>,<numeric>	[No query]
:TRLLine	<numeric>,<numeric>	[No query]
:TRLReflect	<numeric>	[No query]
:TRLThru	<numeric>,<numeric>	[No query]
:ADAPter{[1] 2 3 4}		
:LENGth	<numeric>	
:CKIT		
:LABel	<string>	
:ORDer		
:LOAD	<numeric>,<numeric>	
:OPEN	<numeric>,<numeric>	
[:SElect]	<numeric>	
:SHORt	<numeric>,<numeric>	
:THRU	<numeric>,<numeric>,<numeric>	
:TRLLine	<numeric>,<numeric>,<numeric>	
:TRLReflect	<numeric>	
:TRLThru	<numeric>,<numeric>,<numeric>	
:RESet		[No query]
[:SElect]	<numeric>	
:STAN{[1] 2 3 4 5 6 7 8 9 10 11 12 13 14 15 16 17 18 19 20 21}		
:ARBitrary	<numeric>	
:C0	<numeric>	
:C1	<numeric>	
:C2	<numeric>	
:C3	<numeric>	
:CHARacter	{COAXial WAVeguide}	
:DELay	<numeric>	
:FMAXimum	<numeric>	
:FMINimum	<numeric>	
:L0	<numeric>	
:L1	<numeric>	
:L2	<numeric>	
:L3	<numeric>	
:LABel	<string>	
:LOSS	<numeric>	
:TYPE	{OPEN SHORt LOAD THRU UTHR ARBI NONE}	
:Z0	<numeric>	

Table 14-2 E5070B/E5071B SCPI command tree

Command	Parameters	Note
SENSe{[1] 2 3 4 5 6 7 8 9 10 11 12 13 14 15 16}		
:CORRection		
:COLLect		
:CKIT		
:TRLOption		
:IMPedance	{LINE SYSTem}	[Query only]
:RPLane	{THRU REFLect}	
:CLEar		[No query]
:ECAL		
:CCHeck		
[:ACQuire]		[No query]
:ERESponse	<numeric>,<numeric>	[No query]
:ISOLation		
[:STATe]	{ON OFF 1 0}	
:ORientation		
[:STATe]	{ON OFF 1 0}	
:PATH	<numeric>,<numeric>	[No query]
:SOLT1	<numeric>	[No query]
:SOLT2	<numeric>,<numeric>	[No query]
:SOLT3	<numeric>,<numeric>,<numeric>	[No query]
:SOLT4	<numeric>,<numeric>,<numeric>,<numeric>	[No query]
:THRU	<numeric>,<numeric>	[No query]
:UChar	{CHAR0 CHAR1 CHAR2 CHAR3 CHAR4 CHAR5}	
:UTHRU		
[:STATe]	{ON OFF 1 0}	
:METhod		
:ADAPter		
:REMOval	<numeric>	[No query]
:ERESponse	<numeric>,<numeric>	[No query]
[:RESPonse]		
:OPEN	<numeric>	[No query]
:SHORT	<numeric>	[No query]
:THRU	<numeric>,<numeric>	[No query]
:SOLT1	<numeric>	[No query]
:SOLT2	<numeric>,<numeric>	[No query]
:SOLT3	<numeric>,<numeric>,<numeric>	[No query]
:SOLT4	<numeric>,<numeric>,<numeric>,<numeric>	[No query]
:TRL2	<numeric>,<numeric>	[No query]
:TRL3	<numeric>,<numeric>,<numeric>	[No query]
:TRL4	<numeric>,<numeric>,<numeric>,<numeric>	[No query]
:TYPE?		[Query only]
:PARTial		
:SAVE		[No query]
:SAVE		[No query]
:SIMPlified		
:SAVE		[No query]

Table 14-2 E5070B/E5071B SCPI command tree

Command	Parameters	Note
SENSe{[1] 2 3 4 5 6 7 8 9 10 11 12 13 14 15 16}		
:CORRection		
:EXTeNsion		
:AUTO		
:CONFig	{CSPN AMKR USPN}	
:DCOFset	{ON OFF 1 0}	
:LOSS	{ON OFF 1 0}	
:MEASure	{OPEN SHORT}	
:PORT{[1] 2 3 4}	{ON OFF 1 0}	
:RESet		[No query]
:STARt	<numeric>	
:STOP	<numeric>	
:PORT{[1] 2 3 4}		
:FREQuency{[1] 2}	<numeric>	
:INCLude{[1] 2}		
[:STATe]	{ON OFF 1 0}	
:LDC	<numeric>	
:LOSS{[1] 2}	<numeric>	
[:TIME]	<numeric>	
[:STATe]	{ON OFF 1 0}	
:OFFSet		
:CLEar		[No query]
:COLLect		
[:ACQuire]		
:LOAD	<numeric>,<numeric>	[No query]
:OPEN	<numeric>,<numeric>	[No query]
:PMETer	<numeric>,<numeric>,{ASENSor BSENSor}	[No query]
:SHORT	<numeric>,<numeric>	[No query]
:THRU	<numeric>,<numeric>	[No query]
:CLEar		[No query]
:ECAL		
:SMIX2	<numeric>,<numeric>	[No query]
:SOLT1	<numeric>	[No query]
:METH		
:SMIX2	<numeric>,<numeric>	[No query]
:SOLT1	<numeric>	[No query]
:SAVE		[No query]
:PROPerTy	{ON OFF 1 0}	
:RECEiver{[1] 2 3 4}		
:COLLect		
:ACQuire	<numeric>	[No query]
[:STATe]	{ON OFF 1 0}	
:RVELocity		
:COAX	<numeric>	

Table 14-2 E5070B/E5071B SCPI command tree

Command	Parameters	Note
SENSe{[1] 2 3 4 5 6 7 8 9 10 11 12 13 14 15 16}		
:CORRection		
:STATe	{ON OFF 1 0}	
:TRIGger		
:FREE	{ON OFF 1 0}	
:TYPE{[1] 2 3 4 5 6 7 8 9 10 11 12 13 14 15 16}?		[Query only]
:FREQuency		
:CENTer	<numeric>	
:[CW]FIXed	<numeric>	
:DATA?		[Query only]
:SPAN	<numeric>	
:STARt	<numeric>	
:STOP	<numeric>	
:MULTiplier{[1] 2}		
:OUTPut		
[:DATA]	<numeric>	
PORT{[1] 2 3 4 5 6 7 8 9 10 11 12 13 14 15 16 17 18 19 20}		
CATalog?		[Query only]
[:SELEct]	<string>	
:TSET9		
:OUTPut		
[:DATA]	<numeric>	
:PORT1	{A T1}	
:PORT2	{T1 T2}	
:PORT3	{R1 R2 R3}	
:PORT4	{R1 R2 R3}	
:OFFSet		
:ASPurious	{ON OFF 1 0}	
:LOCal		
:CONTRol		
[:STATe]	{ON OFF 1 0}	
[:FREQuency]		
:DATA?		[Query only]
:DIVisor	<numeric>	
:MULTiplier	<numeric>	
:OFFSet	<numeric>	
:STARt	<numeric>	
:STOP	<numeric>	
:POWer		
[:LEVel]		
[:IMMediate]		
[:AMPLitude	<numeric>	
]		
:SLOPe		
[:DATA]	<numeric>	

Table 14-2 E5070B/E5071B SCPI command tree

Command	Parameters	Note
SENSe{[1] 2 3 4 5 6 7 8 9 10 11 12 13 14 15 16}		
:OFFSet		
:LOCAl		
:POWer		
[:LEVel]		
:SLOPe		
:STATe	{ON OFF 1 0}	
:STATe	{ON OFF 1 0}	
:PORT{[1] 2 3 4}		
[:FREQuency]		
:DATA?		[Query only]
:DIVisor	<numeric>	
:MULTIplier	<numeric>	
:OFFSet	<numeric>	
:STARt	<numeric>	
:STOP	<numeric>	
[:STATe]	{ON OFF 1 0}	
:ROSCillator		
:SOURCce?		[Query only]
:SEGment		
:DATA	<numeric>,...,<numeric>	
:SWEep		
:POINts?		[Query only]
:TIME		
[:DATA]?		[Query only]
:SWEep		
:ASPurious	{ON OFF 1 0}	
:DELay	<numeric>	
:GENeration	{STEPped ANALog}	
:POINts	<numeric>	
:TIME		
:AUTO	{ON OFF 1 0}	
[:DATA]	<numeric>	
:TYPE	{LINear LOGarithmic SEGment POWer}	
SERVice		
:CHANnel		
:ACTive?		[Query only]
:COUNT?		[Query only]
:TRACe		
:COUNT?		[Query only]
:CHANnel{[1] 2 3 4 5 6 7 8 9 10 11 12 13 14 15 16}		
:TRACe		
:ACTive?		[Query only]
:PORT		
:COUNT?		[Query only]
:SREVision?		[Query only]

Table 14-2 E5070B/E5071B SCPI command tree

Command	Parameters	Note
SERVICE		
:SWEep		
:FREQuency		
:MAXimum?		[Query only]
:MINimum?		[Query only]
:POINts?		[Query only]
SOURCE		
:POWer		
:PORT		
:CORRection		
:COLLect		
:ASENsor		
:RCFactor	<numeric>	
:BSEnSor		
:RCFactor	<numeric>	
:TABLE		
:ASENsor		
:DATA	<numeric>,...,<numeric> (1 + number of segments × 2 parameters)	
:BSEnSor		
:DATA	<numeric>,...,<numeric> (1 + number of segments × 2 parameters)	
SOURCE{[1] 2 3 4 5 6 7 8 9 10 11 12 13 14 15 16}		
:POWer		
:ATTenuation		
[:DATA]	<numeric>	
:AUTO	{ON OFF 1 0}	
:CENTer	<numeric>	
[:LEVel]		
[:IMMediate]		
[:AMPLitude]	<numeric>	
:SLOPe		
[:DATA]	<numeric>	
:STATe	{ON OFF 1 0}	
:PORT		
:COUple	{ON OFF 1 0}	
:PORT{[1] 2 3 4}		
:CORRection		
:COLLect		
[:ACQuire]	{ASENsor BSEnSor}	[No query]
:AVERage		
[:COUNt]	<numeric>	
:NTOLerance	<numeric>	

Table 14-2 E5070B/E5071B SCPI command tree

Command	Parameters	Note
SOURce{[1] 2 3 4 5 6 7 8 9 10 11 12 13 14 15 16}		
:POWer		
:PORT{[1] 2 3 4}		
:CORRection		
:COLLect		
:TABLE		
:LOSS		
:DATA	<numeric>, ..., <numeric> (1 + number of segments × 2 parameters)	
[:STATe]	{ON OFF 1 0}	
:DATA	<numeric>, ..., <numeric> (number of measurement points)	
[:STATe]	{ON OFF 1 0}	
[:LEVel]		
[:IMMediate]		
[:AMPLitude]	<numeric>	
:SPAN	<numeric>	
:STARt	<numeric>	
:STOP	<numeric>	
STATus		
:OPERation		
:CONDition?		[Query only]
:ENABle	<numeric>	
[:EVENT]?		[Query only]
:NTRansition	<numeric>	
:PTRansition	<numeric>	
:PRESet		[No query]
:QUEStionable		
:BLIMit		
:CHANnel{[1] 2 3 4 5 6 7 8 9 10 11 12 13 14 15 16}		
:CONDition?		[Query only]
:ECHannel		
:CONDition?		[Query only]
:ENABle	<numeric>	
[:EVENT]?	<numeric>	[Query only]
:NTRansition	<numeric>	
:PTRansition	<numeric>	
:ENABle	<numeric>	
[:EVENT]?		[Query only]
:NTRansition	<numeric>	
:PTRansition	<numeric>	
:CONDition?		[Query only]

14. SCPI Command Reference

Table 14-2 E5070B/E5071B SCPI command tree

Command	Parameters	Note
STATus		
:QUEStionable		
:BLIMit		
:ELIMit		
:CONDition?		[Query only]
:ENABle	<numeric>	
[:EVENT]?		[Query only]
:NTRansition	<numeric>	
:PTRansition	<numeric>	
:ENABle	<numeric>	
[:EVENT]?		[Query only]
:NTRansition	<numeric>	
:PTRansition	<numeric>	
:CONDition?		[Query only]
:ENABle	<numeric>	
[:EVENT]?		[Query only]
:LIMit		
:CHANnel{[1] 2 3 4 5 6 7 8 9 10 11 12 13 14 15 16}		
:CONDition?		[Query only]
:ECHannel		
:CONDition?		[Query only]
:ENABle	<numeric>	
[:EVENT]?	<numeric>	[Query only]
:NTRansition	<numeric>	
:PTRansition	<numeric>	
:ENABle	<numeric>	
[:EVENT]?		[Query only]
:NTRansition	<numeric>	
:PTRansition	<numeric>	
:CONDition?		[Query only]
:ELIMit		
:CONDition?		[Query only]
:ENABle	<numeric>	
[:EVENT]?		[Query only]
:NTRansition	<numeric>	
:PTRansition	<numeric>	
:ENABle	<numeric>	
[:EVENT]?		[Query only]
:NTRansition	<numeric>	
:PTRansition	<numeric>	
:NTRansition	<numeric>	
:PTRansition	<numeric>	

Table 14-2 E5070B/E5071B SCPI command tree

Command	Parameters	Note
STATus		
:QUEStionable		
:RLIMit		
:CHANnel{[1] 2 3 4 5 6 7 8 9 10 11 12 13 14 15 16}		
:CONDition?		[Query only]
:ECHannel		
:CONDition?		[Query only]
:ENABle	<numeric>	
[:EVENT]?	<numeric>	[Query only]
:NTRansition	<numeric>	
:PTRansition	<numeric>	
:ENABle	<numeric>	
[:EVENT]?		[Query only]
:NTRansition	<numeric>	
:PTRansition	<numeric>	
:CONDition?		[Query only]
:ELIMit		
:CONDition?		[Query only]
:ENABle	<numeric>	
[:EVENT]?		[Query only]
:NTRansition	<numeric>	
:PTRansition	<numeric>	
:ENABle	<numeric>	
[:EVENT]?		[Query only]
:NTRansition	<numeric>	
:PTRansition	<numeric>	

Table 14-2 E5070B/E5071B SCPI command tree

Command	Parameters	Note
SYSTem		
:BACKlight	{ON OFF 1 0}	
:BEEPer		
:COMPLete		
:IMMediate		
:STATe	{ON OFF 1 0}	
:WARNing		
:IMMediate		
:STATe	{ON OFF 1 0}	
:COMMunicate		
:GPIB		
:PMETer		
:ADDRESS	<numeric>	
:SGENERator		
:ADDRESS	<numeric>	
:CCOMmand		
:FREQuency	<string>	
:POWer	<string>	
:PRESet	<string>	
:RFON	<string>	
:DWELl	<numeric>	
:TYPE	<numeric>	
:CORRection		
[:STATe]	{ON OFF 1 0}	
:DATE	<numeric>,<numeric>,<numeric>	
:ERRor?		[Query only]
:ISPControl		
:PORT	<numeric>	
:STATe	{ON OFF 1 0}	
:KLOCK		
:KBD	{ON OFF 1 0}	
:MOUSE	{ON OFF 1 0}	
:POFF		[No query]
:PRESet		[No query]
:SECurity		
[:LELe]	{NONE LOW HIGH}	
:SERVice?		[Query only]
:TEMPerature		
:HIGH	{ON OFF 1 0}	
[:STATe]?		[Query only]
:TIME	<numeric>,<numeric>,<numeric>	
:UPReset		[No query]

Table 14-2 E5070B/E5071B SCPI command tree

Command	Parameters	Note
TRIGger		
:AVERage	{ON OFF 1 0}	
:EXTernal		
:DELay	<numeric>	
:LLATency	{ON OFF 1 0}	
:[SEQuence]		
[:IMMEDIATE]		[No query]
:POINT	{ON OFF 1 0}	
:SINGLE		[No query]
:SCOPE	{ALL ACTive}	
:SOURce	{INTernal EXTernal MANual BUS}	

A **Manual Changes**

This appendix contains the information required to adapt this manual to earlier versions or configurations of the Agilent E5070B/E5071B than that indicated by the current printing date of this manual. The information in this manual applies directly to the E5070B/E5071B model that has the serial number prefix listed on the title page of this manual.

Manual Changes

To adapt this manual to your Agilent E5070B/E5071B, refer to Table A-1 and Table A-2.

Table A-1 Manual Changes by Serial Number

Serial Prefix or Number	Make Manual Changes
MY423	Change 6

Table A-2 Manual Changes by Firmware Version

Version	Make Manual Changes
A.03.0x	Change 1
A.03.53	Change 2
A.03.54	Change 3
A.03.62	Change 4
A.04.00	Change 5
A.05.00	Change 7
A.06.00	Change 8
A.06.50	Change 9
A.08.01	Change 10

The ten-character serial number is stamped on the serial number plate (Figure A-1) on the rear panel.

Execute the *IDN? command on page 288 to check the firmware version.

Figure A-1 Serial Number Plate (Example)



e5070bu7013

Change 10

The firmware revision A.08.01 and below does not support the following SCPI commands. Please delete their descriptions in this manual.

- :CALC{1-16}:MARK:NOTC on page 396
- :CALC{1-16}:MARK{1-10}:NOTC:DATA? on page 410
- :CALC{1-16}:MARK{1-10}:NOTC:THR on page 411

The firmware revision A.08.01 or lower does not support the following functions. Please delete the descriptions about these functions from this manual.

- Notch search function

Change 9

The firmware revision A.06.50 and below does not support the following SCPI commands. Please delete their descriptions in this manual.

- :CALC{1-16}:EQU:STAT on page 311
- :CALC{1-16}:EQU:TEXT on page 312
- :CALC{1-16}:EQU:VAL? on page 313
- :PROG:VAR:ARR{1-10} on page 530
- :PROG:VAR:ARR{1-10}:SIZE on page 531
- :PROG:VAR:DOUB{1-10} on page 532
- :PROG:VAR:LONG{1-10} on page 533
- :PROG:VAR:STR{1-10} on page 534
- :SENS{1-16}:CORR:COLL:ADAP{1-4}:LENG on page 559
- :SENS{1-16}:CORR:COLL:ECAL:UTHR on page 598
- :SENS{1-16}:CORR:COLL:METH:ADAP:REM on page 601
- :SERV:SWE:FREQ:MAX? on page 699
- :SERV:SWE:FREQ:MIN? on page 699
- :SERV:SWE:POIN? on page 699
- :TRIG:SCOP on page 807

The following SCPI commands include parameters, which cannot be chosen with the firmware revision A.06.60 and below.

- :SENS{1-16}:CORR:COLL:CKIT:STAN{1-21}:TYPE on page 586

The firmware revision A.06.50 or lower does not support the following functions. Please delete the descriptions about these functions from this manual.

- Equation editor function
- User definition variable function
- Function to trigger only the active channel
- Change of the dialog box for checking the product information

Manual Changes

Manual Changes

- Calibration kits, 85038A/F/M, have been added
- Available power meters, N1911A/N1912A, have been added.
- Function to remove/insert adapter characteristics.
- Unknown Thru Calibration function

Change 8

The firmware revision A.06.00 and below does not support the following SCPI commands. Please delete their descriptions in this manual.

- :TRIG:EXT:DEL on page 804
- :TRIG:EXT:LLAT on page 805
- :TRIG:AVER on page 803
- :SOUR{1-16}:POW:PORT{1-4}:CORR:COLL:NTOL on page 713
- :SENS{1-16}:CORR:TRIG:FREE on page 651
- :MMEM:STOR:SNP on page 519
- :MMEM:STOR:SNP:FORM on page 520
- :MMEM:STOR:SNP:TYPE:S1P on page 521
- :MMEM:STOR:SNP:TYPE:S2P on page 522
- :MMEM:STOR:SNP:TYPE:S3P on page 523
- :MMEM:STOR:SNP:TYPE:S4P on page 524
- :SENS{1-16}:CORR:COLL:PART:SAVE on page 612

The firmware revision A.06.00 or lower does not support the following functions. Please delete the descriptions about these functions from this manual.

- Low latency external trigger function
- Averaging trigger function
- Function of tolerance setting at power calibration
- Function of trigger source setting at calibration
- Function of data saving in touchstone format by using front panel
- Function of simplified full 3/4 port calibration by using front panel
- Simplified 3/4 port TRL calibration function
- Partial overwrite function

Change 7

The firmware revision A.05.00 and below does not support the following SCPI commands. Please delete their descriptions in this manual.

- :CALC{1-16}:CORR:EDEL:MED on page 303
- :CALC{1-16}:CORR:EDEL:WGC on page 305

- :CALC{1-16}:FSIM:BAL:CZC:BPOR{1-2}:IMAG on page 323
- :CALC{1-16}:FSIM:BAL:CZC:BPOR{1-2}:REAL on page 324
- :CALC{1-16}:FSIM:BAL:DZC:BPOR{1-2}:IMAG on page 335
- :CALC{1-16}:FSIM:BAL:DZC:BPOR{1-2}:REAL on page 336
- :CALC{1-16}:FSIM:SEND:ZCON:PORT{1-4}:IMAG on page 364
- :CALC{1-16}:FSIM:SEND:ZCON:PORT{1-4}:REAL on page 365
- :DISP:WIND{1-16}:ANN:MARK:ALIG on page 471
- :DISP:WIND{1-16}:ANN:MARK:SING on page 472
- :DISP:WIND{1-16}:TRAC{1-16}:ANN:MARK:POS:X on page 478
- :DISP:WIND{1-16}:TRAC{1-16}:ANN:MARK:POS:Y on page 479
- :MMEM:LOAD:CKIT{1-20} on page 499
- :MMEM:STOR:CKIT{1-20} on page 510
- :SENS:CORR:COLL:ECAL:ORI on page 535
- :SENS:CORR:COLL:ECAL:PATH on page 536
- :SENS:MULT:CAT? on page 538
- :SENS:MULT{1-2}:INC? on page 540
- :SENS:MULT{1-2}:NAME on page 541
- :SENS{1-16}:CORR:COLL:CKIT:ORD on page 562
- :SENS{1-16}:CORR:COLL:CKIT:ORD:TRLL on page 567
- :SENS{1-16}:CORR:COLL:CKIT:ORD:TRLR on page 568
- :SENS{1-16}:CORR:COLL:CKIT:ORD:TRLT on page 569
- :SENS{1-16}:CORR:COLL:CKIT:STAN{1-21}:CHAR on page 576
- :SENS{1-16}:CORR:COLL:CKIT:STAN{1-21}:FMAX on page 578
- :SENS{1-16}:CORR:COLL:CKIT:STAN{1-21}:FMIN on page 579
- :SENS{1-16}:CORR:COLL:CKIT:TRL:IMP on page 588
- :SENS{1-16}:CORR:COLL:CKIT:TRL:RPL on page 589
- :SENS{1-16}:CORR:COLL:METH:TRL2 on page 607
- :SENS{1-16}:CORR:COLL:METH:TRL3 on page 608
- :SENS{1-16}:CORR:COLL:METH:TRL4 on page 609
- :SENS{1-16}:CORR:COLL:SUBC on page 615
- :SENS{1-16}:CORR:COLL:TRLL on page 617
- :SENS{1-16}:CORR:COLL:TRLR on page 618
- :SENS{1-16}:CORR:COLL:TRLT on page 619
- :SENS{1-16}:CORR:EXT:AUTO:CONF on page 621
- :SENS{1-16}:CORR:EXT:AUTO:DCOF on page 622
- :SENS{1-16}:CORR:EXT:AUTO:LOSS on page 623

Manual Changes

Manual Changes

- :SENS{1-16}:CORR:EXT:AUTO:MEAS on page 624
- :SENS{1-16}:CORR:EXT:AUTO:PORT{1-4} on page 625
- :SENS{1-16}:CORR:EXT:AUTO:RESet on page 626
- :SENS{1-16}:CORR:EXT:AUTO:STAR on page 627
- :SENS{1-16}:CORR:EXT:AUTO:STOP on page 628
- :SENS{1-16}:CORR:EXT:PORT{1-4}:FREQ{1-2} on page 630
- :SENS{1-16}:CORR:EXT:PORT{1-4}:INCL{1-2} on page 631
- :SENS{1-16}:CORR:EXT:PORT{1-4}:LDC on page 632
- :SENS{1-16}:CORR:EXT:PORT{1-4}:LOSS{1-2} on page 633
- :SENS{1-16}:MULT{1-2}:OUTP on page 659
- :SENS{1-16}:MULT{1-2}:PORT{1-20} on page 660
- :SENS{1-16}:MULT{1-2}:PORT{1-20}:CAT? on page 662
- :SYST:UPR on page 801

The following SCPI commands include parameters, which cannot be chosen with the firmware revision A.05.00 and below.

- :DISP:SPL on page 466
- :DISP:WIND{1-16}:SPL on page 475
- :SENS:MULT{1-2}:COUN? on page 539
- :SENS{1-16}:CORR:COLL:CKIT on page 560
- :SENS{1-16}:CORR:COLL:CKIT:ORD:LOAD on page 563
- :SENS{1-16}:CORR:COLL:CKIT:ORD:OPEN on page 564
- :SENS{1-16}:CORR:COLL:CKIT:ORD:SHOR on page 565
- :SENS{1-16}:CORR:COLL:CKIT:ORD:THRU on page 566
- :SENS{1-16}:CORR:COLL:METH:TYPE? on page 610

The firmware revision A.05.00 or below does not support the following functions. Please delete the descriptions about these functions in this manual.

- User preset function
- Function to display the marker value for non-active traces.
- Function to the display position where the marker value are displayed.
- Function to align the marker value.
- TRL calibration by softkeys
- User recovery function ^{*1}
- Function to set the Waveguide for the media type.
- Loss correction.

*1. This function is available when the volume label on the C-drive is CP600 or higher.

- Auto port extension and auto loss value calculation.
- Function to turn off the auto-detect function of the Ecal module (Manual setting is available).
- Conversion function of differential/common port reference impedance of the fixture simulator in complex format.
- Function to have the E5091A-016 multiport test set correspond to this instrument.
- Function to select the 85052C for the calibration kit.
- Function to specify up to eight calibration standards for each calibration class.
- Reading/Writing of the calibration standard files.
- Function to set the measurement point to a maximum of 20001.*¹

Change 6

The serial prefix MY423 or below does not support the USB(USBTMC) interface port. Please delete the description in this manual.

Change 5

The firmware revision A.04.00 and below does not support the following SCPI commands. Please delete their descriptions in this manual.

- :CALC{1-16}:BLIM on page 293
- :CALC{1-16}:BLIM:DB on page 294
- :CALC{1-16}:BLIM:DISP:MARK on page 295
- :CALC{1-16}:BLIM:DISP:VAL on page 296
- :CALC{1-16}:BLIM:FAIL? on page 297
- :CALC{1-16}:BLIM:MAX on page 298
- :CALC{1-16}:BLIM:MIN on page 299
- :CALC{1-16}:BLIM:REP? on page 300
- :CALC{1-16}:LIM:REP:ALL? on page 388
- :CALC{1-16}:LIM:OFFS:AMPL on page 384
- :CALC{1-16}:LIM:OFFS:MARK on page 385
- :CALC{1-16}:LIM:OFFS:STIM on page 386
- :CALC{1-16}:RLIM on page 426
- :CALC{1-16}:RLIM:DATA on page 427
- :CALC{1-16}:RLIM:DISP:SEL on page 429
- :CALC{1-16}:RLIM:DISP:VAL on page 430
- :CALC{1-16}:RLIM:DISP:LINE on page 428
- :CALC{1-16}:RLIM:FAIL? on page 431

*1. This function is available when the channel/trace is set to Ch 1 / Tr 4 20001 Points.

Manual Changes

Manual Changes

- :CALC{1-16}:RLIM:REP? on page 432
- :MMEM:LOAD:RLIM on page 503
- :MMEM:STOR:RLIM on page 516
- :SENS{1-16}:CORR:COEF on page 548
- :SENS{1-16}:CORR:COEF:METH:ERES on page 550
- :SENS{1-16}:CORR:COEF:METH:OPEN on page 551
- :SENS{1-16}:CORR:COEF:METH:SHOR on page 552
- :SENS{1-16}:CORR:COEF:METH:SOLT1 on page 553
- :SENS{1-16}:CORR:COEF:METH:SOLT2 on page 554
- :SENS{1-16}:CORR:COEF:METH:SOLT3 on page 555
- :SENS{1-16}:CORR:COEF:METH:SOLT4 on page 556
- :SENS{1-16}:CORR:COEF:METH:THRU on page 557
- :SENS{1-16}:CORR:COEF:SAVE on page 558
- :SENS{1-16}:CORR:COLL:ECAL:ERES on page 592
- :SENS{1-16}:CORR:COLL:METH:ERES on page 602
- :STAT:QUES:BLIM? on page 727
- :STAT:QUES:BLIM:CHAN{1-16}? on page 727
- :STAT:QUES:BLIM:CHAN{1-16}:COND? on page 727
- :STAT:QUES:BLIM:CHAN{1-16}:ECH? on page 729
- :STAT:QUES:BLIM:CHAN{1-16}:ECH:COND? on page 729
- :STAT:QUES:BLIM:CHAN{1-16}:ECH:ENAB on page 730
- :STAT:QUES:BLIM:CHAN{1-16}:ECH:NTR on page 731
- :STAT:QUES:BLIM:CHAN{1-16}:ECH:PTR on page 732
- :STAT:QUES:BLIM:CHAN{1-16}:ENAB on page 733
- :STAT:QUES:BLIM:CHAN{1-16}:NTR on page 734
- :STAT:QUES:BLIM:CHAN{1-16}:PTR on page 735
- :STAT:QUES:BLIM:COND? on page 735
- :STAT:QUES:BLIM:ELIM? on page 736
- :STAT:QUES:BLIM:ELIM:COND? on page 736
- :STAT:QUES:BLIM:ELIM:ENAB on page 737
- :STAT:QUES:BLIM:ELIM:NTR on page 738
- :STAT:QUES:BLIM:ELIM:PTR on page 739
- :STAT:QUES:BLIM:ENAB on page 740
- :STAT:QUES:BLIM:NTR on page 741
- :STAT:QUES:BLIM:PTR on page 742
- :STAT:QUES:RLIM? on page 763

- :STAT:QUES:RLIM:CHAN{1-16}? on page 763
- :STAT:QUES:RLIM:CHAN{1-16}:COND? on page 763
- :STAT:QUES:RLIM:CHAN{1-16}:ECH? on page 765
- :STAT:QUES:RLIM:CHAN{1-16}:ECH:COND? on page 765
- :STAT:QUES:RLIM:CHAN{1-16}:ECH:ENAB on page 766
- :STAT:QUES:RLIM:CHAN{1-16}:ECH:NTR on page 767
- :STAT:QUES:RLIM:CHAN{1-16}:ECH:PTR on page 768
- :STAT:QUES:RLIM:CHAN{1-16}:ENAB on page 769
- :STAT:QUES:RLIM:CHAN{1-16}:NTR on page 770
- :STAT:QUES:RLIM:CHAN{1-16}:PTR on page 771
- :STAT:QUES:RLIM:COND? on page 771
- :STAT:QUES:RLIM:ELIM? on page 772
- :STAT:QUES:RLIM:ELIM:COND? on page 772
- :STAT:QUES:RLIM:ELIM:ENAB on page 773
- :STAT:QUES:RLIM:ELIM:NTR on page 774
- :STAT:QUES:RLIM:ELIM:PTR on page 775
- :STAT:QUES:RLIM:ENAB on page 776
- :STAT:QUES:RLIM:NTR on page 777
- :STAT:QUES:RLIM:PTR on page 778
- :SYST:SEC:LEV on page 797

The following SCPI commands include parameters, which cannot be chosen with the firmware revision A.04.00 and below.

- :DISP:TABL:TYPE on page 469
- :SENS{1-16}:CORR:COLL:METH:TYPE? on page 610
- :SENS{1-16}:CORR:TYPE{1-16}? on page 652

The firmware revision A.04.00 and below does not support the following function. Please delete the descriptions about this function in this manual.

- Offset limit line function
- Ripple test function
- Bandwidth test function
- Enhanced response calibration
- Frequency information appearing as asterisks
- Disable USB mass storage devices

Change 4

The firmware revision A.03.62 and below does not support the following SCPI commands. Please delete their descriptions in this manual.

Manual Changes
Manual Changes

- :CALC{1-16}:PAR{1-16}:SPOR on page 425
- :CALC{1-16}:MIX:XAX on page 417
- :CALC{1-16}:OFFS:XAX on page 420
- :SENS{1-16}:CORR:CLE on page 547
- :SENS{1-16}:CORR:COLL:CLE on page 590
- :SENS{1-16}:CORR:OFFS:CLE on page 634
- :SENS{1-16}:CORR:OFFS:COLL:LOAD on page 638
- :SENS{1-16}:CORR:OFFS:COLL:OPEN on page 641
- :SENS{1-16}:CORR:OFFS:COLL:PMET on page 642
- :SENS{1-16}:CORR:OFFS:COLL:SHOR on page 644
- :SENS{1-16}:CORR:OFFS:COLL:THRU on page 645
- :SENS{1-16}:CORR:OFFS:COLL:CLE on page 635
- :SENS{1-16}:CORR:OFFS:COLL:ECAL:SMIX2 on page 636
- :SENS{1-16}:CORR:OFFS:COLL:ECAL:SOLT1 on page 637
- :SENS{1-16}:CORR:OFFS:COLL:METH:SMIX2 on page 639
- :SENS{1-16}:CORR:OFFS:COLL:METH:SOLT1 on page 640
- :SENS{1-16}:CORR:OFFS:COLL:SAVE on page 643
- :SENS{1-16}:CORR:REC{1-4}:COLL:ACQ on page 648
- :SENS{1-16}:CORR:REC{1-4} on page 647
- :SENS{1-16}:OFFS:ASP on page 669
- :SENS{1-16}:OFFS:LOC:CONT on page 670
- :SENS{1-16}:OFFS:LOC:DATA? on page 671
- :SENS{1-16}:OFFS:LOC:DIV on page 672
- :SENS{1-16}:OFFS:LOC:MULT on page 673
- :SENS{1-16}:OFFS:LOC:OFFS on page 674
- :SENS{1-16}:OFFS:LOC:STAR on page 675
- :SENS{1-16}:OFFS:LOC:STOP on page 676
- :SENS{1-16}:OFFS:LOC:POW on page 677
- :SENS{1-16}:OFFS:LOC:POW:SLOP on page 678
- :SENS{1-16}:OFFS:LOC:POW:SLOP:STAT on page 679
- :SENS{1-16}:OFFS:LOC:STAT on page 680
- :SENS{1-16}:OFFS:PORT{1-4}:DATA? on page 681
- :SENS{1-16}:OFFS:PORT{1-4}:DIV on page 682
- :SENS{1-16}:OFFS:PORT{1-4}:MULT on page 683
- :SENS{1-16}:OFFS:PORT{1-4}:OFFS on page 684
- :SENS{1-16}:OFFS:PORT{1-4}:STAR on page 685

- :SENS{1-16}:OFFS:PORT{1-4}:STOP on page 686
- :SENS{1-16}:OFFS on page 668
- :SYST:COMM:GPIB:SGEN:ADDR on page 783
- :SYST:COMM:GPIB:SGEN:CCOM:FREQ on page 784
- :SYST:COMM:GPIB:SGEN:CCOM:POW on page 785
- :SYST:COMM:GPIB:SGEN:CCOM:PRES on page 786
- :SYST:COMM:GPIB:SGEN:CCOM:RFON on page 787
- :SYST:COMM:GPIB:SGEN:DWEL on page 788
- :SYST:COMM:GPIB:SGEN:TYPE on page 789
- :TRIG:POIN on page 806

The following SCPI commands include parameters, which cannot be chosen with the firmware revision A.03.62 and below.

- :CALC{1-16}:FSIM:BAL:PAR{1-16}:SSB on page 341
- :CALC{1-16}:PAR{1-16}:DEF on page 422
- :CALC{1-16}:CONV:FUNC on page 302
- :SENS{1-16}:CORR:TYPE{1-16}? on page 652

The firmware revision A.03.62 and below does not support the following function. Please delete the descriptions about this function in this manual.

- Scalar-mixer calibration
- Vector-mixer calibration
- Absolute measurement function and receiver calibration
- Frequency offset function (including the avoid spurious function)
- External signal generator control function
- Point trigger function
- Z/Y Transmission-Shunt conversion
- Imbalance 3 and 4 parameters for SE-SE-Bal measurement (Fixture simulator)
- Assignable x-axis such as RF+LO, RF-LO, and LO-RF frequencies for each active trace
- Conjugation for converting vector mixer measurement parameters
- 7 mm calibration kits such as 85031B and 85050C/D
- Calibration data and calibration coefficient clear functions

Change 3

The firmware revision A.03.54 and below does not support the following SCPI commands. Please delete their descriptions in this manual.

- :SERV:SREV? on page 698
- :SOUR{1-16}:POW:ATT:AUTO on page 706

Manual Changes

Manual Changes

The firmware revision A.03.54 and below does not support the following function. Please delete the descriptions about this function in this manual

- ❑ Auto Power Range set function

Change 2

The firmware revision A.03.53 and below does not support the following SCPI commands. Please delete their descriptions in this manual.

- :SYST:ISPC:PORT on page 792
- :SYST:ISPC:STAT on page 793

The firmware revision A.03.53 and below does not support the following function. Please delete the descriptions about this function in this manual

- ❑ Initial Source Port Control function

Change 1

The firmware revision A.03.0x does not support the following SCPI commands. Please delete their descriptions in this manual.

- :CALC{1-16}:FSIM:EMB:NETW{1-2}:FIL on page 347
- :CALC{1-16}:FSIM:EMB:NETW{1-2}:TYPE on page 348
- :CALC{1-16}:FSIM:EMB:STAT on page 349
- :CALC{1-16}:FSIM:EMB:TOP:A:PORT on page 350
- :CALC{1-16}:FSIM:EMB:TOP:B:PORT on page 351
- :CALC{1-16}:FSIM:EMB:TOP:C:PORT on page 352
- :CALC{1-16}:FSIM:EMB:TYPE on page 353
- :SENS{1-16}:CORR:COLL:ECAL:CCH on page 591
- :SENS{1-16}:CORR:COLL:ECAL:UCH on page 597
- :SENS{1-16}:CORR:COLL:SIMP:SAVE on page 614

The firmware revision A.03.0x does not support the following function. Please delete the descriptions about this function in this manual

- ❑ Simplified full 3/4 port calibration

B Status Reporting System

This appendix describes the status reporting system of the Agilent E5070B/E5071B.

General Status Register Model

The Agilent E5070B/E5071B has a status reporting system to report the condition of the instrument.

Figure B-1

General status register model

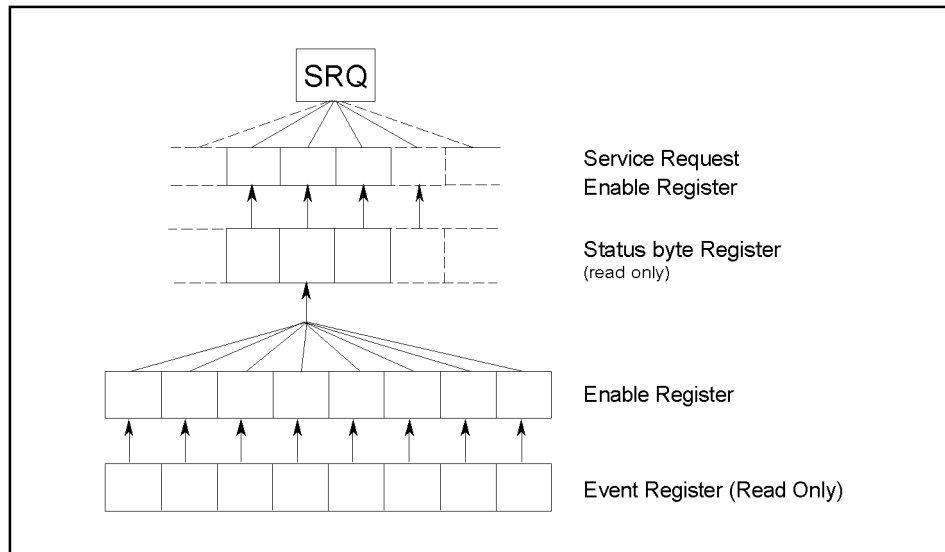

4294ape021

The status reporting system has a hierarchical structure as shown in Figure B-1. When the instrument satisfies a particular condition, the corresponding bit of the event register is set to 1. Therefore, you can check the instrument status by reading the event register.

When the event register bit is set to “1” and a corresponding enable register bit (a bit marked with an arrow in Figure B-1) is also “1,” the summary bit of the status byte register is set to “1.” You can read the status byte register by using the serial poll.

If the bit of the service request enable register is “1,” a service request (SRQ) is generated by the positive transition of the corresponding status byte register bit. By generating SRQ, you can notify the controller that the E5070B/E5071B is requesting service. In other words, interruption by SRQ can be programmed. For more information on using SRQ, see “Using the status register” on page 132 in Chapter 5, “Making a Measurement,” or “Using the status reporting system” on page 230 in Chapter 11, “Working with Automatic Test Systems.”

Event Register

Reflects the corresponding condition of the E5070B/E5071B (e.g., occurrence of an event) as a bit status. These bits continuously monitor changes in the E5070B/E5071B's state and change the bit status when the condition (e.g., change bit status to "1" if a specific event occurs) for each bit is met. You cannot change the bit status by issuing a SCPI command.

Enable Register

Setting the enable register allows you to specify event register bits that can set "1" to the summary bit of the status byte register when an event occurs. The register bits work as mask bits; setting "1" to an enable register will enable a corresponding bit in the event register.

For example, when you want to set "1" as the summary bit in the status byte register by a specific register condition, set the corresponding enable register to "1."

Status Byte Register

If the enabled event register is set to "1," a corresponding bit of the status byte register is also set to "1." This register also indicates the output queue and SRQ status.

The value of the status byte register can be read by using the `*STB?` command on page 291 command or serial poll (SPOLL statement in HTBasic) from the controller.

Reading the status byte register by using the `*STB?` command does not affect the contents of the status byte register. However, reading it with the SPOLL statement of HTBasic will clear the RQS bit in the status byte register.

Also, setting the service request enable register using the `*SRE` command on page 290 command can generate a service request synchronously with the status byte register.

Condition Register and Transition Filter

When the status register has a transition filter, there is a lower register called a condition register under the event register. The transition filter is between the event register and the condition register.

The transition filter enables you to select a positive and/or negative transition of the condition register bit in order to set a bit in the corresponding event register. For example, using the negative transition filter to set bit 3 to “1” causes bit 3 of the event register to be set to “1” when bit 3 of the condition register makes a negative transition, that is, changes from 1 to 0.

Figure B-2

Transition filter and condition register

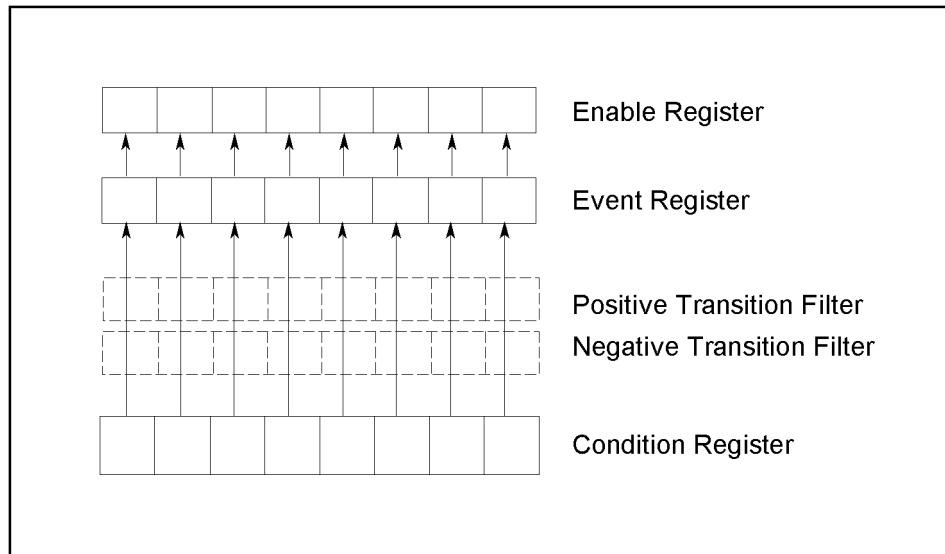

4294ape022

In the E5070B/E5071B, the following registers provide a condition register and transition filter:

- Operation status register
- Questionable status register
- Questionable limit status register
- Questionable limit extra status register
- Questionable limit channel {1-16} status register
- Questionable limit channel {1-16} extra status register
- Questionable bandwidth limit status register
- Questionable bandwidth limit extra status register
- Questionable bandwidth limit channel {1-16} status register
- Questionable bandwidth limit channel {1-16} extra status register
- Questionable ripple limit status register
- Questionable ripple limit extra status register
- Questionable ripple limit channel {1-16} status register
- Questionable ripple limit channel {1-16} extra status register

Status Register Structure

The status reporting system has a hierarchical structure as shown in Figure B-3 through Figure B-12. The status byte register is a summary of registers in the lower level. This section describes the E5070B/E5071B's status registers in each hierarchy. Each bit of the status register is described in Table B-1 through Table B-17.

Status Reporting System Status Register Structure

Figure B-3 Status Register Structure (1 of 10)

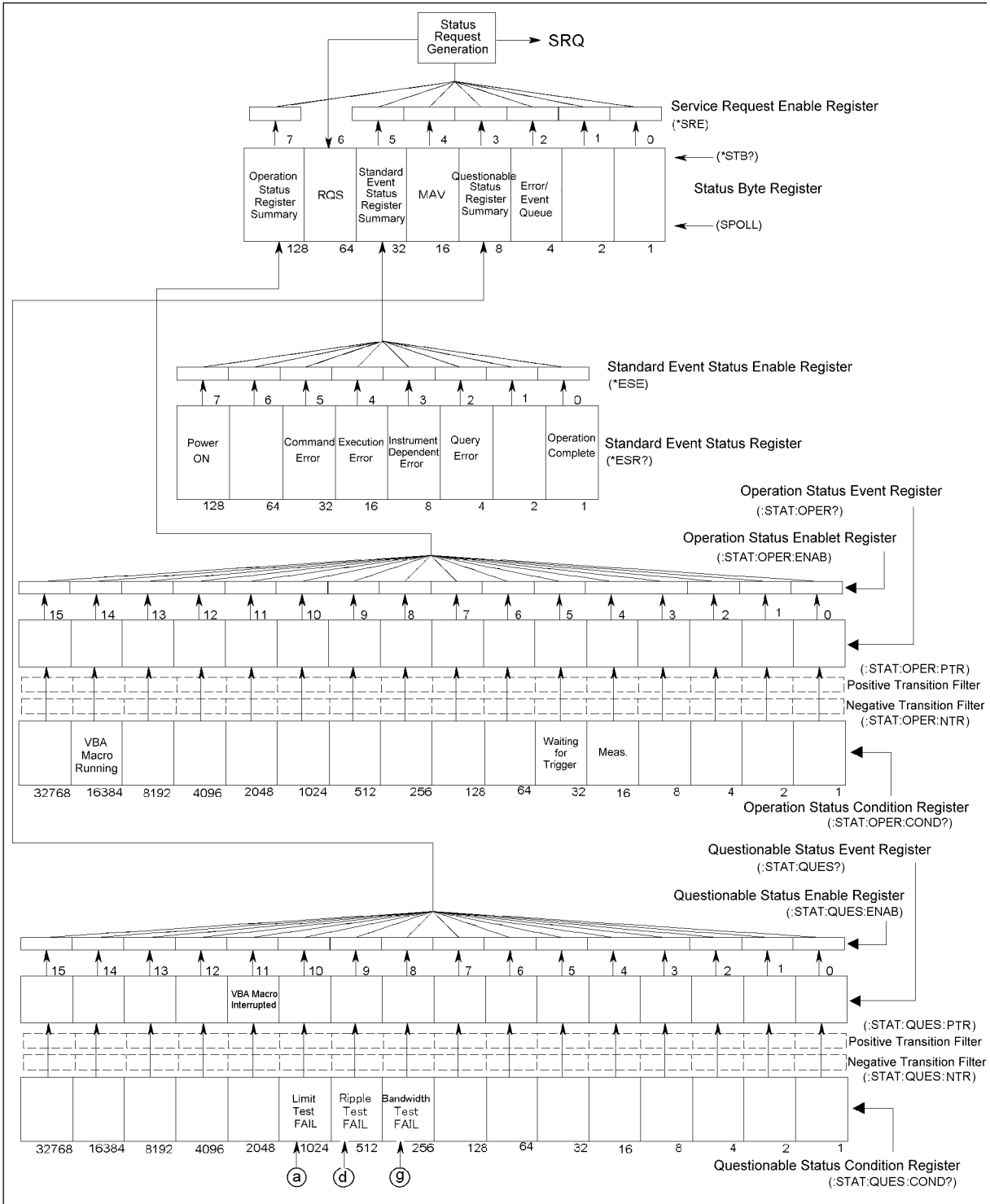

e5070bpe5001

Figure B-4 Status Register Structure (2 of 10)

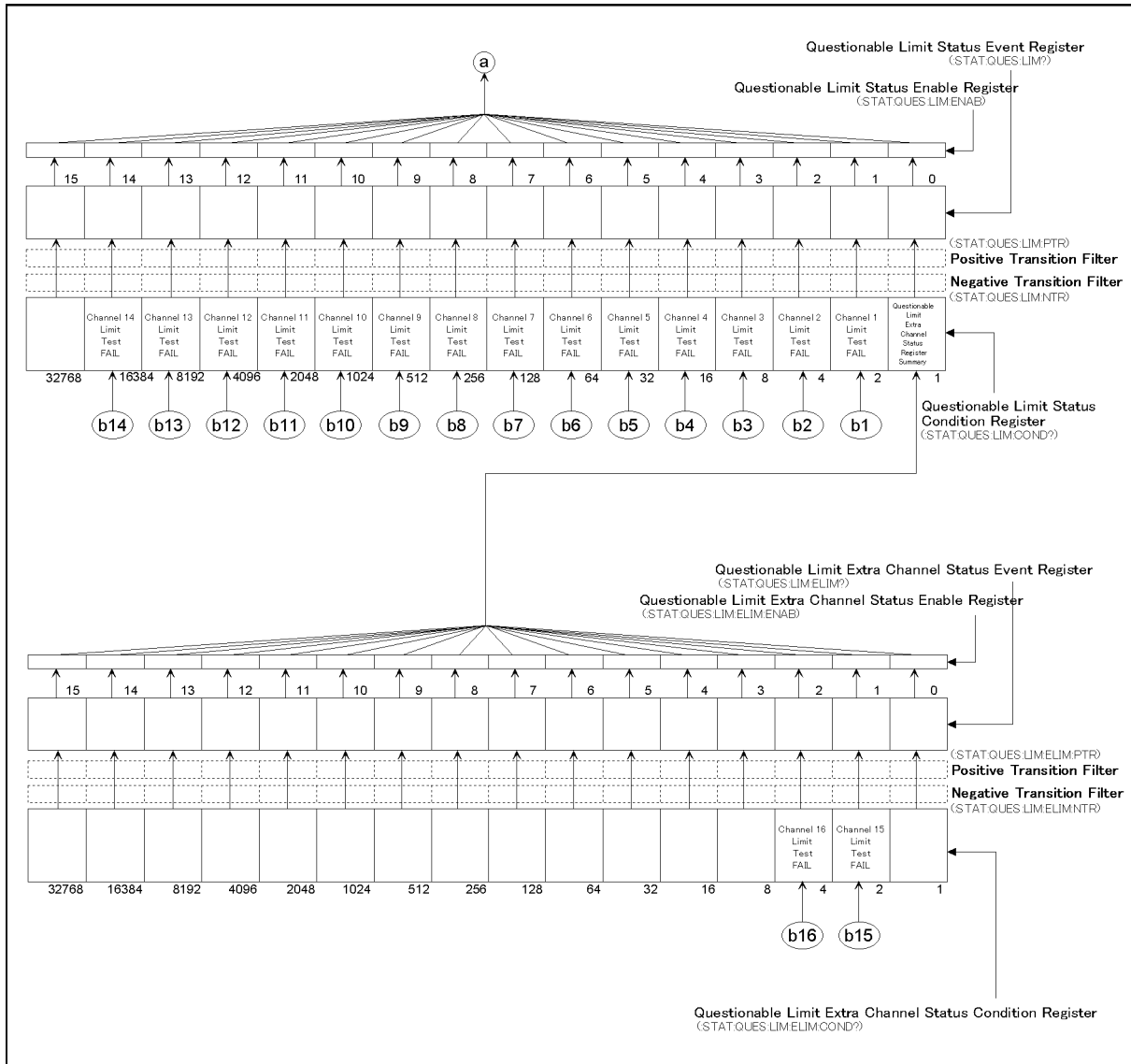

e5070bpe021

Status Reporting System Status Register Structure

Figure B-5 Status Register Structure (3 of 10)

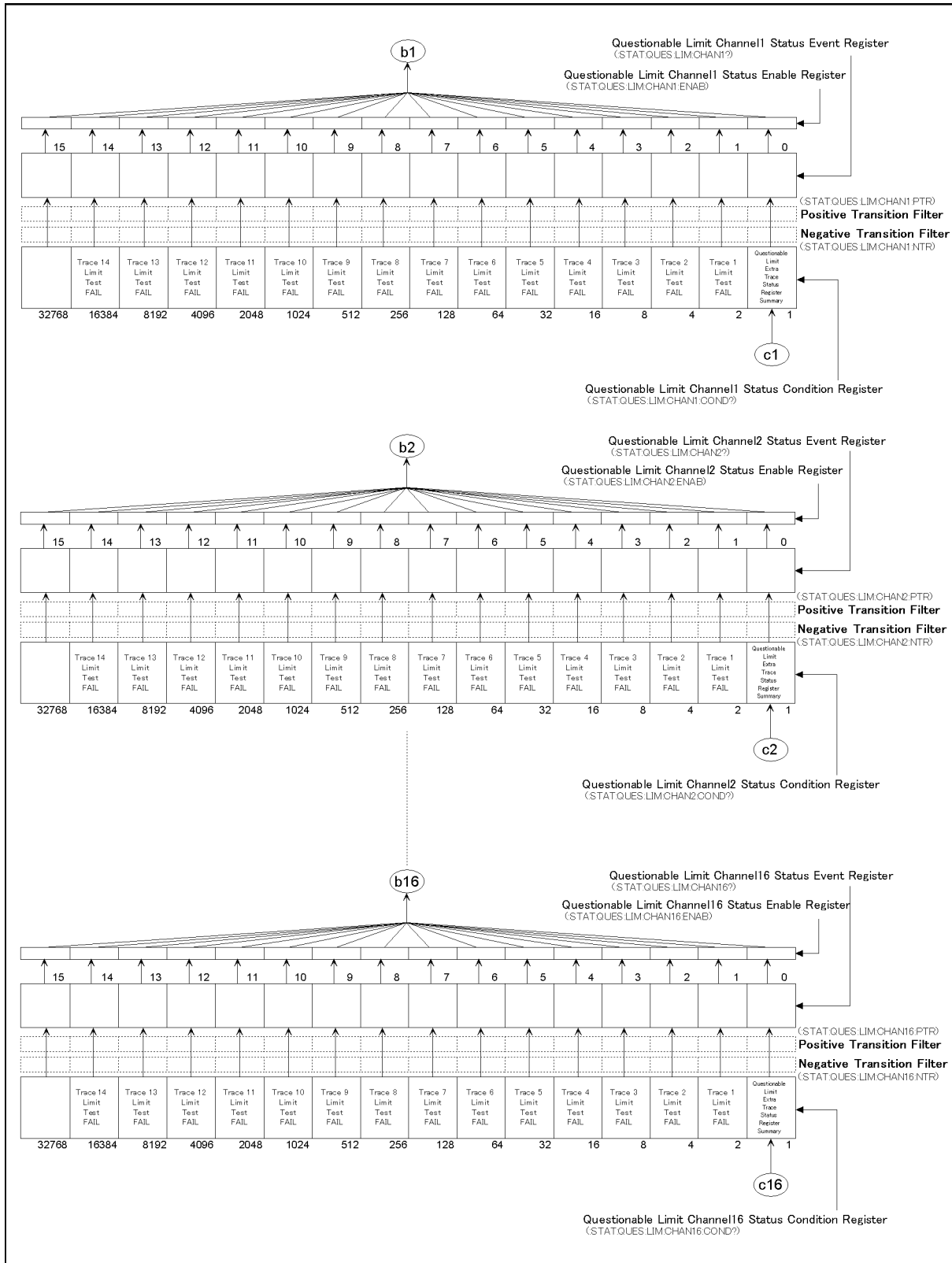

e5070bpe042

Figure B-6 Status Register Structure (4 of 10)

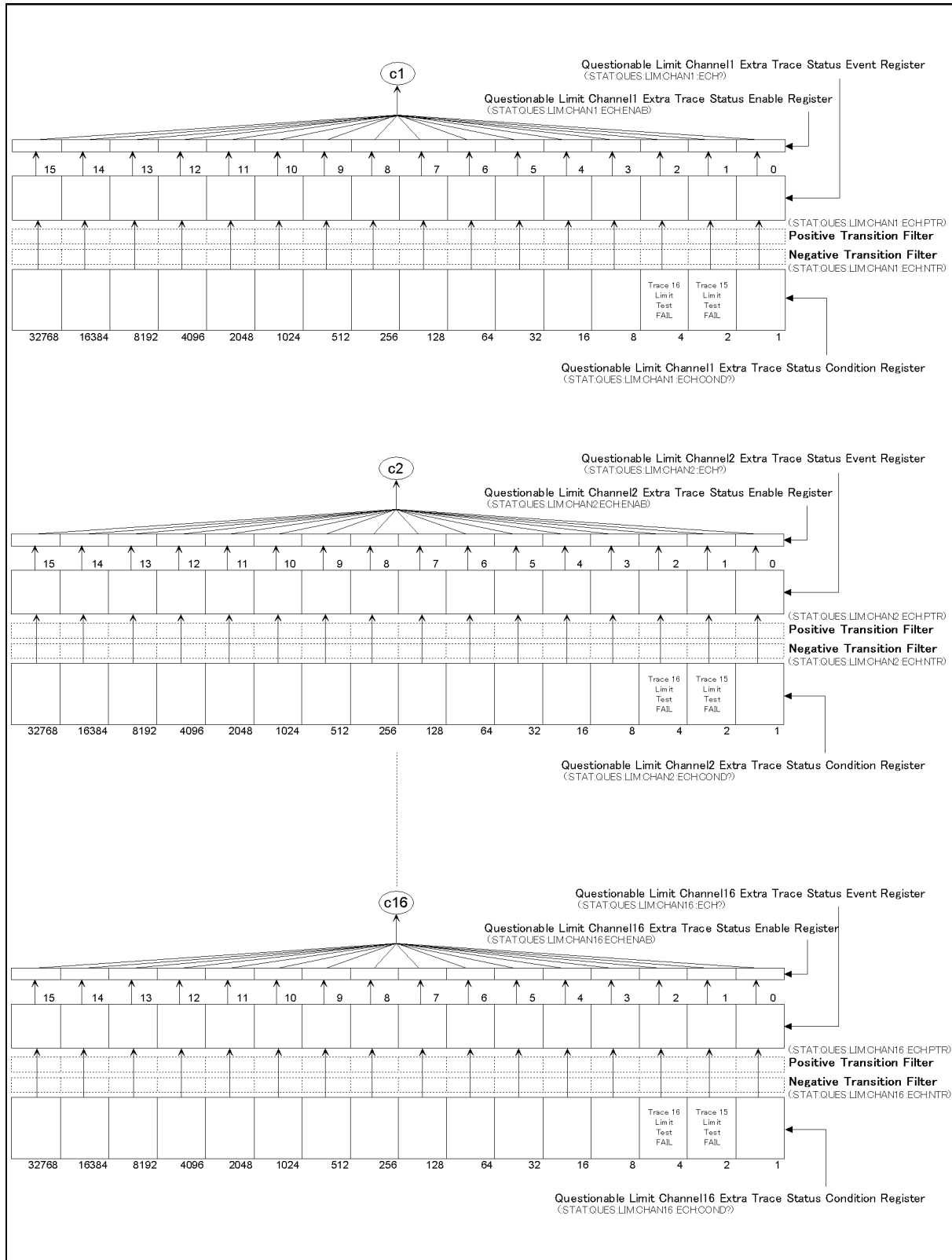

e5070bpe031

Status Reporting System
 Status Register Structure

Figure B-7 Status Register Structure (5 of 10)

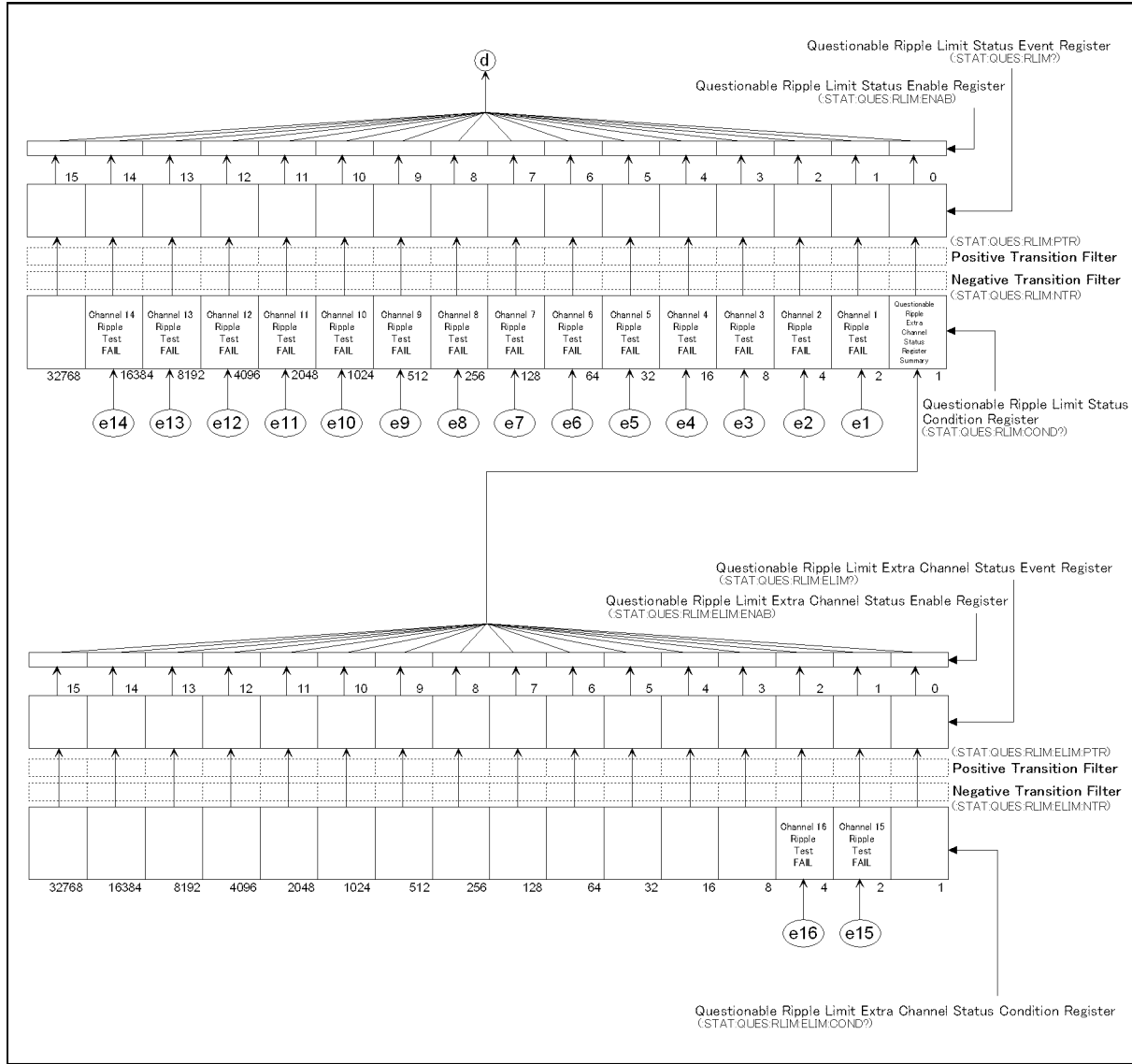

e5070bpe5002

Figure B-8 Status Register Structure (6 of 10)

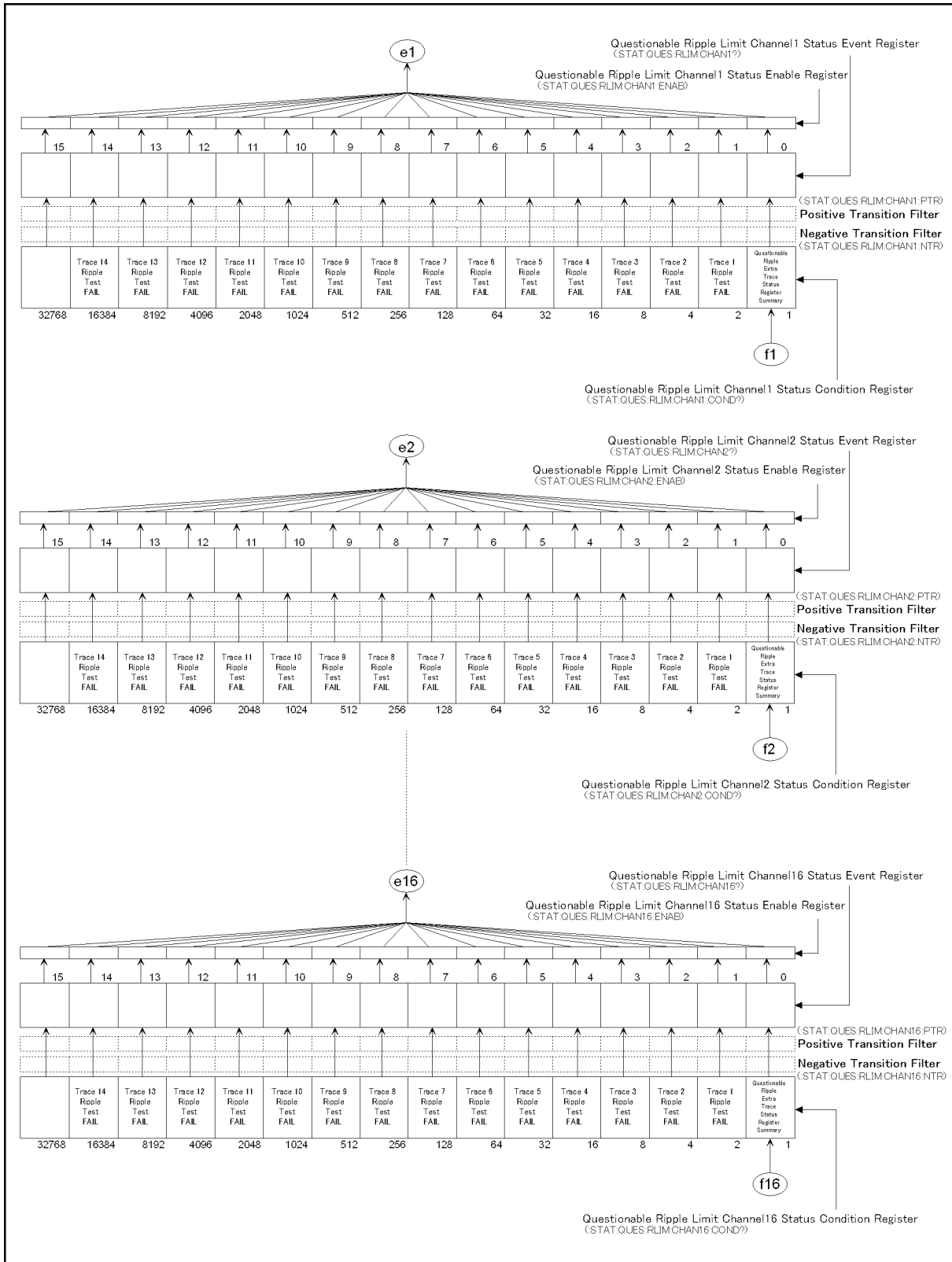

e5070bpe5003

Status Reporting System
Status Register Structure

Figure B-9 Status Register Structure (7 of 10)

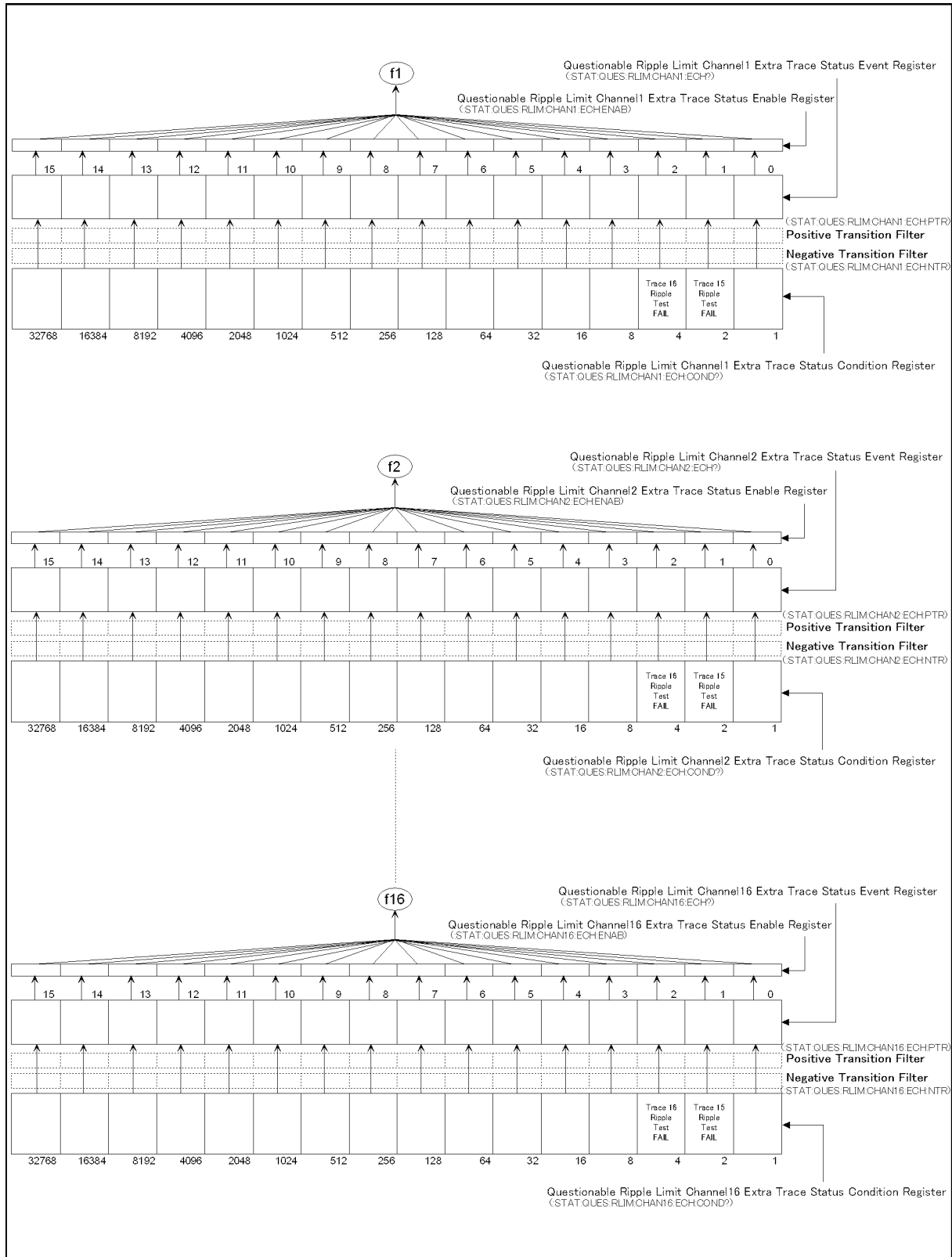

e5070bpe5004

Figure B-10 Status Register Structure (8 of 10)

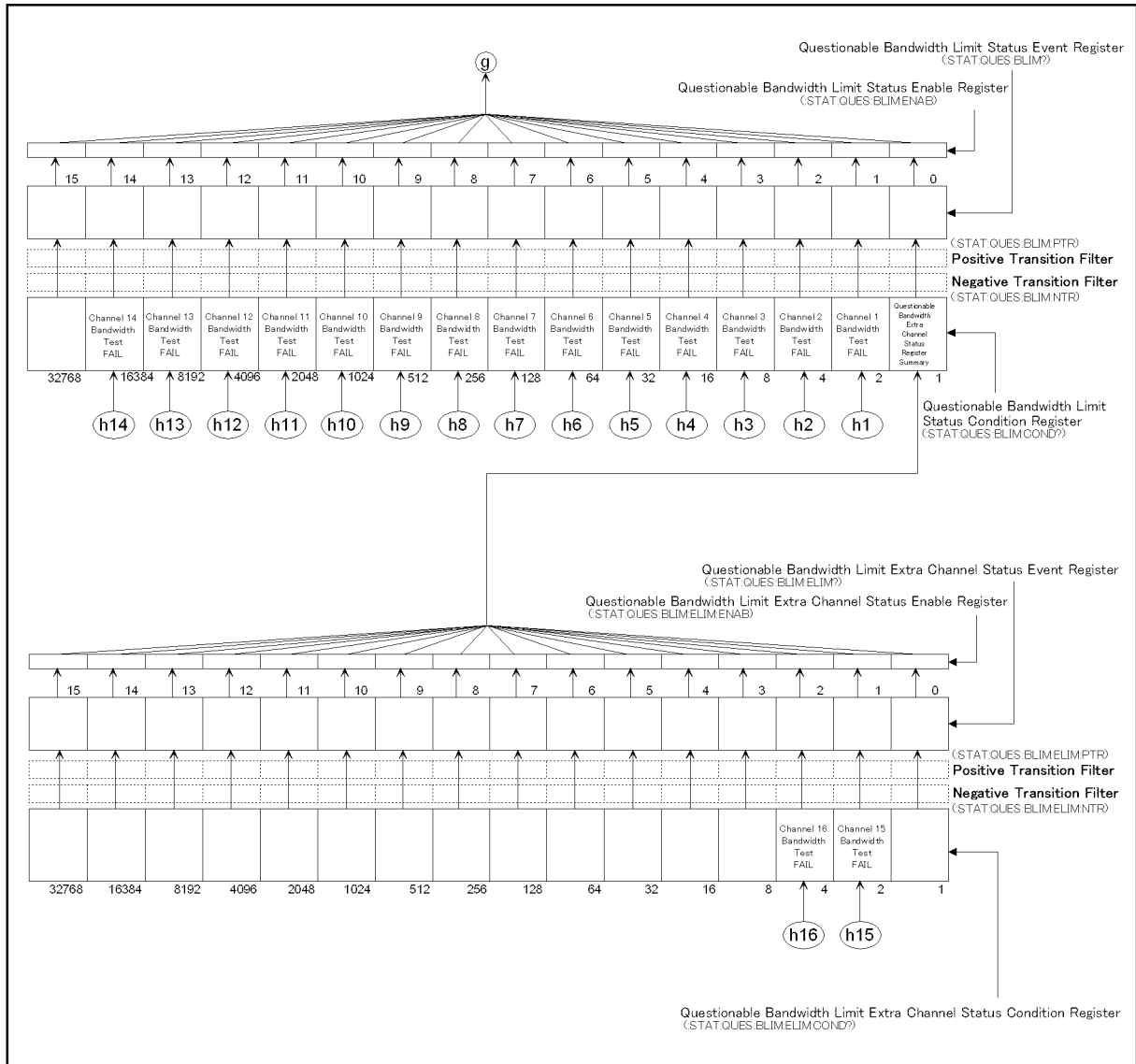

e5070bpe5005

Figure B-12 Status Register Structure (10 of 10)

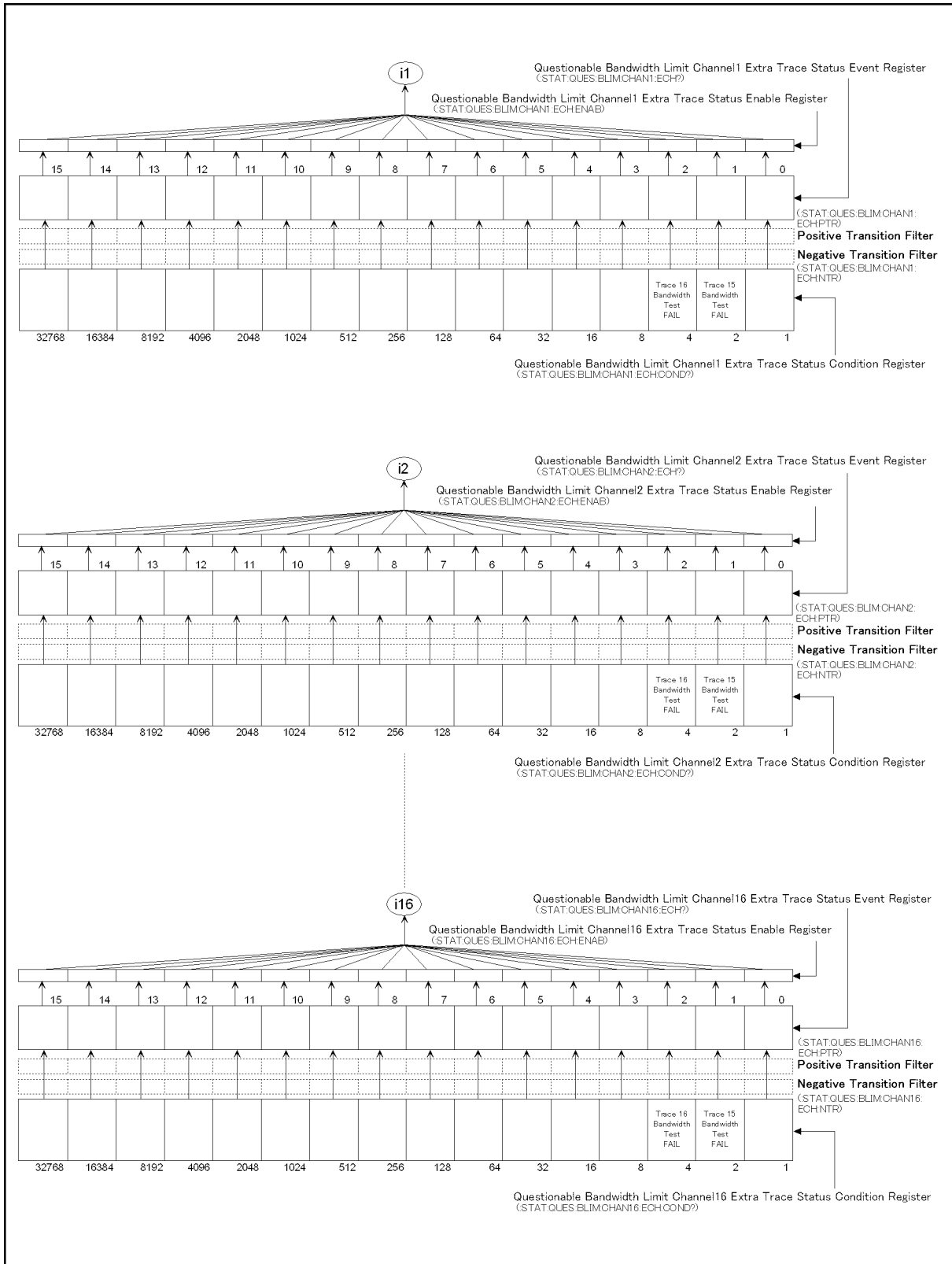

e5070bpe5007

Table B-1

Status Bit Definitions of Status Byte Register

Bit Position	Name	Description
0, 1	Not used	Always 0
2	Error/Event Queue	Set to "1" if the error/event queue contains data; reset to "0" when all the data has been retrieved.
3	Questionable Status Register Summary	Set to "1" when one of the enabled bits in the status event status register is set to "1."
4	MAV (Message Available)	Set to "1" when the output queue contains data; reset to "0" when all the data has been retrieved.
5	Standard Event Status Register Summary	Set to "1" when one of the enabled bits in the status event status register is set to "1."
6	RQS	Set to "1" when any of the status byte register bits enabled by the service request enable register is set to "1"; reset to "0" when all the data has been retrieved through serial polling.
7	Operation Status Register Summary	Set to "1" when one of the enabled bits in the operational status register is set to "1."

Issuing the ***CLS** command will clear all bits from the status byte register.

Table B-2

Status Bit Definitions of Event Status Register (ESR)

Bit Position	Name	Description
0	Operation Complete	Set to "1" upon completion of all operations done by commands that precede the *OPC? command on page 288 command.
1	Not used	Always 0
2	Query Error	<ol style="list-style-type: none"> Set to "1" when the E5070B/E5071B receives a data output request but there is no data to output. Set to "1" when the data of the E5070B/E5071B's output queue has been cleared because of a new message received before the completion of data output.
3	Instrument Dependent Error	Set to "1" when an error has occurred and the error is not a command, query, or execution error.
4	Execution Error	<ol style="list-style-type: none"> Set to "1" when any parameter in an SCPI command exceeds its input range or is inconsistent with the E5070B/E5071B's capabilities. Set to "1" when an SCPI command cannot be properly executed due to some condition of the E5070B/E5071B.
5	Command Error	<ol style="list-style-type: none"> Set to "1" when an IEEE 488.2 syntax error occurs (a command sent to the E5070B/E5071B does not follow the IEEE 488.2 syntax). Possible violations include the command parameter violating the E5070B/E5071B listening formats or being unacceptable. Set to "1" when a semantic error occurs. Possible causes include a command containing misspellings being sent to the E5070B/E5071B or an IEEE 488.2 command not supported by the E5070B/E5071B being sent. Set to "1" when GET (Group Execution Trigger) is input while a program message is being received.
6	Not used	Always 0
7	Power ON	Set to "1" when the E5070B/E5071B is powered ON, or when the firmware is restarted.

Issuing the *CLS command will clear all bits from the standard event status register.

Table B-3

Status Bit Definitions of the Operation Status Condition Register

Bit Position	Name	Description
0 - 3	Not used	Always 0
4	Measurement	Set to "1" during measurement ^{*1} .
5	Waiting for Trigger ^{*2}	Set to "1" while the instrument is waiting for a trigger ^{*3} .
6 - 13	Not used	Always 0
14	VBA Macro Running	Set to "1" while a VBA macro is running.
15	Not used	Always 0

*1. This is the time from the beginning of the first sweep to the end of the last sweep when several sweeps are executed for one measurement.

*2. When the point trigger function is on and the low-latency external trigger mode is on, set to 1 while the instrument is waiting for the trigger of the first measurement point. Set to 0 when the instrument is point-triggered for the first time, and set to 1 again when the measurement of the last measurement point is completed and the instrument is ready for the next sweep.

*3. This is when the trigger system is in "Waiting for Trigger" state. For more information on the trigger system, refer to "Trigger System" on page 128.

Issuing the ***CLS** command will clear all bits from the operation status event register.

Table B-4

Status Bit Definitions of the Questionable Status Condition Register

Bit Position	Name	Description
0 - 7	Not used	Always 0
8	Bandwidth Test Fail (Questionable bandwidth limit status register summary)	Set to "1" while one of the enabled bits in the questionable bandwidth limit status event register is set to "1."
9	Ripple Test Fail (Questionable ripple limit status register summary)	Set to "1" while one of the enabled bits in the questionable ripple limit status event register is set to "1."
10	Limit Test Fail (Questionable limit status register summary)	Set to "1" while one of the enabled bits in the questionable limit status event register is set to "1."
11 - 15	Not used	Always 0

Table B-5

Status Bit Definitions of the Questionable Status Event Register

Bit Position	Name	Description
0 - 7	Not used	Always 0
8	Bandwidth Test Fail (Questionable bandwidth limit status register summary)	Set to "1" when a transition of the condition register occurs if the transition filters are set as valid values.
9	Ripple Test Fail (Questionable ripple limit status register summary)	Set to "1" when a transition of the condition register occurs if the transition filters are set as valid values.
10	Limit Test Fail (Questionable limit status register summary)	Set to "1" when a transition of the condition register occurs if the transition filters are set as valid values.
11	VBA Macro Interrupted	Set to "1" when a VBA macro is interrupted by one of the following reasons.*1 <ul style="list-style-type: none"> • Occurrence of an execution error • Executing "End" statement in the VBA Macro • Executing :PROG:STAT STOP • Operating [Ctrl]+[Break] using the keyboard • Operating [Macro Break] or [Macro Setup] - Stop using the front panel
12 - 15	Not used	Always 0

*1. This setting is made after you click the **End** button in the dialog box displayed when the VBA macro is interrupted.

Issuing the ***CLS** command will clear all bits from the questionable status event register.

Table B-6

Status Bit Definitions of the Questionable Limit Status Condition Register

Bit Position	Name	Description
0	Channel 15, 16 Limit Test summary (questionable limit extra status register summary)	Set to "1" while one of the enabled bits in the questionable limit extra status event register is set to "1."
1	Channel 1 Limit Test Fail (questionable limit channel 1 status register summary)	Set to "1" while one of the enabled bits in the questionable limit channel 1 status event register is set to "1."
2	Channel 2 Limit Test Fail (questionable limit channel 2 status register summary)	Set to "1" while one of the enabled bits in the questionable limit channel 2 status event register is set to "1."
3	Channel 3 Limit Test Fail (questionable limit channel 3 status register summary)	Set to "1" while one of the enabled bits in the questionable limit channel 3 status event register is set to "1."
4	Channel 4 Limit Test Fail (questionable limit channel 4 status register summary)	Set to "1" while one of the enabled bits in the questionable limit channel 4 status event register is set to "1."
5	Channel 5 Limit Test Fail (questionable limit channel 5 status register summary)	Set to "1" while one of the enabled bits in the questionable limit channel 5 status event register is set to "1."
6	Channel 6 Limit Test Fail (questionable limit channel 6 status register summary)	Set to "1" while one of the enabled bits in the questionable limit channel 6 status event register is set to "1."
7	Channel 7 Limit Test Fail (questionable limit channel 7 status register summary)	Set to "1" while one of the enabled bits in the questionable limit channel 7 status event register is set to "1."
8	Channel 8 Limit Test Fail (questionable limit channel 8 status register summary)	Set to "1" while one of the enabled bits in the questionable limit channel 8 status event register is set to "1."
9	Channel 9 Limit Test Fail (questionable limit channel 9 status register summary)	Set to "1" while one of the enabled bits in the questionable limit channel 9 status event register is set to "1."
10	Channel 10 Limit Test Fail (questionable limit channel 10 status register summary)	Set to "1" while one of the enabled bits in the questionable limit channel 10 status event register is set to "1."
11	Channel 11 Limit Test Fail (questionable limit channel 11 status register summary)	Set to "1" while one of the enabled bits in the questionable limit channel 11 status event register is set to "1."
12	Channel 12 Limit Test Fail (questionable limit channel 12 status register summary)	Set to "1" while one of the enabled bits in the questionable limit channel 12 status event register is set to "1."
13	Channel 13 Limit Test Fail (questionable limit channel 13 status register summary)	Set to "1" while one of the enabled bits in the questionable limit channel 13 status event register is set to "1."
14	Channel 14 Limit Test Fail (questionable limit channel 14 status register summary)	Set to "1" while one of the enabled bits in the questionable limit channel 14 status event register is set to "1."
15	Not used	Always 0

Issuing the ***CLS** command will clear all bits from the questionable limit status event register.

Table B-7

Status Bit Definitions of the Questionable Limit Extra Status Condition Register

Bit Position	Name	Description
0	Not used	Always 0
1	Channel 15 Limit Test Fail (questionable limit channel 15 status register summary)	Set to "1" while one of the enabled bits in the questionable limit channel 15 status event register is set to "1."
2	Channel 16 Limit Test Fail (questionable limit channel 16 status register summary)	Set to "1" while one of the enabled bits in the questionable limit channel 16 status event register is set to "1."
3 - 15	Not used	Always 0

Issuing the ***CLS** command will clear all bits from the questionable limit extra status event register.

Table B-8

Status Bit Definitions of the Questionable Limit Channel {1-16} Status Condition Register

Bit Position	Name	Description
0	Trace 15, 16 Limit Test summary (questionable limit channel {1-16} extra status register summary)	Set to "1" while one of the enabled bits in the questionable limit channel {1-16} extra status event register is set to "1."
1	Trace 1 Limit Test Fail	Set to "0" when a measurement cycle begins; set to "1" when the measurement cycle finishes and returns "fail" as the limit test result for trace 1.
2	Trace 2 Limit Test Fail	Set to "0" when a measurement cycle begins; set to "1" when the measurement cycle finishes and returns "fail" as the limit test result for trace 2.
3	Trace 3 Limit Test Fail	Set to "0" when a measurement cycle begins; set to "1" when the measurement cycle finishes and returns "fail" as the limit test result for trace 3.
4	Trace 4 Limit Test Fail	Set to "0" when a measurement cycle begins; set to "1" when the measurement cycle finishes and returns "fail" as the limit test result for trace 4.
5	Trace 5 Limit Test Fail	Set to "0" when a measurement cycle begins; set to "1" when the measurement cycle finishes and returns "fail" as the limit test result for trace 5.
6	Trace 6 Limit Test Fail	Set to "0" when a measurement cycle begins; set to "1" when the measurement cycle finishes and returns "fail" as the limit test result for trace 6.
7	Trace 7 Limit Test Fail	Set to "0" when a measurement cycle begins; set to "1" when the measurement cycle finishes and returns "fail" as the limit test result for trace 7.
8	Trace 8 Limit Test Fail	Set to "0" when a measurement cycle begins; set to "1" when the measurement cycle finishes and returns "fail" as the limit test result for trace 8.
9	Trace 9 Limit Test Fail	Set to "0" when a measurement cycle begins; set to "1" when the measurement cycle finishes and returns "fail" as the limit test result for trace 9.
10	Trace 10 Limit Test Fail	Set to "0" when a measurement cycle begins; set to "1" when the measurement cycle finishes and returns "fail" as the limit test result for trace 10.
11	Trace 11 Limit Test Fail	Set to "0" when a measurement cycle begins; set to "1" when the measurement cycle finishes and returns "fail" as the limit test result for trace 11.
12	Trace 12 Limit Test Fail	Set to "0" when a measurement cycle begins; set to "1" when the measurement cycle finishes and returns "fail" as the limit test result for trace 12.
13	Trace 13 Limit Test Fail	Set to "0" when a measurement cycle begins; set to "1" when the measurement cycle finishes and returns "fail" as the limit test result for trace 13.
14	Trace 14 Limit Test Fail	Set to "0" when a measurement cycle begins; set to "1" when the measurement cycle finishes and returns "fail" as the limit test result for trace 14.
15	Not used	Always 0

Issuing the ***CLS** command will clear all the bits in the questionable limit channel {1-16}

status event register.

Table B-9

Status Bit Definitions of the Questionable Limit Channel {1-16} Extra Status Condition Register

Bit Position	Name	Description
0	Not used	Always 0
1	Trace 15 Limit Test Fail	Set to "0" when a measurement cycle begins; set to "1" when the measurement cycle finishes and returns "fail" as the limit test result for trace 15.
2	Trace 16 Limit Test Fail	Set to "0" when a measurement cycle begins; set to "1" when the measurement cycle finishes and returns "fail" as the limit test result for trace 16.
3 - 15	Not used	Always 0

Issuing the ***CLS** command will clear all the bits in the questionable limit channel {1-16} extra status event register.

Table B-10

Status Bit Definitions of the Questionable Bandwidth Limit Status Condition Register

Bit Position	Name	Description
0	Channel 15, 16 Limit Test summary (questionable bandwidth limit extra status register summary)	Set to "1" while one of the enabled bits in the questionable bandwidth limit extra status event register is set to "1."
1	Channel 1 Bandwidth Test Fail (questionable bandwidth limit channel 1 status register summary)	Set to "1" while one of the enabled bits in the questionable bandwidth limit channel 1 status event register is set to "1."
2	Channel 2 Bandwidth Test Fail (questionable bandwidth limit channel 2 status register summary)	Set to "1" while one of the enabled bits in the questionable bandwidth limit channel 2 status event register is set to "1."
3	Channel 3 Bandwidth Test Fail (questionable bandwidth limit channel 3 status register summary)	Set to "1" while one of the enabled bits in the questionable bandwidth limit channel 3 status event register is set to "1."
4	Channel 4 Bandwidth Test Fail (questionable bandwidth limit channel 4 status register summary)	Set to "1" while one of the enabled bits in the questionable bandwidth limit channel 4 status event register is set to "1."
5	Channel 5 Bandwidth Test Fail (questionable bandwidth limit channel 5 status register summary)	Set to "1" while one of the enabled bits in the questionable bandwidth limit channel 5 status event register is set to "1."
6	Channel 6 Bandwidth Test Fail (questionable bandwidth limit channel 6 status register summary)	Set to "1" while one of the enabled bits in the questionable bandwidth limit channel 6 status event register is set to "1."
7	Channel 7 Bandwidth Test Fail (questionable bandwidth limit channel 7 status register summary)	Set to "1" while one of the enabled bits in the questionable bandwidth limit channel 7 status event register is set to "1."
8	Channel 8 Bandwidth Test Fail (questionable bandwidth limit channel 8 status register summary)	Set to "1" while one of the enabled bits in the questionable bandwidth limit channel 8 status event register is set to "1."
9	Channel 9 Bandwidth Test Fail (questionable bandwidth limit channel 9 status register summary)	Set to "1" while one of the enabled bits in the questionable bandwidth limit channel 9 status event register is set to "1."
10	Channel 10 Bandwidth Test Fail (questionable bandwidth limit channel 10 status register summary)	Set to "1" while one of the enabled bits in the questionable bandwidth limit channel 10 status event register is set to "1."
11	Channel 11 Bandwidth Test Fail (questionable bandwidth limit channel 11 status register summary)	Set to "1" while one of the enabled bits in the questionable bandwidth limit channel 11 status event register is set to "1."
12	Channel 12 Bandwidth Test Fail (questionable bandwidth limit channel 12 status register summary)	Set to "1" while one of the enabled bits in the questionable bandwidth limit channel 12 status event register is set to "1."
13	Channel 13 Bandwidth Test Fail (questionable bandwidth limit channel 13 status register summary)	Set to "1" while one of the enabled bits in the questionable bandwidth limit channel 13 status event register is set to "1."
14	Channel 14 Bandwidth Test Fail (questionable bandwidth limit channel 14 status register summary)	Set to "1" while one of the enabled bits in the questionable bandwidth limit channel 14 status event register is set to "1."
15	Not used	Always 0

Issuing the ***CLS** command will clear all bits from the questionable bandwidth limit status

event register.

Table B-11

Status Bit Definitions of the Questionable Bandwidth Limit Extra Status Condition Register

Bit Position	Name	Description
0	Not used	Always 0
1	Channel 15 Bandwidth Test Fail (questionable bandwidth limit channel 15 status register summary)	Set to "1" while one of the enabled bits in the questionable bandwidth limit channel 15 status event register is set to "1."
2	Channel 16 Bandwidth Test Fail (questionable bandwidth limit channel 16 status register summary)	Set to "1" while one of the enabled bits in the questionable bandwidth limit channel 16 status event register is set to "1."
3 - 15	Not used	Always 0

Issuing the ***CLS** command will clear all bits from the questionable bandwidth limit extra status event register.

Table B-12

Status Bit Definitions of the Questionable Bandwidth Limit Channel {1-16} Status Condition Register

Bit Position	Name	Description
0	Trace 15, 16 Bandwidth Test summary (questionable bandwidth limit channel {1-16} extra status register summary)	Set to "1" while one of the enabled bits in the questionable bandwidth limit channel {1-16} extra status event register is set to "1."
1	Trace 1 Bandwidth Test Fail	Set to "0" when a measurement cycle begins; set to "1" when the measurement cycle finishes and returns "fail" as the bandwidth test result for trace 1.
2	Trace 2 Bandwidth Test Fail	Set to "0" when a measurement cycle begins; set to "1" when the measurement cycle finishes and returns "fail" as the bandwidth test result for trace 2.
3	Trace 3 Bandwidth Test Fail	Set to "0" when a measurement cycle begins; set to "1" when the measurement cycle finishes and returns "fail" as the bandwidth test result for trace 3.
4	Trace 4 Bandwidth Test Fail	Set to "0" when a measurement cycle begins; set to "1" when the measurement cycle finishes and returns "fail" as the bandwidth test result for trace 4.
5	Trace 5 Bandwidth Test Fail	Set to "0" when a measurement cycle begins; set to "1" when the measurement cycle finishes and returns "fail" as the bandwidth test result for trace 5.
6	Trace 6 Bandwidth Test Fail	Set to "0" when a measurement cycle begins; set to "1" when the measurement cycle finishes and returns "fail" as the bandwidth test result for trace 6.
7	Trace 7 Bandwidth Test Fail	Set to "0" when a measurement cycle begins; set to "1" when the measurement cycle finishes and returns "fail" as the bandwidth test result for trace 7.
8	Trace 8 Bandwidth Test Fail	Set to "0" when a measurement cycle begins; set to "1" when the measurement cycle finishes and returns "fail" as the bandwidth test result for trace 8.
9	Trace 9 Bandwidth Test Fail	Set to "0" when a measurement cycle begins; set to "1" when the measurement cycle finishes and returns "fail" as the bandwidth test result for trace 9.
10	Trace 10 Bandwidth Test Fail	Set to "0" when a measurement cycle begins; set to "1" when the measurement cycle finishes and returns "fail" as the bandwidth test result for trace 10.
11	Trace 11 Bandwidth Test Fail	Set to "0" when a measurement cycle begins; set to "1" when the measurement cycle finishes and returns "fail" as the bandwidth test result for trace 11.
12	Trace 12 Bandwidth Test Fail	Set to "0" when a measurement cycle begins; set to "1" when the measurement cycle finishes and returns "fail" as the bandwidth test result for trace 12.
13	Trace 13 Bandwidth Test Fail	Set to "0" when a measurement cycle begins; set to "1" when the measurement cycle finishes and returns "fail" as the bandwidth test result for trace 13.
14	Trace 14 Bandwidth Test Fail	Set to "0" when a measurement cycle begins; set to "1" when the measurement cycle finishes and returns "fail" as the bandwidth test result for trace 14.
15	Not used	Always 0

Issuing the ***CLS** command will clear all the bits in the questionable bandwidth limit

channel {1-16} status event register.

Table B-13 Status Bit Definitions of the Questionable Bandwidth Limit Channel {1-16} Extra Status Condition Register

Bit Position	Name	Description
0	Not used	Always 0
1	Trace 15 Bandwidth Test Fail	Set to “0” when a measurement cycle begins; set to “1” when the measurement cycle finishes and returns “fail” as the bandwidth test result for trace 15.
2	Trace 16 Bandwidth Test Fail	Set to “0” when a measurement cycle begins; set to “1” when the measurement cycle finishes and returns “fail” as the bandwidth test result for trace 16.
3 - 15	Not used	Always 0

Issuing the ***CLS** command will clear all the bits in the questionable bandwidth limit channel {1-16} extra status event register.

Table B-14

Status Bit Definitions of the Questionable Ripple Limit Status Condition Register

Bit Position	Name	Description
0	Channel 15, 16 Limit Test summary (questionable ripple limit extra status register summary)	Set to "1" while one of the enabled bits in the questionable ripple limit extra status event register is set to "1."
1	Channel 1 Ripple Test Fail (questionable ripple limit channel 1 status register summary)	Set to "1" while one of the enabled bits in the questionable ripple limit channel 1 status event register is set to "1."
2	Channel 2 Ripple Test Fail (questionable ripple limit channel 2 status register summary)	Set to "1" while one of the enabled bits in the questionable ripple limit channel 2 status event register is set to "1."
3	Channel 3 Ripple Test Fail (questionable ripple limit channel 3 status register summary)	Set to "1" while one of the enabled bits in the questionable ripple limit channel 3 status event register is set to "1."
4	Channel 4 Ripple Test Fail (questionable ripple limit channel 4 status register summary)	Set to "1" while one of the enabled bits in the questionable ripple limit channel 4 status event register is set to "1."
5	Channel 5 Ripple Test Fail (questionable ripple limit channel 5 status register summary)	Set to "1" while one of the enabled bits in the questionable ripple limit channel 5 status event register is set to "1."
6	Channel 6 Ripple Test Fail (questionable ripple limit channel 6 status register summary)	Set to "1" while one of the enabled bits in the questionable ripple limit channel 6 status event register is set to "1."
7	Channel 7 Ripple Test Fail (questionable ripple limit channel 7 status register summary)	Set to "1" while one of the enabled bits in the questionable ripple limit channel 7 status event register is set to "1."
8	Channel 8 Ripple Test Fail (questionable ripple limit channel 8 status register summary)	Set to "1" while one of the enabled bits in the questionable ripple limit channel 8 status event register is set to "1."
9	Channel 9 Ripple Test Fail (questionable ripple limit channel 9 status register summary)	Set to "1" while one of the enabled bits in the questionable ripple limit channel 9 status event register is set to "1."
10	Channel 10 Ripple Test Fail (questionable ripple limit channel 10 status register summary)	Set to "1" while one of the enabled bits in the questionable ripple limit channel 10 status event register is set to "1."
11	Channel 11 Ripple Test Fail (questionable ripple limit channel 11 status register summary)	Set to "1" while one of the enabled bits in the questionable ripple limit channel 11 status event register is set to "1."
12	Channel 12 Ripple Test Fail (questionable ripple limit channel 12 status register summary)	Set to "1" while one of the enabled bits in the questionable ripple limit channel 12 status event register is set to "1."
13	Channel 13 Ripple Test Fail (questionable ripple limit channel 13 status register summary)	Set to "1" while one of the enabled bits in the questionable ripple limit channel 13 status event register is set to "1."
14	Channel 14 Ripple Test Fail (questionable ripple limit channel 14 status register summary)	Set to "1" while one of the enabled bits in the questionable ripple limit channel 14 status event register is set to "1."
15	Not used	Always 0

Issuing the ***CLS** command will clear all bits from the questionable ripple limit status

event register.

Table B-15 **Status Bit Definitions of the Questionable Ripple Limit Extra Status Condition Register**

Bit Position	Name	Description
0	Not used	Always 0
1	Channel 15 Ripple Test Fail (questionable ripple limit channel 15 status register summary)	Set to “1” while one of the enabled bits in the questionable ripple limit channel 15 status event register is set to “1.”
2	Channel 16 Ripple Test Fail (questionable ripple limit channel 16 status register summary)	Set to “1” while one of the enabled bits in the questionable ripple limit channel 16 status event register is set to “1.”
3 - 15	Not used	Always 0

Issuing the ***CLS** command will clear all bits from the questionable ripple limit extra status event register.

Table B-16

Status Bit Definitions of the Questionable Ripple Limit Channel {1-16} Status Condition Register

Bit Position	Name	Description
0	Trace 15, 16 Ripple Test summary (questionable ripple limit channel {1-16} extra status register summary)	Set to "1" while one of the enabled bits in the questionable ripple limit channel {1-16} extra status event register is set to "1."
1	Trace 1 Ripple Test Fail	Set to "0" when a measurement cycle begins; set to "1" when the measurement cycle finishes and returns "fail" as the ripple test result for trace 1.
2	Trace 2 Ripple Test Fail	Set to "0" when a measurement cycle begins; set to "1" when the measurement cycle finishes and returns "fail" as the ripple test result for trace 2.
3	Trace 3 Ripple Test Fail	Set to "0" when a measurement cycle begins; set to "1" when the measurement cycle finishes and returns "fail" as the ripple test result for trace 3.
4	Trace 4 Ripple Test Fail	Set to "0" when a measurement cycle begins; set to "1" when the measurement cycle finishes and returns "fail" as the ripple test result for trace 4.
5	Trace 5 Ripple Test Fail	Set to "0" when a measurement cycle begins; set to "1" when the measurement cycle finishes and returns "fail" as the ripple test result for trace 5.
6	Trace 6 Ripple Test Fail	Set to "0" when a measurement cycle begins; set to "1" when the measurement cycle finishes and returns "fail" as the ripple test result for trace 6.
7	Trace 7 Ripple Test Fail	Set to "0" when a measurement cycle begins; set to "1" when the measurement cycle finishes and returns "fail" as the ripple test result for trace 7.
8	Trace 8 Ripple Test Fail	Set to "0" when a measurement cycle begins; set to "1" when the measurement cycle finishes and returns "fail" as the ripple test result for trace 8.
9	Trace 9 Ripple Test Fail	Set to "0" when a measurement cycle begins; set to "1" when the measurement cycle finishes and returns "fail" as the ripple test result for trace 9.
10	Trace 10 Ripple Test Fail	Set to "0" when a measurement cycle begins; set to "1" when the measurement cycle finishes and returns "fail" as the ripple test result for trace 10.
11	Trace 11 Ripple Test Fail	Set to "0" when a measurement cycle begins; set to "1" when the measurement cycle finishes and returns "fail" as the ripple test result for trace 11.
12	Trace 12 Ripple Test Fail	Set to "0" when a measurement cycle begins; set to "1" when the measurement cycle finishes and returns "fail" as the ripple test result for trace 12.
13	Trace 13 Ripple Test Fail	Set to "0" when a measurement cycle begins; set to "1" when the measurement cycle finishes and returns "fail" as the ripple test result for trace 13.
14	Trace 14 Ripple Test Fail	Set to "0" when a measurement cycle begins; set to "1" when the measurement cycle finishes and returns "fail" as the ripple test result for trace 14.
15	Not used	Always 0

Issuing the ***CLS** command will clear all the bits in the questionable ripple limit channel

{1-16} status event register.

Table B-17

Status Bit Definitions of the Questionable Ripple Limit Channel {1-16} Extra Status Condition Register

Bit Position	Name	Description
0	Not used	Always 0
1	Trace 15 Ripple Test Fail	Set to "0" when a measurement cycle begins; set to "1" when the measurement cycle finishes and returns "fail" as the ripple test result for trace 15.
2	Trace 16 Ripple Test Fail	Set to "0" when a measurement cycle begins; set to "1" when the measurement cycle finishes and returns "fail" as the ripple test result for trace 16.
3 - 15	Not used	Always 0

Issuing the ***CLS** command will clear all the bits in the questionable ripple limit channel {1-16} extra status event register.

Using the Status Reporting System

You can manage the status report system using the following commands in any combination:

- *CLS on page 286
- *SRE on page 290
- *STB? on page 291
- *ESE on page 287
- *ESR? on page 287
- :STAT:PRES on page 726
- :STAT:OPER:ENAB on page 723
- :STAT:OPER:COND? on page 722
- :STAT:OPER? on page 722
- :STAT:OPER:PTR on page 725
- :STAT:OPER:NTR on page 724
- :STAT:QUES:ENAB on page 744
- :STAT:QUES:COND? on page 743
- :STAT:QUES? on page 726
- :STAT:QUES:PTR on page 762
- :STAT:QUES:NTR on page 761
- :STAT:QUES:LIM:ENAB on page 758
- :STAT:QUES:LIM:COND? on page 754
- :STAT:QUES:LIM? on page 745
- :STAT:QUES:LIM:PTR on page 760
- :STAT:QUES:LIM:NTR on page 759
- :STAT:QUES:LIM:ELIM:ENAB on page 755
- :STAT:QUES:LIM:ELIM:COND? on page 755
- :STAT:QUES:LIM:ELIM? on page 754
- :STAT:QUES:LIM:ELIM:PTR on page 757
- :STAT:QUES:LIM:ELIM:NTR on page 756
- :STAT:QUES:LIM:CHAN{1-16}:ENAB on page 751
- :STAT:QUES:LIM:CHAN{1-16}:COND? on page 745
- :STAT:QUES:LIM:CHAN{1-16}? on page 745
- :STAT:QUES:LIM:CHAN{1-16}:PTR on page 753
- :STAT:QUES:LIM:CHAN{1-16}:NTR on page 752
- :STAT:QUES:LIM:CHAN{1-16}:ECH:ENAB on page 748
- :STAT:QUES:LIM:CHAN{1-16}:ECH:COND? on page 747
- :STAT:QUES:LIM:CHAN{1-16}:ECH? on page 747
- :STAT:QUES:LIM:CHAN{1-16}:ECH:PTR on page 750
- :STAT:QUES:LIM:CHAN{1-16}:ECH:NTR on page 749
- :STAT:QUES:BLIM:ENAB on page 740
- :STAT:QUES:BLIM:COND? on page 735
- :STAT:QUES:BLIM? on page 727
- :STAT:QUES:BLIM:PTR on page 742
- :STAT:QUES:BLIM:NTR on page 741
- :STAT:QUES:BLIM:ELIM:ENAB on page 737
- :STAT:QUES:BLIM:ELIM:COND? on page 736
- :STAT:QUES:BLIM:ELIM? on page 736
- :STAT:QUES:BLIM:ELIM:PTR on page 739
- :STAT:QUES:BLIM:ELIM:NTR on page 738

- :STAT:QUES:BLIM:CHAN{1-16}:ENAB on page 733
- :STAT:QUES:BLIM:CHAN{1-16}:COND? on page 727
- :STAT:QUES:BLIM:CHAN{1-16}? on page 727
- :STAT:QUES:BLIM:CHAN{1-16}:PTR on page 735
- :STAT:QUES:BLIM:CHAN{1-16}:NTR on page 734
- :STAT:QUES:BLIM:CHAN{1-16}:ECH:ENAB on page 730
- :STAT:QUES:BLIM:CHAN{1-16}:ECH:COND? on page 729
- :STAT:QUES:BLIM:CHAN{1-16}:ECH? on page 729
- :STAT:QUES:BLIM:CHAN{1-16}:ECH:PTR on page 732
- :STAT:QUES:BLIM:CHAN{1-16}:ECH:NTR on page 731
- :STAT:QUES:RLIM:ENAB on page 776
- :STAT:QUES:RLIM:COND? on page 771
- :STAT:QUES:RLIM? on page 763
- :STAT:QUES:RLIM:PTR on page 778
- :STAT:QUES:RLIM:NTR on page 777
- :STAT:QUES:RLIM:ELIM:ENAB on page 773
- :STAT:QUES:RLIM:ELIM:COND? on page 772
- :STAT:QUES:RLIM:ELIM? on page 772
- :STAT:QUES:RLIM:ELIM:PTR on page 775
- :STAT:QUES:RLIM:ELIM:NTR on page 774
- :STAT:QUES:RLIM:CHAN{1-16}:ENAB on page 769
- :STAT:QUES:RLIM:CHAN{1-16}:COND? on page 763
- :STAT:QUES:RLIM:CHAN{1-16}? on page 763
- :STAT:QUES:RLIM:CHAN{1-16}:PTR on page 771
- :STAT:QUES:RLIM:CHAN{1-16}:NTR on page 770
- :STAT:QUES:RLIM:CHAN{1-16}:ECH:ENAB on page 766
- :STAT:QUES:RLIM:CHAN{1-16}:ECH:COND? on page 765
- :STAT:QUES:RLIM:CHAN{1-16}:ECH? on page 765
- :STAT:QUES:RLIM:CHAN{1-16}:ECH:PTR on page 768
- :STAT:QUES:RLIM:CHAN{1-16}:ECH:NTR on page 767

For sample programs that demonstrate the use of the commands listed above, refer to “Using the status register” on page 132 in Chapter 5 or “Obtaining Test Results” on page 181 in Chapter 8.

Status Reporting System
Using the Status Reporting System

C

Comparing Commands on the 8753ES and E5070B/E5071B

The following table presents a comparison of commands on the Agilent 8753ES and Agilent E5070B/E5071B, listed alphabetically by function.

8753ES vs. E5070B/E5071B Command Correspondence (by function)

Function	Item to be specified/executed		Command (For footnotes, see page 928.)		Remarks
			8753ES	E5070B/E5071B	
Measurement	Reset		PRES	:SYST:PRES	After execution, the *RST on the E5070B/E5071B set the trigger state to Hold.
			RST	*RST	
	Setting up the active channel	Channel 1	CHAN1	:DISP:WIND{1-16}:ACT (Setting up the active channel) or :CALC{1-16}:PAR{1-16}:SEL (Setting up an active trace on each channel)	The outline of channels and traces on the E5070B/E5071B is described in the "User's Guide."
		Channel 2	CHAN2		
		Channel 3	CHAN3		
		Channel 4	CHAN4		
	Reading the active channel		OUTPCHAN	:DISP:WIND{1-16}:ACT? (Reading the active channel) or :CALC{1-16}:PAR{1-16}:SEL? (Reading the active trace on each channel)	
	Selection of measurement parameters	S11	S11^{*1}	:CALC{1-16}:PAR{1-16}:DEF S11^{*2}	E5070B/E5071B can select S-parameters and absolute measurement parameters.
			RFLP^{*1}		
		S21	S21^{*1}	:CALC{1-16}:PAR{1-16}:DEF S21^{*2}	
			TRAP^{*1}		
		S12	S12^{*1}	:CALC{1-16}:PAR{1-16}:DEF S12^{*2}	
		S22	S22^{*1}	:CALC{1-16}:PAR{1-16}:DEF S22^{*2}	
		Aux Input	ANAI^{*1}	Not available	
		A/R	AR^{*1}		
		B/R	BR^{*1}		
		A/B	AB^{*1}		
		A	MEASA^{*1}		
		B	MEASB^{*1}		
		R	MEASR^{*1}		
Designates a test port when parameters other than S-parameters are selected.		TSTP^{*1}			
S-parameters conversion	Turning off the transformation function	CONVOFF^{*1}	:CALC{1-16}:CONV^{*3}		
	Impedance (reflection)	CONVZREF^{*1}	:CALC{1-16}:CONV:FUNC ZREF^{*3}		
	Impedance (transmission)	CONVZTRA^{*1}	:CALC{1-16}:CONV:FUNC ZTR^{*3}		
	Admittance (reflection)	CONVYREF^{*1}	:CALC{1-16}:CONV:FUNC YREF^{*3}		
	Admittance (transmission)	CONVYTRA^{*1}	:CALC{1-16}:CONV:FUNC YTR^{*3}		
	1/S	CONVIDS^{*1}	:CALC{1-16}:CONV:FUNC INV^{*3}		

Comparing Commands on the 8753ES and E5070B/E5071B
8753ES vs. E5070B/E5071B Command Correspondence (by function)

Function	Item to be specified/executed		Command (For footnotes, see page 928.)		Remarks
			8753ES	E5070B/E5071B	
Measurement (cont'd.)	Setting up display formats (data formats)	Log magnitude format	LOGM ^{*1}	:CALC{1-16}:FORM MLOG ^{*3}	When the data format for the E5070B/E5071B is defined in Smith chart or polar format, the format for reading marker values is defined at the same time.
		Phase format	PHAS ^{*1}	:CALC{1-16}:FORM PHAS ^{*3}	
		Group delay format	DELA ^{*1}	:CALC{1-16}:FORM GDEL ^{*3}	
		Smith chart format	SMIC ^{*1}	:CALC{1-16}:FORM SLIN ^{*3} :CALC{1-16}:FORM SLOG :CALC{1-16}:FORM SCOM :CALC{1-16}:FORM SMI :CALC{1-16}:FORM SADM	
		Polar format	POLA ^{*1}	:CALC{1-16}:FORM PLIN ^{*3} :CALC{1-16}:FORM PLOG :CALC{1-16}:FORM POL	
		Linear magnitude format	LINM ^{*1}	:CALC{1-16}:FORM MLIN ^{*3}	
		SWR format	SWR ^{*1}	:CALC{1-16}:FORM SWR ^{*3}	
		Real format	REAL ^{*1}	:CALC{1-16}:FORM REAL ^{*3}	
		Imaginary format	IMAG ^{*1}	:CALC{1-16}:FORM IMAG ^{*3}	
	Sweep type selection	Linear sweep	LINFREQ ^{*1*4}	:SENS{1-16}:SWE:TYPE LIN ^{*5}	With the E5070B/E5071B, you cannot select the CW TIME seep.
Log sweep		LOGFREQ ^{*1*4}	:SENS{1-16}:SWE:TYPE LOG ^{*5}		
List sweep		LISFREQ ^{*1*4}	:SENS{1-16}:SWE:TYPE SEGM ^{*5}		
Power sweep		POWS ^{*1*4}	:SENS{1-16}:SWE:TYPE POW ^{*5}		
CW TIME sweep		CWTIME ^{*1*4}	Not available		
Setting up the sweep range	Start value	STAR ^{*1*4}	:SENS{1-16}:FREQ:STAR ^{*5} :SOUR{1-16}:POW:STAR ^{*5}		
	Stop value	STOP ^{*1*4}	:SENS{1-16}:FREQ:STOP ^{*5} :SOUR{1-16}:POW:STOP ^{*5}		
	Center value	CENT ^{*1*4}	:SENS{1-16}:FREQ:CENT ^{*5} :SOUR{1-16}:POW:CENT ^{*5}		
	Span value	SPAN ^{*1*4}	:SENS{1-16}:FREQ:SPAN ^{*5} :SOUR{1-16}:POW:SPAN ^{*5}		
Sweep time	Setting up the sweep time	SWET ^{*1*4}	:SENS{1-16}:SWE:TIME ^{*5}		
	Automatic setting to the shortest time	SWEA ^{*1*4}	:SENS{1-16}:SWE:TIME:AUTO ON ^{*5}		
Specifying the number of points		POIN ^{*1*4}	:SENS{1-16}:SWE:POIN ^{*5}		
Specifying the IF bandwidth		IFBW ^{*1*4}	:SENS{1-16}:BAND ^{*5}		
Averaging	On/Off setting	AVERO ^{*1*4}	:SENS{1-16}:AVER ^{*5}		
	Specifying the number of times	AVERFACT ^{*1} ^{*4}	:SENS{1-16}:AVER:COUN ^{*5}		
	Restart	AVERREST ^{*1} ^{*4}	:SENS{1-16}:AVER:CLE ^{*5}		
Specifying the power level		POWE ^{*1*4}	:SOUR{1-16}:POW ^{*5}	When the power range setting in one channel differs from that in another channel on the 8753ES, a sweep is not performed on channels whose settings are different from those on the active channel.	

C. Comparing Commands on the
8753ES and E5070B/E5071B

Comparing Commands on the 8753ES and E5070B/E5071B
8753ES vs. E5070B/E5071B Command Correspondence (by function)

Function	Item to be specified/executed		Command (For footnotes, see page 928.)		Remarks	
			8753ES	E5070B/E5071B		
Measurement (cont'd.)	Setting the power range	Setting the range	POWR ^{*1*4}	:SOUR{1-16}:POW:ATT ^{*5} (attenuator settings)	The E5070B/E5071B is compatible with Options 214, 314, and 414 only. When the power range setting in one channel differs from that in another channel on the 8753ES, a sweep is not performed on channels whose settings are different from those on the active channel.	
			PRAN ^{*1*4}			
		Auto/Manual setting for range changeover	PWRR ^{*1*4}	Not available		
	Attenuator settings	Port 1	ATTP1 ^{*1*4}	:SOUR{1-16}:POW:ATT ^{*5}		
		Port 2	ATTP2 ^{*1*4}			
	Power slope	On/Off	SLOPO ^{*1*4}	:SOUR{1-16}:POW:SLOP:STAT ^{*5}		
		Specifying values	SLOPE ^{*1*4}	:SOUR{1-16}:POW:SLOP ^{*5}		
	Couple/Uncouple setting for the power level	Between ports	PORTP ^{*1*4}	:SOUR{1-16}:POW:PORT:COUP ^{*5}		On the E5070B/E5071B, coupling does not work between channels.
		Between channels	COUP	Not available		
	Turning the signal source output On/Off		POWT	:OUTP		
			SOUP			
	Editing the list frequency sweep table	Start of editing	EDITLIST	:SENS{1-16}:SEGM:DATA ^{*5}		The E5070B/E5071B uses one command to edit segments. A segment table also exists for each channel. The 8753ES uses more than one command to set up a segment. Two types of segments can be set up: one for channels 1 and 3 and the other for channels 2 and 4.
			End of editing			
Deleting an entire table			CLEL			
		CLEAL				
Editing segments		Selection	SEDI			
		End	SDON			
		Addition	SADD			
		Deletion	SDEL			
		Start value	STAR			
		Stop value	STOP			
		Center value	CENT			
		Span value	SPAN			
		Number of points	POIN			
		Sweep step value	STPSIZE			
		IFBW settings are Valid/Not valid.	LISIFBWM			
		IFBW settings	SEGIFBW			
		Power settings are Valid/Not valid.	LISPWRM			
	Power	SEGPOWER				

Comparing Commands on the 8753ES and E5070B/E5071B
8753ES vs. E5070B/E5071B Command Correspondence (by function)

Function	Item to be specified/executed		Command (For footnotes, see page 928.)		Remarks
			8753ES	E5070B/E5071B	
Measurement (cont'd.)	Selecting list mode	Stepped mode	LISTTYPE LSTP	:SENS{1-16}:SWE:GEN STEP	On the E5070B/E5071B, the IF bandwidth and power level can be set segment by segment even in swept mode. In addition, you can select stepped/swept mode for the linear sweep.
		Swept mode	LISTTYPE LSWP	:SENS{1-16}:SWE:GEN ANAL	
Setting up segments for the list frequency sweep	All segments are used.		ASEG	Not available	In its segment sweep operation, the E5070B/E5071B sweeps all segments.
		Only designated segments are used.	SSEG	Not available	
Smoothing	On/Off setting		SMOOO ^{*1}	:CALC{1-16}:SMO ^{*3}	
	Setting up the smoothing aperture		SMOOAPER ^{*1}	:CALC{1-16}:SMO:APER ^{*3}	
	Reading the smoothing aperture	%	SMOOAPER? ^{*1}	:CALC{1-16}:SMO:APER? ^{*3}	
		Unit for stimulus values	OUTPAPER ^{*1}	Not available	
Setting the electrical delay	Setting values		ELED ^{*1}	:CALC{1-16}:CORR:EDEL:TIME ^{*3}	
	Setting types	Coaxial cable	COAD ^{*1}	Not available	The E5070B/E5071B is compatible with coaxial cables only.
		A waveguide is selected and the cut-off frequency is specified.	WAVD ^{*1}	Not available	
Specifying the phase offset		PHAO ^{*1}	:CALC{1-16}:CORR:OFFS:PHAS ^{*3}		
Setting sweep conditions at Couple/Uncouple between channels		COUC	Traces are coupled on the same channel and not coupled between channels.	On the 8753ES, coupling between channels 1 and 2 is set at On/Off. Channels 1 and 3 and channels 2 and 4 are always coupled.	
Setting the trigger mode	Continuous sweep		CONT ^{*1*4}	:INIT{1-16}:CONT ON ^{*5}	On the E5070B/E5071B, the number of triggers required for the specified number of sweeps differs.
			FRER ^{*1*4}		
	Single sweep		SING ^{*1*4}	:ABOR :INIT{1-16}:CONT OFF ^{*5} :INIT{1-9} (These commands must be sent.)	
	specifying number of sweeps		NUMG ^{*1*4}	:TRIG:AVER ON	
	Hold		HOLD ^{*1*4}	:INIT{1-16}:CONT OFF ^{*5}	
Setting up external trigger	Per sweep		EXTTON	:TRIG:SOUR EXT ^{*5} :TRIG:POIN OFF	On the E5070B/E5071B, the per-sweep setting is valid when the external trigger mode is ON. A manual trigger at each point is not available. The external trigger line is set to Low.
	Per point		EXTTPOIN	:TRIG:POIN ON	
	Off		EXTTOFF	In :TRIG:SOUR , setting the parameter to EXT causes external trigger mode to automatically turn OFF.	
	Trigger line	High	EXTTHIGH	Not available	
		Low	EXTTLOW	Not available	
Manual (at each point)		MANTRIG	Not available		
Suspend sweep and then resume.		REST	Not available		
Specifying the signal source frequency for the power level sweep or CW TIME sweep		CWFREQ ^{*1*4}	:SENS{1-16}:FREQ		

C. Comparing Commands on the 8753ES and E5070B/E5071B

Comparing Commands on the 8753ES and E5070B/E5071B
8753ES vs. E5070B/E5071B Command Correspondence (by function)

Function	Item to be specified/executed		Command (For footnotes, see page 928.)		Remarks
			8753ES	E5070B/E5071B	
Screen display	Setting up the active channel	Channel 1	CHAN1	:DISP:WIND{1-16}:ACT (Setting up the active channel) or :CALC{1-16}:PAR{1-16}:SEL (Setting up the active trace)	The concepts of a channel and a trace on the E5070B/E5071B are different. For more information, refer to the individual User's Guides.
		Channel 2	CHAN2		
		Channel 3	CHAN3		
		Channel 4	CHAN4		
	Reading the active channel		OUTPCHAN	:DISP:WIND{1-16}:ACT? (Reading the active channel) or :CALC{1-16}:PAR{1-16}:SEL? (Reading the active trace)	
	Channel memory	Copying a data trace into the channel memory.	DATI* ¹	:CALC{1-16}:MATH:MEM* ³	
		Display a data trace only.	DISPDATA* ¹	:DISP:WIND{1-16}:TRAC{1-16}:STAT ON* ² :DISP:WIND{1-16}:TRAC{1-16}:MEM OFF* ² :CALC{1-16}:MATH:FUNC NORM* ³ (All three commands above must be sent.)	
		The data trace and memory trace are displayed at the same time.	DISPDATM* ¹	:DISP:WIND{1-16}:TRAC{1-16}:STAT ON* ² :DISP:WIND{1-16}:TRAC{1-16}:MEM ON* ² :CALC{1-16}:MATH:FUNC NORM* ³ (All three commands above must be sent.)	
Display the result of dividing the data trace by the memory trace.		DISPDDM* ¹	:DISP:WIND{1-16}:TRAC{1-16}:STAT ON* ² :DISP:WIND{1-16}:TRAC{1-16}:MEM OFF* ² :CALC{1-16}:MATH:FUNC DIV* ³ (All three commands above must be sent.)		
		DIVI* ¹			
Display the result of dividing the data trace by the memory trace.		DISPDMM* ¹	:DISP:WIND{1-16}:TRAC{1-16}:STAT ON* ² :DISP:WIND{1-16}:TRAC{1-16}:MEM OFF* ² :CALC{1-16}:MATH:FUNC SUBT* ³ (All three commands above must be sent.)		
	MINU* ¹				
Display the memory trace only.	DISPMEMO* ¹	:DISP:WIND{1-16}:TRAC{1-16}:STAT OFF* ² :DISP:WIND{1-16}:TRAC{1-16}:MEM ON* ² (Both commands above must be sent.)			
Sending the title to the memory trace	TITTMEM* ¹	Not available			

Comparing Commands on the 8753ES and E5070B/E5071B
8753ES vs. E5070B/E5071B Command Correspondence (by function)

Function	Item to be specified/executed		Command (For footnotes, see page 928.)		Remarks	
			8753ES	E5070B/E5071B		
Screen display (cont'd.)	Turns off the frequency display on the LCD.		FREO	:DISP:ANN:FREQ OFF	The 8753ES and E5070B/E5071B are both effective on all channels.	
	Display channel 2 data/channel 1 data in channel 2.		D1DIVD2	Not available		
	On/Off setting for Channels 3 and 4		AUXC	:CALC{1-16}:PAR{1-16}:COUN (Specifying the number of traces) enables you to perform the equivalent.		
	On/Off setting for simultaneous display of two channels		DUAC	:DISP:SPL (Setting up a window array in a channel) and :DISP:WIND{1-16}:SPL (Setting up an array of trace graphs) are combined to perform the equivalent.		
	Graph layout	On/Off setting for display splitting	SPLD	:DISP:SPL (Setting up a window array in a channel) and	an array of trace graphs) are combined to perform the equivalent.	
			Specifying the number of screens	SPLID1		:DISP:WIND{1-16}:SPL (Setting up
			1	SPLID2		
			2	SPLID4		
		4				
		Upper screen (Channels 1 and 2) and lower screen (Channels 3 and 4)	D2XUPCH2	Not available		
		Upper screen (Channels 1 and 3) and lower screen (Channels 2 and 4)	D2XUPCH3	:DISP:SPL (Setting up a window array in a channel) and :DISP:WIND{1-16}:SPL (Setting up an array of trace graphs) are combined to perform the equivalent.		
		Upper left (Channel 1), upper right (Channel 2), lower left (Channel 3), lower right (Channel 4)	D4XUPCH2			
	Upper left (Channel 1), upper right (Channel 3), lower left (Channel 2), lower right (Channel 4)	D4XUPCH3	Not available			
	Setting up a scale	Executing autoscale	AUTO ^{*1}	:DISP:WIND{1-16}:TRAC{1-16}:Y:AUTO ^{*2}		
		Setting values	SCAL ^{*1}	:DISP:WIND{1-16}:TRAC{1-16}:Y:PDIV ^{*2}		
Setting the reference line	Position	REFP ^{*1}	:DISP:WIND{1-16}:TRAC{1-16}:Y:RLEV ^{*2}	On the 8753ES, reference lines are set at graticule lines 1 to 10.		
	Value	REFV ^{*1}	:DISP:WIND{1-16}:TRAC{1-16}:Y:RPOS ^{*2}	The E5070B/E5071B allows the number of graticule lines to be changed; you can place as many graticule lines as you need, from zero to the specified number of lines.		

C. Comparing Commands on the 8753ES and E5070B/E5071B

Comparing Commands on the 8753ES and E5070B/E5071B
8753ES vs. E5070B/E5071B Command Correspondence (by function)

Function	Item to be specified/executed		Command (For footnotes, see page 928.)		Remarks	
			8753ES	E5070B/E5071B		
Screen display (cont'd.)	List display	Start	LISV* ¹	Not available	The E5070B/E5071B does not have a list display function.	
		To next page	NEXP* ¹			
		To previous page	PREP* ¹			
		Return to the display of measurement results.	RESD* ¹			
	Displaying the softkey area	On	MENUON	:DISP:SKEY ON		
		Off	MENUOFF	:DISP:SKEY OFF		
	Title	Read	OUTPTITL	:DISP:WIND{1-16}:TITL:DATA?* ⁵		
		Setup	TITL	:DISP:WIND{1-16}:TITL:DATA* ⁵		
	Display the Instrument State status list.		OPEP	Not available	The E5070B/E5071B does not have the function of displaying the Instrument State status list.	
	Return the color settings to the initial state.		DEFC	:DISP:COL{1-2}:RES		
	Selecting the object for which colors are set up	Data trace	Channel 1	COLOCH1D	A :DISP:COL{1-2}:TRAC{1-16}:DAT :DISP:COL{1-2}:TRAC{1-16}:MEM :DISP:COL{1-2}:LIM{1-2} :DISP:COL{1-2}:GRAT{1-2} :DISP:COL{1-2}:BACK	
			Channel 2	COLOCH2D		
			Channel 3	COLOCH3D		
			Channel 4	COLOCH4D		
		Memory trace	Channel 1	COLOCH1M		
Channel 2			COLOCH2M			
Channel 3			COLOCH3M			
Channel 4			COLOCH4M			
Others		Graticule lines	COLOGRAT			
		Reference line	COLOLREF			
		Character string	COLOTEXT			
		Warning message	COLOWARN			
Changing colors		Returning to initial values	RSCO			
	Tint	TINT				
	Color saturation	COLOR				
	Brightness	CBRI				
Specifying the screen brightness		BACI	Not available	The E5070B/E5071B allows On/Off setting for backlighting only.		
		INTE				
On/Off setting for the LCD displaying.		BLAD	:SYST:BACK (On/Off setting for the backlighting)	When the E5070B/E5071B is turned ON, the 8753ES is turned OFF, and vice versa.		

Comparing Commands on the 8753ES and E5070B/E5071B
8753ES vs. E5070B/E5071B Command Correspondence (by function)

Function	Item to be specified/executed		Command (For footnotes, see page 928.)		Remarks
			8753ES	E5070B/E5071B	
Calibration	Displaying the softkeys in the calibration menu		CAL1	Not available	
	Selecting a calibration kit	2.4 mm Calibration Kit (85056A/D)	CALK24MM* ⁶	:SENS{1-16};CORR:COLL:CKIT* ⁵	
		2.92 mm Calibration Kit	CALK292MM* ⁶		
		2.92 mm Calibration Kit (85056K)	CALK292S* ⁶		
		3.5 mm Calibration Kit (85033C)	CALK35MC* ⁶		
		3.5 mm Calibration Kit (85033D)	CALK35MD* ⁶		
		7-16 Calibration Kit (85038)	CALK716* ⁶		
		7 mm Calibration Kit (85031B)	CALK7MM* ⁶		
		N-type 50 Calibration Kit (85032B/E)	CALKN50* ⁶		
		N-type 75 Calibration Kit (85036B/E)	CALKN75* ⁶		
		TRL 3.5 mm Calibration Kit (85052C)	CALKTRLK* ⁶		
	User-defined calibration kit	CALKUSED* ⁶			
	Starting the calibration	Forward enhanced response calibration	CALIERC* ¹	:SENS{1-16};CORR:COLL:METH:ERES* ⁵	The E5070B/E5071B uses different commands depending on the standard used. Isolation can be performed optionally. Calibration type can be set after measuring standard on the E5070B/E5071B
		Reverse enhanced response calibration	CALIRERC* ¹		
		Response calibration	CALIRESP* ¹	:SENS{1-16};CORR:COLL:METH:OPEN* ⁵ or :SENS{1-16};CORR:COLL:METH:SHOR* ⁵ or :SENS{1-16};CORR:COLL:METH:THRU* ⁵	
Response & isolation calibration		CALIRAI* ¹			
S11 1-port calibration		CALIS111* ¹			
S22 1-port calibration		CALIS221* ¹	SOLT1* ⁵	The E5070B/E5071B requires a port to be assigned to a command parameter.	
Full 2-port calibration		CALIFUL2* ¹	:SENS{1-16};CORR:COLL:METH:SOLT2* ⁵		
TRL*/LRM* Calibration	CALITRL2* ¹	:SENS{1-16};CORR:COLL:METH:TRL2* ⁵	VBA also supports the TRL calibration function.		

C. Comparing Commands on the 8753ES and E5070B/E5071B

Comparing Commands on the 8753ES and E5070B/E5071B
8753ES vs. E5070B/E5071B Command Correspondence (by function)

Function	Item to be specified/executed		Command (For footnotes, see page 928.)		Remarks
			8753ES	E5070B/E5071B	
Calibration (cont'd.)	Finishing the calibration and calculating the calibration coefficients.	Forward enhanced response calibration	ERCDONE* ¹	:SENS{1-16}:CORR:COLL:SAVE* ⁵	The E5070B/E5071B allows you to use the same command to finish calibration regardless of the type of calibration.
			SAVERC* ¹		
		Reverse enhanced response calibration	RERCDONE* ¹		
			SAVRERC* ¹		
		Response calibration	RESPDONE* ¹		
		Response & isolation calibration	RAID* ¹		
		S11 1-port calibration or S22 1-port calibration	SAV1* ¹		
	Full 2-port calibration	SAV2* ¹			
	TRL*/LRM* calibration	SAVT* ¹		VBA also supports the TRL calibration function	
	Starting calibration data measurement	Reflection measurement (Enhanced response calibration)	REFOP* ¹	:SENS{1-16}:CORR:COLL:OPEN* ⁵ (Open) or :SENS{1-16}:CORR:COLL:SHOR* ⁵ (Short)	The E5070B/E5071B uses different commands depending on the standard used.
			REFL* ¹	Not available	
		Transmission measurement (enhanced response calibration)	TRAOP* ¹	:SENS{1-16}:CORR:COLL:THRU* ⁵	The E5070B/E5071B performs both transmission and match measurements.
			TRAN* ¹	Not available	
		Forward transmission measurement (2-port calibration)	FWDT* ¹	:SENS{1-16}:CORR:COLL:THRU* ⁵	The E5070B/E5071B performs both transmission and match measurements.
FWDM* ¹					
Reverse transmission measurement (2-port calibration)		REVT* ¹			
Forward match measurement (2-port calibration)		REVM* ¹			
Response measurement (response & isolation calibration)		RAIRES* ¹	:SENS{1-16}:CORR:COLL:OPEN* ⁵ (Open) :SENS{1-16}:CORR:COLL:SHOR* ⁵ (Thru) :SENS{1-16}:CORR:COLL:THRU* ⁵ (Thru)	The E5070B/E5071B uses different commands depending on the standard used.	
Isolation measurement (response & isolation calibration)	RAISOL* ¹	:SENS{1-16}:CORR:COLL:ISOL* ⁵			
Isolation measurement (enhanced response calibration)	ISOOP* ¹	:SENS{1-16}:CORR:COLL:ISOL* ⁵			

Comparing Commands on the 8753ES and E5070B/E5071B
8753ES vs. E5070B/E5071B Command Correspondence (by function)

Function	Item to be specified/executed		Command (For footnotes, see page 928.)		Remarks	
			8753ES	E5070B/E5071B		
Calibration (cont'd.)	Starting calibration data measurement (cont'd.)	Isolation measurement (2-port calibration)	ISOL ^{*1}	Not available		
		Forward isolation measurement (2-port calibration)	FWDI ^{*1}	:SENS{1-16}:CORR:COLL:ISOL ^{*5}		
		Reverse isolation measurement (2-port calibration)	REVI ^{*1}	:SENS{1-16}:CORR:COLL:ISOL ^{*5}		
		S11A (OPEN) Measurement	CLASS11A ^{*1}	:SENS{1-16}:CORR:COLL:OPEN ^{*5}		
		S11B (SHORT) Measurement	CLASS11B ^{*1}	:SENS{1-16}:CORR:COLL:SHOR ^{*5}		
		S11C (LOAD) Measurement	CLASS11C ^{*1}	:SENS{1-16}:CORR:COLL:LOAD ^{*5}		
		S22A (OPEN) Measurement	CLASS22A ^{*1}	:SENS{1-16}:CORR:COLL:OPEN ^{*5}		
		S22B (SHORT) Measurement	CLASS22B ^{*1}	:SENS{1-16}:CORR:COLL:SHOR ^{*5}		
		S22C (LOAD) Measurement	CLASS22C ^{*1}	:SENS{1-16}:CORR:COLL:LOAD ^{*5}		
		Offset and LOAD measurement	Measurement without offset	LOAN ^{*1}	Not available	The E5070B/E5071B handles LOAD as a fixed load.
			Measurement with offset	LOAO ^{*1}		
		Sliding LOAD measurement	Measurement after sliding	SLIS ^{*1}	Not available	
			End	SLID ^{*1}		
		Selecting the standard to be measured (corresponding to the softkeys)	1st from the top	STANA ^{*1}	:SENS{1-16}:CORR:COLL:SUBC{1-8}	The E5070B/E5071B has eight different standards that can be registered in each calibration class.
			2nd from the top	STANB ^{*1}		
			3rd from the top	STANC ^{*1}		
			4th from the top	STAND ^{*1}		
			5th from the top	STANE ^{*1}		
			6th from the top	STANF ^{*1}		
			7th from the top	STANG ^{*1}		
THRU measurement	TRLT ^{*1}	:SENS{1-16}:CORR:COLL:TRLT ^{*5}	VBA also supports the TRL calibration function.			
S11 Reflection measurement	TRLR1 ^{*1}	:SENS{1-16}:CORR:COLL:TRLR ^{*5}				
S22 Reflection measurement	TRLR2 ^{*1}	:SENS{1-16}:CORR:COLL:TRLR ^{*5}				

C. Comparing Commands on the 8753ES and E5070B/E5071B

Comparing Commands on the 8753ES and E5070B/E5071B
8753ES vs. E5070B/E5071B Command Correspondence (by function)

Function	Item to be specified/executed		Command (For footnotes, see page 928.)		Remarks	
			8753ES	E5070B/E5071B		
Calibration (cont'd.)	Starting calibration data measurement (cont'd.)	Port 1 Line/Match measurement	TRLL1 ^{*1}	Not available	The E5070B/E5071B supports the TRL calibration function using VBA.	
		Port 2 Line/Match measurement	TRLL2 ^{*1}			
		Finishing measuring the standard	DONE ^{*1}	Not available		The 8753ES requires this to be executed when two or more standards exist in the calibration class.
	Finishing measuring calibration data	Reflection measurement	REFD ^{*1}	Not available	The E5070B/E5071B has no similar commands.	
		Transmission measurement	TRAD ^{*1}	Not available		
		Isolation measurement	ISOD ^{*1}	Not available		
		Offset and LOAD measurement	OFLD ^{*1}	Not available	The E5070B/E5071B does not handle offset and LOAD.	
	Setting error correction On/Off	On/Off setting	CORR ^{*1*4}	:SENS{1-16};CORR:STAT ^{*5}		
		Setting to OFF	CALN ^{*1*4}	:SENS{1-16};CORR:STAT OFF ^{*5}		
		On/Off setting for error correction by interpolation of calibration coefficients	CORI ^{*1*4}	Not available		Always On on the E5070B/E5071B
	Omitting the isolation measurement	OMII ^{*1}	Not available		On the E5070B/E5071B, isolation measurement is optional.	
	Setting up the characteristic impedance of the measurement system	SETZ ^{*6}	:CALC{1-16};FSIM:SEND:ZCON:PORT{1-4};Z0 ^{*5} (Fixture simulator)		The E5070B/E5071B enables you to do the equivalent by using the fixture simulator.	
	Specifying the velocity factor	VELOFACT ^{*6}	:SENS{1-16};CORR:RVEL:COAX ^{*5}			
Setting up port extension correction	On/Off	PORE ^{*6}	:SENS{1-16};CORR:EXT ^{*5}			
	Corrected value for port 1	PORT1 ^{*6}	:SENS{1-16};CORR:EXT:PORT ^{*5}			
	Corrected value for port 2	PORT2 ^{*6}				
	Corrected value for input A	PORTA ^{*6}	Not available			The E5070B/E5071B does not have the input port extension function.
	Corrected value for input B	PORTB ^{*6}				

Comparing Commands on the 8753ES and E5070B/E5071B
8753ES vs. E5070B/E5071B Command Correspondence (by function)

Function	Item to be specified/executed			Command (For footnotes, see page 928.)		Remarks	
				8753ES	E5070B/E5071B		
Calibration (cont'd.)	Adapter removal	Calling data	Port 1	CALSPORT1*6	Not available		
			Port 2	CALSPORT2*6			
		Setting the electrical delay for the adapter		ADAPI*6	Not available		
		Selecting the adapter	Coaxial cable	ADPTCOAX*6	Not available		
			Wave guide	ADPTWAVE*6	Not available		
		Calculating the calibration set		MODS*6	Not available		
	Selecting between alternate sweep and chop sweep	Alternate sweep		ALTAB*6	Not available		On the E5070B/E5071B, traces in the same channel are measured by the same method as the chop sweep. When traces belong to different channels, they are measured by the same method as the alternate sweep.
		Chop sweep		CHOPAB*6	Not available		
	Take4 mode	Turning Take4 mode On/Off		TAKE4	Not available		The E5070B/E5071B does not have the Take4 mode.
		Turning offset correction for the sampler and attenuator On/Off		RAWOFFS			
Turning sampler correction On/Off		SAMC					
Turning spur avoidance On/Off		SM8					
Executing a sweep in Take4 mode		SWPSTART					
Calibrating the receiver	Setting the power reference		REIC*1	Not available			
	Executing the receiver calibration		TAKRS*1	:SENS{1-16}:CORR:REC{1-4}:COLL:ACQ*5			
Power meter calibration	Display the softkey for the power meter calibration to specify the power level.		PWRMCAL	Not available			
	Selecting a power meter		POWM	Not available			
	Starting a data sweep for power meter calibration		TAKCS*1	:SOUR{1-16}:POW:PORT{1-4}:CORR:COLL*5			
	Editing the calibration coefficients table	Editing start	Sensor A	CALFSENA		Sensor A	
			Sensor B	CALFSENB		:SOUR:POW:PORT:CORR:COLL:ASEN:RCF	
	Deleting the entire list			CLEL		:SOUR:POW:PORT:CORR:COLL:TABLE:ASEN:DATA	
				CLEAL			
	Editing segments	Selection		SEDI		Sensor B	
			Addition	SADD		:SOUR:POW:PORT:CORR:COLL:BSEN:RCF	
			Deletion	SDEL		:SOUR:POW:PORT:CORR:COLL:TABLE:BSEN:DATA	
End			SDON				
		Frequency	CALFCALF				
		Calibration coefficients	CALFFREQ				

C. Comparing Commands on the 8753ES and E5070B/E5071B

Comparing Commands on the 8753ES and E5070B/E5071B
8753ES vs. E5070B/E5071B Command Correspondence (by function)

Function	Item to be specified/executed			Command (For footnotes, see page 928.)		Remarks	
				8753ES	E5070B/E5071B		
Calibration (cont'd.)	Power meter calibrati on (cont'd.)	Power loss list editing	Start	POWLLIST	: SOUR{1-16};POW:PORT{1-4};CO RR:COLL:TABL:LOSS:DATA *5		
			Deleting the entire list				CLEL
							CLEAL
		Editing segments	Selection	SEDI			
			Addition	SADD			
			Deletion	SDEL			
			End	SDON			
			Frequency	POWLFREQ			
	Loss		POWLLOSS				
	Specifying the number of measurements per point			NUMR	: SOUR{1-16};POW:PORT{1-4};CO RR:COLL:AVER *5		
	Defining the GPIB reading from the power meter as the title			PMTRTTIT	Not available		
	Selecting a power sensor	Sensor A		USESENSA *1*4	Not available		
		Sensor B		USESENSB *1*4			
	Executin g a calibrati on	Per sweep		PWMCEACS *1	Not available	The E5070B/E5071B does not have per sweep mode.	
		One time		PWMCONES *1			
		Off		PWMCOFF *1			
	Specifying to Use/Not Use the power loss list			PWRLOSS *1*4	: SOUR{1-16};POW:PORT{1-4};CO RR:COLL:TABL:LOSS *5		
	Defining the calibrati on kit	Start of defining the calibration kit		MODII	Not available	The E5070B/E5071B has no command for starting/ending kit definition. The calibration kit assigned for each channel is already defined.	
		End of defining the calibration kit		STDD	Not available		
		Setting up the calibration kit label		LABK	: SENS{1-16};CORR:COLL:CKIT:LAB		
Defining the selected calibration kit as a user calibration kit			SAVEUSEK	Not available	On the E5070B/E5071B, Any calibration kit numbers can be assigned as user calibration kits.		
Defining the calibrati on class		S11A (OPEN)		SPECS11A	: SENS{1-16};CORR:COLL:CKIT:OR RD:OPEN	The E5070B/E5071B uses a parameter to specify a port.	
				SPECTRFM			
		S11B (SHORT)		SPECS11B	: SENS{1-16};CORR:COLL:CKIT:OR RD:SHOR		
			SPECTLFM				
	S11C (LOAD)		SPECS11C	: SENS{1-16};CORR:COLL:CKIT:OR RD:LOAD			
			SPECTLFT				
S22A (OPEN)		SPECS22A	: SENS{1-16};CORR:COLL:CKIT:OR RD:OPEN				
		SPECTRRM					
S22B (SHORT)		SPECS22B	: SENS{1-16};CORR:COLL:CKIT:OR RD:SHOR				
		SPECTLRM					
S22C (LOAD)		SPECS22C	: SENS{1-16};CORR:COLL:CKIT:OR RD:LOAD				
		SPECTLRT					

Comparing Commands on the 8753ES and E5070B/E5071B
8753ES vs. E5070B/E5071B Command Correspondence (by function)

Function	Item to be specified/executed		Command (For footnotes, see page 928.)		Remarks				
			8753ES	E5070B/E5071B					
Calibration (cont'd.)	Defining the calibration kit (cont'd.)	Defining the calibration class (cont'd.)	Forward match	SPECFWDM SPECTTFM	:SENS{1-16}:CORR:COLL:CKIT:ORD:THRU (definition of the calibration class THRU)	Registering a standard in the THRU calibration class on the E5070B/E5071B is equivalent to registering one standard in four types of calibration classes on the 8753ES.			
			Forward transmission	SPECFWDT SPECTTFT					
			Reverse match	SPECREVM SPECTTRM					
			Reverse transmission	SPECREVT SPECTTRT					
			Response	SPECRESP			Not available	The E5070B/E5071B is not provided with any response class.	
			Response & isolation	SPECRESI					
			TRL line/match	SPECTRLL			:SENS{1-16}:CORR:COLL:CKIT:ORD;TRL	VBA also supports the TRL calibration function.	
			TRL thru	SPECTRLT			:SENS{1-16}:CORR:COLL:CKIT:ORD;TRLT		
			TRL reflection	SPECTRLR			:SENS{1-16}:CORR:COLL:CKIT:ORD;TRLR		
			Editing the calibration class label				S11A (OPEN)	LABES11A LABETRFM	Not available
	S11B (SHORT)	LABES11B LABETLFM							
	S11C (LOAD)	LABES11C LABETLFT							
	S22A (OPEN)	LABES22A LABETRRM							
	S22B (SHORT)	LABES22B LABETLRM							
	S22C (LOAD)	LABES22C LABETLRT							
	Forward match	LABEFWDM LABETTFM							
	Forward transmission	LABEFWDT LABETTFT							
	Reverse match	LABEREVM LABETTRM							
	Reverse transmission	LABEREVT LABETTRT							
	Response	LABERESP							
	Response & isolation	LABERESI							
	TRL line/match	LABETRLL							
	TRL thru	LABETRLT							
	TRL reflection	LABETRLR							
	Setting up the reference for the TRL*/LRM* calibration	Reflect			SETRREFL	:SENS{1-16}:CORR:COLL:CKIT:TRL:RPL	VBA also supports the TRL calibration function.		
		Thru			SETRTHRU				
	Designating the number of the standard to be defined and starting definition of the standards		DEFS	Not available					

C. Comparing Commands on the 8753ES and E5070B/E5071B

Comparing Commands on the 8753ES and E5070B/E5071B
8753ES vs. E5070B/E5071B Command Correspondence (by function)

Function	Item to be specified/executed		Command (For footnotes, see page 928.)		Remarks	
			8753ES	E5070B/E5071B		
Calibration (cont'd.)	Defining the calibration kit (cont'd.)	End of defining the standards		KITD	Not available	
		Setting up the standard label		LABS	:SENS{1-16};CORR:COLL:CKIT:STAN{1-21}:LAB	
	Setting up the type of standard	OPEN standard		STDOPEN	:SENS{1-16};CORR:COLL:CKIT:STAN{1-21}:TYPE OPEN	
		SHORT standard		STDTSHOR	:SENS{1-16};CORR:COLL:CKIT:STAN{1-21}:TYPE SHOR	
		LOAD standard		STDLOAD	:SENS{1-16};CORR:COLL:CKIT:STAN{1-21}:TYPE LOAD	
		THRU standard		STDDELA	:SENS{1-16};CORR:COLL:CKIT:STAN{1-21}:TYPE THRU	
		Arbitrary impedance		STDARBI	:SENS{1-16};CORR:COLL:CKIT:STAN{1-21}:TYPE ARBI	
	Specifying the calibrated value of a standard	Offset delay		OFSD	:SENS{1-16};CORR:COLL:CKIT:STAN{1-21}:DEL	Setup items of the calibrated value are the same as standard type items.
		Offset loss		OFSL	:SENS{1-16};CORR:COLL:CKIT:STAN{1-21}:LOS	
		Offset impedance		OFSZ	:SENS{1-16};CORR:COLL:CKIT:STAN{1-21}:Z0	
		C0		C0	:SENS{1-16};CORR:COLL:CKIT:STAN{1-21}:C0	Setup is effective for the OPEN standard only. (8753ES/E5070B/E5071B Common)
		C1		C1	:SENS{1-16};CORR:COLL:CKIT:STAN{1-21}:C1	
		C2		C2	:SENS{1-16};CORR:COLL:CKIT:STAN{1-21}:C2	
		C3		C3	:SENS{1-16};CORR:COLL:CKIT:STAN{1-21}:C3	
		Terminal impedance		TERI	:SENS{1-16};CORR:COLL:CKIT:STAN{1-21}:ARB	Setup can be performed only when Arbitrary Impedance is used for setup. (8753ES/E5070B/E5071B Common)
		Types of LOAD standards	Fixed	FIXE	Not available	The E5070B/E5071B handles all as fixed load.
			Sliding	SLIL		
	Offset		OFLS			
	Frequency range	Minimum	MINF	:SENS{1-16};CORR:COLL:CKIT:STAN{1-21}:FMIN	The E5070B/E5071B does not allow you to set the frequency range.	
		Maximum	MAXF	:SENS{1-16};CORR:COLL:CKIT:STAN{1-21}:FMAX		
	Setting up the offset type	Coaxial cable	COAX	:SENS{1-16};CORR:COLL:CKIT:STAN{1-21}:CHAR	The E5070B/E5071B treats the offset type as a coaxial cable.	
		Wave guide	WAVE			
End of defining standards		STDO	Not available	The E5070B/E5071B does not have the command for ending definition.		
Options for TRL*/LRM* calibration.	Specifying the characteristic impedance	Standard	CALZLINE	:SENS{1-16};CORR:COLL:CKIT:TRL:IMP	VBA also supports the TRL calibration function.	
		System	CALZSYST			

Comparing Commands on the 8753ES and E5070B/E5071B
8753ES vs. E5070B/E5071B Command Correspondence (by function)

Function	Item to be specified/executed		Command (For footnotes, see page 928.)		Remarks	
			8753ES	E5070B/E5071B		
Calibration (cont'd.)	ECal	Setting up the active module	A	ECALMODSE LA	Not available	E5070B/E5071B activate the ECal module connected first.
			B	ECALMODSE LB		
	Executing calibration	Forward enhanced response calibration		ECALERC	:SENS{1-16}:CORR:COLL:ECAL:ERES	
				ECALRERC		
		Reverse enhanced response calibration				
		1-port calibration	S11	ECALS11	:SENS{1-16}:CORR:COLL:ECAL:SO OLT1 1	
			S22	ECALS22	:SENS{1-16}:CORR:COLL:ECAL:SO OLT1 2	
	Full 2-port calibration		ECALS22	:SENS{1-16}:CORR:COLL:ECAL:SO OLT2		
	Turning the omission of isolation On/Off		ECALOMII	:SENS{1-16}:CORR:COLL:ECAL:ISOL	When the E5070B/E5071B is turned on, the 8753ES is turned off, and vice versa.	
	Designating the averaging factor for isolation		ECALISOAVG	Not available		
	Module information	Reading the selected module		ECALAB?	Not available	
		Reading the product number and serial number		ECALMODID		
	Calibration frequency array	Reading the frequency array		ECALFREQS	Not available	
		Designating the size of the frequency array to be read		ECALNFREQS		
	Interruption	Turning Manual THRU Measurement On/Off		ECALMANTHRU	Not available	E5070B/E5071B can not pause the ECal.
Reading during Interruption/Execution			ECALPAUSED			
Resuming a suspended ECal			ECALCONT			

C. Comparing Commands on the 8753ES and E5070B/E5071B

Comparing Commands on the 8753ES and E5070B/E5071B
8753ES vs. E5070B/E5071B Command Correspondence (by function)

Function	Item to be specified/executed		Command (For footnotes, see page 928.)		Remarks
			8753ES	E5070B/E5071B	
Reading/Writing data	Transfer format designation	Intra-device binary format	FORM1	Not available	
		IEEE 32-bit floating point format	FORM2	:FORM:DATA REAL32 :FORM:BORD NORM	
		IEEE 64-bit floating point format	FORM3	:FORM:DATA REAL :FORM:BORD NORM	
		ASCII format	FORM4	:FORM:DATA ASC	
		PC-DOS 32-bit floating point format	FORM5	:FORM:DATA REAL32 :FORM:BORD SWAP	
Raw data array	Array 1 (S11)	Read	OUTPRAW1 *1	Not available	The E5070B/E5071B does not allow you to read/write the raw data array.
			OUTPRAF1 *1		
	Write	INPURAW1 *1			
		Array 2 (S21)	Read		
	OUTPRAF2 *1				
	Write	INPURAW2 *1			
		Array 3 (S12)	Read		
	OUTPRAF3 *1				
	Write	INPURAW3 *1			
		Array 4 (S22)	Read		
	OUTPRAF4 *1				
	Write	INPURAW4 *1			
Calibration coefficient array data		Before interpolating	Read	OUTPCALC *1	:SENS{1-16}:CORR:COEF?
	Write		INPUCALC *1	:SENS{1-16}:CORR:COEF	
	After interpolating	End of writing	SAVC *1	:SENS{1-16}:CORR:COEF:SAVE	
			OUTPICAL{01-12} *1	:SENS{1-16}:CORR:COEF?	
Corrected data array	Read		OUTPDATA *1	:CALC{1-16}:DATA:SDAT?	
		Read (high-speed data transfer)	OUTPDATF *1		
		Write	INPUDATA *1	:CALC{1-16}:DATA:SDAT	
Memory trace	Read		OUTPMEMO *1	:CALC{1-16}:DATA:SMEM?	
		Read (high-speed data transfer)	OUTPMEMF *1		
Formatted data array	Read		OUTPFORM *1	:CALC{1-16}:DATA:FDAT? *3	
		Read (high-speed data transfer)	OUTPFORMF *1		
		Write	INPUFORM *1	:CALC{1-16}:DATA:FDAT? *3	

Comparing Commands on the 8753ES and E5070B/E5071B
8753ES vs. E5070B/E5071B Command Correspondence (by function)

Function	Item to be specified/executed			Command (For footnotes, see page 928.)		Remarks
				8753ES	E5070B/E5071B	
Reading/Writing data (cont'd.)	Reading trace data at a designated point	Designating the point		SELPT* ¹	Not available	The E5070B/E5071B does not allow you to read trace data in a range that you have limited.
		Read		OUTDATP* ¹		
	Reading trace data for a designated measurement range	Specifying the range	Upper limit value	SELMAXPT* ¹		
			Lower limit value	SELMINPT* ¹		
		Read		OUTDATR* ¹		
	Reading a Pre-Raw Data Array (in Take4 mode)			OUTPPRE* ¹	Not available	The E5070B/E5071B does not allow you to read/write pre-raw data array.
	Calibration kit array data	Read		OUTPCALK	Not available	The E5070B/E5071B does not allow you to read/write the calibration kit array.
		Write		INPUCALK		
	Power meter calibration coefficient array	Port 1	Before interpolating	Read	OUTPPMCAL1	Not available
				Write	INPUPMCAL1	Not available
			After interpolating	Read	OUTPIPMCL1	:SOUR{1-16}:POW:PORT1:CORR:DATA?
				Write	Not available	:SOUR{1-16}:POW:PORT1:CORR:DATA
		Port 2	Before interpolating	Read	OUTPPMCAL2	Not available
				Write	INPUPMCAL2	Not available
			After interpolating	Read	OUTPIPMCL2	:SOUR{1-16}:POW:PORT2:CORR:DATA?
Write				Not available	:SOUR{1-16}:POW:PORT2:CORR:DATA	
Reading the entry area display			OUTPACTI	Not available		
Reading error information from the error cue			OUTPERRO	:SYST:ERR?		
All lists at the time when the lists are displayed			OUTPPRINAL	Not available		
Learn string	Designating revisions		SELL	Not available	The E5070B/E5071B does not allow you to read/write the learn string.	
	Read	OUTPLEAS				
		LRN?				
	Write	INPULEAS				
LRN						
Reading product information			OUTPIDEN	*IDN?		
Reading a product's serial number			OUTPSERN	Included in the value read from *IDN?		
Reading the firmware revision			SOFR			
Reading the installed options			OUTPOPTS	*OPT?		

C. Comparing Commands on the 8753ES and E5070B/E5071B

Comparing Commands on the 8753ES and E5070B/E5071B
8753ES vs. E5070B/E5071B Command Correspondence (by function)

Function	Item to be specified/executed		Command (For footnotes, see page 928.)		Remarks	
			8753ES	E5070B/E5071B		
Markers	Activate the marker and move it to the designated stimulus value.	Marker 1	MARK1 ^{*1}	: CALC{1-16};MARK{1-10};ACT ^{*7} (Setting up the active marker)		
		Marker 2	MARK2 ^{*1}			
		Marker 3	MARK3 ^{*1}			: CALC{1-16};MARK{1-10};X ^{*7} (Specifying the stimulus value of the marker)
		Marker 4	MARK4 ^{*1}			
		Marker 5	MARK5 ^{*1}			These two commands enables you to perform the equivalent.
	Move to the designated point		MARKBUCK ^{*8}	Not available		
	Setting up the marker move mode	Continuous mode	MARKCONT ^{*8}	: CALC{1-16};MARK{1-10};DISC OFF ^{*5}		
		Discrete mode	MARKDISC ^{*8}	: CALC{1-16};MARK{1-10};DISC ON ^{*5}		
	Specifying Couple/Uncouple between channels	Couple	MARKCOUP ^{*8}	: CALC{1-16};MARK{1-10};COUP ON ^{*5}	On the E5070B/E5071B, Couple/Uncouple between traces in the same channel is specified.	
		Uncouple	MARKCOUP ^{*8}	: CALC{1-16};MARK{1-10};COUP OFF ^{*5}		
	On/Off setting for all marker value displays		DISM ^{*1}	Not available	The E5070B/E5071B always displays all marker values.	
	Turning off all markers and the marker function		MARKOFF ^{*1}	: CALC{1-16};MARK{1-10} ^{*7} can be used to turn off the marker display but the function remains turned on)		
	Delta marker(Reference marker)	Turning off the delta marker	DELO ^{*1}	: CALC{1-16};MARK:REF OFF ^{*3}	The E5070B/E5071B assigns marker 10 as the delta marker.	
		Designating a delta marker	DEL R ^{*1}	Not available		
	Designating the position of a fixed marker	Auxiliary measured value	MARKFAUV ^{*1}	Not available	The E5070B/E5071B does not have the fixed marker function.	
Stimulus value		MARKFSTI ^{*1}				
Designated point		MARKFVAL ^{*1}				
Position of the active marker		MARKZERO ^{*1}				
Designating a fixed marker as the reference marker		DELRFIXM ^{*1}				
Selecting readout format on a Smith chart	Admittance	SMIMGB	Not available	On the E5070B/E5071B, readout format is specified when setting up data format.		
	Linear magnitude	SMIMLIN				
	Log magnitude	SMIMLOG				
	Real/Imaginary	SMIMRI				
	Impedance	SMIMRX				
Selecting readout format on a polar display	Linear magnitude	POLMLIN				
	Log magnitude	POLMLOG				
	Real/Imaginary	POLMRI				

Comparing Commands on the 8753ES and E5070B/E5071B
8753ES vs. E5070B/E5071B Command Correspondence (by function)

Function	Item to be specified/executed		Command (For footnotes, see page 928.)		Remarks
			8753ES	E5070B/E5071B	
Markers (cont'd.)	Setting the marker value at a different value	Starting value for the sweep range	MARKSTAR* ⁸	:CALC{1-16}:MARK{1-10}:SET STAR* ⁷	
		Ending value for the sweep range	MARKSTOP* ⁸	:CALC{1-16}:MARK{1-10}:SET STOP* ⁷	
		Center value of the sweep range	MARKCENT* ⁸	:CALC{1-16}:MARK{1-10}:SET CENT* ⁷	
		Span value of the sweep range	MARKSPAN* ⁸	Not available	
		Reference value	MARKREF* ⁸	:CALC{1-16}:MARK{1-10}:SET RLEV* ⁷	
		CW frequency value	MARKCW* ⁸	Not available	
	Reading the marker value of the active marker		OUTPMARK* ⁸	:CALC{1-16}:MARK{1-10}:X?* ⁷ (stimulus value) :CALC{1-16}:MARK{1-10}:Y?* ⁷ (stimulus value) allows you to read the marker value of any marker.	The return value from 8753ES includes the both of stimulus value and response value
	Specify the electrical length so that the group delay becomes zero at the position of the active marker.		MARKDELA* ⁸	:CALC{1-16}:MARK{1-10}:SET DEL* ⁷	
Marker search	Turning off the search function		SEAOFF* ⁸	Not available	The E5070B/E5071B requires you to send two commands, one for designating the search type and the other for executing the search.
		Maximum	MARKMAXI* ⁸ SEAMAX* ⁸	:CALC{1-16}:MARK{1-10}:FUNC: TYPE MAX* ⁷ :CALC{1-16}:MARK{1-10}:FUNC: EXEC* ⁷	
	Minimum		MARKMINI* ⁸ SEAMIN* ⁸	:CALC{1-16}:MARK{1-10}:FUNC: TYPE MIN* ⁷ :CALC{1-16}:MARK{1-10}:FUNC: EXEC* ⁷	
		Target search	Left side	SEAL* ⁸	
		Right side	SEAR* ⁸	:CALC{1-16}:MARK{1-10}:FUNC: TYPE RTAR* ⁷ :CALC{1-16}:MARK{1-10}:FUNC: EXEC* ⁷	
		Specifying the search value	SEATARG* ⁸	:CALC{1-16}:MARK{1-10}:FUNC: TARG* ⁷	
	Bandwidth search	On/Off	WIDT* ⁸	:CALC{1-16}:MARK:BWID* ⁷	
		Specifying parameters	WIDV* ⁸	:CALC{1-16}:MARK{1-10}:BWID: THRU* ⁷	
		Turning the tracking On/Off	TRACK* ⁸	:CALC{1-16}:MARK{1-10}:FUNC: TRAC* ⁷	
	Statistics analysis	On/Off	MEASTAT* ⁸	:CALC{1-16}:MST* ³	
Reading the results		OUTPMSTA* ⁸	:CALC{1-16}:MST:DATA?* ³		

C. Comparing Commands on the 8753ES and E5070B/E5071B

Comparing Commands on the 8753ES and E5070B/E5071B
8753ES vs. E5070B/E5071B Command Correspondence (by function)

Function	Item to be specified/executed		Command (For footnotes, see page 928.)		Remarks		
			8753ES	E5070B/E5071B			
Device test	Limit test	Turning the limit test On/Off	LIMITEST *1	:CALC{1-16};LIM*3			
		Turning the limit line display On/Off	LIMILINE *1	:CALC{1-16};LIM:DISP*3			
	Limit Editing the test list	Start of editing	EDITLIML	:CALC{1-16};LIM:DATA*3 is used to set up the limit test table.			
		End of editing	EDITDONE				
	Deleting the entire list		CLEL	:CALC{1-16};LIM:DATA 0*3			
			CLEAL				
	Setting the marker value at the offset along the Y-axis		LIMIMAOF	:CALC{1-16};LIM:OFFS:MARK			
	Editing segments	Selection	Addition	SEDI	:CALC{1-16};LIM:DATA*3 is used to set up the limit test table.		
			Deletion	SDEL			
			End	SDON			
			Boundary value	LIMS			
			Upper limit value	LIMU			
			Lower limit value	LIML			
			Delta value	LIMD			
			Center value	LIMM			
			Sloping line	LIMITSL			
			Flat line	LIMTFL			
			Single point	LIMITSP			
			Setting the boundary value at the active marker's response value			MARKSTIM	
			Setting the center value at the active marker's response value			MARKMIDD	
			Specifying the offset	Along the X-axis		LIMISTIO	:CALC{1-16};LIM:OFFS:STIM
	Along the Y-axis	LIMIAMPO		:CALC{1-16};LIM:OFFS:AMPL			
	Turning the function On/Off that records the maximum and minimum for each segment		MINMAX	Not available			

Comparing Commands on the 8753ES and E5070B/E5071B
8753ES vs. E5070B/E5071B Command Correspondence (by function)

Function	Item to be specified/executed		Command (For footnotes, see page 928.)		Remarks			
			8753ES	E5070B/E5071B				
Device test (cont'd.)	Limit test (cont'd.)	Reading the results	Reading the pass/fail of a channel	OUTPLIM{1-4}	:CALC{1-16}:LIM:FAIL? ^{*3} (Reading the pass/fail of a active trace)	The E5070B/E5071B has a different returned value.		
			Intra-segment maximum measured value	OUTPAMAX	Not available	The E5070B/E5071B does not allow you to read data for each segment/each point.		
			Intra-segment minimum measured value	OUTPAMIN	Not available			
			Number of valid segments and results for each segment	OUTPSEGAF	Not available			
			Maximum/minimum in all segments	OUTPSEGAM	Not available			
			Designating the segment to be read by OUTPSEGF and OUTPSEGM	SELSEG	Not available			
			Pass/Fail of the designated segment	OUTPSEGF	Not available			
			Maximum/Minimum of the designated segment	OUTPSEGM	Not available			
			Point information	OUTPLIML	:CALC{1-16}:LIM:REP:ALL?			
			Information on the position of the active marker	OUTPLIMM	Not available			
			Information on a failed point and the number of failed points	OUTPLIMF	Not available		The E5070B/E5071B allows you to read the number of points by using :CALC{1-16}:LIM:REP:POIN? , and the stimulus value by using :CALC{1-16}:LIM:REP? , but other values cannot be read.	
			Number of failed points, and the stimulus and measured values of the failed points	OUTPFAIP	Not available			
			Ripple test	Turning the ripple test On/Off		RLIMTEST	:CALC{1-16}:RLIM	
					Turning the limit line display On/Off	RLIMLINE	:CALC{1-16}:RLIM:DISP:LINE	
Ripple limit editing	Start of editing	EDITRLIM		:CALC{1-16}:RLIM:DATA				
	End of editing	EDITDONE		Not available				
	Deleting all of the limits	CLEL						
		CLEAL						
Clear the limits of ripple test	CLER	:CALC{1-16}:RLIM:DATA						

C. Comparing Commands on the 8753ES and E5070B/E5071B

Comparing Commands on the 8753ES and E5070B/E5071B
8753ES vs. E5070B/E5071B Command Correspondence (by function)

Function	Item to be specified/executed				Command (For footnotes, see page 928.)		Remarks	
					8753ES	E5070B/E5071B		
Device test (cont'd.)	Ripple test (cont'd.)	Ripple limit editing (cont'd.)	Editing the band	Selection	SEDI	Not available		
				Addition	SADD			
				Deletion	SEDEL			
				End	SDON			
				Upper limit value	RLIMM			:CALC{1-16}:RLIM:DATA
				Start value	RLIMSTR			
			Stop value	RLIMSTP				
			Displaying the ripple value					
			Absolute value	RLIMVALABS	:CALC{1-16}:RLIM:DISP:VAL			
				Margin		RLIMVALMAR		
	Off	RLIMVALOFF						
	Reading the results	Information on failed points	Magnitude of ripples in all valid bands	OUTPRPLBN DALL	:CALC{1-16}:RLIM:REP?			
			Designated band results	OUTPRPLBN DPF				
			Magnitude of designated bands ripples	OUTPRPLBN DVAL				
	Bandwidth test	Turning the bandwidth test On/Off	Turning the bandwidth test On/Off		BWLIMTEST^{*1}	:CALC{1-16}:BLIM		
			Turning the bandwidth display On/Off		BWLIMDISP^{*1}	:CALC{1-16}:BLIM:DISP:VAL		
			Specifying the bandwidth threshold value (attenuation from the peak)		BWLIMDB^{*1}	:CALC{1-16}:BLIM:DB		
			Specifying the upper limit value for the test		BWLIMMAX^{*1}	:CALC{1-16}:BLIM:MAX		
			Specifying the lower limit value for the test		BWLIMMIN^{*1}	:CALC{1-16}:BLIM:MIN		
Reading the results		Bandwidth, center value, Q value	Bandwidth, center value, Q value		OUTPMWID^{*1}	Not available		
			Bandwidth, center value, Q value, loss		OUTPMWIL^{*1}	:CALC{1-16}:MARK{1-10}:BWID:DATA? ^{*7}		
		Reading the bandwidth value		BWLIMVAL^{*1}	:CALC{1-16}:BLIM:REP?			
		Reading the results (pass/fail)		BWLIMSTAT^{*1}	:CALC{1-16}:BLIM:FAIL?			
Status report		Clearing the status byte register, event status register, and valid register.			CLES	*CLS		
	CLS							
	Reading the status byte register			OUTPSTAT	*STB?			
				STB?	*STB?			
	Setting up the service request valid register			SRE	*SRE			
	Reading the event status register			ESR?	*ESR?			
Setting up the event status valid register			ESE	*ESE				

Comparing Commands on the 8753ES and E5070B/E5071B
8753ES vs. E5070B/E5071B Command Correspondence (by function)

Function	Item to be specified/executed		Command (For footnotes, see page 928.)		Remarks		
			8753ES	E5070B/E5071B			
Status report (cont'd.)	Event status register B	Read	ESB?	Not available	The E5070B/E5071B have questionable channel limit fail registers, which report result of Ilimit test. 8753ES reports the completion of the next command. E5070B/E5071B reports the completion when all commands being executed have been completed.		
		Setting up valid registers	ESNB	Not available			
	When all operations on standby have been completed, bit 0 of the event status register is set.	OPC	*OPC				
Save /Recall	Instrument State	Save	Internal register	SAVE	:MMEM:STOR	On the E5070B/E5071B, the same command is used regardless of the type of media.	
				SAVEREG			
			Internal disk	STOR			
		Call	Internal register	RECA			:MMEM:LOAD
				RE CAREG			
			Internal disk	LOAD			
	Naming a file to be saved			TITF	Designated by using parameters before the file is saved.		
	Selecting the format of the Instrument State file.	ASCII format		SAVUASCI	Not available		
		Binary format		SAVUBINA			
	Selecting the data to be saved in a file	Corrected data array		EXTMDATA ^{*1}	:MMEM:STOR:STYP ^{*3}		The E5070B/E5071B can save the Instrument State plus corrected data array and calibration data. (The 8753ES Instrument State file contains calibration data.)
		Raw data array		EXTMRAW ^{*1}	Not available		
		Trace data		EXTMFORM ^{*1}	Not available		
		LCD screen display		EXTMGRAP	Not available		
		Measurement data only		EXTMDATO ^{*1}	Not available		
	Test sequence	Save		STORSEQ	Not available		The E5070B/E5071B uses VBA for creating internal programs.
		Load	Floppy disk	LOADSEQ			
	LCD screen image	Save		SAVEJPG	:MMEM:STOR:IMAG		Image files on the E5070B/E5071B are stored in Windows [®] Bitmap or PNG format, while the 8753ES saves files in JPEG format.
Measurement data (CSV format)	Save		SAVECSV ^{*1}	:MMEM:STOR:FDAT ^{*3}			
Saving color settings	Save		SVCO	Not available			
	Load		RECO	Not available			

C. Comparing Commands on the 8753ES and E5070B/E5071B

Comparing Commands on the 8753ES and E5070B/E5071B
8753ES vs. E5070B/E5071B Command Correspondence (by function)

Function	Item to be specified/executed		Command (For footnotes, see page 928.)		Remarks	
			8753ES	E5070B/E5071B		
Save/Recall (cont'd.)	Selecting media for saving files	Internal memory	INTM	Not available	The E5070B/E5071B allows the media to be selected by designating the drive name at the time the file is saved. A file can be saved on either the internal hard disk drive or to the floppy disk drive.	
		Floppy disk drive	INTD	Not available		
		External disk drive	EXTD	Not available		
		Designating the external disk number	DISCUNIT	Not available		
		Partition on the external disk to be designated	DISCVOLU	Not available		
	Designating the storage format	DOS	FORMATDOS	Not available	The E5070B/E5071B is compatible with the DOS format only.	
		LIF	FORMATLIF			
	Initializing the storage medium	Floppy disk	INID	Not available	On the E5070B/E5071B, the storage media can be initialized using a mouse.	
		Specifying the size of the LIF directory	DIRS	Not available	The E5070B/E5071B is compatible with the DOS format only.	
		External disk	INIE	Not available		
	Save/Recall register	Giving a title		TITR	Not available	The E5070B/E5071B stores all data on the hard disk or to a floppy disk.
				TITREG	Not available	
		Clear	Clearing the designated number	CLEA	Not available	
All clear			CLEARREG	Not available		
File manipulation	Deletion		PURG	:MMEM:DEL		
	Reading the file title from the disk		REFT	Not available		
Test sequence	Creating/Revising a new sequence		NEWSEQ	Not available	The E5070B/E5071B does not have the test sequence function. Macros are created using VBA.	
	Selecting a test sequence		Q	:PROG:NAME		
			SEQ	(Selecting a VBA program)		
	Reading a test sequence		OUTPSEQ	Not available		
	Executing the selected sequence		DOSEQ	:PROG:STAT RUN (Executing the selected VBA program)		
	Stopping the selected sequence		PTOS	:PROG:STAT STOP (Stopping the selected VBA program)		
	Resuming a stopped test sequence		CONS	Not available		
	Executing another sequence from the test sequence		GOSUB	Not available		
	Naming the test sequence	Name	TITSEQ	Not available		
		Displaying the softkey menu for setup	TITSEQ	Not available		
	Specifying waiting time in the test sequence		SEQWAIT	Not available		
	Displaying the softkey menu while the test sequence is in progress.		SHOM	Not available		
	Specifying the status bit in the event status register		ASSS	Not available		

Comparing Commands on the 8753ES and E5070B/E5071B
8753ES vs. E5070B/E5071B Command Correspondence (by function)

Function	Item to be specified/executed		Command (For footnotes, see page 928.)		Remarks
			8753ES	E5070B/E5071B	
Test sequence (cont'd.)	GPIO	Designating the bit number of the input port to be used for branching	PARAIN	Not available	The E5070B/E5071B does not have a test sequence function. Macros are created using VBA.
		Setting the designated bit	SETBIT	Not available	
		Clearing the designated bit	CLEABIT	Not available	
		Setting all bits	PARAOUT	Not available	
	TTL output	Set to High after ending sweep	TTLHPULS	Not available	
		Set to Low after ending sweep	TTLLPULS	Not available	
		Always set to High	TTLOH	Not available	
		Always set to Low	TTLOL	Not available	
	Loop counter	Setting values	LOOC	Not available	
		Subtract one.	DECRLOOC	Not available	
		Add one.	INCRLOOC	Not available	
	Branching	Executes the sequence when the designated GPIO bit is set to High.	IFBIHIGH	Not available	
		Executes the sequence when the designated GPIO bit is set to Low.	IFBILOW	Not available	
		Executes the sequence when the loop counter is at zero.	IFLCEQZE	Not available	
		Executes the sequence when the loop counter is not at zero.	IFLCNEZE	Not available	
		Executes the sequence when the limit test fails.	IFLTFAIL	Not available	
		Limit test passes, and the sequence executes.	IFLTPASS	Not available	
	Specifying the bit for selecting the attenuator in the test set.	Forward	TSTIOFWD	Not available	
		Reverse	TSTIOREV	Not available	
	Clearing the designated sequence from the register		CLEASEQ	Not available	
	Ending editing of the test sequence		DONM	Not available	
	Copying the test sequence		DUPLSEQ	Not available	

C. Comparing Commands on the 8753ES and E5070B/E5071B

Comparing Commands on the 8753ES and E5070B/E5071B
8753ES vs. E5070B/E5071B Command Correspondence (by function)

Function	Item to be specified/executed		Command (For footnotes, see page 928.)		Remarks	
			8753ES	E5070B/E5071B		
System	Reset		PRES	:SYST:PRES	After execution, the * RST on the E5070B/E5071B set the trigger state to Hold.	
			RST	*RST		
	Executes a self-test and returns the results.		TST?	Not available		
	Internal clock	Setting the date	SETDATE	:SYST:DATE		
		Reading the date	READDATE	:SYST:DATE?		
		Setting the time	SETTIME	:SYST:TIME		
		Reading the time	READTIME	:SYST:TIME?		
	Setting up the beep sound	On/Off operations at the time an action is completed	BEEPDONE	:SYST:BEEP:COMP:STAT		
		On/Off at the time the limit test fails	BEEPFAIL	Not available	On the E5070B/E5071B, the beep sound for a failed limit test is set up based on the beeper setup for the warning sound.	
		On/Off at the time a warning occurs	BEEPWARN	:SYST:BEEP:WARN:STAT		
		Sounds the beep sound.	EMIB	:SYST:BEEP:COMP:IMM (Beep sound when an action completes) or :SYST:BEEP:WARN:IMM (Beep sound when a warning occurs)		
	Selecting the measurement mode	Standard network analyzer	INSMNETA	Not available	The E5070B/E5071B is always considered a standard network analyzer.	
		External source (automatic)	INSMEXSA			
		External source (manual)	INSMEXSM			
		Tuned receiver	INSMTUNR			
	Printer/Plotter output	Printing	Plotter	PLOT	Not available	
Printer			LCD screen	PRINALL	:HCOP	
			Test sequence	PRINSEQ	Not available	The E5070B/E5071B does not have the test sequence function.
			List display	PRINTALL	Not available	The E5070B/E5071B does not have the list display function.
Output the LCD screen to the printer by using a PCL raster dump.		OUTPPRIN	:HCOP			
The LCD screen in the HP-GL is output from the GPIB port.		OUTPLOT	Not available	The E5070B/E5071B does not allow output from the GPIB.		
Setting the line type			LINTDATA	Not available	The E5070B/E5071B always gives the data trace in a solid line.	
		Memory trace	LINTMEMO			
Setting up the printer		Return to the initial state		DEFPRINT	Not available	On the E5070B/E5071B, the printer setup is executed by using the front panel.
		Setting up for printing	Color	PRIC	Not available	
	Monochrome		PRIS			

Comparing Commands on the 8753ES and E5070B/E5071B
8753ES vs. E5070B/E5071B Command Correspondence (by function)

Function	Item to be specified/executed		Command (For footnotes, see page 928.)		Remarks	
			8753ES	E5070B/E5071B		
Printer/Plotter output (cont'd.)	Setting up the printer (cont'd.)	Color	Trace data	PCOLDATA	Not available	On the E5070B/E5071B, color setup is allowed only for turning highlighting of the entire screen On/Off.
			Graticule lines	PCOLGRAT		
			Memory trace	PCOLMEMO		
			Reference line	PCOLREFL		
			Text	PCOLTEXT		
			Warning message	PCOLWARN		
	Setting the printer port	GPIB	Parallel port	PRNPRTHPIB	Not available	On the E5070B/E5071B, the printer setup is executed by using the front panel.
			Serial port	PRNPRTSERI		
	Setting the printer type	HP DeskJet 540/850C	HP DeskJet	PRNTYP540	Not available	On the E5070B/E5071B, the printer setup is executed by using the front panel.
			HP DeskJet	PRNTYPDJ		
			Epson ESC/P2	PRNTYPEP		
			HP LaserJet	PRNTYPLJ		
			HP PaintJet	PRNTYPPJ		
			HP ThinkJet	PRNTYPTJ		
	Handshake mode		PRNHNDSHK	Not available		
	Turning the automatic feed On/Off		PRNTRAUTF	Not available		
	Serial port baud rate		PRNTRBAUD	Not available		
	Sending a form feed		PRNTRFORF	Not available		
Plotter setup	Returning to the initial state		DFLT	Not available	The E5070B/E5071B does not support plotters.	
	Setting the print scope	Entire sheet	FULP			
		Lower-left 1/4 of a sheet	LEFL			
		Upper-left 1/4 of a sheet	LEFU			
		Lower-right 1/4 of a sheet	RIGL			
		Upper-right 1/4 of a sheet	RIGU			
	Turning the plot On/Off	Trace data	PDATA			
		Graticule lines	PGRAT			
		Memory trace	PMEM			
		Marker	PMKR			
		Softkey	PSOFT			
		Text	PTEXT			
	Pen number	Trace data	PENNDATA			
		Graticule lines	PENNGRAT			
		Memory trace	PENNMARK			
		Marker	PENNMEMO			
		Text	PENNTEXT			
	Pen speed	High speed	PLOSSLOW			
		Low speed	PLOFAST			
Setting up the scale	FULL	SCAPFULL				
	GRAT	SCAPGRAT				

C. Comparing Commands on the 8753ES and E5070B/E5071B

Comparing Commands on the 8753ES and E5070B/E5071B
8753ES vs. E5070B/E5071B Command Correspondence (by function)

Function	Item to be specified/executed			Command (For footnotes, see page 928.)		Remarks
				8753ES	E5070B/E5071B	
Printer/Plotter output (cont'd.)	Plotter setup (cont'd.)	Plotter port	Disk	PLTPRTDISK	Not available	The E5070B/E5071B does not support plotters.
			GPIB	PLTPRTHPIB		
			Parallel port	PLTPRTPARA		
			Serial port	PLTPRTSERI		
		Plotter type	PCL5-compatible	PLTTYHPGL		
			Plotter	PLTTYPLTR		
		Handshake mode		PLTHNSHK		
		Turning the automatic feed On/Off		PLTTRAUTF		
		Serial port baud rate		PLTTRBAUD		
		Sending a form feed		PLTTRFORF		
Setting up printing	Initialization	DEFLTCPIO	Not available			
Turning the timestamp print On/Off			TIMESTAM	Not available	On the E5070B/E5071B, always display the timestamp on LCD.	
Naming a file to receive plot output.			TITP	Not available		
Test set	Confirming the test set connection			TESS	Not available	
	Switching the changeover for the test set	Setting up Continuous/Stop	CSWI	Not available	On the E5070B/E5071B, always continuous.	
		Specifying the number of times to change over.	TSSWI			
Time domain transformation	Turning the transformation On/Off		TIMDTRAN	:CALC{1-16}:TRAN:TIME:STAT		
	Selecting the mode	Low-pass impulse	LOWPIMPU	:CALC{1-16}:TRAN:TIME		
		Low-pass step	LOWPSTEP	:CALC{1-16}:TRAN:TIME:STIM		
		Bandpass	BANDPASS			
	Display the softkeys for setting up the gate			SPEG	Not available	
	Turning the time-domain gate On/Off			GATEO	:CALC{1-16}:FILT:TIME:STAT	
	Time-domain gate time	Start	GATESTAR	:CALC{1-16}:FILT:TIME:STAR		
		Stop	GATESTOP	:CALC{1-16}:FILT:TIME:STOP		
		Center	GATECENT	:CALC{1-16}:FILT:TIME:CENT		
		Span	GATESPAN	:CALC{1-16}:FILT:TIME:SPAN		
	Form of the time-domain gate	Minimum	GATSMINI	:CALC{1-16}:FILT:TIME:SHAP		
		Normal	GATSNORM			
		Wide	GATSWIDE			
		Maximum	GATSMAXI			
	Demodulation function	Off	DEMOOFF	Not available		
		AM modulation	DEMOAMPL	Not available		
		Phase modulation	DEMOPHAS	Not available		
	Setting up the display	Maximum	WINDMAXI	:CALC{1-16}:TRAN:TIME:KBES		
		Minimum	WINDMINI			
		Normal	WINDNORM			
Specifying values		WINDOW				
Turning use of the memory trace On/Off			WINDUSEM	Not available		
Freq low-pass measurement			SETF	:CALC{1-16}:TRAN:TIME:LPFR		

Comparing Commands on the 8753ES and E5070B/E5071B
8753ES vs. E5070B/E5071B Command Correspondence (by function)

Function	Item to be specified/executed		Command (For footnotes, see page 928.)		Remarks	
			8753ES	E5070B/E5071B		
Others (cont'd.)	Mixer measurement	Turning the frequency offset mode On/Off	FREQOFFS	Not available	The E5070B/E5071B does not have the mixer measuring function.	
		Selecting the down conversion.	DCONV			
		Selecting the up conversion.	UCONV			
		Reading the frequency of the external RF signal source.	OUTPRFFR			
		Specifyi ng LO	Turning control On/Off			LOCONT
			Frequency			LOFREQ
			Setting the frequency in sweep mode			LOFSWE
			Starting frequency			LOFSTAR
			Stop frequency			LOFSTOP
			Power			LOPOWER
			Setting the power in sweep mode			LOPSTAR
			Start power			LOPSTOP
			Stop power			LOPSWE
			Setting the signal source			RF > LO
		RF < LO				RFLTLO
		Setting up the display	Setup screen			VIEMOFF
	Measurement screen		VIEMON			
		LO frequency is used in the offset mode.	VOFF			
	Harmonics measurement mode	Turning off the measurement mode.	HARMOFF	Not available		The E5070B/E5071B does not have the harmonics measurement mode.
		2nd harmonics measurement	HARMSEC			
3rd harmonics measurement		HARMTHIR				
Key manipulation related commands	Performing the same processing as with the front panel key designated.		KEY	Not available		
	Performs the same processing as with the [↑] key on the front panel.		UP	Not available		
	Performs the same processing as with the [↓] key on the front panel.		DOWN	Not available		
	Returns the code of the last key manipulated on the front panel.		KOR?	Not available		
			OUTPKEY	Not available		
	Displaying the softkey menu corresponding to the front panel key.	[Avg]	MENUAVG	Not available		
		[Cal]	MENUCAL	Not available		
		[Copy]	MENUCOPY	Not available		
		[Display]	MENUDISP	Not available		
		[Format]	MENUFORM	Not available		
[Marker]		MENUMARK	Not available			
	[Meas]	MENUMEAS	Not available			

C. Comparing Commands on the 8753ES and E5070B/E5071B

Comparing Commands on the 8753ES and E5070B/E5071B
8753ES vs. E5070B/E5071B Command Correspondence (by function)

Function	Item to be specified/executed		Command (For footnotes, see page 928.)		Remarks	
			8753ES	E5070B/E5071B		
Others (cont'd.)	Key manipulation related commands (cont'd.)	Displaying the softkey menu corresponding to the front panel key. (cont'd.)	[Marker Fctn]	MENUMRKF	Not available	
			[Power]	MENUPOWE	Not available	
			[Save/Recall]	MENURECA	Not available	
			[Save/Recall]	MENUSAVE	Not available	
			[Scale Ref]	MENUSCAL	Not available	
			[Seq]	MENUSEQU	Not available	
			[Marker Search]	MENUSRCH	Not available	
			[Sweep Setup]	MENUSTIM	Not available	
			[Sweep Setup]	MENUSWEE	Not available	
		[System]	MENUSYST	Not available		
		Performing the same processing as with the designated softkey.	SOFT{1-8}	Not available		
		Editing softkey labels	WRSK	Not available		
	GPIB	Turning the debug mode On/Off		DEBU	Not available	
		Setting to talker/listener mode		TALKLIST	Not available	
		Sending the title character string	Peripherals	TITTPERI	Not available	
Power meter			TITTPMTR			
Printer			TITTPRIN			
pass control		USEPASC	Not available			
Setting the GPIB address		Controller	ADDRCONT	Not available	The E5070B/E5071B does not allow these GPIB addresses to be specified.	
			PCB			
		External disk drive	ADDRDISC			
		LO source	ADDRLSRC			
		Peripheral	ADDRPERI			
	Plotter	ADDRPLOT				
	Printer	ADDRPRIN				
	Power meter	ADDRPOWM	:SYST:COMM:GPIB:PMET:ADDR			
Specifying uses of the parallel port	GPIB use	PARALGPIO	Not available	The E5070B/E5071B uses the GPIO for the printer.		
	Printer use	PARALCPY				
Service mode	ALC control	ALC	Not available			
	Setting the analog bus On/Off	ANAB	Not available			

- *1. Effective for the active channel (8753ES)
- *2. Effective for channels and traces designated in the command. (E5070B/E5071B)
- *3. Effective for the active trace designated in the command (E5070B/E5071B)
- *4. Effective both for the main and auxiliary channels. (8753ES)
- *5. Effective for the channels designated in the command. (E5070B/E5071B)
- *6. Effective for all channels (8753ES)
- *7. Effective command for the marker number, designated within that command, on the active trace in the channel having the channel number also designated in that command. (E5070B/E5071B)
- *8. Effective command for the active marker (8753ES)

8753ES vs. E5070B/E5071B Command Comparison (8753ES-only commands excluded)

8753ES	Function overview	E5070B/E5071B
[A]		
AB	Select A/B measurement and display the traces.	Not available (A/B measurement not available.)
ADAPI	Set up the electrical delay in the adapter removal calibration.	Not available
ADDRCONT	Specify the controller GPIB address.	Not available
ADDRDISC	Specify the GPIB address of the external disk drive.	Not available
ADDRLSRC	Specify the GPIB address of the LO source.	Not available
ADDRPERI	Specify the GPIB addresses of peripherals.	Not available
ADDRPLOT	Specify the GPIB address of the plotter.	Not available
ADDRPOWM	Specify the GPIB address of the power meter.	:SYST:COMM:GPIB:PMET:ADDR
ADDRPRIN	Specify the GPIB address of the printer.	Not available (Not compatible with a GPIB printer.)
ADPTCOAX	Select the adapter-coaxial in the adapter removal calibration.	Not available
ADPTWAVE	Select the adapter-waveguide in the adapter removal calibration.	Not available
ALC	Control ALC (for service use).	Not available
ALTAB	Set to an alternate measurement mode.	Not available (The sweeping of traces on the same channel is performed in chop measurement mode, while traces between different channels is performed in alternate mode.)
ANAB	On/Off setting for the analog bus (for service use)	Not available
ANAI	Select the measurement of the signal input to the AUX Input and display the trace.	Not available (Measurement parameters are selected S-parameters and absolute measurement parameters.)
AR	Select the A/R measurement and display the traces.	Not available (Measurement parameters are selected S-parameters and absolute measurement parameters.)
ASEG	All segments are used during the list frequency sweep.	Not available (All segments are always used.)
ASSS	Specify the sequence bit of the event status register.	Not available
ATTP1	Specify the value for the attenuator at port 1.	:SOUR{1-16}:POW:ATT
ATTP2	Specify the value for the attenuator at port 2.	(Channels are used for setup.)
AUTO	Perform autoscale.	:DISP:WIND{1-16}:TRAC{1-16}:Y:AUTO
AUXC	Set channels 3 and 4 On/Off.	Using the command :CALC{1-16}:PAR{1-16}:COUN enables you to do the equivalent.
AVERFACT	Specify the averaging factor.	:SENS{1-16}:AVER:COUN
AVERO	Set the averaging On/Off.	:SENS{1-16}:AVER
AVERREST	Restart the averaging.	:SENS{1-16}:AVER:CLE
[B]		
BACI	Specify the screen brightness.	:SYST:BACK (On/Off setting for the backlight only allowed)
BANDPASS	Select the BANDPASS mode in the time-domain transformation.	:CALC{1-16}:TRAN:TIME BPAS
BEEPDONE	Set the beep (n) sound at the end of an action On/Off.	:SYST:BEEP:COMP:STAT
BEEPFAIL	Set the beep (n) sound for the limit test FAIL On/Off.	Not available (Setting is the same as for the warning beep sound.)
BEEPWARN	Set the warning beep (n) sound On/Off.	:SYST:BEEP:WARN:STAT
BLAD	Set the display On/Off.	:SYST:BACK (Set the LCD backlight On/Off) The On/Off relation on the 8753ES is opposite that on the E5070B/E5071B.

Comparing Commands on the 8753ES and E5070B/E5071B
8753ES vs. E5070B/E5071B Command Comparison (8753ES-only commands excluded)

8753ES	Function overview	E5070B/E5071B
BR	Select the B/R measurement and display the traces.	Not available (Measurement parameters are selected S-parameters and absolute measurement parameters.)
BWLIMDB	Specify the value indicating the position of the bandwidth (attenuation from the peak) in the bandwidth test.	:CALC{1-16}:BLIM:DB
BWLIMDISP	Set the bandwidth value display in the bandwidth test On/Off.	:CALC{1-16}:BLIM:DISP:VAL
BWLIMMAX	Specify the upper limit value in the bandwidth test.	:CALC{1-16}:BLIM:MAX
BWLIMMIN	Specify the lower limit value for the bandwidth test.	:CALC{1-16}:BLIM:MIN
BWLIMSTAT	Read the results of the bandwidth test.	:CALC{1-16}:BLIM:FAIL?
BWLIMTEST	Set the bandwidth test On/Off.	:CALC{1-16}:BLIM
BWLIMVAL	Read the bandwidth value during the bandwidth test.	:CALC{1-16}:BLIM:REP?
[C]		
C0	Specify the C0 value of the OPEN standard.	:SENS{1-16}:CORR:COLL:CKIT:STAN{1-21}:C0
C1	Specify the C1 value of the OPEN standard.	:SENS{1-16}:CORR:COLL:CKIT:STAN{1-21}:C1
C2	Specify the C2 value of the OPEN standard.	:SENS{1-16}:CORR:COLL:CKIT:STAN{1-21}:C2
C3	Specify the C3 value of the OPEN standard.	:SENS{1-16}:CORR:COLL:CKIT:STAN{1-21}:C3
CAL1	Cause the softkey for the calibration menu.	Not available (Can be ignored in the case of replacement)
CALFCALF	Specify the calibration coefficients while editing the calibration coefficients table for the power sensor to be used in power meter calibration.	Not available
CALFFREQ	Specify the frequency while editing the calibration coefficients table for the power sensor to be used for power meter calibration.	
CALFSENA	Start editing the calibration coefficients table for power sensor A to be used for power meter calibration.	
CALFSENB	Start editing the calibration coefficients table for power sensor B to be used for power meter calibration.	
CALIERC	Start measuring data in forward enhanced response calibration.	:SENS{1-16}:CORR:COLL:METH:ERES
CALIFUL2	Start measuring data in full 2-port calibration.	:SENS{1-16}:CORR:COLL:METH:SOLT1
CALIRAI	Start measuring data in response & isolation calibration.	:SENS{1-16}:CORR:COLL:METH:OPEN :SENS{1-16}:CORR:COLL:METH:SHOR :SENS{1-16}:CORR:COLL:METH:THRU (The commands differ depending on the standard used in the isolation calibration.)
CALIRERC	Start measuring data in reverse enhanced response calibration.	:SENS{1-16}:CORR:COLL:METH:ERES
CALIRESP	Start measuring data in response calibration.	:SENS{1-16}:CORR:COLL:METH:OPEN or :SENS{1-16}:CORR:COLL:METH:SHOR or :SENS{1-16}:CORR:COLL:METH:THRU (The commands differ depending on the standard used in the isolation calibration.)
CALIS111	Start measuring data in S11 1-port calibration.	:SENS{1-16}:CORR:COLL:METH:SOLT1 (You must designate a port with the parameter.)
CALIS221	Start measuring data in S22 1-port calibration.	
CALITRL2	Start measuring data in TRL*/LRM* 2-port calibration.	

Comparing Commands on the 8753ES and E5070B/E5071B
8753ES vs. E5070B/E5071B Command Comparison (8753ES-only commands excluded)

8753ES	Function overview	E5070B/E5071B	
CALK24MM	Select 2.4 mm Calibration Kit (85056A/D) as the default calibration kit.	:SENS{1-16};CORR:COLL:CKIT	
CALK292MM	Select 2.92 mm Calibration Kit as the default calibration kit.		
CALK292S	Select 2.92 mm Calibration Kit (85056K) as the default calibration kit.		
CALK35MC	Select 3.5 mm Calibration Kit (85033C) as the default calibration kit.		
CALK35MD	Select 3.5 mm Calibration Kit (85033D) as the default calibration kit.		
CALK716	Select 7-16 Calibration Kit (85038) as the default calibration kit.		
CALK7MM	Select 7 mm Calibration Kit (85031B) as the default calibration kit.		
CALKN50	Select N-type 50 Calibration Kit (85032B/E) as the default calibration kit.		
CALKN75	Select N-type 75 Calibration Kit (85036B/E) as the default calibration kit.		
CALKTRLK	Select TRL 3.5 mm Calibration Kit (85052C) as the default calibration kit.		
CALKUSED	Select a user-defined calibration kit as the default calibration kit.		
CALN	Set the error correction to Off.		:SENS{1-16};CORR:STAT OFF
CALSPORT1	Call the data on port 1 for adapter removal calibration.		Not available
CALSPORT2	Call the data on port 2 for adapter removal calibration.		
CALZLINE	Set the characteristic impedance for TRL*/LRM* 2-port calibration at the impedance value of the standard.	:SENS{1-16};CORR:COLL:CKIT:TRL:IMP LINE	
CALZSYST	Set the characteristic impedance for TRL*/LRM* 2-port calibration at the characteristic impedance value of the measurement system.	:SENS{1-16};CORR:COLL:CKIT:TRL:IMP SYST	
CBRI	Specify the display color brightness for the items selected.	Not available (Color setup is allowed only for turning highlighting of the entire screen On/Off.)	
CENT	Specify the center value of the sweep range.	:SENS{1-16};FREQ:CENT (Cannot be used for segment editing.) :SOUR{1-16};POW:CENT	
CHAN1	Specify channel 1 as the active channel.	:DISP:WIND{1-16};ACT (Specifying the active channel) or :CALC{1-16};PAR{1-16};SEL (Specifying the active channel) For an outline of channels and traces, refer to the "Users' Guide."	
CHAN2	Specify channel 2 as the active channel.		
CHAN3	Specify channel 3 as the active channel.		
CHAN4	Specify channel 4 as the active channel.		
CHOPAB	Set the system to chop measurement mode.	Not available (Traces on the same channel are measured using the same method as the chop sweep. When traces belong to different channels, they are measured using the same method as the alternate sweep.)	
CLAD	Complete the class designation in defining the calibration kits.	Not available (Can be ignored in the case of replacement.)	
CLASS11A	Measure S11A.	:SENS{1-16};CORR:COLL:OPEN	
CLASS11B	Measure S11B.	:SENS{1-16};CORR:COLL:SHOR	
CLASS11C	Measure S11C.	:SENS{1-16};CORR:COLL:LOAD	
CLASS22A	Measure S22A.	:SENS{1-16};CORR:COLL:OPEN	
CLASS22B	Measure S22B.	:SENS{1-16};CORR:COLL:SHOR	
CLASS22C	Measure S22C.	:SENS{1-16};CORR:COLL:LOAD	
CLEA	Clear the register for saving/recalling the designated number.	Not available	
CLEABIT	Clear the designated GPIO bit.	Not available (No GPIO interface)	

Comparing Commands on the 8753ES and E5070B/E5071B
8753ES vs. E5070B/E5071B Command Comparison (8753ES-only commands excluded)

8753ES	Function overview	E5070B/E5071B	
CLEAL	Clear the entire list.	Not available (Define the editing of each list by using one command.)	
CLEARALL	Clear all registers for saving/recalling.	Not available (:MMEM:DEL can be used to erase files stored on the internal hard disk.)	
CLEAREG	Clear the register for saving/recalling the designated number.		
CLESEQ	Clear the designated sequence.	Not available (Test sequence function not available.)	
CLEL	Clear the lists designated.	Not available (The editing of each table is defined by using one command.)	
CLER	Clear all limits for the ripple test.	:CALC{1-16}:RLIM:DATA	
CLES	Clear the status byte register, event status register, and enable register.	*CLS	
CLS			
COAD	Select coaxial as the type of electrical delay.	:CALC{1-16}:CORR:EDEL:MED COAX	
COAX	Select coaxial in specifying the offset when defining a standard.	:SENS{1-16}:CORR:COLL:CKIT:STAN{1-21}; CHAR COAX	
COLOCH1D	Select the data trace and limit in channel 1 to specify their colors.	:DISP:COL{1-2}:TRAC{1-16}:DATA :DISP:COL{1-2}:TRAC{1-16}:MEM :DISP:COL{1-2}:LIM{1-2} :DISP:COL{1-2}:GRAT{1-2} :DISP:COL{1-2}:BACK	
COLOCH1M	Select the memory trace in channel 1 to specify its color.		
COLOCH2D	Select the data trace and limit line in channel 2 to specify their colors.		
COLOCH2M	Select the memory trace in channel 2 to specify its color.		
COLOCH3D	Select the data trace and limit line in channel 3 to specify their colors.		
COLOCH3M	Select the memory trace in channel 3 to specify its color.		
COLOCH4D	Select the data trace and limit line in channel 4 to specify their colors.		
COLOCH4M	Select the memory trace in channel 4 to specify its color.		
COLOGRAT	Select a graticule line to specify its color.		
COLOTEXT	Select a character string to specify its color.		
COLOR	Specify the saturation of the display colors for the selected items.		
COLOLREF	Select the reference line to specify its color.		
COLOWARN	Select a warning message to specify its color.		
CONS	Resume execution of a suspended test sequence.		Not available (Test sequence function not available.)
CONT	Set the trigger mode to continuous mode.		:INIT{1-16}:CONT ON
CONVIDS	Transform the S-parameter measurement data into inverted S-parameters.		:CALC{1-16}:CONV:FUNC INV :CALC{1-16}:CONV ON
CONVOFF	Set the S-parameter transformation function to Off.	:CALC{1-16}:CONV OFF	
CONVYREF	Transform the S-parameter measurement data into impedances (reflections).	:CALC{1-16}:CONV:FUNC YREF :CALC{1-16}:CONV ON	
CONVYTRA	Transform the S-parameter measurement data into impedances (transmissions).	:CALC{1-16}:CONV:FUNC YTR :CALC{1-16}:CONV ON	
CONVZREF	Transform the S-parameter measurement data into impedances (reflections).	:CALC{1-16}:CONV:FUNC ZREF :CALC{1-16}:CONV ON	
CONVZTRA	Transform the S-parameter measurement data into impedances (transmissions).	:CALC{1-16}:CONV:FUNC ZTR :CALC{1-16}:CONV ON	
COPYFRFT	Copy a label from the file title.	Not available	
COPYFRRT	Copy a label from the register title.	Not available	
CORI	Set the error correction by interpolation of calibration coefficients to On/Off.	Not available (Always On)	
CORR	Set the error correction On/Off.	:SENS{1-16}:CORR:STAT	

Comparing Commands on the 8753ES and E5070B/E5071B
8753ES vs. E5070B/E5071B Command Comparison (8753ES-only commands excluded)

8753ES	Function overview	E5070B/E5071B
COUC	Set the sweep condition at Couple/Uncouple between channels.	The sweep condition is not coupled between channels. The sweep condition for traces on the same channel is coupled.
COUP	Set the power level at Couple/Uncouple between channels.	You can do the same thing in the channel and trace setup.
CSWI	Set the switch changeover in the test set to Continuous/Stop.	Not available
CWFREQ	Specify the signal source frequency for the power level sweep or CW TIME sweep.	:SENS{1-16};FREQ
CWTIME	Set the sweep type to CW TIME.	Not available (CW TIME sweep function not available.)
[D]		
D1DIVD2	Display on channel 2 the result of dividing the measurement on channel 2 by that on channel 1.	Not available
D2XUPCH2	Places two graphs on the LCD screen: an upper one (for channels 1 and 2) and a lower one (for channels 3 and 4).	Not available
D2XUPCH3	Places two graphs on the LCD screen: an upper one (for channels 1 and 3) and a lower one (for channels 2 and 4).	:DISP:SPL (Sets up the channel window layout.) and :DISP:WIND{1-16};SPL (Sets up the trace graph layout.) are combined to enable you to perform the equivalent.
D4XUPCH2	Places four graphs on the LCD screen: one in the upper left (for channel 1), one in the upper right (for channel 2), one in the lower left (for channel 3), and one in the lower right (for channel 4).	
D4XUPCH3	Places four graphs on the LCD screen: one in the upper left (for channel 1), one in the upper right (for channel 3), one in the lower left (for channel 2), and one in the lower right (for channel 4).	Not available
DATI	Save the measurement data in memory.	:CALC{1-16};MATH:MEM
DCONV	Select Down Convert in the mixer measurement.	Not available (Mixer measurement function not available.)
DEBU	Set the GPIB debug mode On/Off.	Not available
DECRLOOC	Subtract one from the loop counter value.	Not available (Test sequence function not available.)
DEFC	Return the color settings of all items to their initial states.	:DISP:COL{1-2};REF
DEFLPRINT	Return the printer setup to its initial state.	Not available
DEFLTPIO	Return the copy setup to its initial state.	Not available
DEFS	In defining calibration kits, start defining each standard.	Not available (You do not need to send the command for defining a standard.)
DELA	Set the display format to the group delay format.	:CALC{1-16};FORM GDEL
DELO	Turn off the delta marker mode.	:CALC{1-16};MARK{1-10};REF OFF
DELR	Designate the delta marker as the designated marker.	Not available (Marker 10 is assigned as the delta marker.)
DELRFIXM	Designate the delta marker as a fixed delta marker.	Not available (No functions for fixed markers are available.)
DEMOAMPL	Display the AM modulated component only.	Not available (Demodulation function not available.)
DEMEOFF	Turn off the demodulation function.	
DEMOPHAS	Display the phase-modulated component only.	
DFLT	Return the plotter setup to its initial state.	Not available (Plotters are not supported.)
DIRS	Specify the size of the directory used in initializing a disk with LIF.	Not available (The LIF format is not supported.)
DISCUNIT	Specify the external disk to be used for Save/Recall.	Not available
DISCVOLU	Specify the partition on the external disk to be used for Save/Recall.	Not available
DISM	Set the LCD screen for all marker values to On/Off.	Not available (Always displays all marker values.)

Comparing Commands on the 8753ES and E5070B/E5071B
8753ES vs. E5070B/E5071B Command Comparison (8753ES-only commands excluded)

8753ES	Function overview	E5070B/E5071B
DISPDATA	Display data traces.	:DISP:WIND{1-16}:TRAC{1-16}:STAT ON :DISP:WIND{1-16}:TRAC{1-16}:MEM OFF :CALC{1-16}:MATH:FUNC NORM (All three commands must be sent.)
DISPDATM	Display the data trace and memory trace at the same time.	:DISP:WIND{1-16}:TRAC{1-16}:STAT ON :DISP:WIND{1-16}:TRAC{1-16}:MEM ON :CALC{1-16}:MATH:FUNC NORM (All three commands must be sent.)
DISPDDM	Display the result of dividing the data trace by the memory trace.	:DISP:WIND{1-16}:TRAC{1-16}:STAT ON :DISP:WIND{1-16}:TRAC{1-16}:MEM OFF :CALC{1-16}:MATH:FUNC DIV (All three commands must be sent.)
DISPDMM	Display the result of subtracting the memory trace from the data trace.	:DISP:WIND{1-16}:TRAC{1-16}:STAT ON :DISP:WIND{1-16}:TRAC{1-16}:MEM OFF :CALC{1-16}:MATH:FUNC SUBT (All three commands must be sent.)
DISPMEMO	Display the memory trace.	:DISP:WIND{1-16}:TRAC{1-16}:STAT OFF :DISP:WIND{1-16}:TRAC{1-16}:MEM ON (Both commands must be sent.)
DIVI	Display the result of dividing the data trace by the memory trace.	:DISP:WIND{1-16}:TRAC{1-16}:STAT ON :DISP:WIND{1-16}:TRAC{1-16}:MEM OFF :CALC{1-16}:MATH:FUNC DIV (All three commands must be sent.)
DONE	When two or more standards exist in a calibration class, complete the measurement of the calibration data.	Not available (Only one type of standard is assigned to each calibration class.)
DONM	Complete the editing of the test sequence.	Not available (Test sequence function not available.)
DOSEQ	Start executing the selected test sequence.	Not available (Test sequence function not available.)
DOWN	Performs the same processing as pressing the [↓] key on the front panel.	Not available
DUAC	Set the simultaneous two-channel display On/Off.	:DISP:SPL (Sets up the channel window layout.) and :DISP:WIND{1-16}:SPL (Sets up the trace graph layout) are combined to enable you to perform the equivalent.
DUPLSEQ	Copy the test sequence.	Not available (Test sequence function not available.)
[E]		
ECALAB?	Read the selected ECAL module.	Not available
ECALCONT	Resume the suspended ECAL operation.	Not available
ECALDONE	Read to see if the ECAL operation has ended.	Not available
ECALERC	Perform ECAL forward enhanced response calibration.	:SENS{1-16}:CORR:COLL:ECAL:ERES
ECALFREQS	Read the calibration frequency array store in the ECAL module.	Not available
ECALFUL2	Perform ECAL full 2-port calibration.	:CALC{1-16}:CORR:COLL:ECAL:SOLT2
ECALISOAVG	Specify the averaging factor during isolation measurement using the ECAL module.	Not available
ECALMANTHRU	Set the manual THRU measurement for ECAL On/Off	Not available (Always performs automatic measurement)
ECALMODID	Read the product number and serial number of the ECAL module.	Not available
ECALMODINF	Read the information on the ECAL module.	Not available
ECALMODSELA	Select module A as the active module.	Not available
ECALMODSELB	Select module B as the active module.	Not available

Comparing Commands on the 8753ES and E5070B/E5071B
**8753ES vs. E5070B/E5071B Command Comparison (8753ES-only commands
excluded)**

8753ES	Function overview	E5070B/E5071B
ECALNFREQS	Specify the size of the calibration frequency array to be read from the ECal module.	Not available
ECALOMII	Set the omission of isolation for ECal On/Off.	:CALC{1-16}:CORR:COLL:ECAL:ISOL (The On/Off relation on the 8753ES is opposite that on the E5070B/E5071B.)
ECALPAUSED	Read to see if the ECal operation is interrupted.	Not available
ECALRERC	Perform ECal reverse enhanced response calibration.	:SENS{1-16}:CORR:COLL:ECAL:ERES
ECALS11	Perform ECal S11 1-port calibration.	:CALC{1-16}:CORR:COLL:ECAL:SOLT1 1
ECALS22	Perform ECal S22 1-port calibration.	:CALC{1-16}:CORR:COLL:ECAL:SOLT1 2
EDITDONE	Complete editing the tables.	Not available (Each table is edited using one command; there is no corresponding command.)
EDITLIML	Start editing the limit test table.	Not available (:CALC{1-16}:LIM:DATA is used to edit the limit test table.)
EDITLIST	Start editing the list (segment) sweep table.	Not available (:SENS{1-16}:SEGM:DATA is used to edit the segment table.)
EDITRLIM	Start editing the ripple limit.	:CALC{1-16}:RLIM:DATA
ELED	Specify the electrical delay value.	:CALC{1-16}:CORR:EDEL:TIME
EMIB	Sounds beeps during the test sequence.	:SYST:BEEP:COMP:IMM (beep sound when an action completes) or :SYST:BEEP:WARN:IMM (beep sound when a warning occurs)
ENTO	Cause the entry area display to disappear from the LCD screen.	Not available (The entry area is not displayed in remote control.)
ERCDONE	Complete the measurement of forward enhanced response calibration and calculate the calibration coefficients on the basis of the data obtained.	:SENS{1-16}:CORR:COLL:SAVE
ESB?	Read the value of event status register B.	Not available (Register corresponding to event status register not available.)
ESE	Specify the value of the event status valid register.	*ESE
ESNB	Specify the value of event status valid register B.	Not available (Register corresponding to event status valid register B not available.)
ESR?	Read the value of the event status register.	*ESR?
EXTD	Designate the external disk drive as the storage to be manipulated.	Not available (Storing data to the external disk drive is not allowed.)
EXTMDATA	Determine whether or not to save corrected data along with the device status.	:MMEM:STOR:STYP (Selection of the contents to be saved (v) in the Instrument State file)
EXTMDATO	Save the data array selected only.	Not available (:MMEM:STOR:FDAT can be used to save the formatted memory array for the active trace on the active channel.)
EXTMFORM	Determine whether or not to save trace data along with the device status.	Not available
EXTMGRAP	Determine whether or not to save the LCD screen along with the device status.	Not available (Adding images on the LCD screen to the Instrument State file is not allowed.)
EXTMRAW	Determine whether or not to save raw data along with the device status.	Not available (Adding raw data is not allowed.)
EXTTOFF	Turn off the external trigger mode.	Not available (Automatically turns off if a setting other than external trigger is selected in :TRIG:SOUR .)
EXTTON	Set to the external trigger mode (per sweep).	:TRIG:SOUR EXT :TRIG:POIN OFF
EXTTHIGH	Set the external trigger line to High.	Not available (The external trigger line is set to Low.)
EXTTLOW	Set the external trigger line to Low.	

Comparing Commands on the 8753ES and E5070B/E5071B
8753ES vs. E5070B/E5071B Command Comparison (8753ES-only commands excluded)

8753ES	Function overview	E5070B/E5071B
EXTTPOIN	Set to the external trigger mode (point by point).	:TRIG:POIN ON
[F]		
FIXE	In defining the calibration kits, set the type of LOAD to fixed load.	Not available (The LOAD standard is treated as fixed LOAD)
FORM1	Select the intra-device binary format for data transfers.	Not available (Selecting the intra-device binary format is not allowed.)
FORM2	Select the IEEE 32-bit floating point format for data transfers.	:FORM:DATA REAL32 :FORM:BORD NORM
FORM3	Select the IEEE 64-bit floating point format for data transfers.	:FORM:DATA REAL :FORM:BORD NORM
FORM4	Select the ASCII format for data transfers.	:FORM:DATA ASC
FORM5	Select the PC-DOS 32-bit floating point format for data transfers.	:FORM:DATA REAL32 :FORM:BORD SWAP
FORMATDOS	Select DOS as the storage format.Çı	Not available (Not compatible with the LIF format)
FORMATLIF	Select LIF as the storage format.	
FREQO	Cause the frequency display on the LCD screen to disappear.	:DISP:ANN:FFREQ OFF (Executing this command does not increase the coverage of the graph.)
FREQOFFS	Set the frequency offset mode in the mixer measurement On/Off.	Not available (Mixer measurement function not available.)
FRER	Set the trigger mode to continuous mode.	:INIT{1-16}:CONT ON
FULP	Set up the system for full page plotting.	Not available (Plotters are not supported.)
FWDI	Start measuring the data from the forward isolation in 2-port calibration.	:SENS:CORR:COLL:ISOL (Measures isolation bi-directionally.)
FWDM	Start measuring the data from the forward match in full 2-port calibration.	:SENS:CORR:COLL:THRU (Measures both transmission and match.)
FWDT	Start measuring the data from the forward transmission in full 2-port calibration.	
[G]		
GATECENT	Specify the center value for the time-domain gate.	:CALC{1-16}:FILT:TIME:CENT
GATEO	Set the time-domain gate On/Off.	:CALC{1-16}:FILT:TIME:STAT
GATESPAN	Specify the span value of the time-domain gate.	:CALC{1-16}:FILT:TIME:SPAN
GATESTAR	Specify the start value of the time-domain gate.	:CALC{1-16}:FILT:TIME:STAR
GATESTOP	Specify the stop value of the time-domain gate.	:CALC{1-16}:FILT:TIME:STOP
GATSMAXI	Set the shape of the time-domain gate to maximum.	:CALC{1-16}:FILT:TIME:SHAP MAX
GATSMINI	Set the shape of the time-domain gate to minimum.	:CALC{1-16}:FILT:TIME:SHAP MIN
GATSNORM	Set the shape of the time-domain gate to normal.	:CALC{1-16}:FILT:TIME:SHAP NORM
GATSWIDE	Set the shape of the time-domain gate to wide.	:CALC{1-16}:FILT:TIME:SHAP WIDE
GOSUB	Perform another sequence from the test sequence.	Not available (Test sequence function not available.)
[H]		
HARMOFF	Set the harmonics measurement mode to Off.	Not available (Harmonics measurement mode not available.)
HARMSEC	Select 2nd harmonics measurement.	
HARMTHIR	Select 3rd harmonics measurement.	
HOLD	Stop the sweep operation (Hold mode)	:INIT{1-16}:CONT OFF
[I]		
IDN?	Read the product information.	*IDN?
IFBIHIGH	Execute the test sequence when the designated GPIO bit is at High.	Not available (Test sequence function not available.)
IFBILOW	Execute the test sequence when the designated GPIO bit is at Low.	Not available (Test sequence function not available.)

Comparing Commands on the 8753ES and E5070B/E5071B
8753ES vs. E5070B/E5071B Command Comparison (8753ES-only commands excluded)

8753ES	Function overview	E5070B/E5071B
IFBW	Specify the IF bandwidth.	:SENS{1-16}:BAND
IFLCEQZE	Execute the test sequence when the loop counter is at zero.	Not available (Test sequence function not available.)
IFLCNEZE	Execute the test sequence when the loop counter is at a value other than zero.	Not available (Test sequence function not available.)
IFLTFAIL	Execute the test sequence when the limit test fails.	Not available (Test sequence function not available.)
IFLTPASS	Execute the test sequence when the limit test passes.	Not available (Test sequence function not available.)
IMAG	Set the display format to Imaginary.	:CALC{1-16}:FORM IMAG
INCRLOOC	Add one to the loop counter reading.	Not available (Test sequence function not available.)
INID	Initialize the floppy disk.	Not available(Able to execute using a mouse)
INIE	Initialize the external disk.	Not available
INPUCALC	Enter data into the calibration coefficient array.	:SENS{1-16}:CORR:COEF You need to specify the calibration type with " :SENS{1-16}:CORR:COEF:METH:xxxx " in E5070B/E5071B before writing the calibration coefficient array.
INPUCALK	Enter data into the calibration kit array.	Not available (No access is allowed to the calibration kit array.)
INPUDATA	Enter data into the corrected data array.	:CALC{1-16}:DATA:SDAT
INPUFORM	Enter data into the formatted array.	:CALC{1-16}:DATA:FDAT
INPULEAS	Enter the learn string.	Not available (Reading/Writing the learn string is not allowed.)
INPUPMCAL1	Enter data into the power meter calibration array for channel 1.	Not available
INPUPMCAL2	Enter data into the power meter calibration array for channel 2.	
INPURAW1	Enter data into raw data array 1 (S11).	Not available (Reading/Writing the raw data array is not allowed.)
INPURAW2	Enter data into raw data array 2 (S21).	
INPURAW3	Enter data into raw data array 3 (S12).	
INPURAW4	Enter data into raw data array 4 (S22).	
INSMEXSA	Select the external source (auto) as the measuring instrument mode.	Not available (Always a standard network analyzer)
INSMEXSM	Select the external source (manual) as the measuring instrument mode.	
INSMNETA	Select the standard network analyzer as the measuring instrument mode.	
INSMTUNR	Select the tuned receiver as the measuring instrument mode.	
INTD	Designate the floppy disk drive as the storage to be manipulated.	Not available (When the file is saved in drive A using the file save command: MMEM:SAVE , it is saved to the floppy disk drive.)
INTE	Specify the brightness of the LCD screen.	Not available (Only On/Off setting for the backlight is allowed.)
INTM	Designate the internal memory as the storage to be manipulated.	Not available (Designated by the file Read/Write command.)
ISOD	Complete the measurement of data from the isolation of full 2-port calibration.	Not available (Data measurement completion command not available.)
ISOL	Start measuring the data from the isolation of full 2-port calibration.	Not available (Data measurement completion command not available.)

Comparing Commands on the 8753ES and E5070B/E5071B
8753ES vs. E5070B/E5071B Command Comparison (8753ES-only commands excluded)

8753ES	Function overview	E5070B/E5071B	
ISOOP	Start measuring the data from the isolation of one-bus 2-port calibration.	:SENS{1-16}:CORR:COLL:ISOL	
[K]			
KEY	Performs the same processing as pressing the designated key on the front panel.	Not available (No command available equivalent to the front panel key manipulation in terms of processing.)	
KITD	Complete the operation for defining calibration kits.	Not available (No command available for ending defining operations.)	
KOR?	Read the information for the previous front panel manipulation.	Not available	
[L]			
LABEFWDM	Give an arbitrary name to the Forward Match calibration class.	Not available (Editing of calibration class labels is not allowed.)	
LABEFWDT	Give an arbitrary name to the Forward Transmission calibration class.		
LABERESI	Give an arbitrary name to the Response & Isolation calibration class.		
LABERESP	Give an arbitrary name to the Response calibration class.		
LABEREVM	Give an arbitrary name to the Reverse Match calibration class.		
LABEREVT	Give an arbitrary name to the Reverse Transmission calibration class.		
LABES11A	Give an arbitrary name to the S11A (OPEN) calibration class.		
LABES11B	Give an arbitrary name to the S11B (SHORT) calibration class.		
LABES11C	Give an arbitrary name to the S11C (LOAD) calibration class.		
LABES22A	Give an arbitrary name to the S22A (OPEN) calibration class.		
LABES22B	Give an arbitrary name to the S22B (SHORT) calibration class.		
LABES22C	Give an arbitrary name to the S22C (LOAD) calibration class.		
LABETRL	Give an arbitrary name to the TRL Line/Match calibration class.		
LABETRLT	Give an arbitrary name to the TRL Thru calibration class.		
LABETRLR	Give an arbitrary name to the TRL Reflection calibration class.		
LABETLFM	Give an arbitrary name to the S11B (SHORT) calibration class.		
LABETLFT	Give an arbitrary name to the S11C (LOAD) calibration class.		
LABETLRM	Give an arbitrary name to the S22B (SHORT) calibration class.		
LABETLRT	Give an arbitrary name to the S22C (LOAD) calibration class.		
LABETRFM	Give an arbitrary name to the S11A (OPEN) calibration class.		
LABETRRM	Give an arbitrary name to the S22A (OPEN) calibration class.		
LABETTFFM	Give an arbitrary name to the Forward match calibration class.		
LABETTFT	Give an arbitrary name to the Forward Transmission calibration class.		
LABETTRM	Give an arbitrary name to the Reverse Match calibration class.		
LABETTRT	Give an arbitrary name to the Reverse Transmission calibration class.		
LABK	Give an arbitrary name to the user-defined calibration kit label.		:SENS{1-16}:CORR:COLL:CKIT:LAB
LABS	Give an arbitrary name to the calibration standard.		:SENS{1-16}:CORR:COLL:CKIT:STAN{1-21}:LAB
LEFL	Set up the system so the object is output through the plotter onto the lower-left 1/4 of a sheet.	Not available (Plotters are not supported.)	
LEFU	Set up the system so the object is output through the plotter onto the upper-left 1/4 of a sheet.		
LIMD	Specify the limit delta value for the limit test.	Not available (:CALC{1-16}:LIM:DATA is used to perform all the limit table setup work.)	

Comparing Commands on the 8753ES and E5070B/E5071B
**8753ES vs. E5070B/E5071B Command Comparison (8753ES-only commands
excluded)**

8753ES	Function overview	E5070B/E5071B
LIMIAMPO	Specify the offset along the Y-axis in the limit range for the limit test.	:CALC{1-16}:LIM:OFFS:AMPL
LIMILINE	Set the limit line display On/Off.	:CALC{1-16}:LIM:DISP
LIMIMAOF	Set the marker value at the offset along the Y-axis in the limit range for the limit test.	:CALC{1-16}:LIM:OFFS:MARK
LIMISTIO	Specify the offset along the X-axis in the limit range for the limit test.	:CALC{1-16}:LIM:OFFS:STIM
LIMITEST	Set the limit test On/Off.	:CALC{1-16}:LIM
LIML	Specify the lowest value of the limit for the limit test.	Not available (:CALC{1-16}:LIM:DATA is used to perform all the limit table setup work.)
LIMM	Specify the center value of the limit for the limit test.	
LIMS	Specify the boundary value of the segment in the limit test.	
LIMTFL	Select a flat line as the limit type in the limit test.	
LIMTSL	Select a sloping line as the limit type in the limit test.	
LIMTSP	Select a single point as the limit type in the limit test.	
LIMU	Specify the highest value of the limit in the limit test.	
LINFREQ	Select linear sweep as the type of sweep.	
LINM	Select the linear magnitude format as the display format.	:CALC{1-16}:FORM MLIN
LINTDATA	Specify the line type for data traces.	Not available (Always a solid line)
LINTMEMO	Specify the line type for memory traces.	
LISFREQ	Select the list frequency sweep as the type of sweep.	:SENS{1-16}:SWE:TYPE SEGM
LISIFBWM	Make the segment-by-segment IFBW setup for the list frequency sweep Valid/Invalid.	Not available (The :SENS{1-16}:SEGM:DATA command takes care of the entire segment setup.)
LISPWM	Make the segment-by-segment power level setup for the list frequency sweep Valid/Invalid.	Not available (The :SENS{1-16}:SEGM:DATA command takes care of the entire segment setup.)
LISTTYPELSTP	Select the stepped list mode to perform the list frequency sweep.	:SENS{1-16}:SWE:GEN STEP(E5070B/E5071B change stepped/swept mode for the linear sweep.)
LISTTYPELSWP	Select the swept list mode to perform the list frequency sweep.	:SENS{1-16}:SWE:GEN ANAL (E5070B/E5071B change stepped/swept mode for the linear sweep. The swept mode also allows the IF bandwidth and power level to be specified segment by segment.)
LISV	Display the measurement results in a list.	Not available (List display function not available.)
LOAD	Call the Instrument State from a file on the disk.	:MMEM:LOAD
LOADSEQ	Call the test sequence from a file on the disk.	:MMEM:LOAD:PROG (Call a macro created with VBA.)
LOAN	If LOAD is defined as offset LOAD, measure LOAD without the offset.	Not available (LOAD is treated as fixed LOAD.)
LOAO	If LOAD is defined as offset LOAD, measure LOAD with the offset.	
LOCONT	Set the LO control On/Off.	Not available (LO control function not available.)
LOFREQ	Specify the LO frequency.	
LOFSTAR	Specify the starting frequency for LO.	
LOFSTOP	Specify the ending frequency for LO.	
LOFSWE	Select the sweep mode for the LO frequency.	
LOGFREQ	Select the log sweep as the type of sweep.	
LOGM	Select the log magnitude format as the display format.	:CALC{1-16}:FORM MLOG
LOOC	Specify the loop counter reading.	Not available (Test sequence function not available.)

Comparing Commands on the 8753ES and E5070B/E5071B
8753ES vs. E5070B/E5071B Command Comparison (8753ES-only commands excluded)

8753ES	Function overview	E5070B/E5071B
LOPOWER	Specify the power level for LO.	Not available (LO control function not available.)
LOPSTAR	Specify the starting power level for LO.	
LOPSTOP	Specify the ending power level for LO.	
LOPSWE	Select the power sweep mode for LO.	
LOWPIMPU	Select the LOWPASS IMPULSE mode for the time-domain transformation.	:CALC{1-16};TRAN:TIME LPAS :CALC{1-16};TRAN:TIME:STIM IMP
LOWPSTEP	Select the LOW PASS STEP mode for the time-domain transformation.	:CALC{1-16};TRAN:TIME LPAS :CALC{1-16};TRAN:TIME:STIM STEP
LRN	Perform Setup/Read of the learn string.	Not available (Setup/Read of the learn string is not allowed.)
[M]		
MANTRIG	Select the manual trigger mode (point by point).	Not available
MARK1	Activate marker 1 and move it to the designated position.	:CALC{1-16};MARK{1-10} (Marker On/Off) and :CALC{1-16};MARK{1-10};X (Marker stimulus value) are combined for execution.
MARK2	Activate marker 2 and move it to the designated position.	
MARK3	Activate marker 3 and move it to the designated position.	
MARK4	Activate marker 4 and move it to the designated position.	
MARK5	Activate marker 5 and move it to the designated position.	
MARKBUCK	Move the active marker to the designated point.	Not available (Specify the stimulus value when moving the marker.)
MARKCENT	Change the sweep center value to the stimulus value at the position of the active marker.	:CALC{1-16};MARK{1-10};SET CENT
MARKCONT	Select the mode in which the marker moves on the trace continuously.	:CALC{1-16};MARK{1-10};DISC OFF
MARKCOUP	Select the mode in which markers are coupled between channels.	:CALC{1-16};MARK:COUP ON (Coupled between traces on the same channel)
MARKCW	Change the CW frequency value to the frequency value at the position of the active marker.	Not available (CW TIME sweep function and power sweep function not available.)
MARKDELA	Specify the electrical length so that the group delay is zero at the position of the active marker.	:CALC{1-16};MARK{1-10};SET DEL
MARKDISC	Select the mode in which the marker moves from one point to another on the trace.	:CALC{1-16};MARK{1-10};DISC ON
MARKFAUV	Move the fixed marker to the position of the designated auxiliary measured value.	Not available (Fixed marker function not available.)
MARKFSTI	Move the fixed marker to the position of the fixed stimulus value.	
MARKFVAL	Move the fixed marker to the position of the designated measured value.	
MARKMAXI	Move the active marker to the position of the maximum value.	:CALC{1-16};MARK{1-10};FUNC:TYPE MAX :CALC{1-16};MARK{1-10};FUNC:EXEC (Both commands must be sent.)
MARKMIDD	Set the center value of the limit in the delta limit test to the measured value at the position of the active marker.	Not available
MARKMINI	Move the active marker to the position of the minimum value.	:CALC{1-16};MARK{1-10};FUNC:TYPE MIN :CALC{1-16};MARK{1-10};FUNC:EXEC (Both commands must be sent.)
MARKOFF	Set all markers and the marker function to Off.	Not available
MARKREF	Change the reference value to the measured value at the position of the active marker.	:CALC{1-16};MARK{1-10};SET RLEV
MARKSPAN	Change the span value of the sweep range to the stimulus value at the position of the active marker.	Not available (The stimulus value is not allowed to be set to the span value of the sweep range.)
MARKSTAR	Change the starting value of the sweep range to the stimulus value at the position of the active marker.	:CALC{1-16};MARK{1-10};SET STAR

Comparing Commands on the 8753ES and E5070B/E5071B
8753ES vs. E5070B/E5071B Command Comparison (8753ES-only commands excluded)

8753ES	Function overview	E5070B/E5071B
MARKSTIM	Set the boundary value of the segment in the limit test to the stimulus value at the position of the active marker.	Not available
MARKSTOP	Change the ending value of the sweep range to the stimulus value at the position of the active marker.	:CALC{1-16}:MARK{1-10}:SET STOP
MARKUNCO	Select the mode in which the markers are not coupled between channels.	:CALC{1-16}:MARK{1-10}:COUP OFF (Turn off the coupling between traces on the channel.)
MARKZERO	Move the fixed marker to the position of the active marker.	Not available (Fixed marker function not available.)
MAXF	In defining calibration kits, specify the maximum frequency value.	:SENS{1-16}:CORR:COLL:CKIT:STAN{1-21}:FMAX
MEASA	Select measurement A and display the traces.	Not available(The E5070B/E5071B does not have absolute value measuring function.)
MEASB	Select measurement B and display the traces.	
MEASR	Select measurement R and display the traces.	
MEASTAT	Set the statistics analysis function On/Off.	:CALC{1-16}:MST
MENUAVG	Display the softkey menu appearing when the [Avg] key is pressed.	Not available (No command is available that displays the softkey menu corresponding to each key.)
MENUCAL	Display the softkey menu appearing when the [Cal] key is pressed.	
MENUCOPY	Display the softkey menu appearing when the [Copy] key is pressed.	
MENUDISP	Display the softkey menu appearing when the [Display] key is pressed.	
MENUFORM	Display the softkey menu appearing when the [Format] key is pressed.	
MENUMARK	Display the softkey menu appearing when the [Marker] key is pressed.	
MENUMEAS	Display the softkey menu appearing when the [Meas] key is pressed.	
MENUMRKF	Display the softkey menu appearing when the [Marker Fctn] key is pressed.	
MENUOFF	Set the softkey menu display to Off.	
MENUON	Set the softkey menu display to On.	
MENUPOWE	Display the softkey menu appearing when the [Power] key is pressed.	
MENURECA	Display the softkey menu appearing when the [Save/Recall] key is pressed.	
MENUSAVE	Display the softkey menu appearing when the [Save/Recall] key is pressed.	
MENUSCAL	Display the softkey menu appearing when the [Scale Ref] key is pressed.	
MENUSEQU	Display the softkey menu appearing when the [Seq] key is pressed.	
MENUSRCH	Display the softkey menu appearing when the [Marker Search] key is pressed.	
MENUSTIM	Display the softkey menu appearing when the [Sweep Setup] key is pressed.	
MENUSWEE	Display the softkey menu appearing when the [Sweep Setup] key is pressed.	
MENUSYST	Display the softkey menu appearing when the [System] key is pressed.	
MINF	In defining calibration kits, specify the minimum frequency value.	:SENS{1-16}:CORR:COLL:CKIT:STAN{1-21}:FMIN
MINMAX	Set the function for recording the maximum and minimum for each segment in the limit test to On/Off.	Not available

C. Comparing Commands on the 8753ES and E5070B/E5071B

Comparing Commands on the 8753ES and E5070B/E5071B
8753ES vs. E5070B/E5071B Command Comparison (8753ES-only commands excluded)

8753ES	Function overview	E5070B/E5071B
MINU	Display the result of subtracting the memory trace from the data trace.	:DISP:WIND{1-16}:TRAC{1-16}:STAT ON :DISP:WIND{1-16}:TRAC{1-16}:MEM OFF :CALC{1-16}:MATH:FUNC SUBT (All three commands must be sent.)
MODII	Start defining the calibration kits.	Not available
MODS	Calculate the new calibration set using the adapter removal function.	Not available
[N]		
NEWSEQ	Create/Revise a test sequence.	Not available (Test sequence function not available.)
NEXP	Go to next page while the list is displayed on the LCD screen.	Not available (List display function not available.)
NOOP	Wait for a while without doing anything.	Not available
NUMG	Perform the sweep operation the specified number of times.	:TRIG:AVER ON
NUMR	Specify the number of power meter readings.	:SOUR{1-16}:POW:PORT{1-4}:CORR:COLL: AVER
[O]		
OFLD	Complete the offset LOAD measurement.	Not available (The LOAD standard is treated as fixed LOAD.)
OFLS	In defining calibration kits, select the offset LOAD as the type of LOAD.	
OFS	Specify the offset value of the electrical delay.	:SENS{1-16}:CORR:COLL:CKIT:STAN{1-21}: DEL
OFSL	Specify the loss offset.	:SENS{1-16}:CORR:COLL:CKIT:STAN{1-21}: LOSS
OFSZ	Specify the offset value of the characteristic impedance.	:SENS{1-16}:CORR:COLL:CKIT:STAN{1-21}: Z0
OMII	Omit the isolation measurement when performing calibration.	Not available (Isolation measurement is treated as an option.)
OPC	When the next command have been completed , set bit 0 of the event status register standby.	*OPC(When all operations on standby have been completed, set bit 0 of the event status register.)
OPEP	Display the list of Instrument State statuses on the LCD screen.	Not available
OUTPACTI	Read the entry area value.	Not available
OUTPAMAX	Read the maximum of the measured values in the segments in the limit test.	Not available
OUTPAMIN	Read the minimum of the measured values in the segments in the limit test.	Not available
OUTPAPER	Read the smoothing aperture value.	:CALC{1-16}:SMO:APER?
OUTPCALC{01-12}	Read the calibration coefficient array.	:SENS{1-16}:CORR:COEF?
OUTPCALK	Read the data about the calibration kit setup.	Not available (Reading/Writing the calibration kit array is not allowed.)
OUTPFARPLPT	Read the information about fails in the ripple test.	:CALC{1-16}:RLIM:REP?
OUTPCHAN	Read the active channel.	:DISP:WIND{1-16}:ACT? (Reading of the active channel) :CALC{1-16}:PAR{1-16}:SEL? (Reading of the active trace)
OUTPDATA	Read the corrected data array.	:CALC{1-16}:DATA:SDAT?
OUTPDATF	Read the corrected data array. (High-speed data transfer command)	:CALC{1-16}:DATA:SDAT? (High-speed data transfer command not available.)
OUTPDATP	Read the trace data at the designated point.	Not available
OUTPDATR	Read the trace data at points within the designated range.	Not available
OUTPERRO	Read error information from the error cue.	:SYST:ERR?

Comparing Commands on the 8753ES and E5070B/E5071B
8753ES vs. E5070B/E5071B Command Comparison (8753ES-only commands excluded)

8753ES	Function overview	E5070B/E5071B
OUTPFAIP	Read the number of failed points and the stimulus value at points in the limit test.	Not available (The number of points can be read by :CALC{1-16}:LIM:REP:POIN? , and the stimulus value by :CALC{1-16}:LIM:REP? , but the measured values cannot be read.)
OUTPFORF	Read the formatted data array. (High-speed data transfer command)	:CALC{1-16}:DATA:FDAT? (High-speed data transfer command not available.)
OUTPFORM	Read the formatted data array.	:CALC{1-16}:DATA:FDAT?
OUTPICAL{01-12}	Read the interpolated calibration coefficient array.	:SENS{1-16}:CORR:COEF?
OUTPIDEN	Read the product information.	*IDN?
OUTPIPMCL{1-2}	Read the interpolated power meter calibration array.	:SOUR{1-16}:POW:PORT{1-2}:CORR:DATA?
OUTPKEY	Read the code of the key you last pressed.	Not available
OUTPLEAS	Read the learn string.	Not available (Reading/Writing a learn string is not allowed.)
OUTPLIM{1-4}	Read the results of the limit test.	:CALC{1-16}:LIM:FAIL? (Read the result of the active trace on the specified channel. The value read from the results is different from that obtained by the 8753ES.)
OUTPLIMF	Read the information on the failed points and the number of failed points in the limit test.	Not available (You can read the number of failed points by using :CALC{1-16}:LIM:REP:POIN? .)
OUTPLIML	Read the results of the limit test for each point.	:CALC{1-16}:LIM:REP:ALL?
OUTPLIMM	Read the results of the limit test at the position of the active marker.	Not available
OUTPMARK	Read the value of the active marker.	:CALC{1-16}:MARK{1-10}:X? (Stimulus value) :CALC{1-16}:MARK{1-10}:Y? (Response value) can be used to read the marker value, but you must designate the channel and marker in the command.
OUTPMEMF	Read the data about the memory trace. (High-speed data transfer command)	:CALC{1-16}:DATA:SMEM? (High-speed data transfer command not available.)
OUTPMEMO	Read the data about the memory trace.	:CALC{1-16}:DATA:SMEM?
OUTPMSTA	Read the results of the statistics analysis.	:CALC{1-16}:MST:DATA?
OUTPMWID	Read the results of the bandwidth search (bandwidth, center value, and Q value).	:CALC{1-16}:MARK{1-10}:BWID:DATA? (The array read contains data on the loss value.)
OUTPMWIL	Read the results of the bandwidth search (bandwidth, center value, Q value, and loss value).	:CALC{1-16}:MARK{1-10}:BWID:DATA?
OUTPOPTS	Read the information about the installed options.	*OPT?
OUTPLOT	Outputs the LCD screen to the GPIB port in HP-GL format.	Not available (The LCD screen is not allowed as output from the GPIB.)
OUTPPMCAL{1-2}	Read the power meter calibration array.	Not available
OUTPPRE{1-4}	Read the pre-raw data (command for Take4 mode)	Not available (Reading/Writing pre-raw data is not allowed.)
OUTPPRIN	Outputs the LCD screen to the printer in PCL raster dump format.	:HCOP
OUTPPRINALL	Prints out all lists when lists are displayed.	Not available (List display function not available.)
OUTPRAF{1-4}	Read the raw data array (High-speed data transfer command).	Not available (Reading/Writing raw data array is not allowed.)
OUTPRAW{1-4}	Read the raw data array.	
OUTPRFFR	Read the frequency of the external RF signal source.	Not available (External RF signal source cannot be used.)

Comparing Commands on the 8753ES and E5070B/E5071B
8753ES vs. E5070B/E5071B Command Comparison (8753ES-only commands excluded)

8753ES	Function overview	E5070B/E5071B
OUTPRPLBNDALL	Read the magnitudes of ripples in the ripple test in all valid bands.	:CALC{1-16}:RLIM:REP?
OUTPRPLBNDPF	Read the Pass/Fail of the ripple test in the designated band.	
OUTPRPLBNDVAL	Read the results of the ripple test and magnitudes of ripples in the designated band.	
OUTPSEGAF	Read the number of segments and segment-by-segment test results in the limit test.	Not available (Segment-by-segment test results are not allowed to be read.)
OUTPSEGAM	Read the maximum value/minimum value in all segments in the limit test.	
OUTPSEGF	Display the results in the designated segment in the limit test.	
OUTPSEGM	Display the maximum value/minimum value in the designated segment.	
OUTPSEQ{1-6}	Read the contents of the test sequence.	Not available (Test sequence function not available.)
OUTPSERN	Read the product serial number.	Included in the value read from *IDN?
OUTPSTAT	Read the value of the status byte register.	*STB?
OUTPTITL	Read the title on the LCD screen.	:DISP:WIND{1-16}:TITL:DATA?
[P]		
PDATA	Determine whether or not to output the data trace when plotting.	Not available (Plotters are not supported.)
PGRAT	Determine whether or not to output graticule lines when plotting.	
PMEM	Determine whether or not to output the memory trace when plotting.	
PMKR	Determine whether or not to output markers when plotting.	
PSOFT	Determine whether or not to output softkeys when plotting.	
PTEXT	Determine whether or not to output the text when plotting.	
PARAIN{0-4}	Specify the bit number of the GPIO input port to be used for branching in the test sequence.	Not available (Test sequence function not available.)
PARAOUT{0-255}	Specify the output from the GPIO output port for all bits at the same time.	Not available (GPIO output is not supported.)
PARALGPIO	Set up the parallel port for GPIO use.	Not available (Parallel port is intended for the printer.)
PARALCPY	Set up the parallel port for printer use.	
PAUS	Insert a pause into the test sequence.	Not available (Test sequence function not available.)
PCB{0-30}	Specify the GPIB address where control is returned.	Not available (Pass control function not available)
PCOLDATA{1-4}	Specify the color for the data trace for printing.	Not available (Color setup is allowed only for turning highlighting of the entire screen On/Off.)
PCOLGRAT	Specify the color for graticule lines for printing.	
PCOLMEMO{1-4}	Specify the color for the memory trace for printing.	
PCOLREFL	Specify the color for the reference line for printing.	
PCOLTEXT	Specify the color for text for printing.	
PCOLWARN	Specify the color for warning messages for printing.	
PENNDATA{0-10}	Specify the pen number for the data trace for plotting.	Not available (Plotters are not supported.)
PENNGRAT{0-10}	Specify the pen number for the graticule lines for plotting.	
PENMARK{0-10}	Specify the pen number for the marker for plotting.	
PENMEMO{0-10}	Specify the pen number for the memory trace for plotting.	
PENNTTEXT{0-10}	Specify the pen number for text for plotting.	
PHAO{0-360}	Specify the phase offset.	:CALC{1-16}:CORR:OFFS:PHAS

Comparing Commands on the 8753ES and E5070B/E5071B
8753ES vs. E5070B/E5071B Command Comparison (8753ES-only commands excluded)

8753ES	Function overview	E5070B/E5071B
PHAS	Select the phase format as the display format.	:CALC{1-16}:FORM PHAS
PLOSSLOW	Set the pen speed for plotting to Slow.	Not available (Plotters are not supported.)
PLOFAST	Set the pen speed for plotting to Fast.	
PLOT	Start plotting.	
PLTHNSHK	Select the handshake mode for the plotter.	
PLTPRTDISK	Select the disk as the plotter port.	
PLTPRTHPIB	Select GPIO as the plotter port.	
PLTPRTPARA	Select the parallel port as the plotter port.	
PLTPRTSERI	Select the serial port as the plotter port.	
PLTTRAUTF	Set the plotter auto feed On/Off.	
PLTTRBAUD	Specify the baud rate for the serial port when using the plotter.	
PLTTRFORF	Send a form feed to the plotter.	
PLTTYHPGL	Select a PCL5-compatible printer as the plotter type.	
PLTTYPLTR	Set up the plotter type in the plotter.	
PMTRTTIT	Select the GPIB reading from the power meter as the title.	Not available
POIN	Specify the number of points.	:SENS{1-16}:SWE:POIN (Cannot be used for editing segments.)
POLA	Select the polar format as the display format.	:CALC{1-16}:FORM PLIN :CALC{1-16}:FORM PLOG :CALC{1-16}:FORM POL (you have to select the marker value reading format also.)
POLMLIN	Select LIN as the marker value reading format when using the polar format.	Not available (Selected at the same time the polar format is selected as the data format.)
POLMLOG	Select Log as the marker value reading format when using the polar format.	Not available (Selected at the same time the polar format is selected as the data format.)
POLMRI	Select Re/Im as the marker value reading format when using the polar format.	Not available (Selected at the same time the polar format is selected as the data format)
PORE	Set the port extension On/Off.	:SENS{1-16}:CORR:EXT
PORT1	Specify the port extension correction value for port 1.	:SENS{1-16}:CORR:EXT:PORT
PORT2	Specify the port extension correction value for port 2.	
PORTA	Specify the port extension correction value for input A.	Not available (Port extension correction for input is not allowed.)
PORTB	Specify the port extension correction value for input B.	
PORTP	Select Couple/Uncouple between ports for the power level.	:SOUR{1-16}:POW:PORT:COUP
POWE	Specify the power level.	:SOUR{1-16}:POW
POWLFREQ	Create the power loss list for power meter calibration.	Not available
POWLLIST		
POWLLOSS		
POWM	Specify the type of power meter.	
POWR{00-07}	Specify the power range of the signal source.	Specify the power range by using :SOUR{1-16}:POW:ATT to designate the attenuator.
POWS	Select the power level sweep as the type of sweep.	:OUTP
POWT	Set the signal source output On/Off.	Not available (Always On)
PRAN{0-7}	Specify the power range of the signal source.	Specify the power range by using :SOUR{1-16}:POW:ATT to designate the attenuator.
PREP	Go back to the previous page while the list is displayed on the LCD screen.	Not available (List display function not available.)

Comparing Commands on the 8753ES and E5070B/E5071B
8753ES vs. E5070B/E5071B Command Comparison (8753ES-only commands excluded)

8753ES	Function overview	E5070B/E5071B
PRES	Reset	:SYST:PRES *RST(Stop sweeping.)
PRIC	Select color printing.	Not available (Printer setup executed by using the front panel.)
PRIS	Select black-and-white printing.	
PRINALL	Start printing the LCD screen.	:HCOP
PRINSEQ	Start printing the test sequence.	Not available (Test sequence function not available.)
PRINTALL	Start printing the list.	Not available (List display function not available.)
PRNHNSHK	Select the handshake mode for the printer.	Not available
PRNPRTHPIB	Select GPIB as the printer port.	Not available (GPIB printers are not supported.)
PRNPRTPARA	Select the parallel port as the printer port.	Not available
PRNPRTSERI	Select the serial port as the printer port.	Not available
PRNTRAUTF	Set the printer auto feed On/Off.	Not available
PRNTRBAUD	Specify the baud rate of the serial port when using the printer.	Not available
PRNTRFORF	Send a form feed to the printer.	Not available
PRNTYP540	Select the HP DeskJet 540/850C as the printer.	Not available (Printer setup executed by using the front panel.)
PRNTYPDJ	Select the HP DeskJet as the printer.	
PRNTYPEP	Select the Epson ESC/P2 as the printer.	
PRNTYPLJ	Select the HP LaserJet as the printer.	
PRNTYPPJ	Select the HP PaintJet as the printer.	
PRNTYPTJ	Select the HP ThinkJet as the printer.	
PTOS	Stop the designated sequence.	:PROG:STA STOP(Stop the VBA program.)
PURG	Delete the file.	:MMEM:DEL
PWMCEACS	Calibrate the power meter at every sweep.	Not availabl
PWMCOFF	Turn Off the power meter calibration.	:SOUR{1-16}:POW:PORT{1-4}:CORR OFF
PWMCONES	Calibrate the power meter in one sweep operation.	:SOUR{1-16}:POW:PORT{1-4}:CORR ON
PWRLOSS	Determine whether or not to use the power loss list for calibrating the power meter.	:SOUR{1-16}:POW:PORT{1-4}:CORR:TABL:LOSS
PWRMCAL	Cause the softkey for the power meter calibration menu to appear and specify the power level for calibration.	Not availabl
PWRR	Set the signal source power range changeover to Manual/Auto.	Not available (Always on Manual)
[Q]		
Q	Select the test sequence.	:PROG:STA STOP(Select the VBA program.)
[R]		
RAID	Calculate the calibration coefficients for the response & isolation calibration.	:SENS{1-16}:CORR:COLL:SAVE
RAIISOL	Execute the isolation measurement for the response & isolation calibration.	:SENS{1-16}:CORR:COLL:ISOL
RAIRESP	Start measuring the response for the response and isolation calibration.	:SENS{1-16}:CORR:COLL:THRU
RAWOFFS	Set the offset of the sampler and attenuator On/Off. (Take4 mode)	Not available
READDATE	Read the date from the internal clock.	:SYST:DATE?
READTIME	Read the time from the internal clock.	:SYST:TIME?
REAL	Select the real format as the display format.	:CALC{1-16}:FORM REAL
RECA	Recall the Instrument State status from the internal register.	:MMEM:LOAD
RECAREG		

Comparing Commands on the 8753ES and E5070B/E5071B
**8753ES vs. E5070B/E5071B Command Comparison (8753ES-only commands
excluded)**

8753ES	Function overview	E5070B/E5071B
RECO	Recall the color settings for the LCD screen.	Not available (Color setup is allowed only for turning highlighting of the entire screen On/Off.)
REFD	Complete the reflection data measurement for the 2-port calibration.	Not available (You do not need to send any completion command.)
REFL	Start measuring the reflection data for the 2-port calibration.	Not available (You do not need to send any start command.)
REFOP	Start measuring the data for reflection in the one-bus 2-port calibration (forward enhanced response calibration).	:SENS{1-16};CORR:COLL:OPEN or :SENS{1-16};CORR:COLL:SHOR
REFP	Specify the position of the reference line.	:DISP:WIND{1-16};TRAC{1-16};Y:RLEV
REFV	Specify the value for the reference line.	:DISP:WIND{1-16};TRAC{1-16};Y:RPOS
REFT	Read the title of the file from the disk.	Not available
REIC	Specify the power reference value for the receiver calibration.	Not available
RERCDONE	Complete the data measurement for the reverse enhanced response calibration and calculate the calibration coefficients on the basis of the data obtained.	:SENS{1-16};CORR:COLL:SAVE
RESC	Resume the measurement of the calibration data interrupted immediately before.	Not available (Calibration resumption function not available.)
RESD	Return the list display screen for the measurement results to the normal graph screen.	Not available (List display function not available.)
RESPDONE	Calculate the calibration coefficients for the response calibration.	:SENS{1-16};CORR:COLL:SAVE
REST	Interrupt the sweep and start sweeping over again.	Not available
REVI	Start measuring the data for reverse isolation of the full 2-port calibration.	:SENS{1-16};CORR:COLL:ISOL
REVM	Start measuring the data for reverse match of the full 2-port calibration.	Not available (You do not need to send any start command.)
REVT	Start measuring the data for reverse transmission of the full 2-port calibration.	
RFGTLO	Set the signal source frequency to a value greater than LO.	Not available (Mixer measurement function not available.)
RFLTLO	Set the signal source frequency to a value smaller than LO.	
RFLP	Select the S11 measurement.	:CALC{1-16};PAR{1-16};DEF S11
RIGL	Set up the system so the object is output through the plotter onto the lower-right 1/4 of a sheet.	Not available (Entire screen is always output.)
RIGU	Set up the system so the object is output through the plotter onto the upper-right 1/4 of a sheet.	
RLIMLINE	Set the ripple limit line display On/Off.	:CALC{1-16};RLIM:DISP:LINE
RLIMM	Specify the upper limit value for the ripple test.	:CALC{1-16};RLIM:DATA
RLIMSTP	Specify the frequency band stop value for the ripple test.	
RLIMSTR	Specify the frequency band start value for the ripple test.	
RLIMTEST	Set the ripple test On/Off.	:CALC{1-16};RLIM
RLIMVALABS	Set the ripple value display (absolute) On.	:CALC{1-16};RLIM:DISP:VAL
RLIMVALMAR	Set the ripple value display (margin) On.	
RLIMVALOFF	Set the ripple value display Off.	
RSCO	Return the color setup to the initial state.	Not available (Color setup is allowed only for turning highlighting of the entire screen On/Off.)
RST	Reset	:SYST:PRES *RST(Stop sweeping)
[S]		
S11	Select the S11 measurement.	:CALC{1-16};PAR{1-16};DEF S11

Comparing Commands on the 8753ES and E5070B/E5071B
8753ES vs. E5070B/E5071B Command Comparison (8753ES-only commands excluded)

8753ES	Function overview	E5070B/E5071B
S12	Select the S12 measurement.	:CALC{1-16};PAR{1-16};DEF S21
S21	Select the S21 measurement	:CALC{1-16};PAR{1-16};DEF S12
S22	Select the S22 measurement	:CALC{1-16};PAR{1-16};DEF S22
SADD	Add segments while editing tables.	Not available (Each table is edited using one command; there is no corresponding command.)
SAMC	Set the sampler correction On/Off.	:SYST:CORR
SAV1	Complete the data measurement for 1-port calibration and calculate the calibration coefficients on the basis of the data obtained.	:SENS{1-16};CORR:COLL:SAVE
SAV2	Complete the data measurement for 2-port calibration and calculate the calibration coefficients on the basis of the data obtained.	:SENS{1-16};CORR:COLL:SAVE
SAVC	Finish writing from the external data to the calibration coefficient array.	:SENS{1-16};CORR:COEF:SAVE
SAVE	Save the Instrument State status into the internal register.	:MMEM:STOR
SAVECSV	Save the measurement data in CSV format.	:MMEM:STOR:FDAT
SAVEJPG	Save the LCD screen image as a JPEG format file.	:MMEM:STOR:IMAG (Stored in Windows® Bitmap format/PNG format.)
SAVERC	Complete the data measurement of the forward enhanced response calibration and calculate the calibration coefficients on the basis of the data obtained.	:SENS{1-16};CORR:COLL:SAVE
SAVEREG	Save the Instrument State status in the internal register.	:MMEM:STOR
SAVEUSEK	Save the selected calibration kit as a user calibration kit.	Not available
SAVRERC	Complete the data measurement for the reverse enhanced response calibration and calculate the calibration coefficients from the data saved.	:SENS{1-16};CORR:COLL:SAVE
SAVT	Complete the data measurement for the TRL*/LRM* 2-port calibration and calculate the calibration coefficients on the basis of the data obtained.	:SENS{1-16};CORR:COLL:SAVE
SAVUASCI	Select ASCII as the format for saving data.	Not available (Stored in binary format)
SAVUBINA	Select binary as the format for saving data.	
SCAL	Specify the Y-axis scale for displaying traces.	:DISP:WIND{1-16};TRAC{1-16};Y:PDIV
SCAPFULL	Select FULL as the plotting scale.	Not available (Plotters are not supported.)
SCAPGRAT	Select GRAT as the plotting scale.	
SDEL	Delete segments while editing tables.	Not available (Each table is edited using one command; there is no corresponding command.)
SDON	Complete the editing of segments while editing tables.	Not available (Each table is edited using one command; there is no corresponding command.)
SEAL	Search for the left target value.	:CALC{1-16};MARK{1-10};FUNC:TYPE LTAR :CALC{1-16};MARK{1-10};FUNC:EXEC (Both commands must be sent.)
SEAMAX	Search for the maximum value.	:CALC{1-16};MARK{1-10};FUNC:TYPE MAX :CALC{1-16};MARK{1-10};FUNC:EXEC (Both commands must be sent.)
SEAMIN	Search for the minimum value.	:CALC{1-16};MARK{1-10};FUNC:TYPE MIN :CALC{1-16};MARK{1-10};FUNC:EXEC (Both commands must be sent.)
SEAOFF	Set the marker search function Off.	Not available
SEAR	Search for the right target value.	:CALC{1-16};MARK{1-10};FUNC:TYPE RTAR :CALC{1-16};MARK{1-10};FUNC:EXEC (Both commands must be sent.)
SEATARG	Specify the target value.	:CALC{1-16};MARK{1-10};FUNC:TARG

Comparing Commands on the 8753ES and E5070B/E5071B
**8753ES vs. E5070B/E5071B Command Comparison (8753ES-only commands
excluded)**

8753ES	Function overview	E5070B/E5071B
SEDI	Select the number of the segment to be edited while editing tables.	Not available (Each table is edited using one command; there is no corresponding command.)
SEGIFBW	Specify the IFBW of segments while editing tables.	Not available (Each table is edited using one command; there is no corresponding command.)
SEGPPOWER	Specify the POWER segment while editing tables.	Not available (Each table is edited using one command; there is no corresponding command.)
SELMAXPT	Specify the point at the upper limit of the range for reading.	Not available (Limiting the range for reading is not allowed.)
SELMINPT	Specify the point at the lower limit of the range for reading.	
SELPT	Specify the point for reading.	
SELSEG	Select the segment for reading.	
SELBND	Select the band for reading.	
SELL	Select REDIVISION of a learn string.	
SEQ	Select the test sequence.	Not available
SEQWAIT	Specify the waiting time in the test sequence.	(Test sequence function not available.)
SETBIT	Set the designated bit in the GPIO port to 1.	Not available (GPIO is not supported.)
SETDATE	Set the date of the internal clock.	:SYST:DATE
SETF	Measure low pass frequencies.	Not available (Time-domain transformation function not available.)
SETRTHRU	Select THRU as the reference for the TRL*/LRM* 2-port calibration.	:SENS{1-16}:CORR:COLL:CKIT:TRL:RPL THRU
SETRREFL	Select REFLECT as the reference for the TRL*/LRM* 2-port calibration.	:SENS{1-16}:CORR:COLL:CKIT:TRL:RPL REFL
SETTIME	Set the time of the internal clock.	:SYST:TIME
SETZ	Specify the characteristic impedance of the measurement system.	:CALC{1-16}:FSIM:SEND:ZCON:PORT{1-4}: Z0 (Allowed on the fixture simulator)
SHOM	Specify the softkey display in the test sequence.	Not available (Test sequence function not available.)
SING	Perform one sweep operation. (Single mode)	Not available
SLID	Finish measuring a sliding load.	Not available (The LOAD standard is treated as fixed LOAD.)
SLIL	In defining calibration kits, select sliding LOAD as the type of LOAD.	
SLIS	Make measurements after sliding the sliding LOAD.	
SLOPE	Specify the power slope value.	:SOUR{1-16}:POW:SLOP
SLOPO	Set the power slope On/Off.	:SOUR{1-16}:POW:SLOP:STAT
SM8	Set the spur avoidance function On/Off (Take4 mode).	Not available (not in Take4 mode)
SMIC	Select the Smith chart format as the display format.	:CALC{1-16}:FORM SLIN :CALC{1-16}:FORM SLOG :CALC{1-16}:FORM SCOM :CALC{1-16}:FORM SMI :CALC{1-16}:FORM SADM (Designate any one of the above commands, and select the marker value read format at the same time.Åj

Comparing Commands on the 8753ES and E5070B/E5071B
8753ES vs. E5070B/E5071B Command Comparison (8753ES-only commands excluded)

8753ES	Function overview	E5070B/E5071B
SMIMGB	Select G+jB as the marker value read format when using the Smith chart format.	Not available (Selected at the same time the Smith chart format is selected as the data format)
SMIMLIN	Select LIN as the marker value read format when using the Smith chart format.	
SMIMLOG	Select LOG as the marker value read format when using the Smith chart format.	
SMIMRI	Select Re/Im as the marker value read format when using the Smith chart format.	
SMIMRX	Select R+jX as the marker value read format when using the Smith chart format.	
SMOOPER	Specify the smoothing aperture.	:CALC{1-16}:SMO:APER
SMOOO	Set the smoothing On/Off.	:CALC{1-16}:SMO
SOFR	Display the firmware version on the screen.	Included in the value read from *IDN?
SOFT{1-8}	Perform the same processing as pressing the designated softkey.	Not available
SOUP	Set the signal source output On/Off.	Not available (Always On)
SPAN	Specify the span value of the sweep range.	:SENS{1-16}:FREQ:SPAN (Cannot be used for editing segments.) :SOUR{1-16}:POW:SPAN
SPECFWDM	In defining calibration kits, specify the standard for forward match.	:SENS{1-16}:CORR:COLL:CKIT:ORD:THRU (Definition of the Thru calibration class) Registering the Thru standard as the calibration class is equivalent to registering one standard in all calibration classes necessary for the thru measurement of full 2-port calibration on the 8753ES.
SPECFWDT	In defining calibration kits, specify the standard for forward transmission.	
SPECRESP	In defining calibration kits, specify the standard for response.	Not available (In the response measurement, the standards defined in the calibration classes of OPEN, SHORT, LOAD, and THRU are used. Therefore, a calibration class for response does not exist.)
SPECRESI	In defining calibration kits, specify the standard for response (response & isolation).	
SPECREVM	In defining calibration kits, designate a standard for reverse match.	:SENS{1-16}:CORR:COLL:CKIT:ORD:THRU (Definition of the Thru calibration class) Registering the Thru standard as the calibration class is equivalent to registering one standard in all calibration classes necessary for the thru measurement of full 2-port calibration on the 8753ES.
SPECREVT	In defining calibration kits, designate a standard for reverse transmission.	
SPECS11A	In defining calibration kits, designate a standard for S11A.	:SENS{1-16}:CORR:COLL:CKIT:ORD:OPEN (Designate a port by using a parameter.)
SPECS11B	In defining calibration kits, designate a standard for S11B.	:SENS{1-16}:CORR:COLL:CKIT:ORD:SHOR (Designate a port by using a parameter.)
SPECS11C	In defining calibration kits, designate a standard for S11C.	:SENS{1-16}:CORR:COLL:CKIT:ORD:LOAD (Designate a port by using a parameter.)
SPECS22A	In defining calibration kits, designate a standard for S22A.	:SENS{1-16}:CORR:COLL:CKIT:ORD:OPEN (Designate a port by using a parameter.)
SPECS22B	In defining calibration kits, designate a standard for S22B.	:SENS{1-16}:CORR:COLL:CKIT:ORD:SHOR (Designate a port by using a parameter.)
SPECS22C	In defining calibration kits, designate a standard for S22C.	:SENS{1-16}:CORR:COLL:CKIT:ORD:LOAD (Designate a port by using a parameter.)
SPECTRLL	In defining calibration kits, designate a standard for TRL Line/Match.	:SENS{1-16}:CORR:COLL:CKIT:ORD:TRLL
SPECTRLT	In defining calibration kits, designate a standard for TRL Thru.	:SENS{1-16}:CORR:COLL:CKIT:ORD:TRLT
SPECTRLR	In defining calibration kits, designate a standard for TRL Reflection.	:SENS{1-16}:CORR:COLL:CKIT:ORD:TRLR

Comparing Commands on the 8753ES and E5070B/E5071B
8753ES vs. E5070B/E5071B Command Comparison (8753ES-only commands excluded)

8753ES	Function overview	E5070B/E5071B
SPECTRFM	In defining calibration kits, designate a standard for S11A.	:SENS{1-16}:CORR:COLL:CKIT:ORD:OPEN (Designate a port by using a parameter.)
SPECTRRM	In defining calibration kits, designate a standard for S22A.	
SPECTLFM	In defining calibration kits, designate a standard for S11B.	:SENS{1-16}:CORR:COLL:CKIT:ORD:SHOR (Designate a port by using a parameter.)
SPECTLFT	In defining calibration kits, designate a standard for S11C.	:SENS{1-16}:CORR:COLL:CKIT:ORD:LOAD (Designate a port by using a parameter.)
SPECTLRM	In defining calibration kits, designate a standard for S22B.	:SENS{1-16}:CORR:COLL:CKIT:ORD:SHOR (Designate a port by using a parameter.)
SPECTLRT	In defining calibration kits, designate a standard for S22C.	:SENS{1-16}:CORR:COLL:CKIT:ORD:LOAD (Designate a port by using a parameter.)
SPECTTFM	In defining calibration kits, designate a standard for forward match.	:SENS{1-16}:CORR:COLL:CKIT:ORD:THRU (Definition of the Thru calibration class) Registering the Thru standard as the calibration class is equivalent to registering one standard in all calibration classes necessary for the thru measurement of full 2-port calibration on the 8753ES.
SPECTTFT	In defining calibration kits, designate a standard for forward transmission.	
SPECTTRM	In defining calibration kits, designate a standard for reverse match.	
SPECTTRT	In defining calibration kits, designate a standard for reverse transmission.	
SPEG	Cause the softkey in the gate setup menu to appear.	Not available
SPLD	Set the split display On/Off.	:DISP:SPL (Setting up the window array for a channel) and :DISP:WIND{1-16}:SPL (Setting up the array of trace graphs) are combined to perform the equivalent.
SPLID1	Select one-screen display.	
SPLID2	Select two-screen display.	
SPLID4	Select four-screen display.	
SRE	Specify the value of the service request valid register.	*SRE
SSEG	Use only the designated segment for the list frequency sweep.	Not available (All segments are always used.)
STANA	Execute measurement of the standard displayed in the first softkey from the top.	:SENS{1-16}:CORR:COLL:SUBC{1-8}
STANB	Execute measurement of the standard displayed in the second softkey from the top.	
STANC	Execute measurement of the standard displayed in the third softkey from the top.	
STAND	Execute measurement of the standard displayed in the fourth softkey from the top.	
STANE	Execute measurement of the standard displayed in the fifth softkey from the top.	
STANF	Execute measurement of the standard displayed in the sixth softkey from the top.	
STANG	Execute measurement of the standard displayed in the seventh softkey from the top.	
STAR	Specify the start value of the sweep range.	:SENS{1-16}:FREQ:STAR (Cannot be used for editing segments.) :SOUR{1-16}:POW:STAR
STB?	Read the value of the status byte register.	*STB?
STDD	In defining calibration kits, complete the defining job for each standard.	Not available (Takes effect automatically upon sending the setup command.)
STDTARBI	Select Arbitrary Impedance as the type of standard being defined.	:SENS{1-16}:CORR:COLL:CKIT:STAN{1-21}: TYPE ARBI
STDTDELA	Select Delay/Thru as the type of standard being defined.	:SENS{1-16}:CORR:COLL:CKIT:STAN{1-21}: TYPE THRU
STDTLOAD	Select LOAD as the type of standard being defined.	:SENS{1-16}:CORR:COLL:CKIT:STAN{1-21}: TYPE LOAD
STDTOPEN	Select OPEN as the type of standard being defined.	:SENS{1-16}:CORR:COLL:CKIT:STAN{1-21}: TYPE OPEN

Comparing Commands on the 8753ES and E5070B/E5071B
8753ES vs. E5070B/E5071B Command Comparison (8753ES-only commands excluded)

8753ES	Function overview	E5070B/E5071B
STDTSHOR	Select SHORT as the type of standard being defined.	:SENS{1-16}:CORR:COLL:CKIT:STAN{1-21}: TYPE SHOR
STOP	Specify the stop value of the sweep range.	:SENS{1-16}:FREQ:STOP (Cannot be used for editing segments.) :SOUR{1-16}:POW:STOP
STOR	Save the Instrument State status to the file.	:MMEM:STOR
STORSEQ	Save the test sequence to the file.	Not available (Test sequence function not available.)
STPSIZE	Specify the sweep step values between points in the segment.	Not available
SVCO	Save the color setup for the LCD screen.	Not available (No function available that saves the setup for colors only.)
SWEA	Automatically sets the sweep time to the shortest possible.	:SENS{1-16}:SWE:TIME:AUTO ON
SWET	Specify the sweep time.	:SENS{1-16}:SWE:TIME
SWPSTART	Initialize the sweep (in connection with Take4).	Not available (Take4 mode not available.)
SWR	Select the SWR format as the display format.	:CALC{1-16}:FORM SWR
[T]		
TAKCS	Start the sweep to acquire the data for the power meter calibration.	:SOUR{1-16}:POW:PORT{1-4}:CORR:COLL
TAKRS	Start the sweep to acquire the data for the receiver calibration.	:SENS{1-16}:CORR:REC{1-4}:COLL:ACQ
TAKE4	Set the system to the Take4 mode.	Not available (Take4 mode not available.)
TALKLIST	Select the talker/listener mode.	Not available (Can be set up from the front panel.)
TERI	Specify the terminal impedance when defining standards.	:SENS{1-16}:CORR:COLL:CKIT:STAN{1-21}: ARB
TESS?	Check to see if the test set is connected.	Not available (Test set cannot be used.)
TIMDTRAN	Set the time-domain transformation On/Off.	:CALC{1-16}:TRAN:TIME:STAT
TIMESTAM	Set the output time stamp from the printer/plotter On/Off.	Not available (Printed image include the timestamp because LCD always display it).
TINT	Specify the hue of the display color for the selected item.	Not available (Color setup is allowed only for turning highlighting of the entire screen On/Off.)
TITF	Assign a file name to the file for saving.	Not available (Assigned when saved)
TITL	Assign a title to the LCD screen.	:DISP:WIND{1-16}:TITL:DATA
TITP	Assign a file name to the file that receives plot output.	Not available (Plot output to a file is not allowed.)
TITR	Assign a name to the register for Save/Recall.	Not available (Register for Save/Recall not available.)
TITREG	Assign a name to the register for Save/Recall.	
TITSEQ	Name the test sequence.	Not available (Test sequence function not available.)
TITSQ	Display the softkey for naming the test sequence.	
TITMEM	Send the title to the memory trace.	Not available
TITTPERI	Send the title to the GPIBaddresses of the peripherals.	Not available
TITTPMTR	Send the title to the GPIBaddress of the power meter.	Not available
TITTPRIN	Send the title to the GPIB address of the printer.	Not available
TRACK	Set the search tracking function On/Off.	:CALC{1-16}:MARK{1-10}:FUNC:TRAC
TRAD	Complete measuring the data to be transmitted on full 2-port calibration or enhanced response calibration.	Not available
TRAN	Start measuring the data to be transmitted on full 2-port calibration or enhanced response calibration.	Not available
TRAOP	Start measuring the data to be transmitted on the one-bus 2-port calibration.	:SENS{1-16}:CORR:COLL:THRU
TRAP	Select the S21 measurement.	:CALC{1-16}:PAR{1-16}:DEF S21
TRLL1	In measuring the data on TRL*/LRM* 2-port calibration, measure the data on Line/Match of port 1.	:SENS{1-16}:CORR:COLL:TRLL

Comparing Commands on the 8753ES and E5070B/E5071B
8753ES vs. E5070B/E5071B Command Comparison (8753ES-only commands excluded)

8753ES	Function overview	E5070B/E5071B
TRLL2	In measuring the data on TRL*/LRM* 2-port calibration, measure the data on Line/Match of port 2.	:SENS{1-16};CORR:COLL:TRLL
TRLR1	In measuring the data on TRL*/LRM* 2-port calibration, measure the data on S11 reflection.	:SENS{1-16};CORR:COLL:TRLR
TRLR2	In measuring the data on TRL*/LRM* 2-port calibration, measure the data on S22 reflection.	:SENS{1-16};CORR:COLL:TRLR
TRLT	In measuring the data on TRL*/LRM* 2-port calibration, measure the data on THRU.	:SENS{1-16};CORR:COLL:TRLT
TSSWI	Specify the number of sweep operations in switch changeover in the test set.	Not available (Always continuous)
TST?	Perform the self-test and read the results of the test.	Not available
TSTIOFWD	Specify the bit in the test set in which the forward attenuator is set up.	Not available
TSTIOREV	Specify the bit in the test set in which the reverse attenuator is set up.	
TSTP	Select the port to be used when S-parameters are not measured.	Not available (Only S-parameters can be selected.)
TTLHPULS	Set up the system so that the pulse from Low to High can be output to TTL when sweep operations are finished.	Not available
TTLLPULS	Set up the system so that the pulse from High to Low can be output to TTL when sweep operations are finished.	
TTLOH	Always set TTL output to High.	
TTLOL	Always set TTL output to Low.	
[U]		
UCONV	Select the Up conversion in the mixer measurement.	Not available (Mixer measurement function not available.)
UP	Perform the same processing as pressing the [↑]key.	Not available
USEPASC	Select the pass control mode.	Not available (Cannot be set in pass control mode.)
USESENSA	Select A as the sensor for the power meter.	Not available
USESENSB	Select B as the sensor for the power meter.	
[V]		
VELOFACT	Specify the velocity factor of the transmission line.	:SENS{1-16};CORR:RVEL:COAX
VIEMOFF	Display the mixer measurement setup on the LCD screen.	Not available (Mixer measurement function not available.)
VIEMON	Display the traces of the mixer measurement on the LCD screen.	
VOFF	Use the LO frequency for the offset mode.	
[W]		
WAIT	Wait for the sweep operation to end.	Not available
WAVD	Select waveguide as the type of electrical delay and specify the cutoff frequency.	:CALC{1-16};CORR:EDEL:MED WAV :CALC{1-16};CORR:EDEL:WGC
WAVE	Select waveguide as the offset setting in defining standards.	:SENS{1-16};CORR:COLL:CKIT:STAN{1-21}; CHAR WAV
WIDT	Set the bandwidth search function On/Off.	:CALC{1-16};MARK:BWID
WIDV	Specify the parameters for the bandwidth search.	:CALC{1-16};MARK{1-10};BWID:THRU
WINDMAXI	Set the maximum window size for the time-domain transformation.	:CALC{1-16};TRAN:TIME:KBES 13
WINDMINI	Set the minimum window size for the time-domain transformation.	:CALC{1-16};TRAN:TIME:KBES 0
WINDNORM	Set the normal window size for the time-domain transformation.	:CALC{1-16};TRAN:TIME:KBES 6
WINDOW	Set the window size to an arbitrary value for the time-domain transformation.	:CALC{1-16};TRAN:TIME:KBES
WINDUSEM	Set the use of memory traces for the time-domain transformation On/Off.	Not available
WRSK	Assign an arbitrary name to the softkey currently displayed.	Not available (Changing the softkeys is not allowed.)

C. Comparing Commands on the 8753ES and E5070B/E5071B

Comparing Commands on the 8753ES and E5070B/E5071B
**8753ES vs. E5070B/E5071B Command Comparison (8753ES-only commands
excluded)**

Numerics

- 24-bit I/O port, 210
- 2-port touchstone file
 - Differential matching circuit, 333
 - Matching circuit, 362
 - Network de-embedding, 355
- 4 port touchstone file
 - network embedding/de-embedding, 347
- 4-port network embedding/de-embedding, 152
- 8753ES, 897

A

- A:, 194
- Active channel, 52
- Active low, 211
- Active trace, 52
- Address
 - GPIB address, 32
 - IP address, 33
 - SICL-LAN address, 34
- Agilent I/O Libraries, 34
- Allocation, 57
- Analog measurement, 212
- Analysis command, 143
- Analysis results, 144
- Analysis(search) range, 143
- Analysis(search) type
 - Analysis command, 143
- Aperture
 - Smoothing aperture, 60
- Application Programs, 239
- Arbitrary impedance, 81
- ASCII transfer format, 165
- Auto recall, 194
- Auto scale, 62
- autorec.sta, 194
- Average
 - Analysis command, 143
 - Statistical analysis, 149
- Averaging, 55
- averaging trigger, 138

B

- Balance device type, 153
- Balance port, 153
- Balance-unbalance conversion, 153
- bandwid.htb, 148
- Bandwidth, 54
- Bandwidth definition value, 147
- Bandwidth search, 147
- bandwidth test, 920
- Basic measurement
 - Sample program, 240
- Beeper
 - Generates a beep
 - Completion of the operation, 780

- Notification of warning/limit test result, 781
- Turns on/off
 - Completion of the operation, 780
 - Notification of warning/limit test result, 781
- Binary transfer format
 - byte order, 167
 - format, 166
- Bit definitions
 - Operation status register, 880
 - Questionable bandwidth limit channel{1-16} extra status register, 889
 - Questionable bandwidth limit channel{1-16} status register, 888
 - Questionable bandwidth limit extra status register, 887
 - Questionable bandwidth limit status register, 886
 - Questionable limit channel{1-16} extra status register, 885
 - Questionable limit channel{1-9} status register, 884
 - Questionable limit extra status register, 883
 - Questionable limit status register, 882
 - Questionable ripple limit channel{1-16} extra status register, 893
 - Questionable ripple limit channel{1-16} status register, 892
 - Questionable ripple limit extra status register, 891
 - Questionable ripple limit status register, 890
 - Questionable status register, 880
 - Standard event status register, 879
 - Status byte register, 878
- Bitmap, 196
- Bus trigger, 129
- Byte order, 167

C

- C0, 81
- C1, 81
- C2, 81
- C3, 81
- cal.htb, 100
- Calculation of scalar mixer calibration coefficient, 93
- Calibration
 - Sample program, 96
- Calibration coefficient arrays
 - Saving/recalling, 194
- Calibration Coefficient Data Array, 170
- Calibration coefficients
 - Calculating, 77
- Calibration data, 75
- Calibration factor table
 - Power sensor, 87
- Calibration Kit, 74, 81
- Calibration kit name, 81
- Calibration property, 646
- Calibration type
 - Checking the applied calibration type, 80
 - Selecting, 74
- Center frequency
 - Bandwidth search, 147
- Center value

- Frequency sweep range, 54
 - Power sweep range, 55
 - Channel display, 57
 - Characteristic impedance, 56
 - chop/alternate, 909
 - Class assignment, 82
 - Class Module
 - Importing, 198
 - Clear
 - Averaging, 55
 - Echo window, 63
 - Error message display, 454
 - Error queue, 286
 - Status registers, 286
 - Clock
 - turning on or off screen display, 63
 - Command list by front panel key, 810
 - Command tree, 828
 - Concepts, 48
 - Communication with external instruments, 209
 - Condition register, 866
 - cont_upd.htb, 229
 - Continuous initiation mode, 130
 - Control over SICL-LAN server, 34
 - Controlling over LAN
 - Using SICL-LAN server, 265
 - Using telnet server, 273
 - Controlling the E5091A
 - Application program, 256
 - Copy
 - File, 202
 - The data trace to the memory trace, 60
 - Corrected data arrays, 168
 - Saving/recalling, 194
 - Corrected memory arrays, 168
 - Creating directory, 202
 - ctrl_lan.xls, 273
 - ctrl_lansicl.xls, 265
 - CW frequency, 55
 - CW TIME sweep, 899
- D**
- Data arrays
 - Corrected, 168
 - Formatted, 169
 - Data flow, 168
 - Data format, 60
 - Data math operations, 60
 - Data trace, 60
 - Data transfer format, 164
 - Date display
 - On/off, 63
 - Defining a peak
 - Analysis command, 143
 - Marker search, 142
 - Defining a target
 - Analysis command, 144
 - Marker search, 142
 - Delay time
 - Port extension, 625, 626, 627, 628, 629
 - Sweep delay time, 54
 - Delete, 202
 - Delta marker(Reference marker), 140
 - Detecting Occurrence of an Error, 230
 - Device selector, 32
 - Device type, 153
 - Difference between the maximum and minimum values
 - Analysis command, 143
 - Statistical analysis, 149
 - Differential matching circuit embedding, 154
 - Differential port impedance conversion, 155
 - Directory
 - Creating, 202
 - Deleting, 202
 - Retrieving file property, 202
 - Disabling the network function, 33
 - Discrete mode, 402
 - Display of the calibration property, 646
 - Display scale, 62
 - Display update on/off
 - screen display, 63
 - Divisions, 62
- E**
- E5091A property display, 234
 - e5091ctr.htb, 237
 - ECal, 79
 - Auto-detect function, 80
 - Sample program, 104, 113
 - ecal.htb, 106, 120
 - Echo window
 - printing a message, 63
 - Showing/hiding, 59
 - Electrical Characteristics
 - Input signal, 222
 - Output signal, 223
 - Power supply, 223
 - Electrical delay time, 303, 304, 305
 - Electronic calibration, 79
 - Enable register, 865
 - Enabling the network function, 33
 - enhanced response calibration, 905
 - Equivalent key to SCPI command, 285
 - Error correction, 78
 - Power level
 - Turning on or off, 89
 - Error detection, 230
 - Error message
 - Clear, 454
 - Reading method, 230
 - Error queue, 230
 - Clear, 286
 - Event register, 865
 - Ex_3_1.sta, 66

Ex_4_1.sta, 96
 Ex_4_2.sta, 104
 Expanded phase format, 60
 Extension, 194
 External reference signal, 687
 External trigger, 129
 external trigger delay time, 137

F

F/W version, 288
 Fail display
 Showing/hiding, 180
 FEM, 256
 File
 Copying, 202
 Deleting, 202
 Retrieving file property, 202
 Saving/recalling, 194
 Transferring
 Command, 202
 Sample program, 203
 file_sav.htb, 200
 file_xfr.htb, 206
 Firmware version, 288, 852
 Fixed frequency, 55
 Fixture simulator, 150
 fixture.htb, 157
 Flexible disk, 194
 Flow
 Data flow, 168
 Folder
 Creating, 202
 Deleting, 202
 Formatted data arrays, 169
 Saving, 195
 Formatted memory arrays, 170
 Frequency base, 485
 frequency offset sweep, 927
 Front panel key
 Equivalent key to SCPI command, 285
 Full n-port calibration, 74
 Full scale value, 62

G

GPIB, 31
 GPIB address, 32
 Power meter, 87
 GPIB remote control system, 31
 Graph
 Layout, 57
 Maximizing, 57
 Graph horizontal axis, 485
 Graticule label, 62
 Group delay format, 60

H

Handler I/O port
 Inputting/outputting data, 215
 Overview, 210
 Pin layout, 211
 Timing chart, 218
 handler.htb, 224
 harmonics measurement, 927
 Hiding frequency labels, 63
 High temperature measurement mode, 799
 Hold state, 129
 How to use this manual, 26

I

Idle state, 130
 IEEE 32-bit floating point format, 167
 IEEE 64-bit floating point format, 166
 IF bandwidth, 54
 Images on the LCD screen
 Saving, 196
 Imaginary format, 60
 Importing, 198
 INDEX, 212
 Information
 Product information, 288
 Property of file, 202
 Initialization
 Error queue, 286
 Instrument setting, 289, 796
 Status registers, 286
 Initiate state, 130
 Inputting data
 Handler I/O port, 215
 Trace(formatted data array), 175
 Installation and Quick Start Guide, 4
 Instrument status
 Saving/recalling, 194
 Internal clock
 Turning on or off screen display, 63
 Internal data arrays, 168
 Internal data processing, 168
 Internal trigger, 129
 IP address, 33
 Isolation, 75

K

Key lock feature, 226

L

L0, 81
 L1, 81
 L2, 81
 L3, 81
 LAN remote control system, 33
 lim_test.htb, 189
 Limit Lines

- Configuring, 180
- Showing/hiding, 180
- Limit table
 - Saving/recalling, 197
 - Setting, 180
 - Showing/hiding, 59
- Limit test, 179
 - Turning on or off, 180
- Limit test result write strobe signal, 214
- Linear magnitude format, 60
- Linear sweep, 54
- List(segment) sweep, 55
- LOAD, 82
- Loading, 198
- Local key, 50
- Logarithmic magnitude format, 60
- Logical port, 153
- Looking up commands, 26
- Loss
 - Bandwidth search, 147
- Loss compensation, 88
- Loss compensation table
 - Saving/recalling, 198
- low-latency external trigger, 137

M

- Macro(VBA)
 - Control, 529
 - Saving/loading, 198
- Managing Files, 202
- Manual change, 852
- Manual printing history, 2
- Manual trigger, 129
- Manufacture, 288
- Marker
 - How to use, 140
 - List, 59
- Marker list table, 59
- Marker search, 141
 - range, 141
- Matching circuit embedding, 150
- Math operations, 60
- Maximizing a window and a graph, 57
- Maximum value search
 - Analysis command, 143
 - Marker search, 141
- meas_bpf.htb, 243
- meas_fem.htb, 261
- meas_sys.htb, 249
- Measurement data
 - Saving, 195
- Measurement of scalar mixer calibration data, 92
- Measurement parameters, 53
- Measurement state, 130
- Measuring a band pass filter, 240
- Measuring FEM, 256
- Measuring the calibration data, 75

- Memory arrays
 - Corrected, 168
 - Formatted, 170
- Memory trace, 60
- Message terminator, 49
- Minimum value search
 - Analysis command, 143
 - Marker search, 141
- Mixed mode S parameter, 153
- mixer measurement, 927
- Model number, 288

N

- Name
 - Calibration kit, 81
 - Standard, 81
- Negative logic, 211
- Negative transition filter, 866
- Network de-embedding
 - 2-port, 151
 - 4-port, 152
- Network embedding, 152
- Network function
 - Enabling/disabling, 33
- Number of measurement points, 54
 - Reading out
 - Linear sweep, 693
 - Segment sweep, 690
- Number of traces, 53

O

- Obtaining test results, 181
 - Each channel, 182
 - Each measurement point, 181
 - Each trace, 181
 - Overall test result, 184
- Offset delay, 81
- Offset loss, 81
- Offset Z0, 81
- OPEN, 82
- Operation status register, 867
 - Bit definitions, 880
 - Reading out the condition register, 722
 - Reading out the event register, 722
 - Setting the enable register, 723
 - Setting the negative transition filter, 724
 - Setting the positive transition filter, 725
- Order base, 485
- Output port write strobe signal, 213
- Outputting data
 - Handler I/O port, 215
 - Internal data arrays, 171
- Overall test result, 184

P

- parameter

-
- SCPI command, 285
 - partial overwrite, 95
 - pass control, 928
 - PASS FAIL STROBE, 214
 - Pass/Fail test, 179
 - Peak excursion value, 142, 143
 - Peak search
 - Analysis command, 143
 - Marker search, 141
 - Performing a calibration, 74
 - Phase format, 60
 - Pin layout, 211
 - Point trigger, 137
 - Polar format, 60
 - Polarity
 - Analysis command, 143
 - Marker search, 142
 - Port
 - Handler I/O port, 215
 - Port 23, 40
 - Port 5025, 41
 - Port extension, 620, 621, 622, 623, 624, 625, 626, 627, 628, 629
 - Port impedance conversion, 151
 - Positive transition filter, 866
 - pow_cal.htb, 110
 - Power, 54
 - Power calibration, 87
 - Sample program, 108
 - Power calibration data array, 89
 - Power level error correction, 89
 - Power meter, 87
 - Power range, 54
 - Power sensor, 87
 - Power sensor calibration factor table, 87
 - Saving/recalling, 197
 - Power slope, 54
 - Power sweep, 55
 - Prefix, 852
 - Preset, 289, 796
 - Primary value, 169
 - Printer
 - Aborts the print output, 489
 - Outputs the display image, 489
 - Selects the print color, 490
 - Product information, 288
 - Program (sample)
 - file name
 - bandwid.htb, 148
 - cal.htb, 100
 - cont_upd.htb, 229
 - ctrl_lan.xls, 273
 - ctrl_lansicl.xls, 265
 - e5091ctr.htb, 237
 - ecal.htb, 106, 120
 - file_sav.htb, 200
 - file_xfr.htb, 206
 - fixture.htb, 157
 - handler.htb, 224
 - lim_test.htb, 189
 - meas_bpf.htb, 243
 - meas_fem.htb, 261
 - meas_sys.htb, 249
 - pow_cal.htb, 110
 - read_asc.htb, 172
 - read_bin.htb, 174
 - search.htb, 146
 - setup.htb, 70
 - srq_err.htb, 232
 - srq_meas.htb, 134
 - time_dom.htb, 160
 - trg_sing.htb, 136
 - write_a.htb, 176
 - write_b.htb, 178
 - title
 - Bandwidth Search, 148
 - Calibration, 100
 - Communicating with external instruments, 224
 - Configuring measurement conditions, 70
 - Controlling E5091A, 237
 - Controlling the update timing of LCD display, 229
 - Controlling using SICL-LAN server, 265
 - Controlling using telnet server, 273
 - ECal, 106, 120
 - Error detection using an SRQ, 232
 - File transfer, 206
 - Fixture simulator, 157
 - Limit test, 189
 - Measurement of band pass filter, 243
 - Measurement of FEM, 261
 - Measurement with Automatic Test Systems, 249
 - Peak search, 146
 - Power calibration, 110
 - Saving file, 200
 - Time Domain Transformation, 160
 - Using an SRQ to detect the end of measurement, 134
 - Using the :TRIG:SING command to wait until end of measurement, 136
 - Using the ASCII transfer format to retrieve internal data arrays, 172
 - Using the ASCII transfer format to write formatted data arrays, 176
 - Using the binary transfer format to retrieve internal data arrays, 174
 - Using the binary transfer format to write formatted data arrays, 178
 - Program message terminator, 49
 - Program(VBA)
 - Control, 529
 - Saving/loading, 198
 - Programmer's Guide, 4
 - Property display
 - Calibration, 646
 - E5091A, 234

Property of file, 202

Pulse width, 218

Q

Q value, 147

Questionable bandwidth limit channel{1-16} extra status register

Bit definitions, 889

Reading out the condition register, 729

Reading out the event register, 729, 765

Setting the enable register, 730

Setting the negative transition filter, 731

Setting the positive transition filter, 732

Questionable bandwidth limit channel{1-16} status register

Bit definitions, 888

Reading out the condition register, 727

Reading out the event register, 727

Setting the enable register, 733

Setting the negative transition filter, 734

Setting the positive transition filter, 735

Questionable bandwidth limit extra status register

Bit definitions, 887

Reading out the condition register, 736

Reading out the event register, 736

Setting the enable register, 737

Setting the negative transition filter, 738

Setting the positive transition filter, 739

Questionable bandwidth limit status register

Bit definitions, 886

Reading out the condition register, 735

Reading out the event register, 727

Setting the enable register, 740

Setting the negative transition filter, 741

Setting the positive transition filter, 742

Questionable limit channel{1-16} extra status register

Bit definitions, 885

Reading out the condition register, 747

Reading out the event register, 747

Setting the enable register, 748

Setting the negative transition filter, 749

Setting the positive transition filter, 750

Questionable limit channel{1-16} status register, 867

Bit definitions, 884

Reading out the condition register, 745

Reading out the event register, 745

Setting the enable register, 751

Setting the negative transition filter, 752

Setting the positive transition filter, 753

Questionable limit extra status register

Bit definitions, 883

Reading out the condition register, 755

Reading out the event register, 754

Setting the enable register, 755

Setting the negative transition filter, 756

Setting the positive transition filter, 757

Questionable limit status register, 867

Bit definitions, 882

Reading out the condition register, 754

Reading out the event register, 745

Setting the enable register, 758

Setting the negative transition filter, 759

Setting the positive transition filter, 760

Questionable ripple limit channel{1-16} extra status register

Bit definitions, 893

Reading out the condition register, 765

Setting the enable register, 766

Setting the negative transition filter, 767

Setting the positive transition filter, 768

Questionable ripple limit channel{1-16} status register

Bit definitions, 892

Reading out the condition register, 763

Reading out the event register, 763

Setting the enable register, 769

Setting the negative transition filter, 770

Setting the positive transition filter, 771

Questionable ripple limit extra status register

Bit definitions, 891

Reading out the condition register, 772

Reading out the event register, 772

Setting the enable register, 773

Setting the negative transition filter, 774

Setting the positive transition filter, 775

Questionable ripple limit status register

Bit definitions, 890

Reading out the condition register, 771

Reading out the event register, 763

Setting the enable register, 776

Setting the negative transition filter, 777

Setting the positive transition filter, 778

Questionable status register, 867

Bit definitions, 880

Reading out the condition register, 743

Reading out the event register, 726

Setting the enable register, 744

Setting the negative transition filter, 761

Setting the positive transition filter, 762

Quick Start Guide, 4

R

read_asc.htb, 172

read_bin.htb, 174

READY FOR TRIGGER, 213

Real format, 60

Recall, 194

Auto recall, 194

Receiver Calibration, 91

receiver calibration, 909

Ref In connector, 687

Reference graticule line, 62

Reference marker, 140

Releasing key lock, 226

Remote Control System

USB remote control system, 42

Remote control system

- GPIB remote control system, 31
- LAN remote control system, 33
- Overview, 30
- Remote mode, 50
- Reset
 - Instrument setting, 289, 796
 - Status registers, 286
- Response calibration, 74
- Restart, 55
- Retrieving file property, 202
- Retrieving measurement results
 - All measurement points, 171
 - Specified point, 140
- Retrieving search(analysis) results, 144
- RF Out
 - On/Off, 53
- ripple test, 919, 920
- S**
- S parameter, 53
- Sample Application Programs, 239
- Sample Program, 3
 - file name
 - bandwid.htb, 148
 - cal.htb, 100
 - cont_upd.htb, 229
 - ctrl_lan.xls, 273
 - ctrl_lansicl.xls, 265
 - e5091ctr.htb, 237
 - ecal.htb, 106, 120
 - file_sav.htb, 200
 - file_xfr.htb, 206
 - fixture.htb, 157
 - handler.htb, 224
 - lim_test.htb, 189
 - meas_bpf.htb, 243
 - meas_fem.htb, 261
 - meas_sys.htb, 249
 - pow_cal.htb, 110
 - read_asc.htb, 172
 - read_bin.htb, 174
 - search.htb, 146
 - setup.htb, 70
 - srq_err.htb, 232
 - srq_meas.htb, 134
 - time_dom.htb, 160
 - trg_sing.htb, 136
 - write_a.htb, 176
 - write_b.htb, 178
 - How to load, 27
 - title
 - Bandwidth Search, 148
 - Calibration, 100
 - Communicating with external instruments, 224
 - Configuring measurement conditions, 70
 - Controlling E5091A, 237
 - Controlling the update timing of LCD display, 229
 - Controlling using SICL-LAN server, 265
 - Controlling using telnet server, 273
 - ECal, 106, 120
 - Error detection using an SRQ, 232
 - File transfer, 206
 - Fixture simulator, 157
 - Limit test, 189
 - Measurement of band pass filter, 243
 - Measurement of FEM, 261
 - Measurement with Automatic Test Systems, 249
 - Peak search, 146
 - Power calibration, 110
 - Saving file, 200
 - Time Domain Transformation, 160
 - Using an SRQ to detect the end of measurement, 134
 - Using the :TRIG:SING command to wait until end of measurement, 136
 - Using the ASCII transfer format to retrieve internal data arrays, 172
 - Using the ASCII transfer format to write formatted data arrays, 176
 - Using the binary transfer format to retrieve internal data arrays, 174
 - Using the binary transfer format to write formatted data arrays, 178
- Save, 194
- Saving/Recalling the Definition File, 82
- Scalar mixer calibration, 92
- Scale per division, 62
- SCPI command
 - *CLS, 286
 - *ESE, 287
 - *ESR?, 287
 - *IDN?, 288
 - *OPC, 288
 - *OPC?, 288
 - *OPT?, 289
 - *RST, 289
 - *SRE, 290
 - *STB?, 291
 - *TRG, 291
 - *WAI, 291
 - :ABORt, 292
 - :CALCulate{1-16}:FSIMulator:BALun:CZConversion:BPORt{1-2}:IMAG, 323
 - :CALCulate{1-16}:FSIMulator:BALun:CZConversion:BPORt{1-2}:REAL, 324
 - :CALCulate{1-16}:FSIMulator:BALun:CZConversion:BPORt{1-2}:Z0[:R], 325
 - :CALCulate{1-16}:FSIMulator:BALun:CZConversion:STATe, 326
 - :CALCulate{1-16}:FSIMulator:BALun:DEVice, 327
 - :CALCulate{1-16}:FSIMulator:BALun:DMCircuit:BPORt{1-2}:PARAMeters:C, 329
 - :CALCulate{1-16}:FSIMulator:BALun:DMCircuit:BPORt{1-2}:PARAMeters:G, 330

- :CALCulate{1-16}:FSIMulator:BALun:DMCircuit:BPORt{1-2}:PARAmeters:L, 331
- :CALCulate{1-16}:FSIMulator:BALun:DMCircuit:BPORt{1-2}:PARAmeters:R, 332
- :CALCulate{1-16}:FSIMulator:BALun:DMCircuit:BPORt{1-2}[:TYPE], 328
- :CALCulate{1-16}:FSIMulator:BALun:DMCircuit:BPORt{1-2}:USER:FILEName, 333
- :CALCulate{1-16}:FSIMulator:BALun:DMCircuit:STATe, 334
- :CALCulate{1-16}:FSIMulator:BALun:DZConversion:BPORt{1-2}:IMAGinary, 335
- :CALCulate{1-16}:FSIMulator:BALun:DZConversion:BPORt{1-2}:REAL, 336
- :CALCulate{1-16}:FSIMulator:BALun:DZConversion:BPORt{1-2}:Z0[:R], 337
- :CALCulate{1-16}:FSIMulator:BALun:DZConversion:STATe, 338
- :CALCulate{1-16}:FSIMulator:BALun:PARAmeter{1-16}:BBALanced[:DEFine], 339
- :CALCulate{1-16}:FSIMulator:BALun:PARAmeter{1-16}:SBALanced[:DEFine], 340
- :CALCulate{1-16}:FSIMulator:BALun:PARAmeter{1-16}:SSBalanced[:DEFine], 341
- :CALCulate{1-16}:FSIMulator:BALun:PARAmeter{1-16}:STATe, 342
- :CALCulate{1-16}:FSIMulator:BALun:TOPology:BBALanced[:PPORts], 343
- :CALCulate{1-16}:FSIMulator:BALun:TOPology:PROPErty:STATe, 344
- :CALCulate{1-16}:FSIMulator:BALun:TOPology:SBALanced[:PPORts], 345
- :CALCulate{1-16}:FSIMulator:BALun:TOPology:SSBalanced[:PPORts], 346
- :CALCulate{1-16}:FSIMulator:EMBed:NETWork{1-2}:FILEName, 347
- :CALCulate{1-16}:FSIMulator:EMBed:NETWork{1-2}:TYPE, 348
- :CALCulate{1-16}:FSIMulator:EMBed:STATe, 349
- :CALCulate{1-16}:FSIMulator:EMBed:TOPology:A:PORts, 350
- :CALCulate{1-16}:FSIMulator:EMBed:TOPology:B:PORts, 351
- :CALCulate{1-16}:FSIMulator:EMBed:TOPology:C:PORts, 352
- :CALCulate{1-16}:FSIMulator:EMBed:TYPE, 353
- :CALCulate{1-16}:FSIMulator:SENDEd:DEEMbed:PORt{1-4}[:TYPE], 354
- :CALCulate{1-16}:FSIMulator:SENDEd:DEEMbed:PORt{1-4}:USER:FILEName, 355
- :CALCulate{1-16}:FSIMulator:SENDEd:DEEMbed:STATe, 356
- :CALCulate{1-16}:FSIMulator:SENDEd:PMCircuit:PORt{1-4}:PARAmeters:C, 358
- :CALCulate{1-16}:FSIMulator:SENDEd:PMCircuit:PORt{1-4}:PARAmeters:G, 359
- :CALCulate{1-16}:FSIMulator:SENDEd:PMCircuit:PORt{1-4}:PARAmeters:L, 360
- :CALCulate{1-16}:FSIMulator:SENDEd:PMCircuit:PORt{1-4}:PARAmeters:R, 361
- :CALCulate{1-16}:FSIMulator:SENDEd:PMCircuit:PORt{1-4}[:TYPE], 357
- :CALCulate{1-16}:FSIMulator:SENDEd:PMCircuit:PORt{1-4}:USER:FILEName, 362
- :CALCulate{1-16}:FSIMulator:SENDEd:PMCircuit:STATe, 363
- :CALCulate{1-16}:FSIMulator:SENDEd:ZCONversion:PORt{1-4}:IMAGinary, 364
- :CALCulate{1-16}:FSIMulator:SENDEd:ZCONversion:PORt{1-4}:REAL, 365
- :CALCulate{1-16}:FSIMulator:SENDEd:ZCONversion:PORt{1-4}:Z0[:R], 366
- :CALCulate{1-16}:FSIMulator:SENDEd:ZCONversion:STATe, 367
- :CALCulate{1-16}:FSIMulator:STATe, 368
- :CALCulate{1-16}:PARAmeter:COUNt, 421
- :CALCulate{1-16}:PARAmeter{1-16}:DEFine, 422
- :CALCulate{1-16}:PARAmeter{1-16}:SELEct, 424
- :CALCulate{1-16}:PARAmeter{1-16}:SPORt, 425
- :CALCulate{1-16}[:SELEct]:BLIMit:DB, 294
- :CALCulate{1-16}[:SELEct]:BLIMit:DISPlay:MARKer, 295
- :CALCulate{1-16}[:SELEct]:BLIMit:DISPlay:VALue, 296
- :CALCulate{1-16}[:SELEct]:BLIMit:FAIL, 297
- :CALCulate{1-16}[:SELEct]:BLIMit:MAXimum, 298
- :CALCulate{1-16}[:SELEct]:BLIMit:MINimum, 299
- :CALCulate{1-16}[:SELEct]:BLIMit:REPort[:DATA]?, 300
- :CALCulate{1-16}[:SELEct]:BLIMit:STATe], 293
- :CALCulate{1-16}[:SELEct]:CONVersion:FUNctIon, 302
- :CALCulate{1-16}[:SELEct]:CONVersion[:STATe], 301
- :CALCulate{1-16}[:SELEct]:CORRection:EDELay:ME D, 303
- :CALCulate{1-16}[:SELEct]:CORRection:EDELay:TI ME, 304
- :CALCulate{1-16}[:SELEct]:CORRection:EDELay:WG C, 305
- :CALCulate{1-16}[:SELEct]:CORRection:OFFSet:PHA Se, 306
- :CALCulate{1-16}[:SELEct]:DATA:FDATA, 307
- :CALCulate{1-16}[:SELEct]:DATA:FMEMory, 308
- :CALCulate{1-16}[:SELEct]:DATA:SDATA, 309
- :CALCulate{1-16}[:SELEct]:DATA:SMEMory, 310
- :CALCulate{1-16}[:SELEct]:EQUation:STATe, 311
- :CALCulate{1-16}[:SELEct]:EQUation:TEXT, 312
- :CALCulate{1-16}[:SELEct]:EQUation:VALid, 313
- :CALCulate{1-16}[:SELEct]:FILTer[:GATE]:TIME:CE NTER, 315
- :CALCulate{1-16}[:SELEct]:FILTer[:GATE]:TIME:SH APE, 316

- :CALCulate{ 1-16}[:SElected]:FILTer[:GATE]:TIME:SPAN, 317
- :CALCulate{ 1-16}[:SElected]:FILTer[:GATE]:TIME:START, 318
- :CALCulate{ 1-16}[:SElected]:FILTer[:GATE]:TIME:STATE, 319
- :CALCulate{ 1-16}[:SElected]:FILTer[:GATE]:TIME:STOP, 320
- :CALCulate{ 1-16}[:SElected]:FILTer[:GATE]:TIME[:TYPE], 314
- :CALCulate{ 1-16}[:SElected]:FORMat, 321
- :CALCulate{ 1-16}[:SElected]:FUNctIon:DATA?, 369
- :CALCulate{ 1-16}[:SElected]:FUNctIon:DOMain:COUPle, 371
- :CALCulate{ 1-16}[:SElected]:FUNctIon:DOMain:START, 372
- :CALCulate{ 1-16}[:SElected]:FUNctIon:DOMain:STATE], 370
- :CALCulate{ 1-16}[:SElected]:FUNctIon:DOMain:STOP, 373
- :CALCulate{ 1-16}[:SElected]:FUNctIon:EXECute, 373
- :CALCulate{ 1-16}[:SElected]:FUNctIon:PEXECursion, 374
- :CALCulate{ 1-16}[:SElected]:FUNctIon:POINTs?, 375
- :CALCulate{ 1-16}[:SElected]:FUNctIon:PPOLarity, 376
- :CALCulate{ 1-16}[:SElected]:FUNctIon:TARGet, 377
- :CALCulate{ 1-16}[:SElected]:FUNctIon:TTRansition, 378
- :CALCulate{ 1-16}[:SElected]:FUNctIon:TYPE, 379
- :CALCulate{ 1-16}[:SElected]:LIMit:DATA, 381
- :CALCulate{ 1-16}[:SElected]:LIMit:DISPlay[:STATE], 382
- :CALCulate{ 1-16}[:SElected]:LIMit:FAIL, 383
- :CALCulate{ 1-16}[:SElected]:LIMit:OFFSet:AMPLitude, 384
- :CALCulate{ 1-16}[:SElected]:LIMit:OFFSet:MARKer, 385
- :CALCulate{ 1-16}[:SElected]:LIMit:OFFSet:STIMulus, 386
- :CALCulate{ 1-16}[:SElected]:LIMit:REPort POINTs?, 389
- :CALCulate{ 1-16}[:SElected]:LIMit:REPort:ALL?, 388
- :CALCulate{ 1-16}[:SElected]:LIMit:REPort[:DATA]?, 387
- :CALCulate{ 1-16}[:SElected]:LIMit[:STATE], 380
- :CALCulate{ 1-16}[:SElected]:MARKer:BWIDth[:STATe], 390
- :CALCulate{ 1-16}[:SElected]:MARKer:COUPle, 391
- :CALCulate{ 1-16}[:SElected]:MARKer:FUNctIon:DOMain:COUPle, 393
- :CALCulate{ 1-16}[:SElected]:MARKer:FUNctIon:DOMain:START, 394
- :CALCulate{ 1-16}[:SElected]:MARKer:FUNctIon:DOMain[:STATE], 392
- :CALCulate{ 1-16}[:SElected]:MARKer:FUNctIon:DOMain:STOP, 395
- :CALCulate{ 1-16}[:SElected]:MARKer:NOTCh[:STATE], 396
- :CALCulate{ 1-16}[:SElected]:MARKer:REFeRence[:STATE], 397
- :CALCulate{ 1-16}[:SElected]:MARKer{ 1-10}:ACTivate, 399
- :CALCulate{ 1-16}[:SElected]:MARKer{ 1-10}:BWIDth:DATA?, 400
- :CALCulate{ 1-16}[:SElected]:MARKer{ 1-10}:BWIDth:THReShold, 401
- :CALCulate{ 1-16}[:SElected]:MARKer{ 1-10}:DISCrete, 402
- :CALCulate{ 1-16}[:SElected]:MARKer{ 1-10}:FUNctIon:EXECute, 403
- :CALCulate{ 1-16}[:SElected]:MARKer{ 1-10}:FUNctIon:PEXCursion, 404
- :CALCulate{ 1-16}[:SElected]:MARKer{ 1-10}:FUNctIon:PPOLarity, 405
- :CALCulate{ 1-16}[:SElected]:MARKer{ 1-10}:FUNctIon:TARGet, 406
- :CALCulate{ 1-16}[:SElected]:MARKer{ 1-10}:FUNctIon:TRACking, 407
- :CALCulate{ 1-16}[:SElected]:MARKer{ 1-10}:FUNctIon:TTRansition, 408
- :CALCulate{ 1-16}[:SElected]:MARKer{ 1-10}:FUNctIon:TYPE, 409
- :CALCulate{ 1-16}[:SElected]:MARKer{ 1-10}:NOTCh:DATA?, 410
- :CALCulate{ 1-16}[:SElected]:MARKer{ 1-10}:NOTCh:THReShold, 411
- :CALCulate{ 1-16}[:SElected]:MARKer{ 1-10}:SET, 412
- :CALCulate{ 1-16}[:SElected]:MARKer{ 1-10}[:STATE], 398
- :CALCulate{ 1-16}[:SElected]:MARKer{ 1-10}:X, 413
- :CALCulate{ 1-16}[:SElected]:MARKer{ 1-10}:Y?, 414
- :CALCulate{ 1-16}[:SElected]:MATH:FUNctIon, 415
- :CALCulate{ 1-16}[:SElected]:MATH:MEMorize, 416
- :CALCulate{ 1-16}[:SElected]:MSTatistics:DATA?, 419
- :CALCulate{ 1-16}[:SElected]:MSTatistics[:STATE], 418
- :CALCulate{ 1-16}[:SElected]:RLIMit:DATA, 427
- :CALCulate{ 1-16}[:SElected]:RLIMit:DISPlay:LINE, 428
- :CALCulate{ 1-16}[:SElected]:RLIMit:DISPlay:SElect, 429
- :CALCulate{ 1-16}[:SElected]:RLIMit:DISPlay:VALue, 430
- :CALCulate{ 1-16}[:SElected]:RLIMit:FAIL, 431
- :CALCulate{ 1-16}[:SElected]:RLIMit:REPort[:DATA], 432
- :CALCulate{ 1-16}[:SElected]:RLIMit[:STATE], 426
- :CALCulate{ 1-16}[:SElected]:SMOothing:APERTure, 434
- :CALCulate{ 1-16}[:SElected]:SMOothing[:STATE], 433
- :CALCulate{ 1-16}[:SElected]:TRANsform:TIME:CENTer, 436
- :CALCulate{ 1-16}[:SElected]:TRANsform:TIME:IMPulse:WIDTh, 437

- :CALCulate{ 1-16}[:SElected]:TRANSform:TIME:KBESsel, 438
- :CALCulate{ 1-16}[:SElected]:TRANSform:TIME:LPFRequency, 439
- :CALCulate{ 1-16}[:SElected]:TRANSform:TIME:SPAN, 439
- :CALCulate{ 1-16}[:SElected]:TRANSform:TIME:START, 440
- :CALCulate{ 1-16}[:SElected]:TRANSform:TIME:STATe, 441
- :CALCulate{ 1-16}[:SElected]:TRANSform:TIME:STEP:RTIME, 442
- :CALCulate{ 1-16}[:SElected]:TRANSform:TIME:STIMulus, 443
- :CALCulate{ 1-16}[:SElected]:TRANSform:TIME:STOP, 444
- :CALCulate{ 1-16}[:SElected]:TRANSform:TIME[:TYPE], 435
- :CALCulate{ 1-16}[:SElected]:MIXer:XAXis, 417
- :CALCulate{ 1-16}[:SElected]:OFFSet:XAXis, 420
- :CONTRol:HANDler:A[:DATA], 445
- :CONTRol:HANDler:B[:DATA], 445
- :CONTRol:HANDler:C[:DATA], 446
- :CONTRol:HANDler:C:MODE, 447
- :CONTRol:HANDler:D[:DATA], 448
- :CONTRol:HANDler:D:MODE, 449
- :CONTRol:HANDler:E[:DATA], 450
- :CONTRol:HANDler[:EXTension]:INDEX:STATe, 452
- :CONTRol:HANDler[:EXTension]:RTRigger:STATe, 453
- :CONTRol:HANDler:F[:DATA], 451
- :CONTRol:HANDler:OUTPut{ 1-2}[:DATA], 452
- :DISPlay:ANNOtation:FREQuency[:STATe], 454
- :DISPlay:CCLear, 454
- :DISPlay:CLOCK, 455
- :DISPlay:COLor{ 1-2}:BACK, 456
- :DISPlay:COLor{ 1-2}:GRATICule{ 1-2}, 457
- :DISPlay:COLor{ 1-2}:LIMit{ 1-2}, 458
- :DISPlay:COLor{ 1-2}:RESet, 458
- :DISPlay:COLor{ 1-2}:TRAC{ 1-16}:DATA, 459
- :DISPlay:COLor{ 1-2}:TRAC{ 1-16}:MEMory, 460
- :DISPlay:ECHO:CLEar, 461
- :DISPlay:ECHO[:DATA], 461
- :DISPlay:ENABle, 462
- :DISPlay:FSIGN, 463
- :DISPlay:IMAGe, 464
- :DISPlay:MAXimize, 465
- :DISPlay:SKEY[:STATe], 465
- :DISPlay:SPLit, 466
- :DISPlay:TABLE[:STATe], 468
- :DISPlay:TABLE:TYPE, 469
- :DISPlay:UPDate[:IMMEDIATE], 470
- :DISPlay:WINDow{ 1-16}:ACTivate, 470
- :DISPlay:WINDow{ 1-16}:ANNOtation:MARKer:ALIGN[:STATe], 471
- :DISPlay:WINDow{ 1-16}:ANNOtation:MARKer:SINGLE[:STATe], 472
- :DISPlay:WINDow{ 1-16}:LABel, 473
- :DISPlay:WINDow{ 1-16}:MAXimize, 474
- :DISPlay:WINDow{ 1-16}:SPLit, 475
- :DISPlay:WINDow{ 1-16}:TITLE:DATA, 477
- :DISPlay:WINDow{ 1-16}:TITLE[:STATe], 476
- :DISPlay:WINDow{ 1-16}:TRACe{ 1-16}:ANNOtation:MARKer:POSITION:X, 478
- :DISPlay:WINDow{ 1-16}:TRACe{ 1-16}:ANNOtation:MARKer:POSITION:Y, 479
- :DISPlay:WINDow{ 1-16}:TRACe{ 1-16}:MEMory[:STATe], 480
- :DISPlay:WINDow{ 1-16}:TRACe{ 1-16}:STATe, 481
- :DISPlay:WINDow{ 1-16}:TRACe{ 1-16}:Y[:SCALE]:AUTO, 481
- :DISPlay:WINDow{ 1-16}:TRACe{ 1-16}:Y[:SCALE]:PDIVisions, 482
- :DISPlay:WINDow{ 1-16}:TRACe{ 1-16}:Y[:SCALE]:RLEVel, 483
- :DISPlay:WINDow{ 1-16}:TRACe{ 1-16}:Y[:SCALE]:RPOStition, 484
- :DISPlay:WINDow{ 1-16}:X:SPACing, 485
- :DISPlay:WINDow{ 1-16}:Y[:SCALE]:DIVisions, 486
- :FORMat:BORDER, 487
- :FORMat:DATA, 488
- :HCOPY:ABORT, 489
- :HCOPY:IMAGe, 490
- :HCOPY[:IMMEDIATE], 489
- :INITiate{ 1-16}:CONTInuous, 491
- :INITiate{ 1-16}[:IMMEDIATE], 490
- :MMEMory:CATalog?, 492
- :MMEMory:COPY, 493
- :MMEMory:DELeTe, 494
- :MMEMory:LOAD:ASCFactor, 496
- :MMEMory:LOAD:BSCFactor, 497
- :MMEMory:LOAD:CHANnel[:STATe], 498
- :MMEMory:LOAD:CKIT{ 1-20}, 499
- :MMEMory:LOAD:LIMit, 500
- :MMEMory:LOAD:PLOSs{ 1-4}, 501
- :MMEMory:LOAD:PROGram, 502
- :MMEMory:LOAD:RLIMit, 503
- :MMEMory:LOAD:SEGMENT, 504
- :MMEMory:LOAD[:STATe], 495
- :MMEMory:MDIRectory, 505
- :MMEMory:STORE:ASCFactor, 507
- :MMEMory:STORE:BSCFactor, 508
- :MMEMory:STORE:CHANnel[:STATe], 509
- :MMEMory:STORE:CKIT{ 1-20}, 510
- :MMEMory:STORE:FDATa, 511
- :MMEMory:STORE:IMAGe, 512
- :MMEMory:STORE:LIMit, 513
- :MMEMory:STORE:PLOSs{ 1-4}, 514
- :MMEMory:STORE:PROGram, 515
- :MMEMory:STORE:RLIMit, 516
- :MMEMory:STORE:SALL, 517
- :MMEMory:STORE:SEGMENT, 518
- :MMEMory:STORE:SNP[:DATA], 519
- :MMEMory:STORE:SNP:FORMat, 520
- :MMEMory:STORE:SNP:TYPE:SIP, 521

:MMEMory:STORe:SNP:TYPE:S2P, 522
 :MMEMory:STORe:SNP:TYPE:S3P, 523
 :MMEMory:STORe:SNP:TYPE:S4P, 524
 :MMEMory:STORe:STATe], 506
 :MMEMory:STORe:STYPe, 525
 :MMEMory:TRANsfer, 526
 :OUTPut[:STATe], 527
 :PROGram:CATalog?, 527
 :PROGram[:SElected]:NAME, 528
 :PROGram[:SElected]:STATe, 529
 :PROGram:VARiable:ARRay{1-10}[:DATA], 530
 :PROGram:VARiable:ARRay{1-10}:SIZE, 531
 :PROGram:VARiable:DOUBle{1-10}[:DATA], 532
 :PROGram:VARiable:LONG{1-10}[:DATA], 533
 :PROGram:VARiable:STRing{1-10}[:DATA], 534
 :SENS{1-16}:CORR:COLL:CKIT:TRL
 RPL, 589
 :SENSe:CORRection:COLLect:ECAL:ORientation[:STA
 Te], 535
 :SENSe:CORRection:COLLect:ECAL:PATH, 536
 :SENSe:CORRection:IMPedance[:INPut[:MAGNitude],
 537
 :SENSe:MULTiplexer{1-2}
 CATalog?, 538
 :SENSe:MULTiplexer{1-2}:COUNT?, 539
 :SENSe:MULTiplexer{1-2}:DISPlay[:STATe], 539
 :SENSe:MULTiplexer{1-2}:INCount?, 540
 :SENSe:MULTiplexer{1-2}:NAME, 541
 :SENSe:MULTiplexer{1-2}:STATe, 542
 :SENSe{1-16}:
 CORRection:EXTension:AUTO:CONFig, 621
 CORRection:EXTension:AUTO:DCOFFset, 622
 CORRection:EXTension:AUTO:LOSS, 623
 CORRection:EXTension:AUTO:MEASure, 624
 :SENSe{1-16}:AVERAge:CLear, 543
 :SENSe{1-16}:AVERAge:COUNt, 544
 :SENSe{1-16}:AVERAge[:STATe], 543
 :SENSe{1-16}:BANDwidth[:RESolution], 545
 :SENSe{1-16}:BWIDTH[:RESolution], 546
 :SENSe{1-16}:CORRection:CLear, 547
 :SENSe{1-16}:CORRection:COEFFicient[:DATA], 548
 :SENSe{1-16}:CORRection:COEFFicient:METHod:ERES
 Ponse, 550
 :SENSe{1-16}:CORRection:COEFFicient:METHod[:RES
 Ponse]:OPEN, 551
 :SENSe{1-16}:CORRection:COEFFicient:METHod[:RES
 Ponse]:SHORT, 552
 :SENSe{1-16}:CORRection:COEFFicient:METHod[:RES
 Ponse]:THRU, 557
 :SENSe{1-16}:CORRection:COEFFicient:METHod:SOLT
 1, 553
 :SENSe{1-16}:CORRection:COEFFicient:METHod:SOLT
 2, 554
 :SENSe{1-16}:CORRection:COEFFicient:METHod:SOLT
 3, 555
 :SENSe{1-16}:CORRection:COEFFicient:METHod:SOLT
 4, 556
 :SENSe{1-16}:CORRection:COEFFicient:SAVE, 558
 :SENSe{1-16}:CORRection:COLLect[:ACQuire]:ISOLati
 on, 599
 :SENSe{1-16}:CORRection:COLLect[:ACQuire]:LOAD,
 600
 :SENSe{1-16}:CORRection:COLLect[:ACQuire]:OPEN,
 611
 :SENSe{1-16}:CORRection:COLLect[:ACQuire]:SHORT,
 613
 :SENSe{1-16}:CORRection:COLLect[:ACQuire]:SUBCla
 ss, 615
 :SENSe{1-16}:CORRection:COLLect[:ACQuire]:THRU,
 616
 :SENSe{1-16}:CORRection:COLLect[:ACQuire]:TRLLin
 e, 617
 :SENSe{1-16}:CORRection:COLLect[:ACQuire]:TRLRef
 lect, 618
 :SENSe{1-16}:CORRection:COLLect[:ACQuire]:TRLThr
 u, 619
 :SENSe{1-16}:CORRection:COLLect:ADAPter{1-4}:LE
 NGth, 559
 :SENSe{1-16}:CORRection:COLLect:CKIT:LABel, 561
 :SENSe{1-16}:CORRection:COLLect:CKIT:ORDer:LOA
 D, 563
 :SENSe{1-16}:CORRection:COLLect:CKIT:ORDer:OPE
 N, 564
 :SENSe{1-16}:CORRection:COLLect:CKIT:ORDer:SHO
 Rt, 565
 :SENSe{1-16}:CORRection:COLLect:CKIT:ORDer:THR
 U, 566
 :SENSe{1-16}:CORRection:COLLect:CKIT:ORDer:TRL
 Line, 567
 :SENSe{1-16}:CORRection:COLLect:CKIT:ORDer:TRL
 Reflect, 568
 :SENSe{1-16}:CORRection:COLLect:CKIT:ORDer:TRL
 Thru, 569
 :SENSe{1-16}:CORRection:COLLect:CKIT:ORDer[:SEL
 ect], 562
 :SENSe{1-16}:CORRection:COLLect:CKIT:RESet, 570
 :SENSe{1-16}:CORRection:COLLect:CKIT[:SElect],
 560
 :SENSe{1-16}:CORRection:COLLect:CKIT:STAN{1-21}
 :ARBItrary, 571
 :SENSe{1-16}:CORRection:COLLect:CKIT:STAN{1-21}
 :C0, 572
 :SENSe{1-16}:CORRection:COLLect:CKIT:STAN{1-21}
 :C1, 573
 :SENSe{1-16}:CORRection:COLLect:CKIT:STAN{1-21}
 :C2, 574
 :SENSe{1-16}:CORRection:COLLect:CKIT:STAN{1-21}
 :C3, 575
 :SENSe{1-16}:CORRection:COLLect:CKIT:STAN{1-21}
 :CHARacter, 576
 :SENSe{1-16}:CORRection:COLLect:CKIT:STAN{1-21}
 :DELay, 577
 :SENSe{1-16}:CORRection:COLLect:CKIT:STAN{1-21}
 :FMAX, 578

:SENSe{1-16}:CORRection:COLLect:CKIT:STAN{1-21}:FMIN, 579
:SENSe{1-16}:CORRection:COLLect:CKIT:STAN{1-21}:L0, 580
:SENSe{1-16}:CORRection:COLLect:CKIT:STAN{1-21}:L1, 581
:SENSe{1-16}:CORRection:COLLect:CKIT:STAN{1-21}:L2, 582
:SENSe{1-16}:CORRection:COLLect:CKIT:STAN{1-21}:L3, 583
:SENSe{1-16}:CORRection:COLLect:CKIT:STAN{1-21}:LAbel, 584
:SENSe{1-16}:CORRection:COLLect:CKIT:STAN{1-21}:LOSS, 585
:SENSe{1-16}:CORRection:COLLect:CKIT:STAN{1-21}:TYPE, 586
:SENSe{1-16}:CORRection:COLLect:CKIT:STAN{1-21}:Z0, 587
:SENSe{1-16}:CORRection:COLLect:CKIT:TRLOption:IMPedance, 588
:SENSe{1-16}:CORRection:COLLect:CLear, 590
:SENSe{1-16}:CORRection:COLLect:ECAL:CCheck[:ACquire], 591
:SENSe{1-16}:CORRection:COLLect:ECAL:ERESponse, 592
:SENSe{1-16}:CORRection:COLLect:ECAL:ISOLation[:STATe], 593
:SENSe{1-16}:CORRection:COLLect:ECAL:SOLT1, 594
:SENSe{1-16}:CORRection:COLLect:ECAL:SOLT2, 594
:SENSe{1-16}:CORRection:COLLect:ECAL:SOLT3, 595
:SENSe{1-16}:CORRection:COLLect:ECAL:SOLT4, 595
:SENSe{1-16}:CORRection:COLLect:ECAL:THRU, 596
:SENSe{1-16}:CORRection:COLLect:ECAL:UChar, 597
:SENSe{1-16}:CORRection:COLLect:ECAL:UTHRU[:STATe], 598
:SENSe{1-16}:CORRection:COLLect:METHod:ADAPter:REMOval, 601
:SENSe{1-16}:CORRection:COLLect:METHod:ERESponse, 602
:SENSe{1-16}:CORRection:COLLect:METHod[:RESPonse]:OPEN, 603
:SENSe{1-16}:CORRection:COLLect:METHod[:RESPonse]:THRU, 606
:SENSe{1-16}:CORRection:COLLect:METHod:SOLT1, 604
:SENSe{1-16}:CORRection:COLLect:METHod:SOLT2, 604
:SENSe{1-16}:CORRection:COLLect:METHod:SOLT3, 605
:SENSe{1-16}:CORRection:COLLect:METHod:SOLT4, 605
:SENSe{1-16}:CORRection:COLLect:METHod:TRL2, 607
:SENSe{1-16}:CORRection:COLLect:METHod:TRL3, 608
:SENSe{1-16}:CORRection:COLLect:METHod:TRL4, 609
:SENSe{1-16}:CORRection:COLLect:METHod:TYPE?, 610
:SENSe{1-16}:CORRection:COLLect:METHod[:RESPonse]:SHORT, 603
:SENSe{1-16}:CORRection:COLLect:PARTial:SAVE, 612
:SENSe{1-16}:CORRection:COLLect:SAVE, 613
:SENSe{1-16}:CORRection:COLLect:SIMPLified:SAVE, 614
:SENSe{1-16}:CORRection:EXTension:AUTO:PORT{1-4}, 625
:SENSe{1-16}:CORRection:EXTension:PORT{1-4}, 626, 629
:SENSe{1-16}:CORRection:EXTension:PORT{1-4}:FREQuency{1-2}, 630
:SENSe{1-16}:CORRection:EXTension:PORT{1-4}:INCLude{1-2}, 631
:SENSe{1-16}:CORRection:EXTension:PORT{1-4}:LDC, 632
:SENSe{1-16}:CORRection:EXTension:PORT{1-4}:LOSS{1-2}, 633
:SENSe{1-16}:CORRection:EXTension:START, 627
:SENSe{1-16}:CORRection:EXTension[:STATe], 620
:SENSe{1-16}:CORRection:EXTension:STOP, 628
:SENSe{1-16}:CORRection:OFFSet:CLear, 634
:SENSe{1-16}:CORRection:OFFSet:COLLect:CLear, 635
:SENSe{1-16}:CORRection:OFFSet:COLLect:ECAL:SMIX2, 636
:SENSe{1-16}:CORRection:OFFSet:COLLect:ECAL:SOULT1, 637
:SENSe{1-16}:CORRection:OFFSet:COLLect:METHod:SMIX2, 639
:SENSe{1-16}:CORRection:OFFSet:COLLect:METHod:SOLT1, 640
:SENSe{1-16}:CORRection:OFFSet:COLLect:SAVE, 643
:SENSe{1-16}:CORRection:OFFSet:COLLect[:ACquire]:LOAD, 638
:SENSe{1-16}:CORRection:OFFSet:COLLect[:ACquire]:OPEN, 641
:SENSe{1-16}:CORRection:OFFSet:COLLect[:ACquire]:PMETER, 642
:SENSe{1-16}:CORRection:OFFSet:COLLect[:ACquire]:SHORT, 644
:SENSe{1-16}:CORRection:OFFSet:COLLect[:ACquire]:THRU, 645
:SENSe{1-16}:CORRection:PROPerTy, 646
:SENSe{1-16}:CORRection:RECeiver{1-4}[:STATe], 647
:SENSe{1-16}:CORRection:RECeiver{1-4}COLLect:ACquire, 648
:SENSe{1-16}:CORRection:RVELocity:COAX, 649
:SENSe{1-16}:CORRection:STATe, 650
:SENSe{1-16}:CORRection:TRIGge:FREE[:STATe], 651
:SENSe{1-16}:CORRection:TYPE{1-16}?, 652
:SENSe{1-16}:FREQuency:CENTER, 654
:SENSe{1-16}:FREQuency:DATA, 655
:SENSe{1-16}:FREQuency:SPAN, 656
:SENSe{1-16}:FREQuency:START, 657

:SENSe{1-16}:FREQUency:STOP, 658
 :SENSe{1-16}:FREQUency[:CW], 653
 :SENSe{1-16}:MULTiplexer{1-2}:OUTPut[:DATA], 659
 :SENSe{1-16}:MULTiplexer{1-2}:PORT{1-20}:CATalog?, 662
 :SENSe{1-16}:MULTiplexer{1-2}:PORT{1-20}[:SElect], 660
 :SENSe{1-16}:MULTiplexer{1-2}:TSET9:OUTPut[:DATA], 663
 :SENSe{1-16}:MULTiplexer{1-2}:TSET9:PORT1, 664
 :SENSe{1-16}:MULTiplexer{1-2}:TSET9:PORT2, 665
 :SENSe{1-16}:MULTiplexer{1-2}:TSET9:PORT3, 666
 :SENSe{1-16}:MULTiplexer{1-2}:TSET9:PORT4, 667
 :SENSe{1-16}:OFFSet:ASPurious, 669
 :SENSe{1-16}:OFFSet:LOCAL:CONTRol[:STATE], 670
 :SENSe{1-16}:OFFSet:LOCAL:POWer[:LEVel]:SLOPe:STATE, 679
 :SENSe{1-16}:OFFSet:LOCAL:POWer[:LEVel]:SLOPe[:DATA], 678
 :SENSe{1-16}:OFFSet:LOCAL:POWer[:LEVel][:IMMediate][:AMPLitude], 677
 :SENSe{1-16}:OFFSet:LOCAL:STATE, 680
 :SENSe{1-16}:OFFSet:LOCAL[:FREQUency]:DATA?, 671
 :SENSe{1-16}:OFFSet:LOCAL[:FREQUency]:DIVisor, 672
 :SENSe{1-16}:OFFSet:LOCAL[:FREQUency]:MULTIplier, 673
 :SENSe{1-16}:OFFSet:LOCAL[:FREQUency]:OFFSet, 674
 :SENSe{1-16}:OFFSet:LOCAL[:FREQUency]:START, 675
 :SENSe{1-16}:OFFSet:LOCAL[:FREQUency]:STOP, 676
 :SENSe{1-16}:OFFSet:PORT{1-4}[:FREQUency]:DATA?, 681
 :SENSe{1-16}:OFFSet:PORT{1-4}[:FREQUency]:DIVisor, 682
 :SENSe{1-16}:OFFSet:PORT{1-4}[:FREQUency]:MULTIplier, 683
 :SENSe{1-16}:OFFSet:PORT{1-4}[:FREQUency]:OFFSet, 684
 :SENSe{1-16}:OFFSet:PORT{1-4}[:FREQUency]:START, 685
 :SENSe{1-16}:OFFSet:PORT{1-4}[:FREQUency]:STOP, 686
 :SENSe{1-16}:OFFSet[:STATE], 668
 :SENSe{1-16}:ROSCillator:SOURce, 687
 :SENSe{1-16}:SEGMENT:DATA, 688
 :SENSe{1-16}:SEGMENT:SWEEP:POINTS?, 690
 :SENSe{1-16}:SEGMENT:SWEEP:TIME?, 690
 :SENSe{1-16}:SWEEP:ASPurious, 691
 :SENSe{1-16}:SWEEP:DELAy, 691
 :SENSe{1-16}:SWEEP:GENeration, 692
 :SENSe{1-16}:SWEEP:POINTS, 693
 :SENSe{1-16}:SWEEP:TIME:AUTO, 695
 :SENSe{1-16}:SWEEP:TIME[:DATA], 694
 :SENSe{1-16}:SWEEP:TYPE, 696
 :SERvice:CHANnel:ACTive?, 696
 :SERvice:CHANnel:COUNt?, 697
 :SERvice:CHANnel:TRACe:COUNt?, 697
 :SERvice:CHANnel{1-16}:TRACe:ACTive?, 697
 :SERvice:PORT:COUNt?, 698
 :SERvice:SEREvision, 698
 :SERvice:SWEEP:FREQUency:MAXimum?, 699
 :SERvice:SWEEP:FREQUency:MINimum?, 699
 :SERvice:SWEEP:POINT?, 699
 :SOURce:POWer:PORT:CORRection:COLLect:ASENSor:RCFactor, 700
 :SOURce:POWer:PORT:CORRection:COLLect:BSENSor:RCFactor, 701
 :SOURce:POWer:PORT:CORRection:COLLect:TABLE:ASENSor:DATA, 702
 :SOURce:POWer:PORT:CORRection:COLLect:TABLE:BSENSor:DATA, 703
 :SOURce{1-16}:POWer:ATTenuationr:AUTO[:DATA], 706
 :SOURce{1-16}:POWer:ATTenuation[:DATA], 705
 :SOURce{1-16}:POWer:CENter, 708
 :SOURce{1-16}:POWer[:LEVel][:IMMediate][:AMPLitude], 704
 :SOURce{1-16}:POWer[:LEVel]:SLOPe[:DATA], 717
 :SOURce{1-16}:POWer[:LEVel]:SLOPe:STATE, 718
 :SOURce{1-16}:POWer:PORT:COUPle, 709
 :SOURce{1-16}:POWer:PORT{1-4}:CORRection:COLLect[:ACquire], 711
 :SOURce{1-16}:POWer:PORT{1-4}:CORRection:COLLect:AVERage[:COUNt], 712
 :SOURce{1-16}:POWer:PORT{1-4}:CORRection:COLLect:NTOLerance, 713
 :SOURce{1-16}:POWer:PORT{1-4}:CORRection:COLLect:TABLE:LOSS:DATA, 715
 :SOURce{1-16}:POWer:PORT{1-4}:CORRection:COLLect:TABLE:LOSS[:STATE], 714
 :SOURce{1-16}:POWer:PORT{1-4}:CORRection:DATA, 716
 :SOURce{1-16}:POWer:PORT{1-4}:CORRection[:STATe], 711
 :SOURce{1-16}:POWer:PORT{1-4}[:LEVel][:IMMediate][:AMPLitude], 710
 :SOURce{1-16}:POWer:SPAN, 719
 :SOURce{1-16}:POWer:START, 720
 :SOURce{1-16}:POWer:STOP, 721
 :STATus:OPERation:CONDition?, 722
 :STATus:OPERation:ENABle, 723
 :STATus:OPERation[:EVENT]?, 722
 :STATus:OPERation:NTRansition, 724
 :STATus:OPERation:PTRansition, 725
 :STATus:PRESet, 726
 :STATus:QUESTionable:BLIMit:CHANnel{1-16}:CONDition?, 727
 :STATus:QUESTionable:BLIMit:CHANnel{1-16}:ECHANnel:CONDition?, 729
 :STATus:QUESTionable:BLIMit:CHANnel{1-16}:ECHANnel:ENABle, 730
 :STATus:QUESTionable:BLIMit:CHANnel{1-16}:ECHANnel[:EVENT]?, 729
 :STATus:QUESTionable:BLIMit:CHANnel{1-16}:ECHANnel:NTRansition, 731

:STATUS:QUESTIONABLE:BLIMIT:CHANNEL{1-16}:ECHANNEL:PTRANSITION, 732
:STATUS:QUESTIONABLE:BLIMIT:CHANNEL{1-16}:ENABLE, 733
:STATUS:QUESTIONABLE:BLIMIT:CHANNEL{1-16}[:EVENT]?, 727
:STATUS:QUESTIONABLE:BLIMIT:CHANNEL{1-16}:NTRANSITION, 734
:STATUS:QUESTIONABLE:BLIMIT:CHANNEL{1-16}:PTRANSITION, 735
:STATUS:QUESTIONABLE:BLIMIT:CONDITION?, 735
:STATUS:QUESTIONABLE:BLIMIT:ELIMIT:CONDITION?, 736
:STATUS:QUESTIONABLE:BLIMIT:ELIMIT:ENABLE, 737
:STATUS:QUESTIONABLE:BLIMIT:ELIMIT[:EVENT]?, 736
:STATUS:QUESTIONABLE:BLIMIT:ELIMIT:NTRANSITION, 738
:STATUS:QUESTIONABLE:BLIMIT:ELIMIT:PTRANSITION, 739
:STATUS:QUESTIONABLE:BLIMIT:ENABLE, 740
:STATUS:QUESTIONABLE:BLIMIT[:EVENT]?, 727
:STATUS:QUESTIONABLE:BLIMIT:NTRANSITION, 741
:STATUS:QUESTIONABLE:BLIMIT:PTRANSITION, 742
:STATUS:QUESTIONABLE:CONDITION?, 743
:STATUS:QUESTIONABLE:ENABLE, 744
:STATUS:QUESTIONABLE[:EVENT]?, 726
:STATUS:QUESTIONABLE:LIMIT:CHANNEL{1-16}:CONDITION?, 745
:STATUS:QUESTIONABLE:LIMIT:CHANNEL{1-16}:ECHANNEL:CONDITION?, 747
:STATUS:QUESTIONABLE:LIMIT:CHANNEL{1-16}:ECHANNEL:ENABLE, 748
:STATUS:QUESTIONABLE:LIMIT:CHANNEL{1-16}:ECHANNEL[:EVENT]?, 747
:STATUS:QUESTIONABLE:LIMIT:CHANNEL{1-16}:ECHANNEL:NTRANSITION, 749
:STATUS:QUESTIONABLE:LIMIT:CHANNEL{1-16}:ECHANNEL:PTRANSITION, 750
:STATUS:QUESTIONABLE:LIMIT:CHANNEL{1-16}:ENABLE, 751
:STATUS:QUESTIONABLE:LIMIT:CHANNEL{1-16}[:EVENT]?, 745
:STATUS:QUESTIONABLE:LIMIT:CHANNEL{1-16}:NTRANSITION, 752
:STATUS:QUESTIONABLE:LIMIT:CHANNEL{1-16}:PTRANSITION, 753
:STATUS:QUESTIONABLE:LIMIT:CONDITION?, 754
:STATUS:QUESTIONABLE:LIMIT:ELIMIT:CONDITION?, 755
:STATUS:QUESTIONABLE:LIMIT:ELIMIT:ENABLE, 755
:STATUS:QUESTIONABLE:LIMIT:ELIMIT[:EVENT]?, 754
:STATUS:QUESTIONABLE:LIMIT:ELIMIT:NTRANSITION, 756
:STATUS:QUESTIONABLE:LIMIT:ELIMIT:PTRANSITION, 757
:STATUS:QUESTIONABLE:LIMIT:ENABLE, 758
:STATUS:QUESTIONABLE:LIMIT[:EVENT]?, 745
:STATUS:QUESTIONABLE:LIMIT:NTRANSITION, 759
:STATUS:QUESTIONABLE:LIMIT:PTRANSITION, 760
:STATUS:QUESTIONABLE:NTRANSITION, 761
:STATUS:QUESTIONABLE:PTRANSITION, 762
:STATUS:QUESTIONABLE:RLIMIT:CHANNEL{1-16}:CONDITION?, 763
:STATUS:QUESTIONABLE:RLIMIT:CHANNEL{1-16}:ECHANNEL:CONDITION?, 765
:STATUS:QUESTIONABLE:RLIMIT:CHANNEL{1-16}:ECHANNEL:ENABLE, 766
:STATUS:QUESTIONABLE:RLIMIT:CHANNEL{1-16}:ECHANNEL[:EVENT]?, 765
:STATUS:QUESTIONABLE:RLIMIT:CHANNEL{1-16}:ECHANNEL:NTRANSITION, 767
:STATUS:QUESTIONABLE:RLIMIT:CHANNEL{1-16}:ECHANNEL:PTRANSITION, 768
:STATUS:QUESTIONABLE:RLIMIT:CHANNEL{1-16}:ENABLE, 769
:STATUS:QUESTIONABLE:RLIMIT:CHANNEL{1-16}[:EVENT]?, 763
:STATUS:QUESTIONABLE:RLIMIT:CHANNEL{1-16}:NTRANSITION, 770
:STATUS:QUESTIONABLE:RLIMIT:CHANNEL{1-16}:PTRANSITION, 771
:STATUS:QUESTIONABLE:RLIMIT:CONDITION?, 771
:STATUS:QUESTIONABLE:RLIMIT:ELIMIT:CONDITION?, 772
:STATUS:QUESTIONABLE:RLIMIT:ELIMIT:ENABLE, 773
:STATUS:QUESTIONABLE:RLIMIT:ELIMIT[:EVENT]?, 772
:STATUS:QUESTIONABLE:RLIMIT:ELIMIT:NTRANSITION, 774
:STATUS:QUESTIONABLE:RLIMIT:ELIMIT:PTRANSITION, 775
:STATUS:QUESTIONABLE:RLIMIT:ENABLE, 776
:STATUS:QUESTIONABLE:RLIMIT[:EVENT]?, 763
:STATUS:QUESTIONABLE:RLIMIT:NTRANSITION, 777
:STATUS:QUESTIONABLE:RLIMIT:PTRANSITION, 778
:SYSTEM:BACKLIGHT, 779
:SYSTEM:BEEP:COMPLETE:IMMEDIATE, 780
:SYSTEM:BEEP:COMPLETE:STATE, 780
:SYSTEM:BEEP:WARNING:IMMEDIATE, 781
:SYSTEM:BEEP:WARNING:STATE, 781
:SYSTEM:COMMUNICATE:GPIO:PMETER:ADDRESS, 782
:SYSTEM:COMMUNICATE:GPIO:SGENERATOR:ADDRESS, 783
:SYSTEM:COMMUNICATE:GPIO:SGENERATOR:CCOMMAND:FREQUENCY, 784
:SYSTEM:COMMUNICATE:GPIO:SGENERATOR:CCOMMAND:POWER, 785
:SYSTEM:COMMUNICATE:GPIO:SGENERATOR:CCOMMAND:PRESET, 786
:SYSTEM:COMMUNICATE:GPIO:SGENERATOR:CCOMMAND:RFON, 787
:SYSTEM:COMMUNICATE:GPIO:SGENERATOR:DWELL, 788
:SYSTEM:COMMUNICATE:GPIO:SGENERATOR:TYPE, 789
:SYSTEM:CORRECTION[:STATE], 790
:SYSTEM:DATE, 790
:SYSTEM:ERROR, 791
:SYSTEM:ISPCONTROL:PORT, 792
:SYSTEM:ISPCONTROL:STATE, 793
:SYSTEM:KLOCK:KBD, 794
:SYSTEM:KLOCK:MOUSE, 795
:SYSTEM:POFF, 796

- :SYSTem:PRESet, 796
- :SYSTem:SECurity:LEVel, 797
- :SYSTem:SERVice, 798
- :SYSTem:TEMPerature:HIGH, 799
- :SYSTem:TEMPerature[:STATe]?, 799
- :SYSTem:TIME, 800
- :SYSTem:UPReset, 801
- :TRIGger[:SEquence]:AVERage, 803
- :TRIGger[:SEquence]:EXTernal:DELay, 804
- :TRIGger[:SEquence]:EXTernal:LLATency[:STATe], 805
- :TRIGger[:SEquence][:IMMEDIATE], 802
- :TRIGger[:SEquence]:SCOPE, 807
- :TRIGger[:SEquence]:SINGLE, 808
- :TRIGger[:SEquence]:SOURCE, 809
- :TRIGger[:SEquence]:POINT, 806
- Command list by front panel key, 810
- Command reference
 - E5070B/E5071B commands, 292
 - IEEE common commands, 286
 - Notational conventions, 284
- Command tree, 828
- Comparison of commands on the 8753ES and E5070B/E5071B, 897
- Lookup, 26
- Screen display
 - update on/off, 63
- Search
 - Analysis command, 143
 - Marker search, 141
- Search range
 - Analysis command, 143
 - Marker search, 141
- Search tracking, 142
- Search type
 - Analysis command, 143
 - Marker search, 141
- search.htb, 146
- Secondary value, 169
- Segment sweep, 55
 - Total number of measurement points, 690
 - Total sweep time, 690
- Segment sweep table
 - Saving/recalling, 197
- Setting, 55
 - Showing/hiding, 59
- Sending several commands, 49
- Serial number, 852
 - Plate, 852
 - Reading out, 288
- Service mode, 798
- Service request, 864
 - Example of use
 - Error detection, 230
 - Waiting for the end of measurement, 132
- Service request enable register, 867
 - Setting, 290
- Setting frequency offset function, 92
- Setting the delay time, 625, 626, 627, 628, 629
- Setting the title display area, 63
- setup.htb, 70
- SHORT, 82
- Shutdown, 796
- SICL-LAN, 34
 - Example of use, 265
- SICL-LAN address, 34
- SICL-LAN server
 - Turning on/off, 34
- simplified 3/4-port TRL calibration, 78
- simplified full 3/4 port calibration, 77
- Smith chart format, 60
- Smoothing, 60
- Softkey Labels
 - Showing/hiding, 59
- Source power, 54
- Span value
 - Frequency sweep range, 54
 - Power sweep range, 55
- Specifying file, 194
- SRQ, 864
 - Example of use
 - Error detection, 230
 - Waiting for the end of measurement, 132
- srq_err.htb, 232
- srq_meas.htb, 134
- Standard class assignment, 82
- Standard deviation
 - Analysis command, 143
 - Statistical analysis, 149
- Standard event status register, 867
 - Bit definitions, 879
 - Reading out the event register, 287
 - Setting the enable register, 287
- Standard module
 - Importing, 198
- Standard name, 81
- Standard type, 81
- Standard value, 81
- Start value
 - Frequency sweep range, 54
 - Marker search range, 141
 - Power sweep range, 55
 - Search(analysis) range, 143
- Starting a measurement, 131
- Statistical analysis results
 - Analysis command, 144
 - Statistical analysis, 149
- Status byte register, 865
 - Bit definitions, 878
 - Reading out, 291
- Status register
 - Example of use
 - Error detection, 230
 - Obtaining test results, 181

- Waiting for the end of measurement, 132
 - Register structure, 867
 - Status reporting system, 864
 - Stepped mode, 53
 - Stimulus, 53
 - Stimulus data arrays, 170
 - Stimulus signal output
 - On/Off, 53
 - Stop value
 - Frequency sweep range, 54
 - Marker search range, 141
 - Power sweep range, 55
 - Search(analysis) range, 143
 - Subclass setting, 82
 - Sweep condition, 53
 - Sweep delay time, 54
 - Sweep mode, 53
 - Sweep range, 54
 - Power sweep, 55
 - Sweep time, 54
 - Reading out
 - Linear sweep, 694
 - Segment sweep, 690
 - Sweep type, 53
 - Swept mode, 53
 - Switching Over Modes, 137
 - SWR format, 60
 - System error correction, 790
 - System Z0, 56
- T**
- Table
 - Limit table
 - Showing/hiding, 59
 - Marker list table, 59
 - Segment sweep table
 - Setting, 55
 - Showing/hiding, 59
 - Take4 mode, 909
 - Target search
 - Analysis command, 143
 - Marker search, 141
 - telnet, 40
 - Telnet server
 - Example of use, 273
 - Turning on/off, 33
 - telnet server
 - Turning on/off, 39
 - Test results, 181
 - Each channel, 182
 - Each measurement point, 181
 - Each trace, 181
 - Overall test result, 184
 - test sequence, 922
 - THRU, 82
 - Time
 - Show or hide, 63
 - time_dom.htb, 160
 - Timing chart, 218
 - Topology, 153
 - Total number of measurement points of all segments, 690
 - Total sweep time of all segments, 690
 - Touchstone file
 - Differential matching circuit, 333
 - Matching circuit, 362
 - Network de-embedding, 355
 - touchstone file
 - 4 port network embedding/de-embedding, 347
 - Trace display, 57
 - Tracking, 142
 - Transferring files
 - Command, 202
 - Sample program, 203
 - Transition filter, 866
 - Transitional direction
 - Analysis command, 144
 - Marker search, 142
 - trg_sing.htb, 136
 - Trigger source, 129
 - trigger source for calibration, 75
 - Trigger system, 128
 - Triggering a measurement, 131
 - TRL*/LRM* calibration, 905
 - Turning on or off error correction, 78
 - Turning on or off the backlight, 63
 - Turning on or off the port extension, 620, 621, 622, 623, 624
 - Turning on or off the system error correction, 790
 - Turns off the analyzer, 796
 - Typeface conventions, 3
 - Types of remote control system, 30
- U**
- Unbalance, 153
 - Update of the LCD display, 227
 - Turning on or off, 227
 - Update once, 227
 - Update on/off
 - Screen display, 63
 - USB remote control system, 42
 - User form
 - Importing, 198
 - User's Guide, 4
- V**
- VBA, 30
 - VBA macro
 - Control, 529
 - VBA Programmer's Guide, 4
 - VBA project
 - Saving/loading, 198
 - VEE, 41
 - Velocity factor, 649

W

Waiting for the end of measurement
 Inserting wait time, 136
 Using the :TRIG:SING command, 135
 Using the status register, 132
Waiting for trigger state, 129
Warm-up, 799
Window
 Layout, 57
 Maximizing, 57
WinSock API
 Example of use, 273
 Overview, 41
WRITE STROBE, 213
Write strobe signal
 Limit test result, 214
 Output port, 213
write_a.htb, 176
write_b.htb, 178

Z

Z0, 56

REGIONAL SALES AND SUPPORT OFFICES

For more information about Agilent Technologies test and measurement products, applications, services, and for a current sales office listing, visit our web site: <http://www.agilent.com/find/tmdir>. You can also contact one of the following centers and ask for a test and measurement sales representative. 21/01/2004

United States:

Test and Measurement Call Center
(tel) 1 800 452-4844
(fax) 1 888 900-8921

Australia/New Zealand:

(tel) (61 3) 9210-5555 (Australia)
(fax) (61 3) 9210-5899
(tel) (64 4) 939-0636 (New Zealand)
(fax) (64 4) 972-5364

Canada:

Test and Measurement Call Center
(tel) 1 877 894-4414
(fax) 1 888 900-8921

Asia Pacific:

(tel) (65) 6375-8100
(fax) (65) 6836-0252
Email: tm_asia@agilent.com

China:

(tel) 800 810-0189
(fax) 800 820-2816

Europe:

(tel) (31 20) 547-2323
(fax) (31 20) 547-2390

Japan:

Call Center
(tel) 0120 421-345
(tel) (81) 426 56-7832
(fax) (81) 426 56-7840

Korea:

(tel) (82 2) 2004-5004
(fax) (82 2) 2004-5115

Latin America:

(tel) (305) 269-7500
(fax) (305) 269-7599

Taiwan:

(tel) 0800 047 866
(fax) 0800 286 331