Caution



Do not exceed the operating input power, voltage, and current level and signal type appropriate for the instrument being used, refer to your instrument's Function Reference.



Electrostatic discharge(ESD) can damage the highly sensitive microcircuits in your instrument. ESD damage is most likely to occur as the test fixtures are being connected or disconnected. Protect them from ESD damage by wearing a grounding strap that provides a high resistance path to ground. Alternatively, ground yourself to discharge any static charge built-up by touching the outer shell of any grounded instrument chassis before touching the test port connectors.

Safety Summary

When you notice any of the unusual conditions listed below, immediately terminate operation and disconnect the power cable.

Contact your local Agilent Technologies sales representative or authorized service company for repair of the instrument. If you continue to operate without repairing the instrument, there is a potential fire or shock hazard for the operator.

- Instrument operates abnormally.
- Instrument emits abnormal noise, smell, smoke or a spark-like light during operation.
- Instrument generates high temperature or electrical shock during operation.
- Power cable, plug, or receptacle on instrument is damaged.
- Foreign substance or liquid has fallen into the instrument.

Herstellerbescheinigung

GERÄUSCHEMISSION

LpA < 70 dB
am Arbeitsplatz
normaler Betrieb
nach DIN 45635 T. 19

Manufacturer's Declaration

ACOUSTIC NOISE EMISSION

LpA < 70 dB
operator position
normal operation
per ISO 7779

Regulatory compliance information

This product complies with the essential requirements of the following applicable European Directives, and carries the CE marking accordingly:

The Low Voltage Directive 73/23/EEC, amended by 93/68/EEC

The EMC Directive 89/336/EEC, amended by 93/68/EEC

To obtain Declaration of Conformity, please contact your local Agilent Technologies sales office, agent or distributor.

Safety notice supplement

- This equipment complies with EN/IEC61010-1:2001.
- This equipment is MEASUREMENT CATEGORY I (CAT I). Do not use for CAT II, III, or IV.
- Do not connect the measuring terminals to mains.
- This equipment is POLLUTION DEGREE 2, INDOOR USE product.
- This equipment is tested with stand-alone condition or with the combination with the accessories supplied by Agilent Technologies against the requirement of the standards described in the Declaration of Conformity. If it is used as a system component, compliance of related regulations and safety requirements are to be confirmed by the builder of the system.

Agilent E5053A Microwave Downconverter

User's Guide

Third Edition

FIRMWARE REVISIONS

This manual applies directly to instruments that have the E5052A firmware revision A.02.00 and later.

For additional information about firmware revisions, see Appendix A.



Agilent Technologies

Manufacturing No. E5053-90020

November 2008

Notices

The information contained in this document is subject to change without notice.

This document contains proprietary information that is protected by copyright. All rights are reserved. No part of this document may be photocopied, reproduced, or translated to another language without the prior written consent of Agilent Technologies.

Microsoft®, MS-DOS®, Windows®, Visual C++®, Visual Basic®, VBA® and Excel® are registered

UNIX is a registered trademark in U.S. and other countries, licensed exclusively through X/Open Company Limited.

Portions ©Copyright 1996, Microsoft Corporation. All rights reserved.

© Copyright 2005, 2007 Agilent Technologies

Manual Printing History

The manual's printing date and part number indicate its current edition. The printing date changes when a new edition is printed (minor corrections and updates that are incorporated at reprint do not cause the date to change). The manual part number changes when extensive technical changes are incorporated.

August 2005	First Edition (part number: E5053-90000)
November 2007	Second Edition (part number: E5053-90010)
November 2008	Third Edition (part number: E5053-90020)

Safety Summary

The following general safety precautions must be observed during all phases of operation, service, and repair of this instrument. Failure to comply with these precautions or with specific WARNINGS elsewhere in this manual may impair the protection provided by the equipment. Such noncompliance would also violate safety standards of design, manufacture, and intended use of the instrument. Agilent Technologies assumes no liability for the customer's failure to comply with these precautions.

NOTE The E5053A complies with INSTALLATION CATEGORY II as well as POLLUTION DEGREE 2 in IEC61010-1. The E5053A is an INDOOR USE product.

NOTE The LEDs in the E5053A are Class 1 in accordance with IEC60825-1, CLASS 1 LED PRODUCT

NOTE  This equipment is MEASUREMENT CATEGORY I (CAT I). Do not use for CAT II, III, or IV.

NOTE This equipment is tested with stand-alone condition or with the combination with the accessories supplied by Agilent Technologies against the requirement of the standards described in the Declaration of Conformity. If it is used as a system component, compliance of related regulations and safety requirements are to be confirmed by the builder of the system.

- **Ground the Instrument**
To avoid electric shock, the instrument chassis and cabinet must be grounded with the supplied power cable's grounding prong.
- **DO NOT Operate in an Explosive Atmosphere**
Do not operate the instrument in the presence of inflammable gasses or fumes. Operation of any electrical instrument in such an environment clearly constitutes a safety hazard.
- **Keep Away from Live Circuits**
Operators must not remove instrument covers. Component replacement and internal adjustments must be made by qualified maintenance personnel. Do not replace components with the power cable connected. Under certain conditions, dangerous voltage levels may remain even after the power cable has been disconnected. To avoid injuries, always disconnect the power and discharge circuits before touching them.
- **DO NOT Service or Adjust the Instrument Alone**
Do not attempt internal service or adjustment unless another person, capable of rendering first aid and resuscitation, is present.
- **DO NOT Substitute Parts or Modify the Instrument**
To avoid the danger of introducing additional hazards, do not install substitute parts or perform unauthorized modifications to the instrument. Return the instrument to an Agilent Technologies Sales and Service Office for service and repair to ensure that

safety features are maintained in operational condition.

- Dangerous Procedure Warnings

Warnings, such as the example below, precede potentially dangerous procedures throughout this manual. Instructions contained in the warnings must be followed.

WARNING

Dangerous voltage levels, capable of causing death, are present in this instrument. Use extreme caution when handling, testing, and adjusting this instrument.

Safety Symbols

General definitions of safety symbols used on the instrument or in manuals are listed below.



Instruction Manual symbol: the product is marked with this symbol when it is necessary for the user to refer to the instrument manual.



Alternating current.



Direct current.



On (Supply).



Off (Supply).



In-position of push-button switch.



Out-position of push-button switch.



A chassis terminal; a connection to the instrument's chassis, which includes all exposed metal structure.



Stand-by.

WARNING

This warning sign denotes a hazard. It calls attention to a procedure, practice, or condition that, if not correctly performed or adhered to, could result in injury or death to personnel.

CAUTION

This Caution sign denotes a hazard. It calls attention to a procedure, practice, or condition that, if not correctly performed or adhered to, could result in damage to or destruction of part or all of the instrument.

NOTE

This Note sign denotes important information. It calls attention to a procedure, practice, or condition that is essential for the user to understand.

Certification

Agilent Technologies certifies that this product met its published specifications at the time of shipment from the factory. Agilent Technologies further certifies that its calibration measurements are traceable to the United States National Institute of Standards and Technology, to the extent allowed by the Institution's calibration facility or by the calibration facilities of other International Standards Organization members.

Exclusive Remedies

The remedies provided herein are Buyer's sole and exclusive remedies. Agilent Technologies shall not be liable for any direct, indirect, special, incidental, or consequential damages, whether based on contract, tort, or any other legal theory.

Assistance

Product maintenance agreements and other customer assistance agreements are available for Agilent Technologies products.

For any assistance, contact your nearest Agilent Technologies Sales and Service Office. Addresses are provided at the back of this manual.

Typeface Conventions

Sample (bold)

Boldface type is used when a term is defined or emphasized.

Sample (Italic)

Italic type is used for emphasis and for titles of manuals and other publications.

Sample menu/button/box/tab

Indicates a menu/button/box/tab on the screen labeled “Sample” which can be selected/executed by clicking. “menu”, “button”, “box”, or “tab” may be omitted.

Sample key

Indicates a hardkey (key on the front panel or external keyboard) labeled “Sample.” “key” may be omitted.

[Sample]

Indicates the hardkey whose key label is “Sample”.

[Sample] - Item

Indicates a series of key operations in which you press the **[Sample]** key, make the item called “Item” on the displayed menu blink by using the [↓] or in other ways, and then press the **[Enter]** key.

1. Installation	
Incoming inspection	10
Requirements for installation environment.	13
Operating environment	13
Heat dissipation clearance.	14
Antistatic measures	15
Providing space to disconnect the power cable's plug	15
Mounting front handles/flanges for rackmount	16
Mounting handle kit (Option 1CN).	17
Mounting rackmount kit (Option 1CM)	18
Mounting rackmount/handle kit (Option 1CP)	18
Power supply and fuse	19
Checking the power supply.	19
Setting up the fuse.	19
Checking and connecting the power cable	20
Starting up E5053A.	22
Turning ON/OFF the power	22
Cutting power supply	22
2. Overview of Product	
About This Product.	24
Names and Functions of Parts	25
Front Panel	25
Rear Panel	27
3. Connecting Devices to E5052A for Operation	
Connecting E5052A and E5053A.	30
Required Devices	30
Connection on Front Panel	30
Connection on Rear Panel.	31
Turning on Power	31
Basic Operation.	32
4. Specifications and Supplemental Information	
Definitions	34
General Information	35
5. Information on Maintenance	
Cleaning this Instrument.	42
Maintenance of Interconnection Ports and Test Ports.	42
Cleaning a Display Other than Interconnection Ports and Test Ports	42
Cautions Applicable to Requesting Repair, Replacement, Regular Calibration, etc.	43
Devices to be Sent Back for Repair or Regular Calibration	43
Recommended Calibration Period	43
A. Manual Changes	
Manual Changes	46

1 Installation

This chapter provides information on how to set up the Agilent E5053A microwave downconverter.

Incoming inspection

When you receive the product, follow the steps below to perform the incoming inspection.

WARNING

If there are signs of shipping damage to any portion of the outer enclosure when opening the package (for example, the cover, front/rear panel, power switch, and port connectors), do not turn on the power. You may get an electrical shock.

Step 1. Check the shipping container and cushioning material for damage.

NOTE

If the shipping container or cushioning material is damaged, it should be kept until all the other inspections have been done.

Step 2. Check the contents of the package for mechanical damage or defects.

Step 3. Check the contents of the shipment using Table 1-1 and Figure 1-1 to see if all your specified options are complete.

Step 4. If you detect any of the following in the inspection, contact you nearest Agilent Technologies sales office.

1. If the shipping container or cushioning material is damaged or the cushioning material shows signs of unusual stress.
2. If you find any mechanical damage or defect to the contents.
3. If the contents of the shipment are not complete.
4. If you find any fault with the product during operational checks described below.

In the case of 1, notify the carrier as well as your nearest Agilent Technologies sales office. Keep the shipping container, cushioning material, and the contents of the shipment for the carrier's inspection.

Table 1-1 Contents of the E5053A package

Name	Agilent product/part number	Quantity
Standard contents		
<input type="checkbox"/> E5053A	E5053A	1
<input type="checkbox"/> Power cable *1	8120-4753	1
<input type="checkbox"/> USB cable	8121-0770	1
<input type="checkbox"/> RF SMA cable	E5053-61621	2
<input type="checkbox"/> RF SMA cable	E5053-61622	2
<input type="checkbox"/> BNC(m)-BNC(m) cable, 61 cm	8120-1839	1
<input type="checkbox"/> 3.5(f)-3.5(f) adapter *2	5061-5311	1
<input type="checkbox"/> BNC adapter	1250-1859	1
<input type="checkbox"/> CD-ROM (of the manual) *3	E5053-905xx	1
<input type="checkbox"/> Termination-Coaxial SMA, 0.5W, 50ohm	1810-0118	4
Option		
<input type="checkbox"/> Manual (Option ABA) *4		
• User's Guide	E5053-900x0	1
<input type="checkbox"/> Handle kit (Option 1CN) *5	5063-9227	1
<input type="checkbox"/> Rackmount kit (Option 1CM) *5	5063-9214	1
	E5053-61623	2
	E5053-61624	2
<input type="checkbox"/> Rackmount/handle kit (Option 1CP) *5	5063-9221	1
	E5053-61623	2
	E5053-61624	2

*1. This accessory varies from country to country. For the power cable option, see Figure 1-6.

*2. The contents of these accessories are not shown in Figure 1-1.

*3. The CD-ROM contains the same information as in the User's Guide. The 'xx' in the part number is a number that is incremented each time a revision is made, with '00' regarded as the first edition. The latest edition comes with the product.

*4. The number of "x" in the part number of the manual, 0 for the first edition, is incremented by 1 each time a revision is made. The latest edition comes with the product.

*5. The contents of these accessories are not shown in Figure 1-1. For more information on them, refer to Table 1-5 on page 16.

Figure 1-1

Accessories

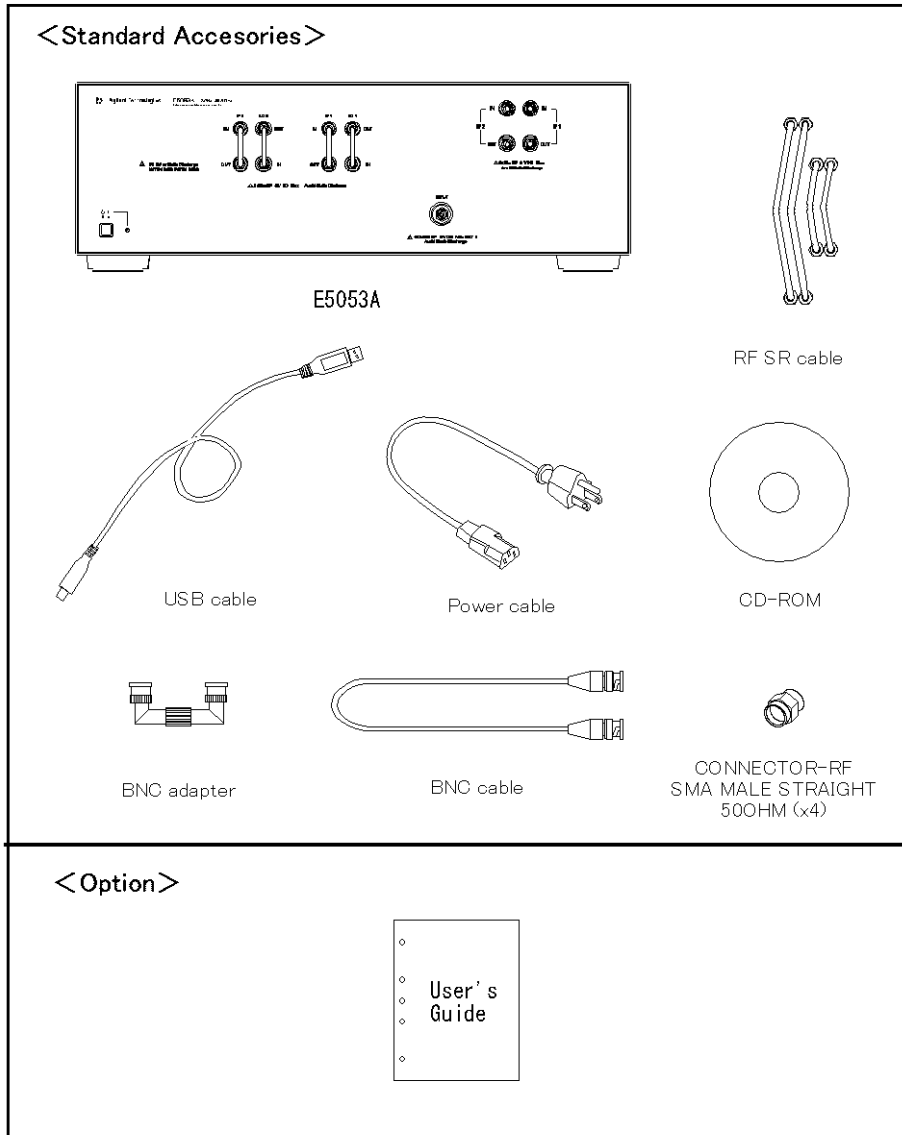

e5053aue1013

Requirements for installation environment

Install the E5053A under an environment that satisfies the following conditions.

Operating environment

Use the E5053A under the following environmental conditions.

Table 1-2

Temperature	10 °C to 40 °C
Temperature range for error-correction	23 °C ± 5 °C (< 1 °C deviation from the temperature when performing the error-correction)
Humidity	20 % to 80 % at wet bulb temperature < +28 °C (non-condensation)
Altitude	0 m to 2,000 m (0 to 6,561 feet)
Vibration	0.21 G maximum, 5 Hz to 500 Hz

CAUTION

The above environmental requirements are **not** intended for the specifications and measurement accuracy of the analyzer but for the operating environment of the analyzer.

Heat dissipation clearance

To satisfy the safety, specifications, and measurement accuracy of the product, you need to keep the temperature around the product within a specific range by providing proper heat dissipation clearance around the product or by forcefully air-cooling the inside of the rack. For information on ambient temperature to satisfy the specifications and measurement accuracy of the product, refer to the “Specifications and supplemental performance characteristics” Chapter in *the User’s Guide*.

When the temperature around the product is kept within the specified temperature range, the product will comply with the safety standards. Furthermore, the product will also comply with the safety standards when the product is installed with clearance for heat dissipation according to Table 1-3 and Figure 1-2 below.

Table 1-3

	Condition
Rear	≥ 180 mm
Sides	≥ 60 mm (both right and left)

Figure 1-2

Providing heat dissipation clearance

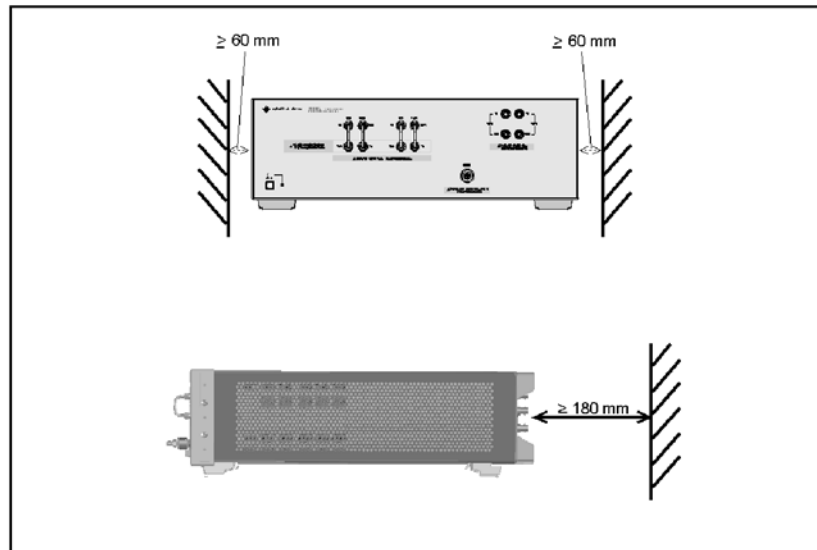

e5053auj1001

Antistatic measures

To protect electronic components from static damage, take antistatic measures as shown in Figure 1-3.

Figure 1-3

Example of antistatic measures

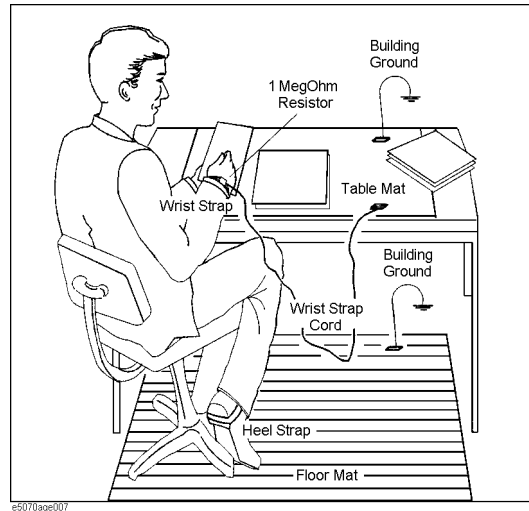

Providing space to disconnect the power cable's plug

As described in “Cutting power supply” on page 22, the disconnecting device (the device to cut the supply of power) of the E5053A is the plug of the power cable. When installing the E5053A, provide sufficient clearance not to hinder the operation of disconnecting the plug of the power cable (on the power outlet side or the E5053A side) in an emergency to cut the supply of power.

Mounting front handles/flanges for rackmount

You can use the E5053A on a workbench or mounted in a rack. This section describes how to mount the front handles used to move/transport it (Option 1CN) and how to mount it into a rack as part of a measurement system (Option 1CM: without handles/Option 1CP: with handles).

Table 1-4 Handle/rack options for the E5053A

Option	Name	Agilent part number
1CN	Handle kit	5063-9227
1CM	Rackmount kit	5063-9214 E5053-61623 E5053-61624
1CP	Rackmount/handle kit	5063-9221 E5053-61623 E5053-61624

Table 1-5 Contents of each option kit

Option	Contents	Quantity
1CN	Front handle	2
	Screw	6
	Trim strip	2
1CM	Flange for rackmount (side plate for securing)	2
	Screw	6
1CP	Flange for rackmount (side plate for securing)	2
	Front handle	2
	Screw	6

Figure 1-4 Mounting the handle/rackmount kit

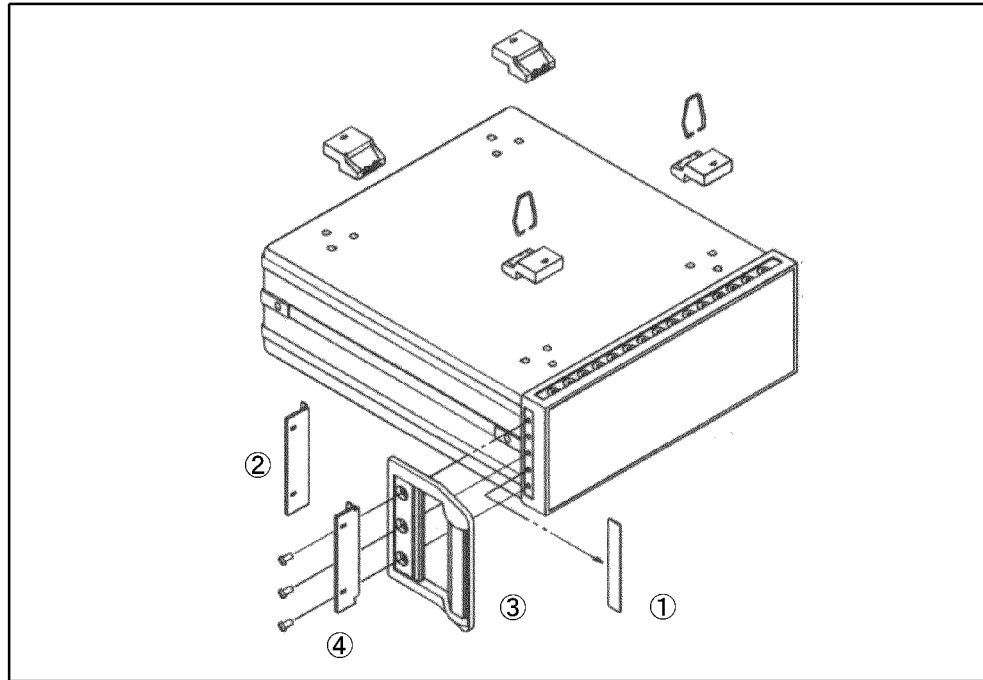

e5053aue1003

Mounting handle kit (Option 1CN)

The handle kit is a kit that contains a pair of front handles used to move/transport the E5053A. Follow these steps to mount it, referring to the Figure 1-4.

- Step 1.** Remove the trim strips (1) stuck to both the sides of the front panel (stuck to the frame).
- Step 2.** Mount the front handles (3) to both the sides of the front panel of the E5053A with the attached screws.

WARNING

If a front handle you mounted is damaged, replace it with new one immediately. If you use a damaged front handle to move/transport the instrument, the handle may break, which may injure the operator or break the instrument.

Mounting rackmount kit (Option 1CM)

The rackmount kit is a kit that contains 2 flanges (side plates for securing) to mount the E5053A into the standard rack (width: 482.6 mm) of the EIA standard. Follow these steps to mount it, referring to the Figure 1-4.

- Step 1.** Remove the trim strips (1) stuck to both the sides of the front panel (stuck to the frame).
- Step 2.** Mount the flanges for rackmount (2) to both the sides of the front panel of the E5053A with the attached screws.
- Step 3.** Remove the four legs on the bottom of the E5053A (pull up the part with the **(TAB** indication and slide it to the arrow direction).
- Step 4.** Mount the E5053A into the rack.

Mounting rackmount/handle kit (Option 1CP)

The rackmount/handle kit is a kit that contains both the flanges for rackmount and the front handles for the E5053A. Follow these steps to mount it, referring to the Figure 1-4.

- Step 1.** Remove the trim strips (1) stuck to both the sides of the front panel (stuck to the frame).
- Step 2.** Mount the front handles (3) and the flanges for rackmount (4) to both the sides of the front panel of the E5053A with the attached screws.

WARNING

Be sure to use both the front handles and the rack-mounting flanges at the same time. Do not attempt to install flanges or handles separately with the hardware provided, since this risks serious electrical damage to the instrument.

- Step 3.** Remove the 4 legs on the bottom of the E5053A (pull up the part with the **(TAB** indication and slide it to the arrow direction).
- Step 4.** Mount the E5053A into the rack.

Power supply and fuse

Before turning ON the E5053A, check the following.

Checking the power supply

Check that the power supplied to the E5053A satisfies the following conditions.

Table 1-6

	Condition
Voltage	90 to 132 Vac or 198 to 264 Vac *1
Frequency	47 to 63 Hz
Power consumption	Max. 250 VA

*1. The E5053A automatically switches between them depending on the voltage.

Setting up the fuse

Use the fuse that meets the following specifications.

UL/CSA type, Slo-Blo, 5×20 mm miniature fuse, 3A 250V (Agilent part number: 2110-1017)

Spare fuses are available from Agilent Technologies sales offices. To check or replace the fuse, disconnect the power cable and pull out the fuse holder.

Figure 1-5

Fuse holder and power cable inlet

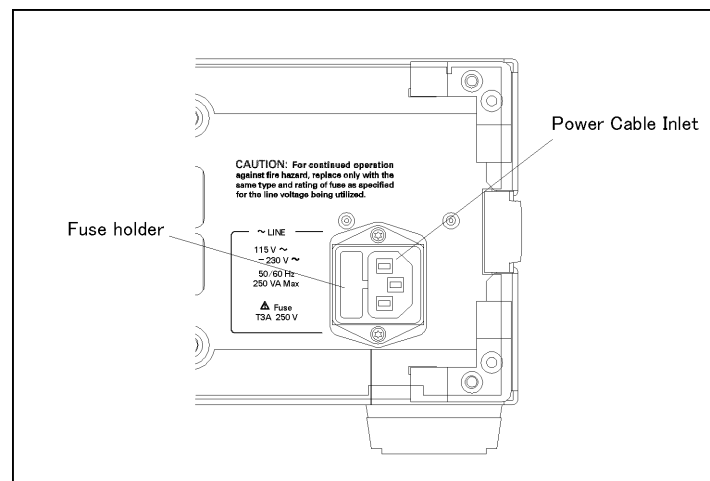

Checking and connecting the power cable

The power cable that comes with the E5053A has a three-wire structure and one of them is the grounding wire. This power cable grounds the E5053A through an outlet, protecting the operator from shock hazards.

Step 1. Check the power cable you use for damage.



WARNING Never use a power cable that may be damaged. You may get an electrical shock.

Step 2. Connect the attached power cable between the power cable receptacle on the rear panel of the E5053A (see Figure 1-5 on page 19) and a three-pole outlet whose grounding terminal is grounded securely.

WARNING Securely ground the E5053A with the attached 3-wire power cable with the grounding wire.

Figure 1-6 shows the power cable options.

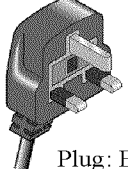
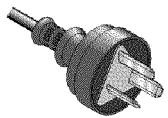
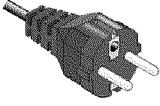
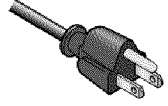
Figure 1-6 Power cable options

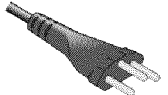
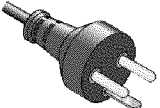
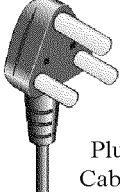
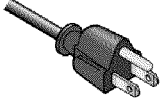
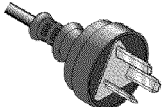
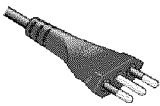
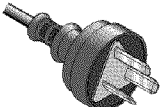
<p>OPTION 900</p>  <p>United Kingdom</p> <p>Plug: BS 1363/A, 250V, 10A Cable: 8120-1351, 8120-8705</p>	<p>OPTION 901</p>  <p>Australia/New Zealand</p> <p>Plug: AS 3112, 250V, 10A Cable: 8120-1369</p>
<p>OPTION 902</p>  <p>Continental Europe</p> <p>Plug: CEE 7 Standard Sheet VII, 250V, 10A Cable: 8120-1689</p>	<p>OPTION 903</p>  <p>U.S./Canada</p> <p>Plug: NEMA 5-15P, 125V, 10A Cable: 8120-1378</p>
<p>OPTION 904</p>  <p>U.S./Canada</p> <p>Plug: NEMA 6-15P, 250V, 6A Cable: 8120-0698</p>	<p>OPTION 906</p>  <p>Switzerland</p> <p>Plug: SEV Type 12, 250V, 10A Cable: 8120-2104</p>
<p>OPTION 912</p>  <p>Denmark</p> <p>Plug: SR 107-2-D, 250V, 10A Cable: 8120-2956</p>	<p>OPTION 917</p>  <p>India/Republic of S. Africa</p> <p>Plug: IEC 83-B1, 250V, 10A Cable: 8120-4211</p>
<p>OPTION 918</p>  <p>Japan</p> <p>Plug: JIS C 8303, 125V, 12A Cable: 8120-4753</p>	<p>OPTION 920</p>  <p>Argentina</p> <p>Plug: Argentine Resolution 63, Annex IV, 250V, 10A Cable: 8120-6870</p>
<p>OPTION 921</p>  <p>Chile</p> <p>Plug: CEI 23-16, 250V, 10A Cable: 8120-6978</p>	<p>OPTION 922</p>  <p>China</p> <p>Plug: GB 1002, 250V, 10A Cable: 8120-8376</p>

NOTE: Each option number includes a 'family' of cords and connectors of various materials and plug body configurations (straight, 90° etc.).





power_e

Starting up E5053A

This section describes how to turn ON/OFF the E5053A and how to cut the power supply in an emergency.



Turning ON/OFF the power

Turning ON the power

- Step 1.** Check that the line switch in the lower left part of the front panel is pulled up (). If it is pushed in (), which means the power is OFF, push the standby switch to pull it up ().
- Step 2.** Push the line switch to push it in ().

Turning OFF the power

To turn OFF the E5053A, do the following.

- Push the line switch in the lower left part of the front panel so that the switch pushed in () is pulled up ().

NOTE

To turn OFF the E5053A under normal conditions, press the line switch. **Under normal conditions, never disconnect the power cable to cut the power supply to the power cable receptacle on the rear panel.**

Cutting power supply

For the E5053A, the disconnecting device (the device to cut the power supply) is the power cable's plug (on the power outlet side or the E5053A side).

If you need to cut the power supply to avoid danger of electric shocks, disconnect the power cable's plug (on the power outlet side or the E5053A side).

NOTE

Follow the description in “Providing space to disconnect the power cable's plug” on page 15 so that you can perform this operation reliably.

To turn OFF the power under normal conditions, be sure to follow the procedure in “Turning OFF the power”.

2 Overview of Product

This chapter presents an overview of the E5053A microwave downconverter.

About This Product

The Agilent E5053A is a microwave downconverter associated with the E5052A (signal source analyzer). The E5053A expands the maximum frequency of the E5052A to 26.5 GHz. Operating the E5053A requires, firmware of version A.02.00 or greater for the E5052A.

Names and Functions of Parts

This section describes the names and functions of the parts on the front panel of the E5053A.

Front Panel

The names and functions of these parts are described below.

Figure 2-1

Front Panel

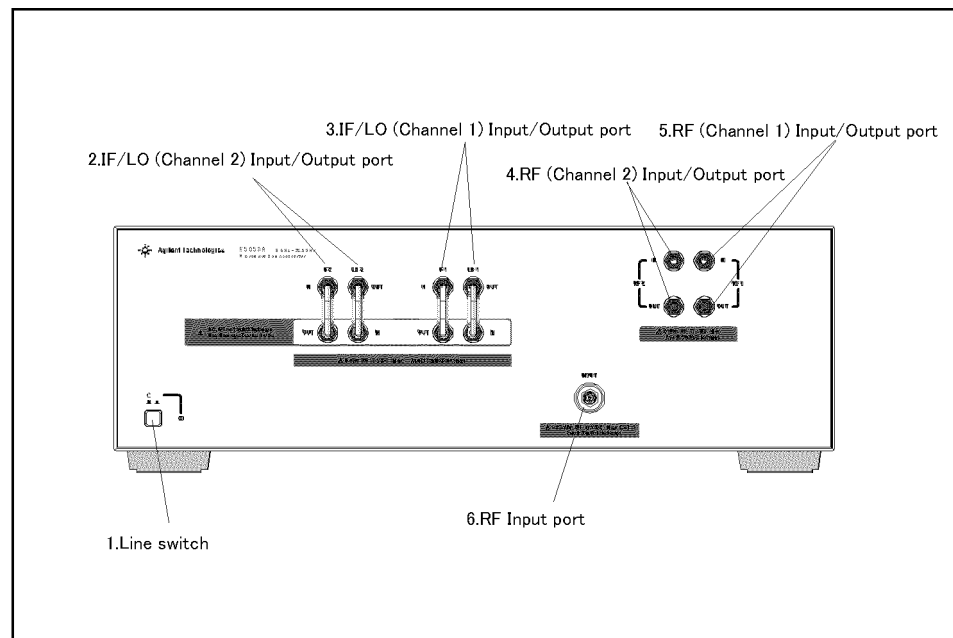

e5053aue1004

1. Line switch

Turns on (I)/off (O) the E5053A.

2. IF/LO (channel 2) input/output port

When using an external mixer, disconnect this port.

3. IF/LO (channel 1) input/output port

When using an external mixer, disconnect this port.

4. RF (channel 2) input/output port

Connect to the E5052A (signal source analyzer) with the RF cable.

5. RF (channel 1) input/output port

Connect to the E5052A (signal source analyzer) with the RF cable.

CAUTION 

Do not apply a DC current or DC voltage to ports 2 - 5 to avoid device failures. Do not connect the measurement sample (DUT) to the port.

The individual ports comply with Installation Category I of IEC60101-1.

6. RF input port

Input the RF output signal (signal to be measured) from the DUT. A 3.5-mm (female) connector is used.

CAUTION 

Do not apply a DC voltage greater than 0 V to the connection port. In particular, there is the risk of the capacitor remaining charged. Connect the measurement sample (DUT) after the analyzer has been completely discharged.

CAUTION

Take antistatic measurements when operating the product.

Because the E5053A includes semiconductor internal parts that may be damaged by static electricity through the input ports, take appropriate antistatic measures when operating it.

The port complies with Installation Category I of IEC61010-1.

Rear Panel

The names and functions of the parts on the rear panel of the E5053A are described below.

Figure 2-2

Rear Panel

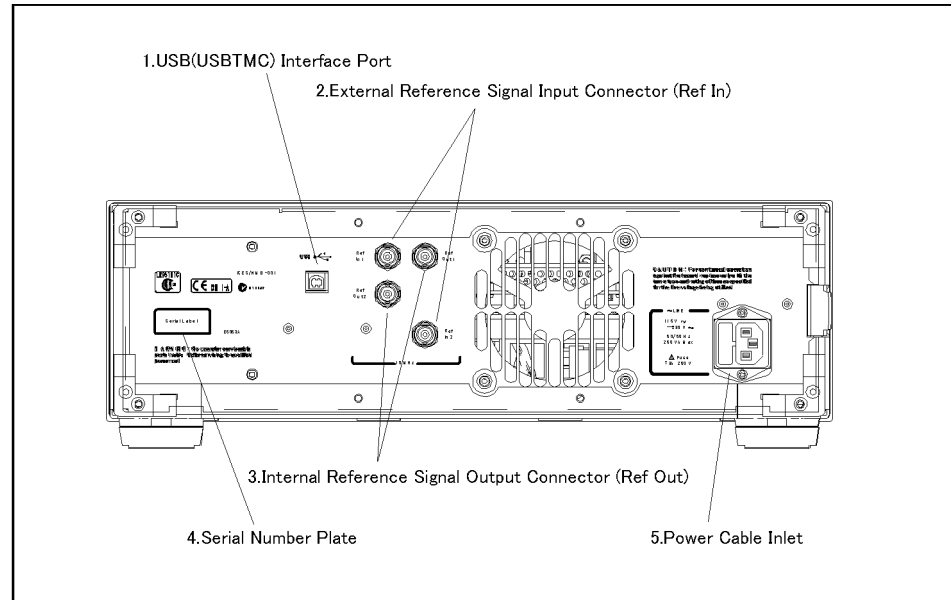

e5053aue1005

1. USB (USBTMC) interface port

Connect to the USB port on the rear panel of the E5052A signal source analyzer with the USB cable.

Connector type: Universal serial bus jack, B type (four contacts); female

NOTE

Connection on of devices other than the E5052A signal source analyzer to the USB port is not supported.

2. External reference signal input connector channel 1/channel 2 (Ref In)

A reference signal input connector in order to phase-lock the E5053A measurement signal with an external frequency reference signal. Supplying a reference signal to this connector improves the accuracy and stability of the E5053A's measurement signal frequency.

Table 2-1

Channel 1:	Connect to the 10 MHz Ref Out connector of the E5052A with a BNC cable.
Channel 2:	Connect to the Channel 1 Ref Out of the E5053A with a BNC cable.

Connector type: BNC connector, female

Input signal (typical): 10 MHz±10 Hz, 0 dBm±5 dB

3. Internal reference signal output connector channel 1/channel 2 (Ref Out)

Table 2-2

Channel 1:	Connect to the Channel 2 Ref In of the E5053A with a BNC adapter.
Channel 2:	A connector for outputting the internal frequency reference signal from the E5053A. By connecting this output connector to the external reference signal input connector of another device, the device can be phase-locked to the internal reference signal of the E5053A and used under this condition.

Connector type: BNC connector, female
Output signal (typical): 10 MHz \pm 50 Hz, 2.5 dBm \pm 3 dB
Output impedance (nominal): 50 Ω

4. Serial number plate

The seal showing the serial number of the E5053A.

5. Power cable receptacle

The receptacle to which the power cable is connected.

NOTE

To feed power, use the included three-prong power cable with a ground conductor.

The plug attached to the power cable (on the power outlet side or device side of the cable) serves as the disconnecting device (device that cuts off power supply) of the E5053A. When the power supply must be cut off to avoid danger such as electric shock, pull out the power cable plug (on the power outlet side or device side of the cable). The procedure for turning off the mains in normal use is given in "1. Line switch" on page 25.

3 Connecting Devices to E5052A for Operation

This chapter describes how to connect the E5052A signal source analyzer and the E5053A microwave downconverter for operation.

Connecting E5052A and E5053A

Required Devices

The following list shows devices required for connecting the E5052A and the E5053A.

- E5052A
- E5053A
- RF cable (supplied with the E5053A, Agilent part number: E5053-61621, E5053-61622)
- USB cable (supplied with the E5053A, Agilent part number: 8121-0770)
- BNC(m)-BNC(m) cable, 61 cm (supplied with the E5053A, Agilent part number: 8120-1839)
- BNC adapter (supplied with the E5053A, Agilent part number: 1250-1859)

Connection on Front Panel

As shown in Figure 3-1, connect the E5053A and the front panel of the E5052A with the RF cable.

Figure 3-1

Connecting E5052A and E5053A (Front Panel)

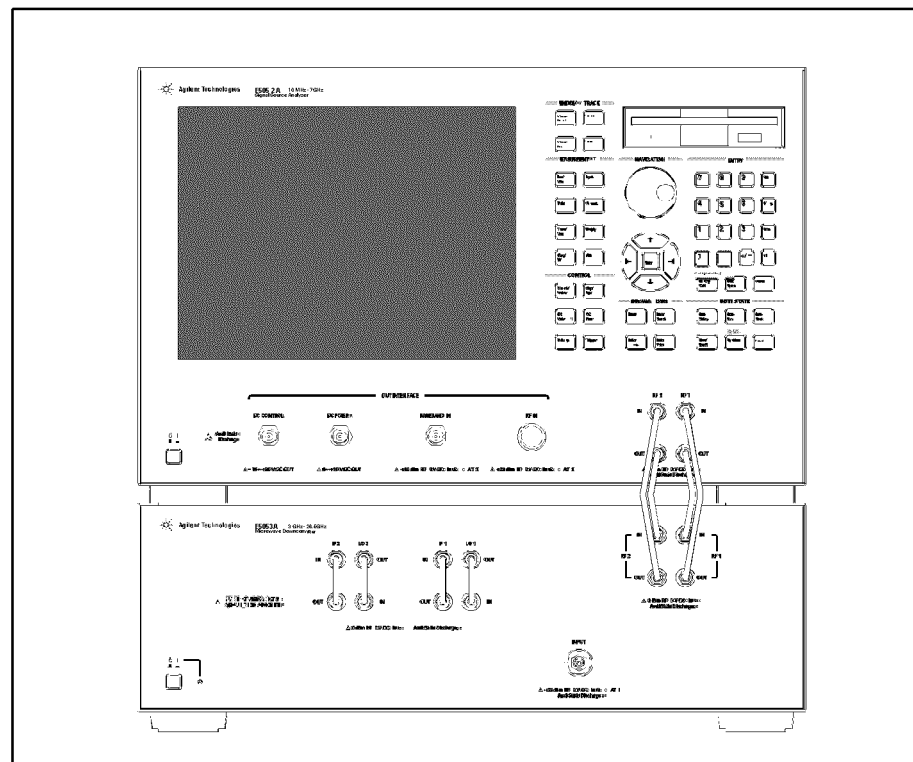

e5053auj1006

Connection on Rear Panel

As shown in Figure 3-2, connect the E5052A and the rear panel of the E5053A with the USB cable, BNC cable and BNC adapter.

Figure 3-2 Connecting E5052A and E5053A (Rear Panel)

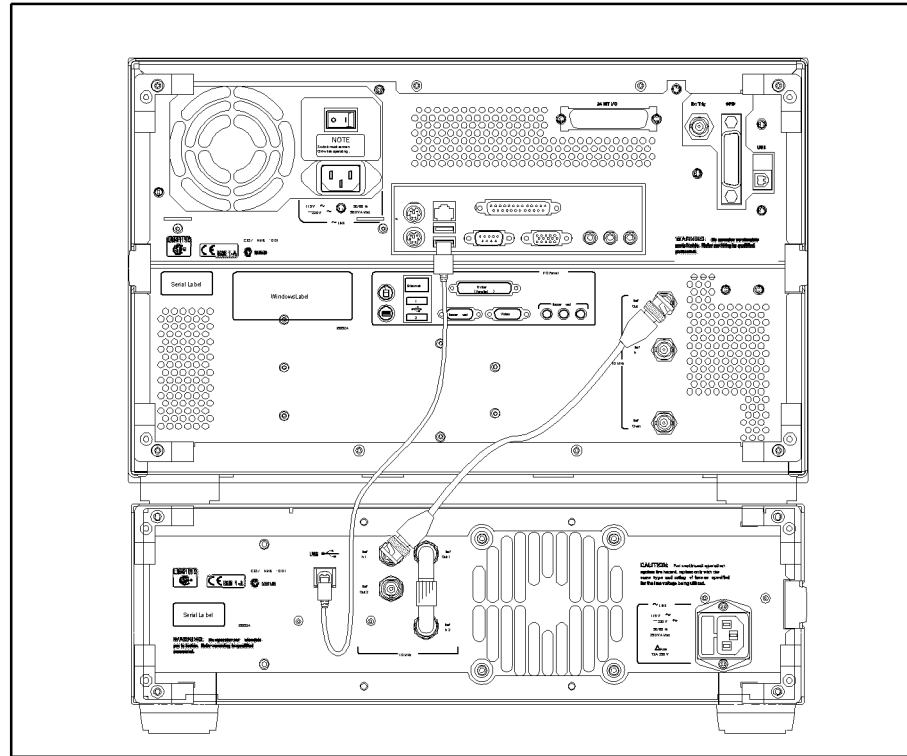

NOTE Do not connect/disconnect the USB cable of the devices (printer and E5053A) connected to the USB host port (both front and rear) or turn them on/off during measurement.

Turning on Power

After connecting the E5052A and the E5053A, follow these steps to turn on the power.

Step 1. Turn on the E5053A.

Step 2. Turn on the E5052A.

NOTE If the E5052A is turned on first, the E5053A cannot be recognized, and the downconverter setting of the E5052A is disabled. Note that, if the auto recall function with the function of the E5053A enabled is executed under this condition, recall is performed normally, but the "No Downconverter Unit Connected" error message appears. They become available by enabling the downconverter setting manually.

Basic Operation

For information on operation, see the "Measurement Using the E5053A and a External Mixer" chapter in the "E5052A Signal Source Analyzer User's Guide."

4 Specifications and Supplemental Information

This chapter provides specifications and supplemental information for the Agilent E5053A.

Definitions

All specifications apply over a 18°C to 28°C range (unless otherwise stated) and 90 minutes after the instrument has been turned on.

Specification (spec.): Warranted performance. Specifications include guardbands to account for the expected statistical performance distribution, measurement uncertainties, and changes in performance due to environmental conditions.

Supplemental information is intended to provide information that is helpful for using the instrument but that is not guaranteed by the product warranty. This information is denoted as either typical or nominal.

Typical (typ.): Expected performance of an average unit that does not include guardbands. It is not guaranteed by the product warranty.

Nominal (nom.): A general, descriptive term that does not imply a level of performance. It is not guaranteed by the product warranty.

General Information

Table 4-1 Front Panel

Description	Supplemental Information
RF Connector	
Connector Type	APC 3.5 male, with 3.5 mm female - female adapter, 50 Ω (nominal)
Frequency Range	3 G to 26.5 GHz
Maximum Input Level	+10 dBm @3 to 10 GHz Range +5 dBm @9 to 26.5 GHz Range
Damage Level	+23 dBm (nominal)
LO Output	
Frequency Range	3.025 G to 10.025 GHz
Resolution	50 MHz
Frequency Accuracy ^{*1}	10 ppm (23 °C \pm 5 °C)
Output Level	10 to 16 dBm @3.025 to 6.025 GHz 10 to 15 dBm @6.075 to 10.025 GHz
Level Accuracy	\pm 2 dB (23 °C \pm 5 °C)
Spurious	-50 dBc (300 Hz < Frequency Offset \leq 100 kHz, typical) -65 dBc (Frequency Offset > 100 kHz, typical)
IF Input	
Frequency Range	250 M to 1250 MHz
Maximum Input Level	0 dBm (typical)
IF Gain	0 to 35 dB (5 dB step)
Noise Floor	-163 dBm/Hz (typical)
Mixer Bias Output	
Current	-10 mA to + 10 mA
Accuracy	\pm (10% + 0.1 mA) (23 °C \pm 5 °C)

*1. When the LO is locked to the built-in 10 MHz reference of the E5053A.

Table 4-2 Rear Panel

Description	Supplemental Information
External Reference Signal Input Connector	
Connector Type	BNC, female
Input Frequency	10 MHz \pm 10 Hz, typical
Input Level	0 dBm \pm 5 dB, typical
Internal Reference Signal Output Connector	
Connector Type	BNC, female
Output Frequency	10 MHz \pm 50 Hz, typical
Output Level	2.5 dBm \pm 3 dB, typical
USB (USBTMC^{*1}) interface Port	
Connector Type	Universal Serial Bus jack, Type B configuration (4 contacts inline); female; provides connection to an external PC; compatible with USBTMC-USB488 and USB 2.0.
Line Power^{*2}	
Frequency	47 Hz to 63 Hz
Voltage	90 to 132 VAC, or 198 to 264 VAC (automatically switched)
VA Max	250 VA max.

*1. USB Test and Measurement Class (TMC) interface that communicates over USB, complying with the IEEE 488.1 and IEEE 488.2 standards.

*2. A third-wire ground is required.

Table 4-3 E5053A LO Phase Noise Sensitivity (23 °C ± 5 °C)

Input Frequency		Offset from carrier (Hz)								
		1	10	100	1 k	10 k	100 k	1 M	10 M	40 M
3 GHz	spec.				-110.5	-116.5	-113.5	-127.5	-140.0	-140.0
	typ.	-49.5	-79.5	-94.5	-114.5	-120.5	-117.5	-131.5	-144.0	-144.0
6 GHz	spec.				-104.4	-110.4	-109.4	-123.4	-140.0	-140.0
	typ.	-43.4	-73.4	-88.4	-108.4	-114.4	-113.4	-127.4	-144.0	-144.0
10 GHz	spec.				-100.0	-103.0	-102.0	-119.0	-140.0	-140.0
	typ.	-39.0	-69.0	-84.0	-104.0	-107.0	-106.0	-123.0	-144.0	-144.0

Figure 4-1 LO Phase Noise Sensitivity, Typical

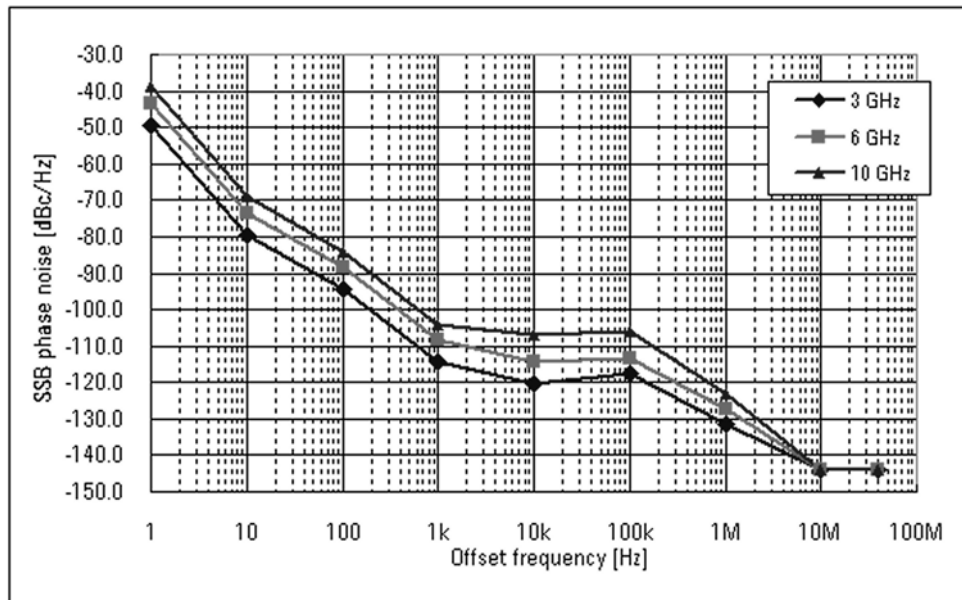

e5053auj1 01 2

Specifications and Supplemental Information
General Information

Table 4-4 EMC and Safety





Description	Supplemental Information
EMC	
 ISM 1-A	European Council Directive 89/336/EEC EN / IEC 61326-1:1997+A1:1998 A2:2001 CISPR 11:1997+A1:1999 / EN 55011:1998+A1:1999 Group 1, Class A IEC 61000-4-2:1995 / EN 61000-4-2:1995 +A1:1998 4 kV CD / 4 kV AD IEC 61000-4-3:1995 / EN 61000-4-3:1996 +A1:1998 3 V/m, 80-1000 MHz, 80% AM IEC 61000-4-4:1995 / EN 61000-4-4:1995 1 kV power / 0.5 kV Signal IEC 61000-4-5:1995 / EN 61000-4-5:1995 0.5 kV Normal / 1 kV Common IEC 61000-4-6:1996 / EN 61000-4-6:1996 3 V, 0.15-80 MHz, 80% AM IEC 61000-4-11:1994 / EN 61000-4-11:1994 100% 1cycle Canada ICES001:1998
ICES/NMB-001	This ISM device complies with Canadian ICES-001. Cet appareil ISM est conforme à la norme NMB-001 du Canada.
 N10149	AS/NZS 2064.1/2 Group 1, Class A
Safety	
 ISM 1-A	European Council Directive 73/23/EEC IEC 61010-1:1990+A1+A2 / EN 61010-1:1993+A2 INSTALLATION CATEGORY II, POLLUTION DEGREE 2 INDOOR USE IEC60825-1:1994 CLASS 1 LED PRODUCT
 LR95111C	CAN/CSA C22.2 No. 61010-1-04

Table 4-5 Test set Environment and Dimensions

Description	Supplemental Information
Operating Environment	
Temperature	+10 °C to +40 °C
Error-Corrected Temperature Range	23 °C ± 5 °C with < 1°C deviation from calibration temperature
Humidity	20 % RH to 80% @<28 °C (non-condensing)
Altitude	0 to 2,000 m (0 to 6,561 feet)
Vibration	0.21 G maximum, 5 Hz to 500 Hz
Non-Operating Storage Environment	
Temperature	-10 °C to +60 °C
Humidity	20 % RH to 90% @<+40 °C (non-condensing)
Altitude	0 to 4,572 m (0 to 15,000 feet)
Vibration	0.5 G maximum, 5 Hz to 500 Hz
Weight, Dimension	
Dimension	See Figure 4-2 through Figure 4-4.
Net	11 kg (Nominal)

Figure 4-2 Dimensions (front view, in millimeters, nominal)

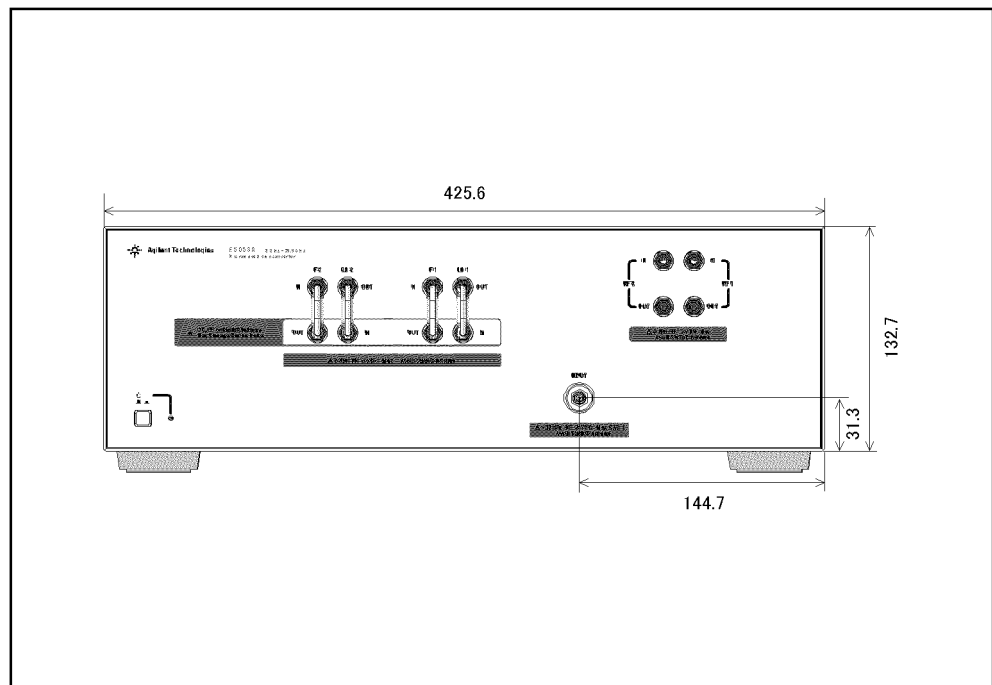

e5053auj1009

4. Specifications and Supplemental Information

Figure 4-3

Dimensions (rear view, in millimeters, nominal)

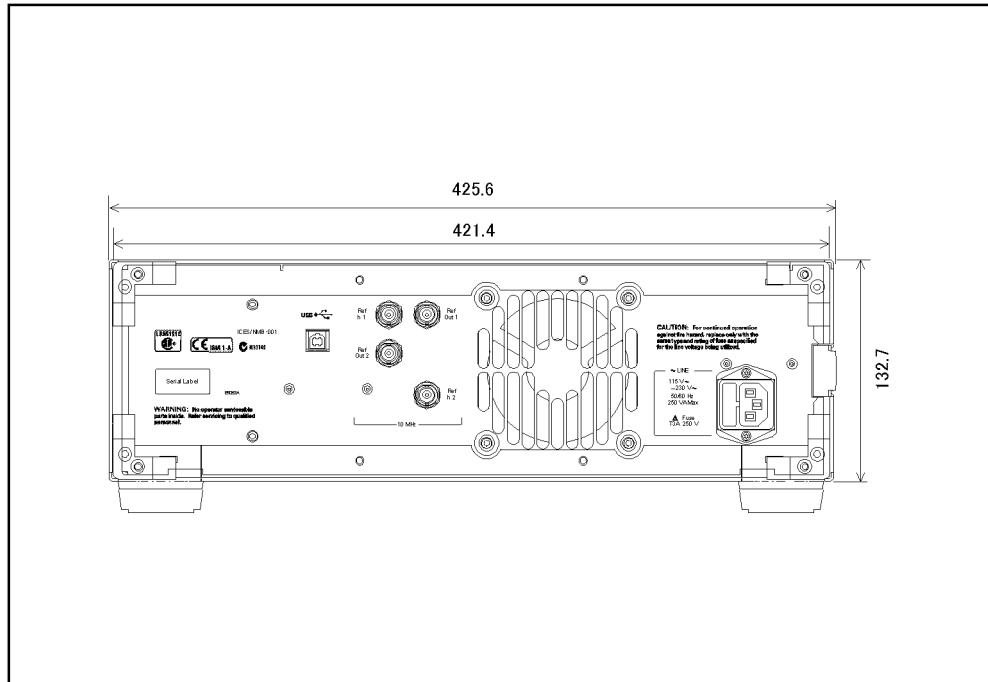

e5053auj1010

Figure 4-4

Dimensions (side view, in millimeters, nominal)

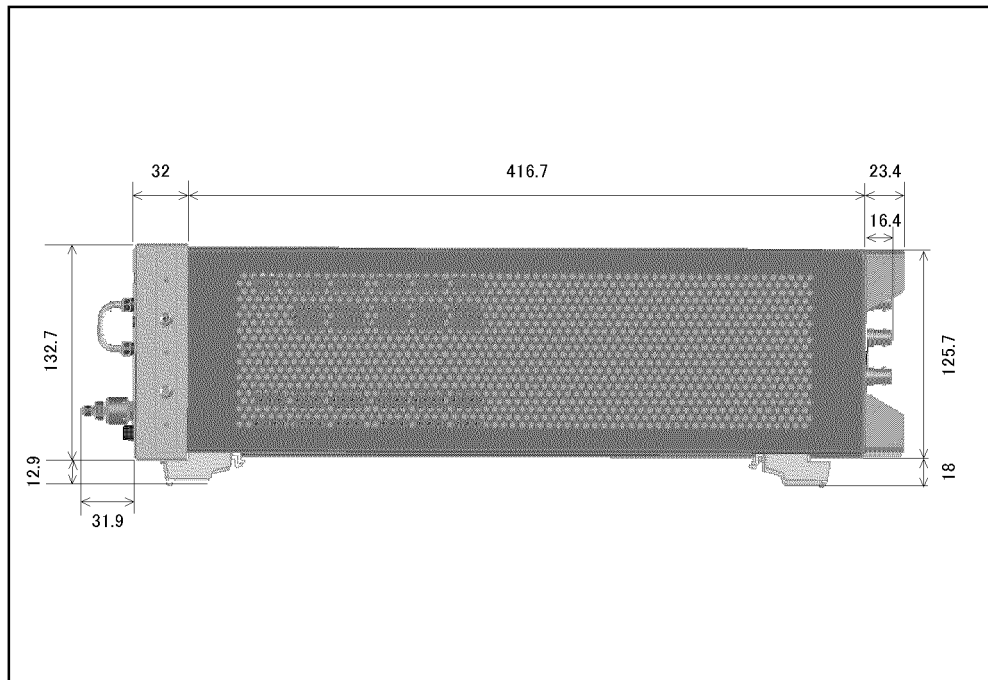

e5053auj1011

5 Information on Maintenance

This chapter explains the measures you should take to maintain the Agilent E5053A.

Cleaning this Instrument

This section describes how to clean the instrument.

WARNING

To protect yourself from electrical shock, be sure to unplug the power cable from the outlet before cleaning the instrument.

Never clean the internal components of the instrument.

Maintenance of Interconnection Ports and Test Ports

Stains or other damage to these connectors would significantly affect the accuracy in measurements in the RF range. Always pay attention to the following precautions.

- Always keep the connectors free from stains and dust.
- Do not touch the contact surface on the connectors.
- Do not plug damaged or scratched connectors into the test ports.
- Use compressed air for cleaning connectors. Do not use abrasives under any circumstance.

Cleaning a Display Other than Interconnection Ports and Test Ports

To remove stains on parts other than Interconnection ports and test ports of the instrument, wipe them gently with a soft cloth that is dry or wetted with a small amount of water and wrung tightly.

Cautions Applicable to Requesting Repair, Replacement, Regular Calibration, etc.

Devices to be Sent Back for Repair or Regular Calibration

If it is necessary to send the unit to the Service Center of Agilent Technologies for repair or regular calibration, please follow the instructions below.

Equipment to be Sent

When requesting repair or regular calibration of the unit by our Service Center, send only the E5053A main unit without any installed option you may have ordered. Unless specifically instructed, it is not necessary to send accessories and calibration kits.

Packing

Use the original package and shock absorbers, or equivalent antistatic packing materials, when sending the unit.

Shipping Address

For the location of the nearest Agilent Technologies Service Center, contact the Customer Contact listed at the end of this brochure.

Recommended Calibration Period

The recommended calibration period for this instrument is one year. The user is recommended to request the Company's Service Center to perform regular calibration every year.

Information on Maintenance

Cautions Applicable to Requesting Repair, Replacement, Regular Calibration, etc.

A **Manual Changes**

This appendix contains the information required to adapt this manual to versions or configurations of the E5053A manufactured earlier than the current printing date of this manual.

Manual Changes

To adapt this manual to your E5053A, refer to Table A-1.

Table A-1 **Manual Changes by Serial Number**

Serial Prefix or Number	Make Manual Changes

Agilent Technologies uses a two-part, ten-character serial number that is stamped on the serial number plate (Figure A-1). The first five characters are the serial prefix and the last five digits are the suffix.

Figure A-1 **Example of Serial Number Plate**

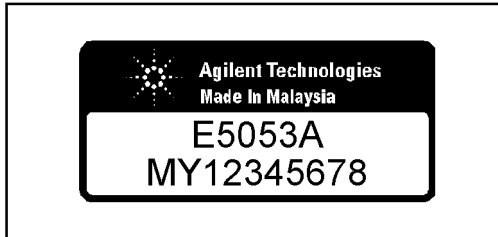

e5053auj1005

-
- A**
about this product, 24
accessories, 12
assistance, 5
- C**
certification, 5
Cleaning, 42
Connectors
 Maintenance, 42
- E**
E5053A
 connection, 30
exclusive remedies, 5
External Reference Signal Input Connector, 27
- F**
flange for rackmount
 mounting, 16
front handle
 mounting, 17
- H**
handle kit
 mounting, 18
history,
 manual printing, 2
- I**
inspection
 incoming inspection, 10
Interconnection Ports
 Maintenance, 42
Internal Reference Signal Output Connector, 28
- M**
manual changes, 45
manual printing history, 2
- N**
names and functions of parts, 25
nominal
 definitions, 34
- O**
operating environment, 13
- P**
power supply
 checking cable, 20
 checking the supply, 19
 connecting cable, 20
 cutting power, 22
 turning on/off, 22
- R**
rackmount kit
 mounting, 18
rackmount/handle kit
 mounting, 18
- S**
safety
 symbols, 4
safety summary, 3
serial number plate, 46
space to disconnect the plug, 15
specifications, 33
 definitions, 34
starting up E5053A, 22
- T**
Test Ports
 Maintenance, 42
typeface conventions, 6
typical
 definitions, 34
- U**
USB (USBTMC) Interface Port, 27

REGIONAL SALES AND SUPPORT OFFICES

For more information about Agilent Technologies test and measurement products, applications, services, and for a current sales office listing, visit our web site: <http://www.agilent.com/find/tmdir>. You can also contact one of the following centers and ask for a test and measurement sales representative. 21/01/2004

United States:

Test and Measurement Call Center
(tel) 1 800 452-4844
(fax) 1 888 900-8921

Australia/New Zealand:

(tel) (61 3) 9210-5555 (Australia)
(fax) (61 3) 9210-5899
(tel) (64 4) 939-0636 (New Zealand)
(fax) (64 4) 972-5364

Canada:

Test and Measurement Call Center
(tel) 1 877 894-4414
(fax) 1 888 900-8921

Asia Pacific:

(tel) (65) 6375-8100
(fax) (65) 6836-0252
Email: tm_asia@agilent.com

China:

(tel) 800 810-0189
(fax) 800 820-2816

Europe:

(tel) (31 20) 547-2323
(fax) (31 20) 547-2390

Japan:

Call Center
(tel) 0120 421-345
(tel) (81) 426 56-7832
(fax) (81) 426 56-7840

Korea:

(tel) (82 2) 2004-5004
(fax) (82 2) 2004-5115

Latin America:

(tel) (305) 269-7500
(fax) (305) 269-7599

Taiwan:

(tel) 0800 047 866
(fax) 0800 286 331